

LAMP BASED – PANEL-MOUNT INDICATORS

NON-RELAMPABLE 1/2" PANEL MOUNT INDICATORS

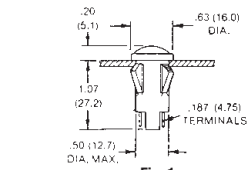

Fig. 1 Wire Leads Q.C. Terminals Shown

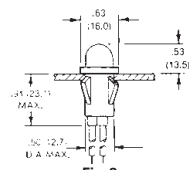

Fig. 2 Wire Leads Shown Q.C. Terminals

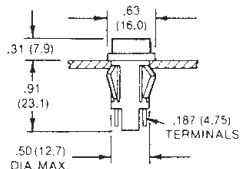

Fig. 3 Wire Leads Q.C. Terminals Shown

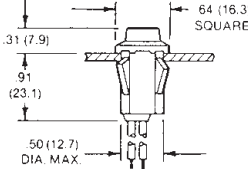

Fig. 4 Wire Leads Shown Q.C. Terminals

Neon, incandescent and LED indicators snap-fit into 0.5-0.505" (12.7-12.83mm) diameter hole in panels 0.02-0.100" (0.51-2.54mm) thick. All have 4.4-4.8" (112-122.9mm) long, 22 AWG wire leads except Mfg. Part Nos. with Q in the part number which have 0.187" (4.75mm) tinned-brass quick-connect terminals. Polished stainless steel bezel, white nylon housing. Mfg. Part Nos. 1050C/1051C feature wire leads (Q.C. terminals shown). Mfg. Part Nos. 1050QA/1051QA feature Q.C. terminals (wire leads shown). Wire lead models Mfg. Part Nos. 1030 and 1050 feature black leads; Mfg. Part Nos. 1031 and 1051 feature one black lead and one red lead. Mfg. Part Nos. 1090 12V indicators feature yellow leads for 12V; 28V models feature purple leads.

NEON INDICATORS WITH BUILT-IN RESISTOR

Mfg. Part No.	Fig.	Lens Color	Volts (VAC)	Stock No.	Price Each	
					1-24	
1030D1	1	Red	125	18M7882	2.160	
1030D3	1	Amber	105-125	18M7883	2.160	
1030D4	1	White	105-125	18M7884	2.160	
1030QD1	1	Red	125	18M7885	2.360	
1030QD3	1	Amber	105-125	93F3557	2.360	
1030QD4	1	White	105-125	18M7886	2.360	
1031D1	1	Red	208-250	18M7887	2.160	
1031D3	1	Amber	208-250	18M7888	2.160	
1031QD1	1	Red	208-250	18M7889	2.360	
1032D5	1	Green	105-125	18M7890	3.250	
1032QD5	1	Green	105-125	18M7891	3.490	
1050A1	2	Red	125	18M7892	2.160	
1050A2	2	Clear	105-125	18M7893	2.160	
1050A3	2	Amber	105-125	18M7894	2.160	
1050A4	2	White	105-125	18M7895	2.160	
1050QA1	2	Red	125	18M7903	2.360	
1050QA2	2	Clear	105-125	18M7904	2.360	
1050QA3	2	Amber	105-125	18M7905	2.360	
1050QA4	2	White	105-125	93F3539	2.360	
1051A1	2	Red	208-250	18M7912	2.160	
1051A2	2	Clear	208-250	18M7913	2.160	
1051QA1	2	Red	208-250	20M7057	2.360	
1052A5	2	Green	105-125	18M7916	3.250	
1052QA5	2	Green	105-125	18M7918	3.460	
1050C1	3	Red	125	18M7896	2.160	
1050C2	3	Clear	105-125	18M7897	2.160	
1050C3	3	Amber	105-125	18M7898	2.160	
1050QC1	3	Red	125	18M7906	2.360	
1050QC2	3	Clear	105-125	18M7907	2.360	
1050QC3	3	Amber	125	19M0212	2.360	
1050QC4	3	White	105-125	18M7908	2.360	
1051C1	3	Red	208-250	18M7914	2.160	
1051QC1	3	Red	250	18M7915	2.360	
1051QC3	3	Amber	208-250	19M0213	2.360	
1052C5	3	Green	105-125	18M7917	3.250	
1052QC5	3	Green	125	20M7058	3.460	
1050C4	4	White	105-125	18M7899	2.160	
1050N1	4	Red	105-125	18M7900	2.360	
1050N3	4	Amber	105-125	18M7901	2.360	
1050N4	4	White	105-125	18M7902	2.360	
1050QN1	4	Red	105-125	18M7909	2.530	
1050QN3	4	Amber	105-125	18M7910	2.530	
1050QN4	4	White	105-125	18M7911	2.530	
1052QN5	4	Green	105-125	18M7919	3.630	

INCANDESCENT INDICATORS WITH BUILT-IN RESISTOR

1090D1-28V	1	Red	28	18M7928	2.770
1090D5-28V	1	Green	28	18M7929	2.910

▶ CONTINUED ▶

NON-RELAMPABLE 1/2" PANEL MOUNT INDICATORS (CONT.)

INCANDESCENT INDICATORS WITH BUILT-IN RESISTOR

Mfg. Part No.	Fig.	Lens Color	Volts (VAC)	Stock No.	Price Each	
					1-24	
1090A1-12V	2	Red	12	18M7920	2.770	
1090A1-28V	2	Red	28	18M7921	2.770	
1090A3-12V	2	Amber	12	18M7922	2.770	
1090A3-28V	2	Amber	28	18M7923	2.770	
1090A5-28V	2	Green	28	18M7924	2.770	
1090QA1-12V	2	Red	12	18M7930	2.940	
1090QA1-28V	2	Red	28	18M7931	2.940	
1090QA3-12V	2	Amber	12	18M7932	2.940	
1090QA3-28V	2	Amber	28	05C1213	2.940	
1090C1-12V	3	Red	12	18M7925	2.770	
1090C1-28V	3	Red	28	18M7926	2.770	
1090C3-12V	3	Amber	12	20M4360	2.770	
1090C3-28V	3	Amber	28	98F9115	2.770	
1090QC1-12V	3	Red	12	18M7933	2.940	
1090QC1-28V	3	Red	28	18M7934	2.940	
1090QC3-12V	3	Amber	12	18M7935	2.940	
1090QC3-28V	3	Amber	28	18M7936	2.940	
1090QC4-28V	3	White	28	18M7937	2.940	
1090QC5-12V	3	Green	12	18M7938	2.940	
1090QC5-28V	3	Green	28	18M7938	2.940	
1090C5-28V	4	Green	28	18M7927	2.770	

LED INDICATORS WITH BUILT-IN RESISTOR

1091QM1-12V	...	Red	12	01C3789	3.220
1091QM1-24V	...	Red	24	93K6628	4.420
1091QM5-12V	...	Green	12	93K6629	4.420
1091QM5-24V	...	Green	24	88F4882	3.220
1091QM7-24V	...	Yellow	24	93K6631	4.420

900 SERIES INSTRUMENT LIGHTS

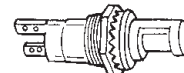

Mfg. Part No. 900-200 fixed hood, solder lug terminals. Mounts hole 0.688" in diameter to 0.406" panel thickness. Uses T-3/4 miniature bayonet lamp.

Mfg. Part No.	Description	Stock No.	Price Each	
			1-24	
900-200	Fixed Hood, Solder Lug Terminals	39F3462	22.230	

MIL SPEC PANEL-MOUNT INDICATORS

Dialight

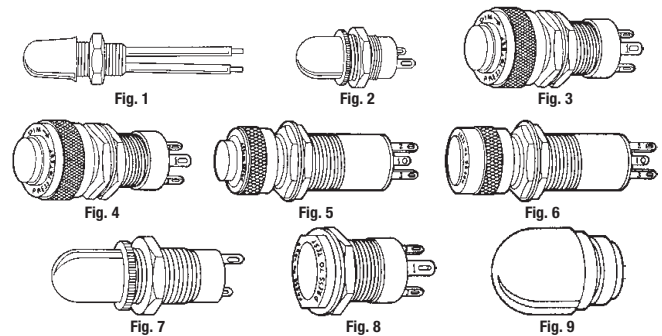

Military type panel-mount indicators are QPL listed per MIL-L-780 (MS25041 & MS25331). The MIL-L-3661 number permits the ordering of a complete assembly, or separate lens cap and base, with the MIL designation for the base only marked on the lamp holder. The MS number specifies a complete assembly and the full MS number (less lamp) is marked on the lamp holder. Available in red, green, amber, blue, clear and white. Uses 5V non-replaceable incandescent lamp.

252 SERIES 0.193" MOUNTING HOLE

Mfg. Part No.	MIL No.	Color	Fig.	Stock No.	Price Each		
					1-24	25-49	50-99
252-9951-0971	LHC82/1RT2	Red	1	25F1295	34.620	31.650	29.570
252-9951-0972	LHC82/1GT2	Green	1	25F1294	28.690	26.230	24.500
252-9951-0973	LHC82/1YT2	Amber	1	25F1297	28.910	26.430	24.690
252-9951-0974	LHC82/1BT2	Blue	1	25F1293	62.970	57.560	53.780

162 SERIES 15/32" MOUNTING HOLE

Can use T-1-3/4 (Mfg. Part No. 521-0327) midget flange base incandescent lamp. 28V indicators.

162-8430-0931-502	MS25256-6	Red	2	25F1205	18.050	16.500	15.410
162-8430-0932-502	MS25256-4	Green	2	25F1204	18.050	16.500	15.410

▶ CONTINUED ▶



LAMP BASED – PANEL-MOUNT INDICATORS

MIL SPEC PANEL-MOUNT INDICATORS (CONT.)

162 SERIES 15/32" MOUNTING HOLE

Mfg. Part No.	MIL No.	Color	Fig.	Stock No.	Price Each		
					1-24	25-49	50-99
162-8430-0933-502	MS25256-2	Amber	2	25F1203	18.050	16.500	15.410
162-8430-0934-502	MS25256-12	Blue	2	25F1208	22.030	20.140	18.810
162-8430-0937-502	MS25256-8	Clear	2	25F1206	22.030	20.140	18.810

800 SERIES 15/32" MOUNTING HOLE

Non-dimming press-to-test, can use T-1-3/4 (Mfg. Part No. 521-0327) midjet flange base incandescent lamp or based LED lamp. 28V indicators.

Mfg. Part No.	MIL No.	Color	Fig.	Stock No.	1-24	25-49	50-99
800-1030-0331-504	MS25041-6	Red	3	25F988	39.840	36.420	34.030
800-1030-0332-504	MS25041-7	Green	3	25F989	42.580	38.930	36.370
800-1030-0333-504	MS25041-8	Amber	3	25F990	39.840	36.420	34.030
800-1030-0334-504	MS25041-11	Blue	3	25F1515	42.580	38.930	36.370
800-1030-0337-504	MS25041-5	Clear	3	25F987	39.840	36.420	34.030

801 SERIES 15/32" MOUNTING HOLE

Press-to-test with dimmer, can use T-1-3/4 (Mfg. Part No. 521-0327) midjet flange base incandescent lamp or based LED lamp. 28V indicators.

Mfg. Part No.	MIL No.	Color	Fig.	Stock No.	1-24	25-49	50-99
801-1030-0331-504	MS25041-2	Red	4	25F984	51.320	46.920	43.830
801-1030-0332-504	MS25041-3	Green	4	25F985	51.320	46.920	43.830
801-1030-0333-504	MS25041-4	Amber	4	25F986	51.320	46.920	43.830
801-1030-0334-504	MS25041-10	Blue	4	25F1514	54.840	50.130	46.830

803 SERIES 5/8" MOUNTING HOLE

Press-to-test, can use T-3-1/4 (Mfg. Part No. 521-0757) miniature bayonet base incandescent lamp. 2-55V indicators.

Mfg. Part No.	MIL No.	Color	Fig.	Stock No.	1-24	25-49	50-99
803-1710-0331-504	MS25331-6	Red	5	25F995	49.190	44.970	42.010
803-1710-0332-504	MS25331-7	Green	5	25F996	53.960	49.320	46.080
803-1710-0333-504	MS25331-8	Amber	5	25F997	53.960	49.320	46.080

804 SERIES 5/8" MOUNTING HOLE

Press-to-test with dimmer, can use T-3-1/4 (Mfg. Part No. 521-0757) miniature bayonet base incandescent lamp. 2-55V indicators.

Mfg. Part No.	MIL No.	Color	Fig.	Stock No.	1-24	25-49	50-99
804-1710-0331-504	MS25331-2	Red	6	25F991	61.170	55.920	52.240
804-1710-0332-504	MS25331-3	Green	6	25F992	69.900	63.900	59.700
804-1710-0333-504	MS25331-4	Amber	6	25F993	61.170	55.920	52.240

137 SERIES 15/32" MOUNTING HOLE

Use C7A (Mfg. Part No. 521-9047) neon glow lamp with built-in G2 resistor. Indicators are 105-125VAC/DC.

Mfg. Part No.	Color	Fig.	Stock No.	1-24	25-49	50-99	
137-0931-003	...	Red	7	05B3667	4.060	3.710	3.470
137-8836-0931-552	MS25257-4	Red	7	25F1201	28.430	25.990	24.280
137-8836-0933-552	MS25257-2	Amber	7	25F1200	28.430	25.990	24.280
137-8836-0937-552	MS25257-6	Clear	7	25F1202	28.430	25.990	24.280

812 SERIES 1 9/32" MOUNTING HOLE

Press-to-test, can use T-1 3/4 (Mfg. Part No. 521-0327) midjet flange base incandescent lamp. Mfg. Part No. 812-1030-09-506 is a 1.35-28V indicator.

Mfg. Part No.	Color	Fig.	Stock No.	Price Each		
				1-24	25-49	50-99
812-1030-09-506	...	8	25F1600	22.940	20.970	19.590
812-0971	Red	9	25F1610	12.070	11.030	10.310
812-0972	Green	9	25F1611	12.070	11.030	10.310
812-0973	Amber	9	25F1612	13.190	12.060	11.270

(2588)

eInvoices

Now you can view, print or email Newark invoices from our website under MY ACCOUNT eSuite. Log in or register today.



Make it easy. Make it fast. Make it Newark.

(148828)

125 SERIES OILTIGHT INDICATORS

RoHS Compliant Available

Dialight

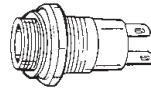

Fig. 1. Solder Terminal

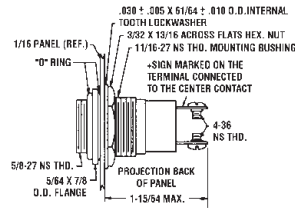

Fig. 2. Screw Terminal



Fig. 3. Stovepipe Lens Cap

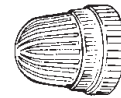

Fig. 4. Stovepipe Lens Cap (Internal Fluting)

125 SERIES BASE - 1 1/16" MOUNTING HOLE

Mfg. Part No.	Lamp Type	Volts AC	Fig.	Stock No.	Price Each	
					1-24	25-49
125-0410-11-103	T-3/4 MB INC*	2-120	1	45F966	16.340	15.980
● 125-1310-11-103	T-3/4 MB INC*	2-120	2	25F906	17.370	16.990
125-0408-11-143	B1A neon	105-125†	1	45F567	19.550	19.120
● 125-1308-11-143	B1A neon	105-125†	2	25F907	29.540	28.900
125-0463-11-113	B2A neon	110-125	1	45F618	19.730	19.300
● 125-1363-11-113	B2A neon	110-125	2	52M0965	22.160	21.680

* Can also use cluster based LED or multichip based LED lamps. † are AC/DC.

125 SERIES CAP - UNFROSTED

Mfg. Part No.	Color	Fig.	Stock No.	Price Each	
				1-24	25-49
125-1131-403	Red	3	45F582	8.120	7.940
125-1132-403	Green**	3	45F583	8.450	8.260
125-1133-403	Amber	3	45F584	16.090	15.740
125-1135-403	White	3	45F586	11.290	11.050
125-1137-403	Clear	3	45F588	8.120	7.940
125-1191-403	Red	4	45F568	8.120	7.940
125-1192-403	Green**	4	45F569	8.450	8.260
125-1193-403	Amber	4	45F570	8.450	8.260
125-1195-403	White	4	45F572	11.290	11.050
125-1197-403	Clear	4	45F574	16.230	15.880

** Not recommended for neon applications. (2537)

177 SERIES OILTIGHT INDICATORS

RoHS Compliant Available

Dialight

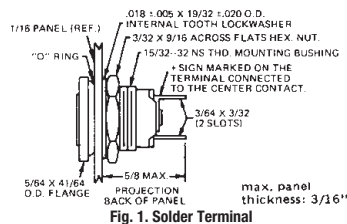

Fig. 1. Solder Terminal

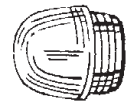

Fig. 2. Stovepipe Lens Cap

177 SERIES BASE - 1 5/32" MOUNTING HOLE, FIG. 1

Mfg. Part No.	Lamp Type	Voltage	Stock No.	Price Each		
				1-24	25-49	50-99
177-8430-09-503	T-1 3/4 MF INC	1.35-28	25F1637	12.660	11.440	10.850

177 SERIES LENS CAP - UNFROSTED, FIG. 2

Mfg. Part No.	Color	Stock No.	Price Each		
			1-24	25-49	50-99
● 177-0931-003	Red	74M8428	6.330	5.720	5.430
● 177-0932-003	Green	61M2812	12.060	10.890	10.330
● 177-0933-003	Amber	66M8538	6.330	5.720	5.430
● 177-0935-003	White	25F1642	8.900	8.040	7.630
● 177-0937-003	Clear	65M6754	17.080	15.760	14.580

(2538)

LAMP BASED – PANEL-MOUNT INDICATORS

250 SERIES CAPS FOR 507 SERIES CARTRIDGES

Features

- Can be used with any 250 series holder
- Short cylindrical
- Fresnel lens, plastic
- Unfrosted or transparent finish
- Black anodized metal finish

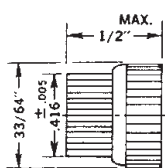

OIL-TIGHT INCANDESCENT INDICATORS



Materials and Finishes

- Mounting Bushing: aluminum, black anodized finish
- Internal-tooth lockwasher and mounting nut: Steel, cadmium plated with yellow iridescent chromate finish
- Terminals: Brass, hot tinned, with elongated slots
- Lens: High-impact plastic

Anti-rotation (locked) construction: Provides for secure locking of the socket terminal assembly in the mounting bushing and of the center terminal to the insulating disc. The notched mounting bushing receives the matched insulating disc to prevent the rotation of the mounting bushing. All are EDO Parts.

Mfg. Part No.	Color	Stock No.	Price Each		
			1-24	25-49	50-99
250-3331-500	Red	25F1523	10.560	9.490	8.150
250-3332-500	Green*	28F1805	6.340	5.700	4.890
250-3333-500	Amber	28F1806	10.560	9.490	8.150
250-3335-500	White	28F1807	10.210	9.180	7.880

*Not recommended for neon units. (2587)

Mfg. Part No.	Description	Stock No.	Price Each	
			1-24	25-49
367-8430-09-503	CAP AND BASE	94F1816	11.710	11.020

LENSES

Mfg. Part No.	Lens Style	Color	Stock No.	Price Each
				1-24
128-0931-003	Stovepipe - Non Diffusing	Red	94F1189	5.100
128-0934-003	Stovepipe - Non Diffusing	Blue	05B3612	12.800
128-0937-003	Stovepipe - Non Diffusing	Clear	61M2795	5.370
128-0971-003	Stovepipe - Translucent	Red	61M2796	5.370
128-0975-003	Stovepipe - Translucent	White	94F1191	5.940
160-0111-203	Convex Diffusing, Complete Blackout	Red	05B3690	24.940
160-0112-203	Convex Diffusing, Complete Blackout	Green	98F1517	25.250
160-0113-203	Stovepipe - Translucent	Yellow	77C5927	25.250
160-0117-203	Convex Diffusing, Complete Blackout	Clear	05B3692	51.000
161-0111-203	Convex Diffusing, Semi-Blackout	Red	05B3693	32.160
161-0112-203	Convex Diffusing, Semi-Blackout	Green	05B3694	32.160
161-0113-203	Convex Diffusing, Semi-Blackout	Yellow	05B3695	38.380
161-0117-203	Convex Diffusing, Semi-Blackout	Clear	88F1530	35.880

(82373)

103 SERIES OILTIGHT BASES AND LENSES

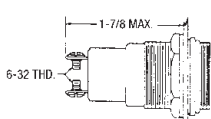

Fig. 1. Screw Terminal

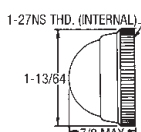

Fig. 2. Dome Lens

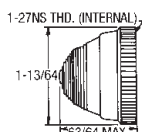

Fig. 3. Torpedo Lens

Oil-tight indicators are manufactured with a rubber gasket installed between the plastic lens and metal holder, as well as with a rubber O-ring which fits tightly on to a notch in the base. These make assembly virtually impervious to oil, water and dust. The lens holder is brass with either satin chrome or white nickel finish, and the base is white nickel-plated brass. 103 series base models can be used with either dome or torpedo lens. Torpedo faceted lens mfg. part no. 103-1331-403 also available. Order lamps separately; go online or call.

103 SERIES BASE - 1" MOUNTING HOLE, FIG. 1

Mfg. Part No.	Lamp Type	Stock No.	Price Each		
			1-24	25-49	50-99
103-0901-05-103	S-6 Candelabra Base	57F3733	30.790	30.120	29.720
103-3101-05-103	S-6 Candelabra Base	45F590	27.180	26.590	26.230
103-3114-05-103	Neon Candelabra	45F607	54.150	52.970	52.270
103-3202-05-103	S-6 Double Contact Bayonet Base	65F1095	34.320	32.360	31.050
103-3502-05-103	S-6 Double Contact Bayonet Base	45F589	30.620	28.870	27.700

103 SERIES CAP - UNFROSTED

Mfg. Part No.	Color	Fig	Stock No.	Price Each		
				1-24	25-49	50-99
103-1231-403	Red	2	61M2789	13.570	12.790	12.280
103-1232-403	Green	2	61M2790	22.680	22.190	21.900
103-1233-403	Amber	2	61M2791	16.520	15.570	14.940
103-1235-403	White	2	61M2792	14.450	13.620	13.070
103-1237-403	Clear	2	61M2793	15.500	14.620	14.020
103-0531-403	Red	3	65F1099	11.400	11.150	11.000
103-0532-403	Green	3	65F1100	12.640	12.370	12.200
103-0533-403	Amber	3	65F1101	13.870	13.560	13.380
103-0535-403	White	3	61M2788	13.870	13.560	13.380
103-1331-403	Red	...	45F591	11.910	11.650	11.500
103-1332-403	Green	...	61M2794	13.610	13.320	13.140

(2674)

CARTRIDGE HOLDERS FOR 507 SERIES DATALAMPS

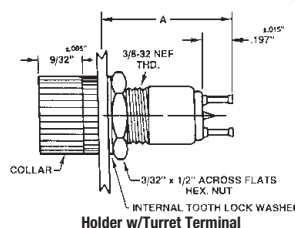

Holder w/Turret Terminal

Order 507 series datalamps, cartridge connectors, speed clips, and caps separately.

Mfg. Part No.	Terminal Type	Dimension A	Stock No.	Price Each		
				1-24	25-49	50-99
250-8738-14-504*	Turret	1.031" (26.19)	25F1485	12.340	11.120	9.560
250-8745-14-504*	Turret	1.125" (28.58)	25F1486	23.280	20.980	18.040
250-8758-33-504*	Turret	1.428" (36.27)	28F1801	36.770	33.140	28.490
508-7538-504	Solder Cup	0.891" (22.63)	25F1167	16.220	14.620	12.570
508-8738-504	Turret	0.891" (22.63)	70M8864	15.470	13.940	11.980
508-8745-504	Turret	0.984" (24.99)	25F1292	16.220	14.620	12.570

* Holder without collar. (2585)

eQuotes



Retrieve and process Newark quotes online from our website under MY ACCOUNT eSuite. Or email them to your Purchasing department. Log in or register today.

Make it easy. Make it fast. Make it Newark.

(148837)

LAMP BASED – PANEL-MOUNT INDICATORS

051 AND 080 SERIES SPLASH-PROOF INDICATORS, 1" MOUNTING HOLE



Dialight

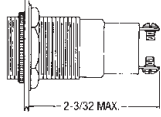

Fig. 1

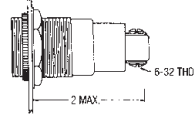

Fig. 2

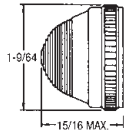

Fig. 3

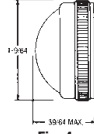

Fig. 4

Uses S6 candelabra screw base incandescent, convex, torpedo lens style lamp. Watertight. 2 to 120V operation. Mfg. part no. 051-3101-01-303 terminal: screw with protruding positions. Mfg. part no. 080-0901-05-303 terminal: screw with side positions.

051 AND 080 SERIES SOCKETS

Mfg. Part No.	Fits Lens Fig.	Fig.	Stock No.	Price Each		
				1-24	25-49	50-99
051-3101-01-303	3	1	50F6068	40.510	36.510	31.390
080-0901-05-303	4	2	50F6069	46.020	41.480	35.650

051 AND 080 SERIES LENS CAPS

Mfg. Part No.	Color	Fig.	Stock No.	Price Each		
				1-24	25-49	50-99
080-0531-303	Red	3	50F6070	11.330	10.220	8.780
080-0532-303	Green	3	50F6071	12.080	10.880	9.360
080-0533-303	Amber	3	50F6072	15.380	13.860	11.920
080-0535-303	White	3	51M9269	15.380	13.860	11.920
080-0537-303	Clear	3	50F6074	13.450	12.120	10.420
080-0111-303	Red	4	50F6075	17.220	15.520	13.340
080-0112-303	Green	4	50F6076	17.220	15.520	13.340
080-0113-303	Amber	4	50F6077	17.220	15.520	13.340
080-0117-303	Clear	4	50F6079	17.220	15.520	13.340
080-1232-303	Green	4	05B3274	25.630	23.100	19.860

(2607)

150 AND 151 SERIES UNIVERSAL INDICATOR LIGHTS

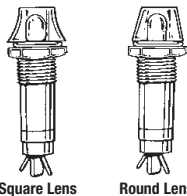

Square Lens Round Lens

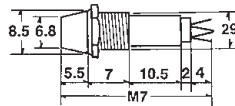

- Mounted in 0.281" (7.14mm) Hole
- Nut and Washer Supplied

- Versatile, High-Impact Plastic Units
- Provide Excellent Visibility

Digits after dash in type number denote voltage.

INCANDESCENT LAMPS - ROUND

Mfg. Part No.	Lens	Stock No.	Price Each		
			1-24	25-49	50-99
F151-24C	Clear	50F7397	7.150	6.680	6.600
F151-12R	Red	23F5518	7.150	6.680	6.600
F151-12G	Green	23F5520	7.150	6.680	6.600
F151-24R	Red	23F5521	7.150	6.680	6.600
F151-24A	Amber	23F5522	7.150	6.680	6.600
F151-24G	Green	23F5523	7.150	6.680	6.600
F151-12B	Blue	50F7394	7.150	6.680	6.600

LED LAMPS - ROUND

L151-12R	Red	23F5542	9.420	8.790	8.690
L151-24R	Red	23F5545	9.420	8.790	8.690
L151-24G	Green	23F5546	11.080	10.350	10.230
L151-24Y	Yellow	23F5547	11.080	10.350	10.230

NEON LAMPS*

Lens	Square Type	Stock No.	Round Type	Stock No.	Price Each		
					1-24	25-49	50-99
Red	NR150-110R	23F5524	NR151/110R	23F5527	12.630	11.790	11.660
Amber	NR150-110A	23F5525	NR151/110A	23F5528	11.080	10.350	10.230
Clear	NR151/110C	23F5529	11.080	10.350	10.230
Green	NR150-110G	50F7398	NR151-110G	50F7403	11.080	10.350	10.230

* Also available in 220V; go online or call.

(2502)

100 AND 101 SERIES MODULAR INDICATOR LIGHT ASSEMBLIES

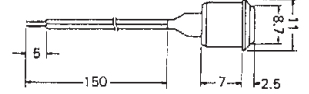
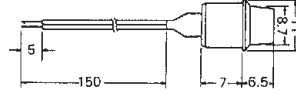

- 100 and 101 Series Modular Lights
- Mounted with a Rubber Bushing
- Snap into a 9mm Diameter Panel Cutout

- No Nuts or Washers Required
- 6" (152.4mm) Wire Leads

A variety of light sources—incandescent, neon, green glow and LED—fit into the bushing. A complete color selection of lens assemblies are shipped in from the top. Lens assemblies may be mounted independently from light source and mated in the final assembly. Lens colors/light sources are interchangeable.

LAMP ASSEMBLIES

Mfg. Part No.	Description	Volts	mA	Avg. Life (Hrs.)	Stock No.	Price Each
						1-24
F614	Incandescent	12-14	80	30,000	39F3526	9.420
F628	Incandescent	24-28	40	30,000	39F3527	9.420
N5115	Neon	100-120	1.5	10,000	39F3528	16.560
G5115	Green Glow	100-120	1.5	10,000	39F3529	18.980

LENS/BUSHING ASSEMBLIES

Flush Style Lens/100			Top Hat Style Lens/101			Price Each
Mfg. Part No.	Stock No.	Color	Mfg. Part No.	Stock No.	Color	
100-R	39F3531	Red	101-R	39F3537	Red	2.730
100-Y	39F3532	Yellow	101-Y	39F3538	Yellow	2.730
100-W	39F3535	White	101-W	39F3541	White	2.730
100-G	39F3533	Green	101-G	39F3539	Green	2.730
100-C	39F3536	Clear	101-C	39F3542	Clear	2.730
...	101-B	39F3540	Blue	2.730

(2518)

105 SERIES MODULAR INDICATOR LIGHT ASSEMBLIES

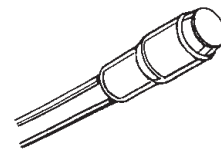

105 - Flush

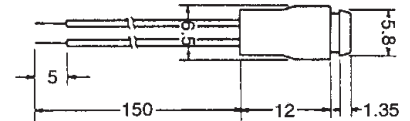

- Modular Design Similar to 100 / 101 Series Assemblies, Only Smaller
- Lens Pressed into 5mm Hole in Front Panel
- No Nuts or Washers Required
- 6" (152.4mm) Wire Leads

Light sources include incandescent or neon, and a variety of lens colors are available.

LAMP ASSEMBLIES

Mfg. Part No.	Description	Volts	mA	Avg. Life (Hrs.)	Stock No.	Price Each
						1-24
F305	Incandescent	4-6	60	50,000	35F3710	12.290
F314	Incandescent	12-14	40	10,000	35F3711	12.290
F328	Incandescent	24-28	24	10,000	35F3712	12.290
N3115	Neon	100-120	1	10,000	35F3713	14.440

105 SERIES FLUSH STYLE LENS

Mfg. Part No.	Color	Stock No.	Price Each
			1-24
105-R	Red	35F3700	2.270
105-Y	Yellow	35F3701	2.270
105-W	White	35F3704	2.270

(2519)

Expert technical support

Chat online to our team of engineers, or connect to them through your representative.

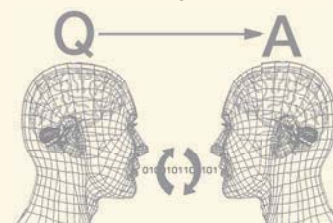

(148840)

LAMP BASED – PANEL-MOUNT INDICATORS

32 SERIES PRESSFIT INDICATORS FOR 1/2" PANEL MOUNTING HOLE



Features: Neon, Incandescent and LED indicators; choice of lens: flush, square, flat cylindrical or dome (hi-hat and square lens is available), 6" wire leads or 3/16" brass tab terminals (T). 32R Neon indicators supplied with current limiting resistors for 125V, 1/2W with 25,000-hour life. 28V=.04A with 7,000-hours life (32,000-hour life at 24V). 14V=.10A with 10,000-hours life. 6V-.20A with 5,000-hours life. 32RG1 Series for 6V, 32RG3 Series for 14V and 32RG18 Series for 28V also available. Other colors and voltages are available; go online or call. UL listed, CSA certified.

125V NEON INDICATORS WITH DOME LENS AND BEZEL

Mfg. Part No.	Lens Color	Stock No.	Price Each	
			1-24	25-49
32R-2211	Red	94F5487	4.770	4.120
32R-2212	Green	16F743	5.330	4.600
32R-2213	Amber	16F744	5.330	4.600
32R-2211T	Red	94F5488	5.810	5.020
32R-2212T	Green	16F745	5.810	5.020
32-2211T	Red	60F1278	9.090	7.850
32-2215	White	60F1277	8.620	7.440

125V NEON INDICATORS WITH FLAT CYLINDRICAL LENS AND BEZEL

32R-2111	Red	25F1331	5.330	4.600
32R-2112	Green	94F5485	5.650	4.880
32R-2113	Amber	16F742	5.330	4.600
32R-2115	White	16F777	5.930	5.120
32R-2111T	Red	25F1333	4.900	4.230
32R-2112T	Green	94F5486	5.810	5.020

125V NEON INDICATORS WITH FLAT CYLINDRICAL LENS AND NO BEZEL

32-2112	Green	70B5265	16.330	14.100
32-2117T	Clear	25F1381	12.610	10.890

125V NEON INDICATORS WITH FLUSH LENS AND BEZEL

32R-2311	Red	16F746	9.380	8.090
32R-2312	Green	16F747	5.650	4.880
32R-2313	Amber	16F748	9.380	8.090
32R-2311T	Red	94F5240	13.340	11.510
32R-2312T	Green	16F749	13.340	11.510

FLAT CYLINDRICAL LENS WITH CHROME BEZEL

Mfg. Part No.	Lens	Volt	Stock No.	Price Each	
				1-24	25-49
32RG3-2113T	Amber	14	60F1487	13.110	11.320

(2516)

31 SERIES RECTANGULAR NEON INDICATORS FOR 1.281" x .395" MOUNTING HOLE



31 series single indicator units have chrome-plated bezels, snap-fit in panel thickness to 0.090"; rated 125V, 1/2W, 25,000 hour life. UL listed, CSA certified. 6V, 14V, 28V, and 250V units, amber, blue and clear colors, and wire leads and 3/16" tab terminals also available; go online or call.

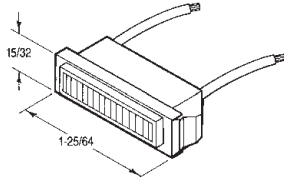

NEON LAMP AND 0.25" TAB TERMINALS

Mfg. Part No.	Lens Color	Voltage	Stock No.	Price Each	
				1-24	25-49
31-2111T	Red	125 V	25F1395	10.810	9.760
31-2112T	Green	125 V	16F787	12.940	11.680
31-2115T	White	125 V	25F1398	9.150	8.160

INCANDESCENT LAMP AND 0.25" TAB TERMINAL

31G18-2111T	Red	28 V	98F878	16.330	11.220
31G18-2112T	Green	28 V	94F5471	16.330	11.220
31G18-2115T	White	28 V	25F1330	22.650	15.560

(2622)

39 SERIES NEON INDICATORS FOR 5/16" MOUNTING HOLE

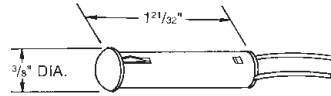

39 Series indicators feature 1-piece housing with snap-fit mounting ears; semi-dome lens; panel range: .020" - .060" maximum. 6" wire leads, stripped 1/2" or 3/16" Q.C. tab terminals. Suffix "T" in mfg. part no. denotes 3/16" terminals. Neon indicators feature current-limiting resistors for 125V and 250V, and 1/2W with 25,000-hour life. 6V, 14V, and 28V incandescent and LED units are available; go online or call.

Mfg. Part No.	Lens Color	Volts	Stock No.	Price Each	
				1-24	25-99
39-0382	Green	125	16F782	7.910	6.000
39-0381T	Red	125	16F783	7.060	5.400
39H-0382	Green	250	16F725	9.530	7.230

(2656)

REAR PANEL MOUNTING



A neon indicator requiring only 9mm clearance behind the panel. The indicator is rear panel mounting and snaps into the lens making a simple and secure mounting. An appropriate resistor is incorporated in the body molding. Termination 200mm PVC flexible leads. Length (excluding leads): 31mm. Lens: 2.5 x 12mm dia. Panel cutout: 9.5mm dia. Panel thickness: 2mm max.

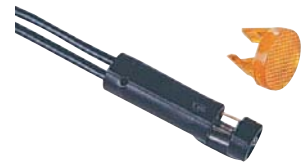

Mfg. Part No.	Color	Stock No.	Price Each	
			1-99	
● 3151-81-02A	Red	93K3661		1.620
● 3151-81-05A	Green	93K3663		1.650
● 3151-81-03A	Amber	93K3662		1.620

(116542)

Huge Expanded Selection of Semiconductors

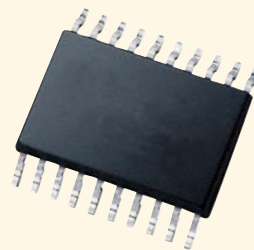

Go online to find new technologies and proven solutions from world-class and specialist suppliers.

Make it easy. Make it fast. Make it Newark.

(148844)

LAMP SELECTION CHART

BULB TYPES

Bulbs and Bases

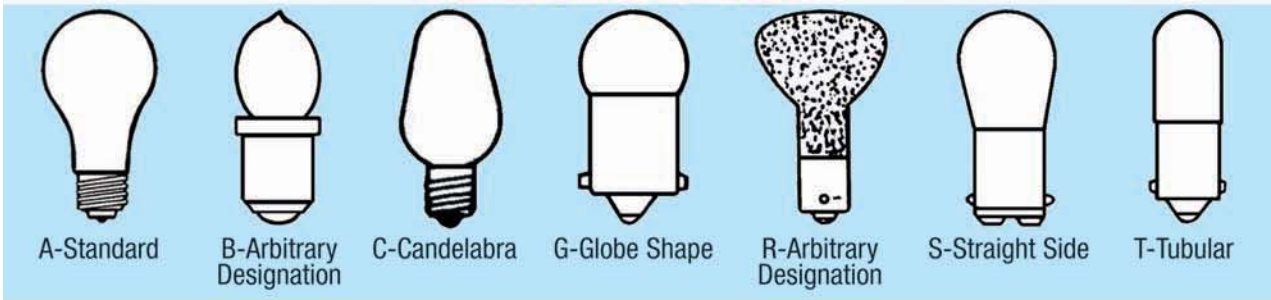

BASE TYPES

Bases provide electrical contact to the lamp and, in most cases, also support the lamp in the fixture. For miniature and subminiature lamps, bayonet or wedge base types are generally preferred over screw types when vibration is present. In addition, wedge bases reduce socket size and complexity.



* Contact Your Local Newark Sales Office for information on this item.

(75639)

4

MINIATURE INCANDESCENT LAMPS

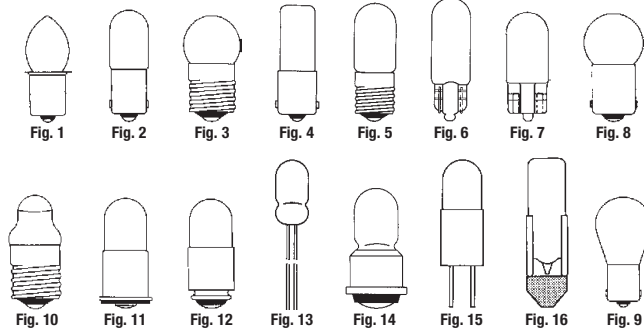

Sold in packages of 10. Other base styles and voltages available; go online or call.

Mfg. Part No.	Fig.	Design		Average Life (Hrs.)	Lamp Size	Stock No.	Price Each
		Volts	Amps				
PR2-10PK	1	2.38	0.500	15	B-3/2	75M5244	5.000
PR6	1	2.47	0.300	30	B-3/2	27F103	0.758
PR12-10PK	1	5.95	0.500	15	B-3/2	96F5648	5.550
43-10PK	2	2.5	0.500	3,000	T-3/4	93K6776	18.190
1434	2	3.7	2.750	100	T-5	96B2721	69.650
1850	2	5	0.090	1,500	T-3/4	93K6683	7.490
44-10PK	2	6.3	0.250	3,000	T-3/4	93K6780	5.140
47-10PK	2	6.3	0.150	3,000	T-3/4	93K6781	14.560
755	2	6.3	0.150	20,000	T-3/4	12P6322	6.890
1847-10PK	2	6.3	0.150	7,500	T-3/4	93K6682	16.910
1866-10PK	2	6.3	0.250	5,000	T-3/4	93K6698	8.560
1816-10PK	2	13	0.330	1,000	T-3/4	96F5859	5.920
756-10PK	2	14	0.080	15,000	T-3/4	93K6828	5.350
1815-10PK	2	14	0.200	3,000	T-3/4	93K6677	10.920
1891-10PK	2	14	0.240	500	T-3/4	93K6700	18.190
1893-10PK	2	14	0.330	3,000	T-3/4	96F5711	4.900
1813-10PK	2	14.4	0.100	1,000	T-3/4	93K6676	10.350
1892-10PK	2	14.4	0.120	1,000	T-3/4	19M0223	8.420
1818-10PK	2	24	0.170	250	T-3/4	93K6679	23.540
313-10PK	2	28	0.170	500	T-3/4	96F5737	7.530
757-10PK	2	28	0.080	7,500	T-3/4	06M4903	4.830
1495-10PK	2	28	0.300	500	T-4 1/2	96F5678	16.980
CM1820-10PK	2	28	0.100	1,000	T-3/4	15M8867	6.490
CM1864-10PK	2	28	0.170	1,500	T-3/4	93K6540	9.850
1873*	2	28	0.500	7,000	T-3/4	93K6699	1.720
1822-10PK	2	36	0.100	1,000	T-3/4	16M0448	10.860
CM1835-10PK	2	55	0.500	5,000	T-3/4	93K6539	24.830
8-3995 PK10	2	130	0.200	2,000	T-3/4	19M0296	9.660
13-10PK	3	3.7	0.300	15	G-3 1/2	96F5671	6.540
81*	3	6.5	1.02	500	G-6	25F093	0.455
50	3	7.5	0.220	1,000	G-3 1/2	96F5787	8.740
509K-10PK	3	24	0.180	1,000	G-6	19M0259	18.430
24MB-10PK	4	24	0.073	10,000	T-2	19M0228	11.640
28MB-10PK	4	28	0.040	5,000	T-2	19M0231	11.640
120MB*	4	120	0.025	5,000	T-2	90F7486	0.941
120MB-10PK	4	120	0.025	5,000	T-2	19M0218	9.410
8-967-10PK	4	120	0.025	5,000	T-2	28M8267	39.820
8362	5	14	0.080	15,000	T-1 1/4	96F5870	9.600
335-10PK	5	28	0.040	4,000	T-1 1/4	19M0239	8.050
399-10PK	5	28	0.040	10,000	T-1 1/4	96F5776	5.960
1821-10PK	5	28	0.170	500	T-3/4	19M0222	18.290
1823	5	48	0.100	1,000	T-3/4	93K6680	7.490
86-10PK	6	6.3	0.200	20,000	T-1 1/4	93K6839	8.350
18*	6	14	0.500	5,000	T-3/4	01C4621	0.436
73*	6	14	0.08	15,000	T-1 3/4	25F1646	0.479
73-10PK	6	14	0.080	15,000	T-1 1/4	16M0909	4.790
85*	6	28	0.040	10,000	T-1 1/4	93K6837	1.060
CM757*	6	28	0.08	7,500	T-3 1/4	10M8268	0.429
259-10PK	7	6.3	0.250	10,000	T-3/4	93K6773	9.630
161-10PK	7	14	0.19	1,500	T-3/4	93K6675	8.140
194-10PK	7	14	0.270	1,500	T-3/4	16M0455	4.100
2470X-10PK	7	24	0.30	12,000	T-3/4	19M0230	10.350
656-10PK	7	28	0.060	5,000	T-3/4	93K6824	7.490
219-10PK	8	6.3	0.25	5,000	G-3 1/2	19M0224	11.230
55-10PK	8	7	0.41	500	G-4 1/2	96F5792	5.800
51-10PK	8	7.5	0.22	1,000	G-3 1/2	93K6782	11.240
53	8	14.4	0.12	1,000	G-3 1/2	93K6787	8.320
356-10PK	8	24	0.17	500	G-3 1/2	93K6774	17.680

➔ CONTINUED ➔

MINIATURE INCANDESCENT LAMPS (CONT.)

Mfg. Part No.	Fig.	Design		Average Life (Hrs.)	Lamp Size	Stock No.	Price Each
		Volts	Amps				
1450-10PK	8	24	0.035	3,000	G-3 1/2	19M0220	15.510
1493-10PK	9	6.5	2.75	100	S-8	96F5677	45.090
88-PK10	9	6.8	1.91	300	S-8	96F5876	22.010
93	9	12.8	1.04	500	S-8	96F5879	11.060
1156-10PK	9	12.8	2.1	600	S-8	96F5662	14.120
307-10PK	9	28	0.66	300	S-8	96F5735	23.900
222-10PK	10	2.25	0.25	5	GTL-3	19M0225	10.150
338-10PK	11	2.7	0.06	6,000	T-1 1/4	19M0241	9.240
3150-10PK	11	5	0.060	5,000	T-1 1/4	19M0234	9.780
7333-10PK	11	5	0.06	25,000	T-1 1/4	20M4449	14.530
7335-10PK	11	5	0.115	40,000	T-1 1/4	96F5835	14.530
328-10PK	11	6	0.2	1,000	T-1 1/4	19M0237	7.320
345-10PK	11	6	0.04	10,000	T-1 1/4	19M0242	8.430
349-10PK	11	6.3	0.2	5,000	T-1 1/4	19M0243	8.430
381-10PK	11	6.3	0.2	20,000	T-1 1/4	19M0247	9.470
367-10PK	11	10	0.04	5,000	T-1 1/4	19M0244	8.020
394-10PK	11	12	0.04	10,000	T-1 1/4	19M0255	12.240
330-10PK	11	14	0.08	1,500	T-1 1/4	19M0238	7.920
382-10PK	11	14	0.08	15,000	T-1 1/4	19M0248	11.800
370-10PK	11	18	0.04	10,000	T-1 1/4	19M0245	9.070
327-10PK	11	28	0.04	4,000	T-1 1/4	19M0236	8.500
376-10PK	11	28	0.06	25,000	T-1 1/4	19M0246	9.470
385-10PK	11	28	0.04	50,000	T-1 1/4	19M0249	11.800
387*	11	28	0.040	7,000	T-1 3/4	26F919	0.498
387-10PK	11	28	0.04	10,000	T-1 1/4	19M0250	7.050
7341-10PK	11	28	0.065	5,000	T-1 1/4	19M0278	9.240
398-10PK	12	6.3	0.2	5,000	T-1 1/4	19M0256	12.420
336-10PK	12	14	0.08	1,500	T-1 1/4	19M0240	8.140
386-10PK	12	14	0.08	15,000	T-1 1/4	96F5770	13.550
388-10PK	12	28	0.04	10,000	T-1 1/4	19M0251	8.490
683	13	5	0.06	40,000	T-1	96F5813	13.210
680-10PK	13	5	0.06	60,000	T-1	96F5811	13.580
715-10PK	13	5	0.115	40,000	T-1	19M0275	14.540
6833-10PK	13	5	0.06	25,000	T-3/4	19M0270	17.920
7152-10PK	13	5	0.115	40,000	T-1	96F5824	14.980
7153-10PK	13	5	0.115	40,000	T-3/4	19M0276	18.510
7153AS15-10PK	13	5	0.115	40,000	T-3/4	96F5827	23.330
7219-10PK	13	12	0.06	16,000	T-1	96F5829	5.410
6838*	13	28	0.024	4,000	Wire Leads	25F1904	2.250
6838-10PK	13	28	0.024	16,000	T-1	19M0271	22.470
685-10PK	14	5	0.06	40,000	T-1	19M0273	21.520
6839*	14	28	0.024	4,000	Sub-Midget Flanged	25F191	2.300
6839-10PK	14	28	0.024	16,000	T-1	19M0272	22.950
7361-10PK	15	5	0.06	25,000	T-1 1/4	96F5837	12.250
7680-10PK	15	5	0.06	60,000	T-1	19M0287	23.290
7683-10PK	15	5	0.06	40,000	T-1	19M0288	27.120
7715-10PK	15	5	0.115	40,000	T-1	96F5851	22.470
7328-10PK	15	6	0.2	1,000	T-1 1/4	19M0277	14.740
7381-10PK	15	6.3	0.2	20,000	T-1 1/4	19M0281	9.310
7373-10PK	15	14	0.1	10,000	T-1 1/4	96F5863	13.240
7382-10PK	15	14	0.08	15,000	T-1 1/4	19M0282	13.410
7646-10PK	15	14	0.08	1,000	T-1 1/4	19M0286	28.970
7327-10PK	15	28	0.04	4,000	T-1 1/4	96F5864	14.740
7374-10PK	15	28	0.04	50,000	T-1 1/4	19M0279	14.980
7387-10PK	15	28	0.04	10,000	T-1 1/4	88M9626	11.800
7632-10PK	15	28	0.04	1,000	T-1 1/4	19M0285	25.930
7839-10PK	15	28	0.024	16,000	T-1	19M0289	25.410
7876-10PK	15	28	0.06	25,000	T-1 1/4	19M0290	9.370
12ESB-10PK	16	10	0.035	5,000	T-2	19M0216	15.290
10ESB	16	12	0.04	15,000	T-2	19M0211	12.790
12PSB-10PK	16	12	0.17	12,000	T-2	19M0217	14.540
16ESB-10PK	16	16	0.04	7,500	Slide	19M0221	11.560
24ESB-10PK	16	24	0.04	8,000	T-2	19M0227	15.910
24PSB-10PK	16	24	0.073	10,000	T-2	19M0229	13.340
28ESB-10PK	16	28	0.04	6,000	T-2	18M8033	15.150
28PSB-10PK	16	28	0.04	5,000	T-2	21M5206	11.020
120PSB-10PK	16	120	0.025	5,000	T-2	18M7939	13.990
1080*	...	30	0.900	5,000	S-8	19M0215	2.860

* Sold Individually (2611)



LAMPS

NEON LAMPS

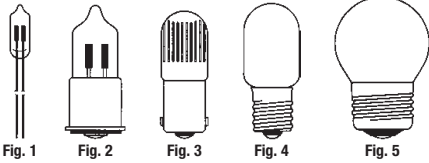

Sold in packages of 10.

Mfg. Part No.	Design Current (mA)	Series Resistor		Fig.	Lamp Size	Stock No.	Price per Pkg.	
		Ohms	Watts				Each	1-249
● 2ML-10PK	0.30	100K	¼	1	T-1¼	75M5701		8.920
● A1H-10PK	1.20	47K	¼	2	T-1¼	18M7203		29.660

Sold individually.

Mfg. Part No.	Design Current (mA)	Series Resistor		Fig.	Lamp Size	Stock No.	Price Each	
		Ohms	Watts				1-249	1-249
● A1C	1.20	47K	¼	1	T-2	25F811		0.365
● A9A	0.7	100K	¼	1	T-2	25F812		0.326
● C2A-10PK	1.90	30K	¼	1	T-2	19M0202		0.398
● B1A-10PK	0.30	220K	¼	3	T-3¼	19M0199		0.831
● B2A-10PK	1.20	47K	¼	3	T-3¼	19M0200		0.972
● B7A	2.00	30K	¼	4	T-4¼	18M7205		5.640
J5A	8.00	7.5K	¼	5	S-11	81F193		10.180

(2527)

4

MINIATURE LAMPS

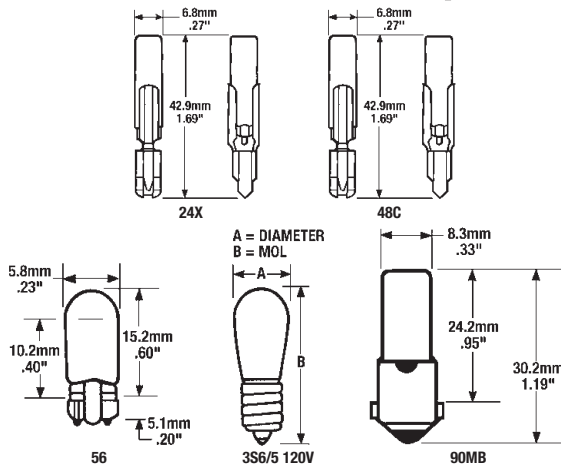

Lamps are listed by type number. Sold in packages of 10.

Mfg. Part No.	Volts	Amps	Life Hours	Size	Stock No.	Price Each
● 24X	24.00	0.035	8,000	T2	75M6083	12.510
56	5.00	0.115	20,000	T1.75	96F6677	8.720
3S6/5 120V	120.00	3W	3,000	T1.75	96F6633	32.860
● 90MB	90.00	0.03	5,000	T2.5	96F6717	16.400
10S6/10 230V	115/120	6W	1,500	S6	96F6563	37.780
● 120MB	120	.025	7,500	T2-½	98M5045	12.640
● 120MB/6	120.0	.052	3,000	T2-½	75M6081	14.950
● 120PSB	120	.025	7,500	T2	98M5046	10.360
● 12PSB	12	.170	12,000	T2	96F6573	13.470
● 16ESB	16	.040	7,500	T2	96F6544	14.770
● 1815	14	.200	3,000	T3-¼	96F6589	9.220
● 1816	13	0.33	1,000	T3-¼	96F6590	9.320
● 1819	28	.040	2,500	T3-¼	96F6591	7.130
● 1820	28	.100	1,000	T3-¼	96F6592	11.210
● 1829	28	.070	1,000	T3-¼	96F6595	8.070
● 1835	55	.050	5,000	T3-¼	96F6596	18.790
● 1864	28	.170	1,500	T3-¼	96F6599	11.540
● 24E	24	.035	7,000	T2	96F6620	12.020
● 24MB	24	.070	10,000	T2-½	96F6622	14.470
● 24PSB	24	.073	10,000	T2	96F6624	9.650
● 28ESB	28	.040	6,000	T2	75M6084	16.520
● 28MB	28	.040	5,000	T2-½	96F6629	17.920
● 60PSB	28	.040	5,000	T2	75M6087	16.090

CONTINUED

MINIATURE LAMPS (CONT.)

Mfg. Part No.	Volts	Amps	Life Hours	Size	Stock No.	Price Each
● 327	28	.040	4,000	T1-¾	96F6642	7.140
● 328	6.0	.200	1,000	T1-¾	96F6643	10.730
382	14	.080	15,000	T1-¾	96F6651	11.540
● 313	28	.017	500	T3-¾	50N8081	7.640
387	28	.040	7,000	T1-¾	96F6654	6.330
388	28	.040	7,000	T1-¾	96F6655	13.390
40 S11N/115-125V	115-125	40W	500	S11	96F6657	38.180
● 44	13	.330	1,000	T3-¼	96F6658	6.170
● 47	6.3	0.15	3,000	T3-¼	96F6660	6.170
● 48PSB	48	.050	10,000	T2	98M5489	12.110
20T3Q/CL 12V	512	20W	2,000	T3-¼	99F6527	6.950
● 60PSB	60	.050	7,500	T2	75M6087	16.090
64111	12	5W	240	HAL/T2-3/4	92F2702	72.080
● 64156	24	70	225	T3-¼	01N4426	114.520
658	14	.080	15,000	T3-¼	96F6695	9.940
● 6S6 120V	120	.05	1,500	S6	01N4425	13.160
6S6-145V	145	6W	1,500	S6	96F6685	116.580
6S6 155V	155	6W	1,500	S6	96F6683	116.580
● 6S6DC 120V	120	6W	1,500	S6	96F6686	21.570
73	14	.080	15,000	T1-¾	96F6701	6.530
755	6.3	.150	20,000	T3-¼	96F6707	6.500
756	14	.080	15,000	T3-¼	96F6708	8.240
757	28	.080	7,500	T3-¼	96F6709	8.790
85	28	.040	7,000	T1-¾	96F6713	4.980
● 86	6.3	.200	20,000	T1-3/4	96F6714	8.240
● 90	13	.580	750	G6	96F6716	14.450

(10024)

WIRE ENDED T11/4 AND T2 NEON LAMPS



Neon lamp without series resistor.

SPECIFICATIONS
4mm T1 1/4

Mfg. Part No.	Brightness	Body L (mm)	Lead L (mm)	Current (mA)	Max. Strike V		Rec. Series Resistor	
					AC	DC	110VAC	240VAC
● MC08010000	Standard	10.5	23	0.55	65	90	100K 1/4W	330K 1/4W
● MC08020000	High	10.5	23	1.8	95	135	33K 1/4W	100K 1/4W
● MC08030000	Green	10.5	23	0.55	65	90	100K 1/4W	330K 1/4W

6mm T2

● MC08130000	Standard	12.5	30	0.8	65	90	68K 1/4W	220K 1/4W
● MC08310015	Green	16	30	4.5	95	135	12K 1/4W	39K 1/4W
● MC08320000	High	16	30	0.55	65	90	100K 1/4W	330K 1/4W

ORDER MULTIPLES = 10

600W UNIDIRECTIONAL

Mfg. Part No.	Stock No.	Price Each
● MC08010000	26M1309	0.313
● MC08020000	26M1311	0.313
● MC08030000	26M1312	0.810

1500W UNIDIRECTIONAL

● MC08130000	26M1313	0.728
● MC08310015	26M1314	0.219
● MC08320000	26M1315	0.238

(116536)

RADION™ BRAND INCANDESCENT LAMPS



Sold in packages of 10 (unless noted +, sold individually). EFC* indicates end foot candle. Some lamps also available in packages of 100. For bulb and base illustrations plus lamp terminology, on page 1352; or go online or call.

BULB TYPE B-3 ½

Mfg. Part No.	Base	Volts	Amps	MSCP	Avg. Life Hrs.	Stock No.	Price Each
● PR-2	S.C. Mini Flanged	2.38	0.500	0.8	15	50N8050	6.550
● PR-3	S.C. Mini Flanged	3.57	0.5	1.5	15	13P0373	5.130
● PR4	S.C. Mini Flanged	2.33	0.27	0.4	10	53M4991	6.550
● PR6	S.C. Mini Flanged	2.47	0.400	0.45	30	96F7950	4.420

BULB TYPE G-3 1/2

12	Miniature Bi-Pin	6.3	0.15	0.35	5000	96F7956	14.160
● 13	Midget Screw	3.7	0.3	0.98	15	12P6305	5.360

CONTINUED

RADION™ BRAND INCANDESCENT LAMPS (CONT.)

BULB TYPE G-3 1/2

Mfg. Part No.	Base	Volts	Amps	MSCP	Avg. Life Hrs.	Stock No.	Price Each 1-24
● 14	Miniature Screw	2.47	0.3	0.5	15	12P6307	5.360
19	Miniature Bi-Pin	14.4	0.100	0.9	1000	84N643	14.160
● 50	Mini Screw	7.5	0.22	1	1000	53M5086	8.830
● 53	Miniature Bayonet	14.4	0.12	1	1000	50N8065	8.790
● 356	Miniature Bayonet	28	0.17	3.5	500	12P6315	9.450

BULB TYPE G-4 1/2

● 55	Miniature Bayonet	7	0.41	2	500	50N8066	4.940
● 57	Miniature Bayonet	14	0.24	2	500	50N8067	7.350

BULB TYPE G-6

● 90	D.C. Bayonet	13	0.58	6	750	61M2949	8.120
------	--------------	----	------	---	-----	---------	-------

BULB TYPE R-12 +

● 1383	S.C. Bayonet	13	1.5	...	300	12P6306	4.540
--------	--------------	----	-----	-----	-----	---------	-------

BULB TYPE RP-11

● 1133	S.C. Bayonet	6.2	3.91	32	200	50N8128	14.450
--------	--------------	-----	------	----	-----	---------	--------

BULB TYPE S-8

93	S.C. Bayonet	12.8	1.04	15	700	96F7944	8.120
307	S.C. Bayonet	28	0.67	21	300	50N171	18.830
1156	S.C. Bayonet	12.8	1.44	21	1200	96F7954	11.130
1157	D.C. Bayonet	12.8	0.59	32/3	5000	96F7955	6.890
● 1460X	D.C. Prefocus	6.5	2.75	23	100	53M5053	13.310
1493	D.C. Bayonet	6.5	2.75	23	100	50N8130	15.960
1619	S.C. Bayonet	6.7	1.9	15	500	96F7965	11.660
● 1630	D.C. Prefocus	6.5	2.75	23	100	50N8131	13.010
1683	S.C. Bayonet	28	1.02	32	500	50N8132	19.890

BULB TYPE T-1

● 683	Wire Leads	5	0.06	0.05	25000	53M5330	12.350
683AS15	Wire Leads	5	0.06	0.05	25000	50N8111	11.330
● 685	Midget Flanged	5	0.06	0.05	25000	53M5333	15.560
● 715	Wire Leads	5	0.12	0.15	40000	53M5338	12.350
● 718	Midget Flanged	5	0.12	0.15	40000	53M5339	15.560
● 6838	Wire Leads	28	0.024	0.15	4000	53M5331	10.970
● 6839	Midget Flanged	28	0.024	0.15	4000	53M5332	19.920
● 7219	Wire Leads	12	0.06	0.15	10000	53M5340	4.640
7683	Bi-Pin	5	0.06	0.05	25000	84N660	16.760
● 7714	Bi-Pin	5	0.075	0.09	25000	50N8227	16.760
● 7715	Bi-Pin	5	0.115	0.15	40000	50N8189	16.760
7839	Bi-Pin	28	0.025	0.15	4000	50N8190	19.010

BULB TYPE T 1-3/4

● 17	Wedge	28	0.065	0.65	5000	61M2945	7.120
● 37	Wedge	14	0.09	0.5	1500	50N8056	7.120
● 56	Wedge	5	0.115	0.15	20000	53M5321	7.120
● 73	Wedge	14	0.08	0.3	15000	53M5341	4.230
● 74	Wedge	14	0.100	0.7	500	50N8069	7.120
● 85	Wedge	28	0.04	0.3	7000	53M5351	4.090
86	Wedge	6.3	0.200	0.4	20000	50N8071	5.960
● 327	Midget Flanged	28	0.04	0.34	4000	53M5071	5.860
● 328	Midget Flanged	6	0.200	0.34	1000	53M5072	6.240
● 330	Midget Flanged	14	0.08	0.5	1500	50N8084	8.070
● 334	Midget Grooved	28	0.04	0.34	4000	53M5073	13.150
● 335	Mini Screw	28	0.04	0.34	4000	50N8088	7.120
338	Midget Flanged	2.7	0.06	0.04	6000	50N8226	6.820
342	Mini Screw	6	0.04	0.03	10000	50N8089	11.380
● 344	Midget Flanged	10	0.014	0.002	50000	50N8090	12.470
● 345	Midget Flanged	6	0.04	0.03	10000	50N8091	7.180
● 370	Midget Flanged	18	0.04	0.15	10000	54M6087	7.730
● 376	Midget Flanged	28	0.06	0.34	25000	53M5074	8.070
● 378	Midget Screw	6.3	0.200	0.4	20000	53M5075	13.610
● 379	Midget Grooved	6.3	0.200	0.4	20000	53M5076	13.090
● 381	Midget Flanged	6.3	0.200	0.4	20000	53M5077	8.070
● 382	Midget Flanged	14	0.08	0.3	15000	50N8100	9.070
● 385	Midget Flanged	28	0.04	0.15	10000	12P6317	7.110
386	Midget Grooved	14	0.08	0.3	15000	50N8102	13.150
● 387	Midget Flanged	28	0.04	0.3	7000	53M5078	5.480
● 388	Midget Grooved	28	0.04	0.3	7000	50N8104	6.020
● 394	Midget Flanged	12	0.04	0.12	10000	53M5079	9.650
● 1768	Mini Screw	6	0.200	0.6	1000	50N8134	11.000
● 1769	Mini Screw	2.5	0.200	0.22	500	50N8135	11.000
● 2174	Wire Leads	12	0.400	0.1	1000	50N8114	13.140
● 2181	Wire Leads	6.3	0.200	0.4	20000	50N8117	8.460
● 2182	Wire Leads	14	0.08	0.3	40000	50N8118	8.460
2185	Wire Leads	28	0.04	0.15	10000	50N8119	7.580
● 2187	Wire Leads	28	0.04	0.3	7000	50N8120	7.120

▶ CONTINUED ▶

RADION™ BRAND INCANDESCENT LAMPS (CONT.)

BULB TYPE T 1-3/4

Mfg. Part No.	Base	Volts	Amps	MSCP	Avg. Life Hrs.	Stock No.	Price Each 1-24
● 7327	Bi-Pin	28	0.04	0.34	4000	53M5342	10.140
● 7328	Bi-Pin	6	0.200	0.6	1000	53M5343	13.590
● 7330	Bi-Pin	14	0.08	0.5	1500	53M5344	13.300
7333	Midget Flanged	5	0.06	0.05	25000	50N8170	10.370
7341	Midget Flanged	28	0.065	0.65	5000	50N8172	7.870
7349	Bi-Pin	6.3	0.200	0.55	5000	50N8173	13.590
● 7373	Bi-Pin	14	0.100	0.5	10000	50N8178	12.400
● 7377	Bi-Pin	6.3	0.075	0.23	1000	53M5345	12.400
● 7381	Bi-Pin	6.3	0.200	0.4	20000	50N8182	7.980
● 7382	Bi-Pin	14	0.08	0.3	15000	53M5346	12.400
● 7387	Bi-Pin	28	0.04	0.3	7000	53M5347	10.560

BULB TYPE T 1-1/4

● 6PSB	Slide	6	0.14	550	20000	61M2947	13.000
● 12ESB	Slide	12	0.04	650 EFC	7500	50N8212	12.180
● 12PSB	Slide	12	0.17	2000 EFC	12000	50N8211	9.560
● 12RB	Miniature Bayonet	12	0.17	2000 EFC	12000	53M5048	42.610
● 12RC	Candelabra Screw	12	0.17	2000 EFC	12000	12P6304	53.150
● 16ESB	Slide	16	0.04	800 EFC	7500	50N8213	9.920
● 24E3	Slide	24	0.035	600 EFC	7000	53M5063	9.560
● 24ESB	Slide	24	0.04	850 EFC	8000	50N8216	12.530
● 24PSB	Slide	24	0.073	3000 EFC	10000	53M5064	9.560
● 28ESB	Slide	28	0.04	1500 EFC	6000	50N8220	12.710
● 28PSB	Slide	28	0.04	1600 EFC	5000	53M5069	8.250
● 48PSB	Slide	48	0.053	1800 EFC	10000	53M5085	9.850
● 60RB	Miniature Bayonet	60	0.05	1800 EFC	7500	16N7510	42.280
● 120PSB	Slide	120	0.025	1200 EFC	10000	53M5050	8.310
● 120RB	Miniature Bayonet	120	0.025	1000 EFC	7500	53M5051	37.810
● 120RC	Candelabra Screw	120	0.025	1000 EFC	7500	16N7514	37.810
● 7632	Bi-Pin	28	0.04	0.32	1000	53M5349	17.280
● 8627	Wire Leads	28	0.04	0.32	1000	50N8194	8.460

BULB TYPE T 2-1/2

● 12MB	Miniature Bayonet	12	0.17	0.35	12000	16N7507	13.070
● 24MB	Miniature Bayonet	24	0.07	0.5	10000	16N7512	17.430
● 28MB	Miniature Bayonet	28	0.04	0.29	5000	53M5068	10.300
● 60MB	Miniature Bayonet	60	0.05	0.73	7500	16N7513	17.430
● 90MB	Miniature Bayonet	90	0.03	0.37	5000	16N7515	13.290
● 120MB	Miniature Bayonet	120	0.03	0.36	7500	53M5049	13.570
● 120MB/6	Miniature Bayonet	120	0.052	1.43	3000	84N656	17.010

BULB TYPE T 2-1/4

787	Bi-Pin	6	1.67	16	100	16N8748	17.760
-----	--------	---	------	----	-----	---------	--------

BULB TYPE T-3

● 211-2	Rigid Loops / End Caps	12.8	0.97	12	1000	53M5062	12.360
---------	------------------------	------	------	----	------	---------	--------

BULB TYPE T 3-1/4

● 8-3995	Miniature Bayonet	130	0.025	0.3	2000	53M5350	14.320
● 40	Mini Screw	6.3	0.15	0.52	3000	12P6318	5.580
● 43	Miniature Bayonet	2.5	0.500	0.5	3000	50N8057	11.600
44.	Miniature Bayonet	6.3	0.25	0.9	3000	50N8058	5.010
● 46	Midget Screw	6.3	0.25	0.9	3000	14P9580	5.580
● 47	Miniature Bayonet	6.3	0.15	0.5	3000	11R6433	5.580
48	Midget Screw	2	0.06	0.04	1000	50N8061	15.710
● 656	Wedge	28	0.06	0.62	2500	53M5327	7.120
● 161	Wedge	14	0.19	1	1500	53M5054	6.550
● 168	Wedge	14	0.35	3	1500	53M5055	6.340
● 194	Wedge	14	0.27	2	2500	53M5060	3.630
● 259	Wedge	6.3	0.25	0.65	5000	53M5067	5.480
● 313	Miniature Bayonet	28	0.17	3.5	500	50N8081	7.640
555.	Wedge	6.3	0.25	0.9	3000	96F7961	6.410
● 555	Wedge	6.3	0.25	0.9	3000	53M5320	6.390
● 657	Wedge	28	0.08	0.62	15000	53M5328	6.390
● 658	Wedge	14	0.08	0.31	15000	53M5329	6.390
● 755	Miniature Bayonet	6.3	0.15	0.33	20000	12P6322	6.890
● 756	Miniature Bayonet	14	0.08	0.31	15000	53M5348	4.570
● 757	Miniature Bayonet	28	0.08	0.62	7500	12P6323	6.890
● 1490	Miniature Bayonet	3.2	0.16	0.2	3000	13P0406	6.890
● 1813	Miniature Bayonet	14.4	0.100	0.86	1000	50N8137	7.640
● 1815	Miniature Bayonet	14	0.200	1.4	3000	12P6308	5.990
● 1816	Miniature Bayonet	13	0.33	3	1000	53M5056	5.230
● 1818	Miniature Bayonet	24	0.17	3.3	250	53M5057	11.360
● 1819	Miniature Bayonet	28	0.1	0.34	2500	50N8141	8.790
● 1820	Miniature Bayonet	28	0.1	0.34	2500	53M5058	5.740
● 1821	Midget Screw	28	0.17	3.4	500	12P6309	7.290
● 1822	Miniature Bayonet	36	0.100	2.1	1000	50N8144	11.360

▶ CONTINUED ▶

LAMPS

RADION™ BRAND INCANDESCENT LAMPS (CONT.)

BULB TYPE T 3-1/4

Mfg. Part No.	Base	Volts	Amps	MSCP	Avg. Life Hrs.	Stock No.	Price Each
● 1828	Miniature Bayonet	37.5	0.05	0.65	3000	53M5059	11.600
● 1829	Miniature Bayonet	28	0.07	1	1000	50N8145	7.120
● 1835	Miniature Bayonet	55	0.05	1.1	5000	50N8146	11.480
● 1847	Miniature Bayonet	6.3	0.15	0.38	5000	50N8147	7.640
● 1850	Miniature Bayonet	5	0.09	0.25	1500	50N8148	5.900
● 1864	Miniature Bayonet	28	0.17	3	1500	50N8149	7.350
● 1866	Miniature Bayonet	6.3	0.25	0.65	5000	50N8150	7.330
● 1893	Miniature Bayonet	14	0.33	2	7500	50N8153	4.340

BULB TYPE T-3/4

● 2	Wire Leads	5	0.02	0.03	10000	10R6574	11.610
● 6833	Wire Leads	5	0.06	0.05	25000	50N8159	15.380

BULB TYPE T-5

● 912	Wedge	12.8	1	12	1000	12P6324	5.130
-------	-------	------	---	----	------	---------	-------

BULB TYPE TL-3

● 222	Mini Screw	2.25	0.25	...	5	50N8077	7.010
-------	------------	------	------	-----	---	---------	-------

(2582)

4

MICROSCOPE LAMPS

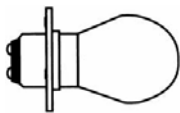

RoHS Compliant Available

For base illustrations, go online or call.

Mfg. Part No.	Amps (Watts)	Width (Max.)	Length (Max.)	Base	Stock No.	Price Each
● 1460X	2.75	26.5mm	50mm	D.C. Prefocus	53M5053	13.310
● 1630	2.75	26.5mm	50mm	D.C. Prefocus	50N8131	13.010

(13436)

MBC/MCC (BA9s) 10mm, T31/4 LAMPS



RoHS Compliant Available

Neon lamps with integral resistor. These capped neons have a white body with a clear lens.

SPECIFICATIONS

Mfg. Part No.	Color	Voltage (V)
● MC09321150	Amber-Red	100-120
● MC09322250	Amber-Red	220-250
● MC09322750	Green	200-250

ORDER MULTIPLES = 5

Mfg. Part No.	Stock No.	Price Each
● MC09321150	26M1316	0.849
● MC09322250	26M1317	1.080
● MC09322750	26M1318	1.470

(118516)

NEON GLOW LAMPS

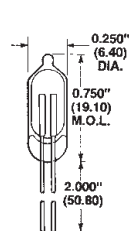

Fig. 1 Wire Leads

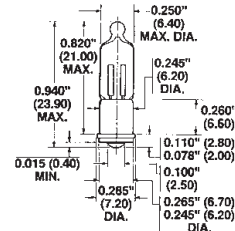

Fig. 2 Midget Flange Base

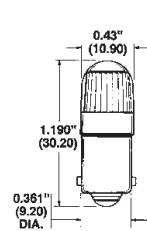

Fig. 3 Min. Bayonet Base

Neon glow lamps are used for indicators and circuit control applications. Two closely spaced electrodes cause neon gas to ionize and glow when voltage is applied. Since they have no filament, lamps withstand considerable shock vibration. Neon lamps are ideal for line-voltage AC as well as for 90V and up DC applications. They are rugged and long-lived; properly specified neon lamps will outlast the equipment in which they are incorporated. Neon lamps have tinned leads, and are ideal for use on printed circuit boards. External resistors not included except resistor included in base. Current voltage: 120 except (+) 105-125. Sold in packages of 10.

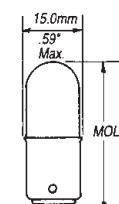

Fig. 4 D.C. Bayonet

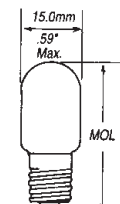

Fig. 5 Candelabra Screw

FIG. 1

Mfg. Part No.	Bulb Type	Max. Overall Length	Current (mA)	Max. Break-down Volts AC DC	Average Life Hours	Series Resistor	Stock No.	Price Per Pkg.
● A1A(NE-2)	T-2	1.000"	0.7	65 90	25,000	100K	61M2935	5.890
● A1C	T-2	1.000"	1/2	95 135	25,000	47K	25F811	0.365
● A9A(NE-2E)	T-2	1.000"	0.7	65 90	25,000	100K	12P6270	1.930

FIG. 2

● C7A(NE-2D)	T-2	0.940"	0.7	65 90	25,000	100K	61M2940	18.980
● C9A	T-2	0.940"	1/4	95 135	25,000	30K	61M2941	15.020

FIG. 3

● B1A(NE-51)	T-3/4	1.186"	0.3	65 90	15,000	220K	61M2936	9.460
● B1A-R (NE-51R)	T-3/4	1.186"	0.3	65 90	15,000	150K*	61M2937	16.600
● B2A(NE-51H)	T-3/4	1.186"	1.2	95 135	20,000	47K	61M2938	9.700

FIG. 4

B9A(NE48)+	T-4/4	1.500"	2.0	65 90	7,500	30K	16N7495	60.940
------------	-------	--------	-----	-------	-------	-----	---------	--------

FIG. 5

● B7A(NE45)+	T-4/4	1.540"	2.0	65 90	5,000	None *	61M2939	59.440
--------------	-------	--------	-----	-------	-------	--------	---------	--------

*30K ohm resistor built in base. (2625)

VEHICLE/MEDICAL LAMPS

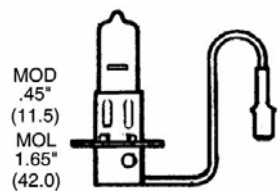

RoHS Compliant Available

Mfg. Part No.	Volts	Watts	Avg. Life (Hrs.)	Description	Stock No.	Price Each
● 01006	6.0	55	150	H3-Type	92N5693	3.790
● 01007	12.0	55	225	H3-Type	92N5694	7.870
● 01008	24.0	70	225	H3-Type	92N5695	7.870

(13440)

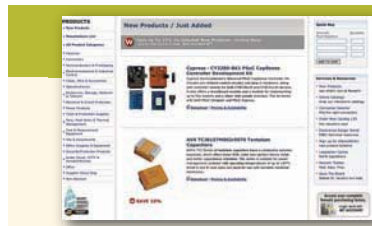

(148890)



New products added weekly

See the newest products, technologies and suppliers on our website.

LED REPLACEMENTS

TRUE 360™ MINIATURE LEDS



TRUE 360™ MINIATURE LEDS (CONT.)



Features and Benefits:

- Major reduction in heat generation
- Shatter resistant plastic envelope
- AC-DC bi-polar design
- Low maintenance/labor savings
- True 360° viewing angle
- Long life: 100,000 hours
- Solid state, high shock/vibration resistant

T-1 3/4, WEDGE BASE, 6.3V

Mfg. Part No.	Color	Wave-length (nm)	Luminous Flux (Lumens)	Can replace these bulbs	Stock No.	Price Each 1-9
LM0506WB-A	Amber	590	1	56,79,86	85K8114	5.050
LM0506WB-B	Blue	470	0.5		85K8115	5.630
LM0506WB-G	Green	525	2		85K8116	5.630
LM0506WB-R	Red	625	1.5		85K8117	5.050
LM0506WB-W	White	...	0.55		85K8118	5.630
LM0506WB-WW	Warm White	...	0.55		85K8119	5.630

T-1 3/4, WEDGE BASE, 12V

LM0512WB-A	Amber	590	1	18,37,73,74	85K8120	5.050
LM0512WB-B	Blue	470	0.5		85K8121	5.630
LM0512WB-G	Green	525	2		85K8122	5.630
LM0512WB-R	Red	625	1.5		85K8123	5.050
LM0512WB-W	White	...	0.55		85K8124	5.630
LM0512WB-WW	Warm White	...	0.55		85K8125	5.630

T-3 1/4, MINIATURE SCREW BASE, 6.3V

LM1006MS-A	Amber	590	2.8	40,46,50,133,134,401,438,502,1482	85K8132	8.270
LM1006MS-B	Blue	470	1.3		85K8133	13.430
LM1006MS-G	Green	525	6.3		85K8134	13.430
LM1006MS-R	Red	625	3.8		85K8135	8.270
LM1006MS-W	White	...	3.1		85K8136	13.430
LM1006MS-WW	Warm White	...	0.45		85K8137	13.430

T-3 1/4, WEDGE BASE, 12V

LM1012WB-A	Amber	590	2.8	158,159,161,168,184,193,194,658	85K8156	8.270
LM1012WB-B	Blue	470	1.3		85K8157	13.430
LM1012WB-G	Green	525	6.3		85K8158	13.430
LM1012WB-R	Red	625	3.8		85K8159	8.270
LM1012WB-W	White	...	3.1		85K8160	13.430
LM1012WB-WW	Warm White	...	0.45		85K8161	13.430

T-3 1/4, MINIATURE BAYONET BASE, 12V

LM1012MB-A	Amber	590	2.8	53,57,182,293,756,1445,1488,1815,1816,1889,1891,1893,1895	85K8144	8.270
LM1012MB-B	Blue	470	1.3		85K8145	13.430
LM1012MB-G	Green	525	6.3		85K8146	13.430
LM1012MB-R	Red	625	3.8		85K8147	8.270
LM1012MB-W	White	...	3.1		85K8148	13.430
LM1012MB-WW	Warm White	...	0.45		85K8149	13.430

T-3 1/4, MINIATURE BAYONET BASE, 24V

LM1024MB-A	Amber	590	2.8	313,757,1818,1819,1820,1829,1843,1864,1873,1437,1450,1484	85K8174	8.270
LM1024MB-B	Blue	470	1.3		85K8175	13.430
LM1024MB-G	Green	525	6.3		85K8176	13.430
LM1024MB-R	Red	625	3.8		85K8177	8.270
LM1024MB-W	White	...	3.1		85K8178	13.430
LM1024MB-WW	Warm White	...	0.45		85K8179	13.430

T-3 1/4, MINIATURE SCREW BASE, 24V

LM1024MS-A	Amber	590	1.85	1448,1821	85K8180	8.270
LM1024MS-B	Blue	470	0.88		85K8181	13.430
LM1024MS-G	Green	525	3.85		85K8182	13.430
LM1024MS-R	Red	629	3.8		85K8183	8.270
LM1024MS-W	White	...	3.1		85K8184	13.430
LM1024MS-WW	Warm White	...	2.5		85K8185	13.430

▶ CONTINUED ▶

LED REPLACEMENTS

TRUE 360™ MINIATURE LEDS (CONT.)

T-3 1/4, MINIATURE BAYONET BASE, 48V

Mfg. Part No.	Color	Wave-length (nm)	Luminous Flux (Lumens)	Can replace these bulbs	Stock No.	Price Each 1-9
LM1048MB-A	Amber	590	0.5	48MB,3T4/48V	85K8192	8.270
LM1048MB-B	Blue	470	0.22		85K8193	13.430
LM1048MB-G	Green	525	0.95		85K8194	13.430
LM1048MB-R	Red	629	0.95		85K8195	8.270
LM1048MB-W	White	...	0.78		85K8196	13.430
LM1048MB-WW	Warm White	...	0.65		85K8197	13.430

T-3 1/4, MINIATURE BAYONET BASE, 60V

Mfg. Part No.	Color	Wave-length (nm)	Luminous Flux (Lumens)	Can replace these bulbs	Stock No.	Price Each 1-9
LM1060MB-A	Amber	590	0.6	60MB,3T4/60V, 1835	85K8198	8.270
LM1060MB-B	Blue	470	0.3		85K8199	13.430
LM1060MB-G	Green	525	1.2		85K8200	13.430
LM1060MB-R	Red	629	1.2		85K8201	8.270
LM1060MB-W	White	...	1		85K8202	13.430
LM1060MB-WW	Warm White	...	0.85		85K8203	13.430

T-3 1/4, MINIATURE BAYONET BASE, 120V

Mfg. Part No.	Color	Wave-length (nm)	Luminous Flux (Lumens)	Can replace these bulbs	Stock No.	Price Each 1-9
LM10120MB-A	Amber	590	0.75	120 MB	85K8162	8.270
LM10120MB-B	Blue	470	0.35		85K8163	13.430
LM10120MB-G	Green	525	1.5		85K8164	13.430
LM10120MB-R	Red	629	1.5		85K8165	8.270
LM10120MB-W	White	...	1.2		85K8166	13.430
LM10120MB-WW	Warm White	...	1		85K8167	13.430

T-3 1/4, MINIATURE BAYONET BASE, 160V

Mfg. Part No.	Color	Wave-length (nm)	Luminous Flux (Lumens)	Can replace these bulbs	Stock No.	Price Each 1-9
LM10160MB-A	Amber	590	0.75	160 MB	85K8168	8.270
LM10160MB-B	Blue	470	0.35		85K8169	13.430
LM10160MB-G	Green	525	1.5		85K8170	13.430
LM10160MB-R	Red	629	1.5		85K8171	8.270
LM10160MB-W	White	...	1.2		85K8172	13.430
LM10160MB-WW	Warm White	...	1		85K8173	13.430

T-6, CANDELABRA SCREW BASE, 6.3V

Mfg. Part No.	Color	Wave-length (nm)	Luminous Flux (Lumens)	Can replace these bulbs	Stock No.	Price Each 1-9
LM2006CS-A	Amber	590	1.54	3S6/6V, 6S6/6V	85K8210	8.840
LM2006CS-B	Blue	470	0.8		85K8211	14.000
LM2006CS-G	Green	525	3.5		85K8212	14.000
LM2006CS-R	Red	629	3.15		85K8213	8.840
LM2006CS-W	White	...	2.8		85K8214	14.000
LM2006CS-WW	Warm White	...	2.3		85K8215	14.000

T-6, CANDELABRA SCREW BASE, 30V

Mfg. Part No.	Color	Wave-length (nm)	Luminous Flux (Lumens)	Can replace these bulbs	Stock No.	Price Each 1-9
LM2030CS-A	Amber	590	0.95	6S6/30V, 6S6/32V, 6S6/34V, 1224K	85K8246	8.840
LM2030CS-B	Blue	470	0.45		85K8247	14.000
LM2030CS-G	Green	525	1.9		85K8248	14.000
LM2030CS-R	Red	629	1.9		85K8249	8.840
LM2030CS-W	White	...	1.5		85K8250	14.000
LM2030CS-WW	Warm White	...	1.3		85K8251	14.000

T-6, CANDELABRA SCREW BASE, 120V

Mfg. Part No.	Color	Wave-length (nm)	Luminous Flux (Lumens)	Can replace these bulbs	Stock No.	Price Each 1-9
LM20120CS-A	Amber	590	1.8	4C7/120V, 4C7/130V, 6S6/120V, 6S6/130V	85K8222	8.840
LM20120CS-B	Blue	470	0.88		85K8223	14.000
LM20120CS-G	Green	525	3.85		85K8224	14.000
LM20120CS-R	Red	629	3.8		85K8225	8.840
LM20120CS-W	White	...	3.1		85K8226	14.000
LM20120CS-WW	Warm White	...	1		85K8227	14.000

T-6, CANDELABRA SCREW BASE, 145V

Mfg. Part No.	Color	Wave-length (nm)	Luminous Flux (Lumens)	Can replace these bulbs	Stock No.	Price Each 1-9
LM20145CS-A	Amber	590	1.85	6S6/135V, 6S6/145V, 6S6/155V, 6S6/160V	85K8228	8.840
LM20145CS-B	Blue	470	0.88		85K8229	14.000
LM20145CS-G	Green	525	3.85		85K8230	14.000
LM20145CS-R	Red	629	3.8		85K8231	8.840
LM20145CS-W	White	...	3.1		85K8232	14.000
LM20145CS-WW	Warm White	...	2.5		85K8233	14.000

G-12, E26 BASE, 240V

Mfg. Part No.	Color	Wave-length (nm)	Luminous Flux (Lumens)	Can replace these bulbs	Stock No.	Price Each 1-9
LM40F1WE26-A	Amber	590	23	71/2S/120V, 11S14/130V	85K8270	31.000
LM40F1WE26-B	Blue	470	5		85K8271	34.430
LM40F1WE26-G	Green	525	25		85K8272	34.430
LM40F1WE26-R	Red	629	21		85K8273	31.000
LM40F1WE26-W	White	...	18		85K8274	34.430
LM40F1WE26-WW	Warm White	...	15		85K8275	34.430

(88574)

Sixcess 6S6 LED REPLACEMENTS



Features

- Long Life expectancy
- Rugged solid-state construction for shock & vibration resistance
- Reduced operating costs
- Low Power Consumption
- Reduce down time
- Looks identical to 6S6 day or night

Utilizing state of the art LED and packaging technology, CML introduces a device that has the appearance of an incandescent bulb whether it is day or night. The new Sixcess lamp replaces a traditional 6 Watt 6S6 candelabra bulb while consuming only 20% of the energy and lasting up to 20 times longer. It has a warm white color similar to the bulb it replaces.

SOLD IN MULTIPLES OF 10.

Mfg. Part No.	Replaces	Color	Voltage Rating (V)	Stock No.	Price Each	
					1-24	25-49
● 2410F73-12V	6S6-12V	White	12	52M1721	24.000	22.080
● 2410F73-24V	6S6-24V	White	24	87K5992	24.000	22.080

(88642)

BASED LEDS - T-1 3/4 THROUGH T-3 1/4

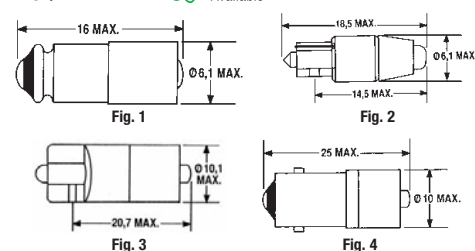

Based LEDs are available in various base styles, sizes, voltages and colors. Life on these based LEDs are typically in excess of 100K hours as opposed to as low as 500 for some based incandescent bulbs.

T 1 1/4 MIDGET GROOVE BASE LEDS - FIGURE 1

Mfg. Part No.	Color	Voltage Rating (VDC)	Current AC/DC (mA)	Typical Intensity (mcd)	Stock No.	Price Each	
						1-9	10-99
● 1512125B3	Blue	12	14	350	93K6660	9.180	7.960
● 1512125UG3	Green	12	14	910	93K6661	9.180	7.960
● 1512125UR3	Red	12	14	330	93K6662	6.640	5.760
● 1512125UY3	Yellow	12	14	280	93K6663	7.520	6.520
● 1512125W3	White	12	14	700	93K6664	9.180	7.960
● 1512135UG3	Green	24	14	700	93K6666	9.180	7.960
● 1512135UR3	Red	24	14	330	93K6667	6.640	5.760
● 1512135UY3	Yellow	24	14	280	93K6668	7.520	6.520
● 1512135W3	White	24	14	700	93K6669	9.180	7.960
● 1512145B3	Blue	28	7	350	93K6670	9.180	7.960
● 1512145UG3	Green	28	14	910	93K6671	9.180	7.960
● 1512145UR3	Red	28	14	330	93K6672	6.640	5.760

T 1-3/4 WEDGE BASE LEDS - FIGURE 2

Mfg. Part No.	Color	Voltage Rating (VDC)	Current AC/DC (mA)	Typical Intensity (mcd)	Stock No.	Price Each	
						1-9	10-99
● 1511A25B3	Blue	12	12	300	93K6632	10.190	8.840
● 1511A25UG3	Green	12	12	780	93K6633	10.190	8.840
● 1511A25UR3	Red	12	12	280	93K6634	7.660	6.640
● 1511A25UY3	Yellow	12	12	240	93K6635	7.660	6.640
● 1511A25W3	White	12	12	600	93K6636	10.190	8.840
● 1511A35UG3	Green	24	12	780	93K6638	10.190	8.840
● 1511A35UR3	Red	24	12	280	93K6639	7.660	6.640
● 1511A35UY3	Yellow	24	12	240	93K6640	7.660	6.640
● 1511A45B3	Blue	28	12	300	93K6642	10.190	8.840
● 1511A45W3	White	28	12	600	93K6645	10.190	8.840
● 1511B45B3	Blue	28	12	300	93K6655	10.190	8.840
● 1512145W3	White	28	12	600	93K6674	9.180	7.960

T 3-1/4 WEDGE BASE LEDS - FIGURE 3

Mfg. Part No.	Color	Voltage Rating (VDC)	Current AC/DC (mA)	Typical Intensity (mcd)	Stock No.	Price Each	
						1-9	10-99
● 1511B25UR3	Red	12	14	330	35C0058	7.660	6.640
● 1511B25W3	White Clear	12	14	700	93K6649	10.190	8.840
● 1860225W3	White Clear	12	15	750	93K6684	9.950	8.630
● 1860225I	Green	12	15	1000	93K6686	9.950	8.630
● 1511A35B3	Blue	24	14	350	93K6637	10.190	8.840
● 1511A35W3	White	24	14	700	93K6641	10.190	8.840
● 1511B35B3	Blue	24	14	350	93K6650	10.190	8.840
● 1511B35UR3	Red	24	14	330	93K6652	7.660	6.640
● 1511B35UY3	Yellow	24	14	280	93K6653	7.660	6.640
● 1511B35W3	White Clear	24	14	700	93K6654	10.190	8.840
● 1511A45UR3	Red	28	12	280	93K6644	7.660	6.640
● 1511A45UY3	Yellow	28	14	280	35C0054	7.660	6.640

▶ CONTINUED ▶

LED REPLACEMENTS

BASED LEDS - T-1 3/4 THROUGH T-3 1/4 (CONT.)

T 3-1/4 WEDGE BASE LEDS - FIGURE 3

Mfg. Part No.	Color	Voltage Rating (VDC)	Current AC/DC (mA)	Typical Intensity (mcd)	Stock No.	Price Each	
						1-9	10-99
● 1511B45UY3	Yellow	28	14	280	93K6658	7.660	6.640
● 1511B45W3	White Clear	28	14	700	93K6659	10.190	8.840

T10 BA9 STYLE SINGLE CONTACT BAYONET BASE - FIGURE 4

● 18602252	Yellow	12	15	300	93K6687	8.030	6.960
● 18602257	Blue	12	15	400	35C0090	9.950	8.630
● 1860235W3	White	24	15	750	93K6688	9.950	8.630
● 1860235W3D	White	24	15	750	50H7189	9.950	8.630
● 18602350	Red	24	15	350	93K6689	7.260	6.300
● 18602351	Green	24	15	1000	93K6690	9.950	8.630
● 18602352	Yellow	24	15	400	93K6691	8.030	6.960
● 18602357	Blue	24	15	300	93K6692	9.950	8.630
● 1860245W3	White	24	15	750	93K6693	9.950	8.630
● 18602450	Red	28	15	350	93K6694	7.260	6.300
● 18602451	Green	28	15	1000	93K6695	9.950	8.630
● 18602452	Yellow	28	15	300	93K6696	8.030	6.960
● 18602457	Blue	28	15	400	93K6697	9.950	8.630
● 1860613W3D	White	130 VAC	5	250	82H9458	13.260	11.500

(69151)

MULTIPLE LED EXIT SIGN REPLACEMENT LAMPS

Ideal for exit signs as well as other commercial lighting applications. These replacement bulbs are long-lasting and are a high-performance alternative to incandescent lamps. Solid-state electronics minimize the detrimental effects of vibration, temperature swings, and power surges. Uniform lighting eliminates hot spots and distortion. Low power consumption reduces energy costs and maintenance. UL listed.

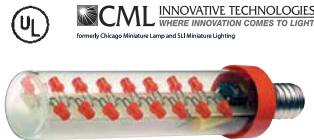

Mfg. Part No.	Lamp Assembly	Stock No.	Price Each	
			1-24	10-99
2410D41-A	20-LED Intermediate	95B9466	15.680	
2410D42-A	20-LED Bayonet	95B9469	15.680	
2410D43-A	16-LED Candelabra	95B9474	15.680	

(65570)

586 SERIES BASED LED LAMPS



- LEDs Feature 100,000 Life Hours
- Highly Reliable, Shock and Vibration Resistant
- Uses up to 90% less energy than incandescent lamps

Dialight's 586 series based LED lamps are designed to directly replace many subminiature and miniature incandescent lamps. The benefits of LED technology over incandescent are significant.

T1-3/4 SINGLE CHIP LED

Mfg. Part No.	Color	Base Type	Wave-length (nm)	Voltage (V)	Current (mA)	Intensity Typ. (mcd)	Stock No.	Price Each	
								1-24	10-99
● 586-1101-105F	Red	Midget Flanged	639	28	10	775	33M4494	3.160	
● 586-1106-105F	White	Midget Flanged	...	28	10	460	33M4502	5.030	
● 586-2402-205F	Green	Mini-Bayonet	525	28	7.5	825	20M6818	6.550	
● 586-2406-203F	White	Mini-Bayonet	...	14	15	825	33M4606	6.550	
● 586-2406-205F	White	Mini-Bayonet	...	28	7.5	412	33M4607	6.550	

T3-1/4 CLUSTER LED

Mfg. Part No.	Color	Base Type	Wave-length (nm)	Voltage (V)	Current (mA)	Intensity Typ. (mcd)	Stock No.	Price Each	
								1-24	10-99
586-6406-205	White	Miniature Bayonet	...	28	11	4000	82K1670	18.030	

(97802)



Current Order Status & History
Check the status of your current order or access past orders from our website under MY ACCOUNT eSuite. Log in or register today.

(148881)

SINGLE BASED CHIP LED



Features:

- Easy installation
- Super bright single chip design
- AlInGaP and InGaIn technology
- High brightness with low current draw - uses up to 90% less energy than an incandescent
- Long life - typically 100K hours
- No heat generated
- Resistant to shock and vibration
- Integral resistor

Mfg. Part No.	Color	Nom. Voltage (V)	I _F (TYP.-mA)	Intensity (TYP.-mcd)	Stock No.	Price Each
586-3501-204	Red	24	25	600	95B9116	9.270
586-3502-204	Green	24	25	5000	95B9117	10.960
586-3503-204	Yellow	24	25	1700	95B9118	6.710
586-3505-204	Blue	24	25	1500	73H5055	12.900
586-3506-204	White	24	25	5600	73H5056	11.050

(78452)

HL SERIES RETROFIT LED UNITS



Features:

- Operating life typically 50,000 hours
- Intense colours with greater depth
- Dimensionally similar to MR16 halogen lamp
- Cool beam - safe to touch
- No ultraviolet radiation
- Monoblock optic for easy beam angle selection
- Die cast heat sink assembly
- Energy efficient



The HL series consists of modules designed to fit within standard MR11 and MR16 housings, providing a quick path from light engine to finished fixture. They come supplied with the option of selecting either spot or wide angle illuminations by simply adding or removing a snap-on front lens. Provided with on-board power control circuitry, the modules also have flying leads for easy termination and are available in saturated colors and R/G/B. Speedy installation is possible using a simple plug and play connector with pre-assembled RJ45 cables or IDC termination for fixed cable installations.

Mfg. Part No.	Number of LEDs	Power (W)	Output Current (A)	Intensity (Lumens)	Stock No.	Price Each
● HL16-RGB	3	3	0.35	R-32; G-42; B-204mW	20M5175	72.580

(90064)

T-3/4 MINIATURE BAYONET LED LAMPS (BA9's)



Replace incandescent lamps with a LED lamp for greater brightness and longer life. The 586 series LED lamps are polarized single LEDs in a T-3/4 bayonet based package, designed to directly replace popular incandescent lamps. Example incandescent lamp replacement numbers are: 44, 47, 313, 755, 757, 1815, 1819, 1847, 1866, 1889, 1891, 1892, 1893 and 1895. 586-2 models are 29.21mm (1.15") L x 10.92mm (0.43") W.



Mfg. Part No.	Color	Dominant Wavelength (nm)	Nominal Voltage (V)	Forward Current Typ. (mA)	Intensity Typ. (mcd)	Stock No.	Price Each
● 586-2401-101F	Red	630	6	15	1400	33M4576	5.440
586-2401-103	Red	630	14	15	1400	25C0082	8.140
586-2401-105	Red	630	28	15	1050	23C7007	5.440
● 586-2402-101F	Green	525	6	15	2200	33M4583	8.670
586-2402-103	Green	525	14	15	2200	25C0091	8.670
586-2402-105	Green	525	28	15	1650	92B5446	8.670
● 586-2403-101F	Amber	592	6	15	1275	33M4588	8.140
586-2403-103	Amber	592	14	15	1700	25C0102	5.440
586-2405-101	Blue	470	6	15	650	25C0104	8.510
586-2405-103	Blue	470	14	15	650	25C0107	8.670
586-2405-105	Blue	470	28	20	650	26C9513	8.670
586-2406-101	White	*	6	15	1100	25C0112	8.670
586-2406-103	White	*	14	15	1100	25C0117	8.670
● 586-2406-105F	White	*	28	15	825	33M4604	8.670

*Color Coordinates: x = 0.33, y = 0.365
(72858)

LED REPLACEMENTS

T-3/4 BAYONET LED CLUSTER LAMPS



Cluster

- LEDs Feature 100,000 Life Hours
- Highly Reliable, Shock and Vibration Resistant

Dialight

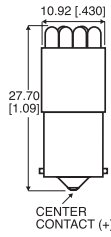

- AC or DC Operation
- 120 Degree Viewing Angle

Replace incandescent lamps with a cluster of LEDs for greater brightness and longer life. **585 series** LED cluster lamps are available polarized or non-polarized, up to 120VAC, in a T-3/4 bayonet based package. The lamps directly replace a wide variety of incandescent lamps, for example: 44, 47, 313, 755, 757, 1815, 1819, 1847, 1866, 1889, 1891, 1892, 1893 and 1895. **585-5 models** are 1.09" (27.7mm) L x 0.430" (10.92mm) W.

Based LED Color	For Use With Lens Cap
Red	Red Transparent, Red Transparent Fluted
Yellow	Amber Transparent, Amber Transparent Fluted
Green	Green Transparent, Green Transparent Fluted

CLUSTER

Mfg. Part No.	Color	Base Type	Wave-length (nm)	Voltage (V)	Current (mA)	Intensity Typ. (mcd)	Stock No.	Price Each
585-5523	Bright Yellow	Bayonet	592	14	60	1800	52F393	22.090
585-5525	Bright Yellow	Bayonet	592	28	30	2100	52F464	22.090
585-5556	Bright Yellow	Bayonet	592	120VAC	9	945	52F468	12.750
585-4323	Green	Bayonet	565	14	28	70	52F373	11.210
585-5325	Green	Bayonet	565	28	20	490	52F466	18.690
585-4325	Green	Bayonet	565	28	15	75	52F381	11.210
585-5356	Green	Bayonet	565	120VAC	9	220	52F469	12.750
585-5223	Ultra Red	Bayonet	660	14	40	480	52F389	18.690
585-4223	Ultra Red	Bayonet	660	14	30	60	52F371	12.830
585-5225	Ultra Red	Bayonet	660	28	20	560	52F397	18.690
585-4225	Ultra Red	Bayonet	660	28	16	64	52F379	11.890
585-5256	Ultra Red	Bayonet	660	120VAC	9	252	52F1839	12.750
585-4423	Yellow	Bayonet	585	14	30	23	52F375	12.100
585-5323	Yellow	Bayonet	565	14	40	420	52F395	18.690
585-4425	Yellow	Bayonet	585	28	15	23	52F383	11.210
585-4425	Yellow	Bayonet	585	28	15	23	52F383	11.210

T-1-3/4 BI-PIN, WEDGE AND MIDGET FLANGE

585-3323	Green	Bi-Pin	565	14	23	56	52F450	10.450
585-1315	Green	Midget Flange	565	28	15	75	52F417	8.840
585-1325	Green	Midget Flange	565	28	13	65	52F418	9.690
585-2325	Green	Wedge	565	28	13	65	52F438	9.690
585-3325	Green	Bi-Pin	565	28	13	65	52F460	10.450
585-1225	Red	Midget Flange	660	28	14	56	52F416	9.690
585-2223	Ultra Red	Wedge	660	14	16	50	52F428	10.450
585-3223	Ultra Red	Bi-Pin	660	14	26	50	52F448	10.450
585-2311	Ultra Red	Wedge	660	28	46	77	52F423	9.530
585-3225	Ultra Red	Bi-Pin	660	28	14	56	52F456	10.450
585-1115	Yellow	Flange	585	14	15	38	52F413	9.530
585-2423	Yellow	Wedge	585	14	24	18	52F432	10.450
585-3423	Yellow	Bi-Pin	585	14	24	18	52F452	10.450
585-1425	Yellow	Midget Flange	585	28	13	20	52F420	9.690
585-2425	Yellow	Wedge	585	28	13	20	52F440	10.450
585-3425	Yellow	Bi-Pin	585	28	13	20	52F462	10.450

(48287)

TechCast® Product Training

Use the library of online training modules located on our homepage under Useful Tools, with specific guidance for complex solutions.

(148857)

E26 EDISON SCREW BASED LED LAMP



Dialight

Designed to replace an existing incandescent light bulb, these innovative lights contain multiple high flux LEDs. Patented design provides an even illumination over the lens, which can be tinted to match the illuminating color. LED placement and use of high flux LEDs allow for custom emitted colors. E26 base size. 120VAC operation. 250mA input current. Operating temperature -40°C to +55°C.

TINTED LENS

Mfg. Part No.	Color	Wavelength (nm)	Lumens Output	Stock No.	Price Each
EBA-26014-DAA	Amber	590	100	91H3752	111.830
EBB-26004-DAA	Blue	470	32	91H3754	109.850
EBG-26012-DAA	Green	530	100	91H3756	111.830
EBR-26018-DAA	Red	627	120	91H3758	111.830

NON-TINTED, DIFFUSED LENS

EBA-26014-DAB	Amber	590	100	91H3753	111.830
EBB-26004-DAB	Blue	470	32	91H3755	111.830
EBG-26012-DAB	Green	530	100	91H3757	111.830
EBW-26014-DAB*	Warm White	...	80	91H3760	109.850

* CCT = 3200° K (77956)

205 SERIES FILAMENT REPLACEMENT LEDs—T1 3/4

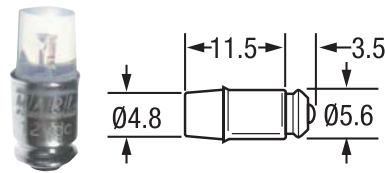

Replace incandescent lamps with longer lasting, brighter LEDs. Direct replacement for T1-3/4 MG S5.7s. Reverse polarity options. Center contact, anode as standard. Mean time between failure: 100,000 hours. Typical technical characteristics: Ta = 25°C. Water clear lens. Wide viewing angle. Operating temp.: -40°C ~ +80°C. Storage temp.: -40°C ~ +80°C.

Mfg. Part No.	Color	Voltage	Current DC (mA)	Luminous Intensity (mcd)	Wave Length (nm)	Stock No.	Price Each
● 205-501-04-38	Red	1.9 VDC	20	11000	643	68K1147	8.280
● 205-501-20-38	Red	5-6 VDC	20	11000	643	81C9240	8.280
● 205-501-21-38	Red	12 VDC	20	11000	643	68K1148	8.280
● 205-501-22-38	Red	24 VDC	20	11000	643	68K1149	8.280
● 205-501-23-38	Red	24-28 VDC	20	11000	643	99H6144	11.830
● 205-501-31-38	Red	12 VDC	20	11000	643	85K7635	11.830
● 205-521-04-38	Yellow	2.1 VDC	20	16000	591	68K1150	8.280
● 205-521-20-38	Yellow	5-6 VDC	20	16000	591	81C9244	8.280
● 205-521-21-38	Yellow	12 VDC	20	16000	591	68K1151	8.280
● 205-521-22-38	Yellow	24 VDC	20	16000	591	81C9246	8.280
● 205-521-23-38	Yellow	24-28 VDC	20	16000	591	99H6145	11.830
● 205-532-20-38	Green	5-6 VDC	20	23000	527	81C9248	10.230
● 205-532-21-38	Green	12 VDC	20	23000	527	81C9249	10.230
● 205-532-22-38	Green	24 VDC	20	23000	527	68K1152	10.230
● 205-532-23-38	Green	24-28 VDC	20	23000	527	99H6146	14.620
● 205-930-04-38	Blue	3.4 VDC	20	7000	470	99H6147	14.620
● 205-930-21-38	Blue	12 VDC	20	7000	470	99H6148	14.620
● 205-930-22-38	Blue	24 VDC	20	7000	470	99H6149	14.620
● 205-930-23-38	Blue	24-28 VDC	20	7000	470	99H6150	14.620
● 205-993-20-38	Warm White	5-6 VDC	20	9200	...	02N4551	14.620
● 205-993-21-38	Warm White	12 VDC	20	9200	...	31M0648	14.620
● 205-993-23-38	Warm White	24-28 VDC	20	9200	...	31M0649	14.620
● 205-997-04-38	Cold White	3.4 VDC	20	14000	...	68K1153	10.230
● 205-997-20-38	Cold White	5-6 VDC	20	14000	...	81C9252	10.230
● 205-997-21-38	Cold White	12 VDC	20	14000	...	68K1154	10.230
● 205-997-31-38	Cold White	12 VDC	20	14000	...	85K7636	14.620
● 205-997-22-38	Cold White	24 VDC	20	14000	...	68K1155	10.230
● 205-997-32-38	Cold White	24 VDC	20	14000	...	73J6454	14.620
● 205-997-23-38	Cold White	24-28 VDC	20	14000	...	99H6151	14.620

(72263)

LED REPLACEMENTS

206 SERIES FILAMENT REPLACEMENT LEDs—T1 3/4

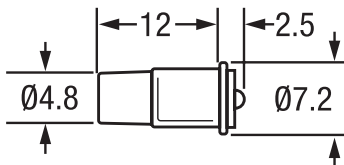

- Direct Replacement for T13/4 MF SX6s
- Reverse Polarity Options
- Center Contact, Anode as Standard

206 series filament replacement LEDs are ideal for replacing incandescent lamps with longer lasting, brighter LEDs. Mean time between failure: 100,000 hours. Typical technical characteristics: Ta = 25°C. Water clear lens. Wide viewing angle. Operating temperature: -40°C ~ +80°C. Storage temperature: -40°C ~ +80°C.

Mfg. Part No.	Color	Voltage (VDC)	Current DC (mA)	Luminous Intensity (mcd)	Wave Length (nm)	Stock No.	Price Each
● 206-501-04-38	Red	1.9	20	11000	643	68K1156	8.280
● 206-501-20-38	Red	5-6	20	11000	643	68K1157	8.280
● 206-501-21-38	Red	12	20	11000	643	81C9257	8.280
● 206-501-22-38	Red	24	20	11000	643	68K1158	8.280
● 206-501-23-38	Red	24-28	20	11000	643	81H0445	11.720
● 206-501-32-38	Red	24	20	11000	643	12K5110	11.720
● 206-521-04-38	Yellow	2.1	20	16000	591	68K1159	8.280
● 206-521-20-38	Yellow	5-6	20	16000	591	68K1160	8.280
● 206-521-21-38	Yellow	12	20	16000	591	81C9261	8.280
● 206-521-22-38	Yellow	24	20	16000	591	81C9262	8.280
● 206-521-23-38	Yellow	24-28	20	16000	591	99H6154	11.720
● 206-521-32-38	Yellow	24	20	16000	591	12K5106	11.720
● 206-532-04-38	Green	3.4	20	23000	527	68K1161	10.230
● 206-532-20-38	Green	5-6	20	23000	527	81C9264	10.230
● 206-532-21-38	Green	12	20	23000	527	68K1162	10.230
● 206-532-22-38	Green	24	20	23000	527	68K1163	10.230
● 206-532-23-38	Green	24-28	20	23000	527	81H0449	14.490
● 206-532-32-38	Green	24	20	23000	527	12K5108	14.490
● 206-930-04-38	Blue	3.4	20	7000	470	99H6155	14.490
● 206-930-21-38	Blue	12	20	7000	470	99H6156	14.490
● 206-930-22-38	Blue	24	20	7000	470	98H3463	14.490
● 206-930-23-38	Blue	24-28	20	7000	470	99H6157	14.490
● 206-993-21-38	Warm White	12	20	9200	...	31M0650	14.490
● 206-993-23-38	Warm White	24-28	20	9200	...	31M0651	14.490
● 206-997-04-38	Cold White	3.4	20	14000	...	68K1164	10.230
● 206-997-20-38	Cold White	5-6	20	14000	...	81C9269	10.230
● 206-997-21-38	Cold White	12	20	14000	...	81C9269	10.230
● 206-997-22-38	Cold White	24	20	14000	...	68K1165	10.230
● 206-997-23-38	Cold White	24-28	20	14000	...	81H0447	14.490

(72261)

215 SERIES FILAMENT REPLACEMENT LEDs — T1 3/4 BA9s



NEW TECHNOLOGY

- Features:
- Direct replacement for BA9's
 - Flat-topped for enhanced, even illumination of large lens areas
 - Reverse polarity options availability
 - Ideal for industrial pushbutton switches
 - Centre contact Anode as standard

The 215 Series is a high intensity LED element in a range of colors and voltages. The LED provides excellent wide angle viewing for switchtop and annunciator illumination.

Mfg. Part No.	Color	Voltage (VDC)	Current DC (mA)	Luminous Intensity (mcd)	Wave-length (nm)	Stock No.	Price Each
● 215-501-04-38	Red	1.9	20	11000	643	99H6239	14.620
● 215-501-21-38	Red	12	20	11000	643	99H6240	14.620
● 215-501-22-38	Red	24	20	11000	643	98H3465	14.620
● 215-501-23-38	Red	24-28	20	11000	643	99H6241	14.620
● 215-501-75-38	Red	110	20	11000	643	31M0657	14.620
● 215-521-04-38	Yellow	1.9	20	16000	591	99H6242	14.620
● 215-521-21-38	Yellow	12	20	16000	591	99H6243	14.620
● 215-521-22-38	Yellow	24	20	16000	591	98H3467	14.620
● 215-521-23-38	Yellow	24-28	20	16000	591	99H6244	14.620
● 215-521-75-38	Yellow	110	20	16000	591	31M0658	14.620
● 215-532-04-38	Green	1.9	20	23000	527	99H6245	15.420
● 215-532-21-38	Green	12	20	23000	527	99H6246	15.420

▶ CONTINUED ▶

215 SERIES FILAMENT REPLACEMENT LEDs — T1 3/4 BA9s (CONT.)

Mfg. Part No.	Color	Voltage (VDC)	Current DC (mA)	Luminous Intensity (mcd)	Wave-length (nm)	Stock No.	Price Each
● 215-532-22-38	Green	24	20	23000	527	99H6247	15.420
● 215-532-23-38	Green	24 - 28	20	23000	527	99H6248	15.420
● 215-532-75-38	Green	110	20	23000	527	31M0659	15.420
● 215-930-04-38	Blue	1.9	20	7000	470	99H6249	15.420
● 215-930-21-38	Blue	12	20	7000	470	99H6250	15.420
● 215-930-22-38	Blue	24	20	7000	470	99H6251	15.420
● 215-930-23-38	Blue	24-28	20	7000	470	99H6252	15.420
● 215-930-75-38	Blue	110	20	7000	470	31M0660	15.420
● 215-993-04-38	Warm White	2	20	9200	...	02N4565	17.590
● 215-993-21-38	Warm White	12	20	9200	...	31M0661	17.590
● 215-993-23-38	Warm White	24-28	20	9200	...	31M0662	17.590
● 215-993-75-38	Warm White	110	20	9200	...	31M0663	17.590
● 215-997-04-38	Cold White	1.9	20	14000	...	99H6253	17.590
● 215-997-21-38	Cold White	12	20	14000	...	99H6254	17.590
● 215-997-22-38	Cold White	24	20	14000	...	99H6255	17.590
● 215-997-23-38	Cold White	24-28	20	14000	...	99H6256	17.590

209 SERIES FILAMENT REPLACEMENT LEDs—T5.5SB



- Features
- Direct replacement for T5.5SB
 - Ideal for industrial pushbutton switches and annunciator panels
 - Durable to shock and vibration
 - Fit and forget reliability



T1XXX sized, (T5.5 SB) slide based style incandescent replacement features a high intensity LED in a variety of colors and voltages. The 209 Series has a flat-topped LED to provide excellent wide angle viewing for switchtop and annunciator illumination.

Mfg. Part No.	Color	Voltage	Current DC (mA)	Luminous Intensity (mcd)	Wave Length (nm)	Stock No.	Price Each
● 209-501-04-38	Red	1.9 VDC	20	11000	643	99H6182	15.740
● 209-501-21-38	Red	12 VDC	20	11000	643	99H6183	15.740
● 209-501-22-38	Red	24 VDC	20	11000	643	28H9170	15.740
● 209-501-23-38	Red	24-28 VDC	20	11000	643	99H6184	15.740
● 209-521-04-38	Yellow	2.1 VDC	20	16000	591	99H6185	15.740
● 209-521-21-38	Yellow	12 VDC	20	16000	591	99H6186	15.740
● 209-521-22-38	Yellow	24 VDC	20	16000	591	99H6187	15.740
● 209-521-23-38	Yellow	24-28 VDC	20	16000	591	99H6188	15.740
● 209-532-04-38	Green	3.4 VDC	20	23000	527	99H6189	20.520
● 209-532-21-38	Green	12 VDC	20	23000	527	99H6190	20.520
● 209-532-22-38	Green	24 VDC	20	23000	527	28H9198	20.520
● 209-532-23-38	Green	24-28 VDC	20	23000	527	99H6191	20.520
● 209-930-04-38	Blue	3.4 VDC	20	7000	470	99H6192	20.520
● 209-930-21-38	Blue	12 VDC	20	7000	470	99H6193	20.520
● 209-930-22-38	Blue	24 VDC	20	7000	470	99H6194	20.520
● 209-930-23-38	Blue	24-28 VDC	20	7000	470	99H6195	20.520
● 209-993-21-38	Warm White	12 VDC	20	9200	...	31M0655	20.520
● 209-993-23-38	Warm White	24-28 VDC	20	9200	...	31M0656	20.520
● 209-997-04-38	Cold White	3.4 VDC	20	14000	...	99H6196	20.520
● 209-997-21-38	Cold White	12 VDC	20	14000	...	99H6197	20.520
● 209-997-22-38	Cold White	24 VDC	20	14000	...	99H6198	20.520
● 209-997-23-38	Cold White	24-28 VDC	20	14000	...	99H6199	20.520

(90558)

eInvoices



Now you can view, print or email Newark invoices from our website under MY ACCOUNT eSuite. Log in or register today.

Make it easy. Make it fast. Make it Newark.

(148829)

LED REPLACEMENTS

208 SERIES FILAMENT REPLACEMENT LEDS—T6.8SB

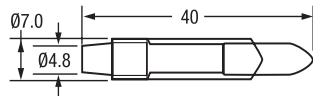

- Direct Replacement for T6.8 SB
- Flat-Topped for Enhanced, Even Illumination of Large Lens Areas
- Durable to Shock and Vibration

208 series filament replacement LEDs are ideal for replacing incandescent lamps with longer lasting, brighter LEDs. Mean time between failure: 100,000 hours. Typical technical characteristics: Ta = 25°C. Water clear lens. Wide viewing angle. Operating temperature: -40°C ~ +80°C. Storage temperature: -40°C ~ +80°C.

Mfg. Part No.	Color	Voltage (VDC)	Current DC (mA)	Luminous Intensity (mcd)	Wave Length (nm)	Stock No.	Price Each	
							1-9	
● 208-501-04-38	Red	1.9	20	11000	643	68K1166	10.720	
● 208-501-20-38	Red	5-6	20	11000	643	68K1167	10.720	
● 208-501-21-38	Red	12	20	11000	643	68K1168	10.720	
● 208-501-22-38	Red	24	20	11000	643	81C9274	10.720	
● 208-501-23-38	Red	24-28	20	11000	643	99H6162	14.720	
● 208-521-04-38	Yellow	2.1	20	16000	591	68K1169	10.720	
● 208-521-20-38	Yellow	5-6	20	16000	591	68K1170	10.720	
● 208-521-21-38	Yellow	12	20	16000	591	68K1171	10.720	
● 208-521-22-38	Yellow	24	20	16000	591	68K1172	10.720	
● 208-521-23-38	Yellow	24-28	20	16000	591	99H6163	14.720	
● 208-532-04-38	Green	3.4	20	23000	527	68K1173	13.680	
● 208-532-20-38	Green	5-6	20	23000	527	68K1174	13.680	
● 208-532-21-38	Green	12	20	23000	527	68K1175	13.680	
● 208-532-22-38	Green	24	20	23000	527	81C9282	13.680	
● 208-532-23-38	Green	24-28	20	23000	527	99H6164	18.790	
● 208-930-04-38	Blue	3.4	20	7000	470	99H6165	18.790	
● 208-930-21-38	Blue	12	20	7000	470	99H6166	18.790	
● 208-930-22-38	Blue	24	20	7000	470	99H6167	18.790	
● 208-930-23-38	Blue	24-28	20	7000	470	99H6168	18.790	
● 208-997-04-38	Cold White	3.4	20	14000	...	68K1176	13.680	
● 208-997-20-38	Cold White	5-6	20	14000	...	68K1177	13.680	
● 208-997-21-38	Cold White	12	20	14000	...	68K1178	13.680	
● 208-997-22-38	Cold White	24	20	14000	...	68K1179	13.680	
● 208-997-23-38	Cold White	24-28	20	14000	...	99H6169	18.790	

(72264)

245 SERIES FILAMENT REPLACEMENT LEDS—T1 3/4

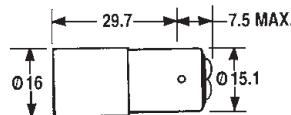

- AC/DC Operation - Bi-Polar
- Internal Potting for Vibration Resistance
- Low Heat Generation
- Low Power Requirements

Replace incandescent lamps with longer lasting and brighter LEDs. Lens: water clear. Wide viewing angle. Operating temperature: -20°C ~ +50°C. Mean time between failure: 100,000 hours.

Mfg. Part No.	Color	Voltage	Current DC (mA)	Luminous Intensity (mcd)	Wave Length (nm)	Stock No.	Price Each	
							1-9	
● 245-501-93-38	Red	28 V	20	11000	643	68K1191	55.620	
● 245-501-95-38	Red	60 V	12	11000	643	68K1192	55.620	
● 245-501-87-38	Red	130 V	5	11000	643	68K1190	55.620	
● 245-521-87-38	Yellow	28 V	5	16000	591	68K1193	55.620	
● 245-521-93-38	Yellow	60 V	20	16000	591	68K1194	55.620	

▶ CONTINUED ▶

Mfg. Part No.	Color	Voltage	Current DC (mA)	Luminous Intensity (mcd)	Wave Length (nm)	Stock No.	Price Each	
							1-9	
● 245-521-95-38	Yellow	130 V	12	16000	591	68K1195	55.620	
● 245-532-93-50	Green	28 V	18	23000	527	68K1197	46.300	
● 245-532-95-50	Green	60 V	11	23000	527	35C0808	46.300	
● 245-532-87-50	Green	130 V	5	23000	527	68K1196	46.300	
● 245-930-93-50	Blue	28 V	18	7000	470	68K1199	46.300	
● 245-930-95-50	Blue	60 V	11	7000	470	35C0811	46.300	
● 245-930-87-50	Blue	130 V	5	7000	470	68K1198	46.300	
● 245-997-93-50	Cold White	28 V	18	14000	...	68K1201	46.300	
● 245-997-95-50	Cold White	60 V	11	14000	...	35C0814	46.300	
● 245-997-87-50	Cold White	130 V	5	14000	...	68K1200	46.300	

(69172)

255 SERIES FILAMENT REPLACEMENT LEDS—T1 3/4 BAYONET CAP

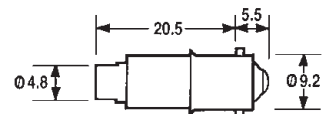

- Unique SOLO Technology - Single Product for Multivoltage Operating Range: 8-48VAC/DC
- Resistant to Vibration and Shock

Replace incandescent lamps with longer lasting and brighter LEDs. Lens: water clear. Wide viewing angle. Operating temperature: -20°C to +50°C. Mean time between failure: 100,000 hours.

Mfg. Part No.	Color	Voltage (VDC)	Current DC (mA)	Luminous Intensity (mcd)	Wave Length (nm)	Stock No.	Price Each	
							1-9	
● 255-501-64-38	Red	8 - 48	10	2750	660	68K1207	15.030	
● 255-521-64-38	Yellow	8 - 48	10	4500	590	68K1208	15.030	
● 255-532-64-38	Green	8 - 48	10	6000	525	69K4415	18.040	
● 255-930-64-38	Blue	8 - 48	10	2000	470	99H6569	25.550	
● 255-993-64-38	Warm White	8 - 48	10	9200	...	31M0691	25.550	
● 255-997-64-38	Cool White	8 - 48	10	3000	...	68K1209	18.040	

(69174)

218 SERIES FILAMENT REPLACEMENT LED CLUSTER—E26 STYLE BASE

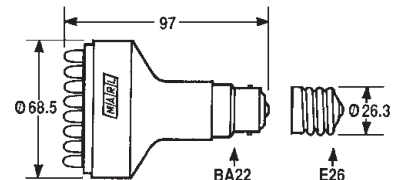

Replace incandescent lamps with longer lasting and brighter LEDs. 20-LED cluster. Lens: water clear. Narrow viewing angle. Operating temperature: -10°C to +40°C. Order base separately; go online or call.

Mfg. Part No.	Color	Voltage	Current DC (mA)	Luminous Intensity (mcd)	Wave Length (nm)	Stock No.	Price Each	
							1-9	
● 218-930-22-65	Blue	24 VDC	80	7000	470	68K1186	241.970	
● 218-930-23-65	Blue	28 VDC	40	7000	470	68K1187	241.970	
● 218-930-25-65	Blue	110 VAC	20	7000	470	35C2251	241.970	
● 218-997-23-65	Cold White	28 VDC	40	14000	...	35C2253	241.970	
● 218-997-25-65	Cold White	110 VAC	20	14000	...	68K1189	241.970	

(69171)



eQuotes

Retrieve and process Newark quotes online from our website under MY ACCOUNT eSuite. Or email them to your Purchasing department. Log in or register today.

(148836)

LED REPLACEMENTS

LED LAMPS WITH BASES

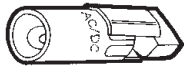

Fig. 1 PSB-Slide Base

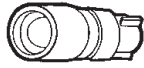

Fig. 2 Wedge Base (Subminiature)

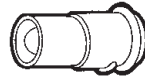

Fig. 3 T1 - 3/4 Midget Flange

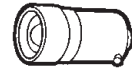

Fig. 4 S.C. Min. Bayonet



Single LEDs are available in 4 colors and 4 styles. Resistors are in base AC and DC. Lenses are water-clear.

PSB-SLIDE BASES

Mfg. Part No.	Replaces Incandescent Mfg. Part No.'s	Fig.	Volts	Emitted Color	MOL	Wavelength Peak (nm)	Typ. I _v (MCD)* @ I _f =20mA	Viewing Angle	Stock No.	Price Each
● SPC10538	24PSB5 or 28PSB5	1	24-28 AC/DC	White	1.18"	Mixed	1270	60°	12P6297	11.290
● SPC10539				Red		635	2000	50°	19C8073	11.140
● SPC10540				Green		520	3400	45°	19C8074	8.540
● SPC10541	120PSB5	1	110-130 AC/DC	Yellow	1.18"	590	1300	30°	19C8075	8.540
● SPC10542				Yellow		Mixed	1270	60°	19C8076	11.140
● SPC10543				Red		635	2000	50°	19C8077	11.140
● SPC10544				White		520	3400	45°	19C8078	18.000
● SPC10545				Green		590	1300	30°	61M2944	11.140

SUBMINIATURE WEDGE BASES

● SPC10546	85	2	24-28 DC	White	0.80"	Mixed	1270	60°	19C8080	11.860
● SPC10547				Red		635	2000	50°	19C8081	7.250
● SPC10548				Green		520	3400	45°	19C8082	7.250
● SPC10549				Yellow		590	1300	30°	19C8083	7.890

MIDGET FLANGE BASES

● SPC10550	327, 376, 385, 387	3	24-28 AC/DC	White	0.63"	Mixed	1207	60°	19C8084	8.540
● SPC10551				Red		635	2000	50°	19C8085	8.540
● SPC10553				Yellow		590	1300	30°	19C8087	11.860

MINI BAYONET BASES

● SPC10554	24MB, 28MB, 1818, 1843, 1819, 1829, 757, 1820, 1864, 313, 1873	4	24-28 AC/DC	White	1.19"	Mixed	1560	50°	19C8088	17.850
● SPC10556				Green		520	2400	45°	19C8090	11.610
● SPC10557				Yellow		590	2500	30°	19C8091	11.140
● SPC10558	120MB	4	110-130 AC/DC	White	1.19"	Mixed	1560	50°	19C8092	18.000
● SPC10560				Green		520	2400	45°	19C8094	11.140
● SPC10561				Yellow		595	2500	30°	19C8095	11.140

* mcd correct only for 20mA; lamps may not be 20mA due to different resistors (59577)

BASED LEDs

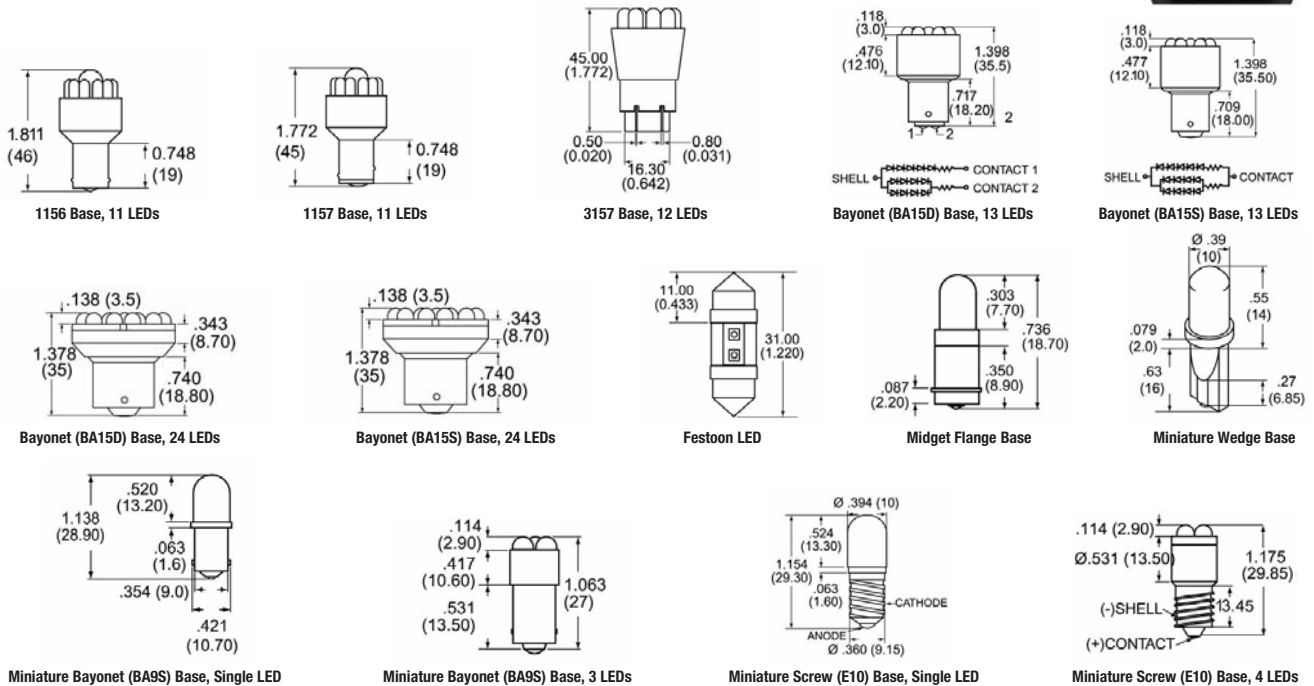

1156 BAYONET BASE, 3 LEDs

Mfg. Part No.	Emitted Color	Wavelength (nm)	I _v (mcd)	Viewing Angle	Stock No.	Price Each
SSP-03TB9912	Ultra White	...	7000	30	09J9364	7.400
SSP-03TB97U12	Super Blue	470	3000	30	09J9363	7.400
SSP-03TB92UP12	Ultra Green	525	3700	30	09J9360	9.570

▶ CONTINUED ▶

LED REPLACEMENTS

BASED LEDs (CONT.)

Mfg. Part No.	Emitted Color	Wavelength (nm)	I _v (mcd)	Viewing Angle	Stock No.	Price Each
						1-9
SSP-03TB93S12	Super Yellow	590	3500	30	09J9361	3.190
SSP-03TB96U12	Ultra Red	626	4600	30	09J9362	3.190
1156 BASE, 11 LEDs						
SSP-1156B15912	Ultra White	...	48000	30	09J9384	20.300
SSP-1156B157U12	Super Blue	470	13500	30	09J9383	18.560
SSP-1156B152UP12	Ultra Pure Green	525	70400	30	09J9380	20.300
SSP-1156B153S12	Super Yellow	590	48500	30	09J9381	7.250
SSP-1156B156U12	Ultra Red	626	47000	30	09J9382	7.250
1157 BASE, 11 LEDs						
SSP-1157B15912	Ultra White	...	48000	30	09J9387	20.300
SSP-1157B153S12	Super Yellow	590	48500	30	09J9385	7.250
SSP-1157B156U12	Ultra Red	626	47000	30	09J9386	7.250
3157 BASE, 12 LEDs						
SSP-3157WB912	Ultra White	...	8,200/2,800	35	09J9409	21.410
SSP-3157WB7U12	Super Blue	470	8,300/2,800	35	09J9408	19.780
SSP-3157WB2UP12	Ultra Green	525	12,000/4,000	35	09J9405	19.780
SSP-3157WB3S12	Super Yellow	590	8,300/2,800	35	09J9406	9.080
SSP-3157WB6U12	Ultra Red	626	8,000/2,700	35	09J9407	9.080
BAYONET (BA15D) BASE, 13 LEDs						
SSP-13MDB152UP12G	Ultra Pure Green	525	99100	30	09J9391	21.350
SSP-13MDB153S12G	Super Yellow	590	57500	30	09J9392	7.250
SSP-13MDB156U12G	Super Intensity Red	626	55500	30	09J9393	7.250
BAYONET (BA15S) BASE, 13 LEDs						
SSP-13MB152UP12G	Ultra Pure Green	525	99100	30	09J9388	21.350
SSP-13MB153S12G	Super Yellow	590	57500	30	09J9389	7.250
SSP-13MB156U12G	Super Intensity Red	626	55500	30	09J9390	7.250
BAYONET (BA15D) BASE, 24 LEDs						
SSP-24MDB152UP12G	Ultra Pure Green	525	183000	30	09J9397	38.950
SSP-24MDB153S12G	Super Yellow	590	106200	30	09J9398	12.880
SSP-24MDB156U12G	Super Intensity Red	626	102400	30	09J9399	12.880
BAYONET (BA15S) BASE, 24 LEDs						
SSP-24MB152UP12G	Ultra Pure Green	525	183000	30	09J9394	38.950
SSP-24MB153S12G	Super Yellow	590	106200	30	09J9395	12.910
SSP-24MB156U12G	Super Intensity Red	626	102400	30	09J9396	12.910
FESTOON LED						
SSP-02TFS912	Ultra White	...	5500	60	09J9359	6.700
SSP-02TFS7U12	Ultra Blue	470	4500	60	09J9358	6.090
MIDGET FLANGE BASE						
SSP-D19F9SUGC-12V	Super Pure Green	574	300	45	09J9332	4.590
SSP-D19F9SYC-12V	Super Intensity Yellow	590	400	45	09J9333	3.920
SSP-D19F9SIC-12V	Super Intensity Red	636	1200	45	09J9331	3.920
MINIATURE WEDGE BASE						
SSP-01TWB9WB12	Ultra White	...	11000	30	09J9356	2.010
● SSP-01TWB7UWB12	Super Blue	470	7000	30	09J9354	2.010
SSP-01TWB2UPWB12	Ultra Green	525	9000	30	09J9348	2.010
SSP-01TWB3SWB12	Super Yellow	590	7000	30	09J9350	1.160
SSP-01TWB6UWB12	Ultra Red	626	8000	30	09J9352	1.160
SSP-01TWB9W12	Ultra White	...	3300	60	09J9357	2.010
SSP-01TWB7UW12	Ultra Super Blue	470	1600	60	09J9355	2.010
SSP-01TWB2UPW12	Ultra Green	525	2800	60	09J9349	2.010
SSP-01TWB3SW12	Super Yellow	590	2200	60	09J9351	1.160
● SSP-01TWB6UW12	Ultra Red	626	2800	60	09J9353	1.160
MINIATURE WEDGE BASE, 4 LEDs						
SSP-04MWB9L2	Ultra White	...	7000	30	09J9369	7.250
SSP-04MWB7UL2	Ultra Super Blue	470	3000	30	09J9368	6.380
SSP-04MWB2UPL2	Ultra Green	525	4500	30	09J9365	7.250
SSP-04MWB6UL2	Ultra Red	626	3500	30	09J9367	2.730
MINIATURE BAYONET (BA9S) BASE, SINGLE LED						
● SSP-D29B9SUGC-12V	Super Pure Green	574	1000	40	09J9335	3.460
SSP-D29B9SYC-12V	Super Intensity Yellow	590	1500	40	09J9336	2.670
SSP-D29B9SIC-12V	Super Intensity Red	636	2500	40	09J9334	2.670
MINIATURE BAYONET (BA9S) BASE, 3 LEDs						
SSP-3MB9912G	Ultra White	...	13100	30	09J9404	6.010
SSP-3MB92UP12G	Ultra Green	525	10000	30	09J9400	6.010
SSP-3MB93S12G	Super Intensity Yellow	590	2400	30	09J9401	2.270
SSP-3MB96U12G	Super Intensity Red	626	3600	30	09J9402	2.270
MINIATURE SCREW (E10) BASE, SINGLE LED						
SSP-D29E10SUGC-12V	Super Pure Green	574	1000	40	09J9337	3.460
SSP-D29E10SYC-12V	Super Intensity Yellow	590	1500	40	09J9339	2.670
SSP-D29E10SIC-12V	Super Intensity Red	636	2500	40	09J9338	2.670
MINIATURE SCREW (E10) BASE, 4 LEDs						
SSP-4SE10912G	Ultra White	...	7000	30	09J9414	7.250
● SSP-4SE107U12G	Ultra Blue	470	3000	30	09J9413	6.960

➤ CONTINUED ➤



LED REPLACEMENTS • LAMP SOCKETS/HOLDERS

BASED LEDs (CONT.)

MINIATURE SCREW (E10) BASE, 4 LEDs

Mfg. Part No.	Emitted Color	Wavelength (nm)	I _v (mcd)	Viewing Angle	Stock No.	Price Each	
						1-9	10-99
SSP-4SE103S12G	Super Intensity Yellow	590	3500	30	09J9411		2.560
SSP-4SE106U12G	Super Intensity Red	626	3500	30	09J9412		2.560

SUBMINIATURE WEDGE BASE LEDs

SSP-01SWB9C12-FT	Ultra White	...	1400	100	09J9347		3.050
SSP-01SWB7UC12-FT	Ultra Super Blue	470	850	100	09J9346		3.050
SSP-01SWB2UPC12-FT	Ultra Pure Green	525	1650	100	09J9343		3.050
SSP-01SWB6UC12-FT	Super Intensity Red	626	850	100	09J9345		3.050

(80510)

MR16 LED LAMPS

Features

- Low Power Consumption
- Direct replacement for MR16 incandescent

Applications

- Spot Lights
- Track Lighting
- Automotive Lighting



AllInGaP TYPE

Mfg. Part No.	Emitted Color	Wave-length (nm)	DC Fwd. Voltage (V)	Typ. Lumens Intensity (mcd)	Stock No.	Price Each	
						1-9	10-99
SSP-11CR6U12	Ultra Red	626	12	11000	09J9372	20.000	16.370
SSP-11CR3S12	Super Yellow	590	12	11000	09J9371	28.580	23.390

InGaN/SiC TYPE

SSP-11CR2UP12	Ultra Pure Green	525	12	12000	09J9370	34.850	28.520
SSP-11CR912	White	...	12	12000	09J9374	37.210	30.460
SSP-11CR7U12	Ultra Super Blue	470	12	10000	09J9373	28.580	23.390

(80587)

LUXSPOT HIGH LUMINOUS EFFICACY WHITE LED MODULE

Features:

- Integrated ultra compact form factor
- Fanless air cooling technology
- Multiple mounting options
- Fully dimmable
- Powered by LedEngin's highest flux density, ultra reliable 4-chip LED
- Precision optics delivering narrow flood beam pattern
- Beam Type: Narrow Flood
- Beam Angle (FWHM): 21°

Applications:

- General Lighting
- Museum Lighting
- Retail & Display Lighting

- Hospitality Lighting
- Accent & Task Lighting
- Architectural Detail Lighting



LedEngin, Inc.

LuxSpot™ delivers the lighting equivalence of a conventional 50W halogen MR16 lamp in a similar form factor with a 70% power savings and >10 times the service life. The combination of LedEngin's industry leading high performance LED technology with optical, electrical, and thermal management solutions enable this innovative source replacement, delivering both the performance of a conventional halogen or incandescent light source and the benefits of solid state lighting.

Mfg. Part No.	Color	Color Temp. (K)	CRI	Luminous Flux (lm)	Stock No.	Price	
						1-9	10-99
LS17-002W14	Warm White	3200	80	350	47P5949		97.500
LS17-012W14	Warm White	3200	90	325	47P5950		105.000
LS17-002N14	Neutral White	4100	75	420	47P5947		97.500
LS17-002D14	Daylight White	5500	75	500	47P5945		97.500

(147087)

element14

Research, Refine, Design Seamlessly

Experience the definitive technical portal/community for electronic design engineers at www.element-14.com

(148859)

HIGH LUX PERFORMANCE WHITE LED MR16 LAMP

Features:

- Performance equivalent to narrow flood 35W halogen MR16
- Precision optic delivering high quality uniform beam pattern
- Form factor meets IEC 60630:2002 standards for GU5.3/GX5.3 package
- Plug and play; compatible with standard MR16 based fixtures
- Dimmable and compatible with most magnetic and electronic transformers
- Power factor > 0.9
- Powered by LedEngin's latest high flux density LED

NEW TECHNOLOGY

LedEngin, Inc.



Applications:

- General Lighting
- Museum Lighting
- Retail & Display Lighting
- Hospitality Lighting
- Accent & Task Lighting
- Architectural Detail Lighting

LuxDot™ offers the quality and quantity of light ideal for spot, accent, track and down lighting applications in a narrow flood beam pattern. The new, high-brightness LED lamp delivers a smooth, superior-quality light beam to a target area, with 80-percent-reduced power consumption and over 10 times the service life of a 35-watt halogen. Its plug-and-play compatible with standard MR16 based fixtures and provides uncompromising fit, form and performance compared to 35W halogen MR16 lamps.

Mfg. Part No.	Color	Color Temp. (K)	CRI	Lumens (lm)	Stock No.	Price	
						1-9	10-99
LD16-022W07	Warm White	2900	80	160	08R4592		48.060

(147869)

0.719" DIA. UNIVERSAL LAMP HOUSING FOR PILOT LAMP

RoHS Compliant Available

OSRAM SYLVANIA

Select Lens Cap Style and Color

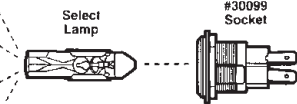

Mfg. Part No. 30099 assembly dimensions - Socket: 0.91" (23.11) (front of panel to end of terminals). Lenses: 0.63" (16.00) diameter, 0.38" (9.65) height. Select T-2 lamp and lens capability to comprise complete lamp assembly, sold separately on pages 1354 and 1366.

Mfg. Part No.	Description	Stock No.	Price Each	
			1-9	10-99
30099/PLH	Universal lamp housing	35F2829		3.060

(2580)

31099 SERIES T-2½ OR T-3¼ MINIATURE BAYONET BASE LAMP ASSEMBLY

RoHS Compliant Available

OSRAM SYLVANIA

Select Lens Cap Style and Color

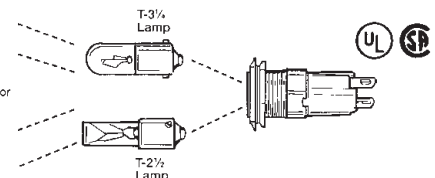

31099 series assembly dimensions - Socket: 1.68" (42.67) (front of panel to end of terminals). Lenses: 0.63" (16.00) diameter, 0.38" (9.65) height. Select T-2½ or T-3¼ lamp and cap on pages 1354 and 1366 UL listed, CSA certified.

Mfg. Part No.	Description	Stock No.	Price Each	
			1-9	10-99
31099/PLH/BAY	Miniature bayonet base lamp assembly	44F1326		8.120

(2581)

LAMP SOCKETS/HOLDERS

LENS CAPS FOR 30099 AND 31099 SERIES ASSEMBLIES



Order mfg. part nos. 30099 and 31099 separately on page 1365.

Mfg. Part No.	Description	Stock No.	Price Each	
			1-24	25-49
● 30200/FT/TLR	Flat Top Translucent Red	35F2788	1.240	1.030
● 30100/PILOT/JLR	Jeweled Red	35F2831	3.040	2.530
● 30102/PILOT/JLG	Jeweled Green	35F2833	1.870	1.550
● 30106/PILOT/JLA	Jeweled Amber	35F2832	3.300	2.740
● 30110/PILOT/TPLR	Dome Transparent Red	35F2835	0.756	0.628
● 30111/PILOT/TPLA	Dome Transparent Yellow	35F2836	0.917	0.761
● 30112/PILOT/TPLG	Dome Transparent Green	35F2837	0.801	0.665
● 30120/PILOT/FLR	Dome Fluted Red	35F2792	0.815	0.677
● 30122/PILOT/FLG	Dome Fluted Green	35F2794	0.776	0.644
● 30126/PILOT/FLA	Dome Fluted Amber	35F2793	0.700	0.581
● 30145/PC/TLTY	Lexan Translucent Yellow	35F2945	4.090	3.390

(48285)

CANDELABRA BAYONET SOCKETS

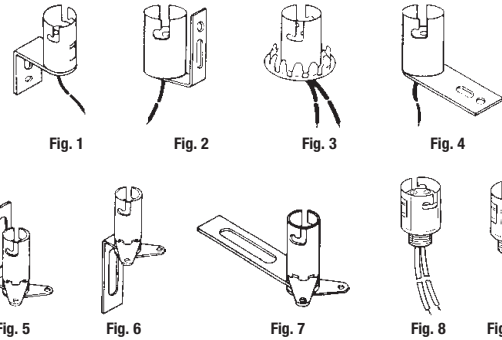

These sockets accept single contact candelabra bayonet-based lamps. Single #22 AWG, 6" wire lead provides voltage to socket. Mounting bracket is electrically connected to socket shell, providing ground connection. Brackets are 0.025/0.42" cadmium plated steel.

Mfg. Part No.	Fig.	Stock No.	Price Each
			1-24
● SPC21736	1*	16M1227	2.640
● SPC21737	2*	16M1228	3.230
● SPC21738	4	16M1229	3.420
● SPC21739	9	16M1230	6.280

These sockets accept double contact candelabra bayonet-based lamps. Two #18 AWG, 6" wire leads and Nema grade phenolic washers provide insulation from mounting bracket. Brackets are 0.30/0.48" cadmium plated steel.

● SPC21740	1	16M1231	3.090
● SPC21741	2	16M1232	3.180
● SPC21744	3	16M1235	5.610
● SPC21749	3	16M1240	9.970
● SPC21742	4	16M1233	3.020
● SPC21743	8	16M1234	6.370

These sockets accept single contact candelabra bayonet-based lamps. Supplied with two solder terminals, steel with tin-electro plating, and a shell insulated from the bracket. Designed for low voltage incandescent lamps, 6V to 28V.

● SPC21734	5	16M1225	2.030
● SPC21733	6	16M1224	2.030
● SPC21735	7	16M1226	2.030

* Single wire terminal.
(2678)

MINIATURE AND MIDGET SCREW SOCKETS

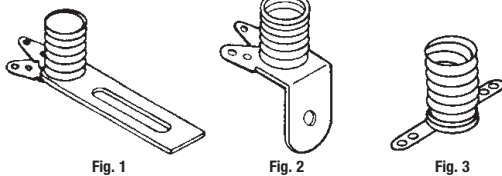

Sockets have soldering lugs and accept miniature screw-based lamps. Solder lug terminals insulated from mounting bracket. Mounting brackets are 0.025/0.032" (0.635/0.813) cadmium-plated steel. For low-voltage incandescent lamps, 6 volts to 28 volts.

Mfg. Part No.	Fig.	Stock No.	Price Each		
			1-24	25-49	100-249
● SPC21732	1	16M1223	1.910	1.630	1.330
● SPC21745	2	16M1236	8.100	6.840	5.560
● SPC21729	3	16M1220	1.660	1.410	1.140

(2627)

MINIATURE BAYONET SOCKETS WITH WIRE LEADS

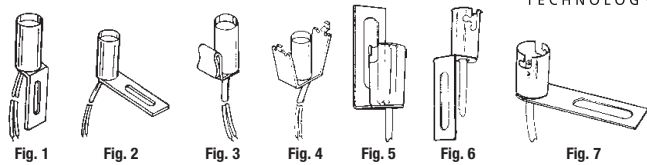

Single contact miniature bayonet sockets with molded black nylon housings. Insulated and break resistant. Mounting brackets insulated from socket. Brackets are 0.025/0.032" (0.635/0.813) cadmium-plated steel. Rating: 75 watts @ 125V.

Mfg. Part No.	Fig.	Stock No.	Price Each			
			1-24	25-49	50-99	100-249
● SPC21761	1	16M1252	4.030	3.400	3.070	2.780
● SPC21763	2	16M1254	4.030	3.400	3.070	2.780
● SPC21764	3	16M1255	4.030	3.400	3.070	2.780
● SPC21762	4	16M1253	5.200	4.380	3.960	3.580

These sockets feature a grounded socket case with one wire lead.

● SPC21767	5	16M1258	2.790	2.350	2.120	1.920
● SPC21765	6	16M1256	2.790	2.350	2.120	1.920
● SPC21766	7	16M1257	2.790	2.350	2.120	1.920

(2671)

Expert technical support

Chat online to our team of engineers, or connect to them through your representative.

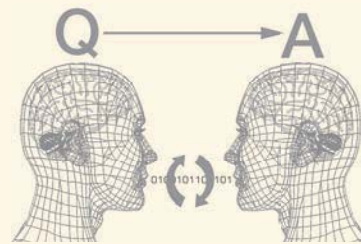

Make it easy. Make it fast. Make it Newark.

(148839)