

## Latest Products from...

### "Multicrimp" Crimping Pliers

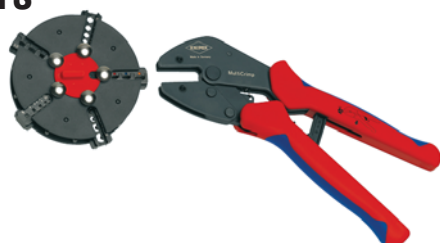

See page 1862

### "Zyklop" Ratchet Sets



See page 1956

### Clean Room Stainless Steel Pliers



See page 1889

### QUANTUMIKE Fast Action Micrometer



See page 2024

## Contents

Page

Abrasives	2004
Adjustable Wrenches	1948
Calipers	2022
Crimp Tools	1861
Cutters - Bolt	1996
Cutters - Cable	1849
Deburring	2005
Engineering Materials	2039
Extraction & Pick-Up Tools	1902
Hammers	1978
Hex/Torx/Switch Keys	1936
IDC / Punchdown Tools	1900
Insulated Tools	2004
Knives	1988
Lubricating Guns	2037
Magnets	1975
Measurement and Inspection	2024
Multitools	1994
Nutspinners	1936
Pliers	1872
Plumbing Tools	2038
Punches	1982
Saws	1998
Scissors & Snips	2004
Screwdrivers	1919
Side Cutters	1888
Socket Sets	1956
Spanners	1949
Taps & Dies	2010
Tool Kits	1828
Torque Tools	1944
Tweezers	1904
Vices & Tool Holding	1968
Wire Strippers	1852
Wire Wrapping	1870

Tool Kits

Electricians Toolkit 4720

32 Pieces



Set Content:			
Mfrs. List No	Description	Mfrs. List No	Description
806-1-1	Mains tester	8231	225mm slip joint plier
BE-8010S	0.4 X 2.5mm Slotted 1000 volt	319	300mm Hacksaw frame
BE-8220S	0.5 X 3.0mm Slotted 1000 volt	268	Junior hacksaw frame
BE-8040S	0.8 X 4.0mm Slotted 1000 volt	9031	8" adjustable wrench 38mm wide opening jaw
BE-8050S	1.0 X 5.5mm Slotted 1000 volt	428-16	16oz Fibre glass claw hammer
BE-8800S	No 1 Pozi 1000 volt	484-1250	1250gm club hammer
BE-8820S	No 2 Pozi 1000 volt	PC-12-VEN	Floorboard Saw (Veener Saw)
BE-8830S	No 3 Pozi 1000 volt	1-210-08-2-2	Half round second cut file
BE-8610S	NO 1 Philips 1000 volt	424P-16	16mm wood chisel
BE-8620S	NO 2 Philips 1000 volt	424P-20	20mm wood chisel
BE-8630S	NO 3 Philips 1000 volt	424P-25	25mm wood chisel
4130	120mm side cutter	3834-ARBR-930	14-30mm arbor
2101G-180	180mm side cutter	3830-20-VIP	20mm Holesaw
2628G-180	180mm combination plier	3830-25-VIP	25mm Holesaw
2430G-160	160mm snipe nose plier	3830-32-VIP	32mm Holesaw
2233D-200	200mm cable cutter		Toolbox

527341

45

Set	Order Code	Price Per Set		
		1+	3+	5+
4720	167-1607	275.00	259.00	249.00

Engineers Toolkit 4730

25 Pieces



Set Content:			
Mfrs. List No	Description	Mfrs. List No	Description
BE-8010	0.4 x 2.5 Slotted	1435/5	M3-M18 Stud Extractor set
BE-8020	0.5 x 3.0 Slotted	9045-B-250	250mm Engineers Square
BE-8040	0.8 x 4.0 Slotted	111M/7T	8,10,13,14,17,19 & 22mm Spanner Set
BE-8150	1.0 x 5.5 Slotted	111Z/8T	3/8,7/16,1/2,9/16,5/8,11/16,3/4, & 7/8" Spanner Set
BE-8810	No 1 Pozi	7800DM-8	1/2" Drive 8mm Dynamic Drive Socket
BE-8820	No 2 Pozi	7800DM-10	1/2" Drive 10mm Dynamic Drive Socket
BE-8830	No 3 Pozi	7800DM-13	1/2" Drive 13mm Dynamic Drive Socket

Set Content:			
2101G-180	180mm side cutter	7800DM-17	1/2" Drive 17mm Dynamic Drive Socket
2628G-180	180mm combination plier	7800DM-19	1/2" Drive 19mm Dynamic Drive Socket
2800-150	12-25mm Internal circlip pliers	7800DM-24	1/2" Drive 24mm Dynamic Drive Socket
2900-150	10-25mm External circlip pliers	7800DM-30	1/2" Drive 30mm Dynamic Drive Socket
1420	470mm Pipe Wrench	7800DZ-3/8	1/2" Drive 3/8" Dynamic Drive Socket
8224	250mm slip joint plier	7800DZ-7/16	1/2" Drive 7/16" Dynamic Drive Socket
325	300mm Hacksaw frame	7800DZ-1/2	1/2" Drive 1/2" Dynamic Drive Socket
268	Junior hacksaw frame	7800DZ-9/16	1/2" Drive 9/16" Dynamic Drive Socket
9073P	12" Adjustable wrench with reversible jaw	7800DZ-5/8	1/2" Drive 5/8" Dynamic Drive Socket
479-16	16oz Ball Pein Hammer	7800DZ-3/4	1/2" Drive 3/4" Dynamic Drive Socket
BE-9770	Metric Hexagon Key Set	7800DZ-7/8	1/2" Drive 7/8" Dynamic Drive Socket
BE-9780	Imperial Hexagon Key Set	8150-1/2	1/2" Drive Ratchet
1-473-08-2-2	3 Piece Engineer File Set	8160-1/2	1/2" 250mm extension bar
3735-4-120	120 x 4mm Centre Punch	8166-1/2	1/2" Universal Joint
3734S/6	2,3,4,5,6 & 8mm Drift punch set		Toolbox
3740-175	175 x 21mm Flat Chisel		

527343

Set	Order Code	Price Per Set		
		1+	3+	5+
4730	167-1606	450.00	429.00	410.00

General Purpose Toolkit 4740

17 Pieces



Set Content:			
Mfrs. List No	Description	Mfrs. List No	Description
813-2.5-75	0.4 X 2.5mm Slotted	319	300mm Hacksaw frame
813-3-75	0.5 X 3.0mm Slotted	239	Junior hacksaw frame
813-4-100	0.8 X 4.0mm Slotted	9031	8" adjustable wrench 38mm wide opening jaw
813-5.5-150	1.0 X 5.5mm Slotted	428-16	16oz Fibre glass claw hammer
816-1-100	PZ1	300-14-F15/16-HP	Toolbox saw
816-2-125	PZ2	2817	Retractable Knife
2101G-180	180mm side cutter	1-210-08-2-2	Half round second cut file
2628G-180	180mm combination plier	Toolbox	
8224	250mm slip joint plier		

527345

Set	Order Code	Price Per Set		
		1+	3+	5+
4740	167-1605	149.00	139.00	129.00

Express checkout



With no need to re-enter your details, returning customers can now buy products even faster - order online today at [www.farnell.co.uk](http://www.farnell.co.uk)

**Electricians Pouch With Tools**



- Set Content:**  
 Electrician's Pouch  
 Quick Release Belt  
 3 Insulated screwdrivers for slotted head screws, for work on live equipment up to 1000 volts: 0.5x3.0x100mm; 0.6x3.5x100mm; 0.8x4.0x100  
 2 Insulated screwdrivers for Phillips PH-head screws, for work on live equipment up to 1000 volts: PH2 and PH1  
 2 Insulated screwdrivers for Pozidriv PZ head screws, for work on live equipment up to 1000 volts: PZ1 and PZ2  
 Side cutting plier  
 Wire stripping plier  
 239 Junior hacksaw frame, with 6" (150 mm), 32-TPI blade for metalworking

527350

Set	Order Code	Price Per Set		
		1+	3+	5+
4750-ETK	167-1604	92.00	87.40	82.80

**Premium Electricians Tool Kit**



- Everything the apprentice or new starter would need, featuring:
- Designed with Electrician's, Service Engineers and Technicians in mind
- The Extra heavy duty polyester case has 50 internal pockets and padded internal compartments
- Giving enough room to store the full premium tool kit
- Case has carry strap and shoulder strap
- Contents: 1 each of the following:
- VDE Combination Pliers 200mm, VDE Snipe Nose Pliers 170mm, VDE Side Cutters 160mm
- VDE Slotted Screwdrivers 2.5x75, 4x100mm
- VDE PH1, PH2, PZD 1, PZD 2 Screwdrivers
- VDE Modulo 2 Screwdriver for size 2 terminal screws
- Junior Hacksaw, Fusion Tape Measure 5m, Electrician's Pocket Knife and VDE Main-stester
- Claw Hammer and Re-Threading Tool
- Dimensions: 430x190x320mm

448367

Mftrs. List No.	Order Code	Price Each	
		1+	5+
595003	128-3227	158.59	149.61

**700 products added online every week**

See our pick of the hottest products and latest technologies in 'What's New?' at [www.farnell.co.uk](http://www.farnell.co.uk)

**Type 002101TL mounting box**



Toolbox  
 Front pocket made of a strong cowhide, outer edges reinforced, zinc-plated bottom.

- 1 combination pliers, length 180 mm
- 1 flat round pliers, length 160 mm
- 1 side cutters, length 160 mm
- 1 stripping pliers, length 160 mm
- 1 cable blade
- 1 cable blade with hooked blade
- 1 safety slotted screwdriver in each case, 2.5 x 80 mm / 3.5 x 100 mm / 5.5 x 125 mm / 6.5 x 150 mm
- 1 safety cross-headed screwdriver in each case, PH 1/80 + PH 2/100 mm
- 1 slotted screwdriver in each case 6.0 x 125 mm, 6.5 x 150 mm
- 1 voltage tester
- 1 300 g fitter's hammer
- 1 bit gauge
- 1 electrician's bit 250 x 10 mm
- 1 mason's chisel 300 mm
- 1 PUK saw
- 1 gypsum pan
- 1 water brush
- 1 40 mm painter's spatula
- 1 metre rule (with inches) 2 m

WET336

Mftrs. List No.	Order Code	Price Each		
		1+	5+	10+
002101TL	876-082	217.00	210.50	204.00

**69 Piece Tool Kit**



A 69 piece tool kit ideal for the household, supplied in a handy fold-up blow moulded carry case.

**Contents:**

- Junior hacksaw
- 150mm mini level
- 125mm x 250mm roofing square
- 3m measuring tape with rubber cover
- 16oz tubular hammer with rubber grip
- Ratchet screwdriver
- 60mm bit holder
- 200mm adjustable wrench with dipped handle
- 175mm (7") carpenter pencil
- 150mm (6") stainless ruler
- Trim knife with soft comfortable handle
- 2 x electric clips
- 150mm (6") combination pliers
- 150mm (6") long nose pliers
- 150mm (6") side cutting pliers
- 4 x screwdrivers with cushion grip:
  - Slotted: 5 x 75mm, 6 x 100mm
  - Phillips: PH1 x 75mm, PH2 x 100mm
- 9 x hex keys: 1.5, 2, 2.5, 3, 4, 5, 6, 8, 10mm
- 40 x 25mm bits:
  - Slotted: 3, 3, 4, 4, 5, 5, 6, 6, 7, 7mm
  - Phillips: PH0, PH1, PH2, PH2, PH2, PH3
  - Pozidriv: PZ0, PZ1, PZ2, PZ2, PZ2, PZ3
  - Torx: T10, T15, T20, T25, T27, T30, T40
  - Square: S0, S1, S2, S2, S3
  - Hex: 3, 4, 5, 6, 7mm

477636.452483

Order Code	Price Each			
	1+	5+	10+	20+
136-1386	16.27	15.11	14.10	13.22

Over 480,000 products online

**Tool Kits - continued**

**Starter Electricians Tool Kit**



- Ideal for apprentices and new starters, all carried close at hand in the tool belt set, featuring:
- Extra Heavy Duty polyester tool belt with enough pockets to carry everything you need
- Designed to fit Waists 32-42"
- Padded construction for added comfort
- Dimensions: 1148 x155mm
- Contents: 1 each of the following:
- VDE Combination Pliers 200mm, VDE Snipe Nose Pliers 170mm, VDE Sidecutters 160mm
- VDE Slotted Screwdrivers, 2.5 x 75, 5.5x125, 6.5x150mm
- VDE PZD 2, VDE Mainstester
- Junior Hacksaw, Fusion Tape Measure 5m, Electrician's Pocket Knife, Pocket level and the Tool belt

448368

Mfrs. List No.	Order Code	1+	5+	Price Each
595001	128-3228	130.86	123.45	

**Electricians Belt Set**



- Tough heavy-duty construction incorporating metal eyelets
- Long belt fits 32" - 42" waists
- Extra wide for great comfort and support
- 4 x loops for attachment to braces
- Securing clip to stop belt pulling through loops when loaded
- **NB: Tools Not Supplied**

448685.470077

Mfrs. List No.	Order Code	1+	5+	Price Each
T1715	128-3275	35.35	34.30	

**Builders Belt Set**



- Tough heavy-duty construction incorporating metal eyelets
- Long belt fits 32" - 42" waists
- Huge array of pockets and carrying straps for those essential tools
- Self adjusting hammer loop
- Convenient metal tape clip
- Cordless drill holster with velcro strap
- Padded mobile phone pocket
- **NB: Tools Not Supplied**

448687

Mfrs. List No.	Order Code	1+	5+	Price Each
T1714	128-3274	35.35	34.30	

**Electricians Tool Kit**



- Handy electricians tool wallet
- Dimensions(WxHxD): 244x345x50mm
- Contents: 1 each of the following:
- VDE Slotted Screwdrivers, 0.8 x 4.0, 0.5x3.0mm
- VDE PZD 2, VDE Mainstester
- Softech Tape Measure 5m, Electrician's Scissors, Pocket level and re-threading tool

448369

Mfrs. List No.	Order Code	1+	5+	Price Each
595002	128-3229	74.51	70.30	

**Tool Box, 7 parts**

For electrical contractors



- High quality, versatile, shock-resistant plastic case
- Foam insert with honeycomb structure for variable equipment
- Outside dimensions (H x W x D): 65 x 327 x 275 mm

**Inhalt:**

Mfrs. Part No.	Description	Length	Order Code
03 06 180	Combination Pliers	180mm	348-3344
26 16 200	Snipe Nose Side Cutting Pliers, Stork Beak Pliers	200mm	348-3411
70 06 160	Diagonal Cutter	160mm	348-3460
88 03 180	Water Pump Pliers	180mm	916-8460
WERA 6100	Screwdriver, for slotted screws 0,4x2,5mm		311-0588
WERA 6115	Screwdriver, for slotted screws 0,8x4,0mm		311-0618
WERA 6152	Insulated Screwdriver, for cross recessed screws PH1		311-0552

404636

Tool Box	Mfrs. Part No.	Order Code	1+	5+	+	Price Each
	00 21 15	413-2105	75.30	73.05	--	

**Tool Pocket**



- Universal pliers,
- Stripping pliers,
- Side-cutting pliers,
- Needle pliers,
- Long-nose pliers - flat,
- Long-nose pliers - round,
- Heavy-duty end-cutting pliers,
- Side-cutting pliers,
- x Slot: 2.8/4.0,
- x Cross: PH1

WET317

Mfrs. List No.	Order Code	1+	5+	10+	Price Each
00 19 41	875-922	116.00	112.50	109.05	

45

Farnell

16 Piece Service Toolkit



A 16pc service toolkit of high quality tools contained in a zippered wallet. Tools for maintenance and repair as well as precision work. Tools included are pliers, cutters, screwdrivers, adjustable wrench, tweezers, knife and tape measure.

356940

Size	Weight	Order Code	Price Each
40 x 310 x 220mm	1.885 kgs	385-1928	259.92

Professional 'Ergo' Engineers Tool Kit



A set of high quality true ergonomic hand tools from Bacho Sweden. Ideal for the professional service, repair or maintenance engineer who wants the best comfort and performance from their tools. All tools have ergonomic non-slip handles and come supplied in a strong plastic wallet.

Contents	Overall Length
Pliers	160mm
Combination pliers	160mm
Long nose pliers	160mm
Cutters	160mm
Side cutters	150mm
Adjustable Wrench (Reversible)	150mm
Screwdrivers	152mm
Slot 50 x 3.0mm	197mm
Slot 75 x 7.5mm	222mm
Slot 100 x 5.5mm	197mm
Phillips 75mm No.1	222mm
Phillips 100mm No.2	

222888

Mfrs. List No.	Order Code	Price Each
9845	310-5600	94.00

Maintenance Tool Kit



- A well equipped tool kit for the maintenance engineer
- Supplied in a durable, soft nylon zipper case
- Exclusive to Farnell

Content	
Digital Multimeter	VDE Cable Stripper
Mains Tester	Electrician Scissors
40W Soldering Iron	Utility Knife
Soldering Tip Cleaner	2 VDE Slot Screwdrivers: 3.0, 5.5
Desoldering Pump	2 VDE Phillips Screwdrivers: PH1, PH2
VDE Combination Pliers	Ball-Point Hex Key Set: 2.5, 3, 4, 5, 6, 8, 10
VDE Side Cutter	2 PCS Tweezer Set
VDE Long Nose Pliers	Utility Component Storage Box
	Adjustable Wrench

525814

Description	Mfrs. List No.	Order Code	1+	5+	10+
Tool Kit (sold. iron with UK plug)	PK-2807C-40	166-6227	61.40	58.32	55.25
Tool Kit (sold. iron with EU plug)	PK-2807B-40	166-6229	61.40	58.32	55.25

Maintenance Kit



A 20 piece tool kit designed for the maintenance engineer. Supplied in a durable, soft nylon zipper case. Dimensions: 305x215x45mm. Contents:

- 3m (10') steel tape measure with spring return and lock
- 40W Soldering iron
- Flat and round needle files. Length: 170mm
- Insulation tape
- Slotted (flared) screwdrivers: 3mmx75mm, 6mmx100mm
- Phillips screwdrivers: No 0, 1, 2
- Nutspinner: 3/16"
- Neon mainstester screwdriver
- 7 Piece pocket hexagonal key set: 1.3, 1.5, 2, 2.5, 3, 4, 5mm
- Alignment/trimming tool
- Utility knife with retractable blade
- 6" Adjustable wrench
- 6" Long nose pliers
- 6" Side cutters
- 6" Combination pliers
- 6" Slip joint pliers

RoHS

Compliant Non-compliant



08447 11 11 11

Compact Service Tool Kit



A useful 10 piece tool kit suitable for small general purpose, mechanical and electrical work. Supplied in a soft nylon zipper case. Dimensions: 190x95x30mm. Contents:

- 4.5" Side cutters manufactured from high carbon steel. The jaws are sprung providing excellent cutting action.
- 5" Long nose precision pliers with sprung, serrated jaws that provide excellent grip.
- Precision, straight point tweezers manufactured from stainless steel. Length: 125mm.
- Retractable blade craft knife.
- Screwdrivers with break resistant, cellulose acetate handles and chrome vanadium steel blades. Slotted (flared) – 3mmx75mm, Phillips – No 0.
- Precision screwdrivers with revolving tops and finger grips. Slotted – 2mmx75mm, Phillips – No 00x75mm.
- Round, half round needle files. Length: 170mm.

496042.269440

Mfrs. List No.	Order Code	1+	Price Each	5+
1PK-301-WDM	152-2406	10.30		9.26

All In One Tool Kit



**Content** (166-6214)  
 Long nose plier 150mm  
 Adjustable wrench 6"  
 Flexible extension: 190mm(L)  
 Magnetic bit adaptor: 60mm(L)  
 Socket adaptor  
 Bits:  
 -Phillips: 1,2,3  
 -Slotted: 1/8", 5/32", 3/16", 1/4", 9/32"  
 -Pozi driv: PZ1, PZ2, PZ3  
 -Hex: H5/64", H3/32", H1/8", H5/32", H3/16", H7/32", H1/4"  
 -SafetyTorx: T-10 / T-15 / T-20 / T-25 / T-27 / T-30 / T-40  
 -Square: S1, S2, S3  
 Drill bits:  
 1/16", 3/32", 1/8", 5/32", 3/16"  
 Multi-angle ratchet handle  
 18pcs socket set:  
 3/16", 7/32", 1/4", 9/32", 5/16", 11/32", 3/8", 7/16", 1/2"(inch) 5, 6, 7, 8, 9, 10, 11, 12, 13(mm)  
 Zipper bag

525429

Description	Mfrs. List No.	Order Code	1+	5+	10+
All In One Tool Kit (Inch)	1PK-943	166-6214	25.11	23.88	22.60
All In One Tool Kit (metric)	1PK-943B	166-6215	25.11	23.88	22.60

Mechanics



H=205, W=530, D=200

**Tool Kits - continued**

**Mechanics - continued**

A high quality mechanics tool kit containing a good selection of tools suitable for maintenance or fitting. 96 pieces supplied in a strong cantilever tool box.

**Best value**

<b>Contents:</b>	130mm side cutters	
560mm cantilever tool box	Set of 3 hand files	
42 piece AF/MM 12.7mm (½") drive socket set	Oil filter wrench	
6 piece screwdriver set	450g ball pein hammer	
7 piece metric hexagon set	Rubber mallet	
7 piece imperial hexagon set	Wire brush	
14 piece metric spanner set 8mm to 32mm	Trimming knife + blades	
12.7 mm impact driver set	Junior hacksaw + blades	
250mm water pump pliers	240mm tinman's shears	
180mm combination pliers	Tyre pressure gauge	
160mm radio pliers	Feeler gauges	

222799

Order Code	Price Each
559-313	1+ 259.54

**Heavy Screwdriver/Spanner Module**



This module includes:

Slot, 200 6.5mm blade	281-130 Chubby Pozidriv, 25mm blade No.2 point	281-487
Slot, 250 9.5mm blade	281-165 Pozidriv, 150mm blade No.3 point	267-028
	300mm Adjustable Spanner	105-218
Phillips, 100mm blade No.2 point	281-311 254mm Self Grip Wrench	708-7615

222742

Heavy screwdriver/ spanner module	Order Code	Price Each
	281-797	1+ 62.10

45

**Engineers' Deluxe Case Kit**

**FARNELL**



H=146, W=483, D=356

**Note:** Tool case and contents may be subject to minor substitutions to ensure availability.

<b>Contents:</b>	pack of 10	
<b>Screwdrivers</b>	Needle files, precision, set of 6	442-719
Slot 102 3.2mm blade	441-454 150mm flat, Bastard cut, file	222-069
Slot 100 6mm blade	281-104 150mm round, Bastard cut, file	222-094
Slot 150 5mm blade	281-232 6.35mm Masonry drill	= 1
Slot 150 6.5mm blade	281-116 HSS drills, set of 13, 1.59mm to 6.35mm	100-605
Slot, mains tester, 150/250V ac	108-753	
Pozidriv, 80mm blade No.1 point	281-384 Boxed 'T' handle reamer, 3.1mm to 12.7mm	443-062
Pozidriv, 100mm blade No.2 point	281-396	
<b>Cutting/Drilling</b>	<b>Grippers/Spanners/Wrenches</b>	
Light duty CK cutters	108-714 Tweezers, pointed end, straight	441-156
Heavy duty CK cutters	263-540 Snipe nose pliers, fine point, 140mm long	440-607
Wire stripper/cutters	440-759	
Retractable blade knife, including 2 blades	610-045 Combination pliers, 150mm long	263-590
Medium duty knife	440-980 Adjustable spanner, 150mm long	105-215
Spare blades for above, pack of 5	441-016 20mm opening	
Junior hacksaw	441-016 "Mole" style grips, 197mm long	442-458
Spare junior hacksaw blades,	442-641 Allen keys, set of 8, ⅛" to ¼" AF	109-235
	100-608 Allen keys, set of 7, 1.5mm to 6mm	109-232

<b>Grippers/Spanners/Wrenches</b>		
Spanners, set of 6, 4mm to 11mm	108-819	<b>Soldering</b>
Nutdriver, 5.5mm A/F - M3 thread	281-645	Portasol Professional, portable gas soldering iron kit
Nutdriver, 7mm A/F - M4 thread	281-669	Solder dispenser
Nutdriver, 8mm A/F - M5 thread	281-670	Desoldering gun
Nutdriver, 10mm A/F - M6 thread	281-682	Solder sucking wick, 1.5m 2.2mm, flux impregnated
<b>Measuring/Marking</b>		
150mm steel rule mm and decimal inches (⅛toths)	443-268	<b>Miscellaneous</b>
3m metric/imperial tape rule	628-815	Inspection mirror, swivel head and extension handle
Scriber, double ended	= 1	Brass wire brush
Centre punch, square head, 3.1mm point	443-037	Hammer, 227g ball pein, graphite Tool case

**Note:** Soldering iron is NOT supplied with gas

TEESX/223012.401701

	Order Code	Price Each
Tool kit complete with case	281-840	1+ 476.61
Tool case only	440-103	131.00

**Engineers' Standard Case Kit**

**FARNELL**



H=146, W=483, D=356

**Note:** Tool case and contents may be subject to minor substitutions to ensure availability.

<b>Contents:</b>	Circclip pliers, external type	722-1058
<b>Screwdrivers</b>	Adjustable spanner, 150mm long, 20mm opening	105-215
Slot 64 3.2mm blade	441-442	
Slot 102 3.2mm blade	441-454	
Slot 100 5mm blade	281-219	
Slot 150 5mm blade	281-232	
Slot 150 6.5mm blade	281-116	
Slot, mains tester, 150/250V ac	108-753	
Phillips, 80mm blade No.1 point	281-300	
Phillips, 100mm blade No.2 point	281-311	
Pozidriv, 80mm blade No.1 point	281-384	
Pozidriv, 100mm blade No.2 point	281-396	
<b>Cutting/Drilling</b>	<b>Measuring/Marking</b>	
Light duty Lindstrom cutters	440-140	
Wire stripper/cutters	440-759	
Junior hacksaw	442-641	
Spare junior hacksaw blades, pack of 10	100-608	
Conecut 6 to 20mm	100-677	
'T' handle reamer, 3.1mm to 12.7mm	443-062	
<b>Grippers/Spanners/Wrenches</b>	<b>Soldering</b>	
Snipe nose pliers, 127mm long	100-677	
Snipe nose combination pliers	443-062	
Combination pliers, 150mm long	263-576	
	263-590	
	<b>Miscellaneous</b>	
	Tool case	109-252

**Note:** Soldering iron is NOT supplied with gas

232196

	Order Code	Price Each
Tool kit complete with case	281-839	1+ 428.67
Tool case only	440-103	131.00

**Troubleshooting tips**



Chat live online to one of our technical engineers at [www.farnell.co.uk](http://www.farnell.co.uk)

Standard Case Kit



H=121, W=419, D=305

Note: Tool case and contents may be subject to minor substitutions to ensure availability.

<b>Contents:</b>	Snipe nose pliers, 127mm long	440-577
<b>Screwdrivers</b>	Snipe nose combination pliers	263-576
Slot 64 3.2mm blade	Combination pliers, 150mm long	263-590
Slot 102 3.2mm blade	Adjustable spanner, 150mm long, 20mm opening	105-215
Slot 100 5mm blade	Spanners, set of 6, 4mm to 11mm	108-819
Slot 150 5mm blade	Nutdriver, 5.5mm A/F - M3 thread	281-645
Slot, mains tester, 150/250V ac	Nutdriver, 7mm A/F - M4 thread	281-669
Phillips, 80mm blade No.1 point	Nutdriver, 8mm A/F - M5 thread	281-670
Phillips, 100mm blade No.2 point	Nutdriver, 10mm A/F - M6 thread	281-682
Pozidriv, 80mm blade No.1 point	<b>Measuring/Marking</b>	
Pozidriv, 100mm blade No.2 point	150mm steel rule metric/imperial divisions	443-244
<b>Cutting/Drilling</b>	<b>Soldering</b>	
Light duty cutters	Portasol, portable gas soldering iron	148-636
Wire strippers/cutters	Solder dispenser	146-706
Junior hacksaw	Desoldering gun	419-011
Spare junior hacksaw blades, pack of 10	<b>Miscellaneous</b>	
<b>Grippers/Spanners/Wrenches</b>	Tool case	109-252

Note: Soldering iron is NOT supplied with gas, see Order Code 200-001

222860

	Order Code	Price Each
Tool kit complete with case	281-827	335.22
Tool case only		
38mm laminated/split foam	440-097	112.90

Basic Case Kit

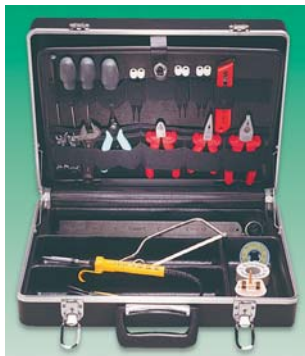

H=121, W=419, D=305

Note: Tool case and contents may be subject to minor substitutions to ensure availability.

<b>Contents:</b>	Combination pliers, 150mm long	263-590
<b>Screwdrivers</b>	Adjustable spanner, 150mm long, 20mm opening	105-215
Jeweller's, 3 slot and Phillips 0, 00, 1	Spanners, set of 6, 4mm to 11mm	108-819
Slot 102 3.2mm blade	<b>Measuring</b>	
Slot 150 5mm blade	281-232 300mm steel rule, metric/imperial	109-165
Pozidriv, 80mm blade No.1 point	281-384	
Pozidriv, 102mm blade No.2 point	<b>Soldering</b>	
<b>Cutting</b>	281-396 24W, 480°C, 240V soldering iron	146-706
Light duty cutters	Solder dispenser	146-706
Heavy duty CK cutters	202-332 Solder sucking wick, 1.5mm 2.2mm, flux impregnated	252-499
Retractable blade knife, including 3	<b>Miscellaneous</b>	
Junior hacksaw	442-641 13A plug (for soldering iron), 3A fuse	964-396
<b>Grippers/Spanners</b>	Tool case	109-251
Snipe nose combination pliers		

222840, 401846

	Order Code	Price Each
Tool kit complete with case	281-815	215.66
Tool case only	109-251	76.71

FARNELL

Tool Roll Kits



The 281-852 is a general purpose tool kit with sufficient tools for most office, workshop and maintenance applications including the home and car.

The 281-864 is a more comprehensive kit having twice as many tools as the TRK1 to cope with more varied maintenance applications. The tools chosen are not specific to any one industry and hence offer a very usable selection in many situations.

<b>281-852 Contents:</b>		
<b>Screwdrivers</b>		
Slot, 100 5mm blade	281-219	
Slot, 150 5mm blade	281-232	
Slot, mains tester, 150/250V ac	108-753	
Phillips, 60mm blade No. 0 point	281-293	
Phillips, 80mm blade No. 1 point	281-300	
Pozidriv, 100mm blade No 2 point	281-396	
<b>Cutting</b>		
Heavy duty CK cutters	263-540	
Junior hacksaw	442-641	
<b>Gripping/Spanners/Wrenches</b>		
Snipe nose combination pliers	263-576	
Combination pliers, 152mm long	263-590	
Adjustable spanner, 203mm long, 27mm opening	105-216	
Adjustable grip wrench 240mm long, 45mm opening	108-355	
<b>Miscellaneous</b>		
Tool roll	105-381	

<b>281-864 Contents:</b>		
<b>Screwdrivers</b>		
Slot, 100 5mm blade	281-219	
Slot, 150 5mm blade	281-232	
Slot, mains tester, 150/250V ac	108-753	
Phillips, 60mm blade No. 0 point	281-293	
Phillips, 80mm blade No. 1 point	281-300	
Pozidriv, 100mm blade No 2 point	281-396	
<b>Cutting</b>		
Heavy duty CK cutters	263-540	
Retractable blade knife, including 2 blades	610-045	
Junior hacksaw	442-641	
Needle files, precision, set of 6	442-719	
<b>Gripping/Spanners/Wrenches</b>		
Tweezers, pointed tip, straight, 120mm long	441-132	
<b>Measuring</b>		
152mm steel rule, mm and decimal inches (1/10 ths)	443-268	
3m metric/imperial tape rule	628-815	
Tool roll	105-382	

Note: Tool Kits and contents subject to design change.

222598

Order Code	Price Each
281-852	100.66
281-864	195.51

Tool Wallet Kits

FARNELL



The 281-876 is a compact tool wallet kit populated with high quality tools for the smaller precision applications.

The 281-888 is a tool wallet kit with a very high density of carefully chosen tools suitable for most electronic applications.

**Tool Kits - continued**

**Tool Wallet Kits - continued**

**281-876 Contents:**

Screwdrivers/Trimmers		Gripping/Spanners	
Potentiometer trimmers	145-307	Tweezers, pointed tip, straight, 120mm long	441-132
Slot, 100 5mm blade	281-219	Tweezers, round point, straight, 150mm long	441-200
Slot, mains tester, 150/250V ac	108-753	Seizers, straight nosed, serrated jaw 150mm Long	202-710
Phillips, 80mm blade No. 1 point	281-300	Snipe nose combination pliers	263-576
Pozidriv, 100mm blade No 2 point	281-396	Combination spanners ring/open, set of 6.5mm to 10mm	105-965
Cutting		Miscellaneous	
Light duty side cutters	108-714	Torch	538-050
Wire stripper/cutter	440-759	Tool wallet	105-383

**281-888 Contents:**

Screwdrivers/Trimmers		Flat nose pliers	
Potentiometer trimmers set of 3	145-507	Combination pliers, 152mm long	263-590
Slot, 100 5mm blade	281-219	Crimp tool for red, blue, and yellow insulated crimps	150-353
Slot, 150 5mm blade	281-232	Adjustable spanner, 150mm long, 20mm opening	105-215
Slot, mains tester, 150/250V ac	108-753	Combination Spanners, ring/open set of 6.5mm to 10mm	105-965
Phillips, 80mm blade No. 1 point	281-300	Measuring/Marking	
Pozidriv, 100mm blade No 2 point	281-396	150mm steel rule, mm and decimal inches (1/16ths)	443-268
		3m metric/imperial tape rule	628-815
Cutting		Soldering	
Light duty side cutters	108-714	Solder dispenser	146-706
Retractable blade knife, including 2 blades	610-045	Tip tinner/cleaner	419-631
Wire stripper/cutter	440-759	Desoldering gun, miniature	143-919
Gripping/crimping/spanners		Miscellaneous	
Tweezers, pointed tip, straight, 120mm long	441-132	Inspection mirror, swivel head extension handle	724-6298
Tweezers, round point, straight, 150mm long	441-200	Torch	538-050
Seizers, Straight nosed, serrated jaw, 152mm long	202-710	Tool wallet	105-384
Snipe nose combination pliers	263-576		

**Note:** Tool kits and contents subject to design change.

TEE11X/222618, 401947

Order Code	Price Each
281-876	130.11
281-888	270.60

**Service Engineer's Tool Kit**



A comprehensive tool kit designed for the mobile service engineer. Supplied in a robust, aluminium case with two removable tool pallets, key locks and corner guards. Dimensions: 460x333x130mm.

- Contents:**
- 40W soldering iron
  - Component storage box
  - Multimeter
  - Hobby vice with 'G' clamp

- Mini vacuum cleaner
- Soldering aid set
- Insulation tape
- Soldering iron stand
- Neon mainstester screwdriver
- 6" Stainless steel scissors
- Miniature torch
- Slotted (flared) screwdrivers: 5mmx38mm, 5mmx75mm, 5mmx150mm, 6mmx100mm, 6mmx150mm
- Nutspinners: 1/4", 3/16"
- Antistatic wrist strap
- Insulated IC extractor
- Phillips screwdrivers: No 1x38mm, No 1 x 75mm, No 2x100mm
- 10 Piece metric combination wrench set (4, 4.5, 5, 5.5, 6, 7, 8, 9, 10 and 11mm)
- Torx screwdriver: with T10/T15 reversible bit
- Desoldering pump
- 9.5" 5 way crimping tool with integral cutter
- 5 piece needle file set
- 7 Piece pocket hexagonal key set: 1.3, 1.5, 2.0, 2.5, 3.0, 4.0, 5.0mm
- 9.5" Crimping tool
- 8" Combination pliers
- Small component pick up tool
- 5" Bent nose pliers
- VDU, keyboard cleaning solution
- 5" Flat nose pliers
- 6" Tweezers
- 6" Diagonal cutters
- Utility knife with retractable blade
- 5" Side cutters
- 6" Adjustable wrench
- Long precision screwdrivers - colour coded: Slotted: 2.4x75mm, 3.0x100mm, 3.8mm x Phillips: 2.4mm diax75, 3.0mm diax100mm, 3.8mm diax100mm
- 5" Long nose pliers
- Head cleaning fluid

**Image may differ from products supplied - see contents above for accurate list of products contained**

496058

Mfrs. List No.	Order Code	Price Each
1PK-900-NC	149-4159	99.32 93.59

**Electronic Master Tool Kit**



A tool kit containing a wide range of tools associated with electronic engineering and servicing activities. Supplied in an attractive brief case with hinge locks and corner guards. Ideal for the mobile engineer. Dimensions: 460x330x115mm.

**Contents:**

- 40W soldering iron
- Component storage tube
- Solder and solder braid
- 5" Bent nose pliers
- 6" Tweezers
- 9.5" Water pump pliers
- Utility knife with retractable blade
- 5" Side cutters
- Inspection mirror
- 6" Adjustable wrench
- Lubricating Oil
- 5" Miniature long nose pliers
- 8" Combination pliers
- 6 Piece open ended spanner set
- 6" Diagonal cutters
- 9.5" Crimping tool
- Carpenter's hammer
- Precision watchmakers screwdriver set
- Component box
- 7 Piece pocket hexagonal key set: 1.3, 1.5, 2.0, 2.5, 3.0, 4.0, 5.0mm
- 6" Cutting pliers
- Alignment/trimming tool
- Soldering aid set
- Insulation tape
- Soldering iron stand
- Neon mainstester screwdriver
- 7" Stainless steel scissors
- Miniature torch
- Slotted (flared) screwdrivers: 3mmx75mm, 5mmx75mm, 6mmx100mm
- Nutspinners: 1/4", 3/16"
- Insulated IC extractor
- Phillips screwdrivers: No 0, 1, 2
- 3m (10') steel measuring tape
- 4 way crimping tool with integral cutter
- Needle file set
- Desoldering pump
- Antistatic brush
- 5" and 6" Snipe nose pliers
- Small component pick up tool

496057, 269456

Mfrs. List No.	Order Code	Price Each
1PK-700N	149-4158	1+ 3+ 93.43 81.60

**Electronic Tool Kit**



- Content (166-6221)**
- Long nose plier 135mm
  - Diagonal cutting plier 110mm
  - Lineman's plier 210mm
  - Long nose plier 150mm
  - Adjustable wrench 6"
  - Side cutting plier 165mm
  - 5pcs needle file set
  - Soldering iron 40W 220V
  - Professional multimeter
  - Measuring tape (3M/10FT)
  - Solder core 63%, SN
  - 7pcs hex key set
  - Wire stripper cutter
  - Utility knife (3 blades self loading)
  - Electrician's scissors
  - Solder aid tools

- Desoldering pump
- 10pcs electronic combination wrench
- Flux bottle (2pcs/pack)
- Blow brush (ø62mm)
- IC extractor
- Slip joint plier 154mm
- 9 Pro-soft screwdrivers: 3.0 x 75mm, #0 x 75mm, 5.0 x 75mm, #1 x 75mm, 6.0 x 100mm, #2 x 100mm, #2 x 250mm, 6.0x40mm, #2 x 40mm
- 6 pcs electronic screwdriver set
- Soldering tip cleaner
- Super fine tip straight
- Utility component storage box
- Hobby Vice
- Pallet for PK-5307
- Aluminum frame tool case w/1 pallet

525683

Description	Mfrs. List No.	Order Code	1+	Price Each	10+
Tool Kit (sold. iron with UK plug)	PK-5307CM-40	166-6221	80.98	76.88	72.88
Tool Kit (sold. iron with EU plug)	PK-5307BM-40	166-6222	80.98	76.88	72.88

**Electronics Tool Kit**



An advanced tool kit containing everything necessary for today's electronics engineer supplied in a heavy duty rigid case with strong sides, carry handles and rounded corners measuring 312x216x89mm (LxWxD). The kit contains:

- 5" (125mm) diagonal cutting nipper
- 5" (125mm) snipe nose pliers
- 6" (150mm) slant edge cutting nippers
- 6" (150mm) long nose pliers



- 7 in 1 crimp tool (0.9–5.5mm<sup>2</sup>)
- 3 Crystal line colour screwdrivers Phillips (3x75, 5x75, 6x100mm)
- 3 Crystal line screwdrivers Slotted (3x75, 5x75, 6x100mm)
- Utility knife (snap off blades)
- Stainless tweezers (9/16")
- 1 Roll PVC tape
- 7 piece folding hex wrench (1.2, 1.5, 2.0, 2.5, 3.0, 4.0, 5.0)
- 6" Stainless steel scissors
- 2 Piece needle file set (round & flat)
- 3 Piece soldering aid kit
- Utility component storage box (165x90x45mm)
- Soldering iron stand
- 60/40 Rosin core solder
- Desolder pump
- Digital multimeter AC/DC voltage DC current resistance diode/transistor tester
- Interior tool tray
- 40W Soldering iron

496060.269434

Mfrs. List No.	Order Code	Price Each	
		1+	3+
1PK-710K	149-4161	61.90	58.32

**Electronic Tool Kit**



- A well equipped tool kit for the electronics engineer
- Supplied in a sturdy zipper case
- Exclusive to Farnell



**Content**  
 Micro-Cutting Plier  
 Clean Cut Micro Nipper  
 Heavy Duty Long Nose Plier  
 Desoldering Pump  
 Solder Aid Tool Kit  
 Slot Screwdrivers 2.0mm, 2.5mm, 3.0mm  
 Phillips Screwdrivers PH0, PH00  
 Tamperfree Torx Screwdrivers T5, T6, T7, T8, T10, T15  
 Extremely Fine And Sharp Tip Tweezer  
 Super Fine Tip Straight Tweezer  
 2 SMD Tweezers

4 PCS Plastic Tweezer Set  
 Precision Knife  
 40W Soldering Iron  
 Soldering Tip Cleaner  
 Helping Hand with Soldering Stand  
 3 PCS Anti-Static Alignment Tool Kit  
 Quick-Fasten ESD Wrist Band  
 Vacuum pick-up Tool  
 PLCC Extractor

IC Extractor  
 Inspection Mirror  
 Flux Bottle

525810

Description	Mfrs. List No.	Order Code	Price Each		
			1+	5+	10+
Tool Kit (sold. iron with UK plug)	PK-4025C-40	166-6225	71.65	68.06	64.52
Tool Kit (sold. iron with EU plug)	PK-4025B-40	166-6226	71.65	68.06	64.52

**Electronic Maintenance Tool Kit**



**Content** (166-6219)  
 Side cutter 125mm  
 Long nose plier 138mm  
 3pcs soldering aid tools  
 Dual color long nose plier 165mm  
 Cabling splicing knife  
 Adjustable wrench 8"  
 Soldering iron 220V  
 DMM with mechanical prevent mistaken operation  
 8 Line color screwdrivers:  
 3.2x75mm, #0x75mm, #1x75mm, 3.2x100mm,  
 6.0x100mm, 6.0x38mm, #2x38mm, 8.0x150mm  
 Desoldering wick  
 6pcs electronic screwdriver set  
 Multi-purpose crimping tool  
 Mini flash light  
 Steel ruler 6"

Solder core 63%, SN  
 Super torque ratchet handle  
 4pcs Hex driver blades: 1/16", 5/64", 3/32", 1/8"  
 7pcs nut driver blades:  
 3/16", 1/4", 5/16", 11/32", 3/8", 7/16", 1/2"  
 Driver blade T10  
 Driver blade T15  
 Double ended screwdriver 3mm/#0  
 Electrician's scissors  
 10pcs electronic combination wrench

Inspection mirror  
 Pallet for 1PK-9385 serious  
 Top pallet for 1PK-9385 serious  
 Deluxe carry bag with 2 pallets of 1PK-9383

525561

Description	Mfrs. List No.	Order Code	Price Each		
			1+	5+	10+
Tool Kit (sold. iron with UK plug)	1PK-9385C-40	166-6219	128.13	121.98	115.31
Tool Kit (sold. iron with EU plug)	1PK-9385B-40	166-6220	128.13	121.98	115.31

**Technician's Tool Kit**



An advanced tool kit containing everything necessary for today's electrical technician. Supplied in a heavy duty case with strong rigid sides and protected corners, measuring 440x320x100mm (LxWxD). The kit contains:

- 40w Soldering iron
- 5 Piece needle file set
- PLCC extraction tool
- 3 Piece soldering aid kit
- 6[inch] Reverse action stainless steel tweezers
- 4.5[inch] Stainless steel tweezers
- Small cleaning brush
- 6 Piece precision screwdriver set
- 7 in 1 tool
- IC extractor tool
- 150mm flash light
- Utility knife with snap off blade
- Anti-static elasticated wrist strap
- Screwdriver handle
- 5 Piece 175mm double ended screwdrivers and nut driver (4xTorx, 2xSlotted, 2xPhillips)
- Mini hammer set including 4 separate faces
- 7 piece folding hex wrench (1.2, 1.5, 2.0, 2.5, 3.0, 4.0, 5.0)
- Three prong pick-up tool
- 8[inch] Adjustable wrench
- 5[inch] cutting pliers
- 5[inch] long nose pliers
- 4.5[inch] flat nose pliers
- 4.5[inch] bent nose pliers
- 8[inch] linesman combination pliers
- 7[inch] wire strippers (0.9[EN-dash]5.5mm<sup>2</sup>)
- 13[inch] Deluxe desoldering pump
- 60/40 Rosin core solder
- Heat sink
- Carrying strap

Image may differ from products supplied – see contents above for accurate list of products contained

496059.269454

Mfrs. List No.	Order Code	Price Each	
		1+	3+
1PK-2002C	149-4160	65.32	61.56

**Professional Electronic Tool Kit**



**Content**  
 Lineman's plier 165mm  
 Side Cutter 125mm  
 Long nose plier 150mm  
 Soldering iron stand with sponge  
 Desoldering pump  
 Soldering iron 220V  
 8 Line color screwdrivers:  
 3.2x75mm, #0x75mm, 5.0x75mm, #1x75mm,  
 6.0x100mm, #2x100mm, nut 3/16", nut 1/4"

6Pcs Electronic screwdriver set  
 Professional multimeter  
 7pcs Folding type hex key set (inch) or (metric)  
 PVC insulated tape  
 Solder core 63%, SN  
 Carrying zipper bag

525469

Description	Mfrs. List No.	Order Code	Price Each		
			1+	5+	10+
Tool Kit (sold. iron with UK plug)	1PK-616C-40	166-6217	50.23	47.71	45.20
Tool Kit (sold. iron with EU plug)	1PK-616B-40	166-6218	50.23	47.71	45.20

**Telecommunications Tool Kit**



A well equipped tool kit for installation and maintenance of telecom equipment. All the tools are manufactured from quality materials and the kit is supplied in a deluxe case, complete with two removable tool holders and three external pockets to store paperwork, or other hand tools.

- 150mm adjustable wrench
- Anti-static strap
- 155mm cable splicing knife
- DB25 gender changer (male-male)
- DB25 gender changer (female-female)
- D-SUB insertion/extraction tool
- 125mm locking pliers

**Help us to help the environment**



This catalogue has been printed on paper certified from a sustainable source.  
 Please recycle after use.

**Tool Kits - continued**

**Telecommunications Tool Kit - continued**

- 125mm long nose pliers
- 125mm side cutters
- 125mm electricians scissors
- 3.5mm hand drill
- Mini torch
- Inspection mirror
- Precision wire stripper
- Pocket clip
- Punch down tool with 66/110 blade
- Rotary coaxial cable stripper
- 125mm straight forceps
- Telecom tester
- Cable tie gun
- Utility knife
- 40W Soldering iron
- 13 component storage box
- 7 x Nutdriver bits (1/4" hex): 5, 6, 8, 9, 10, 11, 12mm
- 3 x Slot screwdriver bits (1/4" hex): 3, 5, 6mm
- 3 x Phillips screwdriver bits (1/4" hex): No. 0, 1, 2
- 2 x Torx screwdriver bits (1/4" hex): T10, T15
- Case dimensions: 440x320x110mm

Tone probe not included. See Test section.

496061.269470

Mftrs. List No.	Order Code	1+	3+	Price Each
1PK-7110B-W	149-4162	69.00	62.00	

**Category 5 Termination Kit**



A low cost, Category 5, termination tool kit. Supplied in a handy zipper case measuring 280x197x70mm.

- Ratchet modular crimping tool for 6P2C and 8P8C connectors
- Wire stripper and punch-down tool
- Punch-down tool with 66/110 blades
- 50 x RJ-22 modular plugs (4P4C flat)
- 25 x RJ-45 modular plugs (8P8C round)
- 20 x RJ-45 strain relief hoods
- Network cable tester

496046.269469

Mftrs. List No.	Order Code	1+	3+	Price Each
1PK-940-WDM	152-2410	62.45	59.62	

45

**25 Piece Cable Service Termination Kit**



A low cost cable termination tool kit. Supplied in a plastic blow moulded case measuring 570 x 320 x 320 mm

- Contents:
- 10 x RJ45 8P6C modular plugs, 10 x RJ12 6P6C modular plugs, Enhanced network cable tester, network cable terminator, wrist strap set, 2-in-1 modular telephone plug crimp tool

472552.527324

Order Code	1+	5+	Price
166-4788	19.89	18.87	

**Mini Electronics**



A mini tool kit providing a basic range of tools for use in electronics, supplied in a strong PVC/fabric tool roll.

- Contents
- Wire stripper 100mm plain screwdriver
  - Diagonal cutters 100mm No. 1 cross point screwdriver
  - Long nose plier 64mm plain slot terminal screwdriver
  - 150mm steel rule PVC/fabric tool roll
  - Fine tweezers

222786

Order Code	1+	Price Each
500-501	14.69	

**Tool selection Mftrs. List No. 002018**



8-piece tool set for work on electronic equipment.

- Contents:
- locking pliers
  - Side-cutting pliers 0.4 x 2.5/0.5 x 3.0/0.6 x 3.5/0.8 x 4.0
  - Micro Slot Screwdrivers: PH0/PH1

WET 351

Mftrs. List No.	Order Code	1+	Price Each
00 20 18	876-094	73.85	

**Electronics pliers - 8-piece set**



Used when working on electronic components



- 8-piece, comprising 2 sets of electronics pliers and 6 electronics screwdrivers, ESD construction, electrically insulating
- practical storage box made from impact-resistant plastic, with foam inserts

contents:

Mftrs. List No.	Description	Length	Order Code
35 22 115 ESD	Gripper pliers, flat round-nosed pliers	115mm	876-752
77 02 115 ESD	Side-cutting pliers, round-nosed, small chamfer	115mm	876-100
Screwdriver ESD 0.4x2.5 / 0.5x3.0 / 0.6x3.5 / 0.8x4.0mm / PH0 / PH1			

404674

Set of electronics pliers	Mftrs. List No.	Order Code	Price Each		
			1+	5+	10+
	00 20 18 ESD	916-8303	79.90	77.50	75.10

**Electronics Tool Kit in Service Case**



14 Piece



- Electronics tool kit comprising Senso Plus cutter & pliers, Xonic precision screwdrivers and tweezers, all complete in a service case with foam inserts.

Contents:

Snipe Nose Pliers, Straight, Smooth Jaw	3772D-120
Side Cutters, Oval Head, Mini Bevel	3773D-115
SMD Positioning Tweezers, SM104.SA	2334
Precision Tweezers, Fine, MM, SA	2343
XonicXM Screwdrivers	
Slot (4880X) 1.5 x 60, 1.8 x 60, 2.5 x 60, 2.5 x 75, 3.0 x 100, 4.0 x 100mm	
PH (4882X) No.000 x 60, No.00 x 60, No.0 x 60, No.1 x 80mm	

230606

Mftrs. List No.	Order Code	1+	Price Each
14 Pc Tool Kit	T3707DX	352-4255	135.00

**High Precision Swiss Tool kit**  
Erem Toolset Universal



- 11- piece tool kit in an ESD-safe plastic case, 2 cutters, 1 plier, 2 tweezers, 6 screwdrivers (L x W x D: 255x220x55mm Weight 480g)
- High-quality precision tweezers, cutters and screwdriver, non-reflecting surface, resharpenable
- Internal Erem Magic Spring: constant spring force, guarantees more than 1 million operations
- High precision screw joint: smooth jaw action with no play, smooth cutting operation with no jaw overlapping
- Maximum opening stop: the limited extent to which the handles can open prevent user

- hand fatigue
- For use in electronics assembly, the watchmaking industry, medicine
- Precision screwdriver with hardened, durable Tips, for precision working in confined areas

Mfrs List No:

XP600 Precision-screwdriver set for electronics	4 regular screwdrivers: 1,5x60mm/.059x2.36inch, 2,0 x 60mm/.078x2.36inch 2,5 x 60mm/.098x2.36inch 3,0 x 60mm/.118x2.36inch - Philips Nr. 0- - Philips Nr. 00
2412E Ergo, ovaler Kopf, mit Wate	Most widely used head shape. It is robust and size for size offers the highest cutting capacity.Hard wire 0,5mm, medium hardness 1,0mm,Cu. 1,6mm
2442P Ergo, flat nose plier	With smooth jaws, precision-machined edges, e.g. for gripping flat workpieces
622NB Tip cutter, flush, relieved,long, fine head	Miniature cutter for excellent access, medium hardness 0,6mmCu. 0,8 mm
AASA Precision tweezers	Pointed Tipps straight, special stainless steel, non-magnetic
2ASASL Precision tweezers	With flat rounded tips, Tip widths 2mm/.078inch, spezial stainless steel, non-magnetic

514903

Mfrs List no:	Order Code	1+	3+	5+
3600KU	161-5473	123.75	120.04	116.44

**Tool kit**



High quality service kit containing a variety of cutters and pliers, screwdrivers, tweezer and adjustable wrench, supplied in a zipped wallet.

- Set Content:**  
Diagonal cutters, Supreme Series  
Snipe nose pliers, Supreme Series  
Boley style tweezers  
Slotted screwdrivers 0.5x3.0 mm and 0.8x4.0 mm  
Phillips screwdriver PH 1  
Phosphated Adjustable Wrench

527352

Set	Order Code	1+	3+	5+
9841	167-1603	129.44	122.35	116.79

**Tool kit**



High quality service kit containing a variety of cutters and pliers, screwdrivers, tweezers and adjustable wrench, supplied in a zipped wallet.

- Set Content:**  
Diagonal cutters, 80 Series  
Snipe nose pliers, Supreme Series  
Phosphated Adjustable Wrench, 80 Series  
Slotted screwdrivers 0.5x3.0 mm and 0.8x4.0 mm  
Phillips screwdriver PH1  
Boley style tweezers

527358

Set	Order Code	1+	3+	5+
9848	167-1602	131.58	124.44	118.32

**ESD Profi-Set TRENDY**  
2280 and 2285



**Contents:**

- PLCC extractor
- Side cutters, 120mm, with conductive black hand-guard
- Mini side cutters EUROline-Conductive, 120 mm, without sideface, for soft wire up to 0.6mm Ø, copper wire up to 1.2 mm Ø, box joint, double leaf spring, fine polished and bright burnished, conductive bicoloured hand-guard
- Flat nose pliers EUROline-Conductive, 130 mm, as above
- Snipe nose pliers EUROline-Conductive, 130 mm, short jaws, as above
- Screwdriver 50 x 0.8 mm, with conductive handle, blade form chrome vanadium, chrome-plated, with black tip
- Screwdriver 50 x 1.5 mm, with conductive handle, blade form chrome vanadium, chrome-plated, with black tip
- Screwdriver 50 x 2.0 mm, with conductive handle, blade form chrome vanadium, chrome-plated, with black tip
- Cross-recess screwdriver size 000, with conductive handle, blade from chrome vanadium, chrome-plated, with black tip
- Cross-recess screwdriver size 00, with conductive handle, blade from chrome vanadium, chrome-plated, with black tip

Outside dimensions = 350 x 310 x 65 mm (when closed)  
Weight = approx. 1.65 kg / 1.5 kg

- Cross-recess screwdriver size 0, with conductive handle, blade from chrome vanadium, chrome-plated, with black tip
- SMD tweezers, 110 mm, straight, very sharply pointed, ESD-coating
- SMD tweezers, 120 mm, sickle-shaped, very sharply pointed, as above
- SMD tweezers, 120 mm, flat, rounded tips, 2.0 mm width, as above
- TORX screwdriver T 5, with conductive handle, blade made from chrome vanadium, chrome-plated, with black tip
- TORX screwdriver T 6, with conductive handle, blade made from chrome vanadium, chrome-plated, with black tip
- TORX screwdriver T 7, with bore-hole in the tip, with conductive handle, blade made from chrome vanadium, chrome-plated, with black tip
- ESD brush, bristles width 20 mm
- ESD handling set (only in set 2280), consisting of: foldable, green workbench pad (surface resistance according to DIN 53482, approx. 10<sup>8</sup> Ohm); 500 x 400 x 0.35 mm, contact bracelet with spiral cord, earth wire 2500 mm long with 1MOhm safety resistor including crocodile clip



Selected ESD tools in handy plastic case made from conductive material. The tools are clearly arranged in accurate-sized cutouts in conductive hardfoam. For individual accessories are one resp. two cutouts available.

- The professional kit for ESD-Specialists for local and mobile use
- 2280: tool set including ESD handling set
- 2285 : tool set without ESD handling set

Type	Order Code	1+	3+
2280	160-5865	270.30	256.79
2285	160-5864	219.30	208.34

45



1000V Insulated Tools

TEE68/223018,401705

Insulated Tool Kit, 10-Piece Set

IEC 60900:2004 The International Standard for Live Line Working Tools



In Tool Roll



Type Test Requirement

- Low Temperature Impact Test carried out at - 20°C
- Extreme Cold Climate, Category "C", Impact Test carried out at - 40°C
- Adhesion Test carried out after 168 hrs at 70°C
- Flame Retardant
- Indentation Test
- 100% Production Test
- 10KV for 3 minutes submerged in water

524462

Set, 10-piece	Mfrs. Part No	Order Code	Price Each		
			1+	3+	5+
Insulated Tool Kit	IT.GPT10	165-5272	143.87	138.12	132.38
<b>Set Contents:</b>					
Junior Hacksaw 1000V	IT/HSFJ	165-5275	39.90	37.90	35.95
Combi Pliers 200mm	IT/CP-8	165-5278	24.79	23.81	22.82
Snipe Nose Pliers 150mm	IT/SNP-6	165-5281	19.67	18.89	18.11
Cable Cropper 200mm	IT/CC-8	165-5282	23.13	22.20	21.27
Adjustable Wrench 200mm	IT.BA/8	165-5283	21.89	21.01	20.13
Terminal Screwdriver 75mm	IT.18/3	165-5284	3.16	3.05	2.90
Electrician's Screwdriver 150 x 5mm	IT.500/6	165-5285	5.43	5.23	5.02
Electrician's Screwdriver 150 x 6.5mm	IT.316/6	165-5286	11.18	10.71	10.30
Pozi Screwdriver PZ1	IT.PX1/3	165-5287	6.16	5.90	5.64
Pozi Screwdriver PZ2	IT.PX2/4	165-5288	7.66	7.35	7.04

1000V Insulated Tools BS60900



H=146, W=483, D=356

All the hand tools supplied conform to **BS60900**. 1000V live line working. The safety gloves conform to **BS697/1986**, 1000V working.

Contents:

Screwdrivers

Slot, 75 3mm blade	108-000
Slot, 100 3mm blade	108-001
Slot, 152 5mm blade	108-003
Slot, 152 8mm blade	108-006
Pozidriv, 75mm blade No.1 point	108-013
Pozidriv, 100mm blade No.2 point	108-014
Phillips, 75mm blade No.1 point	108-347
Phillips, 100mm blade No.2 point	108-348

Cutting/Stripping

Cutters, diagonal 160mm long	202-400
Cable cutter, 250mm long	107-995
Wire Strippers	202-435
Stripping knife	107-999
Junior hacksaw	165-5275

Grippers/Spanners/Wrenches

Long nose combination pliers, 165mm long	107-996
Combination pliers, 150mm long	107-997
Adjustable grip, 300mm long	108-044
Adjustable spanner, 210mm long	202-423
Ring spanner, 8mm	108-037
Ring spanner, 10mm	108-038
Ring spanner, 13mm	108-039

Miscellaneous

Tool case	109-252
-----------	---------

Note: Tool case and contents may be subject to minor substitutions to ensure availability.

	Order code	Price each
Tool kit complete with case	725-833	400.80

Insulated Deluxe Tool Kit, 21-Piece Set

IEC 60900:2004 The International Standard for Live Line Working Tools



In Orange Tool Case



Type Test Requirement

- Low Temperature Impact Test carried out at - 20°C
- Extreme Cold Climate, Category "C", Impact Test carried out at - 40°C
- Adhesion Test carried out after 168 hrs at 70°C
- Flame Retardant
- Indentation Test
- 100% Production Test
- 10KV for 3 minutes submerged in water

526854

Set, 21-piece	Mfrs. List No	Order Code	Price Each		
			1+	3+	5+
Insulated Tool Kit	IT.GPT21	165-5311	388.13	372.60	357.08
<b>Set Contents:</b>					
Terminal Screwdriver 75mm	IT.18/3	165-5284	3.16	3.05	2.90
Electrician's Screwdriver 150 x 5mm	IT.500/6	165-5285	5.43	5.23	5.02
Electrician's Screwdriver 150 x 6.5mm	IT.316/6	165-5286	11.18	10.71	10.30
Pozi Screwdriver PZ1	IT.PX1/3	165-5287	6.16	5.90	5.64
Pozi Screwdriver PZ2	IT.PX2/4	165-5288	7.66	7.35	7.04
Combi Pliers 200mm	IT/CP-8	165-5278	24.79	23.81	22.82
Snipe Nose Pliers 150mm	IT/SNP-6	165-5281	19.67	18.89	18.11
Cable Cropper 200mm	IT/CC-8	165-5282	23.13	22.20	21.27
Diagonal Cutters, 150mm	IT/DCN6*				
Waterpump Pliers	IT/WP10*				
Cable Jointer Coring Knife	IT.CCK*				
Adjustable Wrench 200mm	IT.BA/8	165-5283	21.89	21.01	20.13
Junior Hacksaw 1000V	IT/HSFJ	165-5275	39.90	37.90	35.95
Open Ended Spanner 28A	00970*				
Open Ended Spanner 13mm	00300	165-5289	11.33	10.87	10.40
Open Ended Spanner 17mm	00340	165-5290	13.71	13.15	12.63
Open Ended Spanner 19mm	00360	165-5291	15.84	15.22	14.59
Open Ended Spanner 24mm	00410	165-5293	17.39	16.72	15.99
Ring Spanner, 13mm	01080	165-5294	12.99	12.47	11.95
Ring Spanner, 17mm	01090	165-5295	14.28	13.71	13.15
Ring Spanner, 19mm	01120	165-5296	21.58	20.70	19.87

VDE SensoPlus Plier and Screwdriver Zip Case Tool Kit



9 piece VDE set in strong zip case with 2 SensoPlus Pozidrive and 3 Slotted Screwdrivers, SensoPlus VDE Side Cutter, Long Nose Plier, Wire Stripper and Mainstester.

All the tools meet the criteria for **VDE 0680/201** and **IEC900**.

Contents:

Screwdrivers

Slotted 125 x 5.5mm
Slotted 100 x 3.0mm
Slotted 75 x 2.5mm
Pozidrive 80 x 1
Pozidrive 100 x 2
Mainstester

Pliers

160mm Side Cutters
160mm Wire Stripper
165mm Long Nose Plier

TMM376/220251,401606

Mfrs. List No.	Order Code	Price Each			
		1+	5+	10+	20+
331002	128-7324	94.85	92.00	89.00	85.35

Technical information at your fingertips

Over **352,000** technical datasheets available online.

Visit [www.farnell.co.uk](http://www.farnell.co.uk) and look for the **Tech Info** heading in your search results.



**4-Part Tool Box,**

"Compact box" with VDE tools



**New**



- All pliers are VDE certified in accordance with **DIN EN 60900 1000V**, construction 6
- High strength and multi-purpose, impact resistant plastic case
- Foam insert with woven structure for various contents
- The tools are also available individually

**Contents:**

Mfrs. List No.	Description	Length	Order Code
03 06 180	Combi-pliers	180mm	348-3344
11 06 160	Stripping pliers	160mm	348-3356
26 16 200	Flat round-nosed pliers with cutting edge	200mm	348-3411
70 06 160	Side cutters	160mm	348-3460

404631

Tool box	Mfrs. List No.	Order Code	Price Each		
			1+	5+	10+
	00 20 15	<b>916-8281</b>	64.00	62.10	60.15

**VDE Plier Set**



- 3-part pliers set in attractive sales packaging
- All pliers chromed
- Handles VDE-isolated 1000V
- Content:
- 1 Combination Pliers 180mm
- 1 Diagonal Cutter 160mm
- 1 Stork Beak Pliers 200mm

245719

Mfrs. Part No.	Order Code	Price Each		
		1+	5+	10+
00 20 12	<b>381-4002</b>	53.60	52.00	50.40

**VDE Plier Set**



- Chrome vanadium steel
- 2 colour handle with slip guard
- Individually tested to 10,000V
- Meets VDE 0682-0201, IEC 60900



**Contents:**

- 160mm Diagonal pliers
- 180mm Combination pliers
- 200mm Long nose pliers

493019.492647

Order Code	Price Each			
	1+	5+	10+	20+
<b>149-6340</b>	23.84	22.14	19.79	18.69

**FREE global legislation support**



RoHS, REACH, WEEE, EuP, Batteries Directive - we've got it covered at:  
[www.global-legislation.com](http://www.global-legislation.com)

**VDE Side Cutter**



- Chrome vanadium steel
- 2 colour handle with slip guard
- Individually tested to 10,000V
- Meets VDE 0682-0201, IEC 60900

Cutting Capacity: wire

Size	Soft	Med/Hard
160mm	2.8mm	2.0mm

493014.492614

Order Code	Price Each			
	1+	5+	10+	20+
<b>149-6333</b>	11.08	10.28	9.18	8.00

**Heavy Duty VDE Side Cutter**



- Chrome vanadium steel
- 2 colour handle with slip guard
- Individually tested to 10,000V
- Meets VDE 0682-0201, IEC 60900

Cutting Capacity: wire

Size	Soft	Med/Hard	Piano
180mm	3.8mm	2.7mm	2.3mm

493015.492615

Order Code	Price Each			
	1+	5+	10+	20+
<b>149-6334</b>	13.38	12.43	11.11	9.67

**Diagonal Cutter 70 VDE**



- The indispensable diagonal cutter for all-round use
- High quality material and precise workmanship for long service life
- Precision cutting edges for soft and hard wire
- Clean cutting at cutting edge tips; also in case of thin copper wires
- Cutting edges additionally induction hardened, cutting edge hardness approx. 62 HRC
- Narrow head style for use in confined areas
- Vanadium electric steel, oil-hardened and tempered
- Handles insulated with two-colour dual component handles
- VDE-tested according to **DIN EN 60 900**, 1000 V

Mfrs. Part No.	Head	Cutting performance wires Ø mm			Length mm	Weight g
		soft	medium	hard		
70 06 125		3.0	2.3	1.5	125	120
70 06 140		4.0	2.5	1.8	140	160
70 06 160		4.0	2.8	2.0	160	210
70 06 180		4.0	3.0	2.5	180	255

403064

	Mfrs. Part No.	Order Code	Price Each		
			1+	5+	10+
Diagonal cutting nipper	70 06 125	<b>348-3435</b>	14.50	14.05	13.65
Diagonal cutting nipper	70 06 140	<b>348-3459</b>	16.70	16.20	15.70
Diagonal cutting nipper	70 06 160	<b>348-3460</b>	17.95	17.40	16.85
Diagonal cutting nipper	70 06 180	<b>413-5490</b>	16.95	16.45	15.95

**High Leverage Diagonal Cutter 74 VDE**



- With forged-on axle for heaviest duty
- Suitable for all types of wire including piano wire
- High cutting performance with minimum effort due to optimum co-ordination of the cutting edge angle and transmission ratio
- Precision cutting edges additionally induction-hardened, cutting edge hardness approx. 64 HRC

**1000V Insulated Tools - continued**

**High Leverage Diagonal Cutter 74 VDE - continued**

- The 250-mm-long diagonal cutter is suitable for copper conductors up to 16 mm<sup>2</sup> and aluminium conductors up to 35 mm<sup>2</sup>
- Chrome Vanadium electric steel, oil-hardened and tempered
- With two-colour dual component handles, **1000V VDE-tested**
- According to **DIN ISO 5749**

Mfrs. Part No.	Head	Cutting Performance Ø (mm)			Length	Weight
		soft	medium	hard		
74 06 160	polished	3.4	2.0		160mm	215g
7406180	chromed	3.8	2.7	2.2	180mm	260g
7406200	chromed	4.2	3.0	2.5	200mm	305g
74 06 250	polished	4.6	3.0		250mm	440g

408250

Mfrs. Part No.	Order Code	Price Each		
		1+	5+	10+
74 06 160	<b>916-8419</b>	22.10	21.45	20.75
7406180	<b>348-3472</b>	21.65	21.00	20.35
7406200	<b>348-3484</b>	22.95	22.25	21.55
74 06 250	<b>916-8427</b>	32.30	31.35	30.35

**VDE Combicutter**



- Fully approved and independently audited by German VDE institute
- Individually tested to 10,000v
- Meets VDE 0682-0201, IEC 60900:2004, ASTM-F 1505-94
- Ergonomic handles for comfort and safety
- Hardened and precision ground for high performance
- Finished with Anti - glare coating
- 160mm Side cutter with additional Patress Screw Shearing hole
- Ideal for clean cutting of patress screws without damage to thread
- 180mm size also available

Mfrs. List No	Hard Wire	Capacity Ø(mm)		Length (mm)	Order Code
		Med/Hard Wire	Soft Wire		
431004	1.6	2.1	≥4.0	160	128-3255
431005	1.8	2.3	≥4.0	180	128-3256
T39071-1180	1.8	2.3	≥4.0	180	151-8932

448409.458304

Mfrs. List No.	Order Code	Price Each		
		1+	5+	10+
431004	<b>128-3255</b>	19.75	19.15	
431005	<b>128-3256</b>	24.35	23.60	
T39071-1180	<b>151-8932</b>	25.03	24.28	

**VDE Combicutter 2**



- Fully approved and independently audited by German VDE institute
- Individually tested to 10,000v
- Meets VDE 0682-0201, IEC 60900:2004, ASTM-F 1505-94
- Ergonomic handles for comfort and safety
- Hardened and precision ground for high performance
- Finished with Anti - glare coating
- 160mm Side cutter Wire Stripping notches

Mfrs. List No	Hard Wire	Capacity Ø(mm)		Length (mm)	Order Code
		Soft Wire			
431004	2.0	≥4.0		160	128-3255

448413.458358

Mfrs. List No.	Order Code	Price Each		
		1+	5+	10+
431009	<b>128-3257</b>	26.45	25.65	

**VDE Heavy Duty Side Cutters**



- Fully approved and independently audited by German VDE institute
- Individually tested to 10,000v
- Meets VDE 0682-0201, IEC 60900:2004, ASTM-F 1505-94
- Ergonomic handles for comfort and safety
- Hardened and precision ground for high performance
- Finished with Anti - glare coating
- Heavy duty design with higher cutting capacity
- Extra leverage for superior cutting performance
- Available in two different sizes

Mfrs. List No	Hard Wire	Capacity Ø(mm)		Length (mm)	Order Code
		Med/Hard Wire	Soft Wire		
431006	2.0	2.5	≥4.0	160	128-3259
431007	2.5	3.0	≥4.0	180	128-3260

448379

Mfrs. List No.	Order Code	Price Each		
		1+	5+	10+
431006	<b>128-3259</b>	23.45	22.75	
431007	<b>128-3260</b>	31.60	30.65	

**Side Cutter VDE/1000V**

With and without wire stripping function



- Manufactured in accordance with VDE 0682-0201 / IEC 60900:2004
- Each plier is individually tested to 10.000V to ensure completely safe working on live equipment up to 1000V
- Ergonomic handles for comfort and safety
- Hardened and precision ground cutting edges for high performance
- Anti glare and anti corrosion finish
- Total length: 160 mm
- Version 431019 only : with wire stripping notches for 1,5mm<sup>2</sup> and 2,5 mm<sup>2</sup>
- Cutting capacities: hard: 1,6 mm; soft: ≥ 4,0 mm

495897

Mfrs. List No.	Order Code	Price Each		
		1+	5+	10+
431017	<b>152-1876</b>	22.30	21.65	
431019	<b>152-1877</b>	26.80	26.00	

**Diagonal cutters Inomic® VDE**



Wiha. Premium Tools for Professionals.

- For cutting hard wires in the joint area and flush, burr-free cutting of soft wires, cables and plastics in the front cutting area.
- Innovative head with dual cutting function. Cutting edge with bevel near the joint, cutting edge without bevel in the front cutting area.
- Arms of the pliers move in parallel: +25% force transfer.
- With opening spring and locking mechanism.
- Head of pliers made of ball-bearing steel, hardened to approx. 60 HRC.

- Handles made of tough fibre-glass reinforced plastic, ergonomic soft grip zone in the handle
- Standards: IEC 60900:2004

441942

Mfrs. List No. / Length	cutting performance			Weight	Order Code	Price Each	
	soft	medium	hard			1+	5+
Z 12 9 16 160MM	4.0mm	2.8mm	2.0mm	140g	<b>124-2233</b>	19.82	18.16

45

Over 480,000 products online



Farnell

**Round Nose Pliers Type 22, VDE**



- For forming wire loops
- Precision ground, short, round jaws
- Smooth tips
- Special tool steel, oil-hardened and tempered
- With two-colour dual component handles, **1000V, VDE-tested**
- According to **DIN ISO 5745**

Mfrs. Part No.	Head	Length mm	Weight g
22 06 160	chrome-plated	160	170

403282

	Mfrs. Part No.	Order Code	Price Each		
			1+	5+	10+
Round Nose Plier	22 06 160	<b>413-2014</b>	15.50	15.05	14.55

**VDE Snipe Nose Pliers**



- Serrated jaws with cutter
- Chrome vanadium steel
- 2 colour handle with slip guard
- Individually tested to 10,000V
- Meets VDE 0682-0201, IEC 60900
- Available in two different sizes

Cutting Capacity: wire

Size	Soft	Med/Hard
160mm	2.5mm	1.6mm
200mm	2.8mm	1.8mm

493012.492598

Size	Order Code	Price Each			
		1+	5+	10+	20+
160mm	<b>149-6330</b>	10.53	9.77	8.73	7.60
200mm	<b>149-6331</b>	10.90	10.13	9.06	7.89

**VDE Bent Snipe Nose Plier**



- Serrated jaws with cutter
- Chrome vanadium steel
- 2 colour handle with slip guard
- Bent to 40°
- Individually tested to 10,000V
- Meets VDE 0682-0201, IEC 60900

Cutting Capacity: wire

Size	Soft	Med/Hard
200mm	2.8mm	1.8mm

493013.492609

Order Code	Price Each			
	1+	5+	10+	20+
<b>149-6332</b>	13.11	12.18	10.87	9.47

**Snipe Nose Side Cutting Pliers 25 VDE**  
Radio pliers



348-3393



916-8370

- Suitable for gripping and cutting work in precision mechanics
- Pointed, half-round jaws
- Serrated gripping surfaces
- With cutting edges for medium hard and hard wire
- Cutting edges additionally induction hardened, cutting edge hardness approx. 61 HRC
- High grade special tool steel, oil-hardened and tempered
- Handles: insulated with two-colour dual component handles **1000V VDE-tested**
- According to **DIN ISO 5745**

Mfrs. Part No.	Jaws	Head	Length	Weight
25 06 160	straight	chromed	160	150g
25 26 160	40°-bent	chromed	160	150g

403094

Description	Mfrs. Part No.	Order Code	Price Each		
			1+	5+	10+
Snipe Nose Side Cutting Pliers, straight jaws	25 06 160	<b>348-3393</b>	13.95	13.55	13.10
Snipe Nose Side Cutting Pliers, bent jaws	25 26 160	<b>916-8370</b>	19.00	18.45	17.85

**Snipe Nose Side Cutting Pliers 26 VDE**



**Stork Beak Pliers**



- High loadable, elastic precision points
- Half-round, long jaws
- Serrated gripping surfaces
- With cutting edges for medium hard wire max.  $\varnothing$  3.2 mm and hard wire max.  $\varnothing$  2.2 mm
- Cutting edges additionally induction hardened, cutting edge hardness approx. 61 HRC
- Vanadium steel, oil-hardened and tempered
- Handles: insulated with two-colour dual component handles, **1000V VDE-tested**
- According to **DIN ISO 5745**

Mfrs. Part No.	Form	Head	Length (mm)	Weight
26 16 200	straight jaws	chromed	200	205g
26 26 200	40° bent jaws	chromed	200	205g

403106

Mfrs. Part No.	Order Code	Price Each		
		1+	5+	10+
26 16 200	<b>348-3411</b>	17.80	17.25	16.75
26 26 200	<b>348-3423</b>	23.45	22.75	22.05

**VDE Snipe Nose Pliers**



- Fully approved and independently audited by German VDE institute
- Individually tested to 10,000v
- Meets VDE 0682-0201, IEC 60900:2004, ASTM-F 1505-94
- Ergonomic handles for comfort and safety
- Hardened and precision ground for high performance

- Finished with Anti - glare coating
- Serrated inside jaws with rod gripping hole and cutting edges
- Available in two different sizes

Mfrs. List No	Capacity $\varnothing$ (mm)		Length (mm)	Order Code
	Med/Hard Wire	Soft Wire		
431013	1.6	$\geq$ 4.0	175	128-3265
431014	1.6	$\geq$ 4.0	200	128-3266

448426.458376

Mfrs. List No.	Order Code	Price Each	
		1+	5+
431013	<b>128-3265</b>	16.25	15.75
431014	<b>128-3266</b>	18.50	17.95

**VDE Bent Nose Pliers**



- Fully approved and independently audited by German VDE institute
- Individually tested to 10,000v
- Meets VDE 0682-0201, IEC 60900:2004, ASTM-F 1505-94
- Ergonomic handles for comfort and safety
- Hardened and precision ground for high performance
- Finished with Anti - glare coating
- Length: 200mm
- Cutting capacity (mm  $\varnothing$ ) Med./Hard Wire: 1.6
- Cutting capacity (mm  $\varnothing$ ) Soft Wire:  $\geq$ 4.0

1000V Insulated Tools - continued

VDE Bent Nose Pliers - continued

448428.458378

Mfrs. List No.	Order Code	1+	5+	Price Each
431015	128-3267	19.95	19.35	

Needle nose pliers Inomic® VDE



- For gripping, holding, cutting and stripping. With improved access to the objects to be processed.
- Straight shape with blade and three stripping points 2.5 mm<sup>2</sup>, 1.5 mm<sup>2</sup>, 0.75 mm<sup>2</sup>. Parallel and crosswise profiling for gripping in all directions.
- Arms of the pliers move in parallel: +25% force transfer. With opening spring and locking mechanism.

- Head of pliers made of ball-bearing steel, hardened to approx. 60 HRC. Handles made of tough fibre-glass reinforced plastic, ergonomic soft grip zone in the handle.
- Standard: EN/IEC 60900:2004

441939

Mfrs. List No. / Length	cutting performance			Weight	Order Code	Price Each		
	medium	hard	Weight			1+	5+	10+
Z 06 9 16 160MM	2.5mm	1.6mm	150g	124-2231	20.16	18.48	17.06	

VDE Combination Pliers



- Chrome vanadium steel
- 2 colour handle with slip guard
- Individually tested to 10,000V
- Meets VDE 0682-0201, IEC 60900

Cutting Capacity: wire

Size	Soft	Med/Hard
180mm	2.8mm	2.5mm
200mm	3.0mm	2.8mm

493016.492621

Size	Order Code	1+	5+	10+	20+	Price Each
180mm	149-6336	11.08	10.28	9.18	8.00	
200mm	149-6337	11.74	10.89	9.74	8.48	

VDE-Combination Pliers



0106190

- With high-precision cutting edges for soft, hard and piano wire
- Long cutting edges for thicker cables
- Particularly wear resistant gripping jaws
- VDE-tested handles (1000V)
- Chrome Vanadium electric steel, oil-hardened and tempered

245683

Mfrs. Part No.	Head	Cutting value Ø mm		Length in mm	Weight in g
		soft	hard		
0106160	chromed	2.0	1.5	160	200
0106190	chromed	2.5	2.0	190	300

Length	Weight	Mfrs. Part No.	Order Code	1+	5+	10+	Price Each
160mm	200g	0106160	348-3216	22.45	21.80	21.10	
190mm	300g	0106190	348-3228	24.90	24.15	23.40	

High Leverage Combination Pliers Type 02 VDE



DIN ISO 5746



- for heaviest duty
- 35% saving in power due to new, improved lever action compared with conventional universal pliers
- with gripping zones for flat and round material, suitable for versatile use
- with cutting edges for soft, hard and piano wire
- long cutting edges for thicker cables
- cutting edges additionally induction hardened, cutting edge hardness approx. 64 HRC
- high grade special tool steel, oil-hardened and tempered
- insulated with two-colour dual component handles, 1000V VDE-tested

Mfrs. Part No.	Head	Cutting Values Ø mm		Length mm	Weight g
		hard	Piano		
02 06 180	polished	2.5	2.0	180	240
02 06 225	polished	3.0	2.5	225	405

403911

Mfrs. Part No.	Order Code	Price Each		
		1+	5+	10+
02 02 180	348-3230	15.65	15.20	14.70
02 06 225	413-1850	22.35	21.70	21.00

Combination Pliers Type 03 VDE



DIN ISO 5746



- with gripping zones for flat and round material, suitable for versatile use
- with cutting edges for soft and hard wire
- long cutting edges for thicker cables
- cutting edges additionally induction hardened, cutting edge hardness approx. ca. 60 HRC
- special tool steel, oil-hardened and tempered
- insulated with two-colour dual component handles 1000V, VDE-tested

Mfrs. Part No.	Head	Cutting Values Ø mm		Length mm	Weight g
		soft	hard		
03 06 160	chromed	3.1	2.0	160	220
03 06 180	chromed	3.4	2.2	180	265

403917

Mfrs. Part No.	Order Code	Price Each		
		1+	5+	10+
03 06 160	348-3320	16.25	15.75	15.30
03 06 180	348-3344	17.50	17.00	16.45

Combination Access Pliers VDE, 180mm



New

A development of combination pliers specially designed to give Electricians:

- Better access in tight situations
- Effectively grips the square nuts of gutter screws used on cable management systems and control boxes
- Hold pins and nails vertically for easy driving

Range Features

- Certified & approved by the world renowned VDE
- Each tool is tested to 10,000v for the complete assurance of safety when working on live equipment up to 1000v AC
- GS safety marked
- Ergonomic dual compound handle offering the perfect balance of grip and comfort
- Induction hardened and precision ground cutting edges for the ultimate in performance

525112

Mfrs. List No.	Order Code	Price Each		
		1+	5+	10+
Combination Access Pliers VDE T39077-180	166-0783	26.95	25.60	24.25

Coming soon



Register your interest for items that are 'Coming Soon' at [www.farnell.co.uk](http://www.farnell.co.uk) and we'll email you to let you know that they're in stock.





Combination Pliers



- Fully approved and independently audited by German VDE institute
- Individually tested to 10,000v
- Meets VDE 0682-0201, IEC 60900:2004, ASTM-F 1505-94
- Extra long cutting edges
- Induction hardened for use on medium and hard wire, round and flat cable
- Ergonomic handles for comfort and safety
- Hardened and precision ground for high performance
- Finished with Anti - glare coating

Mfrs. List No	Capacity		Length (mm)	Order Code
	Med/Hard Wire	Soft Wire		
431001	1.6	≥4.0	165	128-3252
431002	1.6	≥4.0	185	128-3253
431003	2.0	≥4.0	205	128-3254

448372.458803

Mfrs. List No.	Order Code	Price Each	
		1+	5+
431001	128-3252	18.25	17.70
431002	128-3253	19.20	18.60
431003	128-3254	20.30	19.70

Combination pliers Inomic® VDE



- For gripping, holding and cutting. With improved access to the objects to be processed.
- Innovative head with three parallel gripping surfaces at opening angles of 2°, 10° and 20° offers an improved and secure hold of the workpiece.
- Crosswise-profiled gripping surfaces with specially shaped teeth for gripping in all directions.
- Arms of the pliers move in parallel: +25% force transfer. With opening spring and locking mechanism.

- Head of pliers made of ball-bearing steel, hardened to approx. 60 HRC. Handles made of tough fibre-glass reinforced plastic, ergonomic soft grip zone in the handle.
- Standard: EN/IEC 60900:2004

441937

Mfrs. List No. / Length	cutting performance		Weight	Order Code	Price Each		
	medium	hard			1+	5+	10+
Z 01 9 16 180MM	3.3mm	2.2mm	155g	124-2229	19.82	18.16	16.77

Cable Shear



950-230

- not suitable for steel wire and hard drawn copper conductors
- precision ground, hardened blades
- no crushing, slight deformation of the cable only with guard
- for copper conductors single wire up to 16 mm<sup>2</sup>, multiple wire up to 50 mm<sup>2</sup>, fine stranded up to 70 mm<sup>2</sup> and aluminium conductors multiple wire up to 70 mm<sup>2</sup>
- easy cutting with one-hand operation due to high transmission ratio
- stainless - special grade - steel, oil-hardened and tempered
- VDE tested according to DIN EN/IEC 60900 : 2004

245771

Length	Weight	Mfrs. Part No.	Order Code	Price Each		
				1+	5+	10+
230mm	280g	9506230	348-3514	35.90	34.80	33.75

Diagonal Insulation Strippers 14 VDE



- The essential pliers for electrical installation work
- Precision stripping holes for single (solid) conductors of 1.5 and 2.5 mm<sup>2</sup>
- Induction hardened precision blades for soft wire up to 4.0 mm ∅, cutting edge hardness approx. 60 HRC
- Handles insulated with two-colour dual component handles, VDE-tested 1000V
- Vanadium electric steel, oil-hardened and tempered

Mfrs. Part No.	Stripping capacities	Stripping capacities	Length (mm)	Weight (g)
14 26 160	1,5 + 2,5 mm <sup>2</sup>	15 + 13 AWG	160	210

403079

Diagonal Insulation Strippers	Mfrs. Part No.	Order Code	Price Each		
			1+	5+	10+
	14 26 160	348-3370	29.50	28.60	27.75

VDE Wire Stripper



- Chrome vanadium steel
- 2 colour handle with slip guard
- Strips wire up to 5mm in ∅
- Individually tested to 10,000V
- Meets VDE 0682-0201, IEC 60900

493017.492645

Order Code	Price Each			
	1+	5+	10+	20+
149-6338	11.74	10.89	9.74	8.48

VDE Wire Stripping Pliers



- Fully approved and independently audited by German VDE institute
- Individually tested to 10,000v
- Meets VDE 0682-0201, IEC 60900:2004, ASTM-F 1505-94
- Ergonomic handles for comfort and safety
- Hardened and precision ground for high performance
- Finished with Anti - glare coating
- Ideal for repetitive wire stripping
- Features adjustable capacity and spring assisted opening
- Stripping capacity (mm∅) 0.3-5.0

448421.458371

Mfrs. List No.	Order Code	Price Each	
		1+	5+
431012	128-3264	20.30	19.70

Cable Cutter



95 36 280

1000V Insulated Tools - continued

Cable Cutter - continued

- for cutting copper and aluminium cables, single and multiple wire
- not suitable for steel wire and wire ropes
- precision ground, hardened blades
- clean and smooth cut without crushing and deformation
- one-hand operation using ratchet principle
- little handforce required due to very high transmission ratio
- two-stage ratchet drive for easy cutting
- simple handling as a result of low weight and compact design - can be used even in confined areas with guard
- special grade tool steel

240786

Length	Weight	Mftrs. Part No.	Order Code	Price Each		
				1+	3+	5+
mm250	560g	9536250	348-3538	124.80	121.05	--
mm280	735g	9536280	348-3540	165.90	160.90	--

VDE Waterpump Plier



- Six positions with groove joint
- Chrome vanadium steel
- 2 colour handle with slip guard
- Strips wire up to 5mm in Ø
- Individually tested to 10,000V
- Meets VDE 0682-0201, IEC 60900

Size  
250mm

Max Jaw Width  
36mm

493018.492646

Order Code	Price Each			
	1+	5+	10+	20+
149-6339	15.31	14.22	12.70	11.06

"Alligator" Water Pump Pliers Type 88 VDE  
DIN ISO 8976



- Box-joint design: high stability because of double guide
- Self-locking on pipes and nuts: no slipping on the workpiece and low handforce required
- Guard prevents operators' fingers being pinched
- Favourable lever action: optimum transmission of force
- Gripping surfaces with special hardened teeth, teeth hardness approx. 61 HRC: low wear and secure gripping
- Chrome Vanadium electric steel, oil-hardened and tempered

Handles insulated with two-colour dual component handles, VDE-tested according to EN 60 900	Capacities for Tubes		Working Capacities (mm)	Length (mm)	Weight (g)
	1 1/2	36			
	1 1/2	36	250	370	

405363

Mftrs. Part No.	Order Code	Price Each		
		1+	5+	10+
88 06 250	348-3502	21.75	21.10	20.45

VDE Waterpump Pliers



- Fully approved and independently audited by German VDE institute
- Individually tested to 10,000v
- Meets VDE 0682-0201, IEC 60900:2004, ASTM-F 1505-94
- Ergonomic handles for comfort and safety
- Hardened and precision ground for high performance
- Finished with Anti - glare coating
- Hot drop forged chrome vanadium steel, hardened and tempered
- Box joint construction for accurate setting and long life
- Slim head pattern for use in confined spaces
- A built in stop prevents finger nipping
- Length: 250mm
- Cutting capacity: 35mm

448429.471417

Mftrs. List No.	Order Code	1+	5+
431016	128-3268	36.50	35.40

Insulated Spanners Set, 8-Piece Set

In Tool Roll

IEC 60900:2004 The International Standard for Live Line Working Tools



Type Test Requirement

- Low Temperature Impact Test carried out at - 20°C
- Extreme Cold Climate, Category "C", Impact Test carried out at - 40°C
- Adhesion Test carried out after 168 hrs at 70°C
- Flame Retardant
- Indentation Test
- 100% Production Test
- 10KV for 3 minutes submerged in water

526851

Set, 8-piece	Mftrs. List No	Order Code	Price Each		
			1+	3+	5+
Insulated Spanner Set	IT.ISS8	165-5273	113.85	109.30	104.74
<b>Set Contents:</b>					
Open Ended Spanner 2BA	00970*				
Open Ended Spanner 13mm	00300	165-5289	11.33	10.87	10.40
Open Ended Spanner 17mm	00340	165-5290	13.71	13.15	12.63
Open Ended Spanner 19mm	00360	165-5291	15.84	15.22	14.59
Open Ended Spanner 24mm	00410	165-5293	17.39	16.72	15.99
Ring Spanner, 13mm	01080	165-5294	12.99	12.47	11.95
Ring Spanner, 17mm	01090	165-5295	14.28	13.71	13.15
Ring Spanner, 19mm	01120	165-5296	21.58	20.70	19.87

\* Not available as single product

Insulated Socket Set 1/2", 12 Pieces

IEC 60900:2004 The International Standard for Live Line Working Tools

In Metal Box



Type Test Requirement

- Low Temperature Impact Test carried out at - 20°C
- Extreme Cold Climate, Category "C", Impact Test carried out at - 40°C
- Adhesion Test carried out after 168 hrs at 70°C
- Flame Retardant
- Indentation Test
- 100% Production Test
- 10KV for 3 minutes submerged in water

524480

Set, 12-piece	Mftrs. Part No	Order Code	Price Each		
			1+	3+	5+
Insulated Socket Set 1/2"	IT.SKTS12	165-5274	201.83	193.75	185.68
<b>Set Contents:</b>					
Insulated Reversible Ratchet	IT/RR	165-5297	70.17	67.38	64.58
Insulated Extension Bar, 125mm	IT/RR/E5	165-5298	17.96	17.23	16.51
Insulated Socket, 8mm	01330	165-5299	10.30	9.88	9.47
Insulated Socket, 10mm	01350	165-5300	8.90	8.54	8.18
Insulated Socket, 13mm	01380	165-5301	9.32	8.95	8.59
Insulated Socket, 17mm	01420	165-5302	9.88	9.47	9.11
Insulated Socket, 19mm	01440	165-5303	10.30	9.88	9.47
Insulated Socket, 20mm	01450	165-5304	10.56	10.14	9.73
Insulated Socket, 3/8 A/F	01570	165-5305	8.54	8.18	7.87
Insulated Socket, 1/2 A/F	01590	165-5306	8.64	8.28	7.97
Insulated Socket, 3/4 A/F	01630	165-5307	9.52	9.16	8.75
Insulated Socket, 7/8 A/F	01650	165-5308	9.78	9.37	9.01

Troubleshooting tips



Chat live online to one of our technical engineers at [www.farnell.co.uk](http://www.farnell.co.uk)

VDE Insulated Socket Set



- A 9-piece 1/2" square drive insulated socket set which is equivalent to 26 pieces
- Sockets are designed to drive on the flats not corners which enables them to suit metric/imperial, A/F, Whitworth, BSF and BA hexagon nuts and bolts
- Manufactured from high grade chrome vanadium steel which are insulated using two contrasting insulating layers
- Manufactured to VDE standard and supplied complete in high visibility plastic case
- 1/2" drive reversible ratchet has a socket locking facility quick release button

Contents: 1/2" Ratchet, 10, 13, 14, 16, 17, 19, 20/21mm, 12mm Extension bar

mm	Compatibility Socket Sizes						
	10	13	14	16	17	19	20/21
A/F	3/8	1/2	9/16	5/8	11/16	3/4	25/32 / 13/16
BSW			1/4	5/16		3/8	7/16
BSF			5/16	3/8		7/16	1/2

494131

Mftrs. List No.	Order Code	Price Each			
		1+	5+	10+	20+
144-0001	151-8529	209.81	205.62	201.42	199.32

Screwdrivers

BS60900



Blade Size (mm)	Dia. over Insulation (mm)	Handle Size (mm)	Overall Length (mm)	Order Code
<b>Terminal Screwdrivers - Fluted Handle - Parallel Blade</b>				
75x 3	5	75 x 13	150	108-000
100x3	5	75 X 13	175	108-001
<b>Electricians Screwdrivers - Fluted Handle - Parallel Blade</b>				
152x5	8	75 X 19	227	108-003
203x5	8	75 X 19	279	108-004
<b>Engineers Screwdrivers - Fluted Handle - Parallel Blade</b>				
152x8	13	102 X 25	254	108-006
245x10	14	114 X 32	368	108-008
<b>Pozidriv Screwdrivers</b>				
75x No. 1	6	75 X 19	150	108-013
100x No. 2	8	90 X 25	190	108-014
150x No.3	12	100 X 25	250	108-015
<b>Phillips Screwdrivers</b>				
75x No. 1	6	75 X 19	150	108-347
100x No. 2	8	90 X 25	190	108-348
150x No. 3	12	100 X 25	250	108-349

401892

Mftrs. List No.	Length (mm)	Tip Size (mm)	Order Code	Price Each
<b>Terminal Screwdrivers</b>				
IT.18/3	75	3	165-5284	3.16
IT18/4	100	3	108-001	3.30
<b>Electricians' Screwdriver</b>				
ITX500/6	152	5	108-003	6.54
ITX500/8	203	5	108-004	7.27
<b>Pozidriv Screwdrivers</b>				
IT.PX1/3	75	No. 1	165-5287	6.16
IT.PX2/4	100	No. 2	165-5288	7.66
IT/PX3/6	150	No. 3	108-015	11.10
<b>Phillips Screwdrivers</b>				
ITPH1/3	75	No. 1	108-347	7.69
ITPH2/4	100	No. 2	108-348	9.20
ITPH3/6	150	No. 3	108-349	11.10

Premium service without a premium price



With thousands of prices already reduced, go online to see our most up-to-date pricing: [www.farnell.co.uk](http://www.farnell.co.uk)

VDE Insulated Screwdrivers - 1000V



dextro



New



- Designed in conjunction with professional electricians - optimised for specific tasks
- Extra response, extra feel and extra speed
- Long, fine neck for ultimate fingertip control
- Ergonomically shaped smooth, round head to allow it to pivot easily in the palm of the hand
- Ridges along the head for that last 1/4 turn of power when tightening down
- Range features Grip-Tip™ technology\* - specially designed ribs positively engage with the screw slot to reduce the risk of Cam-out and slipping
- Fully insulated to offer safe 1000V live working
- Full compliance with European Standard IEC 60900:2004
- Individually tested to 10,000V
- Certified and independently audited by the German VDE institute for 100% safety
- GS safety approved
- Permanent tip type marking on the end of the handle for convenient identification
- Non-roll flats - won't roll off uneven surfaces
- Precision machine tip for ultimate screw fit and high torque output
- Toughened, high alloy steel blade for excellent wear resistance
- Torque performance substantially in excess of the international standard requirements

	Tip size	Blade length (mm)	Mftrs. List No.	Order Code
<b>Slotted</b>				
	2.5	75	T49144-025	166-4278
	3	100	T49144-030	166-4279
	3.5	100	T49144-035	166-4280
	4	100	T49144-040	166-4282
	5.5	125	T49144-055	166-4283
	6.5	150	T49144-065	166-4284
	8	175	T49144-080	166-4285
	10	200	T49144-100	166-4286
<b>Phillips</b>				
	PH0	60	T49142-0	166-4267
	PH1	80	T49142-1	166-4269
	PH2	100	T49142-2	166-4271
	PH3	150	T49142-3	166-4272
<b>Pozidriv</b>				
	PZ0	60	T49143-0	166-4273
	PZ1	80	T49143-1	166-4274
	PZ2	100	T49143-2	166-4275
	PZ2	200	T49143-2200	166-4276
	PZ3	150	T49143-3	166-4277
<b>Modulo</b>				
	No.1	75	T49145-1	166-4265
	No.2	100	T49145-2	166-4266

526889

Mftrs. List No.	Order Code	1+	5+	10+
<b>Slotted</b>				
T49144-025	166-4278	3.50	3.40	3.30
T49144-030	166-4279	3.75	3.65	3.55
T49144-035	166-4280	3.75	3.65	3.55
T49144-040	166-4282	4.30	4.15	4.05
T49144-055	166-4283	4.95	4.80	4.65
T49144-065	166-4284	5.40	5.25	5.10
T49144-080	166-4285	7.00	6.80	6.60
T49144-100	166-4286	9.00	8.75	8.45
<b>Phillips</b>				
T49142-0	166-4267	3.60	3.50	3.40
T49142-1	166-4269	4.20	4.05	3.95
T49142-2	166-4271	4.75	4.60	4.45
T49142-3	166-4272	6.85	6.65	6.45
<b>Pozidriv</b>				
T49143-0	166-4273	3.75	3.65	3.55
T49143-1	166-4274	4.50	4.35	4.25
T49143-2	166-4275	5.40	5.25	5.10
T49143-2200	166-4276	6.75	6.55	6.35
T49143-3	166-4277	7.80	7.55	7.35
<b>Modulo</b>				
T49145-1	166-4265	4.50	4.35	4.25
T49145-2	166-4266	5.40	5.25	5.10

1000V Insulated Tools - continued

8 Piece VDE Insulated Screwdrivers Sets - dextro



- Designed in conjunction with professional electricians - optimised for specific tasks
- Extra response, extra feel and extra speed
- Long, fine neck for ultimate fingertip control
- Ergonomically shaped smooth, round head to allow it to pivot easily in the palm of the hand
- Ridges along the head for that last ¼ turn of power when tightening down
- Range features Grip-Tip™ technology\* - specially designed ribs positively engage with the screw slot to reduce the risk of Cam-out and slipping
- Fully insulated to offer safe 1000V live working
- Full compliance with European Standard IEC 60900:2004
- Individually tested to 10,000V
- Certified and independently audited by the German VDE institute for 100% safety
- GS safety approved
- Permanent tip type marking on the end of the handle for convenient identification
- Non-roll flats - won't roll off uneven surfaces
- Precision machine tip for ultimate screw fit and high torque output
- Toughened, high alloy steel blade for excellent wear resistance
- Torque performance substantially in excess of the international standard requirements

Content 166-4290

2.5x75 mm
4.0x100 mm
5.5x125 mm
6.5x150 mm
PH 0x60 mm
PH 1x80 mm
PH 2x100 mm
Mainstester 3.0x65 mm

Content 166-4291

2.5x75 mm
4.0x100 mm
5.5x125 mm
6.5x150 mm
PZ 0x60 mm
PZ 1x80 mm
PZ 2x100 mm
Mainstester 3.0x65 mm

526873

Mfrs. List No.	Order Code	1+	5+	10+
T49192	166-4290	29.85	28.95	28.05
T49193	166-4291	30.80	29.90	28.95

VDE Insulated Terminal Screwdrivers Set - dextro 1000V



- Designed in conjunction with professional electricians - optimised for specific tasks
- Extra response, extra feel and extra speed
- Long, fine neck for ultimate fingertip control
- Ergonomically shaped smooth, round head to allow it to pivot easily in the palm of the hand
- Ridges along the head for that last ¼ turn of power when tightening down
- Fully insulated to offer safe 1000V live working
- Full compliance with European Standard IEC 60900:2004
- Individually tested to 10,000V
- Certified and independently audited by the German VDE institute for 100% safety
- GS safety approved
- Permanent tip type marking on the end of the handle for convenient identification
- Non-roll flats - won't roll off uneven surfaces
- Precision machine tip for ultimate screw fit and high torque output
- Toughened, high alloy steel blade for excellent wear resistance
- Torque performance substantially in excess of the international standard requirements

Content: Terminal screwdriver size 1x75 mm and 2x100 mm

526876

Mfrs. List No.	Order Code	1+	5+	10+
T49146	166-4287	8.90	8.65	8.35

VDE Insulated screwdriver



Series 100 VDE



- Lasertip®
- Insulated blade for safe working up to 1000V
- Kraftform® with anti-roll protection for fatigue-proof and faster screwing

334208

Type	Size	Order Code	1+	5+	10+	
Slotted	6100	2.5 x 80	311-0588*	4.01	3.71	3.35
	6105	3.0 x 100	311-0590*	4.17	3.86	3.55
	6110	3.5 x 100	311-0606	4.26	3.95	3.60
	6115	4.0 x 100	311-0618	5.23	4.81	4.45
	6120	5.5 x 125	311-0620	6.29	5.83	5.32
	6125	6.5 x 150	311-0631	7.69	7.12	6.52
	6130	8.0 x 175	311-0643	9.59	8.88	8.14
	Phillips (PH)	6150	PH0 x 80	311-0540*	4.56	4.22
6151		PH1 x 80	311-0552	5.77	5.35	4.90
6154		PH2 x 100	311-0564	7.84	7.26	6.66
6155		PH3 x 150	311-0576	7.26	6.72	6.16
Pozidriv (PH)		6160	Pozidriv No.0 x 80	443-2988*	4.71	4.48
	6162	Pozidriv No1 x 80	443-2990	5.42	5.12	4.86
	6164	PZ No.2 x 100	443-3002	7.67	7.29	6.91
	6166	Pozidriv No 3 x 150	443-3014	10.14	9.63	9.13
	*not available as Lasertip® version. Delivered with Standard blade.					

Safety screwdriver set



Kraftform® Plus Series 100



- With Lasertip blade, voltage tester and rack
- For slotted and Phillips screws
- 7 piece set in display carton + rack

Content: each	
Slotted	0.4x2.5x80; 0.6x3.5x100; 0.8x4.0x100; 1.0x5.5x125
Phillips	PH 1x80; PH 2x100
voltage tester	0.5x3.0x70

334209

Type	Order Code	1+	5+	10+
160 I/7	443-3026	27.59	26.20	24.83

45

6 Piece VDE Insulated Screwdrivers Sets - dextro 1000V



- Designed in conjunction with professional electricians - optimised for specific tasks
- Extra response, extra feel and extra speed
- Long, fine neck for ultimate fingertip control
- Ergonomically shaped smooth, round head to allow it to pivot easily in the palm of the hand
- Ridges along the head for that last ¼ turn of power when tightening down
- Range features Grip-Tip™ technology\* - specially designed ribs positively engage with the screw slot to reduce the risk of Cam-out and slipping
- Fully insulated to offer safe 1000V live working
- Full compliance with European Standard IEC 60900:2004
- Individually tested to 10,000V
- Certified and independently audited by the German VDE institute for 100% safety
- GS safety approved
- Permanent tip type marking on the end of the handle for convenient identification
- Non-roll flats - won't roll off uneven surfaces
- Precision machine tip for ultimate screw fit and high torque output
- Toughened, high alloy steel blade for excellent wear resistance
- Torque performance substantially in excess of the international standard requirements

Content 166-4288

2.5x75 mm
4.0x100 mm
5.5x125 mm
PH 1x80 mm
PH 2x100 mm
Mainstester 3.0x65 mm

Content 166-4289

2.5x75 mm
4.0x100 mm
5.5x125 mm
PZ 1x80 mm
PZ 2x100 mm
Mainstester 3.0x65 mm

526875

Mfrs. List No.	Order Code	1+	5+	10+
T49182	166-4288	21.75	21.10	20.45
T49183	166-4289	22.55	21.85	21.20



**VDE screwdriver set**  
7 pcs set in display carton



- Screwdriver Set Kraftform Plus Series 100 + Voltage Tester + Rack
- For slotted and Phillips screws

Content: each	
	2,5 x 80mm; 3,5 x 100mm 4,0 x 100mm; 5,5 x 125mm
	PH1/80; PH2/100
1 voltage tester	

475514

Type	Order Code	Price Each		
1160/7	133-7752	1+	5+	10+
		19.65	17.86	16.37

**Kraftform Kompakt® VDE**



120-0039



120-0040

- VDE tools for mobile applications
- 1000V-Insulated Kraftform® handle with hexagonal nest for blades
- Insulated exchangeable blades (154 mm long) suitable for working at voltages up to 1000 V AC and 1500 V DC. They fulfil all requirements corresponding to national and international standards (IEC 60900:2004 or DIN EN 60900)
- Practical belt-pouch: all tools constantly at hand
- Compact, light and handy: one handle and different blades (including the PlusMinus-profile)

	Content:	
	7 pieces set	18 pieces set
VDE-Blades	120-0040	120-0039
	0,4 x 2,5mm; 0,6 x 3,5mm; 0,8 x 4,0mm; 1,0 x 5,5mm	0,4 x 2,5mm; 0,6 x 3,5mm; 0,8 x 4,0mm; 1,0 x 5,5mm
	PH1; PH2	PH1; PH2
		PZ1; PZ2
		PH/S#1; PH/S#2
		PZ/S#1; PZ/S#2
		Switch key wrench square 6mm
		Switch key wrench square 8mm
		Switch key wrench triangular
		Switch key wrench double pin
		Voltage tester
Handle type:	1 Handle 817 VDE Kraftform®	

435026

Mftrs List No.	Order Code	Price Each		
KRAFTFORM KOMPAKT VDE 60I/62I/65I/18	120-0039	1+	5+	
KRAFTFORM KOMPAKT VDE 60I7	120-0040	42.11	40.04	21.62

**1000V Screwdriver with Bit Magazine**  
8 different bits



162-8090



Wiha. Premium Tools for Professionals.

- Insulation up to 1000 V AC
- Blade made of high grade chrome-vanadium steel, through hardened
- Insulation moulded directly onto blade
- Ergonomic Wiha SoftFinish® multi-component handle with roll-off protection
- Stainless steel bits with strong magnet
- According to DIN 3126, ISO 1173, style D 6.3
- Bit length: 25 mm
- Alternative to a screwdriver set

Contained bits:	
	6.5mm; 4.5mm
	PH1; PH2; PH3
	PZ1; PZ2; PZ3

518346

Mftrs. List No.	Order Code	Price Each		
38090201	162-8090	1+	5+	10+
		17.25	16.40	15.55

**Screwdriver Slotted VDE, 320 N Series**



Wiha. Premium Tools for Professionals.



- Wiha SoftFinish handle
- Insulation moulded directly onto blade
- Manufactured according to DIN EN 60900, VDE IEC 900 to 1000 Volts
- Tested to the professional "GS" standard
- Blade through hardened

Blade: Chrome Vanadium Molybdenum

Mftrs. Part No.	Tip Size	Blade Length	Length
320n-2.5	2.5mm	75	150
320N-3.0	3mm	100	175
320N-3.5	3.5mm	100	180
320N-4.0	4mm	100	190
320N-5.5	5.5mm	125	215
320N-6.0	6mm	150	250
320N-8.0	8mm	175	285

241203

Mftrs. Part No.	Order Code	Price Each		
320n-2.5	401-7304	1+	5+	
320N-3.0	831-232	2.88	2.66	3.16
320N-3.5	831-244	3.44	3.32	3.96
320N-4.0	831-256	4.32	5.11	5.42
320N-5.5	831-281	5.57	5.42	6.83
320N-6.0	831-300	5.91		
320N-8.0	831-323	7.48		

**Screwdriver Phillips VDE**  
21N Series



Wiha. Premium Tools for Professionals.

45



- Wiha SoftFinish handle
- Insulation moulded directly onto blade
- Manufactured according to DIN EN 60900, VDE IEC 900 to 1000 Volts
- Tested to the professional "GS" standard
- Blade through hardened

Mftrs. Part No.	Blade Length	Length
321 N 0	60	164
321 N 1	80	191
321 N 2	100	218

241247

Mftrs. Part No.	Order Code	Price Each		
321 N 0	381-2455	1+	5+	
321 N 1	381-2467	3.34	3.07	3.69
321 N 2	381-2479	4.03	5.06	4.66

**Hex Nutdriver VDE, 322 Series**



Wiha. Premium Tools for Professionals.



- Wiha SoftFinish handle
- Insulation moulded directly onto blade
- Manufactured according to DIN EN 60900, VDE IEC 900 to 1000 Volts
- Tested to the professional "GS" standard
- Blade through hardene
- Deep drawn socket



1000V Insulated Tools - continued

Hex Nutdriver VDE, 322 Series - continued

Mftrs. Part No.	Blade Length	Total Length
322-5.5	125	215
322-7.0	125	225
322-8.0	125	225
322-10.0	125	225
322-13.0	125	235

246080

Mftrs. Part No.	Order Code	Price Each		
		1+	5+	10+
322-5.5	831-505	6.36	5.85	5.30
322-7.0	831-529	7.42	6.79	6.16
322-8.0	831-530	7.85	7.17	6.51
322-10.0	831-554	7.82	7.16	6.50
322-13.0	831-580	10.59	9.68	8.79

Screwdriver Set Slotted and Phillips VDE



Wiha. Premium Tools for Professionals.



- Wiha SoftFinish handle, 6 pieces
  - Insulation moulded directly onto blade
  - Manufactured according to DIN EN 60900, VDE IEC 900 to 1000 Volts
  - Tested to the professional "GS" standard
  - Blade through hardened
- Content:  
Slotted: 3.0 x 100; 4.0 x 100  
5.5 x 125; 6.5 x 150  
Phillips: 1 x 80; 2 x 100

241128

Mftrs. Part No.	Order Code	Price Each	
		1+	5+
320NK6	831-335	27.08	25.18

Screwdriver Set - VDE



11 piece fully insulated screwdriver set containing Parallel tip, Phillips and Pozidriv screwdrivers manufactured and individually certified to EN60900 : 1994. Tested to 10KV, suitable for working on live circuits of 1kV (A.C.) and 1.5 kV (D.C.). Chrome vanadium steel blades hardened, tempered and chemically blacked. Fully insulated ergonomic handle soft grip handle with deep set blade sheath for total safety

Contents:  
75 x 2.5, 100 x 3.0, 125 x 4.0, 125 x 5.5, 150 x 6.5mm, No. 0 x 60, No. 1 x 80, No.2 x 100, No. 0 x 60, No.1 x 80 and No.2 x 100

493906

Order Code	Price Each		
	1+	5+	10+
135-9499	33.90		

Ergonomic VDE Screwdrivers



- Set of Ergo screwdrivers for work on live equipment up to 1000 volts
  - Meet all criteria for IEC900, EN60900 & DIN-EN 60900
  - Three component handles: combines strong core with good grip
  - Blade fine polished vanadium - extra, bright chrome plated, entirely hardened, & tip black oxidised
- 5 Piece Set Contains:  
Slotted 0.5 x 3 x 100, 0.8 x 4 x 100, 1 x 5.5 x 125  
Phillips No. 1 x 80, No 2 x 100

231780

Mftrs. List No.	Order Code	Price Each	
		1+	5+
BE-9881S	352-4164	29.40	

VDE Screwdriver Sets



- Tested to 1000V
- Handle moulded direct to bar for durability
- High grade steel bar allows for high torque and reduce the chance of tip breakage
- Anti-slip soft grip handle provides excellent comfort and grip
- Large diameter handle offers extra torque for driving screws
- Smooth domed end for spinning speed and comfort
- Colour coded ends for easy identification



Contents:  
**6 Piece:** Parallel: 2.5 x 50, 3.5 x 75, 5.5 x 150mm Phillips: PH1 x 100, PH2 x 125mm and 1 x Voltage tester  
**10 Piece:** Parallel: 2.5 x 50, 3.5 x 75, 5.5 x 150mm Phillips: PH0 x 75, PH1 x 100, PH2 x 125mm Pozidriv: PZ0 x 75, PZ1 x 100, PZ2 x 125mm 1 x Voltage tester and carry case

495874.495864

Sets	Mftrs. List No.	Order Code	Price Each	
			1+	5+
6 Piece	0-65-441	152-0955	20.87	19.22
10 Piece	5-62-573	152-0962	25.30	23.39

FatMax XL 6PC VDE Screwdriver Set



- Tested to 1000V
  - Handle moulded direct to bar for durability
  - High grade steel bar allows for high torque and reduce the chance of tip breakage
  - Anti-slip soft grip handle provides excellent comfort and grip
  - Large diameter handle offers extra torque for driving screws
  - Smooth domed end for spinning speed and comfort
  - Colour coded ends for easy identification
- Contents:  
Parallel: 2.5 x 50, 3.5 x 75, 5.5 x 150mm Phillips: PH1 x 100, PH2 x 125mm and 1 x Voltage tester



495876.495868

Mftrs. List No.	Order Code	Price Each	
		1+	5+
0-66-309	152-0960	27.21	25.07

Electronic Screwdrivers



AYB.J Borneo® Combination Head Screwdriver Sets For Electrical Terminals



Supplied in box.

487144

No. of Screw-Drivers	Content	Order Code	Price Each			
			1+	5+	10+	20+
4	Pozidriv®: 1x100, 2x125 Phillips: 1x100, 2x125	137-5445	32.61	31.95	31.31	30.31

VDE Modulo Terminal Screwdriver Set



- Ergonomic dual compound handle offering grip and comfort
- Contoured blade insulation for better access
- Toughened high alloy steel blade for high wear resistance
- Precision machine tip for ultimate screw fit and high torque output
- Non - roll flats, won't roll off uneven surfaces
- Permanent tip type marking on the end of the handle for convenient identification
- Pack of two: 1pt x 80 and 2pt x 100

448552

Mftrs. List No.	Order Code	Price Each	
		1+	5+
440003	128-3247	10.30	10.00

**Insulated Hacksaws**

IEC 60900:2004 The International Standard for Live Line Working Tools



**Type Test Requirement**

- Low Temperature Impact Test carried out at - 20°C
- Extreme Cold Climate, Category "C", Impact Test carried out at - 40°C
- Adhesion Test carried out after 168 hrs at 70°C
- Flame Retardant
- Indentation Test
- 100% Production Test
- 10KV for 3 minutes submerged in water

524481

	Mftrs. List No.		Order Code	Price Each		
	Blade	Overall		1+	3+	5+
Junior Hacksaw	IT/HSFJ	150mm 270mm	<b>165-5275</b>	39.90	37.90	35.95
Hacksaw 12"	IT/HSF12	300mm 480mm	<b>165-5276</b>	9.90	9.40	8.90

**Tape Measure ,3M, Non-Conductive**



524485

	Length	Mftrs. List No.	Order Code	Price Each		
				1+	3+	5+
Non-Conductive Tape Measure	3m	IT/3MT	<b>165-5277</b>	33.17	31.83	30.53

**Electricians Gloves**



- for protection when working live or close to live parts
- classification: 0
- tested according to DIN EN/ IEC 60903

404701

Mftrs. Part No.	Size	Order Code	Price Each		
			1+	5+	10+
98 65 40	9	<b>916-8575</b>	37.70	36.55	35.45
98 65 41	10	<b>916-8583</b>	36.55	35.45	34.35

**Insulating Mat**



- for protection when working live or close to live parts
- tested according to VDE 0680/1

404702

Mftrs. Part No.	Dimensions	Thickness	Order Code	Price Each		
				1+	5+	10+
98 67 05	500 x 500mm	1,6mm	<b>916-8591</b>	36.55	35.45	34.35

**Cutters - Cable**



- Sturdy wire and cable cutting scissors
- Stainless steel
- Comfortable plastic bows
- Wire stripping notch
- Length: 140mm

419484, 422826

Mftrs list no.	Order Code	Price Each
492001	<b>109-8807</b>	1+ 10.30

**Cable Shears Type 9505**



- For universal use; cuts cables up to 10 mm  $\varnothing$  / 24 mm<sup>2</sup>
- With opening spring and locking lever
- Blades made of stainless steel
- Oil-hardened and tempered

Mftrs. Part No.	Cutting performances Copper/Aluminium $\varnothing$ mm/mm <sup>2</sup>	Length
95 05 165	10/24	165

240781

Mftrs. Part No.	Order Code	Price Each		
		1+	5+	10+
95 05 165	<b>876-331</b>	15.05	14.60	14.15

**Combination Shears**



- Combination shears for cutting cardboard, plastics, aluminium, brass and copper foils
- Not suitable for steel wire or iron sheets
- Precision ground, hardened blades
- With opening spring and locking lever
- With guard
- Adjustable screw joint
- Blades made of stainless steel
- Oil-hardened and tempered

Material: stainless steel Handles: plastic coated  
Length: 190mm Weight: 110g

245803

Mftrs. Part No.	Order Code	1+	+	+
9505190	381-4026	<b>11.65</b>	--	--

**Cutter**

**Stainless Steel**



- General purpose stainless steel cutter
- Suitable for cutting a wide range of materials: plastic, cable, wire, laminate, tinplate, leather, etc.

222901

Order Code	Price Each
<b>313-3400</b>	1+ 5.72

**Cutters - Cable - continued**

**Long Bladed Shear**



- Combines long cut of tinner's snips with the strength of compound action
- Great for making long, fast cuts in several types of material including: plastic, sheet metal, aluminium, vinyl siding and screening
- Compound action multiplies the force of the hand by 5 times
- Cuts up to 20-gauge steel
- Non-slip, serrated jaws and non-slip textured grips

225355

Mfrs. List No.	Order Code	Price Each
M300	722-2075	1+ 22.00

**Kevlar Cutter**



- Designed to cut through Kevlar fibres.
- High carbon steel blades.
- ESD safe non-slip grips to cushion the hands
- Ideal for many other applications such as cutting insulation, cables, ties, and corded material of all types.

247420

Mfrs. List No.	Order Code	1+	5+	10+	20+
HS6000	385-2003	43.30	41.55	39.85	38.10

45

**Cable Cutters**



- 2-component handle with slip guard
- Shock proof handle
- Drop forged, heat treated fully polished steel
- Available in two sizes: 160mm or 210mm

493008.492579

Size	Order Code	Cutting Capacity: wire			
		Copper	Aluminium	12mm	14mm
160mm	149-6325	12.10	11.23	10.04	8.73
210mm	149-6326	13.63	12.66	11.30	9.84

**Cable Shear Typ 951**



- for cutting copper and aluminium cables, single and multiple wire
- not suitable for steel wire and hard drawn copper conductors
- precision ground, hardened blades
- clean and smooth cut without crush-

- ing and deformation
- easy cutting with one-hand operation with guard
- adjustable screw joint, self-locking
- forged
- special tool steel, oil-hardened and tempered
- universal use for dismantling and stripping

242844

Mfrs. Part No.	Head	Cutting Performance Copper $\varnothing$ mm/mm <sup>2</sup>	Length
95 12 165	browned	15/50	165

Mfrs. Part No.	Order Code	1+	5+	10+
95 12 165	876-318	22.45	21.80	21.10

**Cable Cutting Pliers**



Cable/wire stripping pliers that can both cut and strip copper/aluminium cables. Manufactured from carbon steel with all surfaces phosphated and heads with mirror polish finish. Handles are PVC coated.

356990

Model	Stripping Capacity (mm)	Cutting Capacity (mm)	Order Code	Price Each
2233D-160	10	50/35	429-7040	16.35
2233D-200	13	70/50	429-7052	20.05
2233D-240	16	95/70	429-7064	22.70

**Cable Cutters**

Red Line



- For one handed use on cables up to 14mm /  $\frac{9}{16}$ " in dia (50mm<sup>2</sup>)
- Compact but extremely powerful on copper and aluminium cable
- Razor sharp edges cut cleanly through cable with no 'squeeze', additional knife like edges can also split insulation with ease
- Not suitable for steel wire

214189

Length	Order Code	Price Each
160mm	725-4301	1+ 26.55

**Cable Shear**



- for cutting copper and aluminium cables, single and multiple wire
- not suitable for steel wire and hard drawn copper conductors
- precision ground, hardened blades
- clean and smooth cut without crushing and deformation
- easy cutting with one-hand operation
- initial and final cut (upper and lower blade) allows cables of up to 20 mm dia. to be cut
- low handforce required due to favourable lever ratio and new blade geometry with guard
- adjustable screw joint, self-locking
- forged
- special tool steel, oil-hardened and tempered

Material:

Mfrs. Part No.	Head	Cutting Performance		Length	Weight
		$\varnothing$ mm	mm <sup>2</sup>		
95 12 200	burnished	20	70	200	340
95 16 200	Chrome Plated	20	70	200	345

242844

Description	Mfrs. Part No.	Order Code	1+	5+	10+
Cable Shear	95 12 200	413-2075	34.75	33.70	32.65
Cable Shear	95 16 200	876-320	37.00	35.90	34.80





**Universal pliers for Data Cable STP**



- for cutting the whole cable, the single conductor, the shield and the plastic core
- steel point at the joint for longitudinal scratching of the shield foil
- prismatic blades below the joint for dismantling the cables
- special tool steel, oil-hardened

404697

Mftrs. Part No.	Length	Order Code	1+	5+	10+
13 72 160 SB	160mm	916-8362	32.17	29.28	26.82

**Cutter for Ribbon Cables Type 94**



- for crushing-free cutting of ribbon cable up to 56 mm width
- exchangeable cutting base with fence angle for rectangular cuts
- replaceable, conventional trapezoidal blade
- with opening spring and locking lever
- handles and blade mounting made of high-strength special grade steel

Type	Head	Cutting performance	Length
94 15 215	chrome plated	Ribbon cable	215
94 19 215	spare blade	up to 58mm	

245801

Type	Order Code	1+	5+	10+
94 15 215	876-290	49.25	47.75	46.30
94 19 215	876-306	7.80	7.55	7.35

**Wire Rope Cutter**



- for medium hard wire up to 6 mmdia., e.g. Bowden cords, but also for cables and steel rods
- with opening spring and locking lever
- cutting edges additionally induction hardened
- special blade geometry prevents the wire rope fanning out

Typ	Schneidleistung Cu + Al mm <sup>2</sup>	Ø mm Drahtseil	Ø mm Eisen	Länge (mm)
95 61 190	10	6	4	190

404698

Mftrs. Part No.	Order Code	1+	5+	10+
95 61 190	916-8486	25.05	24.30	23.55

**FREE global legislation support**



RoHS, REACH, WEEE, EuP, Batteries Directive - we've got it covered at: [www.global-legislation.com](http://www.global-legislation.com)

**Wire Rope Cutter**



- Professional tool which will cut wire rope, fencing wire, barbed wire, Bowden cable etc
- Angled blades for clean cut
- Comfortable grips

Cutting Capacity (mm) Ø	6mm High Tensile Steel	4mm
Stranded Mild Steel	2mm Mild Steel	4mm

225196

Overall Length	Order Code	Price Each
190mm/7½"	725-4350	1+ 15.95

**Ratchet Cable Cutter**



- Compact heavy duty cutter with ratchet mechanism for effortless cutting cable up to 32mm
- Featuring high quality chrome molybdenum profiled steel blade for easy cutting of hard drawn copper, aluminium cable or 200 pairs of communications cable
- Full ratcheting cycle for easy use
- Integral locking mechanism and impact resistant
- Anti-slip handles for safety
- Not designed for use on steel or ACSR cable
- Length: 190mm
- Cutting Capacity: 32.0mm Ø

448360

Mftrs. List No.	Order Code	1+	5+
430007	128-3223	99.89	94.24

**High Leverage End Cutting Nippers**



- With cutting edges for soft, hard and piano wire
- High cutting capacity with little effort due to optimum coordination of cutting edge angle and transmission ratio
- Cutting edges additionally induction hardened, cutting edge hardness approx. 64 HRC
- Chrome Vanadium electric steel, oil-hardened and tempered
- Handles plastic coated

Mftrs. Part No.	Cutting Performance Wires Ø mm				Length mm	Weight g
	soft	medium	hard	Piano		
67 01 160	>4.0	3.4	2.5	2.0	160	240
67 01 200	>4.0	4.2	3.0	2.5	200	330

242834

	Mftrs. Part No.	Order Code	1+	5+	10+
High Leverage End Cutting Nipper	67 01 160	413-5465	17.35	16.85	16.30
High Leverage End Cutting Nipper	67 01 200	413-5477	21.55	20.90	20.25

**End Cutting Nippers**



- With cutting edges for soft and hard wire
- Also suitable for twisting and cutting binding wire
- Cutting edges additionally induction hardened, cutting edge hardness approx. 61 HRC
- High grade special tool steel, oil-hardened and tempered

Mftrs. Part No.	Cutting performance wires Ø mm	Length mm	Weight g
68 01 200	soft >4 medium 3.5 hard 2.8	200	335

243016

	Mftrs. Part No.	Order Code	1+	5+	10+
End Cutting Nipper	68 01 200	413-5489	9.10	8.10	7.29

**Cutters - Cable - continued**

**High Leverage End Cutting Nippers**

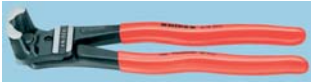

- With cutting edges for soft, hard and piano wire
- High cutting capacity with little effort due to optimum coordination of cutting edge angle and transmission ratio
- Cutting edges additionally induction hardened, cutting edge hardness approx. 64 HRC
- Head polished, handles plastic coated
- Chrome Vanadium electric steel, oil-hardened and tempered

Mftrs. Part No.	soft	Cutting Performance Wires Ø (mm)			Piano max. 3	Length 200mm
		medium 4	hard 3,5			
61 01 200	1 - 6					403253

Mftrs. Part No.	Order Code	Price Each		
		1+	5+	10+
61 01 200	916-8400	30.45	29.55	28.60

**Concretors' Nipper (Tower Pincers / Steel Fixers Nippers)**



- to twist and cut wire in one operation: fast, reliable and economical
- unobtained precision and long service life make these the most widely purchased concretors' nippers in the world
- special tool steel, oil-hardened and tempered

345435

Description	Length (mm)	Mftrs. Part No.	Order Code	Price Each		
				1+	5+	10+
Concretors' Nipper	250	99 00 250	541-6670	6.56	6.06	5.73
Concretors' Nipper	280	99 00 280	541-6681	9.35	9.05	8.80

**Wire Strippers**

**Cable Knife**



16 20 65

Stripping capacity: 8-28mm Length: mm165

- For stripping all common round cables from 8.0 up to 28.0 mm dia.
- Impact resistant plastic body
- Adjusting screw for cutting depth adaptation
- Self-cocking holding lever
- Spare blade inside the handle
- Supplied with knife and hook blade and protective cap

240794

	Mftrs List No.	Order Code	Price Each		
			1+	5+	10+
Cable Knife	1620165 SB	348-3721	14.35	13.90	13.50
Spare blade	1629165	348-3733	5.05	4.90	4.75

**JOKARI Cable Knife**



- Double-sided trimming knife blade, hook and straight
- Quick and exact cutting of round and flat cable
- Spare blade stored in handle
- Capacity: 8-28mm

419467, 422818

Mftrs List No.	Order Code	Price Each
T10280	109-8786	10.95

**Premium service without a premium price**



With thousands of prices already reduced, go online to see our most up-to-date pricing: [www.farnell.co.uk](http://www.farnell.co.uk)

**Cable Knife**



- solid, fixed straight blade
- replaceable specially ground blade
- blade made of stainless steel
- with hinged blade guard, integrated in the handle, captive
- back of the blade plastic coated to avoid short circuit
- handle with slip guard
- VDE tested according to DIN EN/IEC 60900 : 2004

404703

Description	Mftrs. Part No.	Length		Order Code	Price Each		
		Blade	Total		1+	5+	10+
Cable Knife	98 56	50mm	185	916-8559	13.20	12.80	12.40
Spare Blade	98 56 09	50mm	-	916-8567	5.60	5.45	5.25

**Cutting Knife**



- ergonomic safety handle
- stable and fixed blade
- transparent cap
- isolated and tested according to VDE norm

240788

Total	Länge		Mftrs. Part No.	Order Code	Price Each		
	Blade	Weight			1+	5+	10+
180mm	50mm	70g	9852	348-3599	8.30	8.05	7.80

**Cable Sheath Knife**



98 55

- with slide shoe at cutting tip
- sickle shaped blade of stainless steel
- isolated and tested according to VDE norm
- no damage at lead isolation
- transparent cap

240804

Gesamt-	Länge		Gewicht	Typ	Best.-Nr.	Preis pro Stück		
	Klinge-					1+	5+	10+
155mm	38mm	90g	9855	348-3587	20.00	19.40	18.80	

**Dismantling Tool**



- for stripping all common round cables
- self-cocking holding lever
- with adjusting screw for cutting depth adaptation
- turnable blade for circular and longitudinal cutting
- spare blade inside the handle
- impact resistant plastic body made of wear-resistant polyamide
- secure grip due to soft component material on handle and holding lever to avoid slipping

405338

Mftrs. Part No.	Order Code	Price Each		
		1+	5+	10+
16 20 16 SB	916-8613	13.15	12.75	12.35

Over 480,000 products online



**Dismantling Tool**



- for stripping all common round cables
- self-cocking holding lever
- with adjusting screw for cutting depth adaptation
- turnable blade for circular and longitudinal cutting
- spare blade inside the handle
- impact resistant plastic body made of wear-resistant polyamide
- secure grip due to soft component material on handle and holding lever to avoid slipping

405342

Mfrs. Part No.	Order Code	Price Each		
		1+	5+	10+
16 20 28 SB	916-8621	13.15	12.75	12.35

**Coated-Wire Stripping Tweezers**



- For stripping off varnished insulation on copper wires
- Precisely milled blades for clean stripping
- Blades for other wire diameters available separately

Material (Tweezers): Spring steel  
Material (Handle): Laminated plastic

Mfrs List No.	Stripping Capacity mm <sup>2</sup>	Length mm
15 11 120	0.6	120
15 19 005	0.5	
15 19 006	0.6	
15 19 008	0.8	

240793

Mfrs List No.	Stripping Capacity	Order Code	1+	5+	10+
<b>Tweezers + 0.6mm Blade</b>					
15 11 120	0.6 mm <sup>2</sup>	875-958	7.55	7.30	7.10
<b>Blades</b>					
15 19 005	0.5 mm <sup>2</sup>	875-960	2.35	2.30	2.20
15 19 006	0.6 mm <sup>2</sup>	875-971	2.35	2.30	2.20
15 19 008	0.8 mm <sup>2</sup>	875-983	2.35	2.30	2.20

**Stripping Tool**

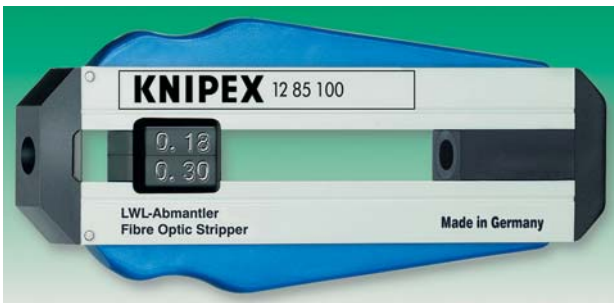

- to remove primary coating of fibre optics 0.125 mm dia.
- blade dia. 0.18 mm, hole for cable feeding 0.30 mm dia.
- adjustable length stop
- shock-resistant plastic body

240814

Mfrs. Part No.	Stripping ∅	Length	Order Code	1+	5+	10+
1285100SB	0.125 - 25mm	100mm	348-3680	66.75	64.75	62.75

**Troubleshooting tips**



Chat live online to one of our technical engineers at [www.farnell.co.uk](http://www.farnell.co.uk)

**Mini Stripping Tool**



12 80 100 SB

- for stripping thin copper conductors of 0.25 - 0.8 mm dia.
- precise stripping because of the tool's stepwise adjustment to the conductor's diameter
- with wire cutter
- adjustable length stop from 4.0 - 15.0 mm
- with locking device
- shock-resistant plastic body

240812

Mfrs. Part No.	Order Code	1+	5+	10+
1280100SB	348-3678	31.55	30.60	29.65

**Precision Wire Strippers**



A range of three precision hand wire strippers designed to remove KYNAR, TEFLON, PTFE, Kapton, Mylar and PVC insulation from solid or stranded wire. They are excellent for stripping wire wrap wire as the stripper does not dent or nick the conductor. Each stripper is manufactured for a particular size of conductor covering the range 0.25, 0.3 and 0.4mm diameter.

222635

Description	Order Code	Price Each
Wire Stripper - 0.25mm	146-419	1+
Wire Stripper - 0.3mm	146-420	19.24
Wire Stripper - 0.4mm	146-421	19.24

45

**Micro-Wire Stripper**



- Easily adjustable to 6 wire diameters
- Adjustable length stop with 15 mm scale
- Precision metal cutting and stripping blade, hardened
- Integrated wire cutter for copper wires up to 0.8 mm ∅

Adjusts to:	0.25	0.30	0.40	0.5	0.60	0.80
mm						
AWG	30	28	26	24	22	20

516478

Mfrs. List No.	Order Code	1+	5+	10+	20+
330012	162-0972	23.59	22.40	21.58	--

**Precision Wire Strippers**

ESD



**Wire Strippers - continued**

**Precision Wire Strippers - continued**

**ESD - continued**

- Blades accurately ground and fully hardened for long life
- 50mm scale with 1mm graduations and length stop
- For solid and standard wire with PVC, Teflon or similar insulation

ESD Adjustable Precision Wire Stripper		Mfrs List No. 3757 ESD 2	Adjustable to (solid wire) size:			Order Code 725-4295
mm	0.25	0.30	0.40	0.50	0.60	0.80
AWG	30	28	26	24	22	20

222854

Mfrs. List No.	Order Code	Price Each
3757 ESD 2	725-4295	1+ 30.85

**Precision Wire Strippers**



Compact wire strippers offering fast and precise wire stripping.

- Designed to remove Kynar, Tefzel, PTFE, Kapton, Mylar and PVC insulation
- Adjustable conductor size strippers

- Adjustable to 6 diameters
- 50mm depth stop scale with 1mm graduations
- Front hole diameter of 2mm

Order Code	Adjusts to:	Price Each					
		1+	5+	10+	20+		
141-6123	mm	0.12	0.16	0.20	0.25	0.30	0.40
	AWG	36	34	32	30	28	26
136-4514	mm	0.25	0.30	0.40	0.50	0.60	0.80
	AWG	30	28	26	24	22	20
146-1967	mm	0.30	0.40	0.50	0.60	0.80	1.00
	AWG	28	26	24	22	20	18

479517.405857

Mfrs. List No.	Order Code	1+	5+	10+	20+
330009	141-6123	22.02	20.62	19.82	18.30
330013	136-4514	22.02	20.18	19.82	18.29
330011	146-1967	22.02	20.18	19.82	18.29

**Coax Stripping Tool**



- for stripping Coax-cables (RG 58, RG 59 and RG 62)
- for stripping outer sheath, shield and dielectricum in one operating cycle
- with three built-in blades
- the cutting depth of each blade can be adjusted individually by means of a hexagonal key (Allen key)
- the blade spacing remains constant
- tool body made of plastic

Mfrs. Part No.	Length (mm)	Weight (g)
16 60 05 SB	100	22

243009

Description	Mfrs. Part No.	Order Code	1+	5+	10+
Coax Stripping Tool	16 60 05 SB	413-4084	17.80	17.25	16.75

**Rotary Coaxial Cable Stripper**



- A high-quality rotary coax cable stripper which is suitable for stripping RG6, RG58 and RG59 cables as well as cable with a diameter between 4 and 10mm
- Simply insert the cable into the tool, swing the tool two or three times around the cable and the outer sheath is stripped and the braid is exposed

- The blades can be adjusted to the cable size by inserting an Allen key (supplied) into the built-in hex key and turning clockwise for larger cables, and anti-clockwise for smaller diameter cables

482913.411436

Order Code	1+	5+
145-4282	5.77	5.28

**Rotary Coaxial Cable Stripper**



- For stripping RG-58, RG-59/62, RG6 and 60S coaxial cables
- Each of the three blades is independently adjustable and once set is capable of 2 or 3 step strips without further adjustment

222992

Coax stripper	Order Code	Price Each
	312-5658	1+ 12.13

**LC CST Strippers**



Mfrs List No.	Preset Strip Lengths	Strip Types	Cable Groups
LC CST-58/59	0.315" outer jacket 0.157" inner jacket	2 and 3 level adjustable	RG58, RG59, RG62 AU, RG6
LC CST-11	0.315" outer jacket 0.157" inner jacket	2 level	RG8, RG11 and RG213
LC CST CATV F	0.236" outer jacket	2 and 3 level adjustable	RG59, RG6
LC CST-MINI	0.344" outer jacket 0.094 inner jacket	2 and 3 level adjustable	RG178, RG179, RG188, RG187 RG188A, RG405

232022

Mfrs. List No.	Order Code	1+	3+	5+
LC CST-58/59	386-3293	13.67	12.88	12.35
LC CST-11	386-3300	13.67	12.88	12.35
LC CST CATV F	386-3311	13.67	12.88	12.35
LC CST-MINI	386-3323	13.67	12.88	12.35

45

**Data SureStrip™**

UTP, STP, 25-Pair, Flat Satin Cable - Cutter and Stripper



Overall length = 220mm

- Universal, easy to use cable cutter and stripper for data, telephone and network solutions.
- Cuts and strips unshielded twisted pair (UTP) and shielded twisted pair (STP) data cables
  - Cuts and strips 25-pair multi-conductor cables
  - Cuts and strips 4, 6 and 8 conductor flat satin cables
  - Cuts and strips 14 - 8 AWG (2.5 - 0.75mm)

244022

Mfrs. List No.	Order Code	1+	5+	10+
1116	413-2713	14.15	13.61	13.21

**High-Precision Wire Stripping Tool**

Specially developed for thin cables



World Novelty: Nitronic MiniStrip



MiniStrip with Bench Clamp

Nitronic MiniStrip features a patented four-blade system, which provides accurate and exactly repeated stripping of cables. The coating is removed by cutting with rotating blades and strip-off in one single step. This innovative procedure allows processing of fiberoptic cables (primary coating) as well as coax and Teflon coated cables. The high precision avoids damage to wires or fibers. Precision blade diameter control with a micrometer scale, allows a quick set-up of diameter. The locking screw of the diameter adjusting system makes the tool available even for military applications (mil-spec). The high quality of the product guarantees a precise repetitiveness.

**Features**

- Wire size range from 0.16 mm (0.006") to 1.5 mm (0.06") (15 - 34 AWG) depending on isolation type down to 0.10 mm (0.004") 38 AWG
- Outer cable diameter max. 2.5 mm (0.1")
- Stripping length up to 15 mm (0.6")
- Four cutting blades on one plane
- Rotating cut
- No wire damage
- Fast and easy change of length and diameter
- Mobile, no power supply
- HSS blades replaceable by user without tools
- Suitable for Teflon, PVC, Kynar and Kapton isolations
- Attractive price

**Accessory**

- Titan coated carbide blades for special applications
- Bench clamp for production use

MiniStrip is developed and manufactured in Switzerland by Nitronic. For more than 20 years, Nitronic develops electrical / microelectronic controls and mechanical solutions for cable treatment



Centring Device

**NEW MINISTRIP: now also available with centring device!**

The centring device allows to position the cable at exactly 90° to the cutting blades, thus increasing the cutting accuracy and avoiding possible damages to the wire. Moreover in case the user doesn't pull the cable straight, but at an angle (as it often happens), the centring device prevents the wire to be shaved by the blades. The user impact in the stripping process is therefore kept to a minimum. The use of this extremely precise version of the MiniStrip is recommended for high precision applications, particularly when the stripped wire is to be inspected with microscopes or magnifiers.

381172

Description	Mfrs List No.	Order Code	Price Each		
			1+	3+	+
Stripping Tool	MINISTRIP	<b>843-9141</b>	306.93	296.03	--
High Precision Stripping Tool with centring device	MINISTRIPZH	<b>112-1011</b>	467.68	452.08	--
Bench Clamp	MS-1431	<b>843-9176</b>	50.12	46.00	--
			<b>Price per Set (4 pcs)</b>		
Spare Blades, HSS	MS-0519S	<b>843-9150</b>	47.37	43.94	--
Spare Blades, titanium coated carbide	MS-0519SH	<b>843-9168</b>	63.17	58.35	--

**Oden Precision Stripping Tool**



Oden is a precision stripping tool for removing sheath from signal, telephone, audiovisual, instrumentation and data transmission copper and fibre optic cables.

- Precise: Fine adjustability and repeatability assured by 9-position adjustment wheel.
- Easy to use: Simply squeezing Oden together opens the stripping cavity - insert cable, rotate once, remove from cable and pull off scrap insulation sheath.
- Safe: Smooth, rounded, pocketable and lightweight design. No open blade.
- Flexible: Strips the sheath from most multi-core and fibre optic cables up to 11mm.
- Reliable: Tested to over 50,000 cycles

	Insulation Thickness (mm)	Cable Capacity (mm)	Length	Weight
Oden Stripping Tool	Up to 1.0mm	2.5 - 11mm	150mm	116g

246726

	Mfrs. List No.	Order Code	Price Each
Oden Stripping Tool	4320-0617	<b>422-8900</b>	8.14

**Cable Stripper**



- Dual purpose cable stripper and plastic tube cutting tool
- Cuts and removes insulation from cables, solid conductors and standardised wire
- Safe and fast stripping of cable insulation up to strong outer sheaths
- Automatic change from circular to longitudinal cut
- Adjustable cutting depth and replaceable hardened blade ensure a fast and easy cut
- Capacity Ø: 6-28mm, 1" tube
- Length: 90mm

419477, 422821

Description	Mfrs. list no.	Order Code	Price Each
Cable stripper	430004	<b>109-8789</b>	35.50
Spare blade	395041	<b>109-8790</b>	11.40

**Dismantling Tool Type 163**



for dismantling round PVC, rubber, silicone, PTFE cables from 6.0 - 29.0 mm dia. self-cocking holding lever with knurled nut for cutting depth adjustment changing from circular to longitudinal cutting by turning the tool body spiral cutting for longer stripping areas shock-resistant plastic body exchangeable blade

Mfrs. Part No.	Length
16 30 135 SB	120
16 39 135	Spare Blade

Material: Fiber Glass forced plastic  
Material of handle: Shock-resistant plastic body

240840

Mfrs. Part No.	Order Code	Price Each		
		1+	5+	10+
16 30 135 SB	<b>875-934</b>	38.15	37.00	35.85
16 39 135	<b>875-946</b>	7.50	7.30	7.05

**Tor Heavy-Duty Cable Stripping Tool**



45

Tor is a professional stripping tool for cables of all insulation types. Supplied with both small and large hooks to allow a cable stripping capacity of 4.5mm to 40mm.

- Large capacity: Interchangeable hook feature means that Tor can replace two or more similar products in the toolbox.
- Easy to use: Positive locking positions for circular, lengthways and spiral strips.
- No special tools required to change hooks.
- Durable: Replacement cutting blades can be stored in a pocket located within the tool body.
- Reliable: Tested to over 100,000 cycles

Tor Stripping Tool	Insulation Thickness (mm)	Cable Capacity Large Hook (mm)	Cable Capacity Small Hook (mm)	Length	Weight
	Up to 4.5mm	20 - 40mm Dia	4.5 - 25mm Dia	150mm	116g

246715

Description	Mfrs. List No.	Order Code	Price Each
Stripping Tool (2 Hooks)	4320-0617	<b>422-8893</b>	31.35
Spare Blade Sets Blade, Spare	4320-0618	<b>422-8959</b>	13.06

**Express checkout**



With no need to re-enter your details, returning customers can now buy products even faster - **order online today at [www.farnell.co.uk](http://www.farnell.co.uk)**



Wire Strippers - continued

Cable Stripper



Overall length=140

Capacity 4.5 to 28mm. Eliminates damage to inner conductors. Simple to use.

The MKO2 has been specially designed to quickly remove the outer sheathing on multicore, co-axial and circular cables. The tool is fitted with an insulation ripping blade to remove insulation from rubberised or cheap sticky cables.

222637

Description	Mfrs. List No.	Order Code	Price Each
Stripper	MK02	440-796	18.11
Spare blades, pack of 5		202-277	13.70

Universal Stripping Tool



- for dismantling and stripping all common round and damp-proof installation cables between 8.0 - 13.0 mm dia. (e. g. 3 x 1.5 mm<sup>2</sup> up to 5 x 2.5 mm<sup>2</sup>)
- also for use in conduit and distribution boxes
- double shell, folding back stripping tool
- with opening spring and locking lever
- practical clip for safe transport
- with additional blade for longitudinal cuts
- telescopic blade inside
- stripping device for cross-sections 0.2 - 0.3 - 0.8 - 1.5 - 2.5 - 4.0 mm<sup>2</sup>

405343

Mfrs. Part No.	Order Code	1+	5+	10+
16 85 125 SB	916-8630	25.50	24.75	23.95

Data Cable Stripper



- For stripping data cables of 5 to 15mm diameter
- 6 preset stripping positions
- With opening spring and holding slider
- Glass fibre reinforced plastic housing

Stripping range	Length (mm)	Weight (g)
Dia. 5-15mm, AWG 24-11	125	65

245826

Type	Order Code	1+	5+	10+
1665125SB	381-4014	27.15	26.35	25.50

Coax Stripping Tool



mmLength:100 gWeight:35

- for dismantling and stripping all common round and damp-proof installation cables between 8.0 - 13.0 mm dia.
- also for use in conduit and distribution boxes
- double shell, folding back stripping tool
- with opening spring and locking lever
- practical clip for safe transport
- tool body made of fibreglass reinforced polyamide
- Modell: 16 85 125 SB
- with additional blade for longitudinal cuts
- telescopic blade inside
- stripping device for cross-sections 0.2 - 0.3 - 0.8 - 1.5 - 2.5 - 4.0 mm<sup>2</sup>

240823

Mfrs. Part No.	Order Code	1+	+	+
1660100SB	333-0977	12.10	--	--

Stripax Tool



Stripping and cutting tool for flexible, stranded and solid conductors with PVC insulation for cross sections 0.08mm to 6mm<sup>2</sup> (AWG28-10).

Stripping length adjustable by setting wire stop. Jaws open automatically after stripping, no splay of individual strands, special self adjustment stripping blades avoid damage of conductor, adjustable to different insulation cross sections, strips multiple conductors, even seven flat ribbon conductors simultaneously.

Strips double-insulation conductors in two steps, no additional adjustment necessary, precise, self adjusting cable cutter. Long working life, improved ergonomic design.

484652

Order Code	Price Each
828-087	1+ 42.21

Self-Adapting Universal Insulation Stripper



- Fully automated adjustment to the respective cross-sections, depending on insulation thicknesses, in a range from 0.03 - 10.0mm<sup>2</sup> (AWG 32 - 7)
- Fine adjustment of the tool is no longer necessary due to the unique self-feeding of the cutting depth, preventing damage to the conductor
- Steel restrain jaws with integrated cutting edges allow professional stripping of cables with demanding insulating materials like Teflon® and Radox®
- Wire cutter for copper and aluminium wires, multiple stranded up to 10mm<sup>2</sup> and single stranded up to 6mm<sup>2</sup>
- Smooth operating mechanism
- Easily interchangeable screw-on style blades, length stop and restrain jaws with cutting edges available separately
- Body made of tough fibreglass reinforced plastic
- Ergonomic soft-grip handle

374579

	Mfrs List No.	Order Code	1+	5+	10+
Universal Insulation Stripper	12 42 195	815-6921	56.15	54.45	52.80
Spare Blades	12 49 21	916-8311	11.75	11.40	11.05
Spare Restrain Jaws	12 49 22	916-8320	11.75	11.40	11.05
Spare Length Stop	12 49 23	916-8338	1.50	1.45	1.40

Self-Adjusting Insulation Strippers



- for single, multiple and fine-stranded wire cables with plastic or rubber insulation
- adjusts automatically to the respective cable cross-section, which prevents damage to the conductor
- cutting depth can be adjusted for different insulation materials
- with wire cutter for copper and aluminium

- wires, multiple stranded up to 10 mm<sup>2</sup> and single stranded up to 6 mm<sup>2</sup>
- smoothly operating mechanism
- easily interchangeable blades and plastic jaws
- low weight
- body made of tough fibreglass reinforced plastic
- range of application: conductors 2.5 - 16.0 mm<sup>2</sup>

Mfrs. Part No.	Stripping performance
12 40 200	0,08 - 10,0mm <sup>2</sup>
12 49 01	Spare blade
12 49 02	Spare clamping jaws

240846

Mfrs. Part No.	Order Code	1+	5+	10+
12 40 200	876-264	44.05	42.75	41.40
12 49 01	876-276	12.00	11.65	11.30
12 49 02	876-288	2.75	2.65	2.60

700 products added online every week



See our pick of the hottest products and latest technologies in 'What's New?' at [www.farnell.co.uk](http://www.farnell.co.uk)

**Self-Adjusting Insulation Stripper**



- Compact standard tool for all current cable cross-sections and insulating materials
- For single, multiple and fine stranded cables of 0.2 up to 6.0mm<sup>2</sup> with standard insulation
- Adjusts automatically to the respective cable cross-section, which prevents damage to the conductor
- Comfortable operation

- Narrow head for use in confined areas
- Wire cutter for copper and aluminium wires up to 2.5mm<sup>2</sup>
- Adjustable length stop from 6.0 - 18.0mm for constant stripping length during repetitive work
- Easily interchangeable blades
- Body made of tough, fibreglass reinforced plastic with ergonomic soft plastic gripping zone in the handle

374605

	Mftrs List No.	Order Code	1+	5+	10+
Insulation Stripper	12 62 180	815-6930	24.65	23.90	23.15
Spare Blades	12 69 21	916-8346	7.15	6.95	6.70

**Self-Adjusting Insulation Stripper**



- for single, multiple and fine-stranded wire cables with plastic or rubber insulation of 0.08 - 1.0 mm<sup>2</sup>
- adjusts automatically to the respective cable cross-section, which prevents damage to the conductor
- for thin ribbon cables in a single pass
- with wire cutter for copper and aluminium wires, multiple stranded up to 1.0 mm<sup>2</sup>
- length stop adjustable from 2.5 - 7.0 mm
- easily exchangeable blades

- smoothly operating mechanism
- low weight
- body made of tough fibreglass reinforced plastic

403919

Description	Mftrs. Part No.	Order Code	1+	5+	+
Insulation Stripper	12 60 135	413-1952	91.45	88.70	--

**Embla Self-Adjusting Cut and Strip Tool**



- Self-adjusting cutting and stripping tool for modern electrical installation and equipment wires.
- Used with easily interchangeable multiple stripping cassettes enable precision stripping of a wide range of insulations within the tools specified range.
- Precise: Fine adjustability ensures that fine insulations can be stripped without damage to conductors.
- The ergonomic design of the Embla results in a lightweight (but strong) and comfortable tool equally qualified for high volume production and portable/field usage.
- Reliable: Tested to over 150,000 cycles

	Insulations	Stripping Capacity (mm)	Cutting Capacity Flexible (mm)	Cutting Capacity Rigid (mm)	Weight
Embla - Straightblade	PVC	0.02 - 10mm <sup>2</sup>	10mm <sup>2</sup>	1.5mm <sup>2</sup>	136
Embla - V Blade	All Insulations	0.02 - 10mm <sup>2</sup>	10mm <sup>2</sup>	1.5mm <sup>2</sup>	136

246640

Description	Mftrs. List No.	Order Code	Price Each
Embla - Straight Blade	4320-0612	422-8870	39.06
Embla - V Blade	4320-0613	422-8881	43.21
<b>Spare Blade Sets</b>			
Straight Blade Cassette	4320-0614	422-8923	11.54

**Help us to help the environment**



This catalogue has been printed on paper certified from a sustainable source. Please recycle after use.

**Automatic Wire Stripper Super 4 Plus**



- Automatic adjustment for conductor cross section
- Damage to conductor not possible
- Suitable for all common stranded and solid conductors
- From 0.2 - 6.0 mm<sup>2</sup> (24-10 AWG)
- With integrated cutter for wires up to 2.5 mm<sup>2</sup>
- Stripping length from 6 up to 15 mm



525274

Mftrs. List No.	Order Code	1+	5+	10+
T20050	166-1094	17.08	16.30	15.37

**Jokari High-Strip Automatic Wire Stripper**



- Ergonomic precision wire stripper for conductors with hard to strip insulations such as rubber, silicone, TPE etc
- With 5-15mm adjustable length stop

Capacity	0.5-4.0mm <sup>2</sup>
	20-11 AWG
Weight	121g

223041

Order Code	722-5751
Price Each	45.90

**Jokari Special - Automatic Wire Stripping Plier**



- Ergonomic, easy to use automatic wire stripper for wires from 0.5mm<sup>2</sup> to 6mm<sup>2</sup> (AWG20-10)
- Integrated wire cutter for wires up to 2.8mm dia.
- Speedy and precise stripping of cables even where access is limited, due to side insertion of wires
- No adjustment necessary and impossible to damage conductors or insulation
- Adjustable wire stop, with replacement hardened blades

223037

Order Code	722-5726
Price Each	1+ 39.89

**Technical information at your fingertips**



Over **352,000** technical datasheets available online.

Visit [www.farnell.co.uk](http://www.farnell.co.uk) and look for the **Tech Info** heading in your search results.

**Wire Strippers - continued**

**Jokari Flat Cable - Automatic Wire Stripper**



- For stripping outer sheathing and inner insulation of flat cable eg. NM-B 14/2
- No adjustment necessary

Capacity	Wire stripping	0.76-6.0mm <sup>2</sup> 18-10 AWG
Weight	Cable stripping	Up to 12mm (1 <sup>5</sup> / <sub>32</sub> "")

223039

<b>Order Code</b>	<b>Price Each</b>
722-5740	38.55

**'Mega Strip'**



H=140,  
W=25,  
L=260

The 'Mega Strip' is a heavy duty cable stripping tool for large round or multicore cables with either stranded or solid conductors. Self-adjusting to strip from 0.5mm<sup>2</sup> to 25mm<sup>2</sup>, with a simple gauge selection knob requiring only three basic positions.

Robust construction of steel and aluminium

222641

<b>Description</b>	<b>Order Code</b>	<b>Price Each</b>
Mega Strip	105-958	1+ 79.57

**Wire Strippers, Flexi Jaw**



Micro Strip (MS1)

MK1FD

MK2FC.

A range of automatic wire strippers to cover cable sizes 0.25mm<sup>2</sup> to 6.00mm<sup>2</sup>. They all operate using a unique system of self adjusting multiple blades which slice cleanly through the insulation but then form around the conductors to give a clean cut without causing any damage.

There are four patterns available:

**Micro Strip (MS1)** - Fabricated in glass reinforced polyamide. Stripping capacity 0.25mm<sup>2</sup> to 1.5mm<sup>2</sup>. Particularly suited for stripping fine wires with soft, delicate insulations. Three interchangeable gripping surfaces are supplied (fine, medium & coarse) to suit all types of wire. A wire cutter is also incorporated in the tool. Replacement jaws Order Code 105-955.

**MK1FD** - Aluminium bodied to withstand the rough treatment of field use. Capacity 0.25mm<sup>2</sup> to 2.5mm<sup>2</sup>. Replacement jaw assembly for original MK1F, Order Code 215-302.

**MK2FC** - "Power Strip" glass re-inforced polyamide body weighing only 150g. Stripping capacity 0.25mm<sup>2</sup> to 6.0mm<sup>2</sup> PVC insulated, solid or stranded wires and multi-core. The integral cutter will cut up to 6.0mm<sup>2</sup> stranded wire and 4.0mm<sup>2</sup> solid copper. Replacement jaws Order Code 105-957.

222639

<b>Description</b>	<b>Mftrs. List No.</b>	<b>Order Code</b>	<b>Price Each</b>
1.5mm <sup>2</sup> Stripper/cutter	MS1	440-802	1+ 36.90
Replacement jaws	04301	105-955	7.16
2.5mm <sup>2</sup> Stripper	MK1FD	440-814	43.26
6.0mm <sup>2</sup> Stripper/cutter	MK2FC	440-826	42.87
Replacement jaws	04601/701	No Order Code	--

**Maxistrip V16**



- Equipped with a power shift mechanism allowing for easy stripping of both hard and soft insulations
- Self-adjusting over its capacity range, can be manually adjusted for non-standard wires
- Solid curved jaw and an integral wire cutter

Stripping capacity	0.25-16mm <sup>2</sup>
Cutting capacity	up to 6mm <sup>2</sup> (stranded copper)
Weight	285gms
Dimensions	225x100x208mm

222857

<b>Description</b>	<b>Order Code</b>	<b>Price Each</b>
Maxistrip V16	725-5883	1+ 60.39

**Safe-Strip**



- Self-adjusting over entire stripping range
- Unique powershift mechanism allowing efficient stripping of both hard and soft insulations
- Adjustable length stop for non-standard wires
- Features an integral wire cutter
- Profiled handles to minimise operator fatigue

Stripping capacity	0.08-6mm <sup>2</sup>	Weight	150g
Cutting capacity	<4mm <sup>2</sup> (stranded copper)	Dimensions	180 x 70 x 18mm

222855

<b>Description</b>	<b>Order Code</b>	<b>Price Each</b>
Safe-Strip 049	725-5871	1+ 32.96

**7" Automatic Wire Stripper**



- Parrot type
- For all types of wire from 0.2-6mm
- Strips lengths up to 25mm
- Self adjusting mechanism
- Also has a cable cutter

481978.454212

<b>Order Code</b>	<b>1+</b>	<b>5+</b>	<b>10+</b>	<b>20+</b>	<b>50+</b>
144-7421	4.27	3.55	3.13	2.73	2.44

**Universal Insulation Stripper**

Particularly suitable for solar cables



- With new stripping mechanism
- For solar cables (weather-resistant cable for connecting photovoltaic power generation devices)
- Particularly adjusted to RADOX® insulations of solar cables
- With additional cable support facilitating the alignment of multilayered insulated conductors
- Blades adapted to match larger wire cross-sections
- Smoothly operating mechanism
- Compact design, lightweight construction
- High operation comfort thanks to handy shape

<b>Mftrs List No</b>	<b>Order Code</b>	<b>Stripping Capacity</b>	<b>Length</b>	<b>Weight</b>
12 12 11	156-0910	mm <sup>2</sup> 1.5 - 6.0	AWG 15 - 9	mm 195
		g 450		

508228

	<b>Mftrs List No.</b>	<b>Order Code</b>	<b>1+</b>	<b>3+</b>	<b>5+</b>
Stripping Pliers	12 12 11	156-0910	76.94	73.08	69.22
Spare Blades	12 19 11	156-0911	37.29	35.43	33.53



### Universal Insulation Stripper

particularly suitable for Teflon and solar cables



Länge: 195 mm

- with new stripping mechanism
- easy stripping of difficult insulating materials such as Teflon®, silicone, Radox®, Kapton® and rubber as well as multilayered insulations
- leaves wire undamaged thanks to precision-ground blade shapes; even multi-stranded conductors are stripped gently
- with length stop for constant stripping length during repetitive work
- 4 replaceable blades
- smoothly operating mechanism
- compact design, lightweight construction
- high operation comfort thanks to handy shape

Mfrs. Part No.	Order Code	Stripping capacities		Length mm	Weight g
		mm <sup>2</sup>	AWG		
12 12 02	394-7877	0.03 - 2.08	32 - 14	195	430
12 12 06	413-3330	0.14 - 6.00	26 - 10	195	430
12 12 10	413-3353	2.50 - 10.0	13 - 7	195	430

242840

Description	Mfrs. Part No.	Order Code	Price Each		
			1+	5+	10+
Wire Stripper	12 12 02	394-7877	66.80	64.80	62.80
Universal Insulation Stripper	12 12 06	413-3330	66.00	64.00	62.05
Universal Insulation Stripper	12 12 10	413-3353	66.00	64.00	62.05

### Automatic Insulation Stripper



- with replaceable blades of special steel with 4 and 6 positions resp. for different wire cross sections
- leaves wire undamaged thanks to precision-ground blade shapes; even multi-stranded conductors are stripped gently
- during stripping, the wire is held firmly by clamping jaws
- with length stop for constant stripping length during repetitive work
- a spring leads the stripper back to the starting position
- strong light-metal body

Typ	Insulation performance						Length	Weight
Mfrs. Part No.	∅							
12 11 180	0,5mm	1,2mm	1,6mm	2,0mm			180	400
12 11 180	0,5 - 0,75 mm2	1,0 mm2	1,5 mm2	2,5 mm2	4,0 mm2	6,0 mm2	180	400

242850

Description	Mfrs. Part No.	Order Code	Price Each	
			1+	5+
Automatic Insulation Stripper	12 11 180	413-1903	39.45	38.25
Automatic Insulation Stripper	12 11 180	413-1915	45.00	43.65

### Stripmaster



- Stripmasters give quick, clean, repeatable insulation strips for a wide range of wire
- Clean and complete removal of insulation without damaging the conductors

**Stripmaster** - Strips most common plastic and rubber insulations.

**Stripmaster Lite** - 1/3 of the operating force of the other tools, lighter and smaller, for common plastics and rubber.

**Custom Stripmaster** - Unique blade design with counterbored recesses sized to the insulator and inner stripping hole sized to the conductor preventing the blade touching the conductor. In certain military and high reliability applications the integrity of the conductors is mandatory.

**Wire Stop** - Is an accessory that fits all tools and gives repeatable strip lengths.

### Tool/Wire Size Selection Chart

AWG	10	12	14	16	18	20	Tool Order Code	Blade Order Code
Dia mm	3.658	3.378	2.286	1.829	1.549	1.219		
Strands	84/0.3	56/0.3	50/0.25	30/0.25	32/0.2	24/0.2		
Stripmaster	Y	Y	Y	Y	Y	Y	290-099	290-166
							290-105	290-178
Stripmaster Lite				Y	Y	Y	290-117	290-180
							290-129	290-191
Custom Stripmaster	Y	Y	Y				290-130	-
				Y	Y	Y	290-142	290-210
AWG	22	24	26	28	30		Tool Order Code	Blade Order Code
Dia mm	0.991	0.813	0.660	0.533	0.406			
Strands	16/0.2	7/0.2	7/0.15	10/0.1	7/0.1			
Stripmaster	Y						290-099	290-166
	Y	Y	Y	Y	Y		290-105	290-178
Stripmaster Lite	Y						290-117	290-180
		Y	Y	Y	Y		290-129	290-191
Custom Stripmaster							290-130	-
	Y	Y	Y				290-142	290-210

	Max. Strip (mm)	Free Wire (mm)	Weight	Overall Length	Width Open
Stripmaster	20	17	370g	170	128
Stripmaster Lite	15	12	160g	140	100
Custom Stripmaster	20	17	370g	170	128

Mfrs. List No.	Mfrs. List No.	Mfrs. List No.	Mfrs. List No.
45-092 =	290-099	45-672 =	290-129
45-098 =	290-105	45-173M =	290-130
45-092-M =	609-225	45-174M =	290-142
45-671 =	290-117		
		L-4421 =	290-166
		L-5361 =	290-178
		LB1001 =	290-180
			L-5270 =
			LB1002 =
			L-5563 =
			L-5270 =

491043

Stripmaster	Order Code	Price Each
10 to 22 AWG	290-099	24.96
20 to 30 AWG	290-105	25.09
<b>Stripmaster-Metric</b>		
0.75mm <sup>2</sup> to 6.0mm <sup>2</sup>	609-225	25.09
<b>Stripmaster Lite</b>		
16 to 22 AWG	290-117	28.10
24 to 30 AWG	290-129	31.63
<b>Custom Stripmaster</b>		
10 to 14 AWG	290-130	114.55
16 to 26 AWG	290-142	114.55
<b>Spare Blade Sets</b>		
Stripmaster, 10 to 22 AWG	290-166	9.77
Stripmaster, 20 to 30 AWG	290-178	9.83
Stripmaster Lite, 16 to 22 AWG	290-180	8.72
Stripmaster Lite, 24 to 30 AWG	290-191	9.83
Custom Stripmaster, 16 to 26 AWG	290-210	58.90
Wire Stop	290-154	10.36

### 5-in-1 Automatic Wire Stripper



- Designed for easy wire stripping
- Steel jaws automatically adjust to strip wire from 10-26AWG
- Built-in wire cutter
- Crimps insulated and non-insulated terminals 10-22AWG
- Ergonomic grip for comfort
- Length: 215mm

443411.423852

Order Code	Price Each	
	1+	5+
125-7167	8.44	7.31

### Automatic Wire Stripper



- Automatic stripping of wires without adjustment
- Crimping of insulated and non insulated terminals
- Micro adjustment knob allows wires smaller than 0.2mm<sup>2</sup> to be stripped
- Hardened Steel blades for long life
- Capacities: Stripping 0.2 - 6.0mm<sup>2</sup> copper or aluminium wire

**Wire Strippers - continued**

**Automatic Wire Stripper - continued**

- Cutting Wire HRC 40 - 50
- Crimping 1.5, 2.5, 6.0mm insulated terminals
- 1.5, 2.5, 4.0, 6.0mm non insulated terminals and non insulated spades

448366

Mfrs. List No.	Order Code	1+	5+	Price Each
495001	128-3226	14.20	13.75	

**Sheath Stripper**



H=30,  
W=100,  
D=18

The "OPTI-STRIP" is designed for the precision stripping of the outer plastic sheathing of optical fibres. It also performs extremely well on PVC and PTFE insulated wires.

The tool has two spring loaded blades, the gap between these can be very accurately adjusted to cleanly cut the sheathing/insulation with no damage to the fibre/wire.

Once the adjustment has been set it can be locked to give repeatable results. In operation, once the blades have been adjusted and set, the fibre/wire is inserted, the tool is then rotated and the sheath/insulation pulled off. The waste falls through the hollow handle.

Supplied with six bushes and guides to accommodate fibres/wires with an outer diameter of 0.5 to 3mm. Suitable for fibre optic cables from 15 to 1000 microns. Supplied in a plastic box complete with instructions.

222642

Description	Mfrs. List No.	Order Code	1+	Price Each
Stripper	OPTISTRIP	202-174	73.22	
Pack 2 Blades	0680402	311-5719	3.84	

**Wire Stripper For Fibre Optics**



- to remove primary and secondary coating of fibre optics

Mfrs. Part No.  
12 82 130 SB

Capacity Ø (mm)  
primary coating: 0,125  
secondary coating: 0,250

Length (mm)  
130

404696

Description	Mfrs. Part No.	Order Code	1+	5+	10+	Price Each
Wire Stripper	12 82 130 SB	916-8354	43.80	42.50	41.15	

**Fibre Optic Stripper**



**For Right Hand Use Only**

Strips outer jacket from 2.0 - 2.4mm fibre, 2.8 - 3.0mm loose tube fibre. Will strip 900µm buffer from loose buffer without removing acrylate. Also strips buffer and acrylate from 900/125µm and 250/125µm fiber. Precision, CNC-formed stripping areas. Factory set and calibrated. Locking handle for safe transport. 22° operating angle. Rubber embedded handles.

443745

Mfrs. List No.	Order Code	1+	10+	Price Each
1163	748-7770	43.52	36.26	

**Precision Wire Strippers**



- Precision wire strippers - can also be used as pliers and shears
- Built-in closed stopper and constant force recovery spring

Wire Sizes		Order Code
AWG	mm	
30, 28, 26, 24, 22, 20	0.2, 0.3, 0.4, 0.5, 0.6, 0.8	312-5452
20, 18, 16, 14, 12, 10	0.8, 1.0, 1.3, 1.6, 2.0, 2.6	312-5464

222921

Order Code	Price Each
312-5452	1+
312-5464	9.63
	8.90

**Metric Wire Stripper and Cutter**



High quality metric hand wire stripping tools with precision ground knife type blades to ensure clean and accurate stripping of wires. They have a built-in loop hole and cutter to eliminate the needs for additional tools.

The 45-120M and 45-125M are sturdy, compact and lightweight. They are spring-loaded for automatic opening.

Wire Thickness (mm <sup>2</sup> )
0.75, 1.0, 1.5, 4.0, 6.0
0.5, 0.75, 1.0, 1.5, 2.5, 4.0

TEE258X/222801.401941

Order Code	Price Each
45-120-341	1+
45-125-341	609-183
	609-195
	10.91
	10.91

**Wire Stripper and Cutter**



Overall length=152

The specially ground cutting edges ensure a clean cut around the entire circumference of the insulation enabling the insulation to be easily removed from the conductor.

The 45-121 and 45-216 are designed to strip and cut stranded wires, the 45-215 is designed to strip and cut solid wires.

The 45-215 has better sleeves on the handles. They are broader and more comfortable than the 45-121.

These tools are suitable for the following wire sizes.

45-121 Stranded Wire						
AWG	16	18	20	22	24	26
Dia (mm)	1.83	1.55	1.22	0.99	0.81	0.66
Strands	30/0.25	32/0.2	24/0.2	16/0.2	7/0.12	7/0.15
45-215 Solid Wire						
AWG	10	12	14	16	18	
Dia (mm)	2.59	2.06	1.63	1.30	1.02	

222630

Description	Mfrs. List No.	Order Code	Price Each
16 to 26 AWG stranded	45-121	440-759	1+
10 to 18 AWG solid	45-215-241	458-338	10.36
			14.12

**Wire Strippers**



**T Series**



All Ideal T-strippers have the following features: Precision ground knife type blades that assure clean accurate stripping; compact size, lightweight, cushioned plastic grips ensure smooth operation and reduce operator fatigue. Sturdy steel construction ensures long life. Black oxide finish resists corrosion. Convenient loop-hole simplifies wire looping for screw terminal connections. Built-in wire cutter. Spring loaded for automatic opening. Painted wire gauge. Plier nose for simple gripping or tightening jobs. Model Super T-6 is fitted with static dissipative grips.

Order Code	Model	Range	Wire
136-2195	Super T-6	16-26	AWG stranded

485479

Order Code	1+	50+	100+
136-2195	17.70	16.38	16.09

**7 in 1 Stripper**



- High quality 7 in 1 cutting and stripping tool
- Heat-treated precision ground blades provide nick free stripping
- Cushioned handles

Strips 10 - 22 AWG stranded wire  
 Square cuts up to 6 gauge wire  
 Cuts unhardened bolts and screws  
 Accurately crimps and insulated terminals 22-10 AWG wire sizes  
 Accurately verifies wire sizes 6-16 AWG solid and 8-18 AWG stranded wire  
 Allows wire looping from either front or back of the tool  
 Overlapping jaws at nose of tool can be used to ream conduit

222800

Order Code	Price Each
609-237‡	1+ 26.74

‡Subject to design change

**Adjustable Jacket Stripper**



Perfect for cutting jackets off a variety of fibre optic cable

- Adjustable blades from 10-30 AWG
- Economical tool for multiple cables

240402

Mfrs. List No.	Order Code	1+	5+	10+	25+
1161	413-2646	2.54	2.41	2.34	2.21

**Wire Stripper and Cutter**



Has an adjustable screw stop for different wire sizes. Cuts and strips both solid and stranded wire cleanly, neatly.  
 Hardened with ground blades. Cushion grip handles.  
 101SV specification is the same as 100V but with spring equipped self-opening handles.

222627

Mfrs. List No.	Order Code	Price Each
100V	440-735	1+ 5.93
101SV	440-747	7.43

**Wire Strippers**



- Lockable brass adjusting screw
- Suitable for wire up to 5mm in diameter

222997

Overall Length	Order Code	Price Each
160mm	312-7205	1+ 6.95

**Wire Stripper**



- 2-component handle with slip guard
- Shock proof handle
- Adjustable screw and release spring
- Drop forged, heat treated fully polished steel
- Strips wire up to 5mm in  $\varnothing$

493009.492583

Order Code	1+	5+	10+	20+
149-6327	10.32	9.58	8.57	7.45

**Wire Stripping Pliers - 'Redline'**



Wire stripping pliers, plain ground finish with lockable brass adjusting screw. The generous PVC handle covers have large anti-slip guards which make this tool particularly suited to production. Suitable for wire diameters up to 5mm.

222636

Mfrs. List No.	Order Code	Price Each
3754160	263-606	1+ 14.15

**Wire Stripping plier type 11**



- 1106160 in accordance with the Association of German Electrical Engineers insulation

With locking adjustable screw for setting the desired diameter



Material Tool steel, oil hardened  
 Handle Material 1102160  
 Handle Material 1106160  
 Overall Length 160mm  
 Cutting Capacity 5mm diameter or 10mm<sup>2</sup> cable cross section

240558

Type	Order Code	1+	5+	10+
11 02 160	876-227	10.75	10.45	10.10
11 06 160	348-3356	18.25	17.70	17.15

**Crimp Tools**

**Crimp Tooling For Bootlace Ferrules**



**Insulated and Non-Insulated**

A range of ergonomically designed full cycle action crimp tools. M series designed for single handed use and the K series for either single or double handed use. Soft rounded handles designed for optimal load distribution. Toggle action for mechanical advantage.



MEB 0560



KEB 4010

**Crimp Tools - continued**

**Crimp Tooling For Bootlace Ferrules - continued**

Insulated and Non-Insulated - continued



KEB 1025



KEB 3550



PZD 3

**MEB 0560** single handed crimp tool with 5 crimp nests for crimps on 0.5-6.0mm<sup>2</sup> / 22-10 AWG wires.

**KEB 4010** double handed crimp tool with 3 crimp nests for crimps on 4-10mm<sup>2</sup> / 12-8 AWG wires.

**KEB 1025** double handed crimp tool with 3 crimp nests for crimps on 10-25mm<sup>2</sup> / 6-4 AWG wires.

**KEB 3550** double handed crimp tool with 2 crimps nests for crimps on 35-50mm<sup>2</sup> / 2-0/1 AWG wires.

**PZD 3** single handed tool with self adjusting dies for square crimps on 0.5-6.0mm<sup>2</sup> / 22-10 AWG wires.

443904

Type	Order Code	1+	5+	10+	50+
MEB 0560	<b>399-3061</b>	93.33	86.11	74.78	67.36
KEB 4010	<b>399-3073</b>	93.33	86.11	74.78	67.36
KEB 1025	<b>399-3085</b>	93.33	86.11	74.78	67.36
KEB 3550	<b>399-3097</b>	93.33	86.11	74.78	67.36
PZD 3	<b>399-3050</b>	76.95	72.12	64.08	55.54

45

**Crimp Tooling For Non Insulated Terminals**



Closed Barrel

A range of ergonomically designed full cycle action crimp tools. M series designed for single handed use and the K series for either single or double handed use. Soft rounded handles designed for optimal load distribution. Toggle action for mechanical advantage.



MKB 0325



KWB 4099

**MKB 0325** single handed crimp tool for non insulated terminals for 0.35mm-2.5mm<sup>2</sup> / 22-14 AWG wires.

**KWB 4099** double handed crimp tool for non insulated terminals for 4-10mm<sup>2</sup> / 12-8 AWG wires.

443906

Type	Order code	1+	5+	10+	50+
MKB 0325	<b>399-3036</b>	92.22	84.90	75.13	66.55
KWB 4099	<b>399-3048</b>	93.33	85.94	76.00	67.36

**Crimp Tooling For Insulated Terminals**



A range of ergonomically designed full cycle action crimp tools. M series designed for single handed use and the K series for either single or double handed use. Soft rounded handles designed for optimal load distribution. Toggle action for mechanical advantage.



MSA 0110



KSA 0760



KAA 0760

**MSA 0110** single handed crimp tool for miniature yellow and red insulated terminals for 0.14-1.0mm<sup>2</sup> / 26-16 AWG wires.

**KSA 0760** double handed crimp tool for red, blue and yellow insulated terminals for 0.75-6.0mm<sup>2</sup> / 22-10 AWG wires.

**KAA 0760** double handed crimp tool with asymmetrical dies for premium crimps on standard and vibration resistant type terminals. 0.75-6.00mm<sup>2</sup> / 22-10 AEG wires.

443905

Type	Order Code	1+	5+	10+	50+
MSA 0110	<b>399-3000</b>	85.63	78.73	69.67	61.81
KSA 0760	<b>399-3012</b>	85.30	78.34	69.34	61.57
KAA 0760	<b>399-3024</b>	90.13	83.75	74.04	65.07

**"MultiCrimp" Lever Action Crimping Pliers with quick changer magazine**



97 33 01



97 33 02

- Set composed of pliers and quick changer magazine for common crimping applications
- For solder-free electrical connections
- Repetitive, high crimping quality due to precision profiles and integral lock with very fine adjustment (self-releasing mechanism)
- These tools have been set precisely (calibrated) in the factory
- ergonomically shaped two-colour dual component handles for one and two-hand operation
- very easy and quick change of crimping dies without any additional tool
- interchangeable crimping dies are securely held in the tool
- secure and dirt-proof storage of the interchangeable crimping dies in a round magazine
- round magazine with practical belt clip - interchangeable dies are always ready to hand
- all stressed parts are made of special steel, oil-hardened and tempered
- head burnished, two-colour dual component handles



**Model: 97 33 01**

Crimping pliers with round magazine and 3 interchangeable dies for non-insulated open plug-type connectors (4.8 + 6.3 mm width) from 0.5 - 6.0 mm<sup>2</sup>; insulated terminals + plug connectors from 0.5 - 6.0 mm<sup>2</sup>; end sleeves (ferrules) from 0.25 - 6.0 mm<sup>2</sup>.

**Model: 97 33 02**

Crimping pliers with round magazine and 5 interchangeable dies for non-insulated open plug-type connectors (4.8 + 6.3 mm width) from 0.5 - 6.0 mm<sup>2</sup>; insulated terminals + plug connectors from 0.5 - 6.0 mm<sup>2</sup>; end sleeves (ferrules) from 0.25 - 6.0 mm<sup>2</sup>; non-insulated terminals and plug connectors from 0.5 - 10 mm<sup>2</sup>; non-insulated butt connectors from 1.5 - 10 mm<sup>2</sup>

508243

	Mfrs' List No.	Order Code	1+	3+	5+
Multicrimp Pliers with quick changer magazine and 3 dies	97 33 01	<b>156-0899</b>	138.48	131.58	124.63
Multicrimp Pliers with quick changer magazine and 5 dies	97 33 02	<b>156-0900</b>	180.46	171.44	162.43

**Crimp System Pliers**  
for crimping solar connectors



- Crimping pliers to be used with exchangeable crimping dies
- Delivered in plastic case without crimping dies and locators
- For solder-free electrical connections
- Repetitive, high crimping quality due to precision dies and integral lock (self-releasing mechanism)
- Optimum transmission of force force due to lever action for fatigue-reduced operation
- Factory calibrated crimping pressure
- Head burnished; with ergonomically designed plastic handles
- Length 200mm
- Crimping dies and locators to be ordered separately

**Crimp System Pliers and Crimp Profiles**



- Crimp system with interchangeable die sets
- Features integrated stop: the user is forced to complete the crimping process. This ensures crimping complying to DIN standards
- Supplied in a service box without dies but with assembly tool
- 2 crimp tools with fully assembled die sets are available

**Note:** 853-290 is only designed for HTS and Harting contacts

Mfrs List no.	Connector	Application	Crimping Capacity		Weight g
			mm <sup>2</sup>	AWG	
97 49 62		Solar Connectors Huber + Suhner	2.5 / 4.0	13 / 11	35
97 49 63		Solar Connectors Huber + Suhner	4.0 / 6.0	13 / 11 / 10	35
97 49 65		Solar Connectors MC 3 (Multi-Contact)	2.5 / 4.0 / 6.0	11 / 10	35
97 49 65 1		Locator for 97 49 65			80
97 49 66		Solar Connectors MC 4 (Multi-Contact)	2.5 / 4.0 / 6.0	13 / 11	35
97 49 66 1		Locator for 97 49 66			70
97 49 67		Solar Connectors Hirschmann	2.5 / 4.0 / 6.0	13 / 11 / 10	35
97 49 68		Solar Connectors Solarlok (Tyco)	2.5 / 4.0 / 6.0	13 / 11 / 10	35
97 49 68 1		Locator for 97 49 68			70

508217



	Mfrs List No.	Order Code	Price Each		
			1+	3+	5+
Crimping Pliers and Case, without dies	97 43 200	<b>853-173</b>	84.250	--	--
Crimping die for connectors Huber + Suhner	97 49 62	<b>134-3511</b>	51.130	49.329	48.233
Crimping die for connectors Huber + Suhner	97 49 63	<b>156-0901</b>	84.720	80.500	76.270
Crimping die for connectors MC 3 Multicontact	97 49 65	<b>156-0902</b>	95.120	90.330	85.590
Locator for 97 49 65	97 49 65 1	<b>156-0903</b>	47.540	45.170	42.800
Crimping die for connectors MC 4 Multicontact	97 49 66	<b>156-0904</b>	100.320	95.280	90.280
Locator for 97 49 66	97 49 66 1	<b>156-0905</b>	47.540	45.170	42.800
Crimping die for connectors Hirschmann	97 49 67	<b>156-0907</b>	84.250	80.080	75.860
Crimping die for connectors Solarlok Tyco	97 49 68	<b>156-0908</b>	144.610	137.350	130.140
Locator for 97 49 68	97 49 68 1	<b>156-0909</b>	47.540	45.170	42.800

Connector	Mfrs. Part No.	Application Range	Capacity	
			mm <sup>2</sup>	AWG
	97 49 04	uninsulated plug-in connectors 2.8 + 4.8 mm	0.1 - 2.5	27 - 13
		unisolierter, offene Steckverbinder 4.8 + 6.3 mm uninsulated plug-in connectors 4.8 + 6.3 mm	0.5 - 6.0	20 - 10
	97 49 06	insulated cable sockets + connectors	0.5 - 6.0	20 - 10
	97 49 08	Aderendhülsen	0.5 - 6	20 - 10
	97 49 13	insulated cable sockets + connectors	0.5 - 10.0	20 - 7
	97 49 15	exchangeable crimping die	1.5 - 2.5	16 - 13
		+ uninsulated plug-in connectors 4.8 + 6.3mm	3 - 4 / 4 - 6	12 - 10
	97 49 18	wire-end ferrules	2 x 6.0; 2 x 10.0; 2 x 16.0	
	97 49 24	D-Sub plug	0.03 - 0.56	32 - 20
	97 49 30	uninsulated	1.5 - 10.0	15 - 7
	97 49 40	Coax connector	RG58, 59, 62, 71, 223	
		Coax Connector / car phone	RG58, 174, 188, 316	
	97 49 44	turned contacts	0.14 - 1.5	26 - 15
	97 49 54	crimping die	0.5 - 2.5	20 - 13

Over 480,000 products online

**Crimp Tools - continued**

**Crimp System Pliers and Crimp Profiles - continued**

Connector	Mftrs. Part No.	Application Range	Capacity	
			mm <sup>2</sup>	AWG
	97 49 60	turned contacts (HTS + Harting)	0,14 - 4	26 - 11
	97 49 62	Solar connector	2,5 + 4,0	13 + 11
	97 49 70	Western plug	4 / 6 / 8-polig RJ10, 11, 12, 45	
<b>Crimp plier with mounted crimp profile; in cardboard box</b>				
	97 43 05	uninsulated cable sockets + connectors	0.5 - 6.0	
	97 43 06	crimp tool, insulated crimps	0.5 - 6.0	20 - 10

245831

Mftrs. Part No.	Order Code	Price Each		
		1+	3+	5+
<b>Crimp plier + case without crimp profiles</b>				
97 43 200	853-173	84.250	--	--
<b>Crimp profiles</b>				
97 49 04	853-185	42.350	--	--
97 49 05	853-197	40.600	--	--
97 49 06	853-203	32.350	--	--
97 49 08	853-227	31.350	--	--
97 49 09	853-239	31.350	--	--
97 49 19	853-240	52.550	--	--
97 49 13	853-215	31.350	--	--
97 49 15	571-4783	109.700	106.400	103.100
97 49 18	134-3510	42.300	40.802	39.895
97 49 24	853-252	74.600	--	--
97 49 30	853-264	31.350	--	--
97 49 40	853-276	52.750	--	--
97 49 50	853-288	62.100	--	--
97 49 44	571-4795	75.850	73.550	71.300
97 49 54	571-4801	75.850	73.550	71.300
97 49 60	853-290	79.200	--	--
97 49 62	134-3511	51.130	49.329	48.233
97 49 70	853-306	66.550	--	--
97 49 76	571-4813	44.320	--	--
97 49 81	571-4825	84.000	--	--
97 49 82	571-4837	31.820	--	--
97 49 84	571-4849	82.800	--	--
97 49 83	571-4850	38.880	--	--
<b>Positioning aids</b>				
97 49 90 for 853-290	853-318	61.800	--	--
97 49 94 for 853-185	853-320	19.700	--	--
97 49 95 for 853-197	853-331	19.700	--	--
<b>Pliers with assembled crimp profiles without box and assembly tool (for flat plugs, 4.8 and 6.3mm)</b>				
97 43 05 Uninsulated	853-343	103.600	--	--
97 43 06 Insulated	853-355	95.100	--	--

45

**Technical information at your fingertips**



Over **352,000** technical datasheets available online.

Visit [www.farnell.co.uk](http://www.farnell.co.uk) and look for the **Tech Info** heading in your search results.

**Lever Action Crimping Pliers**



Länge: 195 mm



- new generation of lever action crimping pliers
- for solder-free electrical connections
- the new lever transmission reduces the handforce up to 30% compared with regular crimping pliers
- repetitive, high crimping quality due to precision profiles and integral lock (self-releasing mechanism)
- these tools have been set precisely (calibrated) in the factory
- two-hand operation for easy crimping of large conductor diameters
- easy handling as a result of well balanced centre of gravity, angled head and ergonomically shaped handles
- all stressed parts are made of special steel, oil-hardened and tempered
- head burnished, non-slip plastic coated handles



Material:

Material of handle:

Handles with plastic coats

Mftrs. Part No.	Range of Application	Capacity		Length mm	Weight g
		mm	AWG		
97 52 05	non-insulated, open plug-type connectors 4,8 + 6,3 mm width;	0.5 - 6.0		250	570
97 52 06	isolated plug-type connectors and other isolated connectors	0.5 - 6.0		250	560
97 52 10	Coax - BNC- and TNC-Connectors RG 58/ 59/ 62/ 71 7 233			250	560

243024

Description	Mftrs. Part No.	Order Code	Price Each	
			1+	3+
Lever Action Crimping Plier	97 52 05	413-5532	79.60	77.20
Lever Action Crimping Plier	97 52 06	413-5544	68.45	66.40
Lever Action Crimping Plier	97 52 10	413-5556	93.55	90.75

**Four mandrel crimping tool**



- For crimping turned contacts
- 12-part positioning aid for contact insertion
- Four mandrel crimping for exact crimping performance
- Adjustment matrix

- Material: special quality steel
- Handle Material: handles with plastic covers
- Handy shape easy to use

Type	mm <sup>2</sup>	AWG	Length mm	Weight g
97 52 64	0.08 - 2.5	28 - 13	180	415

242909

Mftrs List No.	Order Code	Price Each	
		1+	3+
97 52 64	413-5568	283.90	275.40

**Coming soon**



Register your interest for items that are 'Coming Soon' at [www.farnell.co.uk](http://www.farnell.co.uk) and we'll email you to let you know that they're in stock.

**Crimping Tool, Wire end ferrule**



- Model 97-53-09 front loading
- For DIN standard crimping of cable ferrules
- Square crimping for consistent optimum area of contact despite the positioning of the clamp connector
- Reinforcement through leverage
- Head burnished
- Compact lightweight tool
- Ergonomically designed for ease of use, Reduces fatigue

- Pre set stop and auto release guarantees a full cycle crimp lock can be released
- All stressed parts are made of special steel and are hardened and tempered

Modell 97 53 08: self-adjusting between 0.08 to 6.0 mm<sup>2</sup>; manually only adjustable to 10.0 mm<sup>2</sup> (via pivoting lever); wire-end ferrules up to 25 mm<sup>2</sup> can also be inserted in the opening from the side;

Modell 97 53 09: manual adjustment to 10.0 mm<sup>2</sup> or 16.0 mm<sup>2</sup> (via pivoting lever)

Material: special quality steel  
Handle material: Handles have plastic covers

Order code	Wire size		Weight g	Length mm
	mm <sup>2</sup>	AWG		
333-1015	0.08 - 10.0	28 - 7	475	190
381-4038	0.08 + 16.0	7 + 5	475	190

242887

Mfrs. List No.	Order Code	Price each		
		1+	5+	10+
97 53 08	333-1015	96.55	93.65	90.75
97 53 09	381-4038	104.25	101.10	98.00

**Self-Adjusting Crimping Pliers for End Sleeves (Ferrules)**



**New**



Länge: 195 mm



- for crimping end sleeves (ferrules) according to DIN 46228 parts 1 + 4
- for solder-free electrical connections
- lateral loading of the end sleeves (ferrules) into the tool
- simple handling as a result of self-adjustment to the size of the end sleeve (ferrule)
- repetitive, high crimping quality due to integral lock (self-releasing mechanism)
- these tools have been set precisely (calibrated) in the factory
- optimum transmission of force due to lever action for fatigue-reduced operation
- high operation comfort thanks to handy shape and low weight
- all stressed parts are made of special steel, oil-hardened and tempered
- Model: 97 53 04
- square crimping for optimum contact areas in the clamp connection
- Model: 97 53 14
- hexagonal crimping for optimum positioning in confined areas

Mfrs. Part No.	Range Of Application	Crimp Style mm	Capacity		Weight g	Length mm
			mm	AWG		
97 53 04	End Sleeves (Ferrules)	Square	0.08 - 10.0	28 - 7	380	180
97 53 14	End Sleeves (Ferrules)	Hexagon	0.08 - 6.0	28 - 10	400	180

243033

Description	Mfrs. Part No.	Order Code	Price Each	
			1+	5+
Crimping Plier	97 53 04	834-701	97.50	94.60
Crimping Plier	97 53 14	413-5520	102.60	99.50

**Parallel Crimping Pliers**



- parallel crimping performance to satisfy the particularly high standards of small connectors
- for solder-free electrical connections
- repetitive, high crimping quality due to precision profiles and integral lock (self-releasing mechanism)
- fixed locator for D-Sub micro plugs for an exact positioning of connector and cable
- these tools have been set precisely (calibrated) in the factory
- optimum transmission of force due to toggle lever for fatigue-reduced operation
- crimping pliers for other mini plugs as e. g. HD 22, Modu IV, Micro Timer, MQS, ... on request
- all stressed parts are made of special steel, oil-hardened and tempered

Head	Handles	Range of Application	Capacity mm <sup>2</sup>	AWG	Length
chrome plated	with two-coloured dual component handles	D-Sub, D-Sub-HD 20 and D-Sub-HDE plugs	0.03 - 0.56	32 - 20	190

405344

Mfrs. Part No.	Order Code	Price Each		
		1+	5+	10+
97 54 24	916-8494	147.05	142.65	138.25

**Wire Stripper/Crimper  
AWS Wire Stripper/Crimper**



3 in 1 automatic wire stripper/crimper. Single motion stripping of wires/insulation and the crimping of insulated and non-insulated terminals. Wire stripping range of 0.13 - 6.0mm<sup>2</sup>/10 - 26AWG. Carbon steel blades, alloy steel jaws hardened and tempered, with plastic hand grips.

490665

Order Code	Price Each			
	1+	5+	10+	20+
135-9493	13.71	13.43	13.17	12.90

**Ratchet Crimp Pliers**



45



- Ratchet action crimp tool for non-insulated wire ferrules
  - Capacity 1,5 - 10 mm<sup>2</sup> / 16 - 8 AWG
  - High quality carbon alloy steel for durability
  - High compression pressure for secure crimping
  - Quick release lever
- Length: 230mm

494988.471146

Mfrs. List No.	Order Code	Price Each			
		1+	5+	10+	20+
430025	151-8898	29.86	28.97	28.06	27.17

**Ratchet Crimp Pliers**



- Ratchet action crimp tool for insulated wire ferrules
- Capacity 10 - 25 mm<sup>2</sup> / 8 - 3 AWG
- High quality carbon alloy steel for durability
- High compression pressure for secure crimping
- Quick release lever
- Length: 230mm

**Crimp Tools - continued**

**Ratchet Crimp Pliers - continued**

494987.471145

Mfrs. List No.	Order Code	Price Each			
		1+	5+	10+	20+
430022	151-8897	33.88	32.86	31.84	30.84

**Ratchet Crimp Pliers for Ferrules**



- High quality carbon alloy steel for durability
- High compression pressure for secure crimping
- Quick release lever
- Length: 190mm

494985.470527

Mfrs. List No.	Capacity	Order Code	Price Each			
			1+	5+	10+	20+
430018	14-26 / 0.14-2.5mm <sup>2</sup>	151-8893	33.97	32.95	31.93	30.91
430029	10-20 / 0.25-6.0mm <sup>2</sup>	151-8894	33.97	32.95	31.93	30.91

**Ratchet Crimping Pliers**



- For insulated terminals: red, blue and yellow
- Size: 220mm
- Capacity: 0.50-0.6mm $\varnothing$ /20-10 AWG

448352.470522

Mfrs. List No.	Order Code	Price Each	
		1+	5+
430021	128-3217	27.20	26.40

**Crimp Tool**

**Interchangeable Die Sets**



- Ratchet crimp action enables the user to make reliable and repeatable terminations
- Pressure adjustment for actuation force
- Crimp release provides operator safety
- Dies can be quickly changed
- Interchangeable dies for a wide range of applications, providing versatility in a single tool

**Interchangeable Dies**  
Order Code Application

312-5154	22-10 AWG insulated terminals/colour coded nests
312-5166	22-12 AWG non-insulated open barrel connectors
312-5178	Cambridge CP-88, CP-89 BNC/TNC coax connectors with RG-58, RG-59/62 AU cables
312-5180	RG-58, RG-174 and RG-8218 for both 50 and 75 ohm cables
312-5191	N-Series and RG-8/11 connectors
312-5208	RG-174, Mini 59 BNC,TNC connectors
312-5210	RG-59, RG-6, F-type CATV connectors
312-5221	RJ-45, eight-position keyed or non-keyed modular plugs (excluding AMP)
312-5233	RJ-11 two, four and six-position modular plugs
312-5245	RJ-11 DEC MMJ six-position modular plugs with an offset release tab
312-5257	AMP RJ-45 eight-position modular plugs/primary strain relief crimp bar is located further back on die/modular plugs
312-5269	RG-58, RG-59/62, BNC/TNC coax connectors

222889

	Order Code	Price Each
		1+
Crimp tool frame	312-5142	29.00
22-10 AWG insulated	312-5154	11.14
22-12 AWG non-insulated	312-5166	4.58
Cambridge CP-88, CP-89	312-5178	2.70
RG-58, RG174 and RG-8218	312-5180	9.16
N-Series, RG-8/11	312-5191	6.08
RG-174, Mini 59 BNC/TNC	312-5208	9.15
RG-59, RG-6, F-type	312-5210	4.58
RJ-45	312-5221	11.14
RJ-11	312-5233	8.74
RJ-11 DEC MMJ	312-5245	5.57
AMP RJ-45	312-5257	4.37
RG-58, RG-59/62	312-5269	11.14

**Crimp Tool**

**Non-insulated Terminals**



- For crimping interlocking and non-insulated terminals

AWG	Crimping Capacity		
	20-18	16-14	12-10
mm <sup>2</sup>	0.5-1	1.5-2.5	4-6

**Crimp Tool**

**Insulated Terminals**



- For crimping insulated terminals

Overall length = 220mm

AWG	Crimping Capacity		
	20-18	16-14	12-10
mm <sup>2</sup>	0.5-1	1.5-2.5	4-6
	Red	Blue	Yellow

222952

Order Code	Price Each
	1+
312-6353	21.45

**Crimping Pliers for End Sleeves (Ferrules)**

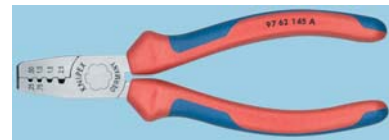

- For crimping end sleeves (ferrules) according DIN 46228 parts 1 + 4 in an area of application from 0.25 up to 2.5mm<sup>2</sup>
- Crimping in marked trapezoidal dies for secure connections between the sleeve and the conductor
- Vanadium steel, oil-hardened and tempered
- Polished head, two-colour dual component handles

Mfrs List No.	Head	Range of Application	Capacity		
			mm <sup>2</sup>	AWG	Length
97 62 145 A	Polished	End Sleeves (ferrules)	0.25 - 2.5	23 - 13	145

405345

Mfrs. List No.	Order Code	Price Each		
		1+	5+	10+
97 62 145 A	916-8508	15.55	15.10	14.60

**Crimping Pliers for End Sleeves (Ferrules)**



- For crimping end sleeves (ferrules) according DIN 46228 parts 1 + 4 from 0.25 to 16mm<sup>2</sup>
- Crimping in marked half-round dies for secure connections between the sleeve and the conductor
- 9 extremely deep troughs with conical side faces
- Special tool steel, oil-hardened and tempered
- Polished head, two-colour dual component handles

Mfrs List No.	Order Code	Price Each		
		1+	5+	10+
97 72 180	916-8516	23.10	22.40	21.70

405346

45

Farnell





**Cable Link Crimping Plier**



- High alloy carbon steel drop forged for long life
- Matt chrome plated for corrosion resistance
- Contoured grips with anti-slip horns for comfort and safety

Mfrs. List No	Capacity Ø(mm)	AWG	Length (mm)	Order Code
430005	0.25-2.5	23 - 13	150	128-3215
430006	0.5 - 16	20 - 5	190	128-3216

448343.470085

Size (mm)	Mfrs. List No.	Order Code	Price Each	
			1+	5+
150	430005	128-3215	15.10	14.65
190	430006	128-3216	27.75	26.90

**Crimping Pliers For Scotchlok Connectors**



**Scotchlock Connectors Type 9750**



- for crimping plastic-insulated telecommunication or signal cables using the U-contact principle in single Scotchlok connectors
- no stripping necessary, U-shaped elements make the connection

- cutting edges additionally induction hardened
- with opening spring

Material: Vanadium steel, oil-tempered  
Material of handle: Plastic

Mfrs. Part No.	Range of Application	Capacity mm Ø	Length
975001	Scotchlock - Connectors	0,4 -1,1	155

245847

Mfrs. Part No.	Order Code	Price Each		
		1+	5+	10+
975001	875-739	27.40	26.60	25.75

**Crimping Tool**



- Specially hardened steel crimper with soft grips for prolonged comfortable use
- 4 functions in the one tool
- Wire cutting: soft wire only
- Crimping: Non insulated terminals 1.5, 2.5, 4-6.0mmØ
- Bolt shearing: 2.6, 3.0, 3.5, 4.0, 5.0mmØ
- Wire Stripping: 0.75, 1.0, 1.5, 2.5, 4.0, 6.0mmØ
- Length: 250mm

448355

Mfrs. List No.	Order Code	1+	5+
430024	128-3220	5.45	5.30

**Wire Stripper and Crimper**



- Hardened and tempered crimping and cutting edges
- Vinyl handles
- Length: 230mm (9")
- Crimping
  - Insulated: 1.5, 2.5, 6mm
  - Non-Insulation: 4-6, 2.5, 1.5mm
  - ISO: M2.6, M3, M3.5, M4, M5
- Stripping
  - 0.75, 1, 1.5, 2.5, 4, 6mm

481976.457890

Order Code	Price Each			
	1+	5+	10+	20+
144-7419	2.18	1.68	1.59	1.47
				50+
				1.05

**Crimping/Stripping Tool Kit**



A crimping, stripping and cutting tool complete with 60 insulated terminals.

- Features:
- Stripping - 0.75, 0.9, 1.25, 2.0, 3.5, 5.5mm<sup>2</sup>
  - Crimping - 1.25, 2.0, 3.5-5.5mm<sup>2</sup> (non-insulated), 1.25, 2.0, 5.5mm<sup>2</sup> (insulated)
  - Bolt cutter - M2.6, M3, M3.5, M4, M5
  - Length: 230mm

482918.432354

Order Code	Price/Kit	
	1+	5+
145-4283	4.16	3.56

**Draper Crimping Toolset**



**Crimping Tool Set CT-K/PRO**



Ratchet crimping tool manufactured from carbon steel with hardened and tempered jaws. Continuous crimping at preset tension ensures accurate crimp. Chemically blacked finish with PVC grips. Suitable for crimping insulated terminals as follows:- red channel: 0.5 - 1.0mm<sup>2</sup>, blue channel: 1.5 - 2.5mm<sup>2</sup> and yellow channel: 4.0 - 6.0mm<sup>2</sup>. Supplied complete with 590 (approx.) mixed pre-insulated terminals in a steel storage case with insert.

490668

Order Code	Price Each			
	1+	5+	10+	20+
135-9494	53.89	52.82	51.76	50.73

**Crimping Pliers for Western Plugs**

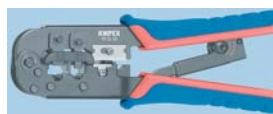

97 51 10 Länge 190mm



97 51 12 Länge 190mm

**Crimping Pliers for Western Plugs 97 51 10**

- professional tool for cutting and stripping unshielded ribbon telephone cables
- for crimping 6- and 8-pole Western plugs type RJ 11/12 (9.65 mm width) and type RJ 45 (11.68 mm width)
- exact crimping process due to parallel crimping
- repetitive, high crimping quality due to integral lock (self-releasing mechanism)
- optimum transmission of force due to lever action for fatigue-reduced operation
- with length cutter and dismantling knife for ribbon cables 6 and 12 mm length
- with additional stripping device for round cables
- head burnished, two-colour dual component handles

**Crimping Pliers for Western Plugs 97 51 12**

- professional tool for cutting and stripping unshielded ribbon telephone cables
- for crimping 4-, 6- and 8-pole Western plugs type RJ 10 (7.65 mm width), type RJ 11/12 (9.65 mm width) and type RJ 45 (11.68 mm width)
- exact crimping process due to parallel crimping
- repetitive, high crimping quality due to integral lock (self-releasing mechanism)
- optimum transmission of force due to lever action for fatigue-reduced operation
- with length cutter and dismantling knife for ribbon cables 6 and 12 mm length
- head burnished, two-colour dual component handles

245846

Mfrs. Part No.	Order Code	1+	3+	5+
975110	348-3708	33.50	32.50	--
975112	348-3710	108.70	105.45	--

**Premium service without a premium price**



With thousands of prices already reduced, go online to see our most up-to-date pricing: [www.farnell.co.uk](http://www.farnell.co.uk)

**Crimp Tools - continued**

**Ratchet Crimping Pliers COAX-BNC, TNC**



- For 58,59,62,8X,140,141,174,210,233,303,400
- Size: 230mm

448354.471147

Mfrs. List No.	Order Code	1+	5+	Price Each
430026	128-3218	29.30	28.40	

**Modular Ratchet Crimp Tool**



- Built in wire cutters
- Vinyl grip
- Locking mechanism

An 8 Contact (RJ45) modular ratchet crimp tool for crimping 8 way (8P8C) modular telephone plugs.

481977.457892

Order Code	1+	5+	10+	20+	50+	Price Each
144-7420	5.85	4.95	4.48	4.35	3.98	

**Modular Crimp Tool**



- For 8P8C (RJ45), 6P6C (RJ12) and 6P4C (RJ11) plugs
- High quality carbon alloy steel for durability
- High compression pressure for secure crimping
- Quick release lever and pressure adjustment for ease of use
- Wire cutting: soft wire only
- Length: 185mm

448356.471148

Mfrs. List No.	Order Code	1+	5+	Price Each
430028	128-3219	36.45	35.35	

**Modular Ratchet Crimping Pliers**



- For 4P2C, 4P4C, 6P4C (RJ11), 6P6C (RJ12), 8P8C (RJ45) and 6P6C/Offset (Dec)
- Cuts, strips and crimps all types without change of die
- Built in stripper on front - cutter on reverse
- Guide for precise stripping and quick release lever / screw

494986.470549

Mfrs. List No.	Order Code	1+	5+	10+	20+	Price Each
430020	151-8895	89.55	86.85	84.20	80.60	

**Telemaster™ Telephone Crimp Tool**



The Telemaster™ is a multi-functional telephone-crimping tool that will cut and strip the cable as well as crimping it. The tool is manufactured from durable steel with black plastic handles and a spring loaded mechanism suitable from crimping RJ-11 (1,2 and 3 pair) and RJ-45 (4 pair) plugs.

235594.401532

Order Code	1+	Price Each
394-9278	24.80	

**All-in-One Telephone Tools**



**Economy Crimping Tools - WE/SS and AMP**

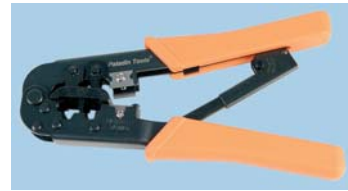

Ratcheted design. Embedded cable cutter and stripper. Crimps 6-position RJ11/RJ12 connectors, 8-position RJ45 connectors, 28-22 AWG (0.08-0.34mm) telephone and data cables. Two models available: Western Electric (WE) Stewart Stamping (SS) types and AMP (Tyco) for 6 and 8 position modular telephone plugs.

443732

Description	Mfrs. List No.	Order Code	1+	10+	Price Each
All-in-one Tool (WE/SS)	1545	454-9430	34.55	32.63	
All-in-one Tool (AMP)	1554	748-7703	34.55	32.63	

**All-in-One Pro Telephone Tools**



**Crimping Tools - WE/SS and AMP**

Rubber-embedded handles with hand stops. Smooth ratcheted design. Embedded cable cutter and stripper. Crimps 4-position RJ22 handset connectors, 4 and 6-position RJ11/RJ12 connectors, 8-position RJ45 (non-keyed) connectors and 28-22 AWG (0.08-0,34mm) telephone and data cables. Built-in safety ratchet release. Crimps CAT-3 to CAT-6 with one crimping tool. Two models available: Western Electric (WE) Stewart Stamping (SS) types and AMP (Tyco) for 4-6 and 8 position modular telephone plugs.

443716

Description	Mfrs. List No.	Order Code	1+	10+	25+	Price Each
All-in-one Pro (WE/SS)	1530R	182-9865	52.24	48.06	45.97	
All-in-one Pro (AMP)	1540	748-7690	52.24	48.06	45.93	

**Modular Ratchet Tool And Dies**



**For DataCom Connectors**

Modular tool with interchangeable die sets. 7 die sets to suit most RJ connectors. ABS case holds 1 tool and 7 die sets.

Part No.	Description	Part No.	Description
1302	1300 Series Universal Tool Frame	2065	Crimp Die RJ11 RJ12 6P6C
2061	Crimp Die RJ45 8P8C (8 Pin) WE / Stewart	2068	6P4C 6P2C Tyco AMP Crimp Die RJ50 10P10C (10 Pin)
2062	Crimp Die RJ11/RJ12 6P6C, 6P4C 6P2C WE / Stewart	901013	ABS Tool Case
2064	Crimp Die RJ45 8P8C (8 Pin) Tyco AMP		

443832

Mfrs. List No.	Order Code	1+	Price Each 3+	5+
<b>Universal Tool Frame</b>				
1302	887-146	34.99	32.54	31.15
<b>Crimp Dies</b>				
2061	439-2474	13.87	12.90	12.35
2062	439-2498	13.87	12.90	12.35
2064	439-2516	13.87	12.90	12.35
2065	439-2528	13.87	12.90	12.35
2068	439-2530	13.87	12.77	12.21
<b>ABS Tool Case</b>				
901013	377-6657	21.71	20.74	19.80

**"F" Type Waterproof Connectors**

**Paladin Tools®**



**With Matching Crimp Tool**

**SealTite® Pro CATV "F" waterproof connections**

Designed for home or business networking and video distributing: satellite, CATV and UHF. Quick and easy to assemble. Good quality crimp connections assured. Can be used outdoors as well as indoors.

**SealTite® Pro crimp tool**

Crimps weatherproof and waterproof linear CATV "F", BNC, RCA and right-angle compression-type connectors from multiple manufacturers. Precise crimp assured. Accommodates multiple connectors. Single reversible head. No additional parts or attachments required.

Compression connectors compatible with SealTite® Pro	LRC (Augat/T&B)	Snap-n-Seal™
<b>Manufacturer</b>	Calrad	Permaseal™
Paladin Tools	PCT	PCT-DRS
ICM Corp.	Stirling	SPL
Gem	PPC	EX
Gilbert		

443612

Description	Mfrs. List No.	Order code	1+	Price Each 10+	50+
<b>"F" Type Waterproof connectors</b>					
RG55 Cable	9610	748-7622	14.48	12.86	10.50
RG6 Cable	9611	748-7630	14.48	12.86	10.50
<b>Crimp tool</b>					
SealTite Pro	1555	748-7614	58.78	54.42	--

**8000 Series CrimpALL™ Fibre Optic Crimp Tool**

**Paladin Tools®**



**Interchangeable die sets**

Incorporates 4 important ergonomic features that improve user satisfaction and job function:

1. Angled head prevents awkward wrist bending during operation.
2. Reduced handle grip distance is comfortable for workers with small and large hands.
3. The higher crimp force is produced with a lower hand force so hands don't tire as quickly.
4. No breakover hand force.

Ultra-smooth, fully ratcheting crimp cycle with built-in safety release. Interchangeable die sets of heat-treated steel for long life. Soft, rubber-embedded handles. Long lasting tool that delivers over 50,000 crimp cycles. Rugged, double-plated jaw design to increase life span.

Interchangeable dies	Interchangeable dies
Order code	Application
413-2660	SMA, SMB, SFR, ST and SC type

443750

Description	Order Code	1+	Price Each 5+	10+
Crimp tool frame	413-2658	40.75	38.72	37.08
Die set 2652	413-2660	13.46	12.69	12.22

**Heavy Duty Crimping Tool**



For terminating cable lugs from 10mm<sup>2</sup>-120mm<sup>2</sup> with non-ratchet screw adjustment design for aluminum (8AWG TO 4/0) and copper (8AWG TO 300MCM). Body with aluminium alloy and SCM 4 cutter (hardness: HRC 55°±3°).

525405

Description	Mfrs. List No.	Order Code	1+	Price Each 5+	10+
Heavy Duty Crimping Tool (670mm)	8PK-CT150	166-6207	51.20	48.64	46.07

**Crimping Tool**

**Hydraulic Crimping Tool HT51**



This hydraulic compression tool develops a crimping force of 50kN with a built in safety valve and a pressure releasing system that can be operated at any stage of the compression. With spring loaded handles and a tool head that rotates through 180 degrees connectors can be positioned with one hand while the other advances the dies. For use with copper cables up to 150mm<sup>2</sup>. Complete with steel carrying case. Die sets are to be purchased seperately.

492543

Order Code	Price Each 1+
271-505	476.86

**Crimping Tools**

**Hydraulic Crimping Tool HT131-C**



A twin stage hydraulic hand compression tool developing a crimping force of 130kN, suitable for installing crimp type electrical connectors on copper cables up to 400sq mm and on aluminium cables up to 300sq mm. The built in safety valve will by-pass the oil supply when the maximum pressure is reached and a pressure releasing system can be easily operated at any stage of the compression. For ease of operation and comfort of the operator the tool head can be fully rotated through 180 degrees. This robust and self contained tool uses the semi-circular slotted dies which are common to most 130kN tools, but are not supplied with the tool. Complete with steel carrying case.

rust and self contained tool uses the semi-circular slotted dies which are common to most 130kN tools, but are not supplied with the tool. Complete with steel carrying case.

Order Code	Price Each 1+
271-510	777.72

**Die Sets**

491460

Conductor Size(mm <sup>2</sup> )	Order Code	Price Each 1+
10	271-547	39.75
16	271-548	42.95
25	271-549	39.75
35	271-550B	39.76
35 (flexible)	271-551	39.75
50	271-552	42.95
70	271-554	40.90
95	271-511	40.90
120	271-512B	39.76
150	271-513	39.75
150 (flexible)	271-558	42.95
185	271-514	39.75
185 (flexible)	271-559	42.95
240	271-560	39.75
300	271-561	39.75
400	271-562	39.75

**Die Sets**



**Crimp Tools - continued**

**Die Sets - continued**

493418

Conductor Size(mm <sup>2</sup> )	Order Code	Price Each
		1+
4 - 6	271-536B	28.00
10	271-537	24.59
16	271-538	24.59
25	271-539	24.59
35	271-540	24.59
35 (flexible)	271-541	24.59
50	271-506	22.75
50 (flexible)	271-542	20.30
70	271-507	22.75
70 (flexible)	271-543	22.75
95	271-508	24.59
95 (flexible)	271-544	24.59
120	271-509	22.75
120 (flexible)	271-545	22.75

**DataReady™ Kit**

**Paladin Tools®**



**CAT5 AMP/Krone Kit**

**Kit contains:**  
 AM 12 UTP/STP cutter/stripper - 1112  
 All-in-one telephone tool for RJ45 & RJ11 modular plug (AMP) - 1545  
 Standard impact punchdown tool - 3526  
 Standard 110 blade - 4526  
 Standard Krone blade - 4527  
 Patch-Check™ tester - 1529  
 RJ45 connectors - 9546

A complete Category 5 datacomm tool set in a zip up case. The kit includes everything needed for a CAT-5 installation.

443466

Mfrs. list no.	Order Code	Price Each
9010531	748-7665	139.96

**Premise Service Kit**

**Paladin Tools®**



**AMP/Krone Kit**

A large data, voice and coaxial LAN installation kit providing everything for twisted pair and coaxial cable installation.

**Kit contains:**  
 KT8 round cable cutter - 900265  
 Data SureStrip™ UTP/STP & flat satin cutter/stripper - 1116  
 LC CST - 58/59 coax stripper - 1255  
 FlatCat™ flat satin cable/stripper - 1160  
 CrimpALL® CrimpFrame with EZI-CHANGE™ thumb screws - 8000  
 Die sets:  
 RJ45 AMP style - 2061  
 RJ11 AMP style - 2062  
 RG58/59/62AU BNC/TNC - 2034

**Kit contains:**  
 SurePunch™ PDT punchdown tool - 3570  
 SurePunch™ 110 reversible blade - 4572  
 SurePunch™ Krone reversible blade - 4573  
 LAN ProNavigator™ tester - 1543  
 Speaker probe with volume control and light - 1571

443510

Mfrs. list no.	Order Code	Price Each
9010391	748-7657	322.20

**Troubleshooting tips**



Chat live online to one of our technical engineers at [www.farnell.co.uk](http://www.farnell.co.uk)

**Coax Ready Kit**

**Paladin Tools®**



The complete tool kit for coaxial installation and assembly. Ideal for LAN/Ethernet or video installers.

Description	Mfrs List No.	Order Code
1300 Crimp Tool	1302	887-146
Crimp Die	2034	887-158
Crimp Die	2075	386-3270
Crimp Die	2653	386-3281
Three Level Coax Stripper	LC CST-58/59	386-3293
Coax Cable Cutter	KT8	NA

Kit includes space for Local or Remote Coax Tester

443710

Mfrs. List No.	Order Code	1+	3+	5+
901054	386-3268	92.78	88.45	85.93

**DataReady kit**

**Paladin Tools®**



A complete Cat5 datacomm tool set in a handy zipper case.

**Kit contains:**  
 All in one telephone tool for RJ45 and RJ11  
 Impact punch-down tool with 110 and 66 blades  
 AM12 cutter/stripper for unshielded and shielded cable  
 Patch-Check continuity tester  
 Category 5 RJ45 connectors (x20)  
 Zipper case with carrying strap and complete instructions

443795

Mfrs. list no.	Order code	Price each
901053	388-8320	139.96

**Wire Wrapping**

**Electric Powered 240V ac**

**GARDNER-DENVER/COOPER**



- Powerful mains wire wrap tool
- Rapid acceleration to 2300rpm
- Universal collet accommodates all bits listed below

222652

Mfrs. List No.	Order Code	Price Each
29315AA3	628-785	332.25

	Order Code	1+	5+	10+
Manual Wire Wrapping Tool	826-4414	96.74	93.83	91.95

Bits and Sleeves



All bits and sleeves listed below fit the universal collet as fitted to the tools opposite.

Wire Size AWG	Terminal Min.	Diagonal Max.	Terminal Hole Depth	BIT		SLEEVE	
				Mfrs. List No.	Order Code	Mfrs. List No.	Order Code
<b>Standard Wrap</b>							
22	1.55	2.18	25.4	18632	147-841	18840	147-842
24	1.4	1.88	25.4	512058	147-845	512056	147-846
<b>Modified wrap</b>							
24	1.33	1.88	28.8	26263	147-848	18840	147-842
26	0.58	0.99	19.1	506445	147-849	507100	147-850
26	1.35	1.75	25.4	502118	147-851	512056	147-846
30	0.79	0.86	19.1	507063	147-853	507100	147-850
30	0.84	0.91	19.1	507573	147-854	507100	147-850
<b>Cut Strip and Wrap</b>							
30	0.76	0.86	25.4	990764	109-261	990765	109-365

222653,401577

	BITS		SLEEVES	
	Order Code	Price Each	Order Code	Price Each
<b>Standard Wrap</b>				
22AWG	147-841	31.58	147-842	12.24
24AWG	147-845	72.00	147-846	38.25
<b>Modified Wrap</b>				
26AWG	147-849	72.00	147-850	30.75
26AWG	147-851	69.75	147-846	38.25
30AWG	147-853	72.00	147-850	30.75
30AWG	147-854	72.00	147-850	30.75
<b>Cut Strip and Wrap</b>				
30AWG	109-261	182.25	109-365	98.25

Squeeze Handle



- Ideal for field service engineers
- One squeeze produces ten revolutions of the wrapping bit
- Suitable for use with 22 to 30 AWG
- Universal collet accommodates all wrapping bits listed above.

222651

Mfrs. List No.	Order Code	Price Each
28000AC1	147-865	96.75

Hand Strip/Wrap/Unwrap Tool



- Wire stripping wrap and unwrap tool
- Gives modified wrap on 0.6mm square terminals using 0.25mm wire
- 112mm x 8mm size allows easy access to restricted spaces

222654,401578

Mfrs. List No.	Order Code	Price Each
WSU30M	441-089	23.56

Lexan™ Manual Wire Wrapping Tool



- For precise and reliable wrapping
- Lightweight and robust
- Designed with a chuck nose piece and sleeves
- Tool accommodates wire sizes from AWG 22 (0.65mm) - AWG 32 (0.20mm)

373826

Wire Wrapping Bits & Sleeves

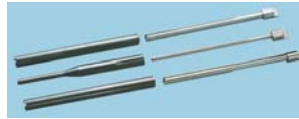

Fully compatible with any make or model wire wrapping tool.



Wire Gauge AWG	mm	Bits Mfrs. List No	Sleeves Mfrs. List No	Max. Insulation ∅ (mm)	Terminal Min	Terminal Diagonal Max	Square Terminals (mm)
22	0.65	WB2275M	P2224	1.32	1.24	1.87	1.0 x 1.0 0.8 x 1.6
24	0.50	WB24DH	P2224	1.17	1.37	1.85	1.0 x 1.0 0.8 x 1.6
26	0.5	WB2426M	P2224	1.17	1.37	1.85	1.0 x 1.0 0.8 x 1.6
26	0.4	WB26SM	P26LN	0.79	0.58	0.96	0.6 x 0.6
30	0.25	SB30MMK	P3032	0.58	0.79	0.89	0.6 x 0.6

373849

	Order Code	1+	5+	10+
<b>Bits</b>				
WB2275M	826-4503	32.24	31.28	30.66
WB24DH	826-4481	34.41	33.36	32.70
WB2426M	826-4490	34.41	33.36	32.70
WB26SM	826-4473	34.41	33.36	32.70
SB30MMK	118-1734	37.33	36.50	35.45
<b>Sleeves</b>				
P2224	826-4538	17.20	16.69	16.35
P26LN	826-4520	23.65	22.93	22.47
P3032	826-4511	23.65	22.93	22.47

Hand Wrapping and Unwrapping Tools



- 2 in 1 Wrapping and Unwrapping in one tool
- Easy and quick switch from wire wrapping to unwrapping
- Precise and long-lasting
- Suitable for field service



Mfrs. List No	Wire size AWG	mm	Terminal Min	Terminal Diagonal Max	Square Terminals (mm)
HW-UW-224	22-24	0.50-0.65	1.37	1.85	1.0 x 1.0 0.8 x 1.6
HW-UW-2426	24-26	0.40-0.50	1.39	1.87	1.0 x 1.0 0.8 x 1.6
HW-UW26SM	26	0.40	0.58	0.96	0.6 x 0.6
HW-UW 30	30	0.25	0.79	0.89	0.6 x 0.6

373857

Mfrs. List No	Order Code	1+	5+	10+
HW-UW-224	826-4570	56.28	54.70	51.90
HW-UW-2426	826-4562	58.04	56.30	55.16
HW-UW26SM	826-4554	64.50	62.56	61.31
HW-UW 30	826-4546	64.50	62.56	61.31

45

Hand Unwrapping Tool



- For easy and quick removing of wire connections
- Wire size 18 - 30 (1,0 - 0,25mm)



Mfrs. List No	Wrapping Typ	Wire size AWG	mm	Terminal mm	Square Terminals (mm)
UW-1	D	20-26	0.80-0.40	1.73	1.0 x 1.0 0.8 x 1.6
UW -4	B	20-26	0.80-0.40	1.73	1.0 x 1.0 0.8 x 1.6
UW -2832 C	D	28-32	0.50-0.20	0.92	0.6 x 0.6

373934

Mfrs. List No	Order Code	1+	5+	10+
UW-1	826-4600	18.28	17.73	17.37
UW -4	826-4597	25.80	25.02	24.52
UW -2832 C	826-4589	33.32	32.32	31.68

3 in 1 Combination Tools



- Wrapping, unwrapping and wire stripping in one tool
- Suitable for service and maintenance
- Integrated wire stripper



**Wire Wrapping - continued**

**3 in 1 Combination Tools - continued**

Mfrs. List No	AWG	Wire size mm	Terminal Depth (mm)	Square Terminals (mm)
WSU 2224	22-24	0.65-0.50	38.1	1.0 x 1.0 0.8 x 1.6
WSU 24 M	24	0.50	38.1	1.0 x 1.0 0.8 x 1.6
WSU 26 M	26	0.40	38.1	1.0 x 1.0 0.8 x 1.6
WSU-30	30	0.25	38.1	0.6 x 0.6
WSU30M	30	0.25	38.1	0.6 x 0.6

373942

Mfrs. List No	Order Code	Price Each		
		1+	5+	10+
WSU 2224	<b>826-4619</b>	33.32	32.32	31.68
WSU 24 M	<b>826-4627</b>	33.32	32.32	31.68
WSU 26 M	<b>826-4635</b>	33.32	32.32	31.68
WSU-30	<b>826-4643</b>	21.50	20.86	20.44
WSU30M	<b>441-089</b>	23.56	--	--

**Pliers - Standard**

**Ergo Pliers Set**



487490

Model	Contents	Order Code	Price Per Set			
			1+	5+	10+	20+
9897	8224 slip joint, 2628G-160 combination, 228G-160 side cutting, 2430GT-160 long snipe nose.	<b>135-6143</b>	59.87	58.67	57.50	55.93

**Installation Pack**

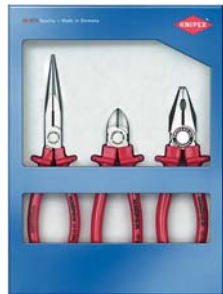

- The indispensable set of pliers for all installation work
- Contents:**  
 Combination pliers with polished head and plastic-coated handles (length: 180 mm)  
 Pantograph pliers with polished head and thick-walled plastic sleeves (length: 200 mm)  
 Side cutters with polished head and thick-walled plastic sleeves (length: 160 mm)

245758

Mfrs. Part No.	Order Code	Price Each	
		1+	32.85
002011	<b>333-0965</b>		

**Power Package**



- 3-part pliers set in attractive sales packaging
- Content:  
 1 High Leverage Combination Pliers 180mm  
 1 High Leverage Diagonal Cutter 160mm  
 1 KNIPEX-"Cobra", the HiTech Water Pump Pliers 250mm

245760

Mfrs. Part No.	Order Code	Price Each		
		1+	+	+
002010	<b>381-3990</b>	41.05	--	--

**Pliers, Box Set of 3.**



Box Set contains:  
 3754 160 mm Wire Strippers  
 2750 160 mm Side Cutter  
 3906 200 Snipe Nose Pliers

- Hot drop forged from special alloy steel for strength and durability
- Ergonomically designed sleeves for comfort and effortless use
- Contoured anti slip shoulders for safety in use
- Dual compound technology features soft grip non-slip inlays for grip and control
- Matt chrome finish for corrosion protection
- Gas/Oil hardened for optimum performance
- Induction hardened and precision ground cutting edges for precision cutting and long life

525113

PLIER SET OF 3	Mfrs. List No.	Order Code	Price Each		
			1+	5+	10+
	T3804	<b>166-0784</b>	49.00	46.55	44.15

**Heavy Duty Plier Set**



**Redline**



- Heavy duty pliers and cutters for professional use
- Cutting edges are induction hardened for durability and clean cutting action
- Satin chrome plated finish for protection
- Moulded high grip PVC handles with anti-slip guards
- Supplied in presentation box

Kit Contents:	Length	Cutting Capacity,	
		Piano Wire	
Side cutters	160	2.0	
Combination pliers	180	1.6	
Snipe nose pliers	200	1.6	

222720.401768

Mfrs. List No.	Order Code	Price Each	
		1+	49.75
T3803	<b>765-661</b>		

**3 Piece Plier Set**



- 2-component handle with slip guard
- Shock proof handle
- Drop forged, heat treated fully polished steel

**Contents:**  
 - 160mm Diagonal pliers  
 - 180mm Combination pliers  
 - 200mm Long nose pliers

493010.492588

Order Code	Price Each			
	1+	5+	10+	20+
<b>149-6328</b>	20.55	19.08	17.05	15.19

45

Farnell

5 Piece Pliers Set



- Ergonomically designed double injected handles
  - Drop forged, heat treated fully polished steel machine finish
- Set contents:
- 1 x 256mm (10") Waterpump pliers
  - 1 x 205mm (8") Slip joint pliers
  - 1 x 205mm (8") Long nose pliers
  - 1 x 180mm (7") Combination pliers
  - 1 x 180mm (7") Diagonal cutter pliers

482104.462290

Order Code	1+	5+	Price/Set 10+	20+	50+
144-7569	11.20	10.25	9.56	8.40	7.83

Side Cutters



- 2-component handle with slip guard
- Shock proof handle
- Drop forged, heat treated fully polished steel
- Available in two sizes: 140mm or 160mm

Cutting Capacity: wire

Size	Soft	Med/Hard
140mm	2.5mm	1.8mm
160mm	2.8mm	2.0mm

493005.492559

Size	Order Code	1+	5+	Price Each 10+	20+
140mm	149-6318	8.44	7.83	7.00	6.09
160mm	149-6319	8.99	8.35	7.46	6.50

Heavy Duty Side Cutter



- 2-component handle with slip guard
- Shock proof handle
- Drop forged, heat treated fully polished steel

Cutting Capacity: wire

Size	Soft	Med/Hard	Hard
180mm	3.8mm	2.7mm	2.3mm

493006.492563

Order Code	1+	5+	Price Each 10+	20+
149-6320	11.13	10.33	9.23	8.04

Diagonal Cutters Type 70



- the indispensable diagonal cutter for all-round use
- high quality material and precise workmanship for long service life
- precision cutting edges for soft and hard wire
- clean cutting at cutting edge tips; also in case of thin copper wires
- cutting edges additionally induction hardened, cutting edge hardness approx. 62 HRC
- narrow head style for use in confined areas
- Vanadium electric steel, oil-hardened and tempered
- with two-colour dual component handles
- according to **DIN ISO 5749**

Mftrs. Part No.	Head	Cutting performance Ø mm			Length mm	Weight g
		soft	medium	hard		
7002160	Polished	4.0	2.8	2.0	160	205
70 05 125	Chromed	3.0	2.3	1.5	125	115
70 05 140	Chromed	4.0	2.5	1.8	140	155
70 05 160	Chromed	4.0	2.8	2.0	160	205

403063

Mftrs. Part No.	Order Code	Price Each		
		1+	5+	10+
7002160	439-4197	13.25	--	--
70 05 125	876-185	15.05	14.60	14.15
70 05 140	876-197	15.10	14.65	14.20
70 05 160	876-203	15.75	15.30	14.80

High Leverage Diagonal Cutter Type 74



- with forged-on axle for heaviest duty
- suitable for all types of wire including piano wire
- high cutting performance with minimum effort due to optimum co-ordination of the cutting edge angle and transmission ratio
- precision cutting edges additionally induction-hardened, cutting edge hardness approx. 64 HRC
- the 250-mm-long diagonal cutter is suitable for copper conductors up to 16 mm<sup>2</sup> and aluminium conductors up to 35 mm<sup>2</sup>
- Chrome Vanadium electric steel, oil-hardened and tempered
- with two-colour dual component handles
- according to **DIN ISO 5749**

Mftrs. Part No.	Head	Cutting performance Ø (mm)			Length	Weight
		soft	medium	hard		
74 02 180	polished	3.8	2.7	2.2	180mm	255g
74 02 200	polished	4.2	3.0	2.5	200mm	300g

403237

Mftrs. Part No.	Order Code	Price Each		
		1+	5+	10+
74 02 180	876-215	17.90	17.35	16.85
74 02 200	108-353	19.05	18.50	17.90

Side Cutters



45

Blade Type	Overall Length	Blade Length	Blade Angle	Piano Wire Cutting Capacity	Mftrs. List No.	Order Code
Diagonal	130	17	15°	1.2	3751-130	263-540
Diagonal	180	25	15°	1.8	T37517	765-612
Semi Flush	145	18	15°	1.8	3750-145	263-552
Semi Flush	160	22	15°	2	3750-160	263-564
Semi Flush	180	—	15°	2	T3750 180	311-7145
Heavy Duty	165	—	15°	2	3720-6.5	765-715
Heavy Duty	200	—	15°	2.5	3720-8	765-727

223011

Blade Type	Overall Length	Order Code	Price Each
			1+
Diagonal	130	263-540	14.80
Diagonal	180	765-612	21.20
Semi Flush	145	263-552	15.90
Semi Flush	160	263-564	16.63
Semi Flush	180	311-7145	21.20
Heavy Duty	165	765-715	22.30
Heavy Duty	200	765-727	24.10

Premium service without a premium price



With thousands of prices already reduced, go online to see our most up-to-date pricing: [www.farnell.co.uk](http://www.farnell.co.uk)

**Pliers - Standard - continued**

**Pliers**

**Diagonal Cutting Nippers**



Chrome finish with ergonomic grips with return spring. High frequency treated cutting edges ensure durable cut quality for hard wire up to 200kg/mm<sup>2</sup>.

486571

Model	Capacity (mm)	Size		Order Code	Price Each		
		(mm)	(in)		1+	5+	10+
192.14CPE	1.4	145	5¾	<b>431-1978</b>	16.22	15.42	14.60
192.16CPE	1.6	160	6¼	<b>365-3961</b>	17.52	16.00	14.72
192.18CPE	1.8	180	7	<b>137-4300</b>	22.15	21.70	21.26
192.20CPE	2.0	200	8	<b>431-1980</b>	21.97	20.87	19.75



**Diagonal cutters Inomic®**



- For cutting hard wires in the joint area and flush, burr-free cutting of soft wires, cables and plastics in the front cutting area.
- Innovative head with dual cutting function. Cutting edge with bevel near the joint, cutting edge without bevel in the front cutting area.
- Arms of the pliers move in parallel: +25% force transfer.
- With opening spring and locking mechanism.
- Head of pliers made of ball-bearing steel, hardened to approx. 60 HRC.

- Handles made of tough fibre-glass reinforced plastic, ergonomic soft grip zone in the handle
- Standards: IEC 60900:2004

441940

Mfrs. List No. / Length	cutting performance			Weight	Order Code	Price Each	
	soft	medium	hard			1+	5+
Z 12 9 15 160MM	4.0mm	2.8mm	2.0mm	140g	<b>124-2226</b>	18.36	16.83

**Long Nose Pliers**



- Serrated jaws and side cutter

223001

Overall Length	Order Code	Price Each
160mm	<b>312-7199</b>	5.49

**Snipe Nose Pliers**



- 2-component handle with slip guard
- Serrated grip with cutter
- Shock proof handle
- Drop forged, heat treated fully polished steel
- Available in two sizes: 160mm or 200mm

Size	Soft	Med/Hard
160mm	2.5mm	1.6mm
200mm	2.8mm	1.8mm

493003.492552

Size	Order Code	1+	5+	10+	20+
160mm	<b>149-6314</b>	7.83	7.28	6.50	5.66
200mm	<b>149-6315</b>	8.79	8.16	7.30	6.36

**Bent Snipe Nose Pliers**



- 2-component handle with slip guard
- Serrated grip with cutter
- Shock proof handle
- Drop forged, heat treated fully polished steel
- Bent to 40°
- Available in two sizes: 160mm or 200mm

Size	Soft	Med/Hard
160mm	2.5mm	1.6mm
200mm	2.8mm	1.8mm

493004.492558

Size	Order Code	1+	5+	10+	20+
160mm	<b>149-6316</b>	8.68	8.06	7.20	6.27
200mm	<b>149-6317</b>	9.70	9.01	8.05	7.01

**Electricians' Pliers Type 1301**



- The ideal pliers for cable work
- For gripping and bending wire
- For cutting soft, medium and hard wire
- Precision cutting edges additionally induction hardened, cutting edge hardness approx. 60 HRC
- With precision stripping holes
- For crimping end sleeves (ferrules)
- High grade special tool steel, oil-hardened and tempered 0,75/1,5/2,5mm<sup>2</sup>

Material: High grade special tool steel, oil-hardened  
Material of handles: Plastic

Mfrs. Part No.	Stripping capacities	Length
1301160	0,5-0,75/1,5/2,5	160

245673

Mfrs. Part No.	Order Code	1+	4+	20+
1301160	<b>282-157</b>	22.15	21.50	20.80

**Long Nose Combination Pliers**



- Ergonomic anti-slip handles
- Induction hardened cutting edges
- Hot drop forged alloy steel
- Matt chrome finish - better presentation and rust protection

Overall Length	Jaw Length	Jaw Width	Mfrs. List No.	Order Code
145mm	42mm	1.7mm	3909145	263-576
210mm	72mm	2mm	3906200	263-588
177mm	55mm	4mm	T3909 6	139-1007

223029

Overall Length	Mfrs. List No.	Order Code	Price Each
145mm	3909145	<b>263-576</b>	1+
210mm	3906200	<b>263-588</b>	10.45
177mm	T3909 6	<b>139-1007</b>	14.95
			14.20

**Bent Nose Pliers**



- 45° bent nose for extra accessibility
- Complete with rod gripping hole, side cutter and serrated jaws
- Lap joint and Red high grip handles

Overall Length = 200mm

222878

45



Over 480,000 products online



Mfrs. List No. T3907 200	Order Code 311-7297	Price Each 1+ 19.35
-----------------------------	------------------------	---------------------------

**Pliers**  
Snipe Nose



Chrome finish with ergonomic grips with return spring. Side cutter for steel wire up to 160kg/mm<sup>2</sup>. Serrated jaws with central area for holding rods.

486298

Model	Size (mm)	Size (in)	Order Code	Price Each		
				1+	5+	10+
193.16CPE	168	6½	352-2143	14.48	13.04	11.88
185.20CPE	200	8	137-4299	22.29	21.85	21.41

**Needle nose pliers Inomic®**



Wihla. Premium Tools for Professionals.



- For gripping, holding, cutting and stripping. With improved access to the objects to be processed.
- Straight shape with blade and three stripping points 2.5 mm<sup>2</sup>, 1.5 mm<sup>2</sup>, 0.75 mm<sup>2</sup>.
- Parallel and crosswise profiling for gripping in all directions.
- Arms of the pliers move in parallel: +25% force transfer.

- With opening spring and locking mechanism.
- Head of pliers made of ball-bearing steel, hardened to approx. 60 HRC.
- Handles made of tough fibre-glass reinforced plastic, ergonomic soft grip zone in the handle.

441938

Mfrs. List No. / Length	cutting performance		Weight	Order Code	Price Each		
	medium	hard			1+	5+	10+
Z 06 9 15 160MM	2.5mm	1.6mm	150kg	124-2224	18.96	17.39	16.05

**Combination Pliers**



- Serrated jaws, rod gripping hole and side cutter

223003

Overall Length	Order Code	Price Each		
		1+	5+	10+
160mm	312-7801	5.65		
200mm	312-7230	8.12		

**Combination Pliers**



- 2-component handle with slip guard
- Shock proof handle
- Drop forged, heat treated fully polished steel

Size	Cutting Capacity: wire		
	Soft	Med/Hard	
160mm	2.5mm	1.8mm	
180mm	2.8mm	2.5mm	
200mm	3.0mm	2.8mm	

493007.492575

Size	Order Code	Price Each			
		1+	5+	10+	20+
160mm	149-6321	7.84	7.28	6.51	5.67
180mm	149-6322	8.37	7.77	6.95	6.05
200mm	149-6324	8.86	8.23	7.35	6.41

**Combination Pliers Type 03**

DIN ISO 5746



- With gripping zones for flat and round material, suitable for versatile use
- With cutting edges for soft and hard wire
- Long cutting edges for thicker cables
- Cutting edges additionally induction hardened, cutting edge hardness approx. ca. 60 HRC
- Special tool steel, oil-hardened and tempered
- With two-colour dual component handles

Mfrs. Part No.	Head	Cutting performances Ø mm		Length mm	Weight g
		soft	hard		
03 02 160	polished	3.1	2.0	160	215
03 02 180	polished	3.4	2.2	180	260
03 02 200	polished	3.8	2.5	200	330
03 05 160	chromed	3.1	2.0	160	215
03 05 180	chromed	3.4	2.2	180	260

403914

Mfrs. Part No.	Order Code	Price Each		
		1+	5+	10+
03 02 160	NEW 413-1861	9.60	9.30	9.00
03 02 180	NEW 413-1873	10.55	10.25	9.90
03 02 200	NEW 413-1885	12.85	12.45	12.10
03 05 160	875-892	13.90	13.50	13.05
03 05 180	875-909	15.00	14.55	14.10

**High Leverage Combination Pliers Type 02**

DIN ISO 5746



- For heaviest duty
- 35% saving in power due to new, improved lever action compared with conventional universal pliers
- With gripping zones for flat and round material, suitable for versatile use
- With cutting edges for soft, hard and piano wire
- Long cutting edges for thicker cables
- Cutting edges additionally induction hardened, cutting edge hardness approx. 64 HRC
- High grade special tool steel, oil-hardened and tempered
- With two-colour dual component handles

Mfrs. Part No.	Head	Cutting performances Ø mm		Length mm	Weight g
		hard	Piano		
02 02 180	polished	2.5	2.0	180	235
02 02 200	polished	2.8	2.2	200	330
02 02 225	polished	3.0	2.5	225	400
02 05 180	chromed	2.5	2.0	180	235

403909

Mfrs. Part No.	Order Code	Price Each		
		1+	5+	10+
02 02 180	875-879	14.75	14.30	13.85
02 02 200	875-880	16.05	15.55	15.10
02 02 225	NEW 108-354	17.10	16.60	16.05
02 05 180	440-6618	16.25	--	--

**Combination Pliers**



- Serrated Jaws
- Lap Joint
- Red high grip handles

Overall Length	Jaw Length	Jaw Width	Hard Wire Cutting Capacity	Order Code
160mm	35mm	9mm	1.6mm	263-590
180mm	40mm	10mm	1.6mm	765-624
200mm	44mm	10mm	2.0mm	765-636

223033

Overall Length	Mfrs. List No.	Order Code	Price Each	
			1+	10+
160mm	3867160	263-590	12.70	
180mm	T3867 7	765-624	15.75	
200mm	T3867 8	765-636	17.40	

**Pliers - Standard - continued**

**Pliers Engineers**



Chrome finish with ergonomic grips with return spring. High frequency hardened cutting edges for power and durability.

486288

Model	Size (mm)	Size (in)	Order Code	Price Each			
				1+	5+	10+	20+
187.16CPE	165	6 1/4	137-4297	16.70	16.35	16.04	15.52
187.18CPE	185	7	352-2120	13.05	11.76	10.72	--
187.20CPE	205	8	137-4298	19.94	19.53	19.14	18.52

**Combination pliers Inomic®**



- For gripping, holding and cutting. With improved access to the objects to be processed.
- Innovative head with three parallel gripping surfaces at opening angles of 2°, 10° and 2°0 offers an improved and secure hold of the workpiece.
- Crosswise-profiled gripping surfaces with specially shaped teeth for gripping in all directions.
- Arms of the pliers move in parallel: +25% force transfer.
- With opening spring and locking mechanism.

- Handles made of tough fibre-glass reinforced plastic, ergonomic soft grip zone in the handle.

441934

Mfrs. List No. / Length	cutting performance		Weight	Order Code	Price Each		
	medium	hard			1+	5+	10+
Z 01 9 15 180MM	3.3mm	2.2mm	155g	124-2221	18.58	17.04	15.74

**Halogen lamp pliers**



- With plastic flanges for mounting and demounting of glass socket light bulbs

403251

Mfrs. Part No.	Order Code	Price Each		
		1+	5+	10+
Halogen lamp pliers 30 41 160 S	916-8389	21.45	20.80	20.15

**Wire Twisting Pliers**



- Manufactured from chrome vanadium steel
- Hardened and tempered
- For twisting and sealing wires in industry to ensure non-tempered fixings
- Used extensively in aircraft and heavy engineering
- For wire size 0.020 - 0.060 ∅

231040

Mfrs. List No.	Order Code	Price Each
		1+
38896	722-1022	26.07

**Troubleshooting tips**



Chat live online to one of our technical engineers at [www.farnell.co.uk](http://www.farnell.co.uk)

**Pliers - Precision**

**Electronic Pliers & Cutters**



**Supreme Range**

Precision pliers with forged box joint incorporating long contact surfaces. Fitted with double leaf springs and plastic covered handles.

**Cutting**

Description	Order Code	Price Each			
		1+	5+	10+	20+
L7285 Oblique full flushcutter with long jaws and 45° cutting edge. For copper wire up to 1.0mm. Length 120mm.	135-6208	52.50	51.45	50.42	49.41
L7190 diagonal cutter with micro bevel cutting edge for copper wire up to 1.25mm. Length 109mm.	723-8393	28.95	--	--	--
L7191 as model 7190 but with flush cut.	723-8400	30.35	29.15	27.90	26.70
L7290 Oblique cutter with outer bevel edge for copper wire up to 1.25mm. Length 108mm.	440-401	36.15	34.70	33.25	31.80
L7293 Oblique cutter with flush cut relieved jaws. For copper wire up to 1mm. Length 108mm.	440-371	36.35	34.90	33.45	32.00

**Gripping**

487143

Description	Order Code	Price Each			
		1+	4+	20+	40+
L7490 Flat nose pliers with smooth grip jaws. Length 130mm.	440-644	28.15	27.00	25.90	24.75
L7893 Snipe nose pliers with smooth grip jaws. Length 120mm.	440-530	25.75	--	--	--
L7890 Long snipe nose pliers with smooth grip jaws. Length 132mm.	440-577	28.95	--	--	--
L7891 Long snipe nose pliers with serrated grip jaws. Length 132mm.	135-6210	27.41	26.86	26.33	25.80

**Diagonal Cutters, Supreme Series**



These cutters are made from high performance ball bearing steel, polished. Numerically controlled machine grinding guarantees edge angle accuracy and contact which increases the tools reliability and consistency.

Precision induction hardened edges 63-65

HRC. Handles in synthetic material and come with return spring.

Length 109 mm

Cutting Capacity 7190 0.2-1.0 mm, Micro Bevel

Cutting Capacity 7191 0.1-1.0 mm, Flush Cut

Length jaw: 9 mm

527326

Mfrs. List No.	Order Code	Price Each		
		1+	5+	10+
7190	167-1589	34.58	32.84	31.11
7191	167-1590	34.58	32.84	31.11

**Oblique Cutters, Supreme Series**



These cutters are produced in high performance tool steel with specially forged box joint with polished surface, extra long contact surfaces made possible by a special manufacturing technique. Precision induction hardened edges, 58-60 HRC.

Handles in plastic and come with return spring.  
 Angled end cutter for use in confined spaces.  
 Length, 108 mm  
 Capacity, jaw 0.35-1.25 mm  
 Length, jaw 8 mm  
 Flush Cut

527333

Mftrs. List No.	Order Code	1+	5+	10+
7293	167-1591	37.69	35.80	33.92

**Oblique Cutters, Supreme Series**



These cutters are produced in high performance tool steel with specially forged box joint with polished surface, extra long contact surfaces made possible by a special manufacturing technique. Precision induction hardened edges, 58-60 HRC.



Handles in plastic and come with return spring.  
 Angled end cutter for use in confined spaces.  
 Length, 108 mm  
 Capacity, jaw 0.35-1.25 mm  
 Length, jaw 8 mm

527375

Mftrs. List No.	Order Code	1+	5+	10+
7290	167-1592	38.00	36.11	34.22
7291	167-1593	38.71	36.77	34.83

**Snipe Nose Pliers, Supreme Series**



These pliers are made from high performance tool steel with specially forged box joint with polished surface, extra long contact surfaces made possible by a special manufacturing technique.



The pliers are tough hardened 45-48 HRC. Handles in plastic material and come with return spring.  
 This plier has smooth jaws.  
 Length 120 mm  
 Length, jaw 20 mm

527376

Mftrs. List No.	Order Code	1+	5+	10+
7893	167-1594	30.04	28.56	27.03

**Snipe Nose Pliers, Supreme Series**



These pliers are made from high performance tool steel with specially forged box joint with polished surface, extra long contact surfaces made possible by a special manufacturing technique.



The pliers are tough hardened 45-48 HRC. Handles in plastic material and come with return spring.  
 Smooth jaws.  
 Length 132 mm  
 Length, jaw 32 mm

527378

Mftrs. List No.	Order Code	1+	5+	10+
7890	167-1596	30.45	28.92	27.39

**Lindstrom 'Supreme' Module**



This module includes:  
 Semi flush side cutters Order code 440-140  
 Snipe nose pliers 440-530  
 Long nose pliers 440-577

490926

Order Code	Price Each
105-412	96.61

**End Cutters**



Blade length=4  
 Overall length=115  
 Blade angle=90°  
 Cutting capacity 0.8mm copper wire  
 Box joint  
 White handles

223024

Mftrs. List No.	Order Code	Price Each
Full Flush L7292	440-425	34.75

**Bent Nose Pliers**



Jaw length = 29  
 Jaw width = 1  
 Overall length = 129  
 Tip angle = 60°  
 Smooth jaws  
 Box joint  
 White handles

222615

Mftrs. List No.	Order Code	Price Each
L7892	440-681	31.00

**Diagonal cutters - 80 Series**



These cutters are made from high performance ball bearing steel, black oxidised. Numerically controlled machine grinding guarantees edge angle accuracy and contact which increases the tools reliability and consistency. Precision induction hardened edges, 63-65 HRC. Handles in synthetic material and come with return spring. These Oval Head cutters are ideal for wire harness work and standard printed circuit board assembly.



	8130	8142
Length	110	110
Cutting Capacity	0.2 - 1.0 mm	0.1 - 1.0 mm
Length jaw	8 mm	10 mm

527379

Mftrs. List No.	Order Code	1+	5+	10+
8130	167-1597	33.92	32.23	30.55
8142	167-1598	36.67	34.83	33.00

**Oblique cutters - 80 Series**



These cutters are made from high performance ball bearing steel, black oxidised. Numerically controlled machine grinding guarantees edge angle accuracy and contact which increases the tools reliability and consistency. Precision induction hardened edges, 63-65 HRC. Handles in synthetic material and



come with return spring. This Oblique cutter is ideal for rework and close assembly needs.  
 Length 110 mm  
 Capacity, jaw 0.2-1.2 mm  
 Length, jaw 9.5 mm

527380

Mftrs. List No.	Order Code	1+	5+	10+
8211	167-1599	54.01	51.31	48.60

**FREE global legislation support**



RoHS, REACH, WEEE, EuP,  
 Batteries Directive - we've got it covered at:  
[www.global-legislation.com](http://www.global-legislation.com)



**Pliers - Precision - continued**

**Tip Cutter**



Yellow PVC handles  
Lap Joint

Overall Length 110mm  
Cutting Blade Width = 5mm  
Length = 5mm  
Depth = 1mm at tip up to 4mm  
Length of Head 14mm  
Cutting Capacity 0.1 - 0.6mm copper wire

222882

Mfrs. List No.	Order Code	Price Each
Full Flush 8149	310-5556	1+ 64.36

**Oblique Cutters 45° Long Head 80 Series**



484658

Model	Bevel	Length	Capacity	Order Code	1+	5+	10+	25+
L8247		117.5	1	440-360	56.85	54.60	52.30	50.05

**Electronic Pliers & Cutters Ergo Series**

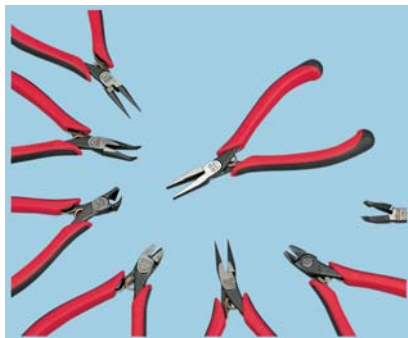

487202

Precision pliers with return spring for minimum effort and handle designed for maximum comfort. The smooth handle design has optimum handle shape, curvature and length combined with a non slip handle surface.

Model	Description	Order Code	Price Each
L4130	Micro side cutter	483-849	27.39
L4131	Flush side cutter	483-850	26.25
L4231	Flush oblique cutter, 45°	483-874	35.71
L4239	Flush oblique cutter, 15°	483-862	33.50
L4430	Flat nose plier	483-898	19.70
L4830	Snip nose plier	483-886	20.42
L4833	Snipe nose plier, bent tip	483-904	23.50
L4530	Round nose plier	483-916	21.55

**Bahco 'Ergo' Module 3 Piece**



This module includes:  
Semi flush side cutter  
Long nose pliers  
Flat nose pliers

Order Code  
483-849  
483-886  
483-898

222836

Order Code	Price Each
Bahco 'Ergo' Module - 3 piece 628-517	1+ 72.34

**Bahco 'Ergo' Module-4 piece**

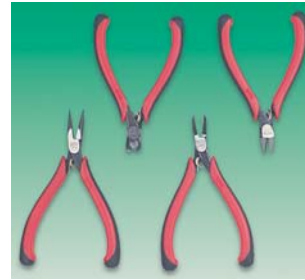

This module includes:  
Semi flush side cutters  
Micro flush oblique cutters

Order Code  
483-849  
483-874

Long reach oblique cutters  
Snipe nose pliers

Order Code  
483-862  
483-886

222773

Order Code	Price Each
Bahco 'Ergo' Module 483-928	1+ 115.16

**Knipex, Electronics, Side cutting pliers**



413-4035



413-4047



413-4059



134-3521

- Precision-ground Blades without a bevel for mirror cutting,
- Precision shaped tips also cut wires up to Ø 0.2 mm;
- Extremely light operation for fatigue reduction,
- Grips moulded from soft plastic to protect hands



413-4060



413-4072



134-3522

Order Code	Model
413-4035	Cutting hardness approx. 53 HRc, without facet
413-4047	Material: INOX stainless steel .
413-4059	
413-4060	Inductively hardened cutting for higher exposure time cutting hardness approx. 64 HRc, without facet
413-4072	Tool special steel, Burnished head
134-3521	Inductively hardened cutting for higher exposure time cutting hardness approx. 64 HRc, with very small facet
134-3522	Tool special steel, Burnished head

Order Code	Cutting values Ø mm			
	Soft	medium hard	Hard	mm
413-4035	0.2 - 1.6	1.0		125
413-4047	0.2 - 1.6	1.0		125
413-4059	0.2 - 1.0	0.6		125
413-4060	0.2 - 1.6	1.2	0.6	125
413-4072	0.2 - 1.6	1.2	0.6	125
134-3521	0.2 - 1.6	1.2	0.6	125
134-3522	0.2 - 1.6	1.2	0.6	125

242842

Mfrs. List No.	Order Code	1+	5+	10+
78 03 125	413-4035	14.35	13.90	13.50
78 13 125	413-4047	16.10	15.60	15.15
78 23 125	413-4059	16.20	15.70	15.25
78 61 125	413-4060	14.95	14.50	14.05
78 71 125	413-4072	16.70	16.20	15.70
78 81 125	134-3521	15.65	15.20	14.70
78 91 125	134-3522	17.50	17.00	16.45

**Electronics Diagonal Cutters Type 77**



- precision pliers for ultra fine cutting work, e. g. in electronics and fine mechanics
- precision box joint
- low-friction double spring for gentle and even opening
- the polish or mirror polish (only finish 2)

together with a fine film of oil offer the best possible rust protection - no circuit faults caused by peeling chrome from plated tools

- cutting edges additionally induction hardened, cutting edge hardness approx. 62 HRC
- special tool steel, oil-hardened and tempered

Material: Tool Steel, Oil-hardened  
Material of handles: Plastic

Mfrs. Part No.	Cutting form	Cutting performance soft/hard	Length
7702115	round head, with small bevel	0,3 - 1,6/0,5	115
7712115	round head, with bevel and lead catcher	0,3 - 1,6/0,5	115
7732115	pointed head, with small bevel	0,3 - 1,3/0,5	115
7742115	pointed head, without bevel	0,3 - 1,3/-	115
7752115	pointed, flat head, with small bevel	0,3 - 1,0/0,5	115
7772115	pointed, flat head, with small bevel	0,3 - 1,0/-	115

WET332

Mfrs. Part No.	Order Code	Price Each		
		1+	5+	10+
7702115	333-0400	23.05	22.35	21.65
7712115	333-0412	27.60	26.75	25.95
7732115	333-0436	25.45	24.70	23.90
7742115	333-0394	24.85	24.10	23.35
7752115	333-0448	26.10	25.30	24.55
7772115	333-0450	24.85	24.10	23.35

**Precision electronics pliers**



110-9178

the joints are adjusted without play by means of self-securing screws the precision-ground joint surfaces ensure an even, low-friction movement over the entire opening range

- DIN ISO 9654 and 9655
- alloyed ballbearing steel, forged
- screwed joint
- opening spring
- nonreflective finish
- ergonomic 2-component handle
- low weight

Mfrs' List No.	Description	Cutting values Ø mm			Length mm
		soft	medium	hard	
79 02 125	Side cutters, rounded head, with facet	0.2 - 1.5	0.8	0.5	125
79 22 125	Side cutters, rounded head, without facet	0.1 - 1.2	0.65	-	125
79 32 125	Side cutters, pointed head, with facet	0.2 - 1.3	0.7	0.4	125
79 42 125	Side cutters, pointed head, without facet	0.1 - 1.0	0.55	-	125
79 02 120	Side cutters, mini, with facet	0.2 - 1.0	0.55	0.3	120
79 22 120	Side cutters, mini, without facet	0.1 - 0.8	0.4	-	120
79 52 125	Side cutters with wire clamp, pointed head, with very small facet	0.1 - 1.3	0.7	0.4	125
79 62 125	Side cutters with wire clamp, pointed head, without facet	0.1 - 1.0	0.55	-	125
34 12 130	Flat pliers, wide jaws, straight	-	-	-	130
34 22 130	Flat, rounded pliers, straight	-	-	-	130
34 32 130	Rounded pliers, pointed jaws, straight	-	-	-	130

423833

Mfrs' List No.	Order Code	Price Each		
		1+	5+	10+
79 02 125	110-9174	28.05	27.20	26.35
79 22 125	110-9176	31.30	30.35	29.40
79 32 125	110-9178	28.05	27.20	26.35
79 42 125	110-9180	31.30	30.35	29.40
79 02 120	110-9183	28.85	28.00	27.10
79 22 120	110-9185	32.10	31.15	30.15
79 52 125	134-3523	31.65	30.70	29.75
79 62 125	134-3525	34.95	33.90	32.85
34 12 130	110-9166	24.15	23.45	22.70
34 22 130	110-9168	24.15	23.45	22.70
34 32 130	110-9172	24.15	23.45	22.70

**Express checkout**



With no need to re-enter your details, returning customers can now buy products even faster - **order online today at [www.farnell.co.uk](http://www.farnell.co.uk)**

**Electronics End Cutting Nippers Type 64**



- Precision pliers for ultra fine cutting work, e. g. in electronics and fine mechanics
- Precision box joint
- Low-friction double spring for gentle and even opening
- The polish or mirror polish (only finish 2)

best possible rust protection - no circuit faults caused by peeling chrome from plated tools

- Cutting edge hardness at least 56 HRC
- Special tool steel, oil-hardened and tempered

Material: Tool Steel, Oil-hardened  
Material of handles: Plastic

Mfrs. Part No.	Cutting form	Cutting performance Copper/Steel	Length
6402115	Normal bevells	2.0/0.6	115
6422115	Mini-blade, small bevells	/	115
6432120	Small bevells	1.5/0.5	120
6442115	Small head, small bevells	1.5/0.5	115

WET307

Mfrs. Part No.	Order Code	Price Each		
		1+	5+	10+
64 02 115	876-021	26.60	25.80	25.00
64 22 115	876-033	24.05	23.35	22.60
64 32 120	876-045	28.55	27.70	26.85
64 42 115	876-057	25.50	24.75	23.95

**Electronics Pliers**



**Diagonal Cutters for plastics and lead Type 72**



- Cutting face flush ground
- Non-bevelled, for flush cutting sprues off plastic components or soft materials such as lead
- With opening spring
- Vanadium electric steel, oil-hardened and tempered

Material: Chrome Vanadium Oilhardened  
Material of handles: Plastic

Mfrs. Part No.	Cutting form	Head	Length
7201160	without bevel	polished	160
7251160	without bevel	polished	160

240690

Mfrs. Part No.	Order Code	Price Each		
		1+	5+	10+
7201160	875-995	14.95	14.50	14.05
7251160	876-008	17.55	17.00	16.50

**Diagonal Insulation Stripper Type 14**



- the essential pliers for electrical installation work
- precision stripping holes for single (solid) conductors of 1.5 and 2.5 mm<sup>2</sup>
- induction hardened precision blades for soft wire up to 4.0 mm Ø, cutting edge

hardness approx. 60 HRC

- Vanadium electric steel, oil-hardened and tempered

Mfrs. Part No.	Stripping capacities	Capacity	Length (mm)	Weight (g)
14 22 160	1,5 + 2,5 mm <sup>2</sup>	15 + 13 AWG	160	205

403068

Diagonal Insulation Stripper	Mfrs. Part No.	Order Code	Price Each		
			1+	5+	10+
	14 22 160	875-727	23.00	22.30	21.60

**Troubleshooting tips**



Chat live online to one of our technical engineers at [www.farnell.co.uk](http://www.farnell.co.uk)

**Pliers - Precision - continued**

**Snipe Nose Side Cutting Pliers Type 25**

Radio Pliers



- Suitable for gripping and cutting work in precision mechanics
- Pointed, half-round jaws
- Serrated gripping surfaces
- With cutting edges for medium hard and hard wire
- Cutting edges additionally induction hardened, cutting edge hardness approx. 61 HRC
- High grade special tool steel, oil-hardened and tempered
- With two-colour dual component handles
- According to **DIN ISO 5745**

Mftrs. Part No.	Head	Length	Weight
25 02 140	polished	140	110g
25 05 140	chromed	140	110g
25 05 160	chromed	160	145g

403087

Description	Mftrs. Part No.	Order Code	Price Each		
			1+	5+	10+
Snipe Nose Side Cutting Pliers	25 02 140	<b>413-2026</b>	12.70	12.30	11.95
Snipe Nose Side Cutting Pliers	25 05 140	<b>875-820</b>	15.50	15.05	14.55
Snipe Nose Side Cutting Pliers	25 05 160	<b>875-831</b>	15.00	14.55	14.10

**Snipe Nose Side Cutting Pliers Type 26**

Stork Beak Pliers



- High loadable, elastic precision points
- Half-round, long jaws
- Serrated gripping surfaces
- With cutting edges for medium hard wire max. dia. 3.2 mm and hard wire max. dia.

2.2 mm

- Cutting edges additionally induction hardened, cutting edge hardness approx. 61 HRC
- Vanadium steel, oil-hardened and tempered
- With two-colour dual component handles
- According to **DIN ISO 5745**

Mftrs. Part No.	Form	Head	Length (mm)	Weight
26 12 200	straight jaws	polished	200	200g
26 15 200	straight jaws	chromed	200	200g
26 22 200	40° bent jaws	polished	200	200g
26 25 200	40° bent jaws	chromed	200	200g

403101

Mftrs. Part No.	Order Code	Price Each		
		1+	5+	10+
26 12 200	<b>413-2040</b>	14.00	13.60	13.15
26 15 200	<b>875-855</b>	18.10	17.55	17.00
26 22 200	<b>413-2051</b>	17.80	17.25	16.75
26 25 200	<b>875-867</b>	20.95	20.30	19.70

**Electronics Mounting Pliers Type 36**



- Precision pliers for ultra fine assembly work, e. g. in electronics and fine mechanics
- For bending and cutting wire ends
- Precision box joint
- Smooth ground gripping surfaces

- Edges carefully deburred
- Low-friction double spring for gentle and even opening
- The mirror polish together with a fine film of oil offer the best possible rust protection - no circuit faults caused by peeling chrome from plated tools
- Special tool steel, oil-hardened and tempered

Mftrs. Part No.	Appliance	Length
3612130	to bend wire in shape	130
3622125	to bend and cut wire at 1.6 mm	115
3642125	to cut wire at 1.3 mm	115

241411

Mftrs. Part No.	Order Code	Price Each		
		1+	5+	10+
36 12 130	<b>875-788</b>	29.50	28.60	27.75
36 22 125	<b>875-790</b>	40.25	39.05	37.85
36 42 125 SB	<b>875-818</b>	38.10	36.95	35.80

**Grab Pliers**

Needle Nose Pliers



- Precision pliers for very exact assembly, bending and adjusting work
- With extra long jaws: length of jaws 55.0 mm
- Smooth ground gripping surfaces
- Edges carefully deburred
- Chrome Vanadium electric steel, oil-hardened and tempered
- 45° bent jaws
- With two-colour dual component handles

404515

Mftrs. Part No.	Length		Order Code	Price Each		
	Jaws-	Overall-		1+	5+	10+
31 25 160	55mm	160mm	<b>413-2063</b>	23.45	22.75	22.05

**Round Nose Pliers Type 22**



- For forming wire loops
- Precision ground, short, round jaws
- Smooth tips
- Special tool steel, oil-hardened and tempered
- With two-colour dual component handles
- According to **DIN ISO 5745**

Mftrs. Part No.	Head	Length mm	Weight g
22 02 140	Polished	140	135
22 02 160	chrome-plated	160	165
22 05 160	chrome-plated	160	165

403279

Round Nose Plier	Mftrs. Part No.	Order Code	Price Each		
			1+	5+	10+
Round Nose Plier	22 02 140	<b>413-1990</b>	10.55	10.25	9.90
Round Nose Plier	22 02 160	<b>413-2002</b>	10.75	10.45	10.10
Round Nose Plier	22 05 160	<b>413-5430</b>	13.15	12.75	12.35

45

**Flat Nose Pliers 20**



- Short, flat jaws
- Serrated gripping surfaces
- Special tool steel, oil-hardened and tempered
- Handles: insulated with two-colour dual component handles,
- According to **DIN ISO 5745**

Mftrs. Part No.	Head	Length	Weight
20 02 140	buffed	140	145g

403277

Description	Mftrs. Part No.	Order Code	Price Each		
			1+	5+	10+
Flat nose pliers	20 02 140	<b>413-1964</b>	10.75	10.45	10.10

**Small Combination Pliers**

New



- Compact combination pliers for professionals and hobbyists
- With gripping zones for flat and round material, suitable for versatile use
- With cutting edges for soft and hard wire
- Cutting edges additionally induction hardened, cutting edge hardness approx. ca. 60 HRC
- Vanadium steel, oil-hardened and tempered
- With two-colour dual component handles

Mfrs. Part No.	Head	Length (mm)
08 05 110	Chromed	110

242916

Mfrs. Part No.	Order Code	1+	5+	10+
Small Combination Plier 08 05 110	413-4199	13.95	13.55	13.10

**Electronic pliers - Case Mfrs List No. 002016**



Tool kit for working on electronic components.

- Assembly:  
 3 pairs of electronic gripping pliers 115mm  
 3 pairs of electronic side-cutters 115mm  
 1 pair of angle-cutters 120mm  
 1 pair of precision tweezers 115mm

WET337

Mfrs. List No.	Order Code	1+	5+	10+
00 20 16	875-910	128.55	124.70	120.85

**Side Cutters**



	Overall Length	Blade Length	Blade Angle	Cutting Capacity			Order Code
				Soft Steel	Hard Steel	Copper	
Semi Flush	115	13	15°	1	0.4	1.5	493-650
Full Flush	120	13	15°	1	—	1.5	493-661

TEE241X/222781, 401995

	Order Code	Price Each
Semi Flush	493-650	16.20
Full Flush	493-661	16.20

**Side Cutters**



- Oval head
- Blade length=13
- Overall length=115
- Blade angle=15°
- Cutting capacity
- 1.0mm Iron wire
- 1.5mm Copper wire
- 0.4mm Steel Wire (bevel head only)

223008

Mfrs. List No.	Order Code	Price Each	
<b>PVC Handles</b>		1+	
Bevel	3773	108-714	24.90
Semi Flush	3773F	765-570	28.60
Full Flush	3773EF	765-582	28.60
<b>Static Dissipative Handles</b>			
Bevel	3773H	109-132	31.47
Full Flush	3773HEF	765-600	33.63

**Side Cutters**



- Blade length=9,
- Overall length=110,
- Blade angle=15°
- Cutting capacity
- 0.6mm Iron wire
- 1.0mm Copper wire

222931

Mfrs. List No.	Order Code	Price Each	
<b>PVC Handles</b>		1+	
Semi Flush	3780F	765-557	29.95
Full Flush	3780EF	108-713	29.95

**Side Cutter**



- Comfortable black plastic coated grips anti-slip
- Spot-welded double leaf springs ensure consistently repeatable functioning
- Precision box joint means butter smooth action for exact guidance of jaws without need of readjustment
- Mirror polishing notably reduces risk of corrosion, chrome flaking and is easy to clean

Blade Length	13mm	Copper	1.2mm
Overall Length	115mm	Soft Wire	0.4mm
<b>Cutting Capacity</b>			

495164

Mfrs. List No.	Order Code	1+	5+	10+	20+
T3781	151-8915	29.95	28.75	27.55	26.35

**Mini Side Cutter**



- Comfortable black plastic coated grips anti-slip
- Spot-welded double leaf springs ensure consistently repeatable functioning
- Precision box joint means butter smooth action for exact guidance of jaws without need of readjustment
- Mirror polishing notably reduces risk of corrosion, chrome flaking and is easy to clean

Blade Length	9mm	Copper	1.2mm
Overall Length	110mm	Soft Wire	0.6mm
<b>Cutting Capacity</b>			

495167

Mfrs. List No.	Order Code	1+	5+	10+	20+
T3880F	151-8916	27.95	26.85	25.70	24.60

**Heavy Duty 135mm Side Cutters**



- Oval head with mini bevel cut for extra full flush cut
- High grade alloy steel, hot drop forged, Oil hardened and tempered
- Comfortable black plastic coated grips, anti-slip
- Spot-welded double leaf springs ensure consistent use
- Precision box joint means butter smooth action for exact guidance of jaws without need of readjustment.
- Mirror polishing notably reduces risk of corrosion, chrome flaking and is easy to clean.

Type	Soft Wire	Hard Wire	Overall Length	Blade Length
T3775	2mm	0.7mm	135mm	20mm
T3775EF	2mm	1mm	135mm	20mm

**Pliers - Precision - continued**

**Heavy Duty 135mm Side Cutters - continued**

476034

Mfrs. List No.	Order Code	Price Each			
		1+	5+	10+	20+
T3775	139-0998	28.80	27.95	27.05	25.90
T3775EF	151-8911	28.50	27.65	26.80	25.65

**115 mm Tungsten Carbide Side Cutter**



- Oval head with tungsten carbide edges for very hard and tough materials
- Mini bevel cut
- High grade alloy steel, hot drop forged, Oil hardened and tempered
- Comfortable black plastic coated grips, anti-slip
- Spot-welded double leaf springs ensure consistent use
- Precision box joint means butter smooth action for exact guidance of jaws without need of readjustment.
- Mirror polishing notably reduces risk of corrosion, chrome flaking and is easy to clean.

Blade Length	10 mm
Overall Length	115 mm
<b>Cutting Capacity</b>	
Piano Wire	0.6 mm
Soft Wire	2 mm
Hard Wire	1.0 mm

480131

Mfrs. List No.	Order Code	Price Each			
		1+	5+	10+	20+
T3779	139-0999	72.55	69.65	66.75	63.85

**Oblique Cutters**



Matt polished, PVC dip coated handles

Cutting Capacity	Order Code		
	Soft Steel	Hard Steel	Copper
1.2	0.5	1.5	493-673
1.2	0.5	1.3	493-685

TEE243X/222784,401996

Overall Length	Blade Length	Blade Angle	Order Code	Price Each
120	15	70°	493-673	27.10
120	8	45°	493-685	27.10

**End Cutters**



Blade length=12  
Overall length=110  
Blade angle=75°  
Cutting capacity:  
0.4mm steel wire  
1.0mm iron wire  
1.2mm copper wire

223021

Mfrs. List No.	Order Code	Price Each
Semi flush PVC handle	3799F	1+ 31.45
Semi flush, static dissipative handle	3799HF	109-389 35.70

**Oblique Cutter**



- Comfortable black plastic coated grips anti-slip
- Spot-welded double leaf springs ensure consistently repeatable functioning
- Precision box joint means butter smooth action for exact guidance of jaws without need of readjustment
- Mirror polishing notably reduces risk of corrosion, chrome flaking and is easy to clean
- Wide head with extra long cutting edges
- Full flush cut

Blade Length	15mm	Copper	1.6mm
Overall Length	120mm	Soft Wire	0.5mm
<b>Cutting Capacity</b>			

495155

Mfrs. List No.	Order Code	Price Each			
		1+	5+	10+	20+
T3778F	151-8913	36.00	34.55	33.10	31.70

**120 mm Oblique Cutter**



- Comfortable black PVC coated grips, anti-slip
- High grade alloy steel, hot drop forged, Oil hardened and tempered
- Oblique head angled at 29° for horizontal or vertical use on PCB's
- Full flush and extra full flush cut
- Spot-welded double leaf springs ensure consistent use
- Precision box joint means butter smooth action for exact guidance of jaws without need of readjustment.
- Mirror polishing notably reduces risk of corrosion, chrome flaking and is easy to clean

Overall Length	120 mm
Blade Length	5 mm
<b>Cutting Capacity</b>	
Soft Wire	0.6 mm
Copper	0.8 mm

480096

Mfrs. List No.	Order Code	Price Each			
		1+	5+	10+	20+
T3786F 4	139-1001	31.75	30.50	29.20	27.95

**130mm Top Cutter**



- Very wide and heavy head with long cutting edges
- High cutting capacity
- Extra full flush cutting edges
- High grade alloy steel, hot drop forged, Oil hardened and tempered
- Comfortable black plastic coated grips, anti-slip
- Spot-welded double leaf springs ensure consistent use
- Precision box joint means butter smooth action for exact guidance of jaws without need of readjustment.
- Mirror polishing notably reduces risk of corrosion, chrome flaking and is easy to clean.

Type	Soft Wire	Hard Wire	Overall Length
T3776EF 5	1.8mm	0.7mm	130mm
T3776F	1.6mm	0.5mm	115mm

480091

Mfrs. List No.	Order Code	Price Each			
		1+	5+	10+	20+
T3776EF 5	139-1000	39.00	37.45	35.90	34.30
T3776F	151-8912	31.50	30.25	29.00	27.70

45

Farnell



**Long Nose Pliers**



Jaw length=22  
Jaw width=1  
Overall length=120  
Long Nose jaws  
Box joint  
Matt polished, PVC dip coated handles



TEE242X/222783,401997

Mfrs. List No.	Order Code	Price Each
XF3772S	493-703	1+ 17.60

**Flat Nose Pliers**

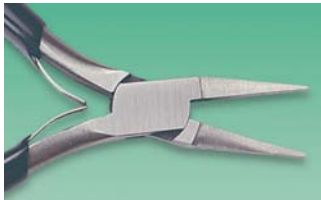

Blade length = 22mm  
Overall length = 120mm  
Jaw width = 3mm  
Smooth jaws  
Box joint  
Matt polished, PVC dip coated handles



TEE244X/222785

Mfrs. List No.	Order Code	Price Each
XF3770S	493-697	1+ 18.25

**Flat Nose Pliers**



- Comfortable black PVC coated grips, anti-slip
- High grade alloy steel, hot drop forged, oil hardened and tempered
- Spot-welded double leaf springs ensure consistent use
- Precision box joint means butter smooth action for exact guidance of jaws without need of readjustment.
- Mirror polishing notably reduces risk of corrosion, chrome flaking and is easy to clean



480074.405835

Type	Jaw Type	Overall Length	Jaw Length	Tip Width
T3770	Smooth	mm120	22mm	1.5 x 3mm
T3789	Smooth	145mm	40mm	1.5 x 4.5mm

Mfrs. List No.	Order Code	1+	5+	10+	20+
T3770	139-0992	19.95	19.15	18.35	17.55
T3789	151-8909	25.50	24.50	23.45	22.45

**Snipe Nose Pliers**



Blade Type Long Nose  
Handles Static Diss  
Overall Length 150  
Jaw length 40  
Jaw Width 1  
Mfrs. List No. 3777H  
Order Code 628-750

223040

Static Diss.	Overall Length	Order Code	Price Each
	150	628-750	1+ 29.14

**Snipe Nose Pliers**



- Comfortable black PVC coated grips, anti-slip
- High grade alloy steel, hot drop forged, Oil hardened and tempered
- Spot-welded double leaf springs ensure consistent use
- Precision box joint means butter smooth action for exact guidance of jaws without need of readjustment.
- Mirror polishing notably reduces risk of corrosion, chrome flaking and is easy to clean

Type	Jaw Type	Overall Length	Jaw Length	Tip Width
T3772	Smooth	mm120	22mm	2 x 1mm
T3772 1	Serrated	mm120	22mm	2 x 1mm

476033

Mfrs. List No.	Order Code	1+	5+	10+	20+
T3772	139-0994	19.95	19.15	18.35	17.55
T3772 1	151-8910	19.95	19.15	18.35	17.55

**Bent Snipe Nose Pliers**



- Comfortable black PVC coated grips, anti-slip
- Bent to 45°
- High grade alloy steel, hot drop forged, Oil hardened and tempered
- Spot-welded double leaf springs ensure consistent use
- Precision box joint means butter smooth action for exact guidance of jaws without need of readjustment.
- Mirror polishing notably reduces risk of corrosion, chrome flaking and is easy to clean

Type	Jaw Type	Overall Length	Jaw Length	Jaw Length Bent
T3769	Serrated	180mm	44mm	18 mm
T3767	Smooth	120mm	20mm	18 mm

480083

Mfrs. List No.	Order Code	1+	5+	10+	20+
T3769	139-0996	27.90	26.80	25.65	24.55
T3767	151-8908	22.95	22.25	21.55	20.65

**Needle Nose Pliers**



45

- Comfortable black PVC coated grips, anti-slip
- Extra slim jaws and fine tips
- High grade alloy steel, hot drop forged, Oil hardened and tempered
- Spot-welded double leaf springs ensure consistent use
- Precision box joint means butter smooth action for exact guidance of jaws without need of readjustment.
- Mirror polishing notably reduces risk of corrosion, chrome flaking and is easy to clean

Jaw Type	Overall Length	Jaw Length	Tip Width
Straight Jaw	mm145	38mm	1.5mm

480086

Mfrs. List No.	Order Code	1+	5+	10+	20+
T3783	139-0997	21.95	21.05	20.20	19.30

**Round Nose Pliers**



- Comfortable black PVC coated grips, anti-slip
- High grade alloy steel, hot drop forged, Oil hardened and tempered
- Spot-welded double leaf springs ensure consistent use
- Precision box joint means butter smooth action for exact guidance of jaws without need of readjustment.
- Mirror polishing notably reduces risk of



**Pliers - Precision - continued**

**Round Nose Pliers - continued**

corrosion, chrome flaking and is easy to clean

Jaw Type Smooth	Overall Length mm120	Jaw Length 20mm	Tip Width 2 x 1mm
--------------------	-------------------------	--------------------	----------------------

480080

Mfrs. List No.	Order Code	1+	5+	10+	20+	Price Each
T3771	139-0993	20.95	20.10	19.25	18.45	

**CEKA 'Electronic' Module**



This module includes Full flush side cutters  
Full bevel side cutters

This module includes Oblique cutters  
Snipe nose cutters

Order Code 108-713  
108-714

Order Code 109-388  
108-716

222705

CEKA module	Order Code	1+	Price Each
	108-853		86.96

**Plier/Cutter Set, 6 pce**



Box Set contains:  
T3773 Side Cutter oval head  
T3780F Side Cutter tapered head  
T3799F Oblique Cutter angled at 29° for horizontal and vertical use  
T3772 Snipenose Pliers straight  
T3767 Snipenose Pliers bent nose  
T3770 Flatnose Pliers



525114

Mfrs. List No.	Order Code	1+	5+	10+	Price Each
PLIER / CUTTER SET, 6PCE T3703	166-0785	169.00	159.00	149.00	

**Electronic Pliers & Shears**



The superior range of electronic pliers are of box joint construction with black burnished heads, double leaf springs and blue PVC covered handles.

**Side Cutters**

Description	Order Code	1+	4+	20+	40+	Price Each
155 SEB sidecutters for assembly work, for copper wire up to 1.0mm diameter. Length 110mm.	800-399	19.13	18.56	18.00	--	
357 SEB triangular head sidecutters for copper wire up to 0.9mm diameter. Length 110mm.	440-267	17.63	17.10	16.59	16.09	

**Electronic Shears**

A lightweight flush cutter with durable edges for soft wire up to 22 AWG. Comfortable spring handles with cushion grip. Extra slim tips.

485395

Description	Order Code	1+	4+	20+	40+	Price Each
170M flush cutter for wire up to 14 AWG. Length 127mm.	202-332	5.06	--	--	--	
175M as 170M but fitted with kilp grip to hold cirtt off wires. Length 127mm.	202-344	5.85	--	--	--	

**Side Cutters  
Semi Flush**

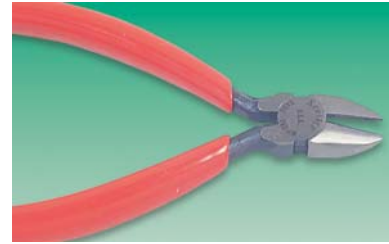

Overall Length	Blade Length	Blade Angle	Cutting Capacity Soft Steel	Copper	Mfrs. List No.	Order Code
102	12	16°	0.6	1	54CG	440-231

223007

Overall Length	Mfrs. List No.	Order Code	Price Each
102	54CG	440-231	17.50

**Oblique Cutters  
Full Flush**



Jaw Length	Overall Length	Blade Length	Blade Angle	Cutting Capacity (Copper)	Mfrs. List No.	Order Code
12	120	9	42°	1.5	EROP331	440-383

TEE72/223020,401637

Overall Length	Mfrs. List No.	Order Code	1+	4+	20+	40+	Price Each
120	EROP331	440-383	24.00	23.28	22.58	21.90	

**Long Nose Pliers  
Serrated**



Standard	Overall Length	Jaw Length	Jaw Width	Mfrs. List No.	Order Code
	140	47	1.75	57CG	440-632

222605

Standard	Mfrs. List No.	Order Code	Price Each
	57CG	440-632	19.50

**Coming soon**



Register your interest for items that are 'Coming Soon' at [www.farnell.co.uk](http://www.farnell.co.uk) and we'll email you to let you know that they're in stock.

**Diagonal Cutters**



- Drop forged black oxidized head
- Chrome vanadium steel
- PVC handle with slip guard
- Length: 110mm

**1496344:** Cutter no bevel round head with spring release handle  
**1496345:** Cutter with bevel round head and spring release handle  
**1496346:** Cutter no bevel with lead catcher round head and spring release handle

Size	Soft	Med/Hard
110mm	1.5mm	0.2mm
110mm	1.5mm	0.2mm
110mm	1.5mm	0.2mm

493023.492656

Size	Order Code	1+	5+	10+	20+
110mm	<b>149-6344</b>	9.25	8.60	7.68	6.69
110mm	<b>149-6345</b>	8.33	7.72	6.92	6.01
110mm	<b>149-6346</b>	9.70	9.01	8.05	7.01

**Front Cutter**



- Drop forged black oxidized head
- Spring release handle
- Chrome vanadium steel
- PVC handle with slip guard
- Length: 130mm

Size	Cutting Capacity: Max
130mm	1.5mm

493024.492678

Order Code	1+	5+	10+	20+
<b>149-6348</b>	7.50	6.97	6.23	5.43

**Round Nose Plier**



- Drop forged black oxidized head
- Plain jaws with spring release handle
- Chrome vanadium steel
- PVC handle with slip guard
- Length: 130mm

493021.492652

Order Code	1+	5+	10+	20+
<b>149-6342</b>	8.27	7.68	6.87	5.97

Over 480,000 products online

**Snipe Nose Pliers**



- Drop forged black oxidized head
- Plain jaws with spring release handle
- Chrome vanadium steel
- PVC handle with slip guard
- Length: 130mm

493022.492654

Type	Order Code	1+	5+	10+	20+
Straight Nose	<b>149-6343</b>	7.50	6.97	6.23	5.43
Bent Nose (30°)	<b>149-6349</b>	8.49	7.90	7.04	6.13

**Flat Nose Plier**



- Drop forged black oxidized head
- Plain jaws with spring release handle
- Chrome vanadium steel
- PVC handle with slip guard
- Length: 130mm

493020.492648

Order Code	1+	5+	10+	20+
<b>149-6341</b>	7.42	6.90	6.16	5.36

**Combination Plier**



- Drop forged black oxidized head
- Cutter with spring release handle
- Chrome vanadium steel
- PVC handle with slip guard
- Length: 120mm

Size	Cutting Capacity: Max
120mm	1.5mm

**Pliers - Precision - continued**

**Combination Plier - continued**

493025.492679

Order Code	Price Each			
	1+	5+	10+	20+
149-6350	8.73	8.11	7.26	6.31

**Side Cutters**



Blade length=9.00  
Overall length=132  
Blade angle=20°  
Cutting capacity=20 AWG  
Full flush  
Thick, soft padded handles  
Supplied with or without safety clip

**Best value**

222953

	Order Code	Price Each
		1+
Without safety clip	202-332	5.06
With safety clip	202-344	5.85

**5" (125mm) Micro Cutter**

**DURATOOL**



- An exceptionally clean smooth cut
- Lightweight and easy to handle
- Suitable for copper wire, not for use with steel wire
- Length: 5" (125mm)

Jaw Length 20mm Cutting Angle 23° Cutting Capacity 1.2mm

454577.427439.423850

Order Code	Price Each
	1+
115-6001	3.44

45

**Side Cutters**



Edge Finish	Overall Length	Jaw Length	Cutting Capacity	
Full Flush	125	8	1.3 (16AWG)	312-7485
Safety clip full flush	125	8	1.3 (16AWG)	312-7497
Full Flush	129	9.5	1.3 (16AWG)	312-7436
Full Flush	127	11	1.6 (14AWG)	312-7515

222925

Order Code	Price Each
	1+
312-7485	10.40
312-7497	10.82
312-7436	6.57
312-7515	7.14

**Side Cutters**



	Overall length	Blade length	Blade angle	Cutting capacity		Order code
				Soft iron	Copper	
Semi Flush	151	12	15°	2	—	147-208
Full Flush	127	9.5	15°	—	0.8	147-206

TEE42/  
222964.401656

	Order Code	Price Each
		1+
Semi Flush	147-208	12.66
Full Flush	147-206	8.60

**Long Nose Pliers**

**Serrated Jaws**



Overall Length 145 Jaw Length 30 Jaw Width 3

222908

	Order Code	Price Each
		1+
Long nose pliers	312-7448	6.44

**Flat Nose Pliers**



Jaw Type	Overall Length	Jaw Length	Jaw Width	Order Code
Flat Nose	135	21.5	1.5	147-211
Flat Nose	135	21.5	1.5	147-213
Flat Nose	150	32.5	3	147-212
Flat Nose	150	32.5	3	147-214

222608

Jaw Type	Overall Length	Order Code	Price Each
			1+
Flat Nose	135	147-211	10.66
Flat Nose	135	147-213	31.89
Flat Nose	150	147-212	10.66
Flat Nose	150	147-214	10.66

**Mini Cutters and Pliers**

**DURATOOL**



Long Nose Pliers



Side Cutters

- Mini cutters and pliers for precision work
- Drop forged
- Double-dipped handles for added comfort
- Jaw Capacity: 25mm
- Length: 120mm

457653.454204

Mfrs. List No.	Description	Order Code	Price Each	
			1+	5+
D00119	Long Nose Pliers	132-8714	0.85	0.71
D00120	Side Cutters	132-8715	0.99	0.84

**Cutters and Pliers**

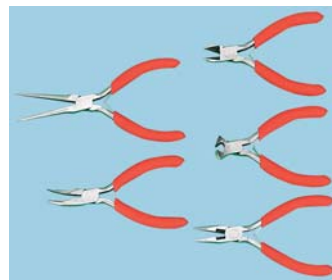

- High quality Electronic Cutters and Pliers, heat treated for excellent cutting capacity and durability
- Edges are full cut and recommended for cutting copper and soft lead wires thus ideal for precise circuit board work



	Overall Length	Jaw Length	Blade Width	Order Code
Snipe nose pliers	145	50		312-5373
Bent nose plier	125	30		312-5385
Diagonal cutters	110	14		312-5397
Long nose plier	125	25	7	312-5415

222894

	Order Code	Price Each
		1+
Snipe nose pliers	312-5373	4.56
Bent nose plier	312-5385	3.55
Diagonal cutters	312-5397	4.57
Long nose plier	312-5415	4.53
and cutters set, 5pc	312-5427	22.50

**Micro Cutters and Pliers**

Stainless Steel



222890

	Order Code	Price Each
		1+
Cutter 90mm	312-5476	4.60
Flat Nose Plier 100mm	312-5488	4.54
Bent nose plier 100mm	312-5490	2.26
Round Nose Plier 100mm	312-5506	2.26
Long nose plier 100mm	312-5518	4.54
5 piece set	312-5520	20.31

**Budget Module - Pressed Steel**



This module includes:	Order Code	This module includes:	Order Code
Full flush side cutters	147-206	Flat nose pliers, long smooth	147-212
Flat nose pliers, short serrated	147-213	Large side cutters	147-208

222640

	Order Code	Price Each
		1+
Budget module pressed	105-414	32.16

**Premium service without a premium price**



With thousands of prices already reduced, go online to see our most up-to-date pricing: [www.farnell.co.uk](http://www.farnell.co.uk)

**Budget Module - Forged Steel**



This module includes:

Full flush side cutters	Order Code 493-661	Long nose pliers	Order Code 493-703
Full flush oblique cutters	493-673	Flat nose pliers	493-697

222837

	Order Code	Price Each
		1+
Budget module forged	628-529	57.79

**5 Piece Mini Plier Set**



Carbon steel, hardened and tempered with textured grips and captive double leaf springs. Ideal for the hobbyist and model making

Contents:

105mm End cutter, 110mm Diagonal Cutter, 120mm Long Nose Plier, 120mm Flat Nose Plier and 120mm Bent Nose Plier

493854

	Order Code	Price Each
		1+
	135-9492	13.34

**5 Piece Mini Pliers Set**



- Mini plier and cutter set
- Ergonomic handles for extra comfort
- Two tone anti-slip handles
- Supplied in a handy zipped wallet

Contents:

Round nose pliers - (5") 120mm  
Top cutter pliers - (4") 100mm  
Flat nose pliers - (5") 120mm  
Bent nose pliers - (4 1/2") 110mm  
Diagonal cutters - (4 1/2") 110mm

457657.454209

	Order Code	Price/Set
		1+
	132-8716	6.78
		5+
		6.22

**Pliers - Precision ESD**

**Erem cutters and pliers**



457907

Erem cutters and pliers are unique in terms of quality, precision, reliability, ergonomics and longevity. Erem tools are convincing because of the following:

**Technology**

- Special tool steel owing to particular hardening process extremely compressed and durable
- The invisible Erem magic spring (patented) incorporated guarantees more than 1 million cutting operations with a constant spring force
- Self-locking screw system: play-free, frictionless movement run of the tool jaws
- Opening limitation of the blade points to 5mm: prevention of manual opening for fatigue-free work
- ESD-safe

Cut



Mfrs' List No.	Application	Order Code	Price Each 1+
<b>Pointed cutters, angled narrow</b>			
575E	45° angled. For fine work on hybrid circuits or microcomponents	904-703	39.75
572E	40° angled. For work in tight and difficult-to-reach places	101-4376	40.50
593AE	50° angled. Ideal maintenance tool. For tightly packed printed circuit boards.	725-6449	39.90
582E	Cuts DIL contacts from behind 45° angled. Very suitable for work on printed circuit boards, component terminals, etc.	101-4373	38.25
582EW	as 582E but with wire support	132-6102	46.13
555E	Ideal for work with a high cutting force in tight places	132-6101	44.25
<b>Pointed cutters, bevelled head</b>			
570E	For cutting at the outermost point	904-715	37.00

**Side cutters**

**Series 800, Maxi**

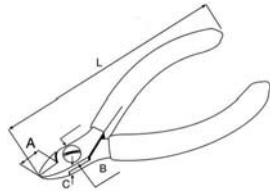

- The strongest and most robust head shape for general electronics
- Cuts relatively large wire diameters and for applications in which accessibility is not a problem
- Length: 120mm
- ESD-safe

Mfrs' List No.	Head	Surface	Cut	Dimensions in mm					Weight 85g
				L	A	B	C	Max. Cu	
812N	oval head	no reflection	with facet	120	15	13.5	7.5	1.8	85g
822N	oval head	no reflection	without facet	120	15	13.5	7.5	1.8	85g
886E	bevelled head	no reflection	without facet	120	15	13.5	7.5	1.8	83g
884E	cut-out head	no reflection	without facet	120	15	13.5	7.5	1.6	81g

458059

Mfrs' List No.	Order Code	Price Each	
		1+	4+
<b>Side cutters for relatively thick wires</b>			
812N	101-4379	36.25	35.16
822N	101-4380	36.25	35.16
886E	101-4371	45.50	44.14
884E	NEW 132-6095	47.75	46.32

**High Precision Swiss Tool Kit**

**Series 2450K**



- 3-piece tool kit in an ESD-safe plastic case (L x W x D: 270x170x50mm - Weight 602g)
- For use in electronics, PCB assembly, wire, connection handling and stripping of fine wires
- MagicSense moulded handle with soft touch for increased comfort and grip
- Induction-hardened cutting edges in Rockwell hardness 64-65 HRC
- High grade of hardness for exceptionally long life
- High grade tool steel, non-reflecting surface, ESD-safe, resharpenable

- Internal Erem Magic Spring: constant spring force, guarantees more than 1 million operations
- High precision screw joint: smooth jaw action with no play, smooth cutting operation with no jaw overlapping
- Maximum opening stop: the limited extent to which the handles can open prevent user hand fatigue

Order Code	Mfrs List No.	Description	Application
132-6105	2412E	Ergo, oval head, semi-flush	Most widely used head shape. It is robust and size for size offers the highest cutting capacity. Hard wire 0.5mm, medium hardness 1,0mm, Cu. 1,6mm
904-739	510AE	High precision stripping pliers (AWG 30-18)	Suitable for all types of insulation and optical fibres. Integral side cutting blade
132-6116	2411P	Ergo, Needle nose plier	With very precise, smooth and rounded jaws

514901

Mfrs List No.	Order Code	1+	3+	5+
2450K	161-5471	114.75	111.31	107.97

**High Precision Swiss Tool Kit**

**2400 MagicSense**



- 3-piece tool kit in an ESD-safe plastic case (L x W x D: 270x170x50mm Weight 605g)
- For use in electronics, PCB assembly, wire and connection handling
- MagicSense moulded handle with soft touch for increased comfort and grip
- Induction-hardened cutting edges in Rockwell hardness 64-65 HRC
- High grade of hardness for exceptionally long life
- High grade tool steel, non-reflecting surface, ESD-safe, resharpenable

- Internal Erem Magic Spring: constant spring force, guarantees more than 1 million operations
- High precision screw joint: smooth jaw action with no play, smooth cutting operation with no jaw overlapping
- Maximum opening stop: the limited extent to which the handles can open prevent user hand fatigue

Order Code	Mfrs Part No.	Description	Application
132-6105	2412E	Ergo, oval head, semi-flush	Most widely used head shape. It is robust and size for size offers the highest cutting capacity. Hard wire 0.5mm, medium hardness 1,0mm, Cu. 1.6mm.
132-6113	2482E	Ergo, Tip cutter, 45° angled narrow head, flush.	For precise cuts at different working angles. medium hardness 0,6mm, CU. 1,2mm
132-6116	2411P	Ergo, Needle nose plier	With very precise, smooth and rounded jaws

514902

Mfrs Part No.	Order Code	Price Each		
		1+	3+	5+
2400KMS	161-5472	108.00	104.76	101.62

**INOX Stainless Steel Pliers**

For use in clean rooms (autoclavable), antiseptic or in ESD protected areas



164-8506



164-8507



164-8508



164-8509



164-8510



164-8511

- Swaged stainless steel pliers
- Fine polished surface
- High corrosion resistance which guarantees a long life time also under aggressive influence
- Abrasionproof
- Smooth surface which prevents any kind of sediments and so simplifies the cleaning process
- Easy to clean
- Toxical attributes which especially in the hygienical area are from major importance
- With screwed stainless double leaf spring
- Box joint construction
- Suitable for use in industries like aerospace, medical and dental technique, chemical and electronic, shipbuilding and oil/gas production and finally for the food production

Mfrs. List No.	Length mm	Cutting capacity (mm)			Weight g
		soft wire	hard wire	copper wire	
33-115	110	0.4	0	1.1	36
33-215	115	0.6	0.2	1.1	53
33-135	110	0.6	0.2	0.8	40
33-235	120	0.2	0	0.4	43
33-255	120				43
33-275	120				44

523262

Mfrs. List No.	Description	Order Code	1+	5+	10+
33-115	SIDE CUTTERS, STAINLESS STEEL	164-8506	47.90	45.55	43.15
33-215	SIDE CUTTERS, STAINLESS STEEL	164-8507	46.40	44.10	41.75
33-135	OBLIQUE CUTTERS, STAINLESS STEEL	164-8508	52.40	49.80	47.15
33-235	TOP CUTTERS, STAINLESS STEEL	164-8509	53.60	50.95	48.25
33-255	SNIPER NOSE PLIERS, STAINLESS STEEL	164-8510	42.35	40.25	38.10
33-275	FLAT NOSE PLIERS, STAINLESS STEEL	164-8511	42.35	40.25	38.10

Pliers - Precision ESD - continued

Side Cutters  
Oval Head



	Overall length	Blade length	Cutting capacity	Mftrs. list no.	Order code
Micro Bevel	133.5	8.5	0.2 - 1.0mm	RX8130	904-764
Micro Bevel	135.5	10.5	0.2 - 1.25mm	RX8140	904-776
Flush	135.5	10.5	0.1 - 1.25mm	RX8141	904-788
Ultra Flush	135.5	10.5	0.1 - 1.0mm	RX8142	904-790
Micro Bevel	138	13	0.3 - 1.6mm	RX8150	904-806
Micro Bevel	145	16	0.4 - 2.0mm	RX8160	352-4061
Flush	145	16	0.3 - 1.6mm	RX8161	352-4073
Ultra Flush	145	16	0.3 - 1.6mm	RX8162	352-4085

TEE103/222602,401978

Cutting Edge	Blade Length	Order Code	Price Each
Micro Bevel	8.5	904-764	41.25
Micro Bevel	10.5	904-776	37.55
Flush	10.5	904-788	40.22
Ultra Flush	10.5	904-790	44.94
Micro Bevel	13	904-806	40.73
Micro Bevel	16	352-4061	42.15
Flush	16	352-4073	48.05
Ultra Flush	16	352-4085	55.45

Side Cutters  
Tapered Head



- Flush cutting edge
- Overall Length = 139
- Blade Length = 10.5
- Cutting Capacity = 0.1 - 1.25

TEE105/222604,401992

Mftrs. List No.	Order Code	Price Each
RX8144	904-818	37.40

45

Electronic Pliers & Cutters  
RX Series



Ergonomically designed range of pliers and cutters with handles that fit comfortably in the hand, thus allowing repetitive use without causing discomfort. Unique return spring can be adjusted to suit customer's own requirements and reduces the effort required as the force is concentrated on the cutting action.

Side Cutters

Model	Description	Order Code	Price Each			
			1+	4+	20+	40+
RX8140	Side cutter with oval head, medium jaws and micro-bevel cut. Cuts copper wire 0.2 - 1.25mm. Length 135.5mm, jaw length 10.5mm.	904-776	37.55	36.80	36.07	35.35
RX8141	Side cutter with oval head, medium jaws and flush cut. Cuts copper wire 0.1 - 1.25mm. Length 135.5mm, jaw length 10.5mm.	904-788	40.22	39.42	38.63	37.86
RX8142	Side cutter with oval head, medium jaws and ultra-flush cut. Cuts copper wire 0.1 - 1.0mm. Length 135.5mm, jaw length 10.5mm.	904-790	44.94	44.04	43.16	42.29
RX8150	Side cutter with oval head, large jaws and micro-bevel cut. Cuts copper wire 0.3 - 1.6mm. Length 138mm, jaw length 13mm.	904-806	40.73	39.92	39.12	38.34
RX8151	Side cutter with oval head, large jaws and flush cut. Cuts copper wire 0.2 - 1.6mm. Length 138mm, jaw length 13mm.	135-6211	37.91	37.16	36.41	35.68

Flat Nose

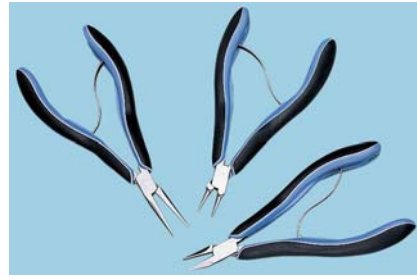

Model	Description	Order Code	Price Each			
			1+	4+	20+	40+
RX7490	Flat nose pliers with smooth jaw. Length 146.5mm, jaw length 20mm.	904-831	33.60	32.25	30.90	29.55

Round Nose

Model	Description	Order Code	Price Each			
			1+	5+	10+	20+
RX7590	Round nose pliers with very fine jaw. Length 146.5mm, jaw length 20mm.	135-6212	35.72	35.01	34.31	33.62

Snipe Nose

487205

Model	Description	Order Code	Price Each			
			1+	5+	10+	20+
RX7890	Flat nose pliers with smooth jaw. Length 146.5mm, jaw length 20mm.	135-6213	35.72	35.01	34.31	33.62
RX7891	Snipe nose pliers with serrated jaw. Length 158.5mm, jaw length 32mm.	135-6214	36.67	35.94	35.22	34.51

Snipe nose plier with bent tip



These pliers are made from high performance tool steel with specially forged box joint with polished surface, extra long contact surfaces made possible by a special manufacturing technique.



The pliers are toughness hardened to 45-48 HRC  
Handles in two component synthetic material and come with return spring  
This plier has smooth jaws  
Bent tip angled at 60°  
Length 155.5 mm  
Length, jaw 29 mm

527302

Mftrs. List No.	Order Code	1+	5+	10+
RX7892	167-1584	39.63	37.64	35.65

Oblique cutters 45° long head



These cutters are made from high performance ball bearing steel, black oxidised. Numerically controlled machine grinding guarantees edge angle accuracy and contact which increases the tools reliability and consistency.



Precision induction hardened edges 63-65 HRC.  
This Oblique cutter is ideal for rework and close assembly needs.  
Handles in two component synthetic material and come with return spring.  
Length, 143 mm  
Capacity, jaw 0.2-1.0 mm  
Length, jaw 18 mm  
Flush Cut

527305

Mftrs. List No.	Order Code	1+	5+	10+
RX8247	167-1586	71.35	67.78	64.77

Oblique cutters



These cutters are made from high performance ball bearing steel, black oxidised. Numerically controlled machine grinding guarantees edge angle accuracy and contact which increases the tools reliability and consistency. This



Oblique cutter is ideal for rework and close assembly needs.  
Precision induction hardened edges 63-65 HRC.  
Handles in two component synthetic material and come with return spring.  
Length, 134.5 mm  
Capacity, jaw 0.2-1.2mm  
Length, jaw 9.5 mm  
Flush cut.



527303

Mftrs. List No.	Order Code	1+	5+	10+
RX8211	167-1585	66.25	62.93	59.62

**Oblique cutters 45° long head**



These cutters are made from high performance ball bearing steel, black oxidised. Numerically controlled machine grinding guarantees edge angle accuracy and contact which increases the tools reliability and consistency.



Precision induction hardened edges 63-65 HRC.  
This Oblique cutter is ideal for rework and close assembly needs. Handles in two component synthetic material and come with return spring. Length, 143 mm  
Capacity, jaw 0.2-0.8 mm  
Length, jaw 18 mm  
Flush Cut

527315

Mftrs. List No.	Order Code	1+	5+	10+
RX8248	167-1587	78.44	74.51	70.58

**Tip cutters**

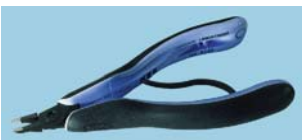

These cutters are made from high performance ball bearing steel, black oxidised. Numerically controlled machine grinding guarantees edge angle accuracy and contact which increases the tools reliability and consistency.



Precision induction hardened edges 63-65 HRC.  
Handles in two component synthetic material and come with return spring. This Tip cutter is ideal for use with multi-lead components and for rework. Length, 139 mm  
Capacity, jaw 0.1-0.6 mm  
Length, jaw 14 mm  
Flush cut

527317

Mftrs. List No.	Order Code	1+	5+	10+
RX8149	167-1588	85.58	81.29	77.01

**Heavy duty cutter**



Side cutter with progressive edges designed to cut hard material such as hard steel wire close to the joint and cut soft material such as copper wire and plastic insulated wire at the tip.

- Black oxidised, anti-corrosion treated finish
- Material: Chrome-Vanadium steel
- Two-component handles: Polypropylene core with a thermoplastic surface for superior grip and comfort
- Shape: An open lapjoint with rivet, in which the distance from the joint to the cutting edges is reduced, results in greater leverage and increased cutting capacity
- Progressive cutting edges give improved accessibility in confined spaces and return spring featuring an on/off function
- Cutting capacity: Hard steel wire
- Length 210 mm
- Capacity, jaw 2.25 mm
- Length, jaw 22 mm

527360

Set	Order Code	1+	5+	10+
TRX-8180	167-1600	40.70	38.66	36.62

**Tension Springs**

\* Replacement springs for RX Series



222644

5 Per Pack Mftrs. List No.	Order Code	Price Per Pack
RX01	893-663	4.40

**Electronics Side Cutting Pliers ESD**



413-5581  
876-434  
876-434



413-5593  
876-446  
876-446

- ESD version: electrically conductive - dissipative,
- precision-ground cutting without facets to surface cut
- precision-shaped tips also cut wires up to Ø 0.2 mm
- extremely light operation for reduced fatigue
- grips made of moulded soft plastic, to protects hands

Mftrs. List No.	
78 13 125 ESD	Cutting hardness approx. 53 HRC, without facet Material: INOX stainless steel
78 03 125 ESD	
78 61 125 ESD	Inductively hardened cutting for higher exposure time Cutting hardness approx. 64 HRC, without facet Material: special tool steel, head burnished
78 71 125 ESD	

Mftrs. List No.	Design	Cutting values Ø mm			Length
		Soft	Medium	Hard	mm
78 13 125 ESD	With wire clamp	0.2 - 1.6	1.0	-	125
78 03 125 ESD	With wire clamp	0.2 - 1.6	1.0	-	125
78 61 125 ESD	also for glass fibre cable	0.2 - 1.6	1.2	0.6	125
78 71 125 ESD	With wire clamp	0.2 - 1.6	1.2	0.6	125

243029

Mftrs. List No.	Order Code	1+	5+	10+
ESD pliers 78 13 125 ESD	413-5581	15.85	15.35	14.90
ESD pliers 78 03 125 ESD	876-434	17.30	16.80	16.25
ESD pliers 78 61 125 ESD	413-5593	16.40	15.90	15.40
ESD pliers 78 71 125 ESD	876-446	17.90	17.35	16.85

**ESD Diagonal Cutters Type 77**



- precision pliers for ultra fine cutting work, e. g. in electronics and fine mechanics
- precision box joint
- low-friction double spring for gentle and even opening
- the polish or mirror polish (only finish 2)

together with a fine film of oil offer the best possible rust protection - no circuit faults caused by peeling chrome from plated tools

- cutting edges additionally induction hardened, cutting edge hardness approx. 62 HRC
- special tool steel, oil-hardened and tempered

Mftrs. Part No.	Cutting form	Cutting performance soft/hard	Length
7702115	round head, with small bevel	0.3 - 1,6/0,5	115
7712115	round head, with bevel and lead catcher	0,3 - 1,6/0,5	115
7722115	round head, without bevel	0,3 - 1,3/-	115
7732115	pointed head, with small bevel	0,3 - 1,3/0,5	115
7742115	pointed head, without bevel	0,3 - 1,3/-	115
7752115	pointed, flat head, with small bevel	0,3 - 1,0/0,5	115
7772115	pointed mini-head, with small bevel	0,3 - 1,0/-	115

Material: Tool Steel, Oil-hardened  
Material of handles: Plastic

WET332

	1+	5+	10+	
77 02 115 ESD	876-100	24.35	23.60	22.90
77 12 115 ESD	876-112	28.70	27.85	27.00
77 22 115 ESD	876-124	24.60	23.85	23.10
77 32 115 ESD	876-136	26.35	25.55	24.75
77 42 115 ESD	876-148	26.20	25.40	24.65
77 52 115 ESD	876-150	27.40	26.60	25.75

**Premium service without a premium price**



With thousands of prices already reduced, go online to see our most up-to-date pricing:  
[www.farnell.co.uk](http://www.farnell.co.uk)

Pliers - Precision ESD - continued

ESD precision electronics pliers



110-9179



The joints are adjusted without play by means of self-securing screws the precision-ground joint surfaces ensure an even, low-friction movement over the entire opening range.

- DIN ISO 9654 and 9655
- High quality ball bearing steel, forged
- Joint with screw
- Opening spring
- Non-reflective finish
- Ergonomically shaped, two-colour dual component ESD handles, black/grey
- Low weight

Mftrs' List No.	Description	Cutting values Ø mm			Length mm
		soft	medium	hard	
79 02 125 ESD	Side cutters, rounded head, with facet	0,2 - 1.5	0.8	0.5	125
79 22 125 ESD	Side cutters, rounded head, without facet	0,1 - 1.2	0.65	-	125
79 32 125 ESD	Side cutters, pointed head, with facet	0,2 - 1.3	0.7	0.4	125
79 42 125 ESD	Side cutters, pointed head, without facet	0,1 - 1.0	0.55	-	125
79 02 120 ESD	Side cutters, mini, with facet	0,2 - 1.0	0.55	0.3	120
79 22 120 ESD	Side cutters, mini, without facet	0,1 - 0.8	0.4	-	120
79 52 125 ESD	Side cutters with wire clamp, pointed head, with very small facet	0,1 - 1.3	0.7	0.4	125
79 62 125 ESD	Side cutters with wire clamp, pointed head, without facet	0,1 - 1.0	0.55	-	125
34 12 130 ESD	Flat pliers, wide jaws, straight	-	-	-	130
34 22 130 ESD	Flat, rounded pliers, straight	-	-	-	130
34 32 130 ESD	Rounded pliers, pointed jaws, straight	-	-	-	130

423847

Mftrs' List No.	Order Code.	Price Each	
		1+	5+
79 02 125 ESD	110-9175	29.20	28.30
79 22 125 ESD	110-9177	32.40	31.45
79 32 125 ESD	110-9179	29.20	28.30
79 42 125 ESD	110-9181	32.40	31.45
79 02 120 ESD	110-9184	30.00	29.10
79 22 120 ESD	110-9186	33.15	32.15
79 52 125 ESD	134-3524	32.80	31.80
79 62 125 ESD	134-3526	36.05	34.95
34 12 130 ESD	110-9167	25.30	24.55
34 22 130 ESD	110-9171	25.30	24.55
34 32 130 ESD	110-9173	25.30	24.55

45

Electronics Pliers Type 35 ESD



3522115 ESD



- precision pliers for ultra fine assembly work, e. g. in electronics and fine mechanics
- for gripping, holding and bending
- precision box joint
- smooth ground gripping surfaces
- edges carefully deburred
- low-friction double spring for gentle and even opening
- the polish or mirror polish (only finish 2) together with a fine film of oil offer the best possible rust protection - no circuit faults caused by peeling chrome from plated tools
- special tool steel, oil-hardened and tempered

Mftrs. Part No.	Form	Length
35 12 115 ESD	flat, wide jaws	115
35 22 115 ESD	half-round jaws	115
35 32 115 ESD	round, pointed jaws	115
35 42 115 ESD	45° bent, half-round jaws	115

Material: Special Tool Steel  
Material of handles: Plastic

WET331

Mftrs. Part No.	Order Code	1+	5+	10+
35 42 115 ESD	875-776	19.65	19.05	18.45
35 22 115 ESD	875-752	18.20	17.65	17.10
35 32 115 ESD	875-764	18.20	17.65	17.10
35 42 115 ESD	875-776	19.65	19.05	18.45

Electronics Pliers Set, 6 parts

for working on electronic components



- 6 parts, contains 6 ESD electronics pliers, electrically discharging version
- case made of hard-wearing polyester fabric, pliers are held by elastic band, with zip fastener

Content:

Mftrs. Part No.	Description	Length	Order Code
35 12 115 ESD	Electronics pliers, flat, wide jaws	115mm	876-740
35 22 115 ESD	Electronics pliers, half-round jaws	115mm	876-752
35 42 115 ESD	Electronics pliers, 45° bent, half-round jaws	115mm	876-776
64 32 120 ESD	Oblique End Cutter, short head, with small bevel	120mm	875-697
77 02 115 ESD	Electronics Diagonal Cutters, round head, with small bevel	115mm	876-100
77 32 115 ESD	Electronics Diagonal Cutters ESD, pointed head, without bevel	115mm	876-136

404673

Electronics Pliers Sets	Mftrs. Part No.	Order Code	Price Each		
			1+	5+	10+
	00 20 17	916-8290	130.05	126.15	122.25

SensoPlus ESD Tungsten Carbide Side Cutter



- Oval head with tungsten carbide edges for very hard and tough materials
- Mini bevel cut
- SensoPlus handle design tailored to your hand shape and feel
- High grade alloy steel, hot drop forged, Oil hardened and tempered
- ESD safe - 2 compound ergonomic handles
- Spot-welded double leaf springs ensure consistent use
- Precision box joint means butter smooth action for exact guidance of jaws without need of readjustment.
- Mirror polishing notably reduces risk of corrosion, chrome flaking and is easy to clean

Overall Length	Cutting Capacity			Mftrs. List No.	Order Code
	Piano Wire	Soft Wire	Hard Wire		
125 mm	0.6 mm	2 mm	1.0 mm	T3779D 115	139-1002
125 mm	0.4 mm	1.8 mm	0.8 mm	T3787DF 115	146-5985

476036

Mftrs. List No.	Order Code	Price Each			
		1+	5+	10+	20+
T3779D 115	139-1002	72.55	69.65	66.75	63.85
T3787DF 115	146-5985	72.95	70.05	67.10	64.20

Technical information at your fingertips

Over 352,000 technical datasheets available online.



Visit [www.farnell.co.uk](http://www.farnell.co.uk) and look for the Tech Info heading in your search results.

**SensoPlus ESD Side Cutter**



Sensoplus side cutters with wire catch

- Oval head with mini bevel cut
- SensoPlus handle design tailored to your hand shape and feel
- High grade alloy steel, hot drop forged, Oil hardened and tempered
- Comfortable black plastic coated grips, anti-slip
- Spot-welded double leaf springs ensure consistent use
- Precision box joint means butter smooth action for exact guidance of jaws without need of readjustment.
- Mirror polishing notably reduces risk of corrosion, chrome flaking and is easy to clean.

Blade Length	12 mm
Overall Length	125 mm
<b>Cutting Capacity</b>	
Copper	1.5 mm
Soft Wire	2 mm

480132

Mfrs. List No.	Order Code	1+	5+	10+	20+
T3782DEF 115 Extra Full Flash	<b>139-1003</b>	38.55	37.40	36.25	34.70
T3782D 115 Mini Bevel	<b>151-8921</b>	39.95	38.35	36.75	35.15

**Side Cutters**



Type of head	Overall length	Cutting edge	Cutting capacity			Order Code
			Soft steel	Copper		
Oval	120	9	0.6	1.2		872-283
Tapered/Relieved	120	9	0.6	1.0		872-106
Tapered/Relieved	120	9	0.6	1.0		872-118

220262

Mfrs. List No.	Cut Type	Order Code	Price Each
T3880 DF-110	Full flush	<b>872-283</b>	28.65
T3766 DF-110	Full Flush	<b>872-106</b>	29.40
T3766 DEF-110	Extra Full Flush	<b>872-118</b>	29.40

**Side Cutters**

Oval



Type of head	Overall Length	Cutting Edge	Cutting capacity	Copper	Order Code
Oval	125	13	1.0	1.5	872-155
Oval	125	13	1.0	1.5	872-167
Oval	125	13	1.0	1.5	872-179

220263

Mfrs. List No.	Cut Type	Order Code	Price Each
T3773 D-115	Mini Bevel	<b>872-155</b>	28.60
T3773 DF-115	Full Flush	<b>872-167</b>	28.60
T3773 DEF-115	Extra Full Flush	<b>872-179</b>	28.60

**Side Cutters**

Tapered



Type of head	Overall Length	Cutting Edge	Hard	Cutting Capacity	Copper	Order Code
Tapered	120	9		Soft Steel 0.6	1	872-209
Tapered	125	13	0.4	1.0	1.2	872-210
Tapered	125	13		1.0	1.2	872-222
Tapered	125	13		1.0	1.2	872-234

220264

Mfrs. List No.	Cut Type	Order Code	Price Each
T3780 DF-110	Full Flush	<b>872-209</b>	1+
T3781 D-115	Mini Bevel	<b>872-210</b>	29.95
T3781 DF-115	Full Flush	<b>872-222</b>	29.95
T3781 DEF-115	Extra Full Flush	<b>872-234</b>	29.95

**ESD Oblique Cutter**



- Soft, comfortable and slip-free thermoplastic material compound grips
- Anti-slip bow enhances pinpoint control
- Spot-welded double leaf spring ensures consistently repeatable functioning
- Precision box joint means butter smooth action for exact guidance of jaws without need for readjustment
- Mirror polishing notably reduces risks of corrosion, chrome flaking, and is easy to clean
- Long-life cutting edges are induction hardened to maintain cutting ease

Blade length	9mm
Overall Length	120mm
<b>Cutting Capacity</b>	
Copper	2mm
Soft Wire	1mm

495171

Mfrs. List No.	Order Code	1+	5+	10+	20+
T3760DF 110	<b>151-8917</b>	87.95	84.45	80.90	77.40

**Oblique Cutters**



Type of head	Overall Length	Cutting Edge	Cutting Capacity	Copper	Order Code
Slim	135	20	Soft Steel 0.6	0.8	872-246
Extra Long	135	21		0.6	872-260

220265

Mfrs. List No.	Cut Type	Order Code	Price Each
T3786 DF-120	Full Flush	<b>872-246</b>	1+
T3871 DF-120	Full Flush	<b>872-260</b>	33.95
			45.00

**Angled Flush Cutters**



Type of head	Overall Length	Cutting Edge	Cutting Capacity	Copper	Order Code
Oblique	120	10	Soft Steel 1.0	1.2	872-258

**Pliers - Precision ESD - continued**

**Angled Flush Cutters - continued**

220266

Mfrs. List No.	Cut Type	Order Code	Price Each
T3799 DF-110	Full Flush	872-258	1+ 35.50

**ESD Snipe Nose Pliers – Bent**



Overall Length	151-8918	151-8919
Jaw Length	120mm 25mm	150mm 33mm

495037.471378

Mfrs. List No.	Order Code	1+	5+	10+	20+	Price Each
T3767D 120	151-8918	26.90	25.80	24.75	23.65	
T3769D 150	151-8919	29.00	27.85	26.70	25.50	

**ESD Round Nose Pliers**



Technical Data

Length:	135mm
Jaw Specification:	
Inside Surface	Smooth
Length	20mm

495045.471379

Mfrs. List No.	Order Code	1+	5+	10+	20+	Price Each
T3771D 120	151-8920	22.95	22.05	21.10	20.20	

**ESD Needle Nose Plier**



- Straight extra-slim long smooth jaws
- Soft comfortable slip-free thermoplastic grip
- Fatigue-free safe control for the most exacting
- Spot-welded double leaf spring, anti-slip box, precision box joint and mirror polished

Jaw Type	Smooth
Overall Length	160mm
Jaw Length	38mm

495338

Mfrs. List No.	Order Code	1+	5+	10+	20+	Price Each
T3783D	151-8922	26.05	25.25	24.50	23.45	

**ESD Cutters**



- Drop forged fine polished black oxidized head
  - Plain jaws with spring release handle
  - Chrome vanadium steel
  - 2-Component handle with slip guard
  - ESD Electro static discharge certified
  - Length: 130mm
- 1496354: Cutter no bevel round head with spring  
 1496355: Cutter with bevel round head and spring  
 1496356: Cutter no bevel with lead catcher round head and spring

Size	Soft	Med/Hard
110mm	1.5mm	0.2mm
110mm	1.5mm	0.2mm
110mm	1.5mm	0.2mm

Cutting Capacity: wire

493029.492684

Size	Order Code	1+	5+	10+	20+	Price Each
110mm	149-6354	11.03	10.23	9.14	7.96	
110mm	149-6355	9.83	9.13	8.16	7.10	
110mm	149-6356	10.05	9.33	8.34	7.26	

**ESD Front Cutter**



- Drop forged fine polished black oxidized head
- Cutter with spring release handle
- Chrome vanadium steel
- 2-Component handle with slip guard
- ESD Electro static discharge certified
- Length: 130mm

Size	Cutting Capacity: Max
130mm	1.5mm

493030.492685

Order Code	1+	5+	10+	20+	Price Each
149-6357	9.93	9.21	8.23	7.17	

**ESD Snipe Nose Pliers**



- Drop forged fine polished black oxidized head
- Plain jaws with spring release handle
- Chrome vanadium steel
- 2-Component handle with slip guard
- ESD Electro static discharge certified
- Length: 130mm

Type	Order Code	1+	5+	10+	20+	Price Each
Straight Nose	149-6353	9.23	8.59	7.67	6.67	
Bent Nose (30°)	149-6358	10.42	9.68	8.65	7.54	

493028.492682

45

**ESD Flat Nose Plier**



- Drop forged fine polished black oxidized head
- Plain jaws with spring release handle
- Chrome vanadium steel
- 2-Component handle with slip guard
- ESD Electro static discharge certified
- Length: 130mm

493026.492680

Order Code	Price Each			
	1+	5+	10+	20+
149-6351	9.25	8.60	7.68	6.69

**ESD Round Nose Plier**



- Drop forged fine polished black oxidized head
- Plain jaws with spring release handle
- Chrome vanadium steel
- 2-Component handle with slip guard
- ESD Electro static discharge certified
- Length: 130mm

493027.492681

Order Code	Price Each			
	1+	5+	10+	20+
149-6352	10.48	9.72	8.69	7.57

**ESD Combination Plier**



- Drop forged fine polished black oxidized head
- Cutter with spring release handle
- Chrome vanadium steel
- 2-Component handle with slip guard
- ESD Electro static discharge certified
- Length: 130mm

Size  
120mm

Cutting Capacity: Max  
1.5mm

493031.492687

Order Code	Price Each			
	1+	5+	10+	20+
149-6361	10.93	10.16	9.08	7.91

**Pliers - Waterpump**

**Groove Joint Pliers**



Overall length = 250mm  
Jaw opening = 45mm

- Manufactured from chrome vanadium steel, drop forged and heat treated and fitted with PVC handle

223005

Order Code	Price Each	
	1+	2.38
312-7862		

**Water Pump Pliers**

**Soft Jaws**



- Seven position selection up to 40mm jaw opening
- Sprung adjuster mechanism prevents adjusted plier slipping and thus opening the jaws whilst in use

TEE359,401828,222898

Order Code	Price Each	
	1+	12.05
312-7898		

**Waterpump Plier**



- Six positions with groove joint
- 2-component handle with slip guard for comfort
- Shock proof handle
- Drop forged, heat treated fully polished steel

Size  
250mm

Max Jaw Width  
36mm

493011.492592

Order Code	Price Each			
	1+	5+	10+	20+
149-6329	8.22	7.63	6.82	5.94

**Waterpump Plier**



Manufactured from hot deep forged chrome vanadium steel, oil hardened and tempered. Featuring box joint construction for accuracy and long life. 7 position adjustment and parallelogram shaped jaws for gripping smooth and irregular surfaces. Built in stops prevent fingers being caught and handles are PVC coated. Manufactured to DIN5231D/ISO 8976.

491094

Size (in)	Size (mm)	Jaw Cap. (mm)	Order Code	Price Each
9 1/2	240	32	010-781	15.24
12	300	38	010-782	25.33

**"Smart-Grip" Water Pump Plier**

DIN ISO 8976



Typ 85 01: die neue Smart-Grip. Patentiert

**Pliers - Waterpump - continued**

**"Smart-Grip" Water Pump Plier - continued**

DIN ISO 8976 - continued

self-controlled adjustment on the workpiece simply by squeezing the handles - ideal for frequent changeover to workpieces of different size one-hand operation for left and right handed people locking lever for space saving transport with reliable closed handles fine adjustment for favourable handle width slim dimensions for good access to the workpiece capacity: for nuts 10 - 36 mm (1 3/8" a/f; for pipes 1/8" - 1 1/4" box-joint design: high stability because of double guide and secure catching of the hinge bolt self-locking on pipes and nuts: no slipping on the workpiece and low handforce required gripping surfaces with special hardened teeth, teeth hardness approx. 61 HRC: low wear and secure gripping favourable lever action: optimum transmission of force guard prevents operators' fingers being pinched Chrome Vanadium electric steel, forged, oil-hardened and tempered

Mftrs. Part No.	Handles	Capacity for pipes	Capacity for nuts	Length (mm)	Weight (g)
85 01 250	with non-slip plastic coating	1 1/4"	10 - 36 (mm)	250	340

423829

Mftrs. Part No.	Order Code	1+	Price Each	5+	10+
85 01 250	110-9187	29.30	28.40		27.55

**Pliers Wrench**

Pliers and wrench in a single tool



Typ 86 03

Typ 86 05

- excellent for gripping, holding, pressing and bending workpieces
- for careful installation of finished-surface components
- zero backlash jaw surface pressure prevents damage to edges of sensitive components
- fast adjustment by pushing a button directly on the workpiece
- no unintentional shift of the gripping jaws and no slipping of the joint
- replaces a complete set of spanners
- parallel jaws allow infinitely variable gripping of all widths to the specified maximum size
- the action of the jaws allows screwed connections to be tightened and released quickly using the ratchet principle
- lever transmission greater than 10 - 1 for strong gripping power
- also for tile breaking

Mftrs. Part No.	Head	Handles	Working Capacities		Length	Weight
			mm	Inch		
86 03 180	nickel-plated	with plastic coating	up to 35	1 3/8"	180	260
86 03 250	nickel-plated	with plastic coating	up to 46	1 3/4"	250	540
86 05 180	nickel-plated	with two-colour dual comp. handle	up to 35	1 3/8"	180	280
86 05 250	nickel-plated	with two-colour dual comp. handle	up to 46	1 3/4"	250	570

405348

Mftrs. Part No.	Order Code	1+	Price Each	5+
86 03 180	348-3563	34.00	33.00	
86 03 250	628-530	38.95	37.80	
86 05 180	NEW 916-8435	34.65	33.60	
86 05 250	NEW 916-8443	40.10	38.90	

**HiTech Water Pump Pliers Mini-"Cobra"**

DIN ISO 8976



Typ 87 01

Typ 87 02

Typ 87 51: die neue Greif-Cobra. Länge: 250mm. Patentiert

- fast adjustment directly on the workpiece: fast and comfortable handling
- fine adjustment: ensures optimum adjustment to differently sized workpieces and user-friendly handle position. Number of adjustment positions see table
- secure catching of the hinge bolt: no unintentional shifting
- box-joint design:
- high stability because of double guide
- self-locking on pipes and nuts:
- no slipping on the workpiece and low handforce required
- gripping surfaces with special hardened teeth, teeth hardness approx. 61 HRC: low wear and secure gripping
- one-hand adjustment
- guard prevents operators' fingers being pinched
- favourable lever action:
- optimum transmission of force
- Chrome Vanadium electric steel, oil-hardened and tempered
- length: 250 mm
- very large gripping capacity
- good access to the workpiece
- high load capacity having a slim design

Mftrs. Part No.	Handles	Capacity for pipes	Capacities for nuts	Length (mm)	Weight (g)
87 01 150	with non-slip plastic coating	1 1/4"	30	150	150
87 01 180	with non-slip plastic coating	1 1/4"	30	180	170
87 01 250	with non-slip plastic coating	1 1/2"	36	250	300
87 51 250	with non-slip plastic coating	1/2 - 1 1/2"	10 - 35	250	325
87 02 250	with two-colour dual comp. handle	1 1/2"	36	250	320
87 01 300	with non-slip plastic coating	2"	46	300	545

405350

Mftrs. Part No.	Order Code	1+	Price Each	5+	10+
87 01 150	NEW 916-8451	14.45	14.00		13.60
87 01 180	842-229	17.20	16.70		16.15
87 01 250	501-001	18.20	17.65		17.10
87 51 250	NEW 110-9188	16.75	16.25		15.75
87 02 250	NEW 439-4185	18.55	--		--
87 01 300	833-150	25.00	24.25		23.50

**Wrench Pliers, 1000V insulated**

Pliers and wrench in a single tool



- Pliers and Wrench in a single tool
- excellent for gripping, holding, pressing and bending workpieces
- zero backlash jaw surface pressure prevents damage to edges of sensitive and soft nuts (Cu)
- with scale for presetting the opening width apart from the workpiece
- no unintentional shift of the gripping jaws and no slipping of the joint
- parallel jaws allow infinitely variable gripping of all widths to the specified maximum size
- the action of the jaws allows screwed connections to be tightened and released quickly using the ratchet principle
- lever transmission greater than 10 - 1 for strong gripping power

Mftrs. Part No.	Head	Handles	Capacity		Length	Weight
			mm	Inch		
86 07 250	nickel-plated	plastic dipped, VDE-tested	bis 46	1 3/8"	250	660

474832

Mftrs. Part No.	Order Code	1+	Price Each	5+	10+
86 07 250	134-3527	39.65	38.45		37.25

**'Cobra' Multiple Slip Joint Spanner**



- for hexagonal screws and nuts width across flats 10 - 32 mm (3/8" - 1 1/4"); self-locking in the range of 17 - 32 mm (11/16" - 1 1/4"). No slip on workpieces; less effort required
- replaces a complete set of spanners
- perfect fitting grip on bolt heads and nuts with metric or imperial sizes; no rounding of gripping surfaces
- the plier-type gripping movement of the jaws allows threaded connections to be tightened and released quickly using the ratchet principle
- ideal for tightening locknuts
- secure and tight grabbing of even bolt heads with rounded edges, rusted nuts or heavily coated workpieces
- secure catching of the hinge bolt: no unintentional shifting
- box-joint design:
- high stability because of double guide
- guard prevents operators' fingers being pinched

- ergonomic handle design with non-slip plastic coating for comfortable grip particularly with large and tight nuts
- one-hand fine adjustment by pushing a button with 15 adjustment positions directly on the workpiece for perfect grip on different sized workpieces and a favourable position of the hand
- Chrome Vanadium electric steel, oil-hardened and tempered

374606

Mftrs. Part No.	Order Code	1+	5+	10+
87 41 250	815-6948	18.65	18.10	17.55

**"Alligator" Water Pump Pliers Type 88**

DIN ISO 8976



box-joint design:high stability because of double guide self-locking on pipes and nuts: no slipping on the workpiece and low handforce required guard prevents operators' fingers being pinched favourable lever action:optimum transmission of force gripping surfaces with special hardened teeth, teeth hardness approx. 61 HRC: low wear and secure gripping Chrome Vanadium electric steel, oil-hardened and tempered

405361

Mftrs. Part No.	Griffe	Capacity for pipes $\varnothing$ Inch	Capacity for nuts (mm)	Length (mm)	Weight (g)
88 01 180	with non-slip plastic coating	1 1/4	30	180	185
88 01 250	with non-slip plastic coating	1 1/2	36	250	315
88 01 300	with non-slip plastic coating	2	46	300	505

Mftrs. Part No.	Order Code	1+	5+	10+
88 01 180	NEW 916-8460	11.95	11.60	11.25
88 01 250	108-355	12.95	--	--
88 01 300	NEW 916-8478	19.10	18.55	17.95

**Pliers Waterpump**



High performance multigrip pliers. 7 position slip joint 52mm capacity. Chrome finish for maximum rust protection. Non-slip comfort grip handle for a secure grip.

486283

Model	Size (mm)	Size (in)	Order Code	1+	5+	10+
180CPE	250	10	352-2106	17.39	16.94	16.70

**Multi-Pliers**



Strong jaws with aligned teeth for secure grip. Heavier forged section where most strain occurs.

**Straight Jaws**

Model	Size (mm)	Size (inches)	Order code	1+	5+	10+	20+
R27CV	178	7	137-1652	15.97	15.49	15.03	14.58
R210CV	254	10	137-1653	25.19	24.43	23.70	22.99
R212CV	305	12	137-1655	25.19	24.43	23.70	22.99

**Curved Jaws**

485292

Model	Size (mm)	Size (inches)	Order Code	1+	5+	10+	20+
R410CV	254	10	137-1656	20.97	20.34	19.73	19.14

Over 480,000 products online



**Pliers - Locking**

**Locking Pliers**



A selection of adjustable locking pliers manufactured from heat treated drop forged steel.

- Fully polished jaws
- Straight jaws
- Serrated for extra grip

481973.457888

Size	Order Code	1+	5+	10+	20+	50+
127mm	144-7410	1.75	1.50	1.42	1.32	1.18
177mm	144-7411	2.05	1.87	1.63	1.54	1.41
254mm	144-7412	2.34	2.11	1.87	1.75	1.59

**Locking Pliers**

**Curved Jaw**



- Self-locking, adjustable, curved jaws incorporating a wire cutter

222910

Length (open)	Order Code	Price Each
125/5"	312-7746	6.22
175/7"	312-7734	8.84
250/10"	312-7722	7.61

**Grip Pliers**

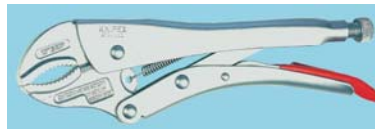

- holds round, section and flat material securely
- heavy duty model
- with adjustment screw and release lever
- one-hand operation
- high clamping pressure due to toggle lever action
- pliers body: high strength spring steel
- inserted jaws made from Chrome Vanadium steel, drop forged

Mftrs. Part No.	Order Code	Clamping width (mm)		Length (mm)
		$\varnothing$	$\square$	
41 04 180	541-6590	8 - 35	0 - 20	180
41 04 250	541-6607	8 - 35	0 - 20	250

344234

Grip Plier	Mftrs. Part No.	Order Code	Price Each		
			1+	5+	10+
Grip Plier	41 04 180	541-6590	11.65	11.30	10.95
Grip Plier	41 04 250	541-6607	11.50	11.15	10.80

**Self Grip Wrenches**



- Straight and curves jaws for gripping round and square material
- Black rust resistant epoxy coated finish
- Quick release action
- Hot drop forged chrome vanadium steel lower jaw and head
- Chrome vanadium steel upper jaw welded to pressed steel frame

Overall Length	442-458	151-8905
Max. Round Object	180mm	250mm
Max. Flat Object	25mm	35mm
	25mm	32mm

494991.471298

Mftrs. List No.	Order Code	1+	5+	10+	20+
36387	442-458	13.70	--	--	--
T3638 10	151-8905	16.70	16.20	15.70	15.05

**Pliers - Locking - continued**

**Self Locking Wrenches**



Wrench — Overall length 9 1/2" (241mm)

Order Code 442-460 Jaw Straight

- Self locking adjustable jaws. Quick release lever. Riveted assembly for extra strength. Finger control screw for accurate grip
- Chrome plated jaws for protection. Enamelled hammer finish to body

223308

	Order Code	Price Each
9 1/2" Standard	442-460	1+ 15.80

**4 Piece Locking Pliers Set**



- Drop forged, heat treated, serrated steel jaws
  - Adjustment screw and quick release lever
  - Black finish
- Set contents:
- 125mm (5") curved jaws
  - 180mm (7") curved jaws
  - 150mm (6") long nose
  - 250mm (10") straight jaws

481974.457889

	Order Code	1+	5+	Price/Set	10+	20+	50+
	144-7413	7.85	7.51	6.29	5.89	5.36	

**Selr Grip Wrench**

**Chain Clamp**



Adjusts quickly around any shape in difficult places. Will not crush thin walled tube or plastic pipes.

491558

Size (mm)	Capacity (in)	Capacity (mm)	Order Code	Price Each
250	10	160	216-088	1+ 19.46

**Chain Pipe Wrenches**



Useful in confined spaces, for instance where the pipe is in a trench, against a wall or close to a nest of other piping. Double ended reversible jaws provide maximum grip on round and irregular shapes. This design carries the USA Federal proof torque specification.

483628

Model	Capacity O.D. (mm)	Length (mm)	Proof Torque (lb / in)	Order Code	1+	5+	10+	20+
231 1/2	61	356	3600	134-8455	99.95	96.00	93.10	86.21
232 1/2	90	546	6000	134-8456	153.00	147.25	141.15	130.71
234C	220	1295	20000	134-8454	379.00	366.00	349.00	323.17
235C	330	1638	25000	134-8457	495.00	475.00	455.00	429.07

**Pliers - Circlip**

**4 Piece Circlip Pliers Set**



- Drop forged, heat treated steel
- Contents:
- Internal-Straight tip - 180mm
  - Internal 90° tip - 170mm
  - External-Straight tip - 180mm
  - External 90° tip - 170mm

481979.462084

Order Code	1+	5+	Price/Set	10+	20+	50+
144-7423	4.11	3.59	3.27	2.88	2.40	

**4 Piece Circlip Plier Set**



- Drop forged, heat treated steel
  - Double-dipped handles
  - Blow moulded storage tray
- Contents:
- 180mm Internal straight tip
  - 170mm Internal 90° tip
  - 180mm External straight tip
  - 170mm External 90° tip

481986.460955

Order Code	1+	5+	Price/Set	10+	20+	50+
144-7422	8.71	8.22	7.21	6.55	5.94	

**Precision Circlip Pliers Set**



- 4-piece precision circlip pliers set in a roll-bag or thermoform
- Each fitted with 1 item:
  - 48 11 J1 internal circlip pliers (holes)
  - 48 11 J2 internal circlip pliers (holes)
  - 49 11 A1 external circlip pliers (shafts)
  - 49 11 A2 external circlip pliers (shafts)
- Size of contact surfaces of the tips: virtually no twisting of the circlips, easy installation.
- No rim, with inserted tips composed of highly compressed spring steel wire. High load capacity even in continuous use.

- The tips are attached in an interlocking manner by pressing, and are thus held captive.
- precise, easy-movement screw joint
- Thin pliers head for optimum access to the workpiece
- both models with straight tips
- External circlip pliers (Models 49 11) with opening spring protected in the joint.
- Head phosphated
- Handle coated with rough plastic, to prevent slipping

Material of pliers: chrome-vanadium electrical steel, forged  
Roll-up bag material: soft synthetic leather

**Comprises:**

Mftrs. List No.	Shape	for holes/shafts ∅ mm	Length mm	Weight g
48 11 J1	Straight	8 - 13	140	100
48 11 J2	Straight	8 - 13	180	180
49 11 A1	Straight		140	100
49 11 A2	Straight		180	180

311191

Mftrs. List No.	Order Code	1+	Price Each	3+	5+
00 19 57	440-1311	48.50	47.05	45.60	

**Premium service without a premium price**



With thousands of prices already reduced, go online to see our most up-to-date pricing: [www.farnell.co.uk](http://www.farnell.co.uk)



**Circlip Plier Sets**

4 Piece



Quality circlip plier with extra protective black finish and colour coated handles Red (external) Blue (internal).

Contents	Size (mm)	Description
1x A2 External	19 - 60 capacity	Straight nose
1x A21 External	19 - 60 capacity	Bent nose
1x J2 Internal	19 - 60 capacity	Straight nose
1x J21 Internal	19 - 60 capacity	Bent nose

Order Code	Price Each
136-9607	30.99

8 Piece



The complete kit to cover sizes 1 & 2 straight and bent nose.

Contents	Size (mm)	Description
1x A1 External	10 - 25 capacity	Straight nose
1x A2 External	19 - 60 capacity	Bent nose
1x A11 External	10 - 25 capacity	Straight nose
1x A21 External	19 - 60 capacity	Bent nose
1x J1 Internal	10 - 25 capacity	Straight nose
1x J2 Internal	19 - 60 capacity	Bent nose
1x J11 Internal	10 - 25 capacity	Straight nose
1x J21 Internal	19 - 60 capacity	Bent nose

Order Code	Price Each
136-9608	54.49

**Precision Circlip Pliers**

for internal circlips (bore holes)



- for fitting circlips on bore holes, range of application from 8 - 140 mm dia.
- inserted tips of high density drawn spring wire
- heavy duty under continuous use; up to 10 times longer service life
- precise, smoothly-operating screw joint
- forged
- large contact faces on the tips: no distortion of circlips, easy fitting
- slim head style allows use in confined areas
- handles with non-slip plastic coating
- Chrome Vanadium electric steel
- Model 48 11 with straight tips
- Model 48 21 with bent tips

Material: chrome vanadium electric steel, forged

Mfrs. Part No.	Form	for bore holes Ø mm	Length mm	Weight g
48 11 J0	Straight	8 - 13	140	100
48 11 J1	Straight	8 - 13	140	100
48 11 J2	Straight	8 - 13	180	180
48 11 J3	Straight	8 - 13	225	260
48 11 J4	Straight	8 - 13	320	580
48 21 J01	90° bent	8 - 13	130	100
48 21 J11	90° bent	8 - 13	130	100
48 21 J21	90° bent	8 - 13	165	180
48 21 J31	90° bent	8 - 13	210	260
48 21 J41	90° bent	8 - 13	305	580

311184

Mfrs. Part No.	Order Code	1+	5+	10+
48 11 J0	440-1116	9.55	9.25	9.00
48 11 J1	440-1128	9.55	9.25	9.00
48 11 J2	440-1130	10.05	9.75	9.45
48 11 J3	440-1141	11.35	11.00	10.65
48 11 J4	440-1153	19.45	18.85	18.30
48 21 J01	440-1165	10.90	10.55	10.25
48 21 J11	440-1177	6.96	6.34	5.80
48 21 J21	440-1189	11.05	10.70	10.40
48 21 J31	440-1190	12.15	11.80	11.40
48 21 J41	440-1207	20.80	20.20	19.55

**Precision Circlip Pliers**

For external circlips (shafts)



- for fitting circlips on shafts, range of application from 3 - 140 mm dia.
- inserted tips of high density drawn spring wire
- heavy duty under continuous use; up to 10 times longer service life
- precise, smoothly-operating screw joint
- forged
- large contact faces on the tips: no distortion of circlips, easy fitting
- slim head style allows use in confined areas
- protective captive spring in the joint
- handles with non-slip plastic coating
- Chrome Vanadium electric steel

Material: chrome vanadium electric steel, forged

Mfrs. Part No.	Form	for shaft Ø mm	Length mm	Weight g
49 11 A0	Straight		140	100
49 11 A1	Straight		140	100
49 11 A2	Straight		180	180
49 11 A3	Straight		225	260
49 11 A4	Straight		320	595
49 21 A01	90° bent		130	100
49 21 A11	90° bent		170	100
49 21 A21	90° bent		210	180
49 21 A31	90° bent		210	260
49 21 A41	90° bent		305	595

311190

Mfrs. Part No.	Order Code	1+	5+	10+
49 11 A0	440-1219	11.05	10.70	10.40
49 11 A1	440-1220	10.35	10.05	9.75
49 11 A2	440-1232	11.45	11.10	10.75
49 11 A3	440-1244	12.50	12.15	11.75
49 11 A4	440-1256	21.65	21.00	20.35
49 21 A01	440-1268	12.00	11.65	11.30
49 21 A11	440-1270	11.35	11.00	10.65
49 21 A21	440-1281	12.50	12.15	11.75
49 21 A31	440-1293	13.70	13.30	12.90
49 21 A41	440-1300	23.60	22.90	22.20

**Resettable Circlip Pliers**

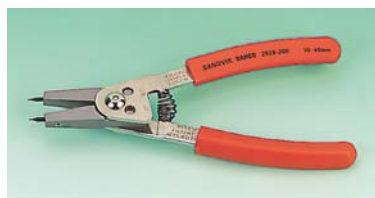

- Interchangeable tips: straight; 15 and 90 degrees
- Easily adapted for use for internal or external circlips as required
- Regulation stop mechanism for easier use and prevention of damage due to excess force

	Internal Circlips	External Circlips	Mfrs. List No.	Order Code
Resettable Circlip pliers	8-25	3-25	2928-160	723-8617
Resettable circlip pliers	10-48	10-48	2928-200	723-8629
Spare tips for Circlip pliers 160	(Order Code 723-8617)		2928-1	723-8630
Spare tips for circlip pliers 200	(Order Code 723-8629)		2928-2	723-8642

225248

	Mfrs. List No.	Order Code	Price Each
Circlip Pliers	2928-160	723-8617	27.45
	2928-200	723-8629	38.75
Spare Tips	2928-1	723-8630	8.00
	2928-2	723-8642	8.00

**Pliers - Circlip - continued**

**Circlip Pliers**



- Manufactured from high quality chrome-nickel carbon steel
- Correctly hardened and tempered
- Polished joints
- Fitted with non-slip comfort grips



225246

Type	Size	Mfrs. List No.	Order Code	Price Each
Internal Straight	180	38995	722-1034	9.95
Internal Bent	170	38996	722-1046	9.95
External Straight	180	38997	722-1058	10.53
External Bent	170	38998	722-1060	10.53

**IDC / Punchdown Tools**

**Cable Stripper & Punch Down Tool**



- A clever little stripping tool for stripping different size cables up to 6.2mm in diameter
- The unit is also a punch down tool, ideal for IDC connection
- The tool measures only 95mm in length, which makes it small enough for a key ring

481954.411434

Order Code	1+	Price Each	5+
144-7388	1.16		1.08

**IDC Hand Tool**



- Professional BT type terminal tool
- Manufactured from toughened plastic with a hardened steel blade
- Quickly and safely cuts and terminates cables
- Handle houses wire hooks and extractors
- Supplied with moulded belt holder

427039.411908

Order Code	1+	10+	Price Each	20+	50+
114-9079	7.29	6.93		6.54	6.15

**IDC Hand Tool**



The professional terminal hand tool is designed to be used with the BT 2A type connector. Manufactured from toughened plastic and fitted with a hardened steel blade. This tool is ideal for telephone engineers as it terminates and trims the wire to the correct length in one push of the impact tool. The handle houses wire hooks and extractors. Supplied with moulded, plastic belt loop holder.

235595

Order Code	1+	Price Each
394-9280		23.15

**Insertion Tool for LSA-Plus**



Length: 175 mm

- Insertion Tool for use with boards, sockets and patch fields
- Cut and push down in one operation
- For UTP and STP cables, conductor cross section 0.4mm to 0.8mm diameter
- Integrated pulling hook and release blade
- Body, plastic construction

Mfrs List No.	Conductor cross section	Length mm
97 40 10	4,4 - 0,8	175

243012

Mfrs List No.	Order Code	1+	Price Each	5+	10+
97 40 10	413-4096	25.75		25.00	24.20

**Punchdown Tool**



- For seating Telecom and data cables into terminals
- Automatically trims excess wires during punchdown action
- Suitable for a wide range of terminal blocks, including KRONE and similar
- Handle includes wire extractor hook and spudger
- Size 180mm

448365.471151

Mfrs. List No.	Order Code	1+	Price Each	5+
495033	128-3225	22.80		22.10

**Punch Down Tools For twisted Pair Cable**



Terminates and cuts telephone wire and data cable. Removable blades for cabling into 110 and Krone LSA panels. The optional detachable LED light makes working in dark cabinets or during power failures very much easier. The tool will accept all manufacturers twist and lock blades. Within the handle the adjustable impact force control ensures that the tool meets the demands of all cables. Also fitted to the handle are two tools, a hook to feed wires through holes and a multi use spudger: screwdriver and IDC contact insertion tool.

347146

Mfrs. List No.	Order Code	1+	Price Each	10+
<b>Tools - with Blades</b>				
SurePunch with 110 reversible Blade	3592	748-7711	56.16	47.90
SurePunch with Krone LSA Blade	3595	748-7720	56.16	47.90
<b>Replacement parts</b>				
Krone LSA Blade	4575	748-7754	13.68	12.52

**Component Forming**

**Bending and Cropping Tools**



Simple to use hand tools for precise lead bending of printed circuit board components, such as resistors, capacitors etc. The TP9 and TP12 have the additional facility of cropping the leads to the required length. Both operations (cropping and bending) are carried out simultaneously. The length of cut is adjustable, each side independent of the other.

	TP8	TP12	TP9
Wire capacity diameter	0.25-1.0	0.25-1.00	0.25-1.0
Maximum Length of Bend	30	16	32
Minimum length of bend	9.5	6	9.5
Minimum distance of bend from body of component	1	1	1
Maximum component diameter	12.5	12.5	12.5
Maximum length of cut	—	16	64
Minimum length of cut	—	6	19
Weight	226g	240g	350g

222647

Description	Mfrs. List No.	Order Code	Price Each
Forming handtool	TP8	441-053	32.24
Form/Crop handtool, small	TP12	441-065	59.66
Form/Crop handtool, large	TP9	441-077	59.66

Component Pre-Form Machine



This machine is designed to cut to length and pre-form axial leaded components ready for fitting into PCB's, where the component is parallel to the board. The components are fed in banded form and are cut and formed without scoring or damaging the leads.

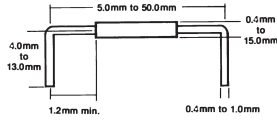

The unit is manufactured with heavy steel plate sides with free running tool steel cutting blades of 35mm diameter. The cutting and bending wheels are in high carbon steel. (Not fitted with tray.)

Available as either manually operated or assembled motor driven versions.

Input	240V ac	Capacity	25000 Pieces / Hour	222648
-------	---------	----------	---------------------	--------

Description	Order Code	Price Each
Manual machine	147-835	435.73
Assembled motor version	150-396	653.76

Electronics Accessories

Glass Fibre Pen Type Holder



Pen type holder with glass fibre brush for fine cleaning of metallic components. The brush can be adjusted to give differing degrees of stiffness.

494647

Description	Order Code	Price Each
Micro scratch brush	142-1553	5.61
Box of 10 re-fills	142-1555	6.30

General Cleaning Brushes

TECHSPRAY



165-6839

165-6840

165-6841

165-6842

165-6844

Techspray® has designed a brush line which offers a brush for your specific needs, whether you are cleaning sensitive optics or scrubbing heavy soils. The bristle cut is designed to offer optimum cleaning with minimum effort. The quality natural bristle materials selected are thoroughly cleaned prior to manufacturing.

- Wide Range
- Various Bristle Materials
- Static safe brushes

TechBrush® handles are designed for a comfortable fit, while offering a variety of handle materials, including anodized aluminum, stainless steel, wood, and Delrin® material. The TechBrush® manufacturing process insures a durable long-lasting brush which will suit your specific needs.

Bristle Material	Handle Length / Material	Mftrs. List No.	Order Code	Price Each		
				1+	6+	12+
Horse Hair	7.3/4" Wood Laminate	2020-1	165-6839	2.02	1.92	1.81
Hog Bristle	7.3/4" Wood Laminate	2021-1	165-6840	2.95	2.80	2.64
Hog Bristle	8.3/8" Wood Laminate	2022-1	165-6841	6.06	5.74	5.43
Soft Brass	7.3/4" Wood Laminate	2025-1	165-6842	6.88	6.52	6.21
Hog Bristle	4.15/16" Wood Laminate	2027-1	165-6844	4.92	4.66	4.45

Technical Cleaning Brushes

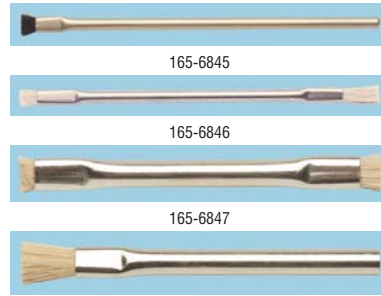

165-6845

165-6846

165-6847

165-6848

Bristles	Handle	Mftrs. List No.	Order Code	Price Each		
Goat Hair	3.1/2" Stainless Steel	2030-1	165-6845	6.16	5.85	5.54
Horse Hair	4.1/2" Stainless Steel	2031-1	165-6846	5.64	5.38	5.07
Horse Hair	4.1/2" Zinc Plated Steel	2032-1	165-6847	5.43	5.18	4.92
Horse Hair	4.1/2" Zinc Plated Steel	2033-1	165-6848	5.12	4.87	4.61

Metal Handle Brushes

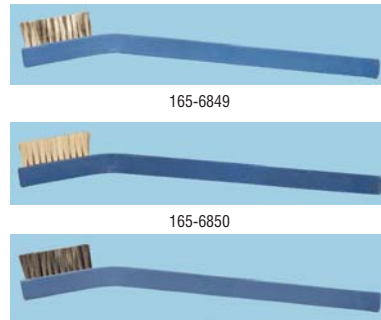

165-6849

165-6850

165-6851

Bristles	Handle	Mftrs. List No.	Order Code	Price Each		
Horse Hair	6.7/6" Anodized Aluminium	2040-1	165-6849	7.71	7.71	7.30
Horse Hair	6.7/6" Anodized Aluminium	2042-1	165-6850	13.20	12.52	11.90
Stainless Steel	6.7/6" Anodized Aluminium	2043-1	165-6851	13.61	12.94	12.27

Static Dissipative Brushes



165-6852

These dissipative brushes have a surface resistivity of 106 - 108 ohms, which makes them an excellent addition to any ESD program. Each brush is made with a revolutionary, non-sloughing, static dissipative material to prevent any static generation. For your safety, please use these brushes with a wrist strap or other mechanism to provide a good path to ground.

524871

Bristle Material	Handle Length / Material	Mftrs. List No.	Order Code	Price Each		
Static Dissipative Material	6.7/16" Aluminium	2061-1	165-6852	15.01	15.01	14.23

700 products added online every week



See our pick of the hottest products and latest technologies in 'What's New?' at [www.farnell.co.uk](http://www.farnell.co.uk)



**Electronics Accessories - continued**

**ESD-Safe Wands**



For a large variety of applications in the electronic industry as well as in laboratories. These tools can be used as:

- probe in lead-free soldering operations
- positioning aid in assembly operations
- spatula for applying adhesives, dosing chemicals in labs
- stirring rod for the preparations of adhesives, solutions
- scraper to remove solder masking agents, rubber latex, adhesive coatings

The Magic Wands are made of **ESD safe high performance PEEK (CP)** very high rigidity, excellent tensile and flexural strength, fatigue and creep resistance. Excellent wear and abrasion resistance. Extremely high heat capability (max. 300°C), good dimensional stability. Excellent resistance to chemicals and aggressive agents, excellent resistance to thermal ageing. ESD safe material, 10E6 Ohm

443386

Mfrs List No.	Description	Order Code	Price Each	
			1+	5+
MPT1.CP	fine tip and flat strong tip	125-6969	4.03	3.72
MPT2.CP	curved fine tip and flat strong tip	125-6971	4.03	3.72
MPT3.CP	flat large fine tip and flat fine sharp tip	125-6972	4.03	3.72
MPT123.CP	Kit (MPT1, MPT2 & MPT3)	136-0344	8.55	8.14

**Helping hand**



- Allows a PCB or any delicate or small work item to be held in position using the two crocodile clips
- The user can keep both hands free for positioning, soldering and assembling

TEE444/222989

Order Code	Price Each	
	1+	6.07
312-5350		

**Board holder**

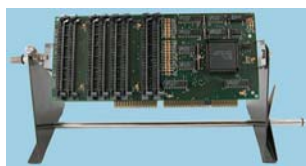

- Versatile PCB-Holder
- Ideal for populating, desoldering and repairing printed circuit boards
- The board can be turned through 360°
- Dimensions: 300 x 120x 120 mm
- Max. board length: 250 mm
- The holder is supplied without the printed circuit board



473284

Mfrs. List No.	Order Code	Price Each		
		1+	5+	10+
PC-40	136-0332	30.53	29.01	27.49

**Stencils**

**Interlocking Brass Sets**



**76 Piece**

In plastic wallet. 2 each A to Z (1 each to Q, X, Z). 1 each &, £, p. 2 each no 0 and 1. 1 each 2, 3, 4, 5, 6, 7, 8, 9.

493625

Size (mm)	Order Code	Price Each
25	012-876	1+
37.5	012-877	25.71
50	012-878	30.91
		33.08

**30 Piece A-Z**

1 each A to Z, spaces, obliques and blanks.

Size (mm)	Order Code	Price Each
25	012-879	1+
37.5	012-881	11.50
50		13.64

**13 Piece 0-9**

1 each 0, 1, 2, 3, 4, 5, 6, 7, 8, 9. 3 spaces and blanks.

Size (mm)	Order Code	Price Each
25	012-882	1+
012883	012-884	4.53
		6.27

**Extraction & Pick-up Tools**

**PLCC Extractor Tool**



- For removing PLCC type devices from their sockets
- Prevents damage to the IC packaging and socket
- Easy to use, simply squeeze the tool handle to extract
- Length: 98mm

443416.435486

Order Code	Price Each				
	1+	5+	20+	50+	200+
125-7169	3.08	2.75	2.54	2.42	2.13

**PLCC Extractor**



- A spring assisted clip carrier extraction tool, specially designed for the safe removal of PLCCs from their sockets without damage to component parts

222981

Order Code	Price Each	
	1+	19.01
312-5361		

**PLCC Extraction Tool - Static Safe**



- Eliminates the risk of component and socket damage when removing PLCC IC packages
- Simple and safe 'squeeze to remove' operation
- Durable hardened steel extraction jaws
- E.S.D. safe plastic arms
- Universal size - fits all PLCC packages

230489

Order Code	Price Each		
	1+	5+	10+
517-082	16.10	15.60	15.15

**Coming soon**



Register your interest for items that are 'Coming Soon' at [www.farnell.co.uk](http://www.farnell.co.uk) and we'll email you to let you know that they're in stock.

**Extraction Tool Set Type 401B5**  
For Flat And Round Receptacle Terminals



Wiha. Premium Tools for Professionals.



This Extraction Tool Set including 10 pieces is suitable for extracting round and flat receptacle terminals. All tools of this set have red handles and are packed in a black coated steel plate box. Its dimensions are 225 x 115 x 38mm.

Blade Material: Chrome vanadium steel  
Handle Material: Cellulose acetate (impact proof and cadmium free)

Content: 10 pieces  
1 Extraction tool Ø 3.3mm  
1 Extraction tool Ø 5.0mm  
4 Space Sleeves Ø 3,3mm  
2 Space Sleeves Ø 5,0mm  
1 Extraction tool for plugs 3.3mm  
1 Extraction tool for plugs 6.3mm

Weight: 808g

240843

Mfrs. List No.	Order Code	Price Per Set	
		1+	5+
401B5	832-479	82.33	75.92

**SMD Vacuum Pick Up Tool**



- This vacuum pick up tool has been designed to secure and place SMD flat components without touching or bending the leads
- Manufactured with a full metal body and conductive tips to ensure total ESD protection for static sensitive components
- H.P. spare parts set can be ordered separately. Contents: 2 H.P. ESD probes (1 straight and 1 45° angled), 1 straight needle and 2 ESD-cups (Ø 4 - 6mm)

Description	Order Code	Price Each		
		1+	5+	10+
Vacuum Pick Up Tool	468-1812	39.90	35.60	32.90
H.P. ESD Spare Parts Set	473-3599	16.95	15.25	14.25

**Vacuum Pen**



A lightweight, portable vacuum pump suitable for the picking and placing of small components weighing up to 50g and having a flat surface, DIL packages and surface mount components etc. Held like a pen, the vacuum is operated by a simple press and release action of a button, side mounted within the aluminium body.

Supplied with 3 angled and 3 straight pick-up heads with a choice of 3mm, 6mm or 10mm cup diameters.

TEE230X/222772

Order Code	1+	Price Each	
		5+	10+
201-170	59.09	53.19	49.75

**Vacuum Pick-Up Heads**



A variety of different replacement pick-up heads for use with many vacuum pens.

Lightweight probe with syringe style connection, internal diameter nominally 4mm. Blue silicone cup. Style, straight or angled.

222787

Cup Diameter	Style	Order Code	Price Each
3mm	Straight	483-989	3.94
3mm	Angled	483-990	4.21
6mm	Straight	484-003	3.94
6mm	Angled	484-015	4.21
10mm	Straight	484-027	3.94
10mm	Angled	484-039	4.21

**Medium Duty**



- 5 spring hooks, 2 extensions and a handle in stainless steel
- Ideal for pushing and placing springs

Wallet  
H=120, W=55, D=9  
L=110 to 380 (dependent on extensions),  
Dia=4.8

222717

Order Code	Price Per Set
	1+
222-598	17.61

**Small**



L=143 (closed), 217 (open)

- 5 spring hooks supplied in a combined holder/handle
- Fitted with a pocket clip., ideal for service/maintenance engineer

222715

Order Code	Price Each
	1+
109-153	12.73

45

**Spring Hooks**



- Precision tools for handling small springs, wires, etc.
- Ideal for the service/maintenance engineer

TEE443/222990,401817

Hook Design	Order Code	Price Each
		1+
C-Lift	312-5312	2.44
C-W	312-5324	2.35

**4 Piece Hook And Pick Set**



Designed to ease the removal of O rings, cotter pins, seals and bushes in various automotive and engineering applications. Blades are stainless steel hardened and tempered with impact resistant handles.

Contents:  
AW1 Clevis pin remover OLO and OVO hooks

493908

Order Code	Price Each
	1+
135-9500	6.64

**Extraction & Pick-up Tools - continued**

**Magnetic**



L = 115 closed, 480 open, Dia = 8

This telescopic tool is fitted with a powerful permanent magnet and is designed to retrieve small magnetic objects. Fitted with a pocket clip.

222712

Order Code	Price Each
289-220	1+ 5.21

**Pick Up Tool With LED**



- Powerful magnet bearing weight up to 2.25kg (5lb)
- Long life LED helpful in narrow and dark areas
- Lightweight and compact
- Wrist strap attached
- Adjustable length from 225mm to 650mm
- Handle diameter: 19mm

481959

Order Code	Price Each
144-7393	1+ 7.49

**Telescopic Magnetic Pick Up Tool**



- Pen style with black body and pocket clip
- Extends from 130mm to 625mm
- Powerful magnet for retrieving objects up to 5lb (2.27kg)
- Ideal for home, shop, garage and workplace
- Weight: 0.04kg

457689.452313

Order Code	Price/Set
132-8721	1+ 5+ 1.02 0.83

**Magnetic Pick-up Tool**



- Magnetic tip on an extendable chrome-plated blade
- Extended blade length = 480mm (overall 540mm)

222982

Order Code	Price Each
312-5671	1+ 4.14

**Express checkout**



With no need to re-enter your details, returning customers can now buy products even faster - **order online today at [www.farnell.co.uk](http://www.farnell.co.uk)**

**Nut-Launcher/Pick-up Tool**



Length=122, Dia.=7

- Three gripping prongs extended by pressing a button
- Ideal for launching nuts or retrieving objects

TEE170X/222714.401740

Order Code	Price Each
312-7783	1+ 5+ 5.49 -- --

**600mm Claw Pick Up Tool**



- A 600mm long claw tool for retrieving small objects

482100.454495

Order Code	Price Each
144-7564	1+ 5+ 10+ 20+ 50+ 1.14 0.93 0.84 0.78 0.67

**Safe Step**



A high performance anti-slip coating suitable for heavy vehicular traffic. Suitable for interior and exterior conditions. Ideal for use on fork lift truck ramps and loading bays. Coverage 5m<sup>2</sup> per pack.

494856

Colour	Order Code	Price Each
Grey	112-461	1+ 115.80
Safety yellow	112-463	115.80

**Tweezers**



**Precision Tweezer Set**  
5-Pieces, Budget Range



- The 5 most used precision tweezers supplied in a practical plastic wallet
- in anti-magnetic stainless steel (SA)

Typ	Description	Total length
00 SA	Tweezers with flat, strong tips	120mm
2A SA	Tweezers with flat, rounded tips	120mm
3C SA	Tweezers with very sharp tips	110mm
5 SA	Tweezers with very fine tips	110mm
7 SA	Tweezers with fine, bent tips	110mm

451048.506124

Order Code	Price Each
130-6402	1+ 5+ 10+ 25.59 23.53 20.45

**Precision Tweezers**  
Budget Range

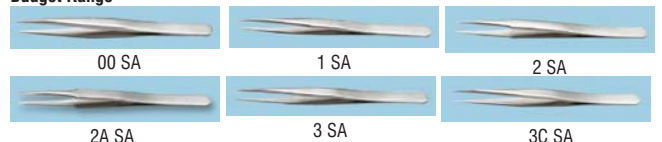

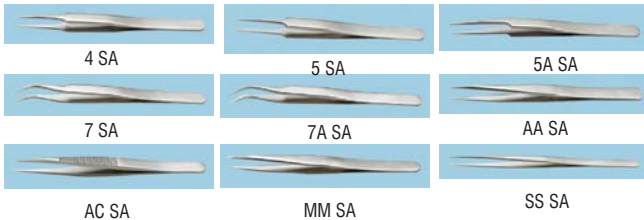

- A budget range of precision tweezers
- in anti-magnetic stainless steel (SA)
- wide choice of shapes for a large variety of industrial applications
- quality controlled
- packaged in a practical plastic wallet

Mfrs. List No.	Model	Description	Length	
			inches	mm
D00334	00 SA	Flat edges, thick	4 3/4	120
D00335	1 SA	Accurate, strong tips	4 3/4	120
D00337	2 SA	Flat, sharp fine tips	4 3/4	120
D00337	2A SA	Flat, round tip	4 3/4	120
D00338	3 SA	Very sharp tips	4 3/4	120
D00339	3C SA	Very sharp tips, superior finish	4 1/4	110
D00340	4 SA	Fine tips	4 1/4	110
D00341	5 SA	Extra fine tips	4 1/2	115
D00342	5A SA	Extra fine tips	4 1/2	115
D00343	7 SA	Fine curved tips	4 1/2	115
D00344	7A SA	Fine strong curved tips	4 1/2	115
D00345	AA SA	Strong tips for general use	5	130
D00346	AC SA	Strong tips, serrated grips	4 1/4	110
D00347	MM SA	General purpose, strong fine tips	5	130
D00348	SS SA	Super slim, extra fine	5 1/2	140

450985.506125

Mfrs. List No.	Tweezers Model	Order Code	1+	5+	10+
D00334	00 SA	130-6385	5.14	4.71	4.09
D00335	1 SA	130-6386	5.14	4.71	4.09
D00336	2 SA	130-6387	5.14	4.71	4.09
D00337	2A SA	130-6389	5.14	4.71	4.09
D00338	3 SA	130-6391	5.14	4.71	4.09
D00339	3C SA	130-6392	5.14	4.71	4.09
D00340	4 SA	130-6393	5.61	5.24	4.56
D00341	5 SA	130-6394	5.61	5.24	4.56
D00342	5A SA	130-6395	5.61	5.24	4.56
D00343	7 SA	130-6396	5.61	5.24	4.56
D00344	7A SA	130-6397	5.61	5.24	4.56
D00345	AA SA	130-6398	4.09	3.83	3.46
D00346	AC SA	130-6399	5.61	5.24	4.56
D00347	MM SA	130-6400	4.09	3.83	3.46
D00348	SS SA	130-6401	5.14	4.71	4.09

**High Precision Tweezer Set**  
5-Piece



The set is comprised of hand-made precision tweezers which have perfect symmetry and identical weight. Polished edges and matt surface, the tweezers are made of high quality stainless steel (DIN1.4404, AISI316L) This material has the following properties:- antimagnetic  
- resistance against most other chemical substances and acids  
- resistance to corrosion  
Supplied complete in a plastic storage case.

Typ	Description	Total length
00 SA	Tweezers with flat, strong tips	120mm
2A SA	Tweezers with flat, rounded tips	120mm
3C SA	Tweezers with very sharp tips	110mm
5 SA	Tweezers with very fine tips	110mm
7 SA	Tweezers with fine, bent tips	110mm

242819, 386280

	Order Code	1+	5+	10+
High precision tweezers set	397-2951	40.57	39.33	37.22

**High Precision Tweezers**

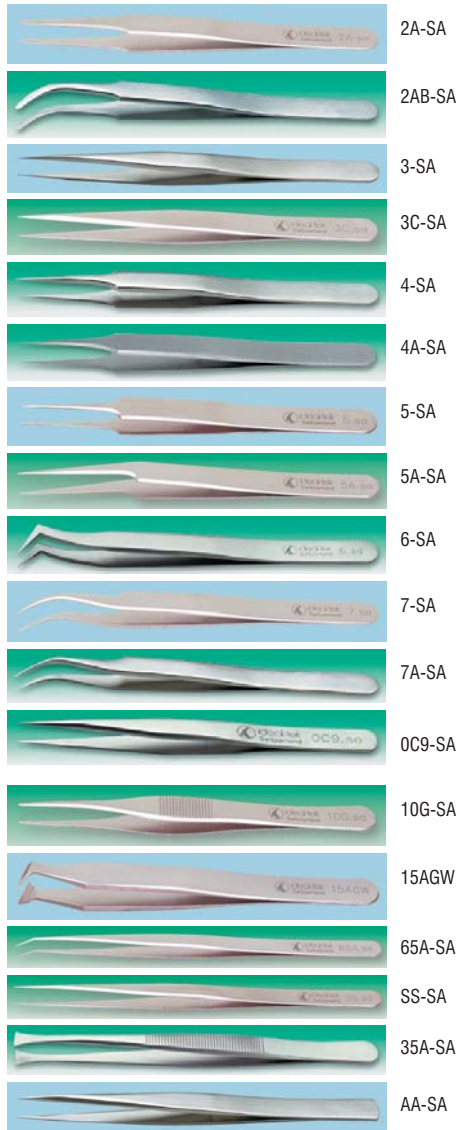

A range of hand crafted very precise tweezers manufactured from anti-magnetic stainless steel (SA) with a wide choice of shapes for a large variety of industrial applications like: small component assembly, microcircuit handling, etc

- accurate symmetry, balanced
- fine polished, mat anti-glare finish
- burr-free edges
- optimized tension
- piece by piece quality controlled

Mfrs. List No.	Description	Length	
		inches	mm
00-SA	Flat edges, thick	4 3/4	120
00D-SA	Flat edges, thick, serrated handle	4 3/4	120
1-SA	Accurate, strong tips	4 3/4	120
2-SA	Strong, fine tips	4 3/4	120
2A-SA	Flat, round tip	4 3/4	120
2AB-SA	Flat, round and bent tips	4 3/4	120
3-SA	Very sharp tips	4 3/4	120
3C-SA	Very sharp tips, superior finish	4 1/4	110
4-SA	Fine tips	4 1/4	110
4A-SA	Fine and strong tips	4 1/4	110
5-SA	Extra fine tips	4 1/2	115
5A-SA	Extra fine tips	4 1/2	115
6-SA	Fine angled tips	4 1/2	115
7-SA	Fine curved tips	4 1/2	115
7A-SA	Fine strong curved tips	4 1/2	115
0C9-SA	Flat edge, fine, short	3 1/2	90
10G-SA	Fine tips, serrated handle, general use	4 1/4	110
15AGW	For cutting hairsprings	4 1/2	115
65A-SA	Super slim, bent tip	5 1/2	140
SS-SA	Super slim, extra fine	5 1/2	140
35A-SA	Flat tip, fine and smooth	4 3/4	120
AA-SA	Strong tips, for general use	5	130

240865, 386286

Mfrs. List No.	Order Code	1+	5+	10+
00-SA	348-0616	8.74	8.45	7.85
00D-SA	468-1538	9.62	9.14	8.67
1-SA	468-1540	8.45	8.05	7.58
2-SA	136-0331	8.20	7.80	7.39
2A-SA	348-0628	8.74	8.45	7.85
2AB-SA	468-1551	9.88	9.42	8.94
3-SA	468-1563	8.45	8.05	7.58
3C-SA	348-0630	8.61	8.25	7.72
4-SA	468-1575	9.42	8.94	8.45
4A-SA	468-1587	9.42	8.94	8.45
5-SA	348-0641	10.49	10.09	9.42

**Tweezers - continued**

**High Precision Tweezers - continued**

Mfrs. List No.	Order Code	1+	5+	10+
5A-SA	348-0653	10.49	10.09	9.42
6-SA	468-1599	12.80	12.19	11.50
7-SA	348-0665	11.17	10.76	10.09
7A-SA	468-1605	10.90	10.43	9.82
0C9-SA	468-1617	8.45	8.05	7.58
10G-SA	348-0677	10.36	9.88	9.28
15AGW	348-0689	18.68	17.94	16.79
65A-SA	348-0690	8.94	8.61	8.12
SS-SA	348-0707	8.25	7.85	7.38
35A-SA	468-1629	7.58	7.18	6.83
AA-SA	468-1630	5.00	4.77	4.54

**Tweezers For SMD Components  
5-Piece Set**



The set is comprised of hand-made precision tweezers. Different tips and angles for all areas of application. Ergonomically designed. Matt finish, flat surface. The tweezers are made of high quality stainless steel(DIN1.4404, AISI316L) This material has the following properties:  
 - antimagnetic  
 - resistant against most other chemical substances and acids  
 - resistant to corrosion  
 Supplied complete in a plastic storage case

Typ	Description	Total Length
SM 103	To grip and hold components in SOT housing. Angle: 45°	115mm
SM 107	To grip all flat SMD housing. Angle: 60°	120mm
SM 108	With slot to hold components up to 1mm wide. Extra-light cushioning.	120mm
SM 111	To hold 5mm chip capacitors with flat base. Tips 2mm long with slot.	120mm
SM 115	With slot and 30° angle to grip cylindrical housing.	120mm

242824, 386281

Description	Order Code	1+	5+	10+
Tweezer set for SMD applications	397-2963	52.75	49.50	45.80

**SMD Tweezers**



45

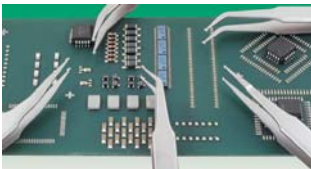

- Specifically intended for a smooth handling and positioning of most SMD components
- Accurate symmetry and balance
- Fine polished, mat anti-glare finish
- Manufactured from anti-magnetic stainless steel (SA).



SM2 - For SOT packages length 120 mm (4¾")



SM103 - For handling and positioning of 2 and 3 lead SOT packages at 45° length 115mm (4½")



SM104 - For handling and positioning of 3 lead SOT packages, monolithic chip capacitors etc. length 120mm (4¾")



SM107 - For positioning all flat devices at 60° angle. Length 120mm (4¾")



SM108 - For positioning and soldering 1 mm wide components. Tips grooved outside. Length 120mm (4¾")



SM111 - For positioning 5mm monolithic chip capacitors with flat base. Grooved tips (2mm long). Length 120mm (4¾")



SM115 - Grooved tips at 30° angle for holding and positioning cylindrical devices (up to 1 mm Ø). Length 120mm (4¾")



SM117 - For positioning SOT packages at 30° angle. Length 120mm (4¾")



SM116 - Grooved straight tips. For positioning of cylindrical devices (up to 1mm or more) Length 120mm (4¾")

240884, 386287

Mfrs. List No.	Order Code	Price Each		
		1+	5+	10+
SM2	348-0537	8.53	8.19	7.64
SM103	348-0549	8.53	8.19	7.64
SM104	348-0550	8.53	8.19	7.64
SM107	348-0562	8.53	8.19	7.64
SM108	348-0574	8.53	8.19	7.64
SM111	348-0586	8.53	8.19	7.64
SM115	348-0598	8.53	8.19	7.64
SM116 SA	468-1642	8.45	8.12	7.58
SM117	348-0604	8.53	8.19	7.64



2 Piece Tweezer Set



Fine tip tweezer set, supplied with a PVC pouch.

356984

Order Code	Price Each
352-4140	14.25

Titanium Precision Tweezer Set  
4 Piece



- Extremely high quality Swiss tweezers
  - Tips always line up & meet perfectly
  - Reduced glare from satin finish
  - Polished edges and hand crafted to perfect tip symmetry & balance
  - Made from titanium IMI 125
  - Extremely high heat resistance 870°C/1600°F
  - Lightweight
  - Solder Resistance
  - Acid Resistance
  - Supplied in a covered wallet
- |              |                                   |
|--------------|-----------------------------------|
| 1 x TL 3C-TA | Extra Fine and Sharp Tips - 110mm |
| 1 x TL AA-TA | Strong Precision Tips - 130mm     |
| 1 x TL 5A-TA | Extra Fine Tips - 115mm           |
| 1 x TL 3-TA  | Fine Tips - 120mm                 |

230728

Description	Mfrs. List No.	Order Code	Price Each
Titanium Set	9856	352-4139	112.15

5 Piece General Purpose Tweezer Set



High precision general purpose tweezer set supplied with PVC pouch.

356986

Order Code	Price Each
352-4127	41.50

SMD Precision Tweezer Set



- Extremely high quality Swiss tweezers
- All SA Tweezers are anti-acid, anti-magnetic, stainless steel
- Tips always line up & meet perfectly
- Reduced glare from satin finish
- Polished edges and hand crafted to perfect tip symmetry & balance
- Supplied in a covered wallet

- |                  |                                                                                                  |
|------------------|--------------------------------------------------------------------------------------------------|
| 1 x TL 5-SA      | Extra fine tips - 110mm                                                                          |
| 1 x TL 5C-SA     | Double bent tips - 115mm                                                                         |
| 1 x TL SM 101-SA | Picker reverse action. For soldering and desoldering, 8, 14 or 16 lead SMD's                     |
| 1 x TL SM 102-SA | Picker reverse action. For soldering and desoldering, 20, 28, 44 and 68 LCC and PLCC pad devices |
| 1 x TL SM 107-SA | Positioning all flat devices at 60° angle                                                        |
| 1 x TL SM 108-SA | Tips are grooved inside. Anti-crush feature for delicate handling. Up to 1mm wide components     |
| 1 x TL SM 115-SA | Grooved tips at 30° angle for holding and positioning cylindrical devices up to 1mm              |

230727

Description	Mfrs. List No.	Order Code	Price Each
SMD Tweezers	9854	352-4115	1+ 121.40

High Precision Swiss Tool Kit

Toolset SMD 3900KC



COOPER Hand Tools



- 6-piece tool kit in an ESD-safe plastic case (L x W x D 270x170x50mm, Weight 602g)
- Tip Cutter to remove fine pitch SMD IC,s
- High grade tool steel, non reflecting surface, ESD safe
- High precision screw joint: smooth jaw action with no play, smooth cutting operation with no jaw overlapping
- Internal Erem Magic Spring: constant spring force, guarantees more than 1 million operations
- Maximum opening stop: the limited extent to which the handles can open prevent user hand fatigue
- High-quality precision tweezers, non magnetic, for SMD work.

Mfrs List No	Description	Specification
51SA	Precision tweezers	With very pointed Tips, angled 30°,relieved
102ACA	SMD Precision Tweezers	Tip width 0,5mm/.019inch, angled 45°
103ACA	SMD Precision Tweezers	Tip width 1mm/.039inch,angled 45°
150SAMB	SMD Precision Tweezers	With round Tips, dia. 1.2mm-2.5mm/.047inch-.098, angled 40°, serrated finger grips for gripping cylindrical components.
150SAMF	SMD Precision Tweezers	With fine round tips
670EP	Miniature Tip Cutter, Flush	Fine Tip cutter to remove fine pitch SMD lcs. For SMD and micro-package contents up to 0.25mm/.010inch

514904

Mfrs List no	Order Code	1+	3+	5+
3900KC	161-5474	137.25	133.13	129.14

Erem tweezers



446822

	Mfrs. List No.	Order code	Price each
Syn. Tips, 130mm	249SA	725-6541	14.80
Syn. Fine ESD, 120mm	258SA	725-6553	15.80
Flat inside edges, 120mm	00SA	725-6565	11.00
Serr. tips, 115mm	00DSA	725-6577	10.60
Cutting, Oblique Head, 115mm	15AGW	725-6589	16.88

Erem Surface Mount

High Precision



230722

Description	Mfrs. List No.	Order Code	Price Each
Angled Head -SMD	102ACA	725-6516	1+ 9.60
Bent Tip-SMD	103ACA	725-6528	11.93
Angled Head	102ACAX	725-6530	17.25

**Tweezers - continued**

Xcelite



ISA: Stainless steel sharp pointed tweezers, length 120

XHT434: Sharp point tweezers, length 121

XHT412: Cross lock tweezers, length 115

XHT612: Cross lock tweezers, length 165

XHT678: Curved tweezers, length 174

XHT700: Straight tweezers, length 178

XHT600: Round point tweezers, length 152

222708

Description	Mftrs. List No.	Order Code	Price Each
Sharp Point	ISA	441-132	11.10
Sharp Point	XHT434	441-156	3.00
Cross Lock	XHT412	441-168	3.40
Cross Lock	XHT612	441-170	3.80
Curved	XHT678	441-181	3.90
Straight	XHT700	441-193	3.80
Round Point	XHT600	441-200	4.00

**Tweezer Set**



4 piece stainless steel tweezer set. Includes self locking needle point, angle point, straight point and flat point. Supplied in a handy PVC wallet.

491216

Order Code	Price Each
214-824	8.35



446824

- Range of high quality, stainless steel tweezers, designed to meet the requirements of the electronics and precision engineering industries
- Non-magnetic except for order codes 312-7606 and 312-7618
- Fibre handles on order codes 312-7655, 312-7667 and 312-7679

	Order code	Price each
Super fine straight tip, 110mm	312-7576	4.60
Fine curved tip, 110mm	312-7588	4.61
Fine straight tip, 140mm	312-7590	4.61
Universal, 140mm	312-7606	4.70
Reverse action, 160mm	312-7618	5.09
Cutting, 115mm	312-7620	5.09
Extra fine and sharp tip, 120mm	312-7631	4.75
Long Nose, 200mm	312-7643	6.18
Cross-leg soldering, 160mm	312-7655	2.65
Heavy duty, 160mm	312-7667	2.65
Point, 200mm	312-7679	4.45
Heavy-duty, 160mm	312-7680	2.95
Fine straight tip, 120mm	312-7692	4.61

**ESD Black Coating Tweezers**



- Manufactured from Anti-Magnetic Anti-Acid stainless Steel with ESD polyester epoxy coating (10<sup>5</sup>-10<sup>6</sup> Ohm)
- Specifically intended for a smooth handling and positioning of most SMD components
- Accurate symmetry and balance
- Fine polished, mat anti-glare finish

Mftrs. List No.	Model	Description	Length mm
D00830	2A.SA ESD	Flat Round Tweezers	120
D00831	3.SA ESD	Sharp Tweezers	120
D00832	3C.SA ESD	Sharp Tweezers	110
D00833	5.SA ESD	Fine Tips Tweezers	110
D00834	7A.SA ESD	Fine Curved Tweezers	115
D00835	AA.SA ESD	Straight Fine Tweezers	130
D00836	12.SA.SMD	SMD Tweezers for handling and positioning 2 and 3 lead SOT 45° bent	120
D00837	13.SA.SMD	SMD Tweezers for handling and positioning 1mm components	120

516076

Mftrs. List No.	Order Code	1+	5+	10+
D00830	161-6325	7.95	7.55	7.25
D00831	161-6326	7.95	7.55	7.25
D00832	161-6327	7.95	7.55	7.25
D00833	161-6329	8.55	8.15	7.75
D00834	161-6331	8.55	8.15	7.75
D00835	161-6332	6.95	6.65	6.30
D00836	161-6333	8.95	8.55	8.00
D00837	161-6334	8.95	8.55	8.00

**Precision Tweezer Sets**



ESD-conductive



161-7215 (includes: 3.SA; 7A.SA; 12.SA.SMD; 13.SA.SMD)	161-7216 (includes: 3.SA; 5.SA; 7A.SA; 12.SA.SMD; 13.SA.SMD)	161-7218 (includes: 3.SA; 3C.SA; 5.SA; 7A.SA; 12.SA.SMD; 13.SA.SMD)
-----------------------------------------------------------	-----------------------------------------------------------------	------------------------------------------------------------------------

- The Set contains the most used precision tweezers
- Made of Anti-Magnetic Anti-Acid stainless Steel with ESD polyester epoxy coating (10<sup>5</sup> - 10<sup>6</sup> ohm)
- Comfortable handling and insertion of SMD components



Mfrs. List No.	Type	Description	length
D00831	3.SA ESD	Sharp Tweezers	120
D00832	3C.SA ESD	Sharp Tweezers	110
D00833	5.SA ESD	Fine Tips Tweezers	110
D00834	7A.SA ESD	Fine Curved Tweezers	115
D00836	12.SA.SMD	SMD Tweezers for handling and positioning 2 and 3 lead SOT 45° bent	120
D00837	13.SA SMD	SMD Tweezers for handling and positioning 1mm components	120

Mfrs. List No.	Order Code	1+	5+	10+
D00838	161-7215	29.95	28.75	27.55
D00839	161-7216	36.95	35.50	34.00
D00840	161-7218	39.95	38.35	36.75

Fibre Tip Tweezers



249 CF SA  
L=130mm  
Strong tip



269 CF SA L=130mm  
Strong flat tip



259 CF SA L=130mm  
Fine tip



00 CF SA L=125mm  
Strong tip



2A CF SA L=125mm  
Flat round tip



3C CF SA L=110mm  
Fine tip, short



5 CF SA L=125mm  
Very fine tip



5X CF SA L=120mm  
Very fine tip, reverse action



7 CF SA L=115mm  
Fine curved tip

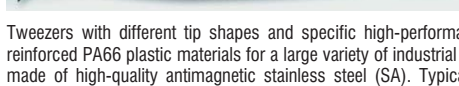

Tweezers with different tip shapes and specific high-performance ESD CF carbon fiber reinforced PA66 plastic materials for a large variety of industrial applications. The handle is made of high-quality antimagnetic stainless steel (SA). Typical applications include the handling of scratch and break sensitive components like thin film resistors, SMD parts, microchips, etc. and also cleaning and etching processes.

Fibre Tips Technical Data:

- heat stabilized
- very high rigidity, excellent tensile and flexural strength, fatigue and creep resistance
- low friction, self lubricating properties, excellent wear and abrasion resistance
- good heat capability max 270 °C
- good chemical resistance (oils, grease, fuels, non polar solvents); not resistant to strong acids, alkalis and hot water or steam
- ESD safe material, (avoid powder attraction, sparks generation, ignition sources)

240985, 386288

Mfrs List No.	Order Code	1+	5+	10+
249 CF SA	348-0458	9.04	8.42	7.72
269 CF SA	348-0460	9.04	8.42	7.72
259 CF	468-1654	10.17	9.66	9.15
00 CF SA	348-0471	9.04	8.42	7.72
2A CF SA	348-0483	9.04	8.42	7.72
3C CF SA	348-0495	9.04	8.42	7.72
5 CF SA	348-0501	9.04	8.42	7.72
5X CF SA	348-0513	11.07	10.36	9.65
7 CF	468-1666	10.17	9.66	9.15

Plastic Replaceable Tip Tweezers



242CP. SA L=130mm  
Strong flat round tip



249CPR.SA L=130mm  
Strong rounded tip



259CPR.SA L=130mm  
Fine tip



2ACPR.SA L=130mm  
Flat round tip

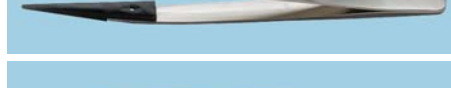

5CPR.SA L=130mm  
Very fine tip



5XCPR.SA L=125mm  
Very fine tip, self-closing



7CPR.SA L=130mm  
Fine curved tip



- High precision replaceable plastic tip tweezers
  - Replacement tip set (2 tips + 3 screws) available
  - Different tip shapes available for a large variety of industrial applications
  - The handle is made of high-quality antimagnetic stainless steel (SA, AISI 316L)
- Typical applications include the handling of scratch and break sensitive components like thin film resistors, SMD parts, microchips, etc. Well suited for soldering operations also at lead-free temperatures.
- The tips are made of ESD safe high performance PEEK (CP)
  - ✓ very high rigidity, excellent tensile and flexural strength, fatigue and creep resistance
  - ✓ excellent wear and abrasion resistance
  - ✓ extremely high heat capability (max. 300°C), good dimensional stability
  - ✓ excellent resistance to chemicals and aggressive agents, excellent resistance to thermal ageing
  - ✓ ESD safe material, 10E6 Ohm

446207

Mfrs. List No.	Order Code	1+	5+	10+
242CPR.SA	122-7451	11.09	10.53	9.97
249CPR.SA	122-7453	11.09	10.53	9.97
259CPR.SA	122-7454	11.09	10.53	9.97
2ACPR.SA	122-7456	11.09	10.53	9.97
5CPR.SA	122-7457	11.09	10.53	9.97
5XCPR.SA	122-7458	11.09	10.53	9.97
7CPR.SA	122-7459	11.09	10.53	9.97

Spare Tips	Order Code	1+	5+	10+
A242CP	122-7460	3.49	3.29	2.99
A249CP	122-7461	3.49	3.29	2.99
A259CP	122-7462	3.49	3.29	2.99
A2ACP	122-7465	3.49	3.29	2.99
A5CP	122-7466	3.49	3.29	2.99
A7CP	122-7467	3.49	3.29	2.99

Ceramic Replaceable Tip Tweezers



2AMZ. SA Flat rounded tips



71MZ.SA Fine pointed tips



7MZ.SA Fine pointed tips, curved



- Zirconia ceramic precision tips (MZ)
- Surface resistivity 10E12 Ohm
- Contamination free, high temperature (1500°C), wear and solder resistant
- Stainless steel (SA) handle
- PATENT PENDING NO.1750/97, alignable replaceable tips system

496328

Mfrs List No.	Order Code	1+	5+	10+
2AMZ.SA	152-3377	29.17	27.69	26.27
71MZ.SA	152-3378	29.17	27.69	26.27
7MZ.SA	152-3379	29.17	27.69	26.27

Spare Tips	Order Code	1+	5+	10+
A2AMZ	152-3380	14.59	13.87	13.11
A71MZ	152-3381	14.59	13.87	13.11
A7MZ	152-3382	14.59	13.87	13.11

Over 480,000 products online



**Tweezers - continued**

**Wafer tweezers**



	2WF.SA
	2WFG.SA
	2WFCPR.SA
	4WF.SA
	4WFG.SA
	4WFCPR.SA
	SP4T.SA

SP4T.SA: Upper grip area made from Teflon

- made from special stainless steel, nonreflective surface, nonmagnetic
- Developed for extremely sensitive and fragile wafers, glass wafers etc.

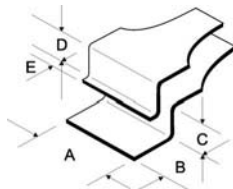

Mfrs' List No.	Dimensions									
	A mm	A" mm	B mm	B" mm	C mm	C" mm	D mm	D" mm	E mm	E" mm
2WF.SA	6.5	0.25	9.0	0.35	2.5	0.10	4.0	0.15	2.5	0.10
2WFG.SA	6.5	0.25	9.0	0.35	2.5	0.10	4.0	0.15	2.5	0.10
2WFCPR.SA	6.6	0.25	10.5	0.41	2.0	0.08	3.5	0.14	4.5	0.18
4WF.SA	12.0	0.47	9.0	0.33	2.5	0.1	4.0	0.15	2.5	0.10
4WFG.SA	12.0	0.47	9.0	0.33	2.5	0.1	4.0	0.15	2.5	0.10
4WFCPR.SA	12.0	0.47	10.5	0.41	2.0	0.08	3.5	0.14	4.5	0.18
SP4T.SA	12.0	0.47	8.5	0.33	-	-	6.5	0.25	-	-

473290

45

Mfrs' List No.	Order Code	Price Each		
		1+	5+	10+
2WF.SA	136-0333	9.14	8.68	8.21
2WFG.SA	136-0335	9.14	8.68	8.21
2WFCPR.SA	136-0336	11.57	11.00	10.44
4WF.SA	136-0337	9.14	8.68	8.21
4WFG.SA	136-0338	7.31	6.94	6.57
4WFCPR.SA	136-0339	11.57	11.00	10.44
SP4T.SA	136-0340	16.27	15.44	14.67

**Insulated Tweezer Set**

2 pcs



- 2 Piece economic type tweezers with insulated coating handle
- Non-magnetic

- Material: AISI304
- Length: 145mm



525409

Description	Mfrs. List No.	Order Code	Price Each		
			1+	5+	10+
Insulated Tweezer Set	908-T301	166-6210	5.02	4.77	4.25

**Anti-static Tweezer Set**



The set comprises 5 precision tweezers made of reinforced plastic. These tweezers are particularly suited for secure handling of sensitive parts and use with aggressive chemicals (cleaning and caustic baths, production of semiconductors etc.)

Mfrs. List No.	Description	Total length
702A	Tweezers with flat, rounded tip	116mm
707	Tweezer with fine tip	114mm
708	Tweezers with fine, 45° curved tip	110mm
709	Tweezers with smooth flat, small tip	116mm
710	Tweezers with smooth flat, wide tip	116mm

The tweezers are available in 2 different technical plastics:

**CF (PA66/CF30)**

- carbon reinforced polyamide
- high mechanical properties
- electroconductive (no electrostatic charging)
- good thermal resistance (up to 190°C)
- good chemical resistance (oil, grease, solvents)

**SV (PVDF/CF30)**

- carbon reinforced polyvinylidene fluoride
- good mechanical resistance and toughness
- electroconductive (no electrostatic charging)
- good thermal resistance (up to 190°C)
- high level of purity (accepted clean room)
- excellent resistance against most chemicals particularly to acids such as fluoride, nitric acid and hydrochloric acid.
- High abrasive resistance
- resistant against UV and radioactive radiation (sterilization)

242832, 386282/408098

Order code	Description	Price each
397-2987	CF tweezer set	8.07
397-2999	SV tweezer set	15.53

**Plastic Tweezers**



- Strong flexible and durable glass-filled Delrin™ body and tips
- Resistant to commercial solvents such as Nitric Acid, Aqua-Regia, Acetic acid, Acetone
- Tips will not open/spread when extra pressure is applied
- Length: 115mm

493782

Mfrs. List No.	Order Code	Price Each			
		1+	5+	10+	20+
132-0023	151-8408	2.94	2.74	2.67	2.56
132-0024	151-8411	3.21	3.10	2.95	2.74
132-0025	151-8412	9.22	8.99	8.54	8.35
132-0029	151-8413	4.58	4.44	4.34	4.18
132-0033	151-8414	3.21	3.08	2.87	2.75
132-0034	151-8415	3.76	3.69	3.60	3.57
132-0035	151-8416	4.43	4.34	4.25	4.21
132-0036	151-8417	4.43	4.34	4.25	4.21
132-0040	151-8418	3.21	3.15	3.08	3.04
132-0048	151-8419	2.84	2.78	2.72	2.69
132-0050	151-8420	6.07	5.94	5.83	5.77

**Forceps**

**Seizers**



Used for gripping and holding wires and retrieving small parts. May also be used as a heat sink.

495209



Type	Size (mm)	Order Code	Price Each
Straight	150	386-1284	1+ 6.02
Bent	150	386-1296	1+ 6.02

**Stainless Steel Forceps**



- Serrated jaw, three position snap lock, box joint, stainless steel forceps

TEE433/222978,401805

	Order Code	1+	Price Each	+
Straight, (6") 150mm	312-5294	7.44	--	--
Curved, (6") 150mm	312-5300	7.50	--	--

**Trimming Tools**

**Trimming Tool Set**



- 10 piece Trimming Tool Set
- Fits all popular Trimmer sizes

223035

Order Code	Price Each
312-5063	1+ 3.26

**Anti-static Trimmers**

3 Piece Set



- Duplex, trimmer and square/hex tools
- Conductive nylon - non-insulating

TEE441/222987,401815

Order Code	1+	Price Each	+
312-5051	4.91	--	--

**Ceramic Blade Screwdriver Set**



- Non-conductive
- Non-magnetic
- High heat resistance
- High resistance to wear
- Corrosion resistant

**Tip Type**  
slotted 0.9mm, 2.6mm  
phillips No. 0  
Blade 15mm length

A set of 3 high quality ceramic blade screwdrivers with anti-static handles and rotating palm rests. Ideal for use in electronics production, supplied in a plastic box.

222768

Order Code	Price Each
609-780	1+ 40.54

**Screwdrivers - Precision**

**6 Piece Jewellers Screwdriver Set**



A 6 piece precision screwdriver set containing a selection of screwdrivers, all manufactured with selected steel handles and chemically hardened, high carbon steel blades. The set is supplied in a rigid, hinged case. The set contains:  
Phillips: PH0, PH1  
Slotted: 1.4, 2, 2.4 and 3mm

462026.461194

Order Code	1+	5+	Price/Set	10+	20+
134-1142	0.99	0.90	0.84	0.68	

**11 Piece Precision Screwdriver Set**



An 11 piece precision screwdriver set manufactured with steel blades which have precision ground tips and metallic handles with a rotating tip. The kit is supplied in a moulded, impact resistant case with a durable hinge and a snap shut fastener. The kit contains

462028.461199

- 6 x Slotted Screwdrivers, 1, 1.2, 1.4, 1.8, 2.4, and 3mm
- 3 x Phillips Screwdrivers, PH00, PH0 and PH1
- 1 x Pointing Awl
- 1 x Magnetic Pick-up Tool

Order Code	1+	5+	Price/Set	10+	20+
134-1143	1.92	1.58	1.49	1.30	

**6 Piece Torx Jewellers Screwdriver Set**



A 6 piece precision screwdriver set containing a selection of screwdrivers, all manufactured with selected steel handles and chemically hardened, high carbon steel blades. The set is supplied in a rigid, hinged case.  
The set contains:  
Torx: T5, T6, T7, T8, T9 and T10

461233.461189

Order Code	1+	5+	Price/Set	10+	20+
134-1141	1.59	1.39	1.21	1.09	

**5 Piece Long Jewellers Screwdriver Set**



- Superslim jewellers screwdriver set
- Rotating caps allow ease of use and greater control
- 150mm blade length

Contents:

Slotted screwdriver (2mm tip)      Phillips screwdriver (PH00 tip)  
Slotted screwdriver (3mm tip)      Phillips screwdriver (PH0 tip)  
Slotted screwdriver (4mm tip)

457692.454529

Order Code	1+	Price/Set	5+
132-8722	2.10		1.59

**Help us to help the environment**



This catalogue has been printed on paper certified from a sustainable source.  
Please recycle after use.

**Screwdrivers - Precision - continued**

**Jewellers Screwdrivers**



**Service Set**

Screwdriver body with revolving black plastic hexagon cupped head. Hardened steel blade provides a positive grip in the screw. Set of six complete screwdrivers in a fitted case: 1 each - 0.6mm, 1.0mm, 1.4mm, 1.8mm, 2.1mm, 2.5mm blade width.

Model	Order code	Price Per Set			
777/1	137-3789	1+	5+	10+	20+
		33.93	33.25	32.58	31.93

**Pocket Set**

Comprising a screwdriver body and chuck with six interchangeable blades - widths 0.6mm to 2.5mm. Each blade is contained in a separate compartment.

488331

Model	Order code	Price Each			
777/2	137-3790	1+	5+	10+	20+
		12.96	12.70	12.44	12.19

**Precision Screwdrivers**



- Soft grip handles with swivel tops for added control
- Blade length: 75mm; Overall length: 165mm

482150.464822

Type/Size	Order Code	Price Each			
		1+	5+	10+	20+
<b>Slotted</b>					
1.5 x 75mm	144-7590	1.24	1.11	1.01	0.86
2.0 x 75mm	144-7591	1.24	1.11	1.01	0.86
3.0 x 75mm	144-7593	1.24	1.11	1.01	0.86
4.0 x 75mm	144-7594	1.24	1.11	1.01	0.86
<b>Phillips</b>					
PH00	144-7595	1.24	1.11	1.01	0.86
PH0	144-7596	1.24	1.11	1.01	0.86
PH1	144-7597	1.24	1.11	1.01	0.86

**6 Piece Precision Screwdriver Set Slotted & Phillips**



- Soft grip handles with swivel tops for added control
- Blade length: 75mm; Overall length: 165mm
- Tip sizes, Slotted: 2, 3, 4mm; Phillips: PH00, PH0, PH1

482161.464818

Order Code	Price Set			
	1+	5+	10+	20+
144-7588	9.09	8.28	7.22	5.87

**6 Piece Precision Insulated Screwdriver Set**



- Soft grip handles with swivel tops for added control
- Blade length: 75mm; Overall length: 165mm
- Tip sizes, Slotted: 2, 3, 4mm; Phillips: PH00, PH0, PH1

482105.462293

482153.464834

Order Code	Price/Set			
	1+	5+	10+	20+
144-7604	9.90	9.01	7.85	6.38

**Torx Precision Screwdrivers**



- Soft grip handles with swivel tops for added control
- Blade length: 75mm; Overall length: 165mm

482151.464832

Size	Order Code	Price Each			
		1+	5+	10+	20+
T5	144-7598	1.29	1.12	1.02	0.88
T6	144-7599	1.29	1.12	1.02	0.88
T7	144-7600	1.29	1.12	1.02	0.88
T8	144-7601	1.29	1.12	1.02	0.88
T9	144-7602	1.29	1.12	1.02	0.88
T10	144-7603	1.29	1.12	1.02	0.88

**6 Piece Precision Torx Set**



- Soft grip handles with swivel tops for added control
- Blade length: 75mm; Overall length: 165mm
- Tip sizes: T5, T6, T7, T8, T9, T10

482149.464820

Order Code	Price Set			
	1+	5+	10+	20+
144-7589	9.61	8.76	7.64	6.20

**6 Piece Precision Insulated Torx Screwdriver Set**



- Soft grip handles with swivel tops for added control
- Blade length: 75mm; Overall length: 165mm
- Tip sizes: T5, T6, T7, T8, T9, T10

482154.464836

Order Code	Price/Set			
	1+	5+	10+	20+
144-7605	10.18	9.29	8.11	6.58

**15 Piece Precision Screwdriver Set**



- Cushion handle provides super soft comfortable grip allowing use over prolonged periods
  - Supplied in a convenient plastic carry case
- Set contents:  
 Slotted - 2 x 65mm, 2.5 x 65mm, 3 x 65mm, 4 x 65mm  
 Phillips - PH000 x 65mm, PH00 x 65mm, PH0 x 65mm, PH1 x 65mm  
 Torx - T6 x 50mm, T7 x 50mm, T8 x 50mm, T9 x 50mm, T10 x 50mm, T15 x 50mm, T20 x 50mm

482105.462293

Order Code	1+	5+	Price/Set	10+	20+	50+
144-7570	7.26	6.45	5.75	5.31	4.95	

**Electronic Screwdriver Set**

7 pcs



**Kit Content:**  
Screwdriver  
-Slotted: 2.4x75mm, 3.0x100mm, 4.0x150mm  
-Phillips: 1x150mm, 0x100mm, 0-2x75mm  
Alignment tool



525407

Description	Mfrs. List No.	Order Code	1+	5+	10+
Electronic Screwdriver Set	8PK5141N	166-6209	10.20	9.69	9.17

**Precision Screwdriver Set**

Duplex Colour Handles



- Duplex colour precision screwdriver set
- Nylon handles with soft-grip panels and plastic revolving top
- Blades manufactured from chrome-molybdenum vanadium steel with a satin finish
- Set supplied in a plastic case

Contents: Slot 1.6, 2.0, 2.4, 3.0, Phillips No.00, 0, 1 all 50mm long

222995

	Order Code	Price Per Set
7 piece set	312-5531	12.37

**14 in 1 Reversible Screwdriver Set**

Duplex Colour Handle



- Duplex colour reversible precision screwdriver set
- Nylon handle with soft-grip panels, plastic revolving top and collar chuck
- Blades manufactured from chrome-molybdenum vanadium steel with a satin finish
- Blade sizes: PH.1 PH.0, PH.0 Slot 3.0, Slot 1.5 3.0, Slot 2.0 PH.00, Slot 4.0 PH.1, Hex 2 Ball Hex 2, Hex 2.5 Ball Hex 2.5
- Supplied in a plastic case

222994

	Order Code	Price Per Set
14 in 1 set	312-5543	12.68

**Precision Screwdriver Sets**



- Screwdriver sets with CV-Molybdenum steel blades, hardened and tempered, and nylon handles with revolving tops
- Sets supplied in plastic cases

Set contents:

6 piece Slot/Phillips PH.00, 0, Slot 1.5, 2, 2.5, 3 all 50mm long  
7 piece Slot/Phillips/Torx PH.00, 0, Slot 2, 2.5, 3, Torx TX15, T20 all 50mm long  
7 piece Torx TX6, TX7, TX8, TX9, TX10, TX15, TX20 all 50mm long

222973

	Order Code	Price Each
6 piece Slot/Phillips	312-6936	9.15
7 piece Slot/Phillips/Torx	312-6948	1.99
7 piece Torx	312-6950	7.64

**14 in 1 Precision Screwdriver Set**



- 7 double-ended blades manufactured from CV or SNMG steel, hardened and tempered with black tips
- Nylon handle fitted with plastic revolving top and collar chuck
- Blade sizes: TX6xTX10, TX7xTX15, TX8xTX20, TX9xTX15, PH.00xSlot 2.0, PH.0xSlot 3.0, PH.1xSlot 4.0
- Supplied in a plastic case

222974

Order Code	Price Each
312-6961	10.58

**Electronic Screwdriver Set**



Contents: Slot 1.4 x 20mm, 1.8 x 20mm, 2.4 x 20mm  
Phillips No.00 20mm, No.0 20mm, No.1 20mm

222984

Order Code	Price Per Set
312-5555	5.02

**Precision Screwdrivers**



Wiha - Premium Tools for Professionals.



- Ergonomic handle design with soft zone for comfortable work
- Easy-movement rotating cap for rapid hand action
- Colour-coded marking of the drive symbol for easy identification
- Through-hardened, chromeplated blade made of chromevanadium-molybdenum steel for a long tool life
- Wiha ChromTop® tip guarantees a secure hold in the screw head
- Ideal for all fine, filigree applications in electronics and precision-mechanics applications, as well as for DIY and model-building

338085

	Typ	Size	Order Code	Price Each
Slotted - 260 P Series	475	0.8 x 40	282-212	5.48
	478	1.5 x 40	282-224	4.10
	482	2 x 40	282-236	2.36
	486	2.5 x 50	282-248	3.27
	490	3 x 50	282-250	3.08
	493	3 x 150	282-261	2.66
	Phillips - 261 P Series	513	Phillips No 000 x 40	282-297
512		Phillips No 00 x 40	282-303	4.46
511		Phillips No 0 x 50	282-315	3.62
516		Phillips No 1 x 60	282-327	2.87
518		Phillips No 1 x 150	282-339	3.49
Pozidriv - 274 Series		4461	Pozidriv No.0 x 50	282-273
	4462	Pozidriv No1 x 60	282-285	4.64
Ball Hex - 264 P Series	531	1.3 x 40	310-6159	3.64
	532	1.5 x 50	310-6160	3.30
	533	2.0 x 50	310-6172	2.91
	534	2.5 x 60	310-6184	2.71
	535	3.0 x 60	310-6196	2.60
	Ball Hex Socket - 265 P Series	544	1.5 x 60	310-6202
546		2.0 x 60	310-6214	4.19
548		60 x 60	310-6238	3.38
551		4.0 x 60	310-6251	4.19
552		4.5 x 60	310-6263	4.11
553		5.0 x 60	310-6275	4.11

**Screwdrivers - Precision - continued**

**Precision Screwdrivers - continued**

Typ	Size	Order Code	Price Each
<b>TORX - 267 P Series</b>			
	566 T5 x 40	630-354	5.85
	567 T6 x 40	630-366	3.45
	568 T7 x 40	630-378	3.45
	569 T8 x 40	630-380	3.45
	570 T9 x 40	630-391	3.50

**Precision Screwdriver Set  
6 Pieces, With Practical Rack**



- "Electronic" range of screwdrivers are designed for delicate assembly of small components
- Handle has free rotating cap
- Blades made from chrome vanadium molybdenum steel satin chrome plated
- Slim handle made from high quality cadmium free engineering plastic
- The screwdriver set is supplied with a 6 space stand/holder



Content: 6 pieces  
4 Slot and 2 Phillips screwdrivers

Tip Size	Blade Length	Phillips Size
1,5	40	
2,0	50	
2,5	50	
3,0	50	
	40	00
	50	0

Weight: 160g  
Dimensions in mm

245960

Mfrs. Part No.	Order Code	Price Each
260K6	282-340	1+ 25.78

**Precision Screwdriver Set Ball Hex  
With 6 Space Stand/Holder**



- "Electronic" range of screwdrivers are designed for delicate assembly of small components
- Handle has free rotating cap
- Blades made from chrome vanadium molybdenum steel satin chrome plated
- Wiha ChromTop finish on tip for a perfect fit every time

Tip Size Ball	Blade Length
0,9	40

Tip Size	Blade Length
1,3	40
1,5	50
2,0	50
2,5	60
3,0	60

Weight: 195g



Dimensions in mm

241182

Mfrs. List No.	Order Code	Price Each
264PK6	831-608	1+ 25.80 5+ 23.79

**Premium service without a premium price**



With thousands of prices already reduced, go online to see our most up-to-date pricing: [www.farnell.co.uk](http://www.farnell.co.uk)

**Precision Screwdriver Set Type 265PK6**

With 6 Space Stand/Holder



- "Electronic" range of screwdrivers are designed for delicate assembly of small components
- Handle has free rotating cap
- Blades made from chrome vanadium molybdenum steel satin chrome plated
- Wiha ChromTop finish on tip for a perfect fit

Tip Size	Blade Length	Tip Size	Blade Length
2,5	60	4,0	60
3,0	60	5,0	60
3,0	60	5,5	60

Weight: 240g

Dimensions in mm

241187

Mfrs. Part No.	Order Code	Price Each
265PK6	831-610	1+ 33.83 5+ 30.95

**TORX® MagicSpring screwdriver set**



- MagicSpring holding spring made of stainless steel holds any TORX® screw reliably.
- No more tedious searching for dropped screws
- Ideal when access is difficult
- Also suitable for TORX® screws composed of aluminium, stainless steel, plastic and titanium
- Blades composed of high-quality, chrome-vanadium-molybdenum steel, continuously hardened and matt-chromium-plated
- Wiha PicoFinish handle for lightning-fast screwdriving
- With practical plastic holder for hanging up or placing down

Content: 6 pieces as follows  
T6x40, T7x40, T8x40, T9x50, T10x50, T15x60  
Dimensions in mm

413198

Mfrs. List No.	Order Code	Price Per Set
267PR K6	978-7690	1+ 28.19 5+ 26.75

**Precision Screwdriver Set, TORX®  
6 Pieces, With Practical Rack**



- Ideal for high-precision work with electro-technical and precision components, e.g. mobile phones
- High Quality chrome vanadium molybdenum steel, through hardened, chrome-plated
- Wiha ChromTop finish on a tip for a perfect fit every time
- Handle for a rapid rotation
- 6 space stand/holder

Content: TORX® T4, T5, T6, T7, T8, T9  
6 space stand / holder

241157

Mfrs. Part No.	Order Code	Price Each
267 PK 6 M	358-4562	1+ 20.79 5+ 20.06 10+ 19.36



**Screwdrivers with Magic Spring**

**TORX® Magic Spring Screwdriver Set - 6 Pieces**



Magic Spring retaining spring holds TORX® screws securely in place. With rotating cap and rapid turning zone.

**Blade:**  
High quality chrome-vanadium-molybdenum steel, through hardened chrome plate.  
Wiha Chrome Top finish on tip for a perfect fit every time.  
**Handle:**  
Wiha Pico Finish handle for rapid rotation.  
**Application:**  
For setting and tightening TORX® screws in hard to reach areas.  
**Extra:**  
With practical plastic rack with hanging holes.

485384

Description	Mfrs. List No.	TORX Size	Order Code	Price Per Set		
				1+	5+	10+
TORX Magic Spring Precision Screwdriver Set	27747	T6, T7, T8, T9, T10, T15	978-7690	28.19	26.75	25.35

**Precision Screwdriver Set Torx, 6 pieces**

**Type 267 PK 6 with Wiha PicoFinish Tip and Holder**



- Wiha PicoFinish Handle for rapid rotation
- Blade made of chrome vanadium molybdenum steel, through hardened, chrome-plated, Tip: Wiha ChromTop
- Ideal for high-precision work with small components

Content: 40xT7; 40xT8; 50xT9; 50xT10; 60xT15; 60xT20

241162

Mfrs. Part No.	Order Code	Price Per Set		
		1+	4+	20+
267PK6	310-6743	22.82	19.04	17.49

**Electronics Screwdriver Micro**

**Series 2035/6A**



- Electronic screwdriver with improved ergonomics
- For slotted and Phillips screws
- 6 pieces in a display carton + Rack

**Content:**  
Slotted: 0.30x1.8x60; 0.40x2.0x60; 0.40x2.5x80; 0.50x3.0x80  
PH: PH00; PH0

241152

Type	Order Code	Price Each	
		1+	5+
2035/6A	876-707	15.93	14.05

**Technical information at your fingertips**

Over **352,000** technical datasheets available online.

Visit [www.farnell.co.uk](http://www.farnell.co.uk) and look for the **Tech Info** heading in your search results.



**TORX® B0 Screwdriver Set with Rack**

**Typ 2067/6**



- 6 pieces in a display carton + Rack
- TORX® socket screws with safety pin (B0 = with bore hole)

**Blade:** Round  
**Tip:** Mat nickel, Black Point  
**Handle:** Kraftform Micro with anti-roll protection and rotating cap, multi-component  
**Content:** TX7; TX8, TX9; TX10; TX15; TX20



241173

Type	Order Code	Price Each		
		1+	5+	10+
2067/6	311-0539	20.01	18.97	18.48

**Xonic Precision Screwdrivers**



Handles are manufactured in shatterproof cellulose acetate. The blades of chrome vanadium or chrome molybdenum steel as appropriate for use, are matt chrome plated with gun finished tips. Blades fully hardened along whole length to 52-60 HCR.

- Colour coded cap, indented to fit index finger, and revolves independently of the screwdriver
- Set of 4 Slot/Phillips: Slot 1.5 x 60, 2.5 x 75, 3.0 x 100mm, PH 0 60
- Set of 5 Tamperproof Torx Precision Screwdrivers, TX07 TX08, TX09, TX10, TX15
- Set of 7 Slot/Phillips: Slot 2.5 x 75, 3.0 x 100, 4.0 x 100, 4.0 x 150mm, PH 0 60, PH 1 80

Set of	Mfrs. List No.	Order Code	Price Per Set	
			1+	
5 Tamperproof Torx		724-6614	40.80	
Blade length x tip (mm) Slotted tip	60 x 1.5	T4880X 15	139-1004	4.05
	60 x 2.5	T4880X 256	327-9224	3.45
	75 x 2.5	T4880X 257	327-9236	3.70
	100 x 3	T4880X 310	327-9248	3.45
	150 x 4	T4880X 415	327-9250	4.10

222866

Set of	Mfrs. List No.	Order Code	Price Each	
			1+	
Phillips 60 x 000 60 x 00 60 x 0	T4882X 000	327-9261	5.65	
	T4882X 00	327-9273	4.90	
	T4882X 0	327-9285	3.10	
Torx 60 x T08	T4877X 08	327-9303	4.15	
Sets	Set 4 Slot/PH Set 7 Slot/PH	T4884X T4883X	307-8851 307-8954	13.45 20.25

**Pocket**



222730

Blade	Mfrs. List No.	Order Code	Price Each
			1+
64 x 3.2	P18-2BLACK	441-442	0.70
102 x 3.2	P18-4BLACK	441-454	0.72

**DUO Superslim**

**Set of 5**

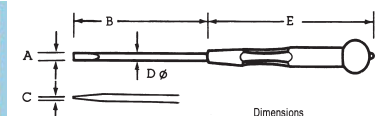

- Shatterproof polypropylene handles, chrome vanadium blades, gun finished tips
- Speed Grip - adjustable finger grip for improved comfort and handling
- Swivel top for greater ease of use

**Screwdrivers - Precision - continued**

**DUO Superslim - continued**

Set of 5 - continued

Blade Type	Dimensions				
	A	B	C	D	E
Slot	2.5	75	0.4	2.5	85
Slot	3.0	100	0.5	3.0	85
Slot	4.0	100	0.6	4.0	85
Phillips	No.0	60	—	3.0	85
Phillips	No.00	60	—	2.5	85

222851

Mfrs. List No.	Order Code	Price Each
T4880X/5 S	722-5817	17.95

7 Piece



- Comfortable two component screwdriver handle, shaped to provide ideal grip for both high torque and fine tuning action
- Oval rotating indented end allows fingertip control
- Double-ended, fully hardened, chrome plated blades with black anti-peel tips
- Blades hold securely in brass ferrule
- Supplied in a storage case
- Blades contain following tip sizes:
  - Slotted: 1.5, 2, 3, 4mm
  - Phillips: PH000, PH00, PH0, PH1
  - Torx: T05, T06, T07, T08

419500, 422838

Mfrs list no.	Order code	Price each
T4896	109-8819	8.89

**SYSTEM 4**

With Ergonomic Handles and Colour Coded Blades



- Ideal for precision work
- Flexible and versatile industry quality reversible blade system
- Ergonomic handles for all applications
- Colour-coded blades made of high-quality, tough-but-flexible chrome-vanadium-molybdenum steel, through-hardened, chrome-plated
- The new SoftFinish® telescopic handle with click-stop ball clamping for a secure hold and rapid blade change

434840

Mfrs. List No.	Hex Retainer	Length	Width max.	Order Code	Price Each
2691	4mm	105mm	23mm	120-0658	5.39
269	4mm	110mm	14mm	120-0659	2.54
280UTG	4mm	110mm	14mm	120-0660	3.33

**SYSTEM 4 Handles**

SoftFinish-telescopic handles	2691	4mm	105mm	23mm	120-0658	5.39
Precision handles	269	4mm	110mm	14mm	120-0659	2.54
Precision-telescopic ESD handles	280UTG	4mm	110mm	14mm	120-0660	3.33

Tip 1	Tip 2	Blade Length	Blade Width	Order Code	Price Each 1+	Price Each 5+
<b>SYSTEM 6 Reversible Blades</b>						
<b>Slotted - Slotted</b>						
		SLOT 1.5	SLOT 3.0	120mm	4mm	120-0661 3.68 3.37
		SLOT 2.0	SLOT 3.5	120mm	4mm	120-0662 3.68 3.37
		SLOT 2.5	SLOT 4.0	120mm	4mm	120-0663 3.68 3.37
<b>Slotted - Phillips</b>						
		SLOT 3.0	PH 0	120mm	4mm	120-0664 3.68 3.37
		SLOT 4.0	PH1	120mm	4mm	120-0666 3.68 3.37
<b>Phillips - Phillips</b>						
		PH 000	PH 0	120mm	4mm	120-0667 3.68 3.37
		PH 0	PH1	120mm	4mm	120-0668 3.68 3.37
<b>Pozidriv - Pozidriv</b>						
		PZ0	PZ1	120mm	4mm	120-0669 3.68 3.37
<b>Torx® - Torx®</b>						
		T 1	T 2	120mm	4mm	120-0670 4.33 3.97
		T 3	T 4	120mm	4mm	120-0671 4.33 3.97
		T 5	T 6	120mm	4mm	120-0672 3.98 3.64
		T 6	T 8	120mm	4mm	120-0673 3.98 3.64
		T 7	T 9	120mm	4mm	120-0674 3.98 3.64
		T 10	T 15	120mm	4mm	120-0675 3.98 3.64
		T 15	T 20	120mm	4mm	120-0676 3.98 3.64
<b>Hex - Ballpoint Hex</b>						
		HEX 1.3	Hex Ball End 1.3	120mm	4mm	120-0678 3.68 3.37
		HEX 1.5	Hex Ball End 1.5	120mm	4mm	120-0679 3.68 3.37
		HEX 2.0	Hex Ball End 2.0	120mm	4mm	120-0680 3.68 3.37
		HEX 2.5	Hex Ball End 2.5	120mm	4mm	120-0681 3.68 3.37
		HEX 3.0	Hex Ball End 3.0	120mm	4mm	120-0682 3.68 3.37
<b>SYSTEM 4 Bit holders</b>						
Suitable for C4 (4mm) bits				135mm	4mm	120-0683 5.24 4.81

**System 4 Kits in Clip / Roll-Up Pouches**

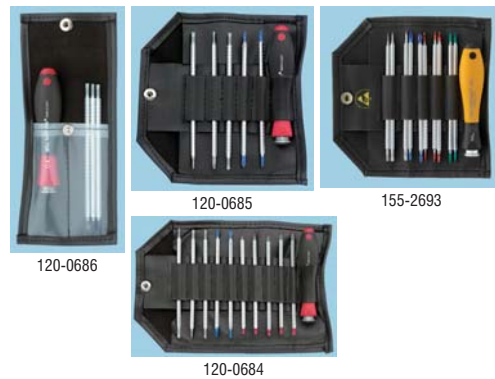

- Through hardened and chrome plated blades made from high-quality, tough-but-flexible chrome-vanadium-molybdenum steel
- Colour coded Wiha ChromTop® blade tips
- In extra strong clip or roll-up black artificial leather pouches

		Kit Contents:			
Reversible Blades		120-0684	120-0685	120-0686	155-2693
Tip 1	Tip 2	In Clip / Roll-up Pouch		In Roll-up Pouch	
		2.0 - PH00 3.0 - PH0 4.0 - PH1			
			1.5 - 3.0 2.0 - 3.5 2.5 - 4.0	1.5 - 3.0 2.0 - 3.5 2.5 - 4.0	1.5 - 3.0 2.0 - 3.5 2.5 - 4.0
			PH000 - PH00 PH0 - PH1	PH000 - PH00 PH0 - PH1	PH000 - PH00 PH0 - PH1
					T6 - T8 T7 - T9
				1,3 - 1,3 1,5 - 1,5 2,0 - 2,0 2,5 - 2,5 3,0 - 3,0	1,5 - 1,5 2,0 - 2,0 2,5 - 2,5
System 4 Handle:		SoftFinish®-telescopic handle			Precision-telescopic ESD handle

434985

Mfrs. List No.	Order Code	1+	Price Each 5+	10+
269 T4	120-0684	17.57	16.11	14.87
269 T6	120-0685	26.23	24.05	22.20
269 T11	120-0686	45.15	41.38	38.20
269 T11 ESD	155-2693	47.65	45.25	42.85

45

Farnell

**System 4 Set**  
16 pieces



Content:	
	4,0x104
	4,0x110
	1,5x0,25; 2,0x0,4; 3,0x0,5; 4,0x0,8
	PH00x28; PH0x28; PH1x28
	T6x28; T8x28; T10x28; T15x28
	2,0x28; 2,5x28; 3,0x28

- The universal set for all precision assembly work
- With Bit holder and Slotted/ Phillips/ TORX®/ Hex C4-Bits
- DIN 3126, ISO 1173, Style C4

413175

Mfrs. Part No.	Order Code	1+	5+	10+
7000 EB16	978-7712	32.61	30.98	29.34

**Screwdrivers - ESD**

**Precision ESD Screwdrivers**



- Dissipative handle designed to discharge uniformly, surface resistance 106-109 Ohms
- Safety as a result of electrostatic discharge
- Rotating cap with large surface for extra fast working
- Large handle end for powerful tightening and loosening screws
- Wiha ChromTop®-finish on tip for a perfect fit every time

330619

Mfrs. Part No.	Size	Order Code	1+	5+	10+	
<b>Slotted - 272 Series</b>						
	7634	1.5 x 0,25	443-1157	3.75	3.60	3.42
	7635	2 x 0,40	443-1169	3.20	3.07	2.91
	7636	2.5 x 0,40	443-1170	2.97	2.85	2.71
	7637	3 x 0,50	443-1182	2.23	2.14	2.03
	7638	3.5 x 0,60	443-1194	3.19	3.07	2.92
	7639	4 x 0,80	443-1200	3.39	3.26	3.09
<b>Phillips -273 Series</b>						
	7640	Phillips No 00	443-1212	4.09	3.92	3.72
	7641	Phillips No 0	443-1224	3.19	3.07	2.92
	7642	Phillips No 1	443-1236	3.73	3.58	3.40
<b>Pozidriv - 274 Series</b>						
	7643	Pozidriv No1	443-1248	4.09	3.92	3.72
<b>Ball Hex - 276 Series</b>						
	7649	1.5	443-1250	4.45	4.27	4.05
	7650	2.0	443-1261	4.57	4.39	4.17
	7651	2.5	443-1273	4.09	3.92	3.72
	7652	3.0	443-1285	3.15	3.03	2.88
<b>Ball Hex Socket - 277 Series</b>						
	7653	2.5	443-1297	5.90	5.65	5.35
	7654	3.0	443-1303	5.90	5.65	5.35
	7655	3.5	443-1315	6.19	5.94	5.62
	7656	4.0	443-1327	6.19	5.94	5.62
	7657	5.0	443-1339	6.34	6.09	5.78
	7658	5.5	443-1340	6.32	6.07	5.76
<b>TORX - 278 Series</b>						
	7659	T5	443-1352	5.93	5.67	5.37
	7660	T6	443-1364	4.48	4.31	4.08
	7661	T7	443-1376	2.98	2.86	2.72
	7662	T8	443-1388	4.48	4.31	4.08
	7663	T9	443-1390	4.50	4.32	4.09
	7664	T10	443-1406	4.50	4.32	4.09
	7665	T15	443-1418	4.71	4.52	4.29
	7666	T20	443-1420	3.25	3.12	2.96

**Coming soon**



Register your interest for items that are 'Coming Soon' at [www.farnell.co.uk](http://www.farnell.co.uk) and we'll email you to let you know that they're in stock.

**ESD 6-Part Screwdriver Sets.**



- Blade: High-strength chrome vanadium molybdenum steel, super-hardened, smooth chrome-plated
- Grip: Wiha micro-finish grip with rotary cap made from electrostatically-discharging plastic
- Standards: DIN EN 61340-5-1/ 61340-5-2
- Applications: for all types of work on components susceptible to electrical discharge

Mfrs. List No.		Contents
272K6		Slot: 1.5 - 2.0 - 2.5 - 3.0 Phillips: PH00 - PH0
278K6		TORX: T5 - T6 - T7 - T8 - T10 - T15
275 K6		Hex: 0.9; 1.3; 1.5; 2.0; 2.5; 3.0mm
277 K6		Nutdriver: 2.5; 3.0; 3.5; 4.0; 5.0; 5.5mm

330688

Mfrs. List No.	Order Code	1+	3+	5+
272K6	443-1443	24.76	23.98	22.74
278K6	443-1455	34.36	32.98	31.26
275 K6	155-2691	16.85	15.95	15.15
277 K6	155-2692	29.20	27.75	26.30

**ESD Screwdriver Sets**

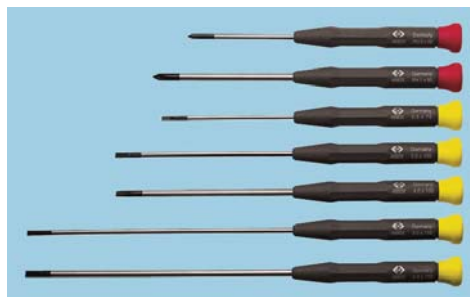

45

- Rotating caps allow ease of use and greater control at low torque
- Manufactured in high alloy chrome vanadium steel for strength and durability
- Black tips for ultimate screw fit, non-peel

Contents:  
Set of 4: 1.5 x 60, 2.5 x 75, 3 x 100mm, PH 0 x 60  
Set of 7: 2.5 x 75, 3 x 100, 4 x 100, 4 x 150mm, PH 0 x 60, PH 1 x 80mm

480780.471414

Description	Mfrs. List No.	Order Code	Price Each
Set of 4	T4884X	307-8851	13.45
Set of 7	T4883X	307-8954	20.25

**Troubleshooting tips**



Chat live online to one of our technical engineers at [www.farnell.co.uk](http://www.farnell.co.uk)



**Screwdrivers - ESD - continued**

**ESD Torx Screwdriver Sets**



- Rotating caps allow ease of use and greater control at low torque
- Manufactured in high alloy chrome vanadium steel for strength and durability
- Black tips for ultimate screw fit, non-peel

Contents: TX06 x 50, TX07 x 50, TX08 x 60, TX09 x 60, TX10 x 80, TX15 x 80, TX20 x 100mm

480822

Mfrs. List No.	Order Code	Price Per Set			
		1+	5+	10+	20+
T4877PX	139-1005	25.00	24.25	23.50	22.50

**ESD Tamper Proof Torx Screwdriver Set**



- Rotating caps allow ease of use and greater control at low torque
- Manufactured in high alloy chrome vanadium steel for strength and durability
- Black tips for ultimate screw fit, non-peel

Contents: TX07 x 50, TX08 x 60, TX09 x 60, TX10 x 80, TX15 x 80mm

480781

Mfrs. List No.	Order Code	Price Each		
		1+	5+	10+
4881X/5	724-6614	40.80		

**ESD Hexagon Screwdriver Set**



- Rotating caps allow ease of use and greater control at low torque
- Manufactured in high alloy chrome vanadium steel for strength and durability
- Black tips for ultimate screw fit, non-peel

Contents: Hex 07. x 50, 0.9 x 50, 1.3 x 50, 1.5 x 50, 2.0 x 50, 2.5 x 60, 3.0 x 60mm

480823

Mfrs. List No.	Order Code	Price Each			
		1+	5+	10+	20+
T4874X	139-1006	28.90	28.05	27.15	26.00

**Xonic Precision Screwdrivers**



ESD



- High quality Electro-Static Discharge (ESD) screwdrivers that safely discharge static charges without damaging nearby delicate electronic components
- Screwdrivers meet the requirements of the relevant DIN/EN standards
- Resistivity between blade and handle:  $10^2 - 10^5 \Omega$

Set 7	Mfrs. List No. Order Code Parallel Blade Phillips	T4883XESD 725-4246 2.5 x 75, 3 x 100, 4 x 150, 4 x 150 0 x 60, 1 x 80
Set 4	Mfrs. List No. Order Code Parallel Blade Phillips	T4884X ESD 939-8775 1.8 x 60, 3 x 100, 4 x 150 0 x 60

222862

Sets	Mfrs. List No.	Order Code	Price Each	
			1+	5+
	T4883XESD	725-4246	25.50	
	T4884X ESD	939-8775	17.10	

**ESD Screwdriver Set**

5-Piece



Wiha. Premium Tools For Professionals.



Contents:	
	3.0x100; 4.0x100
	PH0; PH1; PH2

- ESD Phillips head screwdriver set, 5-piece round blade
- High strength chrome vanadium molybdenum steel, super-hardened, smooth chrome-plated
- Wiha ChromTop blade point guarantees optimum dimensional stability
- Ergonomic Wiha SoftFinish® multi-component grip with slip protection, electrostatically insulating (dissipative)
- Surface resistance  $10^6 - 10^9 \text{ Ohm}$
- According to DIN EN 61340-5-1/ 61340-5-2
- For work on all electronic components susceptible to electrostatic charges

413197

Mfrs. List No.	Order code	Price Per Set		
		1+	5+	10+
302ESD HK5 01	978-7704	20.62	19.59	18.56

**Triton ESD Dissipative**



- Triton ESD screwdrivers for use in static safe areas
- Injection moulded from black, dissipative special plastic material direct on to blade
- Tri square sculptured design for fatigue free user comfort
- Chrome-Vanadium or Chrome-Molybdenum alloy steel blades with black antipeel finish
- Available individually or as sets

Mfrs. List No.	Set Contents	Order Code
T4741ESD	Slotted 75 x 3, 100 x 3, 125 x 5 PZD/SDV 0, 1, 2	628-670
T4741SESD	Slotted 75 x 3, 100 x 3, 125 x 5 PH 0, 1, 2	628-682
4730ESD	TX08, TX09, TX10, TX15, TX20	628-694

Warning: Dissipative tools do not offer insulating properties

222834

Blade length x tip	Order Code	Price Each
		1+
<b>Slot ,Parallel Blade</b>		
75 x 3	311-6967	2.05
100 x 3	311-6979	2.30
125 x 5	311-6980	2.90
150 x 5	311-6992	2.95
<b>Posidrive</b>		
60 x No.0	311-7029	2.90
80 x No.1	311-7030	3.30
100 x No.2	311-7042	4.00
<b>Phillips</b>		
60 x No.0	311-7054	2.25
80 x No.1	311-7066	3.05
100 x No.2	311-7078	3.90
<b>Tamperproof Torx</b>		
80 x TX09	311-6920	6.00
80 x TX10	311-6931	6.50
90 x TX20	311-6955	6.50
		<b>Price Per Set</b>
		1+
T4741ESD	628-670	17.90
T4741SESD	628-682	16.35
4730ESD	628-694	24.35

ESD Magnetic Bit Holder



- To use with 1/4" bits
- 125mm in length
- ESD Safe

495507

Mfrs. List No.	Order Code	1+	5+	10+	20+
T4582ESD	151-8939	8.60	8.35	8.10	7.75

Screwdrivers - Standard

Screwdrivers

dextro

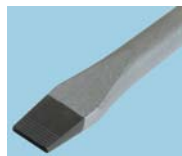

- Designed in conjunction with professionals - optimised for specific tasks
- Extra response, extra feel and extra speed
- Long, fine neck for ultimate fingertip control
- Ergonomically shaped smooth, round head to allow it to pivot easily in the palm of the hand
- Ridges along the head for that last 1/4 turn of power when tightening down
- Range features Grip-Tip™ technology\* - specially designed ribs positively engage with the screw slot to reduce the risk of Cam-out and slipping
- Permanent tip type marking on the end of the handle for convenient identification
- Non-roll flats - won't roll off uneven surfaces
- Precision machine tip for ultimate screw fit and high torque output
- Toughened, high alloy steel blade for excellent wear resistance
- Torque performance substantially in excess of the international standard requirements

Tip size	Blade length (mm)	Mfrs. List No.	Order Code
<b>Engineers Slotted</b>			
	4.0	75	T49110-040
	5.5	100	T49110-055
	6.5	150	T49010-065
	10.0	200	T49110-100
<b>Phillips</b>			
	PH0	60	T49112-0
	PH1	80	T49112-1
	PH2	100	T49112-2
	PH3	150	T49112-3
<b>Phillips long versions</b>			

Tip size	Blade length (mm)	Mfrs. List No.	Order Code
	PH1	250	T49112-1250
	PH2	250	T49112-2250
<b>Posidriv</b>			
	PZ0	60	T49113-0
	PZ1	80	T49113-1
	PZ2	100	T49113-2
	PZ3	150	T49113-3
<b>Posidriv long versions</b>			
	PZ1	250	T49113-1250
	PZ2	250	T49113-2250
<b>Instrument Slotted</b>			
	3.0	75	T49125-030
	3.0	250	T49125-03025
	3.5	100	T49125-035
	4.0	125	T49125-040
	5.5	150	T49125-055
<b>Torx</b>			
	TX06	70	T49117-06
	TX07	70	T49117-07
	TX08	70	T49117-08
	TX09	70	T49117-09
	TX10	80	T49117-10
	TX15	80	T49117-15
	TX20	90	T49117-20
	TX25	90	T49117-25
	TX27	110	T49117-27
	TX30	110	T49117-30
TX40	120	T49117-40	

526877

Mfrs. List No.	Order Code	1+	5+	10+
<b>Engineers Slotted</b>				
T49110-040	166-4292	3.10	3.00	2.90
T49110-055	166-4294	3.55	3.45	3.35
T49010-065	166-4295	4.45	4.30	4.20
T49110-100	166-4296	6.75	6.55	6.35
<b>Phillips</b>				
T49112-0	166-4297	3.10	3.00	2.90
T49112-1	166-4298	3.95	3.85	3.70
T49112-2	166-4299	4.35	4.20	4.10
T49112-3	166-4301	5.30	5.15	5.00
<b>Phillips long versions</b>				
T49112-1250	166-4302	5.45	5.30	5.10
T49112-2250	166-4303	6.30	6.10	5.90
<b>Posidriv</b>				
T49113-0	166-4304	3.10	3.00	2.90
T49113-1	166-4305	3.70	3.60	3.50
T49113-2	166-4306	4.35	4.20	4.10
T49113-3	166-4307	6.75	6.55	6.35
T49143-3	166-4277	7.80	7.55	7.35
<b>Posidriv long versions</b>				
T49113-1250	166-4308	5.65	5.50	5.30
T49113-2250	166-4309	6.90	6.70	6.50
<b>Instrument Slotted</b>				
T49125-030	166-4324	2.75	2.65	2.60
T49125-03025	166-4322	4.55	4.40	4.30
T49125-035	166-4325	3.10	3.00	2.90
T49125-040	166-4326	3.95	3.85	3.70
T49125-055	166-4327	4.65	4.50	4.35
<b>Torx</b>				
T49117-06	166-4310	5.05	4.90	4.75
T49117-07	166-4312	5.05	4.90	4.75
T49117-08	166-4313	4.65	4.50	4.35
T49117-09	166-4314	4.65	4.50	4.35
T49117-10	166-4315	5.05	4.90	4.75
T49117-15	166-4316	5.05	4.90	4.75
T49117-20	166-4317	5.30	5.15	5.00
T49117-25	166-4318	5.35	5.20	5.05
T49117-27	166-4319	5.95	5.75	5.60
T49117-30	166-4320	6.20	6.00	5.85
T49117-40	166-4321	7.45	7.25	7.00

7 Piece Screwdrivers Sets

dextro





- Designed in conjunction with professionals - optimised for specific tasks
- Extra response, extra feel and extra speed
- Long, fine neck for ultimate fingertip control
- Ergonomically shaped smooth, round head to allow it to pivot easily in the palm of the hand

**Screwdrivers - Standard - continued**

**7 Piece Screwdrivers Sets - continued**

hand

- Ridges along the head for that last ¼ turn of power when tightening down
- Range features Grip-Tip™ technology\* - specially designed ribs positively engage with the screw slot to reduce the risk of Cam-out and slipping
- Permanent tip type marking on the end of the handle for convenient identification
- Non-roll flats - won't roll off uneven surfaces
- Precision machine tip for ultimate screw fit and high torque output
- Toughened, high alloy steel blade for excellent wear resistance
- Torque performance substantially in excess of the international standard requirements

 <b>Content 166-4329</b> Engineers Slotted 4.0x75 mm 5.5x100 mm 6.5x150 mm Instrument Slotted 3.0x75 mm Phillips PH 0x60 mm PH 1x80 mm PH 2x100 mm	 <b>Content 166-4330</b> Engineers Slotted 4.0x75 mm 5.5x100 mm 6.5x150 mm Instrument Slotted 3.0x75 mm PZ 0x60 mm PZ 1x80 mm PZ 2x100 mm
----------------------------------------------------------------------------------------------------------------------------------------------------------------------------------------------------------------------------------------------------------------------	----------------------------------------------------------------------------------------------------------------------------------------------------------------------------------------------------------------------------------------------------------



526905

Mftrs. List No.	Order Code	1+	5+	10+	Price Each
T49162	166-4329	22.55	21.85	21.20	
T49163	166-4330	22.75	22.05	21.40	

**5 Piece Screwdrivers Sets - Dextro Series**



- Designed in conjunction with professionals - optimised for specific tasks
- Extra response, extra feel and extra speed
- Long, fine neck for ultimate fingertip control
- Ergonomically shaped smooth, round head to allow it to pivot easily in the palm of the hand
- Ridges along the head for that last ¼ turn of power when tightening down
- Range features Grip-Tip™ technology\* - specially designed ribs positively engage with the screw slot to reduce the risk of Cam-out and slipping
- Permanent tip type marking on the end of the handle for convenient identification
- Non-roll flats - won't roll off uneven surfaces
- Precision machine tip for ultimate screw fit and high torque output
- Toughened, high alloy steel blade for excellent wear resistance
- Torque performance substantially in excess of the international standard requirements

	Content
	Engineers Slotted 4.0x75 mm 5.5x100 mm 6.5x150 mm
	Pozidriv PZ 1x80 mm PZ 2x100 mm

526912

Mftrs. List No.	Order Code	1+	5+	10+	Price Each
T49153	166-4328	17.25	16.75	16.20	

**Technical information at your fingertips**



Over **352,000** technical datasheets available online.

Visit [www.farnell.co.uk](http://www.farnell.co.uk) and look for the **Tech Info** heading in your search results.

**Screwdrivers**



- A range of screwdrivers with a satin finish shaft, magnetic tip and a 2 component handle

482071.457905

Type/Size	Order Code	1+	5+	10+	20+	50+	Price Each
<b>Slotted</b>							
3 x 0.4mm	144-7443	1.11	1.01	0.89	0.80	0.67	
4 x 0.7mm	144-7444	1.11	1.01	0.89	0.80	0.67	
5.5 x 0.8mm	144-7445	1.29	1.12	1.05	0.95	0.88	
6.5 x 0.9mm	144-7446	1.29	1.12	1.05	0.95	0.88	
8 x 1.5mm	144-7447	1.39	1.19	1.10	0.98	0.89	
<b>Pozi</b>							
1 x 80mm	144-7448	1.11	1.01	0.89	0.80	0.67	
2 x 100mm	144-7449	1.29	1.12	1.05	0.95	0.88	
2 x 38mm	144-7450	1.29	1.12	1.05	0.95	0.88	
3 x 150mm	144-7532	1.55	1.29	1.23	1.10	1.00	
<b>Phillips</b>							
PH0 x 80mm	144-7533	1.11	1.01	0.89	0.80	0.67	
PH2 x 100mm	144-7534	1.29	1.12	1.05	0.95	0.88	

**20pc Screwdriver Set**



A 20pc screwdriver set contained in a neat little carry case with handle. Set contains the following items:- 6 workshop screwdrivers 5 x 100, 6 x 100, 8 x 100, slotted 3 workshop screwdrivers 0 x 75, 1 x 85, 2 x 100, pozi 3 precision screwdrivers pozi 0 x 40, slotted 2 x 40, 5 x 40mm 1 magnetic bit holder  
10 chrome vanadium screwdriver bits 10 x 25, ¼in hex drive, phillips 1, 2, torx TX10, T5, 20, 25, 30, hexagon bits 2, 3, 4.

494188

Order Code	Price Each
010-784	1+ 20.11

**42 Piece Screwdriver Accessory Kit**



The kit contains:

- 1 x 150mm flexible shaft
- 1 x High torque screwdriver bit holder
- 2 x Insulated chrome vanadium screwdrivers: Slotted 5 x 75mm & Phillips 1 x 75mm
- 6 x Chrome vanadium screwdrivers: Slotted 6 x 100mm, 8 x 150mm, 6 x 38mm, Phillips: PH2 x 100mm, PH3 x 150mm, PH2 x 38mm
- 7 x Chrome vanadium precision screwdrivers
- 25 x 25mm/1" Chrome vanadium screwdriver bits with holder: Slotted 3mm, 4mm, 5mm, 6mm, 7mm, Phillips PH0, PH1, PH2, PH3, Torx T10, T15, T20, T25, T30, T40, Hex 2,,m 3mm, 4mm, 5mm, 5.5mm, 6mm
- Kit supplied in moulded case

482070.461000

Order Code	1+	5+	10+	20+	50+	Price Each
144-7441	7.60	7.05	6.08	5.71	5.19	

### 21 Piece Screwdriver Set

#### Cushion Grip



- Cushion grip handles enable extra torque to be applied
- Chrome vanadium steel blades with hardened magnetised tips
- Supplied in a blow moulded case

**Contents:**

5 cushion grip screwdrivers

Slot 4 75, 6 100, 8 150  
Phillips No.1 75, No.2 100  
Slot 3 60

1 insulated cushion grip screwdriver  
1 cushion grip screwdriver handle  
14 Hex bits

Torx T10, T15, T20, T25, T 27, T30, T 40  
Hex 2, 2.5, 3, 4, 5, 5.5, 6mm

222958

	Order Code	Price Each
21 piece set	312-7000	1+ 3.98

### 30 Piece Screwdriver Set



- Cushion grip handles enable extra torque to be applied
- Chrome vanadium steel blades with hardened magnetised tips
- Supplied in a blow moulded case

**Contents:**

5 cushion grip screwdrivers  
2 insulated cushion grip screwdrivers  
7 precision screwdrivers

Slot 4 75, 6 100, 8 150, Phillips No.1 75, No.2 100  
Slot 5 75, Phillips No.1 75  
Slot 2 50, 2.5 50, 3 50mm, Phillips No.00 50 No.0 50  
Torx T15 50, T20 50

1 extra torque cushion grip handle, 1 flexible Hex shaft  
14 hex bits

Slot 3, 4, 5, 5.5, 6mm, Phillips No.1, 2  
Torx T10, T15, T20, T25, T30, Hex 5, 6mm

222960

	Order Code	Price Each
30 piece set	312-7011	1+ 16.15

### 20 in 1 Screwdriver Set

#### Extra Torque Cushion Grip



- Chrome vanadium steel interchangeable blades with hardened, magnetised tips
- The cushion grip handle enables extra torque to be applied
- Supplied in a blow moulded case

**Contents:**

Extra torque, cushion grip, screwdriver handle  
10 175mm long, double end screwdriver blades:  
Phillips No. 1, 2, Pozi No. 1, 2, Torx T10, T15, T20, T25, T30, T40  
Hex and Ball Hex 4, 5, 6mm

222934

### Stainless Steel Tool Set

#### Inox Stainless Steel



The ideal tool set for threaded connections with stainless steel screws. Kraffform® Stainless Steel Screwdriver, Stainless Steel wrench set, bit-check® with 9 bits and a Rapidaptor®-holder for a quick bit exchange. Stainless Steel tools avoid the risk of extraneous rust. Delivered in a practical storage and transport case

Wrench:		
		each 1 x SW 1.5; SW 2.0; SW 2.5; SW 3.0; SW 4.0; SW 5.0; SW 6.0; SW 8.0; SW 10.0
Bits:		
		1 x holder 1/4" x 50
		1 x PH2
		1 x PZ 1; 2 x PZ2
		each 1 x TX 10; TX 15; TX 20; TX 25; TX 30
Screwdriver:		
		1 x 0.5 x 3.0 x 80mm 1 x 1.2 x 6.5 x 150mm
		each 1 x PH1/80; PH2/100
		each 1 x PZ1/80; PZ2/100

472797

Mfrs. List No.	Order code	1+	3+	5+
0507118001	135-9358	79.07	76.99	75.02

### Screwdriver with hexagonal blade



45

- Screwdriver for the industrial use
- Hexagonal blade allows the use of a jaw wrench or a ring wrench for a better torque
- Extremely robust and durable
- Kraffform with anti-roll protection, multi-component
- Mat nickel, Lasertip
- Slotted: DIN 5264-A, ISO 2380, Lasertip®, DIN 5260-PH, ISO 8764-PH, Lasertip®

474772

Type	Size	Hexagonal size	wrench support	Order Code	1+	5+	10+	
<b>Slotted</b> 	007670	3.5 x 75mm	4 mm	-	133-7743	2.79	2.53	2.33
	007671	4.0 x 90mm	4 mm	-	133-7744	3.47	3.15	2.90
	007672	4.5 x 90mm	5 mm	8 mm	133-7745	3.91	3.55	3.25
<b>Phillips (PH)</b> 	008750	Ph0 x 60mm	-	-	133-7746	3.78	3.44	3.15
	008751	Ph1 x 80mm	5 mm	8 mm	133-7747	4.21	3.84	3.51
	008752	Ph2 x 100mm	6 mm	10 mm	133-7748	5.89	5.36	4.91

### 334/6 Rack Screwdriver set Kraffform® Plus Lasertip®



#### 6 pieces set in display carton + rack



Content: each	
	3.5 x 75mm; 4.0 x 90mm
	5.5 x 100mm; 6.5 x 125mm PH1/80; PH2/100

- With Lasertip hexagon blades + Rack
- For slotted and Phillips screws

**Screwdrivers - Standard - continued**

**334/6 Rack Screwdriver set Kraftform® Plus Lasertip® - continued**  
6 pieces set in display carton + rack - continued

474793

Type	Order Code	Price Each		
		1+	5+	10+
334SK/6	133-7751	26.15	23.78	21.79

**Screwdriver- Series 300**



- Extremely robust and durable
- Kraftform with anti-roll protection, multi-component
- Mat nickel, Lasertip®

334198

	Typ	Size	Order Code	Price Each		
				1+	5+	10+
<b>Slotted</b>	8007	2,5 x 75	311-3917*	2.97	2.72	2.34
	110001	3 x 80	311-3929*	2.53	2.30	1.95
	8015	3,5 x 100	311-3930	2.71	2.53	2.11
	110004	4 x 100	311-3942	3.14	2.93	2.46
	110007	5,5 x 125	311-3954	4.80	4.44	3.71
<b>Phillips (PH)</b>	8705	PH0 x 60	310-9290*	3.20	2.98	2.71
	8710	PH1 x 80	310-9306	4.42	4.11	3.74
	8720	PH2 x 100	310-9320	6.08	5.61	5.13
	8735	PH3 x 150	310-9343	8.83	8.15	7.50
<b>Pozidriv (PH)</b>	9310	Posidriv No1 x 80	443-2836	4.66	4.43	4.19
	9315	PZ No.2 x 100	443-2848	6.36	6.04	5.72
<b>TORX®</b>	28000	T5 x 60	443-2850	3.72	3.53	3.35
	28001	T6 x 60	443-2861	3.72	3.53	3.35
	28002	T7 x 60	443-2873	3.64	3.47	3.28
	28003	T8 x 60	443-2885	3.64	3.47	3.28
	28004	T9 x 60	443-2897	3.64	3.47	3.28
	28005	T10 x 80	443-2903	3.75	3.56	3.38
	28008	T15 x 80	443-2915	3.79	3.59	3.41
	28010	T20 x 100	443-2927	3.87	3.66	3.47
	28012	T25 x 100	443-2939	4.14	3.94	3.72
	28013	T27 x 115	443-2940	4.49	4.26	4.05
	28015	T30 x 115	443-2952	4.58	4.35	3.99
	28020	T40 x 115	443-2964	5.34	5.04	4.78
	<b>TORX® with bore hole</b>	138260	T10 x 80	310-9136	5.29	4.90
138261		T15 x 80	310-9148	5.41	5.00	4.58
138262		T20 x 80	310-9150	5.54	5.10	4.68
<b>TRI-WING®</b>	28120	2 x 80	311-0655	6.34	5.59	5.13
	28122	3 x 80	311-0679	6.34	5.59	5.12
<b>Ballhead Hexagon Screwdriver</b>	22795	1,5 x 60	310-9185	3.12	2.90	2.60
	22800	2,0 x 100	310-9197	3.12	2.90	2.60
	138070	2,5 x 100	310-9203	3.13	2.91	2.61
	22805	3,0 x 100	310-9215	3.15	2.91	2.61
	22810	4,0 x 100	310-9227	3.54	3.27	2.97
	22815	5,0 x 100	310-9240	3.78	3.48	3.18
	22820	6,0 x 125	310-9264	5.30	4.94	4.49

\*not available as Lasertip® version. Delivered with Standard blade.

**TORX® HF Kraftform Plus Screwdriver set with holding function + Rack**



- 6 pieces set in display carton + Rack
- Torx® screwdriver with holding function of Camcar Textron

Type	Content: each
367/6 HF	TX10; TX15; TX20; TX25; TX30; TX40

413077

Type	Order Code	Price Each		
		1+	5+	10+
367/6 HF	967-3261	20.44	19.62	18.40

**HF TORX® Screwdriver with holding function Series 367 HF**



- For TORX® socket screws
- Round blade
- Kraftform handle with anti-roll protection, multi component
- With holding function for TORX® screws according to Acument Global Technologies Inc. specifications, mat nickel

413108

	Type	Size	Order Code	Price Each		
				1+	5+	10+
<b>TORX®</b>	367 HF TX 10	Torx	967-3270	3.59	3.44	3.18
	367 HF TX 15	Torx	967-3288	3.75	3.59	3.39
	367 HF TX 20	Torx	967-3296	3.87	3.70	3.44
	367 HF TX 25	Torx	967-3300	4.07	3.92	3.64
	367 HF TX 30	Torx	967-3318	4.69	4.48	4.17
	367 HF TX 40	Torx	967-3326	5.21	5.05	4.74

**Screwdriver Set Kraftform Plus Lasertip + Rack with Lasertip® round blades + rack**



- For slotted and Pozidriv screws
- 6 pieces set in display carton + Rack

Content: each	
	3.0 x 80mm; 4.0 x 100mm
	5.5 x 125mm; 6.5 x 150mm
	PZ1/80; PZ2/100

413018

Type	Order Code	Price Each		
		1+	5+	10+
334/355/6	439-4136	23.66	--	--

**TORX® screwdriver set - series 300 6 pieces set in display carton + Rack**



	Type	Content: each
	367/6 BO	TX10; TX15; TX20; TX25; TX30; TX40

334207

Type	Order Code	Price Each		
		1+	5+	10+
367/6 TORX	443-2976	24.69	23.45	22.23
367/6 BO	333-1120	16.68	--	--

**Troubleshooting tips**



Chat live online to one of our technical engineers at [www.farnell.co.uk](http://www.farnell.co.uk)



Vario set  
in metal box



- 11-piece range specifically for high load

Content:	
	0.6 x 4 - 1.0 x 6; 0.8 x 5 - 1.2 x 7
	SW4 - SW4; SW5 - SW5; SW6 - SW6
	PH1 - PH2
	PZ1 - PZ2
	TX10 - TX15; TX20 - TX25; TX30 - TX40

241140

Mftrs. List No.	Order Code	1+	+	Price Each
88/1Vario set	333-1040	37.08	--	--

Chiseldriver



- Hexagon "pound-thru" with impact cap, hexagonal bolster from 0.8 x 4.5
- Extra tough
- Mat nickel, Black Point
- Kraftform® handle with anti-roll protection

334155

	Type	Size	Order Code	1+	5+	10+	Price Each
Slotted		18262	0,8 x 4,5	443-3038	4.10	3.90	3.69
		18264	1,0 x 5,5	443-3040	5.38	5.08	4.83
		18266	1,2 x 7	443-3051	6.61	6.28	5.96
		18268	1,6 x 9	443-3063	8.79	8.34	7.92
		18270	1,6 x 10	443-3075	11.06	10.52	9.97
		18272	2,0 x 12	443-3087	14.13	13.42	12.72
		Phillips (PH)		17005	Phillips No 1	443-3099	4.79
17010	Phillips No 2			443-3105	6.74	6.42	6.07
17015	Phillips No 3			443-3117	9.90	9.42	8.93
17020	Phillips No 4			443-3129	12.52	12.00	11.48
Pozidriv (PH)		17050	Posidriv No1	443-3130	5.09	4.85	4.59
		17052	PZ No.2	443-3142	7.30	6.94	6.57
		17054	Posidriv No 3	443-3154	10.51	9.99	9.45

Chiseldriver set



6 pieces set in display carton + Rack



- For slotted and Phillips screws
- Hexagon "pound-thru" blade with impact cap, hexagonal bolster from 0.8 x 4.5
- Mat nickel, Black Point
- Suitable for loosening of firmly bonded screws, as well as chiselling

Content: each	
	3.5 x 80mm; 4.5 x 90mm
	5.5 x 100mm; 7.0 x 125mm
	PH1/80; PH2/100

334169

Type	Order Code	1+	+	Price Each
932/6	439-4148	29.14	--	--

SoftFinish® Screwdrivers



with round blade



with hex blade



- Multi-component SoftFinish handle provides maximum user comfort
- Ergonomically perfect handle design
- Printed screw symbol on handle end for fast identification
- Available in versions with round or hex blade
- Blade made of chrome vanadium molybdenum steel, through hardened, chrome-plated
- Wiha ChromTop finish on tip for a perfect fit every time

338102

Mftrs. Part No.	Tip Size (mm)	Blade Length (mm)	Order Code	1+	5+	10+	Price Each
<b>Slotted - 302 Series</b>							
	685	2.5mm	75	401-7353	1.98	1.71	1.44
	686	3	80	830-835	2.40	2.18	2.00
	691	3.5	100	401-7365	2.36	2.05	1.70
	692	4	100	830-859	2.94	2.69	2.44
	700	5.5	150	830-872	4.35	3.97	3.60
	703	6.5	150	835-432	5.39	5.11	4.66
	707	8	175	830-902	5.89	5.38	4.86
711	10	200	830-926	8.34	7.65	6.93	
<b>Slotted with hex blade - 308 Series</b>							
	733	5,5	100	401-7328	4.64	4.13	3.34
	735	7	125	401-7330	5.05	4.39	3.64
<b>Phillips - 311 Series</b>							
	754	Phillips No 0	60	831-098	2.98	2.70	2.46
	756	Phillips No 1	80	831-104	3.65	3.34	3.03
	757	Phillips No 1	200	831-116	4.56	4.22	3.81
	759	Phillips No 2	100	831-128	4.58	4.22	3.79
	760	Phillips No 2	200	831-130	5.79	5.36	4.84
	762	Phillips No 3	150	831-141	6.74	6.19	5.60
<b>Pozidriv - 313 Series</b>							
	768	Pozidriv No.0	60	831-177	3.29	3.01	2.73
	770	Pozidriv No1	80	831-189	3.93	3.60	3.26
	772	Pozidriv No2	100	831-190	5.48	5.03	4.55
<b>Ball Hex - 367 Series</b>							
	26305	2.5 Hex Key	100	832-042	2.93	2.70	2.45
	26328	3 Hex Ball	100	832-054	2.77	2.55	2.29
	26329	4 Hex Ball	100	832-066	3.49	3.23	2.93
	26330	5 Hex Ball	100	832-078	3.45	3.16	2.88
	26331	6Hex Ball	125	832-080	4.57	4.22	3.80
<b>TORX - 362 Series</b>							
	1286	T6	60	831-633	3.20	2.91	2.64
	1287	T7	60	831-645	3.44	3.16	2.87
	1288	T8	60	831-657	3.64	3.34	3.03
	1289	T9	60	831-669	3.05	2.77	2.52
	1290	T10	80	831-670	3.14	2.92	2.65
	1291	T15	80	831-682	3.17	2.92	2.64
	1292	T20	100	831-694	3.18	2.94	2.66
	1293	T25	100	831-700	3.42	3.13	2.85
	1294	T27	115	831-712	4.01	3.69	3.33
	1295	T30	115	831-724	3.76	3.44	3.13
	1296	T40	130	831-736	4.67	4.29	3.86
	1297	T45	130	831-748	5.59	5.10	4.64
<b>TORX - TR Series 362TR for Safety Screws</b>							
	1300	T10	80	215-557	9.67	--	--
	1301	T15	80	215-569	9.81	--	--
	1302	T20	100	215-570	9.92	--	--
	1303	T25	100	282-182	10.09	--	--
	1304	T27	115	282-194	4.67	--	--
1305	T30	115	282-200	5.56	--	--	

6 Piece Electricians Screwdriver Set



Hex Blades with Hex Bolster



- Multi-component SoftFinish handle provides maximum user comfort
- Ergonomically perfect handle design
- Blade made of chrome vanadium molybdenum steel, through hardened, chrome-plated
- Wiha ChromTop finish on tip for a perfect fit every time

Types:  
Slotted: 3.5 x 75; 4.5 x 90; 5.5 x 100; 7.0 x 125  
PH 1 x 80; 2 x 100



241144

Mftrs. List No.	Order Code	1+	5+	Price Per Set
308 HK 6	381-1608	29.31	27.03	--

**Screwdrivers - Standard - continued**

**Screwdriver Set: Slotted and Phillips**

Type 530 HK 6 with solid steel cap



Wiha. Premium Tools for Professionals.



- WihaSoftFinish handle, 6 pieces
- Hex blade extending through handle, hex bolster for additional torque
- Solid steel cap

High Quality chrome vanadium molybdenum steel, through hardened, chrome-plated, Wiha ChromTop Tip Size: 8; 10

Components: Slotted: 75x3,5; 90x4,5; 100x5,5; 125x6,5  
Phillips: 80x1; 100x2



241146

Mfrs. Part No.	Order Code	1+	3+	10+
530 HK 6	310-6780	33.19	30.18	26.63

**TORX® MagicSpring Screwdrivers**



Wiha. Premium Tools for Professionals.



- Retaining Spring holds Torx Screw in Place
- Especially for dry and general applications
- Made of high quality materials in well-known Wiha quality
- Ideal for Torx Screws made of Aluminium, Steel, Plastic and Titanium
- High Quality chrome vanadium molybdenum steel, through hardened, chrome-plated
- Ergonomic handle with Roll-off protection

408363

Mfrs. Part No.	Tip Size	Blade Length (mm)	Order Code	Price Each		
				1+	5+	10+
<b>TORX® MagicSpring - 362R Series</b>						
362R T6	T6	60	958-2509	3.45	3.14	2.88
362R T7	T7	60	958-2517	3.10	2.84	2.63
362R T8	T8	60	958-2525	3.10	2.84	2.63
362R T9	T9	60	958-2533	3.52	3.22	2.97
362R T10	T10	80	958-2541	3.77	3.40	3.13
362R T15	T15	80	958-2550	3.82	3.45	3.19
362R T20	T20	100	958-2568	4.17	3.78	3.50
362R T25	T25	100	958-2576	4.04	3.69	3.36
362R T27	T27	115	958-2584	4.40	3.98	3.65
362R T30	T30	115	958-2592	4.81	4.39	4.02
362R T40	T40	130	958-2606	5.20	4.79	4.37

**TORX® MagicSpring Screwdriver Set**



Wiha. Premium Tools for Professionals.



- Retaining Spring holds TORX® screw in Place
- Especially for dry and general applications



- Made of high quality materials in well-known Wiha quality
- High Quality chrome vanadium molybdenum steel, through hardened, chrome-plated
- Ideal for TORX® screws made of aluminium, steel, plastic and titanium
- Ergonomic handle with Roll-off protection

Content:

6 pieces

Torx Screwdrivers T10x80; T15x80; T20x100; T25x10; T30x115; T40x130mm

Dimensions in mm

408415

Mfrs. List No.	Order Code	1+	5+
362R K6 S0	958-2614	25.21	22.89

**Screwdriver Set Torx Type 362 K7**



Wiha. Premium Tools for Professionals.



- Wiha SoftFinish Handle, 7 pieces
- Through hardened, chrome plated

Blade material: Chrome Vanadium Molybdenum special steel  
Handle material: Cellulose acetate (impact-proof and cadmium-free)

Content: 7 pieces  
7 screwdriver Torx  
T8, T9, T10, T15, T20, T25, T30  
Weight: 670g

Dimensions in mm



241170

Mfrs List No.	Order Code	1+	5+
362 K7	831-761	22.13	20.30

**Torx Screwdriver Set 362 K6 Series**



Wiha. Premium Tools for Professionals.



- Wiha SoftFinish handle, 6 pieces
- Through hardened, chrome-plated

Blade: Chrome - Vanadium - Molybdenum  
Content: T10 - T15 - T20 - T25 - T30 - T40



241166

Type	Order Code	1+	5+
362 K6 S0	831-750	18.01	16.63

**Screwdriver Sets**



- Handle moulded direct to bar for durability
- High grade steel bar allows for high torque and reduce the chance of tip breakage
- Anti-slip soft grip handle provides excellent comfort and grip
- Large diameter handle offers extra torque for driving screws
- Smooth domed end for spinning speed

and comfort

- Colour coded ends for easy identification

Contents:

**7 Piece:** Flared 5.5 x 100, 8 x 150mm Parallel: 3.5 x 75, 3 x 100mm Pozidriv: PZ0 x 75, PZ1 x 100, PZ2 x 125mm

**10 Piece:** Flared: 4 x 100, 8 x 150mm Parallel: 3 x 100, 4 x 100, 5.5 x 150mm Pozidriv: PZ0 x 75, PZ1 x 30, PZ1 x 100, PZ2 x 125mm and carry case

**20 Piece:** Flared: 4 x 100, 5.5 x 100, 6.5 x 30, 8 x 150mm Parallel: 2.5 x 50, 3 x 100, 4 x 100, 4 x 150, 5.5 x 150mm Phillips: PH00 x 50, PH0 x 75, PH1 x 30, PH1 x 100, PH2 x 125, PH3 x 150mm Pozidriv: PZ0 x 75 PZ1 x 100, PZ2 x 30, PZ2 x 125, PZ3 x 150mm and carry case

495873.495818

Sets	Mfrs. List No.	Order Code	1+	5+
7 Piece	0-65-425	152-0953	20.87	19.22
10 Piece	5-65-427	152-0954	31.74	29.26
20 Piece	5-62-572	152-0961	63.51	58.53

**Premium service without a premium price**



With thousands of prices already reduced, go online to see our most up-to-date pricing: [www.farnell.co.uk](http://www.farnell.co.uk)

**FatMax XL Screwdriver Sets**



- Flared style handle with anti-slip soft grip for excellent comfort and grip
  - Pinched waist for detailed precision adjustment
  - Handle moulded direct to bar for durability
  - High grade steel bar allows for high torque and reduce the chance of tip breakage
  - Large diameter handle offers extra torque for driving screws
  - Smooth domed end for spinning speed and comfort
  - Colour coded ends for easy identification
- Contents:

**12 Piece:** Flared: 4 x 100, 6.5 x 150, 8 x 175. 10 x 200mm Parallel: 3 x 75, 3.5 x 100, 5.5 x 150mm, Phillips: PH0 x 60, PH1 x 80, PH2 x 100mm, Pozidriv: PZ1 x 80, PZ2 x 100mm and carry case

**7 Piece:** Flared: 4 x 100, 6.5 x 150, 8 x 175mm Parallel: 3 x 100, 5.5 x 150mm Pozidriv: PZ1 x 80, PZ2 x 100mm

**10 Piece:** Flared: 4 x 100, 6.5 x 150, 8 x 175. 10 x 200mm Parallel: 3 x 100, 5.5 x 125mm, Phillips: PH0 x 60, PH1 x 80, PH2 x 100mm, Pozidriv: PZ1 x 80, PZ2 x 100mm and carry case

495875.495865

Mftrs. List No.	Sets	Order Code	Price Per Set	
			1+	5+
5-66-281	12 Piece	<b>152-0956</b>	45.35	41.78
0-66-282	7 Piece	<b>152-0958</b>	27.21	25.07
5-66-296	10 Piece	<b>152-0959</b>	39.31	36.77

**Slotted Phillips Screwdriver PH Type 153 Extra Long Blade**



Slotted Phillips Screwdriver according to **DIN5262** with extra long blade and red, transparent square handle. The blade is through hardened and nickel-plated. Series includes extra long dimensions for screws in difficult to reach locations.

Blade material: Chrome vanadium molybdenum steel  
Handle material: Cellulose acetate (impact-proof and cadmium-free)

Mftrs. Part No.	PH Size	Blade length	Blade $\varnothing$	Total length	Handle length	Square handle	Weight (g)
153-2+	Phillips No 1	350	4,5	295	95	24	0,9
153-2+	Phillips No 2	350	6	455	105	28	150
153-3+	Phillips No 3	300	8	415	115	32	240

Dimensions in mm

241275

Mftrs. Part No.	Order Code	Price Each
153-2+	<b>630-408</b>	3.83
153-2+	<b>830-800</b>	5.69
153-3+	<b>830-811</b>	7.04

**Slotted Screwdriver 186 Series Extra Long Blades**



Slotted Screwdrivers according to **DIN5262** with extra long blade and red, transparent square handle. The blade is through hardened and nickel-plated. Series includes extra long dimensions for screws in difficult to reach location.

Blade material: Chrome vanadium molybdenum steel  
Handle material: Cellulose acetate (impact-proof and cadmium-free)

Mftrs. Part No.	Tip size	Blade length	Blade- $\Omega$	Total length	Handle length	Square handle	Weight(g)
18630	3mm	300	3	385	85	22	50
18640	4mm	300	4	385	85	22	70
18650	5mm	300	5	395	95	24	100
18680	8mm	300	7	415	115	32	190

Dimensions in mm

245993

Mftrs. Part No.	Order Code	Price Each
18630	<b>108-708</b>	2.91
18640	<b>108-709</b>	3.33
18650	<b>108-710</b>	6.29
18680	<b>108-711</b>	9.83

**Holding Screwdriver 390 Series**



Holding screwdriver with red transparent square handle. Blade through hardened and nickel-plated.

Blade material: Chrome vanadium steel  
Handle material: Cellulose acetate (impact-proof and cadmium-free)

Mftrs. Part No.	Tip size	Blade length	Tip strength	Total length	Handle length	Handle $\varnothing$	Weight (g)
390-3.5	3.5	125	0,6	220	95	24	78
390-5.5	5.5	125	0,6	220	95	24	78

Dimensions in mm

241230

Mftrs. Part No.	Order Code	Price Each		
		1+	5+	10+
390-3.5	<b>831-049</b>	11.13	10.20	9.27
390-5.5	<b>831-050</b>	10.36	9.49	8.58

**Offset Double End PH Driver, 161 Series**



Offset Double End Driver PH according to **DIN 5208** with black plastic handle, through hardened and chrome-plated.

Blade material: Chrome vanadium molybdenum steel  
Handle material: ABS plastic (impact-proof and cadmium-free)

Mftrs. Part No.	PH size	Total length	Short side	Blade $\varnothing$	Weight (g)
161-1+2	Phillips No 1 + No 2	125	14,5	5,5	27
162-2+3	Phillips No 2 + No 3	150	21,0	8,0	76

Dimensions in mm

241297

Mftrs. Part No.	Order Code	Price Each		
		1+	5+	10+
161-1+2	<b>831-153</b>	3.50	3.21	2.92
162-2+3	<b>831-165</b>	5.39	4.94	4.47

**Offset Double End PZ Driver, 224 Series**



Offset Double End Slot Driver Pozidriv with red plastic handle. Blades through hardened, black finish.

Blade material: Chrome vanadium molybdenum steel  
Handle material: ABS-plastic (impact-proof and cadmium-free)

Typ	PZ size	Total length	Short journal	Blade $\varnothing$	Weight (g)
224-1+2	Pozidriv No 1 + No 2	125	14,5	5,5	27

Dimensions in mm

241475

Mftrs. Part No.	Order Code	Price Each		
		1+	5+	10+
224-1+2	<b>831-219</b>	4.18	3.84	3.50

**Offset Double End Slot Driver 207 Series**



Offset Double End Slot Driver with black plastic handle. Blades through hardened and chrome-plated.

Blade material: Chrome vanadium molybdenum steel  
Handle material: ABS-plastic (impact-proof and cadmium-free)

Mftrs. Part No.	Tip size	Total length	Short side	Blade strength	Blade $\varnothing$	Weight (g)
207-3.5	3.5	90	8,5	0,6	3,5	12
207-4.0	4.0	100	9,0	0,8	4,0	0.1
207-5.5	5.5	125	10,5	1,0	5,5	32
207-6.5	6.5	125	13,5	1,2	6,5	0.04
207-8.0	8.0	150	17,0	1,2	8,0	53

**Screwdrivers - Standard - continued**

**Offset Double End Slot Driver 207 Series - continued**

Dimensions in mm

241219

Mfrs. Part No.	Order Code	1+	5+	10+
207-3.5	<b>831-074</b>	2.94	2.72	2.47
207-4.0	<b>108-701</b>	4.54	--	--
207-5.5	<b>831-086</b>	3.41	3.13	2.83
207-6.5	<b>108-702</b>	6.18	--	--
207-8.0	<b>108-703</b>	7.12	--	--

**SYSTEM 6**

With Ergonomic Handles and Colour Coded Blades



- Flexible & versatile industrial quality tools
- Ergonomic handles for almost every application
- Colour-coded blades made of high-quality, tough-but-flexible chrome-vanadium-molybdenum steel, through-hardened, chrome-plated
- The new SoftFinish® telescopic handle with click-stop ball clamping for a secure hold and rapid blade change.

	Mfrs. List No.	Hex Retainer	Length	Width max.	Order Code	Price Each
<b>SYSTEM 6 Handles</b>						
SoftFinish-telescopic Handle	284	6mm	115mm	36mm	<b>120-0625</b>	6.65
Topra Ratchet*	282	6mm	100mm	85mm	<b>282-170</b>	25.94

\* for System 6 reversible blades und 1/4" bits

434821

	Tip 1	Tip 2	Blade Length	Blade Width	Order Code	Price Each
					1+	5+
<b>SYSTEM 6 Reversible Blades</b>						
<b>Slotted - Slotted</b>						
	SLOT 3.5	SLOT 4.5	150mm	6mm	<b>120-0626</b>	3.04 2.77
	SLOT 4.0	SLOT 6.0	150mm	6mm	<b>120-0627</b>	3.04 2.77
	SLOT 5.5	SLOT 6.5	150mm	6mm	<b>120-0629</b>	3.04 2.77
<b>Slotted - Phillips</b>						
	SLOT 4.0	PH1	150mm	6mm	<b>120-0631</b>	3.04 2.77
	SLOT 6.0	PH2	150mm	6mm	<b>120-0632</b>	3.04 2.77
	SLOT 6.5	PH3	150mm	6mm	<b>120-0633</b>	3.04 2.77
<b>Phillips - Phillips</b>						
	PH1	PH2	150mm	6mm	<b>120-0634</b>	3.04 2.77
	PH2	PH3	150mm	6mm	<b>120-0635</b>	3.04 2.77
<b>Pozidriv - Pozidriv</b>						
	PZ1	PZ2	150mm	6mm	<b>120-0636</b>	3.04 2.77
	PZ2	PZ3	150mm	6mm	<b>120-0637</b>	3.04 2.77
<b>Hex - Ballpoint Hex</b>						
	HEX 2.5	Hex Ball End 2.5	150mm	6mm	<b>120-0638</b>	3.04 2.77
	HEX 3.0	Hex Ball End 3.0	150mm	6mm	<b>120-0639</b>	3.04 2.77
	HEX 4.0	Hex Ball End 4.0	150mm	6mm	<b>120-0640</b>	3.04 2.77
	HEX 5.0	Hex Ball End 5.0	150mm	6mm	<b>120-0642</b>	3.04 2.77
<b>Torx® - Torx®</b>						
	T 6	T 8	150mm	6mm	<b>120-0643</b>	3.33 3.05
	T 7	T 9	150mm	6mm	<b>120-0644</b>	3.33 3.05
	T 10	T 15	150mm	6mm	<b>120-0645</b>	3.33 3.05
	T 20	T 25	150mm	6mm	<b>120-0646</b>	3.33 3.05
	T 30	T 40	150mm	6mm	<b>120-0647</b>	3.33 3.05
<b>Tri-Wing® - Tri-Wing®</b>						
	TW 0	TW 1	150mm	6mm	<b>120-0648</b>	3.62 3.32
	TW 2	TW 3	150mm	6mm	<b>120-0649</b>	3.62 3.32
	TW 4	TW 5	150mm	6mm	<b>120-0650</b>	3.62 3.32
<b>SYSTEM 6 Bit Holders / Adapters</b>						
Bit holder - suitable for C 6.3 and E 6.3 (1/4") bits			164mm	6mm	<b>120-0651</b>	6.18 5.68
Adapter blade - suitable for 1/4" square nuts			164mm	6mm	<b>120-0652</b>	5.50 5.04
Extension blade for reversible blades			166mm	6mm	<b>120-0654</b>	5.50 5.04

45

**System 6 Starter Kits**

6 Piece



Wiha. Premium Tools for Professionals.



120-0655



155-2694



120-0657

- Through hardened and chromeplated high-quality chrome-vanadium-molybdenum-steel
- Colour-coded Wiha ChromTop® tips
- Delivered with:
  - SYSTEM 6 SoftFinish®-telescopic handle (120-0655)
  - SYSTEM 6 SoftFinish® ESD handle (120-0656)
  - SYSTEM 6 magnetic handle (120-0657)
- In durable canvas pouch with Velcro fastening for practical storage

Kombiklingen:		
		3.5 - 4.5; 4.0 - 6.0; 5.5 - 6.5
		PH1 - PH2
		5 - 5

434970

Mfrs. List No.	Order Code	1+	5+	10+
281 T6	<b>120-0655</b>	21.26	19.48	17.99
284 ESD T6 01	<b>155-2694</b>	23.95	22.75	21.55
481 T6	<b>120-0657</b>	17.52	16.95	16.42

**System 6 Set**

12 Piece



Wiha. Premium Tools for Professionals.



Weight: 500 g

- Set with replaceable blades for locking screws
- Tri-Wing®, Torq-Set®, TORX®/TR
- Locking screws are used for electrical equipment (games consoles, hairdryers, kettles ...)
- Blade diameter reduced, so that it is also possible to operate screws in narrow, recessed areas
- Clearly arranged blades
- Additional blades can be added
- Robust folding bag, space-saving
- SoftFinish handle for dry and general purposes
- Ideal tool set for technicians

Contents:  
4 Tri-Wing® blades: TW1, TW2, TW3, TW4  
2 Torq-Set blades: TS6, TS8  
5 TORX®/TR blades: TR10, TR15, TR20, TR25, TR30

241505

Mfrs. List No.	Order Code	1+	5+	10+
U 110 T12	<b>358-4549</b>	31.15	28.92	25.57

**Express checkout**



With no need to re-enter your details, returning customers can now buy products even faster - **order online today at [www.farnell.co.uk](http://www.farnell.co.uk)**

**System 6 - Reversible Blade Screwdriver Set**

11 Pieces



Wiha. Premium Tools for Professionals.



Content:	
	6,0x100
	4,0 - 6,0; 5,5 - 6,5
	PH1 - PH2
	PZ1 - PZ2
	T10 - T15 T20 - T25 T30 - T40
	4 - 4 5 - 5 6 - 6

- Slotted/ Phillips/ Pozidriv/ TORX®/ Hex/ Ball Hex
- Chrome vanadium molybdenum steel, through hardened, chrome-plated
- Wiha ChromTop-Blade tip for best quality
- SYSTEM 6 Topra handle Ratchet
- Supplied in a robust metal box

413196

Mfrs. Part No.	Order Code	1+	5+	10+
282B 11-1	978-7720	55.73	52.94	50.15

**'T' Handle, 6mm Hex Blades**



Overall length = 110

A roller ratchet 'T' handle for use with Wiha and other manufacturers 6mm Hex screwdriver blades. The roller ratchet has three working positions, forward, locked and reverse, it is smooth and quiet in operation. The handle is very strong being virtually solid engineering plastic. The handle fits comfortably in the hand allowing considerable torque to be applied to the screwdriver blade.



TEE185X,401796

Order Code	1+	+	+	+
282-170	25.94	--	--	--

**Xcelite Compact Convertible**



- 'Piggy Back' torque amplifier handle that slips over the top of the colour coded midsize drivers to provide larger gripping surface, extended reach and increased driving power
- Set is housed in a rigid flip-open transparent case

	Length	Tip width		Length	Tip width
Green slotted driver	89mm	2.38mm	Blue Phillips driver	89mm	No. 0
Red slotted driver	89mm	3.18mm	Brown Phillips driver	89mm	No. 1
Black slotted driver	89mm	3.96mm	Amber Phillips driver	89mm	No. 2
Orange slotted driver	89mm	4.76mm	Black torque amplifier handle		
Amber slotted driver	89mm	6.35mm			

222751

Mfrs. List No.	Order Code	Price Per Set
PS88V	441-491	28.50

**FREE global legislation support**



RoHS, REACH, WEEE, EuP, Batteries Directive - we've got it covered at: [www.global-legislation.com](http://www.global-legislation.com)

**Metric/Imperial Sets**

Xcelite Compact Convertible



- Two sets, nine piece metric and nine piece imperial supplied in a flip-open transparent case
- The sets include a 'piggy back' torque amplifier handle

Contents Description	Blade Length		Width Across Flats	
	Metric	Imperial	Metric	Imperial
Allen hex socket driver	P78	P18	90mm	0.89mm 0.028"
Allen hex socket driver	P71	P19	90mm	1.27mm 0.035"
Allen hex socket driver	P72	P20	90mm	1.50mm 0.05"
Allen hex socket driver	P73	P21	90mm	2.0mm 1/16"
Allen hex socket driver	P74	P22	90mm	2.5mm 5/64"
Allen hex socket driver	P75	P23	90mm	3.0mm 3/32"
Allen hex socket driver	P76	P764	90mm	4.0mm 7/64"
Allen hex socket driver	P77	P24	90mm	5.0mm 1/8"
Torque amplifier handle	TA-2	TA-2	90mm	—

223370

Mfrs. List No.	Order Code	Price Each
PS90MM	442-290	27.08
PS89V	442-306	27.36

**Compact Convertible Nutdrivers**

Xcelite



Compact convertible nutdriver sets, include a range of miniature drivers together with slip on 'torque amplifier' handle, which provides a larger gripping surface and extended reach.

**Model PS120 hex AFIn**

- Contents:-**
- Torque amplifier handle
  - One each of the following nutdrivers:  
P3 - 3/32", P4 - 1/8", P5 - 3/32", P6 - 3/16", P7 - 7/32"  
P8 - 1/4", P9 - 9/32", P10 - 5/16", P11 - 11/32", P12 - 3/8"

Order Code	Price Per Set			
	1+	4+	20+	40+
442-380	32.40	31.43	30.49	29.57

**Model PS121MM hex AF Metric**

- Contents:-**
- Torque amplifier handle
  - One each of the following nutdrivers:  
P3MM - 3mm, P3.5MM - 3.5mm, P4MM - 4mm, P4.5MM - 4mm, P5MM - 5mm  
P5.5MM - 5.5mm, P6MM - 6mm, P7MM - 7mm, P8MM - 8mm, P10MM - 10mm

486877

Order Code	Price Per Set			
	1+	4+	20+	40+
442-379	40.05	38.85	37.68	36.55

**Screwdriver Service Set**

Xcelite



Compact, interchangeable blade, hex socket metric screwdrivers. A 9-piece kit comprising 7 metric across flat keys together with a handle and a 101mm extension. Working lengths of tools 101mm.

- Contents:-**
- Regular handle, 99-1
  - One extension blade, 99-X5
  - One each of the following hex type screwdrivers:

**Screwdrivers - Standard - continued**

**Screwdriver Service Set - continued**

99PS-41MM - continued

99-71MM - 1.27mm, 99-72MM - 1.5mm, 99-73MM - 2mm, 99-74MM - 2.5mm, 99-75MM - 3mm, 99-76MM - 4mm, 99-77MM - 5mm

487061

Order Code	Price Per Set			
	1+	4+	20+	40+
442-318	43.61	42.29	41.03	38.97

**Screwdriver/Nutdriver Set**

Xcelite Series 99



Thirteen-piece set, in stand up plastic see-through cover.

Contents	Description	Blade Length	Width across flats
99-6V	Nutdriver blade	92mm	4.76mm opening
99-7V	Nutdriver blade	92mm	5.56mm opening
99-8V	Nutdriver blade	92mm	6.35mm opening
99-9V	Nutdriver blade	92mm	7.014mm opening
99-10V	Nutdriver blade	92mm	7.94mm opening
99-11V	Nutdriver blade	92mm	8.73mm opening
99-12V	Nutdriver blade	92mm	9.53mm opening
99-811V	Slotted screwdriver blade	98mm	4.76mm tip width
99-250V	Slotted screwdriver blade	98mm	6.35mm tip width
99-821	Phillips screwdriver blade	102mm	No. 1 point size
99-822	Phillips screwdriver blade	102mm	No. 2 point size
99-X5V	Extension shaft	102mm	—
99-1V	Regular handle	102mm	—

Note: Case subject to design change

222752

Mfrs. List No.	Order Code	Price Per Set
99PS50	441-508	1+ 49.50

45

**Screwdriver Service Set**

99PS-51MM Compact Interchangeable Shank Metric Nutdrivers

**Xcelite**

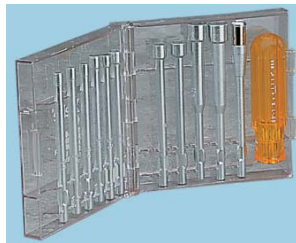

Twelve-piece set comprising 10 of the most frequently used metric sizes. Complete with a regular handle and extension piece. In fitted see-through plastic case. Working length of tools 92mm.

**Contents:-**

- Regular handle, 99-1
- One extension blade, 99-X5
- One each of the following nutdrivers:  
99-4MM - 4mm, 99-4.5MM - 4.5mm, 99-5MM - 5mm, 99-5.5MM - 5.5mm, 99-6MM - 6mm, 99-7MM - 7mm, 99-8MM - 8mm, 99-9MM - 9mm, 99-10MM - 10mm, 99-11MM - 11mm

487067

Order Code	Price Per Set			
	1+	4+	20+	40+
442-392	54.90	53.25	51.66	50.11

**Express checkout**



With no need to re-enter your details, returning customers can now buy products even faster - **order online today at [www.farnell.co.uk](http://www.farnell.co.uk)**

**Screwdriver and Nutdriver Set**

Xcelite Series 99®

**Xcelite**



- 12 piece screwdriver and nutdriver set
- Designed for use with cordless rechargeable screwdrivers
- Contains 7 nutdrivers, 4 screwdrivers and a power adaptor
- Spring collar connection on power adaptor
- Supplied in plastic wallet

Contents:	Nutdrivers	6, 7, 8, 9, 10, 11, 12	Phillips screwdriver	No. 1, No. 2
	Slotted screwdrivers	4.76mm, 6.35mm	Power adaptor	

222835

Mfrs. List No.	Order Code	Price Per Set
99-PA50	628-402	1+ 23.00

**99 Series Interchangeable Driver System**

**Xcelite**  
COOPER CooperTools



Interchangeable blades, shanks and handles are available separately, allowing the economical selection of individual items without having to purchase complete sets.

**Handles**

Description	Model	Order Code	Price Each		
			1+	4+	20+
Regular	99-1	441-521	3.87	3.75	3.64
Tee	99-4	441-533	5.13	4.98	4.83
Tee ratchet	99-4-R	441-557	24.30	23.57	22.86

**Screwdriver Blades - Ballpoint Hexagon Socket Type**

**Metric**

Model	Size	Order Code	Price Each		
			1+	4+	20+
99-74	2.5mm	441-946	5.22	5.06	4.91
99-75	3.0mm	441-958	5.22	5.06	4.91
99-76	4.0mm	441-960	5.22	5.06	4.91

**Hexagon Socket Type**

**AF**

Model	Size	Order Code	Price Each		
			1+	4+	20+
9920	0.05"	441-661	3.20	3.10	3.01
9921BP	1/16"	441-831	5.54	5.37	5.21
9922BP	5/64"	441-843	5.54	5.37	5.21
9923BP	3/32"	441-855	5.54	5.37	5.21
99764BP	7/64"	441-867	5.49	5.33	5.17
9924BP	1/8"	441-879	5.54	5.37	5.21
99964BP	9/64"	441-880	5.49	5.33	5.17
9925BP	5/32"	441-892	5.54	5.37	5.21
9926BP	3/16"	441-909	5.54	5.37	5.21

**Hexagon Socket Type**

**Metric**

Model	Size	Order Code	Price Each		
			1+	4+	20+
9920	0.05"		3.20	3.10	3.01
9972	1.5mm	441-764	4.10	3.98	3.86
9973	2mm	441-776	4.10	3.98	3.86
9974	2.5mm	441-788	4.10	3.98	3.86
9975	3mm	441-790	4.10	3.98	3.86
9976	4mm	441-806	4.10	3.98	3.86
9977	5mm	441-818	4.10	3.98	3.86

Hexagon Socket Type

AF					
Model	Size	Order Code	Price Each		
			1+	4+	20+
9920	0.05"	441-661	3.20	3.10	3.01
9921	1/16"	441-673	3.20	3.10	3.01
9922	0.078125"	441-685	3.20	3.10	3.01
9923	5/64"	441-697	3.20	3.10	3.01
99764	7/64"	441-703	3.20	3.10	3.01
9924	1/8"	441-715	3.20	3.10	3.01
9926	3/16"	441-740	3.20	3.10	3.01

Nutdrivers

Metric					
Model	Size	Order Code	Price Each		
			1+	4+	20+
994	4mm	442-136	4.10	3.98	3.86
995	5mm	442-150	4.10	3.98	3.86
995.5	5.5mm	442-161	4.10	3.98	3.86
996	6mm	442-173	4.10	3.98	3.86
997	7mm	442-185	4.10	3.98	3.86
998	8mm	442-197	4.10	3.98	3.86
999	9mm	442-203	5.00	4.85	4.70
	10mm	442-215	5.00	4.85	4.70

Extensions

485409

Model	Extends by	Order Code	Price Each		
			1+	4+	20+
99-X5	100mm	442-239	5.04	4.89	4.74
99-X10	175mm	442-240	5.49	5.33	5.17

Kraftform Kompakt® 60

17 pieces set



- Suitable for manual or machine drive
- High-quality assembly tools for screws
- Pouch with 89 mm long bits

Content:		
Each		PH1; PH 2; PH 3
Each		PZ 1; PZ 2; PZ 3
Each		TX 10; TX 15; TX 20; TX 25; TX 30
Each		1.0 x 5.5
Each		SW 3; SW 4; SW 5; SW 6
1 Kraftform bitholding screwdriver 816 R with Rapidaptor quick release chuck		

345629

Type	Order Code	Price Each		
		1+	5+	10+
KRAFTFORM KOMPAKT 60	762-1205	44.39	40.36	37.00

Kraftform Kompakt® 61

17 pieces set



- Suitable for manual or machine drive
- High-quality assembly tools for screws
- Pouch with 89 mm long bits

Content:		
Each		TX 10; TX 15; TX 20; TX 25; TX 30
Each		#6; #8; #10
Each	#1; #2; #3; #4 bit icon"/>	#1; #2; #3; #4
Each	#4; #6; #8; #10 bit icon"/>	#4; #6; #8; #10
1 Kraftform bitholding screwdriver 816 R with Rapidaptor quick release chuck		

345630

Type	Order Code	Price Each		
		1+	5+	10+
KRAFTFORM KOMPAKT 61	762-1213	44.01	40.00	36.68

Screwdriver- and Bit-Set  
14 pieces



- Applicable for switch cabinet buildings
- With 90 mm bits for reaching lower-lying screws in switch cabinet systems, fuse boxes and terminal blocks
- CentroFix quick release holder, style E6.3
- Bit holder with SoftFinish handle
- Practical, space-saving roll-up bag for the workbench and on the road

Bits, style E6.3:		
		PH1, PH2 Xeno-Bit, slotted/Phillips For terminal screws
		PZ1, PZ2 Xeno-Bit, slotted/Pozidriv For terminal screws
		PH1, PH2
		PZ1, PZ2
		T10, T15, T20; T25

518640

Mftrs. List. No.	Order Code	Price Each		
		1+	5+	10+
79187 T01	162-9861	54.90	52.15	49.40

46 Piece Ratchet Screwdriver/Socket Set



- Screwdriver style driver with a hi-torque reversible ratchet
- Magnetised shaft holds bits
- Cushion grip with internal bits storage
- 12 chrome plated alloy steel 1/4" sockets on 2 removable plastic clips
- 32 high grade bits with rust resistant finish on 4 removable plastic clips

Contents:

- Reversible ratchet screwdriver
- Metric sockets: 6, 7, 8, 10, 11, 12mm
- A/F sockets: 3/16, 1/4, 5/16, 11/32, 3/8, 7/16"
- Slotted bits: 3, 4, 4.5, 5, 6, 7, 8, 9mm
- Phillips bits: PH0, PH1, PH2, PH3
- Pozidriv bits: PZ0, PZ1, PZ2, PZ3
- Tamperproof torx bits: T8, T10, T15, T20, T25, T27, T30, T40
- Hexagon bits: 1.5, 2, 2.5, 3, 4, 5, 5.5, 6mm
- 1/4" square drive adaptor

419497, 422837

Mftrs. list no.	Order code	Price each
T4826D	109-8818	25.60

Express checkout



With no need to re-enter your details, returning customers can now buy products even faster - order online today at [www.farnell.co.uk](http://www.farnell.co.uk)



**Screwdrivers - Standard - continued**

**29 Piece Articulated Ratchet Set**



- A compact set containing the most popular sizes of 1/4" drive sockets and bits
- Articulated ratchet allows access where conventional drivers cannot reach
- High torque joint adjustable from 45° to 90°
- Right and left hand action
- Cushioned comfort handle with storage space for bits
- Hex drive shaft magnetised to hold bits securely

**Contents:**

- Reversible ratchet screwdriver
- Sockets: 5.5, 6, 7, 8, 9, 10, 12mm
- Slotted bits: 4, 5, 6, 7.2mm
- Phillips bits: PH1, PH2, PH3
- Pozidriv bits: PZ1, PZ2, PZ3
- Tamperproof torx bits: T15, T20, T25, T27, T30
- Hexagon bits: 4, 5, 6, 7mm
- Bit holder

419496, 422836

Mfrs. list no.	Order code	Price each
T4818S	109-8817	19.85

**Offset Ratchet Set**



45



- All purpose 5 piece midget reversible ratchet offset screwdriver set
- Simple to use in all kinds of assembly adjustment and repair work involving Phillips and slotted screws

Contents:  
Slotted screw bits 4.76mm (XL25), 6.35mm (XL17), Phillips screw bits No. 1 (XL20), No. 2 (XL21), 95mm Reversible ratchet arm (XL27)  
All driver bits 6.35mm hex shank



222745

Mfrs. List No.	Order Code	Price per Set
XL75	441-478	18.63

**Offset Ratchet Set**



Contents:  
Slotted screw bits 6.35mm, 4.76mm  
Allen hex type screw bits (width across flats) 1.27mm, 1.98mm, 2.38mm, 1.54mm, 3.17mm, 3.57mm, 3.97mm, 4.76mm, 5.56mm, 6mm, 7.94mm  
Phillips bits No 1, No. 2.  
95mm Reversible ratchet arm.  
150mm Spinner extension (25mm x 76mm handle, 76mm shaft).  
6.35mm hex to 6.35mm square adaptor bit.

19 piece set moulded plastic case. All driver bits 6.35mm hex shank.

222748

Mfrs. List No.	Order Code	Price Per Set
XL70	441-480	1+ 66.78

**14-in-1 Stubby Ratchet Screwdriver**



- Stubby ratchet screwdriver
  - 3 Settings - forward, reverse and fixed
  - Supplied with 7 x 32mm long double ended bits
  - Phillips, slotted, torx, hex and square combination bits
  - Overall length: 120mm
- Bit Combinations:  
PH1 - SL3, PH2 - SL5, PH3 - SL6, T15 - T20, T25 - T30, H4 - H5, S1 - S2 (square)

482148.464816

Order Code	Price Each			
	1+	5+	10+	20+
144-7587	5.35	4.71	4.11	3.34

**14-in-1 Ratchet Stubby Screwdriver**



- High torque ratchet screwdriver handle
- Can be angled up to 60°
- Precision 3 setting ratchet function
- Screwdriver bits fit comfortably in the handle
- 6 x sockets - 6, 8, 9, 10, 12, 13mm
- 1 x socket adaptor
- 6 x screwdriver bits: Slotted: 3/16", 9/32", Phillips: PH1, 2
- Torx: T15, 20
- Length: 120mm

482920.435188

Order Code	Price Each			
	1+	5+	10+	50+
139-0404	3.14	2.95	2.71	2.45

**6-in-1 Gearless Angled Ratchet Screwdriver**



- High torque ratchet screwdriver handle
  - Fixed angle at 60°
  - Operates with friction rather than teeth for a smoother, non-stepping action
  - Forward and reverse settings
  - Screwdriver bits store easily in the handle
  - Comfortable, ergonomic rubber grip
  - 6 x screwdriver bits:
- Slotted: 3/16", 1/4, Phillips: PH1, PH2, Torx: T15, T20  
● Overall length: 195mm

481956.435199

Order Code	Price Each			
	1+	5+	10+	50+
144-7390	4.56	4.29	4.05	3.64

**700 products added online every week**



See our pick of the hottest products and latest technologies in 'What's New?' at [www.farnell.co.uk](http://www.farnell.co.uk)



**Gearless Ratchet Screwdrivers**



- Gearless ratchet screwdrivers for confident driving
- Operates with friction rather than teeth for a smoother, non-stepping action
- Forward and reverse settings
- Available as long shaft or stubby versions
- 6 x screwdriver bits:
  - Slotted: 5, 6mm
  - Phillips: PH1, 2
  - Pozidriv: PZ1, 2
- Length: 300mm (Long Shaft), 110mm (Stubby)

460551.435197

Description	Order Code	Price Each			
		1+	5+	10+	50+
Long Shaft Screwdriver	<b>133-6739</b>	4.25	4.02	3.78	3.42
Stubby Screwdriver	<b>133-6740</b>	3.82	3.57	3.18	2.99

**40 Piece GearDriver™ Set**



- Package Case Contains:
- GearDriver™ Handle, Stubby GearDriver™ Handle and T- Handle
  - 2 Pc. Magnetic Bit Driver Shafts 3-1/2" and 6"
  - 2 Pc. Driver Shafts 3-1/2" and 6"
  - 180° Cable Drive Flex Shaft, 1/4" Drive Adapter, 180° Cable Driver Flexible Shaft

524444

Mfrs. List No.	Order Code	Price Each		
		1+	5+	10+
8940	<b>164-7971</b>	51.70	49.63	47.56

**39 Piece GearDriver™ Set**



- Package Case Contains:
- GearDriver™ Handle
  - 7 Shafts:
    - Magnetic Bit (3-1/2", 6" and 10")
    - 1/4" Socket (3-1/2", 6" and 10")
    - 6" Flexible Shaft
  - 30 Piece Bit Set:
    - (8 - Torx, 12 - Hex, 4 - Phillips, 6 - Slotted)

524445

Mfrs. List No.	Order Code	Price Each		
		1+	5+	10+
8939	<b>164-7972</b>	35.45	34.05	32.60

**Screwdrivers**



**Gearless Ratcheting Screwdrivers**



1011629

1011630

1011631

All feature a gearless ratcheting mechanism. Fewer moving parts & the absence of teeth results in a stronger mechanism & eliminates slipping. Each screwdriver comes complete with the following 6 bits in a holder: Slotted 4, 6.5mm, Pozidriv #1&2, Phillips #1 & 2.

487716

Length (mm)	Type	Order Code	Price Each			
			1+	5+	10+	20+
225	Standard	<b>141-8799</b>	7.13	6.99	6.84	6.71
115	Stubby	<b>141-8800</b>	8.02	7.86	7.71	7.55
310	Long reach	<b>141-8801</b>	8.03	7.87	7.71	7.56

**Stepless Ratchet**



- **T4921S**
- Cam-Drive stepless ratchet driver, with smooth positive action
- Operates with friction rather than teeth and eliminates the need to go onto the next tooth when tightening up
- 1/4" hexagon drive magnetic bit holder has Hi-Torque capability C Driver supplied with 8 screwdriver bits
- Reversible chunky handle with bit storage offers an easy one-hand, drive-direction adjustment
- **T4921**
- Cam-Drive stepless ratchet driver as 4921S above but with extra long 190mm blade
- Supplied without bits
- **T4920**
- Cam-Drive stepless ratchet driver with stubby handle and short blade
- Supplied without bits

Blade	Handle	Overall	Mfrs. List No.	Order Code
45	65	110	T4920	709-9228
190	120	310	T4921 190	709-9230
100	120	220	T4921 100	709-9241

225205

Order Code	Price Each
	1+
<b>709-9228</b>	13.40
<b>709-9230</b>	12.63
<b>709-9241</b>	13.04

**Ratchet**

**Magnetic**



H=230 Dia.=35

- High Torque reversible ratchet screwdriver
- Magnetic shaft holds steel screws to bit for ease of positioning
- Easy to adjust reversing collar
- Magazine in handle stores 9 spare bits
- Supplied with POZI 0, 1, 2 Slotted 3, 4.7, 6.3mm and Hexagon 3, 4, 5mm

222819

Order Code	Price Each
	1+
<b>609-742</b>	10.40

**Ratchet Screwdriver**

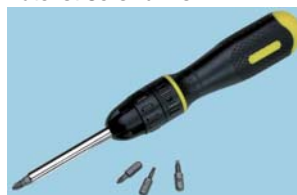

3 position audible ratcheting mechanism screwdriver. Tri-lobular bi-material handle with textured finish for maximum torque with minimum effort. Magnetic bit holder for quick, secure change over of standard 1/4in bits. Supplied with 10 assorted bits.

478106

Order Code	Price Each		
	1+	5+	10+
<b>135-3429</b>	10.05	9.75	9.25
			20+
			8.83

**20 in 1 Screwdriver**

**With Telescopic Pick-up Tool**



- Screwdriver complete with bits: Slot 4, 5, 6mm, Phillips No. 1, 2, 3, Pozi No. 1, 2, 3, Torx T15, T20, Hex 4, 6mm, 1/4" Sockets 4, 5, 6, 7, 8mm and Hex to 1/4" Drive adaptor
- Includes a telescopic magnetic pick-up tool

222904

Order Code	Price Each
	1+
<b>312-6857</b>	5.40



**Screwdrivers - Standard - continued**

**10 Way Flexible Screwdriver**



Soft grip handle for comfort and easy use, this flexible shaft screwdriver gives easy access to many applications. Set includes a range of popular size bits in Phillips, slotted and torx.

477914

Order Code	Price Each			
	1+	5+	10+	20+
135-3420	10.05	9.75	9.25	9.07

**8 in 1 Screwdriver**



8 in 1 screwdriver with built in magnetic telescopic pick up tool  
Includes:  
1 x Magnetic pick up tool  
2 x Slotted - 4 and 6mm  
3 x Phillips - PH1, PH2 and PH3  
2 x Pozi - PZ1 and PZ2

482923.460998

Order Code	Price Per Set				
	1+	5+	10+	20+	50+
136-7041	1.05	0.99	0.84	0.80	0.71

**105 Piece Screwdriver Bit Set**



A complete screwdriver bit set including a heavy-duty ratchet screwdriver with forward, reverse and fixed settings. All bits fit any 1/4" hex driver and most power screwdrivers.

Kit contains following bits:

- Slotted - 3/32", 7/64", 1/8", 9/64", 5/32", 3/16", 7/32", 1/4", 9/32", 5/16"
- Phillips - PH0, PH1, PH2, PH3, PH4, drywall PH2
- Star Drive - 5, 5.5, 6, 7, 8, 9, 10, 15, 20, 25, 27, 30, 35, 40, 45, 50
- Square Drive - 0, 1, 2, 3
- Hex SAE - 1/16", 5/64", 3/32", 7/64", 1/8", 9/64", 5/32", 3/16", 7/32", 1/4", 9/32", 5/16"
- Pozidriv - PZ0, PZ1, PZ2, PZ3, PZ4
- Hex - 1.5, 2, 2.5, 3, 4, 5, 5.5, 6, 7, 8mm
- Clutch - 1/8", 5/32", 3/16", 1/4", 7/32"
- Tamperproof Torx - T8, T10, T15, T20, T25, T27, T30, T35, T40
- Torx - 6, 8, 10mm
- Security Hex - 3/32", 9/64", 1/8", 7/64", 5/32", 3/16", 2, 2.5, 3, 4, 5, 6mm
- Tri-Wing - #1, #2, #3, #4
- Spanner - 4, 6, 8, 10mm
- 29/16" magnetic extension bit holder
- 1/4" hex x 1/4" dr. socket adaptor

482940.423840

Order Code	Price/Set	
	1+	5+
115-5996	13.91	12.64

**Screwdriver and Bits Set**



29 Piece



Contents: Magnetic bit screwdriver, socket bit holder, socket adaptor  
Hex bits: Slot 3,4,5mm, Phillips No. 1,2,3, Security Hex 2,2.5,3,4,5,5.5,6  
Security Torx T7, T8, T9, T10, T15, T20, T25, T30, T40  
Security Square Drive No. 0,1,2,3

222907

Order Code	Price Each	
	1+	13.32
312-5087		

**109 Piece Professional Multi-bit Set**



Contains 108 high grade S2 steel, detachable 1/4" bits with rust protected finish. Hardened and heat treated for maximum strength and durability. 14 different patterns - all the bits you will ever need. Complete with extensions and adaptors. Includes quick release multi-bit screwdriver with rubberised, soft grip handle.

494682

Order Code	Price Each	
	1+	39.93
141-8802		

**Kraftform Kompakt® 90 and 91**



22 pieces set



Kraftform Kompakt® 90

Kraftform Kompakt® 91

Quick fastening and easy direction reversal with only one hand with the Kraftform Kompakt® Handy-Ratchet.

Content:		Content:	
<b>Kraftform Kompakt® 90, 22-pcs</b>		<b>Kraftform Kompakt® 91, 18-pcs</b>	
Each	TX10; TX15; TX20 TX25; TX30; TX40	Each	TX15; TX20; TX25; TX30
2 Bits	PZ1/25; PZ2/25;	Each	PH1/25; PH2/25; PH3/25
3 Bits	PZ3/25	Each	SW3; SW4; SW5
1 Bit	PH1/25; PH2/25; PH3/25	Bits:	
Each	1,0x5,5; 1,2x6,5	Each	SW5,5; SW7; SW8; SW10; SW13
Each	SW3; SW4; SW5	1/4" Kraftform Kompakt® Handy-Ratchet with quick-release chuck	
1/4" Kraftform Kompakt® Handy-Ratchet with quick-release chuck		1 Universal bit holder	
1 Adaptor		1 Adaptor	

278547

Description	Order Code	Price Each		
		1+	3+	5+
KRAFTFORM KOMPAKT 90	440-0884	65.23	59.29	54.36

**Kraftform Kompakt® 70 and 71**



32 pieces set



Kraftform Kompakt® 70

Kraftform Kompakt® 71

- Kraftform Kompakt® 70 ideal for all common applications in trade and industry
- Kraftform Kompakt® 71 ideal for all common applications in service and maintenance
- For both manual and machine operation
- Engineered to the highest quality for professional use
- Packaged in unique, spacesaving format

45

Farnell



Content:		
Kraftform Kompakt® 70:		
Each		3x PH1/25; 3x PH2/25; 3x PH3/25
Each		3x PZ1/25; 3x PZ2/25; 3x PZ3/25
Each		TX10; TX15; TX20 TX25; TX30; TX40
Each		SW4; SW5; SW6
Each		0,6x4,5; 1,0x5,5; 1,2x6,5
1 Kraftform bitholding screwdriver with Rapidaptor quick release chuck		
1 Universal bit holder		

Content:		
Kraftform Kompakt® 71:		
Each		SW2; SW2,5; SW3; SW4; SW5; SW6
Each		#4; #6; #8; #10
Each		TX7; TX8; TX9; TX10; TX15; TX20; TX25; TX30; TX40
Each		#6; #8; #10; #1/4"
Each	#1 bit icon"/>	#1; #2; #3
Each	#0 bit icon"/>	#0; #1; #2; #3
1 Kraftform bitholding screwdriver with Rapidaptor quick release chuck		
1 Universal bit holder		

278531

Description	Order Code	Price Each		
		1+	3+	5+
KRAFTFORM KOMPAKT 70	440-0860	37.42	37.42	37.42
KRAFTFORM KOMPAKT 71	440-0872	56.50	56.50	56.50



Kraftform Kompakt® 31

Content:		
Kraftform Kompakt® 31:		
Each		TX10; TX15; TX20; TX25; TX30; TX40
Each		PZ1/25; PZ2/25; PZ3/25
1 bit holder 815/4/1 Kraftform with quick-release chuck		
1 Universal bit holder 895/4/1		



Kraftform Kompakt® 32

Content:		
Kraftform Kompakt® 32:		
Each		PZ1/25; PZ2/25; PZ3/25
1 bit holder 815/4/1 Kraftform with quick-release chuck		
1 Universal bit holder 895/4/1		

- Compact tools for both manual and power screwdriving
- For continuous operation in industry and handcraft
- With quick release adapter for electric, cordless and pneumatic screwdriver
- Strong magnet
- 1 bit holder 815/4/1 Kraftform with quick-release chuck, 1 Universal bit holder 895/4/1

278165

Type	Order Code	Price Each		
		1+	3+	5+
KRAFTFORM KOMPAKT 30	440-0823	24.44		

### Kraftform Kompakt® 22 with pouch



- For 1/4" DIN 3126-C 6,3 and E 6,3 (ISO 1173) hexagon socket
- Opening mechanism supported by a spring
- Integrated magazin with 6 Bits
- Connector, bayonet, Rapidaptor rapid-in,

rapid-out, rapid-spin, chuck-all, and single-hand technology

- Kraftform® handle with anti-roll protection, multi-component, integrated magazine



Content:		
1 x		PZ 1
2 x		PZ 2
Each		TX15; TX20; TX25;

413043

Type	Order Code	Price Each		
		1+	5+	10+
KRAFTFORM KOMPAKT 22	967-3253	24.63	23.54	22.04

### Kraftform Kompakt® 20 with pouch



- Opening mechanism supported by a spring
- Integrated magazin with 6 Bits
- For 1/4" DIN 3126-C 6,3 and E 6,3 (ISO 1173)
- Connector, bayonet, Rapidaptor rapid-in,

rapid-out, rapid-spin, chuck-all, and single-hand technology

- Kraftform® handle with anti-roll protection, multi-component, integrated magazine



Content:		
Each		PH 1; PH 2
Each		1,0 x 5,5; 1,2 x 6,5
Each		PZ 1x25; PZ 2x25

413043

Type	Order Code	Price Each		
		1+	5+	10+
KRAFTFORM KOMPAKT 20	967-3245	24.63	23.54	22.04

### Kraftform Kompakt® 50

With bayonet blade, 14 pcs



Kraftform Kompakt® 50



Handle with withdrawn blade

- The right tool for all users who place the greatest emphasis on versatility
- For both manual and machine operation
- Engineered to the highest quality for professional use
- Packaged in unique, spacesaving format

Content:		
Kraftform Kompakt® 50:		
Each		TX10; TX15; TX20; TX25; TX30; TX40
Each		PZ1/25; PZ2/25
Each		PH1/25; PH2/25
Each		0,6x4,5; 1,0x5,5
1 bayonet bit holder 817 R Kraftform with quick-release chuck Rapidaptor		

278337

Description	Order Code	Price Each		
		1+	3+	5+
KRAFTFORM KOMPAKT 50	440-0859	35.82	35.82	35.82

### Kraftform Kompakt® 30, 31 and 32

For every application the right range, 11 piece



Kraftform Kompakt® 30

Content:		
Kraftform Kompakt® 30:		
Each		PZ1/25; PZ2/25; PZ3/25
Each		PH1/25; PH2/25; PH3/25
Each		0,6x4,5; 1,0x5,5; 1,2x6,5
1 bit holder 815/4/1 Kraftform with quick-release chuck		
1 Universal bit holder 895/4/1		

**Screwdrivers - Standard - continued**

**Security Bits-Collector 27 Piece**  
Type 7928-928 For All Standard Locking Screws



Wiha. Premium Tools for Professionals.



- Universal, with universal holder 1/4", magnetic and microfinish handle for
- screwing in locations where access is difficult.
- For all standard security screws

Contents: 1each:7015TZR8-10-15-20-25-27-30-40x25  
7019 TS6-8-10x5  
7019 TW1-2-3x25  
7019 SP4-0-6.0-8.0-10.0x25  
7013 TR 5/64"-3/32" 7/64" 1/8" 9/64" 5/32"  
7113 1/4", 281-2

241340

Mfrs. List No.	Order Code	1+	5+	10+
09393	310-7267	42.25	38.70	33.74

**33 Piece Security Bit Set**



A 33 piece security bit set ideal for use with cordless screwdrivers and drills.

- Compact pocket sized bit box
- Supplied with 1 x 60mm bit holder
- Torq bits: T8, T10, T15, T20, T25, T27, T30, T35, T40
- Hex bits: 5/64", 3/32", 7/64", 1/8", 9/64", 5/32"
- Hex bits: 2, 2.5, 3, 4, 5, 6mm
- Tri-Ling bits: #1, #2, #3, #4
- Spanner bits: #4, #6, #8, #10
- Cross-head bits: #6, #8, #10
- Magnetic bit holder

461231.461196

Order Code	1+	5+	10+	20+
134-1140	4.05	3.91	3.58	3.31

**Hex Bit Set**



45



- High grade alloy steel bits with rust resistant finish
- 1/4" hex drive
- Held securely in a handy clip
- Length: 25 mm

Contents:  
Hex: 1.5, 2, 2.5, 3, 4, 5, 5.5, 6mm

495504

Mfrs. List No.	Order Code	1+	5+	10+	20+
T4524	151-8936	3.40	3.28	3.19	3.09

**8 Piece Torx Bit Set**



- An 8 piece torx bit set for use with screwdriver handles and portable screwdrivers with 1/4" hex drives
- Manufactured from chrome vanadium steel
- Bit lengths: 50mm
- Sizes included: T8, T10, T15, T20, T25, T27, T30 and T40

482072.453124

Order Code	1+	5+	10+	20+	50+
144-7535	1.30	1.12	1.00	0.93	0.79

**Help us to help the environment**



This catalogue has been printed on paper certified from a sustainable source. Please recycle after use.

**Torx Bit Set**



- High grade alloy steel bits with rust resistant finish
  - 1/4" hex drive
  - Held securely in a handy clip
  - Length: 25 mm
- Contents:  
Torx: T8, T10, T15, T20, T25, T27, T30, T40

495501

Mfrs. List No.	Order Code	1+	5+	10+	20+
T4523	151-8935	3.40	3.28	3.19	3.09

**Screwdriver with Bit Magazine**

8 different bits



Wiha. Premium Tools for Professionals.



162-8089



- Blade made of high grade chrome-vanadium steel, through hardened
- Ergonomic Wiha SoftFinish® multi-component handle with roll-off protection
- Stainless steel bits with strong magnet
- According to DIN 3126, ISO 1173, style D 6.3
- Bit length: 25 mm
- Alternative to a screwdriver set

Contained bits:	
	6.5mm
	PH1; PH2; PH3
	T15; T20; T25
	PZ2

518338

Mfrs. List No.	Order Code	1+	5+	10+
38090101	162-8089	13.50	12.85	12.15

**Hex Bit Driver, Flexible 1/4" 386 Series**



Wiha. Premium Tools for Professionals.



WIHA SoftFinish multi-component handle with roll-off protection. Suitable for: 1/4 DIN3126 FORM C 6.3. Made from rust proof steel. Plastic coated flexible metal. For offset screws.

Mfrs. Part No. - Tip Size	Blade Length	Total Length
386 - 1/4	150	250

241234

Mfrs. Part No.	Order Code	1+	5+	10+
386-1/4	832-509	10.53	9.68	8.76

**Hex Bit Driver, Magnetic 1/4 Zoll Type 385**



Wiha. Premium Tools for Professionals.



Bit holder with red multi-component handle with roll-off protection. It is made from rust proof steel. Hex bolster for higher torque.

Blade material: Chrome Vanadium Steel  
Handle material: Cellulose acetate (Impact resistant and cadmium-free)

Mfrs Part No.	1/4"	Blade Length	Overall Length	Gewicht
385		120	200	134g

Dimensions in mm

241225

Mfrs. Part No.	Order Code	1+	5+	10+
385	832-492	9.85	9.03	8.18

Over 480,000 products online



**Magnetizer/De-Magnetizer**



- Pocket sized magnetizer/demagnetizer
- Magnetizes or demagnetizes most steel screwdrivers or other small tools
- Collects metal items from inaccessible places
- Allows easy and precise handling in confined spaces

495508.410667

Mfrs. List No.	Order Code	Price Each			
		1+	5+	10+	20+
T1350	151-8941	5.70	5.55	5.35	5.15

**Magnetiser/De-Magnetiser**



A neat simple device to magnetise or de-magnetise screwdriver blades, tweezers, allen keys or similar tools made from steel.

Supplied with instructions

H = 50, W = 52, D = 29

401878

Order Code	Price Each
	1+
150-2627	4.33

**Screw Remover**



- Removes damaged screws in seconds
- Works on all types of screws
- To be used with reversible drill
- Pack contains 2 sizes for screws 6 -10 and 12 - 14mm

484544

Mfrs. List No.	Order Code	Price Each			
		1+	5+	10+	20+
422003	146-5984	9.10	8.85	8.55	8.20

**5 Piece Screw Extractor Set**



- Removes broken screws or bolts without damaging hole threads
- Manufactured from chrome vanadium steel
- Black oxide finished for durability
- Comes complete with plastic storage case
- Contains sizes: 3-6mm 1/8" - 1/4", 6-8mm 1/4" - 5/16", 8-11mm 5/16" - 7/16", 11-14mm 7/16" - 9/16" and 14-19mm 9/16" - 3/4"

482080.461012

Order Code	Price/Set				
	1+	5+	10+	20+	50+
144-7442	2.85	2.52	2.22	1.95	1.73

**Screwdrivers - Mains Testers**

**Mains Tester With Neon Indicator - (150-250V ac)**



VDE approved.

222741

Blade (mm)	Order Code	Price Each
		1+
60 x 3	108-753	1.80
100 x 4	108-754	2.51

**Voltage Tester Type 255-8**



Voltage tester 150-250V according to VDE 0680/6 und DIN 57680/6. Proofed Safety «GS»-Mark. With long slotted blade.

Blade material: Chrome Vanadium

Material of Blade insulation and handle: Cellulose acetate, black

Mfrs. Part No.	Tip Size	Blade Length	Length	Handle Length	Handle Ø	Weight (g)
255-8	3.5	100	185	85	19	32

Dimensions in mm

241117

Mfrs. Part No.	Order Code	Price Each		
		1+	5+	10+
255-8	831-591	6.22	5.72	5.16

**VDE**



- 220-250Vac VDE approved mainstester with pocket clip
- Blade manufactured from chrome vanadium steel
- One piece moulded blade and handle insulation for assured safety

422842

Tip size	Blade length	Overall length	Mfrs. list no.	Order code	Price each
3mm	65mm	140mm	440007	109-8821	1.90
3.5mm	100mm	185mm	440012	151-8946	2.80

**Screwdriver**



Multi-test screwdriver  
Multi-function mains tester screwdriver battery powered.  
Suitable for:-  
AC voltage test contact 70-250VAC  
AC voltage test non-contact 70-600VAC  
Polarity test 1.5V-36VDC  
Continuity check 0.50MΩ

Microwave leakage detection 5MW/CM<sup>2</sup>  
Battery life 5 hours continuous operation. CE and GS approved.

494024

Order Code	Price Each
	1+
151-0926	5.17

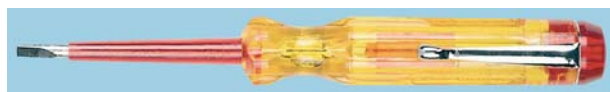

- 100-250Vac mainstester with pocket clip
- Blade manufactured from chrome vanadium steel

419502.422840

Tip size	Blade length	Overall length	Mfrs. list no.	Order code	Price each
3.5mm	55mm	140mm	440005	109-8820	3.40



**Screwdrivers - Impact**

1/2" (12.7 mm)



- For loosening or tightening stubborn nuts, bolts or screws
- Supplied with a selection of screw-driver bits in a metal storage case

H=40, W=190, D=43

TEE268X

Mfrs. List No.	Order Code	1+	4+	20+	40+
4928	629-947	15.95	15.45	15.00	14.35

**Nutspinners**

Nut Driver Set



6 piece nut driver set. Feature a rotating head which allows for greater control of the blade. Supplied in a plastic storage case.

490956

Contents	Order Code	Price Each
3.2, 4.0, 5.0, 5.5mm 1/8, 3/16in AF	490-9562	47.94



- Chrome vanadium steel with injection moulded cellulose acetate handles
- Extra deep sockets to reach nuts through which bolts protrude
- Heavy duty comfort

419479, 422823

Tip size	Blade length (mm)	Overall length (mm)	Mfrs. list no.	Order code	Price each
3mm	130	220	T4334M 03	109-8791	7.65
3.5mm	130	220	T4334M 035	109-8793	7.65
4mm	130	220	T4334M 04	109-8794	7.65
4.5mm	130	220	T4334M 045	109-8795	7.65
5mm	130	220	T4334M 05	109-8796	7.65
5.5mm	130	220	T4334M 055	109-8797	7.65
6mm	130	220	T4334M 06	109-8798	7.65
7mm	130	230	T4334M 07	109-8799	8.30
8mm	130	230	T4334M 08	109-8800	8.65
9mm	130	230	T4334M 09	109-8801	8.85
10mm	130	230	T4334M 10	109-8802	8.85
11mm	120	220	T4334M 11	109-8803	9.70
12mm	120	220	T4334M 12	109-8804	9.50
13mm	120	220	T4334M 13	109-8805	12.05

Hex Nutdriver

Type 341 For Dry Applications



Wiha. Premium Tools for Professionals.



- Wiha SoftFinish handle, DIN 3125
- Blade chrome vanadium molybdenum steel, chrome-plated
- Deep drawn socket

246084

Mfrs. Part No.	Size x Blade Length	Order Code	Price Each		
			1+	5+	10+
1020	5x125mm	310-6615	3.34	2.78	2.45
1021	5.5x125mm	310-6627	3.34	2.78	2.45
1022	6x125mm	310-6639	3.34	2.78	2.45
1023	7x125mm	310-6640	4.17	3.55	3.16
1024	8x125mm	310-6652	4.31	3.62	3.24
1026	10x125mm	310-6676	4.55	3.77	3.40
1028	12x125mm	310-6718	5.64	4.90	4.28
1029	13x125mm	310-6731	6.45	5.84	4.90

Nutdriver 336 Series Imperial



Blade material: Chrome vanadium steel  
Handle material: ABS plastic (impact-proof and cadmium-free)

Mfrs. Part No.	Tip Size	Blade length	Handle length	Weight (g)
336-53	3/16"	150		84
336-59	1/4"	150		82
336-65	5/16"	150		94
336-71	3/8"	150		96

Dimensions in mm

246093

Mfrs. Part No.	Order Code	1+	5+	10+
336-53	832-418	4.04	3.92	3.53
336-59	832-420	5.02	4.85	4.40
336-65	832-431	4.57	4.42	3.99
336-71	832-443	4.98	4.79	4.35

9 Piece Metric Ratcheting Nut Driver Set



Package Case Contains:  
GearDriver™ Stubby Handle  
5mm, 6mm, 7mm, 8mm, 9mm, 10mm,  
11mm, 12mm  
Nut Driver Shaft

524446

Mfrs. List No.	Order Code	1+	5+	10+
8909	164-7973	31.00	29.76	28.51

**Hex Keys**

Short Hexagonal Ball Ended Keys



- A range of high quality chrome vanadium steel, metric hexagonal keys
- Smaller metric sizes are precision ground
- Chamfered ball point head enables users to use at angles up to 25°

494556.472583

Diameter	Longest Length	Shortest Length	Pack Size	Order Code	Price Each			
					1+	5+	10+	20+
1.5mm	45mm	14mm	5	151-7780	0.87	0.82	0.78	0.75
2mm	50mm	16mm	5	151-7781	0.87	0.82	0.78	0.75
2.5mm	55mm	19mm	5	151-7782	0.87	0.82	0.78	0.75
3mm	63mm	21mm	5	151-7783	0.87	0.82	0.78	0.75
4mm	70mm	27mm	5	151-7784	1.16	1.10	1.05	1.01
4.5mm	70mm	29mm	1	151-7785	1.29	1.19	1.14	1.08

45

Farnell

Diameter	Longest Length	Shortest Length	Pack Size	Order Code	Price Each			
					1+	5+	10+	20+
5mm	81mm	31mm	1	151-7787	1.29	1.19	1.14	1.08
5.5mm	87mm	34mm	1	151-7789	1.35	1.27	1.19	1.13
6mm	92mm	36mm	1	151-7791	1.41	1.34	1.27	1.19
8mm	104mm	42mm	1	151-7792	1.61	1.51	1.44	1.37
10mm	116mm	48mm	1	151-7793	2.20	2.08	1.98	1.89

Long Ball Hex Keys



- A range of high quality chrome vanadium steel, metric hexagonal keys
- Chamfered ball point end on one side allows user to work at angles up to 25°

494559.472593

Diameter	Longest Length	Shortest Length	Pack Size	Order Code	Price Each			
					1+	5+	10+	20+
1.5mm	90mm	14mm	5	151-7794	1.10	1.04	0.99	0.97
2mm	100mm	16mm	5	151-7795	1.13	1.07	1.02	1.00
2.5mm	111mm	19mm	5	151-7796	1.17	1.10	1.05	1.02
3mm	125mm	21mm	5	151-7797	1.29	1.19	1.14	1.11
4mm	140mm	27mm	5	151-7798	1.66	1.55	1.48	1.44
4.5mm	152mm	29mm	1	151-7799	1.39	1.32	1.26	1.18
5mm	161mm	31mm	1	151-7800	1.45	1.38	1.32	1.24
5.5mm	170mm	34mm	1	151-7801	1.57	1.49	1.43	1.36
6mm	182mm	36mm	1	151-7802	1.64	1.54	1.48	1.41
8mm	202mm	42mm	1	151-7803	1.95	1.85	1.77	1.67
10mm	228mm	48mm	1	151-7804	2.64	2.50	2.40	2.26

Loose Keys and Bagged Sets



- A range of Allen Hex keys in Metric and Imperial sizes
- The Metric products conform to **BS4168 Pt 9, ANSI B18.3.2M, ISO2936** and **DIN911** and the Imperial to **BS2470**
- The sets are supplied as bagged loose keys
- Dimensions are Across Flats (AF)

Metric 7 piece	1.5, 2, 2.5, 3, 4, 5 and 6mm
Metric 9 piece	1.5, 2, 2.5, 3, 4, 5, 6, 8 and 10mm
Imperial 8 piece	1/16", 5/64", 3/32", 1/8", 1/32", 1/16", 1/32" and 1/4"
Imperial 10 piece	1/16", 5/64", 3/32", 1/8", 1/32", 1/16", 1/32", 1/4", 5/16" and 3/8"

223245

Keys	Order Code	Price Each
<b>Order Multiple=1</b>		
<b>Imperial</b>		
0.050" (1.27mm)	109-226	0.45
1/16" (1.59mm)	109-227	0.23
5/64" (2mm)	108-661	0.44
3/32" (2.38mm)	109-229	0.46
1/8" (3.18mm)	109-230	0.23
5/32" (3.97mm)	109-231	0.53
3/16" (4.76mm)	100-638	0.37
7/32" (5.56mm)	100-639	0.49
<b>Order Multiple=1</b>		
1/4" (6.35mm)	109-234	0.47
5/16" (7.94mm)	100-640	0.58
3/8" (9.53mm)	100-641	0.98
1/2" (12.7mm)	100-642	1.89
<b>Order Multiple=1</b>		
<b>Metric</b>		
1.27mm	109-226	0.45
1.5mm	108-660	0.44
2.0mm	108-661	0.44
2.5mm	108-662	0.44
3.0mm	108-663	0.44
4.0mm	108-664	0.52
5.0mm	100-675	0.28
6.0mm	100-671	0.37
<b>Order Multiple=1</b>		
8.0mm	100-672	0.56
10.0mm	100-673	1.03
12.0mm	109-248	2.26
14.0mm	100-674	3.20
<b>Sets</b>		
Metric 7 piece	109-232	4.36
Metric 9 piece	109-233	7.82
Imperial 8 piece	109-235	5.98
Imperial 10 piece	109-236	9.59

Hex Key Sets



Metric and imperial hexagonal key sets manufactured from hardened and tempered chrome vanadium steel. Each set is supplied with a plastic holder for easy storage.

Metric Sets

8 piece: 2, 2.5, 3, 3.5, 4, 5, 5.5 and 6mm  
11 piece: 1.2, 1.5, 2, 2.5, 3, 3.5, 4, 4.5, 5, 5.5, and 6mm

Imperial Sets

8 piece: 3/32, 7/64, 1/8, 9/64, 5/32, 3/16, 7/32, and 1/4"  
11 piece: 0.05", 1/16, 5/64, 3/32, 7/64, 1/8, 9/64, 5/32, 3/16, 7/32, and 1/4"

494560.473404

Description	Order Code	Price/Set			
		1+	5+	10+	20+
8PC Metric	151-7805	2.12	1.79	1.66	1.55
8PC Imperial	151-7807	2.12	1.79	1.66	1.55
11PC Metric	151-7808	2.94	2.50	2.26	2.07
11PC Imperial	151-7809	2.94	2.50	2.26	2.07

3 - Way Handle Hex Key Sets



Metric hexagonal key sets manufactured from hardened and tempered steel. Each set is supplied with a plastic holder/handle for easy storage. The plastic handle can be fitted with individual keys to work as a 3 way handle this gives more torque for the user compared to conventional hexagonal keys

**Metric:** 2, 2.5, 3, 4, 5, 6, 8, and 10mm

Description	Order Code	Price/Set			
		1+	5+	10+	20+
8PC Metric	151-7810	5.26	4.83	4.50	4.17

494561.473420

Hex Keys



9 Piece Sets



- Hardened chrome vanadium steel, professional quality keys with a gun finish
- 9 piece sets supplied in a storage bracket
- Long or short series

Set sizes: 1.5, 2, 2.5, 3, 4, 5, 6, 8, 10mm

222916/401720

	Order Code	Price Each		
		1+	+	+
Hex short series	312-6900	2.28	--	--
Hex long series	312-6912	5.02	--	--
Ball hex short series	312-6882	5.20	--	--
Ball hex long series	312-6894	8.00	--	--

**Hex Keys - continued**

**Ball End Hex Key Sets**



- Quality sets of Ball End Hex keys manufactured from hardened chrome vanadium steel
- 8 piece sets supplied in a unique multi-handle case
- Contents: 2, 2.5, 3, 4, 5, 6, 8 and 10mm

222943/401766

	Order Code	1+	Price Each	+
Ball Hex	312-7140	6.11	--	--
Long Ball Hex	312-7102	6.56	--	--

**9 Piece Ball Ended Hex Key Sets**



- A range of high quality chrome vanadium steel, metric hexagonal keys
  - Chamfered ball point end on one side allows user to work at angles up to 25°
- Metric:** 1.5, 2, 2.5, 3, 4, 5, 6, 8, and 10mm  
**Imperial:** 1/16, 5/64, 3/32, 1/8, 5/32, 3/16, 1/4, 5/16, and 3/8"

494562.473443

Description	Order Code	Price/Set			
		1+	5+	10+	20+
9PC Metric	151-7812	7.93	7.49	7.20	6.93
9PC Imperial	151-7813	7.93	7.49	7.20	6.93

**13 Piece Long Arm Ball Ended Hex Key Sets**



- A range of high quality chrome vanadium steel, metric and imperial hexagonal keys
  - Extra long arm for deep insertions of hex nuts or screws
  - Chamfered ball point end on one side allows user to work at angles up to 25°
- Metric:** 1.27, 1.5, 2, 2.5, 3, 3.5, 4, 5, 5.5, 6, 7, 8, and 10mm  
**Imperial:** 0.05, 1/16, 5/64, 3/32, 7/64, 1/8, 5/64, 3/32, 1/8, 5/16, and 3/8"

494563.473445

Description	Order Code	Price/Set			
		1+	5+	10+	20+
13PC Metric	151-7814	13.08	11.77	10.80	9.89
13PC Imperial	151-7815	13.08	11.77	10.80	9.89

**6 Piece Metric Flexible Hex Key Set.**



Pouch Contains:  
 3mm, 4mm, 5mm, 6mm, 8mm,  
 10mm  
 Flexible Hex Key

- 180 degree flex head
- Thinner profile vs traditional fold-ups
- Canvas pouch for compact storage
- Available in:  
 — Torx® Head Style  
 — Hex Head Style

524413

Mfrs. List No.	Order Code	1+	Price Each	5+	10+
82410	164-7965	51.70	49.63	47.56	

**Imperial/Metric Hexagon Key Sets**

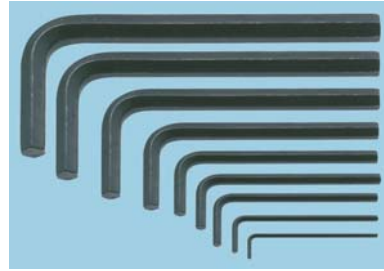

A/F Set, 10 Keys: 1/16", 5/64", 3/32", 1/8", 5/32", 3/16", 7/32", 1/4", 5/16", and 3/8".  
 Metric Set, 9 Keys: 1.5, 2, 2.5, 3, 4, 5, 6, 8 & 10mm

223336

	Order Code	Price Each
A/F sizes (set of 10)	105-605	1+
Metric sizes (set of 9)	105-606	7.95
		6.25

**Magnet Hex Key Set, BlackLaser® Hex-Plus**



- Hex Keys for hexagon socket screws, Hex-Plus, metric
- 7 pieces in two-component clip with magnetizer

Content : 1.5x90; 2.0x101; 2.5x112; 3.0x123; 4.0x137; 5.0x154; 6.0x172

475517

Type	Order Code	1+	Price Each	5+	10+
950 SPKL/7B SM	133-7755	16.34	14.85	13.62	

**Hex Key Set, BlackLaser® Hex-Plus**



Content : 1.5x90 (Regular hexagon); 2.0x100; 2.5x112; 3.0x126; 4.0x140; 5.0x160; 6.0x180; 8.0x200; 10.0x219

- 9 pieces in two-component clip
- Hex Keys for hexagon socket screws, Hex-Plus, metric

475522

Type	Order Code	1+	Price Each	5+	10+
950 PKL/9 BM N	133-7756	11.24	10.21	9.36	

**Ballpoint Hex L-Key Set Inch Set With 13 Pieces In Holder ProStar**



- Space saving ProStar allows the easy removal of each key without moving any others
- Especially for inch-sized screws that are difficult to access
- Chrome vanadium steel, through hardened, manganese-phosphated
- 13 Inch sizes for all common screw sizes

Content:  
 0.05, 1/16, 5/64, 3/32, 7/64, 1/8, 5/64, 3/32, 3/16, 7/32, 1/4, 5/16, 1/8 ;

241427

Mfrs. Part No.	Order Code	1+	Price Each	5+	10+
SB 369 SZ 13B	358-4598	17.55	16.10	15.16	



**Ballpoint Hex L-Key Set in Holder 369 Series**



Wiha. Premium Tools for Professionals.



- Ballpoint Hex L-Key Set in Plastic Holder
- Version in mm and inch available

Material: Chrome vanadium steel

Mfrs. Part No. 369-H7  
Content: 7 pieces  
7 Ballpoint Hex L-Keys  
1,5; 2,0; 2,5; 3,0; 4,0; 5,0; 6,0mm

Weight: 135g

Mfrs. Part No. 369-H9  
Content: 9 pieces  
9 Ballpoint Hex L-Keys  
1,5; 2,0; 2,5; 3,0; 4,0; 5,0; 6,0; 8; 10mm

Weight: 420g

Mfrs. Part No. 369-HZ8  
Content: 8 pieces  
8 Ballpoint Hex L-Keys  
5/64; 3/32; 1/8; 5/32; 3/16; 7/32; 1/4; 5/16 Zoll.

Weight: 280g

241407

Mfrs. Part No.	Order Code	Price Each		
		1+	5+	10+
369-H7	832-017	12.89	11.85	10.74
369-H9	832-029	13.39	12.25	11.01
369-HZ8	832-030	13.71	12.51	11.31

**Ballpoint Hex L-Key Set in ProStar With MagicRing, Type 369R S9, 9 pieces**



Wiha. Premium Tools for Professionals.



- Insert screws into or remove from boreholes, especially in areas that are difficult to access
  - Space saving ProStar allows the easy removal of each key without moving any others
  - MagicRing made from Spring steel holds all standard screws tight at various angles (available from 3mm)
  - The Ballpoint enables the user to work at angles up to 25°
  - Surface chrome-plated
- Sizes:1,5;2,5;3,4;5,6;8,10

246121

Mfrs. Part No.	Order Code	Price Per Set		
		1+	5+	10+
369R S9	301-7977	18.73	16.81	15.14

**Hex L-Key Set in ProStar Wrench Key with MagicRing Type 352R S9, 9 pieces**



Wiha. Premium Tools for Professionals.



- Insert screws into or remove from boreholes, especially in areas that are difficult to access
  - MagicRing made from spring steel holds all standard screws tight at various angles (available from 3mm)
  - Blade nickel-plated
- Size:1,5;2,5;3,4;5,6;8,10

246122

Mfrs. Part No.	Order Code	Price Each	
		1+	11.52
352RS9	301-7989		

**Ballpoint Hex L Key Set in ProStar Type 369 S9, 9 pieces**



Wiha. Premium Tools for Professionals.



- The ballpoint enables the user to work at angles up to 25°
- Space saving ProStar allows the easy removal of each key without moving any others
- Chrome vanadium steel, surface chrome-plated
- SW:1,5; 2,0; 2,5; 3,0; 4,0; 5,0; 6,0; 8,0; 10,0

246123

Mfrs. Part No.	Order Code	Price Per Set	
		1+	5+
369 S9	871-886	19.47	19.06

**Folding Ball End Hex Key Set**



- Chamfered ball point end allows user to work at angles up to 25°
- Keys easily fold into case for easy storage
- Manufactured from hardened and tempered chrome vanadium steel
- Set contains 8 popular sizes Metric Set – 1.5, 2, 2.5, 3, 4, 5, 6 and 8mm

494564.473535

Order Code	Price/Set		
	1+	5+	20+
151-7816	3.64	3.43	2.95

**Mini Pocketstar Hex Fold Out Sets**



Wiha. Premium Tools for Professionals.



- Practical fold out holder for mini keys so they not longer get lost
- Chrome vanadium steel, through hardened, electro-plated
- Ergonomic, reinforced fibreglass housing, 55mm long
- Particularly suitable for use with the smallest screws, e.g. when tightening screws or for the accurate setting of sensors
- Robust casing with eject button for simple and easy key selection
- Hanging loop with matching snap-hook
- With additional blades, 8 pieces

	978-7550	978-7569
	0,7; 0,9; 1,3; 1,5; 2,0	2,0
	1,5; 2,0	1,5; 2,0
	PH 00	PH 00
		T4; T5; T6; T7

413118

Mfrs. Part No.	Order Code	Price Per Set		
		1+	5+	10+
SB 351 PM8X	978-7550	10.32	9.80	9.29
SB 363 PM8X	978-7569	12.18	11.58	10.97

Hex Keys - continued

PocketStar Hex Key Fold Out Set

Type 369 RP7 Ballpoint with MagicRing, 7 pieces



- MagicRing fixes screws in every position through spring steel ring
- Practical fold out holder
- Ergonomic, reinforced fibreglass housing, 95mm long
- Chrome vanadium steel, through hardened, electro-plated

Sizes: 2.0, 2.5, 3.0, 4.0, 5.0, 6.0, 8.0

241361

Mfrs. Part No.	Order Code	Price Each		
		1+	5+	10+
369RP7	310-8028	13.57	11.93	10.57

PocketStar Hex Key Fold Out Set

In Large PocketStar Holder, 7 pieces



- Chrome vanadium steel, through hardened, electro-plated
- Ergonomic, reinforced fibreglass housing, 120mm long
- Practical fold out holder for hex screws in the workplace or on the job
- Robust casing with eject button for simple and easy key selection

Sizes: 2.0, 2.5, 3.0, 4.0, 5.0, 6.0, 8.0

241392

Mfrs. Part No.	Order Code	Price Each		
		1+	5+	10+
351 PG7	310-8030	7.75	6.81	6.28

PocketStar Hex Key Fold Out Set

In Small PocketStar, 7 pieces



- Chrome vanadium steel, through hardened, electro-plated
- Ergonomic, reinforced fibreglass housing, 95mm long
- Practical fold out holder for hex screws in the workplace or on the job
- Robust casing with eject button for simple and easy key selection

Sizes: 1.5; 2.0; 2.5; 3.0; 4.0; 5.0; 6.0

241398

Mfrs. Part No.	Order Code	Price Each		
		1+	5+	10+
351 PK7	310-8193	7.06	6.52	5.84

Ball Hex Driver 540 Series



Ball Hex Driver with T-Handle. The blades are through hardened and nickel-plated.

241490

Mfrs. Part No.	Tip Size (mm)	Blade length (mm)	Order code	Price Each		
				1+	5+	10+
540-4	4	150	848-700	2.91	2.60	2.38
540-5	5	150	848-712	3.76	3.43	3.21
540-6	6	150	848-724	4.60	4.18	3.75

Hex Driver 334 Series



Hex driver with T-Handle. Blades through hardened and nickel-plated. For high torque transfer with low effort.

Blade material: Chrome vanadium steel  
Handle material: ABS plastic (impact-proof and cadmium-free)

Mfrs. Part No.	Tip Size	Blade length	Handle length	Weight (g)
334-2.0	2.0	100	70	28
334-2L	2.0	200	70	31
334-2.5	2.5	100	70	30
334-2.5L	2.5	200	70	35
334-3.0	3.0	100	70	32
334-3L	3.0	200	70	40
334-4.0	4.0	100	70	38
334-5.0	5.0	100	90	60
334-5L	5.0	200	90	82

Dimensions in mm

241492

Mfrs. Part No.	Order Code	Price Each		
		1+	5+	10+
334-2.0	832-108	1.93	1.79	1.59
334-2L	832-110	2.62	2.37	2.17
334-2.5	832-121	1.99	1.83	1.65
334-2.5L	832-133	2.62	2.37	2.17
334-3.0	832-145	1.83	1.66	1.52
334-3L	832-157	2.65	2.30	2.20
334-4.0	832-169	1.95	1.77	1.61
334-5.0	832-182	2.21	1.99	1.81
334-5L	832-194	2.68	2.45	2.23

Hex Driver 334 Series

Imperial



Mfrs. Part No.	Tip Size	Blade length	Handle length	Weight (g)
334-53	3/32"	150	70	31
334-56	7/64"	150	70	34
334-59	1/8"	150	70	36
334-62	9/64"	150	70	40
334-68	3/16"	150	90	70
334-71	7/32"	150	90	79

Dimensions in mm

241496

Mfrs. Part No.	Order Code	Price Each		
		1+	5+	10+
334-53	832-510	2.51	2.28	2.09
334-56	832-522	2.51	2.28	2.09
334-59	832-534	2.40	2.20	1.97
334-62	832-546	2.47	2.27	2.03
334-68	832-560	2.59	2.35	2.13
334-71	832-571	2.89	2.67	2.41

Hex Driver with ComfortGrip

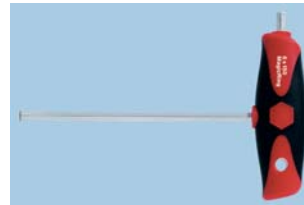

- Hex Driver with T-Handle, MagicRing (Holding function) and Side Blade
- Wiha ComfortGrip, the comfortable multi-component T-handle with soft zones for maximum working comfort.
- For comfortable high torque transfer. Especially useful for loosening or tightening screws that are hard to move.
- One piece blade, through the handle withstands even the highest stresses.

345659

Mfrs. Part No.	AF size mm	Order Code	Price Each		
			1+	5+	10+
334DSR3	3 x 100	762-3658	3.14	2.86	2.62
334DSR4	4 x 150	762-3666	3.60	3.27	3.00
334DSR5	5 x 150	762-3674	3.77	3.44	3.15
334DSR6	6 x 150	762-3682	4.04	3.66	3.34
334DSR8	8 x 200	762-3690	5.37	4.89	4.48
334DSR10	10 x 200	762-3704	8.33	7.59	6.95

**Hex Driver Set with T-Handle**



Wiha. Premium Tools for Professionals.



- Blister-packed, 6 pieces
- 6 common sizes packed in set

345776

Mfrs. Part No.	Order Code	1+	5+	10+
334DSK6	Hex 762-3798	15.23	13.84	12.69
364DSK6	TORX 762-3801	26.44	24.03	22.02

**Torx Keys**

**7 piece Hex Key set with Magic Spring function**  
Angled Screwdriver Set With MagicSpring



Wiha. Premium Tools for Professionals.



- MagicSpring holding spring composed of stainless steel reliably holds any TORX®screw firmly.
- No more tedious searching for screws that have been dropped
- Ideal where access is difficult
- Manufactured from high-quality materials based on the known Wiha quality
- Also suitable for TORX® screws composed of aluminium, stainless steel, plastic and titanium

345771

Mfrs. List No.	Sizes	Order Code	1+	5+	10+
371RHM7	7pcs. (T6 to T20)	762-3780	15.13	14.60	13.99
<b>Single Keys</b>					
371R T6	Tx 6	135-9433	3.34	3.18	3.08
371R T7	Tx 7	135-9434	3.23	3.13	2.98
371R T8	Tx 8	135-9436	3.23	3.13	2.98
371R T9	Tx 9	135-9437	3.29	3.13	3.03
371R T10	Tx 10	135-9438	3.40	3.29	3.13
371R T15	Tx 15	135-9439	3.50	3.39	3.23
371R T20	Tx 20	135-9440	3.60	3.44	3.29
371R T25	Tx 25	135-9441	3.82	3.65	3.49
371R T27	Tx 27	135-9442	3.99	3.81	3.65
371R T30	Tx 30	135-9443	4.19	4.02	3.86
371R T40	Tx 40	135-9444	4.88	4.70	4.48

**TORX® L-Key Set**

13 pieces in ProStar holder



Wiha. Premium Tools for Professionals.



- Space saving ProStar allows the easy removal of each key without moving any other
- For all TORX screw applications
- All keys from T5 to T50 in one set
- 13 TORX sizes for all common screw sizes
- Chrome vanadium steel, through hardened, manganese-phosphated

Content:  
T5; T6; T7; T8; T9; T10; T15; T20; T25; T27; T30; T40; T50

241428

Mfrs. Part No.	Order Code	1+	5+	10+
SB 366 SZ 13	358-4586	23.33	21.88	20.94

**6 Piece Torx® Flexible Hex Key Set**



- 180 degree flex head
- Thinner profile vs traditional fold-ups
- Canvas pouch for compact storage
- Available in:
  - Torx®Head Style
  - Hex Head Style

Pouch Contains:  
T-25, T-27, T-30, T-40, T-45, T-50  
Flexible Torx Key

524436

Mfrs. List No.	Order Code	1+	5+	10+
82420	164-7966	60.39	57.96	55.58

**TORX® BO Key Set, BlackLaser®**



967 SPKL/9



- L-Key Sets for TORX® screws
- Powerful, long service life, ergonomic
- 9 pieces in two-component clip with magnetizer

Content:	
Each	TX 8x76 <sup>1</sup> ; TX 9x79 <sup>1</sup> ; TX 10x85 <sup>2</sup> ; TX 15x90; TX 20x96; TX 25x104; TX 27x112; TX 30x122; TX 40x132
<sup>1</sup> Product without bore hole at the short and without ball-end at the long arm	
<sup>2</sup> Product without ball-end at the long arm	

475525

Type	Order Code	1+	5+	10+
967 SPKL/9 TORX BO	133-7757	23.90	21.73	19.91

**9 Piece Tamperproof Torx Key Set**



9 piece torx key set comprising of the following sizes:  
 ● T10, T15, T20, T25, T27, T30, T40, T45 and T50  
 ● Chrome plated finish  
 ● Supplied in a handy, impact resistant holder which allows easy access to each key

482085.462205

Order Code	1+	5+	10+	20+	50+
144-7546	5.79	5.19	4.64	4.35	3.95

**40 Piece Torx Set**

TX-Star



- Super TX-Star offset wrenches, sockets and 1/4", 3/8", 1/2" Square Drive socket bit holders complete in a metal case
- Inserts are hardened and tempered, with a matt finish
- Sockets are chrome vanadium steel, hardened and tempered with a chrome plated finish

222965

Order Code	Price Each
312-7242	1+ 44.37

**Torx Keys - continued**

**Torx Driver with T-Handle and Side Blade**

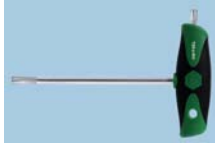

- For comfortable high torque transfer - Especially useful for loosening or tightening screws that are hard to move
- One piece blade, through the handle withstands even the highest stresses

345765

Mftrs. Part No.	AF size mm	Order Code	1+	5+	10+
364DST10	T10 x 100	<b>762-3712</b>	4.68	4.26	3.90
364DST15	T15 x 100	<b>762-3720</b>	4.86	4.42	4.05
364DST20	T20 x 100	<b>762-3739</b>	5.24	4.77	4.37
364DST25	T25 x 150	<b>762-3747</b>	5.24	4.77	4.37
364DST27	T27 x 150	<b>762-3755</b>	5.37	4.89	4.48
364DST30	T30 x 150	<b>762-3763</b>	5.42	4.93	4.53
364DST40	T40 x 150	<b>762-3771</b>	5.67	5.16	4.73

**Hex Driver Set with T-Handle**



- Blister-packed, 6 pieces
- 6 common sizes packed in set

345776

Mftrs. Part No.	Order Code	1+	5+	10+
334DSK6	Hex <b>762-3798</b>	15.23	13.84	12.69
364DSK6	TORX <b>762-3801</b>	26.44	24.03	22.02

45

**PocketStar TORX® Key Fold Out Set**  
In Small PocketStar, 7 pieces



- Chrome vanadium steel, through hardened, electro-plated
- Ergonomic, reinforced fibreglass housing, 95mm long
- Practical fold out holder for TORX® Tamper Resistant (with security pin) screws in the workplace or on the job
- Robust casing with eject button for simple and easy key selection. Borehole in every blade tip.

Sizes: T7; T8; T9; T10; T15; T20; T25

241406

Mftrs. Part No.	Order Code	1+	5+	10+
363 P7	<b>310-8223</b>	10.48	9.54	8.64

**PocketStar TORX® Key Hold Out Set**  
In Large PocketStar, 8 pieces



- Chrome vanadium steel, through hardened, electro-plated
- Ergonomic, reinforced fibreglass housing, 120mm long
- Practical fold out holder for TORX® screws in the workplace or on the job
- Robust casing with eject button for simple and easy key selection.

Sizes: T9; T10; T15; T20; T25; T27; T30; T40

241420

Mftrs. Part No.	Order Code	1+	5+	10+
363 P8	<b>310-8235</b>	11.39	10.54	9.57

**Tamperproof Torx Bit Set**



- High grade alloy steel bits with rust resistant finish
- Held securely in a handy clip
- 1/4" hex drive
- Length: 25 mm

Contents:  
T06, T07, T08, T09, T10, T15, T20, T25

495506

Mftrs. List No.	Order Code	1+	5+	10+	20+
T4407	<b>151-8937</b>	22.65	21.95	21.30	20.40

**Switch Keys**

**Pen-Style Control Cabinet Key with voltage tester**  
for all standard cabinets and shut-off systems



New additional feature allows reliable detection of alternating current in insulated cables, conductors, plugs and power sockets; also without current flow. After switching-on an LED indicates the readiness for operation; this provides certainty in application.

- with voltage tester for contactless detection of alternating current 50-60 Hz
- easy to carry pen-style control cabinet key with fastening clip
- four different key profiles can be utilized by swivelling the key holder for control cabinets and shut-off systems in the supply of gas, water and electricity
- for technical installations in buildings, e. g. air conditioning and ventilation systems, shut-off valves, mains switch-boards, etc.
- magnetic 1/4" bit adapter for standard bits as well as additional bit adapter for 1/4" bits inside one key profile
- cross recess PH 2 bit included
- battery compartment with bayonet catch for easy battery exchange (2 x LR44)
- corpus and fastening clip made from plastic material;
- tool holder and key profiles of diecast zinc

506100

Mftrs' List No.	Order Code	1+	3+	5+
00 11 17	<b>156-0898</b>	40.58	38.52	36.51

**Pen-type switchgear cabinet key**  
for current cabinets and shut-off systems



- transport-friendly switchgear cabinet key in the form of a ballpoint pen with fastening clip
- by swivelling out the key holder four different key profiles can be made available for use
- for switchgear cabinets, shut-off systems for gas, water and electricity supply
- for technical installations in buildings such as air-conditioning and ventilation systems, shut-off valves, mains switch-boards etc. square 5 / 6 / 8 mm
- triangle 9 mm

- two-way key bit Ø 5 mm (inner) / Ø 9 mm (outer)
- universal 1/4" bit holder for conventional bits (permanent magnet for fixing)
- additional bit holder for 1/4" bits in a key profile
- with bit: cross recess PH 2 and option of storing a second bit
- fastening clip for secure storage
- length: 145 mm

471220

Mftrs' List No.	Order Code	1+	5+	10+
00 11 07	<b>134-3517</b>	16.05	15.55	15.10



**Pen-type professional key**  
for current shut-off systems



- transport-friendly switchgear cabinet key in the form of a ballpoint pen with fastening clip
- by swivelling out the key holder four different key profiles can be made available for use
- universal key for all building tradesmen
- key for the sectors of heating, air-conditioning, hygiene and buildings engineering, e.g. for door and window handles or for heating deaeration
- square 5 / 8 mm
- triangle 9 mm

- stepped square 6 / 7 / 8 / 9 mm
- universal 1/4" bit holder for conventional bits (permanent magnet for fixing)
- additional bit holder for 1/4" bits in a key profile
- with bit: cross recess PH 2 and option for storing a second bit
- fastening clip for secure storage
- Length: 145 mm

471230

Mfrs' List No.	Order Code	Price Each		
		1+	5+	10+
00 11 08	134-3519	16.05	15.55	15.10

**Universal Pen Style Switch Key**



Unique, compact pen-style key, designed to be stored with ease and fit conveniently in the pocket, the keys fold back into the body.

- Pocket clip
- Multi-purpose functionality for use on locking systems of electric, gas and water cupboards and mains consoles etc
- Features a Modulo size 2 terminal screwdriver bit

476042.509489

Mfrs. List No.	Order Code	Price Each			
		1+	5+	10+	20+
T4451-1	139-1009	17.25	16.65	15.92	15.22

**Wrench Switch Key**



A multi purpose tool designed for use on locking systems of electric, gas and water cupboards, in industry and / or technical equipment in buildings such as air conditioning, ventilation systems, stop valves, mains console etc.

- Manufactured from zinc -die cast
- The tool comprises of:
  - 6mm, 8mm, square, 9mm triangular and 5mm double pin type keys
  - Key supplied with tooling adaptor for 1/4" hex bits
  - Complete with double ended screwdriver bit, 7mm slotted x Phillips No.2

448435.509365

Mfrs. List No.	Order Code	Price Each	
		1+	5+
495002	128-3272	8.06	7.91

**Technical information at your fingertips**



Over **352,000** technical datasheets available online.

Visit [www.farnell.co.uk](http://www.farnell.co.uk) and look for the **Tech Info** heading in your search results.

**Switchgear Cabinet Spanner**  
Small and large version



- For all standard locking systems for gas, water and electricity supply, as well as technical systems in buildings such as air-conditioning and ventilation systems, shut-off valves, mains switch panels, etc. with alternate bit insert and matching holder
- 6 + 8 mm quadrilateral
- 9 mm triangle
- 9 mm diameter double bit
- With attachment chain
- Bit insert: 1.0 x 7 mm slot and PH2 cruciform slot
- 413-3889: small version, super-handly (use and capacity as 413-3890!)

Mfrs. List No.	Length mm	Capacity			Weight g
		Quadrilateral	Triangle	Double bit	
00 11 02	44	6 + 8			50
00 11 03	76	5 / 6 / 8		9	50

Material: Zinc casting

242897

Mfrs. List No.	Order Code	Price Each		
		1+	5+	10+
00 11 02	416-3989	8.00	7.75	7.50
00 11 03	416-3990	8.85	8.60	8.30

**Profi-Key**



- key for heating, air-conditioning, sanitary and building engineering, e. g. for door and window handles or for air bleeding heaters
- with bit insert: slot 1.0 x 7 mm and cross recess PH 2
- with adaptor for 1/4" bits on securing chain
- additional bit adapter for 1/4" bits in one arm
- total length: 90 mm
- zinc die-casting

Knipex	Capacity Square	Capacity step-like square	Bit Slotted Screwdriver	Bit Phillips
Mfrs. Part No.	mm	mm	mm	
00 11 04	5 / 7 / 8	4 - 10	1,0 X 7 mm	PH 2

242858

Mfrs. Part No.	Order Code	Price Each		
		1+	5+	10+
00 11 04	416-4003	7.80	7.55	7.35

**Switch Key Wrench**



This switch key wrench has been designed for unlocking electric, gas and water cupboards. It can also be used to gain access to air conditioning, ventilation systems, stop valves or mains consoles etc. It is supplied with a tooling adaptor for 6.35mm (1/4") hexagon bits and a double ended slotted screwdriver 7mm and Philips No2 bits.

495365.460537

Mfrs. List No.	Order Code	Price Each		
		1+	5+	10+
495015	151-8931	11.62	11.27	10.92

**Torque Tools**

**Adjustable torque screwdriver & sets**  
with Rapidaptor® quick-release chuck



133-7758, 133-7759



133-7760



133-7765



133-7766

- **Simple:** rapid adjustment of the torque value without auxiliary tool
- **Variable:** rapid and unproblematic bit replacement thanks to the Rapidaptor® quick-release chuck
- **Ergonomic:** fitted with a multi-component Kraftform® handle
- **Exact:** meets the standard EN ISO 6789 in relation to the measurement accuracy
- For 1/4" bits DIN 3126-C 6.3 and E 6.3
- **Certificate:** a test certificate is also supplied
- Set 133-7765 includes: torque drivers 7440 and 7441; hexagon bits (2.0; 2.5; 3.0; 4.0; 5.0; 6.0), Torx bits (TX6; TX7, TX8, TX9, TX10, TX15, TX20, TX25, TX30); TorxPlus bits (6IP; 7IP; 8IP, 9IP, 10IP, 15IP, 20IP, 25IP, 30IP)
- Set 133-7766 includes: torque drivers 7440, 7441 and 7442; hexagon bits (2.0; 2.5; 3.0; 4.0; 5.0; 6.0), Torx bits (TX6; TX7, TX8, TX9, TX10, TX15, TX20, TX25, TX30); TorxPlus bits (6IP; 7IP; 8IP, 9IP; 10IP, 15IP, 20IP, 25IP, 30IP)

Mftrs' List No.	Holder	Measurement range Nm	Scale graduation	Length	
				mm	Inch
7440	1/4"	0.3 - 1.2	0.05 Nm	155	6
7441	1/4"	1.2 - 3.0	0.10 Nm	155	6
7442	1/4"	3.0 - 6.0	0.25 Nm	150	6

475582

Mftrs' List No.	Order Code	Price Each		
		1+	3+	5+
7440	133-7758	44.09	40.70	37.81
7441	133-7759	36.69	33.87	31.46
7442	133-7760	52.80	48.73	45.25
7440/41	133-7765	90.68	83.70	77.72
7740/41/42	133-7766	135.42	124.99	121.38

**Preset torque screwdriver**  
with Rapidaptor® quick-release chuck



133-7761, 133-7763



133-7764

- Supplied with a fixedly preset torque
- The torque can nevertheless be altered within the measurement range\*
- For 1/4" bits DIN 3126-C 6.3 and E 6.3
- ideal for all applications in which the same torque is constantly required and a high de-

- degree of repetition accuracy is required
- The preset torque screwdrivers meet the requirements of the standard EN ISO 6789 in relation to the measurement accuracy of  $\pm 6\%$
- A test certificate is also supplied

\* For this remove the cap at the upper end of the handle and actuate the adjusting nut with the aid of a plug-in key screwdriver. After setting the desired torque by means of a conventional torque testing unit, the handle is resealed with a cap.

Mftrs' List No.	Holder	preset Torque Nm	Measurement range Nm	Length	
				mm	Inch
7460	1/4"	0.3 Nm	0.3 - 1.2	155	6
7461	1/4"	1.2 Nm	1.2 - 3.0	155	6
7462	1/4"	3.0 Nm	3.0 - 6.0	150	6

475630

Mftrs' List No.	Order Code	Price Each		
		1+	3+	5+
7460	133-7761	27.48	25.38	23.57
7461	133-7763	27.48	25.38	23.57
7462	133-7764	33.62	31.04	28.82

**ESD Adjustable Torque Screwdrivers**  
with Rapidaptor® Quick-Release Chuck



- **Easy:** Quick and easy pre-set torque adjustment through an integrated adjustment ring: no special tool required
- **Flexible:** the Rapidaptor quick release bit holder allows changing of bits in seconds - even single-handedly
- **Ergonomic:** Kraftform® Handle with ergonomic shape and excellent power transfer capabilities
- **Accurate:** meet the standards of the EN ISO 6789 with regards to measuring accuracy
- **Better than the Norm:** perform better than the European Norm EN 100-015 Part 1 with regards to ESD safety
- **Certified:** All torque screwdrivers are supplied with a calibration certificate

Mftrs List No.	Drive	Measuring Range	Graduation	Length	
				mm	Inch
7440 ESD	122-7106	0.3 - 1.2N-m	0,05 Nm	155	6
7441 ESD	122-7107	0.3 - 1.2N-m	0,10 Nm	155	6
7445 ESD	122-7108	2.5 - 11.5 in.lbs	0.5 in.lbs.	155	6
7446 ESD	122-7109	11.0 - 29.0 in.lbs	1.0 in.lbs.	155	6

440382

Mftrs List No.	Order Code	Price Each		
		1+	3+	5+
7440 ESD	122-7106	53.40	49.11	45.37
7441 ESD	122-7107	46.75	43.00	39.73
7445 ESD	122-7108	51.94	47.78	44.14
7446 ESD	122-7109	51.94	47.78	44.14

**13 Piece Torque Vario - S® ESD Set**



Wiha. Premium Tools for Professionals.



- ESD-safe
- with variable torque setting capability
- With universal bit holder and 10 Slot/Phillips/Pozidriv/TORX standard bits
- Numerical torque indication on a window scale
- Torque variable as required within the specified torque range
- The torque itself is read on a commercially available torque meter

Content:

2882	ESD TorqueVario-S® 0.8 to 2.0 Nm
2889	ESD Bit Holder 1/4x4
288-900	ESD Adjusting Tool ToqueSetter
7013 Z	4.0x25 5.5x25
7011 Z	PH0x25 PH1x25
7012 Z	PZ0x25 PZ1x25
7015 Z	T7x25 T8x25 T9x25 T10x25

457779

Mftrs. List No.	Order Code	Price Each		
		1+	3+	5+
TorqueVario-S® ESD Set	132-7539	103.25	98.09	92.92

### 13 Piece Torque Vario - S® Set

TorqueVario-S<sup>+</sup> } Set



Wiha. Premium Tools for Professionals.



#### 13-Piece With Scale

- with variable torque setting capability
- With universal bit holder and 10 Phillips/Pozidriv/TORX/hexagonal standard bits
- Numerical torque indication on a window scale
- Torque variable as required within the specified torque range
- The torque itself is read on a commercially available torque meter

Content:

2852	TorqueVario-S® 1.0 to 5.0 Nm
26163	Standard Bit Holder
26864	Adjusting Tool TorqueSetter
7011 Z	PH1 PH2
7012 Z	PZ1 PZ2
7015 Z	T10 T15 T20 T25
7013 Z	SW 2.5 SW 3

333302

Mfrs. List No.	Order Code	1+	3+	5+
TorqueVario-S® Set	443-1492	89.83	86.27	82.70

### easyTorque Torque Screwdriver

With a Pre-Set Fixed Torque Setting



Wiha. Premium Tools for Professionals.



- Ideal for applications where the exact torque is always needed, e.g. the changing of indexable inserts
- Comfortable handle for good power transfer
- Lightweight design, torque value printed on foot
- Internal mechanism slips when torque value has been attained
- Opening torque not mechanically limited in anti-clockwise direction
- Release accuracy ± 10%
- Interchangeable blades with colour coding

427222

Mfrs. List No./ Torque (Nm)	Order Code	1+	3+	10+
291 0.5	115-6338	22.07	20.98	19.87
291 0.6	115-6339	21.48	20.40	19.32
291 0.9	115-6340	21.48	20.40	19.32
291 1.1	115-6341	21.48	20.40	19.32
291 1.2	115-6343	21.48	20.40	19.32
291 1.4	115-6344	21.48	20.40	19.32
291 2.0	115-6345	21.48	20.40	19.32
291 2.5	115-6346	21.48	20.40	19.32
291 3.0	115-6347	21.48	20.40	19.32
291 3.8	115-6348	21.48	20.40	19.32

### Ergonomic Torque Screwdriver

TorqueFix® and TorqueVario®

- Designed especially for industrial applications
- Ergonomical in use
- Precise and compact in construction
- Click signal at achieving torque
- Both ideal for dry and humid applications
- Colour-coded reversing blade
- Universal Bitholder for all C6,3 and E6,3 bits
- Adapting blades for all 1/4" wrench sockets
- Meets following requirements: EN ISO 6789, BS EN 26789, ASME B107.14M

333297

## Coming soon



Register your interest for items that are 'Coming Soon' at [www.farnell.co.uk](http://www.farnell.co.uk) and we'll email you to let you know that they're in stock.

### Torque Screwdriver TorqueFix®

With Defined Fix Torque Value



Wiha. Premium Tools for Professionals.



- Ideal for applications with continuous same torque value, i.e.
- - for industrial serial screwing
- - for changing of reversible plate on CNC-working centres
- TorqueFix® is offered in torque interval 0,5 - 7,2Nm (±6%)
- Supplied in convenient plastic box

Mfrs. Part No.	Order Code	Torque (±6%)		Handle Length
		Nm	in.lbs	mm
26127	443-1509	0.5	4,43	112
26047	443-1510	0.6	5,32	112
26048	443-1522	0.9	7,79	112
26133	443-1534	1.1	9,74	119
26051	443-1546	2.0	17,7	119
26128	443-1558	2.5	22,1	119
26052	443-1560	3.0	26,6	126
26129	443-1571	3.8	33,6	112
26130	443-1583	5.5	48,7	132
26131	443-1595	7.2	63,7	132

333299

Mfrs. Part No.	Order Code	Price Each		
		1+	3+	5+
26127	443-1509	49.44	47.45	44.98
26047	443-1510	49.44	47.45	44.98
26048	443-1522	49.44	47.45	44.98
26133	443-1534	54.65	52.47	49.73
26051	443-1546	54.65	52.47	49.73
26128	443-1558	43.72	41.98	39.78
26052	443-1560	49.71	47.73	45.24
26129	443-1571	54.70	52.52	49.78
26130	443-1583	62.31	59.82	56.69
26131	443-1595	62.31	59.82	56.69

### Torque Screwdriver TorqueVario®-S With Scale

With Variable Torque Adjustment Possibility



Wiha. Premium Tools for Professionals.



- Numeric torque display on scale
- Torque can be adjusted continuously within defined Torque interval
- Separate tool for changing torque (torque-setter) supplied
- Torque can be read off at standard torque tester
- Supplied in convenient plastic box

Mfrs. Part No.	Order Code	Torque (±6%)		Length
		Nm	in.lbs	mm
26461	443-1467	0.4 - 1.0	3,54 - 8,85	127
26462	443-1479	0.8 - 2.0	7,08 - 17,7	131
26463	443-1480	1.0 - 5.0	8,85 - 53,1	138

333298

Mfrs. Part No.	Order Code	Price Each		
		1+	3+	5+
26461	443-1467	57.18	54.88	52.03
26462	443-1479	54.10	51.94	49.22
26463	443-1480	71.72	68.87	65.29

### Reversing Blades

For TorqueFix® and TorqueVario®-S



Wiha. Premium Tools for Professionals.

- Chrome vanadium steel, through hardened and chrome-plated
- Wiha ChromTop Blade tip
- For Slotted, Phillips, Pozidriv, Torx® and Allen screw



Mfrs. Part No.	Colour Code	Order Code	Price Each			
			1+	3+	5+	
26277	Slotted 0,5x3,0	gray	443-1601	2.77	2.66	2.52
26278	Slotted 0,6x3,5	gray	443-1613	2.77	2.66	2.52
26279	Slotted 0,8x4,0	gray	443-1625	2.77	2.66	2.52



**Torque Tools - continued**

**Reversing Blades - continued**

For TorqueFix® and TorqueVario®-S - continued

Mfrs. Part No.	Colour Code	Order Code	1+	3+	5+	Price Each
26199	Phillips No 000	dark blue	<b>443-1637</b>	2.77	2.66	2.52
26196	Phillips No 00	dark blue	<b>443-1649</b>	2.77	2.66	2.52
26197	Phillips No 0	dark blue	<b>443-1650</b>	2.77	2.66	2.52
26058	Phillips No 1	dark blue	<b>443-1662</b>	2.77	2.66	2.52



Mfrs. Part No.	Colour Code	Order Code	1+	3+	5+	Price Each
26198	Pozidriv No.0	light blue	<b>443-1674</b>	2.22	2.13	2.02
26198	Posidriv No1	light blue	<b>443-1686</b>	2.77	2.66	2.52



Mfrs. Part No.	Colour Code	Order Code	1+	3+	5+	Price Each
26158	T5	dark green	<b>443-1698</b>	2.77	2.66	2.52
26064	T6	dark green	<b>443-1704</b>	2.77	2.66	2.52
26065	T7	dark green	<b>443-1716</b>	2.77	2.66	2.52
26066	T8	dark green	<b>443-1728</b>	2.77	2.66	2.52
26059	T9	dark green	<b>443-1730</b>	2.22	2.13	2.02
26067	T10	dark green	<b>443-1741</b>	2.77	2.66	2.52
26068	T15	dark green	<b>443-1753</b>	2.77	2.66	2.52
26069	T20	dark green	<b>443-1765</b>	2.77	2.66	2.52
26070	T25	dark green	<b>443-1777</b>	2.77	2.66	2.52



333304

Mfrs. Part No.	Colour Code	Order Code	1+	3+	5+	Price Each
26221	SW 1,5	red	<b>443-1789</b>	2.77	2.66	2.52
26222	SW 2	red	<b>443-1790</b>	2.77	2.66	2.52
26223	SW 2,5	red	<b>443-1807</b>	2.77	2.66	2.52
26224	SW 3	red	<b>443-1819</b>	2.77	2.66	2.52
26225	SW 4	red	<b>443-1820</b>	2.77	2.66	2.52

**Preset Torque Screwdriver**



Comfortable shape and user friendly designed grip these torque screwdrivers feature cam-over torque limiting clutch for repeatability and accuracy. (Accuracy ± 6% DIN/ISO 6789, EN 26789/1994). ¼ hexagon non-magnetic spring loaded bit holder is fitted to avoid damaging sensitive equipment or components in electronic applications. Also included is an adaptor to use ¼ sockets.

357015

Model	Torque Range (cNm)	Square Drive (inch)	Length (mm)	Order Code	Price Each
PS501-2	7 - 70	¼	141	<b>352-4188</b>	109.62

**Micro adjustable torque screwdriver**



This torque screwdriver features a cam-over torque limiting clutch for repeatability and accuracy. An easy to read window scale and easy to use adjustment knob for precise settings. (Accuracy ± 6% DIN/SIO 6789, EN26789/1994). A comfortable friendly designed grip makes the tool easy to use. A ¼in hexagon non-magnetic spring loaded bit holder is included to avoid damaging sensitive equipment or components in electronic applications. Also included is a ¼in adaptor to use hexagon sockets.

357017

Model	Torque Range (cNm)	Square Drive (inch)	Length (mm)	Order Code	Price Each
MA500-1	10 - 80	¼	138	<b>352-4218</b>	159.36
MA500-3	50 - 450	¼	171	<b>352-4231</b>	166.46

**Torque wrench**

Type FS



**Insert:**

- monitored screw tightening in the range from 0.02 -13.6 N.m
- production installation with tightening to a constant value
- electronics industry, precision mechanics and industrial manufacture

**Version:**

- fixed presettable torque wrench - without scale
- with ¼"hexagonal insert holder for operation of ¼" bits to DIN 3126 - C 6.3
- also with adapter fitting ¼"socket inserts to DIN 3124
- release accuracy: ±6% tolerance of the selected value
- to DIN EN ISO 6789, traceable to national standards
- precision revolving ball coupling for monitored clockwise and anti-clockwise tightening
- precision mechanism slips on reaching the selected value
- automatic reset to the original position

- light design with anodized aluminium handles
- ESD (Electro Static Discharge) = proof against electrostatic discharge (except for the Model 755 05)
- the fixed setting can be produced autonomously on suitable test equipment

**Items supplied:**

- ✓ Torque wrench
- ✓ ¼" square/hexagonal adapter drive piece (No. 757-20)
- ✓ Test certificate to DIN EN ISO 6789
- ✓ Operating instructions
- ✓ Supplied in a robust carton

Mfrs List No.	Order Code	Drive	Torque Range	Length mm	Colour	Weight
755-02	472-6820	1/4"	0.5 - 22 cN m	104	Gold	72g
755-03	472-6832	1/4"	2 - 135 cN m	111	Blue	210g
755-04	472-6844	1/4"	6 - 406 cN m	127	Green	280g
755-05	979-1507	1/4"	1 - 13.6 N m	137	Black	325g

334175

Mfrs. List No.	Colour	Order Code	1+	3+	5+	Price Each
755-02	Gold	<b>472-6820</b>	123.69	118.66	114.02	
755-03	Blue	<b>472-6832</b>	102.44	97.33	92.69	
755-04	Green	<b>472-6844</b>	110.75	105.32	99.88	
755-05	Black	<b>979-1507</b>	160.97	152.99	144.80	

**Dial Indicating Screwdriver**



Dial measuring torque screwdrivers for the measurement and application of low torque values. Accuracy ± 5% of reading. All models can be used in either track mode, where the pointer tracks the applied torque, or in memory mode where the pointer remains at the maximum torque applied. The mode is easily changed by withdrawing a slider and resetting the bezel ring. Flat torsion spring mechanism gives the best linear characteristics in both directions. Stainless steel shafts with colour coded aluminium handles and glass filled nylon dials. All with ¼in female hexagon drive. Supplied with calibration certificate traceable to International Standards.

492367

Model	Range	Sub Division	Colour	Order Code	Price Each
TT50 F/Hex	14 - 70 ozf in 10 - 50 cNm	2 ozf in 2 cNm	Gold	<b>150-9456</b>	112.93
TT100 F/Hex	28 - 140 ozf in 20 - 100 cNm	5 ozf in 5 cNm	Blue	<b>150-9458</b>	112.93
TT250 F/Hex	4 - 20 lbf in 80 - 250 cNm	0.5 lbf in 10 cNm	Red	<b>150-9459</b>	119.88
TT500 F/Hex	8 - 40 lbf in 100 - 500 cNm	1 lbf in 20 cNm	Green	<b>150-9460</b>	119.88

**Torque Wrench**



- ½" square drive with reversible ratchet head, calibrated in Nm and Mkg, settings etched on barrel.
- Micrometer type sleeve ensures accurate setting of torque, individually calibrated with Certificate of Calibration. Manufactured to **DIN 3122**
- Housed in strong storage case with 120mm extension and ¾" adaptor
- Range: 28-210Nm/2.9-21.4Mkg, 600mm long, weight 1.8kg

231792

Mfrs. List No.	Order Code	Price Each
T4463	<b>327-9870</b>	1+ 48.50



**Slimline Torque Wrenches**  
Slimline



Feature a push through ratchet head for clockwise and anti-clockwise applications. Calibrated to an accuracy greater than ±4% of full scale with an easily read scale and positive torque adjustment locking ring. The handle has been moulded to aid correct hand location and operator comfort. Supplied with a traceable certificate of calibration.

489086

Model	Torque Range		Square drive	Order Code	Price Each			
	(Nm)	(lbf.ft)			1+	5+	10+	20+
SL1	8 - 54	5 - 40	3/8	<b>137-5318</b>	53.30	49.50	46.20	43.31
SL1	8 - 54	5 - 40	1/2	<b>137-5288</b>	53.30	49.50	46.20	43.31
SL2	30 - 150	20 - 110	1/2	<b>137-4364</b>	55.81	51.82	48.37	45.90
SL3	50 - 230	40 - 170	1/2	<b>137-4365</b>	68.82	67.46	66.10	63.54

**Torque Wrenches**



Designed for applications at the lower end of the torque scale. Available in 1/4in or 3/8in reversible ratchets or as 3/8in fixed head. Calibrated to an accuracy greater than ±4% of full scale exceeding all international standards. Supplied with a traceable certificate of calibration.

494268

Model	Torque Range		Square Drive	Order Code	Price Each			
	(Nm)	(lbf.in)			1+	5+	10+	20+
SLO	4 - 20	40 - 180	1/4	<b>137-5312</b>				52.40
SLO	4 - 20	40 - 180	3/8	<b>137-5307</b>				52.40
SLOFH	4 - 20	40 - 180	3/8	<b>137-5317</b>				52.40

**Professional Torque Wrenches**  
Industrial Ratchet Models



The push-through ratchets on these models are robustly engineered for strength and durability. The strength and high wear resistance comes from the design of the tooth pattern while a principle of offset ratchet pawls gives a narrow engagement angle.

The push through square drive is not only a robust design but allows the wrench to be used for torque control in both the clockwise and anti clockwise directions. Please note that the 3/4" square drive of Model 400 has to be removed and re-inserted on the other side of the ratchet head rather than pushed through.

489093

Model	Torque Range		Square drive	Order Code	Price Each			
	(Nm)	(lbf.ft)			1+	5+	10+	20+
330	60 - 330	45 - 250	1/2	<b>137-4372</b>	104.37	102.28	100.24	98.23
400	80 - 400	60 - 300	3/4	<b>137-5287</b>	146.52	143.59	140.72	137.90

**Torque Wrenches**  
Miniature Torque Safe Slipper Wrenches

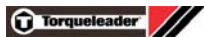

- 1/4" square-drive ratchet slipper wrenches
- Automatic resetting with audible click when wrench slips
- Eliminates the possibility of overtightening
- Wrench incorporates micrometer-style fine adjustment with positive lock



Range	Increments	Length	Weight (g)	Mfrs. List No.	Order Code
1-5N-m	0.05 Nm	195	235	TSC 5	708-9636
2-10N-m	0.1 Nm	195	235	TSC 10	708-9648

225293

Order Code	Price Each	
	1+	137.50
<b>708-9636</b>		137.50
<b>708-9648</b>		141.29

Over 480,000 products online



**Breaking Torque Handles**



- Production lever-type wrenches for applying low torque values
- Ideal for use in restricted space
- Torque handles break at predetermined torque value to give movement in either direction

Range Nm	Length (mm)	Weight (g)	Mfrs. List No.	Order Code
0.20-2.00	105	100	TBN 2	709-0705
1.0 - 10.0	105	120	TBN 10	709-0717

225297

Order Code	Price Each	
	1+	79.63
<b>709-0705</b>		79.63
<b>709-0717</b>		80.28

**Interchangeable End Fittings**



- Open end spanner fitting for TBN 2 and TBN 10 handles
- Available in popular metric sizes

225299

Metric	Mfrs. List No.	Order Code	Price Each	
			1+	25.54
5.5	012015	<b>709-0833</b>		25.54
6	012020	<b>709-0845</b>		25.54
7	012025	<b>709-0857</b>		24.48
8	012030	<b>709-0869</b>		25.54
10	012040	<b>709-0870</b>		25.54

**Professional Torque Wrenches**  
Automotive Ratchet Models



- Accuracy of ±3% of reading exceeds all international standards for torque wrenches
- Every wrench is supplied with a calibration certificate to satisfy the requirements of ISO 9000:2000

- Soft feel handle provides excellent grip even in oily conditions
- Handle material and lens resist all chemicals in common automotive, industrial and aviation use
- Locking mechanism prevents accidental adjustment of the wrench during operation
- Long scale graduated in N.m and lbf.ft allows for foolproof and accurate setting
- Supplied in moulded box for storage and protection

486630

Model	Torque Range		Square Drive	Order Code	Price Each	
	(Nm)	(lbf.ft)			1+	90.06
60	8 - 60	5 - 45	3/8	<b>722-8909</b>		90.06
100	20 - 100	15 - 80	3/8	<b>137-5311</b>		78.26
200	40 - 200	30 - 150	1/2	<b>722-8922</b>		107.32

**16mm Male Spigot Torque Handles**



Based on the professional wrench range designed primarily for use with hydraulic and pneumatic pipe unions, bolts or studs, and where space restrictions limit the use of standard ratchet tools. Accuracy greater than ±3% of full scale. Supplied with a traceable certificate of calibration to satisfy the requirements of BS5750/ISO9000.

494876

Model	Torque Range		Order Code	Price Each	
	(Nm)	(lbf.ft)		1+	55.11
60TH	8-60	5-45	<b>137-5310</b>		55.11
100TH	20-100	15-80	<b>137-5299</b>		55.11
200TH	40-200	30-150	<b>137-5300</b>		60.85
300TH	60-300	45-220	<b>137-5302</b>		72.63

**Production Torque Wrenches**  
Model 5



The model 5 is a unique torque wrench that offers high accuracy and the convenience of interchangeable 1/4in hexagon bits. Accuracy better than ± 3% of full scale exceeding all torque wrench standards. The model 5 is non length dependant maintaining accuracy regardless of hand position. Supplied in a plastic case



**Torque Tools - continued**

**Production Torque Wrenches - continued**

**Fixed Scale Models - continued**

with a traceable calibration certificate to satisfy ISO9000 quality systems.

486605

Model	Range	Square Drive	Order Code	Price Each			
				1+	4+	10+	20+
5	1-5 N-m	0.25"	<b>722-8892</b>	131.64	118.55	111.96	105.37
5	10-50 lbf. in	0.25"	<b>137-5308</b>	92.98	91.12	89.30	87.52

**Fixed Scale Models**

Developed specifically for the requirements of production line work. These models have no adjustment scale and must be pre-set against an electronic torque wrench analyser or similar instrument. Hexagon key setting prevents unauthorised adjustment. All models feature a colour coded end cap seal to identify wrenches outside their calibration period.

Model	Torque Range (N-m)	Square Drive (lbf.ft)	Order Code	Price Each			
				1+	5+	10+	20+
5P	1-5	1/4"	<b>137-5309</b>	92.98	91.12	89.30	87.52
60P	8-60	3/8"	<b>137-5315</b>	64.46	63.17	61.91	60.67
200P	20-200	1/2"	<b>137-4373</b>	70.43	69.02	67.64	66.29
300P	30-300	1/2"	<b>137-5319</b>	91.04	89.22	87.43	85.69
550P	110-550	3/4"	<b>137-5316</b>	299.86	293.87	287.99	282.23

**Industrial Torque Wrenches**



The robust construction of this wrench gives accurate results to  $\pm 4\%$  even in arduous working conditions. The break action improves accuracy by reducing the possibility of over torquing and gives an unmistakable signal. These wrenches are supplied with a traceable calibration certificate that should satisfy the requirements of BS5750/ISO9000.

493992

Model	Torque Range (Nm)	Length (lbf.ft)	Length (mm)	Square Drive (in)	Order Code	Price Each			
						1+	5+	10+	20+
3AR	100 - 500	70 - 350	915	36 3/4	<b>137-4366</b>	203.29			
3AR/01	100 - 500	70 - 350	1090	43 1	<b>137-5294</b>	224.79			
4R	150 - 700	100 - 500	1090	43 3/4	<b>137-5289</b>	216.11			
4R	200 - 800	150 - 600	1140	44.9 3/4	<b>137-5293</b>	218.29			
4R/01	200 - 800	150 - 600	1140	44.9 1	<b>137-5296</b>	239.84			
5R	300 - 1000	200 - 750	1470	57.9 3/4	<b>137-5290</b>	242.98			
5R/01	300 - 1000	200 - 750	1470	57.9 1	<b>137-5297</b>	221.00			
5AR/01	700 - 1500	500 - 1000	1470	57.9 1	<b>137-5298</b>	310.49			

**Production Torque Wrenches**

**Safe Slipper**



Designed to suit production torque requirements in high volume manufacturing. Accuracy  $\pm 5\%$ , repeatable, guarantees equal tightness every time. Lightweight construction provides less fatigue for the operator and encourages use. Wrenches slip when predetermined torque setting is reached, thus completely eliminating overtightening. Automatic reset signalled by audible click. All models have corrosion resistant stainless steel head and moulded non slip hand grip.

TSN25D has 36 teeth ratchet. TSN55 and TSN125 have 48 teeth ratchet. Setting the required torque is easily done using either static or electronic instruments.

492792

Model	Torque Range (Nm)	Length (lbf.ft)	Length (mm)	Square Drive (in)	Order Code	Price Each	
						1+	5+
TSN25D	3 - 25	2 - 18	216	8.5 1/4	<b>150-9454</b>	150.84	
TSN55	15 - 55	10 - 40	324	12.8 3/8	<b>150-9455</b>	193.15	
TSN125	40 - 125	30 - 90	460	18.1 1/2	<b>150-9453</b>	219.45	

**Dial Indicating Torque Wrenches**



Robustly constructed for the precise application and measurement of torque values. Easy to read SI and imperial two-tone dual scale with clearly visible main and slave pointers. Double ended spindle ratchet mechanism on all models allowing

torque to be measured in both clockwise and anti-clockwise directions. All models are accurate to  $\pm 3\%$  of reading and have overload protection. Each tool is supplied with a traceable calibration certificate. The preferred and certified ranges of these tools is in accordance with the requirements of ISO 6789:1992 and BS 6703. 150-9451 has an audio visual signal that shows when the required torque is reached.

491420

Model	Torque Range (Nm)		Length (mm)	Length (in)	Square Drive	Order Code	Price Each
	imperial						
ADS4	0.3 - 4	3 - 5lbf in	244	9.6	1/4	<b>150-9447</b>	160.43
ADS8	0.5 - 8.5	5 - 75lbf in	244	9.6	1/4	<b>150-9452</b>	165.37
ADS12A	0.5 - 13.5	4 - 120 lbf in	244	9.6	3/8	<b>149-8347</b>	165.37
ADS25	1 - 27	10 - 240 lbf in	244	9.6	3/8	<b>150-9444</b>	160.43
ADS40	3 - 40	20 - 360 lbf in	244	9.6	3/8	<b>150-9448</b>	165.37
BDS80E	6 - 80	5 - 60 lbf ft	435	17.1	1/2	<b>150-9449</b>	251.49
BDS200	20 - 215	15 - 160 lbf ft	515	20.2	1/2	<b>150-9450</b>	251.49
CDS400S	30 - 400	20 - 300 lbf ft	710	27.9	3/4	<b>150-9451</b>	405.10

**Adjustable Wrenches**



**Adjustable Wrenches**



- Adjustable wrenches with metric scale
- Drop forged, heat treated jaws
- Polished and chrome plated

481969.462055

Length	Jaw Size	Order Code	Price Each				
			1+	5+	10+	20+	50+
150mm	20mm	<b>144-7404</b>	1.87	1.69	1.49	1.36	1.12
200mm	24mm	<b>144-7405</b>	2.29	2.11	1.84	1.63	1.43
250mm	30mm	<b>144-7406</b>	2.89	2.81	2.31	2.17	1.94
300mm	40mm	<b>144-7407</b>	3.96	3.71	3.16	2.94	2.52

**Adjustable Wrench**

**Chrome Finish**



- Drop forged, chrome vanadium steel
- Metric scale to assist pre-setting the jaw opening
- Precision machined, positive action thumbwheel and jaw

222937

Length	Max. Jaw Opening	Order Code	Price Each	
			1+	5+
100	(4")	<b>313-3412</b>	4.46	
150	(6")	<b>313-3424</b>	4.98	
200	(8")	<b>313-3436</b>	7.15	
250	(10")	<b>313-3448</b>	9.79	

**Adjustable Wrenches with Soft Grip Handles**



- Adjustable wrenches with metric scale
- Rubberized soft grip
- Drop forged, heat treated, polished and black nickel plated jaws
- Laser marked graduations

481975.462064

Length	Jaw Size	Order Code	Price Each				
			1+	5+	10+	20+	50+
150mm	20mm	<b>144-7414</b>	2.34	2.19	1.87	1.75	1.59
200mm	25mm	<b>144-7416</b>	3.17	2.89	2.55	2.40	2.17
250mm	30mm	<b>144-7417</b>	4.01	3.85	3.20	3.01	2.72
300mm	40mm	<b>144-7418</b>	5.66	5.52	4.54	4.24	3.85

**Adjustable Wrench**

**Soft Grip Handle**



- Phosphated with a soft grip handle
- Metric scale to assist pre-setting the jaw opening
- Precision machined, positive action thumbwheel and jaw

222936

Length	Max. Jaw Opening	Order Code	Price Each
100mm (4")	13	312-7850	6.14
150mm (6")	20	312-7849	6.14
200mm (8")	27	312-7837	7.18
250mm (10")	30	312-7825	8.92

**Adjustable Wrench Set**



2 piece adjustable wrench set manufactured from chrome vanadium steel with black phosphate finish. Set comprised of 200 and 300mm long wrenches.

493421

Order Code	Price Each
248-017	16.47

**Ergo Adjustable Wrenches Phosphate**



484583

Model	Length	Jaw Opening	Order Code	Price Each			
				1+	5+	10+	25+
8069	110mm	4"	105-214	11.80	11.35	10.85	10.40
8070	155mm	6"	135-6221	11.40	11.16	10.94	10.64
8071	205mm	8"	105-216	13.45	--	--	--
8072	255mm	10"	105-217	17.60	16.90	16.20	15.50
8073	305mm	12"	105-218	25.65	--	--	--
8074	380mm	15"	708-7482	42.55	40.85	39.15	37.45
8075	455mm	18"	708-7494	49.31	47.97	46.71	45.51

**Ergo Adjustable Wrenches 90 series**



Features include an ergonomic handle that provides a comfortable non-slip grip, even when the handle is oily and dirty. Models 9070P, 9071P, 9072P and 9073P all have a reversible jaw that converts the wrench into an efficient pipe wrench.

484608

Size	Jaw Opening	Order Code	Price Each
			1+
9070	152mm	6"	20mm 501-499 15.70
9070P	158mm	6"	21mm 326-2509 14.80
9071	203mm	8"	27mm 501-505 17.13
9071P	208mm	8"	28mm 326-2510 19.00
9072	254mm	10"	31mm 501-517 21.75
9072P	257mm	10"	33mm 326-2522 24.60
9073	305mm	12"	34mm 590-265 31.60
9073P	308mm	12"	35mm 326-2534 25.90

**Spanners**

**Jaw Spanners**

Manufactured To BS192 And DIN3110.



**Whitworth**

Whit (in)	Order Code	Price Each
1/8 x 3/16	248-144	2.64
3/16 x 1/4	248-145	2.75
1/4 x 5/16	248-146	3.87
5/16 x 3/8	248-147	5.10
3/8 x 7/16	248-148	7.30
7/16 x 1/2	248-149B	6.69
1/2 x 9/16	248-150B	9.78
9/16 x 5/8	248-151	11.65
5/8 x 1	248-153	22.03

**AF**

493322

AF (in)	Order Code	Price Each
3/8 x 7/16	248-231	2.64
7/16 x 1/2	248-232	2.91
1/2 x 9/16	248-233	3.60
9/16 x 5/8	248-234	3.71
1 1/16 x 3/4	248-236	4.67
1 5/16 x 1	248-238	8.55

**Metric Spanners**



Size (mm)	Number	Order Code	Price Each
4 x 5	2JM45	137-7864	3.09
5.5 x 7	2JM557	137-7865	3.09
6 x 7	2JM67	137-7852	2.61
8 x 9	2JM89	137-7854	2.85
8 x 10	2JM810	137-7855	2.95
10 x 11	2JM1011	137-7856	3.10
10 x 13	2JM1013	137-7944	3.73
12 x 13	2JM1213	137-7857	3.66
13 x 17	2JM1317	137-7858	4.23
14 x 15	2JM1415	137-7859	4.20
16 x 17	2JM1617	141-8702	4.28
17 x 19	2JM1719	141-8703	5.13
18 x 19	2JM1819	141-8704	5.00
19 x 22	2JM1922	141-8705	6.40
20 x 22	2JM2022	141-8706	7.00
21 x 23	2JM2123	141-8707	7.03
22 x 24	2JM2224	141-8708	9.04
24 x 27	2JM2427	141-8710	11.30
24 x 30	2JM2430	141-8715	14.97
25 x 28	2JM2528	137-7866	14.55
27 x 30	2JM2730	141-8711	15.28
30 x 32	2JM3032	141-8712	14.20
32 x 36	2JM3236	141-8821	20.46
36 x 41	2JM3641	141-8822	31.90
46 x 50	2JM4650	141-8823	43.45
55 x 60	2JM5560	141-8824	62.05

**AF**

AF (in)	Number	Order Code	Price Each
1/4 x 5/16	2J2531	137-7847	2.65
5/16 x 3/8	2J3137	141-8691	2.65
3/8 x 7/16	2J3743	137-7848	2.95
7/16 x 1/2	2J4350	141-8692	3.50
1/2 x 9/16	2J5056	137-7849	3.80
9/16 x 5/8	2J5662	141-8693	4.07
5/8 x 1 1/16	2J5668	141-8814	4.28
3/4 x 1 1/8	2J6268	141-8694	4.20
3/4 x 3/4	2J6275	141-8815	5.27
1 1/16 x 3/4	2J6875	141-8696	5.00
3/4 x 7/8	2J7587	141-8697	5.70
3/4 x 3/8	2J8187	141-8698	6.23
1 3/16 x 1 1/8	2J8193	141-8699	6.48
3/4 x 1	2J93100	141-8700	7.71
1 5/16 x 1 1/8	2J93112	141-8716	12.63
1 1/8 x 1 1/8	2J106112	141-8813	13.15
1 1/8 x 1 1/4	2J106125	137-7850	13.63
1 1/4 x 1 1/8	2J125143	141-8817	21.40
1 5/16 x 1 1/2	2J131150	141-8818	22.85
1 5/8 x 1 13/16	2J162181	141-8819	34.33
1 11/16 x 1 7/8	2J168187	141-8820	35.48

Spanners - continued

Metric Spanners - continued

Whitworth

494692

Whit (in)	Number	Order Code	Price Each
			1+
1/8 x 3/16	2J3344	141-8682	4.48
3/16 x 1/4	2J4452	141-8684	4.92
5/16 x 3/8	2J6071	141-8685	6.28
3/8 x 7/16	2J7182	141-8686	7.81
7/16 x 1/2	2J8292	141-8687	9.27
1/2 x 9/16	2J92101	141-8688	11.57
9/16 x 5/8	2J101110	141-8689	15.16
5/8 x 11/16	2J101120	141-8717	18.75
3/4 x 1 1/16	2J110120	141-8690	18.20
3/4 x 7/8	2J130148	141-8811	33.63
7/8 x 1	2J148167	141-8718	46.96
1 1/8 x 1 1/4	2J186205	141-8812	55.17

Combination wrenches - metric/inch



440 Series



- High mechanical performance
- Wide range of openings:
  - Metric sizes: 4 to 41 mm
  - Inch sizes: 1/4" to 1 1/2"
- Ring clearance designed for better access to recessed or closely spaced screws
- 12-point OGV profile for a high torque without damaging the nut/prefix H
- Angled at 15[Degree]
- Optimised open end / handle geometry for increased accessibility
- Ground contact faces
- Satin chrome finish



520429

Size (mm)	Lenght (mm)	Mftrs. List No	Order Code	Price Each		
				1+	5+	10+
4	105	440.4H	164-0727	3.39	3.22	3.05
5	113	440.5H	164-0728	3.41	3.25	3.07
5.5	113	440.5.5H	164-0729	3.43	3.26	3.09
6	113	440.6	164-0730	3.41	3.25	3.07
7	121	440.7	164-0731	3.44	3.27	3.10
8	130	440.8	164-0733	3.52	3.33	3.16
9	137	440.9	164-0734	3.55	3.38	3.21
10	145	440.10	164-0735	3.60	3.42	3.25
11	153	440.11	164-0736	3.81	3.61	3.42
12	161	440.12	164-0737	3.91	3.72	3.51
13	170	440.13	164-0739	4.20	4.00	3.78
14	178	440.14	164-0740	4.31	4.08	3.87
15	185	440.15	164-0741	4.99	4.74	4.49
16	193	440.16	164-0742	5.23	4.96	4.71
17	200	440.17	164-0745	5.95	5.65	5.36
18	208	440.18	164-0746	6.21	5.90	5.58
19	216	440.19	164-0747	6.68	6.34	6.01
20	224	440.20	164-0748	7.33	6.96	6.60
21	233	440.21	164-0749	7.69	7.31	6.93
22	248	440.22	164-0750	7.90	7.50	7.11
23	258	440.23	164-0751	8.44	8.01	7.59
24	268	440.24	164-0752	9.00	8.56	8.10
25	270	440.25	164-0753	9.60	9.12	8.64
26	284	440.26	164-0754	10.25	9.74	9.23
27	294	440.27	164-0755	10.70	10.17	9.63
28	305	440.28	164-0757	11.23	10.67	10.11
29	320	440.29	164-0758	11.74	11.17	10.58
30	340	440.30	164-0759	12.58	11.94	11.32
32	356	440.32	164-0760	13.00	12.36	11.70

Combination Spanners

Bi-Hexagon Ring



Forged from the finest chrome vanadium steel. Satin finish shanks, polished jaws and chrome plated overall. Manufactured to BS7586 and DIN3113.

Metric

Size (mm)	Order Code	Price Each
		1+
7	386-0619	2.83
8	386-0620	2.48
9	386-0632	2.48
10	386-0644	2.95
11	386-0656	2.88

Size (mm)	Order Code	Price Each
		1+
12	386-0668	4.16
13	386-0670	3.46
14	386-0681	4.64
15	386-0693	4.85
16	386-0700	4.19
17	386-0711	4.67
18	386-0723	4.82
19	386-0735	6.94
20	386-0747	7.79
21	386-0759	8.32
22	386-0760	7.89
24	386-0784	8.38
27	386-0814	10.98
30	386-0838	14.74
32	386-0840	16.46

Whitworth

Whit (in)	Order Code	Price Each
3/16	248-123	3.90
1/4	248-124	4.58
5/16	248-125B	6.38
3/8	248-126	6.86
7/16	248-127	8.88
1/2	248-128	13.09
9/16	248-129	15.10
1 1/16	248-131	22.60
3/4	248-132	28.75

AF

490892

AF (in)	Order Code	Price Each
5/16	155-4410	0.83
3/8	155-4412	0.83
1/2	248-213	3.27
5/8	248-215	4.93
1 1/16	248-216B	4.92
3/4	248-217	6.50
7/8	248-218	8.59
1 5/16	248-118	9.39
1	248-119	10.32
1 1/16	248-120	11.30
1 1/8	248-172	10.32
1 1/4	248-121	11.54

Combination Spanners



Metric



- Chrome alloy steel
- Bi-hexagon ring

494477

Size (mm)	Number	Order Code	Price Each
			1+
6	RJM6	141-8354	3.30
7	RJM7	137-7880	3.30
8	RJM8	137-7881	3.30
9	RJM9	141-8355	3.50
10	RJM10	137-7882	3.29
11	RJM11	137-7883	3.93
12	RJM12	137-7884	3.99
13	RJM13	137-7885	4.40
14	RJM14	137-7886	4.50
15	RJM15	141-8356	4.97
16	RJM16	141-8357	5.13
17	RJM17	137-7888	5.90
18	RJM18	141-8358	6.18
19	RJM19	137-7889	6.89
20	RJM20	141-8359	7.61
21	RJM21	141-8360	8.17
23	RJM23	141-8362	9.98
24	RJM24	137-7891	10.83
25	RJM25	141-8363	11.68
26	RJM26	141-8410	13.52
27	RJM27	141-8411	13.55
28	RJM28	141-8412	16.57
30	RJM30	137-7892	18.53
32	RJM32	141-8413	20.80
36	RJM36	141-8414	32.59
41	RJM41	141-8416	42.60
46	RJM46	141-8347	58.97
50	RJM50	141-8349	72.31
55	RJM55	141-8351	102.33
60	RJM60	141-8352	140.06
65	RJM65	141-8353	169.74

Single Open Ended Spaners



Black finish manufactured to DIN 894, ISO 3318. Sizes 10-120mm with hanging hole.

Metric	Size	Length	Order Code	Price Each			
				1+	5+	10+	20+
	6mm	73mm	136-9609	2.25	2.13	2.03	1.90
	7mm	78mm	136-9610	2.18	2.08	1.97	1.85
	8mm	94mm	136-9612	2.46	2.33	2.23	2.05
	9mm	100mm	136-9613	2.30	2.18	2.08	1.95
	10mm	106mm	136-9614	2.23	2.13	2.03	1.85
	11mm	112mm	136-9615	2.46	2.33	2.23	2.05
	12mm	124mm	136-9616	2.62	2.48	2.38	2.20
	13mm	132mm	136-9617	2.07	1.95	1.88	1.75
	14mm	140mm	136-9618	2.66	2.53	2.38	2.25
	15mm	145mm	136-9619	3.41	3.24	3.09	2.85
	16mm	155mm	136-9620	3.41	3.24	3.09	2.85
	17mm	159mm	136-9621	3.11	2.94	2.78	2.60
	18mm	159mm	136-9622	5.66	5.37	5.11	4.75
	19mm	170mm	136-9624	3.82	3.65	3.44	3.20
	22mm	193mm	136-9625	4.12	3.90	3.70	3.45
	24mm	217mm	136-9626	5.56	5.27	5.01	4.65
	25mm	217mm	136-9627	5.82	5.52	5.27	4.90
	27mm	239mm	136-9628	6.53	6.23	5.87	5.50
	30mm	263mm	136-9629	7.88	7.49	7.09	6.60
	32mm	275mm	136-9630	8.49	8.05	7.64	7.10
	34mm	290mm	136-9631	17.05	16.20	15.34	14.30
	36mm	305mm	136-9632	11.66	11.09	10.48	9.80
	38mm	305mm	136-9633	13.42	12.76	12.10	11.25
	41mm	344mm	136-9634	14.60	13.87	13.16	12.25
	46mm	380mm	136-9636	18.04	17.16	16.25	15.15
	50mm	413mm	136-9637	24.47	23.24	22.02	20.55
	55mm	459mm	136-9638	27.64	26.27	24.86	23.20
	60mm	494mm	136-9639	35.32	33.56	31.79	29.65
	65mm	528mm	136-9640	43.54	41.36	39.18	36.55
	70mm	572mm	136-9641	37.91	36.01	34.13	31.82
	80mm	645mm	136-9643	56.32	53.51	50.67	47.29
	85mm	688mm	136-9644	78.91	74.97	71.04	66.24
	90mm	740mm	136-9645	92.69	88.06	83.42	77.81
	95mm	740mm	136-9646	120.34	114.32	108.30	101.01
	100mm	740mm	136-9648	125.98	119.67	113.40	105.77
	105mm	847mm	136-9649	185.84	176.55	167.27	156.03
	110mm	1000mm	136-9650	280.39	266.39	252.37	235.40
	120mm	1000mm	136-9652	402.30	382.17	362.07	337.75

485315

Combination Wrench Set 11pc

'Expert Range'



- Forged from chrome vanadium steel, hardened and tempered
- Chrome-plated for corrosion protection
- Polished bi-hexagon ring and jaw offset at 15°
- DIN 3113, ISO 3318, ISO 1085
- Supplied in vinyl wallet
- Available in metric and AF sets

Metric set: 6, 7, 8, 9, 10, 11, 12, 13, 14, 17, 19mm  
 AF set: 1/4", 5/16", 3/8", 7/16", 1/2", 9/16", 5/8", 11/16", 3/4", 13/16", 7/8" AF

HAT26.401880

	Mfrs. list no.	Order Code	Price Each
Metric	29545	707-8997	15.79
AF	29546	707-9000	18.50

6 Piece



- 'Ratchet' speed action enables the user to reposition the spanner without removing it from the nut
- Manufactured from drop forged chrome vanadium steel
- Colour coded for quick selection of correct size
- Contents: 10, 12, 13, 14, 15, 17mm

419483, 422825

Mfrs List No.	Order Code	Price Each
T4345/6ST	109-8806	28.30

Spanner Sets

11 Piece Combination Spanner Set



- 11 piece metric combination spanner set in a plastic rack
- Drop forged and chrome plated
- Sizes included: 6, 7, 8, 9, 10, 11, 12, 13, 14, 17 and 19mm

482088.462213

Order Code	Price/Set				
	1+	5+	10+	20+	50+
144-7549	4.34	3.57	3.42	3.09	2.65

14 Piece Spanner Set



- Drop forged, heat treated steel and satin finish
- Extra soft contoured grips for maximum comfort and superior control
- High polish finish helps reduce corrosion and retain original luster
- Precision machined open and boxed ends
- Sizes: 6, 8, 10, 12, 13, 14, 15, 17, 19, 22, 24, 27, 30 and 32mm
- Supplied with a heavy-duty vinyl pouch

481958.462048

Order Code	Price Each				
	1+	4+	10+	20+	50+
144-7392	21.15	19.65	16.93	15.86	14.42

Standard Combination Wrench Sets



45



New

- OGV® Series 440 combination spanners in 9 and 12 piece sets
- Torque capacity exceeds standard specifications
- 12 point ring angled at 15°
- Slim ends offer easy accessibility
- Satin chrome finish
- Supplied in storage box
- 9 piece sizes: 8, 10, 11, 12, 13, 16, 17, 18, 19
- 12 piece sizes: 7, 8, 10, 11, 12, 13, 16, 17, 18, 19, 22, 24

520430

Set	Mfrs. List No.	Order Code	Price/Set		
			1+	5+	10+
9 Piece	440.JP9PB	164-0761	43.65	42.50	41.41
12 Piece	440.JP12PB	164-0762	63.33	61.67	60.09

Troubleshooting tips



Chat live online to one of our technical engineers at [www.farnell.co.uk](http://www.farnell.co.uk)

Premium service without a premium price



With thousands of prices already reduced, go online to see our most up-to-date pricing: [www.farnell.co.uk](http://www.farnell.co.uk)



**Spanner Sets - continued**

**Combination Wrench Sets**

in thermo-formed modules



- OGV® Series 440 combination wrench set
- Compatible with the FACOM modular storage system
- 16 piece sizes: 6, 7, 8, 9, 10, 11, 12, 13, 14, 15, 16, 17, 18, 19, 22, 24
- Supplied in thermo-formed modules

527080

Mfrs. List No.	Order Code	1+	5+	10+
MOD440-1	164-0763	76.94	74.92	73.00

**14 Piece Combination Spanner Set**



14 piece set ranging from 10mm to 32mm complete with storage roll. Spanners conform to ISO 3318/DIN 3113.

- 10, 11, 12, 13, 14, 17, 19, 21, 22, 23, 24, 28, 30, 32mm

478397

Order Code	1+	5+	10+	20+
135-3669	41.86	41.02	40.21	39.42

**Open Jaw Spanners**

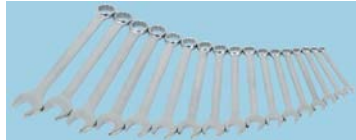

Supplied in a PVC wallet.

490949

Type	Contents	Order Code	Price Each
Metric	10, 11, 12, 13, 14, 17, 19mm		1+
7 piece		<b>386-0863</b>	24.54
Metric	8, 10, 11, 12, 13, 14, 15, 16, 17, 18, 19mm	<b>386-0875</b>	40.08
11 piece			
AF	3/8, 7/16, 1/2, 9/16, 5/8, 11/16, 3/4in AF	<b>248-262</b>	24.92
7 piece			
WW	1/8, 3/16, 1/4, 5/16, 3/8, 7/16, 1/2in Whit	<b>248-267</b>	29.06
7 piece			
AF	3/8, 7/16, 1/2, 9/16, 5/8, 11/16, 3/4, 13/16, 7/8, 15/16	<b>867-3390</b>	47.46
10 piece			
AF	3/8, 7/16, 1/2, 9/16, 5/8, 11/16, 3/4, 7/8, 15/16, 1	<b>867-3403</b>	89.55
14 piece			

**Kamasa 24 Piece Combination Spanner Set Imperial/Metric**



Set contains 24 spanners 6mm to 22mm and 1/4in to 1in A/F. All spanners are fully polished chrome Vanadium steel. Spanners supplied in a reinforced storage wallet.

492406

Order Code	Price Each
040-278	18.60

**Combination Spanner Set**



**12 Piece Ratcheting Combination Wrench Set**



Contains Ratcheting metric combination wrenches: 8 - 9 - 10 - 11 - 12 - 13 - 14 - 15 - 16 - 17 - 18 - 19mm 1.5kg

486652

Order Code	1+	Price Each	5+	10+
855-7101	179.11	170.14	161.19	

**Metrich Combination Spanner Set**

**4 and 6WD**



6WD Socket



- High quality 6, 7, 8, 10, 14, and 15 piece metric/imperial sets
  - Metrich 4 and 6 wall drive profile
  - Chrome vanadium steel, chrome plated and polished
- METRINCH® is a trade mark of Surelab, USA.**

**Size**

**Metric / Imperial**

6 Piece	10, 11, 13, 14, 16, 17 mm - 3/8", 7/16", 1/2", 9/16", 5/8", 11/16"
7 Piece	10, 11, 13, 14, 16, 17, 19 mm - 3/8", 7/16", 1/2", 9/16", 5/8", 11/16", 3/4"
10 Piece	10, 11, 12, 13, 14, 15, 16, 17, 18, 19mm - 3/8", 7/16", 15/32", 1/2", 9/16", 19/32", 5/8", 11/16", 23/32", 3/4"
14 Piece	8mm to 22mm - 5/16" to 7/8"
15 Piece	8mm to 32mm - 5/16" to 1-1/4"

TMM23X, 401894

	Order code	Price each
6 Piece	<b>282-583</b>	28.12
7 Piece	<b>282-595</b>	32.79
10 Piece	<b>321-6858</b>	41.33
14 Piece	<b>321-6860</b>	63.57
15 Piece	<b>321-6871</b>	101.66

**Combination, Small Metric**

**ELORA**



- Set of six chrome vanadium metric spanners in a plastic wallet
- Sizes covered: 5, 5.5, 6, 7, 8, and 10mm.

TMM21X, 401877

Mfrs List No	Order Code	Price Each
04212	<b>105-965</b>	32.41

**Slim Type Open Ended**

**ELORA**



METRIC: 4, 4.5, 5, 5.5, 4, 6	Order Code	METRIC: 6, 7, 8, 9, 10, 11	Order Code
(Set 1)	108-819	(Set 2)	12, 13, 14, 15, 16, 17
			104-685

- Sets of six chrome vanadium spanners
- 15° angle opening, chrome plated and polished

401904

	Order code	Price each
Metric spanner set 1	<b>108-819</b>	29.31
Metric spanner set 2	<b>104-685</b>	29.31

**Open Jaw Spanner Sets**



The open jaw spanner sets conform to DIN3110/ISO1085, 15° angle. Supplied in plastic wallet.

Set	Contents
6M/8T	6 x 7, 8 x 9, 10 x 11, 12 x 13, 14 x 15, 16 x 17, 18 x 19, 20 x 22mm
6M/S8	6 x 7, 8 x 9, 10 x 11, 12 x 13, 14 x 15, 16 x 17, 18 x 19, 20 x 22mm
6M/10T	6 x 7, 8 x 9, 10 x 11, 12 x 13, 14 x 15, 16 x 17, 18 x 19, 20 x 22, 24 x 27, 30 x 32mm
6M/12T	6 x 7, 8 x 9, 10 x 11, 12 x 13, 14 x 15, 16 x 17, 18 x 19, 20 x 22, 21 x 23, 24 x 27, 25 x 28, 30 x 32mm
6Z/8T	1/4 x 9/16, 5/16 x 1/2, 3/8 x 7/16, 1/2 x 9/16, 19/32 x 1/16, 5/8 x 3/4, 13/16 x 7/8, 15/16 x 1 inch AF

484611

Set	Order Code	Price Per Set	
		1+	5+
6M/8T	<b>802-396</b>	28.15	27.00
6M/S8	<b>706-2308</b>	31.15	29.90
6M/10T	<b>135-6206</b>	40.80	39.99
6M/12T	<b>706-2310</b>	56.90	54.60
6Z/8T	<b>706-2321</b>	44.15	42.40

**Open Jaw Spanners**

Sets

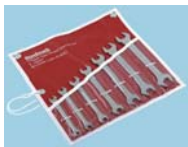

Supplied in a PVC wallet.

492950

Type	Contents	Order Code	Price Each
AF	5/16 x 3/8, 7/16 x 1/2, 9/16 x 5/8, 11/16 x 3/4, 3/4 x 7/8, 6 piece 15/16 x 1 in AF	<b>248-264</b>	22.36
WW	1/8 x 3/16, 3/16 x 1/4, 1/4 x 5/16, 5/16 x 3/8, 3/8 x 7/16, 7 piece 7/16 x 1/2, 1/2 x 9/16 in Whit	<b>248-268</b>	29.01
AF	1/4 x 3/16, 3/16 x 3/8, 3/8 x 7/16, 7/16 x 1/2, 1/2 x 9/16, 10 piece 9/16 x 5/8, 5/8 x 11/16, 11/16 x 3/4, 3/4 x 7/8, 15/16 x 1 piece	<b>867-3373</b>	20.93

**Electronic Double Open-End Spanner Set**



- High-quality, 6-piece metric spanner set
- Head angle 15° with one end 10° offset
- Spanners extra long and very slender for working on electronic appliances
- Conforms to **DIN 934**
- Supplied in plastic wallet

Contents: 4x4, 4.5x4.5, 5x5, 5.5x5.5, 6x6, 7x7

225225

Mftrs. List No.	Order Code	Price Each
1933M/6T	<b>706-2606</b>	28.65

**Premium service without a premium price**



With thousands of prices already reduced, go online to see our most up-to-date pricing: [www.farnell.co.uk](http://www.farnell.co.uk)

**Lilliput Double Open-End Spanner Set**

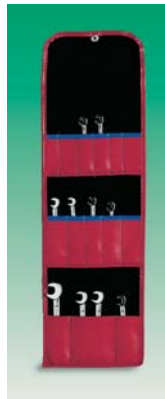

- High-quality specialist spanner set
- 10-piece metric set
- Head angles are 82.5° and 15°
- Chrome vanadium extra finish
- Supplied in plastic wallet

Contents: 4, 4.5, 5, 5.5, 6, 7, 8, 9, 10, 11mm

HAT4,401905

Mftrs. list no.	Order code	Price each
1931M/10T	<b>706-2588</b>	52.70

**Spanners - Ratchet**

**Ring Ratchet**



A range of wrenches incorporating a bi-hexagon reversible ratchet ring spanner at each end.

Sizes	Length	Mftrs' List No.	Order Code
6 & 8mm	110	31993	109-206
10 & 11mm	135	31994	109-207
19 & 22mm	225	31997	109-210

Metric Set 6, 8, 10, 11, 13, 14, 15, 17, 19 and 22mm

Mftrs. List No. 31991 = 109-215

223275

	Order Code	Price Each
		1+
6 & 8mm	<b>109-206</b>	4.86
10 & 11mm	<b>109-207</b>	3.98
19 & 22mm	<b>109-210</b>	7.38
Metric set	<b>109-215</b>	34.96

**Ratcheting Box Spanners**



- High-quality spanners incorporating a bi-hexagon reversible ratchet ring at each end
- All spanners chrome vanadium
- Metric spanners 9-10 have 6-point heads
- Imperial spanners all have 12-point heads
- Ideal for use in areas of restricted access

225234

Size	Mftrs. List No.	Order Code	Price Each
			1+
<b>Metric</b>			
9 - 10	1320M-9-10	<b>706-2394</b>	22.71
<b>Imperial</b>			
3/8 - 7/16"	1320Z-3/8-7/16	<b>706-2461</b>	22.19

**Express checkout**



With no need to re-enter your details, returning customers can now buy products even faster - **order online today at [www.farnell.co.uk](http://www.farnell.co.uk)**

**Spanners - Ratchet - continued**

**Offset Ring Ratchet Wrench**

Metric, 5 Piece Set



- Chrome vanadium steel body and hardened sockets
- 5 piece set containing: 6x8, 10x12, 11x13, 15x17, 19x21mm

222940

Order Code	Price Each
312-8088	1+ 23.38

**Ratchet Ring Spanners**



Ratcheting ring spanners are designed for use in areas where access is restricted. The ratchet is reversed simply by turning the wrench over. The bi-hexagon ring form is broached for accuracy to ensure a perfect non slip fit. The wrench body is nickel and chrome plated to prevent corrosion and extend tool life.

**BRITool**

Metric

Size (mm)	Number	Order Code	Price Each
7 x 8	RBB78	137-7963	7.30
9 x 10	RBB910	137-7964	8.45
11 x 12	RBB1112	141-7905	10.71
13 x 14	RBB1314	137-7965	8.15
15 x 17	RBB1517	141-7906	12.83
16 x 18	RBB1618	141-7907	12.83
19 x 21	RBB1921	137-7967	13.80

AF

495311

AF (in)	Number	Order Code	Price Each
1/4 x 5/16	RBB2531	141-7908	6.87
3/8 x 7/16	RBB3743	141-7909	8.10
7/16 x 1/2	RBB4350	141-7910	12.28
1/2 x 9/16	RBB5056	141-7911	11.87
9/16 x 5/8	RBB5662	137-7968	13.64
5/8 x 11/16	RBB6268	141-7912	13.53
3/4 x 7/8	RBB7587	141-7913	13.76

**5 Piece Ratchet Spanner Set**

**DURATool**



- Metric flat ratchet ring spanner set
- Ideal for getting at hard to reach nuts & bolts
- 12 point for maximum surface contact
- Drop forged heat treated steel
- Sizes: 6x8, 10x12, 11x13, 14x17 and 19x21mm

482089.45404

Order Code	1+	5+	10+	20+	50+
144-7550	8.19	7.22	6.56	6.15	5.59

**FREE global legislation support**



RoHS, REACH, WEEE, EuP, Batteries Directive - we've got it covered at:  
[www.global-legislation.com](http://www.global-legislation.com)

**5 Piece Offset Ratchet Spanner Set**

**DURATool**



- Metric offset ratchet ring spanner set
- Ideal for getting at hard to reach nuts & bolts
- 30° offset design helps prevent bruised and scraped nuckles
- 12 point for maximum surface contact
- Drop forged heat treated steel
- Sizes: 6x8, 10x12, 11x13, 14x17 and 19x21mm

482090.454406

Order Code	1+	5+	10+	20+	50+
144-7551	8.19	7.22	6.56	6.15	5.59

**Offset Ratchet Spanner Set**



5 piece reverse action offset spanner set. Manufactured from chrome vanadium steel.

491362

Contents (mm)	Order Code	Price Each
6 x 8, 10 x 11, 12 x 14, 15 x 17, 19 x 21	393-6314	1+ 24.51

**12 Piece Combination Ratchet Spanner Set**

**carolus**



Contents:

- Lever ratchet offset to 15°
- Spanners - 8, 9, 10, 11, 12, 13, 14, 15, 16, 17, 18, 19mm
- Adaptors for ratcheting function
- Sq. Drive 1/2" x 19mm, 3/8" x 15mm, 1/4" x 10mm
- Hex Drive 5/16" x 13mm, 1/4" x 8mm

485318

Order Code	1+	5+	10+	20+
136-9705	191.48	181.90	172.30	165.00

**Ratcheting ring spanner set**

**BAHCO**



- Ratcheting box spanner in Metric sizes
- Finish: Forged, nickel and chrome-plated, matt-finished
- Material: CrV
- Turnable for left and right direction. 5° action
- 12-point with Dynamic-Drive Profile™
- 3 pcs set in practical pouch to carry on your belt
- 12 sizes: 8x9x10x11, 12x13x14x15, 16x17x18x19 mm

**New**

527339

Set	Order Code	1+	5+	10+
4SRM/3T	167-1609	39.00	37.05	35.10



**Ratchet combination spanner Set metric**



- Ratchet in the ring and a switch for quick change of right and left direction. 5° Action. 15° offset head. With Dynamic-Drive-Profile™
- Sets with practical plastic handle to carry or for hanging on the wall
- Finish: forged, nickel and chrome-plated, fine-polished
- Material: CrV
- Set of ratchet combination wrenches in Metric sizes: 8 10 12 13 14 17 mm



527335

Set	Order Code	Price Per Set		
		1+	5+	10+
1RM/S6	167-1611	69.95	66.45	62.95

**Ratchet combination spanner Set metric**



- Ratchet in the ring and a switch for quick change of right and left direction
- 5° Action and 15° offset head
- With Dynamic-Drive-Profile™
- Sets of ratchet combination wrenches in Metric sizes: 8 9 10 11 12 13 14 15 16 17 18 19 mm
- Sets with practical plastic handle to carry or for hanging on the wall
- Finish: forged, nickel and chrome-plated, fine-polished
- Material: CrV



527338

Set	Order Code	Price Per Set		
		1+	5+	10+
1RM/S12	167-1610	145.00	137.75	130.50

**Flat Ratcheting Ring Wrenches 64 Series**



Chrome plated for corrosion protection. 72 tooth mechanism giving a 5° minimum working arc. Both rings feature OGV® drive - increasing grip and reducing fastener wear.

487862

Size (mm)	Order Code	Price Each			
		1+	5+	10+	20+
6 x 7	137-5423	23.09	22.64	22.18	21.47
8 x 9	137-5424	24.48	24.48	23.98	23.21
10 x 11	137-5425	23.96	23.49	23.02	22.28
12 x 13	137-5426	25.05	24.55	24.06	23.28
14 x 15	137-5427	27.76	27.21	26.66	25.80
16 x 18	137-5429	31.12	30.48	29.90	28.92
17 x 19	137-5431	21.29	20.85	20.45	19.78
21 x 23	137-5432	38.49	37.71	36.96	35.77
22 x 24	137-5433	39.44	38.65	37.88	36.66

Size (in)	Order Code	Price Each			
		1+	5+	10+	20+
1/4 x 5/16	137-5434	19.43	19.05	18.66	18.06
5/16 x 11/32	137-5435	21.50	21.07	20.65	19.99
3/8 x 7/16	137-5436	22.66	22.21	21.76	21.06
1/2 x 9/16	137-5437	26.80	26.27	25.74	24.91
5/8 x 11/16	137-5438	31.80	31.14	30.55	29.55
3/4 x 13/16	137-5439	34.50	33.81	33.14	32.08
7/8 x 15/16	137-5440	38.91	38.12	37.38	36.17

**Gearless Ratchet Spanners**



- Professional quality gearless ratchet spanners
- Ratchet ring and open ended combination
- Heat treated chrome vanadium steel with mirrored chrome finish
- Smooth gearless ratchet mechanism with 72 teeth gear ratchet function

482157.464867

Size	Order Code	Price Each			
		1+	5+	10+	20+
8 mm	144-7621	4.97	4.35	3.95	3.55
10 mm	144-7623	5.07	4.44	4.03	3.61
11 mm	144-7624	5.13	4.51	4.09	3.65
12 mm	144-7625	5.42	4.74	4.30	3.89
13 mm	144-7626	5.53	4.85	4.39	3.95
14 mm	145-6355	5.75	5.17	4.70	4.21
15 mm	145-6356	6.51	5.69	5.17	4.64
16 mm	145-6357	6.76	5.92	5.38	4.81
17 mm	145-6358	7.28	6.38	5.79	5.20
18 mm	145-6359	7.96	6.96	6.32	5.68
19 mm	145-6360	7.96	6.96	6.32	5.68
21 mm	145-6361	10.93	10.37	9.46	8.77

**Combination Wrenches**



**67 Series Ratcheting Combination Wrenches**



Fine tooth mechanism for minimal working arc, minimal reverse torque - avoids loosening fastener on reverse, 15° offset for increased accessibility, recessed thumb lever - avoids accidental direction change.

487066

Size(mm)	Order Code	Price Each			
		1+	5+	10+	20+
6	137-5414	13.31	13.03	12.77	12.36
7	137-5415	12.86	12.60	12.35	11.95
8	137-5459	10.32	10.12	9.91	9.60
9	137-5460	10.32	10.12	9.91	9.60
10	137-5449	11.11	10.89	10.68	10.33
11	137-5450	11.40	11.16	10.93	10.59
12	137-5451	11.84	11.60	11.37	11.00
13	137-5452	12.17	11.93	11.69	11.32
14	137-5454	14.85	14.57	14.27	13.81
15	137-5455	14.85	14.57	14.27	13.81
16	137-5456	16.76	16.43	16.09	15.58
17	137-5457	16.76	16.43	16.09	15.58
18	137-5458	15.68	15.36	15.05	14.58
19	137-5444	19.08	18.70	18.33	17.73
21	137-5417	26.96	26.45	25.91	25.07
22	137-5418	26.59	26.05	25.53	24.72
24	137-5419	33.22	32.57	31.91	30.89
27	137-5420	49.69	48.70	47.72	46.18
30	137-5421	55.89	54.78	53.67	51.96
32	137-5422	70.50	69.09	67.71	65.53

**6 Piece Gearless Ratchet Spanner Set**



- Professional quality gearless ratchet spanners
- Ratchet ring and open ended combination
- Heat treated chrome vanadium steel with mirrored chrome finish
- Smooth gearless ratchet mechanism with 72 teeth gear ratchet function

- Supplied in a blow moulded carrying case
- Overall length for the range 139mm (8mm) - 247mm (19mm)
- Contents: 8, 10, 12, 13, 17 and 19mm

483834.464870

Order Code	Price/Set			
	1+	5+	10+	20+
145-6363	31.74	29.78	26.80	24.70

**Combination Spanner Set**



**7 Piece Ratcheting Combination Wrench Set**



Contains metric ratcheting combination wrenches: 8 - 10 - 12 - 13 - 14 - 17 - 19mm, 700g.

487132

Order Code	Price Each			
	1+	5+	10+	20+
137-5448	118.49	116.12	113.79	110.15

**Express checkout**



With no need to re-enter your details, returning customers can now buy products even faster - order online today at [www.farnell.co.uk](http://www.farnell.co.uk)



**Spanners - Ratchet - continued**

**10 Piece Metric Stubby Combination Ratcheting Gearwrench™ Set**



Package Tray Contains:  
10mm, 11mm, 12mm, 13mm, 14mm, 15mm, 16mm, 17mm, 18mm, 19mm Stubby Combination Gearwrench™

524440

Mfrs. List No.	Order Code	1+	5+	10+
9520	164-7967	72.40	69.50	66.60

**7 Piece Metric Flex Head Combination Gearwrench™ Set**



Package Tray Contains:  
10mm, 11mm, 12mm, 13mm, 14mm, 15mm, 16mm, 17mm, 18mm, 19mm Stubby Combination Gearwrench™

524442

Mfrs. List No.	Order Code	1+	5+	10+
9900	164-7968	86.89	83.42	79.95

**Socket Sets - 1/4"**

**8100 SA 1 Zyklop ratchet set, 1/4" drive, metric**

18 piece set in strong metal case



- Rotating mass design and handy freewheel sleeve for faster work
- Swivelling ratchet head
- Defined lock positions at 0°, 15°, 90° right and left
- Can be used like a conventional screwdriver
- Pushbutton release
- CW/ACW toggle, fine-pitched tooth design, with small return angle of 5° - 6°
- Multicomponent Kraftform handle for comfort and torque

Set content:	length
1 Zyklop ratchet	1/4" x 152mm
13 Zyklop sockets (metric)	4,0; 4,5; 5,0; 5,5; 6,0; 7,0; 8,0; 9,0; 10,0; 11,0; 12,0; 13,0; 14,0 x 23mm
2 Zyklop extensions with freewheel sleeve	1/4" x 75mm and 1/4" x 150mm
1 T-handle	1/4" x 110mm
1 universal joint	1/4" x 35,5mm

517069

Mfrs List No.	Order Code	1+	5+
8100 SA 1	158-0992	96.60	91.80

**8100 SA 2 Zyklop ratchet set, 1/4" drive, metric**

42 piece set in strong metal case



- Rotating mass design and handy freewheel sleeve for faster work
- Swivelling ratchet head
- Defined lock positions at 0°, 15°, 90° right and left
- Can be used like a conventional screwdriver
- Pushbutton release
- CW/ACW toggle, fine-pitched tooth design, with small return angle of 5° - 6°
- Multicomponent Kraftform handle for comfort and torque

Set content:	length
1 Zyklop ratchet	1/4" x 152mm
13 Zyklop sockets (metric)	4,0; 4,5; 5,0; 5,5; 6,0; 7,0; 8,0; 9,0; 10,0; 11,0; 12,0; 13,0; 14,0 x 23mm
2 Zyklop flexible-lock™ extensions with freewheel sleeve	1/4" x 75mm and 1/4" x 150mm
1 wobble extension	1/4" x 56mm
1 T-handle	1/4" x 110mm
1 universal joint	1/4" x 35,5mm
1 adaptor with quick-release chuck	1/4" x 1/4" x 37mm
22 bits	Slotted: 0,6 x 4,5; 1,0 x 5,5; 1,2 x 8,0 x 25mm Hex-Plus: 3,0; 4,0; 5,0; 6,0; 8,0 x 25mm Phillips: 1; 2; 3 x 25mm Pozidriv: 1; 2; 3 x 25mm TORX® B0: 8; 9; 10; 15; 20; 25; 30; 40 x 25mm

517167

Mfrs List No.	Order Code	1+	5+
8100 SA 2	158-0994	121.80	115.70

**8100 SA 3 ratchet set, 1/4" drive, imperial**

15 piece set in strong metal case



- Rotating mass design and handy freewheel sleeve for faster work
- Swivelling ratchet head
- Defined lock positions at 0°, 15°, 90° right and left
- Can be used like a conventional screwdriver
- Pushbutton release
- CW/ACW toggle, fine-pitched tooth design, with small return angle of 5° - 6°
- Multicomponent Kraftform handle for comfort and torque

Set content:	length
1 Zyklop ratchet	1/4" x 152mm
10 Zyklop sockets (imperial)	3/16"; 7/32"; 1/4"; 9/32"; 5/16"; 11/32"; 3/8"; 7/16"; 1/2"; 9/16" x 23mm
2 Zyklop extensions with freewheel sleeve	1/4" x 75mm and 1/4" x 150mm
1 T-handle	1/4" x 110mm
1 universal joint	1/4" x 35,5mm

517182

Mfrs List No.	Order Code	1+	5+
8100 SA 3	158-0995	91.60	87.00

45

Farnell

**8100 SA 4 ratchet set, 1/4" drive, imperial**

41 piece set in strong metal case



**New**



- Rotating mass design and handy freewheel sleeve for faster work
- Swivelling ratchet head
- Defined lock positions at 0°, 15°, 90° right and left
- Can be used like a conventional screwdriver
- Pushbutton release
- CW/ACW toggle, fine-pitched tooth design, with small return angle of 5° - 6°
- Multicomponent Kraftform handle for comfort and torque

Set content:	length
1 Zyklop ratchet	1/4" x 152mm
10 Zyklop sockets (imperial)	3/16"; 7/32"; 1/4"; 9/32"; 5/16"; 11/32"; 3/8"; 7/16"; 1/2"; 9/16" x 23mm
2 Zyklop flexible-lock" extensions with free-wheel sleeve	1/4" x 75mm and 1/4" x 150mm
1 wobble extension	1/4" x 56mm
1 T-handle	1/4" x 110mm
1 universal joint	1/4" x 35,5mm
1 adaptor with quick-release chuck	1/4" x 1/4" x 37mm
24 bits	Slotted: 0,6 x 4,5; 1,0 x 5,5; 1,2 x 8,0 x 25mm Hex-Plus: 5/64"; 3/32"; 1/8"; 9/64"; 5/32"; 3/16"; 7/32" x 25mm Phillips: 1; 2; 3 x 25mm Pozidriv: 1; 2; 3 x 25mm Torx® B0: 8; 9; 10; 15; 20; 25; 30; 40 x 25mm

517204

Mfrs List No.	Order Code	1+	5+
8100 SA 4	158-0996	116.80	110.90

**39 Piece 'SURE DRIVE' 1/4" Socket Set**



- Metric socket set forged from chrome vanadium alloy steel for long life
- Non-slip satin chrome finish for maximum resistance to shock and peeling
- 'Sure Drive' system exerts torque through the flats of the socket rather than the corners, eliminating rounding off at high torque
- Ratchet features a soft grip, dual compound handle

**Contents:**

- 1/4" 45 tooth quick release ratchet
- Sockets: 4, 4.5, 5, 5.5, 6, 7, 8, 9, 10, 11, 12, 13, 14mm
- Slotted bits: 4, 5.5, 7mm
- Phillips bits: PH1, PH2, PH3
- Pozidriv bits: PZ1, PZ2, PZ3
- Tamperproof torx bits: T8, T10, T15, T20, T25, T27, T30, T40
- Hexagon bits: 3, 4, 5, 6mm
- 50mm extension
- 50mm extension/driver
- Universal joint
- Adaptor

419492, 422834, 422834

Mfrs list no.	Order Code	1+	5+
T4655	109-8815	54.57	52.18

**25 Piece Socket Set**

6WD



- Professional socket set 3/8" and 1/4" drive 25 piece metric/imperial set
  - Mettrinch 6 wall drive profile
  - Chrome vanadium steel, chrome plated and polished
  - Supplied in a heavy duty plastic case
- Mettrinch is a trademark of Surelab, USA**



	Metric	Imperial
1/4" Drive	5, 6, 7, 8, 9, 10, 11, 12	3/16, 1/4, 5/32, 3/16, 1/2, 3/8, 7/16, 1/2
3/8" Drive	13, 14, 16, 17, 19, 20/21, 22	1/2, 9/16, 5/8, 11/16, 3/4, 7/8

231778

Order Code	Price Each
321-6895	1+ 75.42

**Draper 1/4 in Socket Set**



**B20M**

20 piece 1/4in square drive socket set. Manufactured from chrome vanadium steel hardened, tempered, chrome plated and polished for corrosion protection. Packed in rigid plastic case with foam insert and display sleeve.

490647

Contents	Order Code	1+	5+	10+	20+
Hexagon sockets 4, 4.5, 5, 5.5, 6, 7, 8, 9, 10, 11, 12, 13, 14mm Extension bars 20, 75, 150mm Reversible ratchet Sliding T bar Universal joint Flexible handle	135-9490	24.64	24.15	23.66	23.20

**40 Piece AF/BA/Metric - 1/4" Square Drive**

'Expert Range'



H=43, W=310, D=155.

- The 'Expert Range' is a professional quality socket set featuring highly finished triple chrome plated sockets and accessories
- The case is blow moulded in a resilient plastic which accurately holds the contents in labelled spaces

**Contents**

- 5 Hexagon AF Sockets: 1/4", 5/16", 3/8", 7/16", 1/2"
- 12 Hexagon MM Sockets: 4, 4.5, 5, 5.5, 6, 7, 8, 9, 10, 11, 12, 13
- 4 Hexagon BA Sockets: 6, 4, 2, 0
- Reversible Ratchet, 2", 3", 6" Extension Bars, Sliding Tee Bar, Universal Joint, Spinner Handle, Bit Holder 1/4" x 1/4" Hexagon
- 11 Insert Bits 1/4" Hexagon: 4 Plain Slot 3.5, 4.5, 5.5, 6.5mm. 2 Crosspoint No. 1, No. 2. 2 Pozidriv No. 1, No. 2. 3 Torx T15, T20, T25.

223330

Mfrs. List No.	Order Code	Price Each
18965	106-085	1+ 40.48

45



**Socket Sets - 1/4" - continued**

**Socket set**  
1/4in Square Drive



Manufactured from chrome alloy steel. Set includes quick release ratchet, 100mm extension, universal joint, spinner handle, sliding T-handle and bit holder. Supplied in a moulded case. Single hex.

Contents		Contents	
Standard socket	4, 4.5, 5, 5.5, 6, 7, 8, 9, 10, 11, 12, 13, 14mm	Slotted bit	4, 5.5, 6.5mm
Deep socket	6, 7, 8, 9, 10, 11, 12, 13mm	Phillips bit	No1, No2, No3
Hexagon bit	3, 4, 5, 6, 7mm	Pozidriv bit	No1, No2, No3
Torx bit	T10, T15, T20, T25, T27, T30		

491054

Set	Order Code	Price Each
Metric 46 piece	386-0942	56.57

**60 Piece Socket and Bit Set**  
1/4" Square Drive



- Sockets forged from quality carbon steel, hardened and tempered with a chrome plated finish
- Bits manufactured from chrome vanadium steel hardened and tempered

Contents:  
1/4" Hex sockets: 4, 4.5, 5, 6, 7, 8, 9, 10, 11, 12, 13mm  
1/2", 7/16", 3/8", 5/16", 9/32", 1/4", 7/32", 3/16", 5/32" AF  
0, 2, 4, 6, 8 BA  
1/4" Hex Drive bits: Hex 2.5, 3, 4, 4.5, 5, 5.5, 6, 7, 8, Torx T8, T9, T10, T15, T20, T25, T27  
Slot 3, 4, 4.5, 5, 5.5, 6, 7mm, Pozi No. 1, 2, 3, Phillips No. 1, 2, 3  
Screwdriver 1/4" Hex Drive, 1/4" Hex and Square Drive ratchet  
Magnetic extension, male and female 1/4" Hex to 1/4" Square Drive adaptors

222961

Order Code	Price Each
312-7254	28.38

**24 Piece 1/4" Socket Set**



Manufactured from chrome vanadium steel and supplied in a blow moulded case

Contents:  
Sockets 1/4": 4, 5, 5.5, 6, 8, 9, 10, 11, 12, 13 mm  
Slotted: 4, 5, 6 mm  
Phillips: PH1, PH2  
Pozidriv: PZ1, PZ2  
Torx: T10, T15, T20  
Hex: 4 mm 1 x 1/4"  
Screwdriver bit holder, 1 x Drive socket adaptor, 1 x 1/4" Drive ratchet handle

472548.527323

Order Code	price/set
166-4787	10.15

**Socket Set 1/4" + 1/2", 94 pieces**



- 18 Hexagon Sockets 1/2" drive: 10/ 11/ 12/ 13/ 14/ 15/ 16/ 17/ 18/ 19/ 20/ 21/ 22/ 23/ 24/ 27/ 30/ 32 mm
- 4 Hexagon Sockets 1/2" deep drive: 14/ 15/ 17/ 19 mm
- 2 Spark Plug Sockets: 16 und 21 mm
- 1 1/2" Ratchet Handle
- 2 Extensions: 125 and 250 mm
- 3 Hexagon Keys 1,5/ 2/ 2,5 mm
- 1 Kardangelen
- 1 Adapter from 1/2" to Allen screw
- 1 Adapter for T-Handle
- 15 Screwdriver Sockets
- 13 Hexagon Sockets 1/4" drive: 4/4,5/ 5/ 5,5/

- 6/ 7/ 8/ 9/ 10/ 11/ 12 13/ 14 mm
- 8 Hexagon Sockets 1/4" deep drive: 6/ 7/ 8/ 9/ 10/ 11/ 12/ 13 mm
- 1 1/4" Ratchet Handle
- 2 Extensions: 50 and 100 mm
- 1 flexible Extension
- 1 T-Handle
- 1 Universal Joint
- 1 Adapter from 1/4" to Allen Screw
- 1 Screwdriver Handle
- 17 Screwdriver Sockets
- Blow moulded case

497350

Order Code	1+	5+	10+	20+
152-8998	55.86	51.76	46.56	41.41

**75 Piece AF/BA/Metric - 1/4" Square Drive**  
'Expert Range'



H=51, W=425, D=210.

- The 'Expert Range' is a professional quality socket set featuring highly finished triple chrome plated sockets and accessories
- The case is blow moulded in a resilient plastic which accurately holds the contents in labelled spaces

Contents:  
9 Hexagon AF Sockets: 3/16" 7/32" 1/4" 3/32" 5/16" 11/32" 3/8" 7/16" 1/2" AF  
12 Hexagon MM Sockets: 4, 4.5, 5, 5.5, 6, 7, 8, 9, 10, 11, 12, 13mm  
4 Hexagon BA Sockets: 0, 2, 4, 6 BA  
6 Hexagon AF Deep Sockets: 3/16", 1/4", 5/16", 3/8", 7/16", 1/2" AF  
10 Hexagon MM Deep Sockets: 4, 5, 5.5, 6, 7, 8, 9, 10, 11, 13mm  
Reversible Ratchet, Sliding Tee Bar, Flexible Handle, 2", 3", 6" Extension Bars, 6" Flexible Extension Bar, Spinner Handle, Bit Holder  
25 Insert Bits 1/4" Hexagon: 4 Plain Slot 3.0, 4.0, 5.5, 7.0mm. 3 Crosspoint No. 1, 2, 3.3  
Pozidriv No. 1, 2, 3. 5 Hex mm 3, 4, 5, 6, 7.  
3 Hex AF: 1/8", 3/16", 1/4"  
7 Torx: T10, T15, T20, T25, T27, T30, T40.

223331

Mfrs. List No.	Order Code	Price Each
18966	106-088	73.06

**700 products added online every week**



See our pick of the hottest products and latest technologies in 'What's New?' at [www.farnell.co.uk](http://www.farnell.co.uk)

Over 480,000 products online



**37 Piece Combination Set**  
4 and 6WD



- Professional 37 piece metric/imperial combination wrench and socket set
  - 3/8" and 1/4" drive
  - Metrinch 4 and 6 wall drive profile
  - Chrome vanadium steel, chrome plated and polished
  - Supplied in heavy duty plastic case
- Metrinch is a trademark of Surelab, USA**

4WD Spanner



6WD Socket



231779

	Size Metric	Imperial
1/4" Drive - Socket	5, 6, 7, 8, 9, 10	3/16, 1/4, 9/32, 5/16, 11/32, 3/8
3/8" Drive Deep Wall - Socket	10, 11, 12, 13, 14, 16, 17, 19	3/8, 7/16, 15/32, 1/2, 9/16, 5/8, 11/16, 3/4
3/8" Drive Socket	10, 11, 12, 14, 17, 19	3/8, 7/16, 15/32, 1/2, 9/16, 11/16, 3/4, 7/8
Combination Wrenches	10, 11, 12, 14, 16, 17, 19	3/8, 7/16, 15/32, 9/16, 5/8, 11/16, 3/4

Order Code	Price Each
321-6913	1+ 121.60

**76 Piece Combination Set**  
4 and 6WD



- Professional 76 piece metric/imperial combination wrench and socket set
  - 1/4", 3/8" and 1/2" drive
  - Metrinch 4 and 6 wall drive profile
  - Chrome vanadium steel, chrome plated and polished
  - Supplied in a heavy duty plastic case
- Metrinch is a trademark of Surelab, USA**

4WD Spanner



6WD Socket



527314

	Size Metric	Imperial
1/4" Drive - Socket	5, 6, 7, 8, 9, 10, 11, 12, 13	3/16, 1/4, 9/32, 5/16, 11/32, 3/8, 7/16, 15/32, 1/2
1/4" Drive Deep Wall - Socket	5, 6, 7, 8, 9, 10, 11, 12	3/16, 1/4, 9/32, 5/16, 11/32, 3/8, 7/16, 15/32, 1/2
3/8" Drive Socket	10, 11, 12, 13, 14, 17, 19, 22	3/8, 7/16, 15/32, 1/2, 9/16, 11/16, 23/32
3/8" Drive Socket	10, 11, 12, 13, 14, 15, 16, 17, 18, 19, 3/4, 3/16, 7/8, 15/16, 1, 1 1/16, 1 3/16, 1 1/4	
Combination Wrenches	20/21, 22, 24, 25, 26/27, 29/30	
	10, 11, 12, 13, 14, 15, 16, 17, 18, 19, 3/4, 3/16, 25/32, 1/2, 9/16, 19/32, 5/8, 11/16, 23/32, 20/21	3/4, 13/16

Order Code	Price Each
321-6925	1+ 192.20

**25 Pieces Socket set 1/4" drive**  
Dynamic-Drive-Profile™



- Matt Chrome-plated finish
- Material: Chrome Vanadium
- Case material: High Density Polythene (HDPE)



527308

- Set contents:
- 12 pcs 1/4" 6-pt Sockets Dynamic-Drive-Profile™
  - 4, 4.5, 5, 5.5, 6, 7, 8, 9, 10, 11, 12, 13 mm
  - 1 pcs Ratchet 1/4" compact length only 125 mm with two components handle, and quick release button
  - 2 pcs bit 1/4" PH 2
  - 2 pcs bit HEX 5, 6
  - 6 pcs bit TORX 10, 15, 20, 25, 30, 40
  - 1 pcs bit holder 1/4" with locking spring, 1/4" female square
  - 1 pcs 1/4" Wobblers Extension bar, length 100 mm

Set	Order Code	1+	5+	10+
SL25	167-1619	19.95	18.95	17.95

**91 Piece Socket set 1/4" and 1/2" & Combination Spanners**  
with Dynamic-Drive-Profile



- Finish: Matt Chrome-plated
- Material: Chrome Vanadium



- Set Content:
- 12 pcs 1/4" 6-pt Sockets Dynamic Drive 4 4.5 5.5 6 7 8 9 10 11 12 13 mm
  - 10 pcs 1/4" 6-pt Deep Sockets Dynamic Drive 4 5 6 7 8 9 10 11 12 13 mm
  - 13 pcs 1/2" 6-pt Sockets Dynamic Drive 10 11 12 13 14 15 17 19 22 24 27 30 32 mm
  - 2 pcs 1/4" Extension bars 2" & 4"
  - 1 pc 1/4" Sliding T-bar
  - 1 pc 1/4" Universal joint
  - 1 pc 1/4" Bit holder
  - 1 pc 1/4" Bit adapter
  - 1 pc 1/4" Spinner handle
  - 1 pc 1/4" Magnetic adapter
  - 4 pcs 1/4" Bits phillips # 0, 1, 2 and 3
  - 3 pcs 1/4" Bits Flat 4 5.5 7 mm
  - 3 pcs 1/4" Bits Pozidriv # 1, 2 and 3
  - 6 pcs 1/4" Bits Hex 3 4 5 6 8 10 mm
  - 8 pcs 1/4" Bits Torx 8 10 15 20 25 27 30 40
  - 3 pcs 5/16" Bits Torx 45 50 55
  - 2 pcs 1/2" Extension bars 5" & 10"
  - 1 pc 1/2" Universal joint
  - 1 pc 1/2" Spark Plug Socket 6-pt 21 mm (13/16")
  - 1 pc 1/2" x 5/16" Bit holder
  - 1 pc 1/2" T-adapter
  - 3 pcs L-keys Hex 1.5 2 2.5 mm
  - 1 pc 1/4" Ratchet handle 45 teeth
  - 1 pc 1/2" Ratchet handle 54 teeth
  - 4 pcs Flex Head Wrenches 8-9 10-11 12-13 14-15 mm
  - 6 pcs Comb.Wrenches 8 10 12 13 14 17 mm

Set	Order Code	1+	5+	10+
S910	167-1618	144.00	136.80	129.60

**Socket set 1/4" and 1/2" drive and Combination spanners**  
with Dynamic-Drive-Profile



- Finish: Matt Chrome-plated
- Material: Chrome Vanadium
- Case Material: High Density Polythene (HDPE)



- Set Content:
- 12 pcs 1/4" 6-pt Sockets Dynamic Drive 4 4.5 5.5 6 7 8 9 10 11 12 13 mm
  - 9 pcs 1/4" 6-pt Deep Sockets Dynamic Drive 4 5 6 7 8 9 10 11 13 mm
  - 15 pcs 1/2" 6-pt Sockets Dynamic Drive 10 12 13 14 15 16 17 18 20 21 23 24 27 32 34 mm
  - 9 pcs 1/2" 6-pt Sockets Dynamic Drive AF 3/8 7/16, (11) 1/2 9/16 11/16 3/4, (19) 13/16 7/8, (22) 1-3/16"
  - 4 pcs 1/2" 6pt- Impact sockets 17 19 21 24 mm
  - 4 pcs 1/4" Socket drivers PH 1 2 3 4
  - 3 pcs 1/4" Socket drivers Flat 4 5 5 7 mm
  - 6 pcs 1/4" Socket drivers Hex 3 4 5 6 8 10 mm
  - 2 pcs 1/4" Extension bars 50 mm / 2" & 100 mm / 4"
  - 1 pce 1/4" Sliding T-bar 100 mm / 4"
  - 1 pce 1/4" Universal joint
  - 1 pce 1/4" Spinner with two components handle
  - 2 pcs 1/2" Extension bars 125 mm / 5" & 250 mm / 10"
  - 1 pce 1/2" Universal joint
  - 1 pce 1/2" Spark Plug Socket 6-pt 21 mm (13/16")
  - 1 pce 1/2" T-adapter
  - 3 pcs L-Keys Hex 1.5 2 2.5 mm

45



**Socket Sets - 1/4" - continued**

**Socket set 1/4" and 1/2" drive and Combination spanners - continued with Dynamic-Drive-Profile - continued**

**Set Content:**

- 1 pce 1/4" Ratchet with two components handle, 60 teeth
- 1 pce 1/2" Ratchet with two components handle, 60 teeth
- 4 pcs Flex Head spanners 8-9 10-11 12-13 14-15 mm
- 13 pcs Combination spanners 7 8 9 10 11 12 13 14 15 16 17 18 19 mm on practical removable tool-rack
- 1 pce Removable three section plastic box with lid

527321

Set	Order Code	1+	5+	10+
S87+7	167-1617	173.00	164.35	155.70

**Socketry 1/4" Drive Sets**



**S160**

Manufactured from matt chrome-plated vanadium steel conforming to ISO standards. Supplied in an impact proof, oil and temperature resistant polypropylene transport case.

The S160 set contains:-

- Sockets with Dynamic Drive 4, 4.5, 5, 5.5, 6, 7, 8, 9, 10, 11, 12, 13mm
- Ratchet handle
- Sliding T-bar
- Extension bar, 75mm
- Flexible extension bar, 150mm

Set	Order Code	1+	5+	10+	20+
S160	135-6167	19.16	18.68	18.23	17.60



**S290**

The S290 set contains:-

- Sockets with Dynamic Drive Profile 4, 4.5, 5, 5.5, 6, 7, 8, 9, 10, 11, 12, 13mm
- Phillips bit sockets No. 1, 2, 3
- Slotted bit sockets 4, 5.5, 7mm
- Hex bit sockets 3, 4, 5, 6, 8mm
- Extension bars, 50mm and 150mm
- Sliding T-bar
- Universal joint
- Spinner handle
- Ratchet handle

Set	Order Code	1+	5+	10+	20+
S290	135-6168	38.60	37.82	37.07	36.06



**S460**

The S460 set contains:-

- Sockets with Dynamic Drive 4, 4.5, 5, 5.5, 6, 7, 8, 9, 10, 11, 12, 13mm
- Phillips bit sockets No. 1, 2, 3, 4
- Socket drivers slotted 4, 5.5, 7mm
- Socket drivers Hex 3, 4, 5, 6, 8, 10mm
- Socket drivers Torx 8, 10, 15, 20, 25, 27, 30
- Socket Torx E6, E7, E8
- Spinner Disc
- Extension bars, 50mm and 100mm
- Sliding T-bar
- Universal joint
- Spinner handle
- Flexible extension bar, 150mm
- L-Keys Hex 1.5, 2, 2.5mm
- Ratchet handle

488115

Set	Order Code	1+	5+	10+	20+
S460	135-6169	66.04	64.72	63.42	61.70

**Help us to help the environment**



This catalogue has been printed on paper certified from a sustainable source.

**Please recycle after use.**



**Socket wrench set, 1/4"**



37-piece



- With forged, tempered hexagon profile socket wrench sets, manually actuated from Gedore vanadium steel 31CrV3
- Screwdriver bits from Gedore vanadium special steel
- Adjustable with ratchet T-handle and telescopic extension of 186-296mm
- In plastic box, dimensions 200 x 120 x 38mm
- "Check-Tool-System": check for completeness via 2-coloured plastic inlay

Mfrs' List No.	Order Code	Ratchet Bits	Accessories	Weight
U-3 T		Outer hexagon: 4 5 6 7 8 9 10 11 12 13 mm Slot: 4 6.5 mm Inner hexagon: 3 4 5 6 mm Inner dodecahedron: 5 6 8 mm Torx: T8 T9 T10 T15 T20 T25 T27 T30 T40 Phillips: PH1 PH2 Pozidriv: PZD1 PZD2 PZD3	Bit holder Extension Cardan joint	0.8 kg
20 XLU-3 T	135-7704			

469247

Mfrs' List No.	Order Code	1+	3+	5+
20 XLU-3 T	135-7704	82.54	79.23	75.93

**Socket wrench set, 1/4"**



37-piece



- With forged, tempered unit drive profile socket wrench sets, manually actuated and actuating tools from Gedore vanadium steel 31CrV3
- In plastic box, dimensions 200 x 120 x 38mm

Mfrs' List No.	Order Code	Ratchet Bits	Accessories	Weight
U-20		Outer hexagon: Unit Drive 4 5 6 7 8 9 10 11 12 13 mm Slot: 4 5.5 6.5 mm Inner hexagon: 3 4 5 6 mm Multi-point: 5 6 8 mm Torx: T10 T15 T20 T25 T27 T30 T40 Phillips: PH1 PH2 Pozidriv: PZD1 PZD2 PZD3	Bit adapter Extension Multi-grip Bit holder	656 g
D 20 KMU-20	135-7703			

469963

Mfrs' List No.	Order Code	1+	3+
D 20 KMU-20	135-7703	89.75	86.18

**addigrip driver set® compact 1/4"**



with 31-piece Rastoflex®,



**Flexible head ratchet®, Rastoflex System®, fine-tooth**

- 1/4" Socket spanner inserts, 6-sided SW 4 - 4.5 - 5 - 5.5 - 6 - 7 - 8 - 9 - 10 - 11 - 12 - 13 mm
- Screwdriver inserts: Torx with face bore: TX10 - TX15 - TX20 - TX25 - TX27 - TX30 - TX40
- Internal hex 3 - 4 - 5 - 6 - 8 - 10 mm
- Extensions 50, 100 mm
- Knuckle joint, anti-slip grip
- Machine adaptor 1/4" square x 1/4" hex, Length 50 mm
- Minimus grip change tool bit connection 1/4" with magnetic collet

**Steel-Steel toolbox compact addigrip series:**  
Permanently fast tool change using technically correct location with minimal space requirement.

413380

Mfrs. List No.	Order Code	1+	3+	5+
4004.81TK.	979-1370	75.08	71.42	67.56



**addigrip driver set® compact 1/4"**

with reversible ratchet and lever switch-over, 32-piece



**Reversible ratchet®, lever switch-over, oval head 1/4" Socket spanner inserts 6-sided**  
 SW 4-4.5-5-5.5-6-7-8-9-10-11-12-13 mm  
**Screwdriver inserts:**  
 Torx with face bore: TX10 - TX15 - TX20 - TX25 - TX27 - TX30 - TX40  
 Internal hex 3 - 4 - 5 - 6 - 8 - 10 mm  
 Extensions 50, 100 mm  
 Knuckle joint, anti-slip grip  
 Machine adapter 1/4" square x 1/4" hex, Length 50 mm  
 Minimus grip change hex shaft with 1/4" collet  
**tool bit connection 1/4" with magnetic collet**

**Steel-Steel toolbox compact addigrip series:**  
 Permanent fast tool change using technically correct location with minimal space requirement.

413358

	Order code	1+	3+	5+
4004.79.	979-1353	48.18	45.84	43.31

**addigrip driver set® compact 1/4"**

with 31-piece Rastoflex®,



**Flexible head ratchet®, Rastoflex System®, fine-tooth 1/4" Socket spanner inserts, 6-sided**  
 SW 4-4.5-5-5.5-6-7-8-9-10-11-12-13 mm  
**Screwdriver inserts:**  
 Torx with face bore: TX10 - TX15 - TX20 - TX25 - TX27 - TX30 - TX40  
 Internal hex 3 - 4 - 5 - 6 - 8 - 10 mm  
 Extensions 50, 100 mm  
 Knuckle joint, anti-slip grip  
 Machine adaptor 1/4" square x 1/4" hex, Length 50 mm  
 Minimus grip change  
**tool bit connection 1/4" with magnetic collet**

**Steel-Steel toolbox compact addigrip series:**  
 Permanently fast tool change using technically correct location with minimal space requirement.

413378

Mftrs. List no.	Order Code	1+	3+	5+
4004.81.	979-1361	62.62	59.53	56.34

**Socket Set**

1/4in Square Drive 46 Piece Metric Socket Set



**Contents:**  
 Quick release fine tooth ratchet  
 Spinner handle  
 Sliding T handle  
 100mm & 50mm extensions, 150mm flexible extension  
 Universal joint  
 1/4" Hex - 1/4" Square adaptor  
 1.3, 1.5, 2 & 2.5mm hex keys  
 13 x Hexagon sockets: 4-14mm  
 6 x Hex bit sockets: 3-8mm  
 6 x Torx® bit sockets: TX10-40  
 3 x Pozidriv® bit sockets: PZ1-PZ3  
 3 x Slotted bit sockets: 4-7mm  
 3 x Phillips® bit sockets: PH1-3

487746

Order Code	1+	5+	10+	20+
141-8809	57.78	56.63	55.50	54.39

**Coming soon**



Register your interest for items that are 'Coming Soon' at [www.farnell.co.uk](http://www.farnell.co.uk) and we'll email you to let you know that they're in stock.

**50 Piece AF/BA/Metric - 1/4", 3/8" and 1/2" Square Drive 126 Piece Equivalent**



4WD Spanner



6WD Socket



Mettrinch® sockets have a patented 6 wall drive design that protects nuts and bolts from damage and eases removal of old rusty or worn hexagonal fasteners. Each socket can fit up to four different metric and imperial sizes. All parts are made from chrome plated, chrome vanadium steel.

The set is supplied in an accurately made plastic case that holds the set securely. The ratchet handle has a positive lock mechanism that holds the attached socket or extension bar firmly in place.

**Contents: Sockets and Spanners**

Metric	AF	WW	BSF	BA	1/2" Socket	3/8" Socket	3/8" Long Socket	1/4" Socket	Spanner
5mm	3/16"	--	--	6	--	--	--	✓	--
6mm	1/4"	--	--	4	--	--	--	✓	--
7mm	9/32"	--	--	3	--	--	--	✓	--
8mm	5/16"	--	--	2	--	--	--	✓	--
9mm	11/32"	--	--	6	--	--	--	✓	--
10mm	3/8"	--	--	--	--	✓	✓	✓	✓
11mm	7/16"	3/16"	1/4"	--	--	✓	✓	--	✓
12mm	15/32"	--	--	--	--	✓	✓	--	--
13mm	1/2"	--	--	--	--	✓	✓	--	✓
14mm	9/16"	1/4"	5/16"	--	--	✓	✓	--	✓
16mm	5/8"	5/16"	3/8"	--	--	✓	✓	--	✓
17mm	11/16"	--	--	--	✓	✓	✓	--	✓
19mm	3/4"	3/8"	7/16"	--	✓	--	--	--	✓
20mm	13/16"	7/16"	1/2"	--	✓	--	--	--	✓
21mm	13/16"	7/16"	1/2"	--	✓	--	✓	--	--
22mm	7/8"	--	--	--	✓	--	--	--	--
24mm	15/16"	1/2"	9/16"	--	✓	--	--	--	--
27mm	1 1/16"	3/8"	11/16"	--	✓	--	--	--	--
30mm	1 3/16"	11/16"	3/4"	--	✓	--	--	--	--
32mm	1 1/4"	3/4"	7/8"	--	✓	--	--	--	--

**Other Items**

27mm and 16mm spark plug sockets  
 400mm breaker bar  
 230mm 1/2" drive ratchet handle  
 180mm 3/8" drive ratchet handle  
 250mm, 152mm, 75mm Wobble 1/2" extensions.

152mm and 75mm 3/8" extensions  
 3/8" and 1/4" universal joints  
 3/8" to 1/4" drive adaptor  
 152mm combined 1/4" extension/drive handle, and a 1/2" drive sliding head that used with an extension bar makes a 'T' bar

METRINCH® is a trademark of Surelab, USA

223338

Order Code	Price Each
282-613	1+ 148.19

**Technical information at your fingertips**



Over **352,000** technical datasheets available online.

Visit [www.farnell.co.uk](http://www.farnell.co.uk) and look for the **Tech Info** heading in your search results.



**Socket Sets - 1/4" - continued**

**Socket Set 1/2in Drive**

**1/4 & 1/2in 94 Piece Socket Set**



Manufactured from chrome alloy steel. Set includes 1/4 and 1/2in square drive ratchet handles, 1/4 and 1/2in universal joints, 1/4 and 1/2in sliding T bars, 1/4in drive 50 and 100mm extensions 1/2in drive 125mm extension. Supplied in a blow moulded case.

- Contents**  
 Hexagon sockets  
 1/4in drive 4, 4.5, 5, 5.5, 6, 7, 8, 9, 10, 11, 12, 13, 14mm  
 Hexagon sockets  
 1/2in drive deep 6, 7, 8, 9, 10, 11, 12, 13mm  
 Hexagon sockets  
 1/2 drive 10, 11, 12, 13, 14, 15, 16, 17, 18, 19, 20, 21, 22, 24, 27, 30, 32mm

- Hexagon sockets  
 1/2in drive deep 14, 15, 17, 19, 22mm  
 Spark plug sockets 16, 21mm  
 Slotted screwdriver sockets 1/4in drive 4, 5.5 and 6.5mm  
 Pozidriv screwdriver sockets 1/4in drive No1, No2  
 Phillips screwdriver sockets 1/4in drive No1, No2  
 Torx screwdriver sockets 1/4in drive T8, T10, T15, T20, T25, T27, T30 Hex sockets  
 1/4in drive 3, 4, 5, 6mm Hex bits slotted 8, 10, 12mm  
 Hex bits Pozidriv No3, No4  
 Hex bits Phillips No3, No4  
 Hex bits Torx T40, T45, T50, T55  
 Hex bits 7, 8, 10, 12, 14mm  
 3 x Hexagon keys  
 1 x 1/2inch hexagon bit adaptor

491541

Order Code	Price Each
152-8998	1+ 55.86

**1/4" Drive Clip Rail Set**

**6WD**



6WD Socket



45

- High quality 9 piece clip rail set
- Metrinch 6 wall drive profile
- Chrome vanadium steel, chrome plated and polished
- Conform to **DIN 3124 Metrinch** is a trademark of Surelab, USA

**Size**

Metric	Imperial
5,6,7,8,9,10,11,12,13mm	3/16,1/4,9/32,5/16,11/32,3/8,7/16,1/2"

231034

Order Code	Price Each
321-6883	1+ 17.42

**Reversible Ratchet 1/4"**



- **6950** Reversible ratchet with 1/4 drive, 12° action, 30 teeth, plastic handle and forward/reverse lever in head
- **6950RN** Reversible ratchet with 1/4" drive, close 6° action, 60 teeth, plastic handle and forward/reverse knurled lever in head
- Chrome vanadium extra finish
- Conform to **DIN 3122** and **DIN 3123**

225251

Mfrs. List No.	Order Code	1+	4+	10+	20+	40+
6950	707-8791	24.90	23.90	22.90	21.90	19.32
6950RN	707-8808	22.55	21.65	20.75	19.85	17.51

**1/4" Drive Bar**



- Made from chrome vanadium steel
- Forward/Reverse action
- Plastic handle at end for comfort
- Length 140mm



493845

Mfrs. List No.	Order Code	1+	5+	10+	20+
146-0031	151-8440	20.65	19.87	19.71	19.66

**Spanners And Sockets**



**Accessories**



R161



R157



R158



R240A



R216

486300

Number	Description	Order Code	1+	5+	10+
R161	Ratchet, non slip handle	352-3354	24.97	22.81	20.79
R157	Ratchet, steel handle, long reach,	137-4358	27.53	26.98	26.44
R158	Ratchet, steel handle, long reach, hinged	137-4359	35.19	34.49	33.79
R240A	Universal joint	352-3378	10.81	10.39	9.61
R216	Flexible extension 150mm	137-4335	10.39	10.18	9.99
R209	Extension 55mm	352-3550	3.93	3.77	3.49
R217	Extension 250mm	137-4336	13.11	12.84	12.59

**Socket Sets - 3/8"**

**8100 SB 1 Zyklop ratchet set, 3/8" drive, metric**



23 piece set in strong metal case



- Rotating mass design and handy freewheel sleeve for faster work
- Swivelling ratchet head
- Defined lock positions at 0°, 15°, and 90° right and left
- Can be used like a conventional screwdriver
- Pushbutton release
- CW/ACW toggle, fine-pitched tooth design, with small return angle of 5° - 6°
- Multicomponent Kraftform handle for comfort and torque

Set content:	length
1 Zyklop ratchet	3/8" x 199mm
18 Zyklop sockets (metric)	6,0; 7,0; 8,0; 9,0; 10,0; 11,0; 12, 13,0; 14,0; 15,0 x 29mm 16,0; 17,0; 18,0; 19,0; 20,0; 21,0; 22,0 x 30mm 24,0 x 32mm
2 Zyklop extensions with freewheel sleeve	3/8" x 125mm and 3/8" x 200mm
1 T-handle	3/8" x 165mm
1 universal joint	3/8" x 50mm

517274

Mfrs. List No.	Order Code	1+	5+
8100 SB 1	158-0997	130.20	123.70

**8100 SB 2 Zyklop ratchet set, 3/8" drive, metric**



43 piece set in strong metal case

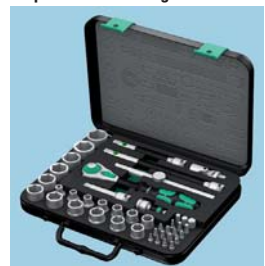



- Rotating mass design and handy freewheel sleeve for faster work
- Swivelling ratchet head
- Defined lock positions at 0°, 15°, and 90° right and left
- Can be used like a conventional screwdriver
- Pushbutton release
- CW/ACW toggle, fine-pitched tooth design, with small return angle of 5° - 6°
- Multicomponent Kraftform handle for comfort and torque

Set content:	length
1 Zyklop ratchet	3/8" x 199mm
18 Zyklop sockets (metric)	6,0; 7,0; 8,0; 9,0; 10,0; 11,0; 12, 13,0; 14,0; 15,0 x 29mm 16,0; 17,0; 18,0; 19,0; 20,0; 21,0; 22,0 x 30mm 24,0 x 32mm
2 Zyklop flexible-lock" extensions with freewheel sleeve	3/8" x125mm and 3/8" x 200mm
1 T-handle	3/8" x 165mm
1 wobble extension	3/8" x 76mm
1 universal joint	3/8" x 50mm
1 adaptor with quick-release chuck	1/4" x 3/8" x 44mm
18 bits	Slotted: 1,0 x 5,5 x 25mm Hex-Plus: 3,0; 4,0; 5,0; 6,0; 8,0; 10,0 x 25mm Phillips: 2; 3 x 25mm Pozidriv: 2; 3 x 25mm TORX® B0: 10; 15; 20; 25; 27; 30; 40 x 25mm

517333

Mfrs List No.	Order Code	1+	5+	Price Each
8100 SB 2	158-0998	155.40	147.60	

- Rotating mass design and handy freewheel sleeve for faster work
- Swivelling ratchet head
- Defined lock positions at 0°, 15°, and 90° right and left
- Can be used like a conventional screwdriver
- Pushbutton release
- CW/ACW toggle, fine-pitched tooth design, with small return angle of 5° - 6°
- Multicomponent Kraftform handle for comfort and torque

Set content:	length
1 Zyklop ratchet	3/8" x 199mm
12 Zyklop sockets (imperial)	1/4"; 5/16"; 11/32"; 3/8"; 7/16"; 1/2"; 9/16" x 29mm 5/8"; 11/16"; 3/4"; 13/16"; 7/8" x 30mm
2 Zyklop flexible-lock" extensions with freewheel sleeve	3/8" x125mm and 3/8" x 200mm
1 T-handle	3/8" x 165mm
1 wobble extension	3/8" x 76mm
1 universal joint	3/8" x 50mm
1 adaptor with quick-release chuck	1/4" x 3/8" x 44mm
19 bits	Slotted: 1,0 x 5,5 x 25mm Hex-Plus: 5/64"; 3/32"; 1/8"; 9/64"; 5/32"; 3/16"; 7/32" x 25mm Phillips: 2; 3 x 25mm Pozidriv: 2; 3 x 25mm TORX® B0: 10; 15; 20; 25; 27; 30; 40 x 25mm

517355

Mfrs List No.	Order Code	1+	5+	Price Each
8100 SB 4	158-1000	142.00	134.90	

**8100 SB 3 Zyklop ratchet set, 3/8" drive, imperial**

17 piece set in strong metal case



- Rotating mass design and handy freewheel sleeve for faster work
- Swivelling ratchet head
- Defined lock positions at 0°, 15°, and 90° right and left
- Can be used like a conventional screwdriver
- Pushbutton release
- CW/ACW toggle, fine-pitched tooth design, with small return angle of 5° - 6°
- Multicomponent Kraftform handle for comfort and torque

Set content:	length
1 Zyklop ratchet	3/8" x 199mm
12 Zyklop sockets (imperial)	1/4"; 5/16"; 11/32"; 3/8"; 7/16"; 1/2"; 9/16" x 29mm 5/8"; 11/16"; 3/4"; 13/16"; 7/8" x 30mm
2 Zyklop extensions with freewheel sleeve	3/8" x 125mm and 3/8" x 200mm
1 T-handle	3/8" x 165mm
1 universal joint	3/8" x 50mm

517343

Mfrs List No.	Order Code	1+	5+	Price Each
8100 SB 3	158-0999	116.80	110.90	

**8100 SB 4 Zyklop ratchet set, 3/8" drive, imperial**

38 piece set in strong metal case



**23 Piece 'SURE DRIVE' 3/8" Socket Set**



- Bi-hex metric socket set forged from chrome vanadium alloy steel for long life
- Two-tone chrome finish for maximum resistance to shock and peeling
- 'Sure Drive' system extends torque through the flats of the socket rather than the corners, eliminating rounding off at high torque
- Ratchet features a soft grip, dual compound handle

**Contents:**

- 1/4" 45 tooth quick release ratchet
- Bi-hex sockets: 6, 7, 8, 9, 10, 11, 12, 13, 14, 15, 16, 17, 18, 19, 20, 21, 22, 24mm
- 75mm extension
- 150mm extension/driver
- Universal joint
- T-bar / 1/2" Adaptor

419495, 422835

Mfrs List No.	Order Code	Price Each
T4656	109-8816	61.53

**42 Piece AF/BA/Metric - 3/8" Square Drive**

'Expert Range'



H=60,  
W=525,  
D=200.

- The 'Expert Range' is a professional quality socket set featuring highly finished chrome plated sockets and accessories
- The case is blow moulded in a resilient plastic which accurately holds the contents in labelled spaces

**Socket Sets - 3/8" - continued**

**42 Piece AF/BA/Metric – 3/8" Square Drive - continued**  
 'Expert Range' - continued

**Contents:**  
 9 Bi-Hex AF Sockets: 1/4", 3/16", 1/8", 1/8", 1/8", 9/16", 3/8", 1/2", 5/8", 3/4" AF  
 17 Bi-Hex Metric Sockets: 6, 7, 8, 9, 10, 11, 12, 13, 14, 15, 16, 17, 18, 19, 20, 21, 22mm  
 4 Bi-Hex BA Sockets: 0, 2, 4, 6 BA  
 3 Bi-Hex Sockets for 10, 12 and 14mm Spark Plugs  
 Reversible Ratchet, Sliding Tee Bar, Flexible Handle, 3", 6", 8", 12" Extensions Bars  
 Universal joint, Spinner Handle

223332

Mfrs. List No.	Order Code	Price Each
18970	106-086	73.44

**Kamasa 50 Piece 3/8in Drive Metric/Imperial Socket Set**



Set contains:- Sockets metric 8mm to 22mm  
 Sockets imperial 3/8in to 1 1/8in  
 9 accessories.  
 All contained in a blow moulded carrycase.

494105

Order Code	Price Each
049-501	36.60

**3/8in Square Drive Chrome Alloy Steel Accessories**  
 3/8in Accessories



Number	Description
A46	Ratchet 72 teeth reversible, quick release, polypropylene handle
A77	Ratchet, roller bearing mechanism, polypropylene handle
A70	Sliding T bar
A91	Universal joint
APES	Adapter
	3/8in male x 1/2in female
ASEP	Adapter
	3/8in female x 1/2in male

495318

Number	Order Code	Price Each
A46	137-7753	32.07
A77	141-8367	29.17
A70	137-7728	8.93
A91	137-7729	17.10
APES	137-7724	5.32
ASEP	137-7725	5.42

**Socket Accessories**

3/8in Square Drive



493083

Description	Order Code	Price Each
Reversible ratchet fine tooth	248-681	22.90
Sliding T handle	248-682	7.22
Extension 125mm 5in	248-684	7.49
Extension 220mm 9in	248-685	8.73
Universal joint	248-686	12.50
Swivel handle	248-687	16.80
Adaptor 3/8in- 1/2in	155-3739	1.40
Adaptor 3/8in- 1/2in	248-690	6.41

**Facom Accessories**



Number	Description	Order Code	Price Each
J.158	Ratchet, steel handle, long reach, hinged	137-4362	45.97
J.120	Sliding, T bar	137-4337	8.97
J.140	Hinged handle	137-4338	20.97
J.110	Speed brace	137-4339	11.63
J.240A	Universal joint	137-4340	13.31
J.208	Extension 50mm	137-4341	7.08
J.209	Extension 75mm	137-4342	7.08
J.210	Extension 125mm	137-4343	7.19
J.215	Extension 250mm	137-4344	10.60
J.217	Extension 500mm	137-4346	16.75

486572

**Socket Sets 1/2"**

**8100 SC 1 Zyklop ratchet set, 1/2" drive, metric**  
 22 piece set in strong metal case



- Rotating mass design and handy freewheel sleeve for faster work
- Swivelling ratchet head
- Defined lock positions at 0°, 15°, 90° right and left
- Can be used like a conventional screwdriver
- Pushbutton release
- CW/ACW toggle, fine-pitched tooth design, with small return angle of 5° - 6°
- Multicomponent Kraftform handle for comfort and torque

Set content:	length
1 Zyklop ratchet	1/2" x 277mm
17 Zyklop sockets (metric)	10; 11; 12; 13; 14; 15; 16; 17; 18; 19; 20; 21; 22; 24 x 37mm 27 x 40mm 30; 32 x 42mm
2 Zyklop extensions with freewheel sleeve	1/2" x 125mm and 1/2" x 250mm
1 T-handle	1/2" x 250mm
1 universal joint	1/2" x 69mm

517424

Mfrs List No.	Order Code	Price Each
8100 SC 1	158-1001	167.20
		5+ 158.80

**8100 SC 2 Zyklop ratchet set, 1/2" drive, metric**  
 37 piece set in strong metal case



- Rotating mass design and handy freewheel sleeve for faster work
- Swivelling ratchet head
- Defined lock positions at 0°, 15°, 90° right and left
- Can be used like a conventional screwdriver
- Pushbutton release
- CW/ACW toggle, fine-pitched tooth design, with small return angle of 5° - 6°
- Multicomponent Kraftform handle for comfort and torque

Set content:	length
1 Zyklop ratchet	1/2" x 277mm
17 Zyklop sockets (metric)	10; 11; 12; 13; 14; 15; 16; 17; 18; 19; 20; 21; 22; 24 x 37mm 27 x 40mm 30; 32 x 42mm
2 Zyklop flexible-lock" extensions with free-wheel sleeve	1/2" x 125mm and 1/2" x 250mm
1 wobble extension	1/2" x 52mm
1 T-handle	1/2" x 250mm
1 universal joint	1/2" x 69mm
1 adaptor with quick-release chuck	1/2" x 5/16" x 50mm
13 bits	Hex-Plus: 5; 6; 8; 10 x 30mm Phillips: 3 x 32 Pozidriv: 3 x 32mm TORX®: 20; 25; 30; 40; 45; 50; 55 x 35mm

517428

Mftrs List No.	Order Code	Price Each	
		1+	5+
8100 SC 2	158-1002	197.40	187.50

Set content:	length
1 Zyklop ratchet	1/2" x 277mm
18 Zyklop sockets (imperial)	3/8"; 7/16"; 1/2"; 9/16"; 19/32"; 5/8"; 11/16"; 3/4"; 25/32"; 13/16"; 7/8"; 15/16"; 31/32" x 37mm 1"; 1 1/16"; 1 1/8" x 40mm 1 3/16"; 1 1/4" x 42mm
2 Zyklop flexible-lock" extensions with freewheel sleeve	1/2" x 125mm and 1/2" x 250mm
1 wobble extension	1/2" x 52mm
1 T-handle	1/2" x 250mm
1 universal joint	1/2" x 69mm
1 adaptor with quick-release chuck	1/2" x 5/16" x 50mm
13 bits	Hex-Plus: 7/32"; 1/4"; 5/16"; 3/8" x 30mm Phillips: 3 x 32 Pozidriv: 3 x 32mmTORX®: 20; 25; 30; 40; 45; 50; 55 x 35mm

517435

Mftrs List No.	Order Code	Price Each	
		1+	5+
8100 SC 4	158-1005	205.80	195.50

**8100 SC 3 Zyklop ratchet set, 1/2" drive, imperial**  **23 piece set in strong metal case**



**New**

- Rotating mass design and handy freewheel sleeve for faster work
- Swivelling ratchet head
- Defined lock positions at 0°, 15°, 90° right and left
- Can be used like a conventional screwdriver
- Pushbutton release
- CW/ACW toggle, fine-pitched tooth design, with small return angle of 5° - 6°
- Multicomponent Kraftform handle for comfort and torque

Set content:	length
1 Zyklop ratchet	1/2" x 277mm
18 Zyklop sockets (imperial)	3/8"; 7/16"; 1/2"; 9/16"; 19/32"; 5/8"; 11/16"; 3/4"; 25/32"; 13/16"; 7/8"; 15/16"; 31/32" x 37mm 1"; 1 1/16"; 1 1/8" x 40mm 1 3/16"; 1 1/4" x 42mm
2 Zyklop extensions with freewheel sleeve	1/2" x 125mm and 1/2" x 250mm
1 T-handle	1/2" x 250mm
1 universal joint	1/2" x 69mm

517431

Mftrs List No.	Order Code	Price Each	
		1+	5+
8100 SC 3	158-1003	178.10	169.20

**8100 SC 4 Zyklop ratchet set, 1/2" drive, imperial**  **38 piece set in strong metal case**



**New**

- Rotating mass design and handy freewheel sleeve for faster work
- Swivelling ratchet head
- Defined lock positions at 0°, 15°, 90° right and left
- Can be used like a conventional screwdriver
- Pushbutton release
- CW/ACW toggle, fine-pitched tooth design, with small return angle of 5° - 6°
- Multicomponent Kraftform handle for comfort and torque

**Socket set with Dynamic-Drive Profile**



**New**

- Hexagon socket set in Metric sizes 10 - 32 mm on plastic rail with holder
- Includes reversible ratchet S82
- Nickel and matt chrome-plated finish
- Material: VANADIUM-EXTRA

527327

Set	Order Code	Price Per Set		
		1+	5+	10+
S80/17	167-1616	74.95	71.20	67.45

**40 Pieces Socket set 1/2" drive & Combination spanners**  **with Dynamic-Drive Profile**



**New**

- Finish: Matt Chrome-plated
- Material: Chrome Vanadium
- Case Material: High Density Polythene (HDPE)

**Set Content:**

- 21 pcs 1/2" 6-pt Sockets Dynamic Drive:
- 10 11 12 13 14 15 16 17 18 19 20 21 22 23 24 25 26 27 28 30 32 mm
- 2 pcs 1/2" Extension bars 5" & 10"
- 1 pce 1/2" Universal joint
- 1 pce 1/2" T-adaptor
- 1 pce 1/2" Breaker bar with two component handle 10" with flexible 1/2 square
- 1 pce 1/2" Ratchet with two component handle, 60 teeth
- 13 pcs Combination spanners:
- 7 8 9 10 11 12 13 14 15 16 17 18 19 mm on practical removable tool-rack
- 1 pce Removable three section plastic box with lid

527329

Set	Order Code	Price Per Set		
		1+	5+	10+
S400	167-1615	135.00	128.25	121.50

**Socket Sets 1/2" - continued**

**Socket set 1/2" drive, metric**  
with Dynamic-Drive Profile



- Matt Chrome-Plated finish
- Material: Chrome Vanadium
- Case Material: High Density Polythene (HDPE)
- DIN3120/ ISO 1174

**Set Content:**

18 pcs 1/2" 6-pt Sockets Dynamic Drive 10 11 12 13 14 15 16 17 18 19 20 21 22 23 24 27 30 32 mm  
2 pcs 1/2" Extension bar 5" & 10"  
1 pce 1/2" Universal joint  
1 pce 1/2" T-adaptor  
1 pce 1/2" Breaker bar with two components handle 10" with flexible 1/2" square  
1 pce 1/2" Ratchet with two components handle, 60 teeth  
1 pce Removable three section plastic box with lid

527331

Set	Order Code	1+	Price Per Set	5+	10+
S240	167-1614	79.00	75.05		71.10

**106 Pieces Socket set 1/4" and 1/2" drive and Combination spanners**  
with Dynamic-Drive-Profile



- Finish: Matt Chrome-plated.
- Material: Chrome Vanadium. Case: High Density Polythene (HDPE)

**Set Content:**

12 pcs 1/4" 6-pt Sockets Dynamic Drive 4 4.5 5 5.5 6 7 8 9 10 11 12 13 mm  
10 pcs 1/4" 6-pt Deep Sockets Dynamic Drive 4 5 6 7 8 9 10 11 12 13 mm  
15 pcs 1/2" 6-pt Sockets Dynamic Drive 10 12 13 14 15 16 17 18 20 21 23 24 27 32 34 mm  
9 pcs 6-pt Sockets Dynamic Drive AF 3/8 7/16 (11) 1/2 9/16 11/16 3/4 (19) 13/16 7/8 (22) 1-3/16"  
4 pcs 1/2" 6-pt Impact sockets 17 19 21 24 mm  
4 pcs 1/4" Socket drivers Phillips PH 1 2 3 4  
3 pcs 1/4" Socket drivers Flat 4 5.5 7 mm  
6 pcs 1/4" Socket drivers Hex 3 4 5 6 8 10 mm  
3 pcs 1/4" Socket drivers Pozidriv PZ 1 2 3  
8 pcs 1/4" Socket drivers Torx T 8 10 15 20 25 27 30 40  
2 pcs 1/4" Extension bars 50 mm / 2" & 100 mm / 4"  
1 pce 1/4" Sliding T-bar 100 mm / 4"  
1 pce 1/4" Universal joint  
1 pce 1/4" Spinner with two component handle  
2 pcs 1/2" Extension bars 125 mm / 5" & 250 mm / 10"  
1 pce 1/2" Universal joint  
1 pce 1/2" Spark Plug Socket 6-pt 21 mm (13/16")  
1 pce 1/2" T-adaptor  
3 pcs L-Keys Hex 1.5 2 2.5 mm  
1 pce 1/4" Ratchet with two component handle, 60 teeth  
1 pce 1/2" Ratchet with two component handle 60 teeth  
4 pcs Flex head spanners 8-9 10-11 12-13 14-15 mm  
13 pcs Comb. spanners 7 8 9 10 11 12 13 14 15 16 17 18 19 mm on practical removable tool-rack  
1 pce Removable three section plastic box with lid

527332

Set	Order Code	1+	Price Per Set	5+	10+
S106	167-1612	199.00	189.05		179.10

**22 Piece 1/2" Drive**  
C.K. Sure-Drive



- 22 piece metric set in robust steel case
- 'Sure-Drive' sockets grip on the flat of the nut, allowing more torque and eliminating the risk of 'rounding off'
- Forged chrome vanadium steel with matt satin finish

**Contents:**

1/2" drive sockets: 10, 11, 12, 13, 14, 15, 16, 17, 18, 19, 22, 24, 27, 30, 32mm  
Extensions 125mm & 250mm, reversible ratchet, Universal joint, Sliding T handle,  
3/8" drive adaptor, Plug sockets 16mm & 21mm

225286,471218

Mfrs. List No.	Order Code	Price Each
T4657	327-9947	1+ 66.32

**25 Piece AF/Metric - 1/2" Square Drive**



H=55, W=160, D=340

- 'Silverdrive' socket sets are good quality and economically priced
- The sockets are made from chrome vanadium steel while the other parts are made from carbon steel
- This gives the best price/performance combination. The carbon steel parts are marginally heavier than if they had been made from chrome vanadium steel. All parts are bright chrome plated
- The sets are supplied in a double skinned case that holds all the parts safely in place
- Ideal for the professional user who does not use a socket set on a daily basis

**Contents:**

11 Bi-Hex mm Sockets: 10, 11, 12, 13, 14, 15, 16, 17, 18, 19, 22mm  
7 Bi-Hex AF Sockets: 3/8, 7/16, 1/2, 9/16, 5/8, 11/16, 3/4 AF  
2 Spark Plug Sockets: 10, 14mm  
1 \* Tee Bar Head  
2 Extension Bars: 3" & 10"  
1 Universal Joint  
1 Reversible Ratchet  
\* The Tee Bar head should be used in conjunction with the 10" Extension Bar to form a Sliding Tee Bar.

223333

Mfrs. List No.	Order Code	Price Each
SD25AM	282-108	1+ 43.20

**48 Piece AF/Metric — 1/2" Square Drive**  
'Expert Range'



H=60  
W=525  
D=200

- The 'Expert Range' is a professional quality socket set featuring highly finished triple chrome plated sockets and accessories
- The case is blow moulded in a resilient plastic which accurately hold the contents in labelled spaces

**Contents:**

22 Bi-Hex MM Sockets: 8, 9, 10, 11, 12, 13, 14, 15, 16, 17, 18, 19, 20, 21, 22, 24, 25, 26, 27, 28, 30, 32mm  
 10 Bi-Hex AF Sockets: 7/16, 1/2, 9/16, 5/8, 11/16, 3/4, 13/16, 7/8, 15/16, 1" AF  
 3 Bi-Hex Sockets for 10, 12 and 14mm Spark Plugs  
 Reversible Ratchet, 3", 5", and 10" Extension Bars  
 Sliding Tee Bar, Universal Joint, Speed Brace

223334

Mfrs. List No.	Order Code	Price Each
18974	106-087	89.76

**1/2" Square Drive Socket Set**



**Contents:**

- Standard lever change ratchet
- 6 point sockets - 10, 11, 12, 13, 14, 15, 16, 17, 18, 19, 21, 22, 24, 27, 28, 30, 32mm
- Adaptor 1/2" x 9/16"
- Universal joint
- Sliding T-handle
- Extensions - 75, 125, 250mm

485304

Order Code	1+	3+	5+
979-1396	79.87	75.93	71.89

**58 Piece Socket Set 1/2" DR. MM/Bi-Hex**



Chrome Vanadium with satin finish. Supplied with blow mould case. Single hex.

**Contents**

Sockets: 10, 11, 12, 13, 14, 15, 16, 17, 19, 20, 21, 22, 23, 24, 25, 26, 27, 28, 29, 30, 32 mm  
 1/8", 3/16", 1/4", 5/16", 3/8", 7/16", 1/2", 9/16", 5/8", 11/16", 3/4" WW 3/8", 7/16", 1/2", 9/16", 5/8", 11/16", 3/4", 25/62", 13/16", 7/8", 15/16", 1", 1-1/16", 1-1/8", 1-1/4, AF  
 Disc type ratchet handle (satin finish, grip handle)  
 Sliding T bar  
 3" Extension Bar  
 5" Extension Bar  
 10" Extension Bar  
 Speeder handle  
 Universal joint (pin type)  
 1/2" Dr flexible handle 15" (satin finish, pin type)

491159

Order Code	Price Each
968-4573	293.52

**1/2in Square Drive 26 Piece Metric Socket Set**



**Contents:**

Quick release fine tooth ratchet  
 75mm, 125mm, & 250mm extension bars  
 Universal joint  
 Sliding T adaptor  
 16mm & 21mm spark plug sockets  
 18 x Hexagon sockets: 10-32mm

495801

Order Code	Price Each
141-8810	94.49

**Chrome Alloy Steel**

1/2in Square Drive



494492

No.	Description	Order Code	Price Each
E74	Ratchet 40 teeth reversible, polypropylene handle	137-7938	35.92
E75	Ratchet 40 teeth, reversible, quick release, polypropylene handle	137-7961	35.14
E77	Ratchet, roller bearing mechanism, polypropylene handle	141-8368	33.82
E70	Sliding T bar	137-7937	12.07
E86	Swivel handle 620mm 24in polypropylene handle	137-7959	32.17
E91	Universal joint	141-8366	17.67
ESHP	Adapter 1/2in female x 3/4 in male	141-8365	7.87
EPHS	Adapter 1/2in male x 3/4in female	141-8364	10.72

**1/2" Drive Clip Rail Sets**



Standard set: H=45, W=200, Dia.=27  
 Deep set: H=75, W=200, Dia.=27



- 8 piece clip rail sets of Mettrinch® sockets in standard or deep drive
- A handy way to expand any tool set, with wall drive sockets

**Contents**

These sets will accommodate the following sizes:-

MM 10, 11, 12, 13, 14, 16, 17, 19  
 AF 3/8, 7/16, 1/2, 9/16, 5/8, 11/16, 3/4  
 WW 3/8, 1/2, 5/16  
 BSF 1/4, 5/16, 3/8

223286

Mfrs. List No.	Order Code	Price Each
Standard Set	MET0431	559-489
Deep Set	MET0441	559-490

**Socket Accessories**



Number	Description	Order Code	1+	5+	10+	20+
S.171	Ratchet, safety lock	137-5392	34.88	34.18	33.51	32.42
S.161	Ratchet, palm control	352-3366	28.57	26.72	24.35	--
S.110	Speed brace	137-5393	13.87	13.59	13.32	12.89
S.141	Hinged handle	137-5394	25.37	24.85	24.36	23.58
S.120A	Sliding T bar	137-5395	10.86	10.65	10.42	10.10
S.240A	Universal joint	137-5396	13.86	13.58	13.30	12.89
S.206	Extension 52.5mm	137-5397	6.80	6.66	6.54	6.31
S.210	Extension 130mm	352-3597	6.30	6.06	5.52	--
S.217	Extension 500mm	137-5399	19.32	18.92	18.55	17.97

486315

**Socket Accessories**

1/2in Square Drive



492344

Description	Order Code	Price Each
Ratchet 32 teeth, reversible	248-410	24.16
Ratchet 72 teeth, reversible	248-765	23.41
Sliding T bar	155-3740	4.23
Speed brace	248-755	11.34
Swivel handle 380mm 15in	248-766	18.95
Extension 75mm 3in	155-2588	1.30
Extension 125mm 5in	155-3106	2.27
Extension 250mm 10in	155-3107	3.36
Offset L handle	248-760	6.06
Converter 1/2 x 3/8in	155-2353	1.47
Converter 1/2 x 3/4in	155-2354	3.36

**Socket Sets 3/4"**

**3/4 Socket Sets**

**3/4in Bi-Hexagon Square Drive**



All sets include: reversible ratchet, sliding T bar, extension 200mm 8in and extension 400mm 16in. Bi-Hexagon.

493851

Set	Sockets	Order Code	Price Each
Metric 14 piece	22, 24, 27, 30, 32, 36, 38, 41, 46, 50mm	<b>248-406</b>	1+ 277.10

**3/4in Square Drive**



494018

Description	Order Code	Price Each
Ratchet 24 teeth, reversible	<b>248-767</b>	1+ 75.50
Sliding T bar	<b>248-445</b>	27.69
Swivel handle 495mm 20in	<b>248-446</b>	61.05
Extension 200mm 8in	<b>248-447B</b>	20.52
Extension 400mm 16in	<b>248-448</b>	34.89
Converter 3/4 x 1in	<b>248-444</b>	14.35

**Gripper Nut Driver**



45



- Housing made from alloyed steel
- 54 spring-loaded hardened steel pins
- DIN 3120, Style C 10
- Replaces nuts from 7mm to 19mm
- Regardless of whether inch or metric dimensions
- The 54 steel pins fit every nut or screw with an external profile
- For screws up to a height of 8mm
- The Gripper also works on hooks or eyebolts

Typ	Length	Diameter	Max. Profile depth
Gripper	53,5	25,4	8,5

Dimensions in mm

241091

Mfrs. Part No.	Order Code	Price Each
Gripper	<b>871-965</b>	1+ 16.12

**Double Ended Box Spanner Sets**



All sets include tommy bars. Sets number 7 and 9 include two single ended spanners and a 14mm spark plug spanner.

492088

Set	Contents	Order Code	Price Each
10	1/8 x 3/16, 1/4 x 5/16, 3/8 x 7/16, 1/2 x 9/16, 5/8 x 3/4, 7/8 x 1in Whit	<b>046-715</b>	1+ 22.20
16	1/8 x 3/16, 1/4 x 5/16, 3/8 x 7/16, 1/2 x 9/16 Whit	<b>046-717</b>	10.91
45	3/8 x 7/16, 1/2 x 9/16, 5/8 x 3/4, 7/8 x 1 1/4in AF	<b>046-718</b>	11.78
59	7/16 x 1/2, 9/16 x 5/8, 1 1/16 x 3/4, 1 3/16 x 7/8, 1 9/16 x 1 1/4in AF	<b>046-719</b>	16.69

**Double Head Socket Spanner sets**



- Two metric, straight, tubular, double-head socket spanner sets
- Nickel and chrome plated, finely polished
- Conforms to **DIN 896-B**
- Both sets contain two stepped tommy bars

Type	Contents	Mfrs' List No.	Order
Metric 7pcs	8x9, 10x11, 12x13, 14x15, 16x17, 18x19, 20x22mm	1936M/7	706-3076
Metric 12pcs	6x7, 8x9, 10x11, 12x13, 14x15, 16x17, 18x19, 20x22, 21x23, 24x27, 25x28, 30x32mm	1936M/12	706-3088

225233

Order Code	Price Each
<b>706-3076</b>	1+ 53.00
<b>706-3088</b>	91.80

**3 Piece Ratchet Set**



- Drop forged heat treated steel with satin finish
- Quick action reverse lever
- Spring loaded ball bearings hold sockets and accessories securely
- Sizes: 1/4" drive, 3/8" drive, 1/2" drive

482083

Order Code	1+	5+	10+	20+	50+
<b>144-7544</b>	14.61	12.80	11.70	10.96	9.96

**Vices and Tool Holding**

**Spannfix Clamping Vices**



Bernstein clamping equipment is constructed on ball-and-socket joints, thus enabling it to be rotated and set firmly, in order to create maximum possibilities for work..

**Small vice on ball-and-socket joint rotatable in any direction and capable of being set securely.**

The "Spannfix" vice simplifies many jobs in precision engineering, in laboratories, in test rooms and all engineering and electronics workshops.

333839

**Spannfix Screw-On Vice**



The small vice with ball-and-socket joint can be mounted quickly and easily onto a work bench or table. Slight pressure on the lever is sufficient, and the clamped workpiece can be moved into any suitable position.

**Technical data:**

Clamping pressure:	150 kp
Clamping capacity:	70mm
Clamping depth:	38mm
Jaw width:	50mm
Jaws:	(interchangeable) plastic

333840

max. table thickness	Weight (kg)	Mfrs. List No.	Order Code	Price Each
80mm	1,450	9-205	<b>830-756</b>	1+ 91.76
Spare Jaws		9-206-50	<b>805-932</b>	0.95 5+ 84.90

**Troubleshooting tips**



Chat live online to one of our technical engineers at [www.farnell.co.uk](http://www.farnell.co.uk)

**Spannfix for permanent mounting using bolts**



**Technical Data:**  
as per 9-205  
Size of base: 150 x 105mm

333841

	Weight (kg)	Mftrs. List No.	Order Code	Price Each	
				1+	5+
Spannfix	1,3	9-215	<b>830-768</b>	91.76	84.90
Spare Jaws		9-206-50	<b>805-932</b>	0.95	0.89

**Spannfix base for permanent mounting using bolts with universal ball joint and threaded stud M 12 x 1.5**



The carrying element of the Spannfix series clamping devices. This base can be used for holding vices, circuit board holders, monitors, cameras and various equipment in different application areas.

Bearing surface  $\varnothing$ : 40mm  
Thread length: 25mm

523351

Size of base (mm)	Weight (kg)	Mftrs. List No.	Order Code	Price Each	
				1+	5+
150 x 105	0.8	9-262	<b>164-8513</b>	76.00	72.20

**Spannfix base for permanent mounting using bolts with universal ball joint and threaded stud M 12 x 1.5**



The carrying element of the Spannfix series clamping devices. This base can be used for holding vices, circuit board holders, monitors, cameras and various equipment in different application areas.

333842

Size of base (mm)	Weight (kg)	Mftrs. List No.	Order Code	Price Each	
				1+	3+
150 x 105	0,800	9-261	<b>465-9284</b>	66.40	60.35

**Spannfix-Vario Assembly Vice**



5-teiliges Sortiment mit aufwechselbaren Aufschraub-Arbeitsköpfen.

Content: Mftrs List No. Content: Mftrs List No.  
 Universal clamp mounting ball joint base 9-251 Universal screw-on plate 9-254  
 Screw-on mounting vice 9-252 Angular adapter 9-255  
 Circuit board holder 9-253

333844

	Weight (kg)	Mftrs. List No.	Order Code	Price Each	
				1+	5+
5-piece Set	2,000	9-250	<b>830-665</b>	185.49	171.27

**Universal clamp mounting ball joint base**



for work benches with a max. table thickness of 80 mm.

333845

Weight (kg)	Mftrs List No.	Order Code	Price Each	
			1+	5+
0,950	9-251	<b>830-677</b>	68.15	62.74

Over 480,000 products online

**Screw-on mounting vice**



**Technical data:**  
 Clamping pressure 150 kp  
 Clamping capacity 70 mm  
 Clamping depth 38 mm  
 Jaw width 50 mm  
 Jaws (interchangeable) plastic

333847

	Weight (kg)	Mftrs. List No.	Order Code	Price Each	
				1+	5+
Vice	0,560	9-252	<b>830-689</b>	55.94	51.52
Spare Jaws		9-206-50	<b>805-932</b>	0.95	0.89

**Circuit board holder**



Adjustable from 25 mm to 270 mm clamping capacity, can be extended as required at any time, correct setting by adjusting the centre position, protected against contact voltages, firm clamping of the printed circuit by built-in resilience in the locating arms, height of locating arms 70 mm.

If the circuit board holder is to be used with universal ball joint base 9-251, we recommend that the combination is used with angular adapter 9-255 or with rapid turning device 9-257 in order to obtain a larger turning circle.

333848

	Weight (kg)	Mftrs. List No.	Order Code	Price Each	
				1+	5+
Circuit board holder	0,270	9-253	<b>830-690</b>	57.46	53.08

**Angular adapter**



To be used as an additional attachment with every work mount, permits an even larger turning circle.

333849

	Weight (kg)	Mftrs. List No.	Order Code	Price Each	
				1+	5+
Angular adapter	0,080	9-255	<b>830-719</b>	16.61	15.42

**Clamping lid for circuit boards with components**



Components of different sizes are pressed in such a way that soldering can be carried out correctly after the circuit board holder has been turned.

333850

Size of cover:	Weight (kg)	Mftrs. List No.	Order Code	Price Each	
				1+	5+
240 x 130mm	0,280	9-256	<b>830-720</b>	43.35	40.01

**Table Vice**



Suitable for use on smaller tasks i.e. model engineering, handicrafts and fine soldering. Vice may be positioned at any angle due to ball swivel base. Supplied with slide-off rubber safety jaws. Jaw width 75mm, maximum opening 55mm.

491025

Order Code	Price Each	
393-6387	1+	23.23

Vices and Tool Holding - continued

Wide Opening Bench Vice



A very high quality, bench mounting vice with extra wide capacity clamping jaws. The vice is fully adjustable with tilt, turn and swivel around the advanced ball and socket mechanism which supports the jaws. The jaws are adjusted with a unique hand wheel mechanism; ideal for fast, yet precise, adjustment. The jaws have a capacity from 0±170mm and have soft padded rubber jaws to prevent damage to even the most fragile components which are to be clamped.

- Manufactured in the USA to precise, exacting standards
- 183mm high
- 1.4kg in weight

236113

Order Code	Price Each
394-9564	1+ 48.20

Rapid Assembly Circuit Board Holder



A very high quality, fully adjustable clamping mechanism, ideal for supporting circuit boards during repair. The holder features a four position, spring loaded locking mechanism, allowing the board, once clamped, to be simply moved in every direction through 36°. The vice is also fully height adjustable, allowing a board to be situated vertically between 50 to 340mm from the bench level. The board clamping arms are also adjustable and can be mounted on any of the four sides of the cross-supporting bar. The clamping arms are also fully adjustable in width from 11 to 245mm. The vice is manufactured from high grade, chrome vanadium steel with a cast base for weight and stability which can be bench mounted for added stability.

- Easy turn adjusting wheels for speedy adjustment
- Manufactured in the USA to precise, exacting standards
- The vice weighs 2.9kg

236114

Order Code	Price Each
394-9576	1+ 69.83

Helping Hand Magnifier



Useful bracket suitable for electronic work, model and jewellery making. Complete with fully adjustable holding clips and a 50mm diameter magnifying lens (x 2.5 magnification). The solid cast base approves stability.

490705

Order Code	Price Each			
	1+	5+	10+	20+
135-9501	5.14	5.04	4.94	4.85

Clamp Tool With Magnifier



- Third hand tool with magnifying glass
- Ideal tool for modelling, DIY or professionals
- Adjustable joints for movement in all directions
- Strong alligator clips hold work securely
- Heavy cast iron base for added stability
- Distortion free magnifying glass

482925.454492

Order Code	Price Each				
	1+	5+	10+	20+	50+
136-7049	2.58	2.35	2.06	1.94	1.82

SPANNFIX VICE MAXI screw-on



Heavy-duty vice on ball-and-socket joint rotatable in any direction and capable of being set securely. For work benches with a max. table thickness of 85 mm.

The same functioning as the Spannfix small vice also distinguishes the large models. To be used when working on larger and heavier workpieces.

**Technical data:**  
 Clamping pressure: 300 kp  
 Clamping capacity: 100mm  
 Clamping depth: 50mm  
 Jaw width: 100mm  
 Jaws (rotatable): steel, smooth and fluted

333852

Weight (kg)	Mfrs List No.	Order Code	Price Each	
			1+	+
4,000	9-225	830-770	217.38	--

Light Duty Work Vice



- Versatile ball vice with suction base
- Grooved jaws with soft rubber covers
- Dual slide rods ensure accurate alignment
- Ball joint allows 360° rotation, 90° sideways and 120° front to back
- Body is heavy gauge die cast aluminium and jaws are hardened steel

H=160  
 W=150  
 D=180  
 Jaw width=75,  
 Jaw opening=55

223260

Mfrs. List No.	Order Code	Price Each	
		1+	80.83
VAC10	108-390	40.83	

60mm Swivel Table Vice With Anvil



- Heat treated jaws, 60mm wide & 25mm deep
- Open to 80mm
- Locking swivel base turns through 360°
- Mounting clamp opens up to 45mm
- Paint coated body
- Weight: 2.3kg

482921.454201

Order Code	Price Each				
	1+	5+	10+	20+	50+
139-1488	6.39	6.19	5.11	4.79	4.36

Swivel Vice



- Swivel vice made from cast iron with black crackle finish
- Fully rotational and lockable in any position

Jaw width = 65mm (2½")  
 Jaw opening = 35mm (1½")  
 Clamp opening = 65mm (2½")

H = 150mm (6")  
 L = 145 - 180mm (5¾" to 7")  
 W = 65mm (2½")

223259





Order Code	Price Each
146-830	1+ 38.91

Vices

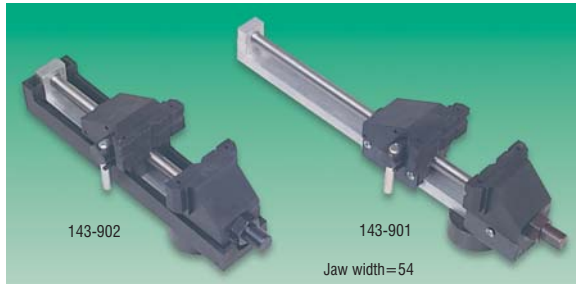

- General purpose vices available with jaw opening of 90mm
- Quick release adjustment, mates with either of the bench bases. Supplied with one pair of plastic serrated jaws.

223247

Description	Order Code	Price Each
Vice 90mm jaw opening	143-902	1+ 44.73

Portable Table Vice



A small portable vice which can be easily and quickly fitted by a clamp on to any work surface. It is an ideal vice for the modelmaker and home craftsman, having pipe grips below the jaws and a small anvil on the rear of the body.

483487

Model	Jaw Width		Order Code	Price Each			
	(mm)	(inches)		1+	5+	10+	20+
V75B	75	3	134-8430	19.70	18.90	18.10	17.52

Mechanics Vices



Medium duty vices commonly found in workshops and garages. Steel handle and plain screw with hardened replaceable jaw plates.

483414

Model	Jaw Width		Jaw Opening		Order Code	Price Each			
	(mm)	(inches)	(mm)	(inches)		1+	5+	10+	20+
1	75	3	85	3 1/4	134-8399	39.35	37.80	36.20	35.04
3	100	4	120	4 3/4	134-8400	82.70	79.40	76.10	71.76
4	115	4 1/2	140	5 1/2	134-8402	133.00	127.70	122.35	114.64
5	125	5	165	6 1/2	134-8403	154.00	147.90	141.75	133.67
6	150	6	205	8	134-8404	212.00	203.00	194.00	182.94
8	205	8	235	9 1/4	134-8405	378.00	363.00	347.00	321.32

Fitters Vices



Heavy duty vice with quick-release mechanism for industrial workshops.

483422

Model	Jaw Width		Jaw Opening		Order Code	Price Each			
	(mm)	(inches)	(mm)	(inches)		1+	5+	10+	20+
23	110	4 1/4	165	6 1/2	134-8406	279.00	267.00	255.00	240.47
25	150	6	210	8 1/4	134-8407	356.18	330.75	308.68	291.13

Vice Spares

Detachable Fibre Vice Grips



Designed to give a firm grip without damaging soft or polished surfaces. Round corners reduce the risk of injury to hands.

491554

Jaw Width (mm)	(in)	Order Code	Price Each
			1+
90	3 1/2	155-3083	10.36
110	4 1/4	212-938	8.63
133	5 1/4	212-941	10.08

Vice Spares

Steel Jaw Plates



45

Supplied as a pair complete with screws.

483427

To Suit Vice	Jaw Width		Order Code	Price Per Pair			
	(mm)	(inches)		1+	5+	10+	20+
3	100	4	134-8408	15.50	14.90	14.25	13.81
4	115	4 1/2	134-8409	25.15	24.15	23.15	22.41
5	125	5	134-8410	25.35	24.35	23.30	22.55
6	150	6	134-8411	25.93	25.23	24.56	23.93
23	110	4 1/4	134-8414	24.76	24.26	23.78	23.01
25	150	6	134-8412	38.85	37.30	35.75	34.61

FREE global legislation support



RoHS, REACH, WEEE, EuP, Batteries Directive - we've got it covered at: [www.global-legislation.com](http://www.global-legislation.com)



Vices and Tool Holding - continued

Pipe Vices  
Hinged Pipe Vices



The frame containing mainscrew and top jaw are hinged together. A hook on the frame locks the jaws and final adjustment is made by the mainscrew. For fast, repetitive work.

483463

Model	Capacity O.D. (mm)	Nominal Bore (inches)	Order Code	Price Each			
				1+	5+	10+	20+
92C	10 - 60	1/2 - 2	134-8422	122.50	117.25	112.40	105.99
92½C	10 - 76	1/2 - 2½	134-8423	144.88	134.54	125.56	116.27
93½C	10 - 102	1/2 - 3½	134-8424	215.29	199.90	186.59	172.77
96	10 - 165	1/2 - 6	134-8426	489.00	469.00	449.00	415.77

Drill Press Vice



Ideal for safe drilling and light milling operations, one grooved one plain replaceable jaw, will hold round, square and hexagonal shapes across flats or corners. Jaws and lead screw are made from high quality steel which has been hardened, ground and blacked.

495332

Jaw Opening (mm)	Order Code	Price Each
85	138-1336	36.17
100	439-4215	43.83

Drill Press Vices

45

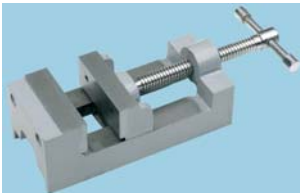

Ideal for drilling, tapping and reaming operations. Vice's shown can be turned on either side or placed on end for general use.

494604

Jaw Width (in)	Jaw Depth (in)	Jaw Opening (in)	Order Code	Price Each
2-½	1-½	2-½	162-3567	13.35
3	1-½	3	024-021	13.75
4	1-¾	4	024-027	21.67

Drill Press Vice

Model 414



Quality cast bodies and sliding jaws incorporating V grooves to grip round sections. Suitable for the engineering workshop or tool-room.

483493

Jaw Width (mm)	Jaw Opening (mm)	Jaw Depth (mm)	Order Code	1+	5+	10+	20+
100	4	75	134-8431	99.95	96.00	92.95	89.42

Milling Machine Vices

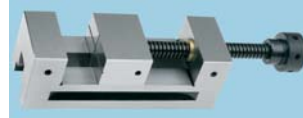

Ideal for use when precise holding is necessary. All surfaces are hardened and precision ground.

494789

Jaw width (in)	Jaw opening (in)	Order Code	Price Each
2-¾	2-½	024-053	53.54

Precision Machine Vice



Ground steel jaw plates.

495175

Jaw Width (mm)	Opening (mm)	Order Code	Price Each
155mm	125mm	138-1326	397.94
210mm	205mm	138-1327	633.15

52 Piece Clamping Kit



Each kit comprises of the following items:  
24 studs, 4 of each 3", 4", 5", 6", 7" and 8" long.  
6 flange nuts.  
4 coupling nuts.  
6 step blocks and clamps comprising of 2 of each 2-1/2", 4" and 6" long.  
6 "T" nuts.

Suitable For 5/8 in or 16mm Table Slots

494683

Order Code	Price Each
021-654	31.07

Mini-Vice

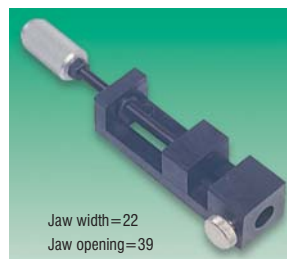

- Miniature moulded vice with a jaw opening of 39mm
- The jaw surfaces have a plain smooth finish
- The vice clamps on to either the 50mm or the 100mm extension rods or the swivel knuckle joint

Jaw width=22  
Jaw opening=39

223249

Order Code	Price Each
143-912	9.60

Pin vices



Chuck type workholding tools for hand use designed for holding round material. Having hollow handles, material of any length can be handled.

485978

Model	Capacity (mm)	Length (mm)	Order code	Price Each			
				1+	4+	20+	40+
121	0 - 1.0	75	146-443	7.31	6.73	6.42	5.86
122	0.75 - 1.5	85	146-444	7.66	7.04	6.70	6.14
123	1.4 - 3.1	95	137-3841	7.46	7.32	7.17	7.02
124	3.1 - 5.00	105	137-3843	10.30	10.08	9.88	9.70
120	Set of 4 above		137-3844	32.57	31.91	31.27	30.65

**Toolmakers Clamps**



These clamps are made of steel, case hardened with ground flat faces.

Model	Jaw length		Jaw size		Opening	
	(mm)	(in)	(mm)	(in)	(mm)	(in)
410	50	2	8.0	5/16	25	1
411	75	3	11.1	7/16	38	1 1/2
412	100	4	14.8	9/16	63	2 1/2
413	125	5	17.5	1 1/16	89	3 1/2

488364

Model	Order code	Price Each			
		1+	5+	10+	20+
410	137-3908	15.96	15.65	15.34	15.03
411	137-3909	17.62	17.27	16.92	16.58
412	137-3910	22.87	22.41	21.96	21.52
413	137-3911	32.13	31.49	30.87	30.24

**Parallel Clamps**



Designed for maximum strength and rigidity. Jaws are case hardened for optimum strength and wear resistance. Knurled screw heads have cross holes for use with a tommy bar for secure tightening. Fitted with a spring clip located in a retaining groove on the screw head.

Jaw length (mm)	(in)	Jaw capacity (mm)		Order Code	Price Each
		(mm)	(in)		
50	2	31	1 1/4	210-340	6.54
63	2 1/2	44.5	1 3/4	210-341B	7.16
75	3	56.5	2 1/4	155-3077	10.13
100	4	69.5	2 3/4	210-343	13.12
125	5	88.5	3 1/2	210-344	21.42

493776

**Bar Clamps**



Fast and easy to operate with one hand only, increasing speed of operation. Can be changed into a spreader in seconds without the need of additional tools. The high tech resin body is stronger than steel and temperature resistant, yet lightweight and easy to use.



Model	Capacity		Order Code	Price Each
	(mm)	(in)		
506QC	152	6	138-9247	16.80
512QC	305	12	138-9249	18.80
518QC	457	18	138-9250	19.60
524QC	610	24	138-9251	21.60
536QC	915	36	138-9252	27.00
550QC	1270	50	138-9253	33.30

495160

**Micro Plastic Spring Clamp Set**



- 3 1/2" 90mm clamp set
- Compact design for hobby and craft projects, household applications and fine woodworking
- Fast, firm positive gripping of both flat and odd shaped work pieces
- Rust resistant lightweight resin construction
- Supplied in a set of 4

482098, 461157

Order Code	Price/Set				
	1+	5+	10+	20+	50+
144-7562	1.48	1.29	1.17	1.11	1.01

**8 Piece Clamp Set**



- Ratcheting trigger advanced action
- Easy to use push button for quick release
- Easily convert the bar clamp to a spreader - no tools required
- Ratchet bar clamp: 2 pcs 2.5" x 12", 2 pcs 1.5" x 4"

482099, 461158

Order Code	Price/Set				
	1+	5+	10+	20+	50+
144-7563	8.22	7.31	6.58	6.18	5.61

**G Clamps**



- All metal construction
- G clamp with fine thread
- Matt black finish

481968, 453104

Size	Order Code	Price Each				
		1+	5+	10+	20+	50+
2"	144-7399	1.36	1.09	0.93	0.72	0.56
4"	144-7400	2.31	2.09	1.86	1.73	1.57
6"	144-7401	3.16	2.82	2.53	2.39	2.16
8"	144-7402	4.70	4.28	3.76	3.53	3.19

**'G' Clamps 119 Series**



A medium drop forged, strong G clamp for use on smaller applications and in restricted spaces.

483589

Capacity (mm)	Capacity (inches)	Order Code	Price Each			
			1+	5+	10+	20+
50	2	134-8440	4.66	4.57	4.48	4.31
75	3	134-8441	6.13	6.01	5.89	5.69
100	4	134-8442	9.20	8.85	8.45	8.17

**'G' Clamps 120 Series**



Heavy duty clamp. I-section frame for both wood and metal working applications.

483581

Capacity (mm)	Capacity (inches)	Order Code	Price Each			
			1+	5+	10+	20+
75	3	134-8433	16.05	15.40	14.75	13.76
100	4	134-8434	11.10	10.87	10.44	9.87
150	6	134-8435	15.90	14.75	13.77	12.99
200	8	134-8436	33.45	32.10	30.75	28.78
250	10	134-8438	51.70	49.65	47.55	44.84
300	12	134-8439	72.55	69.65	66.75	62.48

Vices and Tool Holding - continued

135 Sash Clamps

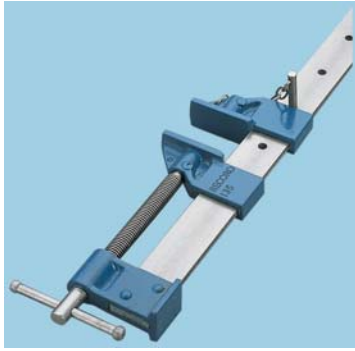

For clamping large section workpieces during joint gluing. Cast-iron fixed head and sliding head secured by pin. Bar size 32 x 6mm 1 1/4 x 1/4in.



Model	Capacity		Bar Length		Order Code	Price Each			
	(mm)	(inches)	(mm)	(inches)		1+	5+	10+	20+
135/2	610	24	760	30	134-8443	34.60	33.20	31.85	29.49
135/3	760	30	915	36	134-8444	35.95	34.50	33.05	30.87
135/4	915	36	1070	42	134-8445	37.90	36.40	34.85	32.27
135/5	1070	42	1220	48	134-8446	40.35	38.75	37.10	34.36
135/6	1220	48	1370	54	134-8447	41.20	39.55	37.90	35.10
135/7	1380	54	1500	60	134-8451	42.15	40.45	38.80	36.28
135/9	1680	66	1800	72	134-8452	43.10	41.40	39.65	37.11

L135 Lengthening Bar

Extends the capacity of all sash clamps.

483599

Model	Capacity		Order Code	Price Each			
	(mm)	(inches)		1+	5+	10+	20+
L135/4	915	36	134-8448	27.80	26.70	25.60	23.71

Toggle Clamp - Vertical



- The most popular of toggle clamps
- High clamping forces can be generated
- Complete with cushioned PVC handle grip
- Extendible base to guide the clamping arm
- Removable stop pin to alter operating angles
- Zinc-plated and passivated steel

	V75/2B	V150/2B	V250/2B	V350/2B
Nominal holding force	75kg	150kg	250kg	350kg
Weight	0.05kg	0.15kg	0.38kg	0.8kg
Height	98	125	175	220
Length	57	70	110	146
Hole centres	24 x 16	27 x 12.7	32 x 19	45 x 32
Hole Ø	4.4	5.1	7.1	8.3
Clamp arm length	31	43	74	95
Order Code	714-7510	714-7521	714-7533	714-7545

MAT113/225430,401808

Mfrs. List No.	Order Code	1+	+	+	+
V75/2B	714-7510	9.36	--	--	--
V150/2B	714-7521	10.53	--	--	--
V250/2B	714-7533	13.34	--	--	--
V350/2B	714-7545	18.02	--	--	--

Toggle Clamps - Horizontal



- Used where height restrictions prevent use of a vertical clamp
- Complete with cushioned PVC handle grip
- All models have closed ends for rigidity
- Zinc plated and passivated steel

	H250/2B	H75/2B	H150/2B	H250/2B
Nominal holding force	50kg	75kg	150kg	250kg
Weight	0.036kg	0.1kg	0.25kg	0.9kg
Height	22	36	53	108
Length	70	116	170	280
Hole centres	16 x 16	16.8 x 13.5	28 x 26	31 x 26
Hole Ø	4.2	5.2	5.5 slotted	6.6 slotted
Clamp arm length	26	37	61	79
Order Code	714-7636	714-7648	714-7661	714-7673

MAT116/225431,401809

Mfrs. List No.	Order Code	1+	+	+	+
H50/2B	714-7636	8.29	--	--	--
H75/2B	714-7648	10.18	--	--	--
H150/2B	714-7661	11.77	--	--	--
H250/2B	714-7673	17.69	--	--	--

Toggle Clamps - Push Pull



- A range of toggle clamps for use when positive clamping is required
- P50 is light-duty base-mounted clamp
- P600 and P1200 are heavy-duty clamps
- Complete with cushioned PVC handle grip
- Main components steel

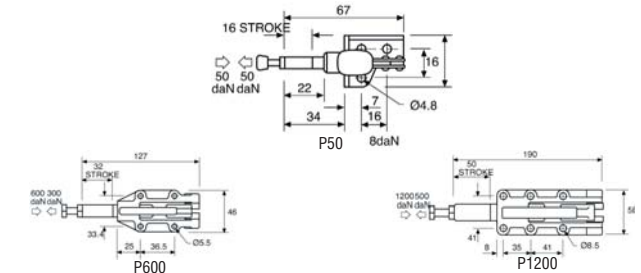

	P50	P600	P1200
Nominal holding force	50kg	600kg	1200kg
Weight	0.05kg	0.45kg	1.35kg
Height	42	67	88
Order Code	714-7843	714-7855	714-7867

MAT118/225432,401810

Mfrs. List No.	Order Code	1+	+	+	+
P50	714-7843	9.46	--	--	--
P600	714-7855	26.68	--	--	--
P1200	714-7867	42.53	--	--	--

Toggle Clamps - Long Handle Push-Pull



- A range of toggle clamps for use when positive clamping is required
- P50 is light-duty base-mounted clamp
- P600 and P1200 are heavy-duty clamps
- Complete with cushioned PVC handle grip
- Main components steel

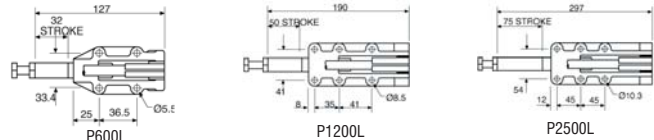

	P600L	P1200L	P2500L
Nominal holding force	600kg	1200kg	2500kg
Weight	0.55kg	1.60kg	4.15kg
Height	130	200	280
Order Code	714-8148	714-8161	714-8173

MAT120,401811

Mfrs. List No.	Order Code	1+	+	+	+
P600L	714-8148	35.17	--	--	--
P1200L	714-8161	47.45	--	--	--
P2500L	714-8173	87.45	--	--	--

Manual Assembly Presses



- Generate high forces end of stroke
- Suitable for light work such as swaging, press-fitting and rivetting
- Handle can be mounted to front or rear, depending on application
- Base machined from icon casting

	P600PR	P1200PR	P2500PR
Nominal holding force	600kg	1200kg	2500kg
Overall height	232	330	468
Stroke	32	50	75
Throat clearance	50	60	75
Height clearance	75	100	120
Weight	3.6kg	7.35kg	15.5kg
Order Code	714-8781	714-8793	714-8800

MAT121,401848

Mftrs. List No.	Order Code	1+	+	Price Each	+
P600PR	714-8781	117.84	--	--	--
P1200PR	714-8793	196.39	--	--	--
P2500PR	714-8800	332.98	--	--	--

**Magnets**

**Adjust-O Magnet Square**

Model: MSA46-HD



- Heavy duty
  - Switchable on/off magnet
  - Ideal for round and square tubing, angle and flat stock
  - Simple to clean, switch off then wipe away
- A fast and easy way to hold work pieces between 45° and 90°.



Technical Data	
Angles	45° x 90°
Magnetic Force	80 lbs
Dimensions (HxLxD)	110x95x28mm
Fixing Holes	3
Weight	0.68kg

464244.527318

Order Code	1+	Price each	5+
166-4781	23.78		23.14

**Mini Magnets**

Model: MS346A1 (Single) MS346AT (Twin)



- Centre hole for easy handling
- Two riveted holes for linking magnets together
- 30°/60°, 45°, 90°edges
- Useful in light duty applications
- Sold as single or in packs of 2



Technical Data		Technical Data	
Angles	30°, 45°, 60°, 90°	Dimensions (HxLxD)	60x50x14mm
Magnetic Force	25 lbs	Weight	0.136kg

464312.527319

Description	Order Code	1+	Price each	5+
Single Magnet	166-4782	2.95		2.75
Twin Pack	166-4783	5.45		4.95

**Pocket**



- Conventional one-piece horseshoe magnet in Alnico material
- Supplied with keepers
- Powerful 2.4kg pull
- Both poles in the same plane

H	W	D	G	Weight kg
25.4	22.2	7.9	6.4	0.03

211868

Order Code	1+	30+	Price Each	50+	100+	200+
707-1644	3.73	3.35		3.07	2.87	2.64

**Cylindrical Bar**



- Cylindrical one-piece magnet in Alcomac III material
- Supplied in matched pairs
- Two poles at opposite ends

mm	mm	Weight per pair
20	6	0.02
20	8	0.04
30	10	0.07

211869

Length	Ø	Order Code	1+	30+	Price Per Pair	50+	100+	200+
20	6	707-1759	3.51	3.13	2.89	2.68	2.50	
20	8	707-1760	4.67	4.19	3.84	3.57	3.33	
30	10	707-1772	6.58	5.87	5.38	5.01	4.65	

**Rectangular Bar**

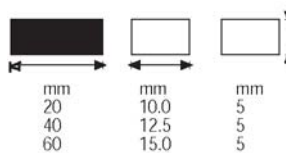

- Rectangular bar magnets in Alcomax III material
- Supplied in matched pairs
- North polarity is indicated by a dimple

211870

L	W	D	Order Code	1+	15+	Price Per Pair	25+	50+	100+
20	10	5	707-1814	4.51	4.03	3.69	3.44	3.20	
40	12.5	5	707-1826	6.95	6.21	5.69	5.30	4.93	
60	15	5	707-1838	10.79	9.65	8.82	8.22	7.65	

**Magnetic Workholders And Magnets**

**Rectangular**



One piece rectangular bar magnet. Priced per pair.

494491

Length x Width Depth (mm)	Order Code	Price Each
20 x 10 x 5	210-359	1+ 4.09
40 x 12.5 x 5	210-360	4.09
50 x 15 x 10	210-362	12.15
75 x 15 x 10	151-6774	14.64

45

**Button**



- Alnico material
- Supplied with keepers
- High working temperature of up to 550°C
- Both poles at one of the cylinder, separated by a slot

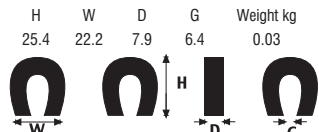

211872

**Button**

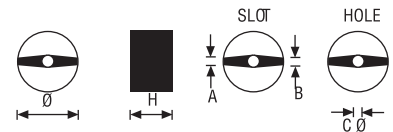

- Alnico material
- Supplied with keepers
- High working temperature of up to 550°C
- Both poles at one of the cylinder, separated by a slot
- Supplied with a plain fixing hole
- Primarily for attracting applications

Ø	H	A	B	C	Ø	Pull (Max)kg	Weight g	Order Code
19.1	12.7	5.6	8.7	4.8	1.9	1.9	20	707-1863
25.4	15.9	5.6	8.7	4.8	3.4	3.4	50	707-1875

211872

Pull kg	Order Code	1+	30+	Price Each	50+	100+	200+
1.9	707-1863	3.68	3.31	3.04	2.83	2.62	
3.4	707-1875	6.89	6.16	5.64	5.23	4.88	

**Premium service without a premium price**



With thousands of prices already reduced, go online to see our most up-to-date pricing: [www.farnell.co.uk](http://www.farnell.co.uk)



**Magnets - continued**

**Magnet**

**Button**



A cylindrical magnet. Both poles are at one end of the cylinder, separated by a slot. These magnets are primarily for attracting applications.

494305

Diameter x Height (mm)	Pull (kg)	Order Code	Price Each
25.4 x 15.9	3.4	210-347	5.39
31.8 x 25.4	4.8	210-348	7.14

**Shallow Pot**



- Alcomax IV magnet material
- Keeper supplied with each magnet
- North polarity in centre
- High working temperature of up to 220°C
- Designed for applications where height restricts the use of conventional deep pot magnets



∅	H	∅A	∅B	Pull (Max) kg	Weight g	Order Code
19.1	7.75	3.7	6.7	3.0	13	707-2454
28.6	8.7	4.8	8.6	5.0	36	707-2466
38.1	10.6	4.8	8.6	13.5	80	707-2478

211875

∅	Order Code	Price Each				
		1+	30+	50+	100+	200+
19.1	707-2454	4.67	4.19	3.84	3.57	3.33
28.6	707-2466	6.18	5.81	5.56	5.30	5.07
38.1	707-2478	10.82	9.26	8.84	8.24	7.67

**Pot**



- Powerful Alcomax III magnet material
- Supplied with keepers
- North polarity in centre
- High working temperature of up to 220°C
- Primarily for gripping applications
- Deep cylindrical design assembled concentrically in steel pot



∅	Height	Pull (Max) kg	Weight g	Order Code
17.5	16	2.65	23	707-2545
20.5	19	4.0	40	707-2557
35	30	14.75	184	707-2570

211876

Pull kg	Order Code	Price Each				
		1+	30+	50+	100+	200+
2.65	707-2545	5.01	4.49	4.11	3.82	3.55
4.00	707-2557	5.27	4.72	4.33	4.04	3.74
14.75	707-2570	14.32	12.76	11.35	10.90	10.13

**Magnetic Workholders And Magnets**

**Pot**



Gripping magnets designed to exert maximum grip on workpieces placed in contact with them. This style of magnet is generally used in jigs and fixtures. A drilled and tapped M6 hole in the back of the magnet may be used for fixing.

495003

Diameter x Height (mm)	Pull (kg)	Order Code	Price Each
17 x 16	2.7	155-3711	3.70
21 x 19	4.5	210-307	5.76
27 x 25	8.2	210-308	6.67
35 x 30	19.0	210-309	11.17

**Ferrite Shallow Pot**



- Ferrite material
- Working temperature of up to 80°C
- Fitted with J-bolt
- Ideal for limpet-type gripping applications
- Standard M6 thread for building into jigs and fixtures
- Uses include bases to machine tool accessories and industrial light fittings

∅	H	∅A	Weight each
56	0.7	1	M6, 13

211883

∅	Height	Pull kg	Order Code	Price Each				
				1+	15+	30+	50+	100+
56	10.7	16.0	700-0637	7.78	6.93	6.36	5.93	5.51

**Ferrite Shallow Holdfasts**



- Ferrite material
- Working temperature of up to 80°C
- Three pre-threaded holes with M6 thread
- Screw-down releasing bolt for easy workpiece disengagement

∅	H	Fixing stud centres	Weight each	Pull (max)
76	12.5	46	0.30	33

211884

∅	Height	Pull kg	Order Code	Price Each				
				1+	5+	10+	25+	50+
76	12.5	33.0	706-9030	13.86	12.33	11.32	10.55	9.79

**Rare Earth Permanent Neo-Hold Bi-Pole Gripping**



- Powerful Neodymium Iron Boron rare earth magnets
- Supplied with keepers
- High working temperatures of up to 100°C
- 5.5mm between poles
- Very strong gripping forces are achieved by having two poles close together
- Ideal for situations where space is restricted and more holding power required

∅	H	A	Fixing Hole Size	Pull kg	Weight g	Order Code
12.7	11.6	5.5	M5 x 5	2.0	10	707-6009
25	15.6	5.5	M6 x 5	5.0	18	707-6010
22	20	5.5	M6 x 6	9.0	40	707-6022
25	25	5.5	M6 x 6	15.0	70	707-6034

211882

Ø	Order Code	Price Each				
		1+	20+	30+	50+	100+
12.7	707-6009	8.40	7.47	6.84	6.38	5.93
25	707-6010	9.90	8.80	8.08	7.53	6.98
		1+	10+	25+	50+	100+
22	707-6022	12.62	11.26	10.30	9.62	8.92
25	707-6034	15.90	14.15	12.99	12.08	11.23

Discs



- Ceramic/Ferrite materials
- One face magnetic - reverse will accept adhesive
- Not susceptible to demagnetisation up to a maximum temperature of 180°C

Multipole on one face

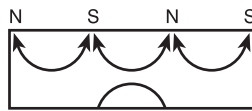

Non-magnetic face

211726

10 Per Pack		Order Code	Price Per Pack				
Ø	Thickness		1+	3+	5+	10+	20+
14	5	700-5120	1.13	1.02	0.95	0.87	0.83
30	5	700-5143	3.78	3.51	3.23	3.04	2.82

Flexible Strip  
Adhesive Backed



- Barium ferrite loaded flexible thermo-plastic
- Soft material helps prevent slippage on vertical surfaces
- Acrylic adhesive backed

Ideal for:- Door closures, reed switch operators, signs, shelf marking

Thickness = 0.8mm

214002.401261

10M Per Coil		Order Code	Price Per Coil			
Width			1+	+	+	+
7.5mm		723-9166	9.23	--	--	--
12.5mm		723-9178	10.19	--	--	--
20mm		723-9180	15.88	--	--	--
10 Strips Per Pack		Order Code	Price Per Pack			
Size			1+	+	+	+
12.7mm x 100mm		723-9191	2.28	--	--	--

Magnetic Workholders And Magnets



Ferrite Shallow Holdfasts



Manufactured with three pre-threaded holes with standard M6 thread. Fitted with a screw down releasing bolt for easy disengagement of workpieces.

Model	Diameter (mm)	Thickness (mm)	Fixing stud centres (mm)
E895	66	10.7	46
E896	76	12.5	46
E897	100	15.0	63

Model	No. of holes	Hole	Max. pull (kg)
E895	3	M6	25
E896	3	M6	33
E897	3	M6	55

494793

Model	Order Code	Price Each
E895	218-244	13.05
E896	706-9030	13.86
E897	218-246	24.16

Magnets

Neodymium Disc Magnets



Ultra high performance rare earth Neodymium Iron Boron disc magnets. These magnets can be bonded in place using structural adhesive and offer incredible performances through large air gaps. Maximum operating temperature 100°C.

493041

Diameter (mm)	Length (mm)	Pack Quantity	Order Code	Price Each
3	4	5	162-3553	1+
10	4	5	162-3554	4.33
12	3	5	162-3555	7.02
				7.60

Fastening & Fixing

Tie Gun Cabler



- Strong and Lightweight
- Glass fibre reinforced body
- Tension adjuster for secure binding
- Automatic cut off - pull trigger and the tie is automatically tensioned and cut

- Suitable for cable ties 2.4 - 4.8mm wide
- Size.2.4-4.8mm

448562.471419

Mftrs. List No.	Order Code	1+	Price Each	5+
495003	128-3289	11.40		11.05

3-in-1 Staple Gun



- Heavy duty 3-in-1 staple gun
- Impact pressure adjustment
- Handle lock
- Contents: 3-in-1 heavy duty staple gun, 200x8mm staples, 200x12mm u-shaped staples, 200x10mm nails
- Uses: 140-type staples, 180-type nails and CT45 U-staples

Nail Length Capacity	10-14mm
Staple Length Capacity	4-14mm
U-shaped Staple Length Capacity	10-12mm
Weight	0.54kg

457669.452469

Mftrs. List No.	Description	Order Code	1+	Price Each	5+
D00223	3-in-1 Staple Kit	132-8719	7.43		6.95

Heavy Duty Riveting Kit



An engineering riveting kit comprising a high quality, hand riveting tool with ergonomic/high friction handles, 200 aluminium rivets (3, 4 and 5mm) and a robust blow moulded case. The tool is supplied with 3 interchangeable tips for the 3 sizes of rivets supplied.

495794.268993

Mftrs. List No.	Order Code	1+	Price Each	5+
2735	152-1965	38.37		36.08

**Fastening & Fixing - continued**

**Trim Pin Remover**



Wiha. Premium Tools for Professionals.

Blade: Chrome vanadium steel, through hardened chrome-plated  
Wiha Power Handle, Cellulos acetate, impact oil and grease resistant

Application: fast removal of trim pins, e.g. on internal car panels

Mfrs. Part No.	Trim Pin Width mm	Blade length mm
430-10	7,5	175

241456

Mfrs. Part No.	Order Code	1+	5+	10+	Price Each
430-10	311-6773	6.81	6.05	5.28	

**Hammers**

**4oz Crosspein Hammer**



- 4oz cross-pein hammer with wooden handle

481960.453085

Order Code	1+	5+	10+	20+	50+	Price Each
144-7394	2.29	1.85	1.52	1.34	1.11	

**Pin Hammer**



Heat treated and polished forged steel head. Evertite fixed hickory shaft.

478251

Model	Weight (gm)	Weight (oz)	Order Code	1+	5+	10+	20+	Price Each
1-54-077	100g	3½	135-3670	8.60	8.35	7.90	7.74	

**Cross Pein Pin Hammer**



- Drop forged high carbon steel head
- Hardened and tempered with polished face
- Head secured to ash handle by wooden and iron wedges

495544

Weight	Mfrs. List No.	Order Code	1+	5+	10+	20+	Price Each
4oz	T4203	151-8952	8.94	8.66	8.40	8.12	

**FREE global legislation support**



RoHS, REACH, WEEE, EuP, Batteries Directive - we've got it covered at:  
[www.global-legislation.com](http://www.global-legislation.com)

**Claw Hammers**



- Tubular steel handle
- Vinyl grip

457630.452304

Weight	Order Code	1+	5+	Price Each
8oz (0.38kg)	132-8710	1.58	1.36	
16oz (0.74kg)	132-8711	2.11	2.02	

**Claw Hammers**



- 16 and 20oz claw hammers
- One piece construction
- Impact absorbant rubber handle
- Ergonomically designed for comfort
- Narrow shaft for excellent balance and control

481966.453087

Weight	Order Code	1+	5+	10+	20+	50+	Price Each
16oz	144-7395	7.05	6.14	5.63	5.28	4.80	
20oz	144-7396	7.60	6.89	6.04	5.65	5.04	

**Blue Strike Claw**



Blue painted heads are secured by an interference fit onto a chrome plated tubular steel shaft. Blue colour co-ordinated flock filled vinyl grips are impervious to heat, oil and most solvents.

478245

Model	Weight (gm)	Weight (oz)	Order Code	1+	5+	10+	20+	Price Each
51-488	450	16	135-3725	7.25	7.05	6.65	6.52	
51-489	570	20	135-3726	7.95	7.70	7.30	7.15	

**Forged Claw Hammers**



- Single piece forged steel shaft for maximum strength and performance
- Shock absorbing contoured grip system for comfort and control
- Balanced weight design with energy saving claw geometry

495535

Weight	Mfrs. List No.	Order Code	1+	5+	10+	20+	Price Each
16oz	357001	151-8947	17.00	16.50	16.00	15.30	
20oz	357002	151-8948	19.50	18.90	18.35	17.55	

**Fibreglass Shaft Hammers**





- Strong fibreglass shaft for strength and performance
- Balanced weight design with energy saving claw geometry
- Shock absorbing contoured grip system for comfort and control

495541.470083

Mftrs. List No.	Weight	Order Code	1+	5+	10+	20+
357004	20oz	151-8950	14.30	13.87	13.43	13.02

**Ball Pein**  
Graphite Shaft

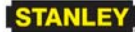

Ball pein hammers with a graphite core shaft, surrounded by a thick resin coating with a high resistance to overstrikes and excellent shock absorption properties.

223311

	Order Code	1+	4+	20+	40+
227g(8oz)	628-888	13.45	--	--	--
340g(12oz)	628-890	14.15	13.75	13.00	12.13
454g(16oz)	628-906	15.65	15.20	14.40	12.76
680g(24oz)	628-918	17.90	17.35	16.45	14.49
907g(32oz)	628-920	19.40	18.80	17.85	16.40

**Club Hammers**



- Drop forged head
- Hickory handle



457695.454537

Weight	Order Code	1+	5+
2.5lb	132-8723	4.24	3.89
4lb	132-8725	5.21	4.78

**Club Hammer**



- Single piece forged steel shaft for maximum strength and performance
- Shock absorbing contoured grip system for comfort and control

494984.470084

Mftrs. List No.	Weight	Order Code	1+	5+	10+	20+
357005	3lb	151-8892	21.00	20.37	19.74	19.12

**Sledge Hammers**

Sledge - Fibreglass Handle



Heads manufactured from EN9 steel fully in accordance with BS876 and fitted with comfortable, hard-wearing cushion grips.

495236

Weight (kg)	(lb)	Order Code	1+
3.2	7	216-970	28.50
4.5	10	216-971	30.43
6.4	14	216-972	37.10

**32oz Rubber Mallet**



- 32oz rubber mallet with wooden handle
- Solid rubber head

481967.453100

Order Code	1+	5+	10+	20+	50+
144-7398	2.00	1.63	1.42	1.27	1.02

**Rubber Hammers**



Durable black rubber hammers with fibreglass pinned handle for maximum safety in use.

494239

Model	Weight (lb)	Order Code	Price Each
RM1	1	016-207	14.77

**Dead Blow Nylon Hammers**



Die-cast one piece head and handle of aluminium alloy. Fitted with shock absorbent rubber grip. Screw-in faces of special nylon. The hollow head is partially filled with shot which adds to the weight and prevents re-bounce. Allowing heavy and effective blows with maximum impact control.

Model	∅ Of Face (mm)	(in)	Weight (gm)	Order Code	Price Each
1010	32	1¼	525	138-1112	10.70
1212	38	1½	750	138-1113	13.15
1414	44	1¾	950	138-1115	14.85
1616	50	2	1250	138-1138	17.10
2020	63	2½	2000	138-1139	25.60

**Replacement Faces**

495312

∅ Of Face (mm)	(in)	Nylon Order Code	Price Each
32	1¼	106-559	1.20
38	1½	106-562	1.50
44	1¾	106-564	1.95
50	2	138-1099	2.45
63	2½	138-1137	3.20

∅ Of Face (mm)	(in)	Polyurethane Order Code	Price Each
32	1¼	138-1150	1.30
38	1½	106-563	1.60
50	2	138-1151	2.65
63	2½	138-1152	3.50

**Surface Protective Hammers**



Zinc or aluminium heads with epoxy bonded fibreglass shaft and non-slip grip. Shafts outlast conventional wooden types many times and together with the secure epoxy bond ensure maximum safety in use. Tips supplied separately. Weight shown is when fitted with tips.

**Holders**

Model	∅(mm)	∅(in)	Weight (lb)	Order Code	Price Each
SPS105	25	1	11oz	016-160	11.05
SPS150	38	1½	1	016-161	11.70
SPS155	38	1½	1½	016-162	12.07
SPS200	50	2	1¾	016-163	13.65
SPS205	50	2	2½	016-164	15.07
SPS255	63	2½	5	016-166	30.85

**Tips**



**Hammers - continued**

**Surface Protective Hammers - continued**

**Cream - Medium Hard - continued**

Any of the holders listed may be fitted with a combination of 9 different tips.  
 Yellow - extra hard replaces copper.  
 Black - hard replaces soft copper, hard plastic.  
 Cream - medium hard replaces rawhide, medium plastic, lead.  
 Green - tough replaces rawhide, medium plastic, lead.  
 Red - medium replaces rubber, wood, rawhide, brass.  
 Brown - soft replaces soft rubber, wood, soft lead.  
 Grey - super soft replaces very soft rubber.  
 Brass

**Yellow - Extra Hard**

Ø(mm)	Ø(in)	Order Code	Price Each
			1+
25	1	016-168	4.15
38	1½	016-169	8.05
50	2	016-170	11.32

**Black - Hard**

Ø(mm)	Ø(in)	Order Code	Price Each
			1+
25	1	016-173	3.66
38	1½	016-174	7.07
50	2	016-175	12.00

**Cream - Medium Hard**

Ø(mm)	Ø(in)	Order Code	Price Each
			1+
50	2	016-180	11.90

**Green - Tough**

Ø(mm)	Ø(in)	Order Code	Price Each
			1+
50	2	016-185	6.77

**Red - Medium**

Ø(mm)	Ø(in)	Order Code	Price Each
			1+
38	1½	016-189	5.05
50	2	016-190	6.77

**Brown - Soft**

Ø(mm)	Ø(in)	Order Code	Price Each
			1+
38	1½	016-194	4.22

**Grey - Super Soft**

Ø(mm)	Ø(in)	Order Code	Price Each
			1+
50	2	016-200	12.05

**Brass**

493672

Ø(mm)	Ø(in)	Order Code	Price Each
			1+
38	1½	016-154	10.08

**Dead Blow Hammers**



Special heat resistant material is virtually indestructible under normal usage conditions. Dead blow, no rebound action delivers 30% more striking force. Epoxy bonded fibreglass shaft for maximum safety. Reverse taper grip is ideal for wet, oily or gloved hands.

494154

Model	Ø(mm)	Ø(in)	Weight (lb)	Order Code	Price Each
					1+
SF2-SG	50	2	2	016-204	26.31
SF3-SG	60	2¾	3	016-205	34.80
SF4-SG	70	2¾	4	016-206	50.25

**Copper And Rawhide Hammers**



Malleable iron head fitted with one face of pure copper, the other rawhide. Both faces are replaceable when worn. An ideal dual purpose hammer.



Size	Model	Ø Of Face (mm)	(in)	Weight (gm)	Order Code	Price Each
						1+
A	208	25	1	400	138-1066	6.50
1	210	32	1¼	725	559-325	9.05
2	212	38	1½	1070	559-337	11.60
3	214	44	1¾	1650	138-1067	14.70
4	216	50	2	2500	138-1068	21.25
5	222	70	2¾	5150	138-1125	49.40

**Replaceable Copper Faces**

495011

Size	Number	Order Code	Price Each
			1+
A	308C	138-1074	1.55
1	310C	559-349	2.14
2	312C	138-1075	3.00
3	314C	138-1077	4.85
4	316C	138-1078	6.17
5	322C	138-1132	15.70

**Bradawl**

**STANLEY**



Hardened, tempered and sharpened blades. Plastic handle, textured for improved grip.

478308

Model	Length (mm)	Length (in)	Point (mm)	Order Code	1+	5+	10+	20+
69-014	32	1¼	2	135-3704	2.25	2.20	2.05	2.00

**Bradawls**

**IRWIN**  
Marples.

**1828M**



Round section blade with slotted screw-driver type tip and plastic handle.

Model	Point Size	Order Code	1+	5+	10+	20+
1828M	Medium	134-8466	2.53	2.47	2.42	2.37

**M1838W**

Beech handle fitted with a square section blade with sharp point for faster penetration.

483678

Model	Order Code	1+	5+	10+	20+
M1838W	134-8465	5.65	5.40	5.20	5.09

**FREE global legislation support**



RoHS, REACH, WEEE, EuP, Batteries Directive - we've got it covered at:  
[www.global-legislation.com](http://www.global-legislation.com)

**Chisels**

**4 Piece Wood Chisel Set**



- Precision ground, drop forged, heat treated blades
- Plastic blue handles
- Sizes: 12, 19, 25, 32mm

482924.462255

Order Code	Price/Set				
	1+	5+	10+	20+	50+
136-7048	5.28	4.79	4.22	3.97	3.60

**4 Piece Wood Chisel Set**



- Rugged high carbon steel blades with durable plastic handle
- Sizes: 1/4", 1/2", 3/4" and 1"
- Supplied in a hinged plastic case

482994.462260

Order Code	Price/Set				
	1+	5+	10+	20+	50+
144-7558	8.55	7.65	6.84	6.42	5.82

**Chisels**



**Cold Chisels**

Manufactured to BS3066.

Size (mm)	(in)	Order Code	Price Each
100 x 6.5	4 x 1/4	010-329	1.60
125 x 6.5	5 x 1/4	010-341	1.56
150 x 9.5	6 x 3/8	010-330	1.77
150 x 12.7	6 x 1/2	155-2239	2.67
205 x 12.7	8 x 1/2	010-332	2.11
175 x 16	7 x 5/8	010-342	2.30
205 x 19	8 x 3/4	155-2980	3.94
250 x 19	10 x 3/4	010-334	3.29
205 x 25.4	8 x 1	155-2981	5.54
250 x 25.4	10 x 1	010-336	4.65
450 x 25.4	18 x 1	010-338	8.35

**Cast Steel Flat Cut**

Complete with grip and hand guard.

Size (mm)	(in)	Order Code	Price Each
250 x 19	10 x 3/4	010-346	5.28
250 x 25.4	10 x 1	010-347	6.87
300 x 25.4	12 x 1	010-348	7.26

**Floorboard Chisel**

Size (mm)	(in)	Order Code	Price Each
230 x 57	9 x 2 1/4	155-4380	5.79

**Fitted with grip and hand guard.**

493964

Size (mm)	(in)	Order Code	Price Each
230 x 57	9 x 2 1/4	010-345	6.52

**Wrecking, Pry, Heel, & Crow Bars**

**Wrecking Bar**



- Suitable for removing nails, dismantling, prising and opening
- Size: 24" x 3/4" (600 x 19mm)
- Weight: 1.9kg

482069.454213

Order Code	Price Each				
	1+	5+	10+	20+	50+
144-7438	3.16	2.80	2.49	2.35	2.15

**Pry & Heel Bars**



**Heel Bars**

493290

Length x Diameter (mm)	(in)	Order Code	Price Each
600 x 19	24 x 3/4	016-655	16.27
750 x 22	30 x 7/8	016-656	18.40

**Pry Bars**

Length x Diameter (mm)	(in)	Order Code	Price Each
175 x 10	7 x 3/8	016-650	8.64
300 x 13	12 x 1/2	016-651	11.18
400 x 16	16 x 5/8	016-652	11.44
450 x 19	18 x 3/4	016-653	16.22

**Crowbars**



**Wrecking Bars**

Octagonal section with nail pulling claw.

Length x Diameter (mm)	(inches)	Order Code	Price Each
750 x 19	30 x 3/4	210-189	9.70
900 x 19	36 x 3/4	210-190	9.33

**Crowbars**

Chisel and point.

494636

Length x Diameter (mm)	(inches)	Order Code	Price Each
900 x 25	36 x 1	155-2982	17.79
1200 x 29	48 x 1 1/8	010-532	14.37
1500 x 32	60 x 1 1/4	010-533	24.80
1800 x 38	72 x 1 1/2	010-534	45.55

**Scribers**

**Centre Punch and Scriber**



- Hand operated automatic centre punch with a carbide point which gives this tool exceptional wear resistance
- Fine point angle and pen style appearance make this tool particularly suited to scribing or dot punching on soft ductile materials
- 20° point angle
- Shank diameter of 3.0mm
- Overall length of 139mm
- Replacement point available

**Scribers - continued**

**Centre Punch and Scriber - continued**

494081

Mftrs. List No.	Order Code	1+	5+	10+	20+	
187-0053	Centre Punch	151-8515	7.91	7.75	7.59	7.51
187-0054	Replacement Point	151-8516	2.41	2.36	2.32	2.29

**Double Ended Scriber**



- Engineering pattern straight shaft or straight 90° angled point
- Tungsten Carbide tipped
- Intended for use on hard or abrasive materials
- Machined steel shaft
- Overall length 230mm
- Replacement body available

494108

Mftrs. List No.	Order Code	1+	5+	10+	20+	
187-0069	Scriber	151-8520	5.51	5.39	5.29	5.23
187-0068	6mm Body	151-8519	3.12	3.05	2.99	2.96

**Diamond Tipped Scriber**



- A polished 90° cone-shaped industrial diamond mounted in steel on the end of a plastic holder for hand marking very hard components and materials
- Comes complete with pocket clip top
- Capable of engraving stainless steel, glass, ceramic, silicon and silica filled plastics
- Also suitable for hand scribing and breaking of glass rod and ceramic or silicon substrates up to 0.5 mm thick
- Length 165mm

493987

Mftrs. List No.	Order Code	1+	5+	10+	20+	
176-0036		151-8502	9.55	9.37	9.17	9.08

45

**Diamond Tipped Marker**



- Fine dual ground point angle for precision work
- Spring loaded retractable carbide fine point Tip
- Adjustable scribe length (internal adjustment)
- Machined aluminium, high quality pen style body
- Pocket clip for easy storage
- Overall length 165mm

494122

Mftrs. List No.	Order Code	1+	5+	10+	20+	
187-0071		151-8521	20.65	20.23	19.82	19.61

**Engineers Scribers**



Model	Description	Order code	1+	4+	20+	40+
E222	Double ended engineers	425-357	3.71	3.46	3.31	2.83
E225	Pocket detachable point	425-369	13.16	12.11	11.54	10.54
E220	Pocket carbide point	137-3770	5.99	5.87	5.76	5.63
E227	Machinists one piece single ended	137-3771	2.39	2.35	2.29	2.25
76-229R	Handy double ended, pointed/knife	137-3772	4.99	4.89	4.79	4.71

485979

**Scriber points**  
For model E225.

Order code	1+	4+	20+	40+
425-370	8.93	8.22	7.85	7.18

**Engineers Scribers**



Perfectly balanced with hardened and ground points to facilitate accurate marking out.

494553

Description	Order Code	Price Each
Double ended, pointed and knife	212-638	7.43
Pocket carbide point	155-3715	4.96

**Punches**

**Automatic Centre Punch**



- No hammer needed
- This punch is made with a knurled brass handle and hardened tip for instant marking
- Size (Lx Dia): 130mm (5") x 13mm (1/2")

482067.462139

Order Code	1+	5+	10+	20+	50+
144-7436	2.85	2.65	2.49	2.33	2.11

**Automatic Centre Punch**

**RENNSTEIG**



- Self-striking
- Precision guidance
- With replaceable hardened tip and sleeve
- Hammer force adjustable
- Made of nickel-plated steel

Mftrs. List No.	Order Code	Length mm	ShankØ mm	TipØ mm	Weightg
9R 430 130	413-3602	125	14	2.5	65

242801

Mftrs. List No.	Order Code	1+	5+	10+	
Automatic Centre Punch	9R 430 130	413-3602	14.45	14.00	13.60

**Automatic Centre Punches**



Depth of impression is variable and can be adjusted by turning the knurled head.

493757

Model	Length (mm)	Length (in)	Pressure (kg)	Order Code	Price Each
65-171R	120	4 11/16	13.5-2.25	443-050	15.29
E172	149	5 7/8	22.5-6.3	710-2100	41.13

**Transfer Punch Set**



- Imperial/metric or odd sized hole centres can be transferred from pre-drilled components
- Spring loaded
- Pocket size case (110 x 59 x 21mm)

Sizes: Imperial: 3/16, 1/4, 5/16, 3/8, 7/64, 31/64

Metric: 6, 8, 10, 12, 14, 16 x 105mm

494123



Mfrs. List No.	Order Code	Price Each			
		1+	5+	10+	20+
187-0101	151-8523	15.64	15.33	15.02	14.85

### 3 Piece Nail Punch Set



- Fully hardened and tempered steel for wear resistance
- Moulded elastomer jacket for improved grip
- Long bevelled tips for easier nail alignment
- Sizes: 0.8mm (1/32"), 1.6mm (1/16") and 2.4mm (3/32")

482106.462296

Order Code	Price/Set				
	1+	5+	10+	20+	50+
144-7571	3.51	2.75	2.52	2.34	1.95

### Centre Punch

### RENNSTEIG



- chrome vanadium steel
- according to **DIN 7250**
- polished head
- coated shaft

Mfrs. Part No.	Lengthmm	ShaftØ mm	TipØ mm	Weightg
9R 430 100 0	100	8	3	30
9R 430 120 0	120	10	4	70

242777

Description	Mfrs. Part No.	Order Code	Price Each		
			1+	5+	10+
Centre Punch	9R 430 100 0	413-3500	1.03	1.02	1.00
Centre Punch	9R 430 120 0	413-3511	0.79	0.70	0.62

### Key Drift Set

### RENNSTEIG



- key drift set in metal case
- key drifts according to **DIN 6450**
- polished tip
- coated shaft

Mfrs. Part No.	Length mm	Shaft Ø mm	Tip Ø mm	Weight g
9R 450 003 0	150	10	3	70
9R 450 004 0	150	10	4	70
9R 450 005 0	150	10	5	75
9R 450 006 0	150	10	6	80
9R 450 008 0	150	12	8	115
9R 450 010 0	150	12	10	125

242780

Description	Mfrs. Part No.	Order Code	Price Each		
			1+	5+	10+
Key Drift Set	9R 425 160 09	413-3523	16.65	16.15	15.65

### Key Drift

### RENNSTEIG



Length: 150mm

- key drift according to **DIN 6450**
- chrome vanadium steel
- polished head
- coated shaft

242794

Description	Mfrs. Part No.	Order Code	Price Each		
			1+	5+	10+
Key Drift Ø2mm	9R 450 002 0	413-3547	1.85	1.80	1.75
Key Drift Ø3mm	9R 450 003 0	413-3559	1.85	1.80	1.75
Key Drift Ø4mm	9R 450 004 0	413-3560	1.85	1.80	1.75
Key Drift Ø5mm	9R 450 005 0	413-3572	1.85	1.80	1.75
Key Drift Ø6mm	9R 450 006 0	413-3584	1.85	1.80	1.75

### Split-Pin Driver Set



### RENNSTEIG



- Split-pin driver set in metal cassette
- Split-pin driver with guide sleeve

Type	Length mm	Shank Ø mm	Tip Ø mm	Weight g
9R 457 009 5	84	6	0.9	10
9R 457 014 5	89	6	1.4	11
9R 457 018 5	92	6	1.8	12
9R 457 024 5	97	8	2.4	23
9R 457 028 5	100	8	2.8	24
9R 457 034 5	100	8	3.4	25
9R 457 039 5	100	8	3.9	27
9R 457 059 5	100	8	5.9	31

242780

Split-Pin Driver Set	Mfrs. List No.	Order Code	Price Each		
			1+	5+	10+
	9R 457 100 5	413-3596	21.70	21.05	20.40

### 6 Piece Parallel Pin Punch Set



A set of 6 parallel pin punches made from Chrome Molybdenum steel for strength & durability.

- Octagonal shank and a polished drift
  - Manufactured to **DIN 6450**
- Contents: 2, 2.5, 3, 4, 5 and 6 mm

495002.471266

Mfrs. List No.	Order Code	Price Each			
		1+	5+	10+	20+
T3328S	151-8907	23.24	22.54	21.84	21.15

### 16 Piece Mechanics Punch and Chisel Set



The set contains:

#### 5 Pin Punches:

- 1 x 2mm x 108mm (3/32" x 4 1/4")
- 1 x 3mm x 120mm (1/8" x 4 1/4")
- 1 x 4mm x 127mm (5/32" x 5")
- 1 x 5mm x 133mm (3/16" x 5 1/4")
- 1 x 6mm x 146mm (1/4" x 5 3/4")

#### 5 Taper Punches:

- 1 x 2mm x 133mm (3/32" x 4 1/4")
- 1 x 3mm x 146mm (1/8" x 5 3/4")
- 1 x 4mm x 150mm (5/32" x 6")
- 1 x 5mm x 158mm (3/16" x 6 1/4")
- 1 x 6mm x 170mm (1/4" x 6 3/4")

#### 3 Cold Chisels

- 1 x 9.5mm x 140mm (1/8" x 5 1/2")
- 1 x 12.5mm x 150mm (1/2" x 6")
- 1 x 16mm x 165mm (5/8" x 6 1/2")

#### 2 Centre Punches

- 1 x 3mm x 125mm (1/8" x 5")
- 1 x 5mm x 150mm (3/16" x 6")

#### 1 x Chisel Punch

- Heat treated steel

482068.462142

Order Code	Price/Set				
	1+	5+	10+	20+	50+
144-7437	10.14	9.79	8.12	7.60	6.90

### Round Head Centre Punches



100mm 4in long.

486001

Model	Point (mm)	Point (in)	Order Code	Price Each
				1+
351A	3.2	1/8	443-037	2.66
351B	4.0	5/32	137-3743	2.57
351C	4.8	3/16	443-049	2.64
351D	6.35	1/4	137-3744	2.57

**Punches - continued**

**Punches**

**Parallel pin punch**



485995

Model	Size		Order Code	Price Each			
	(mm)	(in)		1+	5+	10+	20+
161AA	100 x 1.6	4 x 1/16	137-3745	2.45	2.41	2.36	2.31
161A	100 x 2.4	4 x 3/32	137-3746	2.45	2.41	2.36	2.31
161B	100 x 3.2	4 x 1/8	137-3747	2.10	2.05	2.02	1.98
161CC	100 x 4.0	4 x 5/32	137-3748	2.10	2.05	2.02	1.98
161C	100 x 4.8	4 x 3/16	137-3749	2.10	2.05	2.02	1.98
161DD	100 x 5.5	4 x 7/32	137-3750	2.37	2.32	2.28	2.24
161D	100 x 6.4	4 x 1/4	137-3751	2.45	2.41	2.36	2.31
161E	150 x 8.0	6 x 3/16	137-3752	4.42	4.33	4.25	4.17
161FF	150 x 9.5	6 x 3/8	137-3792	4.42	4.33	4.25	4.17
161W	Wallet containing one of each	Wallet containing one of each	443-025	34.23	31.45	30.00	27.44

**Wad And Belt Punches**

**Belt Punches**



494838

Size (mm)	Order Code	Price Each
4	155-2249	1+
5	155-2250	0.96
6	155-2471	1.04
9	012-439	1.17
10-11	012-439	2.89
12	155-2987	1.84
13-14	012-441	5.34
15	012-442	6.24
24-25	012-443	7.65
	012-449	14.00

**Punch and Chisel Set**

**12 Piece**



222912

- Fully hardened and tempered chrome vanadium steel
  - Supplied in a storage roll and each tool has a plastic hand grip
- Contents: Cold Chisels 1/2", 5/8", 3/4", 7/8", Pin Punches 1/4", 5/32", Taper Punches 1/4", 1/8", Solid Punch 5/16", Centre Punch 3/4", Utility Chisel 5/32" and Diamond Point Chisel 1/2"

Order Code	Price Each
313-3369	1+ 14.42

**Drive Pin Punch Set**

**Standard & Long Series**



- Manufactured from tool steel, hardened and tempered at each end between 45-52 Rockwell
- Knurled body and black oxide finish
- Standard and long sets available
- Both sets supplied in fitted vinyl wallet

Parallel Length	Description	Overall Length	Contents (Imperial)	Mfrs. List No.	Order Code
87	Drive pin punch set (5 piece)	205	1/8, 3/16, 1/4, 5/16, 3/8	6301-058	709-3974
19	Drive pin punch set (8 piece)	102	1/16, 3/32, 1/8, 5/32, 3/16, 7/32, 1/4, 5/16	6300-008	709-3986

225360

Order Code	Price Each
709-3974	1+
709-3986	21.98 24.42

**Fox Wedge**

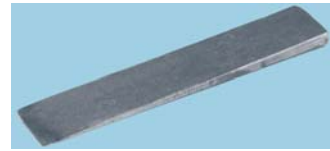

494289

Size (in)	Order Code	Price Each
3 1/2 x 1/2 x 1/4	155-2358	1+ 2.67

**38 Piece Number & Letter Stamp Set**



- Simply place number or letter in automatic punch and stamp where needed
- Size of number and letter: 3mm (1/8")
- Ideal for security marking on personal belongings
- Includes blow moulded storage case

481957.452992

Order Code	Price Each				
	1+	4+	10+	20+	50+
144-7391	6.42	5.86	5.13	4.80	4.38

**Letter And Figure Punch Sets**

**Positive Impression Figure And Letters**



Produce sharp faced characters on anything from aluminium to stainless steel.

**10 Figures**

Size Of Characters (mm)		(in)	Order Code	Price Each
1.0		.040	212-827	1+ 15.35
1.5		1/16	012-831	13.69
2.0		5/64	212-828	10.37
2.5		3/32	012-832	10.99
3.0		1/8	012-833	10.37
4.0		5/32	212-831	12.46
5.0		3/16	155-3639	17.03
6.0		1/4	012-835	13.69
8.0		5/16	212-832	26.80
10.0		3/8	012-836	33.26
12.5		1/2	212-833	44.14

**27 Letters**

492514

Size Of Characters (mm)		(in)	Order Code	Price Each
1.5		1/16	012-837	1+ 33.80
2.0		5/64	212-830B	29.37
2.5		3/32	012-838	29.35
3.0		1/8	012-839	26.48
4.0		5/32	213-834B	29.09
5.0		3/16	012-840	29.67
6.0		1/4	012-841	33.80
10.0		3/8	012-842	83.13

**Express checkout**



With no need to re-enter your details, returning customers can now buy products even faster - **order online today at [www.farnell.co.uk](http://www.farnell.co.uk)**

Figure and Letter Punches



- Number punches supplied as set of 9 in tough plastic case
- Manufactured from specially-selected steel, correctly hardened and tempered
- Letter punches supplied as set of 27, A to Z plus the & symbol, in tough plastic case

B>Figure Size	Length	Mfrs. List No.	Order Code
6mm/¼"	75mm	T3301-25	709-7372
Letter Size	75mm	T3303-25	709-7396

223208

	Order Code	Price Each
Punch Set, Numbers, 6mm	709-7372	11.40
Punch Set, Letters, 6mm	709-7396	28.02

Wad Punches



491705

Size (mm)	Order Code	Price Each
6	155-2988	3.20
8	155-2989	3.20
9	155-2990	3.20
10	155-3637	5.54
12	155-3638	5.03
13	012-456	5.50
15	155-4306	6.63
17	155-3081	7.73
20	012-459	8.91
22	012-460	9.27
23	012-461	13.45
25	012-462	12.03
28	012-463	14.24
34	012-465	24.85
38	012-466	23.50
41	012-467	33.15

Metal Punches



494457

No 5 Junior Hand Punch Set

Complete with 7 punches and dies. Sizes: 3/32, 1/8, 5/32, 3/16, 7/32, 1/4 and 5/16in. Supplied in a plastic case.

XX Deep Throat Punch Set

Complete with 7 punches and dies. Sizes: 5/32, 7/32, 9/32, 11/32, 13/32 and 17/32in. Supplied in a plastic case.

Model	Capacity Hole x Thickness	Max Hole Size(in)	Throat Depth (in)	Order Code	Price Each
No 5	¼ x 16 swg	5/32	1¼	012-476	87.47
XX	¼ x 16 swg	17/32	3¼	212-490B	256.07

Maun Wad Punch Kits



495305

Single punch handle onto which screws a series of interchangeable punches. All parts are fully treated and chemically blacked.

Model	Punch Diameter	Order Code	Price Each
1001-05	¼, ⅜, ⅝, ⅞, 1, 1½, 2, 2½, 3, 4, 5, 6, 8, 10, 12, 15, 20, 25, 32mm	138-6961	1+
1000-05	5, 6, 8, 10, 12, 15, 20, 25, 32mm	138-6964	24.30
			25.29

Punch

Hollow Punch Sets



3 sets of hollow punches ideal for cutting out washers and sealing rings in foam, cardboard, leather, rubber, fibre, plastics, lead and various other materials. Each set contains a single punch handle onto which the punches are locked by means of a patented system.

493390

Model	Punch Diameter	Order Code	Price Each
JLB320	3, 4, 6, 8, 10, 12, CM	010-568	1+
JLB330	3, 4, 6, 8, 10, 12, CM	010-569	62.19
JLP250P	14, 16, 18, 20, 22, 24, 26, 28, 30mm	010-570	110.44
	2, 3, 4, 5, 6, 7, 8, 9, 10, 12, 14, 16, 18, 20, 22, 24, 26, 28, 30, 32, 34, 36, 38, 40, 42, 44, 46, 48, 50mm		233.82

Screw-Hole Punches

with three-point cutting tip



- Suitable for sheet steel, stainless-steel sheets, non-ferrous and light metals, plastics.
- Die: three-point cutting
- Material: special steel
- Material thickness: up to 4mm
- Draw-in-bolt: metric fine-thread from MF 10 grade 12.9

Anchor Hole Ø	Thread Size	Fastens Up To	Material	Min. Hole Depth	Anchor Hole Ø	Thread Size	Fastens Up To	Material	Min. Hole Depth
109127	12.7	7		M8	109283	28.3	21		M12
109165	16.5				109320	32			
109186	18.6	11		M10	109325	32.5			
109200	20				109350	35			
109204	20.4	13.5		M10	109405	40.5			
109220	22				109450	45			
109225	22.5	16		M10	109505	50.5			
109254	25.4				109600	60	48		M16

241113

Mfrs. Part No.	Order Code	1+	5+	10+
109127	379-256	11.30	10.20	9.30
109165	470-0790	12.48	11.86	11.24
109186	379-281	—	—	—
109200	470-0806	14.82	14.07	13.34
109204	379-311	15.10	13.60	12.30
109220	470-0818	16.18	15.39	14.58
109225	379-323	16.50	14.80	13.45
109254	470-0820	17.77	16.91	16.01
109283	379-335	16.50	14.80	13.45
109320	470-0843	19.77	18.78	17.78
109325	470-0855	22.72	21.58	20.44
109350	470-0867	22.72	21.58	20.44
109405	470-0879	31.06	29.51	27.96
109450	470-0880	36.96	35.12	33.25
109505	470-0892	44.48	42.26	40.03
109600	382-887	51.20	46.10	41.90
109635	470-0909	68.43	65.01	61.59

Q-Max Sheet Metal Punches



For punching burr-free and accurate holes in sheet metal. Up to 1.625mm thick mild steel, 2mm thick copper, brass and aluminium.

Punch Key Size	Bolt Size	Recommended Pilot Hole Size
MT	M6	8mm
MA	M8	10mm
MB	M10	12mm
MC	M12	14mm
ME	M14	16mm

Metric Round



**Punches - continued**

**Q-Max Sheet Metal Punches - continued**

**Metric Round - continued**

Size (mm)	Key Size	Order Code	Price Each
10	MT	139-1568	5.12
12.5	MA	139-1569	5.45
14	MA	139-1587	5.45
15	MA	139-1570	5.60
16	MA	139-1571	5.60
17.5	MA	139-1572	5.89
19	MB	139-1588	5.89
20	MB	139-1573	6.30
21	MB	139-1589	6.30
22.5	MB	139-1575	6.35
24	MB	139-1590	6.59
25	MB	139-1576	6.59
27.5	MB	139-1577	7.00
29	MB	139-1591	7.00
30	MB	139-1578	7.44
31	MB	139-1592	7.44
32.5	MC	139-1579	7.91
34	MC	139-1593	7.98
35	MC	139-1580	8.57
37.5	MC	139-1581	10.18
40	MC	139-1582	11.63
45	MC	139-1583	12.35
50	MC	139-1584	14.38
51	MC	139-1595	14.97
55	ME	139-1594	18.38
60	ME	139-1597	26.58
64	ME	139-1596	31.13
65	ME	139-1599	34.85
75	ME	139-1601	60.07
76.5	ME	139-1602	60.21

**Metric Square**

Size (mm)	Key Size	Order Code	Price Each
19	*	139-1603	33.13
24	B	139-1605	34.68

**Rectangular**

Size (mm)	Order Code	Price Each
17.5 x 24	139-1606	42.46

**Fractional Round**

Size (in)*	Key Size	Order Code	Price Each
3/8	T	139-1551	5.14
7/16	T	139-1552	5.35
1/2	A	139-1553	5.45
5/8	A	139-1554	5.60
3/4	A	139-1555	4.53
13/16	A	139-1556	5.89
7/8	A	139-1557	6.30
1	B	139-1558	6.59
1 1/16	B	139-1559	6.90
1 1/8	B	139-1560	7.08
1 1/4	B	139-1561	7.55
1 1/2	B	139-1563	7.69
1 3/4	B	139-1564	8.57
1 7/8	B	139-1565	7.66
1 5/8	B	139-1566	11.32
1 3/4	B	139-1567	11.98

**Keys**

494237

Size	AF	Order Code	Price Each
T	3/8in	155-2285	0.28
A	7/32in	155-3031	0.32
B	5/16in	102-168	0.99
MA	6mm	155-2117	0.36
MB	8mm	155-2118	0.62
MC	10mm	155-2282	1.19

**'D' Connector Punch**

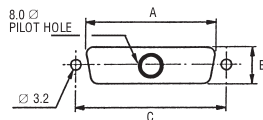

A range of D-connector hole punches suitable for use on mild steel up to 1.6mm (16 swg) and aluminium up to 2mm (14swg). They are available to suit either rear or front/through mounting of the connectors.

	9 Way		15 Way		25 Way		37 Way		50 Way	
	Front	Rear	Front	Rear	Front	Rear	Front	Rear	Front	Rear
A	21.3	19.8	29.6	28.2	43.4	41.9	59.8	58.4	55.7	55.7
B	12.9	11.3	12.9	11.3	12.9	11.3	12.9	11.3	13.9	13.9
C	25.0	25.0	33.3	33.3	47.0	47.0	63.5	63.5	61.1	61.1

223220

Connector	Mftrs. List No.	Order Code	Price Each
Rear			1+
9Way	976-0010	146-822	110.53
15Way	976-0020	146-823	118.95
25Way	976-0030	146-824	115.73
37Way	976-0040	146-825	121.00
50Way	976-0050	146-826	116.59
Connector Front/Through			
Through Mounting			
9Way	975-0010	146-817	111.29
15Way	975-0020	146-818	115.24
25Way	975-0030	146-819	114.80
37Way	975-0040	146-820	107.47

**3000lb Lever Press**



- Designed to manufacture sheet material and bar into prototypes for development and production runs
- Ideal for the manufacture of sheet metal and plastic components
- Robust frame being high quality carbon steel which is then stove enamelled
- Wide range of accessory tools below enable it to shear, bend, bar crop, form and shape
- Complete with instruction manual
- Supplied without bench

Throat clearance	150 deep 83mm high	Material	Max. recommended sheet thickness (mm)
Stroke length	6 to 60	Aluminium	2.50
Ram spigot hole	18 dia., 22 deep	Mild Steel	1.62
Base hole	38 dia.	Fibre Glass	2.00
Bench mounting, 4 holes	10mm dia.	Paper PCB	3.20
Weight	14.2 kg		

223220

Mftrs. List No.	Order Code	Price Each
900-0000	149-343	512.09

**Rectangular Punches and Dies**



- Range of useful rectangular punches and dies suitable for many rocker switches and IEC panel mounting connectors
- Manufactured in case hardened steel to the same high tolerances as the circular punches and dies

Use die holder 903-0030 (Order Code 149-387)

223226

Size	Mftrs. List No.	Order Code	Price Each
15.9 x 13.0	906-0020	149-374	37.33
29.4 x 22.0	906-0060	149-378	47.43

**700 products added online every week**



See our pick of the hottest products and latest technologies in 'What's New?' at [www.farnell.co.uk](http://www.farnell.co.uk)



**Boxed Sets of Punches and Dies**



- Two boxed sets of circular punches and dies
- Thirteen piece set (3 - 12mm)
- Seven piece set (12.5 - 27.5mm)
- Housed in strong stove enamelled boxes with hinged lids
- The 149-431 also includes a stripper plate

	Mfrs List No.	Order Code
13 Piece 3-12mm dia	907-0010	149-431
7 Piece 12.5 - 27.5mm	902-0010	108-177

223229

Diameter	Order Code	Price Each
3-12mm	149-431	1+
12.5 - 27.5mm	108-177	304.97
		142.23

**Circular Punches and Dies**



Tool Steel



3 to 12mm

Use die holder 5563-6 (Order Code 149-385)  
Stripper 5514-02 (Order Code 149-388)

Spring loaded centring pin

- Fully hardened and tempered tool steel
- Suitable for fibreglass SRBP boards, aluminium and mild steel

223230

Diameter	Mfrs. List No.	Order Code	Price Each
3.5	912-0020	149-347	1+
4	912-0030	149-348	13.82
5	912-0050	149-350	14.53
6	912-0070	149-352	14.53
12	914-0140	149-358	13.57
			12.34

**Nibbling Tools**

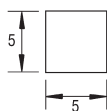

Use die holder 903-0010 (Order Code 149-385)  
and Stripper 902-0010 (Order Code 149-388)

- Versatile nibbling tool enabling the operator to produce a wide range of cut-outs

223231

	Mfrs. List No.	Order Code	Price Each
Square	901-0120	149-393	1+
			37.33

**Corner Notching Tool**

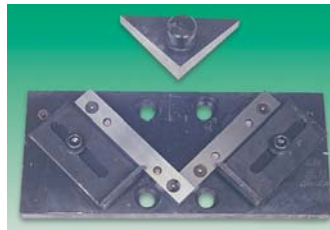

- For precise 90° notches, up to 53mm per side. Adjustable stops make continuous production easy, particularly useful for box making.

223233

Mfrs. List No.	Order Code	Price Each
901-0040	149-400	1+
		168.73

**Vee Bending Tool**



- Baseplate 160mm long and five bending punches: 50, 75, 100, 125 and 150mm long
- Punches can be cut or machined to any required length allowing manufacture of brackets and boxes

223235

Mfrs. List No.	Order Code	Price Each
901-0050	149-401	1+
		158.10

**Slot Guillotine**



- For cutting and slotting without distorting the material
- Cut slot is 3mmx70mm

223238

Mfrs. List No.	Order Code	Price Each
901-0070	149-403	1+
		159.48

**Components Punches and Dies**



- A range of specially designed punches for the popular panel mounted components

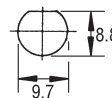

Mfrs List No. 911-0060  
Order Code 149-433

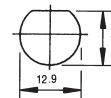

Mfrs List No. 911-0070  
Order Code 149-434

223242

Order Code	Price Each
149-433	1+
149-434	40.44
	41.66

**Punches - continued**

**Die Holders**



- Die holder to securely mount the dies to the press

Application	Mfrs List No.	Order Code
3 — 12mm Circular dies and all nibbling tools	903-0010	149-385

223243

Die Holders	Order Code	Price Each
3 — 12mm circular	149-385	15.00

**Knives**

**Disposable Knife**



Yellow moulded plastic handle with integral blade. 478371

Model	Order Code		Price Per Box (50 pcs)		
			1+	5+	10+
10-601RB	135-3707	25.90	25.10	23.85	22.80
Model	Order Code		Price Per Card (3pc)		
			1+	5+	10+
10-6013R	135-3708	1.90	1.74	1.66	1.63

**Folding Knife**



- Die cast body with folding, lockable blade.
- 2 blades supplied.
- Knife uses Stanley 5901 blades (order code 722-1216).

478365

Order Code		Price Each			
		1+	5+	10+	20+
135-3683		6.84	6.46	6.17	5.98

**Interlock Knife**



Lightweight, die cast body slimline knife ideal for modelling. Supplied with 5 blades. 478364

Order Code		Price Each			
		1+	5+	10+	20+
135-3681		4.85	4.70	4.45	4.37

**Interlock Knife**

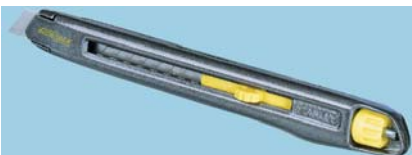

Interlock knife with finger screw operated wedge lock to hold blade securely. Die cast metal body. 478373

Blade width (mm)	Order Code	Price Each			
		1+	5+	10+	20+
9	135-3684	3.10	3.00	2.85	2.78
18	135-3710	4.85	4.70	4.45	4.37

**SM9 & SM18 Knife**



Plastic knife with blade snapping slot in end cap. 478381

Model	Blade width (mm)	Order Code	Price Each			
			1+	4+	20+	40+
SM9	9	610-057	1.15	1.10	1.05	0.99
SM18	18	610-069	2.57	2.34	2.22	2.18

**Dynagrip Knife**



Stainless steel barrel with grey soft touch polypropylene grip. Screw clamp locking device ensures security of blade. Blade snapper incorporated in end cap. 478374

Blade width (mm)	Order Code	Price Each			
		1+	5+	10+	20+
9	135-3693	3.55	3.45	3.25	3.17
18	135-3694	4.85	4.70	4.45	4.37

**10-280, 10-380 & 10-400 Knives**



Ergonomically designed for comfort and cutting power cartridge knives. The 18mm blade is automatically locked in the selected position for safe, positive cutting. After removing used blade from nose of cutter, the new blade automatically feeds into position when the slider is retracted. Model 21-4403 can store 2 standard blades whilst 21-4404 and 21-4405 can store upto 6 standard blades. 478391

Model	Blade width (mm)	Order Code	Price Each			
			1+	5+	10+	20+
10-280	18	135-3716	3.45	3.35	3.15	3.09
10-380	18	135-3717	5.00	4.85	4.60	4.50
10-480	18	135-3719	7.78	7.61	7.46	7.31

**Titan Knife**



Enamel painted aluminium body. Supplied with 5 blades and polypropylene scabbard. Easy blade change using solid brass notched wheel. 478352

Order Code		Price Each			
		1+	5+	10+	20+
135-3714		9.30	9.00	8.55	8.37

**Help us to help the environment**



This catalogue has been printed on paper certified from a sustainable source. Please recycle after use.

**Retractable Utility Knife**



- Retractable blade with 3 positions
- Cast metal construction
- Precision die-cast ergonomically designed handle
- Easy blade change without the use of any tools

482102.462286

Order Code	Price Each				
	1+	5+	10+	20+	50+
144-7566	1.73	1.60	1.41	1.30	1.17

**Lightweight Knife**



Lightweight knife with ABS body and screwless blade changing mechanism. Supplied with 2 blades.

478363

Order Code	Price Each			
	1+	5+	10+	20+
135-3692	1.85	1.80	1.70	1.67

**199 Knife**



Grey painted die cast body with textured grip and 5 assorted blades.

478346

Order Code	Price Each			
	1+	5+	10+	20+
135-3680	4.28	4.04	3.88	3.72

**99E Knife**



Grey painted die cast body with variable blade extension and 5 assorted blades.

478359

Order Code	Price Each			
	1+	5+	10+	20+
135-3682	4.24	4.16	3.99	3.85

**C.K Trimming knife auto retracting**



- Blade retracts automatically when lever is released, reducing risk of injury
- Ergonomic, lightweight design
- Simple blade change

525117

Mfrs. List No.	Order Code	Price Each		
SAFETY KNIFE T0969		1+	5+	10+
	166-0787	3.60	3.40	3.25

**Trimming Knives**



non retractable



retractable

- Trimming knife with lockable body
- Magnetic blade holder
- Supplied with 10 spare blades in a dispenser

blade type	Mfrs. List No.	Order Code	Price Each			
			1+	5+	10+	20+
non retractable	T0956-2	151-8924	4.02	3.90	3.77	3.65
retractable	T0956-1	151-8925	4.91	4.76	4.61	4.47

495348

Spares	Mfrs. List No.	Order Code	Price Each			
			1+	5+	10+	20+
Pack of 10	T0959-10	151-8927	2.22	2.16	2.09	2.03
Pack of 50	T0959-50	151-8928	8.94	8.66	8.40	8.12

**Trimming Knives**



- Soft grip handle
- Interlocking body with captive body
- Magnetic blade holder for easy change of blade
- Internal storage can hold up to 5 blades
- Supplied with blade dispenser and 10 blades
- Retractable Version equipped with string/strap cutting notch

484549

Type	Mfrs. List No.	Order Code	Price Each			
			1+	5+	10+	20+
Non-retractable	T0957-2	146-5986	5.34	4.88	4.50	4.30
Retractable	T0957-1	146-5987	6.97	6.39	5.89	5.63

**Metal Mitey Knife**



Rugged metal body construction with retractable blade with two cutting positions. Two spare blades and key chain included.

478003

Order Code	Price Each			
	1+	5+	10+	20+
135-3422	2.25	2.20	2.05	2.01

**Lightweight Trimming Knife**



Lightweight die cast metal body supplied with 3 blades.

478351

Order Code	Price Each			
	1+	5+	10+	20+
135-3713	2.30	2.25	2.10	2.06

**Interlock Adjustable Knife**



**Knives - continued**

**Interlock Adjustable Knife - continued**

Interlock knife with wedge design for secure blade location, and 5 assorted blades. 478357

Order Code	Price Each			
	1+	5+	10+	20+
135-3711	6.35	6.15	5.85	5.72

**Springback Knife**



For added safety, blade automatically springs back into handle when button is released. Supplied with 1992 blade. 478355

Order Code	Price Each			
	1+	4+	20+	40+
108-392	5.25	5.10	4.85	4.56

**Titan RB Knife**



Heavy duty retractable blade knife. Supplied with 5 blades and polypropylene scabbard. 478356

Order Code	Price Each			
	1+	4+	10+	20+
709-4024	10.80	10.50	9.95	9.36

**5901 Straight Knife Blades**



General purpose, for modelling and craft work. 478341

No. of blades	Order Code	Price Each			
		1+	4+	10+	20+
3	722-1216	1.40	1.35	1.30	1.22
50	135-3715	15.35	14.90	14.10	13.80

**Saw Knife Blades**



For use with 199, 199A and 10-010 knives. Two types for sawing in restricted areas and cutting curved shapes. 478340

Model	Type	Order Code	Price Each			
			1+	4+	20+	40+
0-15-276	Wood	628-980	1.40	1.35	1.30	1.24
0-15-277	Metal	628-979	1.40	1.35	1.30	1.24

**Snap-Off Blades**



Supplied in safety storage box which provides effective snapping and storage of waste segments. 478232

Model	Size (mm)	Pack quantity	Order Code	Price Each			
				1+	5+	10+	20+
11-300	9	100	135-3685	16.90	16.40	15.55	15.24
11-301	18	100	709-3433	23.05	22.35	21.20	19.97

**100 Knife Blades & Dispenser**



- Dispenser can be mounted on wall or carried around
- Used blade section for safe disposal
- Contains 100 two notch stainless steel blades
- Suitable for use with most retractable knives

Order Code	Price Each			
	1+	5+	20+	50+
144-7568	5.83	5.30	4.67	3.98

**Knife Blades**

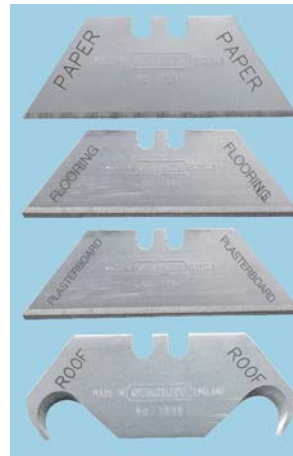

New technology knife blade lasts 80% longer and are 50% sharper than a standard duty Stanley blade

**Paper**

- Ideal for cutting cardboard, paper, adhesive tape, shrink wrapping, fabric, nylon banding

**Flooring**

- Ideal for cutting foam backed carpet, reinforced carpet, underlay, lino, coco fibre, cork tiles, pvc adhesive tiles

**Plasterboard**

- Ideal for cutting and scoring plasterboard, ceiling tile, wallboard and similar materials

**Roofing**

- Ideal for cutting roofing felt, shingle, roofing insulation, polystyrene tiles, tar paper

Sold in packs of 5

482980.467747

Type	Mfrs. List No.	Order Code	Price/Pack	
			1+	5+
Paper	5-11-938	145-4284	1.08	1.01
Flooring	5-11-943	145-4285	1.25	1.14
Plasterboard	5-11-937	145-4287	1.25	1.14
Roofing	5-11-939	145-4288	1.25	1.14

**1991 Normal Duty Knife Blades**



Normal duty, general purpose blade for paper, card and most thin sheet material. Not suitable for 99E and 10-089 knife.

478326

Model	Number blades	Pack details	Order Code	Price Each			
				1+	5+	10+	20+
1991	5	Card	135-3686	1.00	0.95	0.90	0.89
1991	100	Plastic box	135-3689	13.80	13.40	12.70	12.43

**1992 Heavy Duty Knife Blades**



Heavy duty, general purpose blade, ideal for carpet, vinyl and other materials requiring a stiffer and stronger blade.

Model	Number of blades	Pack details	Order Code	Price Each			
				1+	5+	10+	20+
1992	5	Card	<b>135-3687</b>	1.15	1.10	1.05	1.03
1992	100	Plastic box	<b>135-3691</b>	16.90	16.40	15.55	15.24
1992	10	1 Dispenser of 10	<b>135-3696</b>	1.70	1.65	1.55	1.52
1992	400	Box bulk packed	<b>135-3705</b>	61.00	59.15	56.10	54.98

**1992R**

Heavy duty, general purpose blade with a round nose end for additional user safety.

478339

Model	Number of blades	Pack details	Order Code	Price Each			
				1+	5+	10+	20+
1992R	10	Card of 10	<b>135-3678</b>	1.70	1.65	1.55	1.52

**Trimming Knife Blades**



All blades are manufactured to fit standard international holders.

491259

Blade Type	Pack qty	Order Code	Price Each	
			1+	10+
Heavy duty standard	10	<b>385-9794</b>	1.40	
Heavy duty standard	100	<b>214-801</b>	9.58	

**Window Scraper**



Plastic handle fitted with 1992 blade and guard.

478318

Mfrs. List No.	Order Code	Price Each			
		1+	5+	10+	20+
5930	<b>135-3709</b>	1.10	1.05	1.00	0.98

**Knives**

**Palette Knives**



Best quality extra flexible blades. Rosewood handles.

494773

Blade Size (mm)	(in)	Order Code	Price Each			
			1+	5+	10+	20+
100	4	<b>116-080</b>	11.71			
150	6	<b>116-081</b>	13.05			
200	8	<b>116-082</b>	15.80			
250	10	<b>116-083</b>	25.95			

**Painters Scraper**



- High-quality spring steel, taper ground
- Strong enough for scraping but flexible enough for filling

SE055

Size mm/inch	Mfrs. List No.	Order Code	Price Each			
			1+	3+	6+	12+
25/1	T5075 1	<b>716-7120</b>	8.75	8.50	8.25	7.90
50/2	T5075 2	<b>716-7131</b>	8.55	8.30	8.05	7.70
75/3	T5075 3	<b>716-7155</b>	9.20	8.90	8.65	8.30
100/4	T5075 4	<b>716-7167</b>	10.95	10.60	10.30	9.85

**Electricians Knife**



- Lock Knife with sharp high carbon steel blade
- Wire stripping notch
- Brass riveted for smoother opening and closing action
- Size: 95mm

448431.471150

Mfrs. List No.	Order Code	Price Each	
		1+	5+
484001	<b>128-3270</b>	8.35	8.10

**Electricians Knife**



- Sharp, high carbon steel blade
- Slotted screwdriver blade featuring a convenient stripping notch
- Both blades lock for safety in use
- Size: 110mm

448432.471418

Mfrs. List No.	Order Code	Price Each	
		1+	5+
484002	<b>128-3271</b>	12.00	11.65

**Tradesman Pocket Knives**



Stainless steel blades mounted in a virtually unbreakable moulded handle.

493365

Size (mm)	(in)	Description	Order Code	Price Each	
				1+	5+
79	3 1/8	Clit point general purpose	<b>215-302B</b>	11.87	
69	2 3/4	Clit point blade and screwdriver/wire stripper blade for electricians etc	<b>215-303</b>	17.72	
69	2 3/4	Heavy duty blade general purpose	<b>215-304</b>	9.89	

**Tradesman Pocket Knives**



**Plumbers**

Best quality steel blades simulated staghorn scales. Model 01-3477 has a spring loaded blade locking feature that ensures it remains open when in use.

Order Code	Price Each	
	1+	5+
<b>013-477</b>	16.70	

**Knives - continued**

**Tradesman Pocket Knives - continued**

**Plumbers - continued**

**Model 85**

Electricians/engineers NATO specification knife with single blade that incorporates screw-driver, file cable/wire stripper and cutting edge. Nickel bolster with black fibre scales.

Model	Size (in)	Order Code	Price Each
85	3¾	013-474	15.12

**Model 80BEX**

General purpose lock knife. Simulated stag horn scales.

495189

Model	Size (in)	Order Code	Price Each
80BEX	4½	013-472	22.50

**Sports Utility Knife**



Multi-functional combination knife. Features traditional utility blade and serrated edged blade. Soft panels provide for a safe grip with instant push button blade change without the need of tools. Supplied in a heavy duty holster with pack of 10 heavy duty blades.

478325

Order Code	Price Each			
	1+	5+	10+	20+
135-3667	20.57	19.87	19.24	18.86

**Trimaway & Retractable Scalpels**

**SWANN MORTON**



**Trimaway**

Purposely designed as an economic throwaway knife, the Trimaway has a strong nylon-based handle fitted with a fixed surgical quality heavy-duty No.25A blade and comes complete with guard. The Trimaway is particularly suitable for artwork, crafts and model making and the cutting edge requirements of the handy person and D.I.Y. enthusiast.



**Retractable**

The Retractable is a sleek graphite-finish metal handle offering the added safety of a hand retractable blade mechanism. It is a highly versatile cutting tool produced with designers, graphic artists and model makers in mind. With easy blade changing it fits and safely retracts surgical blade No's 10, 10A, 11 and 15.

507350

Description	Mfrs List No.	Order Code	Price Each		
			1+	5+	10+
Trimaway Scalpel Handle with blade 25A	2338	155-1300	1.10	1.05	1.00
Retractable Scalpel Handle with blade 10A	2800 0102	155-1301	5.60	5.30	5.05

**Retractable Scalpel Knife**



493842

Mfrs. List No.	Order Code	Price Each			
		1+	5+	10+	20+
145-0003	151-8439	2.24	2.16	2.09	2.01

- Lightweight scalpel handle
- Virtually unbreakable
- Supplied with one No.10A blade

**Scalpels and Surgical Quality Blades**

**SWANN MORTON**

This professional range of blades and handles are used in a variety of different industries from mould cutting and prototyping to printing and artwork. The No.3 handle is available for use with the small fitment blades. The No. 4 handle is available for use with the larger fitment blades. Especially with craft professionals and enthusiasts in mind, Swann-Morton has developed two acrylic handles (5A and 6A) with a nickel blade fitting that takes standard surgical blades. Handle 5A is for use with the small fitment blades. Handle 6A is to be used with the larger fitment blades.



**Scalpel Handles No. 3 and 5A**



Handle 3



Handle 5A

Blades for use with handles 3 and 5A			
Mfrs List No.	Image	Blade No.	Order Code
0101		No. 10	155-1278
0102		No. 10A	155-1281
0103		No. 11	155-1282
0104		No. 12	155-1283
0239		No. 13	155-1284
0119		No. 14	155-1285
0105		No. 15	155-1286

**Scalpel Handles No. 4 and 6A**



Handle 4



Handle 6A

Blades for use with handles 4 and 6A			
Mfrs List No.	Image	Blade No.	Order Code
0123		No. 18	155-1289
0124		No. 19	155-1290
0106		No. 20	155-1291
0107		No. 21	155-1293
0108		No. 22	155-1294
0110		No. 23	155-1295
0111		No. 24	155-1296
0112		No. 25	155-1297
0113		No. 26	155-1298
0236		No. 36	155-1299

507342

Handles	Mfrs. List No.	Order Code	Price Each		
Handle No. 3	0803	155-1277	1+	5+	10+
Handle No. 5A	1005	155-1276	4.30	4.10	3.85
Handle No. 4	0804	155-1288	12.95	12.30	11.65
Handle No. 6A	1006	155-1287	4.30	4.10	3.85
			12.95	12.30	11.65
			Price Per Pack		
<b>Blades for Handles No. 3 and 5A</b>			1+	5+	10+
Surgical Quality Blades, Pack of 5	0101	155-1278	1.30	1.25	1.15
Surgical Quality Blades, Pack of 5	0102	155-1281	1.30	1.25	1.15
Surgical Quality Blades, Pack of 5	0103	155-1282	1.30	1.25	1.15
Surgical Quality Blades, Pack of 5	0104	155-1283	1.30	1.25	1.15
Surgical Quality Blades, Pack of 5	0239	155-1284	1.30	1.25	1.15
Surgical Quality Blades, Pack of 5	0119	155-1285	1.30	1.25	1.15
Surgical Quality Blades, Pack of 5	0105	155-1286	1.30	1.25	1.15
			Price Per Pack		
<b>Blades for Handles No. 4 and 6A</b>			1+	5+	10+
Surgical Quality Blades, Pack of 5	0123	155-1289	1.30	1.25	1.15
Surgical Quality Blades, Pack of 5	0124	155-1290	1.30	1.25	1.15
Surgical Quality Blades, Pack of 5	0106	155-1291	1.30	1.25	1.15
Surgical Quality Blades, Pack of 5	0107	155-1293	1.30	1.25	1.15

Blades for Handles No. 4 and 6A	Mfrs.	Price Each			
		1+	5+	10+	
Surgical Quality Blades, Pack of 5	0108	155-1294	1.30	1.25	1.15
Surgical Quality Blades, Pack of 5	0110	155-1295	1.30	1.25	1.15
Surgical Quality Blades, Pack of 5	0111	155-1296	1.30	1.25	1.15
Surgical Quality Blades, Pack of 5	0112	155-1297	1.30	1.25	1.15
Surgical Quality Blades, Pack of 5	0113	155-1298	1.30	1.25	1.15
Surgical Quality Blades, Pack of 5	0236	155-1299	1.30	1.25	1.15

**High Precision Scalpels and Blades**

**SWANN MORTON**

The ACM Boxed Set is a comprehensive set of 13 precision ground carbon steel blades, made by one of the world's leading surgical blade manufacturers to the same high surgical quality for which the company is renowned, together with 3 handles. Handles and blades available also individually.



Handle 1 with blade 11: order code 155-1262

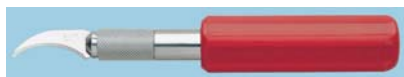

Handle 5 with blade 28: order code 155-1269

Blades for use with handle 1			
Typ	Image	Blade No.	Best.-Nr.
9327		ACM7SM	155-1263
9301		ACM10SM	155-1264
9303		ACM11SM	155-1265
9316		ACM16SM	155-1266
9307		ACM17SM	155-1268

Blades for use with handle 5			
Typ	Image	Blade No.	Best.-Nr.
9322		ACM2SM	155-1270
9318		ACM18SM	155-1271
9308		ACM22SM	155-1272
9311		ACM24SM	155-1273
9328		ACM28SM	155-1274

507349

Description	Mfrs List No.	Order Code	Price Each		
			1+	5+	10+
ACM Set	9101	155-1275	28.10	26.70	25.30
Handle No. 1 with blade 11	9102	155-1262	4.75	4.50	4.30
Handle No. 5 with blade 28	9104	155-1269	6.90	6.55	6.20
			Price Per Pack		
Blades for Handle No. 1	Mfrs List No.	Order Code	1+	5+	10+
High Precision Blades, Pack of 5	9327	155-1263	2.15	2.05	1.95
High Precision Blades, Pack of 5	9301	155-1264	2.15	2.05	1.95
High Precision Blades, Pack of 5	9303	155-1265	2.15	2.05	1.95
High Precision Blades, Pack of 5	9316	155-1266	2.15	2.05	1.95
High Precision Blades, Pack of 5	9307	155-1268	2.15	2.05	1.95
			Price Per Pack		
Blades for Handle No. 5	Mfrs List No.	Order Code	1+	5+	10+
High Precision Blades, Pack of 5	9322	155-1270	2.60	2.45	2.35
High Precision Blades, Pack of 5	9318	155-1271	2.60	2.45	2.35
High Precision Blades, Pack of 5	9308	155-1272	2.60	2.45	2.35
High Precision Blades, Pack of 5	9311	155-1273	2.60	2.45	2.35
High Precision Blades, Pack of 5	9328	155-1274	2.60	2.45	2.35

45

**35 Piece Hobby Knife Set**

**DURATOOL**



- 35 piece hobby knife craft set
- Contains everything you would need to get you started
- Ideal for the modeller or craft worker
- Tweezers for the safe removal of blades
- Supplied with: 23 assorted blades, 2 x handles, 1 x plane, sanding block, tweezers, 3 x scoring points and handle,
- Contained in a handy carry case

457701.453015

Order Code	Price/Set		
	1+	5+	10+
132-8726	5.87	5.28	

**Technical information at your fingertips**

Over **352,000** technical datasheets available online.

Visit [www.farnell.co.uk](http://www.farnell.co.uk) and look for the **Tech Info** heading in your search results.



**Knives - continued**

**Knives**



Machined from lightweight metal with interchangeable surgical steel blades firmly held in a 4 jaw chuck.

Type	Description	Order Code	Price Each			
			1+	10+	25+	40+
XN100	Light duty. Uses 100 series blades.	440-942	2.34	2.27	2.20	2.14
XN200	Medium duty. Uses 200 series blades.	440-980	3.51	--	--	--
XNS-100	Light and medium duty set complete with 10 assorted blades.	440-930	9.36	9.08	8.81	8.54

**Spare Blades**

In packs of 5.

485405

Type	Description	Order Code	Price Per Pack			
			1+	10+	25+	40+
XNB103	Fine Point	440-954	2.07	2.01	1.95	1.89
XNB101	Standard	440-966	2.88	2.79	2.71	2.63
XNB205	Pointed	441-016	2.16	--	--	--
XNB203	General purpose	441-028	3.15	3.06	2.96	2.87

**Multitools**

**NMP12 Multimax Pro Universal Tool**



- 14 tools in 1
- Made of stainless steel
- Components can be removed and replaced
- Blades can be opened with handles closed
- Supplied with a nylon sheath, can be attached to the belt vertically or horizontally
- Includes 14 tools: multi-purpose pliers and wire cutters, 2 flat-blade screwdrivers, Phillips screwdriver, pocket-knife blade, serrated blade, rule with metric and imperial graduations (measures up to 20cm), attaching ring, can opener/bottle opener, metal/wood file

450704

Mfrs. List No.	Order Code	1+	+	+
0010020265	122-9796	79.78	--	--

**NMP15 Multimax Pro XL Universal Tool**



- 15 tools in 1
- Made of stainless steel
- Components can be removed and replaced
- Blades can be opened with handles closed
- Supplied in a nylon sheath, can be attached to the belt vertically or horizontally
- Includes 15 tools: large jaw multi-purpose pliers for crimping and wire cutting, locking pocket-knife blade, 3 flat-blade screwdrivers (small, medium, large), Phillips screwdriver, rule with metric and imperial graduations, attaching ring, can opener/bottle opener, metal/wood file, saw, awl

450707

Mfrs. List No.	Order Code	1+	+	+
0010020268	122-9797	102.88	--	--

**7 Function Multi-Tool**



- High grade stainless steel
- Precision engineered
- Compact and lightweight
- Length: 100mm (Closed)
- Weight: 140g
- Supplied with 4 x LR41 batteries and black nylon pouch with belt loop



454052

Order Code	1+	Price Each	5+
166-4778	4.50		4.25

**Scissors**

**Electricians' Snips**



**WILLIAM WHITELY**

- Specially designed for electricians use for wire cutting

Overall length = 130

223358

Order Code	Price Each
289-231	1+ 9.50

**Factory Scissors**

**WILLIAM WHITELY**



Overall length = 165

TMM76X

Order Code	1+	Price Each	4+	20+
440-863	7.26		6.52	5.73

**Lightweight Scissors**



High grade stainless steel blades, chemical and heat resistant handles. Very powerful scissor able to cut carpet, underlay, thick fabric, leather etc.

**General Purpose**

Durable all-rounder. Unique oversized handles for greater comfort and flexibility.

Cut	Order Code	Price Each
2.25" (6cm)	138-2442	1+ 5.50

**Embroidery**

Two sharp points for delicate/accurate work. Unique oversized handles for greater comfort and flexibility.

495370

Cut	Order Code	Price Each
2.25" (6cm)	138-2441	1+ 5.50
4.5" (11.5cm)	138-2446	19.69

**Coming soon**



Register your interest for items that are 'Coming Soon' at [www.farnell.co.uk](http://www.farnell.co.uk) and we'll email you to let you know that they're in stock.



Trimmers



- Stainless steel blades with tough ABS handles
- Smooth blades, ideal for paper, card, foil, etc.
- Side bend handles for cutting on a surface

223297.401885

Order Code	1+	+	+	+
609-766	7.98	--	--	--

Heavy Duty



Heavy duty cutting out shears with black japanned easy bows

223316

Size	Mftrs. List No.	Order Code	Price Each
205mm	80788	628-761	10.40
250mm	809510	628-773	18.00

Tin Snips

Aviation Tin Snips



- Manufactured from chrome vanadium steel
- Specially strengthened jaws are serrated for extra grip and pull through
- Non-slip, spring loaded handles, for ease of use and to reduce user fatigue
- Manual locking catch reduces the risk of injury when the cutters are not in use
- Length: 250mm (10")

481980.457891

Order Code	Price Each				
	1+	5+	10+	20+	50+
144-7424	2.65	2.58	2.11	1.99	1.82

3 Piece Aviation Tin Snip Set



- Aviation style straight cut tin snips
- Includes 9 1/2" left curve, 10" straight and 9 1/2" right curve snips
- Manufactured from chrome vanadium steel
- Specially strengthened jaws are serrated for extra grip and pull through
- Non-slip, spring loaded handles, for ease of use and to reduce user fatigue
- Manual locking catch reduces the risk of injury when the cutters are not in use

481981.457893

Order Code	Price/Set				
	1+	5+	10+	20+	50+
144-7425	7.83	7.56	6.26	5.88	5.35

Metalmaster Aviation Snips



Compound action. Suitable for mild steel sheet up to 1.2mm 18g.

485287

Model	Description	Order Code	Price Each			
			1+	5+	10+	20+
M1R	For cutting to left	122-9766	22.26	--	--	--
M2R	For cutting to right	122-9767	22.26	--	--	--
M3R	For straight cutting	122-9768	22.26	--	--	--
M5R	For notching	137-1661	24.97	24.22	23.49	22.79
M6R	Offset snips for straight and left hand curves	137-1662	24.34	23.61	22.90	22.21
M7R	Offset snips for straight and right hand curves	137-1664	24.34	23.61	22.90	22.21

Troubleshooting tips



Chat live online to one of our technical engineers at [www.farnell.co.uk](http://www.farnell.co.uk)

Over 480,000 products online



Tin Snips - continued

Max Steel Snips

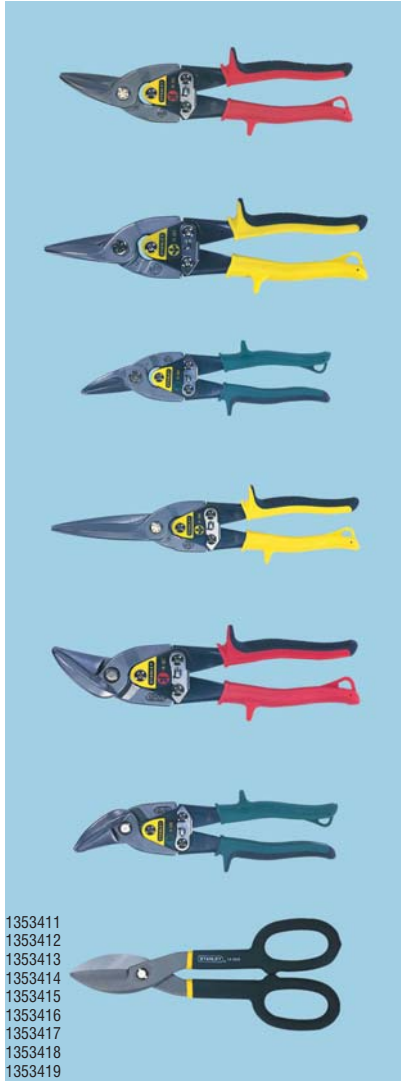

1353411  
1353412  
1353413  
1353414  
1353415  
1353416  
1353417  
1353418  
1353419

Max steel snips are forged alloy steel construction with chrome plated jaws. Bi-material handles provide comfort and a better grip. Features include serrated cutting edges to prevent slippage when cutting aluminium, sheet UPVC, wire mesh, leather, copper and plastic. One handed, automotive latch release with squeeze of the handle.

477918

Description	Order Code	Price Each			
		1+	5+	10+	20+
Left hand	135-3411	10.05	9.75	9.25	9.07
Straight	135-3412	10.05	9.75	9.25	9.07
Right hand	135-3413	10.05	9.75	9.25	9.07
Long cut	135-3414	11.60	11.25	10.65	10.44
Offset left	135-3415	11.60	11.25	10.65	10.44
Offset right	135-3416	11.60	11.25	10.65	10.44
175 Straight pattern snip	135-3417	10.05	9.75	9.25	9.07
250 Straight pattern snip	135-3418	11.60	11.25	10.65	10.44
300 Straight pattern snip	135-3419	13.15	12.75	12.10	11.86

Tinsnips

G245 Straight Blade



Open joint design for easy sharpening. Replaceable nut and bolt for long life. Precision blades for maximum cutting efficiency. No nip handles.

For general purpose, straight cutting of sheet metal.

483388

Size (mm)	Size (inches)	Order Code	Price Each			
			1+	5+	10+	20+
200	8	134-8389	14.75	14.15	13.55	13.28
250	10	134-8390	17.85	17.15	16.40	16.09
300	12	134-8391	20.00	19.20	18.40	18.03
350	14	134-8392	22.95	22.05	21.10	20.68

Tinsnips

G246 Curved Blade



Suitable for cutting clockwise, tight radii and small angle cutting.

Size (mm)	Size (inches)	Order Code	Price Each			
			1+	5+	10+	20+
200	8	134-8393	23.40	22.45	21.55	21.12
250	10	134-8394	24.65	23.65	22.70	21.70
300	12	134-8396	28.45	27.30	26.15	24.53

Jewellers Snips

Two patterns of short-bladed light duty snip designed for use on precious metals by silversmiths etc.

483403

Model	Type	Size (mm)	Size (inches)	Order Code	Price Each			
					1+	5+	10+	20+
G56	Straight	175	7	134-8397	12.64	12.39	12.14	11.90
G056	Curved	175	7	134-8398	18.31	17.95	17.59	17.23

Cutters - Bolt

Bolt Cutters



- Drop forged, heat treated steel
- Tubular steel handles with rubber grips allow maximum leverage
- Adjustable replacement jaws
- Ideal for cutting bolts, rivets, rods, bars, chains etc.

481982.453110

Length	Order Code	Price Each				
		1+	5+	10+	20+	50+
455mm (18")	144-7426	7.41	6.92	5.92	5.56	5.05
600mm (24")	144-7428	9.25	7.78	7.39	6.93	6.29

Compact Bolt Cutters Type 71



- With precision cutting edges for soft, hard and piano wire
- Cuts material like bolts, nails, rivets, etc. up to 5.2 mm dia.
- Exceptional cutting performance with minimum effort because of highly effective lever action design

- Cutting edges additionally induction hardened, cutting edge hardness approx. 64 HRC
- Forged
- High performance Chrome Vanadium steel, oil-hardened and tempered



71 02 200



71 11 200

- Model 71 01: Head atramentized handles plastic coated
- Model 71 02: Head atramentized two-colour dual component handles
- Model 71 11: Spring for gentle and even opening head atramentized handles plastic coated

Mftrs. Part No.	Order Code	Cutting Performance Wires $\varnothing$ mm				Length mm
		$\varnothing$ soft	$\varnothing$ medium	$\varnothing$ hard	$\varnothing$ Plano	
71 01 200	875-715	>		4.0	3.6	200
71 02 200	439-4173	> 6.0	5.2	4.0	3.6	200
71 12 200	541-6632	> 6.0	5.2	4.0	3.6	200

240752

Mftrs. Part No.	Order Code	Price Each		
		1+	5+	10+
71 01 200	875-715	27.00	26.20	25.40
71 02 200	439-4173	28.80	--	--
71 12 200	541-6632	31.75	30.80	29.85

**Bolt Cutters**



A wide range of bolt cutters with a cutting capacity up to 15mm in concrete reinforced rod or 9mm valve spring steel. Cutters between 18in and 36in have jaws that can be easily adjusted by a simple patented adjusting system.

Forged from precision high grade steel these cutters have a phosphated corrosion resistant finish with comfortable handles.

Order Code	Length		Reinforced Rod Capacity (mm)	Ferrous Capacity (mm)	Plano Wire Capacity (mm)	Weight (g)
	(in)	(mm)				
135-6137	12	320	6	5	4	900
135-6138	18	430	8	7	6	1990
135-6139	24	600	10	9	8	2860
135-6140	30	750	13	1	9	3670
135-6141	36	900	15	12	11	5980
135-6142	42	1060	15	12	11	8510

487378

Model	Order Code	Price Each			
		1+	5+	10+	20+
4559-12	135-6137	77.15	75.61	74.10	72.08
4559-18	135-6138	109.34	107.16	105.01	102.15
4559-24	135-6139	130.36	127.75	125.20	121.78
4559-30	135-6140	148.49	145.51	142.60	138.71
4559-36	135-6141	185.17	181.46	177.83	172.98
4559-42	135-6142	263.87	258.60	253.43	246.51

**Carpenter's Pincer**



- for heaviest duty
- specially favoured by craftsmen due to precision workmanship
- extreme wear resistance and good balance
- special tool steel, oil-hardened and tempered

344228

	Length (mm)	Mftrs. Part No.	Order Code	Price Each		
				1+	5+	10+
Carpenter's Pincer	180	50 00 180	541-6619	7.15	6.95	6.70
Carpenter's Pincer	210	50 00 210	541-6620	7.65	7.40	7.20

**Cutters - Pipe**

**Cutter For Plastic Pipes**



- for clean cutting of plastic pipes (e.g. plastic clad pipes) with 6 - 35 mm dia.
- not suitable for cutting cables
- blade is replaceable and can be retracted in any position
- low force requirement due to special blade geometry and optimum transmission
- minimum operator fatigue due to ergonomic handle design and ratchet blade feed in stages
- die-cast aluminium body, red lacquered
- blade made of tool steel, oil-hardened and tempered

241272

Description	Mftrs. Part No.	Order Code	Price Each		
			1+	5+	10+
Cutter	94 00 185	348-3605	41.55	40.30	39.05
Spare Blade	94 09 185	348-3629	16.50	16.00	15.50

**Vinyl Pipe Cutter**



These strong pipe cutters have a razor sharp, stainless steel blade which gives effortless straight cuts time and time again. The cutters have a smooth comfortable handle design for extended use.

- Hardened steel blade will cut pipe and conduit up to 42mm

481983.460958

Order Code	Price Each				
	1+	5+	10+	20+	50+
144-7429	3.27	3.12	2.63	2.46	2.23

**PVC Conduit Pipe Cutter**



- Suitable for PVC conduit pipes and similar materials
- Used for blue water pipe, rubber hose, pneumatic pipe, electrical sleeving etc
- Razor sharp, stainless steel blade for effortless straight cuts
- Strong, lightweight, glass fibre re-inforced body with comfortable handle design
- A convenient tool providing effortless one handed straight cutting
- Length: 195mm
- Cutting Capacity: 28.0mm  $\varnothing$

448359

Mftrs. List No.	Order Code	Price Each	
		1+	5+
430001	128-3222	22.55	21.85

**Ratchet PVC Pipe Cutter**



- Heavy duty pattern for PVC conduit pipes and similar materials
- Used for blue water pipe, rubber hose, pneumatic pipe, electrical sleeving etc
- Supplied with special adaptor allowing the square cutting of rectangular cross section trunking
- Aluminium body with extra sharp stainless steel blade and ratchet action for effortless straight cuts
- Length: 220mm
- Cutting Capacity: 32.0mm  $\varnothing$

448358

Mftrs. List No.	Order Code	Price Each	
		1+	5+
430003	128-3221	22.40	21.75

**Cutter for flexible hoses and conduit pipes**



- For cutting thin walled plastic pipes (e.g. armoured plastic pipes) and hoses, also with fabric reinforcement, of plastic and rubber up to 25 mm dia. / 1" exterior dia.
- Not suitable for cutting cables
- Exchangeable blade
- With opening spring and locking lever
- Tool made of tough fibreglass reinforced plastic
- Blade made of high-strength special grade steel, oil-hardened and tempered

508231

	Mftrs' List No.	Order Code	Price Each		
			1+	3+	5+
Cutter	90 20 185	156-0912	32.24	30.64	29.05
Spare blade	90 29 185	156-0913	16.17	15.35	14.52

**Cutters - Pipe - continued**

**Tube Cutters**  
200-30C



For thin walled copper, brass, aluminium and steel conduit. Built in de-burrer and spare wheel.

483374

Description	Order Code	Price Each			
		1+	5+	10+	20+
200-30C tube cutter	<b>134-8372</b>	19.95	19.15	18.35	17.76
Spare cutting wheel	<b>134-8370</b>	4.65	4.45	4.30	4.16

**Tube Cutters**  
Roller Pipe Cutters



One cutting wheel and two rollers which ensure the cutter is set and kept square to the pipe. The fast cutting wheel is of special hardened, thin section material for use on all steel pipes.

483363

Description	Order Code	Price Each			
		1+	5+	10+	20+
202 pipe cutter 10-60mm O.D.	<b>134-8367</b>	135.50	129.95	124.85	120.86
Spare cutting wheel 16.71for 202	<b>134-8368</b>	19.45	18.65	17.90	17.31
Spare cutting wheel 23.28 for 203/204	<b>134-8453</b>	22.19	21.74	21.31	20.62

**Notching Pliers**



45



- special pliers for notching out recesses in plastic ledges and casing boxes for electric and sanitary installation
- notches can be enlarged by initial and final cut
- clean cut edges - no additional work needed on the cut profile
- high cutting performance with little handforce due to optimum lever transmission
- easy handling
- with opening spring, restricted opening and locking lever
- cutter head: special tool steel, oil-hardened and tempered

Mfrs. Part No.	Length mm	Capacity	Weight g
90 61 16	250	16 x 32	402

243034

Description	Mfrs. Part No.	Order Code	1+	5+	10+
Plier, notching 90 61 16		<b>524-5618</b>	34.65	33.60	32.55

**Saws**

**6" Junior Hacksaw**



- Drop forged frame
- High-quality, extra fine saw blade for thick metal and wood
- Fine saw blade for thick metal and hard-wood
- Medium saw blade for wood
- Hack saw blade for metal

482097.461154

Order Code	Price Each				
	1+	5+	10+	20+	50+
144-7561	2.05	1.84	1.63	1.54	1.41

**Minisaws**

**70-14JR Junior Hacksaw Frame**



Order code	Price Each			
	1+	5+	10+	20+
<b>137-3840</b>	2.28	2.23	2.18	2.13

**Junior Saw Blades**

Card of 10.

485969

Description	Order code	Price Each			
		1+	4+	20+	40+
Metal cutting	<b>100-607</b>	2.50	2.32	2.21	2.02
Wood cutting	<b>137-3913</b>	1.39	1.37	1.34	1.31

**Junior Hacksaw**

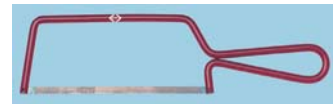

- Red epoxy steel frame 58 mm deep
- Blade are fixed in frame and do not therefore protrude to injure the hand
- 150 mm in length
- 32 tpi blade fitted plus one spare blade supplied

495546

Mfrs. List No.	Order Code	1+	5+	10+	20+
T0834	<b>151-8954</b>	3.10	3.00	2.90	2.80
T0835	<b>151-8955</b>	3.10	3.00	2.90	2.80

**Hacksaw Blade Holder**



Length without blade=230

- Strong diecast aluminium hacksaw blade holder
- Suitable for cutting metals and hard plastics in awkward places
- A bi-metal hacksaw blade is supplied

Warning: Under no circumstances should an all hard HSS blade be used in this tool.

TMM110X

Mfrs. List No.	Order Code	1+	4+	20+	40+
208	<b>282-455</b>	8.90	8.55	8.20	7.85

**Mini Hacksaw**



- Strong rigid aluminium frame
- Adjustable to 6 cutting position
- Supplied with top quality metal cutting blade
- Fast easy blade fitting

525116

Mfrs. List No.	Order Code	1+	5+	10+
T0836A	<b>166-0786</b>	4.85	4.60	4.35

**Minisaw**

**70-675R Minisaw Frame**



488159



Order Code	Price Each			
	1+	5+	10+	20+
137-3755	7.02	6.88	6.75	6.60

**Mini Hacksaw**



Mini-hacksaw frame with solid steel profile. The frame is chrome finished and fitted with a glass fibre handle to give a good comfortable grip.

484597

Order Code	Price Each			
	1+	5+	10+	20+
282-431			8.55	

**Hacksaw  
70-20TND**

Die-cast handle and tubular frame



488119

Order Code	Price Each			
	1+	5+	10+	20+
137-3753	12.47	12.23	11.98	11.74

**Dynagrip Hacksaw**



Dynagrip hacksaw, innovative bi-material frame design combines a rigid steel core jacketed by reinforced glass fibre to withstand shock and heavy duty use. Forward frame slot helps position blade angles for standard and flush cutting operation. Forward thumb grip improves precision and power of cut while reducing user grip force and joint stress.

478107

Order Code	Price Each			
	1+	5+	10+	20+
135-3431	14.90	14.45	13.70	13.43

**Professional Hacksaw**



- Robust heavy duty hacksaw with aluminium handle
- Box section steel beam
- High leverage tensioning device
- 300mm in length
- 24 tpi HSS bi-metal blade supplied

495553

Mfrs. List No.	Order Code	Price Each			
		1+	5+	10+	20+
T0905	151-8956	12.52	12.14	11.77	11.39

**Hacksaws  
325 Ergo**



Ergonomically designed with very high blade tension for straight, accurate and exact kerfs. Centred blade for correct balance. Spring tensioned blade loading mechanism for quick blade changes. Alternative 55° blade mounting for flush cutting. Supplied with a bi-metal blade.

Order Code	Price Each		
	1+	5+	10+
326-2390	31.00	29.75	28.50

**319**



Two component handle hacksaw frame. Dual position 55 degree and 90 degree blade angle. Easy blade change mechanism.

488063

Order Code	Price Each			
	1+	5+	10+	20+
135-6166	19.50	19.12	18.81	18.42

**Hacksaw Blades**



**Bi-Metal**

**Plus 30**

Cuts 30% more effectively than a conventional blade. Benefits include a sharper first cut, faster cut and longer blade life

Size (mm)	Teeth Per (in)	Order Code	Price Each
250 x 13 x 0.65	10 x 1/2 x 0.025	137-3895	1.43
250 x 13 x 0.65	10 x 1/2 x 0.025	137-3896	1.46
250 x 13 x 0.65	10 x 1/2 x 0.025	137-3897	1.46
300 x 13 x 0.65	12 x 1/2 x 0.025	137-3898	1.47
300 x 13 x 0.65	12 x 1/2 x 0.025	137-3899	1.47
300 x 13 x 0.65	12 x 1/2 x 0.025	137-3901	1.48

**Hi-Cut**

HSS cutting edge, electron beam welded to a tough spring back. More shatter-resistant than other types of blade.

Size (mm)	Teeth Per (in)	Order Code	Price Each
300 x 25 x 1.25	12 x 1 x 0.050	137-3914	5.10
300 x 25 x 1.25	12 x 1 x 0.050	137-3915	5.10
300 x 25 x 1.25	14 x 1 x 0.050	137-3916	5.95
300 x 25 x 1.25	14 x 1 x 0.050	137-3917	5.95
350 x 32 x 1.6	14 x 1 1/4 x 0.062	137-3918	8.09
350 x 32 x 1.6	14 x 1 1/4 x 0.062	137-3919	8.09
400 x 32 x 1.6	16 x 1 1/4 x 0.062	137-3920	9.24
400 x 32 x 1.6	16 x 1 1/4 x 0.062	137-3921	9.24
400 x 40 x 2.0	16 x 1 1/2 x 0.075	137-3922	13.07
450 x 32 x 1.6	18 x 1 1/4 x 0.062	137-3923	10.50
450 x 32 x 1.6	18 x 1 1/4 x 0.062	137-3925	10.50
450 x 40 x 2.0	18 x 1 1/2 x 0.075	137-3926	14.72
525 x 40 x 2.0	21 x 1 1/2 x 0.075	137-3927	19.45
525 x 45 x 2.5	21 x 1 1/4 x 0.088	137-3928	21.95

**Flexible Silicon Steel**

Designed primarily for the occasional user. Will cut most types of softer materials.

Size (mm)	Teeth Per (in)	Order Code	Price Each
250 x 13 x 0.65	10 x 1/2 x 0.025	137-3902	0.44
250 x 13 x 0.65	10 x 1/2 x 0.025	137-3903	0.44
300 x 13 x 0.65	12 x 1/2 x 0.025	137-3904	0.48
300 x 13 x 0.65	12 x 1/2 x 0.025	137-3905	0.48
300 x 13 x 0.65	12 x 1/2 x 0.025	137-3906	0.48
300 x 13 x 0.65	12 x 1/2 x 0.025	137-3907	0.45

**All Hard**

**Plus 30**

Cuts 30% more effectively than a conventional blade. Benefits include a sharper first cut, faster cut and longer blade life.

493775

Size (mm)	Teeth Per (in)	Order Code	Price Each
250 x 13 x 0.65	10 x 1/2 x 0.025	137-3887	1.45
250 x 13 x 0.65	10 x 1/2 x 0.025	137-3888	1.45
300 x 13 x 0.65	12 x 1/2 x 0.025	137-3889	1.46
300 x 13 x 0.65	12 x 1/2 x 0.025	137-3890	1.46
300 x 13 x 0.65	12 x 1/2 x 0.025	137-3892	1.46
300 x 13 x 0.65	12 x 1/2 x 0.025	137-3893	1.46



Saws - continued

Mitre Saws

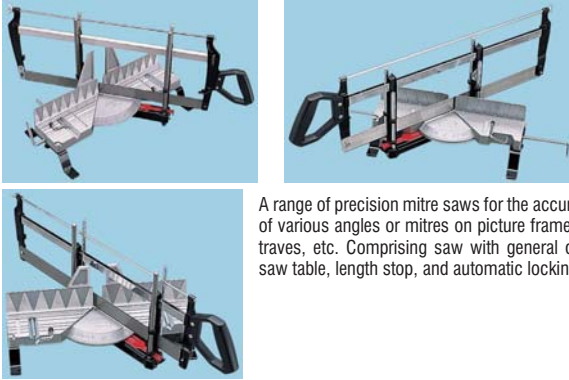

A range of precision mitre saws for the accurate cutting of various angles or mitres on picture frames or architraves, etc. Comprising saw with general duty blade, saw table, length stop, and automatic locking facility.

	Champion	Proman	Saw blade length	630mm	565mm
Maximum cutting depth	180mm	110mm	Compound facility	Yes	Yes
Maximum cutting width 90	200mm	170mm	Material clamp	2	1
Maximum cutting width 45	125mm	100mm	Length stop	Yes	Yes
Base length	500mm	350mm	Stepless locking	Yes	No

Model	Order Code	Price Each
Champion	014-700	126.80
Proman	014-701	60.82

Replacement Blades

Suitable for models Royal 125 and Proman

Description	Order Code	Price Each
Carpentry fast cut 12tpi	014-704	11.95
Carpentry general duty 18tpi	014-705	10.69
Picture framing 24tpi	014-706	11.16
Non-ferrous metals 32tpi	014-707	10.69

Replacement Blades

Blades suitable for Champion model only.

Description	Order Code	Price Each
Extra fast cut 10tpi	014-708	12.95
General duty 18tpi	014-709	12.95
Picture framing 24tpi	014-710	12.06
Non-ferrous metals 32tpi	014-711	12.95
Ferrous bi-metal	014-712	21.40

Replacement Blades

Blade suitable for the following manufacturers mitre saws: Blackforge, Clark, Draper, Jorgensen, Nutool, Richmond, Tyzack, Wickes and Axminster 602. 550 x 45 x 0.7mm x 18tpi.

Description	Order Code	Price Each
General duty 18tpi	014-715	11.16

Technical information at your fingertips



Over **352,000** technical datasheets available online.

Visit [www.farnell.co.uk](http://www.farnell.co.uk) and look for the **Tech Info** heading in your search results.

Coming soon



Register your interest for items that are 'Coming Soon' at [www.farnell.co.uk](http://www.farnell.co.uk) and we'll email you to let you know that they're in stock.

Coping Saw and Blades



Correct tension is applied to the blade by turning the handle. The blade can be turned to cut at any angle. Depth of bow 120mm 4 3/4 in.

Model	Order Code	Price Each			
		1+	5+	10+	20+
70-CP1R	137-3756	8.11	7.95	7.79	7.64
71-CP7R spare blades (pack of 10)	137-3757	2.80	2.75	2.68	2.63

Piercing Saw Frame & Blades

Piercing Saw Frame



For sawing gold, silver, steel, copper, brass, aluminium, nickel, etc. Length 125mm 5 in.

Model	Bow depth (mm)	Bow depth (in)	Order Code	Price Each			
				1+	5+	10+	20+
PS51	85	3 3/8	137-3793	9.43	9.24	9.05	8.87

Piercing Saw Blades

Model	Teeth per (in)	Order Code	Price Each			
			1+	5+	10+	20+
PS80	80	137-3758	0.27	0.26	0.25	0.24
PS60	60	137-3759	0.28	0.27	0.26	0.25
PS52	52	137-3761	0.28	0.27	0.26	0.25
PS44	44	137-3762	0.28	0.27	0.26	0.25
PS32	32	137-3763	0.28	0.27	0.26	0.25

Fretsaw Frame and Blades

Fretsaw Frame



For fine cutting work in thin materials such as wood, bone, plastics, etc.

Model	Bow Depth (mm)	Bow Depth (in)	Order Code	Price Each			
				1+	5+	10+	20+
70-FS1R	290	11 1/2	137-3764	9.79	9.59	9.40	9.22

Fretsaw Blades

Model	Teeth per (in)	Order Code	Price Each			
			1+	5+	10+	20+
FS32	32	137-3765	0.24	0.23	0.22	0.21
FS22	22	137-3767	0.24	0.23	0.22	0.21
FS18	18	137-3768	0.24	0.23	0.22	0.21
FS16	16	137-3769	0.26	0.25	0.24	0.23

Sabretooth Saws



- Rigid 1 mm blade - for non flex and perfect straight cuts
- Triple edge precision ground hard point
- Easy start tooth configuration for clean and accurate cut starts
- Fast cut on push and pull - for fewer strokes, saving time and effort
- Ergonomic handle design featuring a soft grip insert for comfort
- 45/90° marking bevvels for convenience

494989.470081

Mftrs. List No.	TPI	Order Code	Price Each			
			1+	5+	10+	20+
481001	7	<b>151-8899</b>	10.82	10.50	10.17	9.84
481002	11	<b>151-8900</b>	10.82	10.50	10.17	9.84

**Fatmax Jabsaw**



Sharpened tip and thicker blade to punch through and easily cut through drywall material. Ergonomic design of handle for comfortable easy use.

477958

Order Code	Price Each			
	1+	5+	10+	20+
<b>135-3423</b>	7.45	7.25	6.85	6.71

**Compass Saw**



Supplied with two blades, one for wood, the other for metal. Die-cast two position handle to facilitate access to awkward locations.

Length (mm)	(in)	Order Code	Price Each
			1+
276	11	<b>137-3786</b>	7.46

**Blades**

Set of two blades one suitable for cutting wood and one for cutting metal. Length 203mm/8in.

493778

Order Code	Price Each
	1+
<b>137-3798</b>	2.61

**Reciprocating blade set with universal handle in plastic case**



**Reciprocating blade set with universal handle 6 pcs.**

- Easy tool change through pull mechanism
- Sawing, cutting and screwing with one tool
- Turning momentanum up to 28Nm

**RUKO 8908** Reciprocating blade HSS bimetal (**Bosch Nr. S 922 EF**) for thin sheeting 150.0 x 18.0 x 0.9 mm Tooth spacing 1.4 mm / 18 tpi

**RUKO 8915** Reciprocating blade HSS bimetal (**Bosch Nr. S 922 BF**) for thick sheeting, stainless steel sheet metal, pipes and profiles

150.0 x 18.0 x 0.9 mm Tooth spacing 1.8 mm / 14 tpi

**RUKO 8909** Reciprocating blade HSS bimetal (**Bosch Nr. S 1022 HF**) for wood, metal sheeting and aluminium profiles

200.0 x 18.0 x 0.9 mm Tooth spacing 2.5 mm / 10 tpi

**RUKO 8924** Reciprocating blade HCS (**Bosch Nr. S 644 D**) for plywood, chipboard and plastics

150.0 x 18.0 x 1.25 mm Tooth spacing 4.2 mm / 6 tpi

**RUKO 8905** Reciprocating blade HCS (**Bosch Nr. S 617 K**) for every kind of wood, pruning 150.0 x 18.0 x 1.25 mm Tooth spacing 8.5 mm / 3 tpi

515136

Mftrs. Part No.	Order Code	Price Each		
		1+	5+	10+
331100	<b>160-7524</b>	47.07	44.70	42.33

**Files & Brushes**

**10 Piece Needle File Set**

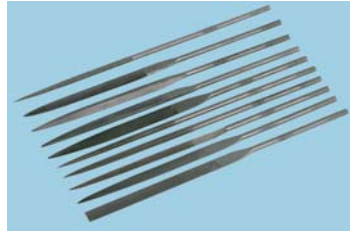

A standard 10 piece steel needle file set supplied in a neat, plastic wallet. Set contains:

- 1 x half round
- 1 x square
- 1 x round
- 1 x knife
- 1 x triangular
- 1 x flat parallel
- 1 x oval
- 1 x crossing
- 1 x flat tapered
- 1 x barrette

482063.453112

Order Code	Price/Set				
	1+	5+	10+	20+	50+
<b>144-7432</b>	1.62	1.44	1.34	1.24	1.13

**6 Piece Needle File Set**



- 6 piece needle file kit with cushion grip
- Size: 3 x 140mm
- Contents: flat taper, half round, three square, square, round and flat parallel - supplied in a plastic carry case

482064.452396

Order Code	Price/Set				
	1+	5+	10+	20+	50+
<b>144-7431</b>	2.34	2.18	1.87	1.75	1.59

**Needle, CV Steel**



Overall length=140, blade length=70, shaft dia.=3.0

- Set of six precision needle files in plastic wallet
- Comprising 1 of each of the following: Equalling, Half round, Flat, Round, Square and Three square

223372

Order Code	Price Per Set
	1+
<b>442-719</b>	16.10

**Diamond Needle File Sets**



- Sets of 5 diamond needle files
- Medium grit size D126
- Round, half round, square, triangular, flat/hand
- Available in two popular sizes

Overall Length	Diamond Coating Length	Grit	Mftrs. List No.	Order Code
140	70	D126	NF4205-D126	701-8230
140	40	D126	M18632-D126	701-8241

225318

Order Code	Price Each
	1+
<b>701-8230</b>	101.75
<b>701-8241</b>	70.55

45



**Files & Brushes - continued**

**Miniature**



Blade length=106, Overall length=172



- Set of four small, 2nd cut files ideal for use on plastics, soft metals and mild steel
- Supplied complete with comfortable wooden handles
- Comprises one each of the following, round, triangular, flat and tapered end
- The flat files have a safe edge, supplied in a plastic wallet

**Best value**

223374

Mfrs. List No.	Order Code	Price Each
119	202-149	9.68

**Needle File Sets**

**Diamond Coated**



- High quality sets of six industrial standard needle files
- The sets consist of: hand, round, half round, square, three square and taperflat types. Supplied in plastic wallet
- Fully coated with fine grade diamond grit for improved durability

223293

	Order Code	Price Each
Diamond coated	609-626	51.43

**Needle File Sets**



- 6 piece file set: Contains one each of hand, flat, three square, square, half round and round
- Three sets available: bastard, smooth and dead smooth
- 12 piece file set: Contains one each of hand, flat, three square, square, half round crossing, round, knife, barrette, slitting, round-edged joint and marking
- All sets come in a snap-shut plastic wallet

	Grade	Mfrs. List No.	Order Code
6 piece:	Bastard	2-470-14-0-0	702-4873
	Smooth	2-470-14-2-0	702-4885
	Dead Smooth	2-470-14-4-0	702-4897
12 piece:	Bastard	2-472-16-0-0	702-4903
	Smooth	2-472-16-2-0	702-4915

225319

Order Code	Price Each
702-4873	1+
702-4885	22.10
702-4897	22.10
702-4903	23.25
702-4915	54.95

Order Code	Price Each
702-4873	1+
702-4885	22.10
702-4897	22.10
702-4903	23.25
702-4915	54.95

**12 Piece Needle File Set**



A 12 piece needle file set manufactured from high quality, chrome vanadium steel supplied complete in plastic wallets. The files are all about 16mm in length and have textured handles for added grip. The set contains:

- 2 x Flat square ended
- 2 x Half circle
- 1 x Oval
- 1 x Flat tapered
- 1 x Square
- 2 x Triangular
- 1 x Round
- 2 x Flat pointed

235611

	Order Code	Price Each
12 Piece File Set	394-9308	24.95

**Needle File Handle**



L=110, Dia.=22, File not supplied

- Suitable for holding any circular shaft from 2.3 to 3.1mm diameter
- Accommodates shafts up to 100mm in length

223375

	Order Code	Price Each
	202-150	6.09

**Needle File Handle**



Universal collet accepts most regular needle files. Manufactured from best quality hardwood with brass fitting.

495288

	Order Code	Price Each
	142-1537	2.46

**Engineers Files**



A professional assortment of engineers files complete with Ergo handle. Each file is individually packed in a clearly marked re useable protective sleeve. The Ergo handle fits naturally into the hand and is made with a non-slip surface.

**Hand**

Parallel in width, cut on both sides and on one edge.

**Second**



Model	Size		Order Code	1+	Price Each		
	(mm)	(Inches)			3+	12+	24+
1-100-06-2-3	150	6	702-3110	5.05	4.85	4.65	4.45
1-100-08-2-3	200	8	702-3121	5.85	5.60	5.40	5.15

**Smooth**



Model	Size		Order Code	1+	Price Each		
	(mm)	(Inches)			5+	10+	20+
1-100-06-3-3	150	6	135-6145	5.40	5.29	5.19	5.04
1-100-08-3-3	200	8	135-6146	6.23	6.11	5.99	5.82
1-100-10-3-3	250	10	135-6147	7.44	7.28	7.14	6.95
1-100-12-3-3	300	12	135-6149	9.16	8.98	8.80	8.56

**Flat**

Tapered in width, cut on both sides and on one edge.

45

Farnell



**Bastard**



Model	Size		Order Code	Price Each			
	(mm)	(Inches)		1+	5+	10+	20+
1-110-06-1-3	150	6	<b>135-6151</b>	5.07	4.97	4.87	4.73
1-110-08-1-3	200	8	<b>135-6152</b>	5.94	5.82	5.71	5.55
1-110-10-1-3	250	10	<b>135-6153</b>	7.09	6.95	6.81	6.63
1-110-12-1-3	300	12	<b>135-6154</b>	8.92	8.74	8.56	8.33

**Half Round**

For filing both flat and concave surfaces, parallel in width and thickness.

**Second**



Model	Size		Order Code	Price Each			
	(mm)	(Inches)		1+	5+	10+	20+
1-210-06-2-3	150	6	<b>135-6155</b>	6.60	6.21	5.95	5.76
1-210-08-2-3	200	8	<b>135-6156</b>	7.70	7.25	6.94	6.71
1-210-10-2-3	250	10	<b>135-6157</b>	9.10	8.57	8.21	7.93
1-210-12-2-3	300	12	<b>135-6158</b>	12.40	11.66	11.17	10.81

**Round**

For circular openings and conductive surfaces, tapers slightly to a point.

**Second**



487518

Model	Size		Order Code	Price Each			
	(mm)	(Inches)		1+	5+	10+	20+
1-230-06-2-3	150	6	<b>135-6159</b>	5.40	5.28	5.06	4.91
1-230-08-2-3	200	8	<b>135-6160</b>	6.07	5.85	5.60	5.42
1-230-10-2-3	250	10	<b>135-6162</b>	7.14	6.79	6.49	6.29
1-230-12-2-3	300	12	<b>135-6163</b>	8.70	8.19	7.86	7.59

**5 Piece Engineers File Set**



- Manufactured from high carbon alloy steel
- Soft grip handles with hanging holes
- File blades measure 200mm (8") in length
- Contents: Flat, half-round, round, square and triangular files

482065.462138

Order Code	1+		5+		Price/Set	
	6.96	6.38	5.56	5.21	10+	50+
<b>144-7434</b>					4.73	

**Engineers File Sets**



- Sets of four high quality engineers files. Set comprises of one each of the following: hand, flat, round, and half-round styles
- Fitted with wooden handles, supplied in a plastic wallet

**Best value**

223295

Order Code	Price Each	
	1+	20+
152mm set	<b>609-596</b>	14.70
203mm set	<b>609-602</b>	15.66
254mm set	<b>609-614</b>	22.24

**File Sets**



Model	Size		Contents
	(mm)	(in)	
1-473-06-2-2 3pc	150	6	hand second, half round second, round second.
1-473-08-2-2 3pc	200	8	hand second, half round second, round second.
1-473-10-2-2 3pc	250	10	hand second, half round second, round second.
1-477-08-2-2 5pc	200	8	hand second, half round bastard, round second, 3 square second, half round rasp.
1-477-10-2-2 5pc	250	10	hand second, half round second, round second, 3 square second, half round rasp.
1-478-08-1-2 5pc	200	8	hand bastard, hand second, square bastard, half round bastard, round bastard.
1-479-08-1-2 5pc	200	8	hand bastard, half round bastard, round bastard, flat bastard, cabinet rasp.
1-479-08-2-2 5pc	200	8	hand second, half round second, round second, flat second, cabinet rasp.

487801

Model	Order Code	Price Per Set			
		1+	5+	10+	25+
1-473-06-2-2 3pc	<b>723-8654</b>	15.85	15.20	14.60	13.95
1-473-08-2-2 3pc	<b>723-8666</b>	18.25	17.50	16.80	16.05
1-473-10-2-2 3pc	<b>135-6164</b>	20.60	20.19	19.79	19.25
1-477-08-2-2 5pc	<b>135-6217</b>	30.50	29.89	29.29	28.49
1-477-10-2-2 5pc	<b>702-4538</b>	35.55	34.15	32.70	31.30
1-478-08-1-2 5pc	<b>135-6218</b>	23.88	23.41	22.94	22.31
1-479-08-1-2 5pc	<b>135-6165</b>	35.11	34.41	33.72	32.80
1-479-08-2-2 5pc	<b>135-6219</b>	35.68	34.96	34.27	33.33

**Wood Rasp Set**



- Consists of a flat, round and half round file
- All with rubberised handles for comfortable grip
- Blade length 200mm (8")

482066.462137

Order Code	1+		Price/Set	
	5.25	4.69	10+	50+
<b>144-7433</b>			4.21	3.95



For cutting, shaping, shaving, rasping and filing most materials without any adjustment or need to re-sharpen.

478278

Model	Type	Order Code	Price Each			
			1+	5+	10+	20+
21-295	Flat file	<b>135-3721</b>	9.45	9.15	8.70	8.51
21-122	Planer file	<b>135-3723</b>	12.40	12.05	11.40	11.18
21-115	Shaver tool	<b>135-3722</b>	2.15	2.10	2.00	1.96

**Files & Brushes - continued**

**Spare blades**



478281

Model	Description	Order Code	Price Each			
			1+	5+	10+	20+
21-293	Flat standard cut	<b>135-3697</b>	2.30	2.25	2.10	2.06
21-299	Half round standard cut	<b>135-3698</b>	2.70	2.60	2.50	2.45
21-515	To suit shaver tool only	<b>135-3724</b>	1.15	1.10	1.05	1.02

**6 Piece Mini Brush Set**



6 piece  
175mm (7")  
mini wire  
brush set  
with plastic handles.  
The kit includes:

- Brass brush for cleaning
- Steel brush for removal of rust
- Nylon brush for detailing dash and upholstery

482087.453132

Order Code	Price/Set				
	1+	5+	10+	20+	50+
<b>144-7548</b>	2.31	2.05	1.86	1.73	1.57

**Wire Brush**



- Heavy duty construction with a comfortable grip handle
- Ideal for cleaning metal before welding
- Brassed steel wire
- Length: 265mm

482086.453011

Order Code	Price Each				
	1+	5+	10+	20+	50+
<b>144-7547</b>	0.77	0.65	0.61	0.55	0.51

**Abrasives**

**Sheets And Rolls**



**3M Red Paper Rolls**



A very open coat, F-weight paper roll. Designed to minimise loading when used to sand soft, resinous woods.

493807

Grit	Order Code	Price Each
		1+
P60	<b>149-5843</b>	45.63
P80	<b>149-5844</b>	44.06
P100	<b>149-5845</b>	38.46
P120	<b>149-5846</b>	36.66
P150	<b>149-5848</b>	36.66
P180	<b>149-5849</b>	36.66

**301D Cloth Sheets & Rolls**



A resin-bonded, flexible cloth product. Designed for maintenance and general workshop applications.

493122

Grade	Sheet / Roll Size	Order Code	Price Each			
			1+	5+	10+	25+
P40	Sheet - 230 x 280mm	<b>149-5828</b>	1.19	1.16	1.12	1.09
P60	Sheet - 230 x 280mm	<b>149-5829</b>	1.03	1.00	0.96	0.93
P80	Sheet - 230 x 280mm	<b>149-5830</b>	0.90	0.87	0.85	0.83
P240	Sheet - 230 x 280mm	<b>149-5834</b>	0.83	0.81	0.77	0.75
P40	Roll - 25mm x 25m	<b>149-5780</b>	12.31	11.95	11.58	11.24
P60	Roll - 25mm x 25m	<b>149-5782</b>	11.19	10.85	10.53	10.20
P80	Roll - 25mm x 25m	<b>149-5783</b>	11.40	11.05	10.72	10.39
P150	Roll - 25mm x 25m	<b>149-5785</b>	10.28	9.97	9.67	9.39
P180	Roll - 25mm x 25m	<b>149-5786</b>	10.28	9.97	9.67	9.39
P320	Roll - 25mm x 25m	<b>149-5788</b>	10.28	9.97	9.67	9.39
P60	Roll - 38mm x 25m	<b>149-5790</b>	16.97	16.46	15.97	15.49
P80	Roll - 38mm x 25m	<b>149-5791</b>	15.99	15.51	15.04	14.59
P120	Roll - 38mm x 25m	<b>149-5792</b>	14.83	14.39	13.96	13.53
P150	Roll - 38mm x 25m	<b>149-5794</b>	14.08	13.66	13.26	12.86
P180	Roll - 38mm x 25m	<b>149-5795</b>	14.08	13.66	13.26	12.86
P240	Roll - 38mm x 25m	<b>149-5796</b>	14.08	13.66	13.26	12.86
P320	Roll - 38mm x 25m	<b>149-5797</b>	14.08	13.66	13.26	12.86
P60	Roll - 50mm x 25m	<b>149-5799</b>	21.26	20.62	20.00	19.40
P80	Roll - 50mm x 25m	<b>149-5801</b>	20.19	19.57	18.98	18.41
P120	Roll - 50mm x 25m	<b>149-5802</b>	19.22	18.65	18.09	17.55
P150	Roll - 50mm x 25m	<b>149-5803</b>	19.22	18.65	18.09	17.55
P180	Roll - 50mm x 25m	<b>149-5804</b>	19.22	18.65	18.09	17.55
P240	Roll - 50mm x 25m	<b>149-5805</b>	19.22	18.65	18.09	17.55

**Emery Cloth**

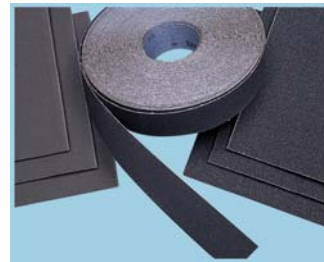

Best blue emery cloth for general hand, tool-room and workshop applications, particularly de-burring and removing scratch marks.

493001

Grade	Sheet / Roll Size	Order Code	Price Each
3 - extra coarse	Sheet - 230 x 280mm	<b>062-321</b>	0.54
2½	Sheet - 230 x 280mm	<b>062-322</b>	0.54
2 - coarse	Sheet - 230 x 280mm	<b>155-2087</b>	0.56
1½	Sheet - 230 x 280mm	<b>062-324</b>	0.54
F	Sheet - 230 x 280mm	<b>155-2088</b>	0.56
FF - fine	Sheet - 230 x 280mm	<b>062-327</b>	0.53
0	Sheet - 230 x 280mm	<b>155-2495</b>	0.56
3 - extra coarse	Roll - 25mm x 50m	<b>062-401</b>	28.40
2 - coarse	Roll - 25mm x 50m	<b>062-402</b>	23.10
1 - medium	Roll - 25mm x 50m	<b>062-403</b>	12.66
FF - fine	Roll - 25mm x 50m	<b>062-404</b>	21.85
2 - coarse	Roll - 38mm x 50m	<b>062-412</b>	31.58
1 - medium	Roll - 38mm x 50m	<b>062-413</b>	30.15
FF - fine	Roll - 38mm x 50m	<b>062-414</b>	26.44
3 - extra coarse	Roll - 50mm x 50m	<b>062-421</b>	40.29
2 - coarse	Roll - 50mm x 50m	<b>062-422</b>	33.93
1 - medium	Roll - 50mm x 50m	<b>062-423</b>	38.51
FF - fine	Roll - 50mm x 50m	<b>062-424</b>	38.51

**Abrasives**



**Scotch-Brite™ Handpads**

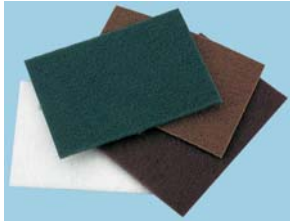

A wide range of hand pads for cleaning and finishing applications.

491223

Colour	Density/Grade	Order Code	Price Each			
			1+	5+	10+	25+
Brown	A/Medium	149-5870	2.08	2.01	1.96	1.90
White	Type T	149-5865	1.45	1.41	1.37	1.33
D. Grey	S/Coarse	149-5869	1.56	1.52	1.46	1.42
L. Green	A/Fine	149-5868	0.87	0.85	0.82	0.80
D. Green	A/Coarse	149-5871	1.45	1.41	1.37	1.33
Maroon	A/Very fine	149-5867	0.96	0.92	0.90	0.87
Grey	S/Ultra fine	149-5866	0.96	0.92	0.90	0.87

**Diamond Tipped Spatulas**



- Long life hard wearing diamond spatulas suitable for general cleaning of electrical contacts
- Diamond coated tips on both sides at one end
- Flexible polythene handle
- Overall length 165mm

494139

Mfrs. List No.	Colour	Grade	Order Code	Price Each			
				1+	5+	10+	20+
188-0001	Red	Medium	151-8526	7.54	7.38	7.24	7.16
188-0002	Blue	Coarse	151-8527	7.54	7.38	7.24	7.16
188-0003	Yellow	Fine	151-8528	7.54	7.38	7.24	7.16

**3 Piece Diamond Sharpening Blades**

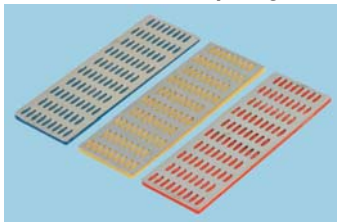

- Water needed only when using with blades
- Quick, easy and effortless sharpening
- Supplied with 3 faces, 1 x fine, 1 x medium and 1 x coarse
- Size 50mm (2") x 150mm (6")

482062.460960

Order Code	Price/Set				
	1+	5+	10+	20+	50+
144-7430	6.14	5.87	4.90	4.60	4.17

**Diamond Sharpeners**



- Two sizes of stainless steel diamond sharpeners
- Use to rework hardened metal components
- Supplied in PVC wallet

493968

Mfrs. List No.	Grit Size	Dim (LxW)	Order Code	Price Each			
				1+	5+	10+	20+
176-0027	400	150 x 19mm	151-8496	9.03	8.85	8.66	8.57
176-0031	1200	82.5 x 51mm	151-8497	15.09	14.79	14.49	14.34
176-0032	1200	82.5 x 51mm	151-8498	15.09	14.79	14.49	14.34
176-0033	400	82.5 x 51mm	151-8499	20.13	19.73	19.32	19.13
176-0034	600	82.5 x 51mm	151-8500	22.32	21.87	21.43	21.20

**Diamond Folding Sharpeners**



- Folding type stainless steel diamond sharpeners
- Use to rework hardened metal components
- 235 x 28mm in length when opened and 125 x 28mm when closed

493999

Mfrs. List No.	Grit Size	Order Code	Price Each			
			1+	5+	10+	20+
176-0037	400	151-8503	29.05	28.47	27.89	27.60
176-0038	600	151-8504	22.32	21.87	21.43	21.20
176-0039	1200	151-8505	22.32	21.87	21.43	21.20

**Finished Sticks**



Hand stoning with finished sticks is an essential operation in the manufacture of precision machine parts and in tool and die making. Finished sticks are available in three shapes for easy deburring, chamfering, radiusing and fitting delicate parts.

Part no.	Size (mm)	Size (in)	Grade
75462	150 x 13	6 x 1/2	Medium
75703	150 x 25	6 x 1	Coarse
75702	150 x 25	6 x 1	Medium
75701	150 x 25	6 x 1	Fine

495161

Part Number	Order Code	Price Each
		1+
75462	146-2097	11.25
75703	146-2098	10.20
75702	146-2099	13.55
75701	146-2100	13.55

**Flexible Polisher**



The polisher is impregnated throughout with sharp abrasive grain. It is recommended for cleaning and polishing on iron, steel, aluminium, plastics, ceramics, paintwork etc. For a finer result the polisher can be used with water, washing-up liquid, white spirit and paraffin. Used in industry by sheetmetal workers, stainless steel fabricators, metal finishers, moulders and metalware manufacturers. Each polishing block measures 80 x 50 x 20mm. \*3 x 06-7995, 6 x 06-7996, 6 x 06-7997 and 3 x 06-7998

495232

Grade	Order Code	Price Each
		1+
Extra-coarse (Wine)	067-998	2.90
Mixed box of 18*	067-999	51.80

**Deburring**

**Tools**

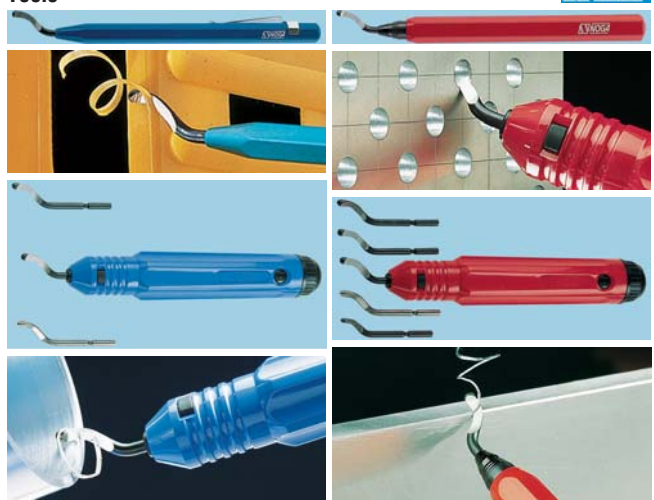

**Deburring - continued**

**Tools - continued**

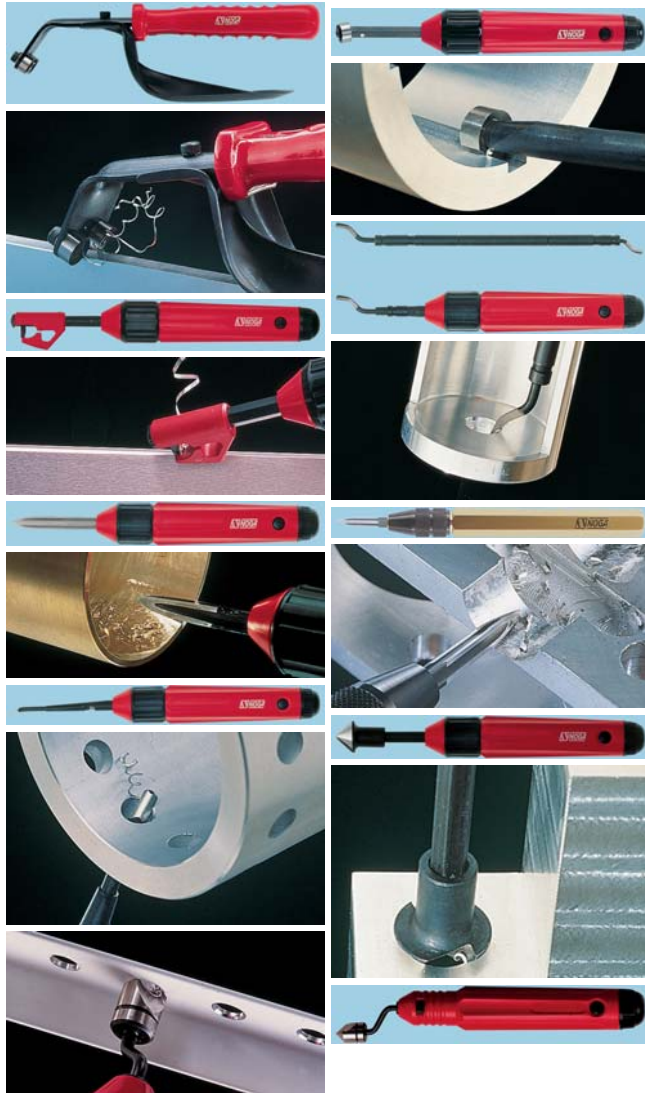

493791

Kit/Set	Description	Order Code	Price Each
Edge off EO 1000	Edge off consists of S10 non-removable blade mounted on a hexagon handle 125mm long	137-4051	3.78
Rapid burr RB 1000	Rapid burr supplied with S10 blade. Will accept all S type blades	137-4063	6.11
Noga burr 3	Noga burr 3 comes complete with S10, S20, S35 blades and is capable of holding all S type blades. For coarse and fine deburring	137-4071	9.59
Noga burr 5	Noga burr 5 is similar to Noga burr 3 but is supplied with 5 blades S10/S20/S35/S101/S202	137-4073	13.94
Double burr DB 1000	Double burr is a dual purpose tool for sheet metal. Adjustable up to 10mm thickness. Standard tool supplied with 2 N80 blades and hand guard for safety	137-4074	19.05
Keyway burr KW 1000	Keyway burr for internal and external keyways, Tool length 236mm. Supplied with N80K blade	137-4075	13.83
Tele burr LB 1000	Telescopic blade holder. Double ended taking heavy and light blades. Supplied with N1 and N2 blades	137-4076	11.71
Leader LD 1000	Used to put chamfer on straight and curved components. Supplied with L1 blade	137-4077	17.90
Scraper SC 1000	Supplied with T120 blade ground on both ends. Blade slides into handle and locks in any position	137-4078	16.89
Medium scraper SC 8000	As above but supplied with T80 blade	137-4089	15.48
Internal scraper IS 1000	For deburring cross holes supplied with universal handle, D holder and D66 blade	137-4079	15.07
Countersink CS1000	Hexagon blade holder. Can be locked in any position. Complete with C20 90° countersink	137-4090	23.56
Roto-drive RD 1040	Roto-drive allows continuous rotation of tool. Supplied with fixed 8.3mm countersink	137-4091	17.85

Over 480,000 products online



**Holders**



493790

Holders	Handle	Order Code	Price Each
NB	Handle to suit all S blades with roto-drive Countersink bits	137-4092	5.63
UNI	Handle holds SN, C and D holders plus T120 scraper	137-4061	4.89
Adjustable handle	Holds T80 blade	137-4093	8.79
SN holder	Double headed holder for use with UNI handle. Takes S and N type blades	137-4094	5.63
C holder	Holds C12, C20 and C30 countersinks. For use with UNI handle	137-4062	4.40
D holder	Holds D50 and D66 blades. For use with UNI handle	137-4050	5.44

**Blades**



493803

Light Duty Blades	Description	Order Code	Price Each
N1	Light duty HSS blade used for steel and aluminium	137-4064	0.87
N2	Light duty HSS blade used for brass and cast iron. For left and right hand use	137-4052	0.87
N3	Light duty HSS blade removes external and internal burrs simultaneously from holes drilled in tubing and sheet materials	137-4095	1.37
Heavy Duty Blades	Description	Order Code	Price Each
S10	Heavy duty HSS blade used for steel and aluminium	137-4065	1.19
S10 L/H	Heavy duty Left Hand HSS blade used for steel and aluminium	137-4066	1.48
S10 Coated	Heavy duty HSS tin coated blade used for plastic parts	137-4053	2.17
S10S	Heavy duty HSS blade specially hardened for stainless steel	137-4097	1.47
S20	Heavy duty HSS blade used for brass and cast iron. For both left and right handed use	137-4067	1.19
S30	Heavy duty HSS blade removes external and internal burrs simultaneously from holes drilled in tubing and sheet materials	137-4068	1.37
S35	Heavy duty HSS blade especially handy for straight edges. For both left and right handed use	137-4054	1.46

**FREE global legislation support**



RoHS, REACH, WEEE, EuP, Batteries Directive - we've got it covered at: [www.global-legislation.com](http://www.global-legislation.com)

Blades

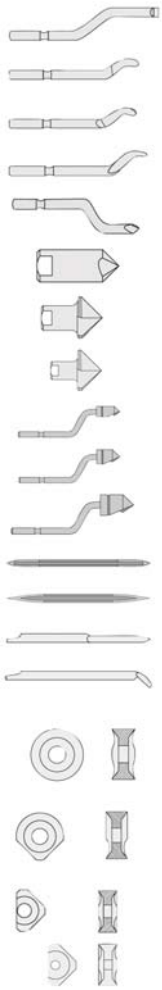

Blades	Description	Order Code	Price Each 1+
N80K M42	Similar to the N80 but ground as shown, to facilitate use in narrow keyways. The N80K M42 Blade is used on stainless steel (2.5mm - 11mm)	137-4106	5.00
N70K	Square Blade for shallow keyways (1.2mm - 8mm)	137-4107	5.42
N90K	Heavy duty blade for wide keyways (3mm - 15mm)	137-4108	6.09

Tool Kits And Sets



Noga hand deburring tools and kits cover a wide range of application and material uses.

493806

Kit/Set	Description	Order Code	Price Each 1+
Unikit standard UK 1000	Deburring kit consists of universal handle, SN and C holder and N1/N2/S10/S20/S30/S101 blades	137-4082	58.90
Unikit special UK 2000	Deburring kit consists of universal handle, D, SN and C holder and C12/N1/N2/S10/S20/S30/S101 blades	137-4083	74.23
Unikit extra UK 3000	Deburring kit consists of universal handle, D, L and C holder and L2/C12/N1/N2/S10/S20/S30/S101 blades	137-4085	99.09
Tele burr set LB 5000	Telescopic deburring set consists of universal handle, SN holder and N1/N2/N3/S10/S20/S30 blades	137-4086	20.40
Scraper set SC 5000	Scraper set consists of universal handle, D holder and T120/D50/D60 scraper blades	137-4087	38.59
Countersink set CS500	Counter sink set includes universal handle, C holder and C12/C20/C30 countersinks	137-4088	58.99

Rapid Deburrer with HSS Blade



470-0776

374-507

- Hexagonal aluminium handle
- Small and handy
- Pocket-sized for permanent readiness

240994

Type	Order Code	1+	5+	10+	Price Each
107052	374-507	6.49	5.91	5.41	
107054	470-0776	4.30	4.07	3.85	

Sheet-metal deburrer with tungsten-carbide cutting edges



**New**

- Plastic handle with hand protector and 1 tungsten-carbide blades
- This sheet-metal deburrer processes two edges in one operation
- Suitable for double-sided deburring of steel, aluminium, brass, copper and plastic sheets
- Sheet-metal deburrer for materials up to 5 mm

515132

Mfrs. Part No.	Order Code	1+	5+	10+	Price Each
107064	160-7521	20.19	19.16	18.13	

Coming soon



Register your interest for items that are 'Coming Soon' at [www.farnell.co.uk](http://www.farnell.co.uk) and we'll email you to let you know that they're in stock.



493785

Blades	Description	Order Code	Price Each 1+
S60	Heavy duty HSS blade for heavy duty internal deburring in difficult to reach places	137-4069	3.23
S101	Extra fine point HSS blade used for steel and aluminium	137-4080	1.33
S202	Extra fine point HSS blade used for brass and cast iron. For both left and right handed use	137-4081	1.40
S150	HSS blade for 0.75mm radius or larger, holes 1.5mm diameter or larger	137-4098	1.52
BC3200	3.2mm countersink. For use with the NB handle and/or SN holder	137-4099	5.67
C12	90°, 12mm countersink for use with the C holder	137-4055	12.66
C20	90°, 20mm countersink for use with the C holder	137-4056	16.94
C30	90°, 30mm countersink for use with the C holder	137-4057	24.83
BC6300	Single flute, 6.3mm countersink. For use with NB handle and/or SN holder	137-4100	11.28
BC8300	Single flute, 8.3mm countersink. For use with NB handle and/or SN holder	137-4101	11.54
BC1040	Single flute, 10.4mm countersink. For use with NB handle and/or SN holder	137-4103	12.66
T120	7mm triangular section x 120mm long Scraper Blade, ground both ends for prolonged life. For use with the Uni Handle only	137-4049	12.93
D66	HSS 3.2mm Internal Scraper Blade. Most useful on cross holes	137-4109	4.69
N80	Used in the Double Burr, cutting along the circumference of each face	137-4070	3.89
N80 M42	Used in the Double Burr, cutting along the circumference of each face. The N80 M42 blade is used for stainless steel	137-4105	5.00

**Deburring - continued**

"Unigrat Starter-Kit" with handle incl.  
Blades in plastic case



Set consisting of  
1 x universal handle, 1 x steel holder E  
3 x blade E 100 HSS-TiN, 2 x blade E 200  
HSS-TiN,  
1 x blade E 300 HSS-TiN, 1 x blade E 350  
HSS-TiN

515135

Mfrs. Part No.	Order Code	1+	5+	10+	Price Each
107100	160-7523	33.63	31.93	30.23	

**Edge Trimmers**



Plastic handle with exchangeable blades and spare blade storage in back of handle. Provide a solution for trimming internal and external edges and tubes.

485349

Model	Description	Order Code	1+	5+	10+	20+	Price Each
107250	With E100 blade	136-8566	11.85	11.24	10.68	10.30	
107051	With E100, E200 and E300 blades	136-8567	12.71	12.05	11.44	11.05	

**Deburring Tools**



Ruko Deburring Programme  
A complete system for all deburring work done by hand. The wide range of holders and blades allow deburring of edges and bores from inside, outside or on both sides.  
Unigrat System

The universal handle accepts holders B and E. With the locking head withdrawn holders may be locked into position and adjusted to 100mm in length. Blades can only be used with a holder of the same series (B10 blade with B holder etc.) The replacement blades can be stored in the back of the handle.

**Universal Handle A**



Model	Description	Order Code	1+	5+	10+	Price Each
107-010	Universal Handle A	374-386	4.37	4.10	3.68	

**B Holder**



Model	Description	Order Code	1+	5+	10+	Price Each
107011	B holder		4.37	4.10	3.68	

**B10 Blade**



General purpose blade for steel, aluminium and plastics.

Model	Description	Order Code	1+	5+	10+	20+	Price Each
107012	B10 blade	136-8570	1.37	1.32	1.22	1.20	

**B20 Blade**



General purpose blade for brass and cast iron.

Model	Description	Order Code	1+	5+	10+	20+	Price Each
107014	B20 blade	136-8571	1.37	1.32	1.22	1.20	

**B30 Blade**



Blade for simultaneous removal of internal and external burrs in material up to 4mm thick.

Model	Description	Order Code	1+	5+	10+	20+	Price Each
107015	B30 blade	136-8572	1.62	1.52	1.47	1.40	

**E Holder**



Model	Description	Order Code	1+	5+	10+	20+	Price Each
107025	E holder	136-8572	1.62	1.52	1.47	1.40	

**E100 Blade**



Heavy duty blade for steel, aluminium and plastics.

485335

Model	Description	Order Code	1+	5+	10+	Price Each
107-026	B30 blade	374-416	1.05	0.99	0.85	

**Hand deburrer**

DIN 335 Form 90° HSS



CBN ground mit fix plastic handle

238590

Mfrs. Part No.	Order Code	1+	5+	10+	Price Each
102143 -	374-532	13.50	12.41	10.92	
102146 -	374-568	22.39	20.56	18.28	

45

**Cutting Tools  
Handiburr Tools**



Specially designed to deburr chamfer or enlarge holes in metal, plastic or wood. Fitted plastic handle for positive grip.

487692

Model	Description	Diameter (mm)	Order Code	1+	4+	20+	40+	Price Each
HB1	Chamfer bit	12.4	147-936	12.04	--	--	--	
HB2	Chamfer bit	25	827-848	26.43	--	--	--	
HB3	Pipe reamer	10 - 34	105-205	20.71	19.94	18.82	16.20	
HB4	Taper reamer	3 - 12	147-889	18.91	18.06	17.03	15.57	
HB5	Taper reamer	10 - 25	147-890	31.55	30.25	28.59	25.56	

**Hand Drill**



Model 803 has an iron machine cut gear wheel which is die cast aluminium on other models.



478294

Model	Capacity (mm)	Capacity (in)	Order Code	Price Each			
				1+	5+	10+	20+
103	8	5/16	135-3673	25.25	24.50	23.25	22.79
105	8	5/16	135-3672	12.45	12.10	11.45	11.23

**Taper and Deburring Countersinker Set HSS, CBN Ground**



The deep-ground cutting grooves mean the cutting edges are absolutely sharp. For countersinking, deburring and recessing in steel, cast iron, non-ferrous heavy metals and light alloys without burrs and without chattering.

DIN 335 Form C 90°  
Ø 6,3 - 8,3 - 10,4 - 12,4 - 16,5 - 20,5 mm

Countersink angle: 90°  
Shank: cylindrical  
Cutting edges: 3  
Surface: bright  
right hand cutting

413278

Mfrs. List No.	Order Code	Price Each		
		1+	5+	10+
A102156	970-0862	32.16	30.55	28.55

**Taper and Deburring Countersinkers DIN 335 Form C 90° HSS, CBN ground**



Because of the CBN deep-ground flutes the cutting edges are extremely sharp. Ideal for burr- and chatter-free deburring and countersinking. Best results at low cutting speeds. Suitable for steel, cast iron, non-ferrous and light metals.

Countersink angle: 90°  
Shank: zylindric  
Cutting: 3

Supplied in a metal case

Set of 6: 374-982

Mfrs. Part No.	Countersinker		Shank	Countersinking as per	
	mm	mm		DIN74	
102 107	6.3	5	5	M3	
102 111	8.3	6	6	M4	
102 114	10.5	6	6	M5	
102 116	12.4	8	8	M6	
102 119-1	16.5	8	8		
102 121	20.5	10	10	M10	
102 152 (Satz)		10	10		

240969

Mfrs. Part No.	Order Code	Price Each		
		1+	4+	20+
102-107	483-783	5.94	5.36	4.75
102-111	374-799	7.25	6.79	6.13
102-114	483-795	8.07	7.25	6.44
102-116	374-891	9.33	8.78	8.15
102-119	483-801	10.56	9.50	8.45
102-121	483-813	18.65	16.78	14.91
102-152	374-982	78.38	75.14	69.11

**Countersinks and Deburring Tools**

DIN 335 Form C 90° HSS Co 5 - CBN ground for VA steels

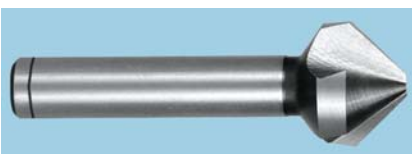

- The deep ground flutes provide an absolutely sharp cutting edge, ideal for deburring and chatter-free countersinking.
- Deburring and countersinking in V2A, V4A.
- The best results are obtained at low cutting speeds.

Countersink angle: 90°  
Shank: cylindrical  
Cutters: 3  
Surface: polished

451629

Mfrs. List No.	Nominal Ø	Total length	shank Ø mm	countersink to DIN 74 (BF)	Order Code	Price Each		
						1+	5+	10+
102107E	6.3 mm	45 mm	5	M 3	130-7283	4.49	4.28	4.03
102111E	8.3 mm	50 mm	6	M 4	130-7284	5.21	4.96	4.70
102114E	10.4 mm	50 mm	6	M 5	130-7285	5.89	5.58	5.31
102116E	12.4 mm	56 mm	8	M 6	130-7286	6.61	6.30	5.94
102119E	16.5 mm	60 mm	8	M 8	130-7287	7.74	7.39	6.97
102121E	20.5 mm	63 mm	10	M 10	130-7288	11.26	10.69	10.12
102152E	6-piece set Ø 6.3; 8.3; 10.4; 12.4; 16.5 (Shank Ø 10 mm); 20.5 mm				130-7291	52.67	50.04	47.40

**Slotted Taper and Deburring Countersinkers 90°**



- Self centering and supported over the majority of their circumference
- These factors stop the tool chattering
- Gives an exceptionally clean and precise hole finish

- Each tool covers a range of hole sizes
- Swarf removal is very efficient given the large hole in the tool head
- Suitable for use with brass, aluminium and ferrous metals
- Manufactured from HSS steel with ground shaft and cutting head

Deburring Range mm	Head Dia. mm	Overall Length mm	Shaft Length mm	Shaft Dia. mm	Mfrs. Part No.	Order Code
2 - 5	10	45	27	6	102301E	483-722
5 - 10	14	48	24	8	102302E	483-734
10 - 15	21	65	31	10	102303E	483-746

213472

Deburrers	Order Code	Price Each		
		1+	4+	20+
2 - 5mm	483-722	5.57	5.52	5.38
5 - 10mm	483-734	10.40	9.36	8.32
10 - 15mm	483-746	15.08	13.56	12.01

**G136 HSS Straight Shank Countersink, 90 Degrees**



DIN 335 Type C  
Flute geometry  
3 Flute, ground all over  
90° included angle

**Shank**  
Straight shank  
**Range**  
8 - 12.4mm

**Application**  
To produce 90° countersinks. Also used as a deburring tool.

495153

Diameter Min	Diameter Max	Shank Diameter(mm)	Overall Length(mm)	Order Code	Price Each	
					1+	20+
2.0	8.0	6	50	025-682	17.05	
2.5	10.0	6	50	025-683	24.35	
2.8	12.4	8	56	025-684	29.20	

45

**HSS 90 3 Flute Countersinks**



**Application**  
Suitable for all general purpose chamfering, deburring and countersinking.

493075

Diameter Min	Diameter Max	Overall Length(mm)	Shank Diameter(mm)	Order Code	Price Each	
					1+	20+
2.50	10.40	50	6	150-6424	7.44	
2.80	12.40	56	8	150-6425	6.99	
3.20	16.50	60	10	150-6426	8.38	
3.80	25.00	67	10	150-6427	16.87	

**HSS 90 Deburring Cutters**



Deburring countersinks allow fast metal removal and chatter-free finish in all types of materials.

492364

Diameter range	Overall length (mm)	Shank diameter (mm)	Order Code	Price Each	
				1+	20+
2 - 5	45	6	147-1906	6.10	
5 - 10	48	8	147-1907	9.05	
10 - 15	65	10	147-1908	12.59	
15 - 20	84	12	147-1911	25.21	
20 - 25	102	15	147-1912	32.05	



**Deburring - continued**

**Flat countersinkers DIN 373 HSS**

with fixed guide, Medium grade for through hole

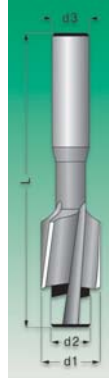

For producing countersinkings for cylinderhead screws, thread-cutting screws and thread-furrowing screws. Ideal for burr- and chatter-free deburring and countersinking. Applicable for steel, cast iron, non-ferrous and light metals. Best results at low cutting speeds. Set content: each 1 of M3, M4, M5, M6, M8, M10.

Counters. angle	180°	Surface:	blank		
Shank:	cylindric	Right-hand cutting			
Cutting edges:	3				
Mfrs. Part No.	Thread	Pilot $\varnothing$ d1 mm	CSK $\varnothing$ d2 mm	Shank $\varnothing$ d3 mm	Total length mm
102408	M3	6	3,4	5,0	71,0
102409	M4	8	4,5	5,0	71,0
102410	M5	10	5,5	8,0	80,0
102411	M6	11	6,6	8,0	80,0

225016

Size	Order Code	1+	Price Each	4+	20+
M3	282-364	9.36	8.42	7.50	
M4	282-376	8.37	7.53	6.68	
M5	282-388	8.77	7.89	7.01	
M6	282-390	9.74	8.79	7.81	
Set of above	282-420	115.96	104.36	6+	92.77

**TC Rotary Burrs Set 3-piece**



The rotary burrs composed of high-performance tungsten carbide offer very good cutting edge robustness with high cutting toughness at the same time. The cruciform teeth provide better cutting performance than single teeth. This has a particularly positive effect on materials that are difficult to machine.

Applications: for highly alloyed, rust-resistant, acid-resistant and heat-resistant steels, cast iron and plastics. For deburring, edge removal, finishing, weld bead machining and surface machining.

Set of TC rotary burrs, 3 pcs./ each 1x  $\varnothing$  D1 10.0 mm  
 1 TC rotary burr shape A, cylinder (ZYA) with end tooling  
 1 TC rotary burr shape G, pointed arch (SPG)  
 1 TC rotary burr shape D, cone (KUD)

413256

Mfrs. List No.	Order Code	1+	5+	10+
116001	970-0811	27.06	25.85	24.75

**TC Rotary Burrs Set 10-piece**



The rotary burrs, composed of high-performance tungsten carbide, offer very good cutting edge robustness with high cutting toughness at the same time. The cruciform teeth provide better cutting performance than single teeth. This has a particularly positive effect on materials that are difficult to machine.

Applications: for highly alloyed, rust-resistant, acid-resistant and heat-resistant steels, cast iron and plastics. For deburring, edge removal, finishing, weld bead machining and surface machining.

Set of TC rotary burrs, 10 pcs. / each 1x  $\varnothing$  D1 6.0 + 12.0 mm  
 1 TC rotary burr shape A, cylinder (ZYA) with end tooling  
 1 TC rotary burr shape G, pointed arch (SPG)  
 1 TC rotary burr shape D, cone (KUD)  
 1 TC rotary burr shape C, spherocylindrical (WRC)  
 1 TC rotary burr shape F, full arch (RBF)

413259

Mfrs. List No.	Order Code	1+	5+	10+
116002	970-0820	99.95	91.80	84.12

**Carbide Burrs**

**Ball Nosed Cylinder**



493974

Head Diameter (mm)	Length (mm)	Shank Diameter (mm)	Overall Length (mm)	Standard Cut Order Code	Diamond Cut Order code	Price Each 1+
3	13	3	38	229-465B	222-631	4.84
6	19	6	50	229-489B	222-633	10.31
10	19	6	65	229-430B	222-635	10.63
12	25	6	70	229-490B	222-637	14.63

**Carbide Burrs**

**Ball Nosed Tree**



494828

Head diameter (mm)	Head length (mm)	Shank diameter (mm)	Overall length (mm)	Standard cut Order code	Diamond cut Order code	Price each
3	13	3	38	229-472	222-679	5.11
6	16	6	50	229-436	222-681	11.75
10	19	6	65	-	222-682	11.09
12	25	6	70	229-499	222-683	11.72

**Rotary Burrs**



493536

Head Diameter (mm)	Head Length (mm)	Shank Diameter (mm)	Overall Length (mm)	Standard Cut Order Code	Diamond Cut Order Code	Price Each
3	19	3	38	229-462	222-608	4.33
6	19	6	50	155-3733	222-611	8.16
10	19	6	65	229-427	222-613	12.46
12	19	6	65	229-428B	222-614	14.70
15	25	6	70	229-429	222-615	17.70

**Carbide Burrs**

**Ball**



494459

Head Diameter (mm)	Head Length (mm)	Shank Diameter (mm)	Overall Length (mm)	Standard Cut Order Code	Diamond Cut Order Code	Price Each 1+
3	2.7	3	38	229-467	222-667	9.52
10	7.2	6	53	229-433	222-672	9.65
12	10.8	6	53	229-497	222-673	10.67

**Taps & Dies**

**6 Piece Die Set**



- This 6 piece die set is made from high quality steel
- Sizes included: 6 x 1.0, 7 x 1.0, 8 x 1.25, 10 x 1.5, 12 x 1.75mm
- Die handle 1" OD

482076.461036

Order Code	1+	5+	Price/Set 10+	20+	50+
144-7539	4.11	3.77	3.27	3.09	2.80

**Troubleshooting tips**



Chat live online to one of our technical engineers at [www.farnell.co.uk](http://www.farnell.co.uk)





**6 Piece Tap and Wrench Set**



- 6 piece tap set
- Kit includes: T-bar wrench, M3 x 0.5, M4 x 0.7, M5 x 0.8, M6 x 1.0, M8 x 1.25mm

482077.461056

Order Code	1+		5+		Price/Set	
	10+	20+	10+	20+	50+	
144-7540	4.95	3.70	4.38	3.70	3.95	3.37

**HSS 8 Piece Metric Tap Set**



- High quality, high speed steel ISO straight flute taps
- Sizes M3, M4, M5, M6, M8, M10, M12
- Die cast tap wrench

493920

Price Each	Order Code		10+		20+	
	1+	5+	10+	20+	50+	
147-2151	38.27	37.50	36.75	36.02		

**Metric 8 Piece HSS Die Set**



- High quality, high speed steel. ISO dies
- Sizes M3, M4, M5, M6, M8, M10, M12
- Die cast die holder to suit

493747

Order Code	1+		5+		Price Each	
	10+	20+	10+	20+		
147-2152	38.27	37.50	36.75	36.02		

**20 Piece Tap and Die Set**



Set contains:  
 9 pc dies set: 3 x 0.5, 4 x 0.7, 5 x 0.8, 6 x 1.0, 7 x 1.0, 8 x 1.25, 10 x 1.5, 12 x 1.75, 1/8-27  
 9 pc taps: 3 x 0.5, 4 x 0.7, 5 x 0.8, 6 x 1.0, 7 x 1.0, 8 x 1.25, 10 x 1.5, 12 x 1.75, 1/8-27  
 1 pc tap wrench  
 1 pc die handle 1" OD

482079.461063

Order Code	1+		5+		Price/Set	
	10+	20+	10+	20+	50+	
144-7542	11.48	8.62	10.42	8.62	9.18	7.81

**Premium service without a premium price**



With thousands of prices already reduced, go online to see our most up-to-date pricing: [www.farnell.co.uk](http://www.farnell.co.uk)

**40 Piece Tap and Die Set**



- Heat treated alloy steel
  - national coarse, national fine and pipe combination thread
  - 1 x Long handle adjustable tap wrench
  - 1 x "T" handle tap wrench
  - 1 x Die handle
  - 1 x Flat screwdriver
  - 1 x Screwpitch gauge
  - Supplied in blow moulded case
- The kit contains:  
 ● One tap and one die of the following sizes: 3 x 0.5, 3 x 0.6, 4 x 0.7, 4 x 0.75, 5 x 0.8, 5 x 0.9, 6 x 1.0, 6 x 0.75, 7 x 1.0, 7 x 0.75, 8 x 1.25, 8 x 1.0, 10 x 1.25, 10 x 1.5, 12 x 1.75, 12 x 1.5 and 1/8NPT

482078.461060

Order Code	1+		5+		Price/Set	
	10+	20+	10+	20+	50+	
144-7541	21.15	15.86	19.17	15.86	16.93	14.42

**Drill And Tap Sets**

**M3 - M12 Drill And Tap Set**



HSS drill and tap set  
 Metric Coarse M3, 4, 5, 6, 8, 10 and 12  
 1 taper and 1 plug tap for all sizes.  
 Tapping drills to suit  
 Tap wrench  
 Supplied in a metal case.

492489

Size (mm)	Order Code	Price Each			
		1+	5+	10+	20+
3, 4, 5, 6, 8, 10, 12	147-2117	71.77	70.32	68.92	67.53

**Metric Tap and Drill Set**



- Boxed set of HSS drills, DIN standard metric HSS taps and a tap wrench
- There is a taper and a bottoming tap
- M3, M4, M5, M6, M8, M10 and M12 fasteners
- Conforms to BS328 and ISO529

225051.401282

Order Code	Price Each			
	1+	+	+	+
282-352	99.53	--	--	--

**Machine Taps Set DIN 371 HSS Co 5**



in plastic case, 10 pieces



Type	Ø
Machine Taps M DIN 371 HSS Co5	M4, M5, M6, M8, M10
Machine Taps RSP DIN 371 HSS Co5	M4, M5, M6, M8, M10

**Taps & Dies - continued**

**Machine Taps Set DIN 371 HSS Co 5 - continued**  
in plastic case, 10 pieces - continued

439479

Mfrs List No.	Description	Order Code	Price Each		
			1+	5+	10+
A245055E	10-pieces Set	122-1868	50.95	48.46	43.67

**Combined Machine Taps Bit HSS, ground**



- In one working stroke:
- Core hole drilling with twist drill
  - Thread cutting
  - Thread deburring
  - Thread cleaning

Set consisting of  
M3, M4, M5, M6, M8, M10  
+ 1 Hexagon magnetic holder

Thread: metric DIN ISO 13  
Flanks: relief-ground  
Tolerance: ISO 2 / 6 H  
Surface: blank  
Shank: 1/4" Hexagon  
Right-hand cutting

The combined machine tap is suitable for sheet metal working with right/left handed rotation cordless drilling machines. The thread is cut in one operation, without any tool changing. The tool incorporates a twist drill before the thread-tapping part. For core holes and through threads in unalloyed and alloyed steels up to 600N/mm<sup>2</sup> stability, malleable and non-ferrous metals. The twist drill consists of highly alloyed high-speed steel.

413246

Mfrs. Part No.	Thread size	Length	Price Each			
			Order Code	1+	5+	10+
270014	M3	36mm	970-0749	3.96	3.61	3.46
270015	M4	39mm	970-0757	4.77	4.03	3.83
270016	M5	41mm	970-0765	3.96	3.61	3.57
270017	M6	44mm	970-0773	3.96	3.61	3.31
270018	M8	51mm	970-0781	5.32	4.84	4.44
270019	M10	59mm	970-0790	6.57	5.98	5.47
270020	Set of 7		970-0803	30.21	27.87	25.88

45

**Machine Tap Sets**  
7 piece set in steel case



970-0870: Form B  
4 - 5 threads  
with progressive tap

970-0889: Form C  
2 - 3 threads

**970-0870:** Machine taps mit reinforced shank, for through thread, in unalloyed and alloyed steels up to 1000 N/mm<sup>2</sup> and VA metals. The thread is cut in one stroke.

**970-0889:** Machine taps mit reinforced shank and right-hand spiral flutes for bottoming threads, in unalloyed and alloyed steels up to 1000 N/mm<sup>2</sup> VA metals. The thread is cut in one stroke.

Thread: metric DIN ISO 13  
Flanks: relief-ground  
Tolerance: ISO 2 / 6 H  
Surface: vaporised  
Right-hand cutting

	970-0870	970-0889
Set consisting of:		
	M3, M4, M5, M6, M8, M10, M12	M3, M4, M5, M6, M8, M10, M12

413279

Mfrs. Part No.	Order Code	Price Each		
		1+	5+	10+
245063	970-0870	57.00	52.61	48.86
245064	970-0889	63.34	58.47	54.29

**Tap Index Set**



**Hex Bit Tap Set**

High speed steel taps with 1/4in hexagon shank for use in power tool bit holders.

Size (mm)	Order Code	Price Each			
		1+	5+	10+	20+
3,4,5,6,8,10	147-2140	29.56	28.97	28.39	27.83

**Hex Bit Tap And Drill Set**

High speed steel taps and the correct size drill bits with 1/4in hexagon shanks. For fast tapping in sheet metals with power tools.

Size (mm)	Order Code	Price Each			
		1+	5+	10+	20+
3, 4, 5, 6, 8, 10mm taps, 2.5, 3.3, 4.2, 5.0, 6.8, 8.5mm drills	147-2141	41.48	40.65	39.84	39.05

**1/4in Hex Shank Taps**

High speed steel metric taps with 1/4in hexagon shank for use in power tool bit holders.

493053

Size x Pitch (mm)	Order Code	Price Each			
		1+	5+	10+	20+
3.0 x 0.5	147-2143	3.06	3.00	2.94	2.89
4.0 x 0.7	147-2144	3.06	3.00	2.94	2.89
5.0 x 0.8	147-2145	3.82	3.74	3.66	3.59
6.0 x 1.0	147-2146	3.82	3.74	3.66	3.59
8.0 x 1.25	147-2147	5.51	5.39	5.28	5.18
10.0 x 1.5	147-2149	6.72	6.59	6.46	6.32

**Tap & Die Set**

**Tap, Die & Tapping Drill Set**



- High speed steel tap, die and tapping drill set for general engineering and workshop applications
- DIN standard taps and solid circular dies
- Supplied in a metal box
- Set contains taps plus dies M3 to M12 complete with tap wrenches, die stocks and thread gauge

493300

Order Code	Price Each			
	1+	5+	10+	20+
147-2154	137.70	134.94	132.24	129.60

**Tap & Die Set**

**M3-M12 Tap & Die Set**



Comes in strong light plastic carrying case. HSS taps & dies to DIN standard with tap wrenches & diestock ideal for maintenance applications.

491229

Order Code	Price Each			
	1+	5+	10+	20+
147-1877	93.64	91.76	89.93	88.13

**HSS Metric Tap & Die Set**



- High quality set to DIN standard for general engineering
  - Set contains: Taps M3 - 12mm in taper, second, plug
- Dies M3 - M12  
Tap wrenches and diestocks  
Screw pitch gauge and screwdriver

492311

Order Code	Price Each			
	1+	5+	10+	20+
147-2153	103.31	101.24	99.22	97.23

**Thread-Cutting Set**  
37 pieces, HSS



- one three-piece set each of hand taps M DIN 352 M3, M4, M5, M6, M8, M10, M12
- 7 die, M DIN EN 22568 in each of the sizes M3, M4, M5, M6, M8, M10, M12
- 5 die stock DIN 225 in each of the sizes 20x5mm, 20x7mm, 25x9mm, 30x11mm, 38x14mm
- 2 tap wrench, size 1 and size 2 DIN 1814
- 1 screwdriver
- 1 screw-pitch gauge

240621

Mfrs. Part No.	Order Code	Price Each		
		1+	5+	10+
245020	375-019	177.04	156.35	137.50

**Thread Repair Workshop Kits**



Thread repair workshop kit. Thread repair for damaged or worn out threads. Range 5 -12 mm. With STI machine taps (spiral point), inserting tool, drill and inserts.

494739

Range	Order Code	Price Each		
		1+	5+	10+
M5 - M12	147-1821	119.33	116.95	114.61
				112.31

**Keyway Broach Sets**



High speed steel. For cutting keyways in gears, milling cutters, pulley hubs, collars, couplings etc. Use with hand-operated or hydraulic arbor press. 15 keyway combinations. Collared bushings

**No 00 Precision Set**

Keyway Size (in)	Broach Style	Bushing Diameter (in)	Order Code	Price Each
1/16, 3/32, 1/8	A	1/4, 5/16, 3/8, 7/16, 1/2	025-787	143.55

**No 70 Metric Set**

26 Keyway combinations. Collared brushings.

493691

Keyway Size (in)	Broach Style	Bushing Diameter (in)	Order Code	Price Each
4, 5, 6, 8	B - 1, C	12, 14, 15, 16, 18, 19, 20, 22, 24, 25, 26, 28, 30	025-792	273.61

**Die Stocks as per DIN 225**



For closed and slotted taps as per DIN EN 24231. With steel handles one of which can be unscrewed and five screws for clamping the tap.

Version: Die-cast zinc housing  
Packing unit: individual plastic pack

Mfrs. Part No.	Size in mm	Depth, external in mm	Length, Total	for die stocks
242165	16	5	160	M1 - M2,6
242205	20	5	200	M3 - M4
242207	20	7	200	M4,5 - M6
242259	25	9	224	M7 - M9
2423011	30	11	280	M10 - M11
2423814	38	14	315	M12 - M14

240675

Mfrs. Part No.	Order Code	Price Each		
		1+	5+	10+
242165	377-119	3.40	3.05	2.80
242205	377-120	3.40	3.05	2.80
242207	377-132	3.10	2.80	2.50
242259	377-144	3.70	3.30	3.00
2423011	377-156	4.65	4.15	3.80
2423814	377-168	5.20	4.70	4.25

**Round dies M DIN EN 22568 HSS**



Ground



Type B closed, preslotted, metric thread, DIN ISO 13, right-hand cutting.

Mfrs List No	Thread	Pitch (mm)	Outer Diameter (mm)	Thickness (mm)
237020	M2			5
237030	M3		20	5
237040	M4		20	5
237050	M5		20	7
237060	M6		20	7
237080	M8		25	9
237120	M10		30	11
237120	M12		38	14

240656

Mfrs List No	Order Code	Price Each		
		1+	5+	10+
237020	376-668	5.30	4.90	4.50
237030	376-802	4.49	4.32	4.05
237040	376-905	4.49	4.32	4.05
237050	376-929	4.23	4.08	3.84
237060	376-954	4.49	4.32	4.05
237080	377-004	4.41	4.25	3.95
237120	377-090	5.13	4.95	4.57
237120	377-107	6.45	6.10	5.72

45

**HSS Dies**



BS1127:1950

**Tolerance**

Class B

**Chamfer lead**

1.5 threads

**Cutting rake**

8°

**Surface treatment**

Bright

**Range**

1/8 - 1in

**Application**

For hand or machine production of components less than 3x diameter in length.

494300

Size x Pitch (in x mm)	OD (in)	Order Code	Price Each
1/8 x 28	1	147-4021	22.56
1/4 x 19	1 1/16	147-4022	33.18
3/8 x 19	1 1/2	147-4023	38.73
1/2 x 14	2	147-4024	57.36
5/8 x 14	2	147-4025	72.37
3/4 x 14	2	147-4026	72.37

**F310 HSS Metric Fine Dies**



BS1127:1950

**Tolerance:** 6g

**Chamfer lead:** 1.5 threads

**Cutting rake:** 8°

**Surface treatment:** Bright

**Range:** 5 - 25mm

**Application:** For hand or machine production of components less than 3x diameter in length.



**Taps & Dies - continued**

**F310 HSS Metric Fine Dies - continued**

494130

Size x Pitch(mm)	Cutter Diameter(in)	Order Code	Price Each
			1+
5 x 0.50	1 <sup>3</sup> / <sub>16</sub>	024-748	23.85
6 x 0.75	1 <sup>3</sup> / <sub>16</sub>	147-4009	20.31
8 x 1.00	1.000	147-4010	24.15
10 x 0.75	1.000	147-4011	31.02
10 x 1.00	1.000	147-4012	24.15
10 x 1.25	1.000	147-4013	24.15
12 x 1.00	1 <sup>3</sup> / <sub>16</sub>	147-4014	35.63
12 x 1.25	1 <sup>3</sup> / <sub>16</sub>	147-4015	35.63
12 x 1.50	1 <sup>3</sup> / <sub>16</sub>	147-4016	35.63
14 x 1.25	1 <sup>3</sup> / <sub>16</sub>	147-4018	35.63
14 x 1.50	1 <sup>3</sup> / <sub>16</sub>	147-4019	35.63
16 x 1.50	1 <sup>3</sup> / <sub>16</sub>	147-7476	41.56
18 x 1.50	1 <sup>1</sup> / <sub>2</sub>	147-4020	41.56
25 x 1.50	2.000	147-7494	81.82

**Metric Coarse Dies**



BS1127:1950

**Tolerance**  
6g  
**Chamfer lead**  
1.5 threads  
**Cutting rake**  
8°  
**Flute geometry**  
Straight flutes

**Surface treatment**  
Bright  
**Range**  
2 - 30mm  
**Application**  
For hand or machine production of components less than 3 x diameter in length.



494746

Size x Pitch (mm)	OD (in)	Order Code	Price Each
			1+
2 x 0.40	1 <sup>3</sup> / <sub>16</sub>	137-5800	23.12
3 x 0.50	1 <sup>3</sup> / <sub>16</sub>	147-4027	13.38
4 x 0.70	1 <sup>3</sup> / <sub>16</sub>	147-4028	13.38
5 x 0.80	1 <sup>3</sup> / <sub>16</sub>	147-4031	13.38
6 x 1.00	1 <sup>3</sup> / <sub>16</sub>	137-5682	13.55
6 x 1.00	1	137-5683	16.07
6 x 1.00	1 <sup>3</sup> / <sub>16</sub>	147-4033	28.47
8 x 1.25	1 <sup>3</sup> / <sub>16</sub>	147-4034	23.23
10 x 1.50	1	147-4032	15.86
10 x 1.50	1 <sup>3</sup> / <sub>16</sub>	137-5686	23.53
10 x 1.50	1 <sup>1</sup> / <sub>2</sub>	147-4036	34.95
11 x 1.50	1 <sup>3</sup> / <sub>16</sub>	147-4035	28.47
12 x 1.75	1 <sup>3</sup> / <sub>16</sub>	137-5687	23.53
14 x 2.00	1 <sup>1</sup> / <sub>2</sub>	147-4037	38.44
16 x 2.00	1 <sup>1</sup> / <sub>2</sub>	147-4038	27.15
18 x 2.50	2	147-4039	40.09
20 x 2.50	2	147-4040	40.09
22 x 2.50	2	147-4041	40.09
24 x 3.00	2	147-4043	40.09

**Die Stocks**



For circular split dies.

494304

Model	Capacity (in)	Order Code	Price Each
			1+
D1	1 <sup>3</sup> / <sub>16</sub>	147-1921	4.68
D2	1	147-1923	5.36
D3	1 <sup>3</sup> / <sub>16</sub>	147-1924	7.86
D4	1 <sup>1</sup> / <sub>2</sub>	147-1925	9.88
D5	2	147-1926	20.10

**Hand taps M DIN 352 HSS**

ground



For through threads and bottoming threads in unalloyed and low-alloyed steels up to a strength of 800 N/mm<sup>2</sup>, malleable cast iron and non-ferrous metals. The thread is cut in three operation.

Set of 3

Taper tap: 5-6 thread chamfer  
Second tap: 4-5 thread chamfer  
Final chamfer: 2-3 thread chamfer  
Thread: metric  
Right-hand cutting



Mfrs. Part No.	Thread	Steigung in mm	thread core hole in mm	total length in mm	thread length in mm
230020	M2	0.40	1.60	36	8.0
230030	M3	0.50	2.50	40	10.0
230040	M4	0.70	3.30	45	12.0
230050	M5	0.80	4.20	50	13.0
230060	M6	1.00	5.00	50	15.0

240508

Mfrs. Part No.	Order Code	1+	Price Each	5+	10+
230020	375-202	5.65	5.10	4.71	
230030	375-238	6.18	5.65	5.18	
230040	375-299	6.18	5.65	5.18	
230050	375-317	5.89	5.32	4.91	
230060	375-342	6.47	5.92	5.41	
230120	375-408	8.21	7.57		

**Single-cut taps M DIN 352 HSS**

ground



For through threads in unalloyed or low-alloyed steels up to 800 N/mm<sup>2</sup> strength, malleable cast iron and non-ferrous metals. The thread can be cut in one operation by hand or machine.

Chamfer: Form B 4-5 threads with progressive tap

Thread: metric DIN ISO 13

Flanks: relief-ground

Surface: blank

Right-hand cutting

240476

Mfrs. Part No.	Thread	Pitch	Thread core hole	Total Length	Thread Length	Order Code	1+	5+	10+
231030	M3	0.5mm	2.50mm	40mm	10mm	375-032	2.47	2.38	2.16
231040	M4	0.7mm	3.30mm	45mm	12mm	375-070	2.35	2.26	2.06
231050	M5	0.8mm	4.20mm	50mm	13mm	375-100	2.70	2.50	2.25
231060	M6	1.00mm	5.00mm	50mm	15mm	375-123	2.67	2.57	2.35
231080	M8	1.25mm	6.80mm	56mm	18mm	375-147	2.95	2.85	2.50

**Machine Taps M DIN 371 HSS**

ground



Machine taps with reinforced shank, for through threads, in unalloyed an low alloyed steel up to 800N/mm, malleable cast iron and non-ferrous metal.

Chamfer: Form B, 4-5 threads with progressive tap

Thread: metric DIN ISO 13

Flanks: relief-ground

Right-hand cutting

Mfrs. Part No.	Thread	Pitch (mm)	Thread core Hole (mm)	Total Length (mm)	Thread (mm)
232020	M2	0.40	1.6	45	8.0
232030	M3	0.50	2.5	56	9.0
232040	M4	0.70	3.3	63	10.0
232050	M5	0.80	4.2	70	12.0
232060	M6	1.00	5.0	80	13.0
232080	M8	1.25	6.8	90	18.0
232100	M10	1.50	100	100	20.0

240559

Mfrs. Part No.	Order Code	1+	Price Each	5+	10+
232020	375-421	4.15	3.89	3.65	
232030	375-433	3.95	3.75	3.50	
232040	375-457	4.12	3.95	3.52	
232050	375-482	4.12	3.95	3.52	
232060	375-500	4.36	4.08	3.82	
232080	375-524	5.29	4.79	4.42	
232100	375-548	5.03	4.63	4.10	

**Extension Sleeves DIN 377**



- Version: hardened and ground
- Shaft: square as per DIN 10
- As extension to hand thread-cutting tools. Inside and outside square of identical size.

Mfrs. Part No.	Square	Length	for
241034	3.4mm	95mm	M4
241049	4.9mm	110mm	M5-M8
241055	5.5mm	115mm	M9-M10

240604

Mfrs. Part No.	Order Code	1+	5+	10+
241034	375-901	2.79	2.75	2.52
241049	375-962	3.15	3.00	2.76
241055	375-986	3.15	3.00	2.76

**E513 HSS Metric Fine Taps Straight Flute**



ISO 529

**Tap tolerance** - Class 2 for 6H fit  
**Chamfer thread numbers** - 1,2 and 3  
**Cutting rake** - 7°  
**Flute geometry** - Straight flutes

**Surface treatment** - Bright  
**Range** - 4 - 20mm  
**Application** - For hand or machine tapping of through or blind holes.

492542

Size x Pitch (mm)	Overall Length (mm)	Flute Length (mm)	Shank Diameter (mm)	Square A/F (mm)	Type	Order Code	1+	5+	10+	20+
3 x 0.35	48	12.5	3.15	2.5	Taper	148-5407	9.23	9.04	8.86	8.69
3 x 0.35	48	12.5	3.15	2.5	Second	148-5408	9.23	9.04	8.86	8.69
3 x 0.35	48	12.5	3.15	2.5	Plug	148-5409	9.23	9.04	8.86	8.69
4 x 0.50	53	14	4	3.15	Taper	148-5410	8.80	8.63	8.46	8.28
4 x 0.50	53	14	4	3.15	Second	148-5411	10.28	10.08	9.88	9.67
4 x 0.50	53	14	4	3.15	Plug	148-5413	9.23	9.04	8.86	8.69
5 x 0.50	58	11	5	4	Taper	148-5414	10.28	10.08	9.88	9.67
5 x 0.50	58	11	5	4	Second	148-5415	10.28	10.08	9.88	9.67
5 x 0.50	58	11	5	4	Plug	148-5417	9.23	9.04	8.86	8.69
6 x 0.75	66	13	6.3	5	Taper	148-5418	7.33	7.19	7.03	6.90
6 x 0.75	66	13	6.3	5	Second	148-5419	8.17	8.01	7.85	7.69
6 x 0.75	66	13	6.3	5	Plug	148-5420	7.33	7.19	7.03	6.90
8 x 1.00	72	16	8	6.3	Taper	148-5421	8.49	8.31	8.15	7.99
8 x 1.00	72	16	8	6.3	Second	148-5422	9.45	9.26	9.07	8.89
8 x 1.00	72	16	8	6.3	Plug	148-5423	8.49	8.31	8.15	7.99
10 x 1.00	80	18	10	8	Taper	148-8972	10.87	10.66	10.44	10.23
10 x 1.00	80	18	10	8	Second	148-5424	12.10	11.86	11.62	11.39
10 x 1.00	80	18	10	8	Plug	148-5425	10.87	10.66	10.44	10.23
10 x 1.25	80	18	10	8	Taper	148-5426	10.87	10.66	10.44	10.23
10 x 1.25	80	18	10	8	Second	148-5427	12.10	11.86	11.62	11.39
10 x 1.25	80	18	10	8	Plug	137-4247	11.83	11.59	11.22	10.99
12 x 1.00	89	22	9	7.1	Taper	148-5429	22.88	22.42	21.98	21.53
12 x 1.00	89	22	9	7.1	Second	148-5431	25.50	24.99	24.49	24.00
12 x 1.00	89	22	9	7.1	Plug	148-5432	22.88	22.42	21.98	21.53
12 x 1.25	89	22	9	7.1	Taper	148-5433	15.20	14.89	14.60	14.30
12 x 1.25	89	22	9	7.1	Second	148-5434	15.73	15.42	15.11	14.81
12 x 1.25	89	22	9	7.1	Plug	148-5435	15.20	14.89	14.60	14.30
12 x 1.50	89	22	9	7.1	Taper	148-5436	15.20	14.89	14.60	14.30
12 x 1.50	89	22	9	7.1	Second	148-5437	15.73	15.42	15.11	14.81
12 x 1.50	89	22	9	7.1	Plug	148-5438	15.20	14.89	14.60	14.30
14 x 1.50	95	24	11.2	9	Second	148-5439	17.54	17.18	16.85	16.50
16 x 1.50	102	24	12.5	10	Second	148-5357	19.67	19.28	18.89	18.51
18 x 1.50	112	29	14	11.2	Second	148-5440	27.28	26.74	26.21	25.68
20 x 1.50	112	29	14	11.2	Second	148-8965	33.10	32.44	31.79	31.15

**E500 HSS Metric Coarse Taps Straight Flute**



ISO 529  
**Tap tolerance** - Class 2 for 6H fit  
**Chamfer thread numbers** - 1,2 and 3  
**Cutting rake** - 7°  
**Flute geometry** - Straight flutes  
**Surface treatment** - Bright  
**Range** - 2 - 30mm  
**Application** - For hand or machine tapping of through or blind holes.

492531

Size x Pitch (mm)	Overall Length (mm)	Flute Length (mm)	Shank Diameter (mm)	Square A/F (mm)	Type	Order Code	1+	5+	10+	20+
2 x 0.40	41	8	2.5	2	Set 3	138-9498	26.22	25.69	24.87	24.37
2.5 x 0.45	44.5	9.5	2.8	2.24	Set 3	138-9499	21.54	21.11	20.43	20.03
2.5 x 0.45	44.5	9.5	2.8	2.24	Taper	138-9424	7.19	7.04	6.81	6.68
2.5 x 0.45	44.5	9.5	2.8	2.24	Second	138-9425	7.19	7.04	6.81	6.68
2.5 x 0.45	44.5	9.5	2.8	2.24	Plug	138-9426	7.19	7.04	6.81	6.68
3 x 0.50	48	12.5	3.15	2.5	Set 3	138-9500	13.96	13.68	13.24	12.97
3 x 0.50	48	12.5	3.15	2.5	Taper	138-9428	4.67	4.58	4.43	4.33
3 x 0.50	48	12.5	3.15	2.5	Second	138-9429	4.67	4.58	4.43	4.33
3 x 0.50	48	12.5	3.15	2.5	Plug	138-9430	4.67	4.58	4.43	4.33
3.5 x 0.60	50	14	3.55	2.8	Taper	138-9431	5.34	5.23	5.06	4.95
3.5 x 0.60	50	14	3.55	2.8	Plug	138-9432	5.34	5.23	5.06	4.95
4 x 0.70	53	14	4	3.15	Set 3	138-9501	12.69	12.43	12.04	11.79
4 x 0.70	53	14	4	3.15	Taper	138-9433	4.23	4.15	4.02	3.94
4 x 0.70	53	14	4	3.15	Plug	138-9435	4.23	4.15	4.02	3.94
5 x 0.80	58	11	5	4	Set 3	138-9502	13.43	13.17	12.74	12.49
5 x 0.80	58	11	5	4	Taper	138-9436	4.49	4.39	4.25	4.16
5 x 0.80	58	11	5	4	Second	138-9437	4.49	4.39	4.25	4.16
5 x 0.80	58	11	5	4	Plug	138-9438	4.49	4.39	4.25	4.16
6 x 1.00	66	13	6.3	5	Set 3	138-9503	13.70	13.42	12.99	12.74
6 x 1.00	66	13	6.3	5	Taper	138-9441	4.57	4.47	4.32	4.24
6 x 1.00	66	13	6.3	5	Second	138-9442	4.57	4.47	4.32	4.24
6 x 1.00	66	13	6.3	5	Plug	138-9443	4.57	4.47	4.32	4.24
8 x 1.25	72	16	8	6.3	Set 3	137-4246	15.22	14.90	14.42	14.14
8 x 1.25	72	16	8	6.3	Taper	138-9444	5.08	4.97	4.81	4.72

Size x Pitch (mm)	Overall Length (mm)	Flute Length (mm)	Shank Diameter (mm)	Square A/F (mm)	Type	Order Code	1+	5+	10+	20+
8 x 1.25	72	16	8	6.3	Plug	138-9445	5.08	4.97	4.81	4.72
10 x 1.50	80	18	10.00	8.00	Taper	138-9446	6.51	6.37	6.17	6.05
10 x 1.50	80	18	10.00	8.00	Second	138-9447	6.51	6.37	6.17	6.05
10 x 1.50	80	18	10.00	8.00	Plug	138-9448	6.51	6.37	6.17	6.05
12 x 1.75	89	22	9.00	7.10	Taper	138-9449	9.21	9.02	8.74	8.56

**Straight Flute Taps**



ISO 529  
**Tap tolerance**: Class 1,2 and 3  
**Chamfer thread number**: 1, 2 and 3  
**Cutting rake**: 7°  
**Flute geometry**: Straight flutes  
**Surface treatment**: Bright  
**Range**: 1/8 - 1in  
**Application**: For hand or machine tapping of through or blind holes.

495208

Size x Pitch (mm)	Cutter Overall Length (mm)	Flute Length (mm)	Shank Square A/F (mm)	Type	Order Code	Price Each	
1/8 x 28	9.728	59	15	8.0	Set 2	148-5393	16.10
1/8 x 28	9.728	59	15	8.0	Taper	138-9422	8.16
1/8 x 28	9.728	59	15	8.0	Second	138-9495	8.16
1/8 x 28	9.728	59	15	8.0	Plug	147-4166	8.06
1/4 x 19	13.157	67	19	10.0	Set 2	148-5394	22.24
1/4 x 19	13.157	67	19	10.0	Taper	138-9423	11.27
1/4 x 19	13.157	67	19	10.0	Second	147-7502	11.12
1/4 x 19	13.157	67	19	10.0	Plug	147-4167	11.12
3/8 x 19	16.662	75	21	12.5	Set 2	148-8969	33.88
3/8 x 19	16.662	75	21	12.5	Taper	147-4168	16.69
3/8 x 19	16.662	75	21	12.5	Plug	147-4171	16.94
1/2 x 14	20.955	87	26	16.0	Set 2	148-5395	46.35
1/2 x 14	20.955	87	26	16.0	Taper	147-4172	23.17
1/2 x 14	20.955	87	26	16.0	Second	147-7503	23.17
1/2 x 14	20.955	87	26	16.0	Plug	147-4173	23.17
3/4 x 14	26.441	96	28	20.0	Set 2	148-5396	64.98
3/4 x 14	26.441	96	28	20.0	Taper	147-4174	32.50
3/4 x 14	26.441	96	28	20.0	Second	147-7504	32.50
3/4 x 14	26.441	96	28	20.0	Plug	147-4175	32.50
1 x 11	33.249	109	33	25.0	Taper	147-4176	58.14
1 x 11	33.249	109	33	25.0	Second	147-7505	58.14
1 x 11	33.249	109	33	25.0	Plug	147-4177	80.27

**Taps Straight Flute**



ISO 2284  
**Tap tolerance**  
 In accordance with BS21  
**Chamfer thread number** 3  
**Cutting rake** 7°  
**Application**  
 For hand or machine tapping of through or blind holes.  
 Supplied singly.

493430

Size (in)	Pitch (mm)	Order Code	Price Each
1/8	28	150-6404	14.27
1/4	19	150-6405	15.23
1/2	14	150-6406	26.04

**Metric Fine Taps Straight Flute**



ISO 529  
**Tap tolerance**: Class 2 for 6H fit  
**Chamfer thread numbers**: 1,2 and 3  
**Cutting rake**: 7°

**Flute geometry**: Straight flutes  
**Surface treatment**: Bright  
**Range**: 4 - 20mm  
**Application**: For hand or machine tapping of through or blind holes.

493945

Size x Pitch (mm)	Overall Length (mm)	Flute Length (mm)	Shank Diameter (mm)	Square A/F (mm)	Type	Order Code	Price Each
3 x 0.35	48	12.5	3.15	2.5	Taper	148-5407	9.23
3 x 0.35	48	12.5	3.15	2.5	Second	148-5408	9.23
3 x 0.35	48	12.5	3.15	2.5	Plug	148-5409	9.23
4 x 0.50	53	14	4	3.15	Taper	148-5410	8.80
4 x 0.50	53	14	4	3.15	Second	148-5411	10.28
4 x 0.50	53	14	4	3.15	Plug	148-5413	9.23
5 x 0.50	58	11	5	4	Taper	148-5414	10.28
5 x 0.50	58	11	5	4	Second	148-5415	10.28
5 x 0.50	58	11	5	4	Plug	148-5417	9.23
6 x 0.75	66	13	6.3	5	Taper	148-5418	7.33
6 x 0.75	66	13	6.3	5	Second	148-5419	8.17
6 x 0.75	66	13	6.3	5	Plug	148-5420	7.33
8 x 1.00	72	16	8	6.3	Taper	148-5421	8.49

**Taps & Dies - continued**

**Metric Fine Taps Straight Flute - continued**

Size x Pitch (mm)	Overall Length (mm)	Flute Length (mm)	Shank Diameter (mm)	Square A/F (mm)	Type	Order Code	Price Each 1+
8 x 1.00	72	16	8	6.3	Second	148-5422	9.45
8 x 1.00	72	16	8	6.3	Plug	148-5423	8.49
10 x 1.00	80	18	10	8	Taper	148-8972	10.87
10 x 1.00	80	18	10	8	Second	148-5424	12.10
10 x 1.00	80	18	10	8	Plug	148-5425	10.87
10 x 1.25	80	18	10	8	Taper	148-5426	10.87
10 x 1.25	80	18	10	8	Second	148-5427	12.10
10 x 1.25	80	18	10	8	Plug	137-4247	11.83
12 x 1.00	89	22	9	7.1	Taper	148-5429	22.88
12 x 1.00	89	22	9	7.1	Second	148-5431	25.50
12 x 1.00	89	22	9	7.1	Plug	148-5432	22.88
12 x 1.25	89	22	9	7.1	Taper	148-5433	15.20
12 x 1.25	89	22	9	7.1	Second	148-5434	15.73
12 x 1.25	89	22	9	7.1	Plug	148-5435	15.20
12 x 1.50	89	22	9	7.1	Taper	148-5436	15.20
12 x 1.50	89	22	9	7.1	Second	148-5437	15.73
12 x 1.50	89	22	9	7.1	Plug	148-5438	15.20
14 x 1.50	95	24	11.2	9	Second	148-5439	17.54
16 x 1.50	102	24	12.5	10	Second	148-5357	19.67
18 x 1.50	112	29	14	11.2	Second	148-5440	27.28
20 x 1.50	112	29	14	11.2	Second	148-8965	33.10

**Metric Coarse Taps Straight Flute**



ISO 529  
**Tap tolerance:** Class 2 for 6H fit  
**Chamfer thread numbers:** 1, 2 and 3  
**Cutting rake:** 7°  
**Flute geometry:** Straight flutes  
**Surface treatment:** Bright  
**Range:** 2 - 30mm  
**Application:** For hand or machine tapping of through or blind holes.



493936

Size x Pitch (mm)	Overall Length (mm)	Flute Length (mm)	Shank Diameter (mm)	Square A/F (mm)	Type	Order Code	Price Each 1+
2 x 0.40	41	8	2.5	2	Set 3	138-9498	26.22
2.5 x 0.45	44.5	9.5	2.8	2.24	Set 3	138-9499	21.54
2.5 x 0.45	44.5	9.5	2.8	2.24	Taper	138-9424	7.19
2.5 x 0.45	44.5	9.5	2.8	2.24	Second	138-9425	7.19
2.5 x 0.45	44.5	9.5	2.8	2.24	Plug	138-9426	7.19
3 x 0.50	48	12.5	3.15	2.5	Set 3	138-9500	13.96
3 x 0.50	48	12.5	3.15	2.5	Taper	138-9428	4.67
3 x 0.50	48	12.5	3.15	2.5	Second	138-9429	4.67
3 x 0.50	48	12.5	3.15	2.5	Plug	138-9430	4.67
3.5 x 0.60	50	14	3.55	2.8	Taper	138-9431	5.34
3.5 x 0.60	50	14	3.55	2.8	Plug	138-9432	5.34
4 x 0.70	53	14	4	3.15	Set 3	138-9501	12.69
4 x 0.70	53	14	4	3.15	Taper	138-9433	4.23
4 x 0.70	53	14	4	3.15	Plug	138-9435	4.23
5 x 0.80	58	11	5	4	Set 3	138-9502	13.43
5 x 0.80	58	11	5	4	Taper	138-9436	4.49
5 x 0.80	58	11	5	4	Second	138-9437	4.49
5 x 0.80	58	11	5	4	Plug	138-9438	4.49
6 x 1.00	66	13	6.3	5	Set 3	138-9503	13.70
6 x 1.00	66	13	6.3	5	Taper	138-9441	4.57
6 x 1.00	66	13	6.3	5	Second	138-9442	4.57
6 x 1.00	66	13	6.3	5	Plug	138-9443	4.57
8 x 1.25	72	16	8	6.3	Set 3	137-4246	15.22
8 x 1.25	72	16	8	6.3	Taper	138-9444	5.08
8 x 1.25	72	16	8	6.3	Plug	138-9445	5.08
10 x 1.50	80	18	10.00	8.00	Taper	138-9446	6.51
10 x 1.50	80	18	10.00	8.00	Second	138-9447	6.51
10 x 1.50	80	18	10.00	8.00	Plug	138-9448	6.51
12 x 1.75	89	22	9.00	7.10	Taper	138-9449	9.21

**E600 HSS Metric Coarse Taps Long Shank Straight Flute**

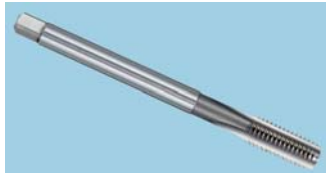

ISO 2283/8051  
**Tap tolerance**  
 Class 2 for 6H fit  
**Chamfer thread numbers**  
 1, 2 and 3  
**Cutting rake**  
 7°  
**Flute geometry**  
 Straight flutes

**Surface treatment**  
 Bright  
**Range**  
 3 - 16mm  
**Application**  
 For hand or machine tapping of through or blind holes in ferrous and non-ferrous alloys where a long reach is required.



493741

Size x Pitch (mm)	Overall Length (mm)	Flute Length (mm)	Shank Diameter (mm)	Square A/F (mm)	Type	Order Code	Price Each 1+
4 x 0.70	73	13	3.15	2.50	Second	022-117	16.53
4 x 0.70	73	13	3.15	2.50	Plug	022-118	18.50
5 x 0.80	79	16	4.00	3.15	Second	022-119	20.76
5 x 0.80	79	16	4.00	3.15	Plug	022-120	20.76
6 x 1.00	89	19	4.50	3.55	Second	022-121	17.83
6 x 1.00	89	19	4.50	3.55	Plug	022-122	17.96
8 x 1.25	97	22	6.30	5.00	Second	022-123	20.15
8 x 1.25	97	22	6.30	5.00	Plug	022-124	20.15
10 x 1.50	108	24	8.00	6.30	Second	022-125	23.35
10 x 1.50	108	24	8.00	6.30	Plug	022-126	23.35
12 x 1.75	119	29	9.00	7.10	Second	022-127	40.20
12 x 1.75	119	29	9.00	7.10	Plug	022-128	40.20

**Metric Standard Right Hand Cutting**



490915

Size x pitch (mm)	Type	Order Code	Price Each 1+	5+	10+	20+
2.0 x 0.4	Taper	147-2077	4.83	4.73	4.64	4.55
2.0 x 0.4	Second	147-2078	4.83	4.73	4.64	4.55
2.0 x 0.4	Plug	147-2079	4.97	4.86	4.76	4.67
2.5 x 0.45	Taper	147-2080	3.94	3.85	3.77	3.70
2.5 x 0.45	Second	147-2081	3.94	3.85	3.77	3.70
2.5 x 0.45	Plug	147-2083	3.94	3.85	3.77	3.70
3.0 x 0.5	Taper	150-6414	2.67	2.62	2.57	2.52
3.0 x 0.5	Second	150-6415	2.67	2.62	2.57	2.52
3.0 x 0.5	Plug	150-6416	2.67	2.62	2.57	2.52
3.5 x 0.6	Taper	147-2084	2.90	2.83	2.77	2.72
3.5 x 0.6	Second	147-2085	2.90	2.83	2.77	2.72
3.5 x 0.6	Plug	147-2086	3.08	3.02	2.96	2.91
4.0 x 0.7	Taper	147-2087	2.44	2.39	2.35	2.29
4.0 x 0.7	Second	147-2088	1.45	1.42	1.39	1.37
4.0 x 0.7	Plug	147-2089	2.44	2.39	2.35	2.29
5.0 x 0.8	Taper	147-2090	2.73	2.68	2.63	2.58
5.0 x 0.8	Second	147-2091	2.73	2.68	2.63	2.58
5.0 x 0.8	Plug	147-2092	2.73	2.68	2.63	2.58
6.0 x 1.0	Taper	147-2093	2.73	2.68	2.63	2.58
6.0 x 1.0	Second	147-2095	2.73	2.68	2.63	2.58
6.0 x 1.0	Plug	147-1822	2.73	2.68	2.63	2.58
7.0 x 1.0	Taper	147-1823	4.27	4.19	4.11	4.03
7.0 x 1.0	Second	147-1824	4.19	4.11	4.03	3.95
7.0 x 1.0	Plug	147-1825	4.27	4.19	4.11	4.03
8.0 x 1.25	Taper	147-1826	3.07	3.01	2.95	2.90
8.0 x 1.25	Second	147-1827	3.07	3.01	2.95	2.90
8.0 x 1.25	Plug	147-1828	3.07	3.01	2.95	2.90
9.0 x 1.25	Taper	147-1829	4.94	4.84	4.74	4.65
9.0 x 1.25	Second	147-1830	4.94	4.84	4.74	4.65
9.0 x 1.25	Plug	147-1832	4.94	4.84	4.74	4.65
10.0 x 1.5	Taper	147-1833	3.89	3.81	3.72	3.65
10.0 x 1.5	Second	147-1834	3.89	3.81	3.72	3.65
10.0 x 1.5	Plug	147-1835	3.89	3.81	3.72	3.65
11.0 x 1.5	Taper	147-1836	6.05	5.93	5.81	5.69
11.0 x 1.5	Second	147-1837	6.05	5.93	5.81	5.69
11.0 x 1.5	Plug	147-1838	6.05	5.93	5.81	5.69
12.0 x 1.75	Taper	147-1839	5.51	5.39	5.28	5.18
12.0 x 1.75	Second	147-1840	5.51	5.39	5.28	5.18
12.0 x 1.75	Plug	147-1841	5.51	5.39	5.28	5.18
14.0 x 2.0	Taper	147-1842	6.78	6.65	6.52	6.39
14.0 x 2.0	Second	147-1844	6.78	6.65	6.52	6.39
14.0 x 2.0	Plug	147-1845	6.77	6.64	6.51	6.38
16.0 x 2.0	Taper	147-1846	8.31	8.15	7.98	7.82
16.0 x 2.0	Second	147-1847	8.31	8.15	7.98	7.82
16.0 x 2.0	Plug	147-1848	8.31	8.15	7.98	7.82
18.0 x 2.5	Taper	147-1849	11.51	11.28	11.05	10.83
18.0 x 2.5	Second	147-1850	11.51	11.28	11.05	10.83
18.0 x 2.5	Plug	147-1851	11.51	11.28	11.05	10.83
20.0 x 2.5	Taper	147-1852	13.11	12.85	12.59	12.34
20.0 x 2.5	Second	147-1853	13.11	12.85	12.59	12.34
20.0 x 2.5	Plug	147-1854	13.11	12.85	12.59	12.34
24.0 x 3.0	Taper	147-1856	19.60	19.21	18.82	18.45
24.0 x 3.0	Second	147-1857	19.60	19.21	18.82	18.45
24.0 x 3.0	Plug	147-1858	19.60	19.21	18.82	18.45
27.0 x 3.0	Taper	147-1878	47.20	46.25	45.33	44.42
27.0 x 3.0	Second	147-1881	40.39	39.59	38.79	38.02
27.0 x 3.0	Plug	147-1882	40.39	39.59	38.79	38.02
30.0 x 3.5	Taper	147-1883	37.29	36.55	35.81	35.10
30.0 x 3.5	Second	147-1884	37.29	36.55	35.81	35.10
30.0 x 3.5	Plug	147-1885	37.29	36.55	35.81	35.10

**Dormer E550 HSSBSPT Taps Straight Flute**



ISO 2284  
**Tap tolerance**  
 In accordance with BS21  
**Chamfer thread number**  
 3  
**Cutting rake**  
 7°

**Flute geometry**  
 Straight flutes  
**Surface treatment**  
 Bright

**Range**  
 1/8 - 1in  
**Application**  
 For hand or machine tapping of through or blind holes.

491211

Size x pitch	Cutter diameter (mm)	Overall length (mm)	Flute length (mm)	Shank diameter A/F (mm)	Square (mm)	Order Code	Price Each	
							1+	5+
1/8 x 28	9.728	59	15	8.0	6.3	147-4178	19.44	19.05
1/4 x 19	13.157	67	19	10.0	8.0	147-4179	21.52	21.09
3/8 x 19	16.662	75	21	12.5	10.0	147-4180	37.06	36.32
1/2 x 14	20.955	87	26	16.0	12.5	147-4181	40.71	39.90
3/4 x 14	26.441	96	28	20.0	16.0	147-4183	56.20	55.07
1 x 11	33.249	109	33	25.0	20.0	147-4184	82.17	80.53

**HSS Hand Taps Metric Sets**

**Metric Standard**



Standard ISO 529. Straight flute.  
**Sets of three**  
 Comprising - 1 each taper, second and bottoming.

**Right Hand Cutting**

Size x Pitch (mm)	Order Code	Price Each			
		1+	5+	10+	20+
2.0 x 0.4	147-2052	14.44	14.15	13.87	13.59
2.5 x 0.45	147-2053	11.75	11.51	11.28	11.06
3.0 x 0.5	147-2054	7.97	7.81	7.66	7.50
3.5 x 0.6	147-2055	8.63	8.45	8.28	8.12
4.0 x 0.7	147-2056	7.24	7.10	6.95	6.81
5.0 x 0.8	147-2058	8.02	7.86	7.70	7.56
7.0 x 1.0	147-2060	12.54	12.28	12.04	11.80
9.0 x 1.25	147-2062	13.34	13.08	12.81	12.56
10.0 x 1.5	147-2063	11.56	11.33	11.10	10.88
11.0 x 1.5	147-2064	18.13	17.76	17.41	17.05
12.0 x 1.75	147-2065	17.26	16.92	16.58	16.24
14.0 x 2.0	147-2066	20.26	19.85	19.45	19.07
16.0 x 2.0	147-2067	24.87	24.37	23.88	23.40
18.0 x 2.5	147-2068	36.15	35.43	34.71	34.02
20.0 x 2.5	147-2071	41.04	40.21	39.41	38.62
24.0 x 3.0	147-2072	58.68	57.51	56.36	55.22

**Left Hand Cutting**

491415

Size x Pitch (mm)	Order Code	Price Each			
		1+	5+	10+	20+
3.0 x 0.5	147-2118	29.51	28.92	28.34	27.78
4.0 x 0.7	147-2119	26.55	26.02	25.50	24.99
5.0 x 0.8	147-2120	28.74	28.17	27.61	27.06
6.0 x 1.0	147-2121	29.56	28.97	28.39	27.83
8.0 x 1.25	147-2122	32.09	31.45	30.81	30.20
10.0 x 1.50	147-2123	42.82	41.96	41.13	40.30

**HSS Hand Taps Metric**

**Metric Fine**

Standard ISO 529. Straight flute.  
**Sets of three**  
 Comprising - 1 each taper, second and bottoming.

492349

Size x Pitch (mm)	Order Code	Price Each			
		1+	5+	10+	20+
3.0 x 0.35	147-2096	14.84	14.54	14.25	13.96
4.0 x 0.5	147-2097	14.84	14.54	14.25	13.96
5.0 x 0.5	147-2098	14.84	14.54	14.25	13.96
6.0 x 0.75	147-2099	14.84	14.54	14.25	13.96
8.0 x 1.0	147-2101	15.63	15.31	15.01	14.71
10.0 x 1.0	147-2102	20.62	20.21	19.81	19.40
10.0 x 1.25	147-2103	20.62	20.21	19.81	19.40
12.0 x 1.0	147-2104	41.96	41.12	40.30	39.49
12.0 x 1.25	147-2105	27.34	26.79	26.26	25.74
12.0 x 1.5	147-2106	27.34	26.79	26.26	25.74
14.0 x 1.25	147-2107	21.35	20.92	20.50	20.09
14.0 x 1.5	147-2108	31.11	30.49	29.88	29.27
16.0 x 1.5	147-2109	33.29	32.63	31.98	31.33
18.0 x 1.5	147-2110	46.47	45.54	44.64	43.74

Size x Pitch (mm)	Order Code	Price Each			
		1+	5+	10+	20+
20.0 x 1.5	147-2111	39.26	38.47	37.70	36.95
20.0 x 2.0	147-2113	49.30	48.31	47.36	46.40
22.0 x 1.5	147-2114	44.74	43.85	42.97	42.11
24.0 x 1.5	147-2115	63.78	62.50	61.25	60.03
24.0 x 2.0	147-2116	54.39	53.31	52.23	51.19

**HSS Metric Coarse Taps Spiral Point**



492533

Size x Pitch (mm)	Order Code	Price Each			
		1+	5+	10+	20+
2 x 0.4	147-1859	7.12	6.97	6.83	6.70
2.5 x 0.45	147-1860	5.82	5.71	5.60	5.49
3 x 0.5	147-1861	4.06	3.98	3.91	3.82
3.5 x 0.6	147-1862	4.34	4.25	4.16	4.08
4 x 0.7	147-1863	3.61	3.54	3.47	3.41
5 x 0.8	147-1864	3.83	3.75	3.67	3.60
6 x 1.0	147-1865	3.89	3.81	3.72	3.65
8 x 1.25	147-1866	4.53	4.44	4.35	4.25
10 x 1.5	147-1868	5.62	5.51	5.40	5.28
12 x 1.75	147-1869	7.84	7.69	7.54	7.39
14 x 2.0	147-1870	9.55	9.36	9.18	8.99
16 x 2.0	147-1871	11.78	11.54	11.31	11.08
18 x 2.5	147-1872	16.76	16.42	16.10	15.77
20 x 2.5	147-1873	19.42	19.04	18.66	18.28
24 x 3.0	147-1874	28.53	27.96	27.40	26.86

**Malleable Tap Wrenches**



493855

Model	Capacity (in)	(mm)	Order Code	Price Each
				1+
0	1/16 - 1/4	1 - 6	147-1887	8.79
1	1/32 - 3/8	1 - 8	147-1888	8.91
1 1/2	1/32 - 1/2	1 - 12	147-1889	10.52
2	5/32 - 1/2	4 - 12	147-1890	14.42
3	7/32 - 3/4	5 - 20	147-1891	22.23
4	7/16 - 1	11 - 24	147-1893	32.29
5	1/2 - 1 1/4	13 - 32	147-1894	42.45

**Adjustable Ball Tap Wrenches DIN 1814**



45



Ideal for thread-cutting in inaccessible places. With two-jaw chuck for tensioning square shanks. With steel handles one of which can be unscrewed.

Version: die-cast zinc housing  
 Chuck jaws: hardened  
 Packing unit: individual plastic pack

Anchor Hole Mfrs. Part No.	Thread	Fastens Material for
241100	0	M1 - M8
241101	1	M1 - M10
241112	1 1/2	M1 - M12
241102	2	M3,5 - M12

240627

Mfrs. Part No.	Order Code	Price Each		
		1+	5+	10+
241 100	376-050	3.75	3.40	3.15
241 101	376-139	3.99	3.09	2.68
241 112	376-140	4.59	4.41	4.10
241 102	376-220	5.85	5.40	4.90

**Tap Wrench With Ratchet**



- Version: adjustable left, right, fixed
- Shank: Sliding cross-handle with grooves at both ends
- Surface: chrome-plated

**Taps & Dies - continued**

**Tap Wrench With Ratchet - continued**

Mfrs. Part No.	Size	for hand taps	Length
241001	1	M3-M10	85
241002	2	M5-M12	100
241010	10	M3-M10	250
241020	20	M5-M12	300

240634

Mfrs. Part No.	Order Code	Price Each		
		1+	5+	10+
241001	<b>376-395</b>	7.05	6.75	6.40
241002	<b>376-425</b>	8.90	8.30	7.95
241010	<b>376-541</b>	13.86	13.20	12.44
241020	<b>376-553</b>	18.09	16.77	15.70

**Ratchet Long Reach**



Collet type with forward/lock/reverse operation ratchet. Ideal for use in difficult areas. Plated finish

493640

Model	Capacity (in)	Length (mm)	Price Each			
			Order Code	1+	5+	10+
10	1/8 - 1/4	3 - 6	<b>147-1904</b>	15.17	14.87	14.57
20	1/4 - 1/2	6 - 12	<b>147-1905</b>	20.06	19.66	19.27

**Hand Reamer Spiral Flutes**



DIN 206 B/BS 328  
Flute geometry  
6° Left hand spiral  
Bevel lead  
45° a side



**Taper lead**

2° Included Angle and length 1 1/2in x Diameter or 19mm Maximum

**Surface treatment**

Blue Flutes, Bright Lands

**Range**

3 - 30mm, 1/2 - 1in

**Metric**

Ø(mm)	Overall Length(mm)	Flute Length(mm)	No Of Flutes	Order Code	Price Each	
					1+	5+
4.00	76	38	6	<b>138-9470</b>	10.20	
5.00	87	44	6	<b>138-9471</b>	10.78	
6.00	93	47	6	<b>137-4245</b>	11.36	
8.00	115	58	6	<b>138-9472</b>	12.94	
10.00	133	66	6	<b>138-9473</b>	15.17	

**Fractional**

493918

Ø(in)	Overall Length(mm)	Flute Length(mm)	No. Of Flutes	Order Code	Price Each	
					1+	5+
1/16	52	21	3	<b>138-9468</b>	23.20	
1/4	100	50	6	<b>138-9469</b>	11.25	

**B101 HSS Morse Taper Shank Machine Reamer Spiral Flute**



ISO/BS 328  
Flute geometry  
6° Left hand spiral  
Bevel lead  
45° a side  
Surface treatment  
Blue flutes, bright lands  
Range  
3 - 30mm, 1/8 - 1 1/4in

**Application**

For finishing existing holes to H7 tolerance in most ferrous and non-ferrous materials.

**Metric**

Size (mm)	Overall Length (mm)	Flute Length (mm)	Morse Taper	Order Code	Price Each	
					1+	5+
3.00	105	31	1	<b>025-524</b>	19.05	
4.00	106	33	1	<b>025-526</b>	14.34	
5.00	119	44	1	<b>025-528</b>	15.01	
6.00	15	47	1	<b>025-530</b>	15.46	
6.50	130	50	1	<b>025-531</b>	27.00	
7.00	134	54	1	<b>025-532</b>	19.80	
8.00	138	58	1	<b>025-534</b>	16.08	
10.00	146	66	1	<b>025-538</b>	18.35	
11.00	151	71	1	<b>025-540</b>	18.61	
12.00	156	76	1	<b>025-542</b>	19.80	
13.00	156	76	1	<b>025-544</b>	19.70	
14.00	161	81	1	<b>025-546</b>	22.10	
15.00	181	81	2	<b>025-548</b>	24.28	

Size (mm)	Overall Length (mm)	Flute Length (mm)	Morse Taper	Order Code	Price Each	
					1+	5+
16.00	187	87	2	<b>025-550</b>	24.38	
17.00	187	87	2	<b>025-552</b>	32.75	
18.00	193	93	2	<b>025-554</b>	27.63	
20.00	200	100	2	<b>025-558</b>	34.90	
30.00	251	124	3	<b>025-573</b>	89.70	

**Fractional**

492566

Size (in)	Overall Length (mm)	Flute Length (mm)	Morse Taper	Order Code	Price Each	
					1+	5+
3/8	146	66	1	<b>025-471</b>	18.35	

**Re-Threading Tool**



For cleaning and recutting damaged or badly formed threads in socket boxes

- Manufactured from high speed steel and precision ground for a clean cut
- Impact resistant handle

494990.471162

Mfrs. List No.	Pitch	Blade Length	Size	Order Code	Price Each			
					1+	5+	10+	20+
495028	0.6mm	50 mm	M3.5	<b>151-8901</b>	4.47	4.33	4.19	4.07
495029	0.7mm	50 mm	M4	<b>151-8903</b>	4.47	4.33	4.19	4.07

**Inspection**

**32mm Telescopic Inspection Mirror**



- Chrome finish telescopic shaft with pocket clip
- Extends from 125mm (5") to 463mm (18 1/2")
- Diameter: 32mm (1-1/4")

48926.453014

Order Code	Price Each			
	1+	5+	10+	20+
<b>136-1385</b>	1.59	1.37	1.27	1.19

**Dental Mirror**



The mirror is set into stainless steel mounts with anodised aluminium handles. A universal balljoint allows the mirror to be easily adjusted to the required angle.

494545

Type	Order Code	Price Each	
		1+	5+
Magnifying	<b>270-341</b>	15.82	

**Inspection Mirror**



- Chrome finish telescopic shaft
- Non slip cushion grip handle
- Extends from 350mm (14") to 750mm (30")
- Mirror size: 50mm (2") x 100mm (4")

482101.453145

Order Code	Price Each				
	1+	5+	10+	20+	50+
<b>144-7565</b>	1.85	1.63	1.48	1.39	1.24

Over 480,000 products online



45

Farnell



Inspection Mirrors

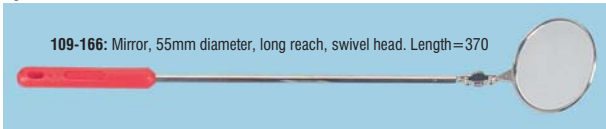

109-166: Mirror, 55mm diameter, long reach, swivel head. Length=370

- Inspection of components and mechanisms in awkward places

222716

	Order Code	Price Each
55mm mirror, long reach, swivel head, insulated handle	109-166	6.41

Long Reach Mirror



- High quality glass lens mirror 30mm diameter
- Flat, No.8 lens
- Heavy duty knurled black anodised aluminium handle 235mm long
- Lockable articulated ball joint offers easy adjustment of the mirror angle

494102

Mfrs. List No.	Order Code	1+	5+	10+	20+
187-0094	151-8522	13.16	12.90	12.63	12.49

Insulated Dental Mirror



- Fully insulated handle and head
- Allows safe inspection of inaccessible areas of equipment carrying low voltages
- Overall length 170mm

494076

Mfrs. List No.	Length	Size	Order Code	1+	5+	10+	20+
187-0043	170mm	No4	151-8514	10.59	10.38	10.16	10.06
187-0064	170mm	No6	151-8517	10.81	10.59	10.37	10.27
187-0065	170mm	No8	151-8518	10.81	10.59	10.37	10.27

Inspection Mirrors



152-3383



- Small mirrors designed for optical inspection of the hidden corners or of the bottom side of components on boards.
- Typical application is the verification of solder joints and contacts
- Designed for usage in connection with illuminated lenses and magnifiers
- 152-3383: Kit with handle and 1 Square mirror-probe (9.50 mm) straight needle, Side Small rectangular mirror-probe (9.5 x 3.00 mm) 45° angled needle, T-Large rectangular mirror-probe(19.00 x 5.00 mm) 45° angled needle
- 152-3384: Kit with handle and 1 Square mirror-probe (9.50 mm) straight needle
- 152-3385: Kit with handle and Side Small rectangular mirror-probe (9.5 x 3.0 mm) 45° angled needle
- 152-3386: Kit with handle and T-Large rectangular mirror-probe (19.0 x 5.0mm) 45° angled needle

496590

Mfrs List No.	Order Code	1+	3+
EMR HT	152-3383	132.40	125.77
EMR2001001	152-3384	66.86	63.55
EMR2001002	152-3385	66.86	63.55
EMR2001013	152-3386	66.86	63.55

Eye Magnifiers



- Inspection eye magnifiers
- Lens holder is made from a semi-rigid plastic
- Lens is made from a high quality scratch resistant optical grade polymer
- x7 and x4 magnification but can be piggy-backed to give x28

L=32, Dia.=43

221178



	Mfrs. List No.	Order Code	Price Each
x 4	5404	201-870	1+
x 7	5408	201-881	5.07
			5.07

Loupe Style



- x3 magnification Loupe style magnifier
- Designed to give optimum magnification, with low distortion at the focal plane

H=30, W=59, D=49



221176

Mfrs. List No.	Order Code	Price Each
21558	108-339	1+
		6.68

Focal Plane Magnifier



- Magnifier for inspecting flat surfaces such as unpopulated PCBs, print quality or fabric structure
- The lens has x1.7 magnification and is a simple hemisphere made of acrylic

H=30, Dia.=50

221175

Mfrs. List No.	Order Code	Price Each
5850	267-260	1+
		16.01

High Power, Round



- 50mm x6 magnification bi-aspheric lens of exceptional quality
- Ideal for inspection of PCB soldering. Supplied with a protective pouch

L=135, Lens dia.=50

221174

Mfrs. List No.	Order Code	Price Each
5206	267-259	1+
		25.31

Spectacle, Clip On Magnifier



- Magnifier is designed to clip onto a pair of spectacles
- Can be flipped up out of the line of sight
- Held in place on the spectacle lens by a pair of clips with soft plastic covers
- A high quality optical polymer which is scratch resistant

H=50, W=35, D=11

221180

	Mfrs. List No.	Order Code	Price Each
x2.5	5328	201-893	1+
x3.5	5329	201-900	20.78
x4.75	5330	201-911	20.66
			23.86

Magnifiers



468-1680



468-1691



468-1708



- plastic housing
- lenses Ø: 24 mm
- exceptional quality

Inspection - continued

Magnifiers - continued

Mfrs. List No.	Description	Dimensions mm
802.01 10X	Magnifier 10X, with scale in mm	45 x 30 x 40
812.01 8X	Magnifier 8X	36 x 36 x 45
818.01 8X	Magnifier 8X, wide visible area, with scale in mm	45 x 50 x 45

334131

Mfrs. List No. / magnification	Price Each			
	1+	5+	10+	
802.01 10X	468-1680	13.62	13.16	12.75
812.01 8X	468-1691	6.66	6.33	6.00
818.01 8X	468-1708	9.52	9.05	8.57

Standard Round Magnifier



- ABS plastic magnifier with a 75mm Ø acrylic lens
- Main lens gives a x2 magnification with an inset giving a x4 magnification

445901

Mfrs List No.	Order Code	Price Each	
		1+	5+
1130P	126-7537	7.09	6.68

Handheld Metal Magnifier with LEDs



- Up to 12 LED lights with high-quality illumination
- Lighting adjustable, min. 6 and max. 12 LEDs
- Quality 88mm optical glass lens

- Durable, zinc alloy handle
- Easy to transport and store
- Protective case is included
- Batteries (1.5V x 2 AA), to be ordered separately



525713

Description	Mfrs. List No.	Order Code	Price Each		
			1+	5+	10+
Handheld Metal Magnifier with LEDs	MA-017	166-6223	20.40	19.37	18.35
Battery 1.5V x 2AA	V4006	304-1761	0.58	0.52	0.48

Work Magnifier



- Magnification of x 1.7 and can be adjusted to suit the user
- Made from optical grade acrylic

H=205, W=170, D=18

221188

Mfrs. List No.	Order Code	Price Each	
		1+	19.31
5820	267-272		

700 products added online every week



See our pick of the hottest products and latest technologies in 'What's New?' at [www.farnell.co.uk](http://www.farnell.co.uk)



Magnifier With 2 Arms



- Rimless Optical Lens Magnifier with Detail Inset
- Sturdy Alloy Clamp with Protective Coated Clip holds Magnifier firmly
- Stands on Desk or Tabletop with Legs Pulled Out
- Flexible Goose Neck adjusts to any position
- 2 LED Lights can also be used as a Reading Light

525718

Description	Mfrs. List No.	Order Code	Price Each		
			1+	5+	10+
Two-Arms Clip/Stand Magnifier	MA-018	166-6224	20.40	19.37	18.35

PCB Inspection Magnifiers



- Integral metric/imperial graticule for direct measurement of the object
- Acrylic lens and body
- base cover incorporates 35mm film negative and 35mm slide viewing apertures

Type	Lens Dia	Base Dia	Height (Angled)
8X	24mm	74mm	48 - 60mm
5X	24mm	74mm	67 - 80mm
Graticule (5x and 8x)	56g	56g	56g

494021

Mfrs. List No.	Type	Order Code	Price Each			
			1+	5+	10+	20+
187-0007	8 x	151-8506	22.35	21.90	21.46	21.23
187-0014	5 x	151-8507	17.95	17.59	17.23	17.05

Measuring Magnifier



- A focusable x10 magnifier, equipped with a 1cm scale divided into 0.1mm graduations
- Suitable for measuring flat surface features

H=40, W=45, D=35

221181

Order Code	Price Each	
	1+	14.69
201-960		

Inspection/Measurement Magnifier



- An ideal inspection tool for quality control
- Eye lens can be focused to accommodate sight irregularities and the focus setting locked if desired
- Base allows light onto the inspection area
- The field of view is 25mm
- Graticules can be mounted in the base ring
- 0 to 25mm centre zero divided down to 0.1mm

H=57, Dia=40

221182

Magnifier	Mfrs. List No.	Order Code	Price Each	
			1+	50.17
0 - 25mm graticule	MAG6	456-962	96.80	
	M6T1	456-974	50.17	

Pocket Magnifiers



- Handy instrument for localised magnification
- Ideal for use in the printing industry

230743

Magnification	Order Code	Price Each	
		1+	124.00
25x(slim type)	322-8629	56.50	
50x	322-8642	124.00	



**Monocular Measurement Microscope**



- x20 magnification monocular measuring microscope
- 4mm measuring eye piece divided into 0.02mm
- Light weight but robust construction make it ideal for inspection and measurement
- Works well in normal lighting, but fitted with a penlight torch illumination

H = 163  
Dia. = 50

221184

Mfrs. List No.	Order Code	Price Each
P821	456-949	388.93

**PCB Through Hole Inspection**



- Maxta PCB through-hole microscope for critical inspection of plated through holes in printed circuit boards
- Inspector has a view of the complete hole, the image is distorted to a bucket (truncated cone) shape
- Should be used in conjunction with a light box
- Faults can be quickly identified such as voids, drill damage, burrs, de-wetting etc.
- Suitable for use on holes 0.5 to 3mm in diameter on boards up to 3mm thick

H=215, Dia.=50

221186

Mfrs. List No.	Order Code	Price Each
P875	456-950	420.02

**Monocular Measurement Microscope**



- Lightweight microscope capable of measuring linear and depth dimensions
- Fitted with a measuring graticule for linear dimensions and the focusing mechanism is graduated for depth measurement
- The microscope is supported on a transparent perspex skirt

H=125, W=40, D=40

Magnification	Linear Measurement	Depth Measurement	Mfrs. List No.	Order Code
50	0.02 mm	0.1 mm	2008-50	201-947

221185

	Order Code	Price Each
x 50	201-947	167.03

**Refractometer**



- Provides accurate read out (strength/mix ratio) of water mix cutting and grinding fluids

494282

Product Number	Order Code	Price Each
52060	360-001	211.73

**Stereo Microscopes**



- High quality stereo microscopes for surface inspection

**Stereo Standard**

- Supplied with 2x and 4x objectives and 10x eye piece, top illumination
- Objectives are mounted on a revolving turret with a positive click stop
- Adjustable eyepieces are set at 45°
- positive rack and pinion focussing

**Stereo Deluxe**

- As above with top, bottom or both lighting options
- Eyepiece turret rotates through 360°

221154

**Stereo Zoom**

- 10x magnification lens, 0.65-4.5x stereo objective gives 6.5x45x variable magnification
- Incidental and transmitted light, working distance 95mm

	Mfrs. List No.	Order Code	Price Each
Stereo Standard	59-020-040	722-2294	215.70
Stereo Deluxe	59-020-060	722-2300	260.81
Stereo Zoom	59-020-200	722-2312	545.85
12V 10W Halogen		321-5090	7.15
6V 15W Bulb		321-5120	16.90

**Microscope Accessories**

- Range of lenses suitable for use with the microscopes listed above

221156

Mfrs. List No.	Description	Order Code	Price Each
59-020-042	Eyepiece 20x for	722-2348	1+
59-020-045	Eyepiece 10x metric scale	722-2350	21.55
59-020-046	Magnification Lens 16x	722-2361	64.87

**Microscope 30X**



- Give unparalleled sharp and brilliant vision with wide field of view with 30X magnification
- Unique built-in light and easy focusing system
- Uses two standard 1.5 V batteries (not included)
- A must for inspection of PC boards and miniature parts

334128, 386294

Microscope	Magnification	Orde Code	1+	Price Each	5+	10+
	30X	468-1678	25.87	24.58		23.29

**Digital Microscope with Rack**



Digital Microscope with Rack AMITA



Rack AM35B



Digital Microscope

- Practical Uses
- Quality control in industrial field
- After-Sales Services
- Technical teleconferences
- Research and science

Studied and designed for a professional use, this digital very compact microscope allows the users all high standard shootings (pictures and videos) even in real time and has a zoom feature that may magnify a picture up to 200 x. Measurements features such as lines, angles, diameters and radius, calibration as well are, on top of the normal features, a plus this small portable microscope may offer.

523231

Description	Mfrs. List No.	Order Code	1+	3+	5+	Price Each
Digital Microscope with rack AMITA	413T-A	164-0612	299.00	289.00	279.00	
Rack	AM35B	164-0613	115.00	109.00	99.00	

45



**Calipers**

**150mm Digital Caliper**



- LCD, internal/external measurement
- True mm/inch conversion
- Thumb roll for fine adjustment
- Supplied in fitted case with spare battery

Measuring Capacity 150mm (6") Graduation 0.01mm  
452821.423831

Order Code	Price Each		
	1+	5+	5+
131-5135 ●	21.32	19.22	

**Carbon Fibre Digital Caliper**



- Manufactured from extra strong carbon fibre composites
- LCD, internal/external measurement
- True mm/inch conversion
- Lightweight and durable

Measuring Capacity 150mm0- (6")  
Graduation 0.1mm

462357.462354

Order Code	Price Each			
	1+	5+	10+	20+
134-1278	10.11	9.59	8.96	8.22

**Digital Plastic Calliper**



762-3607



762-3615



762-3623

- Non-metallic high-tec material with 60% fibre-glass content, extremely high rigidity. Is used, for example, as replacement for metal die-casting alloys
- Extremely wear-resistant measuring jaw for precise measurements in the long-term
- Non-corrosive, non-magnetic, hardly conductive and electrically insulated
- Resistant to chemicals (organic solvents, alkalis, petrol, oil, grease, etc.)
- Materials fulfil EU guidelines for contact with food
- Thermal stability of the measuring surfaces: short-term up to 180°C, continuous 100-120°C
- Practical ratchet guarantees uniform clamping force of the measuring jaw
- Unlike metallic callipers, prevents damage to delicate surfaces

345775

Description	Measuring Range, max.	Order Code	Price Each		
			1+	5+	10+
digitMax	150	762-3607	55.95	50.87	46.64
dialMax	150	762-3615	17.59	15.99	14.67
caliMax	150	762-3623	12.70	11.55	10.58

**Digital Calipers**

Metric/Imperial

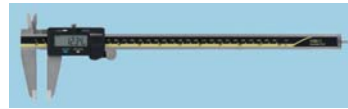

- The most advanced caliper yet
- ABSolute Zero setting function
- Zero point at any position, deviation from a nominal (±) can be read directly

- Non-contact linear measuring system unaffected by electrical or magnetic interference
- Manufactured from fully-hardened stainless steel
- Imperial/metric switchable
- Automatic wear compensation
- Fully portable
- Positive locking clamp
- Operating temp. range 0-40°C
- Oil and dust-resistant - suitable for workshop use
- Data output, absolute and incremental operation modes incorporated into **715-5633**

This is the latest version of the digimatic caliper in the 500 series. It has all the features of its predecessor with the addition of absolute zero origin point set anywhere within the measuring range, larger clearer display, single chip electronics and a new slim profile. For outside, inside, depth and step measurements.

221151

Range	Resolution	Mfrs. List No.	Order Code	1+	3+	12+
150mm/8"	0.01mm/0.0005"	500-171-21	559-507	124.00	117.80	102.48
200mm/8"	0.01mm/0.0005"	500-172-21	715-5633	153.00	--	--
300mm/12"	0.01mm / 0.0005"	500-173.	166-7281	285.00	269.00	--

**Electronic Digital Calipers**



Digimatic Caliper With Absolute™ Encoder



The Absolute™ MyCal E-Z allows direct measurement from power on. You can forget the time consuming origin setup which otherwise is required each time the power is turned on. Large .295" high LCD digits allows measurement results to be at a glance.

491486

Measuring Range	Resolution	Order Code	Price Each		
			1+	3+	12+
0-6"/0-150mm		152-1216	84.25		

**Digital Caliper**

Metric/Imperial



- Large LCD display
- Imperial/Metric conversion
- Origin Setting
- Zero setting/ABSolute Feature
- Data hold available (optional switch required)
- Data output
- Lock nut
- Measurement applications: Large external and internal jaw capacity caliper with SPC data output

525729

Range	Resolution	Mfrs. List No.	Order Code	1+	3+	+
450mm/18"	0.01mm / 0.0005"	500-505-10.	166-7283	489.00	459.00	--

**Digital Caliper**

Metric/Imperial



- Water, Oil, Dust, Coolant and Submersion resistance (on IP67 model)
- Imperial/Metric conversion
- Large LCD Display
- Origin Setting
- ABSolute feature
- Error free with no overspeed error
- Auto power on/off
- Incorporates Quadri Feature
- Lock Nut
- Thumb Roller

525800

Range	Resolution	Mfrs. List No.	Order Code	1+	3+	+
150mm/6"	0.01mm (0.0005")	500-752-10	166-7284	95.00	90.25	--

**Digital Caliper**  
Metric/Imperial

Mitutoyo

New



- Water, Oil, Dust, Coolant and Submersion resistance (on IP67 model)
- Data Output
- Imperial/Metric conversion
- Large LCD Display
- Origin Setting
- ABSolute feature
- Error free with no overspeed error
- Auto power on/off
- Incorporates Quadri Feature
- Lock Nut
- Thumb Roller
- Measurement applications: Superb resistance to Water, Oil, Dust and Coolant, making it ideal for tough workshop applications

525801

Range	Resolution	Mfrs. List No.	Order Code	1+	3+	+
150mm/6"	0.01 mm (0.0005")	500-762-10	<b>166-7285</b>	128.00	119.95	--

**Digital Calipers**

MAHR



- Functions include: ON/OFF, reset, mm/inch
- High contrast 7.5mm LCD display
- Slide and beam made of stainless steel, hardened
- Suitable for depth, inside and step measurement
- Locking screw
- Supplied in carry case

Measuring Range	Resolution	Error Limit (DIN 862)
150(6")	0.01(0.0005")	0.03(0.0015")

230927

	Order Code	Price Each
caliper (no data output)	<b>324-1040</b>	102.14

**Digimatic Caliper**



Digimatic caliper suitable for general use. Features include instant mm/in conversion, zero in any position

491006

Capacity (mm)	(in)	Resolution	Accuracy	Order Code	Price Each
150	6	0.01mm/0.0005in	±0.03mm	<b>147-1323</b>	37.32

**Precision Tools**



**Digital Workshop Caliper**



Large 7.5mm character height digital display, Accuracy : 0.02mm, Repeatability : 0.01mm, Functions : mm/in conversion, on/off, zero setting, low battery indicator, DIN862 specification.

488957

Model	Capacity	Order Code	1+	5+	10+	20+
M11015DDL	0-150mm/6in	<b>137-6783</b>	40.48	37.58	35.08	32.89
M11020DDL	0-200mm/8in	<b>137-6784</b>	69.46	64.49	60.20	57.51
M11030DDL	0-300mm/12in	<b>137-6785</b>	114.76	106.56	99.45	93.24

**Caliper**

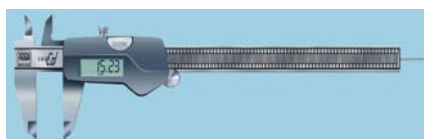

**TESA Shopcal Caliper**  
0-150 mm measuring range. Metric/Inch conversion. Thumbwheel as standard. ABSolute/Incremental functions. 0.01mm/0.0005in resolution. Single button operation. Large 7mm easy to read display. Certificate of conformity..

494623

Description	Order Code	Price Each
TESA SHOPCAL 150mm	<b>101-1811</b>	65.92

**CAL IP67 Coolant Proof Caliper**

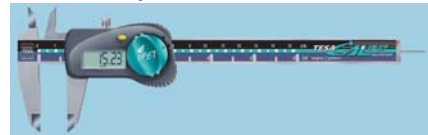

"The world's first caliper with 100% protection against oil, coolant, and dust" 100% protection against oil, coolant and dust. Patented magnetic scale. 0-150 mm measuring range. 0.01mm/0.0005in resolution. 7mm LCD display. Metric - Inch conversion. With thumbwheel. Swiss-made precision and high quality construction.

494235

Description	Order Code	Price Each
TESA CAL ip67 150mm without wheel	<b>101-1812</b>	109.90
TESA CAL IP67 150mm with wheel	<b>101-1813</b>	100.84
TESA CAL IP67 200mm with wheel	<b>101-1814</b>	168.40

**Heavy Duty Vernier Caliper**

Mitutoyo

Metric/Imperial

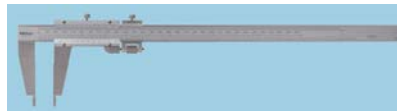

New

- Clear graduations on satin chrome finish
- Beam and slide made of hardened stainless steel
- Thumb wheel and locknut
- Heavy duty vernier caliper
- Fine adjustment
- Round-faced jaws for measuring inside dimensions

525806

Range	Resolution	Mfrs. List No.	Order Code	1+	3+	+
600mm/24"	0.02mm / 0.001"	160-103.	<b>166-7288</b>	319.00	299.00	--

**Vernier calipers**

Mitutoyo



- Plain and basic design
- Can measure OD (outside diameter), ID (inside diameter), depth and steps
- The small vernier face angle (14°) provides easy reading
- Carbide-tipped jaw type calipers are also available
- With depth gauge
- Measuring surface and nonius satin chrome finished
- Reading: 0,02 mm
- Supplied with a holster

477874

Range	Jaw length	Mfrs List No.	Order Code	1+	5+	10+
0-150mm	40mm	530-122	<b>441-5759</b>	19.47	19.00	18.56
0-200mm	50mm	530-123	<b>441-5760</b>	32.72	31.96	31.23
0-150mm	40mm	530-104	<b>441-5772</b>	35.40	33.65	32.91
0-200mm	50mm	530-114	<b>441-5784</b>	45.70	44.64	43.61

**Type Caliper**

Mitutoyo

Series 530



Standard type caliper for general purpose external, internal, depth and step measurements.

491204

Measuring range (mm)	(in)	Resolution	Accuracy	Jaw length	Order Code	Price Each
0-150	0-6	0.02mm/0.001in	±0.03mm/±0.0015"	40mm	<b>715-6080</b>	35.40
0-200	0-8	0.02mm/0.001in	±0.03mm/±0.0015"	50mm	<b>715-6091</b>	50.90
0-300	0-12	0.02mm/0.001in	±0.04mm/±0.002"	64mm	<b>321-6299</b>	139.00

Calipers - continued

Vernier Calipers

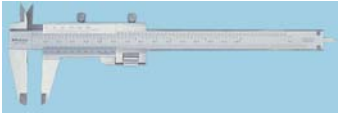

- Design accommodates external, internal, depth, and step measurements
- Range of high quality instruments with metric and imperial scales

221227

Maximum Measurement	Mfrs. List No.	Order Code	1+	3+	6+
150mm (6")	531128	715-5890	36.95	35.10	33.80
180mm (7")	532120	457-358	59.60	56.60	53.26

Vernier Calipers



- Vernier and main scale with satin chrome finish for glare free reading
- Slide and beam made of hardened stainless steel
- Locking screw on top
- Raised sliding surfaces for protection of the scale
- Measuring blades for inside measurement

- Step measuring function
- Supplied in plastic case

Measuring Range	Readings	Error Limit (DIN 862)
150mm/6"	mm/1/128"	0.05mm

230917

Order Code	Price Each
324-1063	39.42

Dial Caliper



Metric



- Wear resistant and easy moving
- High precision
- Easy to read
- Made from stainless steel
- High precision jewelled bearing mechanism

- Clear graduations on satin chrome finish
- Thumb wheel and locknut
- Incorporates Quadri feature

525807

Range	Graduation	Accuracy	Mfrs. List No.	Order Code	1+	3+	12+
0-150mm	0.02mm	±0.03mm	505-671	715-6121	60.595	59.186	56.556
0-200mm	0.02mm	±0.03mm	505-672	166-7290	109.000	103.550	--
0-300mm	0.02mm	±0.04mm	505-673	166-7291	186.000	176.700	--

45

Vernier Depth Gauge



Metric



- Measures the depth of bores, recesses and steps
- Main and vernier scales satin chrome plated
- The measuring faces and guideways are hardened and micro-lap finished
- Stainless
- Standard model
- Fine adjustment
- Clear graduations on satin chrome finish



525803

Range	Resolution	Mfrs. List No.	Order Code	1+	3+	+
0-150mm	0.02mm/0.001"	527-101	166-7286	75.55	71.75	--
0-300mm	0.02 mm/0.001"	527-103	166-7289	115.00	109.00	--

Digimatic Depth Gauge

Metric/Imperial



- One-time settings of origin that holds until the battery is changed or the origin point is reset
- Guaranteed precision even with high speed movements
- Large-digit display for easy reading
- Rustless, hardened and lapped measuring faces
- Imperial/Metric conversion
- Zero setting/ABSolute feature
- ABSolute feature allows caliper to retain origin setting even when switched off
- Error free with no overspeed error
- Data hold available (optional switch required)
- Data output
- Lock nut
- Base width: 100mm
- Length: 237mm

525804

Range	Resolution	Mfrs. List No.	Order Code	1+	3+	+
0-150mm/0-6"	0.01mm / 0.0005"	571-211-20	166-7287	269.00	255.00	--

HDS Digimatic Height Gauge



Robust construction with thick column providing highly repeatable height measurement and stability.

- Fine adjustment
- Clear LCD screen for error free reading
- Tungsten Carbide tipped scriber
- Imperial/Metric conversion
- Zero/ABSolute
- Presetting
- Direction change
- Data Hold
- Data output

Measuring Range	Accuracy	Height (mm)	Base (mm) Length	Mfrs. List No.
0-300 mm/0-12"	±0.03 mm/0.0015"	507	160 122 72.6	570-312

526012

Mfrs. List No.	Order Code	1+	3+	5+
570-312	166-7331	369.00	349.00	330.50

Tyre Tread Depth Gauge

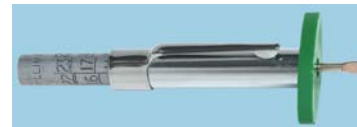

Complies with EC Directive 89/459/EEC. 1.6mm marking.

492105

Model	Order Code	Price Each
TDG16C05	280-479	1+ 2.39

Micrometers



Ultra-Fast and Water resistant, this ground breaking Micrometer is suitable for use in areas when there is a high risk of coolant splash. Large LCD display for error free external measurements.

Features:

- Ultra-Fast Measurement
- Large LCD display.
- Imperial/Metric conversion

- Origin setting and Zero setting
- Data hold and Data output
- Auto power off
- IP65 Rated
- Tungsten Carbide tipped measuring faces
- Accuracy:  $\pm 1\mu\text{m}$

525857

Range	Resolution	Mftrs. List No.	Order Code	1+	3+	+
0-25mm/0-1"	0.001mm / 0.00005"	293-185	<b>166-7339</b>	149.00	141.55	--
25-50mm/1-2"	0.001mm / 0.00005"	293-186	<b>166-7340</b>	205.00	194.75	--

### Digimatic Outside Micrometer

Metric/Imperial

Mitutoyo



- External screw type micrometer with large digit display, 1  $\mu\text{m}$  resolution
- Imperial/Metric conversion
- Origin setting and Zero setting
- Data hold and Data output
- Auto power off

- Tungsten Carbide tipped measuring faces
- Type R = Ratchet
- IP65 Rated

525837

Range	Resolution	Mftrs. List No.	Order Code	1+	3+	12+
0-25mm	0.001mm	293-230	<b>441-5930</b>	184.00	174.80	--
25-50mm	0.001mm / 0.00005"	293-331	<b>166-7292</b>	195.00	185.25	--
50-75mm	0.001mm / 0.00005"	293-332	<b>166-7293</b>	224.00	212.00	--
75-100mm	0.001mm / 0.00005"	293-333	<b>166-7295</b>	239.00	225.00	--

### Digimatic Outside Micrometer

Water Resistant

Mitutoyo



- External screw type micrometer with large digit display, 1  $\mu\text{m}$  resolution
- Imperial/Metric conversion
- Ratchet thimble type

- Origin setting
- Auto power off
- IP-65 Level Water resistance
- Tungsten Carbide tipped measuring faces

525844

Range	Resolution	Mftrs. List No.	Order Code	1+	3+	+
0-25mm	0.001mm / 0.00005"	293-334	<b>166-7296</b>	184.00	174.00	--

### Water Resistant

Mitutoyo



- Large LCD display
- Imperial/Metric conversion
- Origin setting
- Auto power off
- IP-65 Level Water resistance
- Tungsten Carbide tipped measuring faces

230747

Range	Resolution	Mftrs. List No.	Order Code	1+	3+	12+
0-25mm/0-1"	0.001mm / 0.00005"	293-344	<b>106-718</b>	124.00	118.00	109.54
25-50mm/1-2"	0.001mm / 0.00005"	293-345	<b>166-7297</b>	173.00	164.00	--

### Quickmike Micrometer

Mitutoyo



- Offers very latest in high-speed digital measurement
- Covers 30mm range in only 3 thimble revolutions
- 16 times faster than conventional designs

- Absolute feature for error-free operation
- Ideal for production applications
- Can be connected to an SPC data processor
- Measuring force 5-10N

221195,401286

Mftrs. List No.	Order Code	Price Each
293-676	<b>715-6327</b>	1+ 219.00

### Imperial/Metric

Mitutoyo



- Large LCD display
- Imperial/Metric conversion
- 215g lightweight construction
- Vernier Sleeve
- Easy single handed operation
- Tungsten Carbide tipped measuring faces
- Accuracy:  $\pm 2\mu\text{m} / \pm 0.0001"$

525854

Range	Resolution	Mftrs. List No.	Order Code	1+	3+	12+
0-25mm/0-1"	0.001mm / 0.00005"	293-832	<b>321-6238</b>	79.95	75.95	72.94

### Imperial/Metric

Mitutoyo



- Digital display allows quick easy depth measurements
- Large LCD display
- Ratchet performs uniform and consistent readings
- 4mm diameter measuring rods
- Imperial/Metric conversion
- Zero setting
- Data hold and Data output
- Spindle lock
- Auto power off
- Accuracy:  $\pm 3\mu\text{m}$
- Base size: 100x16mm

New

525855

Range	Resolution	Mftrs. List No.	Order Code	1+	3+	+
0-150mm/0-6"	0.001mm / 0.00005"	329-350	<b>166-7298</b>	369.00	349.00	--

### Outside Micrometer

Mitutoyo



- External screw-type micrometer with combined ratchet stop.
- Consistent measuring force due to combination ratchet design of thimble and speeder
- Ideal for single-handed operation
- Heavy duty version available
- Carbide tipped measuring faces

- Clear graduations on satin chrome finish
- Spindle lock
- Frame is fitted with heat shields
- Accuracy:  $\pm 2\mu\text{m}$

525924

Range	Graduation	Mftrs. List No.	Order Code	1+	3+	+
0-25mm	0.01mm	102-701	<b>441-5899</b>	48.35	45.95	--
0-25mm	0.001mm	102-707	<b>166-7299</b>	53.90	51.20	--

### Micrometer

Mitutoyo



- Suitable for all external measurements in either workshop or inspection departments
- Enamelled frame
- Tungsten Carbide tipped measuring faces
- Clear graduations on satin chrome finish
- Spindle lock

New

Range	Type	Graduation	Accuracy	Mftrs. List No.
<b>Imperial</b>				
0" - 1"	F	0.001"	$\pm 0.0001$ "	103-127
0" - 1"	R	0.001"	$\pm 0.0001$ "	103-177
0" - 1"	R	0.001"	$\pm 0.0001$ "	103-131
0" - 1"	F	0.0001"	$\pm 0.0001$ "	103-135
1" - 2"	R	0.0001"	$\pm 0.0001$ "	103-132H
1" - 2"	R	0.001"	$\pm 0.0001$ "	103-178H
<b>Metric</b>				
0 - 25mm	F	0.01mm	$\pm 2\mu\text{m}$	103-125
0 - 25mm	R	0.001mm	$\pm 2\mu\text{m}$	103-129
0 - 25mm	R/F	0.01mm	$\pm 2\mu\text{m}$	103-137
25 - 50mm	R	0.001mm	$\pm 2\mu\text{m}$	103-130H
25 - 50mm	R	0.01mm	$\pm 2\mu\text{m}$	103-138H
50 - 75mm	R	0.01mm	$\pm 2\mu\text{m}$	103-139-10H

Micrometers - continued

Micrometer - continued

525927

Mfrs. List No.	Order Code	1+	Price Each	3+	5+
<b>Imperial</b>					
103-127	166-7302	36.85	35.00	33.18	
103-177	166-7310	36.00	34.20	--	
103-131	166-7305	41.50	39.45	--	
103-135	166-7307	48.25	45.85	--	
103-132H	166-7306	53.90	51.20	--	
103-178H	166-7311	48.45	46.05	--	
<b>Metric</b>					
103-125	166-7301	36.85	35.00	--	
103-129	166-7303	41.50	39.45	--	
103-137	457-371	35.95	34.15	30.56	
103-130H	166-7304	53.90	51.20	--	
103-138H	166-7308	48.45	45.95	--	
103-139-10H	166-7309	63.95	60.75	--	

Fixed Rod type Depth Micrometer



- Ideal for general depth measurement
- 4mm diameter measuring rod
- 2 base sizes available
- Ratchet performs uniform and consistent readings
- Clear graduations on satin chrome finish
- Accuracy:  $\pm 3\mu\text{m}$

Mitutoyo

New

525939

Range	Resolution	Base Size	Mfrs. List No.	Order Code	1+	Price Each	3+	5+
0-25mm	0.01mm	60 x 16mm	128-101	166-7313	70.90	67.35	63.78	
0-1"	0.001"	2.5" x 0.63"	128-105	166-7314	70.90	67.35	63.78	

Metric/Imperial



- Flexible depth measurements over a wide range with interchangeable rods
- 4mm diameter measuring rod
- 2 base sizes available
- Ratchet performs uniform and consistent readings
- Clear graduations on satin chrome finish
- Zero adjustable thimble
- Accuracy:  $\pm 3\mu\text{m}$

Mitutoyo

New

525959

Mfrs. List No.	Order Code	1+	Price Each	3+	5+
<b>Metric</b>					
129-110	166-7315	103.00	97.85	92.66	
129-116	166-7316	139.00	129.95	123.06	
<b>Imperial</b>					
129-126	166-7317	103.00	97.85	92.66	
129-132	166-7318	139.00	129.95	123.06	

Troubleshooting tips



Chat live online to one of our technical engineers at [www.farnell.co.uk](http://www.farnell.co.uk)

Large Range Extension Rod Inside Micrometer

Mitutoyo

New

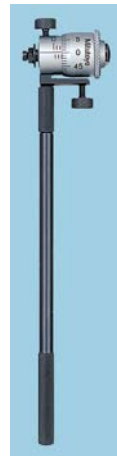

- Wide measuring range with interchangeable anvils which are hardened and ground
- Lightweight but rigid
- Clear graduations on satin chrome finish
- Accuracy:  $\pm (6+L/50)\mu\text{m}$

Measuring Range	Graduation	Stroke	Number of rods	Spacing collars	Mfrs. List No.
25-50mm	0.01mm	7 mm	2	1 (6 mm)	141-101.

525962

Mfrs. List No.	Order Code	1+	Price Each	3+	5+
141-101.	166-7319	75.95	72.15	68.33	

Metric/Imperial

Mitutoyo

New



- Digital, non-rotating spindle, high-resolution type provides a solution for precision positioning applications unmatched by analogue heads.
- The clear, easily read digital display promotes fast, error-free reading
- Large LCD display
- IP65
- Imperial/Metric conversion
- Readings can be held in display as long as required using the Hold function and the Preset function allows a previously set value to be recalled and used as measurement datum instead of zero
- Zero setting
- Data hold and Data output
- Tungsten Carbide tipped measuring faces

Measuring Range	Graduation	Accuracy	Stem	Mfrs. List No.
0-25mm/0-1"	0.001mm/0.00005"	2 $\mu\text{m}$	0.375"	350-351

525988

Mfrs. List No.	Order Code	1+	Price Each	3+	5+
350-351	166-7320	163.00	154.00	145.84	

Metric

Mitutoyo

New



- Standard type Micrometer Head
- Clear graduations on satin chrome finish

525989

Range	Graduation	Mfrs. List No.	Order Code	1+	Price Each	3+	5+
0-13mm	0.01mm	148-104	166-7321	35.50	33.75	31.93	

Metric

Mitutoyo



- Miniature Micrometer Head for incorporating into small jigs and fixtures
- Clear graduations on satin chrome finish
- Accuracy:  $\pm 5\mu\text{m}$

525991

Range	Graduation	Mfrs. List No.	Order Code	1+	Price Each	3+	5+
0-6.5mm	0.01mm	148-201	166-7322	34.80	33.05	31.33	



Metric

Mitutoyo



New

- Standard Type Micrometer Head
- Clear graduations on satin chrome finish
- Zero adjustable Thimble
- Accuracy:  $\pm 2\mu\text{m}$

525992

Range	Graduation	Mftrs. List No.	Order Code	1+	3+	5+
0-13mm	0.01mm	148-503	166-7323	36.45	34.65	32.85

Metric

Mitutoyo



New

- Standard Type Micrometer Head
- Clear graduations on satin chrome finish
- Zero adjustable Thimble
- Accuracy:  $\pm 2\mu\text{m}$
- Supplied with spindle lock and set nut

525993

Range	Graduation	Mftrs. List No.	Order Code	1+	3+	5+
0-13mm	0.01mm	148-504	166-7325	42.35	40.25	38.12

Micrometer Heads



Accurate to BS1734. For use in jigs, fixtures or precision measuring instruments.

489381

Description	Order Code	1+	5+	10+	20+
0 - 13mm graduations 0.01mm.	137-6781	43.92	40.78	38.06	36.19
Fitted with ratchet but not locknut					
0 - 25mm graduations 0.01mm.	137-6782	42.08	39.08	36.47	34.68
Fitted with ratchet and locking screw					

for Standard Outside Micrometers

Mitutoyo



New

- Designed specifically for use with Mitutoyo Standard Micrometers up to 100mm/4"
- Cast iron, attractively enamelled with clamping jaws displaceable in a parallel direction
- Adjustable angle type
- Ideal for bench use

526018

Height (mm)	Length (mm)	Mftrs. List No.	Order Code	1+	3+	5+
102.15	139.5	156-101	166-7332	29.70	28.20	26.76

for Standard Outside Micrometers

Mitutoyo

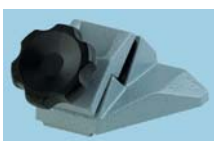

New

- Designed specifically for use with Mitutoyo Digimatic Micrometers up to 50mm/2"
- Cast iron, attractively enamelled with clamping joints
- Fixed angle type
- Inclination fixed at 45°
- Ideal for bench use

526020

Height (mm)	Length (mm)	Mftrs. List No.	Order Code	1+	3+	5+
63	97	156-105	166-7333	23.30	22.15	20.95

Blue Micrometer Marking



- The paste shows an easily visible bright mark on all metal parts
- It transfers easily from one surface to another and is ideal for marking mating parts
- Non abrasive and does not affect the skin, it can be wiped off metal parts and is soluble in soap, detergent and water

491474

Description	Order Code	Price Each
Small tin	311-232	2.09
Tube	311-233	2.78

Flexigrip Major

Mitutoyo



- A heavy-duty clamp fitted to a uni-joint arm for versatile gauging applications
- Detachable clamp can be used independently from arm
- Suitable for stands and workholding
- Holds stem sizes 8mm/3/8"

Indicator sold separately

221202

Mftrs. List No.	Order Code	Price Each
7019-001	715-7095	194.00

Magnetic Base

LINEAR TOOLS



- Segmented snake arm can be locked in any position
- Provides clamping for plunger and lever indicators between 1/8" and 1/2"  $\varnothing$
- Fitted with a powerful magnetic base which has 80 kg pull

Indicator supplied separately

221228

Mftrs. List No.	Order Code	Price Each
MB-SX	716-1384	71.25

Magnetic Bases And Stands



Primarily for holding dial gauge indicators. Vee slot on base facilitates gripping on curved surfaces.

49484

Model E903CP

Push button switching magnetic base with backlug adaptor style clamp 8mm(1/4in). Pillar 185mm high x 12.5mm, crossbar 150mm long x 6.3mm diameter. Maximum pull 30kg.

Order Code	Price Each
232-108	66.05

Model E906

Toggle switching type magnetic base with fine adjusting fitment. Universal clamping mechanism. Pillar 200mm high x 14mm diameter, crossbar 175mm long x 10mm diameter. Maximum pull 50kg.

**Micrometers - continued**

**Magnetic Bases And Stands - continued**

Model E903CP - continued

Order Code	Price Each
030-490	1+ 49.49

**Indicators and Magnetic Stands**

**Digimatic Indicators**

**Mitutoyo**



- Absolute function
- Inch/metric conversion
- Zero/ABS
- Preset
- Tolerance setting
- Counting direction change
- On/off button
- Data output
- Bezel rotates 330°
- Large clear LCD for error-free reading

221199,401288

Range	Resolution	Mftrs. List No.	Order Code	1+	3+	Price Each
0-12.7mm/0.5"	0.001mm/0.00005"	543-251B	<b>715-6790</b>	239.00	--	--
0-25mm/1"	0.001mm/0.00005"	543-451B	<b>715-6807</b>	399.99	--	--
0-12.7mm/1"	0.01mm/0.00005"	543-271B	<b>166-7326</b>	175.00	166.00	

**Digital Display "Dial" Indicator**

**Mitutoyo**



- IDS type Digimatic indicator is a plunger style comparative measuring gauge
- LCD readout and SPC connectability
- Splash proof construction with membrane sealed buttons
- Readout is metric or Imperial in the range 12.7mm (0.5") with a resolution of 0.01mm (0.0005")

221164

Mftrs. List No.	Order Code	1+	3+	6+	Price Each
543-682	<b>457-449</b>	90.65	86.10	84.38	

45

**Digimatic Indicators**

**Mitutoyo**



- One-time setting of origin that holds until the battery is changed or the origin point is reset.
- Guaranteed precision even with high speed movements
- Large digit display for easy reading
- Slim compact low cost design
- ABSolute feature
- Imperial/Metric conversion
- Zero set
- On/Off
- Direction change
- Data output
- Accuracy: 0.02mm
- Supplied with 1 Battery SR-44, life approximately 1 years continuous use

525995

Range	Resolution	Mftrs. List No.	Order Code	1+	3+	5+	Price Each
25.4mm/1"	0.01mm (0.0005")	575-123	<b>166-7327</b>	122.00	115.90	109.76	

**Express checkout**



With no need to re-enter your details, returning customers can now buy products even faster - **order online today at [www.farnell.co.uk](http://www.farnell.co.uk)**

Farnell

**Metric Dial Indicator**

**Mitutoyo**



Water resistant for harsher environments where Indicator is liable to be splashed

Measuring Range	Graduation	Accuracy	Scale	Range per revolution	Mftrs. List No.
0-10mm	0.01mm	±13µm	0-100 (100-0)	1mm	2046S

526145

Mftrs. List No.	Order Code	1+	5+	10+	Price Each
2046S	<b>441-5980</b>	28.25	26.85	26.21	

**Metric Dial Indicator**

**Mitutoyo**



Conventional size, easy to read Indicator for most general applications

- Features:
- Revolution Counter
  - Limit Hands
  - Jewelled
  - Accuracy: ± 5µm

Measuring Range	Graduation	Scale	Measuring force	Range per revolution	Mftrs. List No.
0-1mm	0.001mm	0-100-0	1.5N	0.2mm	2109S-10

525997

Mftrs. List No.	Order Code	1+	3+	5+	Price Each
2109S-10	<b>166-7328</b>	60.35	57.35	54.31	

**Single Revolution Dial Indicators**

**Mitutoyo**

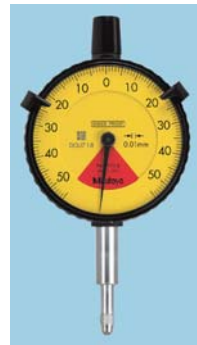

Dedicated short range, balanced Dial Indicator for applications to suit.

- Single revolution Dial Indicator with a damping mechanism for improved shock resistance
- One piece moulded case and back provides superior resistance to splashing
- Lightweight in design
- All these indicators can be fitted with optional backs
- Accuracy: ± 12µm

Measuring Range	Graduation	Scale	Measuring force	Range per revolution	Mftrs. List No.
1mm	0.01mm	50-0-50	1.4N	1.4mm	2972

526000

Mftrs. List No.	Order Code	1+	3+	5+	Price Each
2972	<b>166-7329</b>	28.05	26.65	25.26	

**Dial Indicators**

**Mitutoyo**

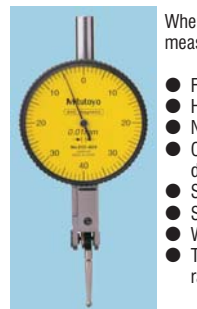

Where access is restricted. Machine Tool settings or for comparative measurement with Height Gauge/stand.

- Face diameter 39mm
- High sensitivity and quick response from jewelled bearings
- Non clutch type for automatic reversal of measuring direction
- One piece bezel and crystal fitted with '0' ring to resist water and dust
- Scratch resistant, glare free crystal
- Supplied with Tungsten Carbide tipped contact point
- With Dovetail mounts
- T Suffix products supplied as sets containing Indicator and a range of accessories

Measuring Range	Graduation	Reading	Accuracy	Mfrs. List No.
0.8mm	0.01mm	0-40-0	8µm	513-404E
0.8mm	0.01mm	0-40-0	8µm	513-404T

526009

Mfrs. List No.	Order Code	1+	3+	5+	Price Each
513-404E	166-7330	64.70	61.45	58.19	
513-404T	441-6053	78.25	74.35	72.64	

Dial Gauges



Dial size 60mm/2 1/4in diameter. Fitted with standard lug back fitting, hardened and ground racks, adjustable dial, bezel lock and tolerance pointers.

Metric

Reading (mm)	Travel/ Rev (mm)	Total Travel (mm)	Graduations	Order Code	Price Each
0.01	1.0	10.0	0 - 100	137-5877	16.03
0.01	1.0	25.0	0 - 100	137-5879	17.02

Imperial

495303

Reading (in)	Travel/ Rev (in)	Total Travel (in)	Graduation	Order Code	Price Each
0.001	0.1	0.5	0 - 100	137-5990	16.03
0.001	0.1	1.0	0 - 100	137-5992	17.02

Magnetic Stand

Mitutoyo



- Magnetic base stand suitable for most Mitutoyo dial indicators
- The indicator can be lug or stem mounted (stem 8mm dia.)
- Powerful magnetic base has an on/off lever preventing damage to delicate surfaces

Overall height=220mm, Maximum reach = 145mm

221142

Mfrs. List No.	Order Code	1+	3+	6+	12+	Price Each
7010SN	457-450	52.25	49.65	47.17	44.48	

Flexible Magnetic Stand

Mitutoyo



- Flexible Magnetic Stand
- Adjustable segments connected with steel cable
- Cable locked with lever at bottom of base
- On/off lever to release the magnet
- Suitable for stem diameters of 6mm, 8mm and 3/8"
- 60kgf Magnetic Pull

Working radius ca.	Total height	Fine adjustment	Base size	Mfrs. List No.
250mm	393mm	1.5mm	50x60x55mm	7012-10

526026

Mfrs. List No.	Order Code	1+	3+	5+	Price Each
7012-10	166-7334	109.00	103.55	98.06	

Help us to help the environment



This catalogue has been printed on paper certified from a sustainable source. Please recycle after use.

Mini Magnetic Stand

Mitutoyo

New



- Mini Magnetic Stand for tight applications
- Permanent Magnet
- Ideal for Dial Test Indicators with 6mm or 8mm diameter stems or dovetail
- 15kgf Magnetic Pull

526054

Total length	Mfrs. List No.	Order Code	1+	3+	5+	Price Each
102mm	7014	166-7335	47.80	45.40	43.04	

Articulated Magnetic Stand

Mitutoyo



- Uni joint stand sections fixed by means of hydraulic clamping
- Suitable for stem diameters of 8mm and 3/8"
- 60kgf Magnetic Pull

Working radius ca.	Total height	Fine adjustment	Base size	Bore for dial indicator stem	Mfrs. List No.
320mm	420mm	±5°	50x60x55mm	∅8mm/∅0.375"	7019B

526152

Mfrs. List No.	Order Code	1+	5+	10+	Price Each
7019B	427-3436	127.00	119.95	117.19	

Thickness Gauges

45

Thickness Gauge

Mitutoyo



- Compact pocket sized Digimatic thickness gauge
- Inch/metric conversion
- Measuring faces are hardened, ground and lapped
- Ideal for measuring paper, leather, plastic, sheet metal and film

Resolution	Measuring Range	Accuracy	Mfrs. List No.
0.01mm	0-12mm	±0.02mm	700-118
0.00005"	0-05"	±0.001mm	

220016

Order Code	1+	+	+	+	Price Each
321-6342	56.20	--	--	--	

Metric

Mitutoyo



Allows simple, quick and accurate thickness measurement.

New

- Thumb lever to lift spindle
- Flat anvils made of ceramic
- Bezel is adjustable for easy zero setting

Graduation	Range	Throat Depth	Measuring Force	Mfrs. List No.
0.01mm	0-10mm	30mm	1.4N	7014

526056

Mfrs. List No.	Order Code	1+	3+	5+	Price Each
7014	166-7335	47.80	45.40	43.04	



Pocket thickness Gauge

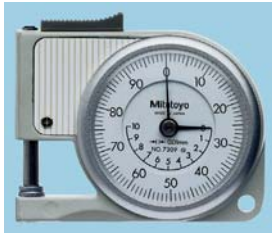

Ideal for measuring paper, leather, plastic, sheet metal and film.

Mitutoyo

New

- Compact pocket sized thickness gauge
- Preloaded spindle to provide a constant 0.2N (or less) measuring force
- Measuring faces are hardened, ground and lapped
- Easy zero adjustment
- Accuracy:  $\pm 20\mu\text{m}$

526057

Resolution	Range	Order Code	1+	3+	5+
0.01mm	0-10mm	166-7338	69.45	66.00	62.50

Verdict Metrinch



Fitted with pear-shaped contact, reading 0.0005"/0.01mm, range 0.020"/0.44mm, stylus length 0.770"/19.5mm, clamping facilities by means of dovetail or end spigot

VERDICT

494450

Order Code	Price Each
231-018	1+ 100.00

Gauges

Metric Pin Gauge Set



Highly accurate precision pin gauges, surface finish RA 0.25, roundness tolerance  $1.27\mu\text{m}$ . Heat treated to 60/63 HRC, gauge member length 2in. Accurate  $\pm 0.001\text{mm}$

494526

Range (mm)	Number Of Pieces	Steps (mm)	Order Code	Price Each
1.01-2.00	100	0.01	030-346	143.35
0.30-5.00	95	0.05	030-347	157.29
5.05-10	100	0.05	030-348	191.10

Eclipse Angle Plates



Web End

Length (mm)	Width (mm)	Height (mm)	Order Code	Price Each
125	80	100	030-353	62.00
160	100	125	030-354	99.30
200	125	160	030-355	156.25

Open End

491553

Length (mm)	Width (mm)	Height (mm)	Order Code	Price Each
125	80	100	030-358	93.95
200	125	160	030-360	194.00



Plastigauge



Provides a simple but accurate method for measurement of running/static clearance between hidden surfaces, such as big end or mains bearings, pipe flanges, head gasket, high spots, housings, injection moulding tools etc

- Can highlight, clearance, lobing, ovality on shafts
- Volumetric measurement takes surface roughness into account
- Calibration card supplied
- Non corrosive and oil soluble

Type	Inch	Measurement Range	mm
A	0.001-0.007		0.025-175
B	0.004-0.010		0.1-0.
C	0.008-0.020		0.2-0.5

494039

Mfrs. List No.	Order Code	1+	5+	10+	20+
187-0017	151-8508	3.31	3.25	3.18	3.15
187-0018	151-8509	3.42	3.34	3.28	3.24
187-0019	151-8510	4.83	4.74	4.64	4.60

Feeler Gauges



Overall Length  
 108-342, 108-343=105  
 108-344=160  
 IMPERIAL 108-342  
 10 blades at 1.5, 2, 3, 4, 6, 8, 10, 12, 15, and 25 thousandths of an inch  
 METRIC 108-343  
 100.05, 0.1, 0.15, 0.2, 0.3, 0.4, 0.5, 0.6, 0.7, 0.8mm  
 COMBINED IMPERIAL/METRIC 108-344  
 18 blades at 1.5, 2, 3, 4, 6, 8, 10, 12, 15, 25 Thousandths of an inch and 0.05, 0.1, 0.2, 0.25, 0.3, 0.4, 0.5mm

221187

Mfrs. List No.	Order Code	Price Each
Imperial 73970	108-342	1+ 2.76
Metric 73988	108-343	2.74
Imperial/Metric 10094	108-344	3.38

Feeler Gauges



- Precision gauges with tapered 100 mm blades and electrically etched numerals
  - Blades fold into metal case
- Set contents:  
**Metric:** 0.05, 0.1, 0.15, 0.20, 0.25, 0.30, 0.40, 0.50, 0.60, 0.70, 0.80, 0.90, 1.00mm  
**Imperial:** 0.002, 0.003, 0.004, 0.005, 0.006, 0.008, 0.010, 0.012, 0.015, 0.020, 0.025, 0.030, 0.035 Thousandths of an inch

495572

Description	Mfrs. List No.	Order Code	1+	5+	10+
Metric	T3525M413	151-8959	3.70	3.60	3.50
Imperial	T3525 413	151-8960	3.70	3.60	3.50

**Feeler Gauges**



187-0033

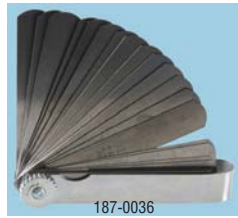

187-0036

Both sets have blades manufactured from hardened and tempered steel, and have mild steel cases. Blades conform to DIN 2275, shape & thickness

Set contents:

**Metric:** 0.05, 0.10, 0.15, 0.20, 0.25, 0.30, 0.40, 0.50, 0.60, 0.70, 0.80, 0.90, 1.00mm  
**Imperial:** 0.0015, 0.003, 0.005, 0.006, 0.007, 0.008, 0.009, 0.010, 0.011, 0.012, 0.013, 0.014, 0.015, 0.016, 0.018, 0.020, 0.022, 0.024, 0.025, 0.028, 0.030, 0.032, 0.035  
 Thousandths of an inch

494053

Mfrs. List No.	Order Code	Price Each			
		1+	5+	10+	20+
187-0033	151-8511	4.46	4.37	4.29	4.23
187-0036	151-8512	8.79	8.61	8.44	8.35

**Feeler Gauge Sets**



Each gauge comprises a set of steel tapered blades, hardened, tempered and polished, mounted in a steel case. 12.7mm width.

**Metric - DIN 2275**

Length (mm)	No. Of Blades	Thickness Of Blades x 0.01 (mm)	Order Code	Price Each
				1+
75	13	3, 4, 5, 6, 7, 8, 9, 10, 15, 20, 30, 40, 50	137-6793	9.85
100	13	3, 4, 5, 6, 7, 8, 9, 10, 15, 20, 30, 40, 50	137-6794	10.69
100	13	5, 10, 15, 20, 25, 30, 40, 50, 60, 70, 80, 90, 100	137-6795	10.45
100	20	5, 10, 15, 20, 25, 30, 35, 40, 45, 50, 55, 60, 65, 70, 75, 80, 85, 90, 95, 100	137-6796	14.67
75	11	5, 10, 15, 20, 25, 30, 40, 50, 60, 70, 80	137-6797	8.08
75	20	5, 10, 15, 20, 25, 30, 35, 40, 45, 50, 55, 60, 65, 70, 75, 80, 85, 90, 95, 100	137-6798	15.13
150	13	5, 10, 15, 20, 25, 30, 40, 50, 60, 70, 80, 90, 100	137-6799	21.25
150	20	5, 10, 15, 20, 25, 30, 35, 40, 45, 50, 55, 60, 65, 70, 75, 80, 85, 90, 95, 100	137-6800	30.56
300	20	5, 10, 15, 20, 25, 30, 35, 40, 45, 50, 55, 60, 65, 70, 75, 80, 85, 90, 95, 100	137-6878	52.69

**Metric - General Purpose**

Length (mm)	No. Of Blades	Thickness Of Blades x 0.01 (mm)	Order Code	Price Each
				1+
100	10	5, 10, 15, 20, 30, 40, 50, 60, 70, 80	137-6801	5.79
150	10	5, 10, 15, 20, 30, 40, 50, 60, 70, 80	137-6880	18.08
300	10	5, 10, 15, 20, 30, 40, 50, 60, 70, 80	137-6877	23.28

**Imperial - DIN 2275**

Length (in)	No. Of Blades	Thickness Of Blades x 0.001 (in)	Order Code	Price Each
				1+
3	10	1 1/2, 2, 3, 4, 6, 8, 10, 12, 15, 25	137-6802	9.47
6	10	1 1/2, 2, 3, 4, 6, 8, 10, 12, 15, 25	137-6803	21.49
3	17	1 1/2, 2, 2 1/2, 3, 3 1/2, 4, 5, 5 1/2, 6, 7, 8, 9, 10, 12, 15, 20, 25	137-6804	12.95
4	17	1 1/2, 2, 2 1/2, 3, 3 1/2, 4, 5, 5 1/2, 6, 7, 8, 9, 10, 12, 15, 20, 25	137-6805	15.74
3	26	1 1/2, 2, 2 1/2, 3, 4, 5, 6, 7, 8, 9, 10, 11, 12, 13, 14, 15, 16, 17, 18, 19, 20, 21, 22, 23, 24, 25	137-6808	20.45
4	10	1 1/2, 2, 3, 4, 6, 8, 10, 12, 15, 25	137-6811	10.20

**Imperial - General Purpose**

495024

Length (in)	No. Of Blades	Thickness Of Blades x 0.001 (in)	Order Code	Price Each
				1+
3	10	1 1/2, 2, 3, 4, 6, 8, 10, 12, 15, 25	137-6806	5.67
4	10	1 1/2, 2, 3, 4, 6, 8, 10, 12, 15, 25	137-6807	5.79
6	10	1 1/2, 2, 3, 4, 6, 8, 10, 12, 15, 25	137-6876	18.08
12	10	1 1/2, 2, 3, 4, 6, 8, 10, 12, 15, 25	137-6879	23.28

**Squares**

**7 1/2" Rosewood Sliding Bevel**



- Hardwood handle
- Etched stainless steel sliding blade
- Blade length 9"

482095.462266

Order Code	Price Each				
	1+	5+	10+	20+	50+
144-7559	3.47	2.81	2.67	2.55	2.36

**9" Rosewood Square**



- Solid redwood handle
- Durable laser etched blade
- Brass face and fasteners
- 1/16" graduations

482096.462271

Order Code	Price Each				
	1+	5+	10+	20+	50+
144-7560	4.32	4.01	3.47	3.23	2.96

**Combination Square**

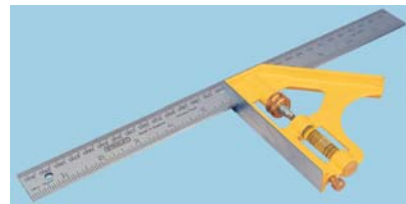

Diecast metal body precision machined on three faces, finished in a high Vis yellow for ease of location.

The head also includes 360° all round visibility vial, brass nut and scriber fittings.

The blade is 12 inch/300mm long and is etched with clear graduations and coated to provide resistance to rust.

478002

Order Code	Price Each			
	1+	5+	10+	20+
135-3443	14.90	14.45	13.70	13.43

**Combination Square**



Metal body with 3 machined faces, this square is lightweight, durable and accurate. Featuring a 30° all round visibility vial and scriber fitting for convenience and marking.

The 12 inch/300mm stamped blade is easy to read and long lasting.

477999

Order Code	Price Each			
	1+	5+	10+	20+
135-3409	7.45	7.25	6.85	6.73

**Combination Try and Mitre Square**

**RABONE**



- A 90° try square, 45° try square, height/depth gauge, spirit level, marking gauge and ruler

**Squares - continued**

**RABONE - continued**

221170

Mfrs. List No.	Order Code	Price Each
1912	108-391	22.40

**Combination Set Series 180**

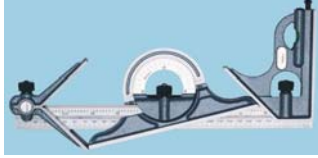

Three components on one rule, made of hardened stainless steel with graduated scales. Protractor scale satin chrome finished, reversible (front and rear side can be used). Hardened square head, with level and hardened centre head.

493947

Description	Order Code	Price Each
Set: 30mm blade, protractor, square head and centre head	230-703	96.96

**Engineers Squares**

**Workshop Grade B**

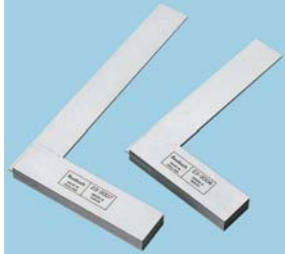

Conforms to BS 939:1977, grade B. Manufactured to close tolerances in high grade steel. Both blade and stock are ground and polished with the blade being hardened and tempered.

492528

Size (mm)	Size (in)	Order Code	Price Each
75	3	233-005	16.36
100	4	162-3439	21.57
225	9	233-008	36.98
300	12	233-009	52.45

45

**Dividers And Calipers**

**No 50 Dividers**



Spring type. Solid nut. Points are hardened and ground to allow for marking out.

488440

Size (mm)	Size (in)	Order Code	1+	5+	10+	20+
75	3	137-6786	11.25	11.02	10.81	10.59
100	4	137-6787	11.53	11.30	11.08	10.85
150	6	137-6788	12.29	12.04	11.80	11.56
200	8	137-6789	17.24	16.90	16.56	16.23
250	10	137-6790	19.57	19.18	18.80	18.42
300	12	137-6791	21.90	21.47	21.03	20.62

**Protractors**



- Used for drawing radial lines, transferring angles and setting bevells
- Made from tempered steel with satin-chrome finish
- Measures angles from 0° - 180°C
- Features 6" arm and knurled thumb lock nut
- Head measures 3" x 2"
- Available with round or square end

221212

Mfrs. List No.	Order Code	Price Each
Round end 5180	715-9547	20.69
Square end 5170	715-9559	26.51

**Chalk Refills**



Made from food grade calcium carbonate. Good colour fastness and resistance to bad weather. Supplied in plastic bottles with twist and pour cap. Blue: All round colour for interior and exterior use. Red: For exterior masonry work. Indelible in use. White: For interior work such as carpet fitting.

478316

Model	Colour	Weight (g)	Order Code	1+	5+	10+	20+
47-405	White	115	135-3677	2.05	2.00	1.90	1.87
47-403	Blue	115	135-3675	2.05	2.00	1.90	1.87
47-404	Red	115	135-3674	2.28	2.24	2.18	2.14
1-47-803	Blue	225	380-8555	2.75	2.65	2.55	2.30
1-47-804	Red	225	135-3660	3.95	3.75	3.50	3.25
1-47-917	Blue	1000	135-3661	6.95	6.75	6.40	6.27
1-47-919	Red	1000	135-3662	14.50	14.20	13.95	13.65

**Levels**

**Torpedo Levels**



Rigid aluminium frame for long life. Shock resistant rubber ends prevent damage. 300mm long, 3 vial. Three options available.

478314

Description	Order Code	1+	5+	10+	20+
High impact torpedo level	135-3663	6.70	6.50	6.15	6.03
Magnetic high impact torpedo level	135-3665	8.95	8.70	8.25	8.09
Lighted high impact torpedo level	135-3666	12.65	12.25	11.65	11.42

**Torpedo Level**



Heavy duty aluminium cast frame level. Large top read vial window, tinted 360° vials for easy reading. Magnetic strip allows hand free operation on metal surfaces.

478312

Length (mm)	Length (in)	Order Code	1+	3+	6+	12+
230	9	716-8810	7.89	7.50	7.24	6.89

**Foamcast**



Lightweight and shock resistant ABS structure. 0°, 90° and 45° vials for accuracy. Hi-Viz yellow open frame girder body.

478311

Length (cm)	Length (in)	Order Code	1+	5+	10+	20+
30	12	135-3656	3.00	2.90	2.75	2.69
45	18	135-3657	3.70	3.60	3.40	3.33
60	24	135-3658	4.45	4.30	4.10	4.01
120	48	135-3659	8.20	7.95	7.55	7.41

Series 2-3 vial



Extruded aluminium box-section body. Sizes up to and including 120cm long are fitted with three vials and model 180cm has four vials. Accuracy 0.5mm per metre.

478229

Length (cm)	Length (in)	Order Code	Price Each			
			1+	5+	10+	20+
60	24	135-3438	12.00	11.77	11.53	11.30
90	36	135-3439	13.85	13.45	12.75	12.50
100	40	135-3440	15.77	15.45	15.14	14.84
120	48	135-3441	18.55	17.70	16.93	16.20
180	72	135-3442	27.70	26.85	25.50	24.99

Spirit Levels



81S

Light metal pressure cast profile with milled measuring surface, 1 vertical and 1 horizontal vial.

Measurement accuracy in the normal position 0.029=0.25mm/m. For overhead measurements: 0.043=0.75 mm/m. Suitable for working in cramped spaces, it handles overhead measurements as easily as it resists hard shocks.

Length (cm)	(in)	Order Code	Price Each
			1+
25	10	016-642	22.29

494621

Bull's-Eye Level

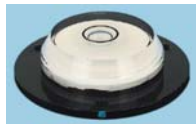

- Levels in all directions in one easy reading
- Moulded from acrylic plastic with mounting holes
- 1 3/4" diameter

223048

Order Code	Price Each
723-9324	2.16

Engineers Levels

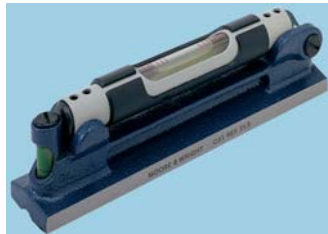

Precision ground base with full vee for location on cylindrical work pieces. Both levels have a main vial with safety cover, also a cross vial and a plumb vial. Main vial is graduated. All vials filled with tinted liquid for easy reading. Sensitivity - 1 minute of arc.

491208

Model	Length		Order Code	Price Each
	(mm)	(in)		1+
ELS	165	6.5	137-6905	81.94
ELM	310	12	137-6906	121.42

Engineers Levels



- High precision longitudinal and traverse vials make it possible to check or level surfaces
- Incorporates zero adjustment levels
- Vee slot in base

Size	Sensitivity	Indicating Error Graduation	Order Code
200mm	0.02mm/1m	0.02mm/1m	321-6410

220013

Sensitivity	Order Code	Price Each
0.02mm/1m	321-6410	259.00

Intellimeasure



A compact electronic measure which offers the following features. Safe, visible laser pointer to precisely locate the point to be measured. Accurate to ± 0.5% of a reading over 0.6m - 15.0m. Fast measurement time of 2-6 seconds. Will calculate area and volume, stores and recalls memory, automatically sums measurements. Low battery indicator.

478219

Order Code	Price Each			
	1+	5+	10+	20+
135-3436	45.35	44.00	41.70	40.87

AL-24 DVP Automatic Optical Level



High quality, competitively priced 24x automatic optical level, supplied with Tripod and Rod, with many features normally seen on a more expensive product.

Magnetic dampened, wire hung compensator for optimum accuracy and range.

Compensator lock protects unit in transit.

Large effective aperture with 30 cm's minimum range.

Top mounted optical peepsight for ease of ranging.

Right angle prism for easy bubble viewing.

Large easy to use focusing knob.

Fine motion knobs for endless, easy horizontal movement.

1:100 stadia for estimating distance.

Available in 360 degree or 400 GON versions.

Sealed, dust & water protected for working in all conditions.

Scope has sun-shade for bright light working.

Fits to standard tripod.

Technical Specification	
Working Range	90 metres
Working Environment	Built for all-weather general work
Levelling Accuracy	2mm for 1km double run levelling 1.6mm @ 50 metres
Levelling Type	3 screw setting. Viewed through angular prism Automatic compensator +/- 2 degrees
Angular Accuracy	1 degree (DVP) / 1 Gon (GVP)
Compensator	Magnetically dampened wire hung type
Compensator Setting Accuracy	+/- 0.8"
Compensator Working Range	+/- 15' minutes
Vial Sensitivity	2mm
Clear Objective Aperture	36mm
Resolution	9cm
Build Standard	IP54 (dust & water resistant)
Operating Temperature Range	-6 Deg Celsius to +49 Deg Celsius
Warranty	5 years

478413

Order Code	Price Each			
	1+	5+	10+	20+
135-3728	199.00	193.00	183.00	179.34

Self - Leveling Line Laser



Horizontal & Vertical



Model: DW087K-XJ

● Self-levelling cross line laser is accurate to ±0.3 mm/m in levelling applications

● Self-Levelling up to 4° surface angle with automatic out of level indication, marks a levelled line in seconds

● 2-button operation & low battery indication for ease of use

● Built-in magnetic pivot bracket mounts easily on metal surfaces

● Over moulded housing helps maintain calibration under jobsite conditions

● Includes 3 (AA) batteries for 20+ hours runtime

● Lightweight 1/4 inch Mini Tripod  
Contents: 3 x AA alkaline batteries, 1 x Wall mount bracket, 1 x Heavy duty carrying case

**Levels - continued**

**Self - Leveling Line Laser - continued**

**Horizontal & Vertical - continued**

Laser Class	2, <1mW	Self Leveling Range	+ / - 4°
Line Accuracy	±0.3mm/m	Power Supply	4.5V - 3 x AA
Number of Beams	2	Tripod Connection	¼"
Indoor Visibility Range	15 m		

494199.469957

Mfrs. List No.	Order Code	Price Each
DW087K-XJ	151-8878	161.34

**Rulers**

**Stainless Steel Rulers**

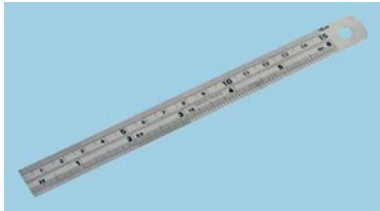

- Satin finish stainless steel rulers in 3 sizes
- Conversion chart on reverse

482093.462236

Length	Order Code	1+	5+	10+	20+	50+
150mm (6")	144-7554	0.95	0.81	0.68	0.62	0.56
300mm (12")	144-7556	1.80	1.65	1.54	1.34	1.22
600mm (24")	144-7557	2.96	2.58	2.38	2.05	1.88

**Imperial and Metric**



Stainless steel rules graduated in imperial and metric measurements. Metric/Imperial conversion tables on reverse of 6in and 12in rules. Manufactured to EC Class II accuracy.

477898

Length (mm)	Length (in)	Width (in)	Order Code	Price Each
150	6	25	133-8103	2.40
300	12	25	133-8104	4.15
600	24	25	133-8105	6.95
1000	39	25	133-8106	10.40

**Imperial Steel Rules**



Two sides - four edges. Subdivided inches in 16ths, 32nds, 64ths, 10ths, 20ths, 50ths, 100ths one side. mm, 0.5mm, figured every 10mm in mm other side. One round end. Rustless. SR patterns are supplied with an easy to read anti-glare finish.

495219

Length (mm)	Length (in)	Width (mm)	Order Code	Price Each
150	6	19	138-8954	5.30
300	12	25	138-8955	8.90
600	24	25	138-8956	17.35
1000	39	25	138-8957	41.15
1000	39	25	138-8963	22.35
150	6	12.5	138-8958	5.30
300	12	12.5	138-8959	8.90

**Steel Rules**

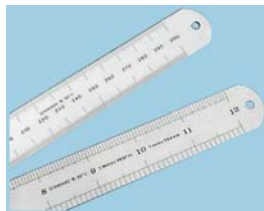

**Imperial And Metric**

Front side figured in inches 16ths, 32nds, 64ths, 10ths, 20ths, 50ths and 100ths. Reverse side figured in millimetres 0.5 and 1.0.

491055

Model	Length (mm)	Width (in)	Width (mm)	Order Code	1+	5+	10+	20+
ER106F	150	6	19	137-6848	4.48	4.39	4.31	4.22
ER112	300	12	25	137-6849	7.66	7.50	7.36	7.20
ER206F	150	6	12.5	137-6850	4.48	4.39	4.31	4.22
ER212	300	12	12.5	137-6851	7.66	7.50	7.36	7.20
ER424	600	24	25	137-6852	21.17	20.74	20.33	19.92

**Metric**

Both sides figured in millimetres 0.5 and 1.0.

Model	Length(mm)	Width(mm)	Order Code	Price Each
ER306F	150	19	137-6853	4.48
ER312	300	25	137-6854	7.52

**Steel Rules**

**Metric**

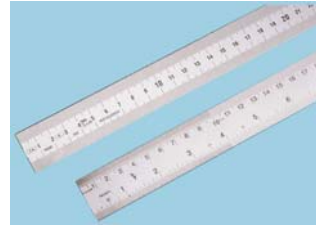

EC Class 2. Both edges: 1mm, figured in cm.

Length (m)	Section (mm)	Order Code	Price Each
1	30 x 1	032-120	33.90
1.5	30 x 1	032-121	58.85
2	30 x 1	032-123	69.02
2	40 x 2	032-124	155.95

**Metric/English**

EC Class 2. Top edge: 0.5mm and 1mm, figured in cm. Bottom edge: 16ths, 32nds, 64ths, figured in inches.

492369

Length (m)	Section (in)	Section (mm)	Order Code	Price Each
1	40	30 x 1	032-125	33.90
1.5	60	30 x 1	032-126	58.85
2	80	30 x 1	032-128	62.36

**General Purpose Straight Edges**

**Ungraduated**



A range of general purpose carbon steel straight edges. Available graduated in mm on bevel edge or ungraduated.

493058

Length (mm)	Section (mm)	Order Code	Price Each
500	40 x 5	031-555	27.85
1000	40 x 5	031-556	51.77
1500	40 x 5	031-557	93.05
2000	40 x 5	031-558	115.25

**Graduated**

Length (mm)	Section (mm)	Order Code	Price Each
500	40 x 5	031-559	35.97
1000	40 x 5	031-560	92.90
2000	40 x 5	031-561	180.25

**Ungraduated**



A range of general purpose carbon steel straight edges. Available graduated in mm's on bevel edge or ungraduated.

349238

Order code	Length (mm)	Section (mm)	Price each
031-555	500	40 x 5	27.85
031-556	1000	40 x 5	51.77
031-557	1500	40 x 5	93.05
031-558	2000	40 x 5	115.25



**Graduated**

Order code	Length (mm)	Section (mm)	Price each
031-559	500	40 x 5	35.97
031-560	1000	40 x 5	92.90
031-561	2000	40 x 5	180.25

**Folding Ruler**

Longlife Plus and Longlife



- Glass fibre reinforced
- Scratch, weather and chemical resistant
- Patented, play free, wear resistant and maintenance free joint with steel spring pin for constant tension
- Useful 90° snap-in position
- Deep embossed black scale in 1mm increments. Every 10 cm is marked in red

345774

Mftrs. Part No.	Order Code	Price Each		
		1+	5+	10+
41020011	762-3631	4.98	4.54	4.16
41010001	762-3640	3.07	2.80	2.57

**Vernier Circumference And DiameterTape**



16mm wide hardened spring steel tape with 0.1mm vernier reading. Circumference graduations in millimetres on lower edge and diameter graduations on upper edge.

492599

Circumference (mm)	Diameter (mm)	Order Code	Price Each		
			1+	5+	10+
60 - 950	20-300	032-129	80.63		
940 - 2200	300-700	032-130	100.87		
2190 - 3460	700-1100	032-131	127.05		

**Tape Measures**

**Hi-Vis Tape Measures**



- Tape measures in high visibility plastic housing
- Thumb operated blade lock
- Belt clip and wrist strap

482917.432350

Length	Width	Colour	Order Code	Price Each	
				1+	5+
3m/10ft	13mm	Yellow	136-7033	0.91	0.83
5m/16ft	19mm	Orange	136-7034	1.16	1.02
8m/26ft	25mm	Green	136-7035	2.57	2.44

**Pocket Tapes**

High Visibility



- High visibility, easy-to-find, yellow case
- Dual markings: metric and Imperial
- High-contrast, easy-to-read markings

221152

Size	Order Code	Price Each	
		1+	5+
3m/10ft	717-0725	2.10	
5m/16ft	717-0737	4.10	

**ABS Tape Measures**



- ABS cases and steel inserts
- Metric and Imperial markings
- Suitable for internal and external measurements
- Supplied with belt clip

Length	Blade Width	Order Code
5m/16ft	19mm	313-3394

223060

Size	Order Code	Price Each	
		1+	5+
5m/16ft	313-3394	3.43	

**Hi-Vis Measuring Tape**



These tapes feature a case made from durable ABS plastic contoured to fit comfortably in your hand. The hi-vis colour makes locating the product easy. Features include: Unique slide lock for easy control, belt clip, re-inforced end-hook which is double riveted on the 3M version and triple riveted on the 5M and 8M versions.

485297

Length (m)	(ft)	Width (mm)	(inches)	Order Code	Price Each			
					1+	5+	10+	20+
3	10	13	1/2	137-1657	3.00	2.91	2.82	--
5	16	19	3/4	137-1658	5.00	4.85	4.70	4.56
8	26	25	1	137-1659	9.00	8.73	8.47	8.21

**Tape Measures**



**A tape measure with 5 fantastic features**

- Autobrake system - Stops the tape from recoiling when extended
- Magnetic rubber grip hook - the magnet will hold the end of the tape to metal surfaces and it's rubber grip hook holds the tape securely over the edge of non - metal surfaces, particularly smooth and chamfered surface
- Big Blade standout. - over two metres without bending
- ABS and Rubber body - designed to take a lot of wear and tear
- Class II accuracy - plus dual metric / imperial markings and convenient 16" centre joist markings
- Sizes: 5m /16ft or 7.5m /25ft

448558.470086

Model/Description	Mftrs. List No.	Order Code	Price Each	
			1+	5+
5.5/18ftm	461003	128-3287	8.15	7.90
7.5m/25ft	461005	128-3288	10.80	10.50

**8 Metre Powerlock**

Tape With Blade Armor



The first 150mm/6in of the tape blade is reinforced with blade armor for added strength and durability. Entire blade coated with mylar polyester for durability. Durable chrome case.

477993

Length (m)	(ft)	Width (mm)	(in)	Order Code	Price Each			
					1+	5+	10+	20+
8	26	25	1	135-3424	13.45	13.05	12.35	12.10

**Tape Measures - continued**

**Fatmax Bladearmor**



Extra wide 1 1/4 inch blade for easier reading and 11 feet of stand-out, constructed with a 3m industrial thermo-plastic coating for maximum durability and reduced breakage. Impact blade is mylar coated for long life and features a 3 rivet corrosion resistant end hook, which gives true zero reading and accurate inside and outside measurement. The end hook is also multi-functional allowing grip on side, top and bottom. Conforms to class II accuracy.

477998

Length (m)	Length (ft)	Width (mm)	Order Code	Price Each			
5	16	32	135-3446	1+	5+	10+	20+
8	26	32	135-3449	12.45	12.10	11.45	11.22
				17.02	16.34	15.65	14.98

**Fibreglass Tape Measures**



- Durable vinyl-coated fibreglass measuring tapes with easy to read markings
- Metal hook end for anchoring tape over long distances
- Metric and imperial measurements on opposite sides
- Tough plastic casing
- Folding winder with handle

482919.432352

Length	Width	Order Code	Price Each			
20m/33ft	13mm	136-7727	1+	5+	10+	20+
30m/100ft	13mm	136-7728	5.31	5.09	4.76	4.67
			6.34	6.12	5.85	5.68

**Closed Frame**



This measure has two colour graduations that are easy to read in all conditions. A high impact yellow ABS case with the handle folding for storage. Conforms to Class II accuracy.

478216

Length (m)	Length (ft)	Width (mm)	Order Code	Price Each			
20	66	12.7	380-8488	1+	6+	12+	24+
30	100	12.7	135-3451	6.35	6.15	5.85	5.25
				7.70	7.55	7.39	7.25

**Glass Fibre Measuring Tape**

**Closed Case**



Folding winder handle. Strong steel coated case. Hand strap fitted to 30m tape only.

495023

Length (m)	Length (ft)	Width (mm)	Width (in)	Order Code	Price Each
10	33	13	1/2	231-701	16.20
20	66	13	1/2	231-702	21.82
30	100	13	1/2	231-703	28.54

**Wheel Measure**



- Calculate the size of large areas without the hassle of measuring tape
- Perfect for making estimates for remodeling, landscaping fencing and more
- One person operation - automatically records measurements as you walk
- Ideal for builders, farmers, road contractors, councils, schools, real estate and police accident investigations
- The mechanical counting head is a fine digit read out
- Lightweight aluminium handle
- 12 1/2" rubber wheel
- Counter with reset button measures distances upto 10000ft
- Precision engineered to the highest quality
- One person operation - automatically records measurements as you walk
- Ideal for builders, farmers, road contractors, councils, schools, real estate and police accident investigations
- Durable lightweight and compact design
- 300mm measuring wheel

- Reset lever on the counter meter
- The counter adds when the wheel is in a forward motion and subtracts in reverse
- The mechanical counting head is a fine digit read out
- Light facility for night use
- Comes with a canvas storage bag

482092.461140

Order Code	Price Each				
144-7553	1+	5+	10+	20+	50+
	22.92	21.02	18.34	17.20	15.62

**Counter Measuring Wheel**



Durable traditional counter measuring wheel for best value. Gear driven counter with tough plastic housing. 5 digit counter with manual reset button. Heavy duty meta folding handle and rubber hand grip. Folding wheel mount. Diecast aluminium wheel, wear resistant rubber tread. Folding kick stand.

Technical Specification	
Working Range	9999.99 metres
Wheel Diameter	318mm (12.5")
Working Environment	Built for exterior use, larger wheel for rougher ground
Working Accuracy	+/- 1% typically
Units Of Measurement	Metres & Dm's
Wheel Mount	Folding wheel mount included
Build Standard	Diecast wheels, HD rubber tyres for durability. Tough counter moulding for strength
Warranty	24 months

478418

Order Code	Price Each			
135-3729	1+	5+	10+	20+
	57.95	56.79	55.66	54.54

**Battery Testers and Jump Leads**

**Battery Testers**



**20 - 120Ah Battery Tester**

For testing 6 or 12V batteries of 20 to 120Ah capacity. Two flexible prods are held on the battery terminals for a few seconds and a meter reading diagnoses battery condition by referring to a chart permanently attached to the tester.

Model	Order Code	Price Each
0-524-08	282-410	94.05

**Anti-Freeze Hydrometers**

**Model 0-55-00:-** Designed for ethylene-glycol solutions only. Integral thermometer and drum calculator enables the correct % anti-freeze to be determined accurately over a wide temperature range.

**Model 0-711-00:-** Polarmaster model indicates the amount of undiluted anti-freeze to add to obtain correct degree of frost protection. Specific gravity range 5 - 60%.

Model	Specific Gravity Range	Order Code	Price Each
0-550-00	0-25%	282-414	46.60
0-711-00	5-60%	282-415	55.15

**Battery Hydrometers**

Battery hydrometers covering specific gravity range 1.150 - 1.400°.

Description	Model	Specific Gravity Range	Order Code	Price Each
For medium sized batteries.	0-070-00	1.150 - 1.400°	081-014	13.51
For small batteries with less than 10cc of battery acid.	0-059-00	1.150 - 1.350°	281-411	10.88

**Battery Filler**

140cc capacity with 305mm 12in tube.

Model	Order Code	Price Each
0-149-00	081-034	12.10

**Professional Jump Leads**



Top quality jump leads for general through to heavy-duty commercial use. 100% copper conductors, flexible and durable PVC cables and robust clamps. Each set includes a strong PVC storage carry bag.

Order Code	Model	Engine cap (petrol)	Maximum amp cable rating
145-5460	CJL16C	Up to 2.5 litres	220
145-5462	CJL25C	Up to 5.5 litres	350
145-5463	CJL35C	Up to 7 litres	500

Engine cap (petrol)	Length (m)	Cable size (mm)2	Order Code	Price Each 1+
Up to 2.5 litres	3	16	145-5460	13.57
Up to 5.5 litres	3.5	25	145-5462	24.28
Up to 7 litres	4.5	35	145-5463	42.34

**Lubricating Guns**

**Precision Pen-Oiler**



- Precision placement of oil or other lubricants
- Smooth actuator allows for greater control
- All aluminium construction
- Protective screw-on cover prevents leakage
- Convenient pocket clip
- Overall length: 140mm



Order Code	Price each
166-4784	5.05

**Heavy Duty Grease Gun**



Grease Gun 120, 550, 60

- High pressure grease gun up to 5800 psi
- Will accept cartridges or bulk grease
- Supplied with delivery table and 4 jaw coupler
- Extension hoses and hydraulic coupler available separately

	Mftrs. List No.	Order Code	1+	4+	20+	40+
Grease Gun	6270	629-959	17.45	16.95	16.40	15.70
Flexi Hose 11 500	62703	629-960	6.20	6.00	5.85	5.60
Flexi Hose 8 330	62702	629-972	3.95	3.85	3.70	3.55
4 Jaw Coupler	62704	629-984	2.25	2.20	2.10	2.05

**Dispensing Gun Accessories**

**Straight Steel**



1/8in BSP thread fits the majority of guns available.

**Delivery Tubes**

Model	Length (mm)	(in)	Order Code	Price Each 1+
RTS6	150	6	361-006	2.02
RTS10	250	10	155-3783	1.50

**Flexible Nylon**

Model	Length (mm)	(in)	Order Code	Price Each 1+
RTN9	225	9	361-010B	3.60
RTN12	300	12	361-011	4.05
RTN18	450	18	361-012	4.81

**Super-Flexible Rubber**

Model	Length (mm)	(in)	Order Code	Price Each 1+
RTR9	225	9	361-013	5.39
RTR12	300	12	155-2370	5.36

**Lubricating Nipples Selection Box**



- Each accessory box contains a wide selection of popular nipple sizes, straight and angled type plus a 4 jaw hydraulic connector

Pack Quantity	Order Code	Price Each 1+
81	151-0929	25.88

**E35 Foot Pump**



All steel construction, fitted with preset dial gauge. Model E35DB is a double barrel pump giving increased efficiency and greater stability.

Model	Vol. (cm <sup>3</sup> )	Swept (in <sup>3</sup> )	Weight (kg)	Order Code	Price Each 1+
E35	220	13.4	1.9	280-471B	10.02
E35DB	440	26.9	2.2	280-477	18.95

**Lubricating Guns - continued**

**Soft Kneeling Mat**



One side with indents for kneeling. Reverse side flat for sitting. Soft, washable, CFC-free foam rubber. SATRA approved 445 x 245 x 30mm.

494115

Order Code	Price Each
963-4592	14.12

**Plumbing Tools**

**Plumber Tools**

**Man Hole Cover Lifting Keys**



Heavy duty manhole cover lifting keys. All manhole lifting keys are sold in pairs.

494351

Order Code	(mm)	(in)	(mm)	(in)
155-3141	125	5	100	4
828-8585	200	8	100	4
828-8607	300	12	100	4
828-8615	500	20	100	4
828-8623	600	24	100	4

Order Code	Handle Type	End Shape
155-3141	Malleable iron tee	D
828-8585	Triangular	Round
828-8607	Closed handle	Rectangular
828-8615	Closed handle	Rectangular
828-8623	Closed handle	Rectangular

Order Code	Price Each
155-3141	13.65
828-8585	18.91
828-8607	18.79
828-8615	27.43
828-8623	30.38

**Plunger Unblocker**



- Used to clear and free blocked drains
- Fits baths, sinks and shower waste pipes
- Suction pump diameter: 160mm



482927.462276

Order Code	1+	5+	10+	20+	50+
139-1489	2.11	1.87	1.68	1.59	1.45

**Plumber Tools**

**Hand Operated Pressure Test Pump**

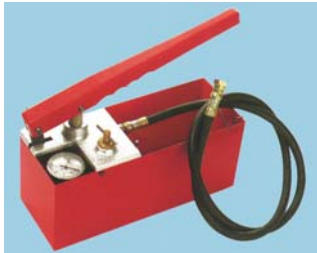

Hand operated hydraulic test pump for proving central heating systems, waterpipes, boilers, vessels etc.

492530

Tank	Test capacity	Order Code	Price Each
Tank capacity litres	Bar	Hose Connection	1+
12	100	1400 ½	828-8437 206.53

**14" Neon Grip Pipe Wrench**



- Drop forged, heat treated jaw and nut
- Comfortable cushion matted grip for a non-slip hold
- Ideal for plumbing, steam fitting and many other applications
- Overall length 350mm
- 50mm jaw capacity

481971.460950

Order Code	1+	5+	10+	20+	50+
144-7409	5.69	4.74	4.49	4.11	3.33

**3 Piece Steel Pipe Wrench Set**



- Drop forged, heat treated steel jaws and nuts
- Heavy duty cast I-Beam handles
- Matted handles for a comfortable grip
- Sizes: 10", 14" and 18"

481970.460941

Order Code	1+	5+	10+	20+	50+
144-7408	10.57	9.77	8.89	8.34	7.91

**Stillson Pipe Wrenches 300**



Handle and jaws are drop forged from high quality steel. Special heat treatment gives the gripping teeth the extra hardness necessary to withstand heavy use.

483375

Length (mm)	Length (inches)	Capacity O.D. (mm)	Order Code	1+	5+	10+	20+
200	8	27	134-8373	20.40	19.60	18.75	17.70
250	10	34	134-8374	17.71	17.35	17.01	16.06
300	12	42	134-8375	21.23	20.80	20.39	19.74
350	14	49	134-8376	31.05	29.80	28.55	26.92
450	18	60	134-8377	45.10	43.30	41.50	38.84
600	24	76	134-8378	85.95	82.50	79.05	74.54
900	36	102	134-8379	163.00	157.25	149.90	145.10

**Stillson Pipe Wrenches 350 Leader**



Used extensively in the oil, gas and civil engineering industries. One piece frame and handle are stronger and have greater capacity than equivalent size 300 series stillson. Drop forged steel jaws are replaceable.

483381

Length (mm)	Length (inches)	Capacity O.D. (mm)	Order Code	1+	5+	10+	20+
200	8	34	134-8380	19.30	18.55	17.75	16.74
250	10	49	134-8381	21.85	21.00	20.10	18.61
300	12	55	134-8382	58.80	56.45	54.10	50.10
350	14	60	134-8384	79.40	76.20	73.05	68.89
450	18	76	134-8385	99.95	96.00	93.60	86.67
600	24	90	134-8386	188.00	179.00	173.00	163.14
900	36	140	134-8387	23.65	22.70	21.75	20.51
1200	48	162	134-8388	299.00	288.00	275.00	254.65

**Aluminium Pipe Wrenches**



These lightweight wrenches are manufactured from titanium alloy

492947

Length		Capacity		Order Code	Price Each
(mm)	(in)	O.D. (mm)			
350	14	50		<b>016-281</b>	58.68
450	18	60		<b>016-282</b>	73.07
600	24	80		<b>016-283</b>	119.01
1050	48	210		<b>016-285</b>	485.05

**Engineering Materials**

**Torlon 4203 Resins**

Rod 200mm lengths  
Electrical grade

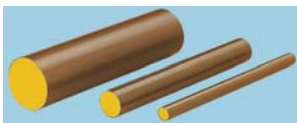

Torlon resins have exceptional physical and chemical properties, that can withstand continuous exposures to temperatures between 230°C and 260°C.

Applications include: connectors, switches, re-lays, thrust washers, valve seats, piston rings,

mechanical linkages, bushings, electrical and thermal insulators.

- High stiffness/strength
- Wide operating temperature range - 190°C to 260°C
- Good dimensional stability
- Excellent chemical resistance
- Excellent creep resistance
- Good radiation resistance
- Good electrical/dielectric performance

Colour	Dark Brown
Specific Gravity	1.4
Tensile Strength	192 N/mm <sup>2</sup>
Elongation	15%
Flexural Strength	244 N/mm <sup>2</sup>
Rockwell Hardness	E86
Melt Point	340°C
Linear Thermal Expansion Coefficient	3.06 K x 10
Volume Resistivity	2 x 10 <sup>12</sup> Ωcm
Dielectric Strength	23.6 kV/mm

All dimensions are approximate

486462

Diameter (mm)	Order Code	Price Each			
		1+	5+	10+	20+
½in	<b>722-0601</b>	14.98	14.50	13.88	13.47
¾in	<b>722-0613</b>	31.76	30.51	29.02	27.95
1in	<b>722-0625</b>	54.60	52.25	49.49	47.54
1¼in	<b>722-0637</b>	84.24	78.41	74.75	72.74
2in	<b>722-0650</b>	207.92	199.00	188.45	181.00

**High Performance Engineering Plastic**

PEEK

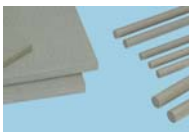

A high performance engineering thermoplastic with excellent chemical, electrical and mechanical properties. PEEK is a tough, abrasion resistant material that retains good tensile and flexural properties at temperatures in excess of 250°C. % Elongation 15 Dielectric strength 23.6kV/mm, flexural strength 244N/mm

- Excellent chemical resistance
- Wide operating range (-60°C to 250°C)
- Superb electrical/dielectric performance
- Good radiation resistance (>1000Mrads)
- High stiffness/strength
- Good abrasion resistance
- Hydrolysis resistance
- Non-flammable

Specific Gravity	1.06	Melt Point	340°C
Water Absorption	0.45	Max. Service Temperature	250°C (20000hrs)
Tensile Strength	110 N/mm <sup>2</sup>	Min Service Temperature	-60°C
Tensile Modulus	4200 N/mm <sup>2</sup>	Linear Thermal Expansion Coefficient	5 K x 10
Flexural Strength	170 N/mm <sup>2</sup>	Thermal Conductivity	0.25 W/K.m
Flexural Modulus	3600 N/mm <sup>2</sup>	Volume Resistivity	4-9 x 10
Elongation	20%	Dielectric Strength	24 kV/mm
Hardness (Rockwell M)	105		

All dimensions are approximate

**Rod 300mm length**

Length Diameter (mm)	Order Code	Price Each			
		1+	5+	10+	20+
16	<b>717-5590</b>	15.93	15.42	14.79	14.49
25	<b>717-5772</b>	34.77	33.66	33.21	31.63
30	<b>717-5796</b>	52.25	49.95	48.33	47.37
35	<b>717-5802</b>	68.77	65.75	63.62	62.37
40	<b>717-5838</b>	88.11	84.22	81.51	79.89
45	<b>717-5840</b>	113.13	108.13	104.65	102.56
50	<b>717-5851</b>	140.03	133.87	129.57	126.97
60	<b>717-5863</b>	195.59	186.97	180.96	177.34

**Plate 245mm x 305mm**

Thickness (mm)	Order Code	Price Each			
		1+	5+	10+	20+
8	<b>717-5875</b>	170.91	163.38	158.14	154.96
10	<b>717-5887</b>	201.12	192.24	186.07	182.34
16	<b>717-5905</b>	320.45	306.34	296.49	290.56

**Strip 45mm x 500mm**

486302

Thickness (mm)	Order Code	Price Each			
		1+	5+	10+	20+
8	<b>717-5929</b>	68.16	65.97	63.24	61.99
10	<b>717-5978</b>	77.54	75.07	71.97	70.52
12	<b>717-5980</b>	95.75	92.70	88.87	87.10
16	<b>717-5991</b>	121.85	116.82	113.07	110.82
20	<b>717-6004</b>	148.18	--	--	--

**Engineering Thermoplastic**

Sheet 610mm x 1220mm Acrylonitrile Butadiene Styrene

ABS is a tough and rigid thermoplastic exhibiting high impact resistance and which can be thermally formed easily. It also has good electrical properties and reasonable chemical resistance to acids and alkalis.

- High impact strength
- Good electrical insulator
- Natural white
- Easily formed
- Reasonable chemical resistance

Specific Gravity	1.06
Tensile Strength	37 N/mm <sup>2</sup>
Flexural Strength	65 N/mm <sup>2</sup>
Flexural Modulus	1800 N/mm <sup>2</sup>
Impact Strength Izod Notched	290
Hardness (Rockwell R)	85
Linear Thermal Expansion Coefficient	9.5 K x 10

All dimensions are approximate

486296

Thickness (mm)	Order Code	Price Each			
		1+	5+	10+	20+
1.5	<b>717-5541</b>	26.61	25.41	24.59	24.09
3.0	<b>717-5553</b>	29.91	28.96	27.76	27.19
4.5	<b>717-5565</b>	40.10	38.29	37.06	36.32
6.0	<b>717-5577</b>	51.50	48.97	47.40	46.29

45

**Engineering Material**

Polytetrafluoroethylene (P.T.F.E.)



This material provides the ultimate in chemical resistance, ability to withstand extremes of operating temperature, very low friction and superb electrical performance. Applications include: gaskets, chute linings, insulators, valve seats, 'O' rings.

- Excellent chemical resistance (pH 0-14)
- Very low coefficient of friction
- Wide operating range (-260°C to 250°C)
- Superb electrical/dielectric performance
- Tough and flexible
- Non-stick surface
- Natural white colour

All dimensions are approximate

**Rod**

Length Diameter (mm)	Quantity per lot	Order Code	Price Each			
			1+	5+	10+	20+
6	5	<b>717-4433</b>	10.210	9.750	9.450	9.250
10	5	<b>717-4445</b>	24.280	23.180	22.430	22.000
15	3	<b>717-4457</b>	32.980	31.500	30.480	29.880
32	2	<b>717-4482</b>	95.970	91.660	88.720	86.950
36	1	<b>717-4494</b>	67.620	64.590	62.520	61.290
40	1	<b>717-4500</b>	72.160	68.920	66.710	65.380
45	1	<b>717-4524</b>	90.440	86.390	83.630	81.960
65	1	<b>717-4548</b>	135.300	131.268	128.143	125.163

**Rod 500mm length**

Length Diameter (mm)	Quantity per lot	Order Code	Price Each			
			1+	5+	10+	20+
40	1	<b>717-4597</b>	34.48	33.06	32.01	31.37
45	1	<b>717-4603</b>	42.93	41.17	39.84	39.06
50	1	<b>717-4615</b>	53.08	50.90	49.26	48.28
65	1	<b>717-4627</b>	84.20	80.75	79.13	77.55

**Rod 300mm length**



**Engineering Materials - continued**

**Engineering Material - continued**

**Rod 300mm - continued**

Length Diameter (mm)	Quantity Per Lot	Order Code	Price Each			
			1+	5+	10+	20+
70	1	717-4639	71.49	68.56	66.35	65.03
77	1	717-4640	84.37	80.90	78.29	76.74
83	1	717-4652	98.24	94.19	91.20	89.35
102	1	717-4688	129.36	124.04	120.05	117.66
110	1	717-4690	164.84	158.07	152.99	149.94
120	1	717-4706	265.11	243.02	221.55	205.73

**Sheet 610 x 305mm**

Thickness (mm)	Quantity per lot	Order Code	Price Each			
			1+	5+	10+	20+
1.5	1	717-4720	53.58	51.12	49.48	48.51
3	1	717-4731	69.68	66.47	64.33	63.06
6	1	717-4743	69.67	66.46	64.32	63.05
10	1	717-4755	112.50	107.33	103.89	101.82
15	1	717-4767	166.03	158.36	153.29	150.24

**Sheet 305 x 305mm**

486281

Thickness (mm)	Quantity Per Lot	Order Code	Price Each			
			1+	5+	10+	20+
10	1	717-4810	54.60	52.36	50.69	49.65
15	1	717-4883	79.49	76.20	73.77	72.29
20	1	717-4895	104.39	100.12	96.88	94.95
25	1	717-4901	129.24	123.94	119.95	117.56

**Engineering Material**

**Acetal Homopolymer Natural**



Similar properties to that of Acetal Copolymer, except with marginally superior mechanical properties and better wear resistance. Slightly lower maximum continuous operating temperature and less resistance to hot water.

Applications include: similar applications to Acetal Copolymer but requiring marginally superior mechanical properties and

wear resistance.

- High rigidity
- Good impact resistance
- Low moisture absorption
- Continuous working temperature 90°C (Max 150°C)
- Good chemical resistance
- Excellent dimensional stability
- Ideal for close tolerance parts
- Suitable for food contact
- All dimensions are approximate

Specific gravity	1.43	Hardness (Rockwell M)	90
Water absorption	0.85%	Melt point	175°C
Tensile strength	80 N/mm <sup>2</sup>	Max. service temperature (5000 hrs)	95°C
Tensile modulus	3300 N/mm <sup>2</sup>	Min. service temperature	-50°C
Flexural strength	98 N/mm <sup>2</sup>	Linear thermal expansion coefficient	11.0 x 10 K
Flexural modulus	2620 N/mm <sup>2</sup>	Flammability	Slow burning
Elongation	30%	Volume resistivity	10Ωcm

**Rod 1 Metre Length**

Length Diameter (mm)	Quantity Per Lot	Order Code	Price Each			
			1+	5+	10+	20+
10	5	717-1821	9.10	8.62	8.36	8.14
15	3	717-1833	10.73	10.19	9.85	9.60
25	2	717-1857	13.75	13.03	12.63	12.29
30	1	717-1948	13.18	12.49	12.08	11.78
36	1	717-1950	17.51	16.59	16.07	15.64
40	1	717-1961	20.89	19.80	19.18	18.67
45	1	717-2060	25.68	24.36	23.57	22.95
50	1	717-2072	30.69	29.11	28.18	27.42
55	1	717-2084	37.54	35.61	34.45	33.56
60	1	717-2096	43.13	40.89	39.58	38.53

**Sheet 500 x 305mm**

486264

Thickness (mm)	Quantity Per Lot	Order Code	Price Each			
			1+	5+	10+	20+
10	1	717-2114	30.47	29.00	28.07	27.42
16	1	717-2126	43.98	41.85	40.51	39.60
20	1	717-2138	52.99	50.42	48.79	47.72
25	1	717-2151	64.21	61.11	59.15	57.81
30	1	717-2163	76.99	73.27	70.91	69.32
35	1	717-2175	88.24	83.98	81.29	79.45

**Engineering Material**

**Acetal Homopolymer Black**

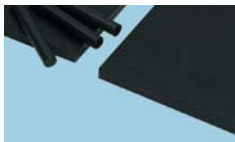

Black Acetal Homopolymer is superior to the natural equivalent in environments where exposure to ultra-violet is a consideration.

Similar properties to that of Acetal Copolymer, except with marginally superior mechanical properties and better wear resistance, slightly lower maximum continuous operating temperatures and less resistance to hot water.

Similar applications to Acetal Copolymer but requiring marginally superior mechanical properties and wear resistance.

- High rigidity
- Good impact resistance
- Low moisture absorption
- Continuous working temperature 90°C (Max. 150°C)
- Good chemical resistance
- Excellent dimensional stability
- Ideal for close tolerance parts
- Suitable for food contact
- All dimensions are approximate

Specific gravity	1.43	Hardness (Rockwell M)	90
Water absorption	0.85%	Melt point	175°C
Tensile strength	80 N/mm <sup>2</sup>	Max. service temperature (5000 hrs)	95°C
Tensile modulus	3300 N/mm <sup>2</sup>	Min. service temperature	-50°C
Flexural strength	98 N/mm <sup>2</sup>	Linear thermal expansion coefficient	11.0 x 10 <sup>-5</sup> K
Flexural modulus	2620 N/mm <sup>2</sup>	Flammability	Slow burning
Elongation	30%	Volume resistivity	10 <sup>14</sup> Ωcm

**Rod 1 Metre Length**

Length Diameter (mm)	Quantity Per Lot	Order Code	Price Each			
			1+	5+	10+	20+
16	3	717-3702	9.84	9.43	9.11	8.92
20	2	717-3714	10.02	9.64	9.29	9.10
25	2	717-3726	14.31	13.75	13.27	13.00
30	1	717-3738	10.98	10.51	10.19	9.97
45	1	717-3751	21.03	20.15	19.50	19.10
50	1	717-3763	25.93	24.94	24.04	23.56
60	1	717-3775	35.73	34.36	33.14	32.48
65	1	717-3787	43.80	42.10	40.58	39.77

**Sheet 500mm x 305mm**

486271

Thickness (mm)	Order Code	Price Each			
		1+	5+	10+	20+
10	717-3799	29.74	28.40	27.46	26.92
16	717-3805	43.06	41.10	39.77	38.98
20	717-3817	51.91	49.56	47.97	47.00
25	717-3829	62.99	60.12	58.20	57.03
30	717-3842	75.56	72.14	69.82	68.42
40	717-3854	87.95	83.98	81.27	79.65

**Engineering Plastic**

**Nylon 66- Nylatron® GS**

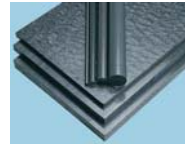

- High stiffness and strength
- Self-lubricating
- Excellent wear resistance
- Dark grey colour
- Continuous working temperature 80/95°C (Max 145°C)
- Greater load bearing capacity
- Excellent dynamic bearing material

Based on Nylon 66, this material is enhanced with molybdenum disulphide (MoS<sub>2</sub>) filler to produce a low friction, self lubricating material with superior properties over unfilled Nylon 66. Applications: as for Ertalon® 62A and 66GF-30.

Specific gravity	1.14-1.18	Hardness (Shore D)	80-90
Water absorption (saturation at 23°C)	6-8%	Linear thermal expansion coefficient	6.3 x 10 K
Tensile strength	69/96 N/mm <sup>2</sup>	Minimum service temperature	-40°C
Tensile modulus	3130/4160 N/mm <sup>2</sup>	Melting point	260°C
Elongation	5-150%	Thermal conductivity	0.30W/km
Flexural strength (23°C)	110-130 N/mm <sup>2</sup>	Flammability	Self-extinguishing
Flexural modulus	2758-3448 N/mm <sup>2</sup>	Coefficient of friction	0.15-0.35

All dimensions are approximate

**Rod 1 Metre Length**

Diameter (m)	Qty Per Lot	Order Code	Price Each		
			1+	5+	20+
12	3	520-639	4.68	4.36	4.22
16	3	520-640	7.88	7.31	7.07
20	2	520-652	8.23	7.88	7.63
25	2	520-664	11.69	10.83	10.43
30	1	520-676	9.39	8.65	8.40
35	1	520-688	13.03	12.03	11.66

**Sheet**

486163

Sheet Size (mm)	Qty Per Lot	Order Code	Price Each		
			1+	5+	20+
8 x 500 x 305	2	520-720	39.43	35.33	34.20
12 x 500 x 305	1	520-731	27.61	25.21	24.37
16 x 500 x 305	1	520-743	36.65	33.14	32.07
20 x 500 x 305	1	520-755	47.03	42.92	41.54
25 x 500 x 305	1	520-767	57.58	52.56	50.87
30 x 500 x 305	1	520-779	68.42	63.38	61.34

**Engineering Material**

**Acetal Copolymer Natural**



This proven engineering material has a good combination of all round properties, distinguished by its low moisture absorption and excellent machinability.

Applications include: pump housing, impellers, gears, bearings, valves, valve seats, domestic applications, electrical components.

- High rigidity
- Good impact resistance
- Low moisture absorption
- Continuous working temperature 100°C (Max. 140°C)

- Good chemical resistance (pH5-11)
- Excellent dimensional stability
- Ideal for close tolerance parts
- Natural white colour
- All dimensions are approximate

Specific gravity 1.41  
Water absorption 0.22% in 24 hrs  
Tensile strength 62 N/mm<sup>2</sup>

Hardness (Rockwell R) 120  
Melt point 165°C  
Max. service temp. (5000 hrs) 115°C  
Min. service temp. -50°C  
Liner thermal expansion coefficient 12.5 x 10 K  
Flammability Slow burning

Elongation 60%  
Flexural strength 90 N/mm<sup>2</sup>

Flexural modulus 2585 N/mm<sup>2</sup>  
Shear strength 53 N/mm<sup>2</sup>

**Rod 1 metre length**

Diameter (mm)	Qty Per Pack	Order Code	1+	5+	20+
6	5	520-986	5.08	4.76	4.60
10	5	520-998	8.19	7.59	7.34
15	3	521-000	9.26	8.58	8.31
20	2	521-012	10.22	9.46	9.15
25	2	521-024	15.14	14.04	13.59
30	1	716-8391	10.66	10.21	9.88
36	1	716-8408	14.16	13.57	13.13
40	1	716-8410	16.15	15.43	14.94
45	1	716-8421	22.43	21.41	20.73
50	1	716-8433	25.97	24.82	24.03
56	1	716-8445	33.51	31.96	30.92
60	1	716-8457	37.06	35.40	34.26
65	1	716-8469	44.01	42.08	40.73

**Sheet**

486184

Sheet Size (mm)	Qty Per Pack	Order Code	1+	5+	20+
8 x 500 x 305	2	521-036	43.99	40.24	38.94
16 x 500 x 305	1	521-050	47.31	44.00	42.59
25 x 500 x 305	1	521-061	55.13	51.02	50.00
20 x 500 x 305	1	716-8500	43.42	41.60	40.77
30 x 500 x 305	1	716-8512	67.44	63.97	61.92
35 x 500 x 305	1	716-8524	77.73	74.39	72.00

**Engineering Material**

**Acetal Copolymer Black**

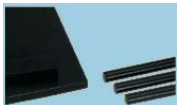

Black Acetal Copolymer is superior to the natural equivalent in environments where exposure to ultra violet light is a consideration. Similar properties to that of Acetal Copolymer, except with marginally superior mechanical properties and better wear resistance, slightly lower maximum continuous operating temperature and less resistance to hot water. Similar applications to acetal copolymer but requiring marginally superior mechanical properties and wear resistance.

- High rigidity
- Good impact resistance
- Low moisture absorption
- Continuous working temperature 100°C (Max. 140°C)

- Good chemical resistance (pH5-11)
- Excellent dimensional stability
- Ideal for close tolerance parts
- Black

Specific gravity 1.41  
Water absorption 0.22% in 24 hrs  
Tensile strength 62 N/mm<sup>2</sup>  
Tensile modulus 2795 N/mm<sup>2</sup>

Shear strength 53 N/mm<sup>2</sup>  
Hardness (Rockwell R) 120  
Melt point 165°C  
Max. service temp. (5000 hrs) 115°C  
Min. service temp. -50°C  
Liner thermal expansion coefficient 12.5 x 10 K  
Flammability Slow burning

Elongation 60%  
Flexural strength 90 N/mm<sup>2</sup>

Flexural modulus 2585 N/mm<sup>2</sup>

All dimensions are approximate.

**Rod 1 metre length**

Length	Quantity Per Lot	Order Code	1+	5+	10+	20+
6	5	717-1470	5.18	4.94	4.79	4.69
10	5	717-1481	8.82	8.37	8.12	7.92
15	3	717-1493	9.16	8.76	8.48	8.31
20	2	717-1500	11.24	10.56	10.26	9.83
25	2	717-1511	14.08	13.47	13.05	12.77
36	1	717-1535	15.90	15.15	14.66	14.38
40	1	717-1547	18.39	17.55	16.99	16.65
45	1	717-1559	21.94	20.98	20.30	19.90
50	1	717-1560	26.19	25.04	24.24	23.74
56	1	717-1572	32.74	31.27	30.26	29.67
60	1	717-1584	37.40	35.72	34.57	33.88

**Sheet 500 x 305mm**

486199

Sheet Size (mm)	Quantity Per Lot	Order Code	1+	5+	10+	20+
15	1	717-1626	38.47	36.77	35.59	34.88
20	1	717-1651	51.29	48.90	47.35	46.40
30	1	717-1341	74.56	71.12	68.83	67.44
40	1	717-1365	96.39	91.95	88.98	87.21

**Engineering Plastic**

**Nylon 66 - Ertalon® 66SA**

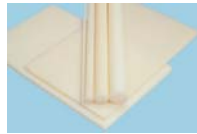

- Tough and resilient
- Good wear resistance
- Good electrical insulator
- Natural white colour
- Continuous working temperature 80°C (Max. 160°C)

- Good chemical resistance (pH5-11)
- Lightweight (1/6 vs steel)
- Good flexible fatigue resistance

Nylon 66 is a highly versatile engineering plastic due to its excellent combination of the above properties. Applications include: gears, bearings, rollers, wheels, cams, nuts, valve seats, pulleys, gaskets, electrical insulators.

Specific gravity 1.14 - 1.15

Thermal conductivity 0.24 W/K

Water absorption 7-9% Max  
Tensile strength 62-83 N/mm  
Flexural strength 88-97 N/mm  
Shear strength 66 N/mm  
Melt point 260°C

Flammability Self extinguishing  
Volume resistivity 10 Ωm  
Dielectric strength <2 kV/mm

All dimensions are approximate

**Rod 1 metre**

Diameter (m)	Qty Per Lot	Order Code	1+	5+	20+
6	5	520-287	4.31	3.76	3.65
10	5	520-299	7.38	6.52	6.30
15	3	520-305	7.69	7.12	6.88
20	2	520-317	8.52	7.89	7.65
30	2	520-330	16.41	15.15	14.66
36	1	520-342	12.25	11.31	10.96
40	1	520-354	14.88	13.76	13.32
45	1	520-366	18.45	17.07	16.52
50	1	520-378	22.20	20.54	19.87
60	1	520-391	30.79	28.49	27.57
65	1	520-408	35.48	32.82	31.76
70	1	520-410	41.14	38.05	36.82
75	1	520-421	43.54	40.19	38.89

**Sheet**

486135

Sheet Size (mm)	Qty Per Lot	Order Code	1+	5+	20+
8 x 500 x 305	2	520-433	32.81	31.39	30.40
12 x 500 x 305	1	520-445	28.70	26.50	25.66
16 x 500 x 305	1	520-457	38.77	35.91	34.74
20 x 500 x 305	1	520-469	41.13	37.97	36.74
30 x 500 x 305	1	520-470	49.93	46.07	44.61
30 x 500 x 305	1	520-482	62.83	57.84	55.98
50 x 500 x 305	1	520-500	98.29	90.78	87.88

**Clear Polycarbonate Sheet**

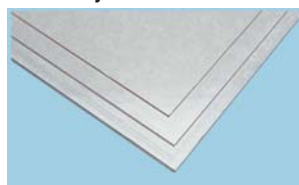

- Good mechanical strength
- Exceptional impact resistance
- Clear, high optical quality
- Good thermal and noise barrier
- Continuous working temperature 80°C (Max. 120°C)
- Good UV/weather resistance

Polycarbonate sheet is a virtually unbreakable, flexible material of optical quality which can be fabricated into a wide variety of clear components.

Applications include: flat and curved glazing, machine guards, riot shields, door viewing panels, light covers.

Density	1.2	Thermal conductivity	0.21W/K.m
Tensile strength at break	>60 N/mm <sup>2</sup>	Flammability	UL94V-2
Elongation at break	80%	Coefficient of linear thermal expansion	6.5K.10
Nail indentation hardness	110 N/mm <sup>2</sup>	Volume resistivity	10/cm
Impact strength	No break	Dielectric strength	25 kV/mm
Melt point	230°C		

All dimensions are approximate

**Sheet**

494262

Sheet Size (mm)	Order Code	Price Each
4 x 1250 x 610	521-401	45.77
5 x 1250 x 610	521-413	63.32

Over 480,000 products online



**Engineering Materials - continued**

**Polypropylene Rods And Sheets**



- High flexural fatigue resistance
- Good impact strength
- Resists steam cleaning
- Natural white colour
- Excellent electrical properties
- Continuous working temperature 80°C (Max. 100°C)
- Excellent chemical resistance (pH4-11)
- Limited UV resistance
- All dimensions are approximate

Specific gravity	1.43	Relative permittivity at 1kHz	2.25
Flexural modulus of elasticity	1150 N/mm <sup>2</sup>	Volume resistivity	10 <sup>15</sup> Ωcm
Tensile strength at yield	27 N/mm <sup>2</sup>	Surface resistivity	1011 to 1015Ω
Elongation at yield	15%		

**Rod 1 Metre Length**

Diameter (mm)	Quantity Per Lot	Order Code	Price Each
20	3	521-309	13.32
30	2	521-310	18.03
40	1	521-322	15.85

**Sheet**

Sheet Size (mm)	Quantity Per Lot	Order Code	Price Each
3 x 995 x 495	3	521-334	28.36
4.5 x 995 x 495	2	521-346	29.88
6 x 995 x 495	2	521-358	40.66
9 x 995 x 495	1	521-360	26.64
10 x 995 x 495	1	521-371	33.21
15 x 995 x 495	1	521-383	55.91

**Clear Sheet PETG**



PETG sheets have high impact strength even at temperatures below zero. This allows punching, die cutting, shearing, cold bending riveting etc. as well as conventional fabricating techniques.

PETG sheets have a light transmission at up to 90% combined with high surface gloss and optical quality.

PETG sheets are food compatible complying with FDA regulations. Applications vary but include machine guards, point of sale items,

food displays and containers, signs, and shop fitting items.

- Excellent thermoformability
- High clarity
- Good impact resistance
- Food compatible
- Sterilisable with ETO or Gamma-Rays

Specific Gravity	1.27
Tensile Strength 23°C	50 N/mm
Tensile Modulus	2050 N/mm
Coefficient of Expansion	5 x 10 K
Deformation Temp	
A: 1.81 N/mm	63°C
B: 0.45 N/mm	70°C
Specific Heat 30°C	1170J/kg.k
Specific Resistance	10 Ωcm

All dimensions are approximate

Sheet Size(mm)	Order Code	1+	5+	10+	20+
1250 x 600 x 3	320-2756	26.04	23.87	23.09	20.62
1250 x 600 x 4	320-2768	34.71	31.84	30.78	27.46

**Acrylic Sheet**

**Perspex® Acrylic**

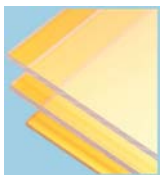

An acrylic sheet is a most useful material in the workshop because its properties make it very suitable for a wide range of different purposes, from precision engineering components to domestic and commercial products. Some of the many applications are: signs, glazing, safety screens, roofing, lighting fittings, medical and research apparatus, furniture and craft work.

- Excellent surface quality
- Hygienic
- Consistent mechanical properties
- Low density
- Good abrasion resistance

Sheet Size(mm)	Order Code	1+	5+	10+	20+
1010 x 670 x 5mm	320-2471	37.12	34.03	32.92	29.38
1010 x 670 x 6mm	320-2483	44.55	40.84	39.50	35.28

All dimensions are approximate

**PVC Rods And Sheets**

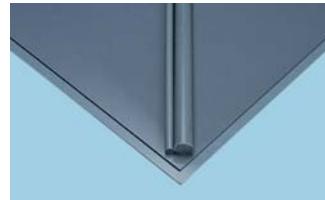

A long established plastic with quite good mechanical properties, generally chosen when chemical resistance is required at low cost.

Applications include: mainly static applications for prototyping, models, electrical insulation, chemical valves and pumps.

- Reasonable mechanical properties
- Limited impact strength
- Low moisture absorption
- Light grey colour
- Easily fabricated
- Continuous working temperature 50°C (Max. 80°C)
- Good UV/weather resistance
- All dimensions are approximate

Density	1.38	Impact strength	No break
Tensile strength at break	50 N/mm <sup>2</sup>	Thermal conductivity	0.16 W/(k.m)
Elongation at break	>5%	Linear thermal expansion coefficient	8K <sup>-1</sup> 10 <sup>-5</sup>
Tensile modulus	2400-3000 N/mm <sup>2</sup>	Volume resistivity	-10 <sup>16</sup> Ωcm
Ball indentation hardness	95-100 N/mm <sup>2</sup>	Dielectric strength	-30 kV/mm

**Rod - 1 Metre Length**

Diameter (mm)	Quantity Per Lot	Order Code	Price Each
6	5	521-231	2.96
10	5	521-243	4.59
15	3	521-255	7.89
25	2	521-279	11.49

**Sheet**

Sheet Size (mm)	Quantity Per Lot	Order Code	Price Each
4.5 x 1000 x 500	3	521-292	43.80

**Plastic Shim**



Fourteen assorted sizes, cut into 20in x 5in lengths. 0.0005in, 0.001in, 0.0015in, 0.002in, 0.003in, 0.004in, 0.005in, 0.0075in, 0.010in, 0.0125in, 0.015in, 0.020in, 0.025in, 0.030in.

Description	Order Code	Price Each
Plastic shim assorted sizes	031-904	54.35

**Bearing Grade PETP & Solid Lubricant Eralyte TX**



The material has a good combination of properties, distinguished by its low moisture absorption, excellent machinability and its improved bearing performance. Applications include: bearings, thrust washers, slideways, gears, rollers, pump components etc.

- High mechanical strength, stiffness and hardness
- Continuous working temperature of 100°C (max 160°C)
- Very good creep resistance
- Low coefficient of friction
- Low moisture absorption
- Very good dimensional stability
- Excellent wear resistance

Colour	Light grey
Specific gravity	1.44
Water absorption	0.47%
Saturation in water	
Tensile strength	78 N/mm <sup>2</sup>
Elongation	8%
Hardness (Shore D)	94
Thermal conductivity	0.29W/K.m
Linear thermal expansion coefficient	6.5-8.5K <sup>-1</sup> x 10 <sup>-5</sup>
Volume resistivity	10cm
Dielectric strength	21kV/mm

All dimensions are approximate

45

Farnell



Diameter (mm)	Length (mm)	Quantity per lot	Order Code	Price Each			
				1+	5+	10+	20+
10	1000	5	722-0790	12.40	11.49	11.10	10.61
20	1000	2	722-0819	18.07	16.72	16.17	15.44
25	1000	1	722-0820	14.64	13.53	13.11	12.52
40	1000	1	722-0832	33.15	30.66	29.70	28.37
50	1000	1	722-0844	50.50	46.71	45.23	43.21
80	500	1	722-0856	74.55	69.69	65.42	61.64

**Precision Shim Steel**



Cut into 300mm lengths. Approximately 0.5kg package.

**Assortment Pack**

494194

Pack Contents	Order Code	Price Each
4 x 0.50mm, 3 x 0.075mm, 2 x 0.10mm, 0.125mm, 1 x 0.15mm, 0.20mm, 0.30mm, 0.50mm	031-983	9.69

**Imperial**

Sizes 0.002in to 0.015in rolled and packed in tins each containing approx 0.5kg. Size 0.020in and 0.025in supplied in flat pack approx 100mm wide.

Thickness (in)	Length (ft)	Order Code	Price Each
0.002	36.6	031-951	20.19
0.003	24.3	031-952	11.25
0.004	18.3	031-953	6.95
0.005	14.6	031-954	6.63
0.006	12.2	031-955	6.70
0.007	10.3	031-956	6.35
0.008	9.1	031-957	5.28
0.010	7.3	031-958	4.88
0.012	6.1	031-959	5.26
0.015	4.9	031-960	4.77
0.025	2.9	031-962	3.86

**Key Steel**

Specially processed steel bars of the type used to make machine keys. Each bar is zinc plated. Tolerance 0.000 to +0.002 oversize in both directions. Each bar is clearly size marked. Supplied in 12in lengths.

**Machine Key Bars**

**Imperial**

Available in sizes up to 2in square.

493934

**Metric**

Available in sizes up to 25mm x 28mm.

Size (in)	Order Code	Price Each
1/8 x 1/8	231-910	1.31
3/16 x 3/16	231-911	1.74
1/4 x 1/4	231-912	1.89
5/16 x 5/16	231-913	3.05
3/8 x 3/8	231-914	3.02
7/16 x 7/16	231-915B	3.98
1/2 x 1/2	231-916	5.95
5/8 x 5/8	233-930	9.65
1 x 1	233-933	21.25

Size (mm)	Order Code	Price Each
4 x 4	233-940	1.59
5 x 5	233-941	2.59
6 x 6	155-3101	4.91
7 x 7	233-943	3.95
8 x 8	233-944	3.95
10 x 10	233-945	4.17
12 x 12	233-946	6.95
16 x 16	233-947	11.25
20 x 20	233-948B	24.30

**Technical information at your fingertips**



Over **352,000** technical datasheets available online.

Visit [www.farnell.co.uk](http://www.farnell.co.uk) and look for the **Tech Info** heading in your search results.

**Silver Steel**



**Metric**

Over 25mm +0.0mm - 0.002mm  
25 and below +0.00mm - 0.01mm 333mm lengths

**333mm Lengths**

Diameter (mm)	Order Code	Price Each
4.0	155-2178	0.70
5.0	155-2179	0.92
6.0	155-2180	1.33
7.0	155-3734	1.60
8.0	155-2182	1.77
9.0	232-164	1.59
10.0	162-3437	2.00
11.0	232-168	2.38
13.0	232-172	2.88
14.0	232-174	3.37
15.0	232-176	3.99
16.0	155-2345	5.63
18.0	232-182	6.00
20.0	232-186	5.77
25.0	232-191B	9.17
30.0	232-196	13.50
40.0	231-153	29.40

**Imperial**

1in and above ±0.0005

Below 1in ±0.0003 333mm lengths

**333mm Lengths**

492290

Diameter (in)	Order Code	Price Each
1/32	155-3097	0.40
1/16	155-3098	0.53
3/32	232-203	0.61
1/8	232-204	0.60
1/4	155-3099	1.27
5/16	232-208B	1.36
3/8	232-210B	1.76
7/16	232-212	3.10
1/2	155-3735	3.90
5/8	232-218	3.82
3/4	232-222	6.60
13/16	232-223	8.70
7/8	232-224	8.55
1	232-226	8.63

**Dowel Pins**



BS 1804 (part 2, grade 1). A parallel pin used to locate mating parts.

491348

Thread x lgth (mm)	Pack qty	Order Code	Price Each
M4 x 10	50	155-2400	10.29
M4 x 16	50	155-3160	10.90
M4 x 20	50	887-6002	6.09
M4 x 25	50	887-6010	10.18
M5 x 10	50	887-6029	5.13
M5 x 12	50	887-6037	5.85
M5 x 16	50	887-6045	6.98
M5 x 20	50	887-6053	6.43
M5 x 25	50	887-6061	8.11
M5 x 36	50	887-6088	15.59
M5 x 40	50	887-6096	8.90
M6 x 20	25	887-6118	5.92
M6 x 25	25	887-6126	11.07
M6 x 30	25	887-6134	11.27
M6 x 32	25	887-6142	6.36
M6 x 40	25	887-6169	9.32
M6 x 50	25	887-6177	12.30
M6 x 60	25	887-6185	8.40
M8 x 20	25	887-6193	3.58
M8 x 25	25	887-6207	6.92
M8 x 30	25	887-6215	7.29
M8 x 40	25	887-6231	6.00
M8 x 50	25	887-6240	6.00

## Engineering Materials - continued

## Extractable Dowel Pins



BS 1804 (part 3, grade 1). Case hardened extractable pins.

494862

Thread x lgth (mm)	Pack qty	Order Code	Price Each
M8 x 25	25	887-6339	1+
M8 x 30	25	887-6347	24.60
M8 x 40	25	887-6363	25.00
M8 x 50	25	887-6371	17.35
M10 x 25	25	887-6398	21.20
M10 x 30	25	887-6398	25.60
M10 x 30	25	887-6401	27.05
M10 x 40	25	887-6410	21.35
M10 x 50	25	887-6428	22.41
M10 x 60	10	887-6436	10.24

## Netlon Protective Slewing

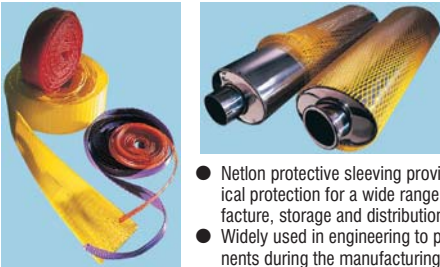

- Netlon protective sleeving provides effective and economical protection for a wide range of products during manufacture, storage and distribution
- Widely used in engineering to protect machined components during the manufacturing process and on through delivery to the end user
- Netlon protective sleeving offers exceptional stretch capability and flexibility - enabling a wide range of diameters and irregular shapes to be protected
- Manufactured from chemically resistant polymers, Netlon protective sleeving is very easy to handle and apply

494151

Colour	To Fit Diameter(mm)	Length (m)	Order Code	Price Each
White	50-65	25	310-088	1+
Grey	65-80	25	310-089	17.96
Yellow	80-100	25	310-090	24.36
Light blue	100-125	25	310-091	23.42
Green	125-160	25	310-092	35.36
Royal blue	190-225	25	310-094	39.65
				70.20

45

## Express checkout



With no need to re-enter your details, returning customers can now buy products even faster - **order online today at [www.farnell.co.uk](http://www.farnell.co.uk)**



## Over 700 new products added online every week!

At Farnell, we research the latest developments to deliver our customers brand new technologies first. From the biggest names in the industry to innovative solutions from niche suppliers, access the latest technology at [www.farnell.com](http://www.farnell.com)

Latest technology, available first  
See 'what's new' at [\*\*www.farnell.com\*\*](http://www.farnell.com)





# 5 great reasons to register online

- 1 Even more choice with over 480,000 products
- 2 700 new products added online every week
- 3 Search from over 352,000 technical datasheets
- 4 Latest pricing and exclusive promotions
- 5 Plus, advanced technical & legislation advice

Register today  
[www.farnell.com](http://www.farnell.com)



A Premier Farnell Company