

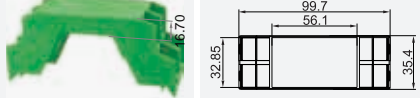

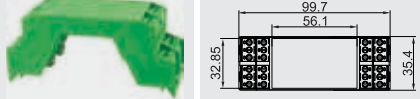







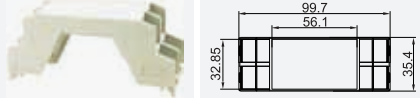

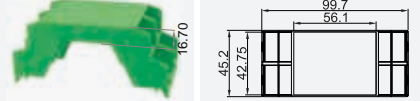
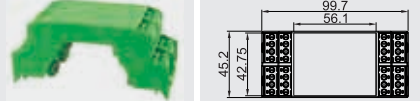

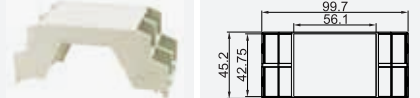

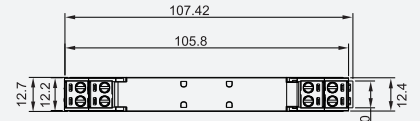

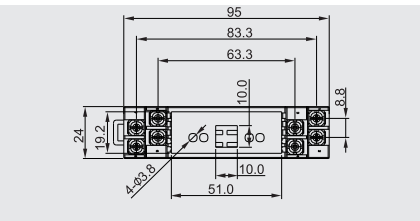

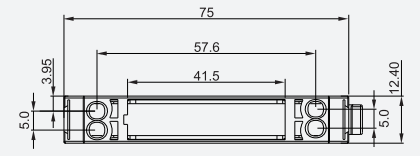
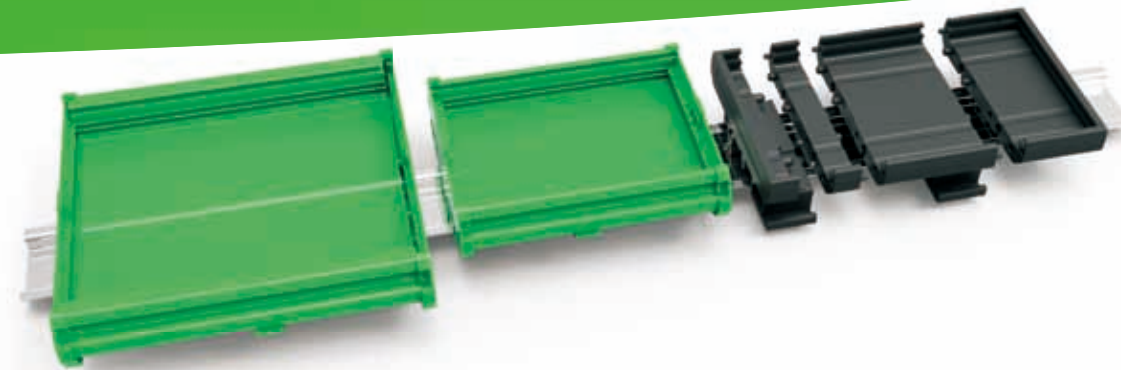
壳体 Housing	型号 Type	上盖 / 尺寸图 Top cover/Drawing	插头 Plug 2EDGKF -5.0-03P	插座 Socket 2EDGRF -5.0-03P 2EDGLF -5.0-03P	附件 Accessory FMET-03-14 -00AH-COVER
	FMET-06P-14-00A-TOP				
FMET-06P-1Y-01A 宽度 Width : 35.4mm 线径 Wire range : 2.5mm ²	FMET-06P-14-15A-TOP				
	FMET-06P-11-24A-TOP				

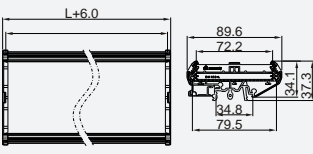
壳体 Housing	型号 Type	上盖 / 尺寸图 Top cover/Drawing	插头 Plug 2EDGKF -5.0-04P	插座 Socket 2EDGRF -5.0-04P 2EDGLF -5.0-04P	附件 Accessory FMET-04-14 -00AH-COVER
	FMET-08P-14-00A-TOP				
FMET-08P-1Y-01A 宽度 Width : 45.2mm 线径 Wire range : 2.5mm ²	FMET-08P-14-15A-TOP				
	FMET-08P-11-24A-TOP				

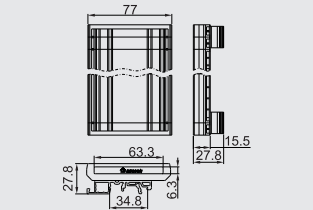
壳体 Housing	型号 Type	尺寸图 Drawing	插头 Plug 2EDGKF -5.0-04P	插座 Socket 2EDGRF -5.0-04P 2EDGLF -5.0-04P	附件 Accessory FMET-04-14 -00AH-COVER
	FMPH-02P-14-00A				
宽度 Width : 12.7mm 线径 Wire range : 2.5mm ²					
	FMWS-02P-13-00A				
宽度 Width : 24.0mm 线径 Wire range : 16AWG					
	DMG-02P-14-00A				
宽度 Width : 12.4mm 线径 Wire range : 2.5mm ²					

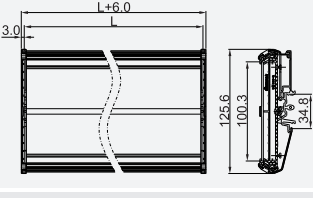

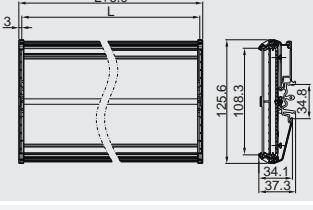
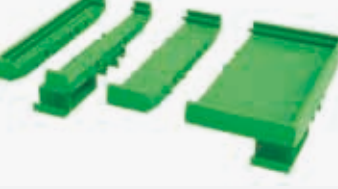
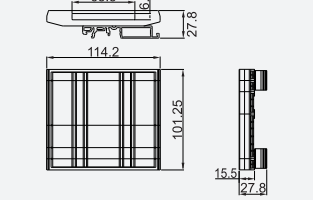
壳体 Housing	宽度 Width	型号 Type	尺寸图 Drawing
	89.6mm	DM 72	
	77.0mm	DMK 72	
	125.6mm	DM 100	
	125.6mm	DM 108	
	125.6mm	DMK 108	



INTERFACE MODULE



DEGSON ELECTRONICS CO.,LTD.

地址：中国宁波慈溪市逍林大道1585号
Add : No.1585 Xiaolin Road.Cixi,
Ningbo China











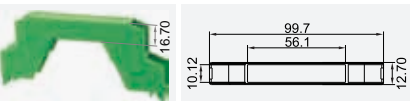
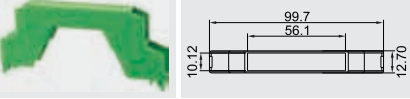
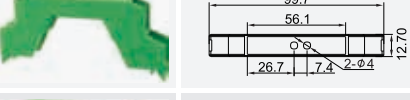
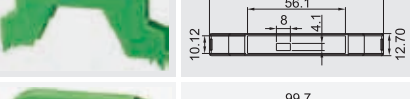



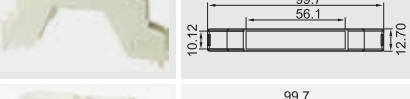
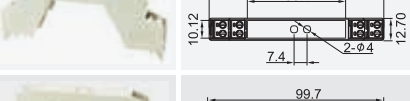

P.C. : 315321
Tel : +86-574-63504333
Fax : +86-574-63512345
E-mail : sale@degson.com
www.degson.com









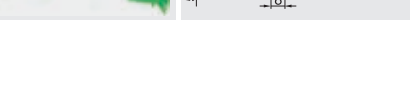



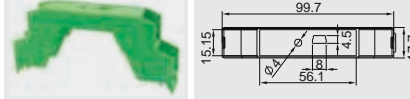
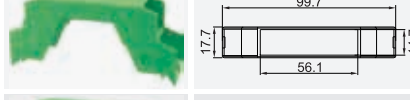







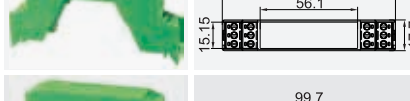

DEGSON Germany GmbH

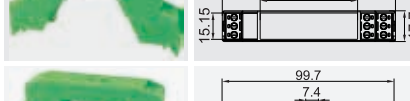
Add : Lindley str. 22-25
DE-60314 Frankfurt/Main
Tel : +49(0)6990 43 72 98
Fax : +49(0)6990 43 72 97
www.degson.de







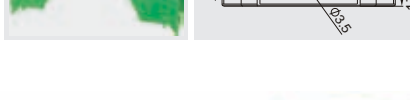



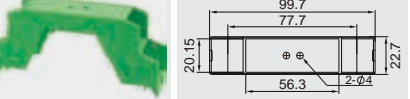
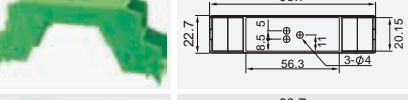
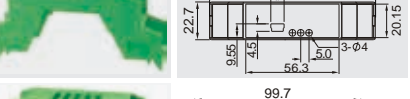



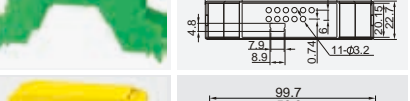



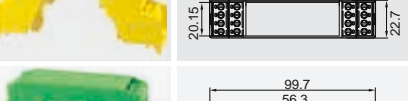











宁波高正(高松)电子有限公司
DEGSON ELECTRONICS CO., LTD.
ISO9001 ISO14001     

壳体 Housing	型号 Type	上盖 / 尺寸图 Top cover/Drawing	插头 Plug			插座 Socket			附件 Accessory
			2EDGKF -5.0-02P	2EDGRF -5.0-02P	2EDGLF -5.0-02P	FMET-02P-14- -00AH-COVER			
 FMET-02P-1Y-60A	FMET-02P-14-60AH-TOP								
	FMET-02P-14-00AH-TOP								
	FMET-02P-14-02A-TOP								
	FMET-02P-14-03A-TOP								
	FMET-02P-14-05A-TOP								
 FMET-02P-1Y-01A 宽度 Width : 12.7mm 线径 Wire range : 2.5mm ²	FMET-02P-11-24A-TOP								
	FMET-02P-11-25A-TOP								
	FMET-02P-11-27A-TOP								
	FMET-02P-1Y-31A-TOP								
	FMET-02P-14-33A-TOP								
	FMET-02P-14-36A-TOP								
	FMET-02P-14-50A-TOP								

壳体 Housing	型号 Type	上盖 / 尺寸图 Top cover/Drawing	插头 Plug			插座 Socket			附件 Accessory
			2EDGKF -5.0-03P	2EDGRF -5.0-03P	2EDGLF -5.0-03P	FMET-03P-14- -00AH-COVER			
 FMET-03P-1Y-10A 宽度 Width : 17.7mm 线径 Wire range : 2.5mm ²	FMET-03P-14-00A-TOP								
	FMET-03P-14-12A-TOP								
	FMET-03P-14-00A-TOP								
	FMET-03P-14-04A-TOP								
	FMET-03P-14-05A-TOP								
 FMET-03P-1Y-01A 宽度 Width : 17.7mm 线径 Wire range : 2.5mm ²	FMET-03P-14-11A-TOP								
	FMET-03P-14-15A-TOP								
	FMET-03P-14-16A-TOP								
	FMET-03P-14-17A-TOP								
	FMET-03P-14-31A-TOP								

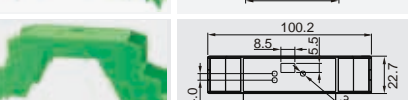
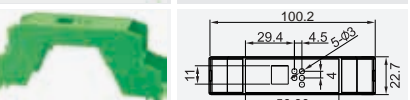
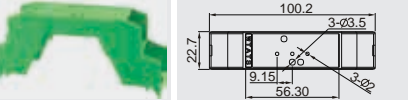

壳体 Housing	型号 Type	上盖 / 尺寸图 Top cover/Drawing	插头 Plug			插座 Socket			附件 Accessory
			2EDGKF -5.0-04P	2EDGRF -5.0-04P	2EDGLF -5.0-04P	FMET-04P-14- -00AH-COVER			
	FMET-04P-14-00A-TOP								
	FMET-04P-14-02A-TOP								
	FMET-04P-14-03A-TOP								
	FMET-04P-14-04A-TOP								
	FMET-04P-14-05A-TOP								
	FMET-04P-14-08A-TOP								
 FMET-04P-1Y-01A 宽度 Width : 22.7mm 线径 Wire range : 2.5mm ²	FMET-04P-14-12A-TOP								
	FMET-04P-18-13A-TOP								
	FMET-04P-14-15A-TOP								
	FMET-04P-14-16A-TOP								
	FMET-04P-14-18A-TOP								
	FMET-04P-1Y-20A-TOP								
	FMET-04P-14-25A-TOP								
	FMET-04P-14-37A-TOP								
	FMET-04P-14-38A-TOP								
	FMET-04P-14-39A-TOP	