

CERN COURIER

International Journal of High Energy Physics



VOLUME 32

5

JUNE 1992

Why Your Next TDC Should be Pipelined, Multihit and from LeCroy:

Simplifies triggering . . .

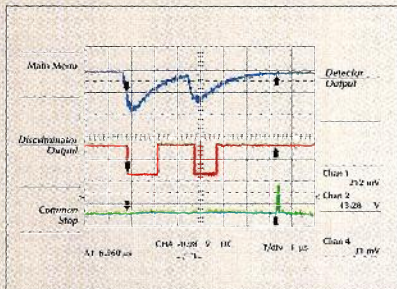

. . . since pipelining allows a trigger decision to be made up to 65.5 μ sec after the event of interest.

Lowers dead time . . .

LeCroy Engineering Model 1876				
Word (hex)	Address	Word Count		
48FF1006	Slot 9	6		
Word (hex)	Event	Chan	Time	Edge
4E0603FC	2	3	1020	-
4A070474	2	3	1140	+
4E060489	2	3	1161	-
4A07055F	2	3	1375	+
4E120369	2	9	873	-
4A130381	2	9	897	+

. . . since only hits are read out quickly (1 μ sec plus 150 nsec/hit in the 1876) into the 8 event buffer.

Introducing the 1876 and 2277 Time-to-Digital Converters

The 1876, 96-channel FASTBUS TDC and the 2277 32-channel CAMAC TDC modules represent the next step in time-to-digital converters. These revolutionary units use the award winning MTD132A application specific IC. Both offer unprecedented resolution, multihit (start/stop) capability and long dynamic range which are ideal for the latest drift, time projection and proportional chambers, as well as other detectors. All these features provide you with more information faster and at a lower cost.

THE 1876 AND 2277 FEATURE:

- ✓ 1 nsec Resolution
- ✓ 16 Hits per Channel
- ✓ Common Start or Stop Operation
- ✓ On-Board, 8-Event Buffer
- ✓ 65.5 μ sec Full Scale
- ✓ Leading and/or Trailing Edge Detection
- ✓ Fast Conversion
- ✓ Low Cost per Channel

1876	96-Channel FASTBUS TDC
2277	32-Channel CAMAC TDC
2277/EXP	4/8-Channel, 128/64 Hit Expander
2277/EXP2	2-Channel, 256 Hit Expander

Multiple signals and pulse width capability . . .

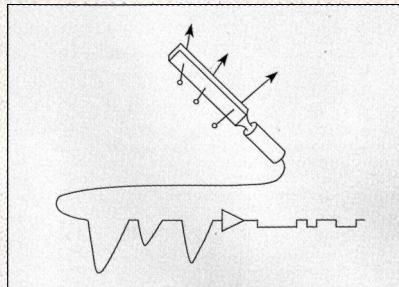

. . . of up to 16 leading and/or trailing edges can be digitized. Signals may be produced by one detector or detectors multiplexed together. Pulse width capability allows pile-up affects to be seen and measures time intervals which can contain information such as pulse area.

Supports fast detectors . .

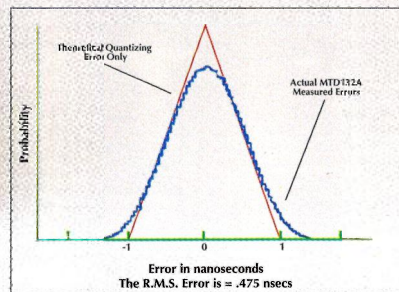

. . . with the inherent high resolution of 1 nsec (< 750 psec R.M.S. error).

For applications such as time-of-flight mass spectroscopy which requires a greater number of hits per channel, the Models 2277/EXP and 2277/EXP2 Hit Expanders are available. When used with either TDC the expander routes the input signals to 4, 8 or 16 TDC channels, providing a greater number of hits per input and improved double pulse resolution.

Call, write or fax us today to receive the most recent data sheets and application notes!

700 Chestnut Ridge Road, Chestnut Ridge, NY 10977-6499 USA Tel: (914) 578-6013 Fax: (914) 578-5984
2, chemin Pre-de-la-Fontaine, 1217 Meyrin 1-Geneva, Switzerland Tel: (022) 719.21.11 Fax: (022) 719.22.30

LeCroy

Innovators in Instrumentation

Advertising enquiries

Europe

Micheline Falciola
Advertising Manager
CERN
CH-1211 Geneva 23, Switzerland
Tel.: +41 (22) 767 4103
Fax: +41 (22) 782 1906

Rest of the world

Yvette M. Perez
Gordon and Breach Science Publishers
Frankford Arsenal, Bldg 110
5301 Tacony Street, Box 330
Philadelphia, PA 19137
Tel.: +1 (215) 537 7262
Fax: +1 (215) 537 0711

Distributed to Member State governments, institutes and laboratories affiliated with CERN, and to their personnel.

General distribution

Jacques Dallemagne
CERN, 1211 Geneva 23, Switzerland

In certain countries, copies are available on request from:

China

Dr. Qian Ke-Qin
Institute of High Energy Physics
P.O. Box 918, Beijing,
People's Republic of China

Germany

Gabriela Heessel
DESY, Notkestr. 85, 2000 Hamburg 52

Italy

Mrs. Pieri or Mrs. Montanari
INFN, Casella Postale 56
00044 Frascati, Roma

United Kingdom

Su Lockley
Rutherford Appleton Laboratory,
Chilton, Didcot, Oxfordshire OX11 0QX

USA/Canada

Cyndi Rathbun (B90904 at FNALVM)
Fermilab, P.O. Box 500, Batavia
Illinois 60510

CERN COURIER is published ten times yearly in English and French editions. The views expressed in the Journal are not necessarily those of the CERN management.

Printed by: Drukkerij Lannoo nv
8700 Tielt, Belgium

Published by:

European Laboratory for Particle Physics
CERN, 1211 Geneva 23, Switzerland
tel.: +41 (22) 767 61 11,
telex: 419 000 CERN CH,
telefax: +41 (22) 767 65 55

CERN COURIER only:
tel. +41 (22) 767 41 03,
telefax +41 (22) 782 19 06

USA: Controlled Circulation
Postage paid at Batavia, Illinois

Volume 32
No. 5
June 1992

CERN COURIER

Covering current developments in high energy physics and related fields worldwide

Editor: Gordon Fraser (COURIER at CERNVM)*
French edition: Henri-Luc Felder
Production and Advertisements:
Micheline Falciola (FAL at CERNVM)*

**(Full electronic mail address... at CERNVM.CERN.CH)*

1 Picking out primordial seeds
The physics of the century? – Fine structure in the cosmic background radiation

3 US recommendations
HEPAP report

5 Accelerating with industry
International conference report

Around the Laboratories

14 CERN: Antiprotons resist annihilation/Schooling

15 BROOKHAVEN: High energy gold

17 FERMILAB: Preparing to collide

18 COLLIDERS: Microvertex detectors

21 People and things

Reader service form, page VI.



Cover photograph:
The Aleph experiment at CERN's LEP electron-positron collider.
The 1992 run began at LEP in April.

High Voltage Applications

Isolation Amplifier

- High Speed 5MHz, 500KHz types
- Shielded on 6 Sides
- Compact, Lightweight



AC/DC High Voltage Meter

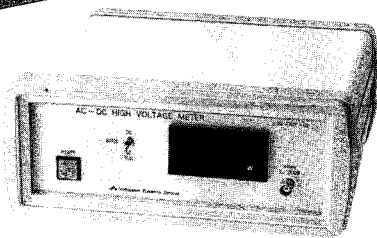

- Measures both AC and DC at high voltages
- Wave forms can be monitored
- Up to DC: 20kV
AC: 15kV (r.m.s.)
40kV (p-p)

PMT On Board Type

- Up to 3kV dc for PMT
- Low Ripple, High Quality

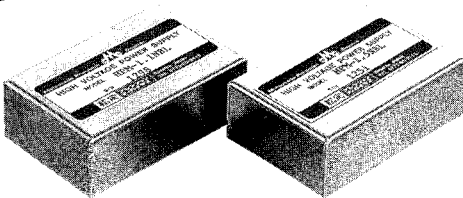

DC Power Supply

- Compact, High Performance
- Easy-to-Read Digital Display
- GP-IB Compatible
- 16-36V, 0.1-2.2A
- 6 models

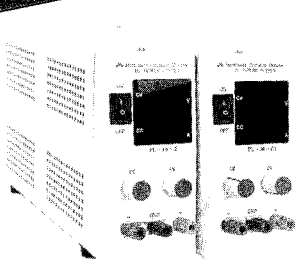

Matsusada Precision Devices Inc.

European Representative
Zettachring 6, D-7000 Stuttgart 80, Germany
Tel: (0711) 7287143 Fax: (0711) 7289631

Head Office
745 Aojicho Kusatsu Shiga 525, Japan
Tel: 81-775-62-3111 Fax: 81-775-65-1211

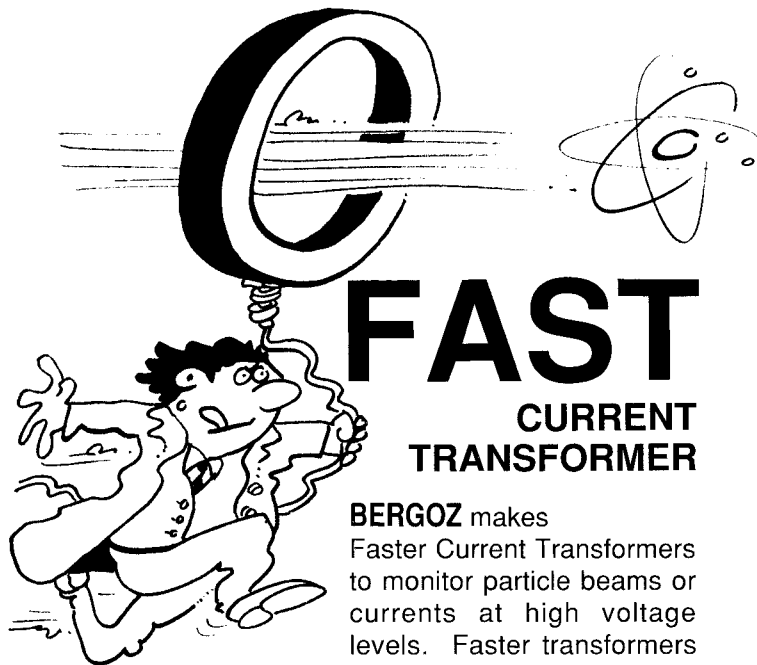

FAST CURRENT TRANSFORMER

BERGOZ makes Faster Current Transformers to monitor particle beams or currents at high voltage levels. Faster transformers are made by BERGOZ using specially annealed Cobalt

alloys. Standard models have 178mm inner diameter, risetime-falltime < 1ns and 1.25 V/A sensitivity. Special models can be as large as 300 mm, or very small. Other models can integrate picosecond risetime primary pulses with less than 1% ratio error.

BERGOZ Crozet, France, Fax 50.41.01.99 • Tel 50.41.00.89
REPIC Tokyo, Japan, Fax 03-3918-5741 • Tel 03-3918-5110
GMW Redwood City, CA, Fax 415-368-0816 • Tel 415-368-4884

17 Circle advertisement number on reader service form

Precision Magnetic Field Measurement

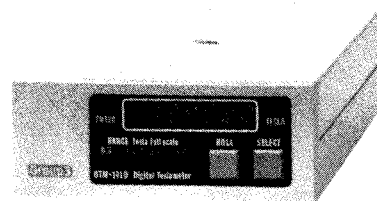

- Digital Hall Effect Teslameter
- Overall precision of 0.01%
- Temperature coefficient < 10 ppm/°C
- Field ranges from 0.03 to 3 T
- RS-232C or IEEE488 interface options
- Miniature probes for field mapping
- Precision, versatility and cost-effectiveness unequalled by any other manufacturer

DANFYSIK

DANFYSIK A/S · Møllehaven 31 · DK-4040 Jyllinge · Denmark
Tel.: +45 46 78 81 50 · Fax: +45 46 73 15 51

In USA: GMW Associates · Tel.: (415) 368-4884 · Fax: (415) 368-0816

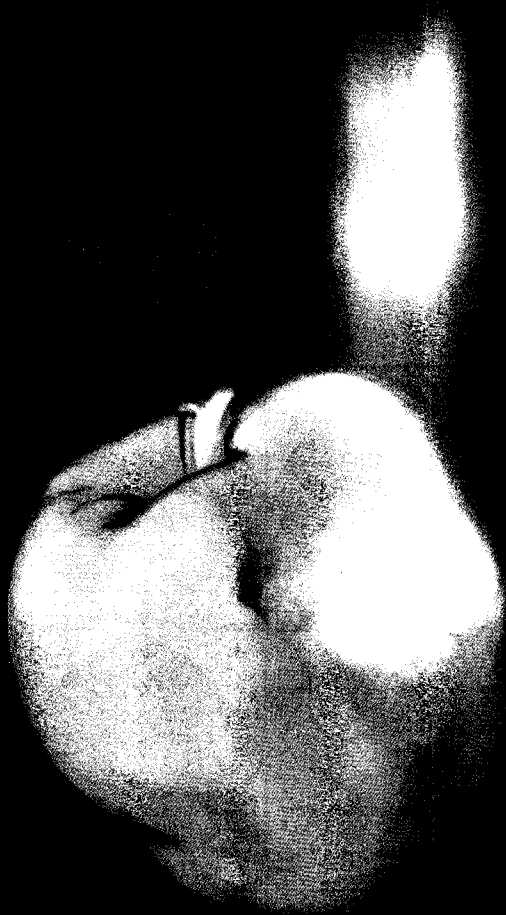

**Metal products
as dependable
as gravity.**

Producers and fabricators of zirconium, niobium,
hafnium, vanadium and titanium.
Post Office Box 460 Albany, Oregon 97321
503 / 967-6905 Fax: 503 / 967-6994

GRAVITY. It affects every aspect of your

life...just as the materials you select affect every aspect of your product's life.

Teledyne Wah Chang Albany understands the gravity of inconsistency. That is why we carefully apply process controls to produce consistently dependable reactive and refractory metals and alloys. TWCA has a 35-year history of living up to and beyond its customers' expectations.

That is consistency.

Consider TWCA's niobium alloy products. Our Niobium-Titanium Alloy is the industry standard. We produce massive quantities of Niobium-Titanium for magnetic resonance imaging and particle accelerator applications. Our patented modified jelly roll process for producing multifilamentary Nb₃Sn performs as expected in critical applications, such as the cable used for the U.S. Demonstration Poloidal Coil.

Teledyne Wah Chang Albany is committed to quality and to your satisfaction. Let the professionals at TWCA take the weight off of your shoulders. Call (503) 967-6905 for more information.

 **TELEDYNE
WAH CHANG ALBANY**

Giant Read-Out Boards?

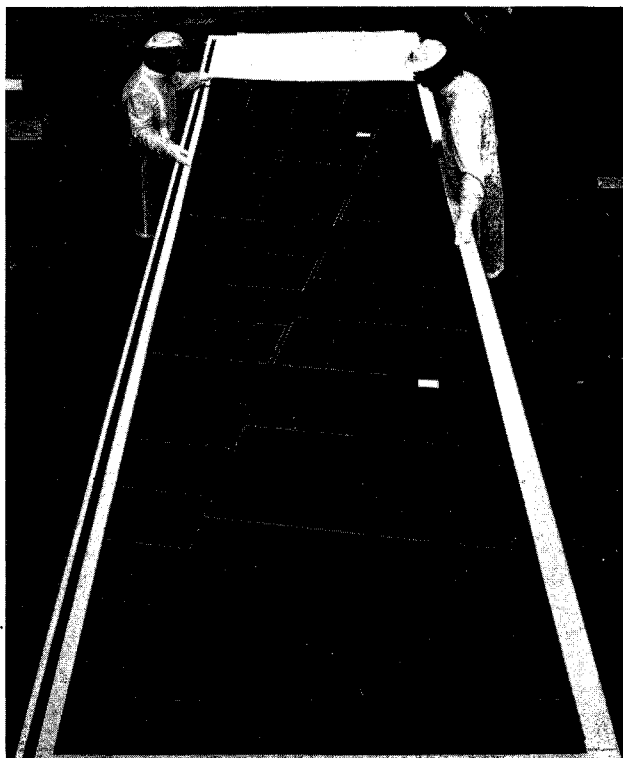

Epoxy laminates FR-4
1300x4400 mm
produced by

DITRON s.r.l.

have been chosen for the construction of the "Read-Out Board" of the hadron calorimeters of the **ALEPH** and **DELPHI** detectors.

Standard production:

- FR-4, G-10, G-11 rigid laminates for printed circuit boards
- thin laminates and prepreg for multilayer boards

DITRON srl

Via Mulino Vecchio, 85 - 28065 CERANO (NO) ITALY
Tel.: 0321/772181 - Telex: 331565 PENCO I
Telefax: 0321/721645

37 Circle advertisement number on reader service form

THEVENET CLERJOUNIE
TRANSITION JUNCTIONS CEA SYSTEM
FOR CRYOGENIC, VACUUM, NUCLEAR AND SPACE APPLICATIONS

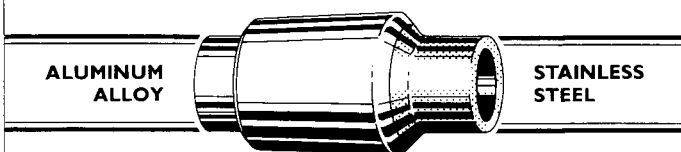

THEY HAVE THE SAME MECHANICAL CHARACTERISTICS AS THE ALUMINUM TUBE AND CAN ALSO BE FABRICATED TO ANY MATERIAL SPECIFICATIONS

TOTALLY RELIABLE BIMETALIC
TRANSITION JUNCTIONS
FOR TUBULAR ASSEMBLIES
UP TO Ø 600 MM (24")
10⁻⁹ atm. cm³. S⁻¹
10 M Pa
0 to 573 K
UNDER RADIATION

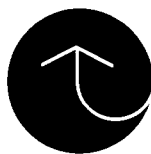

* COMMISSARIAT A L'ENERGIE ATOMIQUE

CALL OR WRITE FOR DOCUMENTATION
THEVENET CLERJOUNIE ■ DEPARTEMENT JONCTIONS TC
CONTACT: M. ARMAND PINET, CONSULTING ENGINEER
22, AVENUE FRANKLIN-ROOSEVELT ■ 69517 VAULX-EN-VELIN
CEDEX FRANCE ■ TELEPHONE: (7) 849.54.64 ■ TELEX 380 544 F

READER SERVICE FORM CERN COURIER

JUNE 1992

Please send information on items circled:

4a 6 9b 10a 12 15d 16 17 18 21a
25d 30b 31 36 37 38a 43b 48a 72 75a
77 81a 85 88 89 90

Please send to:

Judy Pray, **CERN COURIER**
Gordon & Breach Science Publishers
Frankford Arsenal, Building 110
5301 Tacony Street, Box 330
Philadelphia, PA 19 137
USA

Name _____ Title _____
Employer _____ Dept. _____
Address _____
City _____ State _____ Zip _____
Telephone () _____ Country _____

12 Circle advertisement number on reader service form

Picking out primordial seeds

NASA's COBE (Cosmic Background Explorer) satellite, in orbit since 1989, has picked up tiny variations in the cosmic microwave background radiation which could be the 'seeds' from which the present galactic structure of the Universe evolved.

On Friday 24 April, the world's press carried banner headlines of the type 'How the Universe began'. But from these brash stories it was difficult for scientists who had not been at the American Physical Society meeting in Washington the previous day to find out exactly what had been announced.

The fuss was because a team working with NASA's COBE (Cosmic Background Explorer) satellite has picked out tiny variations in the cosmic background radiation at a level of one part per 100,000. COBE, launched in November 1989, takes a long, close look at the faint microwave background rumble which is a relic of the mighty Big Bang, stretched out over 15 Gigayears.

These fluctuations – patches of sky with temperatures slightly higher or lower than surrounding areas – correspond to regions of the early Universe with slightly greater or lesser concentrations of matter and radiation. This pattern was a template for the subsequent cosmic evolution. Small as they are, the observed patches of enhanced density provided a gravitational 'valley' into which surrounding matter gradually collected.

About ten years ago, Big Bang cosmologists proposed how irregularities in the early Universe could have led to its subsequent evolution. Tiny quantum effects would have been amplified by cosmological inflation, the super-rapid expansion of the inflation phase taking these initial fluctuations out of the quantum domain and transforming them into the progenitors of the galaxy structure we now know.

Detailed simulations looked at what would happen to such random fluctuations in the aftermath of the Big Bang. They showed that these fluctuations, as well as seeding galaxies,

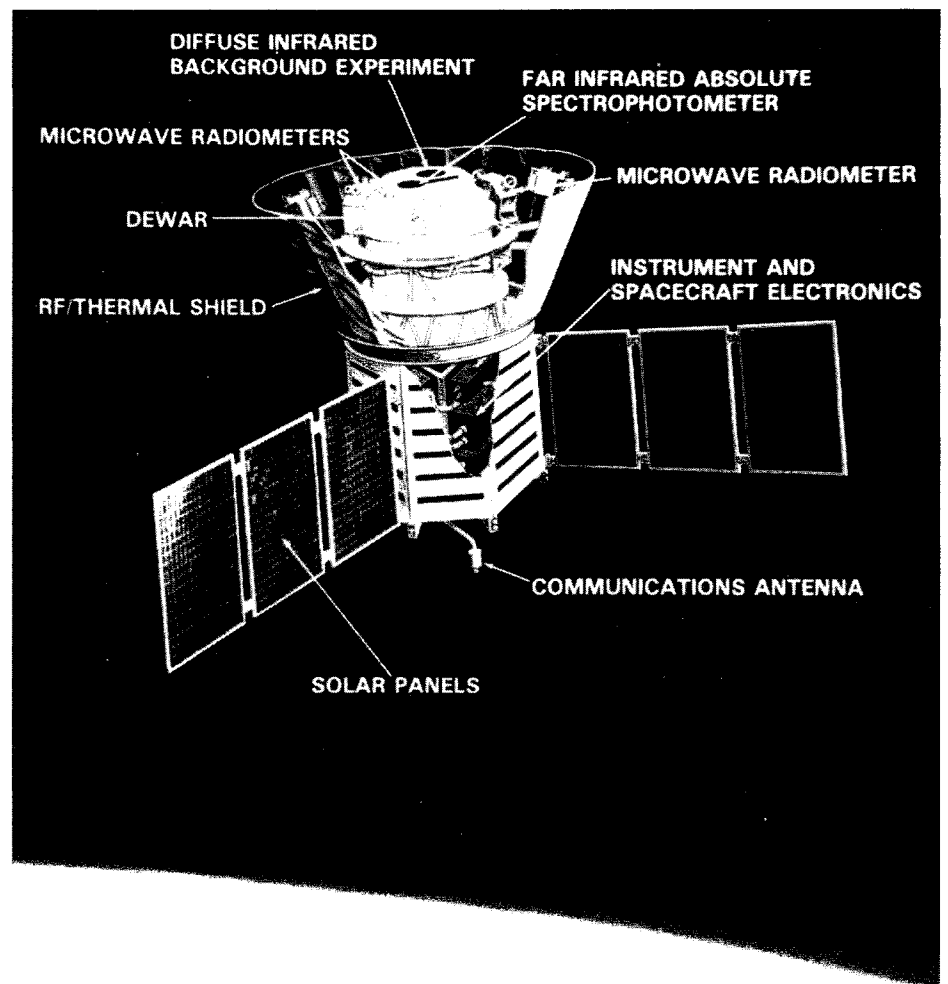

would leave their mark as tiny ripples in the microwave background radiation. (They could perhaps be looked for in the detailed evolution of galaxy clustering, but as galaxies are most likely only a tiny component of the whole Universe, this approach cannot be guaranteed. The microwave background provides a much more direct test.) In 1986, George Efstathiou, now at Oxford and one of the pioneers of this approach, said 'A positive detection of radiation anisotropies would revolutionize the

study of galaxy formation and have profound implications for particle physics'.

Until now, instruments measuring the microwave background, including COBE, were unable to see any such effect. This dearth of measurable structure in the early Universe was beginning to make some Big Bang theorists nervous. How could the Universe have produced galaxies and other larger structures (clusters, superclusters) without there having being precursors? Previous studies

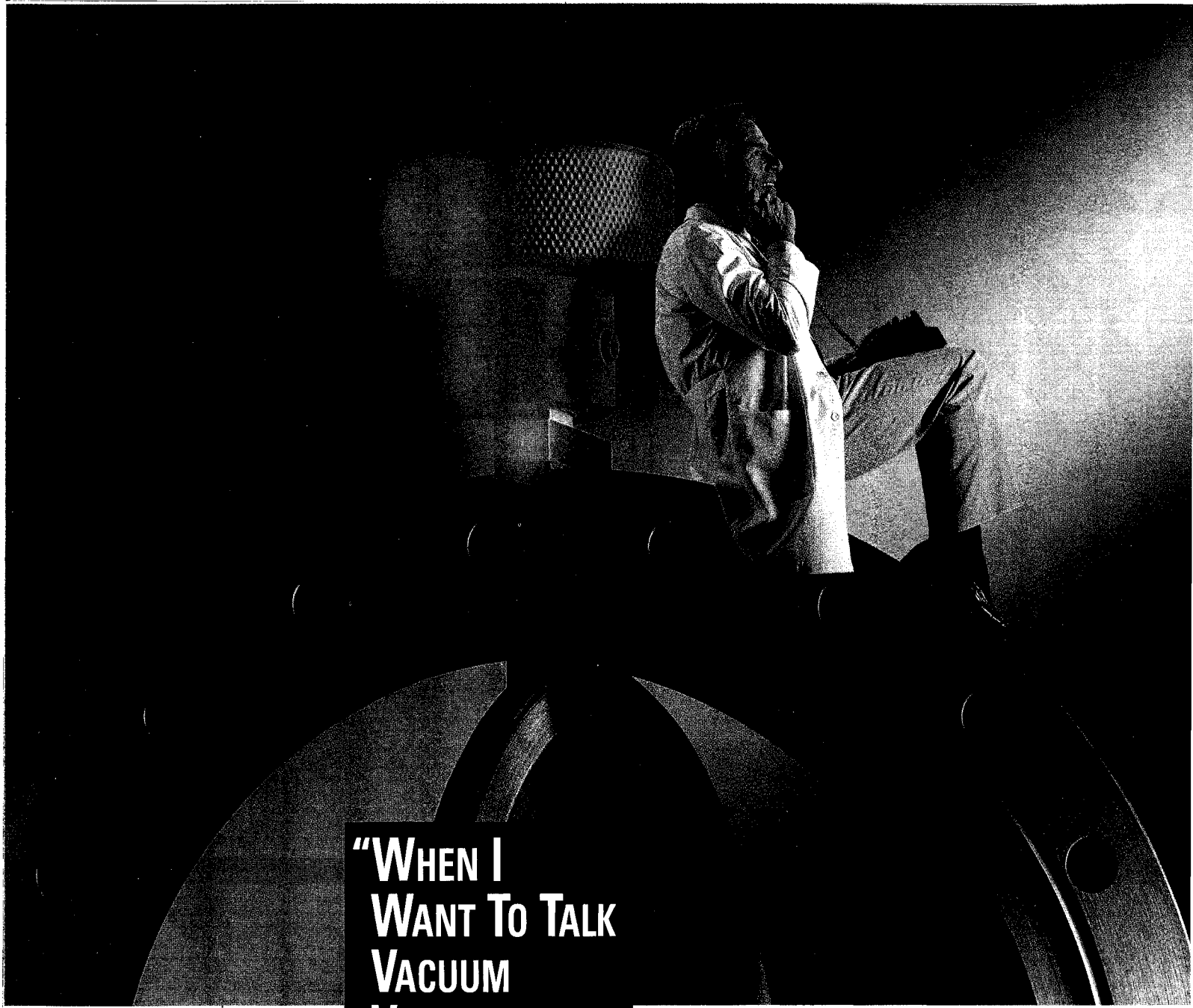

**"WHEN I
WANT TO TALK
VACUUM
VALVES,
I TALK TO
HUNTINGTON."**

**More valves.
Better design.
First-class tech support.**

Whether you need butterfly or gate valves. Pneumatic or manual. Bakeable or elastomer-sealed. Right-angle, in-line or straight-through – Huntington is the place . . .

Broader selection and better designs. Like their unique conical seats, for tighter seals. Or their patented butterfly floating shaft, for perfect flapper centering. Or their solid construction, with less welding for better integrity . . .

And when you call Huntington, you get intelligent

answers. Because their engineers *know* valves. And how to solve vacuum problems.

Plus, they've got a lot more than valves . . .

It's all in the free catalog.

Everything. From positioners to connectors to full custom chambers. To get the catalog, just call: Huntington Laboratories, 1040 L'Avenida, Mountain View, CA 94043. (800) 227-8059 or (415) 964-3323.

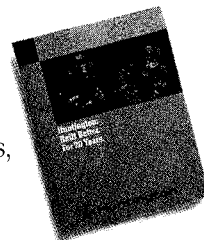

 **Huntington**
Better-Built Vacuum Components

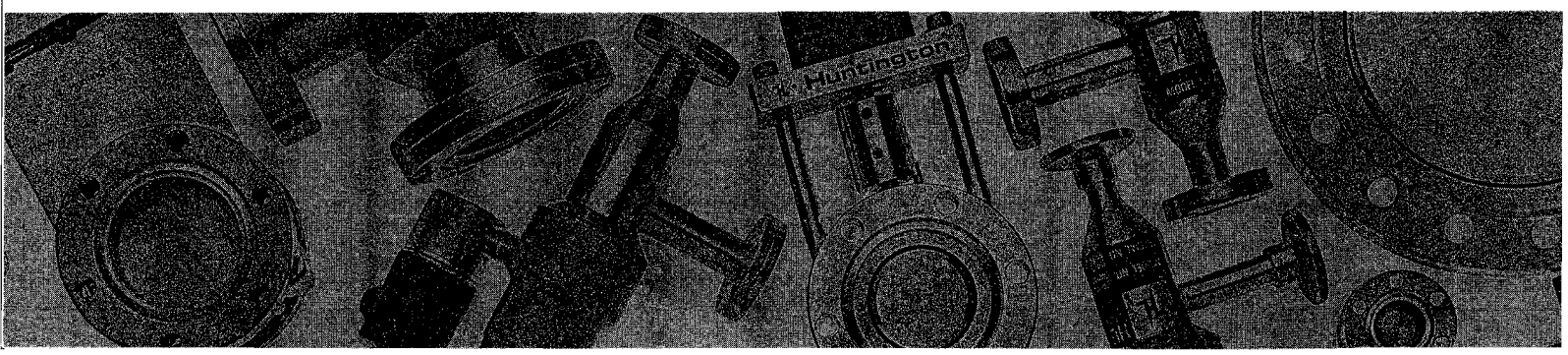

had only succeeded in giving upper limits for such structure.

This changed dramatically at the American Physical Society April Meeting in Washington D.C., with the announcement by COBE scientists of the first observation of temperature variations in the microwave background. Previous COBE results (June 1991, page 1) showed that the radiation was totally in line with what would be expected from a perfect radiator ('black body') at 2.735K, smooth to one part per ten thousand. This was already heralded as a major astronomy result, providing substantial additional evidence for the Big Bang idea. The newly discovered fluctuations are faint indeed – roughly 30 degrees microkelvin, or one part per hundred thousand.

George Smoot of Lawrence Berkeley Laboratory, the head of the team which operated the Differential Microwave Radiometer (DMR), one of three principal instruments on board COBE, reported at Washington that these results were based on the meticulous computer analysis of a

year's worth of data. DMR studies the whole sky, making it an ideal instrument to search for these effects. The result is compatible with COBE's previous black body measurements, and with previous upper limits.

The results presented at Washington cover four major scientific papers, one on the actual data, one on the treatment of errors, one on the separation of cosmic background and galactic signals, and a fourth on the interpretation of the result in terms of gravitational fluctuations.

DMR makes precise maps of the microwave sky on angular scales larger than a few degrees and over a range of microwave frequencies. This way this results are sensitive to a wide range of possible initial fluctuation 'seeds'.

The analysis involved careful subtraction of competing microwave emissions from such nearby objects as the Earth and the Milky Way galaxy, and had to take into account the movement of the Earth and our galaxy through the rest of the Universe. This motion imposes a broad dipole

shift on the pattern of temperature measurements across the sky. The irregularities are a hundred times smaller than this broad dipole effect. A critical issue is whether the anisotropy is due to galactic or extragalactic effects, or can be assigned directly to cosmic background radiation, although the former look to be unlikely. The COBE DMR results, covering a range of frequencies, facilitate the subtraction of angular galactic effects.

Smoot and his colleagues are confident about their measurements, but an enlarged data sample would greatly help to sharpen the primordial structure pattern. Now that the necessary analysis techniques are better understood, the interpretation of data could speed up, so that the several years of COBE data still to be analysed might soon make an appearance. A fourth year of COBE functioning has also been requested, if the instrument and spacecraft continue to function well.

US recommendations

The Superconducting Supercollider (SSC) will dominate the US high energy physics research towards the end of the decade. Less clear is how the US research scene will evolve in the meantime.

Some indications are given in a report by a subpanel chaired by Michael Witherell (Santa Barbara) with recommendations for the direction US high energy physics research should take over the period 1994-7. The report has now been approved by the High Energy Physics Advisory

Panel (HEPAP) of the US Department of Energy.

As usual with these reports, the recommendations are grouped into three budget scenarios – 'middle' with level funding (constant dollars, adjusted for inflation), 'upper' with a modest 2.5% above inflation, and 'lower' with level funding (constant dollars not adjusted for inflation, assumed to be 3.5% per year).

In all these scenarios SSC construction is seen as having highest priority – 'absolutely essential for

continued progress...into the 21st century'.

For the 'middle' budget, the report recommends that construction of the proposed Main Injector at Fermilab's Tevatron should be completed by 1997. The Main Injector (July/August 1990, page 4) would provide a new beam supply system for the superconducting Tevatron and has been acknowledged by previous HEPAP recommendations.

'B factory' electron-positron machines with asymmetric (unequal en-

The proposed new Main Injector Ring to feed Fermilab's superconducting Tevatron is seen as one of the major US projects to be completed in the near future.

ergy) rings have been proposed at Cornell (July/August 1991, page 8) and at Stanford (June 1991, page 8). For the middle budget, the HEPAP report recommends construction of the Stanford plan (using the existing PEP tunnel) starting in 1996, funded out of a reduced local budget.

A new B factory at Cornell would be funded by another body, the National Science Foundation, but so far the indication from this direction has been that nothing could be considered before 1997. On the DoE front, the HEPAP report recommends that Cornell should upgrade its existing CESR collider to reach luminosities of 10^{33} per sq cm per s.

Brookhaven's AGS synchrotron would continue with its own physics programme until 1997, when the AGS high energy physics programme would cease, and the new RHIC heavy ion collider, using the AGS as injector, comes into operation. (RHIC is funded from another budget, not addressed by HEPAP.)

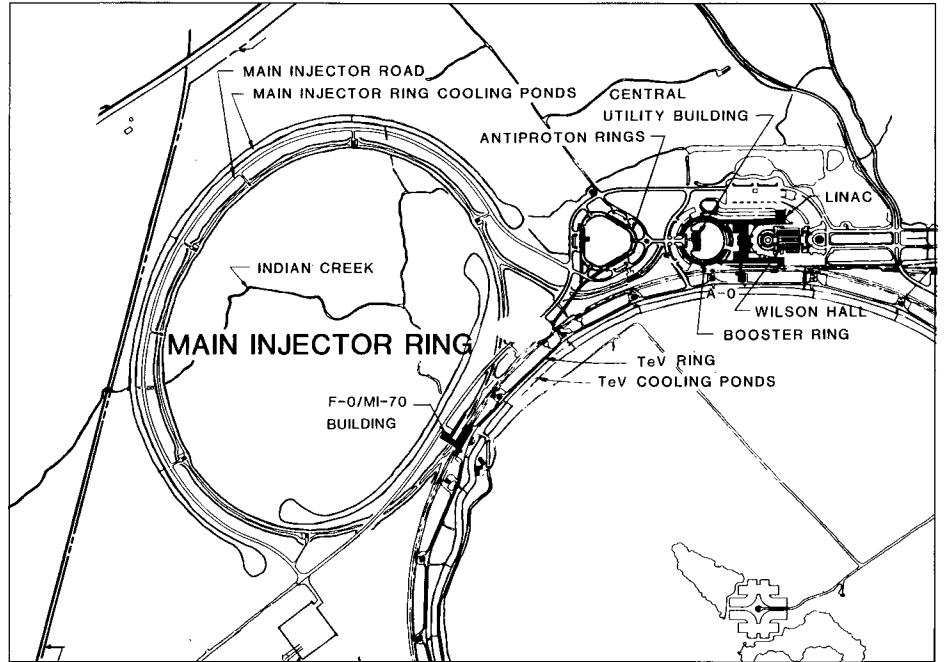

The middle budget would also allow SLAC to continue with its R&D work in linacs and linear colliders, however particle physics research at the SLC collider should be terminated in 1993.

Across the board, support for university groups should increase, and the physics research staff at the SSC should increase steadily, with partial support from the base high energy physics programme.

While the middle budget could retain the vitality of many parts of the overall programme, it nevertheless confronted the panel with some hard choices.

For the optimistic budget, the panel recommended a selective increase in research activities, with the Fermilab Main Injector completed one year earlier (1996), and SLAC B-factory construction advanced to 1994-7. The US research programme would then be in good shape in 1997, allowing increased support for SSC physics.

SLAC/LBL/LLNL B FACTORY

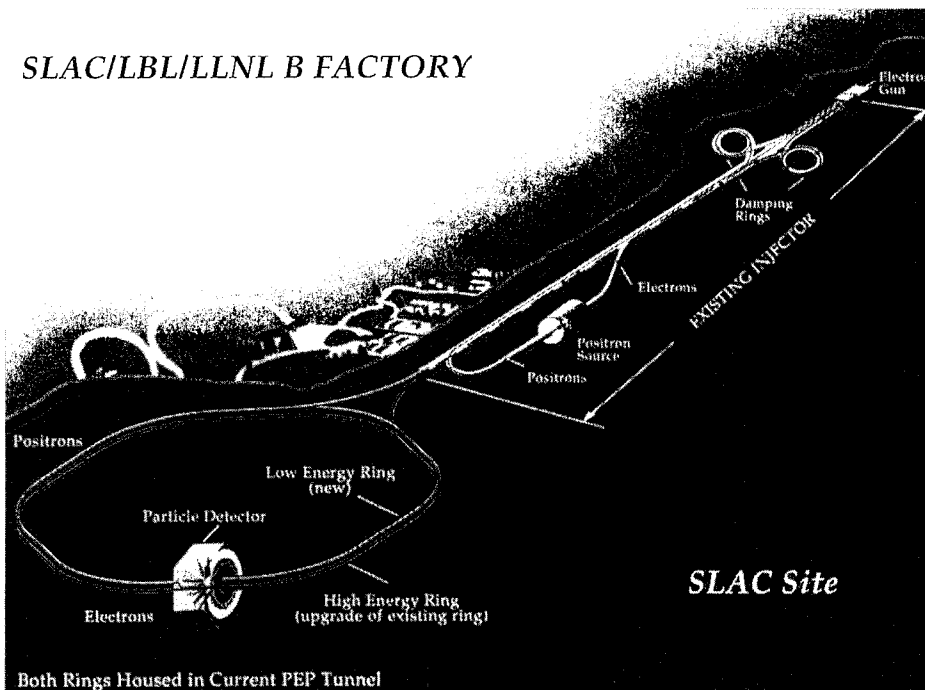

A 'B factory' electron-positron collider with asymmetric (unequal energy) rings have been proposed at Stanford (SLAC). The latest US High Energy Physics Advisory Panel (HEPAP) report also recommends construction of this plan (using the existing PEP tunnel). The start date would depend on the amount of money available.

The pessimistic budget makes for dismal reading – ‘damage to particle physics would be severe’ – and the field would be poorly positioned for the next decade. Future productivity would be endangered by insufficient students and trained personnel. Specifically, Main Injector construction at Fermilab would be stretched out, with completion in 1998, the Stanford B-factory would be shelved, and furthermore the SLAC accelerator complex would have to be closed in 1995.

The subpanel under Michael Witherell included Gerald Dugan,

Gary Feldman, Jerome Friedman, Mary K. Gaillard, Donald Hartill, David Leith, Hugh Montgomery, Piermaria Oddone, James Pilcher, Pierre Ramond, James Siegrist, Robert H. Siemann, A.J. Stewart Smith, Sam Trieman, T. Laurence Trueman and Stanley Wojcicki (ex officio, as HEPAP chairman). Earle Fowler was Executive Secretary and Pat Rapp his deputy.

The subpanel’s charge was to address ‘what emphasis should be placed on university-based research compared to the operation of accelerator facilities at DoE National Labo-

ratories, and consider whether the construction of new or upgraded facilities should be initiated or pursued. The Subpanel should concentrate on the structure of the programme for the next five years. However it would be helpful also to discuss the major elements of the base programme of high energy physics research which includes an operating SSC.’

During January and February, the Subpanel visited the five major US particle physics Laboratories – Cornell, Brookhaven, the SSC, SLAC and Fermilab, in that order.

Accelerating with industry

At the end of March, Berlin was the scene of the third biennial European Particle Accelerator Conference (EPAC). It carried the usual news from the front-line machines in the high energy physics Laboratories and reports on progress with the latest technologies. But the organizers also decided ‘to pay particular attention to developments in the field of synchrotron radiation sources, compact synchrotron radiation sources, as well as smaller accelerators and their applications’. As a result many sessions reemphasized how the mastery of charged particle beams is now commonplace in a multitude of disciplines and applications.

The conference, like its US counterpart, obviously had strong regional bias, reflected here, and underlining the vigour of this branch of science and technology in Europe, both in the Laboratories and in industrial support.

Higher fields and higher energies

The opening talk covered the splendid progress in commissioning the HERA collider in the host country’s DESY Laboratory. First collisions were achieved with modest luminosity towards the end of last year, detectors were moved into place during March and commissioning thereafter. The main tasks are to take the proton beam to its design energy of 820 GeV and to sustain the intensity of the proton beam as it accelerates through the injection system.

This brings particle physicists to the brink of experiments with the unique conditions of high energy electron-proton collisions. The accelerator specialists, meanwhile, rejoice in several HERA achievements: no special problems have emerged while colliding electrons and protons, the huge cryoplant has operated for four

years with complete reliability, and, most encouraging of all, superconducting magnets are now mastered to field levels of 5 T in machine operating conditions.

The major worry in the HERA proton ring had been that persistent currents would distort the low fields at injection; this worry has disappeared because their reproducibility makes compensation straightforward.

The industrial contribution to this achievement was considerable. Over two thousand superconducting magnets were required for HERA and from some 700 dipoles (the most difficult type) only five did not reach acceptable quality. It is interesting, however, that there are small but measurable differences in performance between the magnets, built to the same specification, from the German manufacturer and those from the Italian manufacturer. In machine operation, there are two reference

On Friday 15 May, protons in the superconducting ring of the HERA machine at DESY reached the design energy of 820 GeV. HERA now supplies the world's highest energy protons.

The opening talk at the European Particle Accelerator Conference in Berlin in March covered progress in commissioning the HERA electron-proton collider in the host country's DESY Laboratory.

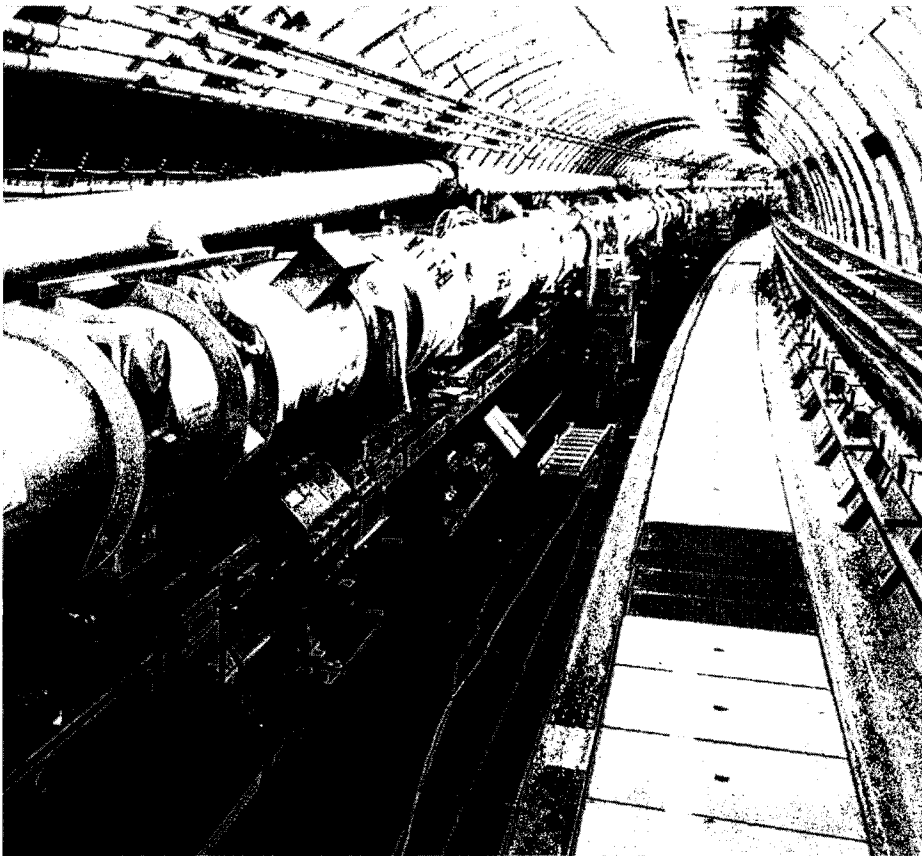

ing dipoles, will be tested next year. While higher field superconducting magnets can retain higher energy beams in a given ring size, superconductivity also has its role to play in radiofrequency accelerating cavities to increase accelerating field gradients and reduce operating costs. Here again there is fairly steady progress towards higher fields for higher energy machines.

Since the first superconducting linac at Stanford HEPL twenty years ago (which incidentally is still working for Free Electron Laser research) gradients have climbed to 5 MV/m reliably achieved in industrially built cavities. The biggest operating system is the 32 five-cell system on the TRISTAN storage ring at the Japanese KEK Laboratory, soon to be overtaken by the rf system to double the energy on the LEP ring at CERN and the CEBAF linac in the USA (where 65 cavities have been tested giving an average gradient of 8.3 MV/m).

Though 5 MV/m may now be available 'off the shelf', field gradients in operating machines are significantly lower – for example 3.3 to 4.7 in TRISTAN, 3.5 to 4.25 in LEP. Happily, these lower performances are not 'cavity-based' but due to external sources such as power supply limitations, degradation due to dirt contamination, and exposure to synchrotron radiation. They indicate, however, that superconducting cavities do need continued nursing after they have been installed in machines, much more so than conventional cavities.

For the future the push to higher gradients continues, led by 34MV/m achieved at Cornell.

Front-runners in colliding electron beams are the TRISTAN and LEP storage rings. TRISTAN is now in action for physics with energies of 29 GeV and a greatly increased lumi-

magnets monitored by NMR, one from each manufacturer.

The push to higher fields continues at the SSC Supercollider Laboratory in the USA and at CERN for the LHC project. News from the SSC is that the increase to 50 cm aperture has been successfully incorporated in the design and the recent magnets built to that specification are performing better than the required 6.6 T (April, page 11). Five full-size magnets are on-site and are judged ready for the move to full-scale industrial production. A test of a complete 'string', consisting of ten dipoles and two quadrupoles, is scheduled before the end of this year.

Magnets for the LHC, adapted to the constraints imposed by going for the highest possible energy in the existing LEP tunnel, attack three novel

challenges simultaneously – fields around 10 T, operation at 1.8 K, and two beam channels in a common yoke. The desired field has been reached in a magnet. More significantly, recent models have quenched only in the ends and splice areas and not in the body of the magnet; it has been shown that the twin-aperture configuration does not bring in new problems and moves from short models to full-scale magnets should not affect performance.

Recent LHC magnet designs look at several options, including separate collars for the coils around each beam to loosen the link between the fields in each aperture and to help in smoothing out magnet properties around each ring. Work continues to refine conductors, coils and collars. A half-cell, including five superconduct-

IT ALL DEPENDS ON THE BALL

CD-Bonn

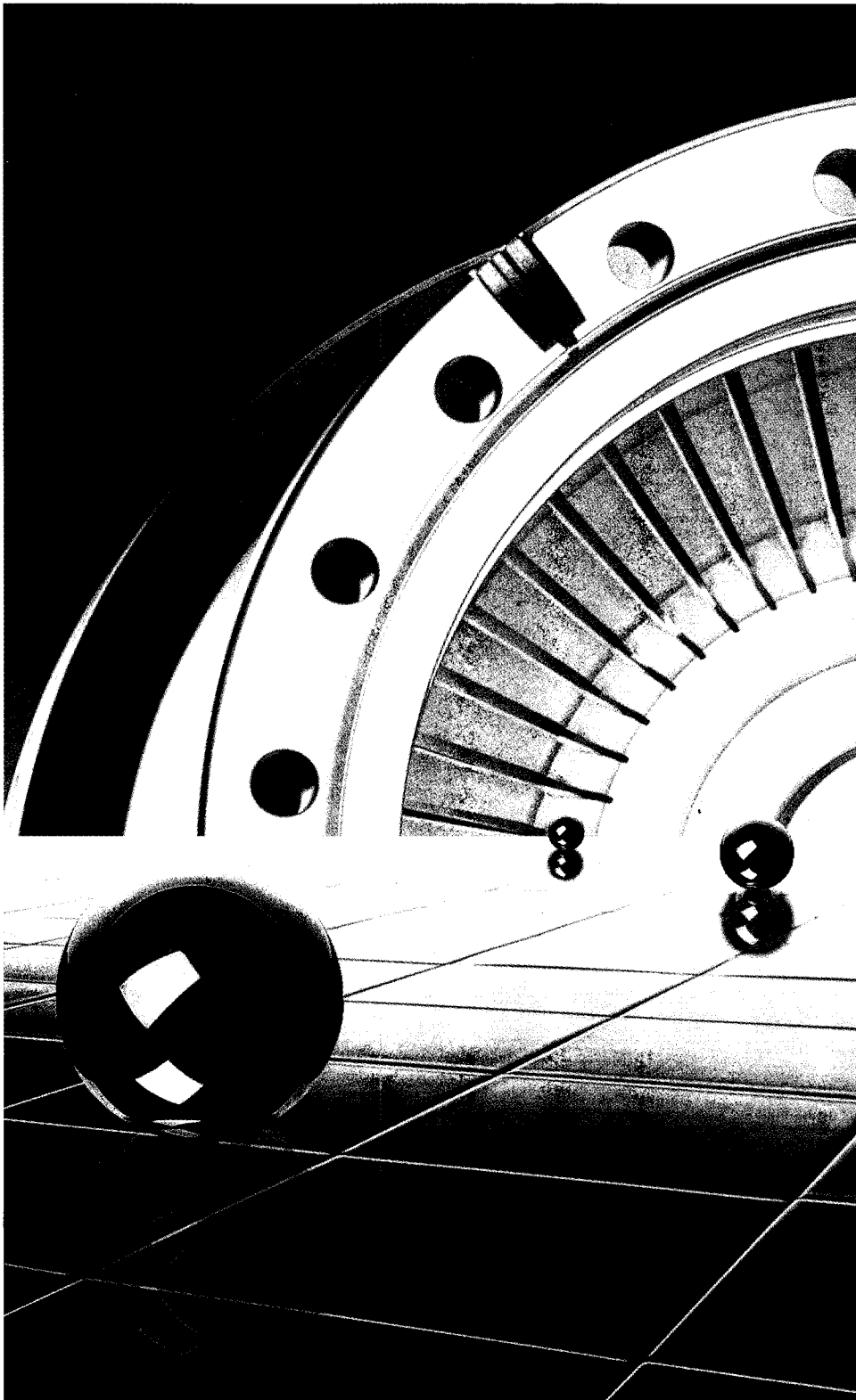

175.2.61.11.006.02

The sphere is the perfect shape. For the perfect shape we had to find the perfect material: CERAMICS

That's the reason why we equipped our NEW series of TURBOVAC Turbomolecular Pumps from 50 to 1000 l x s⁻¹ with ceramic ball-bearings.

The special material properties of ceramics reduce wear and increase lifetime. All these NEW TURBOVAC share the following features:

- Highest reliability ensured by ceramic ball-bearings (MTBF > 25,000 hours)
- Maintenance-free due to lifetime lubrication
- Mountable in any position, at any angle, due to grease lubrication
- Water- or air-cooled

Interested?

**Give us a call at Germany:
(0221) 347-0**

LEYBOLD AG

- Bonner Strasse 498,
D-5000 Cologne 51, Germany
- Leutschenbachstrasse 55,
CH-8050 Zürich, Switzerland
at CERN: (021) 691 84 14



Innovative Vacuum Technology

A Degussa Company

Proposed layout of the Tau-Charm Factory under study, in collaboration with CERN, for Spain. Many such 'Factories' were discussed at the EPAC conference. Their goal is the detailed study of special particles to fill in gaps in understanding at lower masses and energy levels than those confronted by the front-line machines.

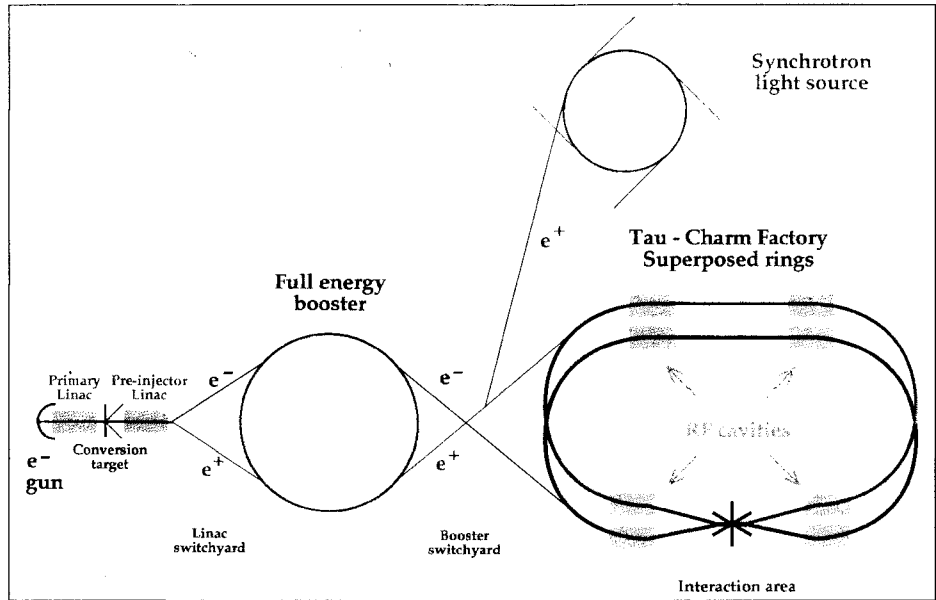

der the name of TESLA (TeV Energy Superconducting Linear Accelerator) it accepts the costs of a longer length machine in the hope that they could be compensated by lower power demand (a factor of a hundred or more) and less stringent demands on spot size to reach the necessary luminosity (100 nm rather than 5 nm). Several laboratories in the US and Europe (April 1991, page 16) are collaborating in TESLA development.

The Factories

As the wave of front-line particle physics research surges on, it leaves in its wake a lot of incomplete knowledge and some fundamental problems which require detailed work with masses of data. Typical examples are the examination of rare decay modes and the long-standing mysteries of charge-parity (CP) violation. To do this work involves comparatively modest energy accelerators but they have their special technological challenges in yielding luminosities a hundred times higher than usual to give the required volume of data.

The machines are of a scale and cost which do not require extensive international collaboration and they have mushroomed in recent years so that a rare particle must feel neglected if there is not a proposal to give it its own 'factory'.

The general purpose Kaon Factory proposal at the TRIUMF laboratory in Canada leads a sinusoidal life of optimism and frustration; the latter phase predominates at the moment – hopefully temporarily. There are Tau-Charm Factory proposals in Russia and in Europe; the latter (July/August 1991, page 13) envisages a site in Spain and has been developed in collaboration with CERN. It has superimposed electron-positron rings of

nosity following machine improvements during the last year (April, page 15). In a few years it is intended to convert the machine to a high brightness synchrotron light source. LEP has scoured the region of the Z mass with beam energies of around 50 GeV. LEP is aiming to do the same job at the W mass with beam energies around 90 GeV.

Beyond this energy, storage rings move out of the region of 'fiscal feasibility' and the biggest challenge in accelerator physics and technology at present is the attempt to achieve higher lepton collision energies via electron linear colliders.

One talk on this subject concluded with the comment that it was necessary to kiss this technological frog to transform it into the desired prince. To which the corridor reply was that it may be necessary to embrace an awful lot of frogs before the prince materializes.

Experience with the SLC Stanford Linear Collider has encouraged this work since it has demonstrated how to produce and handle beams of very small spot size. However, much

higher luminosities (10^{33} to 10^{34}) than at the SLC will be needed at do physics in the TeV range with linear colliders. Add to this the desire to keep machine sizes reasonable, say 20 to 30 km (requiring accelerating gradients of some 100 MV/m), and to keep power requirements acceptable (below 200 MW) using novel r.f. power systems, and the technological difficulties are obvious.

Four different methods are under development at Stanford (NLC), Japan (JLC), Russia (VLEPP) and CERN (CLIC). They each have test facilities in operation tackling one or more of the technological problems. Other Laboratories with linear accelerator traditions are also contributing to this work. A Workshop on electron linear colliders is being organized by the European Committee for Future Accelerators, ECFA, in July.

Another approach to electron linear colliders is back under study after being somewhat put aside in the early days of thinking of possible schemes because of the comparatively low accelerating gradients (25 MV/m maximum) which could be achieved. Un-

Star of the EPAC show was the European Synchrotron Radiation Facility, in Grenoble, reporting impressive progress in commissioning its 6 GeV storage ring as the conference progressed. A stored beam of 10 mA was achieved during the week and the ESRF is the first large machine of its 'third generation' kind to come into action.

2.5 GeV. A Phi Factory, called Daphne, is to be built at Frascati in Italy; it will collide intense electron-positron beams at 500 MeV per beam. Other Phi Factory studies are at Novosibirsk with a 'butterfly' configuration of two superconducting rings, UCLA in the USA with a single superconducting ring, and KEK Japan with two conventional rings. There are no less than six proposals for Beauty Factories – all two asymmetric ring schemes.

Making light

Synchrotron radiation sources were a major theme of the conference and the statistics presented over fifty machines in operation, most of them for a broad range of research but about ten for specific applications like lithography or Free Electron Lasers.

Star of the show was undoubtedly the European Synchrotron Radiation Facility which was commissioning as the conference progressed. ESRF, supported by twelve European countries, is a 6 GeV machine fed by a full energy synchrotron booster. Electron beams are being used initially but they will probably be replaced by positrons in 1994. ESRF is of the third generation type, using undulator and wiggler insertion devices in the straight sections of the machine as the major sources of its intense radiation with well defined properties.

The ESRF has been built, on schedule and within budget, with impressive speed; ground breaking was only three years ago and the storage ring was installed within a year. The first stored beam was achieved on 1 March. As the conference opened, beam-lifetimes of an hour had been achieved and by the time the participants had dispersed 10 mA had been stored. It looks as if research at the



ESRF will open comfortably ahead of other equivalent machines elsewhere.

Of great topical interest is the start up of compact synchrotron radiation sources for X-ray lithography in the electronics industry. IBM produced chips with 0.5 micron line width using beams from the Brookhaven Light Source in 1988. Since then machines have been built or planned with the aim of reducing line width to 0.1 microns. Such compact sources are also to be used in the production of microstructures for the commercial market (using the LIGA method) and for K-edge angiography for heart scans.

There are fourteen such projects in all – eight in Japan, four in Europe and two in the USA. Front-runner is the Aurora model built by Sumitomo in Japan, which came into action in 1989. It uses a compact microtron for injection (and a novel resonance injection technique which is a sort of reverse slow ejection) and has stored 300 mA at 650 MeV in a 1 m diameter single superconducting magnet.

COSY in Germany initially used conventional magnets and stored 100 mA at 50 MeV; the move to superconducting magnets has so far yielded only 1 mA at 550 MeV. Super ALIS in Japan has 200 mA at 600 MeV. Oxford Instruments in the UK have delivered a superconducting machine called Helios to IBM.

Free Electron Lasers also attract a lot of attention but more for what they potentially can deliver in radiation fluxes rather than what they have delivered. There are 41 projects in operation or building (15 in Europe, 14 in the USA, and 12 in Japan). 15 of them have 'lased' so far, five of them coming into action during the past year. It should not be long before their promise is realized.

Some of the uses of synchrotron radiation in biology were described by M. Kock from the European Molecular Biology Laboratory, who does research at DESY. Such research and related applications have recently been reviewed by EMBL in a book of 600 pages!

Painting the alphabet with high energy heavy ion beams at Darmstadt using the raster scan technique. This excellent control of beams bodes well for the use of ions in three dimensional treatment of cancer tumours.

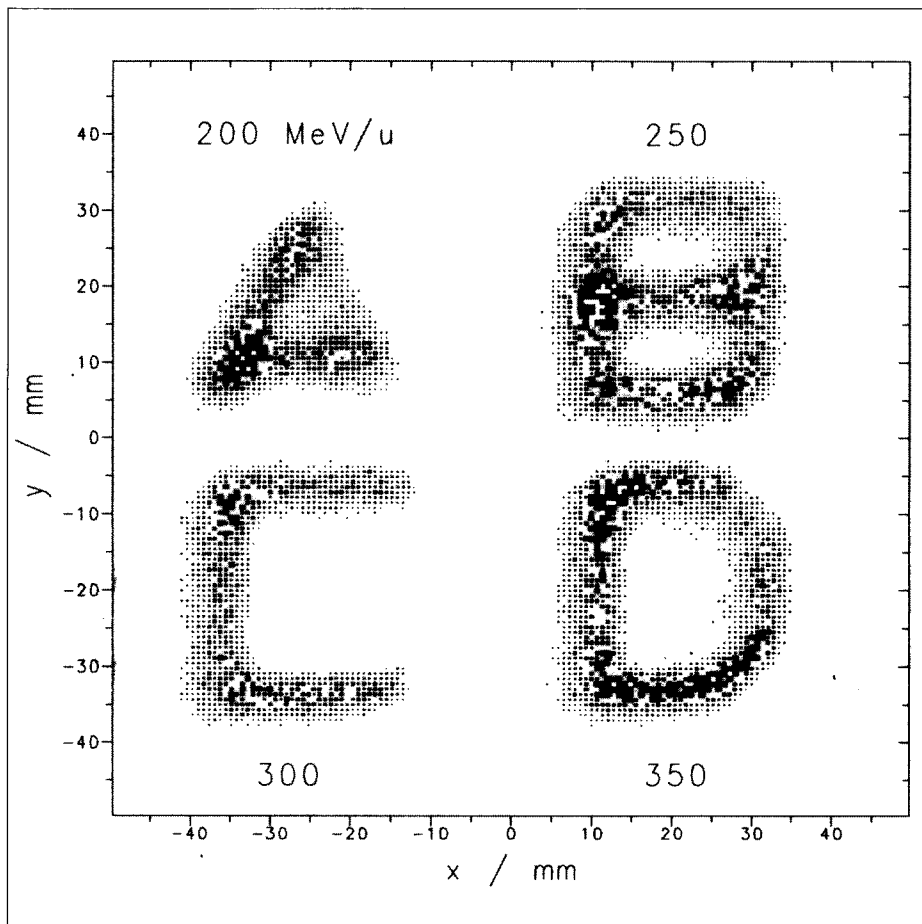

Other research fields and applications

Nuclear physics continues to benefit from advanced accelerators. Progress at the CEBAF project, with its two superconducting linacs, is looking good with cavity performance well above specification. The potential peak energy is under review with optimists predicting as high as 8 or 10 GeV rather than the design 4 GeV. The experience with the S-DALINAC recirculating superconducting linac at Darmstadt (May 1991, page 10) has yielded a lot of information to help the new projects. In Europe, nuclear physicists from several countries have been developing a

microtron-type scheme to go as high as 15 GeV via five passes through three 1 GeV linacs.

CERN Director General Carlo Rubbia gave a special evening talk on the concept of achieving inertial confinement fusion via pellet bombardment by accelerated ion beams. The concept has been around for some time but benefits from the tremendous progress in accelerator technology. It is now a serious alternative to magnetic or laser confinement schemes and thus worth pursuing in parallel. Such techniques of bringing matter to states of high temperature and density promise a new range of physics in addition.

A first step is opening up at the Darmstadt heavy ion complex, SIS/

ESR. In the past two years ions of neon, argon, krypton, xenon, dysprosium, gold and bismuth (the favoured ion in inertial confinement schemes) have been accelerated in the SIS.

The application of such beams for cancer radiotherapy has been investigated with the Darmstadt machine and remarkable control of raster scans with ion beams of small spot size has been demonstrated. Ions have some advantages over other particle species in such treatment because of their sharp 'Bragg peak' deposition of energy and their biological effect in more efficient cell destruction.

A 500 MeV neon ion synchrotron has been studied at Darmstadt but such ion machines are still technically too difficult for operation in hospital environments. Simpler proton and neutron facilities have been used in several countries and a major medical facility is coming into action at Loma Linda hospital in California using a proton synchrotron developed at Fermilab.

Ion beams are also in widespread use in materials research and applications for the analysis and modification of material surfaces. Ion implantation is used in the semiconductor industry and is coming into use on a largescale for implanting impurities to improve material properties. They generally require energies up to about 200 keV. Beams into the MeV region are needed for ion beam synthesis (where heavier doses of ions produce new compounds) and ion beam mixing or assisted deposition (where surface atoms are exchanged and inert atoms inserted). Electro-optical devices, improved mechanical properties of ceramics, better lubricants, filtration membranes with pores produced by parti-

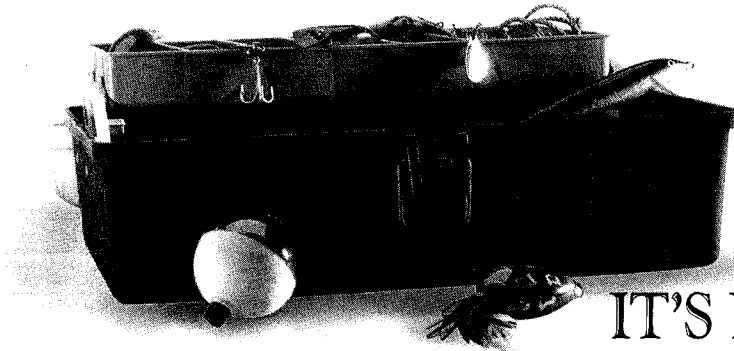

IT'S NOT JUST A QUESTION OF KNOWING WHAT YOU NEED, IT'S KNOWING WHERE TO FIND IT.

Panfish jigs. Slip sinkers. Snelled hooks. When a fisherman needs one, the first place he looks is in his tackle box. ■ After more than 30 years of supplying photonic components, scientists and engineers have come to think of Hamamatsu as a kind of photonics tackle box. Because we have over 150 different PMTs to fit all your applications. They're available in a wide range of spectral response levels and configurations. In sizes from 3/8-inch to 20 inches with six different dynode structures and a variety of photocathode materials. ■ We also have a complete line of PMT accessories. ■ In the unlikely event we don't have what you need on the shelf, our technical people can work with you to modify existing products. Or, custom-design a PMT to fit special needs. ■ You know what you need. Now you know where to find it. Hamamatsu. ■ To discuss your PMT applications, call 1-800-524-0504.

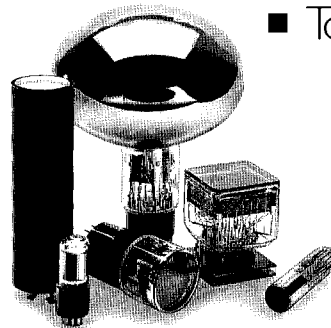

HAMAMATSU

HAMAMATSU CORPORATION ■ 360 FOOTHILL ROAD, P.O. BOX 6910, BRIDGEWATER, NJ 08807

GERMANY 49-8152-375-0 ■ UK 44-81-367-3560 ■ FRANCE (1) 49 75 56 80
SWEDEN 46-760-32190 ■ ITALY 39-2 935 81 733

cles can all benefit from the growing use of higher energy accelerators in materials research.

The treatment of radioactive waste by high power accelerators is under study in the USA and Japan with the aim of chemical transformation of long-lived radioactive elements using intense fluxes of thermal neutrons (April, page 19). In Japan a very high power linac is being studied and Los Alamos have a scheme for a proton c.w. accelerator to deliver over 100 mA at 1 GeV. Though the schemes may be feasible, they need much more work before they are optimal.

Other high power machines are investigated in many countries (Germany, Russia, Poland, Sweden, etc.) to ease environmental problems. Electron beams can help in flue gas treatment, water purification and food irradiation. For example a research project in Poland uses an electron beam to remove 90% of sulphur and nitrogen oxides from flue gas.

Industrious approach

The ever-closer relationship between the European accelerator community and European industry was exceptionally noticeable at the conference. This has not happened overnight; it has been steadily developing for many years.

There are two obvious reasons for this. The first is that the technological abilities of industry have been transformed in the past two decades. For example, when the CERN PS and even ISR were being built almost all the technologically advanced design, prototype and assembly work had to be done 'in-house'. The first sorties to place such work in industry failed. Now in-

dustry is a full partner beyond the stage of initial conception.

These abilities were very obvious in a splendid industry exhibition held in parallel with the conference. Such was the attraction of the displayed work being carried out in industry that this exhibition was frequented every bit as much as the poster sessions of the conference proper.

'Turnkey' accelerators can now be bought from industry for a variety of purposes. Among the hitech presentations were compact superconducting synchrotrons for X-ray lithography, cyclotrons for isotope production and proton cyclotrons for cancer therapy, all built in industry.

The second reason for the increased symbiosis is the sheer scale of the present projects in the high energy physics Laboratories.

Whereas CERN could confront the assembly of the magnets for the PS or ISR there is no way without an unreasonable increase in Laboratory resources that giant rings such as LEP (27 kilometres) or the SSC (87 kilometres) can be equipped without considerable industrial participation.

A reflection of this came in a special session at the conference devoted to transmitting to industrial partners the needs of current European projects. The session opened by recounting the experience in building the ESRF; with a tiny group of only twenty Laboratory professionals the machine came together very rapidly with design and construction by industry. With the exception of the lattice calculations, the insertion devices and the beam monitoring system, everything was contracted out, with almost universal success.

Other projects presented for consideration by industry were BESSY-II in Germany, Daphne in Italy, the Tau-Charm Factory in Spain and the Large Hadron Collider at CERN. In

each case a list of component requirements was presented; for the LHC a fat book of the machine components is already available for industry.

Overall the conference gave evidence of an accelerator community and a surrounding industry in a very good state of health.

By Brian Southworth

Cryogenic Components

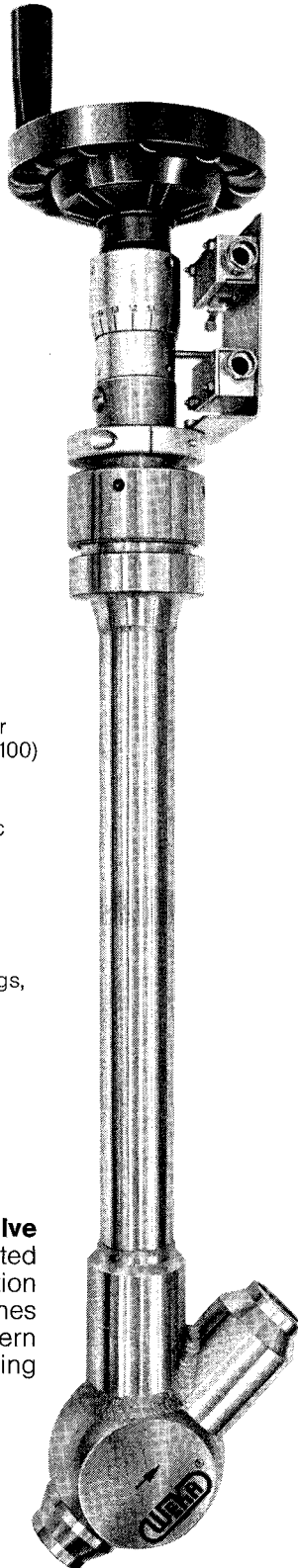

Manufacturing Line

- Cryogenic Valves
(Vacuum Jacketed and also for Cold Box Mounting, DN 2 - DN 100)
- Special Valves for Cryogenic Applications
(Check-Valves, Pilot Cryogenic Valves etc.)
- Bellows Sealed Valves
(DN 2 - DN 100, up to PN 300)
- Cryogenic Transferlines and Couplings
(Bayonet or Johnston Couplings, Multi-Coaxial Couplings)
- Space Cryogenic Fittings
- Tailor made Cryogenic Components e.g. Cryostats and Ejectors

Cryogenic On Off Valve

manually operated with position indication and limit switches "Y" pattern cold box mounting

for further informations:

WEKA AG

Schürlistrasse 8, CH-8344 Bäretswil, Switzerland
Phone (0)1 939 29 59, Telefax (0)1 939 29 63, Telex 875 744

or in USA and Canada:

PROVAC LTD

POB 18411, Greensboro, North Carolina 27419
Phone (919) 282 6618, Telex 510 600 4853, Telefax (919) 288 3375

Editions Frontières announces

Proceedings of

EPAC'92

edited by

H. Henke, H. Homeyer and Ch. Petit-Jean-Genaz

Outstanding contributions on the design of the new generation of accelerating systems leading to unprecedented performance in energy, luminosity, flux and emittance demonstrate that future targets are within reach. The proceedings contain a number of excellent review papers on special topics related to accelerator physics or technology. They include also many short contributions relevant to numerous aspects of accelerator activities.

Readership: High energy physicists, Accelerator physicists and engineers, physicians in the field of medical applications of accelerators.

EPAC'92 : 2 vol, 1700 pages FF 1300 - US\$ 240

EPAC'90 : 2 vol, 2100 pages FF 1300 - US\$ 240

Package : EPAC'92 - EPAC'90 FF 1950 - US\$ 360

Special Edition :

EPAC-Medical Satellite Meeting FF 450 - US \$ 85

Send your order to:

Editions Frontières

B. P. 33, 91192 Gif sur Yvette Cedex, France

Fax : 33 (1) 69288659-Tel : 33 (1) 69285135

88 Circle advertisement number on reader service form



Editor for TeX

- Easy to use
- Complex formulas visualized on-screen
- TeX characters directly available from keyboard
- Standard text editing features
- Concise, example-filled user's manual
- Available in French or English
- Ideal for beginner and TeXpert

Only 950 FF!

For IBM PC AT/XT and compatible

Novedit

7, avenue du Hoggar, Z.I. de Courtabœuf, B.P. 112
91944 Les Ulis CEDEX FRANCE

Tel: (33-1) 69 07 36 88 Fax: (33-1) 69 28 84 91

Recognized distributor of PCTeX software

90 Circle advertisement number on reader service form

48a Circle advertisement number on reader service form

Around the Laboratories

Antiprotons holding out against annihilation in helium. Top – a typical spectrum obtained at 6 atm. pressure, when some of the antiprotons survive for several microseconds before finally annihilating in the nucleus. The lower figure shows the dramatic difference when 400 ppm of hydrogen was added to the helium. Such results are routinely obtained in a few hours of parasitic running at CERN's LEAR low energy antiproton ring.

CERN Antiprotons resist annihilation

Ask any particle physicist what is the eventual fate of an antiproton in matter and he will likely tell you that 'it annihilates'. True as this answer is, it hides a number of fascinating questions about the actual 'route' followed by the antiproton into the nucleus where it finally stops before annihilating with a nuclear particle.

In the first stage of this route the antiproton is captured in a Bohr-like orbit, replacing an atomic electron, and forming an 'exotic atom'. It then has to cascade down through a series of atomic states before it can come within range of the annihilation force – the strong interaction of the nucleus.

As long ago as 1947, Fermi and Teller calculated the time required for the corresponding process involving a negative pion, and came up with a value of about 10^{-13} seconds for solid and liquid targets. A little later, A.S. Wightman did a more sophisticated calculation for hydrogen, and included the case of 'a hypothetical particle of mass 1837 times that of the electron' (the discovery of the antiproton being still eight years in the future). Wightman's result, and indeed nearly all subsequent calculations, supported the conclusion that the total time spent in the atomic cascade should be of the order of a fraction of a picosecond (ps).

With the advent of the bubble chamber some years later, indirect evidence showed that negative pions and kaons typically require more like 100 than 0.1 ps to reach the nucleus. Bubble chambers cannot of course provide time informa-

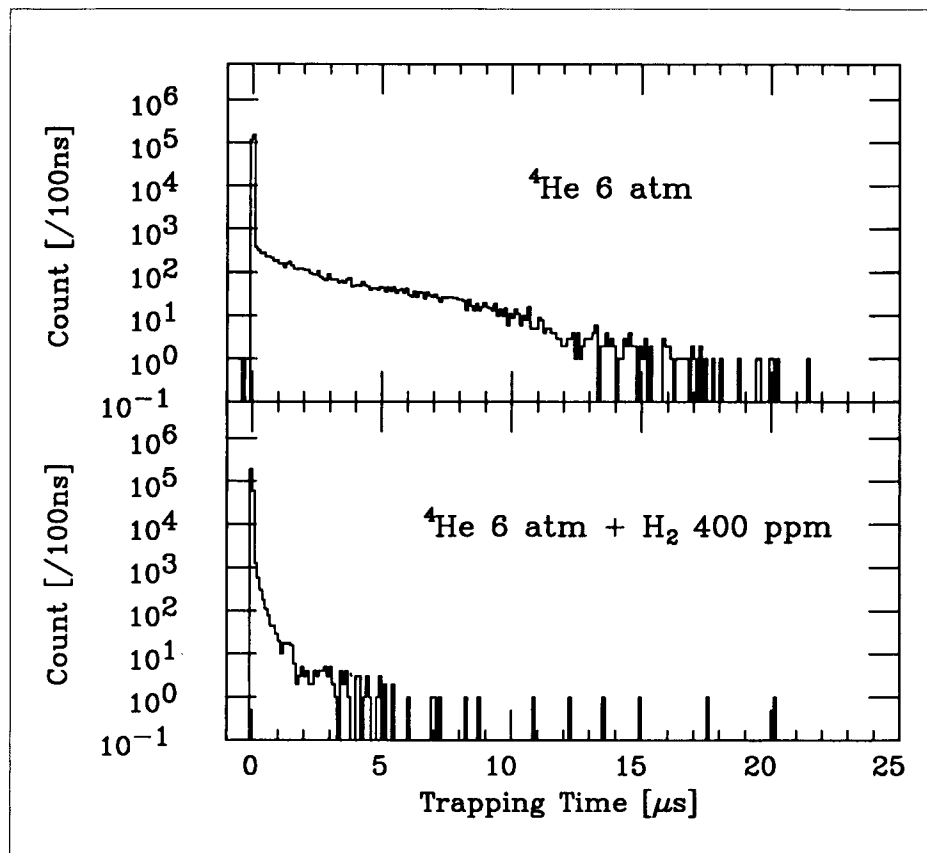

tion, but electronics experiments can, and an even greater surprise followed when a Tokyo group working at the Japanese KEK Laboratory published papers in 1989 and 1991 showing that about two percent of negative kaons stopped in liquid helium stay in their atomic orbits long enough to decay there instead of interacting with the nucleus, and that nearly four percent of the antiprotons fired into liquid helium survived several microseconds before annihilating.

Thus the hundred picosecond figure for negative pions and kaons is the average for a small fraction of exotic helium atoms which are in some way special, and a much larger fraction when nuclear interactions take place immediately after atomic capture, as expected from the theoretical studies.

The special component reveals itself by allowing decay in orbit for pions and kaons, and by delaying the annihilation process in the case of antiprotons. In the trade jargon, the special exotic atoms are those in which the antiproton or negative kaon has been 'trapped' in a metastable state.

Discrepancies between theory and experiment of a factor of a hundred million are unusual to say the least, but just such an effect was predicted in 1964 by G.T. Condo at Oak Ridge, who suggested that the quantum numbers of some of the exotic helium atoms formed might not allow the remaining electron to be ejected immediately, as other authors had supposed was always the case. Its continued presence would then, by the Pauli principle, prevent penetra-

ing collisions of the exotic atom with ordinary neighbouring helium atoms and it was just these collisions which were supposed to short-circuit the slow route of the 'intruder' into the nucleus via successive electromagnetic transitions.

The stable antiproton is evidently a much better tool for studying this phenomenon than the unstable negative kaon. It was also clear to the Tokyo group that the properties of the antiproton beam required for a thorough investigation of the effect make CERN's LEAR low energy antiproton ring the world's only conceivable machine for the job.

No time was lost in moving the experiment to CERN, now as a Tokyo/Munich/CERN collaboration (Experiment PS205). Only eight months after the KEK result, a short test run produced similar effects at LEAR, this time in the gaseous phase and in helium-3 as well as helium-4.

Many questions remain to be answered. Is the Condo trapping mechanism the correct one? Is the effect unique to helium? Does the lifetime depend on the physical/chemical state of the stopping substance, and are there potential applications in exotic atom chemistry?

Four further weeks of running are scheduled this year during which the collaboration plans to answer some of these questions by looking at these trapped antiproton states in solid, liquid and gaseous helium-3 and helium-4. Further projects are underway to detect visible light produced in the deexcitation process and to pump the metastable atoms with lasers, perhaps prolonging their lifetime even further and permitting high precision spectroscopy. It may even prove possible to catalyse antihydrogen production via chemical reactions of the metastable atoms with positrons or positronium.

Schooling

An important CERN contribution to education is its regular Physics Schools in Member States and further afield. These bring together postgraduate students and young research workers, creating valuable additional opportunities for young scientists.

The two-week School of Physics, established in 1962, is held in a different country each year. Since 1970 it has been organized in alternate years with the Joint Institute for Nuclear Research (JINR), Dubna, near Moscow, and located alternately in Eastern and Western Europe. The twelfth joint CERN-JINR School, held in Alushta in the Crimea last May, attracted about 100 students from 18 countries.

The organization of the School now has been modified following recent political evolution. From next year there will be an annual CERN European School of High Energy Physics. JINR will be represented on the Organizing Committee and the location will rotate among all European countries, including the Commonwealth of Independent States. In 1993, Poland will host the first such School.

This year's School takes place from 13-26 September in Monschau, near Aachen, Germany.

Also this year is the 4th Hellenic School of Elementary Particle Physics, to be held in Corfu from 2-20 September. It will be a basic course on the Standard Electroweak Model and Quantum Chromodynamics. The School Secretary is Ms. V. Veziri, Physics Department, National Technical University, 157 73 Zografou, tel/fax (+30 1) 778 4541, telex 221682 NTUA GR.

BROOKHAVEN High energy gold

On April 24, Brookhaven's Alternating Gradient Synchrotron (AGS) started to deliver gold ions at 11.4 GeV per nucleon (2,000 GeV per ion) to experimenters who were delighted not only to receive the world's highest energy gold beam but also to receive it on schedule.

High energy gold beams mark the culmination of the development of the AGS into a fully functioning complex capable of delivering high energy heavy ions of almost any sort. It also promises well for the experimental programme at the RHIC high energy ion collider now under construction at Brookhaven, which will use the AGS as injector.

The beam starts in the Tandem Van de Graaff which every three seconds produces a pulse of 10^9 gold ions of charge +33 and kinetic energy 1 MeV per nucleon. They are transported through a 550 metre transfer line to the new AGS Booster, which accelerates the ions to 0.75 GeV per nucleon by r.f. bunch coalescing. Initially, the very slow heavy ions are collected in the Booster ring in 48 r.f. bunches. During acceleration, as the ions approach a respectable speed, the 48 bunches go through four steps of coalescing two bunches into one (48, 24, 12, 6, 3), reducing the required swing in the r.f. frequency by a factor of 16.

1.5×10^8 ions of gold 33+ are extracted from the Booster and stripped in a 0.05 mm copper foil to yield beams of highly stripped gold ions. Not everything ran smoothly. The AGS injection was initially set up on the fully stripped gold 79+ beam, but it was promptly shut down by a very rare April thunderstorm. In

wie-ner

VME · VXI
CAMAC · NIM
FASTBUS

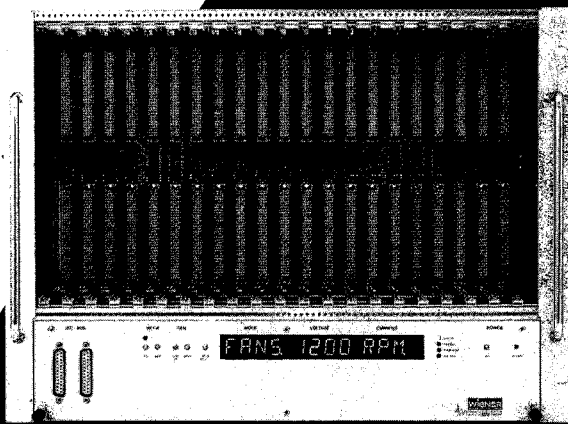

VME · Linear or switched-powered · 500/1250 W.
CERN/DESY-Specs · intelligent monitoring
microprocessor controlled

...to avoid
down times:

wie-ner

Plein & Baus Elektronik

Werk für

Industrie-
elektronik

Nuklear-
elektronik

Regelungs-
technik

excellent source for
trouble-free
CRATE designs
Special power supplies

Plein & Baus Elektronik GmbH
W-5093 Burscheid (W-Germany) · Müllersbaum 20
Tel.: (0 21 74) 6 78-0 · Fax: (0 21 74) 67 85 55

10a Circle advertisement number on reader service form

MANUFACTURER OF VACUUM VESSELS

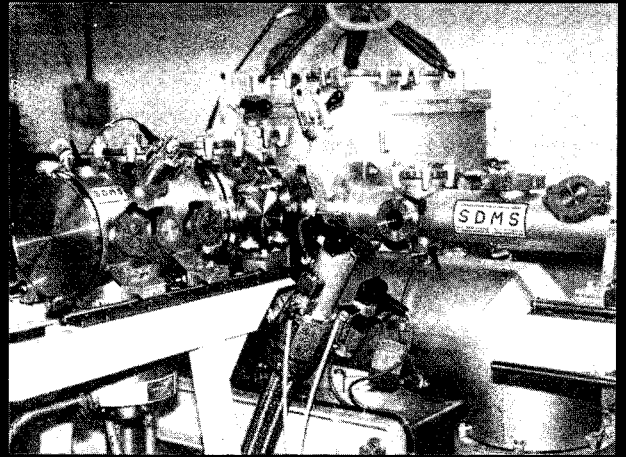

SDMS

chaudronnerie blanche

B.P. 4
F. 38160 SAINT-ROMANS
Tél. (33) 76 38 40 13

15d Circle advertisement number on reader service form

• FIELD EMISSION GUNS • PROJECTION DISPLAYS •

High voltage OEM power supplies? Turn to 42 years of experience

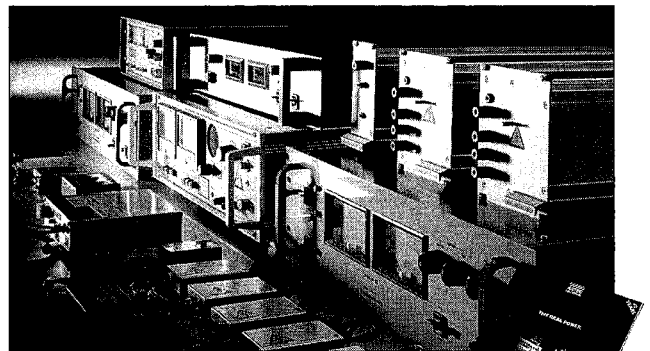

The new brandenburg range of high voltage OEM power supplies still adhere to the same high standards of quality and reliability that have made us the world's number one for high voltage applications.

And now we can offer off the shelf delivery of standard models in a week and custom product in about half the industry norm. We've also broadened our range of HV accessories, from plugs and sockets to probes and insulation testers.

The largest range of high voltage power supplies. In fact when you've got a

high voltage application, we've got the widest range of alternatives under one roof. To tap into our 42 years experience call us now for further details or a copy of our new catalogue.

Astec High Voltage

A Division of Astec Europe Limited
High Street, Stourbridge,
West Midlands DY8 4PG England.
Tel: 0384 393737 Fax: 0384 373511



ASTEC the source for **brandenburg**

Distributors: UK: 0246 455946 GERMANY: 089/14 90 02-20 FRANCE: 1 45 47 15 95 US: 508-881-8407

• SPECTRO-PHOTOMETRY • GAS CHROMATOGRAPHY •

81a Circle advertisement number on reader service form

CRT DISPLAYS • X-RAY IMAGE INTENSIFIERS • ANALYTICAL INSTRUMENTATION

ELECTRONIC MICROSCOPES • MASS SPECTROMETRY • PHOTOMULTIPLIER TUBES

FERMILAB Preparing to collide

Against the background of stringent Environment, Safety and Health (ES&H) regulations mandated by the US Department of Energy for all national Labs, Fermilab prepared to mount the next major Tevatron proton-antiproton collider run.

The Tevatron Collider was last in action in 1989, when a very successful one-year run exceeded all expectations for the number of proton-antiproton collisions recorded. This time the big CDF detector is joined by D0 (March 1990, page 6), one-third the way round the four-mile Tevatron ring. For the first time, two major detectors will operate at the Collider.

The stakes are high as the big prize is the sixth ('top') quark, where data collected across the board suggest that the long-awaited final constituent of hadronic matter should finally be within reach. These indications – consistency arguments from Z decays at CERN's LEP electron-positron collider, supplemented by other data, notably neutrino experiments – are substantially reinforced by results from CDF, which have established that the top quark has to be heavier than 89 GeV.

The upgraded CDF detector employs improved triggering to exploit higher proton-antiproton collision rates, together with a silicon microvertex detector to pick up transient particles decaying near the collision point, improved central tracking and increased muon detection.

With a major physics discovery on the cards and with two detectors at work, each inverse nanobarn of Fermilab's integrated luminosity will be eagerly scanned.

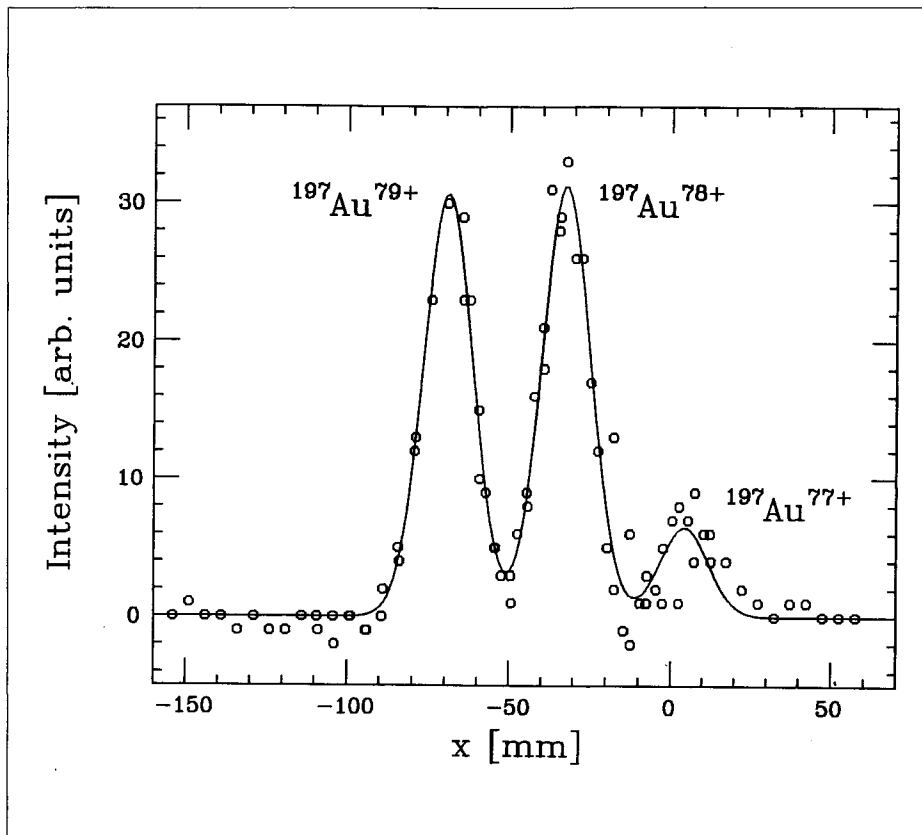

the recovery process, the injection was inadvertently set up for gold 78+. This beam was subsequently accelerated in the AGS and extracted to the experiments. When the error was discovered, it seemed best to leave well enough alone; so the program is operating, rather mysteriously to many, with gold 78+!

The AGS accelerates the nearly fully stripped gold from 0.75 GeV per nucleon to 11.4 GeV per nucleon and then delivers the beam of 10^7 ions per pulse to a total of 11 experiments on four different beamlines. The experiments include four searches for quark gluon plasma or exotic matter using counter techniques and seven small experiments that use either emulsion or track detector stacks.

The gold beam presently being extracted from the AGS is essentially

Brookhaven gold. After acceleration in the Alternating Gradient Synchrotron (AGS) Booster to 0.75 GeV/c per nucleon, the gold 33+ beam passes through a 50 micron thick copper stripping foil in the transfer line to the AGS. This shows the charge distribution of the gold beam after the stripping foil measured with a multiwire profile monitor downstream of two analyzing bending magnets.

the one which will be used in experiments for the next several years and which eventually will be injected into the Relativistic Heavy Ion Collider (RHIC), presently under construction. RHIC will accelerate the ions to 20 TeV per ion (100 GeV/nucleon) giving an ion collision energy of 40 TeV.

From Ed Bleser

The D0 detector, seen here in its assembly hall, is now in position for its first taste of proton-antiproton collisions at Fermilab's Tevatron.

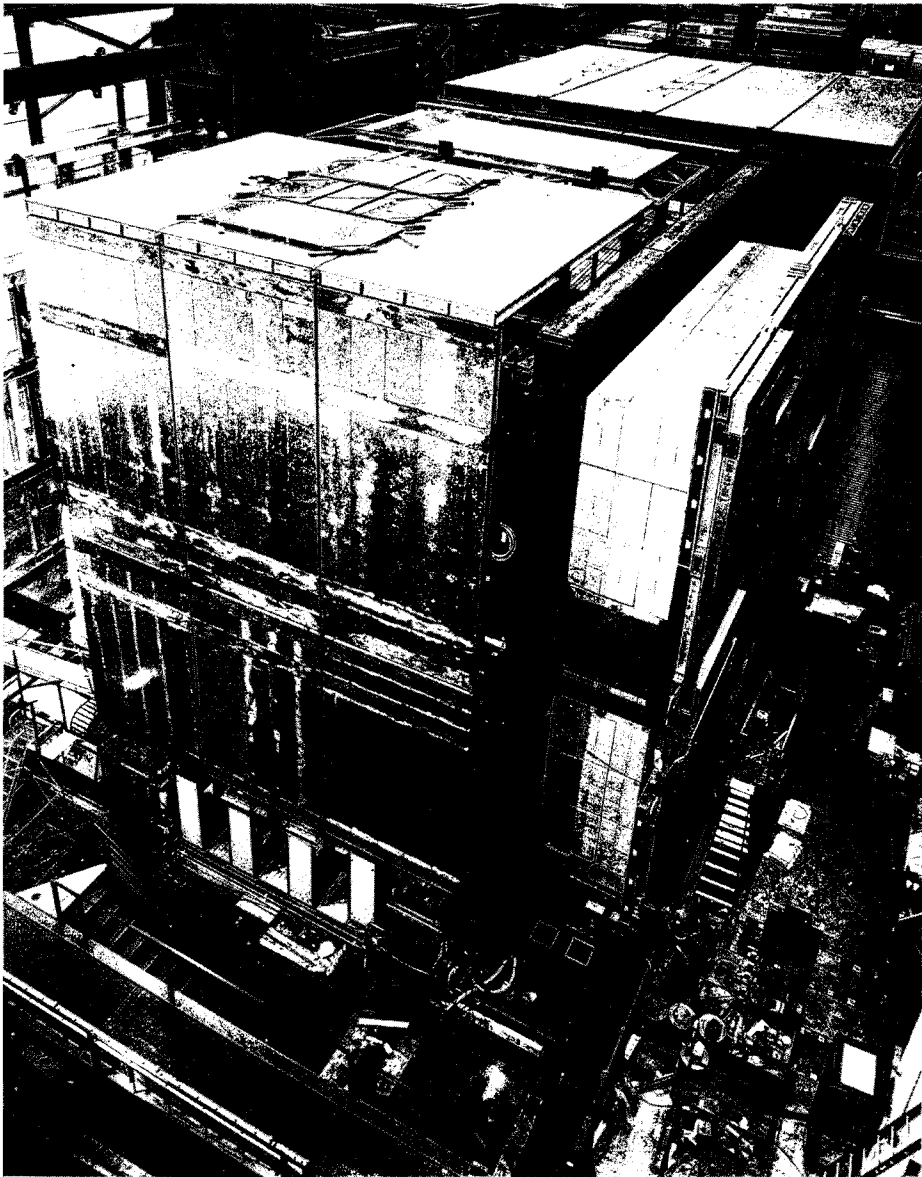

Meanwhile all those having to work in the collider areas have undergone strict ES&H hazard awareness training. For the CDF detector alone, 400 people have completed the course and passed the final written examination. At D0, keys to the experimental pit are only given to those who have passed the test.

COLLIDERS Microvertex detectors

Increasingly, major experiments at colliders are being equipped with microvertex detectors to track the short-lived particles produced close to the beam pipe and which would otherwise be difficult to see before they decay.

In keeping with technology trends, these microvertex detectors make extensive use of silicon strips to achieve the required fine (several micron) resolution. The first collider experiment to be so equipped was Mark II for its run at Stanford's SLC linear collider in 1989. The SLD detector presently running at SLC uses a novel pixel microvertex detector based on CCD chips, developed in the UK (November 1988, page 37). For the coming proton-antiproton run at Fermilab (see previous story), the CDF detector is equipped with a microvertex detector containing 46,000 silicon strips.

At CERN's LEP electron-positron collider, three experiments – Aleph, Delphi and Opal – are so far equipped with silicon microvertex detectors (July/August 1990, page 7). Those at Aleph and Delphi were first used in 1990, while that at Opal produced its first events in June 1991. Now L3 is preparing to follow suit. However because of its size, the L3 microvertex detector will look somewhat different to its LEP companions.

Of the detector designs in use so far, only that for Aleph at LEP uses double-sided strip patterns, with one layer measuring along the beam direction, the other across. This approach was pioneered by the Pisa group, and is now being taken up by L3.

However the special L3 geometry requires a special mechanical structure 1 metre long to support the component 'ladders' of the microvertex detector, rather than the 35 cm or so employed in the other LEP experiments. This structure has been designed at CERN. The cylindrical arrangement is specially mounted inside the L3 Time Expansion Chamber and supported only at its ends. It uses 12 ladders inside and 12 outside, the latter being slightly tilted to

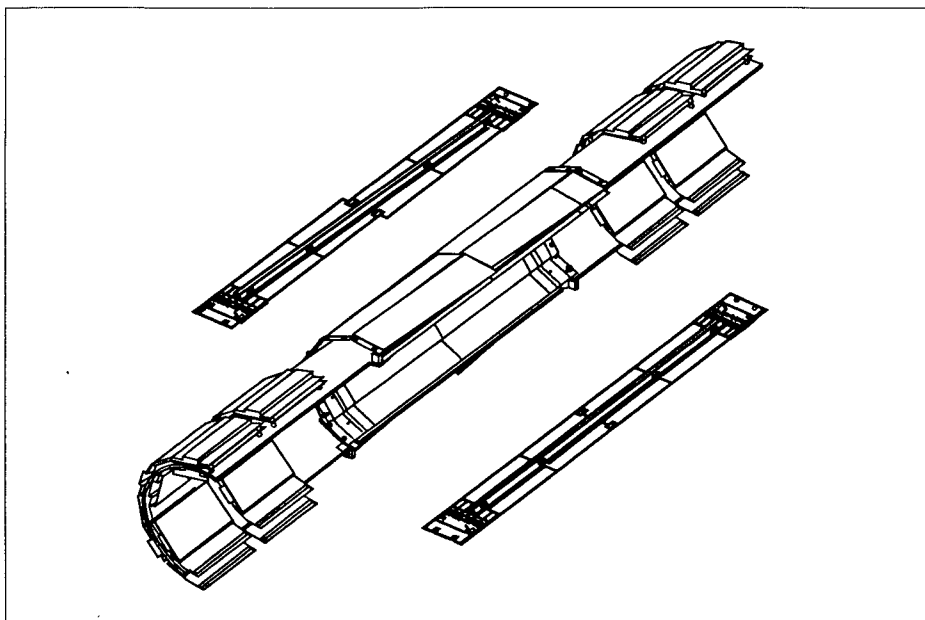

◀ Artist's view of the silicon microvertex detector being built for the L3 experiment at CERN's LEP electron-positron collider. Of the detector designs in use so far, only that for Aleph at LEP uses double-sided strip patterns, with one layer measuring along the beam direction, the other across. This approach, pioneered by the Pisa group, is being taken up by L3.

obtain stereo reconstructions. Limiting resolution is about six microns.

Readout electronics uses the SVX chips originally developed at Berkeley for the CDF experiment at Fermilab, and all electronics are grouped at the ends of the ladders to facilitate cooling. Sophisticated finite element analysis calculations at Los Alamos have assisted this part of the design. On one sensor side (z-side), the electronics uses a specially lithographed kapton cable.

Meanwhile the Argus detector at the DORIS III electron-positron ring at DESY, Hamburg, has also been equipped with a silicon microvertex detector, built by the Max Planck Institute in Heidelberg in collaboration with DESY and the Swiss PSI Laboratory.

In contrast to the microvertex detectors at the big collider experiments, that at Argus has to fit into a very narrow space close to the beam pipe. The beampipe diameter is just 22 mm (compared to 120 at LEP and 60 mm at Stanford's SLC), while that of the surrounding microvertex detector

is 39.4 mm. Readout uses MX3 chips via a 4 cm microadaptor to enable the chips to enjoy lower background radiation.

These microvertex detectors are technologically challenging projects, highlighting the increased collaboration between particle physics and specialist centres in other areas of research and in industry.

To fit around a slender beam pipe, the microvertex detector for the Argus experiment at the DORIS electron-positron ring at DESY, Hamburg, is less than 40 mm wide.



UPPSALA UNIVERSITY

Applications are invited for the position of **Director at the The. Svedberg Laboratory** Uppsala University, Sweden

The The. Svedberg Laboratory (TSL) is a Swedish national research facility for accelerator based research operated by Uppsala University. TSL provides a range of ion beams for Swedish and international scientists with approved projects and it also carries out research using its own resources. The laboratory runs three accelerators : one combined synchrotron and storage ring (CELSIUS) with electron cooling, one K = 200 MeV cyclotron, isochronous or frequency-modulated and one tandem van der Graaff accelerator. The largest beam energy is 1360 MeV for protons accelerated in CELSIUS. Also light heavy ions are available.

Ten scientists form the laboratory research staff and approximately 50 people are employed in total. About 50 research projects are at present in progress, performed by more than 200 PhD scientists. Examples of active fields of research are production processes and rare decays of mesons, intermediate energy heavy-ion physics, radiative processes in intermediate energy physics, nuclear spectroscopy, neutron physics, accelerator mass spectroscopy, electronic sputtering and desorption, radiation biology and biomedical research. The laboratory has a nationally recruited board and a Programme Advisory Committee of international experts.

The Director is appointed by the board of Uppsala University for a periods of six years.

The Director, together with the Programme Advisory Committee and the board of TSL, is responsible for the scientific and technical development of the laboratory. The Director is further responsible for the day to day management of the laboratory.

The board of TSL has appointed a Deputy Director. The Director decides upon the division of work between him-/herself and the Deputy Director. The appointee is expected to take part in the research activities at the laboratory.

Qualifications

Documented wide experience in nuclear or particle physics research.

Established experience of managing research teams at international or large national accelerator laboratories.

Other conditions

The salary will be negotiated.

The applications together with CV and other documents which the applicants wish to refer to should reach Uppsala University, Box 256, S-751 05 Uppsala not later than **August 15th 1992**.

The Programme Advisory Committee will assist the board of TSL to forward a proposal on a new Director to the university board.



RICE

Postdoctoral Fellowships

Nuclear and High Energy Physics

The T. W. Bonner Nuclear Laboratory has vacant positions for postdoctoral fellows. We have a diverse research program with approved experiments at the SSCL (SDC), RHIC (STAR), FNAL (D0), CERN (SMC), and CEBAF (PR-89-024). Physics topics include spin effects at medium and high energies, the nucleon spin structure, searches for the top quark and Higgs boson, and strangeness production in heavy ion collisions. The group consists of seven experimental and two theoretical faculty, four postdoctoral fellows, and about fifteen graduate students. The style of the laboratory is that group members participate in several experiments.

Rice University is a small private university, dedicated to excellence in the academic enterprise. The beauty and serenity of the campus, the proximity of dynamic Houston, the fourth largest city in the US, the temperate climate – all these contribute to making Rice an extraordinary location for study and research. An added attraction is the nearby SSCL, located 200 km north of Houston. *An EO/AA employer.*

Résumés and three letters of reference to: B. E. Bonner, Director
Bonner Nuclear Lab, Rice University, Houston, TX 77251-1892

Fax: (713) 285-5215 E-Mail: BONNER@RICEVM1;
BONNER@PHYSICS.RICE.EDU; FNBIT::RIPHYS::BONNER



DESY has an opening in its Institute for High Energy Physics in Zeuthen for a

SENIOR SCIENTIST

in theoretical elementary particle physics.

A tenured position is offered with a salary equivalent to that of a full Professor at a German University (C4).

Applications and suggestions of candidates should be sent not later than 15 July 1992 to :

Prof. V. Sørgerl
DESY
Notkestraße 85
D – 2000 Hamburg 52

Further information about the position in question can be obtained from Prof. V. Sørgerl.

People and things

Rafel Carreras of CERN – explaining science

On people

Joachim Heintze of Heidelberg receives the Max Born Prize for his work in particle physics, particularly the investigation of the study of weak interactions and the development of precision measurement techniques.

The Max Born Prize is presented jointly by the UK Institute of Physics and the Deutsche Physikalische Gesellschaft.

Rafel Carreras of CERN receives this year's popularization of science prize awarded by Geneva University and sponsored by the weekly 'Médecine et Hygiène'. His memorable weekly 'Science for all' and monthly 'Science today' sessions at CERN attract good audiences, from within CERN and from further afield.

Carl Ivar Bränden from Uppsala has joined the European Synchrotron Radiation Facility in Grenoble as Research Director, taking over from Andrew Miller.

10 Tesla magnet at Berkeley

A 5cm bore dipole magnet built at the Lawrence Berkeley Laboratory has reached a central field of 10.06 Tesla at 1.75K. It has cable identical to that used in the dipoles to be used for the Superconducting Supercollider (SSC), but a slightly different design. The SSC dipoles, operating at 4K liquid helium temperatures, provide 6.6 Tesla. Last year (December 1991, page 1), a twin aperture dipole of the type envisaged for CERN's LHC collider reached a field of 10.2 Tesla.

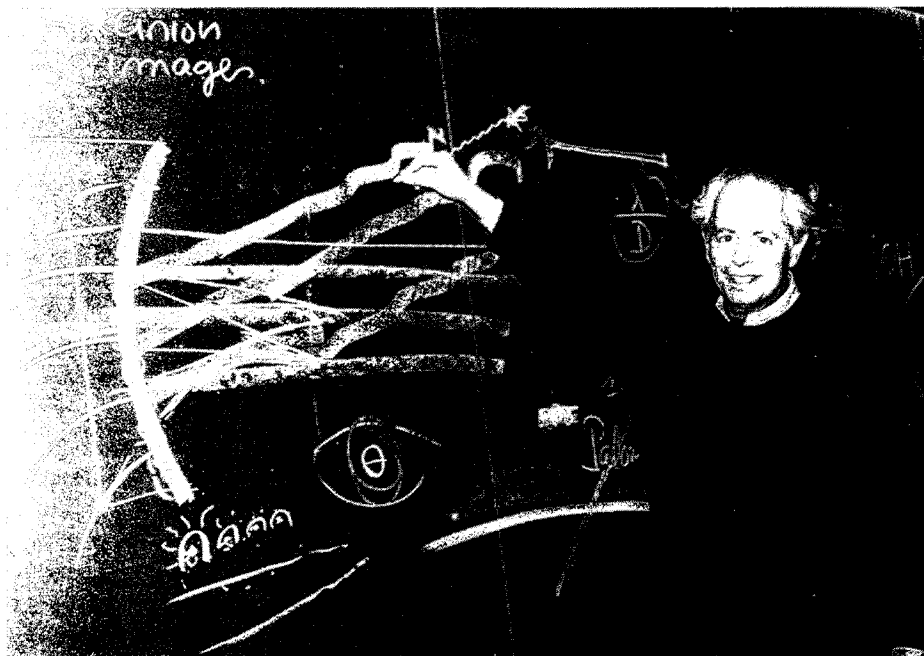

Induction linac systems experiments

On 5 March, William Happer, Director of the Office of Energy Research of the US Department of Energy, approved a mission need statement for the Induction Linac Systems Experiments (ILSE).

The ILSE project is needed to advance the understanding of high-current, heavy-ion accelerator physics so that basic technical questions concerning the suitability of this approach for inertial fusion energy can be resolved on a timescale that meets the goals of the US National Energy Strategy.

Following this approval, N. Anne Davies of the Office of Fusion Energy authorized the Heavy Ion Fusion Accelerator Research Group at Lawrence Berkeley Laboratory to undertake the conceptual design of ILSE. If the project is funded, construction of ILSE could begin as early as 1994. The Berkeley Group currently estimates the total project cost to be about \$70M.

Accelerator Instrumentation Workshop

The dates for the forthcoming Accelerator Instrumentation Workshop at Berkeley have been fixed for 27-30 October. Jim Hinkson and Greg Stover are co-chairmen.

Meanwhile the deadline for nominations for the Bergoz Faraday Cup Award for innovative beam instrumentation (January/February, page 26) has been put back to 1 August.

European Physical Society

The 1992 Council Meeting of the European Physical Society in Athens in March drew record attendance. EPS President Maurice Jacob of CERN was re-elected for a second year, and former CERN Director General Herwig Schopper, now President of the Deutsche Physikalische Gesellschaft, was elected to the EPS Executive Committee.

The Council approved the admission of four new national societies, those of Albania, Croatia, Estonia and Lithuania. In a magnanimous gesture, several Western societies offered to subsidize the fees of some Central and Eastern European partners.

Meetings

An Antihydrogen Workshop will be held in Munich on 30-31 July to review the exciting physics possibilities with atoms of antimatter. Further information from John Eades at CERN, PPE Division, 1211 Geneva 23, Switzerland, fax +41 22 767 3500, or e-mail eades at vxcern.cern.ch quickly because the deadline is imminent.

The Second Workshop on Tau Lepton Physics will be held at Ohio State University (Columbus, Ohio) from 8-11 September. A sequel to the successful workshop at Orsay (December 1990, page 22), this workshop will examine current tau topics including lepton universality, hadronic decays, electroweak interactions, tau mass, tau neutrino mass and its implication for cosmology, and future prospects. This workshop is by invitation only, so please contact K.K. Gan or Chris White for further information (e-mail: TAU92@OHSTPY, fax:614-292-8261).

The Sixth International School of Physics in Bodrum (Turkey) will be held from 12-25 September under the title 'Particle Physics and Cosmology'. It is aimed primarily at students, and lecturers will include E.Kolb of Fermilab, A. Ali of DESY and M. Green, R. Voss and E. Wilson

of CERN, while Ken Peach of Edinburgh is Course Director. Closing date for applications is 15 June. Application forms from Susannah Tracy /DG-A, CERN, 1211 Geneva 23, Switzerland, e-mail tracy at cernvm.cern.ch

The International Workshop on Polarized Ion Sources and Polarized Gas Targets will be held from 23-27 May 1993 at the University of Wisconsin, Madison, Wisconsin, and sponsored by the International Union of Pure and Applied Physics (IUPAP). The Workshop will cover the basic phenomena governing the production of polarized ion beams and polarized gas targets, as well as including reports on the design, construction and performance of polarized gas targets and ion sources for polarized particles.

Further information from L.W. Anderson or W. Haeblerli, Department of Physics, University of Wisconsin, 150 University Avenue, Madison, WI 53706, USA, phone (608) 262-6555/8962, fax (608) 262 - 3598 or e-mail (bitnet) MADSPIN at wiscnuc

Gian Carlo Wick 1909-1992

Gian Carlo Wick, celebrated and prolific theorist, died in his home town of Turin on 20 April at the age of 82 after a remarkably long, productive career. After short spells with Heisenberg's group in Leipzig and Born's group in Göttingen, he moved to Rome in 1932 to begin physics with Enrico Fermi. Here he wrote his famous paper on the magnetic moment on the rotating hydrogen molecule, and went on to address a range of important topical questions, including the implications



of Fermi's picture of weak interactions for positron emission.

After Fermi left Italy for the United States in 1938, Wick was invited to take the vacant professorial chair at Rome, where he played a vital role in the developments leading up to the discovery of what eventually came to be known as the muon.

After the War, Wick went to the United States, eventually settling at Columbia in 1965. In the US he continued his prolific output, in 1950 producing the famous 'Wick Theorem', a vital part of quantum electrodynamics perturbation formalism. In 1959, with Maurice Jacob (later to come to CERN) he developed the famous helicity formalism for handling collision problems. Later, with T.D. Lee at Columbia, he developed the theory of pion condensates. In 1967 he was awarded the prestigious Dannie Heineman Prize of the American In-

Kmax™ and MacVEE - The Perfect Combination



bergoz
 CROZET
 01170 GEX,
 FRANCE
 TEL: 50 41 00 89
 FAX: 50 41 01 99

The direct link from Macintosh II to **CAMAC**
 and VMEbus with full support in the Kmax environment.

SPARROW
 P.O. BOX 6102
 MISSISSIPPI STATE
 MS. 39762 USA
 TEL: (601) 324-0982
 FAX: (601) 324-3231

16 Circle advertisement number on reader service form

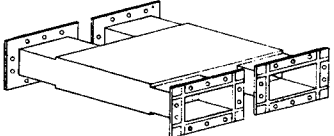
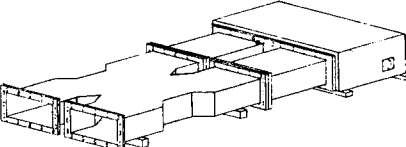
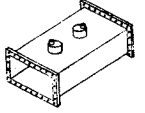
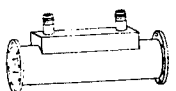
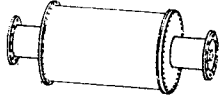
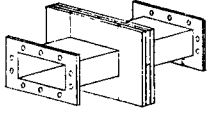
HIGH-POWER AND SUPER-HIGH POWER WAVEGUIDE AND COAX NETWORKS

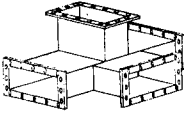
 <p>BROAD BAND SUPER-HIGH POWER, HIGH VACUUM HYBRIDS</p>	 <p>PHASE SHIFTER/ IMPEDANCE MATCHERS</p>
 <p>WAVEGUIDE DIRECTIONAL INSTRUMENTATION COUPLERS</p>	 <p>COAXIAL LINE DIRECTIONAL INSTRUMENTATION COUPLERS</p>
 <p>COAX D.C. BREAKS</p>	 <p>WAVEGUIDE D.C. BREAKS</p>
 <p>HIGH POWER ABSORPTIVE FILTERS</p>	 <p>MAGIC TEES</p>

NOW THERE'S A HIGH POWER RF WAVEGUIDE AND COAX COMPONENTS COMPANY WITH THE KNOW-HOW TO DELIVER COMPLETE SOLUTIONS...

- COAXIAL LINE
- WAVEGUIDE WR-90 - WR-2300
- HYBRIDS
- PHASE SHIFTERS
- IMPEDANCE MATCHERS
- DIRECTIONAL INSTRUMENTATION COUPLERS
- HIGH-ORDER MODE FILTERS
- D.C. BREAKS
- ULTRA-HIGH VACUUM NETWORKS
- TEES
- POWER DIVIDERS
- PRECISION MICROPROCESSOR-BASED RF INSTRUMENTATION AND CONTROL SYSTEMS

RFT RF TECHNOLOGIES CORPORATION

238 GODDARD ROAD
LEWISTON, ME 04240

TEL: (207) 777-7778
FAX: (207) 777-7784

6 Circle advertisement number on reader service form



DESY DEUTSCHES ELEKTRONEN-SYNCHROTRON HAMBURG

DESY is the leading center in Germany for research in high energy physics and with synchrotron radiation. The only electron-proton collider in the world - HERA - has just been completed and the experimental program is about to start. A staff of nearly 1 500 people and about the same number of german and international visiting scientists work on the site.

In its central computing facility, DESY operates an IBM 9021-720 (MVS/ESA), a VAX/VMS cluster, powerful UNIX-computers, disks and cartridge robots. Furthermore, there is distributed equipment connected by modern network based on Ultraset, FDDI, CISCO boxes, Ethernet, Tokenring, etc.

We are seeking the

HEAD of central COMPUTING

who will lead a team of more than 50 collaborators, coordinate the operation, the hard- und software resources of central, distributed computing and networking. He should plan computing according to the scientific needs of the laboratory and cooperate with other physics institutes and with industry.

The new head of central computing should be a highly qualified scientist with good communication and integration skills. He should have experience in leading a large group and should be used to computing in international research. He should have experience with most modern hard- and software, especially with UNIX, networking and distributed computing. Some knowledge of the systems used at DESY is desirable.

Written applications including a curriculum vitæ and three references should be sent to :

DESY - Personalabteilung

Notkestrasse 85

D - 2000 Hamburg 52 (Tel. 0049-40-89 98 3200)

Group Leader Fast Electronics

The Continuous Electron Beam Accelerator Facility (CEBAF) is a 4 GeV high intensity (200 microamp) high duty factor electron accelerator located in Newport News, VA, that will begin operations for physics research in 1994. We have commenced a search for an engineer or physicist to establish and guide an Electronics Group devoted to developing state-of-the-art fast analog electronics for the various particle detectors used by the three large experimental halls. Extensive past experience with the development and use of such electronics is required as well as familiarity with small scale industrial production. The Electronics Group will be expected to work closely with the CEBAF Detector and Data Acquisitions Groups and the physics collaborations. This position offers a challenging opportunity to become a critical member of the Physics Division team developing exciting physics capabilities for the 90's. The qualified candidate must have an advanced degree in electrical engineering or physics and at least ten years experience with the design of state-of-the-art experimental electronics equipment. CEBAF offers a very competitive total compensation package. Applicants should send resume with salary history to: Employment Manager (PR3102), CEBAF, 12000 Jefferson Ave., Newport News, VA 23606. Please specify position #PR3102 and job title when applying. CEBAF is an equal opportunity, affirmative action employer.

CEBAF

The Continuous Electron Beam Accelerator Facility



DESY has two openings for

SENIOR Scientists
in experimental high energy physics.

One position is located at DESY Hamburg, the other at the Institut für Hochenergiephysik Zeuthen.

Tenured positions are offered with a salary equivalent to that of a full Professor (C4) at a German University.

Applications and suggestions of candidates should be sent before 15 July 1992 to :

Prof. V. Særgel
DESY
Notkestraße 85
D - 2000 Hamburg 52

Further information about the positions in question can be obtained from Prof. V.Særgel.

stitute of Physics for his contributions to quantum field theory, for his investigation of the theory of scattering of particles with spin, and his deep analysis of physics symmetry principles. After retiring from Columbia in 1978, he returned to Italy to teach at Pisa.

Gerald Feinberg 1933-92

Theorist Gerald Feinberg of Columbia died on 28 April. In 1958, his theoretical paper on the apparent reluctance of the muon to decay into an electron and a photon stimulated thinking which eventually led to the 1962 discovery by his Columbia colleagues Leon Lederman, Mel Schwartz and Jack Steinberger that there are two distinct kinds of neutrinos. Feinberg was also the author of several books and worked enthusiastically to further the understanding of science in general and physics in particular.

Feza Gürsey 1921-92

The eminent Turkish theorist Feza Gürsey died on 7 April. He was best known for his development (with Luigi Radicati) of SU6 particle symmetry in 1964, one of the landmarks of modern theory.

After initial studies in statistical mechanics, electrodynamics and general relativity, he became interested in the underlying symmetries of basic physics. Although appointed to the Middle East Technical University in Ankara in 1961, he continued to be a frequent visitor to the United States. On one such visit, to Brookhaven in 1964, he and Radicati noticed how the SU3 (quark) symmetry

very much in vogue at the time could be readily combined with spin angular momentum to make an appealing new SU6 picture of particle 'super-multiplets', with powerful new predictions.

In 1968 he moved to Yale, and in 1977 was appointed to the prestigious Gibbs chair. He retired from Yale last year. His later work was much concerned with basic symmetries, where he showed the power of the (exceptional Lie) groups E6, E7 and E8, and with applying mathematical approaches, such as quaternions and octonions, to basic problems.

He was influential in promoting Turkish physics, and it was natural that a high proportion of his students came from that country. He shared the Oppenheimer prize with Sheldon Glashow in 1977, and was awarded the Wigner medal in 1986.

From Louis Michel

Gerry O'Neill

In April, Gerry O'Neill of Princeton died. He played an important role on the US accelerator scene as it grew in strength in the 1950s and 1960s. In particular he pushed the development of colliding beam techniques, making major contributions to the first storage ring project in the US – the two-ring PRISTAN electron-electron collider built at Stanford (using the Mark III linear accelerator) by a Princeton-Stanford collaboration. He was also a strong supporter of the CERN Intersecting Storage Rings project, and never wavered in his belief that the machine would turn out to be a success.

Polarized beams at SLC

The SLC Stanford Linear Collider is colliding electrons and positrons using polarized electrons (about 20-30% polarization). The SLC beams follow installation of a new diode (as opposed to triode) gun early in April. More news next month.



LABORATORY HV SUPPLIES... to 60 kV and 45 W

High performance and low cost DC high voltage are now available for the lab bench with the EL Series of tightly regulated, low ripple, and highly stable power supplies. Voltage ranges are 0 to 3 kV through 0 to 60 kV. Operating features include low stored energy for safety and an automatic crossover from constant-voltage to constant-current regulation for protection from overloads, arcs, and shorts.
Glassman High Voltage



100 W POWER SUPPLY TO 60 kV 3.5 in. and only 13 lbs.

The EH Series offer 100 W high voltage power supplies of superior quality in a compact and low weight package and at an affordable price. Rack panel height is only 3.5 inches and weight 13 lbs. Standard features include local and remote control and monitoring, tight regulation, low ripple, and fast response. Voltage ranges are 0 to 1 kV through 0 to 60 kV. Positive, negative, or reversible polarity models are available.
Glassman High Voltage

2 kW HV SUPPLIES TO 125 kV... only 8.75 in. and 47 lbs.

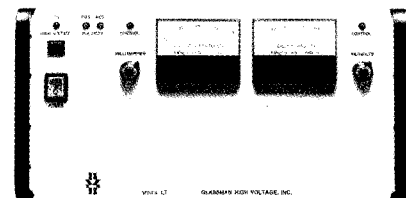

No longer does the combination of high DC voltage and high power mean a big, clumsy supply. The new LT Series from Glassman provides up to 2 kW of power with voltage ranges, depending on the model, from 0 to 1 kV through 0 to 125 kV in only a 8.75 inch high rack panel. Weight is less than 47 pounds. Line voltage is 220/240 V single-phase.

Voltage regulation is better than 0.005% for both load and line variations. Ripple is less than 0.03%. Automatic crossover from constant-voltage to constant-current regulation protects both the supply and load against shorts, arcs, or overloads. Current regulation is 0.05% from short circuit to rated voltage. The LT Series can be ordered with an optional current "trip" circuit that can be switch-selected to provide either current limiting or trip operation in the event of an overload.

All LT Series supplies feature full remote control capabilities including voltage/current program and monitoring terminals, TTL high voltage enable/disable, safety interlock terminals, and a +10 V reference source. Positive, negative, or reversible polarity models are available. Choice of dual analog or digital meters or a blank panel.
Glassman High Voltage

TWO UNBEATABLE HV MODULES...15 W/75 W



The 15 W Series MJ, with outputs from 0 to 3 kV through 0 to 30 kV, and the 75 W Series MK, 0 to 1 kV through 0 to 60 kV, both provide premium regulated and low-ripple power supply performance in a line-operated, compact, and lightweight package. Air insulation allows for easy serviceability, in contrast to wasteful "throw-away" modules.

- Constant voltage/constant current operation
- Low stored energy for safety
- Local and remote control
- Remote TTL enable/disable
- External interlock terminals
- Available with positive or negative polarity

Call for full information on the MJ and MK Series, or other Glassman supplies, 1 kV to 500 kV, 15 W to 15 kW.

Innovations in high voltage power supply technology.

GLASSMAN HIGH VOLTAGE INC.

Glassman High Voltage, PO Box 551, Whitehouse Station, NJ 08889, telephone (908) 534-9007. Also Glassman Europe, in the UK call (0256) 810808 and in Asia, Glassman Japan (044) 877-4546.

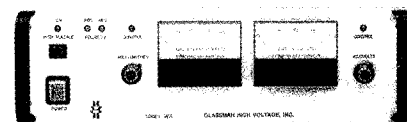

HV TO 75 kV AND 1000 W Rack panel height only 5.25 in.

The WX Series of 1000 W regulated power supplies are available with DC outputs from 0 to 1 kV through 0 to 75 kV. Rack panel height is only 5.25 inches and weight less than 30 lbs. The Series WX is offered with a choice of dual analog voltage and current meters, dual digital meters, or with a blank panel for OEM/system applications. Positive, negative, or reversible polarity models are available.
Glassman High Voltage

R max. 1500 mm

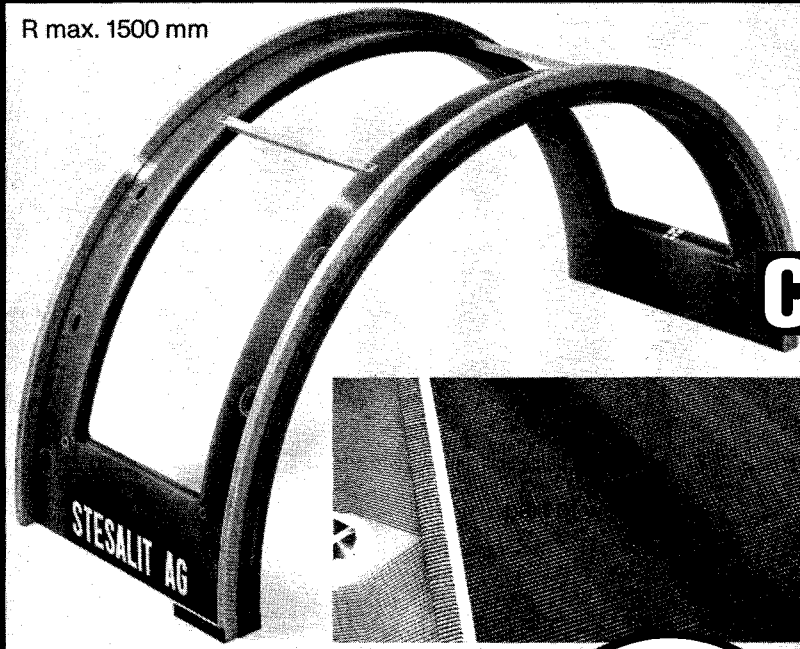

Semicircular, 8-Piece CERN Chamber,

manufactured rigid, with bonded plate-bars.

Please request detailed information. Mr H. Mauch will be glad to advise you personally.

We offer a range that is based on 30 years' experience and know how through successful collaboration with field specialists.



Stesalit AG Kunststoffwerk

We provide easily built-in safety in Know-how.

CH-4234 Zullwil SO Telefax 061/80 06 04
Telephone 061/80 06 01 Telex 963 182

25d Circle advertisement number on reader service form



**HIGH CAPACITY STORAGE SOLUTIONS
HIGH ENERGY PHYSICS APPLICATIONS**



HIGH CAPACITY HARD DRIVES

NEW FOR DSS



SEAGATE WREN & ELITE

VALUE-ADDED SOLUTIONS FOR:
SCSI, DSSI, IPI-2, ESDI

SMALL FOOTPRINT JUKE BOXES

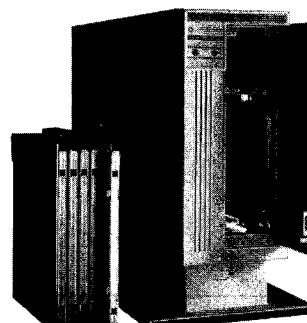

LF4100 & LF4500

• UP TO 28 GB OF DESKTOP ARCHIVAL STORAGE FEATURING WORM DISK AND LMSI'S RAPID CHANGER

8MM & ERASABLE OPTICAL

EXABYTE 8500

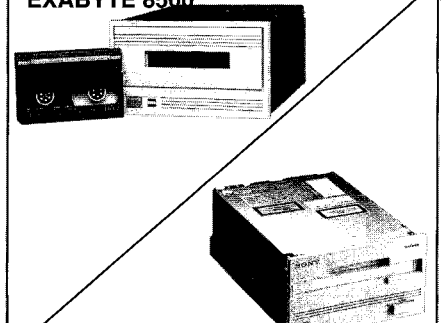

SONY-PANASONIC-PIONEER

• 5 GB TAPE BACK-UP FOR SCSI & PERTEC
• 650 MB-1 GB ERASABLE OPTICAL
• WE STOCK ALL OPTICAL DISKS

**• OEM-APPROVED PERIPHERALS • VALUE-ADDED SOLUTIONS •
DEC™ • SILICON GRAPHICS™ • SUN™ • HP/APOLLO™ • NeXT™**

PH 612 829 0300 US
FAX 612 829 0988 US

RORKE DATA
Technology Park II
9700 West 76th Street
Eden Prairie, MN 55344

Toll Free in the US:
1 800 328 8147

ALL-METAL RIGHT ANGLE VALVES

SERIES 18

- RELIABLE
- COMPACT
- AVAILABLE FROM 16 TO 150 MM

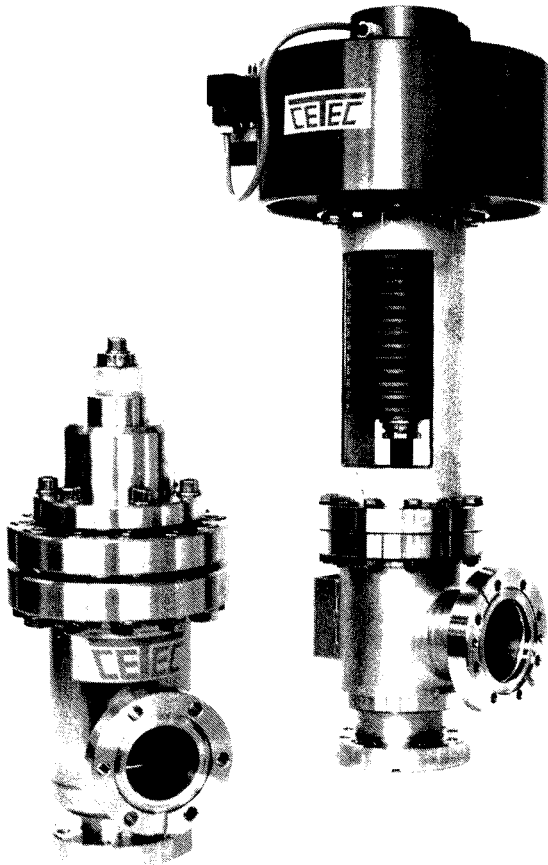

CETEC ALL-METAL RIGHT ANGLE VALVES, ARE FULLY BAKEABLE UP TO 300°C IN BOTH POSITIONS, AND THE LEAK RATE IS BETTER THAN $2 \cdot 10^{-10}$ MBAR L/S AND ...

... WE HAVE NOT ENOUGH SPACE TO SAY ALL THE POSITIVE ITEMS OF THESE VALVES HERE, THEREFORE ...

ORDER YOUR VACUUM VALVE CATALOGUE FOR

- RIGHT ANGLE VALVES
- GATE VALVES
- BUTTERFLY VALVES
- FAST CLOSING VALVES
- REGULATING COMPONENTS

CETEC AG für moderne
Technologie

CH-9468 SAX

Tel. 085-7.50.70

Fax. 085-7.50.86

all stainless steel OPEN DEWARs

0,5 - 1 - 2 - 3 - 6 l

for experiments, storage, transportation



double wall stainless steel * permanent high vacuum insulation * optional cork or s.s. lids * temperature range 20 to 520 K *

European distributor: Dr. Ing. N. Eber & Co.,
CH-8103 Unterengstringen, Switzerland
Tel: (01) 750 55 72 - Fax: (01) 750 55 81

18 Circle advertisement number on reader service form

ENVEX® POLYIMIDE Excellent Radiation Resistance

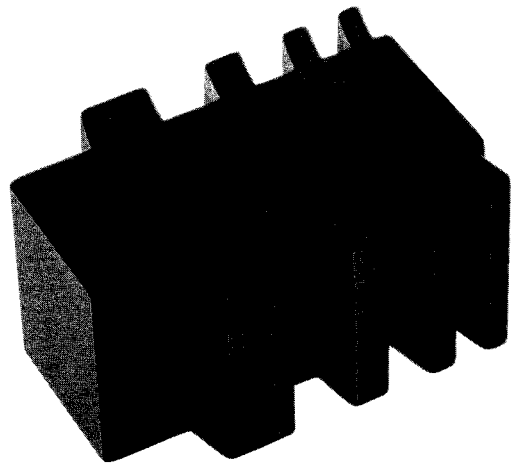

- Continuous use from Cryogenic to 288°C
 - Superior strength and dimensional stability
 - Low cost with short lead times
 - Available in stock shapes and finished parts
- Call or write for a free brochure.

ENVEX® is a registered trademark for Rogers Polyimides.

ROGERS

Rogers Corporation, Composite Materials Division
One Technology Drive, Rogers, CT 06263, 203-774-9605, FAX: 203-774-1973

75a Circle advertisement number on reader service form

77 Circle advertisement number on reader service form

CES PRESENTS:

a Twin 68040 OS-9 Data Acquisition System

In a few months, the first units of the most advanced OS-9 system will be delivered to CERN. This system includes:

The newest processor of the FIC generation: the FIC 8234, equipped with one or two 68040 CPU(s) and providing over 80 Mbytes/s of interprocessor transfer rates and over 25 Mbytes/s on CES VME/VSB memories. Unique features include: Block Mover Accelerator, D64 Master / Slave and Memory Broadcast.

4
times the
performance of
68030 based systems

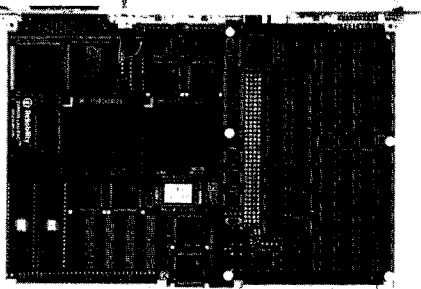

FIC 8234

The FVSBI 9210 / FADAP 9211: FASTBUS master / slave interface, offering more than 6 Mbytes/s when coupled with the FIC 8234 on a long distance VSB cable.

a 1/3
of the ALEPH
event builder price
and twice the speed

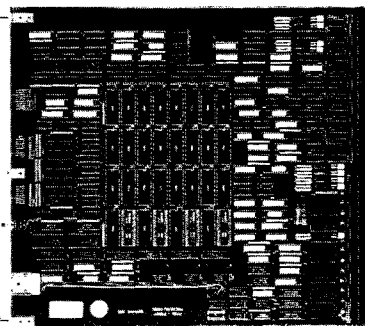

FVSBI 9210

A unique complete OS-9 system package has been designed by CES to make the user unaware of the twin engine architecture as one processor runs OS-9 in the same environment as in the FIC 8232 based workstations.

In case of the FIC 8234A/25/1, the two processors are running in parallel, one performing the front-end task, typically handling the block mover operations, while the other one distributes the reduced data to other elements through the VIC bus, Ethernet or SCSI.

Special Package Price till June 30 th

WOS 8703 18185.-

WOS 8706 19995.-

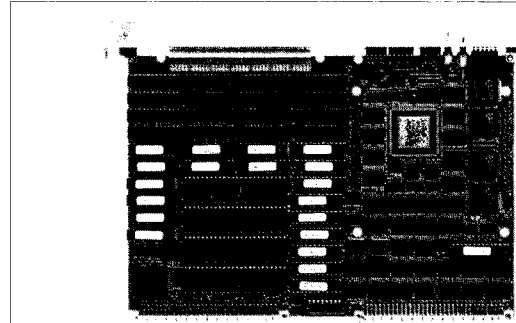

VIC 8251

The most performant of the VIC family: the VIC 8251, equipped with its high-speed synchronous transfer mode and mirrored memories, providing 12 Mbytes/s on any distance up to 100 meters.

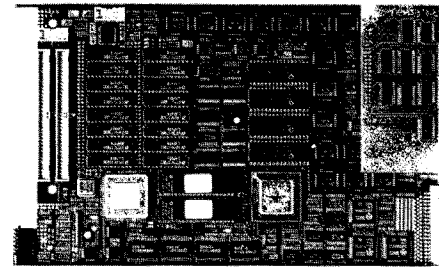

VCC 2117

The transparent VME to CAMAC interface: the VCC 2117. It features an embedded CAMAC list processor with simple memory mapped VIC addressing. It includes a combination of 3 units into 1 (CCA2 back-end, FIC 8232 on-board processor (optional), VIC 8250 front-end).

Configurations

WOS 8703 FIC 8234A/25/1 Single 68040 + DSK 8133/F/48

WOS 8706 FIC 8234B/25/1 Twin 68040 + DSK 8133/F/48

including

OS-9 Professional license with specific port on the FIC 8234

OS-9 Internet license with specific port on Cheapernet

Application software

FASTBUS Library (9210)

VIC Library (8250 and 8251)

CAMAC Library (2117 and 8210)

Block Mover Library



The only company which develops dedicated solutions for physics

For any additional information about those products or our complete VME, CAMAC and FASTBUS line, do not hesitate to contact us.

CES Geneva, Switzerland Tel: +41-22 792 57 45 Fax: +41-22 792 57 48

CES.F France Tel: +33-50 31 55 00 Fax: +33-50 31 55 10

CES.D Germany Tel: +49-60 55 4023 Fax: +49-60 55 82 210

CES Creative Electronic Systems SA, 70 Route du Pont-Butin, P.O. Box 107
CH-1213 PETIT-LANCY 1 SWITZERLAND



GREEN CALORIMETERS?

XP2081
squeezes more resolution out of
your next WLS/SCIFI calorimeter

A complete range of green-extended PMTs

PMT	useful cathode dia. (mm)	number of stages	luminous sensitivity ($\mu\text{A}/\text{lm}$)	stability		pulse linearity (mA)	t_w FWHM (ns)
				16h/0.3 μA	1-0.1 μA		
				(%)	(%)		
XP1981	15	8	110	1.5	1.5	80	3
XP1901	15	10	110	1.5	1.5	80	3.5
XP2961	23	8	110	2	2	80	2.8
XP2971	23	10	110	2	2	80	3
XP2081	34	10	135	1	1	150	7
XP2201	44	10	120	1	1	150	8
XP3461	68	8	140	1	1	200	4

Stability

Linearity

Ytity

Consistency

Economy

Philips Photonics
F-19108 Brive, France
Tel. +33 55 863757
Fax. +33 55 863773

Still setting the standard

Philips Photonics



PHILIPS