

Liebert® GXT4™ UPS 230 V, 5000 VA – 10,000 VA
User Manual



Table of Content

Important Safety Precautions	1
Glossary of Symbols	4
1.0 Product Description	5
1.1 Features	5
1.2 Available Models	5
1.3 Appearance and Components	6
1.3.1 Appearance	6
1.3.2 Rear Panel Features	6
1.4 Removable Power Distribution Box	8
1.5 Internal Battery Packs	8
1.6 Major Components	9
1.6.1 Transient Voltage Surge Suppression (TVSS) and EMI/RFI Filters	9
1.6.2 Rectifier/Power Factor Correction (PFC) Circuit	9
1.6.3 Inverter	9
1.6.4 Battery Charger	9
1.6.5 DC-to-DC Converter	10
1.6.6 Battery	10
1.6.7 Internal Bypass	10
1.6.8 Maintenance Bypass	10
1.7 Operating Mode	10
1.7.1 Mains Mode	10
1.7.2 Manual Bypass Mode	10
1.7.3 Battery Mode	11
1.7.4 Battery Recharge Mode	11
1.7.5 Frequency Converter Mode	11
1.7.6 Active ECO Mode	12
2.0 Installation	13
2.1 Unpacking and Inspection	13
2.2 What's Included	13
2.3 Preparation for Installation	14
2.3.1 Installation Environment	14

2.4 Install the Main Cabinet	14
2.4.1 Tower UPS Installation	14
2.4.2 Rack Installation	15
2.5 External Battery Cabinet Installation	16
2.6 Connect Input/Output Power	17
2.6.1 Install the Power Distribution Box	17
2.6.2 Remove the Power Distribution Box	17
2.6.3 Distribution Box Electrical Connections	18
2.6.3.1 Terminal Block Connections	19
2.7 IT Power System Configuration.	20
3.0 Operation and Display Panel	21
3.1 LED Indicators	21
3.2 Control Buttons	22
3.3 LCD	22
3.4 Menu Structure	23
3.4.1 Startup Screen	24
3.4.2 Default Screen	25
3.4.3 Main Menu Screen	25
3.4.4 Prompt List	34
3.4.5 Warning List	34
3.4.6 Fault List	35
4.0 Operation	37
4.1 Startup Checklist for the Liebert GXT4	37
4.2 Starting the UPS	37
4.3 Manual Battery Test	37
4.4 Manual Bypass	38
4.5 Shut Down the GXT4	38
4.6 Disconnecting Input Power from the GXT4	38
4.7 Maintenance Bypass.	38

5.0 Communication	39
5.1 Liebert IntelliSlot Communication Cards	39
5.1.1 Liebert MultiLink	39
5.2 USB Port Communication	40
5.2.1 Configuration Program	40
5.3 Terminal Block Communication.	41
5.3.1 Any Mode Shutdown.	41
5.3.2 Battery Mode Shutdown	42
5.3.3 On Battery.	42
5.3.4 Low Battery.	42
5.4 Remote Emergency Power Off—GXT4-6000RTL630.	43
6.0 Maintenance	45
6.1 Replacing the Internal Battery Pack	45
6.1.1 Battery Replacement Procedures	46
6.2 Battery Charging	47
6.3 Precautions	48
6.4 Checking UPS Status	48
6.5 Checking UPS Functions	48
7.0 Troubleshooting	49
7.1 UPS Symptoms.	49
7.1.1 Indicator and LCD	49
7.1.2 Audible Alarm	50
7.2 Troubleshooting.	50
8.0 Specifications	53
8.1 Auto-Learning Battery Run Times.	58
8.2 Product Warranty Registration	58
8.3 Technical Support	58

List of Figures

Figure 1-1: Liebert GXT4 5000VA and 6000VA, front view	6
Figure 1-2: Rear panel—5000VA and 6000VA.	7
Figure 1-3: Rear panel—8000VA and 10,000VA	7
Figure 1-4: Power distribution box for 5000 VA and 6000 VA models	8
Figure 1-5: Power distribution box for 10,000 VA models	8
Figure 1-6: Internal battery pack with connector	8
Figure 2-1: Support bases	14
Figure 2-2: Remove the front plastic bezel cover	15
Figure 2-3: Rotate the operation and display panel	15
Figure 2-4: External battery cabinets connected to GXT4	16
Figure 2-5: Power distribution box removal	18
Figure 2-6: Distribution box electrical connections diagram.	19
Figure 2-7: Terminal block connections	19
Figure 3: Remove cover from IT Power System Connectors compartment.	20
Figure 3-1: Operation and display panel	21
Figure 3-2: Menu structure.	23
Figure 3-3: Startup screen	24
Figure 3-4: Startup screens	24
Figure 3-5: Starting and Start Successful screens.	24
Figure 3-6: Default screen	25
Figure 3-7: Main Menu screen	25
Figure 3-8: Status screens	26
Figure 3-9: CONFIGURATION screen.	26
Figure 3-10: UPS screens	27
Figure 3-11: Battery screen	27
Figure 3-12: ECO Mode screen	28
Figure 3-13: LCD screen	28
Figure 3-14: Language screen	29
Figure 3-15: Color screen	29
Figure 3-16: Factory Default screen	29
Figure 3-17: Control screen	30
Figure 3-18: Turn UPS On or Off screen	30
Figure 3-19: Alarm Control screen.	31
Figure 3-20: Batt Test screen	31
Figure 3-21: Log screens	31
Figure 3-22: Clear Log screen	32
Figure 3-23: About screen	32
Figure 3-24: Network screens	33
Figure 5-1: Terminal-block communication pin layout	41
Figure 5-2: REPO switch connection diagram	43
Figure 6-1: Removing the front bezel cover and battery door	46

Figure 6-2: Disconnecting the battery plug and battery receptacle (front view)	46
Figure 6-3: Pull out the battery	47

List of Tables

Table 1-1: UPS models, power ratings.	5
Table 2-1: Branch circuit breaker ratings	18
Table 2-2: Electrical specifications	19
Table 3-1: LED indicators	21
Table 3-2: Control buttons	22
Table 3-3: System prompts and meanings	34
Table 3-4: Warning list	34
Table 3-5: Fault list.	35
Table 5-1: Output voltage option	40
Table 6-1: Replacement internal battery pack model number	45
Table 7-1: Description of the displayed fault	49
Table 7-2: Audible alarm description	50
Table 7-3: Troubleshooting table	50
Table 8-1: UPS specifications	53
Table 8-2: Power distribution specifications	54
Table 8-3: External battery cabinet specifications	55
Table 8-4: Battery run time, minutes, all models	56

Important Safety Precautions



WARNING

Risk of electric shock. Can cause equipment damage, injury or death.

Observe all cautions and warnings in this manual. Failure to do so may result in serious injury or death.

Refer all UPS and battery service to properly trained and qualified service personnel. Do not attempt to service this product yourself.

Opening or removing the cover may expose you to lethal voltages within this unit even when it is apparently not operating and the input wiring is disconnected from the electrical source.

Never work alone.

SAVE THESE INSTRUCTIONS

This manual contains important safety instructions that must be followed during the installation and maintenance of the UPS and batteries. Read this manual thoroughly before attempting to install or operate this UPS.

UPS Safety Notes

This UPS contains no user-serviceable parts except the internal battery pack. The Off/Bypass push button does not electrically isolate internal parts. Under no circumstances attempt to gain internal access other than to replace the batteries due to risk of electric shock or burn. Do not continue to use the UPS if the front panel indications are not in accordance with these operating instructions or if the UPS performance alters in use. Refer all faults to your local dealer, Emerson Network Power representative or Emerson Network Power Channel Support.

This UPS has an internal battery, and the output receptacles of the UPS may carry live voltage even if the UPS is not connected to utility input power.

Before moving or rewiring this UPS, disconnect utility input power and the battery and make sure that the UPS is completely shut down. Otherwise, the output terminal may carry live voltage, presenting an electric shock hazard.

To ensure human safety and normal UPS operation, the UPS must be properly grounded before use.

When the UPS is connected to an IT power distribution system, a short-circuit protection device must be installed on the neutral line.

Install and use the Liebert GXT4 in the following environments:

- Temperature: 32°F - 104°F (0°C - 40°C), relative humidity: 0% to 95% non-condensing
- Out of direct sunlight
- Away from heat sources
- Stable surface, not subject to vibrations or shocks
- Away from dust and other particulates
- Away from corrosive substances, salts and flammable gases

Keep the air inlet and outlet of this UPS unobstructed. Poor ventilation will increase the internal temperature of the UPS and can adversely affect the UPS and its batteries.

Keep liquid and foreign objects away from the UPS.

In case of fire, use a dry chemical fire extinguisher to put out the fire. Using a fluid fire extinguisher may cause electric shock.

This UPS is not intended for use with life support and other designated critical devices. Maximum load must not exceed that shown on the UPS rating label. This UPS is designed for data processing equipment. If uncertain, consult your local dealer or Emerson representative.

Battery Safety



WARNING

Risk of electric shock and explosion. Can cause equipment damage, injury and death.

Do not dispose of the battery in a fire. The battery may explode.

Do not open or damage the battery. Released electrolyte is toxic and is harmful to skin and eyes. If electrolyte comes into contact with the skin, wash the affected area immediately with plenty of clean water and get medical attention.



WARNING

Risk of electric shock. Can cause equipment damage, injury and death.

A battery can present a risk of electrical shock and high short-circuit current. The following precautions should be observed when working on batteries:

- Remove watches, rings and other metal objects.
- Use tools with insulated handles.
- Wear rubber gloves and boots.
- Do not lay tools or metal parts on top of batteries.
- Disconnect charging source prior to connecting or disconnecting battery terminals.
- Determine if the battery is inadvertently grounded. If it is inadvertently grounded, remove the source of the ground. Contact with any part of a grounded battery can result in electrical shock. The likelihood of such shock will be reduced if grounds are removed during installation and maintenance (applicable to a UPS and a remote battery supply not having a grounded supply circuit).

ELECTROMAGNETIC COMPATIBILITY—The Liebert GXT4 series complies with the limits for a CLASS A DIGITAL DEVICE, PURSUANT TO Part 15 of FCC rules. Operation is subject to the following conditions:

- This device may not cause harmful interference.
- This device must accept any interference received, including interference that may cause undesired operation.

Operating this device in a residential area is likely to cause harmful interference that users must correct at their own expense.

The Liebert GXT4 series complies with the requirements of EMC Directive 2004/108/EC and the published technical standards. Continued compliance requires installation in accordance with these instructions and use of accessories approved by Emerson.

Information for the Protection of the Environment

UPS Servicing: UPS makes use of components dangerous for the environment (electronic cards, electronic components). The components removed must be taken to specialized collection and disposal centers.

NOTICE TO EUROPEAN UNION CUSTOMERS: DISPOSAL OF OLD APPLIANCES—This product has been supplied from an environmentally aware manufacturer that complies with the Waste Electrical and Electronic Equipment (WEEE) Directive 2002/96/CE.







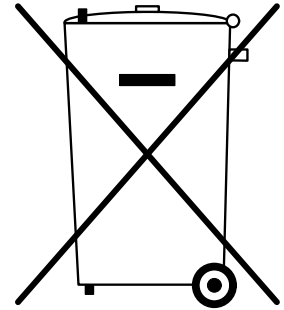



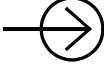

The “crossed-out wheelie bin” symbol at right is placed on this product to encourage you to recycle wherever possible. Please be environmentally responsible and recycle this product through your recycling facility at its end of life. Do not dispose of this product as unsorted municipal waste. Follow local municipal waste ordinances for proper disposal provisions to reduce the environmental impact of waste electrical and electronic equipment (WEEE).

For information regarding the scrapping of this equipment, please browse <http://www.eu.emersonnetworkpower.com> (“Products session” or “Contact us” session) or call our worldwide technical support.

- Toll Free: 00 80011554499
- Toll Number Based in Italy: +39 0298250222



Glossary of Symbols

	Risk of electrical shock
	Indicates caution followed by important instructions
	AC input
	AC output
	Requests the user to consult the manual
	Indicates the unit contains a valve-regulated lead acid battery
	Recycle
	DC voltage
	Equipment grounding conductor
	Bonded to ground
	AC voltage
	WEEE

1.0 Product Description

The Liebert GXT4 is a compact, online uninterruptible power system (UPS) that continuously conditions and regulates its output voltage. The UPS is designed to supply microcomputers and other sensitive electronic equipment with clean sine wave input power.

Upon generation, AC power is clean and stable. However, during transmission and distribution it is subject to voltage sags, spikes and complete failure that may interrupt computer operations, cause data loss and damage equipment.

The Liebert GXT4 protects equipment from these disturbances. The Liebert GXT4 continuously charges its batteries from the mains, enabling it to supply power to connected loads, even when the mains fail.

This section describes the UPS, its features, models, appearance and components, operating principles and operating mode.

1.1 Features

The UPS includes these features:

- Intelligent battery management to extend battery life
- LCD for user-friendly operation and local monitoring and configuration of operational parameters
- Flexible network management with Liebert MultiLink® software
- Fan fault self-inspection and automated diagnostic function
- Intelligent fan operation, automatically changing rotation speed depending on system requirements, to decrease power consumption and noise
- Input circuit breaker to ease recovery from overloads
- CE mark and safety approval from CE
- Communication options: USB port, Liebert IntelliSlot® port and terminal block communication
- Dry contacts for remote monitoring
- Input power factor greater than 0.99
- Output voltage selection function

1.2 Available Models

Available models of the UPS are listed in **Table 1-1**:

Table 1-1 UPS models, power ratings

Model Number	Nominal Power Rating
GXT4-5000RT230 GXT4-5000RT230E	5000VA / 4000W
GXT4-6000RT230 GXT4-6000RT230E	6000VA / 4800W
GXT4-10000RT230 GXT4-10000RT230E	10000VA / 9000W

1.3 Appearance and Components

1.3.1 Appearance

The Liebert GXT4 rack/tower models in various power ratings have the same general appearance, controls and features (see **Figure 1-1**). The various rack/tower models differ largely in the type of receptacles each has.

Figure 1-1 Liebert GXT4 5000VA and 6000VA, front view

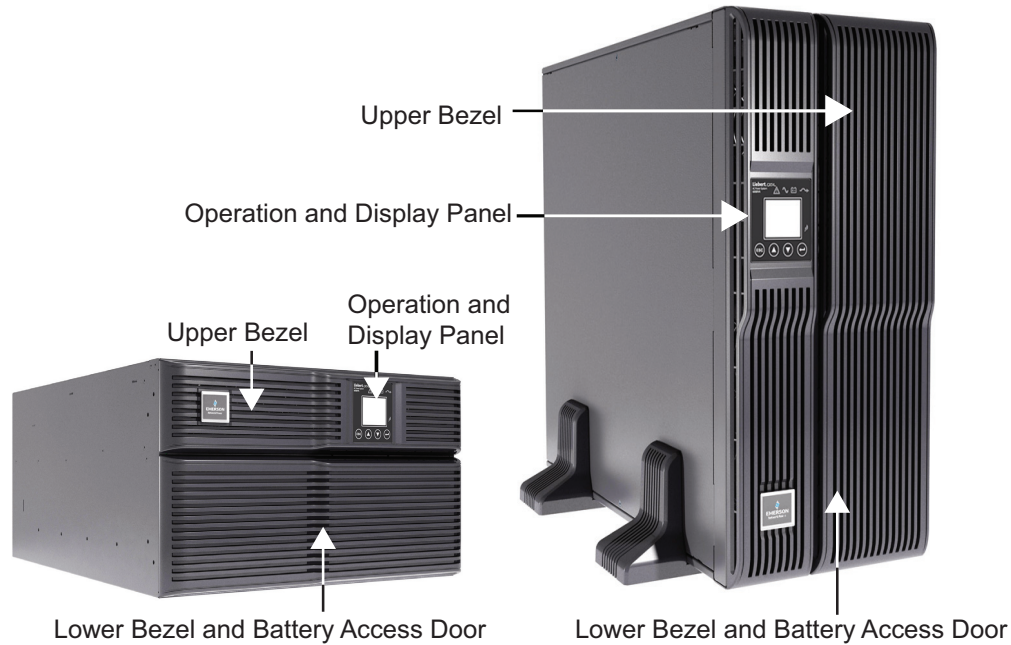

1.3.2 Rear Panel Features

The rear panel of the Liebert GXT4 has these features:

- Liebert IntelliSlot® Port
- USB port
- Input Circuit Breaker
- Maintenance Bypass Circuit Breaker
- General Output Receptacles External Battery Connector
- Cooling Fan
- Terminal Block Communication
- Output Circuit Breakers

Figure 1-2 Rear panel—5000VA and 6000VA

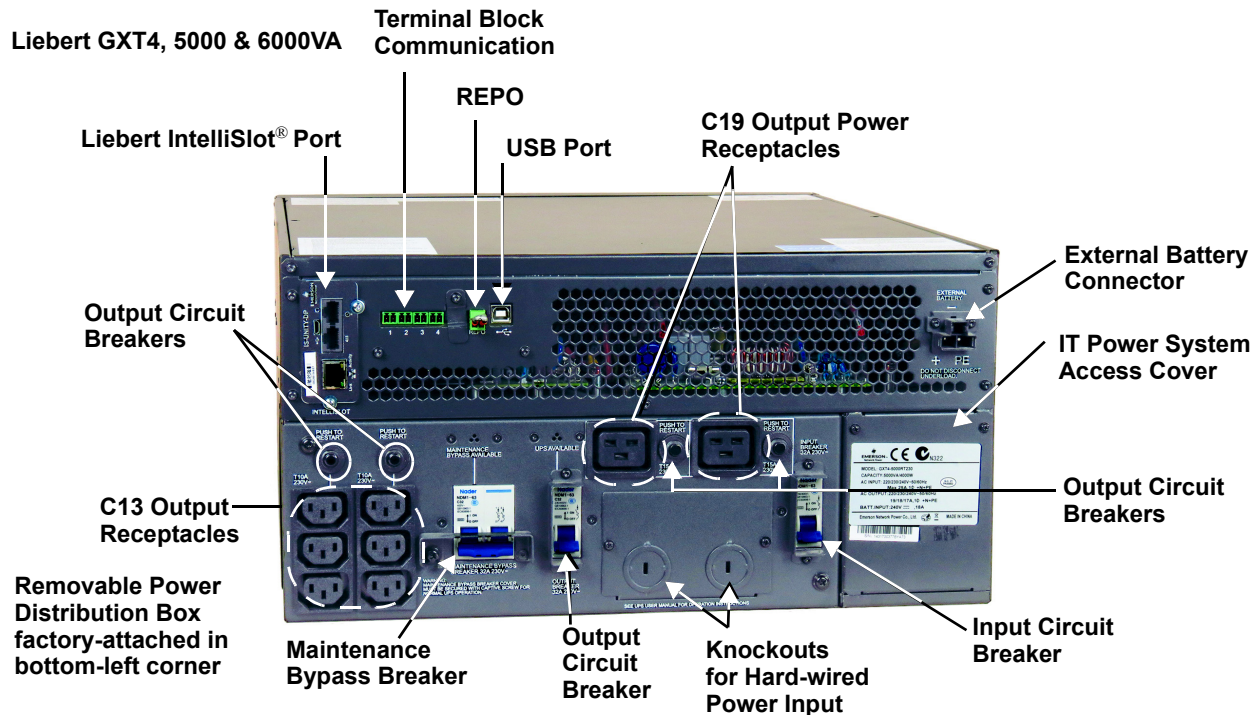

NOTE

Hard-wired and hard-wired/receptacle boxes that include a manual bypass switch permit AC power to continue to flow from the utility input to the load while the box is removed from the UPS. For details, refer to 2.6 - Connect Input/Output Power.

Figure 1-3 Rear panel—8000VA and 10,000VA

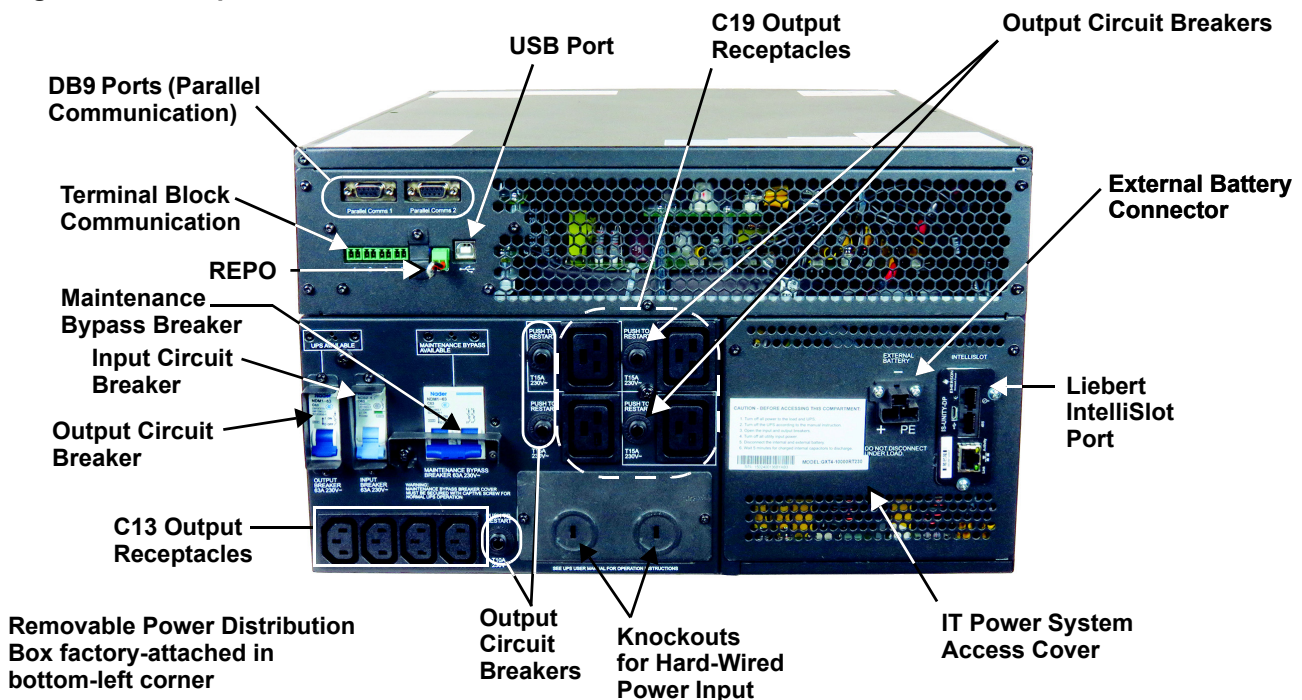

1.4 Removable Power Distribution Box

The UPS is shipped with a power-distribution pack installed. This box contains the UPS input circuit breaker.

Figure 1-4 Power distribution box for 5000 VA and 6000 VA models

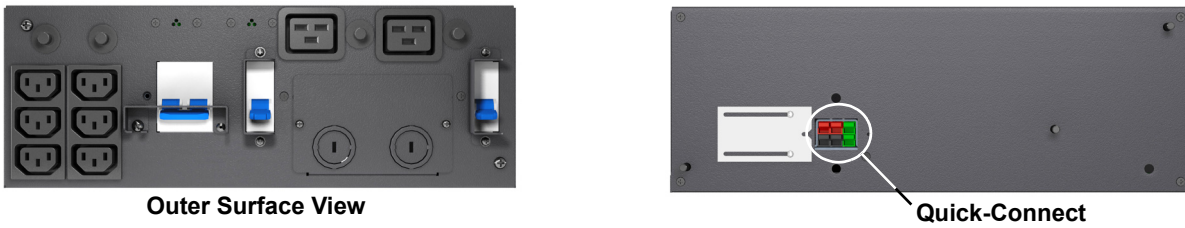
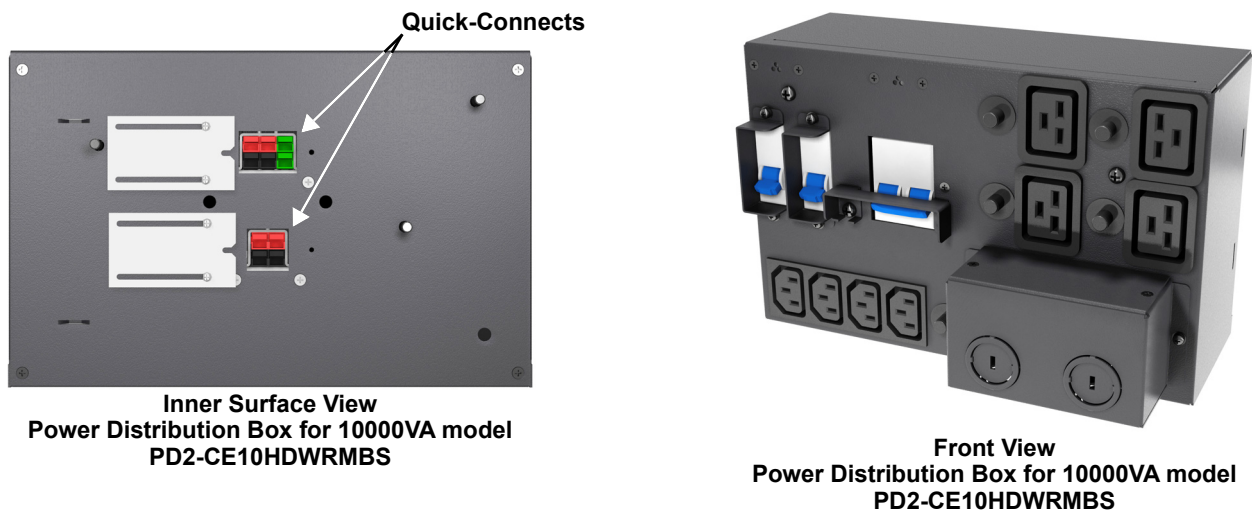

Figure 1-5 Power distribution box for 10,000 VA models



1.5 Internal Battery Packs

The UPS has two internal battery packs behind a battery access door on the front of the unit. Each internal battery pack is fitted with a connector to link to the UPS.



NOTE

*GXT4 10,000-VA battery pack shown in **Figure 1-6**. 5000-VA and 6000-VA battery packs have the same features.*

Figure 1-6 Internal battery pack with connector

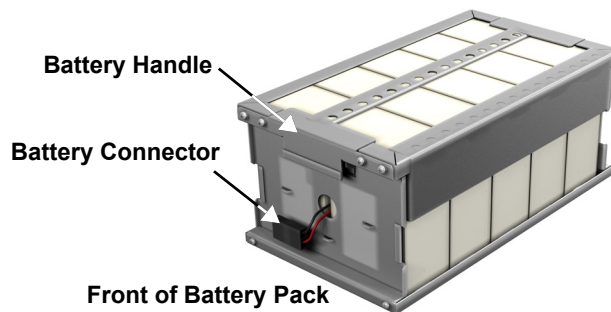

1.6 Major Components

The UPS is composed of mains input, TVSS and EMI/RFI filters, rectifier/PFC, inverter, battery charger, DC-to-DC converter, battery, dynamic bypass and UPS output.

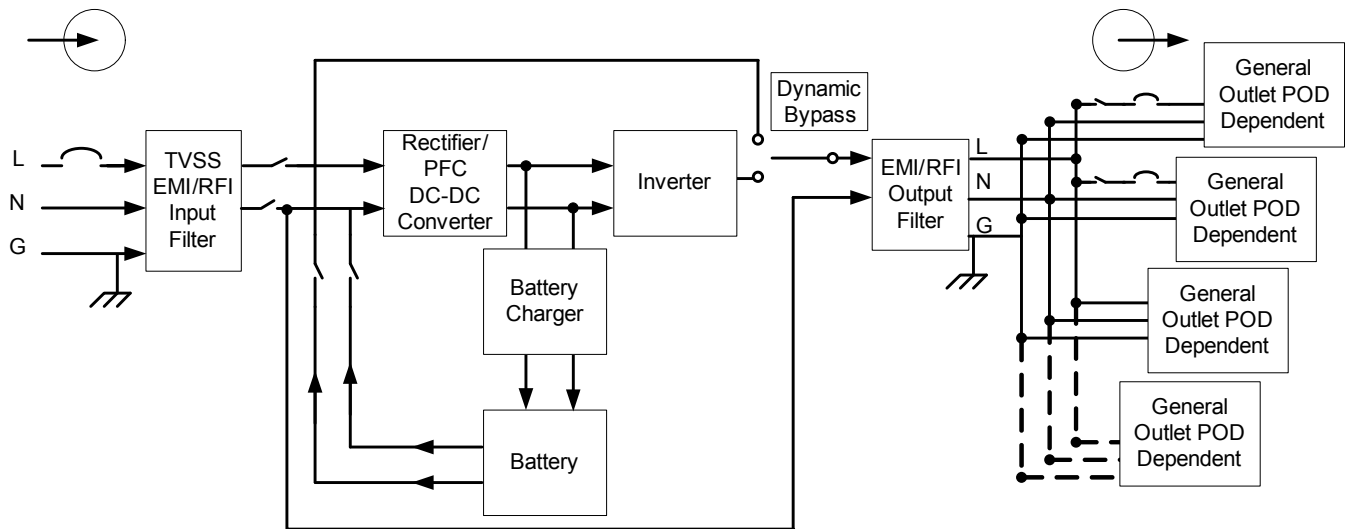

1.6.1 Transient Voltage Surge Suppression (TVSS) and EMI/RFI Filters

These UPS components provide surge protection and filter both electromagnetic interference (EMI) and radio frequency interference (RFI). They minimize any surges or interference present in the mains line and keep the sensitive equipment protected.

1.6.2 Rectifier/Power Factor Correction (PFC) Circuit

In normal operation, the rectifier/power factor correction (PFC) circuit converts mains AC power to regulated DC power for use by the inverter while ensuring that the waveshape of the input current used by the UPS is near ideal. Extracting this sinewave input current achieves two objectives:

- The mains power is used as efficiently as possible by the UPS.
- The amount of distortion reflected on the mains is reduced.

This results in cleaner power being available to other devices in the building not being protected by the Liebert GXT4.

1.6.3 Inverter

In normal operation, the inverter utilizes the DC output of the power factor correction circuit and inverts it into precise, regulated sinewave AC power. Upon a mains power failure, the inverter receives its required energy from the battery through the DC-to-DC converter. In both modes of operation, the UPS inverter is on-line and continuously generating clean, precise, regulated AC output power.

1.6.4 Battery Charger

The battery charger utilizes energy from the mains power and precisely regulates it to continuously float charge the batteries. The batteries are being charged whenever the Liebert GXT4 is connected to mains power.

1.6.5 DC-to-DC Converter

The DC-to-DC converter utilizes energy from the battery system and raises the DC voltage to the optimum operating voltage for the inverter. This allows the inverter to operate continuously at its optimum efficiency and voltage, thus increasing reliability.

1.6.6 Battery

The Liebert GXT4 utilizes valve-regulated, nonspillable, lead acid batteries. To maintain battery design life, operate the UPS in an ambient temperature of 15°C to 25°C (59°F to 77°F). Optional external battery cabinets are available to extend battery run times. For run times, see **Table 8-8**.

1.6.7 Internal Bypass

The Liebert GXT4 provides an alternate path for mains power to the connected load in the unlikely event of a UPS malfunction. Should the UPS have an overload, overtemperature or any other UPS failure condition, the UPS automatically transfers the connected load to bypass. Bypass operation is indicated by an audible alarm and illuminated amber Bypass LED (other LEDs may be illuminated to indicate the diagnosed problem). To manually transfer the connected load from the inverter to bypass, press the Standby/Manual Bypass button once and hold it for about 2 seconds

1.6.8 Maintenance Bypass

The Liebert GXT4 provides a manual maintenance bypass in a removable section of the rear of the UPS. This allows replacement of the UPS in the event of a UPS malfunction while keeping the connected equipment powered with utility power.



NOTE

The bypass power path does NOT protect the connected equipment from disturbances in the mains supply.

1.7 Operating Mode

The UPS operation modes include the following: Mains (AC) Mode, Bypass Mode, Battery Mode, Battery Recharge Mode, Active ECO Mode and Frequency Converter Mode.

Refer to **3.0 - Operation and Display Panel** for details about the operating mode indicators and control buttons.

1.7.1 Mains Mode

During Mains Mode, the mains provides input power to the Liebert GXT4. The filters, PFC circuit and inverter process this power to provide high-quality sine wave power to connected loads. The UPS maintains the batteries in a fully charged state.

1.7.2 Manual Bypass Mode

Manual Bypass Mode occurs when the unit is manually placed in internal bypass by navigating the LCD menu to select **3 Control > 1 Turn On & Off > Turn UPS Bypass**. Bypass operation is indicated by an audible alarm and illuminated amber bypass indicator. (If other indicators are illuminated, refer to **7.0 - Troubleshooting**). During Bypass Mode, mains power bypasses the inverter and provides energy to the connected load.

NOTICE

Risk of loss of power to the connected load. Can cause equipment damage.

Turning Off the UPS in Bypass Mode will result in loss of output power to the connected load.

1.7.3 Battery Mode

The Liebert GXT4 enters Battery Mode when mains power fails or is outside acceptable limits. The battery system supplies power through the DC-to-DC converter to the inverter to generate clean AC power for the connected loads.

When the Liebert GXT4 enters Battery Mode, the UPS sounds a half-second beep at 10-second intervals. When approximately 2 minutes of run time remains, the beeps sound every 5 seconds to warn that the battery is getting low (this Low Battery Warning is user-configurable).

In Battery Mode, the battery indicator will illuminate and the LCD will show the prompt *utility power not available*.

Press either the Up or Down button once, then press the Enter button to clear the prompt and silence the audible alarm. Once the alarm prompt has been acknowledged, the screen showing the estimated battery run time and battery capacity will be visible. Refer to **7.0 - Troubleshooting**.

For approximate battery run times, refer to **Table 8-4**.

NOTICE

Risk of loss of power to the connected load. Can cause equipment damage.

Turning Off the Liebert GXT4 when it is in Battery Mode will result in loss of output power to the connected load.

If the UPS is turned Off manually, it must be manually restarted after mains power returns.

If the UPS is turned Off by a communication signal or because the batteries are depleted, it will operate as set in the configuration program for Auto-Restart (Refer to **5.2.1 - Configuration Program**).

1.7.4 Battery Recharge Mode

Once mains power is applied to the Liebert GXT4, the Battery Charger begins charging the batteries.

1.7.5 Frequency Converter Mode

All models of the Liebert GXT4 are capable of frequency conversion. Frequency Conversion Mode can be selected using the configuration program. Allowable frequency operating modes include:

- Auto Sensing - 50Hz or 60Hz – Bypass Enabled
- Auto Sensing - 50Hz or 60Hz – Bypass Disabled
- Frequency Converter - 50Hz – Bypass Disabled
- Frequency Converter - 60Hz – Bypass Disabled



NOTE

The default for all models of the Liebert GXT4 is "Auto Sensing - 50Hz or 60Hz – Bypass Enabled."



WARNING

Risk of electric shock. Can cause injury or death.

Never touch the AC input receptacle while the UPS is operating. Voltage may still be present even when the AC input indicator is Off.

1.7.6 Active ECO Mode

All Liebert GXT4 models can operate in Active ECO Mode. In this mode, the connected equipment is powered through the bypass path to increase efficiency, reducing the electrical costs.

Active ECO mode keeps the rectifier and inverter operating, allowing the inverter to remain synchronized to bypass. This synchronization allows the transfer of the connected equipment to UPS inverter power almost seamlessly if bypass power falls outside the user-set limits. Once bypass power returns within the acceptable parameters, the UPS will return to Active ECO Mode operation.

The default setting is Active ECO Mode Off.

2.0 Installation

Do NOT attempt to start the UPS, turn on any circuit breaker or energize the input power until instructed to do so in **4.2 - Starting the UPS**.

2.1 Unpacking and Inspection

Unpack the UPS and conduct the following checks:

- Inspect the UPS for shipping damage. Report any shipping damage to the carrier and your local dealer or Emerson® representative immediately.
- Check the accessories against the delivery list. If there is any discrepancy, contact your local dealer or your Emerson representative immediately



CAUTION

The UPS is heavy (see **8.0 - Specifications**). Take proper precautions when lifting or moving it.

2.2 What's Included

The Liebert GXT4 is shipped with the following items:

- Terminal Block Communication terminals
- Compact Disk with
 - Liebert MultiLink®
 - Configuration program
 - User manual (electronic version)
- Liebert IntelliSlot Unity card (IS-UNITY-DP), factory installed (not included with units with model number ending with an "E")
- USB cable, one; 1.2 m (3.9 ft.)
- Rack mounting hardware including screws, handles, and mounting rail kit (not included with units with model numbers ending with an "E")
- Power Distribution Box, installed on Liebert GXT4
- Support base set, one
- Warnings, Safety Instructions booklet and WEEE recycling sheet (ISO 14001 compliance)



NOTE

The GXT4 External Battery Cabinet shipping package includes one battery cabinet, two spacers for tower configuration, one DC power cable and rack mounting hardware, including screws, handles and mounting rail kit (not included with model numbers ending with "E").

2.3 Preparation for Installation

2.3.1 Installation Environment

Install the Liebert GXT4 indoors in a controlled environment, where it cannot be accidentally turned Off. Place it where air flows unrestricted around the unit. The installation location must be free of water, flammable liquids, gases, corrosives and conductive contaminants. Maintain an ambient temperature range of 0 to 32 - 104°F (0 – 40°C).



NOTE

UPS operation in sustained temperatures outside the range of 59° – 77°F (15 – 25°C) reduces battery life.

Installation Clearances

Maintain a clearance of at least 100 mm (4 inches) in the front and rear of the Liebert GXT4. Do not obstruct the air inlets on the front panel or rear panel of the UPS—blocking the air inlets reduces ventilation and heat dissipation, shortening the service life of the Liebert GXT4.

2.4 Install the Main Cabinet

The Liebert GXT4 may be installed in either a tower configuration or in a rack, depending on available space and use considerations. Determine the type of installation and follow the appropriate instructions in either **2.4.1 - Tower UPS Installation** or **2.4.2 - Rack Installation**.

2.4.1 Tower UPS Installation

To install the Liebert GXT4 as a tower:

1. Take the support bases out of the accessories bag (see **Figure 2-1**).

Figure 2-1 Support bases

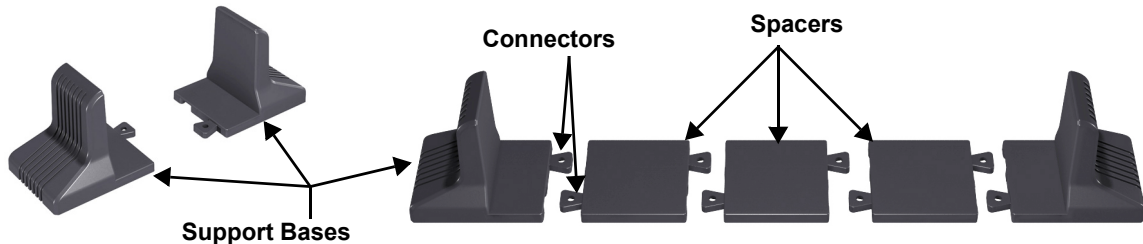

2. If optional Liebert external battery cabinets will be connected to the Liebert GXT4, take out the spacers shipped with the battery cabinet.
3. Connect the spacers and the support bases as shown in **Figure 2-1**. Each Liebert GXT4 needs two assembled support bases, one in the front and one in the rear.

4. Adjust the direction of the operation and display panel and logo on the Liebert GXT4.
 - a. Remove the front plastic bezel cover as shown in **Figure 2-2**.

Figure 2-2 Remove the front plastic bezel cover



- b. Pull the operation and display panel gently, rotate it 90 degrees clockwise and snap it back into position, as shown in **Figure 2-3**.

Figure 2-3 Rotate the operation and display panel

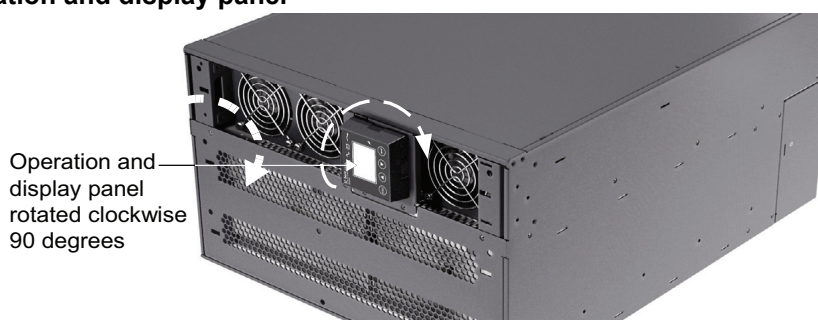

- c. Pull the logo on the front plastic bezel cover gently, rotate it 90 degrees clockwise and snap it back into position. The rotated front plastic bezel cover is shown in **Figure 2-3**.
 - d. Replace the front plastic bezel cover on the Liebert GXT4. At this point, the UPS operation and display panel and logo have been rotated 90 degrees clockwise, which provides upright viewing for users.
5. Place the Liebert GXT4 and any battery cabinets on the support bases. Each Liebert GXT4 needs two support assemblies.

2.4.2 Rack Installation

The Liebert GXT4 UPS and external battery cabinets (EBC), when installed in a rack enclosure, must be supported by a shelf or rack-mount rails. The Liebert GXT4 UPS and EBC units ship with all required hardware to allow rack-mount installation (not included with model numbers that end in "E"). Because different rack-mount options install differently, refer to the installation instructions provided with the rack mount kit being used.



CAUTION

The GXT4 is heavy; see **8.0 - Specifications**. The UPS must be installed as near the bottom of a rack as possible. If placed too high, it can make the rack top-heavy and prone to tipping over.

2.5 External Battery Cabinet Installation



WARNING

Risk of electric shock. Can cause injury or death.

Disconnect all local and remote electric power supplies before working within.

Ensure that the Liebert GXT4 is shut down and power has been disconnected before beginning any work on or in the unit.



CAUTION

The external battery cabinet(s) are heavy (see **Table 8-3**). Take proper precautions when lifting them.

Optional Liebert external battery cabinets may be connected to the UPS to provide additional battery run time. External battery cabinets are designed to be placed on one side of the UPS in a tower configuration or stacked beneath the UPS in a rack configuration.

Figure 2-4 External battery cabinets connected to GXT4

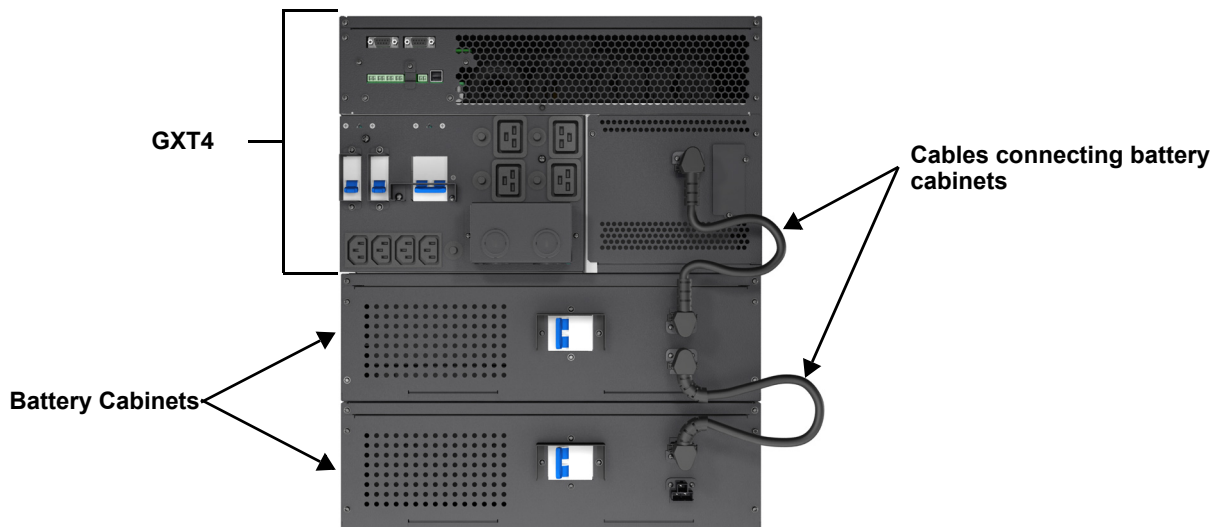

1. Inspect the external battery cabinet for freight damage. Report damage to the carrier and your local dealer or Emerson representative.
2. Optional rack-mount hardware is shipped with the external battery cabinet and may be installed at this time if desired.
 - Securing hardware and slide rails are sold separately. Please contact your local dealer or Emerson representative for these additional options and any assistance needed. Fasten the slides into position with the screws per the instructions included with the slide rails.
3. Use the enclosed support bases for the tower option to prevent tip-over. One additional set of support base extensions ships with each external battery cabinet.
4. Verify the External Battery Cabinet breaker is in the Off position.
5. Connect the supplied external battery cabinet cable to the rear of the external battery cabinet, then to the rear of the UPS.
6. Turn the External Battery Cabinet breaker to the On position.

7. Verify the circuit breaker on the External Battery Cabinet is in the On position.
8. Use the included configuration program or the LCD to program the UPS with the number of external battery cabinets connected. Instructions for the configuration program are in **5.2.1 - Configuration Program**.

The UPS is now equipped with additional backup battery run time. For approximate battery run times, refer to **Table 8-4**.

**NOTE**

When removing an external battery cabinet, the circuit breaker on the rear of the cabinet must be turned off before disconnecting the cable.

**NOTE**

If the UPS is to be shipped or stored for an extended time, the connector should be disconnected. This will minimize any standby current drain on the batteries and help attain their design life.

2.6 Connect Input/Output Power

The GXT4 ships with a power distribution box attached

Follow the instructions below for removal and installation.

**NOTE**

Do not operate the UPS with the power distribution box removed. To shut off all power to this box and to the load, utility input power must be disconnected.

2.6.1 Install the Power Distribution Box

1. Align the connectors and press the power distribution box onto the UPS.
2. Hold the box firmly against the UPS and tighten the captive screws except the one over the maintenance bypass breaker.
3. Turn the output and input breakers On.
4. Start the UPS according to startup instructions.
5. Verify that the UPS lamp is illuminated.
6. Turn the maintenance bypass breaker Off.
7. Insert the maintenance bypass interlock bracket behind the captive screw and tighten the screw.

**NOTE**

The maintenance bypass breaker interlock bracket must be installed behind the captive screw, and the screw must be tightened for the UPS to operate in inverter mode.

2.6.2 Remove the Power Distribution Box

1. Manually transfer the connected equipment to the internal bypass.
 - a. From the main menu select CONTROL, then press **Enter**.
 - b. Select TURN ON & OFF and press **Enter**.
 - c. Select TURN UPS BYPASS and press Enter. The UPS will transfer the connected loads to the internal bypass. (For help, refer to **4.4 - Manual Bypass**.)
 - d. Loosen the captive screw over the maintenance bypass breaker (see **Figure 2-5** for the breaker's location).
 - e. Turn the maintenance bypass breaker On.

NOTICE

The load is unprotected from disturbances in the power supply while the UPS is on bypass.

2. Turn the output and input breakers Off.
3. Loosen other captive screws until the power distribution box releases.
4. Remove the power distribution box from the UPS and set it aside.
5. Loosen the screws over the plastic cover for the connector on the rear of the panel.
6. Slide the plastic cover over the connector and tighten the screws.

Figure 2-5 Power distribution box removal

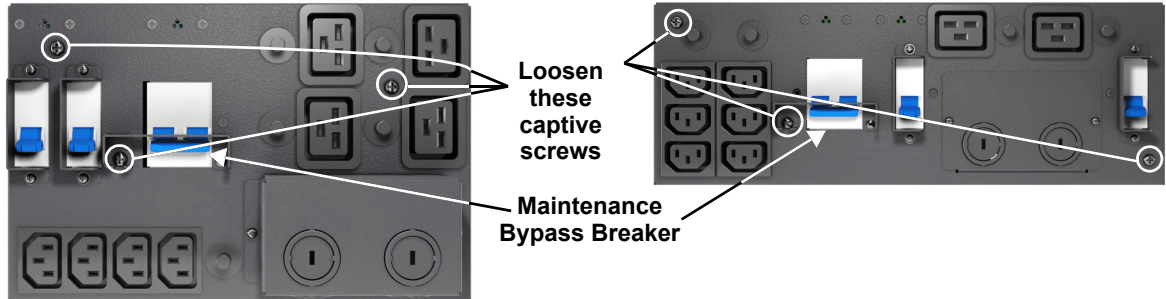

2.6.3 Distribution Box Electrical Connections

Electrical connections are made through a removable power distribution box that attaches to the rear of the UPS.

- PD2-CE6HDWRMBS fits the 5000 and 6000VA models of the Liebert GXT4
- PD2-CE10HDWRMBS fits the 10,000VA model of the Liebert GXT4

The installer must provide an upstream branch circuit breaker. The input circuit breaker on the distribution box and the output circuit breaker on the rear of the power distribution box disconnect all power between the main cabinet and the distribution box.

Models equipped with a manual bypass breaker pass bypass power directly to the bypass breaker from the input terminal block. The input circuit breaker on the distribution box does not disconnect power from the manual bypass breaker.

Table 2-1 Branch circuit breaker ratings

Unit Rating	Maximum Breaker Rating
5000VA	D Type 32A
6000VA	D Type 32A
10,000VA	D Type 63A

Figure 2-6 Distribution box electrical connections diagram

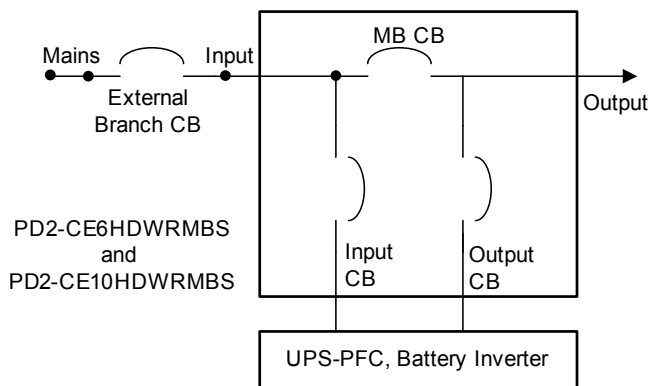

2.6.3.1 Terminal Block Connections

Conduit entry holes are provided on the rear and side of the box. Input and output wiring should not share the same conduit. Emerson recommends using strain relief when installing the wire.

Table 2-2 Electrical specifications

UPS Model	Recommended (Maximum) External Overcurrent Protection	Recommended Wire (Including ground wire) (75°C copper wire)	Maximum Wire Accepted by Terminal Block	Terminal Tightening Torque
GXT4-5000RT230 GXT4-6000RT230	32A	4mm ² (10AWG)	6mm ² (8AWG)	2.26 Nm (20 in-lb)
GXT4-10000RT230	63A	10mm ² (6AWG)	16mm ² (4AWG)	

Figure 2-7 Terminal block connections



NOTE

1. Emerson recommends installing a breaker upstream of unit.
2. The installer must provide circuit breaker protection according to local codes. The mains disconnect should be within sight of the UPS or have appropriate an appropriate lock-out. Maintain service space around the UPS or use flexible conduit.
3. The installer must provide output distribution panels, circuit breaker protection or emergency disconnects according to local codes. Output circuits must not share a common conduit with any other wiring.

2.7 IT Power System Configuration

1. Remove screws on the IT Power System Access Cover as shown in **Figure 3**.
2. Disconnect the connectors as shown in figure.
3. Install IT Power System Access Cover and screws.

Figure 3 Remove cover from IT Power System Connectors compartment

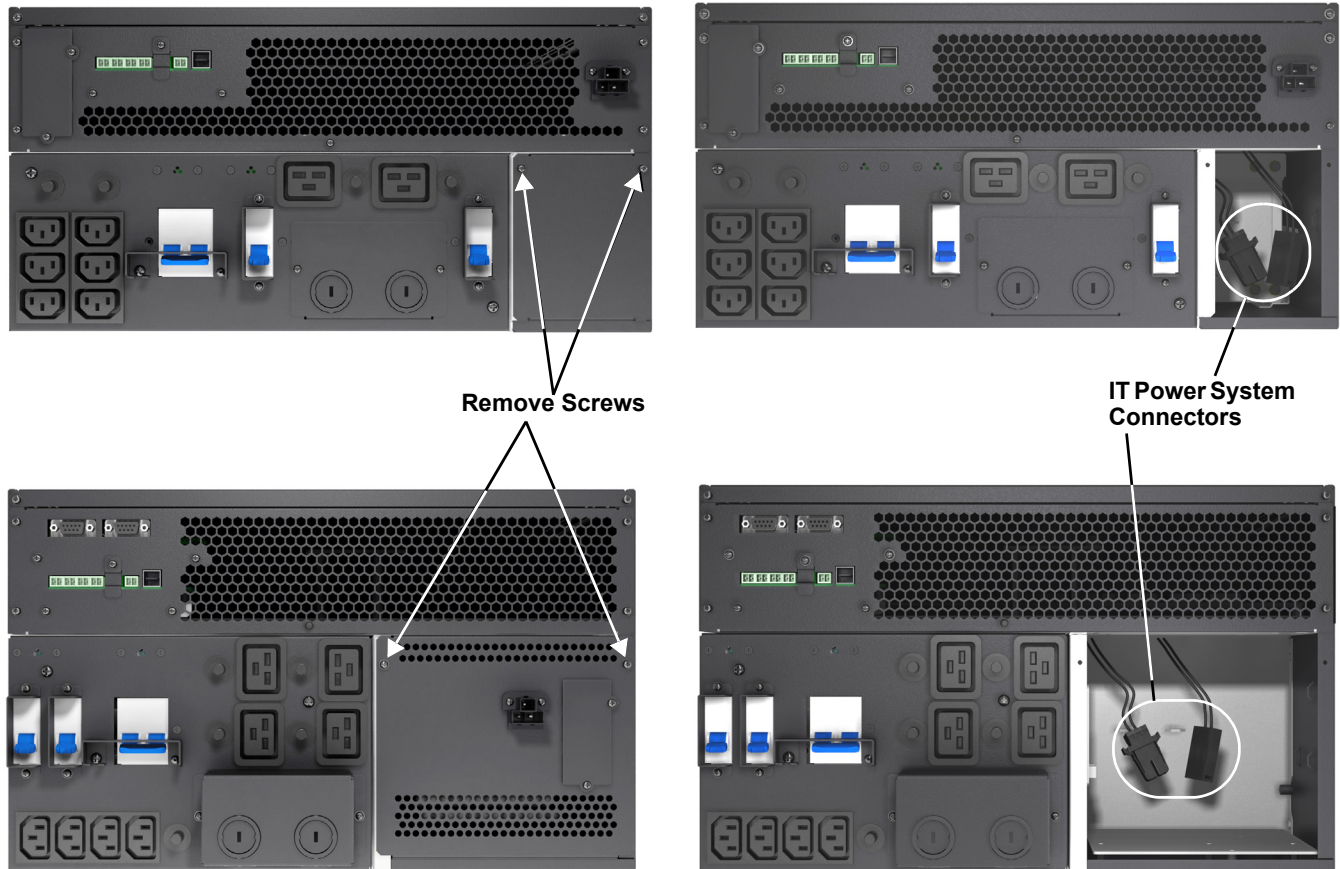

3.0 Operation and Display Panel

This chapter describes the Liebert GXT4 controls, particularly the operation and display panel on the front of the Liebert GXT4. The panel has four control buttons, seven LED indicators and a liquid crystal display (LCD), as shown in **Figure 3-1**.

Figure 3-1 Operation and display panel

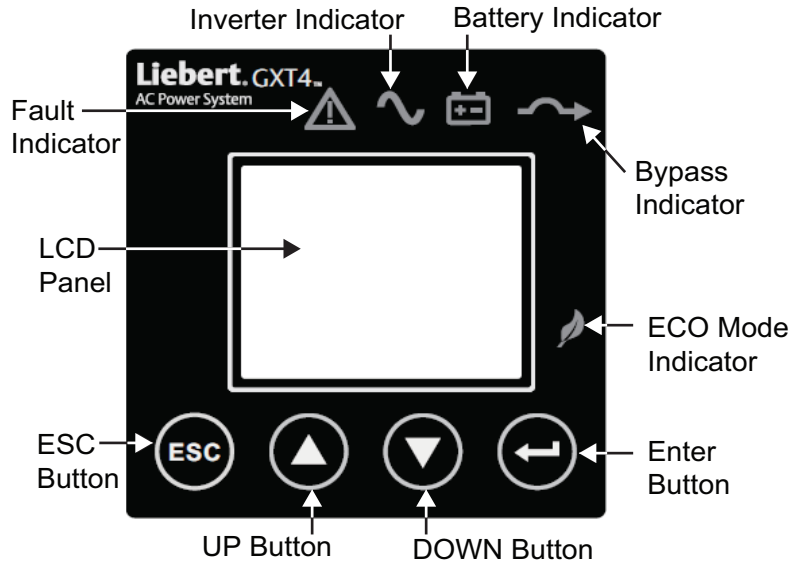

3.1 LED Indicators

The seven LED indicators on the front of the operation and display panel are:

- Inverter
- Battery
- Bypass
- ECO Mode
- Fault

Figure 3-1 shows the indicators' locations; their descriptions and functions are shown in **Table 3-1**.

Table 3-1 LED indicators

LED Indicators	LED Color	Description
Inverter	Green	On when the inverter is supplying power
Bypass	Amber	On when the load is supplied by the mains through automatic/manual bypass
Battery	Amber	On when the load is supplied by the battery
Fault	Red	On when an error has occurred within the UPS
ECO Mode	Green	On when the UPS is in ECO Mode

3.2 Control Buttons

The four control buttons on the front of the operation and display panel are:

- ESC
- Up
- Down
- Enter

Figure 3-1 shows the buttons' locations; their descriptions and functions are shown in Table 3-2.

Table 3-2 Control buttons

Control Buttons	Description
ESC Button	Pressing this button returns to the previous menu or aborts any change in the input data field before confirming.
Up Button	Pressing this button can move the cursor up or increase the value displayed in the input data field. When a menu is displayed on several screens, pressing the button can scroll up.
Down Button	Pressing this button can move the cursor down or decrease the value displayed in the input data field. When a menu is displayed on several screens, pressing the button can scroll down.
Enter Button	Pressing this button can enter the next level menu or confirm the parameter setting value.

3.3 LCD

The LCD panel shows the UPS status and enables changes to the UPS settings by assisting in navigating through the Liebert GXT4's menu (see 3.4 - Menu Structure).

3.4 Menu Structure

The menu structure of the LCD is shown in **Figure 3-2**.

Figure 3-2 Menu structure

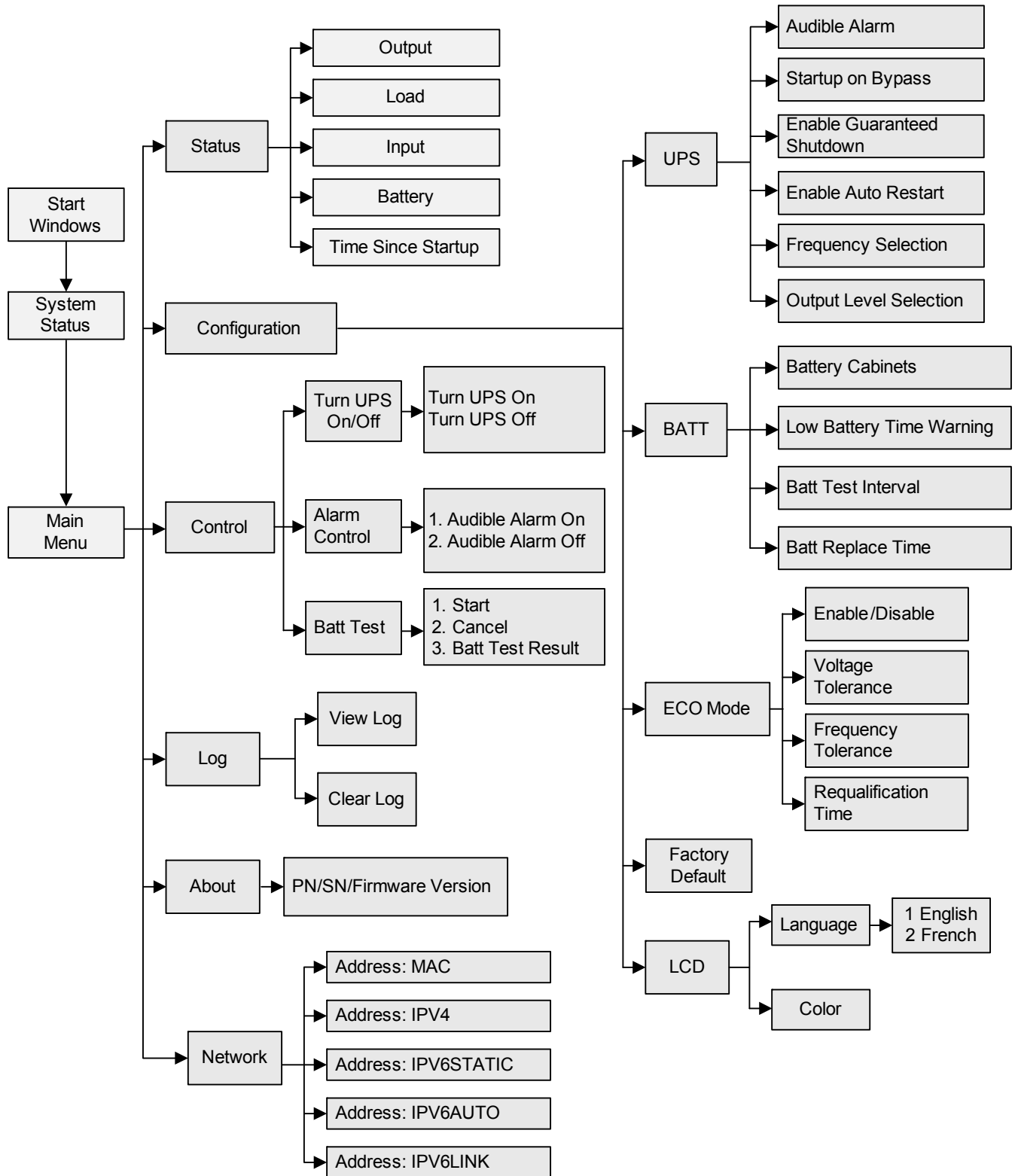

3.4.1 Startup Screen

When the Liebert GXT4 is starting up, it initiates a self-test and displays the screen shown in **Figure 3-3** for about 10 seconds.

Figure 3-3 Startup screen



After about 10 seconds, the LCD shows one of the On screens in **Figure 3-4**; the screen shown depends on whether input power is available.

Figure 3-4 Startup screens

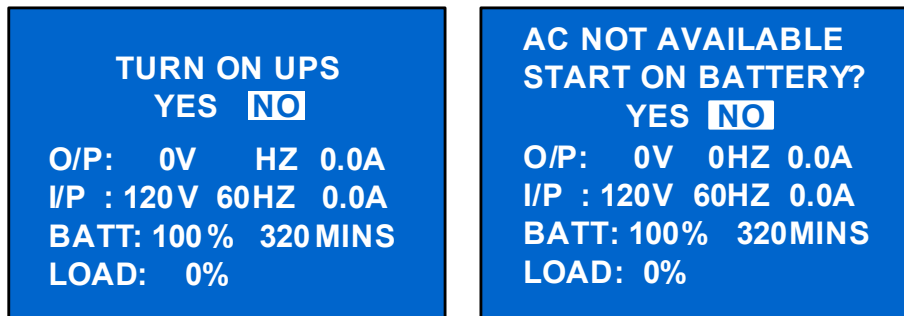

No.	Description
1	Input power is available.
2	Input power is not available.

To turn On the UPS, press either the Up or Down button to select YES and press the Enter button. The UPS will start up, the LCD will display *UPS STARTING* and then *START SUCCESSFUL* after the UPS is turned On, as shown in **Figure 3-5**.

Figure 3-5 Starting and Start Successful screens

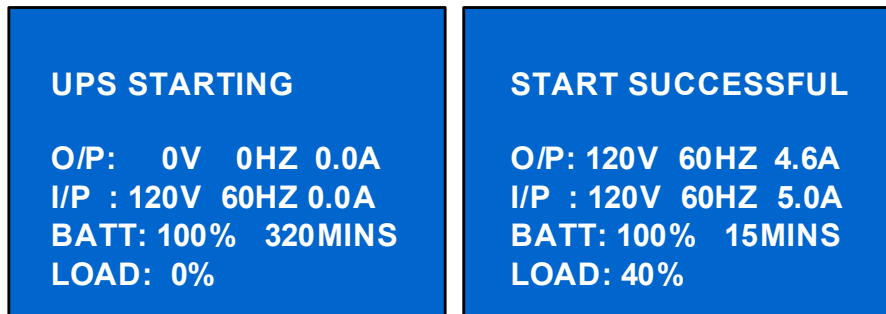

3.4.2 Default Screen

Press any button in the START SUCCESSFUL screen to enter the default interface, shown in **Figure 3-6**.



NOTE

Values shown in the default screen will vary depending on installation and configuration.

In the default screen, the LCD shows the UPS model, output parameters, input parameters, battery capacity with run time estimate and load percentage. The UPS operation mode (online /inverter, ECO, Battery or Bypass) will be indicated by the LED indicators.

If no control button (ESC, Up, Down, Enter) is pressed for 2 minutes, the LCD will enter the screen saver mode (backlight turns off). It will remain off until a control button is pressed.

Figure 3-6 Default screen

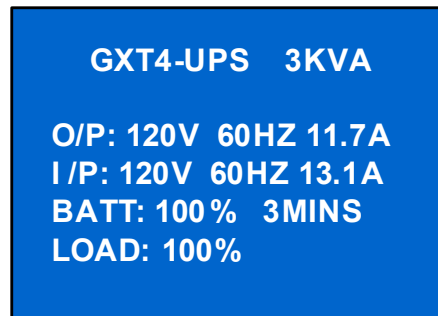

3.4.3 Main Menu Screen

Press the Enter button in the default screen to enter the MAIN MENU screen, as shown in **Figure 3-7**.

To select a submenu, press the Up or Down button to move the cursor to the required item, then press the Enter button to enter its submenu or set its parameter.

Figure 3-7 Main Menu screen

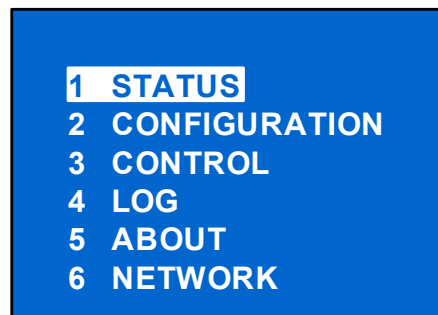

STATUS Screen

In the MAIN MENU screen, select *STATUS* to enter the Status Screen, displaying OUTPUT, LOAD, INPUT, BATTERY and TIME SINCE STARTUP, as shown in **Figure 3-8**.

Figure 3-8 Status screens

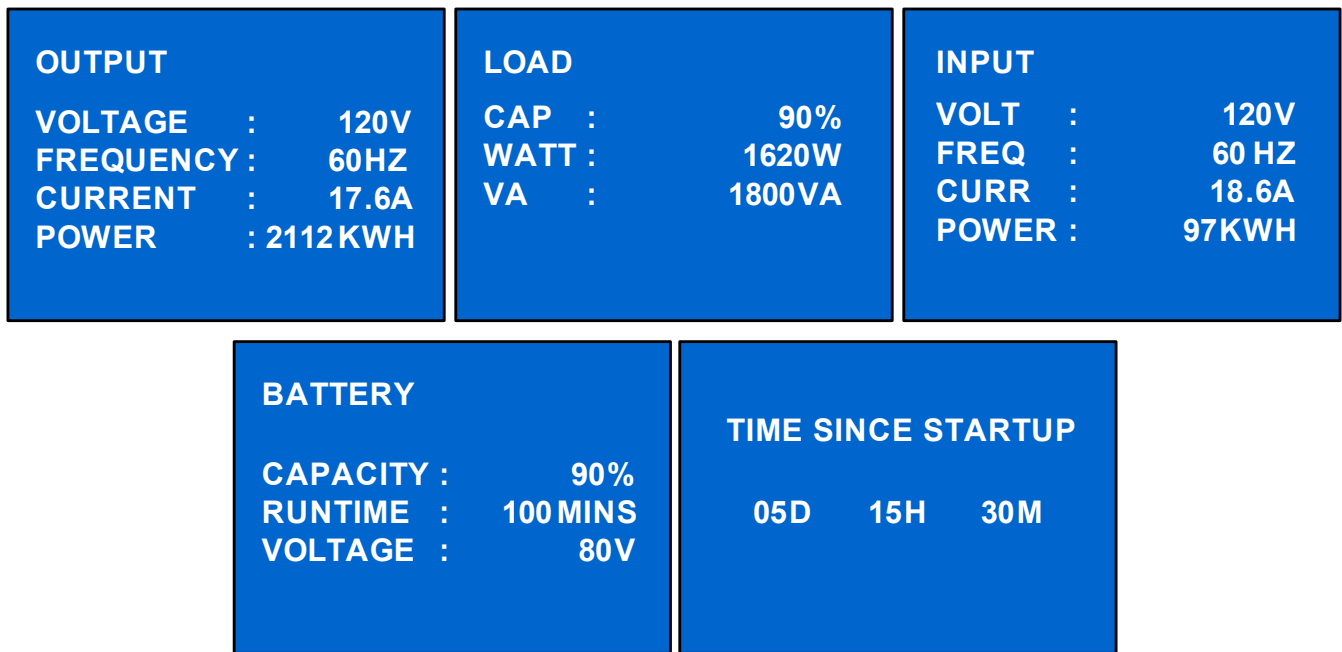

CONFIGURATION Screen

Select *MAIN MENU > CONFIGURATION* to enter the Configuration menu. This menu has seven submenus, as shown in **Figure 3-9**.

In the CONFIGURATION screen, press the Up or Down button to move the cursor to the required item, then press the Enter button to enter a submenu or set its parameters.

Figure 3-9 CONFIGURATION screen

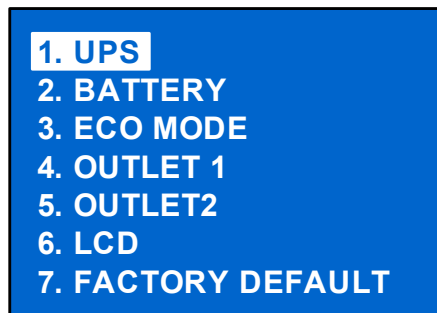

UPS Screen

Select *MAIN MENU > CONFIGURATION > UPS* to enter the UPS screen. This menu has six screens, as shown in **Figure 3-10**.

Press the Up or Down button to move the cursor to the required item, and press the Enter button to confirm the settings.

Figure 3-10 UPS screens

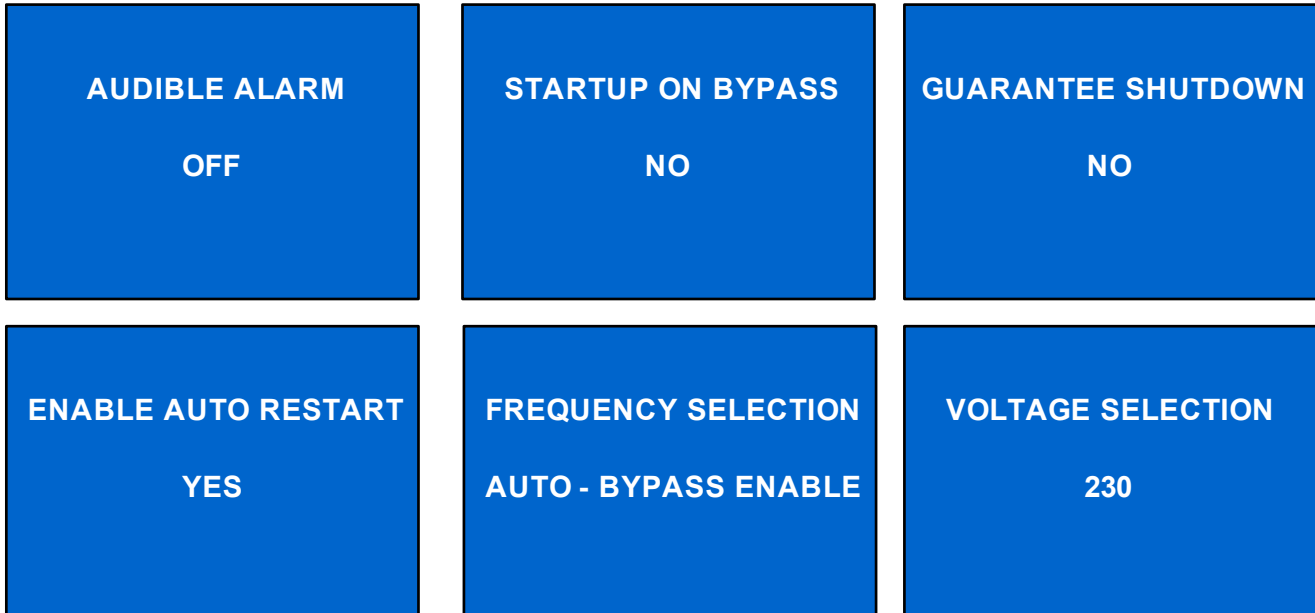

Battery Screen

Select *MAIN MENU > CONFIGURATION > BATTERY* to enter the BATTERY screen. This menu has four screens, as shown in **Figure 3-11**.

Press the Up or Down button to increase or decrease the value of the settings, and press the Enter button to confirm it.

Figure 3-11 Battery screen

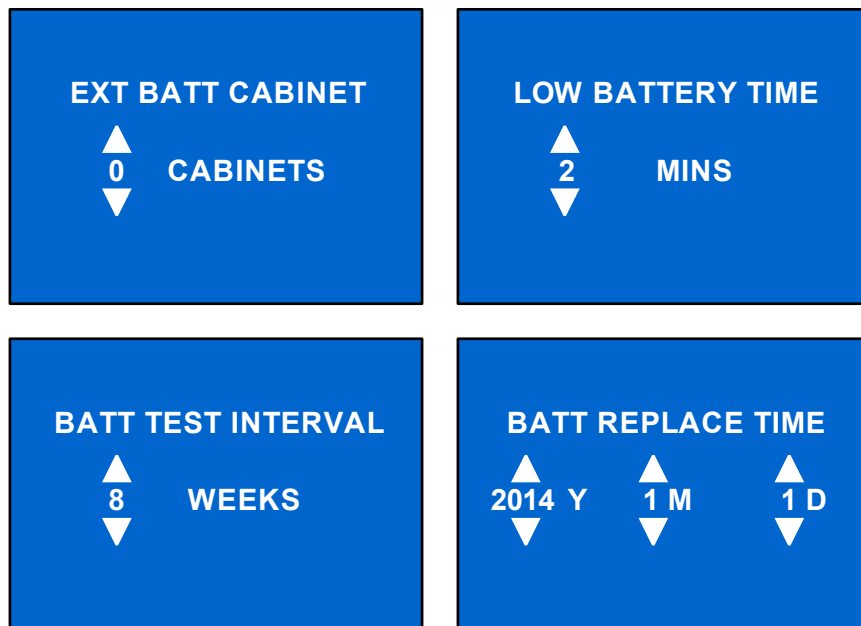

ECO Mode Screens

Select *MAIN MENU* > *CONFIGURATION* > *ECO MODE* to enter the ECO MODE screens, as shown in **Figure 3-12**.

Press the Up or Down button to move the cursor to the required item, and press the Enter button to confirm the settings.

Figure 3-12 ECO Mode screen

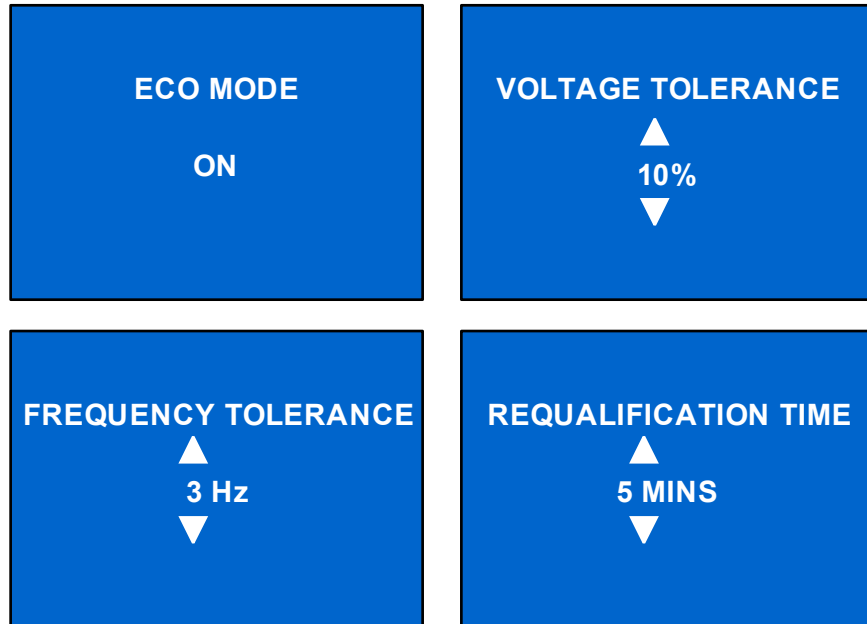

No.	Description
1	Outlet control is on.
2	Outlet control is off.

LCD screen

Select Main Menu -> **2 CONFIGURATION** -> **6 LCD** to enter the LCD screen. This menu has two submenus, LANGUAGE and COLOR, as shown in **Figure 3-13**.

Figure 3-13 LCD screen

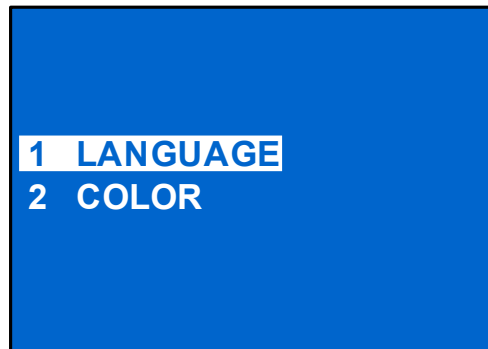

Select *1 LANGUAGE* and press the Enter button to enter the LANGUAGE screen, as shown in **Figure 3-14**.

The Liebert GXT4 is capable of supporting multiple languages. For the list of supported languages and instructions on how to upload them, refer to the Configuration Program user manual on the included CD.

Figure 3-14 Language screen



Select '**2 COLOR**' and press the Enter button to enter the COLOR screen, as shown in **Figure 3-15**.

Figure 3-15 Color screen

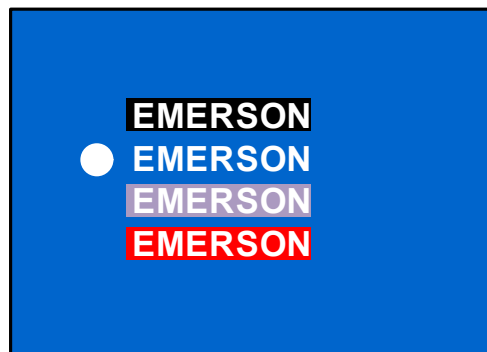

FACTORY DEFAULT screen

Select *MAIN MENU -> 2 CONFIGURATION -> 7 FACTORY DEFAULT* to enter the FACTORY DEFAULT screen, as shown in **Figure 3-16**.

Figure 3-16 Factory Default screen



Control Screen

Select *MAIN MENU* -> **3 CONTROL** to enter the CONTROL screen. This screen has three submenus, TURN ON & OFF, ALARM CONTROL and BATT TEST, as shown in **Figure 3-17**.

In the CONTROL screen, press the Up or Down button to move the cursor to the required item, and press the Enter button to enter its submenu.

Figure 3-17 Control screen



TURN ON & OFF screen

Select *MAIN MENU* -> **3 CONTROL** -> **1 TURN ON & OFF** to enter the TURN ON & OFF screen. This screen shows one of two displays, TURN ON UPS and TURN OFF UPS, depending on the state of the UPS, as shown in **Figure 3-18**.

Figure 3-18 Turn UPS On or Off screen

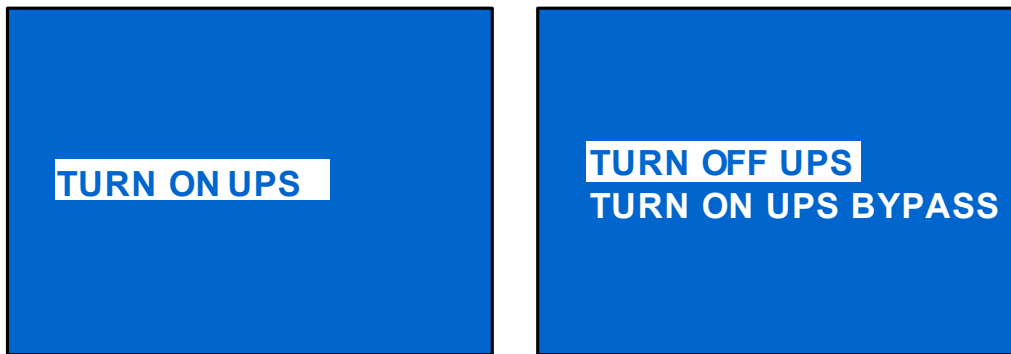

1

2

No.	Description
1	UPS is off.
2	UPS is on.

ALARM CONTROL screen

Select *MAIN MENU* -> 3 *CONTROL* -> 2 *ALARM CONTROL* to enter the ALARM CONTROL screen, as shown in **Figure 3-19**. This section allows active audible alarms to be silenced. To completely turn off the audible alarm, refer to *CONFIGURATION > UPS* as shown in **Figure 3-10**.

Figure 3-19 Alarm Control screen



BATT TEST screen

Select *MAIN MENU* -> 3 *CONTROL* -> 3 *BATT TEST* to enter the BATT TEST screen, as shown in **Figure 3-20**.

Figure 3-20 Batt Test screen

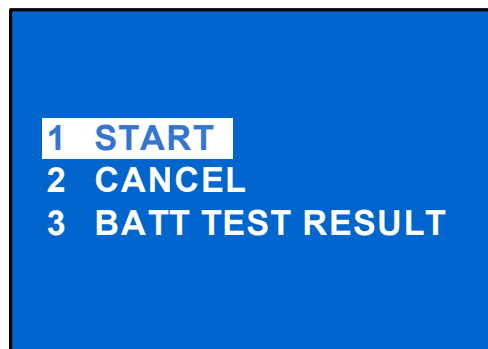

Log Screen

Select *MAIN MENU* -> 4 *LOG* to enter the LOG screen. This screen has two submenus, *VIEW LOG* and *CLEAR LOG*, as shown in **Figure 3-21**.

Figure 3-21 Log screens

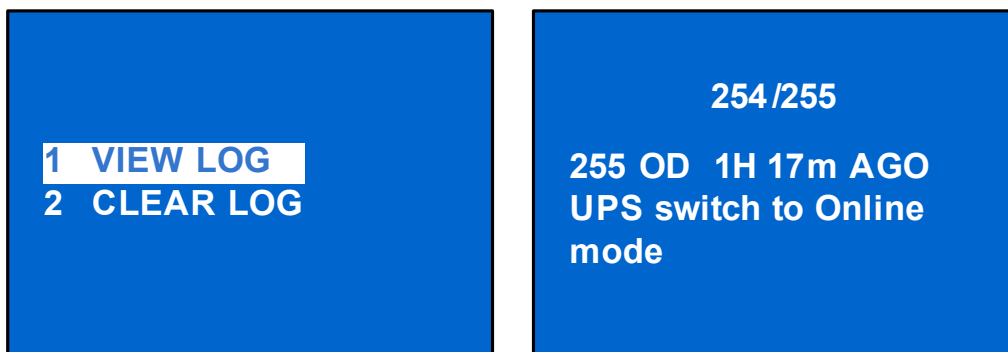

CLEAR LOG Screen

Select *MAIN MENU > LOG > CLEAR LOG* to enter the CLEAR LOG screen, as shown in **Figure 3-22**.

Press the Up or Down button to move the cursor to the required item. Press the Enter button to confirm the settings.

Figure 3-22 Clear Log screen

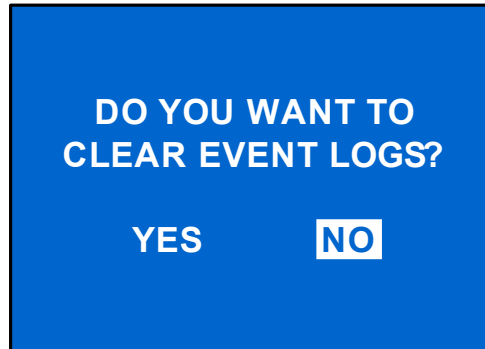

ABOUT Screen

Select *MAIN MENU > ABOUT* to enter the ABOUT screen, as shown in **Figure 3-23**. The ABOUT screen displays UPS model, serial number, software version and hardware version.

Figure 3-23 About screen

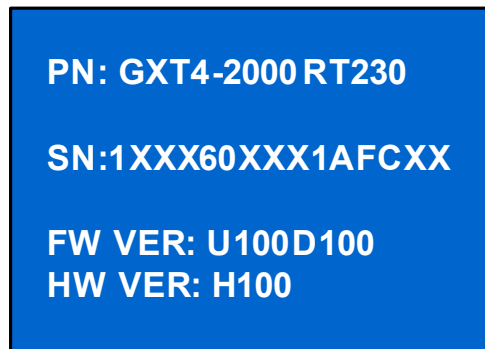

Network

Select *MAIN MENU>NETWORK* to enter the NETWORK screen.

The NETWORK screen displays the MAC address and the IPv4 IP address. If the Liebert GXT4 is fitted with an optional Liebert IntelliSlot® Web card (Liebert IS-WEBCARD), the screen will display IPv6 IP address settings (IPv6 requires configuration), as shown in **Figure 3-24**.

Figure 3-24 Network screens

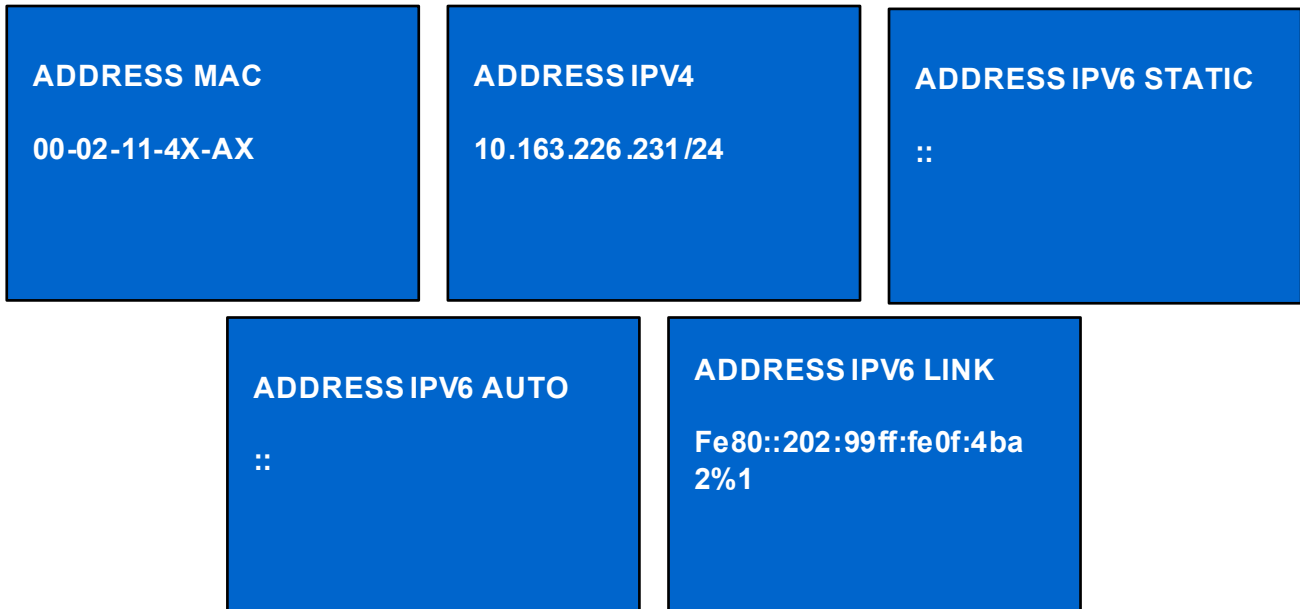

3.4.4 Prompt List

A prompt screen is displayed during the operation of the system to alert you to certain conditions and/or to require your confirmation of a command or other operation. See **Table 3-3** for the prompts and meanings.

Table 3-3 System prompts and meanings

Prompt	Meanings
Mains Power Restored	The mains power returns and the UPS transfers back to mains (AC) mode.
UPS Return From A Low Battery Condition	The UPS transfers back to mains (AC) mode from battery low mode.
UPS Return From Battery Mode	The UPS transfers back to mains (AC) mode from battery mode.
UPS Self Test Successful	The UPS self-test is successfully performed.
UPS Shutdown Command Received	The UPS shut down was initiated through communication.
UPS Turn Off	The UPS shuts down and has no output power.
UPS Turn On	The UPS starts up successfully and supplies protected power to the load.
UPS Shutdown Process Had Been Cancelled	The shutdown command sent through Liebert MultiLink or SNMP card to the UPS is canceled,
ECO Mode Enabled	The UPS is configured to ECO mode operation,
ECO Mode Disabled	The UPS is configured to Online mode, supplying protected power to the load through the inverter.
UPS Internal Temperature Return To Normal	The internal temperature of the UPS recovers to normal range.
UPS Load Return From Overload	The loads are reduced, and the UPS recovers to normal state from overload.
Load On Inverter	The inverter is on and supplies protected power to the load.
Load On ECO Bypass	The UPS is on ECO mode; the mains is supplying power to the load directly to reduce energy usage.
Bypass Power Restored	The bypass power recovered and the UPS can now transfer to bypass.

3.4.5 Warning List

All UPS warning messages are described in **Table 3-4**.

Table 3-4 Warning list

Warning	Description
Mains Power Not Available	The mains power is not available, or it cannot satisfy the input requirements for the UPS to operate from mains power
UPS Batteries Low And Exhausted Soon	The battery capacity is low and will be exhausted soon
UPS Has Switched To Battery Mode	The mains power is abnormal or the PFC side is faulty, the UPS transfers back to Battery mode
Load On Bypass	The UPS transfers to Bypass mode, at this point, the input mains power supplies power to the load directly, and the load is not protected
Input Power Wiring Error	L-N line reverse or PE not connected.
Bypass Power Not Available	The bypass power is not available, or it cannot satisfy the requirements for the UPS transfers to bypass
UPS Maintenance Bypass Output	The UPS transfers to maintenance bypass.
AC input not qualified, cannot start UPS	The utility power is not qualified, the inverter cannot be powered up
Output disabled	REPO terminal connect error

3.4.6 Fault List

All UPS fault messages are described in **Table 3-5**.

Table 3-5 Fault list

Fault	Description
UPS Self-Test Failed	The battery is bad or weak or not connected.
UPS Overload	The UPS is overloaded.
Inverter Out Of Order	The inverter has failed.
Battery Weak/Bad	The battery is bad or weak.
Output Short Circuit	The output connection is short-circuited.
DC Bus Overvoltage	The DC bus is faulty.
UPS Overtemperature	Overtemperature occurs to the UPS and the UPS will transfer to Bypass mode.
Charger Out Of Order	The charger has failed.
Fan Out Of Order	At least one fan is failed.
DC Bus Discharge Fail	DC-DC failure occurs.
Rectifier Out Of Order	Rectifier failure occurs.

If a fault occurs, the UPS automatically switches to Bypass Mode. The original operating mode will be maintained only in the case of a battery disconnection fault. The fault message alternates with UPS Mode once a second, the red fault indicator on the operation and display panel lights up and the alarm sounds continuously.

If a fault occurs:

1. Enter the ALARM CONTROL screen (see **Figure 3-19**), and select *AUDIBLE ALARM ON* or *AUDIBLE ALARM OFF* to switch the alarm On or Off.
2. Enter the EVENT LOG screen (see **Figure 3-21**), and select *VIEW LOG* to view the entire Event log.



NOTE

There will be a short delay before the EVENT LOG screen displays the historical fault log to allow the log to load.

Page intentionally left blank.

4.0 Operation

This section describes checks to be made before starting the UPS, how to start the UPS, manual battery test, manual bypass, shutting down the UPS and disconnecting mains power from the UPS.



NOTE

The Liebert GXT4's battery has been fully charged before delivery, but some charge will be lost during storage and shipping. To ensure that the battery has adequate reserve power to protect the connected load, charge the battery for 5 hours before putting the UPS into service.

4.1 Startup Checklist for the Liebert GXT4

Before starting the UPS, perform these checks:

- ___ 1. Check that the input plugs and loads are connected properly and reliably.
- ___ 2. Check that the battery cable is connected properly.
- ___ 3. Check that the communication cables are connected properly.

4.2 Starting the UPS

1. Plug the UPS into the appropriate AC outlet.
2. Close the input breaker on the rear of the unit.
3. The UPS will begin the startup sequence once AC power is present.



NOTE

The UPS will sound an audible alarm, this is normal.

4. On the LCD, press either the Up or Down button once, then press the Enter button to turn On the UPS. *The UPS will sound the audible alarm again as the output receptacles are now being powered by the internal bypass, then will sound one more time as the inverter powers the connected equipment.*
5. Check the LCD and LED indicators to ensure that the UPS is operating normally.
6. Check the load percentage on the default screen to ensure that the connected equipment is not exceeding the UPS's rated capacity.

The UPS is now providing conditioned and protected power to the connected equipment.

4.3 Manual Battery Test

To initiate a manual battery test, select *MAIN MENU > CONTROL>BATT TEST>START*.

- If the battery test results show *FAILED*, allow the UPS to recharge the batteries for 24 hours.
- Retest the batteries after 24 hours of charging.
- After the batteries have been retested, if the battery test still shows *FAILED*, contact your local Emerson® representative or Emerson Network Power Channel Support.

4.4 Manual Bypass

To manually transfer the connected equipment to the internal bypass:

1. From the main menu select Control then press enter.
2. Select *TURN ON & OFF* and press Enter.
3. Select *TURN UPS BYPASS* and press Enter. The UPS will transfer the connected loads to the internal bypass.

If the internal bypass is not available because of input power problems, pressing this button once will be ignored. Bypass operation is indicated by an audible alarm and illuminated amber Bypass indicator. (If other indicators are illuminated, refer to **7.0 - Troubleshooting**.)

4.5 Shut Down the GXT4

To shut down the UPS from the LCD:

1. From the Main Menu select *CONTROL*, press Enter, then select *TURN ON & OFF*.
2. Press the Enter key.
3. Select *TURN UPS OFF*, then press Enter. Press either the Up or Down button to move the cursor to confirm the turn off command and press Enter. *The UPS will sound an audible alarm; this is normal.*
4. Power to the connected equipment is now Off.

The UPS display will still be illuminated because the batteries are still being charged. The UPS may now be disconnected from AC power, and the UPS will completely shut down in approximately 15 seconds.

4.6 Disconnecting Input Power from the GXT4

1. After the UPS has been shut down as detailed in **4.5 - Shut Down the GXT4**, disconnect the input cable from the wall socket.
2. Wait 30 seconds and verify that all indicators have turned Off and the fan has stopped; this indicates that the power-off is complete.
3. Turn the external battery cabinet breaker switch to the Off position if the UPS has an external battery cabinet.

After powering Off the UPS, the UPS ceases output and the load is powered Off.

4.7 Maintenance Bypass

Maintenance Bypass Mode is used when maintenance or replacement is required. To place the unit in Maintenance Bypass:

1. Place the UPS on internal bypass. This may be done by either of the following methods:
 - a. Refer to **4.4 - Manual Bypass**.
 - b. Slide the bracket away from the manual bypass breaker on the rear of the UPS. This requires loosening the captive screw and sliding the bracket up and away from the Manual Bypass breaker.
2. Move the Manual Bypass breaker on the rear of the UPS to the bypass position. This requires loosening the captive screw and sliding the bracket up and away from the Manual Bypass breaker.

5.0 Communication

This section describes the communication ports on the rear of the UPS:

- Liebert IntelliSlot® port
- USB port (standard B-type)
- Terminal Block Communication



CAUTION

To maintain safety (SELV) barriers and for electromagnetic compatibility, signal cables should be segregated and run separate from all other power cables.

5.1 Liebert IntelliSlot Communication Cards

The Liebert IntelliSlot port accepts four optional cards:

- Liebert IntelliSlot Web Card (IS-WEBCARD)
- Liebert IntelliSlot Relay Card (IS-RELAY)
- Liebert IntelliSlot MultiPort Card (IS-MULTIPORT)
- Liebert IntelliSlot Unity Card (IS-UNITY-DP)

The Liebert IntelliSlot Web Card provides SNMP monitoring and control of the UPS across the network.

The Liebert IntelliSlot Relay Card provides dry contact relay outputs for custom-wired applications and delivers support for Liebert MultiLink® shutdown software.

The Liebert IntelliSlot MultiPort Card provides four sets of contacts for support of up to four computers that have Liebert MultiLink installed.

The Liebert IntelliSlot Unity Card provides SNMP and/or RS-485 monitoring of the UPS across the network and/or building management system. The Liebert IntelliSlot UNITY card also enables monitoring external temperature, humidity and contact closure inputs using external sensors.

Follow instructions provided with the Liebert IntelliSlot card to configure Liebert MultiLink®, the UPS or any additional ancillary product for the Liebert GXT4. These instructions are available at:

multilink.liebert.com

5.1.1 Liebert MultiLink

Liebert MultiLink monitors the UPS continuously and can shut down the computer or server in the event of an extended power failure. Liebert MultiLink can also be configured to shut down the UPS.

Liebert MultiLink can communicate with the UPS via the USB port, RS232 port, contact closures via terminal block or over the network via SNMP using the Liebert IS-WEBCARD. An optional Liebert MultiLink license kit permits shutting down multiple computers that are protected by the UPS.

For more information about the Liebert IntelliSlot SNMP Card, Liebert IntelliSlot Web Card and Liebert MultiLink License Kits, visit the Liebert Web site (www.liebert.com) or contact your local Emerson® representative.

5.2 USB Port Communication

The standard B-type USB port is used to connect the UPS and network server or other computer system using Liebert MultiLink®.

A standard B-type USB port is provided to allow connection to a computer or network server. The USB port can be used to communicate with the Liebert GXT4 configuration program (see section 5.2.1 - **Configuration Program** for details) or Liebert MultiLink (refer to 5.1.1 - **Liebert MultiLink** for description) that is provided on the CD that is included with the UPS.

5.2.1 Configuration Program

The configuration program is on the Liebert GXT4 CD and can be used instead of making configuration setting changes from the LCD panel. The configuration program communicates to a computer running a Microsoft® Windows® operating system via the included USB cable.

For most users, the factory default settings are adequate. This section give a brief overview of the features and parameters that are available for modification, as well as the factory default settings. Should any changes be necessary, refer to the Configuration Program User Manual that is located on the included CD for further details.

The configuration program allows these features of the Liebert GXT4 to be changed:

- Change and set the display language
- Enable/Disable Auto-Restart (default is Enable)
- Select frequency converter operation with a fixed output frequency of 50Hz or 60Hz, bypass disabled (default is Auto-Select with bypass enabled)
- Set the Low Battery Warning alarm time from 2 to 30 minutes (default is 2 minutes)
- Enable/Disable the Auto-Battery test (default is Enable)
- Enable/Disable Auto-Restart after removing Remote shutdown (default is Disable)
- Set the wiring mode of Remote shutdown (default is normally open)
- Set the Auto-Enable output after remote shutdown (default is Disable)
- Set the Auto-Battery test to 8, 12, 16, 20, or 26 weeks (default is 8 weeks)
- Select the number of external battery cabinets connected to the UPS to adjust the remaining run time calculated by Emerson® software products (default is zero)
- Select one of multiple output voltages to match various voltages (see **Table 5-1**).

Table 5-1 Output voltage option

UPS Model	FactoryDefault Setting	Output Voltage Option
All models	230 VAC	200V, 208V, 220V, 230V, 240V

NOTICE

The output voltage settings cannot be changed while the UPS is On and powering connected loads.



NOTE

- *This program is compatible with UPS models beginning with 'GXT4,' as in 'GXT4-3000RT230.' It is not compatible with earlier versions of the Liebert GXT UPS.*
- *A computer running Microsoft® Windows 2000®, Windows XP®, Windows Vista®, Windows 7 or Windows 8 is required to set up and run the configuration program.*

5.3 Terminal Block Communication

The Terminal Block includes eight pins, as shown in **Figure 5-1**.

Figure 5-1 Terminal-block communication pin layout

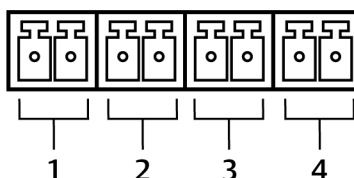

No.	Description
1	Low battery warning
2	On-battery warning
3	Any mode shutdown
4	Battery mode shutdown

5.3.1 Any Mode Shutdown

The purpose of Any Mode Shutdown is to shut down the UPS output by turning Off the rectifier, inverter and static switch so that there is no power to the loads.

Any Mode Shutdown can be operated locally or remotely:

- Local Any Mode Shutdown can be performed by shorting pins 1 and 2.
- Remote Any Mode Shutdown can be performed using a switch mounted at a remote location and connected to pins 1 and 2.



NOTE

Remote Power Off will be performed either by NO or NC contact of Any Mode Shutdown, depending on the settings in the configuration program.

A current-limited source for this optocoupler (+12 VDC, 50 mA) will be available from the UPS.

The connection to the UPS for remote connection will be via terminal block connector.

Any Mode Shutdown wiring must conform to all national, regional and local wiring regulations.



WARNING

When the Auto-Enable output option is selected and the UPS output is disabled using Any Mode Shutdown, the Liebert GXT4's output can turn On automatically and without warning if the connection is changed.

5.3.2 Battery Mode Shutdown

Battery Mode Shutdown permits shutting down the UPS by turning Off the rectifier, inverter and static switch so that there is no power to the load when the UPS is On Battery. The auxiliary power for the UPS will still be active.

Battery Mode Shutdown can be performed locally or remotely:

- Local Battery Mode shutdown can be performed by shorting pins 3 and 4.
- Remote Battery Mode Shutdown can be performed using a switch mounted in a remote location and connected to pins 3 and 4.



NOTE

Remote Power Off will be performed by NO contact.

A current-limited source (+12 VDC, 50 mA) will be available from UPS.

The connection to the Liebert GXT4 for remote connection will be via terminal block connector.

Battery Mode Shutdown wiring must conform to all national, regional and local wiring codes and laws.

This signal must last for 1.5 seconds or longer.

A battery shutdown signal will not cause an immediate shutdown. It will start a 2-minute shutdown timer. This timer cannot be stopped once triggered. If the mains power returns during this countdown, the Liebert GXT4 will still shut down and must remain shut down for 10 seconds. Whether the UPS turns back On when the power is restored depends on the auto-restart setting.

5.3.3 On Battery

On Battery signal is a Normally Open (NO) dry contact. When the UPS is supplying output power from the battery this dry contact will be closed.

5.3.4 Low Battery

Low Battery signal is a Normally Open (NO) dry contact. When the UPS is supplying output power from the battery and has reached the Low Battery Warning time selected in the configuration program, this dry contact will be closed.



NOTE

The rated values for the dry contacts for the On Battery and Low Battery signals are:

- *Rated Voltage: 30 V (AC or DC)*
- *Rated Current: 300 mA*

5.4 Remote Emergency Power Off—GXT4-6000RTL630

The UPS is equipped with a Remote Emergency Power Off (REPO) connector.

The user must supply a means of interfacing with the REPO circuit to allow disconnecting the UPS input feeder breaker to remove all sources of power to the UPS and connected equipment to comply with national and local wiring codes and regulations.

Figure 5-2 REPO switch connection diagram

UPS ships with REPO jumper installed allowing the UPS to operate

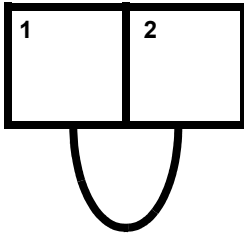

Normally closed switch system
(fail-safe)

Opening the REPO connection will disable the UPS. Manual restart using the front panel is required after the REPO connection is closed again.

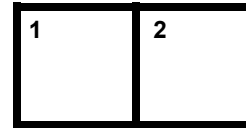

CAUTION

To maintain safety (SELV) barriers and electromagnetic compatibility, signal cables should be shielded and run separately from power cables.

Page intentionally left blank.

6.0 Maintenance

This section describes replacing the internal battery pack, precautions, checking the Liebert GXT4's status and checking UPS functions.



WARNING

The battery can present a risk of electrical shock and high short circuit current. The following precautions should be observed before replacing the battery pack:

- Remove rings, watches and other metal objects.
- Use tools with insulated handles.
- Do not lay tools or other metal objects on the batteries.
- If the battery kit is damaged in any way or shows signs of leakage, contact your local Emerson representative immediately.
- Do not dispose of batteries in a fire. The batteries may explode.
- Handle, transport and recycle batteries in accordance with local regulations.

6.1 Replacing the Internal Battery Pack

The Liebert GXT4 is designed to allow the user to replace the internal battery pack safely. Refer to **Table 6-1** for internal battery pack part numbers for Liebert GXT4 UPS:

Table 6-1 Replacement internal battery pack model number

UPS Model Number	Replacement Internal Battery Pack Model Number	Quantity Required
GXT4-5000RT230 GXT4-5000RT230E	GXT4-240VBATKIT	2
GXT4-6000RT230 GXT4-6000RT230E	GXT4-240VBATKIT	2
GXT4-10000RT230 GXT4-10000RT230E	GXT4-240RTBKIT	2

6.1.1 Battery Replacement Procedures

Read all safety cautions before proceeding. A trained user can replace the internal battery pack when the UPS is always in a restricted access location (such as a rack or server closet). Contact your local dealer or Emerson representative to obtain the pricing of the appropriate replacement battery pack.

CAUTION

Risk of explosion if battery is replaced by an incorrect type. Dispose of used batteries according to the instructions.

1. Remove the front plastic bezel cover from the UPS.
2. Loosen and remove the 6 screws on the battery door, as shown in **Figure 6-1**.
3. Lay the battery door and screws aside for reassembly.

Figure 6-1 Removing the front bezel cover and battery door

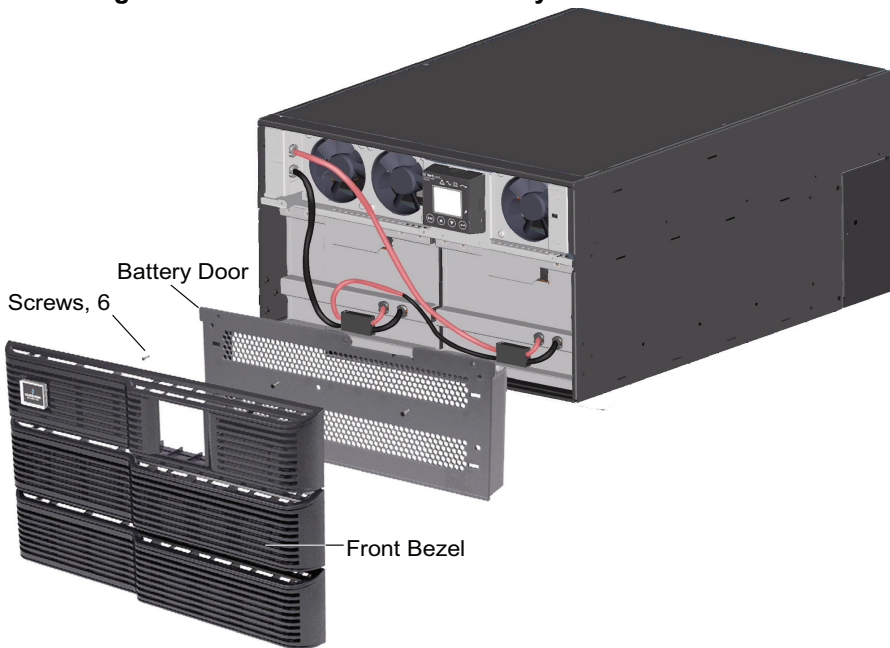

4. Gently pull the battery wire out and disconnect the battery plug and battery receptacle, as shown in **Figure 6-2**.

Figure 6-2 Disconnecting the battery plug and battery receptacle (front view)

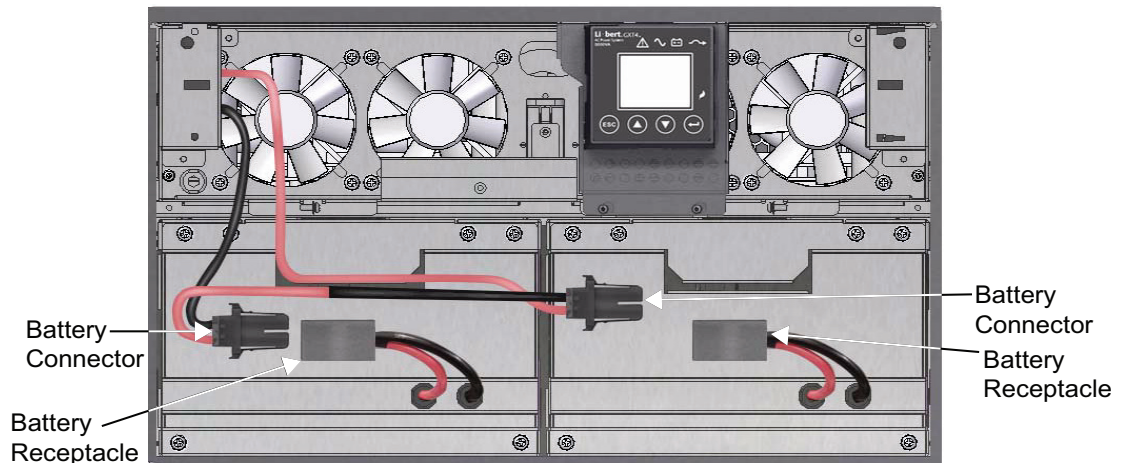

- Grasp the battery handle, and pull the internal battery pack out of the UPS, as shown in **Figure 6-3**. Repeat this step if both battery packs will be replaced. Each model has two battery packs.

Figure 6-3 Pull out the battery

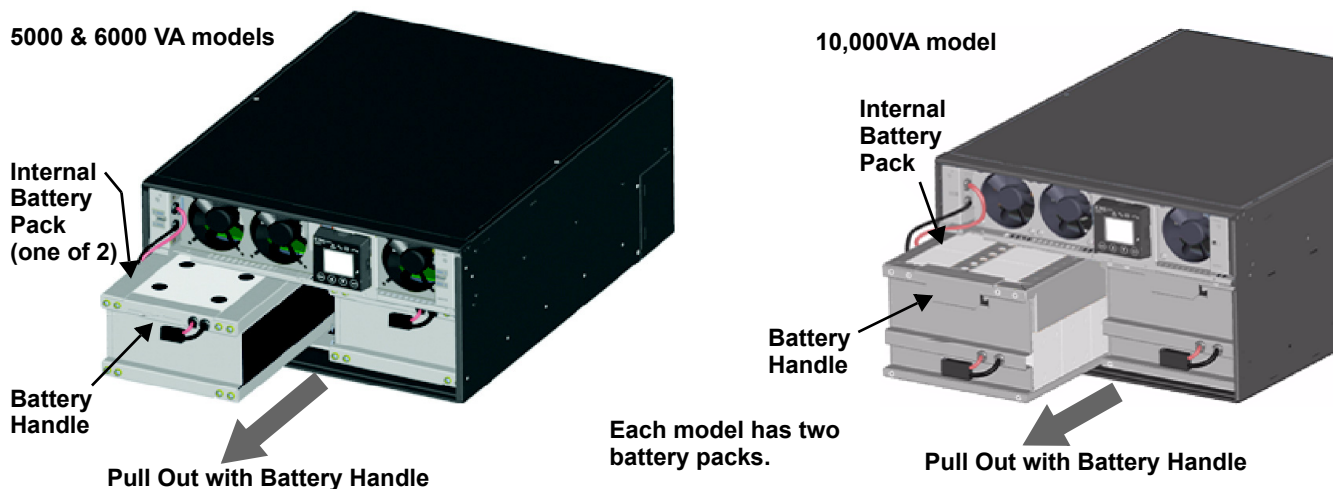

- Unpack the new internal battery pack. Take care not to destroy the packing. Compare the new and old internal battery pack to make sure they are the same type and model. If so, proceed with **Step 7**; if they are different, stop and contact your local Emerson representative, or Emerson Channel Support.
- Line up and slide in the new internal battery pack.
- Reconnect the battery plug and battery receptacle
- Push the battery wire and internal battery pack back into the UPS.
- Reattach the front battery door with the six screws.
- Reattach the front plastic bezel cover to the UPS.



NOTE

The internal battery pack is hot-swappable. However, caution should be exercised because during this procedure the load is unprotected from disturbances and power outages. Do not replace the battery while the UPS is operating in Battery Mode. This will result in a loss of output power and will drop the connected load.

6.2 Battery Charging

The batteries are valve-regulated, nonspillable, lead acid and should be kept charged to attain their design life. The Liebert GXT4 charges the batteries continuously when it is connected to the utility input power.

If the Liebert GXT4 will be stored for a long time, Emerson recommends connecting the UPS to input power for at least 24 hours every four to six months to ensure full recharge of the batteries.

6.3 Precautions

Although the Liebert GXT4 has been designed and manufactured to ensure personal safety, improper use can result in electrical shock or fire. To ensure safety, observe the following precautions:

- Turn Off and unplug the Liebert GXT4 before cleaning it.
- Wear rubber gloves and boots.
- Clean the UPS with a dry cloth. Do not use liquid or aerosol cleaners.
- Never block or insert any objects into the ventilation holes or other openings of the Liebert GXT4.
- Do not place the Liebert GXT4 power cord where it might be damaged.

6.4 Checking UPS Status

Emerson recommends checking the UPS operation status every six months.

- Check if the UPS is faulty: Is the Fault Indicator On? Is the UPS sounding an alarm?
- Check if the UPS is operating in Bypass mode: Normally, the UPS operates in Normal Mode; if it is operating in Bypass Mode, stop and contact your local Emerson representative or Emerson Channel Support.
- Check if the battery is discharging: When the utility input is normal, the battery should not discharge. If the UPS is operating in Battery Mode, stop and contact your local Emerson representative or Emerson Channel Support.

6.5 Checking UPS Functions



NOTE

UPS function check procedures may interrupt power supply to the connected load.

Emerson recommends checking the UPS functions once every six months.

Back up the load data before conducting the UPS functions check. Procedures are as follows:

1. Press the Standby/Manual Bypass button to check whether the alarm and indicators are normal.
2. Press the On/Alarm Silence/Manual Battery Test button to check again whether the indicators are On and the UPS is operating normally.
3. Press the On/Alarm Silence/Manual Battery Test button for three seconds after Inverter Mode. The UPS should initiate battery self-test. Check to determine whether the battery is operating normally. If not, stop and contact your local Emerson representative or Emerson Channel Support.

7.0 Troubleshooting

This section indicates various UPS symptoms a user may encounter and provides a troubleshooting guide in the event the UPS develops a problem. Use the following information to determine whether external factors caused the problem and how to remedy the situation.

7.1 UPS Symptoms

The following symptoms indicate the Liebert GXT4 is malfunctioning:

- The relative indicators illuminate, indicating the UPS has detected a problem.
- An alarm buzzer sounds, alerting the user that the UPS requires attention.

7.1.1 Indicator and LCD

In addition to the fault indicator being illuminated, the LCD will display the fault. The displayed fault on the LCD is described in **Table 7-1**

Table 7-1 Description of the displayed fault

Displayed Fault	Cause	Corrective Steps
UPS self test failed	The battery is bad or weak.	Contact customer service.
UPS shutdown command received	The UPS shuts down through communication.	Contact customer service.
UPS overload	The UPS is overloaded.	Reduce the load and contact customer service.
Inverter Out of Order	The inverter is faulty.	Contact customer service.
Battery Weak/Bad	The battery is bad or weak.	Replace the battery.
Output Short Circuit	The output connection is short-circuited.	Shut down the equipment and contact customer service.
DC Bus Overvoltage	The DC bus is faulty.	Contact customer service.
UPS Overtemperature	Over-temperature occurs to the UPS and the UPS will transfer to Bypass mode.	Reduce the load and contact customer service.
Charger Out of Order	The charger is faulty.	Contact customer service.
Fan Out of Order	At least one fan is faulty.	Contact customer service.
DC Bus Discharge Fail	A DC-DC failure occurs.	Contact customer service.



NOTE

If the UPS encounters a fault and no correction attempt is performed within 2 minutes, the LCD backlight will flash (on 1 second and off 1 second) as an alert.

Press any button to exit the alert mode. If no correction attempt is performed on the UPS, the LCD backlight will flash again until the UPS fault is corrected.

7.1.2 Audible Alarm

An audible alarm will sound in conjunction with the visual indicators to indicate a change in UPS operating status. The audible alarm will sound as described in **Table 7-2**.

Table 7-2 Audible alarm description

Condition	Alarm
Battery discharge	Half-second beep every 10 seconds
Low battery	Two half-second beeps every 5 seconds
UPS fault, load on bypass	1-second beep every 4 seconds
UPS fault, no power to load	Continuous
Overload	Half-second beep every half second
Battery replacement	2-second beep every 2 minutes
Battery loss	Continuous
Wiring problem (loss of proper grounding for UPS)	Continuous
Bypass reminder	1-second beep every 60 seconds

7.2 Troubleshooting

In the event of an issue with the UPS, refer to **Table 7-3** to determine the cause and solution. If the fault persists, contact Emerson® Channel Support.

Table 7-3 Troubleshooting table

Problem	Cause	Solution
UPS fails to start	UPS is short-circuited or overloaded	Ensure UPS is Off. Disconnect all loads and ensure nothing is lodged in output receptacles. Ensure loads are not defective or shorted internally.
	Batteries are not charged enough or not connected	Check to ensure the internal battery is connected. If it is not, make the connection and try to start the unit. If the battery is connected, leave the UPS connected to input power for 24 hours to recharge batteries, then try to start the unit.
Battery indicator is illuminated	UPS is not plugged in	UPS is operating from battery mode. Ensure UPS is securely plugged into the wall receptacle.
	UPS input protection fuse has blown/opened	UPS is operating from battery mode. Save data and close applications. Replace UPS input fuse, then restart UPS.
	Mains power is out of tolerance	UPS is operating from battery mode. Save data and close applications. Ensure mains supply voltage is within acceptable limits for UPS.
UPS has reduced battery backup time	Batteries are not fully charged	Keep UPS plugged in continuously at least 24 hours to recharge batteries.
	UPS is overloaded	Check load level indicator and reduce the load on the UPS.
	Batteries may not be able to hold a full charge due to age	Replace batteries. Contact your local dealer, Emerson representative or Emerson Channel Support for replacement battery kit.
Battery indicator is flashing.	Battery source is not available; continuous horn.	Check battery connections, completely power down and restart UPS. NOTE: If the battery circuit opens while the UPS is running, it will be detected when the next battery test is performed.
Bypass indicator is flashing.	Because the voltage or frequency is outside acceptable limits, the bypass is disabled.	The AC input powers the PFC input and serves as the bypass source. If the AC is present but the voltage or frequency exceeds the acceptable range for safe operation with a load, the bypass will be disabled and this indicator will flash, indicating that the bypass is unavailable.

When reporting a UPS issue to Emerson, include the UPS model and serial number. These are located in several places for your ease of location:

- on the top panel (rack mount orientation)
- the left side (tower orientation)
- the rear panel
- on the front of the unit behind the front plastic bezel
- on the LCD select *Main Menu > About*.

Page intentionally left blank.

8.0 Specifications

Table 8-1 UPS specifications

Model #	GXT4-5000RT230 GXT4-5000RT230E	GXT4-6000RT230 GXT4-6000RT230E	GXT4-10000RT230 GXT4-10000RT230E
Rating	5000VA/4000W	6000VA/4800W	10,000VA/9000W
Dimensions, mm (in)			
Unit, W x D x H	430 x 574 x 217 (16.9 x 22.4 x 8.5)		430 x 581 x 261 (16.9 x 22.9 x 10.3)
Shipping, W x D x H	516 x 745 x 530 (20.3 x 29.3 x 20.9)		530 x 745 x 563 (20.9 x 29.3 x 22.2)
Weight, kg (lb)			
Unit	60 (132.2)		70 (154.3)
Shipping	75 (165.4); "E" model 71 (156.5)		96 (211.6); "E" model 92 (202.8)
Input AC Parameters			
Operating Frequency, Nom	50 or 60Hz (Factory Default is 50)		
Factory Default VAC	230VAC		
User-Configurable VAC	200/208/220/230/240VAC (May be modified using included configuration program)		
Operating Voltage Range Without Battery Operation	176 - 280VAC		
Maximum Allowable VAC	280VAC		
Input Frequency Without Battery Operation	40 - 70Hz		
Input Power Connection	PD2-CE6HDWRMBS Standard (See 1.4 - Removable Power Distribution Box)	PD2-CE10HDWRMBS Standard (See 1.4 - Removable Power Distribution Box)	
Output AC Parameters			
AC-AC Efficiency	92% AC-AC		
Factory Default VAC	230VAC		
Output Connections	PD2-CE6HDWRMBS Standard (See 1.4 - Removable Power Distribution Box)	PD2-CE10HDWRMBS Standard (See 1.4 - Removable Power Distribution Box)	
Frequency	50Hz or 60Hz, Nominal		
Waveform	Sinewave		
Main Mode Overload	>200% for 5 cycles; 151 - 200% for 1 seconds; 131-150% 10 seconds; 105 - 130% 1 minute		
Internal Battery Charger			
Charger Current, Amperes	1.3		2.6
Battery Parameters			
Type	Valve-regulated, non-spillable, lead acid		
Quantity x V	20 x 12V		
Battery Mfr. / Part #	5AH battery, CSB HR1221W or YUASA NPH5-12		9AH battery, CSB UPS12460F2 or CSB HR1234WF2
Backup Time	See Table 8-4 - Battery run time, minutes, all models		
Recharge Time (Internal Batteries)	5 hr. to 90% capacity after full discharge into 100% load		

Table 8-1 UPS specifications (continued)

Model #	GXT4-5000RT230 GXT4-5000RT230E	GXT4-6000RT230 GXT4-6000RT230E	GXT4-10000RT230 GXT4-10000RT230E
Bypass Protection Limits			
Disable Bypass Operation	If input voltage exceeds $\pm 15\%$ of the nominal voltage		
Re-Enable Bypass Operation	If input voltage returns to within $\pm 10\%$ of nominal output voltage		
Disable Bypass operation	When the input frequency prevents synchronous operation		
Environmental			
Operating Temperature, °C (°F)	0 to 40 (32 to 104) (no derating)		
Storage Temperature, °C (°F)	-15 to 50 (5 to 122)		
Relative Humidity	0-95% non-condensing		
Operating Elevation	Up to 1000m (3281 ft) at 25°C (77°F) without derating		
Audible Noise	<55 dBA, at 1 meter from the rear <50 dBA, at 1 meter from the front or sides		
Agency			
Safety	IEC62040-1:2008 version, GS mark		
EMI/EMC/C-Tick EMC	IEC/EN/AS 62040-2 2nd Ed (Cat 2 – Table 6)		
ESD	IEC/EN EN61000-4-2, Level 4, Criteria A		
Radiated Susceptibility	IEC/EN EN61000-4-3, Level 3, Criteria A		
Electrical Fast Transient	IEC/EN EN61000-4-4, Level 4, Criteria A		
Surge Immunity	IEC/EN EN61000-4-5, Level 3, Criteria A		
Transportation	ISTA Procedure 1E		

Table 8-2 Power distribution specifications

Model Number	PD2-CE6HDWRMBS	PD2-CE10HDWRMBS
Amp Rating	32 Amps	63 Amps
Input Power Connection	Single-phase (L-N-G) hard-wired, 6-10mm ² (8-10AWG)	
Output Power Connection	Single-phase (L-N-G) hard-wired, 6-10mm ² (8-10AWG)	
Includes:	Two IEC320 C19 16A/250V Sockets Six C13 10A/250V Sockets Manual Bypass Switch with Indicator Lamps	Four IEC320 C19 16A/250V Sockets, Four C13 10A/250V Sockets Manual Bypass Switch with Indicator Lamps
Input Branch Circuit Breaker, Supplied by User	32A	63A

Table 8-3 External battery cabinet specifications

Model Number	GXT4-240VBATT
Used with UPS Model	GXT4-5000RT230; GXT4-6000RT230; GXT4-10000RT230
Dimensions, W x D x H, mm (in.)	
Unit (with bezel)	430 x 581 x 173 (16.9 x 22.9 x 6.8)
Shipping	530 x 745 x 475 (20.9 x 29.3 x 18.7)
Weight, kg (lb)	
Unit	65 (143.3)
Shipping	80 (176.4); "E" models 76 (167.6)
Battery Parameters	
Type	Valve-regulated, non-spillable, lead acid
Quantity x V	1 x 20 x 12V
Battery Manufacturer, Part #	9AH; CSB UPS12460F2 or CSB HR1234WF2
Backup Time	See Table 8-4
Environmental	
Operating Temp, °C (°F)	0 to 40 (32 to 104)
Storage Temp, °C (°F)	-15 to 50 (5 to 122)
Relative Humidity	0-95% non-condensing
Operating Elevation	Up to 1000m (3280.83 ft.) at 25°C (77°F)
Agency	
Safety	IEC62040-1:2008 version
Transportation	ISTA Procedure 1E

Table 8-4 Battery run time, minutes, all models

Number of Batteries/Cabinets	Load Percent of Capacity	230VAC RT Models		
		5kVA	6kVA	10kVA
Internal Battery	10%	95	86	99
	20%	42	38	44
	30%	36	31	25
	40%	29	23	17
	50%	24	17	13
	60%	18	13	10
	70%	14	11	7
	80%	12	9	6
	90%	11	7	4
	100%	9	7	4
Internal Battery + 1 External Battery Cabinet	10%	273	249	209
	20%	143	116	105
	30%	107	86	63
	40%	80	61	44
	50%	64	45	34
	60%	49	36	26
	70%	38	29	21
	80%	33	24	17
	90%	29	21	14
	100%	24	18	12
Internal Battery + 2 External Battery Cabinets	10%	476	431	327
	20%	254	207	164
	30%	191	158	103
	40%	146	113	76
	50%	119	89	56
	60%	94	69	44
	70%	72	56	37
	80%	63	47	29
	90%	56	42	24
	100%	47	37	22
Internal Battery + 3 External Battery Cabinets	10%	689	627	450
	20%	374	299	221
	30%	274	226	141
	40%	211	165	105
	50%	173	130	82
	60%	137	105	65
	70%	111	88	53
	80%	97	73	43
	90%	88	64	37
	100%	74	58	33

Run times in this table are approximate. They are based on new, fully charged standard battery modules at a temperature of 25°C (77°F) with 100% resistive UPS loading. Run times listed above can vary by ±5% due to manufacturing variances of the batteries.

Table 8-4 Battery run time, minutes, all models (continued)

Number of Batteries/Cabinets	Load Percent of Capacity	230VAC RT Models		
		5kVA	6kVA	10kVA
Internal Battery + 4 External Battery Cabinets	10%	910	824	574
	20%	499	397	282
	30%	363	297	179
	40%	277	216	134
	50%	225	173	106
	60%	182	141	85
	70%	148	118	71
	80%	130	99	57
	90%	118	90	48
	100%	100	82	43
Internal Battery + 5 External Battery Cabinets	10%	1143	1033	695
	20%	626	498	345
	30%	455	371	217
	40%	345	268	164
	50%	281	213	129
	60%	224	176	106
	70%	184	148	87
	80%	163	125	74
	90%	148	114	60
	100%	125	103	55
Internal Battery + 6 External Battery Cabinets	10%	1367	1248	826
	20%	750	601	409
	30%	547	448	257
	40%	416	322	192
	50%	338	256	151
	60%	270	210	125
	70%	217	177	106
	80%	196	151	87
	90%	178	138	75
	100%	152	124	68

Run times in this table are approximate. They are based on new, fully charged standard battery modules at a temperature of 25°C (77°F) with 100% resistive UPS loading. Run times listed above can vary by ±5% due to manufacturing variances of the batteries.

Using the configuration program, the user may specify the number of GXT4-240VBATT external battery cabinets attached to the UPS. The factory default is programmed for internal batteries only.

Table 8-4 shows the estimated run times at different loads.

8.1 Auto-Learning Battery Run Times

As batteries age, the estimated run times may become less accurate. The Liebert GXT4 is programmed to “learn” from a full battery discharge and modify the estimated runtime for the measured battery capacity. This can improve accuracy and compensate for aging batteries or batteries that operate at different ambient temperatures.

The UPS will update the anticipated run time calculation only under certain conditions.

- The UPS must have a steady load that is greater than 20%.
- The UPS must be at 100% charge at the start of a battery discharge.
- The battery discharge must continue uninterrupted until the batteries reach their end-of-discharge voltage.

If all conditions are not met, the run time calculation will not be modified.

If the configuration program is used to change the number of battery cabinets, then the values in the battery above table will be restored. This will override any value that is Auto-Learned.

8.2 Product Warranty Registration

Registration is not required to activate the product warranty on a Liebert UPS. Registration is required to qualify for the Product Protection Promise. To register, visit the Emerson Network Power® Web site to fill out the online form at:

www.emersonnetworkpower.com/en-US/Forms/Pages/LiebertProductWarrantyRegistration.aspx

- To contact warranty support by e-mail: microups.warranty@emerson.com

8.3 Technical Support

Technical support contacts are listed on the back cover of this document. To contact Emerson Channel Product Support:

Phone

- NORTH AMERICA: 1-800-222-5877
- OUTSIDE NORTH AMERICA: 00-800-1155-4499

E-mail

- TECHNICAL SUPPORT: liebert.upstech@emerson.com

Technical Support / Service

Web Site

www.liebert.com

Monitoring

liebert.monitoring@emerson.com

800-222-5877

Outside North America: +00800 1155 4499

Single-Phase UPS & Server Cabinets

liebert.upstech@emerson.com

800-222-5877

Outside North America: +00800 1155 4499

Three-Phase UPS & Power Systems

800-543-2378

Outside North America: 614-841-6598

Thermal Management Systems

800-543-2778

Outside the United States: 614-888-0246

Locations

United States

1050 Dearborn Drive

P.O. Box 29186

Columbus, OH 43229

Europe

Via Leonardo Da Vinci 8

Zona Industriale Tognana

35028 Piove Di Sacco (PD) Italy

+39 049 9719 111

Fax: +39 049 5841 257

Asia

7/F, Dah Sing Financial Centre

108 Gloucester Road, Wanchai

Hong Kong

852 2572220

Fax: 852 28029250

While every precaution has been taken to ensure the accuracy and completeness of this literature, Liebert Corporation assumes no responsibility and disclaims all liability for damages resulting from use of this information or for any errors or omissions.

© 2016 Liebert Corporation

All rights reserved throughout the world.

Specifications subject to change without notice.

® Liebert is a registered trademark of Liebert Corporation. All names referred to are trademarks or registered trademarks of their respective owners.

SLI-23197_REV2_5-16

590-1367-501A

Emerson Network Power

www.emersonnetworkpower.com