



MOTOROLA®

**SEMICONDUCTOR
DATA MANUAL**

**SEMICONDUCTOR
DATA MANUAL**

MOTOROLA®

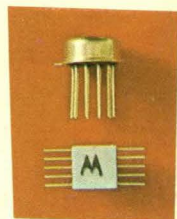
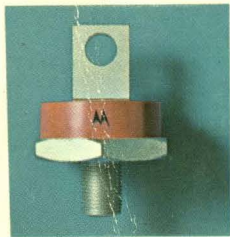
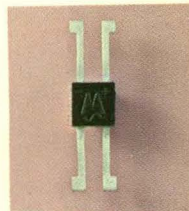
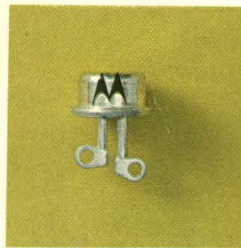
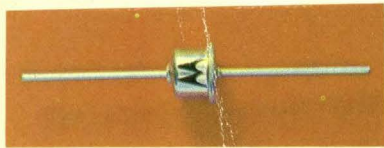
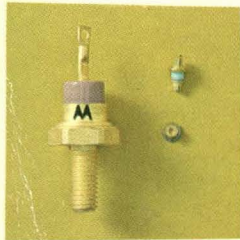
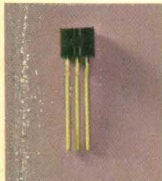
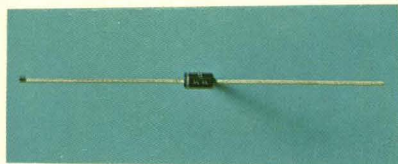
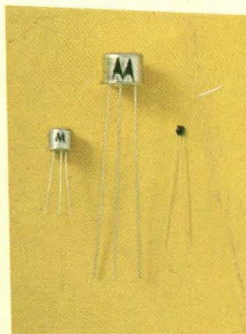
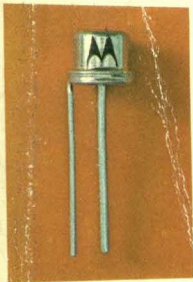

PRICE \$3.50

SILICON ZENER DIODES

SILICON RECTIFIERS

SILICON RECTIFIER ASSEMBLIES

SILICON CONTROLLED RECTIFIERS

POWER TRANSISTORS

LOW-FREQUENCY, LOW-POWER TRANSISTORS

HIGH-FREQUENCY TRANSISTORS

SPECIAL AND MULTIPLE TRANSISTORS

SPECIAL PURPOSE SILICON DIODES

INTEGRATED CIRCUITS

SEMICONDUCTOR DATA MANUAL

The information in this handbook has been carefully checked and is believed to be reliable; however, no responsibility is assumed for inaccuracies. Furthermore, such information does not convey to the purchaser of semiconductor devices described any license under the patent right of Motorola Inc. , or others.

Used throughout this Data Manual are a number of terms that are Trademarks of Motorola Inc. These include: Star, Band -Guard, MIDA, Meg-A-Life, Meg-A-Life II, Epicap, Surmetic, Compatible, 0-pf, and MECL.

© 1965, Motorola Inc.

1st printing May 1965

ABOUT THIS MANUAL

One of the major problems facing workers in the electronics field is the identification and selection of semiconductor devices. Type numbers themselves are of little value since they indicate neither device parameters nor applications. Because it is difficult even to identify the many thousands of device type numbers, let alone evaluate their merits for a particular application, engineers often limit their designs to a few well-known device types -- despite the fact that newer or more suitable devices may be available.

This manual covers the entire line of Motorola semiconductor products -- one of the most extensive in the industry. It includes specifications for semiconductor devices, including zener and reference diodes, rectifiers, varactors, voltage-variable capacitors, controlled rectifiers, transistors, integrated circuits and a variety of other standard and special devices that make up today's semiconductor complement. It is intended to simplify the selection of the most useful type numbers for a given application. Accordingly, it contains a number of selector charts, as well as pertinent electrical specifications for the Motorola product line. Properly used, it can be a useful tool for the design engineer, the component engineer, and the purchasing agent in narrowing the broad categories of potentially useable components to those best suited for a specific project.

CONTENTS

Section 1	<u>General Information</u>	
	How to Use the Motorola Semiconductor Data Manual	1-1
	Alpha-Numeric Index of Devices	1-2
	Military Type Semiconductors	1-18
	Meg-A-Life Certified Reliability Products	1-21
	Meg-A-Life II High-Reliability Products	1-22
	Device Outline Dimensions	1-26
Section 2	<u>Silicon Zener Diodes, Temperature Compensated Diodes and Reference Amplifiers</u>	
	Introduction	2-3
	Quick Selection Chart	2-4
	Zener Diode Data Sheets	2-6
	Temperature Compensated Diode Introduction	2-31
	Temperature Compensated Diode Data Sheets	2-32
	Reference Amplifiers	2-36
Section 3	<u>Silicon Rectifiers</u>	
	Introduction	3-3
	Quick Selection Chart	3-4
	Summary of Rectifier Specifications	3-6
	Data Sheets	3-8
Section 4	<u>Silicon Rectifier Assemblies</u>	
	Listing of Devices	4-1
	Introduction	4-3
	Data Sheets	4-4

Section 5	<u>Silicon Controlled Rectifiers and Gate Controlled Switches</u>	
	Listing of SCRs and GCSs	5-3
	SCR Symbols and Definitions	5-4
	Quick Selection Guide	5-5
	Summary of SCR Specifications	5-6
	Data Sheets	5-9
Section 6	<u>Power Transistors</u>	
	Introduction	6-3
	Selection Guides	6-4
	Summary of Power Transistor Specifications	6-6
	Data Sheets	6-9
Section 7	<u>Low-Frequency, Low-Power Transistors (Milliwatt)</u>	
	Introduction	7-3
	Quick Selection Guide	7-3
	Summary of Milliwatt Transistor Specifications	7-4
	Data Sheets	7-6
Section 8	<u>High-Frequency Transistors</u>	
	Listing of High-Frequency Transistors	8-3
	Listing of Preferred Silicon Transistors	8-5
	Cross Reference Guide (EIA Motorola)	8-6
	Silicon High-Speed Switching Transistor Selection Guides	8-8
	Germanium High-Speed Switching Transistor Selection Guides	8-11
	Silicon Medium-Speed Switching Transistor Selection Guides	8-14
	RF Transistor Selection Guides	8-18
	Small Signal Amplifier and Oscillator Transistor Selection Guides	8-24
	Data Sheets	8-28

Section 9	<u>Multiple and Special Transistors</u>	
	Listing of Devices	9-1
	Introduction	9-3
	Data Sheets	9-4
Section 10	<u>Special Purpose Silicon Diodes</u>	
	Silicon Varactor Diode Introduction	10-3
	Silicon Voltage-Variable Capacitance Diode Introduction	10-3
	4-Layer Diode Introduction	10-5
	RF Switching Diode Introduction	10-5
	Data Sheets	10-6
Section 11	<u>Integrated Circuits</u>	
	Digital Circuits	11-1
	Linear Circuits	11-147
Section 12	<u>Reference Material</u>	
	How to Get More Value Out of a Transistor Data Sheet	12-3
	Determining Maximum Reliable Load Lines for Power Transistors	12-13
	Factors Influencing Selection of Commercial Power Transistor Heat Sinks	12-19
	Understanding Transistor Response Parameters	12-25
	Significance of Q_T in Switching Circuits	12-27
	High-Power Varactor Diodes — Theory and Application	12-40
	Optimizing SCR Turn-Off Parameters with Negative Bias	12-50

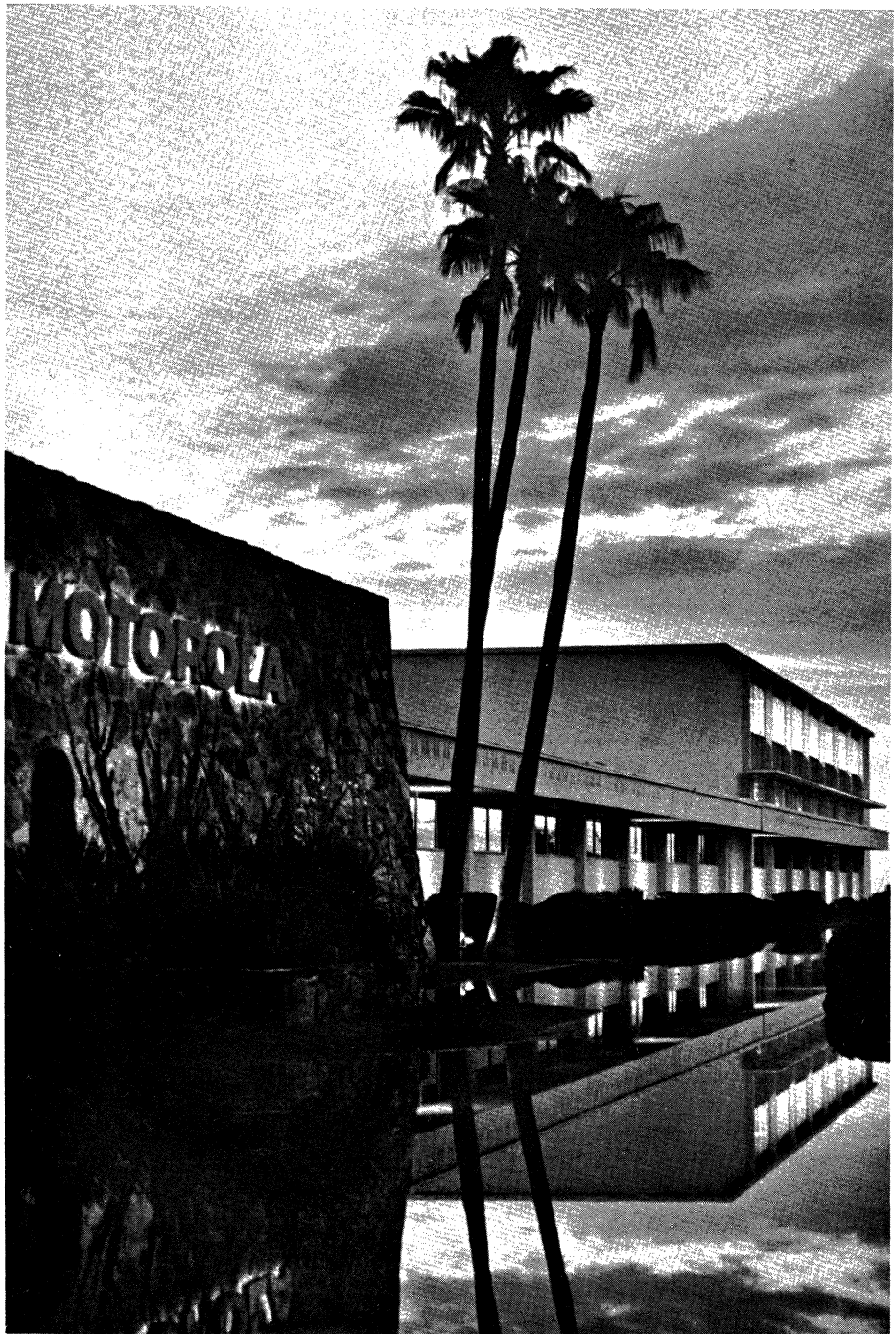

HOW TO USE THE MOTOROLA SEMICONDUCTOR DATA MANUAL

The manual is designed to serve three specific functions:

1. To permit quick selection of the most suitable devices for a specific application;
2. To permit quick selection of the devices that best meet a given set of electrical specifications;
3. To permit quick identification of a particular device number.

To accomplish this, the manual is divided into 10 main sections:

1. Zener diodes, temperature compensated reference diodes and reference amplifiers
2. Rectifiers
3. Varactors, voltage-variable capacitors, 4-layer diodes and RF diodes
4. Silicon controlled rectifiers and gate controlled switches
5. Power transistors
6. Low-power, low-frequency transistors
7. High-frequency transistors
8. Special and multiple transistors
9. Circuit assemblies
10. Integrated circuits.

Each of these sections contains data-sheet specifications of suitable device types, preceded by applicable selection charts.

An introductory section in the front of the book contains general data such as a complete numerical-alphabetical listing of device types, military device type listings, Meg-A-Life and Meg-A-Life II high-reliability device listings and case outlines.

HOW TO SOLVE YOUR SEMICONDUCTOR DEVICE SELECTION PROBLEMS

1. Known: Device type number
Needed Information: Identification, applications, and specifications
Procedure: Locate device type number in numerical -alphabetical listing (Page 1-2) and turn to the page number given for complete data.
2. Known: Desired application or device parameters.
Needed Information: Specific type numbers of devices to fit known application or parameters.
Procedure: Turn to subsection covering desired devices, (e.g., transistors; low-frequency, high-power). Consult appropriate Quick Selection Chart for device types recommended for your application, or units closely approaching the required parameters. Locate device type number listed in alphabetical-numerical order within subsection for more detailed specifications.

DEVICE INDEX

The semiconductor devices listed in this manual are arranged in product groups such as high-frequency transistors, zener diodes and integrated circuits. While this arrangement should best serve the needs of most users of this manual, there are occasions when it will be necessary to locate a device known only by type number. The following index, arranged in alpha-numeric order, will fill this need.

DEVICE LISTING

Device Type	Page	Device Type	Page	Device Type	Page
1/4M2.4AZ	2-6	1/4M6.8Z	2-6	1/4M17Z	2-6
1/4M2.7AZ	2-6	1/4M7.5Z	2-6	1/4M18Z	2-6
1/4M3.0AZ	2-6	1/4M8.2Z	2-6	1/4M19Z	2-6
1/4M3.3AZ	2-6	1/4M9.1Z	2-6	1/4M20Z	2-6
1/4M3.6AZ	2-6	1/4M10Z	2-6	1/4M22Z	2-6
1/4M3.9AZ	2-6	1/4M11Z	2-6	1/4M24Z	2-6
1/4M4.3AZ	2-6	1/4M12Z	2-6	1/4M25Z	2-6
1/4M4.7AZ	2-6	1/4M13Z	2-6	1/4M27Z	2-6
1/4M5.1AZ	2-6	1/4M14Z	2-6	1/4M30Z	2-6
1/4M5.6AZ	2-6	1/4M15Z	2-6	1/4M33Z	2-6
1/4M6.2AZ	2-6	1/4M16Z	2-6	1/4M36Z	2-6

DEVICE LISTING (continued)

Device Type	Page	Device Type	Page	Device Type	Page
1/4M39Z	2-6	3/4M82Z	2-17	1M3. 9ZS	2-28
1/4M43Z	2-6	3/4M91Z	2-17	1M4. 3ZS	2-28
1/4M45Z	2-6	3/4M100Z	2-17	1M4. 7ZS	2-28
1/4M47Z	2-6	3/4M110Z	2-17	1M5. 1ZS	2-28
1/4M50Z	2-6	3/4M120Z	2-17	1M5. 6ZS	2-28
1/4M52Z	2-6	3/4M130Z	2-17	1M6. 2ZS	2-28
1/4M56Z	2-6	3/4M150Z	2-17	1M6. 8ZS	2-28
1/4M62Z	2-6	3/4M160Z	2-17	1M7. 5ZS	2-28
1/4M68Z	2-6	3/4M180Z	2-17	1M8. 2ZS	2-28
1/4M75Z	2-6	3/4M200Z	2-17	1M9. 1ZS	2-28
1/4M82Z	2-6	1M6. 8Z	2-17	1M10ZS	2-28
1/4M91Z	2-6	1M7. 5Z	2-17	1M11ZS	2-28
1/4M100Z	2-6	1M8. 2Z	2-17	1M12ZS	2-28
1/4M105Z	2-6	1M9. 1Z	2-17	1M13ZS	2-28
1/4M110Z	2-6	1M10Z	2-17	1M15ZS	2-28
1/4M120Z	2-6	1M11Z	2-17	1M16ZS	2-28
1/4M130Z	2-6	1M12Z	2-17	1M18ZS	2-28
1/4M140Z	2-6	1M13Z	2-17	1M20ZS	2-28
1/4M150Z	2-6	1M15Z	2-17	1M22ZS	2-28
1/4M175Z	2-6	1M16Z	2-17	1M24ZS	2-28
1/4M200Z	2-6	1M18Z	2-17	1M27ZS	2-28
3/4M6. 8Z	2-17	1M20Z	2-17	1M30ZS	2-28
3/4M7. 5Z	2-17	1M22Z	2-17	1M33ZS	2-28
3/4M8. 2Z	2-17	1M24Z	2-17	1M36ZS	2-28
3/4M9. 1Z	2-17	1M27Z	2-17	1M39ZS	2-28
3/4M10Z	2-17	1M30Z	2-17	1M43ZS	2-28
3/4M11Z	2-17	1M33Z	2-17	1M47ZS	2-28
3/4M12Z	2-17	1M36Z	2-17	1M51ZS	2-28
3/4M13Z	2-17	1M39Z	2-17	1M56ZS	2-28
3/4M13Z	2-17	1M43Z	2-17	1M62ZS	2-28
3/4M15Z	2-17	1M47Z	2-17	1M68ZS	2-28
3/4M16Z	2-17	1M51Z	2-17	1M75ZS	2-28
3/4M18Z	2-17	1M56Z	2-17	1M82ZS	2-28
3/4M20Z	2-17	1M62Z	2-17	1M91ZS	2-28
3/4M22Z	2-17	1M68Z	2-17	1M100ZS	2-28
3/4M24Z	2-17	1M75Z	2-17	1. 5M6. 8Z	2-22
3/4M27Z	2-17	1M82Z	2-17	1. 5M7. 5Z	2-22
3/4M30Z	2-17	1M91Z	2-17	1. 5M8. 2Z	2-22
3/4M33Z	2-17	1M100Z	2-17	1. 5M9. 1Z	2-22
3/4M36Z	2-17	1M110Z	2-17	1. 5M10Z	2-22
3/4M39Z	2-17	1M120Z	2-17	1. 5M11Z	2-22
3/4M43Z	2-17	1M130Z	2-17	1. 5M12Z	2-22
3/4M47Z	2-17	1M150Z	2-17	1. 5M13Z	2-22
3/4M51Z	2-17	1M160Z	2-17	1. 5M15Z	2-22
3/4M56Z	2-17	1M180Z	2-17	1. 5M16Z	2-22
3/4M62Z	2-17	1M200Z	2-17	1. 5M18Z	2-22
3/4M68Z	2-17	1M3. 3ZS	2-28	1. 5M20Z	2-22
3/4M75Z	2-17	1M3. 6ZS	2-28	1. 5M22Z	2-22

DEVICE LISTING (continued)

Device Type	Page	Device Type	Page	Device Type	Page
1.5M24Z	2-22	10M30Z	2-15	50M45Z	2-13
1.5M24Z	2-22	10M33Z	2-15	50M47Z	2-13
1.5M27Z	2-22	10M36Z	2-15	50M50Z	2-13
1.5M30Z	2-22	10M39Z	2-15	50M51Z	2-13
1.5M33Z	2-22	10M43Z	2-15	50M52Z	2-13
1.5M36Z	2-22	10M47Z	2-15	50M56Z	2-13
1.5M39Z	2-22	10M50Z	2-15	50M62Z	2-13
1.5M43Z	2-22	10M51Z	2-15	50M68Z	2-13
1.5M47Z	2-22	10M52Z	2-15	50M75Z	2-13
1.5M51Z	2-22	10M56Z	2-15	50M82Z	2-13
1.5M56Z	2-22	10M62Z	2-15	50M91Z	2-13
1.5M62Z	2-22	10M68Z	2-15	50M100Z	2-13
1.5M68Z	2-22	10M75Z	2-15	50M105Z	2-13
1.5M75Z	2-22	10M82Z	2-15	50M110Z	2-13
1.5M82Z	2-22	10M91Z	2-15	50M110Z	2-13
1.5M91Z	2-22	10M100Z	2-15	50M120Z	2-13
1.5M100Z	2-22	10M105Z	2-15	50M130Z	2-13
1.5M110Z	2-22	10M110Z	2-15	50M140Z	2-13
1.5M120Z	2-22	10M120Z	2-15	50M150Z	2-13
1.5M130Z	2-22	10M130Z	2-15	50M160Z	2-13
1.5M150Z	2-22	10M140Z	2-15	50M175Z	2-13
1.5M160Z	2-22	10M150Z	2-15	50M180Z	2-13
1.5M180Z	2-22	10M160Z	2-15	50M200Z	2-13
1.5M200Z	2-22	10M180Z	2-15	1N248B	3-8
10M3.9AZ	2-24	10M200Z	2-15	1N248C	3-8
10M4.3AZ	2-24	50M6.8Z	2-13	1N249B	3-8
10M4.7AZ	2-24	50M7.5Z	2-13	1N249C	3-8
10M5.1AZ	2-24	50M8.2Z	2-13	1N250B	3-8
10M5.6AZ	2-24	50M9.1Z	2-13	1N250C	3-8
10M6.2AZ	2-24	50M10Z	2-13	1N429	2-31
10M6.8AZ	2-24	50M11Z	2-13	1N702	2-8
10M7.5AZ	2-24	50M12Z	2-13	1N703	2-8
10M6.8Z	2-15	50M13Z	2-13	1N704	2-8
10M7.5Z	2-15	50M14Z	2-13	1N705	2-8
10M8.2Z	2-15	50M15Z	2-13	1N706	2-8
10M9.1Z	2-15	50M16Z	2-13	1N707	2-8
10M10Z	2-15	50M17Z	2-13	1N708	2-8
10M11Z	2-15	50M18Z	2-13	1N709	2-8
10M12Z	2-15	50M19Z	2-13	1N710	2-8
10M13Z	2-15	50M20Z	2-13	1N711	2-8
10M14Z	2-15	50M22Z	2-13	1N712	2-8
10M15Z	2-15	50M24Z	2-13	1N713	2-8
10M16Z	2-15	50M25Z	2-13	1N714	2-8
10M18Z	2-15	50M27Z	2-13	1N715	2-8
10M19Z	2-15	50M30Z	2-13	1N716	2-8
10M20Z	2-15	50M33Z	2-13	1N717	2-8
10M22Z	2-15	50M36Z	2-13	1N718	2-8
10M24Z	2-15	50M39Z	2-13	1N719	2-8
10M27Z	2-15	50M43Z	2-13	1N720	2-8
				1N721	2-8

DEVICE LISTING (continued)

Device Type	Page	Device Type	Page	Device Type	Page
1N722	2-8	1N823	2-31	1N969	2-9
1N723	2-8	1N823A	2-31	1N970	2-9
1N724	2-8	1N825	2-31	1N971	2-9
1N725	2-8	1N825A	2-31	1N972	2-9
1N726	2-8	1N827	2-31	1N973	2-9
1N727	2-8	1N827A	2-31	1N974	2-9
1N728	2-8	1N829	2-31	1N975	2-9
1N729	2-8	1N829A	2-31	1N976	2-9
1N730	2-8	1N935	2-31	1N977	2-9
1N731	2-8	1N935A	2-31	1N978	2-9
1N732	2-8	1N935B	2-31	1N979	2-9
1N733	2-8	1N936	2-31	1N980	2-9
1N734	2-8	1N936A	2-31	1N981	2-9
1N735	2-8	1N936B	2-31	1N982	2-9
1N736	2-8	1N937	2-31	1N983	2-9
1N737	2-8	1N937A	2-31	1N984	2-9
1N738	2-8	1N938	2-31	1N985	2-9
1N739	2-8	1N938A	2-31	1N986	2-9
1N740	2-8	1N938B	2-31	1N987	2-9
1N741	2-8	1N939	2-31	1N988	2-9
1N742	2-8	1N939A	2-31	1N989	2-9
1N743	2-8	1N939B	2-31	1N990	2-9
1N744	2-8	1N941	2-31	1N991	2-9
1N745	2-8	1N941A	2-31	1N992	2-9
1N746	2-8	1N941B	2-31	1N1124	3-10
1N747	2-8	1N942	2-31	1N1124A	3-10
1N748	2-8	1N942A	2-31	1N1125	3-10
1N749	2-8	1N942B	2-31	1N1125A	3-10
1N750	2-8	1N943	2-31	1N1126	3-10
1N751	2-8	1N943A	2-31	1N1126A	3-10
1N752	2-8	1N943B	2-31	1N1127	3-10
1N753	2-8	1N944	2-31	1N1127A	3-10
1N754	2-8	1N944A	2-31	1N1128	3-10
1N755	2-8	1N944B	2-31	1N1128A	3-10
1N756	2-8	1N945	2-31	1N1183	3-10
1N757	2-8	1N945A	2-31	1N1184	3-10
1N758	2-8	1N945B	2-31	1N1185	3-10
1N759	2-8	1N957	2-9	1N1186	3-10
1N761	2-9	1N958	2-9	1N1187	3-10
1N762	2-9	1N959	2-9	1N1188	3-10
1N763	2-9	1N960	2-9	1N1189	3-10
1N764	2-9	1N961	2-9	1N1190	3-10
1N765	2-9	1N962	2-9	1N1191	3-8
1N766	2-9	1N963	2-9	1N1192	3-8
1N767	2-9	1N964	2-9	1N1193	3-8
1N768	2-9	1N965	2-9	1N1194	3-8
1N769	2-9	1N966	2-9	1N1195	3-8
1N821	2-31	1N967	2-9	1N1195A	3-8
1N821A	2-31	1N968	2-9	1N1196	3-8

DEVICE LISTING (continued)

Device Type	Page	Device Type	Page	Device Type	Page
1N1196A	3-8	1N1511	2-11	1N1605	2-11
1N1197	3-8	1N1512	2-11	1N1606	2-11
1N1197A	3-8	1N1513	2-11	1N1607	2-11
1N1198	3-8	1N1514	2-11	1N1608	2-11
1N1198A	3-8	1N1515	2-11	1N1609	2-11
1N1313	2-10	1N1516	2-11	1N1730	4-20
1N1314	2-10	1N1517	2-11	1N1731	4-20
1N1315	2-10	1N1518	2-11	1N1732	4-20
1N1316	2-10	1N1519	2-11	1N1733	4-20
1N1317	2-10	1N1520	2-11	1N1734	4-20
1N1318	2-10	1N1521	2-11	1N1735	2-31
1N1319	2-10	1N1522	2-11	1N1736	2-31
1N1320	2-10	1N1523	2-11	1N1736A	2-31
1N1321	2-10	1N1524	2-11	1N1737	2-31
1N1322	2-10	1N1525	2-11	1N1737A	2-31
1N1323	2-10	1N1526	2-11	1N1738	2-31
1N1324	2-10	1N1527	2-11	1N1738A	2-31
1N1325	2-10	1N1528	2-11	1N1739	2-31
1N1326	2-10	1N1530	2-31	1N1739A	2-31
1N1327	2-10	1N1530A	2-31	1N1740	2-31
1N1351	2-10	1N1563	3-12	1N1740A	2-31
1N1352	2-10	1N1563A	3-12	1N1741	2-31
1N1353	2-10	1N1564	3-12	1N1741A	2-31
1N1354	2-10	1N1564A	3-12	1N1742	2-31
1N1355	2-10	1N1565	3-12	1N1742A	2-31
1N1356	2-10	1N1565A	3-12	1N1765	2-11
1N1357	2-10	1N1566	3-12	1N1766	2-11
1N1358	2-10	1N1566A	3-12	1N1767	2-11
1N1359	2-10	1N1567	3-12	1N1768	2-11
1N1360	2-10	1N1567A	3-12	1N1769	2-11
1N1361	2-10	1N1568	3-12	1N1770	2-11
1N1362	2-10	1N1568A	3-12	1N1771	2-11
1N1363	2-10	1N1588	2-11	1N1772	2-11
1N1364	2-10	1N1589	2-11	1N1773	2-11
1N1365	2-10	1N1590	2-11	1N1774	2-11
1N1366	2-10	1N1591	2-11	1N1775	2-11
1N1367	2-10	1N1592	2-11	1N1776	2-11
1N1368	2-10	1N1593	2-11	1N1777	2-11
1N1369	2-10	1N1594	2-11	1N1778	2-11
1N1370	2-10	1N1595	2-11	1N1779	2-11
1N1371	2-10	1N1596	2-11	1N1780	2-11
1N1372	2-10	1N1597	2-11	1N1781	2-11
1N1373	2-10	1N1598	2-11	1N1782	2-11
1N1374	2-10	1N1599	2-11	1N1783	2-11
1N1375	2-10	1N1600	2-11	1N1784	2-11
1N1507	2-11	1N1601	2-11	1N1785	2-11
1N1508	2-11	1N1602	2-11	1N1786	2-11
1N1509	2-11	1N1603	2-11	1N1787	2-11
1N1510	2-11	1N1604	2-11	1N1788	2-11

DEVICE LISTING (continued)

Device Type	Page	Device Type	Page	Device Type	Page
1N1789	2-11	1N2009	2-12	1N2623B	2-31
1N1790	2-11	1N2010	2-12	1N2624	2-31
1N1791	2-11	1N2011	2-12	1N2624A	2-31
1N1792	2-11	1N2012	2-12	1N2624B	2-31
1N1793	2-11	1N2032	2-12	1N2765	2-31
1N1794	2-11	1N2033	2-12	1N2765A	2-31
1N1795	2-11	1N2034	2-12	1N2766	2-31
1N1796	2-11	1N2035	2-12	1N2766A	2-31
1N1797	2-11	1N2036	2-12	1N2767	2-31
1N1798	2-11	1N2037	2-12	1N2767A	2-31
1N1799	2-11	1N2038	2-12	1N2768	2-31
1N1800	2-11	1N2039	2-12	1N2768A	2-31
1N1801	2-11	1N2040	2-12	1N2769	2-31
1N1802	2-11	1N2041	2-12	1N2769A	2-31
1N1803	2-12	1N2042	2-12	1N2770	2-31
1N1804	2-12	1N2043	2-12	1N2770A	2-31
1N1805	2-12	1N2044	2-12	1N2804	2-13
1N1806	2-12	1N2045	2-12	1N2805	2-13
1N1807	2-12	1N2046	2-12	1N2806	2-13
1N1808	2-12	1N2047	2-12	1N2807	2-13
1N1809	2-12	1N2048	2-12	1N2808	2-13
1N1810	2-12	1N2049	2-12	1N2809	2-13
1N1811	2-12	1N2382	4-20	1N2810	2-13
1N1812	2-12	1N2383	4-20	1N2811	2-13
1N1813	2-12	1N2384	4-20	1N2812	2-13
1N1814	2-12	1N2385	4-20	1N2813	2-13
1N1815	2-12	1N2498	2-12	1N2814	2-13
1N1816	2-12	1N2499	2-12	1N2815	2-13
1N1817	2-12	1N2500	2-12	1N2816	2-13
1N1818	2-12	1N2609	3-13	1N2817	2-13
1N1819	2-12	1N2610	3-13	1N2818	2-13
1N1820	2-12	1N2611	3-13	1N2819	2-13
1N1821	2-12	1N2612	3-13	1N2820	2-13
1N1822	2-12	1N2613	3-13	1N2821	2-13
1N1823	2-12	1N2614	3-13	1N2822	2-13
1N1824	2-12	1N2615	3-13	1N2823	2-13
1N1825	2-12	1N2616	3-13	1N2824	2-13
1N1826	2-12	1N2617	3-13	1N2825	2-13
1N1827	2-12	1N2620	2-31	1N2826	2-13
1N1828	2-12	1N2620A	2-31	1N2827	2-13
1N1829	2-12	1N2620B	2-31	1N2828	2-13
1N1830	2-12	1N2621	2-31	1N2829	2-13
1N1831	2-12	1N2621A	2-31	1N2830	2-13
1N1832	2-12	1N2621B	2-31	1N2831	2-13
1N1833	2-12	1N2622	2-31	1N2832	2-13
1N1834	2-12	1N2622A	2-31	1N2833	2-13
1N1835	2-12	1N2622B	2-31	1N2834	2-13
1N1836	2-12	1N2623	2-31	1N2835	2-13
1N2008	2-12	1N2623A	2-31	1N2836	2-13

DEVICE LISTING (continued)

Device Type	Page	Device Type	Page	Device Type	Page
1N2837	2-13	1N3009	2-15	1N3157	2-31
1N2838	2-13	1N3010	2-15	1N3157A	2-31
1N2839	2-13	1N3011	2-15	1N3189	3-13
1N2840	2-13	1N3012	2-15	1N3190	3-13
1N2841	2-13	1N3013	2-15	1N3191	3-13
1N2842	2-13	1N3014	2-15	1N3208	3-13
1N2843	2-13	1N3015	2-15	1N3209	3-13
1N2844	2-13	1N3016	2-17	1N3210	3-13
1N2845	2-13	1N3017	2-17	1N3211	3-13
1N2846	2-13	1N3018	2-17	1N3212	3-13
1N2970	2-15	1N3019	2-17	1N3213	3-8
1N2971	2-15	1N3020	2-17	1N3214	3-8
1N2972	2-15	1N3021	2-17	1N3282	3-14
1N2973	2-15	1N3022	2-17	1N3283	3-14
1N2974	2-15	1N3023	2-17	1N3284	3-14
1N2975	2-15	1N3024	2-17	1N3285	3-14
1N2976	2-15	1N3025	2-17	1N3286	3-14
1N2977	2-15	1N3026	2-17	1N3305	2-19
1N2978	2-15	1N3027	2-17	1N3306	2-19
1N2979	2-15	1N3028	2-17	1N3307	2-19
1N2980	2-15	1N3029	2-17	1N3308	2-19
1N2981	2-15	1N3030	2-17	1N3309	2-19
1N2982	2-15	1N3031	2-17	1N3310	2-19
1N2983	2-15	1N3032	2-17	1N3311	2-19
1N2984	2-15	1N3033	2-17	1N3312	2-19
1N2985	2-15	1N3034	2-17	1N3313	2-19
1N2986	2-15	1N3035	2-17	1N3314	2-19
1N2987	2-15	1N3036	2-17	1N3315	2-19
1N2988	2-15	1N3037	2-17	1N3316	2-19
1N2989	2-15	1N3038	2-17	1N3317	2-19
1N2990	2-15	1N3039	2-17	1N3318	2-19
1N2991	2-15	1N3040	2-17	1N3319	2-19
1N2992	2-15	1N3041	2-17	1N3320	2-19
1N2993	2-15	1N3042	2-17	1N3321	2-19
1N2994	2-15	1N3043	2-17	1N3322	2-19
1N2995	2-15	1N3044	2-17	1N3323	2-19
1N2996	2-15	1N3045	2-17	1N3324	2-19
1N2997	2-15	1N3046	2-17	1N3325	2-19
1N2998	2-15	1N3047	2-17	1N3326	2-19
1N2999	2-15	1N3048	2-17	1N3327	2-19
1N3000	2-15	1N3049	2-17	1N3328	2-19
1N3001	2-15	1N3050	2-17	1N3329	2-19
1N3002	2-15	1N3051	2-17	1N3330	2-19
1N3003	2-15	1N3154	2-31	1N3331	2-19
1N3004	2-15	1N3154A	2-31	1N3332	2-19
1N3005	2-15	1N3155	2-31	1N3333	2-19
1N3006	2-15	1N3155A	2-31	1N3334	2-19
1N3007	2-15	1N3156	2-31	1N3335	2-19
1N3008	2-15	1N3156A	2-31	1N3336	2-19

— Alpha-Numerical Device Listing —

DEVICE LISTING (continued)

Device Type	Page	Device Type	Page	Device Type	Page
1N3337	2-19	1N3687	2-20	1N3818	2-21
1N3338	2-19	1N3688	2-20	1N3819	2-21
1N3339	2-19	1N3689	2-20	1N3820	2-21
1N3340	2-19	1N3690	2-20	1N3821	2-23
1N3341	2-19	1N3691	2-20	1N3822	2-23
1N3342	2-19	1N3692	2-20	1N3823	2-23
1N3343	2-19	1N3693	2-20	1N3824	2-23
1N3344	2-19	1N3694	2-20	1N3825	2-23
1N3345	2-19	1N3695	2-20	1N3826	2-23
1N3346	2-19	1N3696	2-20	1N3827	2-23
1N3347	2-19	1N3697	2-20	1N3828	2-23
1N3348	2-19	1N3698	2-20	1N3829	2-23
1N3349	2-19	1N3699	2-20	1N3830	2-23
1N3350	2-19	1N3700	2-20	1N3879	3-20
1N3491	3-15	1N3701	2-20	1N3880	3-20
1N3492	3-15	1N3702	2-20	1N3881	3-20
1N3493	3-15	1N3703	2-20	1N3882	3-20
1N3494	3-15	1N3785	2-21	1N3883	3-20
1N3495	3-15	1N3786	2-21	1N3889	3-20
1N3580	2-31	1N3787	2-21	1N3890	3-20
1N3580A	2-31	1N3788	2-21	1N3891	3-20
1N3580B	2-31	1N3789	2-21	1N3892	3-20
1N3581	2-31	1N3790	2-21	1N3893	3-20
1N3581A	2-31	1N3791	2-21	1N3993	2-24
1N3581B	2-31	1N3792	2-21	1N3994	2-24
1N3582	2-31	1N3793	2-21	1N3995	2-24
1N3582A	2-31	1N3794	2-21	1N3996	2-24
1N3582B	2-31	1N3795	2-21	1N3997	2-24
1N3611	3-17	1N3796	2-21	1N3998	2-24
1N3612	3-17	1N3797	2-21	1N3999	2-24
1N3613	3-17	1N3798	2-21	1N4000	2-24
1N3649	3-18	1N3799	2-21	1N4001	3-23
1N3650	3-18	1N3800	2-21	1N4002	3-23
1N3659	3-18	1N3801	2-21	1N4003	3-23
1N3660	3-18	1N3802	2-21	1N4004	3-23
1N3661	3-18	1N3803	2-21	1N4005	3-23
1N3662	3-18	1N3804	2-21	1N4006	3-23
1N3663	3-18	1N3805	2-21	1N4007	3-23
1N3675	2-20	1N3806	2-21	1N4099	2-25
1N3676	2-20	1N3807	2-21	1N4100	2-25
1N3677	2-20	1N3808	2-21	1N4101	2-25
1N3678	2-20	1N3809	2-21	1N4102	2-25
1N3679	2-20	1N3810	2-21	1N4103	2-25
1N3680	2-20	1N3811	2-21	1N4104	2-25
1N3681	2-20	1N3812	2-21	1N4105	2-25
1N3682	2-20	1N3813	2-21	1N4106	2-25
1N3683	2-20	1N3814	2-21	1N4107	2-25
1N3684	2-20	1N3815	2-21	1N4108	2-25
1N3685	2-20	1N3816	2-21	1N4109	2-25
1N3686	2-20	1N3817	2-21	1N4110	2-25

DEVICE LISTING (continued)

Device Type	Page	Device Type	Page	Device Type	Page
1N4111	2-25	1N4729	2-28	1N4778	2-35
1N4112	2-25	1N4730	2-28	1N4779	2-35
1N4113	2-25	1N4731	2-28	1N4780	2-35
1N4114	2-25	1N4732	2-28	1N4781	2-35
1N4115	2-25	1N4733	2-28	1N4782	2-35
1N4116	2-25	1N4734	2-28	1N4783	2-35
1N4117	2-25	1N4735	2-28	1N4784	2-35
1N4118	2-25	1N4736	2-28	2N173	6-16
1N4119	2-25	1N4737	2-28	2N174	6-9
1N4120	2-25	1N4738	2-28	2N176	6-11
1N4121	2-25	1N4739	2-28	2N178	6-13
1N4122	2-25	1N4740	2-28	2N242	6-15
1N4123	2-25	1N4741	2-28	2N277	6-16
1N4124	2-25	1N4742	2-28	2N278	6-16
1N4125	2-25	1N4743	2-28	2N297A	6-19
1N4126	2-25	1N4744	2-28	2N307	6-15
1N4127	2-25	1N4745	2-28	2N307A	6-15
1N4128	2-25	1N4746	2-28	2N319	7-6
1N4129	2-25	1N4747	2-28	2N320	7-6
1N4130	2-25	1N4748	2-28	2N321	7-6
1N4131	2-25	1N4749	2-28	2N322	7-7
1N4132	2-25	1N4750	2-28	2N323	7-7
1N4133	2-25	1N4751	2-28	2N324	7-7
1N4134	2-25	1N4752	2-28	2N331	7-8
1N4135	2-25	1N4753	2-28	2N350A	6-21
1N4370	2-8	1N4754	2-28	2N351A	6-21
1N4371	2-8	1N4755	2-28	2N375	6-23
1N4372	2-8	1N4756	2-28	2N376A	6-21
1N4386	10-6	1N4757	2-28	2N378	6-26
1N4387	10-8	1N4758	2-28	2N379	6-26
1N4388	10-9	1N4759	2-28	2N380	6-26
1N4565	2-35	1N4760	2-28	2N381	7-10
1N4566	2-35	1N4761	2-28	2N382	7-10
1N4567	2-35	1N4762	2-28	2N383	7-10
1N4568	2-35	1N4763	2-28	2N398	7-12
1N4569	2-35	1N4764	2-28	2N398A	7-12
1N4570	2-35	1N4765	2-35	2N441	6-27
1N4571	2-35	1N4766	2-35	2N442	6-27
1N4572	2-35	1N4767	2-35	2N443	6-27
1N4573	2-35	1N4768	2-35	2N459	6-26
1N4574	2-35	1N4769	2-35	2N459A	6-26
1N4719	3-24	1N4770	2-35	2N460	7-14
1N4720	3-24	1N4771	2-35	2N461	7-14
1N4721	3-24	1N4772	2-35	2N464	7-15
1N4722	3-24	1N4773	2-35	2N465	7-15
1N4723	3-24	1N4774	2-35	2N466	7-15
1N4724	3-24	1N4775	2-35	2N467	7-15
1N4725	3-24	1N4776	2-35	2N508	7-7
1N4728	2-28	1N4777	2-35	2N524	7-17

— Alpha-Numerical Device Listing —

DEVICE LISTING (continued)

Device Type	Page	Device Type	Page	Device Type	Page
2N525	7-17	2N828A	8-54	2N1162	6-40
2N526	7-17	2N829	8-54	2N1163	6-40
2N527	7-17	2N834	8-57	2N1164	6-40
2N554	6-13	2N835	8-57	2N1165	6-40
2N555	6-13	2N838	8-59	2N1166	6-40
2N618	6-23	2N869	8-61	2N1167	6-40
2N650	7-20	2N914	8-63	2N1175	7-33
2N650A	7-20	2N915	8-65	2N1185	7-25
2N651	7-20	2N916	8-67	2N1186	7-25
2N651A	7-20	2N918	8-68	2N1187	7-25
2N652	7-20	2N929	8-69	2N1188	7-25
2N652A	7-20	2N930	8-69	2N1189	7-28
2N653	7-22	2N956	8-42	2N1190	7-28
2N654	7-22	2N960	8-71	2N1191	7-30
2N655	7-22	2N961	8-71	2N1192	7-30
2N665	6-31	2N962	8-71	2N1193	7-30
2N669	6-11	2N963	8-73	2N1194	7-30
2N681	5-9	2N964	8-71	2N1195	8-83
2N682	5-9	2N964A	8-75	2N1204	8-85
2N683	5-9	2N965	8-71	2N1204A	8-85
2N684	5-9	2N966	8-71	2N1358	6-9
2N685	5-9	2N967	8-73	2N1359	6-23
2N686	5-9	2N968	8-77	2N1360	6-23
2N687	5-9	2N969	8-77	2N1362	6-23
2N688	5-9	2N970	8-77	2N1363	6-23
2N689	5-9	2N971	8-77	2N1364	6-23
2N697	8-28	2N972	8-77	2N1365	6-23
2N700	8-29	2N973	8-77	2N1408	7-32
2N700A	8-29	2N974	8-77	2N1412	6-43
2N705	8-31	2N975	8-77	2N1413	7-33
2N706	8-33	2N985	8-79	2N1414	7-33
2N706A	8-33	2N995	8-61	2N1415	7-33
2N706B	8-33	2N1008	7-24	2N1420	8-28
2N707	8-35	2N1008A	7-24	2N1494	8-85
2N707A	8-35	2N1008B	7-24	2N1494A	8-85
2N708	8-37	2N1011	6-33	2N1495	8-85
2N710	8-38	2N1073	6-35	2N1496	8-85
2N711	8-39	2N1073A	6-35	2N1529	6-46
2N711A	8-39	2N1073B	6-35	2N1530	6-46
2N711B	8-39	2N1099	6-16	2N1531	6-46
2N718	8-28	2N1100	6-9	2N1532	6-46
2N718A	8-42	2N1120	6-38	2N1533	6-46
2N722	8-44	2N1131	8-81	2N1534	6-46
2N741	8-46	2N1132	8-44	2N1535	6-46
2N741A	8-46	2N1132A	8-44	2N1536	6-46
2N744	8-48	2N1132B	8-44	2N1537	6-46
2N753	8-33	2N1141	8-83	2N1538	6-46
2N827	8-50	2N1142	8-83	2N1539	6-49
2N828	8-52	2N1143	8-83	2N1540	6-49

DEVICE LISTING (continued)

Device Type	Page	Device Type	Page	Device Type	Page
2N1541	6-49	2N1849A	5-15	2N2193B	8-91
2N1542	6-49	2N1850	5-13	2N2194	8-91
2N1543	6-49	2N1850A	5-15	2N2194A	8-91
2N1544	6-49	2N1924	7-37	2N2194B	8-91
2N1545	6-49	2N1925	7-37	2N2195	8-91
2N1546	6-49	2N1926	7-37	2N2195A	8-91
2N1547	6-49	2N1970	6-56	2N2195B	8-91
2N1548	6-49	2N1980	6-56	2N2217	8-93
2N1549	6-52	2N1981	6-56	2N2218	8-93
2N1550	6-52	2N1982	6-56	2N2218A	8-95
2N1551	6-52	2N1991	8-81	2N2219	8-93
2N1552	6-52	2N2042	7-39	2N2219A	8-95
2N1553	6-52	2N2043	7-39	2N2220	8-93
2N1554	6-52	2N2060	9-4	2N2221	8-93
2N1555	6-52	2N2060A	9-4	2N2221A	8-95
2N1556	6-52	2N2075	6-57	2N2222	8-93
2N1557	6-52	2N2076	6-57	2N2222A	8-95
2N1558	6-52	2N2077	6-57	2N2223	9-4
2N1559	6-52	2N2078	6-57	2N2223A	9-4
2N1560	6-52	2N2079	6-57	2N2256	8-99
2N1561	8-88	2N2080	6-57	2N2257	8-99
2N1562	8-88	2N2081	6-57	2N2258	8-99
2N1595	5-11	2N2082	6-57	2N2259	8-99
2N1596	5-11	2N2096	8-85	2N2303	8-44
2N1597	5-11	2N2097	8-85	2N2330	8-102
2N1598	5-11	2N2099	8-85	2N2331	8-102
2N1599	5-11	2N2100	8-85	2N2369	8-104
2N1613	8-42	2N2137	6-60	2N2381	8-107
2N1692	8-88	2N2138	6-60	2N2382	8-107
2N1693	8-88	2N2139	6-60	2N2480	9-4
2N1705	7-35	2N2140	6-60	2N2480A	9-4
2N1706	7-35	2N2141	6-60	2N2481	8-109
2N1707	7-35	2N2142	6-60	2N2490	6-67
2N1711	8-42	2N2143	6-60	2N2491	6-67
2N1842	5-13	2N2144	6-60	2N2492	6-67
2N1842A	5-15	2N2145	6-60	2N2493	6-67
2N1843	5-13	2N2146	6-60	2N2501	8-112
2N1843A	5-15	2N2152	6-63	2N2526	6-68
2N1844	5-13	2N2153	6-63	2N2527	6-68
2N1844A	5-15	2N2154	6-63	2N2528	6-68
2N1845	5-13	2N2156	6-63	2N2537	8-114
2N1845A	5-15	2N2157	6-63	2N2538	8-114
2N1846	5-13	2N2158	6-63	2N2539	8-114
2N1846A	5-15	2N2171	7-10	2N2540	8-114
2N1847	5-13	2N2192	8-91	2N2573	5-17
2N1847A	5-15	2N2192A	8-91	2N2574	5-17
2N1848	5-13	2N2192B	8-91	2N2575	5-17
2N1848A	5-15	2N2193	8-91	2N2576	5-17
2N1849	5-13	2N2193A	8-91	2N2577	5-17

— Alpha-Numerical Device Listing —

DEVICE LISTING (continued)

Device Type	Page	Device Type	Page	Device Type	Page
2N2578	5-17	2N3244	8-145	2N3444	8-155
2N2579	5-17	2N3245	8-145	2N3445	6-84
2N2630	8-115	2N3248	8-148	2N3446	6-84
2N2635	8-117	2N3249	8-148	2N3447	6-84
2N2728	6-70	2N3250	8-151	2N3448	6-84
2N2800	8-119	2N3250A	8-151	2N3467	8-190
2N2801	8-119	2N3251	8-151	2N3468	8-190
2N2832	6-72, 8-121	2N3251A	8-151	2N3480	9-9
		2N3252	8-155	2N3481	9-9
2N2833	6-72	2N3253	8-155	2N3483	9-9
2N2834	6-72, 8-121	2N3279	8-158	2N3484	9-9
		2N3280	8-158	2N3485	8-123
2N2837	8-119	2N3281	8-158	2N3485A	8-123
2N2838	8-119	2N3282	8-158	2N3486	8-123
2N2904	8-123	2N3283	8-160	2N3486A	8-123
2N2904A	8-123	2N3284	8-160	2N3493	8-193
2N2905	8-123	2N3285	8-160	2N3494	8-195
2N2905A	8-123	2N3286	8-160	2N3495	8-195
2N2906	8-123	2N3287	8-163	2N3496	8-195
2N2906A	8-123	2N3288	8-163	2N3497	8-195
2N2907	8-123	2N3289	8-163	2N3498	8-197
2N2907A	8-123	2N3290	8-163	2N3499	8-197
2N2912	6-74	2N3291	8-165	2N3500	8-197
2N2929	8-127	2N3292	8-165	2N3501	8-197
2N2947	8-129	2N3293	8-165	2N3506	8-202
2N2948	8-129	2N3294	8-165	2N3507	8-202
2N2949	8-131	2N3295	8-167	2N3508	8-204
2N2950	8-131	2N3296	8-170	2N3509	8-204
2N2951	8-133	2N3297	8-173	2N3510	8-207
2N2952	8-133	2N3298	8-176	2N3511	8-207
2N2955	8-136	2N3307	8-178	2N3544	8-210
2N2956	8-136	2N3308	8-178	2N3546	8-211
2N2957	8-136	2N3309	8-180	2N3553	8-187
2N2958	8-139	2N3309A	8-182	2N3611	6-88
2N2959	8-139	2N3311	6-81	2N3612	6-88
2N3021	6-76	2N3312	6-81	2N3613	6-88
2N3022	6-76	2N3313	6-81	2N3614	6-88
2N3023	6-76	2N3314	6-81	2N3615	6-91
2N3024	6-76	2N3315	6-81	2N3616	6-91
2N3025	6-76	2N3316	6-81	2N3617	6-91
2N3026	6-76	2N3323	8-184	2N3618	6-91
2N3115	8-139	2N3324	8-184	2N3632	8-187
2N3116	8-139	2N3325	8-184	2N3634	8-214
2N3133	8-141	2N3375	8-187	2N3635	8-214
2N3134	8-141	2N3409	9-7	2N3636	8-214
2N3135	8-141	2N3410	9-7	2N3637	8-214
2N3136	8-141	2N3411	9-7	2N3647	8-207
2N3137	8-143	2N3427	7-41	2N3648	8-207
2N3227	8-104	2N3428	7-41	2N3664	8-218

DEVICE LISTING (continued)

Device Type	Page	Device Type	Page	Device Type	Page
2N3713	6-95	MA888	7-46	MC312	11-8
2N3714	6-95	MA889	7-46	MC351	11-25
2N3715	6-95	MA909	7-48	MC352	11-33
2N3716	6-95	MA910	7-48	MC353	11-31
2N3717	8-220	MA1702	7-49	MC354	11-24
2N3718	8-220	MA1703	7-49	MC355	11-37
2N3719	6-99, 8-222	MA1704	7-49	MC356	11-25
		MA1705	7-49	MC357	11-25
2N3720	6-99, 8-222	MA1706	7-49	MC358	11-33
		MA1707	7-49	MC359	11-25
2N3742	8-225	MA1708	7-49	MC360	11-25
2N3743	8-228	MC201	11-39	MC361	11-25
2N3783	8-231	MC202	11-39	MC362	11-25
2N3784	8-231	MC203	11-41	MC401	11-143
2N3785	8-231	MC204	11-43	MC402	11-145
2N3796	9-11	MC205	11-45	MC908	11-128
2N3797	9-11	MC206	11-47	MC909	11-130
2N3798	8-234	MC207	11-49	MC910	11-132
2N3799	8-234	MC208	11-51	MC911	11-134
2N3800	9-13	MC209	11-53	MC912	11-136
2N3801	9-13	MC212	11-55	MC913	11-138
2N3802	9-13	MC213	11-57	MC921	11-141
2N3803	9-13	MC215	11-59	MC1110	11-148
2N3804	9-13	MC217	11-61	MC1111	11-114
2N3805	9-13	MC251	11-64	MC1112	11-116
2N3806	9-13	MC252	11-64	MC1113	11-118
2N3807	9-13	MC253	11-66	MC1114	11-120
2N3808	9-13	MC254	11-67	MC1115	11-122
2N3809	9-13	MC255	11-69	MC1116	11-124
2N3810	9-13	MC256	11-71	MC1117	11-124
2N3811	9-13	MC257	11-73	MC1118	11-124
2N3818	8-236	MC258	11-76	MC1513	11-153
Series 300	4-4	MC259	11-78	MC1519	11-154
MA112	7-44	MC260	11-80	MC1524	11-158
MA113	7-44	MC262	11-83	MC1525	11-162
MA114	7-44	MC263	11-85	MC1526	11-162
MA115	7-44	MC265	11-88	MC1527	11-162
MA116	7-44	MC267	11-90	MC1528	11-162
MA117	7-44	MC301	11-8	MCA1911	2-36
MA286	7-45	MC302	11-16	MCA1912	2-36
MA287	7-45	MC303	11-14	MCA1913	2-36
MA288	7-45	MC304	11-7	MCA1914	2-36
MA881	7-46	MC305	11-20	MCA1921	2-36
MA882	7-46	MC306	11-8	MCA1922	2-36
MA883	7-46	MC307	11-8	MCA1923	2-36
MA884	7-46	MC308	11-16	MCA1924	2-36
MA885	7-46	MC309	11-8	MCA1931	2-36
MA886	7-46	MC310	11-8	MCA1932	2-36
MA887	7-46	MC311	11-8	MCA1933	2-36

— Alpha-Numerical Device Listing —

DEVICE LISTING (continued)

Device Type	Page	Device Type	Page	Device Type	Page
MCA1934	2-36	MCR729-10	5-23	MCR1308-2	5-25
MCA2011	2-36	MCR808-1	5-25	MCR1308R-2	5-25
MCA2012	2-36	MCR808R-1	5-25	MCR1308-3	5-25
MCA2013	2-36	MCR808-2	5-25	MCR1308R-3	5-25
MCA2014	2-36	MCR808R-2	5-25	MCR1308-4	5-25
MCA2021	2-36	MCR808-3	5-25	MCR1308R-4	5-25
MCA2022	2-36	MCR808R-3	5-25	MCR1308-5	5-25
MCA2023	2-36	MCR808-4	5-25	MCR1308R-5	5-25
MCA2024	2-36	MCR808R-4	5-25	MCR1308-6	5-25
MCA2031	2-36	MCR808-5	5-25	MCR1308R-6	5-25
MCA2032	2-36	MCR808R-5	5-25	MCR1604-1	5-34
MCA2033	2-36	MCR808-6	5-25	MCR1604R-1	5-34
MCA2034	2-36	MCR808R-6	5-25	MCR1604-2	5-34
MCA2111	2-36	MCR846-1	5-28	MCR1604R-2	5-34
MCA2112	2-36	MCR846-2	5-28	MCR1604-3	5-34
MCA2113	2-36	MCR846-3	5-28	MCR1604R-3	5-34
MCA2114	2-36	MCR846-4	5-28	MCR1604-4	5-34
MCA2121	2-36	MCR914-1	5-11	MCR1604R-4	5-34
MCA2122	2-36	MCR914-2	5-11	MCR1604-5	5-34
MCA2123	2-36	MCR914-3	5-11	MCR1604R-5	5-34
MCA2124	2-36	MCR914-4	5-11	MCR1604-6	5-34
MCA2131	2-36	MCR914-5	5-11	MCR1604R-6	5-34
MCA2132	2-36	MCR914-6	5-11	MCR1605-1	5-34
MCA2133	2-36	MCR1304-1	5-34	MCR1605R-1	5-34
MCA2134	2-36	MCR1304R-1	5-34	MCR1605-2	5-34
MCA2211	2-36	MCR1304-2	5-34	MCR1605R-2	5-34
MCA2212	2-36	MCR1304R-2	5-34	MCR1605-3	5-34
MCA2213	2-36	MCR1304-3	5-34	MCR1605R-3	5-34
MCA2214	2-36	MCR1304R-3	5-34	MCR1605-4	5-34
MCA2221	2-36	MCR1304-4	5-34	MCR1605R-4	5-34
MCA2222	2-36	MCR1304R-4	5-34	MCR1605-5	5-34
MCA2223	2-36	MCR1304-5	5-34	MCR1605R-5	5-34
MCA2224	2-36	MCR1304R-5	5-34	MCR1605-6	5-34
MCA2231	2-36	MCR1304-6	5-34	MCR1605R-6	5-34
MCA2232	2-36	MCR1304R-6	5-34	MCR1718-5	5-30
MCA2233	2-36	MCR1305-1	5-34	MCR1718-6	5-30
MCA2234	2-36	MCR1305R-1	5-34	MCR1718-7	5-30
MCR649-1	5-20	MCR1305-2	5-34	MCR1718-8	5-30
MCR649-2	5-20	MCR1305R-2	5-34	MCR1907-1	5-32
MCR649-3	5-20	MCR1305-3	5-34	MCR1907-2	5-32
MCR649-4	5-20	MCR1305R-3	5-34	MCR1970-3	5-32
MCR649-5	5-20	MCR1305-4	5-34	MCR1970-4	5-32
MCR649-6	5-20	MCR1305R-4	5-34	MCR1970-5	5-32
MCR649-7	5-20	MCR1305-5	5-34	MCR1970-6	5-32
MCR729-5	5-23	MCR1305R-5	5-34	MCR2304-1	5-34
MCR729-6	5-23	MCR1305-6	5-34	MCR2304R-1	5-34
MCR729-7	5-23	MCR1305R-6	5-34	MCR2304-2	5-34
MCR729-8	5-23	MCR1308-1	5-25	MCR2304R-2	5-34
MCR729-9	5-23	MCR1308R-1	5-25	MCR2304-3	5-34

DEVICE LISTING (continued)

Device Type	Page	Device Type	Page	Device Type	Page
MCR2304R-3	5-34	MD985	9-21	MDA950-6	4-10
MCR2304-4	5-34	MD986	9-23	MDA950-7	4-10
MCR2304R-4	5-34	MD990	9-25	MDA952-1	4-13
MCR2304-5	5-34	MD1120	9-27	MDA952-2	4-13
MCR2304R-5	5-34	MD1121	9-27	MDA952-3	4-13
MCR2304-6	5-34	MD1122	9-27	MDA952-4	4-13
MCR2304R-6	5-34	MD1123	9-29	MDA952-5	4-13
MCR2305-1	5-34	MD1124	9-29	MDA952-6	4-13
MCR2305R-1	5-34	MD1125	9-29	MDA962-1	4-13
MCR2305-2	5-34	MD1126	9-31	MDA962-2	4-13
MCR2305R-2	5-34	MD1127	9-31	MDA962-3	4-13
MCR2305-3	5-34	MD1128	9-33	MDA962-4	4-13
MCR2305R-3	5-34	MD1129	9-35	MDA962-5	4-13
MCR2305-4	5-34	MD1130	9-37	MDA1330	4-16
MCR2305R-4	5-34	MD1131	9-39	MDA1331	4-16
MCR2305-5	5-34	MD1132	9-41	MDA1332	4-16
MCR2305R-5	5-34	MD1133	9-43	MDA1333	4-16
MCR2305-6	5-34	MD1134	9-45	MDA1491-1	4-13
MCR2305R-6	5-34	MDA920-1	4-10	MDA1491-2	4-13
MCR2604-1	5-34	MDA920-2	4-10	MDA1491-3	4-13
MCR2604R-1	5-34	MDA920-3	4-10	MDA1491-4	4-13
MCR2604-2	5-34	MDA920-4	4-10	MDA1491-5	4-13
MCR2604R-2	5-34	MDA920-5	4-10	MDA1491-6	4-13
MCR2604-3	5-34	MDA920-6	4-10	MDA1505-1	4-13
MCR2604R-3	5-34	MDA920-7	4-10	MDA1505-2	4-13
MCR2604-4	5-34	MDA930-1	4-10	MDA1505-3	4-13
MCR2604R-4	5-34	MDA930-2	4-10	MDA1505-4	4-13
MCR2604-5	5-34	MDA930-3	4-10	MDA1505-5	4-13
MCR2604R-5	5-34	MDA930-4	4-10	MDA1505-6	4-13
MCR2604-6	5-34	MDA930-5	4-10	MDA1591-1	4-13
MCR2604R-6	5-34	MDA930-6	4-10	MDA1591-2	4-13
MCR2605-1	5-34	MDA930-7	4-10	MDA1591-3	4-13
MCR2605R-1	5-34	MDA940-1	4-10	MDA1591-4	4-13
MCR2605-2	5-34	MDA940-2	4-10	MDA1591-5	4-13
MCR2605R-2	5-34	MDA940-3	4-10	MDA1591-6	4-13
MCR2605-3	5-34	MDA940-4	4-10	ME1 USN	11-93
MCR2605R-3	5-34	MDA940-5	4-10	ME2 USN	11-96
MCR2605-4	5-34	MDA940-6	4-10	ME3 USN	11-99
MCR2605R-4	5-34	MDA940-7	4-10	ME4 USN	11-102
MCR2605-5	5-34	MDA942-1	4-13	ME5 USN	11-104
MCR2605R-5	5-34	MDA942-2	4-13	ME6 USN	11-107
MCR2605-6	5-34	MDA942-3	4-13	ME7 USN	11-109
MCR2605R-6	5-34	MDA942-4	4-13	ME8 USN	11-111
MCS2135	8-238	MDA942-5	4-13	MF812	8-242
MCS2136	8-238	MDA942-6	4-13	MF832	8-243
MCS2137	8-240	MDA950-1	4-10	MGCS821-1	5-37
MCS2138	8-240	MDA950-2	4-10	MGCS821-2	5-37
MD981	9-15	MDA950-3	4-10	MGCS821-3	5-37
MD982	9-17	MDA950-4	4-10	MGCS821-4	5-37
MD984	9-19	MDA950-5	4-10	MGCS821-5	5-37

DEVICE LISTING (continued)

Device Type	Page	Device Type	Page	Device Type	Page
MGCS821-6	5-37	MR1030	3-24	MR1261	3-36
MGCS924-1	5-41	MR1031	3-24	MR1262	3-36
MGCS924-2	5-41	MR1032	3-24	MR1263	3-36
MGCS924-3	5-41	MR1033	3-24	MR1264	3-36
MGCS924-4	5-41	MR1034	3-24	MR1265	3-36
MGCS924-5	5-41	MR1035	3-24	MR1266	3-36
MGCS924-6	5-41	MR1036	3-24	MR1267	3-36
MGCS925-1	5-41	MR1038	3-24	MR1290	3-38
MGCS925-2	5-41	MR1040	3-24	MR1291	3-38
MGCS925-3	5-41	MR1200	3-26	MR1292	3-38
MGCS925-4	5-41	MR1201	3-26	MR1293	3-38
MGCS925-5	5-41	MR1202	3-26	MR1294	3-38
MGCS925-6	5-41	MR1203	3-26	MR1295	3-38
MM1803	8-143	MR1204	3-26	MR1296	3-38
MM1941	8-244	MR1205	3-26	MR1297	3-38
MM1943	8-246	MR1206	3-26	MR1337-1	3-40
MM2090	9-47	MR1207	3-26	MR1337-2	3-40
MM2091	9-47	MR1210	3-28	MR1337-3	3-40
MM2092	9-50	MR1211	3-28	MR1337-4	3-40
MM2503		MR1212	3-28	MR1337-5	3-40
MM2550	8-248	MR1213	3-28	MV1808	10-11
MM2552	8-250	MR1214	3-28	MV1864A	10-13
MM2554	8-252	MR1215	3-28	MV1866	10-14
MM2894	8-254	MR1216	3-28	MV1868	10-14
MP500	8-256	MR1217	3-28	MV1870	10-16
MP501	6-102	MR1220	3-30	MV1871	10-14
MP502	6-102	MR1221	3-30	MV1872	10-17
MP504	6-102	MR1222	3-30	MV1874	10-16
MP505	6-102	MR1223	3-30	MV1876	10-19
MP506	6-102	MR1224	3-30	MV1877	10-14
MP2060	6-102	MR1225	3-30	MV1878	10-16
MP2061	6-104	MR1226	3-30	MV1892	10-21
MP2062	6-104	MR1227	3-30	M4L2052	10-22
MP2063	6-104	MR1230	3-32	M4L2053	10-22
MPS706	6-104	MR1231	3-32	M4L2054	10-22
MPS834	8-259	MR1232	3-32		
MPS918	8-261	MR1233	3-32		
MPS2894	8-263	MR1234	3-32		
MPS2923	8-265	MR1235	3-32		
MPS2924	8-267	MR1236	3-32		
MPS2925	8-267	MR1237	3-32		
MPS3563	8-267	MR1240	3-34		
MPS3639	8-263	MR1241	3-34		
MPS3640	8-268	MR1242	3-34		
MR322	8-271	MR1243	3-34		
MR323	3-15	MR1244	3-34		
MR324	3-15	MR1245	3-34		
MR325	3-15	MR1246	3-34		
MR326	3-15	MR1247	3-34		
	3-15	MR1260	3-36		

MILITARY TYPE SEMICONDUCTORS

Motorola offers a number of semiconductor devices that comply with the terms of military specifications. The following table lists these devices, the applicable military specifications and the appropriate page in the data sections of this manual. For additional information, military-type data sheets are available.

SILICON ZENER DIODES		page
USN 1N746A thru USN 1N759A	MIL-S-19500/127C	2-8
USN 1N962B thru USN 1N984B	MIL-S-19500/117B	2-9
JAN 1N2804B thru JAN 1N2811B	MIL-S-19500/114B	2-13
JAN 1N2813B	MIL-S-19500/114B	2-13
JAN 1N2814B	MIL-S-19500. 114B	2-13
JAN 1N2816B	MIL-S-19500/114B	2-13
JAN 1N2818B thru JAN 1N28020B	MIL-S-19500/114B	2-13
JAN 1N2822B thru JAN 1N2827B	MIL-S-19500/114B	2-13
JAN 1N2838B	MIL-S-19500/114B	2-13
JAN 1N2840B thru JAN 1N2846B	MIL-S-19500/114B	2-13
JAN 1N2970B thru JAN 1N2977B	MIL-S-19500/124C	2-15
JAN 1N2979B	MIL-S-19500/124C	2-15
JAN 1N2980B	MIL-S-19500/124C	2-15
JAN 1N2982B	MIL-S-19500/124C	2-15
JAN 1N2984B	MIL-S-19500/124C	2-15
JAN 1N2988B thru JAN 1N2993B	MIL-S-19500/124C	2-15
JAN 1N2995B thru JAN 1N2997B	MIL-S-19500/124C	2-15
JAN 1N2999B thru JAN 1N3005B	MIL-S-19500/124C	2-15
JAN 1N3007B thru JAN 1N3009B	MIL-S-19500/124C	2-15
JAN 1N3011B	MIL-S-19500/124C	2-15
JAN 1N3012B	MIL-S-19500/124C	2-15
JAN 1N3014B	MIL-S-19500/124C	2-15
JAN 1N3015B	MIL-S-19500/124C	2-15
USN 1N3016B thru USN 1N3051B	MIL-S-19500/115D	2-17
USN 1N3821A thru USN 1N3828A	MIL-S-19500/115D	2-23
USA 1N3993A thru USA 1N4000A	MIL-S-19500/272	2-24
USN 1N4370A thru USN 1N4372A	MIL-S-19500/127C	2-8

SILICON REFERENCE DIODES

JAN 1N429	MIL-S-19500/229	2-32
USN 1N821	MIL-S-19500/229	2-32
USN 1N823	MIL-S-19500/229	2-32
USN 1N825	MIL-S-19500/229	2-32
USN 1N827	MIL-S-19500/229	2-32
USN 1N829	MIL-S-19500/229	2-32
USN 1N935B	MIL-S-19500/156B	2-32
USN 1N937B	MIL-S-19500/156B	2-32
USN 1N938B	MIL-S-19500/156B	2-32
USN 1N941B	MIL-S-19500/157C	2-32
USN 1N943B	MIL-S-19500/157C	2-32
USN 1N944B	MIL-S-19500/157C	2-32
USN 1N3154 thru USN 1N3157	MIL-S-19500/158C	2-32

SILICON RECTIFIERS

USN 1N3611 thru USN 1N3613	MIL-S-19500/228B	3-17
----------------------------	------------------	------

POWER TRANSISTORS

JAN 2N174	MIL-T-19500/13A	6-9
JAN 2N297A	MIL-T-19500/36B	6-19
JAN 2N665	MIL-S-19500/58C	6-31
USA 2N1011	MIL-T-19500/67	6-33
USA 2N1120	MIL-T-19500/68	6-38
USN 2N1165	MIL-S-19500/178B	6-40
USN 2N1358	MIL-S-19500/122A	6-9
USN 2N1412	MIL-S-19500/76	6-43

MILLIWATT TRANSISTORS

JAN 2N331	MIL-S-19500/4C	7-8
USN 2N398	MIL-S-19500/174	7-12
USAF 2N461	MIL-T-19500/45	7-14
USA 2N465	MIL-T-19500/50A	7-15
JAN 2N466	MIL-S-19500/51D	7-15
USA 2N467	MIL-T-19500/52B	7-15
JAN 2N526	MIL-S-19500/60D	7-17
USN 2N650A thru USN 652A	MIL-S-19500/175A	7-20

HIGH-FREQUENCY TRANSISTORS

USA 2N700A	MIL-S-19500/123	8-29
USN 2N705	MIL-S-19500/86	8-31
JAN 2N706	MIL-S-19500/120A	8-33
USN 2N962	MIL-S-19500/258A	8-71
USN 2N964	MIL-S-19500/258A	8-71
USN 2N1131	MIL-S-19500/177A	8-81
USN 2N1132	MIL-S-19500/177A	8-44
USN 2N1142	MIL-S-19500/87	8-83
USN 2N1195	MIL-S-19500/71C	8-83
USA 2N2218	MIL-S-19500/251D	8-93
USA 2N2218A	MIL-S-19500/251D	8-95
USA 2N2219	MIL-S-19500/251D	8-93
USA 2N2219A	MIL-S-19500/251D	8-95
USA 2N2221	MIL-S-19500/255D	8-93
USA 2N2221A	MIL-S-19500/255D	8-95
USA 2N2222	MIL-S-19500/255D	8-93
USA 2N2222A	MIL-S-19500/255D	8-95
USN 2N2481	MIL-S-19500/268A	8-109
USA 2N2904, A thru USA 2N2907, A	MIL-S-19500/290A	8-123

INTEGRATED CIRCUITS

USN ME 1	MIL-M-23700/1	11-93
USN ME 2	MIL-M-23700/2	11-96
USN ME 3	MIL-M-23700/3	11-99
USN ME 4	MIL-M-23700/4	11-102
USN ME 5	MIL-M-23700/5	11-104
USN ME 6	MIL-M-23700/6	11-107
USN ME 7	MIL-M-23700/7	11-109
USN ME 8	MIL-M-23700/8	11-111

MEG-A-LIFE CERTIFIED RELIABILITY ASSURANCE

Motorola's pioneering reliability assurance program, "Meg-A-Life", offers germanium industrial transistors with certified reliability. Starting with germanium transistors from established production lines of known high-reliability, each Meg-A-Life production lot must pass a series of electrical, mechanical, environmental and life acceptance tests. The details of these tests, including the quality control limits, are fully specified on the special Meg-A-Life specification sheets available for each device type.

The customer who specified Meg-A-Life transistors receives devices that are guaranteed to meet published specifications within stated quality control limits. With the purchase of 100 or more Meg-A-Life devices, the customer can request a certificate guaranteeing that the actual production lot from which the devices are shipped passed the acceptance tests. In addition, a copy of the actual test data is available to the customer's quality control department.

This certified assurance of critical transistor parameters, in effect, provides the customer with his own quality control inspector within the transistor manufacturing facility.

Meg-A-Life transistors are indicated by the addition of the suffix "A" to the corresponding basic type number. Since Meg-A-Life transistors are electrically identical to the standard versions, the data pages referenced in the following table provide device characterization.

<u>Meg-A-Life Power Transistors</u>	<u>Page</u>
2N1162A thru 2N1167A	6-40
2N1529A thru 2N1532A	6-46
2N1534A thru 2N1537A	6-46
2N1539A thru 2N1542A	6-49
2N1544A thru 2N1547A	6-49
2N1549A thru 2N1560A	6-52
2N2075A thru 2N2082A	6-57
2N2137A thru 2N2146A	6-60
2N2152A thru 2N2154A	6-63
2N2156A thru 2N2158A	6-63
MP500A thru MP502A	6-102
MP504A thru MP506A	6-102
 <u>Meg-A-Life Milliwatt Transistors</u>	
2N524A thru 2N527A	7-17
2N650A thru 2N652A	7-20
2N2042A thru 2N2043A	7-39

MEG-A-LIFE II

A Realistic Approach to High Reliability Assurance

Motorola has instituted the Meg-A-Life II program in order to provide its customers with high-reliability semiconductors at the lowest possible cost and with the shortest possible delivery cycle. Starting with devices from production lines with known histories of reliability, Meg-A-Life II adds testing and processing operations designed to provide three ascending levels of reliability assurance, Level 1, Level 2, and Level 3.

All three levels of Meg-A-Life II devices undergo reliability processing and screening designed to stabilize device parameters and eliminate failure-prone units. For level 2 devices, burn-in at rated load conditions followed by intensive screening is added. In addition to these steps, level 3 units receive individual lot acceptance testing, including life testing, to military or comparable specifications.

Reliability data, including a certificate of compliance and test results, is available on all Meg-A-Life II devices. (For level 3 devices, the reliability data is for the actual lot from which the devices are shipped. For levels 1 and 2, the data is from the most recent lot of continuous production which has completed acceptance tests.)

The most significant feature of the Meg-A-Life II program is that it provides the required level of reliability assurance with a minimum of cost and delivery delay. The cost is low because the cost of acceptance testing is spread over many units and prorated by order size. Delivery is rapid and "on schedule" because much of the testing and processing, including the time consuming life testing, is performed before receipt of the customer's order.

For more detailed information, send for the brochure, "The Meg-A-Life II Program".

The Motorola Meg-A-Life II Program currently applies to a selected number of zener diodes and high-frequency transistors. These devices are electrically similar to the standard versions listed in the data sections of this manual. The following table lists currently available Meg-A-Life II devices and references the appropriate page in this manual for electrical data.

<u>Meg-A-Life II Zener Diodes</u>	<u>Page</u>
1N746A thru 1N759A	2-8
1N962B thru 1N984B	2-9
1N2970B thru 1N3015B	2-15
1N3016B thru 1N3051B	2-17
1N3821A thru 1N3828A	2-23
1N4370A thru 1N4372A	2-8
<u>Meg-A-Life II High-Frequency Transistors</u>	
2N2218 thru 2N2219	8-93
2N2218A thru 2N2219A	8-95
2N2221 thru 2N2222	8-93
2N2221A thru 2N2222A	8-95
2N2904, A thru 2N2907, A	8-123

MEG-A-LIFE II PROCESSING FOR HIGH-RELIABILITY ASSURANCE WITH THREE LEVELS OF RELIABILITY ASSURANCE

(LISTINGS BENEATH BOXES ARE TESTS PERFORMED ON 2N2904 SERIES OF PNP SILICON EPITAXIAL STAR* TRANSISTORS)

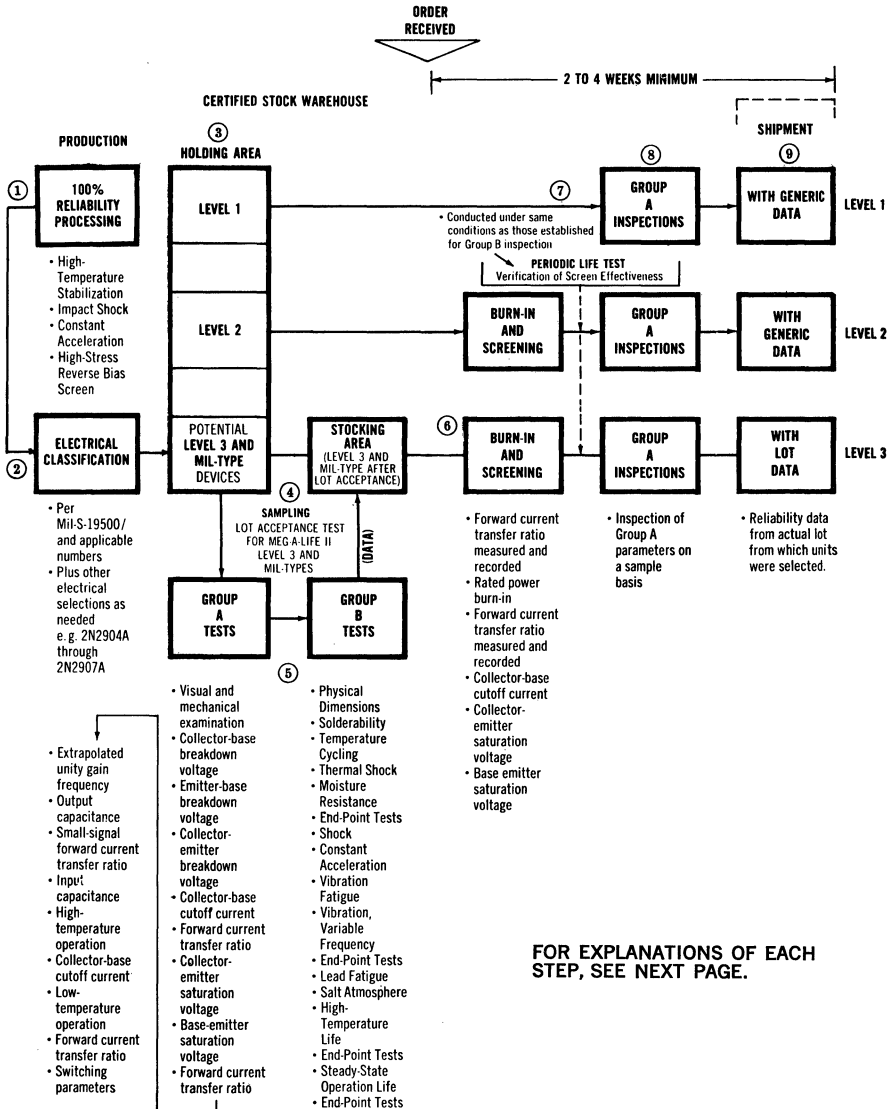

① 100% RELIABILITY PROCESSING

Potential Meg-A-Life II devices are subjected to 100 per cent reliability processing using conditioning steps specifically selected for each type of device.

② PARAMETER CLASSIFYING BY TYPE

Devices that pass 100 per cent reliability processing are submitted to final testing of electrical parameters where classification by types is made.

③ MAINTAINING LOT IDENTITY

The lot is divided into two sections which are moved into the holding area of a certified stock warehouse. Both sections of the lot are identified with a common lot number. One section is used to fill immediate orders for Meg-A-Life II Levels 1 and 2 devices (accompanied by generic Group B test results).

The second section is held intact pending satisfactory completion of lot acceptance tests. After the tests are satisfactorily completed, this second section is transferred to a stocking area in the warehouse from which Motorola can then offer military type devices or potential Meg-A-Life II Level 3 (accompanied by lot Group B test results). Individual lot identity is carefully maintained throughout the entire process.

④ LTPD SAMPLING

The generic data provided with Level 1 and 2 devices is drawn from samples which are taken from a production run during a specific period of time or from a process batch (lot). If you order 10-watt zener diodes under the Meg-A-Life II program, for example, the sample is randomly selected only from the lines producing those diodes, rather than from all zener diode lines. Further, sampling is done on a regular basis. Sampling is based on the Lot Tolerance Percent Defective (LTPD) technique.

⑤ LOT ACCEPTANCE TESTS

Lot acceptance tests consist of Group A inspections (electrical characteristics per military specification or equivalent) and Group B inspections (environmental and life tests per military specification or equivalent). Where an applicable military specification does not exist, an equivalent specification in Mil format is developed.

Group B inspections include a 1000-hour life test at specified conditions.

This lot acceptance testing means that your order starts with devices having a higher assurance of reliability prior to initiating the other Meg-A-Life II screening measures than that which many users are receiving as an end product under other reliability assurance programs. Also it takes less time to fill your order because the mechanical, environmental, and 1000-hour life tests have already been completed.

Effectiveness of the screens is frequently checked by comparing the lot acceptance test data with the screen verification test data obtained later.

⑥ **SCREENING FOR HIGHER RELIABILITY**

After receipt of order, all Level 2 and 3 products undergo burn-in and screening steps to further condition the devices for assurance of a higher degree of reliability (see pages 9 and 10).

The screening procedures used are selected specifically for the type of device ordered. Their selection is based upon a thorough knowledge of the behavior of the devices and the procedures which will accelerate known failure modes. However, when ordering Level 2 or 3 products, you may elect to specify special burn-in and screening steps based upon your particular application.

⑦ **VERIFYING SCREEN EFFECTIVENESS**

This program of failure evaluation and feedback permits design and production improvements. Naturally, these improvements make the device impervious to certain of the failure modes for which the screening was originally selected. As a result, the screens may be changed when so indicated by this analysis and feedback.

Verification of screen effectiveness is determined by periodically conducting follow-on operating life tests on previously screened devices. These life tests are conducted under the same conditions as those established for Group B inspection. This permits a direct comparison of the results before and after screening.

⑧ **PRE-SHIPMENT GROUP A INSPECTION**

All three levels receive a Group A inspection based on your electrical requirements prior to shipment.

⑨ **CERTIFICATE OF COMPLIANCE**

Under Motorola's Meg-A-Life II program you may specify three levels of reliability assurance.

A Certificate of Compliance is provided with each order. This certificate attests to the fact that the devices were processed in conformance with the specifications of the Motorola Meg-A-Life II program.

MOTOROLA DEVICE OUTLINE DIMENSIONS

All dimensions are in inches.

TO-3 PACKAGE
CASE 1, 3, 11

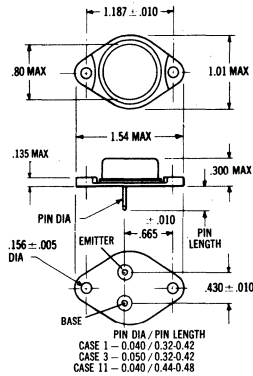

TO-41 PACKAGE
CASE 4, 16

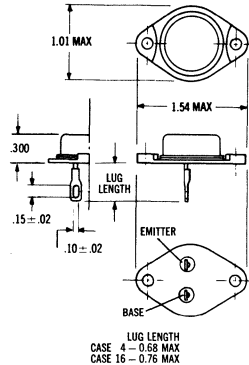

TO-36 PACKAGE
CASE 5, 6, 7

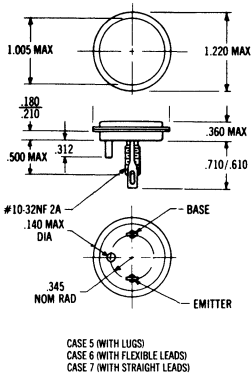

CASE 8

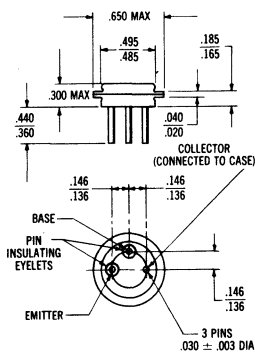

TO-61 PACKAGE
CASE 9

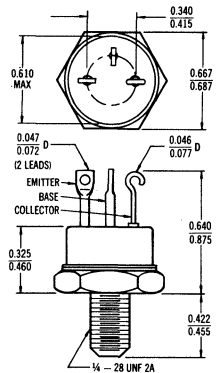

TO-17 PACKAGE
CASE 21

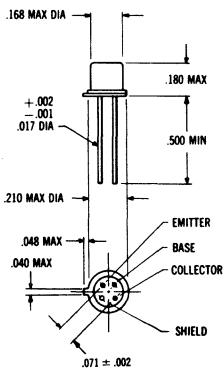

TO-18 PACKAGE
CASE 22

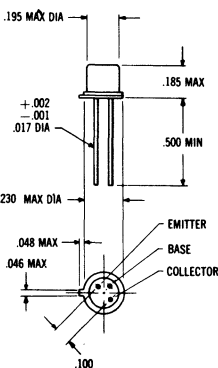

CASE 24

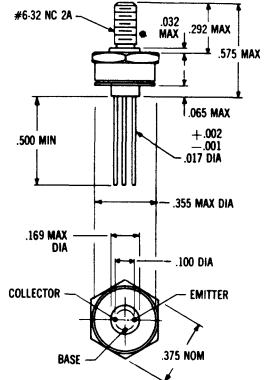

OUTLINE DIMENSIONS (continued)

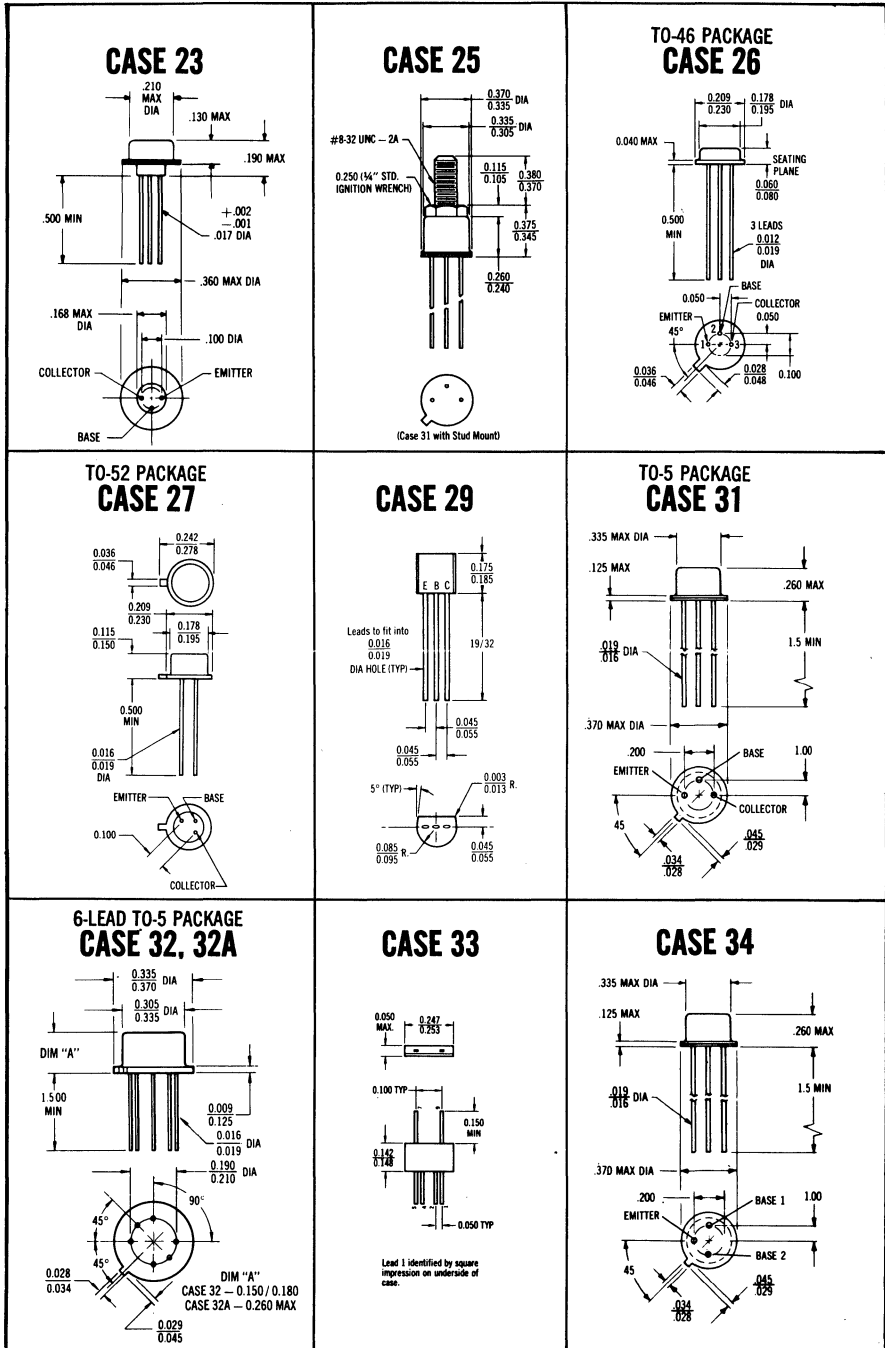

OUTLINE DIMENSIONS (continued)

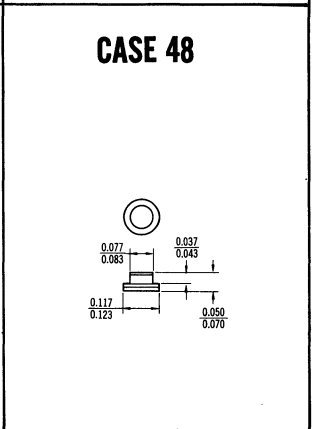
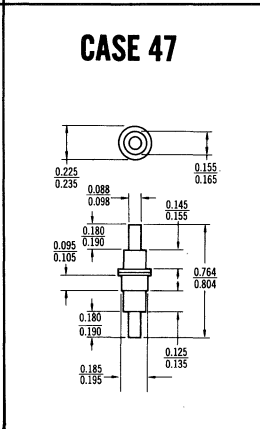
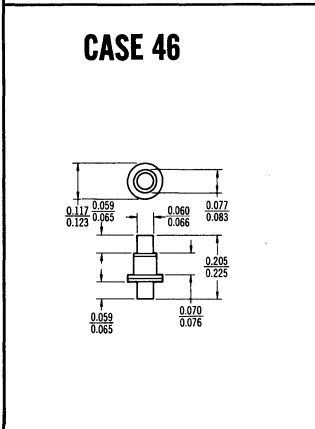
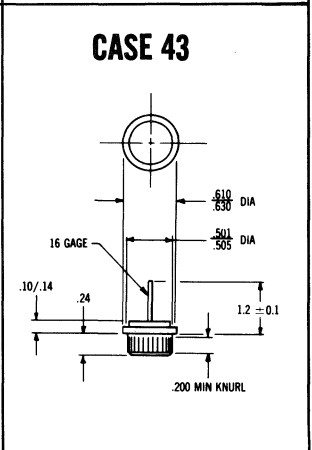
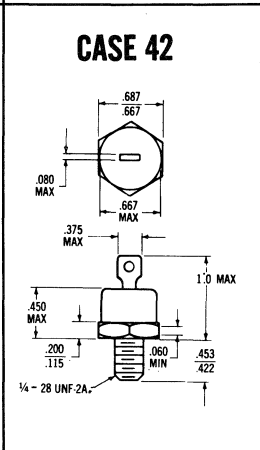
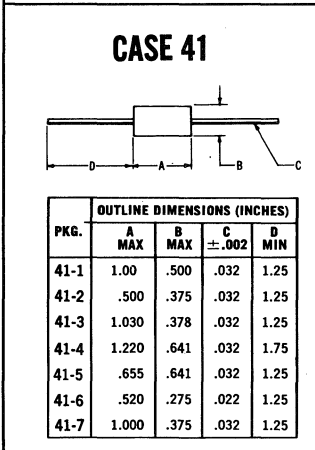
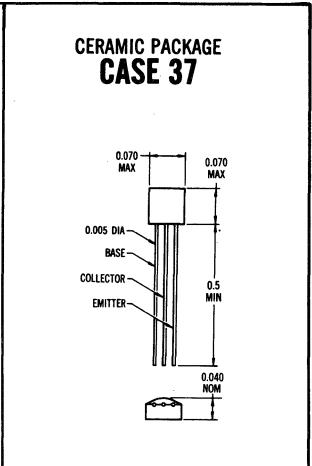
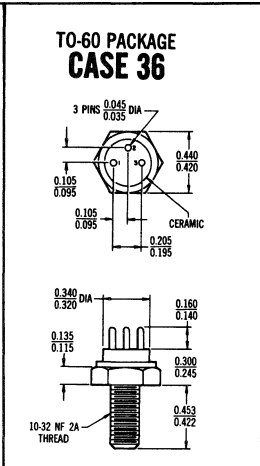
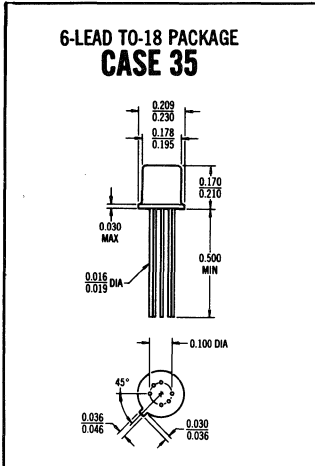

OUTLINE DIMENSIONS (continued)

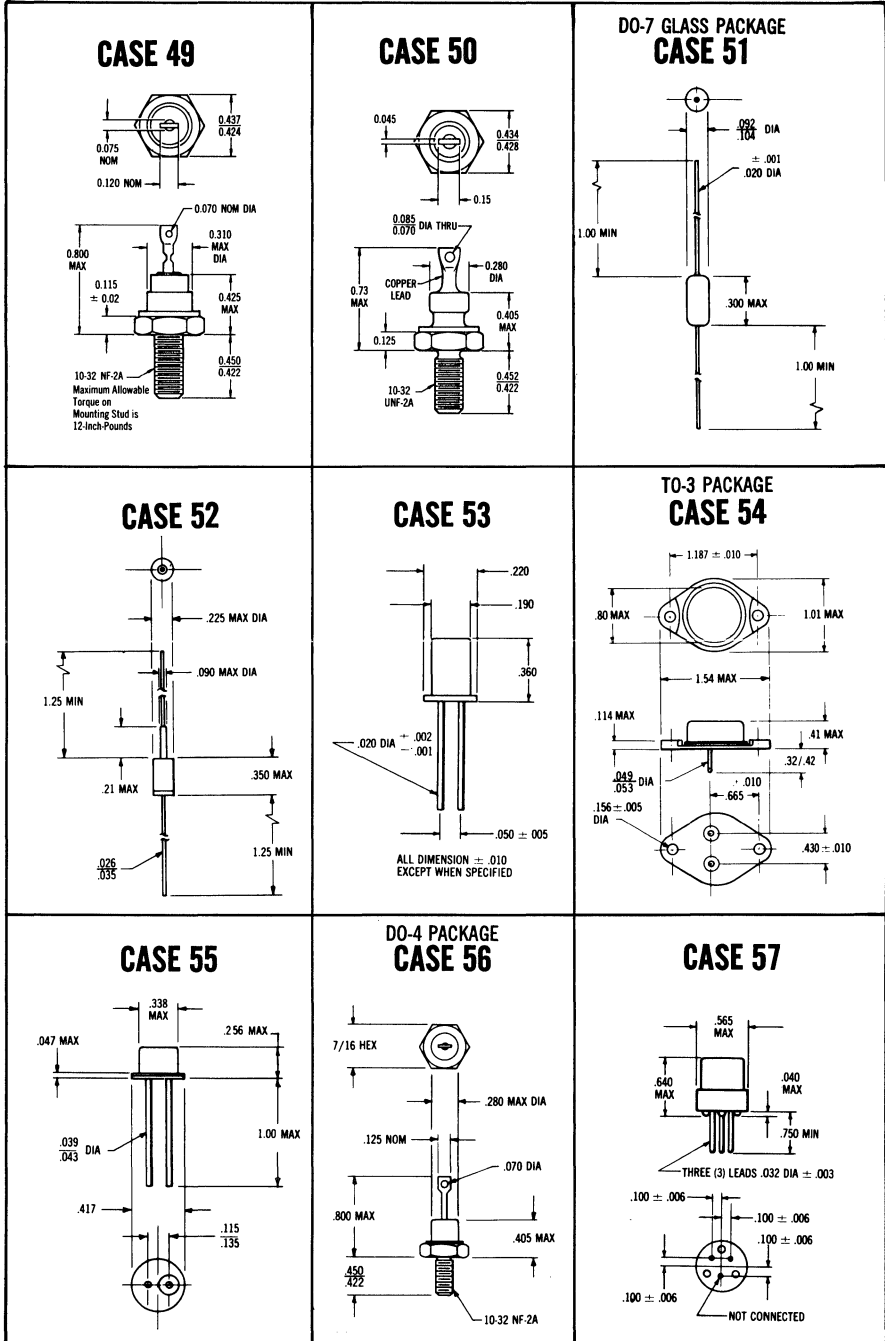

OUTLINE DIMENSIONS (continued)

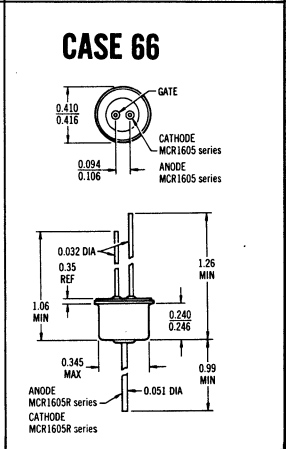
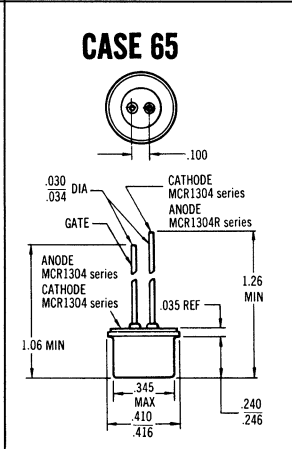
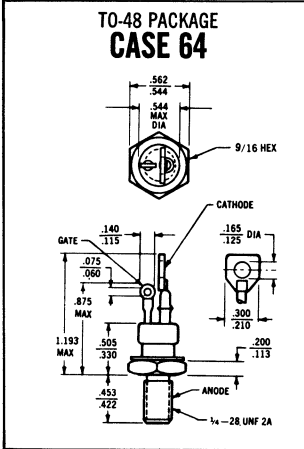
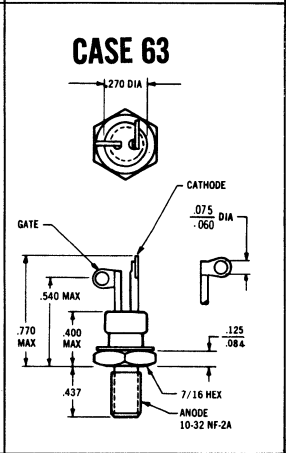
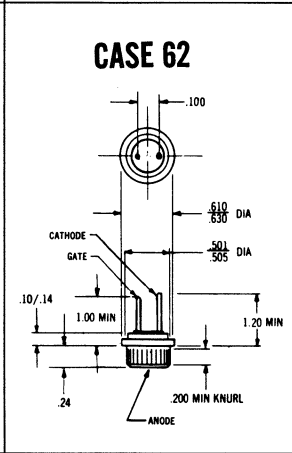
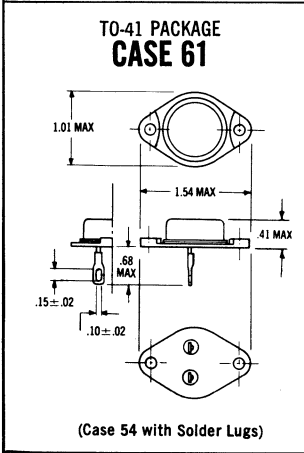
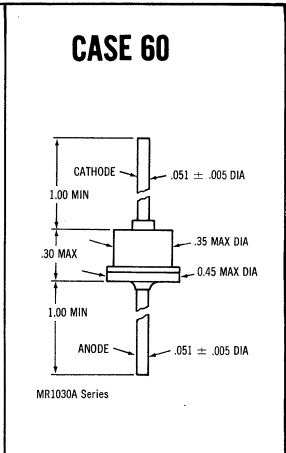
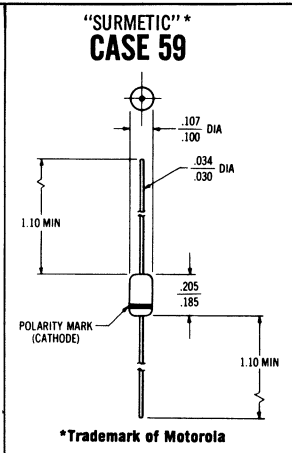
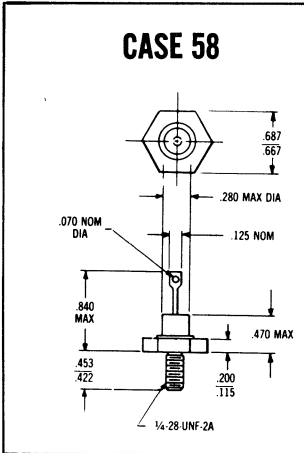

OUTLINE DIMENSIONS (continued)

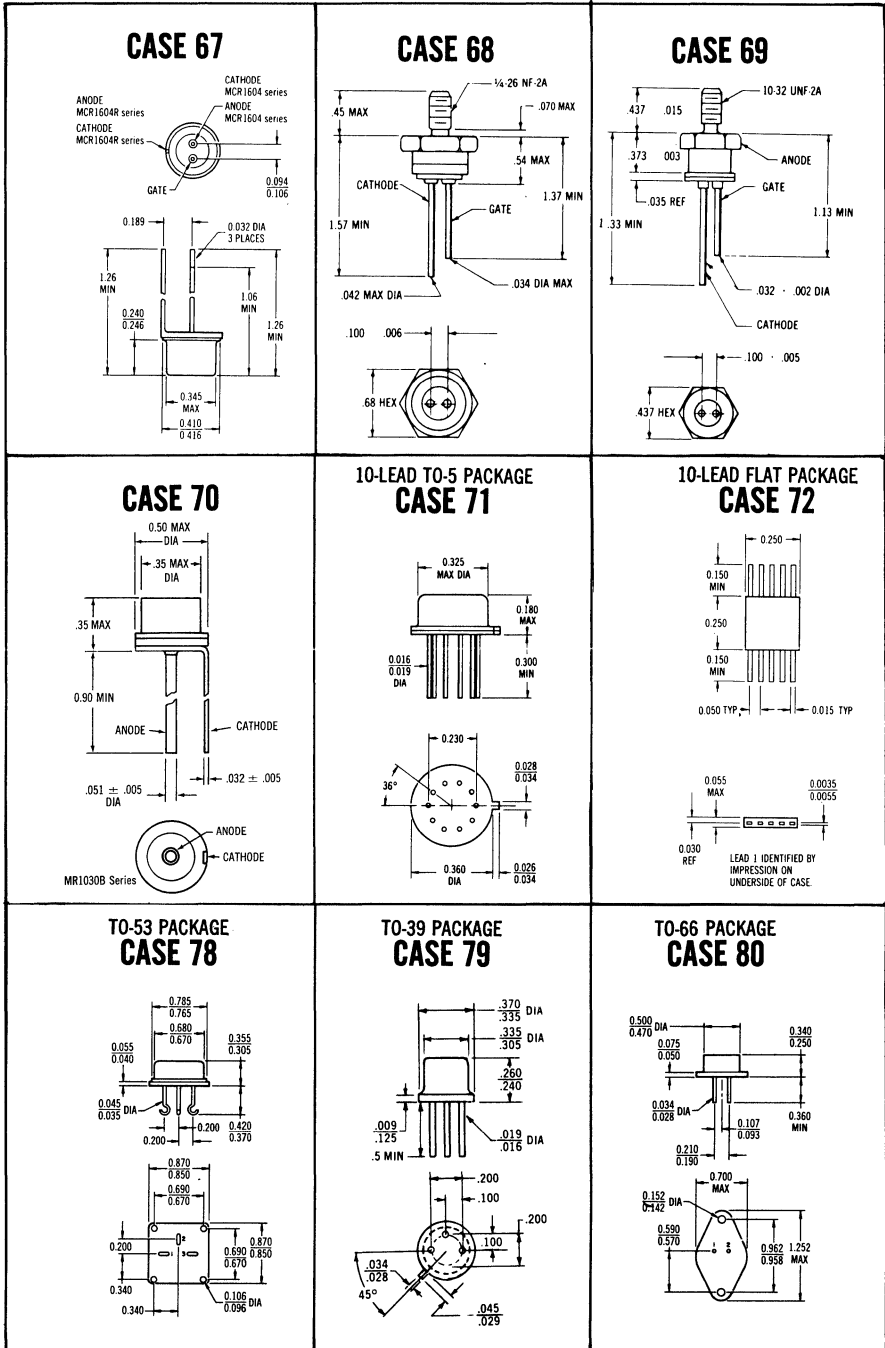

OUTLINE DIMENSIONS (continued)

14-LEAD FLAT PACKAGE
CASE 83

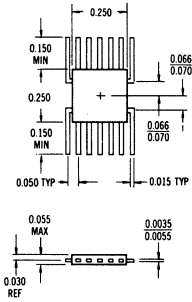

LEAD 1 IDENTIFIED BY IMPRESSION ON UNDERSIDE OF CASE

5-LEAD TO-5 PACKAGE
CASE 89

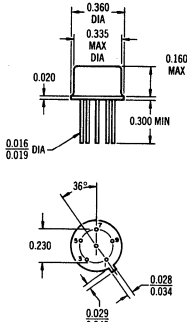

8-LEAD TO-5 PACKAGE
CASE 96, 96A

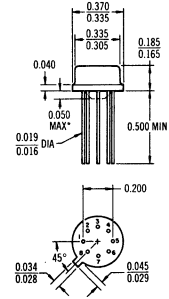

*RTL TYPES ONLY
CASE 96A: 10 PIN TO-5
PIN CIRCLE = 0.230

12-LEAD TO-5 PACKAGE
CASE 98

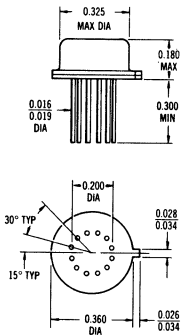

CASE 85

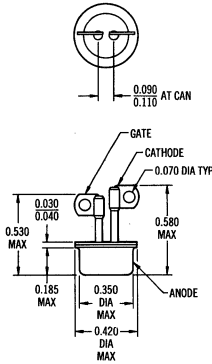

CASE 86

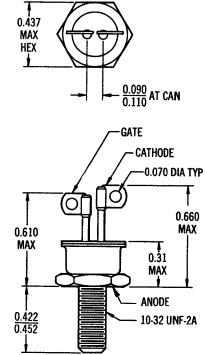

CASE 87

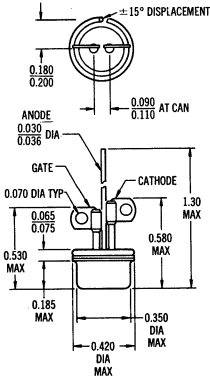

CASE 88

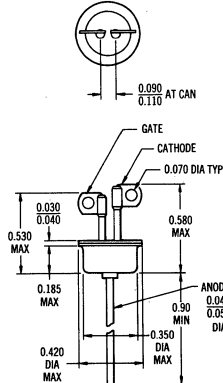



MOTOROLA
SILICON ZENER DIODES
TEMPERATURE COMPENSATED DIODES
REFERENCE AMPLIFIERS

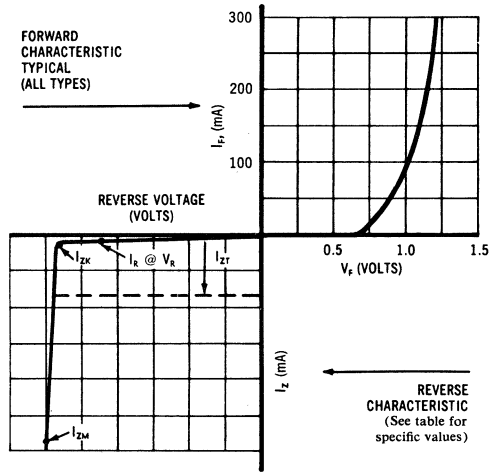

- I_F - Forward Current
- I_Z - Zener Current
- I_{ZK} - Zener Current Near Breakdown Knee
- I_{ZM} - Maximum DC Zener Current (limited by power dissipation)
- I_{ZT} - Zener Test Current
- V_F - Forward Voltage
- V_Z - Nominal Zener Voltage
- Z_Z - Zener Impedance
- Z_{ZK} - Zener Impedance Near Breakdown Knee (I_{ZK})
- Z_{ZT} - Zener Impedance At Test Current (I_{ZT})
- I_R - Reverse Current
- V_R - Reverse Test Voltage

- For high-reliability devices produced under the Meg-A-Life II program, see page 1-22.
- For case outline dimensions, see page 1-26.
- For devices meeting military specifications, see page 1-18.

MOTOROLA SILICON ZENER DIODES

The zener diode is unique within the semiconductor family of devices in that its important electrical properties are associated with a p-n junction operated under reverse-bias avalanche (breakdown) conditions. The major electrical characteristics associated with such devices, from an applications viewpoint, are defined as follows:

Zener Voltage -- (V_Z) -- Nominal zener voltage, measured at a specified test current (I_{ZT}) in the constant-voltage region, with the device junction in thermal equilibrium with a 25°C ambient temperature.

Zener Impedance -- (Z_Z) -- The impedance of a zener diode is normally specified at two points of the zener characteristics curve: at the knee of the zener plateau, and near the midrange of the zener excursion. The values of Z_Z are derived by superimposing a 60-cycle current on the zener test current (I_{ZT}) or on the zener knee current (I_{ZK}) and measuring the resulting AC voltage across the device. The RMS value of the applied 60-cycle current is 10% of the zener current (I_{ZT} or I_{ZK}).

A 100% CRT curve trace is used to insure that each zener diode breakdown region begins at a current lower than I_{ZK} and continues at nearly constant voltage to a current level in excess of I_{ZM} .

Maximum Zener Current Rating -- (I_{ZM}) -- This current rating denotes the maximum current that can be supplied by a device without exceeding the rated power level. This depends, of course, on the nominal zener voltage (V_Z).





Reverse Current -- (I_R) -- Reverse current is the leakage current of the zener diode in the non-conducting region of the device, i. e., in the area of an applied voltage between 0 and avalanche breakdown. It is normally specified at a reverse voltage (V_R) of approximately 0.8 (V_Z -- tolerance)

AVAILABILITY

Because zener diodes are specified at specific voltages ranging, in small increments, from 2.4 volts to 200, and because many of these voltage ratings are duplicated in each of the various power classifications, the number of zener diode type numbers far exceed that of any other semiconductor product. In addition to this wide range of standard devices, an almost unlimited variety of custom units with special tolerances, special voltages, matched pairs, etc., can be readily supplied to order at a nominal cost. For requirements that are not covered by one of the standard devices, consult a Motorola franchised semiconductor distributor or Motorola semiconductor representative.

MOTOROLA ZENER DIODE QUICK SELECTION CHART

IMPORTANT . . . The zener diodes listed below represent only a basic profile of Motorola's zener diode line. While the listing includes the industry-preferred types, many additional types, including in-between voltages, are available.

Nominal Zener Voltage	¼ WATT		400 MILLIWATT		¾ WATT	1 WATT	
							
	CASE 51		CASE 51		*Surmetic CASE 59	CASE 52	
	INDUSTRIAL (NOTE 1)	INDUSTRIAL ±5% TOLERANCE	INDUSTRIAL (NOTE 2)	MEETS SPECS OF MIL-S-19500/127	INDUSTRIAL (NOTE 3)	INDUSTRIAL (NOTE 2)	MEETS SPECS OF MIL-S-19500/115

ALLOY JUNCTION TYPES

2.4	¼M2.4AZ		1N4370	★ 1N4370A			
2.7	¼M2.7AZ		1N4371	★ 1N4371A			
3.0	¼M3.0AZ		1N4372	★ 1N4372A			
3.3	¼M3.3AZ		1N746	★ 1N746A		1N3821	★ 1N3821A
3.6	¼M3.6AZ		1N747	★ 1N747A		1N3822	★ 1N3822A
3.9	¼M3.9AZ		1N748	★ 1N748A		1N3823	★ 1N3823A
4.3	¼M4.3AZ		1N749	★ 1N749A		1N3824	★ 1N3824A
4.7	¼M4.7AZ		1N750	★ 1N750A		1N3825	★ 1N3825A
5.1	¼M5.1AZ		1N751	★ 1N751A		1N3826	★ 1N3826A
5.6	¼M5.6AZ		1N752	★ 1N752A		1N3827	★ 1N3827A
6.2	¼M6.2AZ		1N753	★ 1N753A		1N3828	★ 1N3828A
6.8			1N754	★ 1N754A		1N3829	
7.5			1N755	★ 1N755A		1N3830	
8.2			1N756	★ 1N756A			
9.1			1N757	★ 1N757A			
10			1N758	★ 1N758A			
12			1N759	★ 1N759A			

DIFFUSED JUNCTION TYPES





6.8	¼M6.8Z	1N4099	(NOTE 3)	MEETS SPECS OF MIL-S-19500/117		(NOTE 3)	★ 1N3016B
7.5	¼M7.5Z	1N4100	1N957	★ 1N957B	1N3675	1N3016	★ 1N3017B
8.2	¼M8.2Z	1N4101	1N958	★ 1N958B	1N3676	1N3017	★ 1N3018B
9.1	¼M9.1Z	1N4103	1N959	★ 1N959B	1N3677	1N3018	★ 1N3019B
10	¼M10Z	1N4104	1N960	★ 1N960B	1N3678	1N3019	★ 1N3020B
11	¼M11Z	1N4105	1N961	★ 1N961B	1N3679	1N3020	★ 1N3021B
			1N962	★ 1N962B	1N3680	1N3021	
12	¼M12Z	1N4106	1N963	★ 1N963B	1N3681	1N3022	★ 1N3022B
13	¼M13Z	1N4107	1N964	★ 1N964B	1N3682	1N3023	★ 1N3023B
15	¼M15Z	1N4109	1N965	★ 1N965B	1N3683	1N3024	★ 1N3024B
16	¼M16Z	1N4110	1N966	★ 1N966B	1N3684	1N3025	★ 1N3025B
18	¼M18Z	1N4112	1N967	★ 1N967B	1N3685	1N3026	★ 1N3026B
20	¼M20Z	1N4114	1N968	★ 1N968B	1N3686	1N3027	★ 1N3027B
22	¼M22Z	1N4115	1N969	★ 1N969B	1N3687	1N3028	★ 1N3028B
24	¼M24Z	1N4116	1N970	★ 1N970B	1N3688	1N3029	★ 1N3029B
27	¼M27Z	1N4118	1N971	★ 1N971B	1N3689	1N3030	★ 1N3030B
30	¼M30Z	1N4120	1N972	★ 1N972B	1N3690	1N3031	★ 1N3031B
33	¼M33Z	1N4121	1N973	★ 1N973B	1N3691	1N3032	★ 1N3032B
36	¼M36Z	1N4122	1N974	★ 1N974B	1N3692	1N3033	★ 1N3033B
39	¼M39Z	1N4123	1N975	★ 1N975B	1N3693	1N3034	★ 1N3034B
43	¼M43Z	1N4124	1N976	★ 1N976B	1N3694	1N3035	★ 1N3035B
47	¼M47Z	1N4125	1N977	★ 1N977B	1N3695	1N3036	★ 1N3036B
51	¼M51Z	1N4126	1N978	★ 1N978B	1N3696	1N3037	★ 1N3037B
56	¼M56Z	1N4127	1N979	★ 1N979B	1N3697	1N3038	★ 1N3038B
62	¼M62Z	1N4129	1N980	★ 1N980B	1N3698	1N3039	★ 1N3039B
68	¼M68Z	1N4130	1N981	★ 1N981B	1N3699	1N3040	★ 1N3040B
75	¼M75Z	1N4131	1N982	★ 1N982B	1N3700	1N3041	★ 1N3041B
82	¼M82Z	1N4132	1N983	★ 1N983B	1N3701	1N3042	★ 1N3042B
91	¼M91Z	1N4134	1N984	★ 1N984B	1N3702	1N3043	★ 1N3043B
100	¼M100Z	1N4135	1N985	★ 1N985B	1N3703	1N3044	★ 1N3044B
110	¼M110Z		1N986	★ 1N986B	1N3704	1N3045	★ 1N3045B
120	¼M120Z		1N987	★ 1N987B	1N3705	1N3046	★ 1N3046B
130	¼M130Z		1N988	★ 1N988B	1N3706	1N3047	★ 1N3047B
150	¼M150Z		1N989	★ 1N989B		1N3048	★ 1N3048B
160	¼M160Z		1N990	★ 1N990B		1N3049	★ 1N3049B
180	¼M180Z		1N991	★ 1N991B		1N3050	★ 1N3050B
200	¼M200Z		1N992	★ 1N992B		1N3051	★ 1N3051B

MILITARY TYPES

★ MEG-A-LIFE II TYPES

MOTOROLA ZENER DIODE QUICK SELECTION CHART

IMPORTANT . . . The zener diodes listed below represent only a basic profile of Motorola's zener diode line. While the listing includes the industry-preferred types, many additional types, including in-between voltages, are available.

1 WATT  *Sormetic CASE 59	1½ WATT  CASE 55	10 WATT  CASE 56		50 WATT  CASE 54  CASE 58			Nominal Zener Voltage
		INDUSTRIAL (NOTE 2)	INDUSTRIAL (NOTE 3)	INDUSTRIAL (NOTE 2)	MEETS SPECS OF MIL-S-19500/277	INDUSTRIAL (NOTE 3)	

1N4728 1N4729 1N4730		1N3993	1N3993A				2.4 2.7 3.0 3.3 3.6 3.9
1N4731 1N4732 1N4733 1N4734 1N4735		1N3994 1N3995 1N3996 1N3997 1N3998 1N3999	1N3994A 1N3995A 1N3996A 1N3997A 1N3998A 1N3999A				4.3 4.7 5.1 5.6 6.2 6.8
		1N4000	1N4000A				7.5 8.2 9.1 10 12

REVERSE POLARITIES AVAILABLE IN ALL 10 AND 50 WATT DIFFUSED TYPES.

1N4736 1N4737 1N4738 1N4739 1N4740 1N4741	1N3785 1N3786 1N3787 1N3788 1N3789 1N3790	(NOTE 3) 1N2970 1N2971 1N2972 1N2973 1N2974 1N2975	MEETS SPECS OF MIL-S-19500/124	1N2804 1N2805 1N2806 1N2807 1N2808 1N2809	1N2804B&RB 1N2805B 1N2806B 1N2807B 1N2808B 1N2809B	1N3305 1N3306 1N3307 1N3308 1N3309 1N3310	6.8 7.5 8.2 9.1 10 11
			★ 1N2970B&RB ★ 1N2971B ★ 1N2972B ★ 1N2973B ★ 1N2974B ★ 1N2975B				
1N4742 1N4743 1N4744 1N4745 1N4746 1N4747	1N3791 1N3792 1N3793 1N3794 1N3795 1N3796	1N2976 1N2977 1N2979 1N2980 1N2982 1N2984	★ 1N2976B ★ 1N2977B ★ 1N2979B ★ 1N2980B ★ 1N2982B ★ 1N2984B	1N2810 1N2811 1N2813 1N2814 1N2816 1N2818	1N2810B 1N2811B 1N2813B 1N2814B 1N2816B 1N2818B	1N3311 1N3312 1N3314 1N3315 1N3317 1N3319	12 13 15 16 18 20
1N4748 1N4749 1N4750 1N4751 1N4752 1N4753	1N3797 1N3798 1N3799 1N3800 1N3801 1N3802	1N2985 1N2986 1N2988 1N2989 1N2990 1N2991	★ 1N2985B ★ 1N2986B ★ 1N2988B ★ 1N2989B ★ 1N2990B ★ 1N2991B	1N2819 1N2820 1N2822 1N2823 1N2824 1N2825	1N2819B 1N2820B 1N2822B 1N2823B 1N2824B 1N2825B	1N3320 1N3321 1N3323 1N3324 1N3325 1N3326	22 24 27 30 33 36
1N4754 1N4755 1N4756 1N4757 1N4758 1N4759	1N3803 1N3804 1N3805 1N3806 1N3807 1N3808	1N2992 1N2993 1N2995 1N2997 1N2999 1N3000	★ 1N2992B ★ 1N2993B ★ 1N2995B ★ 1N2997B ★ 1N2999B ★ 1N3000B	1N2826 1N2827 1N2829 1N2831 1N2832 1N2833	1N2826B 1N2827B 1N2829B 1N2831B 1N2832B 1N2833B	1N3327 1N3328 1N3330 1N3332 1N3334 1N3335	39 43 47 51 56 62
1N4760 1N4761 1N4762 1N4763 1N4764	1N3809 1N3810 1N3811 1N3812 1N3813 1N3814	1N3001 1N3002 1N3003 1N3004 1N3005 1N3007	★ 1N3001B ★ 1N3002B ★ 1N3003B ★ 1N3004B ★ 1N3005B ★ 1N3007B	1N2834 1N2835 1N2836 1N2837 1N2838 1N2840	1N2834B 1N2835B 1N2836B 1N2837B 1N2838B 1N2840B	1N3336 1N3337 1N3338 1N3339 1N3340 1N3342	68 75 82 91 100 110
	1N3815 1N3816 1N3817 1N3818 1N3819 1N3820	1N3008 1N3009 1N3011 1N3012 1N3014 1N3015	★ 1N3008B ★ 1N3009B ★ 1N3011B ★ 1N3012B ★ 1N3014B ★ 1N3015B	1N2841 1N2842 1N2843 1N2844 1N2845 1N2846	1N2841B 1N2842B 1N2843B 1N2844B 1N2845B 1N2846B	1N3343 1N3344 1N3346 1N3347 1N3349 1N3350	120 130 150 160 180 200

1/4 M2.4AZ thru 1/4 M200Z

**1/4 Watt
2.4 — 200 V**



**CASE 51
(DO-7)**

Hermetically sealed, all-glass case with all external surfaces corrosion resistant. Cathode end, indicated by color band, will be positive with respect to anode end when operated in the zener region.

ABSOLUTE MAXIMUM RATINGS

Junction and Storage Temperature: -65°C to +175°C
D-C Power Dissipation: 1/4 Watt (Derate 1.67 mW/°C Above 25°C)

SPECIAL TOLERANCE AND VOLTAGE DESIGNATIONS

The type numbers specified on the opposite page have a standard voltage (V_Z) tolerance of $\pm 20\%$. For closer tolerances, add suffix "10" for $\pm 10\%$ or "5" for $\pm 5\%$.

VOLTAGE DESIGNATIONS

To designate units with zener voltages other than those listed, the Motorola type number should be modified as shown below. Unless otherwise specified, the electrical characteristics other than the nominal voltage (V_Z) and test voltage for leakage current will conform to the characteristics of the next higher voltage type shown in the table.

EXAMPLE:

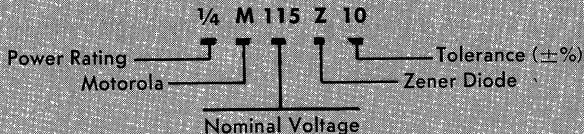

MATCHED SETS FOR CLOSER TOLERANCE OR HIGHER VOLTAGES

Series matched sets make zener voltages in excess of 200 volts or tolerances of less than 5% possible as well as providing lower temperature coefficients, lower dynamic impedance and greater power handling ability.

For Clippers, Parallel Matched Sets or other special circuit requirements, contact your Motorola District Sales Manager.

— Motorola Silicon Zener Diodes —

1/4M2.4AZ thru 1/4M 6.2 AZ (continued)

ELECTRICAL CHARACTERISTICS (At 25°C Ambient $V_F = 1.5V$ max @ 100 mA)

MOTOROLA TYPE NO.	NOMINAL* ZENER VOLTAGE (V_Z) VOLTS @ I_{ZT}	TEST CURRENT (I_{ZT}) mA	MAXIMUM ZENER IMPEDANCE (Z_{ZT}) ohms @ I_{ZT}	MAXIMUM DC ZENER CURRENT (I_{ZM}) mA	REVERSE LEAKAGE CURRENT, (I_R)		
					I_R MAX (μA)	TEST VOLTAGE V_{dc} 5% V_R	10%
1/4M2.4AZ	2.4	10	60	70	75	1	1
1/4M2.7AZ	2.7	10	60	65	75	1	1
1/4M3.0AZ	3.0	10	55	60	50	1	1
1/4M3.3AZ	3.3	10	55	55	50	1	1
1/4M3.6AZ	3.6	10	50	52	50	1	1
1/4M3.9AZ	3.9	10	50	49	25	1	1
1/4M4.3AZ	4.3	10	45	46	25	1.5	1.5
1/4M4.7AZ	4.7	10	35	42	10	1.5	1.5
1/4M5.1AZ	5.1	10	25	39	5	1.5	1.5
1/4M5.6AZ	5.6	10	20	36	5	1.5	1.5
1/4M6.2AZ	6.2	10	15	33	5	3.5	3.5
1/4M6.8Z	6.8	9.2	7.0	33	150	5.2	4.9
1/4M7.5Z	7.5	8.3	8.0	30	75	5.7	5.4
1/4M8.2Z	8.2	7.6	9.0	26	50	6.2	5.9
1/4M9.1Z	9.1	6.9	10	24	25	6.9	6.6
1/4M10Z	10	6.3	11	21	10	7.6	7.2
1/4M11Z	11	5.7	13	19	5	8.4	8.0
1/4M12Z	12	5.2	15	18	5	9.1	8.6
1/4M13Z	13	4.8	18	16	5	9.9	9.4
1/4M14Z	14	4.5	20	15	5	10.6	10.1
1/4M15Z	15	4.2	22	14	5	11.4	10.8
1/4M16Z	16	3.9	24	13	5	12.2	11.5
1/4M17Z	17	3.7	26	12.5	5	13.0	12.2
1/4M18Z	18	3.5	28	11.5	5	13.7	13.0
1/4M19Z	19	3.3	30	11.0	5	14.4	13.7
1/4M20Z	20	3.1	33	10.5	5	15.2	14.4
1/4M22Z	22	2.8	40	9.5	5	16.7	15.8
1/4M24Z	24	2.6	46	9.0	5	18.2	17.3
1/4M25Z	25	2.5	50	8.0	5	19.0	18.0
1/4M27Z	27	2.3	58	7.5	5	20.6	19.4
1/4M30Z	30	2.1	70	7.0	5	22.8	21.6
1/4M33Z	33	1.9	85	6.5	5	25.1	23.8
1/4M36Z	36	1.7	100	6.0	5	27.4	25.9
1/4M39Z	39	1.6	120	5.0	5	29.7	28.1
1/4M43Z	43	1.5	140	4.8	5	32.7	31.0
1/4M45Z	45	1.4	150	4.5	5	34.2	32.4
1/4M47Z	47	1.3	160	4.3	5	35.8	33.8
1/4M50Z	50	1.2	180	4.1	5	38.0	36.0
1/4M52Z	52	1.2	200	4.0	5	39.5	37.4
1/4M56Z	56	1.1	230	3.8	5	42.6	40.3
1/4M62Z	62	1.0	290	3.3	5	47.1	44.6
1/4M68Z	68	0.92	350	3.0	5	51.7	49.0
1/4M75Z	75	0.83	450	2.8	5	56.0	54.0
1/4M82Z	82	0.76	550	2.5	5	62.2	59.0
1/4M91Z	91	0.69	700	2.3	5	69.2	65.5
1/4M100Z	100	0.63	900	2.0	5	76.0	72.0
1/4M105Z	105	0.60	1000	1.9	5	79.8	75.6
1/4M110Z	110	0.57	1200	1.8	5	83.6	79.2
1/4M120Z	120	0.52	1500	1.7	5	91.2	86.4
1/4M130Z	130	0.48	1900	1.5	5	98.8	93.6
1/4M140Z	140	0.45	2200	1.4	5	106.4	100.8
1/4M150Z	150	0.42	2500	1.3	5	114.0	108.0
1/4M175Z	175	0.36	3300	1.1	5	133.0	126.0
1/4M200Z	200	0.31	4300	1.0	5	152.0	144.0

*SPECIAL SELECTIONS 1—Nominal zener voltages between those shown.

AVAILABLE INCLUDE: 2—Matched sets:

a. Two or more units for series connection with specified tolerance on total voltage } Standard Tolerances
 b. Two or more units matched to one another with any specified tolerance } are $\pm 5\%$, $\pm 2\%$, and $\pm 1\%$

1N702 thru 1N745

**¼ Watt
2 – 200 V**

**CASE 51
(DO-7)**



Recommended for applications requiring an exact replacement only. For new designs and for industry preferred replacement devices, see 1N746--, 1N957-- and 1N4370-- series. Absolute maximum rating-junction and storage temperature range -65 to +175°C, derated 1.67 mW/°C.

1N746 thru 1N759 1N4370 thru 1N4372

**400 mW
2.4 – 12 V**

**CASE 51
(DO-7)**



Hermetically sealed, all-glass case with all external surfaces corrosion resistant. Cathode end, indicated by color band, will be positive with respect to anode end when operated in the zener region.

ABSOLUTE MAXIMUM RATINGS

Junction and Storage Temperature: -65°C to +175°C

D-C Power Dissipation: 400 Milliwatts at 50°C Ambient (Derate 3.2 mW/°C Above 50° Ambient)

TOLERANCE DESIGNATION

The type numbers shown have tolerance designations as follows:

1N4370 series: ± 10%, suffix A for ± 5% units.

1N746 series: ± 10%, suffix A for ± 5% units.

ELECTRICAL CHARACTERISTICS (T_A = 25°C unless otherwise noted)

JEDEC TYPE NUMBER	NOMINAL* ZENER VOLTAGE V _Z @ I _{ZT} VOLTS	TEST CURRENT I _{ZT} mA	MAXIMUM ZENER IMPEDANCE Z _{ZT} @ I _{ZT} Ohms	MAXIMUM DC ZENER CURRENT I _{ZM} mA	MAXIMUM REVERSE LEAKAGE CURRENT	
					T _A = 25°C I _R @ V _R = 1 V µA	T _A = 150°C I _R @ V _R = 1 V µA
1N4370	2.4	20	30	150	100	200
1N4371	2.7	20	30	135	75	150
1N4372	3.0	20	29	120	50	100
1N746	3.3	20	28	110	10	30
1N747	3.6	20	24	100	10	30
1N748	3.9	20	23	95	10	30
1N749	4.3	20	22	85	2	30
1N750	4.7	20	19	75	2	30
1N751	5.1	20	17	70	1	20
1N752	5.6	20	11	65	1	20
1N753	6.2	20	7	60	0.1	20
1N754	6.8	20	5	55	0.1	20
1N755	7.5	20	6	50	0.1	20
1N756	8.2	20	8	45	0.1	20
1N757	9.1	20	10	40	0.1	20
1N758	10.0	20	17	35	0.1	20
1N759	12.0	20	30	30	0.1	20

1N761 thru 1N769

Recommended for applications requiring an exact replacement only. For new designs see 1N746 -- and 1N4370 -- series.

1N957 thru 1N992

400 mW
6.8 — 200 V

CASE 51
(DO-7)



Hermetically sealed, all-glass case with all external surfaces corrosion resistant. Cathode end, indicated by color band, will be positive with respect to anode end when operated in the zener region.

MAXIMUM RATINGS

Junction and Storage Temperature: -65 to +175°C

DC Power Dissipation: 400 mW at 50°C Ambient (Derate 3.2 mw/°C above 50°C Ambient.)

TOLERANCE DESIGNATIONS

With no suffix, tolerance is ± 20%, for ± 10% units, add suffix A, for ± 5% units, add suffix B.

ELECTRICAL CHARACTERISTICS (T_A = 25°C unless otherwise noted)

JEDEC TYPE NUMBER	NOMINAL* ZENER VOLTAGE V _Z VOLTS	TEST CURRENT I _T mA	MAXIMUM ZENER IMPEDANCE			MAXIMUM DC ZENER CURRENT I _{ZM} mA	MAXIMUM REVERSE CURRENT		
			Z _{TK} @ I _T Ohms	Z _{TK} @ I _{TK} Ohms	I _{TK} mA		I _R MAXIMUM (μA)	TEST VOLTAGE V _R 5%	V _R 10%
1N957	6.8	18.5	4.5	700	1.0	47	150	5.2	4.9
1N958	7.5	16.5	5.5	700	0.5	42	75	5.7	5.4
1N959	8.2	15	6.5	700	0.5	38	50	6.2	5.9
1N960	9.1	14	7.5	700	0.5	35	25	6.9	6.6
1N961	10	12.5	8.5	700	0.25	32	10	7.6	7.2
1N962	11	11.5	9.5	700	0.25	28	5	8.4	8.0
1N963	12	10.5	11.5	700	0.25	26	5	9.1	8.6
1N964	13	9.5	13	700	0.25	24	5	9.9	9.4
1N965	15	8.5	16	700	0.25	21	5	11.4	10.8
1N966	16	7.8	17	700	0.25	19	5	12.2	11.5
1N967	18	7.0	21	750	0.25	17	5	13.7	13.0
1N968	20	6.2	25	750	0.25	15	5	15.2	14.4
1N969	22	5.6	29	750	0.25	14	5	16.7	15.8
1N970	24	5.2	33	750	0.25	13	5	18.2	17.3
1N971	27	4.6	41	750	0.25	11	5	20.6	19.4
1N972	30	4.2	49	1000	0.25	10	5	22.8	21.6
1N973	33	3.8	58	1000	0.25	9.2	5	25.1	23.8
1N974	36	3.4	70	1000	0.25	8.5	5	27.4	25.9
1N975	39	3.2	80	1000	0.25	7.8	5	29.7	28.1
1N976	43	3.0	93	1500	0.25	7.0	5	32.7	31.0
1N977	47	2.7	105	1500	0.25	6.4	5	35.8	33.8
1N978	51	2.5	125	1500	0.25	5.9	5	38.8	36.7
1N979	56	2.2	150	2000	0.25	5.4	5	42.6	40.3
1N980	62	2.0	185	2000	0.25	4.9	5	47.1	44.6
1N981	68	1.8	230	2000	0.25	4.5	5	51.7	49.0
1N982	75	1.7	270	2000	0.25	4.0	5	56.0	54.0
1N983	82	1.5	330	3000	0.25	3.7	5	62.2	59.0
1N984	91	1.4	400	3000	0.25	3.3	5	69.2	65.5
1N985	100	1.3	500	3000	0.25	3.0	5	76.0	72.0
1N986	110	1.1	750	4000	0.25	2.7	5	83.6	79.2
1N987	120	1.0	900	4500	0.25	2.5	5	91.2	86.4
1N988	130	0.95	1100	5000	0.25	2.3	5	98.8	93.6
1N989	150	0.85	1500	6000	0.25	2.0	5	114.0	108.0
1N990	160	0.80	1700	6500	0.25	1.9	5	121.6	115.2
1N991	180	0.68	2200	7100	0.25	1.7	5	136.8	129.6
1N992	200	0.65	2500	8000	0.25	1.5	5	152.0	144.0

* SPECIAL SELECTIONS 1 — Nominal zener voltages between those shown.

AVAILABLE INCLUDE: 2 — Matched sets:

a. Two or more units for series connection with specified tolerance on total voltage } Standard Tolerances are ±5%, ±2%, and ±1%
 b. Two or more units matched to one another with any specified tolerance }

1N1313 thru 1N1327

150 mW
8.75 — 127.5 V

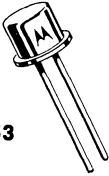

CASE 53

Very low power zener diodes with standard $\pm 10\%$ tolerances. Available with $\pm 5\%$ tolerance by adding suffix "A" to type number. Single-ended hermetically sealed metal case designed for easy insertion in printed-circuit boards.

ABSOLUTE MAXIMUM RATINGS

Junction and Storage Temperature Range: -65 to $+175^\circ\text{C}$ (Derate $1\text{mW}/^\circ\text{C}$ above 25°C).

ELECTRICAL CHARACTERISTICS ($T_A = 25^\circ\text{C}$ unless otherwise noted)

Type	Nominal Voltage $V_Z @ I_{ZT} = 200 \mu\text{A}$ volts	Max Reverse Current		Test Voltage V_R volts	Type	Nominal Voltage $V_Z @ I_{ZT} = 200 \mu\text{A}$ volts	Max Reverse Current		Test Voltage V_R volts
		$T_A = 25^\circ\text{C}$ $I_R @ V_R$ μA	$T_A = 100^\circ\text{C}$ $I_A @ V_R$ μA				$T_A = 25^\circ\text{C}$ $I_R @ V_R$ μA	$T_A = 100^\circ\text{C}$ $I_A @ V_R$ μA	
1N1313	8.75	0.5	5	6.8	1N1318	23.50	0.1	10	18
1N1314	10.50	0.5	5	8.2	1N1319	28.50	0.1	10	22
1N1315	12.75	0.5	5	10	1N1320	34.50	0.1	10	27
1N1316	15.75	0.5	5	12	1N1321	41.00	0.1	10	33
1N1317	19.00	0.5	5	15	1N1322	48.50	0.1	10	39

Type	Nominal Voltage $V_Z @ I_{ZT} = 200 \mu\text{A}$ volts	Max Reverse Current		Test Voltage V_R volts
		$T_A = 25^\circ\text{C}$ $I_R @ V_R$ μA	$T_A = 100^\circ\text{C}$ $I_A @ V_R$ μA	
1N1323	58.00	0.1	10	47
1N1324	71.00	1.0	50	56
1N1325	87.50	1.0	50	68
1N1326	105.0	1.0	50	82
1N1327	127.5	1.0	50	100

1N1351 thru 1N1375

10 Watt
10 — 100 V



CASE 56
(DO-4)

Recommended for applications requiring an exact replacement only. For new designs and for industry preferred replacement devices, see 1N2970 series.

1N1507 thru 1N1517

**3/4 Watt
3.9 – 27 V**



CASE 52

Recommended for applications requiring an exact replacement only. For new designs and for industry preferred replacement devices, see 1-watt, 1N3016 and 1N3821 series.

1N1518 thru 1N1528

**1 Watt
3.9 – 27 V**



**CASE 56
(DO-4)**

Recommended for applications requiring an exact replacement only. For new designs and for industry preferred replacement devices, see 1N3016 and 1N3821 series.

1N1588 thru 1N1598

**3.5 Watt
3.9 – 27 V**



**CASE 56
(DO-4)**

Recommended for applications requiring an exact replacement only. For new designs and for industry preferred replacement devices, see 1N2970 and 1N3993 series.

1N1599 thru 1N1609

**10 Watt
3.9 – 27 V**



**CASE 56
(DO-4)**

Recommended for applications requiring an exact replacement only. For new designs and for industry preferred replacement devices, see 1N2970 and 1N3993 series.

1N1765 thru 1N1802

**1 Watt
5.6 – 200 V**

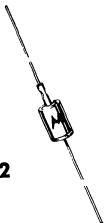

CASE 52

Recommended for applications requiring an exact replacement only. For new designs and for industry preferred replacement devices, see 1N3016 series.

1N1803 thru 1N1836

**10 Watt
5.6 — 200 V**



**CASE 56
(DO-4)**

Recommended for applications requiring an exact replacement only. For new designs and for industry preferred replacement devices, see 1N2970 and 1N3993 series.

1N2008 thru 1N2012

**10 Watt
100 — 150 V**



**CASE 56
(DO-4)**

Recommended for applications requiring an exact replacement only. For new designs and for industry preferred replacement devices, see 1N2970 series.

1N2032 thru 1N2040

**3/4 Watt
4.3 — 12 V**



**CASE 56
(DO-4)**

Recommended for applications requiring an exact replacement only. For new designs and for industry preferred replacement devices, see 1N3821 and 1N3016 series.

1N2041 thru 1N2049

**10 Watt
4.3 — 27 V**



**CASE 56
(DO-4)**

Recommended for applications requiring an exact replacement only. For new designs and for industry preferred replacement devices, see 1N3993 and 1N2970 series.

1N2498 thru 1N2500

**10 Watt
10 — 12 V**



**CASE 56
(DO-4)**

Recommended for applications requiring an exact replacement only. For new designs and for industry preferred replacement devices, see 1N2970 series.

1N2804 thru 1N2846

**50 Watt
6.8 – 200 V**



**CASE 54
(TO-3)**

Units are available with anode-to-case and cathode-to-case connections (standard and reverse polarity). Has two parallel pin connections to ungrounded element so that circuit to load may be broken if unit is removed from socket. For reverse polarity, add suffix "R" to type number. Same devices in stud-type package available— see 1N3305 - 1N3350 series.

ABSOLUTE MAXIMUM RATINGS

Junction and Storage Temperature: -65°C to $+175^{\circ}\text{C}$.

D-C Power Dissipation: 50 Watts. (Derate 0.5 W/ $^{\circ}\text{C}$ above 75°C).

SPECIAL TOLERANCE AND VOLTAGE DESIGNATIONS

The type numbers shown have a standard tolerance of $\pm 20\%$ on the nominal zener voltage. Add suffix "A" for $\pm 10\%$ units or "B" for $\pm 5\%$ units.

NON-STANDARD VOLTAGE DESIGNATION

To designate units with zener voltages other than those assigned JEDEC numbers, the equivalent Motorola type number should be used.

EXAMPLE: TO-3 DIAMOND PACKAGE

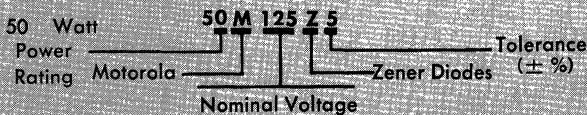

MATCHED SETS FOR CLOSER TOLERANCE OR HIGHER VOLTAGES

Series matched sets make zener voltages in excess of 200 volts or tolerances of less than 5% possible as well as providing lower temperature coefficients, lower dynamic impedance and greater power handling ability.

For Clippers, Parallel Matched Sets or other special circuit requirements, contact your Motorola District Sales Manager.

TO-3 APPLICATIONS INFORMATION

If these units are used with a socket, the unregulated line should feed into one pin through a suitable current limiting resistor and the load should be connected to the other pin. This will result in the circuit to the load being broken when unit is removed from socket. When soldered-in, pins may be connected in series to load, paralleled, or only one may be used as suits the application.

Typical circuit connections for anode-to-case and cathode-to-case polarities (standard and reverse polarities, respectively) are as shown on following page.

1N2804 thru 1N2846 (continued)

CIRCUIT CONNECTIONS

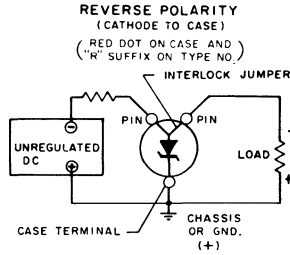
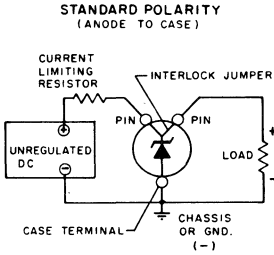

ELECTRICAL CHARACTERISTICS ($T_A = 30^\circ\text{C}$ unless otherwise noted)

EIA Type No. 50 Watt (TO-3)	Nominal Zener Voltage (V_Z) @ I_{ZT} Volts	Test Current (I_{ZT}) mA	Max Zener Impedance		Max DC Zener Current 75°C Case Temp (I_{ZM}) mA	Max Reverse Current			Typical Zener Voltage Temp. Coeff. %/°C
			Z_{ZT} @ I_{ZT} ohms	Z_{ZK} @ $I_{ZK} = 5\text{mA}$ ohms		I_{R1} MAX (μA)	V_{R1}	V_{R2}	
1N2804	6.8	1850	0.2	70	6600	150	4.5	4.3	.040
1N2805	7.5	1700	0.3	70	5900	75	5.0	4.7	.045
1N2806	8.2	1500	0.4	70	5200	50	5.4	5.2	.048
1N2807	9.1	1370	0.5	70	4800	25	6.1	5.7	.051
1N2808	10	1200	0.6	80	4300	10	6.7	6.3	.055
1N2809	11	1100	0.8	80	3900	5	8.4	8.0	.060
1N2810	12	1000	1.0	80	3600	5	9.1	8.6	.065
1N2811	13	960	1.1	80	3300	5	9.9	9.4	.065
1N2812	14	890	1.2	80	3000	5	10.6	10.1	.070
1N2813	15	830	1.4	80	2800	5	11.4	10.8	.070
1N2814	16	780	1.6	80	2650	5	12.2	11.5	.070
1N2815	17	740	1.8	80	2500	5	13.0	12.2	.075
1N2816	18	700	2.0	80	2300	5	13.7	13.0	.075
1N2817	19	660	2.2	80	2200	5	14.4	13.7	.075
1N2818	20	630	2.4	80	2100	5	15.2	14.4	.075
1N2819	22	570	2.5	80	1900	5	16.7	15.8	.080
1N2820	24	520	2.6	80	1750	5	18.2	17.3	.080
1N2821	25	500	2.7	90	1550	5	19.0	18.0	.080
1N2822	27	460	2.8	90	1500	5	20.6	19.4	.085
1N2823	30	420	3.0	90	1400	5	22.8	21.6	.085
1N2824	33	380	3.2	90	1300	5	25.1	23.8	.085
1N2825	36	350	3.5	90	1150	5	27.4	25.9	.085
1N2826	39	320	4.0	90	1050	5	29.7	28.1	.090
1N2827	43	290	4.5	90	975	5	32.7	31.0	.090
1N2828	45	280	4.5	100	930	5	34.2	32.4	.090
1N2829	47	270	5.0	100	880	5	35.8	33.8	.090
1N2830	50	250	5.0	100	830	5	38.0	36.0	.090
1N2831	51	245	5.2	100	810	5	38.8	36.7	.090
—	52	240	5.5	100	790	5	39.5	37.4	.090
1N2832	56	220	6	110	740	5	42.6	40.3	.090
1N2833	62	200	7	120	660	5	47.1	44.6	.090
1N2834	68	180	8	140	600	5	51.7	49.0	.090
1N2835	75	170	9	150	540	5	56.0	54.0	.090
1N2836	82	150	11	160	490	5	62.2	59.0	.090
1N2837	91	140	15	180	420	5	69.2	65.5	.090
1N2838	100	120	20	200	400	5	76.0	72.0	.090
1N2839	105	120	25	210	380	5	79.8	75.6	.095
1N2840	110	110	30	220	365	5	83.6	79.2	.095
1N2841	120	100	40	240	335	5	91.2	86.4	.095
1N2842	130	95	50	275	310	5	98.8	93.6	.095
—	140	90	60	325	290	5	106.4	100.8	.095
1N2843	150	85	75	400	270	5	114.0	108.0	.095
1N2844	160	80	80	450	250	5	121.6	115.2	.095
—	175	70	85	500	230	5	133.0	126.0	.095
1N2845	180	68	90	525	220	5	136.8	129.6	.095
1N2846	200	65	100	600	200	5	152.0	144.0	.100

* SPECIAL SELECTIONS 1 — Nominal zener voltages between those shown.

AVAILABLE INCLUDE: 2 — Matched sets:

- a. Two or more units for series connection with specified tolerance on total voltage } Standard Tolerances
- b. Two or more units matched to one another with any specified tolerance } are $\pm 5\%$, $\pm 2\%$, and $\pm 1\%$

1N2970 thru 1N3015

**10Watt
6.8 – 200 V**

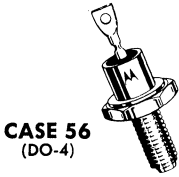

Diffused-junction zener diodes for both military and high-reliability industrial applications. Available with anode-to-case and cathode-to-case connections (standard and reverse polarity), i. e., 1N2970 and 1N2970R. Supplied with mounting hardware.

ABSOLUTE MAXIMUM RATINGS

Junction and Storage Temperature: -65°C to $+175^{\circ}\text{C}$.
D-C Power Dissipation: 10 Watts. (Derate $83.3 \text{ mW}/^{\circ}\text{C}$ above 55°C).

SPECIAL TOLERANCE AND VOLTAGE DESIGNATIONS

The type numbers shown on the table have a standard tolerance of $\pm 20\%$ on the nominal zener voltage. Add suffix "A" for $\pm 10\%$ units or "B" for $\pm 5\%$ units.

To designate units with zener voltages other than those listed, equivalent Motorola type number should be used - modified as shown below. Unless otherwise specified, the electrical characteristics other than the nominal voltage (V_Z) and test voltage for leakage current will conform to the characteristics of the next higher voltage type shown in the table.

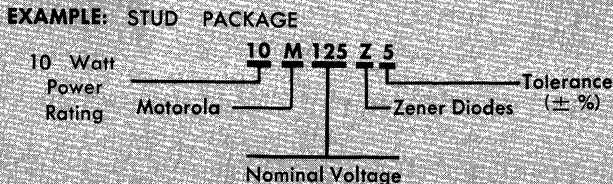

MATCHED SETS FOR CLOSER TOLERANCE OR HIGHER VOLTAGES

Series matched sets make zener voltages in excess of 200 volts or tolerances of less than 5% possible as well as providing lower temperature coefficients, lower dynamic impedance and greater power handling ability.

For Clippers, Parallel Matched Sets or other special circuit requirements, contact your Motorola District Sales Manager.

(cont'd next page)

— Motorola Silicon Zener Diodes —

1N2970 thru 1N3015 (continued)

ELECTRICAL CHARACTERISTICS (At 30°C case temperature unless otherwise specified)
 $V_F = 1.5\text{ V max @ } I_F = 2\text{ amp on all types.}$

JEDEC Type No.	Nominal* Zener Voltage $V_Z @ I_{ZT}$ Volts	Test Current I_{ZT} mA	Max Zener Impedance			Max DC Zener Current I_{ZM} mA	Max. Reverse Current		
			$Z_{ZT} @ I_{ZT}$ Ohms	$Z_{ZK} @ I_{ZK}$ Ohms	I_{ZK} mA		I_R Max (μA)	V_{R1} 5%	V_{R2} 10%
1N2970	6.8	370	1.2	500	1.0	1,320	150	5.2	4.9
1N2971	7.5	335	1.3	250	1.0	1,180	75	5.7	5.4
1N2972	8.2	305	1.5	250	1.0	1,040	50	6.2	5.9
1N2973	9.1	275	2.0	250	1.0	960	25	6.9	6.6
1N2974	10	250	3	250	1.0	860	10	7.6	7.2
1N2975	11	230	3	250	1.0	780	5	8.4	8.0
1N2976	12	210	3	250	1.0	720	5	9.1	8.6
1N2977	13	190	3	250	1.0	660	5	9.9	9.4
1N2978	14	180	3	250	1.0	600	5	10.6	10.1
1N2979	15	170	3	250	1.0	560	5	11.4	10.8
1N2980	16	155	4	250	1.0	530	5	12.2	11.5
1N2982	18	140	4	250	1.0	460	5	13.7	13.0
1N2983	19	130	4	250	1.0	440	5	14.4	13.7
1N2984	20	125	4	250	1.0	420	5	15.2	14.4
1N2985	22	115	5	250	1.0	380	5	16.7	15.8
1N2986	24	105	5	250	1.0	350	5	18.2	17.3
1N2988	27	95	7	250	1.0	300	5	20.6	19.4
1N2989	30	85	8	300	1.0	280	5	22.8	21.6
1N2990	33	75	9	300	1.0	260	5	25.1	23.8
1N2991	36	70	10	300	1.0	230	5	27.4	25.9
1N2992	39	65	11	300	1.0	210	5	29.7	28.1
1N2993	43	60	12	400	1.0	195	5	32.7	31.0
1N2995	47	55	14	400	1.0	175	5	35.8	33.8
1N2996	50	50	15	500	1.0	165	5	38.0	36.0
1N2997	51	50	15	500	1.0	163	5	38.8	36.7
1N2998	52	50	15	500	1.0	160	5	39.5	37.4
1N2999	56	45	16	500	1.0	150	5	42.6	40.3
1N3000	62	40	17	600	1.0	130	5	47.1	44.6
1N3001	68	37	18	600	1.0	120	5	51.7	49.0
1N3002	75	33	22	600	1.0	110	5	56.0	54.0
1N3003	82	30	25	700	1.0	100	5	62.2	59.0
1N3004	91	28	35	800	1.0	85	5	69.2	65.5
1N3005	100	25	40	900	1.0	80	5	76.0	72.0
1N3006	105	25	45	1,000	1.0	75	5	79.8	75.6
1N3007	110	23	55	1,100	1.0	72	5	83.6	79.2
1N3008	120	20	75	1,200	1.0	67	5	91.2	86.4
1N3009	130	19	100	1,300	1.0	62	5	98.8	93.6
1N3010	140	18	125	1,400	1.0	58	5	106.4	100.8
1N3011	150	17	175	1,500	1.0	54	5	114.0	108.0
1N3012	160	16	200	1,600	1.0	50	5	121.6	115.2
1N3014	180	14	260	1,850	1.0	45	5	136.8	129.6
1N3015	200	12	300	2,000	1.0	40	5	152.0	144.0

* SPECIAL SELECTIONS: 1 — Nominal zener voltages between those shown.
 AVAILABLE INCLUDE: 2 — Matched sets:
 a. Two or more units for series connection with specified tolerance on total voltage | Standard Tolerances are $\pm 5\%$, $\pm 2\%$, and $\pm 1\%$
 b. Two or more units matched to one another with any specified tolerance

1N3016 thru **1N3051** FLANGELESS CASE

1 Watt
6.8 — 200 V

1M 6.8 Z thru **1M 200 Z** TOP HAT CASE *

CASE 52



Choice of two hermetically sealed packages, with 36 standard voltage ratings and 5%, 10% and 20% standard tolerances. Cathode connected to case.

ABSOLUTE MAXIMUM RATINGS

Junction and Storage Temperature: -65°C to +175°C.

D-C Power Dissipation: 1 Watt. (Derate 6.67 mW/°C above 25°C).

SPECIAL TOLERANCE AND VOLTAGE DESIGNATIONS

The type numbers in the table have a standard tolerance of ±20% on the nominal zener voltage. Add suffix "A" for ±10% units or "B" for ±5% units.

To designate units with zener voltages other than those assigned JEDEC numbers, the Motorola type number should be used.

EXAMPLE: TOP HAT PACKAGE *



EXAMPLE: FLANGELESS PACKAGE *

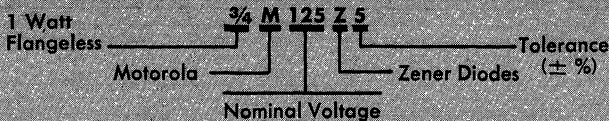

* Production devices are now being supplied in the flangeless package.

MATCHED SETS FOR CLOSER TOLERANCE OR HIGHER VOLTAGES

Series matched sets make zener voltages in excess of 200 volts or tolerances of less than 5% possible as well as providing lower temperature coefficients, lower dynamic impedance and greater power handling ability.

For Clippers, Parallel Matched Sets or other special circuit requirements, contact your Motorola District Sales Manager.

1N3016 thru 1N3051 (continued)

ELECTRICAL CHARACTERISTICS

(At 25°C case temperature unless otherwise specified)

$V_F = 1.5 V_{max}$ @ 200 mA on all types

JEDEC Type No. (Flangeless)	Motorola † Type No. (Flangeless)	Motorola Type No. (Top Hat)	Nominal * Zener Voltage $V_Z @ I_Z$ Volts	Test Current I_Z mA	Max Zener Impedance			Max. Reverse Current			Max DC Zener Current I_{ZM} mA	Typical Zener Voltage Temp. Coeff. %/°C
					$Z_{ZT} @ I_{ZT}$ Ohms	$Z_{ZL} @ I_{ZL}$ Ohms	I_{ZL} mA	I_{ZM} (μA)	V_{R1} 5%	V_{R2} 10%		
1N3016	3/4M6.8Z	1M6.8Z	6.8	37	3.5	700	1.0	150	5.2	4.9	130	.040
1N3017	3/4M7.5Z	1M7.5Z	7.5	34	4.0	700	0.5	75	5.7	5.4	120	.045
1N3018	3/4M8.2Z	1M8.2Z	8.2	31	4.5	700	0.5	50	6.2	5.9	105	.048
1N3019	3/4M9.1Z	1M9.1Z	9.1	28	5.0	700	0.5	25	6.9	6.6	95	.051
1N3020	3/4M10Z	1M10Z	10	25	7	700	0.25	10	7.6	7.2	85	.055
1N3021	3/4M11Z	1M11Z	11	23	8	700	0.25	5	8.4	8.0	75	.060
1N3022	3/4M12Z	1M12Z	12	21	9	700	0.25	5	9.1	8.6	70	.065
1N3023	3/4M13Z	1M13Z	13	19	10	700	0.25	5	9.9	9.4	65	.065
1N3024	3/4M15Z	1M15Z	15	17	14	700	0.25	5	11.4	10.8	56	.070
1N3025	3/4M16Z	1M16Z	16	15.5	16	700	0.25	5	12.2	11.5	53	.070
1N3026	3/4M18Z	1M18Z	18	14	20	750	0.25	5	13.7	13.0	46	.075
1N3027	3/4M20Z	1M20Z	20	12.5	22	750	0.25	5	15.2	14.4	42	.075
1N3028	3/4M22Z	1M22Z	22	11.5	23	750	0.25	5	16.7	15.8	38	.080
1N3029	3/4M24Z	1M24Z	24	10.5	25	750	0.25	5	18.2	17.3	35	.080
1N3030	3/4M27Z	1M27Z	27	9.5	35	750	0.25	5	20.6	19.4	30	.085
1N3031	3/4M30Z	1M30Z	30	8.5	40	1,000	0.25	5	22.8	21.6	28	.085
1N3032	3/4M33Z	1M33Z	33	7.5	45	1,000	0.25	5	25.1	23.8	26	.085
1N3033	3/4M36Z	1M36Z	36	7.0	50	1,000	0.25	5	27.4	25.9	24	.085
1N3034	3/4M39Z	1M39Z	39	6.5	60	1,000	0.25	5	29.7	28.1	20	.090
1N3035	3/4M43Z	1M43Z	43	6.0	70	1,500	0.25	5	32.7	31.0	19	.090
1N3036	3/4M47Z	1M47Z	47	5.5	80	1,500	0.25	5	35.8	33.8	17	.090
1N3037	3/4M51Z	1M51Z	51	5.0	95	1,500	0.25	5	38.8	36.7	16	.090
1N3038	3/4M56Z	1M56Z	56	4.5	110	2,000	0.25	5	42.6	40.3	15	.090
1N3039	3/4M62Z	1M62Z	62	4.0	125	2,000	0.25	5	47.1	44.6	13	.090
1N3040	3/4M68Z	1M68Z	68	3.7	150	2,000	0.25	5	51.7	49.0	12	.090
1N3041	3/4M75Z	1M75Z	75	3.3	175	2,000	0.25	5	56.0	54.0	11	.090
1N3042	3/4M82Z	1M82Z	82	3.0	200	3,000	0.25	5	62.2	59.0	10	.090
1N3043	3/4M91Z	1M91Z	91	2.8	250	3,000	0.25	5	69.2	65.5	9	.090
1N3044	3/4M100Z	1M100Z	100	2.5	350	3,000	0.25	5	76.0	72.0	8	.090
1N3045	3/4M110Z	1M110Z	110	2.3	450	4,000	0.25	5	83.6	79.2	7.2	.095
1N3046	3/4M120Z	1M120Z	120	2.0	550	4,500	0.25	5	91.2	86.4	7.0	.095
1N3047	3/4M130Z	1M130Z	130	1.9	700	5,000	0.25	5	98.8	93.6	6.0	.095
1N3048	3/4M150Z	1M150Z	150	1.7	1,000	6,000	0.25	5	114.0	108.0	5.5	.095
1N3049	3/4M160Z	1M160Z	160	1.6	1,100	6,500	0.25	5	121.6	115.2	5.2	.095
1N3050	3/4M180Z	1M180Z	180	1.4	1,200	7,000	0.25	5	136.8	129.6	4.6	.095
1N3051	3/4M200Z	1M200Z	200	1.2	1,500	8,000	0.25	5	152.0	144.0	4.0	.100

† 1 Watt Ratings

* SPECIAL SELECTIONS 1 — Nominal zener voltages between those shown.

AVAILABLE INCLUDE: 2 — Matched sets:

a. Two or more units for series connection with specified tolerance on total voltage } Standard Tolerances
 b. Two or more units matched to one another with any specified tolerance } are ±5%, ±2%, and ±1%

1N3305 thru 1N3350

50 Watt
6.8 — 200 V



CASE 58

Available with anode-to-case or cathode-to-case connection (standard or reverse polarity). For reverse polarity, add Suffix "R" to type number. Same devices in TO-3 package available for both military and industrial applications, see 1N2804 - 1N2846 series.

ABSOLUTE MAXIMUM RATINGS

Junction and Storage Temperature: -65 to + 175°C

D. C. Power Dissipation: 50 Watts (Derate 0.5 W/°C above 75°C-see Figure 3)

ELECTRICAL CHARACTERISTICS (At 30°C case temperature unless otherwise specified)
V_F = 1.5V max @ 10A on all types.

EIA Type No. 50 Watt (Stud) (Note 1)	Nominal Zener Voltage (V _Z) ^(a) Volts	Test Current (I _{ZT}) mA	Max Zener Impedance		Max DC Zener Current 75°C Case Temp (I _{ZM}) mA	Max Reverse Current			Typical Zener Voltage Temp. Coeff. %/°C
			Z _{ZT} @ I _{ZT} ohms	Z _{ZK} @ I _{ZK} = 5mA ohms		I _R MAX (μA)	V _{R1}	V _{R2}	
1N3305	6.8	1850	0.2	70	6600	150	4.5	4.3	.040
1N3306	7.5	1700	0.3	70	5900	75	5.0	4.7	.045
1N3307	8.2	1500	0.4	70	5200	50	5.4	5.2	.048
1N3308	9.1	1370	0.5	70	4800	25	6.1	5.7	.051
1N3309	10	1200	0.6	80	4300	10	6.7	6.3	.055
1N3310	11	1100	0.8	80	3900	5	8.4	8.0	.060
1N3311	12	1000	1.0	80	3600	5	9.1	8.6	.065
1N3312	13	960	1.1	80	3300	5	9.9	9.4	.065
1N3313	14	890	1.2	80	3000	5	10.6	10.1	.070
1N3314	15	830	1.4	80	2800	5	11.4	10.8	.070
1N3315	16	780	1.6	80	2650	5	12.2	11.5	.070
1N3316	17	740	1.8	80	2500	5	13.0	12.2	.075
1N3317	18	700	2.0	80	2300	5	13.7	13.0	.075
1N3318	19	660	2.2	80	2200	5	14.4	13.7	.075
1N3319	20	630	2.4	80	2100	5	15.2	14.4	.075
1N3320	22	570	2.5	80	1900	5	16.7	15.8	.080
1N3321	24	520	2.6	80	1750	5	18.2	17.3	.080
1N3322	25	500	2.7	90	1550	5	19.0	18.0	.080
1N3323	27	460	2.8	90	1500	5	20.6	19.4	.085
1N3324	30	420	3.0	90	1400	5	22.8	21.6	.085
1N3325	33	380	3.2	90	1300	5	25.1	23.8	.085
1N3326	36	350	3.5	90	1150	5	27.4	25.9	.085
1N3327	39	320	4.0	90	1050	5	29.7	28.1	.090
1N3328	43	290	4.5	90	975	5	32.7	31.0	.090
1N3329	45	280	4.5	100	930	5	34.2	32.4	.090
1N3330	47	270	5.0	100	880	5	35.8	33.8	.090
1N3331	50	250	5.0	100	830	5	38.0	36.0	.090
1N3332	51	245	5.2	100	810	5	38.8	36.7	.090
1N3333	52	240	5.5	100	790	5	39.5	37.4	.090
1N3334	56	220	6	110	740	5	42.6	40.3	.090
1N3335	62	200	7	120	660	5	47.1	44.6	.090
1N3336	68	180	8	140	600	5	51.7	49.0	.090
1N3337	75	170	9	150	540	5	56.0	54.0	.090
1N3338	82	150	11	160	490	5	62.2	59.0	.090
1N3339	91	140	15	180	420	5	69.2	65.5	.090
1N3340	100	120	20	200	400	5	76.0	72.0	.090
1N3341	105	120	25	210	380	5	79.8	75.6	.095
1N3342	110	110	30	220	365	5	83.6	79.2	.095
1N3343	120	100	40	240	335	5	91.2	86.4	.095
1N3344	130	95	50	275	310	5	98.8	93.6	.095
1N3345	140	90	60	325	290	5	106.4	100.8	.095
1N3346	150	85	75	400	270	5	114.0	108.0	.095
1N3347	160	80	80	450	250	5	121.6	115.2	.095
1N3348	175	70	85	500	230	5	133.0	126.0	.095
1N3349	180	68	90	525	220	5	136.8	129.6	.095
1N3350	200	65	100	600	200	5	152.0	144.0	.100

* SPECIAL SELECTIONS 1 — Nominal zener voltages between those shown.

AVAILABLE INCLUDE: 2 — Matched sets:
 a. Two or more units for series connection with specified tolerance on total voltage } Standard Tolerances
 b. Two or more units matched to one another with any specified tolerance } are ±5%, ±2%, and ±1%

1N3305 thru 1N3350 (continued)

SPECIAL TOLERANCE AND VOLTAGE DESIGNATIONS

The JEDEC type numbers shown have a standard tolerance of $\pm 20\%$ on the nominal zener voltage. Suffix "A" for $\pm 10\%$ units or "B" for $\pm 5\%$ units.

To designate units with zener voltages other than those assigned JEDEC numbers, the Motorola type number should be used.

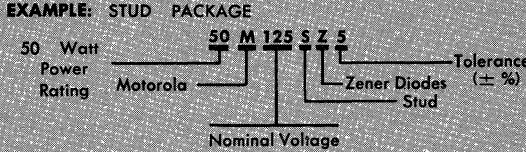

1N3675 thru 1N3703

**3/4 Watt
6.8 — 100 V**

CASE 59



Oxide passivated silicon zener diodes in void-free silicone polymer case. Offer 3/4 Watt performance in a package no larger in volume than a conventional 400 mW glass package.

ABSOLUTE MAXIMUM RATINGS

Junction and Storage Temperature: -65°C to $+175^{\circ}\text{C}$.

D-C Power Dissipation: 750 Milliwatts at 50°C Ambient.
(Derate 6 mW/ $^{\circ}\text{C}$)

Lead Temperature, 1/16 \pm 1/32 inch from case: $+235^{\circ}\text{C}$ for 12 seconds.
(Method 2031, MIL-STD-750).

Tolerance Designation: Tolerances of $\pm 10\%$ or $\pm 5\%$ are indicated by suffixing "A" or "B" respectively to the JEDEC or Motorola type number. Plus or minus 20% tolerances are indicated by the omission of the suffix letter. Examples:

- 1N3680 = 11 Volts $\pm 20\%$ tolerance
- 1N3685A = 18 Volts $\pm 10\%$ tolerance
- MZ623-18B = 25 Volts $\pm 5\%$ tolerance

1N3675 thru 1N3703 (continued)

ELECTRICAL CHARACTERISTICS 25°C Ambient $V_F = 1.5V$ @ $I_F = 200\text{ mA}$ for all units

JEDEC Type No.	Motorola Type No.	Nominal* Zener Voltage V_Z @ I_{ZT} Volts	Test Current I_{ZT} mA	Max Zener Impedance		Max DC Zener Current I_{ZM} mA	$I_R = 5\text{ mA}$ Max @ Reverse Voltage	Typical Zener Voltage Temp. Coeff. %/°C
				Z_{ZK} @ I_{ZK} Ohms	Z_{ZT} @ I_{ZT} Ohms			
1N3675		6.8	18.5	4.5	700	100	5.2	4.9
1N3676		7.5	16.5	5.5	700	90	5.7	5.4
1N3677		8.2	15.0	6.5	700	80	6.2	5.9
1N3678		9.1	14.0	7.5	700	70	6.9	6.2
1N3679		10	12.5	8.5	700	65	7.6	7.2
1N3680	MZ623-6	11	11.5	9.5	700	55	8.4	8.0
1N3681	MZ623-7	12	10.5	11.5	700	53	9.1	8.6
1N3682	MZ623-8	13	9.5	13.0	700	50	9.9	9.4
	MZ623-9	14	9.0	14.5	700	45	10.6	10.1
1N3683	MZ623-10	15	8.5	16.0	700	42	11.4	10.8
1N3684	MZ623-11	16	7.8	17.0	700	40	12.2	11.5
	MZ623-12	17	7.2	19.0	700	38	13.0	12.2
1N3685	MZ623-13	18	7.0	21.0	750	35	13.7	13.0
	MZ623-14	19	6.5	23.0	750	33	14.4	13.7
1N3686	MZ623-15	20	6.2	25.0	750	32	15.2	14.4
1N3687	MZ623-16	22	5.6	29.0	750	29	16.7	15.8
1N3688	MZ623-17	24	5.2	33.0	750	26	18.2	17.3
	MZ623-18	25	5.0	36.0	750	24	19.0	18.0
1N3689	MZ623-19	27	4.6	41.0	750	23	20.6	19.4
1N3690	MZ623-20	30	4.2	49.0	1000	21	22.8	21.6
1N3691	MZ623-21	33	3.8	58.0	1000	20	25.1	23.8
1N3692	MZ623-22	36	3.4	70.0	1000	18	27.4	25.9
1N3693	MZ623-23	39	3.2	80.0	1000	15	29.7	28.1
1N3694	MZ623-24	43	3.0	93.0	1500	14	32.7	31.0
	MZ623-25	45	2.8	99.0	1500	13.5	34.2	32.4
1N3695	MZ623-26	47	2.7	105.0	1500	13	35.8	33.8
1N3696	MZ623-27	51	2.5	125.0	1500	12.2	38.8	36.7
1N3697		56	2.2	150.0	2000	11	42.6	40.3
1N3698		62	2.0	185.0	2000	10	47.1	44.6
1N3699		68	1.8	230.0	2000	9	51.7	49.0
1N3700		75	1.7	270.0	2000	8.5	56.0	54.0
1N3701		82	1.5	330.0	3000	7.5	62.2	59.0
1N3702		91	1.4	400.0	3000	7	69.2	65.5
1N3703		100	1.3	500.0	3000	6	76.0	72.0

1N3785 thru 1N3820

1.5 Watt
6.8 — 200 V



CASE 55

Low silhouette single-ended package for printed circuit or socket mounting. Cathode connected to case, but reverse polarity available on special order.

ABSOLUTE MAXIMUM RATINGS

Junction and Storage Temperature: -65°C to $+175^{\circ}\text{C}$.
D-C Power Dissipation: 1.5 Watts. (Derate 10 mW/°C)

1N3785 thru 1N3820 (continued)

SPECIAL TOLERANCE AND VOLTAGE DESIGNATIONS

The type numbers shown in the table have a standard tolerance of $\pm 20\%$ on the zener voltage. Standard tolerances of $\pm 10\%$ and $\pm 5\%$ on individual units are also available and are indicated by suffixing "A" for $\pm 10\%$ and "B" for $\pm 5\%$ unit to the standard type number.

To designate units with zener voltages other than those assigned JEDEC numbers, the Motorola type number should be used.

EXAMPLE:

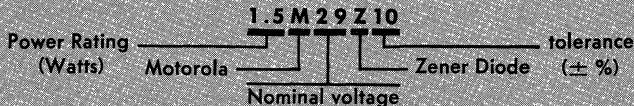

ELECTRICAL CHARACTERISTICS @ 25°C Ambient $V_T = 1.5$ Volts max @ 300 mA

JEDEC Type No.	Nominal* Zener Voltage (V_Z) @ I_{TZ} Volts	Test Current (I_{TZ}) mA	Max Zener Impedance			Max DC Zener Current (I_{ZM}) mA	Max Reverse Current			Typical Zener Voltage Temp. Coeff %/°C
			Z_{TZ} @ I_{TZ} ohms	Z_{ZK} @ I_{ZK} ohms	I_{ZK} mA		I_R Max (μ A)	5% V_{R1}	10% V_{R2}	
1N3785	6.8	55	2.7	700	1.0	195	150	5.2	4.9	.040
1N3786	7.5	50	3.0	700	0.5	175	75	5.7	5.4	.045
1N3787	8.2	46	3.5	700	0.5	155	50	6.2	5.9	.048
1N3788	9.1	41	4.0	700	0.5	140	25	6.9	6.6	.051
1N3789	10	37	5	700	0.25	125	10	7.6	7.2	.055
1N3790	11	34	6	700	0.25	115	5	8.4	8.0	.060
1N3791	12	31	7	700	0.25	105	5	9.1	8.6	.065
1N3792	13	29	8	700	0.25	98	5	9.9	9.4	.065
1N3793	15	25	10	700	0.25	85	5	11.4	10.8	.070
1N3794	16	23	11	700	0.25	80	5	12.2	11.5	.070
1N3795	18	21	13	750	0.25	70	5	13.7	13.0	.075
1N3796	20	19	15	750	0.25	62	5	15.2	14.4	.075
1N3797	22	17	16	750	0.25	56	5	16.7	15.8	.080
1N3798	24	16	17	750	0.25	51	5	18.2	17.3	.080
1N3799	27	14	20	750	0.25	46	5	20.6	19.4	.085
1N3800	30	12	25	1,000	0.25	41	5	22.8	21.6	.085
1N3801	33	11	30	1,000	0.25	38	5	25.1	23.8	.085
1N3802	36	10	35	1,000	0.25	35	5	27.4	25.9	.085
1N3803	39	10	40	1,000	0.25	31	5	29.7	28.1	.090
1N3804	43	9.0	45	1,500	0.25	28	5	32.7	31.0	.090
1N3805	47	8.0	55	1,500	0.25	26	5	35.8	33.8	.090
1N3806	51	7.4	65	2,000	0.25	24	5	38.8	36.6	.090
1N3807	56	6.7	75	2,000	0.25	22	5	42.6	40.3	.090
1N3808	62	6.0	85	2,000	0.25	20	5	47.1	44.6	.090
1N3809	68	5.5	95	2,000	0.25	18	5	51.7	49.0	.090
1N3810	75	5.0	110	2,000	0.25	16	5	56.0	54.0	.090
1N3811	82	4.5	130	3,000	0.25	14	5	62.0	59.0	.090
1N3812	91	4.1	150	3,000	0.25	13	5	69.2	65.5	.090
1N3813	100	3.7	200	3,000	0.25	12.0	5	76.0	72.0	.090
1N3814	110	3.4	300	4,000	0.25	11.0	5	83.6	79.2	.095
1N3815	120	3.1	350	4,500	0.25	10.5	5	91.2	86.4	.095
1N3816	130	2.9	400	5,000	0.25	9.0	5	98.6	93.8	.095
1N3817	150	2.5	700	6,000	0.25	8.0	5	114.0	108.0	.095
1N3818	160	2.3	750	6,500	0.25	8.0	5	121.8	115.0	.095
1N3819	180	2.1	800	7,000	0.25	7.0	5	137.0	130.0	.095
1N3820	200	1.9	1,000	8,000	0.25	6.0	5	152.0	144.0	.100

* SPECIAL SELECTIONS 1 — Nominal zener voltages between those shown.

AVAILABLE INCLUDE: 2 — Matched sets:

a. Two or more units for series connection with specified tolerance on total voltage } Standard Tolerances are $\pm 5\%$, $\pm 2\%$, and $\pm 1\%$
 b. Two or more units matched to one another with any specified tolerance }

1N3785 thru 1N3820 (continued)

ELECTRICAL CHARACTERISTICS (25°C Ambient $V_F = 1.5 V @ I_F = 200 mA$ for all units)

JEDEC TYPE NO.	Nominal Zener Voltage @ I_{ZT} (V_Z) Volts	Test Current I_{ZT} mA	Max Zener Impedance		Max DC Zener Current I_{ZM} mA	$I_A = 10 \mu A$ Max @ Reverse Voltage V_A 5% or V_A 10%	Typical Zener Voltage/Temp. Coeff. %/°C
			Z_{ZT} @ I_{ZT} ohms	Z_{ZK} @ $I_{ZK} = 1.0mA$ ohms			
1N3821	3.3	76	10	400	276	1	- .075
1N3821A	3.3	76	10	400	276	1	- .075
1N3822	3.6	69	10	400	252	1	- .085
1N3822A	3.6	69	10	400	252	1	- .085
1N3823	3.9	64	9	400	238	1	- .055
1N3823A	3.9	64	9	400	238	1	- .055
1N3824	4.3	58	9	400	213	1	- .040
1N3824A	4.3	58	9	400	213	1	- .040
1N3825	4.7	53	8	500	194	1	- .020
1N3825A	4.7	53	8	500	194	1	- .020
1N3826	5.1	49	7	550	178	1	+ .005
1N3826A	5.1	49	7	550	178	1	+ .005
1N3827	5.6	45	5	600	162	2	+ .020
1N3827A	5.6	45	5	600	162	2	+ .020
1N3828	6.2	41	2	700	146	3	+ .035
1N3828A	6.2	41	2	700	146	3	+ .035
1N3829	6.8	37	1.5	500	133	3	+ .040
1N3829A	6.8	37	1.5	500	133	3	+ .040
1N3830	7.5	34	1.5	250	121	3	+ .045
1N3830A	7.5	34	1.5	250	121	3	+ .045

1N3821 thru 1N3830

**1 Watt
3.3 – 7.5 V**



CASE 52

Low-voltage, alloy-junction zener diodes in hermetically sealed package with cathode connected-to-case. Available as standard industrial types as well as for military and high-reliability applications.

Junction and Storage Temperature: $-65^\circ C$ to $+175^\circ C$.
D-C Power Dissipation: 1 Watt. (Derate 6.67 mW/°C above 25°C)

SPECIAL TOLERANCE AND VOLTAGE DESIGNATIONS

The JEDEC type numbers as shown have a standard tolerance on the nominal zener voltage of $\pm 10\%$. A standard tolerance of $\pm 5\%$ on individual units is also available and is indicated by suffixing "A" to the standard type number i. e. 1N3825A is a 4.7 V, $\pm 5\%$ type.

Lower temperature coefficient, lower dynamic impedance and greater power handling ability can be obtained by using two or more units in a series connection. Series matched sets make tolerances of less than $\pm 5\%$ possible. Matched sets for parallel operation (units matched to each other) are available also.

To designate units with nominal voltages other than those assigned JEDEC numbers, the Motorola type number should be used.

Example:

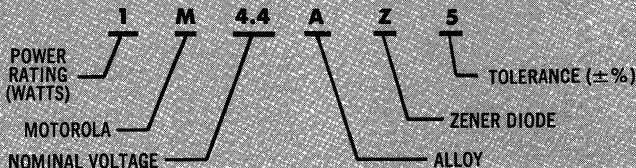

1N3993 thru 1N4000

10 Watt
3.9 – 7.5 V



CASE 56
(DO-4)

Low-voltage, alloy-junction zener diodes in hermetically sealed package with cathode connected to case. Supplied with mounting hardware.

ABSOLUTE MAXIMUM RATINGS

Junction and Storage Temperature: -65°C to $+175^{\circ}\text{C}$.
D-C Power Dissipation: 10 Watts. (Derate $83.3 \text{ mW}/^{\circ}\text{C}$ above 55°C).

SPECIAL TOLERANCE AND VOLTAGE DESIGNATIONS

The type numbers shown in the table have a standard tolerance on the nominal zener voltage of $\pm 10\%$. A standard tolerance of $\pm 5\%$ on individual units is also available and is indicated by suffixing "A" to the standard type number i. e. 1N3995A is a 4.7 V. $\pm 5\%$ type.

Lower temperature coefficient, lower dynamic impedance and greater power handling ability can be obtained by using two or more units in a series connection. Series matched sets make tolerances of less than $\pm 5\%$ possible. Matched sets for parallel operation (units matched to each other) are available also.

To designate units with nominal voltages other than those assigned JEDEC numbers, the Motorola type number should be used.

Example:

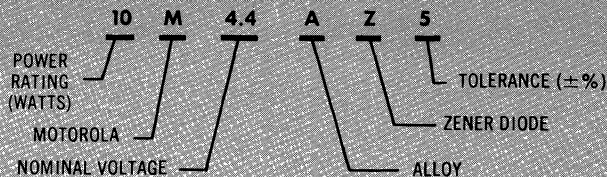

ELECTRICAL CHARACTERISTICS ($T_B = 30^{\circ}\text{C} \pm 3$, $V_F = 1.5 \text{ max}$ @ $I_F = 2 \text{ amp}$ for all units)

JEDEC Type No.	Nominal Zener Voltage $V_Z @ I_{ZT}$ Volts	Test Current I_{ZT} mA	Max Zener Impedance		Max DC Zener Current I_{ZM} mA	@	
			$Z_{ZT} @ I_{ZT}$ Ohms	$Z_{ZK} @ I_{ZK} = 1.0 \text{ mA}$ Ohms		I_{ZM} Max	V_Z Volts
1N3993	3.9	640	2	400	2380	100	0.5
1N3994	4.3	580	1.5	400	2130	100	0.5
1N3995	4.7	530	1.2	500	1940	50	1
1N3996	5.1	490	1.1	550	1780	10	1
1N3997	5.6	445	1.0	600	1620	10	1
1N3998	6.2	405	1.1	750	1460	10	2
1N3999	6.8	370	1.2	500	1330	10	2
1N4000	7.5	335	1.3	250	1210	10	3

1N4099 thru **1N4135**

¼ W
6.8 – 100 V

CASE 51
(DO-7)



Oxide passivated devices with extremely low, specified noise level. Designed for low-level operation over expanded temperature range from -75°C to $+200^{\circ}\text{C}$.

ABSOLUTE MAXIMUM RATINGS

Characteristic	Rating	Unit
DC Power Dissipation, 25°C Ambient	250	mW
Derating Factor	1.43	mW/ $^{\circ}\text{C}$
Junction and Storage Temperature	-65 to +200	$^{\circ}\text{C}$

TOLERANCE AND VOLTAGE DESIGNATION

The JEDEC type numbers shown have a standard tolerance of $\pm 5\%$ on the nominal zener voltage.

MATCHED SETS FOR CLOSER TOLERANCE OR HIGHER VOLTAGES

Series matched sets make zener voltages in excess of 100 volts or tolerances of less than 5% possible as well as providing lower temperature coefficients, lower dynamic impedance and greater power handling ability.

For Clippers, Parallel Matched Sets or other special circuit requirements, contact your Motorola District Sales Manager.

ZENER NOISE DENSITY

A zener diode generates noise when it is biased in the zener direction. A small part of this noise is due to the internal resistance associated with the device. A larger part of zener noise is a result of the zener breakdown phenomenon and is called microplasma noise. This microplasma noise is generally considered "white" noise with equal amplitude for all frequencies from about zero cycles to approximately 200,000 cycles. To eliminate the higher frequency components of noise a small shunting capacitor can be used. The lower frequency noise generally must be tolerated since a capacitor required to eliminate the lower frequencies would degrade the regulation properties of the zener in many applications.

1N4099 thru 1N4135 (continued)

Motorola is rating this series with a maximum noise density at 250 microvolts. The rating of microvolts RMS per square root cycle enables calculation of the maximum RMS noise for any bandwidth.

Noise density decreases as zener current increases. This can be seen by the graph in Figure 2 where a typical noise density is plotted as a function of zener current.

The junction temperature will also change the zener noise levels. As temperature is increased, the noise levels decrease. The change is approximately 20% from 25°C to 100°C. Thus the noise rating must indicate bandwidth, current level and temperature.

The block diagram given in Figure 1 shows the method used to measure noise density. The input voltage and load resistance is high so that the zener is driven from a constant current source. The amplifier must be low noise so that the amplifier noise is negligible compared to the test zener. The filter bandpass is known so that the noise density in volts RMS per square root cycle can be calculated.

FIGURE 1 — NOISE DENSITY MEASUREMENT METHOD

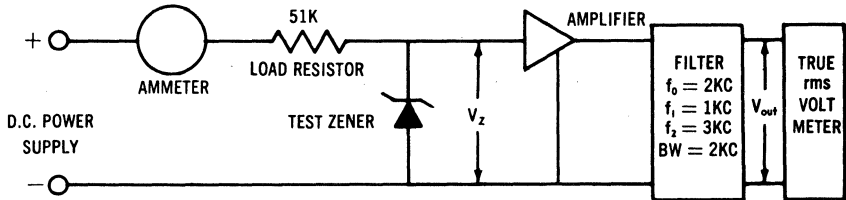
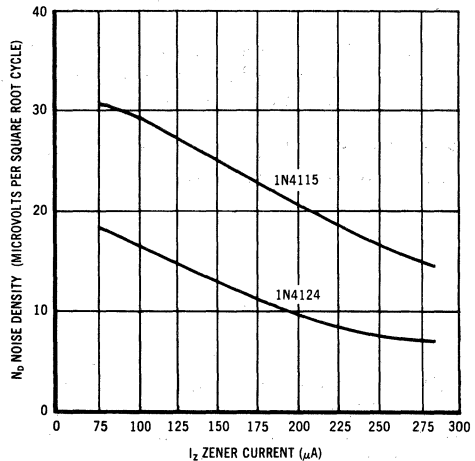

FIGURE 2 — NOISE DENSITY versus ZENER CURRENT



$$\text{NOISE DENSITY (VOLTS PER SQUARE ROOT CYCLE)} = \frac{V_{out}}{\text{OVERALL GAIN} \sqrt{BW}}$$

WHERE: BW = FILTER BANDWIDTH (CYCLES)

V_{out} = OUTPUT NOISE (VOLTS RMS)

1N4099 thru 1N4135 (continued)

ELECTRICAL CHARACTERISTICS (At 25°C Ambient temperature unless otherwise specified.)
 $V_f = 1.0 \text{ max @ } I_f = 200 \text{ mA}$ on all types

JEDEC Type Number (Note 1)	@ $I_T = 250 \mu\text{Amps}$				Max. Reverse Current I_R (μA) (Note 4)	Test Voltage V_R (volts)	Max. Noise Density at $I_T = 250 \mu\text{A}$ N_B (Fig 1) (micro-volts per square root cycle)	Max. Zener Current I_{ZM} (Note 3) (mA)
	Nominal Zener Voltage V_Z (Note 1) (volts)	Min. Zener Voltage V_Z (volts)	Max. Zener Voltage V_Z (volts)	Max. Zener Impedance Z_{ZT} (Note 2) (ohms)				
1N4099	6.8	6.460	7.140	200	10	5.17	40	35.0
1N4100	7.5	7.125	7.875	200	10	5.70	40	31.8
1N4101	8.2	7.790	8.610	200	1.0	6.24	40	29.0
1N4102	8.7	8.265	9.135	200	1.0	6.61	40	27.4
1N4103	9.1	8.645	9.555	200	1.0	6.92	40	26.2
1N4104	10	9.500	10.50	200	1.0	7.60	40	24.8
1N4105	11	10.45	11.55	200	.05	8.44	40	21.6
1N4106	12	11.40	12.60	200	.05	9.12	40	20.4
1N4107	13	12.35	13.65	200	.05	9.87	40	19.0
1N4108	14	13.30	14.70	200	.05	10.65	40	17.5
1N4109	15	14.25	15.75	100	.05	11.40	40	16.3
1N4110	16	15.20	16.80	100	.05	12.15	40	15.4
1N4111	17	16.15	17.85	100	.05	12.92	40	14.5
1N4112	18	17.10	18.90	100	.05	13.67	40	13.2
1N4113	19	18.05	19.95	150	.05	14.44	40	12.5
1N4114	20	19.00	21.00	150	.01	15.20	40	11.9
1N4115	22	20.90	23.10	150	.01	16.72	40	10.8
1N4116	24	22.80	25.20	150	.01	18.25	40	9.9
1N4117	25	23.75	26.25	150	.01	19.00	40	9.5
1N4118	27	25.65	28.35	150	.01	20.46	40	8.8
1N4119	28	26.60	29.40	200	.01	21.28	40	8.5
1N4120	30	28.50	31.50	200	.01	22.80	40	7.9
1N4121	33	31.35	34.65	200	.01	25.08	40	7.2
1N4122	36	34.20	37.80	200	.01	27.38	40	6.6
1N4123	39	37.05	40.95	200	.01	29.65	40	6.1
1N4124	43	40.85	45.15	250	.01	32.65	40	5.5
1N4125	47	44.65	49.35	250	.01	35.75	40	5.1
1N4126	51	48.45	53.55	300	.01	38.76	40	4.6
1N4127	56	53.20	58.80	300	.01	42.60	40	4.2
1N4128	60	57.00	63.00	400	.01	45.60	40	4.0
1N4129	62	58.90	65.10	500	.01	47.10	40	3.8
1N4130	68	64.60	71.40	700	.01	51.68	40	3.5
1N4131	75	71.25	78.75	700	.01	57.00	40	3.1
1N4132	82	77.90	86.10	800	.01	62.32	40	2.9
1N4133	87	82.65	91.35	1000	.01	66.12	40	2.7
1N4134	91	86.45	95.55	1200	.01	69.16	40	2.6
1N4135	100	95.00	105.00	1500	.01	76.00	40	2.3

* SPECIAL SELECTIONS 1 — Nominal zener voltages between those shown.
 AVAILABLE INCLUDE: 2 — Matched sets:
 a. Two or more units for series connection with specified tolerance on total voltage } Standard Tolerances
 b. Two or more units matched to one another with any specified tolerance } are $\pm 5\%$, $\pm 2\%$, and $\pm 1\%$

1N4370 thru 1N4372

For Specifications, see 1N746 thru 1N759 data sheet.

1N4728 thru 1N4764

**1 Watt
3.3-100 V**

CASE 59
("Surmetic" Package)



Watt SURMETIC* silicon zener diodes designed for constant voltage reference from 3.3 thru 100 volts, with 10% and 5% tolerances. These diodes are packaged in a void-free silicone polymer case which is no larger than the conventional 400 mW glass package.

MAXIMUM RATINGS

Characteristic	Rating	Unit
DC Power Dissipation	1	Watt
Derating Factor	6.67	mW/°C
Junction and storage Temperature	-65 to +200	°C

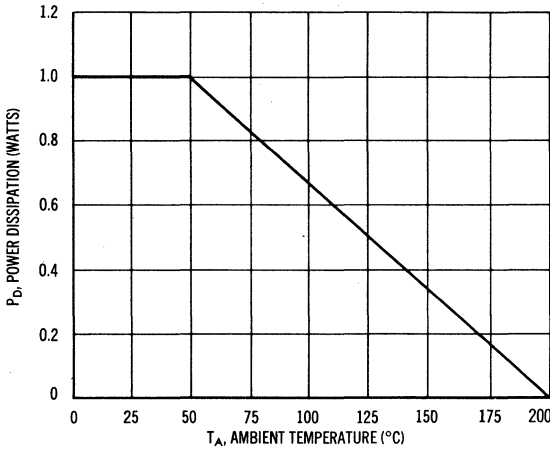

**POWER RATING versus
AMBIENT TEMPERATURE**

MECHANICAL CHARACTERISTICS

CASE: Void free, transfer molded, thermosetting silicone polymer.

FINISH: All external surfaces are corrosion resistant. Leads are readily solderable.

POLARITY: Cathode, indicated by color band. When operated in zener mode cathode will be positive with respect to anode.

MOUNTING POSITION: Any

WEIGHT: 0.42 gram (approximately)

Motorola Silicon Zener Diodes

1N4728 thru 1N4764 (continued)

ELECTRICAL CHARACTERISTICS

(At 25°C ambient temperature unless otherwise specified) $V_r = 1.5V$ max @ 200 mA on all types

JEDEC Type No. (Note 1)	Motorola Type No.	Nominal Zener Voltage V_z @ I_{zT} Volts (Note 2)	Test Current I_{zT} mA	Max Zener Impedance (Note 3)			I_n μA Max @ V_z Volts	Surge Current @ $T_A = 25^\circ C$ mA (Note 5)	Max DC Zener Current I_{zA} mA (Note 4)	Typical Zener Voltage Temp. Coeff. %/°C	
				Z_{ZT} @ I_{zT} Ohms	Z_{ZK} @ I_{zK} Ohms	I_{zK} mA					
1N4728	1M3.3ZS10	3.3	76	10	400	1.0	10	1	1380	276	-.075
1N4729	1M3.6ZS10	3.6	69	10	400	1.0	10	1	1260	252	-.065
1N4730	1M3.9ZS10	3.9	64	9	400	1.0	10	1	1190	234	-.055
1N4731	1M4.3ZS10	4.3	58	9	400	1.0	10	1	1070	217	-.040
1N4732	1M4.7ZS10	4.7	53	8	500	1.0	10	1	970	193	-.020
1N4733	1M5.1ZS10	5.1	49	7	550	1.0	10	1	890	178	.005
1N4734	1M5.6ZS10	5.6	45	5	600	1.0	10	2	810	162	.020
1N4735	1M6.2ZS10	6.2	41	2	700	1.0	10	3	730	146	.039
1N4736	1M6.8ZS10	6.8	37	3.5	700	1.0	10	4	660	133	.040
1N4737	1M7.5ZS10	7.5	34	4.0	700	0.5	10	5	605	121	.045
1N4738	1M8.2ZS10	8.2	31	4.5	700	0.5	10	6	550	110	.048
1N4739	1M9.1ZS10	9.1	28	5.0	700	0.5	10	7	500	100	.051
1N4740	1M10ZS10	10	25	7	700	0.25	10	7.8	454	91	.055
1N4741	1M11ZS10	11	23	8	700	0.25	5	8.4	414	83	.060
1N4742	1M12ZS10	12	21	9	700	0.25	5	9.1	380	76	.065
1N4743	1M13ZS10	13	19	10	700	0.25	5	9.9	344	69	.065
1N4744	1M15ZS10	15	17	14	700	0.25	5	11.4	304	61	.070
1N4745	1M16ZS10	16	15.5	16	700	0.25	5	12.2	285	57	.070
1N4746	1M18ZS10	18	14	20	750	0.25	5	13.7	250	50	.075
1N4747	1M20ZS10	20	12.5	22	750	0.25	5	15.2	225	45	.075
1N4748	1M22ZS10	22	11.5	23	750	0.25	5	16.7	205	41	.080
1N4749	1M24ZS10	24	10.5	25	750	0.25	5	18.2	190	38	.080
1N4750	1M27ZS10	27	9.5	35	750	0.25	5	20.6	170	34	.085
1N4751	1M30ZS10	30	8.5	40	1,000	0.25	5	22.8	150	30	.085
1N4752	1M33ZS10	33	7.5	45	1,000	0.25	5	25.1	135	27	.085
1N4753	1M36ZS10	36	7.0	50	1,000	0.25	5	27.4	125	25	.085
1N4754	1M39ZS10	39	6.5	60	1,000	0.25	5	29.7	115	23	.090
1N4755	1M43ZS10	43	6.0	70	1,500	0.25	5	32.7	110	22	.090
1N4756	1M47ZS10	47	5.5	80	1,500	0.25	5	35.8	95	19	.090
1N4757	1M51ZS10	51	5.0	95	1,500	0.25	5	38.8	90	18	.090
1N4758	1M56ZS10	56	4.5	110	2,000	0.25	5	42.6	80	16	.090
1N4759	1M62ZS10	62	4.0	125	2,000	0.25	5	47.1	70	14	.090
1N4760	1M68ZS10	68	3.7	150	2,000	0.25	5	51.7	65	13	.090
1N4761	1M75ZS10	75	3.3	175	2,000	0.25	5	56.0	60	12	.090
1N4762	1M82ZS10	82	3.0	200	3,000	0.25	5	62.2	55	11	.090
1N4763	1M91ZS10	91	2.8	250	3,000	0.25	5	69.2	50	10	.090
1N4764	1M100ZS10	100	2.5	350	3,000	0.25	5	76.0	45	9	.090

TOLERANCE AND VOLTAGE DESIGNATION

The JEDEC type numbers shown have a standard tolerance of $\pm 10\%$ on the nominal zener voltage. Suffix "A" for $\pm 5\%$ units.

To designate units with zener voltages other than those assigned JEDEC numbers, the Motorola type number should be used.

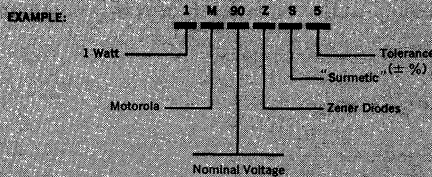

Series matched sets make zener voltages in excess of 100 volts or tolerances of less than 5% possible as well as providing lower temperature coefficients, lower dynamic impedance and greater power handling ability.

For other special circuit requirements, contact your Motorola District Sales Manager.

MOTOROLA TEMPERATURE COMPENSATED REFERENCE DIODES

Temperature compensated reference diodes are made possible by taking advantage of the differing thermal characteristics of forward and reverse biased silicon PN junctions. A forward biased junction has a negative temperature coefficient of approximately 2.0 millivolts/°C. Reverse biased junctions above 5 volts have a positive temperature coefficient and therefore it is possible by judicious selection of combinations of forward and reverse biased junctions to obtain a device which shows a very low temperature coefficient due to cancellation. Because of the differing impedance versus temperature characteristics of the junctions involved, optimum temperature stability is obtained by operating in the zener current range at which the temperature coefficient is a minimum.

VOLTAGE-CURRENT CHARACTERISTICS

All Motorola reference diodes are characterized by the "box" method which specifies a guaranteed maximum voltage variation (ΔV_Z) over an indicated temperature range. This method permits the designer to select the required reference diode directly on the basis of temperature range and voltage variation.

Because of device impedance, the reference voltage will vary with changes in zener current. These variations can be minimized by driving the device from a constant current source.

VOLTAGE VARIATION (ΔV_Z) AND TEMPERATURE COEFFICIENT

All Motorola reference diodes are characterized by the "box" method. This method provides for a guaranteed maximum voltage variation (ΔV_Z in mV) over a specified temperature range, verified by tests at several points within the range. (Maximum voltage variations over the specified temperature ranges are given in Tables associated with each device type.) The design engineer now has a number (without any calculations) telling him the stability of the voltage over the temperature range of interest thus giving him the maximum flexibility as well as economy in selecting the temperature stability required. Military specifications now being issued use this approach to characterize these devices.

Since reference diodes have a non-linear voltage-temperature relationship the temperature coefficients in the tables are tabulated primarily for reference purposes and guaranteed only at the end points of the temperature range.

ZENER IMPEDANCE DERIVATION

The dynamic zener impedance, Z_{ZT} , is derived from the 60 cycle ac voltage which results when an ac current having an rms value equal to 10% of the dc zener current, I_{ZT} , is superimposed on I_{ZT} . Curves showing the variation of zener impedance with zener current for each series are given in figures 7 thru 12. A 100% cathode-ray tube curve trace test is used to ensure that each zener characteristic has a sharp and stable knee region.

— Motorola Temperature Compensated Zener Reference Diodes —

IN429	-----	6.2 V
IN821 SERIES	-----	6.2 V — 400 mW
IN935 SERIES	-----	9.0 V — 500 mW
IN941 SERIES	-----	11.7 V — 500 mW
IN1530 SERIES	-----	8.4 V
IN1735 SERIES	-----	6.2 V thru 49.6 V
IN2620 SERIES	-----	9.3 V — 750 mW
IN2765 SERIES	-----	6.8 V thru 40.8 V
IN3154 SERIES	-----	8.4 V — 400 mW
IN3580 SERIES	-----	11.7 V — 750 mW

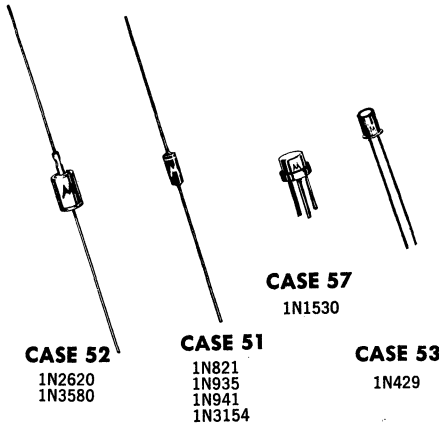

Temperature compensated zener reference diodes for circuits requiring extreme stability, high uniformity and reliable operation.

ABSOLUTE MAXIMUM RATINGS (at 25°C ambient temperature unless otherwise noted)

Characteristic	Symbol	Rating	Unit
Maximum Zener Current 1N821 Series (6.2 V), 1N3580 (11.7 V) 1N935 Series (9.0V) 1N941 Series (11.7 V) 1N2620 Series (9.3V) 1N3154 Series (8.4V) 1N429, 1N1530, 1N1735 & 1N2765 Series (6.2-49.62V)	I_{ZM}	60 50 40 75 45 see Table 2	mA
Power Dissipation (see Figure 13) 1N821 Series (6.2 V), 1N3154 Series (8.4 V) 1N935 Series (9.0 V), 1N941 Series (11.7 V) 1N2620 Series (9.3 V), 1N3580 Series (11.7 V) 1N429, 1N1530, 1N1735, 1N2765 Series	P_D	400 500 750 see Table 2	mW
Operating Temperature Glass & Metal Package Molded Package	T_J	-55 to +175 -55 to +150	°C
Storage Temperature All Types	T_{stg}	-65 to +175	°C

— Motorola Temperature Compensated Zener Reference Diodes —

1N429 (continued)

TABLE 1 - ELECTRICAL CHARACTERISTICS (at I_{ZT} & $T_A = 25^\circ\text{C}$ unless otherwise specified)

JEDEC Type Number	Max Voltage Change ΔV_Z (Volts)	Test Temperature ($^\circ\text{C}$)	Temperature Coefficient (%) / $^\circ\text{C}$	Max Dynamic Impedance Z_{ZT} Ohms	JEDEC Type Number	Max Voltage Change ΔV_Z (Volts)	Test Temperature ($^\circ\text{C}$)	Temperature Coefficient (%) / $^\circ\text{C}$	Max Dynamic Impedance Z_{ZT} Ohms
-------------------	---	---------------------------------------	--	-------------------------------------	-------------------	---	---------------------------------------	--	-------------------------------------

400 MILLIWATTS

$V_Z = 6.2 \text{ Volts} \pm 5\% (I_{ZT} = 7.5 \text{ mA})$					$V_Z = 8.4 \text{ Volts} \pm 5\% (I_{ZT} = 10 \text{ mA})$				
1N821 *	.096	-55, +25, +100	.01	15	1N3154	.130	-55, +25, +100	.01	15
1N823 *	.048		.005		1N3155	.065		.005	
1N825 *	.019		.002		1N3156	.026		.002	
1N827 *	.009		.001		1N3157	.013		.001	
1N829	.004		.0005						
1N821A	.096	-55, +25, +100	.01	10	1N3154A	.172	-55, +25, +100, +150	.01	15
1N823A	.048		.005		1N3155A	.086		.005	
1N825A	.019		.002		1N3156A	.034		.002	
1N827A	.009		.001		1N3157A	.017		.001	
1N829A	.004		.0005						

500 MILLIWATTS

$V_Z = 9.0 \text{ Volts} \pm 5\% (I_{ZT} = 7.5 \text{ mA})$					$V_Z = 11.7 \text{ Volts} \pm 5\% (I_{ZT} = 7.5 \text{ mA})$				
1N935	.067	0, +25, +75	.01	20	1N941	.088	0, +25, +75	.01	30
1N936	.033		.005		1N942	.044		.005	
1N937	.013		.002		1N943	.018		.002	
1N938	.006		.001		1N944	.009		.001	
1N939	.003		.0005		1N945	.004		.0005	
1N935A	.139	-55, 0, +25, +75, +100	.01	20	1N941A	.181	-55, 0, +25, +75, +100	.01	30
1N936A	.069		.005		1N942A	.090		.005	
1N937A	.027		.002		1N943A	.036		.002	
1N938A	.013		.001		1N944A	.018		.001	
1N939A	.007		.0005		1N945A	.009		.0005	
1N935B*	.184	-55, 0, +25, +75, +100, +150	.01	20	1N941B*	.239	-55, 0, +25, +75, +100, +150	.01	30
1N936B*	.092		.005		1N942B*	.120		.005	
1N937B*	.037		.002		1N943B*	.047		.002	
1N938B*	.018		.001		1N944B*	.024		.001	
1N939B	.009		.0005		1N945B	.012		.0005	

750 MILLIWATTS

$V_Z = 9.3 \text{ Volts} \pm 5\% (I_{ZT} = 10 \text{ mA})$					$V_Z = 11.7 \text{ Volts} \pm 5\% (I_{ZT} = 7.5 \text{ mA})$				
1N2620	.070	0, +25, +75	.01	15	1N3580	.088	0, 25, +75	.01	25
1N2621	.035		.005		1N3581	.044		.005	
1N2622	.014		.002		1N3582	.018		.002	
1N2623	.007		.001						
1N2624	.003		.0005						
1N2620A	.144	-55, 0, +25, +75, +100	.01	15	1N3580A	.181	-55, 0, +25, +75, +100	.01	25
1N2621A	.072		.005		1N3581A	.090		.005	
1N2622A	.029		.002		1N3582A	.036		.002	
1N2623A	.014		.001						
1N2624A	.007		.0005						
1N2620B	.191	-55, 0, +25, +75, +100, +150	.01	15	1N3580B	.239	-55, 0, +25, +75, +100, +150	.01	25
1N2621B	.095		.005		1N3581B	.120		.005	
1N2622B	.038		.002		1N3582B	.048		.002	
1N2623B	.019		.001						
1N2624B	.010		.0005						

*Military types available.

Motorola Temperature Compensated Zener Reference Diodes

1N429 (continued)

TABLE 2 - ELECTRICAL CHARACTERISTICS (at $I_{ZT} = 7.5 \text{ mA}$ & $T_A = 25^\circ\text{C}$ unless otherwise specified)

JEDEC Type Number	Zener Voltage $V_z \pm 5\%$ (Volts)	Max Voltage Change @ -55, +25, +100 C ΔV_z (Volts)	Max Dynamic Impedance Z_{ZT} (Ohms)	Temperature Coefficient ($\%/^\circ\text{C}$)	Power Dissipation P_d (mW)**	Package Configuration
1N429*	6.2	.050	20	.01	200	case 53
1N1735	6.2	.050	20	.01	200	Fig. 4-6
1N2765 1N2765A	6.8	.052 .026	20	.005 .0025	400	Fig. 4-2
1N1530† 1N1530A†	8.4	.014 .007	15	.002 .001	250	case 57
1N1736 1N1736A	12.4	.100 .050	40	.01 .005	400	Fig. 4-3
1N2766 1N2766A	13.6	.105 .052	40	.005 .0025	600	Fig. 4-2
1N1737 1N1737A	18.6	.150 .075	60	.01 .005	600	Fig. 4-5
1N2767 1N2767A	20.4	.158 .079	60	.005 .0025	600	Fig. 4-7
1N1738 1N1738A	24.8	.200 .100	80	.01 .005	800	Fig. 4-5
1N2768 1N2768A	27.2	.210 .105	80	.005 .0025	800	Fig. 4-7
1N1739 1N1739A	31.0	.250 .125	100	.01 .005	1000	Fig. 4-4
1N2769 1N2769A	34.0	.265 .132	100	.005 .0025	1000	Fig. 4-1
1N1740 1N1740A	37.2	.300 .150	120	.01 .005	1200	Fig. 4-4
1N2770 1N2770A	40.8	.316 .158	120	.005 .0025	1200	Fig. 4-1
1N1741 1N1741A	43.4	.350 .175	140	.01 .005	1400	Fig. 4-4
1N1742 1N1742A	49.6	.400 .200	180	.01 .005	1600	Fig. 4-4

† $I_{ZT} = 10 \text{ mA}$

* Military type available

** Derate linearly from 25°C to 150°C

MECHANICAL CHARACTERISTICS

	Glass	Metal	Molded
Case:	All glass, hermetically sealed	Welded, hermetically sealed, metal & glass	Void free, thermo-setting polymer
Polarity:	Cathode indicated by polarity band	Indicated by diode symbol	Indicated by diode symbol except 1N429, 1N1530, 1N1530A where cathode indicated by polarity dot of contrasting color
Weight:	0.2 grams (approx.)	1.5 grams (approx.)	Varies according to device min 0.5 grams max 12 grams
Finish:	All external surfaces corrosion resistant and leads readily solderable.		

1N429 (continued)

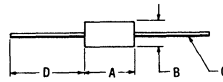
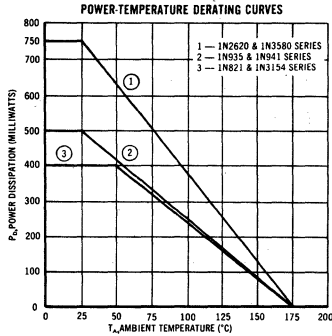

PKG	A MAX	B MAX	C ± .002	D MAX
4-1	.100	.500	.032	1.25
4-2	.500	.375	.032	1.25
4-3	1.030	.378	.032	1.25
4-4	1.220	.641	.032	1.75
4-5	.655	.641	.032	1.25
4-6	.520	.275	.022	1.25
4-7	1.000	.375	.032	1.25

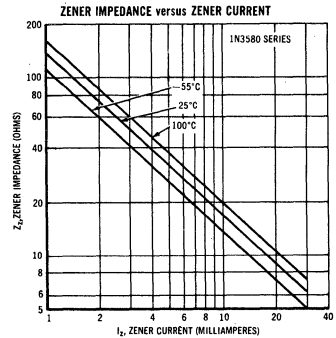
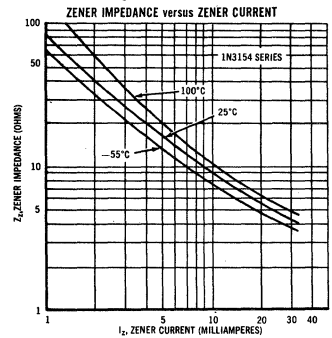
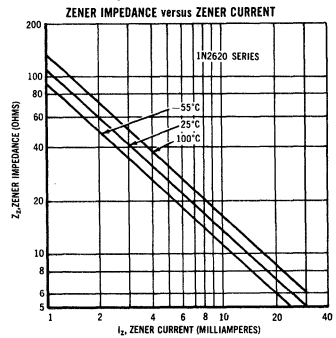
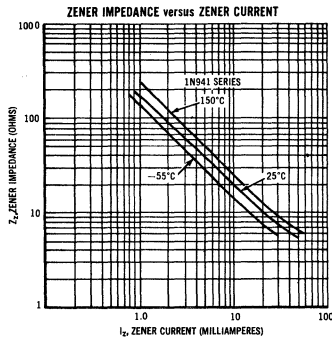
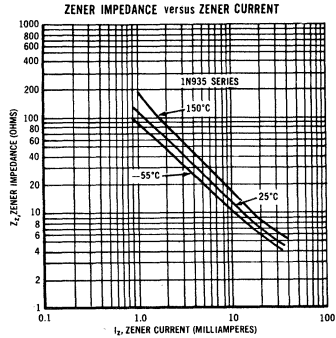
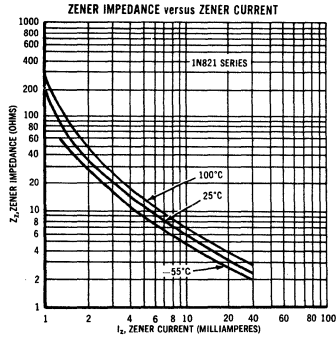

1N4565 thru **1N4574** — — — — — **6.4V ± 5%**
1N4775 thru **1N4784** — — — — — **8.5V ± 5%**
1N4765 thru **1N4774** — — — — — **9.1V ± 5%**

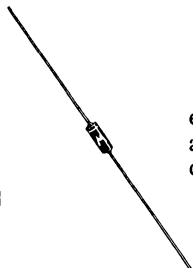

Low level, temperature compensated Zener reference diodes designed for long-term voltage stability in applications requiring stable, reliable operation at low current levels.

CASE 51

MAXIMUM RATINGS

Junction and Storage Temperature: -65°C to +175°C
 D-C Power Dissipation: 250 Mill watts at 50°C Ambient
 (Derate 2 mW/°C Above 50°C)

ELECTRICAL CHARACTERISTICS (at I_{ZT} & $T_A = 25^\circ\text{C}$ unless otherwise specified)

1N4565 Series 6.4 Volts ±5%

0.5		1.0		Test Current I_{ZT} (mA)
200		100		Max Dynamic Impedance Z_{ZT} (Ohms)
JEDEC Number	JEDEC Number	Max Voltage Change (Note 2) ΔV_Z (Volts)	Temperature Coefficient for Reference $\%/^\circ\text{C}$	
TEST TEMPERATURES 0°C, 25°C, 75°C				
1N4565	1N4570	0.048	.01	
1N4566	1N4571	0.024	.005	
1N4567	1N4572	0.010	.002	
1N4568	1N4573	0.005	.001	
1N4569	1N4574	0.002	.0005	
TEST TEMPERATURES -55°C, 0°C, 25°C, 75°C, 100°C				
1N4565A	1N4570A	0.099	.01	
1N4566A	1N4571A	0.050	.005	
1N4567A	1N4572A	0.020	.002	
1N4568A	1N4573A	0.010	.001	
1N4569A	1N4574A	0.005	.0005	

1N4755 Series 8.5 Volts ±5%

0.5		1.0		Test Current I_{ZT} (mA)
200		100		Max Dynamic Impedance Z_{ZT} (Ohms)
JEDEC Number	JEDEC Number	Max Voltage Change (Note 2) ΔV_Z (Volts)	Temperature Coefficient for Reference $\%/^\circ\text{C}$	
TEST TEMPERATURES 0°C, 25°C, 75°C				
1N4775	1N4780	.064	.01	
1N4776	1N4781	.032	.005	
1N4777	1N4782	.013	.002	
1N4778	1N4783	.006	.001	
1N4779	1N4784	.003	.0005	
TEST TEMPERATURES -55°C, 0°C, 25°C, 75°C, 100°C				
1N4775A	1N4780A	.132	.01	
1N4776A	1N4781A	.066	.005	
1N4777A	1N4782A	.026	.002	
1N4778A	1N4783A	.013	.001	
1N4779A	1N4784A	.007	.0005	

1N4765 Series 9.1 Volts ±5%

0.5		1.0		Test Current I_{ZT} (mA)
350		200		Max Dynamic Impedance Z_{ZT} (Ohms)
JEDEC Number	JEDEC Number	Max Voltage Change (Note 2) ΔV_Z (Volts)	Temperature Coefficient for Reference $\%/^\circ\text{C}$	
TEST TEMPERATURES 0°C, 25°C, 75°C				
1N4765	1N4770	0.068	.01	
1N4766	1N4771	0.034	.005	
1N4767	1N4772	0.014	.002	
1N4768	1N4773	0.007	.001	
1N4769	1N4774	0.003	.0005	
TEST TEMPERATURES -55°C, 0°C, 25°C, 75°C, 100°C				
1N4765A	1N4770A	0.141	.01	
1N4766A	1N4771A	0.070	.005	
1N4767A	1N4772A	0.028	.002	
1N4768A	1N4773A	0.014	.001	
1N4769A	1N4774A	0.007	.0005	

REFERENCE AMPLIFIERS

MCA1911 SERIES 6.8 V Reference amplifiers for use in regulated power supplies as a combination reference element and error voltage amplifier. Available with either PNP or NPN transistors.

MCA2011 SERIES 8.0 V

MCA2111 SERIES 9.5 V

MCA2211 SERIES 11.0 V

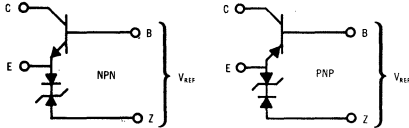

*MCA1911 Series has zener diode only

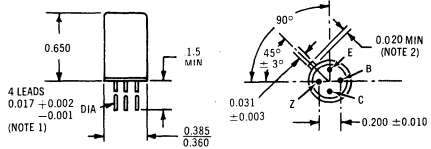

NOTES:

1. The specified lead diameter applies in the zone between 0.050 and 0.250 from the base seat. Between 0.250 and 0.5 maximum of 0.021 diameter is held. Outside of these zones the lead diameter is not controlled.
2. Measured from max diameter of the actual device.

ABSOLUTE MAXIMUM RATINGS (at 25°C ambient temperature unless otherwise noted)

Characteristic	Symbol	Rating	Unit
Zener Current	I_Z	20	mA
Collector Current	I_C	20	mA
Collector-Emitter Voltage	V_{CEO}	30	V
Junction and Storage Temperature Range	T_J T_{stg}	-65 to +175	C

ELECTRICAL CHARACTERISTICS (at 25°C ambient temperature unless otherwise noted)

Characteristic	Symbol	Rating		Unit
		Min	Max	
Nominal Reference Voltage ($I_Z = 5 \text{ mA}$, $V_{CE} = 3 \text{ V}$, $I_C = 250 \text{ } \mu\text{A}$)	V_{REF}	6.8-11.0 nom (See Table 1)		Volts
Maximum Reference Voltage Change with Temperature ($I_Z = 5 \text{ mA}$, $V_{CE} = 3 \text{ V}$, $I_C = 250 \text{ } \mu\text{A}$)	ΔV_{REF}	(See Table 1)		Volts
Zener Impedance ($I_{ZT} = 5 \text{ mA}$, $I_{ac} = 10\% I_{ZT}$)	Z_{ZT}	-	40	Ohms
Collector-Emitter Breakdown Voltage ($I_C = 250 \text{ } \mu\text{A}$)	BV_{CEO}	30	-	Volts
Collector Cutoff Current ($V_{CB} = 45 \text{ V}$) ($V_{CB} = 45 \text{ V}$, $T_A = 150^\circ\text{C}$)	I_{CBO}	-	50 10	μA
DC Current Gain ($I_C = 250 \text{ } \mu\text{A}$, V_{CE})	h_{FE}	50	100	-
Small-Signal Transconductance ($V_{CE} = 3 \text{ V}$, $I_C = 250 \text{ } \mu\text{A}$, $f = 1 \text{ kc}$)	g_{fe}	6500	-	μmhos

TABLE 1 ELECTRICAL CHARACTERISTICS

(at $I_{ZT} = 7.5 \text{ mA}$ & $T_A = 25^\circ\text{C}$ unless otherwise specified)

Type Number (Note 1)	Max Voltage Change (Note 2) ΔV_{REF} (Volts)	Test Temperature ($^\circ\text{C}$)	Reference Voltage V_{REF} (Volts)
6.8 Volt Series ($I_{ZT} = 5 \text{ mA}$)			
MCA1911N MCA1912N MCA1913N MCA1914N	.051 .025 .010 .005	0, +25, +75	$6.8 \pm 10\%$
MCA1921N MCA1922N MCA1923N MCA1924N	.105 .052 .020 .010	-55, 0, +25, +75, +100	$6.8 \pm 5\%$
MCA1931N MCA1932N MCA1933N MCA1934N	.139 .069 .026 .013	-55, 0, +25, +75, +100, +150	$6.8 \pm 5\%$
9.5 Volt Series ($I_{ZT} = 5 \text{ mA}$)			
MCA2111N MCA2112N MCA2113N MCA2114N	.071 .035 .014 .007	0, +25, +75	$9.5 \pm 10\%$
MCA2121N MCA2122N MCA2123N MCA2124N	.147 .073 .028 .014	-55, 0, +25, +75, +100	$9.5 \pm 5\%$
MCA2131N MCA2132N MCA2133N MCA2134N	.194 .097 .038 .019	-55, 0, +25, +75, +100, +150	$9.5 \pm 5\%$

Type Number (Note 1)	Max Voltage Change (Note 2) ΔV_{REF} (Volts)	Test Temperature ($^\circ\text{C}$)	Reference Voltage V_{REF} (Volts)
8.6 Volt Series ($I_{ZT} = 5 \text{ mA}$)			
MCA2011N MCA2012N MCA2013N MCA2014N	.060 .030 .012 .006	0, +25, +75	$8.0 \pm 10\%$
MCA2021N MCA2022N MCA2023N MCA2024N	.124 .062 .024 .012	-55, 0, +25, +75, +100	$8.0 \pm 5\%$
MCA2031N MCA2032N MCA2033N MCA2034N	.164 .082 .032 .016	-55, 0, +25, +75, +100, +150	$8.0 \pm 5\%$
11.0 Volt Series ($I_{ZT} = 5 \text{ mA}$)			
MCA2211N MCA2212N MCA2213N MCA2214N	.082 .041 .016 .008	0, +25, +75	$11.0 \pm 10\%$
MCA2221N MCA2222N MCA2223N MCA2224N	.170 .085 .034 .017	-55, 0, +25, +75, +100	$11.0 \pm 5\%$
MCA2231N MCA2232N MCA2233N MCA2334N	.225 .112 .044 .022	-55, 0, +25, +75, +100, +150	$11.0 \pm 5\%$

NOTES:

- Type numbers shown are for devices containing NPN transistors; for devices with PNP transistors substitute a "P" suffix for the "N" suffix in the type number.
- ΔV_{REF} is the maximum voltage variation over the specified temperature range, verified by tests at specified points within the range.

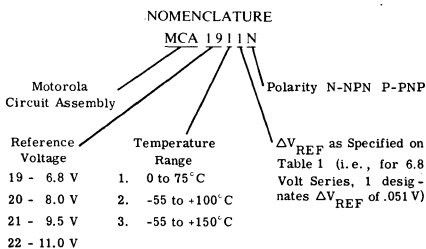

TYPICAL APPLICATION IN REGULATED POWER SUPPLIES

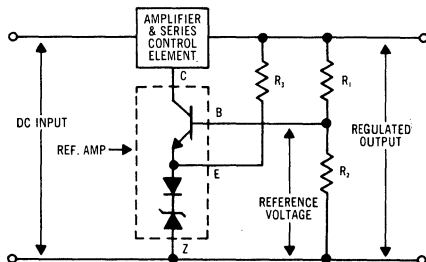

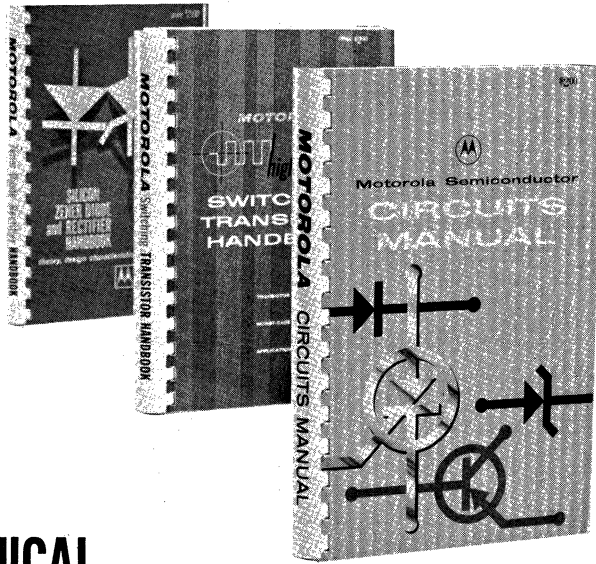

YOUR TECHNICAL LIBRARY ISN'T COMPLETE

Without Motorola's Authoritative Handbooks!

Switching Transistor Handbook — \$2.50

The only reference devoted to the design of high-frequency switching circuits, this valuable handbook not only provides detailed design procedures for saturated and current-mode switching circuits, but relates much needed device characterization and reliability data to practical worst-case design.

Circuits Manual — \$2.00

Perhaps you'll never need to count the number of peas in a can or even feel the urge to add a solid-state ignition system to the family car. If you work with semi-

conductors, however, you will find, in addition to such circuits, a wealth of technical design information and some very useful circuit ideas in the Motorola Semiconductor Circuits Manual.

Zener Diode and Rectifier Handbook — \$2.00

Anyone who designs regulating and power control circuitry needs the Motorola Zener Diode and Rectifier Handbook. This valuable guide provides design analysis and useful circuits for a variety of zener applications ranging from regulated power supplies to surge protection to using the zener diode as a coupling device.



MOTOROLA SILICON RECTIFIERS

- For devices meeting military specifications, see page 1-18.
- For case outline dimensions, see page 1-26.

SILICON RECTIFIERS

The trend in rectifiers, today, is toward silicon. Technically, there are many reasons why this is so. In comparison with thermionic tubes, silicon rectifiers offer a new era of reliability and performance, and no other solid-state rectifier has the inherent advantages of silicon. Silicon shrugs at operating temperatures that would quickly wilt other solid-state devices. The high forward conductance and low-reverse-leakage current of silicon out-classes selenium, and no other type of rectifier packs as much current-carrying capacity into as small a package. Moreover, these advantages of silicon rectifiers are now available at costs that are more than competitive with other types.

Motorola manufactures a complete line of silicon rectifiers for current requirements ranging from milliamperes to kiloamperes. These are housed in a variety of package types, making them suitable for every electrical and electronic application.

In addition, rectifier assemblies for higher voltage and current devices and for applications such as bridges and other circuit configurations are available as standard devices and can easily be made to order for custom applications, (see page 4-3).

MULTI-CELL RECTIFIERS

For high-current rectifiers, Motorola employs the multi-cell concept. This approach not only permits the fabrication of higher-current rectifiers, but also eliminates many of the problems associated with large single-junction devices. The construction of a typical multi-cell rectifier is shown below.

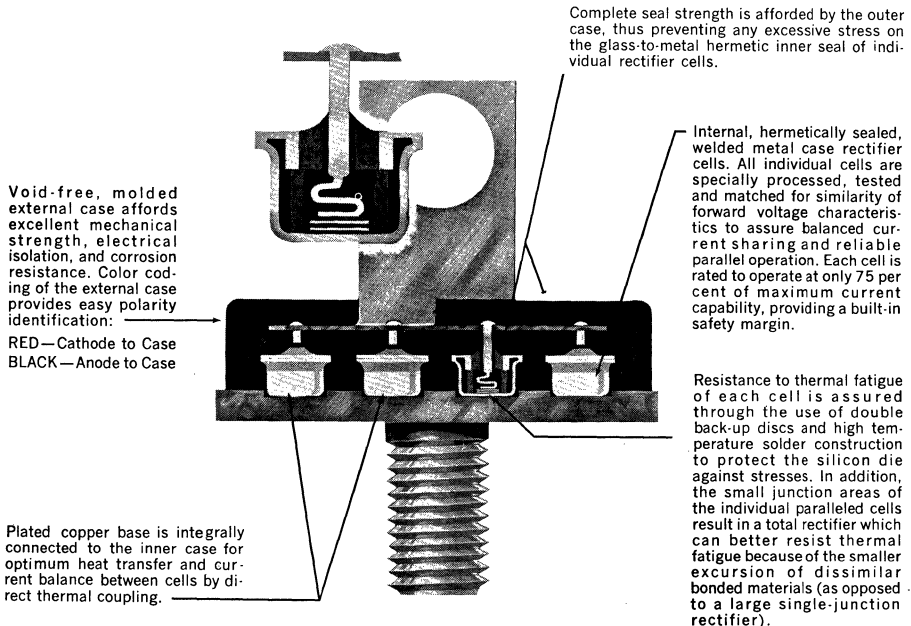

QUICK SELECTION CHART MOTOROLA PREFERRED SILICON RECTIFIERS

**THIS SELECTION CHART IS FOR QUICK REFERENCE
ONLY AND THE DETAILED DATA SHEET SHOULD
BE CONSULTED FOR COMPLETE INFORMATION**

$V_{RM(rep)}$ Max. Peak Repetitive Reverse Voltage	I_O --MAX HALF WAVE, SINGLE PHASE RECTIFIED FORWARD CURRENT (At 25°C Ambient Temp for Axial Lead; 100 to 150°C Case Temp for Stud Mount, Flange Mount or Press Fit)							
	1 A	1.5 A	3 A	6 A	12 A	15 A	20 A	
$V_{RM(rep)}$ --MAX PEAK REPETITIVE REVERSE VOLTAGE	50V	1N4001 MR1337-1		MR1030 1N4719	1N3879	1N3889	1N3208	1N248B
	100V	1N4002 MR1337-2	1N1563	MR1031 1N4720	1N3880	1N3890	1N3209	1N249B
	150V							1N1193
	200V	1N4003 MR1337-3	1N1564	MR1032 1N4721	1N3881	1N3891	1N3210	1N250B
	250V							
	300V	MR1337-4	1N1565	MR1033	1N3882	1N3892	1N3211	1N1195
	350V							
	400V	1N4004 MR1337-5	1N1566	MR1034 1N4722	1N3883	1N3893	1N3212	1N1196
	500V	MR1337-6	1N1567	MR1035			1N3213	1N1197
	600V	1N4005 MR1337-7	1N1568	MR1036 1N4723			1N3214	1N1198
	800V	1N4006		MR1038 1N4724				
	1000V	1N4007		MR1040 1N4725				

LEAD
MOUNTED

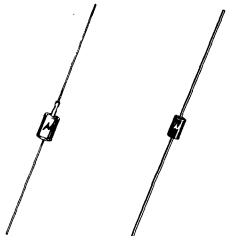

STUD MOUNTED,
FLANGE MOUNTED,
PRESS FIT

— Motorola Silicon Rectifiers —

**THIS SELECTION CHART IS FOR QUICK REFERENCE
ONLY AND THE DETAILED DATA SHEET SHOULD
BE CONSULTED FOR COMPLETE INFORMATION**

25A	30A	35 A	50 A	80 A	160 A	240 A	400 A	650 A	1000 A
1N3491	1N3659	1N1183	MR1200	MR1210	MR1220	MR1230	MR1240	MR1260	MR1290
1N3492	1N3660	1N1184	MR1201	MR1211	MR1221	MR1231	MR1241	MR1261	MR1291
		1N1185	MR1202	MR1212	MR1222	MR1232	MR1242	MR1262	MR1292
1N3493	1N3661	1N1186	MR1203	MR1213	MR1223	MR1233	MR1243	MR1263	MR1293
			MR1204	MR1214	MR1224	MR1234	MR1244	MR1264	MR1294
1N3494	1N3662	1N1187	MR1205	MR1215	MR1225	MR1235	MR1245	MR1265	MR1295
			MR1206	MR1216	MR1226	MR1236	MR1246	MR1266	MR1296
1N3495	1N3663	1N1188	MR1207	MR1217	MR1227	MR1237	MR1247	MR1267	MR1297
		1N1189							
		1N1190							

PRESS FIT

STUD MOUNTED,
FLANGE MOUNTED,

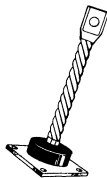

SILICON RECTIFIER SPECIFICATIONS

LOW CURRENT RECTIFIERS - 0.1 to 12.0 Amperes

Type	V _{RM (REP)} volts	Forward Current		I _{R (AV)} mA	Type	V _{RM (REP)} volts	Forward Current		I _{R (AV)} mA
		I _O amps	I _{FM (SURGE)} amps				I _O amps	I _{FM (SURGE)} amps	
Case 51		(25°C)	(25°C)	(100°C)	Case 55	(55°C)	(150°C)	(25°C)	(25°C)
1N3282	1000	0.1	2.5	0.01	1N1567	500	1.5	0.3	70
1N3283	1500	0.1	2.5	0.01	1N1567A	500	1.5	0.3	70
1N3284	2000	0.1	2.5	0.01	1N1568	600	1.5	0.3	70
1N3285	2500	0.1	2.5	0.01	1N1568A	600	1.5	0.3	70
1N3286	3000	0.1	2.5	0.01					
Case 41 (1)					Case 59 - SURMETIC*		(75°C)		(75°C)
1N1730	1000	0.2	2.5	—	1N4001	50	1.0	30	.03
1N1731	1500	0.2	2.5	—	1N4002	100	1.0	30	.03
1N1732	2000	0.2	2.5	—	1N4003	200	1.0	30	.03
1N1733	3000	0.15	2.5	—	1N4004	400	1.0	30	.03
1N1734	5000	0.10	2.5	—	1N4005	600	1.0	30	.03
1N2382	4000	0.15	2.5	—	1N4006	800	1.0	30	.03
1N2383	6000	0.10	2.5	—	1N4007	1000	1.0	30	.03
1N2384	8000	0.07	2.5	—					
1N2385	10000	0.07	2.5	—	Case 60/Case 60, 70 (2)		(75°C)		(75°C)
Case 55		(55°C)	(150°C)	(25°C)	1N4719/MR1030	50	3.0	300	1.5
1N1563	100	1.5	0.3	70	1N4720/MR1031	100	3.0	300	1.5
1N1563A	100	1.5	0.3	70	1N4721/MR1032	200	3.0	300	1.5
1N1564	200	1.5	0.3	70	— /MR1033	300	3.0	300	1.5
1N1564A	200	1.5	0.3	70	1N4722/MR1034	400	3.0	300	1.5
1N1565	300	1.5	0.3	70	— /MR1035	500	3.0	300	1.5
1N1565A	300	1.5	0.3	70	1N4723/MR1036	600	3.0	300	1.5
1N1566	400	1.5	0.3	70	1N4724/MR1038	800	3.0	300	1.5
1N1566A	400	1.5	0.3	70	1N4725/MR1040	1000	3.0	300	1.5

FAST SWITCHING POWER RECTIFIERS - t_{rr} = 0.2 μsec maximum

Type	V _{RM (REP)} volts	Forward Current		I _{R (AV)} mA	Type	V _{RM (REP)} volts	Forward Current		I _{R (AV)} mA
		I _O amps	I _{FM (SURGE)} amps				I _O amps	I _{FM (SURGE)} amps	
Case 52		(75°C)	(75°C)	(75°C)	Case 50	(100°C)	(100°C)	(100°C)	
MR1337-1	50	0.75	30	0.75	1N3881	200	6.0	75	3.0
MR1337-2	100	0.75	30	0.75	1N3882	300	6.0	75	3.0
MR1337-3	200	0.75	30	0.75	1N3883	400	6.0	75	3.0
MR1337-4	300	0.75	30	0.75	1N3888	50	12	150	5.0
MR1337-5	400	0.75	30	0.75	1N3890	100	12	150	5.0
Case 50		(100°C)	(100°C)	(100°C)	1N3891	200	12	150	5.0
1N3879	50	6.0	75	3.0	1N3892	300	12	150	5.0
1N3880	100	6.0	75	3.0	1N3893	400	12	150	5.0

MEDIUM CURRENT RECTIFIERS - 15 to 35 Amperes

Type	V _{RM (REP)} volts	Forward Current		I _{R (AV)} mA	Type	V _{RM (REP)} volts	Forward Current		I _{R (AV)} mA
		I _O amps	I _{FM (SURGE)} amps				I _O amps	I _{FM (SURGE)} amps	
Case 42		(150°C)	(25°C)	(150°C)	Case 42	(150°C)	(150°C)	(150°C)	
1N3208	50	15	250	10	1N1195	300	20	350	5.0
1N3209	100	15	250	10	1N1195A	300	20	350	3.2
1N3210	200	15	250	10	1N1196	300	20	350	5.0
1N3211	300	15	250	10	1N1196A	300	20	350	2.5
1N3212	400	15	250	10	1N1197	500	20	350	5.0
Case 43					1N1197A	500	20	350	2.2
1N3491-MR322	50	18	300	10	1N1198	600	20	350	5.0
1N3492-MR323	100	18	300	10	1N1198A	600	20	350	1.5
1N3493-MR324	200	18	300	8	1N3213	500	20	350	10.0
1N3494-MR325	300	18	300	6	1N3214	600	20	350	10.0
1N3495-MR326	400	18	300	4	Case 43				
Case 42		(150°C)			1N3659	50	25	400	5.0
1N2488	50	20	350	5.0	1N3660	100	25	400	4.5
1N248C	55	20	350	3.8	1N3661	200	25	400	4.0
1N248B	100	20	350	5.0	1N3662	300	25	400	3.5
1N249C	110	20	350	3.6	1N3663	400	25	400	3.0
1N250B	200	20	350	5.0	Case 42	(140°C)	(140°C)	(140°C)	
1N250C	220	20	350	3.4	1N1183	50	35	400	10
Case 42					1N1184	100	35	400	10
1N1191	50	20	350	5.0	1N1185	150	35	400	10
1N1192	100	20	350	5.0	1N1186	200	35	400	10
1N1193	150	20	350	5.0	1N1187	300	35	400	10
1N1194	200	20	350	5.0	1N1188	400	35	400	10
					1N1189	500	35	400	10
					1N1190	600	35	400	10

*Trademark of Motorola Inc.

(1) See data sheet for device dimensions

(2) Suffix A for case 60; Suffix B for case 70; i.e. MR1030A

SILICON RECTIFIER SPECIFICATIONS

HIGH CURRENT RECTIFIERS - 50 to 1000 Amperes

Type	V _{RM (REP)} volts	Forward Current		I _{B (AV)} mA	Type	V _{RM (REP)} volts	Forward Current		I _{B (AV)} mA
		I _O amps	I _{FM (SURGE)} amps				I _O amps	I _{FM (SURGE)} amps	
Flat-mount with solid lug terminal (FL) ①					Stud-mount with flexible braided lead (SB) or solid lug terminal (SL) ①				
		(150°C)	(150°C)	(150°C)					
MR1200	50	50	800	10	MR1230	50	240	5000	35
MR1201	100	50	800	10	MR1231	100	240	5000	35
MR1202	150	50	800	10	MR1232	150	240	5000	35
MR1203	200	50	800	10	MR1233	200	240	5000	35
MR1204	250	50	800	10	MR1234	250	240	5000	35
MR1205	300	50	800	10	MR1235	300	240	5000	35
MR1206	350	50	800	10	MR1236	350	240	5000	35
MR1207	400	50	800	10	MR1237	400	240	5000	35
Stud-mount with flexible braided lead (SB) ①					Stud-mount with flexible braided lead (SB) or solid lug terminal (SL) ①				
Stud-mount with solid lug terminal (SL) ①					Flat-mount with flexible braided lead (FB) or solid lug terminal (FL) ①				
MR1210	50	80	2000	15	MR1240	50	400	8000	50
MR1211	100	80	2000	15	MR1241	100	400	8000	50
MR1212	150	80	2000	15	MR1242	150	400	8000	50
MR1213	200	80	2000	15	MR1243	200	400	8000	50
MR1214	250	80	2000	15	MR1244	250	400	8000	50
MR1215	300	80	2000	15	MR1245	300	400	8000	50
MR1216	350	80	2000	15	MR1246	350	400	8000	50
MR1217	400	80	2000	15	MR1247	400	400	8000	50
Stud-mount with flexible braided lead (SB) or solid lug terminal (SL) ①					Flat-mount with solid lug terminal (FL) ①				
Flat-mount with flexible braided lead (FB) or solid lug terminal (FL) ①									
MR1220	50	160	3600	20	MR1260	50	650	12000	100
MR1221	100	160	3600	20	MR1261	100	650	12000	100
MR1222	150	160	3600	20	MR1262	150	650	12000	100
MR1223	200	160	3600	20	MR1263	200	650	12000	100
MR1224	250	160	3600	20	MR1264	250	650	12000	100
MR1225	300	160	3600	20	MR1265	300	650	12000	100
MR1226	350	160	3600	20	MR1266	350	650	12000	100
MR1227	400	160	3600	20	MR1267	400	650	12000	100
① For desired package configuration (SB, SL, FB, FL) as well as reverse polarity (R), add the proper suffix to the part number, i. e. MR1237SBR. For complete outline dimensions and specifications see data sheets.					Bus-bar mount, water cooled				
					MR1290	50	1000	18000	200
					MR1291	100	1000	18000	200
					MR1292	150	1000	18000	200
					MR1293	200	1000	18000	200
					MR1294	250	1000	18000	200
					MR1295	300	1000	18000	200
					MR1296	350	1000	18000	200
					MR1297	400	1000	18000	200

1N248B, C thru 1N250B, C

1N1191 thru 1N1198
 1N1195A thru 1N1198A
 1N3213 thru 1N3214

$I_O = 20 \text{ AMPS}$
 $V_{RM(rep)} - \text{to } 600 \text{ V}$



CASE 42
(DO-5)

Medium current silicon rectifiers. Unique double-case construction consists of hermetically sealed inner metallic case surrounded by molded external case; provides highest degree of ruggedness and reliability. Type numbers shown have cathode connected to case, but reverse-polarity units can be obtained by adding suffix "R" to standard type number, e. g. 1N248BR.

ABSOLUTE MAXIMUM RATINGS

Characteristics	Symbol	Rating	Unit
Peak Repetitive Reverse Voltage and DC Blocking Voltage 1N248B, 1N1191 1N248C 1N249B, 1N1192 1N249C 1N1193 1N250B, 1N1194 1N250C 1N1195, 1N1195A 1N1196, 1N1196A 1N1197, 1N1197A, 1N3213 1N1198, 1N1198A, 1N3214	$V_{RM} (rep)$ V_R	 50 55 100 110 150 200 220 300 400 500 600	Volts
RMS Reverse Voltage 1N248B, 1N1191 1N248C 1N249B, 1N1192 1N249C 1N1193 1N250B, 1N1194 1N250C 1N1195, 1N1195A 1N1196, 1N1196A 1N1197, 1N1197A, 1N3213 1N1198, 1N1198A, 1N3214	V_R	35 38.5 70 77 105 140 154 210 280 350 420	Volts
Average 1/2-Wave Rectified Forward Current (Resistive Load, 60 cps, $T_C = 150^\circ\text{C}$)	I_O	20	Amps
Peak Repetitive Forward Current ($T_C = 150^\circ\text{C}$)	$I_{FM} (rep)$	90	Amps
Peak Surge Current ($T_C = 150^\circ\text{C}$, superimposed on Rated Current at Rated Voltage, 1/2-Cycle, 1/120 sec)	$I_{FM} (surge)$	350	Amps

1N248B,C thru 1N250B,C (continued)

THERMAL CHARACTERISTICS

Maximum Operating and Storage Temperature: -65 to $+190^{\circ}\text{C}$
 Maximum Thermal Impedance, Junction to Case: $\theta_{jC} = 1.50^{\circ}\text{C/W DC}$

ELECTRICAL CHARACTERISTICS

Characteristics	Symbol	Max	Unit
Full Cycle Average Forward Voltage Drop (I_O (max), rated V_F , 60 cps, $T_C = 150^{\circ}\text{C}$)	$V_{F(AV)}$	0.6	Volts
Instantaneous Forward Voltage Drop ($i_F = 100$ Amps, $T_J = 25^{\circ}\text{C}$)	V_F	1.5	Volts
Full Cycle Average Reverse Current (I_O (max), rated V_R , 60 cps, $T_C = 150^{\circ}\text{C}$) 1N248B thru 1N250B, 1N1191 thru 1N1198 1N248C 1N249C 1N250C 1N1195A 1N1196A 1N1197A 1N1198A 1N3213 and 1N3214	$I_{R(AV)}$	5.0 3.8 3.6 3.4 3.2 2.5 2.2 1.5 10.0	mA
DC Reverse Current (Rated V_R , $T_C = 25^{\circ}\text{C}$)	I_R	1.0	mA

**MAXIMUM AVERAGE FORWARD CURRENT RATING
versus MAXIMUM CASE TEMPERATURE**

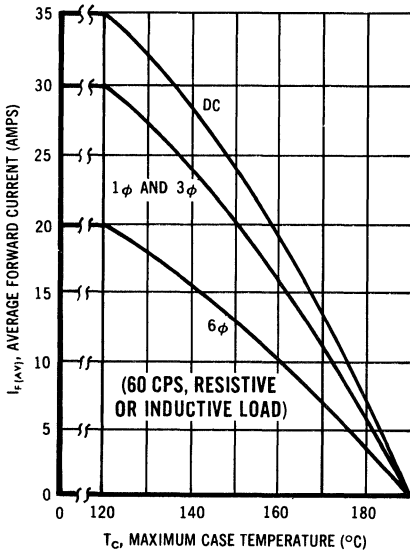

TYPICAL FORWARD CHARACTERISTICS

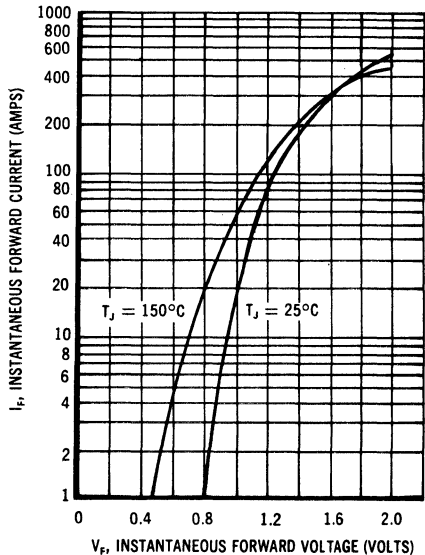

1N1124, A thru 1N1128, A

Obsolete, discontinued types, replace with devices from the MR1030 series.

1N1183 thru 1N1190

I_O = 35 AMPS
V_R — to 600 V

CASE 42
(DO-5)



Medium current silicon rectifiers. Unique double-case construction consists of hermetically sealed inner metallic case surrounded by molded external case; provides highest degree of ruggedness and reliability. Type numbers shown have cathode connected to case, but reverse-polarity units can be obtained by adding suffix "R" to standard type number, e.g. 1N1183R.

ABSOLUTE MAXIMUM RATINGS

Characteristic	Symbol	Rating	Unit
Peak Repetitive Reverse Voltage and DC Blocking Voltage	V _{RM} (rep) V _R	50 100 150 200 300 400 500 600	Volts
RMS Reverse Voltage	V _r	35 70 105 140 210 280 350 420	Volts
Average 1/2-Wave Rectified Forward Current (Resistive Load, 60 cps, T _C = 140°C)	I _O	35	Amperes
Peak Repetitive Forward Current (T _C = 140°C)	I _{FM} (rep)	150	Amperes
Peak Surge Current (T _C = 140°C, superimposed on Rated Current at Rated Voltage)	I _{FM} (surge)	400	Amperes
Operating and Storage Temperature	T _J , T _{stg}	-65 to +190	°C
Thermal Impedance	θ _{JC}	1.0	°C/W, DC steady state

1N1183 thru 1N1190 (continued)

ELECTRICAL CHARACTERISTICS

Characteristics	Symbol	Rating	Unit
Max. Full Cycle Average Forward Voltage Drop (I_O (max), rated V_R , 60 cps, $T_C = 140^\circ\text{C}$)	$V_{F(AV)}$	0.6	Volts
Max Instantaneous Forward Voltage Drop ($i_F = 100$ Amps, $T_J = 25^\circ\text{C}$)	V_F	1.3	Volts
Max Full Cycle Average Reverse Current (I_O (max), rated V_R , 60 cps, $T_C = 140^\circ\text{C}$)	$I_{R(AV)}$	10.0	mA
Max DC Reverse Current (Rated V_R , $T_C = 25^\circ$)	I_R	1.0	mA

MAXIMUM AVERAGE FORWARD CURRENT RATING
versus **MAXIMUM CASE TEMPERATURE**
(60 CPS, RESISTIVE OR INDUCTIVE LOAD)

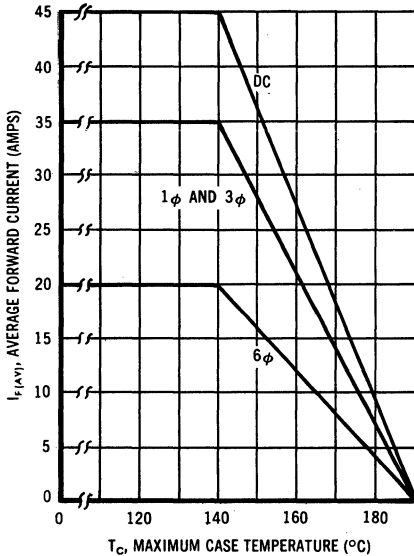

TYPICAL FORWARD CHARACTERISTICS

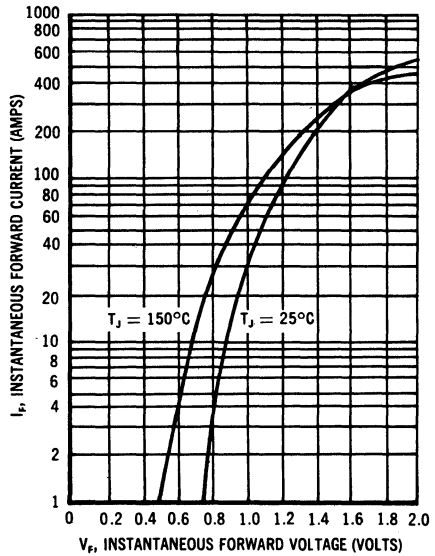

1N1191 thru 1N1198

For Specifications, See IN248B Data Sheet

1N1563, A thru 1N1568, A

I_O = 1.5 AMPS
V_R — to 600 V



CASE 55

Low-current silicon rectifiers in hermetically sealed, low-silhouette single-ended package designed to operate under military environmental conditions. Cathode connected to case, but reverse polarity devices are available on special order.

ABSOLUTE MAXIMUM RATINGS (At 60 cps Sinusoidal Input, Resistive or Inductive Load)

Rating	Symbol	1N1563A 1N1563	1N1564A 1N1564	1N1565A 1N1565	1N1566A 1N1566	1N1567A 1N1567	1N1568A 1N1568	Unit
Peak Repetitive Reverse Voltage DC Blocking Voltage	$V_{RM(rep)}$ V_R	100	200	300	400	500	600	Volts
RMS Reverse Voltage	V_r	70	140	210	280	350	420	Volts
Average Half-Wave Rectified Forward Current (55°C Ambient) (150°C Ambient)	I_O	1500 300	1500 300	1500 300	1500 300	1500 300	1500 300	mA mA
Peak Surge Current (1/2 Cycle Surge, 60 cps)	$I_{FM(surge)}$	70	70	70	70	70	70	Amps
Peak Repetitive Forward Current	$I_{FM(rep)}$	10	10	10	10	10	10	Amps
Operating and Storage Temperature Range	$T_J + T_{stg}$	-65 to +175						°C

ELECTRICAL CHARACTERISTICS

Characteristic	Symbol	1N1563A 1N1568A Rating	1N1563— 1N1568 Rating	Unit
Maximum Forward Voltage Drop @ 500 mA, (25°C) Continuous DC (150°C)	V_F	1.2 0.9	1.2 1.0	Volts
Maximum Reverse Current @ Rated DC Voltage (25°C)	I_R	1.5		μA
Maximum Full-Cycle Average Reverse Current (25°C) @ Max Rated PIV and Current (as Half-Wave (150°C) Rectifier, Resistive Load	$I_{R(AV)}$	3.0 150	5.0 500	μA

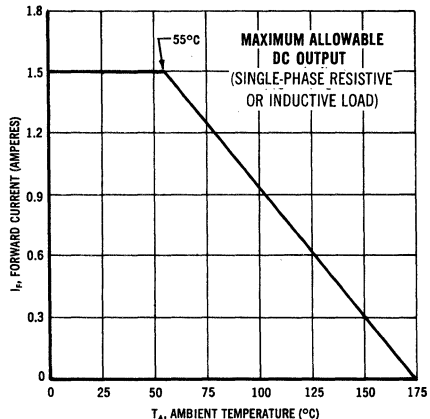
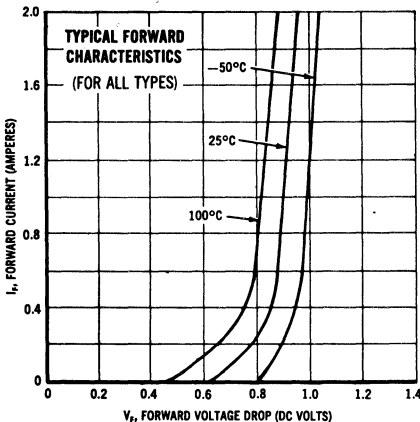

1N2609 thru 1N2617

Obsolete, discontinued types, replace with devices from the 1N4001 series.

1N3189 thru 1N3191

Obsolete, discontinued types, replace with devices from the 1N4001 series.

1N3208 thru 1N3212

$I_O = 15 \text{ AMPS}$
 $V_R \text{ — to } 400V$



CASE 42

Medium-current silicon rectifiers. Cathode connected to case, but reverse polarity (anode-to-case connection) also available by adding suffix "R" to type number, e.g. 1N3208R. Supplied with mounting hardware.

ABSOLUTE MAXIMUM RATINGS

Rating	Symbol	1N3208 1N3208R	1N3209 1N3209R	1N3210 1N3210R	1N3211 1N3211R	1N3212 1N3212R	Unit
D-C Blocking Voltage	V_R	50	100	200	300	400	Volts
RMS Reverse Voltage	V_R	35	70	140	210	280	Volts
Average Half-Wave Rectified Forward Current With Resistive Load	I_O^*	15	15	15	15	15	Amps
Peak One Cycle Surge Current (60 cps & 25°C Case Temp)	$I_{FM}(\text{surge})$	250	250	250	250	250	Amps
Operating Junction Temperature	T_J	-65 to + 175					°C
Storage Temperature	T_{stg}	-65 to + 175					°C

* $T_C = 150^\circ\text{C}$

ELECTRICAL CHARACTERISTICS (All Types) at 25°C Case Temp.

Characteristic	Symbol		
Maximum Forward Voltage at 40 Amp D-C Forward Current	V_F	1.5	Volts
Maximum Reverse Current at Rated D-C Reverse Voltage	I_R	1.0	mAdc
Typical Thermal Resistance, Junction To Case	θ_{JC}	1.7	C/W

1N3213, 1N3214

For Specifications, See IN248B Data Sheet

1N3282 thru 1N3286

$I_o = 100 \text{ mA}$
 $V_R - \text{to } 3000 \text{ V}$

CASE 51
(DO-7)



Low-current silicon rectifiers for applications requiring extremely high reverse-voltage capability. Hermetically sealed, subminiature glass package, offering excellent stability and reliability under environmental extremes.

ABSOLUTE MAXIMUM RATINGS (At 60 cps Sinusoidal Input, Resistive or Inductive Load)

Rating	Symbol	1N3282	1N3283	1N3284	1N3285	1N3286	Unit
Peak Repetitive Reverse Voltage	$V_{RM(rep)}$	1000	1500	2000	2500	3000	Volts
DC Blocking Voltage	V_R						
RMS Reverse Voltage	V_r	700	1050	1400	1750	2100	Volts
Average Half-Wave Rectified Forward Current (25°C Ambient) (100°C Ambient)	I_o	100 50	100 50	100 50	100 50	100 50	mA mA
Peak Surge Current (1/2-cycle, 60 cps)	$I_{FM(surge)}$	2.5	2.5	2.5	2.5	2.5	Amps
Peak Repetitive Forward Current	$I_{FM(rep)}$	0.50	0.50	0.50	0.50	0.50	Amps
Operating and Storage Temperature Range	T_j, T_{stg}	-65 to + 150					°C

ELECTRICAL CHARACTERISTICS

Characteristic	Symbol	Rating	Unit
Maximum Forward Voltage Drop @ 100 mA, Continuous DC (25°C)	V_F	2.5	Volts
Maximum Full-Cycle Average Forward Voltage Drop @ Rated Current (100°C)	$V_{F(AV)}$	1.2	Volts
Maximum Reverse Current @ Rated DC Voltage (25°C) (100°C)	I_R	1.0 10.0	μA
Maximum Full-Cycle Average Reverse Current @ Max Rated PIV and Current (as Half-Wave Rectifier, Resistive Load, 100°C)	$I_{R(AV)}$	10.0	μA
Typical Thermal Resistance, Junction to Air Ambient	θ_{JA}	400°	C/W

1N3282 thru 1N3286 (continued)

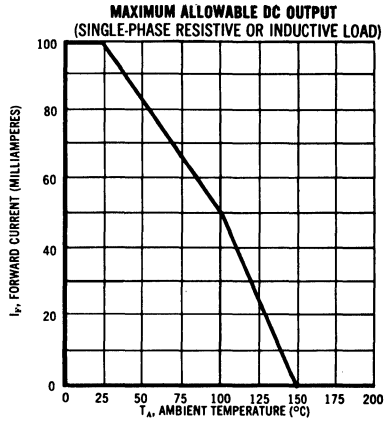
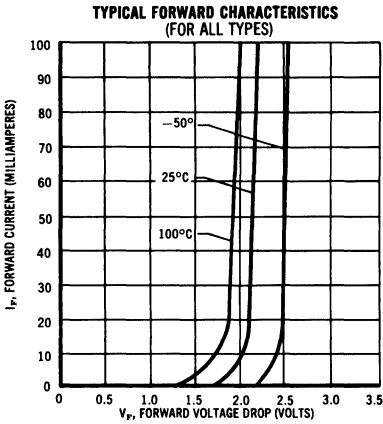

1N3491 thru 1N3495

**FORMERLY
MR 322 thru MR 326**

**$I_O = 25$ AMPS
 V_R — to 400 V**



CASE 43

Low-cost, medium-current, silicon rectifiers in hermetically sealed, press-fit case. Designed for industrial and commercial applications requiring operation under severe environmental conditions. Cathode connected to case, but available with reverse polarity by adding suffix "R" to type number.

ABSOLUTE MAXIMUM RATINGS

Rating	Symbol	1N3491 MR322	1N3492 MR323	1N3493 MR324	1N3494 MR325	1N3495 MR326	Unit
Peak Repetitive Reverse Voltage DC Blocking Voltage	$V_{RM(rep)}$ V_R	50	100	200	300	400	Volts
RMS Reverse Voltage	V_R	35	70	140	210	280	Volts
Average Half-Wave Rectified Forward Current With Resistive Load	I_O						Amps
100°C		25	25	25	25	25	
150°C		18	18	18	18	18	
Peak Repetitive Forward Current (60 cps & 25°C Case Temp.)	$I_{FM(rep)}$	75	75	75	75	75	Amps
Peak One Cycle Surge Current (60 cps & 25°C Case Temp.)	$I_{FM(surge)}$	300	300	300	300	300	Amps
Operating Junction Temperature	T_J	-65 to +175					°C
Storage Temperature	T_{stg}	-65 to +175					°C

1N3491 thru 1N3495 (continued)

ELECTRICAL CHARACTERISTICS (At 25°C case temperature unless otherwise specified)

Characteristic	Symbol	1N3491 MR322	1N3492 MR323	1N3493 MR324	1N3494 MR325	1N3495 MR326	Unit
Maximum Forward Voltage at 100 Amp DC Forward	V_F	1.5	1.5	1.5	1.5	1.5	Volts
Maximum Full-Cycle Average Forward Voltage Drop @ Rated Current and Voltage	$V_{F(AV)}$	0.7	0.7	0.7	0.7	0.7	Volts
Maximum Reverse Current at Rated DC Reverse Voltage	I_R	1.0	1.0	1.0	1.0	1.0	mAdc
Maximum Full-Cycle Average Reverse Current at Rated Current and Voltage (as Half-Wave Rectifier, Resistive Load, 150°C Case)	$I_{R(AV)}$	10	10	8	6	4	mAdc
Thermal Resistance	θ_{JC}	1					°C/W

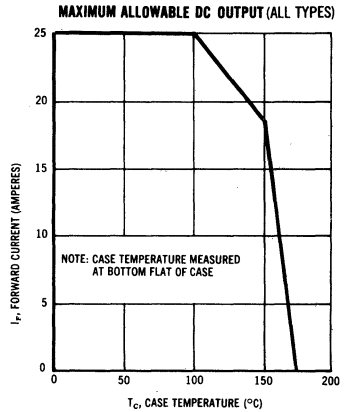
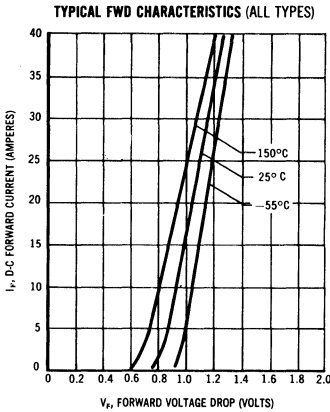

Motorola MR322-MR326 and 1N3491-1N3495 rectifiers are designed for press-fitted mounting in a heat sink. Recommended procedures for this type of mounting are as follows:

1. Drill a hole in the heat sink $0.499 \pm .001$ inch in diameter.
2. Break the hole edge as shown to prevent shearing off the knurled edge of the rectifier when it is pressed into the hole.
3. The depth of the break should be 0.010 inch maximum to retain maximum heat sink surface contact with the knurled rectifier surface.
4. Width of the break should be 0.010 inch as shown.

These procedures will allow proper entry of the rectifier knurled surface, provide good rectifier-heat sink surface contact, and assure reliable rectifier operation. If the break is made too deep, thereby reducing contact area for heat transfer, reliability of operation will be impaired.

These devices can be mounted in a thin chassis by inserting the rectifier through an additional heat sink plate which is mounted in intimate contact with the upper side of the chassis. This provides additional contact area for the rectifier knurled edge, as well as additional heat sink capacity.

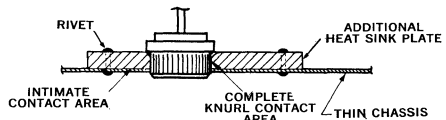
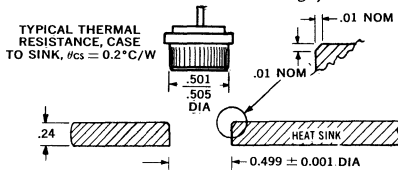

NOTE:

Refer to Motorola brochure PR-104 for additional suggested mounting methods and examples.

USN1N3611 thru USN1N3613

I_O = 1 AMP
V_R — to 600 V

CASE 59

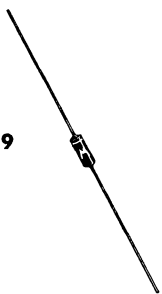

Subminiature silicon rectifier with glass passivated surface in void-free, flame-proof, silicone polymer case. Tested in accordance with MIL-S-19500/228 for military applications requiring up to 1 ampere output at 100°C.

ABSOLUTE MAXIMUM RATINGS

(At 60 cps Sinusoidal Input, Resistive or Inductive Load)

Characteristic	Symbol	USN 1N3611	USN 1N3612	USN 1N3613	Unit
Working Peak Reverse Voltage	V _{RM (wkg)}	200	400	600	Volts
DC Blocking Voltage	V _R				
Peak Repetitive Reverse Voltage	V _{RM (rep)}	240	480	720	Volts
Average Rectified Forward Current T _A = 100°C T _A = 150°C	I _O				Adc
Non-Repetitive Peak Surge Current (1/2 cycle, 60 cps)	I _{FM (surge)}				Amps
Operating and Storage Temperature Range	T _A , T _{stg}				°C

ELECTRICAL CHARACTERISTICS

Characteristics and Conditions	Symbol	Minimum	Maximum	Unit
Forward Voltage (I _F = 1.0 Adc, T _A = 100°C)	V _F	0.6	1.2	Vdc
Reverse Current (V _R = 200 Vdc) USN 1N3611 (V _R = 400 Vdc) USN 1N3612 (V _R = 600 Vdc) USN 1N3613	I _R	—	5	μAdc
Reverse Current at Rated V _{RM(rep)} (V _{RM(rep)} = 240 Vdc) USN 1N3611 (V _{RM(rep)} = 480 Vdc) USN 1N3612 (V _{RM(rep)} = 720 Vdc) USN 1N3613	I _R	—	100	μAdc
High Temperature Operation: Reverse Current @ T _A = 150°C (V _R = 200 Vdc) USN 1N3611 (V _R = 400 Vdc) USN 1N3612 (V _R = 600 Vdc) USN 1N3613	I _R	—	300	μAdc

1N3649 thru 1N3650

Obsolete, discontinued types, replace with devices from the MR1030 series.

1N3659 thru 1N3663

$I_O = 30$ AMPS
 $V_R - 400$ V



CASE 43

Low-cost silicon rectifiers in hermetically sealed, press-fit case, designed for operation under severe environmental conditions. Cathode connected to case, but available with reverse polarity by adding suffix "R" to type number.

ABSOLUTE MAXIMUM RATINGS at 25°C Case Temp. Unless Otherwise Indicated

Rating	Symbol	1N3659 1N3659R	1N3660 1N3660R	1N3661 1N3661R	1N3662 1N3662R	1N3663 1N3663R	Units
Peak Repetitive Reverse Voltage DC Blocking Voltage	$V_{RM(rep)}$ V_R	50	100	200	300	400	Volts
RMS Reverse Voltage	V_R	35	70	140	210	280	Volts
Average Half-Wave Rectified Forward Current with Resistive Load @ 100°C case @ 150°C case	I_O	30 25	30 25	30 25	30 25	30 25	Amps Amps
Peak One Cycle Surge Current (150°C case temp, 60 cps)	$I_{FM(surge)}$	400	400	400	400	400	Amps
Operating Junction Temperature	T_J	-65 to +175					°C
Storage Temperature	T_{stg}	-65 to +200					°C

ELECTRICAL CHARACTERISTICS

Characteristic	Symbol	1N3659 1N3659R	1N3660 1N3660R	1N3661 1N3661R	1N3662 1N3662R	1N3663 1N3663R	Unit
Maximum Forward Voltage at 25 Amp DC Forward Current	V_F	1.2	1.2	1.2	1.2	1.2	Volts
Maximum Full Cycle Average Forward Voltage Drop @ Rated PIV and Current	$V_{F(AV)}$	0.7	0.7	0.7	0.7	0.7	Volts
Maximum Full Cycle Average Reverse Current @ Rated PIV and Current (as half-wave rectifier, resistive load, 150°C)	$I_{R(AV)}$	5.0	4.5	4.0	3.5	3.0	mA
Thermal Resistance	θ_{JC}	1					°C/W

1N3659 thru 1N3663 (continued)

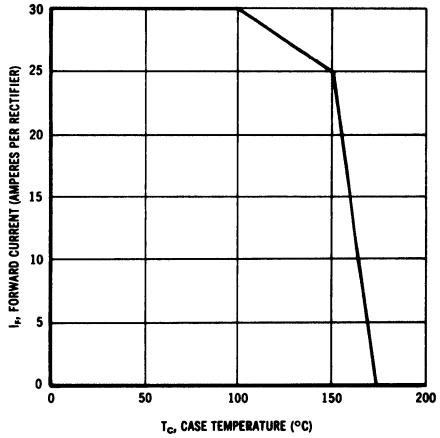
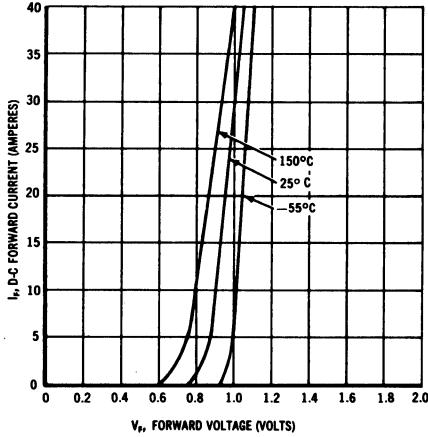

Motorola 1N3659-1N3663 rectifiers are designed for press-fitted mounting in a heat sink. Recommended procedures for this type of mounting are as follows:

1. Drill a hole in the heat sink $0.499 \pm .001$ inch in diameter.
2. Break the hole edge as shown to prevent shearing off the knurled edge of the rectifier when it is pressed into the hole.
3. The depth of the break should be 0.010 inch maximum to retain maximum heat sink surface contact with the knurled rectifier surface.
4. Width of the break should be 0.010 inch as shown.

These procedures will allow proper entry of the rectifier knurled surface, provide good rectifier-heat sink surface contact, and assure reliable rectifier operation. If the break is made too deep, thereby reducing contact area for heat transfer, reliability of operation will be impaired.

These devices can be mounted in a thin chassis by inserting the rectifier through an additional heat sink plate which is mounted in intimate contact with the upper side of the chassis. This provides additional contact area for the rectifier knurled edge, as well as additional heat sink capacity.

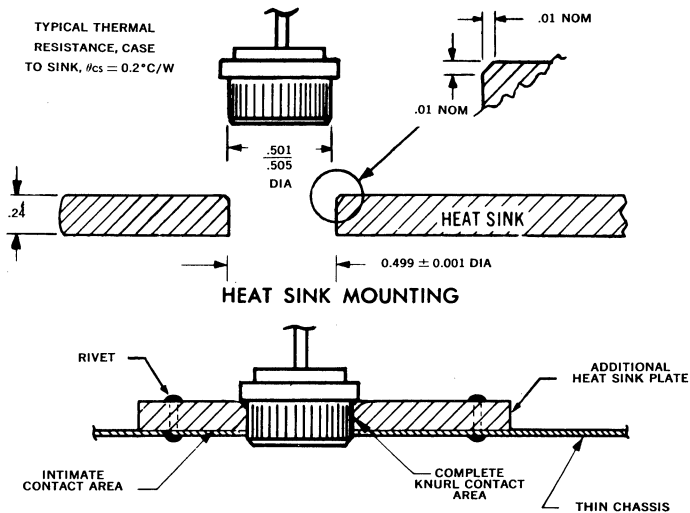

THIN-CHASSIS MOUNTING

NOTE: Refer to Motorola brochure PR-104 for additional suggested mounting methods and examples.

1N3879 thru **1N3883**
6 AMPERES

1N3889 thru **1N3893**
12 AMPERES

I_O = 6 and 12 A
V_R — to 400 V

CASE 50
 (DO-4)



Fast recovery silicon power rectifiers designed for high-frequency power supply, inverter, and converter applications. Typical recovery time of 100 nsec extends practical frequency limit of current rectification to more than 300,000 cps thus permitting the design of power supplies with smaller, lighter, and less expensive associated components. Cathode connected to case, but available with reverse polarity by adding suffix "R" to type number.

ABSOLUTE MAXIMUM RATINGS

Rating	Symbol	1N3879 1N3889	1N3880 1N3890	1N3881 1N3891	1N3882 1N3892	1N3883 1N3893	Unit
Peak Repetitive Reverse Voltage Working Peak Reverse Voltage DC Blocking Voltage	$V_{RM(rep)}$ $V_{RM(wkg)}$ V_R	50	100	200	300	400	Volts
Non-Repetitive Peak Reverse Voltage (half-wave, single phase, 60 cycle peak)	$V_{RM(non-rep)}$	100	200	300	400	500	Volts
RMS Reverse Voltage	V_R	35	70	140	210	280	Volts
Rating	Symbol	1N3879 thru 1N3883		1N3889 thru 1N3893		Unit	
Average Rectified Forward Current (single phase, resistive load, 60 cps, $T_C = 100^\circ C$)	I_O	6		12		Amperes	
Non-Repetitive Peak Surge Current (superimposed on rated current at rated voltage, $T_C = 100^\circ C$)	$I_{FM(surge)}$	75		150		Amperes	
$I^2 t$ Rating (non-repetitive, for t greater than 1 msec and less than 8.3 msec)	$I^2 t$	15		50		$A_{(rms)}^2 sec$	

THERMAL CHARACTERISTICS

Characteristic	Symbol	Max Limit	Unit
Maximum Junction Operating Temperature Range Maximum Case Storage Temperature Range	T_J T_{stg}	-65 to +150 -65 to +175	$^\circ C$
Maximum Steady State DC Thermal Resistance	1N3879-83 1N3889-93 θ_{JC}	5.0 2.5	$^\circ C/Watt$

1N3879 thru 1N3883 (continued)

ELECTRICAL CHARACTERISTICS

1N3879 thru 1N3883

Characteristic	Symbol	Max Limit	Unit
DC Forward Voltage Drop ($I_F = 6.0 \text{ Adc}$, $T_C = 25^\circ\text{C}$)	V_F	1.4	Vdc
Full Cycle Average Reverse Current ($I_O = 6.0 \text{ Amps}$ and Rated V_R , 60 cps $T_C = 100^\circ\text{C}$, single phase)	$I_{R(AV)}$	3.0	mA
DC Reverse Current (Rated V_R , $T_C = 100^\circ\text{C}$)	I_R	1.0	mA

1N3889 thru 1N3893

Characteristic	Symbol	Max Limit	Unit
DC Forward Voltage Drop ($I_F = 12.0 \text{ Adc}$, $T_C = 25^\circ\text{C}$)	V_F	1.4	Vdc
Full Cycle Average Reverse Current ($I_O = 12.0 \text{ Amps}$ and Rated V_R , 60 cps $T_C = 100^\circ\text{C}$, single phase)	$I_{R(AV)}$	5.0	mA
DC Reverse Current (Rated V_R , $T_C = 100^\circ\text{C}$)	I_R	3.0	mA

REVERSE RECOVERY TIME CHARACTERISTICS

Characteristic	Symbol	Max Limit	Unit
Maximum Reverse Recovery Time ($I_F = 1 \text{ Amp min}$, see test circuit)	t_{rr}	200	nsec
Maximum Overshoot Current (see test circuit)	I_{os}	2.0	Amps

TYPICAL RECOVERY PATTERN

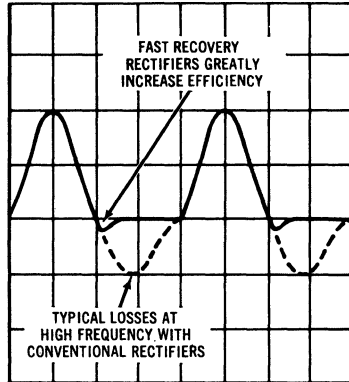
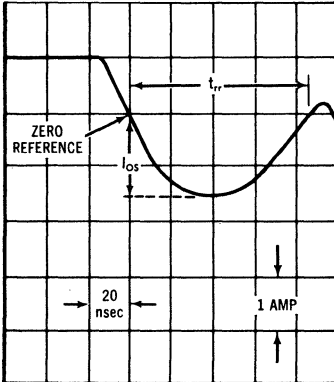

1N3879 thru 1N3883 (continued)

TYPICAL REVERSE RECOVERY TIME-ALL TYPES

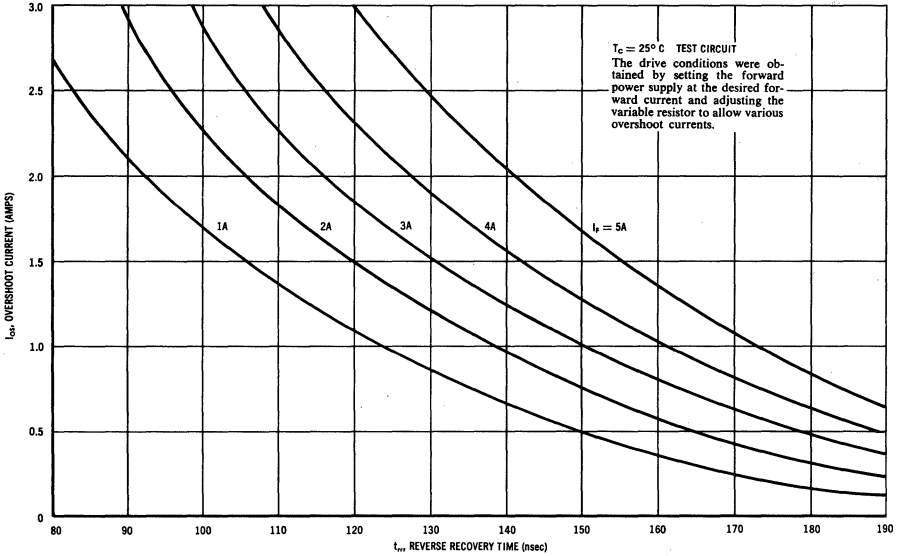

1N3889-93
1N3879-83

MAXIMUM AVERAGE FORWARD CURRENT versus MAXIMUM CASE TEMPERATURE

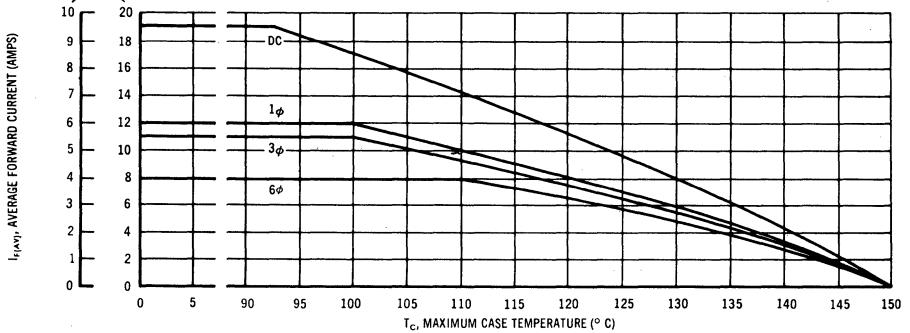

MAXIMUM REVERSE RECOVERY TIME TEST CIRCUIT (t_{rr})

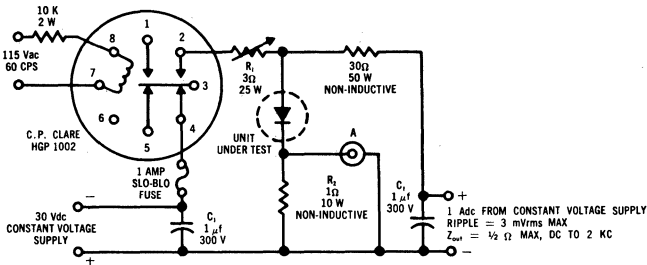

A — Tektronix 545A, K Plug-in Pre-Amp, P6000 Probe of Eq.

R_1 — Adjusted for 1.4Ω between point 2 of relay and rectifier. Inductance $\approx 3 \mu\text{h}$.

R_2 — Ten 1 W, 10 Ω , 1% carbon comp. in parallel.

$T_c = 25 \pm 10^\circ\text{C}$ for rectifiers.

Minimize all lead lengths.

1N4001 thru 1N4007

$I_O = 1 \text{ AMP}$
 $V_R - \text{to } 1000 \text{ V}$

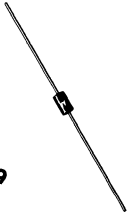

Low-current, glass passivated silicon rectifiers in subminiature void-free, flame-proof silicone polymer case. Designed to operate under military environmental conditions.

CASE 59

ABSOLUTE MAXIMUM RATINGS (At 60 cps Sinusoidal, Input, Resistive or Inductive Load)

Rating	Symbol	1N4001	1N4002	1N4003	1N4004	1N4005	1N4006	1N4007	Unit
Peak Repetitive Reverse Voltage DC Blocking Voltage	$V_{RM(rep)}$ V_R	50	100	200	400	600	800	1000	Volts
RMS Reverse Voltage	V_R	35	70	140	280	420	560	700	Volts
Average Half-Wave Rectified Forward Current (75°C Ambient) (100°C Ambient)	I_O	1000 750	1000 750	1000 750	1000 750	1000 750	1000 750	1000 750	mA mA
Peak Surge Current 25°C (1/2 Cycle Surge, 60 cps)	$I_{FM(surge)}$	30	30	30	30	30	30	30	Amps
Peak Repetitive Forward Current	$I_{FM(rep)}$	10	10	10	10	10	10	10	Amps
Operating and Storage Temperature Range	T_J, T_{stg}	-65 to + 175							°C

ELECTRICAL CHARACTERISTICS

Characteristic	Symbol	Rating	Unit
Maximum Forward Voltage Drop (1 Amp Continuous DC, 25°C)	V_F	1.1	Volts
Maximum Full-Cycle Average Forward Voltage Drop (Rated Current @ 25°C)	$V_{F(AV)}$	0.8	Volts
Maximum Reverse Current @ Rated DC Voltage (25°C) (100°C)	I_R	0.01 0.05	mA
Maximum Full-Cycle Average Reverse Current (Max Rated PIV and Current, as Half-Wave Rectifier, Resistive Load, 100°C)	$I_{R(AV)}$	0.03	mA

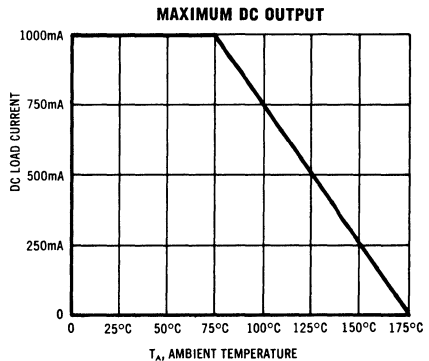
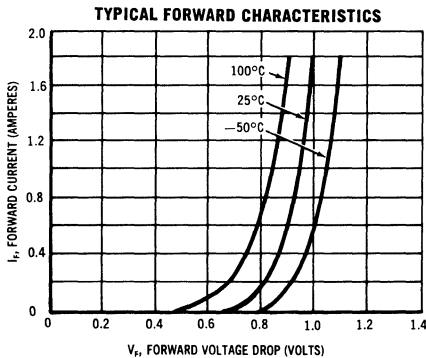

1N4719 thru 1N4725
MR1030 thru MR1036, MR1038, MR1040

$I_O = 3$ Amps
 $V_R - \text{to } 1000$ V



CASE 66A
 1N4719 THRU 1N4725
 MR1030A THRU MR1040A



CASE 67A
 MR1030B THRU MR1040B

Silicon high-conductance rectifiers available in either axial-lead or single-ended packages. Type numbers shown have cathode connected to case. For anode-to-case connection, add suffix "R" to type number, i. e. 1N4720R

ABSOLUTE MAXIMUM RATINGS (Both Package Types) $T_A = 25^\circ\text{C}$ unless otherwise noted

Rating	Symbol	1N4719	1N4720	1N4721	MR1033	1N4722	MR1035	1N4723	1N4724	1N4725	Unit	
		MR1030	MR1031	MR1032		MR1034		MR1036	MR1038	MR1040		
Peak Repetitive Reverse Voltage Working Peak Reverse Voltage DC Blocking Voltage	V_{RM} (rep) V_{RM} (wkg) V_R	50	100	200	300	400	500	600	800	1000	Volts	
Non-Repetitive Peak Reverse Voltage (one half-wave, single phase, 60 cycle peak)	V_{RM} (non-rep)	100	200	300	400	500	600	720	1000	1200	Volts	
RMS Reverse Voltage	V_R	35	70	140	210	280	350	420	560	700	Volts	
Average Rectified Forward Current (single phase, resistive load, 60 cps, $T_A = 75^\circ\text{C}$ see figure 4)	I_O	←————— 3.0 —————→										Amps
Peak Repetitive Forward Current ($T_A = 75^\circ\text{C}$)	I_{FM} (rep)	←————— 25 —————→										Amps
Non-Repetitive Peak Surge Current (superimposed on rated current at rated voltage, $T_A = 75^\circ\text{C}$) see figure 1	I_{FM} (surge)	←————— 300 (for 1/2 cycle) —————→										Amps
I^2t Rating (non-repetitive, 1 msec $< t < 8.3$ msec)	I^2t	←————— 185 —————→										$A_{(rms)}^2 \text{sec}$
Operating and Case Temperature	T_J, T_{stg}	-65 to + 175										$^\circ\text{C}$
Thermal Resistance	θ_{JA}	30										$^\circ\text{C}/\text{Watt}$

1N4719 thru 1N4725 (Continued)

ELECTRICAL CHARACTERISTICS (All Types)

Characteristic	Symbol	Max Limit	Unit
Full Cycle Average Forward Voltage Drop ($I_O = 3.0$ Amps and Rated V_F , $T_A = 75^\circ\text{C}$, Half Wave Rectifier)	$V_{F(AV)}$	0.45	Volts
DC Forward Voltage Drop ($I_F = 3.0$ Adc, $T_A = 25^\circ\text{C}$)	V_F	0.9	Volts
Full Cycle Average Reverse Current ($I_O = 3.0$ Amps and Rated V_R , $T_A = 75^\circ\text{C}$, Half Wave Rectifier)	$I_{R(AV)}$	1.5	mA
DC Reverse Current (Rated V_R , $T_A = 25^\circ\text{C}$)	I_R	0.5	mA

FORWARD VOLTAGE CHARACTERISTICS

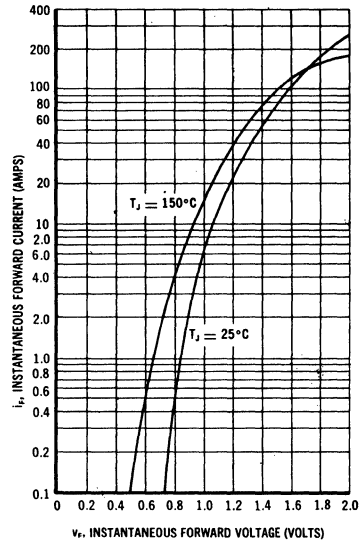

MAXIMUM SURGE CURRENT $T_A = 75^\circ\text{C}$

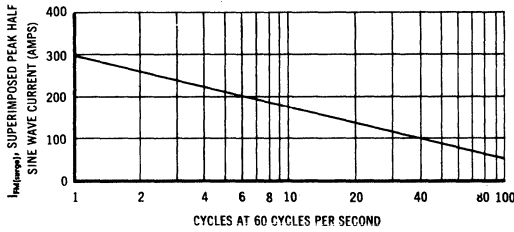

MAXIMUM FORWARD POWER

DISSIPATION versus AVERAGE FORWARD CURRENT

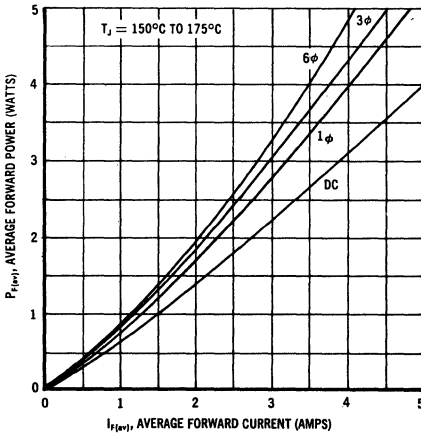

MAXIMUM FORWARD CURRENT versus AMBIENT TEMPERATURE

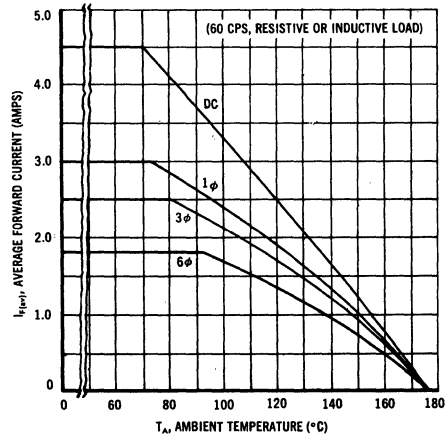

MR322 thru MR326

For Specifications, See IN3491 Data Sheet

MR1030 thru MR1036

MR1038, MR1040

For Specifications, See 1N4719 Data Sheet.

MR1200 thru MR1207

$I_O = 50$ AMPS
 V_R — to 400 V

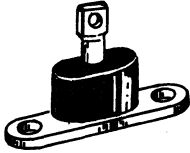

Silicon power rectifiers designed with double-case, multi-cell construction for extreme reliability and ruggedness. Standard cathode-to-case polarity, but available with reverse polarity by adding suffix "R" to type number.

ABSOLUTE MAXIMUM RATINGS

Rating	Symbol	MR 1200	MR 1201	MR 1202	MR 1203	MR 1204	MR 1205	MR 1206	MR 1207	Units
Peak Repetitive Reverse Voltage Working Peak Reverse Voltage DC Blocking Voltage	$V_{RM(rep)}$ $V_{RM(wkg)}$ V_R	50	100	150	200	250	300	350	400	Volts
Non-Repetitive Peak Reverse Voltage (one half-wave, single phase, 60 cycle peak)	$V_{RM(non-rep)}$	150	200	250	300	350	400	450	500	Volts
RMS Reverse Voltage	V_R	35	70	105	140	175	210	245	280	Volts
Average Rectified Forward Current (single phase, resistive load, 60 cps, $T_C = 150^\circ C$)	I_O	← 50 →								Amperes
Non-Repetitive Peak Surge Current (superimposed on rated current at rated voltage, $T_C = 150^\circ C$)	$I_{FM(surge)}$	← 800 (for 1/2 cycle) → ← 500 (for six consecutive 1/2 cycles) →								Amperes
I^2t Rating (non-repetitive, for t greater than 1 msec and less than 8.3 msec)	I^2t	← 1,300 →								$A_{(rms)}^2 sec$
Operating and Storage Temperature	T_J, T_{stg}	-65 to +190								$^\circ C$
Thermal Resistance	θ_{JC}	0.60								$^\circ C/Watt$

ELECTRICAL CHARACTERISTICS

Characteristic and Conditions	Symbol	Maximum Limit	Units
Full Cycle Average Forward Voltage Drop (rated I_O and V_R , single phase, 60 cps, $T_C = 150^\circ C$)	$V_{F(AV)}$	0.4	Volts
Full Cycle Average Reverse Current (rated I_O and V_R , single phase, 60 cps, $T_C = 150^\circ C$)	$I_{R(AV)}$	10	mA

MR1200 thru MR1207 (continued)

FORWARD VOLTAGE CHARACTERISTICS

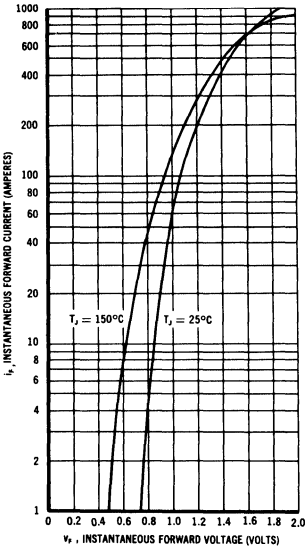

MAXIMUM FORWARD CURRENT versus MAXIMUM CASE TEMPERATURE

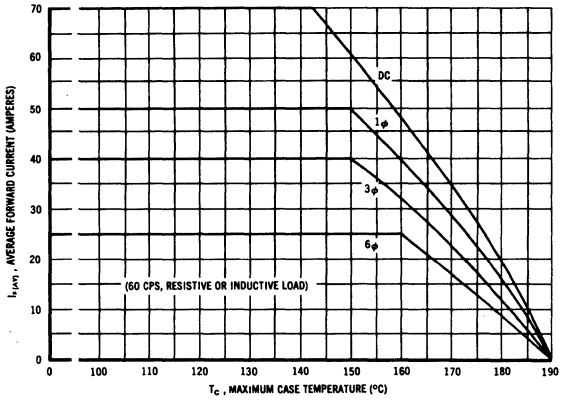

MAXIMUM SURGE CURRENT ($T_C = 150^\circ\text{C}$)

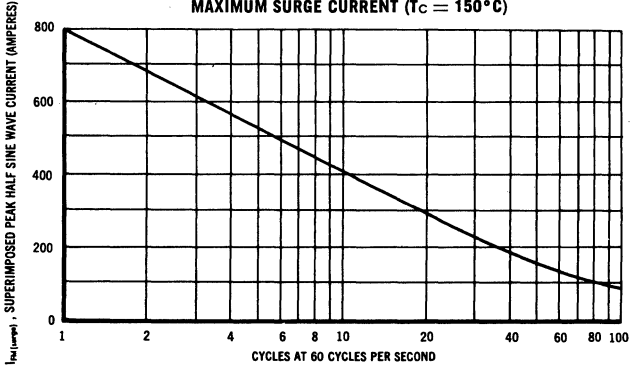

MAXIMUM SINGLE-PHASE CURRENT RATING

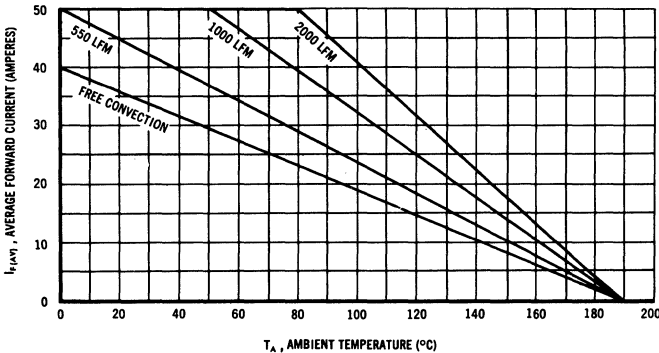

CONDITIONS

5 x 5 x 1/8 copper heat sink
fin $\epsilon \geq 0.9$ and mounted parallel
to air flow, 180° conduction.

For 3 phase ratings multiply
current scale by 0.85.

For 6 phase ratings multiply
current scale by 0.60.

MR 1210 thru MR 1217

I_O = 80 AMPS
V_R — to 400 V

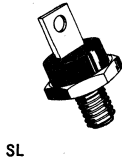

Silicon power rectifiers designed with double-case, multi-cell construction for extreme reliability and ruggedness. Standard cathode-to-case polarity, but available with reverse polarity by adding suffix "R" to type number. Available in two package styles having identical ratings and characteristics. Desired package can be selected by adding suffix "SB" or "SL" to type number.

ABSOLUTE MAXIMUM RATINGS (All Package Types)

Rating	Symbol	MR 1210	MR 1211	MR 1212	MR 1213	MR 1214	MR 1215	MR 1216	MR 1217	Units
Peak Repetitive Reverse Voltage Working Peak Reverse Voltage DC Blocking Voltage	$V_{RM(rep)}$ $V_{RM(wkg)}$ V_R	50	100	150	200	250	300	350	400	Volts
Non-Repetitive Peak Reverse Voltage (one halfwave, single phase, 60 cycle peak)	$V_{RM(non-rep)}$	150	200	250	300	350	400	450	500	Volts
RMS Reverse Voltage	V_r	35	70	105	140	175	210	245	280	Volts
Average Rectified Forward Current (single phase, resistive load, 60 cps, $T_C = 150^\circ C$)	I_o	← 80 →								Amperes
Non-Repetitive Peak Surge Currents (superimposed on rated current at rated voltage, $T_C = 150^\circ C$)	$I_{FM(surge)}$	← 2,000 (for 1/2 cycle) → ← 1,200 (for six consecutive 1/2 cycles) →								Amperes
I^2t Rating (non-repetitive, for t greater than 1 msec and less than 8.3 msec)	I^2t	← 8,300 →								$A_{(rms)}^2 sec$
Operating and Case Temperature	T_J, T_{stg}	-65 to +190								$^\circ C$
Thermal Resistance	θ_{JC}	0.40								$^\circ C/Watt$

ELECTRICAL CHARACTERISTICS (All Package Types)

Characteristic and Conditions	Symbol	Maximum Limit	Units
Full Cycle Average Forward Voltage Drop (rated I_o and V_r , single phase, 60 cps, $T_C = 150^\circ C$)	$V_{F(AV)}$	0.4	Volts
Full Cycle Average Reverse Current (rated I_o and V_r , single phase, 60 cps, $T_C = 150^\circ C$)	$I_{R(AV)}$	15	mA

MR1210 thru MR1217 (continued)

FORWARD VOLTAGE CHARACTERISTICS

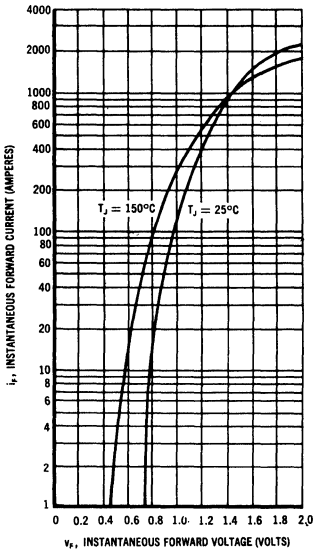

MAXIMUM FORWARD CURRENT versus MAXIMUM CASE TEMPERATURE

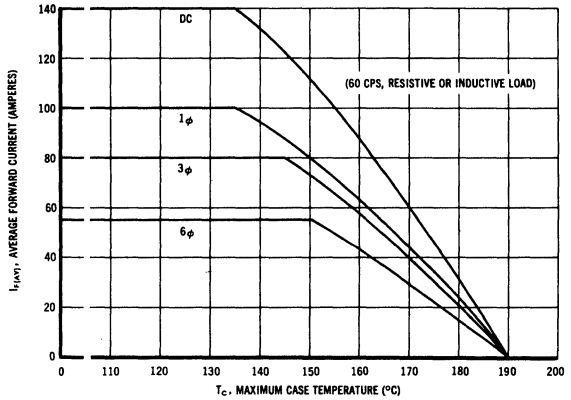

MAXIMUM SURGE CURRENT ($T_C = 150^\circ\text{C}$)

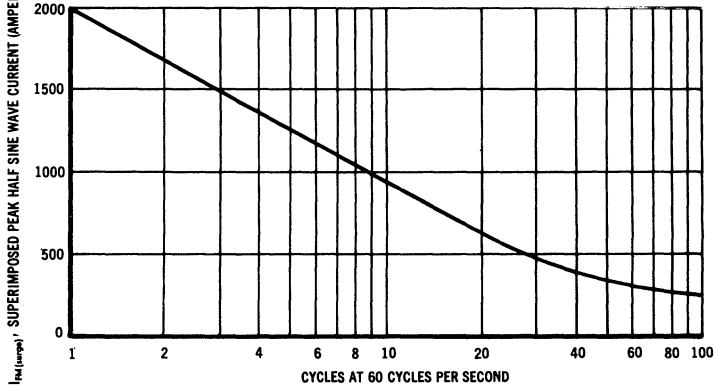

MAXIMUM SINGLE-PHASE CURRENT RATING

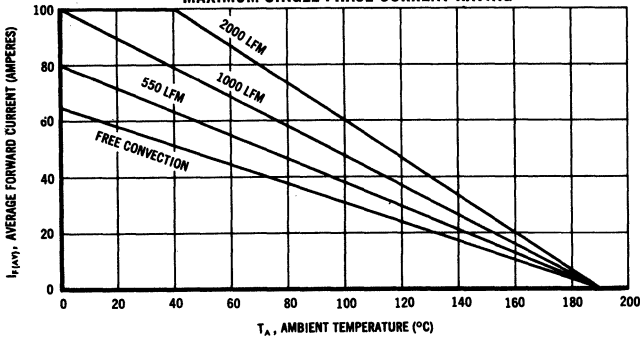

CONDITIONS

5 x 5 x 1/8 copper heat sink
 $fin \epsilon \geq 0.9$ and mounted parallel
 to air flow. 180° conduction.

For 3 phase ratings multiply
 current scale by 0.85.

For 6 phase ratings multiply
 current scale by 0.60.

MR1220 thru **MR1227**

I_o = 160 AMPS
V_R — to 400 V



SB



FB



SL

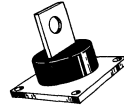

FL

Silicon power rectifiers designed with double-case, multi-cell construction for extreme reliability and ruggedness. Standard cathode-to-case polarity, but available with reverse polarity by adding suffix "R" to type number. Available in a variety of packages, all of which have the same ratings and characteristics. Desired package can be selected by adding suffix "SB", "FB", "SL", or "FL" to type number.

ABSOLUTE MAXIMUM RATINGS

Rating	Symbol	MR 1220	MR 1221	MR 1222	MR 1223	MR 1224	MR 1225	MR 1226	MR 1227	Unit
Peak Repetitive Reverse Voltage Working Peak Reverse Voltage DC Blocking Voltage	V _{RM(rep)} V _{RM(wkg)} V _R	50	100	150	200	250	300	350	400	Volts
Non-Repetitive Peak Reverse Voltage (one halfwave, single phase, 60 cycle peak)	V _{RM(non-rep)}	150	200	250	300	350	400	450	500	Volts
RMS Reverse Voltage	V _r	35	70	105	140	175	210	245	280	Volts
Average Rectified Forward Current (single phase, resistive load, 60 cps. T _C = 150°C)	I _o	160								Amperes
Non-Repetitive Peak Surge Currents (superimposed on rated current at rated voltage, T _C = 150°C)		3,600 (for 1/2 cycle) 2,000 (for six consecutive 1/2 cycles)								Amperes
I ² t Rating (non-repetitive for t greater than 1 msec and less than 8.3 msec)	I ² t	27,000								A _(rms) ² sec
Operating and Case Temperature	T _J , T _{stg}	-65 to +190								°C
Thermal Resistance	θ _{J C}	0.20								°C/Watt

ELECTRICAL CHARACTERISTICS

Characteristics and Conditions	Symbol	Max Limit	Unit
Full Cycle Average Forward Voltage Drop (rated I _o and V _r , single phase, 60 cps. T _C = 150°C)	V _{F(AV)}	0.4	Volts
Full Cycle Average Reverse Current (rated I _o and V _r , single phase, 60 cps. T _C = 150°C)	I _{R(AV)}	20	mA

MR1220 thru MR1227 (continued)

FORWARD VOLTAGE CHARACTERISTICS

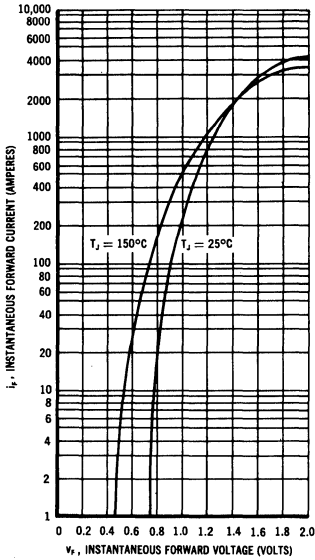

MAXIMUM FORWARD CURRENT versus MAXIMUM CASE TEMPERATURE

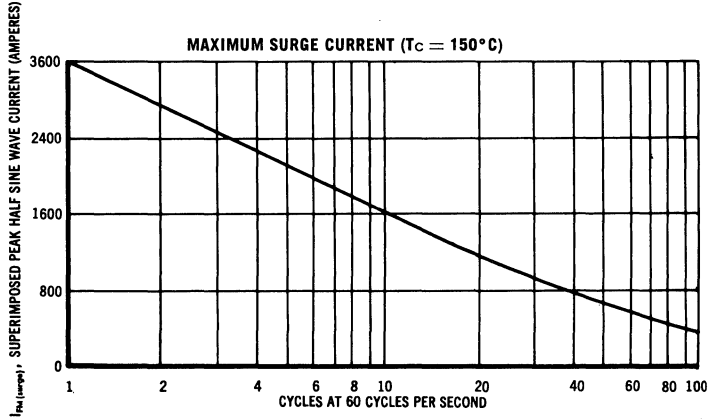
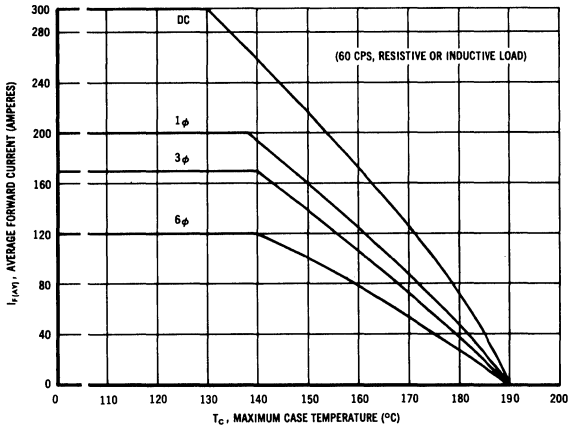

MAXIMUM SINGLE-PHASE CURRENT RATING

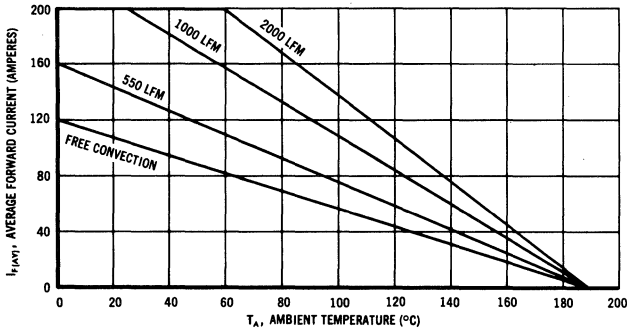

CONDITIONS

7 x 7 x 1/4 copper heat sink
 $\text{fin } \epsilon \geq 0.9$ and mounted parallel
 to air flow. 180° conduction.

For 3 phase ratings multiply
 current scale by 0.85.

For 6 phase ratings multiply
 current scale by 0.60.

MR1230 thru MR1237

$I_O = 240$ AMPS
 $V_R -$ to 400 V

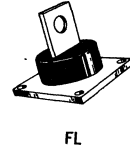

Silicon power rectifiers designed with double-case, multi-cell construction for extreme reliability and ruggedness. Standard cathode-to-case polarity, but available with reverse polarity by adding suffix "R" to type number. Available in a variety of packages, all of which have the same ratings and characteristics. Desired package can be selected by adding suffix "SB", "FB", "SL", or "FL" to type number.

ABSOLUTE MAXIMUM RATINGS

Rating	Symbol	MR 1230	MR 1231	MR 1232	MR 1233	MR 1234	MR 1235	MR 1236	MR 1237	Unit
Peak Repetive Reverse Voltage Working Peak Reverse Voltage DC Blocking Voltage	$V_{RM(rep)}$ $V_{RM(wkg)}$ V_R	50	100	150	200	250	300	350	400	Volts
Non-Repetitive Peak Reverse Voltage (one halfwave, single phase, 60 cycle peak)	$V_{RM(non-rep)}$	150	200	250	300	350	400	450	500	Volts
RMS Reverse Voltage	V_r	35	70	105	140	175	210	245	280	Volts
Average Rectified Forward Current (single phase, resistive load, 60 cps, $T_C = 150^\circ C$)	I_O	← 240 →								Amperes
Non-Repetitive Peak Surge Currents (superimposed on rated current at rated voltage, $T_C = 150^\circ C$)	$I_{FM(surge)}$	← 5,000 (for 1/2 cycle) → ← 3,000 (for six consecutive 1/2 cycles) →								Amperes
I^2t Rating (non-repetitive, for t greater than 1 msec and less than 8.3 msec)	I^2t	← 52,000 →								$A_{(rms)}^2 sec$
Operating and Case Temperature	T_J, T_{stg}	-65 to +190								$^\circ C$
Thermal Resistance	θ_{JC}	0.12								$^\circ C/Watt$

ELECTRICAL CHARACTERISTICS

Characteristics and Conditions	Symbol	Max Limit	Unit
Full Cycle Average Forward Voltage Drop (rated I_O and V_r , single phase, 60 cps = $150^\circ C$)	$V_{F(AV)}$	0.4	Volts
Full Cycle Average Reverse Current (rated I_O and V_r , single phase, 60 cps = $150^\circ C$)	$I_{R(AV)}$	35	mA

MR1230 thru MR1237 (continued)

FORWARD VOLTAGE CHARACTERISTICS

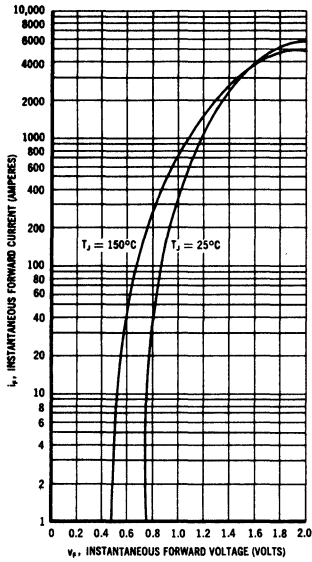

MAXIMUM FORWARD CURRENT versus MAXIMUM CASE TEMPERATURE

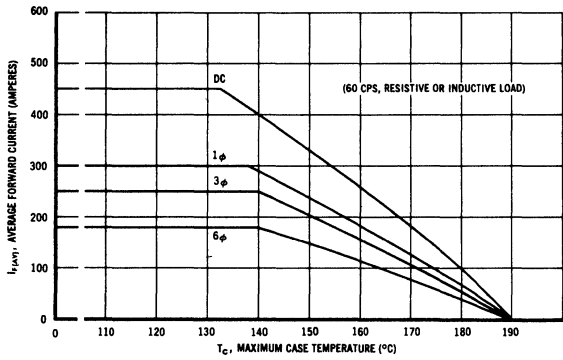

MAXIMUM SURGE CURRENT ($T_C = 150^\circ\text{C}$)

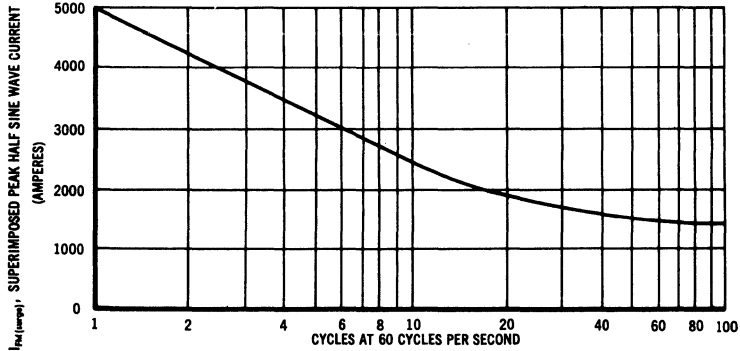

MAXIMUM SINGLE-PHASE CURRENT RATING

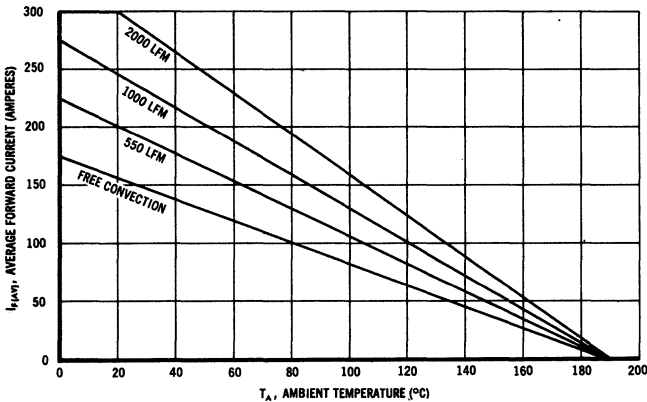

CONDITIONS

8 x 8 x 1/4 copper heat sink
fin $\epsilon \geq 0.9$ and mounted parallel
to air flow. 180° conduction.

For 3 phase ratings multiply
current scale by 0.85.

For 6 phase ratings multiply
current scale by 0.60.

MR 1240 thru MR 1247

$I_O = 400$ AMPS
 $V_R - \text{to } 400$ V



SB



FB



SL

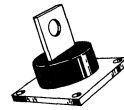

FL

Silicon power rectifiers designed with double-case, multi-cell construction for extreme reliability and ruggedness. Standard cathode-to-case polarity, but available with reverse polarity by adding suffix "R" to type number. Available in a variety of packages, all of which have the same ratings and characteristics. Desired package can be selected by adding suffix "SB", "FB", "SL", or "FL" to type number.

ABSOLUTE MAXIMUM RATINGS

Rating	Symbol	MR 1240	MR 1241	MR 1242	MR 1243	MR 1244	MR 1245	MR 1246	MR 1247	Units
Peak Repetitive Reverse Voltage Working Peak Reverse Voltage DC Blocking Voltage	$V_{RM(rep)}$ $V_{RM(wkg)}$ V_R	50	100	150	200	250	300	350	400	Volts
Non-Repetitive Peak Reverse Voltage (one halfwave, single phase, 60 cycle peak)	$V_{RM(non-rep)}$	150	200	250	300	350	400	450	500	Volts
RMS Reverse Voltage	V_R	35	70	105	140	175	210	245	280	Volts
Average Rectified Forward Current (single phase, resistive load, 60 cps, $T_C = 150^\circ\text{C}$)	I_O	← 400 →								Amperes
Non-Repetitive Peak Surge Currents (superimposed on rated current at rated voltage, $T_C = 150^\circ\text{C}$)	$I_{FM(surge)}$	← 8,000 (for 1/2 cycle) → ← 4,500 (for six consecutive 1/2 cycles) →								Amperes
I^2t Rating (non-repetitive, for t greater than 1 msec and less than 8.3 msec)	I^2t	← 133,000 →								$A_{(rms)}^2 \text{ sec}$
Operating and Case Temperature	T_J, T_{stg}	-65 to +190								$^\circ\text{C}$
Thermal Resistance	θ_{JC}	0.075								$^\circ\text{C/Watt}$

ELECTRICAL CHARACTERISTICS

Characteristic and Conditions	Symbol	Maximum Limit	Units
Full Cycle Average Forward Voltage Drop (rated I_O and V_R , single phase, 60 cps, $T_C = 150^\circ\text{C}$)	$V_{F(AV)}$	0.4	Volts
Full Cycle Average Reverse Current (rated I_O and V_R , single phase, 60 cps, $T_C = 150^\circ\text{C}$)	$I_{R(AV)}$	50	mA

MR1240 thru MR1247 (continued)

FORWARD VOLTAGE CHARACTERISTICS

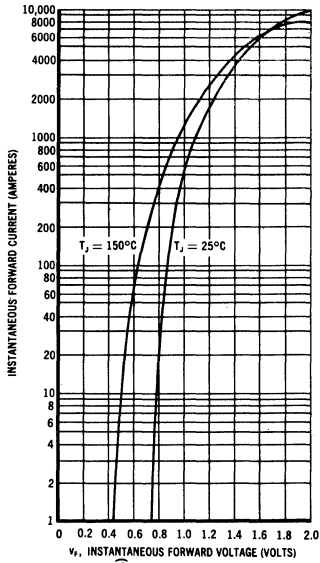

MAXIMUM FORWARD CURRENT versus MAXIMUM CASE TEMPERATURE

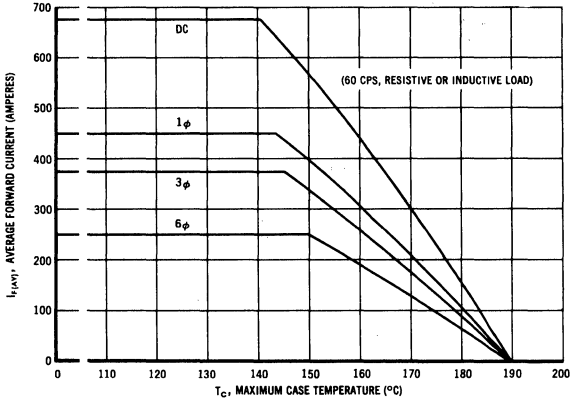

MAXIMUM SURGE CURRENT ($T_c = 150^\circ\text{C}$)

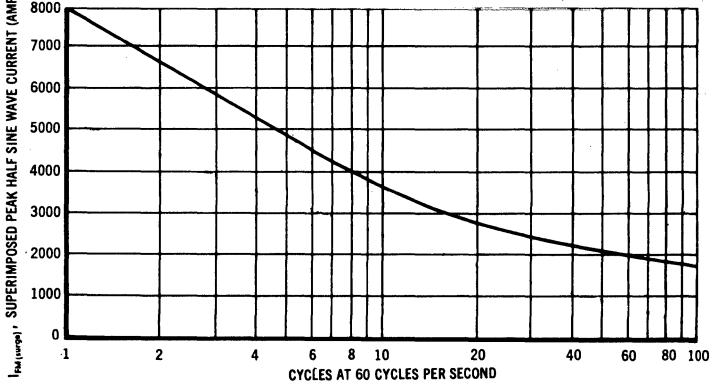

MAXIMUM SINGLE-PHASE CURRENT RATING

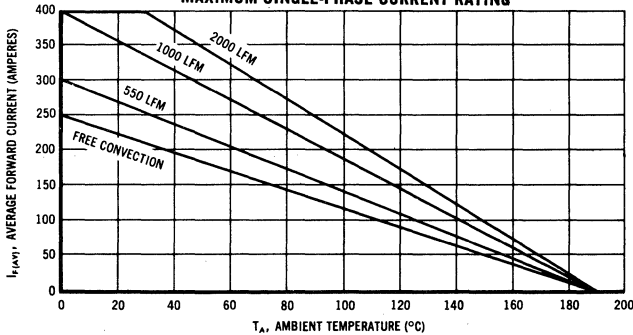

CONDITIONS

8 x 8 x 1/4 copper heat sink
 $\sin \epsilon \geq 0.9$ and mounted parallel
 to air flow. 180° conduction.

For 3 phase ratings multiply
 current scale by 0.85.

For 6 phase ratings multiply
 current scale by 0.60.

MR1260 thru MR1267

$I_O = 650 \text{ AMPS}$
 $V_R - \text{to } 400 \text{ V}$

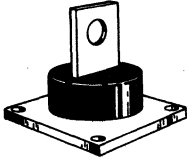

Silicon power rectifiers designed with double-case, multi-cell construction for extreme reliability and ruggedness. Standard cathode-to-case polarity, but available with reverse polarity by adding suffix "R" to type number.

ABSOLUTE MAXIMUM RATINGS

Rating	Symbol	MR 1260	MR 1261	MR 1262	MR 1263	MR 1264	MR 1265	MR 1266	MR 1267	Units
Peak Repetitive Reverse Voltage Working Peak Reverse Voltage DC Blocking Voltage	$V_{RM(rep)}$ $V_{RM(wkg)}$ V_R	50	100	150	200	250	300	350	400	Volts
Non-Repetitive Peak Reverse Voltage (one half-wave, single phase, 60 cycle peak)	$V_{RM(non-rep)}$	150	200	250	300	350	400	450	500	Volts
RMS Reverse Voltage	V_r	35	70	105	140	175	210	245	280	Volts
Average Rectified Forward Current (single phase, resistive load, 60 cps, $T_C = 150^\circ\text{C}$)	I_O	←———— 650 ———→								Amperes
Non-Repetitive Peak Surge Currents (superimposed on rated current at rated voltage, $T_C = 150^\circ\text{C}$)	$I_{FM(surge)}$	←———— 12,000 (for 1/2 cycle) ———→ ←———— 8,000 (for six consecutive 1/2 cycles) ———→								Amperes
I^2t Rating (non-repetitive, for t greater than 1 msec and less than 8.3 msec)	I^2t	←———— 300,000 ———→								$A_{(rms)}^2 \text{ sec}$
Operating and Storage Temperature	T_J, T_{stg}	-65 to +190								$^\circ\text{C}$
Thermal Resistance	θ_{JC}	0.045								$^\circ\text{C/Watt}$

ELECTRICAL CHARACTERISTICS

Characteristic and Conditions	Symbol	Maximum Limit	Units
Full Cycle Average Forward Voltage Drop (rated I_O and V_r , single phase, 60 cps, $T_C=150^\circ\text{C}$)	$V_{F(AV)}$	0.4	Volts
Full Cycle Average Reverse Current (rated I_O and V_r , single phase, 60 cps, $T_C=150^\circ\text{C}$)	$I_{R(AV)}$	100	mA

MR1260 thru MR1267 (continued)

FORWARD VOLTAGE CHARACTERISTICS

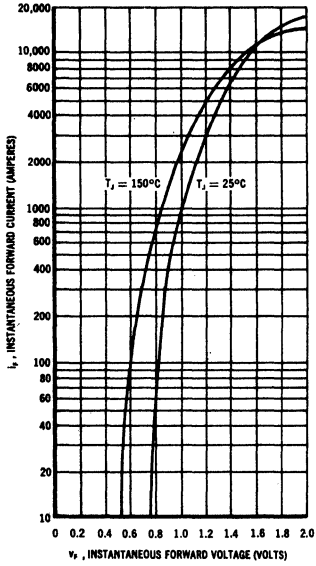

MAXIMUM FORWARD CURRENT versus MAXIMUM CASE TEMPERATURE

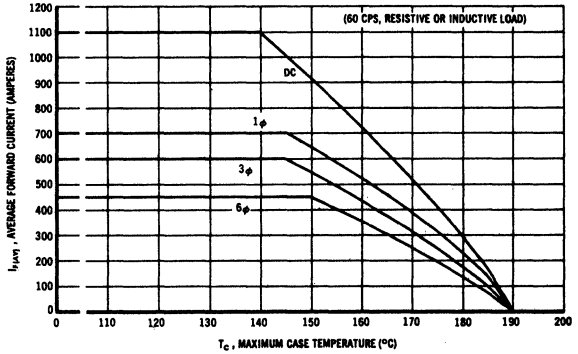

MAXIMUM SURGE CURRENT ($T_C = 150^\circ\text{C}$)

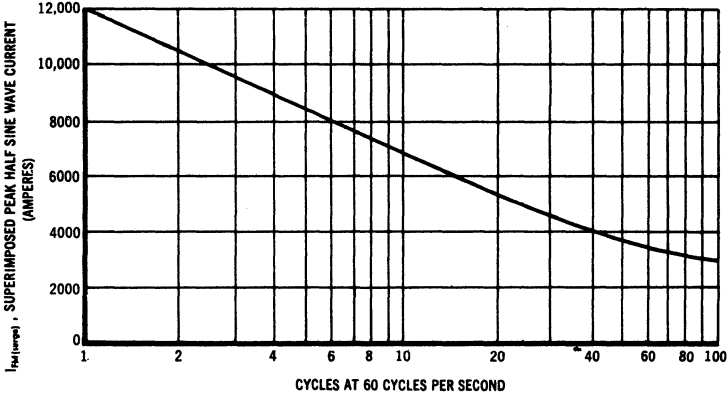

MAXIMUM SINGLE-PHASE CURRENT RATING

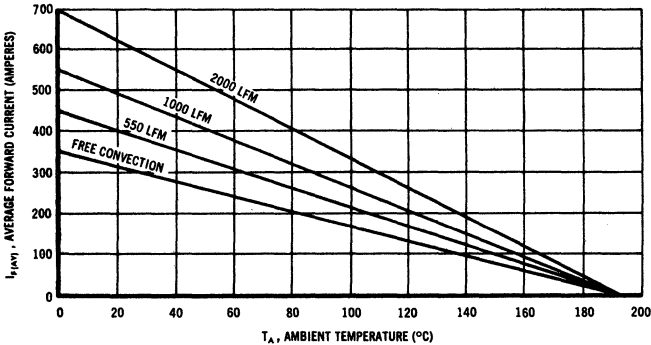

CONDITIONS

$10 \times 10 \times \frac{1}{4}$ copper heat sink
fin $\epsilon \cong 0.9$ and mounted parallel
to air flow, 180° conduction.

For 3 phase ratings multiply
current scale by 0.85.

For 6 phase ratings multiply
current scale by 0.60.

Motorola Silicon Rectifiers

MR1290 thru MR1297

$I_O = 1000$ Amps
 $V_R -$ to 400 V

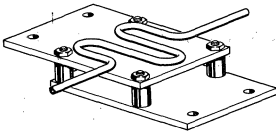

Silicon power rectifiers designed with multi-cell construction for extreme reliability and ruggedness. Standard polarity is cathode-to-water-cooled case, but reverse polarity devices are available designated by an "R" suffix. i.e. MR1295R

MAXIMUM RATINGS

Rating	Symbol	MR 1290	MR 1291	MR 1292	MR 1293	MR 1294	MR 1295	MR 1296	MR 1297	Units
Peak Repetitive Reverse Voltage	$V_{RM(rep)}$									
Working Peak Reverse Voltage	$V_{RM(wkg)}$	50	100	150	200	250	300	350	400	Volts
DC Blocking Voltage	V_R									
Non-Repetitive Peak Reverse Voltage (one half-wave, single phase, 60 cycle peak)	$V_{RM(non-rep)}$	100	200	250	300	350	400	450	500	Volts
RMS Reverse Voltage	V_R	35	70	105	140	175	210	245	280	Volts
Continuous Average Rectified Forward Current (single phase, resistive load, 60 cps, $T_C = 150^\circ C$)	I_O	← 1000 →								Amperes
Non-Repetitive Peak Surge Currents (superimposed on rated current at rated voltage, $T_C = 150^\circ C$)	$I_{FM(surge)}$	← 18,000 (for 1/2 cycle) → ← 13,500 (for six consecutive 1/2 cycles) →								Amperes
Operating and Storage Temperature	T_J, T_{stg}	-65 to +190								$^\circ C$
Thermal Resistance DC 1 and 3 phase 6 phase	θ_{JC}	0.035 0.045 0.060								$^\circ C/Watt$

Case Temperature Reference Point: T_C measured at center edge of the water cooled mounting bus

ELECTRICAL CHARACTERISTICS

Characteristic and Conditions	Symbol	Maximum Limit	Units
Full Cycle Average Forward Voltage Drop (rated I_O and V_R , single phase, 60 cps, $T_C = 150^\circ C$)	$V_{F(AV)}$	0.4	Volts
Full Cycle Average Reverse Current (rated I_O and V_R , single phase, 60 cps, $T_C = 150^\circ C$)	$I_{R(AV)}$	0.2	Amperes

Motorola Silicon Rectifiers

MR1290 thru MR1297 (Continued)

FORWARD VOLTAGE CHARACTERISTICS

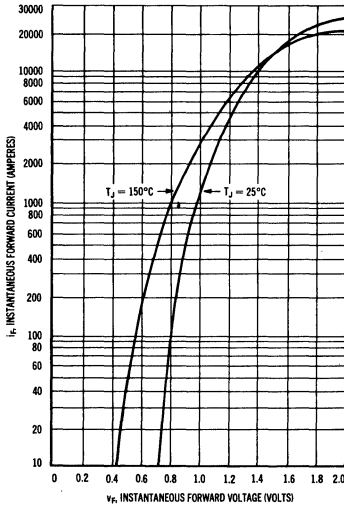

MAXIMUM FORWARD CURRENT versus MAXIMUM CASE TEMPERATURE (100% DUTY)

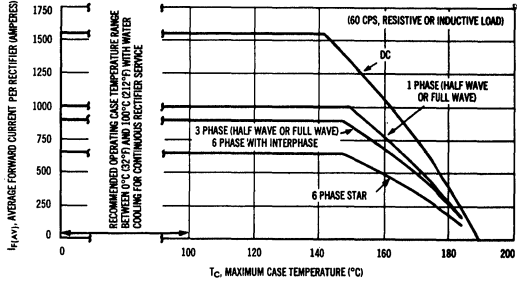

MAXIMUM SURGE CURRENT

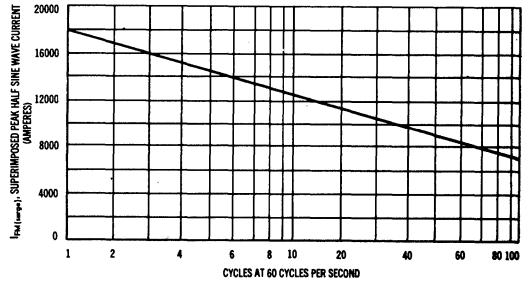

TYPICAL COOLING RATES AT RATED LOAD CONDITIONS

Inlet Water Temperature ($^\circ\text{C}$)	Minimum Water Flow Required (Gallons/Hour)	Approx. Water Temp. Rise at Specified Flow Rate ($^\circ\text{C}$)
15	2	10
50	5	8
75	10	5

NOTE: Water flow rates may be decreased at lighter load demands provided maximum case temperatures are not exceeded. In some applications where cooling systems are operated in series, it may be desirable to increase flow rates in order to minimize water temperature rises.

COOLING REQUIREMENTS

Type of Cooling — Water
 Min Inlet Water Temp. — 0°C
 Max Inlet Water Temp. — 75°C

MAXIMUM RMS DEMAND CURRENT versus PERCENT DUTY

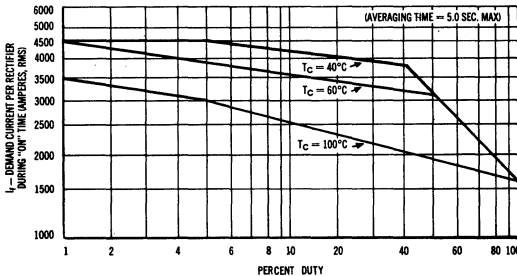

NOTE:

Curves apply to normal rectifier service conditions with maintained Rectifier Case Temperature (T_C) equal to or less than the values specified.

To determine the Maximum Average Current [$I_{F(AV)}$] per rectifier, multiply the RMS Current [I_r] rating by the factor given for the operating condition.

- $I_{F(AV)} = .64I_r$ for Single Phase
- $I_{F(AV)} = .57I_r$ for Three Phase and Six Phase with interphase
- $I_{F(AV)} = .40I_r$ for Six Phase Star

MR1337-1 thru MR1337-5

$I_O = 1 \text{ AMP}$
 $V_R - \text{to } 400 \text{ V}$



CASE 52

Fast recovery silicon rectifiers designed for high-frequency power supply, inverter, and converter applications. Typical recovery time of 100 nsec extends practical frequency limit of current rectification to more than 300,000 cps thus permitting the design of power supplies with smaller, lighter, and less expensive associated components.

ABSOLUTE MAXIMUM RATINGS

Rating	Symbol	MR 1337-1	MR 1337-2	MR 1337-3	MR 1337-4	MR 1337-5	Unit
Peak Repetitive Reverse Voltage	$V_{RM(rep)}$	50	100	200	300	400	Volts
Working Peak Reverse Voltage	$V_{RM(wkg)}$						
DC Blocking Voltage	V_R						
Non-Repetitive Peak Reverse Voltage (half-wave, single phase, 60 cycle peak)	$V_{RM(non-rep)}$	100	200	300	400	500	Volts
RMS Reverse Voltage	V_r	35	70	140	210	280	Volts
All Types							
Average Rectified Forward Current (single-phase resistive load) $T_A=25^\circ\text{C}$ Figure 2 $T_A=75^\circ\text{C}$	I_O			1.0		0.75	Amperes
Non-Repetitive Peak Surge Current Figure 3 (superimposed on rated current at rated voltage, $T_A = 75^\circ\text{C}$)	$I_{FM(surge)}$			30			Amperes
Peak Repetitive Forward Current ($T_A = 75^\circ\text{C}$)	$I_{FM(rep)}$			4.0			Amperes
I^2t Rating (non-repetitive, for t greater than 1 msec and less than 8.3 msec)	I^2t			3.75			$A_{(rms)}^2 \text{ sec}$
Maximum Junction Operating Temperature Range	T_J			-65 to +150			$^\circ\text{C}$
Maximum Case Storage Temperature Range	T_{stg}			-65 to +175			
Maximum Steady State DC Thermal Resistance	θ_{JA}			100			$^\circ\text{C/Watt}$

FIGURE 1 — TYPICAL FORWARD CHARACTERISTICS (FOR ALL TYPES)

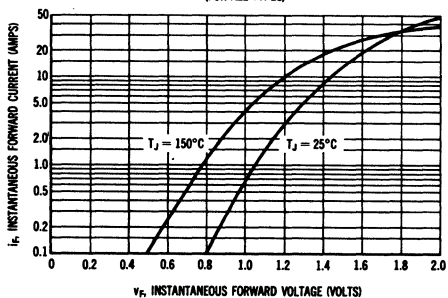
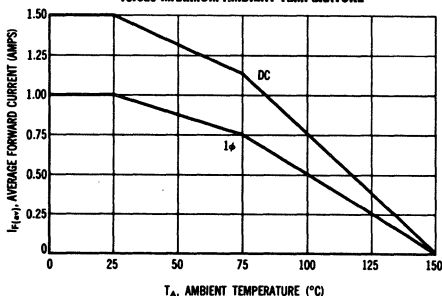

FIGURE 2 — MAXIMUM AVERAGE FORWARD CURRENT RATING versus MAXIMUM AMBIENT TEMPERATURE



MR1337-1 thru MR1337-5 (continued)

ELECTRICAL CHARACTERISTICS

Characteristic	Symbol	Max Limit	Unit
DC Forward Voltage Drop ($I_F = 1.0 \text{ Adc}$, $T_A = 25^\circ\text{C}$)	V_F	1.1	Vdc
Full Cycle Average Forward Voltage Drop ($I_O = 0.75 \text{ Amps}$ and Rated V_R , $T_A = 75^\circ\text{C}$, Half Wave Rectifier)	$V_{F(AV)}$	0.55	Volts
Full Cycle Average Reverse Current ($I_O = 0.75 \text{ Amp}$ and Rated V_R , $T_A = 75^\circ\text{C}$, single phase)	$I_{R(AV)}$	0.75	mA
DC Reverse Current (Rated V_R , $T_A = 25^\circ\text{C}$)	I_R	0.25	mA
Maximum Reverse Recovery Time ($I_F = 1 \text{ Amp min}$)	t_{rr}	200	nsec
Maximum Overshoot Current	I_{os}	2.0	Amps

FIGURE 3 — MAXIMUM ALLOWABLE NON-REPETITIVE SURGE CURRENT

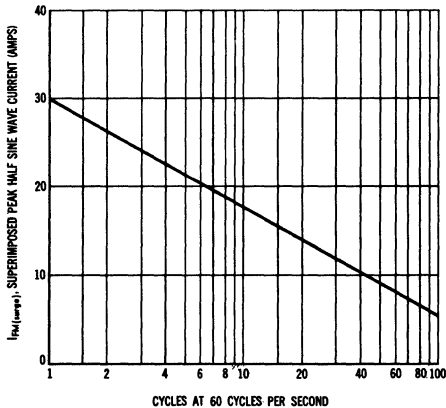

(SUPERIMPOSED ON RATED CONDITIONS, V_{surr} APPLIED AFTER SURGE, $T_A = 75^\circ\text{C}$)

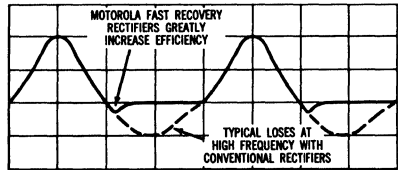

TYPICAL RECOVERY PATTERN

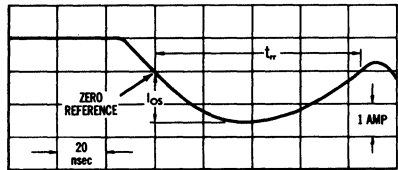
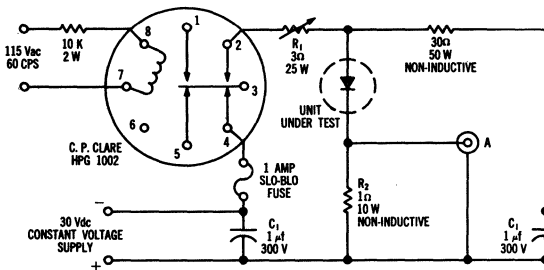

FIGURE 4 — t_r TEST CIRCUIT



- A — TEKTRONIX 545A, K PLUG-IN PRE-AMP, P6000 PROBE OR EQ
- R₁ — ADJUSTED FOR 1.4Ω BETWEEN POINT 2 OF RELAY AND RECTIFIER. INDUCTANCE ~ 38 μh
- R₂ — TEN 1 W, 10Ω, 1% CARBON COMP. IN PARALLEL
- T_A = 25 ± 10 °C FOR RECTIFIER
- MINIMIZE ALL LEAD LENGTHS
- 1 Adc FROM CONSTANT VOLTAGE SUPPLY
- RIPPLE = 3 mVrms MAX
- Z_{out} = ½ Ω, MAX, DC TO 2 kc

HAVING A SEMICONDUCTOR APPLICATIONS PROBLEM?

Perhaps one of Motorola's authoritative Technical Information notes can help you find a solution.

The most recent index to the growing list of Motorola Application Notes appears below.

- AN-111** Video Amplifier with 150-mc Bandwidth
- AN-112** 400-mc Power Oscillator
- AN-114** Modulation of Driver Stage to Increase Power Output of A-M Transmitter
- AN-124** The 2N741 Mesa Transistor as a Power Oscillator and Class C Amplifier
- AN-129** For Computers . . . Basic RCTL Circuits
- AN-130** 2N711 Computer Circuits
- AN-133** Designing Low-Noise RF Input Transistor Stages
- AN-134** Power Inverter Circuits Using Distributor Components
- AN-136** Techniques of Current-Mode Logic Switching
- AN-138** Transistor Switches: The Best Design for the Worst Case
- AN-140** Characterization of SCR's as Switches for Line Type Modulators
- AN-141** Silicon Controlled Rectifiers — New Opportunities for Electronic Applications in the Home
- AN-142** Highlights of Small-Signal Circuit Design
- AN-143** Converting Amplifiers to Integrated Circuit Format
- AN-144** Monolithic or Hybrid?
- AN-146** The Gate Controlled Switch
- AN-148** Integrated Circuit Reliability
- AN-149** Designing Linear Microcircuits: Problems and Solutions
- AN-150** Getting Transistors into Single-Sideband Amplifiers
- AN-151** Charge Storage Varactors Boost Harmonic Power
- AN-152** Thin Film Hybrid Techniques
- AN-153** Monostable Multivibrator
- AN-155** New Masking Techniques for Micro-power Transistors
- AN-156** A Marine Band Transmitter Using 2N2832 Power Transistor
- AN-157** Designing Monolithic I/C
- AN-158** Whats and Whys about y Parameters
- AN-159** A New Look at Coaxial Cavities for Varactor Multipliers
- AN-160** Application of Micro-Electronics to IF Amplifiers
- AN-161** Design, Performance, and Applications of the MV1892 RF Switching Diode
- IC-10** Tuned Amplifier Design with Motorola's MC1110 Integrated Circuit Amplifier
- IC-11** System Design with MECL Integrated Circuit Logic Blocks

You can obtain copies of the notes by writing to:

Technical Information Center
Motorola Semiconductor Products Inc.
Box 955
Phoenix, Arizona 85001



MOTOROLA SILICON RECTIFIER ASSEMBLIES

Devices included in this section:

RECTIFIER STACKS

300 Series

MOLDED BRIDGES

MDA942 Series
MDA952 Series

MDA962 Series
MDA1491 Series

MDA1505 Series
MDA1591 Series

MINIATURE BRIDGE ASSEMBLIES

MDA920 Series
MDA930 Series

MDA940 Series

MDA950 Series

HIGH-VOLTAGE MOLDED ASSEMBLIES

1N1730
1N1731
1N1732
1N1733
1N1734

1N2382
1N2383
1N2384
1N2385

MDA1330H
MDA1331H
MDA1332H
MDA1333H

SILICON RECTIFIER ASSEMBLIES

Silicon rectifiers are available as individual cells with a wide variety of current and voltage ratings, as described in the rectifier section of this manual. In addition, these devices are available in standard and custom assemblies, which greatly increase the range of applications that can be satisfied with single-unit preassembled devices.

Included in these standard assemblies are:

High and low current rectifier circuit configurations

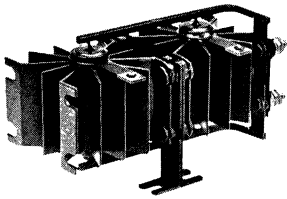

and

Actual Size

Series-connected high-voltage rectifier assemblies.

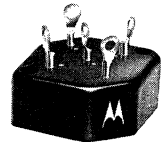
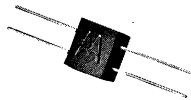

Custom assemblies, including both zener diode and rectifier assemblies, can be obtained inexpensively in quantity by specifying the type of devices needed (from a large selection of individual diodes and rectifiers) and the desired circuit configuration.

SILICON RECTIFIER STACKS

300 SERIES

Motorola silicon rectifier stacks consist of one or more medium current silicon rectifiers interconnected in any of six common rectifier circuits and securely mounted in extruded-fin, aluminum coolers to provide optimum heat-sink surface contact. Configurations in both vertical-fin cooler (for free convection cooling) and horizontal-fin coolers (for forced air cooling) are available.

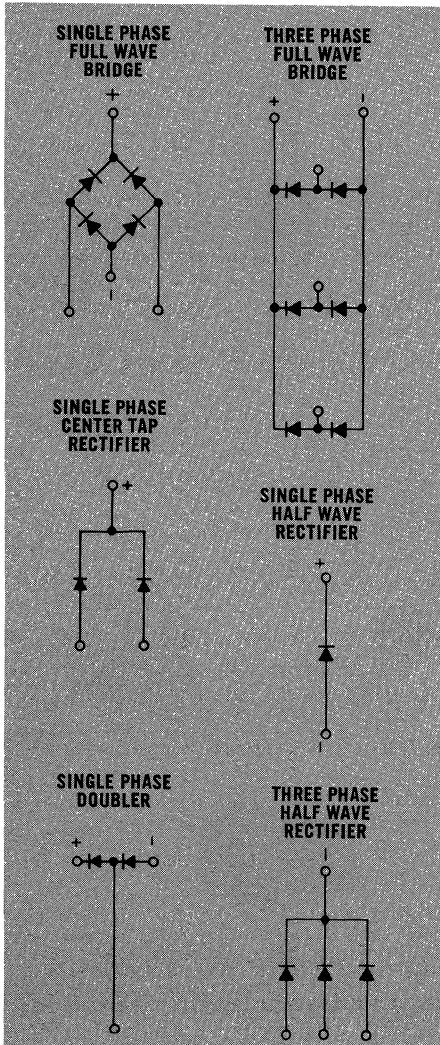

TYPICAL COOLER ORIENTATIONS

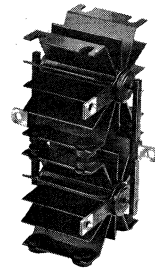

Horizontal Fins — Forced Air Cooling

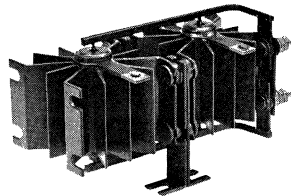

Vertical Fins — Free Convection Cooling

SILICON RECTIFIER STACKS (continued)
MOTOROLA SILICON RECTIFIER STACK CODING SYSTEM



STACK SERIES NUMBER
 3 — Series 300



COOLER ORIENTATION
 V — Vertical, primarily designed for free convection cooling
 H — Horizontal, primarily designed for forced air cooling



COOLER AXIAL LENGTH
 1 — ¾ inch
 2 — 1½ inch
 3 — 3 inches



RECTIFIER CIRCUITS
 B, C, U, D, F, H, Y, W



RECTIFIER CELL PACKAGE



INDIVIDUAL RECTIFIER CELL PIV
 A — 50 Volts
 B — 100 Volts
 C — 200 Volts
 D — 300 Volts
 E — 400 Volts



NUMBER OF RECTIFIER CELLS IN SERIES IN EACH CIRCUIT LEG*
 1 thru 8

*All series or parallel connected rectifiers are matched units.



NUMBER OF RECTIFIER CELLS IN PARALLEL IN EACH CIRCUIT LEG*
 A — one
 B — two
 C — three
 D — four
 E — five



NUMBER OF COOLERS IN COMPLETE STACK
 1 thru 4

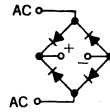

B — Single Phase Bridge

DC Output Current: 12.0 to 70.0 Amps (55°C)
 DC Output Voltage: 31 to 434 Volts (Resistive Load)

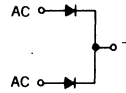

C — Single Phase, Center Tap, common Cathode

U — Single Phase, Center Tap, common Anode

DC Output Current: 12 to 70 Amps (55°C)
 DC Output Voltage: 15 to 382 Volts (Resistive Load)



D — Single Phase Doubler

DC Output Current: 4.5 to 26.5 Amps (55°C)
 DC Output Voltage: 50 to 1200 Volts (Capacitive Load)

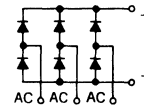

F — Three Phase, Full Wave Bridge

DC Output Current: 18 to 88.5 Amps (55°C)
 DC Output Voltage: 46 to 377 Volts (Resistive Load)



H — Single Phase Half-Wave

DC Output Current: 6.0 to 35.0 Amps (55°C)
 DC Output Voltage: 16 to 635 Volts (Resistive Load)

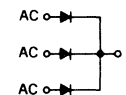

Y — Three Phase Half-Wave, common cathode

W — Three Phase Half-Wave, common anode

DC Output Current: 18 to 105.0 Amps (55°C)
 DC Output Voltage: 23 to 330 Volts (Resistive Load)

SILICON RECTIFIER STACKS (continued)

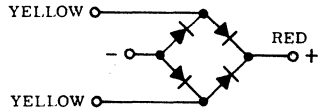

B — SINGLE PHASE FULL WAVE BRIDGE

Max. DC Output		VERTICAL — free convection cooling						Max. RMS Input Voltage
Current		+55°C	12.0A	16.0A	22.0A	32.0A	48.0A	
Voltage		+100°C	5.0A	7.0A	10.0A	14.0A	19.0A	
Res. Load	Cap. Load							Cap. Line to Line
31	50		3V1B1A1A2	3V2B1A1A2	3V3B1A1A2	3V2B1A1A4	3V3B1A1A4	35
62	100		3V1B1B1A2	3V2B1B1A2	3V3B1B1A2	3V2B1B1A4	3V3B1B1A4	70
124	200		3V1B1C1A2	3V2B1C1A2	3V3B1C1A2	3V2B1C1A4	3V3B1C1A4	140
185	300		3V1B1D1A2	3V2B1D1A2	3B3B1D1A2	3V2B1D1A4	3V3B1D1A4	212
250	400		3V1B1E1A2	3V2B1E1A2	3V3B1E1A2	3V2B1E1A4	3V3B1E1A4	282
333	525		3V1B1D2A4	3V2B1D2A4	3V3B1D2A4			370
434	700		3V1B1E2A4	3V2B1E2A4	3V3B1E2A4			494
		HORIZONTAL — forced air cooling (1000 LFM)						Cap. Line to Line
Current		+55°C	37.0A	44.0A	59.0A	68.0A	70.0A	
Voltage		+100°C	15.0A	19.0A	26.0A	34.0A	39.0A	
Res. Load	Cap. Load							Cap. Line to Line
31	50		3H1B1A1A2	3H2B1A1A2	3H3B1A1A2	3H2B1A1A4	3H3B1A1A4	35
62	100		3H1B1B1A2	3H2B1B1A2	3H3B1B1A2	3H2B1B1A4	3H3B1B1A4	70
125	200		3H1B1C1A2	3H2B1C1A2	3H3B1C1A2	3H2B1C1A4	3H3B1C1A4	140
185	300		3H1B1D1A2	3H2B1D1A2	3H3B1D1A2	3H2B1D1A4	3H3B1D1A4	212
250	400		3H1B1E1A2	3H2B1E1A2	3H3B1E1A2	3H2B1E1A4	3H3B1E1A4	282
333	525			3H2B1D2A4	3H3B1D2A4			370
434	700			3H2B1E2A4	3H3B1E2A4			494

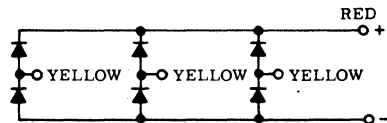

F — THREE PHASE FULL WAVE BRIDGE

Max. DC Output		VERTICAL — free convection cooling				Max. RMS Input Voltage
Current		+55°C	18.0A	24.0A	33.0A	
Voltage		+100°C	7.5A	10.5A	15.0A	
Res. Load	Cap. Load					Line to Line Delta Sec.
46			3V1F1A1A3	3V2F1A1A3	3V3F1A1A3	35
93			3V1F1B1A3	3V2F1B1A3	3V3F1B1A3	70
188			3V1F1C1A3	3V2F1C1A3	3V3F1C1A3	140
283			3V1F1D1A3	3V2F1D1A3	3V3F1D1A3	210
377			3V1F1E1A3	3V2F1E1A3	3V3F1E1A3	280

SILICON RECTIFIER STACKS (continued)

THREE PHASE, FULL WAVE BRIDGE (continued)

HORIZONTAL – forced air cooling (1000 LFM)							Cap. Line to Line Delta Sec.
Current	+55°C		55.0A	66.0A	88.5A		
	+100°C		22.5A	28.5A	39.0A		
Voltage							
46		3H1F1A1A3	3H2F1A1A3	3H3F1A1A3			35
93		3H1F1B1A3	3H2F1B1A3	3H3F1B1A3			70
188		3H1F1C1A3	3H2F1C1A3	3H3F1C1A3			140
283		3H1F1D1A3	3H2F1D1A3	3H3F1D1A3			210
377		3H1F1E1A3	3H2F1E1A3	3H3F1E1A3			280

SINGLE PHASE, CENTER TAP RECTIFIER

C – SINGLE PHASE CENTER TAP, COMMON CATHODE

U – SINGLE PHASE CENTER TAP, COMMON ANODE

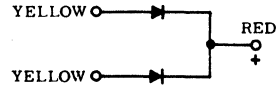

Max. DC Output		VERTICAL – free convection cooling						Max. RMS Input Voltage Cap. or Res.
Current	+55°C		12.0A	16.0A	22.0A	32.0A	48.0A	
	+100°C		5.0A	7.0A	10.0A	14.0A	19.0A	
Voltage								Line to Center Tap
15	25	3V1C1A1A1	3V2C1A1A1	3V3C1A1A1	3V2C1A1A2	3V3C1A1A2		17.5
30	50	3V1C1B1A1	3V2C1B1A1	3V2C1B1A1	3V2C1B1A2	3V3C1B1A2		35
62	100	3V1C1C1A1	3V2C1C1A1	3V3C1C1A1	3V2C1C1A2	3V3C1C1A2		70
92	150	3V1C1D1A1	3V2C1D1A1	3V3C1D1A1	3V2C1D1A2	3V3C1D1A2		105
125	200	3V1C1E1A1	3V2C1E1A1	3B3C1E1A1	3V2C1E1A2	3V3C1E1A2		140
167	262	3V1C1D2A2	3V2C1D2A2	3V3C1D2A2	3V2C1D2A4	3V3C1D2A4		183
222	350	3V1C1E2A2	3V2C1E2A2	3V3C1E2A2	3V2C1E2A4	3V3C1E2A4		245
286	450	3V1C1D4A4	3V2C1D4A4	3V3C1D4A4				315
382	600	3V1C1E4A4	3V2C1E4A4	3V3C1E4A4				420
HORIZONTAL – forced air cooling (1000 LFM)								
Current	+55°C		37.0A	44.0A	59.0A	68.0A	70.0A	Cap. or Res. Line to Center Tap
	+100°C		15.0A	19.0A	26.0A	34.0A	39.0A	
Voltage								
15	25	3H1C1A1A1	3H2C1A1A1	3H3C1A1A1	3H2C1A1A2	3H3C1A1A2		17.5
30	20	3H1C1B1A1	3H2C1B1A1	3H3C1B1A1	3H2C1B1A2	3H3C1B1A2		35
62	100	3H1C1C1A1	3H2C1C1A1	3H3C1C1A1	3H2C1C1A2	3H3C1C1A2		70
92	150	3H1C1D1A1	3H2C1D1A1	3H3C1D1A1	3H2C1D1A2	3H3C1D1A2		105
125	200	3H1C1E1A1	3H2C1E1A1	3H3C1E1A1	3H2C1E1A2	3H3C1E1A2		140
167	262	3H1C1D2A2	3H2C1D2A2	3H3C1D2A2	3H2C1D2A4	3H3C1D2A4		183
222	350	3H1C1E2A2	3H2C1E2A2	3H3C1E2A2	3H2C1E2A4	3H3C1E2A4		245
286	450		3H2C1D4A4	3H3C1D4A4				315
382	600		3H2C1E4A4	3H3C1E4A4				420

SILICON RECTIFIER STACKS (continued)

D-SINGLE PHASE DOUBLER

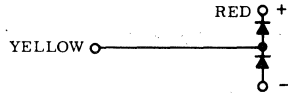

Max. DC Output		VERTICAL – free convection cooling						Max. RMS Input Voltage
Current	Voltage	+55°C	6.0A	8.0A	12.0A	18.0A		
		+100°C	1.8A	2.6A	3.7A	5.0A	7.0A	
							Cap. Line to Line	
	50	3V1D1A1A1	3V2D1A1A1	3V3D1A1A1	3V2D1A1A2	3V3D1A1A2	17.5	
	100	3V1D1B1A1	3V2D1B1A1	3V3D1B1A1	3V2D1B1A2	3V3D1B1A2	35	
	200	3V1D1C1A1	3V2D1C1A1	3V3D1C1A1	3V2D1C1A2	3V3D1C1A2	70	
	300	3V1D1D1A1	3V2D1D1A1	3V3D1D1A1	3V2D1D1A2	3V3D1D1A2	105	
	400	3V1D1E1A1	3V2D1E1A1	3V3D1E1A1	3V2D1E1A2	3V3D1E1A2	140	
	500	3V1D1D2A2	3V2D1D2A2	3V3D1D2A2	3V2D1D2A4	3V3D1D2A4	175	
	700	3V1D1E2A2	3V2D1E2A2	3V3D1E2A2	3V2D1E2A4	3V3D1E2A4	250	
	900	3V1D1D4A4	3V2D1D4A4	3V3D1D4A4			310	
	1200	3V1D1E4A4	3V2D1E4A4	3V3D1E4A4			420	
Max. DC Output		HORIZONTAL – forced air cooling (1000 LFM)						Cap. Line to Line
Current	Voltage	+55°C	13.8A	16.5A	22.0A	25.5A	26.5A	
		+100°C	5.5A	7.0A	9.5A	12.5A	14.5A	
	50	3H1D1A1A1	3H2D1A1A1	3H3D1A1A1	3H2D1A1A2	3H3D1A1A2	17.5	
	100	3H1D1B1A1	3H2D1B1A1	3H3D1B1A1	3H2D1B1A2	3H3D1B1A2	35	
	200	3H1D1C1A1	3H2D1C1A1	3H3D1C1A1	3H2D1C1A2	3H3D1C1A2	70	
	300	3H1D1D1A1	3H2D1D1A1	3H3D1D1A1	3H2D1D1A2	3H3D1D1A2	105	
	400	3H1D1E1A1	3H2D1E1A1	3H3D1E1A1	3H2D1E1A2	3H3D1E1A2	140	
	500	3H1D1D2A2	3H2D1D2A2	3H3D1D2A2	3H2D1D2A4	3H3D1D2A4	175	
	700	3H1D1E2A2	3H2D1E2A2	3H3D1E2A2	3H2D1E2A4	3H3D1E2A4	250	
	900		3H2D1D4A4	3H3D1D4A4			310	
	1200		3H2D1E4A4	3H3D1E4A4			420	

H – SINGLE PHASE HALF-WAVE RECTIFIER

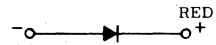

Max. DC Output		VERTICAL – free convection cooling						Max. RMS Input Voltage	
Current	Voltage	+55°C	6.0A	8.0A	11.0A	16.0A	24.0A	Cap.	Res.
		+100°C	2.5A	3.5A	5.0A	7.0A	9.5A		
	16	25			3V1H1A1A1	3V2H1A1A1	3V3H1A1A1	17.5	35
	31	50			3V1H1B1A1	3V2H1B1A1	3V3H1B1A1	35	70
	63	100			3V1H1C1A1	3V2H1C1A1	3V3H1C1A1	70	140
	93	150			3V1H1D1A1	3V2H1D1A1	3V3H1D1A1	105	210
	125	200			3V1H1E1A1	3V2H1E1A1	3V3H1E1A1	140	280
	167	262	3V1H1D2A1	3V2H1D2A1	3V3H1D2A1			183	366
	222	350	3V1H1E2A1	3V2H1E2A1	3V3H1E2A1	3V2H1D3A3	3V3H1D3A3	245	490
	286	450	3V1H1D4A2	3V2H1D4A2	3V3H1D4A2			315	630
	318	500				3V2H1E3A3	3V3H1E3A3	350	700
	382	600	3V1H1E4A2	3V2H1E4A2	3V3H1E4A2	3V2H1E4A4	3V3H1E4A4	420	840
	475	750	3V1H1E6A3	3V2H1E6A3	3V3H1E6A3			525	1050
	635	1000	3V1H1E8A4	3V2H1E8A4	3V3H1E8A4			700	1400

SILICON RECTIFIER STACKS (continued)

SINGLE PHASE, HALF-WAVE RECTIFIER (continued)

		HORIZONTAL – forced air cooling (1000 LFM)						
Voltage	Current	18.5A	22.0A	29.5A	34.0A	35.0A	Cap.	Res.
	+55°C							
16	25						17.5	35
31	50						35	70
63	100						70	140
93	150						105	210
125	200						140	280
167	262	3H1H1D2A1	3H2H1D2A1	3H3H1D2A1	3H2H1D2A1	3H3H1D2A1	183	366
222	350	3H1H1E2A1	3H2H1E2A1	3H3H1E2A1	3H2H1E2A1	3H3H1E2A1	245	490
286	450	3H1H1D4A2	3H2H1D4A2	3H3H1D4A2			315	630
318	500						350	700
382	600	3H1H1E4A2	3H2H1E4A2	3H3H1E4A2	3H2H1E3A3	3H3H1E3A3	420	840
475	750	3H1H1E6A3	3H2H1E6A3	3H3H1E6A3	3H2H1E4A4	3H3H1E4A4	525	1050
635	1000		3H2H1E8A4	3H3H1E8A4			700	1400

THREE PHASE HALF-WAVE RECTIFIER

Y – THREE PHASE HALF-WAVE, COMMON CATHODE
W – THREE PHASE HALF-WAVE, COMMON ANODE

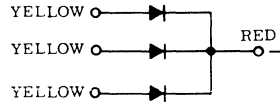

Max. DC Output		VERTICAL – free convection cooling					Max. RMS Input Voltage Cap.
Voltage	Current	18.0A	24.0A	33.0A	48.0A	72.0A	
	+55°C						+100°C
		7.5A	10.5A	15.0A	21.0A	28.5A	Line to Neutral
23							20
46							40
94							80
142							120
188							160
248		3V1Y1D2A3	3V2Y1D2A3	3V3Y1D2A3	3V2Y1D1A3	3V3Y1D1A3	210
330		3V1Y1E2A3	3V2Y1E2A3	3V3Y1E2A3			280
		HORIZONTAL – forced air cooling (1000 LEM)					Cap. Line to Neutral
Voltage	Current	55.5A	66.0A	88.5A	102.0A	105.0A	
	+55°C						+100°C
		22.5A	28.5A	39.0A	51.0A	58.5A	
23							20
46							40
94							80
142							120
188							160
248		3H1Y1D2A3	3H2Y1D2A3	3H3Y1D2A3	3H2Y1D1A3	3H3Y1D1A3	210
330		3H1Y1E2A3	3H2Y1E2A3	3H3Y1E2A3			280

MINIATURE DIODE ASSEMBLIES

MDA920 SERIES
MDA930 SERIES
MDA940 SERIES
MDA950 SERIES

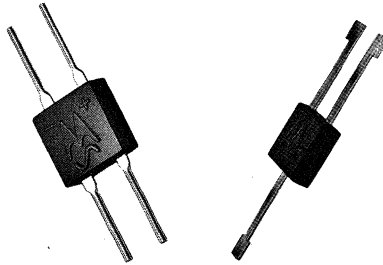

Miniature Integral Diodes Assemblies (MIDA) are low-current rectifier circuit configurations designed with a high output-current/size ratio for applications where space is at a premium.

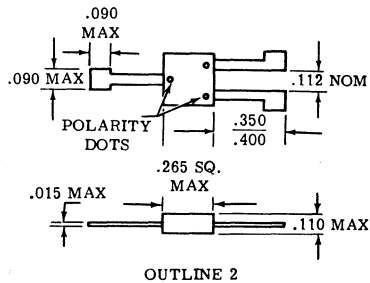
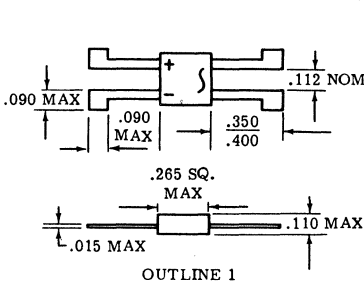

POLARITY DOTS: R; RED-POS. OUT
 W; WHITE-NEG. OUT
 Y; YELLOW-AC IN

ELECTRICAL CHARACTERISTICS (All Types)
 (At 25°C ambient temperature unless otherwise indicated)

Characteristics	Symbol	Rating	Unit
Maximum Forward Voltage Drop (Per Cell.) (500 mAdc)	V_F	1.2	Volts
Peak Recurrent Forward Current (Full Wave, 60 cps)	I_F	5.0	Amps
Peak One Cycle Surge Current (Full Wave, 60 cps)	I_{Surge}	32	Amps
Maximum Reverse Current @ Rated DC Voltage * 25°C 100°C	I_R^*	60 600	μA
Operating and Storage Temperature Range	T_A and T_{stg}	-50 to +175	°C
Typical Thermal Resistance	θ_{JA}	60	°C W

*2 cells in parallel - MDA920 series
 1 cell - MDA930, MDA940, and MDA950 series

MINIATURE DIODE ASSEMBLIES (continued)

Circuit Diagram and
Terminal Identification

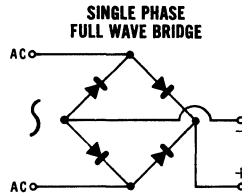

Motorola Type No.	Peak Reverse Voltage per Cell Volts	Max. RMS Input Voltage Cap. Load Volts	Max. DC Output Voltage		Max. DC Output Current At 75°C Amps
			Res. Load Volts	Cap. Load Volts	
MDA920-1	25	18	15	25	1.0
MDA920-2	50	35	30	50	1.0
MDA920-3	100	70	62	100	1.0
MDA920-4	200	140	124	200	1.0
MDA920-5	300	210	185	300	1.0
MDA920-6	400	280	250	400	1.0
MDA920-7	600	420	380	600	1.0

**SINGLE PHASE
VOLTAGE DOUBLER**

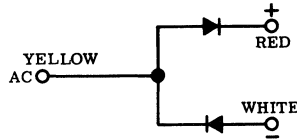

MDA930-1	25	9	8	13	1.0
MDA930-2	50	18	15	25	1.0
MDA930-3	100	35	30	50	1.0
MDA930-4	200	70	62	100	1.0
MDA930-5	300	105	92	150	1.0
MDA930-6	400	140	125	200	1.0
MDA930-7	600	210	190	300	1.0

**SINGLE PHASE CENTER TAP
COMMON ANODE**

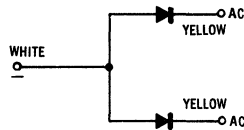

COMMON CATHODE	COMMON ANODE					
MDA940-1	MDA950-1	25	9	---	25	0.5
MDA940-2	MDA950-2	50	18	---	50	0.5
MDA940-3	MDA950-3	100	35	---	100	0.5
MDA940-4	MDA950-4	200	70	---	200	0.5
MDA940-5	MDA950-5	300	105	---	300	0.5
MDA940-6	MDA950-6	400	140	---	400	0.5
MDA940-7	MDA950-7	600	210	---	600	0.5

MINIATURE DIODE ASSEMBLIES (continued)

**MAXIMUM ALLOWABLE SURGE CURRENT
(ALL TYPES)**

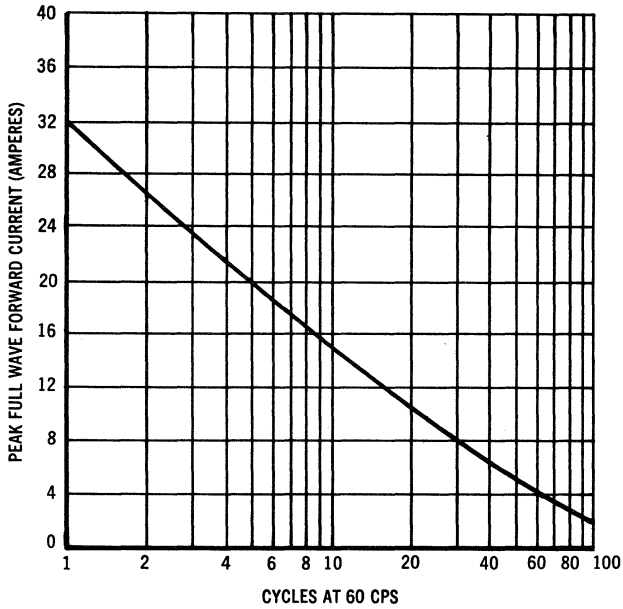

**MAXIMUM ALLOWABLE DC OUTPUT CURRENT
(ALL TYPES)**

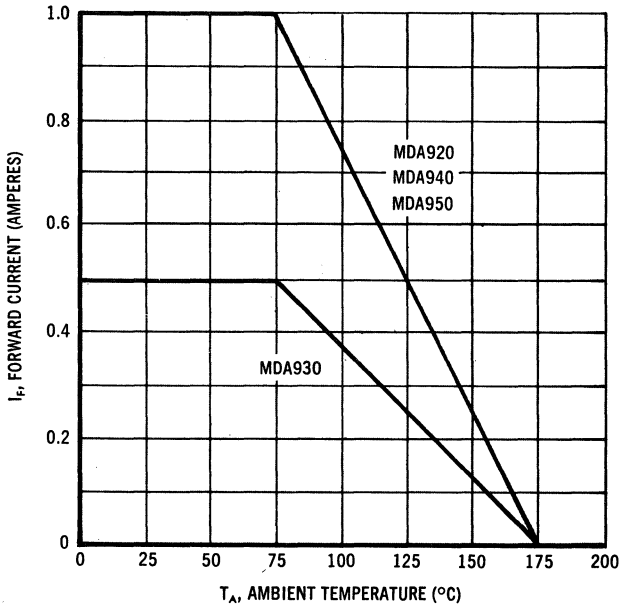

RECTIFIER BRIDGES IN MOLDED ASSEMBLIES

Single Phase Full Wave Bridge

MDA 942 SERIES (1.5 AMPS DC)

MDA 952 SERIES (6 AMPS DC)

MDA 962 SERIES (10 AMPS DC)

MDA 1491 SERIES (1.5 AMPS DC)

MDA 1591 SERIES (4 AMPS DC)



MDA952



MDA942



MDA962



MDA1491
MDA1591



MDA1505

Three Phase Full Wave Bridge

MDA 1505 SERIES (8 AMPS DC)

Hermetically sealed individual rectifier cells interconnected as single-phase and three-phase bridge rectifiers and encapsulated in molded plastic cases.

ABSOLUTE MAXIMUM RATINGS (at 25°C ambient unless otherwise noted)

MOTOROLA TYPE NO.	PEAK REVERSE VOLTAGE PER CELL (DC or RECURRENT) VOLTS	SINE WAVE RMS INPUT VOLTAGE VOLTS	DC OUTPUT VOLTAGE		DC OUTPUT CURRENT @55°C AMBIENT AMPS	PEAK FULL WAVE ONE CYCLE SURGE CURRENT (60 cps) AMPS	PEAK FULL WAVE RE- CURRENT FOR- WARD CURRENT (60 cps) AMPS
			Res. Load Volts	Cap. Load Volts			
MDA 942-1	50	35	30	50	1.50	25	6.0
	100	70	62	100	1.50	25	6.0
	200	140	124	200	1.50	25	6.0
	300	210	185	300	1.50	25	6.0
	400	280	250	400	1.50	25	6.0
	600	420	380	600	1.50	25	6.0
MDA 952-1	50	35	30	50	6.00	150	35
	100	70	62	100	6.00	150	35
	200	140	124	200	6.00	150	35
	300	210	185	300	6.00	150	35
	400	280	250	400	6.00	150	35
	600	420	380	600	6.00	150	35
MDA 962-1	50	35	30	50	10.0	250	60
	100	70	62	100	10.0	250	60
	200	140	124	200	10.0	250	60
	300	210	185	300	10.0	250	60
	400	280	250	400	10.0	250	60
MDA1491-1	50	35	30	50	1.50	25	6.0
	100	70	62	100	1.50	25	6.0
	200	140	124	200	1.50	25	6.0
	300	210	185	300	1.50	25	6.0
	400	280	250	400	1.50	25	6.0
	600	420	380	600	1.50	25	6.0
MDA1591-1	50	35	30	50	4.0	100	25
	100	70	62	100	4.0	100	25
	200	140	124	200	4.0	100	25
	300	210	185	300	4.0	100	25
	400	280	250	400	4.0	100	25
	600	420	300	600	4.0	100	25
MDA1505-1	50	35	30	50	8.00	200	45
	100	70	62	100	8.00	200	45
	200	140	124	200	8.00	200	45
	300	210	185	300	8.00	200	45
	400	280	250	400	8.00	200	45
	600	420	300	600	8.00	200	45

Maximum Operating and Storage Temperature: -65°C to +150°C (All Types)

RECTIFIER BRIDGES (continued)

ELECTRICAL CHARACTERISTICS (at 25° ambient)

Type	Characteristic	Symbol	Rating	Unit
MDA 942 1.5 Amp Series	Max. Fwd. Voltage Drop Per Cell ($I_F = 0.75 \text{ Adc}$)	V_F	1.1	Vdc
	Max. Reverse Current Per Cell ($V_R = \text{Rated PRV}$)	I_R	.01	mAdc
MDA 952 6.0 Amp Series	Max. Fwd. Voltage Drop Per Cell ($I_F = 3.0 \text{ Adc}$)	V_F	1.0	Vdc
	Max. Reverse Current Per Cell ($V_R = \text{Rated PRV}$)	I_R	1.0	mAdc
MDA 962 10.0 Amp Series	Max. Fwd. Voltage Drop Per Cell ($I_F = 5.0 \text{ Adc}$)	V_F	1.0	Vdc
	Max. Reverse Current Per Cell ($V_R = \text{Rated PRV}$)	I_R	1.0	mAdc
MDA 1491 1.5 Amp Series	Max. Fwd. Voltage Drop Per Cell ($I_F = 0.75 \text{ Adc}$)	V_F	1.1	Vdc
	Max. Reverse Current Per Cell ($V_R = \text{Rated PRV}$)	I_R	.01	mAdc
MDA 1505 4.0 Amp Series	Max. Fwd. Voltage Drop Per Cell ($I_F = 4.0 \text{ Adc}$)	V_F	1.0	Vdc
	Max. Reverse Current Per Cell ($V_R = \text{Rated PRV}$)	I_R	1.0	mAdc
MDA 1591 8.0 Amp Series	Max. Fwd. Voltage Drop Per Cell ($I_F = 2.0 \text{ Adc}$)	V_F	1.0	Vdc
	Max. Reverse Current Per Cell ($V_R = \text{Rated PRV}$)	I_R	1.0	mAdc

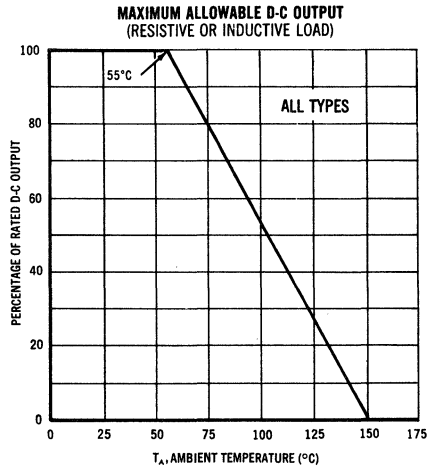
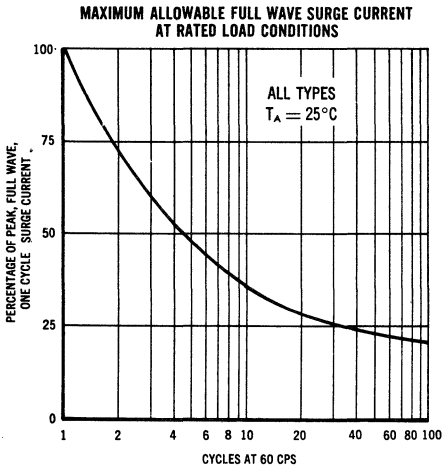

RECTIFIER BRIDGES (continued)

MDA942

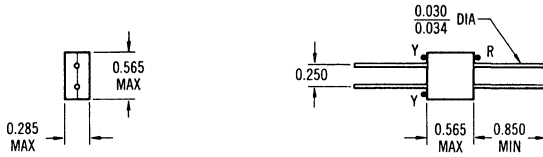

MDA952

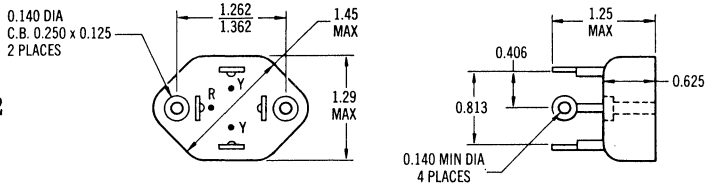

MDA962

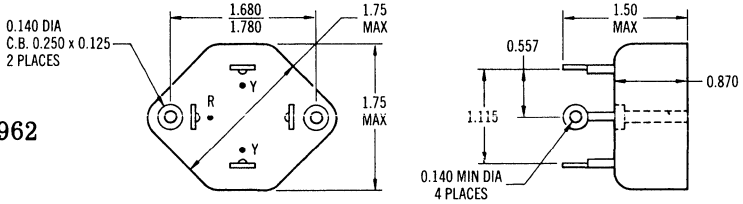

MDA1491

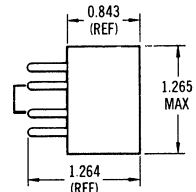
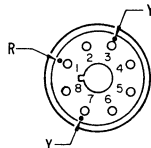

MDA 1591

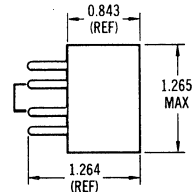
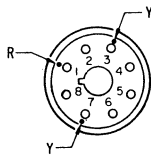

MDA 1505

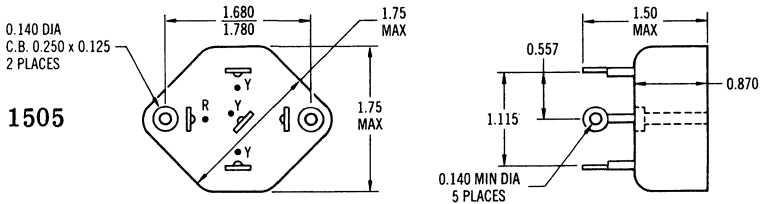

HIGH VOLTAGE SILICON RECTIFIERS MOLDED ASSEMBLIES

MDA1330H
MDA1331H
MDA1332H
MDA1333H



I_O — to 2.5 AMPS
 $V_{RM(rep)}$ = 5000 and 10,000 VOLTS



Compensated series-connected rectifier cells for high-voltage single-phase, half-wave circuit applications. Each cell in the series string is shunted by a high-voltage capacitor and resistor for equal voltage distribution.

MAXIMUM RATINGS

Rating	Symbol	MDA1330H	MDA1331H	MDA1332H	MDA1333H	Units
Peak Repetitive Reverse Voltage (Rated Current, Over Operating Temperature Range) ①	$V_{RM(rep)}$	5,000	10,000	5,000	10,000	Volts
RMS Reverse Voltage (Rated Current Over the Complete Operating Temperature Range) ②	V_r	3,500	7,000	3,500	7,000	Volts
DC Blocking Voltage (Over Operating Temperature Range)	V_R	3,000	6,000	3,000	6,000	Volts
Average Half Wave Rectified Forward Current (Resistive Load, 180° Conduction Angle, 60cps, Free Convection Cooling) $T_A = 40^\circ C$ $T_A = 100^\circ C$	I_O	1.0 0.3	1.0 0.3	2.5 0.5	2.5 0.5	Amps
Peak 1 Cycle Surge Current ($T_A = 40^\circ C$, Superimposed on Rated Current at Rated Voltage)	$I_{FM(surge)}$	25	25	250	250	Amps
Operating Frequency Range	↔ DC to 400 ↔					cps
Operating and Storage Temperature Range	↔ -55 to +110 ↔					°C

- ① $V_{RM(rep)}$ ratings of 5,000 or 10,000 volts peak are both the maximum repetitive and non-repetitive ratings. Where voltage transient suppression is employed, these assemblies can be reliably operated at the maximum ratings.
- ② The DC Blocking Voltage rating (V_R), is established by the continuous power dissipation ratings of the shunting resistors and is not a function of the series rectifiers.

ELECTRICAL CHARACTERISTICS

Rating	Symbol	MDA1330H	MDA1331H	MDA1332H	MDA1333H	Units
Maximum Full-Cycle Average Forward Voltage Drop (Half-Wave, Resistive Load, Rated Current and Voltage, $T_A = 40^\circ C$)	$V_{F(AV)}$	5.0	10.0	5.0	10.0	Volts
Maximum Full-Cycle Average Reverse Current (Half-Wave, Resistive Load, Rated Current and Voltage, $T_A = 40^\circ C$)	$I_{R(AV)}$	0.2	0.2	3.0	3.0	mA

Note: Ambient temperatures are measured at the cold air source point i.e. immediately below the rectifier legs under convection cooling and on the cool air side with forced air cooling.

HIGH VOLTAGE SILICON RECTIFIERS (continued)

ELECTRICAL DESIGN NOTES

1. For single-phase full-wave circuits using "Series 1300" stacks, multiply the current ratings given for the half-wave by two.
2. For three-phase full-wave and half-wave circuits, multiply given current ratings for single-phase half-wave by two and one half.
3. For capacitive loads, sufficient surge and capacitor inrush current protection must be employed. Recurrent peak currents up to six times the single-phase average output current ratings can be safely sustained when the average value of these peaks are held at or below the rated average output. Non-repetitive peak currents must be held to the maximum surge ratings.

TYPICAL FORWARD CHARACTERISTICS
($T_J = 25^\circ\text{C}$)

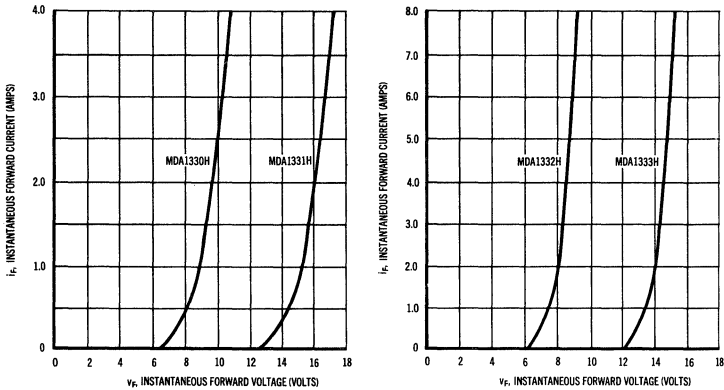

HIGH VOLTAGE SILICON RECTIFIERS (continued)

**MAXIMUM SURGE CURRENT
RATED CONDITIONS**

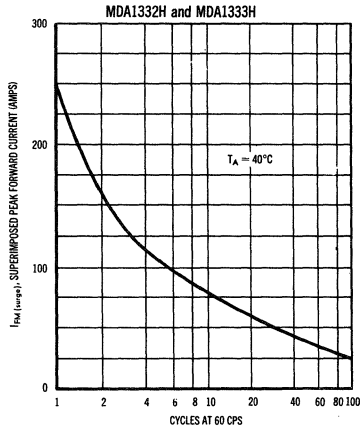
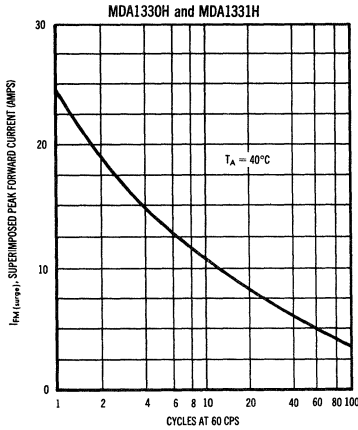

**MAXIMUM AVERAGE HALF-WAVE RECTIFIED CURRENT
(RESISTIVE OR INDUCTIVE LOAD, 180° CONDUCTION ANGLE, 60 CPS)**

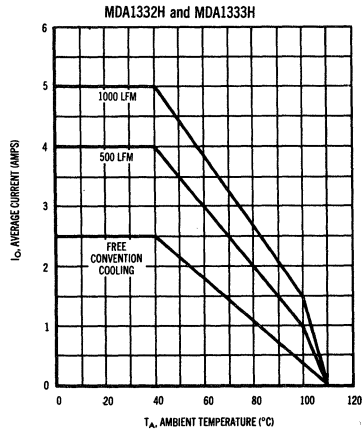
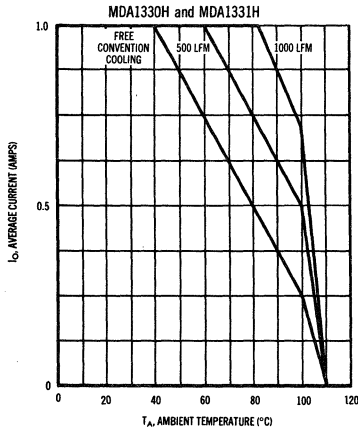

MECHANICAL DESIGN INFORMATION AND OUTLINE DIMENSIONS FOR THE BASIC MDA1330H AND MDA1331H RECTIFIER LEGS.

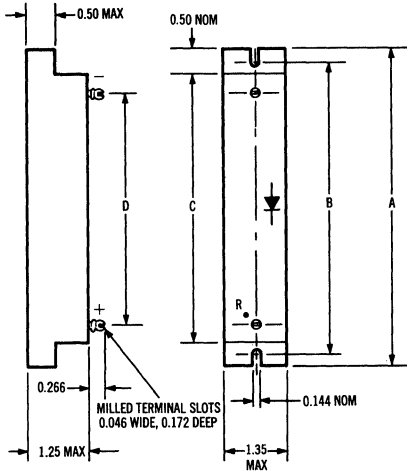

POLARITY DOTS: RED = +DC OUTPUT

Device	A Dim	B Dim	C Dim	D Dim
MDA1330H	4.25 max	3.70 ± 0.05	3.25 max	3.00 nom
MDA1331H	7.00 max	6.39 ± 0.05	6.00 max	5.25 nom

NOTES: These basic rectifier legs are suitable for chassis mounting and connection into multiple leg circuits. Center tapped versions of the MDA1330H and MDA1331H are also available for use in lower voltage, Center tapped and Voltage Doubler applications. The center tapped versions of the MDA1330H and MDA1331H are designated by a different suffix letter as follows: instead of "H" specify "C" for common cathode, center tap "U" for common anode, center tap "D" for voltage doubler.

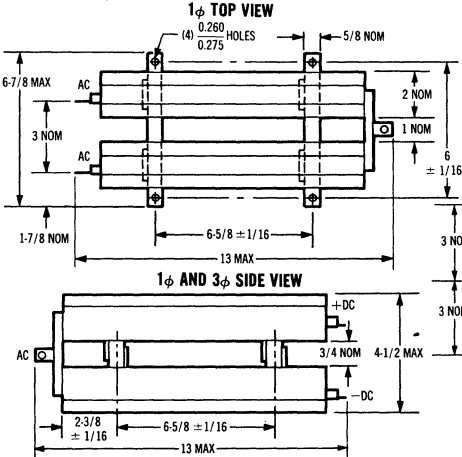

MECHANICAL DESIGN INFORMATION AND OUTLINE DIMENSIONS FOR THE BASIC MDA1332H AND MDA1333H RECTIFIER LEGS.

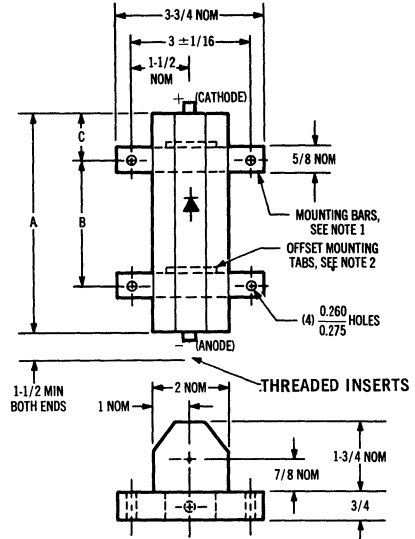

Device	A Dim	B Dim	C Dim
MDA1332H	5-5/8 nom	3-5/16 ± 1/16	1-1/8 nom
MDA1333H	11-1/4 nom	6-5/8 ± 1/16	2-3/8 nom

NOTE 1. Insulated mounting bars are supplied with all Motorola Series 1300 stacks and the single unit bar is shown above. For multiple leg circuits, mounting bars are available in lengths suitable for 2 or 3 legs mounted side by side. In addition, the mounting arrangement used is also suitable for mounting legs top and bottom on the same bar with stand-offs employed for support of the assembly.

NOTE 2. Offset mounting tabs are used to provide more compact multiple leg assemblies. When top & bottom or side by side mounting is employed, reverse polarity legs are often required in some circuits. Legs of reverse polarity to that shown above are designated by an "R" suffix, i.e. MDA1332HR.

HIGH VOLTAGE SILICON RECTIFIERS MOLDED ASSEMBLIES

1N1730 thru 1N1734
1N2382 thru 1N2385

I_o — to 0.2 AMPS
V_p — to 10,000 VOLTS

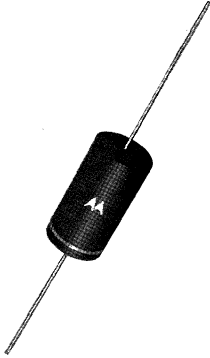

Standard single - phase, half - wave, high - voltage
silicon rectifier assemblies

ELECTRICAL SPECIFICATIONS (covering all devices in the table below)

Max. DC Reverse Current @ Late Peak Reverse Voltage					25 °C 10 μ A 100 °C 100 μ A				
Max. Surge Current (8 nsec)					2.5 A				
Operating Temperature					-55 °C to +150 °C				
Rectifier Types	V _{RM} (rep)	Avg. Rectified Fwd. Current - mA		Max. RMS Input Voltage	Max. DC Fwd. Voltage @ 100mA dc @ 25 °C	Case Dimensions		Lead Dimensions	
		@25 °C	@100 °C			L	Dia.	L	Dia.
1N1730	1000	200	100	700	5	.5	.375	1.250	.030
1N1731	1500	200	100	1050	5	.5	.375	1.250	.030
1N1732	2000	200	100	1400	9	1.0	.375	1.250	.030
1N1733	3000	150	75	2100	12	1.0	.375	1.250	.030
1N1734	5000	100	50	3500	18	1.0	.5	1.250	.030
1N2382	4000	150	75	2800	18	1.5	.5	1.250	.030
1N2383	6000	100	50	4200	27	1.5	.5	1.250	.030
1N2384	8000	70	35	5600	27	1.5	.5	1.250	.030
1N2385	10000	70	35	7000	39	2.0	.5	1.250	.030

In addition to these standard assemblies, a wide variety of custom assemblies is available. For more information, request the brochure "Motorola Molded Diode Assemblies."



**MOTOROLA
SILICON CONTROLLED RECTIFIERS
AND
GATE CONTROLLED SWITCHES**

- For case outline dimensions, see page 1-26.

SILICON CONTROLLED RECTIFIERS & GATE CONTROLLED SWITCHES

The Motorola line of silicon controlled rectifiers is available with current ratings from 1.6 to 25 amps RMS and 1000 amps pulse. The gate controlled switch line is rated at 5 amps.

DEVICES IN THIS SECTION

Motorola Silicon Controlled Rectifiers				Motorola Gate Controlled Switches
2N681	2N1843	2N2573	MCR1305R Series	MGS821 Series MGS924 Series MGS925 Series
2N682	2N1843A	2N2574	MCR1308 Series	
2N683	2N1844	2N2575	MCR1308R Series	
2N684	2N1844A	2N2576	MCR1604 Series	
2N685	2N1845	2N2577	MCR1604R Series	
2N686	2N1845A	2N2578	MCR1605 Series	
2N687	2N1846	2N2579	MCR1605R Series	
2N688	2N1846A	MCR649 Series	MCR1718 Series	
2N689	2N1847	MCR729 Series	MCR1907 Series	
2N1595	2N1847A	MCR808 Series	MCR2304 Series	
2N1596	2N1848	MCR808R Series	MCR2304R Series	
2N1597	2N1848A	MCR846 Series	MCR2305 Series	
2N1598	2N1849	MCR914 Series	MCR2305R Series	
2N1599	2N1849A	MCR1304 Series	MCR2604 Series	
2N1842	2N1850	MCR1304R Series	MCR2604R Series	
2N1842A	2N1850A	MCR1305 Series	MCR2605 Series	
			MCR2605R Series	

SILICON GATE CONTROLLED SWITCHES

The gate controlled switch is a PNP semiconductor device that can be used as a bistable latching switch under complete control of the gate signal. The gate controlled switch is turned on by a positive gate signal and turned off with a negative gate signal.

SCR SYMBOLS AND DEFINITIONS

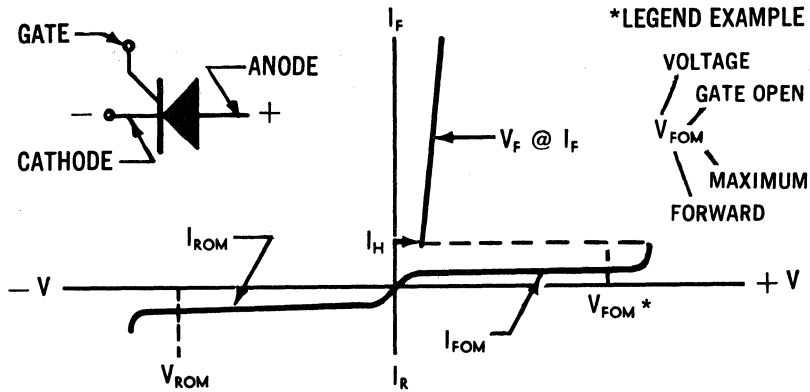

dv/dt	FORWARD VOLTAGE APPLICATION RATE ($V/\mu\text{sec}$) - A rate of applied voltage in excess of this value may cause premature, nondestructive breakthrough.
I_I	FORWARD CURRENT - The RMS value of forward current during the "on" state. RMS value is the same for all conduction angles.
$I_{F(av)}$	AVERAGE FORWARD CURRENT - The full cycle average forward current for specified conditions of case temperature and conduction angle.
I_{FM}	PEAK FORWARD CURRENT, "ON" STATE - The peak current through the collector junction for a positive anode-to-cathode voltage.
$I_{FM(surge)}$	PEAK ONE-CYCLE SURGE FORWARD CURRENT - The maximum forward current having a single forward cycle (8.3 milliseconds duration) in a 60 cps single-phase resistive load system. The surge may be preceded and followed by maximum rated voltage, current, and junction temperature conditions, and maximum allowable gate power may be concurrently dissipated. However, limitations on anode current during turn-on should not be exceeded.
I_{FOM}	PEAK FORWARD BLOCKING CURRENT, GATE OPEN - The peak current through the collector junction when the SCR is in the "off" state for a stated anode-to-cathode voltage and junction temperature.
I_{GT}	GATE TRIGGER CURRENT, DC - The minimum DC gate current required to cause switching from the "off" state to the "on" state for a stated anode-to-cathode voltage.
I_{HO}	HOLDING CURRENT, GATE OPEN - That value of forward anode current below which the controlled rectifier switches from the conducting state to the forward blocking condition.
I_{HX}	HOLDING CURRENT, GATE CONNECTED - That value of forward anode current below which the controlled rectifier switches from the conducting state to the forward blocking condition with the gate terminal returned to the cathode terminal thru specified impedance and/or voltage.
I_{ROM}	PEAK REVERSE BLOCKING CURRENT, GATE OPEN - The peak current through the collector junction when the SCR is in the reverse blocking state for a stated anode-to-cathode voltage and junction temperature.
I_t^2	(FOR CIRCUIT FUSING CONSIDERATIONS) - A measure of the maximum non-recurrent RMS forward current capacity for pulse durations less than 8.3 milliseconds. I is in RMS amperes, and t is pulse duration in seconds. The same conditions as listed for $I_{FM(surge)}$ apply.
$P_{G(av)}$	AVERAGE GATE POWER DISSIPATION - The value of maximum gate power dissipation averaged over a full cycle permitted between gate and cathode.
P_{GM}	PEAK GATE POWER DISSIPATION - The maximum instantaneous value of gate power dissipation permitted between gate and cathode.
R_L	LOAD RESISTOR
T_C	CASE TEMPERATURE
T_J	JUNCTION TEMPERATURE
T_{stg}	STORAGE TEMPERATURE

SCR SYMBOLS AND DEFINITIONS (continued)

t_{on}	TURN-ON TIME - The time interval between initiation of the gate current signal and reduction of the forward voltage to 10% of the blocking value during switching to conduction under stated conditions.
t_{off}	TURN-OFF TIME - The time interval required for the gate to regain control of forward blocking characteristic after interruption of forward anode current.
V_{FM}	PEAK "ON" VOLTAGE - The peak forward voltage for a stated peak forward current when the SCR is in the "on" state.
V_{FOM}	PEAK FORWARD BLOCKING VOLTAGE, GATE OPEN - The peak forward voltage when the SCR is in the "off" state.
V_{GFM}	PEAK FORWARD GATE VOLTAGE - The peak voltage between the gate terminal and the cathode terminal resulting from the flow of forward gate current.
V_{GRM}	PEAK REVERSE GATE VOLTAGE - The peak voltage between the gate terminal and the cathode terminal when the junction between the gate region and the adjacent cathode region is reverse biased.
V_{GT}	GATE TRIGGER VOLTAGE, DC - The DC voltage between the gate and the cathode required to produce the DC gate trigger current.
$V_{ROM(rep)}$	PEAK REVERSE VOLTAGE, GATE OPEN - The maximum allowable instantaneous value of reverse voltage (repetitive or continuous DC) which can be applied to the device with the gate open at rated temperature.
θ_{JC}	THERMAL RESISTANCE, JUNCTION-TO-CASE - The temperature rise per unit power dissipation of a designated junction above the temperature of the case under conditions of thermal equilibrium.

SIMPLIFIED SCR QUICK SELECTION GUIDE

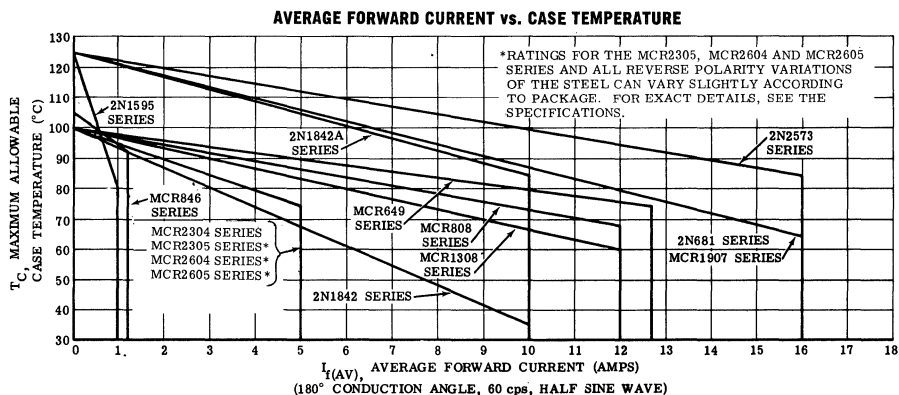

ECONOMY LINE SCR'S

Type	Maximum T_j °C	I_T RMS A	I_{FM} (surge) Peak Surge Current 1 Cycle 60 cps A	Maximum V_{FOM} and V_{ROM} V	Maximum I_{GT} mA	Typical I_{HO} mA	Case
MCR1304, R Series	See MCR2304, R Series for Electrical Specifications						
MCR 2304-1	100	8	100	25	20	10 ↑	Single ended
MCR 2304R-1	100	8	80	25	20		
MCR 2304-2	100	8	100	50	20		
MCR 2304R-2	100	8	80	50	20		
MCR 2304-3	100	8	100	100	20		
MCR 2304R-3	100	8	80	100	20		
MCR 2304-4	100	8	100	200	20		
MCR 2304R-4	100	8	80	200	20		
MCR 2304-5	100	8	100	300	20		
MCR 2304R-5	100	8	80	300	20		
MCR 2304-6	100	8	100	400	20		
MCR 2304R-6	100	8	80	400	20		
MCR1305, R Series	See MCR2305, R Series for Electrical Specifications						
MCR 2305-1	100	8	100	25	20	86	
MCR 2305R-1	100	8	80	25	20		
MCR 2305-2	100	8	100	50	20		
MCR 2305R-2	100	8	80	50	20		
MCR 2305-3	100	8	100	100	20		
MCR 2305R-3	100	8	80	100	20		
MCR 2305-4	100	8	100	200	20		
MCR 2305R-4	100	8	80	200	20		
MCR 2305-5	100	8	100	300	20		
MCR 2305R-5	100	8	80	300	20		
MCR 2305-6	100	8	100	400	20		
MCR 2305R-6	100	8	80	400	20		
MCR1604, R Series	See MCR2604, R Series for Electrical Specifications						
MCR 2604-1	100	8	100	25	20	87	
MCR 2604R-1	100	8	80	25	20		
MCR 2604-2	100	8	100	50	20		
MCR 2604R-2	100	8	80	50	20		
MCR 2604-3	100	8	100	100	20		
MCR 2604R-3	100	8	80	100	20		
MCR 2604-4	100	8	100	200	20		
MCR 2604R-4	100	8	80	200	20		
MCR 2604-5	100	8	100	300	20		
MCR 2604R-5	100	8	80	300	20		
MCR 2604-6	100	8	100	400	20		
MCR 2604R-6	100	8	80	400	20		
MCR1605, R Series	See MCR2605, R Series for Electrical Specifications						
MCR 2605-1	100	8	100	25	20	10 ↓	
MCR 2605R-1	100	8	80	25	20		
MCR 2605-2	100	8	100	50	20		
MCR 2605R-2	100	8	80	50	20		
MCR 2605-3	100	8	100	100	20		
MCR 2605R-3	100	8	80	100	20		
MCR 2605-4	100	8	100	200	20		
MCR 2605R-4	100	8	80	200	20		
MCR 2605-5	100	8	100	300	20		
MCR 2605R-5	100	8	80	300	20		
MCR 2605-6	100	8	100	400	20		
MCR 2605R-6	100	8	80	400	20		

ECONOMY LINE SCR'S (continued)

Type	Maximum T_j °C	I_f RMS A	I_{FM} (surge) Peak Surge Current 1 Cycle 60 cps A	Maximum V_{FOM} and V_{ROM} V	Maximum I_{GT} mA	Typical I_{HO} mA	Case	
MCR 808-1	100	18	225	25	50	15	68	
MCR 808R-1	100	18	225	25	50	15		
MCR 808-2	100	18	225	50	50	15		
MCR 808R-2	100	18	225	50	50	15		
MCR 808-3	100	18	225	100	50	15		
MCR 808R-3	100	18	225	100	50	15		
MCR 808-4	100	18	225	200	50	15		
MCR 808R-4	100	18	225	200	50	15		
MCR 808-5	100	18	225	300	50	15		
MCR 808R-5	100	18	225	300	50	15		
MGR 808-6	100	18	225	400	50	15		
MCR 808R-6	100	18	225	400	50	15		
MCR1308-1	100	18	225	25	50	15		Press Fit
MCR1308R-1	100	18	225	25	50	15		
MCR1308-2	100	18	225	50	50	15		
MCR1308R-2	100	18	225	50	50	15		
MCR1308-3	100	18	225	100	50	15		
MCR1308R-3	100	18	225	100	50	15		
MCR1308-4	100	18	225	200	50	15		
MCR1308R-4	100	18	225	200	50	15		
MCR1308-5	100	18	225	300	50	15		
MCR1308R-5	100	18	225	300	50	15		
MCR1308-6	100	18	225	400	50	15	62	
MCR1308R-6	100	18	225	400	50	15		

SCR'S FOR PULSE MODULATOR APPLICATIONS

Type	T_j °C	V_{FOM} V	V_{ROM} V	I_f RMS A	I_{pulse} A	Maximum I_{GT} ma	Typical I_{HO} mA	dv/dt V/ μ sec	Case
MCR 729-5	105	300	50 ①	2	100	50	25	50 ②	7/16 in. Stud-Mounted Case
MCR 729-6	105	400	50 ①	2	100	50	25	50 ②	
MCR 729-7	105	500	50 ①	2	100	50	25	50 ②	
MCR 729-8	105	600	50 ①	2	100	50	25	50 ②	
MCR 729-9	105	700	50 ①	2	100	50	25	50 ②	
MCR 729-10	105	800	50 ①	2	100	50	25	50 ②	
MCR1718-5	125	300	300	25	1000	50	15	100 ③	TO-48
MCR1718-6	125	400	400	25	1000	50	15	100 ③	TO-48
MCR1718-7	125	500	500	25	1000	50	15	100 ③	TO-48
MCR1718-8	125	600	600	25	1000	50	15	100 ③	TO-48

① Characterized for unilateral applications where reverse blocking capability is not important.
Higher V_{ROM} rated devices available on request

② Minimum value

③ Typical value

INDUSTRIAL SILICON CONTROLLED RECTIFIERS

Type Number	Maximum T_j °C	I_f RMS A	I_{FM} (surge) Peak Surge Current 1/2 Cycle @60 cps A	Maximum V_{FOM} and V_{ROM} V	Maximum I_{GT} mA	Typical I_{HO} mA	Case
2N1595	125	1.6	15	50	10	5	TO-5
2N1596	125	1.6	15	100	10	5	TO-5
2N1597	125	1.6	15	200	10	5	TO-5
2N1598	125	1.6	15	300	10	5	TO-5
2N1599	125	1.6	15	400	10	5	TO-5
MCR 914-1							
MCR 914-2							
MCR 914-3							
MCR 914-4							
MCR 914-5							
MCR 914-6							
← See 2N1595 Series →							
MCR 846-1	105	2	30	25	50	25	7/16 in Stud-Mounted Case
MCR 846-2	105	2	30	50	50	25	
MCR 846-3	105	2	30	100	50	25	
MCR 846-4	105	2	30	200	50	25	
2N1842	100	16	125	25	80	15	TO-48
2N1842A	125	16	125	25	80	15	TO-48
2N1843	100	16	125	50	80	15	TO-48
2N1843A	125	16	125	50	80	15	TO-48
2N1844	100	16	125	100	80	15	TO-48
2N1844A	125	16	125	100	80	15	TO-48
2N1845	100	16	125	150	80	15	TO-48
2N1845A	125	16	125	150	80	15	TO-48
2N1846	100	16	125	200	80	15	TO-48
2N1846A	125	16	125	200	80	15	TO-48
2N1847	100	16	125	250	80	15	TO-48
2N1847A	125	16	125	250	80	15	TO-48
2N1848	100	16	125	300	80	15	TO-48
2N1848A	125	16	125	300	80	15	TO-48
2N1849	100	16	125	400	80	15	TO-48
2N1849A	125	16	125	400	80	15	TO-48
2N1850	100	16	125	500	80	15	TO-48
2N1850A	125	16	125	500	80	15	TO-48
MCR 649-1	100	20	260	25	80	15	TO-41
MCR 649-2	100	20	260	50	80	15	TO-41
MCR 649-3	100	20	260	100	80	15	TO-41
MCR 649-4	100	20	260	200	80	15	TO-41
MCR 649-5	100	20	260	300	80	15	TO-41
MCR 649-6	100	20	260	400	80	15	TO-41
MCR 649-7	100	20	260	500	80	15	TO-41
MCR1907-1*	125	25	150	25	30	15	TO-48
MCR1907-2*	125	25	150	50	30	15	TO-48
MCR1907-3*	125	25	150	100	30	15	TO-48
MCR1907-4*	125	25	150	200	30	15	TO-48
MCR1907-5*	125	25	150	300	30	15	TO-48
MCR1907-6*	125	25	150	400	30	15	TO-48
2N 681	125	25	150	25	25	15	TO-48
2N 682	125	25	150	50	25	15	TO-48
2N 683	125	25	150	100	25	15	TO-48
2N 684	125	25	150	150	25	15	TO-48
2N 685	125	25	150	200	25	15	TO-48
2N 686	125	25	150	250	25	15	TO-48
2N 687	125	25	150	300	25	15	TO-48
2N 688	125	25	150	400	25	15	TO-48
2N 689	125	25	150	500	25	15	TO-48
2N2573	125	25	260	25	40	15	TO-41
2N2574	125	25	260	50	40	15	TO-41
2N2575	125	25	260	100	40	15	TO-41
2N2576	125	25	260	200	40	15	TO-41
2N2577	125	25	260	300	40	15	TO-41
2N2578	125	25	260	400	40	15	TO-41
2N2579	125	25	260	500	40	15	TO-41

* Fast Turn Off at SCR

2N681 thru 2N689

$I_f = 25 \text{ A RMS}$
 $V_{ROM} = 25\text{-}500 \text{ V}$



Industrial-type, silicon controlled rectifiers in a stud package with current handling capability to 25 amperes at junction temperatures up to 125°C.

CASE 64
(TO-48)

MAXIMUM RATINGS ($T_j = 125^\circ\text{C}$ unless otherwise noted)

Characteristic	Symbol	Rating	Unit
Peak Reverse Voltage* † 2N681 2N682 2N683 2N684 2N685 2N686 2N687 2N688 2N689	V_{ROM} (rep)	25	Volts
		50	
		100	
		150	
		200	
		250	
		300	
		400	
		500	
Peak Reverse Voltage* Transient (non-recurrent 5 msec max. duration)	V_{ROM} (non-rep)	35	Volts
		75	
		150	
		225	
		300	
		350	
		400	
		500	
		600	
Forward Current RMS (All Conduction Angles)	I_F	25	Amps
Peak Surge Current (one cycle, 60 cps) ($T_j = -65$ to $+125^\circ\text{C}$)	I_{FM} (surge)	150	Amps
Circuit Fusing Considerations ($T_j = -65$ to $+125^\circ\text{C}$; ≤ 8.3 msec)	I^2t	75	A^2sec
Peak Gate Power	P_{GM}	5	Watts
Average Gate Power	$P_{G(AV)}$	0.5	Watts
Peak Gate Current	I_{GM}	2	Amps
Peak Gate Voltage Forward Reverse	V_{GFM} V_{GRM}	10	Volts
		5	
Operating Temperature	T_J	-65 to +125	°C
Storage Temperature	T_{stg}	-65 to +150	°C
Stud Torque		30	in. lb.

† V_{ROM} for all types can be applied on a continuous DC basis without incurring damage.

* V_{ROM} (rep) ratings apply for zero or negative gate voltage.

2N681 thru 2N689 (continued)

ELECTRICAL CHARACTERISTICS ($T_j = 125^\circ\text{C}$ unless otherwise noted)

Characteristic	Symbol	Min	Typ	Max	Unit
Forward Breakover Voltage	V_{BO}				Volts
2N681		25	----	----	
2N682		50	----	----	
2N683		100	----	----	
2N684		150	----	----	
2N685		200	----	----	
2N686		250	----	----	
2N687		300	----	----	
2N688		400	----	----	
2N689		500	----	----	
Forward or Reverse Leakage Current (Full Cycle Ave.)	i_{S, I_R}				mAdc
2N681 - 2N684		----	----	6.5	
2N685		----	----	6.0	
2N686		----	----	5.5	
2N687		----	----	5.0	
2N688		----	----	4.0	
2N689		----	----	3.0	
Forward Voltage Drop (16 A Full Cycle Average, 180° Conduction Angle)	V_F	----	----	0.86	Volts
Gate Trigger Current (Continuous DC)	I_{GT}	----	10	25	mAdc
Gate Trigger Voltage (Continuous DC)	V_{GT}	0.25	----	3.0	Vdc
Holding Current	I_{HO}	----	20	----	mA
Switching Time (depends on circuit - consult manufacturer for further information)	$t_{on} (t_d + t_r)$		1.0 - 4.0		μsec
	t_{off}		10 - 20		μsec
Forward Voltage Application Rate	dv/dt	----	30	----	V/ μsec
Thermal Resistance (Junction to Stud)	θ_{JS}	----	1.0	2.0	$^\circ\text{C/W}$

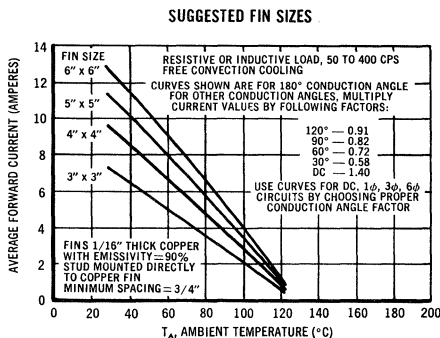
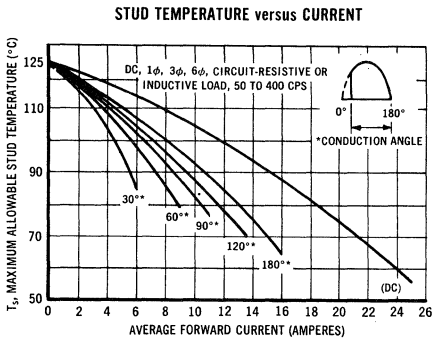
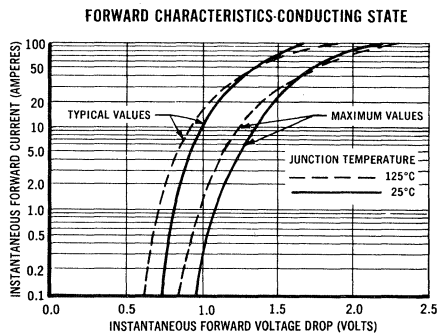
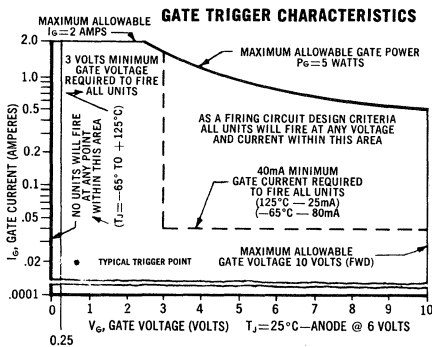

2N1595 thru 2N1599

$I_f = 1.6 \text{ A RMS}$
 $V_{ROM} = 50-400 \text{ V}$



CASE 32
(TO-5)

Industrial-type, low-current silicon controlled rectifiers in a three-lead package ideal for printed-circuit applications. Current handling capability of 1.6 amperes at junction temperatures up to 125°C.

MAXIMUM RATINGS ($T_J = 125^\circ\text{C}$ unless otherwise noted)

Characteristic	Symbol	Rating	Unit
Peak Reverse Blocking Voltage* 2N1595 2N1596 2N1597 2N1598 2N1599	$V_{ROM(rep)}$ *	50 100 200 300 400	Volts
Peak Forward Blocking Voltage* ($R_{GC} = 1000 \text{ ohms}$) 2N1595 2N1596 2N1597 2N1598 2N1599	V_{FOM}	50 100 200 300 400	Volts
Forward Current RMS (All Conduction Angles)	I_f	1.6	Amps
Peak Surge Current (One Cycle, 60 cps, $T_J = -65 \text{ to } +125^\circ\text{C}$)	$I_{FM(surge)}$	15	Amps
Peak Gate Power	P_{GM}	0.1	Watt
Average Gate Power	$P_{G(AV)}$	0.01	Watt
Peak Gate Current	I_{GM}	0.1	Amp
Peak Gate Voltage - Forward Reverse	V_{GFM} V_{GRM}	10 10	Volts
Operating Temperature Range	T_J	-65 to +125	°C
Storage Temperature Range	T_{stg}	-65 to +150	°C

*JEDEC Registered Values

** V_{ROM} & V_{FOM} for all types can be applied on a continuous DC basis without incurring damage.

2N1595 thru 2N1599 (continued)

ELECTRICAL CHARACTERISTICS ($T_J = 25^\circ\text{C}$ unless otherwise noted, $R_{\theta C} = 1000$ ohms)

Characteristics	Symbol	Min	Typ	Max	Unit
Peak Reverse Blocking Current (@ rated V_{ROM} , $T_J = 125^\circ\text{C}$)	I_{ROM}	—	—	1000	μA
Peak Forward Blocking Current (@ rated V_{FOM} , $T_J = 125^\circ\text{C}$)	I_{FOM}	—	—	1000	μA
Forward On Voltage ($I_F = 1$ Adc)	V_F	—	1.1	2.0*	Volts
Gate Trigger Current (Anode Voltage = 7 V, $R_L = 12 \Omega$)	I_{GT}	—	5.0	10.0*	mA
Gate Trigger Voltage (Anode Voltage = 7 V, $R_L = 12 \Omega$) (Anode Voltage = 7 V, $R_L = 12 \Omega$, $T_J = 125^\circ\text{C}$)	V_{GT} V_{GNT}	— 0.2	0.7 —	3.0* —	Volts
Holding Current (Anode Voltage = 7 V)	I_{HX}	—	5.0	—	mA
Turn-on Time ($I_{GT} = 10$ mA, $I_F = 1$ A) ($I_{GT} = 20$ mA, $I_F = 1$ A)	t_{on}	—	0.8 0.6	—	μsec
Turn-off Time ($I_F = 1$ A, $I_R = 1$ A, $dv/dt = 20$ V/ μsec , $T_J = 125^\circ\text{C}$)	t_{off}	—	10	—	μsec

***JEDEC Registered Values**

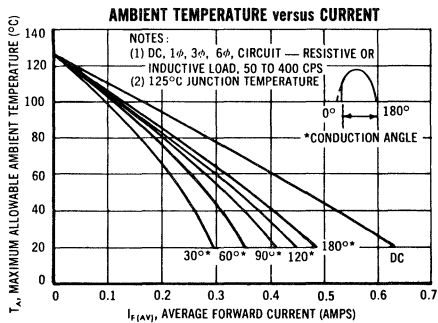
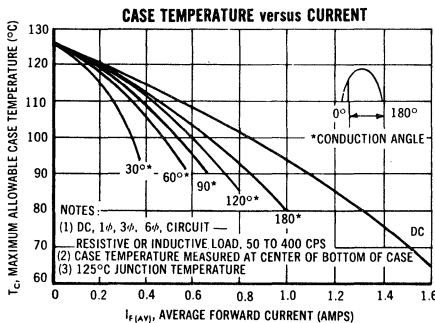
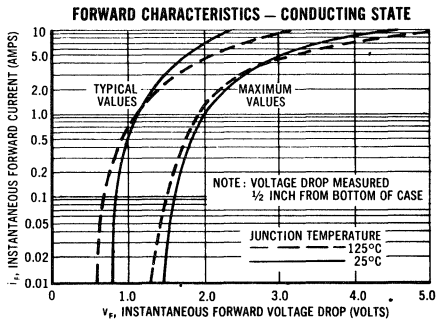
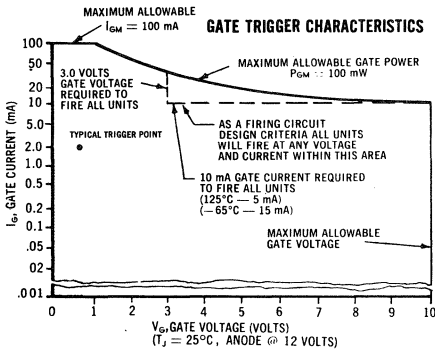

2N1842 thru 2N1850

$I_f = 16 \text{ A RMS}$
 $V_{ROM} = 25\text{-}500 \text{ V}$



CASE 64
(TO-48)

Industrial-type, silicon controlled rectifiers in a stud package with current handling capability to 16 amperes at junction temperatures up to 100°C.

MAXIMUM RATINGS ($T_J = 100^\circ\text{C}$ unless otherwise noted)

Characteristic	Symbol	Rating	Unit
Peak Reverse Blocking Voltage** 2N1842 2N1843 2N1844 2N1845 2N1846 2N1847 2N1848 2N1849 2N1850	$V_{ROM(rep)**}$	25 50 100 150 200 250 300 400 500	Volts
Peak Reverse Voltage Transient 2N1842 (non-recurrent 2N1843 5 msec max. 2N1844 duration) 2N1845 2N1846 2N1847 2N1848 2N1849 2N1850	$V_{ROM(non-rep)}$	35 75 150 225 300 350 400 500 600	Volts
Forward Current RMS (All Conduction Angles)	I_f	16	Amps
Peak Forward Surge Current (One cycle, 60 cps) ($T_J = -40$ to $+100^\circ\text{C}$)	$I_{FM(surge)}$	125	Amps
Circuit Fusing Considerations ($T_J = -40$ to $+100^\circ\text{C}; \leq 8.3$ msec)	I^2t	60	A^2sec
Peak Gate Power	P_{GM}	5	Watts
Average Gate Power	$P_{G(AV)}$	0.5	Watts
Peak Gate Current	I_{GM}	2	Amps
Peak Gate Voltage Forward Reverse	V_{GFM} V_{GRM}	10 5	Volts
Operating Temperature Range	T_J	-40 to +100	$^\circ\text{C}$
Storage Temperature Range	T_{stg}	-40 to +125	$^\circ\text{C}$
Stud Torque		30	in. lb.

* JEDEC - registered values.

** $V_{ROM(rep)}$ for all types can be applied on a continuous DC basis without incurring damage. Ratings apply for zero or negative gate voltage.

2N1842 thru 2N1850 (continued)

ELECTRICAL CHARACTERISTICS ($T_J = 100^\circ\text{C}$ unless otherwise noted)

Characteristic	Symbol	Min	Typ	Max	Unit
Peak Forward Blocking Voltage*	V_{FOM}^*	25	—	—	Volts
		50	—	—	
		100	—	—	
		150	—	—	
		200	—	—	
		250	—	—	
		300	—	—	
		400	—	—	
		500	—	—	
Peak Forward or Reverse Blocking Current	I_{FOM}, I_{ROM}	—	—	6.0	mA
Forward On Voltage (16 Adc, $T_J = 25^\circ\text{C}$)	V_F	—	1.1	1.8	Volts
Gate Trigger Current (Continuous DC) (Anode Voltage = 7 V, $R_L = 50 \Omega$, $T_J = 25^\circ\text{C}$)	I_{GT}	—	15	80	mA
Gate Trigger Voltage (Continuous DC) (Anode Voltage = 7 V, $R_L = 50 \Omega$, $T_J = 25^\circ\text{C}$)	V_{GT}	—	0.8	2.0	Volts
(Anode Voltage = 7 V, $R_L = 50 \Omega$, $T_J = 100^\circ\text{C}$)	V_{GNT}	0.3	—	—	
Holding Current (Anode Voltage = 7 V, Gate Open, $T_J = 25^\circ\text{C}$)	I_{HO}	—	20	—	mA
Switching Time (depends on circuit - consult manufacturer for further information)	$t_{on} (t_d + t_r)$	—	1.0	—	μsec
	t_{off}	—	14-30	—	μsec
Forward Voltage Application Rate	dv/dt	—	30	—	$\text{V}/\mu\text{sec}$
Thermal Resistance (Junction to Stud)	θ_{JC}	—	1.0	2.0	$^\circ\text{C}/\text{W}$

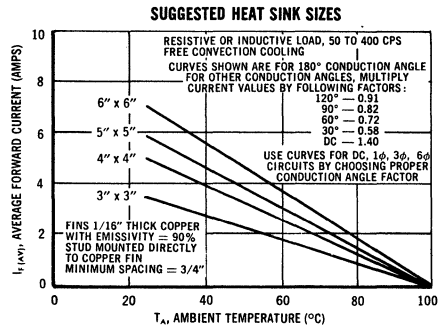
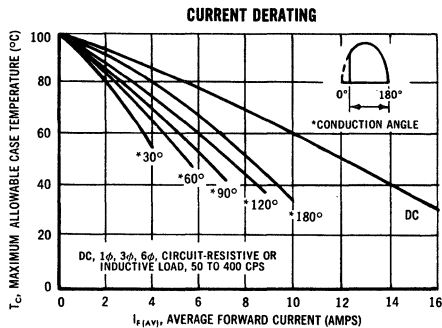
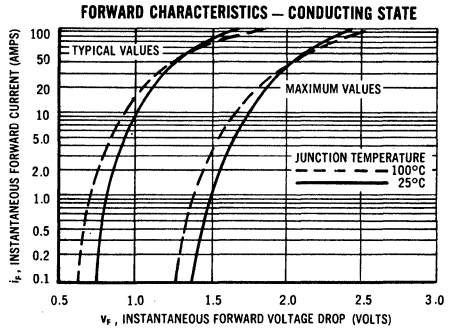
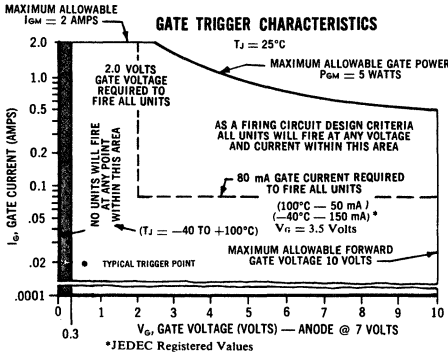

2N1842A thru 2N1850A

$I_f = 16 \text{ A RMS}$
 $V_{ROM} = 25\text{-}500 \text{ V}$



CASE 64
(TO-48)

Industrial-type, silicon controlled rectifiers in a stud package with current handling capability to 16 amperes at junction temperatures up to 125°C.

MAXIMUM RATINGS ($T_J = 125^\circ\text{C}$ unless otherwise noted)

Characteristics	Symbol	Rating	Unit
Peak Reverse Blocking Voltage**	$V_{ROM(rep)}$ **		Volts
2N1842A		25	
2N1843A		50	
2N1844A		100	
2N1845A		150	
2N1846A		200	
2N1847A		250	
2N1848A		300	
2N1849A		400	
2N1850A		500	
Peak Reverse Voltage	$V_{ROM(non-rep)}$		Volts
Transient		35	
(non-recurrent		75	
5 msec max.		150	
duration)		225	
2N1845A		300	
2N1846A		350	
2N1847A		400	
2N1848A		500	
2N1849A		600	
2N1850A			
Forward Current RMS (All Conduction Angles)	I_f	16	Amps
Peak Surge Current (One cycle, 60 cps) ($T_J = -65$ to $+125^\circ\text{C}$)	$I_{FM(surge)}$	125	Amps
Circuit Fusing Considerations ($T_J = -65$ to $+125^\circ\text{C}$; ≤ 8.3 msec)	I^2t	60	A^2sec
Peak Gate Power	P_{GM}	5	Watts
Average Gate Power	$P_{G(AV)}$	0.5	Watts
Peak Gate Current	I_{GM}	2	Amps
Peak Gate Voltage			Volts
Forward	V_{GFM}	10	
Reverse	V_{GRM}	5	
Operating Temperature Range	T_J	-65 to +125	$^\circ\text{C}$
Storage Temperature Range	T_{stg}	-65 to +150	$^\circ\text{C}$
Stud Torque		30	in. lb.

* JEDEC - registered values.

** $V_{ROM(rep)}$ for all types can be applied on a continuous DC basis without incurring damage. Ratings apply for zero or negative gate voltage.

2N1842 A thru 2N1850A (continued)

ELECTRICAL CHARACTERISTICS ($T_J = 125^\circ\text{C}$ unless otherwise noted)

Characteristic	Symbol	Min	Typ	Max	Unit	
Forward Blocking Voltage*	V_{FOM}^*	2N1842A	25	—	—	Volts
		2N1843A	50	—	—	
		2N1844A	100	—	—	
		2N1845A	150	—	—	
		2N1846A	200	—	—	
		2N1847A	250	—	—	
		2N1848A	300	—	—	
		2N1849A	400	—	—	
		2N1850A	500	—	—	
		Forward or Reverse Blocking Current	I_{FOM}, I_{ROM}	—	—	
Forward On Voltage (16 Adc, $T_J = 25^\circ\text{C}$)	V_F	—	1.1	1.6	Volts	
Gate Trigger Current (Anode Voltage = 7 V, $R_L = 50 \Omega$, $T_J = 25^\circ\text{C}$)	I_{GT}	—	15	80	mA	
Gate Trigger Voltage (Anode Voltage = 7 V, $R_L = 50 \Omega$, $T_J = 25^\circ\text{C}$) (Anode Voltage = 7 V, $R_L = 50 \Omega$, $T_J = 125^\circ\text{C}$)	V_{GT}	—	0.8	2.0	Volts	
	V_{GNT}	0.25	—	—		
Holding Current (Anode Voltage = 7 V, Gate Open, $T_J = 25^\circ\text{C}$)	I_{HO}	—	20	—	mA	
Switching Time (depends on circuit - consult manufacturer for further information)	t_{on} ($t_d + t_r$) t_{off}	—	1.0	—	μsec	
		—	14-30	—	μsec	
Forward Voltage Application Rate	dv/dt	—	30	—	V/ μsec	
Thermal Resistance (Junction to Stud)	θ_{JC}	—	1.0	2.0	$^\circ\text{C}/\text{W}$	

* V_{FOM} for all types can be applied on a continuous DC basis without incurring damage. Ratings apply for zero negative gate voltage.

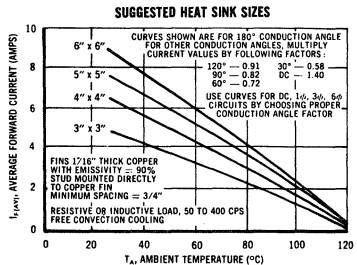
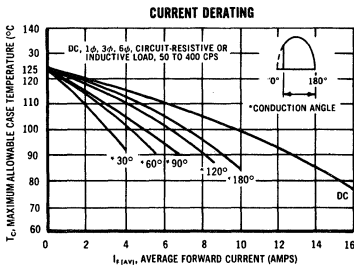
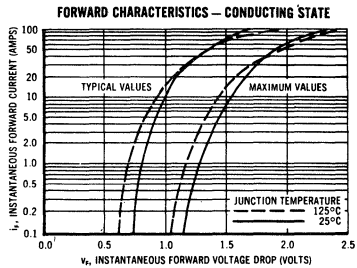
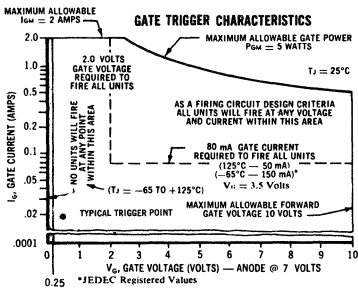

2N2573 thru 2N2579

$I_f = 25 \text{ A RMS}$
 $V_{ROM} = 25\text{-}500 \text{ V}$

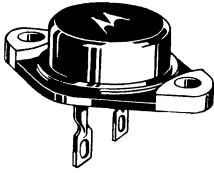

Industrial-type, silicon controlled rectifiers in a "diamond" package for applications requiring a high surge-current rating or low thermal resistance.

CASE 61
(TO-41)

MAXIMUM RATINGS ($T_J = 125^\circ\text{C}$ unless otherwise noted)

Characteristics	Symbol	Rating	Units
Peak Reverse Voltage*	V_{ROM}		Volts
2N2573		25	
2N2574		50	
2N2575		100	
2N2576		200	
2N2577		300	
2N2578		400	
2N2579		500	
Forward Current RMS (All Conduction Angles)		25	Amps
Peak Surge Current (one cycle, 60 cps) ($T_J = -65$ to $+125^\circ\text{C}$)	$I_{(surge)}$	260	Amps
Circuit Fusing Considerations ($T_J = -65^\circ$ to $+125^\circ\text{C}$; ≤ 8.3 msec)	I^2t	275	A^2sec
Peak Gate Power	P_G	5	Watts
Average Gate Power	P_G	0.5	Watts
Peak Gate Current	I_G	2	Amps
Peak Gate Voltage	V_G		Volts
Forward		10	
Reverse	5		
Storage Temperature	T_{stg}	-65 to +150	$^\circ\text{C}$
Operating Temperature	T_J	-65 to +125	$^\circ\text{C}$

* V_{ROM} for all types can be applied on a continuous DC basis without incurring damage. V_{ROM} ratings apply for zero or negative gate voltage.

2N2573 thru 2N2579 (continued)

ELECTRICAL CHARACTERISTICS ($T_J = 125^\circ\text{C}$ unless otherwise noted)

Characteristics	Symbol	Min	Typ	Max	Unit
Forward Breakover Voltage ($T_J = 125^\circ\text{C}$)	V_{FOM}				Volts
2N2573		25	—	—	
2N2574		50	—	—	
2N2575		100	—	—	
2N2576		200	—	—	
2N2577		300	—	—	
2N2578		400	—	—	
2N2579		500	—	—	
Forward Leakage Current (@ Rated V_{BO} with Gate Open) ($T_J = 25^\circ\text{C}$) ($T_J = 125^\circ\text{C}$)	i_S	— —	— 0.6	2 5	mA
Reverse Leakage Current (@ Rated PRV) ($T_J = 25^\circ\text{C}$) ($T_J = 125^\circ\text{C}$)	i_R	— —	— 0.6	2 5	mA
Forward Voltage Drop ($T_J = 125^\circ\text{C}$) (16 A Full Cycle Average, 180° Conduction Angle) (25 Amps DC)	V_F	— —	— 1.1	0.7 —	Volts
Gate Firing Current (Continuous DC)	I_{GT}	—	20	40	mAdc
Gate Firing Voltage (Continuous DC) ($T_J = 25^\circ\text{C}$) ($T_J = 125^\circ\text{C}$)	V_{GT}	— 0.3	1.0 —	3.5 3.5	Vdc
Holding Current	I_H	—	20	—	mA
Forward Voltage Application Rate	dv/dt	—	30	—	V/ μsec
Thermal Resistance	θ_{JC}	—	1.0	1.5	$^\circ\text{C}/\text{W}$

2N2573 thru 2N2579 (continued)

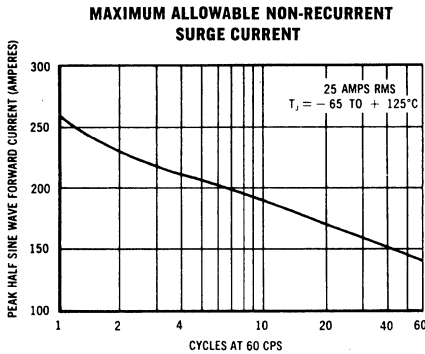

MAXIMUM ALLOWABLE CASE TEMPERATURE

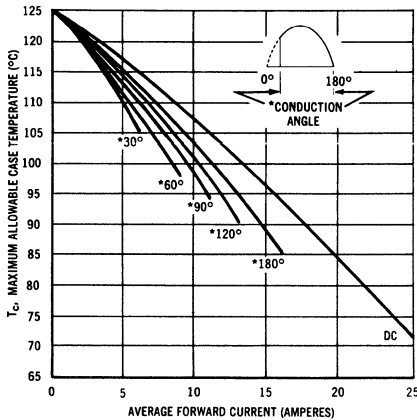

MAXIMUM TRANSIENT THERMAL RESISTANCE JUNCTION TO CASE

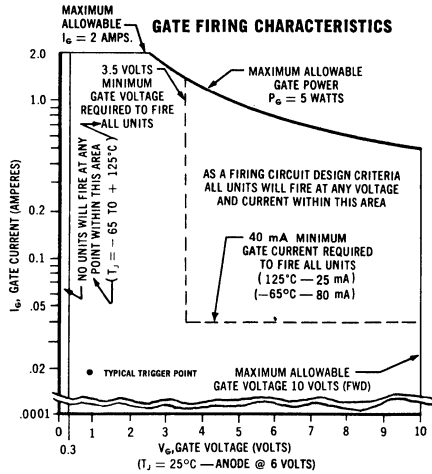
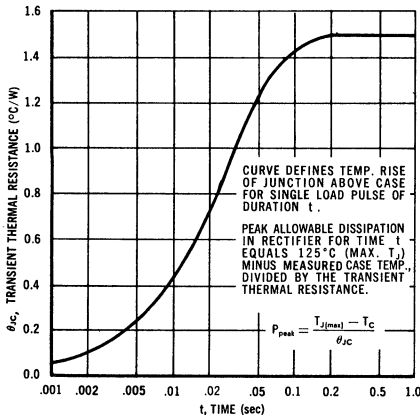

LOW CURRENT LEVEL

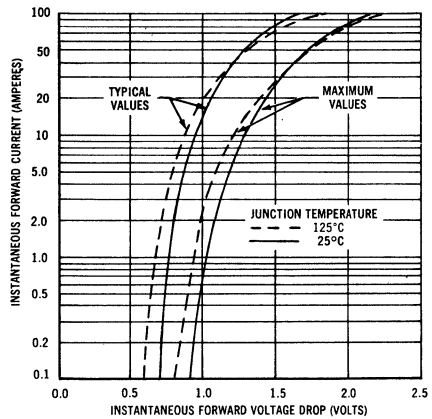

POWER DERATING CURVE

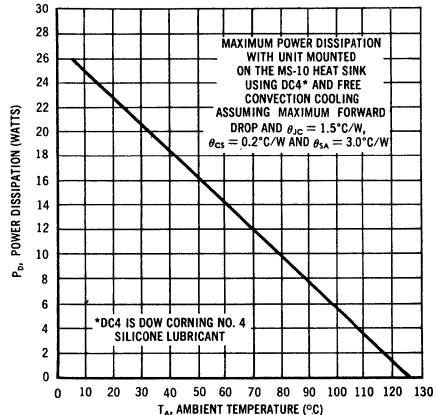

MCR649-1 thru MCR649-7

$I_F = 20 \text{ A RMS}$
 $V_{ROM} = 25\text{-}500 \text{ V}$

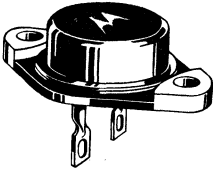

Industrial-type, silicon controlled rectifiers in a "diamond" package for applications requiring a high surge-current rating or low thermal resistance.

CASE 61
(TO-41)

MAXIMUM RATINGS ($T_J = 100^\circ\text{C}$ unless otherwise noted)

Characteristics*	Symbol	Rating	Units
Peak Reverse Voltage * MCR649-1 -2 -3 -4 -5 -6 -7	V_{ROM}	25 50 100 200 300 400 500	Volts
Forward Current RMS (All Conduction Angles)	I_F	20	Amps
Peak Surge Current (full cycle, 60 cps) ($T_J = -40 \text{ to } +100^\circ\text{C}$)	$I_{(surge)}$	260	Amps
Circuit Fusing Considerations ($T_J = -40 \text{ to } +100^\circ\text{C}$; $\leq 8.3 \text{ msec}$)	I^2t	275	A^2sec
Peak Gate Power	P_G	5	Watts
Average Gate Power	P_G	0.5	Watts
Peak Gate Current	I_G	2	Amps
Peak Gate Voltage Forward Reverse	V_G	10 5	Volts
Storage Temperature	T_{stg}	-40 to +150	$^\circ\text{C}$
Operating Temperature	T_J	-40 to +100	$^\circ\text{C}$

* V_{ROM} for all types can be applied on a continuous DC basis without incurring damage.
 V_{ROM} ratings apply for zero or negative gate voltage.

MCR649-1 thru MCR649-7 (continued)

ELECTRICAL CHARACTERISTICS (At $T_J = 25^\circ\text{C}$ unless otherwise noted)

Characteristics	Symbol	Min	Typ	Max	Unit
Forward Breakover Voltage ($T_J = 100^\circ\text{C}$) MCR649-1 -2 -3 -4 -5 -6 -7	V_{FOM}	25 50 100 200 300 400 500	— — — — — — —	— — — — — — —	Volts
Forward Leakage Current (@ Rated V_{BO} with Gate Open) ($T_J = 25^\circ\text{C}$) ($T_J = 100^\circ\text{C}$)		— —	— —	2 5	mA
Reverse Leakage Current (@ Rated PRV) ($T_J = 25^\circ\text{C}$) ($T_J = 100^\circ\text{C}$)		— —	— —	2 5	mA
Forward Voltage Drop ($T_J = 100^\circ\text{C}$) (13 A Full Cycle Average, 180° Conduction Angle) (20 Amps DC)	V_F	— —	— 1.00	0.7 —	Volts
Gate Firing Current (Continuous DC)	I_{GT}	—	30	80	mA
Gate Firing Voltage (Continuous DC) ($T_J = 25^\circ\text{C}$) ($T_J = 100^\circ\text{C}$)	V_{GT}	— 0.3	1.0 —	3.5 —	Volts
Holding Current	I_H	—	20	—	mA
Forward Voltage Application Rate ($R_{GC} = 27 \Omega$) MCR649-1 thru MCR649-4 (25 V - 200 V) MCR649-5 thru MCR649-7 (300 V - 500 V)	dv/dt	— —	10 30	— —	V/ μsec
Thermal Resistance	θ_{JC}	—	1.0	1.5	$^\circ\text{C}/\text{W}$

MCR649-1 thru MCR649-7 (continued)

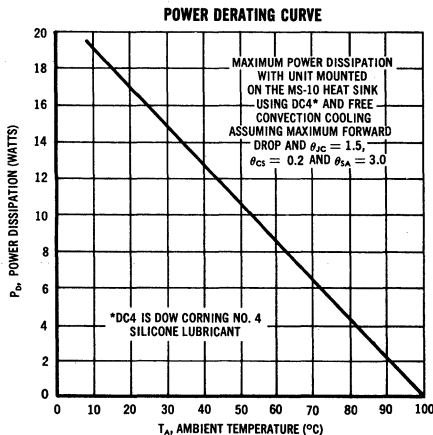
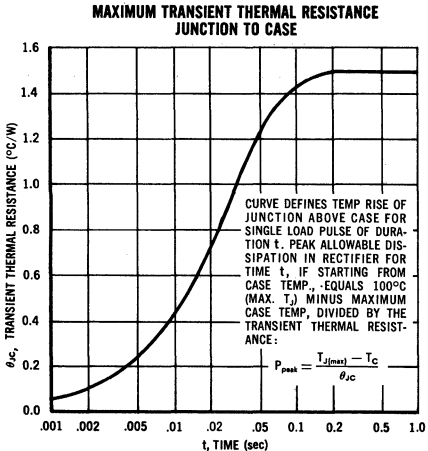
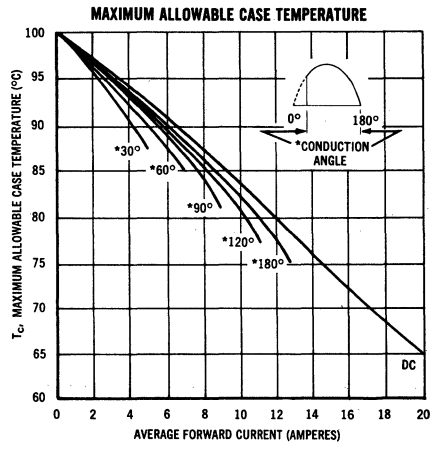
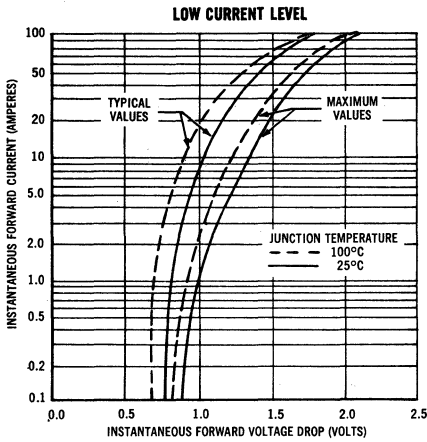
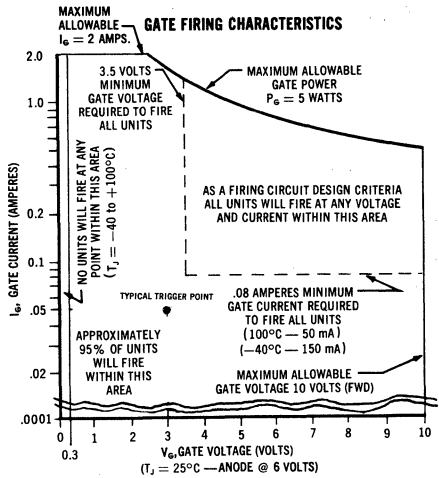
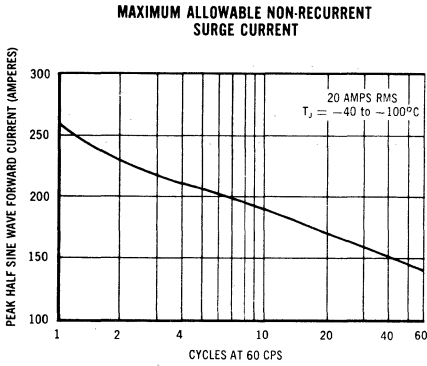

MCR729-5 thru MCR729-10

$I_{\text{pulse}} = 100 \text{ Adc}$
 $V_{\text{ROM}} = 300\text{-}800 \text{ V}$
Pulse Repetition Rates —
to 10,000 pps



CASE 63

Fast-switching, high-voltage silicon controlled rectifier especially designed and characterized for radar, proximity fuse, beacon and similar pulse applications.

MAXIMUM RATINGS ($T_J = 105^\circ\text{C}$ unless otherwise noted)

Characteristic	Symbol	Rating	Unit
Forward Current (continuous)	I_{cont}	2	Adc
Repetitive Pulse Current (10 μsec pulse width)	I_{pulse}	100	Adc
Peak Reverse Voltage*	V_{ROM}	50	Volts
Peak Gate Power	P_G	20	Watts
Average Gate Power	P_G	1	Watt
Peak Gate Current	I_G	5	Amps
Peak Gate Voltage Forward and Reverse	V_G	10	Volts
Operating Temperature	T_J	-65 to +105	$^\circ\text{C}$
Storage Temperature	T_{stg}	-65 to +150	$^\circ\text{C}$
Stud Torque		15	in. lb.

* Characterized for unilateral applications where reverse blocking capability is not important. Higher V_{ROM} rated units available on request.

MCR729-5 thru MCR729-10 (continued)

ELECTRICAL CHARACTERISTICS ($T_J = 105^\circ\text{C}$ unless otherwise noted)

Characteristic	Symbol	Minimum	Typical	Maximum	Unit
Forward Breakover Voltage* MCR729-5 -6 -7 -8 -9 -10	V_{FOM}	300 400 500 600 700 800	- - - - - -	- - - - - -	Volts
Forward Leakage Current (Rated V_{BO} with gate open)	i_S	-	0.2	2	mA
Gate Firing Current ($T_J = 25^\circ\text{C}$)	I_{GF}	-	10	50	mA
Gate Firing Voltage ($T_J = 25^\circ\text{C}$)	V_{GF}	-	0.8	1.5	Volts
Forward Voltage Drop (2 Adc, $T_A = 25^\circ\text{C}$)	V_F	-	1.1	1.5	Volts
Turn-On Time ($t_d + t_r$) ($I_G = 200\text{ mA}$, $T_A = 25^\circ\text{C}$) $I_{\text{pulse}} = 30\text{ amps}$ $I_{\text{pulse}} = 100\text{ amps}$	t_{on}	- -	0.2 0.4	- -	μsec
Turn-On Time Variation ($T_J = +25^\circ\text{C}$ to $+105^\circ\text{C}$ and $+25^\circ\text{C}$ to -65°C)	Δt_{on}	-	± 0.05	-	μsec
Recovery Time (forward) ($I_{\text{pulse}} = 30\text{ amps}$, $I_{\text{reverse}} = 0$, $T_A = 25^\circ\text{C}$ (Inductive charging circuit)	t_{rec}	-	10	-	μsec
Turn-Off Time (Conventional) ($I_{\text{forward}} = 2\text{ amps}$, $I_{\text{reverse}} = 10\text{ amps}$, $T_A = 25^\circ\text{C}$)	t_{off}	-	6	-	μsec
Forward Voltage Application Rate	dv/dt	50	-	-	$\text{V}/\mu\text{sec}$
Drop-Out (Holding) Current ($T_A = 25^\circ\text{C}$)	I_H	5	25	-	mA
Thermal Resistance	θ_{JC}	-	-	4	$^\circ\text{C}/\text{W}$

* Other voltage units available upon request.

MCR808 series

MCR1308 series

$I_f = 18 \text{ A RMS}$
 $V_{ROM} = 25-400 \text{ V}$

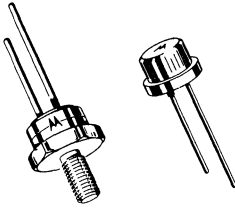

CASE 68

CASE 62

Low-cost, silicon controlled rectifiers available in two package styles and reverse polarity for versatile, economical, general-purpose applications.

MAXIMUM RATINGS (at $T_J = 100^\circ\text{C}$ unless otherwise noted)

Characteristic	Symbol	Rating	Unit
Peak Reverse Voltage* <div style="display: flex; align-items: center; margin-left: 40px;"> <div style="margin-right: 10px;"> <p>MCR808</p> <p>MCR808R</p> <p>MCR1308</p> <p>MCR1308R</p> </div> <div style="font-size: 2em; margin-right: 10px;">}</div> <div style="margin-right: 10px;"> <p>-1</p> <p>-2</p> <p>-3</p> <p>-4</p> <p>-5</p> <p>-6</p> </div> </div>	$V_{ROM(rep)}$	25 50 100 200 300 400	Volts
Forward Current RMS (All Conduction Angles)	I_f	18	Amps
Peak Surge Current (one cycle, 60 cps) ($T_J = -40$ to $+100^\circ\text{C}$)	$I_{FM(surge)}$	225	Amps
Circuit Fusing Considerations ($T_J = -40$ to $+100^\circ\text{C}$; 8.3 msec)	I^2t	235	A^2sec
Peak Gate Power	P_{GM}	5	Watts
Average Gate Power	$P_{G(av)}$	0.5	Watts
Peak Forward Gate Current	I_{GFM}	2	Amps
Peak Gate Voltage Forward Reverse	V_{GFM} V_{GRM}	10 10	Volts
Operating Temperature Range	T_J	-40 to +100	$^\circ\text{C}$
Storage Temperature Range	T_{stg}	-40 to +150	$^\circ\text{C}$
Stud Torque - MCR1308 and MCR1308R	—	30	in. lb.

* $V_{ROM(rep)}$ for all types can be applied on a continuous DC basis without incurring damage. Ratings apply for zero or negative gate voltage.

MCR808, MCR1308 (continued)

ELECTRICAL CHARACTERISTICS ($T_J = 25^\circ\text{C}$ unless otherwise noted)

Characteristic	Symbol	Min	Typ	Max	Unit
Peak Forward Blocking Voltage* ($T_J = 100^\circ\text{C}$)	V_{FOM}	25	—	—	Volts
MCR808		50	—	—	
MCR808R		100	—	—	
MCR1308		200	—	—	
MCR1308R		300	—	—	
Peak Forward Blocking Current (Rated V_{FOM} with gate open, $T_J = 100^\circ\text{C}$)	I_{FOM}	—	1	8	mA
Peak Reverse Blocking Current (Rated V_{ROM} , Gate open, $T_J = 100^\circ\text{C}$)	I_{ROM}	—	1	5	mA
Forward On Voltage (18 Adc, $T_J = 100^\circ\text{C}$)	V_F	—	1.1	1.5	Volts
Gate Triggering Current (Anode Voltage = 7 V, $R_L = 50 \Omega$)	I_{GT}	—	15	50	mA
Gate Firing Voltage (Continuous DC) (Anode Voltage = 7 V, $R_L = 50 \Omega$) (Anode Voltage = 7 V, $R_L = 50 \Omega$, $T_J = 100^\circ\text{C}$)	V_{GT} V_{GNT}	— 0.3	0.7	1.5	Volts
Holding Current (Anode Voltage = 7 V, gate open)	I_{HO}	—	15	—	mA
Turn-On Time ($I_F = 18$ Adc, $I_{GT} = 50$ mAdc)	t_{on}	—	1.0	—	μsec
Turn-Off Time ($I_F = 10$ A, $I_R = 10$ A) ($I_F = 10$ A, $I_R = 10$ A, $T_J = 100^\circ\text{C}$)	t_{off}	—	12 18	—	μsec
Forward Voltage Application Rate ($T_J = 100^\circ\text{C}$)	dv/dt	—	30	—	V/ μsec
Thermal Resistance	θ_{JC}	—	1.0 1.4	1.6 2.0	$^\circ\text{C}/\text{W}$

* V_{FOM} for all types can be applied on a continuous DC basis without incurring damage. Ratings apply for zero or negative gate voltage.

PRESS IN MOUNTING

1. Heat Sink Hole — To provide good SCR heat sink surface contact, the diameter of the heat sink hole should be $0.499 \pm .001$ inch. The edge of the hole into which the SCR will be pressed should be slightly beveled to aid in starting and to prevent shearing off of the package knurl. The depth and width of this beveled break should be 0.010 nominal (see Figure 14).

2. Hardness of Heat Sink Material — If the SCR is pressed into a heat sink material which is harder than the case of the SCR, degradation of voltage characteristics can occur because of stresses placed on the package and consequently on the silicon die inside. Therefore, the following hardnesses for the heat sink material are recommended:

- Copper — less than 50 on the Rockwell F scale
(the MCR808 case is 50 or greater)
- Aluminum — less than 65 on the Brinell scale.

3. Press-In Force — The recommended press-in force is between 250 and 1000 pounds per square inch. It is extremely important that this force be applied only to the external annular ring portion of the device. If pressure is applied to the glass-to-metal seal portion of the device, stresses can result which crack the glass and/or break the hermetic seal.

HEAT SINK MOUNTING

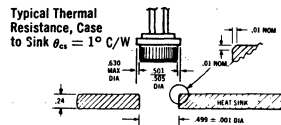

THIN-CHASSIS MOUNTING

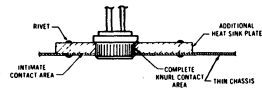

MCR808, MCR1308 (continued)

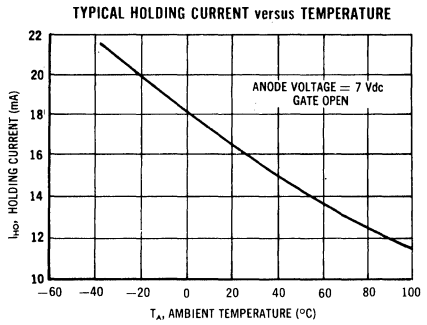
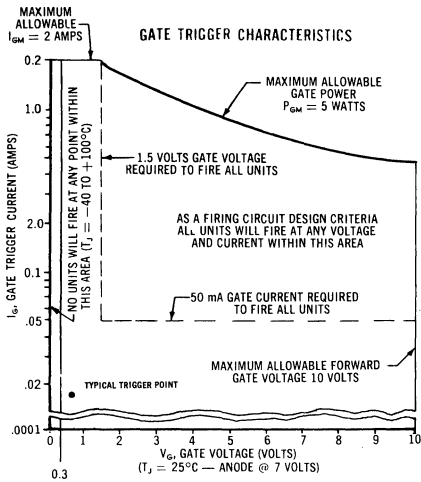

MCR808, R SERIES

HALF WAVE

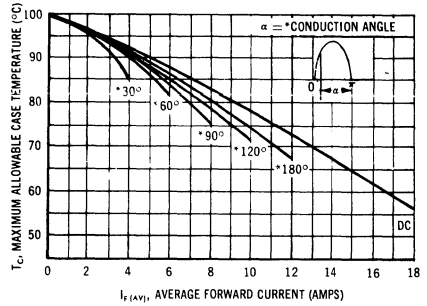

FORWARD CONDUCTION CHARACTERISTICS

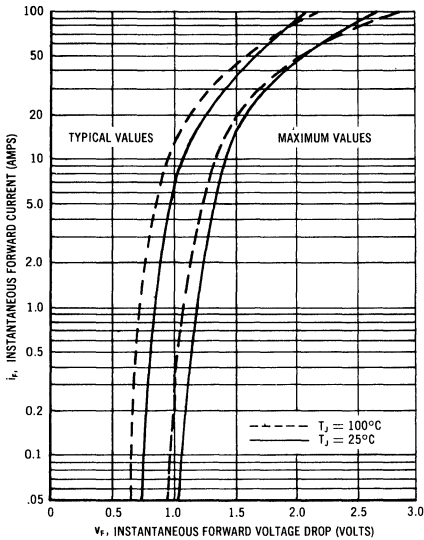

MCR1308, R SERIES

HALF WAVE

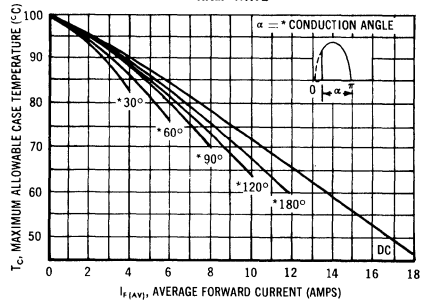

MCR846 series

$I_T = 2 \text{ A RMS}$
 $V_{ROM} = 25\text{-}200 \text{ V}$



Silicon controlled rectifiers for low-power switching and control applications requiring blocking to 200 volts and load currents to 2 amps.

CASE 63

MAXIMUM RATINGS ($T_J = 105^\circ\text{C}$ unless otherwise noted)

Characteristic	Symbol	Rating	Unit
Peak Reverse Voltage MCR 846 - 1 - 2 - 3 - 4	V_{ROM}	25 50 100 200	Volts
RMS Forward Current	I_F	2	Amps
Peak Surge Current (one cycle, 60 cps, $T_j = -65$ to $+105^\circ\text{C}$)	I_{FM} (surge)	30	Amps
Circuit Fusing Considerations	I^2t	35	Amp^2sec
Peak Gate Power	P_G	5	Watts
Average Gate Power	$P_{G(\text{avg})}$	0.5	Watts
Peak Gate Current	I_G	2	Amps
Peak Gate Voltage (forward and reverse)	V_G	10	Volts
Storage Temperature	T_{stg}	-65 to +150	$^\circ\text{C}$
Operating Temperature	T_j	-65 to +105	$^\circ\text{C}$
Stud Torque		15	in-lb

MCR846 (continued)

ELECTRICAL CHARACTERISTICS ($T_J = 105^\circ\text{C}$ unless otherwise noted)

Characteristic	Symbol	Minimum	Typical	Maximum	Unit
Forward Breakover Voltage MCR 846 - 1 - 2 - 3 - 4	V_{ROM}	25 50 100 200			Volts
Forward Leakage Current	i_s			2	ma
Reverse Leakage Current	i_r			2	ma
Forward Voltage Drop $T_C = 25^\circ\text{C}$, $I_F = 2$ amp DC	V_F			1.6	VDC
Gate Firing Current $T_J = 25^\circ\text{C}$	I_{GF}		10	50	ma DC
Gate Firing Voltage $T_J = 25^\circ\text{C}$	V_{GF}		0.8	1.5	VDC
Holding Current	I_H		25		ma DC
Turn On Time ($T_C = 25^\circ\text{C}$) ($I_F = 2$ amps DC)	t_{on}		0.5		usec
Turn Off Time ($T_C = 25^\circ\text{C}$) ($I_F = 2$ amps) ($I_R = 10$ amps)	t_{off}		4		usec
Forward Voltage Application Rate	dv/dt	50			volts/usec
Thermal Resistance	θ_{J-C}			4	$^\circ\text{C/W}$

MCR914 series

For specifications, See 2N1595 Series Data Sheet

MCR1304 series

MCR1305 series

MCR1604 series

MCR1605 series

For Specifications, See MCR2304 Series Data Sheet

MCR1718-5 thru MCR1718-8

$I_{\text{pulse}} = 1000 \text{ A}$
 $V_{\text{ROM}} = 300\text{-}600 \text{ V}$
 $I_{\text{F}} = 25 \text{ A RMS}$

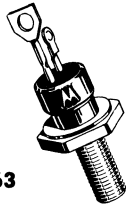

CASE 63

Fast-switching, high-voltage silicon controlled rectifiers for pulse modulator applications requiring blocking to 600 volts and repetitive pulse currents to 1000 amps.

MAXIMUM RATINGS ($T_j = 125^\circ\text{C}$ unless otherwise noted)

Characteristic	Symbol	Rating	Unit
Peak Reverse Blocking Voltage* MCR1718-5 -6 -7 -8	V_{ROM}^* (rep)	300 400 500 600	Volts
Transient Peak Reverse Blocking Voltage (non-recurrent 5 msec max duration) MCR1718-5 -6 -7 -8	V_{ROM} (non-rep)	400 500 600 700	Volts
Peak Repetitive Pulse Current (1-10 microsec pulse width)	I_{pulse}	1000	Amps
RMS Forward Current	I_{F}	25	Amps
Dynamic Average Power Dissipation (At $T_c = 65^\circ\text{C}$)	$P_{\text{F (AV)}}$	30	Watts
Current Application Rate (up to 1000 Amps Peak)	di/dt	1000	A/ μsec
Circuit Fusing Considerations ($T_j = -65$ to $+125^\circ\text{C}$; P.W. < 1.0 msec)	I^2t	250	A^2sec
Peak Gate Power	P_{GM}	20	Watts
Average Gate Power	$P_{\text{G (AV)}}$	1	Watt
Peak Forward Gate Current	I_{GFM}	5	Amps
Peak Gate Voltage - Forward - Reverse	V_{GFM} V_{GRM}	10 10	Volts
Operating Junction Temp. Range	T_j	-65 to +125	$^\circ\text{C}$
Storage Temperature Range	$T_{\text{(stg)}}$	-65 to +150	$^\circ\text{C}$
Stud Torque		30	in-lb

MCR1718-5 thru MCR1718-8 (continued)

ELECTRICAL CHARACTERISTICS ($T_j = 25^\circ\text{C}$ unless otherwise noted)

Characteristic	Symbol	Minimum	Typical	Maximum	Unit
Peak Forward Blocking Voltage* $T_j = 125^\circ\text{C}$ MCR1718-5 -6 -7 -8	V_{FOM}^*	300 400 500 600			Volts
Peak Forward Blocking Current (Rated V_{FOM} ; $T_j = 125^\circ\text{C}$, Gate Open)	I_{FOM}			8	mA
Peak Reverse Blocking Current (Rated V_{ROM} ; $T_j = 125^\circ\text{C}$, Gate Open)	I_{ROM}			8	mA
Gate Trigger Current (continuous DC) (Anode Voltage = 7Vdc, $R_L = 50\Omega$)	I_{GT}		10	50	mAdc
Gate Trigger Voltage (continous DC) (Anode Voltage = 7Vdc, $R_L = 50\Omega$, $T_j = 25^\circ\text{C}$) (Anode Voltage = 7Vdc, $R_L = 50\Omega$, $T_j = 125^\circ\text{C}$)	V_{GT} V_{GNT}	.25	0.8	1.5	Vdc
Turn-on Forward Voltage Drop ($I_{GT} = 500\text{ mA}$, $I_{\text{pulse}} = 500\text{ amps}$) 1.0 μsec after start (10% pt.) of I_{pulse} 5.0 μsec after start (10% pt.) of i_{pulse}	$V_{F(\text{on})}$		30 5		Volts
Forward On Voltage ($I_F = 25\text{ Adc}$)	V_F		1.1	1.3	Vdc
Recovery Time (Forward) ($I_{\text{pulse}} = 500\text{ amps}$, $I_{\text{reverse}} = 10\text{ amps}$) (Inductive charging circuit - circuit dependent)	t_{rec}		20		μsec
Forward Voltage Application Rate (Gate Open, $T_j = 125^\circ\text{C}$)	dv/dt		100		$\text{V}/\mu\text{sec}$
Drop-out (Holding) Current Gate Open; $T_j = 25^\circ\text{C}$ Gate Open; $T_j = 125^\circ\text{C}$	I_{HO}	5	15 6		mAdc
Thermal Resistance (Junction-to-Case)	θ_{JC}			2.0	$^\circ\text{C}/\text{W}$

* V_{FOM} and $V_{ROM(\text{rep})}$ for all types can be applied on a continuous DC basis without incurring damage.

Ratings apply for zero or negative gate voltage.

MCR1907-1 thru MCR1907-6

$I_F = 25 \text{ A RMS}$
 $V_{ROM} = 25\text{-}400 \text{ V}$



CASE 64
(TO-48)

Fast turn-on, fast turn-off silicon controlled rectifiers for high-frequency applications requiring blocking to 400 volts and load currents to 25 amps.

MAXIMUM RATINGS ($T_J = 125^\circ\text{C}$ unless otherwise noted)

Characteristic	Symbol	Rating	Unit
Peak Reverse Blocking Voltage*	$V_{ROM(rep)}$ *		Volts
MCR1907-1		25	
MCR1907-2		50	
MCR1907-3		100	
MCR1907-4		200	
MCR1907-5		300	
MCR1907-6	400		
Peak Reverse Blocking Voltage (non-recurrent, 5 msec max. duration)	$V_{ROM(non-rep)}$		Volts
MCR1907-1		35	
MCR1907-2		75	
MCR1907-3		150	
MCR1907-4		300	
MCR1907-5		400	
MCR1907-6	500		
Forward Current RMS (All Conduction Angles)	I_F	25	Amps
Peak Surge Current (one cycle, 60 cps) ($T_J = -65$ to $+125^\circ\text{C}$)	$I_{FM(surge)}$	150	Amps
Circuit Fusing Considerations ($T_J = -65$ to $+125^\circ\text{C}$; $t \leq 8.3$ msec)	I^2t	75	A^2sec
Peak Gate Power	P_{GM}	5	Watts
Average Gate Power	$P_{G(av)}$	0.5	Watts
Peak Gate Current	I_{GFM}	2	Amps
Peak Gate Voltage: Forward	V_{GFM}	10	Volts
Reverse	V_{GRM}	5	Volts
Operating Temperature	T_J	-65 to +125	$^\circ\text{C}$
Storage Temperature	T_{stg}	-65 to +150	$^\circ\text{C}$

* $V_{ROM(rep)}$ for all types can be applied on a continuous DC basis without incurring damage. Ratings apply for zero or negative gate voltage.

CURRENT DERATING

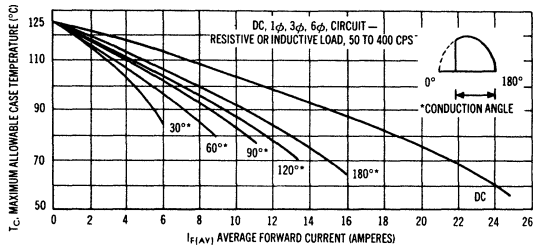

MCR1907-1 thru MCR1907-6 (continued)

ELECTRICAL CHARACTERISTICS ($T_J = 125^\circ\text{C}$ unless otherwise noted)

Characteristic	Symbol	Min	Typ	Max	Unit
Peak Forward Blocking Voltage* MCR1907-1 MCR1907-2 MCR1907-3 MCR1907-4 MCR1907-5 MCR1907-6	V_{FOM}^*	25 50 100 200 300 400	— — — — — —	— — — — — —	Volts
Peak Forward or Reverse Blocking Current	I_{FOM} & I_{ROM}	—	—	4	mA
Forward On Voltage ($I_F = 20$ A, $T_C = 25^\circ\text{C}$)	V_F	—	1.4	1.7	Volts
Gate Trigger Current (Continuous DC) (Anode Voltage = 7 Vdc, $R_L = 50$ ohms, $T_J = 25^\circ\text{C}$)	I_{GT}	—	15	30	mA
Gate Trigger Voltage (Continuous DC) (Anode Voltage = 7 Vdc, $R_L = 50$ ohms, $T_J = 25^\circ\text{C}$) (Anode Voltage = 7 Vdc, $R_L = 50$ ohms, $T_J = 125^\circ\text{C}$)	V_{GT} V_{GNT}	— 0.25	— —	1.5 —	Volts
Holding Current (Anode Voltage = 7 Vdc, gate open, $T_J = 25^\circ\text{C}$)	I_{HO}	—	12	—	mA
Turn-On Time ($I_F = 10$ A, $I_G = 200$ mA, $T_J = 25^\circ\text{C}$)	t_{on}	—	0.5	—	μsec
Turn-Off Time (Figure 3) ($I_F = 10$ A, $I_R = 10$ A, $dv/dt = 30$ V/ μsec min) V_{FXM} = rated voltage V_{RXM} = rated voltage	t_{off}	—	—	12	μsec
Forward Voltage Application Rate	dv/dt	30	—	—	V/ μsec
Thermal Resistance, Junction to Case	θ_{JC}	—	1.0	1.7	$^\circ\text{C}/\text{W}$

* V_{FOM} for all types can be applied on a continuous DC basis without incurring damage. Ratings apply for zero or negative gate voltage. These devices should never be tested with a constant current source for forward or reverse blocking capability such that the voltage applied exceeds the rated blocking voltage.

TURN-OFF TIME TEST CIRCUIT

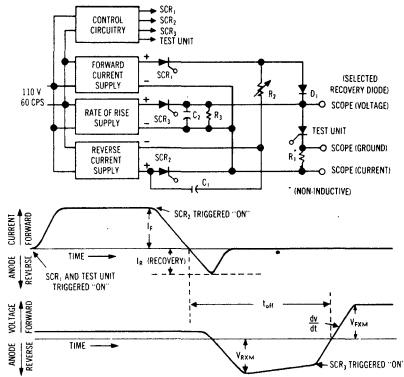

Forward conduction current is passed through the device (SCR_1 and test device triggered on). The anode is then driven negative (SCR_2 triggered on), causing reverse current to flow. The anode-to-cathode potential goes negative with a decrease in reverse current. Forward voltage is then applied to the anode of the device (SCR_3 triggered on). The device has fully recovered when it regains its ability to block the reapplied forward voltage.

† Consult manufacturer for further circuit information.

TYPICAL TURN-OFF TIME versus PEAK FORWARD CURRENT AND JUNCTION TEMPERATURE

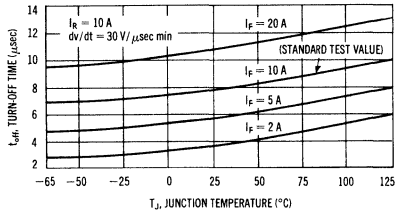

FORWARD CHARACTERISTICS — CONDUCTING STATE

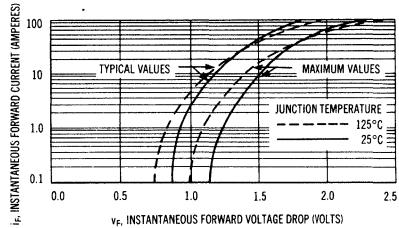

MCR2304 series
MCR2305 series
MCR2604 series
MCR2605 series

I_f = 8 A RMS
V_{ROM} = 25-400 V

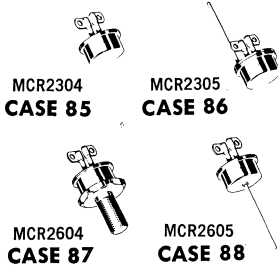

Silicon controlled rectifiers for applications requiring current up to 8 amperes with blocking voltages up to 400 volts. Available in a variety of economical packages for mounting versatility, and in both forward (anode-to-case) connection and reverse (cathode-to-case) connection. (normally anode connected to case. For cathode-to-case connection, add suffix "R" to type number.) Also available in flying lead ('L' suffix) and pin ('P' suffix) versions.

Note: MCR1304, R; MCR1305, R; MCR1604, R; MCR1605, R series are electrically identical to the equivalent "2000" series, but are mounted in cases 65, 69, and 68 respectively.

MAXIMUM RATINGS (T_J = 100°C unless otherwise noted)

Characteristic	Symbol	Rating	Unit
Peak Reverse Blocking Voltage*	V _{ROM(rep)} *		Volts
MCR2304, MCR2304R	}	25	
MCR2305, MCR2305R		50	
MCR2604, MCR2604R		100	
MCR2605, MCR2605R		200	
		300	
		400	
Forward Current RMS (All Conduction Angles)	I _f	8	Amps
Peak Surge Forward Current (One cycle, 60 cps) (T _J = -40 to +100°C)	I _{FM(surge)}		Amps
Forward Polarity		100	
Reverse Polarity		80	
Circuit Fusing Considerations (T _J = -40 + 100°C; t ≤ 8.3 msec)	I ² t		A ² sec
Forward Polarity		40	
Reverse Polarity		25	
Peak Gate Power	P _{GM}	5	Watts
Average Gate Power	P _{G(av)}	0.5	Watt
Peak Forward Gate Current	I _{GFM}	2	Amps
Peak Gate Voltage			Volts
Forward	V _{GFM}	10	
Reverse	V _{GRM}	10	
Operating Temperature Range	T _J	-40 to +100	°C
Storage Temperature Range	T _{stg}	-40 to +150	°C
Stud Torque (MCR1305, MCR1305R series)		15	in. lb.

*V_{ROM(rep)} for all types can be applied on a continuous DC basis without incurring damage. Ratings apply for zero or negative gate voltage.

These devices should never be tested with a constant current source for forward or reverse blocking capability such that the voltage applied exceeds the rated blocking voltage.

MC2304, MCR2305, MCR2604, MCR2605 (continued)

ELECTRICAL CHARACTERISTICS ($T_J = 125^\circ\text{C}$ unless otherwise noted)

Characteristic	Symbol	Min	Typ	Max	Unit
Peak Forward Blocking Voltage* ($T_J = 100^\circ\text{C}$)	V_{FOM}^*	25	—	—	Volts
MCR2304, MCR2304R		-1	50	—	
MCR2305, MCR2305R		-2	100	—	
MCR2604, MCR2604R		-3	200	—	
MCR2605, MCR2605R		-4	300	—	
		-5	400	—	
Peak Forward Blocking Current (Rated V_{FOM} @ $T_J = 100^\circ\text{C}$, gate open)	I_{FOM}	—	—	2	mA
Peak Reverse Blocking Current (Rated V_{ROM} @ $T_J = 100^\circ\text{C}$, gate open)	I_{ROM}	—	—	2	mA
Forward On Voltage ($I_F = 5$ Adc)	V_F	—	1.0	1.3	Volts
Gate Trigger Current (Continuous DC) (Anode Voltage = 7 Vdc, $R_L = 100\Omega$)	I_{GT}	—	10	20	mA
Gate Trigger Voltage (Continuous DC) (Anode Voltage = 7 Vdc, $R_L = 100\Omega$) (Anode Voltage = 7 Vdc, $R_L = 100\Omega$, $T_J = 100^\circ\text{C}$)	V_{GT} V_{GNT}	— 0.2	0.6 —	1.5 —	Volts
Holding Current (Anode Voltage = 7 Vdc, gate open)	I_{HO}	—	10	25	mA
Turn-On Time ($I_F = 5$ Adc, $I_{GT} = 20$ mAdc)	t_{on}	—	1	—	μsec
Turn-Off Time ($I_F = 5$ Adc, $I_R = 5$ Adc) ($I_F = 5$ Adc, $I_R = 5$ Adc, $T_J = 100^\circ\text{C}$)	t_{off}	— —	12 16	—	μsec
Forward Voltage Application Rate ($T_J = 100^\circ\text{C}$)	dv/dt	—	50	—	V/ μsec
Thermal Resistance, Junction to Case MCR2304, MCR2604, MCR2605 MCR2304R, MCR2604R, MCR2605R MCR2305 MCR2305R	θ_{JC}	—	1.5	2.7	$^\circ\text{C}/\text{W}$
		—	2.0	3.1	
		—	1.8	3.0	
		—	2.3	3.4	
		—	—	—	
Thermal Resistance, Case to Ambient MCR2304, MCR2604, MCR2605 and reverse polarity units.	θ_{CA}	—	—	40	$^\circ\text{C}/\text{W}$

* V_{FOM} for all types can be applied on a continuous DC basis without incurring damage. Ratings apply for zero or negative gate voltage. These devices should never be tested with a constant current source for forward or reverse blocking capability such that the voltage applied exceeds the rated blocking voltage.

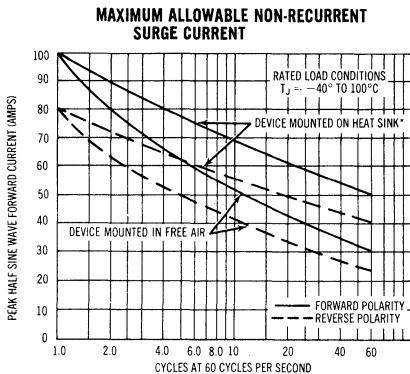

*Heat sink sufficient to maintain allowable case temperature for 180° conduction angle during normal operation.

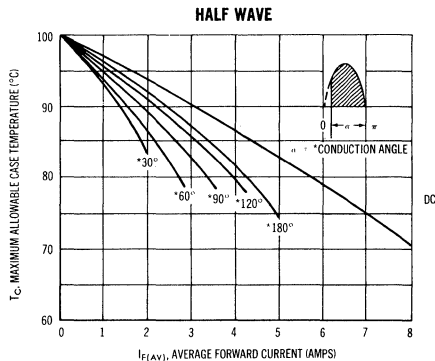

MC2304, MCR2305, MCR2604, MCR2605 (continued)

**FORWARD CONDUCTING CHARACTERISTICS
(ALL TYPES)**

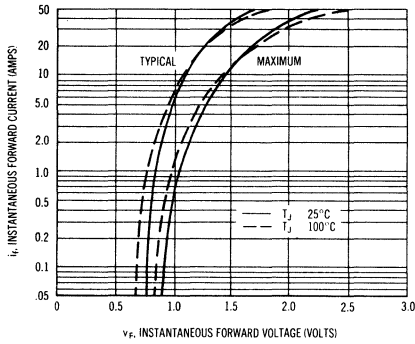

**TYPICAL GATE TRIGGER CURRENT
versus TEMPERATURE**

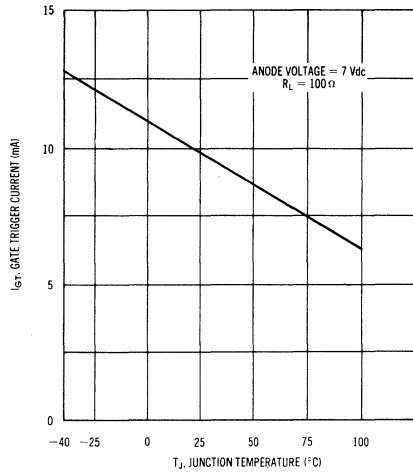

GATE TRIGGER CHARACTERISTICS

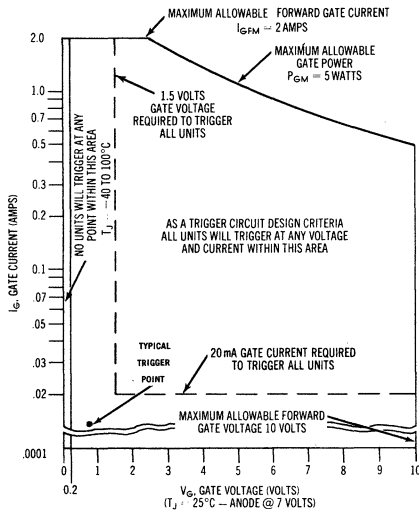

**TYPICAL HOLDING CURRENT
versus TEMPERATURE**

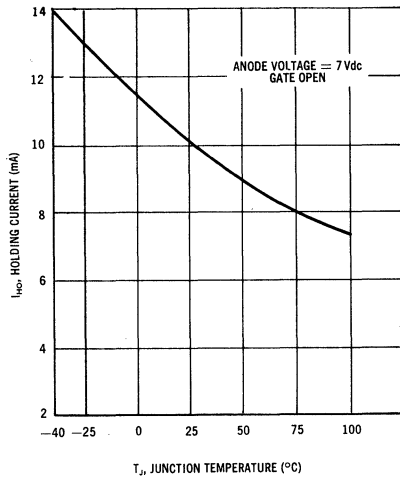

MGCS821-1 thru MGCS821-6

$I_F = 5 \text{ A RMS}$
 $V_{ROM} = 25-400 \text{ V}$

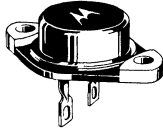

Silicon gate controlled switches for switching and control applications requiring a bistable switch that can be turned off as well as on by a gate signal.

CASE 61
(TO-41)

MAXIMUM RATINGS ($T_J = 105^\circ\text{C}$ unless otherwise specified)

Characteristic	Symbol	Rating	Unit
Peak Reverse Voltage (Note 1) MGCS 821 - 1 - 2 - 3 - 4 - 5 - 6	V_{ROM}	25 50 100 200 300 400	Volts
Forward Current @ $T_C = 80^\circ\text{C}$ (see Figure 1)	I_F	5	Amps
Peak Surge Current (One cycle, 60 cps, $T_J = -40^\circ\text{C}$ to $+105^\circ\text{C}$)	$I_{(surge)}$	60	Amps
Circuit Fusing Considerations ($t < 8.3 \text{ msec}$)	I^2t	65	Amp^2sec
Peak Gate Power Forward Reverse	P_{GF} P_{GR}	10 40	Watts
Average Gate Power Forward Reverse	$P_{GF(av)}$ $P_{GR(av)}$	2 20	Watts
Peak Gate Current Forward Reverse	I_{GF} I_{GR}	2 2.5	Amps
Storage Temperature	T_{stg}	-40 to +150	C
Operating Temperature	T_J	-40 to +105	C

MGCS821 series (continued)

ELECTRICAL CHARACTERISTICS ($T_J = 105^\circ\text{C}$ unless otherwise noted)

Characteristic	Symbol	Minimum	Typical	Maximum	Unit
Forward Breakover Voltage MGCS 821 - 1 - 2 - 3 - 4 - 5 - 6	V_{FOM}	25 50 100 200 300 400			Volts
Controllable Anode Current (see Figure 2)	I_F	5			Amps
Forward Blocking Current (@ rated V_{BO})	I_{FOM}		1	5	ma DC
Reverse Blocking Current (@ rated PRV)	I_{ROM}		1	5	ma
Forward Voltage Drop @ $I_F = 5$ amps DC, $T_C = 25^\circ\text{C}$	V_F		1.0	2.0	V
Gate Turn On (Trigger) Current @ $T_J = 25^\circ\text{C}$ @ $T_J = 105^\circ\text{C}$	I_{GT}		20 5	100 30	ma
Gate Turn On (Trigger) Voltage @ $T_J = 25^\circ\text{C}$ @ $T_J = 105^\circ\text{C}$	V_{GT}	0.3	0.8	3.5	V
Gate Turn Off Current 25-200 volt units 300-400 volt units @ $I_F = 5$ amp DC, $T_J = -40^\circ\text{C}$ to $+105^\circ\text{C}$ Pulse Width = 200 usec	I_{GO}			-500 -1 (See Note 4)	ma amp
Gate Turn Off Voltage @ $I_F = 5$ amp DC, $T_J = -40^\circ\text{C}$ to $+105^\circ\text{C}$ Pulse Width = 200 usec	V_{GQ}			-10	V
Latching Current, $T_C = 25^\circ\text{C}$,	I_L		50		ma
Rise Time (@ $T_C = 25^\circ\text{C}$, $I_F = 5$ amp DC, $I_{GT} = 100$ ma)	t_r		1.0		μsec
Fall Time @ turn off conditions listed above	t_f		2.0		μsec
Thermal Resistance	θ_{JC}			2.5	$^\circ\text{C/W}$
Holding Current @ $T_C = 25^\circ\text{C}$	I_H		40		ma DC
Rate of Applied Forward Voltage	dv/dt		40		$v/\mu\text{sec}$

MGCS821 series (continued)

CURRENT RATING

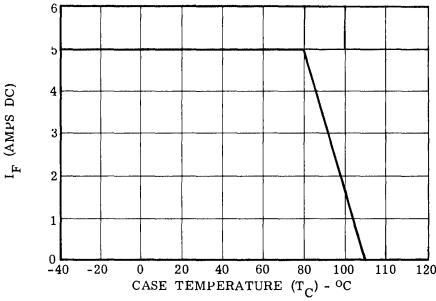

SWITCHING LOAD LINES

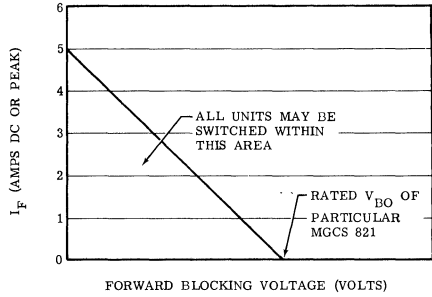

LOW LEVEL ON VOLTAGE

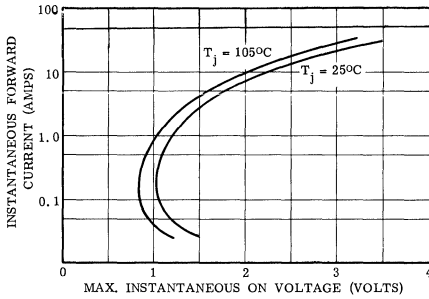

TURN OFF GAIN CHANGE

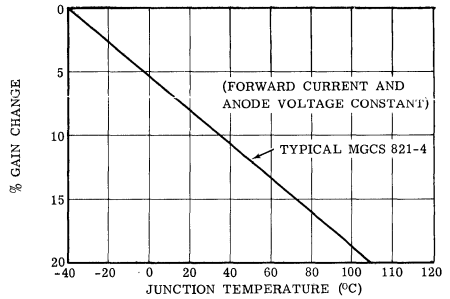

TURN OFF GAIN CHANGE

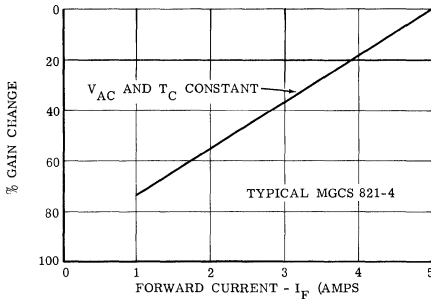

TYPICAL TURN OFF TIME

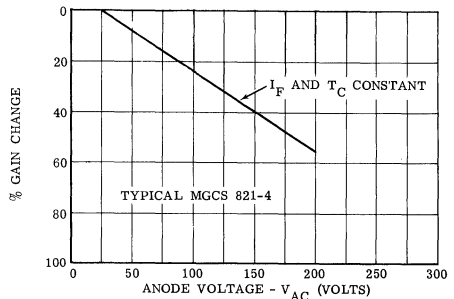

MGCS821 series (continued)

NOTES:

1. Units for DC applications (V_{FOM} only) available on special request.
2. Higher current units available on special request.
3. In addition to the gate to cathode resistor (R_{GC}), performance may be enhanced in certain applications by the use of an anode to cathode capacitor (C_{AC}).
4. (See gate turn off current) Typical units can be turned off with much lower level gate pulses (i. e. , exhibit much higher gain), however, the values specified are recommended for safe area operation in accordance with figure 2. Recommended turn off gains ($\frac{I_F}{I_{GO}}$) for various switching
 - a. Switching from 3-5 amps to 200 volts or less - 10 max.
 - b. Switching from 3-5 amps to 200 volts or more - 5 max.
 - c. Switching from 2-3 amps - 6 max.
 - d. Switching from less than 2 amps - 4 max.

TYPICAL TURN OFF TIME

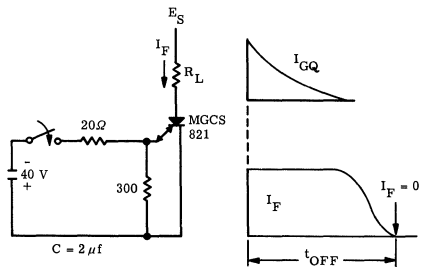
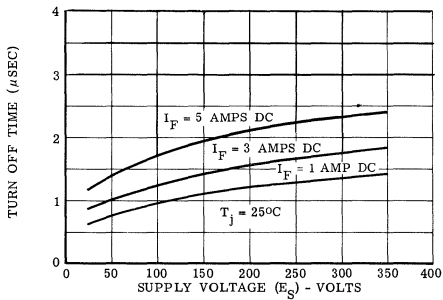

MGCS924-1 thru MGCS924-6
MGCS925-1 thru MGCS925-6

$I_F = 5 \text{ A RMS}$
 $V_{FOM} = 25\text{-}400 \text{ V}$
 $V_{ROM} = 15\text{-}400 \text{ V}$

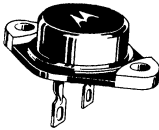

Silicon gate controlled switches for switching and control applications requiring a bistable switch that can be turned off as well as on by a gate signal.

CASE 61
(TO-41)

MAXIMUM RATINGS ($T_J = 105^\circ\text{C}$ unless otherwise noted)

Characteristic	Symbol	Rating	Unit
Peak Reverse Voltage MGCS 924 (All Units) MGCS 925 - 1 - 2 - 3 - 4 - 5 - 6	V_{ROM}	15 25 50 100 200 300 400	Volts
Forward Current @ $T_C = 80^\circ\text{C}$ (see Figure 1)	I_F	5	Amps
Peak Surge Current (One cycle, 60 cps, $T_j = -40^\circ\text{C}$ to $+105^\circ\text{C}$)	$I_{(surge)}$	60	Amps
Circuit Fusing Considerations ($t \geq 8.3 \text{ msec}$)	I^2t	65	Amp^2sec
Peak Gate Power Forward Reverse	P_{GF} P_{GR}	10 40	Watts
Average Gate Power Forward Reverse	$P_{GF (avg)}$ $P_{GR (avg)}$	2 20	Watts
Peak Gate Current Forward Reverse	I_{GF} I_{GR}	2 2.5	Amps
Storage Temperature	T_{stg}	-40 to +150	$^\circ\text{C}$
Operating Temperature	T_j	-40 to +105	$^\circ\text{C}$

MGCS924-MGCS925 (continued)

ELECTRICAL CHARACTERISTICS

Characteristic	Symbol	Minimum	Typical	Maximum	Unit
Forward Breakover Voltage (MGCS 924 & 925) - 1 - 2 - 3 - 4 - 5 - 6	V_{FOM}	25 50 100 200 300 400			Volts
Controllable Anode Current	I_F	5			Amps
Forward Blocking Current (@ rated V_{BO})	I_{FOM}		1	5	ma
Reverse Blocking Current (@ rated PRV)	I_{ROM}		1	5	ma
Forward Voltage Drop @ $I_F = 5$ amps DC, $T_C = 25^\circ\text{C}$	V_F		1.0	2.0	
Gate Turn On (Trigger) Current @ $T_j = 25^\circ\text{C}$ @ $T_j = 105^\circ\text{C}$	I_{GT}		20 5	100 30	ma
Gate Turn On (Trigger) Voltage @ $T_j = 25^\circ\text{C}$ @ $T_j = 105^\circ\text{C}$	V_{GT}	.03	0.8	3.5	V
Gate Turn Off Current @ $I_F = 5$ amp DC, $T_j = -40^\circ\text{C}$ to $+105^\circ\text{C}$ Pulse Width = 200 usec	I_{GQ}			-500 (See Note 2)	ma
Gate Turn Off Voltage @ $I_F = 5$ amp DC, $T_j = -40^\circ\text{C}$ to $+105^\circ\text{C}$ Pulse Width = 200 usec	V_{GO}			-12	V
Latching Current, $T_C = 25^\circ\text{C}$	I_L		50		ma
Rise Time(@ $T_C = 25^\circ\text{C}$, $I_F = 5$ amp DC, $I_{GT} = 100$ ma)	t_r		1.0		μsec
Fall Time @ turn off conditions listed above	t_f		2.0		μsec
Thermal Resistance	θ_{JC}			2.5	$^\circ\text{C}/\text{W}$
Holding Current @ $T_C = 25^\circ\text{C}$	I_M		40		ma
Rate of Applied Forward Voltage	dv/dt		40		$v/\mu\text{sec}$

MGCS924-MGCS925 (continued)

CURRENT RATING

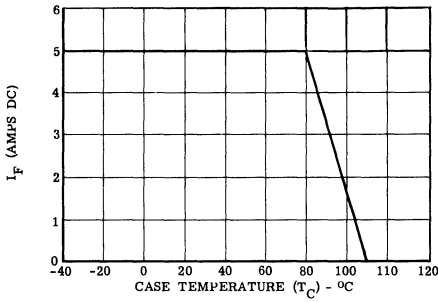

SWITCHING LOAD LINES

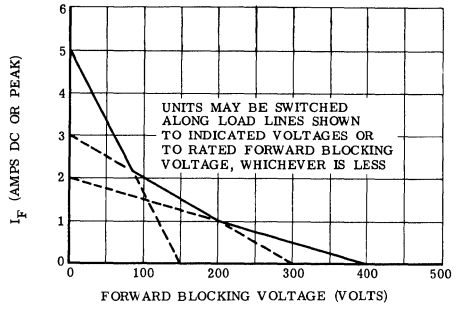

LOW LEVEL ON VOLTAGE

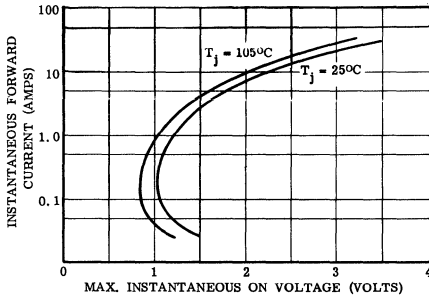

TURN OFF GAIN CHANGE

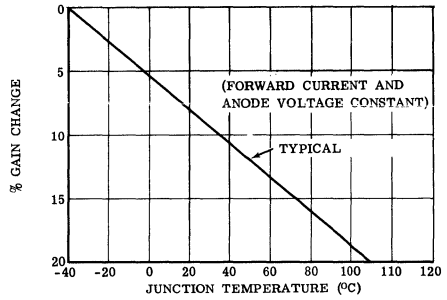

TURN OFF GAIN CHANGE

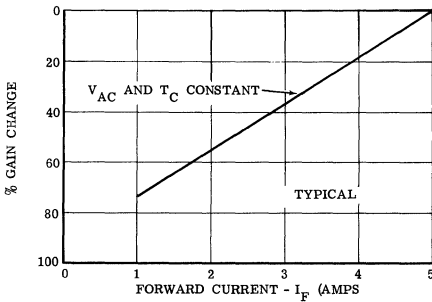

TURN OFF GAIN CHANGE

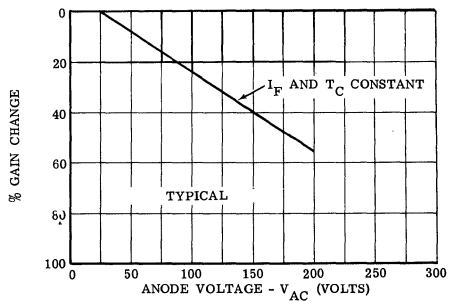

MGCS924-MGCS925 (continued)

NOTES:

1. In addition to the gate to cathode resistor (R_{GC}), performance may be enhanced in certain applications by the use of an anode to cathode capacitor (C_{AC}).
2. (Reference gate turn off current). Typical units can be turned off with much lower level gate pulses (i. e., exhibit higher gain), however, the values specified are recommended for safe area operation in accordance with figure 2. Recommended turn off gains ($\frac{I_F}{I_{GO}}$) for various switching levels are as follows:

a.	Switching from 3-5 amps to 150 volts or less	- 10 max.
b.	Switching from 2-3 amps to 300 volts or less	- 6 max.
c.	Switching from less than 2 amps to 400 volts or less	- 4 max.
3. Units with higher forward blocking voltage available on special request. Also, units with intermediate voltage ratings (150 volts, etc.) available on special request.

TYPICAL TURN OFF TIME

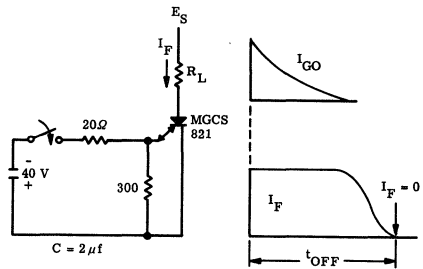
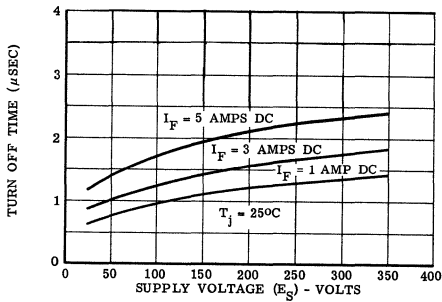



MOTOROLA POWER TRANSISTORS

READING REFERENCES

Factors Influencing Selection of Commercial Power Transistor Heat Sinks.
Page 12-19

How to get more Value out of a Power Transistor Data Sheet. Page 12-3

Determining Maximum Reliable Load Lines for Power Transistors. Page 12-13

- For devices meeting military specifications, see page 1-18.
- For Meg-A-Life devices with certified reliability, see page 1-21.
- For case outline dimensions, see page 1-26.

HIGH POWER TRANSISTORS

Motorola high-power transistors include both germanium and silicon devices. Generally, these transistors are characterized for both amplifier and switching applications requiring power dissipation ratings up to 170 watts.

APPLICATIONS SELECTION GUIDE

The following tables list the preferred power transistors for specific applications categories. For more detailed specifications, refer to individual specification sheets.

(Table I)

Preferred Power Transistors for Audio Amplifier Applications

(Table II)

Preferred Power Transistors for DC Amplifier and Series OR Shunt Regulator Applications

(Tables III, IV, V)

Preferred Transistors for Power Inverter Applications

SELECTOR GUIDES

TABLE I — AUDIO AMPLIFIER TRANSISTORS

POWER OUTPUT	TRANSISTOR VOLTAGE RATING (BVces)						
	30V	45V	60V	75V	90V	120V	160V
1W	2N3611	2N3713*N 3N3612	2N3713*N 2N3615	2N3716*N 2N3616	2N3489*N 2N2141	2N2527	2N2528
5W	2N3613	2N3614	2N3713*N 2N2832 2N3617	2N3716*N 2N2832 2N3618	2N2833 2N2146	2N2834 2N2527	2N2528
10W	2N3613	2N3614	2N3713*N 2N2832 2N3617	2N3716*N 2N2832 2N3618	2N2833 2N2146 2N3492*N	2N2834 2N2527	2N2528
50W	2N1557	2N1558	2N3715*N 2N1599	2N3716*N 2N2832 2N1547	2N2833 2N1548 2N3492*N	2N2834	2N2528
100W	2N2156	2N2157	2N2153	2N3716*N 2N2154	2N1548 2N3492*N		

NOTE: ALL TRANSISTORS ARE GERMANIUM PNP UNLESS OTHERWISE NOTED

* Silicon
N NPN

TABLE II — DC AMPLIFIERS AND SERIES OR SHUNT REGULATOR TRANSISTORS

CURRENT	Vce MAXIMUM VOLTAGE AT SPECIFIED CURRENT; LIMITED BY SAFE AREA						
	20V	30V	45V	60V	80V	120V	160V
0.1A	2N3611	2N3611	2N3612	2N3615 2N3713*N	2N2141	2N2527	2N2528
1.0A	2N3613	2N3715*N 2N1541 2N3312	2N3713*N 2N3313	2N2075			
3.0	2N3311	2N3715*N 2N3313 2N2153	2N2079				
5A	2N3314	2N3715*N					

NOTE: ALL TRANSISTORS ARE GERMANIUM PNP UNLESS OTHERWISE NOTED

* Silicon
N NPN

TABLE III — LOW FREQUENCY INVERTER TRANSISTORS (60-400 CPS)

POWER OUTPUT	TRANSISTOR VOLTAGE RATING (BVces)						
	30	45	60	75	90	120	160
50	2N3611	2N3612	2N3713*N 2N1541	2N3714*N 2N1542	2N3489*N 2N1543	2N2527	2N2528
100	2N1539	2N1540	2N3714*N 2N1541	2N3714*N 2N1542	2N3489*N 2N1543	2N2527	2N2528
200	2N1557	2N1558	2N3715*N 2N1546	2N3716*N 2N1547	2N3491*N 2N1543	2N2527	2N2528
500	MP504	2N2156	2N2153	2N2154	2N1548		

TABLE IV — MEDIUM FREQUENCY INVERTER TRANSISTORS (400CPS-10 KC)

POWER OUTPUT	TRANSISTOR VOLTAGE RATING (BVces)							
	5	30	45	60	75	90	120	160
50	2N2912	2N3611	2N3612	2N3713*N 2N1551	2N3714*N 2N1552 2N2526	2N3489*N 2N2527	2N2527	2N2528
100	2N2728	2N2082	2N2081	2N3715*N 2N1551	2N3716*N 2N1552	2N3489*N 2N2527	2N2527	2N2528
200				2N3715*N 2N2832 2N2080	2N3716*N 2N2079 2N2832	2N3491*N 2N2527 2N2833	2N2527 2N2834	2N2528 2N2834
500					2N2079	2N2833	2N2834	2N2834

TABLE V — HIGH FREQUENCY INVERTER TRANSISTORS (10 KC-50 KC)

POWER OUTPUT	TRANSISTOR VOLTAGE RATING (BVces)							
	5	30	45	60	75	90	120	160
50	2N2912	2N2832	2N3025* 2N2832	2N3026* 2N3713*N 2N3445*N 2N2832	2N3714*N 3N3446*N 2N2833	2N3489*N 2N2833	2N2834	2N2834
100				2N3715* 2N3447* 2N2832	2N3448*N 2N3716*N 2N2833	2N3492*N 2N2833	2N2834	2N2834
200					2N3716* 2N2833	2N3492*N 2N2833	2N2834	2N2834

NOTES: ALL TRANSISTORS ARE GERMANIUM PNP UNLESS OTHERWISE NOTED.

* INDICATES SILICON TRANSISTOR

N INDICATES NPN TRANSISTOR

GERMANIUM POWER TRANSISTOR SPECIFICATIONS

Type	BREAKDOWN VOLTAGE			GAIN			SATURATION VOLTAGE			f _r mc typ	P _o watts	
	V _{ce} volts	V _{ee} volts	V _{ces} volts	h _{FE} min/max	@ amps	I _c amps	V _{ce(sat)} volts max	@ amps	I _c /I _s amps			
I_c = 15 amps (max)												
2N441	40	20	40	20/40	5	0.3 typ	12/2	0.30	150			
2N2078*	40	40	40	20/40	5	0.9	12/2	0.30	170			
2N277	40	20	40	35/70	5	0.3 typ	12/2	0.30	150			
2N2082*	40	40	40	35/70	5	0.9	12/2	0.30	170			
2N1548*	40	20	30	10/30	10	0.7	10/1	0.55	90			
2N1553*	40	20	30	30/60	10	0.7	10/1	0.40	90			
2N1557*	40	20	30	50/100	10	0.5	10/1	0.40	90			
2N442	50	30	45	20/40	5	0.3 typ	12/2	0.30	150			
2N2077*	50	35	50	20/40	5	0.9	12/2	0.30	170			
2N278	50	30	45	35/70	5	1.0	12/2	0.30	165			
2N2081*	50	35	50	35/70	5	0.9	12/2	0.30	170			
2N1980	50	20	30 ^③	50/100	5	0.5	5/0.5	0.30	170			
2N443	60	40	50	20/40	5	1.0	12/2	0.30	150			
2N2491	60	30	50	35/70	5	0.7	12/2	5 ^⑥	170			
2N173	60	40	50	35/70	5	1.0	12/2	0.30	150			
2N1550*	60	30	45	10/30	10	1.0	10/1	0.55	90			
2N1554*	60	30	45	30/60	10	0.7	10/1	0.40	90			
2N1558*	60	30	45	50/100	10	0.5	10/1	0.40	90			
2N2400	70	40	60	20/40	5	0.7	12/2	5 ^⑥	170			
2N2076*	70	25	70	20/40	5	0.7	12/2	0.30	170			
2N2080*	70	25	70	35/70	5	0.7	12/2	0.30	170			
2N1981	70	20	40 ^③	50/100	5	0.5	5/0.5	0.30	170			
2N2075*	80	20	80	20/40	5	0.7	12/2	5 ^⑥	170			
2N2482	80	60	70	25/50	5	12/2	0.30	150				
2N1558†	80	60	70	25/50	5	0.7	12/2	0.30	150			
2N174 †	80	60	70	25/50	5	0.9	12/2	0.30	150			
2N174A	80	60	70	25/50	5	0.7	12/2	0.30	150			
2N1059	80	40	70	35/70	5	0.7	12/2	0.30	150			
2N2079*	80	20	80	35/70	5	0.7	12/2	0.30	170			
2N1551*	80	40	60	10/30	10	1.0	10/1	0.55	90			
2N1120 †	80	40	70	20/50	10	1.0	10/1	0.40	90			
2N1555*	80	40	60	30/60	10	0.7	10/1	0.40	90			
2N1559*	80	40	60	50/100	10	0.5	10/1	0.40	90			
2N1982	90	20	50 ^③	50/100	5	0.5	5/0.5	0.30	170			
2N1970	100	40	50 ^③	17/40	5	1.0	12/2	0.30	170			
2N1412 †	100	60	80	25/50	5	0.7	12/2	0.30	150			
2N1100	100	80	80	25/50	5	0.7	12/2	0.30	150			
2N2493	100	80	85	25/50	5	0.5	12/2	5 ^⑥	170			
2N1552*	100	50	75	10/30	10	1.0	10/1	0.40	90			
2N1556*	100	50	75	30/60	10	0.7	10/1	0.40	90			
2N1560*	100	50	75	50/100	10	0.5	10/1	0.40	90			
I_c = 20 amps (max)												
MP1612	70	2	50 ^③	25/100	10	0.3	10/1	18.0	85 ^②			
2N2832	80	2	50 ^③	25/100	10	0.3	10/1	18.0	85 ^②			
MP1612A	110	2	75 ^③	25/100	10	0.3	10/1	18.0	85 ^②			
2N2833	120	2	75 ^③	25/100	10	0.3	10/1	18.0	85 ^②			
MP1612B	130	2	100 ^③	25/100	10	0.3	10/1	18.0	85 ^②			
2N2834	140	2	100 ^③	25/100	10	0.3	10/1	18.0	85 ^②			
I_c = 25 amps (max)												
2N2912	15	1.5	6 ^③	75/—	10	0.5	25/2.5	30.0	75 ^②			
2N1162*	50	25	35	15/65	25	0.8	25/1.6	0.40	90			
2N1163*	50	25	35	15/65	25	0.8	25/1.6	0.40	90			
2N1164*	80	40	60	15/65	25	0.8	25/1.6	0.40	90			
2N1165*†	80	40	60	15/65	25	0.8	25/1.6	0.40	90			
2N1166*	100	50	75	15/65	25	0.8	25/1.6	0.40	90			
2N1167*	100	50	75	15/65	25	0.8	25/1.6	0.40	90			
I_c = 30 amps (max)												
2N2152*	45	25	45	50/100	5	0.3	25/2	0.30	170			
2N2156*	45	25	45	80/160	5	0.3	25/2	0.30	170			
2N2153*	60	30	60	50/100	5	0.3	25/2	0.30	170			
2N2157*	60	30	60	80/160	5	0.3	25/2	0.30	170			
2N2154*	75	40	75	50/100	5	0.3	25/2	0.30	170			
2N2158*	75	40	75	80/160	5	0.3	25/2	0.30	170			
I_c = 50 amps (max)												
2N2728	15	15	5 ^⑤	40/130	20	0.1	50/5	0.30	170			
I_c = 60 amps (max)												
MP500*	45	25	45	30/60	15	0.45	50/5	0.30	170			
MP504*	45	25	45	50/100	15	0.45	50/5	0.30	170			
MP501*	60	30	60	30/60	15	0.45	50/5	0.30	170			
MP505*	60	30	60	50/100	15	0.45	50/5	0.30	170			
MP502*	75	40	75	30/60	15	0.45	50/5	0.30	170			
MP506*	75	40	75	50/100	15	0.45	50/5	0.30	170			
Type	I _c amps	V _{ce} volts	V _{ee} volts	V _{ces} volts	h _{FE} typ	@ amps	I _c amps	Power Gain db typ	V _{ce(sat)} volts	@ amps	I _c /I _s amps	P _o watts
2 watts Audio												
2N554	3	15	15	16	50	0.5	35	0.6	3/0.3	65		
2N555	3	30	15	30	50	0.5	35	0.6	3/0.3	65		
2N176	3	40	—	30	45	0.5	35	0.4	3/0.3	90		
2N178	3	40	20	30	50	0.5	30	0.6	3/0.3	90		
2N669	3	40	—	30	90	0.5	40	0.4	3/0.3	90		
4 Watts Audio												
2N350A	3	50	—	40	30	0.7	31	0.8	3/0.3	90		
2N351A	4	50	—	40	45	0.7	33	0.8	4/0.4	90		
2N35A	5	50	—	40	60	0.7	35	0.8	5/0.5	90		

* Available as "Meg-A-Life" Units
 † Military type available
 ③ For TO-41 order MP2137, etc.

② See data sheet for safe area operation
 ④ BV_{CER} R = 30 ohms

⑤ BV_{CER} R = 100 ohms
 ⑥ f_{ae} kc min
 ⑦ Minimum

GERMANIUM POWER TRANSISTOR SPECIFICATIONS

Type	BREAKDOWN VOLTAGE			GAIN			SATURATION VOLTAGE			f _t mc/μp	P _o watts
	V _{ca} volts	V _{es} volts	V _{ces} volts	h _{FE} @ I _c min/max	I _c amps	V _{CE(sat)} @ I _c /I _s volts max	I _c /I _s amps	V _{CE(sat)} @ I _c /I _s volts max			
I_c = 3 amps (max)											
2N2137*	30	15	30	30/60	0.5	0.5	2/0.2	0.60			62.5
2N2142*	30	15	30	50/100	0.5	0.5	2/0.2	0.60			62.5
2N2138*	45	25	45	30/60	0.5	0.5	2/0.2	0.60			62.5
2N2143*	45	25	45	50/100	0.5	0.5	2/0.2	0.60			62.5
2N1359	50	25	40	35/90	1	1.0	2/0.2	0.35			90
2N1360	50	25	40	60/140	1	0.8	2/0.2	0.35			90
2N2139*	60	30	60	30/60	0.5	0.5	2/0.2	0.60			62.5
2N2144*	60	30	60	50/100	0.5	0.5	2/0.2	0.60			62.5
2N2140*	75	40	75	30/90	0.5	0.5	2/0.2	0.60			62.5
2N2145*	75	40	75	50/100	0.5	0.5	2/0.2	0.60			62.5
2N375	80	40	60	35/90	1	1.0	2/0.2	0.35			90
2N618	80	40	60	60/140	1	0.8	2/0.2	0.35			90
2N2141*	90	45	90	30/60	0.5	0.5	2/0.2	0.60			62.5
2N2146*	90	45	90	50/100	0.5	0.5	2/0.2	0.60			62.5
2N1362	100	50	75	35/90	1	1.0	2/0.2	0.35			90
2N1363	100	50	75	60/140	1	0.8	2/0.2	0.35			90
2N1364	120	60	100	35/90	1	1.0	2/0.2	0.35			90
2N3165	120	60	100	60/140	1	0.8	2/0.2	0.35			90
I_c = 5 amps (max)											
2N378	20	—	20	40/80	2	1.0	2/0.2	5 Ⓞ			106
2N380	30	—	30	30/70	2	1.0	2/0.2	5 Ⓞ			106
2N311	30	20	30	60/120	3	0.1	3/0.3	0.45			170
2N314	30	20	30	100/200	3	0.1	3/0.3	0.45			170
2N307	35	10	35	20/—	0.2	1.0	2/0.2	3 Ⓞ			106
2N307A	35	10	35	30/—	0.2	0.8	1/0.1	3.5 Ⓞ			106
2N379	40	—	40	20/70	2	1.0	2/0.2	5 Ⓞ			106
2N1529*	40	20	30	20/40	3	1.5	3/0.3	0.35			90
2N1534*	40	20	30	35/70	3	1.2	3/0.3	0.35			90
2N1539*	40	20	30	50/100	3	0.6	3/0.3	0.40			90
2N1544*	40	20	30	75/150	3	0.3	3/0.3	0.40			90
2N242	45	45	45 Ⓞ	30/120	0.5	0.8	2/0.2	5 Ⓞ			106
2N312	45	25	45	60/120	3	0.1	3/0.3	0.45			170
2N315	45	25	45	100/200	3	0.1	3/0.3	0.45			170
2N1530*	60	30	45	20/40	3	1.5	3/0.3	0.35			90
2N1535*	60	30	45	35/70	3	1.2	3/0.3	0.35			90
2N297A†	60	40	50	40/100	0.5	1.0	2/0.2	0.35			90
2N1540*	60	30	45	50/100	3	0.6	3/0.3	0.40			90
2N313	60	30	60	60/120	3	0.1	3/0.3	0.45			170
2N1545*	60	30	45	75/150	3	0.3	3/0.3	0.40			90
2N1316	60	30	60	100/200	3	0.1	3/0.3	0.45			170
2N1531*	80	40	60	20/40	3	1.5	3/0.3	0.35			90
2N1011†	80	40	80	30/75	3	1.5	3/0.2	0.35			90
2N1536*	80	40	60	35/70	3	1.2	3/0.3	0.35			90
2N657	80	40	—	40/80	0.5	0.9	3/0.22	20 Ⓞ			35
2N1541*	80	40	60	50/100	3	0.6	3/0.3	0.40			90
2N1546*	80	40	60	75/150	3	0.3	3/0.3	0.40			90
2N1532*	100	50	75	20/40	3	1.5	3/0.3	0.35			90
2N1537*	100	50	75	35/70	3	1.2	3/0.3	0.35			90
2N1542*	100	50	75	50/100	3	0.6	3/0.3	0.40			90
2N1547*	100	50	75	75/150	3	0.3	3/0.3	0.40			90
2N459	105	10	60	20/70	2	1.0	2/0.2	5 Ⓞ			106
2N459A	105	25	60	40/70	2	0.3	2/0.2	5 Ⓞ			106
2N1533	120	60	90	20/40	3	1.5	3/0.3	0.35			90
2N1538	120	60	90	35/70	3	1.2	3/0.3	0.35			90
2N1543	120	60	90	50/100	3	0.6	3/0.3	0.40			90
2N1548	120	60	90	75/150	3	0.3	3/0.3	0.40			90
I_c = 7 amps (max)											
MP2960	40	20	30	30/200	3	0.25	3/0.3	0.6			85 Ⓞ
2N3611	40	20	30	35/70	3	0.25	3/0.3	0.7			85 Ⓞ
2N3613	40	20	30	60/120	3	0.25	3/0.3	0.7			85 Ⓞ
MP2061	60	20	45	30/200	3	0.25	3/0.3	0.6			85 Ⓞ
2N3612	60	30	45	35/70	3	0.25	3/0.3	0.7			85 Ⓞ
2N3614	60	30	45	60/120	3	0.25	3/0.3	0.7			85 Ⓞ
MP2962	75	20	60	30/200	3	0.25	3/0.3	0.6			85 Ⓞ
2N3615	80	40	60	30/60	3	0.25	3/0.3	0.7			85 Ⓞ
2N3617	80	40	60	45/90	3	0.25	3/0.3	0.7			85 Ⓞ
MP2063	90	20	75	30/200	3	0.25	3/0.3	0.6			85 Ⓞ
2N3616	100	50	75	30/60	3	0.25	3/0.3	0.7			85 Ⓞ
2N3618	100	50	75	45/90	3	0.25	3/0.3	0.7			85 Ⓞ
I_c = 10 amps (max) — PNP											
2N1073	40	1.5	40 Ⓞ	20/60	5	1.0	5/0.5	—			85
2N2526	60	5.0	80 Ⓞ	20/50	3	0.8	10/1	0.70			85
2N1072A	80	1.5	80 Ⓞ	20/60	5	1.0	5/0.5	—			85
2N2527	120	5.0	120 Ⓞ	20/50	3	0.8	10/1	0.70			85
2N1073B	120	1.5	120 Ⓞ	20/60	5	1.0	5/0.5	—			85
2N2528	160	5.0	160 Ⓞ	20/50	3	0.8	10/1	0.70			85
I_c = 10 amps (max) — Industrial											
Case 4											
2N627	40	20	30	10/30	10	1.0	10/1	0.55			90
2N628	60	30	45	10/30	10	1.0	10/1	0.55			90
2N629	80	40	60	10/30	10	1.0	10/1	0.55			90
2N630	100	50	75	10/30	10	1.0	10/1	0.55			90

SILICON POWER TRANSISTOR SPECIFICATIONS

Type	BREAKDOWN VOLTAGE			GAIN			SATURATION VOLTAGE		f _r mc min	P _D ② @ T _C = 25°C watts
	V _{CE} volts	V _{EB} volts	V _{CEO} volts	h _{FE} min/max	@ amps	I _C amps	V _{CE(sat)} volts max	@ I _C /I _B amps		
I _C = 3 amps (max) — PNP										
2N3021	30	4	30	20/60	1	1.5	3/0.3	60	25	
2N3024	30	4	30	50/180	1	1.0	3/0.3	60	25	
2N3719	40	4	40	25/180	1	1.5	3/0.3	60	6	
2N3022	45	4	45	20/60	1	1.5	3/0.3	60	25	
2N3025	45	4	45	50/180	1	1.0	3/0.3	60	25	
2N3023	60	4	60	20/60	1	1.5	3/0.3	60	25	
2N3720	60	4	60	25/180	1	1.5	3/0.3	60	6	
2N3026	60	4	60	50/180	1	1.0	3/0.3	60	25	
I _C = 5 amps (max) — NPN										
2N1722	120	10	80	20/90	2	1.0	2/0.2	15	117	
2N1724	120	10	80	20/90	2	1.0	2/0.2	15	117	
2N1725	120	10	80	50/150	2	1.0	2/0.2	15	117	
I _C = 7.5 amps (max) — NPN										
2N3445	80	6	60	20/60	3	1.5	3/0.3	10	117	
2N3487	80	10	60	20/60	3	1.2	3/0.3	10	117	
2N3447	80	6	60	40/120	5	1.5	5/0.5	10	117	
2N3489	80	10	60	40/120	5	1.5	5/0.5	10	117	
2N3489	100	10	80	20/60	3	1.2	3/0.3	10	117	
2N3446	100	10	80	20/60	3	1.5	3/0.3	10	117	
2N3451	100	10	80	40/120	5	1.5	5/0.5	10	117	
2N3448	100	10	80	40/120	5	1.5	5/0.5	10	117	
2N3489	120	10	100	15/45	3	1.2	3/0.3	10	117	
2N3492	120	10	100	30/90	5	1.5	5/0.5	10	117	
I _C = 10 amps (max) — NPN										
2N3235	55	7	55	20/70	4	1.1	4/0.4	1	117	
2N3232	60	6	60	15/75	3	2.5	3/0.2	1	117	
2N3713	80	7	80	25/90	1	1.0	5/0.5	4	150	
2N3715	80	7	60	50/150	1	0.8	5/0.5	4	150	
2N3055	100	7	60	20/70	4	1.1	4/0.4	1	117	
2N3714	100	7	80	25/90	1	1.0	5/0.5	4	150	
2N3716	100	7	80	50/150	1	0.8	5/0.5	4	150	
I _C = 10 amps (max) — PNP										
2N3789	60	7	60	25/90	1	1.0	4/0.4	4	150	
2N3791	60	7	60	50/150	1	1.0	4/0.4	4	150	
2N3790	80	7	80	25/90	1	1.0	4/0.4	4	150	
2N3792	80	7	80	50/150	1	1.0	4/0.4	4	150	

① Solid Header

② See data sheet for safe area operation

2N173

For Specifications, See 2N277 Data Sheet

2N174

2N1100

2N1358

CASE 5
(TO-36)



PNP germanium power transistors. Power dissipation and junction temperature ratings exceed those of EIA registration.

$P_C = 150 \text{ W}$
 $I_C = 15 \text{ A}$
 $V_{CBO} = 80\text{-}100 \text{ V}$

ABSOLUTE MAXIMUM RATINGS

Characteristic	Symbol	2N174	2N1100	2N1358	Unit
Collector-Base Voltage	V_{CBO}	80	100	80	Vdc
Emitter-Base Voltage	V_{EBO}	60	80	60	Vdc
Emitter Current (Continuous)	I_E	15	15	15	Amps
Base Current (Continuous)	I_B	4	4	4	Amps
Junction and Storage Temperature	T_J, T_{stg}	-65 to +110			$^{\circ}\text{C}$
Thermal Resistance, Junction to Case (Motorola Units)	θ_{JC}	0.5			$^{\circ}\text{C/W}$

POWER-TEMPERATURE DERATING CURVE

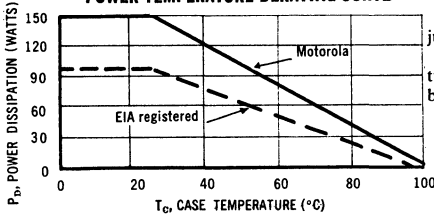

The maximum continuous power is related to maximum junction temperature by the thermal resistance factor.

This curve has a value of 150 Watts at case temperatures of 25°C and is 0 Watts at 100°C with a linear relation between the two temperatures such that:

$$\text{allowable } P_D = \frac{100^{\circ} - T_C}{0.5}$$

2N174 AND 1358

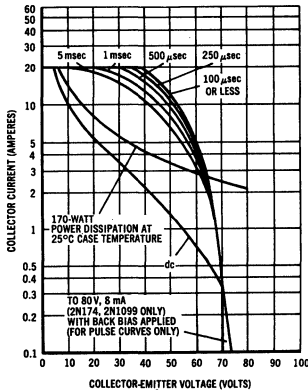

2N1100

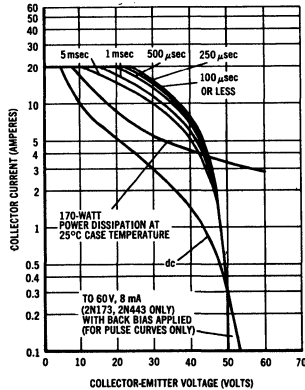

The Safe Operating Area Curves indicate $I_C - V_{CE}$ limits below which the device will not go into secondary breakdown. Collector load lines for specific circuits must fall within the applicable Safe Area to avoid causing a collector-emitter short.

(Duty cycle of the excursions make no significant change in these safe areas.) To insure operation below the maximum T_J , the power-temperature derating curve must be observed for both steady state and pulse power conditions.

2N174, 2N1100, 2N1358 (continued)

ELECTRICAL CHARACTERISTICS

Characteristic	Symbol	Minimum	Typical	Maximum	Unit
Collector-Base Cutoff Current ($V_{CB} = -2$ volts)	I_{CBO}	-	100	-	μA
2N174		-	100	-	
2N1100		-	100	-	
2N1358		-	100	200	
Collector-Base Cutoff Current ($V_{EB} = -1.5$ volts, $V_{CB} = -80$ volts)	I_{CB}	-	2	8	mA
2N174		-	2	8	
2N1100		-	2	8	
2N1358		-	2	8	
Emitter-Base Cutoff Current ($V_{EB} = -60$ volts)	I_{EBO}	-	1	8	mA
2N174		-	1	8	
2N1100		-	1	8	
2N1358		-	1	8	
Collector-Base Cutoff Current ($V_{CB} = -80$ volts, $71^\circ C$)	I_{CBO}	-	-	15	mA
2N174		-	-	15	
2N1100		-	-	15	
2N1358		-	4	6	
Emitter-Base Cutoff Current ($V_{EB} = -30$ volts, $71^\circ C$)	I_{EBO}	-	4	6	mA
2N1358		-	4	6	
Collector-Emitter Voltage ($I_C = 300$ mA, $V_{EB} = 0$)	BV_{CES}^*	-70	-	-	Vdc
2N174		-80	-	-	
2N1100		-70	-	-	
2N1358		-70	-	-	
Collector-Emitter Voltage ($I_C = 1.0$ amp, $I_B = 0$) 1.0 amp, $I_B = 0$ 300 mA, $I_B = 0$	BV_{CEO}^*	-55	-	-	Vdc
2N174		-65	-	-	
2N1100		-40	-	-	
2N1358		-40	-	-	
Floating Potential ($I_E = 0$, $V_{CB} = -80$ volts)	V_{FE}	-	-	1.0	volt
2N174		-	-	1.0	
2N1100		-	-	1.0	
2N1358		-	0.15	1.0	
Current Gain ($I_C = 1.2$ amps, $V_{CB} = -2$ volts) ($I_C = 5$ amps, $V_{CB} = -2$ volts)	h_{FE}	40	55	80	-
2N1358		25	-	50	
2N174		25	-	50	
2N1100		25	35	-	
2N1358		25	35	-	
($I_C = 12$ amps, $V_{CB} = -2$ volts)		-	20	-	
2N174		-	20	-	
2N1100		-	20	-	
Base-Emitter Voltage ($I_C = 1.2$ amps, $V_{CB} = -2$ volts) ($I_C = 5$ amps, $V_{CB} = -2$ volts)	V_{BE}	-	0.35	0.5	Vdc
2N1358		-	0.65	0.9	
2N174		-	0.65	0.9	
2N1100		-	0.65	0.9	
2N1358		-	0.65	0.9	
Saturation Voltage ($I_C = 12$ amps, $I_B = 2$ amps)	$V_{CE(sat)}$	-	0.3	0.9	Vdc
2N174		-	0.3	0.7	
2N1100		-	0.3	0.7	
2N1358		-	0.3	0.7	
Common-Emitter Current Amplification Cutoff Frequency ($I_C = 5$ amp, $V_{CE} = 6$ volts)	f_{ae}	-	10	-	kc
2N174		-	10	-	
2N1100		-	10	-	
Common-Base Current Amplification Cutoff Frequency ($I_C = 1$ amp, $V_{CB} = -12$ volts)	f_{ab}	100	-	-	kc
2N1358		100	-	-	
Rise Time ("on" $I_C = 12$ Adc, $I_B = 2$ Adc, $V_{CE} = -12$ volts)	t_r	-	15	-	μsec
All Types		-	15	-	
Fall Time ("off" $I_C = 0$, $V_{EB} = -6$ volts, $R_{EB} = 10$ ohms)	t_f	-	15	-	μsec
All Types		-	15	-	

* In order to avoid excessive heating of the collector junction, perform test by the sweep method.

2N174, 2N1100, 2N1358 (continued)

CURRENT TRANSFER CHARACTERISTICS

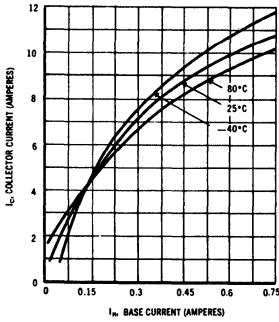

TRANSCONDUCTANCE CHARACTERISTICS

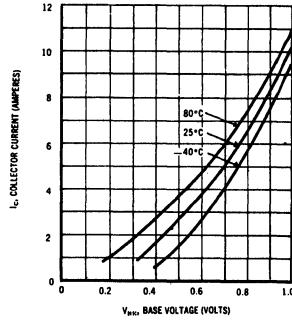

2N176
2N669

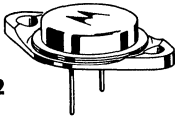

CASE 2
(TO-3)

PNP germanium power transistors for economical power switching circuits and commercial grade power amplifier applications.

$P_C = 90 \text{ W}$
 $I_C = 3 \text{ A}$
 $V_{CB0} = 40 \text{ V}$

ABSOLUTE MAXIMUM RATINGS

Characteristic	Symbol	Rating	Unit
Collector-Base Voltage	V_{CB0}	40	Vdc
Collector-Emitter Voltage	V_{CE1}^*	30	Vdc
Collector Current (Continuous)	I_C	3	Amps
Storage and Junction Temperature	T_j, T_{stg}	-65 to +100	°C
Collector Dissipation (At 25°C Case Temperature)	P_C	90	Watts
Thermal Resistance (Junction to Case)	θ_{JC}	0.8	°C/W

*2N176 figure is V_{CE1} , 2N669 figure is V_{CES}

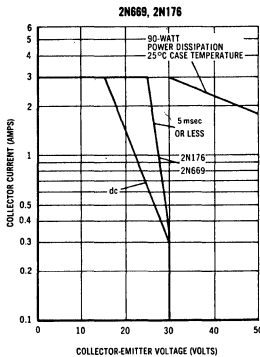

SAFE OPERATING AREAS

The Safe Operating Area Curves indicate $I_C - V_{CE}$ limits below which the device will not go into secondary breakdown. Collector load lines for specific circuits must fall within the applicable Safe Area to avoid causing a collector-emitter short. (Case temperature and duty cycle of the excursions make no significant change in these safe areas.) To insure operation below the maximum T_j , the power-temperature derating curve must be observed for both steady state and pulse power conditions.

2N176, 2N669 (continued)

ELECTRICAL CHARACTERISTICS (At 25°C case temperature unless otherwise specified)

Characteristic	Symbol	Minimum	Typical	Maximum	Unit
Collector-Base Cutoff Current $V_{CB} = 30 \text{ V}, I_E = 0$ $V_{CB} = 2.0 \text{ V}, I_E = 0$ $V_{CB} = 30 \text{ V}, I_E = 0, T_C = 90^\circ\text{C}$	Both Types I_{CB0}	— — —	— 50 —	3 — 20	mA μA mA
Emitter-Base Cutoff Current $V_{EB} = 10 \text{ V}, I_C = 0$	Both Types I_{EBO}	—	—	2	mA
Collector-Emitter Breakdown Voltage $I_C = 330 \text{ mA}, R_{BE} = 10 \text{ Ohms}$	2N176 2N669 BV_{CER} BV_{CES}	30 30	— —	— —	Vdc
Collector-Emitter Saturation Voltage $I_C = 3 \text{ A}, I_B = 300 \text{ mA}$	Both Types $V_{CE(SAT)}$	—	0.4	—	Vdc
DC Forward Current Transfer Ratio $V_{CE} = 2.0 \text{ V}, I_C = 0.5 \text{ A}$	2N176 2N669 h_{FE}	25 75	— —	— 250	—
Power Gain $P_O = 2 \text{ Watts}, V_{CE} = 12 \text{ V}, I_C = 0.5 \text{ Amp},$ $f = 1 \text{ kc}, R_S = 10 \text{ Ohms}, R_L = 26.6 \text{ Ohms}$	2N176 2N669 G_{PE}	34 38	— —	37 —	dc
Total Harmonic Distortion (under same conditions of power gain)	Both Types				%
Small-Signal Current Gain Cutoff Frequency $V_{CE} = 12 \text{ V}, I_C = 0.5 \text{ Amp}, f = 1 \text{ kc ref}$	2N176 2N669 f_{ae}	4 3	7 5	— —	kc
Small-Signal Forward-Current Transfer Ratio $V_{CE} = 2.0 \text{ V}, I_C = 0.5 \text{ Amp}, f = 1 \text{ kc}$	2N176 2N669 h_{FE}	— —	45 90	— —	—
Small-Signal Input Impedance $V_{CE} = 2.0 \text{ V}, I_C = 0.5 \text{ Amp}, f = 1 \text{ kc}$	2N176 2N669 h_{FE}	7 10	— —	25 50	Ohms

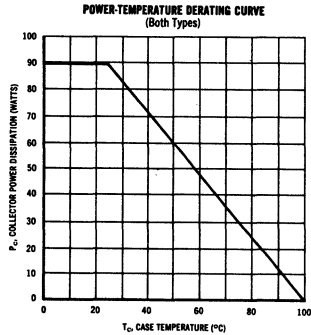
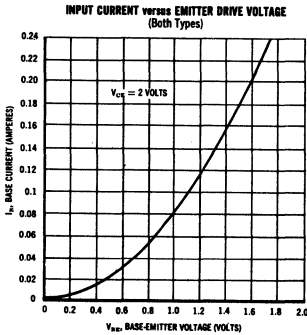

2N178
2N554,
2N555

$P_D = 40\text{ W}$
 $I_C = 3\text{ A}$
 $V_{CBO} = 15\text{-}30\text{ V}$

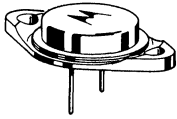

PNP germanium power transistor for non-critical power amplifier and power switching applications requiring economical components.

CASE 2
 (TO-3)

MAXIMUM RATINGS

Characteristic	Symbol	2N178	2N554	2N555	Unit
Collector-Base Voltage	V_{CBO}	30	15	30	Vdc
Collector-Emitter Voltage	V_{CER}	30	16	30	Vdc
Emitter-Base Voltage	V_{EBO}	20	15	15	Vdc
Collector Current	I_C	3	3	3	Amps
Junction and Storage Temperature Range	T_J, T_{stg}	-40 to +90			°C
Collector Power Dissipation (at $T_C = 80^\circ\text{C}$)	P_C	10	10	10	Watts

POWER-TEMPERATURE DERATING CURVE
 (All Types)

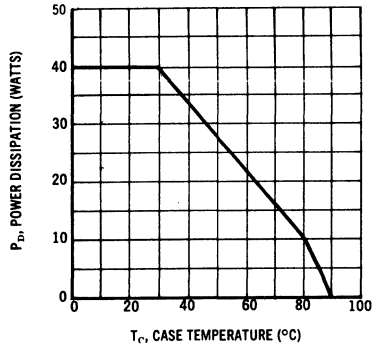

2N178, 2N555

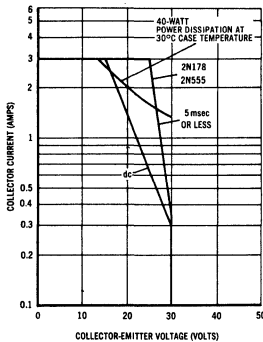

SAFE OPERATING AREAS

2N554

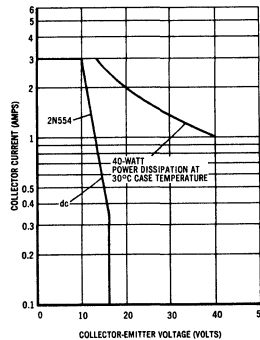

The Safe Operating Area Curves indicate $I_C - V_{CE}$ limits below which the device will not go into secondary breakdown. Collector load lines for specific circuits must fall within the applicable Safe Area to avoid causing a collector-emitter short.

(Duty cycle of the excursions make no significant change in these safe areas.) To insure operation below the maximum T_J , the power-temperature derating curve must be observed for both steady state and pulse power conditions.

2N178, 2N554, 2N555 (continued)

ELECTRICAL CHARACTERISTICS (At 25°C case temperature unless otherwise specified)

Characteristic		Symbol	Min	Typical	Max	Unit
Collector-Base Cutoff Current ($V_{CB} = 30\text{ V}$, $I_E = 0$)	2N178	I_{CBO}	-	-	3.0	mA
($V_{CB} = 15\text{ V}$, $I_E = 0$)	2N554		-	-	10.0	
($V_{CB} = 30\text{ V}$, $I_E = 0$)	2N555		-	-	20.0	
Collector-Base Cutoff Current ($V_{CB} = 2\text{ V}$, $I_E = 0$)	2N178	I_{CBO}	-	50	-	μA
Emitter-Base Cutoff Current ($V_{EB} = 10\text{ V}$, $I_C = 0$)	2N178	I_{EBO}	-	-	2.0	mA
Collector-Base Cutoff Current ($V_{CB} = 30\text{ V}$, $I_E = 0$, $T_C = 90^\circ\text{C}$)	2N178	I_{CBO}	-	-	20.0	mA
Collector-Emitter Breakdown Voltage ($I_C = 330\text{ mA}$, $R_{BE} = 10\ \Omega$)	2N178 2N554 2N555	BV_{CER}	30 16 30	- - -	- - -	Vdc
Power Gain ($P_o = 2\text{ Watts}$; $V_{CE} = 12\text{ V}$, $I_C = 0.5\text{ A}$, $f = 1\text{ kc}$, $R_s = 10\text{ Ohms}$, $R_L = 26.6\text{ Ohms}$)	2N178 2N554 2N555	G_e	28 25 25	- - -	33 - -	db
Total Harmonic Distortion (under same conditions as power gain)	2N178		-	-	5	$\%$
DC Forward Current Transfer Ratio ($V_{CE} = 2\text{ V}$, $I_C = 0.5\text{ A}$)	2N178 2N554 2N555	h_{FE}	15 - -	- 50 50	45 - -	-
Small-Signal Current Gain Cutoff Frequency ($V_{CE} = 12\text{ V}$, $I_C = 0.5\text{ A}$, $f = 1\text{ kc ref}$)	2N178 2N554 2N555	f_{ae}	5 - -	- 6 6	- - -	kc
Small-Signal Forward Current Transfer-Ratio (Base Input) $V_{CE} = 2\text{ V}$, $I_C = 0.5\text{ A}$, $f = 1\text{ kc ref}$)	2N178 2N554 2N555	h_{fe}	- - -	50 55 55	- - -	-
Small-Signal Input Impedance (Base Input) ($V_{CE} = 2\text{ V}$, $I_C = 0.5\text{ A}$, $f = 1\text{ kc}$)	2N178 2N554 2N555	h_{ie}	8 - -	25 25 25	\sim - -	Ohms
Collector-Emitter Saturation Voltage ($I_C = 3\text{ A}$, $I_B = 300\text{ mA}$)	All Types	$V_{CE(sat)}$	-	0.6	-	Vdc

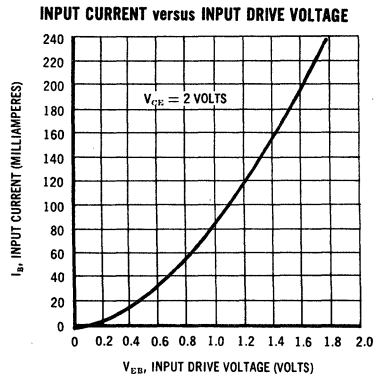
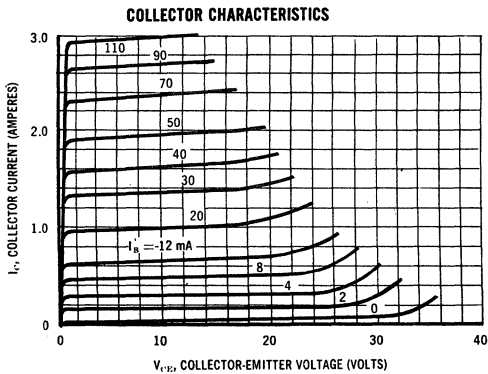

2N242
2N307, A

$P_C = 90 \text{ W}$
 $I_C = 5 \text{ A}$
 $V_{CBO} = 35\text{-}45 \text{ V}$

CASE 1
(TO-3)

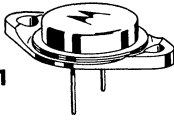

PNP germanium power transistors for general purpose power amplifier and switching applications.

ABSOLUTE MAXIMUM RATINGS

Characteristic	Symbol	2N242	2N307, 307A	Unit
Collector-Base Voltage	V_{CBO}	45	35	Volts
Collector-Emitter Voltage ($R_{BE} = 30 \Omega$)	V_{CER}	-45	—	Volts
Collector-Emitter Voltage	V_{CEO}	—	35	Volts
Emitter-Base Voltage	V_{EBO}	—	10	Volts
Collector Current	I_C	5	5	Amps
Junction Temperature Range	T_J	-65 to +110	-65 to +110	$^{\circ}\text{C}$
Collector Dissipation (at $T_C = 25^{\circ}\text{C}$)	P_C	90	90	Watts

ELECTRICAL CHARACTERISTICS ($T_C = 25^{\circ}\text{C}$ unless otherwise noted)

Characteristic	Symbol	Min	Max	Unit
Collector-Base Cutoff Current ($V_{CB} = -2 \text{ Vdc}$) ($V_{CB} = -25 \text{ Vdc}$) ($V_{CB} = -1 \text{ Vdc}$, $I_E = 0$, $T_C = 85^{\circ}\text{C}$)	2N307 2N307 2N307A 2N242	— — — —	0.5 5 2 5	mAdc
Emitter-Base Cutoff Current ($V_{EB} = -10 \text{ Vdc}$)	All Types	—	2	mAdc
Collector-Emitter Cutoff Current ($V_{CE} = -45 \text{ Vdc}$, $R_{BE} = 30 \Omega$) ($V_{CE} = -25 \text{ Vdc}$, $R_{BE} = 30 \Omega$) ($V_{CE} = -35 \text{ Vdc}$, $R_{BE} = 30 \Omega$)	2N242 2N242 2N307 2N307A	— — — —	5 1 15 7	mAdc
Base-Emitter Voltage ($V_{CE} = -1.5 \text{ Vdc}$, $I_C = 1.0 \text{ Adc}$)	2N242	-0.3	-0.8	Vdc
Collector-Emitter Saturation Voltage ($I_C = 2.0 \text{ Adc}$, $I_B = 200 \text{ mAdc}$) ($I_C = 0.2 \text{ Adc}$, $I_B = 20 \text{ mAdc}$) ($I_C = 1.0 \text{ Adc}$, $I_B = 100 \text{ mAdc}$)	2N242 2N307 2N307A	— — —	-0.8 -1.0 -0.8	Vdc
DC Current Gain ($V_{CE} = -12 \text{ Vdc}$, $I_C = 500 \text{ mAdc}$) ($V_{CE} = -1 \text{ Vdc}$, $I_C = 200 \text{ mAdc}$)	2N242 2N307 2N307A	30 20 30	120 — —	—
Common Emitter Cutoff Frequency ($V_{CE} = -12 \text{ V}$, $I_C = 0.5 \text{ A}$) ($V_{CE} = -6 \text{ V}$, $I_C = 1 \text{ A}$)	2N242 2N307A 2N307	5 3.5 3	— — —	kc
Power Gain ($I_C = 0.5 \text{ A}$, $V_{CE} = -14 \text{ V}$, $R_L = 30 \Omega$, $R_g = 10 \Omega$)	2N242	30	—	db

2N277
2N278
2N173
2N1099

$P_D = 150 \text{ W}$
 $I_C = 15 \text{ A}$
 $V_{CBO} = 40\text{-}60 \text{ V}$

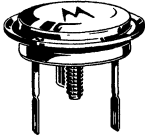

CASE 5
(TO-36)

PNP germanium power transistors for general purpose power amplifier and switching applications. Power and temperature ratings exceed EIA registration.

ABSOLUTE MAXIMUM RATINGS

Characteristic	Symbol	2N277	2N278	2N173	2N1099	Unit
Collector-Base Voltage	V_{CBO}	40	50	60	80	Vdc
Emitter-Base Voltage	V_{EBO}	20	30	40	40	Vdc
Emitter Current (Continuous)	I_E	15	15	15	15	Amp
Base Current (Continuous)	I_B	4	4	4	4	Amp
Junction and Storage Temperature	T_{stg}	← -65 TO +100 →				°C
Thermal Resistance Junction to Case	θ_{JC}	← 0.5 →				°C/W

SAFE OPERATING AREAS

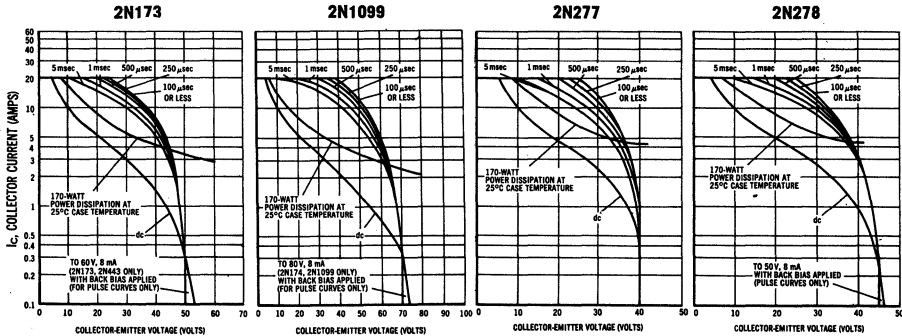

The Safe Operating Area Curves indicate $I_C - V_{CE}$ limits below which the device will not go into secondary breakdown. Collector load lines for specific circuits must fall within the applicable Safe Area to avoid causing a collector-emitter short.

(Duty cycle of the excursions make no significant change in these safe areas.) To insure operation below the maximum T_J , the power-temperature derating curve must be observed for both steady state and pulse power conditions.

2N277, 2N278, 2N173, 2N1099 (continued)

ELECTRICAL CHARACTERISTICS (At 25°C case temperature)

Characteristic		Symbol	Minimum	Typical	Maximum	Unit
Collector-Base Cutoff Current $V_{CB0} = -2$ V	All Types	I_{CBO}	—	100	—	μ A
Collector-Base Cutoff Current $V_{EB} = -1.5$ V, $V_{CB} = -40$ V	2N277 2N278 2N173 2N1099	I_{CB}	— — — —	2 2 2 2	8 8 8 8	mA
Emitter-Base Cutoff Current $V_{EBO} = -20$ V	2N277 2N278 2N173 2N1099	I_{EBO}	— — — —	1 1 1 1	8 8 8 8	mA
Collector-Base Cutoff Current $V_{CB0} = -40$ V, 71°C	2N277 2N278 2N173 2N1099	I_{CBO}	— — — —	— — — —	15 15 15 15	mA
Collector-Emitter Voltage $I_C = 300$ mA, $V_{EB} = 0$	2N277 2N278 2N173 2N1099	BV_{CES}^*	-40 -45 -50 -70	— — — —	— — — —	Vdc
Collector-Emitter Voltage $I_C = 1$ Amp, $I_B = 0$	2N277 2N278 2N173 2N1099	BV_{CEO}^*	-25 -30 -45 -55	— — — —	— — — —	Vdc
Floating Potential $I_E = 0$, $V_{CB} = -40$ V	2N277 2N278 2N173 2N1099	V_{fl}	— — — —	0.15 0.15 0.15 0.15	1.0 1.0 1.0 1.0	volt
Current Gain $I_C = 5$ Amps, $V_{CB} = -2$ V $I_C = 12$ Amps, $V_{CB} = -2$ V	All Types	h_{FE}	35 —	— 25	70 —	—
Base-Emitter Voltage $I_C = 5$ Amps, $V_{CB} = -2$ V	2N277 2N278 2N173 2N1099	V_{BE}	— — — —	0.65 0.65 0.65 0.65	— — — 0.9	Vdc
Saturation Voltage $I_C = 12$ Amps, $I_B = 2$ Amps	2N277 2N278 2N173 2N1099	$V_{CE(SAT)}$	— — — —	0.3 0.3 0.3 0.3	— 1.0 1.0 0.7	Vdc
Common-Emitter Current Amplification Cutoff Frequency $I_C = 5$ Amps, $V_{CE} = -6$ V	All Types	f_{ae}	—	10	—	kc
Rise Time "on" $I_C = 12$ Adc, $I_B = 2$ Adc, $V_{CE} = -12$ V	All Types	t_r	—	15	—	μ sec
Fall Time "off" $I_C = 0$, $V_{EB} = -6$ V, $R_{EB} = 10$ Ohms		t_f	—	15	—	μ sec

* To avoid excessive heating of the collector junction, perform these tests with the sweep method.

2N277, 2N278, 2N173, 2N1099 (continued)

POWER-TEMPERATURE DERATING CURVE

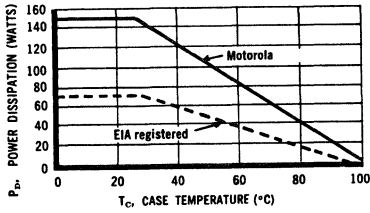

The maximum continuous power is related to maximum junction temperature by the thermal resistance factor.

This curve has a value of 150 Watts at case temperatures of 25°C and is 0 Watts at 100°C with a linear relation between the two temperatures such that:

$$\text{allowable } P_D = \frac{100^\circ - T_C}{0.5}$$

INPUT CHARACTERISTICS

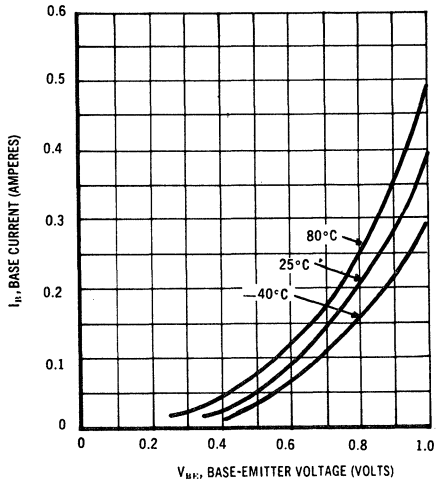

CURRENT TRANSFER CHARACTERISTICS

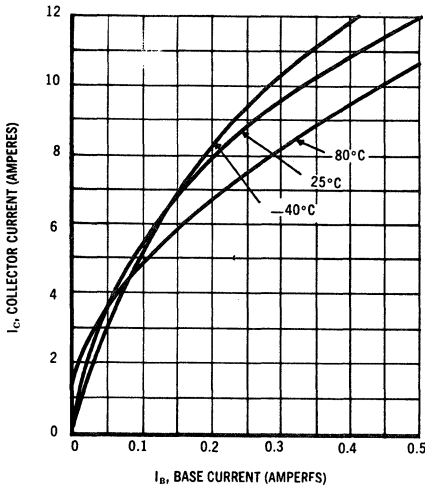

TRANSCONDUCTANCE CHARACTERISTICS

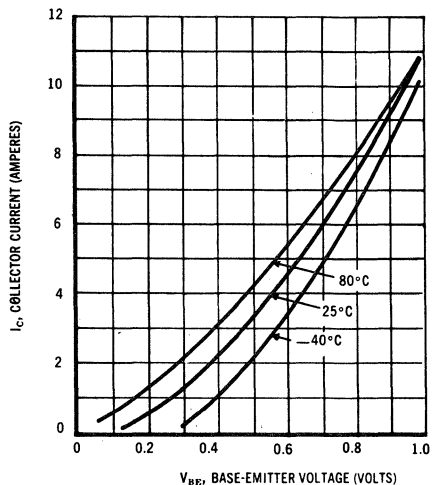

2N297 A

$P_C = 90 \text{ W}$
 $I_E = 5 \text{ A}$
 $V_{CBO} = 60 \text{ V}$

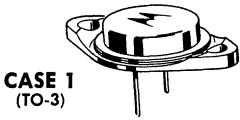

PNP germanium power transistors for military and industrial power switching and amplifier applications. Operating temperature range and collector dissipation rating exceeds military specifications.

MAXIMUM RATINGS

Characteristic	Symbol	Rating	Unit
Collector-Base Voltage	V_{CBO}	60	Vdc
Collector-Emitter Voltage	V_{CEB}	50	Vdc
Collector-Emitter Voltage	V_{CEO}	40	Vdc
Emitter-Base Voltage	V_{EBO}	40	Vdc
Emitter Current	I_E	5	Amps
Operating Temperature Range (MIL-T-19500A/36)	—	-65 to +95	°C
Operating Temperature Range (MOTOROLA 2N297A)	—	-65 to +110	°C
Collector Dissipation at 75°C Case Temperature (MIL-T-19500A/36)	P_C	10	Watts
Collector Dissipation at 25°C Case Temperature (MOTOROLA 2N297A) ($\theta_{JC} = 0.8^\circ\text{C/W max}$)	P_C	85	Watts

**POWER — TEMPERATURE
DERATING CURVE**

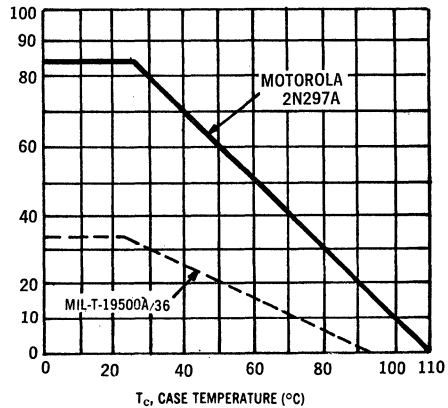

2N297 A (continued)

ELECTRICAL CHARACTERISTICS (At 25°C unless otherwise specified)

Characteristic	Symbol	Minimum	Maximum	Unit
DC Current Transfer Ratio $V_{CE} = 2 \text{ V}$ $I_C = 0.5 \text{ Adc}$	h_{FE}	40	100	—
DC Current Transfer Ratio $V_{CE} = 2 \text{ V}$ $I_C = 2.0 \text{ Adc}$	h_{FE}	20	—	—
Small-Signal Current Transfer Ratio Cutoff Frequency $V_{CE} = 14 \text{ Vdc}$ $I_C = 0.5 \text{ Amp}$	f_{ae}	5	—	kc
Emitter-Base Cutoff Current $V_{EB} = 40 \text{ Vdc}$ $I_C = 0$	I_{EBO}	—	3.0	mAdc
Collector-Base Cutoff Current $V_{CB} = 2 \text{ Vdc}$ $I_E = 0$	I_{CBO}	—	200	μAdc
Collector-Base Cutoff Current $V_{CB} = 60 \text{ Vdc}$ $I_E = 0$	I_{CBO}	—	3.0	mAdc
Base Current $V_{CE} = 2 \text{ Vdc}$ $I_C = 0.5 \text{ Adc}$	I_B	5.0	12.5	mAdc
Base Current $V_{CE} = 2 \text{ Vdc}$ $I_C = 2 \text{ Adc}$	I_B	—	100	mAdc
Emitter-Base Voltage $V_{CE} = 2 \text{ Vdc}$ $I_C = 2 \text{ Adc}$	V_{EB}	—	1.5	Vdc
Floating Potential $V_{CB} = 60 \text{ Vdc}$ (Voltmeter input resistance = 10 Megohm min)	V_{fl}	0.0	0.18	Vdc
Collector-Emitter Saturation Voltage $I_C = 2 \text{ Adc}$ $I_B = 200 \text{ mAdc}$	$V_{CE(SAT)}$	0.0	1.0	Vdc
Collector-Emitter Voltage $I_C = 300 \text{ mAdc}$ $I_B = 0$	BV_{CEO}	40	—	Vdc
Collector-Emitter Voltage $I_C = 300 \text{ mAdc}$ $V_{EB} = 0$	BV_{CES}	50	—	Vdc
Small-Signal Short-Circuit Forward-Current Transfer Ratio Cutoff Frequency $V_{CE} = 14 \text{ Vdc}$ $I_C = 0.5 \text{ Adc}$	f_{ae}	5	—	kc
High-Temperature Operation $T_C = +71^\circ\text{C min}$				
Collector Cutoff Current $V_{CB} = 30 \text{ Vdc}$ $I_E = 0$	I_{CBO}	—	6.0	mAdc

2N307
2N307A

For Specifications, See 2N242 Data Sheet

2N350A
2N351A
2N376A

$P_C = 90 \text{ W}$
 $I_C = 3\text{-}5 \text{ A}$
 $V_{CBO} = 50 \text{ V}$

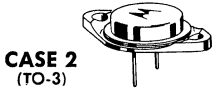

CASE 2
(TO-3)

PNP germanium power transistors for economical power switching applications and for power amplifiers requiring up to 4 watts of output power at relatively low distortion.

MAXIMUM RATINGS

Characteristic	Symbol	Rating	Unit
Collector-Base Voltage	V_{CBO}	50	Vdc
Collector-Emitter Voltage	V_{CES}	40	Vdc
Collector Dissipation at 25°C mounting base temperature	P_C	90	Watts
Collector Junction Temperature	T_j	-65 to +100	°C
Thermal Resistance (Junction to Case)	θ_{JC}	0.8	°C/W

**CURRENT GAIN versus
COLLECTOR CURRENT (COMMON EMITTER)**

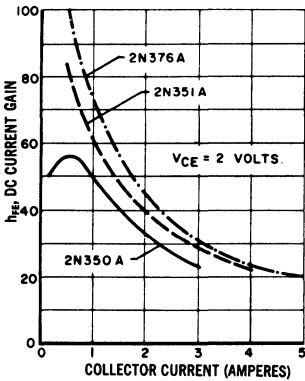

SAFE OPERATING AREAS

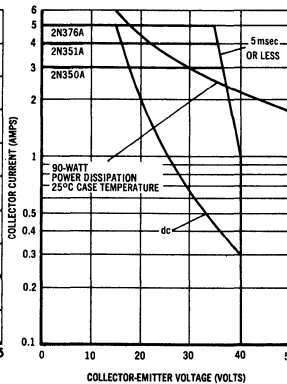

**POWER TEMPERATURE
DERATING CURVE**

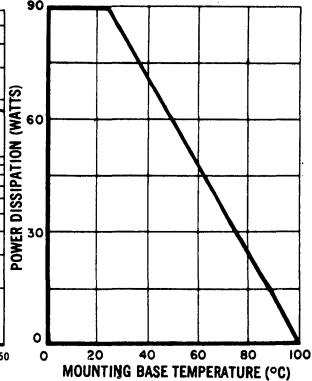

The Safe Operating Area Curves indicate $I_C - V_{CE}$ limits below which the device will not go into secondary breakdown. Collector load lines for specific circuits must fall within the applicable Safe Area to avoid causing a collector-emitter short.

(Duty cycle of the excursions make no significant change in these safe areas.) To insure operation below the maximum T_j , the power-temperature derating curve must be observed for both steady state and pulse power conditions.

2N350A, 2N351A, 2N376A (continued)

ELECTRICAL CHARACTERISTICS (at mounting base temperature 25°C ± 3°C.)

GENERAL	Symbol	Minimum	Typical	Maximum	Unit
Collector Cutoff Current V _{CB} = 30 V V _{CB} = 2 V V _{CB} = 30 V, T = 100°C	I _{CBO}	—	— 50	3.0 — 30	mA μA mA
Emitter Cutoff Current V _{EB} = 10 V	I _{EBO}	—	—	2.0	mA
Collector Breakdown Voltage I _C = 1 A (R _{BE} = 10 Ω) I _C = 330 mA, R _{BE} = 0 (This test should be made under dynamic conditions only)	BV _{CES}	40	—	—	Vdc

ELECTRICAL CHARACTERISTICS (at mounting base temperature 25°C ± 3°C.)

COMMON EMITTER	2N350A			2N351A			2N376A			Unit	
	Sym	Min	Typ	Max	Min	Typ	Max	Min	Typ		Max
Power Gain (± 0.5 db) P _o = 4 Watts, V _{CE} = 12 V, I _C = 0.7 A, f = 1 kc	G _{PE}	—	—	33	32	—	35	34	—	37	db
Total Harmonic Distortion under same conditions as power gain		—	—	7%	—	—	7%	—	—	7%	
DC Forward Current Gain V _{CE} = 2 V, I _C = 0.7 A	h _{FE}	20	—	60	25	—	90	35	—	120	
Current Gain Frequency Cutoff V _{CE} = 12 V, I _C = 0.7 A, f = 1 kc ref	f _{ae}	5	—	—	5	—	—	5	—	—	kc
Small-Signal Forward Current Gain f = 1 kc, V _{CE} = 2 V, I _C = 0.7 A	h _{fe}	—	30	—	—	45	—	—	60	—	
Small-Signal Input Impedance f = 1 kc, V _{CE} = 2 V, I _C = 0.7 A	h _{fe}										Ohms
Collector Saturation Voltage I _C = 3 A, I _B = 300 mA	V _{CE(SAT)}	—	0.8	1.75	—	—	—	—	—	—	Vdc
Base-Emitter Voltage I _C = 3 A, I _B = 300 mA	V _{BE}	—	1.0	2.00	—	—	—	—	—	—	Vdc
Collector Saturation Voltage I _C = 4 A, I _B = 400 mA	V _{CE(SAT)}	—	—	—	—	0.8	1.75	—	—	—	Vdc
Base-Emitter Voltage I _C = 4 A, I _B = 400 mA	V _{BE}	—	—	—	—	1.0	2.00	—	—	—	Vdc
Collector Saturation Voltage I _C = 5 A, I _B = 500 mA	V _{CE(SAT)}	—	—	—	—	—	—	—	0.8	1.75	Vdc
Base-Emitter Voltage I _C = 5 A, I _B = 500 mA	V _{BE}	—	—	—	—	—	—	—	1.0	2.00	Vdc

2N350A, 2N351A, 2N376A (continued)

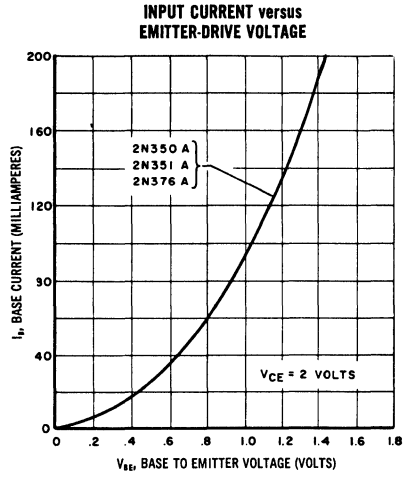
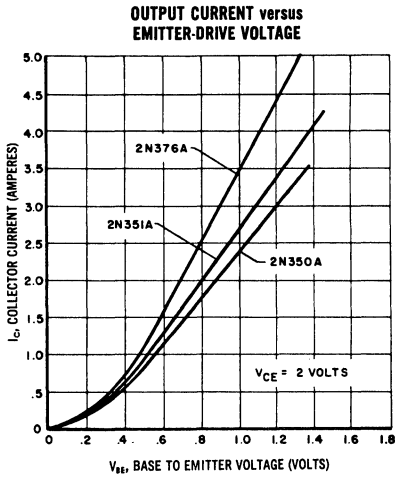

2N375

2N618

2N1359

2N1360

2N1362 thru 2N1365

**$P_C = 90\text{ W}$
 $I_C = 3\text{ A}$
 $V_{CBO} = 50\text{-}120\text{ V}$**

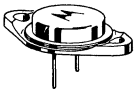

**CASE 1
(TO-3)**

PNP germanium power transistors for general purpose switching and amplifier applications.

MAXIMUM RATINGS

Characteristic	Symbol	2N1359 2N1360	2N375 2N618	2N1362 2N1363	2N1364 2N1365	Unit
Collector-Base Voltage	V_{CBO}	50	80	100	120	Vdc
Collector-Emitter Voltage	V_{CES}	40	60	75	100	Vdc
Emitter-Base Voltage	V_{EBO}	25	40	50	60	Vdc
Collector Current (Continuous)	I_C	3	3	3	3	Amps
Collector Current (Peak)	I_C	10	10	10	10	Amps
Collector Junction Temperature Range	T_J	← -65 TO + 110 →				°C
Collector Dissipation (25°C Case Temperature)	P_C	106	106	106	106	Watts
Thermal Resistance	θ_{JC}	0.8	0.8	0.8	0.8	°C/W

2N375, 2N618, 2N1359, 2N1360, 2N1362 thru 2N1365 (continued)

ELECTRICAL CHARACTERISTICS (At = 25°C unless otherwise noted)

Characteristic	Types	Symbol	Minimum	Typical	Maximum	Unit
Collector-Base Cutoff Current ($V_{CB} = 40\text{ V}, I_E = 0$) ($V_{CB} = 50\text{ V}, I_E = 0$) ($V_{CB} = 60\text{ V}, I_E = 0$) ($V_{CB} = 80\text{ V}, I_E = 0$) ($V_{CB} = 75\text{ V}, I_E = 0$) ($V_{CB} = 100\text{ V}, I_E = 0$) ($V_{CB} = 100\text{ V}, I_E = 0$) ($V_{CB} = 120\text{ V}, I_E = 0$)	2N1359, 2N1360 2N375, 2N618 2N1362, 2N1363 2N1364, 2N1365	I_{CBO}	-- -- -- -- -- -- -- --	-- -- -- -- -- -- -- --	3.0 20.0 3.0 20.0 3.0 20.0 3.0 20.0	mA
Collector-Base Cutoff Current at $T_c = +90^\circ\text{C}$ $V_{CB} = 1/2\text{ BV}_{CES}$ rating	All Types	I_{CBO}	--	--	20	mA
Emitter-Base Cutoff Current ($V_{EB} = 12\text{ V}, I_C = 0$) ($V_{EB} = 25\text{ V}, I_C = 0$) ($V_{EB} = 50\text{ V}, I_C = 0$) ($V_{EB} = 60\text{ V}, I_C = 0$)	All Types 2N1359, 2N1360 2N1362, 2N1363 2N1364, 2N1365	I_{EBO}	-- -- -- --	-- -- -- --	0.5 20 20 20	mA
Collector-Emitter Breakdown Voltage $I_C = 500\text{ mA}, V_{EB} = 0$	2N1359, 2N1360 2N375, 2N618 2N1362, 2N1363 2N1364, 2N1365	BV_{CES}	40 60 75 100	-- -- -- --	-- -- -- --	Vdc
DC Current Transfer Ratio ($V_{CE} = 4\text{ V}, I_C = 1.0\text{ A}$) ($V_{CE} = 4\text{ V}, I_C = 1.0\text{ A}$)	2N1359, 375, 1362, 64 2N1360, 618, 1363, 65 2N1359, 375, 1362, 64 2N1360, 618, 1363, 65	h_{FE}	35 60 15 20	55 90 22 35	90 140 -- --	--
Transconductance ($V_{CE} = 4\text{ V}, I_C = 1.0\text{ A}$)	2N375 2N618 2N1359, 2N1362, 2N1364 2N1360, 2N1363, 2N1365	g_{FE}	0.8 1.0 0.8 1.0	1.25 1.6 1.25 1.6	2.2 2.5 -- --	mhos
Frequency Cutoff ($V_{CE} = 4\text{ V}, I_C = 1\text{ A}$) ($V_{CE} = 4\text{ V}, I_C = 1\text{ A}$) ($V_{CE} = 4\text{ V}, I_C = 3\text{ A}$) ($V_{CE} = 4\text{ V}, I_C = 3\text{ A}$)	2N375 2N618 2N1359, 2N1362, 2N1364 2N1360, 2N1363, 2N1365	f_{ae}	7 5 7 5	10 8.5 10 8.5	-- -- -- --	kc
Collector Saturation Voltage ($I_C = 2.0\text{ A}, I_B = 200\text{ mA}$)	2N1359, 375, 1362, 64 2N1360, 618, 1363, 65	$V_{CE(sat)}$	-- --	0.4 0.3	1.0 0.8	Vdc
Base-Emitter Drive Voltage ($I_C = 2.0\text{ A}, I_B = 200\text{ mA}$)	2N1359, 375, 1362, 64 2N1360, 618, 1363, 65	V_{BE}	-- --	0.7 0.6	-- --	Vdc
Collector-Emitter Punch-Through Voltage ($V_{CB} = 50\text{ V}, I_C = 0$) ($V_{CB} = 100\text{ V}, I_C = 0$) ($V_{CB} = 120\text{ V}, I_C = 0$)	2N1359, 2N1360 2N1362, 2N1363 2N1364, 2N1365	V_{EBF}	-- -- --	-- -- --	1.25 1.25 1.25	Vdc

2N375 (continued)

POWER-TEMPERATURE DERATING CURVE

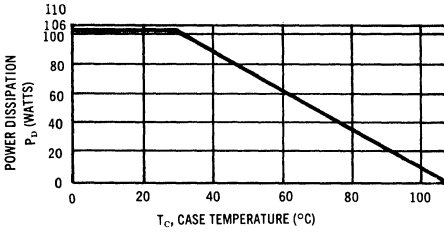

The maximum continuous power is related to maximum junction temperature, by the thermal resistance factor. For d.c. or frequencies below 25 cps the transistor must be operated within the constant $P_D = V_c \times I_c$ hyperbolic curve. This curve has a value of 106 Watts at case temperatures of 25°C and is 0 Watts at 110°C with a linear relation between the two temperatures such that

$$P_D \text{ allowable} = \frac{110^\circ - T_c}{.08}$$

BASE-EMITTER VOLTAGE versus COLLECTOR CURRENT

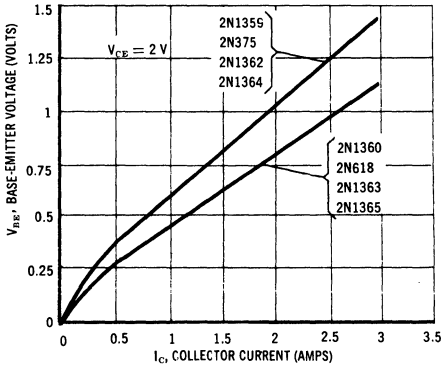

CURRENT GAIN versus COLLECTOR CURRENT

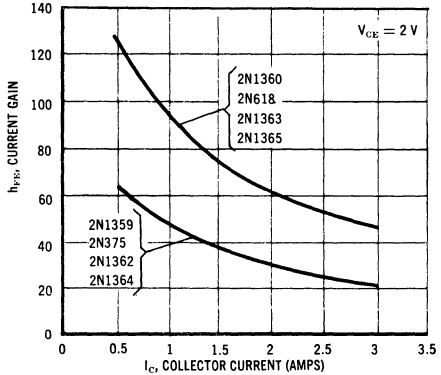

2N375, 2N618

SAFE OPERATING AREAS

2N1362, 2N1363

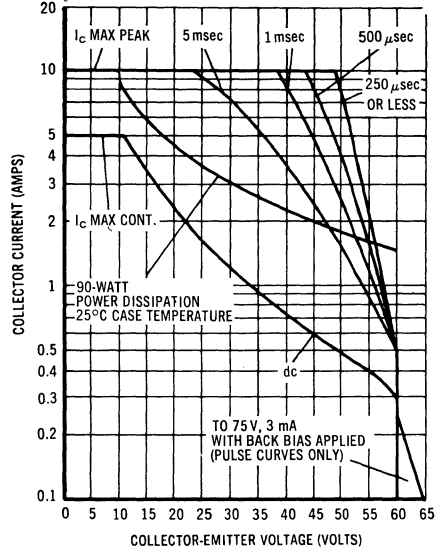
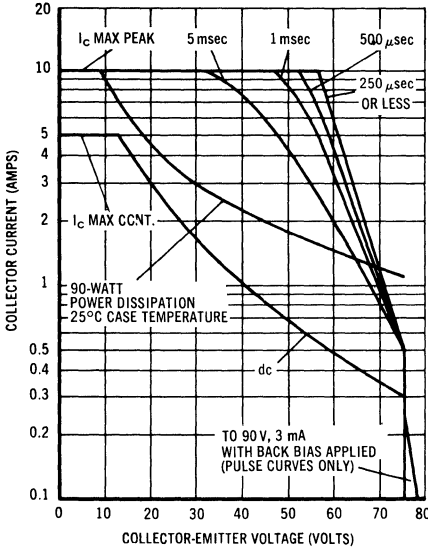

The Safe Operating Area Curves indicate $I_C - V_{CE}$ limits below which the device will not go into secondary breakdown. Collector load lines for specific circuits must fall within the applicable Safe Area to avoid causing a collector-emitter short.

(Duty cycle of the excursions make no significant change in these safe areas.) To insure operation below the maximum T_J , the power-temperature derating curve must be observed for both steady state and pulse power conditions.

2N376A

For Specifications, See 2N350A Data Sheet

2N378 thru 2N380

2N459, A

$P_C = 90W$
 $I_C = 5A$
 $V_{CBO} = \text{to } 105V$

CASE 1
(TO-3)



PNP germanium power transistors for general purpose power amplifier and switching applications.

MAXIMUM RATINGS

Characteristic	Symbol	2N378	2N379	2N380	2N459	2N459A	Unit	
Collector-Base Voltage	V_{CBO}	—	—	—	—	105	Volts	
Collector-Emitter Voltage ($V_{BE} = 1.5V$) ($V_{BE} = 1.0V$)	V_{CEX}	40 —	80 —	60 —	— 105	— 105	Volts	
Collector-Emitter Voltage ($R_{BE} = 0$)	V_{CES}	—	—	—	70	70	Volts	
Collector-Emitter Voltage	V_{CEO}	20	40	30	60	60	Volts	
Emitter-Base Voltage	V_{EBO}	—	—	—	10	25	Volts	
Collector Current	I_C	5	5	5	5	5	Amps	
Junction Temperature Range	T_J	← -65 TO +110 →						°C
Collector Dissipation (at $T_C = 25^\circ C$)	P_C	90	90	90	90	90	Watts	

ELECTRICAL CHARACTERISTICS (at $T_A = 25^\circ C$ unless otherwise noted)

Characteristic	Symbol	Min	Max	Unit
Collector-Base Cutoff Current ($V_{CB} = -25Vdc$) ($V_{CB} = -25Vdc, T_C = 85^\circ C$)	I_{CBO}	— —	0.5 7.5	mAdc
Emitter-Base Cutoff Current ($V_{EB} = -10Vdc$) ($V_{EB} = -25Vdc$)	I_{EBO}	— —	1.5 2 2	mAdc
Collector Cutoff Current ($V_{CE} = -40Vdc, V_{BE} = 1.5Vdc$) ($V_{CE} = -80Vdc, V_{BE} = 1.5Vdc$) ($V_{CE} = -60Vdc, V_{BE} = 1.5Vdc$) ($V_{CE} = -105Vdc, V_{BE} = 1.5Vdc$) ($V_{CE} = -105Vdc, V_{BE} = 1.0Vdc$)	I_{CEX}	— — — — —	10 10 10 10 10	mAdc
Collector-Emitter Breakdown Voltage ($I_C = 100mAdc$)	BV_{CEO}	20 40 30 60	— — — —	Vdc
Base-Emitter Voltage ($I_C = 2Adc, V_{CE} = -2Vdc$)	V_{BE}	— — —	-1.6 -1.3 -1.0	Vdc

2N378, thru 2N380 2N459, 2N459 A

ELECTRICAL CHARACTERISTICS (at $T_c = 25^\circ\text{C}$ unless otherwise specified.)

Characteristic	Symbol	Min	Max	Unit
Collector-Emitter Saturation Voltage ($I_C = 2 \text{ Adc}$, $I_B = 0.2 \text{ Adc}$)	$V_{CE(sat)}$	—	1.0 0.3	Vdc
DC Current Gain ($I_C = 2 \text{ Adc}$, $V_{CE} = 2 \text{ Vdc}$)	h_{FE}	40	80	—
		20	70	
		30	70	
		40	70	
		20	—	
Common Emitter Cutoff Frequency ($I_C = 1 \text{ A}$, $V_{CE} = -2 \text{ V}$) ($I_C = 2 \text{ A}$, $V_{CE} = -2 \text{ V}$)	f_{ae}	5	—	kc
		5	—	

2N441

2N442

2N443

CASE 5
(TO-36)



PNP germanium power transistors for power switching and amplifier applications. Power and temperature ratings exceed EIA registration.

$P_C = 150 \text{ W}$
 $I_C = 15 \text{ A}$
 $V_{CBO} = 40-60 \text{ V}$

MAXIMUM RATINGS

Characteristic	Symbol	2N441	2N442	2N443	Unit
Collector-Base Voltage	V_{CB}	40	50	60	Vdc
Collector-Emitter Voltage	V_{CES}	40	45	50	Vdc
Emitter-Base Voltage	V_{EBO}	20	30	40	Vdc
Emitter Current (continuous)	I_E	15	15	15	Amps
Base Current (continuous)	I_B	4	4	4	Amps
Junction and Storage Temperature	T_{stg}	-65 to +100			$^\circ\text{C/W}$
Thermal Resistance	θ_{JC}		0.5		$^\circ\text{C/W}$

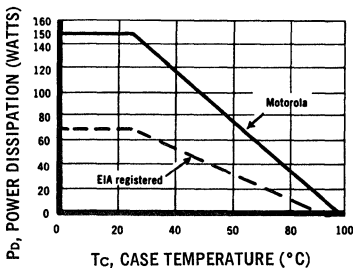

POWER-TEMPERATURE DERATING CURVE

The maximum continuous power is related to maximum junction temperature by the thermal resistance factor. This curve has a value of 150 Watts at case temperatures of 25°C and is 0 Watts at 100°C with a linear relation between the two temperatures such that:

$$P_D \text{ allowable} = \frac{100^\circ - T_c}{0.5}$$

2N441 thru 2N443 (continued)

ELECTRICAL CHARACTERISTICS

Characteristic		Symbol	Minimum	Typical	Maximum	Unit
Collector-Base Cutoff Current $V_{CBO} = -2$ V	All Types	I_{CBO}	—	100	—	μ A
Collector-Base Cutoff Current $V_{EB} = -1.5$ V, $V_{CB} = -40$ V	2N441 2N442 2N443	I_{CB}	— — —	2 2 2	8 8 8	mA
Collector-Base Cutoff Current $T_B = 71^\circ\text{C}$, $V_{CBO} = -40$ V	2N441 2N442 2N443	I_{CBO}	— — —	— — —	15 15 15	mA
Emitter-Base Cutoff Current $V_{EBO} = -20$ V	2N441 2N442 2N443	I_{EBO}	— — —	1 1 1	8 8 8	mA
Collector-Emitter Voltage $I_C = 300$ mA, $V_{EB} = 0^*$	2N441 2N442 2N443	BV_{CES}	-40 -45 -50	— — —	— — —	Vdc
Collector-Emitter Voltage $I_C = 1$ Amp, $I_B = 0^*$	2N441 2N442 2N443	BV_{CEO}	-25 -30 -45	— — —	— — —	Vdc
Floating Potential $I_E = 0$, $V_{CB} = -40$ V	2N441 2N442 2N443	V_{BE}	— — —	— — —	1.0 1.0 1.0	volt
Current Gain $I_C = 5$ Amps, $V_{CB} = -2$ V $I_C = 12$ Amps, $V_{CB} = -2$ V	All Types All Types	h_{FE}	20 —	— 20	40 —	—
Base-Emitter Voltage $I_C = 5$ Amps, $V_{CB} = -2$ V	2N441 2N442 2N443	V_{BE}	— — —	0.65 0.65 0.65	— — 0.9	Vdc
Saturation Voltage $I_C = 12$ Amps, $I_B = 2$ Amps	2N441 2N442 2N443	$V_{CE(SAT)}$	— — —	0.3 0.3 0.3	— — 1.0	Vdc
Common-Emitter Current Amplification Cutoff Frequency $I_C = 5$ Amps, $V_{CE} = -6$ V	All Types	f_{ae}	—	10	—	kc
Rise Time "on" $I_C = 12$ Adc, $I_B = 2$ Adc, $V_{CE} = -12$ V	All Types	t_r	—	15	—	μ sec
Fall Time "off" $I_C = 0$, $V_{EB} = -6$ V, $R_{EB} = 10$ Ohms	All Types	t_f	—	15	—	μ sec

* To avoid excessive heating of the collector junction, perform test with the sweep method.

2N441 thru 2N443 (continued)

SAFE OPERATING AREAS

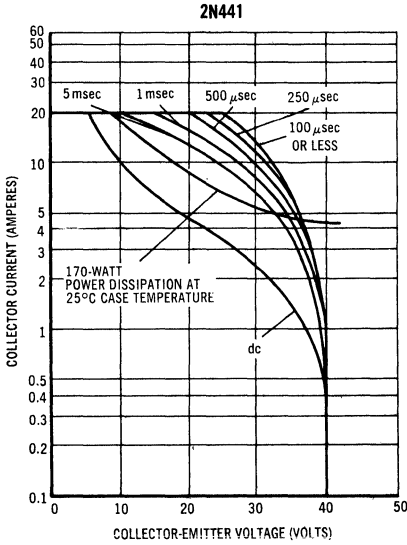

The Safe Operating Area Curves indicate $I_C - V_{CE}$ limits below which the device will not go into secondary breakdown. Collector load lines for specific circuits must fall within the applicable Safe Area to avoid causing a collector-emitter short. (Duty cycle of the excursions make no significant change in these safe areas.) To insure operation below the maximum T_J , the power-temperature derating curve must be observed for both steady state and pulse power conditions.

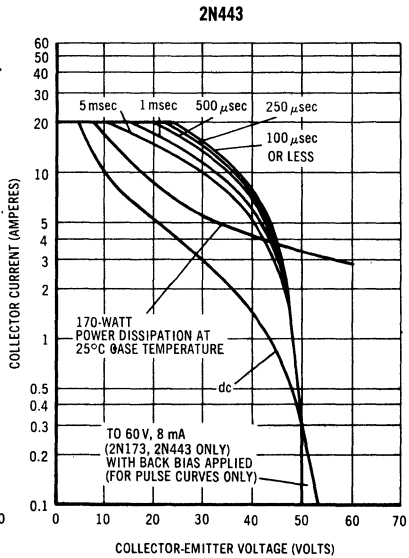
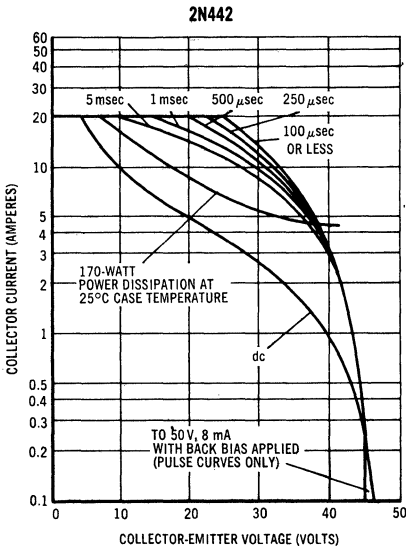

2N441 thru 2N443 (continued)

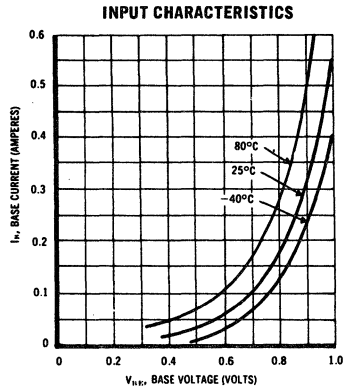
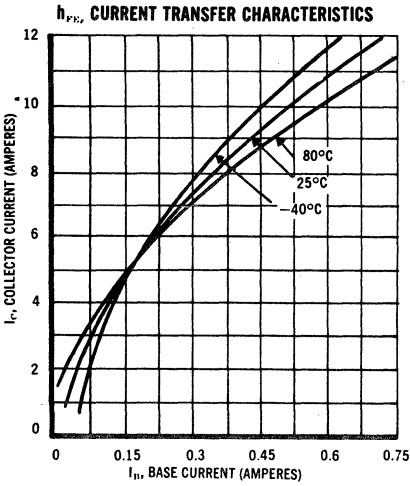

2N459, A

For Specifications, See 2N378-38 Data Sheet

2N554

2N555

For Specifications, See 2N178 Data Sheet

2N618

For Specifications, See 2N375 Data Sheet

2N665—JAN

$P_C = 35 \text{ W}$
 $I_C = 5 \text{ A}$
 $V_{CBO} = 80 \text{ V}$

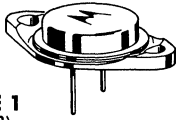

CASE 1
(TO-3)

PNP germanium power transistors for driver and power output amplifier and power switching applications in military and industrial equipment.

MAXIMUM RATINGS

Characteristic	Symbol	Rating	Unit
Collector-Base Voltage	V_{CBO}	80	Vdc
Emitter-Base Voltage	V_{EBO}	40	Vdc
DC Collector Current MIL-S-19500/58C Motorola Unit	I_C	2 3	Amps
DC Emitter Current	I_E	5	Amps
Collector Junction Temperature	T_J	-65 to +95	$^{\circ}\text{C}$
Collector Dissipation Derate above 25°C	P_C	35 0.5	Watts $\text{W}/^{\circ}\text{C}$

ELECTRICAL CHARACTERISTICS

Characteristic	Symbol	Min	Max	Unit
Emitter Cutoff Current ($V_{EBO} = -40 \text{ Vdc}, I_C = 0$)	I_{EBO}	—	-2	mAdc
Collector Cutoff Current ($V_{CBO} = -2 \text{ Vdc}, I_E = 0$) ($V_{CBO} = -60 \text{ Vdc}, I_E = 0$) ($V_{CBO} = -80 \text{ Vdc}, I_E = 0$)	I_{CBO}	—	-.05 -2 -10	mAdc
DC Current Gain ($V_{CE} = -2 \text{ Vdc}, I_C = -0.5 \text{ Adc}$) ($V_{CE} = -2 \text{ Vdc}, I_C = -2 \text{ Adc}$)	h_{FE}	40 20	80 —	—
Emitter-Base Voltage ($V_{CE} = -2 \text{ Vdc}, I_C = -2 \text{ Adc}$)	V_{EB}	—	1.5	Vdc
Floating Potential ($V_{CB} = -80 \text{ Vdc}$, voltmeter input resistance = 10 megohms min, $t \approx 1 \text{ sec}$)	V_{EBF}	—	-1	Vdc
Collector-Emitter Saturation Voltage ($I_C = -3 \text{ Adc}, I_B = -220 \text{ mAdc}$)	$V_{CE(\text{sat})}$	—	-0.9	Vdc
Collector-Emitter Voltage ($I_C = -300 \text{ mAdc}, I_B = 0$)	V_{CEO}	-40	—	Vdc
Small-Signal Short-Circuit Forward-Current Transfer-Ratio Cutoff Frequency ($V_{CE} = -14 \text{ Vdc}, I_C = -2 \text{ Adc}$)	f_{hfe}	20	—	kc
Emitter Cutoff Current ($V_{EBO} = -30 \text{ Vdc}, I_C = 0, T_C = +71^{\circ}\text{C min}$)	I_{EBO}	—	-2	mAdc
Collector Cutoff Current ($V_{CBO} = -30 \text{ Vdc}, I_E = 0, T_C = +71^{\circ}\text{C min}$)	I_{CBO}	—	-2	mAdc

2N665 (continued)

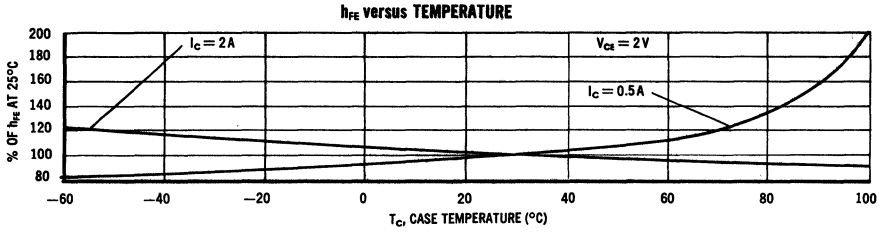

The Safe Operating Area Curves indicate $I_C - V_{CE}$ limits below which the device will not go into secondary breakdown. Collector load lines for specific circuits must fall within the applicable Safe Area to avoid causing a collector-emitter short. (Duty cycle of the excursions make no significant change in these safe areas.) To insure operation below the maximum T_j , the power-temperature de-rating curve must be observed for both steady state and pulse power conditions.

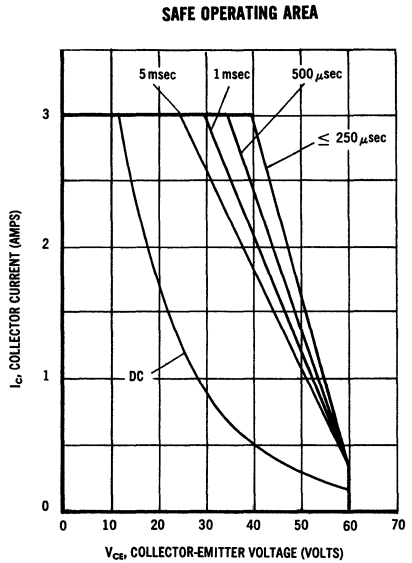
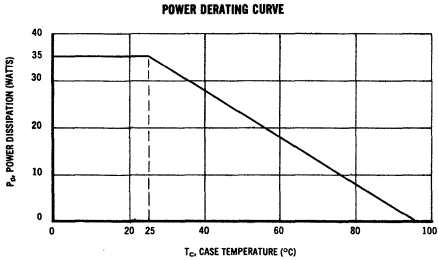

2N669

For Specifications, See 2N176 Data Sheet

2N1011

$P_C = 90 \text{ W}$
 $I_C = 5 \text{ A}$
 $V_{CSO} = 80 \text{ V}$

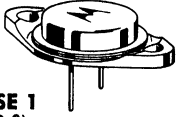

CASE 1
(TO-3)

PNP germanium power transistors for general purpose power amplifier and switching applications in military and industrial equipment. Operating temperature range and power dissipation exceed military specifications.

MAXIMUM RATINGS

Characteristic	Symbol	Rating	Unit
Collector-Base Voltage	V_{CBO}	80	Vdc
Collector-Emitter Voltage	V_{CES}	80	Vdc
Collector-Emitter Voltage	V_{CEO}	40	Vdc
Emitter-Base Voltage	V_{EBO}	40	Vdc
Emitter Current	I_E	5	Amps
Operating Temperature Range (MIL-T-19500A/67)	—	-65 to +95	°C
Operating Temperature Range (MOTOROLA 2N1011)	—	-65 to +100	°C
Collector Dissipation at 75°C Case Temperature (MIL-T-19500A/67)	P_C	10	Watts
Collector Dissipation at 25°C Case Temperature (MOTOROLA 2N1011)	P_C	90	Watts

**POWER — TEMPERATURE
DERATING CURVE**

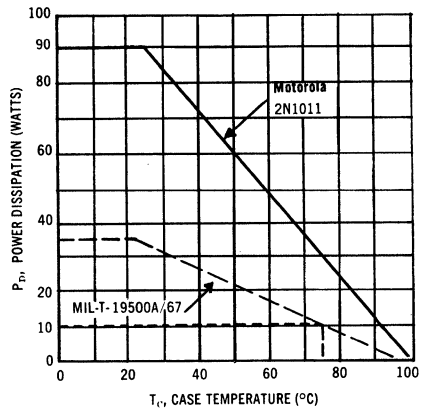

USA2N1011 (continued)

ELECTRICAL CHARACTERISTICS (At 25°C unless otherwise specified)

Characteristic	Symbol	Minimum	Maximum	Unit
DC Current Transfer Ratio $V_{CE} = 2 \text{ V}$ $I_C = 1.0 \text{ Adc}$	h_{FE}	—	150	—
DC Current Transfer Ratio $V_{CE} = 2 \text{ V}$ $I_C = 3.0 \text{ Adc}$	h_{FE}	30	75	—
Small-Signal Current Transfer Ratio Cutoff Frequency $V_{CE} = 2 \text{ Vdc}$ $I_C = 3 \text{ Amps}$	f_{ae}	5	—	kc
Emitter-Base Cutoff Current $V_{EB} = 40 \text{ Vdc}$ $I_C = 0$	I_{EBO}	—	3.0	mAdc
Collector-Base Cutoff Current $V_{CB} = 2 \text{ Vdc}$ $I_E = 0$	I_{CBO}	—	200	μAdc
Collector-Base Cutoff Current $V_{CB} = 80 \text{ Vdc}$ $I_E = 0$	I_{CBO}	—	15.0	mAdc
Base Current $V_{CE} = 2 \text{ Vdc}$ $I_C = 1 \text{ Adc}$	I_B	6.7	—	mAdc
Base Current $V_{CE} = 2 \text{ Vdc}$ $I_C = 3 \text{ Adc}$	I_B	40	100	mAdc
Emitter-Base Voltage $V_{CE} = 2 \text{ Vdc}$ $I_C = 3 \text{ Adc}$	V_{EB}	—	2.0	Vdc
Floating Potential $V_{CB} = 50 \text{ Vdc}$ (Voltmeter input resistance = 10 Megohm min)	V_{fl}	—	1.0	Vdc
Collector-Emitter Saturation Voltage $I_C = 3 \text{ Adc}$ $I_B = 200 \text{ mAdc}$	$V_{CE(SAT)}$	—	1.5	Vdc
Collector-Emitter Voltage $I_C = 300 \text{ mAdc}$ $I_B = 0$	BV_{CEO}	40	—	Vdc
Collector-Emitter Voltage $I_C = 300 \text{ mAdc}$ $V_{EB} = 0$	BV_{CES}	80	—	Vdc
Small-Signal Short-Circuit Forward-Current Transfer Ratio Cutoff Frequency $V_{CE} = 2 \text{ Vdc}$ $I_C = 3 \text{ Adc}$	f_{ae}	5	—	kc
High-Temperature Operation $T_C = +90^\circ\text{C min}$				
Collector Cutoff Current $V_{CB} = 30 \text{ Vdc}$ $I_E = 0$	I_{CBO}	—	20	mAdc

2N1073, A, B

$P_C = 85 \text{ W}$
 $I_C = 10 \text{ A}$
 $V_{CER} = 40-120 \text{ V}$

CASE 4
(TO-41)

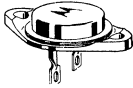

PNP germanium power transistors for high-voltage power switching applications.

For TO-3 package with 50-mil dia. pins (no solder lugs) specify MP1350 thru MP1352.

MAXIMUM RATINGS

Characteristic	Symbol	2N1073	2N1073A	2N1073B	Unit
Collector-Emitter Voltage	V_{CER}	40	80	120	Vdc
Collector-Base Voltage	V_{CB}	40	80	120	Vdc
Emitter-Base Voltage	V_{EB}	1.5	1.5	1.5	Vdc
Collector Current (Cont)	I_C	10	10	10	Amps
Base Current (Cont)	I_B	5	5	5	Amps
Emitter Reverse Current (Surge 60 cps Recurrent)	I_E	1.5	1.5	1.5	Amps
Storage and Operating Temperature	T_{stg} T_J	← -65 to +110 →			$^{\circ}\text{C}$
Collector Dissipation (25 $^{\circ}\text{C}$ Mtg. Case Temp.)	P_C	85	85	85	Watts

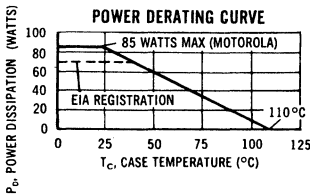

The maximum continuous power is related to maximum junction temperature by the thermal resistance factor. This curve has a value of 85 watts at a case temperature of 25 $^{\circ}\text{C}$ and is 0 watts at 110 $^{\circ}\text{C}$ with a linear relation between the two temperatures such that:

$$\text{Allowable } P_D = \frac{110^{\circ} - T_C}{1.0} \text{ Watts}$$

SAFE OPERATING AREAS — PULSE CONDITIONS

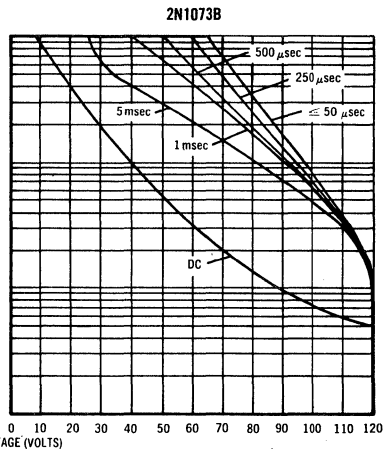
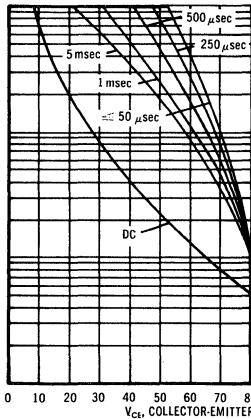
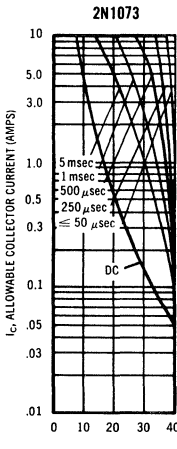

The Safe Operating Area Curves indicate $I_C - V_{CE}$ limits below which the device will not go into secondary breakdown. Collector load lines for specific circuits must fall within the applicable Safe Area to avoid causing a collector-emitter short.

(Duty cycle of the excursions make no significant change in these safe areas.) To insure operation below the maximum T_J , the power-temperature derating curve must be observed for both steady state and pulse power conditions.

2N1073, A, B (continued)

ELECTRICAL CHARACTERISTICS (at $T_A = 25^\circ\text{C}$ unless otherwise noted)

Characteristic	Symbol	Min	Typ	Max	Unit
Collector-Base Cutoff Current ($V_{CB} = 25 \text{ Vdc}, I_E = 0$) ($V_{CB} = 25 \text{ Vdc}, I_E = 0, T_C = 85^\circ\text{C}$) ($V_{CB} = 40 \text{ Vdc}, I_E = 0$) ($V_{CB} = 60 \text{ Vdc}, I_E = 0$) ($V_{CB} = 60 \text{ Vdc}, I_E = 0, T_C = 85^\circ\text{C}$) ($V_{CB} = 80 \text{ Vdc}, I_E = 0$) ($V_{CB} = 100 \text{ Vdc}, I_E = 0$) ($V_{CB} = 100 \text{ Vdc}, I_E = 0, T_C = 85^\circ\text{C}$) ($V_{CB} = 120 \text{ Vdc}, I_E = 0$) ($V_{CB} = 2 \text{ Vdc}, I_E = 0$)	I_{CBO}	—	—	1 15 20 1 15 20 2 20 20 0.3	mAdc
Emitter-Base Leakage Current ($V_{EB} = 0.75 \text{ Vdc}$)	I_{EBO}	—	—	50	mAdc
Emitter Floating Potential ($V_{CE} = 40 \text{ Vdc}$) ($V_{CE} = 80 \text{ Vdc}$) ($V_{CE} = 120 \text{ Vdc}$)	V_{EBF}	—	—	-1.0 -1.0 -1.0	Vdc
Collector-Emitter Breakdown Voltage* ($I_C = 50 \text{ mAdc}, R_{BE} = 100 \Omega$)	BV_{CER}^*	40 80 120	—	—	Vdc
DC Current Gain ($I_C = 5 \text{ Adc}, V_{CE} = -2.0 \text{ Vdc}$)	h_{FE}	20	—	60	—
Small Signal Current Gain ($I_C = 0.5 \text{ Adc}, V_{CE} = 12 \text{ Vdc}, f = 30 \text{ kc}$)	h_{fe}	—	15	—	—
Base Input Voltage ($V_{CE} = 2.0 \text{ Vdc}, I_C = 5 \text{ Adc}$)	V_{BE}	—	—	1.0	Vdc
Collector-Emitter Saturation Voltage ($I_C = 5 \text{ Adc}, I_B = 0.5 \text{ Adc}$)	$V_{CE(sat)}$	—	0.5	1.0	Vdc
Rise Time	t_r	—	5.5	—	μsec
Storage Time	t_s	—	1.2	—	μsec
Fall Time	t_f	—	2.0	—	μsec

*To avoid excessive heating of collector junction, perform this test with a sweep method.

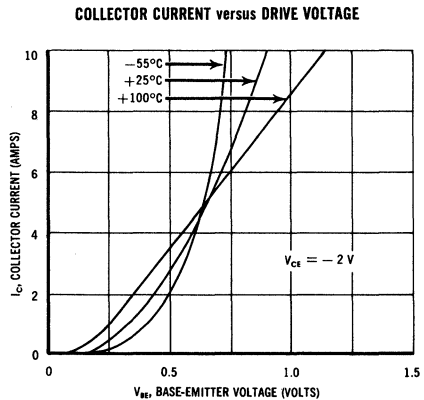
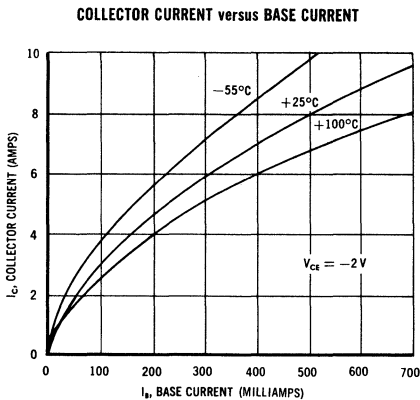

2N1073, A, B (continued)

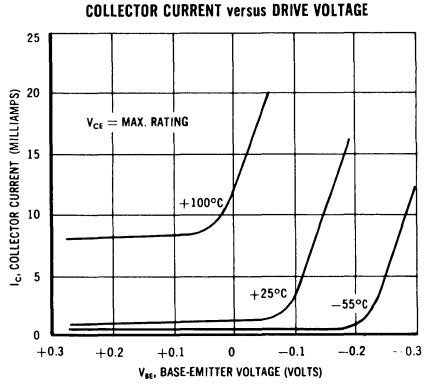
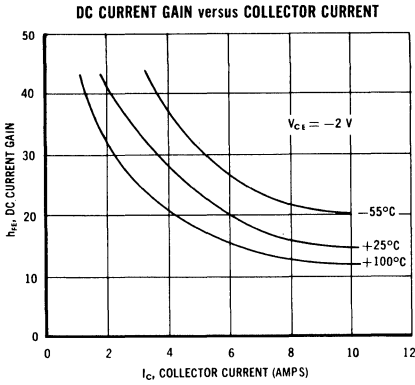

SWITCHING TEST CIRCUIT

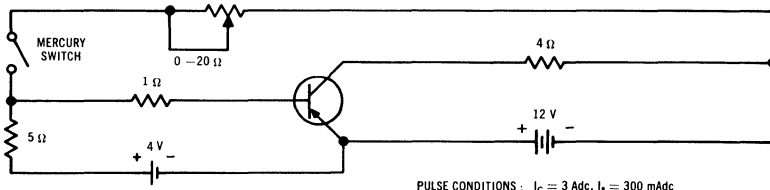

2N1099

For Specifications, See 2N277 Data Sheet

2N1100

For Specifications, See 2N174 Data Sheet

2N1120

$P_C = 90\text{ W}$
 $I_C = 15\text{ A}$
 $V_{CBO} = 80\text{ V}$

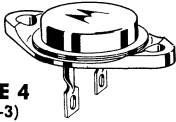

CASE 4
(TO-3)

PNP germanium power transistors for military and industrial power applications.

MAXIMUM RATINGS

Characteristic	Symbol	Rating	Unit
Collector-Base Voltage	V_{CBO}	80	Vdc
Collector-Emitter Voltage	V_{CES}	70	Vdc
Collector-Emitter Voltage	V_{CEO}	40	Vdc
Emitter-Base Voltage	V_{EBO}	40	Vdc
Emitter Current	I_E	15	Amps
Operating Temperature Range (MIL-T-19500/68)	—	-65 to +95	°C
Operating Temperature Range (MOTOROLA 2N1120)	—	-65 to +100	°C
Collector Dissipation at 25°C Case Temperature (MIL-T-19500/68)	P_C	45	Watts
Collector Dissipation at 25°C Case Temperature (MOTOROLA 2N1120)	P_C	90	Watts

**POWER — TEMPERATURE
DERATING CURVE**

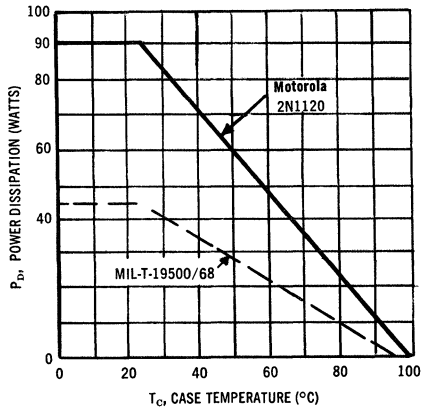

2N1120 (continued)

ELECTRICAL CHARACTERISTICS (At 25°C unless otherwise specified)

Characteristic	Symbol	Min	Max	Unit
DC Current Transfer Ratio V _{CE} = 2V I _C = 5.0 Adc	h _{FE}	—	100	—
DC Current Transfer Ratio V _{CE} = 2V I _C = 10.0 Adc	h _{FE}	20	50	—
Small Signal Current Transfer Ratio Cutoff Frequency V _{CE} = 2 Vdc I _C = 5 amps	f _{ac}	3	—	kc
Emitter-Base Cutoff Current V _{EB} = 40 Vdc I _C = 0	I _{EB0}	—	5.0	mAdc
Collector-Base Cutoff Current V _{CB} = 2 Vdc I _E = 0	I _{CB0}	—	300	μAdc
Collector-Base Cutoff Current V _{CB} = 80 Vdc I _E = 0	I _{CB0}	—	15.0	mAdc
Base Current V _{CE} = 2 Vdc I _C = 5 Adc	I _B	50	—	mAdc
Base Current V _{CE} = 2 Vdc I _C = 10 Adc	I _B	200	500	mAdc
Emitter-Base Voltage V _{CE} = 2 Vdc I _C = 10 Adc	V _{EB}	—	2.0	Vdc
Floating Potential V _{CB} = 80 Vdc Voltmeter Input Resistance = 10 meg. min.	V _{f1}	—	1.0	Vdc
Collector-Emitter Voltage (Saturation) I _C = 10 Adc I _B = 1 Adc	V _{CE(SAT)}	—	1.0	Vdc
Base-Emitter Voltage (Saturation) I _B = 1 Adc I _C = 10 Adc	V _{BE}	—	1.5	Vdc
Collector-Emitter Voltage I _C = 300 mAdc I _B = 0	BV _{CEO}	40	—	Vdc
Collector-Emitter Voltage I _C = 300 mAdc V _{EB} = 0	BV _{CES}	70	—	Vdc
Small-Signal Short-Circuit Forward- Current Transfer Ratio Cutoff Frequency V _{CE} = 2 Vdc I _C = 5 Adc	f _{ac}	3	—	kc
High-Temperature Operation T _C = +90°C (min)				
Collector Cutoff Current V _{CB} = 30 Vdc I _E = 0	I _{CB0}	—	20	mAdc

2N1162 thru 2N1167

P_C = 106 W
I_C = 25 A
V_{CB0} = 50-100 V

CASE 3, 4
(TO-3, 41)

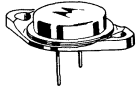

PNP germanium power transistors for switching and amplifier applications in high reliability equipment.

MAXIMUM RATINGS

Characteristics	Symbol	2N1162 2N1163	2N1164 2N1165	2N1166 2N1167	Unit
Collector - Base Voltage	V _{CB0}	50	80	100	Vdc
Collector - Emitter Voltage	V _{CES} *	35	60	75	Vdc
Emitter - Base Voltage	V _{EBO}	25	40	50	Vdc
DC Collector Current	I _C	25	25	25	Amps
Collector Junction Temperature	T _j	110	110	110	C
Collector Dissipation	P _C	106	106	106	Watts
Thermal Resistance	θ _{JC}	← 0.6 →			°C/W

* To avoid excessive heating of the collector junction, perform this test with a sweep method.

POWER-TEMPERATURE DERATING CURVE

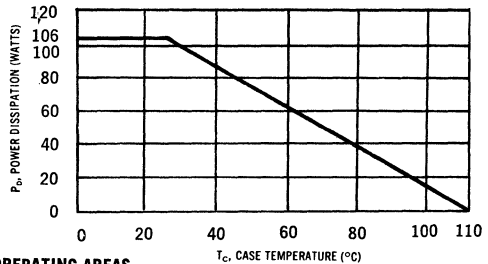

SAFE OPERATING AREAS

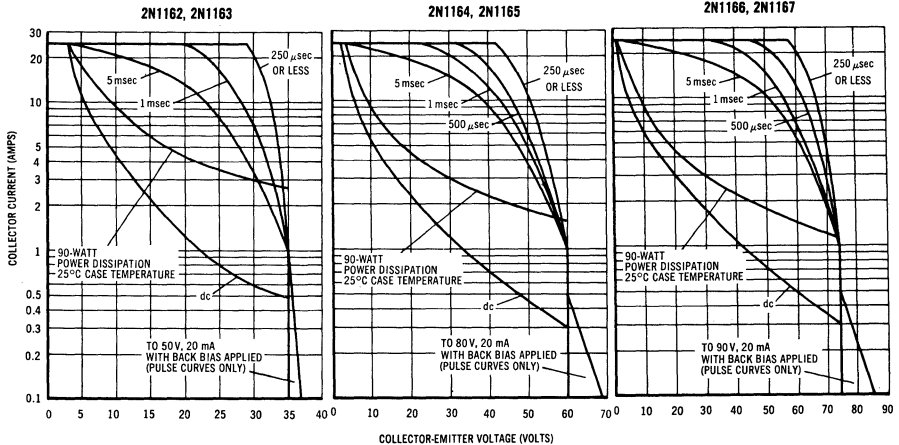

The Safe Operating Area Curves indicate I_C - V_{CE} limits below which the device will not go into secondary breakdown. Collector load lines for specific circuits must fall within the applicable Safe Area to avoid causing a collector-emitter short.

(Duty cycle of the excursions make no significant change in these safe areas.) To insure operation below the maximum T_j, the power-temperature derating curve must be observed for both steady state and pulse power conditions.

2N1162 thru 2N1167 (continued)

ELECTRICAL CHARACTERISTICS (At 25°C case temperature unless otherwise specified)

Parameter	Symbol	Min	Typ	Max	Unit
Collector Cutoff Current $V_{CB} = BV_{CBO(max)}, I_E = 0$ All Types	I_{CBO1}	—	3	15	mA
Collector Cutoff Current $V_{CB} = 2V, I_E = 0$ All Types $V_{CB} = 15V, I_E = 0, T_C = 90^\circ C$ 2N1162-3 $V_{CB} = 30V, I_E = 0, T_C = 90^\circ C$ 2N1164-7	I_{CBO}	—	125 10 10	225 20 20	μA mA mA
Collector-Emitter Breakdown Voltage $I_C = 500mA, V_{EB} = 0$ 2N1162-3 2N1164-5 2N1166-7	$BV_{CES} \dagger$	35 60 75	— — —	— — —	V _{dc}
Emitter Cutoff Current $V_{EB} = 12V, I_C = 0$ All Types	I_{EBO}	—	0.5	1.2	mA
DC Forward Current Gain $V_{CE} = 1V, I_C = 25A$ All Types $V_{CE} = 2V, I_C = 5A$ All Types	h_{FE1} h_{FE}	15 —	25 65	125	—
Collector - Emitter Saturation Voltage $I_C = 25A, I_B = 1.6A$ All Types	$V_{CE(sat)}$	—	0.3	0.8	volts
Base - Emitter Drive Voltage $I_C = 25A, I_B = 1.6A$ All Types	V_{BE}	—	0.7	1.7	volts
Common Emitter - Cutoff Frequency $V_{CE} = 2V, I_C = 2A$ All Types	f_{ae}	—	4	—	kc

SWITCHING CHARACTERISTICS

Saturated Collector Current	Pulsed Drive Base Current		Response times in μsec		
	On	Off	$t_d + t_r$	t_s	t_f
5 amps	330 mA	100 mA	11	5	17
10 amps	660 mA	200 mA	15	4	20
25 amps	1700 mA	500 mA	19	3	18

2N1162 thru 2N1167 (continued)
COLLECTOR CURRENT vs BASE-EMITTER VOLTAGE

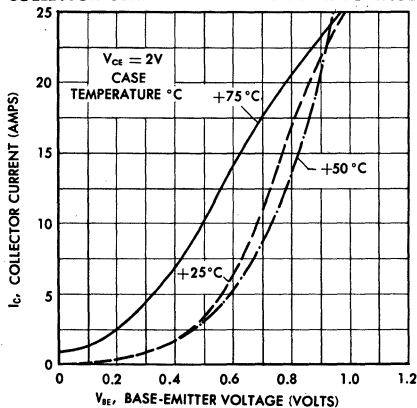

COLLECTOR CURRENT vs BASE CURRENT

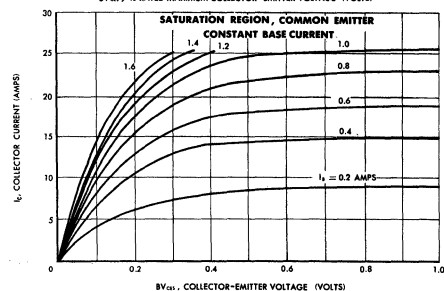
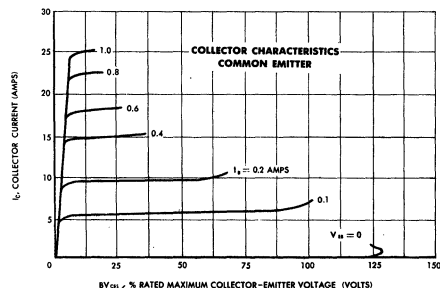
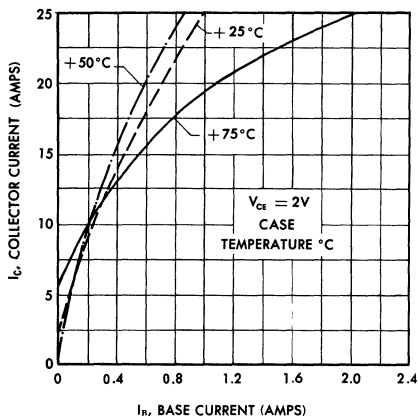

CURRENT GAIN vs COLLECTOR CURRENT

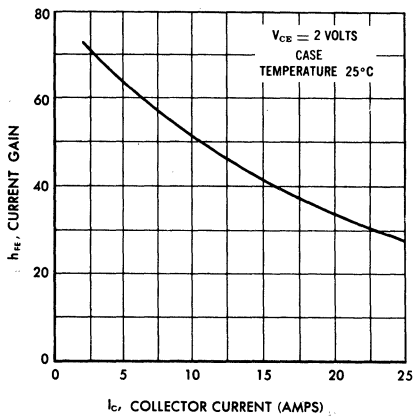

2N1358

For Specifications, See 2N174 Data Sheet

2N1359

2N1360

2N1362 thru 2N1365

For Specifications, See 2N375 Data Sheet

2N1412

$P_C = 150 \text{ W}$
 $I_C = 15 \text{ A}$
 $V_{CBO} = 100 \text{ V}$

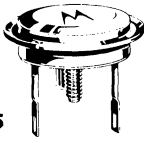

CASE 5
(TO-36)

PNP germanium power transistors for high-voltage power amplifier and switching applications in military and industrial equipment.

MAXIMUM RATINGS

Characteristic	Symbol	Rating	Unit
Collector-Base Voltage	V_{CBO}	100	Vdc
Collector-Emitter Voltage	V_{CES}	80	Vdc
Collector-Emitter Voltage	V_{CEO}	60	Vdc
Emitter-Base Voltage	V_{EBO}	60	Vdc
Emitter Current (Continuous)	I_E	15	Amps
Base Current (Continuous)	I_B	4	Amps
Junction & Storage Temperature	T_{stg}	-65 to +100	°C
Thermal Resistance	θ_{JC}	0.5	°C/W

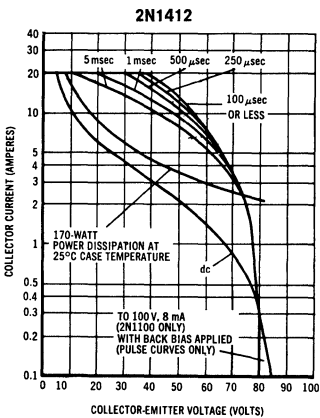

The Safe Operating Area Curves indicate $I_C - V_{CE}$ limits below which the device will not go into secondary breakdown. Collector load lines for specific circuits must fall within the applicable Safe Area to avoid causing a collector-emitter short.

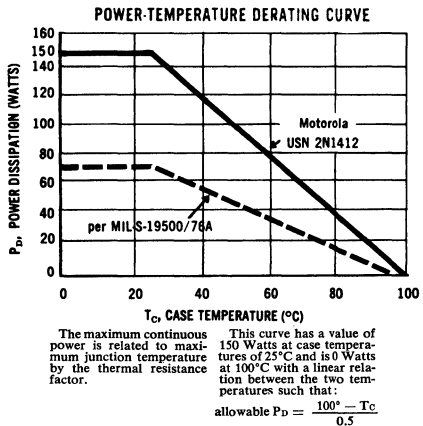

(Duty cycle of the excursions make no significant change in these safe areas.) To insure operation below the maximum T_J , the power-temperature derating curve must be observed for both steady state and pulse power conditions.

2N1412 (continued)

ELECTRICAL CHARACTERISTICS

Characteristic	Symbol	Minimum	Maximum	Unit
Emitter Cutoff Current $V_{EB} = -2.0$ Vdc $I_C = 0$	I_{EBO}	—	200	μ Adc
Emitter Cutoff Current $V_{EB} = -60$ Vdc $I_C = 0$	I_{EBO}	—	10	mAdc
Collector Cutoff Current $V_{CB} = -2.0$ Vdc $I_E = 0$	I_{CBO}	—	200	μ Adc
Collector Cutoff Current $V_{CB} = -100$ Vdc $I_E = 0$	I_{CBO}	—	10	mAdc
Emitter-Base Voltage $V_{CE} = -2.0$ Vdc $I_C = -1.2$ Adc	V_{EB}	0.0	0.5	Vdc
Emitter-Base Voltage $V_{CE} = -2.0$ Vdc $I_C = -5.0$ Adc	V_{EB}	0.0	0.9	Vdc
Floating Potential $V_{CB} = -100$ Vdc $I_E = 0$ (Voltmeter input resistance = 10 Megohm min)	V_{fl}	0.0	1.0	Vdc
Collector-Emitter Saturation Voltage $I_C = -12$ Adc $I_B = -2.0$ Adc	$V_{CE(SAT)}$	0.0	0.7	Vdc
Forward Current Transfer Ratio* $V_{CE} = -2.0$ Vdc $I_C = -15$ Adc	h_{FE}	10	—	—
Forward Current Transfer Ratio $V_{CE} = -2.0$ Vdc $I_C = -5.0$ Adc	h_{FE}	25	50	—
Collector-Emitter Breakdown Voltage* $I_C = -1$ Adc $I_B = 0$	BV_{CEO}	60	—	Vdc
Collector-Emitter Breakdown Voltage* $V_{EB} = 0$ $I_C = 300$ mA	BV_{CES}	80	—	Vdc
Small-Signal Short-Circuit Forward-Current Transfer Ratio Cutoff Frequency $V_{CE} = -12$ Vdc $I_C = -5.0$ Adc	f_{ae}	5	—	kc
High-Temperature Operation Emitter Cutoff Current $T_C = +71^\circ\text{C}$ min $V_{EB} = -30$ Vdc	I_{EBO}	—	6.0	mAdc
Collector Cutoff Current $V_{CB} = -30$ Vdc $I_E = 0$	I_{CBO}	—	6.0	mAdc

*Test by sweep method with a short duty cycle (about 1%) to avoid excessive heating.

2N1412 (continued)

INPUT CHARACTERISTICS

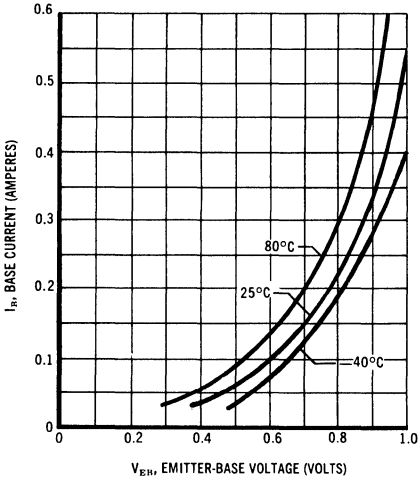

CURRENT TRANSFER CHARACTERISTICS

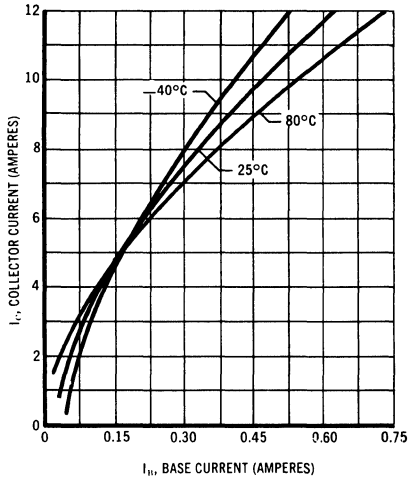

TRANSCONDUCTANCE CHARACTERISTICS

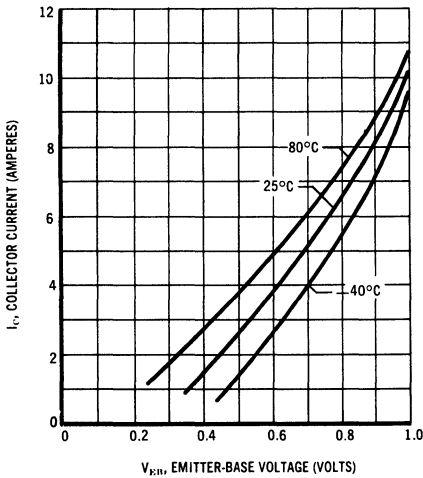

OUTPUT CHARACTERISTICS

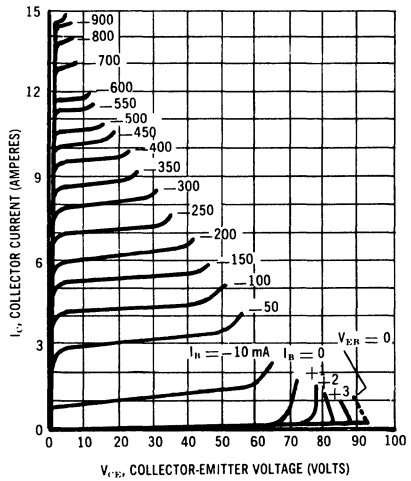

2N1529 thru 2N1538

$P_C = 106W$
 $I_C = 5A$
 $V_{CBO} = 40-120V$

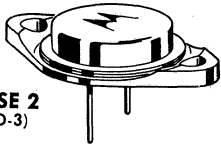

CASE 2
(TO-3)

PNP germanium power transistors for switching and amplifier applications in high-reliability equipment.

For units with solder lugs attached, specify devices MP1529A etc. (TO-41 package)

MAXIMUM RATINGS

Characteristic	Symbol	2N1529 2N1534	2N1530 2N1535	2N1531 2N1536	2N1532 2N1537	2N1533 2N1538	Unit	
Collector-Emitter Voltage	V_{CEX}	40	60	80	100	120	Vdc	
Collector-Emitter Voltage	V_{CES}	30	45	60	75	90	Vdc	
Collector-Emitter Voltage	V_{CEO}	20	30	40	50	60	Vdc	
Collector-Base Voltage	V_{CBO}	40	60	80	100	120	Vdc	
Collector-Base Voltage	V_{EBO}	20	30	40	50	60	Vdc	
Collector Current (Continuous)	I_C	5	5	5	5	5	Amps	
Collector Current (Peak)	I_C	10	10	10	10	10	Amps	
Junction Temperature Range	T_J	← -65 to +110 →						°C
Collector Dissipation (25°C Case Temperature)	P_C	106	106	106	106	106	Watts	
Thermal Resistance	θ_{JC}	← 0.8 →						°C/W

SAFE OPERATING AREAS — PULSE CONDITIONS

The Safe Operating Area Curves indicate $I_C - V_{CE}$ limits below which the device will not go into secondary breakdown. Collector load lines for specific circuits must fall within the applicable Safe Area to avoid causing a collector-emitter short.

(Duty cycle of the excursions make no significant change in these safe areas.) To insure operation below the maximum T_J , the power-temperature derating curve must be observed for both steady state and pulse power conditions.

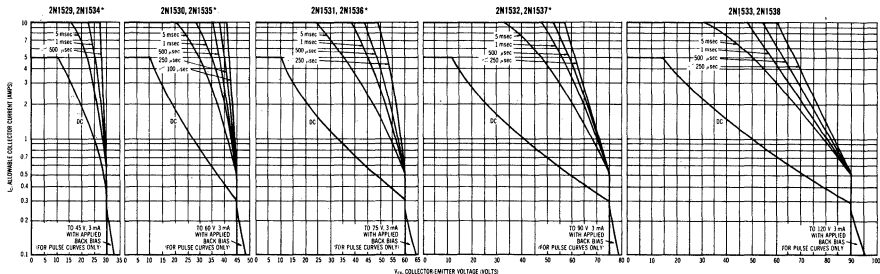

2N1529 thru 2N1538 (continued)

ELECTRICAL CHARACTERISTICS ($T_C = 25^\circ\text{C}$ unless otherwise specified.)

Characteristic		Symbol	Min	Max	Unit
Collector-Base Cutoff Current ($V_{CB} = 25\text{V}$) ($V_{CB} = 40\text{V}$) ($V_{CB} = 55\text{V}$) ($V_{CB} = 65\text{V}$) ($V_{CB} = 80\text{V}$)	2N1529, 2N1534 2N1530, 2N1535 2N1531, 2N1536 2N1532, 2N1537 2N1533, 2N1538	I_{CBO1}	—	2.0	mA
Collector-Base Cutoff Current ($V_{CB} = 2\text{V}$) ($V_{CB} = 1/2 BV_{CES}$ rating; $T_C = +90^\circ\text{C}$)	All Types All Types	I_{CBO}	—	0.2 20	mA
Emitter-Base Cutoff Current ($V_{EB} = 12\text{V}$)	All Types	I_{EBO}	—	0.5	mA
Collector-Emitter Breakdown Voltage ($I_C = 500\text{ mA}$, $V_{EB} = 0$)	2N1529, 2N1534 2N1530, 2N1535 2N1531, 2N1536 2N1532, 2N1537 2N1533, 2N1538	BV_{CES}	30 45 60 75 90	— — — — —	volts
Collector-Emitter Leakage Current ($V_{BE} = 1\text{V}$; V_{CE} @ rated BV_{CBO})	All Types	I_{CEX}	—	20	mA
Collector-Emitter Breakdown Voltage ($I_C = 500\text{ mA}$, $I_B = 0$)	2N1529, 2N1534 2N1530, 2N1535 2N1531, 2N1536 2N1532, 2N1537 2N1533, 2N1538	BV_{CEO}	20 30 40 50 60	— — — — —	volts
Collector-Base Breakdown Voltage ($I_C = 20\text{ mA}$)	2N1529, 2N1534 2N1530, 2N1535 2N1531, 2N1536 2N1532, 2N1537 2N1533, 2N1538	BV_{CBO}	40 60 80 100 120	— — — — —	volts
Current Gain ($V_{CE} = 2\text{V}$, $I_C = 3\text{A}$)	2N1529 - 2N1532 2N1534 - 2N1537 2N1529 - 2N1533 2N1534 - 2N1538	h_{FE1}	20 35 20 35	40 70 40 70	—
Base-Emitter Saturation Voltage ($I_C = 3\text{A}$, $I_B = 300\text{ mA}$)	2N1529 - 2N1532 2N1534 - 2N1537 2N1529 - 2N1533 2N1534 - 2N1538	$V_{BE(sat)}$	— — — —	1.7 1.5 1.7 1.5	volts
Collector-Emitter Saturation Voltage ($I_C = 3\text{A}$, $I_B = 300\text{ mA}$)	2N1529 - 2N1532 2N1534 - 2N1537 2N1529 - 2N1533 2N1534 - 2N1538	$V_{CE(sat)}$	— — — —	1.5 1.2 1.5 1.2	volts
Transconductance ($V_{CE} = 2\text{V}$, $I_C = 3\text{A}$)	2N1529 - 2N1532 2N1534 - 2N1537 2N1529 - 2N1533 2N1534 - 2N1538	g_{FE}	1.2 1.5 1.2 1.5	— — — —	mhos

2N1529 thru 2N1538 (continued)

POWER-TEMPERATURE DERATING CURVE

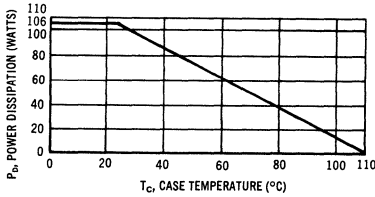

The maximum continuous power is related to maximum junction temperature, by the thermal resistance factor. For d. c. or frequencies below 25 cps the transistor must be operated within the constant $P_D = V_C \times I_C$ hyperbolic curve. This curve has a value of 106 Watts at case temperatures of 25°C and is 0 Watts at 110°C with a linear relation between the two temperatures such that

$$P_D \text{ allowable} = \frac{110^\circ - T_c}{.08}$$

COLLECTOR CURRENT versus BASE CURRENT

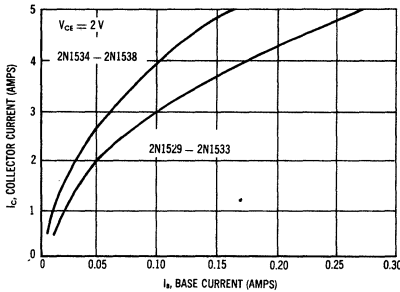

COLLECTOR CURRENT versus EMITTER-BASE VOLTAGE

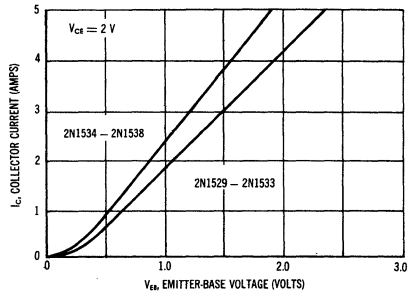

SWITCHING TIME MEASURING CIRCUIT

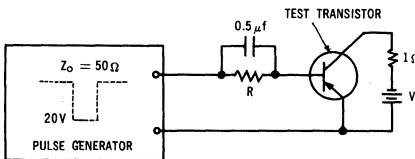

TYPICAL SWITCHING CHARACTERISTICS

	I _C (Amps)	V (Volts)	R (ohms)	t _o +t _r (μsec)	t _f (μsec)	t _r (μsec)
2N1529-33	3	3	65	10	2	5
2N1534-38	3	3	100	8	3	5

DC CURRENT GAIN versus

COLLECTOR CURRENT

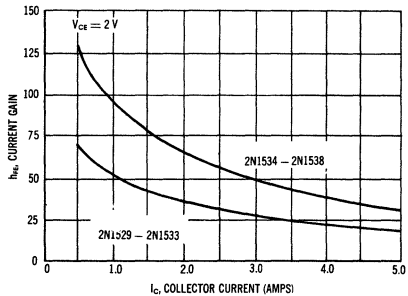

2N1539 thru 2N1548

$P_C = 106 \text{ W}$
 $I_C = 5 \text{ A}$
 $V_{CBO} = 40-120 \text{ V}$

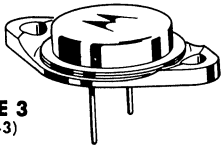

CASE 3
(TO-3)

PNP germanium power transistors for switching and amplifier applications in high-reliability equipment.

For units with solder lugs attached, specify devices MP1539A etc.

MAXIMUM RATINGS

Characteristics	Symbol	2N1539	2N1540	2N1541	2N1542	2N1543	Unit	
		2N1544	2N1545	2N1546	2N1547	2N1548		
Collector-Emitter Voltage	V_{CEX}	40	60	80	100	120	Vdc	
Collector-Emitter Voltage	V_{CES}	30	45	60	75	90	Vdc	
Collector-Emitter Voltage	V_{CEO}	20	30	40	50	60	Vdc	
Collector-Base Voltage	V_{CBO}	40	60	80	100	120	Vdc	
Emitter-Base Voltage	V_{EBO}	20	30	40	50	60	Vdc	
Collector Current (Continuous)	I_C	5	5	5	5	5	Amps	
Collector Current (Peak)	I_C	10	10	10	10	10	Amps	
Collector Junction Temperature Range	T_J	← -65 to +110 →						C
Collector Dissipation (25 C Case Temp.)	P_C	106	106	106	106	106	Watts	
Thermal Resistance	θ_{JC}	← 0.8 →						$^{\circ}\text{C}/\text{W}$

The maximum continuous power is related to maximum junction temperature, by the thermal resistance factor. For d. c. or frequencies below 25 cps the transistor must be operated within the constant $P_D = V_c \times I_c$ hyperbolic curve. This curve has a value of 106 Watts at case temperatures of 25°C and is 0 Watts at 110°C with a linear relation between the two temperatures such that

$$P_D \text{ allowable} = \frac{110^{\circ} - T_c}{0.8}$$

POWER - TEMPERATURE DERATING CURVE

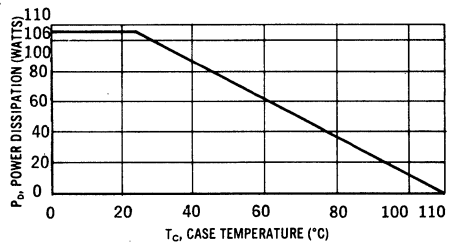

2N1539 thru 2N1548 (continued)

ELECTRICAL CHARACTERISTICS (At 25°C case temperature unless otherwise specified)

Parameter	Symbol	Min	Max	Unit
Collector-Base Cutoff Current ($V_{CB} = 25\text{ V}$) 2N1539, 2N1544 ($V_{CB} = 40\text{ V}$) 2N1540, 2N1545 ($V_{CB} = 55\text{ V}$) 2N1541, 2N1546 ($V_{CB} = 65\text{ V}$) 2N1542, 2N1547 ($V_{CB} = 80\text{ V}$) 2N1543, 2N1548	I_{CBO1}	—	2.0	mA
Collector-Base Cutoff Current ($V_{CB} = 2\text{ V}$) All Types ($V_{CB} = \frac{1}{2} BV_{CES}$ rating, All Types $T_C = 90^\circ\text{C}$)	I_{CBO}	—	0.2 20	mA
Emitter-Base Cutoff Current ($V_{EB} = 12\text{ V}$) All Types	I_{EBO}	—	0.5	mA
Collector-Emitter Breakdown Voltage † ($I_C = 500\text{ mA}$)	BV_{CES}^\dagger			volts
2N1539, 2N1544		30	—	
2N1540, 2N1545		45	—	
2N1541, 2N1546		60	—	
2N1542, 2N1547		75	—	
2N1543, 2N1548		90	—	
Collector-Emitter Leakage Current ($V_{BE} = 1\text{ V}$, V_{CE} @ rated BV_{CBO}) All Types	I_{CEX}	—	20	mA
Collector-Emitter Breakdown Voltage † ($I_C = 500\text{ mA}$, $I_B = 0$)	BV_{CEO}^\dagger			volts
2N1539, 2N1544		20	—	
2N1540, 2N1545		30	—	
2N1541, 2N1546		40	—	
2N1542, 2N1547		50	—	
2N1543, 2N1548		60	—	
Collector-Base Breakdown Voltage ($I_C = 20\text{ mA}$)	BV_{CBO}			volts
2N1539, 2N1544		—	40	
2N1540, 2N1545		—	60	
2N1541, 2N1546		—	80	
2N1542, 2N1547		—	100	
2N1543, 2N1548		—	120	
Current Gain ($V_{CE} = 2\text{ V}$, $I_C = 3\text{ A}$)	h_{FE1}			—
2N1539 - 2N1542		50	100	
2N1544 - 2N1547		75	150	
2N1539 - 2N1543		50	100	
2N1544 - 2N1548		75	150	
Base-Emitter Drive Voltage ($I_C = 3\text{ A}$, $I_B = 300\text{ mA}$)	V_{BE}			volts
2N1539 - 2N1542		—	0.7	
2N1544 - 2N1547		—	0.5	
2N1539 - 2N1543		—	0.7	
2N1544 - 2N1548		—	0.5	
Collector Saturation Voltage ($I_C = 3\text{ A}$, $I_B = 300\text{ mA}$)	$V_{CE(sat)}$			volts
2N1539 - 2N1542		—	0.6	
2N1544 - 2N1547		—	0.3	
2N1539 - 2N1543		—	0.6	
2N1544 - 2N1548		—	0.3	
Transconductance ($V_{CE} = 2\text{ V}$, $I_C = 3\text{ A}$)	g_{FE}			mhos
2N1539 - 2N1542		3.0	—	
2N1544 - 2N1547		5.0	—	
2N1539 - 2N1543		3.0	—	
2N1544 - 2N1548		5.0	—	
Frequency Cutoff ($V_{CE} = 2\text{ V}$, $I_C = 3\text{ A}$) All Types	f_{ae}		^{Typ} 4	kc

* Characteristics apply to corresponding, non-A type numbers also

† To avoid excessive heating of collector junction, perform this test with a sweep method

2N1539 thru 2N1548 (continued)

SWITCHING TIME MEASURING UNIT

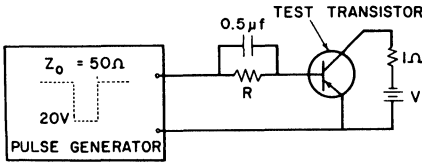

Devices	Conditions*			Typical Switching Times		
	I_C (Amps)	V (Volts)	R (ohms)	$t_d + t_r$ (μ sec)	t_s (μ sec)	t_f (μ sec)
2N1539-43	3	3	165	5	3	5
2N1544-48	3	3	250	5	3	8

*Input Pulse Repetition Rate = 2 kc, Pulse Width = 50 μ sec

COLLECTOR CURRENT versus EMITTER BASE VOLTAGE

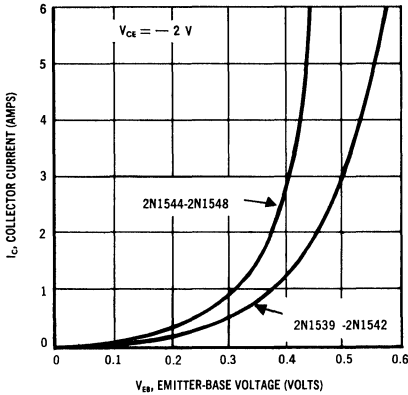

COLLECTOR CURRENT versus BASE CURRENT

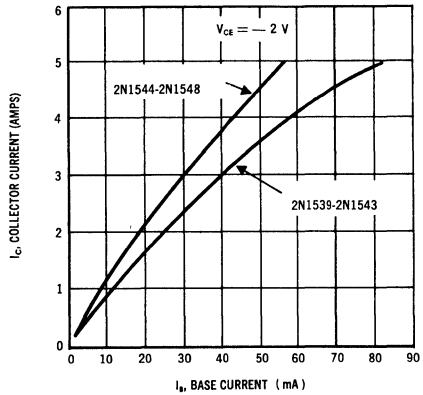

SAFE OPERATING AREAS

The Safe Operating Area Curves indicate $I_C - V_{CE}$ limits below which the device will not go into secondary breakdown. Collector load lines for specific circuits must fall within the applicable Safe Area to avoid causing a collector-emitter short. (Case temperature and duty cycle of the excursions make no significant change in these safe areas.) To insure operation below the maximum T_J , the power-temperature de-rating curve must be observed for both steady state and pulse power conditions.

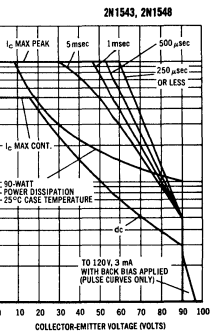
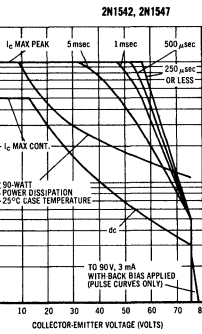
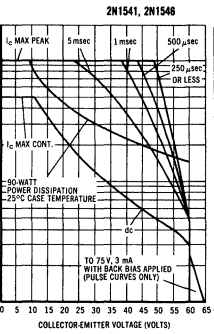
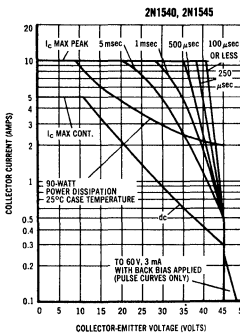
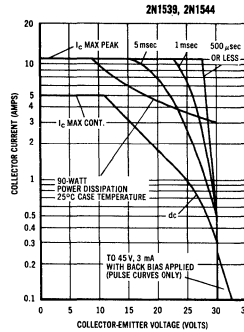

2N1539 thru 2N1548 (continued)

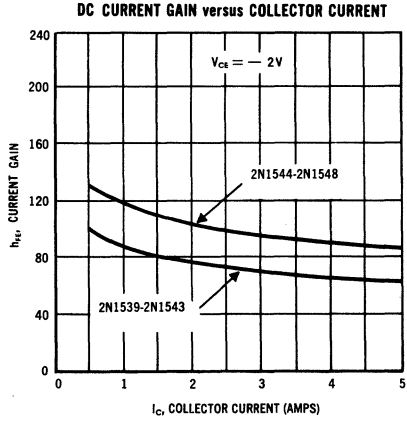
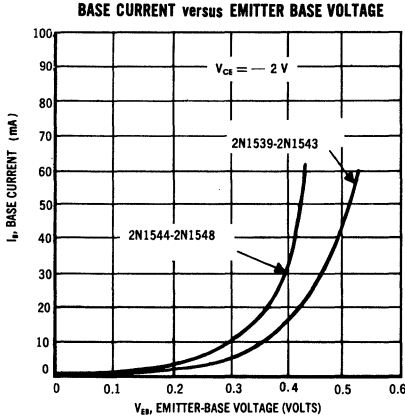

2N1549 thru 2N1560

**$P_C = 106 \text{ W}$
 $I_C = 15 \text{ A}$
 $V_{CBO} = 40-100 \text{ V}$**

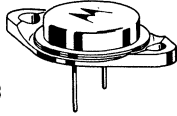

CASE 3
(TO-3)

PNP germanium power transistors for switching and amplifier applications in high-reliability equipment.

For units with solder lugs attached, specify devices MP1549A etc.

MAXIMUM RATINGS

Characteristic	Symbol	2N1549	2N1550	2N1551	2N1552	Unit
		2N1553 2N1557	2N1554 2N1558	2N1555 2N1559	2N1556 2N1560	
Collector-Emitter Voltage	V_{CEX}	40	60	80	100	Vdc
Collector-Emitter Voltage	V_{CES}^*	30	45	60	75	Vdc
Collector-Emitter Voltage	V_{CEO}^*	20	30	40	50	Vdc
Collector-Base Voltage	V_{CBO}	40	60	80	100	Vdc
Emitter-Base Voltage	V_{EBO}	20	30	40	50	Vdc
Collector Current (Continuous)	I_C	15	15	15	15	Amp
Collector Current (Peak)	I_C	20	20	20	20	Amp
Collector Junction Temperature	T_J	← -65 to +110 →				C
Collector Dissipation (25 °C Case Temp.)	P_C	106	106	106	106	Watts
Thermal Resistance	θ_{JC}	← 0.8 →				°C/W

*To avoid excessive heating of collector junction, perform this test with a sweep method.

2N1549 thru 2N1560 (continued)

ELECTRICAL CHARACTERISTICS (At 25°C case temperature unless otherwise specified)

Parameter	Symbol	Min	Max	Unit
Collector-Base Cutoff Current ($V_{CB} = 25$ V) 2N1549, 2N1553, 2N1557	I_{CBO1}	—	3.0	mA
($V_{CB} = 40$ V) 2N1550, 2N1554, 2N1558		—	3.0	
($V_{CB} = 55$ V) 2N1551, 2N1555, 2N1559		—	3.0	
($V_{CB} = 65$ V) 2N1552, 2N1556, 2N1560		—	3.0	
Collector-Base Cutoff Current ($V_{CB} = 2$ V) All Types	I_{CBO}	—	0.2	mA
($V_{CB} = 1/2$ BV_{CES} rating; $T_C = +90$ C)		—	20	
Emitter-Base Cutoff Current ($V_{EB} = 12$ V) All Types	I_{EBO}	—	0.5	mA
Collector-Emitter Breakdown Voltage ($I_C = 300$ mA)	BV_{CES}			volts
2N1549, 2N1553, 2N1557		30	—	
2N1550, 2N1554, 2N1558		45	—	
2N1551, 2N1555, 2N1559		60	—	
2N1552, 2N1556, 2N1560		75	—	
Collector-Emitter Leakage Current ($V_{BE} = 1$ V, V_{CE} @ rated BV_{CBO}) All Types	I_{CEX}	—	20	mA
Collector-Emitter Breakdown Voltage ($I_C = 300$ mA, $I_B = 0$)	BV_{CEO}			volts
2N1549, 2N1553, 2N1557		20	—	
2N1550, 2N1554, 2N1558		30	—	
2N1551, 2N1555, 2N1559		40	—	
2N1552, 2N1556, 2N1560		50	—	
Collector-Base Breakdown Voltage ($I_C = 20$ mA)	BV_{CBO}			volts
2N1549, 2N1553, 2N1557		40	—	
2N1550, 2N1554, 2N1558		60	—	
2N1551, 2N1555, 2N1559		80	—	
2N1552, 2N1556, 2N1560		100	—	
Current Gain ($V_{CE} = 2$ V, $I_C = 10$ A)	h_{FE1}			—
2N1549 - 2N1552		10	30	
2N1553 - 2N1556		30	60	
2N1557 - 2N1560		50	100	
Base-Emitter Drive Voltage ($I_C = 10$ A, $I_B = 1$ A)	V_{BE}			volts
2N1549 - 2N1552		—	1.3	
2N1553 - 2N1556		—	1.0	
2N1557 - 2N1560		—	0.7	
Collector Saturation Voltage ($I_C = 10$ A, $I_B = 1.0$ A)	$V_{CE(sat)}$			volts
2N1549 - 2N1552		—	1.0	
2N1553 - 2N1556		—	0.7	
2N1557 - 2N1560		—	0.5	

2N1549 thru 2N1560 (continued)

ELECTRICAL CHARACTERISTICS (continued)

Parameter	Symbol	Min	Max	Unit
Transconductance ($V_{CE} = 2\text{ V}$, $I_C = 10\text{ A}$)	g_{FE}			mhos
2N1549 - 2N1552		6	18	
2N1553 - 2N1556		8	30	
2N1557 - 2N1560		12	40	
Frequency Cutoff	f_{ae}	Typ		kc
2N1549 - 2N1552		10		
2N1553 - 2N1556		6		
2N1557 - 2N1560		5		

Characteristics apply to corresponding, non-A type numbers also
To avoid excessive heating of collector junction, perform this test with a sweep method

COLLECTOR CURRENT versus BASE CURRENT

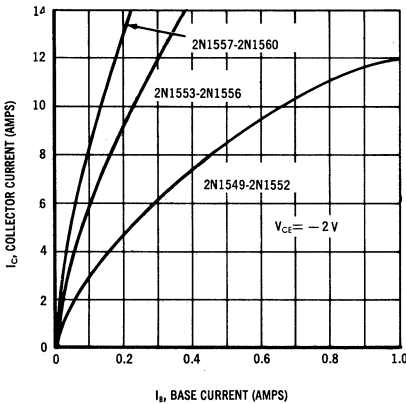

COLLECTOR CURRENT versus EMITTER-BASE VOLTAGE

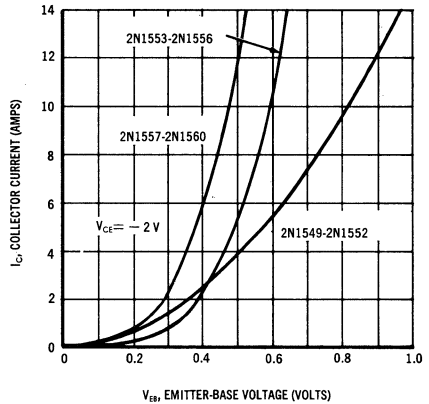

CURRENT GAIN versus COLLECTOR CURRENT

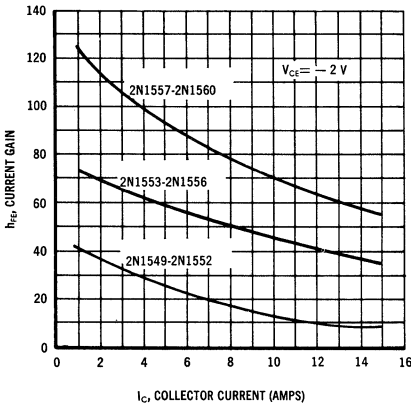

BASE CURRENT versus EMITTER-BASE VOLTAGE

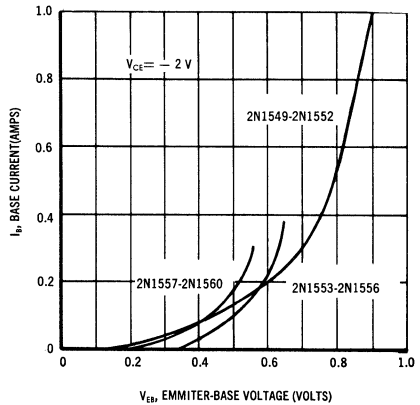

2N1549 thru 2N1560 (continued)

SAFE OPERATING AREAS

The Safe Operating Area Curves indicate I_C — V_{CE} limits below which the device will not go into secondary breakdown. Collector load lines for specific circuits must fall within the applicable Safe Area to avoid causing a collector-emitter short.

(Duty cycle of the excursions make no significant change in these safe areas.) To insure operation below the maximum T_J , the power-temperature derating curve must be observed for both steady state and pulse power conditions.

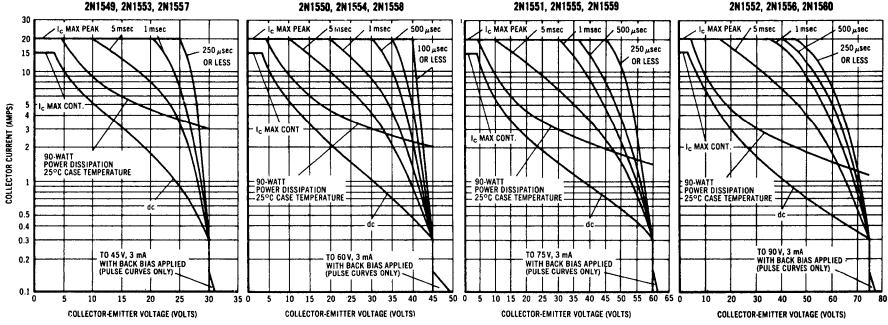

The maximum continuous power is related to maximum junction temperature, by the thermal resistance factor. For d. c. or frequencies below 25 cps the transistor must be operated within the constant $P_D = V_C \times I_C$ hyperbolic curve. This curve has a value of 106 watts at case temperatures of 25°C and is 0 watts at 110°C with a linear relation between the two temperatures such that P_D allowable = $\frac{110^\circ - T_c}{0.8}$

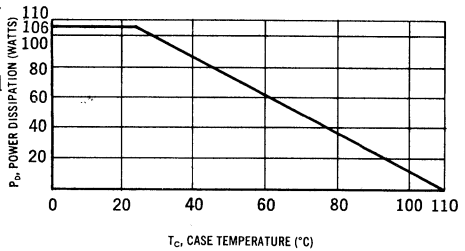

SWITCHING TIME MEASURING UNIT

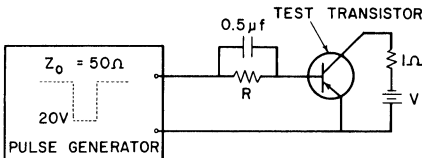

Devices	Conditions*			Typical Switching Times		
	I_C (Amps)	V (Volts)	R (ohms)	$t_r + t_f$ (µsec)	t_r (µsec)	t_f (µsec)
2N1549 -52	10	10	10	5	2	10
2N1553 -56	10	10	30	10	5	25
2N1557 -60	10	10	10	50	10	25

* Input Pulse Repetition Rate = 2 kc, Pulse Width = 50 µsec

2N1970

**$P_C = 170\text{ W}$
 $I_C = 15\text{ A}$
 $V_{CB0} = 50\text{-}100\text{ V}$**

2N1980 thru 2N1982

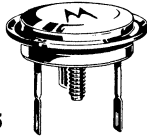

PNP germanium power transistors for general purpose amplifier and switching applications.

CASE 5
(TO-36)

MAXIMUM RATINGS

Characteristic	Symbol	2N1970	2N1980	2N1981	2N1982	Unit
Collector-Base Voltage	V_{CB0}	100	50	70	90	Volts
Collector-Emitter Voltage	V_{CEO}	50	30	40	50	Volts
Emitter-Base Voltage	V_{EBO}	40	20	20	20	Volts
Collector Current	I_C	15	15	15	15	Amps
Power Dissipation at $T_C = 25^\circ\text{C}$	P_C	170	170	170	170	Watts
Junction Temperature Range	T_J	← -65 to +110 →				$^\circ\text{C}$

ELECTRICAL CHARACTERISTICS $T_A = 25^\circ\text{C}$ unless otherwise noted

Characteristic	Symbol	Min	Max	Unit
Collector-Base Cutoff Current ($V_{CB} = -100\text{ Vdc}$)	I_{CBO}	—	4	mAdc
($V_{CB} = -50\text{ Vdc}$)	2N1980	—	6	
($V_{CB} = -70\text{ Vdc}$)	2N1981	—	6	
($V_{CB} = -90\text{ Vdc}$)	2N1982	—	6	
($V_{CB} = -2\text{ Vdc}$)	2N1980-2N1982	—	0.3	
Emitter-Base Cutoff Current ($V_{EB} = -40\text{ Vdc}$)	I_{EBO}	—	4	mAdc
($V_{EB} = -20\text{ Vdc}$)	2N1980-2N1982	—	5	
($V_{EB} = -2\text{ Vdc}$)	2N1980-2N1982	—	0.3	
Collector-Emitter Breakdown Voltage ($I_C = 1\text{ Adc}$, $I_B = 0$)	BV_{CEO}	-50	—	Vdc
	2N1980	-30	—	
	2N1981	-40	—	
	2N1982	-50	—	
Base-Emitter Voltage ($V_{CE} = -2\text{ Vdc}$, $I_C = 5\text{ Adc}$)	V_{BE}	—	-0.9	Vdc
Emitter Floating Potential ($V_{CB} = -50\text{ Vdc}$)	V_{EBF}	—	-1.0	Vdc
($V_{CB} = -70\text{ Vdc}$)	2N1981	—	-1.0	
($V_{CB} = -90\text{ Vdc}$)	2N1982	—	-1.0	
Collector-Emitter Saturation Voltage ($I_C = 12\text{ Adc}$, $I_B = 2\text{ Adc}$)	$V_{CE(sat)}$	—	-1.0	Vdc
($I_C = 5\text{ Adc}$, $I_B = 0.5\text{ Adc}$)	2N1980-2N1982	—	-0.5	
DC Current Gain ($I_C = 5\text{ Adc}$, $V_{CE} = -2\text{ Vdc}$)	h_{FE}	17	40	—
	2N1980-2N1982	50	100	
($I_C = 12\text{ Adc}$, $V_{CE} = -2\text{ Vdc}$)	2N1970	10	—	
Common Emitter Cutoff Frequency ($V_{CE} = -4\text{ V}$, $I_C = 5\text{ A}$)	f_{ae}	5	—	kc
($V_{CE} = -5\text{ V}$, $I_C = 2\text{ A}$)	2N1980-2N1982	3	—	

2N2075 thru 2N2082

$P_C = 170 \text{ W}$
 $I_C = 15 \text{ A}$
 $V_{CBO} = 40\text{-}80\text{V}$



CASE 5
(TO-36)

PNP germanium power transistors for high-power applications in high-reliability equipment.

MAXIMUM RATINGS

Apply to corresponding "Meg-A-Life" series also

CHARACTERISTIC	SYMBOL	2N2078 2N2082	2N2077 2N2081	2N2076 2N2080	2N2075 2N2079	UNIT
Collector-Base Voltage	V_{CBO}	40	50	70	80	Volts
Collector-Emitter Voltage	V_{CES}	40	50	70	80	Volts
Collector-Base Voltage	V_{CEO}	25	45	55	65	Volts
Emitter-Base Voltage	V_{EBO}	20	25	35	40	Volts
Collector Current	I_C	15	15	15	15	Amps
Power Dissipation at $T_C = 25 \text{ C}$	P_C	170	170	170	170	Watts
Junction Temperature Range	T_J	-65 to +110				$^{\circ}\text{C}$
Thermal Resistance, Junction to Case,	θ_{JC}	0.5				$^{\circ}\text{C/W}$

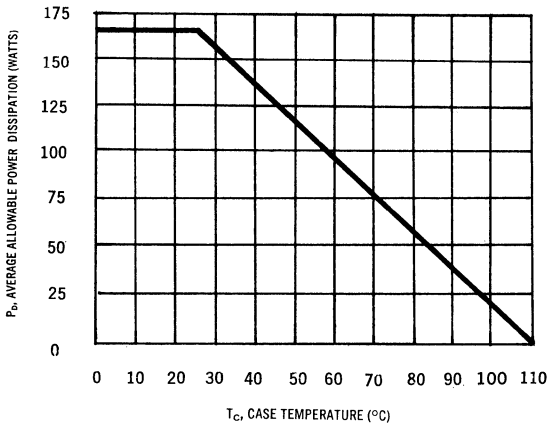

POWER TEMPERATURE DERATING CURVE

The maximum average power is related to maximum junction temperature by the thermal resistance factor.

This curve has a value of 170 Watts at case temperatures of 25°C and is 0 Watts at 110°C with a linear relation between the two temperatures such that:

$$\text{allowable } P_D = \frac{110^{\circ} - T_C}{0.5}$$

2N2075 thru 2N2082 (continued)

ELECTRICAL CHARACTERISTICS (At 25°C case temperature unless otherwise specified)

CHARACTERISTIC		SYMBOL	MIN	MAX	UNIT
Collector-Base Cutoff Current ($V_{CB} = -40\text{ V}$, $V_{EB} = -1.5\text{ V}$) ($V_{CB} = -50\text{ V}$, $V_{EB} = -1.5\text{ V}$) ($V_{CB} = -70\text{ V}$, $V_{EB} = -1.5\text{ V}$) ($V_{CB} = -80\text{ V}$, $V_{EB} = -1.5\text{ V}$)	2N2078, 2N2082 2N2077, 2N2081 2N2076, 2N2080 2N2075, 2N2079	I_{CB1}	-	4.0	mAdc
Collector-Base Cutoff Current ($V_{CB} = V_{CB\text{ max}}$, $I_E = 0$, $T_C = +71^\circ\text{C}$)	All Types	I_{CBO}	-	15	mAdc
Collector-Base Cutoff Current ($V_{CB} = -2\text{ V}$, $I_E = 0$)	All Types	I_{CBO}	-	200	μAdc
Emitter-Base Cutoff Current ($V_{EB} = -20\text{ V}$, $I_C = 0$) ($V_{EB} = -25\text{ V}$, $I_C = 0$) ($V_{EB} = -35\text{ V}$, $I_C = 0$) ($V_{EB} = -40\text{ V}$, $I_C = 0$)	2N2078, 2N2082 2N2077, 2N2081 2N2076, 2N2080 2N2075, 2N2079	I_{EBO}	-	4.0	mAdc
Emitter-Base Cutoff Current ($V_{EB} = V_{EB\text{ max}}$, $I_C = 0$, $T_C = +71^\circ\text{C}$)	All Types	I_{EBO}	-	15	mAdc
Collector-Emitter Breakdown Voltage * ($I_C = 300\text{ mA}$, $V_{EB} = 0$)	2N2078, 2N2082 2N2077, 2N2081 2N2076, 2N2080 2N2075, 2N2079	BV_{CES}	-40 -50 -70 -80	-	Vdc
Collector-Emitter Breakdown Voltage * ($I_C = 1.0\text{ A}$, $I_B = 0$)	2N2078, 2N2082 2N2077, 2N2081 2N2076, 2N2080 2N2075, 2N2079	BV_{CEO}	-25 -45 -55 -65	-	Vdc
Floating Potential ($V_{CB} = -40\text{ V}$, $I_E = 0$) ($V_{CB} = -50\text{ V}$, $I_E = 0$) ($V_{CB} = -70\text{ V}$, $I_E = 0$) ($V_{CB} = -80\text{ V}$, $I_E = 0$)	2N2078, 2N2082 2N2077, 2N2081 2N2076, 2N2080 2N2075, 2N2079	V_{fl}	-	1.0	Vdc
DC Current Transfer Ratio ($I_C = 1.2\text{ A}$, $V_{CB} = -2\text{ V}$) ($I_C = 5\text{ A}$, $V_{CB} = -2\text{ V}$) ($I_C = 12\text{ A}$, $V_{CB} = -2\text{ V}$) ($I_C = 5\text{ A}$, $V_{CB} = -2\text{ V}$, $T_C = -55^\circ\text{C}$)	2N2075 thru 2N2078 2N2079 thru 2N2082 2N2075 thru 2N2078 2N2079 thru 2N2082 2N2075 thru 2N2078 2N2079 thru 2N2082 2N2075 thru 2N2078 2N2079 thru 2N2082	h_{FE}	25 40 20 35 8 12 15 25	100 160 40 70 - - - -	
Collector-Emitter Saturation Voltage ($I_C = 12\text{ A}$, $I_B = 2\text{ A}$)	2N2075 & 76, 2N2079 & 80 2N2077 & 78, 2N2081 & 82	$V_{CE(sat)}$	-	0.7 0.9	Vdc
Base-Emitter Voltage ($I_C = 5\text{ A}$, $V_{CB} = -2\text{ V}$)	All Types	V_{BE}	-	0.9	Vdc
Common Emitter Cutoff Frequency ($I_C = 5\text{ A}$, $V_{CE} = -6\text{ V}$)	All Types	$f_{\alpha e}$	5	-	kc
Rise Time ("On" $I_C = 12\text{ A}$, $V_{CE} = -12\text{ V}$, $I_B = 2\text{ A}$)	2N2075 thru 2N2078 2N2079 thru 2N2082	t_r		Typ 9 6	μsec
Fall Time ("Off" $I_C = 0$, $V_{EB} = -6\text{ V}$, $R_{EB} = 10\text{ Ohms}$)	2N2075 thru 2N2078 2N2079 thru 2N2082	t_f		12 13	μsec

* To avoid excessive heating of collector junction, perform this test with a sweep method.

2N2075 thru 2N2082 (continued)

SAFE OPERATING AREAS

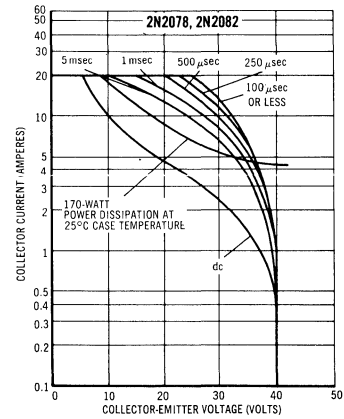
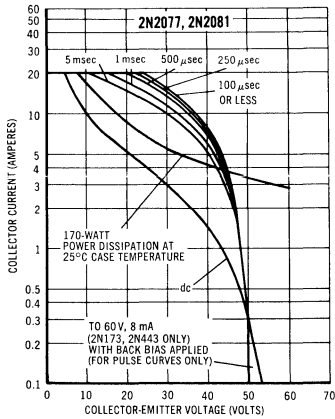
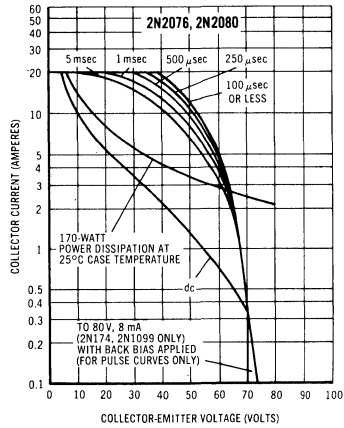
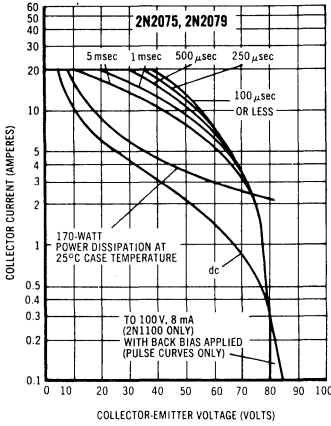

The Safe Operating Area Curves indicate $I_C - V_{CE}$ limits below which the device will not go into secondary breakdown. Collector load lines for specific circuits must fall within the applicable Safe Area to avoid causing a collector-emitter short.

(Duty cycle of the excursions make no significant change in these safe areas.) To insure operation below the maximum T_J , the power-temperature derating curve must be observed for both steady state and pulse power conditions.

2N2075-2N2078

CURRENT TRANSFER CHARACTERISTICS

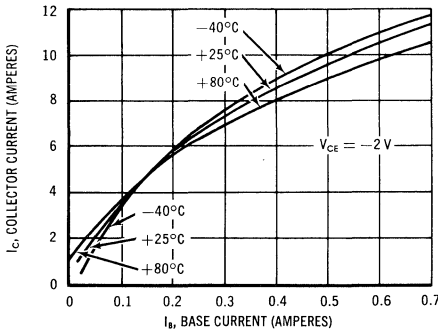

TRANSCONDUCTANCE CHARACTERISTICS

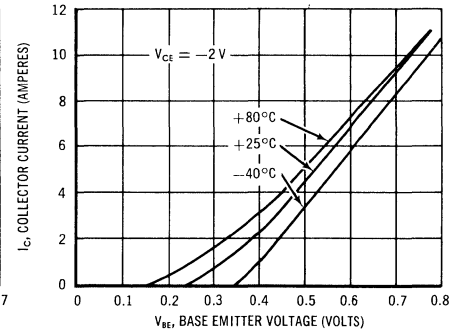

2N2075 thru 2N2082 (continued)

2N2079-2N2082

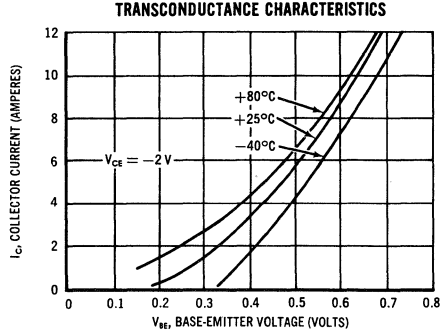
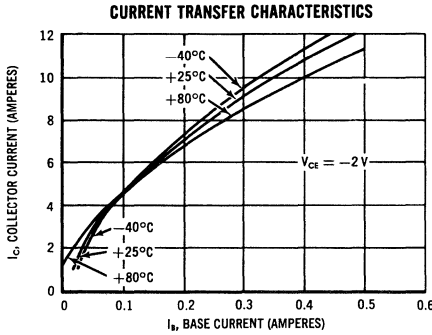

2N2137 thru 2N2146

$P_C = 70 W$
 $I_C = 3 A$
 $V_{CBO} = 30-90 V$

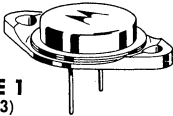

CASE 1
(TO-3)

PNP germanium industrial power transistors for driver applications in high reliability equipment.

ABSOLUTE MAXIMUM RATINGS

Characteristic	Symbol	2N2137	2N2138	2N2139	2N2140	2N2141	Unit	
		2N2142	2N2143	2N2144	2N2145	2N2146		
Collector-Base Voltage	V_{CBO}	30	45	60	75	90	Volts	
Collector-Emitter Voltage	V_{CES}	30	45	60	75	90	Volts	
Collector-Emitter Voltage	V_{CEO}	20	30	45	60	65	Volts	
Emitter-Base Voltage	V_{EBO}	15	25	30	40	45	Volts	
Collector Current	I_C	3	3	3	3	3	Amps	
Power Dissipation at $T_C = 25^\circ C$	P_C	70	70	70	70	70	Watts	
Junction Temperature Range	T_J	← ——— -65 TO +110 ——— →						$^\circ C$
Thermal Resistance, Junction to Case,	θ_{JC}	← ——— 1.2 ——— →						$^\circ C/W$

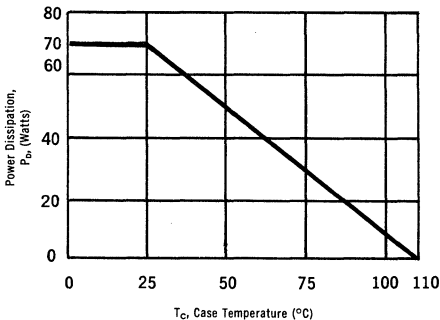

The maximum continuous power is related to maximum junction temperature by the thermal resistance factor. This curve has a value of 70 Watts at case temperatures of $25^\circ C$ and is 0 Watts at $110^\circ C$ with a linear relation between the two temperatures such that:

$$\text{allowable } P_D = \frac{110^\circ - T_c}{1.2}$$

2N2137 thru 2N2146 (continued)

ELECTRICAL CHARACTERISTICS (At 25°C case temperature unless otherwise specified)

Characteristic	Types	Symbol	Minimum	Typical	Maximum	Unit
Collector-Base Cutoff Current ($V_{CB} = -2\text{ V}$, $I_E = 0$)	All Types	I_{CBO}	—	18	50	μAdc
Collector-Base Cutoff Current ($V_{CB} = -30\text{ V}$, $I_E = 0$)	2N2137, 2N2142	I_{CBO}	—	0.1	2	mAdc
($V_{CB} = -45\text{ V}$, $I_E = 0$)	2N2138, 2N2143		—	0.1	2	
($V_{CB} = -60\text{ V}$, $I_E = 0$)	2N2139, 2N2144		—	0.1	2	
($V_{CB} = -75\text{ V}$, $I_E = 0$)	2N2140, 2N2145		—	0.1	2	
($V_{CB} = -90\text{ V}$, $I_E = 0$)	2N2141, 2N2146		—	0.1	2	
Collector-Base Cutoff Current ($V_{CB} = V_{CB\text{ max}}$, $I_E = 0$, $T_C = +71^\circ\text{C}$)	All Types	I_{CBO}	—	0.75	5	mAdc
Emitter-Base Cutoff Current ($V_{EB} = -15\text{ V}$, $I_C = 0$)	2N2137, 2N2142	I_{EBO}	—	0.08	2	mAdc
($V_{EB} = -25\text{ V}$, $I_C = 0$)	2N2138, 2N2143		—	0.08	2	
($V_{EB} = -30\text{ V}$, $I_C = 0$)	2N2139, 2N2144		—	0.08	2	
($V_{EB} = -40\text{ V}$, $I_C = 0$)	2N2140, 2N2145		—	0.08	2	
($V_{EB} = -45\text{ V}$, $I_C = 0$)	2N2141, 2N2146		—	0.08	2	
Emitter-Base Cutoff Current ($V_{EB} = V_{EB\text{ max}}$, $I_C = 0$, $T_C = +71^\circ\text{C}$)	All Types	I_{EBO}	—	0.5	5	mAdc
Collector-Emitter Breakdown Voltage* ($I_C = 300\text{ mA}$, $V_{EB} = 0$)	2N2137, 2N2142	BV_{CES}	-30	—	—	Vdc
	2N2138, 2N2143		-45	—	—	
	2N2139, 2N2144		-60	—	—	
	2N2140, 2N2145		-75	—	—	
	2N2141, 2N2146		-90	—	—	
Collector-Emitter Breakdown Voltage* ($I_C = 500\text{ mA}$, $I_B = 0$)	2N2137, 2N2142	BV_{CEO}	-20	—	—	Vdc
	2N2138, 2N2143		-30	—	—	
	2N2139, 2N2144		-45	—	—	
	2N2140, 2N2145		-60	—	—	
	2N2141, 2N2146		-65	—	—	
Floating Potential ($V_{CB} = 30\text{ V}$, $I_E = 0$)	2N2137, 2N2142	V_{EBF}	—	—	1.0	Vdc
($V_{CB} = 45\text{ V}$, $I_E = 0$)	2N2138, 2N2143		—	—	1.0	
($V_{CB} = 60\text{ V}$, $I_E = 0$)	2N2139, 2N2144		—	—	1.0	
($V_{CB} = 75\text{ V}$, $I_E = 0$)	2N2140, 2N2145		—	—	1.0	
($V_{CB} = 90\text{ V}$, $I_E = 0$)	2N2141, 2N2146		—	—	1.0	
DC Current Transfer Ratio ($I_C = 0.5\text{ A}$, $V_{CE} = 2\text{ V}$)	2N2137 - 2N2141	h_{FE}	30	45	60	—
	2N2142 - 2N2146		50	70	100	
($I_C = 2.0\text{ A}$, $V_{CE} = 2\text{ V}$)	2N2137 - 2N2141		15	25	—	
	2N2142 - 2N2146		25	33	—	
Collector-Emitter Saturation Voltage ($I_C = 2.0\text{ A}$, $I_B = 200\text{ mA}$)	All Types	$V_{CE(sat)}$	—	0.12	0.5	Vdc
Base-Emitter Voltage ($I_C = 2.0\text{ A}$, $I_B = 200\text{ mA}$)	All Types	V_{BE}	—	0.75	1.2	Vdc
Common Emitter Cutoff Frequency ($I_C = 2.0\text{ A}$, $V_{CE} = 6\text{ V}$)	All Types	f_{ae}	12	20	—	kc

*To avoid excessive heating of the collector junction, perform these tests with an oscilloscope

2N2137 thru 2N2146 (continued)

SAFE OPERATING AREAS

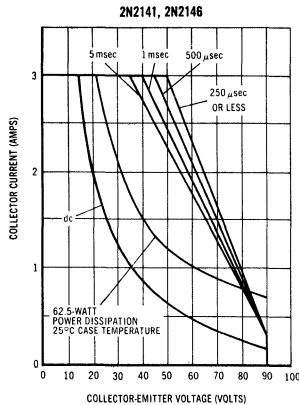
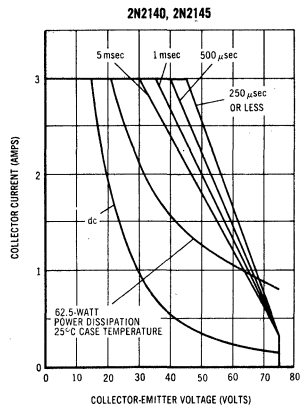
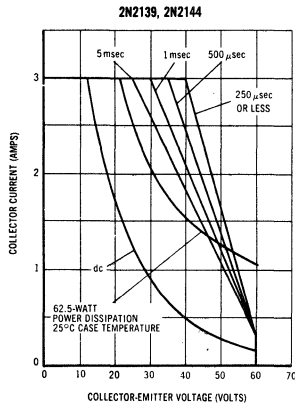
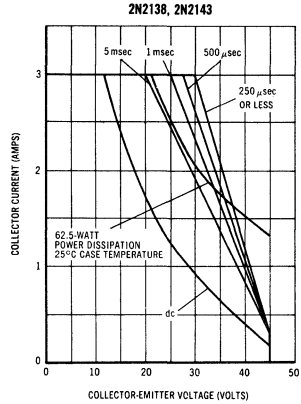
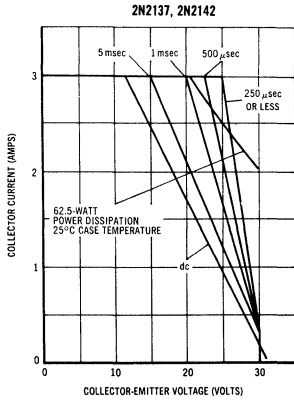

The Safe Operating Area Curves indicate $I_C - V_{CE}$ limits below which the device will not go into secondary breakdown. Collector load lines for specific circuits must fall within the applicable Safe Area to avoid causing a collector-emitter short. (Duty cycle of the excursions make no significant change in these safe areas.) To insure operation below the maximum T_J , the power-temperature derating curve must be observed for both steady state and pulse power conditions.

2N2137 thru 2N2146 (continued)

INPUT & TRANSFER CHARACTERISTICS

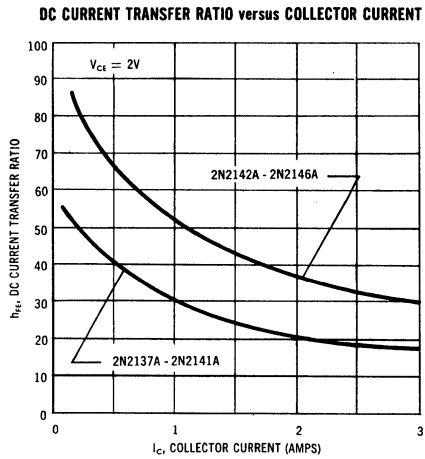
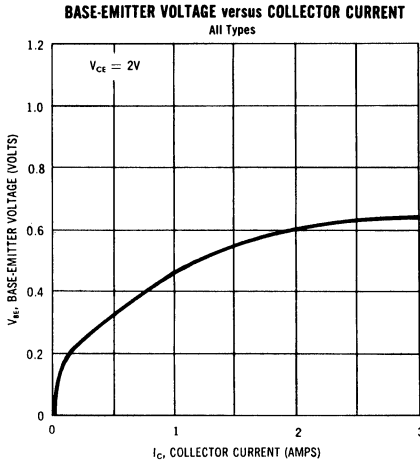

2N2152 thru 2N2154
2N2156 thru 2N2158

$P_C = 170\text{ W}$
 $I_C = 30\text{ A}$
 $V_{CBO} = 45\text{-}75\text{ V}$

CASE 5
(TO-36)

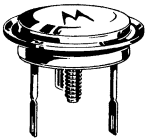

PNP germanium power transistors for high-power, high-gain applications in high-reliability industrial equipment.

MAXIMUM RATINGS

Characteristic	Symbol	2N2152 2N2156	2N2153 2N2157	2N2154 2N2158	Unit
Collector-Base Voltage	V_{CBO}	45	60	75	Volts
Collector-Emitter Voltage	V_{CES}	45	60	75	Volts
Collector-Emitter Voltage	V_{CEO}	30	45	60	Volts
Emitter-Base Voltage	V_{EBO}	25	30	40	Volts
Collector Current	I_C	30	30	30	Amps
Power Dissipation at $T_C = 25^\circ\text{C}$	P_C	170	170	170	Watts
Junction Temperature Range	T_J	← -65 to +110 →			$^\circ\text{C}$
Thermal Resistance, Junction to Case,	θ_{JC}	← 0.5 →			$^\circ\text{C/W}$

2N2152 thru 2N2154 2N2156 thru 2N2158 (continued)

ELECTRICAL CHARACTERISTICS (at $T_A = 25^\circ\text{C}$ unless otherwise noted)

Characteristic		Symbol	Minimum	Typical	Maximum	Unit
Collector-Base Cutoff Current ($V_{CB} = -45\text{ V}, I_E = 0$) ($V_{CB} = -60\text{ V}, I_E = 0$) ($V_{CB} = -75\text{ V}, I_E = 0$)	2N2152, 2N2156 2N2153, 2N2157 2N2154, 2N2158	I_{CBO}	—	0.9	4.0	mAdc
Collector-Base Cutoff Current ($V_{CB} = V_{CB\text{max}}, I_E = 0, T_C = +71^\circ\text{C}$)	All Types	I_{CBO}	—	4.0	15	mAdc
Collector-Base Cutoff Current ($V_{CB} = -2\text{ V}, I_E = 0$)	All Types	I_{CBO}	—	80	200	μAdc
Emitter-Base Cutoff Current ($V_{EB} = -25\text{ V}, I_C = 0$) ($V_{EB} = -30\text{ V}, I_C = 0$) ($V_{EB} = -40\text{ V}, I_C = 0$)	2N2152, 2N2156 2N2153, 2N2157 2N2154, 2N2158	I_{EBO}	—	0.2	4.0	mAdc
Emitter-Base Cutoff Current ($V_{EB} = V_{EB\text{max}}, I_C = 0, T_C = +71^\circ\text{C}$)	All Types	I_{EBO}	—	2.7	15	mAdc
Collector-Emitter Breakdown Voltage* ($I_C = 300\text{ mA}, V_{EB} = 0$)	2N2152, 2N2156 2N2153, 2N2157 2N2154, 2N2158	BV_{CES}	-45 -60 -75	— — —	— — —	Vdc
Collector-Emitter Breakdown Voltage* ($I_C = 1.0\text{ A}, I_B = 0$)	2N2152, 2N2156 2N2153, 2N2157 2N2154, 2N2158	BV_{CEO}	-30 -45 -60	— — —	— — —	Vdc
Floating Potential ($V_{CB} = -45\text{ V}, I_E = 0$) ($V_{CB} = -60\text{ V}, I_E = 0$) ($V_{CB} = -75\text{ V}, I_E = 0$)	2N2152, 2N2156 2N2153, 2N2157 2N2154, 2N2158	V_{EBF}	— — —	— — —	1.0 1.0 1.0	Vdc
DC Current Transfer Ratio ($I_C = 5\text{ A}, V_{CB} = 2\text{ V}$) ($I_C = 15\text{ A}, V_{CB} = 2\text{ V}$) ($I_C = 25\text{ A}, V_{CB} = 2\text{ V}$)	2N2152, 2N2153, 2N2154 2N2156, 2N2157, 2N2158 2N2152, 2N2153, 2N2154 2N2156, 2N2157, 2N2158 All Types	h_{FE}	50 80 25 40 15	75 105 47 63 38	100 160 — — —	—
Collector-Emitter Saturation Voltage ($I_C = 5\text{ A}, I_B = 500\text{ mA}$) ($I_C = 25\text{ A}, I_B = 2\text{ A}$)	All Types All Types	$V_{CE(\text{sat})}$	— —	0.06 0.2	0.1 0.3	Vdc
Base-Emitter Voltage ($I_C = 5\text{ A}, I_B = 500\text{ mA}$) ($I_C = 25\text{ A}, I_B = 2\text{ A}$)	All Types All Types	V_{BE}	— —	0.65 1.0	1.0 2.0	Vdc
Common Emitter Cutoff Frequency ($I_C = 5\text{ A}, V_{CE} = 6\text{ V}$)	All Types	$f_{\alpha e}$	2	2.7	—	—

*To avoid excessive heating of the collector junction, perform these tests with an oscilloscope.

2N2152 thru 2N2154 2N2156 thru 2N2158 (continued)

SAFE OPERATING AREAS

The Safe Operating Area Curves indicate I_C — V_{CE} limits below which the device will not go into secondary breakdown. Collector load lines for specific circuits must fall within the applicable Safe Area to avoid causing a collector-emitter short.

(Duty cycle of the excursions make no significant change in these safe areas.) To insure operation below the maximum T_J , the power-temperature derating curve must be observed for both steady state and pulse power conditions.

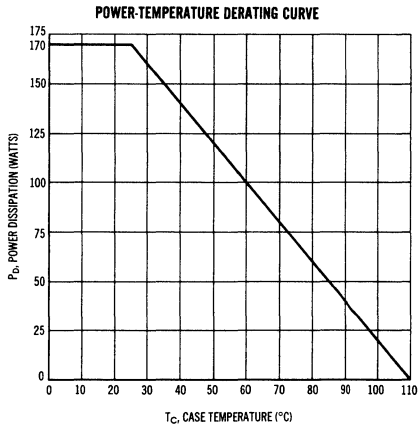
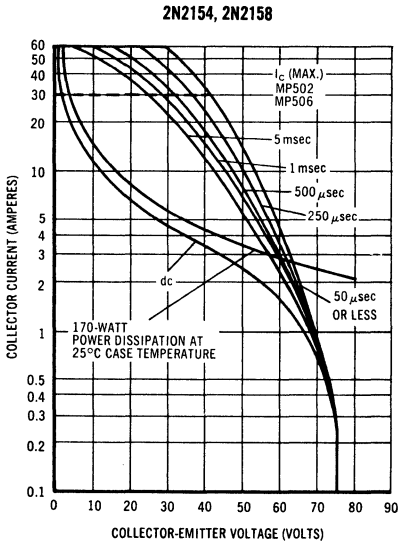
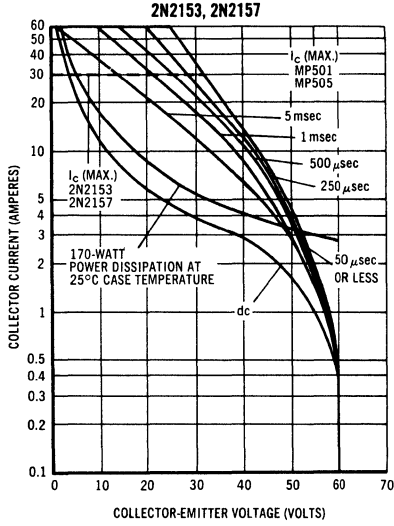
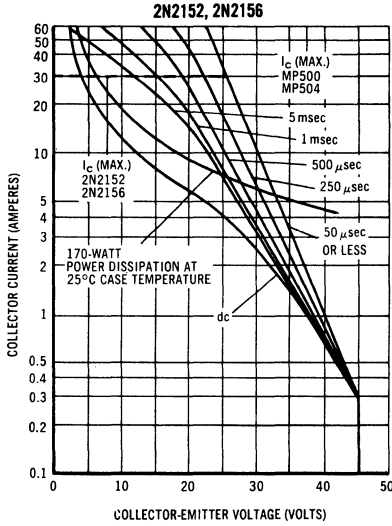

The maximum continuous junction power is related to maximum junction temperature by the thermal resistance factor. This curve has a value of 170 Watts at case temperatures of 25°C and is 0 Watts at 110°C with a linear relation between the two temperatures such that:

$$\text{allowable } P_D = \frac{110^\circ - T_c}{0.5}$$

2N2152 thru 2N2154 2N2156 thru 2N2158 (continued)

TYPICAL INPUT AND TRANSFER CHARACTERISTICS

COLLECTOR CURRENT
versus BASE CURRENT

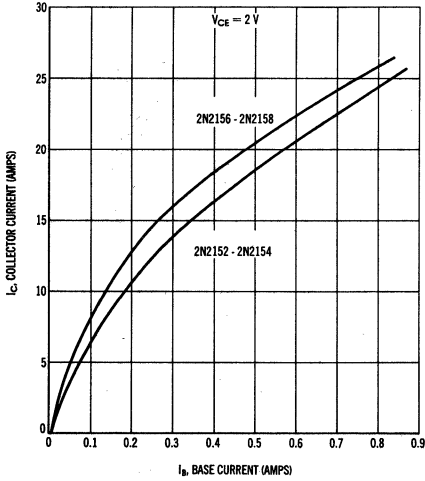

COLLECTOR CURRENT
versus BASE-EMITTER VOLTAGE

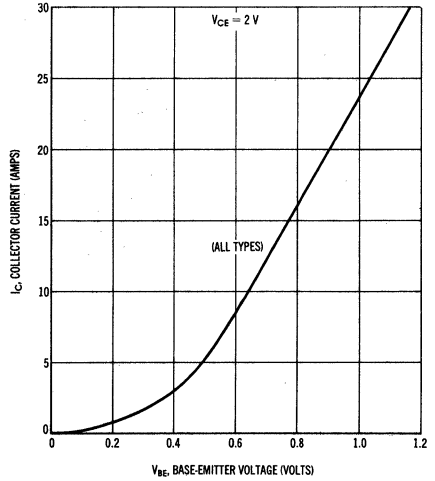

DC CURRENT GAIN
versus COLLECTOR CURRENT

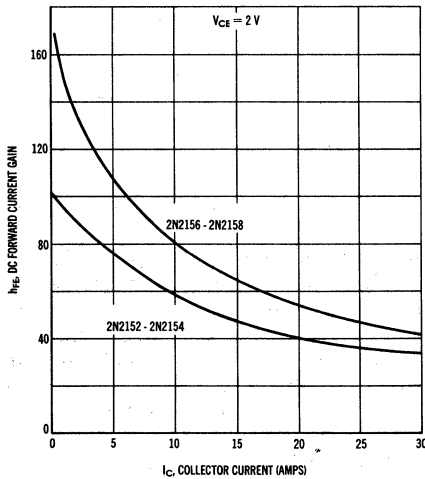

BASE CURRENT versus
BASE-EMITTER VOLTAGE

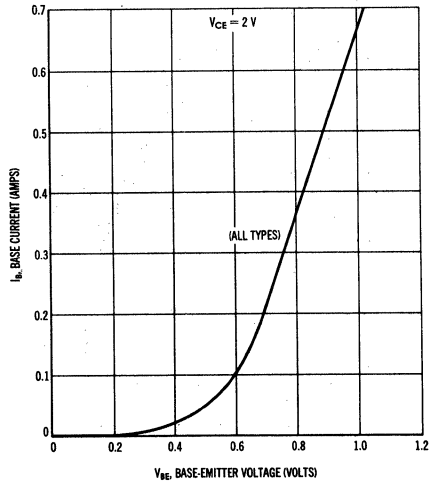

2N2490 thru 2N2493

$P_C = 170 \text{ W}$
 $I_C = 15 \text{ A}$
 $V_{CBO} = 60\text{-}100 \text{ V}$

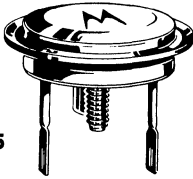

CASE 5
(TO-36)

PNP germanium power transistors for general purpose power and switching applications.

ABSOLUTE MAXIMUM RATINGS

Characteristic	Symbol	2N2490	2N2491	2N2492	2N2493	Unit
Collector-Base Voltage	V_{CBO}	70	60	80	100	Volts
Collector-Emitter Voltage	V_{CES}	60	50	70	85	Volts
Emitter-Base Voltage	V_{EBO}	40	30	60	80	Volts
Collector Current	I_C	15	15	15	15	Amps
Power Dissipation at $T_C = 25^\circ\text{C}$	P_C	170	170	170	170	Watts
Junction Temperature Range	T_J	-65 to +110				$^\circ\text{C}$

ELECTRICAL CHARACTERISTICS (at $T_c = 25^\circ\text{C}$ unless otherwise noted)

Characteristic	Symbol	Min	Max	Unit
Collector-Base Cutoff Current ($V_{CB} = -2 \text{ Vdc}$)	I_{CBO} All Types	—	0.2	mAdc
Emitter-Base Cutoff Current ($V_{EB} = -40 \text{ Vdc}$) ($V_{EB} = -30 \text{ Vdc}$) ($V_{EB} = -60 \text{ Vdc}$) ($V_{EB} = -80 \text{ Vdc}$)	I_{EBO} 2N2490 2N2491 2N2492 2N2493	— — — —	3 3 2 3	mAdc
Collector Cutoff Current ($V_{CE} = -70 \text{ Vdc}, V_{BE} = 1.5 \text{ Vdc}$) ($V_{CE} = -60 \text{ Vdc}, V_{BE} = 1.5 \text{ Vdc}$) ($V_{CE} = -80 \text{ Vdc}, V_{BE} = 1.5 \text{ Vdc}$) ($V_{CE} = -100 \text{ Vdc}, V_{BE} = 1.5 \text{ Vdc}$) ($V_{CE} = -35 \text{ Vdc}, V_{BE} = 1.5 \text{ Vdc}, T_C = +100^\circ\text{C}$) ($V_{CE} = -40 \text{ Vdc}, V_{BE} = 1.5 \text{ Vdc}, T_C = +100^\circ\text{C}$) ($V_{CE} = -50 \text{ Vdc}, V_{BE} = 1.5 \text{ Vdc}, T_C = +100^\circ\text{C}$)	I_{CEX} 2N2490 2N2491 2N2492 2N2493 2N2490, 2N2491 2N2492 2N2493	— — — — — — —	3 3 2 3 35 35 35	mAdc
Collector-Emitter Breakdown Voltage ($I_C = 1 \text{ A}, I_B = 0$)	V_{CEO} 2N2490 2N2491 2N2492 2N2493	-50 -40 -65 -75	— — — —	Volts
Base-Emitter Voltage ($I_C = 5 \text{ Adc}, V_{CE} = -2 \text{ Vdc}$) ($I_C = 12 \text{ Adc}, V_{CE} = -2 \text{ Vdc}$)	V_{BE} 2N2490, 2N2491 2N2492, 2N2493 All Types	— — —	-0.9 -0.8 -1.5	Vdc
Collector-Emitter Saturation Voltage ($I_C = 12 \text{ Adc}, I_B = 2 \text{ Adc}$)	$V_{CE}(\text{sat})$ 2N2490, 2N2491 2N2492, 2N2493	— —	-0.7 -0.5	Vdc
DC Current Gain ($I_C = 1 \text{ Adc}, V_{CE} = -2 \text{ Vdc}$) ($I_C = 5 \text{ Adc}, V_{CE} = -2 \text{ Vdc}$) ($I_C = 5 \text{ Adc}, V_{CE} = -2 \text{ Vdc}, T_A = -65^\circ\text{C}$) ($I_C = 12 \text{ Adc}, V_{CE} = -2 \text{ Vdc}$)	h_{FE} 2N2490 2N2491 2N2492, 2N2493 2N2490 2N2491 2N2492, 2N2493 2N2490 2N2491 2N2492, 2N2493	45 65 50 20 35 25 15 25 20 8 12 10	— — — 40 70 50 — — — — —	—
Common Emitter Cutoff Frequency ($I_C = 5 \text{ A}, V_{CE} = -6 \text{ V}$)	f_{ae}	5	—	kc
Turn-On Time ($I_C = 5 \text{ A}, I_{B1} = I_{B2} = 0.5 \text{ A}$)	t_{on}	—	25	μsec
Turn-Off Time ($I_C = 5 \text{ A}, I_{B1} = I_{B2} = 0.5 \text{ A}$)	t_{off}	—	15	μsec

2N2526
2N2527
2N2528

P_C = 85 W
I_C = 10 A
V_{CB0} = 80-160 V

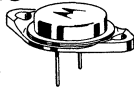

CASE 3,4
(TO-3, TO-4)

PNP germanium power transistors for high-voltage power switching applications.

MAXIMUM RATINGS

Characteristic	Symbol	2N2526	2N2527	2N2528	Unit
Collector-Emitter Voltage	V _{CE}	80	120	160	Vdc
Collector-Base Voltage	V _{CB}	80	120	160	Vdc
Emitter-Base Voltage	V _{EB}	5	5	5	Vdc
Collector Current (Cont)	I _C	10	10	10	Amps
Base Current (Cont)	I _B	5	5	5	Amps
Emitter Reverse Current (Surge 60 cps Recurrent)	I _E	1.5	1.5	1.5	Amps
Storage and Operating Temperatures	T _{stg} T _J	← -65 to +110 →			°C
Collector Dissipation (25°C Mtg. Case Temp.)	P _C	85	85	85	Watts
Thermal Resistance	θ _{JC}	← 1.0 →			°C/W

POWER DERATING CURVE

The maximum continuous power is related to maximum junction temperature by the thermal resistance factor. This curve has a value of 85 watts at a case temperature of 25°C and is 0 watts at 110°C with a linear relation between the two temperatures such that:

$$\text{Allowable } P_o = \frac{110^\circ - T_c}{1.0} \text{ Watts}$$

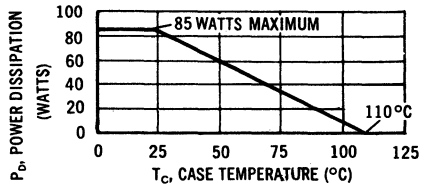

SAFE OPERATING AREAS

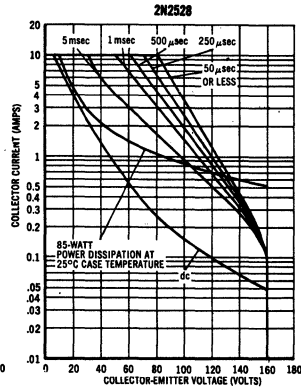
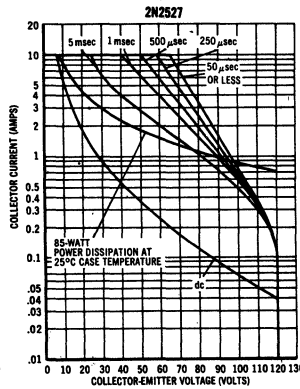
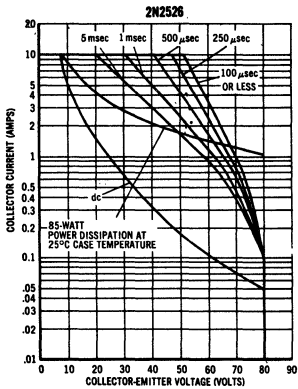

The Safe Operating Area Curves indicate I_C — V_{CE} limits below which the device will not go into secondary breakdown. Collector load lines for specific circuits must fall within the applicable Safe Area to avoid causing a collector-emitter short.

(Duty cycle of the excursions make no significant change in these safe areas.) To insure operation below the maximum T_J, the power-temperature derating curve must be observed for both steady state and pulse power conditions.

2N2526 thru 2N2528 (continued)

ELECTRICAL CHARACTERISTICS (At 25°C unless otherwise noted)

Characteristic	Types	Symbol	Min.	Typ.	Max.	Unit
Collector-Emitter Cutoff Current* ($V_{CE} = -80$ V, $V_{BE} = 0.2$ Vdc, $T_C = 100^\circ\text{C}$) ($V_{CE} = -120$ V, $V_{BE} = 0.2$ Vdc, $T_C = 100^\circ\text{C}$) ($V_{CE} = -160$ V, $V_{BE} = 0.2$ Vdc, $T_C = 100^\circ\text{C}$)	2N2526	I_{CEX}	—	—	35	mA
	2N2527		—	—	35	
	2N2528		—	—	35	
Collector-Base Cutoff Current ($V_{CB} = -80$ Vdc, $I_E = 0$) ($V_{CB} = -120$ Vdc, $I_E = 0$) ($V_{CB} = -160$ Vdc, $I_E = 0$) ($V_{CB} = -2.0$ Vdc, $I_E = 0$)	2N2526	I_{CBO}	—	—	3	mA _{dc}
	2N2527		—	—	3	
	2N2528		—	—	3	
	All Types [†]		—	—	150	μA _{dc}
Collector-Emitter Cutoff Current ($V_{CE} = -80$ Vdc, $R_{BE} = 100$ Ω) ($V_{CE} = -120$ Vdc, $R_{BE} = 100$ Ω) ($V_{CE} = -160$ Vdc, $R_{BE} = 100$ Ω)	2N2526	I_{CER}	—	—	25	mA _{dc}
	2N2527		—	—	25	
	2N2528		—	—	25	
	All Types		—	—	—	
Emitter-Base Breakdown Voltage ($I_E = 50$ mA _{dc})	All Types	BV_{EBO}	5	—	—	Vdc
Collector-Emitter Breakdown Voltage* ($I_C = 100$ mA, $I_B = 0$)	2N2526 2N2527 2N2528	$BV_{CEO(sus)}$	-80 -120 -160	— — —	— — —	Volts
DC Current Gain ($I_C = 3$ Adc, $V_{CE} = -2.0$ Vdc)	All Types	h_{FE}	20	—	50	—
Small Signal Current Gain ($V_{CE} = -12$ Vdc, $I_C = 0.5$ Adc, $f = 30$ kc)	All Types	h_{fe}	10	15	—	—
Transconductance ($V_{CE} = -2.0$ Vdc, $I_C = 3$ Adc)	All Types	g_{FE}	4	6	—	Mhos
Collector-Emitter Saturation Voltage ($I_C = 10$ Adc, $I_B = 1.0$ Adc)	All Types	$V_{CE(sat)}$	—	-0.5	-0.8	Vdc
Base-Emitter Saturation Voltage ($I_C = 10$ Adc, $I_B = 1.0$ Adc)	All Types	$V_{BE(sat)}$	—	0.8	1.2	Vdc
Rise Time	All Types	t_r	—	5.5	—	μsec
Storage Time	All Types	t_s	—	1.2	—	μsec
Fall Time	All Types	t_f	—	2.0	—	μsec

*To avoid excessive heating of collector junction, perform this test with a sweep method.

TYPICAL INPUT CHARACTERISTICS

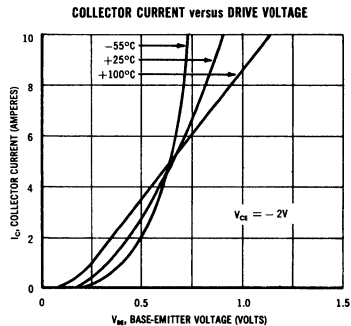
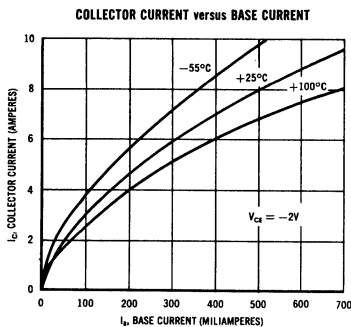

2N2526 thru 2N2528 (continued)

SWITCHING TEST CIRCUIT

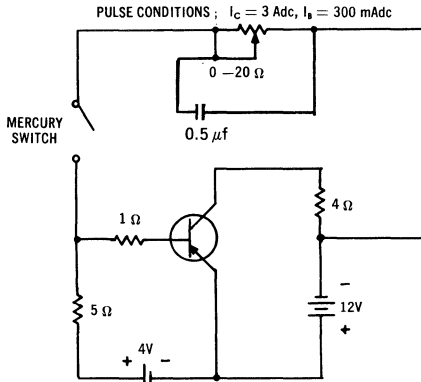

DC CURRENT GAIN versus COLLECTOR CURRENT

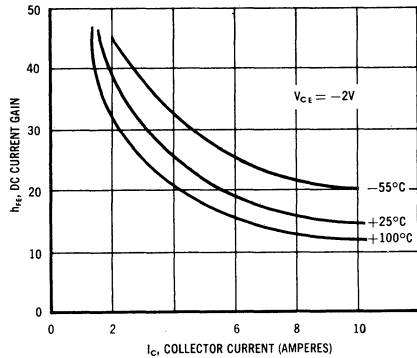

2N2728

**$P_C = 170 \text{ W}$
 $I_C = 50 \text{ A}$
 $V_{CBO} = 15 \text{ V}$**

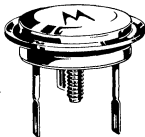

CASE 7
(TO-36)

PNP germanium high-current power transistors especially designed for switching and power converter circuit operating from low-voltage power sources such as solar cells, thermo-electric generators, sea cells, fuel cells, and 1.5-volt batteries.

ABSOLUTE MAXIMUM RATINGS

Characteristic	Symbol	Rating	Unit
Collector-Base Voltage	V_{CBO}	15	Vdc
Collector-Emitter Voltage	V_{CEO}	5	Vdc
Emitter-Base Voltage	V_{EBO}	15	Vdc
Collector Current (continuous)	I_C	50	Adc
Base Current (continuous)	I_B	10	Adc
Total Device Dissipation @ 25°C Case Temperature	P_D	170	Watts
Operating Temperature	T_J	+110	°C
Storage Temperature	T_{stg}	-65 to +110	°C
Thermal Resistance (Junction to Case)	θ_{JC}	0.5	°C/W

2N2728 (continued)

ELECTRICAL CHARACTERISTICS

Characteristic	Symbol	Min	Typ	Max	Unit
Collector Cutoff Current $V_{CE} = 15 \text{ V}, V_{BE} = 1 \text{ V}$ $V_{CE} = 10 \text{ V}, V_{BE} = 1 \text{ V}, T_C = 100^\circ\text{C}$	I_{CEX}	-	-	10 35	mAdc
Emitter-Base Cutoff Current $V_{EB} = 15 \text{ V}$	I_{EBO}	-	-	10	mAdc
Emitter Floating Potential $V_{CB} = 15 \text{ V}, I_E = 0$	V_{EBF}	-	-	0.5	Vdc
Collector-Emitter Breakdown Voltage* $I_C = 500 \text{ mA}, I_B = 0$	BV_{CEO}	5	10	-	V
DC Current Transfer Ratio $I_C = 20 \text{ A}, V_{CE} = 2 \text{ V}$	h_{FE}	40	-	130	-
Collector-Emitter Saturation Voltage $I_C = 50 \text{ A}, I_B = 5 \text{ A}$	$V_{CE(sat)}$	-	.075	0.1	Vdc
Base-Emitter Voltage $I_C = 50 \text{ A}, I_B = 5 \text{ A}$	$V_{BE(sat)}$	-	0.85	1.0	Vdc
Common Emitter Cutoff Frequency $I_C = 20 \text{ A}, V_{CE} = 2 \text{ V}$	f_{ae}	3	4.5	-	kc
Rise Time $I_C = 20 \text{ A}, V_{CC} = 1.75 \text{ V}, I_{B(on)} = 2 \text{ A}$	t_r	-	18	25	μsec
Storage Time $V_{BE} = 6 \text{ V}, R_{be} = 10 \Omega$	t_s	-	15	20	μsec
Fall Time $V_{BE} = 6 \text{ V}, R_{be} = 10 \Omega$	t_f	-	10	15	μsec

* To avoid excessive heating of the collector junction, perform these tests with an oscilloscope.

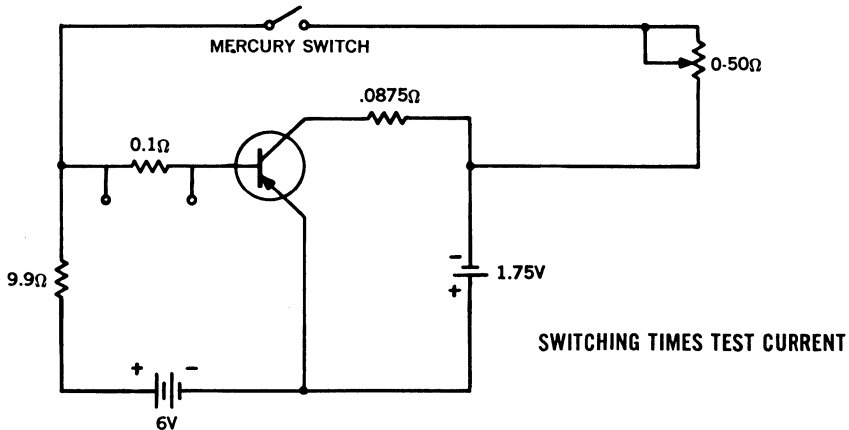

2N2832
2N2833
2N2834

$P_C = 85 \text{ W}$
 $I_C = 20 \text{ A}$
 $V_{CBO} = 80\text{-}140 \text{ V}$

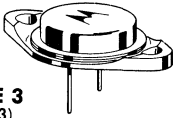

CASE 3
(TO-3)

PNP germanium high-speed, high-frequency, power transistors for output stages of CRT deflection circuits, high-efficiency power inverters, and similar applications.

MAXIMUM RATINGS

Characteristic	Symbol	2N2832	2N2833	2N2834	Unit
Collector-Base Voltage	V_{CBO}	80	120	140	Volts
Collector-Emitter Voltage	V_{CEO}	50	75	100	Volts
Emitter-Base Voltage	V_{EBO}	2	2	2	Volts
Collector Current (Continuous)	I_C	20	20	20	Amps
Base Current (Continuous)	I_B	5	5	5	Amps
Power Dissipation	P_C	85	85	85	Watts
Case Operating & Storage Temperature Range	T_C & T_{stg}	-65 to +110°			°C

POWER DERATING CURVE

THESE TRANSISTORS ARE ALSO SUBJECT TO SAFE AREA CURVES
 BOTH LIMITS ARE APPLICABLE AND MUST BE OBSERVED

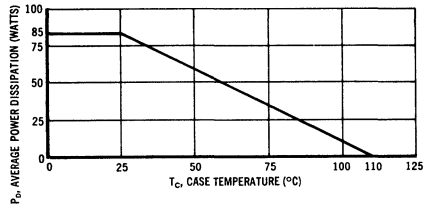

SAFE OPERATING AREAS

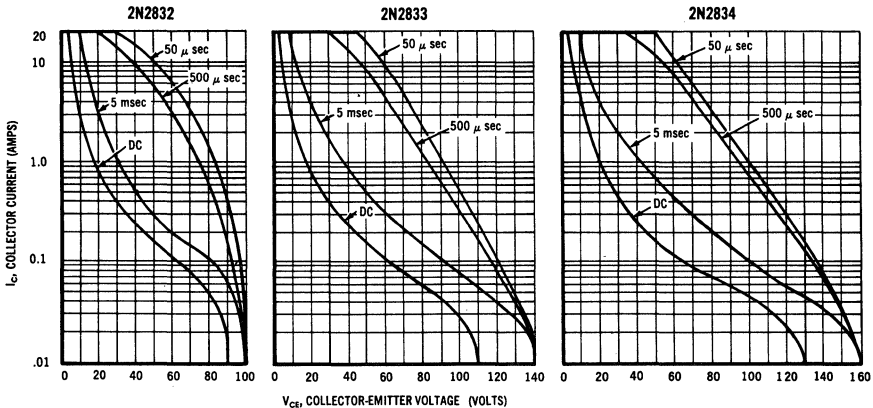

The Safe Operating Area Curves indicate the $I_C - V_{CE}$ limits below which the devices will not go into secondary breakdown. As secondary breakdown is independent of temperature and duty cycle, these curves can be used as long as the average power derating curve is also taken into consideration to insure operation below the maximum junction temperature.

2N2832 thru 2N2834 (continued)

ELECTRICAL CHARACTERISTICS (At 25°C case temperature unless otherwise specified)

Characteristic	Symbol	Min	Typical	Max	Unit
Collector-Base Cutoff Current* ($V_{CB} = 2V, I_E = 0$) ($V_{CB} = 80V, I_E = 0$) ($V_{CB} = 120V, I_E = 0$) ($V_{CB} = 140V, I_E = 0$)	I_{CBO}^*	---	---	0.3 10 10 10	mA
Collector-Emitter Current* ($V_{CE} = 100V, V_{BE} = 0$) ($V_{CE} = 140V, V_{BE} = 0$) ($V_{CE} = 160V, V_{BE} = 0$)	I_{CES}^*	---	---	20 20 20	mA
Collector-Emitter Cutoff Current** ($V_{CE} = 50V, V_{BE} = 0.2V, T_C = +85^\circ C$) ($V_{CE} = 75V, V_{BE} = 0.2V, T_C = +85^\circ C$) ($V_{CE} = 100V, V_{BE} = 0.2V, T_C = +85^\circ C$)	I_{CEX}^{**}	---	---	40 40 40	mA
Emitter-Base Breakdown Voltage ($I_E = 50 \text{ mAdc}, I_C = 0$)	BV_{EBO}	2	---	---	Vdc
Collector-Emitter Breakdown Voltage** ($I_E = 100 \text{ mA}, I_B = 0$)	$BV_{CEO(sus)}^{**}$	50 75 100	---	---	Volts
Emitter Floating Potential* ($V_{CB} = 80V, I_E = 0$) ($V_{CB} = 120V, I_E = 0$) ($V_{CB} = 140V, I_E = 0$)	V_{EBF}^*	---	---	0.5 0.5 0.5	Volts
DC Current Transfer Ratio ($I_C = 1.0 \text{ A}, V_{CB} = 2V$) ($I_C = 10A, V_{CB} = 2V$)	h_{FE}	50 25	75 ---	---	---
Collector-Emitter Saturation Voltage ($I_C = 1.0 \text{ Adc}, I_B = 100 \text{ mAdc}$) ($I_C = 10 \text{ Adc}, I_B = 1.0 \text{ Adc}$) ($I_C = 20 \text{ Adc}, I_B = 2.0 \text{ Adc}$)	$V_{CE(sat)}$	---	---	0.15 0.30 0.5	Vdc
Base-Emitter Saturation Voltage ($I_C = 1 \text{ A}, I_B = 100 \text{ mAdc}$) ($I_C = 10 \text{ A}, I_B = 1 \text{ Adc}$) ($I_C = 20 \text{ A}, I_B = 2 \text{ Adc}$)	$V_{BE(sat)}$	---	---	0.6 0.75 1.0	Vdc
Small Signal Current Gain ($I_C = 1.0 \text{ A}, V_{CE} = 10V, f = 5 \text{ mc}$)	h_{fe}	2	3.5	---	---
Rise Time	t_r	---	2	4	μsec
Storage Time	t_s	---	3	6	μsec
Fall Time	t_f	---	1	2.5	μsec

* SWEEP TEST: 1/2 Sine Wave, 60 cps min
 ** PULSE TEST: PW = 1 msec, 2% Duty Cycle

2N2832 thru 2N2834 (continued)

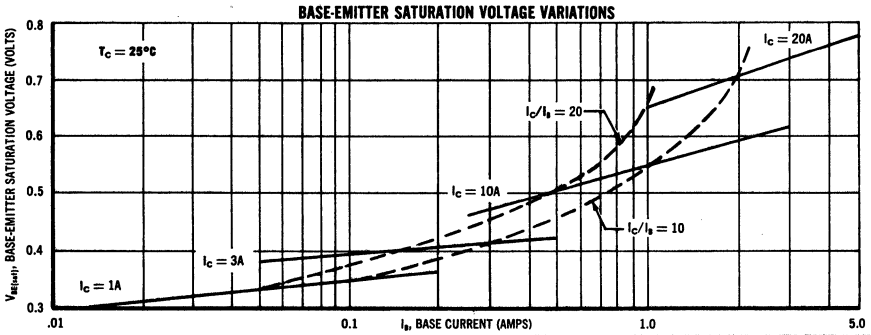
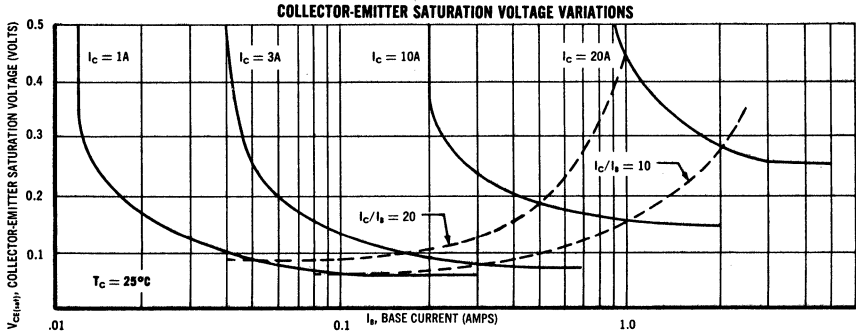

2N2912

**$P_C = 75 W$
 $I_C = 25 A$
 $V_{CBO} = 15 V$**

CASE 8
(TO-8)

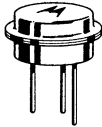

PNP germanium, epitaxial-base, high speed, power transistors for switching and power converter circuits operating from low-voltage power sources such as solar cells, thermo-electric generators, sea cells, fuel cells, and 1.5-volt batteries.

MAXIMUM RATINGS

Characteristic	Symbol	Rating	Unit
Collector-Base Voltage	V_{CBO}	15	Volts
Collector-Emmitter Voltage	V_{CEO}	6	Volts
Emitter-Base Voltage	V_{EBO}	1.5	Volts
Collector Current (Continuous)	I_C	25	Amps
Base Current (Continuous)	I_B	3	Amps
Power Dissipation	P_D	75	Watts
Operating Case Temperature Range	T_C	-65 to +110	$^\circ C$
Storage Temperature Range	T_{stg}	-65 to +110	$^\circ C$
Thermal resistance	θ_{JC}	1	$^\circ C/W$
	θ_{CA}	30	$^\circ C/W$

2N2912 (continued)

ELECTRICAL CHARACTERISTICS (At 25°C unless otherwise specified)

Characteristic	Symbol	Min	Max	Unit
Collector Cutoff Current ($V_{CE} = 15 \text{ Vdc}$, $V_{BE} = 0.2 \text{ Vdc}$) ($V_{CE} = 6 \text{ Vdc}$, $V_{BE} = 0.2 \text{ Vdc}$, $T_C = 85^\circ\text{C}$)	I_{CEX}	---	10 15	mAdc
Collector-Base Cutoff Current ($V_{CB} = 2 \text{ Vdc}$, $I_E = 0$)	I_{CBO}	---	0.2	mAdc
Emitter Floating Potential ($V_{CB} = 15 \text{ Vdc}$, $I_E = 0$)	V_{EBF}	---	0.2	Vdc
Emitter Cutoff Current ($V_{EB} = 1.5 \text{ Vdc}$)	I_{EBO}	---	50	mAdc
Collector-Emitter Voltage* ($I_C = 500 \text{ mAdc}$, $I_B = 0$)	V_{CEO}^*	6	---	Vdc
DC Forward Current Transfer Ratio ($V_{CE} = 2 \text{ Vdc}$, $I_C = 10 \text{ Adc}$)	h_{FE}	75	---	---
Collector-Emitter Saturation Voltage ($I_C = 5 \text{ Adc}$, $I_B = 0.5 \text{ Adc}$) ($I_C = 25 \text{ Adc}$, $I_B = 2.5 \text{ Adc}$)	$V_{CE(sat)}$	---	0.12 0.5	Vdc
Base-Emitter Saturation Voltage ($I_C = 25 \text{ Adc}$, $I_B = 2.5 \text{ Adc}$)	$V_{BE(sat)}$	---	1.2	Vdc
Base-Emitter Saturation Voltage ($I_C = 5 \text{ Adc}$, $I_B = 0.5 \text{ Adc}$)	$V_{BE(sat)}$	---	0.5	Vdc
Rise Time ($I_C = 5 \text{ A}$, $V_{CE} = 10 \text{ V}$, $I_B(\text{on}) = 250 \text{ mA}$)	t_r	---	2	μsec
Storage Time ($I_C = 5 \text{ A}$, $V_{CE} = 10 \text{ V}$, $I_B(\text{on}) = 250 \text{ mA}$)	t_s	---	2.5	μsec
Fall Time ($I_C = 5 \text{ A}$, $V_{CE} = 10 \text{ V}$, $V_{EB} = 1.5 \text{ V}$, $R_{be} = 6 \text{ Ohms}$)	t_f	---	2	μsec
Common Emitter Small-Signal Forward Current Transfer Ratio Cutoff Frequency ($V_{CE} = 2 \text{ V}$, $I_C = 5 \text{ A}$, $f = 1 \text{ mc}$)	$ h_{fe} $	20	---	---

*Sweep Test

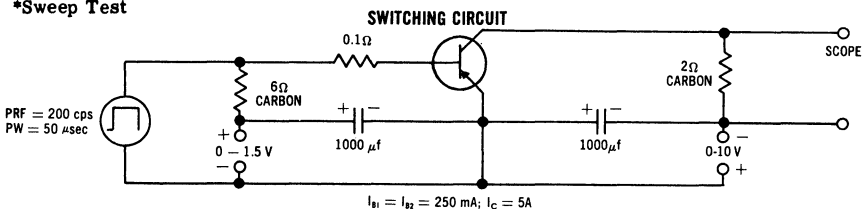

2N2912 (continued)

SAFE AREA OF OPERATION

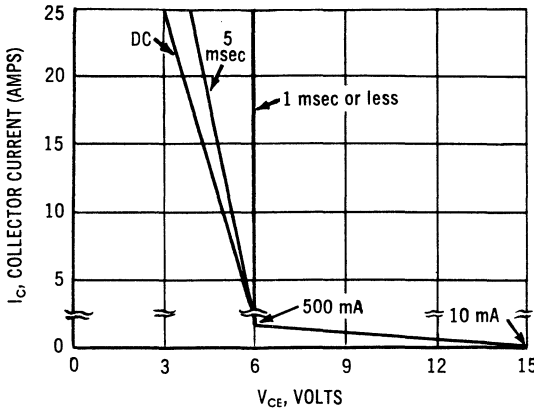

The safe operating area curve is applicable for all case temperatures. The thermal derating curve must also be observed to insure operation below maximum T_J .

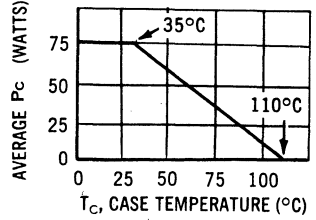

POWER DERATING CURVE

2N3021 thru **2N3026**

$P_C = 25 \text{ W}$
 $I_C = 3 \text{ A}$
 $V_{CB0} = 30\text{-}60 \text{ V}$

CASE 1
(TO-3)

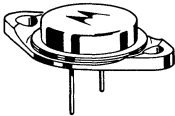

PNP silicon power transistors for Class C power amplifiers, high-current core switching and high-speed switching and amplifier applications.

ABSOLUTE MAXIMUM RATINGS

Characteristic	Symbol	2N3021 2N3024	2N3022 2N3025	2N3023 2N3026	Unit
Collector-Base Voltage	V_{CB}	30	45	60	Volts
Collector-Emitter Voltage	V_{CE}	30	45	60	Volts
Emitter-Base Voltage	V_{EB}	4	4	4	Volts
Collector Current (Continuous)	I_C	3	3	3	Amps
Base Current (Continuous)	I_B	0.5	0.5	0.5	Amp
Power Dissipation	P_C	25	25	25	Watts
Junction Operating Temperature Range	T_J	← -65 to +175 →			$^{\circ}\text{C}$

2N3021 thru 2N3026 (continued)

ELECTRICAL CHARACTERISTICS (At 25°C unless otherwise specified)

Characteristics		Symbol	Min	Max	Unit
Emitter-Base Cutoff Current ($V_{BE} = 4$ Vdc)	All Types	I_{EBO}	—	1	mAdc
Collector-Emitter Cutoff Current ($V_{CE} = 25$ Vdc, $V_{BE} = 2$ Vdc) ($V_{CE} = 40$ Vdc, $V_{BE} = 2$ Vdc) ($V_{CE} = 54$ Vdc, $V_{BE} = 2$ Vdc) ($V_{CE} = 15$ Vdc, $V_{BE} = 2$ Vdc, $T_C = 150^\circ\text{C}$) ($V_{CE} = 25$ Vdc, $V_{BE} = 2$ Vdc, $T_C = 150^\circ\text{C}$) ($V_{CE} = 35$ Vdc, $V_{BE} = 2$ Vdc, $T_C = 150^\circ\text{C}$)	2N3021, 2N3024 2N3022, 2N3025 2N3023, 2N3026 2N3021, 2N3024 2N3022, 2N3025 2N3023, 2N3026	I_{CEX}	— — — — —	0.2 0.2 0.2 2 2	mAdc
Collector-Emitter Breakdown Voltage* ($I_C = 100$ mAdc, $I_B = 0$) ($I_C = 50$ mAdc, $I_B = 0$) ($I_C = 20$ mAdc, $I_B = 0$)	2N3021, 2N3024 2N3022, 2N3025 2N3023, 2N3026	BV_{CEO}^*	30 45 60	— — —	Vdc
DC Current Gain ($I_C = 1.0$ Adc, $V_{CE} = 2$ Vdc)	2N3021, 2N3022, 2N3023 2N3024, 2N3025, 2N3026	h_{FE}	20 50	60 180	—
Collector-Emitter Saturation Voltage ($I_C = 3$ Adc, $I_B = 0.3$ Adc)	2N3021, 2N3022, 2N3023 2N3024, 2N3025, 2N3026	$V_{CE(sat)}$	— —	1.5 1.0	Vdc
Base-Emitter Saturation Voltage ($I_C = 3$ Adc, $I_B = 0.3$ Adc)	All Types	$V_{BE(sat)}$	—	1.5	Vdc
Small Signal Current Gain ($I_C = 0.5$ Adc, $V_{CE} = 15$ Vdc, $f = 30$ mc)	All Types	h_{fe}	2	—	—
Switching Times (Figures 17 and 18) ($I_C = 1$ Adc, $I_{B1} = I_{B2} = 100$ mAdc)	All Types	$t_d + t_r$ t_s t_f	— — —	100 100 75	nsec

*Perform tests using sweep method to prevent heating.

POWER DERATING CURVE

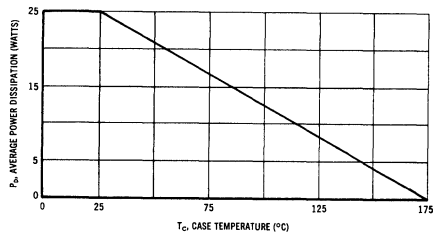

THESE TRANSISTORS ARE ALSO SUBJECT TO SAFE AREA CURVES AS INDICATED BY FIGURES 2, 3, 4. BOTH LIMITS ARE APPLICABLE AND MUST BE OBSERVED

SAFE OPERATING AREAS

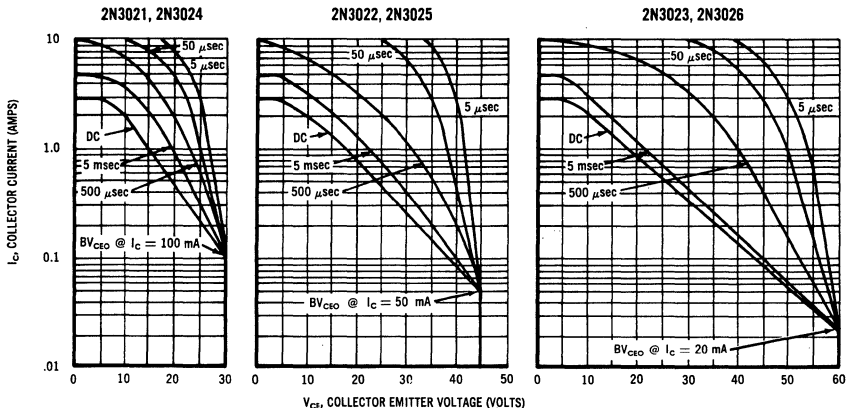

The Safe Operating Area Curves indicate I_C - V_{CE} limits below which the devices will not go into secondary breakdown. As the safe operating areas shown are independent of temperature and duty cycle, these curves can be used as long as the average power derating curve (Figure 1) is also taken into consideration to insure operation below the maximum junction temperature.

2N3021 thru 2N3026 (continued)

BASE-EMITTER SATURATION VOLTAGE VARIATIONS

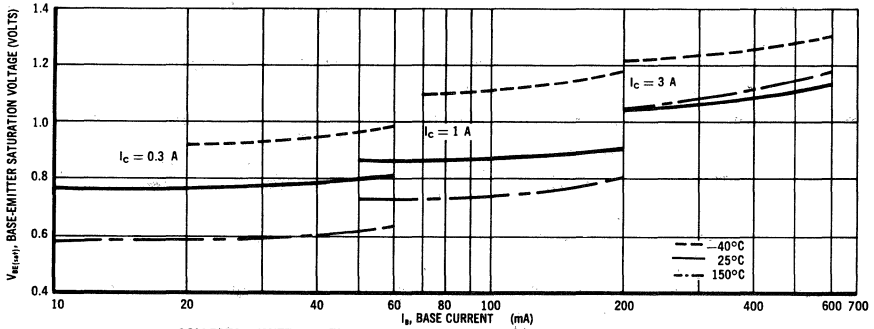

COLLECTOR-EMITTER SATURATION VOLTAGE VARIATIONS, 2N3021 thru 2N3023

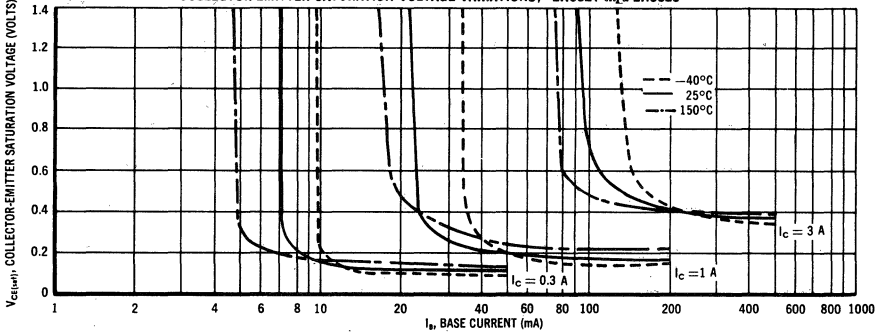

COLLECTOR-EMITTER SATURATION VOLTAGE VARIATIONS, 2N3024 thru 2N3026

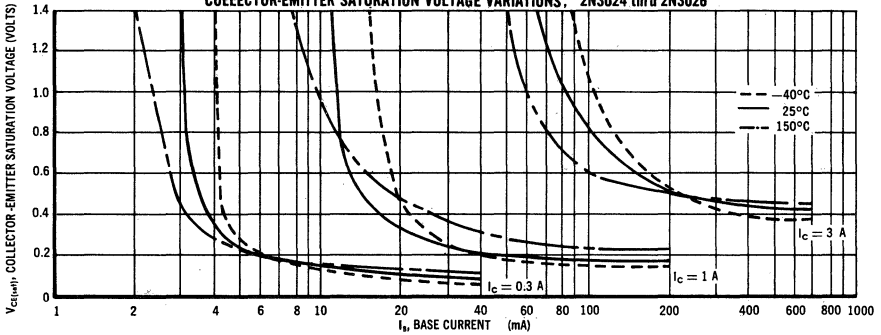

BASE CURRENT - VOLTAGE VARIATIONS

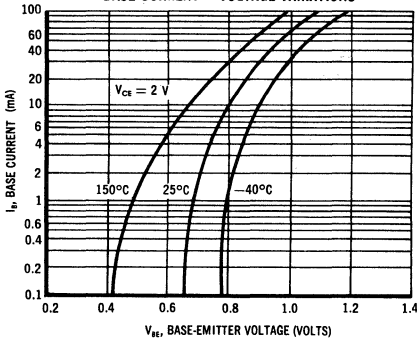

COLLECTOR CURRENT vs BASE-EMITTER VOLTAGE

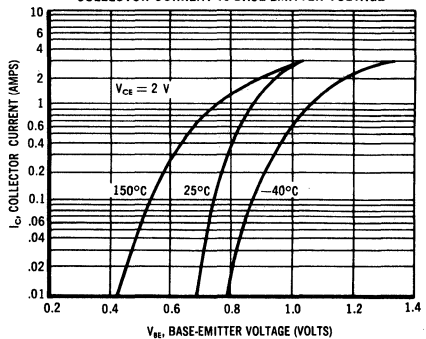

2N3021 thru 2N3026 (continued)

CURRENT GAIN VARIATIONS, 2N3021 thru 2N3023

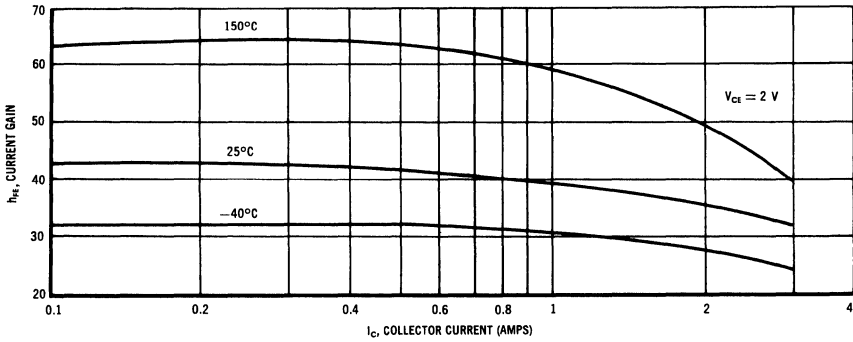

CURRENT GAIN VARIATIONS, 2N3024 thru 2N3026

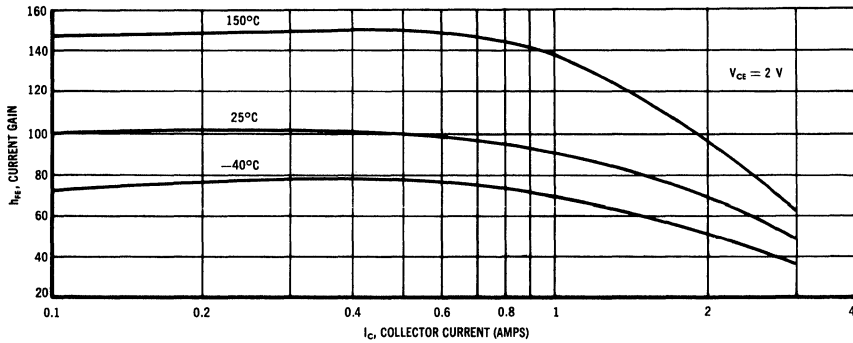

RISE TIME FACTOR

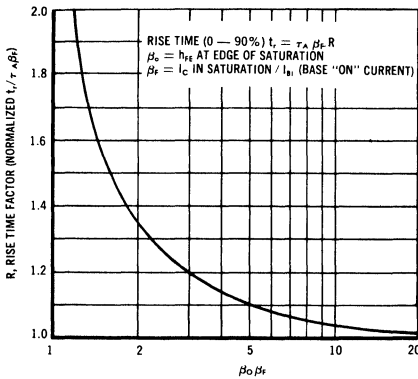

ACTIVE REGION TIME CONSTANT

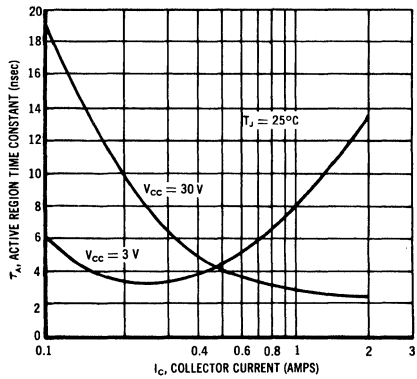

SWITCHING TIME EQUATIONS

Using charge control theory and data given with this transistor, switching times for a wide variety of conditions can be readily computed. For specific information regarding this technique, see Chapter 5 of the Motorola Switching Transistor Handbook.

2N3021 thru 2N3026 (continued)

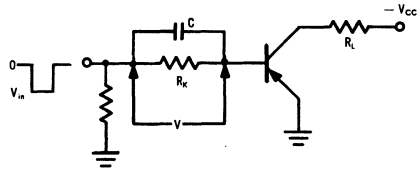
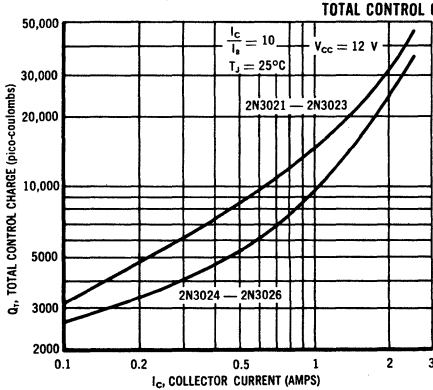
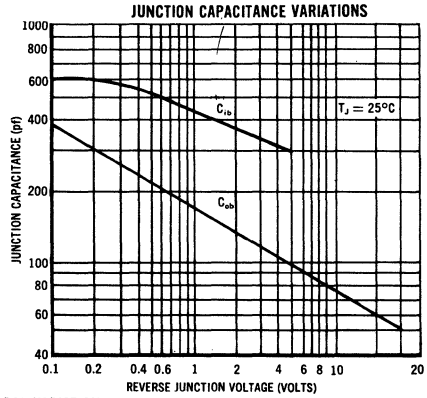
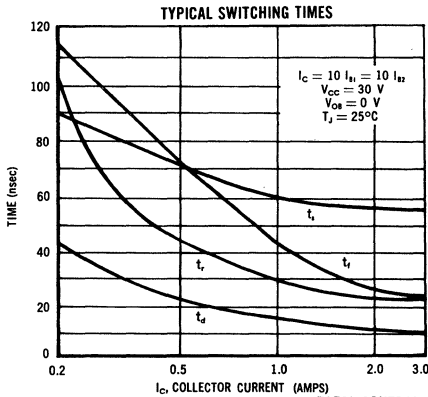

Total Control Charge. When a transistor is held in a conductive state by a current, I_{B1} , a charge, Q_s , is developed in the active region. A charge, Q_r , of opposite polarity, equal in magnitude, can be stored on an external capacitor, C , to neutralize the internal charge and considerably reduce the turn-off time of the transistor. Given Q_r from Figure 16A, the external C for minimum turn-off in any circuit is: $C = Q_r/V$, where V is shown in Figure 16B and is $I_{B1} R_k$.

For additional information, see Chapter 5 of the Motorola Switching Transistor Handbook.

TURN-ON TIME TEST CONDITIONS

V_{in} ADJUSTED TO I_{B1} USING CURRENT PROBE.
 t_f OF INPUT < 10 nsec. SCOPE < 5 nsec.
 $I_{B1} = 100 \text{ mA}$

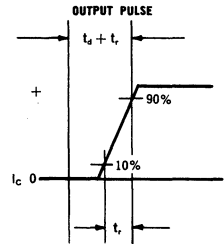
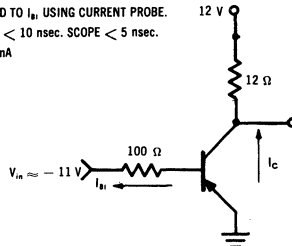
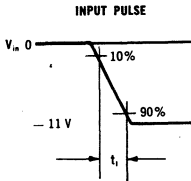

TURN-OFF TIME TEST CONDITIONS

V_{in} ADJUSTED TO I_{B2} USING CURRENT PROBE. $t_f < 10 \text{ nsec}$.
 PULSE WIDTH > 10 μsec
 $I_{B2} = 100 \text{ mA}$

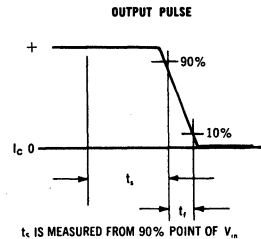
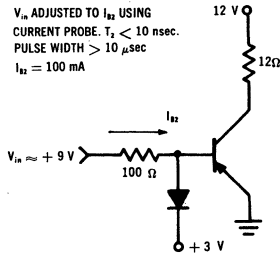
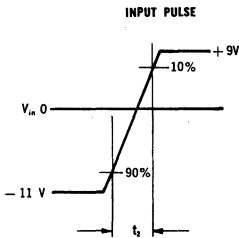

2N3311 thru 2N3316

$P_C = 170 \text{ W}$
 $I_C = 5 \text{ A}$
 $V_{CBO} = 30\text{-}60 \text{ V}$



CASE 7
(TO-36)

PNP germanium power transistors for high-power applications.

MAXIMUM RATINGS

Characteristic	Symbol	2N3311 2N3314	2N3312 2N3315	2N3313 2N3316	Unit
Collector-Base Voltage	V_{CBO}	30	45	60	Volts
Collector-Emitter Voltage	V_{CES}	30	45	60	Volts
Collector-Emitter Voltage	V_{CEO}	20	30	40	Volts
Emitter-Base Voltage	V_{EBO}	20	25	30	Volts
Collector Current (Continuous)	I_C	5	5	5	Amps
Power Dissipation at $T_C = 25^\circ\text{C}$	P_C	170	170	170	Watts
Junction Temperature Range	T_J	-65 to +110			$^\circ\text{C}$
Thermal Resistance	θ_{jc}	0.5			$^\circ\text{C}/\text{W}$

POWER-TEMPERATURE DERATING CURVE

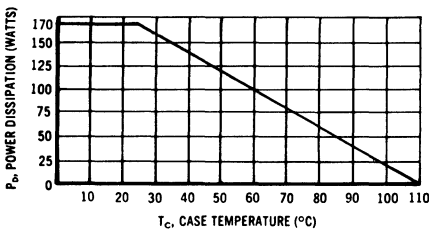

The maximum continuous power is related to maximum junction temperature by the thermal resistance factor. This curve has a value of 170 Watts at case temperatures of 25°C and is 0 Watts at 110°C with a linear relation between the two temperatures such that:

$$\text{allowable } P_D = \frac{110^\circ - T_C}{0.5}$$

2N3311 thru 2N3316 (continued)

ELECTRICAL CHARACTERISTICS (At $T_c = 25^\circ\text{C}$ unless otherwise specified.)

Characteristic	Symbol	Min	Max	Unit
Collector-Base Cutoff Current ($V_{CB} = V_{CB\text{ max}}$) ($V_{CE} = -2\text{ Vdc}, I_E = 0$)	I_{CBO}	—	5.0 0.3	mAdc
Collector Cutoff Current ($V_{CE} = 10\text{ Vdc}, I_B = 0$) ($V_{CE} = 15\text{ Vdc}, I_B = 0$) ($V_{CE} = 20\text{ Vdc}, I_B = 0$)	I_{CEO}	—	200 200 200	mAdc
Collector Cutoff Current ($V_{CE} = 25\text{ Vdc}, V_{BE} = 1\text{ Vdc},$ $T_C = 100^\circ\text{C}$) ($V_{CE} = 40\text{ Vdc}, V_{BE} = 1\text{ Vdc},$ $T_C = 100^\circ\text{C}$) ($V_{CE} = 55\text{ Vdc}, V_{BE} = 1\text{ Vdc},$ $T_C = 100^\circ\text{C}$)	I_{CEX}	—	35 35 35	mAdc
Emitter-Base Cutoff Current ($V_{EB} = V_{EB\text{ max}}, I_C = 0$)	I_{EBO}	—	4	mAdc
Collector-Emitter Breakdown Voltage* ($I_C = 300\text{ mAdc}, V_{EB} = 0$)	BV_{CES}^*	30 45 60	— — —	Vdc
Collector-Emitter Breakdown Voltage* ($I_C = 500\text{ mAdc}, I_B = 0$)	BV_{CEO}^*	-20 -30 -40	— — —	Vdc
Collector-Emitter Saturation Voltage ($I_C = 3\text{ Adc}, I_B = 300\text{ mAdc}$)	$V_{CE(\text{sat})}$	—	0.1	Vdc
Base-Emitter Voltage ($I_C = 3\text{ Adc}, V_{CE} = 2\text{ Vdc}$)	V_{BE}	—	0.6 0.5	Vdc
DC Current Gain ($I_C = 3\text{ Adc}, V_{CB} = 2\text{ Vdc}$) ($I_C = 500\text{ mAdc}, V_{CB} = 2\text{ Vdc}$)	h_{FE}	60 100 — —	120 200 150 250	—
Small Signal Current Gain ($I_C = 3\text{ Adc}, V_{CE} = 2\text{ Vdc},$ $f = 0.5\text{ kc}$)	h_{fe}	30 40	90 120	—
Common Emitter Cutoff Frequency ($I_C = 3\text{ Adc}, V_{CE} = 2\text{ Vdc}$)	f_{ae}	1.0	—	kc

*To avoid excessive heating of the collector junction, perform these tests with an oscilloscope.

2N3311 thru 2N3316 (continued)

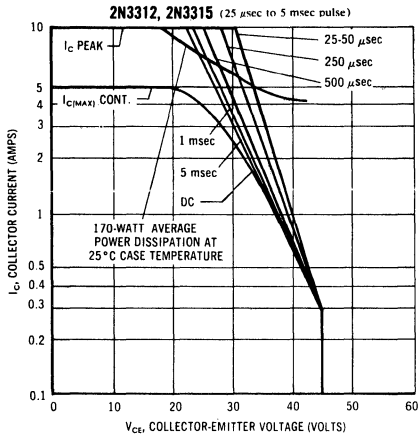
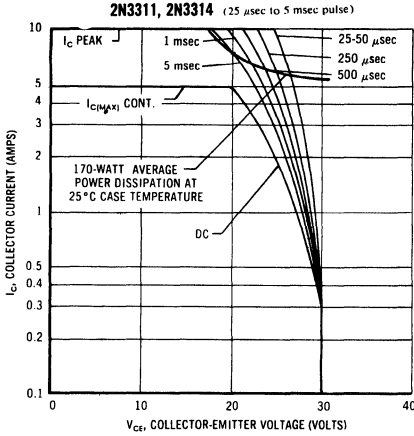

SAFE OPERATING AREA

The Safe Operating Area Curves indicate the I_C - V_{CE} limits below which the devices will not go into secondary breakdown. As the safe operating areas shown are independent of temperature and duty cycle, these curves can be used as long as the average power derating curve is also taken into consideration to insure operation below the maximum junction temperature.

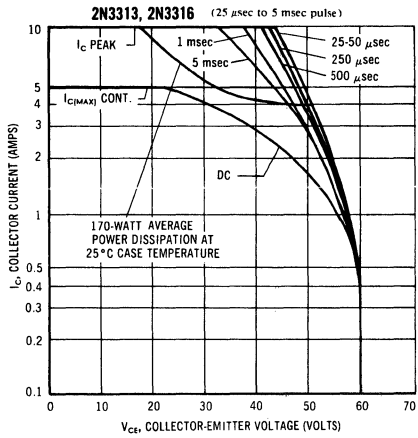

TEMPERATURE CHARACTERISTICS

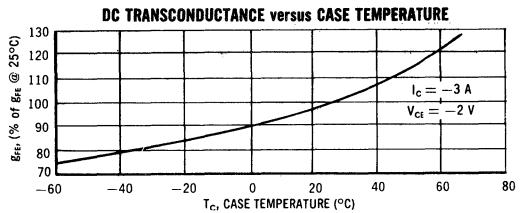
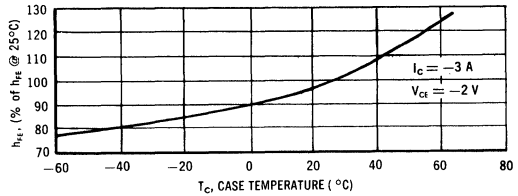
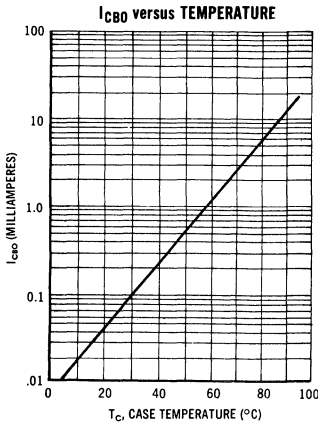

2N3445 thru 2N3448

$P_C = 118 \text{ W}$
 $I_C = 7.5 \text{ A}$
 $V_{CBO} = 80\text{-}100 \text{ V}$

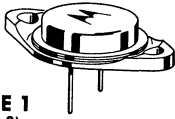

CASE 1
(TO-3)

NPN silicon power transistors for switching and amplifier applications requiring fast response, wide bandwidth and good Beta linearity.

ABSOLUTE MAXIMUM RATINGS

Characteristic	Symbol	2N3445 2N3447	2N3446 2N3448	Unit
Collector-Base Voltage	V_{CB}	80	100	Volts
Collector-Emitter Voltage	V_{CE}	60	80	Volts
Emitter-Base Voltage	V_{EB}	6	10	Volts
Collector Current (Continuous)	I_C	7.5	7.5	Amps
Base Current (Continuous)	I_B	4.0	4.0	Amps
Power Dissipation	P_D	115	115	Watts
Junction Operating Temperature Range	T_J	-65 to +200		$^{\circ}\text{C}$

POWER DERATING CURVE

These transistors are also subject to safe area curves. Both limits are applicable and must be observed.

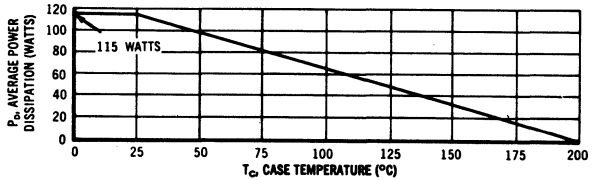

SAFE OPERATING AREAS

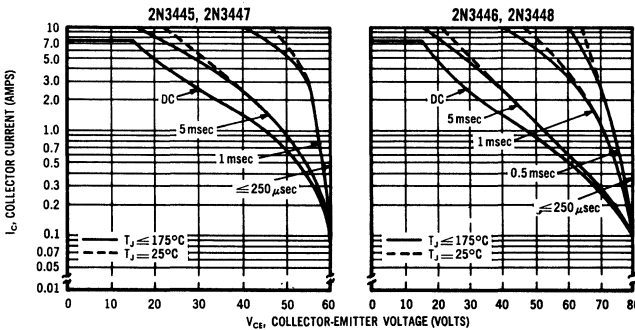

The Safe Operating Area Curves indicate $I_C - V_{CE}$ limits below which the device will not go into secondary breakdown. Collector load lines for specific circuits must fall within the applicable Safe Area to avoid causing a collector-emitter short. (Duty cycle of the excursions make no significant change in these safe areas.) To insure operation below the maximum T_J , the power-temperature derating curve must be observed for both steady state and pulse power conditions.

2N3445 thru 2N3448 (continued)

ELECTRICAL CHARACTERISTICS ($T_c = 25^\circ\text{C}$ unless otherwise noted)

Characteristic	Symbol	Min	Typ	Max	Unit
Emitter-Base Cutoff Current ($V_{EB} = 6 \text{ Vdc}$) ($V_{EB} = 10 \text{ Vdc}$)	I_{EBO}	—	—	0.25 0.25	mAdc
Collector-Emitter Cutoff Current ($V_{CE} = 60 \text{ Vdc}$, $V_{BE} = -1 \text{ Vdc}$) ($V_{CE} = 60 \text{ Vdc}$, $V_{BE} = -1 \text{ Vdc}$, $T_c = 150^\circ\text{C}$) ($V_{CE} = 80 \text{ Vdc}$, $V_{BE} = -1 \text{ Vdc}$) ($V_{CE} = 80 \text{ Vdc}$, $V_{BE} = -1 \text{ Vdc}$, $T_c = 150^\circ\text{C}$)	I_{CEX}	—	—	0.1 1.0 0.1 1.0	mAdc
Collector-Emitter Cutoff Current ($V_{CE} = 40 \text{ Vdc}$, $I_B = 0$) ($V_{CE} = 60 \text{ Vdc}$, $I_B = 0$)	I_{CEO}	—	—	1.0 1.0	mAdc
Collector-Base Breakdown Voltage ($I_C = 1 \text{ mAdc}$, $I_E = 0$)	BV_{CBO}	80 100	—	—	Vdc
Collector-Emitter Sustaining Voltage ($I_C = 100 \text{ mAdc}$, $I_B = 0$)	$V_{CEO(sus)}$	60 80	—	—	Vdc
DC Current Gain ($I_C = 0.5 \text{ Adc}$, $V_{CE} = 5 \text{ Vdc}$) ($I_C = 3 \text{ Adc}$, $V_{CE} = 5 \text{ Vdc}$) ($I_C = 5 \text{ Adc}$, $V_{CE} = 5 \text{ Vdc}$)	h_{FE}	20 40 20 40	45 85 40 75	— — 60 120	—
Collector-Emitter Saturation Voltage ($I_C = 3 \text{ Adc}$, $I_B = 0.3 \text{ Adc}$) ($I_C = 5 \text{ Adc}$, $I_B = 0.5 \text{ Adc}$)	$V_{CE(sat)}$	—	0.6 0.8	1.5 1.5	Vdc
Base-Emitter Saturation Voltage ($I_C = 3 \text{ Adc}$, $I_B = 0.3 \text{ Adc}$) ($I_C = 5 \text{ Adc}$, $I_B = 0.5 \text{ Adc}$)	$V_{BE(sat)}$	—	1.0 1.0	1.5 1.5	Vdc
Base-Emitter Voltage ($I_C = 3 \text{ Adc}$, $V_{CE} = 5 \text{ Vdc}$) ($I_C = 5 \text{ Adc}$, $V_{CE} = 5 \text{ Vdc}$)	V_{BE}	—	1.0 1.0	1.5 1.4	Vdc
Small Signal Current Gain ($V_{CE} = 10 \text{ Vdc}$, $I_C = 0.5 \text{ Adc}$, $f = 1 \text{ kc}$) ($V_{CE} = 10 \text{ Vdc}$, $I_C = 0.5 \text{ Adc}$, $f = 10 \text{ mc}$)	h_{fe}	20 40 1.0	— — 1.6	100 200 —	—
Common Base Output Capacitance ($V_{CB} = 10 \text{ Vdc}$, $f = 0.1 \text{ mc}$)	C_{ob}	—	260	400	pf
Switching Times ($V_{CC} = 25 \text{ Vdc}$, $R_f = 5 \text{ ohms}$, $I_C = 5 \text{ A}$, $I_{B1} = I_{B2} = 0.5 \text{ A}$) Delay Time plus Rise Time Storage Time Fall Time	$t_d + t_r$ t_s t_f	—	0.15 0.9 0.15	0.35 2.0 0.35	μsec

COLLECTOR CURRENT versus BASE CURRENT

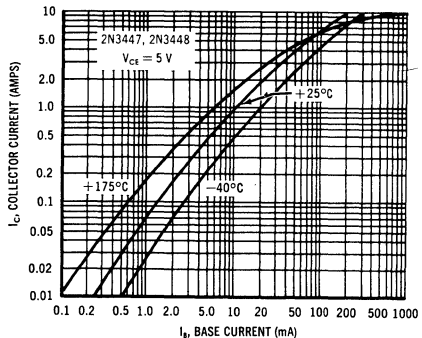
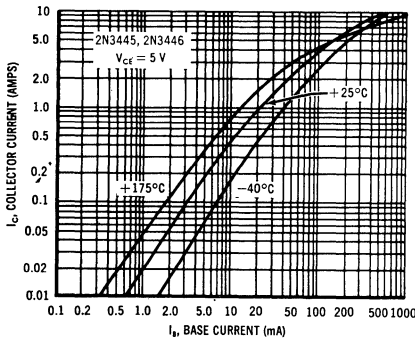

2N3445 thru 2N3448 (continued)

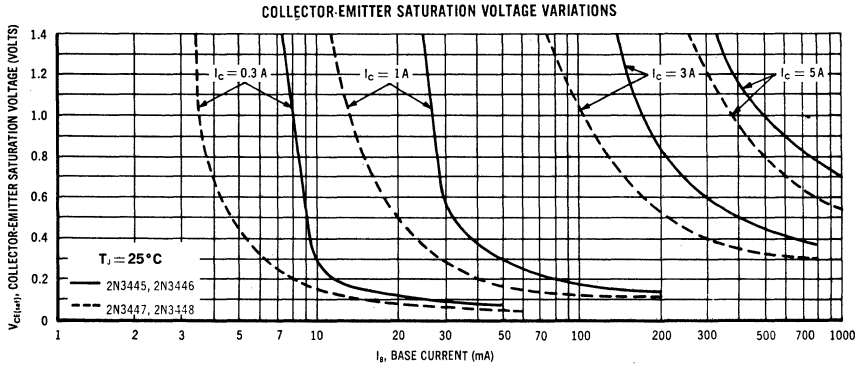
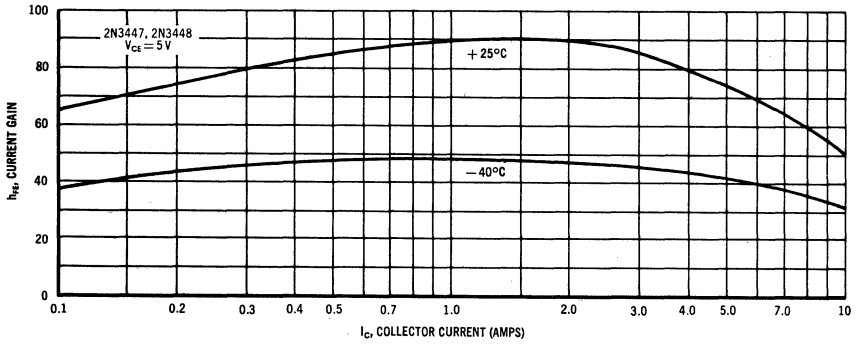
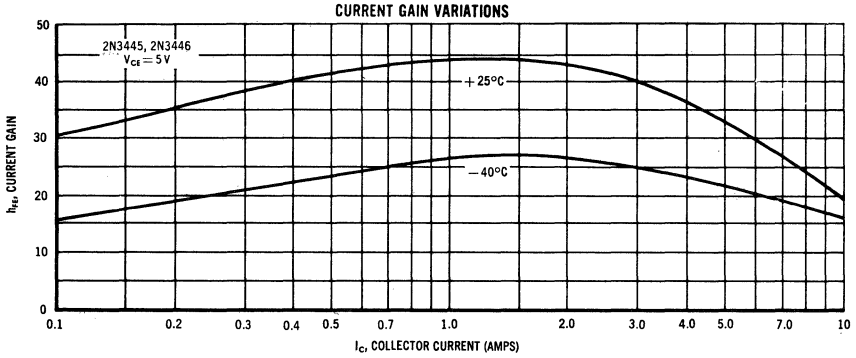

2N3445 thru 2N3448 (continued)

COLLECTOR CURRENT-VOLTAGE VARIATIONS

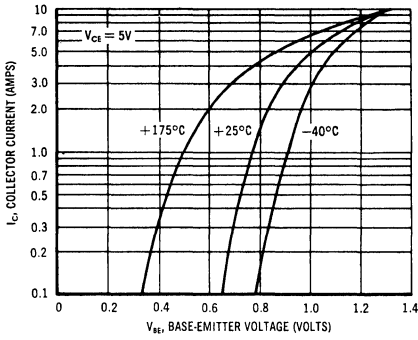

BASE CURRENT-VOLTAGE VARIATIONS

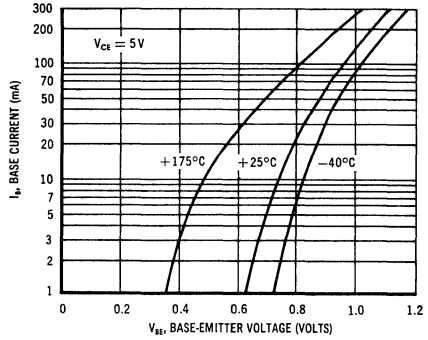

TYPICAL SWITCHING TIMES

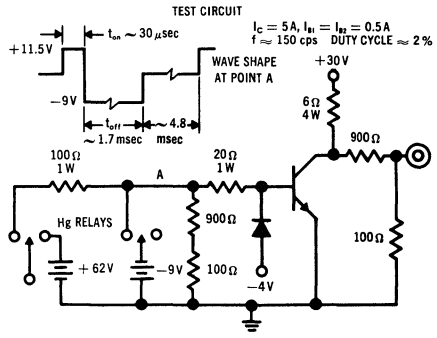
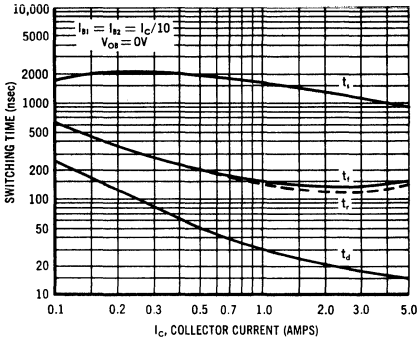

ACTIVE REGION TIME CONSTANT

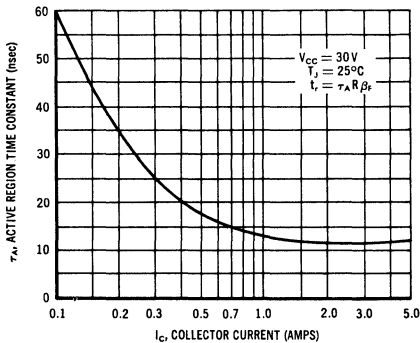

RISE TIME FACTOR

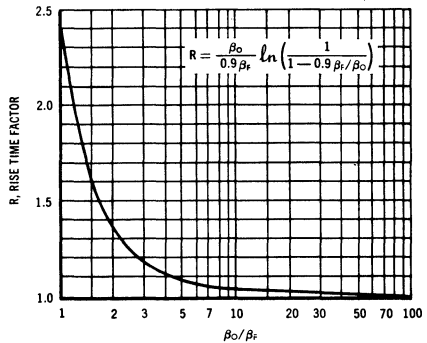

2N3611 thru 2N3614

$P_C = 85 \text{ W}$
 $I_C = 7 \text{ A}$
 $V_{CB0} = 40-6 \text{ V}$

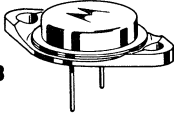

CASE 3
(TO-3)

PNP germanium power transistors for switching and amplifier applications.

MAXIMUM RATINGS

Characteristics	Symbol	2N3611 2N3613	2N3612 2N3614	Unit
Collector-Emitter Voltage	V_{CES}	30	45	Vdc
Collector-Emitter Voltage (Open Base)	V_{CEO}	25	35	Vdc
Collector-Base Voltage	V_{CB0}	40	60	Vdc
Emitter-Base Voltage	V_{EBO}	20	30	Vdc
Collector Current (Continuous)	I_C	7		Adc
Peak Collector Current ($PW \leq 5 \text{ msec}$)	I_C	15		Adc
Base Current (Continuous)	I_B	2		Adc
Storage Temperature Range	T_{stg}	-65 to +110		$^{\circ}\text{C}$
Operating Case Temperature Range	T_C	-65 to +110		$^{\circ}\text{C}$
Total Device Dissipation @ $T_C = 25^{\circ}\text{C}$ Derate above $T_C = 25^{\circ}\text{C}$	P_D	85		Watts W/ $^{\circ}\text{C}$
Thermal Resistance, Junction to Case	θ_{JC}	1.0		$^{\circ}\text{C}/\text{W}$
Thermal Resistance, Case to Ambient	θ_{CA}	32.7		$^{\circ}\text{C}/\text{W}$

SAFE OPERATING AREAS

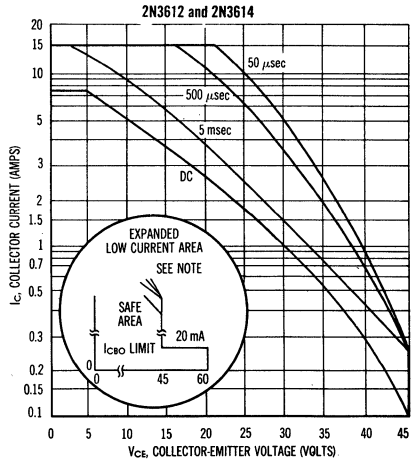
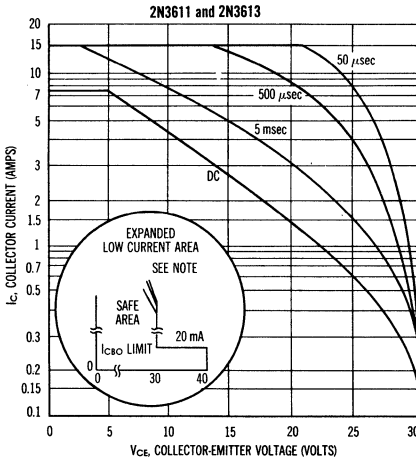

NOTE — The Safe Operating Area Curves indicate I_C - V_{CE} limits below which the device will not go into secondary breakdown. Collector load lines for specific circuits must fall within the applicable Safe Area to avoid causing a collector-emitter short. (Case temperature and duty cycle of the excursions make no significant change in these safe areas.) The load line may exceed the V_{CES} voltage limit only if the collector

current has been reduced to 20 mA or less before or at the V_{CES} limit; then and only then may the load line be extended to the absolute maximum voltage rating of BV_{CE0} . To insure operation below the maximum T_J , the power-temperature derating curve must be observed for both steady state and pulse power conditions.

2N3611 thru 2N3614 (continued)

ELECTRICAL CHARACTERISTICS

Characteristics		Symbol	Min	Max	Unit
Collector-Emitter Breakdown Voltage* ($I_C = 250$ mAdc)	2N3611, 2N3613 2N3612, 2N3614	V_{CES}^*	30 45	— —	Vdc
Collector-Emitter Breakdown Voltage* ($I_C = 500$ mAdc)	2N3611, 2N3613 2N3612, 2N3614	V_{CEO}^*	25 35	— —	Vdc
Floating Potential ($V_{CB} = V_{CB}$ max)	All Types	V_{EBF}	—	1.0	Vdc
Collector-Emitter Leakage Current ($V_{CE} = 1/2 V_{CEO}$ max)	All Types	I_{CEO}	—	30	mAdc
Collector-Emitter Leakage Current ($V_{CE} = V_{CE}$ max, $V_{BE} = 1.0$ Vdc, $T_C = +100^\circ\text{C}$)	All Types	I_{CEX}	—	10	mAdc
Collector-Base Cutoff Current ($V_{CB} = 2$ Vdc) ($V_{CB} = 25$ Vdc) ($V_{CB} = 40$ Vdc) ($V_{CB} = V_{CB}$ max)	All Types 2N3611, 2N3613 2N3612, 2N3614 All Types	I_{CBO}	— — — —	.040 0.5 0.5 5.0	mAdc
Emitter-Base Cutoff Current ($V_{EB} = V_{EB}$ max) ($V_{EB} = 12$ Vdc)	All Types All Types	I_{EBO}	— —	500 100	μ Adc
Collector-Emitter Saturation Voltage ($I_C = 3$ A, $I_B = 300$ mAdc) ($I_C = 7$ A, $I_B = 700$ mAdc)	All Types All Types	$V_{CE(sat)}$	— —	0.25 0.35	Vdc
Base-Emitter Saturation Voltage ($I_C = 3$ A, $I_B = 300$ mAdc) ($I_C = 7$ A, $I_B = 700$ mAdc)	2N3611, 2N3612 2N3613, 2N3614 2N3611, 2N3612 2N3613, 2N3614	$V_{BE(sat)}$	— — — —	0.7 0.6 1.1 0.9	Vdc
Transconductance ($I_C = 3$ A, $V_{CE} = 2$ Vdc)	2N3611, 2N3612 2N3613, 2N3614	g_{FE}	3.0 3.5	— —	mhos
Small Signal Current Gain ($I_C = 0.5$ A, $V_{CE} = 12$ V, $f = 20$ kc) ($I_C = 0.5$ A, $V_{CE} = 2$ V, $f = 1$ kc)	All Types 2N3611, 2N3612 2N3613, 2N3614	h_{fe}	15 40 60	— 100 150	—
DC Current Gain ($I_C = 3$ A, $V_{CE} = 2$ Vdc) ($I_C = 7$ A, $V_{CE} = 2$ Vdc)	2N3611, 2N3612 2N3613, 2N3614 2N3611, 2N3612 2N3613, 2N3614	h_{FE}	35 60 20 30	70 120 — —	—

*Sweep Test: 1/2 sine wave, 60 cps

POWER-TEMPERATURE DERATING CURVE

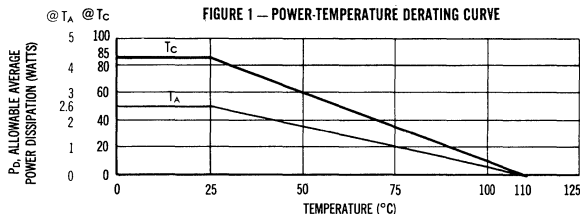

These transistors are also subject to safe area curves. Both limits are applicable and must be observed.

2N3611 thru 2N3614 (continued)

COLLECTOR CURRENT versus BASE-EMITTER VOLTAGE

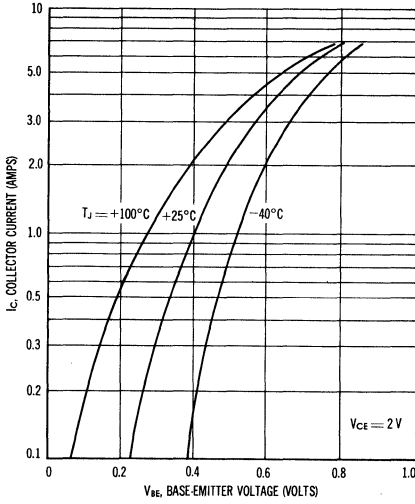

TYPICAL SWITCHING TIMES

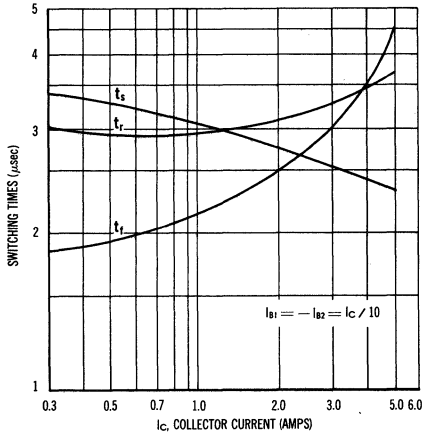

DC CURRENT GAIN versus COLLECTOR CURRENT

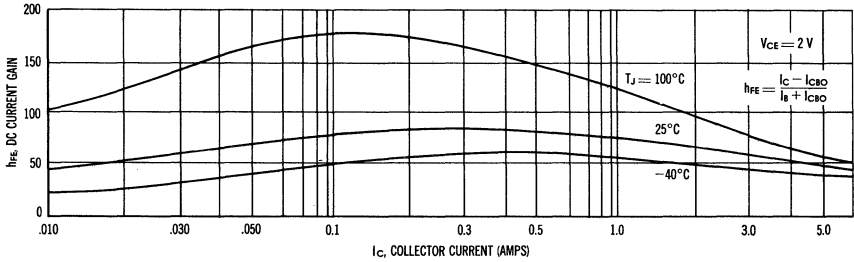

COLLECTOR-EMITTER SATURATION VOLTAGE VARIATIONS

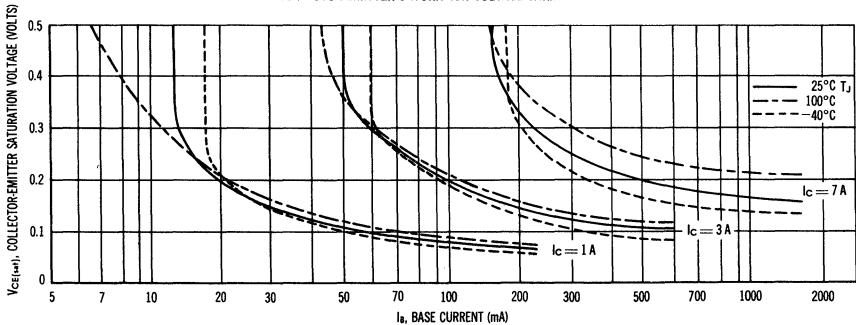

2N3615 thru 2N3618

$P_C = 85 \text{ W}$
 $I_C = 7 \text{ A}$
 $V_{CBO} = 80\text{-}100 \text{ V}$

CASE 3
(TO-3)

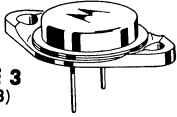

PNP germanium power transistors for switching and amplifier applications.

MAXIMUM RATINGS

Characteristics	Symbol	2N3615 2N3617	2N3616 2N3618	Unit
Collector-Emitter Voltage	V_{CES}	60	75	Vdc
Collector-Emitter Voltage (Open Base)	V_{CEO}	50	60	Vdc
Collector-Base Voltage	V_{CBO}	80	100	Vdc
Emitter-Base Voltage	V_{EBO}	40	50	Vdc
Collector Current (Continuous)	I_C	7		Adc
Peak Collector Current (PW \leq 5 msec)	I_C	15		Adc
Base Current (Continuous)	I_B	2		Adc
Storage Temperature	T_{stg}	-65 to +110		$^{\circ}\text{C}$
Operating Case Temperature	T_C	-65 to +110		$^{\circ}\text{C}$
Total Device Dissipation @ $T_C = 25^{\circ}\text{C}$ Derate above 25°C	P_D	85		Watts
		1		W/ $^{\circ}\text{C}$
Thermal Resistance, Junction to Case	θ_{JC}	1.0		$^{\circ}\text{C}/\text{W}$
Thermal Resistance, Case to Ambient	θ_{CA}	32.7		$^{\circ}\text{C}/\text{W}$

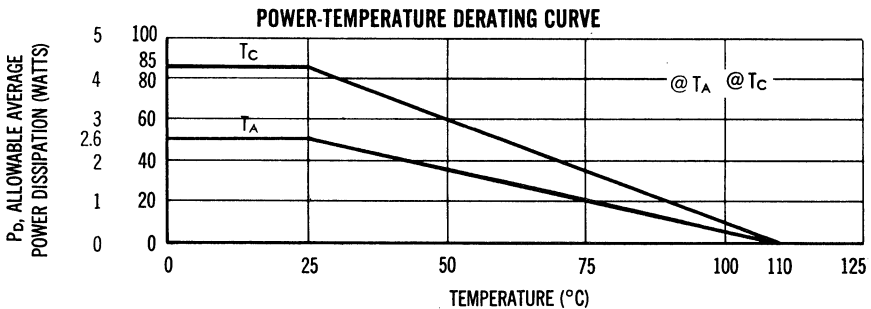

These transistors are also subject to safe area curves
 Both limits are applicable and must be observed.

2N3615 thru 2N3618 (continued)

ELECTRICAL CHARACTERISTICS (at $T_C = 25^\circ\text{C}$ unless otherwise specified)

Characteristics		Symbol	Min	Max	Unit
Collector-Emitter Breakdown Voltage* ($I_C = 250 \text{ mAdc}$)	2N3615, 2N3617 2N3616, 2N3618	BV_{CES}^*	60 75	— —	Vdc
Collector-Emitter Breakdown Voltage* ($I_C = 300 \text{ mAdc}$)	2N3615, 2N3617 2N3616, 2N3618	BV_{CEO}^*	50 60	— —	Vdc
Floating Potential ($V_{CB} = V_{CB \text{ max}}$)	All Types	V_{EBF}	—	1.0	Vdc
Collector-Emitter Leakage Current ($V_{CE} = 1/2 V_{CEO \text{ max}}$)	All Types	I_{CEO}	—	30	mAcd
Collector-Emitter Leakage Current ($V_{CE} = V_{CE \text{ max}}$, $V_{BE} = 1.0 \text{ Vdc}$, $T_C = +100^\circ\text{C}$)	All Types	I_{CEX}	—	10	mAcd
Collector-Base Cutoff Current ($V_{CB} = 2 \text{ Vdc}$)	All Types	I_{CBO}	—	.060	mAcd
($V_{CB} = 55 \text{ Vdc}$)	2N3615, 2N3617		—	1.0	
($V_{CB} = 65 \text{ Vdc}$)	2N3616, 2N3618		—	1.0	
($V_{CB} = V_{CB \text{ max}}$)	All Types		—	5.0	
Emitter-Base Cutoff Current ($V_{EB} = V_{EB \text{ max}}$)	All Types	I_{EBO}	—	500	μAcd
($V_{EB} = 12 \text{ Vdc}$)	All Types		—	100	
Collector-Emitter Saturation Voltage ($I_C = 3 \text{ Adc}$, $I_B = 300 \text{ mAdc}$)	All Types	$V_{CE(\text{sat})}$	—	0.25	Vdc
($I_C = 7 \text{ Adc}$, $I_B = 700 \text{ mAdc}$)	All Types		—	0.35	
Base-Emitter Saturation Voltage ($I_C = 3 \text{ Adc}$, $I_B = 300 \text{ mAdc}$)	2N3615, 2N3616 2N3617, 2N3618	$V_{BE(\text{sat})}$	— —	0.7 0.6	Vdc
($I_C = 7 \text{ Adc}$, $I_B = 700 \text{ mAdc}$)	2N3615, 2N3616 2N3617, 2N3618		— —	1.1 0.9	
Transconductance ($I_C = 3 \text{ A}$, $V_{CE} = 2 \text{ V}$)	2N3615, 2N3616 2N3617, 2N3618	g_{FE}	3.0 3.5	— —	mhos
Small Signal Current Gain ($I_C = 0.5 \text{ A}$, $V_{CE} = 12 \text{ V}$, $f = 20 \text{ kc}$)	All Types	h_{fe}	15	—	—
($I_C = 0.5 \text{ A}$, $V_{CE} = 2 \text{ V}$, $f = 1 \text{ kc}$)	2N3615, 2N3616 2N3617, 2N3618		40 60	100 150	
DC Current Gain ($I_C = 3 \text{ Adc}$, $V_{CE} = 2 \text{ Vdc}$)	2N3615, 2N3616 2N3617, 2N3618	h_{FE}	30 45	60 90	—
($I_C = 7 \text{ Adc}$, $V_{CE} = 2 \text{ Vdc}$)	2N3615, 2N3616 2N3617, 2N3618		20 30	— —	

*Sweep Test: 1/2 sine wave, 60 cps

2N3615 thru 2N3618 (continued)

SAFE OPERATING AREAS

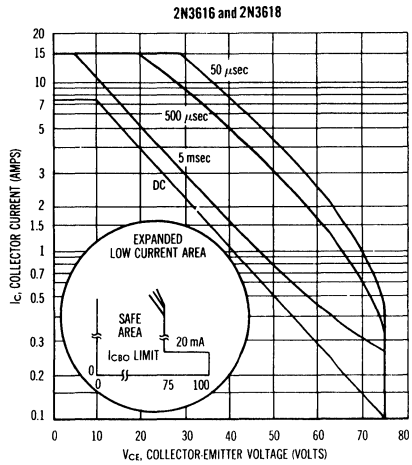
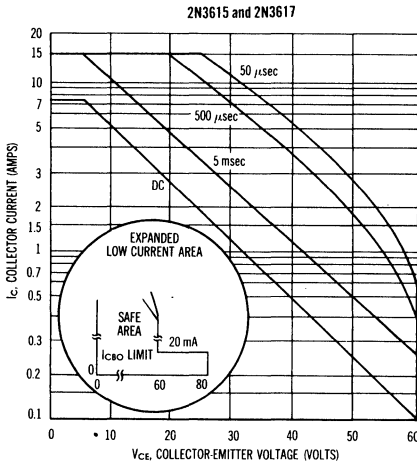

NOTE The Safe Operating Area Curves indicate I_C - V_{CE} limits below which the device will not go into secondary breakdown. Collector load lines for specific circuits must fall within the applicable Safe Area to avoid causing a collector-emitter short. (Case temperature and duty cycle of the excursions make no significant change in these safe areas.) The load line may exceed the BV_{CES} voltage limit only if the collector

current has been reduced to 20 mA or less before or at the BV_{CES} limit; then and only then may the load line be extended to the absolute maximum voltage rating of BV_{CBO} . To insure operation below the maximum T_J , the power-temperature derating curve must be observed for both steady state and pulse power conditions.

DC CURRENT GAIN versus COLLECTOR CURRENT

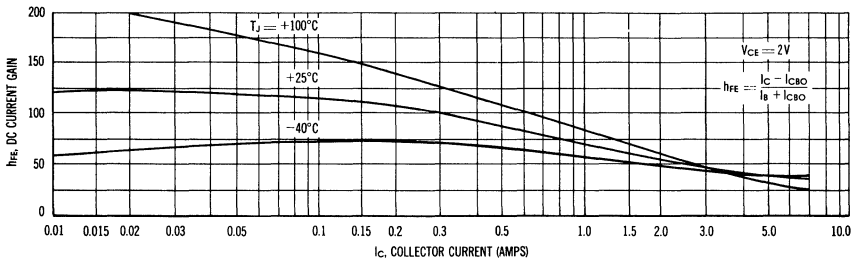

COLLECTOR-EMITTER SATURATION VOLTAGE VARIATIONS

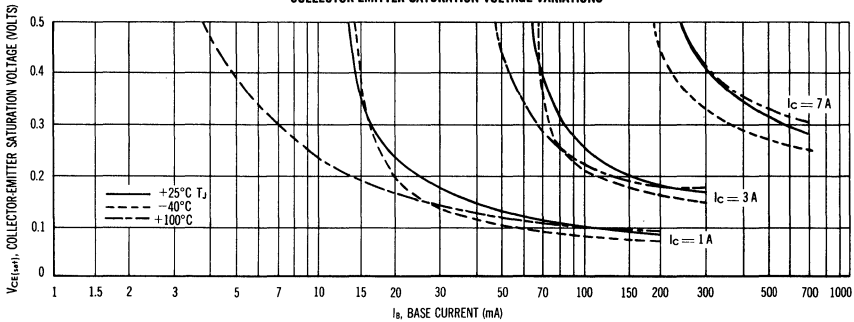

2N3615 thru 2N3618 (continued)

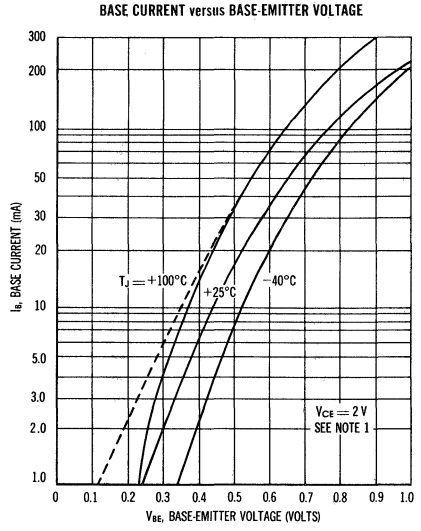
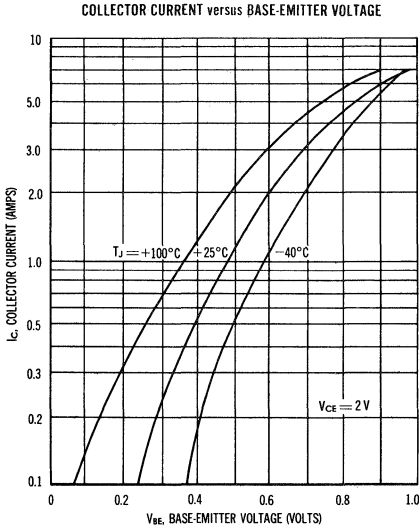

NOTE 1 — Dotted line indicates Metered Base Current plus the $I_{C(BI)}$ of the transistor at 100°C .

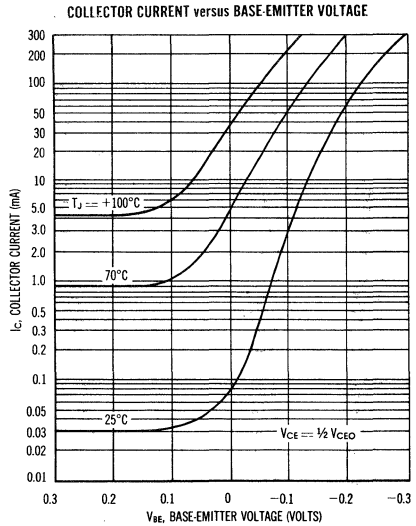
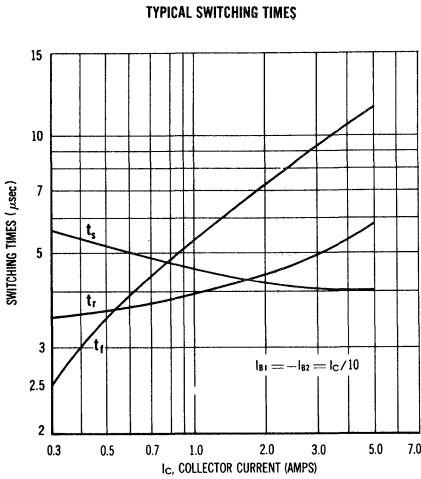

2N3713 thru 2N3716

$P_C = 150\text{ W}$
 $I_C = 10\text{ A}$
 $V_{CBO} = 80\text{--}100\text{ V}$

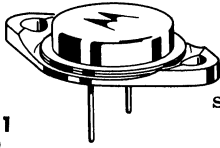

NPN silicon power transistors for medium-speed switching and amplifier applications.

CASE 1
(TO-3)

MAXIMUM RATINGS

Characteristic	Symbol	2N3713 2N3715	2N3714 2N3716	Unit
Collector-Base Voltage	V_{CBO}	80	100	Volts
Collector-Emitter Voltage	V_{CEO}	60	80	Volts
Emitter-Base Voltage	V_{EBO}	7	7	Volts
Collector Current (Continuous)	I_C	10	10	Amps
Base Current (Continuous)	I_B	4.0	4.0	Amps
Power Dissipation	P_C	150	150	Watts
Thermal Resistance	θ_{JC}	1.2	1.2	$^{\circ}\text{C}/\text{W}$
Operating Junction and Storage Temperature Range	T_J and T_{stg}	-65 to +200		$^{\circ}\text{C}$

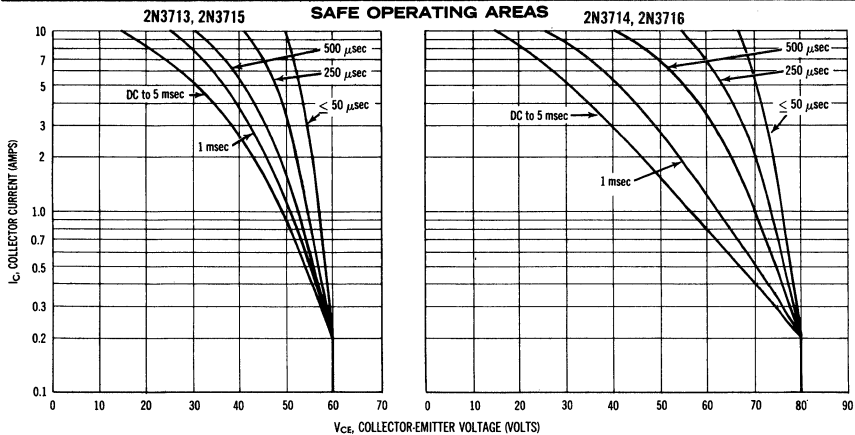

The Safe Operating Area Curves indicate I_C — V_{CE} limits below which the device will not go into secondary breakdown. Collector load lines for specific circuits must fall within the applicable Safe Area to avoid causing a collector-emitter short. (Duty cycle of the excursions make no signifi-

cant change in these safe areas.) To insure operation below the maximum T_J , the power-temperature derating curve must be observed for both steady state and pulse power conditions.

2N3713 thru 2N3716 (continued)

ELECTRICAL CHARACTERISTICS ($T_C = 25^\circ\text{C}$ unless otherwise noted)

Characteristic	Symbol	Min	Max	Unit
Emitter-Base Cutoff Current ($V_{EB} = 7 \text{ Vdc}$)	I_{EBO}	—	5	mAdc
Collector-Emitter Cutoff Current ($V_{CE} = 80 \text{ Vdc}, V_{BE} = -1.5 \text{ Vdc}$) ($V_{CE} = 100 \text{ Vdc}, V_{BE} = -1.5 \text{ Vdc}$) ($V_{CE} = 60 \text{ Vdc}, V_{BE} = -1.5 \text{ Vdc}, T_C = 150^\circ\text{C}$) ($V_{CE} = 80 \text{ Vdc}, V_{BE} = -1.5 \text{ Vdc}, T_C = 150^\circ\text{C}$)	I_{CEX}	—	1	mAdc
	2N3713, 2N3715	—	1	
	2N3714, 2N3716	—	10	
	2N3713, 2N3715	—	10	
	2N3714, 2N3716	—	10	
Collector-Emitter Sustaining Voltage* ($I_C = 200 \text{ mAdc}, I_B = 0$)	$V_{CEO(sus)}$ *	60	—	Vdc
2N3713, 2N3715	80	—		
2N3714, 2N3716	—	—		
DC Current Gain* ($I_C = 1 \text{ Adc}, V_{CE} = 2 \text{ Vdc}$) ($I_C = 3 \text{ Adc}, V_{CE} = 2 \text{ Vdc}$)	h_{FE} *	25	90	—
	2N3713, 2N3714	50	150	
	2N3715, 2N3716	15	—	
	2N3713, 2N3714	30	—	
	2N3715, 2N3716	—	—	
Collector-Emitter Saturation Voltage* ($I_C = 5 \text{ Adc}, I_B = 0.5 \text{ Adc}$)	$V_{CE(sat)}$ *	—	1.0	Vdc
2N3713, 2N3714	—	0.8		
2N3715, 2N3716	—	—		
Base-Emitter Saturation Voltage* ($I_C = 5 \text{ Adc}, I_B = 0.5 \text{ Adc}$)	$V_{BE(sat)}$ *	—	2.0	Vdc
2N3713, 2N3714	—	1.5		
2N3715, 2N3716	—	—		
Base-Emitter Voltage* ($I_C = 3 \text{ Adc}, V_{CE} = 2 \text{ Vdc}$)	V_{BE} *	—	1.5	Vdc
All Types	—	—	—	
Small Signal Current Gain ($V_{CE} = 10 \text{ Vdc}, I_C = 0.5 \text{ Adc}, f = 1 \text{ mc}$)	h_{fe}	4	—	—
All Types	—	—	—	
Switching Times			Typ	μsec
($I_C = 5 \text{ A}, I_{B1} = I_{B2} = 0.5 \text{ A}$)				
Rise Time	t_R		0.45	
Storage Time	t_S		0.3	
Fall Time	t_F		0.4	

*Use sweep test to prevent overheating

COLLECTOR-EMITTER SATURATION VOLTAGE VARIATIONS

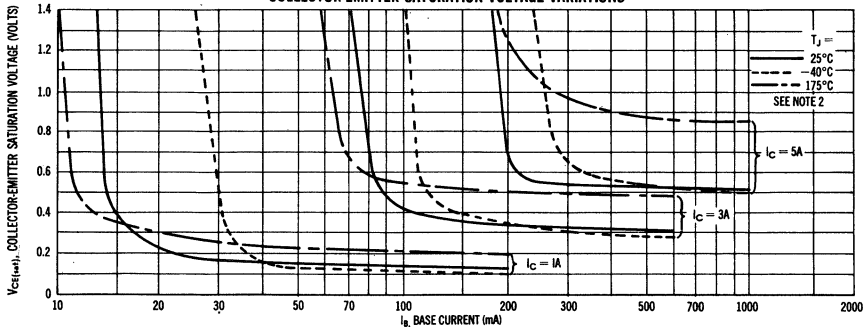

BASE-EMITTER SATURATION VOLTAGE VARIATIONS

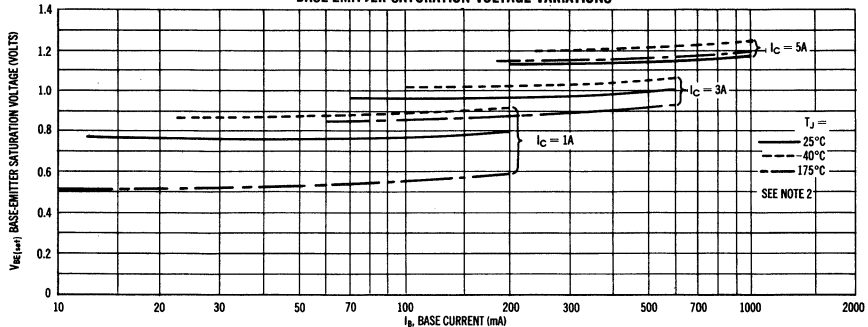

2N3713 thru 2N3716 (continued)

COLLECTOR CURRENT versus BASE CURRENT

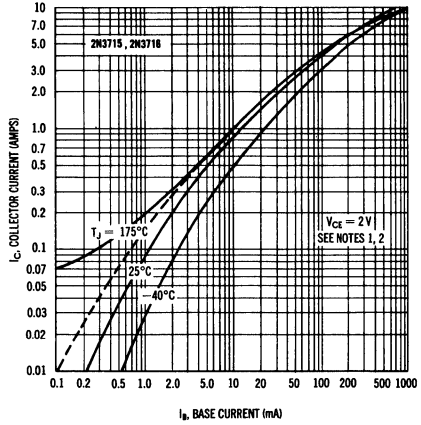
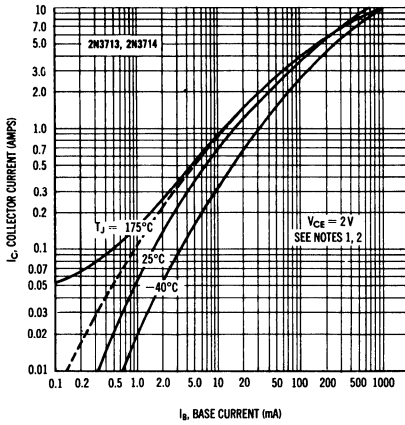

BASE CURRENT-VOLTAGE VARIATIONS

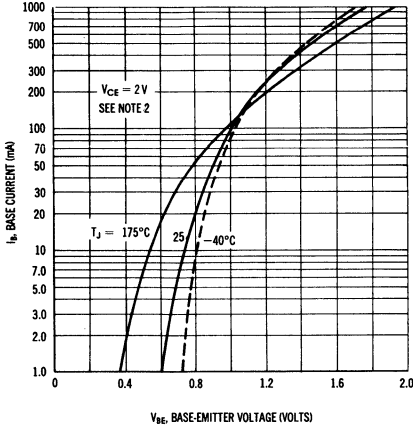

COLLECTOR CURRENT-VOLTAGE VARIATIONS

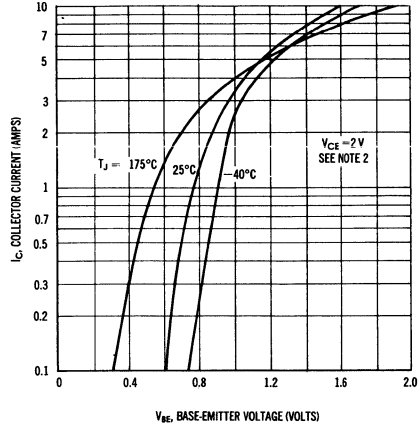

NOTE 1. Dotted line indicates metered base current plus the I_{CBO} of the transistor at 175°C.

NOTE 2. Pulse test: pulse width \approx 200 μ sec, duty cycle \approx 1.5%

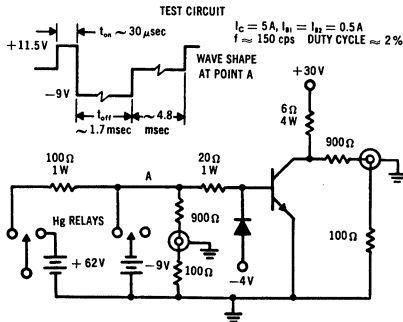

TYPICAL SWITCHING TIMES

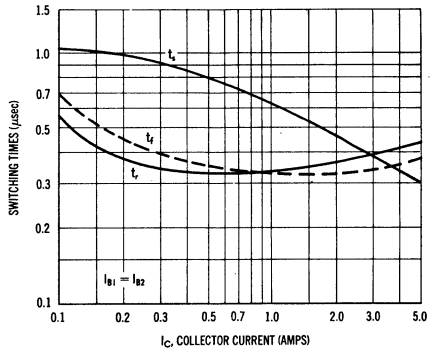

2N3713 thru 2N3716 (continued)

CURRENT GAIN VARIATIONS

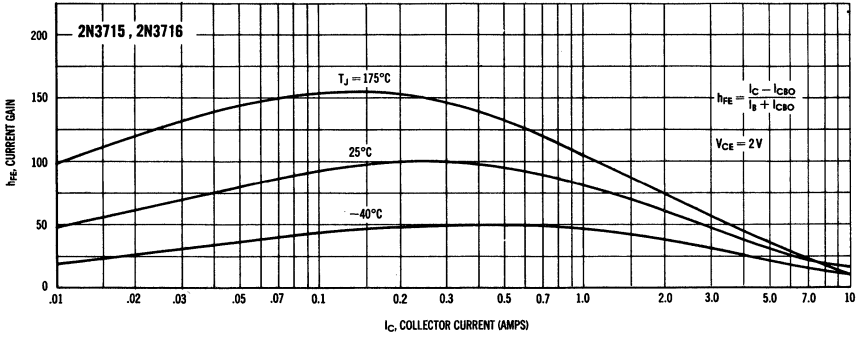
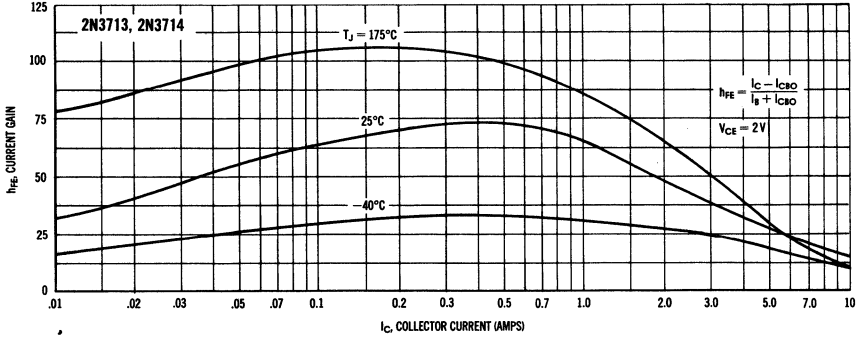

CURRENT GAIN - BANDWIDTH PRODUCT versus COLLECTOR CURRENT

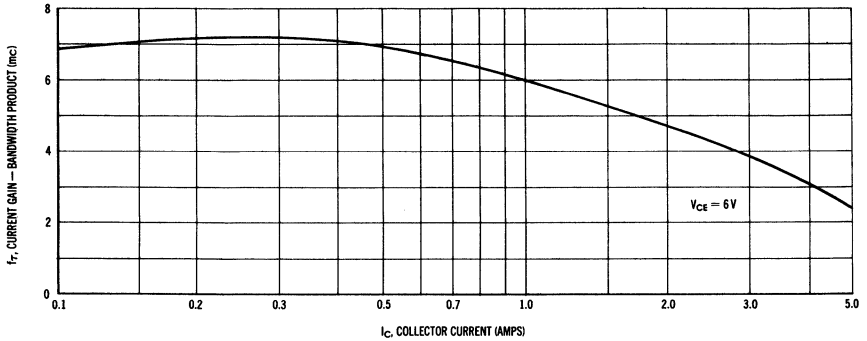

2N3719
2N3720

$P_D = 1\text{ W}$
 $I_C = 3\text{ A}$
 $V_{CBO} = 40\text{-}60\text{ V}$

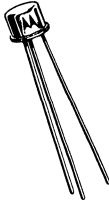

CASE 31
(TO-5)

PNP silicon annular power transistors for high-speed, high-current switching in core, driver and Class C power applications.

ABSOLUTE MAXIMUM RATINGS

Characteristic	Symbol	2N3719	2N3720	Unit
Collector - Base Voltage	V_{CBO}	40	60	Volts
Collector - Emitter Voltage	V_{CEO}	40	60	Volts
Emitter - Base Voltage	V_{EBO}	4	4	Volts
Collector Current—Continuous	I_C	3	3	Amps
Collector Current—Peak		10	10	Amps
Base Current	I_B	0.5	0.5	Amp
Total Device Dissipation @ $T_A = 25^\circ\text{C}$ Derate above 25°C	P_D	1.0	5.72	Watt mW/ $^\circ\text{C}$
Total Device Dissipation @ $T_C = 25^\circ\text{C}$ Derate above 25°C	P_D	6	34.3	Watts mW/ $^\circ\text{C}$
Operating Junction and Storage Temperature Range	T_J and T_{stg}	-65 to +200		$^\circ\text{C}$

SAFE OPERATING AREAS

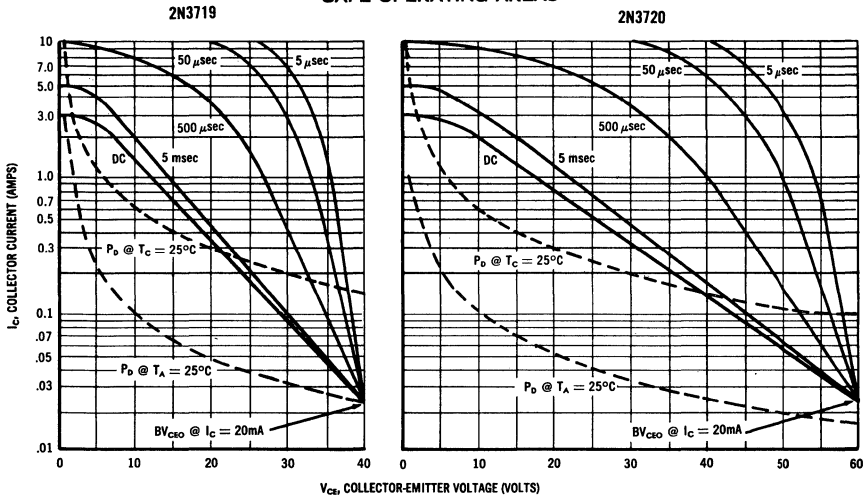

2N3719 and 2N3720 (continued)

ELECTRICAL CHARACTERISTICS (at $T_C = 25^\circ\text{C}$ unless otherwise noted)

Characteristic	Symbol	Min	Max	Unit
Collector Leakage Current ($V_{CE} = 40\text{ Vdc}$, $V_{BE} = 2\text{ Vdc}$)	I_{CEX}	—	10	μAdc
($V_{CE} = 60\text{ Vdc}$, $V_{BE} = 2\text{ Vdc}$)		—	10	
Collector-Base Cutoff Current ($V_{CB} = 40\text{ Vdc}$, $I_E = 0$, $T_A = 25^\circ\text{C}$)	I_{CBO}	—	.010	mAdc
($V_{CB} = 40\text{ Vdc}$, $I_E = 0$, $T_A = 150^\circ\text{C}$)		—	1	
($V_{CB} = 60\text{ Vdc}$, $I_E = 0$, $T_A = 25^\circ\text{C}$)		—	.010	
($V_{CB} = 60\text{ Vdc}$, $I_E = 0$, $T_A = 150^\circ\text{C}$)		—	1	
Emitter-Base Cutoff Current ($V_{BE} = 4\text{ Vdc}$, $I_C = 0$)	I_{EBO}	—	1	mAdc
DC Current Gain* ($I_C = 500\text{ mA}$, $V_{CE} = 1.5\text{ V}$, $T_A = 25^\circ\text{C}$)	h_{FE}^*	20	—	—
($I_C = 1\text{ A}$, $V_{CE} = 1.5\text{ V}$, $T_A = 25^\circ\text{C}$)		25	180	
($I_C = 1\text{ A}$, $V_{CE} = 1.5\text{ V}$, $T_A = -40^\circ\text{C}$)		15	—	
Collector-Emitter Saturation Voltage* ($I_C = 1\text{ A}$, $I_B = 100\text{ mA}$, $T_A = -40\text{ to }+100^\circ\text{C}$)	$V_{CE(sat)}^*$	—	0.75	Volts
($I_C = 3\text{ A}$, $I_B = 300\text{ mA}$, $T_A = 25^\circ\text{C}$)		—	1.5	
Base-Emitter Saturation Voltage* ($I_C = 1\text{ A}$, $I_B = 100\text{ mA}$)	$V_{BE(sat)}^*$	—	1.5	Volts
($I_C = 3\text{ A}$, $I_B = 300\text{ mA}$)		—	2.3	
Collector-Emitter Breakdown Voltage* ($I_C = 20\text{ mA}$, $I_B = 0$)	BV_{CEO}^*	40	—	Volts
		60	—	
Collector Output Capacitance ($V_{CB} = 10\text{ Vdc}$, $I_E = 0$, $f = 100\text{ kc}$)	C_{ob}	—	120	pf
Input Capacitance ($V_{BE} = 0.5\text{ Vdc}$, $I_C = 0$, $f = 100\text{ kc}$)	C_{ib}	—	1000	pf
Current-Gain — Bandwidth Product ($V_{CE} = 10\text{ Vdc}$, $I_C = 500\text{ mAdc}$, $f = 30\text{ mc}$)	f_T	60	—	mc
Delay Plus Rise Time (Figure 14) ($I_C = 1\text{ Adc}$, $I_{B1} = 100\text{ mA}$)	t_{on}	—	75	nsec
Storage Time (Figure 15) ($I_C = 1\text{ Adc}$, $I_{B1} = I_{B2} = 100\text{ mA}$)	t_s	—	150	nsec
Fall Time (Figure 15) ($I_C = 1\text{ Adc}$, $I_{B1} = I_{B2} = 100\text{ mA}$)	t_f	—	75	nsec

BASE-EMITTER SATURATION VOLTAGE VARIATIONS

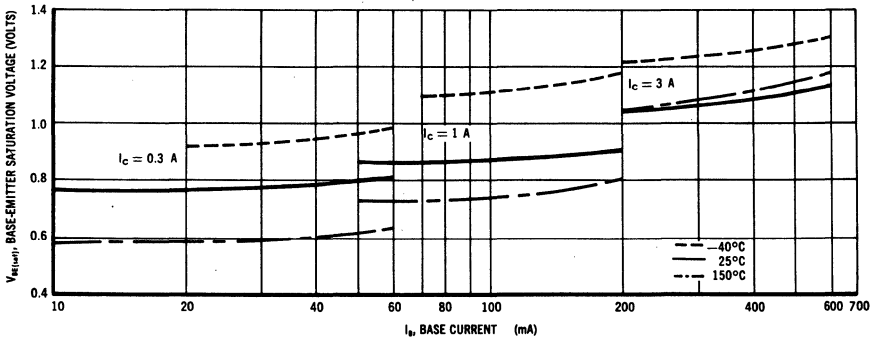

2N3719 and 2N3720 (continued)

CURRENT GAIN VARIATIONS

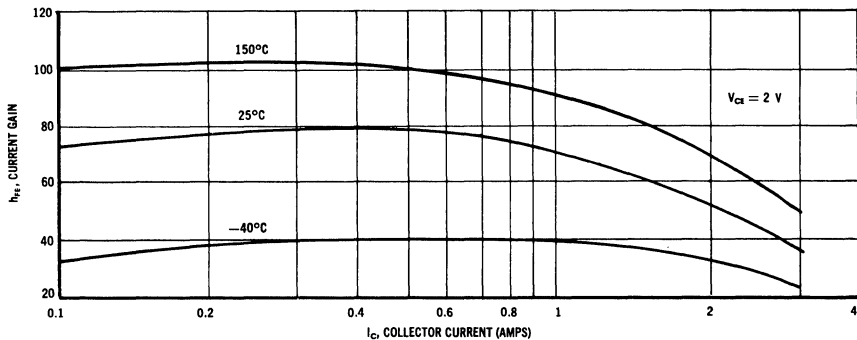

BASE CURRENT - VOLTAGE VARIATIONS

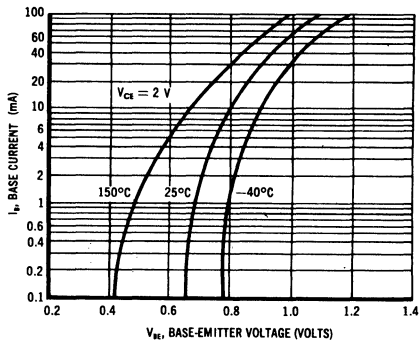

COLLECTOR CURRENT vs BASE-EMITTER VOLTAGE

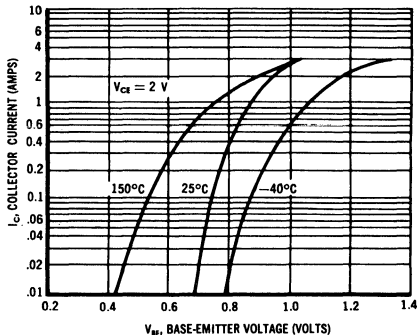

TYPICAL SWITCHING TIMES

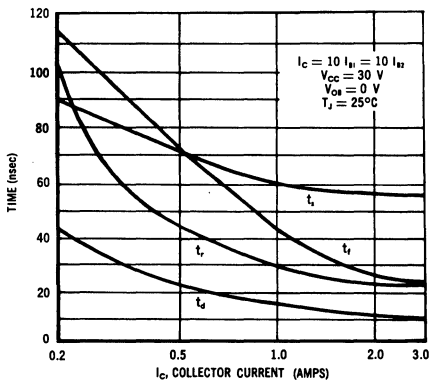

TOTAL CONTROL CHARGE VARIATION

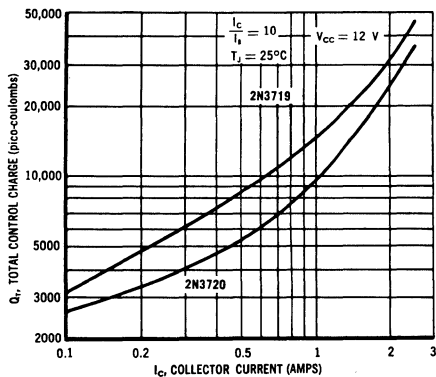

MP500 thru MP502
MP504 thru MP506

$P_C = 170 \text{ W}$
 $I_C = 60 \text{ A}$
 $V_{CBO} = 45\text{-}75 \text{ W}$

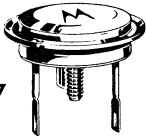

CASE 7
(TO-36)

PNP germanium power transistors for high-gain, high-power amplifier and switching applications in high reliability industrial equipment.

MAXIMUM RATINGS

Characteristic	Symbol	MP500 MP504	MP501 MP505	MP502 MP506	Unit
Collector-Base Voltage	V_{CBO}	45	60	75	Volts
Collector-Emitter Voltage	V_{CES}	45	60	75	Volts
Collector-Emitter Voltage	V_{CEO}	30	45	60	Volts
Emitter-Base Voltage	V_{EBO}	25	30	40	Volts
Collector Current	I_C	60	60	60	Amps
Power Dissipation at $T_C = 25^\circ\text{C}$	P_C	170	170	170	Watts
Junction Temperature Range	T_J	← -65 to +110 →			$^\circ\text{C}$

POWER DERATING

The maximum continuous power is related to maximum junction temperature by the thermal resistance factor.

This curve has a value of 170 Watts at case temperatures of 25°C and is 0 Watts at 110°C with a linear relation between the two temperatures such that:

$$\text{allowable } P_D = \frac{110^\circ - T_C}{0.5}$$

POWER-TEMPERATURE DERATING CURVE

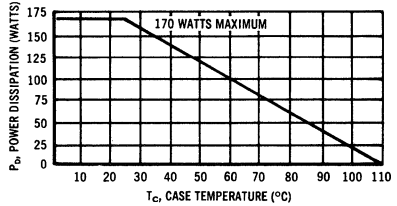

SAFE OPERATING AREA

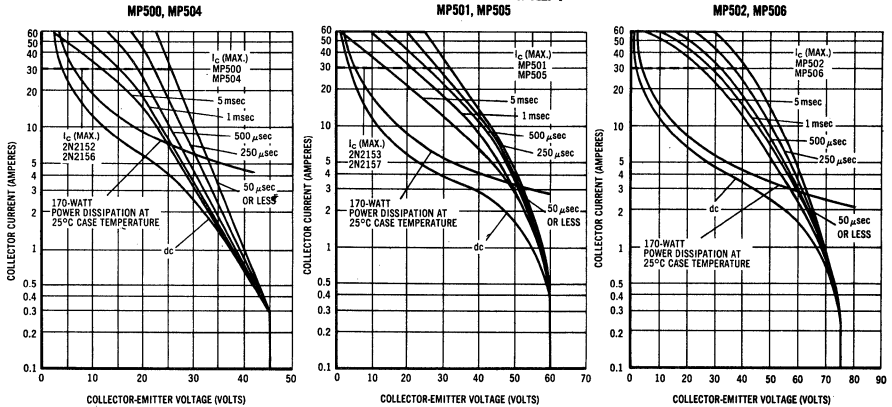

The Safe Operating Area Curves indicate $I_C - V_{CE}$ limits below which the device will not go into secondary breakdown. Collector load lines for specific circuits must fall within the applicable Safe Area to avoid causing a collector-emitter short.

(Duty cycle of the excursions make no significant change in these safe areas.) To insure operation below the maximum T_J , the power-temperature derating curve must be observed for both steady state and pulse power conditions.

MP500 thru MP502 MP504 thru MP506 (continued)

ELECTRICAL CHARACTERISTICS (At 25°C case temperature unless otherwise specified)

LTPD applies to "MEG-A-LIFE" units only

Characteristic	Symbol	Min	Typ	Max	Unit
Collector-Base Cutoff Current (Note 1) ($V_{CB} = -45\text{ V}, I_E = 0$) MP500, MP504 ($V_{CB} = -60\text{ V}, I_E = 0$) MP501, MP505 ($V_{CB} = -75\text{ V}, I_E = 0$) MP502, MP506	I_{CBO1}	—	0.9	4.0	mAdc
Collector-Base Cutoff Current ($V_{CB} = V_{CBmax}, I_E = 0, T_C = +71^\circ\text{C}$) All Types	I_{CBO}	—	4.0	15	mAdc
Collector-Base Cutoff Current ($V_{CB} = -2\text{ V}, I_E = 0$) All Types	I_{CBO}	—	80	200	μAdc
Emitter-Base Cutoff Current (Note 1) ($V_{EB} = -25\text{ V}, I_C = 0$) MP500, MP504 ($V_{EB} = -30\text{ V}, I_C = 0$) MP501, MP505 ($V_{EB} = -40\text{ V}, I_C = 0$) MP502, MP506	I_{EBO}	—	0.2	4.0	mAdc
Emitter-Base Cutoff Current ($V_{EB} = V_{EBmax}, I_C = 0, T_C = +71^\circ\text{C}$) All Types	I_{EBO}	—	2.7	15	mAdc
Collector-Emitter Breakdown Voltage (Notes 1 and 2) ($I_C = 300\text{ mA}, V_{EB} = 0$) MP500, MP504 MP501, MP505 MP502, MP506	BV_{CES}	-45 -60 -75	—	—	Vdc
Collector-Emitter Breakdown Voltage (Notes 1 and 2) ($I_C = 1.0\text{ A}, I_B = 0$) MP500, MP504 MP501, MP505 MP502, MP506	BV_{CEO}	-30 -45 -60	—	—	Vdc
Floating Potential (Note 1) ($V_{CB} = 45\text{ V}, I_E = 0$) MP500, MP504 ($V_{CB} = 60\text{ V}, I_E = 0$) MP501, MP505 ($V_{CB} = 75\text{ V}, I_E = 0$) MP502, MP506	V_{EBF}	—	—	1.0 1.0 1.0	Vdc
DC Current Transfer Ratio (Note 1) ($I_C = 15\text{ A}, V_{CE} = 2\text{ V}$) MP500 through MP502 ($I_C = 50\text{ A}, V_{CE} = 2\text{ V}$) MP504 through MP506 ($I_C = 50\text{ A}, V_{CE} = 2\text{ V}$) All Types	h_{FE1}	30 50 12	47 63 20	80 100 —	—
Collector-Emitter Saturation Voltage ($I_C = 15\text{ A}, I_B = 1\text{ A}$) All Types ($I_C = 50\text{ A}, I_B = 5\text{ A}$) All Types	$V_{CE(sat)}$	—	0.11 0.2	0.2 0.45	Vdc
Base-Emitter Saturation Voltage ($I_C = 15\text{ A}, I_B = 1\text{ A}$) All Types ($I_C = 50\text{ A}, I_B = 5\text{ A}$) All Types	$V_{BE(sat)}$	—	0.7 2.0	1.5 2.5	Vdc
Common Emitter Cutoff Frequency ($I_C = 15\text{ A}, V_{CE} = 2\text{ V}$) All Types	f_{ae}	2	3.6	—	kc

INPUT AND TRANSFER CHARACTERISTICS

**COLLECTOR CURRENT
versus BASE-EMITTER VOLTAGE**

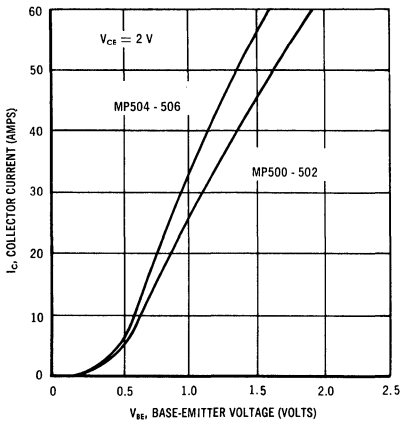

**DC CURRENT GAIN
versus COLLECTOR CURRENT**

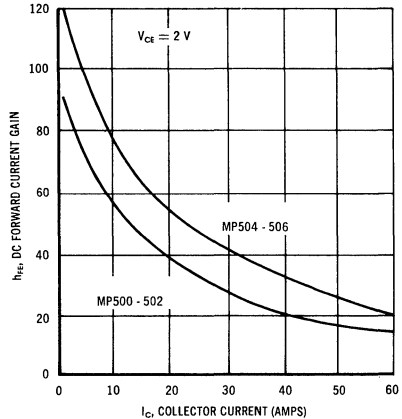

MP2060 thru MP2063

$P_C = 150 \text{ W}$
 $I_C = 10 \text{ A}$
 $V_{CBO} = 80-100 \text{ V}$

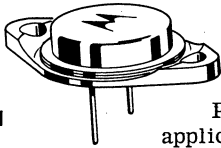

CASE 1
(TO-3)

PNP germanium power transistors for audio amplifier applications.

MAXIMUM RATINGS

Characteristics	Symbol	MP2060	MP2061	MP2062	MP2063	Unit
Collector-Emitter Voltage	V_{CES}	30	45	60	75	Vdc
Collector-Emitter Voltage (Open Base)	V_{CEO}	25	35	50	60	Vdc
Collector-Base Voltage	V_{CBO}	40	60	75	90	Vdc
Emitter-Base Voltage	V_{EBO}	← 20 →				Vdc
Collector Current (Continuous)	I_C	← 7 →				Adc
Peak Collector Current ($PW \leq 5 \text{ msec}$)	I_C	← 15 →				Adc
Base Current (Continuous)	I_B	← 2 →				Adc
Storage Temperature	T_{stg}	← -65 to +110 →				$^{\circ}\text{C}$
Operating Case Temperature	T_C	← -65 to +110 →				$^{\circ}\text{C}$
Total Device Dissipation @ $T_C = 25^{\circ}\text{C}$ Derate above 25°C	P_D	← 85 →				Watts
		← 1 →				$\text{W}/^{\circ}\text{C}$
Thermal Resistance Junction to Case	θ_{JC}	1.0				$^{\circ}\text{C}/\text{W}$
Thermal Resistance Case to Ambient	θ_{CA}	32.7				$^{\circ}\text{C}/\text{W}$

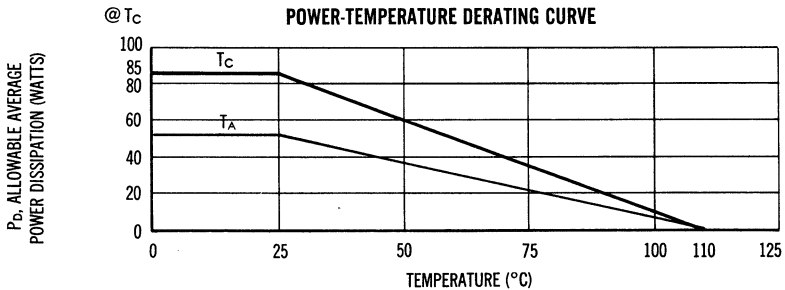

MP2060 thru MP2063 (continued)

ELECTRICAL CHARACTERISTICS (At $T_C = 25^\circ\text{C}$ unless otherwise specified)

Characteristics		Symbol	Min	Typ	Max	Unit
DC Forward Current Gain (Note 1) ($I_C = 3 \text{ Adc}$, $V_{CE} = 2 \text{ Vdc}$)	All Types	h_{FE}	30	—	200	—
Current Gain-Bandwidth Product ($I_C = 0.5 \text{ Adc}$, $V_{CE} = 12 \text{ Vdc}$)	All Types	f_T	—	600	—	kc
Collector-Emitter Saturation Voltage ($I_C = 3.0 \text{ Adc}$, $I_B = 0.3 \text{ Adc}$)	All Types	$V_{CE(sat)}$	—	—	0.25	Vdc
Base-Emitter Saturation Voltage ($I_C = 3.0 \text{ Adc}$, $I_B = 0.3 \text{ Adc}$)	All Types	$V_{BE(sat)}$	—	—	0.70	Vdc
DC Transconductance ($I_C = 3.0 \text{ Adc}$, $V_{CE} = 2 \text{ Vdc}$)	All Types	g_{FE}	3.0	—	—	mhos
Collector-Emitter Breakdown Voltage* ($I_C = 250 \text{ mAdc}$)	MP2060 MP2061 MP2062 MP2063	BV_{CES}^*	30 45 60 75	— — — —	— — — —	Vdc
Collector-Emitter Sustaining Voltage* ($I_C = 500 \text{ mAdc}$)	MP2060 MP2061 MP2062 MP2063	$BV_{CEO(sus)}^*$	25 35 40 60	— — — —	— — — —	Vdc
Collector-Base Breakdown Voltage ($I_C = 20 \text{ mAdc}$)	MP2060 MP2061 MP2062 MP2063	BV_{CBO}	40 60 75 90	— — — —	— — — —	Vdc
Collector-Base Cutoff Current ($V_{CB} = 2 \text{ Vdc}$) ($V_{CB} = 25 \text{ Vdc}$) ($V_{CB} = 35 \text{ Vdc}$) ($V_{CB} = 40 \text{ Vdc}$) ($V_{CB} = 60 \text{ Vdc}$)	All Types MP2060 MP2061 MP2062 MP2063	I_{CBO}	— — — — —	— — — — —	0.060 1.0 1.0 1.0 1.0	mAdc
Collector-Emitter Cutoff Current ($V_{CE} = 30 \text{ Vdc}$, $V_{BE(off)} = 1 \text{ Vdc}$, $T_C = 100^\circ\text{C}$) ($V_{CE} = 45 \text{ Vdc}$, $V_{BE(off)} = 1 \text{ Vdc}$, $T_C = 100^\circ\text{C}$) ($V_{CE} = 60 \text{ Vdc}$, $V_{BE(off)} = 1 \text{ Vdc}$, $T_C = 100^\circ\text{C}$) ($V_{CE} = 75 \text{ Vdc}$, $V_{BE(off)} = 1 \text{ Vdc}$, $T_C = 100^\circ\text{C}$)	MP2060 MP2061 MP2062 MP2063	I_{CEX}	— — — —	— — — —	10 10 10 10	mAdc
Emitter-Base Cutoff Current ($V_{BE} = 20 \text{ Vdc}$)	All Types	I_{EBO}	—	—	1.0	mAdc
Input Impedance ($I_C = -500 \text{ mAdc}$, $V_{CE} = -12 \text{ Vdc}$, $i_b = 1 \text{ mAdc}$, $f = 1 \text{ kc}$)		h_{ie}	—	25	—	ohms
Distortion ($I_C = -500 \text{ mAdc}$, $V_{CE} = -12 \text{ Vdc}$, $R_S = 30 \text{ ohms}$, $R_L = 25 \text{ ohms}$, R_E (unbypassed) = 0.33 ohm , $P_{out} = 2 \text{ watts}$)		η	—	3	—	%

*Sweep Test: 1/2 sine wave, 60 cps

Note 1 :

Upon customer's request the transistors will be numerically coded to identify matched pairs. The DC current transfer ratios are sorted into approximately 1:1.5 ranges. Any two devices within a bracket constitute a matched pair. No guarantee is made of gain distribution; bracket selection available at a slight increase in price.

$I_C = 3 \text{ Adc}$, $V_{CE} = 2 \text{ Vdc}$

Appropriate MP#	h_{FE}	
	Min.	Max.
-1	30	45
-2	40	60
-3	50	75
-4	60	90
-5	80	120
-6	100	150
-7	130	200

MP2060 thru MP2063 (continued)

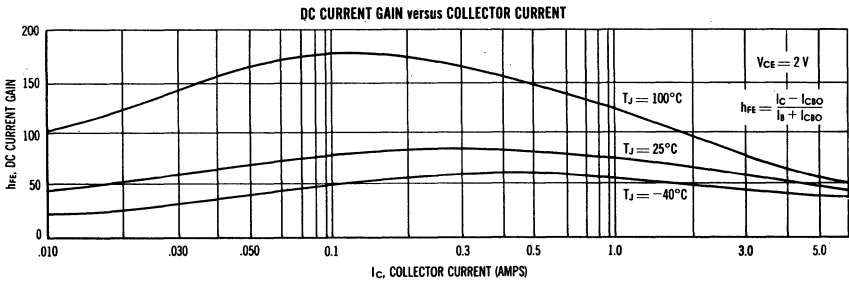
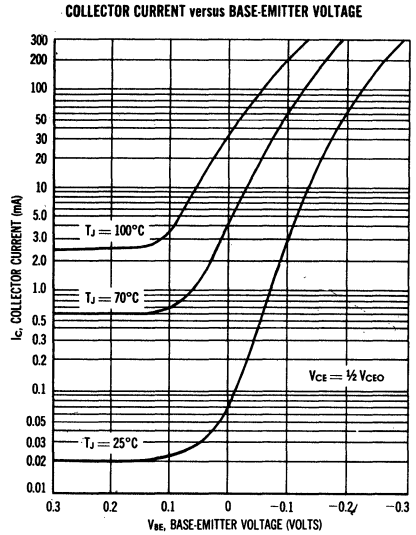
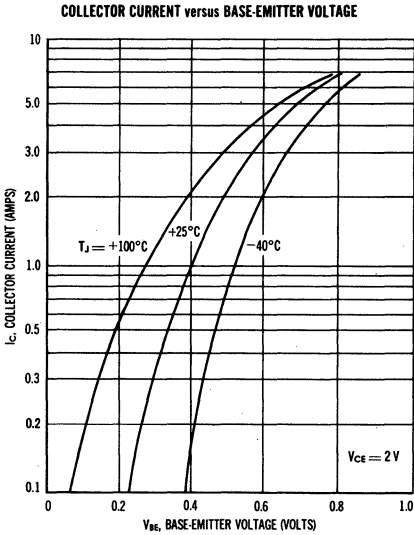
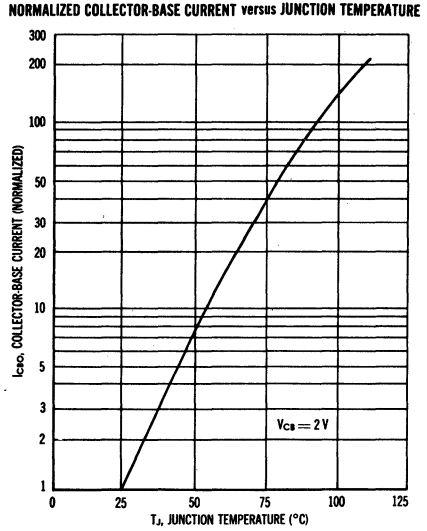
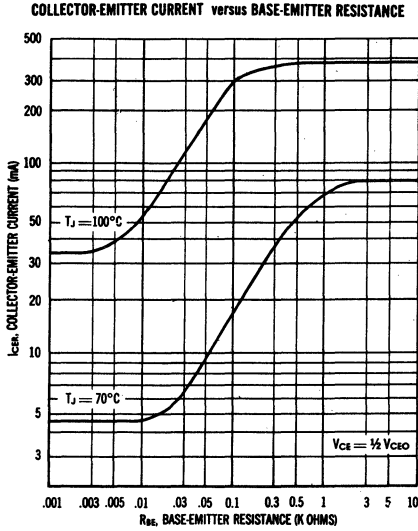

MP2060 thru MP2063 (continued)

COLLECTOR-EMITTER SATURATION VOLTAGE VARIATIONS

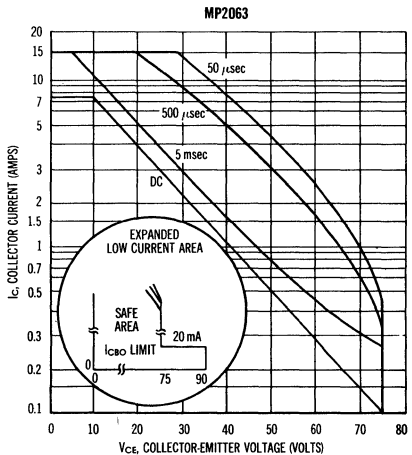
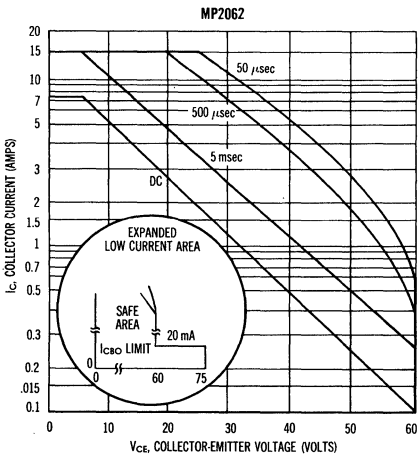
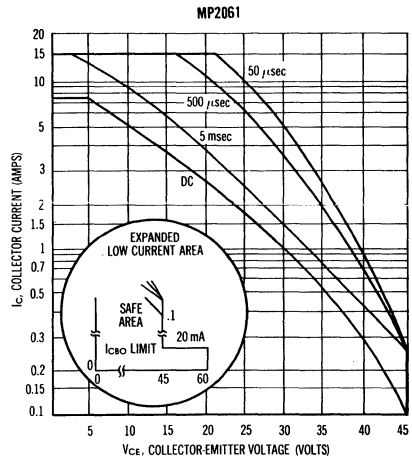
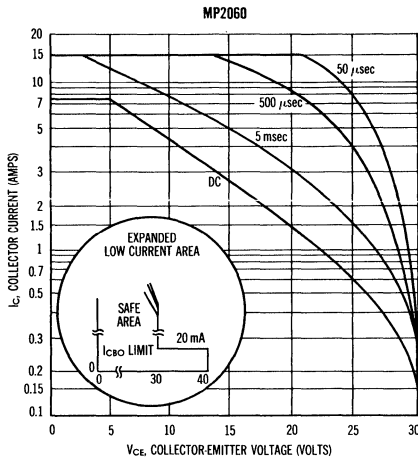
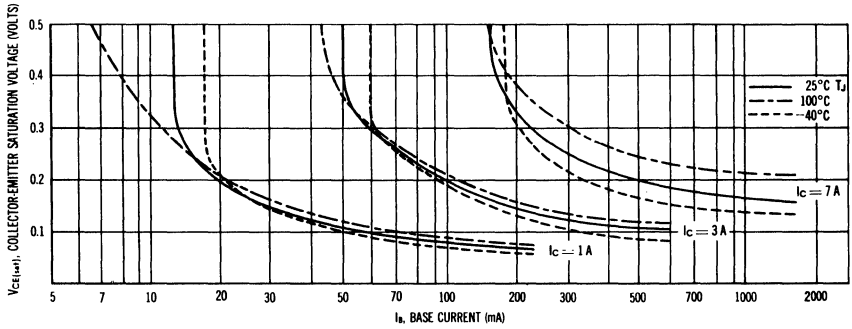

A WORD ABOUT ANNULAR . . .

Cross Section of an Annular Transistor

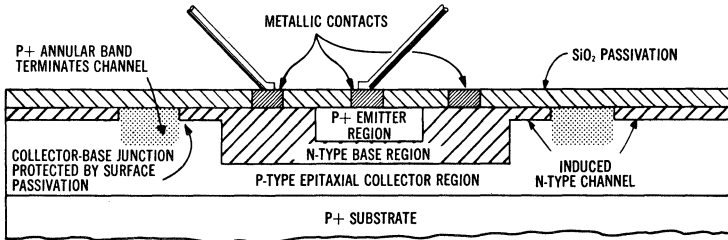

For more than 2 years . . .

Motorola has demonstrated the advantages of the annular process in its line of high-frequency silicon transistors.

This Motorola-developed process represents the most advanced means for manufacturing highly reliable, high-performance, surface-passivated silicon transistors. Initially developed as an answer to channeling, which prevents the fabrication of high-voltage PNP transistors by conventional surface passivation methods, it has been continually refined to provide a proven history of extreme stability and exceptionally long-term reliability.

The annular structure overcomes the randomly induced channeling problem with a deliberately induced channel, with controlled characteristics, terminated by means of an annular diffused region that prevents the spread of the channel to the unpassivated edges of the transistor chip.

The advantages of the annular process are inherent in all Motorola PNP and NPN high-frequency transistors as well as other types of semiconductor devices.

For more detailed information on the Motorola annular process, send for the "Annular Process" brochure.



MOTOROLA
LOW-FREQUENCY, LOW-POWER TRANSISTORS

- For devices meeting military specifications, see page 1-18.
- For Meg-A-Life devices with certified reliability, see page 1-21.
- For case outline dimensions, see page 1-26.

LOW-FREQUENCY, LOW-POWER TRANSISTORS

The Motorola line of low-frequency, low-power transistors, sometimes called the "milliwatt" line, consists of a wide selection of highly reliable germanium PNP devices designed for general purpose switching, and control applications.

The line is generally characterized by devices having a power rating to 225 mW, a maximum operating temperature range from -65°C to +100°C, and a typical cutoff frequency (f_{cb}) to 8 Mc.

QUICK SELECTION GUIDE — FOR AMPLIFIER / OSCILLATOR AND SWITCHING APPLICATIONS TO 20 KILOCYCLES

The following transistors merit first consideration within the specified gain-voltage groups. All of the specified devices have collector power dissipation ratings (P_C) of 150-225 mW, and dc maximum operating junction temperature of 100°C.

MINIMUM DC CURRENT GAIN (h_{FE})	TRANSISTOR VOLTAGE RATING; V_{CEr} (R = 10 K)			
	12-24	25-39	40-49	50-60
20	—	2N524	MA910 ③	2N2042
30	2N322	2N525 2N1191 ①	2N1924 2N1186	—
40	2N323 2N1008 ① ②	2N526 2N1192 ①	2N1008A ① ② 2N1925	2N1008B ① ② 2N2043
60	2N324 2N1705	2N527 2N1175	2N1926	—
90	2N467 2N508 MA1706	2N1193 ① 2N2171 2N3427	2N1188	—
130	MA1707	2N3428	—	—
180	MA1708	2N1194 ① MA1702	—	—

① Small Signal Current Gain h_{fe} ② V_{CEO} ③ V_{CES}

COMPLETE NUMERICAL-ALPHABETICAL LISTING

Type	MAXIMUM RATINGS					ELECTRICAL CHARACTERISTICS					MILITARY and MEG-A-LIFE Type
	Pc mW	T _J °C	V _{ceo} volts	V _{CEr} (R = 10 K) volts	I _c mA	h _{FE} @ V _{CE} & I _c				f _{ab} typ mc	
						min	max	volts	mA		
2N319	225	100	—	20	500	25	42	1	20	1.0 ⑤	
2N320	225	100	—	20	500	34	65	1	20	1.5 ⑤	
2N321	225	100	—	20	500	53	121	1	20	2.0 ⑤	
2N322	225	100	—	18	500	34	65	1	20	1.0 ⑤	
2N323	225	100	—	18	500	53	121	1	20	1.5 ⑤	
2N324	225	100	—	18	500	72	198	1	20	2.0 ⑤	
2N331	200	100	30	V _{EB} = 12	200	30	70	6	1	1.5	JAN 2N331
2N381	225	100	50	25	400	35	65	1	20	3	
2N382	225	100	50	25	400	60	95	1	20	4	
2N383	225	100	50	25	400	75	120	1	20	5	
2N398	50	85	105	V _{pt} = 105	100	20	—	0.35	5	1.0	
2N398A	150	100	105	V _{pt} = 105	200	20	—	0.35	5	1.0	USN 2N398
2N460	225	100	45	35 ⑦	400	31	200	6	1 ②	4	
2N461	225	100	45	35 ⑦	400	0.94 h _{fb}	0.972	6	1 ②	1.2	USAF 2N461
2N464	200	100	45	40	100	14	—	6	1	1.0	
2N465	200	100	45	30	100	27	—	6	1	1.5	USA 2N465
2N466	200	100	35	20	100	56	—	6	1	2.0	JAN 2N466
2N467	200	100	35	15	100	112	—	6	1	2.5	USA 2N467
2N508	225	100	—	18	500	99	198	1	20	2.5 ⑤	
2N524	225	100	—	30	500	25	42	1	20	0.8 ⑤	2N524A ①
2N525	225	100	—	30	500	34	65	1	20	1.0 ⑤	2N525A ①
2N526	225	100	—	30	500	53	90	1	20	1.3 ⑤	JAN 2N526
2N527	225	100	—	30	500	72	121	1	20	1.5 ⑤	2N526A ①
2N650	200	100	45	30	500	30	70	6	1	1.5	2N527A ①
											2N650A ①
2N651	200	100	45	30	500	50	120	6	1	2.0	USN 2N650A
											2N651A ①
2N652	200	100	45	30	500	100	225	6	1	2.5	USN 2N651A
											2N652A ①
											USN 2N652A
2N653	200	100	30	25	250	30	70	6	1	1.5	
2N654	200	100	30	25	250	50	125	6	1	2.0	
2N655	200	100	30	25	250	100	250	6	1	2.5	
2N1008	200	100	20	20 ⑥	300	40 h _{FE}	150	5	10	—	
2N1008A	200	100	40	40 ⑥	300	40 h _{FE}	150	5	10	—	
2N1008B	200	100	60	60 ⑥	300	40 h _{FE}	150	5	10	—	
2N1175	225	100	—	25	500	70	140	1	20	1.5 ⑤	
2N1185	200	100	45	30	500	190	400	6	1	3.0	
2N1186	200	100	60	45	500	30	70	6	1	1.5	
2N1187	200	100	60	45	500	50	120	6	1	2.0	
2N1188	200	100	60	45	500	100	225	6	1	2.5	
2N1189	200	100	45	30	500	60	—	1	10 ②	3.5	
2N1190	200	100	45	30	500	100	—	1	10 ②	4.5	
2N1191	200	100	40	25	200	30	70	6	1	1.5	
2N1192	200	100	40	25	200	50	125	6	1	2.0	

NUMERICAL-ALPHABETICAL LISTING (continued)

Type	MAXIMUM RATINGS					ELECTRICAL CHARACTERISTICS					MILITARY and MEG-A-LIFE Type
	P _c mW	T _J °C	V _{CB0} volts	V _{CEr} (R = 10 K) volts	I _c mA	h _{FE} @ V _{CE} & I _c				f _{ab} typ mc	
						min	max	volts	mA		
2N1193	200	100	40	25	200	100	250	6	1	2.5	
2N1194	200	100	40	25	200	190	500	6	1	3.0	
2N1408	150	100	50	50 ④	200	10	—	1	1 ③	—	
2N1413	225	100	35	25	500	23	65	1	20	0.8 ⑤	
2N1415	225	100	—	25	500	53	—	1	20	1.3 ⑤	
2N1705	200	100	18	12	400	70 h _{FE}	150	6	1	4.5	
2N1706	200	100	25	18	400	50 h _{FE}	150	5	10	3.5	
2N1707	200	100	30	25	400	30 h _{FE}	150	5	10	3.5	
2N1924	225	100	—	40	500	34	65	1	20	1.0 ⑤	
2N1925	225	100	—	40	500	53	90	1	20	1.3 ⑤	
2N1926	225	100	—	40	500	72	121	1	20	1.5 ⑤	
2N2042	200	100	105	55	200	20	50	0.35	5	0.5 ⑤	2N2042A ① 2N2043A ①
2N2043	200	100	105	55	200	40	100	0.35	5	0.75 ⑤	
2N2171	225	100	50	25	400	110	250	1.0	20	7.5	
2N3427	200	100	45	30	500	100	350	1	100	6.0	
2N3428	200	100	45	30	500	150	400	1	100	8.0	
MA112	175	85	15	—	200	30 h _{FE}	70	6	1	—	
MA113	175	85	15	—	200	50 h _{FE}	125	6	1	—	
MA114	175	85	15	—	200	100 h _{FE}	250	6	1	—	
MA115	175	85	15	—	200	30 h _{FE}	125	6	1	—	
MA116	175	85	15	—	200	50 h _{FE}	250	6	1	—	
MA117	175	85	15	—	200	30 h _{FE}	250	6	1	—	
MA286	175	85	10	—	200	14 h _{FE}	40	6	1	—	
MA287	175	85	10	—	200	30 h _{FE}	250	6	1	—	
MA288	175	85	10	—	200	180 h _{FE}	—	6	1	—	
MA881	200	100	60	60 ④	500	30	—	1	10	0.75 ⑤	
MA882	200	100	60	60 ④	500	40	—	1	10	1.0 ⑤	
MA883	200	100	60	60 ④	500	75	—	1	10	1.25 ⑤	
MA884	200	100	60	60 ④	500	125	—	1	10	1.75 ⑤	
MA885	200	100	50	50 ④	500	15 h _{FE}	40	6	1	0.75 ⑤	
MA886	200	100	50	50 ④	500	30 h _{FE}	70	6	1	0.75 ⑤	
MA887	200	100	50	50 ④	500	50 h _{FE}	120	6	1	1.25 ⑤	
MA888	200	100	50	50 ④	500	100 h _{FE}	225	6	1	0.5 ⑤	
MA889	200	100	50	50 ④	500	190 h _{FE}	400	6	1	—	
MA909	150	100	75	35 ④	200	20	—	0.35	5	—	
MA910	150	100	90	45 ④	200	20	—	0.35	5	—	
MA1702	200	100	45	30	500	200	—	1	100	7.0 min	
MA1703	200	100	25	25	500	100	350	1	100	3.0 min	
MA1704	200	100	25	25	500	150	400	1	100	5.0 min	
MA1705	200	100	25	25	500	200	—	1	100	6.0 min	
MA1706	200	100	15	15	500	100	350	1	100	3.0 min	
MA1707	200	100	15	15	500	150	400	1	100	4.0 min	
MA1708	200	100	15	15	500	200	—	1	100	5.0 min	

① MEG-A-LIFE ② I_E ③ I_B ④ BV_{CEs} ⑤ Minimum ⑥ V_{CE0} ⑦ R_{θE} = 1 K

2N319 thru 2N321

$BV_{CBO} = 25 \text{ V}$
 $h_{FE} — \text{to } 53-121 \text{ (min-max)}$
 $f_{\alpha b} — \text{to } 2.0 \text{ MC}$

CASE 31
(TO-5)



PNP germanium transistor for audio amplifier and low-frequency switching applications.

ABSOLUTE MAXIMUM RATINGS

Characteristic	Symbol	Maximum	Unit
Collector-Base Voltage	V_{CBO}	25	Vdc
Collector-Emitter Voltage	V_{CEO}	20	Vdc
Emitter-Base Voltage	V_{EBO}	5	Vdc
Collector Current	I_C	500	mAdc
Junction and Storage Temperature	T_j & T_{stg}	-65 to + 100	°C
Power Dissipation at 25°C Free Air	P_D	225	mW

ELECTRICAL CHARACTERISTICS (At 25°C unless otherwise noted)

Characteristic	Symbol	Minimum	Maximum	Unit
Collector Cutoff Current $V_{CB} = -25 \text{ Vdc}, I_E = 0$	I_{CBO}	-	16	μAdc
Emitter Cutoff Current $V_{EB} = -15 \text{ Vdc}, I_C = 0$	I_{EBO}	-	10	μAdc
Collector-Emitter Voltage $I_C = 0.6 \text{ mAdc}, R_{BE} = 10 \text{ K}$	BV_{CER}	20	-	Vdc
DC Current Gain $I_C = 20 \text{ mAdc}, V_{CE} = -1 \text{ Vdc}$	h_{FE}			
		25	42	-
		34	65	-
		53	121	-
DC Current Gain $I_C = 100 \text{ mAdc}, V_{CE} = -1 \text{ Vdc}$	h_{FE}			
		23	-	-
		30	-	-
		47	-	-
Base Input Voltage $V_{CE} = -1 \text{ Vdc}, I_C = 20 \text{ mAdc}$	V_{BE}	180	320	mVdc
Output Capacitance; Input AC Open Circuit $V_{CB} = -5 \text{ Vdc}, I_E = 1 \text{ mAdc}, f = 1 \text{ Mc}$	C_{ob}	-	35	μf
Frequency Cutoff $V_{CB} = -5 \text{ Vdc}, I_E = 1 \text{ mAdc}$	$f_{\alpha b}$			
		1.0	-	Mc
		1.5	-	Mc
		2.0	-	Mc

2N322 thru **2N324**
2N508

$BV_{CBO} = 18\text{ V}$
 $h_{FE} \text{ - to } 99\text{-}198 \text{ (min-max)}$
 $f_{\alpha b} \text{ - to } 2.5\text{ MC}$



CASE 31
(TO-5)

PNP germanium transistors for audio driver and low-power output service in entertainment equipment.

ABSOLUTE MAXIMUM RATINGS

Characteristic	Symbol	Maximum	Unit
Collector-Base Voltage	V_{CBO}	18	Vdc
Collector-Emitter Voltage	V_{CEO}	18	Vdc
Emitter-Base Voltage	V_{EBO}	5	Vdc
Collector Current	I_C	500	mAdc
Junction and Storage Temperature	T_j & T_{stg}	-65 to + 100	°C
Power Dissipation at 25°C Free Air	P_D	225	mW

ELECTRICAL CHARACTERISTICS (at 25°C case temperature unless otherwise noted)

Characteristic	Symbol	Minimum	Maximum	Unit	
Collector Cutoff Current $V_{CB} = -16\text{ Vdc}, I_E = 0$	I_{CBO}	—	16	μAdc	
Emitter Cutoff Current $V_{EB} = -3\text{ Vdc}, I_C = 0$	I_{EBO}	—	16	μAdc	
Collector-Emitter Voltage $I_C = 0.6\text{ mAdc}, R_{BE} = 5\text{ K}$	BV_{CER}	18	—	Vdc	
DC Current Gain $V_{CE} = -1\text{ Vdc}, I_C = 20\text{ mAdc}$	h_{FE}				
		2N322	34	65	—
		2N323	53	121	—
		2N324	72	198	—
		2N508	99	198	—
Base Input Voltage $V_{CE} = -1\text{ Vdc}, I_C = 20\text{ mAdc}$	V_{BE}	180	320	mVdc	
Output Capacitance; Input AC Open Circuit $V_{CB} = -5\text{ Vdc}, I_E = 1\text{ mAdc}, f = 1\text{ Mc}$	C_{ob}	—	35	pf	
Frequency Cutoff $V_{CB} = -5\text{ Vdc}, I_E = 1\text{ mAdc}$	f_{ab}				
		2N322	1.0	—	Mc
		2N323	1.5	—	Mc
		2N324	2.0	—	Mc
		2N508	2.5	—	Mc

2N331

**$BV_{CBO} = 30\text{ V}$
 $h_{fe} = 30\text{-}70$ (min-max)
 $f_{\alpha_b} - \text{to } 1.5\text{ MC}$**

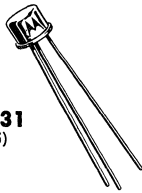

CASE 31
(TO-5)

PNP germanium transistor for audio range amplifier and switching service in military equipment. Have collector dissipation and storage temperature ratings significantly higher than those of the military specification (see maximum ratings table below).

ABSOLUTE MAXIMUM RATINGS

Characteristic	Symbol	Rating	Unit
Collector-Base Voltage	V_{CBO}	-30	Volts
Emitter-Base Voltage	V_{EBO}	-12	Volts
Storage Temperature (MIL-S-19500/4C)	T_{stg}	-65 to + 85	°C
Storage Temperature (Motorola JAN 2N331)	T_{stg}	-65 to + 100	°C
Collector Dissipation at $T_A = 25^\circ\text{C}$ (MIL-S-19500/4C) (Derate 1.25 mW/°C above 25°C)	P_D	75	mW
Collector Dissipation at $T_A = 25^\circ\text{C}$ (Motorola JAN 2N331) (Derate 2.87 mW/°C above 25°C)	P_D	200	mW

ELECTRICAL CHARACTERISTICS (at 25°C case temperature unless otherwise noted)

Characteristic	Symbol	Minimum	Maximum	Unit
Emitter Cutoff Current ($V_{EB} = -12\text{ Vdc}$, $I_C = 0$)	I_{EBO}	—	-10	μAdc
Collector Cutoff Current ($V_{CB} = -30\text{ Vdc}$, $I_E = 0$)	I_{CBO}	—	-10	μAdc
Small-Signal Open-Circuit Output Admittance ($V_{CB} = -6\text{ Vdc}$, $I_E = 1.0\text{ mAdc}$, $f = 1\text{ kc}$)	h_{ob}	—	1	μmho
Small-Signal Short-Circuit Input Impedance ($V_{CB} = -6\text{ Vdc}$, $I_E = 1.0\text{ mAdc}$, $f = 1\text{ kc}$)	h_{ib}	—	50	Ohms
Small-Signal Short-Circuit Forward-Current Transfer Ratio ($V_{CE} = -6\text{ Vdc}$, $I_C = 1.0\text{ mAdc}$, $f = 1\text{ kc}$)	h_{fe}	30	70	—
Small-Signal Short-Circuit Forward-Current Transfer Ratio Cutoff Frequency ($V_{CB} = -6\text{ Vdc}$, $I_E = 1\text{ mAdc}$)	f_{hfb}	0.4	—	mc
Output Capacitance ($V_{CB} = -6\text{ Vdc}$, $I_E = 1\text{ mAdc}$)	C_{ob}	—	50	pf
Noise Figure ($V_{CB} = -6\text{ Vdc}$, $I_E = 1\text{ mAdc}$, $R_S = 1000$, ohms, $f = 1\text{ kc}$, $f = \Delta 1\text{ cps}$)	NF	—	20	db

2N331 (continued)

POWER-TEMPERATURE DERATING CURVE

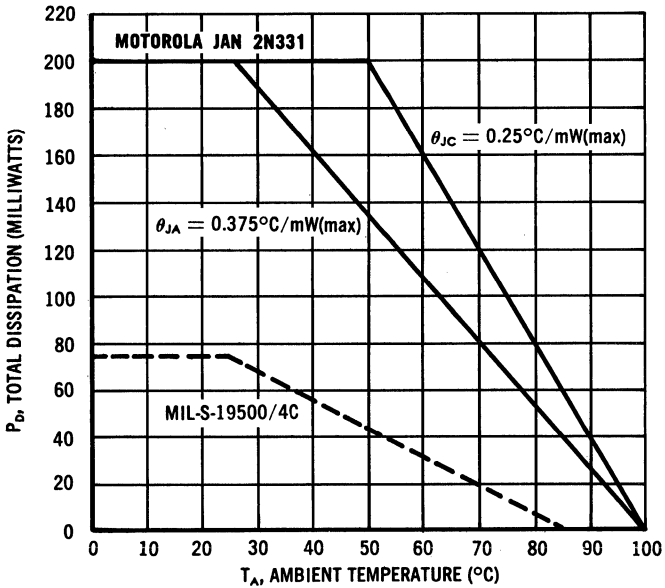

SMALL SIGNAL CURRENT GAIN versus TEMPERATURE

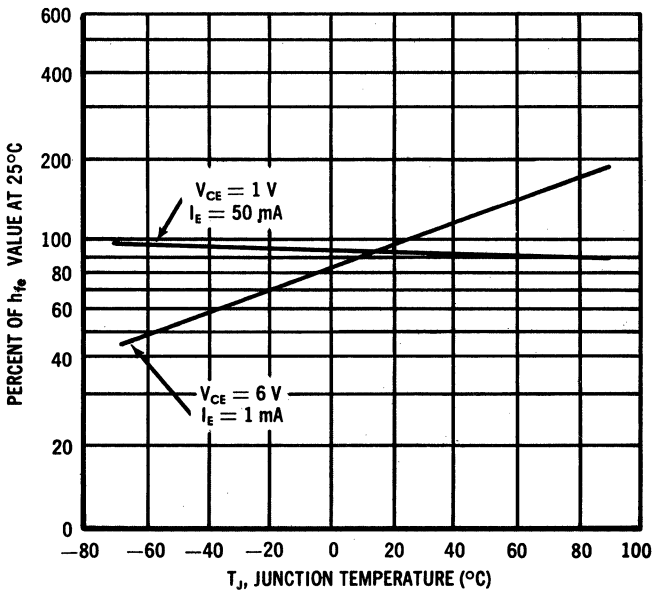

2N381 thru **2N383**
2N2171

$V_{CBO} = 50$ V
 h_{FE} — to 110-250 (min-max)
 f_{α_b} — to 7.5 MC

CASE 31
(TO-5)



PNP germanium transistors for small-signal audio amplifiers, Class B push-pull output stages and medium-speed switching circuits.

ABSOLUTE MAXIMUM RATINGS

Characteristic	Symbol	Rating	Unit
Collector-Base Voltage	V_{CBO}	50	Volts
Collector-Emitter Voltage ($R_{BE} = 10K$)	V_{CER}	25	Volts
Emitter-Base Voltage	V_{EBO}	20	Volts
Collector Current	I_C	400	mA
Junction Temperature	T_J	-65 to +100	°C
Collector Dissipation $T_A = 25^\circ C$ derate $T_C = 25^\circ C$ derate	P_D	225 3 500 6.7	mW mW/°C mW mW/°C

ELECTRICAL CHARACTERISTICS (at 25°C case temperature unless otherwise noted)

Characteristic	Symbol	Minimum	Typical	Maximum	Unit
Collector-Base Cutoff Current ($V_{CB} = -25$ Vdc)	I_{CBO}	---	6	10	μ Adc
Emitter-Base cutoff Current ($V_{EB} = -20$ Vdc)	I_{EBO}	---	5	10	μ Adc
Collector-Emitter Voltage ($I_C = 500 \mu$ Adc, $R_{BE} = 10K$)	V_{CER}	25	---	---	Vdc
Collector-Emitter Voltage ($I_C = 50 \mu$ Adc, $V_{BE} = 1.0$ Vdc)	V_{CER}	---	50 45	---	Vdc
DC Current Gain ($I_C = 20$ mAdc, $V_{CE} = -1.0$ Vdc)	2N381	35	---	65	---
	2N382	60	---	95	---
	2N383	75	---	120	---
	2N2171	110	---	250	---
($I_C = 100$ mAdc, $V_{CE} = -1.0$ Vdc)	2N381	30	---	---	---
	2N382	50	---	---	---
	2N383	65	---	---	---
	2N2171	90	---	---	---

2N381 thru 2N383
2N2171 (continued)

ELECTRICAL CHARACTERISTICS (continued)

Characteristic	Symbol	Minimum	Typical	Maximum	Unit
Small Signal Current Gain $(I_C = 10 \text{ mA}, V_{CE} = -5.0 \text{ V}, f = 1 \text{ kc})$	h_{fe}				---
2N381		35	60	85	
2N382		70	90	135	
2N383		90	115	155	
2N2171		120	210	310	
Voltage Feedback Ratio $(I_C = 10 \text{ mA}, V_{CE} = -5 \text{ V}, f = 1 \text{ kc})$	h_{re}				$\times 10^{-3}$
2N381		---	0.66	---	
2N382		---	0.69	---	
2N383		---	0.72	---	
2N2171		---	0.75	---	
Input Impedance $(I_C = 10 \text{ mA}, V_{CE} = -5.0 \text{ V}, f = 1 \text{ kc})$	h_{ie}				ohms
2N381		---	300	---	
2N382		---	450	---	
2N383		---	550	---	
2N2171		---	850	---	
Output Admittance $(I_C = 10 \text{ mA}, V_{CE} = -5.0 \text{ V}, f = 1 \text{ kc})$	h_{oe}				μmhos
2N381		---	420	---	
2N382		---	400	---	
2N383		---	380	---	
2N2171		---	500	---	
Transducer Gain $(R_g = 300 \Omega, R_L = 500 \Omega)$ $(R_g = 450 \Omega, R_L = 500 \Omega)$ $(R_g = 550 \Omega, R_L = 500 \Omega)$ $(R_g = 785 \Omega, R_L = 500 \Omega)$	G_T				db
2N381		---	36	---	
2N382		---	38	---	
2N383		---	39.5	---	
2N2171		---	42.5	---	
Output Capacitance $(I_C = 1 \text{ mA}, V_{CB} = -6\text{V})$	C_{ob}				pf
2N381		---	20	---	
2N382		---	20	---	
2N383		---	20	---	
2N2171		---	20	---	
Noise Figure $(I_C = 1 \text{ mA}, V_{CE} = -6\text{V}, R_g = 1 \text{ kc}, f = 1 \text{ kc})$	NF				db
2N381		---	6	---	
2N382		---	5.5	---	
2N383		---	5.0	---	
2N2171		---	3.5	---	
Cutoff Frequency $(I_C = 1 \text{ mA}, V_{CB} = -6\text{V})$	f_{hfb}				mc
2N381		---	3	---	
2N382		---	4	---	
2N383		---	5	---	
2N2171		---	7.5	---	

2N398, 2N398 A

**$BV_{CBO} = 105\text{ V}$
 $h_{FE} = 20\text{ (min)}$
 $f_{\alpha_b} - \text{to } 1.0\text{ MC (typ)}$**

CASE 31
(TO-5)



PNP germanium transistor for high-voltage, audio-frequency applications.

ABSOLUTE MAXIMUM RATINGS

Characteristic	Symbol	2N398A	2N398	Unit
Collector-Base Voltage	V_{CBO}	105	105	Vdc
Collector-Emitter Voltage	V_{CEO}	105	105	Vdc
Emitter-Base Voltage	V_{EBO}	50	50	Vdc
DC Collector Current	I_C	200	100	mA
Emitter Current	I_E	200	100	mA
Junction Temperature	T_J	-65 to +100	-65 to +85	°C
Storage Temperature	T_{stg}	-65 to +100	-65 to +85	°C
Collector Dissipation @ 25°C	P_D	150	50	mW
Thermal Resistance, Junction to Air	$\theta_{JA\text{ max}}$	0.5	1.2	°C/mW

ELECTRICAL CHARACTERISTICS (at 25°C case temperature unless otherwise noted)

Characteristic	Symbol	Minimum	Typical	Maximum	Unit
Collector-Base Cutoff Current ($V_{CB} = 105\text{ V}$, $I_B = 0$)	I_{CBO}	-	12.0	50	μA
Collector-Base Cutoff Current ($V_{CB} = 2.5\text{ V}$, $I_B = 0$)	I_{CBO}	-	5.0	14	μA
Emitter-Base Cutoff Current ($V_{EB} = 50\text{ V}$, $I_C = 0$)	I_{EBO}	-	3.0	50	μA
Collector-Emitter Saturation Voltage ($I_C = 5\text{ mA}$; $I_B = 0.25\text{ mA}$)	$V_{CE\text{ (SAT)}}$	-	0.11	0.35	Vdc
Base-Emitter Saturation Voltage ($I_C = 5\text{ mA}$; $I_B = 0.25\text{ mA}$)	$V_{BE\text{ (SAT)}}$	-	0.22	0.40	Vdc
DC Current Transfer Ratio ($I_C = 5\text{ mA}$; $V_{CE} = 0.35\text{ Vdc}$)	h_{FE}	20	65	-	-
DC Collector-Emitter Punch-Through Voltage (V_{CB} necessary to obtain V_{EB} of -1 V max, using instrument with $Z_{in} > 11\text{ megohm}$ to measure V_{BE})	V_{PT}	105	160	-	Vdc
Small-Signal Short-Circuit, Forward Current Transfer Ratio Cutoff Frequency ($V_{CB} = 6\text{ Vdc}$; $I_E = 1\text{ mA}$)	f_{ab}	-	1.0	-	mc

2N398 (continued)

POWER — TEMPERATURE DERATING CURVE

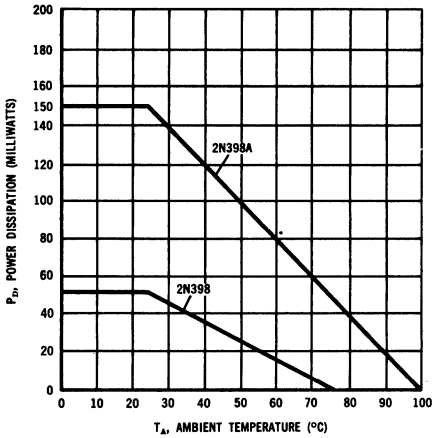

DC CURRENT TRANSFER RATIO versus COLLECTOR CURRENT
 $V_{CE} = 0.35V$

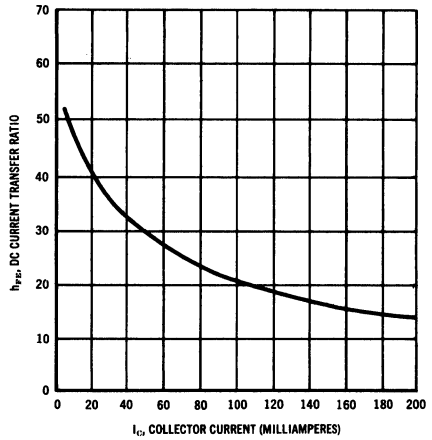

LARGE SIGNAL CURRENT GAIN (h_{FE}) versus TEMPERATURE
 (Normalized to 25°C Value; $V_{CE} = 0.35V$)

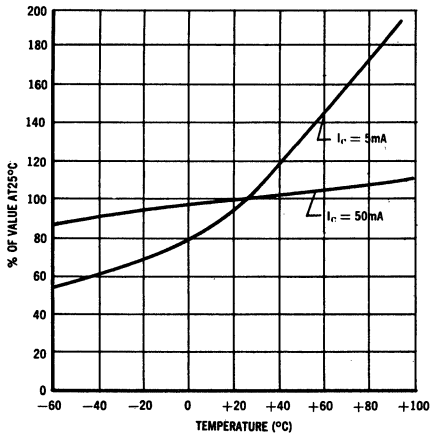

OUTPUT CURRENT versus BASE-DRIVE VOLTAGE
 ($V_{CE} = -1V$)

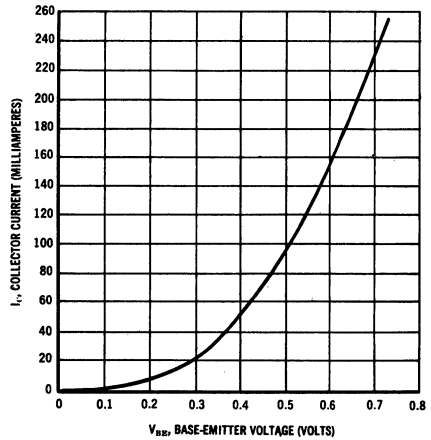

2N460, 2N461

$BV_{CBO} = 45\text{ V}$
 $h_{fe} = 31\text{-}200$ (min-max)
 $f_{\alpha b}$ - to 4 MC (typ)



CASE 31
(TO-5)

PNP germanium transistor for general purpose industrial applications.

ABSOLUTE MAXIMUM RATINGS

Characteristic	Symbol	Rating	Unit
Collector-Base Voltage	V_{CBO}	45	Volts
Collector-Emitter Voltage ($R_{BE} = 1\text{ K}$)	V_{CER}	35	Volts
Emitter-Base Voltage	V_{EBO}	10	Volts
Collector Current	I_C	400	mA
Collector Dissipation at 25° C Case Temperature Derate above 25° C at 25° C Ambient Temperature Derate above 25° C	P_D	500 6.7 225 3	mW mW/° C mW mW/° C
Junction Temperature Range	T_J	-65 to +100	° C

ELECTRICAL CHARACTERISTICS (at 25° C case temperature unless otherwise noted)

Characteristic	Symbol	Minimum	Typical	Maximum	Unit
Collector-Base Cutoff Current ($V_{CB} = 45\text{ Vdc}$)	I_{CBO}	---	---	15	μAdc
Emitter-Base Cutoff Current ($V_{EB} = -10\text{ Vdc}$)	I_{EBO}	---	---	10	μAdc
Collector-Emitter Voltage ($I_C = 1\text{ mAdc}$, $R_{BE} = 1\text{ K}$)	BV_{CER}	35	---	---	Vdc
Small-Signal Current Gain ($V_{CB} = -6\text{ Vdc}$, $I_E = 1\text{ mAdc}$, $f = 1\text{ kc}$)	h_{fb}	0.94 0.955	0.96 0.968	0.972 0.988	---
Small-Signal Current Gain ($V_{CB} = -6\text{ Vdc}$, $I_E = 1\text{ mAdc}$, $f = 1\text{ kc}$)	h_{fe}	31	---	200	---
Reverse Voltage Ratio ($V_{CB} = -6\text{ Vdc}$, $I_E = 1\text{ mAdc}$, $f = 1\text{ kc}$)	h_{rb}	---	2 3	15 15	$\times 10^{-4}$
Input Resistance ($V_{CB} = -6\text{ Vdc}$, $I_E = 1\text{ mAdc}$, $f = 1\text{ kc}$)	h_{ib}	25 25	30 ---	40 40	Ohms
Output Admittance ($V_{CB} = -6\text{ Vdc}$, $I_E = 1\text{ mAdc}$, $f = 1\text{ kc}$)	h_{ob}	---	0.8 0.5	1.5 1.5	μohms
Frequency Cutoff ($V_{CE} = -5\text{ Vdc}$, $I_E = 1\text{ mAdc}$)	f_{hfb}	---	1.2 4	---	mc
Output Capacitance ($V_{CB} = -10\text{ Vdc}$, $I_E = 1\text{ mAdc}$, $f = 1\text{ mc}$)	C_{ob}	---	20	---	pf
Noise Figure ($V_{CE} = -4.5\text{ Vdc}$, $I_E = 0.5\text{ mAdc}$, $R_g = 1\text{ K}$, $f = 1\text{ kc}$)	NF	---	5 4	---	db

2N464 thru **2N467**

$V_{CB0} = 45\text{ V}$
 $h_{fe} - \text{to } 112\text{ (min)}$
 $f_{\alpha_b} - \text{to } 1.2\text{ MC (typ)}$

CASE 31
(TO-5)



PNP germanium transistor for general purpose applications in the audio-frequency range. These devices exceed EIA requirements for collector-current, maximum temperatures and collector dissipation (See maximum Ratings table below).

ABSOLUTE MAXIMUM RATINGS

Characteristic	Symbol	2N464	2N465	2N466	2N467	Unit
Collector-Base Voltage	V_{CB0}	45	45	35	35	Volts
Collector-Emitter Voltage	V_{CE}	40	30	20	15	Volts
Emitter-Base Voltage	V_{EBO}	12				Volts
DC Collector Current EIA Motorola Units	I_C	\longleftrightarrow 100 \longleftrightarrow \longleftrightarrow 500 \longleftrightarrow				mA
Max. Junction & Storage Temperature EIA Motorola Units	T_J and T_{stg}	\longleftrightarrow 85 \longleftrightarrow \longleftrightarrow 100 \longleftrightarrow				$^{\circ}\text{C}$
Collector Dissipation in Free Air EIA Derate 2.5 mW/ $^{\circ}\text{C}$ above 25 $^{\circ}\text{C}$ Motorola Unit Derate 2.67 mW/ $^{\circ}\text{C}$ above 25 $^{\circ}\text{C}$	P_D	\longleftrightarrow 150 \longleftrightarrow \longleftrightarrow 200 \longleftrightarrow				mW
Thermal Resistance, Junction to Air EIA Motorola Units	θ_{JA}	0.40 0.375				$^{\circ}\text{C}/\text{mW}$ $^{\circ}\text{C}/\text{mW}$

ELECTRICAL CHARACTERISTICS (at 25 $^{\circ}\text{C}$ ambient temperature unless otherwise noted)

Characteristic	Symbol	Min	Typical	Max	Unit
Collector-Emitter Breakdown Voltage ($I_C = 0.6\text{ mAdc}$, $R_{BE} = 10\text{ K ohms}$)	BV_{CER}				Vdc
2N464		40	—	—	
2N465		30	—	—	
2N466		20	—	—	
2N467		15	—	—	
Collector-Base Cutoff Current ($V_{CB} = 20\text{ Vdc}$)	I_{CB0}	—	6	15	μAdc
Small Signal Current Gain Cutoff Frequency ($V_{CB} = 6\text{ Vdc}$, $I_E = 1\text{ mAdc}$)	f_{ab}	—	0.7	—	mc
2N464		—	0.8	—	
2N465		—	1.0	—	
2N466		—	1.2	—	
2N467		—	—	—	
Small Signal Current Gain ($V_{CE} = 6\text{ Vdc}$, $I_E = 1.0\text{ mAdc}$, $f = 1\text{ kc}$)	h_{fe}	14	26	—	—
2N464		27	45	—	
2N465		56	90	—	
2N466		112	180	—	
2N467		—	—	—	

2N464 thru 2N467 (continued)

ELECTRICAL CHARACTERISTICS (continued)

Characteristic	Symbol	Min	Typical	Max	Unit
Small Signal Input Impedance ($V_{CE} = 6 \text{ Vdc}$, $I_E = 1.0 \text{ mAdc}$, $f = 1 \text{ kc}$)	h_{ie}	—	900	—	Ohms
	2N464	—	1400	—	
	2N465	—	3000	—	
	2N466	—	5500	—	
	2N467	—	—	—	
Small Signal Power Gain ($V_{CE} = 6 \text{ Vdc}$, $I_E = 1.0 \text{ mAdc}$, $f = 1 \text{ kc}$, matched)	G_e	—	40	—	db
	2N464	—	42	—	
	2N465	—	44	—	
	2N466	—	45	—	
	2N467	—	—	—	
Noise Figure ($V_{CE} = 2.5 \text{ Vdc}$, $I_E = 0.5 \text{ mAdc}$, $f = 1 \text{ kc}$, $R_g = 10 \text{ Kohms}$, $\Delta f = 1 \text{ cps}$)	NF	—	—	22	db

POWER-TEMPERATURE DERATING CURVE

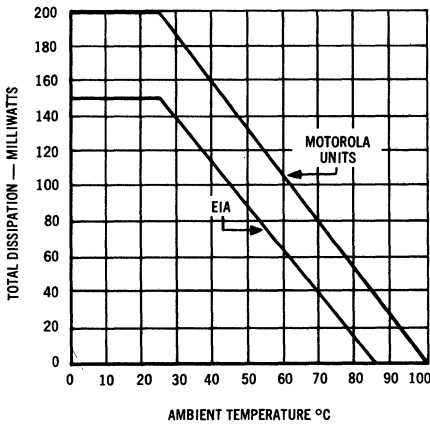

SMALL SIGNAL CURRENT GAIN versus TEMPERATURE

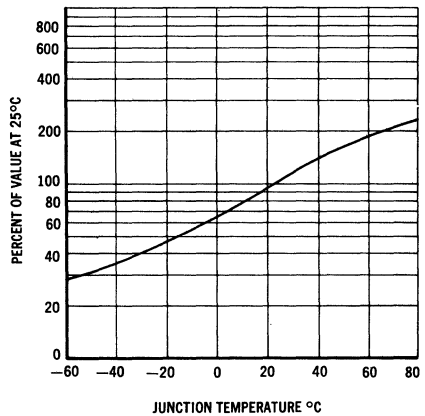

Input Current versus Emitter-Drive Voltage

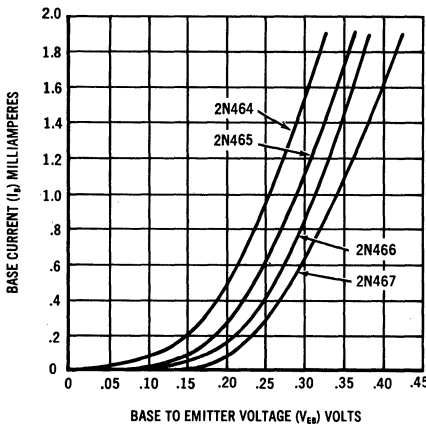

Small Signal Current Gain versus Collector Current
(common emitter 1 kc)

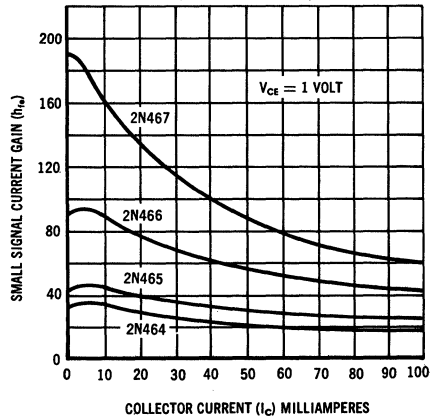

2N508

FOR SPECIFICATIONS, SEE 2N322 DATA SHEET

2N524 thru 2N527

$V_{CBO} = 45 \text{ V}$
 h_{FE} - to 72-121 (min-max)
 f_{α_b} - to 7.0 MC (max)

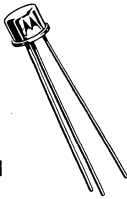

CASE 31
(TO-5)

PNP germanium transistor for switching and amplifier applications in the audio-frequency range. Available for military and high-reliability industrial purposes.

ABSOLUTE MAXIMUM RATINGS

Characteristic	Symbol	Rating	Unit
Collector-Base Voltage	V_{CBO}	45	Vdc
Collector-Emitter Voltage	V_{CEO}	30	Vdc
Emitter-Base Voltage	V_{EBO}	15	Vdc
Collector Current	I_C	500	mA dc
Storage and Operating Temperature	T_{stg}, T_j	-65 to +100	°C
Collector Dissipation in Free Air @ 25°C Ambient	P_D	225	mW
Thermal Resistance (Junction to Air)	θ_{JA}	0.333	°C/mW
Thermal Resistance (infinite heat sink)	θ_{JC}	0.15	°C/mW

2N524 THRU 2N527 (continued)

ELECTRICAL CHARACTERISTICS (at 25°C case temperature unless otherwise noted)

Characteristic	Symbol	Minimum	Maximum	Unit
Collector Cutoff Current ($V_{CB} = 30 \text{ Vdc}$, $I_E = 0$)	I_{CBO}	-	10	μAdc
Emitter Cutoff Current ($V_{EB} = 15 \text{ Vdc}$, $I_C = 0$)	I_{EBO}	-	10	μAdc
Collector-Emitter Breakdown Voltage ($I_C = 0.6 \text{ mAdc}$, $R_{BE} = 10\text{K}$)	BV_{CER}	30	-	μVdc
Collector-Emitter Reach Through (Punch-Thru) Voltage ($V_{EB} = 1 \text{ Vdc}$, $V_{TVM} Z \geq 1 \text{ Megohm}$)	V_{RT}	30	-	μVdc
Static Forward-Current Transfer Ratio ($V_{CE} = 1 \text{ Vdc}$, $I_C = 20 \text{ mAdc}$)	h_{FE}			
		25	42	-
		34	65	-
		53	90	-
		72	121	-
Small-Signal Short-Circuit Forward Current Transfer Ratio Frequency Cutoff ($V_{CB} = 5 \text{ Vdc}$, $I_E = 1 \text{ mAdc}$)	f_{ab}			
		0.8	5.0	Mc
		1.0	5.5	Mc
		1.3	6.5	Mc
		1.5	7.0	Mc
Output Capacitance ($V_{CB} = 5 \text{ Vdc}$, $I_E = 1 \text{ mAdc}$, $f = 1 \text{ Mc}$)	C_{ob}	5	40	pf
Small-Signal Open Circuit Output Admittance ($V_{CB} = 5 \text{ Vdc}$, $I_E = 1 \text{ mAdc}$, $f = 1 \text{ Kc}$)	h_{ob}			
		0.10	1.3	μmho
		0.10	1.2	μmho
		0.10	1.0	μmho
		0.10	0.9	μmho
Small-Signal Open Circuit Reverse Transfer Voltage Ratio ($V_{CB} = 5 \text{ Vdc}$, $I_E = 1 \text{ mAdc}$, $f = 1 \text{ Kc}$)	h_{rb}			
		1.0	10	$X10^{-4}$
		1.0	11	$X10^{-4}$
		1.0	12	$X10^{-4}$
		1.0	14	$X10^{-4}$
Small-Signal Short Circuit Input Impedance ($V_{CB} = 5 \text{ Vdc}$, $I_E = 1 \text{ mAdc}$, $f = 1 \text{ Kc}$)	h_{ib}			
		26	36	ohms
		26	35	ohms
		26	33	ohms
		26	31	ohms
Collector-Emitter Saturation Voltage ($I_C = 20 \text{ mAdc}$) ($I_B = 2 \text{ mAdc}$) ($I_B = 1.33 \text{ mAdc}$) ($I_B = 1.0 \text{ mAdc}$) ($I_B = 0.67 \text{ mAdc}$)	$V_{CE} \text{ (sat)}$			
		55	130	mVdc
		65	130	mVdc
		70	130	mVdc
		80	130	mVdc
Base Input Voltage ($V_{CE} = 1 \text{ Vdc}$, $I_C = 20 \text{ mAdc}$)	V_{BE}			
		220	320	mVdc
		200	300	mVdc
		190	280	mVdc
		180	260	mVdc

2N524 thru 2N527 (continued)

ELECTRICAL CHARACTERISTICS (continued)

Characteristic	Symbol	Minimum	Maximum	Unit
Noise Figure ($V_{CB} = 5 \text{ Vdc}$, $I_E = 1 \text{ mAdc}$, $f = 1 \text{ Kc}$, $BW = 1 \text{ Cycle}$)	NF	1	15	db
Small-Signal Short-Circuit Forward-Current Transfer Ratio ($V_{CE} = 5 \text{ Vdc}$, $I_E = 1 \text{ mAdc}$, $f = 1 \text{ Kc}$)	h_{fe}			
All Types				
2N524		18	41	-
2N525		30	64	-
2N526		44	88	-
2N527		60	120	-

POWER-TEMPERATURE DERATING CURVE

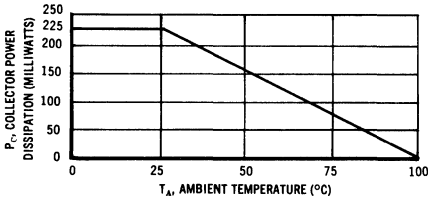

The maximum continuous power is related to maximum junction temperature by the thermal resistance factor.
This curve has a value of 225mW at case temperatures of 25°C and is 0 mW at 100°C with a linear relation between the two temperatures such that:

$$\text{allowable } P_D = \frac{100^\circ - T_A}{0.333}$$

COLLECTOR CUTOFF CURRENT versus TEMPERATURE

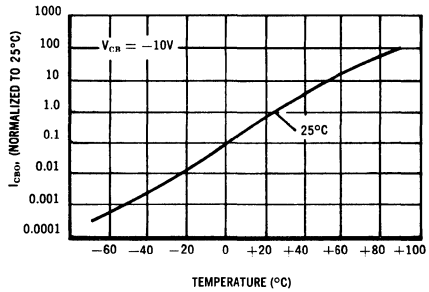

h_{FE} VARIATION WITH TIME

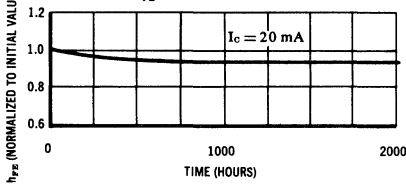

I_{CBO} VARIATION WITH TIME

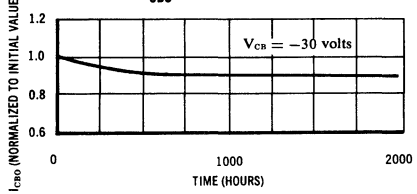

COMMON EMITTER INPUT VOLTAGE versus COLLECTOR CURRENT

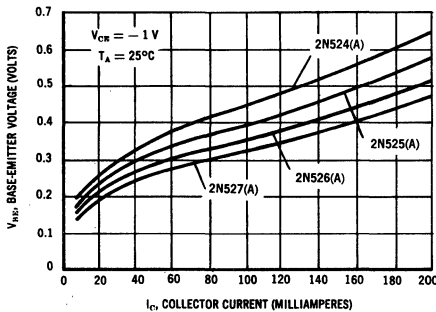

D-C BASE CURRENT GAIN versus COLLECTOR CURRENT

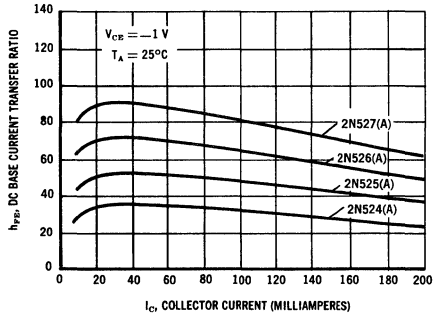

2N650, A thru 2N652, A

$BV_{CBO} = 45 \text{ V}$
 $h_{FE} - \text{to } 80 \text{ (min)}$
 $f_{\alpha b} - \text{to } 2.5 \text{ MC (typ)}$

CASE 31
(TO-5)



PNP germanium transistor for switching and amplifier applications in the audio-frequency range. Available for military and high-reliability industrial purposes.

ABSOLUTE MAXIMUM RATINGS

Characteristic	Symbol	Rating	Unit
Collector-Base Voltage	V_{CBO}	45	Vdc
Collector-Emitter Voltage	V_{CER}	30	Vdc
Emitter-Base Voltage	V_{EBO}	30	Vdc
Collector Current (Continuous)	I_C	500*	mAdc
Junction Temperature Range	$T_J \text{ (max)}$	-65 to +100	°C
Storage Temperature Range	T_{stg}	-65 to +100	°C
Collector Dissipation in Free Air (Derate 2.67 mW/°C above 25°C)	P_D	200	mW
Thermal Resistance (Junction to Air)	θ_{JA}	0.375	°C/mW
Thermal Resistance (Junction to Case)	θ_{JC}	0.250	°C/mW

*Limited by power dissipation.

ELECTRICAL CHARACTERISTICS (at 25°C ambient temperature unless otherwise noted)

Characteristic	Symbol	Minimum	Typical	Maximum	Unit
Collector-Base Cutoff Current ($V_{CB} = 30 \text{ V}, I_E = 0$) ($V_{CB} = 45 \text{ V}, I_E = 0$) ($V_{CB} = 10 \text{ V}, I_E = 0, T_A = +71^\circ\text{C}$)	I_{CBO}	—	3.0	10 50 100	μAdc
Emitter-Base Cutoff Current ($V_{EB} = 30 \text{ V}, I_C = 0$)	I_{EBO}	—	3.0	10	μAdc
Collector-Emitter Leakage Current ($V_{CE} = 30 \text{ V}, R_{BE} = 10 \text{ K}$)	I_{CER}	—	—	600	μAdc
Collector-Emitter Punch-Thru Voltage ($V_F = 1.0 \text{ V}$)	V_{pt}	45	—	—	Vdc
Output Capacitance ($V_{CB} = 6 \text{ V}, I_E = 0$)	C_{ob}	—	10	25	pf
Noise Figure ($V_{CE} = 4.5 \text{ V}, I_E = 0.5 \text{ mA}$, $R_g = 1 \text{ K}, f = 1 \text{ kc}, \Delta f = 1 \text{ cps}$)	NF	—	5	15	db
Small Signal Current Gain Cutoff Frequency ($V_{CB} = 6 \text{ V}, I_E = 1 \text{ mA}$)	$f_{\alpha b}$	0.75 1.0 1.25	1.5 2.0 2.5	— — —	mc

2N650 thru 2N652 (continued)

Characteristic		Symbol	Minimum	Typical	Maximum	Unit
Input Impedance ($V_{CB} = 6\text{ V}$, $I_E = 1\text{ mA}$, $f = 1\text{ kc}$)	2N650	h_{ib}	27	31	37	Ohms
	2N651		27	34	37	
	2N652		27	35	37	
Output Admittance ($V_{CB} = 6\text{ V}$, $I_E = 1\text{ mA}$, $f = 1\text{ kc}$)	2N650	h_{ob}	0.2	0.65	1.0	μmho
	2N651		0.2	0.60	0.9	
	2N652		0.2	0.55	0.8	
Small Signal Current Gain ($V_{CE} = 6\text{ V}$, $I_E = 1\text{ mA}$, $f = 1\text{ kc}$)	2N650	h_{fe}	30	49	70	—
	2N651		50	80	120	
	2N652		100	130	225	
DC Current Transfer Ratio ($V_{CE} = 1.0\text{ V}$, $I_C = 10\text{ mA}$)	2N650	h_{FE}	33	44	—	—
	2N651		45	75	—	
	2N652		80	115	—	
Base-Emitter Drive Voltage ($V_{CE} = 1.0\text{ V}$, $I_C = 10\text{ mA}$)	2N650	V_{EB}	—	0.245	0.270	Vdc
	2N651		—	0.235	0.260	
	2N652		—	0.225	0.250	
Collector-Emitter Saturation Voltage ($I_C = 50\text{ mA}$, $I_B = 2.5\text{ mA}$) ($I_C = 50\text{ mA}$, $I_B = 1.67\text{ mA}$) ($I_C = 50\text{ mA}$, $I_B = 1.25\text{ mA}$)	2N650	$V_{CE}(\text{sat})$	—	0.175	0.250	Vdc
	2N651		—	0.175	0.250	
	2N652		—	0.175	0.250	
Collector-Emitter Saturation Voltage ($I_C = 100\text{ mA}$, $I_B = 5.0\text{ mA}$) ($I_C = 100\text{ mA}$, $I_B = 3.33\text{ mA}$) ($I_C = 100\text{ mA}$, $I_B = 2.5\text{ mA}$)	2N650	$V_{CE}(\text{sat})$	—	0.250	0.500	Vdc
	2N651		—	0.250	0.500	
	2N652		—	0.250	0.500	

POWER-TEMPERATURE DERATING CURVE

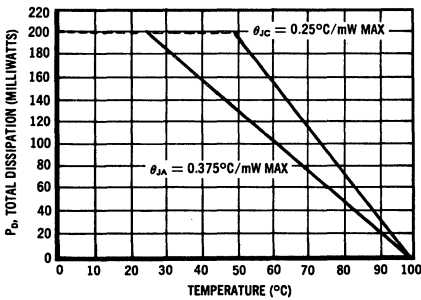

SMALL SIGNAL CURRENT GAIN versus TEMPERATURE

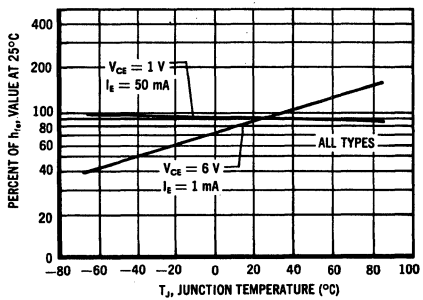

h_{FE} versus COLLECTOR CURRENT

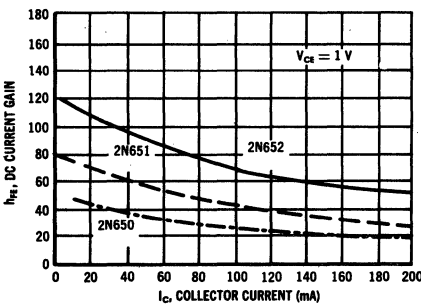

COLLECTOR OUTPUT CURRENT versus BASE DRIVE VOLTAGE

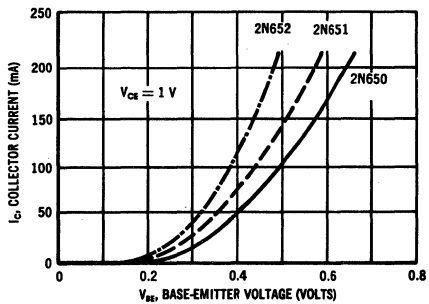

2N653 thru 2N655

$BV_{CBO} = 30\text{ V}$
 h_{fe} - to 100-250 (min-max)
 $f_{\alpha b}$ - to 2.5 MC (typ)

CASE 31
(TO-5)



PNP germanium transistor, for high-gain amplifier and switching service in the audio frequency range.

ABSOLUTE MAXIMUM RATINGS

Characteristic	Symbol	Rating	Unit
Collector to Base Voltage	V_{CBO}	30	Volts
Collector to Emitter Voltage	V_{CER}	25	Volts
Emitter to Base Voltage	V_{EBO}	25	Volts
Collector D. C. Current	I_C	250*	mA
Junction Temperature Limits	T_J	-65 to +10J	°C
Storage Temperature Limits	T_{stg}	-65 to +100	°C
Collector Dissipation in Free Air Derate 2.67 mW/°C above 25°C	P_D	200	mW
Thermal Resistance, Junction to Air	θ_{JA}	0.375	°C/mW

*Limited

ELECTRICAL CHARACTERISTICS (at $T_{sA} = 25^\circ \pm 3^\circ\text{C}$)

Characteristic	Symbol	2N653			2N654			2N655			Unit
		Min	Max	Typ	Min	Max	Typ	Min	Max	Typ	
Small Signal Current Gain $V_{CE} = 6\text{ V}, I_E = 1.0\text{ mA}, f = 1\text{ kC}$	h_{fe}	30	49	70	50	80	125	100	130	250	-
Small Signal Input Impedance $V_{CE} = 6\text{ V}, I_E = 1.0\text{ mA}, f = 1\text{ kC}$	h_{ie}	750	-	2900	1500	-	4700	3000	-	8500	ohms
Small Signal Current Gain Cutoff Frequency $V_{CB} = 6\text{ V}, I_E = 1.0\text{ mA}$	f_{ab}		1.5			2.0			2.5		mc
Output Capacity $V_{CB} = 6\text{ V}, I_E = 0\text{ mA}, f = 1\text{ mc}$	C_{ob}		10			10			10		pf
Noise Figure $V_{CE} = 4.5\text{ V}, I_E = 0.5\text{ mA},$ $R_g = 1, f = 1\text{ kC}$ $\Delta f = 1\text{ cps}$	NF		10			10			10		db
Collector Reverse Current $V_{CB} = 25\text{ V}, I_E = 0$	I_{CBO}		5	15		5	15		5	15	μa
Emitter Reverse Current $V_{EB} = 25\text{ V}, I_C = 0$	I_{EBO}		5	15		5	15		5	15	μa
Collector-Emitter Reverse Current $V_{CE} = 25\text{ V}, R_{BE} = 10\text{ k}$	I_{CER}			600			600			600	μa
Base-Emitter Input Voltage $V_{CE} = 6\text{ V}, I_C = 1.0\text{ mA}$	V_{BE}			0.3			0.3			0.3	Vdc

2N653 thru 2N655 (continued)

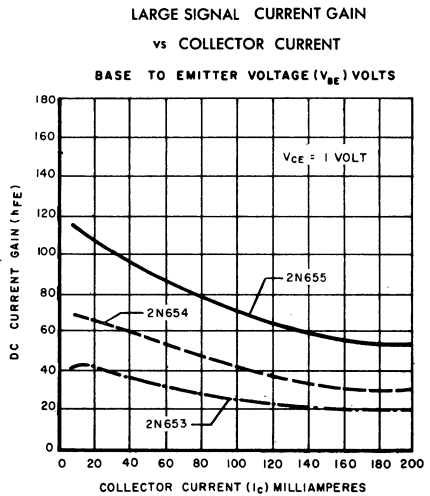
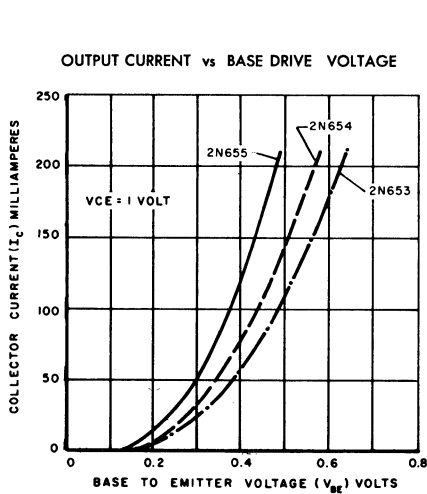
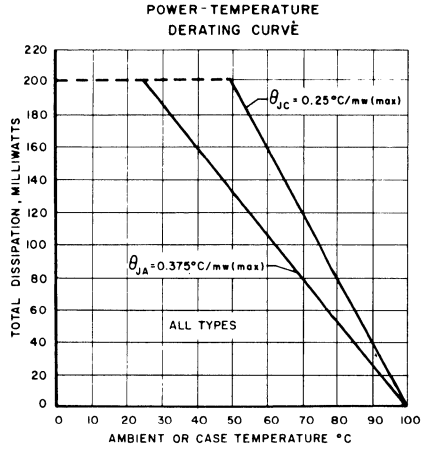
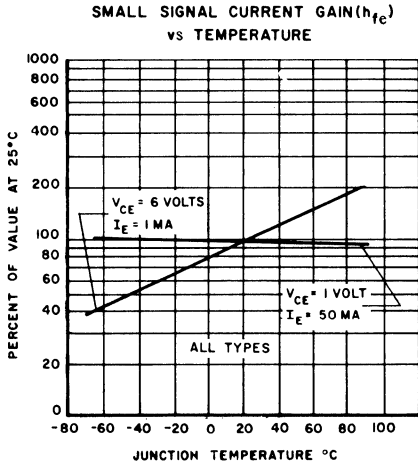

2N1008, A, B

$BV_{CBO} = 60\text{ V}$
 $h_{fe} = 40-150\text{ (min-max)}$

CASE 31
(TO-3)



PNP germanium transistor for audio driver and medium speed switching applications.

ABSOLUTE MAXIMUM RATINGS

Characteristics	Symbol	2N1008	2N1008A	2N1008B	Unit
Collector-Base Voltage	V_{CBO}	20	40	60	Volts
Collector-Emitter Voltage	V_{CEO}	20	40	60	Volts
Emitter-Base Voltage	V_{EBO}	15			Volts
Collector Current	I_C	300			mAdc
Base Current	I_B	30			mAdc
Collector Dissipation $T_A = 25^\circ\text{C}$ derate $T_C = 25^\circ\text{C}$ derate	P_D	200 2.78 300 4.0			mW mW/ $^\circ\text{C}$ mW mW/ $^\circ\text{C}$
Junction and Storage Temperature Range	T_J	-65 to +100			$^\circ\text{C}$

ELECTRICAL CHARACTERISTICS (at 25°C unless otherwise noted)

Characteristics	Symbol	Min	Typ	Max	UNIT
Collector Leakage Current ($V_{CB} = 10\text{ Vdc}$) 2N1008 ($V_{CB} = 10\text{ Vdc}$, $T_A = 85^\circ\text{C}$) 2N1008 ($V_{CB} = 25\text{ Vdc}$) 2N1008A ($V_{CB} = 25\text{ Vdc}$, $T_A = 85^\circ\text{C}$) 2N1008A ($V_{CB} = 45\text{ Vdc}$) 2N1008B ($V_{CB} = 45\text{ Vdc}$, $T_A = 85^\circ\text{C}$) 2N1008B	I_{CBO}	---	5	10 500	μAdc
Emitter Leakage Current ($V_{EB} = 10\text{ Vdc}$) 2N1008 2N1008A 2N1008B	I_{EBO}	---	5	10 10 10	μAdc
Collector-Emitter Breakdown Voltage ($I_C = 1.0\text{ mAdc}$, $R_{BE} = 10\text{ K}$) 2N1008 2N1008A 2N1008B	BV_{CER}	15 35 55	---	---	Vdc
Collector-Emitter Saturation Voltage ($I_C = 100\text{ mAdc}$, $I_B = 10\text{ mAdc}$)	$V_{CE}(\text{sat})$	---	---	0.25	Vdc
Small Signal Current Gain ($I_C = -10\text{ mAdc}$, $V_{CE} = 5.0\text{ Vdc}$, $f = 1\text{ kc}$)	h_{fe}	40	---	150	---
Input Resistance	h_{ie}	200	---	1000	ohms

2N1175

FOR SPECIFICATIONS, SEE 2N1413-2N1415 DATA SHEET

2N1185 thru 2N1188

$BV_{CBO} = 60\text{ V}$
 $h_{FE} - \text{to } 130\text{-}170\text{ (min-max)}$
 $f_{\alpha_b} - \text{to } 3.0\text{ MC}$



CASE 31
(TO-5)

PNP germanium transistors for high-gain audio amplifier and switching applications.

ABSOLUTE MAXIMUM RATINGS

Characteristic	Symbol	Rating	Unit
Collector-Base Voltage 2N1185 2N1186-2N1188	V_{CBO}	45 60	Vdc
Collector-Emitter Voltage 2N1185 2N1186-2N1188	V_{CER}	30 45	Vdc
Emitter-Base Voltage	V_{EBO}	30	Vdc
Collector Current (Continuous)	I_C	500*	mA _{dc}
Storage and Operating Temperature	T_{stg}, T_J	-65 to +100	°C
Collector Dissipation in Free Air (Derate 2.67 mW/°C above 25° C)	P_D	200	mW
Thermal Resistance (Junction to Air)	θ_{JA}	0.375	°C/mW
Thermal Resistance (Junction to Case)	θ_{JC}	0.250	°C/mW

*Limited by power dissipation

2N1185 thru 2N1188 (continued)

ELECTRICAL CHARACTERISTICS (at 25°C ambient temperature unless otherwise noted)

Characteristic	Symbol	Minimum	Typical	Maximum	Unit
Collector-Base Cutoff Current ($V_{CB} = 30\text{ V}$, $I_E = 0$) ($V_{CB} = 45\text{ V}$, $I_E = 0$) ($V_{CB} = 60\text{ V}$, $I_E = 0$) ($V_{CB} = 10\text{ V}$, $I_E = 0$, $T_A = +71^\circ\text{C}$)	I_{CBO}	-	3.0	10	μA
Emitter-Base Cutoff Current ($V_{EB} = 30\text{ V}$, $I_C = 0$)	I_{EBO}	-	3.0	10	μA
Collector-Emitter Leakage Current ($V_{CE} = 30\text{ V}$, $R_{BE} = 10\text{ K}$) ($V_{CE} = 45\text{ V}$, $R_{BE} = 10\text{ K}$)	I_{CER}	-	-	600	μA
Collector-Emitter Punch-Thru Voltage ($V_F = 1.0\text{ V}$)	V_{pt}	45	-	-	Vdc
Output Capacitance ($V_{CB} = 6\text{ V}$, $I_E = 0$)	C_{ob}	-	10	25	pf
Noise Figure ($V_{CE} = 4.5\text{ V}$, $I_E = 0.5\text{ mA}$, $R_g = 1\text{ K}$, $f = 1\text{ kc}$, $\Delta f = 1\text{ cps}$)	NF	-	5	15	db
Small Signal Current Gain Cutoff Frequency ($V_{CB} = 6\text{ V}$, $I_E = 1\text{ mA}$)	f_{ab}	1.75	3.0	-	mc
		0.75	1.5	-	
		1.0	2.0	-	
		1.25	2.5	-	
Input Impedance ($V_{CB} = 6\text{ V}$, $I_E = 1\text{ mA}$, $f = 1\text{ kc}$)	h_{ib}	27	35	37	Ohms
		27	31	37	
		27	34	37	
		27	35	37	
Output Admittance ($V_{CB} = 6\text{ V}$, $I_E = 1\text{ mA}$, $f = 1\text{ kc}$)	h_{ob}	0.2	0.50	0.7	μmho
		0.2	0.65	1.0	
		0.2	0.60	0.9	
		0.2	0.55	0.8	
Small Signal Current Gain ($V_{CE} = 6\text{ V}$, $I_E = 1\text{ mA}$, $f = 1\text{ kc}$)	h_{fe}	190	260	400	-
		30	49	70	
		50	80	120	
		100	130	225	
DC Current Transfer Ratio ($V_{CE} = 1.0\text{ V}$, $I_C = 10\text{ mA}$)	h_{FE}	130	170	-	-
		33	44	-	
		45	75	-	
		80	115	-	

2N1185 thru 2N1188 (continued)

ELECTRICAL CHARACTERISTICS (continued)

Characteristic		Symbol	Minimum	Typical	Maximum	Unit
Base-Emitter Input Voltage ($V_{CE} = 1.0 \text{ V}$, $I_C = 10 \text{ mA}$)	2N1185	V_{BE}	-	0.215	0.240	Vdc
	2N1186		-	0.245	0.270	
	2N1187		-	0.235	0.260	
	2N1188		-	0.225	0.250	
			-	0.225	0.250	
Collector-Emitter Saturation Voltage ($I_C = 50 \text{ mA}$, $I_B = 1.0 \text{ mA}$) ($I_C = 50 \text{ mA}$, $I_B = 2.5 \text{ mA}$) ($I_C = 50 \text{ mA}$, $I_B = 1.67 \text{ mA}$) ($I_C = 50 \text{ mA}$, $I_B = 1.25 \text{ mA}$)	2N1185	$V_{CE} \text{ (sat)}$	-	0.175	0.250	Vdc
	2N1186		-	0.175	0.250	
	2N1187		-	0.175	0.250	
	2N1188		-	0.175	0.250	
			-	0.175	0.250	
Collector-Emitter Saturation Voltage ($I_C = 100 \text{ mA}$, $I_B = 2.0 \text{ mA}$) ($I_C = 100 \text{ mA}$, $I_B = 5.0 \text{ mA}$) ($I_C = 100 \text{ mA}$, $I_B = 3.33 \text{ mA}$) ($I_C = 100 \text{ mA}$, $I_B = 2.5 \text{ mA}$)	2N1185	$V_{CE} \text{ (sat)}$	-	0.250	0.500	Vdc
	2N1186		-	0.250	0.500	
	2N1187		-	0.250	0.500	
	2N1188		-	0.250	0.500	
			-	0.250	0.500	

SMALL SIGNAL CURRENT GAIN(h_{fe}) versus TEMPERATURE

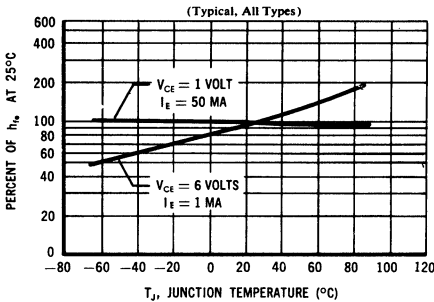

POWER-TEMPERATURE DERATING CURVE

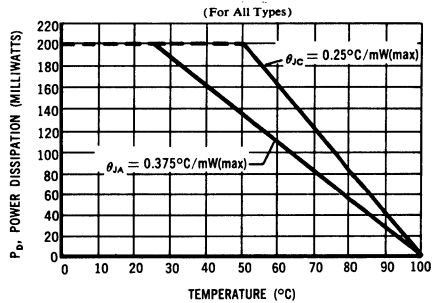

OUTPUT CURRENT versus BASE DRIVE VOLTAGE

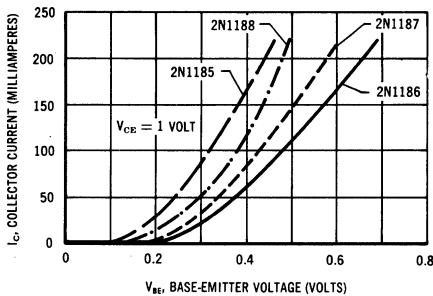

DC CURRENT TRANSFER RATIO versus COLLECTOR CURRENT

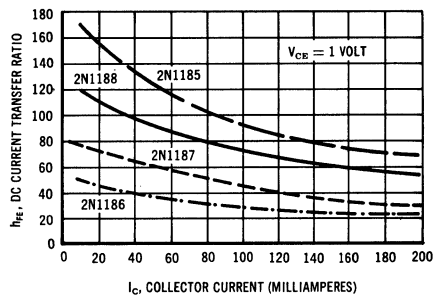

2N1189 2N1190

$BV_{CBO} = 45\text{ V}$

$h_{FE} - \text{to } 100\text{-}170\text{ (min-max)}$

$f_{\alpha_b} - \text{to } 4.5\text{ MC (typ)}$

CASE 31
(TO-5)



PNP germanium transistors for high-gain audio amplifier and switching applications.

ABSOLUTE MAXIMUM RATINGS

Characteristic	Symbol	Rating	Unit
Collector-Base Voltage	V_{CBO}	45	Vdc
Collector-Emitter Voltage	V_{CER}	30	Vdc
Emitter-Base Voltage	V_{EBO}	15	Vdc
Collector Current (Continuous)	I_C	500*	mAdc
Junction, Storage Temperature	T_J, T_{stg}	-65 to +100	°C
Collector Dissipation in Free Air (Derate 2.67 mW/°C above 25°C)	P_D	200	mW
Thermal Resistance (Junction to Air)	θ_{JA}	0.375	°C/mW
Thermal Resistance (Junction to Case)	θ_{JC}	0.250	°C/mW

*Limited by power dissipation.

ELECTRICAL CHARACTERISTICS (at 25°C ambient temperature unless otherwise noted)

Characteristic	Types	Symbol	Min	Typ	Max	Unit
Collector-Base Cutoff Current ($V_{CB} = 30\text{ Vdc}, I_E = 0$) ($V_{CB} = 45\text{ Vdc}, I_E = 0$) ($V_{CB} = 10\text{ Vdc}, I_E = 0, T_A = +71^\circ\text{C}$)		I_{CBO}	—	3.0	10	μAdc
			—	—	50	
			—	55	100	
Emitter-Base Cutoff Current ($V_{EB} = 15\text{ Vdc}, I_C = 0$)		I_{EBO}	—	3.0	10	μAdc
Collector-Emitter Leakage Current ($V_{CE} = 30\text{ Vdc}, R_{BE} = 10\text{K}$)		I_{CER}	—	—	600	μAdc
Collector-Emitter Punch-Thru Voltage ($V_{EB} = 1\text{ Vdc}, VTVM\text{ Impedance} \geq 1\text{ M ohm}$)		V_{pt}	45	—	—	Vdc
Output Capacitance ($V_{CB} = 6\text{ Vdc}, I_E = 0, f = 1\text{ mc}$)		C_{ob}	—	12.0	25	pf
Noise Figure ($V_{CE} = 4.5\text{ Vdc}, I_E = 0.5\text{ mAdc}$ $R_g = 1\text{ K}, f = 1\text{ kc}, \Delta f = 1\text{ cps}$)		NF	—	5	15	db
Small-Signal Current-Gain Cutoff Frequency ($V_{CB} = 6\text{ Vdc}, I_E = 1\text{ mAdc}$)	2N1189	f_{hfb}	1.75	3.5	—	mc
	2N1190		2.25	4.5	—	

2N1189, 2N1190 (continued)

ELECTRICAL CHARACTERISTICS (continued)

Characteristic	Type	Symbol	Min	Typ	Max	Unit
Input Impedance ($V_{CB} = 6 \text{ Vdc}$, $I_E = 1 \text{ mAdc}$, $f = 1 \text{ kc}$)		h_{ib}	27	31	37	Ohms
Output Admittance ($V_{CB} = 6 \text{ Vdc}$, $I_E = 1 \text{ mAdc}$, $f = 1 \text{ kc}$)		h_{ob}	0.1	—	0.9	μmho
Small Signal Current Gain ($V_{CE} = 6 \text{ Vdc}$, $I_E = 1 \text{ mAdc}$, $f = 1 \text{ kc}$)	2N1189 2N1190	h_{fe}	75 125	120 190	175 300	—
DC Current Transfer Ratio ($V_{CE} = 1.0 \text{ Vdc}$, $I_E = 10 \text{ mAdc}$)	2N1189 2N1190	h_{FE}	60 100	115 170	— —	—
Base-Emitter Drive Voltage ($V_{CE} = 1.0 \text{ Vdc}$, $I_E = 10 \text{ mAdc}$)	2N1189 2N1190	V_{BE}	— —	0.24 0.22	0.26 0.25	Vdc
Collector-Emitter Saturation Voltage ($I_C = 50 \text{ mAdc}$, $I_B = 1.5 \text{ mA}$) ($I_C = 50 \text{ mAdc}$, $I_B = 1.0 \text{ mA}$) ($I_C = 100 \text{ mAdc}$, $I_B = 3.0 \text{ mA}$) ($I_C = 100 \text{ mAdc}$, $I_B = 2.0 \text{ mA}$)	2N1189 2N1190 2N1189 2N1190	V_{CE} (sat)	— — — —	0.14 0.15 0.17 0.19	0.22 0.22 0.3 0.3	Vdc

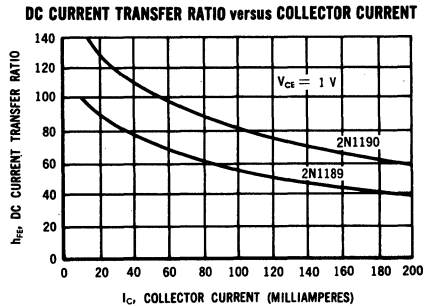
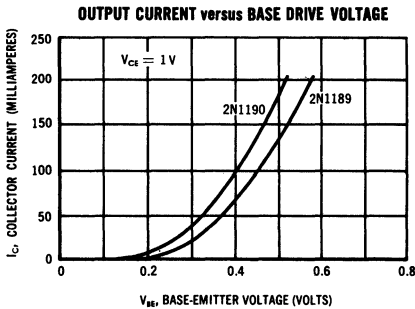
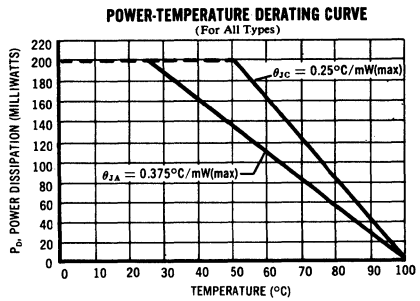
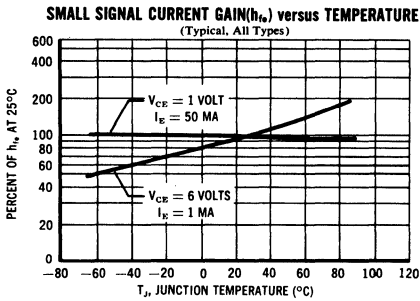

2N1191 thru 2N1194

$BV_{CBO} = 40\text{ V}$
 $h_{FE} - \text{to } 125\text{-}600\text{ (min-max)}$
 $f_{\alpha_b} - \text{to } 3.0\text{ MC (typ)}$

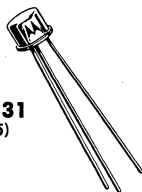

CASE 31
(TO-5)

PNP germanium transistors for high-gain audio amplifier and switching applications.

ABSOLUTE MAXIMUM RATINGS

Characteristic	Symbol	Rating	Unit
Collector-Base Voltage	BV_{CBO}	40	Vdc
Collector-Emitter Voltage	BV_{CER}	25	Vdc
Emitter-Base Voltage	BV_{EBO}	25	Vdc
Collector Current (Continuous)	I_C	200	mAdc
Storage and Operating Temperature	T_{stg}, T_J	-65 to +100	°C
Collector Dissipation in Free Air (Derate 2.67 mW/°C above 25°C)	P_D	200	mW
Thermal Resistance (Junction to Air)	θ_{JA}	0.375	°C/mW
Thermal Resistance (Junction to Case)	θ_{JC}	0.250	°C/mW

ELECTRICAL CHARACTERISTICS (at 25°C ambient temperature unless otherwise noted)

Characteristic	Symbol	Min	Typical	Max	Unit	
Collector-Base Cutoff Current ($V_{CB} = 25\text{ V}, I_E = 0$) ($V_{CB} = 1.0\text{ V}, I_E = 0$)	All Types	I_{CBO}	-	-	15	μAdc
			-	2.0	-	μAdc
Emitter-Base Cutoff Current ($V_{EB} = 25\text{ V}, I_C = 0$)	All Types	I_{EBO}	-	-	15	μAdc
Collector-Emitter Leakage Current ($V_{CE} = 25\text{ V}, R_{BE} = 10\text{ K}$)	All Types	I_{CER}	-	-	600	μAdc
Output Capacitance ($V_{CE} = 6\text{ V}, I_E = 1.0\text{ mA}$)	All Types	C_{ob}	-	20	-	pf
Noise Figure ($V_{CE} = 4.5\text{ V}, I_E = 0.5\text{ mA},$ $f = 1\text{ kc}, R_s = 100\text{ ohms}$)	All Types	NF	-	10	-	db
Small Signal Current Gain Cutoff Frequency ($V_{CB} = 6\text{ V}, I_E = 1.0\text{ mA}$)	2N1191	f_{α_b}	-	1.5	-	mc
	2N1192		-	2.0	-	mc
	2N1193		-	2.5	-	mc
	2N1194		-	3.0	-	mc

2N1191 thru 2N1194 (continued)
ELECTRICAL CHARACTERISTICS (continued)

Characteristic	Symbol	Min	Typical	Max	Unit
Small Signal Current Gain ($V_{CE} = 6 \text{ V}$, $I_E = 1.0 \text{ mA}$, $f = 1 \text{ kc}$)	2N1191	30	40	70	—
	2N1192	50	75	125	—
	2N1193	100	160	250	—
	2N1194	190	280	500	—
DC Current Gain ($V_{CE} = 1 \text{ V}$, $I_C = 10 \text{ mA}$)	2N1191	20	—	80	—
	2N1192	40	—	135	—
	2N1193	70	—	300	—
	2N1194	125	—	600	—
Small Signal Power Gain ($V_{CE} = 6 \text{ V}$, $I_E = 1.0 \text{ mA}$, $f = 1 \text{ kc}$, matched)	2N1191	—	42	—	db
	2N1192	—	44	—	db
	2N1193	—	46	—	db
	2N1194	—	48	—	db
Base-Emitter Input Voltage ($V_{CE} = 6 \text{ V}$, $I_C = 1.0 \text{ mA}$)	All Types	—	—	0.3	Vdc

OUTPUT CURRENT versus BASE DRIVE VOLTAGE

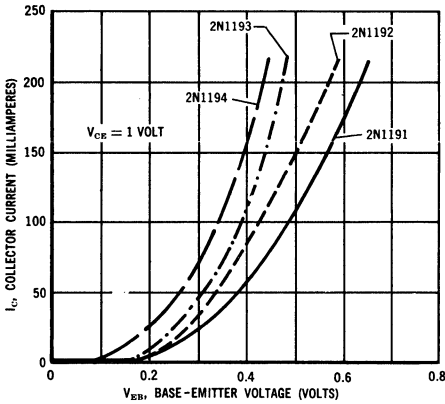

DC CURRENT TRANSFER RATIO versus CURRENT COLLECTOR

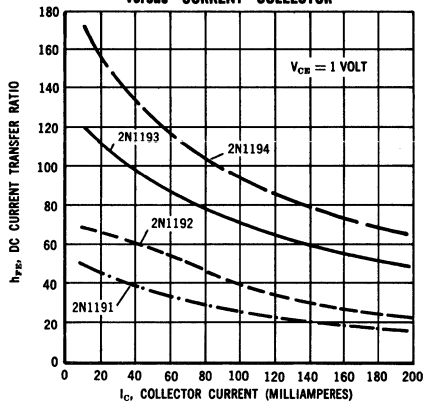

SMALL SIGNAL CURRENT GAIN (h_{fe}) versus TEMPERATURE
(For All Types)

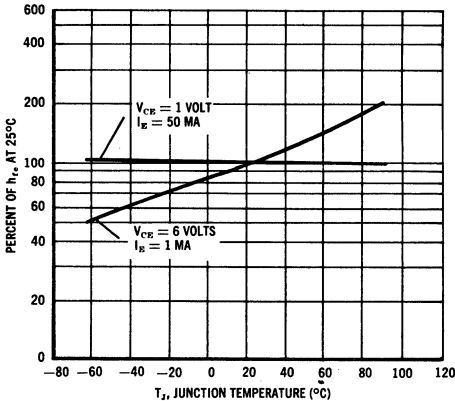

POWER-TEMPERATURE DERATING CURVE
(For All Types)

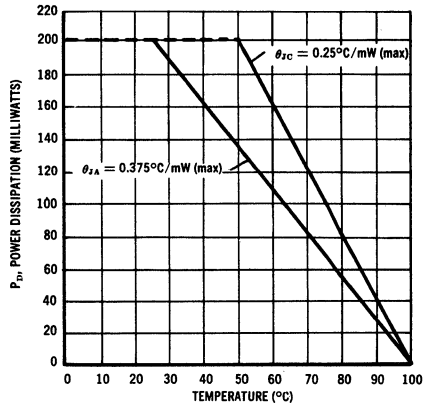

2N1408

$BV_{CBO} = 50\text{ V}$
 $h_{FE} = 10\text{ (min)}$

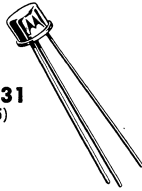

CASE 31
(TO-5)

PNP germanium transistor for high voltage neon driver, solenoid and relay driver circuits.

ABSOLUTE MAXIMUM RATINGS

Characteristic	Symbol	Rating	Unit
Collector-Base Voltage	V_{CBO}	50	Volts
Collector-Emitter Voltage	V_{CES}	50	Volts
Emitter-Base Voltage	V_{EBO}	10	Volts
Collector Current	I_C	200	mA
Collector Dissipation at $T_A = 25^\circ\text{C}$	P_D	150	mW
derating factor		2.0	mW/ $^\circ\text{C}$
Junction Temperature Range	T_J	-65 to +100	$^\circ\text{C}$

ELECTRICAL CHARACTERISTICS (at 25°C case temperature unless otherwise noted)

Characteristic	Symbol	Minimum	Maximum	Unit
Collector-Base Cutoff Current ($V_{CB} = 5\text{ Vdc}$, $I_E = 0$)	I_{CBO}	---	7	μAdc
Emitter-Base Cutoff Current ($V_{EB} = 5\text{ Vdc}$, $I_C = 0$)	I_{EBO}	---	7	μAdc
Collector-Emitter Leakage Current ($V_{CB} = 50\text{ Vdc}$, $R_{BE} = 0$)	I_{CES}	---	150	μAdc
Collector-Base Breakdown Voltage ($I_C = 25\ \mu\text{Adc}$, $I_E = 0$)	BV_{CBO}	50	---	Vdc
Emitter-Base Breakdown Voltage ($I_E = 25\ \mu\text{Adc}$, $I_C = 0$)	BV_{EBO}	10	---	Vdc
Collector-Emitter Punch-Thru Voltage ($I_E = 25\ \mu\text{Adc}$)	V_{pt}	50	---	Vdc
Base-Emitter Input Voltage ($I_B = 1.0\text{ mAdc}$, $V_{CE} = 1.0\text{ Vdc}$)	V_{BE}	---	0.6	Vdc
DC Current Gain ($V_{CE} = 1\text{ Vdc}$, $I_B = 1\text{ mAdc}$)	h_{FE}	10	---	---
Small Signal Current Gain ($V_{CE} = 5.0\text{ Vdc}$, $I_E = 1.0\text{ mA}$, $f = 1\text{ kc}$)	h_{fe}	10	---	---
Output Admittance ($V_{CB} = 5.0\text{ Vdc}$, $I_E = 1.0\text{ mA}$, $f = 1\text{ kc}$)	h_{ob}	---	2.0	μmhos

2N1413 thru **2N1415**
2N1175

$BV_{CBO} = 35\text{ V}$
 $h_{FE} - \text{to } 62\text{ (min)}$
 $f_{\alpha_b} - \text{to } 1.5\text{ MC}$

CASE 31
 (TO-5)

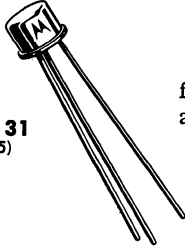

PNP germanium transistor for general purpose low-frequency amplifier and switching applications. Characteristics curves similar to 2N524-2N527 series.

ABSOLUTE MAXIMUM RATINGS

Characteristic	Symbol	Maximum	Unit
Collector-Base Voltage	V_{CBO}	35	Vdc
Collector-Emitter Voltage	V_{CEO}	25	Vdc
Emitter-Base Voltage	V_{EBO}	10	Vdc
Collector Current	I_C	500	mAdc
Junction and Storage Temperature	T_j & T_{stg}	-65 to +100	°C
Power Dissipation at 25°C Free Air	P_D	225	mW

2N1413 thru 2N1415 (continued)

ELECTRICAL CHARACTERISTICS (at 25°C case temperature unless otherwise noted)

Characteristic	Symbol	Minimum	Maximum	Unit
Collector Cutoff Current $V_{CB} = 30 \text{ Vdc}, I_E = 0$	I_{CBO}	—	12	μAdc
Emitter Cutoff Current $V_{EB} = 10 \text{ Vdc}, I_C = 0$	I_{EBO}	—	10	μAdc
Collector-Emmitter Voltage $I_C = 0.6 \text{ mAdc}, R_{BE} = 10 \text{ K}$	V_{CER}	25	—	Vdc
Punch-Thru Voltage	V_{pt}	25	—	Vdc
DC Current Gain $I_C = 20 \text{ mAdc}, V_{CE} = 1 \text{ Vdc}$	h_{FE}			
2N1413		25	42	—
2N1414		34	65	—
2N1415		53	90	—
2N1175		70	140	—
DC Current Gain $I_C = 100 \text{ mAdc}, V_{CE} = 1 \text{ Vdc}$	h_{FE}			
2N1413		23	—	—
2N1414		30	—	—
2N1415		47	—	—
2N1175		62	—	—
Base Input Voltage $V_{CE} = 1 \text{ Vdc}, I_C = 20 \text{ mAdc}$	V_{BE}			
2N1175		—	260	mVdc
Output Capacitance; Input AC Open Circuit $V_{CB} = 5 \text{ Vdc}, I_E = 1 \text{ mAdc}, f = 1 \text{ Mc}$	C_{ob}	—	40	μf
Frequency Cutoff $V_{CE} = 5 \text{ Vdc}, I_E = 1 \text{ mAdc}$	f_{ab}			
2N1413		0.8	—	Mc
2N1414		1.0	—	Mc
2N1415		1.3	—	Mc
2N1175		1.5	—	Mc
Small-Signal Short-Circuit Forward-Transfer Current Ratio $V_{CE} = 5 \text{ Vdc}, I_E = 1 \text{ mAdc}, f = 1 \text{ Kc}$	h_{fe}			
2N1413		20	41	—
2N1414		30	64	—
2N1415		44	88	—
2N1175		60	120	—
Small-Signal Open Circuit Output Admittance $V_{CB} = 5 \text{ Vdc}, I_E = 1 \text{ mAdc}, f = 1 \text{ Kc}$	h_{ob}			
2N1413		0.10	1.3	μmho
2N1414		0.10	1.2	μmho
2N1415		0.10	1.0	μmho
2N1175		0.10	0.9	μmho
Small-Signal Open-Circuit Reverse-Transfer Voltate Ratio $V_{CB} = 5 \text{ Vdc}, I_E = 1 \text{ mAdc}, f = 1 \text{ Kc}$	h_{rb}			
2N1413		1.0	10	$X10^{-4}$
2N1414		1.0	11	$X10^{-4}$
2N1415		1.0	12	$X10^{-4}$
2N1175		1.0	14	$X10^{-4}$
Small-Signal Short-Circuit Input Impedance $V_{CB} = 5 \text{ Vdc}, I_E = 1 \text{ mAdc}, f = 1 \text{ Kc}$	h_{ib}			
2N1413		26	36	ohms
2N1414		26	35	ohms
2N1415		26	33	ohms
2N1175		26	31	ohms

2N1705 thru 2N1707

BV_{CBO} - to 30 V
 h_{FE} - to 60-120 (min-max)
 f_{α_b} - to 4 MC (typ)

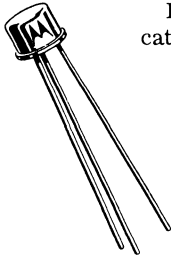

PNP germanium transistors for audio driver applications in transistorized radio receivers.

CASE 31
(TO-5)

ABSOLUTE MAXIMUM RATINGS

Characteristic	Symbol	2N1705	2N1706	2N1707	Unit
Collector-Base Voltage	V_{CBO}	18	25	30	Volts
Collector-Emitter Voltage ($R_{BE} = 1 K$)	V_{CER}	12	18	25	Volts
Emitter-Base Voltage	V_{EBO}	5	5	10	Volts
Collector Current	I_C		400		mA
Collector Dissipation at $T_C = 25^\circ C$	P_D		200		mW
Junction Temperature Range	T_J		-65 to +100		$^\circ C$

2N1705 thru 2N1707 (continued)

ELECTRICAL CHARACTERISTICS (at 25°C case temperature unless otherwise noted)

Characteristic		Symbol	Min	Typical	Max	Unit
Collector-Base Cutoff Current ($V_{CB} = -10$ Vdc) ($V_{CV} = -25$ Vdc)	2N1705 2N1706 2N1707	I_{CBO}	---	5	10 10 15	μ A dc
Emitter-Base Cutoff Current ($V_{EB} = -5$ Vdc) ($V_{EB} = -10$ Vdc)	2N1705 2N1706 2N1707	I_{EBO}	---	4	20 20 10	μ A dc
Collector-Emitter Voltage ($I_C = 1$ mA dc, $R_{BE} = 1$ K)	2N1705 2N1706 2N1707	V_{CER}	12 18 25	---	---	V dc
Base-Emitter Voltage ($I_C = 10$ mA, $V_{CE} = 5$ V) ($I_C = 20$ mA, $V_{CE} = 1$ V)	2N1706 2N1705	V_{BE}	0.15 0.2	---	0.35 0.4	V
DC Current Gain ($I_C = 10$ mA dc, $V_{CE} = -5$ V) ($I_C = 20$ mA dc, $V_{CE} = -1$ V)	2N1707 2N1706	h_{FE}	40 60	90 ---	150 120	---
Small Signal Current Gain ($I_C = 1$ mA, $V_{CE} = -6$ V, $f = 1$ kc) ($I_C = 10$ mA, $V_{CE} = -5$ V, $f = 1$ kc)	2N1705 2N1706 2N1707	h_{ie}	70 50 30	110 90 ---	150 150 150	---
Output Admittance Conductance ($I_C = 1$ mA, $V_{CB} = -6$ V, $f = 1$ kc) ($I_C = 10$ mA, $V_{CE} = -5$ V, $f = 1$ kc)	2N1705 2N1706, 2N1707	h_{ob}	---	0.5 3.0	---	μ mhos
Input Impedance ($I_C = 1$ mA, $V_{CE} = -6$ V, $f = 1$ kc) ($I_C = 10$ mA, $V_{CE} = -5$ V, $f = 1$ kc)	2N1705 2N1706, 2N1707	h_{ib}	---	30 4	---	ohms
Voltage Feedback Ratio ($I_C = 1$ mA, $V_{CB} = -6$ V, $f = 1$ kc) ($I_C = 10$ mA, $V_C = -5$ V, $f = 1$ kc)	2N1705 2N1706 2N1707	h_{rb} h_{re} h_{rb}	---	3 0.69 4.5	---	$X10^{-4}$ $X10^{-3}$ $X10^{-4}$
Frequency Cutoff ($I_C = 1$ mA, $V_C = -6$ V)	2N1706, 2N1707 2N1705	f_{ab}	---	3 4	---	mc
Output Capacitance ($I_C = 1$ mA, $V_{CB} = -6$ V, $f = 1$ mc)		C_{ob}	---	20	---	pf
Noise Figure ($I_C = 1$ mA, $V_{CB} = -6$ V, $R_g = 1$ K, $f = 1$ kc)	2N1705	NF	---	6	---	db

2N1924 thru 2N1926

$V_{CBO} = 60 \text{ V}$
 $h_{FE} - \text{to } 72 \text{ (min)}$
 $f_{\alpha_b} - \text{to } 1.5 \text{ MC}$

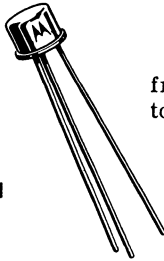

CASE 31
(TO-5)

PNP germanium transistors for general purpose, low-frequency applications. Characteristics curves similar to 2N524-2N527 series.

ABSOLUTE MAXIMUM RATINGS

Characteristic	Symbol	Maximum	Unit
Collector-Base Voltage	V_{CBO}	60	Vdc
Collector-Emitter Voltage	V_{CEO}	40	Vdc
Emitter-Base Voltage	V_{EBO}	25	Vdc
Collector Current	I_C	500	mAdc
Junction and Storage Temperature	T_j & T_{stg}	-65 to +100	°C
Power Dissipation at 25°C Free Air	P_D	225	mW

ELECTRICAL CHARACTERISTICS (at 25°C case temperature unless otherwise noted)

Characteristic	Symbol	Minimum	Maximum	Unit
Collector Cutoff Current $V_{CB} = -45 \text{ Vdc}, I_E = 0$	I_{CBO}	—	10	μAdc
Emitter Cutoff Current $V_{EB} = -25 \text{ Vdc}, I_C = 0$	I_{EBO}	—	10	μAdc
Collector-Base Voltage $I_C = 200 \mu\text{Adc}, I_E = 0$	V_{CBO}	60	—	Vdc
Collector-Emitter Voltage $I_C = 50 \mu\text{Adc}, V_{BE} = +1.5 \text{ Vdc}, R_{BE} = 10 \text{ K}$	V_{CEX}	50	—	Vdc
Collector-Emitter Voltage $I_C = 0.6 \text{ mAdc}, R_{BE} = 10 \text{ K}$	V_{CER}	40	—	Vdc
Punch-Thru Voltage	V_{pt}	50	—	Vdc

2N1924 thru 2N1926 (continued)

ELECTRICAL CHARACTERISTICS (continued)

Characteristic	Symbol	Minimum	Maximum	Unit	
DC Current Gain $I_C = 20 \text{ mAdc}, V_{CE} = -1 \text{ Vdc}$	h_{FE}	2N1924	34	65	—
2N1925		53	90	—	
2N1926		72	121	—	
DC Current Gain $I_C = 100 \text{ mAdc}, V_{CE} = -1 \text{ Vdc}$	h_{FE}	2N1924	30	—	—
2N1925		47	—	—	
2N1926		65	—	—	
Collector-Emitter Saturation Voltage $I_B = 1.33 \text{ mAdc}, I_C = 20 \text{ mAdc}$ 2N1924	$V_{CE(SAT)}$		50	110	mVdc
$I_B = 1.0 \text{ mAdc}, I_C = 20 \text{ mAdc}$ 2N1925			55	110	mVdc
$I_B = 0.67 \text{ mAdc}, I_C = 20 \text{ mAdc}$ 2N1926			60	110	mVdc
Base Input Voltage $V_{CE} = -1 \text{ Vdc}, I_C = 20 \text{ mAdc}$	V_{BE}	2N1924	200	300	mVdc
2N1925		190	280	mVdc	
2N1926		180	260	mVdc	
Output Capacitance; Input AC Open Circuit $V_{CB} = -5 \text{ Vdc}, I_E = 1 \text{ mAdc}, f = 1 \text{ Mc}$	C_{ob}	—	30	pf	
Frequency Cutoff $V_{CB} = -5 \text{ Vdc}, I_E = 1 \text{ mAdc}$	f_{ab}	2N1924	1.0	—	Mc
2N1925		1.3	—	Mc	
2N1926		1.5	—	Mc	
Small-Signal Short-Circuit Forward-Transfer Current Ratio $V_{CE} = -5 \text{ Vdc}, I_E = 1 \text{ mAdc}, f = 1 \text{ Kc}$	h_{fe}	2N1924	30	64	—
2N1925		44	88	—	
2N1926		60	120	—	
Small-Signal Open Circuit Output Admittance $V_{CE} = -5 \text{ Vdc}, I_E = 1 \text{ mAdc}, f = 1 \text{ Kc}$	h_{oe}	2N1924	15	60	μmho
2N1925		20	65	μmho	
2N1926		25	70	μmho	
Small-Signal Open-Circuit Reverse-Transfer Voltage Ratio $V_{CE} = -5 \text{ Vdc}, I_E = 1 \text{ mAdc}, f = 1 \text{ Kc}$	h_{re}	2N1924	2	8	$\times 10^{-4}$
2N1925		3	9	$\times 10^{-4}$	
2N1926		4	10	$\times 10^{-4}$	
Small-Signal Short-Circuit Input Impedance $V_{CE} = -5 \text{ Vdc}, I_E = 1 \text{ mAdc}, f = 1 \text{ Kc}$	h_{ie}	2N1924	700	2200	ohms
2N1925		1200	3200	ohms	
2N1926		1500	4200	ohms	

2N2042, 2N2043

$BV_{CBO} = 105\text{ V}$
 h_{FE} — to 40-100 (min-max)
 $f_{\alpha b}$ — to 0.75 MC



CASE 31
(TO-5)

PNP germanium transistor suitable for high-voltage audio switching and amplifier applications. Suitable for high-reliability projects as MEG-A-LIFE devices.

ABSOLUTE MAXIMUM RATINGS

Characteristic	Symbol	Rating	Unit
Collector-Base Voltage	V_{CBO}	105	Vdc
Collector-Emitter Voltage	V_{CES}	105	Vdc
Emitter-Base Voltage	V_{EBO}	75	Vdc
Collector Current (Continuous)	I_C	200	mAdc
Operating Junction Temperature Range	T_J	-65 to +100	°C
Storage Temperature Range	T_{stg}	-65 to +100	°C
Collector Dissipation in Free Air Derate above 25°C	P_D	200 2.67	mW mW/°C
Thermal Resistance (Junction to Air)	θ_{JA}	0.375	°C/mW
Thermal Resistance (Junction to Case)	θ_{JC}	0.250	°C/mW

ELECTRICAL CHARACTERISTICS (at 25°C case temperature unless otherwise noted)

Characteristic	Symbol	Minimum	Maximum	Unit
Collector-Base Cutoff Current ($V_{CB} = 105\text{ V}$, $I_E = 0$) ($V_{CB} = 2.5\text{ V}$, $I_E = 0$) ($V_{CB} = 105\text{ V}$, $I_E = 0$, $T_A = +71^\circ\text{C}$)	I_{CBO}	—	25 10 500	μAdc
Emitter-Base Cutoff Current ($V_{EB} = 75\text{ V}$, $I_C = 0$) ($V_{EB} = 2.5\text{ V}$, $I_C = 0$)	I_{EBO}	—	50 10	μAdc
Collector-Emitter Cutoff Current ($V_{CE} = 55\text{ V}$, $R_{BE} = 10\text{ K}$)	I_{CER}	—	600	μAdc
Collector-Emitter Cutoff Current ($V_{CE} = 105\text{ V}$, $V_{BE} = 0$)	I_{CES}	—	1.0	mAdc
DC Collector-Emitter Punch-Through Voltage ($V_{fl} = 1.0\text{ V}$, VTVM R_{in} 10-12 megohm)	V_{pt}	105	—	Vdc
DC Current Gain ($I_C = 5\text{ mA}$, $V_{CE} = 0.35\text{ V}$)	h_{FE}		20 40 50 100	—
Common Base, Small-Signal Input Impedance ($V_{CB} = 6\text{ V}$, $I_E = 1\text{ mA}$, $f = 1\text{ kc}$)	h_{ib}	30	50	Ohms

2N2042 , 2N2043 (continued)

ELECTRICAL CHARACTERISTICS (continued)

Characteristic	Symbol	Minimum	Maximum	Unit
Common Base, Small-Signal Output Admittance ($V_{CB} = 6 \text{ V}$, $I_E = 1 \text{ mA}$, $f = 1 \text{ kc}$)	h_{ob}	0.1	1.0	μmho
Common Emitter, Small-Signal Current Transfer Ratio ($V_{CE} = 6 \text{ V}$, $I_C = 1 \text{ mA}$, $f = 1 \text{ kc}$)	h_{fe}	20 45	80 180	—
Base-Emitter Saturation Voltage ($I_C = 5 \text{ mA}$, $I_B = 0.25 \text{ mA}$)	$V_{BE(\text{sat})}$	—	0.30	Vdc
Collector-Emitter Saturation Voltage ($I_C = 5 \text{ mA}$, $I_B = 0.25 \text{ mA}$) ($I_C = 100 \text{ mA}$, $I_B = 10 \text{ mA}$)	$V_{CE(\text{sat})}$	— —	0.25 0.75	Vdc
Collector Output Capacitance ($V_{CB} = 6 \text{ V}$, $I_E = 0$)	C_{ob}	—	25	pf
Common-Base, Small-Signal Forward Current Transfer Ratio Cutoff Frequency ($V_{CB} = 6 \text{ V}$, $I_E = 1 \text{ mA}$)	f_{hfb}	0.50 0.75	— —	mc

POWER-TEMPERATURE DERATING CURVE

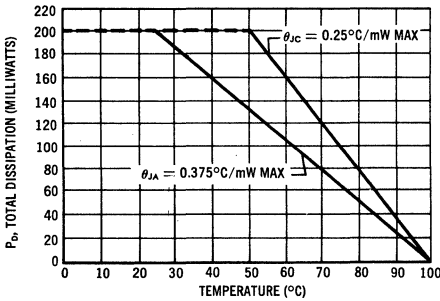

LARGE SIGNAL CURRENT GAIN versus TEMPERATURE

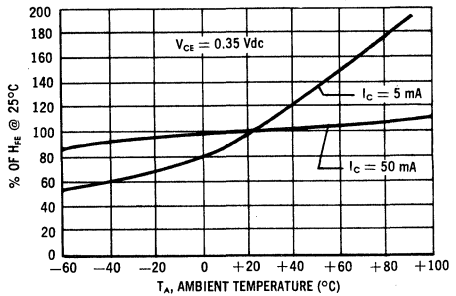

DC CURRENT GAIN versus COLLECTOR CURRENT

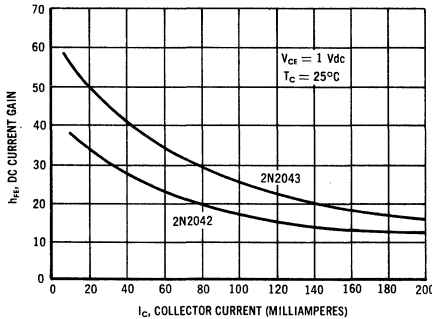

COLLECTOR CURRENT versus BASE-DRIVE VOLTAGE

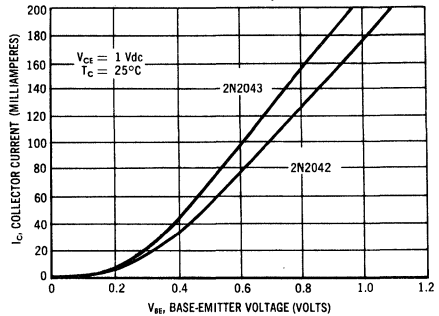

2N2171

FOR SPECIFICATIONS, SEE 2N381 DATA SHEET

2N3427, 2N3428

$BV_{CBO} = 45 \text{ V}$
 $h_{FE} = 350-800 \text{ (min-max)}$
 $f\alpha_b = \text{to } 8.0 \text{ MC}$



CASE 31
 (TO-5)
 All leads isolated
 from case

PNP germanium transistors for audio amplifier and medium-speed switching applications.

ABSOLUTE MAXIMUM RATINGS

Characteristic	Symbol	Rating	Unit
Collector-Base Voltage	V_{CBO}	45	V dc
Collector-Emitter Voltage	V_{CER}	30	V dc
Emitter-Base Voltage	V_{EBO}	30	V dc
Collector Current (Continuous)	I_C	500*	mA dc
Base Current (Continuous)	I_B	50*	mA dc
Storage and Operating Temperature Range	T_{stg} , T_J	-65 to +100	°C
Collector Dissipation in Free Air Derate Above 25 °C	P_D	200 2.67	mW mW/°C

*Limited by power dissipation

2N3427, 2N3428 (continued)

ELECTRICAL CHARACTERISTICS (at 25°C case temperature unless otherwise noted)

Characteristic	Symbol	Minimum	Typical	Maximum	Unit
Collector-Base Cutoff Current ($V_{CB} = 1.5$ Vdc, $I_E = 0$) ($V_{CB} = 10$ Vdc, $I_E = 0$, $T_A = +71^\circ\text{C}$) ($V_{CB} = 30$ Vdc, $I_E = 0$) ($V_{CB} = 45$ Vdc, $I_E = 0$)	I_{CBO}	—	3.0	5	$\mu\text{A dc}$
Emitter-Base Cutoff Current ($V_{EB} = 30$ Vdc, $I_C = 0$)	I_{EBO}	—	3.0	10	$\mu\text{A dc}$
Collector-Emitter Leakage Current ($V_{CE} = 30$ Vdc, $R_{BE} = 10\text{K ohms}$)	I_{CER}	—	—	600	$\mu\text{A dc}$
Collector-Emitter Punch-Thru Voltage ($V_{fl} = 1.0$ Vdc, VTVM impedance ≥ 1 megohm)	V_{pt}	30	—	—	Vdc
Output Capacitance ($V_{CB} = 6$ Vdc, $I_E = 0$, $f = 1$ mc)	C_{ob}	—	10	20	pf
Noise Figure ($V_{CE} = 4.5$ Vdc, $I_E = 0.5$ mA dc, $R_g = 1$ K ohms, $f = 1$ kc, $\Delta f = 1$ cps)	NF	—	5	10	db
Small-Signal Current-Gain Cutoff Frequency ($V_{CB} = 6$ Vdc, $I_E = 1$ mA dc)	f_{hfb}	4.0 5.0	6.0 8.0	— —	mc
Input Impedance ($V_{CB} = 6$ Vdc, $I_E = 1$ mA dc, $f = 1$ kc)	h_{ib}	25	—	35	Ohms
Output Admittance ($V_{CB} = 6$ Vdc, $I_E = 1$ mA dc, $f = 1$ kc)	h_{ob}	0.05	—	0.50	μmho
Small-Signal Current Gain ($V_{CE} = 6$ Vdc, $I_E = 1$ mA dc, $f = 1$ kc)	h_{fe}	200 350	325 475	500 800	—
Small-Signal Current Gain ($V_{CE} = 6$ Vdc, $I_E = 1$ mA dc, $f = 2$ mc)	$ h_{fe} $	2.0 2.5	— —	7 8	—
DC Current Gain ($I_C = 20$ mA dc, $V_{CE} = 1$ Vdc) ($I_C = 100$ mA dc, $V_{CE} = 1$ Vdc) ($I_C = 200$ mA dc, $V_{CE} = 1$ Vdc)	h_{FE}	150 250 100 150 75 125	275 375 210 260 — —	— — 350 400 — —	—
Base-Emitter Input Voltage ($V_{CE} = 1$ Vdc, $I_C = 100$ mA dc)	V_{BE}	—	—	—	Vdc
Collector-Emitter Saturation Voltage ($I_C = 100$ mA dc, $I_B = 2$ mA dc) ($I_C = 200$ mA dc, $I_B = 4$ mA dc)	V_{CE} (sat)	— — — —	0.155 0.150 0.220 0.200	0.200 0.190 0.300 0.280	Vdc

2N3427, 2N3428 (continued)

POWER-TEMPERATURE DERATING CURVE

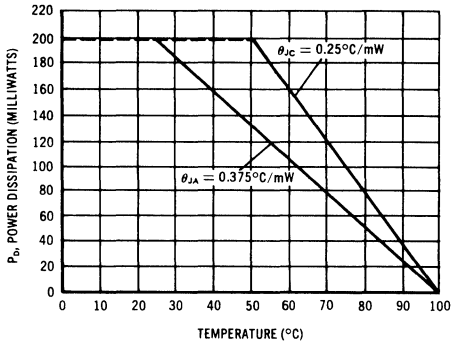

COLLECTOR CURRENT versus BASE CURRENT

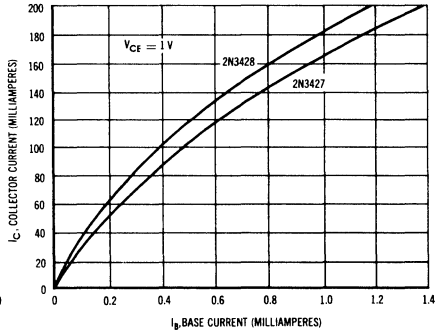

OUTPUT CURRENT versus BASE DRIVE VOLTAGE

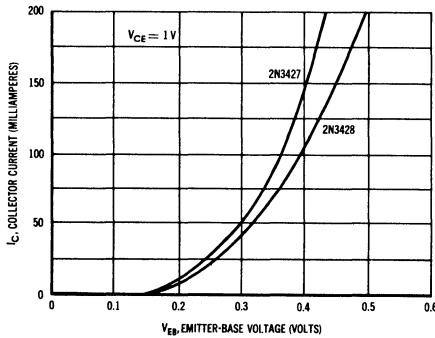

DC CURRENT GAIN versus COLLECTOR CURRENT

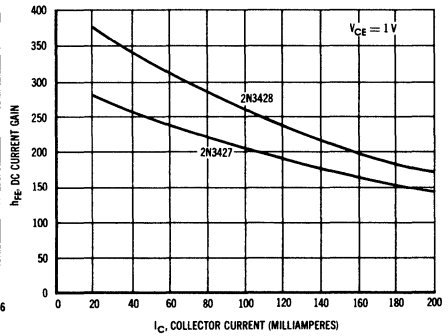

MA112 thru MA117

$BV_{CBO} = 15\text{ V}$
 $h_{fe} - \text{to } 100\text{-}250\text{ (min-max)}$

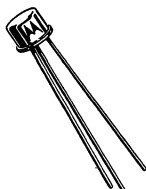

CASE 31
(TO-5)

PNP Germanium transistors for economical circuit applications. Available with a wide variety of gain ranges.

ABSOLUTE MAXIMUM RATINGS

Characteristic	Symbol	Rating	Unit
Collector-Emitter Voltage	V_{CEO}	15	V
Collector-Base Voltage	V_{CBO}	15	V
Emitter-Base Voltage	V_{EBO}	15	V
Collector Current	I_C	200	mA
Storage Temperature Limits	T_{stg}	-55 to +85	$^{\circ}\text{C}$
Power Dissipation @ $T_A = +25^{\circ}\text{C}$	P_D	175	mW

ELECTRICAL CHARACTERISTICS (at 25°C ambient temperature unless otherwise noted)

Characteristic	Minimum	Maximum	Unit
Collector-Emitter Current, I_{CER} ($V_{CE} = 15\text{ V}$, $R_{BE} = 10\text{ K}\Omega$) All Types	-	600	μA
Collector-Base Current, I_{CBO} ($V_{CB} = 15\text{ V}$, $I_E = 0$) All Types	-	15	μA
Small Signal Current Gain, h_{fe} ($V_{CE} = 6\text{ V}$, $I_C = 1\text{ mA}$)			
MA112	30	70	
MA113	50	125	
MA114	100	250	
MA115	30	125	
MA116	50	250	
MA117	30	250	

MA286 thru MA288

$BV_{CBO} = 10\text{ V}$
 $h_{fe} - \text{to } 180\text{ (min)}$



CASE 31
(TO-5)

PNP germanium transistors for very economical circuit applications. Available with wide variety of gain ranges.

ABSOLUTE MAXIMUM RATINGS

Characteristic	Symbol	Rating	Unit
Collector-Emitter Voltage	V_{CEO}	10	V
Collector-Base Voltage	V_{CBO}	10	V
Emitter-Base Voltage	V_{EBO}	10	V
Collector Current	I_C	200	mA
Storage Temperature Limits	T_{stg}	-55 to +85	°C
Power Dissipation @ $T_A = +25^\circ\text{C}$	P_D	175	mW

ELECTRICAL CHARACTERISTICS (at 25°C ambient temperature unless otherwise noted)

Characteristic	Minimum	Maximum	Unit
Collector-Emitter Current, I_{CER} ($V_{CE} = 10\text{ V}$ $R_{BE} = 10\text{ K}\Omega$) All Types	-	600	μA
Small Signal Current Gain, h_{fe} ($V_{CE} = 6\text{ V}$, $I_C = 1\text{ mA}$)			
	MA286 MA287 MA288	14 30 180	40 250 -

MA881 thru MA889

$BV_{CBO} = 60\text{ V}$
 $h_{FE} - \text{to } 125(\text{min})$
 $f_{\alpha b} - \text{to } 1.75\text{ MC}(\text{min})$

PNP germanium transistors for audio amplifier and medium-speed switching applications. Recommended as driver transistors for 50-60 Volt power transistors.



CASE 31
(TO-5)

ABSOLUTE MAXIMUM RATINGS

Characteristic	Symbol	Rating	Unit
Collector-Base Voltage MA881 thru MA884 MA885 thru MA889	V_{CBO}	60 50	Vdc
Collector-Emitter Voltage MA881 thru MA884 MA885 thru MA889	V_{CES}	60 50	Vdc
Emitter-Base Voltage	V_{EBO}	15	Vdc
Collector Current (Continuous)*	I_{C*}	500	mAdc
Collector Dissipation at $T_A = 25^\circ\text{C}$ Derate above 25°C	P_D	200 2.67	mW mW/ $^\circ\text{C}$
Storage and Operating Temperature Range	T_{stg}, T_J	-50 to +100	$^\circ\text{C}$

*Limited by power dissipation

MA881 thru MA889 (continued)

ELECTRICAL CHARACTERISTICS (at 25°C ambient temperature unless otherwise noted)

Characteristic		Symbol	Min	Max	Unit
Collector-Base Cutoff Current ($V_{CB} = 30$ Vdc, $I_E = 0$)		I_{CBO}	---	10	μ Adc
MA881 thru MA884	---		100		
(V _{CB} = 60 Vdc, I _E = 0)			---	15	
MA885 thru MA889	---		100		
Emitter-Base Cutoff Current (V _{EB} = 15 Vdc, I _C = 0)		I_{EBO}	---	10	μ Adc
MA881 thru MA884	---		15		
MA885 thru MA889					
Collector-Emitter Leakage Current (V _{CE} = 60 Vdc, R _{BE} = 0)		I_{CES}	---	100	μ Adc
MA881 thru MA884	---		100		
(V _{CE} = 50 Vdc, R _{BE} = 0)					
MA885 thru MA889					
Output Capacitance (V _{CB} = 6 Vdc, I _E = 0, f = 1 mc)		C_{ob}	---	25	pf
All types					
Input Impedance (V _{CB} = 6 Vdc, I _E = 1 mAdc, f = 1 kc)		h_{ib}	26	40	ohms
All types					
Output Admittance (V _{CB} = 6 Vdc, I _E = 1 mAdc, f = 1 kc)		h_{ob}	0.1	1.0	μ mhos
All types					
DC Current Gain (V _{CE} = 1 Vdc, I _C = 10 mAdc)		h_{FE}	30	---	----
MA881	40		---		
MA882	75		---		
MA883	125		---		
MA884					
Small-Signal Current Gain (V _{CE} = 6 Vdc, I _E = 1 mAdc, f = 1 kc)		h_{fe}	30	70	----
MA881, MA886	50		120		
MA882, MA887	100		225		
MA883, MA888	190		400		
MA884, MA889	15		40		
MA885					
Small-Signal Current Gain Cutoff Frequency (V _{CB} = 6 Vdc, I _E = 1 mAdc)		f_{ab}	0.75	---	mc
MA881, MA886	1.0		---		
MA882, MA887	1.25		---		
MA883, MA888	1.75		---		
MA884, MA889	0.5		---		
MA885					

MA909, MA910

$BV_{CBO} = \text{to } 90 \text{ V}$
 $h_{FE} = 20 \text{ (min)}$

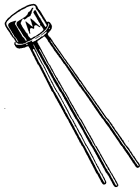

PNP Germanium transistors for high-voltage neon driver, solenoid and relay driver circuits.

CASE 31
(TO-5)

ABSOLUTE MAXIMUM RATINGS

Characteristic	Symbol	MA909	MA910	Unit
Collector-Base Voltage	V_{CB}	75	90	Volts
Collector-Emitter Voltage	V_{CE}	75	90	Volts
Emitter-Base Voltage	V_{EB}	35	45	Volts
Collector Current	I_C	200		mA
Collector Dissipation at $T_C = 25^\circ\text{C}$	P_C	150		mW
Junction and Storage Temperature	$T_{J(\text{max})}$	100		$^\circ\text{C}$

ELECTRICAL CHARACTERISTICS (at 25°C case temperature unless otherwise noted)

Characteristic	Symbol	Min	Max	Unit	
Collector-Base Cutoff Current ($V_{CB} = 2.5 \text{ Vdc}$, $I_E = 0$) ($V_{CB} = 75 \text{ Vdc}$, $I_E = 0$) ($V_{CB} = 90 \text{ Vdc}$, $I_E = 0$)	Both Types MA909 MA910	I_{CBO}	- - -	14 50 50	Adc
Emitter-Base Cutoff Current ($V_{EB} = 35 \text{ Vdc}$, $I_C = 0$) ($V_{EB} = 45 \text{ Vdc}$, $I_C = 0$)	MA909 MA910	I_{EBO}	- -	50 50	Adc
Collector-Emitter Leakage Current ($V_{CE} = 75 \text{ Vdc}$, $R_{BE} = 0$) ($V_{CE} = 90 \text{ Vdc}$, $R_{BE} = 0$)	MA909 MA910	I_{CES}	- -	100 100	Adc
Collector-Emitter Saturation Voltage ($I_C = 5 \text{ mAdc}$, $I_B = 0.25 \text{ mAdc}$)		$V_{CE(\text{sat})}$	-	0.35	Vdc
Base-Emitter Saturation Voltage ($I_C = 5 \text{ mAdc}$, $I_B = 0.25 \text{ mAdc}$)		$V_{BE(\text{sat})}$	-	0.40	Vdc
DC Current Gain ($I_C = 5 \text{ mAdc}$, $V_{CE} = 0.35 \text{ Vdc}$)		h_{FE}	20	-	-
Collector-Emitter Punch-Thru Voltage ($V_{fl} = 1.0 \text{ Vdc}$, R_{in} of VTVM - 10 to 12 Megohms)	MA909 MA910	V_{pt}	75 90	- -	Vdc

MA1702 thru MA1708

BV_{CBO} — to 45 V
 h_{FE} — to 150-400 (min-max)
 $f_{\alpha b}$ — to 7.0 MC



CASE 31
(TO-5)

PNP germanium transistors for audio amplifier and medium speed switching applications requiring high ac gain at low collector current or high dc gain at high collector current.

ABSOLUTE MAXIMUM RATINGS

Characteristic	Symbol	Rating	Unit
Collector-Base Voltage MA1702 MA1703 thru MA1705 MA1706 thru MA1708	V_{CBO}	45 25 15	Vdc
Collector-Emitter Voltage MA1702 MA1703 thru MA1705 MA1706 thru MA1708	V_{CER}	30 25 15	Vdc
Emitter-Base Voltage MA1702 MA1703 thru MA1705 MA1706 thru MA1708	V_{EBO}	30 25 4.5	Vdc
Collector Current (Continuous)	I_C	500*	mAdc
Base Current (Continuous)	I_B	50*	mAdc
Maximum Junction Temperature	$T_{J(max)}$	100	°C
Storage Temperature Range	T_{stg}	-65 to +100	°C
Collector Dissipation in Free Air Derate Above 25°C	P_D	200 2.67	mW mW/°C

*Limited by power dissipation

MA1702 thru MA1708 (continued)

ELECTRICAL CHARACTERISTICS (at 25°C ambient temperature unless otherwise noted)

Characteristic	Symbol	Min	Typ	Max	Unit
Collector-Base Cutoff Current ($V_{CB} = 1.5 \text{ Vdc}, I_E = 0$) MA1702 thru MA1705 ($V_{CB} = 10 \text{ Vdc}, I_E = 0, T_A = +71^\circ \text{C}$) MA1702 ($V_{CB} = 15 \text{ Vdc}, I_E = 0$) MA1706 thru MA1708 ($V_{CB} = 25 \text{ Vdc}, I_E = 0$) MA1703 thru MA1705 ($V_{CB} = 30 \text{ Vdc}, I_E = 0$) MA1702 ($V_{CB} = 45 \text{ Vdc}, I_E = 0$) MA1702	I_{CBO}	-	3.0	5 100 15 15 10 50	μAdc
Emitter-Base Cutoff Current ($V_{EB} = 4.5 \text{ Vdc}, I_C = 0$) MA1706 thru MA1708 ($V_{EB} = 25 \text{ Vdc}, I_C = 0$) MA1703 thru MA1705 ($V_{EB} = 30 \text{ Vdc}, I_C = 0$) MA1702	I_{EBO}	-	- - 3.0	15 15 10	μAdc
Collector-Emitter Leakage Current ($V_{CE} = 15 \text{ Vdc}, R_{BE} = 10 \text{ K ohms}$) MA1706 thru MA1708 ($V_{CE} = 25 \text{ Vdc}, R_{BE} = 10 \text{ K ohms}$) MA1703 thru MA1705 ($V_{CE} = 30 \text{ Vdc}, R_{BE} = 10 \text{ K ohms}$) MA1702	I_{CER}	-	-	600 600 600	μAdc
Collector-Emitter Punch-Thru Voltage ($V_{fl} = 1.0 \text{ Vdc}$, VTVM impedance $\geq 1 \text{ megohm}$) MA1702	V_{pt}	30	-	-	Vdc
Output Capacitance ($V_{CB} = 6 \text{ Vdc}, I_E = 0, f = 1 \text{ mc}$) All Types	C_{ob}	-	10	20	pf
Noise Figure ($V_{CE} = 4.5 \text{ Vdc}, I_E = 0.5 \text{ mA}$, $R_g = 1 \text{ K}, f = 1 \text{ kc}, \Delta f = 1 \text{ cps}$) MA1702	NF	-	5	10	db
Small-Signal Current Gain Cutoff Frequency ($V_{CB} = 6 \text{ Vdc}, I_E = 1 \text{ mA}$) MA1702 MA1703 MA1704 MA1705 MA1706 MA1707 MA1708	f_{hfb}	7.0 3.0 5.0 6.0 3.0 4.0 5.0	- - - - - - -	- - - - - - -	mc
Input Impedance ($V_{CB} = 6 \text{ Vdc}, I_E = 1 \text{ mA}$, $f = 1 \text{ kc}$) MA1702 thru MA1705 MA1706 thru MA1708	h_{ib}	25 25	- -	35 37	Ohms
Output Admittance ($V_{CB} = 6 \text{ Vdc}, I_E = 1 \text{ mA}$, $f = 1 \text{ kc}$) MA1702	h_{ob}	0.05	-	0.50	μmho
Small Signal Current Gain ($V_{CE} = 6 \text{ Vdc}, I_E = 1 \text{ mA}$, $f = 1 \text{ kc}$) MA1702, MA1705, MA1708 MA1703, MA1706 MA1704, MA1707	h_{fe}	500 200 350	- - -	- 500 800	-
DC Current Gain ($I_C = 20 \text{ mA}$, $V_{CE} = 1 \text{ Vdc}$) MA1702 ($I_C = 100 \text{ mA}$, $V_{CE} = 1 \text{ Vdc}$) MA1702, MA1705, MA1708 MA1703, MA1706 MA1704, MA1707 ($I_C = 200 \text{ mA}$, $V_{CE} = 1 \text{ Vdc}$) MA1702 MA1703 MA1704 MA1705	h_{FE}	350 200 100 150 135 70 110 125	- - - - - - - -	- - 350 400 - - - -	-
Collector-Emitter Saturation Voltage ($I_C = 200 \text{ mA}$, $I_B = 4.0 \text{ mA}$) MA1702	$V_{CE}(\text{sat})$	-	-	0.260	Vdc



MOTOROLA HIGH FREQUENCY TRANSISTORS

- For devices meeting military specifications, see page 1-18.
- For high-reliability devices produced under the Meg-A-Life II program, see page 1-22.
- For case outline dimensions, see page 1-26.

MOTOROLA HIGH FREQUENCY SWITCHING AND AMPLIFIER TRANSISTORS

This line of transistors includes germanium and silicon devices designed for switching and amplifier applications at frequencies ranging from a few megacycles to over a gigacycle.

NUMERICAL-ALPHABETICAL LISTING OF DEVICES COVERED IN THIS SECTION

2N697	2N956	2N1561
2N700	2N960	2N1562
2N700A	2N961	2N1613
2N705	2N962	2N1692
2N706	2N963	2N1693
2N706A	2N964	2N1711
2N706B	2N964A	2N1991
2N707	2N965	2N2096
2N707A	2N966	2N2097
2N708	2N967	2N2099
2N710	2N968	2N2100
2N711	2N969	2N2192
2N711A	2N970	2N2192A
2N711B	2N971	2N2192B
2N718	2N972	2N2193
2N718A	2N973	2N2193A
2N722	2N974	2N2193B
2N741	2N975	2N2194
2N741A	2N985	2N2194A
2N744	2N995	2N2194B
2N753	2N1131	2N2195
2N827	2N1132	2N2195A
2N828	2N1132A	2N2195B
2N828A	2N1132B	2N2217
2N829	2N1141	2N2218
2N834	2N1142	2N2218A
2N835	2N1143	2N2219
2N838	2N1195	2N2219A
2N869	2N1204	2N2220
2N914	2N1204A	2N2221
2N915	2N1420	2N2221A
2N916	2N1494	2N2222
2N918	2N1494A	2N2222A
2N929	2N1495	
2N930	2N1496	

NUMERICAL-ALPHABETICAL LISTING (continued)

2N2256	2N3245	2N3506
2N2257	2N3248	2N3507
2N2258	2N3249	2N3508
2N2259	2N3250	2N3509
2N2303	2N3250A	2N3510
2N2330	2N3251	2N3511
2N2331	2N3251A	2N3544
2N2369	2N3252	2N3546
2N2381	2N3253	2N3553
2N2382	2N3279	2N3632
2N2481	2N3280	2N3634
2N2501	2N3281	2N3635
2N2537	2N3282	2N3636
2N2538	2N3283	2N3637
2N2539	2N3284	2N3647
2N2540	2N3285	2N3648
2N2630	2N3286	2N3664
2N2635	2N3287	2N3717
2N2800	2N3288	2N3718
2N2801	2N3289	2N3719
2N2832	2N3290	2N3720
2N2834	2N3291	2N3742
2N2837	2N3292	2N3743
2N2838	2N3293	2N3783
2N2904	2N3294	2N3784
2N2904A	2N3295	2N3785
2N2905	2N3296	2N3798
2N2905A	2N3297	2N3799
2N2906	2N3298	2N3818
2N2906A	2N3307	MCS2135
2N2907	2N3308	MCS2136
2N2907A	2N3309	MCS2137
2N2929	2N3309A	MCS2138
2N2947	2N3323	MF812
2N2948	2N3324	MF832
2N2949	2N3325	MM1803
2N2950	2N3375	MM1941
2N2951	2N3444	MM1943
2N2952	2N3467	MM2503
2N2955	2N3468	MM2550
2N2956	2N3485	MM2552
2N2957	2N3485A	MM2554
2N2958	2N3486	MM2894
2N2959	2N3486A	MPS706
2N3115	2N3493	MPS834
2N3116	2N3494	MPS918
2N3133	2N3495	MPS2894
2N3134	2N3496	MPS2923
2N3135	2N3497	MPS2924
2N3136	2N3498	MPS2925
2N3137	2N3499	MPS3563
2N3227	2N3500	MPS3639
2N3244	2N3501	MPS3640

PREFERRED SILICON TRANSISTORS

Year after year the industry introduces a host of new transistor type numbers to join the growing list of devices already available. Some of the new type numbers represent true state-of-the-art advances in transistor technology, while others are merely improvements of older types already in general use.

Motorola manufactures one of the most extensive lines of high-frequency transistors and will continue to produce many of the older device type numbers — though some of these are recommended for direct replacement only. For new equipment designs, the engineer should consider primarily the more advanced transistors which offer performance and price advantages, and assure a continuing and reliable source of supply.

NUMERICAL LISTING OF PREFERRED MOTOROLA HIGH FREQUENCY SILICON TRANSISTORS

Type Number	Type Number	Type Number	Type Number
2N834	2N2537	2N3253	2N3511
2N835	2N2538	2N3444	2N3544
2N915	2N2539	2N3467	2N3546
2N916	2N2540	2N3468	2N3634
2N918	2N2800	2N3485, A	2N3635
2N2192, A, B	2N2801	2N3486, A	2N3636
2N2193, A, B	2N2837	2N3493	2N3637
2N2194, A, B	2N2838	2N3494	2N3647
2N2195, A, B	2N2904, A	2N3495	2N3648
2N2217	2N2905, A	2N3496	2N3719
2N2218, A	2N2906, A	2N3497	2N3720
2N2219, A	2N2907, A	2N8498	2N3742
2N2220	2N3227	2N3499	2N3743
2N2221, A	2N3244	2N3500	
2N2222, A	2N3245	2N3501	
2N2330	2N3248	2N3506	MM1755
2N2331	2N3249	2N3507	MM1756
2N2369	2N3250, A	2N3508	MM1757
2N2481	2N3251, A	2N3509	MM1758
2N2501	2N3252	2N3510	MM2894

**SILICON HIGH FREQUENCY TRANSISTORS
EIA-MOTOROLA PREFERRED† TYPE
CROSS REFERENCE GUIDE**

EIA	Motorola	EIA	Motorola	EIA	Motorola	EIA	Motorola	EIA	Motorola
2N497	2N3498	2N730	# 2N2220	2N930	2N930	2N1564	2N2218	2N1987	2N2217
2N498	2N3498	2N731	# 2N2221	2N947	2N834	2N1565	2N2218	2N1988	2N2218A
2N656	2N3498	2N734	2N2221	2N956	# 2N2222	2N1566	2N2219	2N1989	2N2218A
2N657	2N3498	2N735	2N2221	2N957	2N2501	2N1566A	2N2219	2N1991	# 2N2800
2N696	# 2N2217	2N736	2N2222	2N978	2N2837	2N1613	# 2N2218A	2N2008	2N3500
2N696A	2N2217	2N736A	2N2222	2N988	2N2221	2N1613A	2N2218	2N2049	2N2219A
2N697	# 2N2218	2N742	2N2220	2N989	2N2221	2N1644	2N2218	2N2106	2N2218
2N697A	2N2218	2N742A	2N2220	2N995	# 2N3250	2N1700	2N2217	2N2107	2N2218
2N698	# 2N3498	2N743	# 2N835	2N995A	2N3250	2N1701	2N2217	2N2108	2N2219
2N699	# 2N3498	2N744	# 2N2501	2N996	# 2N3248	2N1702	2N2217	2N2192	# 2N3253
2N699B	2N3498	2N752	2N2221	2N1060	2N2501	2N1703	2N2217	2N2192A	# 2N3253
2N702	# 2N835	2N753	# 2N835	2N1131	# 2N2800	2N1704	2N2218	2N2192B	# 2N3253
2N703	# 2N835	2N754	2N2220	2N1131A	# 2N2800	2N1711	# 2N2219A	2N2193	# 2N3444
2N706	# 2N835	2N755	2N2220	2N1132	# 2N2800	2N1711A	2N2219A	2N2193A	# 2N3444
2N706A	# 2N835	2N780	2N2220	2N1132A	# 2N2800	2N1711B	2N2219A	2N2193B	# 2N3444
2N706B	# 2N835	2N783	2N834	2N1132B	# 2N2800	2N1837	2N2218	2N2194	# 2N2218A
2N706C	# 2N835	2N784	# 2N834	2N1139	2N835	2N1837A	2N2218	2N2194A	# 2N2218A
2N707	2N707	2N784A	# 2N834	2N1199	2N835	2N1838	2N2218	2N2194B	# 2N2218A
2N707A	2N707A	2N834	# 2N2501	2N1199A	2N835	2N1839	2N2217	2N2195	# 2N2217
2N708	# 2N834	2N835	# 2N2501	2N1252	2N2537	2N1840	2N2217	2N2195A	# 2N2217
2N708A	# 2N834	2N839	2N2220	2N1252A	2N2537	2N1889	# 2N3498	2N2195B	# 2N2217
2N709	2N709	2N840	# 2N2221	2N1253	2N2537	2N1890	# 2N3499	2N2205	# 2N835
2N709A	2N709A	2N841	2N2222	2N1253A	2N2537	2N1893	# 2N3498	2N2206	# 2N835
2N715	# 2N2221	2N842	2N2221	2N1276	2N2501	2N1893A	2N3498	2N2216	2N3498
2N716	# 2N2221	2N843	2N2222	2N1277	2N2501	2N1958	# 2N2537	2N2217	2N2217
2N717	# 2N2221	2N849	2N835	2N1278	2N2501	2N1958A	2N2537	2N2218	* 2N2218
2N717A	# 2N2221	2N850	2N834	2N1279	2N2501	2N1959	# 2N2537	2N2218A	* 2N2218A
2N718	# 2N2221	2N851	2N835	2N1386	2N2218	2N1959A	2N2537	2N2219	* 2N2219
2N718A	# 2N2221	2N852	2N834	2N1387	2N2218	2N1962	2N834	2N2219A	* 2N2219A
2N719	# 2N3498	2N869	# 2N3250	2N1388	2N2218	2N1963	2N834	2N2220	2N2220
2N719A	2N3498	2N869A	2N3250	2N1389	2N2218	2N1964	2N2539	2N2221	* 2N2221
2N720	# 2N3498	2N909	2N2222	2N1390	2N2218	2N1965	2N2539	2N2221A	* 2N2221A
2N720A	# 2N3498	2N914	# 2N834	2N1409	2N2537	2N1972	2N2219	2N2222	* 2N2222
2N721	# 2N2837	2N915	2N915	2N1409A	2N2537	2N1973	2N2219	2N2222A	* 2N2222A
2N722	# 2N2837	2N916	2N916	2N1410	2N2537	2N1974	2N3498	2N2224	# 2N2218
2N722A	# 2N2837	2N919	2N834	2N1410A	2N2537	2N1975	2N3498	2N2242	# 2N2501
2N726	# 2N3250	2N920	2N834	2N1420	# 2N2218	2N1983	2N2218	2N2243	2N2219
2N727	# 2N3250	2N921	2N834	2N1420A	2N2219	2N1984	2N2218	2N2244	2N835
2N728	# 2N2539	2N922	2N834	2N1507	# 2N2219	2N1985	2N2218	2N2245	2N835
2N729	# 2N2539	2N929	2N929	2N1528	2N2218	2N1986	2N2218	2N2246	2N835

† Motorola type indicated generally offers improved performance when used in place of the EIA type listed.

EIA type available in addition to Motorola preferred type.

* Also available in TO-46 package.

— Motorola High-Frequency Transistors —

CROSS REFERENCE GUIDE (continued)

EIA	Motorola	EIA	Motorola	EIA	Motorola	EIA	Motorola	EIA	Motorola
2N2247	2N834	2N2545	2N2222A	2N2949	2N2949	2N3252	2N3252	2N3503	# 2N2905A
2N2248	2N834	2N2651	# 2N2501	2N2950	2N2950	2N3253	2N3253	2N3504	# 2N2907
2N2249	2N834	2N2696	# 2N2837			2N3287	2N3287	2N3505	# 2N2907A
2N2250	2N835			2N2951	2N2951	2N3288	2N3288	2N3506	2N3506
2N2251	2N835	2N2709	2N2800	2N2952	2N2952	2N3289	2N3289	2N3507	2N3507
		2N2711	2N834	2N2958	2N2958				
2N2252	2N834	2N2712	2N834	2N2959	2N2959	2N3290	2N3290	2N3508	2N3508
2N2253	2N834	2N2713	2N834	2N3009	# 2N3511	2N3291	2N3291	2N3509	2N3509
2N2254	2N834	2N2714	2N834			2N3292	2N3292	2N3510	2N3510
2N2255	2N834			2N3010	# 2N3010	2N3293	2N3293	2N3511	2N3511
2N2256	2N2256	2N2715	2N834	2N3011	# 2N3227	2N3294	2N3294	2N3512	2N2537
		2N2716	2N834	2N3012	# MM2894				
2N2257	2N2257	2N2787	2N2217	2N3013	# 2N3511	2N3295	2N3295	2N3544	2N3544
2N2270	# 2N2219	2N2788	# 2N2218A	2N3014	# 2N3511	2N3296	2N3296	2N3546	2N3546
2N2297	# 2N3252	2N2789	# 2N2219A			2N3297	2N3297	2N3634	2N3634
2N2303	# 2N2801			2N3015	# 2N2537	2N3298	2N3298	2N3635	2N3635
2N2318	2N834	2N2790	# 2N2220	2N3019	2N3019	2N3299	# 2N2218A	2N3636	2N3636
		2N2791	# 2N2221A	2N3020	2N3020				
2N2319	2N834	2N2792	# 2N2222A	2N3021	2N3021	2N3300	# 2N2219A	2N3637	2N3637
2N2320	2N834	2N2800	2N2800	2N3022	2N3022	2N3301	# 2N2221A	2N3647	2N3647
2N2330	2N2330	2N2801	2N2801			2N3302	# 2N2222A	2N3648	2N3648
2N2331	2N2331			2N3023	2N3023	2N3304	2N3546	2N3719	2N3719
2N2350	MM1756	2N2837	2N2837	2N3024	2N3024	2N3307	2N3307	2N3720	2N3720
		2N2838	2N2838	2N3025	2N3025				
2N2350A	MM1756	2N2845	# 2N2539	2N3026	2N3026	2N3308	2N3308	2N3742	2N3742
2N2368	# 2N3227	2N2846	# 2N2537	2N3053	# 2N3498	2N3309	2N3309	2N3743	2N3743
2N2369	# 2N3227	2N2847	# 2N2539			2N3326	2N2218A	2N3796	2N3796
2N2369A	# 2N3227			2N3110	# 2N2218A	2N3337	2N3287	2N3797	2N3797
2N2405	# 2N3498	2N2848	# 2N2538	2N3114	# 2N3500	2N3338	2N3289	2N3798	2N3798
		2N2868	2N3252	2N3115	2N3115				
2N2410	# 2N2537	2N2883	2N3309	2N3116	2N3116	2N3339	2N3288	2N3799	2N3799
2N2411	# 2N3250	2N2884	2N3309	2N3120	# 2N2800	2N3467	2N3467	MCS2135	MCS2135
2N2412	# 2N3250	2N2890	2N3507			2N3468	2N3468	MCS2136	MCS2136
2N2476	# 2N3252			2N3121	# 2N2837	2N3485	2N3485	MCS2137	MCS2137
2N2477	# 2N3252	2N2891	2N3507	2N3133	2N3133	2N3486	2N3486	MCS2138	MCS2138
		2N2894	# 2N3248	2N3134	2N3134				
2N2478	2N2218	2N2904	2N2904	2N3135	2N3135	2N3493	2N3493	MF3304	MF3304
2N2479	2N2218	2N2904A	2N2904A	2N3136	2N3136	2N3494	2N3494	MM1755	MM1755
2N2481	2N2481	2N2905	2N2905			2N3495	2N3495	MM1756	MM1756
2N2483	MM2483			2N3209	# MM2894	2N3496	2N3496	MM1757	MM1757
2N2484	MM2484	2N2905A	2N2905A	2N3224	2N3498	2N3497	2N3497	MM1758	MM1758
		2N2906	2N2906	2N3225	2N3498				
2N2501	2N2501	2N2906A	2N2906A	2N3227	?N3227	2N3498	2N3498	MM2090	MM2090
2N2511	2N3444	2N2907	2N2907	2N3244	2N3244	2N3499	2N3499	MM2091	MM2091
2N2537	2N2537	2N2907A	2N2907A			2N3500	2N3500	MM2092	MM2092
2N2538	2N2538			2N3245	2N3245	2N3501	2N3501	MM2483	MM2483
2N2539	2N2539	2N2927	2N2800	2N3248	2N3248	2N3502	# 2N2905	MM2484	MM2484
2N2540	2N2540	2N2947	2N2947	2N3249	2N3249			MM2894	MM2894
2N2605	# 2N3798	2N2948	2N2948	2N3250	2N3250				
				2N3251	2N3251				

† Motorola type indicated generally offers improved performance when used in place of the EIA type listed.

EIA type available in addition to Motorola preferred type.

* Also available in TO-46 package.

SILICON TRANSISTOR HIGH SPEED SWITCHING SELECTION GUIDE

The following tables and graphs are intended for a rapid guide for selecting preferred silicon transistors for high-speed switching applications. The devices in this category are optimized for low storage time.

MIN. V _{CE0} VOLTS	OPTIMUM COLLECTOR CURRENT RANGE											
	10 μ A - 1 mA		1 mA - 10 mA		10 mA - 100 mA		100 mA - 400 mA		400 mA - 800 mA		800 mA - 3 A	
	NPN	PNP	NPN	PNP	NPN	PNP	NPN	PNP	NPN	PNP	NPN	PNP
5-19	2N3493		2N2369 2N2481	2N3248 2N3249 2N3546	2N706 2N708 2N744 2N753 2N835 2N914 2N2369 2N2481 2N3510 2N3511 2N3647 2N3648 MPS706	2N3248 2N3249 2N3546	2N3510 2N3511 2N3647 2N3648					
20-29			2N2501 2N3227 2N3508 2N3509		2N834 2N2501 2N3227 2N3508 2N3509 MPS834							
30-39					2N2537 2N2538 2N2539 2N2540		2N2537 2N2538 2N2539 2N2540 2N3252		2N3252			
40-50						2N2904 2N2905 2N2906 2N2907 2N3485 2N3486	2N3253 2N3444	2N3467 2N3468 2N2904 2N2905 2N2906 2N2907 2N3485 2N3486	2N3253 2N3444 2N3506 2N3507	2N3467 2N3468 2N3719	2N3506 2N3507	2N3719
60-79						2N2904A 2N2905A 2N2906A 2N2907A 2N3485A 2N3486A		2N2904A 2N2905A 2N2906A 2N2907A 2N3485A 2N3486A		2N3720		2N3720

**HIGH-SPEED SILICON TRANSISTORS, FOR
LOW CURRENT SATURATED SWITCHING**

LIMIT SPECIFICATIONS (at 25°C) (for typical variations, see accompanying graphs)

REFERENCE CURVE	Type Number	h_{FE} min/max	$V_{CE(sat)}$ $\beta_F = 10$ (VOLTS)	SWITCHING TIME		
				t_{on} or $t_d + t_r$ (nsec)	t_{off} or $t_s + t_f$ (nsec)	
NPN	CURVE 24	2N3493	40/120 @ $I_C = 0.5$ mA	0.13 @ $I_C = 0.1$ mA $I_B = 0.01$ mA	—	—
	CURVE 1	2N706	20/-	0.6	40	75
		2N708	30/120	0.4	--	--
		2N744	40/120 @ $I_C = 10$ mA	0.35 (+170°C)	16 @ $I_C = 10$ mA	24 @ $I_C = 10$ mA
		2N753	40/120 @ $I_C = 10$ mA	0.6	40	75
		2N834	25/- $V_{CE} = 1$ V	0.25 @ $I_C = 10$ mA	16 $I_B = 3$ mA	30 $V_{CC} = 3$ V
		2N835	20/-	0.3	20	35
	2N914	30/120	0.25 $I_B = 1$ mA	40 @ $I_C = 200$ mA $V_{CC} = 5$ V	40 @ $I_C = 200$ mA $V_{CC} = 5$ V	
	2N2481	40/120	0.25	40 @ $I_C = 10$ mA $V_{CC} = 3$ V	55 @ $I_C = 10$ mA $V_{CC} = 3$ V	
	2N2501	50/150	0.2	--	--	
CURVE 73	2N2369	40/120	0.25 @ $I_C = 10$ mA	12 @ $I_C = 10$ mA	18 @ $I_C = 10$ mA	
	2N3227	100/300 @ $I_C = 10$ mA $V_{CE} = 1$ V	0.25 $I_B = 1$ mA	12 @ $I_C = 10$ mA $V_{CC} = 3$ V	18 @ $I_C = 10$ mA $V_{CC} = 3$ V	
CURVE 45	2N3546	30/120 @ $I_C = 10$ mA $V_{CE} = 1$ V	0.15 @ $I_C = 10$ mA $I_B = 1$ mA	25 @ $I_C = 50$ mA $V_{CC} = 3$ V	35 @ $I_C = 50$ mA $V_{CC} = 3$ V	
	2N3248	50/150 @ $I_C = 10$ mA	0.125 @ $I_C = 10$ mA	20 @ $I_C = 100$ mA	80 @ $I_C = 100$ mA	
CURVE 42	2N3249	100/300 $V_{CE} = 1$ V	0.125 $I_B = 1$ mA	20 $V_{CC} = 10$ V	80 $V_{CC} = 10$ V	

HIGH SPEED SILICON TRANSISTOR CHARACTERISTIC CURVES

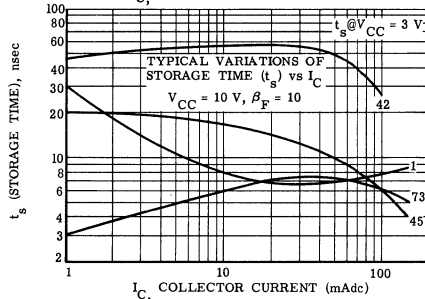
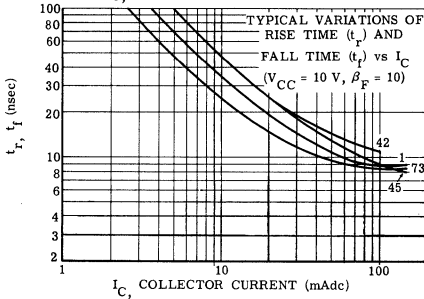
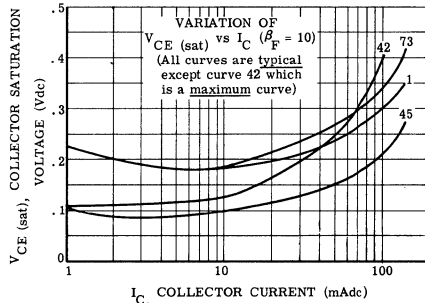
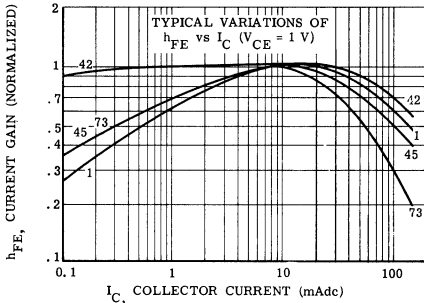

HIGH CURRENT CORE DRIVERS AND PULSE AMPLIFIERS

LIMIT SPECIFICATIONS (at 25°C) (for typical variations, see accompanying graphs)

REFERENCE CURVE	Type Number	h_{FE} min/max	$V_{CE(sat)}$ $\beta_F = 10$ (VOLTS)	SWITCHING TIME		
				t_{on} , or $t_d + t_r$ (nsec)	t_{off} , or $t_s + t_f$ (nsec)	
NPN	CURVE 77	2N3510	25/150 @ $I_C = 150$ mA	0.4 @ $I_C = 150$ mA	20 @ $I_C = 150$ mA	25 @ $I_C = 150$ mA
		2N3511	30/120 @ $I_C = 150$ mA	0.4 @ $I_C = 150$ mA	16 @ $I_C = 150$ mA	18 @ $I_C = 150$ mA
		2N3647	25/150 @ $V_{CE} = 1$ V	0.4 @ $I_B = 15$ mA	20 @ $V_{CC} = 6$ V	25 @ $V_{CC} = 6$ V
		2N3648	30/120 @ $V_{CE} = 1$ V	0.4 @ $I_B = 15$ mA	16 @ $V_{CC} = 6$ V	18 @ $V_{CC} = 6$ V
NPN	CURVE 4	2N2537	50/150 @ $I_C = 150$ mA	0.45 @ $I_C = 150$ mA	40 @ $I_C = 150$ mA	40 @ $I_C = 150$ mA
		2N2538	100/300 @ $I_C = 150$ mA	0.45 @ $I_C = 150$ mA	40 @ $V_{CC} = 7$ V	40 @ $V_{CC} = 7$ V
		2N2539	50/150 @ $V_{CE} = 10$ V	0.45 @ $I_B = 15$ mA	40 @ $V_{CC} = 7$ V	40 @ $V_{CC} = 7$ V
		2N2540	100/300 @ $V_{CE} = 10$ V	0.45 @ $I_B = 15$ mA	40 @ $R_L = 40$ ohms	40 @ $R_L = 40$ ohms
NPN	CURVE 17	2N3252	30/90 @ $I_C = 500$ mA	0.5 @ $I_C = 500$ mA	45 @ $I_C = 500$ mA	70 @ $I_C = 500$ mA
		2N3253	25/75 @ $V_{CE} = 1$ V	0.6 @ $I_C = 500$ mA	50 @ $V_{CC} = 30$ V	70 @ $V_{CC} = 30$ V
		2N3444	20/60 @ $V_{CE} = 1$ V	0.5 @ $I_B = 50$ mA	50 @ $V_{CC} = 30$ V	70 @ $V_{CC} = 30$ V
		2N3506	40/200 @ $I_C = 1.5$ A	1.0 @ $I_C = 1.5$ A	45 @ $I_C = 1.5$ A	90 @ $I_C = 1.5$ A
NPN	CURVE 22	2N3507	30/150 @ $V_{CE} = 2$ V	0.6 @ $I_B = 150$ mA	45 @ $V_{CC} = 30$ V	90 @ $V_{CC} = 30$ V
		2N2904	40/120 @ $I_C = 150$ mA	0.4 @ $I_C = 150$ mA	45 @ $I_C = 150$ mA	100 @ $I_C = 150$ mA
		2N2904A	40/120 @ $I_C = 150$ mA	0.4 @ $I_C = 150$ mA	45 @ $I_C = 150$ mA	100 @ $I_C = 150$ mA
		2N2905	100/300 @ $V_{CE} = 10$ V	0.4 @ $I_B = 15$ mA	45 @ $V_{CC} = 30$ V	100 @ $V_{CC} = 6$ V
NPN	CURVE 33	2N2905A	100/300 @ $V_{CE} = 10$ V	0.4 @ $I_B = 15$ mA	45 @ $V_{CC} = 30$ V	100 @ $V_{CC} = 6$ V
		2N2906	40/120 @ $I_C = 150$ mA	0.4 @ $I_C = 150$ mA	45 @ $I_C = 150$ mA	100 @ $I_C = 150$ mA
		2N2907	100/300 @ $V_{CE} = 10$ V	0.4 @ $I_B = 15$ mA	45 @ $V_{CC} = 30$ V	100 @ $V_{CC} = 6$ V
		2N2907A	100/300 @ $V_{CE} = 10$ V	0.4 @ $I_B = 15$ mA	45 @ $V_{CC} = 30$ V	100 @ $V_{CC} = 6$ V
NPN	CURVE 37	2N3485	40/120 @ $I_C = 150$ mA	0.4 @ $I_C = 150$ mA	45 @ $I_C = 150$ mA	100 @ $I_C = 150$ mA
		2N3485A	40/120 @ $I_C = 150$ mA	0.4 @ $I_C = 150$ mA	45 @ $I_C = 150$ mA	100 @ $I_C = 150$ mA
		2N3486	100/300 @ $V_{CE} = 10$ V	0.4 @ $I_B = 15$ mA	45 @ $V_{CC} = 30$ V	100 @ $V_{CC} = 6$ V
		2N3486A	100/300 @ $V_{CE} = 10$ V	0.4 @ $I_B = 15$ mA	45 @ $V_{CC} = 30$ V	100 @ $V_{CC} = 6$ V
NPN	CURVE 13	2N3467	40/120 @ $I_C = 500$ mA	0.5 @ $I_C = 500$ mA	40 @ $I_C = 500$ mA	90 @ $I_C = 500$ mA
		2N3468	25/75 @ $V_{CE} = 1$ V	0.6 @ $I_B = 50$ mA	40 @ $V_{CC} = 30$ V	90 @ $V_{CC} = 30$ V
NPN	CURVE 13	2N3719	25/180 @ $I_C = 1$ A	0.75 @ $I_C = 1$ A	75 @ $I_C = 1$ A	225 @ $I_C = 1$ A
		2N3720	25/180 @ $V_{CE} = 1.5$ V	0.75 @ $I_B = 100$ mA	75 @ $V_{CC} = 12$ V	225 @ $V_{CC} = 12$ V

HIGH CURRENT SILICON TRANSISTOR CHARACTERISTIC CURVES

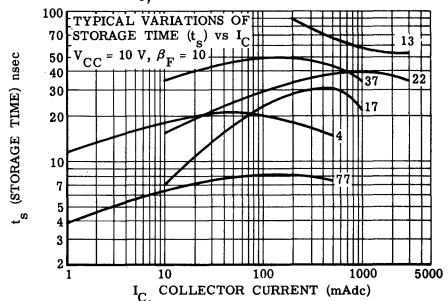
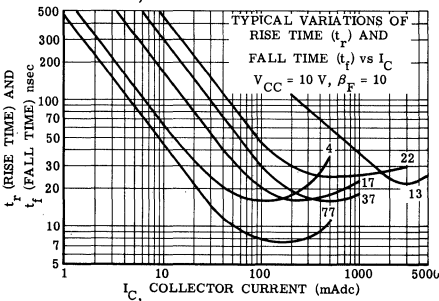
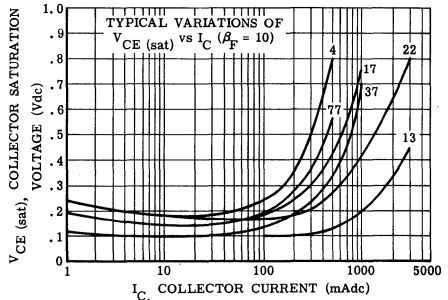
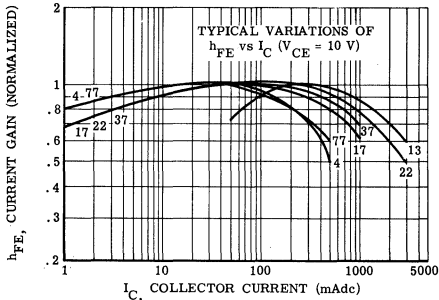

GERMANIUM HIGH SPEED SWITCHING TRANSISTOR SELECTION GUIDE

These tables and graphs are intended as a rapid guide for selection of germanium transistors for high-speed switching applications.

BV _{CEO} MINIMUM VOLTS	OPTIMUM COLLECTOR CURRENT RANGE		
	1 mA - 50 mA	10 mA - 100 mA	100 mA - 500 mA
5 - 9	2N705 2N710 2N711 2N827 2N968 2N969 2N970 2N971 2N972 2N973 2N974 2N975 2N2258 MM2259	2N711A 2N711B 2N828 2N828A 2N829 2N960 2N961 2N962 2N963 2N964 2N964A 2N965 2N966 2N967 2N985	—
10 - 15	MM2550	2N2635 MM2552 MM2554	2N1204 2N1204A 2N1494 2N1494A 2N2096 2N2099 2N2381
16 - 20	—	2N2956 2N2957	2N2097 2N2100 2N2382
more than 21	—	2N838 2N2955	2N1495 2N1496

**GERMANIUM HIGH SPEED SWITCHING TRANSISTOR
SPECIFICATIONS**

Reference Curve	Type Number	h_{FE} @ I_C min/max	$V_{CE(SAT)}$ max Volts @ I_C & I_B	f_T Mc	Switching Times (max)				
					$t_{on} = t_d + t_r$ nsec	$t_{off} = t_s + t_f$ nsec			
1	2N705	25/-	0.3	325*	75	$I_B = 1$ mA	200	$I_{B1} = 1$ mA	
	2N710	25/-	0.5	325*	75		200		
	2N711	20/-	0.5	300*	100	$I_B = 3.3$ mA	350	$I_{B2} = 0.25$ mA	
	2N827	100/-	0.25	250	35		60	$I_{B1} = 3.3$ mA	
	2N968	17/-	$I_C = 10$ mA	0.25	250	75	$I_C = 10$ mA	150	$I_C = 10$ mA
	2N969	17/-		0.25	250	75		150	
	2N970	17/-	0.25	250	100	$I_B = 1$ mA	275	$I_{B1} = 1$ mA	
	2N971	17/-	0.25 $I_C = 10$ mA	250	100		275	$I_{B2} = 0.25$ mA	
	2N972	40/-	0.25	250	75	$I_B = 1$ mA	175		
	2N973	40/-	0.25 $I_B = 1$ mA	250	75		175		
	2N974	40/-	0.25	250	100		275		
	2N975	40/-	0.25	250	100		275		
	2N2258	17/-		250	8**		7**		
	2N2259	40/-		250	8**		7**		
--	MM2550	20/-	0.2	1000	$I_C = 10$ mA $V_{CE} = 5$ V		2.5 V	$I_C = 10$ mA $V_{CE} = 5$ V	
5	2N711A	25/150	0.55 $I_C = 50$ mA	150	100	$I_B = 1$ mA	300	$I_{B1} = 1$ mA	
	2N711B	30/150	0.45 $I_B = 2$ mA	150	100		300		
	2N828	25/-	0.2 $I_C = 10$ mA	300	70	$I_B = 3.3$ mA	100	$I_{B2} = 0.25$ mA	
	2N828A	25/-	0.2 $I_B = 1$ mA	300	50		100	$I_C = 10$ mA	
	2N829	50/-	0.2 $I_B = 0.5$ mA	300	50	100	$I_{B1} = 3.3$ mA		
	2N838	30/-	0.18 $I_B = 3.3$ mA	300	30	40	$I_{B2} = 3.3$ mA		
	2N960	20/-	$I_C = 10$ mA	0.4 $I_C = 50$ mA	300	50	$I_C = 10$ mA	85	$I_{B1} = 1$ mA
	2N961	20/-		0.4 $I_B = 5$ mA	300	50		85	$I_{B2} = 0.25$ mA
	2N962	20/-	0.4	300	50	$I_B = 1$ mA	100	$I_{B1} = 1.0$ mA	
	2N963	20/-	0.2 $I_C = 10$ mA	300	60		120		$I_{B2} = 1.25$ mA
	2N964	40/-	0.35 $I_C = 50$ mA	300	50		85	$I_{B1} = 1$ mA	
	2N964A	40/-	0.28	300	50		85	$I_{B2} = 0.25$ mA	
	2N965	40/-	0.35 $I_B = 5$ mA	300	50	85	$I_{B1} = 1$ mA		
	2N966	40/-	0.35	300	50	100		$I_{B2} = 1.25$ mA	
	2N967	40/-	0.2 $I_C = 10$ mA	300	60	120	$I_{B1} = 1$ mA		
	2N985	40/-	0.15 $I_B = 1$ mA	300	35	$I_B = 5$ mA	80	$I_{B2} = 5$ mA	
	--	MM2552	30/-	$I_C = 25$ mA $I_B = 2.5$ mA	0.2	1000	$I_C = 25$ mA $V_{CE} = 5$ V	3.5	$I_C = 25$ mA $V_{CE} = 5$ V
	--	MM2554	20/-	$I_C = 40$ mA $I_B = 4$ mA	0.25	1000	$I_C = 40$ mA $V_{CE} = 5$ V	3.5	$I_C = 40$ mA $V_{CE} = 5$ V

*TYP

**CURRENT MODE

GERMANIUM HIGH SPEED SWITCHING TRANSISTORS (continued)

Reference Curve	Type Number	h_{FE} @ I_C min/max	$V_{CE(sat)}$ Max Volts @ I_C & I_B	f_T Mc	Maximum Switching Time	
					$t_{on} = t_d + t_r$ nsec	$t_{off} = t_s + t_f$ nsec
14/17	2N2635	45/300	0.4 $I_C = 50$ mA $I_B = 2.5$ mA	150	50 $I_C = 10$ mA $I_B = 1$ mA	250 $I_{B1} = -1$ mA $I_{B2} = 0.25$ mA
	2N2955	20/60 $I_C = 50$ mA	0.3 $I_C = 50$ mA	200	55 $I_C = 50$ mA	80 $I_C = 50$ mA
	2N2956	40/120	0.25 $I_C = 50$ mA	250	45 $I_C = 50$ mA	90 $I_{B1} = -5$ mA
	2N2957	100/-	0.2 $I_B = 5$ mA	300	40 $I_B = 5$ mA	95 $I_{B2} = 5$ mA
7	2N1204	15/- $I_C = 400$ mA	0.5 $I_C = 200$ mA	110	—	—
	2N1204A	25/- $I_C = 200$ mA	0.4 $I_B = 10$ mA	110	—	—
	2N1494	15/- $I_C = 400$ mA	0.4	110	—	—
	2N1494A	25/- $I_C = 200$ mA	0.4	110	—	—
	2N1495	25/- $I_C = 200$ mA	0.3 $I_C = 200$ mA	150	—	—
	2N1496	25/-	0.3 $I_B = 20$ mA	150	—	—
	2N2096	15/-	0.6	—	—	130 $I_C = 200$ mA
	2N2097	20/- $I_C = 400$ mA	0.5 $I_C = 200$ mA	—	—	90 $I_{B1} = -20$ mA
	2N2099	15/-	0.6 $I_B = 10$ mA	—	—	130 $I_{B2} = 20$ mA
	2N2100	20/-	0.5	—	—	90
	2N2381	40/- $I_C = 200$ mA	0.4 $I_C = 200$ mA	300	22 $I_C = 200$ mA	45 $I_C = 200$ mA
	2N2382	40/-	0.4 $I_B = 20$ mA	300	22 $I_B = 40$ mA	45 $I_{B1} = -40$ mA $I_{B2} = 40$ mA

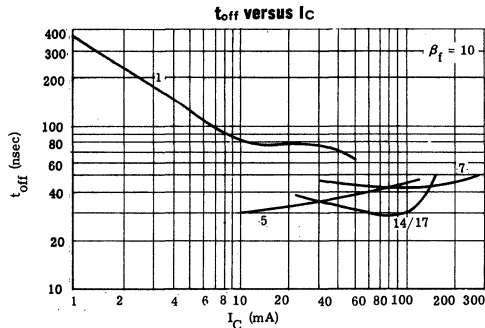
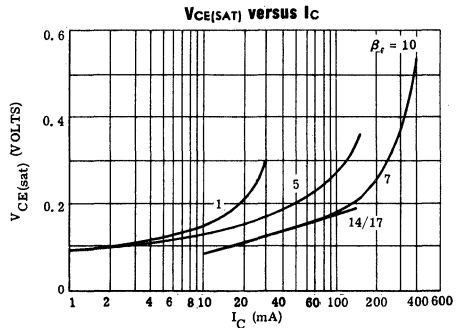
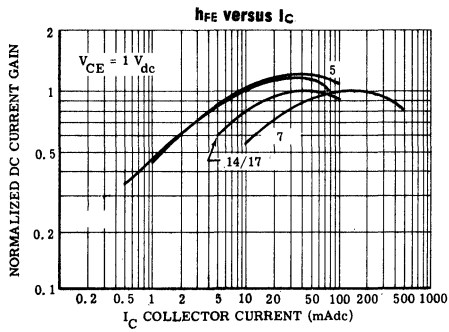

SILICON MEDIUM SPEED, SWITCHING TRANSISTOR SELECTION GUIDE

These tables and graphs are intended to permit rapid comparison and selection of silicon transistors for medium-speed, general-purpose switching applications.

V _{CEO}	Optimum Collector Current Range							
	100 μ A-10 mA		10 mA-100 mA		100 mA-400 mA		400 mA-800 mA	
	PNP	NPN	PNP	NPN	PNP	NPN	PNP	NPN
5-19 V	MM2894 MPS2894 MPS3639 MPS3640	—	2N869 2N995 MM2894 MPS2894 MPS3639 MPS3640	—	—	—	—	—
20-29 V	—	2N916	—	2N916	2N1991	2N697 2N718 2N1420 2N2195 2N2195A 2N2195B 2N2958 2N2959 2N3115 2N3116	—	—
30-39 V	2N2800 2N2801 2N2837 2N2838	2N2217 2N2218 2N2219 2N2220 2N2221 2N2222	2N2800 2N2801 2N2837 2N2838 2N3133 2N3134 2N3135 2N3136	2N2217 2N2218 2N2219 2N2220 2N2221 2N2222	2N722 2N1131 2N1132 2N2303 2N2800 2N2801 2N2837 2N2838 2N3133 2N3134 2N3135 2N3136	2N718A 2N956 2N1613 2N1711 2N2217 2N2218 2N2219 2N2220 2N2221 2N2222	—	—
40-59 V	MCS2137 MCS2138	2N915 MCS2135 MCS2136	2N2904 2N2905 2N2906 2N2907 2N3250 2N3251 2N3485 2N3486	2N2218A 2N2219A 2N2221A 2N2222A	2N1132A 2N1132B 2N2904 2N2905 2N2906 2N2907 2N3244 2N3245 2N3485 2N3486	2N2192 2N2192A 2N2192B 2N2193 2N2193A 2N2193B 2N2194 2N2194A 2N2194B 2N2218A 2N2219A 2N2221A 2N2222A	2N3244 2N3245	—
60-79 V	2N2904A 2N2905A 2N2906A 2N2907A 2N3485A 2N3486A	—	2N2904A 2N2905A 2N2906A 2N2907A 2N3250A 2N3251A 2N3485A 2N3486A	—	2N2904A 2N2905A 2N2906A 2N2907A 2N3485A 2N3486A	—	—	—
80-119 V	—	—	2N3494 2N3496	2N3498 2N3499	—	2N3498 2N3499	—	—
120-300 V	—	—	2N3495 2N3497 2N3634 2N3635 2N3636 2N3637	2N3500 2N3501	—	2N3500 2N3501	—	—

SILICON TRANSISTOR MEDIUM SPEED SWITCHING SELECTION GUIDE

Devices in this category are preferred for applications requiring high DC current gain and low leakage currents.

NPN MEDIUM SPEED SWITCHING TRANSISTOR SPECIFICATIONS

Limit Specifications (at 25°C) (For typical variations, see accompanying graphs)

Reference Curves see page 8 - 17	Type Numbers	h_{FE}		$V_{CE(sat)}$ $I_C/I_B = 10$ max		f_T	C_{ib}	C_{ob}
		min/max	I_C	volts	I_C	min	max	max
						Mc	pf	pf
23	2N915	50/200	10 mA	1.0	10 mA	250	10	3.5
	2N916	50/200	10 mA	0.5	10 mA	300	10	6
2	2N697	40/120	10 mA	1.5	150 mA	50	-	35
	2N718	40/120		1.5		50	-	35
	2N718A	40/120		1.5		60	80	25
	2N956	100/300		1.5		70	80	25
	2N1420	100/300		1.5		50	-	35
	2N1613	40/120		1.5		60	80	25
	2N1711	100/300		1.5		70	80	25
	2N2217	20/60		0.4		250	30	8
	2N2218	40/120		0.4		250	30	8
	2N2218A	40/120		0.3		300	25	8
	2N2219	100/300	150 mA	0.4	150 mA	250	30	8
	2N2219A	100/300		0.3	300	25	8	
	2N2220	20/60		0.4	250	30	8	
	2N2221	40/120		0.4	250	30	8	
	2N2221A	40/120		0.3	300	25	8	
	2N2222	100/300		0.4	250	30	8	
	2N2222A	100/300		0.3	300	25	8	
	2N2958	40/120		0.5	250	-	8	
	2N2959	100/300		0.5	250	-	8	
	2N3115	40/120		0.5	250	-	8	
2N3116	100/300		0.5	250	-	8		
14	2N2192	100/300	150 mA	0.35	150 mA	50	-	20
	2N2192A	100/300		0.25		50	-	20
	2N2192B	100/300		0.18		50	-	20
	2N2193	40/120		0.35		50	-	20
	2N2193A	40/120		0.25		50	-	20
	2N2193B	40/120		0.18		50	-	20
	2N2194	20/60		0.35		50	-	20
	2N2194A	20/60		0.25		50	-	20
	2N2194B	20/60		0.18		50	-	20
	2N2195	20/-		0.35		50	-	20
	2N2195A	20/-		0.25		50	-	20
	2N2195B	20/-		0.18		50	-	20
26	2N3498	40/120	150 mA	0.6	300 mA	150	80	10
	2N3499	100/300		0.6		150	80	10
	2N3500	40/120		0.4		150	80	8
	2N3501	100/300		0.4		150	80	8

PNP MEDIUM SPEED SWITCHING TRANSISTOR SPECIFICATIONS

Limit Specifications (at 25°C) (For typical variations, see accompanying graphs)

Reference Curves	Type Numbers	h_{FE}		$V_{CE(sat)}$ $I_C/I_B = 10$ max		f_T	C_{ib}	C_{ob}
		min/max	I_C	Volts	I_C	min	max	max
						Mc	pf	pf
44	MM 2894	40/150	30 mA	0.2	30 mA	400	6	6
	MPS2894	40/150	30 mA	0.2	30 mA	400	-	6
	MPS3639	30/120	10 mA	0.16	10 mA	500	3.5	3.5
	MPS3640	30/120	10 mA	0.2	10 mA	500	3.5	3.5
35	2N869	20/120	10 mA	1.0	10 mA	-	11	9
	2N995	35/140	20 mA	0.2	20 mA	-	11	10
	2N3250	50/150	10 mA	0.25	10 mA	250	8	6
	2N3250A	50/150	10 mA	0.25	10 mA	250	8	6
	2N3251	100/300	10 mA	0.25	10 mA	300	8	6
	2N3251A	100/300	10 mA	0.25	10 mA	300	8	6
46	2N3494	40/-	10 mA	0.3	10 mA	200	30	7
	2N3495	40/-	10 mA	0.35	10 mA	150	30	6
	2N3496	40/-	10 mA	0.3	10 mA	200	30	7
	2N3497	40/-	10 mA	0.35	10 mA	150	30	6
54	2N3634	50/150	50 mA	0.5	50 mA	150	75	10
	2N3635	100/300	50 mA	0.5	50 mA	200	75	10
	2N3636	50/150	50 mA	0.5	50 mA	150	75	10
	2N3637	100/300	50 mA	0.5	50 mA	200	75	10
31	2N722	30/90	150 mA	1.5	150 mA	60	80	45
	2N1131	20/45	150 mA	1.5	150 mA	50	80	45
	2N1132	30/90	150 mA	1.5	150 mA	60	80	45
	2N1132A	30/90	150 mA	1.5	150 mA	60	80	30
	2N1132B	30/90	150 mA	1.5	150 mA	60	80	30
	2N1991	15/60	150 mA	1.5	150 mA	40	80	45
	2N2303	75/200	150 mA	1.5	150 mA	60	80	45
	2N2800	30/90	150 mA	0.4	150 mA	120	-	25
	2N2801	75/225	150 mA	0.4	150 mA	120	-	25
	2N2837	30/90	150 mA	0.4	150 mA	120	-	25
	2N2838	75/225	150 mA	0.4	150 mA	120	-	25
33	2N2904	40/120	150 mA	0.4	150 mA	200	30	8
	2N2904A	40/120	150 mA	0.4	150 mA	200	30	8
	2N2905	100/300	150 mA	0.4	150 mA	200	30	8
	2N2905A	100/300	150 mA	0.4	150 mA	200	30	8
	2N2906	40/120	150 mA	0.4	150 mA	200	30	8
	2N2906A	40/120	150 mA	0.4	150 mA	200	30	8
	2N2907	100/300	150 mA	0.4	150 mA	200	30	8
	2N2907A	100/300	150 mA	0.4	150 mA	200	30	8
	2N3133	40/120	150 mA	0.6	150 mA	200	40	10
	2N3134	100/300	150 mA	0.6	150 mA	200	40	10
	2N3135	40/120	150 mA	0.6	150 mA	200	40	10
	2N3136	100/300	150 mA	0.6	150 mA	200	40	10
	2N3485	40/120	150 mA	0.4	150 mA	200	30	8
	2N3485A	40/120	150 mA	0.4	150 mA	200	30	8
	2N3486	100/300	150 mA	0.4	150 mA	200	30	8
2N3486A	100/300	150 mA	0.4	150 mA	200	30	8	
38	2N3244	50/150	500 mA	0.5	500 mA	175	100	25
38	2N3245	30/90	500 mA	0.6	500 mA	150	100	25

SILICON MEDIUM SPEED TRANSISTORS CHARACTERISTIC CURVES

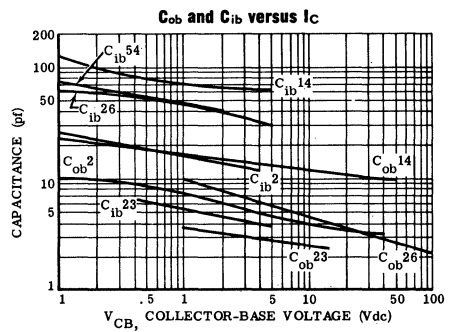
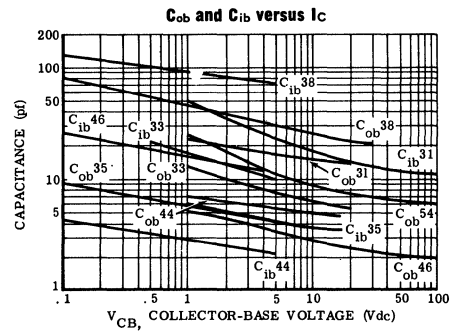
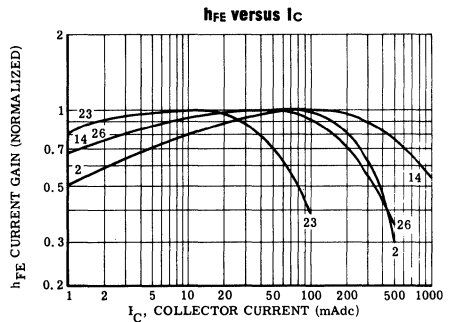
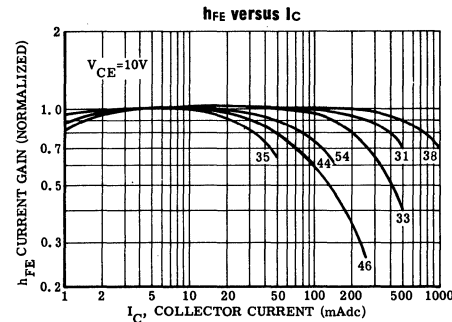
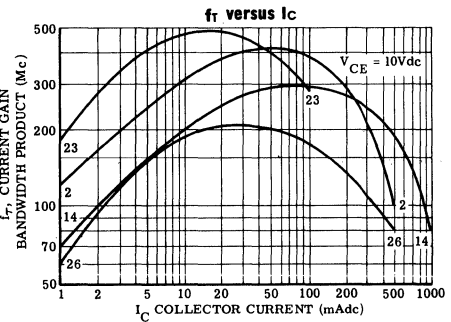
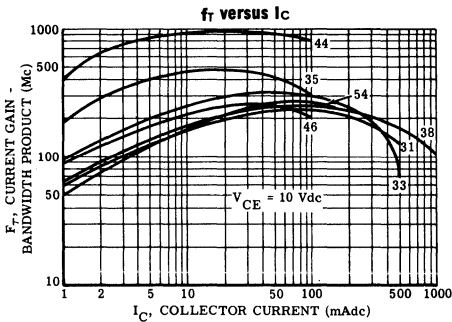
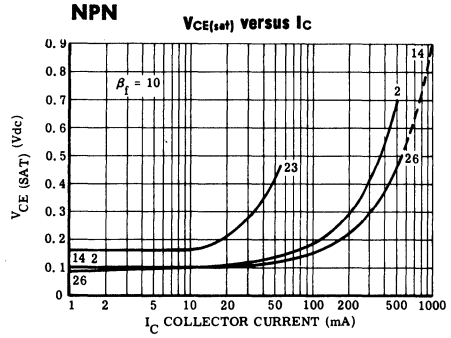
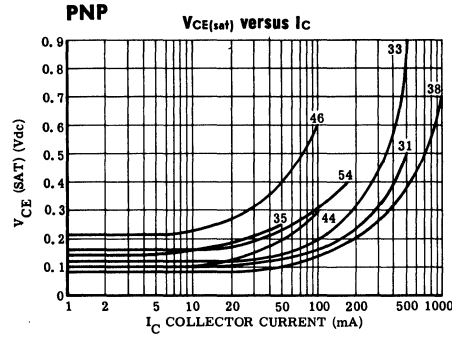

RF TRANSISTOR SELECTOR GUIDE

These tables and graphs are intended to permit rapid comparison and selection of transistors for transmitter and receiver designs. The devices included are suitable for application as RF and IF amplifiers, oscillators, mixers, multipliers, power oscillators, drivers, output and harmonic generator stages.

SMALL SIGNAL RF APPLICATIONS SELECTOR GUIDE

Frequency Range	Polarity and Material	RF and IF Amplifiers, Mixers and Converters	Low-Level Oscillators $P_o < 100 \text{ mW}$	High-Level Oscillators $100 \text{ mW} < P_o < 2 \text{ W}$	Low-Level Wide-Band Amplifiers
2 Mc to 70 Mc	PNP Ge	2N700	2N700	2N1141	2N700
		2N700A	2N700A	2N1142	2N700A
		2N1141	2N1141	2N1143	2N1141
		2N1142	2N1142	2N1195	2N1142
		2N1143	2N1143	2N1561	2N1143
		2N1195	2N1195	2N1562	2N1195
		2N2929	2N2929	2N1692	2N2929
		2N3279	2N3279	2N1693	2N3279
		2N3280	2N3280	2N2929	2N3280
		2N3281	2N3281		2N3281
		2N3282	2N3282		2N3282
		2N3283	2N3283		2N3283
		2N3284	2N3284		2N3284
		2N3285	2N3285		2N3285
		2N3286	2N3286		2N3286
	2N3323	2N3323		2N3323	
	2N3324	2N3324		2N3324	
	2N3325	2N3325		2N3325	
	NPN Si	2N918	2N918	2N2949	2N918
		2N3287	2N3287	2N2951	2N3287
		2N3288	2N3288	2N2952	2N3288
		2N3289	2N3289	2N3309	2N3289
		2N3290	2N3290		2N3290
		2N3291	2N3291		2N3291
		2N3292	2N3292		2N3292
		2N3293	2N3293		2N3293
	2N3294	2N3294		2N3294	
PNP Si	2N3250	2N3250	-	2N3307	
	2N3251	2N3251		2N3308	
	2N3307	2N3307			
	2N3308	2N3308			

— Motorola High-Frequency Transistors —

SMALL SIGNAL RF APPLICATIONS SELECTOR GUIDE (continued)

Frequency Range	Polarity and Material	RF and IF Amplifiers, Mixers and Converters	Low-Level Oscillators $P_o < 100 \text{ mW}$	High-Level Oscillators $100 \text{ mW} < P_o < 2 \text{ W}$	Low-Level Wide-Band Amplifiers
70 Mc to 400 Mc	PNP Ge	2N1141 2N1142 2N1143 2N1195 2N2929 2N3279 2N3280 2N3281 2N3282 2N3283 2N3284 2N3285 2N3286 2N3323 2N3783 2N3784 2N3785 MM2503	2N700 2N700A 2N1141 2N1142 2N1143 2N1195 2N1561 2N1692 2N1693 2N2929 2N3280 2N3281 2N3282 2N3285 2N3323 2N3783 2N3784 2N3785 MM2503	2N1141 2N1142 2N1143 2N1195 2N1561 2N1692 2N1693 2N2929	2N1141 2N1142 2N1143 2N1195 2N2929 2N3279 2N3280 2N3281 2N3282 2N3783 2N3784 2N3785 MM2503
	NPN Si	2N918 2N3287 2N3288 2N3289 2N3290 2N3291 2N3292 2N3293 2N3294	2N918 2N3287 2N3288 2N3289 2N3290 2N3293 2N3298	2N2949 2N2951 2N3137 2N3309	2N918 2N3287 2N3288 2N3289 2N3290
	PNP Si	2N3307 2N3308	2N3307 2N3308	—	2N3307 2N3308
400 Mc to 1 Gc	NPN Si	2N918 2N3287 2N3288 2N3289 2N3290 2N3291 2N3292 2N3293 2N3294 2N3544	2N918 2N3287 2N3288 2N3289 2N3290 2N3293 2N3544	2N3309	2N918
	PNP Si	2N3307 2N3308	2N3307 2N3308	—	2N3307 2N3308
	PNP Ge	2N3783 2N3784 2N3785 MM2503	2N3783 2N3784 2N3785 MM2503	—	2N3783 2N3784 2N3785 MM2503
1 Gc Up	NPN Si	—	—	2N3309 2N3664	—
	PNP Ge	2N3783 2N3784 2N3785	2N3783 2N3784 2N3785	—	2N3783 2N3784 2N3785 MM2503

SMALL SIGNAL RF DEVICE CHARACTERISTICS

Type	ABSOLUTE MAXIMUM RATINGS				ELECTRICAL CHARACTERISTICS			CIRCUIT PERFORMANCE				
	P _D Ambient mW	V _{CB} volts	V _{EB} volts	T _J °C	h _{FE} min/max	C _{ob} max pf	f _T typ Mc	Amplifier			Oscillator	
								G _e typ	NF	@ f	P _o min	@ f
db	db	Mc	mW	mc								

GERMANIUM PNP TYPES

2N700 ①	75	25	0.2	100	4/ - ②	1.4	500	23	6	70	-	-
2N700A ①	75	25	0.2	100	4/50 ②	1.4	800	23	6	70	-	-
2N741	150	15	1.0	100	10/ -	10.0	360	22	7	30	-	-
2N741A	150	20	1.0	100	10/ -	10.0	360	22	7	30	-	-
2N1141	300	35	1.0	100	10/ -	1.5	800	25	4.0	100	-	-
2N1142 ①	300	30	0.7	100	10/ -	1.5	800	24	4.5	100	-	-
2N1143	300	25	0.5	100	10/ -	1.5	800	24	5	100	-	-
2N1195 ①	225	30	1.0	100	12/ - ②	1.5	800	25	4	100	-	-
2N2929	300	25	0.75	100	10/100	2.5	1250	16	5.5	200	-	-
2N3279	100	30	1.0	100	10/70	1.0	500	20	2.9	200	-	-
2N3280	100	30	1.0	100	10/70	1.0	500	20	2.9	200	-	-
2N3281	100	30	0.5	100	10/100	1.2	400	20	4.0	200	-	-
2N3282	100	30	0.5	100	10/100	1.2	400	20	4.0	200	-	-
2N3283	100	25	0.5	100	10/ -	1.5	400	20	4.0	200	-	-
2N3284	100	25	0.5	100	10/ -	1.5	400	20	5	200	-	-
2N3285	100	20	0.5	100	5/ -	1.5	400	-	-	2	257	-
2N3286	100	20	0.5	100	5/ -	1.5	400	18	5.5	200	-	-
2N3323	150	35	3.0	100	30/200	3.0	360	13	-	100	-	-
2N3324	150	35	3.0	100	30/200	3.0	360	29	-	10.7	-	-
2N3325	150	35	3.0	100	30/200	3.0	360	30	-	1.6	-	-
2N3783	150	30	0.5	100	20/200	1.0	800 ③	20 ③	2.2 ④	200	-	-
2N3784	150	30	0.5	100	20/200	1.0	700 ③	20 ③	2.5 ④	200	-	-
2N3785	150	15	0.5	100	15/200	1.2	700 ③	18 ③	2.9 ④	200	-	-
MM2503	75	30	0.5	100	20/ -	2.0	1000 ③	20 ③	3.0 ④	200	-	-

SILICON NPN TYPES

2N918	200	30	3.0	200	20/ -	1.7	900	18	7	200	40	500
2N3287	200	40	3.0	200	15/100	1.1	600	20	4.9	200	-	-
2N3288	200	40	3.0	200	15/100	1.5	600	20	4.9	200	-	-
2N3289	200	30	3.0	200	10/150	1.5	500	20	6	200	-	-
2N3290	200	30	3.0	200	10/150	1.5	500	20	6	200	-	-
2N3291	200	25	3.0	200	10/ -	2.0	600	20	6	200	-	-
2N3292	200	25	3.0	200	10/ -	2.0	600	20	7	200	-	-
2N3293	200	20	3.0	200	10/ -	2.0	600	-	-	2	257	-
2N3294	200	20	3.0	200	10/ -	2.0	600	18	7	200	-	-
MPS918	200	30	3.0	125	20/ -	1.7	-	15	6	200	30	500
MPS3563	200	30	2.0	125	20/200	1.7	-	14	-	200	-	-

SILICON PNP TYPES

2N869	360	25	5.0	200	20/120	9	300	-	-	-	-	-
2N995	360	20	4.0	200	35/140	10	300	-	-	-	-	-
2N3307	200	40	3.0	200	20/125	1.3	600	20	4.0	200	-	-
2N3308	200	30	3.0	200	10/175	1.6	600	20	5.0	200	-	-

- ① Available as MIL types
- ② h_{fe}
- ③ Minimum value
- ④ Maximum value

**SMALL SIGNAL DEVICE
TYPICAL PERFORMANCE**

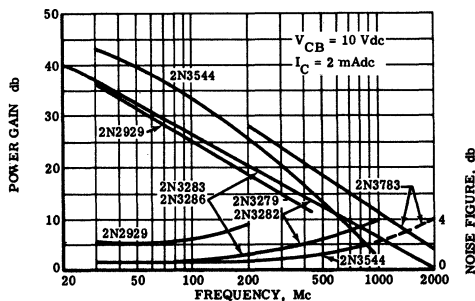

LARGE SIGNAL RF APPLICATIONS SELECTOR GUIDE

Frequency Range	Polarity and Material	Power Amplifier Transistors				Varactors		
		$P_o < 1W$	$1W < P_o < 5W$	$5W < P_o < 15W$	$15W < P_o < 50W$	Frequency Range	$1W < P_o < 50W$	$50W < P_o < 100W$
1 Mc to 10 Mc	PNP Ge	2N1141	2N2832	2N2832	2N2834	1 Mc to 300 Mc	1N4386 1N4387 1N4388	1N4386
		2N1142						
	2N1143							
NPN Si	2N1195	2N2949	2N2950	2N2947	2N2947			
	2N1561							
PNP Si	2N1562	2N2951	2N2948	2N2948	MF812			
	2N1692	2N3295	2N3296	2N3297				
10 Mc to 70 Mc	PNP Ge	2N1693	—	—	—	300 Mc to 600 Mc	1N4387 1N4388	—
		2N2929						
70 Mc to 400 Mc	NPN Si	2N2949	2N2949	2N2947	2N2947	600 Mc to 1000 Mc	1N4388	—
		2N2951						
400 Mc Up	PNP Si	2N2952	2N3296	2N2948	2N2948	1 Ge Up	MV1808	—
		2N3295	2N3298	2N3297				
400 Mc Up	NPN Si	2N3298	2N3309	2N3297	2N3297			
		2N3298	2N3309A	2N3632	2N3632			
400 Mc Up	PNP Si	2N3309	2N3553	2N3632	2N3632			
		2N3309	2N3664	2N3818	2N3818			
400 Mc Up	NPN Si	2N3309A	2N3717	2N3818	2N3818			
		2N3309A	2N3718					
400 Mc Up	PNP Si	MM1803	—	—	—			
		MM1941	—	—	—			
400 Mc Up	NPN Si	MM1943	—	—	—			
		2N2800	—	—	—			
400 Mc Up	PNP Si	2N2801	—	—	—			
		2N2904	—	—	—			
400 Mc Up	NPN Si	2N2905	—	—	—			
		2N918	2N3309	—	—			
400 Mc Up	NPN Si	2N3309	2N3309A	—	—			
		2N3309A	2N3664	—	—			

LARGE SIGNAL RF DEVICE CHARACTERISTICS

POWER AMPLIFIERS/OSCILLATORS

Type	ABSOLUTE MAXIMUM RATINGS				ELECTRICAL CHARACTERISTICS		CIRCUIT PERFORMANCE			
	P _c Case Watts	V _{CB} Volts	V _{EB} Volts	T _J °C	C _{ob} max pf	f _T typ Mc	Amplifier P _o min @ f		Oscillator P _o min @ f	
							watts	Mc	Watts	Mc

PNP GERMANIUM

2N1561	3.0	25	3.0	100	10	500	0.5	160 ^②	—	—
2N1562	3.0	25	2.0	100	10	450	0.4	160 ^②	—	—
2N1692	3.0	25	3.0	100	10	500	0.5	160 ^②	—	—
2N1693	3.0	25	2.0	100	10	450	0.4	160 ^②	—	—

NPN SILICON

2N 707	1.0	56	4.0	175	10	350	0.2	100	—	—
2N 707A	1.2	70	5.0	175	6	350	0.4	100	—	—
2N2947	25	60	3.0	175	60	200	15	50	—	—
2N2948	25	40	2.0	175	60	200	15	30	—	—
2N2949	6.0	60	3.0	175	20	200	3.5	50	—	—
2N2950	6.0	60	3.0	175	20	200	3.5	50	—	—
2N2951	3.0	60	5	175	8	400	0.6	50	—	—
2N2952	1.8	60	5	175	8	400	0.6	50	—	—
2N3137	2.0	40	4	200	3.5	500 min	0.4	250	—	—
2N3298	1.0	25	3	175	6	400	—	—	0.06	80
2N3309	3.5	50	3	175	10	500	2.0	250	—	—
2N3309A	5.0	60	4	200	6	—	2.2	250	—	—
2N3375	11.6	65	4	200	10	500	7.5	100	2.5 ^③	500
2N3553	7	65	4	200	10	500	2.5	175	1.5 ^③	500
2N3632	23	65	4	200	20	400	13.5	175	—	—
2N3664	5	60	4	175	6	300 min	2.2	250	—	—
2N3717	7.5	60	4	200	10	250 min	2	175	—	—
2N3718	10.0	60	4	200	10	250 min	2	175	—	—
2N3818	25	60	4	175	40	150 min	15	100	—	—
MF812	60	60	3	175	150	—	30	30	—	—
MF832	40	60	3	175	100	—	30	50	—	—
MM1803	2.0	50	5	200	3.5	500 min	0.56	250	—	—
MM1941	0.6	30	3	175	2.5	800	0.1	175	0.05	80
MM1943	0.6	40	3	175	4	700	0.3	175	—	—

PNP SILICON

2N2800	3	50	5	200	25	120 ^②	—	—	—	—
2N2801	3	50	5	200	25	120 ^②	—	—	—	—
2N2904	3	60	5	200	8	200	—	—	—	—
2N2905	3	60	5	200	8	200	—	—	—	—

LINEAR AMPLIFIERS (NPN SILICON)

Type	ABSOLUTE MAXIMUM RATINGS				ELECTRICAL CHARACTERISTICS			CIRCUIT PERFORMANCE			
	P _c case watts	V _{CB} volts	V _{EB} volts	T _J °C	h _{FE} min	C _{ob} max pf	f _T typ Mc	P _{out} min watts	G _e min db	I _m min db	f Mc
2N3295	2	60	5	175	20	8	400	0.3 ^④	14	30	30
2N3296	6	60	3	175	5	20	200	3 ^④	16	30	30
2N3297	25	60	3	175	2.5	60	200	12 ^④	10	30	30

② MINIMUM VALUE
 ③ TYPICAL VALUE
 ④ PEP, TWO TONE SSB TEST

— Motorola High-Frequency Transistors —
LARGE SIGNAL RF DEVICE CHARACTERISTICS (continued)

SILICON VARACTOR DIODES

Type	MAXIMUM RATINGS		ELECTRICAL CHARACTERISTICS @ 25°C					
	P_D ($T_c = 75^\circ C$) watts	T_J °C	BV_R min ($I_R = 10 \mu A$) volts	R_S max ($V_R = 6 \text{ Vdc}, f = 50 \text{ mc}$) ohms	C_J max pf	Q min -	Multiplier P_o min @ f	
							Watts	Mc
1N4386	25	175	250	1.5	50	75	32.5	150 ③
1N4387	20	175	150	1.5	35	150	15	450 ④
1N4388	10	175	100	2.0	20 ②	200	11	1000 ⑤
MV1808	5.5	200	75	0.5	7.5 ②	1100 ①	6	2000 ⑥

- ① Typical Value
- ② C_T ($C_T = C_J + C_C$)
- ③ $f_{in} = 50 \text{ Mc}, n = 65\% \text{ min}$
- ④ $f_{in} = 150 \text{ Mc}, n = 50\% \text{ min}$
- ⑤ $f_{in} = 500 \text{ Mc}, n = 55\% \text{ min}$
- ⑥ $f_{in} = 1000 \text{ Mc}, n = 50\% \text{ min}$

**LARGE SIGNAL DEVICE
TYPICAL PERFORMANCE**

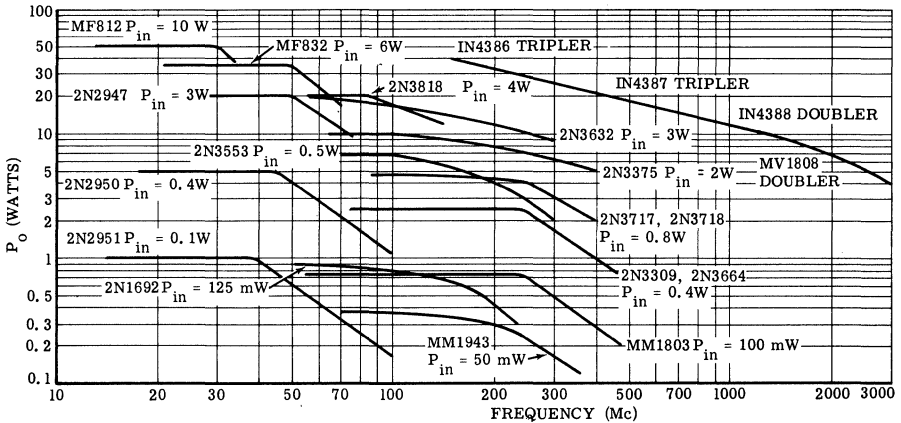

**SMALL SIGNAL AMPLIFIER AND OSCILLATOR TRANSISTORS
— TO 10 MC**

CURRENT GAIN (h_{FE}) — VOLTAGE (V_{CE}) RELATIONSHIP

Maximum V_{CE0} (for Si) V_{CES} (for Ge) Volts	Minimum DC Current Gain (h_{FE})													
	$h_{FE} \geq 15$		$h_{FE} \geq 20$		$h_{FE} \geq 25$	$h_{FE} \geq 30$		$h_{FE} \geq 40$			$h_{FE} \geq 50$	$h_{FE} \geq 100$		
	PNP Si	PNP Ge	NPNSi	PNP Ge	PNP Si	PNPSi	NPNSi	PNP Si	NPNSi	PNP Ge	PNPSi	PNPSi	NPNSi	
7	—	2N971	—	2N975	—	—	—	—	—	2N975	—	—	—	
8	—	—	—	—	—	—	—	—	2N3493	—	—	—	—	
10	—	—	2N706 2N3510 2N3647 MPS706	—	—	—	2N708 2N914 2N3511 2N3648	—	—	—	—	—	2N2959 2N3116 2N3227 2N3509	
12	2N1991	2N969 2N970	MPS3563	2N711 2N961 2N962 2N963	—	2N3248	—	2N3248 MPS2894	—	2N965 2N966 2N967 2N973 2N974	2N3248	2N3249	—	
15	—	2N968	—	2N705 2N710 2N960	—	—	—	—	2N2369	2N964 2N964A 2N972	—	—	—	
20	—	2N1204 2N1494	2N635 2N2195 2N2195A 2N2195B	2N2635	—	—	2N916 2N2958 2N3115 2N3508	—	2N916 2N2958 2N3115 2N3508	2N2381	—	—	2N2959 2N3116 2N3227 2N3509	
30	—	—	2N634 2N2217 2N2220 MPS834	—	—	—	2N697 2N2221 2N3252	—	2N697 2N718 2N2218 2N2221	—	—	—	2N1420 2N2219 2N2222	
35	2N1131	—	—	—	—	2N722 2N1132 2N2800 2N2801	—	2N3133 2N3135	—	—	2N2801 2N2898	2N3134 2N3136	—	
40	2N1132A	2N1495 2N1496 2N2955 2N2956	2N2194 2N2194A 2N2955 2N3253	2N1495 2N1496 2N2955 2N2956	—	2N1132A 2N3245	2N718A 2N1613 2N2218A 2N2221A 2N3506	2N2904 2N2906 2N3485	2N718A 2N1613 2N2218A 2N2221A 2N3506	2N2382 2N2957	2N3244 2N3250	2N2905 2N2907 2N3251 2N3486	2N956 2N1711 2N2192 2N2192A 2N2192B 2N2219A 2N2222A	
50	—	—	2N3444	—	—	—	2N3507	—	2N915 2N2193 2N2193A 2N2193B	—	—	—	2N3499	
60	2N1132B	—	—	—	—	2N1132B	—	2N2904A 2N2906A 2N3485A	—	—	2N3250A	2N2905A 2N2907A 2N3251A 2N3486A	2N3798 2N3799 MCS2137 MCS2138	MCS2135 MCS2136
80	2N3494 2N3496	—	—	—	—	2N3494 2N3496	—	2N3494 2N3496	—	—	—	—	—	—
100	—	—	2N3498	—	—	—	2N3498	—	2N3498	—	—	—	—	2N3499
120	2N3495 2N3497	—	—	—	—	2N3495 2N3497	—	2N3495 2N3497	—	—	2N3634	2N3635	—	—
150	—	—	2N3500	—	—	—	2N3500	—	2N3500	—	—	—	—	2N3601
175	2N3636	—	—	—	—	2N3636	—	2N3636	—	—	2N3636	2N3637	—	—
300	—	—	2N3742	—	2N3743	—	—	—	—	—	—	—	—	—

**NPN SILICON ANNULAR SMALL SIGNAL
TRANSISTORS FOR FREQUENCIES TO 10 MC**

Type	V _{CEO} Volts	h _{FE} @ I _C mA	h _{fe} @ I _C and f			C _{ob} pf	P _D @ 25°C Ambient mW
				mA	Mc		
2N697	40*	40/120 150	2.5	50	20	35	600
2N706	20*	20 10	2	10	100	6	300
2N708	15	30/120 10	3	10	100	6	360
2N718	40*	40/120 150	2.5	50	20	35	400
2N718A	50*	40/120	30	1	1 kc	25	500
2N753	15	40/120	2	10	100	5	300
2N834	30	25	3.5	10	100	4	300
2N835	20	20 10	3	10	100	4	300
2N914	15	30/120	3	20	100	6	360
2N915	50	15/200	—	—	—	3.5	360
2N916	25	15/200	—	—	—	6	360
2N956	50*	100/300 150	70	5	1 kc	25	500
2N1420	30*	100/300	2.5	50	20	35	600
2N1613	50*	40/120	35	5	1 kc	25	800
2N1711	50*	100/300	70	5	1 kc	25	800
2N2192	40	100/300	2.5	50	20	20	800
2N2192A	40	100/300	2.5	50	20	20	800
2N2192B	40	100/300	2.5	50	20	20	800
2N2193	50	40/120	2.5	50	20	20	800
2N2193A	50	40/120	2.5	50	20	20	800
2N2193B	50	40/120	2.5	50	20	20	800
2N2194	40	20/60	2.5	50	20	20	800
2N2194A	40	20/60	2.5	50	20	20	800
2N2194B	40	20/60	2.5	50	20	20	800
2N2195	25	20 150	2.5	50	20	20	800
2N2195A	25	20	2.5	50	20	20	800
2N2195B	25	20	2.5	50	20	20	800
2N2217	30	20/60	2.5	20	100	8	800
2N2218	30	40/120	2.5	20	100	8	800
2N2218A	40	40/120	2.5	20	100	8	800
2N2219	30	100/300	2.5	20	100	8	800
2N2219A	40	100/300	2.5	20	100	8	800
2N2220	30	20/60	2.5	20	100	8	500
2N2221	30	40/120	2.5	20	100	8	500
2N2221A	40	40/120	2.5	20	100	8	500
2N2222	30	100/300	2.5	20	100	8	500
2N2222A	40	100/300	2.5	20	100	8	500
2N2369	15	40/120 10	5	10	100	4	360
2N2958	20	40/120	—	—	—	8	600
2N2959	20	100/300 150	—	—	—	8	600
2N3115	20	40/120	—	—	—	8	400
2N3116	20	100/300	—	—	—	8	400
2N3227	20	100/300 10	5	10	100	4	360
2N3252	30	30/90	—	—	—	12	1000
2N3253	40	25/75 500	—	—	—	12	1000
2N3444	50	20/60	—	—	—	12	1000
2N3493	8	40/120 0.5	4	1	100	0.7	150
2N3498	100	40/120	1.5	20	100	10	1000
2N3499	100	100/300	1.5	20	100	10	1000
2N3500	150	40/120 150	1.5	20	100	8	1000
2N3501	150	100/300	1.5	20	100	8	1000
2N3506	40	40/120 150	—	—	—	40	1000
2N3507	50	30/150	—	—	—	40	1000

*V_{CER}

NPN SILICON ANNULAR SMALL SIGNAL TRANSISTORS (continued)

Type	V _{CEO} Volts	h _{FE} @ I _C mA	h _{fe} @ I _C and f			C _{ob} pf	P _D @ 25°C Ambient mW
				mA	Mc		
2N3508	20	40/120 10	5	10	10	4	400
2N3509	20	100/300 10	5	10	10	4	400
2N3510	10	25/150 ↑	3.5	15	100	4	360
2N3511	15	30/120 150	4.5	15	100	4	360
2N3647	10	25/150 ↓	3.5	15	100	4	400
2N3648	15	30/120 ↓	4.5	15	100	4	400
2N3742	300	20/200 30	1.5	10	20	6	1000
MCS2135	60	100/300 0.1	1	0.5	30	3	150
MCS2136	60	250/750 0.1	1	0.5	30	3	150
MPS706	20*	20/ - 10	2	10	100	6	300
MPS834	30	25/- - 10	3.5	10	100	4	300
MPS2923	25	----	90	2	1 kc	12	200
MPS2924	25	----	150	2	1 kc	12	200
MPS2925	25	----	235	2	1 kc	12	200
MPS3563	12	20/200 8	6	8	100	1.7	200

*V_{CER}

**PNP SILICON ANNULAR SMALL SIGNAL
TRANSISTORS FOR FREQUENCIES TO 10 MC**

Type	V _{CEO} Volts	h _{FE} @ I _C	h _{fe} @ I _C and f			C _{ob} pf	P _D @ 25°C Ambient mW
2N722	35	30/90 ↑	30	5 mA	1 kc	45	400
2N1131	35	20/45	2.5	50 mA	20 Mc	45	600
2N1132	35	30/90 150 mA	30	5 mA	1 kc	45	600
2N1132A	40	30/90	30	5 mA	1 kc	30	600
2N1132B	60	30/90 ↓	30	5 mA	1 kc	30	600
2N1991	20	15/60 ↑	2	50 mA	20 Mc	45	600
2N2800	35	30/90	—	—	—	25	800
2N2801	35	75/225 150 mA	—	—	—	25	800
2N2837	35	30/90	—	—	—	25	500
2N2838	35	75/225	—	—	—	25	500
2N2904	40	40/120 ↑	25	—	—	8	600
2N2904A	60	40/120	40	—	—	8	600
2N2905	40	100/300 150 mA	50	1 mA	1 kc	8	600
2N2905A	60	100/300	100	—	—	8	600
2N2906	40	40/120 ↓	25	—	—	8	400
2N2906A	60	40/120 ↑	40	—	—	8	400
2N2907	40	100/300	50	1 mA	1 kc	8	400
2N2907A	60	100/300 150 mA	100	—	—	8	400
2N3133	35	40/120 ↓	—	—	—	10	600
2N3134	35	100/300 ↓	—	—	—	10	600
2N3135	35	40/120 150 mA	—	—	—	10	400
2N3136	35	100/300 150 mA	—	—	—	10	400
2N3244	40	50/150 500 mA	—	—	—	25	1000
2N3245	50	30/90 500 mA	—	—	—	25	1000
2N3248	12	50/150 10 mA	—	—	—	8	360
2N3249	12	100/300 ↑	—	—	—	8	360
2N3250	40	50/150	50	—	—	6	360
2N3250A	60	50/150 10 mA	50	1 mA	1 kc	6	360
2N3251	40	100/300	100	—	—	6	360
2N3251A	60	100/300 ↓	100	—	—	6	360

— Motorola High-Frequency Transistors —

PNP SILICON ANNULAR SMALL SIGNAL TRANSISTORS (continued)

Type	V _{CEO} Volts	h _{FE} @ I _C	h _{fe} @ I _C and f			C _{ob} pf	P _D @ 25°C Ambient mW
2N3485	40	40/120	—	—	—	8	400
2N3485A	60	40/120	—	—	—	8	400
2N3486	40	100/300	—	—	—	8	400
2N3486A	60	100/300	—	—	—	8	400
2N3494	80	40 10 mA	40	10 mA	1 kc	7	600
2N3495	120	40	40	10 mA	1 kc	6	600
2N3496	80	40 10 mA	40	10 mA	1 kc	7	400
2N3497	120	40	40	10 mA	1 kc	6	400
2N3634	140	50/150	40	10 mA	1 kc	10	1000
2N3635	140	100/300	80	10 mA	1 kc	10	1000
2N3636	175	50/150	40	10 mA	1 kc	10	1000
2N3637	175	100/300	80	10 mA	1 kc	10	1000
2N3743	300	25/250	30	1 mA	1 kc	15	1000
2N3798	60	150/450	150	1 mA	1 kc	4	360
2N3799	60	300/900	300	1 mA	1 kc	4	360
MCS2137	60	100/300	1	0.5 mA	30 Mc	3	150
MCS2138	60	250/750	1	1 μA	30 Mc	3	150
MPS2894	12	40/150	4	30 mA	100 Mc	6	300

**PNP GERMANIUM SMALL SIGNAL
TRANSISTORS FOR FREQUENCIES TO 10 MC**

Type	V _{CES} Volts	I _C mA	h _{FE} @ I _C	C _{ob} pf	P _D @ 25°C Ambient mW
2N705	15	50	25	—	150
2N710	15	50	25	—	150
2N711	12	50	20	10 mA	150
2N960	15	100	20	4	150
2N961	12	100	20	4	150
2N962	12	100	20	4	150
2N963	12	100	20	5	150
2N964	15	100	40	4	150
2N964A	15	100	40	4	150
2N965	12	100	40	4	150
2N966	12	100	40	4	150
2N967	12	100	40	5	150
2N968	15	50	17	9	150
2N969	12	50	17	9	150
2N970	12	50	17	9	150
2N971	7	50	17	9	150
2N972	15	50	40	9	150
2N973	12	50	40	9	150
2N974	12	50	40	9	150
2N975	7	50	40	9	150
2N1204	20	500	15	6.5	250
2N1494	20	500	15	6.5	250
2N1495	40	500	25	6.5	250
2N1496	40	500	25	6.5	300
2N2381	30	500	40	6	300
2N2382	45	500	40	6	300
2N2635	30	100	30	5	150
2N2955	40	100	20	4	150
2N2956	40	100	30	4	150
2N2957	40	100	60	4	150

2N697
2N718
2N1420

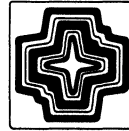

$V_{CER} = 30-40\text{ V}$
 $f_T = 300\text{ Mc}$



CASE 22
 (TO-18)

NPN silicon annular Star transistors for medium-current switching and amplifier applications

MAXIMUM RATINGS

Characteristics	Symbol	Rating		Unit
Collector-Base Voltage	V_{CBO}	60		Vdc
Collector-Emitter Voltage 2N697, 2N718 2N1420	V_{CER}	40 30		Vdc
Emitter-Base Voltage	V_{EBO}	5		Vdc
		2N697 2N1420 TO-5	2N718 TO-18	
Total Device Dissipation at 25°C Case Temperature Derating Factor Above 25°C	P_D	3 20	1.5 10	Watts mW/°C
Total Device Dissipation at 25°C Ambient Temperatures Derating Factor Above 25°C	P_D	0.6 4.0	0.4 2.66	Watts mW/°C
Junction Temperature	T_j	+ 175		°C
Storage Temperature range	T_{stg}	-65 to +300		°C

ELECTRICAL CHARACTERISTICS (at 25°C unless otherwise noted)

Characteristics	Symbol	Min.	Typ.	Max.	Unit
Collector Cutoff Current ($V_{CB} = 30\text{ Vdc}$, $I_E = 0$) ($V_{CB} = 30\text{ Vdc}$, $I_E = 0$, $T_A = 150^\circ\text{C}$)	I_{CBO}	—	.001	1.0 100	μAdc
Collector-Base Breakdown Voltage ($I_C = 100\ \mu\text{Adc}$, $I_E = 0$)	BV_{CBO}	60	—	—	Vdc
Collector-Emitter Breakdown Voltage ($I_C = 100\text{ mAdc}$, pulsed; $R_B \leq 10\text{ Ohms}$) 2N697, 2N718 2N1420	BV_{CER}	40 30	—	—	Vdc
Collector-Emitter Saturation Voltage* ($I_C = 150\text{ mAdc}$, $I_B = 15\text{ mAdc}$)	$V_{CE(sat)}$	—	0.3	1.5	Vdc
Base-Emitter Saturation Voltage* ($I_C = 150\text{ mAdc}$, $I_B = 15\text{ mAdc}$)	$V_{BE(sat)}$	—	—	1.3	Vdc

— Motorola High-Frequency Transistors —

2N697, 2N178, 2N1420 (continued)

ELECTRICAL CHARACTERISTICS (continued)

Characteristic	Symbol	Min	Typ	Max	Unit
DC Forward Current Transfer Ratio* ($I_C = 1 \text{ mAdc}$, $V_{CE} = 10 \text{ Vdc}$)	h_{FE}				—
2N697, 2N718		—	20	—	
2N1420		—	35	—	
($I_C = 150 \text{ mAdc}$, $V_{CE} = 10 \text{ Vdc}$)					
2N697, 2N718		40	—	120	
2N1420		100	—	300	
($I_C = 500 \text{ mAdc}$, $V_{CE} = 10 \text{ Vdc}$)					
2N697, 2N718		—	20	—	
2N1420		—	35	—	
Small Signal Forward Current Transfer Ratio ($I_C = 50 \text{ mAdc}$, $V_{CE} = 10 \text{ Vdc}$, $f = 20 \text{ mc}$)	h_{fe}	2.5	15	—	—
Output Capacitance ($V_{CB} = 10 \text{ Vdc}$, $I_E = 0$)	C_{ob}	—	5	35	pf

2N700, A



$V_{CB0} = 25 \text{ V}$
 $G_e = 20 \text{ db @ } 70 \text{ Mc}$
 $NF = 10 \text{ db @ } 70 \text{ Mc}$



CASE 21
(TO-17)

PNP germanium mesa transistors for oscillator, frequency multiplier, wide-band mixer and wide-band amplifier applications.

MAXIMUM RATINGS

Characteristic	Symbol	Rating	Unit
Collector-Base Voltage	V_{CB0}	25	Vdc
Collector-Emitter Voltage	V_{CE0}		Vdc
2N700		20	
2N700A		25	
Emitter-Base Voltage	V_{EB}	0.2	Vdc
Collector DC Current	I_C	50	mAdc
Junction Temperature	T_J	100	$^{\circ}\text{C}$
Storage Temperature	T_{stg}	-65 to +100	$^{\circ}\text{C}$
Total Device Dissipation at 25 $^{\circ}\text{C}$ Ambient (Derate 1 mW/ $^{\circ}\text{C}$ above 25 $^{\circ}\text{C}$)	P_D	75	mW

2N700,A (continued)

ELECTRICAL CHARACTERISTICS ($T_A = 25^\circ\text{C}$ Unless Otherwise Noted¹)

Characteristic	Symbol	Test Conditions		Min	Typ	Max	Unit
Collector-Base Breakdown Voltage	BV_{CBO}	$I_C = 100 \mu\text{Adc}, I_E = 0$	All Types	25	32	—	Vdc
Collector-Emitter Breakdown Voltage	BV_{CEO}	$I_C = 100 \mu\text{Adc}, I_B = 0$	2N700 2N700A	20 25	— —	— —	Vdc
Emitter-Base Breakdown Voltage	BV_{EBO}	$I_E = 100 \mu\text{Adc}, I_C = 0$	All Types	0.2	0.5	—	Vdc
Collector Cutoff Current	I_{CBO}	$V_{CB} = 6 \text{ Vdc}, I_E = 0$ $V_{CB} = 6 \text{ Vdc}, I_E = 0, T_A = 85^\circ\text{C}$	All Types 2N700 2N700A	— — —	0.4 60 —	2 150 50	μAdc
Small Signal Forward Current Transfer Ratio	h_{fe}	$I_E = 2 \text{ mAdc}, V_{CE} = 6 \text{ Vdc}, f = 1 \text{ kc}$ $I_E = 5 \text{ mAdc}, V_{CE} = 6 \text{ Vdc}, f = 1 \text{ kc}$ $I_E = 2 \text{ mAdc}, V_{CE} = 6 \text{ Vdc}, f = 200 \text{ mc}$	All Types 2N700A 2N700 2N700A	4 — 2.5 5	10 — 7 —	— — — —	— — db db
Input Impedance	h_{ib}	$I_E = 2 \text{ mAdc}, V_{CB} = 6 \text{ Vdc}, f = 1 \text{ kc}$	All Types	—	17	30	Ohms
Base Resistance	r_b'	$I_E = 2 \text{ mAdc}, V_{CB} = 6 \text{ Vdc}, f = 300 \text{ mc}$	All Types	—	55	100	Ohms
Collector-Base Output Capacitance (case grounded)	C_{ob}	$V_{CB} = 6 \text{ Vdc}, I_E = 0, f = 100 \text{ kc}$	2N700 2N700A	— —	1.1 —	1.5 1.4	pf
Power Gain	G_e	$I_E = 2 \text{ mAdc}, V_{CB} = 6 \text{ Vdc}, f = 70 \text{ mc}$ (neutralized)	2N700 2N700A	20 22	23 —	— —	db
Noise Figure	NF		All Types	—	6	10	db
Power Gain	G_e	$I_E = 2 \text{ mAdc}, V_{CB} = 6 \text{ Vdc}, f = 30 \text{ mc}$ (neutralized)	2N700A	26	—	—	

POWER GAIN, CURRENT GAIN, & NOISE FIGURE vs. FREQUENCY

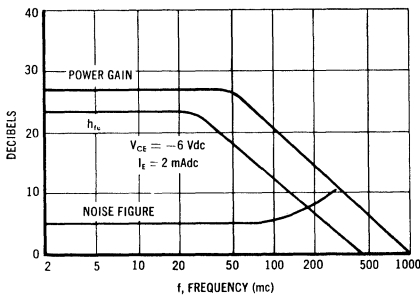

CURRENT-GAIN-BANDWIDTH PRODUCT vs CURRENT AND VOLTAGE

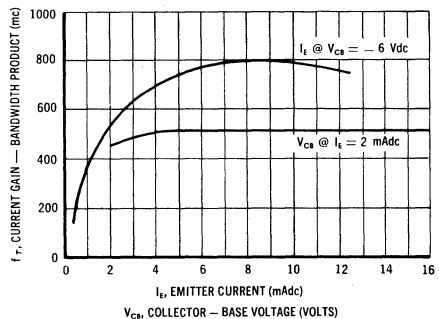

2N705

$V_{CES} = 15\text{ V}$
 $I_C = 50\text{ mA}$
 $f_t = 900\text{ Mc Typ}$



CASE 22
(TO-18)

PNP germanium mesa transistor for high-speed switching applications.

MAXIMUM RATINGS

Characteristic	Symbol	Rating	Unit
Collector-Base Voltage	V_{CBO}	15	Vdc
Collector-Emitter Voltage	V_{CES}	15	Vdc
Emitter-Base Voltage	V_{EBO}	3.5	Vdc
Collector Current	I_C	50	mAdc
Emitter Current	I_E	50	mAdc
Junction Temperature	T_J	100	°C
Storage Temperature	T_{stg}	-65°C to +100°C	°C
Collector Dissipation @ 25°C Case Temp. (Derate 4 mW/°C above 25°C)	P_C	300	mW
Collector Dissipation in Free Air	P_C	150	mW

NORMALIZED D.C. CURRENT GAIN
versus COLLECTOR CURRENT

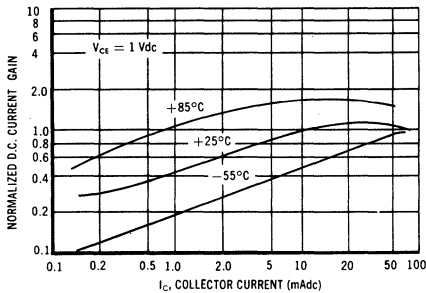

COLLECTOR SATURATION VOLTAGE
versus AMBIENT TEMPERATURE

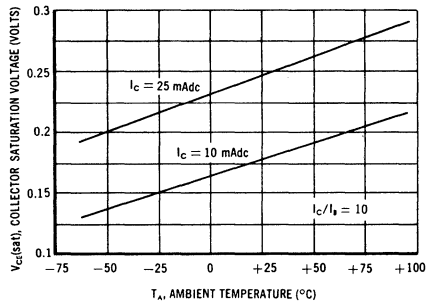

2N705 (continued)

ELECTRICAL CHARACTERISTICS (At 25°C unless otherwise noted)

Characteristic	Symbol	Min	Typ	Max	Unit
Collector-Base Breakdown Voltage ($I_C = 100 \mu\text{Adc}$, $I_E = 0$)	BV_{CBO}	15	—	—	Vdc
Collector-Emitter Breakdown Voltage ($I_{CE} = 100 \mu\text{Adc}$, $V_{BE} = 0$)	BV_{CES}	15	—	—	Vdc
Emitter-Base Breakdown Voltage ($I_E = 100 \mu\text{Adc}$, $I_C = 0$)	BV_{EBO}	3.5	—	—	Vdc
Collector Cutoff Current ($V_{CB} = 5 \text{ Vdc}$, $I_E = 0$)	I_{CBO}	—	0.2	3	μAdc
DC Forward Current Transfer Ratio ($V_{CE} = .3 \text{ Vdc}$, $I_C = 10 \text{ mAdc}$)	h_{FE}	25	40	—	—
Collector Saturation Voltage ($I_B = .4 \text{ mAdc}$, $I_C = 10 \text{ mAdc}$) ($I_B = 5 \text{ mAdc}$, $I_C = 50 \text{ mAdc}$)	$V_{CE(sat)}$	—	0.18 0.45	0.3 —	Vdc
Base-Emitter Voltage ($I_B = .4 \text{ mAdc}$, $I_C = 10 \text{ mAdc}$)	V_{BE}	0.34	0.39	0.44	Vdc
Small Signal Forward Current Transfer Ratio ($V_{CE} = 1.0 \text{ Vdc}$, $I_C = 10 \text{ mAdc}$, $f = 100 \text{ mc}$)	h_{fe}	—	9	—	db
Collector Capacitance ($V_{CB} = 10 \text{ Vdc}$, $I_E = 0$, $f = 1 \text{ mc}$)	C_{ob}	—	5.0	—	pf
Input Capacitance ($V_{EB} = 2 \text{ Vdc}$)	C_{ib}	—	3.5	—	pf
Common Base Alpha Cutoff Frequency ($V_{CB} = 5 \text{ Vdc}$, $I_C = 10 \text{ mAdc}$)	$f_{\alpha b}$	—	300	—	mc
Delay + Rise Time ($I_C = 10 \text{ mAdc}$, $I_B = 1 \text{ mAdc}$)	$t_d + t_r$	—	55	75	nsec
Storage Time ($I_{B1} = 1.0 \text{ mAdc}$, $I_{B2} = .25 \text{ mAdc}$)	t_s	—	65	100	nsec
Fall Time ($I_{B1} = 1.0 \text{ mAdc}$, $I_{B2} = .25 \text{ mAdc}$)	t_f	—	70	100	nsec

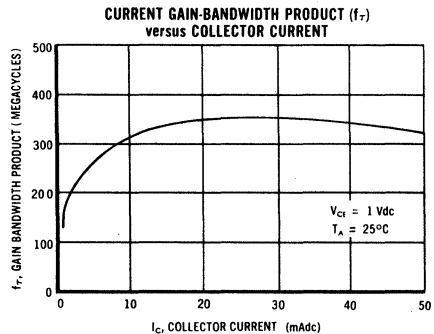
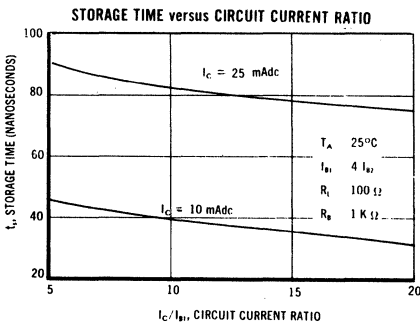

2N706, A, B
2N753

$V_{CE0} = 15\text{ V}$
 $h_{FE} = 20-40$
 $f_T = 400\text{ Mc}$



CASE 22
(TO-18)

NPN silicon annular switching transistors for high-speed switching applications.

MAXIMUM RATINGS

Characteristic	Symbol	Rating	Unit
Collector-Base Voltage	V_{CB}	25	Volts
Collector-Emitter Voltage	V_{CER}^*	20	Volts
Emitter-Base Voltage	V_{EB}	3 5 5 5	Volts Volts Volts Volts
Junction Temperature	T_j	175	$^{\circ}\text{C}$
Storage Temperature	T_{stg}	-65 to -175	$^{\circ}\text{C}$
Total Device Dissipation at 25 $^{\circ}\text{C}$ Case Temperature (Derate 6.67 mW/ $^{\circ}\text{C}$ above 25 $^{\circ}\text{C}$)	P_D	1.0	Watt
Total Device Dissipation at 25 $^{\circ}\text{C}$ Ambient Temperature (Derate 2 mW/ $^{\circ}\text{C}$ above 25 $^{\circ}\text{C}$)	P_D	0.3	Watt
Total Device Dissipation at 100 $^{\circ}\text{C}$ Case Temperature (Derate 6.67 mW/ $^{\circ}\text{C}$ above 100 $^{\circ}\text{C}$)	P_D	0.5	Watt

*Refers to collector breakdown voltage in the high current region when $R_{bc} = 10\Omega$

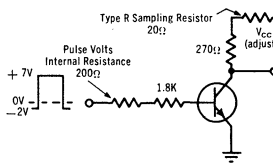

SWITCHING TIME TEST CIRCUIT

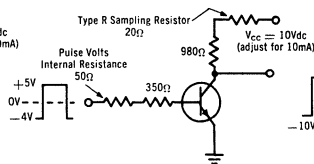

STORAGE TIME TEST CIRCUIT

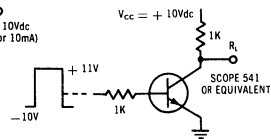

MEASUREMENT CIRCUIT

2N706,A,B,2N753 (continued)

ELECTRICAL CHARACTERISTICS (At 25°C unless otherwise noted)

Characteristic	Type	Symbol	Min	Typ	Max	Unit
Collector Cutoff Current ($V_{CB} = 15Vdc, I_E = 0$) ($V_{CB} = 15Vdc, I_E = 0, T_A = 150^\circ C$) ($V_{CB} = 25Vdc, I_E = 0$)	All Types All Types 2N706A, 2N706B, 2N753	I_{CBO}	- -	005 3	0.5 30	μA_{dc}
Collector-Emitter Cutoff Current ($V_{CE} = 20Vdc, R_{be} = 100k$)	2N706A, 2N706B, 2N753	I_{CER}	-	-	10	μA_{dc}
Emitter Cutoff Current ($V_{EB} = 3Vdc, I_C = 0$) ($V_{EB} = 5Vdc, I_C = 0$)	2N706 2N706A, 2N706B, 2N753	I_{EBO}	- -	- -	10 10	μA_{dc}
Collector-Emitter Breakdown Voltage* ($I_C = 10mA_{dc}, I_B = 0$)	All Types	BV_{CEO}^*	15	24	-	Vdc
Collector-Emitter Breakdown Voltage* ($R = 10\text{ ohms}, I_C = 10mA_{dc}$)	All Types	BV_{CER}^*	20	48	-	Vdc
Forward-Current Transfer Ratio* ($I_C = 10mA_{dc}, V_{CE} = 1Vdc$)	2N706 2N706A, 2N706B, 2N753	h_{FE}^*	20 20 40	20 40 -	- 60 120	
Base-Emitter Voltage* ($I_C = 10mA_{dc}, I_B = 1mA_{dc}$)	2N706 2N706A, 2N706B, 2N753	$V_{BE(sat)}^*$	- 0.7	0.75 0.75	0.9 0.9	Vdc
Collector Saturation Voltage* ($I_C = 10mA_{dc}, I_B = 1mA_{dc}$) ($I_C = 50mA_{dc}, I_B = 5mA_{dc}$)	2N706, 2N706A 2N706B 2N753 2N753	$V_{CE(sat)}^*$	- - - -	0.3 0.3 0.18 0.3	0.6 0.4 0.6 -	Vdc
Collector Capacitance ($V_{CB} = 5Vdc, I_E = 0$) ($V_{CB} = 10Vdc, I_E = 0$)	2N706A, 2N706B, 2N753 2N706	C_{ob}	- -	4.5 5	5 6	pf
Small-Signal Forward Current Transfer Ratio ($V_{CE} = 15Vdc, I_E = 10mA_{dc},$ $f = 100mc$)	All types	h_{fe}	2	4	-	
Current Gain-Bandwidth Product ($V_{CE} = 15Vdc, I_E = 10mA_{dc},$ $f = 100mc$)	All types	f_T	-	400	-	mc
Base Resistance ($V_{CE} = 15Vdc, I_E = 10mA_{dc},$ $f = 300mc$)	2N706B	r_b	-	39	50	ohms
Charge Storage Time Constant (See Figure 2)	2N706 2N706A 2N753	τ_s^{**}	- - -	16 16 19	60 25 35	nsec
Storage Time	2N706B	t_s	-	19	25	nsec
Turn-On Time	All types	t_{on}^{**}	-	30	40	nsec
Turn-Off Time	All Types	t_{off}^{**}	-	50	75	nsec

*Pulse Test: $PW \leq 12\text{ nsec}, \text{Duty Cycle} \leq 2\%$

**Switching Times Measured with Tektronix Type R Plug-In (50 Ω Internal Impedance) and Circuits Shown Below.

2N707, A

$f_{max} = 600 \text{ Mc}$
 $P_o = 200\text{-}400 \text{ mW @ } 100 \text{ Mc}$



CASE 22
(TO-18)

NPN germanium epitaxial mesa transistors for VHF oscillator and class C amplifier applications.

MAXIMUM RATINGS

Characteristic	Symbol	Rating		Unit
		2N707	2N707A	
Collector-Base Voltage	V_{CBO}	56	70	Vdc
Collector-Emitter Voltage	V_{CEO}	28*	40‡	Vdc
Emitter-Base Voltage	V_{EBO}	4	5	Vdc
Total Device Dissipation at 25°C Case Temperature (Derate above 25°C)	P_D	1.0	1.2	Watt
		6.67	8	mW/°C
Total Device Dissipation at 25°C Ambient Temperature (Derate above 25°C)	P_D	0.3	0.5	Watt
		2	3.33	mW/°C
Junction & Storage Temperature Range	T_j, T_{stg}	-65 to +175		°C

*Refers to Collector Breakdown Voltage in the high current region when $R_{be} \leq 10$ ohms. ‡ V_{CEO}

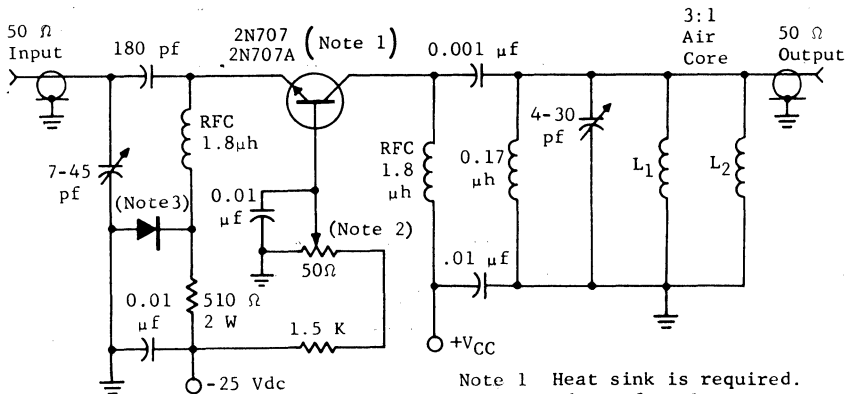

- L1 5 turns #14 wire wound on 1/2" diameter.
- L2 2 turns #14 wire wound on L1.

- Note 1 Heat sink is required.
- Note 2 Adjust for Class C operation.
- Note 3 Very High conductance silicon diode.
- Note 4 Adjust V_{CC} for proper V_{CE}

100 MC, CLASS C, COMMON BASE AMPLIFIER

2N707,A (continued)

ELECTRICAL CHARACTERISTICS (At 25°C unless otherwise noted)

Characteristic	Symbol	Min	Typ	Max	Unit
Collector-Base Breakdown Voltage ($I_C = 10 \mu\text{A}$, $I_E = 0$) 2N707 2N707A	BV_{CBO}	56 70	---	---	Vdc
Collector-Emitter Breakdown Voltage ($I_C = 10 \text{mA}$, $R = 10 \text{ohms}$) 2N707	BV_{CER}	28	---	---	Vdc
Collector-Emitter Breakdown Voltage* ($I_C = 20 \text{mA}$, $I_B = 0$) 2N707A	BV_{CEO}^*	40	---	---	Vdc
Emitter-Base Breakdown Voltage ($I_E = 100 \mu\text{A}$, $I_C = 0$) 2N707A	BV_{EBO}	5	---	---	Vdc
Collector Cutoff Current ($V_{CB} = 15 \text{Vdc}$, $I_E = 0$) 2N707 ($V_{CB} = 15 \text{Vdc}$, $I_E = 0$, $T_A = +150^\circ\text{C}$) 2N707 ($V_{CB} = 30 \text{Vdc}$, $I_E = 0$) 2N707A ($V_{CB} = 30 \text{Vdc}$, $I_E = 0$, $T_A = 150^\circ\text{C}$) 2N707A	I_{CBO}	---	0.005 3.0 .01 5	5 ---	μA
Emitter Cutoff Current ($V_{EB} = 4 \text{Vdc}$, $I_C = 0$) 2N707 ($V_{EB} = 5 \text{Vdc}$, $I_C = 0$) 2N707A	I_{EBO}	---	---	10 100	μA
Forward Current Transfer Ratio ($I_C = 10 \text{mA}$, $V_{CE} = 1 \text{Vdc}$) 2N707 2N707A	h_{FE}	9 9	12 ---	---	---
Collector Saturation Voltage ($I_C = 10 \text{mA}$, $I_B = 1 \text{mA}$)	$V_{CE(sat)}$	---	0.18	0.6	Vdc
Base-Emitter Saturation Voltage ($I_C = 10 \text{mA}$, $I_B = 1 \text{mA}$)	$V_{BE(sat)}$	---	0.75	0.9	Vdc
Collector Capacitance ($V_{CB} = 10 \text{Vdc}$, $I_E = 0$) 2N707 ($V_{CB} = 5 \text{Vdc}$, $I_E = 0$) 2N707A	C_{ob}	---	4.0 4.0	10.0 6.0	pf
Current Gain-Bandwidth Product ($V_{CE} = 10 \text{Vdc}$, $I_E = 15 \text{mA}$)	f_T	70	350	---	mc
Maximum Frequency of Oscillation	f_{max}	---	600	---	mc
r'_{bC} Product ($V_{CB} = 10 \text{Vdc}$, $I_C = 10 \text{mA}$, $f = 4 \text{mc}$)	r'_{bCC}	---	80	---	psec
Power Output, 100-mc, Common Base, Class-C Amplifier (Figure 1) ($V_{CE} = 20 \text{Vdc}$, $P_{in} = 50 \text{mW}$) All Types ($V_{CE} = 40 \text{Vdc}$, $P_{in} = 175 \text{mW}$) 2N707A	P_{out}	200 400	300 ---	---	mW
100-mc Oscillator Efficiency ($V_{CE} = 28 \text{Vdc}$, $I_C = 40 \text{mA}$)		---	38	---	%

*Pulse Test 300 μsec , 2% duty cycle

2N708

V_{CEO} = 15 V
f_T = 450 Mc Typ



CASE 22
(TO-18)

NPN silicon annular transistor for high-speed switching applications.

MAXIMUM RATINGS

Characteristic	Symbol	Rating	Unit
Collector-Base Voltage	V _{CBO}	40	Vdc
Collector-Emitter Voltage	V _{CEO}	15	Vdc
Emitter-Base Voltage	V _{EBO}	5.0	Vdc
Total Device Dissipation 25°C Case Temperature (Derate 6.9 mW/°C above 25°C) 100°C Case Temperature (Derate 6.9 mW/°C above 100°C)	P _D	1.2 0.68	Watts
Total Device Dissipation 25°C Ambient Temperature (Derate 2 mW/°C above 25°C)	P _D	0.36	Watts
Junction Temperature	T _J	+ 200	°C
Storage Temperature	T _{stg}	-65 to +300	°C

ELECTRICAL CHARACTERISTICS (at 25°C unless otherwise specified)

Characteristic	Sym	Min	Typ	Max	Unit
Collector Cutoff Current (V _{CB} = 20 Vdc, I _E = 0) (V _{CB} = 20 Vdc, I _E = 0, T _A = 150°C)	I _{CBO}	—	.005	.025 15	μAdc
Emitter Cutoff Current (V _{EB} = 4.0 Vdc, I _C = 0)	I _{EBO}	—	—	.08	μAdc
Collector-Base Breakdown Voltage (I _C = 1.0 μAdc, I _E = 0)	BV _{CBO}	40	—	—	Vdc
Collector-Emitter Breakdown Voltage (I _C = 30 mAdc, I _B = 0)	BV _{CEO}	15	—	—	Vdc
Collector-Emitter Breakdown Voltage (I _C = 30 mAdc, R _{BE} ≤ 10 Ω)	BV _{CER}	20	—	—	Vdc
Emitter-Base Breakdown Voltage (I _E = 10 μAdc, I _C = 0)	BV _{EBO}	5.0	—	—	Vdc
Forward Current Transfer Ratio (I _C = 0.5 mAdc, V _{CE} = 1.0 Vdc) (I _C = 10 mAdc, V _{CE} = 1.0 Vdc)* (I _C = 10 mAdc, V _{CE} = 1.0 Vdc, T _A = -55°C)*	h _{FE}	15 30 15	—	— 120 —	—
Small Signal Forward Current Transfer Ratio (I _C = 10 mAdc, V _{CE} = 10 Vdc, f = 100 mc)	h _{fe}	3.0	4.5	—	—
Collector Saturation Voltage (I _C = 10 mAdc, I _B = 1.0 mAdc) (I _C = 7.0 mAdc, I _B = 0.7 mAdc, T _A = -55 to 125°C)	V _{CE(sat)}	—	0.2 —	0.4 0.40	Vdc
Base-Emitter Saturation Voltage (I _C = 10 mAdc, I _B = 1.0 mAdc) (I _C = 7.0 mAdc, I _B = 0.7 mAdc, T _A = -55°C)	V _{BE(sat)}	0.72 —	— —	0.80 0.90	Vdc
Output Capacitance (V _{CB} = 10 Vdc, I _E = 0)	C _{ob}	—	3.0	6.0	pf
Storage Time (Figure 1) (I _C = I _{B1} = I _{B2} = 10 mAdc)	t _s	—	15	25	nsec
Collector Current (V _{CE} = 20 Vdc, V _{BE} = 0.25 Vdc, T _A = 125°C)	I _{CEX}	—	—	10	μAdc
Base Resistance (I _C = 10 mAdc, V _{CE} = 10 Vdc, f = 300 mc)	r _{b'}	—	—	50	Ohms

* Pulse Test: Pulse width ≤ 300 μsec, duty cycle ≤ 2%

2N710

**$V_{CES} = 15\text{ V}$
 $I_C = 50\text{ mA}$**



CASE 22
(TO-18)

PNP germanium mesa transistor for saturated and non-saturated switching applications.

MAXIMUM RATINGS (At 25°C unless otherwise noted)

Characteristic	Symbol	Rating	Unit
Collector to Base Voltage	V_{CBO}	15	Vdc
Collector to Emitter Voltage	V_{CES}	15	Vdc
Emitter to Base Voltage	V_{EBO}	2	Vdc
Collector Current	I_C	50	mAdc
Emitter Current	I_E	50	mAdc
Junction Temperature	T_J	100	°C
Storage Temperature	T_{stg}	-65 to +100	°C
Collector Dissipation @ 25°C Case Temp. (Derate 4mW/°C above 25°C)	P_C	300	mW
Collector Dissipation in Free Air	P_C	150	mW

ELECTRICAL CHARACTERISTICS (At 25°C unless otherwise noted)

Characteristic	Symbol	Min	Typ	Max	Unit
Collector to Base Breakdown Voltage $I_C = -100\mu\text{Adc}, I_E = 0$	BV_{CBO}	15	—	—	Vdc
Collector to Emitter Breakdown Voltage $I_{CB} = -100\mu\text{Adc}, V_{EB} = 0$	BV_{CES}	15	—	—	Vdc
Emitter to Base Breakdown Voltage $I_E = -100\mu\text{Adc}, I_C = 0$	BV_{EBO}	2	—	—	Vdc
Collector Cutoff Current $V_{CB} = -6\text{Vdc}, I_E = 0$	I_{CBO}	—	0.2	3	μAdc
Forward Current Transfer Ratio $V_{CB} = -5\text{Vdc}, I_C = -10\text{mAdc}$	h_{FE}	25	—	—	—
Collector Saturation Voltage $I_E = -0.4\text{mAdc}, I_C = -10\text{mAdc}$	$V_{CB(sat)}$	—	—	0.5	Vdc
Base to Emitter Voltage $I_E = -4\text{mAdc}, I_C = -10\text{mAdc}$	V_{BE}	0.34	0.42	0.5	Vdc
Delay + Rise Time (Fig. 1) $I_E = -1.0\text{mAdc}, I_C = -10\text{mAdc}$	$t_d + t_r$	—	60	75	nsec
Storage Time (Fig. 1) $I_{B1} = -1.0\text{mAdc}, I_{B2} = .25\text{mAdc}$	t_s	—	65	100	nsec
Fall Time (Fig. 1) $I_{B1} = -1\text{mAdc}, I_{B2} = .25\text{mAdc}$	t_f	—	70	100	nsec

2N711, A, B

$V_{CEO} = 7\text{ V}$
 $I_C = 50\text{-}100\text{ mA}$
 $f_t = 300\text{-}320\text{ Mc Typ}$

CASE 22
(TO-18)



PNP germanium mesa transistors for high-speed switching applications.

MAXIMUM RATINGS

Characteristic	Symbol	2N711	2N711A	2N711B	Unit
Collector-Base Voltage	V_{CBO}	12	15	18	Vdc
Collector-Emitter Voltage	V_{CES}	12	14	15	Vdc
Collector-Emitter Voltage	V_{CEO}	—	7	7	Vdc
Emitter-Base Voltage	V_{EBO}	1	1.5	2	Vdc
Collector Current (Continuous)	I_C	50	100	100	mAdc
Emitter Current (Continuous)	I_E	50	100	100	mAdc
Junction Temperature	T_J	← 100 →			°C
Storage Temperature	T_{stg}	← -65 to +100 →			°C
Device Dissipation @ $T_C = 25^\circ\text{C}$	P_D	← 300 →			mW
Derating factor above 25°C		← 4 →			mW/°C
Device Dissipation @ $T_A = 25^\circ\text{C}$	P_D	← 150 →			mW
Derating factor above 25°C		← 2 →			mW/°C

2N711, A, B (continued)

ELECTRICAL CHARACTERISTICS (At 25°C unless otherwise noted)

Characteristics	Symbol	Min	Typ	Max	Unit	
Collector-Base Breakdown Voltage ($I_C = 100 \mu\text{A dc}$, $I_E = 0$)	BV _{CB0}	2N711 2N711A 2N711B	12 15 18	— — —	— — —	V _{dc}
($I_C = 20 \mu\text{A dc}$, $I_E = 0$)						
Collector-Emitter Breakdown Voltage ($I_C = 100 \mu\text{A dc}$)	BV _{CE5}	2N711 2N711A 2N711B	12 14 16	— — —	— — —	V _{dc}
($I_C = 20 \mu\text{A dc}$)						
Collector-Emitter Breakdown Voltage ($I_C = 5 \text{ mA dc}$, $I_B = 0$)	BV _{CEO}	2N711A, 2N711B	7	—	—	V _{dc}
Emitter-Base Breakdown Voltage ($I_E = 0.1 \text{ mA dc}$, $I_C = 0$)	BV _{EBO}	2N711 2N711A 2N711B	1.0 1.5 2.0	— — —	— — —	V _{dc}
Collector-Base Cutoff Current ($V_{CB} = 5 \text{ V dc}$, $I_E = 0$)	I _{CBO}	2N711 2N711A 2N711B	— — —	0.2	3.0	$\mu\text{A dc}$
($V_{CB} = 10 \text{ V dc}$, $I_E = 0$)					1.5	
						1.5
Emitter-Base Cutoff Current ($V_{EB} = 1 \text{ V dc}$)	I _{EBO}	2N711A 2N711B	— —	—	100 20	$\mu\text{A dc}$
DC Current Gain ($I_C = 10 \text{ mA dc}$, $V_{CE} = 0.5 \text{ V dc}$)	h _{FE}	2N711 2N711A 2N711B	20 25 30	30	— 150 150	—
($I_C = 50 \text{ mA dc}$, $V_{CE} = 0.7 \text{ V dc}$)						—
			2N711A, 2N711B	40	—	—
Collector Saturation Voltage ($I_C = 10 \text{ mA dc}$, $I_B = 0.5 \text{ mA dc}$)	V _{CE(sat)}	2N711	—	0.2	0.5	V _{dc}
($I_C = 10 \text{ mA dc}$, $I_B = 0.4 \text{ mA dc}$)		2N711A	—	—	0.30	
($I_C = 50 \text{ mA dc}$, $I_B = 2 \text{ mA dc}$)		2N711A	—	—	0.25	
		2N711B	—	—	0.55 0.45	
Small-Signal Current Gain ($I_C = 10 \text{ mA dc}$, $V_{CE} = 5 \text{ V dc}$, $f = 100 \text{ mc}$)	h _{fe}	2N711A, 2N711B	1.5	—	—	—
($I_C = 10 \text{ mA dc}$, $V_{CE} = 0.5 \text{ V dc}$, $f = 100 \text{ mc}$)		2N711A	1.1	—	—	
		2N711B	1.2	—	—	
Base-Emitter Voltage ($I_C = 10 \text{ mA dc}$, $I_B = 0.4 \text{ mA dc}$)	V _{BE}	2N711, 2N711A 2N711B	0.34 —	0.42	0.50 0.45	V _{dc}
($I_C = 50 \text{ mA dc}$, $I_B = 2 \text{ mA dc}$)		2N711A 2N711B	0.45 0.45	—	0.75 0.70	
Collector Output Capacitance ($V_{CB} = 5 \text{ V dc}$, $I_E = 0$, $f = 1 \text{ mc}$)	C _{ob}	2N711A, 2N711B	—	—	6	pf
($V_{CB} = 10 \text{ V dc}$, $I_E = 0$, $f = 1 \text{ mc}$)		2N711	—	5.0	—	
Fall Time	t _f	Figure 1: { 2N711A 2N711B	— —	—	150 110	nsec
		Figure 2: { 2N711A 2N711B 2N711	— — —	—	110 100 150	
Minority Carrier Storage Time	t _s	Figure 1: { 2N711A 2N711B	— —	—	150 140	nsec
		Figure 2: { 2N711A 2N711B 2N711	— — —	—	120 100 200	
Delay Plus Rise Time	t _d + t _r	Figure 1: { 2N711A, 2N711B	—	—	100	nsec
		Figure 2: { 2N711A, 2N711B 2N711	—	—	75 100	

SWITCHING CIRCUITS

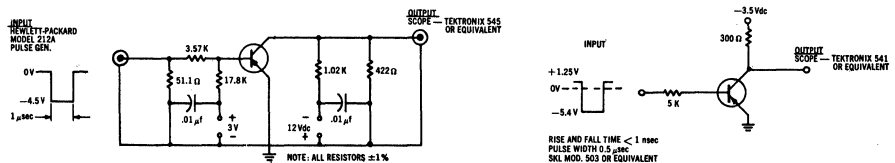

2N711,A,B (continued)

**COLLECTOR SATURATION VOLTAGE
versus AMBIENT TEMPERATURE**

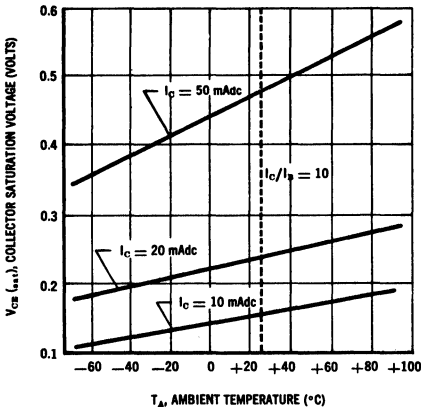

**COLLECTOR SATURATION VOLTAGE
STORAGE TIME versus CIRCUIT CURRENT RATIO**

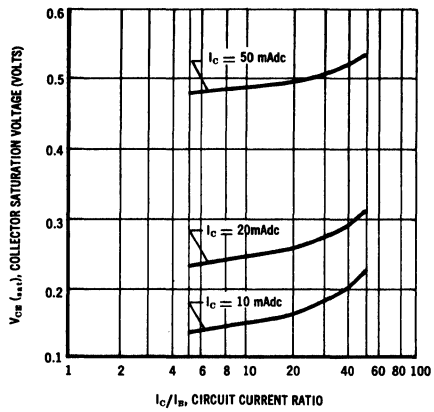

**NORMALIZED DC CURRENT GAIN
versus COLLECTOR CURRENT**

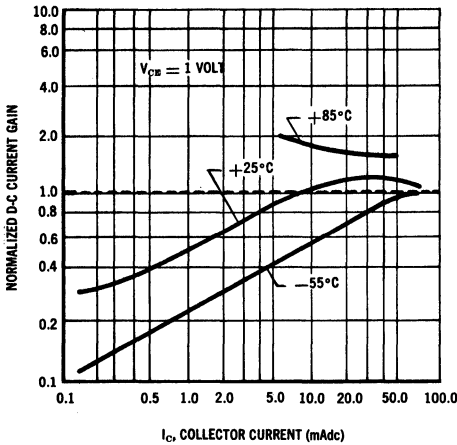

**STORAGE TIME versus
CIRCUIT CURRENT RATIO**

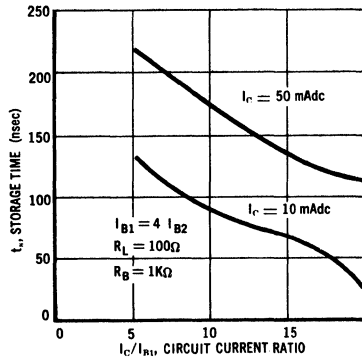

2N718

For Specifications, See 2N697 Data Sheet

2N718A
2N956
2N1613
2N1711

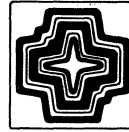

$V_{CER} = 50\text{ V}$
 $f_T = 300\text{ Mc Typ}$

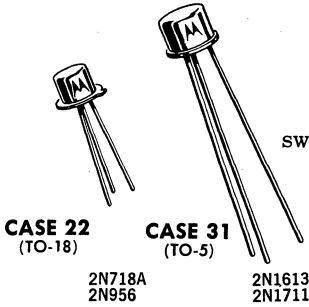

NPN silicon annular Star transistors for high-speed switching and DC to UHF amplifier applications.

MAXIMUM RATINGS

Characteristic	Symbol	2N1613 2N1711 (TO-5)	2N718A 2N956 (TO-18)	Unit
Collector-Base Voltage	V_{CBO}	75	75	Vdc
Collector-Emitter Voltage	V_{CER}	50	50	Vdc
Emitter-Base Voltage	V_{EBO}	7	7	Vdc
Total Device Dissipation at 25°C Case Temperature Derate	P_D	3 17.1	1.8 10.3	Watts mW/°C
Total Device Dissipation at 25°C Ambient Temperature Derate	P_D	0.8 4.57	0.5 2.86	Watt mW/°C
Junction Temperature	T_J	-65 to +200		°C
Storage Temperature	T_{stg}	-65 to +300		°C

2N718A, 2N956, 2N1613, 2N1711 (continued)

ELECTRICAL CHARACTERISTICS (at 25°C unless otherwise specified)

Characteristic	Symbol	Min	Typ	Max	Unit
Collector Cutoff Current ($V_{CB} = 60 \text{ Vdc}$, $I_E = 0$)	I_{CBO}	—	.001	.01	$\mu\text{A dc}$
Collector Cutoff Current ($V_{CB} = 60 \text{ Vdc}$, $T_A = 150^\circ\text{C}$)	I_{CBO}	—	—	10	$\mu\text{A dc}$
Emitter Cutoff Current ($V_{EB} = 5 \text{ Vdc}$, $I_C = 0$)	I_{EBO}	—	—	.010 .005	$\mu\text{A dc}$
Collector-Base Breakdown Voltage ($I_C = 100 \mu\text{A dc}$, $I_E = 0$)	BV_{CBO}	75	—	—	Vdc
Collector-Emitter Breakdown Voltage ($I_C = 100 \text{ mA dc}$, pulsed; $R_{BE} \leq 10 \Omega$)	BV_{CER}	50	—	—	Vdc
Emitter-Base Breakdown Voltage ($I_E = 100 \mu\text{A dc}$, $I_C = 0$)	BV_{EBO}	7	—	—	Vdc
Collector Saturation Voltage ($I_C = 150 \text{ mA dc}$, $I_B = 15 \text{ mA dc}$)	$V_{CE(sat)}^*$	—	0.24	1.5	Vdc
Base-Emitter Saturation Voltage ($I_C = 150 \text{ mA dc}$, $I_B = 15 \text{ mA dc}$)	$V_{BE(sat)}^*$	—	1.0	1.3	Vdc
DC Forward Current Transfer Ratio ($I_C = .01 \text{ mA dc}$, $V_{CE} = 10 \text{ Vdc}$) ($I_C = 0.1 \text{ mA dc}$, $V_{CE} = 10 \text{ Vdc}$) ($I_C = 10 \text{ mA dc}$, $V_{CE} = 10 \text{ Vdc}$) ($I_C = 10 \text{ mA dc}$, $V_{CE} = 10 \text{ Vdc}$, $T_A = -55^\circ\text{C}$) ($I_C = 150 \text{ mA dc}$, $V_{CE} = 10 \text{ Vdc}$) [*] ($I_C = 500 \text{ mA dc}$, $V_{CE} = 10 \text{ Vdc}$) [*]	h_{FE}	20 20 35 35 75 20 35 40 100 20 40	— — — — — — — — — — —	— — — — — — — — 120 300 — —	—
Output Capacitance ($V_{CB} = 10 \text{ Vdc}$, $I_E = 0$, $f = 100 \text{ kc}$)	C_{ob}	—	4	25	pf
Input Capacitance ($V_{EB} = 0.5 \text{ Vdc}$, $I_C = 0$, $f = 100 \text{ kc}$)	C_{ib}	—	20	80	pf
Small Signal Forward Current Transfer Ratio ($V_{CE} = 10 \text{ Vdc}$, $I_C = 50 \text{ mA dc}$, $f = 20 \text{ mc}$)	h_{fe}	3.0 3.5	15 15	— —	—
Current Gain ($I_C = 1 \text{ mA dc}$, $V_{CE} = 5 \text{ Vdc}$, $f = 1 \text{ kc}$) ($I_C = 5 \text{ mA dc}$, $V_{CE} = 10 \text{ Vdc}$, $f = 1 \text{ kc}$)	h_{fe}	30 50 35 70	— — — —	100 200 150 300	—
Input Resistance ($I_C = 1 \text{ mA dc}$, $V_{CB} = 5 \text{ Vdc}$, $f = 1 \text{ kc}$) ($I_C = 5 \text{ mA dc}$, $V_{CB} = 10 \text{ Vdc}$, $f = 1 \text{ kc}$)	h_{ib}	24 4	— —	34 8	Ohms
Voltage Feedback Ratio ($I_C = 1 \text{ mA dc}$, $V_{CB} = 5 \text{ Vdc}$, $f = 1 \text{ kc}$) ($I_C = 5 \text{ mA dc}$, $V_{CB} = 10 \text{ Vdc}$, $f = 1 \text{ kc}$)	h_{rb}	— — — —	— — — —	3×10^{-4} 5×10^{-4} 3×10^{-4} 5×10^{-4}	—
Output Conductance ($I_C = 1 \text{ mA dc}$, $V_{CB} = 5 \text{ Vdc}$, $f = 1 \text{ kc}$) ($I_C = 5 \text{ mA dc}$, $V_{CB} = 10 \text{ Vdc}$, $f = 1 \text{ kc}$)	h_{ob}	0.1 0.1	— —	0.5 1.0	μmho
Noise Figure ($V_{CB} = 10 \text{ Vdc}$, $I_C = 300 \mu\text{A dc}$, $f = 1 \text{ kc}$)	NF	— —	— —	12 8	db

*Pulse Test: Pulse width $\leq 300 \mu\text{sec}$ Duty cycle $\leq 2\%$

2N722
2N1132, A, B
2N2303

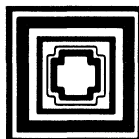

$V_{CEO} = 35-45 \text{ V}$
 $I_C = 500-600 \text{ mA}$
 $f_T = 250 \text{ Mc Typ}$

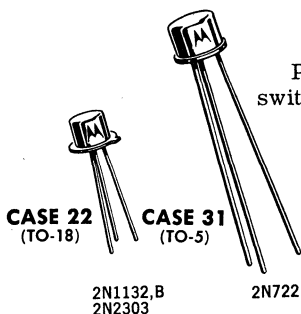

PNP silicon annular transistors for medium-current-switching applications.

MAXIMUM RATINGS

Characteristic	Symbol	Rating	Unit
Collector-Base Voltage 2N722, 2N1132, 2N2303 2N1132A 2N1132B	V_{CBO}	50 60 70	Vdc
Collector-Emitter Voltage 2N722, 2N1132, 2N2303 2N1132A 2N1132B	V_{CEO}	35 40 45	Vdc
Emitter-Base Voltage 2N722, 2N1132, 2N1132A, 2N2303 2N1132B	V_{EBO}	5 6	Vdc
Collector-Emitter Voltage ($R_{BE} \leq 10 \Omega$) 2N722, 2N1132, 2N1132A, 2N2303 2N1132B	V_{CER}	50 60	Vdc
Collector Current 2N2303 2N1132A, 2N1132B	I_C	500 600	mAdc
Total Device Dissipation @ $T_C = 25^\circ\text{C}$ TO-5: 2N1132, 2N1132A, 2N1132B, 2N2303 Derating Factor Above 25°C TO-18: 2N722 Derating Factor Above 25°C	P_D	2 13.3 1.5 10	Watts mW/ $^\circ\text{C}$ Watts mW/ $^\circ\text{C}$
Total Device Dissipation @ $T_A = 25^\circ\text{C}$ TO-5: 2N1132, 2N1132A, 2N1132B, 2N2303 Derating Factor Above 25°C TO-18: 2N722 Derating Factor Above 25°C	P_D	0.6 4.0 0.4 2.67	Watt mW/ $^\circ\text{C}$ Watt mW/ $^\circ\text{C}$
Junction Temperature	T_J	+175	$^\circ\text{C}$
Storage Temperature Range	T_{stg}	-65 to +300	$^\circ\text{C}$

2N722, 2N1132, A, B, 2N2303 (continued)

ELECTRICAL CHARACTERISTICS (At 25°C ambient unless otherwise noted)

Characteristic	Types	Symbol	Min	Max	Unit
Collector-Base Breakdown Voltage ($I_C = 100 \mu\text{A}$, $I_E = 0$)	2N722, 2N1132, 2N2303 2N1132A 2N1132B	BV_{CBO}	50 60 70	— — —	Vdc
Emitter-Base Breakdown Voltage ($I_E = 100 \mu\text{A}$, $I_C = 0$) ($I_E = 1 \text{ mA}$, $I_C = 0$)	2N722, 2N1132, 2N2303 2N1132A 2N1132B	BV_{EBO}	5 5 6	— — —	Vdc
Collector-Emitter Breakdown Voltage ($I_C = 100 \text{ mA}$ pulsed)	2N722, 2N1132, 2N2303 2N1132A 2N1132B	BV_{CEO}	35 40 50	— — —	Vdc
Collector-Emitter Breakdown Voltage ($I_C = 100 \text{ mA}$ pulsed, $R_{BE} \leq 10 \Omega$)	2N722, 2N1132, A, 2N2303 2N1132B	BV_{CER}	50 60	— —	Vdc
Collector Cutoff Current ($V_{CB} = 30 \text{ Vdc}$, $I_E = 0$) ($V_{CB} = 30 \text{ Vdc}$, $I_E = 0$, $T_A = 150^\circ\text{C}$) ($V_{CB} = 50 \text{ Vdc}$, $I_E = 0$) ($V_{CB} = 50 \text{ Vdc}$, $I_E = 0$, $T_A = 150^\circ\text{C}$)	2N722, 2N1132, 2N2303 2N722, 2N1132, 2N2303 2N1132A 2N1132B 2N1132A 2N1132B	I_{CBO}	— — — — — —	1 100 0.5 0.01 50 10	μA
Emitter Cutoff Current ($V_{EB} = 5 \text{ Vdc}$, $I_C = 0$) ($V_{EB} = 2 \text{ Vdc}$, $I_C = 0$)	2N1132A 2N1132B 2N2303	I_{EBO}	— — —	100 0.1 100	μA
DC Forward Current Transfer Ratio ($I_C = 5 \text{ mA}$, $V_{CE} = 10 \text{ Vdc}$) ($I_C = 150 \text{ mA}$, $V_{CE} = 10 \text{ Vdc}$)	2N722, 2N1132, A, B 2N2303 2N722, 2N1132, A, B 2N2303	h_{FE}	25 75 30 75	— — 90 200	—
Collector-Emitter Saturation Voltage ($I_C = 150 \text{ mA}$, $I_B = 15 \text{ mA}$)	All Types	$V_{CE(sat)}$	—	1.5	Vdc
Base-Emitter Saturation Voltage ($I_C = 150 \text{ mA}$, $I_B = 15 \text{ mA}$)	All Types	$V_{BE(sat)}$	—	1.3	Vdc
Output Capacitance ($V_{CB} = 10 \text{ Vdc}$, $I_E = 0$, $f = 100 \text{ kc}$) ($V_{CB} = 10 \text{ Vdc}$, $I_E = 0$, $f = 1 \text{ mc}$)	2N722, 2N1132, 2N2303 2N1132A, 2N1132B	C_{ob}	— —	45 30	pf
Input Capacitance ($V_{EB} = 0.5 \text{ Vdc}$, $I_E = 0$, $f = 100 \text{ kc}$)	All Types	C_{ib}	—	80	pf
Small-Signal Forward Current Transfer Ratio ($I_C = 1 \text{ mA}$, $V_{CE} = 5 \text{ Vdc}$, $f = 1 \text{ kc}$) ($I_C = 5 \text{ mA}$, $V_{CE} = 10 \text{ Vdc}$, $f = 1 \text{ kc}$)	2N722, 2N1132 2N1132A, 2N1132B 2N2303 2N722, 2N1132, A, B 2N2303	h_{fe}	25 25 75 30 75	100 75 300 — —	—
Current-Gain — Bandwidth Product ($I_C = 50 \text{ mA}$, $V_{CE} = 10 \text{ Vdc}$, $f = 20 \text{ mc}$)	All Types	f_T	60	—	mc
Small Signal Input Resistance ($I_C = 1 \text{ mA}$, $V_{CB} = 5 \text{ Vdc}$, $f = 1 \text{ kc}$) ($I_C = 5 \text{ mA}$, $V_{CB} = 10 \text{ Vdc}$, $f = 1 \text{ kc}$)	All Types	h_{ib}	25 —	35 10	ohms
Small Signal Output Admittance ($I_C = 1 \text{ mA}$, $V_{CE} = 5 \text{ Vdc}$, $f = 1 \text{ kc}$) ($I_C = 5 \text{ mA}$, $V_{CE} = 10 \text{ Vdc}$, $f = 1 \text{ kc}$)	All Types	h_{ob}	— —	1 5	μmhos
Small Signal Voltage Feedback Ratio ($I_C = 1 \text{ mA}$, $V_{CE} = 5 \text{ Vdc}$, $f = 1 \text{ kc}$) ($I_C = 5 \text{ mA}$, $V_{CE} = 10 \text{ Vdc}$, $f = 1 \text{ kc}$)	All Types	h_{rb}	— —	8 8	$\times 10^{-4}$

2N741, A

$V_{CBO} = 15-20 \text{ V}$
 $G_o = 16 \text{ db @ } 30 \text{ Mc}$
 $NF = 7 \text{ db @ } 30 \text{ Mc}$



CASE 22
(TO-18)

PNP germanium mesa transistors for oscillator, frequency multiplier and amplifier applications.

ABSOLUTE MAXIMUM RATINGS

Characteristic	Symbol	Type	Rating	Unit
Collector-Base Voltage	V_{CBO}	2N741 2N741A	15 20	Vdc
Collector-Emitter Voltage	V_{CEO}	2N741 2N741A	15 20	Vdc
Emitter-Base Voltage	V_{EBO}		1.0	Vdc
Collector Current (Continuous)	I_C		100	mAdc
Junction Temperature	T_J		100	°C
Storage Temperature	T_{stg}		-65 to +100	°C
Total Device Dissipation @ 25°C Case Temperature (Derate 4 mW/°C above 25°C)	P_D		300	mW
Total Device Dissipation @ 25°C Ambient Temperature (Derate 2 mW/°C)	P_D		150	mW

**POWER OUTPUT versus FREQUENCY,
CLASS C AMPLIFIER***
(See circuit below)

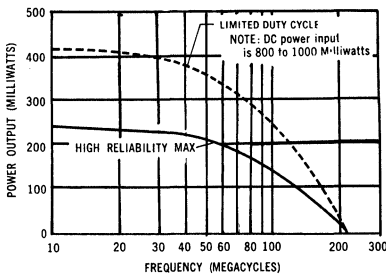

**POWER GAIN AND COMMON EMITTER CURRENT GAIN
versus FREQUENCY**

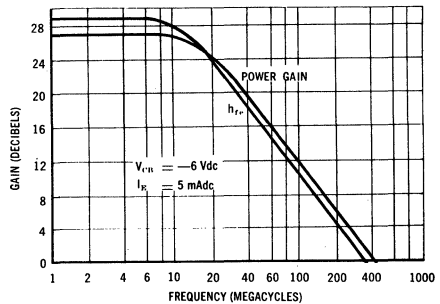

2N741,A (continued)

ELECTRICAL CHARACTERISTICS (at 25°C unless otherwise specified)

Characteristic	Symbol	Type	Min	Typ	Max	Unit
Collector-Base Breakdown Voltage $I_C = -100 \mu\text{Adc}$	BV_{CBO}	2N741 2N741A	15 20	—	—	Vdc
Emitter-Base Breakdown Voltage $I_C = 0, I_E = 100 \mu\text{Adc}$	BV_{EBO}		1.0	—	—	Vdc
Collector-Emitter Cutoff Current $V_{CE} = -15 \text{Vdc}, V_{EB} = 0$	I_{CES}	2N741	—	—	100	μAdc
Collector-Emitter Cutoff Current $V_{CE} = -20 \text{Vdc}, V_{EB} = 0$	I_{CES}	2N741A	—	—	100	μAdc
Collector Cutoff Current $V_{CB} = -6 \text{Vdc}, I_E = 0$	I_{CBO}		—	0.2	3	μAdc
Forward Current Transfer Ratio $V_{CE} = -6 \text{Vdc}, I_C = -5 \text{mAdc}$	h_{FE}		10	25	—	—
Small Signal Forward Current Transfer Ratio $V_{CE} = -6 \text{Vdc}, I_C = -5 \text{mAdc}, f = 1 \text{kc}$	h_{re}		20	—	—	—
Collector Output Capacitance $V_{CB} = -6 \text{Vdc}, I_E = 0, f = 100 \text{kc}$	C_{ob}		—	6	10	pf
Collector Capacitance $V_{CB} = -6 \text{Vdc}, I_E = 0, f = 100 \text{kc}$	C_e		—	3	—	pf
Input Impedance $V_{CB} = -6 \text{Vdc}, I_E = 5 \text{mAdc}, f = 1 \text{kc}$	h_{ib}		—	8	15	Ohms
Output Admittance $V_{CB} = -6 \text{Vdc}, I_E = 5 \text{mAdc}, f = 1 \text{kc}$	h_{ob}		—	45	—	μmhos
Frequency at Which Common-Emitter Current Gain is Unity $V_{CB} = -6 \text{Vdc}, I_E = 5 \text{mAdc}$	f_T	2N741 2N741A	— 300	360 360	—	mc
Base Resistance $V_{CB} = -6 \text{Vdc}, I_E = 5 \text{mAdc}, f = 300 \text{mc}$	r'_b	2N741 2N741A	— —	75 65	—	Ohms
Noise Figure $V_{CB} = -6 \text{Vdc}, I_E = 5 \text{mAdc}, f = 30 \text{mc}$	NF		—	7	—	db
Power Gain, Matched, Neutralized $V_{CB} = -6 \text{Vdc}, I_E = 5 \text{mAdc}, f = 30 \text{mc}$	PG_e		16	22	—	db
Power Output $V_{CB} = -6 \text{Vdc}, I_C = -60 \text{mAdc}$ $PG_e = 8 \text{db}, f = 30 \text{mc}$	P_o	2N741 2N741A	— —	200 250	—	mW
Power Output $V_{CB} = -6 \text{Vdc}, I_C = -60 \text{mAdc}$ $PG_e = 5 \text{db}, f = 70 \text{mc}$	P_o	2N741A	—	200	—	mW

2N744

$V_{CE0} = 12\text{ V}$
 $I_C = 200\text{ mA}$
 $f_T = 450\text{ Mc}$

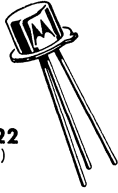

CASE 22
(TO-18)

NPN silicon annular transistor for high-speed switching applications.

ABSOLUTE MAXIMUM RATINGS

Characteristic	Symbol	Rating	Unit
Collector-Base Voltage	V_{CBO}	20	Vdc
Collector-Emitter Voltage*	V_{CEO}	12	Vdc
Emitter-Base Voltage	V_{EBO}	5	Vdc
Collector DC Current	I_C	200	mAdc
Total Device Dissipation at 25 C Case Temperature (Derate 6.67 mW/ C above 25 C)	P_D	1.0	Watt
Total Device Dissipation at 25 C Ambient Temperature (Derate 2 mW/ C above 25 C)	P_D	0.3	Watt
Junction Temperature	T_J	+200	C
Storage Temperature	T_{stg}	-65 to +300	C

*Refers to the voltage at which the magnitude of h_{FE} approaches one when the emitter base diode is open-circuited.

SWITCHING TIME TEST CIRCUIT

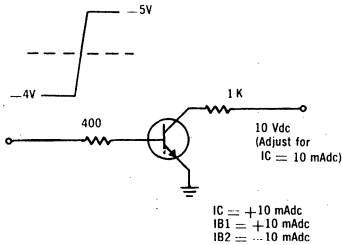

CHARGE STORAGE TEST CIRCUIT

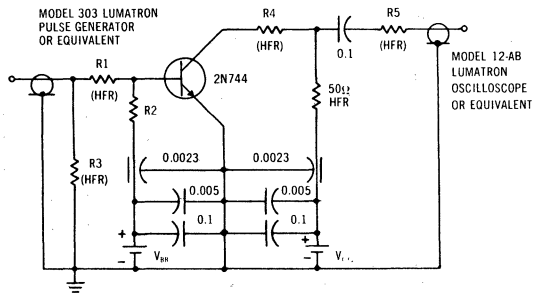

2N744 (continued)

ELECTRICAL CHARACTERISTICS (At 25°C unless otherwise noted)

Characteristic	Sym	Min	Typ	Max	Unit
Collector Cutoff Current ($V_{CE} = 20$ Vdc, $I_E = 0$) ($V_{CE} = 20$ Vdc, $I_B = 0$, $T_A = 170^\circ\text{C}$)	I_{CES}	—	.005	1.0 100	μAdc
Collector Cutoff Current ($V_{CE} = 10$ Vdc, $V_{BE} = 0.35$ Vdc, $T_A = 100^\circ\text{C}$)	I_{CEX}	—	—	30	μAdc
Emitter Cutoff Current ($V_{EB} = 5$ Vdc, $I_C = 0$)	I_{EBO}	—	—	10	μAdc
Collector-Emitter Breakdown Voltage ($I_C = 10$ mAdc, $I_B = 0$)*	BV_{CEO}	12	30	—	Vdc
Forward Current Transfer Ratio ($I_C = 1.0$ mAdc, $V_{CE} = 0.25$ Vdc) ($I_C = 10$ mAdc, $V_{CE} = 0.35$ Vdc) ($I_C = 10$ mAdc, $V_{CE} = 0.35$ Vdc, $T_A = -55^\circ\text{C}$) ($I_C = 100$ mAdc, $V_{CE} = 1.0$ Vdc)*	h_{FE}	20 40 20 20	— — — —	— 120 — —	—
Small Signal Forward Current Transfer Ratio ($I_C = 10$ mAdc, $V_{CE} = 10$ Vdc, $f = 100$ mc)	h_{fe}	2.8	4.5	—	—
Base-Emitter Voltage ($I_C = 10$ mAdc, $I_B = 1$ mAdc) ($I_C = 10$ mAdc, $I_B = 1$ mAdc, $T_A = -55^\circ\text{C}$) ($I_C = 100$ mAdc, $I_B = 10$ mAdc)* ($I_C = 100$ mAdc, $I_B = 10$ mAdc, $T_A = -55^\circ\text{C}$)*	V_{BE}	0.7	—	0.85 1.1 1.5 1.6	Vdc
Collector-Emitter Saturation Voltage ($I_C = 10$ mAdc, $I_B = 1$ mAdc, $T_A = 170^\circ\text{C}$) ($I_C = 100$ mAdc, $I_B = 10$ mAdc, $T_A = 170^\circ\text{C}$)*	$V_{CE(sat)}$	—	—	0.35 1.0	Vdc
Output Capacitance ($V_{CB} = 5$ Vdc, $I_E = 0$)	C_{ob}	—	3.0	5.0	pf
Turn-on Time (Condition 1) (Condition 2) (Condition 3) (Condition 4)	t_{on}	—	26 10 7 6	— 16 — 12	nsec
Turn-off Time (Condition 1) (Condition 2) (Condition 3) (Condition 4)	t_{off}	—	—	30 17 18 23	nsec
Charge Storage Time Constant ($I_C = 10$ mAdc, $I_{B1} = -I_{B2} = 10$ mAdc)	τ_s	—	—	18	nsec

* Pulse Test: Pulse width ≤ 300 μsec , duty cycle $\leq 2\%$

CONDITION	I_C mA	I_{B1} mA	I_{B2} mA	$V_{BE(off)}$ Vdc	V_{CC} Vdc	$R_1 = R_2$ Ω	R_3 Ω	R_4 Ω	R_5 Ω	t_{on}		t_{off}	
										V_{BB} V	V_{IN} V	V_{BB} V	V_{IN} V
1	3	1	-0.5	-0.9	3.4	6.8 K	50	1 K	0	-1.8	10.2	8.4	-10.2
2	10	3	-1.5	-1.5	3.0	3.3 K	50	220	0	-3.0	15.0	12.0	-15.0
3	50	15	-7.5	-1.8	4.0	680	50	18	1 K	-3.5	15.3	*11.7	-15.3
4	100	40	-20.0	-2.4	6.0	330	56	0	1 K	-4.5	20.0	*15.3	-20.0

* V_{BB} is pulsed for 1.5 sec @ less than 10% duty cycle

2N753

For Specifications, See 2N706 Data Sheet

2N827

$V_{CES} = 20 \text{ V}$
 $I_C = 100 \text{ mA}$
 $f_T = 350 \text{ Mc Typ}$



CASE 22
(TO-18)

PNP germanium mesa transistor for high-speed switching applications.

ABSOLUTE MAXIMUM RATINGS

Characteristic	Symbol	Rating	Unit
Collector-Base Voltage	V_{CBO}	20	Vdc
Collector-Emitter Voltage	V_{CES}	20	Vdc
Collector-Emitter Voltage	V_{CEX}	10	Vdc
Emitter-Base Voltage	V_{EBO}	4	Vdc
Collector Current (Continuous)	I_C	100	mAdc
Junction Temperature	T_J	+100	$^{\circ}\text{C}$
Storage Temperature	T_{stg}	-65 to +100	$^{\circ}\text{C}$
Device Dissipation @ 25 $^{\circ}\text{C}$ Ambient Temperature (Derate 2mW/ $^{\circ}\text{C}$ above 25 $^{\circ}\text{C}$)	P_D	150	mW

2N827 (continued)

ELECTRICAL CHARACTERISTICS (at 25°C unless otherwise specified)

Characteristic	Symbol	Min	Typ	Max	Unit
Collector-Base Breakdown Voltage ($I_C = 100 \mu\text{Adc}$, $I_E = 0$)	BV_{CBO}	20	22	---	Vdc
Collector-Emitter Breakdown Voltage ($I_C = 100 \mu\text{Adc}$, $V_{EB} = 0$)	BV_{CES}	20	22	---	Vdc
Emitter-Base Breakdown Voltage ($I_E = 100 \mu\text{Adc}$, $I_C = 0$)	BV_{EBO}	4	5	---	Vdc
Collector Latch-up Voltage	LV_{CEX}	10	---	---	Vdc
Collector-Emitter Cutoff Current ($V_{CE} = 15 \text{ Vdc}$, $V_{EB} = 0$)	I_{CES}	---	0.5	5	μAdc
Collector-Base Cutoff Current ($V_{CB} = 15 \text{ Vdc}$)	I_{CBO}	---	0.5	5	μAdc
DC Forward Current Transfer Ratio ($I_C = 10 \text{ mAdc}$, $V_{CE} = 0.3 \text{ Vdc}$)	h_{FE}	100	150	---	---
Collector-Emitter Saturation Voltage ($I_C = 10 \text{ mAdc}$, $I_B = 3.3 \text{ mAdc}$)	$V_{CE(sat)}$	---	0.16	0.25	Vdc
Base-Emitter Voltage ($I_C = 10 \text{ mAdc}$, $I_B = 3.3 \text{ mAdc}$)	V_{BE}	---	0.39	0.5	Vdc
Small-Signal Forward Current Transfer Ratio ($I_C = 10 \text{ mA}$, $V_{CE} = 1 \text{ V}$, $f = 100 \text{ mc}$)	h_{fe}	2.5	3.5	---	---
Collector Output Capacitance ($V_{CB} = 10 \text{ V}$, $I_E = 0$, $f = 1 \text{ mc}$)	C_{ob}	---	4	9	pf
Delay Time	t_d	---	10	15	nsec
Rise Time	t_r	---	10	20	nsec
Storage Time	t_s	---	15	30	nsec
Fall Time	t_f	---	15	30	nsec

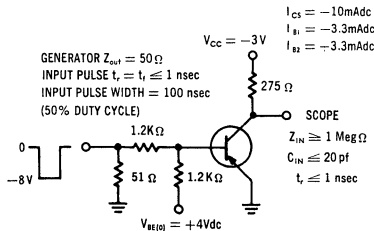

SWITCHING TIME TEST CIRCUIT

2N828

$V_{CES} = 15\text{ V}$
 $I_C = 200\text{ mA}$
 $f_T = 400\text{ Mc Typ}$



CASE 22
(TO-18)

PNP germanium epitaxial mesa transistor for high-speed switching applications.

ABSOLUTE MAXIMUM RATINGS

Characteristic	Symbol	Rating	Unit
Collector-Base Voltage	V_{CBO}	15	Vdc
Collector-Emitter Voltage	V_{CES}	15	Vdc
Emitter-Base Voltage	V_{EBO}	2.5	Vdc
Collector DC Current	I_C	200	mAdc
Junction Temperature	T_j	100	°C
Storage Temperature	T_{stg}	-65 to +100	°C
Total Device Dissipation at 25°C Case Temperature (Derate 4 mW/°C above 25°C)	P_D	300	mW
Total Device Dissipation at 25°C Ambient Temperature (Derate 2 mW/°C above 25°C)	P_D	150	mW

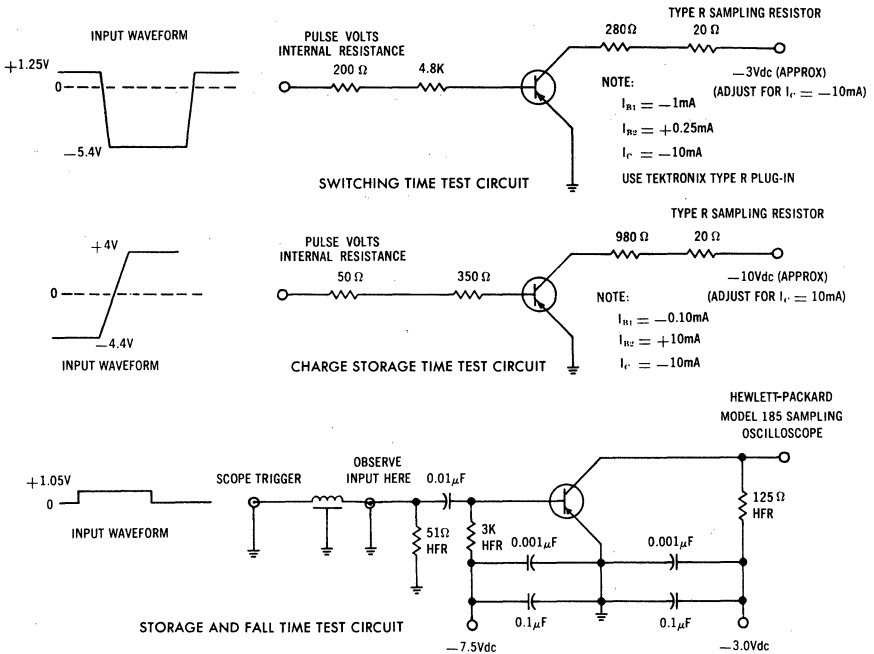

2N828 (continued)

ELECTRICAL CHARACTERISTICS (at 25°C unless otherwise specified)

Characteristic	Symbol	Min	Typ	Max	Unit
Collector-Base Breakdown Voltage $I_E = 0, I_C = -100 \mu\text{A dc}$	BV_{CBO}	15	25	—	Vdc
Collector-Emitter Breakdown Voltage $V_{EB} = 0, I_C = -100 \mu\text{A dc}$	BV_{CES}	15	25	—	Vdc
Collector-Emitter Breakdown Voltage $I_B = 0, I_C = -1 \text{ mA dc}$	BV_{CEO}	—	10	—	Vdc
Emitter-Base Breakdown Voltage $I_C = 0, I_E = -100 \mu\text{A dc}$	BV_{EBO}	2.5	—	—	Vdc
Collector Cutoff Current $I_E = 0, V_{CB} = -6 \text{ V dc}$	I_{CBO}	—	0.4	3	$\mu\text{A dc}$
Forward Current Transfer Ratio $I_C = -10 \text{ mA dc}, V_{CE} = -0.3 \text{ V dc}$	h_{FE}	25	40	—	—
Collector Saturation Voltage $I_C = -10 \text{ mA dc}, I_B = -1 \text{ mA dc}$	$V_{CE(sat)}$	—	0.12	0.2	Vdc
Collector Saturation Voltage $I_C = -50 \text{ mA dc}, I_B = -5 \text{ mA dc}$	$V_{CE(sat)}$	—	0.18	0.25	Vdc
Base-Emitter Voltage $I_C = -10 \text{ mA}$	$V_{BE(sat)}$	0.34	0.39	0.44	Vdc
Collector Capacitance $I_B = 0, V_{CB} = -10 \text{ V dc}$	C_{ob}	—	3.5	—	pf
Small-Signal Forward Current Transfer Ratio $I_C = -10 \text{ mA dc}, V_{CE} = -1 \text{ V dc}, f = 100 \text{ mc}$	h_{fe}	3	4	—	—
Current Gain-Bandwidth Product $V_{CE} = -1 \text{ V dc}, I_C = -10 \text{ mA dc}$	f_T	300	400	—	mc
Delay Plus Rise Time	$t_d + t_r$	—	50	70	nsec
Storage Time	t_s	—	33	50	nsec
Fall Time	t_f	—	35	50	nsec
Charge Storage Time Constant	τ_s	—	14	25	nsec
Rise Time	t_r	—	7	—	nsec
Storage Time	t_s	—	5	—	nsec
Fall Time	t_f	—	3	—	nsec

RISE TIME FACTOR

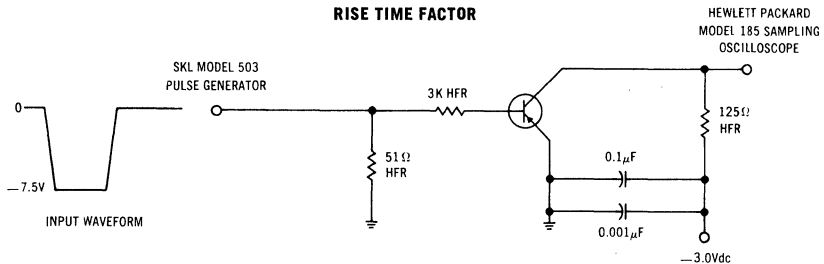

2N828A
2N829

$V_{CES} = 15 \text{ V}$
 $I_C = 200 \text{ mA}$
 $f_T = 300 \text{ Mc Min}$

PNP germanium epitaxial mesa transistors for high-speed switching applications

CASE 22
(TO-18)

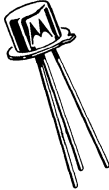

MAXIMUM RATINGS

Maximum Ratings	Symbol	Rating	Unit
Collector to Base Voltage	V_{CBO}	15	Vdc
Collector to Emitter Voltage	V_{CES}	15	Vdc
Emitter to Base Voltage	V_{EBO}	2.5	Vdc
Collector Current (Continuous)	I_C	200	mAdc
Total Device Dissipation at 25°C case Temperature (Derate 4.0mw/°C above 25°C)	P_D	300	mW
Total Device Dissipation at 25°C Ambient Temperature (Derate 2.0mw/°C)	P_D	150	mW
Junction Temperature	T_j	+100	°C
Storage Temperature	T_{stg}	-65 to +100	°C

2N828A, 2N829 (continued)

ELECTRICAL CHARACTERISTICS (at 25°C ambient temperature unless otherwise noted)

Characteristic	Symbol	Minimum	Typical	Maximum	Unit
Collector to Base Breakdown Voltage $I_E = 0, I_C = -100\mu\text{A dc}$	BV_{CBO}	15	25	--	Vdc
Collector to Emitter Breakdown Voltage $B_{EB} = 0, I_C = -100\mu\text{A dc}$	BV_{CES}	15	25	--	Vdc
Emitter to Base Breakdown Voltage $I_C = 0, I_E = -100\mu\text{A dc}$	BV_{EBO}	2.5	--	--	Vdc
Collector Cutoff Current $I_E = 0, V_{CB} = -6\text{Vdc}$	I_{CBO}	--	.4	3	$\mu\text{A dc}$
Forward Current Transfer Ratio $I_C = -10\text{mA dc}, V_{CE} = -.3\text{Vdc}$	h_{FE}			--	--
	2N828A	25	40		
	2N829	50	80		
Forward Current Transfer Ratio $I_C = -150\text{mA dc}, V_{CE} = -1\text{Vdc}$	h_{fe}			--	--
	2N828A	25	40		
	2N829	50	80		
Collector Saturation Voltage $I_C = -10\text{mA dc}, I_B = -1.0\text{mA dc}$	$V_{CE(sat)}$	--			Vdc
	2N828A		0.11	0.20	
$I_C = -10\text{mA dc}, I_B = -0.5\text{mA dc}$	2N829		0.11	0.20	
Collector Saturation Voltage $I_C = -50\text{mA dc}, I_B = -5.0\text{mA dc}$	$V_{CE(sat)}$	--	--	0.25	Vdc
Collector Saturation Voltage $I_C = -150\text{mA dc}, I_B = -15\text{mA dc}$	$V_{CE(sat)}$	--			Vdc
	2N828A		0.35	0.50	
$I_C = -150\text{mA dc}, I_B = -7.5\text{mA dc}$	2N829		0.38	0.50	
Base to Emitter Voltage $I_C = -10\text{mA dc}, I_B = -1\text{mA dc}$	V_{BE}				Vdc
	2N828A	0.34	0.40	0.44	
$I_C = -10\text{mA dc}, I_B = -0.5\text{mA dc}$	2N829	.30	0.38	0.44	
Base to Emitter Voltage $I_C = -150\text{mA dc}, I_B = -15\text{mA dc}$	V_{BE}	--			Vdc
	2N828A		0.70	0.85	
$I_C = -150\text{mA dc}, I_B = -7.5\text{mA dc}$	2N829		0.65	0.85	
Collector Capacitance $I_E = 0, V_{CB} = -6\text{Vdc}$	C_{ob}	--	2.2	4	pf

2N828A, 2N829 (continued)
ELECTRICAL CHARACTERISTICS (continued)

Characteristic	Symbol	Minimum	Typical	Maximum	Unit
Input Capacitance $V_{EB} = 1Vdc$	C_{ib}	--	2.2	3.5	pf
Small Signal Forward Current Transfer Ratio $I_C = -10mA_{dc}, V_{CE} = -1Vdc, f = 100mc$	h_{fe}	3.0	4.0	--	--
Current Gain Bandwidth Product $V_{CE} = -1Vdc, I_C = -10mA_{dc}, f = 100mc$	f_t	300	400	--	Mc
Delay Plus Rise Time (Fig. 1) $I_C = -10mA_{dc}$	t_d+t_r	--	35	50	nsec
Storage Time (Fig. 1) $I_C = -10mA_{dc}$	t_s	--	30	50	nsec
Fall Time (Fig. 1) $I_C = -10mA_{dc}$	t_f	--	30	50	nsec
Total Control Charge (Fig. 3) $I_C = -10mA_{dc}$	Q_T	--	50	80	pC
Delay Plus Rise Time (Fig. 2) $I_C = -150mA_{dc}$	t_d+t_r	--	25	50	nsec
Turn Off Time (Fig. 2) $I_C = -150mA_{dc}$	t_{off}	--	60	100	nsec
Total Control Charge (Fig. 4) $I_C = -150mA_{dc}$	Q_T	--	120	175	pC

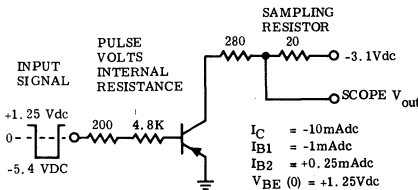

SCOPE INPUT IMPEDANCE = 1Megohm
 SCOPE INPUT CAPACITANCE = 20pf
 GENERATOR OUTPUT IMPEDANCE = 50 ohms
 INPUT PULSE $t_r = t_f = 2nsec$

10mA SWITCHING TIME TEST CIRCUIT
 FIGURE 1

*ADJUST V_{BB} FOR -5.4 VOLT PULSE AT POINT A

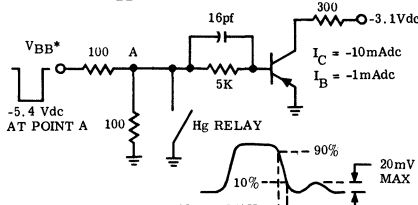

10mA TOTAL CONTROL CHARGE TEST CIRCUIT
 FIGURE 3

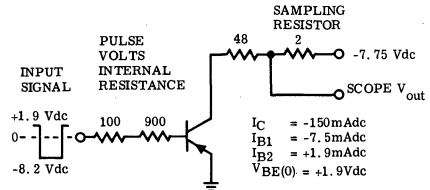

SCOPE INPUT IMPEDANCE = 1Megohm
 SCOPE INPUT CAPACITANCE = 20pf
 GENERATOR OUTPUT IMPEDANCE = 50 ohms
 INPUT PULSE $t_r = t_f = 2nsec$

150mA SWITCHING TIME TEST CIRCUIT
 FIGURE 2

*ADJUST V_{BB} FOR -8 VOLT PULSE AT POINT A

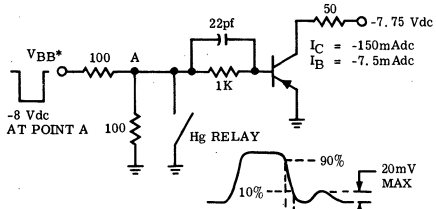

150mA TOTAL CONTROL CHARGE TEST CIRCUIT
 FIGURE 4

2N834
2N835

$V_{CES} = 20-30 \text{ V}$
 $I_C = 200 \text{ mA}$
 $f_T = 500 \text{ Mc Typ}$

CASE 22
(TO-18)



NPN silicon epitaxial mesa transistors for high-speed switching applications.

MAXIMUM RATINGS

Characteristic	Symbol	Type	Rating	Unit
Collector-Base Voltage	V_{CBO}	2N834	40	Vdc
		2N835	25	Vdc
Collector-Emitter Voltage	V_{CES}	2N834	30	Vdc
		2N835	20	Vdc
Emitter-Base Voltage	V_{EBO}	2N834	5	Vdc
		2N835	3	Vdc
Collector Current	I_C		200	mAdc
Junction Temperature	T_J		+175	°C
Storage Temperature	T_{stg}		-65 to +175	°C
Total Device Dissipation @ 25°C Case Temperature (Derate 6.67 mw/°C above 25°C)	P_D		1.0	Watt
Total Device Dissipation @ 100°C Case Temperature (Derate 6.67 mW/°C above 100°C)	P_D		0.5	Watt
Total Device Dissipation @ 25°C Ambient Temperature (Derate 2 mW/°C)	P_D		0.3	Watt

TURN-ON AND TURN-OFF TIME MEASUREMENT CIRCUIT

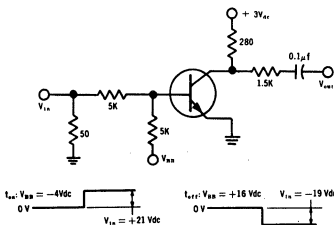

CHARGE STORAGE TIME CONSTANT MEASUREMENT CIRCUIT

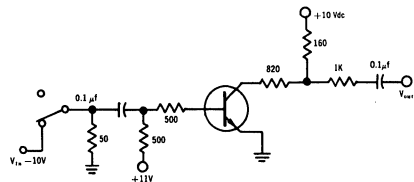

NOTE: ALL SWITCHING TIMES MEASURED WITH LUMATRON MODEL 420 SWITCHING TIME TEST SET OR EQUIVALENT.

2N834, 2N835 (continued)

ELECTRICAL CHARACTERISTICS (At 25°C unless otherwise noted)

Characteristic	Symbol	Type	Min	Typ	Max	Unit
Collector-Base Breakdown Voltage $I_B = 0, I_C = 10 \mu\text{A dc}$	BV_{CBO}	2N834 2N835	40 25	—	—	Vdc Vdc
Emitter-Base Breakdown Voltage $I_C = 0, I_E = 10 \mu\text{A dc}$	BV_{EBO}	2N834 2N835	5 3	—	—	Vdc Vdc
Collector Cutoff Current $V_{BE} = 0, V_{CE} = 30 \text{ Vdc}$	I_{CER}	2N834	—	—	10	$\mu\text{A dc}$
Collector Cutoff Current $V_{BE} = 0, V_{CE} = 20 \text{ Vdc}$	I_{CER}	2N835	—	—	10	$\mu\text{A dc}$
Collector Cutoff Current $I_E = 0, V_{CE} = 20 \text{ Vdc}$	I_{CBO}		—	0.01	0.5	$\mu\text{A dc}$
Collector Cutoff Current $I_B = 0, V_{CE} = 20 \text{ Vdc}, T_A = +150^\circ\text{C}$	I_{CBO}		—	6	30	$\mu\text{A dc}$
Forward Current Transfer Ratio (Note 1) $I_C = 10 \text{ mA dc}, V_{CE} = 1 \text{ Vdc}$	h_{FE}	2N834 2N835	25 20	40 40	—	—
Collector Saturation Voltage $I_C = 10 \text{ mA dc}, I_B = 1.0 \text{ mA dc}$	$V_{CE(sat)}$	2N834 2N835	—	0.15 0.18	0.25 0.30	Vdc Vdc
Collector Saturation Voltage (Note 1) $I_C = 50 \text{ mA dc}, I_B = 5.0 \text{ mA dc}$	$V_{CE(sat)}$	2N834 2N835	—	0.28 0.35	0.4 —	Vdc Vdc
Base-Emitter Saturation Voltage (Note 1) $I_C = 10 \text{ mA dc}, I_B = 1.0 \text{ mA dc}$	$V_{BE(sat)}$		—	0.74	0.9	Vdc
Collector Capacitance $I_B = 0, V_{CE} = 10 \text{ Vdc}, f = 100 \text{ kc}$	C_{cb}		—	2.8	4.0	pf
Small Signal Forward Current Transfer Ratio $I_C = 10 \text{ mA dc}, V_{CE} = 20 \text{ Vdc}, f = 100 \text{ mc}$	h_{fe}	2N834	3.5	5.0	—	—
Small Signal Forward Current Transfer Ratio $I_C = 10 \text{ mA dc}, V_{CE} = 15 \text{ Vdc}, f = 100 \text{ mc}$	h_{fe}	2N835	3.0	4.5	—	—
Current Gain-Bandwidth Product $V_{CE} = 20 \text{ Vdc}, I_C = 10 \text{ mA dc}, f = 100 \text{ mc}$	f_T	2N834	350	500	—	mc
Current Gain-Bandwidth Product $V_{CE} = 15 \text{ Vdc}, I_C = 10 \text{ mA dc}, f = 100 \text{ mc}$	f_T	2N835	300	450	—	mc
Charge-Storage Time Constant (Figure 2; Note 2)	τ_s	2N834 2N835	—	14 16	25 35	nsec nsec
Turn-on Time (Figure 1; Note 3)	t_{on}	2N834 2N835	—	10 11	16 20	nsec nsec
Turn-off Time (Figure 1; Note 3)	t_{off}	2N834 2N835	—	16 20	30 35	nsec nsec

Note 1 — Pulsed Conditions
Pulse length $\leq 12 \text{ msec}$
Duty Cycle $\leq 2\%$

Note 2 — $I_C = 10 \text{ mA}$
 $I_{B1} = I_{B2} = 10 \text{ mA}$

Note 3 — $I_C = 10 \text{ mA}$
 $I_{B1} = 3 \text{ mA}$
 $I_{B2} = 1 \text{ mA}$

RISE TIME FACTOR

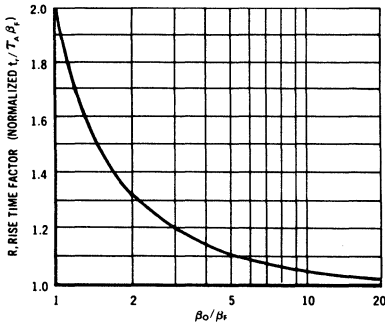

NORMALIZED CURRENT GAIN CHARACTERISTICS

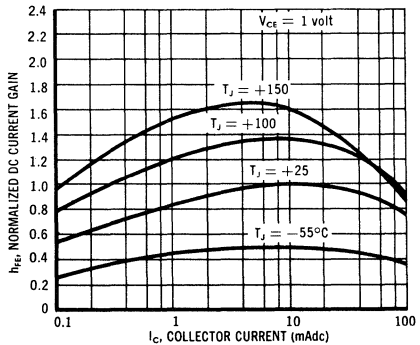

2N838



CASE 22
(TO-18)

PNP germanium epitaxial mesa transistor for high-speed switching applications.

$V_{CES} = 30\text{ V}$
 $I_C = 100\text{ mA}$
 $f_T = 300\text{ Mc}$

ABSOLUTE MAXIMUM RATINGS

Characteristic	Symbol	Rating	Unit
Collector-Base Voltage	V_{CBO}	30	Vdc
Collector-Emitter Voltage	V_{CES}	30	Vdc
Collector-Emitter Voltage (see Figure 2)	V_{CEX}	15	Vdc
Emitter-Base Voltage	V_{EBO}	2.5	Vdc
Collector Current (Continuous)	I_C	100	mAdc
Junction Temperature	T_J	+100	$^{\circ}\text{C}$
Storage Temperature	T_{stg}	-65 to + 100	$^{\circ}\text{C}$
Device Dissipation @ 25 $^{\circ}\text{C}$ Ambient Temperature (Derate 2mW/ $^{\circ}\text{C}$ above 25 $^{\circ}\text{C}$)	P_D	150	mW

AREA OF PERMISSIBLE LOAD LOC1

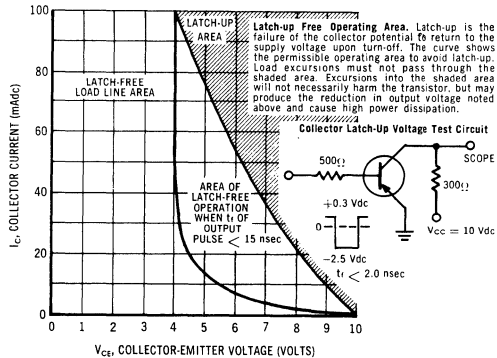

SWITCHING TIME TEST CIRCUIT

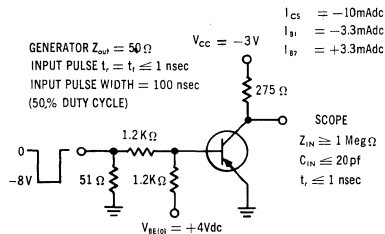

2N838 (continued)

ELECTRICAL CHARACTERISTICS (At 25°C unless otherwise noted)

Characteristic	Symbol	Min	Typ	Max	Unit
Collector-Base Breakdown Voltage ($I_C = 100 \mu\text{A}$, $I_E = 0$)	BV_{CBO}	30	35	---	Vdc
Collector-Emitter Breakdown Voltage ($I_C = 100 \mu\text{A}$, $V_{EB} = 0$)	BV_{CES}	30	35	---	Vdc
Emitter-Base Breakdown Voltage ($I_E = 100 \mu\text{A}$, $I_C = 0$)	BV_{EBO}	2.5	4.5	---	Vdc
Collector Latch-up Voltage (see Figure 2)	LV_{CEX}	15	---	---	Vdc
Collector-Emitter Cutoff Current ($V_{CE} = 15\text{ Vdc}$, $V_{EB} = 0$)	I_{CES}	---	1	10	μA
Collector-Base Cutoff Current ($V_{CB} = 15\text{ V}$)	I_{CBO}	---	1	10	μA
DC Forward Current Transfer Ratio ($I_C = 10\text{mA}$, $V_{CE} = 0.3\text{ Vdc}$)	h_{FE}	30	70	---	---
Collector-Emitter Saturation Voltage ($I_C = 10\text{ mA}$, $I_B = 3.3\text{ mA}$)	$V_{CE(sat)}$	---	0.1	0.18	Vdc
Base-Emitter Voltage ($I_C = 10\text{ mA}$, $I_B = 3.3\text{ mA}$)	V_{BE}	---	0.39	0.5	Vdc
Small-Signal Forward Current Transfer Ratio ($I_C = 10\text{ mA}$, $V_{CE} = 1\text{V}$, $f = 100\text{ mc}$)	h_{fe}	3	4.5	---	---
Collector Output Capacitance ($V_{CB} = 10\text{ V}$, $I_E = 0$, $f = 1\text{ mc}$)	C_{ob}	---	2	4	pf
Delay Time	t_d	---	10	15	nsec
Rise Time	t_r	---	7	15	nsec
Storage Time	t_s	---	10	20	nsec
Fall Time	t_f	---	10	20	nsec

2N869
2N995



$V_{CBO} = 20\text{-}25\text{ V}$
 $f_T = 300\text{ Mc Typ}$

CASE 22
(TO-18)

PNP silicon annular transistors for high-frequency general-purpose amplifier applications.

ABSOLUTE MAXIMUM RATINGS

Characteristics	Symbol	Type	Rating	Unit
Base Voltage	V_{CBO}	2N869	25	Volts
		2N995	20	Volts
Collector-Emitter Voltage	V_{CEO}	2N869	18	Volts
		2N995	15	Volts
Emitter-Base Voltage	V_{EBO}	2N869	5	Volts
		2N995	4	Volts
Total Device Dissipation at 25°C Case Temperature at 100°C Case Temperature (Derate 6.86 mW/°C above 25°C)	P_D	Both	1.2	Watts
		Types	0.68	Watt
Total Device Dissipation at 25°C Ambient Temperature (Derate 2.06 mW/°C above 25°C)	P_D	Both	0.36	Watt
		Types		
Storage Temperature	T_{stg}	Both Types	-65 to +200	°C
Junction Temperature	T_j	Both Types	+200	°C

2N869, 2N995 (continued)

ELECTRICAL CHARACTERISTICS (At 25°C unless otherwise noted)

Characteristics	Symbol	Min	Typ	Max	Unit
Collector-Base Breakdown Voltage ($I_C = 10 \mu\text{Adc}$, $I_E = 0$) 2N869 2N995	BV_{CBO}	25 20	---	---	Volts
Collector-Emitter Sustaining Voltage * ($I_C = 10 \text{ mAdc}$, $I_B = 0$) 2N869 2N995	$V_{CEO}(\text{sust})^*$	18 15	---	---	Volts
Emitter-Base Breakdown Voltage ($I_E = 10 \mu\text{Adc}$, $I_C = 0$) 2N869 2N995	BV_{EBO}	5 4	---	---	Volts
Collector Cutoff Current ($V_{CB} = -15 \text{ Vdc}$, $I_E = 0$) 2N869 2N995 ($V_{CB} = -15 \text{ Vdc}$, $I_E = 0$, $T_A = 150^\circ\text{C}$) Both Types	I_{CBO}	---	---	.010 .005 25	μAdc
Emitter Current ($V_{EB} = 4.0 \text{ Vdc}$, $I_C = 0$) 2N995	I_{EBO}	---	---	10	μAdc
Collector Saturation Voltage ($I_C = 10 \text{ mAdc}$, $I_B = 1.0 \text{ mAdc}$) ($I_C = 20 \text{ mAdc}$, $I_B = 2.0 \text{ mAdc}$) 2N869 2N995	$V_{CE}(\text{sat})$	---	0.17 ---	1.0 0.2	Volt
Base Saturation Voltage ($I_C = 10 \text{ mAdc}$, $I_B = 1.0 \text{ mAdc}$) ($I_C = 20 \text{ mAdc}$, $I_B = 2.0 \text{ mAdc}$) 2N869 2N995	$V_{BE}(\text{sat})$	---	0.78 ---	1.0 0.95	Volt
DC Forward-Current Transfer Ratio * ($I_C = 10 \text{ mAdc}$, $V_{CE} = -5.0 \text{ Vdc}$) ($I_C = 1.0 \text{ mAdc}$, $V_{CE} = -1.0 \text{ Vdc}$) ($I_C = 20 \text{ mAdc}$, $V_{CE} = -1.0 \text{ Vdc}$) ($I_C = 50 \text{ mAdc}$, $V_{CE} = -1.0 \text{ Vdc}$) 2N869 2N995 2N995 2N995	h_{FE}^*	20 25 35 25	---	120 ---	---
Open-Circuit Output Capacitance ($V_{CB} = -10 \text{ V}$, $I_E = 0$) 2N869 2N995	C_{ob}	---	3 3	9 10	pf
Open-Circuit Input Capacitance ($V_{EB} = -0.5 \text{ V}$, $I_C = 0$) Both Types	C_{ib}	---	7	11	pf
Small-Signal Forward-Current Transfer Ratio ($I_C = 10 \text{ mA}$, $V_{CE} = -15 \text{ V}$, $f = 100 \text{ Mc}$) ($I_C = 10 \text{ mA}$, $V_{CE} = -10 \text{ V}$, $f = 100 \text{ Mc}$) 2N869 2N995	h_{fe}	1.0 1.0	3.0 3.0	---	---

*Pulse Note: Pulse Width = 300 μsec , Duty Cycle = 1%

2N914

$V_{CE0} = 15\text{ V}$
 $f_T = 500\text{ Mc Typ}$

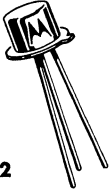

NPN silicon annular transistor for high-speed switching applications.

CASE 22
(TO-18)

ABSOLUTE MAXIMUM RATINGS

Characteristic	Symbol	Rating	Unit
Collector-Base Voltage	V_{CBO}	40	Vdc
Collector-Emitter Voltage	V_{CEO}	15	Vdc
Collector-Emitter Voltage ($R_{BE} \leq 10\ \Omega$)	V_{CER}	20	Vdc
Emitter-Base Voltage	V_{EBO}	5	Vdc
Operating Junction Temperature	T_J	200	$^{\circ}\text{C}$
Storage Temperature	T_{stg}	-65 to +300	$^{\circ}\text{C}$
Lead Temperature (Soldering, no limit)		300	$^{\circ}\text{C}$
Total Device Dissipation at 25 $^{\circ}\text{C}$ Case Temperature (derate 6.9 mW/ $^{\circ}\text{C}$)	P_D	1.2	Watts
Total Device Dissipation at 25 $^{\circ}\text{C}$ Ambient Temperature (derate 2.06 mW/ $^{\circ}\text{C}$)	P_D	0.36	Watt

CHARGE STORAGE TIME CONSTANT TEST CIRCUIT

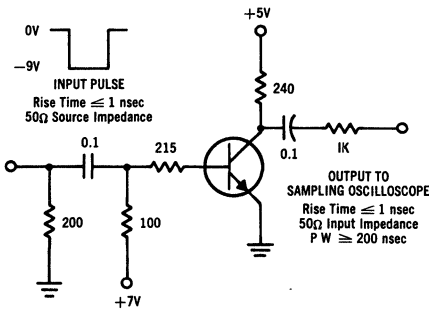

T_{on} and T_{off} TEST CIRCUIT

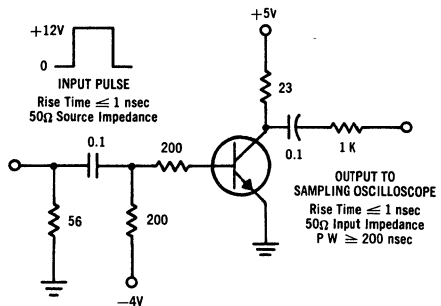

2N914 (continued)

ELECTRICAL CHARACTERISTICS (At 25° unless otherwise specified.)

Characteristic	Symbol	Min	Typ	Max	Unit
Collector Cutoff Current ($V_{CB} = 20\text{ V}$, $I_E = 0$) ($V_{CB} = 20\text{ V}$, $I_E = 0$, $T_A = 150^\circ\text{C}$)	I_{CBO}	— —	4.0 3.0	25 15	nA μA
Emitter Cutoff Current ($V_{EB} = 4.0\text{ V}$, $I_C = 0$)	I_{EBO}	—	—	0.1	μA
Collector Current ($V_{BE} = 0.25\text{ V}$, $V_{CE} = 20\text{ V}$, $T_A = 125^\circ\text{C}$)	I_{CEX}	—	—	10	μA
Collector-Base Breakdown Voltage ($I_C = 1.0\ \mu\text{A}$, $I_E = 0$)	BV_{CBO}	40	—	—	Volts
Emitter-Base Breakdown Voltage ($I_E = 10\ \mu\text{A}$, $I_C = 0$)	BV_{EBO}	5.0	—	—	Volts
Collector-Emitter Sustaining Voltage (Note 1) ($I_C = 30\text{ mA}$ (pulsed), $R_{FE} \leq 10\text{ ohms}$)	$V_{CER(sust)}$	20	—	—	Volts
Collector-Emitter Sustaining Voltage (Note 1) ($I_C = 30\text{ mA}$ (pulsed), $I_B = 0$)	$V_{CEO(sust)}$	15	—	—	Volts
Base Saturation Voltage ($I_C = 10\text{ mA}$, $I_B = 1.0\text{ mA}$)	$V_{BE(sat)}$	0.70	0.74	0.80	Volts
Collector Saturation Voltage ($I_C = 200\text{ mA}$, $I_B = 20\text{ mA}$) ($I_C = 10\text{ mA}$, $T_A = -55^\circ\text{C}$ to $+125^\circ\text{C}$) (Note 3)	$V_{CE(sat)}$	— —	0.40 0.14	0.70 0.25	Volts
DC Forward Current Transfer Ratio (Note 2) ($I_C = 10\text{ mA}$, $V_{CE} = 1.0\text{ V}$) ($I_C = 10\text{ mA}$, $V_{CE} = 1.0\text{ V}$, $T_A = -55^\circ\text{C}$) ($I_C = 500\text{ mA}$, $V_{CE} = 5.0\text{ V}$)	h_{FE}	30 12 10	60 35 20	120 — —	—
Output Capacitance ($V_{CB} = 10\text{ V}$, $I_E = 0$)	C_{ob}	—	2.8	6.0	pf
Small Signal Forward Current Transfer Ratio ($V_{CE} = 10\text{ V}$, $I_C = 20\text{ mA}$, $f = 100\text{ mc}$)	h_{fe}	3.0	5.0	—	—
Charge Storage Time Constant (Note 4) ($I_C = I_{B1} = I_{B2} = 20\text{ mA}$)	τ_s	—	10	20	nsec
Turn-on Time (See Note 4) ($I_C = 200\text{ mA}$, $I_{B1} = 40\text{ mA}$, $I_{B2} = 20\text{ mA}$)	t_{d+r}	—	20	40	nsec
Turn-off Time (See Note 4) ($I_C = 200\text{ mA}$, $I_{B1} = 40\text{ mA}$, $I_{B2} = 20\text{ mA}$)	t_{r+f}	—	25	40	nsec

NOTE 1. Rating refers to a high-current point where collector-emitter voltage is lowest.

NOTE 2. Pulse Conditions: Length = 300 μsec ; duty cycle $\leq 1\%$.

NOTE 3. $I_C = 1.0\text{ mA}$ through 20 mA

NOTE 4. Measured on Sampling Scope. $PW \geq 200\text{ nsec}$.

2N915

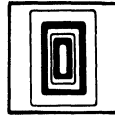

$V_{CEO} = 50 \text{ V}$
 $h_{FE} = 50$
 $f_T = 400 \text{ Mc Typ}$

CASE 22
(TO-18)



NPN silicon annular transistor for high-frequency amplifier, oscillator and switching applications.

MAXIMUM RATINGS

Characteristic	Symbol	Maximum	Unit
Collector-Base Voltage	V_{CBO}	70	Vdc
Collector-Emitter Voltage	V_{CEO}	50	Vdc
Emitter-Base Voltage	V_{EBO}	5	Vdc
Total Device Dissipation @ 25°C Case Temperature Derating Factor Above 25°C	P_D	1.2 6.9	W mW/°C
Total Device Dissipation @ 25°C Ambient Temperature Derating Factor Above 25°C	P_D	.36 2.06	W mW/°C
Junction Temperature, Operating	T_J	+200	°C
Storage Temperature Range	T_{stg}	-65 to +300	°C

2N915 (continued)

ELECTRICAL CHARACTERISTICS

Characteristic	Symbol	Minimum	Maximum	Unit
Collector Cutoff Current $I_E = 0 \quad V_{CB} = 60V$	I_{CBO}		10	nA
Collector Cutoff Current @ 150°C $I_E = 0 \quad V_{CB} = 60V$	I_{CBO}		30	μA
Collector Breakdown Voltage $I_C = 100 \mu A \quad I_E = 0$	BV_{CBO}	70		Volts
Collector to Emitter Sustaining Voltage $I_C = 10mA \quad I_B = 0$	$*V_{CEO}$	50		Volts
Emitter Breakdown Voltage $I_C = 0 \quad I_E = 100 \mu A$	BV_{EBO}	5.0		Volts
Base Saturation Voltage $I_C = 10mA \quad I_B = 1.0mA$	$V_{BE(sat)}$		0.9	Volts
Collector Saturation Voltage $I_C = 10mA \quad I_B = 1.0mA$	$V_{CE(sat)}$		1.0	Volts
DC Pulse Current Gain $I_C = 10mA \quad V_{CE} = 5.0V$	h_{FE}	50	200	
Output Capacitance $I_E = 0 \quad V_{CB} = 10V$	C_{ob}		3.5	pf
Emitter Transition Capacitance $I_C = 0 \quad V_{EB} = 0.5V$	C_{TE}		10	pf
High Frequency Current Gain $f = 100mc$ $I_C = 10mA \quad V_{CE} = 15V$	h_{fe}	2.5		
Small Signal Current Gain $f = 1kc$ $I_C = 1.0mA \quad V_{CE} = 5.0V$ $I_C = 5.0mA \quad V_{CE} = 5.0V$	h_{fe}	40 50	200 250	
Input Resistance $f = 1kc$ $I_C = 1.0mA \quad V_{CE} = 5.0V$ $I_C = 5.0mA \quad V_{CE} = 5.0V$	h_{ie}		6000 2000	ohms ohms
Output Conductance $f = 1kc$ $I_C = 1.0mA \quad V_{CE} = 5.0V$ $I_C = 5.0mA \quad V_{CE} = 5.0V$	h_{oe}		75 125	μmho μmho

*pw = 300 μs
duty cycle $\leq 1\%$

2N916



CASE 22
(TO-18)

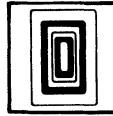

$V_{CE0} = 25\text{ V}$
 $h_{FE} = 50$
 $f_T = 400\text{ Mc Typ}$

NPN silicon annular transistor for high-frequency amplifier, oscillator and switching applications.

MAXIMUM RATINGS

Characteristic	Symbol	Maximum	Unit
Collector-Base Voltage	V_{CBO}	45	Vdc
Collector-Emitter Voltage	V_{CEO}	25	Vdc
Emitter-Base Voltage	V_{EBO}	5	Vdc
Total Device Dissipation @ 25°C Case Temperature Derating Factor Above 25°C	P_D	1.2 6.9	W mW/°C
Total Device Dissipation @ 25°C Ambient Temperature Derating Factor Above 25°C	P_D	.36 2.06	W mW/°C
Junction Temperature, Operating	T_J	+200	°C
Storage Temperature Range	T_{stg}	-65 to +300	C

ELECTRICAL CHARACTERISTICS

Characteristic	Symbol	Minimum	Maximum	Unit
Collector Cutoff Current $I_E = 0$ $V_{CB} = 30\text{V}$	I_{CBO}		10	nA
Collector Cutoff Current @150°C $I_E = 0$ $V_{CB} = 30\text{V}$	I_{CBO}		10	μA
Collector Breakdown Voltage $I_C = 10\mu\text{A}$ $I_E = 0$	BV_{CBO}	45		Volts
Collector to Emitter Sustaining Voltage $I_C = 30\text{mA}$ $I_B = 0$	* V_{CEO}	25		Volts
Emitter Breakdown Voltage $I_C = 0$ $I_E = 10\mu\text{A}$	BV_{EBO}	5.0		Volts
Base Saturation Voltage $I_C = 10\text{mA}$ $I_B = 1.0\text{mA}$	$V_{BE(sat)}$		0.9	Volts
Collector Saturation Voltage $I_C = 10\text{mA}$ $I_B = 1.0\text{mA}$	$V_{CE(sat)}$		0.5	Volts
DC Pulse Current Gain $I_C = 10\text{mA}$ $V_{CE} = 1.0\text{V}$	* h_{FE}	50	200	
Output Capacitance $I_E = 0$ $V_{CB} = 5.0\text{V}$	C_{ob}		6.0	pf
Emitter Transition Capacitance $I_C = 0$ $V_{EB} = 0.5\text{V}$	C_{TE}		10	pf
High Frequency Current Gain $f = 100\text{mc}$ $I_C = 10\text{mA}$ $V_{CE} = 15\text{V}$	h_{fe}	3.0		
Small Signal Current Gain $f = 1\text{kc}$ $I_C = 1.0\text{mA}$ $V_{CE} = 5.0\text{V}$ $I_C = 5.0\text{mA}$ $V_{CE} = 5.0\text{V}$	h_{fe}	40 50	200 250	
Input Resistance $f = 1\text{kc}$ $I_C = 1.0\text{mA}$ $V_{CE} = 5.0\text{V}$ $I_C = 5.0\text{mA}$ $V_{CE} = 5.0\text{V}$	h_{ie}		6000 2000	ohms ohms
Output Conductance $f = 1\text{kc}$ $I_C = 1.0\text{mA}$ $V_{CE} = 5.0\text{V}$ $I_C = 5.0\text{mA}$ $V_{CE} = 5.0\text{V}$	h_{oe}		75 125	μmho μmho

* $p_w = 300\mu\text{s}$ duty cycle $\leq 1\%$

2N918



$G_e = 15 \text{ db @ 200 Mc}$
 $NF = 6 \text{ db @ 60 Mc max}$
 $P_o = 30 \text{ mW @ 500 Mc min}$

CASE 22
(TO-18)

NPN silicon annular transistor for ultra-high frequency oscillator and amplifier applications.

MAXIMUM RATINGS

Characteristic	Symbol	Rating	Unit
Collector-Base Voltage	V_{CBO}	30	Volts
Collector-Emitter Voltage	V_{CEO}	15	Volts
Emitter-Base Voltage	V_{EBO}	3.0	Volts
Total Dissipation at 25°C Case Temperature at 25°C Ambient Temperature	P_D	0.3 0.2	Watt Watt
Operating Junction Temperature	T_J	+200	°C
Storage Temperature	T_{stg}	-65 to +300	°C

ELECTRICAL CHARACTERISTICS (at 25°C unless otherwise specified)

Characteristic	Symbol	Test Conditions	Min	Typ	Max	Unit
Collector Cutoff Current	I_{CBO}	$V_{CB} = 15 \text{ V}, I_E = 0$	-	-	10	nA
		$V_{CB} = 15 \text{ V}, 150 \text{ C}, I_E = 0$	-	-	1.0	μA
Collector-Base Breakdown Voltage	BV_{CBO}	$I_C = 1.0 \text{ μA}, I_E = 0$	30	-	-	Volts
Emitter-Base Breakdown Voltage	BV_{EBO}	$I_C = 10 \text{ μA}, I_C = 0$	3	-	-	Volts
Collector-Emitter Voltage	BV_{CEO}	$I_C = 3 \text{ mA}$	15	-	-	Volts
DC Current Gain	h_{FE}	$V_{CE} = 1.0 \text{ V}, I_C = 3.0 \text{ mA}$	20	50	-	-
Collector-Emitter Saturation Voltage	$V_{CE(sat)}$	$I_C = 10 \text{ mA}, I_B = 1.0 \text{ mA}$	-	-	0.4	Volt
Base-Emitter Saturation Voltage	$V_{BE(sat)}$	$I_C = 10 \text{ mA}, I_B = 1.0 \text{ mA}$	-	-	1.0	Volt
Output Capacitance	C_{ob}	$V_{CB} = 10 \text{ V}$ $I_E = 0, f = 140 \text{ kc}$	-	-	1.7	pf
		$V_{CB} = 0, f = 140 \text{ kc}$ $I_E = 0$	-	-	3.0	pf
Input Capacitance	C_{ib}	$V_{EB} = 0.5 \text{ V}$ $I_C = 0$	-	-	2.0	pf
Small Signal Current Gain	h_{fe}	$I_C = 4.0 \text{ mA}$ $V_{CE} = 10 \text{ V}$ $f = 100 \text{ mc}$	6.0	9.0	-	-
Amplifier Power Gain	G_e	$I_C = 6.0 \text{ mA}$ $V_{CB} = 12 \text{ V}$ $f = 200 \text{ mc}$ $R_G = R_L = 50 \text{ Ω}$	15	-	-	db
Power Output	P_{out}	$I_C = 8.0 \text{ mA}$ $V_{CB} = 15 \text{ V}$ $f = 500 \text{ mc}$	30	-	-	mW
Collector Efficiency	eff	$V_{CB} = 15 \text{ V}$ $f = 500 \text{ mc}$ $I_C = 8.0 \text{ mA}$	25	-	-	%
Noise Figure	NF	$I_C = 1.0 \text{ mA}$ $V_{CE} = 6.0 \text{ V}$ $f = 60 \text{ mc}$ $R_G = 400 \text{ Ω}$	-	3	6	db

2N929
2N930

$V_{CEO} = 45 \text{ V}$
NF = 3-4 db @ 10 cps to 15.7 Kc 1

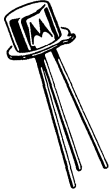

CASE 22
(TO-18)

NPN silicon annular transistors for low-level, low-noise amplifier applications.

MAXIMUM RATINGS

Characteristic	Symbol	Rating	Unit
Collector-Emitter Voltage	V_{CEO}	45	Vdc
Emitter-Base Voltage	V_{EBO}	5	Vdc
Collector Current	I_C	.030	Adc
Total Device Dissipation @ $T_A = 25^\circ\text{C}$	P_D	0.3	Watt
Derating Factor above 25°C		2.0	mW/ $^\circ\text{C}$
Total Device Dissipation @ $T_C = 25^\circ\text{C}$	P_D	0.6	Watt
Derating Factor above 25°C		4.0	mW/ $^\circ\text{C}$
Junction Temperature, Op.	T_J	175	$^\circ\text{C}$
Storage Temperature Range	T_{stg}	-65 to +300	$^\circ\text{C}$

2N929, 2N930 (continued)

ELECTRICAL CHARACTERISTICS (At 25°C unless otherwise noted)

Characteristic	Symbol	Minimum	Maximum	Unit
Collector-Emitter Breakdown Voltage* $I_C = 10 \text{ mA}, I_B = 0$	BV_{CEO}	45		V
Emitter-Base Breakdown Voltage $I_E = 10 \text{ nA}, I_C = 0$	BV_{EBO}	5		V
Collector-Base Cutoff Current $V_{CB} = 45 \text{ V}, I_E = 0$	I_{CBO}		.010	μA
Collector-Emitter Cutoff Current $V_{CE} = 45 \text{ V}, V_{EB} = 0$ $V_{CE} = 45 \text{ V}, V_{EB} = 0, T_A = 170^\circ\text{C}$	I_{CES}		.010 10	μA
Collector-Emitter Cutoff Current $V_{CE} = 5 \text{ V}, I_B = 0$	I_{CEO}		.002	μA
Emitter-Base Cutoff Current $V_{EB} = 5 \text{ V}, I_C = 0$	I_{EBO}		.010	μA
DC Forward Current Transfer Ratio $I_C = 10 \mu\text{A}, V_{CE} = 5 \text{ V}$ $I_C = 10 \mu\text{A}, V_{CE} = 5 \text{ V}, T_A = -55^\circ\text{C}$ $I_C = 500 \mu\text{A}, V_{CE} = 5 \text{ V}$ $I_C = 10 \text{ mA}, V_{CE} = 5 \text{ V}^*$	h_{FE}	2N929 2N930 2N929 2N930 2N929 2N930 2N929 2N930	40 100 10 20 60 150	120 300
Collector-Emitter Saturation Voltage* $I_C = 10 \text{ mA}, I_B = .5 \text{ mA}$	$V_{CE(sat)}$		1.0	V
Base-Emitter Voltage* $I_C = 10 \text{ mA}, I_B = .5 \text{ mA}$	V_{BE}	0.6	1.0	V
Output Capacitance $V_{CB} = 5 \text{ V}, I_E = 0, f = 1 \text{ mc}$	C_{ob}		8.0	pf
High-Frequency Current Gain $I_C = 500 \mu\text{A}, V_{CE} = 5 \text{ V}, f = 30 \text{ mc}$	h_{fe}	1.0		
Small-Signal Current Gain $I_C = 1.0 \text{ mA}, V_{CE} = 5 \text{ V}, f = 1 \text{ kc}$	h_{fe}	2N929 2N930	60 150	350 600
Input Resistance $I_C = 1.0 \text{ mA}, V_{CB} = 5 \text{ V}, f = 1 \text{ kc}$	h_{ib}	25	32	ohms
Output Conductance $I_C = 1.0 \text{ mA}, V_{CB} = 5 \text{ V}, f = 1 \text{ kc}$	h_{ob}		1.0	μmho
Voltage Feedback Ratio $I_C = 1.0 \text{ mA}, V_{CB} = 5 \text{ V}, f = 1 \text{ kc}$	h_{rb}		600	$\times 10^{-6}$
Noise Figure $I_C = 10 \mu\text{A}, V_{CE} = 5 \text{ V}, f = 10 \text{ cps to } 15.7 \text{ kc}, R = 10 \text{ K}\Omega$	NF	2N929 2N930	4.0 3.0	db

*Pulse Conditions: Width $\leq 300 \mu\text{sec}$
Duty Cycle $\leq 2\%$

2N956

For Specifications, See 2N718A Data Sheet

2N960

2N961

2N962

2N964

2N965

2N966



CASE 22
(TO-18)

$V_{CE} = 12-15 \text{ V}$
 $I_C = 100 \text{ mA}$
 $f_T = 460 \text{ Mc}$

PNP germanium epitaxial mesa transistors for high-speed switching applications.

MAXIMUM RATINGS

Characteristic	Symbol	2N960 2N964	2N961 2N965	2N962 2N966	Unit
Collector-Base Voltage	V_{CBO}	15	12	12	Vdc
Collector-Emitter Voltage	V_{CES}	15	12	12	Vdc
Emitter-Base Voltage	V_{EBO}	2.5	2.0	1.25	Vdc
Junction Temperature	T_j	100			$^{\circ}\text{C}$
Storage Temperature	T_{stg}	-65 to +100			$^{\circ}\text{C}$
Total Device Dissipation at 25 $^{\circ}\text{C}$ Case Temperature (derate 4mW/ $^{\circ}\text{C}$ above 25 $^{\circ}\text{C}$)	P_D	300			mW
Total Device Dissipation at 25 $^{\circ}\text{C}$ Ambient Temperature (derate 2 mW/ $^{\circ}\text{C}$ above 25 $^{\circ}\text{C}$)	P_D	150			mW

NORMALIZED D C CURRENT TRANSFER RATIO
versus COLLECTOR CURRENT

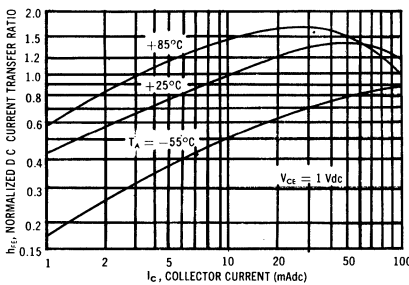

CURRENT GAIN-BANDWIDTH PRODUCT (f_T)
versus COLLECTOR CURRENT

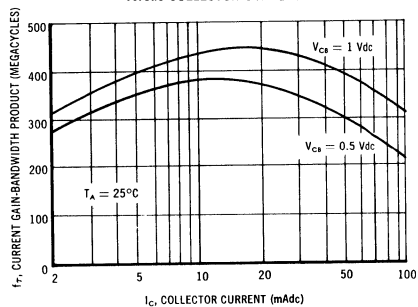

2N960 SERIES (continued)

ELECTRICAL CHARACTERISTICS (At 25°C unless otherwise specified)

Characteristic	Symbol	Min	Typ	Max	Unit
Collector-Base Breakdown Voltage ($I_C = -100 \mu\text{Adc}$, $I_E = 0$)	BV_{CBO}	15 12	25 20	—	Vdc
Collector-Latch-up Voltage $V_{CC} = -11.5 \text{ Vdc}$ (Figure 1)	LV_{CEX}	11.5	—	—	Vdc
Emitter-Base Breakdown Voltage ($I_E = -100 \mu\text{Adc}$, $I_C = 0$)	BV_{EBO}	2.5 2.0 1.25	—	—	Vdc
Collector-Emitter Cutoff Current ($V_{CE} = -15 \text{ Vdc}$) ($V_{CE} = -12 \text{ Vdc}$)	I_{CES}	—	—	100 100	μAdc
Collector-Base Cutoff Current ($V_{CB} = -6 \text{ Vdc}$, $I_E = 0$)	I_{CBO}	—	0.4	3	μAdc
DC Forward Current Transfer Ratio ($I_C = -10 \text{ mAdc}$, $V_{CE} = -0.3 \text{ Vdc}$)	h_{FE}	20 40	40 70	—	—
($I_C = -50 \text{ mAdc}$, $V_{CE} = -1 \text{ Vdc}$)		20 40	55 90	—	—
($I_C = -100 \text{ mAdc}$, $V_{CE} = -1 \text{ Vdc}$)		20 40	50 85	—	—
Collector-Emitter Saturation Voltage ($I_C = -10 \text{ mA}$, $I_E = -1 \text{ mA}$)	$V_{CE(sat)}$	—	0.11 0.13	0.18 0.20	Vdc
($I_C = -50 \text{ mA}$, $I_E = -5 \text{ mA}$)		—	0.18 0.20	0.35 0.40	
($I_C = -100 \text{ mA}$, $I_E = -10 \text{ mA}$)		—	0.27 0.30	0.60 0.70	
Base-Emitter Voltage ($I_C = -10 \text{ mA}$, $I_E = -1 \text{ mA}$)	V_{BE}	0.30	0.40	0.50	Vdc
($I_C = -50 \text{ mA}$, $I_E = -5 \text{ mA}$)		0.40	0.55	0.75	
($I_C = -100 \text{ mA}$, $I_E = -10 \text{ mA}$)		0.40 0.40	0.65 0.75	1.00 1.25	
Current Gain-Bandwidth Product ($I_E = -20 \text{ mAdc}$, $V_{CB} = -1.0 \text{ Vdc}$)	f_T	300	460	—	mc
Collector Output Capacitance ($V_{CB} = -10 \text{ Vdc}$, $I_E = 0$, $f = 1 \text{ mc}$)	C_{ob}	—	2.2	4	pf
Emitter Transition Capacitance ($V_{EB} = 1 \text{ Vdc}$)	C_{Te}	—	2.0	3.5	pf
Turn-on Time — All Types ($I_C = -10 \text{ mAdc}$, $I_{B1} = -1 \text{ mAdc}$, $V_{BE}(0) = +1.25 \text{ Vdc}$) (Fig. 2)	t_{on}	—	35	50	nsec
($I_C = -100 \text{ mAdc}$, $I_{B1} = -5 \text{ mAdc}$, $V_{BE}(0) = +1.25 \text{ Vdc}$) (Fig. 3)		—	30	50	
Turn-off Time ($I_C = -10 \text{ mA}$, $I_{B1} = -1 \text{ mAdc}$, $I_{B2} = 0.25 \text{ mAdc}$) (Fig. 2)	t_{off}	—	60 80	85 100	nsec
($I_C = -100 \text{ mAdc}$, $I_{B1} = -5 \text{ mAdc}$, $I_{B2} = 1.25 \text{ mAdc}$) (Fig. 3)		—	50 60	85 100	
Rise Time Constant (Figure 4)	τ_{RE}	—	0.6	—	nsec
Hole Storage Factor (Figure 6)	K'	—	16	—	nsec
Fall Time Constant (Figure 5)	τ_{FE}	—	0.5	—	nsec
Total Control Charge ($I_C = -10 \text{ mAdc}$, $I_E = -1 \text{ mAdc}$) (Figure 7)	Q_T	—	50 60	80 90	pico-coulombs
($I_C = -100 \text{ mAdc}$, $I_E = -5 \text{ mAdc}$) (Figure 8)		—	80 100	125 150	

STORAGE TIME versus CIRCUIT CURRENT RATIO

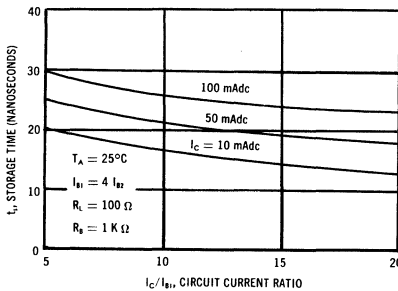

COLLECTOR-EMITTER SATURATION VOLTAGE versus AMBIENT TEMPERATURE

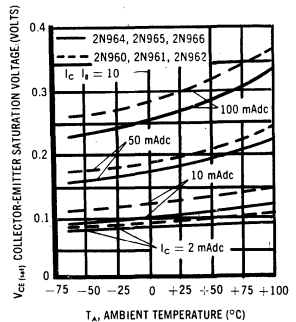

2N963
2N967



$V_{CES} = 12\text{ V}$
 $I_C = 100\text{ mA}$
 $f_T = 300\text{ Mc}$

PNP germanium epitaxial mesa transistors for high-speed switching applications.

CASE 22
(TO-18)

MAXIMUM RATINGS

Characteristic	Symbol	Rating	Unit
Collector-Base Voltage	V_{CBO}	12	Vdc
Collector-Emitter Voltage	V_{CES}	12	Vdc
Junction Temperature	T_J	100	°C
Storage Temperature	T_{stg}	-65 to +100	°C
Device Dissipation @ 25°C Case Temperature (Derate 4 mW/°C above 25°C)	P_D	300	mW
Device Dissipation @ 25°C Ambient (Derate 2 mW/°C)	P_D	150	mW

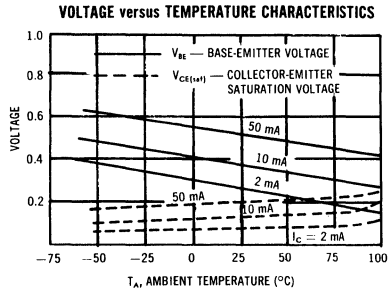
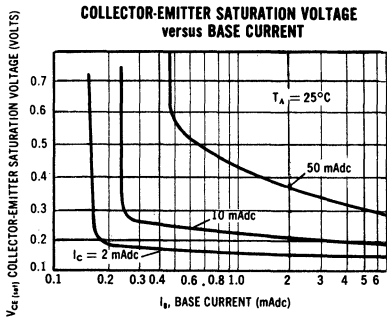
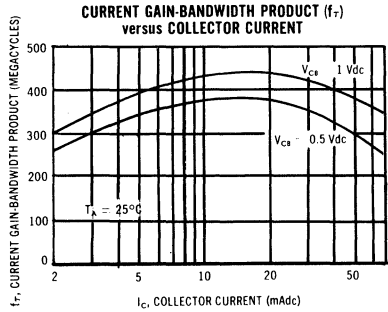
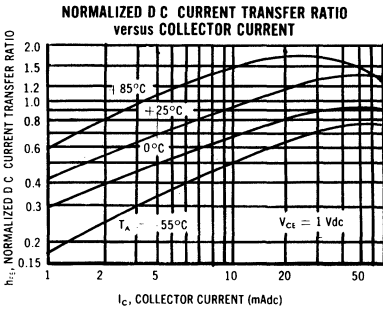

2N963, 2N967 (continued)

ELECTRICAL CHARACTERISTICS (At 25°C unless otherwise specified)

Characteristic	Symbol	Minimum	Maximum	Unit
Collector-Base Breakdown Voltage $I_C = -100 \mu\text{Adc}$, $I_E = 0$	BV_{CBO}	12	—	Vdc
Collector-Latch-up Voltage $V_{CC} = -10 \text{ Vdc}$	LV_{CEX}	10	—	Vdc
Emitter-Base Breakdown Voltage $I_E = -100 \mu\text{Adc}$, $I_C = 0$	BV_{EBO}	2	—	Vdc
Collector-Emitter Cutoff Current $V_{CE} = -12 \text{ Vdc}$, $V_{EB} = 0$	I_{CES}	—	100	μAdc
Collector Cutoff Current $V_{CB} = -6 \text{ Vdc}$, $I_E = 0$	I_{CBO}	—	5	μAdc
Emitter Cutoff Current $V_{EB} = -5 \text{ Vdc}$, $I_C = 0$	I_{EBO}	—	1	mAdc
Collector Cutoff Current $V_{CE} = -10 \text{ Vdc}$, $V_{BE} = +0.3 \text{ Vdc}$, $T_A = 55^\circ\text{C}$	I_{CEX}	—	20	μAdc
Base Cutoff Current $V_{CE} = -10 \text{ Vdc}$, $V_{BE} = +0.3 \text{ Vdc}$, $T_A = 55^\circ\text{C}$	I_{BL}	—	20	μAdc
DC Forward Current Transfer Ratio $I_C = -10 \text{ mAdc}$, $V_{CE} = -0.3 \text{ Vdc}$ 2N963 2N967	h_{FE}	20 40	— —	—
Collector Saturation Voltage $I_C = -10 \text{ mAdc}$, $I_B = -1 \text{ mAdc}$	$V_{CE(sat)}$	—	0.2	Vdc
Base-Emitter Voltage $I_C = -10 \text{ mAdc}$, $I_B = -1 \text{ mAdc}$	V_{BE}	0.3	0.5	Vdc
Current Gain-Bandwidth Product $V_{CE} = -1 \text{ Vdc}$, $I_C = -20 \text{ mAdc}$, $f = 100 \text{ mc}$	f_T	300	—	mc
Collector Output Capacitance $V_{CB} = -5 \text{ Vdc}$, $I_E = 0$, $f = 1 \text{ mc}$	C_{ob}	—	5	pf
Input Capacitance $V_{EB} = -1 \text{ vdc}$, $I_C = 0$, $f = 100 \text{ kc}$	C_{ib}	—	4	pf
Turn-on Time $I_C = -10 \text{ mAdc}$, $I_{B1} = -1 \text{ mAdc}$, $V_{BE(0)} = +1.25 \text{ Vdc}$	t_{on}	—	60	nsec
Turn-off Time $I_C = -10 \text{ mAdc}$, $I_{B1} = -1 \text{ mAdc}$, $I_{B2} = +1.25 \text{ mAdc}$	t_{off}	—	120	nsec
Total Control Charge $I_C = -10 \text{ mAdc}$, $I_B = -1 \text{ mAdc}$	Q_T	—	120	pico-coulombs

COLLECTOR LATCH-UP VOLTAGE TEST CIRCUIT

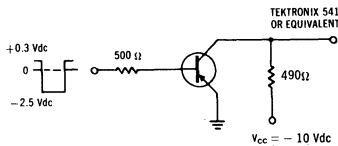

10-mA (I_C) SWITCHING TIME TEST CIRCUIT

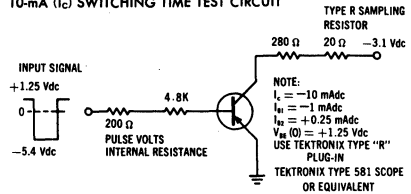

BASE AND COLLECTOR CUTOFF CURRENT TEST CIRCUIT

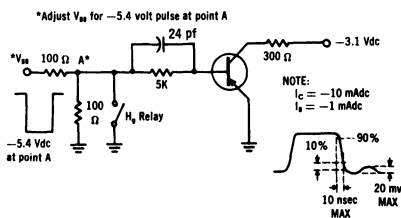

10-mA (I_C) TOTAL CONTROL CHARGE TEST CIRCUIT

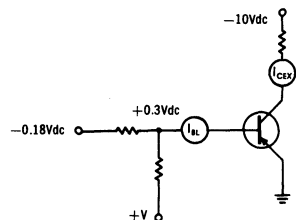

2N964

For Specifications, See 2N960 Data Sheet

2N964A

$V_{CE0} = 7 \text{ V}$
 $I_C = 100 \text{ mA}$
 $f_T = 460 \text{ Mc Typ}$



CASE 22
(TO-18)

PNP germanium epitaxial mesa transistor for high-speed switching applications.

MAXIMUM RATINGS

Characteristic	Symbol	Rating	Unit
Collector-Base Voltage	V_{CB0}	15	Vdc
Collector-Emitter Voltage	V_{CEs}	15	Vdc
Emitter-Base Voltage	V_{EB0}	2.5	Vdc
Collector Current	I_C	100	mAdc
Junction Temperature	T_J	100	$^{\circ}\text{C}$
Storage Temperature	T_{stg}	-65 to +100	$^{\circ}\text{C}$
Total Device Dissipation at 25 $^{\circ}\text{C}$ Case Temperature (Derate 4 mW/ $^{\circ}\text{C}$ above 25 $^{\circ}\text{C}$)	P_D	300	mW
Total Device Dissipation at 25 $^{\circ}\text{C}$ Ambient Temperature (Derate 2 mW/ $^{\circ}\text{C}$ above 25 $^{\circ}\text{C}$)	P_D	150	mW

CURRENT GAIN CHARACTERISTICS

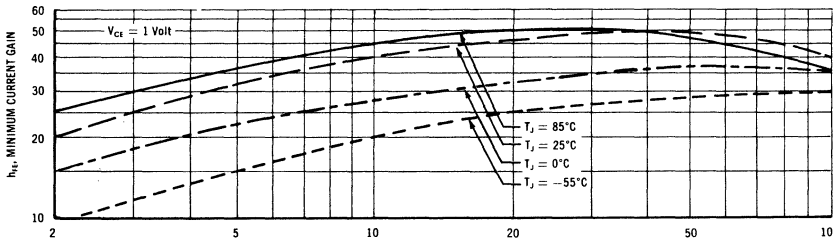

NOTE: Limit Curves are based on periodic engineering evaluation.

I_C , COLLECTOR CURRENT (mAdc)

TOTAL CONTROL CHARGE

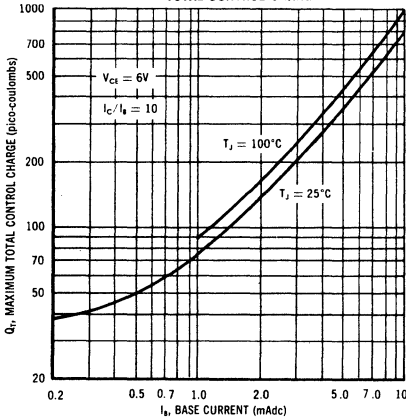

100-mA (I_C) SWITCHING TIME TEST CIRCUIT

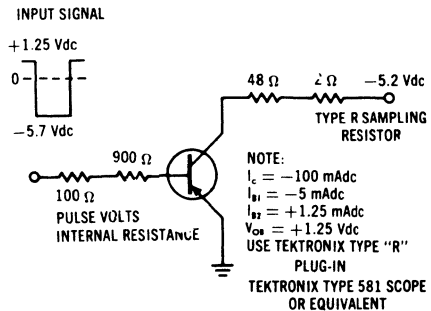

2N964A (continued)

FOR ADDITIONAL CURVES, SEE 2N960 DATA SHEET

ELECTRICAL CHARACTERISTICS

(Registered with EIA as the 2N964A) (at 25°C unless otherwise noted)

Characteristic	Symbol	Min	Typ	Max	Unit
OFF CHARACTERISTICS					
Collector-Base Breakdown Voltage ($I_C = -100 \mu\text{Adc}$, $I_E = 0$)	BV_{CBO}	15	25	—	Vdc
Collector-Emitter Breakdown Voltage ($I_C = 10 \text{ mAdc}$, $I_B = 0$)	BV_{CEO}	7	—	—	Vdc
Collector Latch-up Voltage	LV_{CEX}	11.5	—	—	Vdc
Emitter-Base Breakdown Voltage ($I_E = 100 \mu\text{Adc}$, $I_C = 0$)	BV_{EBO}	2.5	—	—	Vdc
Collector-Emitter Cutoff Current ($V_{CE} = -15 \text{ Vdc}$, $V_{EB} = 0$)	I_{CES}	—	—	100	μAdc
Collector Cutoff Current ($V_{CB} = -6 \text{ Vdc}$, $I_E = 0$)	I_{CAO}	—	0.4	3	μAdc
Base Leakage Current ($V_{CE} = -6 \text{ Vdc}$, $V_{OB} = +0.5 \text{ Vdc}$) ($V_{CE} = -6 \text{ Vdc}$, $V_{OB} = +0.5 \text{ Vdc}$, $T_J = 85^\circ\text{C}$)	I_{BL}	—	—	4	μAdc
—	—	—	50	140	—
ON CHARACTERISTICS					
Forward Current Transfer Ratio ($I_C = -10 \text{ mAdc}$, $V_{CE} = -0.3 \text{ Vdc}$) ($I_C = -10 \text{ mAdc}$, $V_{CE} = -0.3 \text{ Vdc}$, $T_J = -55^\circ\text{C}$) ($I_C = -50 \text{ mAdc}$, $V_{CE} = -1 \text{ Vdc}$) ($I_C = -100 \text{ mAdc}$, $V_{CE} = -1 \text{ Vdc}$) ($I_C = -100 \text{ mAdc}$, $V_{CE} = -1 \text{ Vdc}$, $T_J = 85^\circ\text{C}$)	h_{FE}	40 20 48 40 35	80 45 105 95 85	— — — — —	—
Collector Saturation Voltage ($I_C = -10 \text{ mAdc}$, $I_B = -1 \text{ mAdc}$) ($I_C = -50 \text{ mAdc}$, $I_B = -5 \text{ mAdc}$) ($I_C = -100 \text{ mAdc}$, $I_B = -10 \text{ mAdc}$)	$V_{CE(sat)}$	— — —	0.1 0.16 0.22	0.18 0.28 0.4	Vdc
Base-Emitter Voltage ($I_C = -10 \text{ mAdc}$, $I_B = -1 \text{ mAdc}$) ($I_C = -50 \text{ mAdc}$, $I_B = -5 \text{ mAdc}$) ($I_C = -100 \text{ mAdc}$, $I_B = -10 \text{ mAdc}$)	V_{BE}	0.3 0.4 0.4	0.38 0.48 0.6	0.44 0.58 0.72	Vdc
TRANSIENT CHARACTERISTICS					
Output Capacitance ($V_{CB} = -1 \text{ Vdc}$, $I_E = 0$, $f = 1 \text{ mc}$) ($V_{CB} = -10 \text{ Vdc}$, $I_E = 0$, $f = 1 \text{ mc}$)	C_{ob}	— —	2.7 2.2	5 4	pf
Input Capacitance ($V_{EB} = 1 \text{ Vdc}$, $I_C = 0$, $f = 100 \text{ kc}$)	C_{ib}	—	2	3.5	pf
Small Signal Forward Current Transfer Ratio ($I_C = -20 \text{ mAdc}$, $V_{CE} = -1 \text{ Vdc}$, $f = 100 \text{ mc}$)	h_{fe}	3.0	4.6	—	—
Current-Gain — Bandwidth Product ($I_E = -20 \text{ mAdc}$, $V_{CB} = -1 \text{ Vdc}$)	f_T	300	460	—	mc
Delay Time Plus Rise Time ($I_C = -10 \text{ mA}$) ($I_C = -100 \text{ mA}$)	$t_d + t_r$	— —	35 30	50 50	nsec
Storage Time Plus Fall Time ($I_C = -10 \text{ mA}$) ($I_C = -100 \text{ mA}$)	$t_s + t_f$	— —	60 50	85 85	nsec
Total Control Charge ($I_C = -10 \text{ mA}$, $I_B = -1 \text{ mA}$)	Q_T	—	50	75	pico-coulombs
Active Region Time Constant ($I_C = -10 \text{ mA}$)	T_A	—	0.6	1.5	nsec

2N965

2N966

For Specifications, See 2N960 Data Sheet

2N967

For Specifications, See 2N963 Data Sheet

2N968 thru 2N975

$V_{CES} = 7-15\text{ V}$

$I_C = 100\text{ mA}$

$f_T = 320\text{ Mc}$

CASE 22
(TO-18)



PNP germanium mesa transistors for high-speed switching applications.

MAXIMUM RATINGS

Characteristic	Symbol	2N968	2N969	2N970	2N971	Unit
		2N972	2N973	2N974	2N975	
Collector - Base Voltage	V_{CBO}	15	12	12	7	Vdc
Collector - Emitter Voltage	V_{CES}	15	12	12	7	Vdc
Emitter - Base Voltage	V_{EBO}	2.5	2.0	1.25	1.25	Vdc
Junction Temperature	T_j	+100				$^{\circ}\text{C}$
Storage Temperature Range	T_{stg}	-65 to +100				$^{\circ}\text{C}$
Total Device Dissipation @ $T_j = 25^{\circ}\text{C}$ (Derate 4mW/ $^{\circ}\text{C}$ above 25 $^{\circ}\text{C}$)	P_D	300				mW
Total Device Dissipation @ $T_A = 25^{\circ}\text{C}$ (Derate 2mW/ $^{\circ}\text{C}$ above 25 $^{\circ}\text{C}$)	P_D	150				mW

NORMALIZED D.C. CURRENT GAIN versus COLLECTOR CURRENT

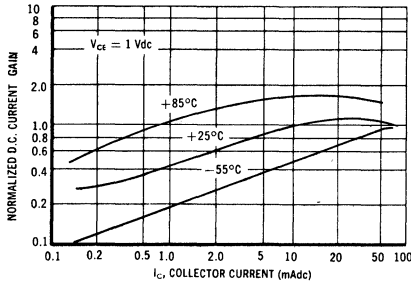

CURRENT GAIN-BANDWIDTH PRODUCT (f_T) versus COLLECTOR CURRENT

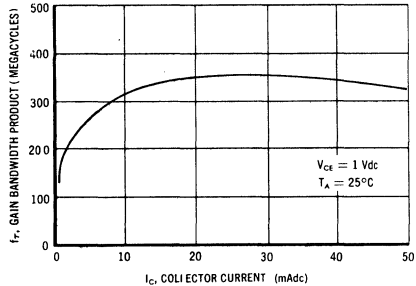

COLLECTOR SATURATION VOLTAGE versus AMBIENT TEMPERATURE

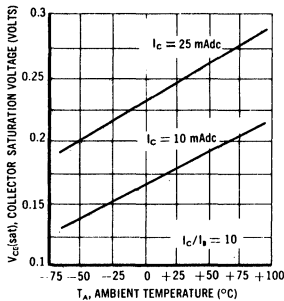

STORAGE TIME versus CIRCUIT CURRENT RATIO

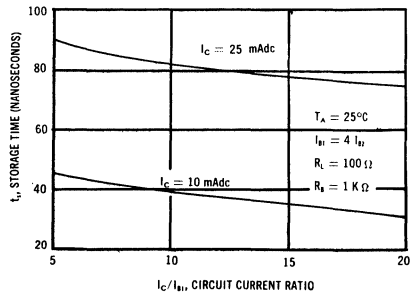

2N968 thru 2N975 (continued)

ELECTRICAL CHARACTERISTICS (At 25°C unless otherwise noted)

Characteristic	Symbol	Minimum	Typical	Maximum	Unit
Collector Base Breakdown Voltage ($I_C = -100 \mu\text{Adc}$, $I_E = 0$)	2N968, 2N972 2N969, 2N970, 2N973, 2N974 2N971, 2N975 BV_{CBO}	15 12 7	25 20 15	— — —	Vdc
Emitter Base Breakdown Voltage ($I_E = 100 \mu\text{Adc}$, $I_C = 0$)	2N968, 2N972 2N969, 2N973 2N970, 2N974 2N971, 2N975 BV_{EBO}	2.5 2.0 1.25 1.25	— — — —	— — — —	Vdc
Collector-Emitter Cutoff Current ($V_{BE} = 0$) ($V_{CE} = -15$ Vdc) ($V_{CE} = -12$ Vdc) ($V_{CE} = -7$ Vdc)	2N968, 2N972 2N969, 2N970, 2N973, 2N974 2N971, 2N975 I_{CES}	— — — —	— — — —	100 100 100	μAdc
Collector-Base Cutoff Current ($V_{CB} = -6$ Vdc, $I_E = 0$)	2N968, 2N969, 2N970, 2N972, 2N973, 2N974 2N971, 2N975 I_{CBO}	— —	— —	3 10	μAdc
DC Forward Current Transfer Ratio ($I_C = -10$ mAdc, $V_{CE} = -0.5$ Vdc) ($I_C = -25$ mAdc, $V_{CE} = -0.7$ Vdc)	2N968, 2N969, 2N970, 2N971 2N972, 2N973, 2N974, 2N975 2N968, 2N969, 2N970, 2N971 2N972, 2N973, 2N974, 2N975 h_{FE}	17 40 20 40	35 75 40 85	— — — —	—
Collector-Emitter Saturation Voltage ($I_C = -10$ mAdc, $I_B = -1$ mAdc) ($I_C = -25$ mAdc, $I_B = -1.5$ mAdc)	All Types All Types $V_{CE(sat)}$	— —	0.19 0.25	0.25 0.5	Vdc
Base-Emitter Voltage ($I_C = -10$ mAdc, $I_B = -1$ mAdc) ($I_C = -25$ mAdc, $I_B = -1.5$ mAdc)	2N968, 2N969, 2N972, 2N973 2N970, 2N971, 2N974, 2N975 2N968, 2N969, 2N972, 2N973 2N970, 2N971, 2N974, 2N975 $V_{BE(sat)}$	0.30 0.30 — —	0.39 0.43 0.45 0.60	0.55 0.65 0.80 1.0	Vdc
Current Gain-Bandwidth Product ($I_E = -10$ mAdc, $V_{CB} = -1$ Vdc)	All Types f_T	250	320	—	mc
Collector Output Capacitance ($V_{CB} = -10$ Vdc, $f = 1$ mc, $I_E = 0$)	All Types C_{ob}	—	4.0	9.0	pf
Emitter Transition Capacitance ($V_{EB} = 1$ Vdc, $I_C = 0$)	All Types C_{Te}	—	3.5	—	pf
Turn-on Time ($I_C = -10$ mAdc, $I_B = -1$ mA) $V_{BE}(0) = +1.25$ Vdc	2N968, 2N969, 2N972, 2N973 2N970, 2N971, 2N974, 2N975 t_{on}	— —	50 65	75 100	nsec
Turn-off Time ($I_C = -10$ mAdc, $I_{B1} = -1$ mAdc) $I_{B2} = 0.25$ mAdc	2N968, 2N969 2N972, 2N973 2N970, 2N971, 2N974, 2N975 t_{off}	— — —	70 75 100	150 175 275	nsec
Total Control Charge ($I_C = -10$ mAdc, $I_B = 1$ mA) ($I_C = -25$ mAdc, $I_B = -1.5$ mA)	2N968, 2N969, 2N972, 2N973 2N970, 2N971, 2N974, 2N975 (Figure 4) 2N968, 2N969, 2N972, 2N973 2N970, 2N971, 2N974, 2N975 Q_T	— — — —	75 80 90 175	100 150 175 300	pico-coulombs

2N985

$V_{CE0} = 7 \text{ V}$
 $I_C = 200 \text{ mA}$
 $f_T = 300 \text{ Mc}$



PNP germanium epitaxial mesa transistor for high-speed switching applications.

CASE 22
(TO-18)

MAXIMUM RATINGS

Characteristic	Symbol	Ratings	Unit
Collector-Base Voltage	V_{CBO}	-15	Vdc
Collector-Emitter Voltage	V_{CEO}	-7	Vdc
Emitter-Base Voltage	V_{EBO}	-3	Vdc
Collector Current	I_C	-200	mAdc
Junction Temperature	T_J	100	$^{\circ}\text{C}$
Storage Temperature	T_{stg}	-65 to +100	$^{\circ}\text{C}$
Device Dissipation @ $T_C = 25^{\circ}\text{C}$ Derating factor above 25°C	P_D	300 4	mW mW/ $^{\circ}\text{C}$
Device Dissipation @ $T_A = 25^{\circ}\text{C}$ Derating factor above 25°C	P_D	150 2	mW mW/ $^{\circ}\text{C}$

SWITCHING TIME TEST CIRCUIT

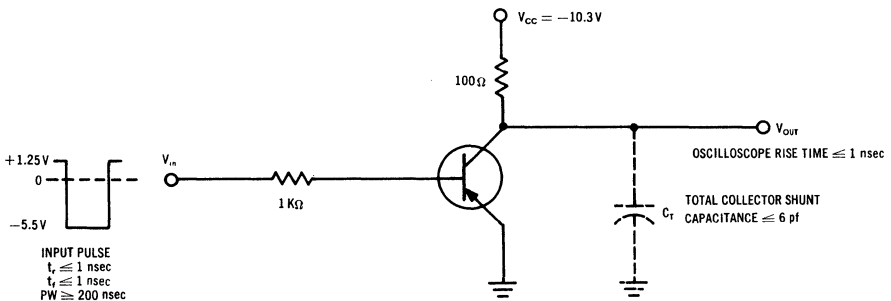

2N985 (continued)

ELECTRICAL CHARACTERISTICS (At 25°C unless otherwise noted)

Characteristic	Symbol	Min	Max	Unit
Collector-Base Breakdown Voltage ($I_C = -100 \mu\text{A dc}$, $I_E = 0$)	BV_{CBO}	-15	—	Vdc
Collector-Emitter Breakdown Voltage ($I_C = -5 \text{ mAdc}$, $I_B = 0$)	BV_{CEO}	-7	—	Vdc
Collector-Emitter Breakdown Voltage ($I_C = -100 \mu\text{A dc}$, $R_{BE} = 0$)	BV_{CES}	-15	—	Vdc
Emitter-Base Breakdown Voltage ($I_E = -100 \mu\text{A dc}$, $I_C = 0$)	BV_{EBO}	-3	—	Vdc
Collector Cutoff Current ($V_{CB} = -5 \text{ Vdc}$, $I_E = 0$)	I_{CBO}	—	-3	$\mu\text{A dc}$
Emitter Cutoff Current ($V_{EB} = -3 \text{ Vdc}$, $I_C = 0$)	I_{EBO}	—	-100	$\mu\text{A dc}$
DC Current Gain ($I_C = -10 \text{ mAdc}$, $V_{CE} = -0.25 \text{ Vdc}$) ($I_C = -100 \text{ mAdc}$, $V_{CE} = -0.5 \text{ Vdc}$)	h_{FE}	40 60	— —	—
Collector Saturation Voltage ($I_C = -10 \text{ mAdc}$, $I_B = -0.5 \text{ mAdc}$) ($I_C = -100 \text{ mAdc}$, $I_B = -5 \text{ mAdc}$)	$V_{CE(sat)}$	— —	-0.15 -0.30	Vdc
Base-Emitter Voltage ($I_C = -10 \text{ mAdc}$, $I_B = 0.5 \text{ mAdc}$) ($I_C = -100 \text{ mAdc}$, $I_B = -5 \text{ mAdc}$)	V_{BE}	-0.28 -0.40	-0.40 -0.60	Vdc
Small Signal Current Gain ($V_{CE} = -2 \text{ Vdc}$, $I_C = -30 \text{ mAdc}$, $f = 100 \text{ mc}$)	$ h_{fe} $	3.0	—	—
Collector Output Capacitance ($V_{CB} = -5 \text{ Vdc}$, $I_E = 0$, $f = 1 \text{ mc}$)	C_{ob}	—	6	pf
Turn-on Time ($I_C = -10 \text{ mAdc}$, $I_{B1} = -5 \text{ mAdc}$, $V_{BE(0)} = +1.25 \text{ Vdc}$)	t_{on}	—	35	nsec
Turn-off Time ($I_C = -10 \text{ mAdc}$, $I_{B1} = -5 \text{ mAdc}$, $I_{B2} = +1.25 \text{ mA}$)	t_{off}	—	80	nsec

2N995

For Specifications, See 2N869 Data Sheet

2N1131
2N1991

$V_{CE0} = 20-35\text{ V}$
 $I_C = 600\text{ mA}$
 $f_T = 120\text{ Mc Typ}$

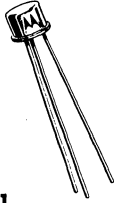

PNP silicon annular transistors for medium-current-switching applications.

CASE 31
(TO-5)

MAXIMUM RATINGS

Characteristics	Symbol	Rating	Unit
Collector-Base Voltage 2N1131 2N1991	V_{CBO}	50 30	Vdc
Collector-Emitter Voltage 2N1131 2N1991	V_{CEO}	35 20	Vdc
Emitter-Base Voltage 2N1131, 2N1991	V_{EBO}	5	Vdc
Collector-Emitter Voltage ($R_{be} \leq 10\ \Omega$) 2N1131	V_{CER}	50	Vdc
Collector Current 2N1131	I_C	600	mAdc
Total Device Dissipation @ 25°C Case Temperature Both Types Derating Factor Above 25°C 2N1131 2N1991	P_D	2 13.3 16.0	Watts mW/°C mW/°C
Total Device Dissipation @ 25°C Ambient Temperature Both Types Derating Factor Above 25°C 2N1131 2N1991	P_D	0.6 4.0 4.8	Watt mW/°C mW/°C
Junction Temperature 2N1131 2N1991	T_J	+175 +150	°C
Storage Temperature Range 2N1131 2N1991	T_{stg}	-65 to +300 -65 to +150	°C

2N1131, 2N1991 (continued)

ELECTRICAL CHARACTERISTICS (At 25°C unless otherwise noted)

Characteristics	Types	Symbol	Min	Max	Unit
Collector-Base Breakdown Voltage ($I_C = 100 \mu\text{A dc}$, $I_E = 0$) ($I_C = 1.0 \text{ mA}$, $I_E = 0$)	2N1131 2N1991	BV_{CBO}	50 30	— —	Vdc
Emitter-Base Breakdown Voltage ($I_E = 100 \mu\text{A dc}$, $I_C = 0$)		BV_{EBO}	5	—	Vdc
Collector-Emitter Breakdown Voltage ($I_C = 100 \text{ mAdc pulse}$, $I_B = 0$)	2N1131 2N1991	BV_{CEO}	35 20	— —	Vdc
Collector-Emitter Breakdown Voltage ($I_C = 100 \text{ mAdc pulsed}$, $R_{\theta E} \leq 10 \Omega$)	2N1131	BV_{CER}	50	—	Vdc
Collector Cutoff Current ($V_{CB} = 30 \text{ Vdc}$, $I_E = 0$) ($V_{CB} = 30 \text{ Vdc}$, $I_E = 0$, $T_A = 150^\circ\text{C}$) ($V_{CB} = 50 \text{ Vdc}$, $I_E = 0$) ($V_{CB} = 10 \text{ Vdc}$, $I_E = 0$) ($V_{CB} = 10 \text{ Vdc}$, $I_E = 0$, $T_A = 150^\circ\text{C}$)	2N1131 2N1131 2N1131 2N1991 2N1991	I_{CBO}	— — — — —	1 100 100 5 200	$\mu\text{A dc}$
Emitter Cutoff Current ($V_{EB} = 2 \text{ Vdc}$, $I_C = 0$) ($V_{EB} = 1 \text{ Vdc}$, $I_C = 0$)	2N1131 2N1991	I_{EBO}	— —	100 200	$\mu\text{A dc}$
DC Forward Current Transfer Ratio ($I_C = 5 \text{ mAdc}$, $V_{CE} = 10 \text{ Vdc}$) ($I_C = 30 \text{ mAdc}$, $V_{CE} = 10 \text{ Vdc}$) ($I_C = 150 \text{ mAdc}$, $V_{CE} = 10 \text{ Vdc}$)	2N1131 2N1991 2N1131 2N1991	h_{FE}	15 15 20 15	— — 60 45	—
Collector-Emitter Saturation Voltage ($I_C = 150 \text{ mAdc}$, $I_B = 15 \text{ mAdc}$)		$V_{CE(sat)}$	—	1.5	Vdc
Base-Emitter Saturation Voltage ($I_C = 150 \text{ mAdc}$, $I_B = 15 \text{ mAdc}$)	2N1131 2N1991	$V_{BE(sat)}$	— —	1.3 1.5	Vdc
Output Capacitance ($V_{CB} = 10 \text{ Vdc}$, $I_E = 0$, $f = 100 \text{ kc}$)		C_{ob}	—	45	pf
Input Capacitance ($V_{EB} = 0.5 \text{ Vdc}$, $I_C = 0$, $f = 100 \text{ kc}$)	2N1131	C_{ib}	—	80	pf
AC Current Gain ($I_C = 50 \text{ mAdc}$, $V_{CE} = 10 \text{ Vdc}$, $f = 20 \text{ mc}$)	2N1131 2N1991	h_{fe}	2.5 2.0	—	—
Small-Signal Forward Current Transfer Ratio ($I_C = 1 \text{ mAdc}$, $V_{CE} = 5 \text{ Vdc}$, $f = 1 \text{ kc}$) ($I_C = 5 \text{ mAdc}$, $V_{CE} = 10 \text{ Vdc}$, $f = 1 \text{ kc}$)	2N1131 2N1131	h_{fe}	15 20	50 —	—
Small Signal Input Resistance ($I_C = 1 \text{ mAdc}$, $V_{CB} = 5 \text{ Vdc}$, $f = 1 \text{ kc}$) ($I_C = 5 \text{ mAdc}$, $V_{CB} = 10 \text{ Vdc}$, $f = 1 \text{ kc}$)	2N1131	h_{ib}	25 —	35 10	ohms
Small Signal Output Admittance ($I_C = 1 \text{ mAdc}$, $V_{CE} = 5 \text{ Vdc}$, $f = 1 \text{ kc}$) ($I_C = 5 \text{ mAdc}$, $V_{CE} = 10 \text{ Vdc}$, $f = 1 \text{ kc}$)	2N1131	h_{ob}	— —	1 5	$\mu\text{ mhos}$
Small Signal Voltage Feedback Ratio ($I_C = 1 \text{ mAdc}$, $V_{CE} = 5 \text{ Vdc}$, $f = 1 \text{ kc}$) ($I_C = 5 \text{ mAdc}$, $V_{CE} = 10 \text{ Vdc}$, $f = 1 \text{ kc}$)	2N1131	h_{rb}	— —	8 8	$\times 10^{-4}$

Pulse Test: Pulse width $\leq 300 \mu\text{sec}$, Duty Cycle $\leq 2\%$

2N1132, A, B

For Specifications, See 2N722 Data Sheet

2N1141 thru 2N1143 2N1195

$G_o = 25 \text{ db @ } 70 \text{ Mc}$
 $NF = 4.5 \text{ db @ } 100 \text{ Mc}$
 $P_D = 300 \text{ mW}$

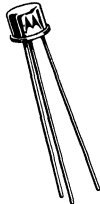

CASE 31
(TO-5)

PNP germanium mesa transistors for amplifier, driver, oscillator and doubler applications.

MAXIMUM RATINGS

Characteristic	Symbol	2N1141	2N1142	2N1143	2N1195	Unit
Collector-Base Voltage	V_{CBO}	35	30	25	30	Vdc
Emitter-Base Voltage	V_{EBO}	1.0	0.7	0.5	1.0	Vdc
Collector Current (Continuous)	I_C	100	100	100	40	mAdc
Emitter Current (Continuous)	I_E	100	100	100	—	mAdc
Base Current	I_B	50	50	50	—	mAdc
Junction Temperature	T_J	+100	+100	+100	+100	°C
Storage Temperature Range	T_{rtg}	-65 to +100				°C
Total Device Dissipation at 25°C Case Temperature (10 mW/°C)	P_D	750	750	750	—	mW
Total Device Dissipation at 25°C Ambient Temperature (Derate 4 mW/°C above 25°C)	P_D	300	300	300	—	mW
Collector Dissipation at 25°C Ambient Temperature (Derate 3 mW/°C above 25°C)	P_C	—	—	—	225	mW

TRANSISTOR SELECTION CHART

TYPE	Minimum V_{CBO} @ $I_C = -100 \mu\text{Adc}$, $I_E = 0$			Typical 100mc Noise Figure @ $V_{CE} = -10\text{Vdc}$, $I_C = 1\text{mAdc}$ $R_s = 75\Omega$			Minimum h_{fe} @ $I_C = -10\text{mAdc}$, $V_{CE} = -10\text{Vdc}$, $f = 100\text{mc}$		
	35 Vdc	30 Vdc	25 Vdc	4.0 db	4.5 db	5.0 db	12 db	10 db	8 db
2N1141	✓			✓			✓		
2N1142		✓			✓			✓	
2N1143			✓			✓			✓
2N1195		✓		✓			✓		

2N1141-2N1143, 2N1195 (continued)

ELECTRICAL CHARACTERISTICS (At 25°C case temperature unless otherwise specified)

Characteristic	Symbol	Minimum	Typical	Maximum	Unit	
Collector-Base Breakdown Voltage ($I_c = -100 \mu\text{A}$, $I_b = 0$)	2N1141 2N1142 2N1143 2N1195	BV_{CBO}	35 30 25 30	45 45 45 45	— — — —	Vdc
Emitter-Base Breakdown Voltage ($I_e = 100 \mu\text{A}$, $I_c = 0$)	2N1141 2N1142 2N1143 2N1195	BV_{EBO}	1.0 0.7 0.5 1.0	1.3 1.3 1.3 1.3	— — — —	Vdc
Collector-Base Cutoff Current ($V_{CB} = -15 \text{Vdc}$, $I_b = 0$) ($V_{CB} = -20 \text{Vdc}$, $I_b = 0$)	2N1141, 2N1142, 2N1143 2N1195	I_{CBO}	— —	0.5 0.5	5 5	μA
Emitter-Base Cutoff Current ($V_{EB} = -0.5 \text{Vdc}$, $I_c = 0$)	All Types	I_{EBO}	—	0.2	—	μA
DC Forward Current Transfer Ratio ($V_{CB} = 10 \text{Vdc}$, $I_c = -10 \text{mA}$)	2N1141, 2N1142, 2N1143 2N1195	h_{FE}	10 —	25 25	— —	—
Collector Saturation Voltage ($I_c = -50 \text{mA}$, $I_b = -10 \text{mA}$)	2N1141, 2N1142, 2N1143 2N1195	$V_{CE(sat)}$	—	0.185 0.185	2 —	Vdc
Small Signal Forward Current Transfer Ratio ($V_{CB} = -10 \text{Vdc}$, $I_c = -10 \text{mA}$, $f = 100 \text{mc}$)	2N1141 2N1142 2N1143 2N1195	h_{FE}	12 10 8 12	18 18 18 18	— — — —	db
Small Signal Forward Current Transfer Ratio ($V_{CB} = -10 \text{Vdc}$, $I_c = -10 \text{mA}$, $f = 1 \text{kc}$)	2N1141, 2N1142, 2N1143 2N1195	h_{FE}	— 0.96	0.98 0.98	0.995 —	—
Small Signal Input Impedance ($V_{CB} = -10 \text{Vdc}$, $I_c = -10 \text{mA}$, $f = 1 \text{kc}$)	2N1141, 2N1142, 2N1143 2N1195	h_{ie}	—	3.6 3.6	— 10	Ohms
Output Admittance ($V_{CB} = 10 \text{Vdc}$, $I_c = -10 \text{mA}$, $f = 1 \text{kc}$)	2N1141, 2N1142, 2N1143 2N1195	h_{oe}	—	10 10	— 20	μmhos
Voltage Feedback Ratio ($V_{CB} = -10 \text{Vdc}$, $I_c = -10 \text{mA}$, $f = 1 \text{kc}$)	2N1141, 2N1142, 2N1143 2N1195	h_{re}	—	0.0013 0.0013	— 0.003	—
Small Signal Current Gain Cutoff Frequency ($V_{CB} = -10 \text{Vdc}$, $I_c = -10 \text{mA}$)	All Types	$f_{\alpha_{FE}}$	—	1000	—	mc
Base Resistance ($V_{CB} = -10 \text{Vdc}$, $I_c = -10 \text{mA}$, $f = 250 \text{mc}$)	2N1141 2N1142 2N1143 2N1195	r_b'	— — — —	65 80 110 65	70 — — 80	Ohms
Collector Transition Capacitance ($V_{CB} = -10 \text{Vdc}$, $I_b = 0$, $f = 1 \text{mc}$)	2N1141 2N1142 2N1143 2N1195	C_{rc}	— — — —	1.1 1.1 1.1 1.1	1.5 — — —	pf
Emitter Transition Capacitance ($V_{EB} = 0.5 \text{Vdc}$, $I_c = 0$, $f = 1 \text{mc}$)	All Types	C_{re}	—	2.5	—	pf
Collector-Base Time Constant ($V_{CB} = -10 \text{Vdc}$, $I_b = 3 \text{mA}$, $f = 30 \text{mc}$)	All Types	τ_{c_c}	—	23	—	p sec
Noise Figure ($V_{CB} = -5 \text{Vdc}$, $I_b = -8 \text{mA}$, $f = 4.5 \text{mc}$, $R_s = 300\Omega$)	2N1141 2N1142 2N1143 2N1195	NF	— — — —	3.0 3.5 4.0 3.0	— — — —	db
($V_{CB} = -10 \text{Vdc}$, $I_b = 1 \text{mA}$, $f = 100 \text{mc}$, $R_s = 75\Omega$)	2N1141 2N1142 2N1143 2N1195		— — — —	4.0 4.5 5.0 4.5	— — — —	
($V_{CB} = -10 \text{Vdc}$, $I_b = 1 \text{mA}$, $f = 200 \text{mc}$, $R_s = 50\Omega$)	2N1141 2N1142 2N1143 2N1195		— — — —	5.5 6.0 6.5 6.0	— — — —	
Oscillator Efficiency ($V_{CB} = -20 \text{Vdc}$, $I_c = -10 \text{mA}$, $f = 400 \text{mc}$)	2N1141 2N1142 2N1143 2N1195	η	— — — —	20 18 12 18	— — — —	%
Collector Series Resistance ($V_{CB} = -10 \text{Vdc}$, $I_b = 10 \text{mA}$)	All Types	r_c'	—	2	—	Ohms

COMMON EMITTER POWER GAIN h_{FE} , AND NOISE FIGURE versus FREQUENCY

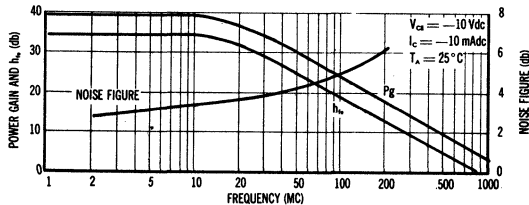

2N1204, A

2N1494, A
 2N1495
 2N1496
 2N2096
 2N2097
 2N2099
 2N2100

$V_{CEO} = 12-25 \text{ V}$
 $I_C = 500 \text{ mA}$
 $f_T = 200 \text{ Mc Typ}$

PNP germanium epitaxial mesa transistors for high-speed, high-current switching in line and core driver applications.

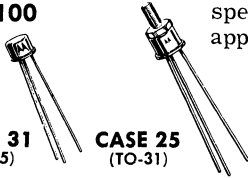

2N1204, A
 2N1495
 2N2099
 2N2100

2N1494, A
 2N1496
 2N2096
 2N2097

MAXIMUM RATINGS

Characteristics	Symbol	Maximum	Unit
Collector-Base Voltage 2N1204, 2N1204A, 2N1494, 2N1494A 2N2096, 2N2099 2N1495, 2N1496, 2N2097, 2N2100	V_{CBO}	20 25 40	Vdc
Collector-Emitter Voltage 2N2096, 2N2099 2N1204, 2N1204A, 2N1494A 2N2097, 2N2100 2N1495, 2N1496	V_{CEO}	12 15 20 25	Vdc
Collector-Emitter Voltage 2N1204, 2N1204A, 2N1494, 2N1494A 2N2096, 2N2099 2N1495, 2N1496, 2N2097, 2N2100	V_{CES}	20 25 40	Vdc
Emitter-Base Voltage	V_{EBO}	4	Vdc
Collector Current	I_C	500	mA _{dc}
Total Device Dissipation @ $T_C = 25^\circ\text{C}$ All Types derating factor above 25°C	P_D	750 10	mW mW/ $^\circ\text{C}$
Total Device Dissipation @ $T_A = 25^\circ\text{C}$ TO-5 Case 2N1204, 2N1204A, 2N1495, 2N2099, 2N2100 derating factor above 25°C TO-31 Case 2N1494, 2N1494A, 2N1496, 2N2096, 2N2097 derating factor above 25°C	P_D	300 4.0 500 6.67	mW mW/ $^\circ\text{C}$ mW mW/ $^\circ\text{C}$
Operating Junction Range Storage Temperature Range	T_J T_{stg}	-65 to +100	$^\circ\text{C}$

2N1204,A SERIES (continued)

ELECTRICAL CHARACTERISTICS (At 25°C ambient unless otherwise noted)

Characteristics	Symbol	Minimum	Typical	Maximum	Unit
Collector-Base Breakdown Voltage ($I_C = 100 \mu\text{A}$, $I_E = 0$)	BV_{CBO}	20 25 40	40 — —	— — —	Vdc
Collector-Base Breakdown Voltage ($I_C = 100 \mu\text{A}$, $V_{EB} = 0$)	BV_{CES}	20 25 40	40 — —	— — —	Vdc
Collector-Base Breakdown Voltage ($I_C = 2 \text{ mA}$, $I_B = 0$)	BV_{CBO}	15 12 20 25	25 — — —	— — — —	Vdc
Emitter-Base Breakdown Voltage ($I_E = 1 \text{ mA}$, $I_C = 0$)	BV_{EBO}	4	—	—	Vdc
Collector Cutoff Current ($V_{CB} = 5 \text{ Vdc}$, $I_E = 0$)	I_{CBO}	—	0.4	7	μA
Collector Cutoff Current ($V_{CB} = 12 \text{ Vdc}$, $I_E = 0$)		—	—	12	
Collector Cutoff Current ($V_{CB} = 15 \text{ Vdc}$, $I_E = 0$)		—	—	12	
Emitter Cutoff Current ($V_{OB} = 0.5 \text{ Vdc}$, $I_C = 0$)	I_{EBO}	—	—	5	μA
Emitter Cutoff Current ($V_{OB} = 1 \text{ Vdc}$, $I_C = 0$)		—	10	50	
DC Current Gain ($I_C = 200 \text{ mA}$, $V_{CE} = 0.5 \text{ Vdc}$)	h_{FE}	25	—	—	—
DC Current Gain ($I_C = 200 \text{ mA}$, $V_{CE} = 1 \text{ Vdc}$)		30	70	—	
DC Current Gain ($I_C = 400 \text{ mA}$, $V_{CE} = 1.5 \text{ Vdc}$)*		15 20	35 50	— —	
Collector-Emitter Saturation Voltage ($I_C = 50 \text{ mA}$, $I_B = 2.5 \text{ mA}$)	$V_{CE(sat)}$	—	—	0.3	Vdc
Collector-Emitter Saturation Voltage ($I_C = 200 \text{ mA}$, $I_B = 10 \text{ mA}$)		—	—	0.4 0.5 0.6	
Collector-Emitter Saturation Voltage ($I_C = 200 \text{ mA}$, $I_B = 20 \text{ mA}$)		—	—	0.3	
Collector-Emitter Saturation Voltage ($I_C = 400 \text{ mA}$, $I_B = 25 \text{ mA}$)**		—	—	0.7	
Base-Emitter Saturation Voltage ($I_C = 50 \text{ mA}$, $I_B = 2.5 \text{ mA}$)	$V_{BE(sat)}$	—	—	0.5	Vdc
Base-Emitter Saturation Voltage ($I_C = 200 \text{ mA}$, $I_B = 10 \text{ mA}$)		0.40	0.80	0.72 0.8 0.9	
Collector Output Capacitance ($V_{CB} = 10 \text{ Vdc}$, $I_E = 0$, $f = 4 \text{ mc}$)	C_{ob}	—	3.5 3.5	6.5 20	pf
Input Capacitance ($V_{OB} = 1 \text{ Vdc}$, $I_C = 0$, $f = 4 \text{ mc}$)	C_{ib}	—	8	50	pf
AC Current Gain ($I_C = 20 \text{ mA}$, $V_{CE} = 10 \text{ V}$, $f = 100 \text{ mc}$)	h_{fe}	1.1 1.5	2	—	—
Rise Time	t_r	—	—	20 35 55	nsec
Minority Carrier Storage Time Constant	τ_s	—	30	75 90	nsec
Storage Time	t_s	—	—	50 70	nsec
Fall Time	t_f	—	—	40 60	nsec

*Pulse Test: Pulse width $\leq 1 \text{ msec}$, Duty cycle $\leq 6\%$

**Pulse Test: Pulse width $\leq 5 \text{ msec}$, Duty cycle $\leq 4\%$

RISE TIME TEST CIRCUIT

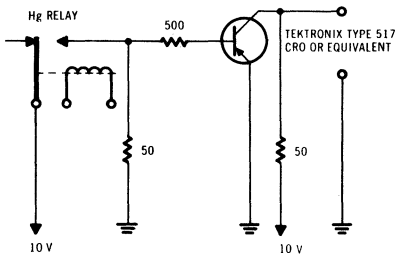

STORAGE AND FALL TIME TEST CIRCUIT

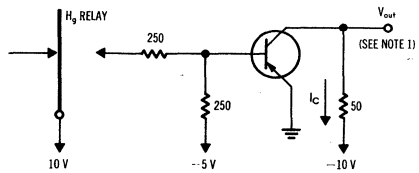

NOTE 1: SCOPE IMPEDANCE SUFFICIENTLY HIGH SO THAT DOUBLING OR HALVING ITS VALUE DOES NOT CHANGE THE READING.
SCOPE RISE TIME FAST ENOUGH SO THAT DOUBLING OR HALVING ITS VALUE DOES NOT CHANGE THE READING.

2N1204,A SERIES (continued)

NORMALIZED CURRENT GAIN CHARACTERISTICS

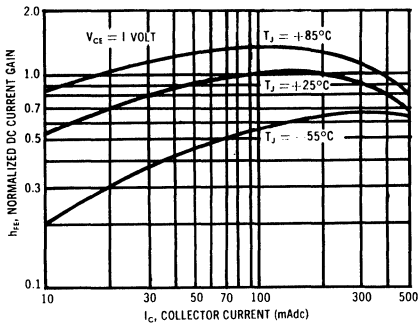

CARRIER STORAGE TIME CONSTANT TEST CIRCUIT

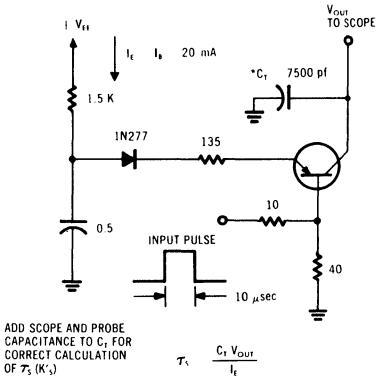

COLLECTOR EMITTER SATURATION VOLTAGES versus BASE CURRENT

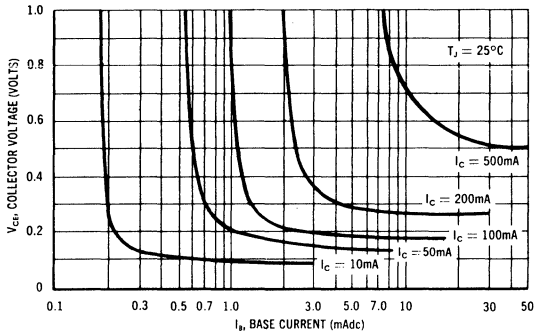

TYPICAL RISE AND FALL-TIME BEHAVIOR

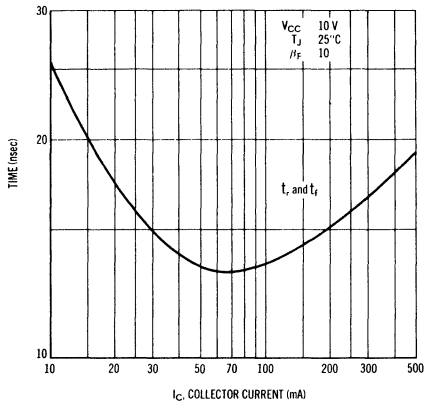

TOTAL CONTROL CHARGE

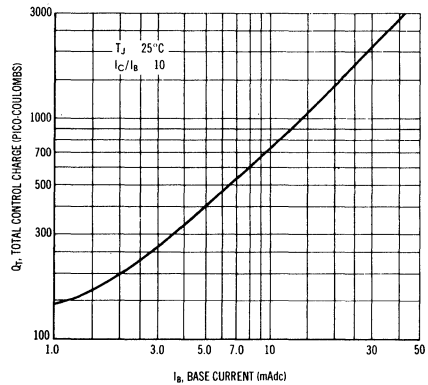

2N1420

For Specifications, See 2N697 Data Sheet

2N1494, A thru 2N1496

For Specifications, See 2N1204 Data Sheet

2N1561

2N1562

2N1692

2N1693

$G_o = 5-6 \text{ db @ } 160 \text{ Mc}$

$P_o = 0.4-0.5 \text{ W @ } 160 \text{ Mc}$

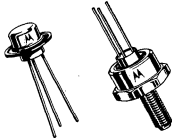

PNP germanium mesa transistors for VHF power amplifier applications.

CASE 23

2N1561
2N1562

CASE 24

2N1692
2N1693

MAXIMUM RATINGS

Characteristic	Symbol	Type	Rating	Unit
Collector-Base Voltage	V_{CBO}		25	V
Collector-Emitter Voltage	V_{CES}		25	V
Emitter-Base Voltage	V_{EBO}	2N1561, 2N1692 2N1562, 2N1693	3* 2*	V V
Collector DC Current (Continuous)	I_C		250	mA dc
Collector Current (Instantaneous)	I_c		500	ma
Junction Temperature	T_j		100	°C
Storage Temperature Range	T_{stg}		-65 to +100	°C
Total Device Dissipation at 25°C Case Temperature (Derate 40 mW/°C above 25°C)	P_D		3	Watts
Total Device Dissipation at 25°C Ambient Temperature (Derate 3.3 mW/°C above 25°C)	P_D	2N1561, 2N1562 2N1692, 2N1693	250 350	mW

*May be exceeded provided total rated device dissipation is not exceeded.

POWER GAIN versus FREQUENCY

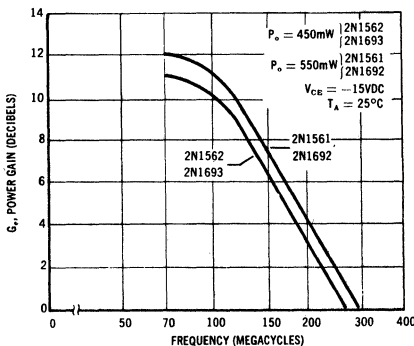

SAFE OPERATING AREA

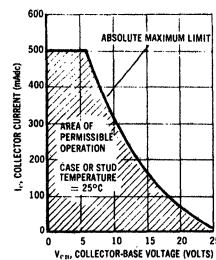

2N1561, 2N1562, 2N1692, 2N1693 (continued)

ELECTRICAL CHARACTERISTICS (At 25°C unless otherwise noted)

Characteristic	Symbol	Type	Min	Typ	Max	Unit
Collector-Base Breakdown Voltage $I_B = 0, I_C = -100 \mu\text{Adc}$	BV_{CBO}		25	—	—	Vdc
Collector-Emitter Breakdown Voltage $V_{BE} = 0, I_C = -100 \mu\text{Adc}$	BV_{CEB}		25	—	—	Vdc
Collector Cutoff Current $I_B = 0, V_{CB} = -10 \text{ Vdc}$	I_{CBO}		—	1.5	10	μAdc
Emitter Cutoff Current $I_C = 0, V_{EB} = -0.4 \text{ Vdc}$	I_{EBO}	2N1562, 2N1693	—	5.0	—	mAdc
Emitter Cutoff Current $I_C = 0, V_{EB} = -1.0 \text{ Vdc}$	I_{EBO}	2N1561, 2N1692	—	5.0	—	mAdc
Collector Saturation Voltage $I_C = -200 \text{ mAdc}, I_B = -40 \text{ mAdc}$	$V_{CE(sat)}$	2N1561, 2N1692 2N1562, 2N1693	—	—	3.0 4.0	Vdc
Small Signal Forward Current Transfer Ratio $I_C = -50 \text{ mAdc}, V_{CB} = -10 \text{ Vdc}, f = 160 \text{ mc}$	h_{fe}	2N1561, 2N1692 2N1562, 2N1693	—	10 9	—	db
Collector Capacitance $I_B = 0, V_{CB} = -10 \text{ Vdc}$	C_{cb}	—	—	7	10	pf
Current Gain-Bandwidth Product $I_C = -50 \text{ mAdc}, V_{CB} = -10 \text{ Vdc}$	f_T	2N1561, 2N1692 2N1562, 2N1693	—	500 450	—	mc
Base Resistance $I_B = -20 \text{ mAdc}, V_{CB} = -10 \text{ Vdc}, f = 300 \text{ mc}$	r_b'	—	—	25	—	Ohms
Power Output $I_B = -100 \text{ mAdc Max}, f = 160 \text{ mc}$ $V_{CB} = 15 \text{ Vdc}, P_{IN} = 125 \text{ mW}$	P_o	2N1561, 2N1692 2N1562, 2N1693	0.5 0.4	—	—	Watts
Power Gain $I_B = -100 \text{ mAdc Max}, V_{CB} = -15 \text{ Vdc}, f = 160 \text{ mc}, P_o = 0.5 \text{ Watt}$	G_o	2N1561, 2N1692	6	—	—	db
Power Gain $I_B = -100 \text{ mAdc Max}, V_{CB} = -15 \text{ Vdc}, f = 160 \text{ mc}, P_o = 0.4 \text{ Watt}$	G_o	2N1562, 2N1693	5	—	—	db

POWER OUT, COLLECTOR CURRENT AND COLLECTOR EFFICIENCY versus POWER IN

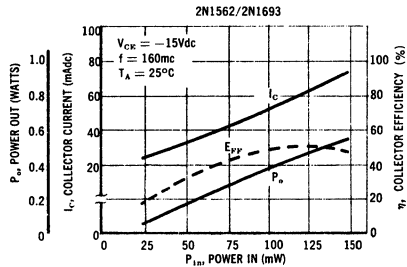
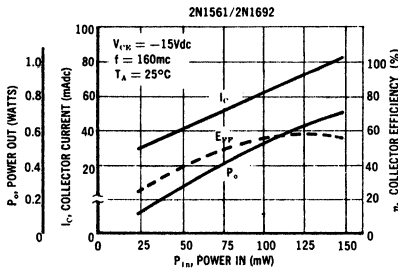

POWER OUT, COLLECTOR CURRENT AND COLLECTOR EFFICIENCY versus FREQUENCY

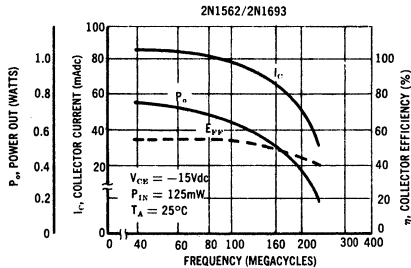
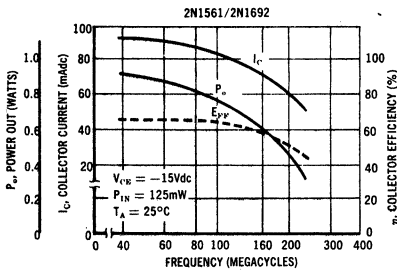

2N1561, 2N1562, 2N1692, 2N1693 (continued)

POWER OUT, COLLECTOR CURRENT AND COLLECTOR EFFICIENCY versus COLLECTOR-EMITTER VOLTAGE

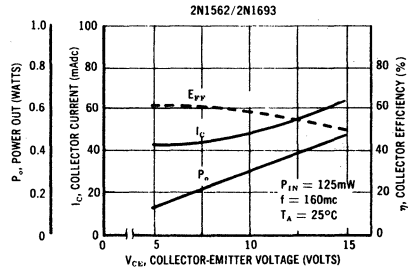
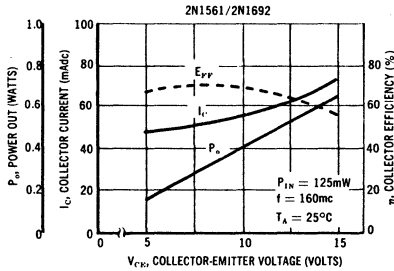

2N1613

For Specifications, See 2N718A Data Sheet

2N1692
2N1693

For Specifications, See 2N1561 Data Sheet

2N1711

For Specifications, See 2N718A Data Sheet

2N1991

For Specifications, See 2N1131 Data Sheet

2N2096
2N2097
2N2099
2N2100

For Specifications, See 2N1204 Data Sheet

2N2192, A, B thru 2N2195, A, B



$V_{CEO} = 25-50 \text{ V}$
 $I_C = 1 \text{ A}$
 $f_T = 250 \text{ Mc}$

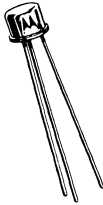

NPN silicon annular transistors for high-current switching and amplifier applications.

CASE 31
(TO-5)

MAXIMUM RATINGS

Characteristic	Symbol	2N2192	2N2193	2N2195	UNIT
		2N2192A 2N2192B 2N2194 2N2194A 2N2194B	2N2193A 2N2193B	2N2195A 2N2195B	
Collector-Base Voltage	V_{CBO}	60	80	45	Vdc
Collector-Emitter Voltage	V_{CEO}	40	50	25	Vdc
Emitter-Base Voltage	V_{EBO}	5	8	5	Vdc
Collector Current	I_C	1.0	1.0	1.0	Adc
Total Device Dissipation @ 25°C Case Temperature Derating Factor Above 25°C	P_D	0.8	0.8	0.6	Watt mW/°C
		4.56	4.56	3.43	
Total Device Dissipation @ 25°C Case Temperature Derating Factor Above 25°C	P_D	$\longleftrightarrow 2.8 \longleftrightarrow$ $\longleftrightarrow 16 \longleftrightarrow$			Watts mW/°C
Junction Temperature, Operating	T_J	-65 to +200			°C
Storage Temperature Range	T_{stg}	-65 to +300			°C

2N2192,A,B thru 2N2195,A,B (continued)

ELECTRICAL CHARACTERISTICS (at 25°C unless otherwise specified)

Characteristics		Symbol	Min	Max	Unit	
Collector-Base Breakdown Voltage ($I_C = 100 \mu\text{A dc}$, $I_E = 0$)	2N2192, A, B, 2N2194, A, B	BV_{CBO}	60	-	Vdc	
	2N2193, A, B		80	-		
	2N2195, A, B		45	-		
Collector-Emitter-Open Base Sustain Voltage* ($I_C = 25 \text{ mA pulsed}$, $I_B = 0$)	2N2192, A, B, 2N2194, A, B	$V_{CEO(sus)}$ *	40	-	Vdc	
	2N2193, A, B		50	-		
	2N2195, A, B		25	-		
Emitter-Base Breakdown Voltage ($I_E = 100 \mu\text{A dc}$, $I_C = 0$)	2N2192, A, D, 2N2194, A, B,	BV_{EBO}	5	-	Vdc	
	2N2195, A, B		8	-		
	2N2193, A, B		-	-		
Collector Cutoff Current ($V_{CB} = 30 \text{ Vdc}$, $I_E = 0$)	2N2192, A, B, 2N2194, A, B	I_{CBO}	-	.010	$\mu\text{A dc}$	
	2N2195, A, B		-	.100		
	($V_{CB} = 30 \text{ Vdc}$, $I_E = 0$, $T_A = 150^\circ\text{C}$)		2N2192, A, B	-		15
	2N2194, A, B		-	25		
	2N2195, A, B		-	50		
	($V_{CB} = 60 \text{ Vdc}$, $I_E = 0$)		2N2193, A, B	-		.010
Emitter Cutoff Current ($V_{EB} = 3 \text{ Vdc}$, $I_C = 0$)	2N2192, A, B, 2N2194, A, B	I_{EBO}	-	.050	$\mu\text{A dc}$	
	2N2195, A, B		-	.100		
Collector-Emitter Saturation Voltage ($I_C = 150 \text{ mA dc}$, $I_B = 15 \text{ mA dc}$)	2N2192 thru 2N2195	$V_{CE(sat)}$	-	0.35	Vdc	
	2N2192A thru 2N2195A 2N2192B thru 2N2195B		-	0.25 0.18		
Base-Emitter Saturation Voltage ($I_C = 150 \text{ mA dc}$, $I_B = 15 \text{ mA dc}$)	All Types	$V_{BE(sat)}$	-	1.3	Vdc	
DC Current Gain* ($I_C = 0.1 \text{ mA dc}$, $V_{CE} = 10 \text{ Vdc}$)	2N2192, A, B, 2N2193, A, B	h_{FE}^*	15	-	-	
	($I_C = 10 \text{ mA dc}$, $V_{CE} = 10 \text{ Vdc}$)		2N2192, A, B	75		-
	2N2193, A, B		30	-		
	2N2194, A, B		15	-		
	($I_C = 10 \text{ mA dc}$, $V_{CE} = 10 \text{ Vdc}$, $T_A = -55^\circ\text{C}$)		2N2192, A, B	35		-
	2N2193, A, B		20	-		
	($I_C = 150 \text{ mA dc}$, $V_{CE} = 10 \text{ Vdc}$)		2N2192, A, B	100		300
	2N2193, A, B		40	120		
	2N2194, A, B		20	60		
	2N2195, A, B		20	-		
	($I_C = 150 \text{ mA dc}$, $V_{CE} = 1.0 \text{ Vdc}$)		2N2192, A, B	70		-
	2N2193, A, B		30	-		
2N2194, A, B	15	-				
2N2195, A, B	10	-				
($I_C = 500 \text{ mA dc}$, $V_{CE} = 10 \text{ Vdc}$)	2N2192, A, B	35	-			
2N2193, A, B	20	-				
2N2194, A, B	12	-				
($I_C = 1.0 \text{ A dc}$, $V_{CE} = 10 \text{ Vdc}$)	2N2192, A, B, 2N2193, A, B	15	-			
Output Capacitance ($V_{CB} = 10 \text{ Vdc}$, $I_E = 0$, $f = 1.0 \text{ mc}$)	All Types	C_{ob}	-	20	pf	
Small Signal Current Gain ($I_C = 50 \text{ mA}$, $V_{CE} = 10 \text{ V}$, $f = 20 \text{ mc}$)	All Types	h_{fe}	2.5	-	-	
Rise Time	2N2192-94, 2N2192A-94A, 2N2192B-94B	t_r	-	70	nsec	
Storage Time		t_s	-	150	nsec	
Fall Time		t_f	-	50	nsec	

*Pulse Test: PW \leq 300 μsec , Duty Cycle \leq 2%

2N2192, A, B - $V_s = 7.5 \text{ V}$, $V_o = 7.5 \text{ V}$
 2N2193, A, B } $V_s = 15 \text{ V}$, $V_o = 15 \text{ V}$
 2N2194, A, B }

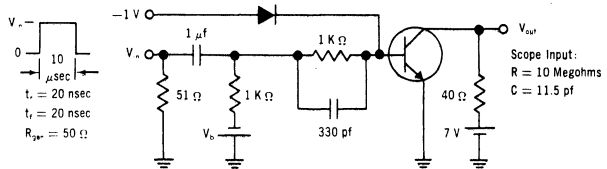

2N2217 thru 2N2222

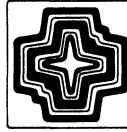

$V_{CE0} = 30\text{ V}$
 $f_T = 400\text{ Mc Typ}$

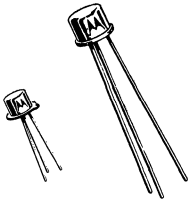

CASE 22 (TO-18) **CASE 31** (TO-5)

NPN silicon annular Star transistors for high-speed switching and DC to UHF amplifier applications.

ABSOLUTE MAXIMUM RATINGS

Characteristic	Symbol	2N2217-19 (TO-5)	2N2220-22 (TO-18)	Unit
Collector-Base Voltage	V_{CBO}	60	60	Vdc
Collector-Emitter Voltage	V_{CEO}	30	30	Vdc
Emitter-Base Voltage	V_{EBO}	5	5	Vdc
Total Device Dissipation at 25°C Case Temperature Derating Factor Above 25°C	P_D	3 20	1.8 12	Watts mW/°C
Total Device Dissipation at 25°C Ambient Temperatures Derating Factor Above 25°C	P_D	0.8 5.33	0.5 3.33	Watts mW/°C
Junction Temperature	T_j	-65 to +175		°C
Storage Temperature	T_{stg}	-65 to +300		°C

2N2217 thru 2N2222 (continued)

ELECTRICAL CHARACTERISTICS (At 25°C unless otherwise noted)

Characteristic	Symbol	Min.	Typ.	Max.	Unit
Collector Cutoff Current ($V_{CE} = 50 \text{ Vdc}$, $I_E = 0$)	I_{CBO}	—	.001	.01	μAdc
Collector Cutoff Current ($V_{CE} = 50 \text{ Vdc}$, $T_A = 150^\circ\text{C}$)	I_{CBO}	—	—	10	μAdc
Collector-Base Breakdown Voltage ($I_C = 10 \mu\text{Adc}$, $I_E = 0$)	BV_{CBO}	60	90	—	Vdc
Collector-Emitter Breakdown Voltage ($I_C = 10 \text{ mAdc}$, $I_E = 0$)	BV_{CEO}	30	45	—	Vdc
Emitter-Base Breakdown Voltage ($I_E = 10 \mu\text{Adc}$, $I_C = 0$)	BV_{EBO}	5	—	—	Vdc
Collector Saturation Voltage ($I_C = 150 \text{ mAdc}$, $I_B = 15 \text{ mAdc}$) ($I_C = 500 \text{ mAdc}$, $I_B = 50 \text{ mAdc}$)	All Types 2N2218, 2N2219 2N2221, 2N2222	—	0.24	0.4	Vdc
			0.8	1.6	Vdc
Base-Emitter Saturation Voltage ($I_C = 150 \text{ mAdc}$, $I_B = 15 \text{ mAdc}$) ($I_C = 500 \text{ mAdc}$, $I_B = 50 \text{ mAdc}$)	All Types 2N2218, 2N2219 2N2221, 2N2222	—	1.0	1.3	Vdc
			1.5	2.6	Vdc
DC Forward Current Transfer Ratio ($I_C = 0.1 \text{ mAdc}$, $V_{CE} = 10 \text{ Vdc}$) ($I_C = 1.0 \text{ mAdc}$, $V_{CE} = 10 \text{ Vdc}$) ($I_C = 10 \text{ mAdc}$, $V_{CE} = 10 \text{ Vdc}$) ($I_C = 150 \text{ mAdc}$, $V_{CE} = 10 \text{ Vdc}$) * ($I_C = 500 \text{ mAdc}$, $V_{CE} = 10 \text{ Vdc}$) *	h_{FE}	20	—	—	—
		35	—	—	—
		12	—	—	—
		25	—	—	—
		50	—	—	—
		17	—	—	—
		35	—	—	—
		75	—	—	—
		20	—	60	—
		40	—	120	—
100	—	300	—		
20	—	—	—		
30	—	—	—		
Output Capacitance $V_{CE} = 10 \text{ Vdc}$, $I_E = 0$, $f = 100\text{KC}$	C_{ob}	—	4	8	pf
Input Capacitance $V_{EB} = 0.5 \text{ Vdc}$, $I_C = 0$, $f = 100\text{KC}$	C_{ib}	—	20	—	pf
Small Signal Forward Current Transfer Ratio ($V_{CE} = 20 \text{ Vdc}$, $I_C = 20 \text{ mAdc}$, $f = 100\text{mc}$)	h_{fe}	2.5	4.0	—	—
Current Gain — Bandwidth Product ($I_C = 20 \text{ mAdc}$, $V_{CE} = 20 \text{ Vdc}$)	f_T	250	400	—	mc
Turn-on Time (Fig. 1)	t_{on}	—	26	—	nsec
Turn-off Time (Fig. 2)	t_{off}	—	68	—	nsec
Total Switching Time (Fig. 3)	t_{total}	—	12	—	nsec

*Pulse Test:
Pulse width $\leq 300 \mu\text{sec}$
Duty Cycle $\leq 2\%$

FOR DESIGN CURVES SEE 2N2218A DATA SHEET

2N2218A
2N2219A
2N2221A
2N2222A



$V_{CE0} = 40\text{ V}$
 $f_T = 400\text{ McTyp}$

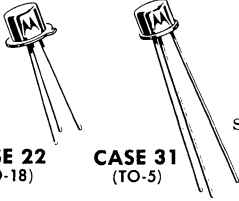

NPN silicon annular Star transistors for high-speed switching and DC to VHF amplifier applications.

CASE 22
(TO-18)

CASE 31
(TO-5)

ABSOLUTE MAXIMUM RATINGS

Characteristic	Symbol	2N2218A 2N2219A (TO-5)	2N2221A 2N2222A (TO-18)	Unit
Collector-Base Voltage	V_{CBO}	75	75	Vdc
Collector-Emitter Voltage	V_{CEO}	40	40	Vdc
Emitter-Base Voltage	V_{EBO}	6	6	Vdc
Total Device Dissipation at 25 C Case Temperature Derating Factor Above 25 C	P_D	3 20	1.8 12	Watts mW/°C
Total Device Dissipation at 25 C Ambient Temperature Derating Factor Above 25 C	P_D	0.8 5.33	0.5 3.33	Watts mW/°C
Junction Temperature Range	T_j	-65 to +175		°C
Storage Temperature Range	T_{stg}	-65 to +300		°C

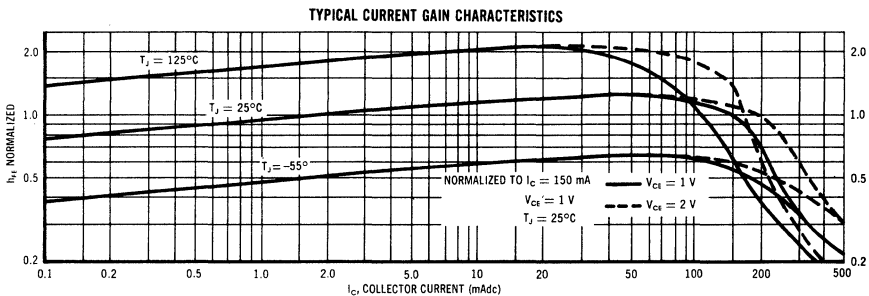

2N2218A, 2N2219A, 2N2221A, 2N2222A (continued)

ELECTRICAL CHARACTERISTICS

(At 25°C Ambient temperature unless otherwise specified.)

Static Characteristics		Symbol	Min	Max	Unit
Collector-Base Breakdown Voltage ($I_C = 10 \mu\text{Adc}$, $I_E = 0$)	All Types	BV_{CBO}	75	—	Vdc
Collector-Emitter Breakdown Voltage ($I_C = 10 \text{ mAdc}$, $I_B = 0$)	All Types	BV_{CEO}	40	—	Vdc
Emitter-Base Breakdown Voltage ($I_E = 10 \mu\text{Adc}$, $I_C = 0$)	All Types	BV_{EBO}	6	—	Vdc
Collector Cutoff Current ($V_{CB} = 60 \text{ Vdc}$, $I_E = 0$)	All Types	I_{CBO}	—	0.01	μAdc
Collector Cutoff Current ($V_{CB} = 60 \text{ Vdc}$, $I_E = 0$, $T_A = 150^\circ\text{C}$)	All Types		—	10	
Collector Cutoff Current ($V_{CE} = 60 \text{ Vdc}$, $V_{OB} = 3 \text{ Vdc}$)	All Types	I_{CEX}	—	10	nAdc
Base Cutoff Current ($V_{CE} = 60 \text{ Vdc}$, $V_{OB} = 3 \text{ Vdc}$)	All Types	I_{BL}	—	20	nAdc
Emitter Cutoff Current ($V_{OB} = 3 \text{ Vdc}$, $I_C = 0$)	All Types	I_{EBO}	—	10	nAdc
Collector-Emitter Saturation Voltage* ($I_C = 150 \text{ mAdc}$, $I_B = 15 \text{ mAdc}$)	All Types	$V_{CE(sat)}$ *	—	0.3	Vdc
($I_C = 500 \text{ mAdc}$, $I_B = 50 \text{ mAdc}$)	All Types		—	1.0	
Base-Emitter Saturation Voltage* ($I_C = 150 \text{ mAdc}$, $I_B = 15 \text{ mAdc}$)	All Types	$V_{BE(sat)}$ *	0.6	1.2	Vdc
($I_C = 500 \text{ mAdc}$, $I_B = 50 \text{ mAdc}$)	All Types		—	2.0	
DC Forward Current Transfer Ratio* ($I_C = 0.1 \text{ mAdc}$, $V_{CE} = 10 \text{ Vdc}$)	2N2218A, 2N2221A 2N2219A, 2N2222A	h_{FE} *	20 35	— —	—
($I_C = 1.0 \text{ mAdc}$, $V_{CE} = 10 \text{ Vdc}$)	2N2218A, 2N2221A 2N2219A, 2N2222A		25 50	— —	
($I_C = 10 \text{ mAdc}$, $V_{CE} = 10 \text{ Vdc}$)	2N2218A, 2N2221A 2N2219A, 2N2222A		35 75	— —	
($I_C = 10 \text{ mAdc}$, $V_{CE} = 10 \text{ Vdc}$, $T_A = -55^\circ\text{C}$)	2N2218A, 2N2221A 2N2219A, 2N2222A		15 35	— —	
($I_C = 150 \text{ mAdc}$, $V_{CE} = 10 \text{ Vdc}$)	2N2218A, 2N2221A 2N2219A, 2N2222A		40 100	120 300	
($I_C = 150 \text{ mAdc}$, $V_{CE} = 1.0 \text{ Vdc}$)	2N2218A, 2N2221A 2N2219A, 2N2222A		20 50	— —	
($I_C = 500 \text{ mAdc}$, $V_{CE} = 10 \text{ Vdc}$)	2N2218A, 2N2221A 2N2219A, 2N2222A		25 40	— —	

* Pulse Test $\leq 300 \mu\text{sec}$, duty cycle $\leq 2\%$ V_{OB} - Base-Emitter Reverse Bias

Small Signal Characteristics		Symbol	Min	Max	Unit
Small Signal Current Gain ($I_C = 1.0 \text{ mA}$, $V_C = 10 \text{ V}$, $f = 1 \text{ kc}$)	2N2218A, 2N2221A 2N2219A, 2N2222A	h_{fe}	30 50	150 300	—
($I_C = 10 \text{ mA}$, $V_C = 10 \text{ V}$, $f = 1 \text{ kc}$)	2N2218A, 2N2221A 2N2219A, 2N2222A		50 75	300 375	
Voltage Feedback Ratio ($I_C = 1.0 \text{ mA}$, $V_C = 10 \text{ V}$, $f = 1 \text{ kc}$)	2N2218A, 2N2221A 2N2219A, 2N2222A	h_{re}	-	5 8	$\times 10^{-4}$
($I_C = 10 \text{ mA}$, $V_C = 10 \text{ V}$, $f = 1 \text{ kc}$)	2N2218A, 2N2221A 2N2219A, 2N2222A		-	2.5 4	
Input Impedance ($I_C = 1.0 \text{ mA}$, $V_{CB} = 10 \text{ V}$, $f = 1 \text{ kc}$)	2N2218A, 2N2221A 2N2219A, 2N2222A	h_{ie}	1 2.0	3.5 8	k ohms
($I_C = 10 \text{ mA}$, $V_{CB} = 10 \text{ V}$, $f = 1 \text{ kc}$)	2N2218A, 2N2221A 2N2219A, 2N2222A		0.2 0.25	1.0 1.25	
Output Admittance ($I_C = 1.0 \text{ mA}$, $V_C = 10 \text{ V}$, $f = 1 \text{ kc}$)	2N2218A, 2N2221A 2N2219A, 2N2222A	h_{oe}	3 5	15 35	μmhos
($I_C = 10 \text{ mA}$, $V_C = 10 \text{ V}$, $f = 1 \text{ kc}$)	2N2218A, 2N2221A 2N2219A, 2N2222A		10 25	100 200	
Collector-Base Time Constant ($I_C = 20 \text{ mA}$, $V_{CE} = 20 \text{ V}$, $f = 31.8 \text{ mc}$)		$r'_{b,c}$		150	psec
Noise Figure ($I_C = 100 \mu\text{A}$, $V_{CE} = 10 \text{ V}$, $R_g = 1 \text{ k}\Omega$, $f = 1 \text{ kc}$)	2N2219A, 2N2222A	NF	-	4	db

— Motorola High-Frequency Transistors —

2N2218A, 2N2219A, 2N2221A, 2N2222A (continued)

SMALL SIGNAL FORWARD CURRENT GAIN AND VOLTAGE FEEDBACK RATIO versus COLLECTOR CURRENT
($V_{CE} = 10\text{ V}$ @ 1 Kc)

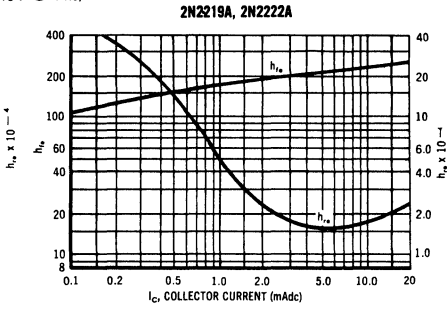
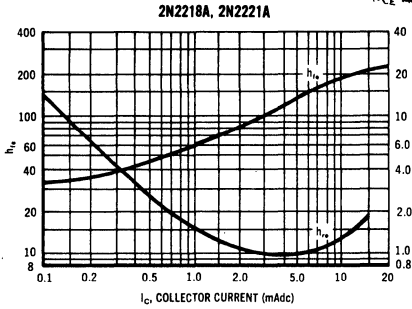

SMALL SIGNAL INPUT IMPEDANCE AND OUTPUT CONDUCTANCE versus COLLECTOR CURRENT
($V_{CE} = 10\text{ V}$ @ 1 Kc)

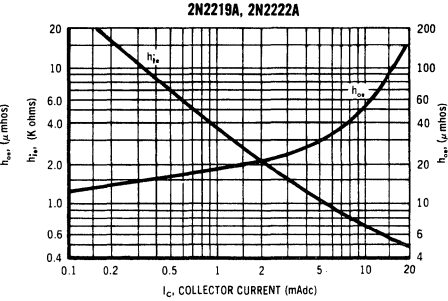
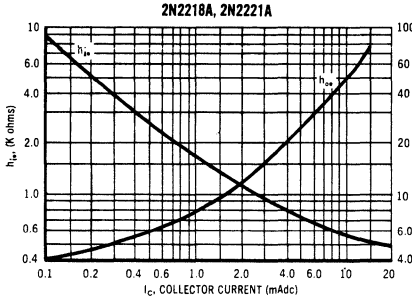

1KC NOISE FIGURE versus SOURCE IMPEDANCE

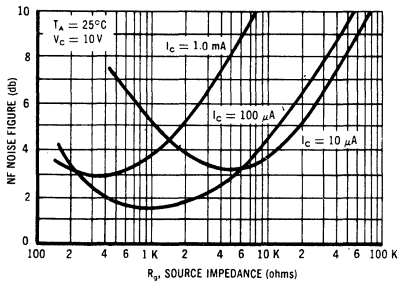

NOISE FIGURE versus FREQUENCY

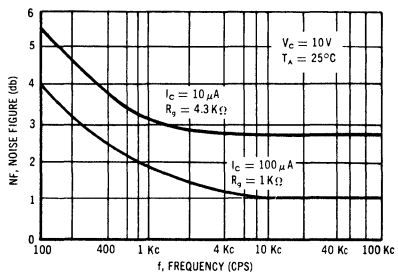

2N2218A, 2N2219A, 2N2221A, 2N2222A (continued)

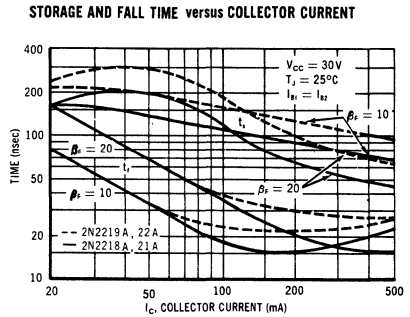
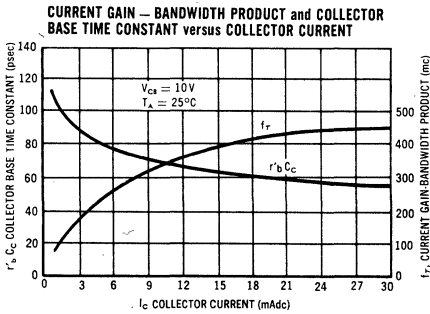
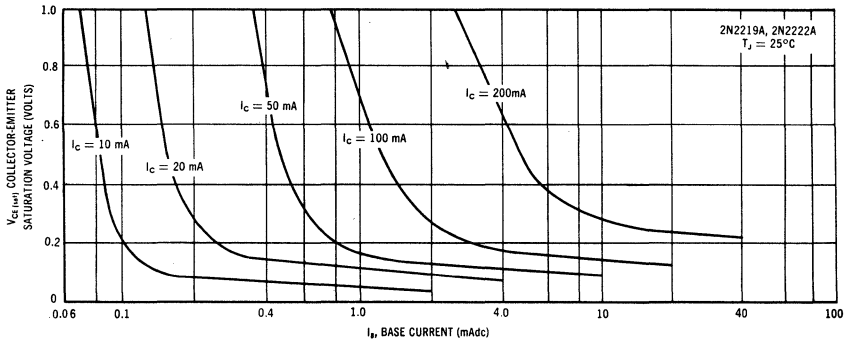
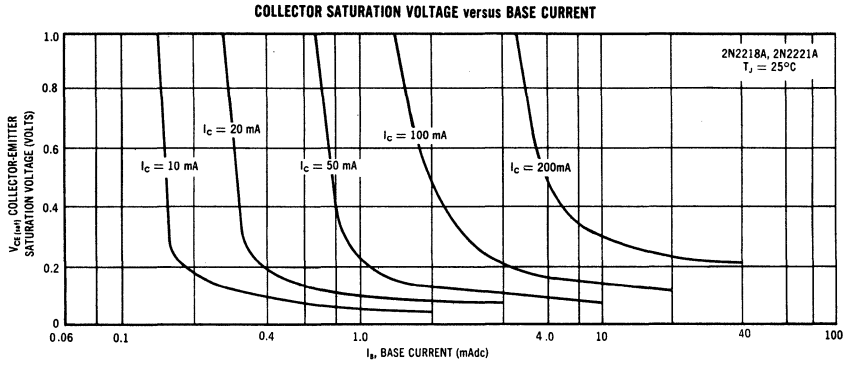

2N2220

For Specifications, See 2N2217 Data Sheet

2N2256 thru 2N2259

$V_{CES} = 7\text{ V}$
 $I_C = 100\text{ mA}$
 $f_T = 320\text{ Mc}$

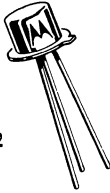

CASE 22
(TO-18)

NPN silicon and PNP germanium mesa complementary transistors for high-speed non-saturated switching applications.

MAXIMUM RATINGS

Characteristic	Symbol	2N2256 2N2257	2N2258 2N2259	Unit
Collector-Base Voltage	V_{CBO}	7	7	Vdc
Collector-Emitter Voltage	V_{CES}	7	7	Vdc
Emitter-Base Voltage	V_{EBO}	1	1	Vdc
DC Collector Current	I_C	100	100	mAdc
Storage Temperature	T_{STG}	65 to +175	65 to +100	°C
Junction Temperature	T_J	+175	+100	°C
Device Dissipation at 25°C Case	P_D	1000	300	mW
Derating factor above 25°C		6.67	4	mW/°C
Device Dissipation at 25°C Ambient	P_D	300	150	mW
Derating factor above 25°C		2	2	mW/°C

TRANSISTOR SELECTION CHART

TYPE	TYPE		$h_{FE} @ I_C = 25\text{ mA}$	
	NPN	PNP	20	40
2N2256	X		X	
2N2257	X			X
2N2258		X	X	
2N2259		X		X

2N2256 thru 2N2259 (continued)

ELECTRICAL CHARACTERISTICS

(At 25°C unless otherwise noted) — All voltages and currents are magnitudes only

Characteristic	Symbol	Minimum	Typical	Maximum	Unit
Collector-Base Breakdown Voltage $I_C = 100\mu\text{Adc}$ $I_E = 0$ ALL TYPES	BV_{CBO}	7	15	—	Vdc
Collector-Emitter Breakdown Voltage $I_C = 100\mu\text{Adc}$ $V_{EB} = 0$ ALL TYPES	BV_{CES}	7	15	—	Vdc
Emitter-Base Breakdown Voltage $I_E = 100\mu\text{Adc}$ $I_C = 0$ ALL TYPES	BV_{EBO}	1	—	—	Vdc
Collector Cutoff Current $V_{CB} = 6\text{Vdc}$ $I_E = 0$ ALL TYPES	I_{CBO}	—	3	10	μAdc
Collector Cutoff Current $V_{CB} = 6\text{Vdc}$ $I_E = 0$ $T_A = 65^\circ\text{C}$ ALL TYPES	I_{CBO}	—	30	100	μAdc
DC Forward Current Transfer Ratio $I_C = 10\text{mAdc}$ $V_{CE} = 1\text{Vdc}$ 2N2256, 2N2258 2N2257, 2N2259 $I_C = 25\text{mAdc}$ $V_{CE} = 1\text{Vdc}$ 2N2256, 2N2258 2N2257, 2N2259	h_{FE}	17 40 20 40	30 50 35 55	— — — —	
Base-Emitter Voltage $I_C = 10\text{mAdc}$ $V_{CE} = 1\text{Vdc}$ 2N2256, 2N2257 2N2258, 2N2259 $I_C = 25\text{mAdc}$ $V_{CE} = 1\text{Vdc}$ 2N2256, 2N2257 2N2258, 2N2259	V_{BE}	— — — —	0.70 0.35 0.8 0.45	0.8 0.5 0.9 0.6	Vdc Vdc Vdc Vdc
Conduction Threshold Base-Emitter Voltage* $I_C = 200\mu\text{A}$ $V_{CE} = 6\text{V}$ 2N2256, 2N2257 2N2258, 2N2259	V_T	0.5 0.1	— —	— —	Vdc
Collector Output Capacitance $V_{CB} = 5\text{Vdc}$ $I_E = 0$ $f = 4\text{mc}$ 2N2256, 2N2257 2N2258, 2N2259	C_{ob}	— —	4 4	5 8	pf pf
Current-Gain — Bandwidth Product $V_{CE} = 1\text{V}$, $I_C = 10\text{mA}$ 2N2258, 2N2259 (Ge) } $V_{CE} = 15\text{V}$, $I_C = 10\text{mA}$ 2N2256, 2N2257 (Si) }	f_T	250	320	—	mc
Turn-on Time 2N2256, 2N2257 2N2258, 2N2259	t_{on}	— —	3 4	7 8	nsec
Turn-off Time 2N2256, 2N2257 2N2258, 2N2259	t_{off}	— —	4 3	7 7	nsec
Base Resistance $V_{CB} = 2\text{V}$ $I_E = 5\text{mA}$ $f = 300\text{mc}$ 2N2256, 2N2257 2N2258, 2N2259	r'_b	— —	50 75	100 125	chms

*Base to emitter forward bias voltage at which transistor will be at the threshold of conduction; i.e. that base to emitter voltage at which the collector current is less than or equal to the specified amount under a given collector to emitter voltage condition.

2N2256 thru 2N2259 (continued)

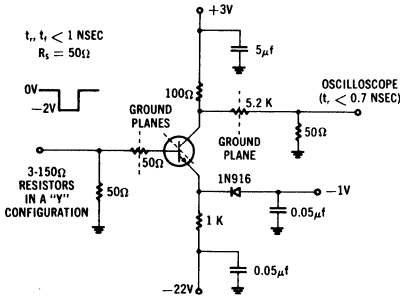

NPN SWITCHING TIME TEST CIRCUIT

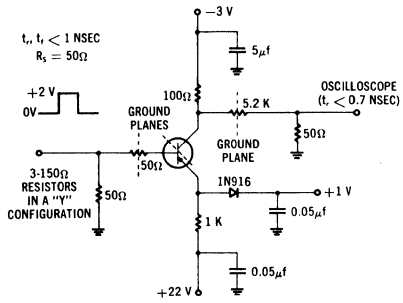

PNP SWITCHING TIME TEST CIRCUIT

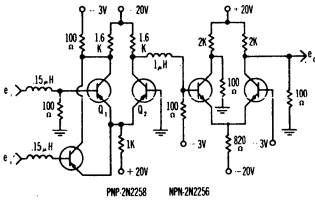

CASCADE COMPLEMENTARY GATE

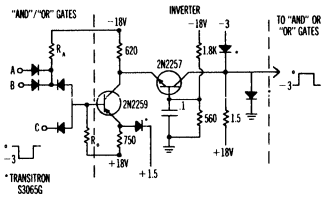

CURRENT MODE INVERTER FOR USE WITH DIODE LOGIC PROPAGATION DELAY TIME 10nSec.

STATIC CHARACTERISTICS

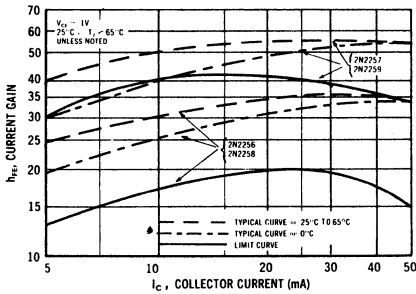

CURRENT GAIN CHARACTERISTICS

DYNAMIC CHARACTERISTICS

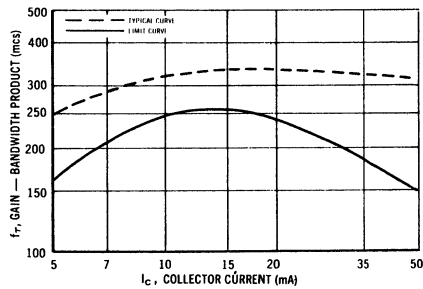

GAIN-BANDWIDTH PRODUCT CHARACTERISTICS

2N2303

For Specifications, See 2N722 Data Sheet

2N2330

2N2331

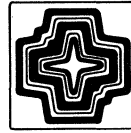
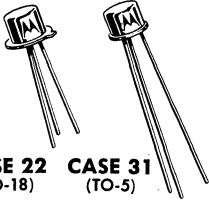

$V_{CBO} = 30\text{ V}$
 $V_{EC(sat)} = 3\text{ mV}$

NPN silicon annular Star transistors for low-level DC/AC chopper applications.

CASE 22 (TO-18) CASE 31 (TO-5)

MAXIMUM RATINGS

Characteristic	Symbol	2N2330 (TO-5)	2N2331 (TO-18)	Unit
Collector-Base Voltage	V_{CBO}	30	30	Vdc
Collector-Emitter Voltage	V_{CEO}	20	20	Vdc
Emitter-Base Voltage	V_{EBO}	5	5	Vdc
Total Device Dissipation at 25°C Case Temperature Derating Factor Above 25°C	P_D	3 20	1.8 12	Watts mW/°C
Total Device Dissipation at 25°C Ambient Temperature Derating Factor Above 25°C	P_D	0.8 5.33	0.5 3.33	Watts mW/°C
Junction Temperature	T_j	-65 to +175		°C
Storage Temperature	T_{stg}	-65 to +300		°C

INVERSE SATURATION VOLTAGE
 versus
 EMITTER CURRENT

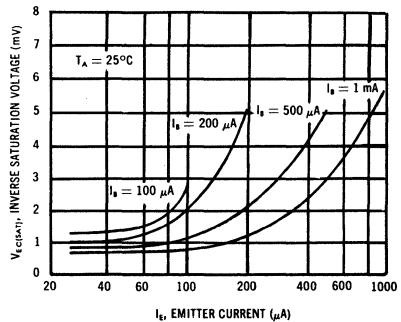

2N2330, 2N2331 (continued)

ELECTRICAL CHARACTERISTICS (At 25°C unless otherwise noted)

Characteristics	Symbol	Min.	Typ.	Max.	Unit
Collector Cutoff Current ($V_{CB} = 4.5 \text{ Vdc}$, $I_E = 0$)	I_{CBO}	—	0.1	1.0	nAdc
Collector-Base Breakdown Voltage ($I_C = 10 \mu\text{Adc}$, $I_E = 0$)	BV_{CBO}	30	60	—	Vdc
Collector-Emitter Breakdown Voltage ($I_C = 1.0 \text{ mAdc}$, $I_B = 0$)	BV_{CEO}	20	30	—	Vdc
Emitter-Base Breakdown Voltage ($I_E = 10 \mu\text{Adc}$, $I_C = 0$)	BV_{EBO}	5	—	—	Vdc
Forward Current Transfer Ratio ($I_C = 10 \text{ mAdc}$, $V_{CE} = 1 \text{ Vdc}$)	h_{FE}	50	—	—	—
Offset Voltage ($I_B = 200 \mu\text{Adc}$, $I_E = 0$)	$V_{(off)}$	—	0.3	0.75	mVdc
Inverse Saturation Voltage ($I_B = 200 \mu\text{Adc}$, $I_E = 50 \mu\text{Adc}$)	$V_{EC(SAT)}$	—	1.0	3.0	mVdc
Offset Current ($V_{BC} = 2.0 \text{ Vdc}$, $V_{CE} = 0$, $T_A = 25^\circ\text{C}$)	$I_{(off)}$	—	0.1	1	nAdc
Offset Current ($V_{BC} = 2.0 \text{ Vdc}$, $V_{CE} = 0$, $T_A = 85^\circ\text{C}$)	$I_{(off)}$	—	1	10	nAdc
Collector Capacitance ($V_{CB} = 2 \text{ Vdc}$, $I_E = 0$)	C_{ob}	—	7	10	pf
Common Base Input Capacitance ($V_{EB} = 2 \text{ Vdc}$, $I_C = 0$)	C_{ib}	—	15	20	pf
Small Signal Forward Current Transfer Ratio ($I_C = 1 \text{ mAdc}$, $V_{CE} = 1 \text{ Vdc}$, $f = 100 \text{ mc}$)	h_{fe}	1	1.5	—	—

OFFSET VOLTAGE
versus
BASE CURRENT

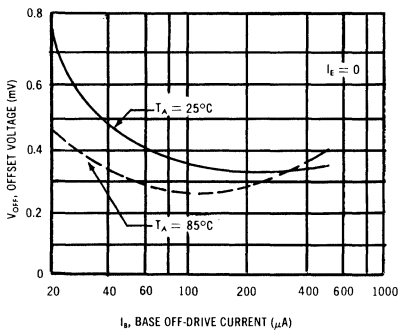

INVERSE SATURATION CHARACTERISTICS

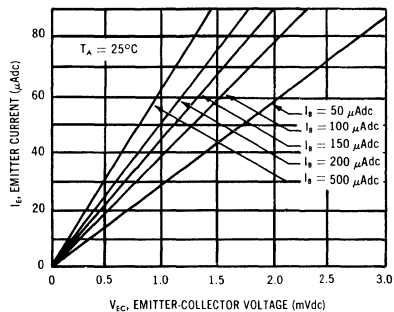

2N2369
2N3227

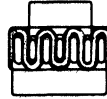

$V_{CE0} = 15-20 \text{ V}$
 $f_T = 600 \text{ Mc Typ}$



NPN silicon annular transistors for low-current, high-speed switching applications.

CASE 22
(TO-18)

MAXIMUM RATINGS

Characteristics	Symbol	Rating	Unit
Collector-Base Voltage	V_{CB0}	40	Vdc
Collector-Emitter Voltage	V_{CES}	40	Vdc
Collector-Emitter Voltage 2N2369 2N3227	V_{CE0}	15 20	Vdc
Emitter-Base Voltage 2N2369 2N3227	V_{EBO}	4.5 6.0	Vdc
Collector Current (10 μ sec pulse)	$I_C(\text{Peak})$	500	mA
Total Device Dissipation @ 25°C Ambient Temperature Derating Factor Above 25°C	P_D	0.36 2.06	Watt mW/°C
Total Device Dissipation @ 25°C Case Temperature Derating Factor Above 25°C	P_D	1.2 6.85	Watts mW/°C
Junction Temperature, Operating	T_J	+200	°C
Storage Temperature Range	T_{stg}	-65 to +200	°C

2N2369, 2N3227 (continued)

ELECTRICAL CHARACTERISTICS ($T_A = 25^\circ\text{C}$ unless otherwise noted)

Characteristics	Symbol	Min	Max	Unit
Collector Cutoff Current ($V_{CB} = 20 \text{ Vdc}$) ($V_{CB} = 20 \text{ Vdc}, T_A = 150^\circ\text{C}$)	I_{CBO}	— — —	0.4 0.2 30 50	$\mu\text{A dc}$
Collector Cutoff Current ($V_{CE} = 20 \text{ Vdc}, V_{OB} = 3 \text{ Vdc}$)	I_{CEX}	—	0.2	$\mu\text{A dc}$
Base Cutoff Current ($V_{CE} = 20 \text{ Vdc}, V_{OB} = 3 \text{ Vdc}$)	I_{BL}	—	0.5	$\mu\text{A dc}$
Collector-Base Breakdown Voltage ($I_C = 10 \mu\text{A dc}, I_B = 0$)	BV_{CBO}	40	—	Vdc
Emitter-Base Breakdown Voltage ($I_E = 10 \mu\text{A dc}, I_C = 0$)	BV_{EBO}	4.5 6.0	— —	Vdc
Collector-Emitter Breakdown Voltage * ($I_C = 10 \text{ mA dc}$)	BV_{CEO}^*	15 20	— —	Vdc
Collector-Emitter Voltage ($I_C = 10 \mu\text{A dc}, I_B = 0$)	BV_{CES}	40	—	Vdc
Collector-Emitter Saturation Voltage * ($I_C = 10 \text{ mA dc}, I_B = 1 \text{ mA dc}$) ($I_C = 100 \text{ mA dc}, I_B = 10 \text{ mA dc}$)	$V_{CE(sat)}^*$	— —	0.25 0.45	Vdc
Base-Emitter Saturation Voltage * ($I_C = 10 \text{ mA dc}, I_B = 1 \text{ mA dc}$) ($I_C = 100 \text{ mA dc}, I_B = 10 \text{ mA dc}$)	$V_{BE(sat)}^*$	0.70 0.8	0.85 1.4	Vdc
DC Current Gain* ($I_C = 10 \text{ mA dc}, V_{CE} = 1.0 \text{ Vdc}$) ($I_C = 10 \text{ mA dc}, V_{CE} = 1.0 \text{ Vdc}, T_A = -55^\circ\text{C}$) ($I_C = 100 \text{ mA dc}, V_{CE} = 1.0 \text{ Vdc}$) ($I_C = 100 \text{ mA dc}, V_{CE} = 2 \text{ Vdc}$)	h_{FE}^*	40 100 20 40 30 20	120 300 — — — —	—
Small Signal Current Gain ($I_C = 10 \text{ mA dc}, V_{CE} = 10 \text{ Vdc}, f = 100 \text{ mc}$)	h_{fe}	5	—	—
Output Capacitance ($V_{CB} = 5 \text{ Vdc}, I_E = 0, f = 140 \text{ kc}$)	C_{ob}	—	4	pf
Input Capacitance ($V_{OB} = 1 \text{ Vdc}, I_C = 0, f = 140 \text{ kc}$)	C_{ib}	—	4	pf
Storage Time ($I_C = I_{B1} = I_{B2} = 10 \text{ mA}$)	$t_s(\tau_s)$	—	13	nsec
Turn-On Time ($I_C = 10 \text{ mA}, I_{B1} = 3 \text{ mA},$ $V_{CC} = 3 \text{ V}, V_{OB} = 1.5 \text{ V}$)	t_{on}	—	12	nsec
Turn-Off Time ($I_C = 10 \text{ mA}, I_{B1} = 3 \text{ mA},$ $I_{B2} = 1.5 \text{ mA}, V_{CC} = 3 \text{ V}$)	t_{off}	—	18	nsec
Total Control Charge ($I_C = 10 \text{ mA}, I_B = 1 \text{ mA}, V_{CC} = 3 \text{ V}$)	Q_T	—	50	pC

2N2369, 2N3227 (continued)

ELECTRICAL CHARACTERISTICS (continued)

Characteristics		Symbol	Min	Max	Unit
Delay Time	$V_{CC} = 10\text{ V}, V_{OB} = 2\text{ V},$ $I_C = 100\text{ mA}, I_{B1} = 10\text{ mA}$	2N3227	—	5	nsec
Rise Time	$V_{CC} = 10\text{ V}, V_{OB} = 2\text{ V},$ $I_C = 100\text{ mA}, I_{B1} = 10\text{ mA}$	2N3227	—	18	nsec
t_r					
Storage Time	$V_{CC} = 10\text{ V},$ $I_C = 100\text{ mA},$ $I_{B1} = I_{B2} = 10\text{ mA}$	2N3227	—	13	nsec
t_s					
Fall Time	$V_{CC} = 10\text{ V}, V_{OB} = 2\text{ V},$ $I_C = 100\text{ mA}, I_{B1} = I_{B2} = 10\text{ mA}$	2N3227	—	15	nsec
t_f					

*Pulse Test: PW = 300 μ sec, Duty Cycle \leq 2%

MINIMUM CURRENT GAIN CHARACTERISTICS

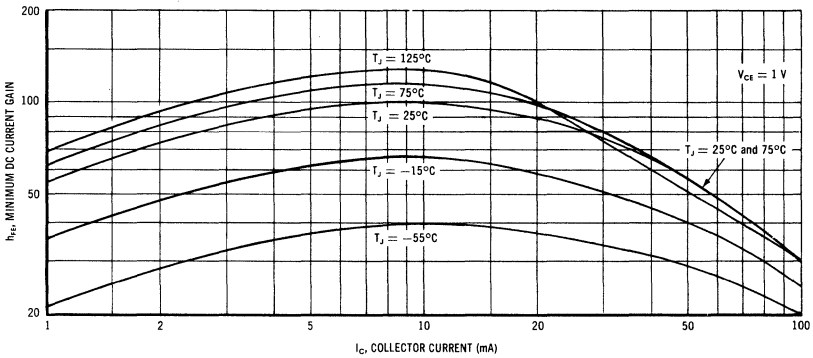

TYPICAL SWITCHING TIMES

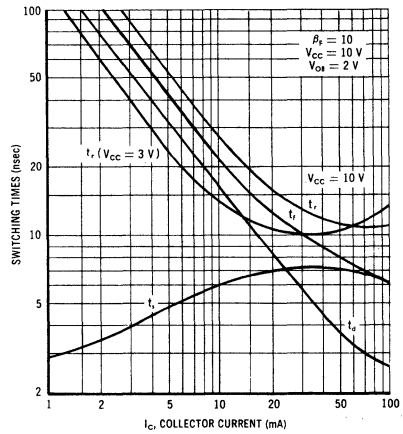

SATURATION VOLTAGE LIMITS

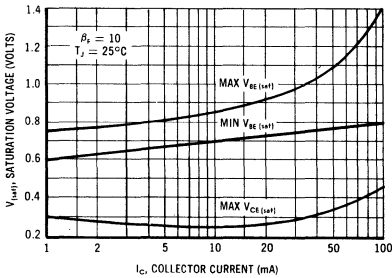

2N2381
2N2382

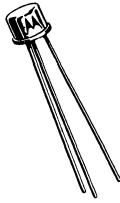

$V_{CEO} = 15-20 \text{ V}$
 $I_C = 500 \text{ mA}$
 $f_T = 300 \text{ Mc}$

PNP germanium epitaxial mesa transistors for high-speed, high-current switching applications.

CASE 31
(TO-5)

MAXIMUM RATINGS

Characteristic	Symbol	Rating		Unit
		2N2381	2N2382	
Collector-Base Voltage	V_{CBO}	30	45	Vdc
Collector-Emitter Voltage	V_{CEO}	15	20	Vdc
Emitter-Base Voltage	V_{EBO}	4	4	Vdc
Collector Current (Continuous)	I_C	500		mAdc
Junction Temperature	T_J	100		$^{\circ}\text{C}$
Storage Temperature	T_{STG}	-65 to +100		$^{\circ}\text{C}$
Device Dissipation @ 25 $^{\circ}\text{C}$ Case Temperature (Derate 10 mW/ $^{\circ}\text{C}$ above 25 $^{\circ}\text{C}$)	P_D	750		mW
Device Dissipation @ 25 $^{\circ}\text{C}$ Ambient (Derate 4 mW/ $^{\circ}\text{C}$)	P_D	300		mW

ACTIVE REGION TIME CONSTANT

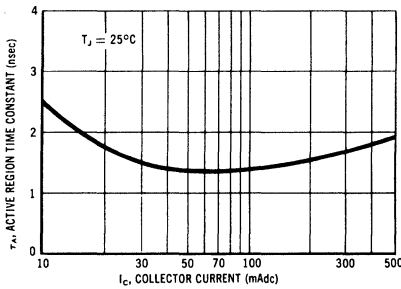

NORMALIZED CURRENT GAIN CHARACTERISTICS

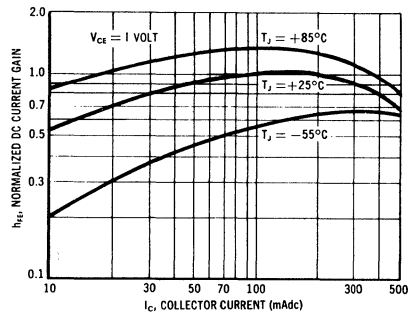

COLLECTOR-EMITTER SATURATION VOLTAGES versus BASE CURRENT

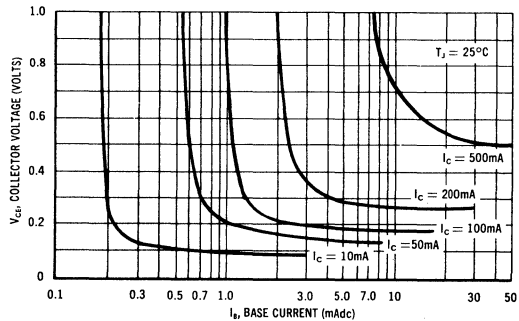

2N2381, 2N2382 (Continued)

ELECTRICAL CHARACTERISTICS (At 25°C unless otherwise noted)

Characteristic	Fig. No.	Symbol	Min.	Typ.	Max.	Unit
Collector-Base Breakdown Voltage ($I_C = 100 \mu\text{Adc}$, $I_E = 0$) 2N2381 2N2382		BV_{CBO}	30 45	— —	— —	Vdc
Collector-Emitter Breakdown Voltage ($I_C = 10 \text{ mAdc}$, $I_B = 0$) 2N2381 2N2382		BV_{CEO}	15 20	— —	— —	Vdc
Latch-Up Voltage 2N2381 2N2382	7	LV_{CEX}	20 25	— —	— —	Vdc
Collector-Emitter Leakage Current ($V_{CE} = 30$, $V_{EB} = 0$) 2N2381 ($V_{CE} = 45$, $V_{EB} = 0$) 2N2382		I_{CES}	— —	— —	100 100	μAdc
Emitter-Base Leakage Current ($V_{EB} = 0.5 \text{ Vdc}$, $I_C = 0$) ($V_{EB} = 4 \text{ Vdc}$, $I_C = 0$)		I_{EBO}	— —	— —	5 1	μAdc mAdc
Collector Cutoff Current ($V_{CB} = 5 \text{ Vdc}$, $I_E = 0$) Both Types ($V_{CB} = 5 \text{ Vdc}$, $I_E = 0$, $T_A = 85^\circ\text{C}$) Both Types ($V_{CB} = 20 \text{ Vdc}$, $I_E = 0$) 2N2381 2N2382		I_{CBO}	— — —	1.0 — —	7 100 25 15	μAdc
DC Forward Current Transfer Ratio ($I_C = 200 \text{ mAdc}$, $V_{CE} = 0.5 \text{ Vdc}$) ($I_C = 400 \text{ mAdc}$, $V_{CE} = 1.0 \text{ Vdc}$)	11	h_{FE}	40 25	— —	— —	—
Collector-Emitter Saturation Voltage ($I_C = 200 \text{ mAdc}$, $I_B = 20 \text{ mAdc}$) ($I_C = 400 \text{ mAdc}$, $I_B = 40 \text{ mAdc}$)	8	$V_{CE(\text{sat})}$	— —	0.25 0.4	0.4 0.7	Vdc
Base-Emitter Voltage ($I_C = 200 \text{ mAdc}$, $I_B = 20 \text{ mAdc}$) ($I_C = 400 \text{ mAdc}$, $I_B = 40 \text{ mAdc}$)	9	V_{BE}	0.45 —	0.54 0.71	0.7 0.9	Vdc
Output Capacitance ($V_{CB} = 10 \text{ Vdc}$, $I_E = 0$, $f = 4 \text{ mc}$)	13	C_{ob}	—	3.5	6	pf
Input Capacitance ($V_{EB} = 1 \text{ Vdc}$, $I_C = 0$, $f = 4 \text{ mc}$)	13	C_{ib}	—	8	15	pf
Current-Gain - Bandwidth Product ($V_{CE} = 10 \text{ Vdc}$, $I_C = 20 \text{ mAdc}$, $f = 100 \text{ mc}$)		f_T	300	—	—	mc
Delay Time	4	t_d	—	4.5	7	nsec
Rise Time	4	t_r	—	8	15	nsec
Storage Time	3, 4	t_s	—	20	30	nsec
Fall Time	4	t_f	—	8	15	nsec
Active Region Time Constant	1, 4	τ_A	—	1.6	3.0	nsec

2N2481

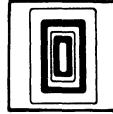

$V_{CE0} = 15\text{ V}$
 $f_T = 450\text{ Mc Typ}$



CASE 22
(TO-18)

NPN silicon annular transistor for high-speed switching applications.

MAXIMUM RATINGS

CHARACTERISTIC	SYMBOL	RATING	UNIT
Collector-Base Voltage	V_{CBO}	40	Vdc
Collector-Emitter Voltage	V_{CEO}	15	Vdc
Emitter-Base Voltage	V_{EBO}	5	Vdc
Total Device Dissipation @ 25°C Ambient Temperature (Derate 2.06 mW/°C above 25°C)	P_D	0.36	Watt
Total Device Dissipation @ 25°C Case Temperature (Derate 6.9 mW/°C above 25°C)	P_D	1.2	Watts
Junction Temperature	T_J	200	°C
Storage Temperature	T_{stg}	-65 to +300	°C

MINIMUM CURRENT GAIN CHARACTERISTICS

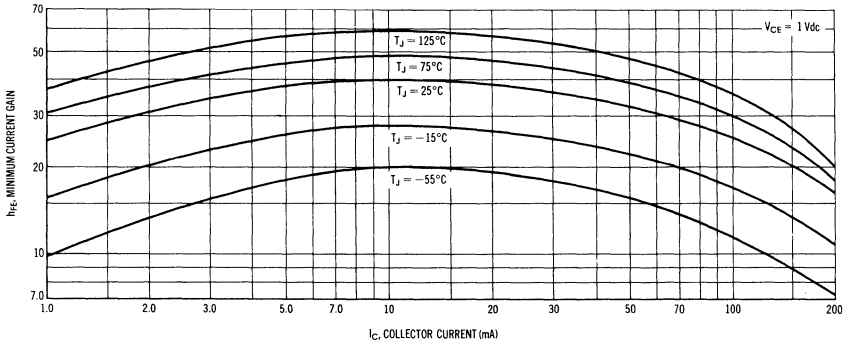

2N2481 (Continued)

ELECTRICAL CHARACTERISTICS (At 25°C unless otherwise noted)

CHARACTERISTIC	SYMBOL	MIN	MAX	UNIT
Collector-Base Breakdown Voltage ($I_C = 10 \mu\text{Adc}$, $I_E = 0$)	BV_{CBO}	40	---	Vdc
Emitter-Base Breakdown Voltage ($I_E = 100 \mu\text{Adc}$, $I_C = 0$)	BV_{EBO}	5	---	Vdc
Collector-Emitter Breakdown Voltage* ($I_C = 30 \text{ mAdc}$, $I_B = 0$)	BV_{CEO}	15	---	Vdc
Collector-Emitter Breakdown Voltage ($I_C = 1.0 \mu\text{Adc}$, $V_{BE} = 0$)	BV_{CES}	30	---	Vdc
Collector Leakage Current ($V_{CE} = 20 \text{ Vdc}$, $V_{BE} = 3 \text{ Vdc}$) ($V_{CE} = 20 \text{ Vdc}$, $V_{BE} = 3 \text{ Vdc}$, $T_A = 150^\circ\text{C}$)	I_{CEX}	---	.050 15	μAdc
Base Leakage Current ($V_{CE} = 20 \text{ Vdc}$, $V_{BE} = 3 \text{ Vdc}$)	I_{BL}	---	50	nAdc
Emitter Cutoff Current ($V_{EB} = 4.0 \text{ Vdc}$, $I_C = 0$)	I_{EBO}	---	100	nAdc
DC Forward Current Transfer Ratio ($I_C = 1.0 \text{ mAdc}$, $V_{CE} = 1.0 \text{ Vdc}$) ($I_C = 10 \text{ mAdc}$, $V_{CE} = 1.0 \text{ Vdc}$)* ($I_C = 10 \text{ mAdc}$, $V_{CE} = 1.0 \text{ Vdc}$, $T_A = -55^\circ\text{C}$)* ($I_C = 150 \text{ mAdc}$, $V_{CE} = 1.0 \text{ Vdc}$)*	h_{FE}	25 40 20 20	--- 120 --- ---	---
Collector-Emitter Saturation Voltage ($I_C = 10 \text{ mAdc}$, $I_B = 1.0 \text{ mAdc}$) ($I_C = 100 \text{ mAdc}$, $I_B = 10 \text{ mAdc}$)*	$V_{CE}(\text{sat})$	---	0.25 0.40	Vdc
Base-Emitter Saturation Voltage ($I_C = 10 \text{ mAdc}$, $I_B = 1.0 \text{ mAdc}$) ($I_C = 100 \text{ mAdc}$, $I_B = 10 \text{ mAdc}$)*	$V_{BE}(\text{sat})$	0.7 ---	0.82 1.25	Vdc
Output Capacitance ($V_{CB} = 5 \text{ V}$, $I_C = 0$, $f = 1 \text{ Mc}$)	C_{ob}	---	5	pf
Input Capacitance ($V_{EB} = 0.5 \text{ V}$, $f = 1 \text{ Mc}$)	C_{ib}	---	7	pf
Small-Signal Forward Current Transfer Ratio ($V_{CE} = 10 \text{ V}$, $I_C = 10 \text{ mA}$, $f = 100 \text{ Mc}$)	h_{fe}	3	---	---
Small-Signal, Short-Circuit, Input Impedance (Real part) ($I_C = 10 \text{ mA}$, $V_{CE} = 10 \text{ V}$, $f = 250 \text{ Mc}$)	$h_{ie}(\text{real})$	---	60	ohms
Turn-On Time ($I_C = 100 \text{ mA}$, $I_{B1} = 10 \text{ mA}$, $V_{BE}(\text{off}) = -2 \text{ V}$) ($I_C = 10 \text{ mA}$, $I_{B1} = 1.0 \text{ mA}$, $V_{BE}(\text{off}) = -2 \text{ V}$)	t_{on}	---	40 75	nsec
Turn-Off Time ($I_C = 100 \text{ mA}$, $I_{B1} = 10 \text{ mA}$, $I_{B2} = -5 \text{ mA}$) ($I_C = 10 \text{ mA}$, $I_{B1} = 1.0 \text{ mA}$, $I_{B2} = -0.5 \text{ mA}$)	t_{off}	---	55 45	nsec
Storage Time ($I_C = 10 \text{ mA}$, $I_{B1} = 10 \text{ mA}$, $I_{B2} = -10 \text{ mA}$)	t_s	---	20	nsec

*Pulse width = 300 μsec , Duty Cycle = 2%

2N2481 (Continued)

TURN-ON TIME VARIATIONS WITH VOLTAGE

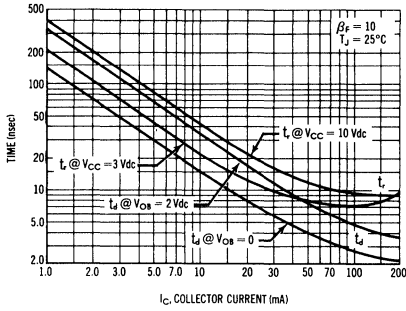

LIMITS OF SATURATION VOLTAGES

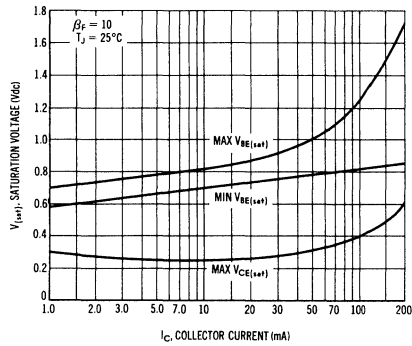

FALL TIME BEHAVIOR

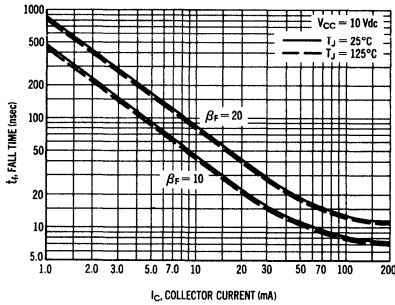

STORAGE TIME BEHAVIOR

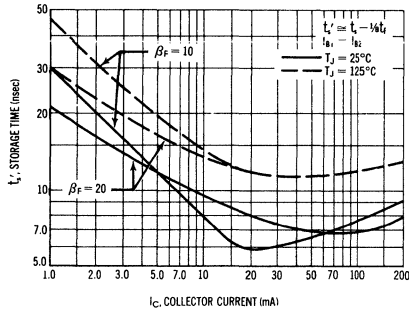

COLLECTOR SATURATION VOLTAGE CHARACTERISTICS

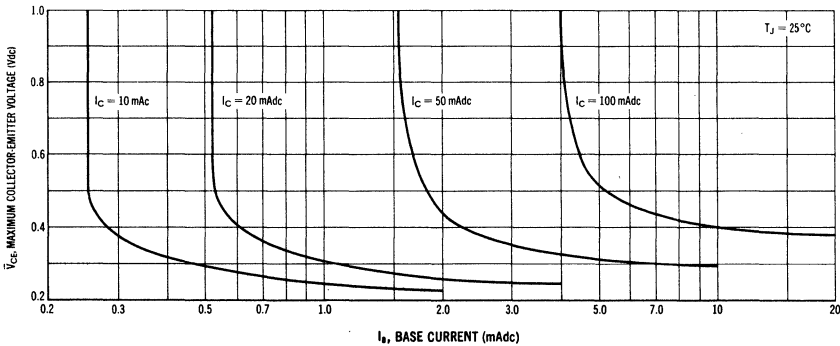

2N2501

$V_{CE0} = 20\text{ V}$
 $f_T = 450\text{ Mc Typ}$



CASE 22
 (TO-18)

NPN silicon annular transistor for high-speed switching applications.

MAXIMUM RATINGS

Characteristic	Symbol	Rating	Unit
Collector-Base Voltage	V_{CBO}	40	Vdc
Collector-Emitter Voltage	V_{CEO}	20	Vdc
Emitter-Base Voltage	V_{EBO}	6	Vdc
Total Device Dissipation @ 25° C Ambient Temperature (Derate 2.06 mW/°C above 25° C)	P_D	0.36	Watts
Junction Temperature	T_J	+200	°C
Storage Temperature	T_{stg}	-65 to +200	°C
Total Device Dissipation @ 25° C Case Temperature (Derate 6.9 mW/°C above 25° C)	P_D	1.2	Watts

TOTAL CONTROL CHARGE

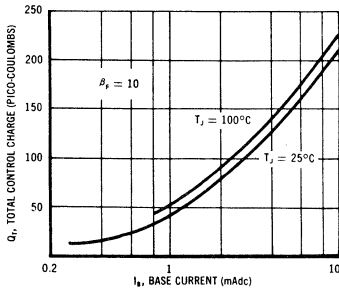

NORMALIZED CURRENT GAIN CHARACTERISTICS

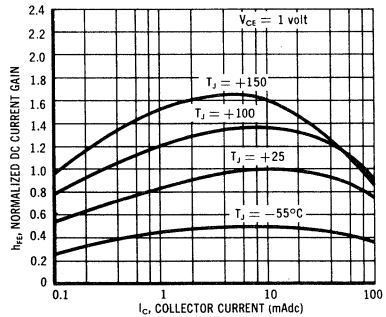

2N2501 (Continued)

ELECTRICAL CHARACTERISTICS (At 25°C unless otherwise noted)

Characteristic	Symbol	Minimum	Maximum	Unit
Collector-Base Breakdown Voltage ($I_C = 10 \mu\text{A dc}$, $I_E = 0$)	BV_{CBO}	40	—	Vdc
Collector-Emitter Breakdown Voltage ($I_C = 30 \text{ mA dc}$, $I_B = 0$, Pulsed)	BV_{CEO}	20	—	Vdc
Emitter-Base Breakdown Voltage ($I_E = 10 \mu\text{A dc}$, $I_C = 0$)	BV_{EBO}	6	—	Vdc
Collector Leakage Current ($V_{CE} = 20 \text{ Vdc}$, $V_{BE} = -3 \text{ Vdc}$)	I_{CEX}	—	25	nA dc
Base Leakage Current ($V_{CE} = 20 \text{ Vdc}$, $V_{BE} = -3 \text{ Vdc}$) ($V_{CE} = 20 \text{ Vdc}$, $V_{BE} = -3 \text{ Vdc}$, $T_A = 150^\circ\text{C}$)	I_{BL}	—	25 50	nA dc $\mu\text{A dc}$
DC Forward Current Transfer Ratio* ($I_C = 100 \mu\text{A dc}$, $V_{CE} = 1 \text{ Vdc}$) ($I_C = 1 \text{ mA dc}$, $V_{CE} = 1 \text{ Vdc}$) ($I_C = 10 \text{ mA dc}$, $V_{CE} = 1 \text{ Vdc}$) ($I_C = 10 \text{ mA dc}$, $V_{CE} = 1 \text{ Vdc}$, $T_A = -55^\circ\text{C}$) ($I_C = 50 \text{ mA dc}$, $V_{CE} = 1 \text{ Vdc}$) ($I_C = 100 \text{ mA dc}$, $V_{CE} = 1 \text{ Vdc}$) ($I_C = 500 \text{ mA dc}$, $V_{CE} = 5 \text{ Vdc}$)	h_{FE}	20 30 50 20 40 30 10	— — 150 — — — —	—
Collector-Emitter Saturation Voltage* ($I_C = 10 \text{ mA dc}$, $I_B = 1 \text{ mA dc}$) ($I_C = 50 \text{ mA dc}$, $I_B = 5 \text{ mA dc}$) ($I_C = 100 \text{ mA dc}$, $I_B = 10 \text{ mA dc}$)	$V_{CE(sat)}$	— — —	0.2 0.3 0.4	Vdc
Base-Emitter Saturation Voltage* ($I_C = 10 \text{ mA dc}$, $I_B = 1 \text{ mA dc}$) ($I_C = 50 \text{ mA dc}$, $I_B = 5 \text{ mA dc}$) ($I_C = 100 \text{ mA dc}$, $I_B = 10 \text{ mA dc}$)	$V_{BE(sat)}$	— — —	0.85 1.0 1.2	Vdc
Output Capacitance ($V_{CB} = 10 \text{ Vdc}$, $I_E = 0$, $f = 100 \text{ kc}$)	C_{ob}	—	4	pf
Input Capacitance ($V_{EB} = 0.5 \text{ Vdc}$, $I_C = 0$, $f = 100 \text{ kc}$)	C_{ib}	—	7	pf
Small Signal Forward Current Transfer Ratio ($V_{CE} = 20 \text{ Vdc}$, $I_C = 10 \text{ mA dc}$, $f = 100 \text{ mc}$)	h_{fe}	3.5	—	—
Current-Gain-Bandwidth Product ($V_{CE} = 20 \text{ Vdc}$, $I_C = 10 \text{ mA dc}$)	f_T	350	—	mc
Charge Storage Time Constant ($I_C = I_{B1} = I_{B2} = 10 \text{ mA dc}$)	τ_S	—	15	nsec
Total Control Charge ($I_C = 10 \text{ mA dc}$, $I_B = 1 \text{ mA dc}$)	Q_T	—	60	pico-coulombs
Active Region Time Constant ($I_C = 10 \text{ mA dc}$)	τ_A	—	2.5	nsec

*Pulse Test: Pulse width $\leq 300 \mu\text{sec}$, duty cycle $\leq 2\%$

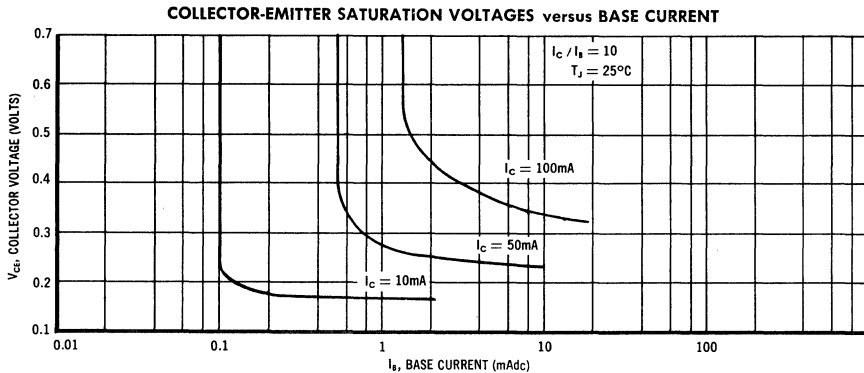

2N2537 thru 2N2540

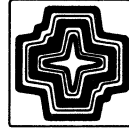

$V_{CE0} = 30\text{ V}$
 $f_T = 400\text{ Mc Typ}$

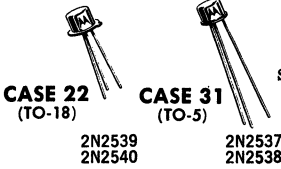

NPN silicon annular Star transistors for high-speed switching.

MAXIMUM RATINGS

Characteristic	Symbol	Types		Unit
		2N2537 2N2538 (TO-5)	2N2539 2N2540 (TO-18)	
Collector-Base Voltage	V_{CBO}	60	60	Vdc
Collector-Emitter Voltage	V_{CEO}	30	30	Vdc
Collector-Emitter Voltage	V_{CER}	40	40	Vdc
Emitter-Base Voltage	V_{EBO}	5	5	Vdc
Total Device Dissipation 25°C Case Temperature Derate above 25°C	P_D	3 17.2	1.8 10.3	Watts mW/°C
Total Device Dissipation 25°C Ambient Temperature Derate above 25°C	P_D	0.8 4.57	0.5 2.86	Watts mW/°C
Junction Temperature	T_J	-65 to +200		°C
Storage Temperature	T_{stg}	-65 to +300		°C

ELECTRICAL CHARACTERISTICS (At 25°C unless otherwise noted)

Characteristic	Symbol	Min.	Max.	Unit
Collector Cutoff Current ($V_{CB} = 40\text{ Vdc}$, $I_E = 0$) ($V_{CB} = 40\text{ Vdc}$, $I_E = 0$, $T_A = 150^\circ\text{C}$)	I_{CBO}	—	0.250 200	$\mu\text{A dc}$
Emitter Cutoff Current ($V_{EB} = 3\text{ Vdc}$, $I_C = 0$)	I_{EBO}	—	0.05	$\mu\text{A dc}$
Collector Cutoff Current ($V_{BE} = 0.2\text{ Vdc}$, $V_{CE} = 20\text{ Vdc}$)	I_{CEX}	—	0.250	$\mu\text{A dc}$
Base Cutoff Current ($V_{BE} = 0.2\text{ Vdc}$, $V_{CE} = 20\text{ Vdc}$) ($V_{BE} = 0.2\text{ Vdc}$, $V_{CE} = 20\text{ Vdc}$, $T_A = 150^\circ\text{C}$)	I_{BL}	—	0.250 200	$\mu\text{A dc}$
Collector-Base Breakdown Voltage ($I_C = 10\ \mu\text{A dc}$, $I_E = 0$)	BV_{CBO}	60	—	Vdc
Collector-Emitter Breakdown Voltage ($I_C = 100\text{ mA dc}$, pulsed, $I_E = 0$)	BV_{CEO}	30	—	Vdc
Collector-Emitter Breakdown Voltage ($I_C = 100\text{ mA dc}$, pulsed, $R_{\theta JE} \approx 10^\circ\text{C}$)	BV_{CER}	40	—	Vdc
Emitter-Base Breakdown Voltage ($I_E = 10\ \mu\text{A dc}$, $I_C = 0$)	BV_{EBO}	5	—	Vdc
Collector Saturation Voltage* ($I_C = 150\text{ mA dc}$, $I_B = 15\text{ mA dc}$) ($I_C = 500\text{ mA dc}$, $I_B = 50\text{ mA dc}$)	$V_{CE(sat)}$	—	0.45 1.6	Vdc
Base-Emitter Saturation Voltage ($I_C = 150\text{ mA dc}$, $I_B = 15\text{ mA dc}$)* ($I_C = 500\text{ mA dc}$, $I_B = 50\text{ mA dc}$)	$V_{BE(sat)}$	—	1.3 2.6	Vdc
DC Forward Current Transfer Ratio ($I_C = 1\text{ mA dc}$, $V_{CE} = 10\text{ Vdc}$) ($I_C = 10\text{ mA dc}$, $V_{CE} = 10\text{ Vdc}$) ($I_C = 150\text{ mA dc}$, $V_{CE} = 10\text{ Vdc}$)* ($I_C = 500\text{ mA dc}$, $V_{CE} = 10\text{ Vdc}$)*	h_{FE}	20 35 30 50 50 100 20 30	— — — 150 300 — —	—
Output Capacitance ($V_{CB} = 10\text{ Vdc}$, $I_E = 0$, $f = 100\text{ kc}$)	C_{ob}	—	8	pf
Input Capacitance ($V_{EB} = 0.5\text{ Vdc}$, $I_C = 0$, $f = 100\text{ kc}$)	C_{ib}	—	25	pf
Small Signal Forward Current Transfer Ratio ($V_{CE} = 20\text{ Vdc}$, $I_C = 20\text{ mA dc}$, $f = 100\text{ mc}$)	h_{fe}	2.5	—	—

*Pulse Test: Pulse width $\leq 300\ \mu\text{sec}$, duty cycle $\leq 2\%$

2N2630

$V_{CEO} = 10\text{ V}$
 $I_C = 100\text{ mA}$



PNP germanium mesa transistor for high-speed switching applications.

CASE 22
(TO-18)

MAXIMUM RATINGS

Characteristic	Symbol	Maximum	Unit
EMITTER-BASE VOLTAGE	V_{EBO}	-4	VOLTS
COLLECTOR-BASE VOLTAGE	V_{CBO}	-18	VOLTS
COLLECTOR-EMITTER VOLTAGE	V_{CEO}	-10	VOLTS
D. C. COLLECTOR CURRENT	I_C	100	mA
STORAGE TEMPERATURE RANGE	T_{stg}	-65 to +100	°C
DEVICE DISSIPATION @25°C CASE TEMPERATURE LINEAR DERATING FACTOR 4 mW/°C		300	mW

SWITCHING TIME TEST CIRCUIT

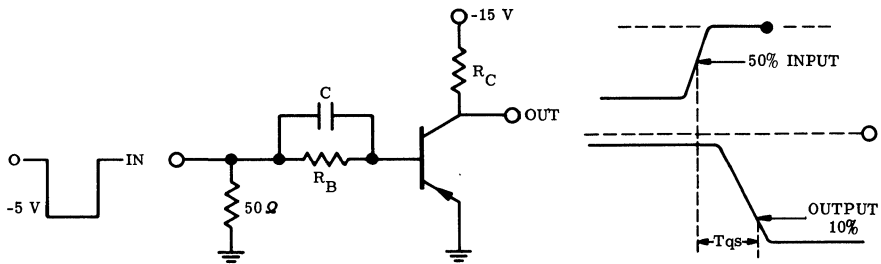

Tqs 1

$R_C = 750\ \Omega$
 $R_B = 3.3\ \text{K}$
 $C = 104\ \text{pf}$
 $I_C = 20\ \text{mA}$
 $I_B = 1.5\ \text{mA}$

Tqs 2

$R_C = 189\ \Omega$
 $R_B = 1.1\ \text{K}$
 $C = 440\ \text{pf}$
 $I_C = 80\ \text{mA}$
 $I_B = 4.5\ \text{mA}$

GENERATOR RISE AND FALL TIME $\leq 10\ \text{nSec}$
 OUTPUT INDICATOR RISE TIME $\leq 4.0\ \text{nSec}$

2N2630 (Continued)

ELECTRICAL CHARACTERISTICS

	Symbol		Minimum	Typical	Maximum	Unit
COLLECTOR-BASE CUTOFF CURRENT	I_{CBO}	$V_{CB} = -15 \text{ Vdc}$	-	-	5	μAdc
EMITTER-BASE CUTOFF CURRENT	I_{EBO}	$V_{EB} = -2 \text{ Vdc}$	-	-	5	μAdc
COLLECTOR-BASE BREAKDOWN VOLTAGE	BV_{CBO}	$I_C = 25 \mu\text{A}$	-18	-	-	Vdc
EMITTER-BASE BREAKDOWN VOLTAGE	BV_{EBO}	$I_E = 100 \mu\text{A}$	-4	-	-	Vdc
COLLECTOR-EMITTER BREAKDOWN VOLTAGE	BV_{CEO}	$I_C = 5 \text{ mA}$	-10	-	-	Vdc
COLLECTOR-EMITTER LATCH-UP VOLTAGE	LV_{CER}		-17	-	-	Vdc
COLLECTOR-EMITTER SATURATION VOLTAGE	$V_{CE(sat)}$	$I_C = 100 \text{ mA}$ $I_B = 10 \text{ mA}$	-	-	-0.45	Vdc
BASE-EMITTER VOLTAGE	V_{BE}	$I_C = 100 \text{ mA}$ $I_B = 10 \text{ mA}$	-	-	-0.8	Vdc
FORWARD CURRENT TRANSFER RATIO	h_{FE}	$I_C = 100 \text{ mA}$ $V_{CE} = -0.75 \text{ V}$	25	-	-	-
OUTPUT CAPACITANCE	C_{ob}	$V_{CB} = -10 \text{ V}, I_E = 0$ $f = 1 \text{ mC}$	-	-	4	pf
INPUT CAPACITANCE	C_{ib}	$V_{EB} = -1 \text{ V}$ $I_C = 0, f = 1 \text{ mC}$	-	-	3.5	pf
SMALL SIGNAL FORWARD CURRENT	h_{fe}	$V_{CE} = -6 \text{ V}$ $I_C = 5 \text{ mA}$ $f = 100 \text{ mC}$	3	-	-	-
TURN OFF TIME	t_{off1}		-	-	20	nSec
TURN OFF TIME	t_{off2}		-	-	20	nSec

2N2635

$V_{CEO} = 15\text{ V}$
 $I_C = 100\text{ mA}$
 $f_T = 150\text{ Mc}$



PNP germanium epitaxial mesa transistor for high-speed switching applications.

CASE 22
(TO-18)

MAXIMUM RATINGS(at $T_A = 25^\circ\text{C}$ unless otherwise noted)

Characteristic	Symbol	Rating	Unit
Collector-Base Voltage	V_{CBO}	30	Vdc
Collector-Emitter Voltage	V_{CEO}	15	Vdc
Emitter-Base Voltage	V_{EBO}	2.5	Vdc
Collector Current (Continuous)	I_C	100	mAdc
Junction Temperature	T_J	+100	$^\circ\text{C}$
Storage Temperature	T_{stg}	-65 to +100	$^\circ\text{C}$
Device Dissipation @ 25°C Ambient Temperature (Derate 2mW/ $^\circ\text{C}$ above 25°C)	P_D	150	mW

SWITCHING TIME TEST CIRCUIT

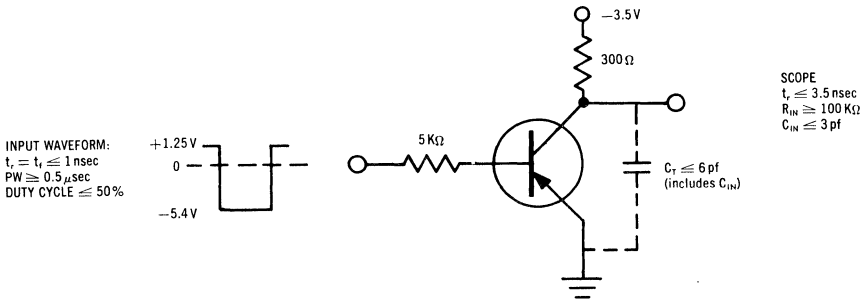

2N2635 (Continued)

ELECTRICAL CHARACTERISTICS (at $T_A = 25^\circ\text{C}$ unless otherwise noted)

Characteristic	Symbol	Min	Typ	Max	Unit
Collector-Base Breakdown Voltage ($I_C = 100 \mu\text{Adc}$, $I_E = 0$)	BV_{CBO}	30	50	---	Vdc
Collector-Emitter Breakdown Voltage ($I_C = 2 \text{ mAdc}$, $I_B = 0$)	BV_{CEO}	15	30	---	Vdc
Emitter-Base Breakdown Voltage ($I_E = 100 \mu\text{Adc}$, $I_C = 0$)	BV_{EBO}	2.5	4.5	---	Vdc
Collector-Base Cutoff Current ($V_{CB} = 25\text{V}$, $I_E = 0$) ($V_{CB} = 25\text{V}$, $I_E = 0$, $T_A = +55^\circ\text{C}$)	I_{CBO}	---	1 5	5 20	μAdc
Emitter-Base Cutoff Current ($V_{EB} = 1\text{V}$, $I_C = 0$)	I_{EBO}	---	2	20	μAdc
Static Forward Current Transfer Ratio ($I_C = 10 \text{ mA}$, $V_{CE} = 0.5\text{V}$) ($I_C = 50 \text{ mA}$, $V_{CE} = 1\text{V}$) ($I_C = 50 \text{ mA}$, $V_{CE} = 1\text{V}$, $T_A = -55^\circ\text{C}$) ($I_C = 100 \text{ mA}$, $V_{CE} = 1\text{V}$)	h_{FE}	30 45 25 30	---	---	---
Base-Emitter Voltage ($I_C = 10 \text{ mA}$, $I_B = 0.5 \text{ mA}$) ($I_C = 50 \text{ mA}$, $I_B = 2.5 \text{ mA}$) ($I_C = 50 \text{ mA}$, $I_B = 2.5 \text{ mA}$, $T_A = -55^\circ\text{C}$) ($I_C = 100 \text{ mA}$, $I_B = 10 \text{ mA}$)	V_{BE}	---	0.36 0.47 0.56 0.57	0.45 0.70 0.85 0.90	Vdc
Collector-Emitter Saturation Voltage ($I_C = 10 \text{ mA}$, $I_B = 0.5 \text{ mA}$) ($I_C = 50 \text{ mA}$, $I_B = 2.5 \text{ mA}$) ($I_C = 50 \text{ mA}$, $I_B = 2.5 \text{ mA}$, $T_A = +55^\circ\text{C}$) ($I_C = 100 \text{ mA}$, $I_B = 10 \text{ mA}$)	$V_{CE(sat)}$	---	0.13 0.20 0.22 0.23	0.20 0.40 0.45 0.75	Vdc
Small-Signal Forward Current Transfer Ratio ($I_C = 30 \text{ mA}$, $V_{CE} = 2\text{V}$, $f = 100 \text{ mc}$)	$ h_{fe} $	1.5	---	---	---
Collector Output Capacitance ($V_{CB} = 5 \text{ V}$, $I_E = 0$, $f = 1 \text{ mc}$)	C_{ob}	---	2.5	5	pf
Input Capacitance ($V_{EB} = 1\text{V}$, $I_C = 0$, $f = 1 \text{ mc}$)	C_{ib}	---	---	4	pf
Delay Time	t_d	---	15	20	nsec
Rise Time	t_r	---	20	30	nsec
Storage Time	t_s	---	100	185	nsec
Fall Time	t_f	---	35	65	nsec

2N2800
2N2801
2N2837
2N2838

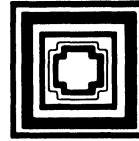

$V_{CEO} = 35 \text{ V}$
 $I_C = 800 \text{ mA}$
 $f_T = 120 \text{ Mc}$

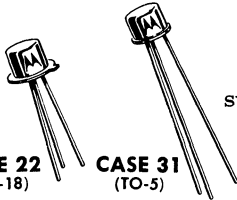

PNP silicon annular transistors for medium-speed switching applications.

CASE 22 (TO-18)
 2N2837
 2N2838

CASE 31 (TO-5)
 2N2800
 2N2801

MAXIMUM RATINGS

Characteristic	Symbol	Maximum	Unit
Collector-Base Voltage	V_{CB0}	50	Vdc
Collector-Emitter Voltage	V_{CEO}	35	Vdc
Emitter-Base Voltage	V_{EBO}	5	Vdc
Collector Current	I_C	800	mA
Total Device Dissipation @ 25°C Ambient Temperature 2N2800, 2N2801 — TO-5 Derating Factor Above 25°C	P_D	0.8 4.57	Watt mW/°C
2N2837, 2N2838 — TO-18 Derating Factor Above 25°C		0.5 2.86	Watt mW/°C
Total Device Dissipation @ 25°C Case Temperature 2N2800, 2N2801 — TO-5 Derating Factor Above 25°C	P_D	3 17.3	Watts mW/°C
2N2837, 2N2838 — TO-18 Derating Factor Above 25°C		1.8 10.3	Watts mW/°C
Junction Temperature, Operating	T_J	+200	°C
Storage Temperature	T_{stg}	-65 to +300	°C

DELAY AND RISE TIME TEST CIRCUIT

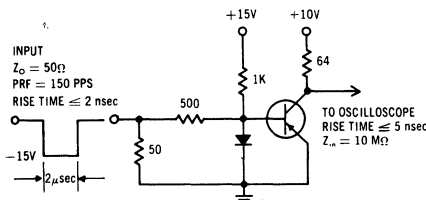

STORAGE AND FALL TIME TEST CIRCUIT

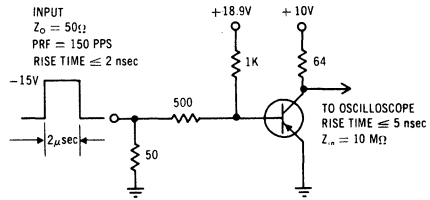

2N2800, 2N2801, 2N2837, 2N2838 (Continued)

ELECTRICAL CHARACTERISTICS (At 25°C unless otherwise noted)

Characteristic	Symbol	Minimum	Maximum	Unit
Collector-Base Breakdown Voltage ($I_C = 10 \mu\text{A}$, $I_E = 0$)	BV_{CBO}	50	-	Vdc
Emitter-Base Breakdown Voltage ($I_E = 100 \mu\text{A}$, $I_C = 0$)	BV_{EBO}	5	-	Vdc
Collector-Emitter Breakdown Voltage ($I_C = 100 \text{mA}$, $I_B = 0$)	BV_{CEO}	35	-	Vdc
Collector Cutoff Current ($V_{CE} = 25 \text{Vdc}$, $V_{BE} = 0.5 \text{Vdc}$)	I_{CEX}	-	100	nA
Base Cutoff Current ($V_{CE} = 25 \text{Vdc}$, $V_{BE} = 0.5 \text{Vdc}$)	I_{BL}	-	100	nA
DC Forward Current Transfer Ratio ($I_C = 0.1 \text{mA}$, $V_{CE} = 10 \text{Vdc}$) 2N2800, 2N2837 2N2801, 2N2838	h_{FE}	20 30	- -	-
($I_C = 150 \text{mA}$, $V_{CE} = 10 \text{Vdc}$)* 2N2800, 2N2837 2N2801, 2N2838		30 75	90 225	
($I_C = 150 \text{mA}$, $V_{CE} = 1 \text{Vdc}$)* 2N2800, 2N2837 2N2801, 2N2838		15 30	- -	
($I_C = 500 \text{mA}$, $V_{CE} = 10 \text{Vdc}$)* 2N2800, 2N2837 2N2801, 2N2838		25 40	- -	
Collector Saturation Voltage ($I_C = 150 \text{mA}$, $I_B = 15 \text{mA}$) ($I_C = 500 \text{mA}$, $I_B = 50 \text{mA}$)	$V_{CE(sat)}$	- -	0.4 1.2	Vdc
Base-Emitter Saturation Voltage ($I_C = 150 \text{mA}$, $I_B = 15 \text{mA}$) ($I_C = 500 \text{mA}$, $I_B = 50 \text{mA}$)	$V_{BE(sat)}$	- -	1.3 1.8	Vdc
Output Capacitance ($V_{CB} = 10 \text{Vdc}$, $f = 100 \text{kc}$)	C_{ob}	-	25	pf
Current-Gain - Bandwidth Product ($I_C = 50 \text{mA}$, $V_{CE} = 10 \text{Vdc}$, $f = 100 \text{mc}$)	f_T	120	-	mc

SWITCHING CHARACTERISTICS (At 25°C unless otherwise noted)

Characteristic	Symbol	Typical	Maximum	Unit
Delay Time	t_d	9	25	nsec
Rise Time	t_r	25	45	nsec
Storage Time	t_s	100	225	nsec
Fall Time	t_f	30	45	nsec

*Pulse Test: Pulse Width $\leq 300 \mu\text{sec}$, duty cycle $\leq 2\%$

2N2832
2N2834

$V_{CEO} = 50-100\text{ V}$
 $I_C = 20\text{ A}$
 $P_D = 85\text{ W}$

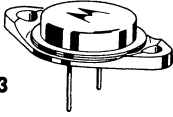

CASE 3
(TO-3)

PNP germanium transistors for switching and amplifier applications.

MAXIMUM RATINGS

Characteristic	Symbol	2N2832	2N2834	Unit
Collector-Base Voltage	V_{CBO}	80	140	Volts
Collector-Emitter Voltage	V_{CEO}	50	100	Volts
Emitter-Base Voltage	V_{EBO}	2	2	Volts
Collector Current (Continuous)	I_C	20	20	Amps
Base Current (Continuous)	I_B	5	5	Amps
Power Dissipation	P_C	85	85	Watts
Junction Operating Temperature Range	T_j	-65 to +110°		°C

CURRENT GAIN VARIATIONS

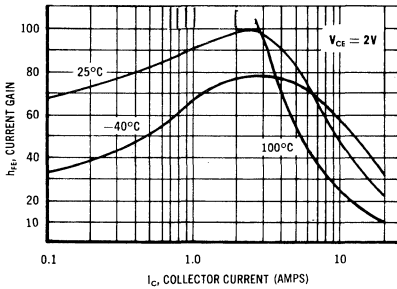

STORAGE TIME versus COLLECTOR CURRENT

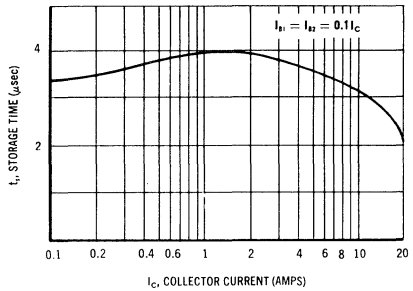

CURRENT GAIN BANDWIDTH PRODUCT
versus COLLECTOR CURRENT

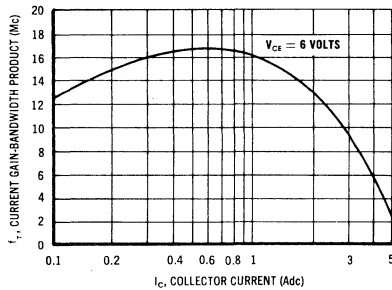

2N2832, 2N2834 (Continued)

ELECTRICAL CHARACTERISTICS (at $T_C = 25^\circ\text{C}$ unless otherwise noted)

Characteristic		Symbol	Min	Typical	Max	Unit
Collector-Base Cutoff Current* ($V_{CB} = 2V, I_E = 0$) ($V_{CB} = 80V, I_E = 0$) ($V_{CB} = 140V, I_E = 0$)	All Types 2N2832 2N2834	I_{CBO}^*	---	---	0.3 10 10	mA
Collector-Emitter Current* ($V_{CE} = 100V, V_{BE} = 0$) ($V_{CE} = 180V, V_{BE} = 0$)	2N2832 2N2834	I_{CES}^*	---	---	20 20	mA
Collector-Emitter Cutoff Current** ($V_{CE} = 50V, V_{BE} = 0.2V, T_C = +85^\circ\text{C}$) ($V_{CE} = 100V, V_{BE} = 0.2V, T_C = +85^\circ\text{C}$)	2N2832 2N2834	I_{CEX}^{**}	---	---	40 40	mA
Emitter-Base Breakdown Voltage ($I_E = 50\text{ mA dc}, I_C = 0$)		V_{EBO}	2	---	---	Vdc
Collector-Emitter Breakdown Voltage** ($I_E = 100\text{ mA}, I_B = 0$)	2N2832 2N2834	$V_{CEO(min)}^{**}$	50 100	---	---	Volts
Emitter Floating Potential* ($V_{CB} = 80V, I_E = 0$) ($V_{CB} = 140V, I_E = 0$)	2N2832 2N2834	V_{EBF}^*	---	---	0.5 0.5	Volts
DC Current Transfer Ratio ($I_C = 1.0\text{ A}, V_{CB} = 2V$) ($I_C = 10A, V_{CB} = 2V$)		h_{FE}	50 25	75 ---	---	---
Collector-Emitter Saturation Voltage ($I_C = 1.0\text{ A dc}, I_B = 100\text{ mA dc}$) ($I_C = 10\text{ A dc}, I_B = 1.0\text{ A dc}$) ($I_C = 20\text{ A dc}, I_B = 2.0\text{ A dc}$)		$V_{CE(sat)}$	---	---	0.15 0.30 0.5	Vdc
Base-Emitter Saturation Voltage ($I_C = 1\text{ A}, I_B = 100\text{ mA dc}$) ($I_C = 10\text{ A}, I_B = 1\text{ A dc}$) ($I_C = 20\text{ A}, I_B = 2\text{ A dc}$)		$V_{BE(sat)}$	---	---	0.6 0.75 1.0	Vdc
Small Signal Current Gain ($I_C = 1.0\text{ A}, V_{CE} = 10\text{ V}, f = 5\text{ mc}$)		h_{fe}	2	3.5	---	---
Rise Time		t_r	---	2	4	μsec
Storage Time		t_s	---	3	6	μsec
Fall Time		t_f	---	1	2.5	μsec

* SWEEP TEST: 1/2 Sine Wave, 80 cps min
** PULSE TEST: PW = 1 msec, 2% Duty Cycle

SWITCHING TIME TEST CIRCUIT

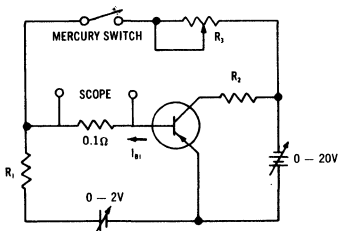

Characteristic	Sym	Max	Unit
Rise Time	t_r	4	μsec
Storage Time	t_s	6	μsec
Fall Time	t_f	2.5	μsec

ADJUST R_1, R_2, R_3 for $I_{B1} = I_{B2} = 0.1I_C$

PULSE CONDITIONS: $I_C = 5\text{ AMP}, I_{B1} = 0.5\text{ AMP}$

Switching times shown are for constant current drive conditions. Faster times can be realized by the use of a lower source impedance or a speed-up capacitor. See Chapter 5 of the Motorola Switching Handbook for a more detailed explanation.

2N2837

2N2838

For Specifications, See 2N2800 Data Sheet

2N2904, A thru 2N2907, A
2N3485, A, 2N3486, A

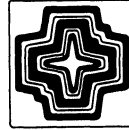

$V_{CE0} = 40-60\text{ V}$
 $I_C = 600\text{ mA}$
 $f_T = 200\text{ Mc}$

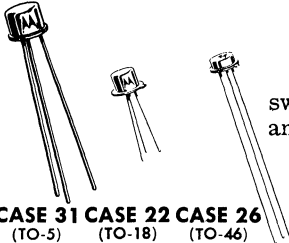

PNP silicon annular Star transistors for high-speed switching, complementary circuitry and DC to VHF amplifier applications.

CASE 31 CASE 22 CASE 26
 (TO-5) (TO-18) (TO-46)

2N2904, A 2N2906, A 2N3485, A
 2N2905, A 2N2907, A 2N3486, A

MAXIMUM RATINGS

CHARACTERISTIC	SYMBOL	RATING	UNIT
Collector-Base Voltage	V_{CBO}	60	Vdc
Collector-Emitter Voltage	V_{CEO}	40	Vdc
2N2904-2N2907, 2N3485, 2N3486		60	
2N2904A-2N2907A, 2N3485A, 2N3486A			
Emitter-Base Voltage	V_{EBO}	5	Vdc
Collector Current	I_C	600	mAdc
Total Device Dissipation @ $T_C = 25^\circ\text{C}$	P_D		
TO-5: 2N2904, 2N2904A, 2N2905, 2N2905A		3	W
DERATING FACTOR		17.2	mW/ $^\circ\text{C}$
TO-18: 2N2906, 2N2906A, 2N2907, 2N2907A		1.8	W
DERATING FACTOR		10.3	mW/ $^\circ\text{C}$
TO-46: 2N3485, 2N3485A, 2N3486, 2N3486A		2	W
DERATING FACTOR		11.43	mW/ $^\circ\text{C}$
Total Device Dissipation @ $T_A = 25^\circ\text{C}$	P_D		
TO-5: 2N2904, 2N2904A, 2N2905, 2N2905A		600	mW
DERATING FACTOR		3.43	mW/ $^\circ\text{C}$
TO-18: 2N2906, 2N2906A, 2N2907, 2N2907A		400	mW
TO-46: 2N3485, 2N3485A, 2N3486, 2N3486A		2.28	mW/ $^\circ\text{C}$
DERATING FACTOR			
Operating Junction Temperature Range	T_J	-65 to +200	$^\circ\text{C}$
Storage Temperature Range	T_{stg}	-65 to +300	$^\circ\text{C}$

2N2904, A-2N2907, A and 2N3485, A, 2N3486, A (Continued)

ELECTRICAL CHARACTERISTICS (At 25°C unless otherwise noted)

Characteristic	Symbol	Min	Max	Unit
Collector Cutoff Current ($V_{CB} = 50 \text{ Vdc}, I_E = 0$) ($V_{CB} = 50 \text{ Vdc}, I_E = 0, T_A = 150^\circ\text{C}$)	I_{CBO}	---	.020 .010 20 10	$\mu\text{A dc}$
Collector Cutoff Current ($V_{CE} = 30\text{V}, V_{BE} = 0.5 \text{ V}$)	I_{CEX}	---	50	nA dc
Base Cutoff Current ($V_{CE} = 30\text{V}, V_{BE} = 0.5 \text{ V}$)	I_{BL}	---	50	nA dc
Collector-Base Breakdown Voltage ($I_C = 10 \text{ A dc}, I_E = 0$)	BV_{CBO}	60	---	V dc
Collector-Emitter Breakdown Voltage* ($I_C = 10 \text{ mAdc}, I_B = 0$)	BV_{CEO}^*	40 60	---	V dc
Emitter-Base Breakdown Voltage ($I_B = 10 \text{ A dc}, I_C = 0$)	BV_{EBO}	5	---	V dc
Collector Saturation Voltage* ($I_C = 150 \text{ mAdc}, I_B = 15 \text{ mAdc}$) ($I_C = 500 \text{ mAdc}, I_B = 50 \text{ mAdc}$)	$V_{CE(sat)}^*$	---	0.4 1.6	V dc
Base-Emitter Saturation Voltage ($I_C = 150 \text{ mAdc}, I_B = 15 \text{ mAdc}$) ($I_C = 500 \text{ mAdc}, I_B = 50 \text{ mAdc}$)	$V_{BE(sat)}^*$	---	1.3 2.6	V dc
DC Forward Current Transfer Ratio ($I_C = 0.1 \text{ mAdc}, V_{CE} = 10 \text{ Vdc}$) ($I_C = 1.0 \text{ mAdc}, V_{CE} = 10 \text{ Vdc}$) ($I_C = 10 \text{ mAdc}, V_{CE} = 10 \text{ Vdc}$) ($I_C = 150 \text{ mAdc}, V_{CE} = 10\text{Vdc}$) ($I_C = 500 \text{ mAdc}, V_{CE} = 10 \text{ Vdc}$)	h_{FE}	20 35 40 75 25 50 40 100 35 75 40 100 40 100 20 30 40 50	---	---
Output Capacitance ($V_{CE} = 10 \text{ Vdc}, I_E = 0, f = 100 \text{ kc}$)	C_{ob}	---	8	pf
Input Capacitance ($V_{BE} = 2 \text{ Vdc}, I_C = 0, f = 100 \text{ kc}$)	C_{ib}	---	30	pf
Current-Gain - Bandwidth Product ($I_C = 50 \text{ mAdc}, V_{CE} = 20 \text{ Vdc}, f = 100 \text{ mc}$)	f_T	200	---	mc

*Pulse Test: Pulse Width = 300 μsec , duty cycle $\leq 2\%$

SATURATED TURN-ON SWITCHING-TIME TEST CIRCUIT

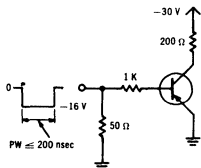

SATURATED TURN-OFF SWITCHING-TIME TEST CIRCUIT

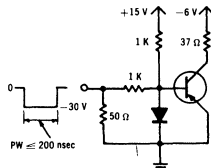

NON-SATURATED SWITCHING-TIME TEST CIRCUIT

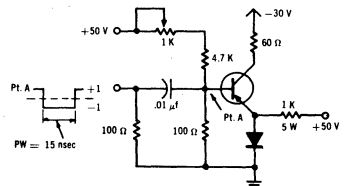

2N2904, A-2N2907, A and 2N3485, A, 2N3486, A (Continued)

SWITCHING CHARACTERISTICS (At 25°C unless otherwise noted)

Characteristic	Symbol	Typical	Max	Unit
Delay Time	t_d	6	10	nsec
Rise Time	t_r	20	40	nsec
Turn-On Time	t_{on}	26	45	nsec
Storage Time	t_s	50	80	nsec
Fall Time	t_f	20	30	nsec
Turn-Off Time	t_{off}	70	100	nsec
Total Switching Time	t_{total}	12	---	nsec

CURRENT GAIN versus COLLECTOR CURRENT

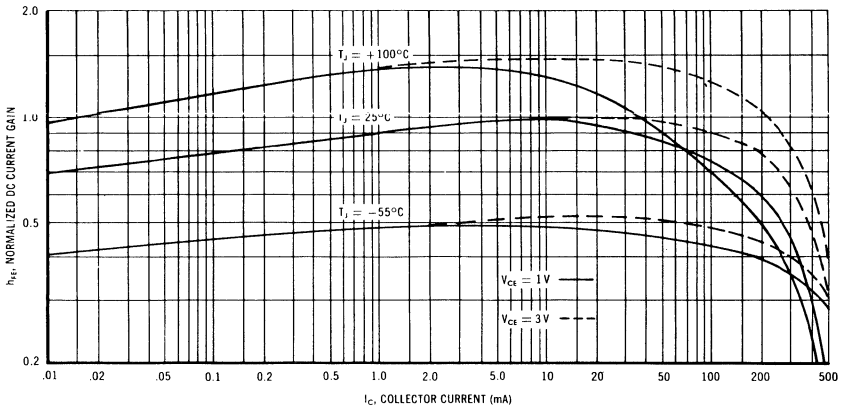

CURRENT GAIN-BANDWIDTH PRODUCT versus COLLECTOR CURRENT

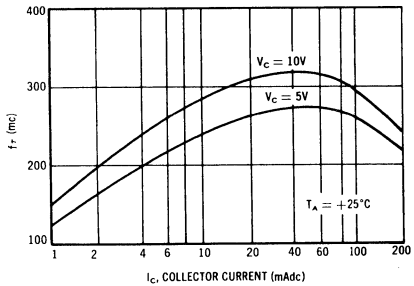

2N2904, A-2N2907, A and 2N3485, A, 2N3486, A (Continued)

COLLECTOR SATURATION VOLTAGE versus BASE CURRENT

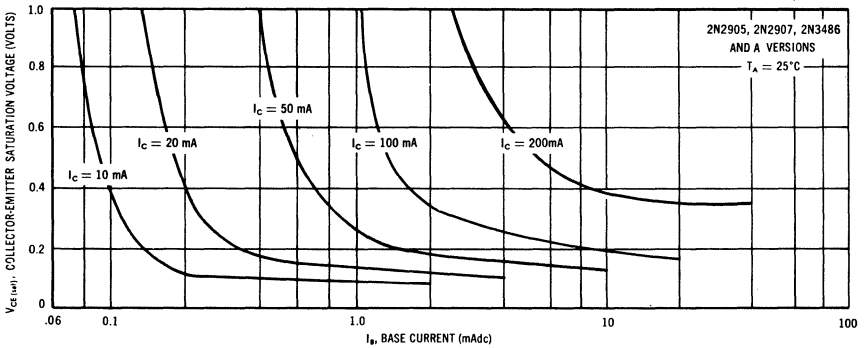
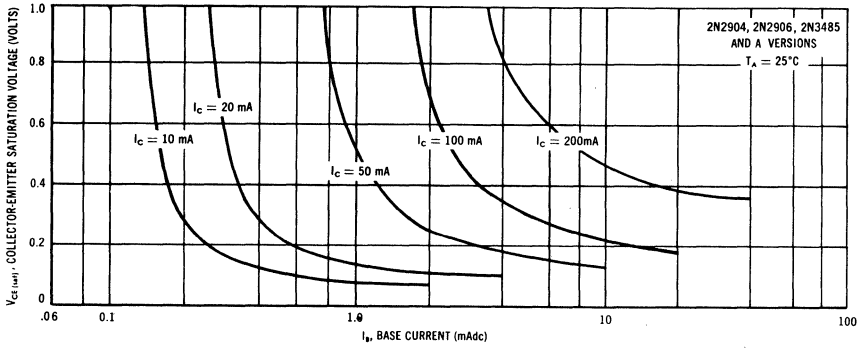

CAPACITANCE VARIATIONS versus VOLTAGE

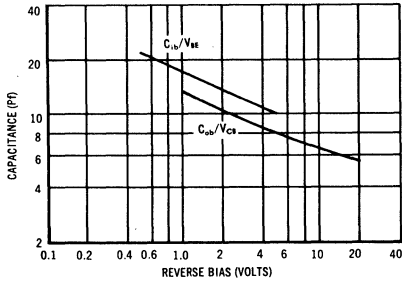

ACTIVE REGION TIME CONSTANT versus COLLECTOR CURRENT

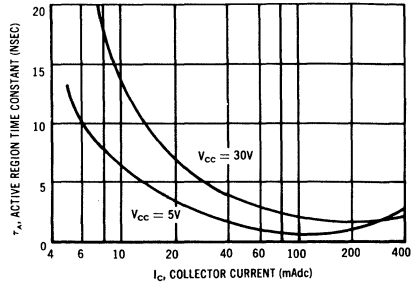

2N2929

$V_{CBO} = 25 \text{ V}$
 $G_e = 26 \text{ db @ } 60 \text{ Mc}$
 $N_F = 5.5 \text{ db @ } 200 \text{ Mc}$
 $P_D = 300 \text{ mW}$

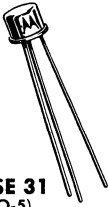

PNP germanium epitaxial mesa transistor for low noise, broadband, power and driver amplifier applications.

CASE 31
(TO-5)

MAXIMUM RATINGS

Characteristic	Symbol	Ratings	Unit
Collector-Base Voltage	V_{CBO}	-25	Volts
Collector-Emitter Voltage	V_{CES}	-25	Volts
Collector-Emitter Voltage	V_{CEO}	-10	Volts
Emitter-Base Voltage	V_{EBO}	-0.75	Volts
Collector Current	I_C	-100	mA
Total Device Dissipation @ $T_A = 25^\circ\text{C}$ Derate above 25°C	P_D	300 4	mW mW/ $^\circ\text{C}$
Total Device Dissipation @ $T_C = 25^\circ\text{C}$ Derate above 25°C	P_D	750 10	mW mW/ $^\circ\text{C}$
Junction Temperature	T_J	100	$^\circ\text{C}$
Storage Temperature	T_{stg}	-65 to +100	$^\circ\text{C}$

NORMALIZED DC CURRENT GAIN CHARACTERISTICS

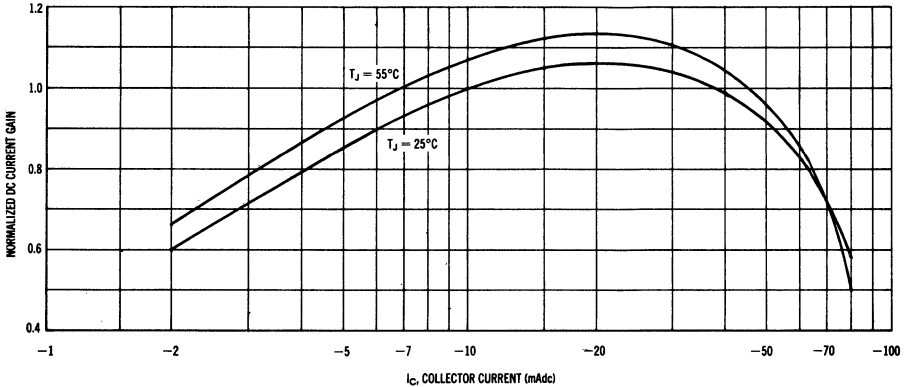

2N2929 (Continued)

ELECTRICAL CHARACTERISTICS

Characteristic	Symbol	Test Conditions	Min	Typ	Max	Unit
Collector-Base Breakdown Voltage	BV_{CBO}	$I_C = -100 \mu\text{A dc}, I_E = 0$	-25	-45	—	Vdc
Collector-Emitter Breakdown Voltage	BV_{CES}	$I_C = -100 \mu\text{A dc}, V_{EB} = 0$	-25	-45	—	Vdc
Collector-Emitter Breakdown Voltage	BV_{CEO}	$I_C = -10 \text{ mA dc}, I_B = 0$	-10	-20	—	Vdc
Emitter-Base Breakdown Voltage	BV_{EBO}	$I_E = -1 \text{ mA dc}, I_C = 0$	-0.75	-1.5	—	Vdc
Collector Cutoff Current	I_{CBO}	$V_{CB} = -10 \text{ V dc}, I_E = 0$ $V_{CB} = -10 \text{ V dc}, I_E = 0, T_A = +55^\circ\text{C}$	—	-0.15	-5	$\mu\text{A dc}$
Emitter Cutoff Current	I_{EBO}	$V_{EB} = -0.5 \text{ V dc}, I_C = 0$	—	-1	-100	$\mu\text{A dc}$
DC Forward Current Transfer Ratio	h_{FE}	$V_{CE} = -10 \text{ V dc}, I_C = -10 \text{ mA dc}$	10	30	100	—
Collector-Emitter Saturation Voltage	$V_{CE(sat)}$	$I_C = -50 \text{ mA dc}, I_B = -10 \text{ mA dc}$	—	-0.15	-0.5	Vdc
Base-Emitter Saturation Voltage	$V_{BE(sat)}$	$I_C = -50 \text{ mA dc}, I_B = -10 \text{ mA dc}$	—	-0.55	-1.0	Vdc
Small-Signal Forward Current Transfer Ratio	h_{fe}	$I_C = -10 \text{ mA dc}, V_{CE} = -10 \text{ V dc}, f = 1 \text{ kc}$	10	35	120	—
Current Gain - Bandwidth Product	f_T	$I_C = -10 \text{ mA dc}, V_{CE} = -10 \text{ V dc}, f = 100 \text{ mc}$	800	1100	1400	mc
		$I_C = -20 \text{ mA dc}, V_{CE} = -10 \text{ V dc}, f = 100 \text{ mc}$	1000	1250	1600	
		$I_C = -40 \text{ mA dc}, V_{CE} = -10 \text{ V dc}, f = 100 \text{ mc}$	700	1200	—	
Collector-Base Time Constant	$r_b' C_c$	$V_{CB} = -10 \text{ V dc}, I_E = +20 \text{ mA dc}, f = 31.8 \text{ mc}$	10	25	40	psec
Real Part of Small-Signal Short Circuit Input Impedance	$\text{Re}(h_{ie})$	$I_C = -10 \text{ mA}, V_{CE} = -10 \text{ V}, f = 1000 \text{ mc}$	—	45	75	ohms
Collector-Base Capacitance	C_{ob}	$V_{CB} = -10 \text{ V dc}, I_E = 0, f = 100 \text{ kc}$	—	1.75	2.5	pf
Power Gain	G_o	$V_{CE} = -10 \text{ V dc}, I_C = -10 \text{ mA dc}, f = 60 \text{ mc}$	26	28	—	db
		$V_{CE} = -10 \text{ V dc}, I_C = -10 \text{ mA dc}, f = 200 \text{ mc}$	—	16	—	
Noise Figure	NF	$V_{CE} = -10 \text{ V dc}, I_C = -2 \text{ mA dc}, f = 200 \text{ mc}$	—	5.5	—	db
		$R_G = 50 \Omega$				

NOISE FIGURE versus FREQUENCY

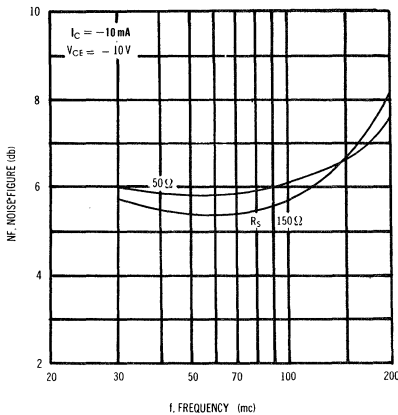

MAXIMUM AVAILABLE GAIN versus FREQUENCY

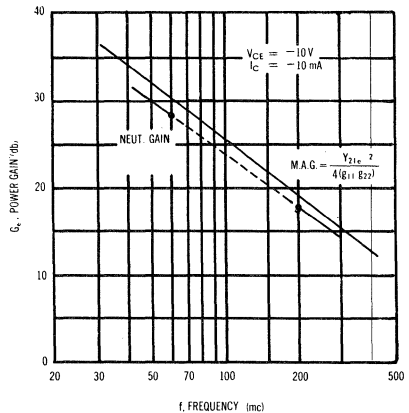

2N2947
2N2948

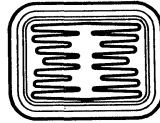

$G_o = 10 \text{ db @ } 50 \text{ Mc}$
 $P_o = 15 \text{ W @ } 50 \text{ Mc}$

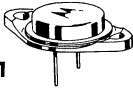

CASE 1
(TO-3)

NPN silicon annular transistors for power amplifier applications to 100 Mc.

MAXIMUM RATINGS (NOTE 1)

Characteristic	Symbol	Rating		Unit
		2N2947	2N2948	
Collector-Base Voltage	V_{CBO}	60	40	Vdc
Collector-Emitter Voltage	V_{CES}	60	40	Vdc
Emitter - Base Voltage	V_{EB}	3	2	Vdc
Collector-Current (continuous)	I_C	1.5		Adc
Base-Current (continuous)	I_B	500		mAdc
Power Input (Nominal)	P_{in}	5.0		Watts
Power Output (Nominal)	P_{out}	20.0		Watts
Total Device Dissipation @ 25°C Case Temperature Derating Factor above 25°C	P_D	25.0		Watts
		167		mW/°C
Junction Temperature	T_J	175		°C
Storage Temperature	T_{stg}	-65 to +175		°C

Note 1. The maximum ratings as given for DC conditions can be exceeded on a pulse basis. See electrical characteristics.

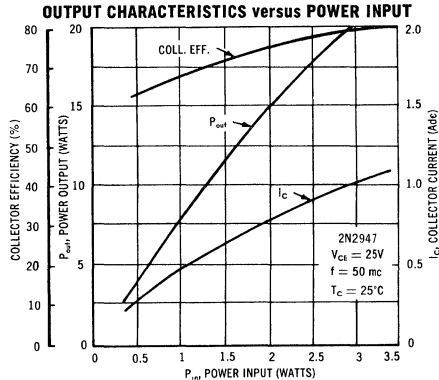
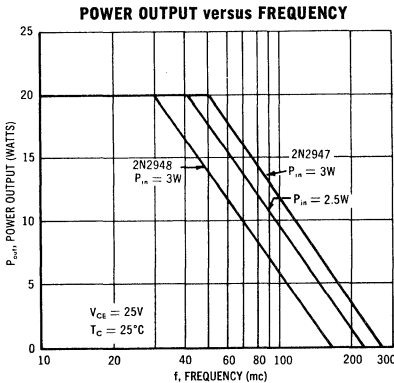

— Motorola High-Frequency Transistors —

2N2947 (Continued)

ELECTRICAL CHARACTERISTICS $T_A = 25^\circ\text{C}$ unless otherwise noted

Characteristic	Symbol	Test Conditions	Min	Typ	Max	Unit
Collector-Emitter Sustain Voltage	V_{CES} (sus)*	2N2947: $I_C = 0.250\text{ A}$, $R_{BE} = 0$ 2N2948: $I_C = 0.250\text{ A}$, $R_{BE} = 0$	90	120	--	Volts
Collector-Emitter-Open Base Sustain Voltage	V_{CEO} (sus)*	2N2947: $I_C = 0.250\text{ A}$, $I_B = 0$ 2N2948: $I_C = 0.250\text{ A}$, $I_B = 0$	40	--	--	Volts
Collector-Emitter Current	I_{CES}	2N2947: $V_{CE} = 60\text{ Vdc}$, $V_{BE} = 0$ $V_{CE} = 50\text{ Vdc}$, $V_{BE} = 0$, $T_C = 175^\circ\text{C}$ 2N2948: $V_{CE} = 40\text{ Vdc}$, $V_{BE} = 0$ $V_{CE} = 30\text{ Vdc}$, $V_{BE} = 0$, $T_C = 175^\circ\text{C}$	--	--	0.5	mAdc
Collector Cutoff Current	I_{CBO}	2N2947: $V_{CB} = 50\text{ Vdc}$, $I_E = 0$ 2N2948: $V_{CB} = 30\text{ Vdc}$, $I_E = 0$	--	--	1	μAdc
Emitter Cutoff Current	I_{EBO}	2N2947: $V_{EB} = 3\text{ Vdc}$, $I_C = 0$ 2N2948: $V_{EB} = 2\text{ Vdc}$, $I_C = 0$	--	--	100	μAdc
DC Current Gain	h_{FE}	2N2947: $I_C = 400\text{ mAdc}$, $V_{CE} = 2\text{ Vdc}$ 2N2948: $I_C = 400\text{ mAdc}$, $V_{CE} = 2\text{ Vdc}$ Both Types: $I_C = 1\text{ Adc}$, $V_{CE} = 2\text{ Vdc}$	2.5	--	35	
Collector-Emitter Saturation Voltage	$V_{CE(sat)}$	$I_C = 1.0\text{ Adc}$, $I_B = 500\text{ mAdc}$	--	--	0.5	Vdc
Base-Emitter Saturation Voltage	$V_{BE(sat)}$	$I_C = 1.0\text{ Adc}$, $I_B = 500\text{ mAdc}$	--	--	2.0	Vdc
AC Current Gain	$ h_{fe} $	$V_{CE} = 2.0\text{ Vdc}$, $I_C = 400\text{ mAdc}$, $f = 50\text{ mc}$	2.0	--	--	
Collector Output Capacitance	C_{ob}	$V_{CB} = 25\text{ Vdc}$, $I_E = 0$, $f = 100\text{ kc}$	--	--	60	pf
Power Input	P_{in}	$P_{out} = 15\text{ W}$, $f = 50\text{ mc}$, $V_{CE} = 25\text{ Vdc}$	--	2.0	3.0	Watts
Efficiency	η	$I_{C(max)} = 1\text{ A}$	60	80	--	%
Power Input	P_{in}	$P_{out} = 15\text{ W}$, $f = 30\text{ mc}$, $V_{CE} = 25\text{ Vdc}$	--	2.0	3.0	Watts
Efficiency	η	$I_{C(max)} = 1.0\text{ A}$	60	70	--	%

* Pulse Measurement: Pulse Width $\leq 100\ \mu\text{sec}$, Duty Cycle = 2%

2N2947 (continued)

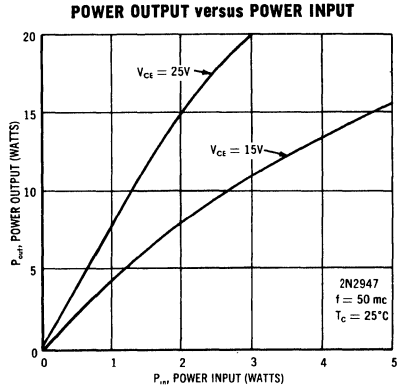
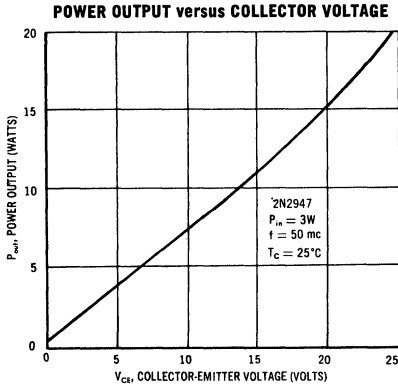

2N2949
2N2950

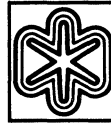

$G_o = 12 \text{ db @ } 50 \text{ Mc}$
 $P_o = 3.5 \text{ W @ } 50 \text{ Mc}$

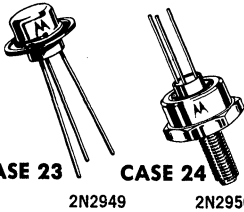

CASE 23 **CASE 24**
2N2949 2N2950

NPN silicon annular transistors for power amplifier and driver applications to 100 Mc.

MAXIMUM RATINGS (Note 1)

Characteristic	Symbol	Rating		Unit
Collector-Base Voltage	V_{CBO}	60		Vdc
Collector-Emitter Voltage	V_{CES}	60		Vdc
Emitter - Base Voltage	V_{EB}	3.0		Vdc
Collector Current (Continuous)	I_C	0.7		Adc
Base Current (Continuous)	I_B	100		mAdc
RF Input Power (Nom)	P_{in}	1.0		Watt
RF Output Power (Nom)	P_{out}	5.0		Watts
Total Device Dissipation (25°C Case temperature) (Derating Factor above 25°C)	P_C	6.0 40		Watts mW/°C
Total Device Dissipation at 25° Ambient (Derating Factor above 25°C)	P_D	2N2949 0.5 3.33	2N2950 0.7 4.67	Watt mW/°C
Junction Temperature	T_J	175		°C
Storage Temperature	T_{stg}	-65 to +175		°C

The maximum ratings as given for DC conditions can be exceeded on a pulse basis. See Electrical Characteristics.

2N2949, 2N2950 (Continued)

ELECTRICAL CHARACTERISTICS $T_A = 25^\circ\text{C}$ unless otherwise noted

Characteristic	Symbol	Test Conditions	Min	Typ	Max	Unit
Collector-Emitter Sustain Voltage	$V_{CES(sus)}^*$	$I_C = 0.250 \text{ A}, R_{BE} = 0$	85	120	--	Volts
Collector Emitter-Open Base Sustain Voltage	$V_{CEO(sus)}^*$	$I_C = 0.250 \text{ A}, I_B = 0$	40	--	--	Volts
Collector-Emitter Current	I_{CES}	$V_{CE} = 60 \text{ Vdc}, V_{BE} = 0$ $V_{CE} = 50 \text{ Vdc}, V_{BE} = 0$ $T_C = +175^\circ\text{C}$	--	--	100 500	$\mu\text{A dc}$
Collector - Cutoff Current	I_{CBO}	$V_{CB} = 50 \text{ Vdc}, I_E = 0$	--	--	0.1	$\mu\text{A dc}$
Emitter-Cutoff Current	I_{EBO}	$V_{EB} = 3 \text{ Vdc}, I_C = 0$	--	--	100	$\mu\text{A dc}$
DC Current Gain	h_{FE}	$V_{CE} = 2.0 \text{ Vdc}$ $I_C = 40 \text{ mA dc}$ $V_{CE} = 2.0 \text{ Vdc}$ $I_C = 400 \text{ mA dc}$	5.0 5.0	--	100	--
Collector - Emitter Saturation Voltage	$V_{CE(sat)}$	$I_C = 400 \text{ mA dc}, I_B = 80 \text{ mA dc}$	--	--	0.5	Vdc
Emitter-Base Saturation Voltage	$V_{BE(sat)}$	$I_C = 400 \text{ mA dc}, I_B = 80 \text{ mA dc}$	--	--	2.0	Vdc
AC Current Gain	$ h_{fe} $	$V_{CE} = 2.0 \text{ Vdc}$ $I_C = 40 \text{ mA dc}, f = 50 \text{ mc}$	2.0	--	--	--
Collector Output Capacitance	C_{ob}	$V_{CB} = 25 \text{ Vdc}, I_E = 0$ $f = 100 \text{ kc}$	--	--	20	pf
Power Input	P_{in}	$P_{out} = 3.5 \text{ watts}, f = 50 \text{ mc}$ $V_{CE} = 25 \text{ Vdc}, I_{C(max)} = 325 \text{ mA}$	--	--	0.35	Watt
Efficiency	η		43	--	--	%

*Pulse Width $\leq 100 \mu\text{sec}$, Duty Cycle = 2%

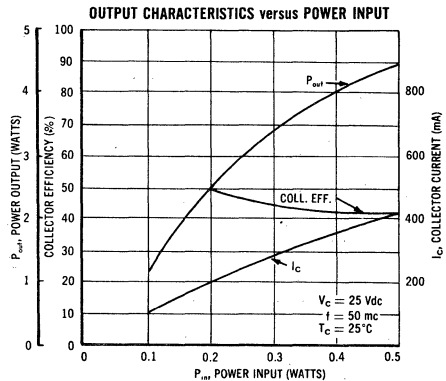
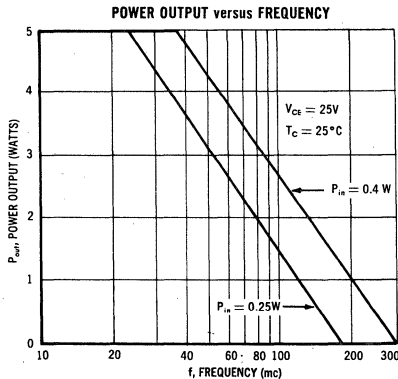

2N2949, 2N2950 (continued)

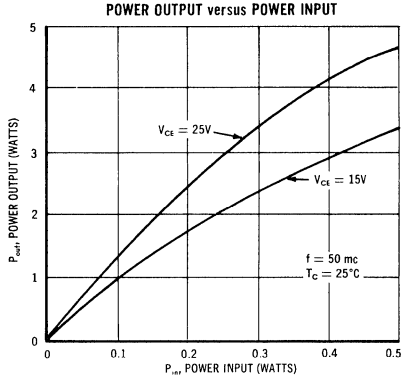
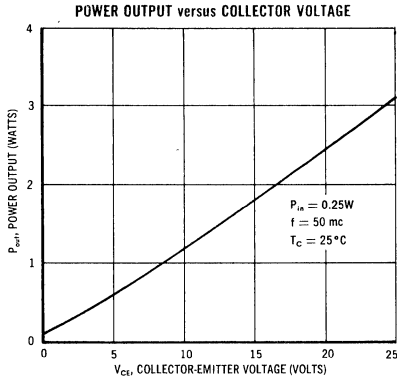

2N2951
2N2952

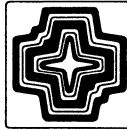

$G_e = 9 \text{ db @ } 50 \text{ Mc}$
 $P_o = 600 \text{ mW @ } 50 \text{ Mc}$



NPN silicon annular Star transistors for power amplifier applications to 100 Mc.

CASE 31 (TO-5) **CASE 22** (TO-18)
2N2951 2N2952

MAXIMUM RATINGS

Characteristics	Symbol	Rating	Unit
Collector-Base Voltage	V_{CBO}	60	Vdc
Collector-Emitter Voltage	V_{CES}	60	Vdc
Emitter-Base Voltage	V_{EBO}	5	Vdc
Collector Current (continuous)	I_C	250	mAdc
Base Current (continuous)	I_B	50	mAdc
Total Device Dissipation (25°C Case Temperature) (Derate above 25°C)	P_C	2N2951	Watts mW/°C
		2N2952	
Total Device Dissipation (25°C Ambient Temperature) (Derate above 25°C)	P_D	0.8	mW/°C
		5.33	
Junction Temperature	T_J	-65 to 175	°C
Storage Temperature	T_{stg}	-65 to 175	°C

NOTE 1: The maximum ratings as given for D.C. conditions can be exceeded on a pulse basis. See Electrical Characteristics.

2N2951, 2N2952 (Continued)

ELECTRICAL CHARACTERISTICS (At 25°C ambient unless otherwise noted)

Characteristic	Symbol	Conditions	Min	Max	Unit
Collector-Emitter Current	I_{CES}	$V_{CE} = 60\text{Vdc}$, $V_{BE} = 0$	--	.00	$\mu\text{A dc}$
		$V_{CE} = 50\text{Vdc}$, $V_{BE} = 0$, $T_C = 175^\circ\text{C}$	--	500	$\mu\text{A dc}$
Collector Cutoff Current	I_{CBO}	$V_{CB} = 50\text{Vdc}$, $I_E = 0$	--	0.1	$\mu\text{A dc}$
Emitter Cutoff Current	I_{EBO}	$V_{EB} = 5\text{Vdc}$, $I_C = 0$	--	100	$\mu\text{A dc}$
DC Current Gain	h_{FE}	$I_C = 10\text{mA dc}$, $V_{CE} = 10\text{Vdc}$	20	150	--
		$I_C = 150\text{mA dc}$, $V_{CE} = 10\text{Vdc}^*$	20	--	--
Collector-Emitter Saturation Voltage	$V_{CE(sat)}$	$I_C = 150\text{mA dc}$, $I_B = 15\text{mA dc}$	--	0.5	Vdc
Base-Emitter Saturation Voltage	$V_{BE(sat)}$	$I_C = 150\text{mA dc}$, $I_B = 15\text{mA dc}$	--	2.0	Vdc
Collector-Emitter Sustain Voltage	$V_{CES(sus)}^*$	$I_C = 100\text{mA}$, $R_{BE} = 0$	30	--	Volts
Collector-Emitter Open Base Sustain Voltage	$V_{CEO(sus)}^*$	$I_C = 100\text{mA}$, $I_B = 0$	20	--	Volts
AC Current Gain	h_{fe}	$V_{CE} = 10\text{Vdc}$, $I_C = 10\text{mA dc}$ $f = 50\text{mc}$	4.0	--	--
Collector Output Capacitance	C_{ob}	$V_{CB} = 10\text{Vdc}$, $I_E = 0$, $f = 100\text{kc}$	--	8	pf
Power Input	P_{in}	$P_{out} = 600\text{mW}$ $f = 50\text{mc}$ $V_{CE} = 13.6\text{Vdc}$ $I_{C(max)} = 125\text{mA}$	--	100	mW
Efficiency	η		35	--	%

*Pulse $\leq 100\text{ nsec}$, Duty Cycle = 2%

2N2951, 2N2952 (Continued)

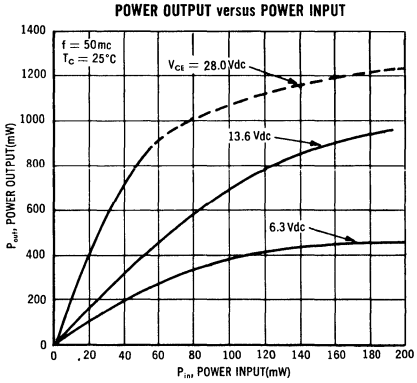
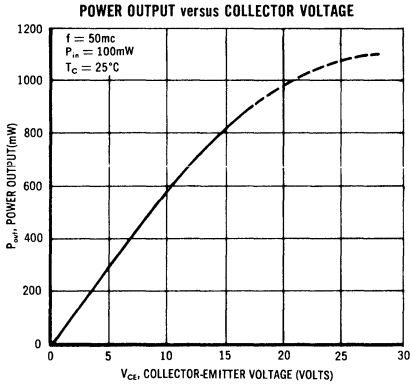
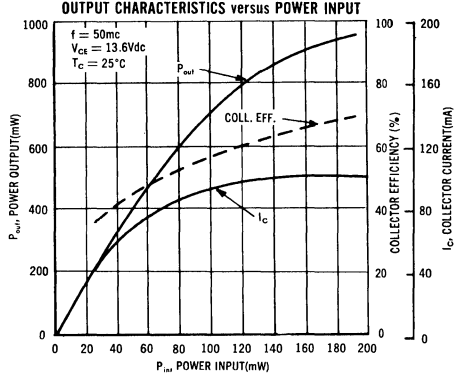
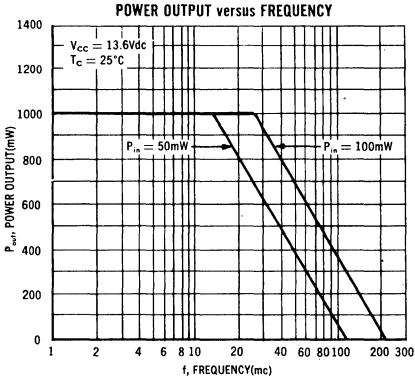

POWER OUTPUT AND POWER GAIN CIRCUIT

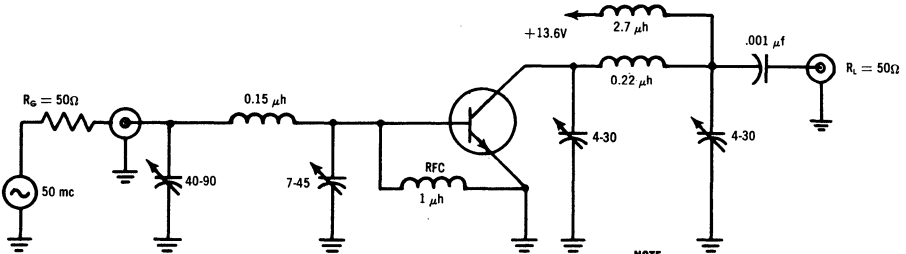

NOTE:
 GROUND POINT must be kept as close as possible to the transistor emitter lead.
 Transistor must be mounted with heat sink.

2N2955
2N2956
2N2957

V_{CEO} = 18-25 V
I_C = 100 mA
f_T = 200-300 Mc

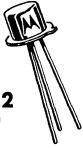

CASE 22
(TO-18)

PNP germanium epitaxial mesa transistors for high-speed switching applications.

MAXIMUM RATINGS T_A = 25°C unless otherwise noted

Characteristic	Symbol	Rating	Unit
Collector-Base Voltage	V _{CBO}	40	Vdc
Emitter-Base Voltage	V _{EBO}	3.5	Vdc
Collector-Emitter Voltage	V _{CEO}	25 20 18	Vdc
Collector Current	I _C	100	mAdc
Junction Temperature	T _J	100	°C
Storage Temperature	T _{STG}	-65 to +100	°C
Total Device Dissipation at 25°C Case Temperature (Derate 4 mW/°C above 25°C)	P _D	300	mW
Total Device Dissipation at 25°C Ambient Temperature (Derate 2 mW/°C above 25°C)	P _D	150	mW

CURRENT GAIN CHARACTERISTICS

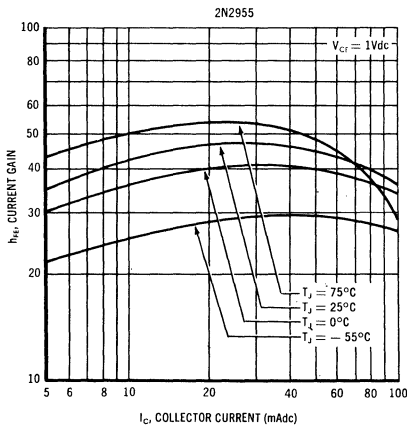

CURRENT GAIN CHARACTERISTICS

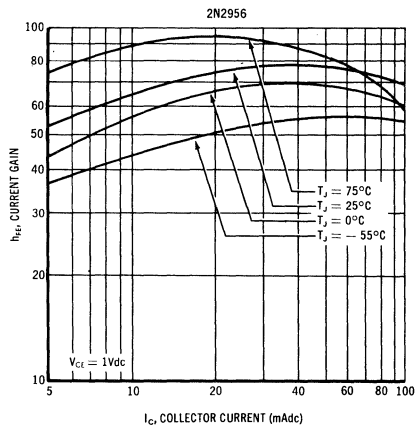

2N2955, 2N2956, 2N2957 (Continued)

ELECTRICAL CHARACTERISTICS (At T_A = 25°C unless otherwise noted)

Characteristic	Symbol	Min	Typ	Max	Unit	
Off Characteristics						
Collector-Base Breakdown Voltage (I _C = 100 μAdc, I _E = 0)	BV _{CB0}	40	60	---	Vdc	
Emitter-Base Breakdown Voltage (I _E = 100 μAdc, I _C = 0)	BV _{EB0}	3.5	5	---	Vdc	
Collector-Emitter Breakdown Voltage (I _C = 10 mAdc, Emitter-Base Termination - Open)	BV _{CEO}	25 20 18	35 28 25	---	Vdc	
Collector-Emitter Reverse Current (V _{CE} = 25 Vdc, V _{EB} = 0.5 Vdc)	I _{CEX}	---	---	10	μAdc	
Base Leakage Current (V _{CE} = 25 Vdc, V _{EB} = 0.5 Vdc)	I _{BL}	---	---	10	μAdc	
On Characteristics						
Forward Current Transfer Ratio (I _C = 10 mAdc, V _{CE} = 1 Vdc)	h _{FE}	20 30 60	43 64 105	---	---	
(I _C = 50 mAdc, V _{CE} = 1 Vdc)		20 40 100	43 76 130	60 120		
(I _C = 100 mAdc, V _{CE} = 1 Vdc)		30 60	69 115	---		
Collector-Emitter Saturation Voltage (I _C = 10 mAdc, I _B = 1 mAdc)	V _{CE(sat)}	---	0.12 0.12 0.09	0.20 0.18 0.15	Vdc	
(I _C = 50 mAdc, I _B = 5 mAdc)		---	0.20 0.16 0.13	0.30 0.25 0.20		
(I _C = 100 mAdc, I _B = 10 mAdc)		---	0.23 0.18	0.34 0.26		
Base-Emitter Voltage (I _C = 10 mAdc, I _B = 1 mAdc)	V _{BE}	---	0.38 0.37 0.36	0.50 0.47 0.44	Vdc	
(I _C = 50 mAdc, I _B = 5 mAdc)		---	0.51 0.48 0.45	0.65 0.60 0.55		
(I _C = 100 mAdc, I _B = 10 mAdc)		---	0.56 0.52	0.70 0.65		
Transient Characteristics						
Output Capacitance (V _{CB} = 5 Vdc, I _E = 0, f = 1 mc)	C _{ob}	10	---	2.5 4	pf	
Input Capacitance (V _{EB} = 1 Vdc, I _C = 0, f = 1 mc)	C _{ib}	10	---	3.3	pf	
Small Signal Forward Current Transfer Ratio (V _{CE} = 5 Vdc, I _C = 10 mAdc, f = 100 mc)	h _{fe}	2N2955 2N2956 2N2957	2 2.5 3	3.5 3.75 4.0	---	
Delay Time (V _{CC} = 12 Vdc, I _{CS} = 50 mAdc, I _{B1} = 5 mAdc, V _{BE} (Off) = 2.2 Vdc)	t _d		---	7 15	nsec	
Rise Time (same conditions as t _d)	t _r	2N2955 2N2956 2N2957	---	25 18 15	40 30 25	nsec
Storage Time (V _{CC} = 12 Vdc, I _{CS} = 50 mAdc, I _{B1} = 5 mAdc, I _{B2} = 5 mAdc)	t _s	2N2955 2N2956 2N2957	---	28 37 42	40 55 60	nsec
Fall Time (same conditions as t _s)	t _f	2N2955 2N2956 2N2957	---	25 18 18	40 35 35	nsec
Total Control Charge (I _C = 10 mAdc, I _B = 1 mAdc)	Q _T	2N2955 2N2956 2N2957	---	84 88 88	---	pc
Active Region Time Constant (I _C = 10 mAdc)	τ _A	14	---	2.9	nsec	

2N2955, 2N2956, 2N2957 (Continued)

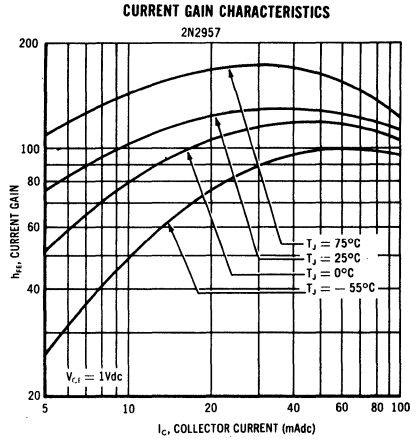
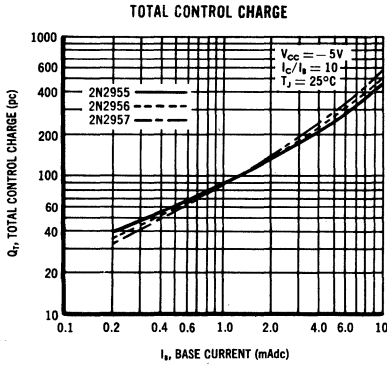

COLLECTOR-EMITTER SATURATION VOLTAGE versus BASE CURRENT

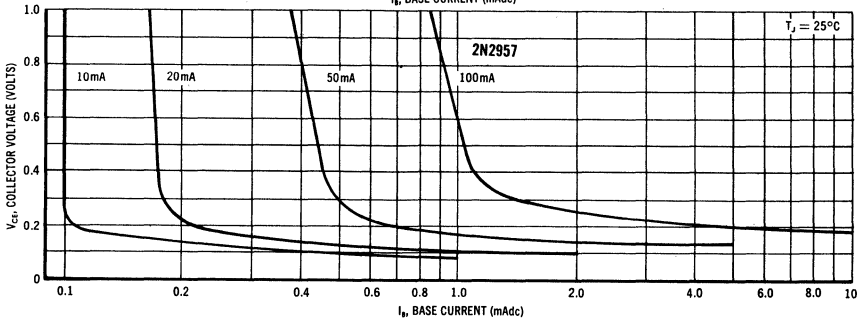
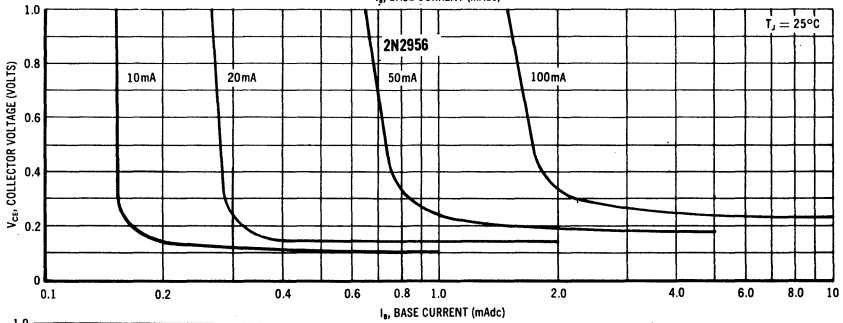
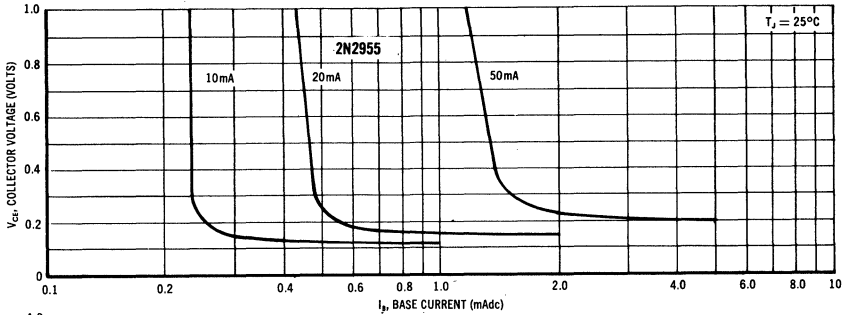

2N2958
2N2959
2N3115
2N3116

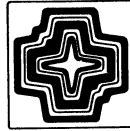

$V_{CEO} = 20\text{ V}$
 $I_C = 600\text{ mA}$
 $f_T = 400\text{ Mc Typ}$

NPN silicon annular Star transistors for high-speed switching and amplifier applications.

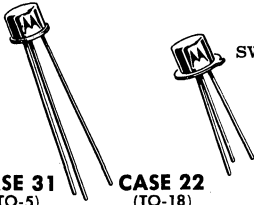

CASE 31 (TO-5) **CASE 22** (TO-18)
 2N2958 2N3115
 2N2959 2N3116

MAXIMUM RATINGS

Characteristics	Symbol	Types		Unit
		2N2958 2N2959 (TO-5)	2N3115 2N3116 (TO-18)	
Collector-Base Voltage	V_{CBO}	60	60	Vdc
Collector-Emitter Voltage	V_{CEO}	20	20	Vdc
Emitter-Base Voltage	V_{EBO}	5	5	Vdc
Collector-Current	I_C	600	600	mAdc
Total Device Dissipation 25°C Case Temperature Derate above 25°C	P_D	3 20	1.8 12	Watts mW/°C
Total Device Dissipation 25°C Ambient Temperature Derate above 25°C	P_D	0.6 4.00	0.4 2.67	Watts mW/°C
Junction Temperature	T_J	-65 to +175		°C
Storage Temperature	T_{stg}	-65 to +200		°C

2N2958, 2N2959, 2N3115, 2N3116 (Continued)

ELECTRICAL CHARACTERISTICS $T_A = 25^\circ\text{C}$ unless otherwise noted

Characteristics	Symbol	Min	Max	Unit
Collector Cutoff Current ($V_{CB} = 50 \text{ Vdc}$, $I_E = 0$) ($V_{CB} = 50 \text{ Vdc}$, $I_E = 0$, $T_A = 150^\circ\text{C}$)	I_{CBO}	---	0.025 15	$\mu \text{ Adc}$
Collector Cutoff Current ($V_{CE} = 30 \text{ Vdc}$, $V_{BE} = -0.5 \text{ Vdc}$)	I_{CEX}	---	.050	$\mu \text{ Adc}$
Base Cutoff Current ($V_{CE} = 30 \text{ Vdc}$, $V_{BE} = -0.5 \text{ Vdc}$)	I_{BL}	---	.050	$\mu \text{ Adc}$
Collector-Base Breakdown Voltage ($I_C = 10 \mu \text{ Adc}$, $I_E = 0$)	BV_{CBO}	60	---	Vdc
Collector-Emitter Breakdown Voltage* ($I_C = 10 \text{ mAdc}$, pulsed, $I_B = 0$)	BV_{CEO}^*	20	---	Vdc
Emitter-Base Breakdown Voltage ($I_E = 10 \mu \text{ Adc}$, $I_C = 0$)	BV_{EBO}	5	---	Vdc
Collector Saturation Voltage* ($I_C = 150 \text{ mAdc}$, $I_B = 15 \text{ mAdc}$)	$V_{CE}(\text{sat})^*$	---	0.5	Vdc
Base-Emitter Saturation Voltage* ($I_C = 150 \text{ mAdc}$, $I_B = 15 \text{ mAdc}$)	$V_{BE}(\text{sat})^*$	---	1.3	Vdc
DC Forward Current Transfer Ratio ($I_C = 150 \text{ mAdc}$, 2N2958, 2N3115 $V_{CE} = 10 \text{ Vdc}$) 2N2959, 2N3116	h_{FE}	40 100	120 300	---
Common-Base Open Circuit Output Capacitance ($V_{CB} = 10 \text{ V}$, $I_E = 0$, $f = 100 \text{ kc}$)	C_{ob}	---	8	pf
Delay Time ($V_{CC} = 30 \text{ V}$, $I_{CS} = 150 \text{ mA}$, $I_{B1} = 15 \text{ mA}$)	t_d	---	20	nsec
Rise Time ($V_{CC} = 30 \text{ V}$, $I_{CS} = 150 \text{ mA}$, $I_{B1} = 15 \text{ mA}$)	t_r	---	75	nsec
Storage Time ($V_{CC} = 6 \text{ V}$, $I_{CS} = 150 \text{ mA}$, $I_{B1} = +15 \text{ mA}$, $I_{B2} = -15 \text{ mA}$)	t_s	---	300	nsec
Fall Time ($V_{CC} = 6 \text{ V}$, $I_{CS} = 150 \text{ mA}$, $I_{B1} = +15 \text{ mA}$, $I_{B2} = -15 \text{ mA}$)	t_f	---	200	nsec
Current Gain-Bandwidth Product ($I_C = 20 \text{ mA}$, $V_{CE} = 20 \text{ V}$, $f = 100 \text{ mc}$)	f_T	250	---	mc

*PULSE TEST: Pulse width $\leq 300 \mu\text{sec}$, duty cycle $\leq 2\%$

2N3133 thru 2N3136



$V_{CE0} = 35\text{ V}$
 $I_C = 600\text{ mA}$
 $f_T = 200\text{ Mc}$



PNP silicon annular Star transistors for high-speed switching and DC to UHF amplifier applications.

CASE 31
(TO-5)

2N3133
2N3134

CASE 22
(TO-18)

2N3135
2N3136

MAXIMUM RATINGS

Characteristic	Symbol	Types		Unit
		(TO-5)	(TO-18)	
		2N3133 2N3134	2N3135 2N3136	
Collector-Base Voltage	V_{CBO}	50	50	Vdc
Collector-Emitter Voltage	V_{CEO}	35	35	Vdc
Emitter-Base Voltage	V_{EBO}	4	4	Vdc
Collector Current	I_C	600	600	mA
Total Device Dissipation @ 25°C Case Temperature Derate Above 25°C	P_D	3 17.3	1.8 10.3	Watts mW/°C
Total Device Dissipation @ 25°C Ambient Temperature Derate Above 25°C	P_D	0.6 3.43	0.4 2.28	Watts mW/°C
Junction Temperature	T_J	-65 to +200		°C
Storage Temperature	T_{stg}	-65 to +300		°C

SWITCHING CHARACTERISTICS (At 25°C unless otherwise noted)

Characteristic	Symbol	Typical	Max	Unit
Turn-On Time ($V_{CC} = -30\text{ V}$, $I_{CS} = 150\text{ mA}$, $I_{B1} = 15\text{ mA}$)	t_{on}	26	75	nsec
Turn-Off Time ($V_{CC} = -6\text{ V}$, $I_{CS} = 150\text{ mA}$, $I_{B1} = I_{B2} = 15\text{ mA}$)	t_{off}	70	150	nsec

2N3133 thru 2N3136 (Continued)

ELECTRICAL CHARACTERISTICS (At 25°C unless otherwise noted)

Characteristic	Symbol	Min	Max	Unit
Collector Cutoff Current ($V_{CB} = 30 \text{ Vdc}$, $I_E = 0$) ($V_{CB} = 30 \text{ Vdc}$, $I_E = 0$, $T_A = 150^\circ\text{C}$)	I_{CBO}	---	0.05 30	μAdc
Collector Cutoff Current ($V_{CE} = 30 \text{ V}$, $V_{BE} = 0.5 \text{ V}$)	I_{CEX}	---	0.1	μAdc
Base Cutoff Current ($V_{CE} = 30 \text{ V}$, $V_{BE} = 0.5 \text{ V}$)	I_{BL}	---	0.1	μAdc
Collector-Base Breakdown Voltage ($I_C = 10 \mu\text{Adc}$, $I_E = 0$)	BV_{CBO}	50	---	Vdc
Collector-Emitter Breakdown Voltage* ($I_C = 10 \text{ mAdc}$, $I_B = 0$)	BV_{CEO}^*	35	---	Vdc
Emitter-Base Breakdown Voltage ($I_E = 10 \mu\text{Adc}$, $I_C = 0$)	BV_{EBO}	4	---	Vdc
Collector Saturation Voltage* ($I_C = 150 \text{ mAdc}$, $I_B = 15 \text{ mAdc}$)	$V_{CE}(\text{sat})^*$	---	0.6	Vdc
Base-Emitter Saturation Voltage* ($I_C = 150 \text{ mAdc}$, $I_B = 15 \text{ mAdc}$)	$V_{BE}(\text{sat})^*$	---	1.5	Vdc
DC Forward Current Transfer Ratio ($I_C = 1.0 \text{ mAdc}$, $V_{CE} = 10 \text{ Vdc}$) $2N3133, 2N3135$ $2N3134, 2N3136$ ($I_C = 150 \text{ mAdc}$, $V_{CE} = 10 \text{ Vdc}$)* $2N3133, 2N3135$ $2N3134, 2N3136$	h_{FE}	25 50 40 100	--- --- 120 300	---
Output Capacitance ($V_{CB} = 10 \text{ Vdc}$, $I_E = 0$, $f = 100 \text{ kc}$)	C_{ob}	---	10	pf
Input Capacitance ($V_{BE} = 2 \text{ Vdc}$, $I_C = 0$, $f = 100 \text{ kc}$)	C_{ib}	---	40	pf
Current-Gain — Bandwidth Product ($I_C = 50 \text{ mAdc}$, $V_{CE} = 20 \text{ Vdc}$, $f = 100 \text{ mc}$)	f_T	200	---	mc

*Pulse Test: Pulse Width $\leq 300 \mu\text{sec}$, duty cycle $\leq 2\%$

2N3137
MM1803

$G_{PE} = 7.7-8.5 \text{ db @ 250 Mc Typ}$
 $P_O = 600-700 \text{ mW @ 250 Mc Typ}$

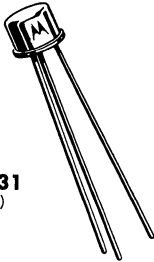

CASE 31
(TO-5)

NPN silicon annular transistors for large signal VHF and UHF applications.

MAXIMUM RATINGS

Characteristic	Symbol	2N3137	MM1803	Unit
Collector-Base Voltage	V_{CBO}	40	50	Vdc
Collector-Emitter Voltage	V_{CEO}	20	25	Vdc
Emitter-Base Voltage	V_{EBO}	4	5	Vdc
Collector Current (Continuous)	I_C	150	150	mAdc
Power Dissipation @25° C Case Temperature @25° C Ambient Temperature	P_D		2.0 0.8	Watts
Operating Junction Temperature	T_J		200	°C
Storage Temperature Range	T_{stg}		-65 to +200	
Thermal Resistance-- Junction to Case	θ_{JC}		87.5	°C/ Watt
Thermal Resistance-- Junction to Air	θ_{JA}		153	°C/ Watt

250 MC POWER GAIN TEST CIRCUIT (2N3137)

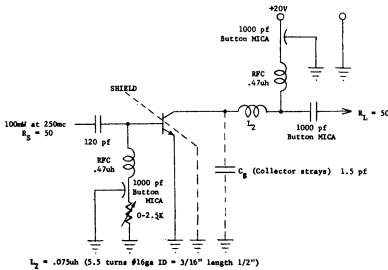

250 MC POWER GAIN TEST CIRCUIT (MM1803)

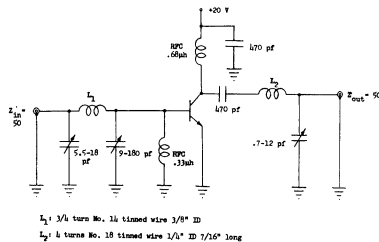

2N3137, MM1803 (Continued)

ELECTRICAL CHARACTERISTICS ($T_A = 25^\circ\text{C}$ unless otherwise specified)

Characteristic	Symbol	Min	Typical	Max	Unit
Collector-Base Breakdown Voltage $I_C = 0.1\text{mA dc}, I_E = 0$	V_{CBO}	40 50			Vdc
Collector-Emitter Open Base Sus. Voltage $I_C = 15\text{mA dc}, I_B = 0$	$V_{CEO(sus)}$	20 25			Vdc
Collector Cutoff Current $V_{CB} = 20\text{Vdc}, I_E = 0, T_C = +150^\circ\text{C}$	I_{CBO}			50	$\mu\text{A dc}$
Collector Cutoff Current $V_{CB} = 20\text{Vdc}, I_E = 0$	I_{CBO}			05	$\mu\text{A dc}$
Emitter-Base Breakdown Voltage $I_E = 100\mu\text{A}, I_C = 0$	V_{EBO}	4 5			Vdc
DC Current Gain $V_{CE} = 5\text{Vdc}, I_C = 50\text{mA dc}$	h_{FE}	20 40		120 160	
Collector-Emitter Saturation Voltage $I_C = 50\text{mA dc}, I_E = 5\text{mA dc}$	$V_{CE(sat)}$			0.3	Vdc
Small Signal Current Gain $V_{CE} = 10\text{Vdc}, I_C = 50\text{mA dc}, f = 100\text{mc}$	$ h_{fe} $	5.0			
Common-base Output Capacitance $V_{CB} = 10\text{Vdc}, I_C = 0, f = 100\text{kc}$	C_{ob}			3.5	pf
Power Output	P_{out}	400	600		mWatts
Power Gain $P_{in} = 100\text{mw}, f = 250\text{mc}$	G_e	6.0	7.7		db
Efficiency $V_{CE} = 20\text{Vdc}$	η	40	65		%
Power Output	P_{out}	560	700		mWatts
Power Gain $P_{in} = 100\text{mw}, f = 250\text{mc}$	G_e	7.5	8.5		db
Efficiency $V_{CE} = 20\text{V}$	η	45	60		%

*Pulse Width $\approx 300 \mu\text{sec}$. Duty cycle = 1%

2N3227

For Specifications, See 2N2369 Data Sheet

2N3244

2N3245



$V_{CE0} = 40-50 \text{ V}$
 $I_C = 1 \text{ A}$
 $f_T = 150-175 \text{ Mc}$



CASE 31
(TO-5)

PNP silicon annular transistors for medium-current, high-speed switching and driver applications.

MAXIMUM RATINGS

Characteristic	Symbol	Maximum		Unit
		2N3244	2N3245	
Collector-Base Voltage	V_{CBO}	40	50	Vdc
Collector-Emitter Voltage	V_{CEO}	40	50	Vdc
Emitter-Base Voltage	V_{EBO}	5		Vdc
Collector Current	I_C	1		Adc
Total Device Dissipation @ 25 °C Ambient Temperature Derating Factor Above 25 °C	P_D	1.0 5.71		Watt mW/°C
Total Device Dissipation @ 25 °C Case Temperature Derating Factor Above 25 °C	P_D	5 28.6		Watts mW/°C
Junction Temperature, Operating	T_J	+200		°C
Storage Temperature Range	T_{stg}	-65 to +200		°C
Thermal Resistance	θ_{JA} JC	0.175 35		°C/mW °C/W

2N3244, 2N3245 (Continued)

ELECTRICAL CHARACTERISTICS (at $T_A = 25^\circ\text{C}$ unless otherwise specified)

Characteristic		Symbol	Min	Max	Unit
Collector Cutoff Current ($V_{CB} = 30\text{ Vdc}$, $I_E = 0$) ($V_{CB} = 30\text{ Vdc}$, $I_E = 0$, $T_A = 100^\circ\text{C}$)		I_{CBO}	—	.050 10	$\mu\text{A dc}$
Collector Cutoff Current ($V_{CE} = 30\text{ Vdc}$, $V_{OB} = 3\text{ Vdc}$)		I_{CEX}	—	50	nA dc
Emitter-Base Leakage Current ($V_{EB} = 3\text{ Vdc}$, $I_C = 0$)		I_{EBO}	—	30	nA dc
Base Cutoff Current ($V_{CE} = 30\text{ Vdc}$, $V_{OB} = 3\text{ Vdc}$)		I_{BL}	—	80	nA dc
Collector-Base Breakdown Voltage ($I_C = 10\ \mu\text{A dc}$, $I_E = 0$)		BV_{CBO}	40 50	— —	V dc
Collector-Emitter Breakdown Voltage* ($I_C = 10\text{ mA dc}$, $I_B = 0$)		BV_{CEO}^*	40 50	— —	V dc
Emitter-Base Breakdown Voltage ($I_E = 10\ \mu\text{A dc}$, $I_C = 0$)		BV_{EBO}	5	—	V dc
Collector Saturation Voltage* ($I_C = 150\text{ mA dc}$, $I_B = 15\text{ mA dc}$) ($I_C = 500\text{ mA dc}$, $I_B = 50\text{ mA dc}$) ($I_C = 1\text{ A dc}$, $I_B = 100\text{ mA dc}$)		$V_{CE(sat)}^*$	— — —	0.3 0.35 0.5 0.6 1.0 1.2	V dc
Base-Emitter Saturation Voltage* ($I_C = 150\text{ mA dc}$, $I_B = 15\text{ mA dc}$) ($I_C = 500\text{ mA dc}$, $I_B = 50\text{ mA dc}$) ($I_C = 1\text{ A dc}$, $I_B = 100\text{ mA dc}$)		$V_{BE(sat)}^*$	— 0.75 —	1.1 1.5 2.0	V dc
DC Forward Current Transfer Ratio* ($I_C = 150\text{ mA dc}$, $V_{CE} = 1.0\text{ Vdc}$) ($I_C = 500\text{ mA dc}$, $V_{CE} = 1.0\text{ Vdc}$) ($I_C = 1\text{ A dc}$, $V_{CE} = 5\text{ Vdc}$)		h_{FE}^*	60 35 50 30 25 20	— — 150 90 — —	—
Output Capacitance ($V_{CB} = 10\text{ Vdc}$, $I_E = 0$, $f = 100\text{ kc}$)		C_{ob}	—	25	pf
Input Capacitance ($V_{OB} = 0.5\text{ Vdc}$, $I_C = 0$, $f = 100\text{ kc}$)		C_{ib}	—	100	pf
Current-Gain - Bandwidth Product ($I_C = 50\text{ mA dc}$, $V_{CE} = 10\text{ Vdc}$, $f = 100\text{ mc}$)		f_T	175 150	— —	mc
Delay Time	($I_C = 500\text{ mA}$, $I_{B1} = 50\text{ mA}$) $V_{OB} = 2\text{ V}$, $V_{CC} = 30\text{ V}$)	t_d	—	15	nsec
Rise Time		t_r	— —	35 40	nsec
Storage Time	($I_C = 500\text{ mA}$, $V_{CC} = 30\text{ V}$) $I_{B1} = I_{B2} = 50\text{ mA}$)	t_s	—	140 120	nsec
Fall Time ($V_{CC} = 30\text{ V}$)		t_f	—	45	nsec
Total Control Charge ($I_C = 500\text{ mA}$, $I_B = 50\text{ mA}$, $V_{CC} = 30\text{ V}$)		Q_T	— —	14 12	nC

* Pulse Test: PW = 300 μsec , Duty Cycle = 2%

2N3244, 2N3245 (Continued)

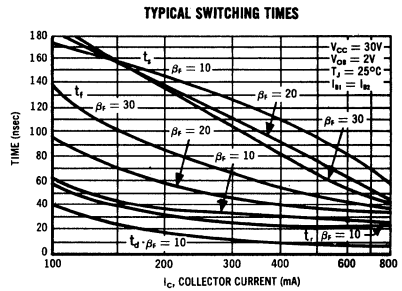
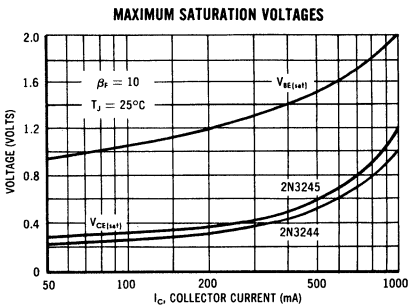
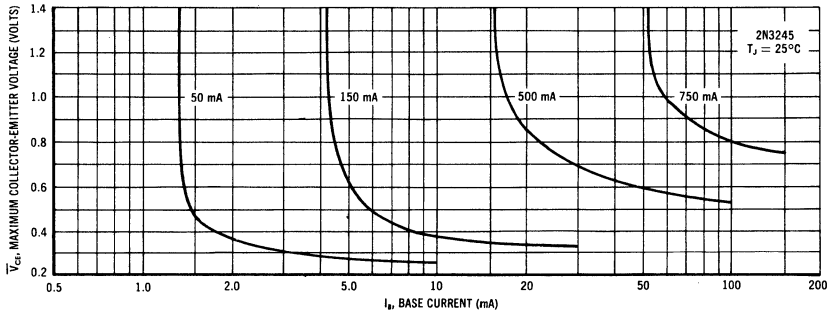
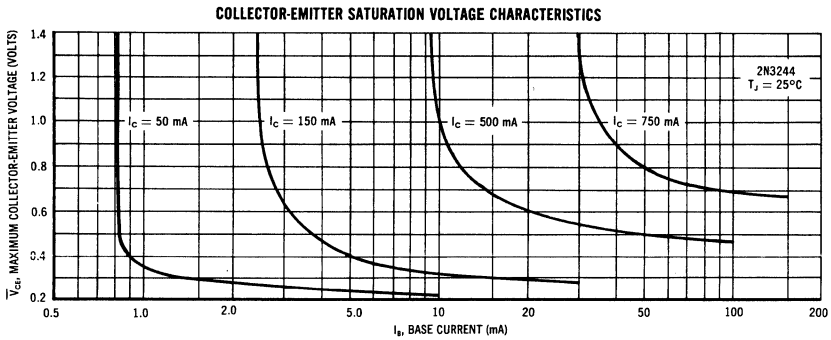
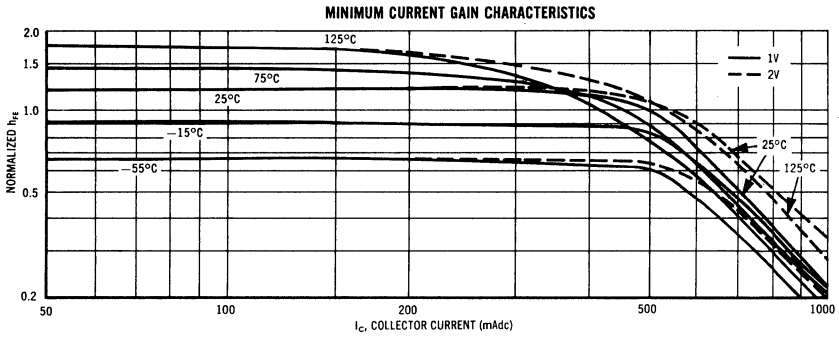

2N3248
2N3249

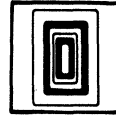

$V_{CE0} = 12\text{ V}$
 $f_T = 250\text{-}300\text{ Mc}$

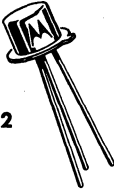

CASE 22
(TO-18)

PNP silicon annular transistors for low-level, high-speed switching applications.

MAXIMUM RATINGS

Characteristics	Symbol	Rating	Unit
Collector-Base Voltage	V_{CB0}	15	Vdc
Collector-Emitter Voltage	V_{CE0}	12	Vdc
Emitter-Base Voltage	V_{EB0}	5	Vdc
Total Device Dissipation @ 25°C Ambient Temperature Derate above 25°C	P_D	0.36 2.06	Watt mW/°C
Total Device Dissipation @ 25°C Case Temperature Derate above 25°C	P_D	1.2 6.9	Watts mW/°C
Operating Junction Temperature	T_J	200	°C
Storage Temperature Range	T_{stg}	-65 to +200	°C

TYPICAL SWITCHING TIME

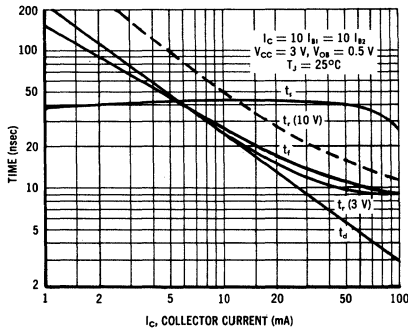

LIMITS OF SATURATION VOLTAGES

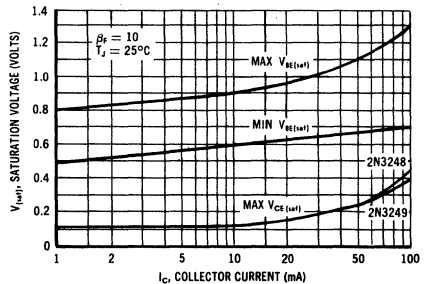

— Motorola High-Frequency Transistors —

2N3248, 2N3249 (Continued)

ELECTRICAL CHARACTERISTICS (at 25°C unless otherwise specified)

Characteristics		Symbol	Min	Max	Unit
Collector-Cutoff Current ($V_{CE} = 10$ Vdc, $V_{OB} = 1$ Vdc) ($V_{CE} = 10$ Vdc, $V_{OB} = 1$ Vdc, $T_A = 100^\circ\text{C}$)		I_{CEX}	— —	.05 5	μAdc
Base Cutoff Current ($V_{CE} = 10$ Vdc, $V_{OB} = 1$ Vdc)		I_{BL}	—	50	nAdc
Collector-Base Breakdown Voltage ($I_C = 10$ μAdc , $I_E = 0$)		BV_{CBO}	15	—	Vdc
Collector-Emitter Breakdown Voltage* ($I_C = 10$ mAdc, $I_B = 0$)		BV_{CEO}^*	12	—	Vdc
Emitter-Base Breakdown Voltage ($I_E = 10$ μAdc , $I_C = 0$)		BV_{EBO}	5	—	vdc
Collector Saturation Voltage ($I_C = 10$ mAdc, $I_B = 1$ mAdc) ($I_C = 50$ mAdc, $I_B = 5$ mAdc) ($I_C = 100$ mAdc, $I_B = 10$ mAdc)		$V_{CE(sat)}$	— — —	0.125 0.25 0.4	Vdc
	2N3249 2N3248			0.4 0.45	
Base-Emitter Saturation Voltage ($I_C = 10$ mAdc, $I_B = 1$ mAdc) ($I_C = 50$ mAdc, $I_B = 5$ mAdc) ($I_C = 100$ mAdc, $I_B = 10$ mAdc)		$V_{BE(sat)}$	0.6 — 0.7	0.9 1.1 1.3	Vdc
DC Current Gain* ($I_C = 0.1$ mAdc, $V_{CE} = 1$ Vdc)		h_{FE}^*	50 100	— —	—
	2N3248 2N3249				
($I_C = 1.0$ mAdc, $V_{CE} = 1$ Vdc)			50 100	— —	
	2N3248 2N3249				
($I_C = 10$ mAdc, $V_{CE} = 1$ Vdc)			50 100	150 300	
	2N3248 2N3249				
($I_C = 50$ mAdc, $V_{CE} = 1$ Vdc)			35 75	— —	
	2N3248 2N3249				
($I_C = 100$ mAdc, $V_{CE} = 1$ Vdc)			25 35	— —	
	2N3248 2N3249				
Output Capacitance ($V_{CE} = 10$ Vdc, $I_E = 0$, $f = 100$ kc)		C_{ob}	—	8	pf
Input Capacitance ($V_{BE} = 1$ Vdc, $I_C = 0$, $f = 100$ kc)		C_{ib}	—	8	pf
Current-Gain — Bandwidth Product ($I_C = 20$ mAdc, $V_{CE} = 10$ Vdc, $f = 100$ mc)		f_T	250 300	— —	mc
	2N3248 2N3249				
Total Control Charge ($I_C = 10$ mA, $I_B = 0.25$ mA, $V_{CC} = 3$ V)		Q_T	—	150	pC
Delay Time	$I_C = 100$ mA, $I_B = 10$ mA, $V_{OB} = 0.5$ V, $V_{CC} = 10$ V	t_d	—	5	nsec
Rise Time		t_r	—	15	nsec
Storage Time	$I_C = 100$ mA, $I_{B1} = I_{B2} = 10$ mA, $V_{CC} = 10$ V	t_s	—	60	nsec
Fall Time		t_f	—	20	nsec
Turn-On Time	$I_C = 10$ mA, $I_{B1} = 1$ mA, $V_{OB} = 0.5$ V, $V_{CC} = 3$ V	t_{on}	—	90	nsec
Turn-Off Time	$I_C = 10$ mA, $I_{B1} = I_{B2} = 1$ mA, $V_{CC} = 3$ V	t_{off}	—	100	nsec

*Pulse Test: PW 300 μsec , Duty Cycle 2%

2N3248, 2N3249 (Continued)

MINIMUM CURRENT GAIN

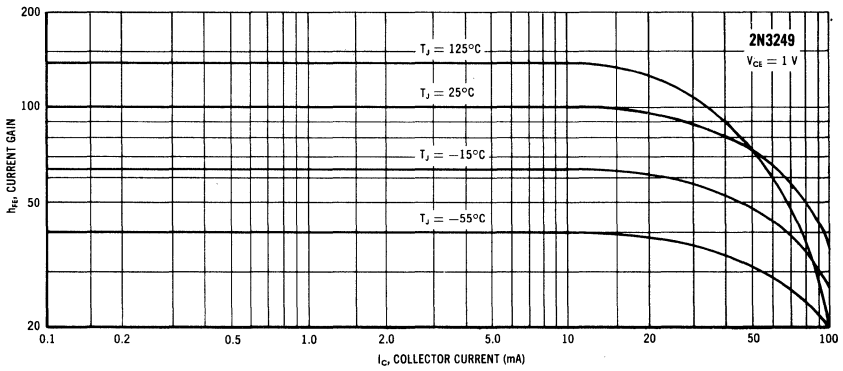
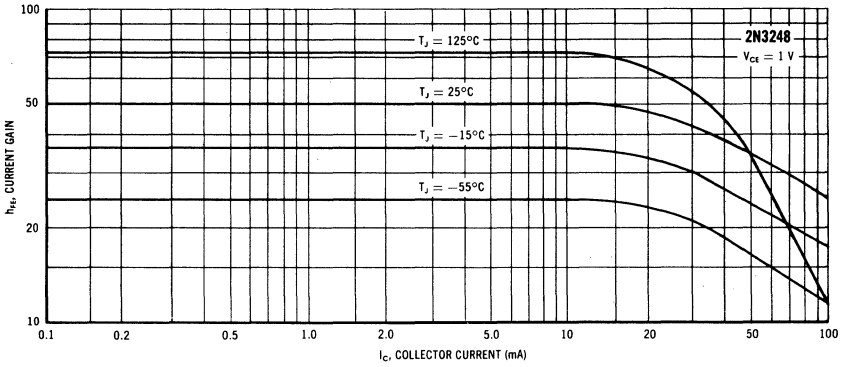

T_{on} and T_{off} TEST CIRCUIT

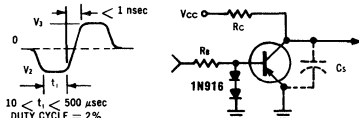
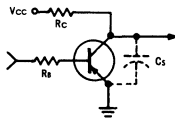
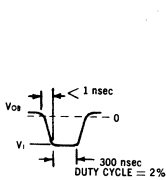

I_C mA	V_{CC} volts	R_a ohms	R_c ohms	$C_{S(\text{total})}$ pf	V_{ce} volts	V_1 volts	V_2 volts	V_3 volts
10	3	10 K	285	4	+0.5	-10.6	-10.9	+9.1
100	10	1 K	95	12	+0.5	-10.7	-11.3	+8.7

* Total shunt capacitance of test jig and connectors.

2N3250, A
2N3251, A

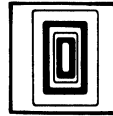

$V_{CEO} = 40-60 \text{ V}$
 $I_C = 200 \text{ mA}$
 $f_T = 250-300 \text{ Mc}$

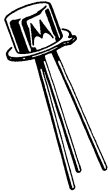

CASE 22
(TO-18)

PNP silicon annular transistors for high-speed switching and amplifier applications.

MAXIMUM RATINGS

Characteristic	Symbol	Rating		Unit
		2N3250 2N3251	2N3250A 2N3251A	
Collector-Base Voltage	V_{CBO}	50	60	Vdc
Collector-Emitter Voltage	V_{CEO}	40	60	Vdc
Emitter-Base Voltage	V_{EBO}	5		Vdc
Collector Current	I_C	200		mAdc
Total Device Dissipation @ 25°C Case Temperature Derating Factor Above 25°C	P_D	1.2 6.9		Watts mW/°C
Total Device Dissipation @ 25°C Ambient Temperature Derating Factor Above 25°C	P_D	0.36 2.06		Watts mW/°C
Junction Operating Temperature	T_J	200		°C
Storage Temperature Range	T_{stg}	-65 to +200		°C
Thermal Resistance	θ_{JA}	0.49		°C/mW
	θ_{JC}	0.15		°C/mW

2N3250, A, 2N3251, A (Continued)

ELECTRICAL CHARACTERISTICS (At 25°C unless otherwise noted)

Characteristic		Symbol	Min	Max	Unit
Collector Cutoff Current ($V_{CE} = 40$ Vdc, $V_{OB} = 3$ Vdc)		I_{CEX}	--	20	nAdc
Base Cutoff Current ($V_{CE} = 40$ Vdc, $V_{OB} = 3$ Vdc)		I_{BL}	--	50	nAdc
Collector-Base Breakdown Voltage ($I_C = 10$ μ Adc)	2N3250, 2N3251 2N3250A, 2N3251A	BV_{CBO}	50 60	--	Vdc
Collector-Emitter Breakdown Voltage * ($I_C = 10$ mAdc)	2N3250, 2N3251 2N3250A, 2N3251A	BV_{CEO}^*	40 60	--	Vdc
Emitter-Base Breakdown Voltage ($I_E = 10$ μ Adc)		BV_{EBO}	5	--	Vdc
Collector Saturation Voltage * ($I_C = 10$ mAdc, $I_B = 1$ mAdc) ($I_C = 50$ mAdc, $I_B = 5$ mAdc)		$V_{CE(sat)}^*$	-- --	0.25 0.5	Vdc
Base-Emitter Saturation Voltage * ($I_C = 10$ mAdc, $I_B = 1$ mAdc) ($I_C = 50$ mAdc, $I_B = 5$ mAdc)		$V_{BE(sat)}^*$	0.6 --	0.9 1.2	Vdc
DC Forward Current Transfer Ratio * ($I_C = 0.1$ mAdc, $V_{CE} = 1$ Vdc) ($I_C = 1$ mAdc, $V_{CE} = 1$ Vdc) ($I_C = 10$ mAdc, $V_{CE} = 1$ Vdc) ($I_C = 50$ mAdc, $V_{CE} = 1$ Vdc)	2N3250, 2N3250A 2N3251, 2N3251A 2N3250, 2N3250A 2N3251, 2N3251A 2N3250, 2N3250A 2N3251, 2N3251A 2N3250, 2N3250A 2N3251, 2N3251A	h_{FE}^*	40 80 45 90 50 100 15 30	-- -- -- -- 150 300 -- --	--
Output Capacitance ($V_{CB} = 10$ Vdc, $I_E = 0$, $f = 100$ kc)		C_{ob}	--	6	pf
Input Capacitance ($V_{OB} = 1$ Vdc, $I_C = 0$, $f = 100$ kc)		C_{ib}	--	8	pf
Current-Gain - Bandwidth Product ($I_C = 10$ mAdc, $V_{CE} = 20$ Vdc, $f = 100$ mc)	2N3250, 2N3250A 2N3251, 2N3251A	f_T	250 300	-- --	mc

Small Signal Characteristics		Symbol	Min	Max	Unit
Small Signal Current Gain ($I_C = 1.0$ mA, $V_{CE} = 10$ V, $f = 1$ kc)	2N3250, 2N3250A 2N3251, 2N3251A	h_{fe}	50 100	200 400	--
Voltage Feedback Ratio ($I_C = 1.0$ mA, $V_{CE} = 10$ V, $f = 1$ kc)	2N3250, 2N3250A 2N3251, 2N3251A	h_{re}	-- --	10 20	$\times 10^{-4}$
Input Impedance ($I_C = 1.0$ mA, $V_{CE} = 10$ V, $f = 1$ kc)	2N3250, 2N3250A 2N3251, 2N3251A	h_{ie}	1 2	6 12	kohms
Output Admittance ($I_C = 1.0$ mA, $V_{CE} = 10$ V, $f = 1$ kc)	2N3250, 2N3250A 2N3251, 2N3251A	h_{oe}	4 10	40 60	μ mhos
Collector-Base Time Constant ($I_C = 10$ mA, $V_{CE} = 20$ V)		r'_{bC_C}	--	250	psec
Noise Figure ($I_C = 100$ μ A, $V_{CE} = 5$ V, $R_g = 1$ k Ω , $f = 100$ cps)		NF	--	6	db

*Pulse Test: PW = 300 μ sec, Duty Cycle = 2%

V_{OB} = Base Emitter Reverse Bias

2N3250, A, 2N3251, A (Continued)

SWITCHING CHARACTERISTICS (At 25°C unless otherwise noted)

Characteristic		Symbol	Max	Unit
Delay Time	$(V_{CC} = 3 \text{ Vdc}, V_{OB} = 0.5 \text{ Vdc}$ $I_C = 10 \text{ mAdc}, I_{B1} = 1 \text{ mA})$	t_d	35	nsec
Rise Time		t_r	35	nsec
Storage Time	$(I_{B1} = I_{B2} = 1 \text{ mAdc}$ $V_{CC} = 3 \text{ V})$	t_s	2N3250, 2N3250A 200	nsec
Fall Time			2N3251, 2N3251A 50	

NORMALIZED CURRENT GAIN CHARACTERISTICS

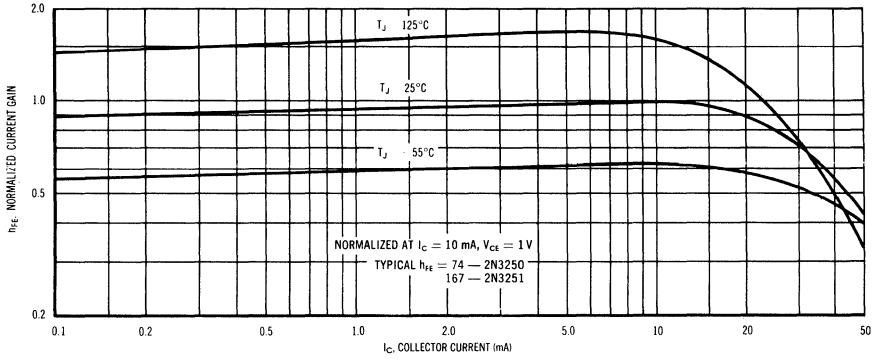

CHARGE DATA

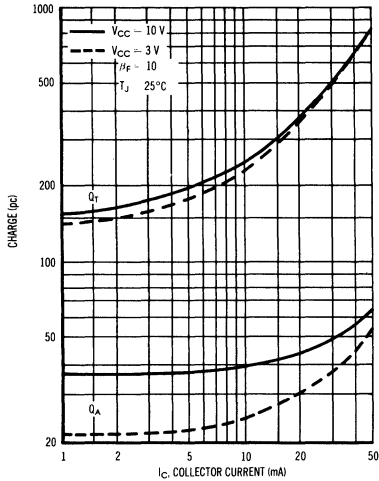

TYPICAL SWITCHING TIMES

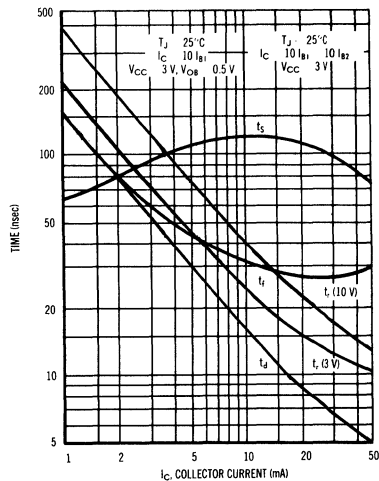

2N3250, A, 2N3251, A (Continued)

AUDIO SMALL SIGNAL CHARACTERISTICS

NOISE FIGURE VARIATIONS

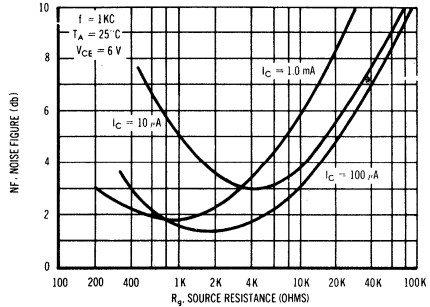
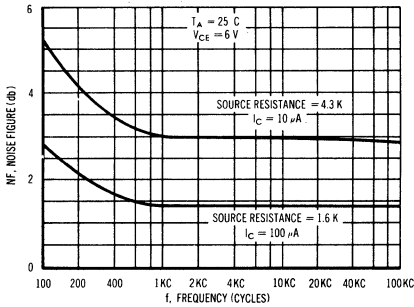

h PARAMETERS

$(V_{CE} = 10\ \text{V}, T_A = 25^\circ\text{C}, f = 1\text{ Kc})$

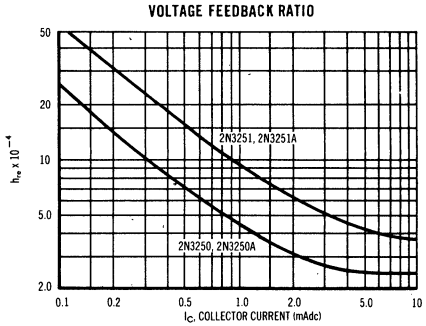
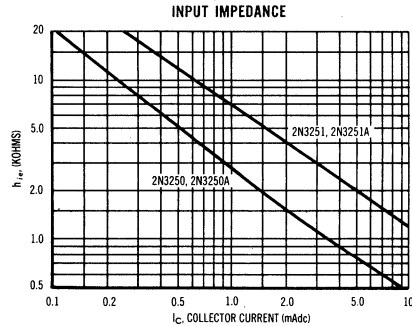
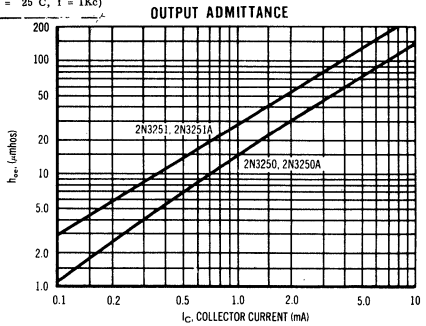
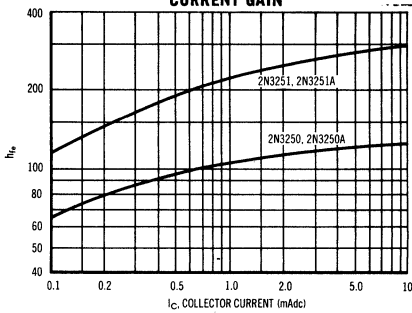

SATURATION VOLTAGES versus COLLECTOR CURRENT

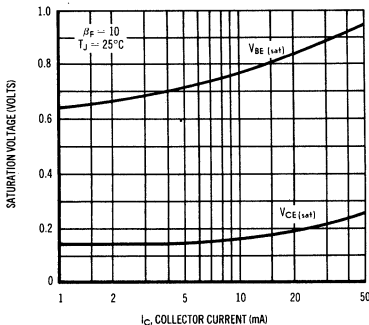

TEMPERATURE COEFFICIENTS

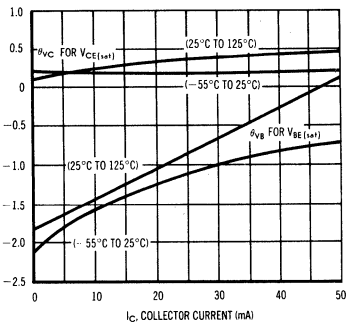

2N3252
2N3253
2N3444

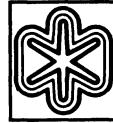

$V_{CEO} = 30-50 \text{ V}$
 $I_C = 1 \text{ A}$
 $f_T = 175-200 \text{ Mc}$



NPN silicon annular transistors for high-current saturated switching and core driver applications.

CASE 31
(TO-5)

MAXIMUM RATINGS

Characteristics	Symbol	Types			Unit
		2N3252	2N3253	2N3444	
Collector-Base Voltage	V_{CB0}	60	75	80	Vdc
Collector-Emitter Voltage	V_{CEO}	30	40	50	Vdc
Emitter-Base Voltage	V_{EBO}	← 5 →			Vdc
Total Device Dissipation 25°C Case Temperature Derate above 25°C	P_D	← 5 →			Watts mW/°C
		← 28.6 →			
Total Device Dissipation 25°C Ambient Temperature Derate above 25°C	P_D	← 1.0 →			Watt mW/°C
		← 5.71 →			
Junction Operating Temperature Range	T_J	← -65 to +200 →			°C
Storage Temperature Range	T_{stg}	← -65 to +200 →			°C
Thermal Resistance:	θ_{JC}		35		°C/W
	θ_{JA}		0.175		°C/mW

SWITCHING CHARACTERISTICS

Characteristics		Symbol	Min	Max	Unit
Output Capacitance ($V_{CB} = 10 \text{ Vdc}, I_E = 0, f = 100 \text{ kc}$)		C_{ob}	—	12	pf
Input Capacitance ($V_{EB} = 0.5 \text{ Vdc}, I_C = 0, f = 100 \text{ kc}$)		C_{ib}	—	80	pf
Current Gain-Bandwidth Product ($I_C = 50 \text{ mAdc}, V_{CE} = 10 \text{ Vdc}, f = 100 \text{ mc}$)		f_T	200	—	mc
Total Control Charge ** ($I_C = 500 \text{ mAdc}, I_{B1} = 50 \text{ mAdc}, V_{CC} = 30 \text{ V}$)		Q_T	—	5	nC
Delay Time	$I_C = 500 \text{ mAdc}, I_{B1} = 50 \text{ mAdc}$ $V_{CC} = 30 \text{ V}, V_{OB} = 2 \text{ V}$	t_d	—	15	nsec
Rise Time					
Storage Time	$I_C = 500 \text{ mAdc}, I_{B1} = I_{B2} = 50 \text{ mAdc}$ $V_{CC} = 30 \text{ V}$	t_s	—	40	nsec
Fall Time					

2N3252, 2N3253, 2N3444 (Continued)

ELECTRICAL CHARACTERISTICS (At 25°C unless otherwise noted)

Characteristics		Symbol	Min	Max	Unit
Collector Cutoff Current ($V_{CB} = 40 \text{ Vdc}, I_E = 0$) ($V_{CB} = 40 \text{ Vdc}, I_E = 0, T_A = 100^\circ\text{C}$) ($V_{CB} = 60 \text{ Vdc}, I_E = 0$) ($V_{CB} = 60 \text{ Vdc}, I_E = 0, T_A = 100^\circ\text{C}$)	2N3252	I_{CBO}	—	0.50	μAdc
	2N3252		75.0		
	2N3253, 2N3444		0.50		
	2N3253, 2N3444		75.0		
Emitter Cutoff Current ($V_{CB} = 4 \text{ Vdc}, I_C = 0$)		I_{EBO}	—	0.05	μAdc
Collector Cutoff Current ($V_{CE} = 40 \text{ Vdc}, V_{OB} = 4 \text{ Vdc}$) ($V_{CE} = 60 \text{ Vdc}, V_{OB} = 4 \text{ Vdc}$)	2N3252	I_{CEX}	—	0.5	μAdc
	2N3253, 2N3444		—	0.5	
Base Cutoff Current ($V_{CE} = 40 \text{ Vdc}, V_{OB} = 4 \text{ Vdc}$) ($V_{CE} = 60 \text{ Vdc}, V_{OB} = 4 \text{ Vdc}$)	2N3252	I_{BL}	—	0.50	μAdc
	2N3253, 2N3444		—	0.50	
Collector-Base Breakdown Voltage ($I_C = 10 \mu\text{Adc}, I_E = 0$)	2N3252	BV_{CBO}	60	—	Vdc
	2N3253		75	—	
	2N3444		80	—	
Collector-Emitter Breakdown Voltage* ($I_C = 10 \text{ mAdc}, \text{pulsed}, I_B = 0$)	2N3252	BV_{CEO}^*	30	—	Vdc
	2N3253		40	—	
	2N3444		50	—	
Emitter-Base Breakdown Voltage ($I_E = 10 \mu\text{Adc}, I_C = 0$)		BV_{EBO}	5	—	Vdc
Collector Saturation Voltage* ($I_C = 150 \text{ mAdc}, I_B = 15 \text{ mAdc}$) ($I_C = 500 \text{ mAdc}, I_B = 50 \text{ mAdc}$) ($I_C = 1.0 \text{ Adc}, I_B = 100 \text{ mAdc}$)	2N3252	$V_{CE(\text{sat})}^*$	—	0.3	Vdc
	2N3253, 2N3444		—	0.35	
	2N3252		—	0.5	
	2N3253, 2N3444		—	0.80	
	2N3252		—	1.0	
	2N3253, 2N3444		—	1.2	
Base-Emitter Saturation Voltage* ($I_C = 150 \text{ mAdc}, I_B = 15 \text{ mAdc}$) ($I_C = 500 \text{ mAdc}, I_B = 50 \text{ mAdc}$) ($I_C = 1.0 \text{ Adc}, I_B = 100 \text{ mAdc}$)		$V_{BE(\text{sat})}^*$	—	1.0	Vdc
			0.7	1.3	
			—	1.8	
DC Forward Current Transfer Ratio* ($I_C = 150 \text{ mAdc}, V_{CE} = 1 \text{ Vdc}$) ($I_C = 500 \text{ mAdc}, V_{CE} = 1 \text{ Vdc}$) ($I_C = 1 \text{ Adc}, V_{CE} = 5 \text{ Vdc}$)	2N3252	h_{FE}^*	30	—	—
	2N3253		25	—	
	2N3444		20	—	
	2N3252		30	90	
	2N3253		25	75	
	2N3444		20	60	
	2N3252		25	—	
	2N3253		20	—	
	2N3444		15	—	

* Pulse Test: Pulse width = 300 μsec , duty cycle = 2%

— Motorola High-Frequency Transistors —

2N3252, 2N3253, 2N3444 (Continued)

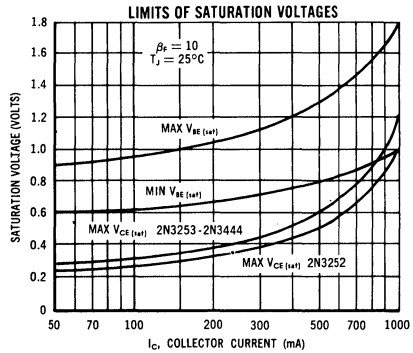
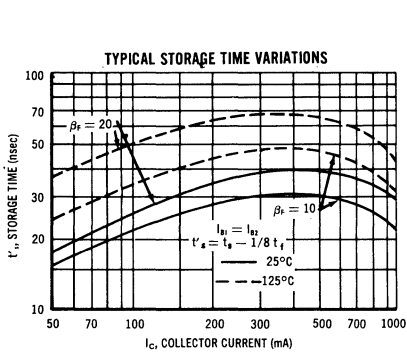
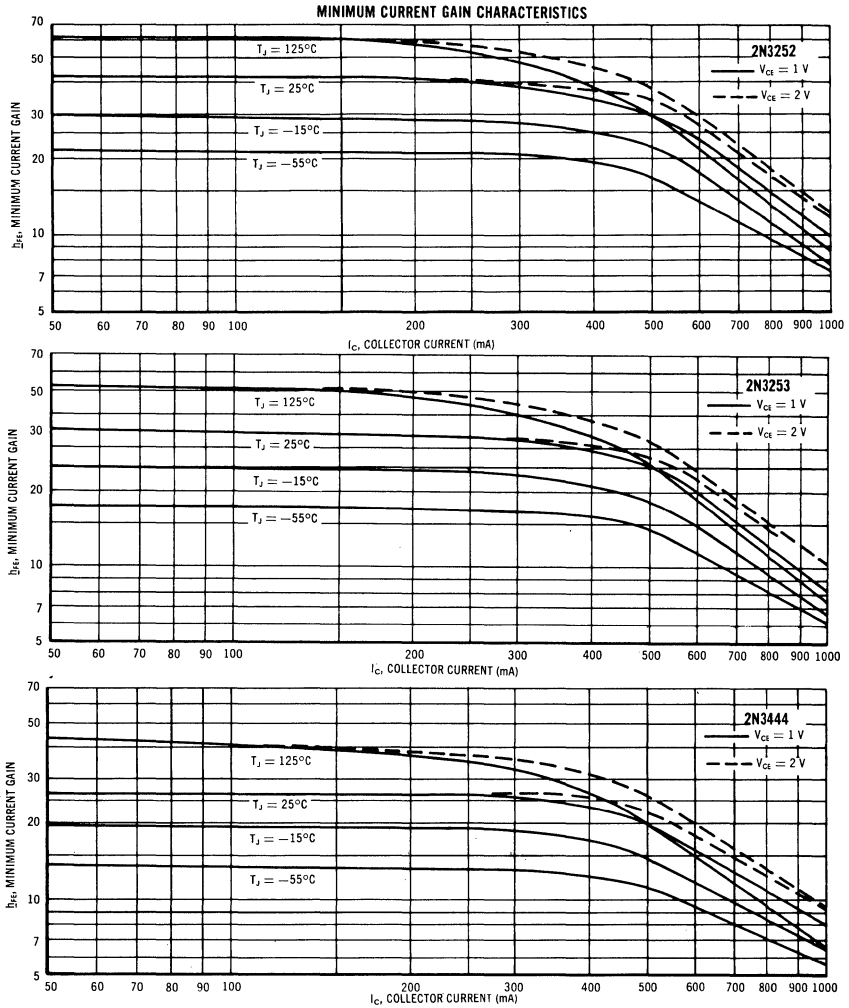

2N3279 thru 2N3282



$V_{CBO} = 30\text{ V}$
 $G_e = 16\text{-}17\text{ db @ } 200\text{ Mc}$
 $NF = 3.5\text{-}5\text{ db @ } 200\text{ Mc}$

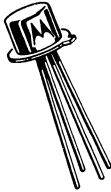

CASE 22
(TO-18)

PNP germanium epitaxial mesa transistors for high-gain, low-noise amplifier, oscillator, mixer and frequency multiplier applications.

MAXIMUM RATINGS

Characteristic	Symbol	Rating	Rating	Unit
		2N3279 2N3280	2N3281 2N3282	
Collector-Base Voltage	V_{CBO}	30	30	Volts
Collector-Emitter Voltage	V_{CES}	30	30	Volts
Collector-Emitter Voltage	V_{CEO}	20	15	Volts
Emitter-Base Voltage	V_{EBO}	1.0	0.5	Volts
Collector Current	I_C	50	50	mA
Total Device Dissipation (25°C Ambient Temperature) Derate above 25°C	P_D	100	100	mW
		1.33	1.33	mW/°C
Junction Temperature	T_j	+100	+100	°C
Storage Temperature	T_{stg}	-65 to +100	-65 to +100	°C

ELECTRICAL CHARACTERISTICS (At 25°C unless otherwise noted)

Characteristic	Symbol	Test Conditions	Min	Typ	Max	Unit
Collector-Base Breakdown Voltage	BV_{CBO}	$I_C = 100\ \mu\text{Adc}$, $I_E = 0$ All Types	30	—	—	Vdc
Collector-Emitter Breakdown Voltage	BV_{CES}	$I_C = 100\ \mu\text{Adc}$, $V_{EB} = 0$ All Types	30	—	—	Vdc
Collector-Emitter Breakdown Voltage	BV_{CEO}	$I_C = 2.0\ \text{mAdc}$, $I_B = 0$ 2N3279, 2N3280 2N3281, 2N3282	20	—	—	Vdc
			15	—	—	

— Motorola High-Frequency Transistors —

2N3279 thru 2N3282 (Continued)

ELECTRICAL CHARACTERISTICS (continued)

Characteristic	Sym		Min	Typ	Max	Unit
Collector Cutoff Current	I_{CBO}	$V_{CB} = 10 \text{ Vdc}, I_E = 0$ All Types $V_{CB} = 10 \text{ Vdc}, I_E = 0, T_A = +55^\circ\text{C}$ 2N3279, 2N3280	—	1	5	$\mu\text{A dc}$
Emitter Cutoff Current	I_{EBO}	$V_{EB} = 0.75 \text{ Vdc}, I_C = 0$ 2N3279, 2N3280 $V_{EB} = 0.5 \text{ Vdc}, I_C = 0$ 2N3281, 2N3282	—	—	100	$\mu\text{A dc}$
DC Forward Current Transfer Ratio	h_{FE}	$V_{CE} = 10 \text{ Vdc}, I_C = 3 \text{ mA dc}$ 2N3279, 2N3280 2N3281, 2N3282	10	—	70	—
Collector-Emitter Saturation Voltage	$V_{CE}(\text{sat})$	$I_C = 5 \text{ mA dc}, I_B = 1.0 \text{ mA dc}$ 2N3279, 2N3280 2N3281, 2N3282	—	—	0.3	Vdc
Base-Emitter Saturation Voltage	$V_{BE}(\text{sat})$	$I_C = 5 \text{ mA dc}, I_B = 1.0 \text{ mA dc}$ 2N3279, 2N3280 2N3281, 2N3282	—	—	1.0	Vdc

Small Signal Forward Current Transfer Ratio	h_{fe}	$V_{CE} = 10 \text{ Vdc}, I_C = 3 \text{ mA dc}, f = 1 \text{ kc}$ 2N3279, 2N3280 2N3281, 2N3282	10	—	100	—
Collector-Base Capacitance	C_{ob}	$V_{CB} = 10 \text{ Vdc}, I_E = 0, f = 100 \text{ kc}$ (Note 1) 2N3279 2N3280 thru 2N3282	—	0.9	1.0	pf
Collector-Base Time Constant	$r_b' C_c$	$V_{CB} = 10 \text{ Vdc}, I_C = 3 \text{ mA dc}, f = 31.8 \text{ mc}$ 2N3279, 2N3280 2N3281, 2N3282	3	5	10	psec
Current Gain - Bandwidth Product	f_T	$V_{CE} = 10 \text{ Vdc}, I_C = 3 \text{ mA dc}$ 2N3279, 2N3280 2N3281, 2N3282	400	500	800	mc
Maximum Frequency of Oscillation	f_{max}	$V_{CE} = 10 \text{ Vdc}, I_C = 3 \text{ mA dc}$ All Types	—	2000	—	mc

Power Gain	G_e	$V_{CE} = 10 \text{ Vdc}, I_C = 3 \text{ mA dc}, f = 200 \text{ mc}$ 2N3279, 2N3280 2N3281, 2N3282	17	—	23	db
Noise Figure	NF	$V_{CE} = 10 \text{ Vdc}, I_C = 3 \text{ mA dc}, f = 200 \text{ mc}$ 2N3279, 2N3280 2N3281, 2N3282	—	2.9	3.5	db
Power Gain (AGC)	G_e	$V_{CE} = 5 \text{ Vdc}, I_C = 20 \text{ mA dc}, f = 200 \text{ mc}$ (Note 2) 2N3279, 2N3281 (Note 2) 2N3280, 2N3282	—	—	0	db

Note 1. C_{ob} is measured in a guarded circuit such that the can capacitance is not included.

Note 2. AGC is obtained by increasing I_C . The circuit remains adjusted for $V_{CE} = 10 \text{ Vdc}$ and $I_C = 3 \text{ mA dc}$ operation.

2N3279 thru 2N3282 (Continued)

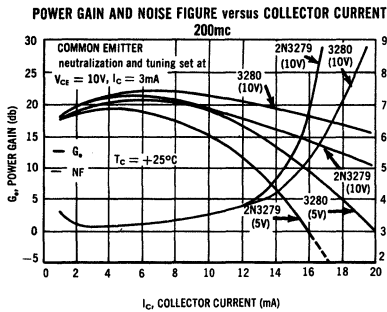

NEUTRALIZED POWER GAIN AND NOISE FIGURE versus FREQUENCY

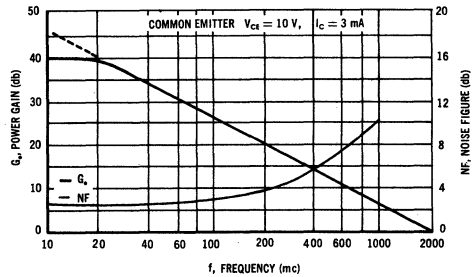

2N3283 thru 2N3286

$V_{CBO} = 20-25V$
 $G_p = 14-16\text{ db @ }200\text{ Mc}$
 $NF = 4-5\text{ db @ }200\text{ Mc}$

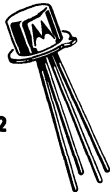

CASE 22
(TO-18)

PNP germanium epitaxial mesa transistors for TV and FM, RF and IF amplifier, oscillator and general purpose high-gain, low-noise amplifier applications.

MAXIMUM RATINGS

Characteristic	Symbol	2N3283 2N3284	2N3285 2N3286	Unit
Collector-Base Voltage	V_{CBO}	25	20	Volts
Collector-Emitter Voltage	V_{CES}	25	20	Volts
Emitter-Base Voltage	V_{EB}	0.5	0.5	Volt
Collector Current	I_C	50	50	mA
Total Device Dissipation at $T_A = 25^\circ C$ Derate above $25^\circ C$	P_D	100 1.33	100 1.33	mW mW/ $^\circ C$
Junction Temperature	T_J	+100	+100	$^\circ C$
Storage Temperature Range	T_{stg}	← -65 to +100 →		$^\circ C$

— Motorola High-Frequency Transistors —

2N3283 thru 2N3286 (Continued)

ELECTRICAL CHARACTERISTICS (At 25°C unless otherwise noted)

Characteristic	Symbol	Test Conditions	Min	Typ	Max	Unit
Collector-Emitter Breakdown Voltage	BV_{CES}	$I_C = 100 \mu\text{A dc}$, $V_{BE} = 0$ 2N3283, 2N3284 2N3285, 2N3286	25 20	30 25	—	Vdc
Collector Cutoff Current	I_{CBO}	$V_{CB} = 10 \text{ Vdc}$, $I_E = 0$	—	2.0	10	$\mu\text{A dc}$
Emitter Cutoff Current	I_{EBO}	$V_{EB} = 0.5 \text{ Vdc}$, $I_C = 0$	—	—	100	$\mu\text{A dc}$
DC Forward Current Transfer Ratio	h_{FE}	$V_{CE} = 10 \text{ Vdc}$, $I_C = 3 \text{ mA dc}$ 2N3283, 2N3284 2N3285, 2N3286	10	30	—	—
			5	15	—	—

AC Current Gain	h_{fe}	$V_{CE} = 10 \text{ Vdc}$, $I_C = 3 \text{ mA dc}$, $f = 1 \text{ kc}$ 2N3283, 2N3284 2N3285, 2N3286	10 5	— —	200 200	—
Output Capacitance	C_{ob}	$V_{CB} = 10 \text{ Vdc}$, $I_E = 0$, $f = 100 \text{ kc}$ Note 1	—	1.0	1.5	pF
AC Current Gain	h_{fe}	$V_{CE} = 10 \text{ Vdc}$, $I_C = 3 \text{ mA dc}$, $f = 100 \text{ mc}$	2.5	4.0	8.0	—
Collector-Base Time Constant	r_b'/C_c	$V_{CB} = 10 \text{ Vdc}$, $I_C = 3 \text{ mA dc}$, $f = 31.8 \text{ mc}$	—	10	25	psec
Maximum Frequency of Oscillation	f_{max}	$V_{CE} = 10 \text{ Vdc}$, $I_C = 3 \text{ mA dc}$	—	2000	—	mc

2N3283

Power Gain	G_e	$V_{CE} = 10 \text{ Vdc}$, $I_C = 3 \text{ mA dc}$ $f = 200 \text{ mc}$	16	20	23	dB
Noise Figure	NF		—	4	5	dB
Power Gain (AGC)	G_e	Circuit Fig. 1 - Note 2 $V_{CE} = 5 \text{ Vdc}$, $I_C = 20 \text{ mA dc}$, $f = 200 \text{ mc}$	—	—	0	dB

2N3284

Power Gain	G_e	$V_{CE} = 10 \text{ Vdc}$, $I_C = 3 \text{ mA dc}$ $f = 200 \text{ mc}$	16	20	23	dB
Noise Figure	NF		—	5	6	dB
Power Gain (AGC)	G_e	$V_{CE} = 5 \text{ Vdc}$, $I_C = 20 \text{ mA dc}$, $f = 200 \text{ mc}$	—	0	—	dB

2N3285

Power Output	P_{out}	$V_{EE} = +12 \text{ Vdc}$, $f = 257 \text{ mc}$	2	—	—	mW
--------------	-----------	---	---	---	---	----

2N3286

Power Gain	G_e	$V_{CE} = 10 \text{ Vdc}$, $I_C = 3 \text{ mA dc}$ $f = 200 \text{ mc}$	14	—	—	dB
Noise Figure	NF		—	5	—	dB

Note 1. C_{ob} is measured in a guarded circuit such that the can capacitance is not included.

Note 2. AGC is obtained by increasing I_C . The circuit remains adjusted for $V_{CE} = 10 \text{ Vdc}$ and $I_C = 3 \text{ mA dc}$ operation.

2N3283 thru 2N3286 (Continued)

NEUTRALIZED POWER GAIN AND NOISE FIGURE versus FREQUENCY

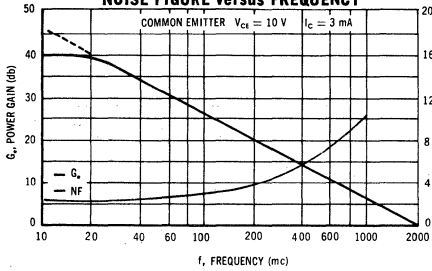

POWER GAIN AND NOISE FIGURE versus COLLECTOR CURRENT 200 mc

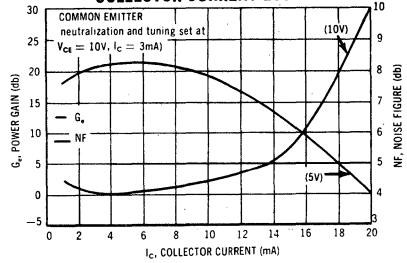

200 MC POWER GAIN AND NOISE FIGURE TEST CIRCUIT

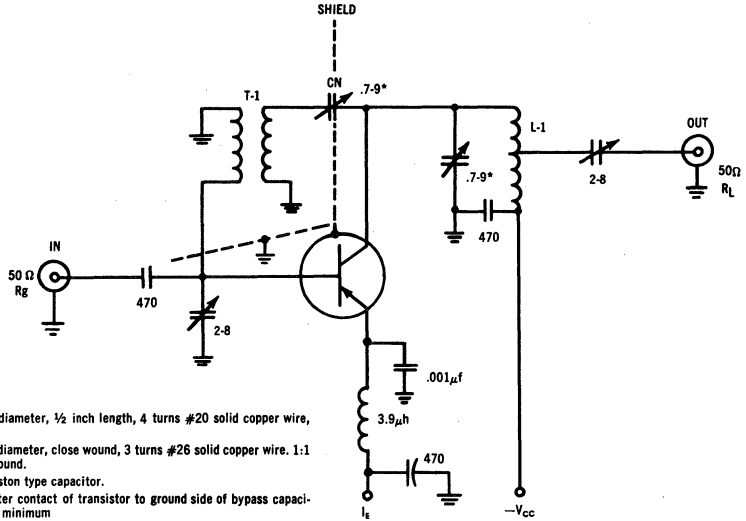

NOTES:

L-1 $\frac{1}{4}$ inch inside diameter, $\frac{1}{2}$ inch length, 4 turns #20 solid copper wire, center tapped.

T-1 $\frac{1}{4}$ inch inside diameter, close wound, 3 turns #26 solid copper wire. 1:1 ratio bi-filler wound.

* High Quality piston type capacitor.

Distance from emitter contact of transistor to ground side of bypass capacitor should be kept minimum

257 MC OSCILLATOR POWER OUTPUT TEST CIRCUIT

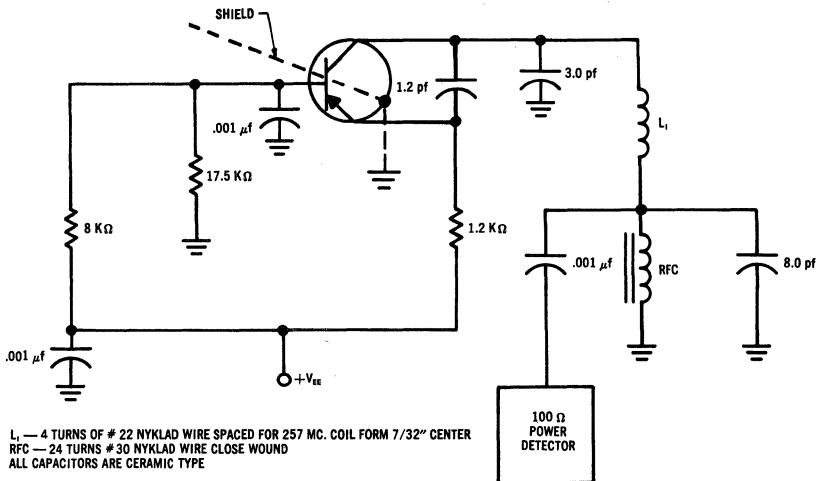

L₁ — 4 TURNS OF # 22 NYKLAD WIRE SPACED FOR 257 MC. COIL FORM 7/32" CENTER
RFC — 24 TURNS # 30 NYKLAD WIRE CLOSE WOUND
ALL CAPACITORS ARE CERAMIC TYPE

2N3287 thru 2N3290

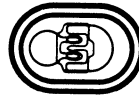

$V_{CBO} = 30-40\text{ V}$
 $G_o = 17\text{ db @ }200\text{ Mc}$
 $NF = 6-7\text{ db @ }200\text{ Mc}$

NPN silicon annular transistors for high-gain, low-noise amplifier, oscillator, mixer and frequency multiplier applications.

CASE 22
(TO-18)

MAXIMUM RATINGS

Characteristic	Symbol	2N3287 2N3288	2N3289 2N3290	Unit
Collector - Base Voltage	V_{CBO}	40	30	Volts
Collector - Emitter Voltage	V_{CES}	40	30	Volts
Collector - Emitter Voltage	V_{CEO}	20	15	Volts
Emitter - Base Voltage	V_{EBO}	3.0	3.0	Volts
Collector Current	I_C	50	50	mA
Power Dissipation at 25°C Case Above 25°C derate 1.71 mW/°C	P_C	300	300	mW
Power Dissipation at 25°C amb. Above 25°C derate 1.14 mW/°C	P_D	200	200	mW
Junction Temperature	T_j	+200	+200	°C
Storage Temperature	T_{stg}	-65 to +200	-65 to +200	°C

200 MC TEST CIRCUIT: POWER GAIN, NOISE FIGURE, & AGC

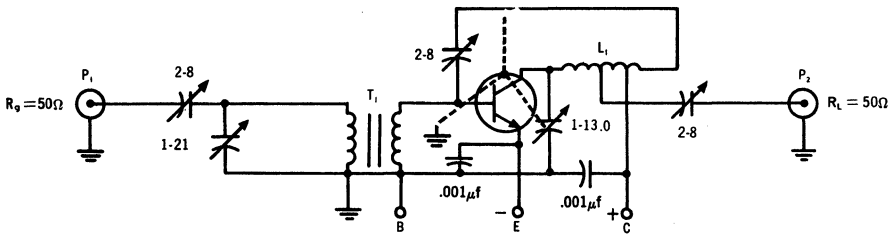

L_1 -6 turns of #16 tinned wire; 3/8" ID; Air wound; winding length 3/4";
 V_{CC} feeds tap 4 3/4 turns from collector end; output tap 3 1/2 turns from collector end.

T_1 -3 turns primary and secondary Bifilar wound (close wound) on 1/4" ceramic form (cambion type) with brass slug. #22 enameled wire.

P_1 -General Radio 874 G6 Pad (6 db)
 P_2 -General Radio 874 G6 Pad (6 db)

2N3287 thru 2N3290 (Continued)

ELECTRICAL CHARACTERISTICS (At 25°C Ambient unless otherwise noted)

Characteristic	Symbol	Test Conditions	Min	Typ	Max	Unit
Collector-Base Breakdown Voltage	BV_{CBO}	$I_C = 10 \mu\text{Adc}, I_E = 0$	2N3287, 2N3288 2N3289, 2N3290	40 30	— —	Vdc
Collector-Emitter Breakdown Voltage	BV_{CES}	$I_C = 10 \mu\text{Adc}, V_{BE} = 0$	2N3287, 2N3288 2N3289, 2N3290	40 30	— —	Vdc
Collector-Emitter Breakdown Voltage	BV_{CEO}	$I_C = 2.0 \text{ mAdc}, I_B = 0$	2N3287, 2N3288 2N3289, 2N3290	20 15	— —	Vdc
Emitter-Base Breakdown Voltage	BV_{EBO}	$I_E = 10 \mu\text{Adc}, I_C = 0$		3.0	—	Vdc
Collector Cutoff Current	I_{CBO}	$V_{CB} = 15 \text{ Vdc}$ $V_{CE} = 15 \text{ Vdc}, T = 150^\circ\text{C}$	All Types	—	.010 3.0	μAdc
DC Forward Current Transfer Ratio	h_{FE}	$V_{CE} = 10 \text{ Vdc}, I_C = 2 \text{ mAdc}$	2N3287, 2N3288 2N3289, 2N3290	15 10	— —	100 150
Collector-Emitter Saturation Voltage	$V_{CE(sat)}$	$I_C = 5 \text{ mAdc}, I_B = 0.5 \text{ mAdc}$	2N3287, 2N3288 2N3289, 2N3290	—	—	0.3 0.4
Base-Emitter Saturation Voltage	$V_{BE(sat)}$	$I_C = 5 \text{ mAdc}, I_B = 0.5 \text{ mAdc}$	2N3287, 2N3288 2N3289, 2N3290	—	—	0.9 1.0
AC Current Gain	h_{fe}	$V_{CE} = 10 \text{ Vdc}, I_C = 2 \text{ mAdc}, f = 1 \text{ kc}$	2N3287, 2N3288 2N3289, 2N3290	15 10	—	150 200
Output Capacitance	C_{ob}	$V_{CB} = 10 \text{ Vdc}, I_E = 0, f = 0.1 \text{ mc (Note 1)}$	2N3287 2N3288 thru 2N3290	—	0.9 1.2	1.1 1.5
Collector-Base Time Constant	$r_b' C_C$	$V_{CB} = 10 \text{ Vdc}, I_C = 2 \text{ mAdc}, f = 31.8 \text{ mc}$	2N3287, 2N3288 2N3289, 2N3290	3 3	8 8	15 20
Current Gain - Bandwidth Product	f_T	$V_{CE} = 10 \text{ Vdc}, I_C = 2 \text{ mAdc}$	2N3287, 2N3288 2N3289, 2N3290	350 300	600 500	1200 1200
Maximum Frequency of Oscillation	f_{max}	$V_{CE} = 10 \text{ Vdc}, I_C = 2 \text{ mAdc}$		—	2000	—
Power Gain	G_p	$V_{CE} = 10 \text{ Vdc}, I_C = 2 \text{ mAdc}, f = 200 \text{ mc}$	All Types	17	—	24
Noise Figure	NF	$V_{CE} = 10 \text{ Vdc}, I_C = 2 \text{ mAdc}, f = 200 \text{ mc}$	2N3287, 2N3288 2N3289, 2N3290	—	4.9 6.0	6.0 7.0
Power Gain (AGC)	G_p	$V_{CE} = 5.0 \text{ Vdc}, I_C = 20 \text{ mAdc}, f = 200 \text{ mc}$	2N3287 2N3289 2N3288, 2N3290	— — —	— — 0	— +5 —

Note 1. C_{ob} is measured in guarded circuit such that the can capacitance is not included.
 Note 2. AGC is obtained by increasing I_C . The circuit remains adjusted for $V_{CE} = 10 \text{ Vdc}, I_C = 2 \text{ mAdc}$ operation.

NEUTRALIZED POWER GAIN AND NOISE FIGURE versus FREQUENCY

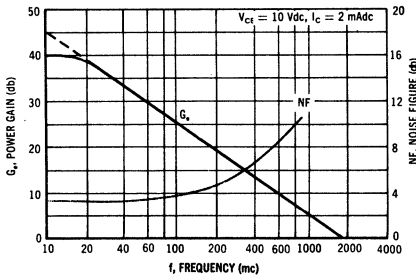

POWER GAIN AND NOISE FIGURE versus COLLECTOR CURRENT

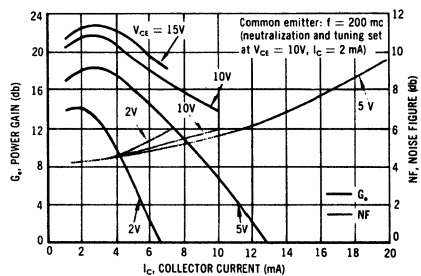

2N3291 thru **2N3294**

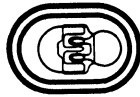

$V_{CBO} = 20-25 V$
 $G_s = 14-16 \text{ db @ } 200 \text{ Mc}$
 $NF = 8 \text{ db @ } 200 \text{ Mc}$

NPN silicon annular transistor for TV and FM mixer, RF and IF amplifier and general-purpose, low-noise, high-gain amplifier applications.



CASE 22
(TO-18)

MAXIMUM RATINGS

Characteristic	Symbol	2N3291 2N3292	2N3293 2N3294	Unit
Collector - Base Voltage	V_{CBO}	25	20	Volts
Collector - Emitter Voltage	V_{CES}	25	20	Volts
Emitter - Base Voltage	V_{EBO}	3.0	3.0	Volts
Collector Current	I_C	50	50	mA
Power Dissipation at 25°C Case Above 25°C derate 1.71 mW/°C	P_C	300	300	mW
Power Dissipation at 25°C Amb. Above 25°C derate 1.14 mW/°C	P_D	200	200	mW
Junction Temperature	T_J	+200	+200	°C
Storage Temperature	T_{stg}	← -65 to +200 →		°C

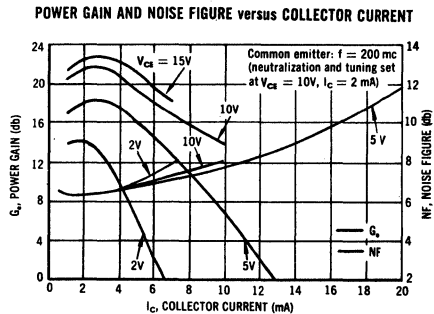
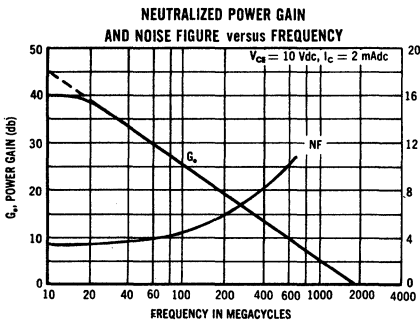

2N3291 thru 2N3294 (Continued)

ELECTRICAL CHARACTERISTICS $T_A = 25^\circ\text{C}$ unless otherwise noted

Characteristic	Symbol	Test Conditions	Min	Typ	Max	Unit
Collector-Emitter Breakdown Voltage	V_{CES}	$I_C = 25 \mu\text{A dc}$, $V_{BE} = 0$ 2N3291, 2N3292 2N3293, 2N3294	25 20	35 30	—	Vdc
Collector Cutoff Current	I_{CBO}	$V_{CB} = 10 \text{ Vdc}$, $I_E = 0$	—	.01	0.1	$\mu\text{A dc}$
Emitter Cutoff Current	I_{EBO}	$V_{EB} = 0.5 \text{ Vdc}$, $I_C = 0$	—	—	100	$\mu\text{A dc}$
DC Forward Current Transfer Ratio	h_{FE}	$V_{CE} = 10 \text{ Vdc}$, $I_C = 2 \text{ mA dc}$	10	—	—	—
AC Current Gain	h_{fe}	$V_{CE} = 10 \text{ Vdc}$, $I_C = 2 \text{ mA dc}$, $f = 1 \text{ kc}$	10	—	200	—
Output Capacitance	C_{ob}	$V_{CB} = 10 \text{ Vdc}$, $I_E = 0$, $f = 100 \text{ kc}$, Note 1	—	1.0	2.0	pf
AC Current Gain	$ h_{fe} $	$V_{CE} = 10 \text{ Vdc}$, $I_C = 2 \text{ mA dc}$ $f = 100 \text{ mc}$	2.5	6.0	12	—
Collector-Base Time Constant	$r_b' C_c$	$V_{CB} = 10 \text{ Vdc}$, $I_C = 2 \text{ mA dc}$ $f = 31.8 \text{ mc}$	—	15	30	psec
Maximum Frequency of Oscillation	f_{max}	$V_{CE} = 10 \text{ Vdc}$, $I_C = 2 \text{ mA}$	—	2000	—	mc

2N3291

Power Gain	G_e	$V_{CE} = 10 \text{ Vdc}$, $I_C = 2 \text{ mA dc}$, $f = 200 \text{ mc}$	16	20	24	db
Noise Figure	NF		—	6	8	db
Power Gain (AGC)	G_e	Note 2 $V_{CE} = 5 \text{ Vdc}$, $I_C = 20 \text{ mA dc}$ $f = 200 \text{ mc}$	—	—	0	db

2N3292

Power Gain	G_e	$V_{CE} = 10 \text{ Vdc}$, $I_C = 2 \text{ mA dc}$ $f = 200 \text{ mc}$	16	20	24	db
Noise Figure	NF		—	7	9	db
Power Gain (AGC)	G_e	Note 2 $V_{CE} = 5 \text{ Vdc}$, $I_C = 20 \text{ mA dc}$ $f = 200 \text{ mc}$	—	0	—	db

2N3293

Power Output	P_{out}	$V_{CE} = -11 \text{ Vdc}$, $f = 257 \text{ mc}$	2	—	—	mW
--------------	-----------	---	---	---	---	----

2N3294

Power Gain	G_e	$V_{CE} = 10 \text{ Vdc}$, $I_C = 2 \text{ mA dc}$ $f = 200 \text{ mc}$	14	—	—	db
Noise Figure	NF		—	7	—	db

Note 1. C_{ob} is measured in guarded circuit such that the can capacitance is not included.

Note 2. AGC is obtained by increasing I_C . The circuit remains adjusted for $V_{CE} = 10 \text{ Vdc}$, $I_C = 2 \text{ mA dc}$ operation.

2N3295

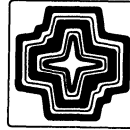
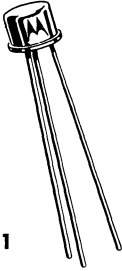

$G_{PE} = 17 \text{ db @ } 30 \text{ Mc Typ}$
 $P_o = 0.3 \text{ W PEP @ } 30 \text{ Mc}$
 $I_m = 32 \text{ db @ } 30 \text{ Mc}$

NPN silicon annular Star transistor for linear amplifier applications from 2 to 100 Mc.

CASE 31
(TO-5)

MAXIMUM RATINGS (Note)

Characteristic	Symbol	Rating	Unit
Collector-Base Voltage	V_{CBO}	60	Vdc
Collector-Emitter Voltage	V_{CES}	60	Vdc
Emitter-Base Voltage	V_{EBO}	5	Vdc
Collector Current (Continuous)	I_C	250	mAdc
Base Current (Continuous)	I_B	50	mAdc
Total Device Dissipation (25°C Case Temperature) Derate above 25°C	P_C	2 13.3	Watts mW/°C
Total Device Dissipation (25°C Ambient Temperature) Derate above 25°C	P_D	0.8 5.33	Watts mW/°C
Junction Temperature Range	T_J	-65 to 175	°C
Storage Temperature Range	T_{stg}	-65 to 175	°C

Note The maximum ratings as given for DC conditions can be exceeded on a pulse basis. See Electrical Characteristics.

2N3295 (Continued)

ELECTRICAL CHARACTERISTICS (At 25°C unless otherwise noted)

Characteristic	Symbol	Conditions	Min	Typ	Max	Unit
Collector-Emitter Current	I_{CES}	$V_{CE} = 60\text{Vdc}, V_{BE} = 0$	--	--	100	μAdc
		$V_{CE} = 50\text{Vdc}, V_{BE} = 0,$ $T_C = 175^\circ\text{C}$	--	--	500	μAdc
Collector Cutoff Current	I_{CBO}	$V_{CB} = 50\text{Vdc}, I_E = 0$	--	--	0.1	μAdc
Emitter Cutoff Current	I_{EBO}	$V_{EB} = 5\text{Vdc}, I_C = 0$	--	--	100	μAdc
DC Current Gain	h_{FE}	$I_C = 10\text{mAdc},$ $V_{CE} = 10\text{Vdc}$	20	--	60	--
		$I_C = 150\text{mAdc},$ $V_{CE} = 10\text{Vdc}^*$	20	--	--	--
Collector-Emitter Saturation Voltage	$V_{CE(sat)}$	$I_C = 150\text{mAdc},$ $I_B = 15\text{mAdc}$	--	--	0.5	Vdc
Base-Emitter Saturation Voltage	$V_{BE(sat)}$	$I_C = 150\text{mAdc},$ $I_B = 15\text{mAdc}$	--	--	2.0	Vdc
Collector-Emitter Sustain Voltage	$V_{CES(sus)}^*$	$I_C = 100\text{mA}, R_{BE} = 0$	30	--	--	Volts
Collector-Emitter Open Base Sustain Voltage	$V_{CEO(sus)}^*$	$I_C = 100\text{mA}, I_B = 0$	20	--	--	Volts
AC Current Gain	$ h_{fe} $	$V_{CE} = 10\text{Vdc},$ $I_C = 10\text{mAdc}, f = 50\text{mc}$	4.0	--	--	--
Collector Output Capacitance	C_{ob}	$V_{CB} = 10\text{Vdc}, I_E = 0,$ $f = 100\text{kc}$	--	--	8	pf
Power Input (PEP) (Note 1)	P_{in}	$P_{out} = 0.3\text{ Watts PEP}$ (0.15 W rms) $f = 30\text{mc}, V_{CE} = 15.0\text{Vdc}$ $I_{C(max)} = 40\text{mA}$	--	--	12	mW
Power Gain	G_e		14	17	--	db
Intermodulation Distortion Ratio	I_m		30	32	--	db
Efficiency	η		25	30	--	%

* Pulse = 100 μsec , Duty Cycle = 2%

Note 1. PEP. Peak Envelope Power

2N3295 (Continued)

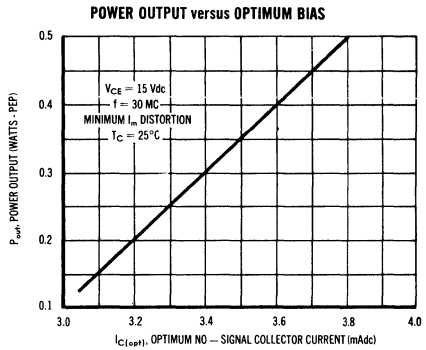
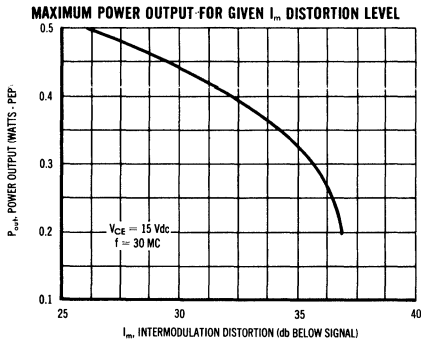
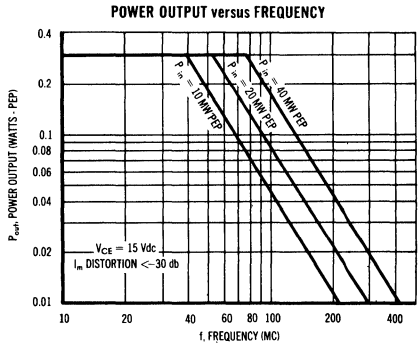
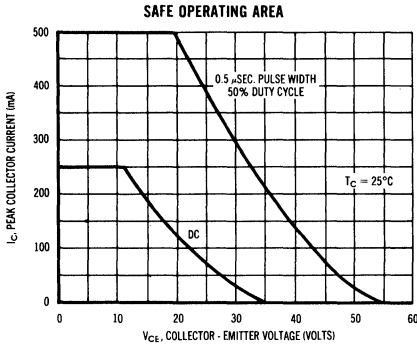

OUTPUT CHARACTERISTICS versus POWER INPUT

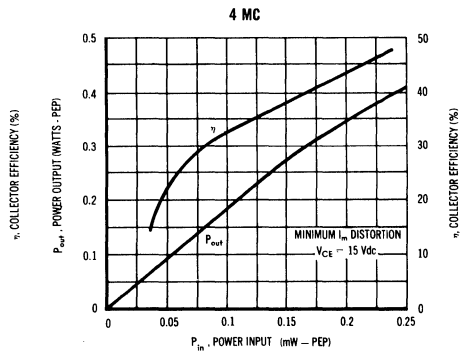
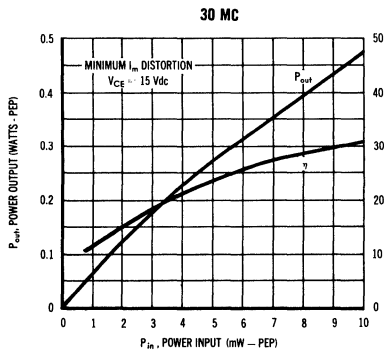

2N3296



$G_{PE} = 19 \text{ db @ 30 Mc Typ}$
 $P_o = 3 \text{ W PEP @ 30 MC}$
 $I_m = 35 \text{ db @ 30 Mc Typ}$

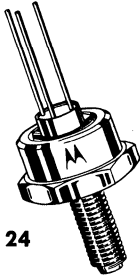

NPN silicon annular transistor for linear amplifier applications from 2 to 100 Mc.

CASE 24

MAXIMUM RATINGS (Note 1)

Characteristic	Symbol	Rating	Unit
Collector-Base Voltage	V_{CBO}	60	Vdc
Collector-Emitter Voltage	V_{CES}	60	Vdc
Emitter-Base Voltage	V_{EB}	3.0	Vdc
Collector Current (Continuous)	I_C	700	mAdc
Base Current (Continuous)	I_B	100	mAdc
RF Input Power (Note 2)	P_{in}	1.0	Watt (PEP)
RF Output Power (Note 2)	P_{out}	5.0	Watts (PEP)
Total Device Dissipation (25°C Case Temperature) Derating Factor above 25°C	P_C	6.0 40	Watts mW/°C
Total Device Dissipation at (25°C Ambient Temperature) Derating Factor above 25°C	P_D	0.7 4.67	Watts mW/°C
Junction Temperature	T_J	175	°C
Storage Temperature Range	T_{stg}	-65 to +175	°C

Note 1: The maximum ratings as given for DC conditions can be exceeded on a pulse basis. See Electrical Characteristics.

Note 2: PEP = Peak Envelope Power.

2N3296 (Continued)

ELECTRICAL CHARACTERISTICS

Characteristic	Symbol	Conditions	Min	Typ	Max	Unit
Collector-Emitter Sustain Voltage	$V_{CES(sus)}$ *	$I_C = 0.200A, R_{BE} = 0$	85	120	--	Volts
Collector Emitter-Open Base Sustain Voltage	$V_{CEO(sus)}$ *	$I_C = 0.200A, I_B = 0$	40	--	--	Volts

Collector-Emitter Current	I_{CES}	$V_{CE} = 60Vdc, V_{BE} = 0$ $V_{CE} = 50Vdc, V_{BE} = 0$ $T_C = +175^\circ C$	--	--	100	μA dc
Collector-Cutoff Current	I_{CBO}	$V_{CB} = 50Vdc, I_E = 0$	--	--	0.1	μA dc
Emitter-Cutoff Current	I_{EBO}	$V_{EB} = 3Vdc, I_C = 0$	--	--	100	μA dc
DC Current Gain	h_{FE}	$V_{CE} = 2.0Vdc,$ $I_C = 40mA$ dc $V_{CE} = 2.0Vdc,$ $I_C = 400mA$ dc	5.0	--	50	--
Collector-Emitter Saturation Voltage	$V_{CE(sat)}$	$I_C = 400mA$ dc, $I_B = 80mA$ dc	--	--	0.5	Vdc
Emitter-Base Saturation Voltage	$V_{BE(sat)}$	$I_C = 400mA$ dc, $I_B = 80mA$ dc	--	--	2.0	Vdc

AC Current Gain	h_{fe}	$V_{CE} = 2.0Vdc,$ $I_C = 40mA$ dc, $f = 50mc$	2.0	--	--	--
Collector Output Capacitance	C_{ob}	$V_{CB} = 25Vdc, I_E = 0,$ $f = 100kc$	--	--	20	pf

Power Input (PEP)	P_{in}	$P_{out} = 3.0$ Watts (PEP) (1.5 W rms) $V_{CE} = 30$ Volts, $f = 30mc$ $I_{C(max)} = 125mA$	--	--	75	mW
Power Gain	G_e		16	19	--	db
Intermodulation Distortion Ratio	I_m		30	35	--	db
Efficiency	η		40	48	--	%

*Pulse Test. Pulse Width = 100 μ sec. Duty Cycle = 2%.

2N3296 (Continued)

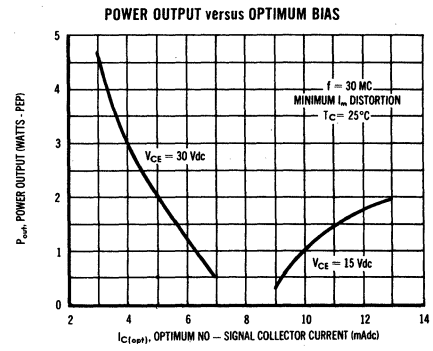
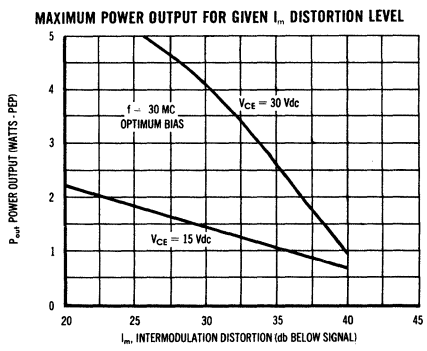
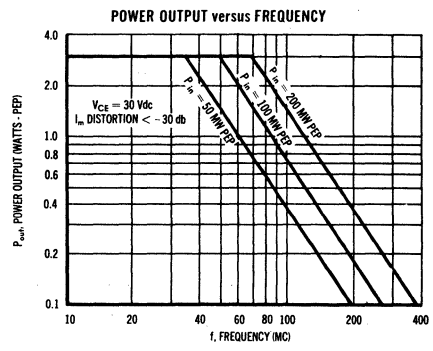
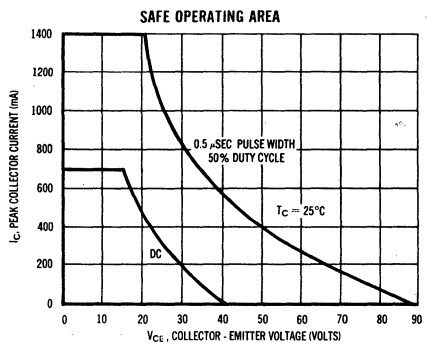

OUTPUT CHARACTERISTICS versus POWER INPUT

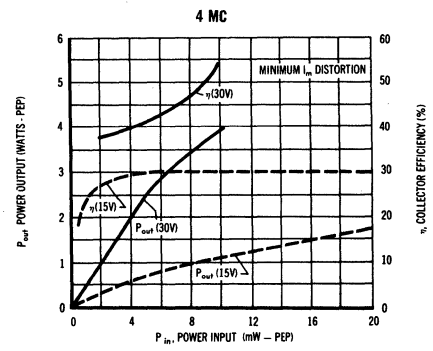
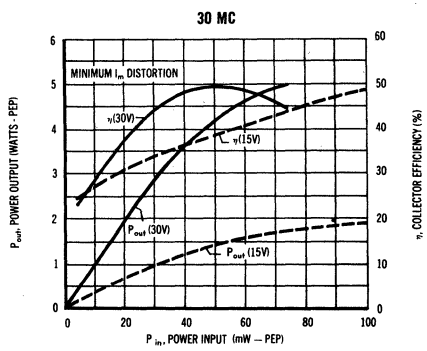

2N3297

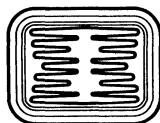

$G_{PE} = 13 \text{ db @ } 30 \text{ Mc Typ}$
 $P_o = 12 \text{ W PEP @ } 30 \text{ Mc}$
 $I_m = 33 \text{ db @ } 30 \text{ Mc Typ}$

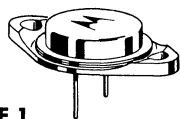

CASE 1
(TO-3)

NPN silicon annular transistor for linear amplifier applications for 2 to 100 Mc.

MAXIMUM RATINGS

Characteristic	Symbol	Rating	Unit
Collector-Base Voltage	V_{CBO}	60	Vdc
Collector-Emitter Voltage	V_{CES}	60	Vdc
Emitter-Base Voltage	V_{EB}	3	Vdc
Collector Current (Continuous)	I_C	1.5	Adc
Base-Current (Continuous)	I_B	500	mAdc
Power Input (PEP)	P_{in}	5.0	Watts (PEP)
Power Output (PEP)	P_{out}	20.0	Watts (PEP)
Total Device Dissipation @ 25°C Case Temperature	P_D	25.0	Watts
Derating Factor above 25°C		167	mW/°C
Junction Temperature	T_J	175	°C
Storage Temperature Range	T_{stg}	-65 to +175	°C

Note: The maximum ratings as given for DC conditions can be exceeded on a pulse basis. See electrical characteristics

2N3297 (Continued)

ELECTRICAL CHARACTERISTICS (At 25°C Ambient unless otherwise noted)

Characteristic	Symbol	Conditions	Min	Typ	Max	Unit
Collector-Emitter Sustain Voltage	$V_{CES(sus)}^*$	$I_C = 0.250A, R_{BE} = 0$	80	100	--	Volts
Collector Emitter-Open Base Sustain Voltage	$V_{CEO(sus)}^*$	$I_C = 0.250A, I_B = 0$	40	--	--	Volts
Collector-Emitter Current	I_{CES}	$V_{CE} = 60Vdc, V_{BE} = 0$	--	--	0.5	mA
		$V_{CE} = 50Vdc, V_{BE} = 0,$	--	--	1.0	
		$T_C = +175^\circ C$	--	--	1.0	
Collector-Cutoff Current	I_{CBO}	$V_{CB} = 50Vdc, I_E = 0$	--	--	1.0	μ A
Emitter-Cutoff Current	I_{EBO}	$V_{EB} = 3Vdc, I_C = 0$	--	--	100	μ A
DC Current Gain	h_{FE}	$I_C = 400mA, V_{CE} = 2Vdc$	2.5	--	35	--
		$I_C = 1A, V_{CE} = 2Vdc$	2.5	--	--	
Collector-Emitter Saturation Voltage	$V_{CE(sat)}$	$I_C = 1A, I_B = 500mA$	--	--	0.5	Vdc
Emitter-Base Saturation Voltage	$V_{BE(sat)}$	$I_C = 1A, I_B = 500mA$	--	--	2.0	Vdc
AC Current Gain	$ h_{fe} $	$V_{CE} = 2Vdc, I_C = 400mA, f = 50mc$	2.0	--	--	--
			2.0	--	--	--
Collector Output Capacitance	C_{ob}	$V_{CE} = 25Vdc, I_E = 0, f = 100kc$	--	--	60	pf
			--	--	60	pf
Power Input (PEP) Note 2	P_{in}	$P_{out} = 12$ Watts PEP (6.0W rms) $V_{CE} = 30$ Volts, $f = 30mc$ $I_{C(max)} = 0.50$ Amp	--	--	1.2	Watts PEP
Power Gain	G_e		10	13	--	db
Intermodulation Distortion Ratio	I_m		30	33	--	db
Efficiency	η		40	45	--	%

* Pulse Test: Pulse Width = 100 μ sec, Duty Cycle = 2 %
Note 2. PEP. Peak Envelope Power

2N3297 (Continued)

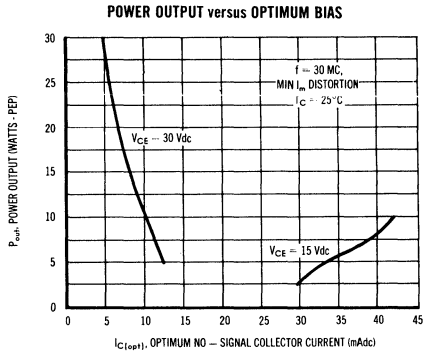
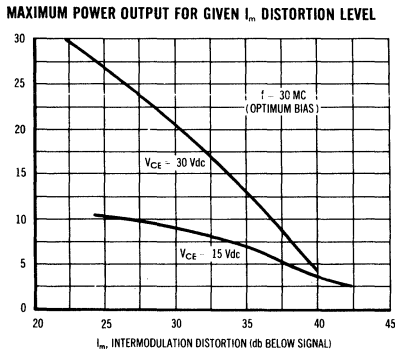
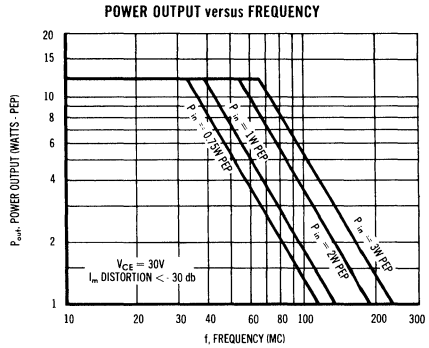
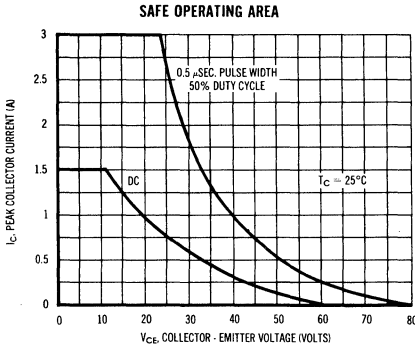

OUTPUT CHARACTERISTICS versus POWER INPUT

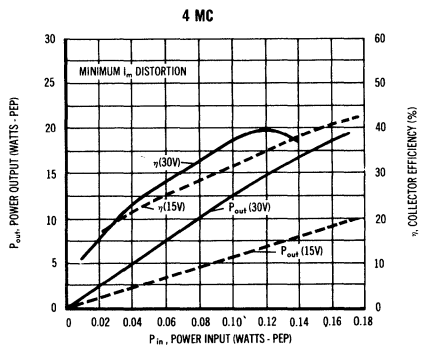
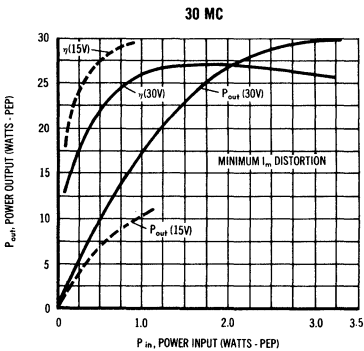

2N3298

$V_{CES} = 25 \text{ V}$
 $P_o = 60\text{-}100 \text{ mW @ } 80 \text{ Mc}$



CASE 22
(TO-18)

NPN silicon annular transistor for power oscillator applications to 150 Mc.

MAXIMUM RATINGS

Characteristic	Symbol	Rating	Unit
Collector-Base Voltage	V_{CBO}	25	Vdc
Collector-Emitter Voltage	V_{CES}	25	Vdc
Emitter-Base Voltage	V_{EBO}	3.0	Vdc
Collector Current	I_C	100	mA
Total Device Dissipation (25°C Case Temperature) Derate Above 25°C	P_C	1.0 6.67	Watt mW/°C
Total Device Dissipation (25°C Ambient Temperature) Derate Above 25°C 2mW/°C	P_D	0.3 2	Watt mW/°C
Junction Temperature	T_J	+175	°C
Storage Temperature Range	T_{stg}	-65 to +175	°C

80 MC OSCILLATOR POWER OUTPUT TEST CIRCUIT

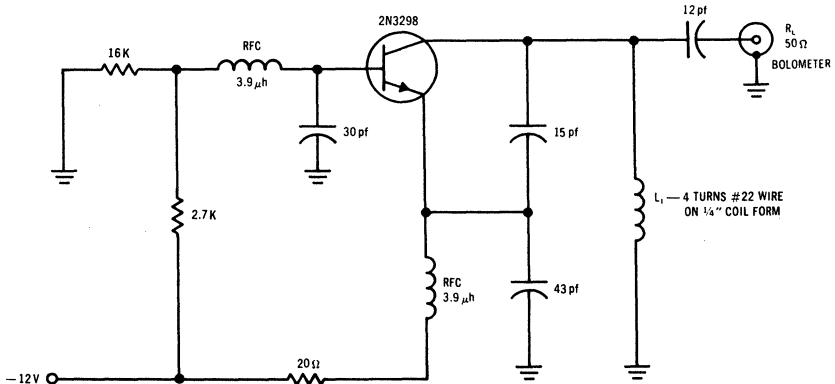

2N3298 (Continued)

ELECTRICAL CHARACTERISTICS (At 25°C Ambient unless otherwise noted)

Characteristic	Symbol	Conditions	Min	Typ	Max	Unit
Collector-Emitter Breakdown Voltage	V_{CES}	$I_C = 25 \mu\text{Adc}$, $V_{BE} = 0$	25	35	-	Vdc
Collector-Emitter Open Base Sustaining Voltage	$V_{CEO(sus)}$ *	$I_C = 10\text{mA}$, $I_B = 0$	15	24	-	Vdc
Collector Cutoff Current	I_{CBO}	$V_{CB} = 10\text{ Vdc}$, $I_E = 0$ $V_{CB} = 10\text{ Vdc}$, $I_E = 0$, $T_A = 150^\circ\text{C}$	-	0.01 10	0.5 50	μAdc
Emitter Cutoff Current	I_{EBO}	$V_{EB} = 3\text{ Vdc}$, $I_C = 0$	-	-	10	μAdc
DC Current Gain	h_{FE}	$V_{CE} = 1\text{ Vdc}$, $I_C = 10\text{ mAdc}$	60	90	120	-
AC Current Gain	$ h_{fe} $	$V_{CE} = 10\text{ Vdc}$, $I_C = 10\text{ mAdc}$, $f = 100\text{mc}$	2	-	-	-
Collector Output Capacitance	C_{ob}	$V_{CB} = 10\text{ Vdc}$, $I_E = 0$, $f = 100\text{ kc}$	-	5	6	pf
Power Output	P_{out}	$f = 80\text{ mc}$	60	-	100	mW
Efficiency	η	$V_{CC} = 12\text{ Vdc}$ $I_{C(max)} = 20\text{ mA}$	25	40	-	%

*Pulse Width = 300 μsec , Duty Cycle = 2%

**NORMALIZED DC CURRENT GAIN
versus AMBIENT TEMPERATURE**

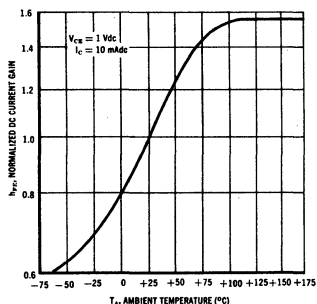

f_T versus COLLECTOR CURRENT

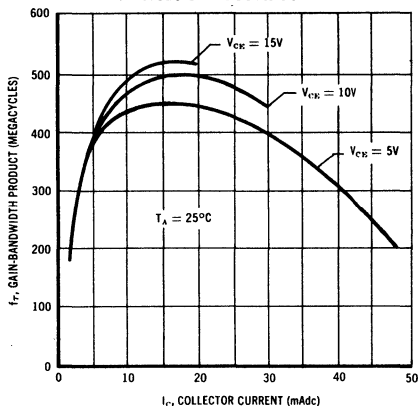

2N3307
2N3308



$G_{PE} = 17 \text{ db @ } 200 \text{ Mc}$
 $NF = 5-6 \text{ db @ } 200 \text{ Mc Typ}$



CASE 22
(TO-18)

PNP silicon annular transistors for high-gain, low-noise amplifier, oscillator, mixer and frequency multiplier applications.

MAXIMUM RATINGS

Characteristics	Symbol	Rating		Unit
		2N3307	2N3308	
Collector-Base Voltage	V_{CBO}	40	30	Vdc
Collector-Emitter Voltage	V_{CES}	40	30	Vdc
Collector-Emitter Voltage	V_{CEO}	35	25	Vdc
Emitter-Base Voltage	V_{EBO}	3.0		Vdc
Collector Current	I_C	50		mAdc
Power Dissipation at $T_C = 25^\circ\text{C}$ Above 25°C derate	P_C	300 1.71		mW mW/ $^\circ\text{C}$
Power Dissipation at $T_A = 25^\circ\text{C}$ Above 25°C derate	P_D	200 1.14		mW mW/ $^\circ\text{C}$
Junction Temperature	T_j	200		$^\circ\text{C}$
Storage Temperature	T_{stg}	-65 to +200		$^\circ\text{C}$

COMMON EMITTER AVERAGE SMALL POWER GAIN & NOISE FIGURE versus COLLECTOR CURRENT

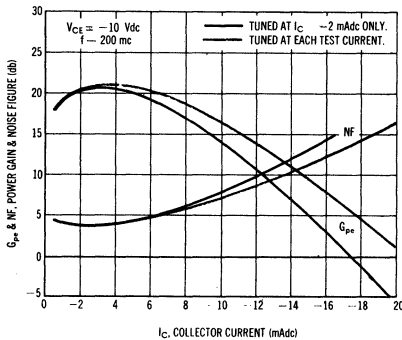

NOISE FIGURE versus FREQUENCY

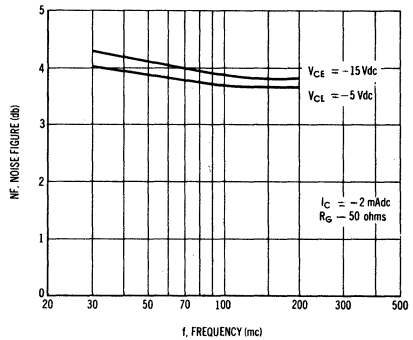

2N3307, 2N3308 (Continued)

ELECTRICAL CHARACTERISTICS (At 25°C unless otherwise noted)

Characteristics	Symbol	Test Conditions	Min	Typ	Max	Unit	
Collector-Base Breakdown Voltage	V_{CBO}	$I_C = -10 \mu\text{Adc}, I_E = 0$	2N3307 2N3308	-40 -30	— —	Vdc	
Collector-Emitter Breakdown Voltage	V_{CES}	$I_C = -10 \mu\text{Adc}, V_{BE} = 0$	2N3307 2N3308	-40 -30	— —	Vdc	
Collector-Emitter Breakdown Voltage	V_{CEO}	$I_C = -2.0 \text{ mAdc}, I_B = 0$	2N3307 2N3308	-35 -25	— —	Vdc	
Emitter-Base Breakdown Voltage	V_{EBO}	$I_E = -10 \mu\text{Adc}, I_C = 0$	Both Types	-3.0	—	Vdc	
Collector Cutoff Current	I_{CBO}	$V_{CB} = -15 \text{ Vdc}$ $V_{CB} = -15 \text{ Vdc}, T = 150^\circ\text{C}$	Both Types 2N3307	— —	-0.001 -0.5	-0.010 -3.0	μAdc
DC Current Gain	h_{FE}	$V_{CE} = -10 \text{ Vdc}, I_C = -2 \text{ mAdc}$	2N3307 2N3308	40 25	— —	250 250	—
Collector-Emitter Saturation Voltage	$V_{CE(sat)}$	$I_C = -3 \text{ mAdc}, I_B = -0.6 \text{ mAdc}$	Both Types	—	—	-0.4	Vdc
Base-Emitter Saturation Voltage	$V_{BE(sat)}$	$I_C = -3 \text{ mAdc}, I_B = -0.6 \text{ mAdc}$	Both Types	—	—	-1.0	Vdc
AC Current Gain	h_{fe}	$V_{CE} = -10 \text{ Vdc}, I_C = -2 \text{ mAdc}, f = 1 \text{ kc}$	2N3307 2N3308	40 25	— —	250 250	—
Output Capacitance	C_{ob}	$V_{CB} = -10 \text{ Vdc}, I_E = 0, f = 0.1 \text{ mc}$	2N3307 2N3308	— —	1.0 1.2	1.3 1.6	pf
Collector-Base Time Constant	$r_b' C_c$	$V_{CB} = -10 \text{ Vdc}, I_C = -2 \text{ mAdc}, f = 31.8 \text{ mc}$	2N3307 2N3308	2 2	— —	15 20	psec
Current Gain-Bandwidth Product	f_T	$V_{CE} = -10 \text{ Vdc}, I_C = -2 \text{ mAdc}, f = 100 \text{ mc}$	Both Types	300	—	1200	mc
Maximum Frequency of Oscillation	f_{max}	$V_{CE} = -10 \text{ Vdc}, I_C = -2 \text{ mAdc}$	Both Types	—	2000	—	mc
Power Gain	G_p	$V_{CE} = -10 \text{ Vdc}, I_C = -2 \text{ mAdc}, f = 200 \text{ mc}$	Both Types	17	—	24	db
Noise Figure	NF	$V_{CE} = -10 \text{ Vdc}, I_C = -2 \text{ mAdc}, f = 200 \text{ mc}$	2N3307 2N3308	— —	4.0 5.0	4.5 6.0	db
Power Gain (AGC)	G_e	$V_{CE} = -5.0 \text{ Vdc}, I_C = -20 \text{ mAdc}, f = 200 \text{ mc}$	2N3307 2N3308	— —	— 0	0 —	db

Note 1. C_{ob} is measured in guarded circuit such that the can capacitance is not included.

Note 2. AGC is obtained by increasing I_C . The circuit remains adjusted for $V_{CB} = -10 \text{ Vdc}, I_C = -2 \text{ mAdc}$ operation.

SMALL SIGNAL CURRENT GAIN versus FREQUENCY

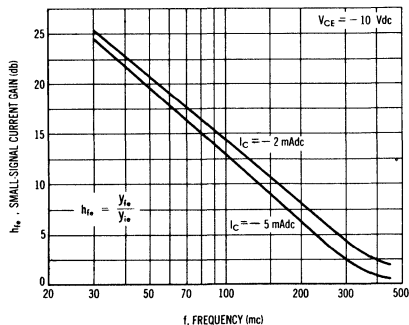

MAXIMUM AVAILABLE GAIN versus FREQUENCY

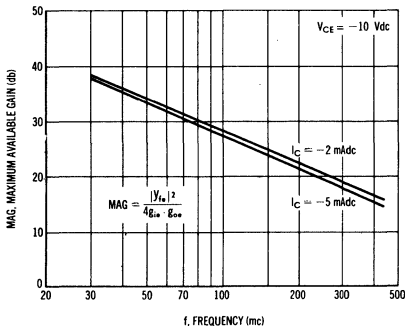

2N3309

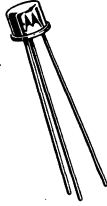

$G_{PE} = 8 \text{ db @ 250 Mc Typ}$
 $P_o = 2 \text{ W @ 250 Mc}$

NPN silicon annular transistor for power amplifier and driver applications to 500 Mc.

CASE 31
(TO-5)

MAXIMUM RATINGS

Characteristic	Symbol	Rating	Unit
Collector-Base Voltage	V_{CBO}	50	Vdc
Collector-Emitter Voltage	V_{CES}	50	Vdc
Emitter-Base Voltage	V_{EB}	3.0	Vdc
Collector Current (Continuous)	I_C	0.5	Adc
Base Current (Continuous)	I_B	0.1	Adc
RF Input Power (Nom)	P_{in}	0.5	Watt
RF Output Power (Nom)	P_{out}	2.5	Watts
Total Device Dissipation (25°C Case temperature) (Derating Factor above 25°C)	P_C	3.5 23.3	Watts mW/°C
Total Device Dissipation at 25° Ambient (Derating Factor above 25°C)	P_D	1.0 6.67	Watt mW/°C
Junction Temperature	T_J	175	°C
Storage Temperature Range	T_{stg}	-65 to +175	°C

NOTE:

The maximum ratings as given for DC conditions can be exceeded on a pulse basis. See Electrical Characteristics.

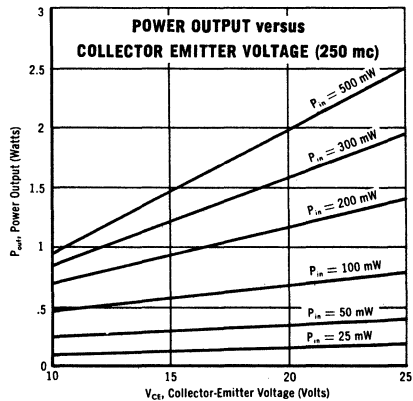
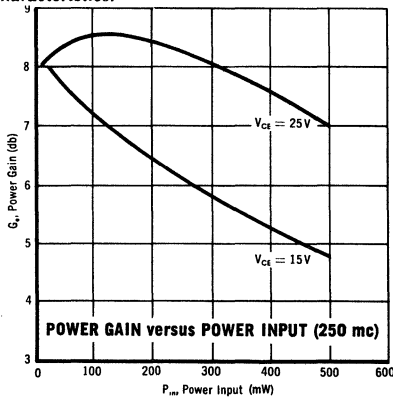

2N3309 (Continued)

ELECTRICAL CHARACTERISTICS (At 25°C unless otherwise noted)

Characteristics	Symbol	Test Condition	Min	Typ	Max	Unit
Collector-Emitter Sustain Voltage	$V_{CES(sus)}$ *	$I_C = 50 \text{ mA}, R_{BE} = 0$	60	75	--	Volts
Collector-Emitter-Open Base Sustain Voltage	$V_{CEO(sus)}$ *	$I_C = 100 \text{ mA}, I_B = 0$	30	--	--	Volts
Collector-Emitter Current	I_{CES}	$V_{CE} = 50 \text{ Vdc}, V_{BE} = 0$	--	--	100	$\mu\text{A dc}$
		$V_{CE} = 25 \text{ Vdc}, V_{BE} = 0$ $T_C = +150^\circ\text{C}$	--	--	500	$\mu\text{A dc}$

Collector-Cutoff Current	I_{CBO}	$V_{CB} = 25 \text{ Vdc}, I_E = 0$	--	0.01	0.5	$\mu\text{A dc}$
Emitter-Cutoff Current	I_{EBO}	$V_{EB} = 3 \text{ Vdc}, I_C = 0$	--	--	100	$\mu\text{A dc}$
DC Current Gain	h_{FE}	$I_C = 30 \text{ mA dc}, V_{CE} = 2.0 \text{ Vdc}$	5	--	100	--
		$I_C = 250 \text{ mA dc}, V_{CE} = 2.0 \text{ Vdc}$	5	--	--	--
Collector-Emitter Saturation Voltage	$V_{CE(sat)}$	$I_C = 250 \text{ mA dc}, I_B = 65 \text{ mA dc}$	--	--	0.5	Vdc
Emitter-Base Saturation Voltage	$V_{BE(sat)}$	$I_C = 250 \text{ mA dc}, I_B = 65 \text{ mA dc}$	--	--	2.0	Vdc

AC Current Gain	$ h_{fe} $	$V_{CE} = 15 \text{ Vdc}$ $I_C = 30 \text{ mA dc}, f = 100 \text{ mc}$	3	4	--	--
Collector Output Capacitance	C_{ob}	$V_{CB} = 15 \text{ Vdc}, I_E = 0,$ $f = 100 \text{ kc}$	--	8.0	10	pf

Power Output**	P_{out} **	$P_{in} = 400 \text{ mW max}, f = 250 \text{ mc}$ $V_{CE} = 25 \text{ Vdc}, I_{C(max)} = 160 \text{ mA}$	2.0	--	--	Watts
Power Gain	G_e		7	8	--	db
Efficiency	η		50	60	--	%

* Pulse Width = 100 μsec , Duty Cycle = 2%

** In functional test, P_{out} is fixed at 2.0 watts and P_{in} is monitored to be 400 mW maximum.

POWER versus FREQUENCY

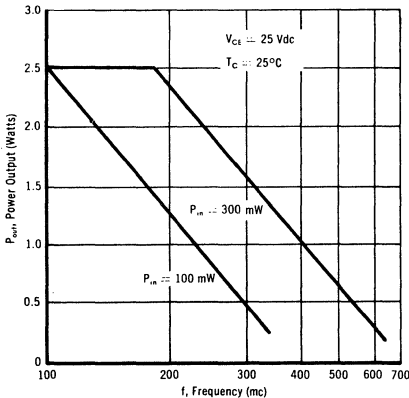

OUTPUT CHARACTERISTICS (250 mc)

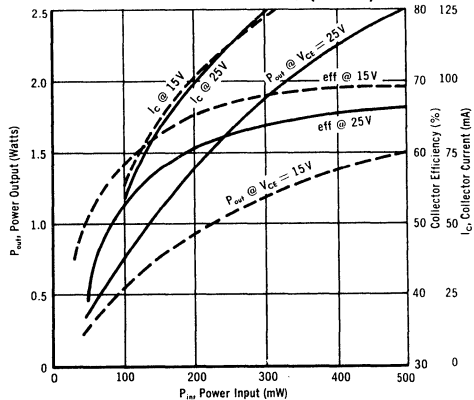

2N3309A

$G_{PE} = 7.4 \text{ db @ } 250 \text{ Mc}$
 $P_o = 2.2 \text{ W @ } 250 \text{ Mc}$



CASE 24

NPN silicon annular transistor for power amplifier and driver applications to 500 Mc.

ABSOLUTE MAXIMUM RATINGS (Note)

Characteristic	Symbol	Rating	Unit
Collector-Base Voltage	V_{CBO}	60	Vdc
Collector-Emitter Voltage	V_{CES}	60	Vdc
Emitter-Base Voltage	V_{EBO}	4	Vdc
Collector Current (Continuous)	I_C	0.5	A dc
Base Current (Continuous)	I_B	0.1	A dc
RF Input Power (Nom)	P_{in}	0.5	Watt
RF Output Power (Nom)	P_{out}	2.5	Watts
Total Device Dissipation (25° C Case Temperature) (Derating Factor Above 25° C)	P_C	5 28.6	Watts mW/ C
Total Device Dissipation at 25° Ambient (Derating Factor Above 25° C)	P_D	1.0 5.7	Watt mW/ C
Junction Temperature	T_J	200	C
Storage Temperature Range	T_{stg}	-65 to +200	C

Note: The maximum ratings as given for DC conditions can be exceeded on a pulse basis. See Electrical Characteristics.

2N3309A (Continued)

ELECTRICAL CHARACTERISTICS (at 25°C ambient temperature unless otherwise noted)

Characteristic	Symbol	TEST CONDITIONS	Min	Typ	Max	Unit
Collector-Emitter Sustain Voltage	$V_{CES(sus)^*}$	$I_C = 50\text{mA}$, $R_{BE} = 0$	60	--	--	Volts
Collector Emitter-Open Base Sustain Voltage	$V_{CEO(sus)^*}$	$I_C = 100\text{mA}$, $I_B = 0$	30	--	--	Volts
Collector-Emitter Current	I_{CES}	$V_{CE} = 50\text{ Vdc}$, $V_{BE} = 0$	--	--	100	$\mu\text{A dc}$
		$V_{CE} = 25\text{ Vdc}$, $V_{BE} = 0$	--	--	500	$\mu\text{A dc}$
		$T_C = +150^\circ\text{C}$				
Collector-Cutoff Current	I_{CBO}	$V_{CB} = 25\text{ Vdc}$, $I_E = 0$	--	--	0.5	$\mu\text{A dc}$
Emitter-Cutoff Current	I_{EBO}	$V_{EB} = 4\text{ Vdc}$, $I_C = 0$	--	--	100	$\mu\text{A dc}$
DC Current Gain	h_{FE}	$I_C = 50\text{ mA dc}$,	8	--	80	--
		$V_{CE} = 2.0\text{ Vdc}$				
		$I_C = 250\text{ mA dc}$,	8	--	--	--
		$V_{CE} = 2.0\text{ Vdc}$				
Collector-Emitter Saturation Voltage	$V_{CE(sat)}$	$I_C = 250\text{ mA dc}$, $I_B = 50\text{ mA dc}$	--	--	0.5	Vdc
Emitter-Base Saturation Voltage	$V_{BE(sat)}$	$I_C = 250\text{ mA dc}$, $I_B = 50\text{ mA dc}$	--	--	1.2	Vdc
AC Current Gain	$ h_{fe} $	$V_{CE} = 15\text{ Vdc}$ $I_C = 30\text{ mA dc}$, $f = 100\text{ mc}$	3	--	--	--
Collector Output Capacitance	C_{ob}	$V_{CB} = 15\text{ Vdc}$, $I_E = 0$, $f = 100\text{ kc}$	--	--	6	pf
Power Output	P_{out}	TEST CIRCUIT $P_{in} = 400\text{ mW max}$, $f = 250\text{ mc}$ $V_{CE} = 25\text{ Vdc}$, $I_{C(max)} = 176\text{ mA}$	2.2	--	--	Watts
Power Gain	G_e		7.4	--	--	db
Efficiency	η		50	--	--	%

*Pulse Width = 100 μsec , Duty Cycle = 2%

2N3323
2N3324
2N3325

$V_{CBO} = 35 \text{ V}$
 $G_o = 11 \text{ db @ } 100 \text{ Mc}$

CASE 22
 (TO-18)



PNP germanium epitaxial transistors for FM RF, IF, mixer and oscillator and AM RF, IF and converter applications.

MAXIMUM RATINGS

Characteristic	Symbol	Rating	Unit
Collector-Base Voltage	V_{CBO}	35	Volts
Collector-Emitter Voltage	V_{CES}	35	Volts
Emitter-Base Voltage	V_{EBO}	3.0	Volts
Collector Current	I_C	100	mA
Total Device Dissipation 25°C Case Temperature Derate Above 25°C	P_C	300 4	mW mW/°C
Total Device Dissipation 25°C Ambient Temperature Derate Above 25°C	P_D	150 2	mW mW/°C
Junction Temperature	T_J	+100	°C
Storage Temperature Range	T_{stg}	-65 to +100	°C

POWER GAIN AND AC CURRENT GAIN versus FREQUENCY

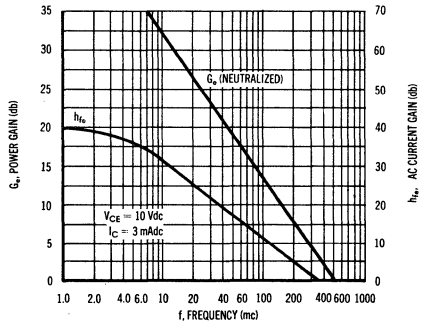

2N3323 thru 2N3325 (Continued)

ELECTRICAL CHARACTERISTICS (At 25°C Ambient unless otherwise noted)

Characteristic	Sym	Conditions	Min	Typ	Max	Unit
Collector-Emitter Breakdown Voltage	V_{CER}	$I_C = 100 \mu\text{A dc}$, $R_{BE} = 10\text{K}$	35	40	--	Vdc
Collector-Emitter Current	I_{CES}	$V_{CE} = 35 \text{ Vdc}$, $V_{BE} = 0$	--	--	100	$\mu\text{A dc}$
Collector Cutoff Current	I_{CBO}	$V_{CB} = 10 \text{ Vdc}$, $I_E = 0$	--	0.5	10	$\mu\text{A dc}$
Emitter Cutoff Current	I_{EBO}	$V_{EB} = 2 \text{ Vdc}$, $I_C = 0$	--	--	100	$\mu\text{A dc}$
DC Current Gain	h_{FE}	$V_{CE} = 10 \text{ Vdc}$, $I_C = 3 \text{ mA dc}$	30	--	200	--
AC Current Gain	h_{fe}	$V_{CE} = 10 \text{ Vdc}$, $I_C = 3 \text{ mA dc}$ $f = 1 \text{ kc}$	30	--	225	--
Current-Gain — Bandwidth Product	f_T	$V_{CE} = 10 \text{ Vdc}$, $I_C = 3 \text{ mA dc}$ $f = 100 \text{ mc}$	200	--	600	mc
Collector-Base Time Constant	$r_b' C_C$	$V_{CE} = 10 \text{ Vdc}$, $I_C = 3 \text{ mA dc}$ $f = 31.8 \text{ mc}$	--	50	100	psec
Output Capacitance	C_{ob}	$V_{CE} = 10 \text{ Vdc}$, $I_E = 0$ $f = 100 \text{ kc}$	--	2.2	3.0	pf
Maximum Frequency of Oscillation	f_{max}	$V_{CE} = 10 \text{ Vdc}$, $I_C = 3 \text{ mA dc}$	--	500	--	mc
Input Resistance, Parallel Equivalent	R_{ie}	$V_{CE} = 10 \text{ Vdc}$, $I_C = 3 \text{ mA dc}$	--	1200	--	ohms
Output Resistance, Parallel Equivalent	R_{oe}	$f = 10 \text{ mc}$	--	11	--	kohms
Input Resistance, Parallel Equivalent	R_{ie}	$V_{CE} = 10 \text{ Vdc}$, $I_C = 3 \text{ mA dc}$	--	100	--	ohms
Output Resistance, Parallel Equivalent	R_{oe}	$f = 100 \text{ mc}$	--	1.0	--	kohms

2N3323 thru 2N3325 (Continued)

ELECTRICAL CHARACTERISTICS (continued)

Characteristic	Sym	Conditions	Min	Typ	Max	Unit
----------------	-----	------------	-----	-----	-----	------

2N3323

Power Gain	G_e	Test Circuit Fig. 1 $V_{CE} = 10 \text{ Vdc}$, $I_C = 3 \text{ mA dc}$ $f = 100 \text{ mc}$	11	--	15	db
------------	-------	---	----	----	----	----

2N3324

Power Gain	G_e	Test Circuit Fig. 2 $V_{CE} = 10 \text{ Vdc}$, $I_C = 3 \text{ mA dc}$ $f = 10 \text{ mc}$	24	--	31	db
------------	-------	--	----	----	----	----

FIGURE 1: 100MC POWER GAIN TEST CIRCUIT — 2N3323

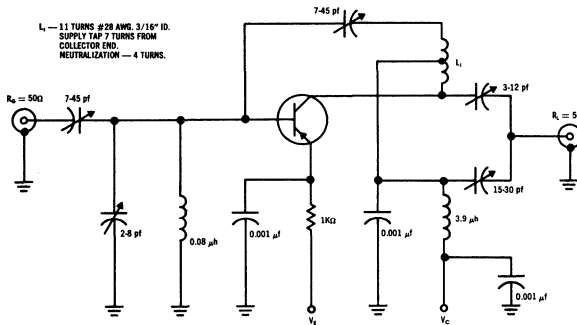
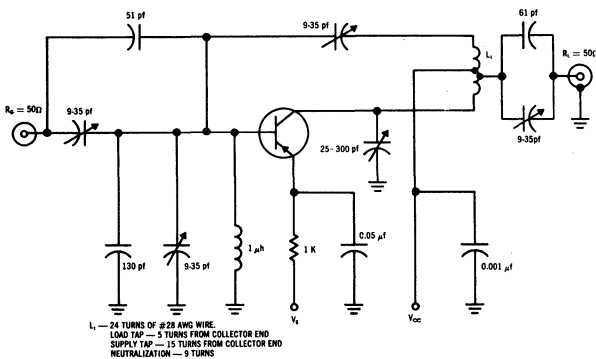

FIGURE 2: 10MC POWER GAIN TEST CIRCUIT — 2N3324



2N3375

2N3553

2N3632

$P_o = 2.5$ to 13.5 W @ 175 Mc

$G_o = 4.8$ - 10 db @ 175 Mc

NPN silicon annular transistors for high-power amplifier and oscillator applications at VHF and UHF.

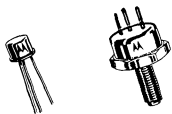

CASE 79
2N3553

CASE 36
2N3375
2N3632

MAXIMUM RATINGS

Characteristic	Symbol	2N3553	2N3375	2N3632	Unit
Collector-Base Voltage	V_{CBO}	65	65	65	Vdc
Collector-Emitter Voltage	V_{CEO}	40	40	40	Vdc
Emitter-Base Voltage	V_{EBO}	4	4	4	Vdc
Collector Current	I_C	1.0	1.5	3.0	Amps
Total Device Dissipation (Up to 25°C Case Temp.)	P_D	7.0	11.6	23	Watts
Derating Factor (Above 25°C Case Temp.)		40.0	66.3	131.4	mW/°C
Storage and Operating Temperature	T_{stg} T_J	← -65 to +200 →			°C

**RF AMPLIFIER CIRCUIT FOR 2N3553
POWER-OUTPUT TEST
(50- & 175-Mc Operation)**

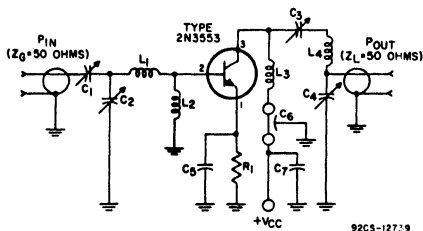

For 50-Mc Operation:

- C₁, C₂: 24-200 pf
- C₃: 32-250 pf
- C₄: 7-100 pf
- C₅: 1,800 pf, disc ceramic
- C₆: 2,000 pf
- C₇: 0.01 μf, disc ceramic

- L₁: 5 turns No.16 wire, 1/4" ID, 1/2" long
- L₂: Ferrite choke, Z = 450 ohms
- L₃: 7-μh choke
- L₄: 6 turns No.20 wire on 3/8" coil form (slug-tuned), 1-1/8" long
- R₁: 1.35 ohms, non-inductive (emitter grounded for 13.5-volt operation)

For 175-Mc Operation:

- C₁, C₂, C₃, C₄: 3-35 pf
- C₅: Not used
- C₆: 1,000 pf
- C₇: 0.005 μf, disc ceramic
- L₁: 2 turns No.16 wire, 3/16" ID, 1/4" long
- L₂: Ferrite choke, Z = 450 ohms

- L₃: 2 turns No.16 wire, 1/4" ID, 1/4" long
- L₄: 4 turns No.16 wire, 3/8" ID, 3/8" long
- R₁: Not used (emitter connected to ground)

2N3375, 2N3553, 2N3632 (continued)

**OSCILLATOR CIRCUIT FOR 2N3553 OR 2N3375
POWER-OUTPUT TEST
(500-Mc Operation)**

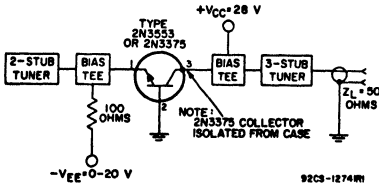

92CS-1274W

**RF AMPLIFIER CIRCUIT FOR 2N3553
POWER-OUTPUT TEST
(260-Mc Operation)**

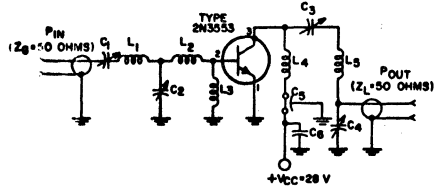

92CS-1274O

C₁, C₄: 1.5-20 pf

C₂, C₃: 3-35 pf

C₅: 1,000 pf

C₆: 0.005 μf, disc ceramic

L₁: 4 turns No.16 wire, 3/8" ID, 3/8" long

L₂: 3/16" wide copper strip, 7/16" long

L₃: Ferrite choke, Z = 450 ohms

L₄: 1/2 turn 3/16" wide copper strip, 1/4" ID

L₅: 2 turns 3/16" wide copper strip, 1/4" ID, 1/2" long

ELECTRICAL CHARACTERISTICS (At 25°C)

Characteristic	Symbol	Min	Typical	Max	Unit
Collector-Cutoff Current (V _{CE} = 30 V, I _B = 0)	I _{CEO}	—	—	0.1 0.1 0.25	mA
Collector-Base Breakdown Voltage (I _C = 0.1 mA, I _E = 0)	BV _{CBO}	65	—	—	Vdc
(I _C = 0.3 mA, I _E = 0)	2N3553	65	—	—	
(I _C = 0.5 mA, I _E = 0)	2N3632	65	—	—	
Collector-Emitter Breakdown Voltage (I _C = 200 mA, I _B = 0)	BV _{CEO}	40	—	—	Vdc
2N3375	40	—	—	—	
2N3553	40	—	—	—	
2N3632	40	—	—	—	
Emitter-Base Breakdown Voltage (I _C = 0, I _E = 0.1 mA)	BV _{EBO}	4	—	—	V _{dc}
2N3375	4	—	—	—	
2N3553	4	—	—	—	
2N3632	4	—	—	—	
Collector-Emitter Saturation Voltage (I _C = 500 mA, I _B = 100 mA)	V _{CE(sat)}	—	—	1	V _{dc}
2N3375	—	—	—	1	
(I _C = 250 mA, I _B = 50 mA)	2N3553	—	—	1	
(I _C = 500 mA, I _B = 100 mA)	2N3632	—	—	1	
Gain-Bandwidth Product (V _{CE} = 28V, I _C = 150 mA)	f _T	—	500	—	f _T
2N3375	—	—	500	—	
(V _{CE} = 28V, I _C = 100 mA)	2N3553	—	500	—	
(V _{CE} = 28V, I _C = 150 mA)	2N3632	—	400	—	
Power Output (P _{in} = 1 W, f = 400 Mc, V _{CE} = 28 V)	P _o	3	—	—	Watts
2N3375	—	—	—	—	
(P _{in} = 0.25 W, f = 175 Mc, V _{CE} = 28 V)	2N3553	2.5	—	—	
(P _{in} = 3.5 W, f = 175 Mc, V _{CE} = 28 V)	2N3632	13.5	—	—	
Efficiency (P _{in} = 1 W, f = 400 Mc, V _{CE} = 28 V)	η	40	—	—	%
2N3375	—	—	—	—	
(P _{in} = 0.25 W, f = 175 Mc, V _{CE} = 28 V)	2N3553	50	—	—	
(P _{in} = 3.5 W, f = 175 Mc, V _{CE} = 28 V)	2N3632	70	—	—	

2N3375, 2N3553, 2N3632 (continued)

2N3375

GAIN-BANDWIDTH PRODUCT versus COLLECTOR CURRENT

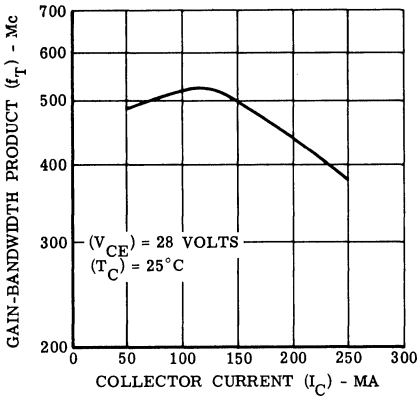

POWER OUTPUT versus FREQUENCY

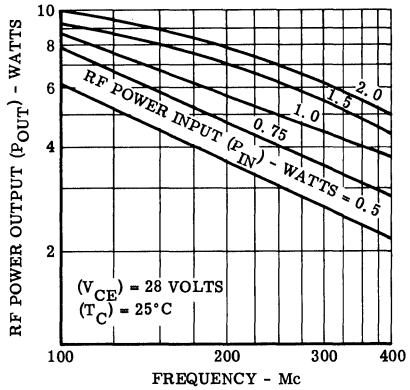

2N3553

GAIN-BANDWIDTH PRODUCT versus COLLECTOR CURRENT

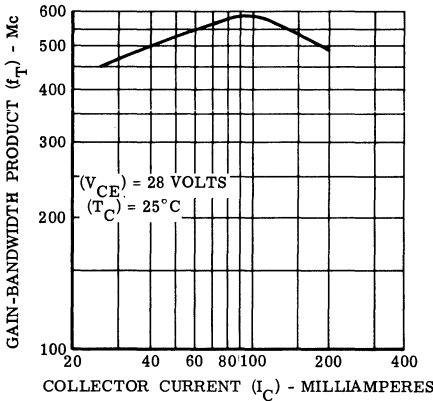

POWER OUTPUT versus FREQUENCY

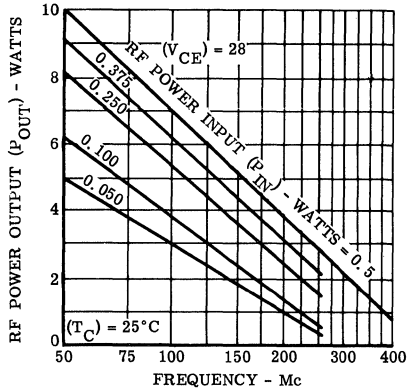

2N3632

GAIN-BANDWIDTH PRODUCT versus COLLECTOR CURRENT

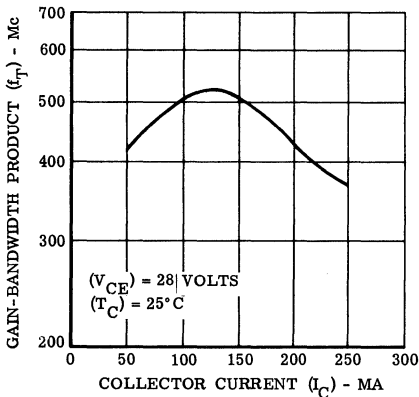

POWER OUTPUT versus FREQUENCY

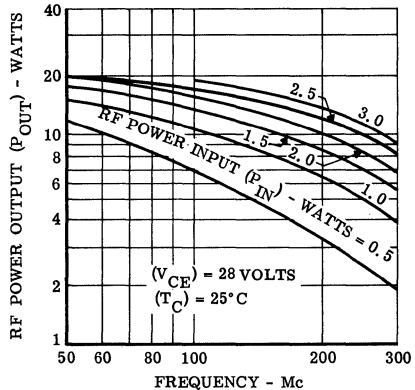

2N3444

For Specifications, See 2N3252 Data Sheet

2N3467

2N3468



$V_{CE0} = 40-50 \text{ V}$
 $I_C = 1 \text{ A}$
 $f_T = 150-175 \text{ Mc}$

CASE 31
(TO-5)

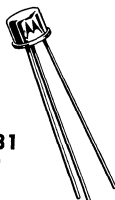

PNP silicon annular transistors for high-speed switching and driver applications.

MAXIMUM RATINGS

Characteristic	Symbol	2N3467	2N3468	Unit
Collector-Base Voltage	V_{CBO}	40	50	Vdc
Collector-Emitter Voltage	V_{CEO}	40	50	Vdc
Emitter-Base Voltage	V_{EBO}	5		Vdc
Collector Current	I_C	1		Adc
Total Device Dissipation (@ $T_A = 25^\circ\text{C}$ Derating Factor Above 25°C)	P_D	1.0	5.71	Watt mW/ $^\circ\text{C}$
Total Device Dissipation (@ $T_C = 25^\circ\text{C}$ Derating Factor Above 25°C)	P_D	5	28.6	Watts mW/ $^\circ\text{C}$
Junction Temperature, Operating	T_J	+200		$^\circ\text{C}$
Storage Temperature Range	T_{stg}	-65 to +200		$^\circ\text{C}$

THERMAL RESISTANCE θ_{JA} (air) = $0.175^\circ\text{C}/\text{mW}$

θ_{JC} (case) = $35^\circ\text{C}/\text{W}$

STORAGE TIME VARIATION WITH TEMPERATURE

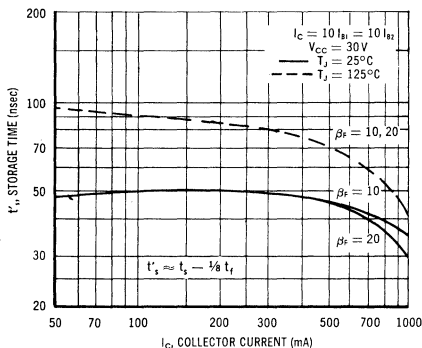

LIMITS OF SATURATION VOLTAGE

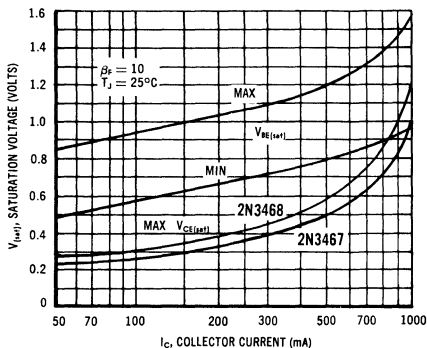

2N3467, 2N3468 (continued)

ELECTRICAL CHARACTERISTICS (At 25°C unless otherwise noted)

Characteristic	Symbol	Min	Max	Unit
Collector Cutoff Current ($V_{CB} = 30$ Vdc, $I_E = 0$) ($V_{CB} = 30$ Vdc, $I_E = 0$, $T_A = 100^\circ\text{C}$)	I_{CBO}	—	0.10 15	μAdc
Collector Cutoff Current ($V_{CE} = 30$ Vdc, $V_{OB} = 3$ Vdc)	I_{CEX}	—	100	nAdc
Base Cutoff Current ($V_{CE} = 30$ Vdc, $V_{OB} = 3$ Vdc)	I_{BL}	—	120	nAdc
Collector-Base Breakdown Voltage ($I_C = 10$ μAdc , $I_E = 0$)	BV_{CBO}	40 50	— —	Vdc
Collector-Emitter Breakdown Voltage* ($I_C = 10$ mAdc, $I_B = 0$)	BV_{CEO}^*	40 50	— —	Vdc
Emitter-Base Breakdown Voltage ($I_E = 10$ μAdc , $I_C = 0$)	BV_{EBO}	5	—	Vdc
Collector Saturation Voltage* ($I_C = 150$ mAdc, $I_B = 15$ mAdc)	$V_{CE(sat)}^*$	—	0.3	Vdc
($I_C = 500$ mAdc, $I_B = 50$ mAdc)		—	0.35	
($I_C = 1$ Adc, $I_B = 100$ mAdc)		—	0.5	
($I_C = 1$ Adc, $I_B = 100$ mAdc)		—	0.6	
Base-Emitter Saturation Voltage ($I_C = 150$ mAdc, $I_B = 15$ mAdc)	$V_{BE(sat)}^*$	—	1.0	Vdc
($I_C = 500$ mAdc, $I_B = 50$ mAdc)		0.8	1.2	
($I_C = 1$ Adc, $I_B = 100$ mAdc)		—	1.6	
DC Forward Current Transfer Ratio* ($I_C = 150$ mAdc, $V_{CE} = 1.0$ Vdc)	h_{FE}^*	40	—	—
($I_C = 500$ mAdc, $V_{CE} = 1.0$ Vdc)		25	—	
($I_C = 1$ Adc, $V_{CE} = 5$ Vdc)		40	120	
($I_C = 1$ Adc, $V_{CE} = 5$ Vdc)		25	75	
Output Capacitance ($V_{CB} = 10$ Vdc, $I_E = 0$, $f = 100$ kc)	C_{ob}	—	25	pf
Input Capacitance ($V_{OB} = 0.5$ Vdc, $I_C = 0$, $f = 100$ kc)	C_{ib}	—	100	pf
Current-Gain - Bandwidth Product ($I_C = 50$ mAdc, $V_{CE} = 10$ Vdc, $f = 100$ mc)	f_T	175 150	— —	mc

2N3467, 2N3468 (continued)

ELECTRICAL CHARACTERISTICS (continued)

Characteristic		Symbol	Min	Max	Unit
Delay Time	$(I_C = 500 \text{ mA}, I_{B1} = 50 \text{ mA}, V_{OB} = 2 \text{ V}, V_{CC} = 30 \text{ V})$	t_d	—	10	nsec
Rise Time		t_r	—	30	nsec
Storage Time	$(I_C = 500 \text{ mA}, I_{B1} = I_{B2} = 50 \text{ mA}, V_{CC} = 30 \text{ V})$	t_s	—	60	nsec
Fall Time		t_f	—	30	nsec
Total Control Charge $(I_C = 500 \text{ mA}, I_B = 50 \text{ mA}, V_{CC} = 30 \text{ V})$		Q_T	—	6	nC

* Pulse Test: $PW \leq 300 \mu\text{sec}$, Duty Cycle $\leq 2\%$

MINIMUM CURRENT GAIN CHARACTERISTICS

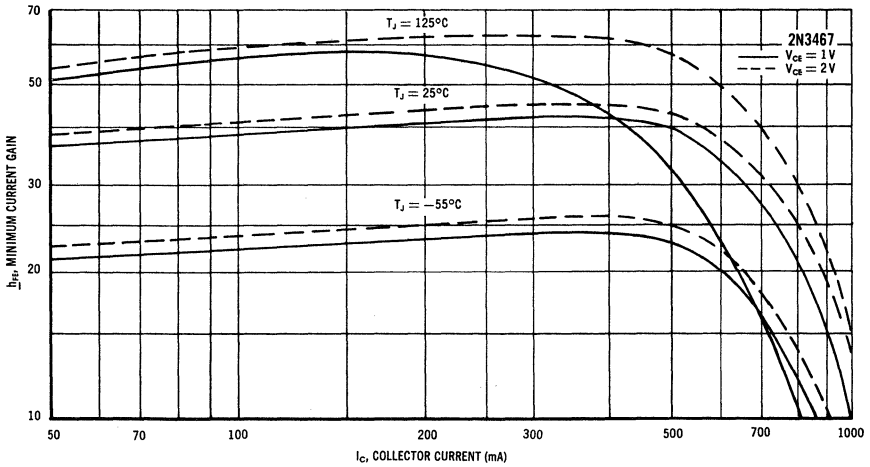

MINIMUM CURRENT GAIN CHARACTERISTICS

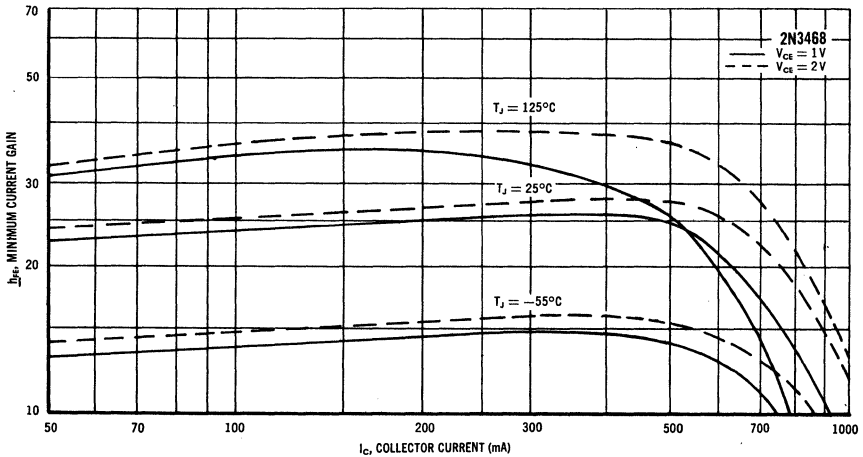

2N3485, A

2N3486, A

For Specifications, See 2N2904 Data Sheet

2N3493

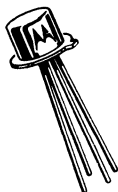

CASE 22
(TO-18)

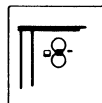

$V_{CE0} = 8\text{ V}$
 $C_{ob} = 0.7\text{ pf}$
 $C_{ib} = 0.7\text{ pf}$

NPN silicon annular transistor for high-speed micro-power logic switching.

MAXIMUM RATINGS

Characteristics	Symbol	Rating	Unit
Collector-Base Voltage	V_{CBO}	12	Vdc
Collector-Emitter Voltage	V_{CEO}	8	Vdc
Emitter-Base Voltage	V_{EBO}	5	Vdc
Total Device Dissipation @ $T_C = 25^\circ\text{C}$ Derate above 25°C	P_D	250	mW
		1.43	mW/ $^\circ\text{C}$
Total Device Dissipation @ $T_A = 25^\circ\text{C}$ Derate above 25°C	P_D	150	mW
		0.86	mW/ $^\circ\text{C}$
Junction Operating Temperature Range	T_J	-65 to +200	$^\circ\text{C}$
Storage Temperature Range	T_{stg}	-65 to +200	$^\circ\text{C}$

THERMAL RESISTANCE $\theta_{JA} = 1.16^\circ\text{C}/\text{mW}$ $\theta_{JC} = 0.70^\circ\text{C}/\text{mW}$

MINIMUM CURRENT GAIN CHARACTERISTICS

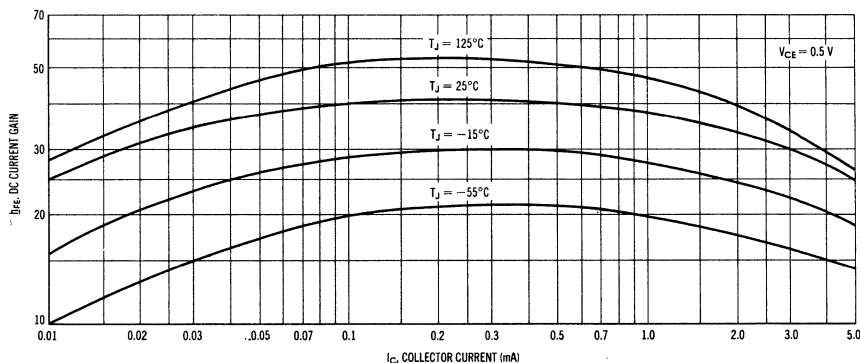

2N3493 (continued)

ELECTRICAL CHARACTERISTICS (At 25°C unless otherwise noted)

Characteristics	Symbol	Min	Max	Unit
Collector Cutoff Current ($V_{CE} = 6\text{ V}$, $V_{EB} = 2\text{ V}$)	I_{CEX}	--	5	nAdc
Base Cutoff Current ($V_{CE} = 6\text{ V}$, $V_{EB} = 2\text{ V}$) ($V_{CE} = 6\text{ V}$, $V_{EB} = 2\text{ V}$, $T_A = 150^\circ\text{C}$)	I_{BL}	--	5	nAdc
Collector-Base Breakdown Voltage ($I_C = 10\ \mu\text{A}$, $I_E = 0$)	BV_{CBO}	12	--	Vdc
Collector-Emitter Breakdown Voltage ($I_E = 1\text{ mA}$, $I_B = 0$)	BV_{CEO}	8	--	Vdc
Emitter-Base Breakdown Voltage ($I_E = 10\ \mu\text{A}$, $I_C = 0$)	BV_{EBO}	5	--	Vdc
Collector-Emitter Saturation Voltage ($I_C = 10\ \mu\text{Adc}$, $I_B = 1\ \mu\text{Adc}$) ($I_C = 100\ \mu\text{A}$, $I_B = 10\ \mu\text{A}$) ($I_C = 5\text{ mA}$, $I_B = 0.5\text{ mA}$)	$V_{CE(sat)}$	--	0.15 0.13 0.25	Vdc
Base-Emitter Saturation Voltage ($I_C = 100\ \mu\text{A}$, $I_B = 10\ \mu\text{A}$) ($I_C = 5\text{ mA}$, $I_B = 0.5\text{ mA}$)	$V_{BE(sat)}$	0.60 --	0.75 0.95	Vdc
DC Forward Current Gain ($I_C = 10\ \mu\text{A}$, $V_{CE} = 0.5\text{ V}$) ($I_C = 100\ \mu\text{A}$, $V_{CE} = 0.5\text{ V}$) ($I_C = 100\ \mu\text{A}$, $V_{CE} = 0.5\text{ V}$ (-55°C)) ($I_C = 500\ \mu\text{A}$, $V_{CE} = 0.5\text{ V}$) ($I_C = 5\text{ mA}$, $V_{CE} = 0.5\text{ V}$)	h_{FE}	25 40 20 40 25	-- -- -- 120 --	--
High Frequency Current Gain ($I_C = 1\text{ mA}$, $V_{CE} = 3\text{ V}$, $f = 100\text{ mc}$)	h_{fe}	4.0	--	--
Output Capacitance ($V_{CB} = 3\text{ V}$, $I_E = 0$, $f = 100\text{ kc}$ - Includes 0.3 pF Can Capacitance)	C_{ob}	--	0.7	pF
Input Capacitance ($V_{OB} = 0.5\text{ V}$, $I_C = 0$, $f = 100\text{ kc}$)	C_{ib}	--	0.7	pF

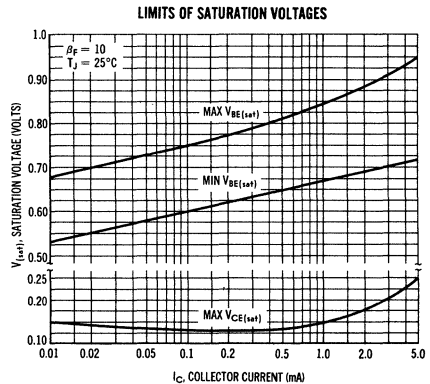
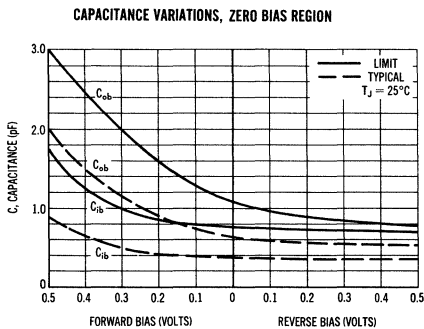

2N3494 thru 2N3497



$V_{CE0} = 80-120\text{ V}$
 $I_C = 100\text{ mA}$
 $f_T = 150-200\text{ Mc}$

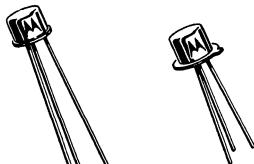

PNP silicon annular Star transistors for high voltage switching and DC to VHF amplifier applications.

CASE 31
(TO-5)

2N3494
2N3495

CASE 22
(TO-18)

2N3496
2N3497

MAXIMUM RATINGS

Characteristic	Symbol	Types				Unit
		(TO-5)		(TO-18)		
		2N3494	2N3495	2N3496	2N3497	
Collector-Base Voltage	V_{CBO}	80	120	80	120	Vdc
Collector-Emitter Voltage	V_{CEO}	80	120	80	120	Vdc
Emitter-Base Voltage	V_{EBO}	4.5		4.5		Vdc
Collector Current	I_C	100		100		mA
Total Device Dissipation @ $T_C = 25^\circ\text{C}$ Derate Above 25°C	P_D	3 17.2		1.8 10.3		Watts mW/ $^\circ\text{C}$
Total Device Dissipation @ $T_A = 25^\circ\text{C}$ Derate Above 25°C	P_D	600 3.43		400 2.28		mW mW/ $^\circ\text{C}$
Junction Temperature	T_J	-65 to +200				$^\circ\text{C}$
Storage Temperature	T_{stg}	-65 to +200				$^\circ\text{C}$

SWITCHING CHARACTERISTICS ($T_A = 25^\circ\text{C}$ unless otherwise specified)

Characteristic	Symbol	Min	Max	Unit
Turn-On Time ($V_{CC} = 30\text{ V}$, $I_C = 10\text{ mA}$, $I_{B1} = 1\text{ mA}$, $V_{OB} = 0$)	t_{on}	—	300	nsec
Turn-Off Time ($V_{CC} = 30\text{ V}$, $I_C = 10\text{ mA}$, $I_{B1} = I_{B2} = 1\text{ mA}$)	t_{off}	—	450	nsec

2N3494 thru 2N3497 (continued)

ELECTRICAL CHARACTERISTICS ($T_A = 25^\circ\text{C}$ unless otherwise specified)

Characteristic		Symbol	Min	Max	Unit
Collector-Base Breakdown Voltage ($I_C = 10 \mu\text{A dc}$, $I_E = 0$)	2N3494, 2N3496 2N3495, 2N3497	BV_{CBO}	80 120	—	Vdc
Collector-Emitter Breakdown Voltage* ($I_C = 10 \text{ mA dc}$, $I_B = 0$)	2N3494, 2N3496 2N3495, 2N3497	BV_{CEO}^*	80 120	—	Vdc
Emitter-Base Breakdown Voltage ($I_E = 10 \mu\text{A dc}$, $I_C = 0$)	All Types	BV_{EBO}	4.5	—	Vdc
Collector Cutoff Current ($V_{CB} = 50 \text{ V dc}$, $I_E = 0$)	2N3494, 2N3496	I_{CBO}	—	100	nA dc
($V_{CB} = 90 \text{ V dc}$, $I_E = 0$)	2N3495, 2N3497		—	100	
Emitter-Base Leakage Current ($V_{CB} = 3 \text{ V dc}$)	All Types	I_{EBO}	—	25	nA dc
DC Forward Current Transfer Ratio ($I_C = 100 \mu\text{A dc}$, $V_{CE} = 10 \text{ V dc}$)	All Types	h_{FE}	35	—	—
($I_C = 1 \text{ mA dc}$, $V_{CE} = 10 \text{ V dc}$)	All Types		40	—	
($I_C = 10 \text{ mA dc}$, $V_{CE} = 10 \text{ V dc}$)	All Types		40	—	
($I_C = 50 \text{ mA dc}$, $V_{CE} = 10 \text{ V dc}$)	All Types		40	—	
($I_C = 100 \text{ mA dc}$, $V_{CE} = 10 \text{ V dc}$)	2N3494, 2N3496		35	—	
Collector Saturation Voltage ($I_C = 10 \text{ mA dc}$, $I_B = 1 \text{ mA dc}$)	2N3494, 2N3496 2N3495, 2N3497	$V_{CE(sat)}$	—	0.3 0.35	Vdc
Base-Emitter Saturation Voltage ($I_C = 10 \text{ mA dc}$, $I_B = 1 \text{ mA dc}$)	All Types	$V_{BE(sat)}$	0.6	0.9	Vdc
Output Capacitance ($V_{CB} = 10 \text{ V dc}$, $I_E = 0$, $f = 100 \text{ kc}$)	2N3494, 2N3496 2N3495, 2N3497	C_{ob}	—	7 6	pf
Input Capacitance ($V_{OB} = 2 \text{ V dc}$, $I_C = 0$, $f = 100 \text{ kc}$)	All Types	C_{ib}	—	30	pf
Current-Gain — Bandwidth Product ($I_C = 20 \text{ mA dc}$, $V_{CE} = 10 \text{ V dc}$, $f = 100 \text{ mc}$)	2N3494, 2N3496 2N3495, 2N3497	f_τ	200 150	—	mc
Small Signal Current Gain ($V_{CE} = 10 \text{ V}$, $I_C = 10 \text{ mA}$, $f = 1 \text{ kc}$)	All Types	h_{fe}	40	300	—
Input Impedance ($V_{CE} = 10 \text{ V}$, $I_C = 10 \text{ mA}$, $f = 1 \text{ kc}$)	All Types	h_{ie}	100	1.2	kohms
Voltage Feedback Ratio ($V_{CE} = 10 \text{ V}$, $I_C = 10 \text{ mA}$, $f = 1 \text{ kc}$)	All Types	h_{re}	—	2.0	$\times 10^{-4}$
Output Admittance ($V_{CE} = 10 \text{ V}$, $I_C = 10 \text{ mA}$, $f = 1 \text{ kc}$)	All Types	h_{oe}	—	300	$\mu\text{ mhos}$
Extrinsic Base Resistance ($V_{CE} = 10 \text{ V}$, $I_C = 20 \text{ mA}$, $f = 300 \text{ mc}$)	All Types	r_b	—	30	ohms

* Pulse width $\leq 300 \mu\text{sec}$, Duty Cycle = 2%

2N3498 thru 2N3501



$V_{CE0} = 100-150\text{ V}$
 $I_C = 300-500\text{ mA}$
 $C_{ob} = 8-10\text{ pf}$

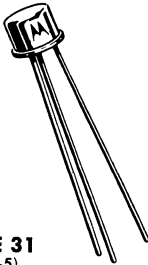

CASE 31
(TO-5)

NPN silicon annular transistors for high voltage switching and low-power amplifier applications.

MAXIMUM RATINGS

Characteristics	Symbol	Maximum		Unit
		2N3498 2N3499	2N3500 2N3501	
Collector-Base Voltage	V_{CBO}	100	150	Vdc
Collector-Emitter Voltage	V_{CEO}	100	150	Vdc
Emitter-Base Voltage	V_{EBO}	6		Vdc
Collector Current	I_C	500	300	mAdc
Total Device Dissipation @ $T_A = 25^\circ\text{C}$ Derating Factor Above 25°C	P_D	1.0		Watt
		5.71		mW/°C
Total Device Dissipation @ $T_C = 25^\circ\text{C}$ Derating Factor Above 25°C	P_D	5		Watt
		28.6		mW/°C
Junction Temperature, Operating	T_J	+200		°C
Storage Temperature Range	T_{stg}	-65 to +200		°C
Thermal Resistance	θ_{JA}	0.175		°C/mW
	θ_{JC}	35		°C/W

2N3498 thru 2N3501 (continued)

SMALL SIGNAL h PARAMETER CHARACTERISTICS

$(V_{CE} = 10V, T_A = 25^\circ C, f = 1\text{ kc})$

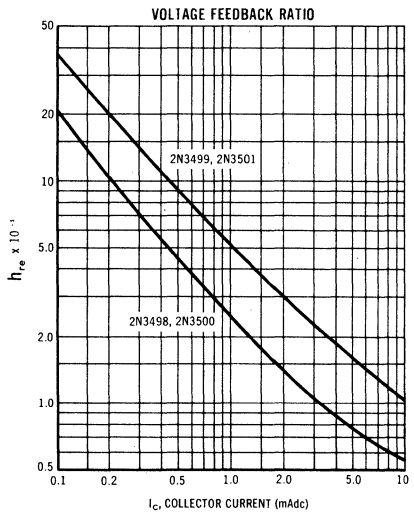
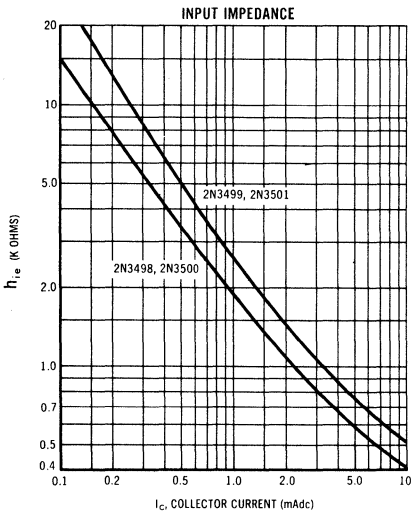
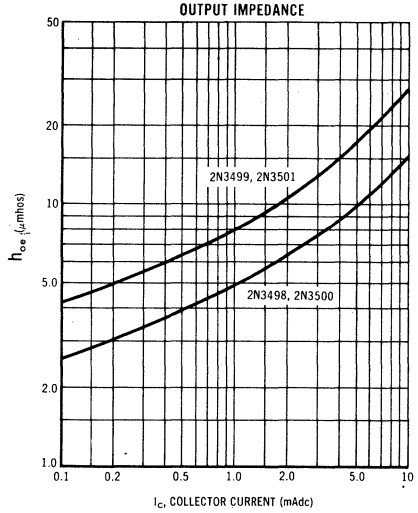
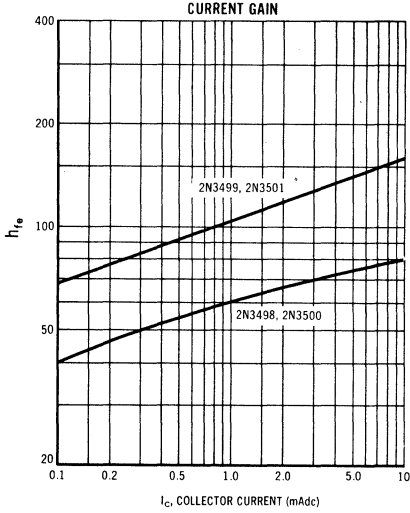

2N3498 thru 2N3501 (continued)

CURRENT GAIN CHARACTERISTICS versus COLLECTOR EMITTER VOLTAGE

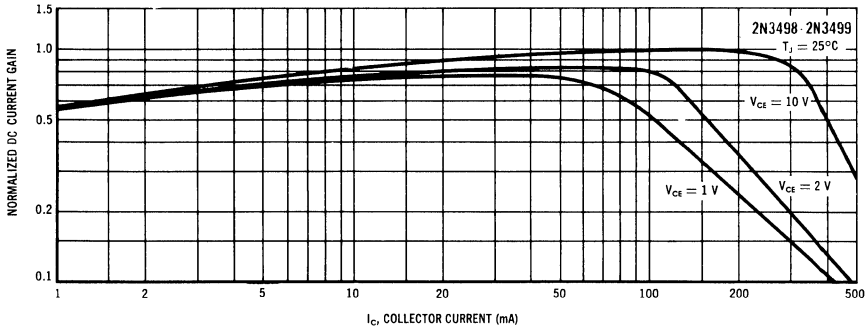

CURRENT GAIN CHARACTERISTICS versus COLLECTOR EMITTER VOLTAGE

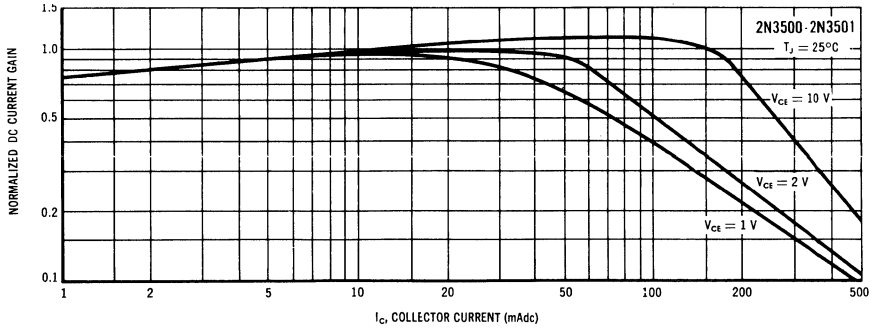

TEMPERATURE COEFFICIENTS

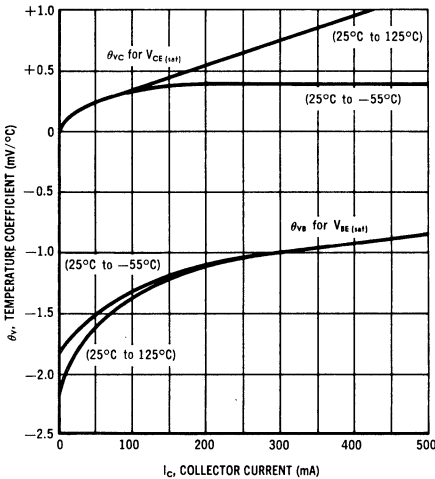

JUNCTION CAPACITANCE VARIATIONS

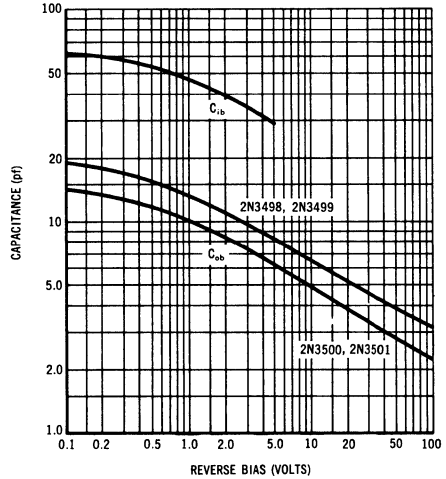

2N3498 thru 2N3501 (continued)

ELECTRICAL CHARACTERISTICS (At 25°C unless otherwise noted)

Static Characteristics		Symbol	Min	Max	Unit
Collector Cutoff Current ($V_{CB} = 50$ Vdc, $I_E = 0$) ($V_{CB} = 50$ Vdc, $I_E = 0$, $T_A = 150$ C)	2N3498, 2N3499	0.050	I_{CBO}	—	μ Adc
		50		—	
Collector Cutoff Current ($V_{CB} = 75$ Vdc, $I_E = 0$) ($V_{CB} = 75$ Vdc, $I_E = 0$, $T_A = 150$ C)	2N3500, 2N3501	0.050		—	
		50		—	
Emitter Cutoff Current ($V_{OB} = 4$ Vdc, $I_C = 0$)	All Types	25	I_{EBO}	—	nAdc
Collector-Base Breakdown Voltage ($I_C = 10$ μ Adc, $I_E = 0$)	2N3498, 2N3499	—	BV_{CBO}	100	Vdc
	2N3500, 2N3501	—		150	
Collector-Emitter Breakdown Voltage* ($I_C = 10$ mAdc, $I_B = 0$)	2N3498, 2N3499	—	BV_{CEO}^*	100	Vdc
	2N3500, 2N3501	—		150	
Emitter-Base Breakdown Voltage ($I_E = 10$ μ Adc, $I_C = 0$)	All Types	—	BV_{EBO}	6	Vdc
Collector Saturation Voltage* ($I_C = 10$ mAdc, $I_B = 1$ mAdc) ($I_C = 50$ mAdc, $I_B = 5$ mAdc) ($I_C = 150$ mAdc, $I_B = 15$ mAdc) ($I_C = 300$ mAdc, $I_B = 30$ mAdc)	All Types	0.2	$V_{CE(sat)}^*$	—	Vdc
	All Types	0.25		—	
	2N3500, 2N3501	0.4		—	
	2N3498, 2N3499	0.6		—	
Base-Emitter Saturation Voltage* ($I_C = 10$ mAdc, $I_B = 1$ mAdc) ($I_C = 50$ mAdc, $I_B = 5$ mAdc) ($I_C = 150$ mAdc, $I_B = 15$ mAdc) ($I_C = 300$ mAdc, $I_B = 30$ mAdc)	All Types	0.8	$V_{BE(sat)}^*$	—	Vdc
	All Types	0.9		—	
	2N3500, 2N3501	1.2		—	
	2N3498, 2N3499	1.4		—	
DC Forward Current Transfer Ratio* ($I_C = 0.1$ mAdc, $V_{CE} = 10$ Vdc) ($I_C = 1.0$ mAdc, $V_{CE} = 10$ Vdc) ($I_C = 10$ mAdc, $V_{CE} = 10$ Vdc) ($I_C = 150$ mAdc, $V_{CE} = 10$ Vdc) ($I_C = 300$ mAdc, $V_{CE} = 10$ Vdc) ($I_C = 500$ mAdc, $V_{CE} = 10$ Vdc)	2N3498, 2N3500	—	h_{FE}^*	20	—
	2N3499, 2N3501	—		35	
	2N3498, 2N3500	—		25	
	2N3499, 2N3501	—		50	
	2N3498, 2N3500	—		35	
	2N3499, 2N3501	—		75	
	2N3498, 2N3500	120		40	
	2N3499, 2N3501	300		100	
	2N3500	—		15	
	2N3501	—		20	
	2N3498	—		15	
	2N3499	—		20	
Small Signal Current Gain ($I_C = 10$ mA, $V_{CE} = 10$ V, $f = 1$ kc)	2N3498, 2N3500	300	h_{fe}	50	—
	2N3499, 2N3501	375		75	
Voltage Feedback Ratio ($I_C = 10$ mA, $V_{CE} = 10$ V, $f = 1$ kc)	2N3498, 2N3500	2.5	h_{re}	—	$\times 10^{-4}$
	2N3499, 2N3501	4		—	
Input Impedance ($I_C = 10$ mA, $V_{CE} = 10$ V, $f = 1$ kc)	2N3498, 2N3500	1.0	h_{ie}	0.2	k ohms
	2N3499, 2N3501	1.25		0.25	
Output Admittance ($I_C = 10$ mA, $V_{CE} = 10$ V, $f = 1$ kc)	2N3498, 2N3500	100	h_{oe}	10	μ mhos
	2N3499, 2N3501	200		20	
Output Capacitance ($V_{CB} = 10$ Vdc, $I_E = 0$, $f = 100$ kc)	2N3498, 2N3499	10	C_{ob}	—	pF
	2N3500, 2N3501	8		—	

2N3498 thru 2N3501 (continued)

ELECTRICAL CHARACTERISTICS (continued)

Static Characteristics	Symbol	Min	Max	Unit
Input Capacitance ($V_{OB} = 0.5$ Vdc, $I_C = 0$, $f = 100$ kc) All Types	C_{ib}	—	80	pF
Small Signal Current Gain ($V_{CE} = 20$ Vdc, $I_C = 20$ mAdc, $f = 100$ mc) All Types	$ h_{fe} $	1.5	—	—
Typical				
Delay Time ($I_C = 150$ mA, $I_{B1} = 15$ mA, $V_{CC} = 100$ V, $V_{OB} = 2.0$ V)	t_d	20	—	nsec
Rise Time ($I_C = 150$ mA, $I_{B1} = 15$ mA, $V_{CC} = 100$ V, $V_{OB} = 2.0$ V)	t_r	35	—	nsec
Storage Time ($I_C = 150$ mA, $I_{B1} = I_{B2} = 15$ mA, $V_{CC} = 100$ V)	t_s	300	—	nsec
Fall Time ($I_C = 150$ mA, $I_{B1} = I_{B2} = 15$ mA, $V_{CC} = 100$ V) 2N3498, 2N3499	t_f	80	—	nsec

*Pulse Test $\leq 300 \mu\text{sec}$, duty cycle $\leq 2\%$ V_{OB} - Base-Emitter

SATURATION VOLTAGES

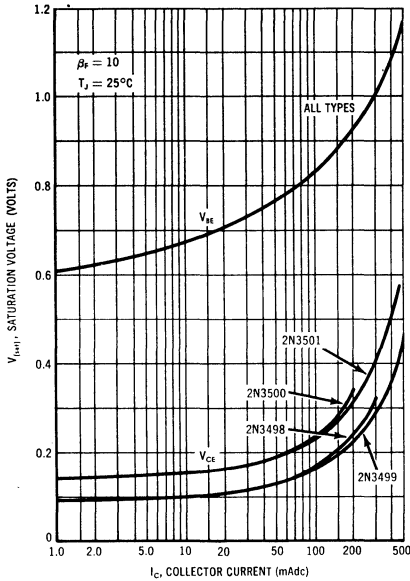

SWITCHING TIMES

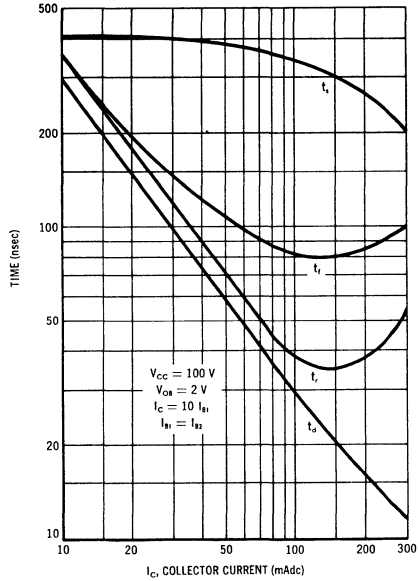

2N3506
2N3507

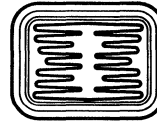

$V_{CE0} = 40-50 \text{ V}$
 $I_C = 3 \text{ A}$
 $f_T = 100 \text{ Mc Typ}$



NPN silicon annular transistors for high-current, high-speed, saturated switching and core driver applications.

CASE 31
(TO-5)

MAXIMUM RATINGS

Characteristics	Symbol	2N3506	2N3507	Unit
Collector-Base Voltage	V_{CBO}	60	80	Vdc
Collector-Emitter Voltage	V_{CEO}	40	50	Vdc
Emitter-Base Voltage	V_{EBO}	5		Vdc
Collector Current	I_C	3		Adc
Total Device Dissipation @ 25°C Case Temperature Derating Factor Above 25°C	P_D	5	28.6	Watts mW/°C.
Total Device Dissipation @ 25°C Ambient Temperature Derating Factor Above 25°C	P_D	1.0	5.71	Watts mW/°C
Junction Operating Temperature	T_J	200		°C
Storage Temperature Range	T_{stg}	-65 to +200		°C

THERMAL RESISTANCE $\theta_{JA} = 0.175^\circ\text{C}/\text{mW}$
 $\theta_{JC} = 35^\circ\text{C}/\text{W}$

SATURATION VOLTAGES

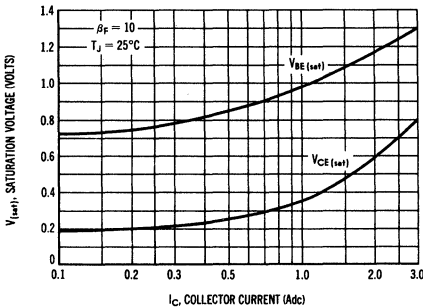

SWITCHING TIMES

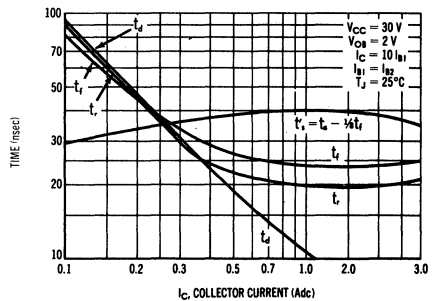

2N3506, 2N3507 (continued)

ELECTRICAL CHARACTERISTICS (At 25°C Ambient unless otherwise specified.)

Characteristics		Symbol	Min	Max	Unit
Collector Cutoff Current ($V_{CE} = 40 \text{ Vdc}$, $V_{OB} = 4 \text{ Vdc}$) ($V_{CE} = 40 \text{ Vdc}$, $V_{OB} = 4 \text{ Vdc}$, $T_A = 100^\circ\text{C}$) ($V_{CE} = 60 \text{ Vdc}$, $V_{OB} = 4 \text{ Vdc}$) ($V_{CE} = 60 \text{ Vdc}$, $V_{OB} = 4 \text{ Vdc}$, $T_A = 100^\circ\text{C}$)	2N3506	I_{CEX}	--	1.0	μAdc
			--	150	
	2N3507		--	1.0	
			--	150	
Base Cutoff Current ($V_{CE} = 40 \text{ Vdc}$, $V_{OB} = 4 \text{ Vdc}$) ($V_{CE} = 60 \text{ Vdc}$, $V_{OB} = 4 \text{ Vdc}$)	2N3506	I_{BL}	--	1.0	μAdc
	2N3507		--	1.0	
Collector-Base Breakdown Voltage ($I_C = 100 \mu\text{Adc}$, $I_E = 0$)	2N3506	BV_{CBO}	60	--	Vdc
	2N3507		80	--	
Collector-Emitter Breakdown Voltage* ($I_C = 10 \text{ mAdc}$, pulsed, $I_B = 0$)	2N3506	BV_{CEO}^*	40	--	Vdc
	2N3507		50	--	
Emitter-Base Breakdown Voltage ($I_E = 10 \mu\text{Adc}$, $I_C = 0$)		BV_{EBO}	5	--	Vdc
Collector Saturation Voltage* ($I_C = 500 \text{ mAdc}$, $I_B = 50 \text{ mAdc}$) ($I_C = 1.5 \text{ Adc}$, $I_B = 150 \text{ mAdc}$) ($I_C = 2.5 \text{ Adc}$, $I_B = 250 \text{ mAdc}$)		$V_{CE(sat)}^*$	--	0.5	Vdc
			--	1.0	
			--	1.5	
			--	1.5	
Base-Emitter Saturation Voltage* ($I_C = 500 \text{ mAdc}$, $I_B = 50 \text{ mAdc}$) ($I_C = 1.5 \text{ Adc}$, $I_B = 150 \text{ mAdc}$) ($I_C = 2.5 \text{ Adc}$, $I_B = 250 \text{ mAdc}$)		$V_{BE(sat)}^*$	--	1.0	Vdc
			0.9	1.4	
			--	2.0	
			--	2.0	
DC Current Gain* ($I_C = 500 \text{ mAdc}$, $V_{CE} = 1 \text{ Vdc}$) ($I_C = 1.5 \text{ Adc}$, $V_{CE} = 2 \text{ Vdc}$) ($I_C = 2.5 \text{ Adc}$, $V_{CE} = 3 \text{ Vdc}$) ($I_C = 3.0 \text{ Adc}$, $V_{CE} = 5 \text{ Vdc}$)	2N3506	h_{FE}^*	50	--	--
	2N3507		35	--	
	2N3506		40	200	
	2N3507		30	150	
	2N3506		30	--	
	2N3507		25	--	
	2N3506		25	--	
	2N3507		20	--	
Output Capacitance ($V_{CB} = 10 \text{ Vdc}$, $I_E = 0$, $f = 100 \text{ kc}$)		C_{ob}	--	40	pf
Input Capacitance ($V_{OB} = 3 \text{ Vdc}$, $I_C = 0$, $f = 100 \text{ kc}$)		C_{ib}	--	300	pf
Current Gain-Bandwidth Product ($I_C = 100 \text{ mAdc}$, $V_{CE} = 5 \text{ Vdc}$, $f = 20 \text{ mc}$)		f_T	60	--	mc
Delay Time $I_C = 1.5 \text{ Adc}$, $I_{B1} = 150 \text{ mAdc}$		t_d	--	15	nsec
Rise Time $V_{CC} = 30 \text{ V}$, $V_{OB} = 0 \text{ V}$		t_r	--	30	nsec
Storage Time $I_C = 1.5 \text{ Adc}$, $I_{B1} = I_{B2} = 150 \text{ mAdc}$		t_s	--	55	nsec
Fall Time $V_{CC} = 30 \text{ V}$		t_f	--	35	nsec

*Pulse Test: Pulse width = 300 μsec , duty cycle = 2%

2N3506, 2N3507 (continued)

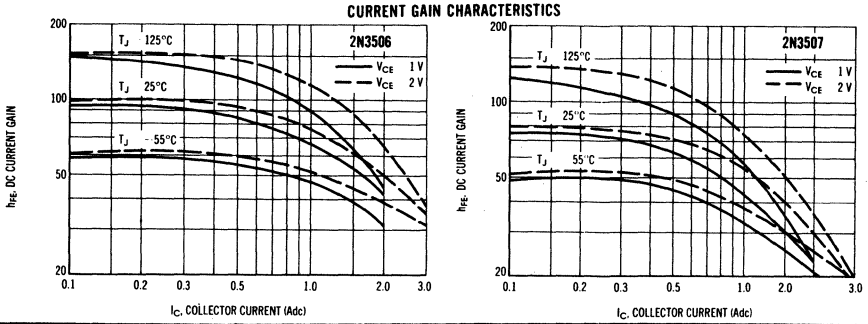

2N3508
2N3509

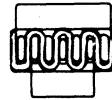
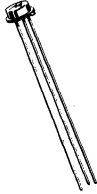

$V_{CE0} = 20\text{ V}$
 $I_C = 500\text{ mA}$
 $f_T = 500\text{ Mc}$

NPN silicon annular transistor for high-speed, low-current switching applications.

CASE 26
(TO-46)

MAXIMUM RATINGS

Characteristics	Symbol	Rating	Unit
Collector-Base Voltage	V_{CBO}	40	Vdc
Collector-Emitter Voltage	V_{CES}	40	Vdc
Collector-Emitter Voltage	V_{CEO}	20	Vdc
Emitter-Base Voltage	V_{EBO}	6.0	Vdc
Collector Current (10 μ sec pulse)	$I_C(\text{Peak})$	500	mA
Total Device Dissipation @ 25°C Ambient Temperature Derating Factor Above 25°C	P_D	0.40 2.29	Watt mW/°C
Total Device Dissipation @ 25°C Case Temperature Derating Factor Above 25°C	P_D	2.0 11.43	Watts mW/°C
Junction Temperature, Operating	T_J	+200	°C
Storage Temperature Range	T_{stg}	-65 to +200	°C
Thermal Resistance	θ_{JC}	0.438	°C/mW
	θ_{JA}	0.0875	°C/mW

2N3508, 2N3509 (continued)

ELECTRICAL CHARACTERISTICS (at 25°C unless otherwise specified)

Characteristic		Symbol	Min	Max	Unit
Collector Cutoff Current ($V_{CB} = 20$ Vdc) ($V_{CB} = 20$ Vdc, $T_A = 150^\circ\text{C}$)	Both Types	I_{CBO}	—	0.2	μAdc
	2N3308		—	30	
	2N3309		—	50	
Collector Cutoff Current ($V_{CE} = 20$ Vdc, $V_{OB} = 3$ Vdc)		I_{CEX}	—	0.2	μAdc
Base Cutoff Current ($V_{CE} = 20$ Vdc, $V_{OB} = 3$ Vdc)		I_{BL}	—	0.5	μAdc
Collector-Base Breakdown Voltage ($I_C = 10$ μAdc , $I_B = 0$)		BV_{CBO}	40	—	Vdc
Emitter-Base Breakdown Voltage ($I_E = 10$ μAdc , $I_C = 0$)		BV_{EBO}	3.0	—	Vdc
Collector-Emitter Breakdown Voltage* ($I_C = 10$ mAdc)		BV_{CEO}^*	20	—	Vdc
Collector-Emitter Voltage ($I_C = 10$ μAdc , $I_B = 0$)		BV_{CES}	40	—	Vdc
Collector-Emitter Saturation Voltage* ($I_C = 10$ mAdc, $I_B = 1$ mAdc) ($I_C = 100$ mAdc, $I_B = 10$ mAdc)		$V_{CE(sat)}^*$	—	0.25 0.45	Vdc
Base-Emitter Saturation Voltage* ($I_C = 10$ mAdc, $I_B = 1$ mAdc) ($I_C = 100$ mAdc, $I_B = 10$ mAdc)		$V_{BE(sat)}^*$	0.70 0.8	0.85 1.4	Vdc
DC Current Gain* ($I_C = 10$ mAdc, $V_{CE} = 1.0$ Vdc)	2N3508	h_{FE}^*	40	120	—
	2N3509		100	300	
($I_C = 10$ mAdc, $V_{CE} = 1.0$ Vdc, $T_A = -55^\circ\text{C}$)	2N3508		20	—	
	2N3509		40	—	
($I_C = 100$ mAdc, $V_{CE} = 1.0$ Vdc)	2N3508		20	—	
	2N3509		30	—	
Small-Signal Current Gain ($I_C = 10$ mAdc, $V_{CE} = 10$ Vdc, $f = 100$ mc)		h_{fe}	5	—	—
Output Capacitance ($V_{CB} = 5$ Vdc, $I_E = 0$, $f = 140$ kc)		C_{ob}	—	4	pf
Input Capacitance ($V_{OB} = 1$ Vdc, $I_C = 0$, $f = 140$ kc)		C_{ib}	—	4	pf
Storage Time ($I_C = I_{B1} = I_{B2} = 10$ mA)		$t_s(\tau_s)$	—	13	nsec
Turn-On Time ($I_C = 10$ mA, $I_{B1} = 3$ mA, $V_{CC} = 3$ V, $V_{OB} = 1.5$ V)		t_{on}	—	12	nsec
Turn-Off Time ($I_C = 10$ mA, $I_{B1} = 3$ mA, $I_{B2} = 1.5$ mA, $V_{CC} = 3$ V)		t_{off}	—	18	nsec
Total Control Charge ($I_C = 10$ mA, $I_B = 1$ mA, $V_{CC} = 3$ V)		Q_T	—	50	pC
Delay Time	$V_{CC} = 10$ V, $V_{OB} = 2$ V, $I_C = 100$ mA, $I_{B1} = 10$ mA	t_d	—	5	nsec
Rise Time		t_r	—	18	nsec
Storage Time		t_s	—	13	nsec
Fall Time		t_f	—	15	nsec

*Pulse Test: PW = 300 μsec , Duty Cycle $\leq 2\%$

2N3508, 2N3509 (continued)

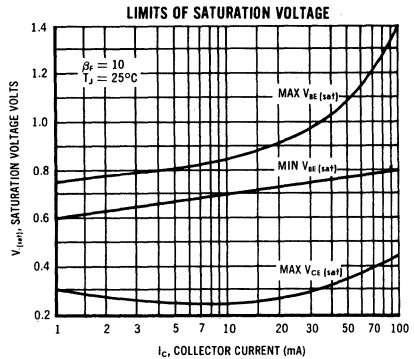
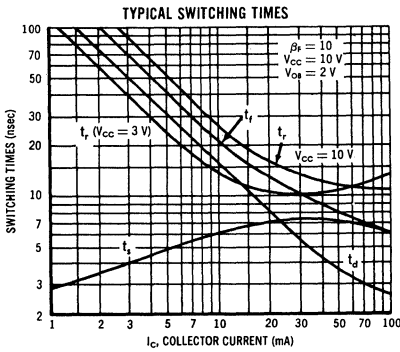
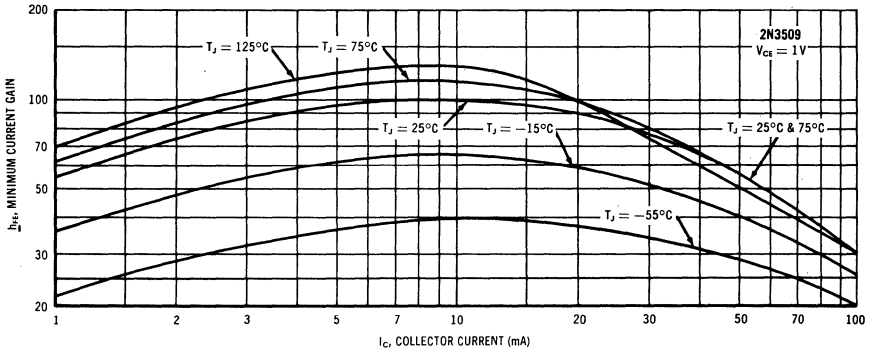
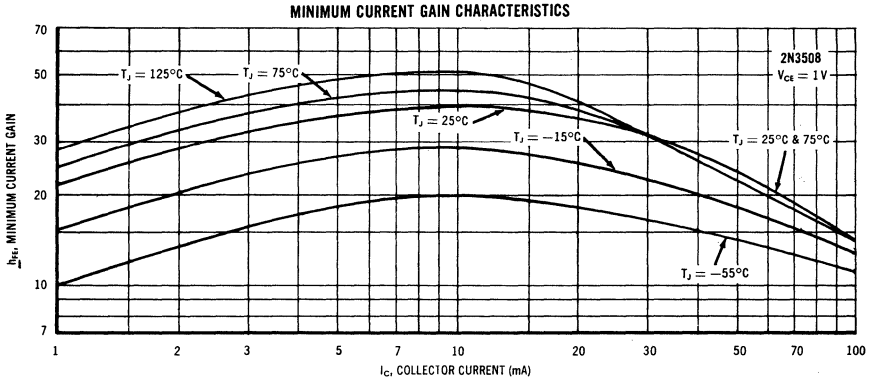

2N3510

2N3511

2N3647

2N3648



$V_{CEO} = 10-15\text{ V}$
 $I_C = 500\text{ mA}$
 $f_T = 350-450\text{ Mc}$

NPN silicon annular transistors for high-speed saturated switching applications to 500 mA.

CASE 27
(TO-52)



CASE 26
(TO-46)

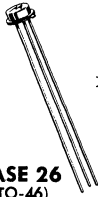

MAXIMUM RATINGS

Characteristic	Symbol	2N3510 2N3647	2N3511 2N3648	Unit
Collector-Base Voltage	V_{CBO}	40	40	Vdc
Collector-Emitter Voltage	V_{CEO}	10	15	Vdc
Emitter-Base Voltage	V_{EBO}	6		Vdc
Collector Current	I_C	500		mAdc
Total Device Dissipation @ $T_A = 25^\circ\text{C}$ Derating Factor Above 25°C	P_D	T0-46 2N3647 2N3648	T0-52 2N3510 2N3511	mW mW/ $^\circ\text{C}$
		400 2.28	360 2.06	
Total Device Dissipation @ $T_C = 25^\circ\text{C}$ Derating Factor Above 25°C	P_D	2.0 11.43	1.2 6.9	Watts mW/ $^\circ\text{C}$
Junction Temperature, Operating	T_J	+ 200		$^\circ\text{C}$
Storage Temperature Range	T_{stg}	-65 to +200		$^\circ\text{C}$

STORAGE TIME VARIATION

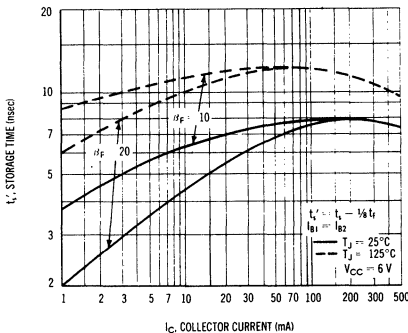

LIMITS OF SATURATION VOLTAGE

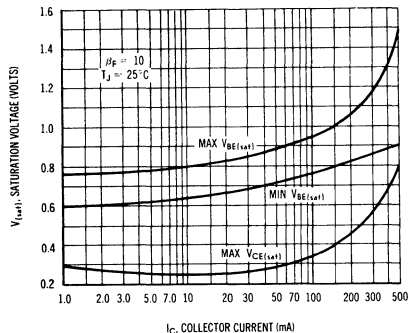

2N3510, 2N3511, 2N3647, 2N3648 (continued)

ELECTRICAL CHARACTERISTICS ($T_A = 25^\circ\text{C}$ unless otherwise specified)

Characteristic	Symbol	Min	Max	Unit	
Collector Cutoff Current ($V_{CE} = 10\text{ Vdc}$, $V_{OB1} = 1\text{ Vdc}$) ($V_{CE} = 10\text{ Vdc}$, $V_{OB} = 1\text{ Vdc}$, $T_A = 150^\circ\text{C}$)	I_{CEX}	—	.025 50	μAdc	
Base Cutoff Current ($V_{CE} = 10\text{ Vdc}$, $V_{OB} = 1\text{ Vdc}$)	I_{BL}	—	.025	μAdc	
Collector-Base Breakdown Voltage ($I_C = 10\ \mu\text{Adc}$, $I_E = 0$)	BV_{CBO}	40	—	Vdc	
Collector-Emitter Breakdown Voltage* ($I_C = 10\text{ mAdc}$, $I_B = 0$)	BV_{CEO}^*	10 15	— —	Vdc	
Emitter-Base Breakdown Voltage ($I_E = 10\ \mu\text{Adc}$, $I_C = 0$)	BV_{EBO}	6	—	Vdc	
Collector Saturation Voltage* ($I_C = 10\text{ mAdc}$, $I_B = 1\text{ mAdc}$) ($I_C = 150\text{ mAdc}$, $I_B = 15\text{ mAdc}$) ($I_C = 300\text{ mAdc}$, $I_B = 30\text{ mAdc}$) ($I_C = 500\text{ mAdc}$, $I_B = 50\text{ mAdc}$)	$V_{CE(sat)}^*$	— — — —	0.25 0.4 0.6 0.8	Vdc	
Base-Emitter Saturation Voltage* ($I_C = 10\text{ mAdc}$, $I_B = 1\text{ mAdc}$) ($I_C = 150\text{ mAdc}$, $I_B = 15\text{ mAdc}$) ($I_C = 300\text{ mAdc}$, $I_B = 30\text{ mAdc}$) ($I_C = 500\text{ mAdc}$, $I_B = 50\text{ mAdc}$)	$V_{BE(sat)}^*$	— 0.8 — —	0.8 1.0 1.15 1.5	Vdc	
DC Current Gain* ($I_C = 1.0\text{ mAdc}$, $V_{CE} = 1\text{ Vdc}$) ($I_C = 10\text{ mAdc}$, $V_{CE} = 1\text{ Vdc}$) ($I_C = 150\text{ mAdc}$, $V_{CE} = 1\text{ Vdc}$) ($I_C = 150\text{ mAdc}$, $V_{CE} = 1\text{ Vdc}$, $T_A = -55^\circ\text{C}$) ($I_C = 300\text{ mAdc}$, $V_{CE} = 1\text{ Vdc}$) ($I_C = 500\text{ mAdc}$, $V_{CE} = 1\text{ Vdc}$)	h_{FE}^*	2N3510, 2N3647 2N3511, 2N3648 2N3510, 2N3647 2N3511, 2N3648 2N3510, 2N3647 2N3511, 2N3648 2N3511, 2N3648 2N3510, 2N3647 2N3510, 2N3647 2N3511, 2N3648	12 15 20 25 25 30 12 15 12	— — — — 150 120 — — —	
Output Capacitance ($V_{CB} = 10\text{ Vdc}$, $I_E = 0$, $f = 100\text{ kc}$)	C_{ob}	—	4	pf	
Input Capacitance ($V_{OB} = 0.5\text{ Vdc}$, $I_C = 0$, $f = 100\text{ kc}$)	C_{ib}	—	8	pf	
Small Signal Current Gain ($I_C = 15\text{ mAdc}$, $V_{CE} = 10\text{ Vdc}$, $f = 100\text{ mc}$)	h_{fe}	2N3510, 2N3647 2N3511, 2N3648	3.5 4.5	— —	
Delay Time	$I_C = 150\text{ mA}$, $I_{B1} = 15\text{ mA}$, $V_{OB} = 0.5\text{ V}$, $V_{CC} = 6\text{ V}$	2N3510, 2N3647 2N3511, 2N3648	— —	10 8	nsec
Rise Time		2N3510, 2N3647 2N3511, 2N3648	— —	12 10	nsec
Turn-On Time		2N3510, 2N3647 2N3511, 2N3648	— —	20 16	nsec
Storage Time		2N3510, 2N3647 2N3511, 2N3648	— —	16 12	nsec
Fall Time		2N3510, 2N3647 2N3511, 2N3648	— —	12 8	nsec
Turn-Off Time		2N3510, 2N3647 2N3511, 2N3648	— —	25 18	nsec
Total Control Charge ($I_C = 150\text{ mA}$, $I_B = 15\text{ mA}$, $V_{CC} = 6\text{ V}$)		Q_T	—	300	pC
Small Signal Current Gain ($I_C = 1\text{ mA}$, $V_{CE} = 10\text{ V}$, $f = 1\text{ kc}$)	h_{fe}	20	150	—	
Voltage Feedback Ratio ($I_C = 1\text{ mA}$, $V_{CE} = 10\text{ V}$, $f = 1\text{ kc}$)	h_{re}	—	25	$\times 10^{-4}$	
Input Impedance ($I_C = 1\text{ mA}$, $V_{CE} = 10\text{ V}$, $f = 1\text{ kc}$)	h_{ie}	0.6	4.5	kohms	
Output Admittance ($I_C = 1\text{ mA}$, $V_{CE} = 10\text{ V}$, $f = 1\text{ kc}$)	h_{oe}	10	100	μmhos	

* Pulse Test: $PW \leq 300\ \mu\text{sec}$, Duty Cycle $\leq 2\%$
 $V_{OB} =$ Base-Emitter Reverse Bias

2N3510, 2N3511, 2N3647, 2N3648 (continued)

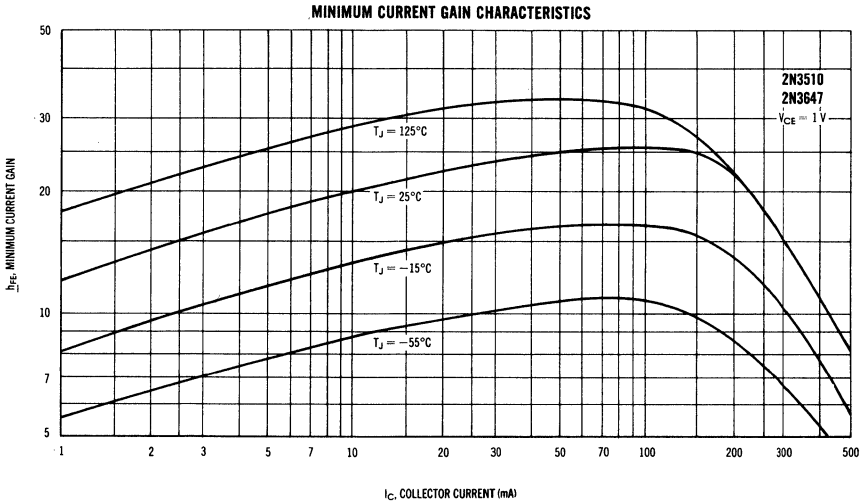
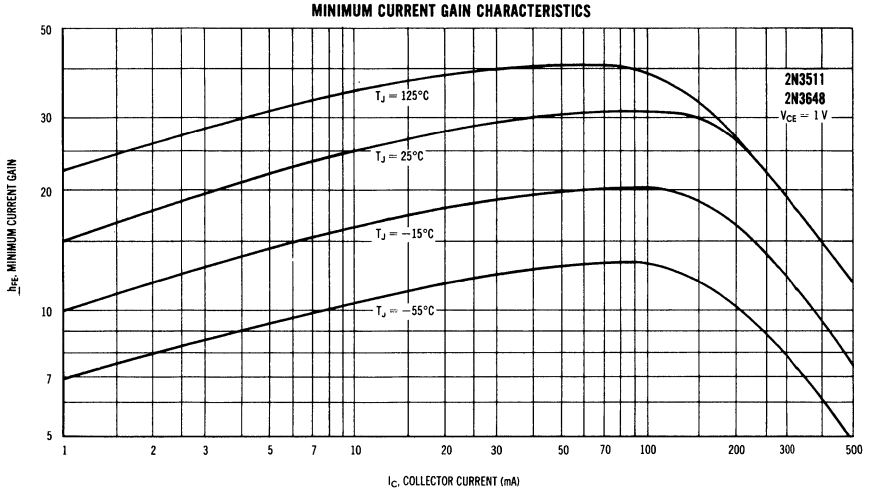

2N3544

V_{CBO} = 25 V
P_o = 10 mW @ 1000 Mc



CASE 22
(TO-18)

NPN silicon annular transistor for VHF and UHF oscillator applications.

MAXIMUM RATINGS

Characteristics	Symbol	Rating	Unit
Collector-Base Voltage	V _{CBO}	25	Volts
Collector-Emitter Voltage	V _{CES}	25	Volts
Emitter-Base Voltage	V _{EB}	3.0	Volts
Collector Current	I _C	100	mA
Power Dissipation @ T _C = 25°C	P _C	400	mW
Derate above 25°C		2.67	mW/°C
Power Dissipation @ T _A = 25°C	P _D	300	mW
Derate above 25°C		2.0	mW/°C
Junction Temperature	T _J	+175	°C
Storage Temperature	T _{stg}	-65 to +175	°C

ELECTRICAL CHARACTERISTICS (T_A = 25°C unless otherwise noted)

Characteristics	Symbol	Condition	Min	Typ	Max	Unit
Collector-Base Breakdown Voltage	BV _{CBO}	I _C = 10 μAdc, I _E = 0	25	30	--	Vdc
Collector-Emitter Breakdown Voltage	BV _{CES}	I _C = 10 μA, V _{BE} = 0	25	30	--	Vdc
Collector Cutoff Current	I _{CBO}	V _{CB} = 15 Vdc, I _E = 0	--	0.01	0.1	μAdc
Emitter Cutoff Current	I _{EBQ}	V _{EB} = 3 Vdc, I _C = 0	--	0.1	10	μAdc
DC Current Gain	h _{FE}	V _{CE} = 10 Vdc, I _C 10 mAdc	25	50	--	--
AC Current Gain	h _{fe}	V _{CE} = 10 Vdc, I _C = 10 mAdc, f = 100 mc	6	9	15	--
Collector Output Capacitance	C _{ob}	V _{CB} = 15 Vdc, I _E = 0, f = 100 kc	--	--	2.5	pF
Collector-Base Time Constant	r _b 'c _c	V _{CB} = 10 Vdc, I _C = 10 mAdc, f = 31.8 mc	--	--	10	psec
Oscillator Power Output	P _{out}	f = 1000 mc, V _C = 12 Vdc, I _C 12 mAdc	10	16	--	mW

2N3544 (continued)

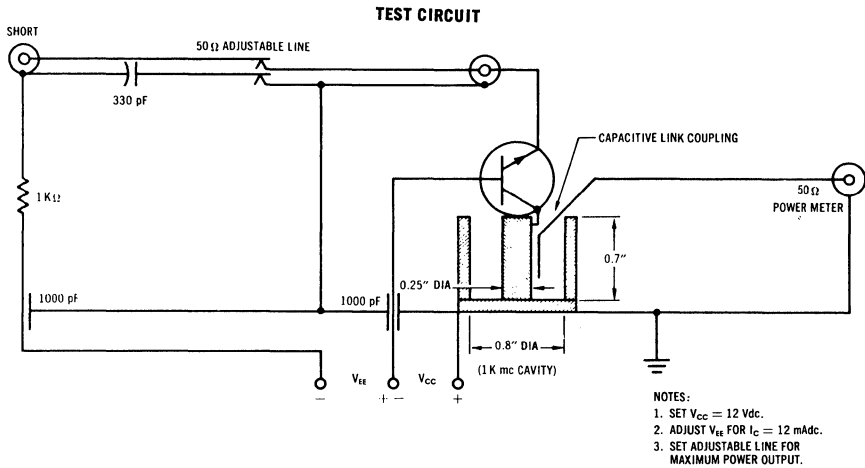

2N3546



$V_{CE0} = 12$ V
 $t_s = 20$ nsec



PNP silicon annular transistor for low-level, high-speed switching applications.

CASE 22
(TO-18)

MAXIMUM RATINGS

Characteristics	Symbol	Rating	Unit
Collector-Base Voltage	V_{CBO}	15	Vdc
Collector-Emitter Voltage	V_{CEO}	12	Vdc
Emitter-Base Voltage	V_{EBO}	4.5	Vdc
Total Device Dissipation @ $T_A = 25^\circ\text{C}$ Derate above 25°C	P_D	0.36 2.06	Watt mW/ $^\circ\text{C}$
Total Device Dissipation @ $T_C = 25^\circ\text{C}$ Derate above 25°C	P_D	1.2 6.9	Watts mW/ $^\circ\text{C}$
Operating Junction Temperature	T_J	200	$^\circ\text{C}$
Storage Temperature Range	T_{stg}	-65 to +200	$^\circ\text{C}$
Thermal Resistance	θ_{JA}	0.49	$^\circ\text{C}/\text{mW}$
	θ_{JC}	0.15	$^\circ\text{C}/\text{mW}$

2N3546 (continued)

ELECTRICAL CHARACTERISTICS (At 25°C ambient unless otherwise noted)

Characteristics		Symbol	Min	Max	Unit
Collector Cutoff Current ($V_{CB} = 10$ Vdc)		I_{CBO}	--	0.010	μ Adc
(V _{CB} = 10 Vdc, T _A = 150°C)			--	10	
Collector Cutoff Current (V _{CE} = 10 Vdc, V _{OB} = 3 Vdc)		I_{CEX}	--	0.010	μ Adc
Base Cutoff Current (V _{CE} = 10 Vdc, V _{OB} = 3 Vdc)		I_{BL}	--	0.10	μ Adc
Collector-Base Breakdown Voltage (I _C = 10 μ Adc, I _E = 0)		BV_{CBO}	15	--	Vdc
Emitter-Base Breakdown Voltage (I _E = 10 μ Adc, I _C = 0)		BV_{EBO}	4.5	--	Vdc
Collector-Emitter Breakdown Voltage* (I _C = 10 mAdc, I _B = 0)		BV_{CEO}^*	12	--	Vdc
Collector Saturation Voltage* (I _C = 10 mAdc, I _B = 1 mAdc)		$V_{CE(sat)}^*$	--	0.15	Vdc
(I _C = 50 mAdc, I _B = 5 mAdc)			--	0.25	
(I _C = 100 mAdc, I _B = 10 mAdc)			--	0.50	
Base-Emitter Saturation Voltage* (I _C = 10 mAdc, I _B = 1 mAdc)		$V_{BE(sat)}^*$	0.7	0.9	Vdc
(I _C = 50 mAdc, I _B = 5 mAdc)			0.8	1.3	
(I _C = 100 mAdc, I _B = 10 mAdc)			--	1.6	
DC Current Gain* (I _C = 1.0 mAdc, V _{CE} = 1 Vdc)		h_{FE}^*	20	--	--
(I _C = 10 mAdc, V _{CE} = 1 Vdc)			30	120	
(I _C = 10 mAdc, V _{CE} = 1 Vdc, T _A = -55°C)			15	--	
(I _C = 50 mAdc, V _{CE} = 1 Vdc)			25	--	
(I _C = 100 mAdc, V _{CE} = 1Vdc)			15	--	
Output Capacitance (V _{CB} = 10 Vdc, I _E = 0, f = 1 mc)		C_{ob}	--	6	pF
Input Capacitance (V _{OB} = 0.5 Vdc, I _C = 0, f = 1 mc)		C_{ib}	--	5	pF
Current-Gain - Bandwidth Product (I _C = 10 mAdc, V _{CE} = 10 Vdc, f = 100 mc)		f_T	700	--	mc
Total Control Charge (I _C = 50 mA, I _B = 5 mA, V _{CC} = 3 V)		Q_T	--	400	pC
Delay Time	I _C = 50 mA, I _{B1} = 5 mA,	t_d	--	10	nsec
Rise Time	V _{OB} = 2 V, V _{CC} = 3 V	t_r	--	15	nsec
Storage Time	I _C = 50 mA, I _{B1} = I _{B2} = 5 mA,	t_s	--	20	nsec
Fall Time	V _{CC} = 3 V	t_f	--	15	nsec
Turn-On Time	See "Switching Time Test Circuit" (page 8-213)	t_{on}	--	40	nsec
Turn-Off Time		t_{off}	--	30	nsec

*Pulse Test: PW = 300 μ sec, Duty Cycle \leq 2%

2N3546 (continued)

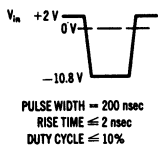
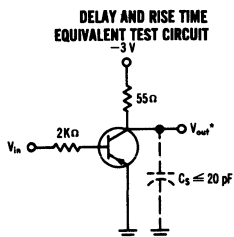
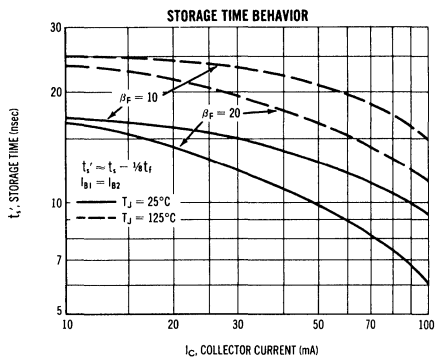
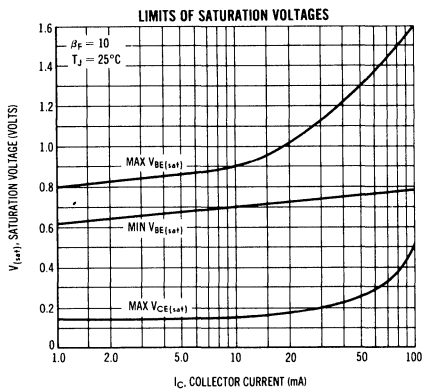

*OSCILLOSCOPE RISE TIME ≤ 1 nsec

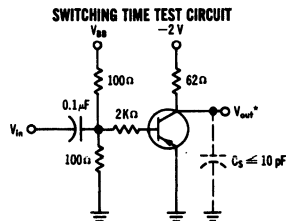
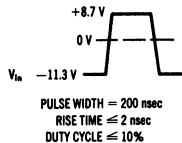
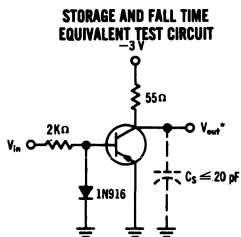

PULSE WIDTH > 200 nsec
RISE TIME < 1 nsec
 $Z_{in} = 50 \Omega$

$t_{on} : V_{BB} = +3\text{V}, V_{in} = -7\text{V}$
 $t_{off} : V_{BB} = -4\text{V}, V_{in} = +6\text{V}$

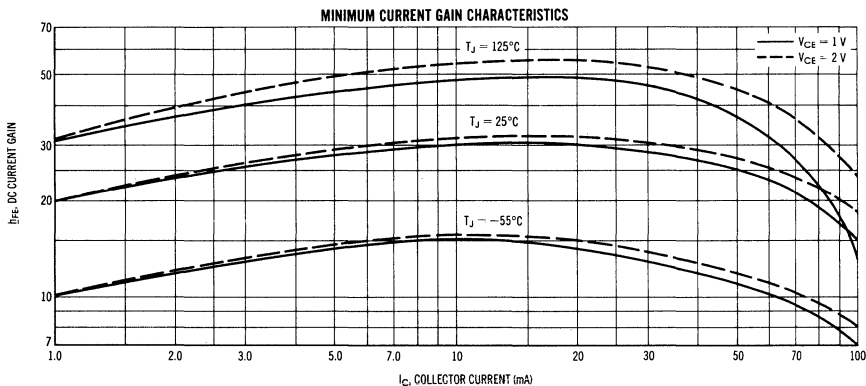

2N3553

2N3632

For Specifications, See 2N3375 Data Sheet

2N3634 thru 2N3637

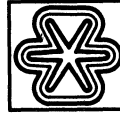

$V_{CEO} = 140-175 \text{ V}$
 $f_T = 150 - 200 \text{ Mc}$



CASE 31
(TO-5)

PNP silicon annular transistor for high voltage switching and low-power amplifier applications.

MAXIMUM RATINGS

Characteristics	Symbol	Maximum		Unit
		2N3634 2N3635	2N3636 2N3637	
Collector-Base Voltage	V_{CBO}	140	175	Vdc
Collector-Emitter Voltage	V_{CEO}	140	175	Vdc
Emitter-Base Voltage	V_{EBO}	5		Vdc
Collector Current	I_C	1		Adc
Total Device Dissipation @ $T_A = 25^\circ\text{C}$ Derating Factor Above 25°C	P_D	1.0	5.71	Watt mW/ $^\circ\text{C}$
Total Device Dissipation @ $T_C = 25^\circ\text{C}$ Derating Factor Above 25°C	P_D	5	28.6	Watts mW/ $^\circ\text{C}$
Junction Temperature, Operating	T_J	+200		$^\circ\text{C}$
Storage Temperature Range	T_{stg}	-65 to +200		$^\circ\text{C}$

SWITCHING TIME TEST CIRCUIT

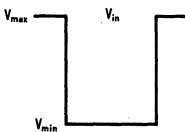

P.W. $\approx 20 \mu\text{sec}$
 DUTY CYCLE $\leq 2\%$
 RISE TIME $\leq 20 \text{ nsec}$

	V_{max}	V_{min}
TURN-ON	+4V	-5.65V
TURN-OFF	+4.1V	-5.9V

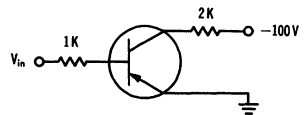

2N3634 thru 2N3637 (continued)

ELECTRICAL CHARACTERISTICS (At 25°C Ambient unless otherwise specified.)

Characteristics		Symbol	Minimum	Maximum	Unit
Collector-Base Breakdown Voltage ($I_C = 100 \mu\text{Adc}$, $I_E = 0$)	2N3634, 2N3635 2N3636, 2N3637	BV_{CBO}	140 175	—	Vdc
Collector-Emitter Breakdown Voltage* ($I_C = 10 \text{ mAdc}$, $I_B = 0$)	2N3634, 2N3635 2N3636, 2N3637	BV_{CEO}^*	140 175	—	Vdc
Emitter-Base Breakdown Voltage ($I_E = 10 \mu\text{Adc}$, $I_C = 0$)	All Types	BV_{EBO}	5	—	Vdc
Collector Saturation Voltage* ($I_C = 10 \text{ mAdc}$, $I_B = 1 \text{ mAdc}$) ($I_C = 50 \text{ mAdc}$, $I_B = 5 \text{ mAdc}$)	All Types All Types	$V_{CE(sat)}^*$	— —	0.3 0.5	Vdc
Base-Emitter Saturation Voltage* ($I_C = 10 \text{ mAdc}$, $I_B = 1 \text{ mAdc}$) ($I_C = 50 \text{ mAdc}$, $I_B = 5 \text{ mAdc}$)	All Types All Types	$V_{BE(sat)}^*$	— 0.65	0.8 0.9	Vdc
DC Current Gain ($I_C = 0.1 \text{ mAdc}$, $V_{CE} = 10 \text{ Vdc}$) ($I_C = 1.0 \text{ mAdc}$, $V_{CE} = 10 \text{ Vdc}$) ($I_C = 10 \text{ mAdc}$, $V_{CE} = 10 \text{ Vdc}$) ($I_C = 50 \text{ mAdc}$, $V_{CE} = 10 \text{ Vdc}$) ($I_C = 150 \text{ mAdc}$, $V_{CE} = 10 \text{ Vdc}$)	2N3634, 2N3636 2N3635, 2N3637 2N3634, 2N3636 2N3635, 2N3637 2N3634, 2N3636 2N3635, 2N3637 2N3634, 2N3636 2N3635, 2N3637	h_{FE}^*	40 80 45 90 50 100 50 100 25 50	— — — — — — 150 300 — —	—
Small Signal Current Gain ($V_{CE} = 30 \text{ Vdc}$, $I_C = 30 \text{ mAdc}$, $f = 100 \text{ mc}$)	2N3634, 2N3636 2N3635, 2N3637	$ h_{fe} $	1.5 2.0	— —	—
Output Capacitance ($V_{CB} = 20 \text{ Vdc}$, $I_E = 0$, $f = 100 \text{ kc}$)	All Types	C_{ob}	—	10	pf
Input Capacitance ($V_{OB} = 1.0 \text{ Vdc}$, $I_C = 0$, $f = 100 \text{ kc}$)	All Types	C_{ib}	—	75	pf
Collector Cutoff Current ($V_{CB} = 100 \text{ Vdc}$, $I_E = 0$)	All Types	I_{CBO}	—	100	nAdc
Emitter Cutoff Current ($V_{OB} = 3 \text{ Vdc}$, $I_C = 0$)	All Types	I_{EBO}	—	50	nAdc
Small Signal Current Gain ($I_C = 10 \text{ mA}$, $V_{CE} = 10 \text{ V}$, $f = 1 \text{ kc}$)	2N3634, 2N3636 2N3635, 2N3637	h_{fe}	40 80	160 320	—
Voltage Feedback Ratio ($I_C = 10 \text{ mA}$, $V_{CE} = 10 \text{ V}$, $f = 1 \text{ kc}$)	All Types	h_{re}	—	3	$\times 10^{-4}$
Input Impedance ($I_C = 10 \text{ mA}$, $V_{CE} = 10 \text{ V}$, $f = 1 \text{ kc}$)	2N3634, 2N3636 2N3635, 2N3637	h_{ie}	100 200	600 1200	ohms
Output Admittance ($I_C = 10 \text{ mA}$, $V_{CE} = 10 \text{ V}$, $f = 1 \text{ kc}$)	All Types	h_{oe}	—	200	μmhos
Noise Figure ($I_C = 0.5 \text{ mA}$, $V_{CE} = 10 \text{ V}$, $f = 1 \text{ kc}$, $R_g = 1 \text{ k}\Omega$)	All Types	NF	—	3	db
Turn-On Time	$V_{CC} = 100\text{V}$, $I_C = 50 \text{ mA}$	All Types	t_{on}	—	400 nsec
Turn-Off Time	$I_{B1} = I_{B2} = 5 \text{ mA}$, $V_{OB} = 4 \text{ V}$	All Types	t_{off}	—	600 nsec

*Pulse Width $\leq 300 \mu\text{sec}$, duty cycle $\leq 2\%$ V_{OB} - Base-Emitter Off Bias

2N3634 thru 2N3637 (continued)

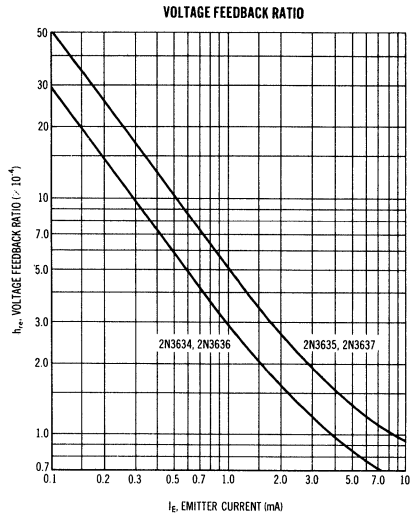
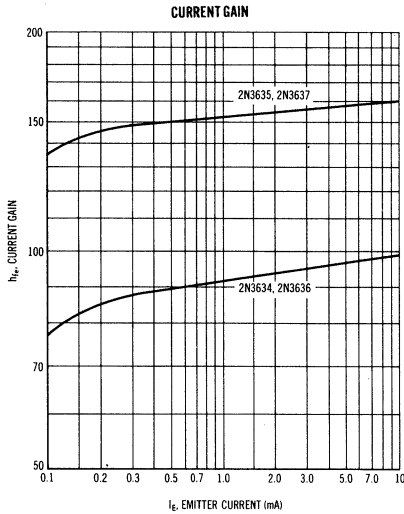
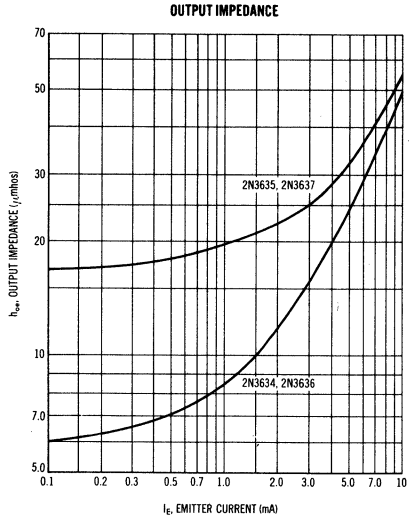
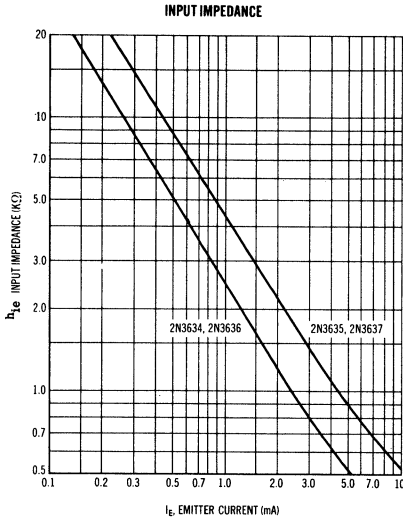

2N3634 thru 2N3637 (continued)

CURRENT GAIN CHARACTERISTICS versus COLLECTOR EMITTER VOLTAGE

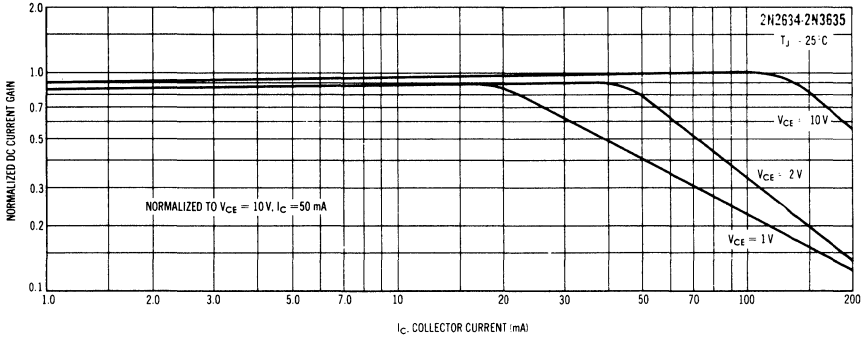

SATURATION VOLTAGES

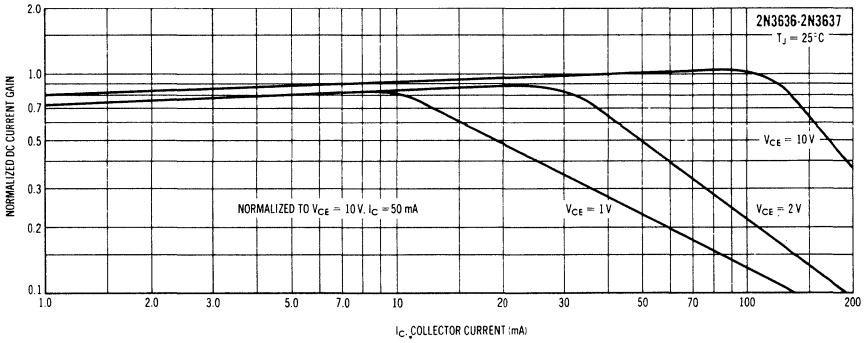

CURRENT GAIN CHARACTERISTICS versus COLLECTOR EMITTER VOLTAGE

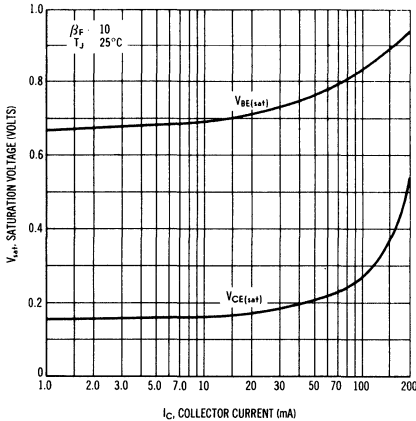

GAIN-BANDWIDTH PRODUCT

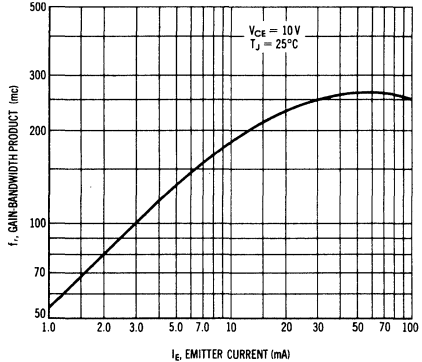

2N3647
2N3648

For Specifications, See 2N3510 Data Sheet

2N3664



$G_{PE} = 7.4 \text{ db @ 250 Mc}$
 $P_o = 2.2 \text{ W @ 250 Mc}$

NPN silicon annular transistor for power amplifier and driver applications to 500 Mc.

CASE 24

MAXIMUM RATINGS

Characteristic	Symbol	Rating	Unit
Collector Base Voltage	V_{CBO}	60	Vdc
Collector Emitter Voltage	V_{CES}	60	Vdc
Collector Emitter Voltage	V_{CEO}	40	Vdc
Emitter Base Voltage	V_{EBO}	4	Vdc
Collector Current (Continuous)	I_C	0.5	Adc
Base Current (Continuous)	I_B	0.1	Adc
Power Dissipation @ 25°C Case Temperature @ 25°C Ambient Temperature	P_D	5.0 1.0	Watts Watts
Operating Junction Temperature	T_j	200	°C
Storage Temperature Range	T_{stg}	-65 to +200	

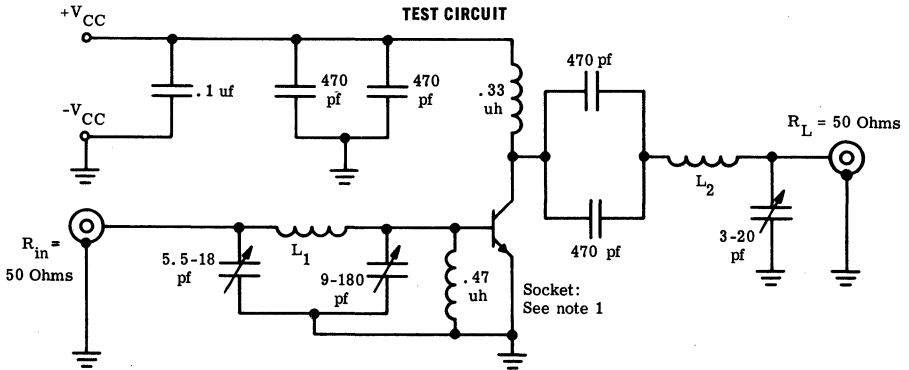

- L_1 : 2T No. 14 tinned wire 5/16" ID, 1/4" long
- L_2 : 2T No. 14 tinned wire 3/8" ID, 3/16" long

Note 1: Use a 0.100" pin circle teflon socket with the emitter grounded to the chassis at the top of the socket.

When making RF power test, the device must be provided with an adequate heat sink.

— Motorola High-Frequency Transistors —

2N3664 (continued)

ELECTRICAL CHARACTERISTICS ($T_A = 25^\circ\text{C}$ unless otherwise specified)

Characteristic	Symbol	Minimum	Maximum	Unit
Collector-Emitter Sustain Voltage $I_C = 30\text{mA dc}$, $R_{BE} = 0$ ohms	$V_{CES(sus)}^*$	60		Vdc
Collector-Emitter Open Base Sustain Voltage $I_C = 30\text{mA dc}$, $I_B = 0$	$V_{CEO(sus)}^*$	40		Vdc
Collector-Emitter Cutoff Current $V_{CE} = 25\text{Vdc}$, $V_{BE} = 0$, $T_C = +150^\circ\text{C}$	I_{CES}		50	$\mu\text{A dc}$
Collector-Emitter Cutoff Current $V_{CE} = 25\text{Vdc}$, $V_{BE} = 0$	I_{CES}		0.05	$\mu\text{A dc}$
Collector-Emitter Cutoff Current $V_{CE} = 50\text{Vdc}$, $V_{BE} = 0$	I_{CES}		10	$\mu\text{A dc}$
Emitter Cutoff Current $V_{EB} = 4\text{Vdc}$, $I_C = 0$	I_{EBO}		100	$\mu\text{A dc}$
DC Current Gain $V_{CE} = 2\text{Vdc}$, $I_C = 250\text{mA dc}$ $V_{CE} = 2\text{Vdc}$, $I_C = 50\text{mA dc}$	h_{FE}	8 8	80	
Collector-Emitter Saturation Voltage $I_C = 250\text{mA dc}$, $I_B = 50\text{mA dc}$	$V_{CE(sat)}$		75	Vdc
Base-Emitter Saturation Voltage $I_C = 250\text{mA dc}$, $I_B = 50\text{mA dc}$	$V_{BE(sat)}$		1.2	Vdc
Small Signal Current Gain $V_{CE} = 15\text{Vdc}$, $I_C = 100\text{mA dc}$, $f = 100\text{mc}$	$ h_{fe} $	3		
Common Base Output Capacitance $V_{CB} = 15\text{Vdc}$, $I_E = 0$, $f = 100\text{kc}$	C_{ob}		6.0	pf
Power Output	$P_{in} = 400$ mW, $f = 250$ mc $V_{CE} = 25$ Vdc	P_{out}^{**}	2.2	Watts
Power Gain		G_{PE}	7.4	db
Efficiency		η	50	%

*Pulse width ≤ 200 μsec Duty cycle $\leq 2\%$

**In functional test P_{out} is fixed at 2.2 watts and P_{in} is monitored to be ≤ 400 mW.

THERMAL CHARACTERISTICS

Characteristic	Symbol	Maximum	Unit
Thermal Resistance - Junction to Case	θ_{JC}	35	$^\circ\text{C/W}$.
Thermal Resistance - Junction to Air	θ_{JA}	175	$^\circ\text{C/W}$.

2N3717
2N3718

$G_{PE} = 7.4 \text{ db @ 250 Mc Typ}$
 $P_O = 4 \text{ W @ 250 Mc Typ}$



CASE 79



CASE 24

NPN silicon annular transistors for power amplifier applications at UHF and VHF. Especially designed for operation from low voltage power supplies.

MAXIMUM RATINGS

Characteristic	Symbol	Rating	Unit
Collector Base Voltage	V_{CBO}	60	Vdc
Collector Emitter Voltage	V_{CES}	60	Vdc
Collector Emitter Voltage	V_{CEO}	40	Vdc
Emitter Base Voltage	V_{EBO}	4	Vdc
Collector Current (Continuous)	I_C	1.0	Adc
Base Current (Continuous)	I_B	0.2	Adc
Power Dissipation @25°C Case Temperature @25°C Ambient Temperature	P_D	2N3717 7.5 2N3718 10.0 2N3717 1.0 2N3718 1.5	Watts
Operating Junction Temperature	T_j	200	°C
Storage Temperature Range	T_{stg}	-65 to +200	
Thermal Resistance-Junction to Case	θ_{JC}	2N3717 23.3 2N3718 17.5	°C/W.
Thermal Resistance-Junction to Air	θ_{JA}	2N3717 175 2N3718 117	°C/W.

— Motorola High-Frequency Transistors —

2N3717, 2N3718 (continued)

ELECTRICAL CHARACTERISTICS ($T_A = 25^\circ\text{C}$ unless otherwise noted)

Characteristic		Symbol	Minimum	Maximum	Unit
Collector-Emitter Sustain Voltage $I_C = 50\text{mA dc}$, $R_{BE} = 0$ ohms		$V_{CES(sus)}$ *	60		Vdc
Collector-Emitter Open Base Sustain Voltage $I_C = 50\text{mA dc}$, $I_B = 0$		$V_{CEO(sus)}$ *	40		Vdc
Collector-Emitter Cutoff Current $V_{CE} = 25\text{Vdc}$, $V_{BE} = 0$, $T_C = +150^\circ\text{C}$		I_{CES}		50	$\mu\text{A dc}$
Collector-Emitter Cutoff Current $V_{CE} = 25\text{Vdc}$, $V_{BE} = 0$		I_{CES}		05	$\mu\text{A dc}$
Collector-Emitter Cutoff Current $V_{CE} = 50\text{Vdc}$, $V_{BE} = 0$		I_{CES}		10	$\mu\text{A dc}$
Emitter Cutoff Current $V_{EB} = 4\text{Vdc}$, $I_C = 0$		I_{EBO}		100	$\mu\text{A dc}$
DC Current Gain $V_{CE} = 2\text{Vdc}$, $I_C = 200\text{mA dc}$		h_{FE}	8		
Collector-Emitter Saturation Voltage $I_C = 500\text{mA dc}$, $I_B = 100\text{mA dc}$		$V_{CE(sat)}$		1.0	Vdc
Small Signal Current Gain $V_{CE} = 10\text{Vdc}$, $I_C = 150\text{mA dc}$, $f = 100\text{mc}$		$ h_{ye} $	2.5		
Common Base Output Capacitance $V_{CB} = 15\text{Vdc}$, $I_E = 0$, $f = 100\text{kc}$		C_{ob}		10	pf
Power Output	$P_{in} = 400$ mw, $f = 175$ mc $V_{CE} = 13.5$ Vdc	P_{out}^{**}	2.0		Watts
Power Gain		G_{PE}	7.0		db
Efficiency		η	60		%
Power Out	$P_{in} = 730$ mw, $f = 250$ mc $V_{CE} = 25$ Vdc	P_{out}^{**}	4.0 Typ.		Watts
Power Gain		G_{PE}	7.4 Typ.		db
Efficiency		η	70 Typ.		%

*Pulse width ≤ 200 μsec Duty cycle $\leq 2\%$

**In functional test P_{out} is fixed at specified value and P_{in} is monitored to be \leq value indicated.

2N3719
2N3720

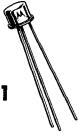

CASE 31
(TO-5)



$V_{CE0} = 40-60\text{ V}$
 $I_C = 3\text{ A}$
 $f_T = 60\text{ Mc}$

PNP silicon annular transistors for high-speed, high-current switching in core and driver applications and Class C power amplifiers.

MAXIMUM RATINGS

Characteristic	Symbol	2N3719	2N3720	Unit
Collector-Base Voltage	V_{CBO}	40	60	Volts
Collector- Emitter Voltage	V_{CEO}	40	60	Volts
Emitter-Base Voltage	V_{EBO}	4	4	Volts
Collector Current—Continuous	I_C	3	3	Amps
Collector Current—Peak		10	10	Amps
Base Current	I_B	0.5	0.5	Amp
Total Device Dissipation @ $T_A = 25^\circ\text{C}$ Derate above 25°C	P_D	1.0	5.72	Watt mW/ $^\circ\text{C}$
Total Device Dissipation @ $T_C = 25^\circ\text{C}$ Derate above 25°C	P_D	6	34.3	Watts mW/ $^\circ\text{C}$
Operating Junction and Storage Temperature Range	T_J and T_{stg}	-65 to +200		$^\circ\text{C}$

SAFE OPERATING AREAS

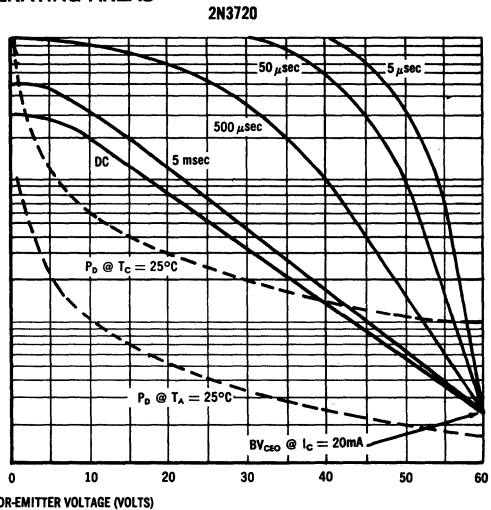
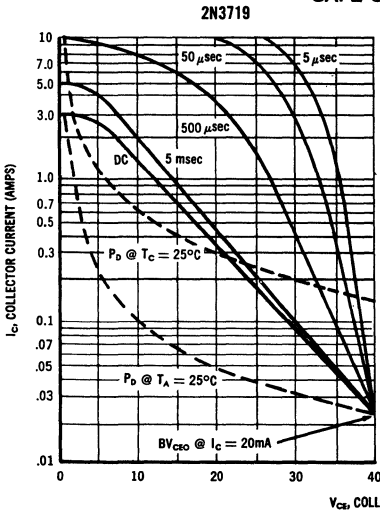

The Safe Operating Area Curves indicate I_C - V_{CE} limits below which the devices will not go into secondary breakdown. As the safe operating areas shown are independent of temperature and duty cycle, these curves can be used as long as the average power derating curve is also taken into consideration to insure operation below the maximum junction temperature.

2N3719, 2N3720 (continued)

ELECTRICAL CHARACTERISTICS (at $T_c = 25^\circ\text{C}$ unless otherwise noted)

Characteristic	Symbol	Min	Max	Unit
Collector Leakage Current ($V_{CE} = 40 \text{ Vdc}$, $V_{BE} = 2 \text{ Vdc}$) ($V_{CE} = 60 \text{ Vdc}$, $V_{BE} = 2 \text{ Vdc}$)	I_{CEX} 2N3719 2N3720	— —	10 10	μAdc
Collector-Base Cutoff Current ($V_{CB} = 40 \text{ Vdc}$, $I_E = 0$, $T_A = 25^\circ\text{C}$) ($V_{CB} = 40 \text{ Vdc}$, $I_E = 0$, $T_A = 150^\circ\text{C}$) ($V_{CB} = 60 \text{ Vdc}$, $I_E = 0$, $T_A = 25^\circ\text{C}$) ($V_{CB} = 60 \text{ Vdc}$, $I_E = 0$, $T_A = 150^\circ\text{C}$)	I_{CBO} 2N3719 2N3719 2N3720 2N3720	— — — —	.010 1 .010 1	mAdc
Emitter-Base Cutoff Current ($V_{BE} = 4 \text{ Vdc}$, $I_C = 0$)	I_{EBO}	—	1	mAdc
DC Current Gain* ($I_C = 500 \text{ mA}$, $V_{CE} = 1.5 \text{ V}$, $T_A = 25^\circ\text{C}$) ($I_C = 1 \text{ A}$, $V_{CE} = 1.5 \text{ V}$, $T_A = 25^\circ\text{C}$) ($I_C = 1 \text{ A}$, $V_{CE} = 1.5 \text{ V}$, $T_A = -40^\circ\text{C}$)	h_{FE}^*	20 25 15	— 180 —	—
Collector-Emitter Saturation Voltage* ($I_C = 1 \text{ A}$, $I_B = 100 \text{ mA}$, $T_A = -40 \text{ to } +100^\circ\text{C}$) ($I_C = 3 \text{ A}$, $I_B = 300 \text{ mA}$, $T_A = 25^\circ\text{C}$)	$V_{CE(sat)}^*$	— —	0.75 1.5	Volts
Base-Emitter Saturation Voltage* ($I_C = 1 \text{ A}$, $I_B = 100 \text{ mA}$) ($I_C = 3 \text{ A}$, $I_B = 300 \text{ mA}$)	$V_{BE(sat)}^*$	— —	1.5 2.3	Volts
Collector-Emitter Breakdown Voltage* ($I_C = 20 \text{ mA}$, $I_B = 0$)	BV_{CEO}^* 2N3719 2N3720	40 60	— —	Volts
Collector Output Capacitance ($V_{CB} = 10 \text{ Vdc}$, $I_E = 0$, $f = 100 \text{ kc}$)	C_{ob}	—	120	pf
Input Capacitance ($V_{BE} = 0.5 \text{ Vdc}$, $I_C = 0$, $f = 100 \text{ kc}$)	C_{ib}	—	1000	pf
Current-Gain — Bandwidth Product ($V_{CE} = 10 \text{ Vdc}$, $I_C = 500 \text{ mAdc}$, $f = 30 \text{ mc}$)	f_T	60	—	mc
Delay Plus Rise Time ($I_C = 1 \text{ Adc}$, $I_{B1} = 100 \text{ mA}$)	t_{on}	—	75	nsec
Storage Time ($I_C = 1 \text{ Adc}$, $I_{B1} = I_{B2} = 100 \text{ mA}$)	t_s	—	150	nsec
Fall Time ($I_C = 1 \text{ Adc}$, $I_{B1} = I_{B2} = 100 \text{ mA}$)	t_f	—	75	nsec

* Pulse Test:

Pulse Width $\leq 300 \mu\text{sec}$
Duty Cycle $\leq 2\%$

2N3719, 2N3720 (continued)

BASE-EMITTER SATURATION VOLTAGE VARIATIONS

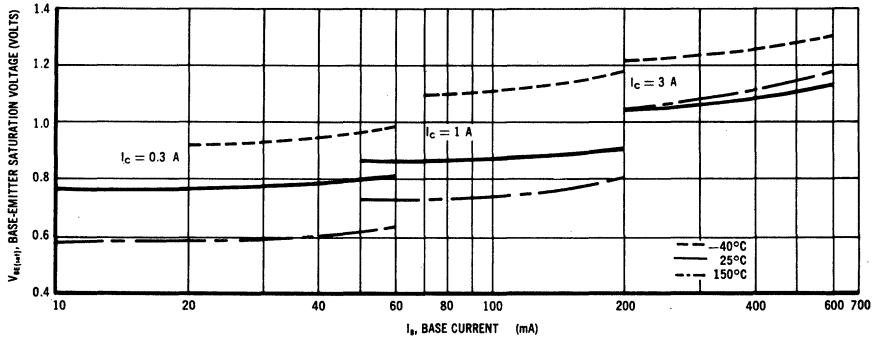

COLLECTOR-EMITTER SATURATION VOLTAGE VARIATIONS

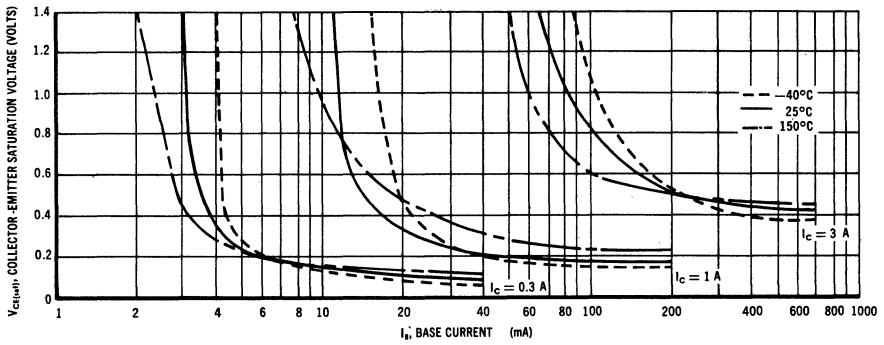

CURRENT GAIN VARIATIONS

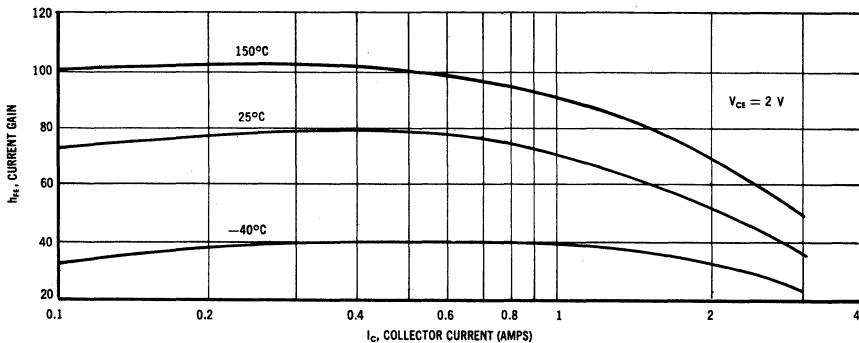

2N3742



$V_{CEO} = 300\text{ V}$
 $I_C = 50\text{ mA}$
 $f_T = 30\text{ Mc}$



CASE 31
(TO-5)

NPN silicon annular transistor for high voltage amplifier applications from DC to VHF.

MAXIMUM RATINGS

Characteristic	Symbol	Rating	Unit
Collector-Base Voltage	V_{CB}	300	Vdc
Collector-Emitter Voltage	V_{CEO}	300	Vdc
Emitter-Base Voltage	V_{EB}	10	Vdc
Collector Current	I_C	50	mAdc
Total Device Dissipation @ $T_A = 25^\circ\text{C}$ Derating Factor Above 25°C	P_D	1.0 5.71	Watt mW/ $^\circ\text{C}$
Total Device Dissipation @ $T_C = 25^\circ\text{C}$ Derating Factor Above 25°C	P_D	5 28.6	Watts mW/ $^\circ\text{C}$
Operating Junction Temperature	T_J	+200	$^\circ\text{C}$
Storage Temperature Range	T_{stg}	-65 to +200	$^\circ\text{C}$

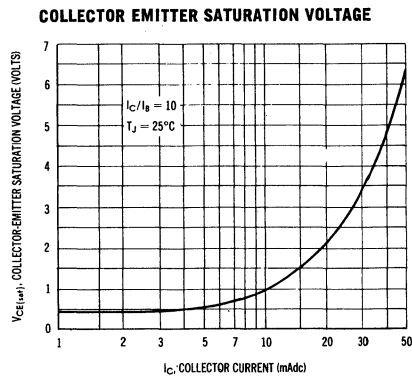
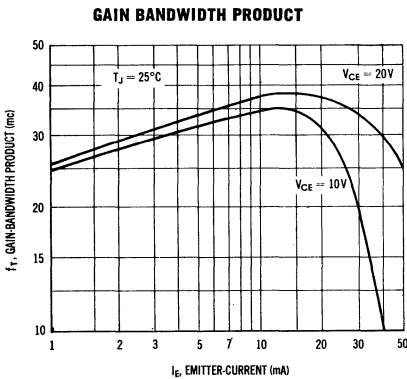

2N3742 (continued)

ELECTRICAL CHARACTERISTICS (At 25°C ambient unless otherwise noted)

Characteristic	Symbol	Min	Max	Unit
Collector-Base Breakdown Voltage ($I_C = 100 \mu\text{A}$, $I_E = 0$)	BV_{CBO}	300	—	Vdc
Collector-Emitter Breakdown Voltage* ($I_C = 10 \text{ mA}$, $I_B = 0$)	BV_{CEO}^*	300	—	Vdc
Emitter-Base Breakdown Voltage ($I_E = 100 \mu\text{A}$, $I_C = 0$)	BV_{EBO}	10	—	Vdc
Collector Saturation Voltage ** ($I_C = 10 \text{ mA}$, $I_B = 1 \text{ mA}$) ($I_C = 30 \text{ mA}$, $I_B = 3 \text{ mA}$)	$V_{CE(sat)}^{**}$	— —	1 5	Vdc
Base-Emitter Saturation Voltage ** ($I_C = 10 \text{ mA}$, $I_B = 1 \text{ mA}$) ($I_C = 30 \text{ mA}$, $I_B = 3 \text{ mA}$)	$V_{BE(sat)}^{**}$	— —	1.0 1.2	Vdc
DC Current Gain ** ($I_C = 3 \text{ mA}$, $V_{CE} = 10 \text{ V}$) ($I_C = 10 \text{ mA}$, $V_{CE} = 10 \text{ V}$) ($I_C = 30 \text{ mA}$, $V_{CE} = 10 \text{ V}$) ($I_C = 50 \text{ mA}$, $V_{CE} = 20 \text{ V}$)	h_{FE}^{**}	10 15 20 20	— — 200 —	—
Collector Cutoff Current ($V_{CB} = 200 \text{ V}$, $I_E = 0$) ($V_{CB} = 200 \text{ V}$, $I_E = 0$, $T_A = 100^\circ\text{C}$)	I_{CBO}	— —	0.2 20	μA
Emitter Cutoff Current $V_{EB} = 6 \text{ V}$, $I_C = 0$)	I_{EBO}	—	0.2	μA
Small Signal Current Gain ($V_{CE} = 20 \text{ V}$, $I_C = 10 \text{ mA}$, $f = 20 \text{ mc}$)	$ h_{fe} $	1.5	—	—
Output Capacitance ($V_{CB} = 10 \text{ V}$, $I_E = 0$, $f = 100 \text{ kc}$)	C_{ob}	—	6	pf
Input Capacitance ($V_{EB} = 0.5 \text{ V}$, $I_C = 0$, $f = 100 \text{ kc}$)	C_{ib}	—	80	pf
Small Signal Current Gain ($I_C = 10 \text{ mA}$, $V_{CE} = 10 \text{ V}$, $f = 1 \text{ kc}$)	h_{fe}	20	200	—
Voltage Feedback Ratio ($I_C = 10 \text{ mA}$, $V_{CE} = 10 \text{ V}$, $f = 1 \text{ kc}$)	h_{re}	—	1.0	$\times 10^{-4}$
Input Impedance ($I_C = 10 \text{ mA}$, $V_{CE} = 10 \text{ V}$, $f = 1 \text{ kc}$)	h_{ie}	—	0.5	Kohms
Output Admittance ($I_C = 10 \text{ mA}$, $V_{CE} = 10 \text{ V}$, $f = 1 \text{ kc}$)	h_{oe}	5	50	μmhos
Real Part of Input Impedance ($I_C = 10 \text{ mA}$, $V_{CE} = 10 \text{ V}$, $f = 5 \text{ mc}$)	$\text{Re}(h_{ie})$	—	40	ohms

*PW $\leq 30 \mu\text{sec}$, Duty Cycle $\leq 1\%$

**PW $\leq 300 \mu\text{sec}$, Duty Cycle $\leq 2\%$

2N3742 (continued)

INPUT ADMITTANCE

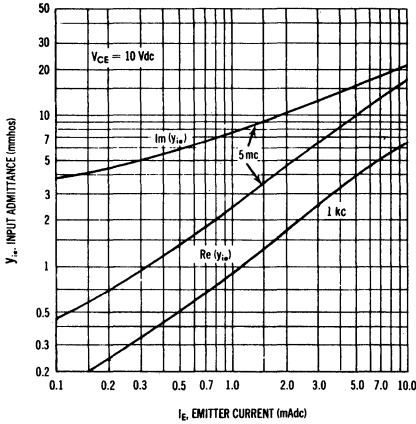

REVERSE TRANSFER ADMITTANCE

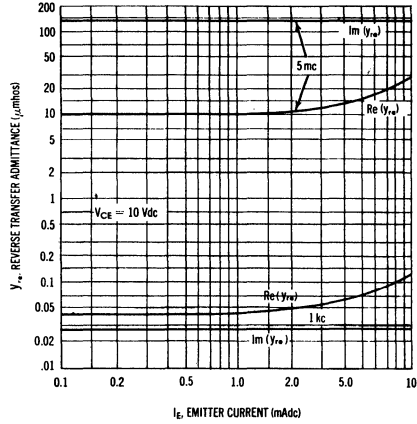

FORWARD TRANSFER ADMITTANCE

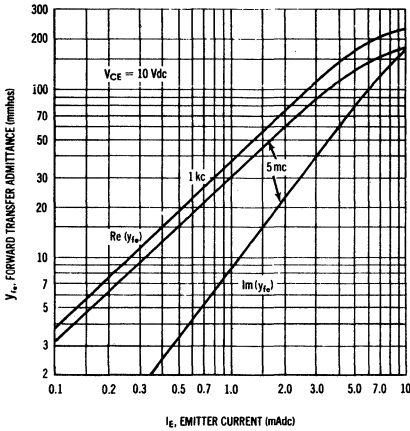

OUTPUT ADMITTANCE

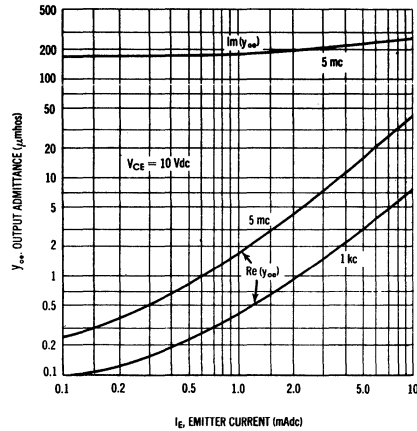

CURRENT GAIN CHARACTERISTICS versus COLLECTOR EMITTER VOLTAGE

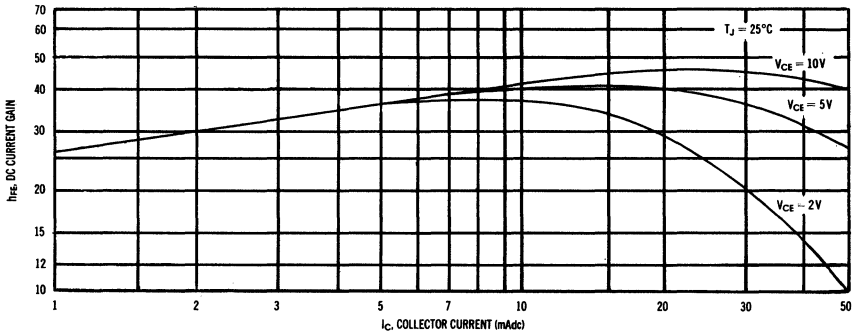

2N3743



CASE 31
(TO-5)

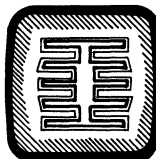

$V_{CEO} = 300\text{ V}$
 $I_C = 50\text{ mA}$
 $f_T = 30\text{ Mc}$

PNP silicon annular transistor for high voltage amplifier applications from DC to VHF.

MAXIMUM RATINGS

Characteristic	Symbol	Rating	Unit
Collector-Base Voltage	V_{CB}	300	Vdc
Collector-Emitter Voltage	V_{CEO}	300	Vdc
Emitter-Base Voltage	V_{EB}	5	Vdc
Collector Current	I_C	50	mAdc
Total Device Dissipation @ $T_A = 25^\circ\text{C}$ Derate Above 25°C	P_D	1.0 5.7	Watt mW/ $^\circ\text{C}$
Total Device Dissipation @ $T_C = 25^\circ\text{C}$ Derate Above 25°C	P_D	5.0 28.6	Watts mW mW/ $^\circ\text{C}$
Operating Junction Temperature	T_J	+200	$^\circ\text{C}$
Storage Temperature Range	T_{stg}	-65 to +200	$^\circ\text{C}$

GAIN BANDWIDTH PRODUCT

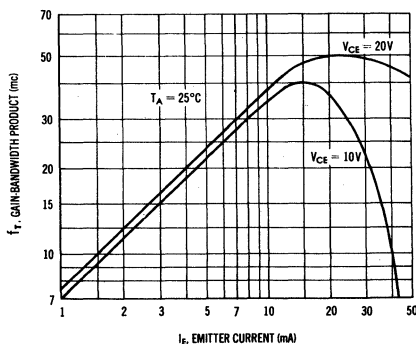

COLLECTOR-EMITTER SATURATION VOLTAGE

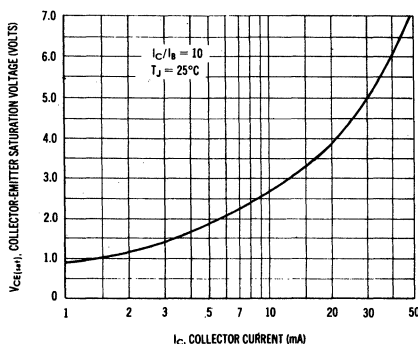

2N3743 (continued)

ELECTRICAL CHARACTERISTICS ($T_A = 25^\circ\text{C}$ unless otherwise specified)

Characteristic	Symbol	Min	Max	Unit
Collector-Base Breakdown Voltage ($I_C = 100 \mu\text{A dc}$, $I_E = 0$)	BV_{CBO}	300	—	Vdc
Collector-Emitter Breakdown Voltage* ($I_C = 10 \text{ mA dc}$, $I_B = 0$)	BV_{CEO}^*	300	—	Vdc
Emitter-Base Breakdown Voltage ($I_E = 100 \mu\text{A dc}$, $I_C = 0$)	BV_{EBO}	5	—	Vdc
Collector Saturation Voltage** ($I_C = 10 \text{ mA dc}$, $I_B = 1 \text{ mA dc}$) ($I_C = 30 \text{ mA dc}$, $I_B = 3 \text{ mA dc}$)	$V_{CE(sat)}^{**}$	— —	5 8	Vdc
Base-Emitter Saturation Voltage** ($I_C = 10 \text{ mA dc}$, $I_B = 1 \text{ mA dc}$) ($I_C = 30 \text{ mA dc}$, $I_B = 3 \text{ mA dc}$)	$V_{BE(sat)}^{**}$	— —	1.0 1.2	Vdc
DC Forward Current Gain** ($I_C = 100 \mu\text{A dc}$, $V_{CE} = 10 \text{ V dc}$) ($I_C = 1 \text{ mA dc}$, $V_{CE} = 10 \text{ V dc}$) ($I_C = 10 \text{ mA dc}$, $V_{CE} = 10 \text{ V dc}$) ($I_C = 30 \text{ mA dc}$, $V_{CE} = 10 \text{ V dc}$) ($I_C = 50 \text{ mA dc}$, $V_{CE} = 20 \text{ V dc}$)	h_{FE}^{**}	20 25 25 25 25	— — — 250 —	—
Collector Cutoff Current ($V_{CB} = 200 \text{ V dc}$, $I_E = 0$) ($V_{CB} = 200 \text{ V dc}$, $I_E = 0$, $T_A = 100^\circ\text{C}$)	I_{CBO}	— —	0.3 30	$\mu\text{A dc}$
Emitter-Base Leakage Current ($V_{EB} = 3 \text{ V dc}$, $I_C = 0$)	I_{EBO}	—	0.1	$\mu\text{A dc}$
Small-Signal Current Gain ($I_C = 10 \text{ mA dc}$, $V_{CE} = 20 \text{ V dc}$, $f = 20 \text{ mc}$)	$ h_{fe} $	1.5	—	—
Output Capacitance ($V_{CB} = 20 \text{ V dc}$, $I_E = 0$, $f = 100 \text{ kc}$)	C_{ob}	—	15	pf
Input Capacitance ($V_{EB} = 1 \text{ V dc}$, $I_C = 0$, $f = 100 \text{ kc}$)	C_{ib}	—	400	pf
Small Signal Current Gain ($V_{CE} = 10 \text{ V}$, $I_C = 10 \text{ mA}$, $f = 1 \text{ kc}$)	h_{fe}	30	300	—
Voltage Feedback Ratio ($V_{CE} = 10 \text{ V}$, $I_C = 10 \text{ mA}$, $f = 1 \text{ kc}$)	h_{re}	—	4.0	$\times 10^{-4}$
Input Impedance ($V_{CE} = 10 \text{ V}$, $I_C = 10 \text{ mA}$, $f = 1 \text{ kc}$)	h_{ie}	—	1.0	kohms
Output Admittance ($V_{CE} = 10 \text{ V}$, $I_C = 10 \text{ mA}$, $f = 1 \text{ kc}$)	h_{oe}	20	100	μmhos
Real Part of Input Impedance ($I_C = 10 \text{ mA dc}$, $V_{CE} = 10 \text{ V dc}$, $f = 5 \text{ mc}$)	$\text{Re}(h_{ie})$	—	40	ohms

*PW $\leq 30 \mu\text{sec}$, Duty Cycle $\leq 1\%$

**PW $\leq 300 \mu\text{sec}$, Duty Cycle $\leq 2\%$

2N3743 (continued)

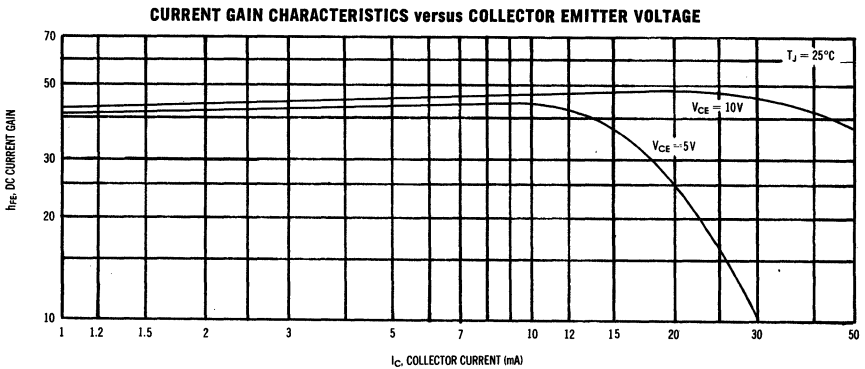
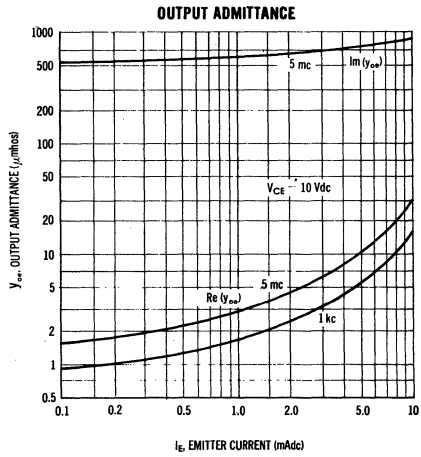
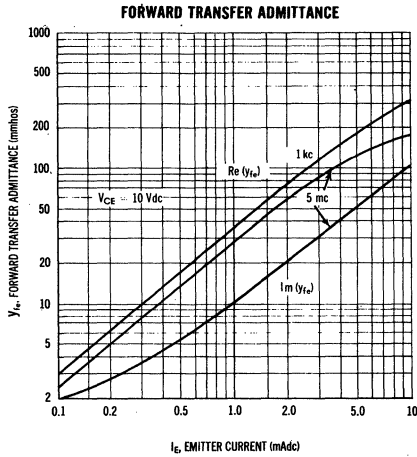
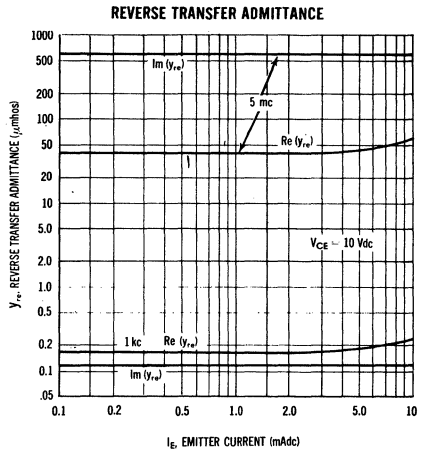
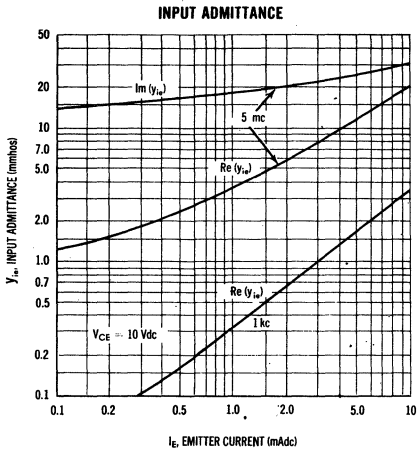

2N3783 thru 2N3785

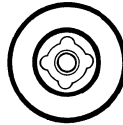

$V_{CBO} = 15-30 \text{ V}$
 $G_o = 18-20 \text{ db @ } 200 \text{ Mc}$
 $NF = 2.2-2.9 \text{ db @ } 200 \text{ Mc}$



PNP germanium epitaxial mesa transistors for high-gain, low-noise amplifier, oscillator and frequency multiplier applications.

CASE 22
(TO-18)

MAXIMUM RATINGS

Characteristics	Symbol	2N3783 2N3784	2N3785	Unit
Collector-Base Voltage	V_{CBO}	30	15	Vdc
Collector-Emitter Voltage	V_{CES}	30	15	Vdc
Collector-Emitter Voltage	V_{CEO}	20	12	Vdc
Emitter-Base Voltage	V_{EBO}	0.5		Vdc
Collector Current	I_C	20		mAdc
Total Device Dissipation @ $T_A = 25^\circ\text{C}$ Derate above 25°C	P_D	150	2	mW mW/ $^\circ\text{C}$
Junction Operating & Storage Temperature Range	$T_J,$ T_{stg}	-65 to +100		$^\circ\text{C}$

200 MC POWER GAIN AND NOISE FIGURE TEST CIRCUIT

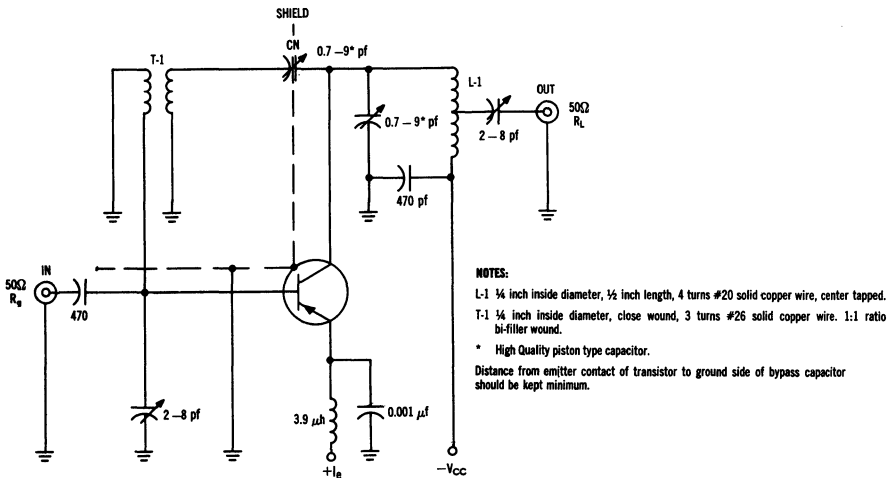

2N3783 thru 2N3785 (continued)

ELECTRICAL CHARACTERISTICS ($T_A = 25^\circ\text{C}$ unless otherwise noted)

Characteristics	Symbol	Test Conditions	Min	Typ	Max	Unit
Collector-Base Breakdown Voltage	V_{CBO}	$I_C = -100 \mu\text{Adc}, I_E = 0$ 2N3783, 2N3784 2N3785	-30 -15	— —	— —	Vdc
Collector-Emitter Breakdown Voltage	V_{CES}	$I_C = -100 \mu\text{Adc}, V_{EB} = 0$ 2N3783, 2N3784 2N3785	-30 -15	— —	— —	Vdc
Collector-Emitter Breakdown Voltage	V_{CEO}	$I_C = -2 \text{ mAdc}, I_B = 0$ 2N3783, 2N3784 2N3785	-20 -12	— —	— —	Vdc
Emitter-Base Breakdown Voltage	V_{EBO}	$I_E = -100 \mu\text{Adc}, I_C = 0$ All Types	-0.5	—	—	Vdc
Collector Cutoff Current	I_{CBO}	$V_{CB} = -10 \text{ Vdc}, I_E = 0$ $V_{CB} = -10 \text{ Vdc}, I_E = 0, T_A = +55^\circ\text{C}$ All Types 2N3783, 2N3784	— —	— —	-5 -50	μAdc
Emitter Cutoff Current	I_{EBO}	$V_{EB} = -0.5 \text{ Vdc}, I_C = 0$ All Types	—	—	-100	μAdc
DC Forward Current Transfer Ratio	h_{FE}	$V_{CE} = -10 \text{ Vdc}, I_C = -3 \text{ mAdc}$ 2N3783, 2N3784 2N3785	20 15	— —	200 200	—
Collector-Emitter Saturation Voltage	$V_{CE(sat)}$	$I_C = -5.0 \text{ mAdc}, I_B = -1.0 \text{ mAdc}$ 2N3783, 2N3784 2N3785	— —	— —	-0.25 -0.35	Vdc
Base-Emitter Saturation Voltage	$V_{BE(sat)}$	$I_C = -5.0 \text{ mAdc}, I_B = -1.0 \text{ mAdc}$ 2N3783, 2N3784 2N3785	— —	— —	-0.55 -0.65	Vdc
Small-Signal Forward Current Transfer Ratio	h_{fe}	$I_C = -3 \text{ mAdc}, V_{CE} = -10 \text{ Vdc}, f = 1 \text{ kc}$ 2N3783, 2N3784 2N3785	20 15	— —	200 200	—
Current Gain - Bandwidth Product	f_T	$I_C = -3 \text{ mAdc}, V_{CE} = -10 \text{ Vdc}, f = 200 \text{ mc}$ 2N3783 2N3784, 2N3785	800 700	— —	1600 1600	mc
Collector-Base Time Constant	$r_b' C_c$	$V_{CB} = -10 \text{ Vdc}, I_E = +3 \text{ mAdc}, f = 31.8 \text{ mc}$ 2N3783, 2N3784 2N3785	1 1	— —	6 10	psec
Collector-Base Capacitance	C_{ob}	$V_{CB} = -10 \text{ Vdc}, I_E = 0, f = 100 \text{ kc}$ 2N3783, 2N3784 2N3785	— —	— —	1.0 1.2	pf
Power Gain	G_e	$V_{CE} = -10 \text{ Vdc}, I_C = -3 \text{ mAdc}, f = 200 \text{ mc}$ 2N3783, 2N3784 2N3785	20 18	— —	33 33	db
Noise Figure	NF	$V_{CE} = -10 \text{ Vdc}, I_C = -3 \text{ mAdc}, f = 200 \text{ mc}$ $R_G = 50 \text{ ohms}$ 2N3783 2N3784 2N3785	— — —	— — —	2.2 2.5 2.9	db
Power Gain (AGC) Note 1	$G_e(\text{AGC})$	$V_{CE} = -10 \text{ Vdc}, I_C = -15 \text{ mAdc}, f = 200 \text{ mc}$ 2N3783 2N3784, 2N3785	— —	— 0	0 —	db
Noise Figure	NF	$V_{CE} = -10 \text{ Vdc}, I_C = -3 \text{ mAdc}, f = 1000 \text{ mc}$ $R_G = 50 \text{ ohms}$ (Note 2) 2N3783 2N3784 2N3785	— — —	— 7.0 7.5	6.5 — —	db

NOTE 1: AGC is obtained by increasing I_C . The circuit remains adjusted for $V_{CE} = -10 \text{ Vdc}$ and $I_C = -3 \text{ mAdc}$.

NOTE 2: This Noise Figure was obtained using Hewlett-Packard Type 342A Noise Figure Meter and Type 349A Noise Source.

2N3783 thru 2N3785 (continued)

GAIN versus COLLECTOR CURRENT

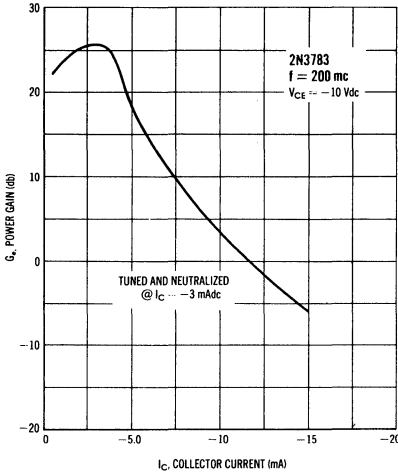

CONTOURS OF CURRENT-GAIN BANDWIDTH PRODUCT — f_T

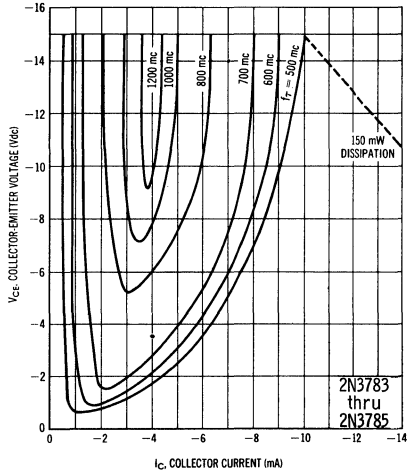

MAG & MAXIMUM NF versus FREQUENCY

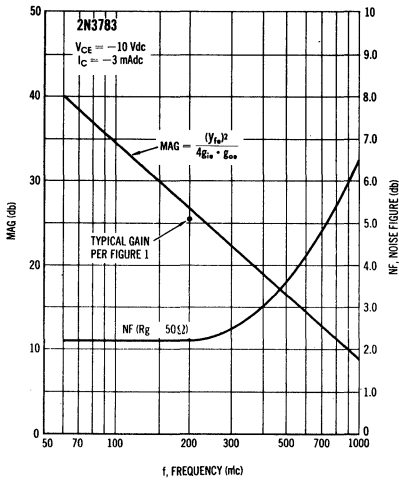

NOISE FIGURE versus SOURCE RESISTANCE

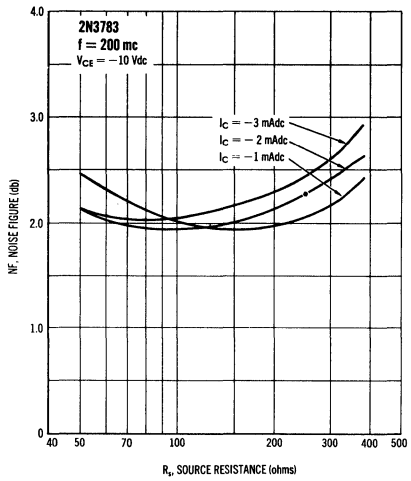

2N3798
2N3799

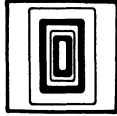

$V_{CE0} = 60\text{ V}$
 $I_C = 50\text{ mA}$
 $H_{FE} = 150 \text{ \& } 300 \text{ min. @ } 100\text{ }\mu\text{A}$
 $NF = 1.5\text{-}2.5 \text{ db @ } 10\text{ kc}$

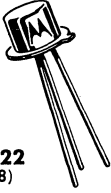

CASE 22
(TO-18)

PNP silicon annular transistors for low-level, low-noise amplifier applications.

MAXIMUM RATINGS

Characteristics	Symbol	Rating	Unit
Collector-Base Voltage	V_{CBO}	60	Vdc
Collector-Emitter Voltage	V_{CEO}	60	Vdc
Emitter-Base Voltage	V_{EBO}	5	Vdc
Collector Current	I_C	50	mAdc
Total Device Dissipation @ $T_C = 25^\circ\text{C}$ Derating Factor Above 25°C	P_D	1.2 6.9	Watts mW/ $^\circ\text{C}$
Total Device Dissipation @ $T_A = 25^\circ\text{C}$ Derating Factor Above 25°C	P_D	0.36 2.06	Watt mW/ $^\circ\text{C}$
Junction Operating Temperature	T_J	200	$^\circ\text{C}$
Storage Temperature Range	T_{stg}	-65 to +200	$^\circ\text{C}$

NOISE FIGURE versus FREQUENCY AND SOURCE RESISTANCE

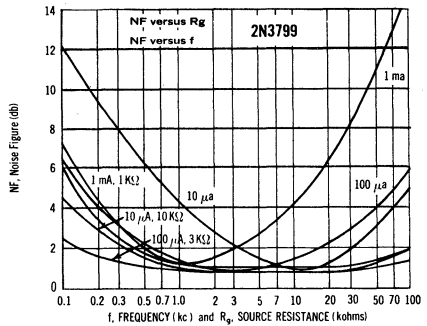
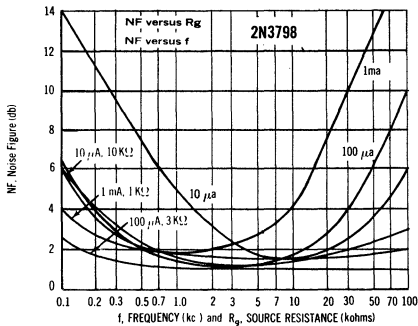

2N3798, 2N3799 (continued)

ELECTRICAL CHARACTERISTICS (At 25°C unless otherwise noted)

Characteristics	Symbol	Min	Typ	Max	Unit
Collector-Base Breakdown Voltage ($I_C = 10 \mu\text{A dc}$, $I_E = 0$)	BV_{CBO}	60	—	—	Vdc
Collector-Emitter Breakdown Voltage ($I_C = 10 \text{ mA dc}$, $I_B = 0$)	BV_{CEO}	60	90	—	Vdc
Emitter-Base Breakdown Voltage ($I_E = 10 \mu\text{A dc}$, $I_C = 0$)	BV_{EBO}	5	—	—	Vdc
Collector Cutoff Current ($V_{CB} = 50 \text{ Vdc}$, $I_E = 0$) ($V_{CE} = 50 \text{ Vdc}$, $I_E = 0$, $T_A = 150^\circ\text{C}$)	I_{CBO}	—	—	.010 10	$\mu\text{A dc}$
Emitter Cutoff Current ($V_{OB} = 4 \text{ Vdc}$, $I_C = 0$)	I_{EBO}	—	—	20	nA dc
Collector-Emitter Saturation Voltage* ($I_C = 100 \mu\text{A dc}$, $I_B = 10 \mu\text{A dc}$) ($I_C = 1 \text{ mA dc}$, $I_B = 100 \mu\text{A dc}$)	$V_{CE(sat)}^*$	—	—	0.2 0.25	Vdc
Base-Emitter Saturation Voltage* ($I_C = 100 \mu\text{A dc}$, $I_B = 10 \mu\text{A dc}$) ($I_C = 1 \text{ mA dc}$, $I_B = 100 \mu\text{A dc}$)	$V_{BE(sat)}^*$	—	—	0.7 0.8	Vdc
DC Forward Current Transfer Ratio* ($I_C = 1 \mu\text{A dc}$, $V_{CE} = 5 \text{ Vdc}$) ($I_C = 10 \mu\text{A dc}$, $V_{CE} = 5 \text{ Vdc}$) ($I_C = 100 \mu\text{A dc}$, $V_{CE} = 5 \text{ Vdc}$) ($I_C = 100 \mu\text{A dc}$, $V_{CE} = 5 \text{ Vdc}$, $T_A = -55^\circ\text{C}$) ($I_C = 500 \mu\text{A dc}$, $V_{CE} = 5 \text{ Vdc}$) ($I_C = 1 \text{ mA dc}$, $V_{CE} = 5 \text{ Vdc}$) ($I_C = 10 \text{ mA dc}$, $V_{CE} = 5 \text{ Vdc}$)	h_{FE}^*	75 100 225 150 300 75 150 150 300 300 150 300 125 250	— — — — — — — — — — — — — —	— — — — — — — — 450 900 — — — — —	—
Base Emitter "ON" Voltage ($I_C = 100 \mu\text{A dc}$, $V_{CE} = 5 \text{ V}$)	$V_{BE(ON)}$	—	—	0.7	Vdc
Output Capacitance ($V_{CB} = 5 \text{ Vdc}$, $I_E = 0$, $f = 100 \text{ kc}$)	C_{ob}	—	—	4	pf
Input Capacitance ($V_{OB} = 0.5 \text{ Vdc}$, $I_C = 0$, $f = 100 \text{ kc}$)	C_{ib}	—	—	8	pf
Small Signal Current Gain ($I_C = 500 \mu\text{A}$, $V_{CE} = 5 \text{ V}$, $f = 30 \text{ mc}$) ($I_C = 1 \text{ mA}$, $V_{CE} = 5 \text{ V}$, $f = 100 \text{ mc}$) ($I_C = 1 \text{ mA}$, $V_{CE} = 10 \text{ V}$, $f = 1 \text{ kc}$)	h_{fe}	1.0 1.0 150 300	— — — —	— — 600 900	—
Voltage Feedback Ratio ($I_C = 1.0 \text{ mA}$, $V_{CE} = 10 \text{ V}$, $f = 1 \text{ kc}$)	h_{re}	—	—	25	$\times 10^{-4}$
Input Impedance ($I_C = 1.0 \text{ mA}$, $V_{CE} = 10 \text{ V}$, $f = 1 \text{ kc}$)	h_{ie}	3 10	— —	25 40	k ohms
Output Admittance ($I_C = 1.0 \text{ mA}$, $V_{CE} = 10 \text{ V}$, $f = 1 \text{ kc}$)	h_{oe}	—	—	60	μmhos
Noise Figure ($I_C = 100 \mu\text{A}$, $V_{CE} = 10 \text{ V}$, $R_G = 3 \text{ K}$), $f = 100 \text{ cps}$ $f = 1 \text{ kc}$ $f = 10 \text{ kc}$ Noise Bandwidth 10 cps to 15.7 kc	NF	— — — — — — —	4 2.5 1.5 0.8 1.0 0.8 2.5	7 4 3 1.5 2.5 1.5 3.5	db

* Pulse Test $\leq 300 \mu\text{sec}$, duty cycle $\leq 2\%$ V_{OB} - Base-Emitter Reverse Bias

2N3818

$G_{PE} = 7 \text{ db @ } 100 \text{ Mc Typ}$
 $P_o = 15 \text{ W @ } 100 \text{ Mc}$



NPN silicon annular transistor for high-frequency power applications to 150 Mc.

CASE 36
(TO-60)

MAXIMUM RATINGS

Characteristic	Symbol	Rating	Unit
Collector-Base Voltage	V_{CBO}	60	Vdc
Collector-Emitter Voltage	V_{CES}	60	Vdc
Emitter-Base Voltage	V_{EB}	4	Vdc
Collector-Current (continuous)	I_C	2.0	Adc
Base-Current (continuous)	I_B	1.0	mAdc
Power Input (Nominal)	P_{in}	5.0	Watts
Power Output (Nominal)	P_{out}	20.0	Watts
Total Device Dissipation @ 25°C Case Temperature	P_D	25.0	Watts
Derating Factor above 25°C		167	mW/°C
Junction Temperature	T_J	175	°C
Storage Temperature	T_{stg}	-65 to +175	°C

Note 1. The maximum ratings as given for DC conditions can be exceeded on a pulse basis. See electrical characteristics.

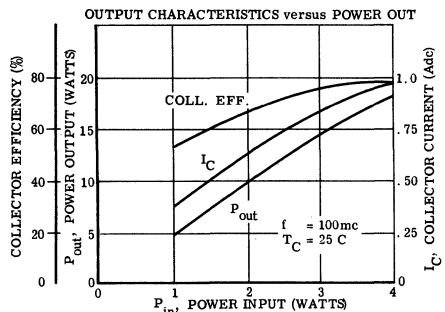
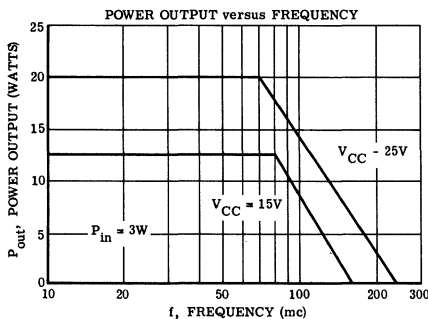

2N3818 (continued)

ELECTRICAL CHARACTERISTICS (at 25°C case temperature unless otherwise noted)

Characteristic	Symbol	Minimum	Typical	Maximum	Unit
Collector-Emitter Sustain Voltage $I_C = 0.25 \text{ Adc}$, $R_{BE} = 0$	$V_{CES(sus)*}$	8C	100	--	Vdc
Collector-Emitter-Open Base Sustain Voltage $I_C = 0.25 \text{ Adc}$, $I_B = 0$	$V_{CEO(sus)*}$	40	--	--	Vdc
Collector-Emitter Current $V_{CE} = 60 \text{ Vdc}$, $V_{BE} = 0$ $V_{CE} = 50 \text{ Vdc}$, $V_{BE} = 0$, $T_C = 175^\circ\text{C}$	I_{CES}	--	--	0.5 1.0	mAdc
Collector Cutoff Current $V_{CB} = 50 \text{ Vdc}$, $I_E = 0$	I_{CBO}	--	--	1	μAdc
Emitter Cutoff Current $V_{EB} = 4 \text{ Vdc}$, $I_C = 0$	I_{EBO}	--	--	100	μAdc
DC Current Gain $I_C = 400 \text{ mAdc}$, $V_{CE} = 2 \text{ Vdc}$ $I_C = 1 \text{ Adc}$, $V_{CE} = 2 \text{ Vdc}$	h_{FE}	5.0 5.0	--	50 --	
Collector-Emitter Saturation Voltage $I_C = 1.0 \text{ Adc}$, $I_B = 250 \text{ mAdc}$	$V_{CE(sat)}$	--	--	0.5	Vdc
Base-Emitter Saturation Voltage $I_C = 1.0 \text{ Adc}$, $I_B = 250 \text{ mAdc}$	$V_{BE(sat)}$	--	--	2.0	Vdc
AC Current Gain $V_{CE} = 2.0 \text{ Vdc}$, $I_C = 400 \text{ mAdc}$, $f = 50 \text{ mc}$	$ h_{fe} $	3	--	--	
Collector Output Capacitance $V_{CB} = 25 \text{ Vdc}$, $I_E = 0$, $f = 100 \text{ kc}$	C_{ob}	--	--	40	pf
Power Input $P_{out} = 15 \text{ W}$, $f = 100 \text{ mc}$	P_{in}	--	3.0	3.75	Watts
Efficiency $V_{CE} = 25 \text{ Vdc}$ $I_{C(max.)} = 1 \text{ Adc}$	η	60	70	--	%

*Pulse Measurement: Pulse Width $\leq 100 \mu\text{sec}$, Duty Cycle = 2%.

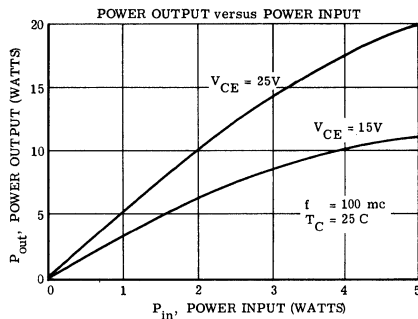
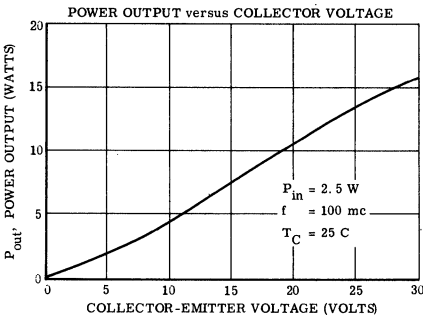

MCS2135, MCS2136

$V_{CEO} = 60\text{ V}$
 $I_C = 50\text{ mA}$
 $C_{ob} = 3\text{ pf}$
 $NF = 3-4\text{ db @ } 15.7\text{ kc}$

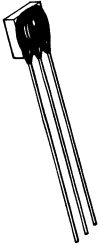

NPN silicon annular transistors in a micro-ceramic package for general-purpose, low-current switching and amplifier applications.

CASE 37

MAXIMUM RATINGS

Characteristic	Symbol	Maximum	Unit
Collector-Base Voltage	V_{CBO}	75	Vdc
Collector-Emitter Voltage	V_{CEO}	60	Vdc
Emitter-Base Voltage	V_{EBO}	6	Vdc
Collector Current	I_C	50	mAdc
Total Device Dissipation @ $T_A = 25^\circ\text{C}$	P_D	150	mW
Derating Factor Above 25°C		1.5	mW/ $^\circ\text{C}$
Junction Temperature, Operating	T_J	+125	$^\circ\text{C}$
Storage Temperature Range	T_{stg}	-65 to +125	$^\circ\text{C}$

MCS2135, MCS2136 (continued)

ELECTRICAL CHARACTERISTICS (25°C Ambient unless otherwise noted)

Characteristic	Symbol	Minimum	Maximum	Unit
Collector-Base Breakdown Voltage ($I_C = 10 \mu\text{Adc}$, $I_E = 0$)	BV_{CBO}	75	-	Vdc
Collector-Emitter Breakdown Voltage* ($I_C = 10 \text{ mAdc}$, $I_B = 0$)	BV_{CEO}^*	60	-	Vdc
Emitter-Base Breakdown Voltage ($I_E = 10 \mu\text{Adc}$, $I_C = 0$)	BV_{EBO}	6	-	Vdc
Collector Cutoff Current ($V_{CB} = 50 \text{ Vdc}$, $I_E = 0$) ($V_{CB} = 50 \text{ Vdc}$, $I_E = 0$, $T_A = 100^\circ\text{C}$)	I_{CBO}	-	.010 2.0	μAdc
Emitter Cutoff Current ($V_{EB} = 5 \text{ Vdc}$, $I_C = 0$)	I_{EBO}	-	20	nAdc
DC Current Gain* ($I_C = 1 \mu\text{Adc}$, $V_{CE} = 5 \text{ Vdc}$) ($I_C = 10 \mu\text{Adc}$, $V_{CE} = 5 \text{ Vdc}$) ($I_C = 10 \mu\text{Adc}$, $V_{CE} = 5 \text{ Vdc}$) ($I_C = 10 \mu\text{Adc}$, $V_{CE} = 5 \text{ Vdc}$, $T_A = -55^\circ\text{C}$) ($I_C = 1.0 \text{ mAdc}$, $V_{CE} = 5 \text{ Vdc}$) ($I_C = 10 \text{ mAdc}$, $V_{CE} = 5 \text{ Vdc}$)	h_{FE}^*	30 40 100 100 250 50 125 150 250 150 250	- - - 300 750 - - - - - -	-
Collector-Emitter Saturation Voltage* ($I_C = 10 \mu\text{Adc}$, $I_B = 10 \mu\text{Adc}$) ($I_C = 1.0 \text{ mAdc}$, $I_B = 100 \mu\text{Adc}$)	$V_{CE(sat)}^*$	- -	0.3 0.5	Vdc
Base-Emitter Saturation Voltage* ($I_C = 100 \mu\text{Adc}$, $I_B = 10 \mu\text{Adc}$) ($I_C = 1.0 \text{ mAdc}$, $I_B = 100 \mu\text{Adc}$)	$V_{BE(sat)}^*$	- -	0.7 1.0	Vdc
Base-Emitter On Voltage ($I_C = 100 \mu\text{Adc}$, $V_{CE} = 5.0 \text{ Vdc}$)	$V_{BE(on)}$	-	0.7	Vdc
High-Frequency Current Gain ($I_C = 500 \mu\text{Adc}$, $V_{CE} = 5 \text{ Vdc}$, $f = 30 \text{ mc}$) ($I_C = 1.0 \text{ mAdc}$, $V_{CE} = 5 \text{ Vdc}$, $f = 100 \text{ mc}$)	h_{fe}	1.0 1.0	- -	-
Output Capacitance ($V_{CB} = 5.0 \text{ Vdc}$, $I_E = 0$, $f = 100 \text{ kc}$)	C_{ob}	-	3.0	pf
Input Capacitance ($V_{EB} = 0.5 \text{ Vdc}$, $I_C = 0$, $f = 100 \text{ kc}$)	C_{ib}	-	8.0	pf
Small Signal Current Gain ($I_C = 1.0 \text{ mAdc}$, $V_{CE} = 5.0 \text{ Vdc}$, $f = 1 \text{ kc}$)	h_{fe}	80 150	450 900	-
Input Impedance ($I_C = 1.0 \text{ mAdc}$, $V_{CE} = 5.0 \text{ Vdc}$, $f = 1 \text{ kc}$)	h_{ie}	3 5	20 25	kohms
Voltage Feedback Ratio ($I_C = 1.0 \text{ mAdc}$, $V_{CE} = 5.0 \text{ Vdc}$, $f = 1 \text{ kc}$)	h_{re}	-	25	$\times 10^{-4}$
Output Admittance ($I_C = 1.0 \text{ mAdc}$, $V_{CE} = 5.0 \text{ Vdc}$, $f = 1 \text{ kc}$)	h_{oe}	-	50	μmhos
Noise Figure (Power Bandwidth = 15.7 kc) ($I_C = 10 \mu\text{Adc}$, $V_{CE} = 5 \text{ Vdc}$, $R_g = 10 \text{ kohms}$)	NF	- -	4 3	db

*Pulse Test: PW \leq 300 μsec , Duty Cycle \leq 2%

MCS2137, MCS2138

**$V_{CEO} = 60\text{ V}$
 $I_C = 50\text{ mA}$
 $C_{ob} = 3\text{ pf}$
 $NF = 3-4\text{ db @ } 15.7\text{ kc}$**

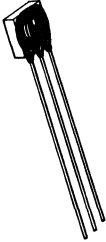

PNP silicon annular transistors in a micro-ceramic package for general-purpose, low-current switching and amplifier applications.

CASE 37

MAXIMUM RATINGS

Characteristic	Symbol	Maximum	Unit
Collector-Base Voltage	V_{CBO}	60	Vdc
Collector-Emitter Voltage	V_{CEO}	60	Vdc
Emitter-Base Voltage	V_{EBO}	5	Vdc
Collector Current	I_C	50	mAdc
Total Device Dissipation @ $T_A = 25^\circ\text{C}$	P_D	150	mW
Derating Factor Above 25°C		1.5	mW/ $^\circ\text{C}$
Junction Temperature, Operating	T_J	+125	$^\circ\text{C}$
Storage Temperature Range	T_{stg}	-65 to +125	$^\circ\text{C}$

MCS2137, MCS2138 (continued)

ELECTRICAL CHARACTERISTICS (25°C Ambient unless otherwise noted)

Characteristic	Symbol	Minimum	Maximum	Unit
Collector-Base Breakdown Voltage ($I_C = 10 \mu\text{Adc}$, $I_E = 0$)	BV_{CBO}	60	-	Vdc
Collector-Emitter Breakdown Voltage* ($I_C = 10 \text{ mAdc}$, $I_B = 0$)	BV_{CEO}^*	60	-	Vdc
Emitter-Base Breakdown Voltage ($I_E = 10 \mu\text{Adc}$, $I_C = 0$)	BV_{EBO}	5	-	Vdc
Collector Cutoff Current ($V_{CB} = 50 \text{ Vdc}$, $I_E = 0$) ($V_{CB} = 50 \text{ Vdc}$, $I_E = 0$, $T_A = 100^\circ\text{C}$)	I_{CBO}	-	.020 2.0	μAdc
Emitter Cutoff Current ($V_{EB} = 5 \text{ Vdc}$, $I_C = 0$)	I_{EBO}	-	20	nAdc
DC Current Gain* ($I_C = 1 \mu\text{Adc}$, $V_{CE} = 5 \text{ Vdc}$) ($I_C = 10 \mu\text{Adc}$, $V_{CE} = 5 \text{ Vdc}$) ($I_C = 10 \mu\text{Adc}$, $V_{CE} = 5 \text{ Vdc}$) ($I_C = 10 \mu\text{Adc}$, $V_{CE} = 5 \text{ Vdc}$, $T_A = -55^\circ\text{C}$) ($I_C = 1.0 \text{ mAdc}$, $V_{CE} = 5 \text{ Vdc}$) ($I_C = 10 \text{ mAdc}$, $V_{CE} = 5 \text{ Vdc}$)	h_{FE}^* MCS2138 MCS2137 MCS2138 MCS2137 MCS2138 MCS2137 MCS2138 MCS2137 MCS2138	50 75 200 100 250 50 125 100 250 100 250	- - - 300 750 - - - - - - -	-
Collector-Emitter Saturation Voltage* ($I_C = 10 \mu\text{Adc}$, $I_B = 10 \mu\text{Adc}$) ($I_C = 1.0 \text{ mAdc}$, $I_B = 100 \mu\text{Adc}$)	$V_{CE(sat)}^*$	-	0.20 0.25	Vdc
Base-Emitter Saturation Voltage* ($I_C = 100 \mu\text{Adc}$, $I_B = 10 \mu\text{Adc}$) ($I_C = 1.0 \text{ mAdc}$, $I_B = 100 \mu\text{Adc}$)	$V_{BE(sat)}^*$	-	0.7 0.8	Vdc
Base-Emitter On Voltage ($I_C = 100 \mu\text{Adc}$, $V_{CE} = 5.0 \text{ Vdc}$)	$V_{BE(on)}$	-	0.7	Vdc
High-Frequency Current Gain ($I_C = 500 \mu\text{Adc}$, $V_{CE} = 5 \text{ Vdc}$, $f = 30 \text{ mc}$) ($I_C = 1.0 \text{ mAdc}$, $V_{CE} = 5 \text{ Vdc}$, $f = 100 \text{ mc}$)	h_{fe}	1.0 1.0	- -	-
Output Capacitance ($V_{CB} = 5.0 \text{ Vdc}$, $I_E = 0$, $f = 100 \text{ kc}$)	C_{ob}	-	3.0	pf
Input Capacitance ($V_{EB} = 0.5 \text{ Vdc}$, $I_C = 0$, $f = 100 \text{ kc}$)	C_{ib}	-	8.0	pf
Small Signal Current Gain ($I_C = 1.0 \text{ mAdc}$, $V_{CE} = 5.0 \text{ Vdc}$, $f = 1 \text{ kc}$)	h_{fe} MCS2137 MCS2138	100 300	450 900	-
Input Impedance ($I_C = 1.0 \text{ mAdc}$, $V_{CE} = 5.0 \text{ Vdc}$, $f = 1 \text{ kc}$)	h_{ie} MCS2137 MCS2138	3 10	15 40	kohms
Voltage Feedback Ratio ($I_C = 1.0 \text{ mAdc}$, $V_{CE} = 5.0 \text{ Vdc}$, $f = 1 \text{ kc}$)	h_{re}	-	25	$\times 10^{-4}$
Output Admittance ($I_C = 1.0 \text{ mAdc}$, $V_{CE} = 5.0 \text{ Vdc}$, $f = 1 \text{ kc}$)	h_{oe} MCS2137 MCS2138	-	60 60	μmhos
Noise Figure (Power Bandwidth = 15.7 kc) ($I_C = 10 \mu\text{Adc}$, $V_{CE} = 5 \text{ Vdc}$, $R_g = 10 \text{ kohms}$)	NF MCS2137 MCS2138	-	4 3	db

*Pulse Test: PW \leq 300 μsec , Duty Cycle \leq 2%

MF812

$V_{CES} = 60 \text{ V}$
 $G_{PE} = 8 \text{ db @ } 30 \text{ Typ}$
 $P_o = 30 \text{ W @ } 30 \text{ Mc}$

CASE 1
(TO-3)

NPN silicon annular transistor for high-frequency amplifier and oscillator applications.

MAXIMUM RATINGS

Characteristic	Symbol	Rating	Unit
Collector-Base Voltage	V_{CBO}	60	Vdc
Collector-Emitter Voltage	V_{CES}	60	Vdc
Emitter-Base Voltage	V_{EE}	3	Vdc
Collector Current (Continuous)	I_C	4	Adc
Base Current (Continuous)	I_B	2.0	Adc
Total Device Dissipation (25°C Case temperature) (Derating Factor above 25°C)	P_D	60 400	Watts mW/°C
Junction Temperature	T_J	175	°C
Storage Temperature	T_{stg}	-65 to +175	°C

ELECTRICAL CHARACTERISTICS (At 25°C)

Characteristic	Symbol	Min	Typ	Max	Unit
Collector-Cutoff Current ($V_{CB} = 30 \text{ Vdc}$, $I_E = 0$)	I_{CBO}	—	—	5	μAdc
Collector-Emitter Cutoff Current ($V_{CE} = 60 \text{ Vdc}$, $V_{BE} = 0$) ($V_{CE} = 50 \text{ Vdc}$, $V_{BE} = 0$, $T_C = 150^\circ\text{C}$)	I_{CES}	—	—	2.0 4.0	mAdc
Emitter-Cutoff Current ($V_{EB} = 3 \text{ Vdc}$, $I_C = 0$)	I_{EBO}	—	—	500	μAdc
Collector-Emitter Sustaining Voltage ($I_C = 0.250 \text{ A}$, $R_{BE} = 0$, $PW \leq 100 \mu\text{sec}$, $DC = 2\%$)	$V_{CES(sus)}$	80	120	—	Vdc
Collector-Emitter Open-Base Sustaining Voltage ($I_C = 0.250 \text{ A}$, $I_B = 0$, $PW \leq 100 \mu\text{sec}$, $DC = 2\%$)	$V_{CEO(sus)}$	40	—	—	Vdc
DC Current Gain ($I_C = 2 \text{ Adc}$, $V_{CE} = 2 \text{ Vdc}$) ($I_C = 4 \text{ Adc}$, $V_{CE} = 2 \text{ Vdc}$)	h_{FE}	2.5	—	50	—
Collector-Emitter Saturation Voltage ($I_C = 4.0 \text{ Adc}$, $I_B = 2 \text{ Adc}$)	$V_{CE(sat)}$	—	—	0.5	Vdc
Base-Emitter Saturation Voltage ($I_C = 4.0 \text{ Adc}$, $I_B = 2 \text{ Adc}$)	$V_{BE(sat)}$	—	—	2.0	Vdc
High-Frequency Current Gain ($I_C = 2 \text{ Adc}$, $V_{CE} = 2 \text{ Vdc}$, $f = 25 \text{ Mc}$)	h_{fe}	2.0	—	—	—
Output Capacitance ($V_{CB} = 25 \text{ Vdc}$, $I_E = 0$, $f = 100 \text{ kc}$)	C_{ob}	—	—	150	pf
Power Input ($P_o = 30 \text{ W}$, $f = 30 \text{ Mc}$, $V_{CE} = 25 \text{ Vdc}$, $I_{C(max)} = 2.4 \text{ A}$)	P_{in}	—	—	6	Watts
Efficiency ($P_o = 30 \text{ W}$, $f = 30 \text{ Mc}$, $V_{CE} = 25 \text{ Vdc}$, $I_{C(max)} = 2.4 \text{ A}$)	η	50	80	—	%
Power Gain ($P_o = 30 \text{ W}$, $f = 30 \text{ Mc}$, $V_{CE} = 25 \text{ Vdc}$, $I_{C(max)} = 2.4 \text{ A}$)	G_e	7.0	8.0	—	db

MF832
 $V_{CES} = 60 \text{ V}$
 $G_{PE} = 8 \text{ db @ } 50 \text{ Typ}$
 $P_o = 30 \text{ W @ } 50 \text{ Mc}$
**CASE 1**
(70-3)

NPN silicon annular transistor for high-frequency amplifier and oscillator applications.

MAXIMUM RATINGS

Characteristic	Symbol	Rating	Unit
Collector-Base Voltage	V_{CBO}	60	Vdc
Collector-Emitter Voltage	V_{CES}	60	Vdc
Emitter-Base Voltage	V_{EB}	3	Vdc
Collector Current (Continuous)	I_C	3.0	Adc
Base Current (Continuous)	I_B	750	mAdc
Total Device Dissipation (25°C Case temperature) (Derating Factor above 25°C)	P_D	40.0 266	Watts mW/°C
Junction Temperature	T_J	175	°C
Storage Temperature	T_{stg}	-65 to +175	°C

ELECTRICAL CHARACTERISTICS

Characteristic	Symbol	Min	Typ	Max	Unit
Collector-Cutoff Current ($V_{CB} = 30 \text{ Vdc}$, $I_E = 0$)	I_{CBO}	—	—	2	μAdc
Collector-Emitter Cutoff Current ($V_{CE} = 60 \text{ Vdc}$, $V_{BE} = 0$) ($V_{CE} = 50 \text{ Vdc}$, $V_{BE} = 0$, $T_C = 150^\circ\text{C}$)	I_{CES}	—	—	0.5 2.0	mAdc
Emitter-Cutoff Current ($V_{EB} = 3 \text{ Vdc}$, $I_C = 0$)	I_{EBO}	—	—	500	μAdc
Collector-Emitter Sustaining Voltage ($I_C = 0.250 \text{ A}$, $R_{BE} = 0$, $PW \leq 100 \mu\text{sec}$, $DC = 2\%$)	$V_{CES(sus)}$	80	120	—	Vdc
Collector-Emitter Open-Base Sustaining Voltage ($I_C = 0.250 \text{ A}$, $I_B = 0$, $PW \leq 100 \mu\text{sec}$, $DC = 2\%$)	$V_{CEO(sus)}$	40	—	—	Vdc
DC Current Gain ($I_C = 2 \text{ Adc}$, $V_{CE} = 2 \text{ Vdc}$) ($I_C = 2 \text{ Adc}$, $V_{CE} = 2 \text{ Vdc}$)	h_{FE}	2.5	—	50	—
Collector-Emitter Saturation Voltage ($I_C = 2.0 \text{ Adc}$, $I_B = 1 \text{ Adc}$)	$V_{CE(sat)}$	—	—	0.5	Vdc
High-Frequency Current Gain ($I_C = 800 \text{ mAdc}$, $V_{CE} = 2.0 \text{ Vdc}$, $f = 50 \text{ Mc}$)	h_{fe}	2.0	—	—	—
Output Capacitance ($V_{CB} = 25 \text{ Vdc}$, $I_E = 0$, $f = 100 \text{ kc}$)	C_{ob}	—	—	100	pf
Power Input ($P_o = 30 \text{ W}$, $f = 50 \text{ Mc}$, $V_{CE} = 25 \text{ Vdc}$, $I_{C(max)} = 2 \text{ A}$)	P_{in}	—	—	6.0	Watts
Efficiency ($P_o = 30 \text{ W}$, $f = 50 \text{ Mc}$, $V_{CE} = 25 \text{ Vdc}$, $I_{C(max)} = 2 \text{ A}$)	η	60	80	—	%
Power Gain ($P_o = 30 \text{ W}$, $f = 50 \text{ Mc}$, $V_{CE} = 25 \text{ Vdc}$, $I_{C(max)} = 2 \text{ A}$)	G_e	7	8.0	—	db

MM1941

**$G_o = 9 \text{ db @ } 175 \text{ Mc}$
 $P_o = 100 \text{ mW @ } 175 \text{ Mc}$**



CASE 22
(TO-18)

NPN silicon annular transistor for high-frequency power oscillator, multiplier and driver applications.

MAXIMUM RATINGS (at 25°C case temperature unless otherwise noted)

Characteristic	Symbol	Rating	Unit
Collector-Base Voltage	V_{CBO}	30	Volts
Collector-Emitter Voltage	V_{CES}	30	Volts
Emitter-Base Voltage	V_{EB}	3.0	Volts
Base Current	I_B	30	mAdc
Collector Current	I_C	200	mAdc
Input Power	P_{in}	100	mW
Output Power	P_{out}	250	mW
Power Dissipation @ $T_C = 25^\circ\text{C}$ Derate above 25°C	P_C^*	600 4.0	mW mW/°C
Power Dissipation @ $T_A = 25^\circ\text{C}$ Derate above 25°C	P_D^*	300 2.0	mW mW/°C
Junction Temperature	T_J	175	°C
Storage Temperature	T_{stg}	-65 to +175	°C

*See Safe Area Curve

ELECTRICAL CHARACTERISTICS (at 25°C ambient temperature unless otherwise noted)

Characteristic	Symbol	Test Conditions	Min	Typ	Max	Unit
Collector-Emitter Sustain Voltage	$V_{CES(sus)}^*$	$I_C = 15 \text{ mA}, R_{BE} = 0$	30	40	-	Volts
Collector-Base Breakdown Voltage	BV_{CBO}	$I_C = 100 \mu\text{Adc}, I_E = 0$	30	40	-	Volts
Collector Emitter-Open Base Sustain Voltage	$BV_{CEO(sus)}^*$	$I_C = 15 \text{ mA}, I_B = 0$	20	-	-	Volts
Collector Cutoff Current	I_{CBO}	$V_{CB} = 15 \text{ Vdc}, I_E = 0$	-	0.01	0.1	μAdc
		$V_{CB} = 15 \text{ Vdc}, I_E = 0, T_C = 100^\circ\text{C}$	-	-	25	
Emitter Cutoff Current	I_{EBO}	$V_{EB} = 3 \text{ Vdc}, I_C = 0$	-	0.1	10	μAdc
DC Current Gain	h_{FE}	$I_C = 10 \text{ mAdc}, V_{CE} = 10 \text{ Vdc}$	25	50	-	-
AC Current Gain	$ h_{fe} $	$V_{CE} = 10 \text{ Vdc}, I_C = 10 \text{ mAdc}$ $f = 100 \text{ mc}$	6	8	-	-
Collector Output Capacitance	C_{ob}	$V_{CB} = 15 \text{ Vdc}, I_E = 0, f = 100 \text{ kc}$	-	-	2.5	pf
Power Output	P_{out}	$P_{in} = 20 \text{ mW max}, f = 175 \text{ mc}$	100	-	-	mW

MM1941 (continued)

ELECTRICAL CHARACTERISTICS (continued)

Characteristic	Symbol	Test Conditions	Min	Typ	Max	Unit
Power Gain	G_e	$V_{CC} = 13.6 \text{ Vdc}$, $I_{C(max)} = 25 \text{ mA}$	7	9	-	db
Power Output (Oscillator)	P_{out}	$f = 80 \text{ mc}$, $V_{CC} = 13.6 \text{ Vdc}$, $I_{C(typ)} = 20 \text{ mAdc}$	-	50	-	mW
Power Gain (Multiplier)	G_e	$f_{in} = 80 \text{ mc}$, $f_{out} = 240 \text{ mc}$ $V_{CC} = 13.6 \text{ Vdc}$, $P_{out} \approx 30 \text{ mW}$ $I_{C(typ)} = 25 \text{ mAdc}$	-	3	-	db

*Pulse Test: PW = 100 μsec ; DC = 2%

POWER OUTPUT versus FREQUENCY

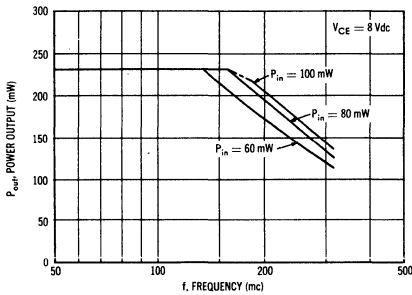

POWER OUTPUT versus FREQUENCY

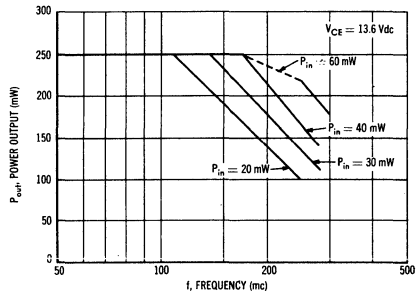

SAFE OPERATING AREA

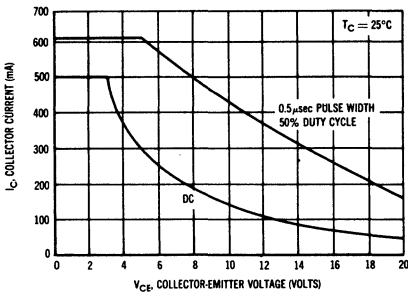

INPUT AND OUTPUT IMPEDANCE versus COLLECTOR CURRENT PARALLEL EQUIVALENT

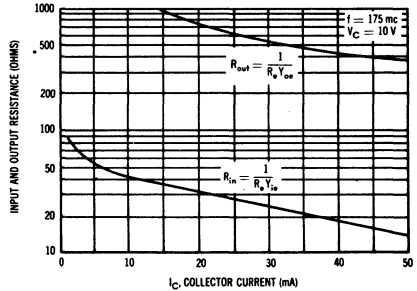

POWER OUTPUT CHARACTERISTICS

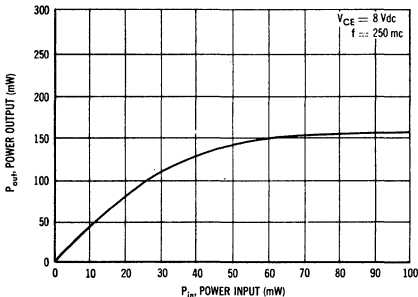

POWER OUTPUT CHARACTERISTICS

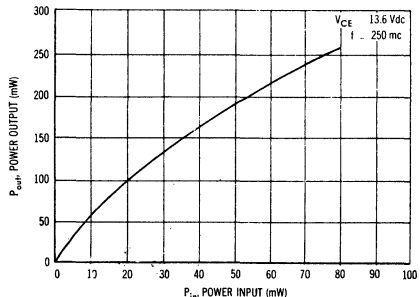

MM1943

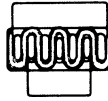

$G_o = 9 \text{ db @ } 175 \text{ Mc}$
 $P_o = 300 \text{ mW @ } 175 \text{ Mc}$



CASE 22
(TO-18)

NPN silicon annular transistor for high-frequency multiplier and driver applications.

MAXIMUM RATINGS (at 25°C case temperature unless otherwise noted)

Characteristic	Symbol	Rating	Unit
Collector-Base Voltage	V_{CBO}	40	Vdc
Collector-Emitter Voltage	V_{CES}	40	Vdc
Emitter-Base Voltage	V_{EB}	3.0	Vdc
Base Current	I_B	30	mA
Collector Current	I_C	200	mA
Input Power	P_{in}	100	mW
Output Power	P_{out}	400	mW
Device Dissipation @ $T_C = 25^\circ\text{C}$ Derate above 25°C	P_C^*	600 4.0	mW mW/°C
Device Dissipation @ $T_A = 25^\circ\text{C}$ Derate above 25°C	P_D^*	300 2	mW mW/°C
Junction Temperature	T_J	+175	°C
Storage Temperature Range	T_{stg}	-65 to +175	°C

ELECTRICAL CHARACTERISTICS (at 25°C ambient temperature unless otherwise noted)

Characteristic	Symbol	Test Conditions	Min	Typ	Max	Unit
Collector-Emitter Sustain Voltage	$V_{CES(sus)}^*$	$I_C = 15 \text{ mA}, R_{BE} = 0$	40	50	-	Volts
Collector-Base Breakdown Voltage	BV_{CBO}	$I_C = 100 \text{ }\mu\text{Adc}, I_E = 0$	40	45	-	Volts
Collector Emitter-Open Base Sustain Voltage	$BV_{CEO(sus)}^*$	$I_C = 15 \text{ mA}, I_B = 0$	20	-	-	Volts
Collector Cutoff Current	I_{CBO}	$V_{CB} = 15 \text{ Vdc}, I_E = 0$ $V_{CB} = 15 \text{ Vdc}, I_E = 0, T_C = 100^\circ\text{C}$	-	0.01 -	0.1 25	μAdc
Emitter Cutoff Current	I_{EBO}	$V_{EB} = 3 \text{ Vdc}, I_C = 0$	-	0.1	10	μAdc
DC Current Gain	h_{FE}	$I_C = 10 \text{ mAdc}, V_{CE} = 10 \text{ Vdc}$	25	50	-	-
AC Current Gain	$ h_{fe} $	$V_{CE} = 10 \text{ Vdc}, I_C = 10 \text{ mAdc}$ $f = 100 \text{ mc}$	5	7	-	-
Collector Output Capacitance	C_{ob}	$V_{CB} = 15 \text{ Vdc}, I_E = 0, f = 100 \text{ kc}$	-	-	4	pf
Power Output	P_{out}	$P_{in} = 47.5 \text{ mW max}, f = 175 \text{ mc}$	300	-	-	mW

MM1943 (continued)

ELECTRICAL CHARACTERISTICS (continued)

Characteristic	Symbol	Test Conditions	Min	Typ	Max	Unit
Power Gain	G_e	$V_{CC} = 13.6 \text{ Vdc}$, $I_{C(max)} = 13.6 \text{ mA}$	8	9	-	db
Efficiency	η		45	55	-	%
Power Gain (Multiplier)	G_e	$f_{in} = 80 \text{ mc}$, $f_{out} = 240 \text{ mc}$ $V_{CC} = 13.6 \text{ Vdc}$, $P_{out} \approx 70 \text{ mW}$ $I_{C(typ)} = 20 \text{ mA}$	-	3	-	db

*Pulse Test: PW = 100 μsec ; DC = 2%

POWER OUTPUT versus FREQUENCY

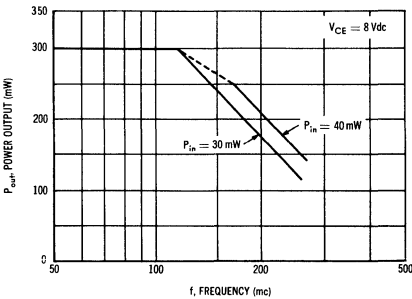

POWER OUTPUT versus FREQUENCY

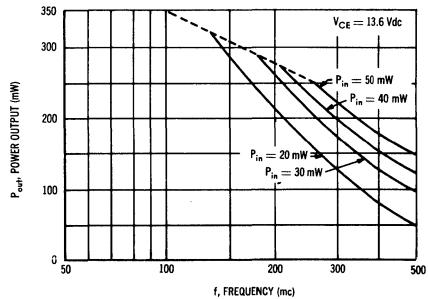

SAFE OPERATING AREA

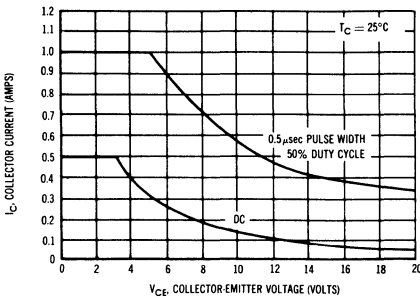

INPUT AND OUTPUT IMPEDANCE versus COLLECTOR CURRENT PARALLEL EQUIVALENT

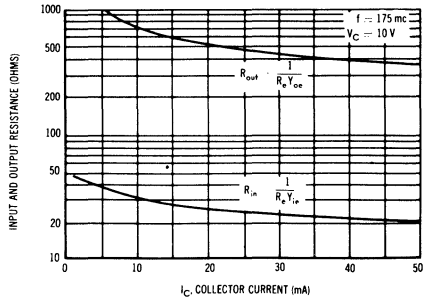

POWER OUTPUT CHARACTERISTICS

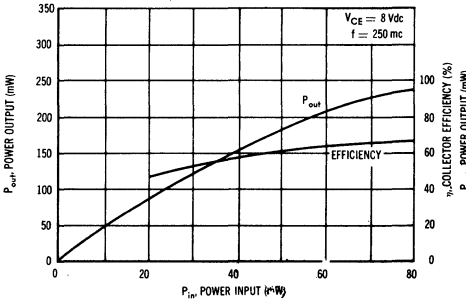

POWER OUTPUT CHARACTERISTICS

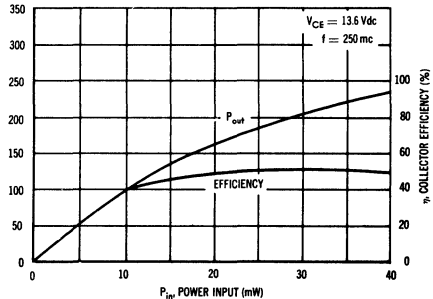

MM2503

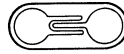

$V_{CBO} = 30\text{ V}$
 $G_o = 20\text{ db @ }200\text{ Mc}$



CASE 22
(TO-18)

PNP germanium annular transistor for high-gain, low-noise amplifier, oscillator and frequency multiplier applications.

MAXIMUM RATINGS

Characteristic	Symbol	Rating	Unit
Collector-Base Voltage	V_{CBO}	-30	Vdc
Collector-Emitter Voltage	V_{CES}	-30	Vdc
Collector-Emitter Voltage	V_{CEO}	-15	Vdc
Emitter-Base Voltage	V_{EBO}	-0.5	Vdc
Collector Current	I_C	-20	mA
Total Device Dissipation (25° C Ambient Temp.) Derate above 25° C	P_D	75 1.0	mW mW/° C
Junction Temperature	T_J	+100	° C
Storage Temperature	T_{stg}	-65 to +100	° C

MM2503 (continued)

ELECTRICAL CHARACTERISTICS (at 25°C case temperature unless otherwise noted)

Characteristic	Symbol	Minimum	Maximum	Typical
Collector-Base Breakdown Voltage $I_C = -100\mu\text{Adc}$, $I_E = 0$	BV_{CBO}	-30		Vdc
Collector-Emitter Breakdown Voltage $I_C = -100\mu\text{Adc}$, $V_{BE} = 0$	BV_{CES}	-30		Vdc
Collector-Emitter Breakdown Voltage $I_C = -1\text{mAdc}$, $I_B = 0$	BV_{CEO}	-15		Vdc
Emitter-Base Breakdown Voltage $I_E = -100\mu\text{Adc}$, $I_C = 0$	BV_{EBO}	-0.5		Vdc
Collector-Cutoff Current $V_{CB} = -6\text{Vdc}$ $V_{CB} = -6\text{Vdc}$, $T_A = +55^\circ\text{C}$	I_{CBO}		-10 -100	μAdc μAdc
DC Forward Current Ratio $V_{CE} = -6\text{Vdc}$, $I_C = -3\text{mAdc}$	h_{FE}	20		
Collector-Emitter Saturation Voltage $I_C = -3\text{mAdc}$, $I_B = -0.3\text{mAdc}$	$V_{CE(\text{sat})}$		-0.2	Vdc
Base-Emitter Saturation Voltage $I_C = -3\text{mAdc}$, $I_B = -0.3\text{mAdc}$	$V_{BE(\text{sat})}$		-0.7	Vdc
Small Signal Forward Current Ratio $V_{CE} = -6\text{Vdc}$, $I_C = -3\text{mAdc}$, $f = 1\text{KC}$	h_{fe}	25		
Collector-Base Capacitance $V_{CB} = -6\text{Vdc}$, $I_E = 0$, $f = 100\text{KC}$	C_{ob}		2.0	pf
Collector-Base Time Constant $V_{CB} = -6\text{Vdc}$, $I_E = +3\text{mAdc}$, $f = 79.8\text{MC}$	$r_b'C_c$		6	psec
Current Gain-Bandwidth Product $V_{CE} = -6\text{Vdc}$, $I_C = -3\text{mAdc}$, $f = 100\text{MC}$	f_T	1000		mc
Power Gain $V_{CE} = -6\text{Vdc}$, $I_C = -3\text{mAdc}$, $f = 200\text{MC}$	G_e	20		db
Noise Figure $V_{CE} = -6\text{Vdc}$, $I_C = -3\text{mAdc}$ $R_g = 50\ \Omega$, $f = 200\text{MC}$	NF		3.0	db
Power Gain (AGC) $V_{CE} = -5\text{Vdc}$, $I_C = -15\text{mAdc}$, $f = 200\text{MC}$	G_e		0	db

MM2550

**$V_{CE0} = 10\text{ V}$
 $I_C = 100\text{ mA}$
 $f_T = 1000\text{ Mc}$
 $t_{off} = 2.5\text{ nsec}$**



CASE 22
(TO-18)

PNP germanium epitaxial mesa transistor for high-speed, low-power, current-mode switching applications.

MAXIMUM RATINGS

Characteristic	Symbol	Rating	Unit
Collector-Base Voltage	V_{CBO}	-20	Vdc
Collector-Emitter Voltage	V_{CEO}	-10	Vdc
Emitter-Base Voltage	V_{EBO}	-0.5	Vdc
Collector Current	I_C	-100	mAdc
Junction Temperature	T_J	100	°C
Storage Temperature	T_{stg}	-65 to +100	°C
Device Dissipation @ $T_C = 25^\circ\text{C}$ Derating factor above 25°C	P_D	300 4	mW mW/°C
Device Dissipation @ $T_A = 25^\circ\text{C}$ Derating factor above 25°C	P_D	150 2	mW mW/°C

ELECTRICAL CHARACTERISTICS (at 25°C case temperature unless otherwise noted)

Characteristic	Symbol	Minimum	Maximum	Unit
Collector-Base Breakdown Voltage ($I_C = -100\ \mu\text{Adc}$, $I_E = 0$)	BV_{CBO}	-20	-	Vdc
Collector-Emitter Breakdown Voltage ($I_C = -10\text{mAdc}$, $I_E = 0$)	BV_{CEO}	-10	-	Vdc
Emitter-Base Breakdown Voltage ($I_E = -100\ \mu\text{Adc}$, $I_C = 0$)	BV_{EBO}	-0.5	-	Vdc
Collector Cutoff Current ($V_{CB} = -10\text{ Vdc}$, $I_E = 0$)	I_{CBO}	-	-10	μAdc
DC Current Gain ($I_C = -10\text{ mAdc}$, $V_{CE} = -5\text{ Vdc}$)	h_{FE}	20	-	-
Collector Saturation Voltage ($I_C = -10\text{ mAdc}$, $I_B = -1.0\text{ mAdc}$)	$V_{CE(sat)}$	-	-0.2	Vdc
Base-Emitter Saturation Voltage ($I_C = -10\text{ mAdc}$, $I_B = -1.0\text{ mAdc}$)	$V_{BE(sat)}$	-0.3	-0.7	Vdc

MM2550 (continued)

ELECTRICAL CHARACTERISTICS (continued)

Characteristic	Symbol	Minimum	Maximum	Unit
Current Gain-Bandwidth Product ($I_C = -5$ mAdc, $V_{CE} = -10$ Vdc, $f = 100$ mc) ($I_C = -10$ mAdc, $V_{CE} = -5$ Vdc, $f = 100$ mc) ($I_C = -15$ mAdc, $V_{CE} = -2$ Vdc, $f = 100$ mc)	f_T	1000		mc
		1000		mc
		1000		mc
Collector Output Capacitance ($V_{CB} = -5$ Vdc, $I_E = 0$, $f = 100$ kc)	C_{ob}	Min	Typ	Max
		-		3
Collector-Base Time Constant ($I_E = +10$ mAdc, $V_{CB} = -5$ Vdc, $f = 31.8$ mc)	$r_b' C_c$	-	50	-
Turn-on Time ($I_C = -10$ mAdc, $V_{CE(on)} = -5$ V)	t_{on}	-	1.8	2.5
Turn-off Time ($I_C = -10$ mAdc, $V_{CE(on)} = -5$ V)	t_{off}	-	1.8	2.5

CURRENT MODE SWITCHING TIME CIRCUIT

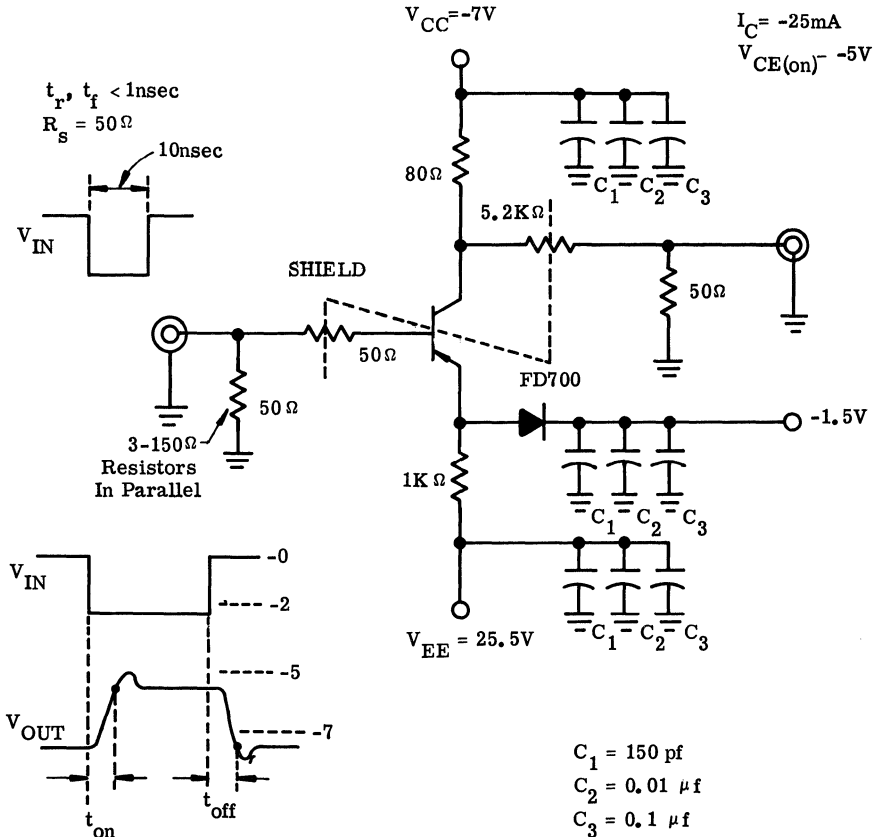

MM2552

**$V_{CE0} = 10\text{ V}$
 $I_C = 100\text{ mA}$
 $f_T = 1000\text{ Mc}$
 $t_{off} = 2.5\text{ nsec}$**



CASE 31
(TO-5)

PNP germanium epitaxial mesa transistor for high-speed, low-power, current-mode switching applications.

MAXIMUM RATINGS

Characteristic	Symbol	Rating	Unit
Collector-Base Voltage	V_{CBO}	-20	Vdc
Collector-Emitter Voltage	V_{CEO}	-10	Vdc
Emitter-Base Voltage	V_{EBO}	-0.5	Vdc
Collector Current	I_C	-100	mAdc
Junction Temperature	T_J	100	°C
Storage Temperature	T_{stg}	-65 to +100	°C
Device Dissipation @ $T_C = 25^\circ\text{C}$ Derating factor above 25°C	P_D	600 8	mW mW/°C
Device Dissipation @ $T_C = 25^\circ\text{C}$ Derating factor above 25°C	P_D	300 4	mW mW/°C

ELECTRICAL CHARACTERISTICS (at 25°C case temperature unless otherwise noted)

Characteristic	Symbol	Minimum	Maximum	Unit
Collector-Base Breakdown Voltage ($I_C = -100\ \mu\text{Adc}$, $I_E = 0$)	BV_{CBO}	-20	-	Vdc
Collector-Emitter Breakdown Voltage ($I_C = -10\text{ mAdc}$, $I_B = 0$)	BV_{CEO}	-10	-	Vdc
Emitter-Base Breakdown Voltage ($I_E = -100\ \mu\text{Adc}$, $I_C = 0$)	BV_{EBO}	-0.5	-	Vdc
Collector Cutoff Current ($V_{CB} = -10\text{ Vdc}$, $I_E = 0$)	I_{CBO}	-	-10	μAdc
DC Current Gain ($I_C = -25\text{ mAdc}$, $V_{CE} = -5\text{ Vdc}$)	h_{FE}	30	-	-
Collector Saturation Voltage ($I_C = -25\text{ mAdc}$, $I_B = -2.5\text{ mAdc}$)	$V_{CE(sat)}$	-	-0.2	Vdc
Base-Emitter Saturation Voltage ($I_C = -25\text{ mAdc}$, $I_B = -2.5\text{ mAdc}$)	$V_{BE(sat)}$	-0.3	-0.7	Vdc

MM2552 (continued)

ELECTRICAL CHARACTERISTICS (continued)

Characteristic	Symbol	Minimum	Maximum	Unit
Current-Gain, Bandwidth Product ($I_C = -30$ mA dc, $V_{CE} = -2$ V dc, $f = 100$ mc) ($I_C = -25$ mA dc, $V_{CE} = -5$ V dc, $f = 100$ mc) ($I_C = -20$ mA dc, $V_{CE} = -10$ V dc, $f = 100$ mc)	f_T	1000		mc
		1000		mc
		1000		mc
Collector Output Capacitance ($V_{CE} = -5$ V dc, $I_E = 0$, $f = 100$ kc)	C_{ob}	—	3	pf
Collector-Base Time Constant ($I_E = +25$ mA, $V_{CE} = -5$ V, $f = 31.8$ mc)	$r_b' C_c$	Min	Typ	Max
		—	50	—
Turn-on Time ($I_C = -25$ mA dc, $V_{CE(on)} = -5$ V dc)	t_{on}	—	2.2	3.5
Turn-off Time ($I_C = -25$ mA dc, $V_{CE(on)} = -5$ V dc)	t_{off}	—	1.8	2.5

CURRENT MODE SWITCHING TIME CIRCUIT

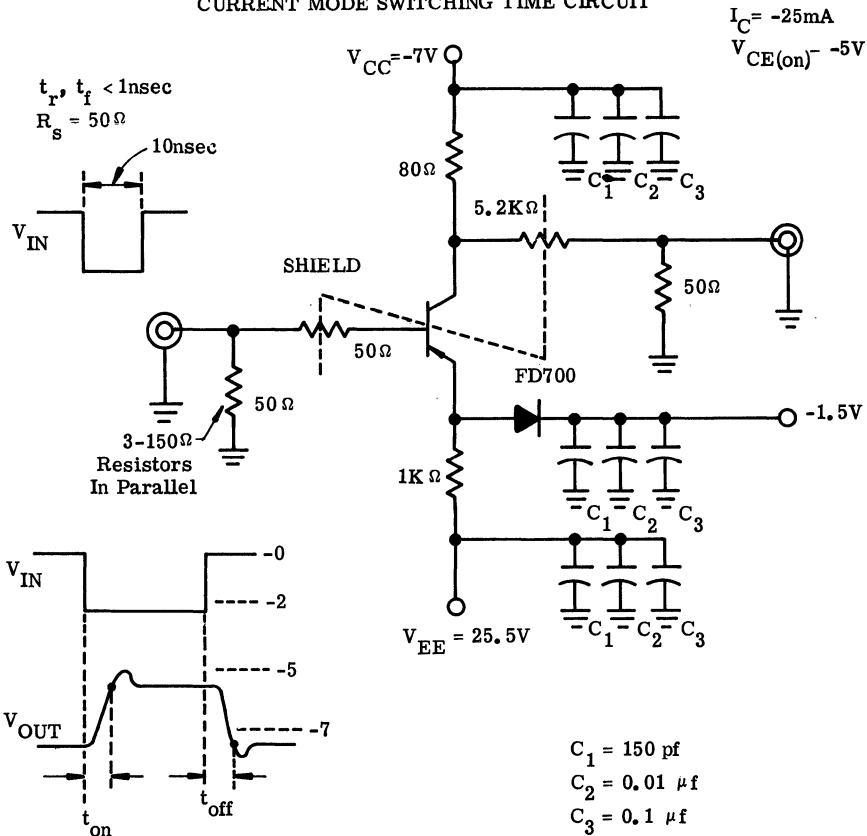

MM2554

$V_{CE0} = 10\text{ V}$
 $I_C = 200\text{ mA}$
 $f_T = 1000\text{ Mc}$
 $t_{off} = 2.5\text{ nsec}$



CASE 31
(TO-5)

PNP germanium epitaxial mesa transistor for high-speed, low-power, current-mode switching applications.

MAXIMUM RATINGS

Characteristic	Symbol	Rating	Unit
Collector-Base Voltage	V_{CBO}	-20	Vdc
Collector-Emitter Voltage	V_{CEO}	-10	Vdc
Emitter-Base Voltage	V_{EBO}	-0.5	Vdc
Collector Current	I_C	-200	mAdc
Junction Temperature	T_J	100	°C
Storage Temperature	T_{stg}	-65 to +100	°C
Device Dissipation @ $T_C = 25^\circ\text{C}$ Derating factor above 25°C	P_D	750 10	mW mW/°C
Device Dissipation @ $T_A = 25^\circ\text{C}$ Derating factor above 25°C	P_D	300 4	mW mW/°C

ELECTRICAL CHARACTERISTICS (at 25°C case temperature unless otherwise noted)

Characteristic	Symbol	Minimum	Maximum	Unit
Collector-Base Breakdown Voltage ($I_C = -100\ \mu\text{Adc}$, $I_E = 0$)	BV_{CBO}	-20		Vdc
Collector-Emitter Breakdown Voltage ($I_C = -10\text{mAdc}$, $I_B = 0$)	BV_{CEO}	-10		Vdc
Emitter-Base Breakdown Voltage ($I_E = -100\ \mu\text{Adc}$, $I_C = 0$)	BV_{EBO}	-0.5		Vdc
Collector Cutoff Current ($V_{CB} = -10\text{Vdc}$, $I_E = 0$)	I_{CBO}		-10	μAdc
DC Current Gain ($I_C = -40\text{mAdc}$, $V_{CE} = -5\text{ Vdc}$)	h_{FE}	20		
Collector Saturation Voltage ($I_C = -40\text{mAdc}$, $I_B = -4\text{mAdc}$)	$V_{CE(sat)}$		-0.25	Vdc
Base-Emitter Saturation Voltage ($I_C = -40\text{mAdc}$, $I_B = -4\text{mAdc}$)	$V_{BE(sat)}$	-0.4	-0.8	Vdc

MM2554 (continued)

ELECTRICAL CHARACTERISTICS (continued)

Characteristic	Symbol	Minimum	Maximum	Unit
Current-Gain, Bandwidth Product ($I_C = -35\text{mA}$, $V_{CE} = -10\text{Vdc}$, $f = 100\text{MC}$) ($I_C = -40\text{mA}$, $V_{CE} = -5\text{Vdc}$, $f = 100\text{MC}$) ($I_C = -45\text{mA}$, $V_{CE} = -2\text{Vdc}$, $f = 100\text{MC}$)	f_T	1000		mc
Collector Output Capacitance ($V_{CB} = -5\text{Vdc}$, $I_E = 0$, $f = 100\text{KC}$)	C_{ob}		4	pf
Collector-Base Time Constant ($I_E = +40\text{mA}$, $V_{CB} = -5\text{Vdc}$, $f = 31.8\text{MC}$)	$r_b' C_c$	Min	Typ	Max
			50	
Turn-on Time ($I_C = -40\text{mA}$, $V_{CE(on)} = -5\text{Vdc}$)	t_{on}	2.4	3.5	nsec
Turn-off Time ($I_C = -40\text{mA}$, $V_{CE(on)} = -5\text{Vdc}$)	t_{off}	1.6	2.5	nsec

CURRENT MODE SWITCHING TIME CIRCUIT

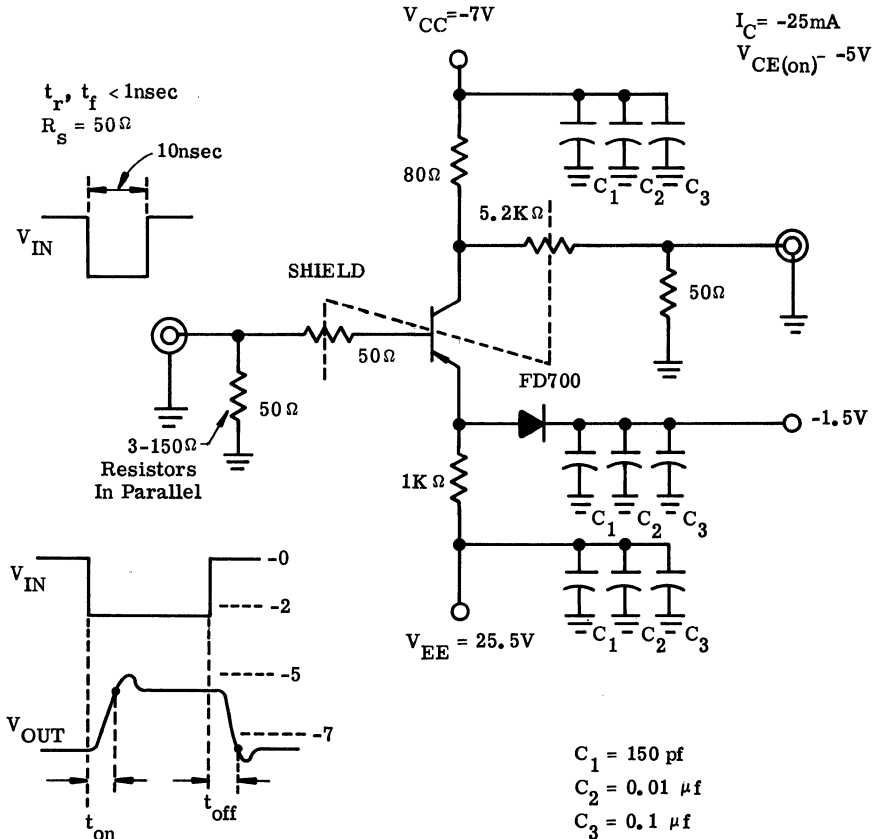

MM2894

$V_{CE0} = 12\text{ V}$
 $I_C = 100\text{ mA}$
 $h_{FE} = 70$
 $t_{OFF} = 60\text{ nsec}$



CASE 22
(TO-18)

PNP silicon annular transistors for low-level, high-speed switching applications.

MAXIMUM RATINGS

Characteristic	Symbol	Rating	Unit
Collector-Base Voltage	V_{CBO}	15	Vdc
Collector-Emitter Voltage	V_{CEO}	12	Vdc
Emitter-Base Voltage	V_{EBO}	4.5	Vdc
Total Device Dissipation @ 25° C Ambient Temperature Derate above 25° C	P_D	0.36 2.06	Watt mW/° C
Total Device Dissipation @ 25° C Case Temperature Derate above 25° C	P_D	1.2 6.9	Watts mW/° C
Operating Junction Temperature	T_J	200	° C
Storage Temperature	T_{stg}	-65 to 200	° C

SWITCHING TIME TEST CIRCUIT

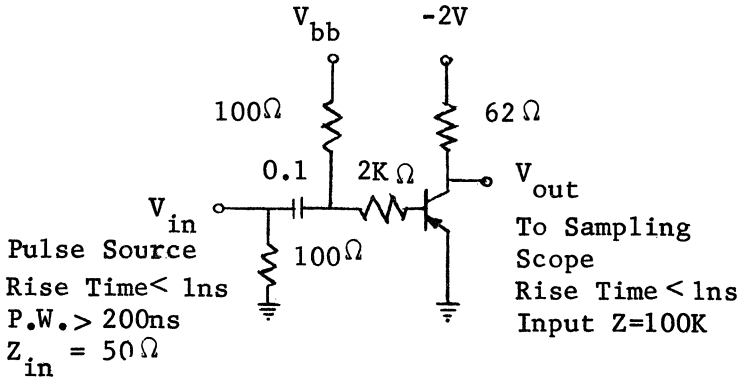

$T_{on} \quad V_{bb} = +3V \quad V_{in} = -7V$

$T_{off} \quad V_{bb} = -4V \quad V_{in} = +6V$

MM2894 (continued)

ELECTRICAL CHARACTERISTICS (at 25°C case temperature unless otherwise noted)

Characteristic	Symbol	Minimum	Typical	Maximum	Unit
Collector Cutoff Current $V_{CB} = -6V, I_E = 0$ $V_{CB} = -6V, I_E = 0, T_A = 125^\circ C$	I_{CBO}			.08 10	μA
Collector-Base Breakdown Voltage $I_C = 10\mu A, I_E = 0$	BV_{CBO}	-15			Vdc
Collector-Emitter Sustaining Voltage* $I_C = 10mA, I_B = 0$	$V_{CEO(sust)}$	-12			Vdc
Emitter-Base Breakdown Voltage $I_E = 100\mu A, I_C = 0$	BV_{EBO}	-4.5			Vdc
Collector-Emitter Saturation Voltage $I_C = 10mA, I_B = 1.0mA$ $I_C = 30mA, I_B = 3.0mA$ $I_C = 100mA, I_B = 10mA$	$V_{CE(sat)}$		-0.1	-0.15 -0.2 -0.5	Vdc
Base-Emitter Saturation Voltage $I_C = 10mA, I_B = 1.0mA$ $I_C = 30mA, I_B = 3.0mA$ $I_C = 100mA, I_B = 10mA$	$V_{BE(sat)}$	-0.68 -0.74		-0.83 -0.89 -1.7	Vdc
DC Pulse Current Gain* $I_C = 1mA, V_{CE} = 0.3v$ $I_C = 10mA, V_{CE} = 0.3v$ $I_C = 30mA, V_{CE} = 0.5v$ $I_C = 30mA, V_{CE} = 0.5v (-55^\circ C)$ $I_C = 100mA, V_{CE} = 1.0V$	h_{FE}^*	25 30 40 17 25	70	150	
High Frequency Current Gain ($f = 100mc$) $V_{CE} = 100, I_C = 30mA$	h_{fe}	4.0			
Output Capacitance $V_{CB} = -5.0V, I_E = 0, f = 140KC$	C_{ob}			6.0	pf
Emitter Transition Capacitance $V_{EB} = -0.5V, I_C = 0, f = 140KC$	C_{TE}			6.0	pf
Turn On Time $I_C = 30mA, I_{B1} = 1.5mA$	T_{on}		23	60	nsec
Turn Off Time $I_C = 30mA, I_{B1} = I_{B2} = 1.5mA$	T_{off}		34	60	nsec

* Pulse Conditions; length = 300 μsec
duty cycle $\leq 2\%$

MM2894 (continued)

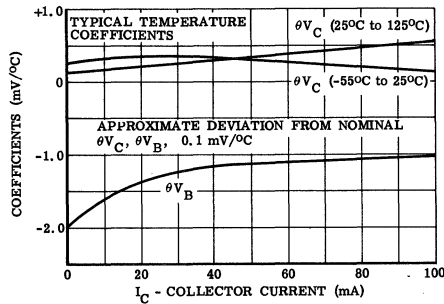
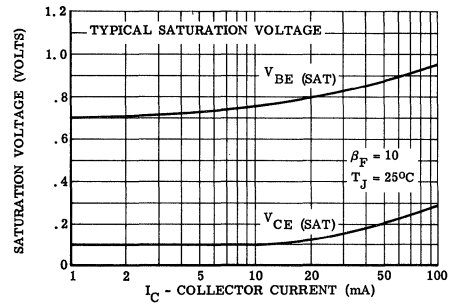
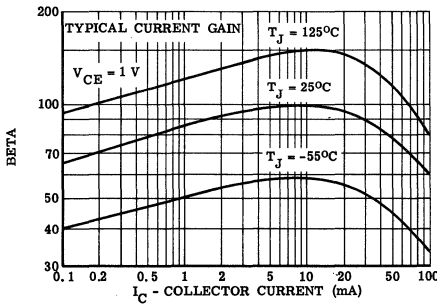
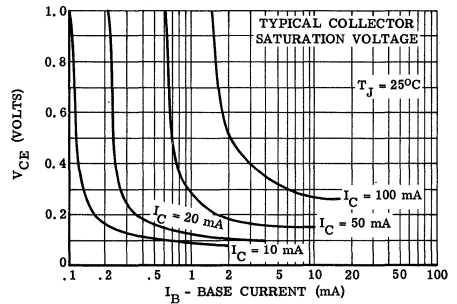
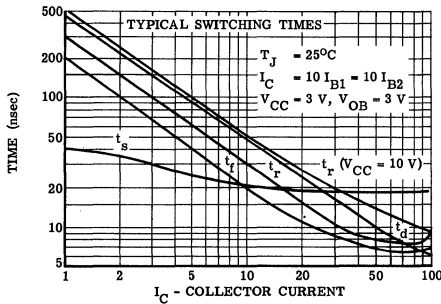
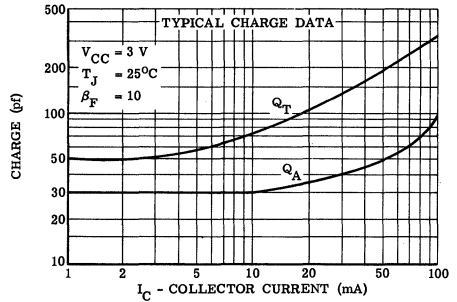
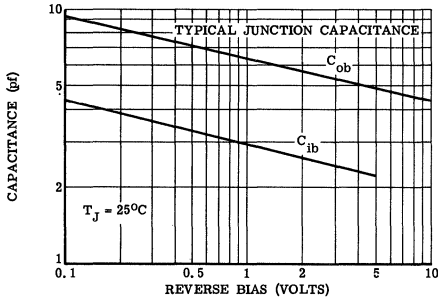

MPS706

$V_{CE0} = 15\text{ V}$
 $h_{FE} = 20$
 $t_s = 60\text{ nsec}$

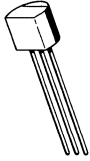

NPN silicon annular, plastic encapsulated transistor designed for low-cost, high-speed switching applications. For typical curves, see 2N706 data sheet.

CASE 29

MAXIMUM RATINGS

Characteristic	Symbol	Rating	Unit
Collector-Base Voltage	V_{CBO}	25	Vdc
Collector-Emitter Voltage	V_{CER}^*	20	Vdc
Emitter-Base Voltage	V_{EBO}	3	Vdc
Junction Temperature	T_J	125	°C
Storage Temperature	T_{stg}	-55 to +125	°C
Total Device Dissipation @ 25°C Case Temperature (Derate 5 mW/°C above 25°C)	P_D	500	mW
Total Device Dissipation @ 25°C Ambient Temperature (Derate 3 mW/°C above 25°C)	P_D	300	mW

MPS706 (continued)

ELECTRICAL CHARACTERISTICS (at 25°C case temperature unless otherwise noted)

Characteristic	Symbol	Minimum	Typical	Maximum	Unit
Collector Cutoff Current $V_{CB} = 15 \text{ V}, I_E = 0$	I_{CBO}	—	.005	0.5	μA
Emitter Cutoff Current $V_{EB} = 3 \text{ V}, I_C = 0$	I_{EBO}	—	—	10	μA
Collector-Emitter Breakdown Voltage* $I_C = 10 \text{ mA}, I_B = 0$	BV_{CEO}^*	15	24	—	Vdc
Collector-Emitter Breakdown Voltage* $I_C = 10 \text{ mA}, R = 10\Omega$	BV_{CER}^*	20	—	—	Vdc
Forward-Current Transfer Ratio* $I_C = 10 \text{ mA}, V_{CE} = 1 \text{ V}$	h_{FE}^*	20	—	—	—
Base-Emitter Voltage* $I_C = 10 \text{ mA}, I_B = 1 \text{ mA}$	$V_{BE(sat)}^*$	—	—	0.9	Vdc
Collector Saturation Voltage* $I_C = 10 \text{ mA}, I_B = 1 \text{ mA}$	$V_{CE(sat)}^*$	—	—	0.6	Vdc
Collector Capacitance $V_{CB} = 10 \text{ V}, I_E = 0$	C_{ob}	—	—	6	pf
Small-Signal Forward Current Transfer Ratio $V_{CE} = 15 \text{ Vdc}, I_E = 10 \text{ mA}, f = 100\text{mc}$	h_{fe}	2	4	—	—
Base Resistance $V_{CE} = 15 \text{ Vdc}, I_E = 10 \text{ mA}, f = 100\text{mc}$	r'_b	—	—	50	ohms
Charge Storage Time Constant (See Figure 2)	τ_s^{**}	—	—	60	nsec
Turn-on Time	T_{on}^{**}	—	—	40	nsec
Turn-off Time	T_{off}^{**}	—	—	75	nsec

* Pulse Test: $PW \leq 12 \text{ nsec}$, Duty Cycle $\leq 2\%$

**Switching Times Measured with Tektronix Type R Plug-In (50Ω Internal Impedance) and Circuits Shown

SWITCHING TIME TEST CIRCUIT

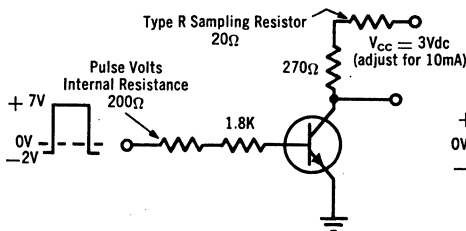

STORAGE TIME TEST CIRCUIT

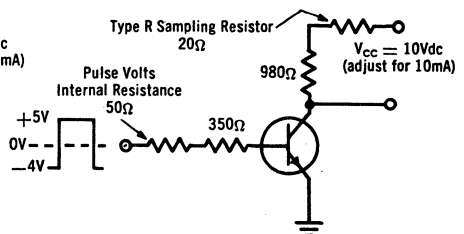

MPS834

**$V_{CEO} = 30\text{ V}$
 $I_C = 200\text{ mA}$
 $t_{off} = 30\text{ nsec}$**

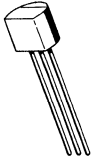

NPN silicon annular, plastic encapsulated transistor for low-cost, high-speed switching applications. For typical curves, see 2N834 data sheet.

CASE 29

MAXIMUM RATINGS

Characteristic	Symbol	Rating	Unit
Collector-Base Voltage	V_{CBO}	40	Vdc
Collector-Emitter Voltage	V_{CEO}	30	Vdc
Emitter-Base Voltage	V_{EBO}	5	Vdc
D. C. Collector Current	I_C	200	mAdc
Junction Temperature	T_J	+125	°C
Storage Temperature Range	T_{stg}	-55 to +125	°C
Total Device Dissipation @ 25°C Case Temperature (Derate 5.0 mW/°C above 25°C)	P_D	500	mW
Total Device Dissipation @ 25°C Ambient Temperature (Derate 3.0 mW/°C above 25°C)	P_D	300	mW

**TURN-ON AND TURN-OFF
TIME MEASUREMENT CIRCUIT**

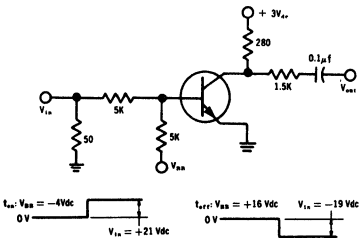

**CHARGE STORAGE TIME
CONSTANT MEASUREMENT CIRCUIT**

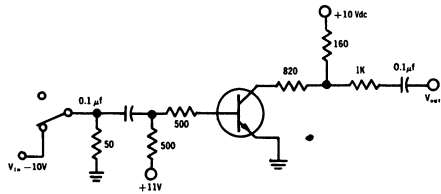

NOTE: ALL SWITCHING TIMES MEASURED WITH LUMATRON MODEL 420 SWITCHING TIME TEST SET OR EQUIVALENT.

MPS834 (continued)

ELECTRICAL CHARACTERISTICS (at 25°C case temperature unless otherwise noted)

Characteristic	Symbol	Minimum	Typical	Maximum	Unit
Collector-Base Breakdown Voltage $I_E = 0, I_C = 10 \mu\text{Adc}$	BV_{CBO}	40	-	-	Vdc
Emitter-Base Breakdown Voltage $I_C = 0, I_E = 10 \mu\text{Adc}$	BV_{EBO}	5	-	-	Vdc
Collector Cutoff Current $V_{BE} = 0, V_{CE} = 20 \text{Vdc}$	I_{CES}	-	-	10	μAdc
Collector Cutoff Current $I_E = 0, V_{CB} = 20 \text{Vdc}$	I_{CBO}	-	-	0.5	μAdc
Forward Current Transfer Ratio* $I_C = 10 \text{mAdc}, V_{CE} = 1 \text{Vdc}$	h_{FE}^*	25	-	-	-
Collector Saturation Voltage* $I_C = 10 \text{mA}, I_B = 1 \text{mA}$	$V_{CE(sat)}^*$	-	-	0.25	Vdc
Collector Saturation Voltage* $I_C = 50 \text{mA}, I_B = 5 \text{mA}$	$V_{CE(sat)}^*$	-	-	0.4	Vdc
Base-Emitter Saturation Voltage* $I_C = 10 \text{mAdc}, I_B = 1.0 \text{mAdc}$	$V_{BE(sat)}^*$	-	-	0.9	Vdc
Collector Capacitance $I_E = 0, V_{CB} = 10 \text{Vdc}, f = 100 \text{kc}$	C_{ob}	-	-	4	pf
Small-Signal Forward Current Transfer Ratio $I_C = 10 \text{mAdc}, V_{CE} = 20 \text{Vdc}, f = 100\text{mc}$	h_{fe}	3.5	-	-	-
Current Gain Bandwidth Product $I_C = 10 \text{mAdc}, V_{CE} = 20 \text{Vdc}, f = 100\text{mc}$	f_T	350	-	-	mc
Charge Storage Time Constant $I_C = 10 \text{mA}, I_{B1} = I_{B2} = 10 \text{mA}$	τ_s	-	-	25	nsec
Turn-on Time $I_C = 10 \text{mA}, I_{B1} = 3 \text{mA}, I_{B2} = 1 \text{mA}$	t_{on}	-	-	16	nsec
Turn-off Time $I_C = 10 \text{mA}, I_{B1} = 3 \text{mA}, I_{B2} = 1 \text{mA}$	t_{off}	-	-	30	nsec

* Pulse Test, PW ≤ 12 nsec, Duty Cycle ≤ 2%

MPS918
MPS3563

$G_o = 14-15 \text{ db @ } 200 \text{ Mc}$
 $\text{NF} = 6 \text{ db @ } 200 \text{ Mc}$
 $P_o = 30 \text{ mW @ } 500 \text{ Mc}$

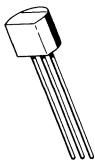

NPN silicon annular, plastic encapsulated transistors for low-cost, amplifier and oscillator applications at VHF and UHF.

CASE 29

MAXIMUM RATINGS

Characteristic	Symbol	MPS918	MPS3563	Unit
Collector-Base Voltage	V_{CBO}	30	30	Volts
Collector-Emmitter Voltage	V_{CEO}	15	12	Volts
Emitter-Base Voltage	V_{EBO}	3	2	Volts
Total Dissipation @ 25°C Case Temperature @ 25°C Ambient Temperature	P_D	0.5 0.2	0.5 0.2	Watts
Operating Junction Temperature	T_J	125	125	°C
Storage Temperature	T_{stg}	-55 to +125		°C

200 MC POWER GAIN TEST CIRCUIT

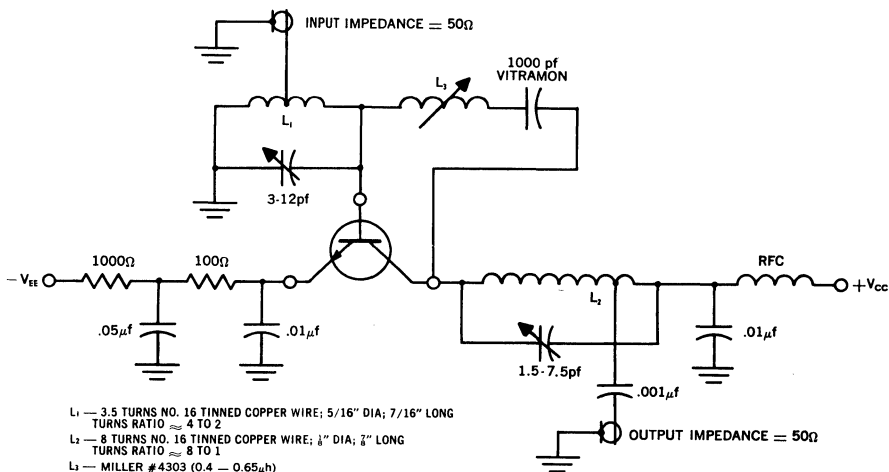

MPS918, MPS3563 (continued)

ELECTRICAL CHARACTERISTICS (at 25°C ambient temperature unless otherwise noted)

Characteristic		Symbol	Minimum	Maximum	Unit
Collector Cutoff Current $V_{CB} = 15V, I_E = 0$	MPS918 MPS3563	I_{CBO}	— —	10 50	nA
Collector-Base Breakdown Voltage $I_C = 1.0 \mu A, I_E = 0$ $I_C = 100 \mu A, I_E = 0$	MPS918 MPS3563	BV_{CBO}	30 30	— —	Volts
Emitter-Base Breakdown Voltage $I_E = 10 \mu A, I_C = 0$	MPS918 MPS3563	BV_{EBO}	3.0 2.0	— —	Volts
Collector-Emitter Voltage $I_C = 3.0 \text{ mA}, I_E = 0$	MPS918 MPS3563	BV_{CEO}^*	15 15	— —	Volts
DC Current Gain $V_{CE} = 1V, I_C = 3\text{mA}$ $V_{CE} = 10V, I_C = 8\text{mA}$	MPS918 MPS3563	h_{FE}^*	20 20	— 200	—
Collector-Emitter Saturation Voltage $I_C = 10\text{mA}, I_B = 1\text{mA}$	MPS918	$V_{CE(sat)}$	—	0.4	Volts
Base-Emitter Saturation Voltage $I_C = 10\text{mA}, I_B = 1\text{mA}$	MPS918	$V_{BE(sat)}$	—	1.0	Volts
Small Signal Current Gain $I_C = 4\text{mA}, V_{CE} = 10V, f = 100\text{mc}$ $I_C = 8\text{mA}, V_{CE} = 10V, f = 100\text{mc}$ $I_C = 8\text{mA}, V_{CE} = 10V, f = 1\text{kc}$	MPS918 MPS3563 MPS3563	h_{fe}	6 6 20	— 15 250	—
Output Capacitance $V_{CB} = 10V, I_E = 0, f = 140\text{kc}$ $V_{CB} = 10V, I_E = 0, f = 1\text{mc}$ $V_{CB} = 0V, I_E = 0, f = 140\text{kc}$	MPS918 MPS3563 MPS918	C_{ob}	— — —	1.7 1.7 3.0	pf
Input Capacitance $V_{EB} = 0.5V, I_C = 0$	MPS918	C_{ib}	—	2.0	pf
Amplifier Power Gain $I_C = 6\text{mA}, f = 200\text{mc}, V_{CB} = 12V$ $I_C = 8\text{mA}, V_{CE} = 10V, f = 200\text{mc}$ $G_{fd} + G_{re} < -20\text{db}$	MPS918 MPS3563	G_e	15 14	— —	db
Power Output $I_C = 8\text{mA}, V_{CB} = 15V, f = 500\text{mc}$	MPS918	P_{out}	30		mW
Collector Efficiency $I_C = 8\text{mA}, V_{CB} = 15V, f = 500\text{mc}$	MPS918	eff	25		%
Noise Figure $I_C = 1\text{mA}, V_{CE} = 6V, f = 60\text{mc},$ $R_g = 400$	MPS918	NF'	—	6	db

*PW ≤ 300 μsec. DC ≤ 1%

MPS2894

$V_{CEO} = 12\text{ V}$
 $h_{FE} = 40$
 $t_{OFF} = 90\text{ nsec}$

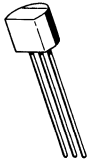

PNP silicon annular, plastic encapsulated transistor for low-cost, low-level, high-speed switching applications.

CASE 29

MAXIMUM RATINGS

Characteristic	Symbol	Rating	Unit
Collector-Base Voltage	V_{CBO}	12	Vdc
Collector-Emitter Voltage	V_{CEO}	12	Vdc
Emitter-Base Voltage	V_{EBO}	4	Vdc
Total Device Dissipation @ 25°C Ambient Temperature Derate above 25°C	P_D	0.3 3	Watt mW/°C
Total Device Dissipation @ 25°C Case Temperature Derate above 25°C	P_D	1.0 10	Watt mW/°C
Operating Junction Temperature	T_J	125	°C
Storage Temperature Range	T_{stg}	-55 to +125	°C

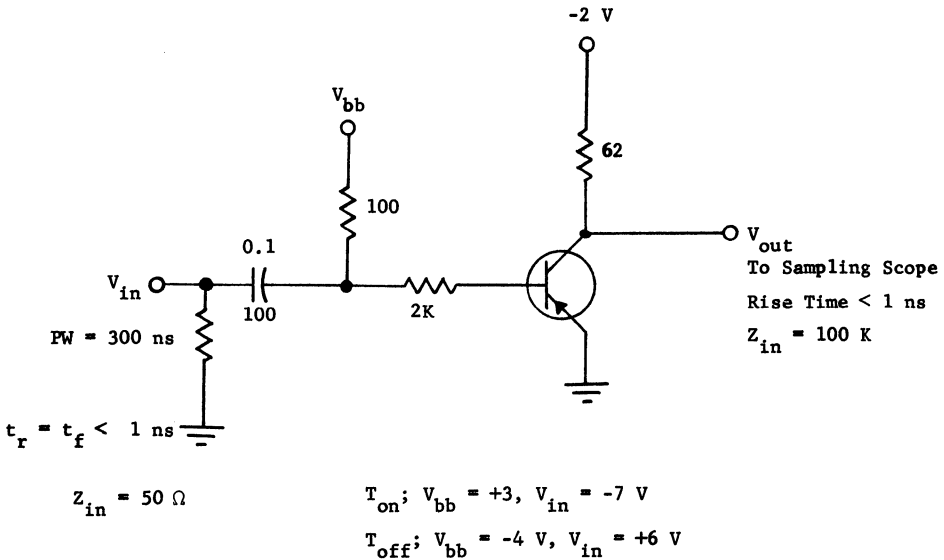

MPS2894 (continued)

ELECTRICAL CHARACTERISTICS (at 25°C case temperature unless otherwise noted)

Characteristic	Symbol	Minimum	Typical	Maximum	Unit
Collector Cutoff Current $V_{CB} = -6 \text{ V}, I_E = 0$ $V_{CB} = -6 \text{ V}, I_E = 0, T_A = 125^\circ\text{C}$	I_{CBO}			.08	μA
Collector-Base Breakdown Voltage $I_C = 10 \mu\text{A}, I_E = 0$	BV_{CBO}	-12			Vdc
Collector-Emitter Sustaining Voltage* $I_C = 10 \text{ mA}, I_B = 0$	$V_{CEO(sust)}$	-12			Vdc
Emitter-Base Breakdown Voltage $I_E = 100 \mu\text{A}, I_C = 0$	BV_{EBO}	-4.0			Vdc
Collector-Emitter Saturation Voltage $I_C = 10 \text{ mA}, I_B = 1.0 \text{ mA}$ $I_C = 30 \text{ mA}, I_B = 3.0 \text{ mA}$ $I_C = 100 \text{ mA}, I_B = 10 \text{ mA}$	$V_{CE(sat)}$		-0.1	-0.15 -0.2 -0.5	Vdc
Base-Emitter Saturation Voltage $I_C = 10 \text{ mA}, I_B = 1.0 \text{ mA}$ $I_C = 30 \text{ mA}, I_B = 3.0 \text{ mA}$ $I_C = 100 \text{ mA}, I_B = 10 \text{ mA}$	$V_{BE(sat)}$	-0.78 -0.85.		-0.98 -1.20 -1.7	Vdc
DC Pulse Current Gain* $I_C = 1 \text{ mA}, V_{CE} = 0.3 \text{ V}$ $I_C = 10 \text{ mA}, V_{CE} = 0.3 \text{ V}$ $I_C = 30 \text{ mA}, V_{CE} = 0.5 \text{ V}$ $I_C = 30 \text{ mA}, V_{CE} = 0.5 \text{ V} (-55^\circ\text{C})$ $I_C = 100 \text{ mA}, V_{CE} = 1.0 \text{ V}$	h_{FE}^*	25 30 40 17 25	70	150	-
High Frequency Current Gain ($f = 100 \text{ mc}$) $V_{CE} = 10 \text{ V}, I_C = 30 \text{ mA}$	h_{fe}	4.0			-
Output Capacitance $V_{CB} = -5.0 \text{ V}, I_E = 0, f = 140 \text{ kc}$	C_{ob}			6.0	pf
Emitter Transition Capacitance $V_{EB} = -0.5 \text{ V}, I_C = 0, f = 140 \text{ kc}$	C_{TE}			6.0	pf
Turn-On Time $I_C = 30 \text{ mA}, I_{B1} = 1.5 \text{ mA}$	t_{on}		23	60	nsec
Turn-Off Time $I_C = 30 \text{ mA}, I_{B1} = I_{B2} = 1.5 \text{ mA}$	t_{off}		34	90	nsec

* Pulse Conditions: Length = 300 μsec
Duty Cycle $\leq 2\%$

MPS2923 thru MPS2925

$V_{CEO} = 25 \text{ V}$
 $I_C = 100 \text{ mA}$
 $P_D = 200 \text{ mW}$

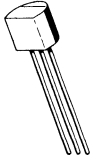

NPN silicon annular, plastic encapsulated transistors for low-cost, medium-speed, general-purpose amplifier and oscillator applications.

CASE 29

MAXIMUM RATINGS

Characteristic	Symbol	Rating	Unit
Collector-Base Voltage	V_{CBO}	25	Vdc
Collector-Emitter Voltage	V_{CEO}	25	Vdc
Emitter-Base Voltage	V_{EBO}	5	Vdc
Collector dc Current	I_C	100	mAdc
Total Device Dissipation @ 25°C Ambient Temperature Derating Factor above 25°C	P_D	200 2.67	mW mW/°C
Total Device Dissipation @ 55°C Ambient Temperature Derating Factor above 25°C	P_D	120 2.67	mW mW/°C
Junction Temperature-Operating	T_J	100	°C
Storage Temperature Range	T_{stg}	-30 to +125	°C

ELECTRICAL CHARACTERISTICS (at 25°C case temperature unless otherwise noted)

Characteristic	Symbol	Minimum	Maximum	Unit
Collector Cutoff Current $V_{CB} = 25 \text{ V}, I_E = 0$	I_{CBO}	—	0.5	μA
$V_{CB} = 25 \text{ V}, I_E = 0, T_A = 100^\circ\text{C}$		—	15	μA
Emitter Cutoff Current $V_{EB} = 5 \text{ V}$	I_{EBO}	—	0.5	μA
Small Signal Current Gain ($f = 1 \text{ kc}$) $V_{CE} = 10 \text{ V}, I_C = 2 \text{ mA}$	h_{fe}			—
MPS2923		90	180	
MPS2924		150	300	
MPS2925		235	470	
Collector Capacitance $V_{CB} = 10 \text{ V}, I_E = 0, f = 1 \text{ mc}$	C_{ob}	—	12	pf

MPS3563

For Specifications, See MPS918 Data Sheet

MPS3639

$V_{CE0} = 6V$
 $I_C = 80mA$
 $t_s = 20nsec$

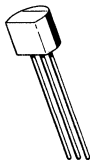

CASE 29

PNP silicon annular, plastic encapsulated transistor for low-cost, low-level, high-speed switching applications.

MAXIMUM RATINGS

Characteristic	Symbol	Rating	Unit
D. C. Collector Current	I_C	80	mAdc
Collector-Base Voltage	V_{CB0}	-6	Vdc
Collector-Emitter Voltage	V_{CE}	-6	Vdc
Emitter-Base Voltage	V_{EB0}	-4	Vdc
Total Device Dissipation @ 25° Ambient Temperature	P_D	0.2	Watts
Derate above 25° C		2.0	mW/°C
Total Device Dissipation @ 25° C Case Temperature	P_D	0.5	Watts
Derate above 25° C		5.0	mW/°C
Operating Junction Temperature	T_J	125	°C
Storage Temperature Range	T_{stg}	-55 to +125	°C

SWITCHING TIME TEST CIRCUIT

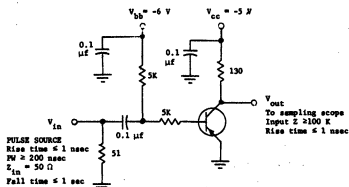
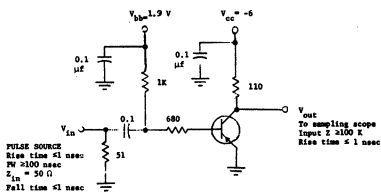

MPS3639 (continued)

ELECTRICAL CHARACTERISTICS (at 25°C case temperature unless otherwise noted)

Characteristic	Symbol	Minimum	Maximum	Unit
Collector Cutoff Current $V_{CE} = 3 \text{ V}, V_{EB} = 0$ $V_{CE} = 3 \text{ V}, V_{EB} = 0, T_A = +65^\circ\text{C}$	I_{CES}	— —	.01 1	μA
Base Current $V_{CE} = 3 \text{ V}, V_{EB} = 0$	I_B	—	10	nA
Collector-Emitter Breakdown Voltage $I_C = 100 \mu\text{A}, V_{BE} = 0$	BV_{CES}	6	—	V
Collector-Base Breakdown Voltage $I_C = 100 \mu\text{A}, I_E = 0$	BV_{CBO}	6	—	V
Emitter-Base Breakdown Voltage $I_E = 100 \mu\text{A}, I_C = 0$	BV_{EBO}	4	—	V
Collector-Emitter Sustaining Voltage $I_B = 0, I_C = 10 \text{ mA}, \text{P.W.} = 300 \mu\text{sec}$ D. C. = 1%	$V_{CEO(sus)}$	6	—	V
Collector-Emitter Saturation Voltage $I_C = 10 \text{ mA}, I_B = 1 \text{ mA}$ $I_C = 50 \text{ mA}, I_B = 5 \text{ mA}, \text{P.W.} = 300 \mu\text{sec}$ D. C. = 1% $I_C = 10 \text{ mA}, I_B = 1 \text{ mA}$	$V_{CE(sat)}$	— — —	0.16 0.5 0.23	V
Base-Emitter Saturation Voltage $I_C = 10 \text{ mA}, I_B = 0.5 \text{ mA}$ $I_C = 10 \text{ mA}, I_B = 1 \text{ mA}$ $I_C = 50 \text{ mA}, I_B = 5 \text{ mA}, \text{P.W.} = 300 \mu\text{sec}$ D. C. = 1%	$V_{BE(sat)}$	0.75 0.8 —	0.95 1 1.5	V
Forward Current Transfer Ratio $V_{CE} = 0.3 \text{ V}, I_C = 10 \text{ mA}, \text{P.W.} = 300 \mu\text{sec}$ D. C. = 1% $V_{CE} = 1.0 \text{ V}, I_C = 50 \text{ mA}, \text{P.W.} = 300 \mu\text{sec}$ D. C. = 1%	h_{FE}	30 20	120 —	—

MPS3639 (continued)

ELECTRICAL CHARACTERISTICS (continued)

Characteristic	Symbol	Minimum	Maximum	Unit
Small-Signal Current Transfer Ratio $V_{CE} = 5 \text{ V}, I_C = 10 \text{ mA}, f = 100 \text{ mc}$ $V_{CB} = 0, I_C = 10 \text{ mA}, f = 100 \text{ mc}$	h_{fe}	5 3	— —	—
Output Capacitance $I_E = 0, V_{CB} = 5 \text{ V}, f = 140 \text{ kc}$	C_{ob}	—	3.5	pf
Input Capacitance $V_{EB} = 0.5 \text{ V}, I_C = 0, f = 140 \text{ kc}$	C_{ib}	—	3.5	pf
Delay Time $V_{CC} = 6 \text{ V}, I_C = 50 \text{ mA}, I_{B1} = 5 \text{ mA}$ $V_{OB} = 1.9 \text{ V}$	t_d	—	10	nsec
Rise Time $V_{CC} = 6 \text{ V}, I_C = 50 \text{ mA}, I_{B1} = 5 \text{ mA}$ $V_{OB} = 1.9 \text{ V}$	t_r	—	30	nsec
Storage Time $V_{CC} = 6 \text{ V}, I_C = 50 \text{ mA}, I_{B1} = I_{B2} = 5 \text{ mA}$	t_s	—	20	nsec
Fall Time $V_{CC} = 6 \text{ V}, I_C = 50 \text{ mA}, I_{B1} = I_{B2} = 5 \text{ mA}$	t_f	—	12	nsec
Turn-On Time $I_C = 50 \text{ mA}, I_{B1} = 5 \text{ mA}, V_{OB} = 1.9 \text{ V}$ $I_C = 10 \text{ mA}, I_{B1} = 0.5 \text{ mA}$	t_{on}	— —	25 60	nsec
Turn-Off Time $I_C = 50 \text{ mA}, V_{OB} = 1.9 \text{ V}, I_{B1} = I_{B2} = 5 \text{ mA}$ $I_C = 10 \text{ mA}, I_{B1} = I_{B2} = 0.5 \text{ mA}$	t_{off}	— —	25 60	nsec

MPS3640

**$V_{CE0} = 12\text{ V}$
 $I_C = 80\text{ mA}$
 $t_s = 20\text{ nsec}$**

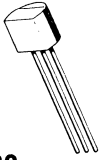

PNP silicon annular, plastic encapsulated transistor for low-cost, low-level, high-speed switching applications.

CASE 29

MAXIMUM RATINGS

Characteristic	Symbol	Rating	Unit
D. C. Collector Current	I_C	80	mAdc
Collector-Base Voltage	V_{CBO}	12	Vdc
Collector-Emitter Voltage	V_{CEO}	12	Vdc
Emitter-Base Voltage	V_{EBO}	4	Vdc
Total Device Dissipation @ 25°C Ambient Temperature	P_D	0.2	Watts
Derate above 25°C		2.0	mW/°C
Total Device Dissipation @ 25°C Case Temperature	P_D	0.5	Watts
Derate above 25°C		5.0	mW/°C
Operating Junction Temperature	T_J	125	°C
Storage Temperature Range	T_{stg}	-55 to +125	°C

ELECTRICAL CHARACTERISTICS (at 25°C case temperature unless otherwise noted)

Characteristic	Symbol	Minimum	Maximum	Unit
Collector Cutoff Current $V_{CE} = 6\text{ V}$, $V_{EB} = 0$ $V_{CE} = 6\text{ V}$, $V_{EB} = 0$, $T_A = +65^\circ\text{C}$	I_{CES}	—	.01 1	μA
Base Current $V_{CE} = 6\text{ V}$, $V_{EB} = 0$	I_B	—	10	nA
Collector-Emitter Breakdown Voltage $I_C = 100\ \mu\text{A}$, $V_{BE} = 0$	BV_{CES}	12	—	V
Collector-Base Breakdown Voltage $I_C = 100\ \mu\text{A}$, $I_E = 0$	BV_{CBO}	12	—	V
Emitter-Base Breakdown Voltage $I_E = 100\ \mu\text{A}$, $I_C = 0$	BV_{EBO}	4	—	V
Collector-Emitter Sustaining Voltage $I_B = 0$, $I_C = 10\text{ mA}$, P.W. = 300 μsec , D.C. = 1%	$V_{CEO(sus)}$	12	—	V

MPS3640 (continued)

ELECTRICAL CHARACTERISTICS (continued)

Characteristic	Symbol	Minimum	Maximum	Unit
Collector-Emitter Saturation Voltage $I_C = 10 \text{ mA}, I_B = 1 \text{ mA}$ $I_C = 50 \text{ mA}, I_B = 5 \text{ mA}, \text{P.W.} = 300 \mu\text{sec},$ D.C. = 1% $I_C = 10 \text{ mA}, I_B = 1 \text{ mA}, T_A = +65^\circ\text{C}$	$V_{CE(\text{sat})}$	—	0.2	V
Base-Emitter Saturation Voltage $I_C = 10 \text{ mA}, I_B = 0.5 \text{ mA}$ $I_C = 10 \text{ mA}, I_B = 1 \text{ mA}$ $I_C = 50 \text{ mA}, I_B = 5 \text{ mA}, \text{P.W.} = 300 \mu\text{sec},$ D.C. = 1%	$V_{BE(\text{sat})}$	0.75 0.8 —	0.95 1 1.5	V
Forward Current Transfer Ratio $V_{CE} = 0.3 \text{ V}, I_C = 10 \text{ mA}, \text{P.W.} = 300 \mu\text{sec},$ D.C. = 1% $V_{CE} = 1.0 \text{ V}, I_C = 50 \text{ mA}, \text{P.W.} = 300 \mu\text{sec},$ D.C. = 1%	h_{FE}	30 20	120 —	—
Small-Signal Current Transfer Ratio $V_{CE} = 5 \text{ V}, I_C = 10 \text{ mA}, f = 100 \text{ mc}$ $V_{CB} = 0, I_C = 10 \text{ mA}, f = 100 \text{ mc}$	h_{fe}	5 3	— —	—
Output Capacitance $I_E = 0, V_{CB} = 5 \text{ V}, f = 140 \text{ kc}$	C_{ob}	—	3.5	pf
Input Capacitance $V_{EB} = 0.5 \text{ V}, I_C = 0, f = 140 \text{ kc}$	C_{ib}	—	3.5	pf
Delay Time $V_{CC} = 6 \text{ V}, I_C = 50 \text{ mA}, I_{B1} = 5 \text{ mA},$ $V_{OB} = 1.9 \text{ V}$	t_d	—	10	nsec
Rise Time $V_{CC} = 6 \text{ V}, I_C = 50 \text{ mA}, I_{B1} = 5 \text{ mA},$ $V_{OB} = 1.9 \text{ V}$	t_r	—	30	nsec
Storage Time $V_{CC} = 6 \text{ V}, I_C = 50 \text{ mA}, I_{B1} = I_{B2} = 5 \text{ mA}$	t_s	—	20	nsec
Fall Time $V_{CC} = 6 \text{ V}, I_C = 50 \text{ mA}, I_{B1} = I_{B2} = 5 \text{ mA}$	t_f	—	12	nsec
Turn-On Time $I_C = 50 \text{ mA}, I_{B1} = 5 \text{ mA}, V_{OB} = 1.9 \text{ V}$ $I_C = 10 \text{ mA}, I_{B1} = 0.5 \text{ mA}$	t_{on}	— —	25 60	nsec
Turn-Off Time $I_C = 50 \text{ mA}, V_{OB} = 1.9 \text{ V}, I_{B1} = I_{B2} = 5 \text{ mA}$ $I_C = 10 \text{ mA}, I_{B1} = I_{B2} = 0.5 \text{ mA}$	t_{off}	— —	35 75	nsec



MOTOROLA SPECIAL AND MULTIPLE TRANSISTORS

DEVICES IN THIS SECTION

2N2060	2N3800	MD981	MD1129
2N2060A	2N3801	MD982	MD1130
2N2223	2N3802	MD984	MD1131
2N2223A	2N3803	MD985	MD1132
2N2480	2N3804	MD986	MD1133
2N2480A	2N3805	MD990	MD1134
2N3409	2N3806	MD1120	MM2090
2N3410	2N3807	MD1121	MM2091
2N3411	2N3808	MD1122	MM2092
2N3480	2N3809	MD1123	
2N3481	2N3810	MD1124	
2N3483	2N3811	MD1125	
2N3484		MD1126	
2N3796		MD1127	
2N3747		MD1128	

- For case outline dimensions, see page 1-26.

SPECIAL AND MULTIPLE TRANSISTORS

Included in this listing of special devices are unijunction and field effect transistors as well as multiple devices consisting of two transistors in a single package. The multiple transistor section includes NPN-PNP complementary pairs and duals for differential amplifier, switching and low-level amplifier applications.

UNIUNCTION TRANSISTORS

Unijunction transistors are three-terminal switching devices suitable for triggering, oscillator, pulse generation and bistable-circuit applications.

2N3480	2N3481	2N3483	2N3484
--------	--------	--------	--------

FIELD EFFECT TRANSISTORS

The Motorola line of field effect transistors includes both tetrode silicon junction and insulated gate devices.

2N3796	2N3797	MM2090	MM2091	MM2092
--------	--------	--------	--------	--------

MULTIPLE TRANSISTORS

In the Motorola multiple transistor line are matched transistors designed for differential amplifier, complementary logic, switching and amplifier applications. The transistor pairs for differential amplifiers are closely matched over a wide range of conditions. In addition, the use of multiple transistors may result in appreciable space-saving since many pairs are packaged in standard transistor case sizes.

Differential Amplifiers		Complementary Pairs	Duals for Switching	Duals for Amplifiers
2N2060	2N3806	MD985	MD981	MD1131
2N2060A	2N3807	MD986	MD982	
2N2223	2N3808		MD984	
2N2223A	2N3809		MD990	
2N2480	2N3810		MD1126	
2N2480A	2N3811		MD1127	
2N3409	MD1120		MD1128	
2N3410	MD1121		MD1133	
2N3411	MD1122		MD1134	
2N3800	MD1123			
2N3801	MD1124			
2N3802	MD1125			
2N3803	MD1129			
2N3804	MD1130			
2N3805	MD1132			

2N2060, A
2N2223, A
2N2480, A

$V_{CEO} = 40-60 \text{ V}$
 $I_C = 500 \text{ mA}$

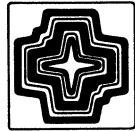

NPN silicon annular Star dual-transistors for differential amplifiers and other applications requiring a matched pair with a high degree of parameter uniformity.

CASE 32
 (TO-5)

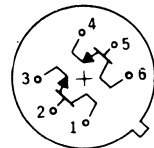

PIN CONNECTIONS
BOTTOM VIEW

MAXIMUM RATINGS (each side)

Characteristic	Symbol	Rating		Unit
Collector-Base Voltage 2N2060, 2N2060A, 2N2223, 2N2223A 2N2480 2N2480A	V_{CBO}	100 75 80		Vdc
Collector-Emitter Voltage 2N2060, 2N2060A, 2N2223, 2N2223A 2N2480, 2N2480A	V_{CEO}	60 40		Vdc
Collector-Emitter Voltage ($R_{BE} \leq 10\Omega$) 2N2060, 2N2060A, 2N2223, 2N2223A	V_{CER}	80		Vdc
Emitter-Base Voltage 2N2060, 2N2060A, 2N2223, 2N2223A 2N2480, 2N2480A	V_{EBO}	7 5		Vdc
DC Collector Current	I_C	500		mAdc
Operating Junction Temperature	T_J	200		°C
Storage Temperature Range	T_{stg}	-65 to +300		°C
		One Side	Both Sides	
Total Device Dissipation @ $T_C = 25 \text{ C}$ Derate above 25 C	P_D	1.6 9.1	3.0 17.2	Watts
Total Device Dissipation @ $T_A = 25 \text{ C}$ Derate above 25 C	P_D	0.5 2.86	0.6 3.43	Watt

2N2060, A, 2N2223, A, 2N2480, A (continued)

ELECTRICAL CHARACTERISTICS (each side)
(at 25°C ambient temperature unless otherwise noted)

Characteristic	Symbol	Min	Max	Unit
Collector-Base Breakdown Voltage ($I_C = 100 \mu\text{Adc}$, $I_E = 0$)	BV_{CBO}	100	-	Vdc
2N2060, 2N2060A, 2N2223, 2N2223A 2N2480 2N2480A		75	-	
		80	-	
Collector-Emitter Breakdown Voltage* ($I_C = 20 \text{ mAdc}$, $I_B = 0$) ($I_C = 30 \text{ mAdc}$, $I_B = 0$)	BV_{CEO}^*	40	-	Vdc
2N2480, 2N2480A 2N2060, 2N2060A, 2N2223, 2N2223A		60	-	
Collector-Emitter Breakdown Voltage* ($I_C = 100 \text{ mA}$, $R_{BE} \leq 10\Omega$)	BV_{CER}^*	80	-	Vdc
2N2060, 2N2060A, 2N2223, 2N2223A				
Emitter-Base Breakdown Voltage ($I_E = 100 \mu\text{Adc}$, $I_C = 0$)	BV_{EBO}	7	-	Vdc
2N2060, 2N2060A, 2N2223, 2N2223A 2N2480, 2N2480A		5	-	
Collector Cutoff Current ($V_{CB} = 60 \text{ Vdc}$, $I_E = 0$)	I_{CBO}	-	.050	μAdc
2N2480 2N2480A		-	.020	
($V_{CB} = 30 \text{ Vdc}$, $I_E = 0$, $T_A = 150^\circ\text{C}$)		-	.15	
($V_{CB} = 80 \text{ Vdc}$, $I_E = 0$)		-	.002	
2N2060, 2N2060A 2N2223, 2N2223A		-	.010	
($V_{CB} = 80 \text{ Vdc}$, $I_E = 0$, $T_A = 150^\circ\text{C}$)		-	.10	
		-	.15	
Emitter Cutoff Current ($V_{EB} = 5 \text{ Vdc}$, $I_C = 0$)	I_{EBO}	-	.2	nAdc
2N2060, 2N2060A 2N2223, 2N2223A		-	.10	
2N2480 2N2480A		-	.50	
		-	.20	
DC Current Gain ($I_C = 10 \mu\text{Adc}$, $V_{CE} = 5 \text{ Vdc}$)	h_{FE}	25	75	-
2N2060, 2N2060A 2N2223, 2N2223A		15	-	
($I_C = 100 \mu\text{Adc}$, $V_{CE} = 5 \text{ Vdc}$)		30	90	
2N2060, 2N2060A 2N2223, 2N2223A		25	150	
2N2480		20	-	
2N2480A		35	-	
($I_C = 1 \text{ mAdc}$, $V_{CE} = 5 \text{ Vdc}$)		40	120	
2N2060, 2N2060A 2N2480		30	350	
2N2480A		50	200	
($I_C = 10 \text{ mAdc}$, $V_{CE} = 5 \text{ Vdc}$)*		50	150	
2N2060, 2N2060A 2N2223, 2N2223A		50	200	
DC Current Gain Ratio** ($I_C = 100 \mu\text{Adc}$, $V_{CE} = 5 \text{ Vdc}$)	$h_{FE1}^h h_{FE2}^{**}$	0.9	1.0	-
2N2060, 2N2060A, 2N2223A 2N2223, 2N2480, 2N2480A		0.8	1.0	
($I_C = 1 \text{ mAdc}$, $V_{CE} = 5 \text{ Vdc}$)		0.9	1.0	
2N2060, 2N2060A 2N2480, 2N2480A		0.8	1.0	
Base Voltage Differential ($I_C = 100 \mu\text{Adc}$, $V_{CE} = 5 \text{ Vdc}$)	$V_{BE1} - V_{BE2}$	-	3	mVdc
2N2060A 2N2060, 2N2223A, 2N2480A		-	5	
2N2480		-	10	
2N2223		-	15	
($I_C = 1 \text{ mAdc}$, $V_{CE} = 5 \text{ Vdc}$)		-	5	
2N2060, 2N2060A, 2N2480A 2N2480		-	10	

2N2060, A, 2N2223, A, 2N2480, A (continued)

ELECTRICAL CHARACTERISTICS (continued)

Characteristic	Symbol	Min	Max	Unit
Collector-Emitter Saturation Voltage ($I_C = 50 \text{ mAdc}$, $I_B = 5 \text{ mAdc}$)	$V_{CE(sat)}$	-	0.6 1.2 1.3	Vdc
Base-Emitter Saturation Voltage ($I_C = 50 \text{ mAdc}$, $I_B = 5 \text{ mAdc}$)	$V_{BE(sat)}$	-	0.9 1.0	Vdc
Small-Signal Forward Current Transfer Ratio ($I_C = 50 \text{ mAdc}$, $V_{CE} = 10 \text{ Vdc}$, $f = 20 \text{ mc}$)	h_{fe}	2.5 3.0	-	-
Collector Output Capacitance ($V_{CB} = 10 \text{ Vdc}$, $f = 1 \text{ mc}$)	C_{ob}	-	15 18 20	pf
Collector Input Capacitance ($V_{EB} = 0.5 \text{ Vdc}$, $F = 1 \text{ mc}$)	C_{ib}	-	85	pf
Small-Signal Current Gain ($I_C = 1 \text{ mAdc}$, $V_{CE} = 5 \text{ Vdc}$, $f = 1 \text{ kc}$)	h_{fe}	50 40 50	150 120 300	-
Input Impedance ($I_C = 1 \text{ mAdc}$, $V_{CE} = 5 \text{ Vdc}$, $f = 1 \text{ kc}$) ($I_C = 1 \text{ mAdc}$, $V_{CE} = 5 \text{ Vdc}$, $f = 1 \text{ kc}$)	h_{ib} h_{ie} h_{ie}	20 20 1000 1000	30 35 4000 5000	ohms
Output Admittance ($I_C = 1 \text{ mAdc}$, $V_{CE} = 5 \text{ Vdc}$, $f = 1 \text{ kc}$) ($I_C = 1 \text{ mAdc}$, $V_{CE} = 5 \text{ Vdc}$, $f = 1 \text{ kc}$)	h_{ob} h_{oe}	- 4.0	0.5 16	μmhos
Voltage Feedback Ratio, Common Base ($I_C = 1 \text{ mAdc}$, $V_{CE} = 5 \text{ Vdc}$, $f = 1 \text{ kc}$)	h_{rb}	-	3	$\times 10^{-4}$
Noise Figure ($I_C = 0.3 \text{ mAdc}$, $V_{CE} = 10 \text{ Vdc}$, $f = 1 \text{ kc}$, $R_G = 510\Omega$, BW = 1 cps) ($I_C = 0.3 \text{ mAdc}$, $V_{CE} = 10 \text{ Vdc}$, $f = 1 \text{ kc}$, $R_G = 510\Omega$, BW = 200 cps) ($I_C = 0.3 \text{ mAdc}$, $V_{CE} = 10 \text{ Vdc}$, $f = 1 \text{ kc}$, $R_G = 1 \text{ k}\Omega$, BW = 15.7 kc†)	NF	-	8 8 8	db
Base Voltage Differential Change ($I_C = 100 \mu\text{A}$, $V_{CE} = 5 \text{ Vdc}$, $T_A = -55 \text{ to } +25^\circ\text{C}$) ($I_C = 100 \mu\text{A}$, $V_{CE} = 5 \text{ Vdc}$, $T_A = 25 \text{ to } 125^\circ\text{C}$)	$\Delta(V_{BE1} - V_{BE2})$	-	0.4 0.8 2.0 1.2 1.0 0.5 2.5 1.5	mVdc

* Pulse Test: Pulse Width $\leq 300 \mu\text{sec}$, Duty Cycle $\leq 2\%$

** The lowest h_{FE} reading is taken as h_{FE1} for this ratio

† Amplifier: 3 db points at 25 cps and 10 kc with a roll-off of 6 db per octave

2N3409 thru 2N3411

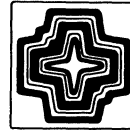

$V_{CEO} = 30\text{ V}$
 $I_C = 500\text{ mA}$

NPN silicon annular Star dual-transistors for differential amplifiers and other applications requiring a matched pair with a high degree of parameter uniformity.

CASE 32
(TO-5)

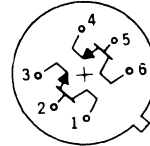

PIN CONNECTIONS
BOTTOM VIEW

ABSOLUTE MAXIMUM RATINGS

Characteristic	Symbol	Rating		Unit
		ONE SIDE	BOTH SIDES	
Collector-Base Voltage	V_{CBO}	60		Vdc
Collector-Collector Voltage	V_{CCO}	100		Vdc
Collector-Emitter Voltage	V_{CEO}	30		Vdc
Emitter-Base Voltage	V_{EBO}	5		Vdc
D.C. Collector Current (Limited by P_D)	I_C	500		mAdc
Junction Temperature	T_J	+200		$^{\circ}\text{C}$
Storage Temperature	T_{stg}	-65 to +200		$^{\circ}\text{C}$
Total Device Dissipation (25 $^{\circ}\text{C}$ Ambient Temperature) Derate above 25 $^{\circ}\text{C}$	P_D	500	600	mW
		2.9	3.4	

ELECTRICAL CHARACTERISTICS (each side)
 (at 25 $^{\circ}\text{C}$ ambient temperature unless otherwise noted)

Characteristic	Symbol	Min	Max	Unit
Collector-Base Breakdown Voltage ($I_C = 10\ \mu\text{Adc}$)	BV_{CBO}	60	—	Vdc
Collector-Emitter Breakdown Voltage* ($I_C = 10\ \text{mAdc}$)	BV_{CEO}^*	30	—	Vdc
Emitter-Base Breakdown Voltage ($I_E^* = 10\ \mu\text{Adc}$)	BV_{EBO}	5	—	Vdc

2N3409-2N3411 (continued)

ELECTRICAL CHARACTERISTICS (each side) (continued)

Characteristic	Symbol	Min	Max	Unit
Collector Cutoff Current ($V_{CB} = 50 \text{ Vdc}$) ($V_{CB} = 50 \text{ Vdc}, T_A = 150^\circ\text{C}$)	I_{CBO}	—	.010 10	$\mu\text{A dc}$
Emitter Cutoff Current ($V_{EB} = 3 \text{ Vdc}$)	I_{EBO}	—	10	nA dc
Collector to Collector Current ($V_{CC} = 100 \text{ Vdc}$)	I_{CCO}	—	100	nA dc
Collector-Emitter Saturation Voltage ($I_C = 10 \text{ mA dc}, I_B = 1 \text{ mA dc}$)	$V_{CE(sat)}$	—	0.15	V dc
Base-Emitter Saturation Voltage ($I_C = 10 \text{ mA dc}, I_B = 1 \text{ mA dc}$)	$V_{BE(sat)}$	—	0.85	V dc
DC Forward Current Transfer Ratio ($I_C = 10 \mu\text{A dc}, V_{CE} = 10 \text{ Vdc}$) ($I_C = 100 \mu\text{A dc}, V_{CE} = 10 \text{ Vdc}$) ($I_C = 1 \text{ mA dc}, V_{CE} = 10 \text{ Vdc}$) ($I_C = 10 \text{ mA dc}, V_{CE} = 10 \text{ Vdc}$)	h_{FE}		20 100 30 120 40 160 50 200	—
DC Current Gain Ratio ** ($I_C = 100 \mu\text{A dc}, V_{CE} = 10 \text{ Vdc}$) ($I_C = 1 \text{ mA dc}, V_{CE} = 10 \text{ Vdc}$)	h_{FE1}/h_{FE2}^{**}		0.8 1.0 0.9 1.0 0.9 1.0	—
Base Voltage Differential ($I_C = 100 \mu\text{A dc}, V_{CE} = 10 \text{ Vdc}$) ($I_C = 1 \text{ mA dc}, V_{CE} = 10 \text{ Vdc}$)	$V_{BE1} - V_{BE2}$		— 10 — 5 — 5	mV dc
Base Voltage Differential Change ($I_C = 100 \mu\text{A dc}, V_{CE} = 10 \text{ Vdc}, T_A = -55 \text{ to } +25^\circ\text{C}$) ($I_C = 100 \mu\text{A dc}, V_{CE} = 10 \text{ Vdc}, T_A = 25 \text{ to } 125^\circ\text{C}$)	$\Delta(V_{BE1} - V_{BE2})$		— 1.6 — 0.8 — 2.0 — 1.0	mV dc
Collector Output Capacitance ($V_{CB} = 10 \text{ Vdc}, f = 1 \text{ mc}$)	C_{ob}		— 8	pf
Collector Input Capacitance ($V_{EB} = 0.5 \text{ Vdc}, f = 1 \text{ mc}$)	C_{ib}		— 20	pf
Small-Signal Forward Current Transfer Ratio ($I_C = 20 \text{ mA dc}, V_{CE} = 20 \text{ Vdc}, f = 100 \text{ mc}$)	h_{fe}	2.5	—	—
Noise Figure ($I_C = 100 \mu\text{A}, V_{CE} = 5 \text{ V}, f = 1 \text{ kc}, \text{BW} = 1 \text{ cps}, R_g = 1 \text{ K}\Omega$)	NF	—	4	db

*Pulse Test: Pulse Width $\leq 300 \mu\text{sec}$, Duty Cycle $\leq 2\%$

**The lowest h_{FE} reading is taken as h_{FE1} for this ratio

2N3480, 2N3481, 2N3483, 2N3484

$V_{BB} = 35 \text{ V}$
 $I_E = 50 \text{ mA RMS}$

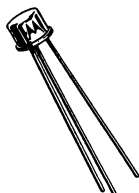

Silicon annular unijunction transistors for SCR triggering, oscillators, timing circuits, pulse generators, bistable circuits and sensing circuits.

CASE 34
(TO-9)

MAXIMUM RATINGS ($T_A = 25^\circ\text{C}$)

Characteristic	Rating	Unit
RMS Power Dissipation*	400	mW
RMS Emitter Current	50	mA
Peak Emitter Current	2	Amps
Emitter Reverse Voltage	30	Volts
Interbase Voltage	35	Volts
Operating Junction Temp. Range	-65 to 125	$^\circ\text{C}$
Storage Temperature Range	-65 to 150	$^\circ\text{C}$

*Derate 4 mW/ $^\circ\text{C}$ ambient temperature increase

ELECTRICAL CHARACTERISTICS ($T_A = 25^\circ\text{C}$ unless otherwise noted)

Device	2N3480			2N3481			Units
	Minimum	Typical	Maximum	Minimum	Typical	Maximum	
η	.56	-	.75	.70	-	.85	
R_{BBO}	4.7	-	9.1	4.7	-	9.1	K Ω
$V_{E(SAT)}$	-	-	5.0	-	-	5.0	Volts
$I_{B2(MOD)}$	-	4	-	-	4	20	mA
I_{EO}	-	-	12	-	-	12	μA
I_p	-	-	20	-	-	20	μA
I_v	4	-	-	4	-	-	mA
V_{oB1}	3	-	-	3	-	-	Volts
t_{oB1}	-	0.3	-	-	0.3	-	μsec

2N3480, 2N3481, 2N3483, 2N3484 (continued)

ELECTRICAL CHARACTERISTICS (continued)

Device	2N3483			2N3484			Units
	Minimum	Typical	Maximum	Minimum	Typical	Maximum	
η	.60	-	.72	.70	-	.85	
R_{BBO}	4.7	-	9.1	6.2	-	9.1	K Ω
$V_{E(SAT)}$	-	-	5.0	-	-	5.0	Volts
$I_{B2(MOD)}$	-	-	15	-	-	15	mA
I_{EO}	-	-	1.0	-	-	0.2	μ A
I_p	-	-	5.0	-	-	5.0	μ A
I_v	4	-	-	4	-	-	mA
V_{oB1}	4	-	-	6	-	-	Volts
t_{oB1}	-	0.3	-	-	0.3	-	μ sec

Definitions and Conditions

Symbol

- η (Eta) Intrinsic Standoff Ratio ($V_{BB} = 10V, V_p = \eta V_{BB} + V_f [E-B_1]$)
- R_{BBO} Interbase Resistance ($V_{BB} = 3V, I_E = 0$)
- $V_{E(SAT)}$ Emitter Saturation Voltage ($V_{BB} = 10V, I_E = 50ma$)
- $I_{B2(MOD)}$ Modulated Interbase Current ($V_{BB} = 10V, I_E = 50ma$)
- I_{EO} Emitter Reverse Current ($V_{B2E} = 30V, I_{B1} = 0$)
- I_p Peak Point Emitter Current ($V_{BB} = 25V$)
- I_v Valley Point Current ($V_{BB} = 20V, R_{B2} = 100\Omega$)
- V_{oB1} Base 1 Peak Pulse Voltage (See Fig. 3)
- t_{oB1} Base 1 Peak Pulse Voltage Rise Time (10%-90% points)

SYMBOL AND NOMENCLATURE

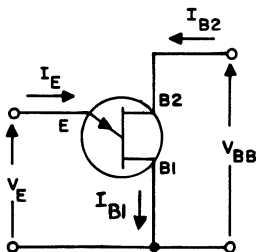

EMITTER CHARACTERISTICS

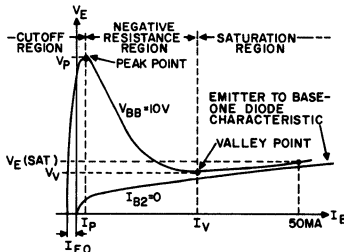

V_{oB1} TEST CIRCUIT

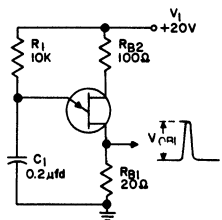

2N3796 2N3797

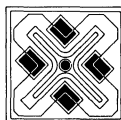

**$V_{DS} = 20-25\text{ V}$
 $I_D = 20\text{ mA}$**



CASE 22
(TO-18)

N-channel insulated gate silicon field effect transistors for low power applications in the audio frequency range.

ABSOLUTE MAXIMUM RATINGS (At 25° ambient temperature unless otherwise noted)

Characteristic	Symbol	Rating	Unit
Drain-Source Voltage 2N3796 2N3797	V_{DS}	25 20	Vdc
Gate-Source Voltage	V_{GS}	+10	Vdc
Drain Current	I_D	20	mAdc
Power Dissipation at $T_A = 25^\circ\text{C}$ Derating Factor above 25°C	P_D	200 1.14	mW mW/°C
Operating Junction Temperature	T_J	+200	°C
Storage Temperature	T_{stg}	-65 to +200	°C

ELECTRICAL CHARACTERISTICS (At 25° ambient temperature unless otherwise noted)

Characteristic	Symbol	Min	Typical	Max	Unit
Drain-Source Breakdown Voltage ($V_{GS} = -4\text{ V}$, $I_D = 5\ \mu\text{A}$) ($V_{GS} = -7\text{ V}$, $I_D = 5\ \mu\text{A}$)	BV_{DSX} 2N3796 2N3797	25 20	30 25	- -	Vdc
Zero-Gate-Voltage Drain Current ($V_{DS} = 10\text{ V}$, $V_{GS} = 0$)	I_{DSS} 2N3796 2N3797	0.5 2	2 4	3 6	mAdc
Gate-Source Voltage Cutoff ($I_D = 0.5\ \mu\text{A}$, $V_{DS} = 10\text{ V}$) ($I_D = 2.0\ \mu\text{A}$, $V_{DS} = 10\text{ V}$)	$V_{GS(off)}$ 2N3796 2N3797	- -	-3 -5	-4 -7	Vdc
"On" Drain Current ($V_{DS} = 10\text{ V}$, $V_{GS} = +3.5\text{ V}$)	$I_{D(on)}$ 2N3796 2N3797	7 9	9 14	14 18	mAdc
Drain-Gate Reverse Current ($V_{DG} = 10\text{ V}$, $I_S = 0$)	I_{DGO}	-	0.1	1.0	pAdc
Gate-Reverse Current ($V_{GS} = -10\text{ V}$, $V_{DS} = 0$) ($V_{GS} = -10\text{ V}$, $V_{DS} = 0$, $T_A = 150^\circ\text{C}$)	I_{GSS}	- -	0.1 50	1.0 200	pAdc
Small-Signal, Common-Source Forward Transfer Admittance ($V_{DS} = 10\text{ V}$, $V_{GS} = 0$, $f = 1\text{ kc}$) ($V_{DS} = 10\text{ V}$, $V_{GS} = 0$, $f = 1.0\text{ mc}$)	$ y_{fs} $ 2N3796 2N3797 2N3796 2N3797	900 1500 900 1500	1300 2100	1800 3000 - -	μmhos

2N3796, 2N3797 (continued)

ELECTRICAL CHARACTERISTICS (continued)

Characteristic	Symbol	Min	Typical	Max	Unit
Small-Signal, Common-Source, Output Admittance ($V_{DS} = 10\text{ V}$, $V_{GS} = 0$, $f = 1\text{ kc}$)	$ y_{os} $ 2N3796 2N3797	- -	12 30	25 60	μmhos
Small-Signal, Common-Source, Input Capacitance ($V_{DS} = 10\text{ V}$, $V_{GS} = 0$, $f = 1\text{ kc}$)	C_{iss} 2N3796 2N3797	- -	4 6	7 8	pf
Small-Signal, Common-Source, Reverse Transfer Capacitance ($V_{DS} = 10\text{ V}$, $V_{GS} = 0$, $f = 1\text{ kc}$)	C_{rss}	-	0.4	0.8	pf
Noise Figure ($V_{DS} = 10\text{ V}$, $V_{GS} = 0$, $f = 1\text{ kc}$, $R_g = 3\text{ megohms}$)	NF	-	4.0	-	db

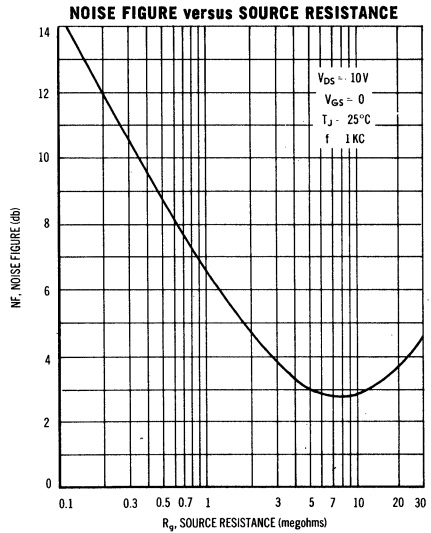
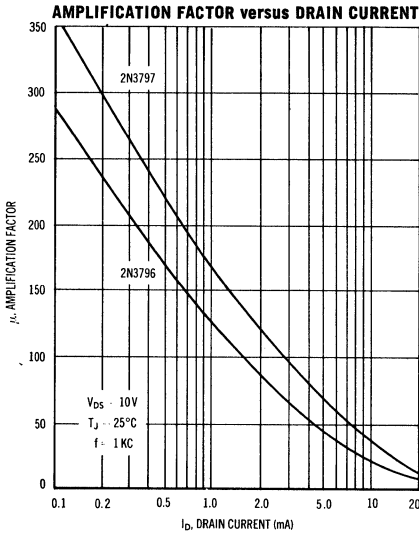
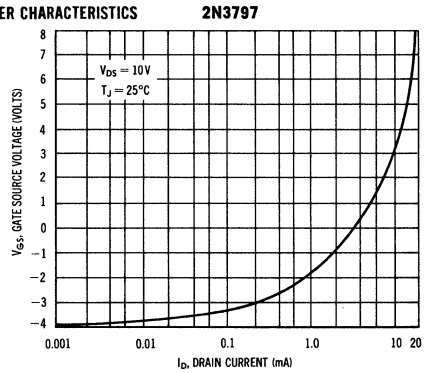
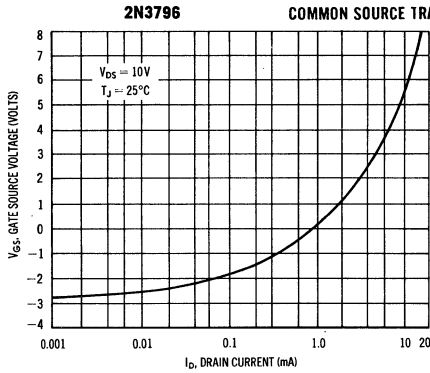

2N3800 thru 2N3811

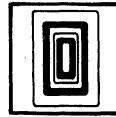

$V_{CEO} = 60\text{ V}$
 $I_C = 50\text{ mA}$

PNP silicon annular dual-transistors for low-level, low-noise differential amplifier applications.

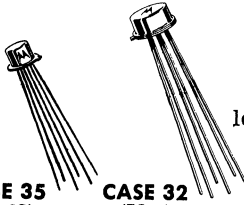

CASE 35
(TO-18)

2N3800
thru
2N3805

CASE 32
(TO-5)

2N3806
thru
2N3811

MAXIMUM RATINGS (at 25°C ambient temperature unless otherwise noted)

Characteristic	Symbol	Rating		Unit	
		One Side	Both Sides		
Collector-Base Voltage	V_{CBO}	60		Vdc	
Collector-Emitter Voltage	V_{CEO}	60		Vdc	
Emitter-Base Voltage	V_{EBO}	5		Vdc	
DC Collector Current	I_C	50		mA dc	
Junction Temperature	T_J	-200		°C	
Storage Temperature Range	T_{stg}	-65 to +200		°C	
Total Device Dissipation @ $T_A = 25^\circ\text{C}$	P_D				
		TO-5 Case Derate above 25°C	500	600	mW
			2.9	3.4	mW/°C
		TO-18 Case Derate above 25°C	250	360	mW
1.5	2.06		mW/°C		

NOISE FIGURE VERSUS FREQUENCY AND SOURCE RESISTANCE

2N3800, 02, 04, 06, 08, 10

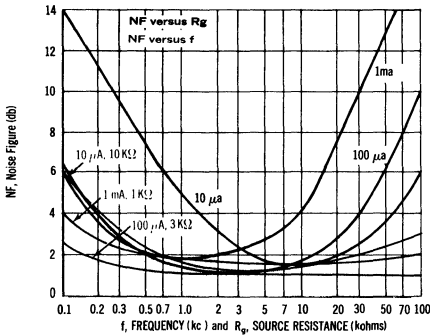

2N3801, 03, 05, 07, 09, 11

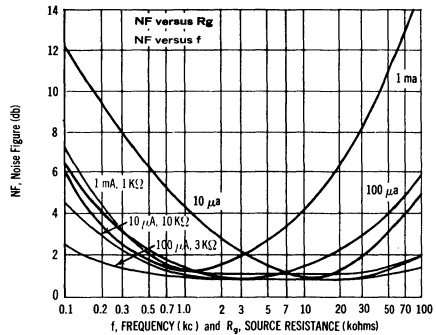

2N3800 thru 2N3811 (continued)

ELECTRICAL CHARACTERISTICS (at 25°C ambient temperature unless otherwise noted)

Characteristic	Symbol	Minimum	Typical	Maximum	Unit
Collector-Base Breakdown Voltage ($I_C = 10 \mu\text{A}$, $I_E = 0$)	BV_{CBO}	60	-	-	Vdc
Collector-Emitter Breakdown Voltage ($I_C = 10 \text{mA}$, $I_B = 0$)	BV_{CEO}	60	90	-	Vdc
Emitter-Base Breakdown Voltage ($I_E = 10 \mu\text{A}$, $I_C = 0$)	BV_{EBO}	5	-	-	Vdc
Collector Cutoff Current ($V_{CB} = 50 \text{Vdc}$, $I_E = 0$) ($V_{CB} = 50 \text{Vdc}$, $I_E = 0$, $T_A = 150^\circ\text{C}$)	I_{CBO}	-	-	010 10	μA
Emitter Cutoff Current ($V_{OB} = 4 \text{Vdc}$, $I_C = 0$)	I_{EBO}	-	-	20	nA
Collector-Emitter Saturation Voltage* ($I_C = 100 \mu\text{A}$, $I_B = 10 \mu\text{A}$) ($I_C = 1 \text{mA}$, $I_B = 100 \mu\text{A}$)	$V_{CE(sat)}$ *	-	-	0.2 0.25	Vdc
Base-Emitter Saturation Voltage* ($I_C = 100 \mu\text{A}$, $I_B = 10 \mu\text{A}$) ($I_C = 1 \text{mA}$, $I_B = 100 \mu\text{A}$)	$V_{BE(sat)}$ *	-	-	0.7 0.8	Vdc
DC Forward Current Transfer Ratio* ($I_C = 1 \mu\text{A}$, $V_{CE} = 5 \text{Vdc}$) ($I_C = 10 \mu\text{A}$, $V_{CE} = 5 \text{Vdc}$) ($I_C = 100 \mu\text{A}$, $V_{CE} = 5 \text{Vdc}$) ($I_C = 100 \mu\text{A}$, $V_{CE} = 5 \text{Vdc}$, $T_A = -55^\circ\text{C}$) ($I_C = 500 \mu\text{A}$, $V_{CE} = 5 \text{Vdc}$) ($I_C = 1 \text{mA}$, $V_{CE} = 5 \text{Vdc}$) ($I_C = 10 \text{mA}$, $V_{CE} = 5 \text{Vdc}$)	h_{FE} *	75	-	-	-
		2N3801, 03, 05, 07, 09, 11			
		2N3800, 02, 04, 06, 08, 10			
		2N3801, 03, 05, 07, 09, 11			
		2N3800, 02, 04, 06, 08, 10			
		2N3801, 03, 05, 07, 09, 11			
		2N3800, 02, 04, 06, 08, 10			
		2N3801, 03, 05, 07, 09, 11			
		2N3800, 02, 04, 06, 08, 10			
		2N3801, 03, 05, 07, 09, 11			
		2N3800, 02, 04, 06, 08, 10			
		2N3801, 03, 05, 07, 09, 11			
Base Emitter "ON" Voltage ($I_C = 100 \mu\text{A}$, $V_{CE} = 5 \text{V}$)	$V_{BE(ON)}$	-	-	0.7	Vdc
Output Capacitance ($V_{CB} = 5 \text{Vdc}$, $I_E = 0$, $f = 100 \text{kc}$)	C_{ob}	-	-	4	pf
Input Capacitance ($V_{OB} = 0.5 \text{Vdc}$, $I_C = 0$, $f = 100 \text{kc}$)	C_{ib}	-	-	8	pf
Small Signal Current Gain ($I_C = 500 \mu\text{A}$, $V_{CE} = 5 \text{V}$, $f = 30 \text{mc}$) ($I_C = 1 \text{mA}$, $V_{CE} = 5 \text{V}$, $f = 100 \text{mc}$) ($I_C = 1 \text{mA}$, $V_{CE} = 10 \text{V}$, $f = 1 \text{kc}$)	h_{ie}	1.0	-	-	-
		2N3800, 02, 04, 06, 08, 10			
		2N3801, 03, 05, 07, 09, 11			
Voltage Feedback Ratio ($I_C = 1.0 \text{mA}$, $V_{CE} = 10 \text{V}$, $f = 1 \text{kc}$)	h_{re}	-	-	25	$\times 10^{-4}$
Input Impedance ($I_C = 1.0 \text{mA}$, $V_{CE} = 10 \text{V}$, $f = 1 \text{kc}$)	h_{ie}	3	-	15	k ohms
		2N3800, 02, 04, 06, 08, 10			
		2N3801, 03, 05, 07, 09, 11			
Output Admittance ($I_C = 1.0 \text{mA}$, $V_{CE} = 10 \text{V}$, $f = 1 \text{kc}$)	h_{oe}	5	-	60	μmhos
Noise Figure ($I_C = 100 \mu\text{A}$, $V_{CE} = 10 \text{V}$, $R_G = 3 \text{K}$) $f = 100 \text{cps}$ $f = 1 \text{kc}$ $f = 10 \text{kc}$ Noise Bandwidth 10 cps to 15.7 kc	NF	-	4	7	db
		2N3800, 02, 04, 06, 08, 10			
		2N3801, 03, 05, 07, 09, 11			
		2N3800, 02, 04, 06, 08, 10			
		2N3801, 03, 05, 07, 09, 11			
		2N3800, 02, 04, 06, 08, 10			
		2N3801, 03, 05, 07, 09, 11			

MATCHING CHARACTERISTICS

DC Current Gain Ratio** ($I_C = 100 \mu\text{A}$, $V_{CE} = 5 \text{Vdc}$)	h_{FE1}/h_{FE2} **	0.8	-	1.0	-
		0.9	-	1.0	-
Base Voltage Differential ($I_C = 10 \mu\text{A}$, to 10 mA, $V_{CE} = 5 \text{Vdc}$) ($I_C = 100 \mu\text{A}$, $V_{CE} = 5 \text{Vdc}$)	$ V_{BE1} - V_{BE2} $	-	-	8	mVdc
		-	-	5	-
		-	-	5	-
		-	-	3	-
Base Voltage Differential Change ($I_C = 100 \mu\text{A}$, $V_{CE} = 5 \text{Vdc}$, $T_A = -55$ to $+25^\circ\text{C}$) ($I_C = 100 \mu\text{A}$, $V_{CE} = 5 \text{Vdc}$, $T_A = 25$ to 125°C)	$\Delta(V_{BE1} - V_{BE2})$	-	-	1.6	mVdc
		-	-	0.8	-
		-	-	2.0	-
		-	-	1.0	-

* Pulse Test $\leq 300\mu\text{sec}$, duty cycle $\leq 2\%$ V_{OB} - Base-Emitter Reverse Bias

** The lowest h_{FE} reading is taken as h_{FE1} for this ratio

MD981

$V_{CEO} = 30\text{ V}$
 $I_C = 200\text{ mA}$

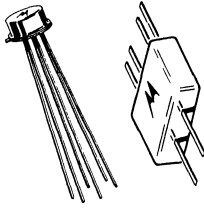

NPN silicon annular Star dual-transistors for high-speed switching and DC to UHF amplifier applications.

MD981

MD981F

CASE 32
(TO-5)

CASE 33

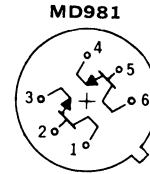
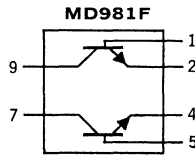

(NPN)

ABSOLUTE MAXIMUM RATINGS (each side)

Characteristic	Symbol	Rating		Unit
		One Side	Both Sides	
Collector-Base Voltage	V_{CBO}	60		Vdc
Collector-Emitter Voltage MD981	V_{CEO}	30		Vdc
Emitter-Base Voltage	V_{EBO}	5		Vdc
Collector Current (Limited by P_D)	I_C	200		mAdc
Operating Junction Temperature	T_J	+200		°C
Storage Temperature	T_{stg}	-65 to +200		°C
Flat Package Total Device Dissipation (25°C Ambient Temperature) Derate above 25°C	P_D	250 1.5	350 2	mW mW/°C
TO-5 Package Total Device Dissipation (25°C Ambient Temperature) Derate above 25°C	P_D	500 2.9	600 3.4	mW mW/°C

MD981 (continued)

ELECTRICAL CHARACTERISTICS (each side)
(At 25° ambient temperature unless otherwise noted)

Characteristic	Symbol	Minimum	Maximum	Unit
Collector-Base Breakdown Voltage ($I_C = 10 \mu\text{A dc}$, $I_E = 0$)	BV_{CBO}	60	---	Vdc
Collector-Emitter Breakdown Voltage* ($I_C = 10 \text{ mA dc}$, $I_B = 0$)	BV_{CEO}^*	30	---	Vdc
Emitter-Base Breakdown Voltage ($I_E = 10 \mu\text{A dc}$, $I_C = 0$)	BV_{EBO}	5	---	Vdc
Collector Cutoff Current ($V_{CB} = 50 \text{ Vdc}$, $I_E = 0$) ($V_{CB} = 50 \text{ Vdc}$, $I_E = 0$, $T_A = 150^\circ\text{C}$)	I_{CBO}	---	.010 10	$\mu\text{A dc}$
Collector-Emitter Saturation Voltage ($I_C = 150 \text{ mA dc}$, $I_B = 15 \text{ mA dc}$)	$V_{CE}(\text{sat})$	---	0.4	Vdc
Base-Emitter Saturation Voltage ($I_C = 150 \text{ mA dc}$, $I_B = 15 \text{ mA dc}$)	$V_{BE}(\text{sat})$	---	1.3	Vdc
DC Forward Current Transfer Ratio ($I_C = 0.1 \text{ mA dc}$, $V_{CE} = 10 \text{ Vdc}$) ($I_C = 1 \text{ mA dc}$, $V_{CE} = 10 \text{ Vdc}$) ($I_C = 10 \text{ mA dc}$, $V_{CE} = 10 \text{ Vdc}$) ($I_C = 150 \text{ mA dc}$, $V_{CE} = 10 \text{ Vdc}$)*	h_{FE}	20 25 35 40*	---	---
Output Capacitance ($V_{CB} = 10 \text{ Vdc}$, $I_E = 0$, $f = 100 \text{ kc}$)	C_{ob}	---	8	pf
Small-Signal Forward Current Transfer Ratio ($I_C = 20 \text{ mA dc}$, $V_{CE} = 20 \text{ Vdc}$, $f = 100 \text{ mc}$) TO-5 Package ($I_C = 20 \text{ mA dc}$, $V_{CE} = 10 \text{ Vdc}$, $f = 100 \text{ mc}$) Flat Package	h_{fe}	2.5 2.0	---	---
Current-Gain-Bandwidth Product ($V_{CE} = 20 \text{ Vdc}$, $I_C = 20 \text{ mA dc}$) TO-5 Package ($V_{CE} = 10 \text{ Vdc}$, $I_C = 20 \text{ mA dc}$) Flat Package	f_T	250 200	---	mc ---

MD982

V_{CEO} = 50 V
I_C = 200 mA

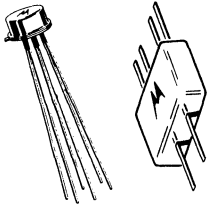

MD982
CASE 32
(TO-5)

MD982F
CASE 33

PNP silicon annular Star dual-transistors for high-speed switching and DC to UHF amplifier applications.

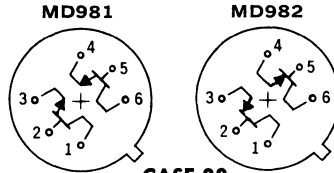

(NPN)

(PNP)

PIN CONNECTIONS
BOTTOM VIEW

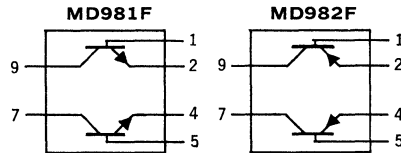

ABSOLUTE MAXIMUM RATINGS (each side)

Characteristic	Symbol	Rating		Unit
Collector-Base Voltage	V _{CB0}	60		Vdc
Collector-Emitter Voltage	V _{CEO}	50		Vdc
Emitter-Base Voltage	V _{EBO}	5		Vdc
Collector Current (Limited by P _D)	I _C	200		mAdc
Operating Junction Temperature	T _J	200		°C
Storage Temperature	T _{stg}	-65 to +200		°C
		ONE SIDE	BOTH SIDES	
Flat Package Total Device Dissipation (25°C Ambient Temperature) Derate above 25°C	P _D	250 1.5	350 2	mW mW/°C
TO-5 Package Total Device Dissipation (25°C Ambient Temperature) Derate above 25°C	P _D	500 2.9	600 3.4	mW mW/°C

MD982 (continued)

ELECTRICAL CHARACTERISTICS (each side)
(at 25°C ambient temperature unless otherwise noted)

Characteristic	Symbol	Min	Max	Unit
Collector-Base Breakdown Voltage ($I_C = -10 \mu\text{A dc}$, $I_E = 0$)	BV_{CBO}	60	—	Vdc
Collector-Emitter Breakdown Voltage* ($I_C = -10 \text{mA dc}$, $I_B = 0$)	BV_{CEO}^*	50	—	Vdc
Emitter-Base Breakdown Voltage ($I_E = -10 \mu\text{A dc}$, $I_C = 0$)	BV_{EBO}	5	—	Vdc
Collector Cutoff Current ($V_{CB} = -50 \text{V dc}$, $I_E = 0$) ($V_{CB} = -50 \text{V dc}$, $I_E = 0$, $T_A = 150^\circ\text{C}$)	I_{CBO}	— —	.020 20	$\mu\text{A dc}$
Collector-Emitter Saturation Voltage ($I_C = -150 \text{mA dc}$, $I_B = -15 \text{mA dc}$)	$V_{CE}(\text{sat})$	—	0.5	Vdc
Base-Emitter Saturation Voltage ($I_C = -150 \text{mA dc}$, $I_B = -15 \text{mA dc}$)	$V_{BE}(\text{sat})$	—	1.4	Vdc
DC Forward Current Transfer Ratio ($I_C = -0.1 \text{mA dc}$, $V_{CE} = -10 \text{V dc}$) ($I_C = -1 \text{mA dc}$, $V_{CE} = -10 \text{V dc}$) ($I_C = -10 \text{mA dc}$, $V_{CE} = -10 \text{V dc}$) ($I_C = -150 \text{mA dc}$, $V_{CE} = -10 \text{V dc}$)*	h_{FE}	20 25 35 40*	— — — —	—
Output Capacitance ($V_{CB} = -10 \text{V dc}$, $I_E = 0$, $f = 100 \text{kc}$)	C_{ob}	—	8	pf
Current-Gain-Bandwidth Product ($V_{CE} = -20 \text{V dc}$, $I_C = -20 \text{mA dc}$) TO-5 Package ($V_{CE} = -10 \text{V dc}$, $I_C = -20 \text{mA dc}$) Flat Package	f_T	200 200	— —	mc

*Pulse Test: Pulse Width $\leq 300 \mu\text{sec}$, Duty Cycle $\leq 2\%$

MD984

$V_{CEO} = 20\text{ V}$
 $I_C = 200\text{ mA}$

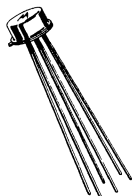

PNP silicon annular dual-transistors for high-speed switching and amplifier applications.

CASE 32
(TO-5)

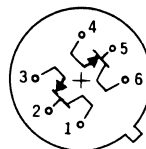

PIN CONNECTIONS
(BOTTOM VIEW)

ABSOLUTE MAXIMUM RATINGS (each side)

Characteristic	Symbol	Rating		Unit
		One Side	Both Sides	
Collector-Base Voltage	V_{CBO}	40		Vdc
Collector-Emitter Voltage	V_{CEO}	20		Vdc
Emitter-Base Voltage	V_{EBO}	5		Vdc
Collector Current	I_C	200		mAdc
Junction Temperature	T_J	+200		°C
Storage Temperature	T_{stg}	-65 to +200		°C
		One Side	Both Sides	
Total Device Dissipation (25°C Case Temperature) Derate above 25°C	P_D	1.6 9.1	3.0 17.2	W mW/°C
Total Device Dissipation (25°C Ambient Temperature) Derate above 25°C	P_D	0.5 2.9	0.6 3.4	W mW/°C

MD984 (continued)

ELECTRICAL CHARACTERISTICS (each side)
(at 25°C ambient temperature unless otherwise noted)

Characteristic	Symbol	Minimum	Maximum	Unit
Collector-Base Breakdown Voltage ($I_C = -10 \mu\text{Adc}$, $I_E = 0$)	BV_{CBO}	40	---	Vdc
Collector-Emitter Breakdown Voltage* ($I_C = -10 \text{ mAdc}$, $I_B = 0$)	BV_{CEO}^*	20	---	Vdc
Emitter-Base Breakdown Voltage ($I_E = -10 \mu\text{Adc}$, $I_C = 0$)	BV_{EBO}	5	---	Vdc
Collector Cutoff Current ($V_{CB} = -20 \text{ Vdc}$, $I_E = 0$) ($V_{CB} = -20 \text{ Vdc}$, $I_E = 0$, $T_A = 150^\circ\text{C}$)	I_{CBO}	---	.025 30	μAdc
Collector-Emitter Saturation Voltage ($I_C = -10 \text{ mAdc}$, $I_B = -1 \text{ mAdc}$) ($I_C = -50 \text{ mAdc}$, $I_B = -5 \text{ mAdc}$)	$V_{CE(\text{sat})}$	---	0.3 0.5	Vdc
Base-Emitter Saturation Voltage ($I_C = -10 \text{ mAdc}$, $I_B = -1 \text{ mAdc}$)	$V_{BE(\text{sat})}$	---	0.9	Vdc
DC Forward Current Transfer Ratio ($I_C = -10 \text{ mAdc}$, $V_{CE} = -10 \text{ Vdc}$)	h_{FE}	25	---	---
Output Capacitance ($V_{CB} = -10 \text{ Vdc}$, $I_E = 0$, $f = 100 \text{ kc}$)	C_{ob}	---	4	pf
Small-Signal Forward Current Transfer Ratio ($I_C = -20 \text{ mAdc}$, $V_{CE} = -20 \text{ Vdc}$, $f = 100 \text{ mc}$)	h_{fe}	2.5	---	---
Current-Gain-Bandwidth Product ($I_C = -20 \text{ mAdc}$, $V_{CE} = -20 \text{ Vdc}$)	f_T	250	---	mc

* Pulse Test: Pulse Width $\leq 300 \mu\text{sec}$, Duty Cycle $\leq 2\%$

MD985

$V_{CEO} = 30\text{ V}$
 $I_C = 500\text{ mA}$

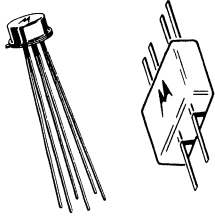

NPN-PNP silicon annular Star complementary pair dual-transistors for high-speed switching circuits and DC to UHF amplifier applications.

CASE 32
 (TO-5)
 MD985

CASE 33
 MD985F

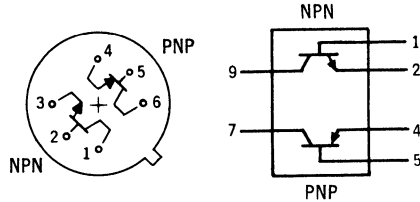

PIN CONNECTIONS
 BOTTOM VIEW

ABSOLUTE MAXIMUM RATINGS (each side)

Characteristic	Symbol	Rating		Unit
		One Side	Both Sides	
Collector-Base Voltage	V_{CBO}	60		Vdc
Collector-Emitter Voltage	V_{CEO}	30		Vdc
Emitter-Base Voltage	V_{EBO}	5		Vdc
Collector Current (Limited by P_D)	I_C	500		mAdc
Operating Junction Temperature	T_J	+200		°C
Storage Temperature	T_{stg}	-65 to +200		°C
Total Device Dissipation @ $T_A = 25^\circ\text{C}$ Flat Package Derating Factor TO-5 Package Derating Factor	P_D	250	350	mW
		1.5	2.0	mW/°C
		500	600	mW
		2.9	3.4	mW/°C

MD985 (continued)

ELECTRICAL CHARACTERISTICS (at 25°C ambient temperature unless otherwise noted)

Characteristic	Symbol	Minimum	Maximum	Unit
Collector-Base Breakdown Voltage ($I_C = 10 \mu\text{Adc}$, $I_E = 0$)	BV_{CBO}	60	-	Vdc
Collector-Emitter Breakdown Voltage** ($I_C = 10 \text{ mAdc}$, $I_B = 0$)	BV_{CEO}^{**}	30	-	Vdc
Emitter-Base Breakdown Voltage ($I_E = 10 \mu\text{Adc}$, $I_C = 0$)	BV_{EBO}	5	-	Vdc
Collector Cutoff Current ($V_{CB} = 50 \text{ Vdc}$, $I_E = 0$) ($V_{CB} = 50 \text{ Vdc}$, $I_E = 0$, $T_A = 150^\circ\text{C}$)	I_{CBO}	- -	.020 20	μAdc
Collector-Emitter Saturation Voltage** ($I_C = 150 \text{ mAdc}$, $I_B = 15 \text{ mAdc}$)	$V_{CE(sat)}^{**}$	-	0.5	Vdc
Base-Emitter Saturation Voltage** ($I_C = 150 \text{ mAdc}$, $I_B = 15 \text{ mAdc}$)	$V_{BE(sat)}^{**}$	-	1.4	Vdc
DC Forward Current Transfer Ratio ($I_C = 0.1 \text{ mAdc}$, $V_{CE} = 10 \text{ Vdc}$) ($I_C = 1 \text{ mAdc}$, $V_{CE} = 10 \text{ Vdc}$) ($I_C = 10 \text{ mAdc}$, $V_{CE} = 10 \text{ Vdc}$) ($I_C = 150 \text{ mAdc}$, $V_{CE} = 10 \text{ Vdc}$)**	h_{FE}	20 25 35 40**	- - - -	-
Output Capacitance ($V_{CB} = 10 \text{ Vdc}$, $I_E = 0$, $f = 100 \text{ kc}$)	C_{ob}	-	8	pf
Current-Gain - Bandwidth Product ($V_{CE} = 20 \text{ Vdc}$, $I_C = 50 \text{ mAdc}$) TO-5 Package ($V_{CE} = 10 \text{ Vdc}$, $I_C = 20 \text{ mAdc}$) Flat Package	f_T	200 200	- -	mc

** Pulse Test: Pulse Width $\leq 300 \mu\text{sec}$. Duty Cycle $\leq 2\%$

MD986

$V_{CEO} = 15\text{ V}$
 $I_C = 200\text{ mA}$

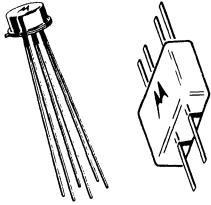

NPN-PNP silicon annular Star complementary pair dual-transistors for high-speed switching circuits and DC to UHF amplifier applications.

CASE 32
(TO-5)
MD986

CASE 33
MD986F

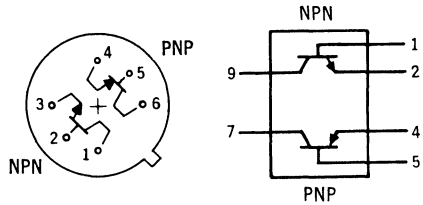

PIN CONNECTIONS
BOTTOM VIEW

ABSOLUTE MAXIMUM RATINGS (each side)

Characteristic	Symbol	Rating		Unit
		ONE SIDE	BOTH SIDES	
Collector-Base Voltage	V_{CB0}	40		Vdc
Collector-Emitter Voltage	V_{CEO}	15		Vdc
Emitter-Base Voltage	V_{EBO}	5		Vdc
Collector Current	I_C	200		mAdc
Operating Junction Temperature	T_J	+200		$^{\circ}\text{C}$
Storage Temperature	T_{stg}	-65 to +200		$^{\circ}\text{C}$
Total Device Dissipation @ $T_A = 25^{\circ}\text{C}$ Flat Package Derate above 25 $^{\circ}\text{C}$ TO-5 Package Derate above 25 $^{\circ}\text{C}$	P_D	250	350	mW
		1.5	2.0	mW/ $^{\circ}\text{C}$
		500	600	mW
		2.9	3.4	mW/ $^{\circ}\text{C}$

MD986 (continued)

ELECTRICAL CHARACTERISTICS (each side)
(at 25°C ambient temperature unless otherwise noted)

Characteristics	Symbol	Min	Max	Unit
Collector-Base Breakdown Voltage ($I_C = 10 \mu\text{Adc}$, $I_E = 0$)	BV_{CBO}	40	—	Vdc
Collector-Emitter Breakdown Voltage* ($I_C = 10 \text{ mAdc}$, $I_B = 0$)	BV_{CEO}^*	15	—	Vdc
Emitter-Base Breakdown Voltage ($I_E = 10 \mu\text{Adc}$, $I_C = 0$)	BV_{EBO}	5	—	Vdc
Collector Cutoff Current ($V_{CB} = 20 \text{ Vdc}$, $I_E = 0$) ($V_{CB} = 20 \text{ Vdc}$, $I_E = 0$, $T_A = 150^\circ\text{C}$)	I_{CBO}	— —	.025 30	μAdc
Collector-Emitter Saturation Voltage ($I_C = 10 \text{ mAdc}$, $I_B = 1 \text{ mAdc}$) ($I_C = 50 \text{ mAdc}$, $I_B = 5 \text{ mAdc}$)	$V_{CE(\text{sat})}$	— —	0.3 0.5	Vdc
Base-Emitter Saturation Voltage ($I_C = 10 \text{ mAdc}$, $I_B = 1 \text{ mAdc}$)	$V_{BE(\text{sat})}$	—	0.9	Vdc
DC Forward Current Transfer Ratio ($I_C = 10 \text{ mAdc}$, $V_{CE} = 10 \text{ Vdc}$)	h_{FE}	25	—	—
Output Capacitance ($V_{CB} = 10 \text{ Vdc}$, $I_E = 0$, $f = 100 \text{ kc}$)	C_{ob}	—	4	pf
Current-Gain — Bandwidth Product ($V_{CE} = 20 \text{ Vdc}$, $I_C = 20 \text{ mAdc}$) TO-5 Package ($V_{CE} = 10 \text{ Vdc}$, $I_C = 20 \text{ mAdc}$) Flat Package	f_T	200 200	— —	mc

*Pulse Test: Pulse Width $\leq 300 \mu\text{sec}$, Duty Cycle $\leq 2\%$

MD990

$V_{CE0} = 35\text{ V}$
 $I_C = 600\text{ mA}$

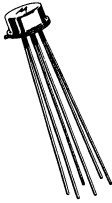

PNP silicon annular dual-transistors for medium-speed switching applications.

CASE 32
(TO-5)

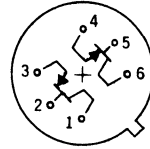

PIN CONNECTIONS
(BOTTOM VIEW)

ABSOLUTE MAXIMUM RATINGS (each side)

Characteristic	Symbol	Rating		Unit
		One Side	Both Sides	
Collector-Base Voltage	V_{CBO}	50		Vdc
Collector-Emitter Voltage	V_{CEO}	35		Vdc
Collector-Emitter Voltage ($R_{BE} \leq 10\Omega$)	V_{CER}	50		Vdc
Emitter-Base Voltage	V_{EBO}	5		Vdc
Collector Current	I_C	600		mAdc
Operating Junction Temperature	T_J	+175		$^{\circ}\text{C}$
Storage Temperature	T_{stg}	-65 to +200		$^{\circ}\text{C}$
Total Device Dissipation (25 $^{\circ}\text{C}$ Case Temperature) Derate above 25 $^{\circ}\text{C}$	P_D	One Side	Both Sides	W mW/ $^{\circ}\text{C}$
		1.6 10.7	3.0 20.0	
Total Device Dissipation (25 $^{\circ}\text{C}$ Ambient Temperature) Derate above 25 $^{\circ}\text{C}$	P_D	0.5 3.3	0.6 4.0	W mW/ $^{\circ}\text{C}$

MD990 (continued)

ELECTRICAL CHARACTERISTICS (each side)
(at 25°C ambient temperature unless otherwise noted)

Characteristic	Symbol	Min	Max	Unit
Collector-Base Breakdown Voltage ($I_C = -100 \mu\text{Adc}$, $I_E = 0$)	BV_{CBO}	50	—	Vdc
Collector-Emitter Breakdown Voltage* ($I_C = -10 \text{ mAdc}$, $I_B = 0$)	BV_{CEO}^*	35	—	Vdc
Collector-Emitter Breakdown Voltage* ($I_C = -30 \text{ mAdc}$, $I_B = 0$, $R_{BE} \leq 10\Omega$)	BV_{CER}^*	50	—	Vdc
Emitter-Base Breakdown Voltage ($I_E = -100 \mu\text{Adc}$, $I_C = 0$)	BV_{EBO}	5	—	Vdc
Collector Cutoff Current ($V_{CB} = -30 \text{ Vdc}$, $I_E = 0$) ($V_{CB} = -30 \text{ Vdc}$, $I_E = 0$, $T_A = 150^\circ\text{C}$)	I_{CBO}	— —	1 100	μAdc
Collector-Emitter Saturation Voltage ($I_C = -150 \text{ mAdc}$, $I_B = -15 \text{ mAdc}$)	$V_{CE(\text{sat})}$	—	1.5	Vdc
Base-Emitter Saturation Voltage ($I_C = -150 \text{ mAdc}$, $I_B = -15 \text{ mAdc}$)	$V_{BE(\text{sat})}$	—	1.3	Vdc
DC Forward Current Transfer Ratio* ($I_C = -150 \text{ mAdc}$, $V_{CE} = -10 \text{ Vdc}$)	h_{FE}^*	50	300	—
Output Capacitance ($V_{CB} = -10 \text{ Vdc}$, $I_E = 0$, $f = 100 \text{ kc}$)	C_{ob}	—	45	pf
Current-Gain-Bandwidth Product ($V_{CE} = -10 \text{ Vdc}$, $I_C = -50 \text{ mAdc}$, $f = 20 \text{ mc}$)	f_T	60	—	mc

*Pulse Test: Pulse Width $\leq 300 \mu\text{sec}$, Duty Cycle $\leq 2\%$

MD1120
MD1121
MD1122

$V_{CEO} = 30\text{ V}$
 $I_C = 500\text{ mA}$

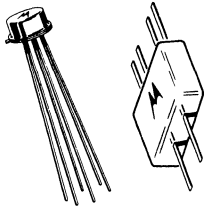

NPN silicon annular Star dual-transistors for differential amplifiers and other applications requiring a matched pair with a high degree of parameter uniformity.

CASE 32
(TO-5)

MD1120
thru
MD1122

CASE 33

MD1120F
thru
MD1122F

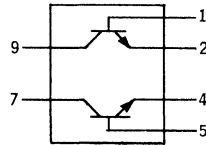
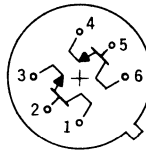

PIN CONNECTIONS
BOTTOM VIEW

MAXIMUM RATINGS (each side)

Characteristic	Symbol	Rating		Unit
		ONE SIDE	BOTH SIDES	
Collector-Base Voltage	V_{CBO}	60		Vdc
Collector-Emitter Voltage	V_{CEO}	30		Vdc
Collector-Emitter Voltage	V_{CER}	40		Vdc
Emitter-Base Voltage	V_{EBO}	5		Vdc
D.C. Collector Current	I_C	500		mAdc
Junction Temperature	T_J	+200		$^{\circ}\text{C}$
Storage Temperature	T_{stg}	-65 to + 200		$^{\circ}\text{C}$
Total Device Dissipation (25 $^{\circ}\text{C}$ Case Temperature) (Derate above 25 $^{\circ}\text{C}$)	P_D	1.6	3.0	W
		9.1	17.2	
Total Device Dissipation (25 $^{\circ}\text{C}$ Ambient Temperature) (Derate above 25 $^{\circ}\text{C}$)	P_D	0.5	0.6	W
		2.9	3.4	

MD1120-MD1122 (continued)

ELECTRICAL CHARACTERISTICS (each side)

(at 25°C ambient temperature unless otherwise noted)

Characteristics	Symbol	Min	Max	Unit
Collector-Base Breakdown Voltage ($I_C = 10 \mu\text{Adc}$)	BV_{CBO}	60	—	Vdc
Collector-Emitter Breakdown Voltage* ($I_C = 10 \text{mAdc}$)	BV_{CEO}^*	30	—	Vdc
Emitter-Base Breakdown Voltage ($I_E = 10 \mu\text{Adc}$)	BV_{EBO}	5	—	Vdc
Collector Cutoff Current ($V_{CB} = 50 \text{Vdc}$) ($V_{CB} = 50 \text{Vdc}$, $T_A = 150^\circ\text{C}$)	I_{CBO}	— —	010 10	μAdc
Emitter Cutoff Current ($V_{EB} = 3 \text{Vdc}$)	I_{EBO}	—	10	nAdc
Collector-Emitter Saturation Voltage ($I_C = 10 \text{mAdc}$, $I_B = 1 \text{mAdc}$)	$V_{CE}(\text{sat})$	—	0.1	Vdc
Base-Emitter Saturation Voltage ($I_C = 10 \text{mAdc}$, $I_B = 1 \text{mAdc}$)	$V_{BE}(\text{sat})$	—	0.85	Vdc
DC Forward Current Transfer Ratio ($I_C = 10 \mu\text{Adc}$, $V_{CE} = 10 \text{Vdc}$) ($I_C = 100 \mu\text{Adc}$, $V_{CE} = 10 \text{Vdc}$) ($I_C = 1 \text{mAdc}$, $V_{CE} = 10 \text{Vdc}$) ($I_C = 10 \text{mAdc}$, $V_{CE} = 10 \text{Vdc}$)	MD1121, MD1122† All Types All Types All Types	h_{FE}	20 30 40 50	100 120 160 200
DC Current Gain Ratio ** ($I_C = 100 \mu\text{Adc}$, $V_{CE} = 10 \text{Vdc}$) ($I_C = 1 \text{mAdc}$, $V_{CE} = 10 \text{Vdc}$)	MD1120† MD1121, MD1122† MD1122†	h_{FE1}/h_{FE2}^{**}	0.8 0.9 0.9	1.0 1.0 1.0
Base Voltage Differential ($I_C = 100 \mu\text{Adc}$, $V_{CE} = 10 \text{Vdc}$) ($I_C = 1 \text{mAdc}$, $V_{CE} = 10 \text{Vdc}$)	MD1120, MD1121† MD1122† MD1122†	$ V_{BE1} - V_{BE2} $	— — —	10 5 5
Base Voltage Differential Change ($I_C = 100 \mu\text{Adc}$, $V_{CE} = 10 \text{Vdc}$, $T_A = -55^\circ\text{C}$ to $+125^\circ\text{C}$)	MD1121, MD1122†	$\Delta(V_{BE1} - V_{BE2})$	—	10
Collector Output Capacitance ($V_{CB} = 10 \text{Vdc}$, $f = 100 \text{kc}$)	C_{ob}	—	8	pf
Small-Signal Forward Current Transfer Ratio ($I_C = 20 \text{mAdc}$, $V_{CE} = 20 \text{Vdc}$, $f = 100 \text{mc}$) TO-5 Package ($I_C = 20 \text{mAdc}$, $V_{CE} = 10 \text{Vdc}$, $f = 100 \text{mc}$) Flat Package		h_{fe}	2.5 2.0	— —
Current-Gain-Bandwidth Product ($V_{CE} = 20 \text{Vdc}$, $I_C = 20 \text{mAdc}$) TO-5 Package ($V_{CE} = 10 \text{Vdc}$, $I_C = 20 \text{mAdc}$) Flat Package		f_T	250 200	— —

* Pulse Test: Pulse Width $\leq 300 \mu\text{sec}$. Duty Cycle = 2%

** The lowest h_{FE} reading is taken as h_{FE1} for this ratio

† Applies to corresponding Flat Package device type also

MD1123
MD1124
MD1125

$V_{CEO} = 40 \text{ V}$
 $I_C = 200 \text{ mA}$

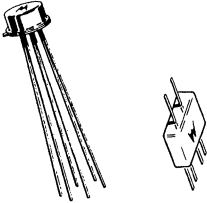

PNP silicon annular dual-transistors for differential amplifiers and other applications requiring a matched pair with a high degree of parameter uniformity.

CASE 32
(TO-5)

MD1123
thru
MD1125

CASE 33

MD1123F
thru
MD1125F

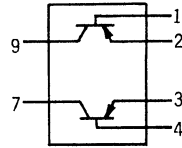
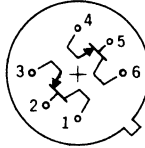

PIN CONNECTIONS
(BOTTOM VIEW)

ABSOLUTE MAXIMUM RATINGS (each side)

Characteristic	Symbol	Rating		Unit
Collector-Base Voltage	V_{CBO}	60		Vdc
Collector-Emitter Voltage	V_{CEO}	40		Vdc
Emitter-Base Voltage	V_{EBO}	5		Vdc
D.C. Collector Current	I_C	200		mAdc
Junction Temperature	T_J	+200		$^{\circ}\text{C}$
Storage Temperature	T_{stg}	-65 to + 200		$^{\circ}\text{C}$
Total Device Dissipation (25 $^{\circ}\text{C}$ Case Temperature) (Derate above 25 $^{\circ}\text{C}$)	P_D	ONE SIDE	BOTH SIDES	W mW/ $^{\circ}\text{C}$
		1.6 9.1	3.0 17.2	
Total Device Dissipation (25 $^{\circ}\text{C}$ Ambient Temperature) (Derate above 25 $^{\circ}\text{C}$)	P_D	0.5 2.9	0.6 3.4	W mW/ $^{\circ}\text{C}$

MD1123-MD1125 (continued)

ELECTRICAL CHARACTERISTICS (each side)
(At 25° ambient temperature unless otherwise noted)

Characteristics	Symbol	Min	Max	Unit
Collector-Base Breakdown Voltage ($I_C = -10 \mu\text{A dc}$)	BV_{CBO}	60	—	Vdc
Collector-Emitter Breakdown Voltage* ($I_C = -10 \text{ mA dc}$)	BV_{CEO}^*	40	—	Vdc
Emitter-Base Breakdown Voltage ($I_E = -10 \mu\text{A dc}$)	BV_{EBO}	5	—	Vdc
Collector Cutoff Current ($V_{CB} = -50 \text{ Vdc}$) ($V_{CB} = -50 \text{ Vdc}$, $T_A = 150^\circ\text{C}$)	I_{CBO}	—	.010 10	$\mu\text{A dc}$
Emitter Cutoff Current ($V_{EB} = -3 \text{ Vdc}$)	I_{EBO}	—	10	nA dc
Collector-Emitter Saturation Voltage ($I_C = -10 \text{ mA dc}$, $I_B = -1 \text{ mA dc}$)	$V_{CE}(\text{sat})$	—	0.25	Vdc
Base-Emitter Saturation Voltage ($I_C = -10 \text{ mA dc}$, $I_B = -1 \text{ mA dc}$)	$V_{BE}(\text{sat})$	—	0.9	Vdc
DC Forward Current Transfer Ratio ($I_C = -10 \mu\text{A dc}$, $V_{CE} = -10 \text{ Vdc}$) ($I_C = -100 \mu\text{A dc}$, $V_{CE} = -10 \text{ Vdc}$) ($I_C = -1 \text{ mA dc}$, $V_{CE} = -10 \text{ Vdc}$) ($I_C = -10 \text{ mA dc}$, $V_{CE} = -10 \text{ Vdc}$)	h_{FE} MD1124, MD1125† All Types All Types All Types	20 30 40 50	100 120 160 200	—
DC Current Gain Ratio ** ($I_C = -100 \mu\text{A dc}$, $V_{CE} = -10 \text{ Vdc}$) ($I_C = -1 \text{ mA dc}$, $V_{CE} = -10 \text{ Vdc}$)	h_{FE1}/h_{FE2}^{**} MD1123† MD1124, MD1125† MD1125†	0.8 0.9 0.9	1.0 1.0 1.0	—
Base Voltage Differential ($I_C = -100 \mu\text{A dc}$, $V_{CE} = -10 \text{ Vdc}$) ($I_C = -1 \text{ mA dc}$, $V_{CE} = -10 \text{ Vdc}$)	$ V_{BE1} - V_{BE2} $ MD1123, MD1124† MD1125† MD1125†	— — —	10 5 5	mVdc
Base Voltage Differential Change ($I_C = -100 \mu\text{A dc}$, $V_{CE} = -10 \text{ Vdc}$, $T_A = -55^\circ\text{C}$ to $+125^\circ\text{C}$)	$\Delta(V_{BE1} - V_{BE2})$ MD1124, MD1125†	—	10	$\mu\text{V}/^\circ\text{C}$
Collector Output Capacitance ($V_{CB} = -10 \text{ Vdc}$, $f = 100 \text{ kc}$)	C_{ob}	—	4	pf
Small-Signal Forward Current Transfer Ratio ($I_C = -20 \text{ mA dc}$, $V_{CE} = -20 \text{ Vdc}$, $f = 100 \text{ mc}$) TO-5 ($I_C = -20 \text{ mA dc}$, $V_{CE} = -10 \text{ Vdc}$, $f = 100 \text{ mc}$) Flat	h_{fe}	2.5 2.0	— —	—
Current-Gain-Bandwidth Product ($V_{CE} = -20 \text{ Vdc}$, $I_C = -20 \text{ mA dc}$) TO-5 ($V_{CE} = -10 \text{ Vdc}$, $I_C = -20 \text{ mA dc}$) Flat	f_T	250 200	— —	mc

*Pulse Test: Pulse Width $\leq 300 \mu\text{sec}$, Duty Cycle $\leq 2\%$

**The lowest h_{FE} reading is taken as h_{FE1} for this ratio

†Applies to corresponding Flat Package device type also

MD1126
MD1127

$V_{CEO} = 15\text{ V}$
 $I_C = 200\text{ mA}$

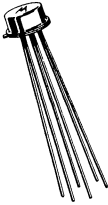

CASE 32
(TO-5)

NPN silicon annular dual-transistors for high-speed switching applications.

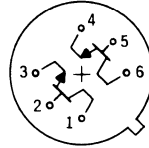

PIN CONNECTIONS
(BOTTOM VIEW)

ABSOLUTE MAXIMUM RATINGS (each side)

Characteristics	Symbol	Rating		Unit
Collector-Base Voltage	V_{CBO}	40		Vdc
Collector-Emitter Voltage	V_{CEO}	15		Vdc
Emitter-Base Voltage	V_{EBO}	5		Vdc
Collector Current	I_C	200		mAdc
Operating Junction Temperature	T_J	+200		$^{\circ}\text{C}$
Storage Temperature	T_{stg}	-65 to +200		$^{\circ}\text{C}$
Total Device Dissipation (25 $^{\circ}\text{C}$ Case Temperature) (Derate above 25 $^{\circ}\text{C}$)	P_D	ONE SIDE	BOTH SIDES	W mW/ $^{\circ}\text{C}$
		0.75 4.3	1.5 8.6	
Total Device Dissipation (25 $^{\circ}\text{C}$ Ambient Temperature) (Derate above 25 $^{\circ}\text{C}$)	P_D	0.30 1.7	0.40 2.3	W mW/ $^{\circ}\text{C}$

MD1126, MD1127 (continued)

ELECTRICAL CHARACTERISTICS (each side)
(At 25° ambient temperature unless otherwise noted)

Characteristic	Symbol	Min	Max	Unit
Collector-Base Breakdown Voltage ($I_C = 1.0 \mu\text{Adc}$, $I_E = 0$)	BV_{CBO}	40	---	Vdc
Collector-Emitter Breakdown Voltage* ($I_C = 30 \text{ mAdc}$, $I_B = 0$)	BV_{CEO}^*	15	---	Vdc
Emitter-Base Breakdown Voltage ($I_E = 10 \mu\text{Adc}$, $I_C = 0$)	BV_{EBO}	5	---	Vdc
Collector Cutoff Current ($V_{CB} = 20 \text{ Vdc}$, $I_E = 0$) ($V_{CB} = 20 \text{ Vdc}$, $I_E = 0$, $T_A = 150^\circ\text{C}$)	I_{CBO}	---	.025 15	μAdc
Collector-Emitter Saturation Voltage ($I_C = 10 \text{ mAdc}$, $I_B = 1 \text{ mAdc}$)	$V_{CE}(\text{sat})$	---	0.40 0.25	Vdc
Base-Emitter Saturation Voltage ($I_C = 10 \text{ mAdc}$, $I_B = 1 \text{ mAdc}$)	$V_{BE}(\text{sat})$	0.7	0.85	Vdc
DC Forward Current Transfer Ratio* ($I_C = 10 \text{ mAdc}$, $V_{CE} = 1 \text{ Vdc}$)	h_{FE}^*	30	---	---
Output Capacitance ($V_{CB} = 10 \text{ Vdc}$, $I_E = 0$, $f = 100 \text{ kc}$)	C_{ob}	---	6.0	pf
Small-Signal Forward Current Transfer Ratio ($I_C = 20 \text{ mAdc}$, $V_{CE} = 10 \text{ Vdc}$, $f = 100 \text{ mc}$)	h_{fe}	3.0	---	---
Charge-Storage Time Constant ($I_C = I_{B1} = I_{B2} = 10 \text{ mAdc}$) ($I_C = I_{B1} = I_{B2} = 20 \text{ mAdc}$)	τ_S	---	40 25	nsec

*Pulse Test: Pulse Width $\leq 300 \mu\text{sec}$, Duty Cycle $\leq 2\%$

CHARGE STORAGE TIME CONSTANT TEST CIRCUIT

MD1126

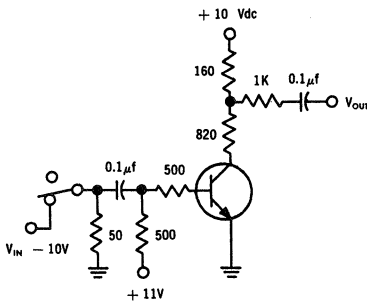

CHARGE STORAGE TIME CONSTANT TEST CIRCUIT

MD1127

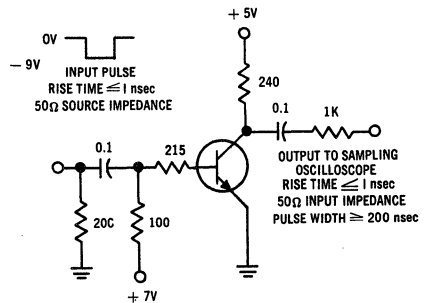

MD1128

$V_{CEO} = 15\text{ V}$
 $I_C = 200\text{ mA}$



NPN silicon annular dual-transistors for high-speed switching applications.

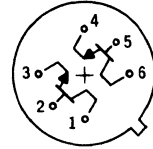

PIN CONNECTIONS
BOTTOM VIEW

CASE 32
(TO-5)

ABSOLUTE MAXIMUM RATINGS (each side)

Characteristic	Symbol	Rating	Unit
Collector-Base Voltage	V_{CBO}	40	Vdc
Collector-Emitter Voltage	V_{CEO}	15	Vdc
Emitter-Base Voltage	V_{EBO}	5	Vdc
Collector Current	I_C	200	mAdc
Operating Junction Temperature	T_J	+200	$^{\circ}\text{C}$
Storage Temperature	T_{stg}	-65 to +200	$^{\circ}\text{C}$
Total Device Dissipation (25 $^{\circ}\text{C}$ Case Temperature) (Derate above 25 $^{\circ}\text{C}$)	P_D	ONE SIDE	W mW/ $^{\circ}\text{C}$
		BOTH SIDES	
Total Device Dissipation (25 $^{\circ}\text{C}$ Ambient Temperature) (Derate above 25 $^{\circ}\text{C}$)	P_D	0.75 4.3	1.5 8.6
		0.30 1.7	0.40 2.3

CHARGE STORAGE TIME CONSTANT TEST CIRCUIT

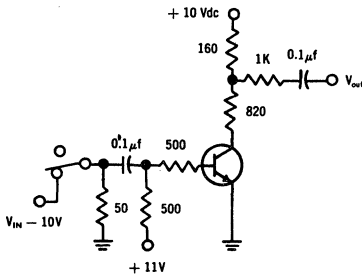

TURN-ON AND TURN-OFF TIME TEST CIRCUIT

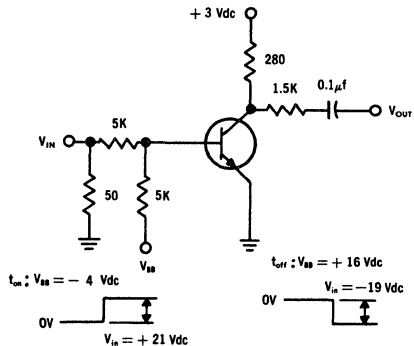

MD1128 (continued)

ELECTRICAL CHARACTERISTICS (each side)
(at 25°C ambient temperature unless otherwise noted)

Characteristic	Symbol	Min	Max	Unit
Collector-Base Breakdown Voltage ($I_C = 10 \mu \text{A dc}$, $I_E = 0$)	BV_{CBO}	40	---	Vdc
Collector-Emitter Breakdown Voltage* ($I_C = 10 \text{ mA dc}$, $I_B = 0$)	BV_{CEO}^*	15	---	Vdc
Emitter-Base Breakdown Voltage ($I_E = 10 \mu \text{A dc}$, $I_C = 0$)	BV_{EBO}	5	---	Vdc
Collector Cutoff Current ($V_{CE} = 20 \text{ Vdc}$, $V_{BE} = 0$)	I_{CES}	---	10	$\mu \text{A dc}$
Collector Cutoff Current ($V_{CB} = 20 \text{ Vdc}$, $I_E = 0$) ($V_{CB} = 20 \text{ Vdc}$, $I_E = 0$, $T_A = +150^\circ\text{C}$)	I_{CBO}	---	.025 30	$\mu \text{A dc}$
Collector-Emitter Saturation Voltage ($I_C = 10 \text{ mA dc}$, $I_B = 1 \text{ mA dc}$) ($I_C = 50 \text{ mA dc}$, $I_B = 5 \text{ mA dc}$)	$V_{CE(sat)}$	---	0.3 0.4	Vdc
Base-Emitter Saturation Voltage ($I_C = 10 \text{ mA dc}$, $I_B = 1 \text{ mA dc}$)	$V_{BE(sat)}$	---	0.9	Vdc
DC Forward Current Transfer Ratio ($I_C = 10 \text{ mA dc}$, $V_{CE} = 1 \text{ Vdc}$)	h_{FE}	25	---	---
Output Capacitance ($V_{CB} = 10 \text{ Vdc}$, $I_E = 0$, $f = 100 \text{ kc}$)	C_{ob}	---	4	pf
Small-Signal Forward Current Transfer Ratio ($I_C = 10 \text{ mA dc}$, $V_{CE} = 20 \text{ Vdc}$, $f = 100 \text{ mc}$)	h_{fe}	3.5	---	---
Current-Gain-Bandwidth Product ($V_{CE} = 20 \text{ Vdc}$, $I_C = 10 \text{ mA dc}$)	f_T	350	---	mc
Charge-Storage Time Constant ($I_C = I_{B1} = I_{B2} = 10 \text{ mA dc}$)	τ_S	---	30	nsec
Turn-On Time ($I_C = 10 \text{ mA dc}$, $I_{B1} = 3 \text{ mA dc}$, $I_{B2} = 1 \text{ mA dc}$)	t_{on}	---	20	nsec
Turn-Off Time ($I_C = 10 \text{ mA dc}$, $I_{B1} = 3 \text{ mA dc}$, $I_{B2} = 1 \text{ mA dc}$)	t_{off}	---	35	nsec

*Pulse Test: Pulse Width $\leq 300 \mu\text{sec}$, Duty Cycle $\leq 2\%$

MD1129

$V_{CEO} = 30\text{ V}$
 $I_C = 200\text{ mA}$

NPN silicon annular dual-transistors for differential amplifiers and other applications requiring a matched pair with a high degree of parameter uniformity.

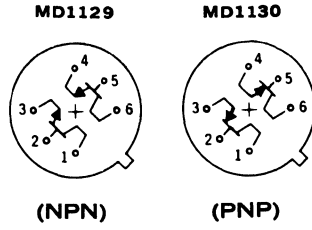
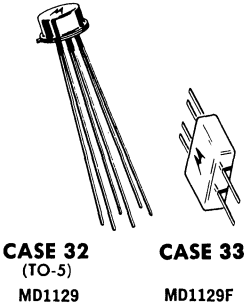

PIN CONNECTIONS
BOTTOM VIEW

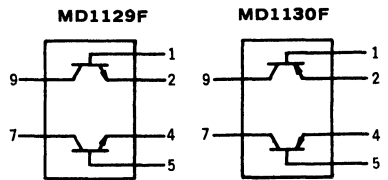

ABSOLUTE MAXIMUM RATINGS (each side)

Characteristic	Symbol	Rating		Unit
		One Side	Both Sides	
Collector-Base Voltage	V_{CBO}	60		Vdc
Collector-Emitter Voltage MD1129	V_{CEO}	30		Vdc
Emitter-Base Voltage	V_{EBO}	5		Vdc
Collector Current (Limited by P_D)	I_C	200		mAdc
Operating Junction Temperature	T_J	+200		°C
Storage Temperature	T_{stg}	-65 to +200		°C
Flat Package Total Device Dissipation (25°C Ambient Temperature) Derate above 25°C	P_D	250	350	mW mW/°C
		1.5	2	
TO-5 Package Total Device Dissipation (25°C Ambient Temperature) Derate above 25°C	P_D	500	600	mW mW/°C
		2.9	3.4	

MD1129 (continued)

ELECTRICAL CHARACTERISTICS (each side)

(At 25° ambient temperature unless otherwise noted)

Characteristic	Symbol	Min	Max	Unit
Collector-Base Breakdown Voltage ($I_C = 10 \mu\text{A dc}$)	BV_{CBO}	60	-	Vdc
Collector-Emitter Breakdown Voltage* ($I_C = 10 \text{ mA dc}$)	BV_{CEO}^*	30	-	Vdc
Emitter-Base Breakdown Voltage ($I_E = 10 \mu\text{A dc}$)	BV_{EBO}	5	-	Vdc
Collector Cutoff Current ($V_{CB} = 50 \text{ Vdc}$) ($V_{CB} = 50 \text{ Vdc}$, $T_A = 150^\circ\text{C}$)	I_{CBO}	-	.010 10	$\mu\text{A dc}$
Emitter Cutoff Current ($V_{EB} = 3 \text{ Vdc}$)	I_{EBO}	-	10	nA dc
Collector-Emitter Saturation Voltage ($I_C = 10 \text{ mA dc}$, $I_B = 1 \text{ mA dc}$)	$V_{CE(\text{sat})}$	-	0.1	Vdc
Base-Emitter Saturation Voltage ($I_C = 10 \text{ mA dc}$, $I_B = 1 \text{ mA dc}$)	$V_{BE(\text{sat})}$	-	0.85	Vdc
DC Forward Current Transfer Ratio ($I_C = 10 \mu\text{A dc}$, $V_{CE} = 10 \text{ Vdc}$) ($I_C = 100 \mu\text{A dc}$, $V_{CE} = 10 \text{ Vdc}$) ($I_C = 1 \text{ mA dc}$, $V_{CE} = 10 \text{ Vdc}$) ($I_C = 10 \text{ mA dc}$, $V_{CE} = 10 \text{ Vdc}$)	h_{FE}	60 100 100 100	- 300 - -	-
DC Current Gain Ratio** ($I_C = 100 \mu\text{A dc}$, $V_{CE} = 10 \text{ Vdc}$) ($I_C = 1 \text{ mA dc}$, $V_{CE} = 10 \text{ Vdc}$)	h_{FE1}/h_{FE2}^{**}	0.9 0.9	1.0 1.0	-
Base Voltage Differential ($I_C = 100 \mu\text{A dc}$, $V_{CE} = 10 \text{ Vdc}$) ($I_C = 1 \text{ mA dc}$, $V_{CE} = 10 \text{ Vdc}$)	$ V_{BE1} - V_{BE2} $	-	5 5	mVdc
Base Voltage Differential Change ($I_C = 100 \mu\text{A dc}$, $V_{CE} = 10 \text{ Vdc}$, $T_A = -55^\circ\text{C}$ to $+125^\circ\text{C}$)	$\Delta(V_{BE1} - V_{BE2})$	-	10	$\mu\text{V}/^\circ\text{C}$
Collector Output Capacitance ($V_{CB} = 10 \text{ Vdc}$, $f = 100 \text{ kc}$)	C_{ob}	-	8	pf
Current-Gain - Bandwidth Product ($V_{CE} = 10 \text{ Vdc}$, $I_C = 20 \text{ mA dc}$)	f_τ	200	-	mc

MD1130

$V_{CEO} = 40\text{ V}$
 $I_C = 200\text{ mA}$

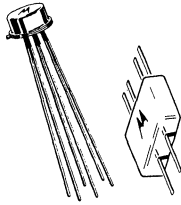

PNP silicon annular dual-transistors for differential amplifiers and other applications requiring a matched pair with a high degree of parameter uniformity.

CASE 32 **CASE 33**
 (TO-5) MD1130F
 MD1130 MD1130F

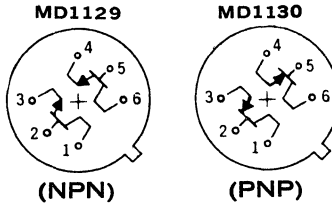

PIN CONNECTIONS
 BOTTOM VIEW

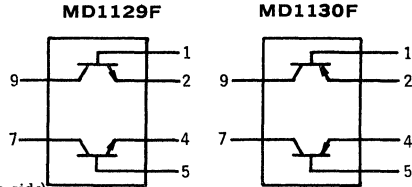

ABSOLUTE MAXIMUM RATINGS (each side)

Characteristic	Symbol	Rating		Unit
		One Side	Both Sides	
Collector-Base Voltage	V_{CBO}	60		Vdc
Collector-Emitter Voltage MD1130	V_{CEO}	40		Vdc
Emitter-Base Voltage	V_{EBO}	5		Vdc
Collector Current (Limited by P_D)	I_C	200		mAdc
Operating Junction Temperature	T_J	+200		°C
Storage Temperature	T_{stg}	-65 to +200		°C
Flat Package Total Device Dissipation (25°C Ambient Temperature) Derate above 25°C	P_D	250	350	mW mW/°C
		1.5	2	
TO-5 Package Total Device Dissipation (25°C Ambient Temperature) Derate above 25°C	P_D	500	600	mW mW/°C
		2.9	3.4	

MD1130 (continued)

ELECTRICAL CHARACTERISTICS (each side)
(at 25°C ambient temperature unless otherwise noted)

Characteristic	Symbol	Min	Max	Unit
Collector-Base Breakdown Voltage ($I_C = -10 \mu\text{A dc}$)	BV_{CBO}	60	-	Vdc
Collector-Emitter Breakdown Voltage* ($I_C = -10 \text{ mA dc}$)	BV_{CEO}^*	40	-	Vdc
Emitter-Base Breakdown Voltage ($I_E = -10 \mu\text{A dc}$)	BV_{EBO}	5	-	Vdc
Collector Cutoff Current ($V_{CB} = -50 \text{ Vdc}$) ($V_{CB} = -50 \text{ Vdc}$, $T_A = 150^\circ\text{C}$)	I_{CBO}	-	010	$\mu\text{A dc}$
Emitter Cutoff Current ($V_{EB} = -3 \text{ Vdc}$)	I_{EBO}	-	10	nA dc
Collector-Emitter Saturation Voltage ($I_C = -10 \text{ mA dc}$, $I_B = -1 \text{ mA dc}$)	$V_{CE(\text{sat})}$	-	0.25	Vdc
Base-Emitter Saturation Voltage ($I_C = -10 \text{ mA dc}$, $I_B = -1 \text{ mA dc}$)	$V_{BE(\text{sat})}$	-	0.9	Vdc
DC Forward Current Transfer Ratio ($I_C = -10 \mu\text{A dc}$, $V_{CE} = -10 \text{ Vdc}$) ($I_C = -100 \mu\text{A dc}$, $V_{CE} = -10 \text{ Vdc}$) ($I_C = -1 \text{ mA dc}$, $V_{CE} = -10 \text{ Vdc}$) ($I_C = -10 \text{ mA dc}$, $V_{CE} = -10 \text{ Vdc}$)	h_{FE}	60 100 100 100	- 300 - -	-
DC Current Gain Ratio** ($I_C = -100 \mu\text{A dc}$, $V_{CE} = -10 \text{ Vdc}$) ($I_C = -1 \text{ mA dc}$, $V_{CE} = -10 \text{ Vdc}$)	h_{FE1}/h_{FE2}^{**}	0.9 0.9	1.0 1.0	-
Base Voltage Differential ($I_C = -100 \mu\text{A dc}$, $V_{CE} = -10 \text{ Vdc}$) ($I_C = -1 \text{ mA dc}$, $V_{CE} = -10 \text{ Vdc}$)	$ V_{BE1} - V_{BE2} $	-	5 5	mVdc
Base Voltage Differential Change ($I_C = -100 \mu\text{A dc}$, $V_{CE} = -10 \text{ Vdc}$, $T_A = -55^\circ\text{C}$ to $+125^\circ\text{C}$)	$\Delta(V_{BE1} - V_{BE2})$	-	10	$\mu\text{V}/^\circ\text{C}$
Collector Output Capacitance ($V_{CB} = -10 \text{ Vdc}$, $F = 100 \text{ kc}$)	C_{ob}	-	4	pf
Current-Gain - Bandwidth Product ($V_{CE} = -10 \text{ Vdc}$, $I_C = -20 \text{ mA dc}$)	f_T	200	-	mc

* Pulse Test: Pulse Width $\leq 300 \mu\text{sec}$, Duty Cycle $\leq 2\%$

** The lowest h_{FE} reading is taken as h_{FE1} for this ratio

MD1131

$V_{CEO} = 15\text{ V}$
 $I_C = 50\text{ mA}$

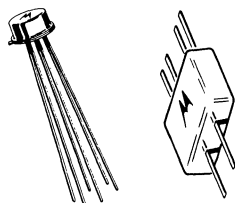

NPN silicon annular dual-transistors for high-frequency oscillator and amplifier transistors.

CASE 32
(TO-5)

MD1131

CASE 33

MD1131F

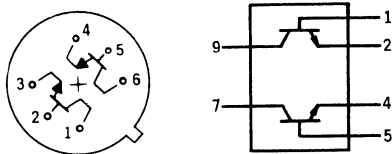

PIN CONNECTIONS
BOTTOM VIEW

ABSOLUTE MAXIMUM RATINGS (each side)

Characteristic	Symbol	Rating		Unit
		One Side	Both Sides	
Collector-Base Voltage	V_{CBO}	30		Vdc
Collector-Emitter Voltage	V_{CEO}	15		Vdc
Emitter-Base Voltage	V_{EBO}	5		Vdc
Collector Current	I_C	50		mAdc
Operating Junction Temperature	T_J	+200		°C
Storage Temperature	T_{stg}	-65 to +200		°C
Total Device Dissipation @ $T_A = 25^\circ\text{C}$ TO-5 Package Derate above 25°C Flat Package Derate above 25°C	P_D	300	400	mW
		1.7	2.3	mW/°C
		250	350	mW
		1.5	2.0	mW/°C

MD1131 (continued)

ELECTRICAL CHARACTERISTICS (each side)
(at 25°C ambient temperature unless otherwise noted)

Characteristic	Symbol	Minimum	Maximum	Unit
Collector-Base Breakdown Voltage ($I_C = 1 \mu\text{Adc}$, $I_E = 0$)	BV_{CBO}	30	-	Vdc
Collector-Emitter Breakdown Voltage ($I_C = 3 \text{ mAdc}$, $I_B = 0$)	BV_{CEO}	15	-	Vdc
Emitter-Base Breakdown Voltage ($I_E = 10 \mu\text{Adc}$, $I_C = 0$)	BV_{EBO}	5	-	Vdc
Collector Cutoff Current ($V_{CB} = 15 \text{ Vdc}$, $I_E = 0$) ($V_{CB} = 15 \text{ Vdc}$, $I_E = 0$, $T_A = +150^\circ\text{C}$)	I_{CBO}	-	.010 1.0	μAdc
Collector-Emitter Saturation Voltage ($I_C = 10 \text{ mAdc}$, $I_B = 1 \text{ mAdc}$)	$V_{CE(\text{sat})}$	-	0.4	Vdc
Base-Emitter Saturation Voltage ($I_C = 10 \text{ mAdc}$, $I_B = 1 \text{ mAdc}$)	$V_{BE(\text{sat})}$	-	1.0	Vdc
DC Forward Current Transfer Ratio ($I_C = 1 \text{ mAdc}$, $V_{CE} = 5 \text{ Vdc}$)	h_{FE}	50	-	-
Output Capacitance ($V_{CB} = 10 \text{ Vdc}$, $f = 140 \text{ kc}$) ($V_{CB} = 0 \text{ Vdc}$, $f = 140 \text{ kc}$)	C_{ob}	-	1.7 3.0	pf
Input Capacitance ($V_{EB} = 0.5 \text{ Vdc}$, $f = 140 \text{ kc}$)	C_{ib}	-	2.0	pf
Small-Signal Forward Current Transfer Ratio ($I_C = 4 \text{ mAdc}$, $V_{CE} = 10 \text{ Vdc}$, $f = 100 \text{ mc}$)	h_{fe}	6.0	-	-

MD1132

$V_{CEO} = 15\text{ V}$
 $I_C = 50\text{ mA}$

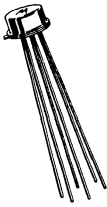

CASE 32
(TO-5)
MD1132



CASE 33
MD1132F

NPN silicon annular dual-transistors for differential amplifiers and other applications requiring a matched pair with a high degree of parameter uniformity.

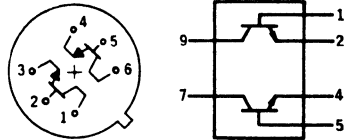

PIN CONNECTIONS
BOTTOM VIEW

ABSOLUTE MAXIMUM RATINGS (each side)

Characteristic	Symbol	Rating		Unit
		ONE SIDE	BOTH SIDES	
Collector-Base Voltage	V_{CBO}	30		Vdc
Collector-Emitter Voltage	V_{CEO}	15		Vdc
Emitter-Base Voltage	V_{EBO}	5		Vdc
Collector Current	I_C	50		mAdc
Junction Temperature	T_J	+200		$^{\circ}\text{C}$
Storage Temperature	T_{stg}	-65 to +200		$^{\circ}\text{C}$
Total Device Dissipation @ $T_A = 25^{\circ}\text{C}$ TO-5: MD1132 Derating Factor Above 25°C Flat Package: MD1132F Derating Factor Above 25°C	P_D			
		300	400	mW
		1.7	2.3	mW/ $^{\circ}\text{C}$
		250	350	mW
		1.5	2.0	mW/ $^{\circ}\text{C}$

MD1132 (continued)

ELECTRICAL CHARACTERISTICS (each side)

(At 25° ambient temperature unless otherwise noted)

Characteristics	Symbol	Min	Max	Unit
Collector-Base Breakdown Voltage ($I_C = 1 \mu\text{Adc}$)	BV_{CBO}	30	—	Vdc
Collector-Emitter Breakdown Voltage ($I_C = 3 \text{mAdc}$)	BV_{CEO}	15	—	Vdc
Emitter-Base Breakdown Voltage ($I_E = 10 \mu\text{Adc}$)	BV_{EBO}	5	—	Vdc
Collector Cutoff Current ($V_{CB} = 15 \text{Vdc}$) ($V_{CB} = 15 \text{Vdc}$, $T_A = 150^\circ\text{C}$)	I_{CBO}	— —	.010 1.0	μAdc
Collector-Emitter Saturation Voltage ($I_C = 10 \text{mAdc}$, $I_B = 1 \text{mAdc}$)	$V_{CE(\text{sat})}$	—	0.4	Vdc
Base-Emitter Saturation Voltage ($I_C = 10 \text{mAdc}$, $I_B = 1 \text{mAdc}$)	$V_{BE(\text{sat})}$	—	1.0	Vdc
DC Forward Current Transfer Ratio ($I_C = 1 \text{mAdc}$, $V_{CE} = 5 \text{Vdc}$)	h_{FE}	50	—	—
DC Current Gain Ratio* ($I_C = 1 \text{mAdc}$, $V_{CE} = 5 \text{Vdc}$)	h_{FE1}/h_{FE2}^*	0.9	1.0	—
Base Voltage Differential ($I_C = 1 \text{mAdc}$, $V_{CE} = 5 \text{Vdc}$)	$ V_{BE1} - V_{BE2} $	—	5	mVdc
Base Voltage Differential Change ($I_C = 1 \text{mAdc}$, $V_{CE} = 5 \text{Vdc}$, $T_A = -55 \text{ to } +25^\circ\text{C}$) ($I_C = 1 \text{mAdc}$, $V_{CE} = 5 \text{Vdc}$, $T_A = +25 \text{ to } +125^\circ\text{C}$)	$\Delta(V_{BE1} - V_{BE2})$	— —	0.8 1.0	mVdc
Collector Output Capacitance ($V_{CB} = 10 \text{Vdc}$, $f = 140 \text{kc}$) ($V_{CB} = 0 \text{Vdc}$, $f = 140 \text{kc}$)	C_{ob}	— —	1.7 3.0	pf
Input Capacitance ($V_{EB} = 0.5 \text{Vdc}$, $f = 140 \text{kc}$)	C_{ib}	—	2.0	pf
Small Signal Forward Current Transfer Ratio ($I_C = 4 \text{mAdc}$, $V_{CE} = 10 \text{Vdc}$, $f = 100 \text{mc}$)	h_{fe}	6.0	—	—

*The lowest h_{FE} reading is taken as h_{FE1} for this ratio

MD1133

V_{CEO} = 30 V

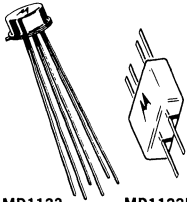

MD1133

MD1133F

CASE 32
(TO-5)

CASE 33

NPN silicon annular dual-transistors for high-current saturated switching and core driver applications.

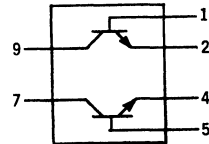
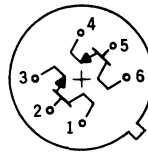

PIN CONNECTIONS
BOTTOM VIEW.

ABSOLUTE MAXIMUM RATINGS (each side)

Characteristic	Symbol	Rating		Unit
		ONE SIDE	BOTH SIDES	
Collector-Base Voltage	V _{CBO}	60		Vdc
Collector-Emitter Voltage	V _{CEO}	30		Vdc
Emitter-Base Voltage	V _{EBO}	5		Vdc
Junction Temperature	T _J	+200		°C
Storage Temperature	T _{stg}	-65 to +200		°C
Flat Package Total Device Dissipation (25°C Ambient Temperature) Derate above 25°C	P _D	250	350	mW mW/°C
		1.5	2.0	
TO-5 Package Total Device Dissipation (25°C Ambient Temperature) Derate above 25°C	P _D	500	600	mW mW/°C
		2.9	3.4	

MD1132 (continued)

ELECTRICAL CHARACTERISTICS (each side)

(At 25° ambient temperature unless otherwise noted)

Characteristic	Symbol	Minimum	Maximum	Unit
Collector Cutoff Current ($V_{CB} = 40 \text{ Vdc}$, $I_E = 0$) ($V_{CB} = 40 \text{ Vdc}$, $I_E = 0$, $T_A = 100^\circ\text{C}$)	I_{CBO}	-	0.50 75.0	μAdc
Emitter Cutoff Current ($V_{CB} = 4 \text{ Vdc}$, $I_C = 0$)	I_{EBO}	-	0.05	μAdc
Collector-Base Breakdown Voltage ($I_C = 10\mu\text{Adc}$, $I_E = 0$)	BV_{CBO}	60	-	Vdc
Collector-Emitter Breakdown Voltage* ($I_C = 10\text{mAdc}$, pulsed, $I_B = 0$)	BV_{CEO}^*	30	-	Vdc
Emitter-Base Breakdown Voltage ($I_E = 10\mu\text{Adc}$, $I_C = 0$)	BV_{EBO}	5	-	Vdc
Collector Saturation Voltage* ($I_C = 150\text{mAdc}$, $I_B = 15\text{mAdc}$) ($I_C = 500\text{mAdc}$, $I_B = 50\text{mAdc}$) ($I_C = 1.0\text{Adc}$, $I_B = 100\text{mAdc}$)	$V_{CE(sat)}^*$	-	0.35 0.60 1.2	Vdc
Base-Emitter Saturation Voltage* ($I_C = 150\text{mAdc}$, $I_B = 15\text{mAdc}$) ($I_C = 500\text{mAdc}$, $I_B = 50\text{mAdc}$) ($I_C = 1.0\text{Adc}$, $I_B = 100\text{mAdc}$)	$V_{BE(sat)}^*$	-	1.0 1.3 1.8	Vdc
DC Forward Current Transfer Ratio* ($I_C = 150\text{mAdc}$, $V_{CE} = 1\text{Vdc}$) ($I_C = 500\text{mAdc}$, $V_{CE} = 1\text{Vdc}$) ($I_C = 1\text{Adc}$, $V_{CE} = 5\text{Vdc}$)	h_{FE}^*	30 30 25	- 120 -	-
Output Capacitance ($V_{CB} = 10\text{Vdc}$, $I_E = 0$, $f = 100\text{kc}$)	C_{ob}	-	12	pf
Input Capacitance ($V_{EB} = 0.5\text{Vdc}$, $I_C = 0$, $f = 100\text{kc}$)	C_{ib}	-	80	pf
Current Gain-Bandwidth Product (TO-5) ($I_C = 50\text{mAdc}$, $V_{CE} = 10\text{Vdc}$, $f = 100\text{mc}$)	f_T	200	-	mc
Current Gain-Bandwidth Product (Flat) ($I_C = 20\text{mAdc}$, $V_{CE} = 10\text{Vdc}$, $f = 100\text{mc}$)	f_T	150	-	mc

* Pulse Test: Pulse width = 300 μsec , duty cycle = 2%

MD1134

$V_{CEO} = 15\text{ V}$
 $I_C = 500\text{ mA (peak)}$

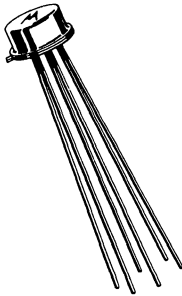

NPN silicon annular dual transistor for high-speed switching applications.

CASE 32
(TO-5)

ABSOLUTE MAXIMUM RATINGS

Characteristic	Symbol	Rating	Unit
Collector to Base Voltage	V_{CBO}	40	Vdc
Collector to Emitter Voltage	V_{CEO}	15	Vdc
Emitter to Base Voltage	V_{EBO}	5	Vdc
Collector Current (10 μ sec pulse) (limited by P_D)	$I_{C(\text{peak})}$	500	mA dc
Operating Junction Temperature	T_j	+200	$^{\circ}\text{C}$
Storage Temperature	T_{stg}	-65 to +200	$^{\circ}\text{C}$
Total Device Dissipation 25 $^{\circ}\text{C}$ Ambient Temperature One Side Both Sides Derate 2.9mW $^{\circ}\text{C}$ above 25 $^{\circ}\text{C}$ (one side) Derate 3.4mW $^{\circ}\text{C}$ above 25 $^{\circ}\text{C}$ (both sides)	P_D	500 600	mW mW

MD1134 (continued)

ELECTRICAL CHARACTERISTICS (At 25° ambient temperature unless otherwise noted)

Characteristic	Symbol	Minimum	Maximum	Unit
Collector Base Breakdown Voltage $I_C = 10\mu A, I_E = 0$	BV_{CBO}	40	-	Vdc
Collector-Emitter Breakdown Voltage $I_C = 10mA, I_B = 0$	BV_{CEO}^*	15	-	Vdc
Emitter-Base Breakdown Voltage $I_E = 10\mu A, I_C = 0$	BV_{EBO}	5	-	Vdc
Collector Cutoff Current $V_{CB} = 20V, I_E = 0$	I_{CBO}	-	0.4	μA dc
Collector Cutoff Current $V_{CB} = 20V, I_E = 0, T_A = 150^\circ C$	I_{CBO}	-	30	μA dc
Forward Current Transfer Ratio $I_C = 10mA, V_{CE} = 1V$ $I_C = 10mA, V_{CE} = 1V, T_A = -55^\circ C$ $I_C = 100mA, V_{CE} = 2V$	h_{FE}	50 20 20	- - -	- - -
Collector Saturation Voltage $I_C = 10mA, I_B = 1mA$	$V_{CE(sat)}$	-	0.25	Vdc
Base Saturation Voltage $I_C = 10mA, I_B = 1mA$	$V_{BE(sat)}$	0.70	0.85	Vdc
Output Capacitance $V_{CB} = 5V, I_E = 0, f = 140kc$	C_{ob}	-	4	pf
Input Capacitance $V_{EB} = 1V, I_C = 0, f = 140kc$	C_{ib}	-	4	pf
Forward Current Transfer Ratio $I_C = 10mA, V_{CE} = 10V, f = 100mc$	h_{fe}	5.0	-	-

* Pulse Condition:

P. W. $\leq 300\mu sec$, D. C. $\leq 2\%$

MM2090
MM2091

$V_{DS} = 50\text{ V}$
 $I_D = 20\text{ mA}$

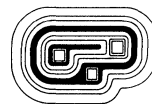

CASE 22
(TO-18)

Silicon N-channel junction field effect transistors for low power switch and amplifier applications in the audio frequency range. Double gate configuration is provided for greater design flexibility.

ABSOLUTE MAXIMUM RATINGS

Characteristic	Symbol	Rating	Unit
Reverse Gate-Source Voltage			
Gate 1	V_{G1S}	50	Vdc
Gate 2	V_{G2S}	50	
Drain-Source Voltage	V_{DS}	50	Vdc
Gate 1-Gate 2 Voltage	V_{G1G2}		Vdc
MM2090		1	
MM2091		3	
Gate 2-Gate 1 Voltage	V_{G2G1}		Vdc
MM2090		2	
MM2091		6	
Gate Current			mAdc
Gate 1	I_{G1}	20	
Gate 2	I_{G2}	20	
Drain Current	I_D	20	mAdc
Junction Operating Temperature	T_J	200	°C
Storage Temperature Range	T_{stg}	-65 to +200	°C
Total Device Dissipation @25°C Ambient Temperature	P_D	200	mW
Derating Factor Above 25°C		1.14	mW/°C

MM2090, MM2091 (continued)

ELECTRICAL CHARACTERISTICS

(At 25° ambient temperature unless otherwise noted)

Characteristic	Symbol	MM2090		MM2091		Unit
		Minimum	Maximum	Minimum	Maximum	
Gate 2 Common to Gate 1						
Gate-Source Breakdown Voltage $I_G = 10 \mu A, V_{DS} = 0, V_{G1G2} = 0$	BV_{GSS}	50	-	50	-	Vdc
Drain-Gate Reverse Current $V_{DG} = 25 V, I_S = 0, V_{G1G2} = 0$	I_{DGO}	-	.001	-	.001	μA dc
Gate Reverse Current $V_{GS} = 25 V, V_{DS} = 0, V_{G1G2} = 0$ $V_{GS} = 25 V, V_{DS} = 0, V_{G1G2} = 0, T_A = 150^\circ C$	I_{GSS}	-	0.001	-	0.001	μA dc
Zero-Gate-Voltage Drain Current $V_{DS} = 10 V, V_{G1G2} = 0, V_{GS} = 0$	I_{DSS}	0.2	2.0	1.5	4.5	mAdc
Gate-Source Voltage $V_{DS} = 10 V, V_{G1G2} = 0, I_D = 20 \mu A$ MM2090 $V_{DS} = 10 V, V_{G1G2} = 0, I_D = 150 \mu A$ MM2091	V_{GS}	0.2	2.0	-	-	Vdc
Gate-Source Cutoff Voltage $V_{DS} = 10 V, I_D = 1 \mu A, V_{G1G2} = 0$	$V_{GS(off)}$	-	-2.5	-	-4.0	Vdc
Static Drain-Source "On" Resistance $V_{GS} = 0, V_{DS} = 0$	$r_{DS(on)}$	1000 Typ		750 Typ		Ohms

Gate 2 Common to Source

Drain-Gate 1 Reverse Current $V_{DG1} = 25 V, I_{G2} = 0, I_S = 0$ $V_{DG1} = 25 V, I_{G2} = 0, I_S = 0, T_A = 150^\circ C$	I_{DG10}	-	.001	-	.001	μA dc
Gate 1-Gate 2 Reach Through Voltage $I_{G1G2} = 10 \mu A, I_D = 0, I_S = 0$	V_{G1G20}	1	-	3	-	Vdc
Gate 2-Gate 1 Reach Through Voltage $I_{G2G1} = 10 \mu A, I_D = 0, I_S = 0$	V_{G2G10}	2	-	6	-	Vdc
Gate 1 - Source Cutoff Voltage $V_{DS} = 10 V, I_D = 1.0 \mu A, V_{G2S} = 0$	V_{G1S}	-	-5	-	-8	Vdc
Gate 2 - Source Cutoff Voltage $V_{DS} = 10 V, I_D = 1.0 \mu A, V_{G1S} = 0$	V_{G2S}	-	-8	-	-12	Vdc

MM2090, MM2091 (continued)

ELECTRICAL CHARACTERISTICS (continued)

SMALL SIGNAL COMMON-SOURCE CHARACTERISTICS

Characteristic	Symbol	MM2090		MM2091		Unit
		Minimum	Maximum	Minimum	Maximum	
Magnitude of Forward Transfer Admittance $V_{DS} = 10 \text{ V}, V_{G1S} = V_{G2S} = 0, f = 1 \text{ kc}$ Gate 2 Common to Source Gate 2 Common to Gate 1	$ y_{fs} $	250 500	1000 1500	400 800	1600 2400	μmhos
Reverse Transfer Capacitance $V_{DS} = 10 \text{ V}, V_{G1S} = V_{G2S} = 0, f = 1 \text{ kc}$ Gate 2 Common to Source Gate 2 Common to Gate 1	C_{rss}	- -	0.5 2.0	- -	0.5 2.0	pf
Input Capacitance $V_{DS} = 10 \text{ V}, V_{G1S} = V_{G2S} = 0, f = 1 \text{ kc}$ Gate 2 Common to Source Gate 2 Common to Gate 1	C_{iss}	- -	5.0 14	- -	5.0 14	pf
Magnitude of Output Admittance $V_{DS} = 10 \text{ V}, V_{G1S} = V_{G2S} = 0, f = 1 \text{ kc}$ Gate 2 Common to Gate 1	$ y_{os} $	-	2.0	-	10	μmhos

MM2092

$V_{DS} = 50 \text{ V}$
 $I_D = 20 \text{ mA}$

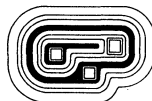

CASE 22
(TO-18)

Silicon N-channel junction field effect transistor for AGC and mixer applications. Double gate configuration is provided for greater design flexibility.

ABSOLUTE MAXIMUM RATINGS

Characteristic	Symbol	Rating	Unit
Reverse Gate-Source Voltage Gate 1	V_{G1S}	50	Vdc
Gate 2	V_{G2S}	50	
Drain-Source Voltage	V_{DS}	50	Vdc
Gate 1-Gate 2 Voltage	V_{G1G2}	5	Vdc
Gate 2-Gate 1 Voltage	V_{G2G1}	10	Vdc
Gate Current Gate 1	I_{G1}	20	mAdc
Gate 2	I_{G2}	20	
Drain Current	I_D	20	mAdc
Junction Operating Temperature	T_J	200	C
Storage Temperature Range	T_{stg}	-65 to +200	C
Total Device Dissipation @ 25 C Ambient Temperature Derating Factor Above 25 C	P_D	200 1.14	mW mW/ C

MM2092 (continued)

ELECTRICAL CHARACTERISTICS (at 25°C ambient temperature unless otherwise noted)

Characteristic	Symbol	Minimum	Maximum	Unit
Gate 2 Common to Gate 1				
Gate-Source Breakdown Voltage $I_G = 10 \mu A, V_{DS} = 0, V_{G1G2} = 0$	BV_{GSS}	50	-	Vdc
Drain-Gate Reverse Current $V_{DG} = 25 V, I_S = 0, V_{G1G2} = 0$	I_{DGO}	-	.001	μA_{dc}
Gate Reverse Current $V_{GS} = 25 V, V_{DS} = 0, V_{G1G2} = 0$ $V_{GS} = 25 V, V_{DS} = 0, V_{G1G2} = 0, T_A = 150 C$	I_{GSS}	-	0.001 1.0	μA_{dc}
Zero-Gate-Voltage Drain Current $V_{DS} = 10 V, V_{GS} = 0, V_{G1G2} = 0$	I_{DSS}	3.0	9.0	mAdc
Gate-Source Voltage $V_{DS} = 10 V, V_{G1G2} = 0, I_D = 300 \mu A$	V_{GS}	1.5	5.5	Vdc
Gate-Source Cutoff Voltage $V_{DS} = 10 V, I_D = 1 \mu A, V_{G1G2} = 0$	$V_{GS(off)}$	-	-6.5	Vdc
Static Drain-Source "On" Resistance $V_{GS} = 0, V_{DS} = 0$	$r_{DS(on)}$	500 Typ.		Ohms

GATE 2 COMMON TO SOURCE

Drain-Gate 1 Reverse Current $V_{DG1} = 25 V, I_{G2} = 0, I_S = 0$ $V_{DG1} = 25 V, I_{G2} = 0, I_S = 0, T_A = 150^\circ C$	I_{DG10}	-	.001 1.0	μA_{dc}
Gate 1-Gate 2 Reach Through Voltage $I_{G1G2} = 10 \mu A, I_D = 0, I_S = 0$	V_{G1G20}	5	-	Vdc
Gate 2-Gate 1 Reach Through Voltage $I_{G2G1} = 10 \mu A, I_D = 0, I_S = 0$	V_{G2G10}	10	-	Vdc
Gate 1-Source Cutoff Voltage $V_{DS} = 10 V, I_D = 1.0 \mu A, V_{G2S} = 0$	V_{G1S}	-	-18	Vdc
Gate 2-Source Cutoff Voltage $V_{DS} = 10 V, I_D = 1.0 \mu A, V_{G1S} = 0$	V_{G2S}	-	-26	Vdc

MM2092 (continued)

ELECTRICAL CHARACTERISTICS (continued)

SMALL SIGNAL COMMON-SOURCE CHARACTERISTICS

Characteristic	Symbol	Minimum	Maximum	Unit
Magnitude of Forward Transfer Admittance $V_{DS} = 10 \text{ V}, V_{G1S} = V_{G2S} = 0, f = 1 \text{ kc}$ Gate 2 Common to Source Gate 2 Common to Gate 1	$ y_{fs} $	600 1200	2700 3600	$\mu\text{ mhos}$
Reverse Transfer Capacitance $V_{DS} = 10 \text{ V}, V_{G1S} = V_{G2S} = 0, f = 1 \text{ kc}$ Gate 2 Common to Source Gate 2 Common to Gate 1	C_{rss}	- -	0.5 2.0	pf
Input Capacitance $V_{DS} = 10 \text{ V}, V_{G1S} = V_{G2S} = 0, f = 1 \text{ kc}$ Gate 2 Common to Source Gate 2 Common to Gate 1	C_{iss}	- -	5.0 14	pf
Magnitude of Output Admittance $V_{DS} = 10 \text{ V}, V_{G1S} = V_{G2S} = 0, f = 1 \text{ kc}$ Gate 2 Common to Gate 1	$ y_{os} $	-	20	$\mu\text{ mhos}$

TYPICAL PERFORMANCE

@ 100 mc ($V_{DS} = 10 \text{ V}, V_{G1S} = 0, G_1 = \text{Signal Rate}, G_2 = \text{Grounded}$)

Characteristic	Symbol	Typical Performance	Unit
Forward Transfer Admittance	y_{fs}	1300 + j 400	$\mu\text{ mhos}$
Input Admittance	y_{is}	200 + j 800	$\mu\text{ mhos}$
Output Admittance	y_{os}	125 + j 1600	$\mu\text{ mhos}$
Maximum Available Gain $R_{11} = 5.0 \text{ k}\Omega, R_{22} = 8.0 \text{ k}\Omega$	M. A. G.	11.3	db



SPECIAL PURPOSE SILICON DIODES

Including:

VARACTOR DIODES

VOLTAGE-VARIABLE

CAPACITANCE DIODES

4-LAYER DIODES

RF SWITCHING DIODE

Devices included in this section:

1N4386	M4L2054	MV1870	MV1877
1N4387	MV1808	MV1871	MV1878
1N4388	MV1864	MV1872	MV1892
M4L2052	MV1866	MV1874	
M4L2053	MV1868	MV1876	

- For case outline dimensions, see page 1-26.

SILICON POWER VARACTOR DIODES

Motorola power varactors are designed for use as frequency multiplier output stages in RF transmitters requiring higher power VHF/UHF output than currently available with high-frequency power transistors.

Motorola power varactors are fabricated by the formation of a deep-diffused silicon junction with a unique impurity profile. The significance of this impurity profile is the enhancement of nonlinearities due to the fast recovery of stored minority carriers after a forward voltage surge. Dependence upon this nonlinearity, rather than on capacity variation with reverse voltage, results in higher efficiency at high-power levels and considerably less distortion of amplitude modulated signals.

For a discussion of Varactor Applications, see page 12-40

SILICON VOLTAGE-VARIABLE CAPACITANCE DIODES

Motorola "EPICAP" voltage-variable capacitance diodes are designed for electronic tuning and harmonic generation applications. The abrupt junction design provides a large variation in capacitance for a change in applied reverse bias.

PARAMETER TEST METHODS

1. L_s , SERIES INDUCTANCE

A. PILL / PILL-PRONG PACKAGE
Series inductance is calculated.

B. GLASS PACKAGE

L_s is measured on a shorted package at 250 mc using an impedance bridge (Boonton Radio Model 250A Rx Meter).
 L = lead length.

2. C_c , CASE CAPACITANCE

C_c is measured on an open package at 1 mc using a capacitance bridge (Boonton Electronics Model 75A).

3. C_r , DIODE CAPACITANCE

($C_r = C_c + C_d$). C_r is measured at 1 mc using a capacitance bridge (Boonton Electronics Model 33ASB).

4. R_s , SERIES RESISTANCE and Q, FIGURE OF MERIT

R_s and Q are calculated by taking the G and C readings of an admittance bridge at the specified frequency and substituting in the following equations:

$$R_s = \frac{G}{(2\pi f)^2 C^2} \quad Q = \frac{2\pi f C}{G}$$

(Boonton Electronics Model 33ASB).

5. f_{CO} , CUTOFF FREQUENCY

f_{CO} is calculated using the equation $f_{CO} = Qf$.

6. α , DIODE CAPACITANCE REVERSE VOLTAGE SLOPE

The diode capacitance, C_r (as measured at $V_A = 4$ Vdc, $f = 1$ mc) is compared to C_r (as measured at $V_A = 60$ Vdc, $f = 1$ mc) by the following equation which defines α .

$$\alpha = \frac{\log C_r(4) - \log C_r(60)}{\log 60 - \log 4}$$

Note that a C_r versus V_A law is assumed as shown in the following equation where C_c is included.

$$C_r = \frac{K}{V_A}$$

α is not the same as γ .

7. TC_C , DIODE CAPACITANCE TEMPERATURE COEFFICIENT

TC_C is guaranteed by comparing C_r at $V_A = 4$ Vdc, $f = 1$ mc, $T_A = -65^\circ\text{C}$ with C_r at $V_A = 4$ Vdc, $f = 1$ mc, $T_A = +85^\circ\text{C}$ in the following equation which defines TC_C :

$$TC_C = \left| \frac{C_r(+85^\circ\text{C}) - C_r(-65^\circ\text{C})}{85 + 65} \right| \cdot \frac{10^4}{C_r(25^\circ\text{C})}$$

EPICAP* VOLTAGE VARIABLE CAPACITANCE DIODE DEVICE CONSIDERATIONS

A. EPICAP NETWORK PRESENTATION

The equivalent circuit in Figure 7 shows the voltage capacitance and parasitic elements of an EPICAP diode. For design purposes at all but very high and very low frequencies, L_s , R_s , and C_c can be neglected. The simplified equivalent circuit of Figure 8 represents the diode under these conditions.

Definitions:

- C_j — Voltage Variable Junction Capacitance
- R_s — Series Resistance (semiconductor bulk, contact, and lead resistance)
- C_c — Case Capacitance
- L_s — Series Inductance
- R_j — Voltage Variable Junction Resistance (negligible above 100 kc)

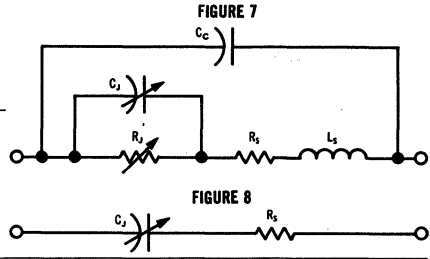

B. EPICAP CAPACITANCE VS REVERSE BIAS VOLTAGE

The most important design characteristic of an EPICAP diode is the C_j versus V_R variation as shown in equations 1 and 2. Since the designer is primarily interested in the slope of C_j versus V_R , the C_c , C_o , ϕ , and γ characteristics have been encompassed by the simplified equation 3. Min/max limits on α (as defined in Note 1) guarantee device C_j over the specified V_R range.

$$C_T = C_c + C_j \quad (1)$$

$$C_j = C_c + \frac{C_o}{(1 + \frac{V_R}{\phi})^\gamma} \quad (2)$$

$$C_o = C_j \text{ at } V_R = 0 \quad V_R = \text{Reverse Bias}$$

$$\phi = \text{Contact Potential, } \phi \approx 0.6 \text{ Volt} \quad \gamma = C_j \text{ slope, } \gamma \approx 0.5$$

$$C_j = \frac{K}{V_R^\alpha} \quad (3)$$

C. EPICAP CAPACITANCE VS FREQUENCY

Variations in EPICAP effective capacitance, as a function of operating frequency, can be derived from a simplified equivalent circuit similar to that of Figure 1, but neglecting R_s and R_j . The admittance expression for such a circuit is given in equation 4. Examination of equation 4 yields the following information:

At low frequencies, $C_{eq} \approx C_j$; at very high frequencies ($f \approx \infty$) $C_{eq} \approx C_c$.

As frequency is increased from 1 mc, C_{eq} increases until it is maximum at $\omega^2 = 1/L_s C_j$; and as ω^2 is increased from $1/L_s C_j$ toward infinity, C_{eq} increases from a very negative capacitance (inductance) toward $C_{eq} = C_c$, a positive capacitance.

Very simple calculations for C_{eq} at higher frequencies indicate the problems encountered when capacity measurements are made above 1 mc. As ω approaches $\omega_c = 1/\sqrt{L_s C_j}$, small variations in L_s cause extreme variations in measured diode capacitance.

$$Y = j\omega C_{eq} = j\omega C_j + \frac{j\omega C_j}{1 - \omega^2 L_s C_j} \quad (4)$$

D. EPICAP FIGURE OF MERIT (Q) AND CUTOFF FREQUENCY (f_{co})

The efficiency of EPICAP response to an input frequency is related to the Figure of Merit of the device as defined in equation 5. For very low frequencies, equation 6 applies whereas at high frequencies, where R_j can be neglected, equation 5 may be rewritten into the familiar form of equation 7.

Another useful parameter for EPICAP devices is the cutoff frequency (f_{co}). This is merely that frequency at which Q is equal to 1. Equation 8 gives this relationship.

$$Q = \frac{X_{scq}}{R_{scq}} \quad (5)$$

$$Q_{vl} = \frac{\omega C_j R_j^2}{R_j + R_s(1 + \omega^2 C_j^2 R_j^2)} \quad (6)$$

$$Q_{vl} = \frac{1}{\omega R_s C_{eq}} \quad (7)$$

$$f_{co} = Q_{f_{max}} \approx \frac{1}{2\pi R_s C_{eq}} \quad (8)$$

E. HARMONIC GENERATION USING EPICAPS

Efficient harmonic generation is possible with Motorola Epicaps because of their high cutoff frequency and breakdown voltage. Since Epicap junction capacitance varies inversely with the square root of the breakdown voltage, harmonic generator performance can be accurately predicted from various idealized models. Equation 9 gives the level of maximum input power for the Epicap and equation 10 gives the relationships governing Epicap circuit efficiency. In these equations, adequate heat sinking has been assumed.

$$P_{in(max)} = \frac{M(BV_R + \phi)^2}{R_s} \frac{f_{in}}{f_{co}} \quad (9)$$

$$M(x2) = 0.0285; M(x3) = 0.0241; M(x4) = 0.196$$

$$Eff = 1 - N \frac{f_{out}}{f_{co}} \quad (10)$$

$$N(x2) = 20.8; N(x3) = 34.8; N(x4) = 62.5$$

M and N are constants.

4-LAYER DIODES

Motorola 4-layer diodes are forward breakover devices designed for low-voltage, two-terminal switching and triggering applications. These devices are recommended for logic circuit applications, as pulse generators, memory and relay drivers and relay replacements as well as for alarm circuits, multi-vibrators, ring counters, telephone switching and SCR trigger circuits.

4-LAYER DIODE SYMBOLS AND DEFINITIONS

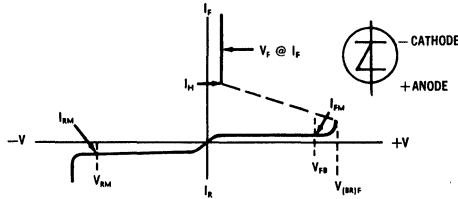

dv/dt **FORWARD VOLTAGE APPLICATION RATE** ($V/\mu\text{sec}$) – The rate of rise of forward voltage.

$I_{(BR)F}$ **FORWARD BREAKOVER (SWITCHING) CURRENT** – The value of anode current at the instant the device switches from the blocking to the "on" state, specified at a particular junction temperature.

I_F **FORWARD CURRENT** – The continuous or DC value of forward current during the "on" state.

I_{FM} **PEAK FORWARD BLOCKING CURRENT** – The peak anode current when the 4-layer diode is in the "off" state for a stated anode-to-cathode voltage and junction temperature.

I_H **HOLDING CURRENT** – That value of forward anode current below which the 4-layer diode switches from the conducting state to the forward blocking condition.

I_{pulse} **PEAK PULSE CURRENT** – The peak repetitive current that can flow through the device for the time duration stated and staying within the P_D rating.

I_{RM} **PEAK REVERSE BLOCKING CURRENT** – The peak current when the 4-layer diode is in the reverse blocking state for a stated anode-to-cathode voltage and junction temperature.

P_D **STEADY STATE POWER DISSIPATION**

T_A **AMBIENT TEMPERATURE**

T_J **JUNCTION TEMPERATURE**

T_{stg} **STORAGE TEMPERATURE**

t_{on} **TURN-ON TIME** – The time interval between the 90% point (90% of forward blocking voltage) and the point 10% above the "on" voltage under stated conditions.

t_{off} **TURN-OFF TIME** – The time interval required for the device to regain control of its forward blocking characteristic after interruption of forward anode current.

$V_{(BR)F}$ **FORWARD BREAKOVER (SWITCHING) VOLTAGE** – The positive anode voltage with respect to cathode required to switch the device from the high impedance blocking state to the low-impedance "on" state, specified at a particular junction temperature.

V_F **FORWARD VOLTAGE** – The forward voltage across the device in the "on" state under stated conditions of current and temperature.

V_{FB} **FORWARD BLOCKING VOLTAGE** – The anode-to-cathode voltage when the 4-layer diode is in the "off" state.

$V_{RM(rep)}$ **PEAK REVERSE VOLTAGE** – The maximum allowable instantaneous value of reverse voltage (repetitive or continuous DC) which can be applied to the device at a stated temperature without damage to the device.

MECHANICAL CHARACTERISTICS

CASE: Void free, Transfer Molding, Thermosetting Silicone Polymer.

MAXIMUM LEAD TEMPERATURE FOR SOLDERING PURPOSES: 350°C, 3/8" from case for 10 seconds at 5 lbs. tension.

FINISH: All external surfaces are corrosion-resistant.

POLARITY: Cathode indicated by color band.

MOUNTING POSITION: Any.

HANDLING PRECAUTIONS: per MIL-S-19500.

WEIGHT: 0.40 Grams (approximately)

RF SWITCHING DIODE

Silicon RF diode designed for high-power, high-frequency signal switching. It is specifically designed as a solid-state replacement for mechanical antenna and coaxial relays.

1N4386

$V_R = 250 \text{ V}$
 $P_O = 37.5 \text{ W @ } 150 \text{ Mc}$
 $\eta = 75\% (f_o = 150 \text{ Mc})$



Silicon varactor diode for high-power frequency multiplication applications.

CASE 49
(DO-4)

cathode connected to stud

MAXIMUM RATINGS

Characteristic	Symbol	Rating	Unit
Reverse Voltage	V_R	250	Volts
RF Power Input	P_{in}	100	Watts
Total Device Dissipation @ $T_C = 75^\circ\text{C}$ (derate 0.25 W/ $^\circ\text{C}$ above 75°C)	P_D	25	Watts
Junction Temperature	T_J	+175	$^\circ\text{C}$
Storage Temperature	T_{stg}	-65 to +175	$^\circ\text{C}$

ELECTRICAL CHARACTERISTICS ($T_c = 25^\circ\text{C}$)

Characteristic	Symbol	Condition	Min	Typ	Max	Unit
Reverse Breakdown Voltage	BV_R	$I_R = 10 \mu\text{A dc}$	250	300	—	Vdc
Series Resistance	R_S	$V_R = 6 \text{ Vdc}$ $f = 50 \text{ mc}$	—	0.75	1.5	Ohms
Junction Capacitance	C_J	$V_R = 6 \text{ Vdc}$ $f = 50 \text{ mc}$	—	35	50	pf
Figure of Merit	Q	$V_R = 6 \text{ Vdc}$ $f = 50 \text{ mc}$	75	125	—	—

Power Output	P_{out}	TRIPLER TEST CIRCUIT	32.5	37.5	—	Watts
Efficiency	η	$P_{in} = 50 \text{ W}$ $f_{in} = 50 \text{ mc}$ $f_{out} = 150 \text{ mc}$	65	75	—	%

1N4386 (continued)

POWER OUTPUT versus OUTPUT FREQUENCY FOR HARMONIC TRIPLING

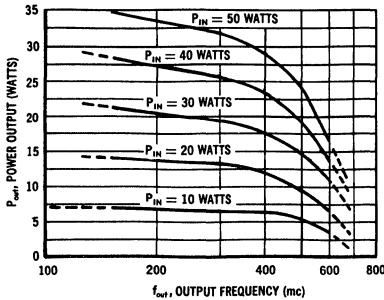

SERIES RESISTANCE AND FIGURE OF MERIT versus REVERSE VOLTAGE

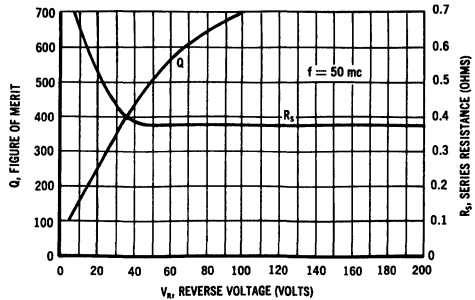

50 mc TO 150 mc TRIPLER TEST CIRCUIT

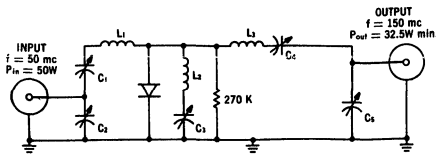

Coil.	LENGTH	DIAMETER (inside)	TURNS	WIRE DIA.
L ₁	1 3/4"	1 1/16"	7	3/32"
L ₂	1 1/2"	11/16"	4 3/4	3/32"
L ₃	1 1/4"	3/4"	3 1/2	3/32"
C ₁	2.8-11 pf	E. F. JOHNSON	167-1	VARIABLE CAPACITOR
C ₂	6.7-140 pf	HAMMARLUND	APC-140	VARIABLE CAPACITOR
C ₃	3.0-25 pf	HAMMARLUND	APC-25	VARIABLE CAPACITOR
C ₄	2.9-35 pf	HAMMARLUND	MAPC-35	VARIABLE CAPACITOR
C ₅	3.0-25 pf	HAMMARLUND	APC-25	VARIABLE CAPACITOR

APPLICATION NOTES

VARACTOR CHARACTERISTICS:

The 1N4386 is designed for RF power inputs up to 100 watts and for output frequencies up to 300 mc. Although power handling capability is stressed in device construction, high-multiplication efficiency is maintained with input powers as low as 10 watts.

Where frequencies with input powers below 10 watts are to be multiplied, or where higher output frequencies are desired, the 1N4387 varactor diode is recommended. That device is designed for maximum power levels up to 40 watts and output frequencies up to 600 mc. (see the 1N4387 data sheet for device specifications.)

Both the 1N4386 and 1N4387 power varactors are fabricated by the formation of a deep diffused silicon junction with a unique impurity profile. One of the significant characteristics of such a profile is enhancement of nonlinearities due to the sharp recovery of stored minority carriers injected during the forward voltage swing. This increased nonlinearity results in better efficiency retention at high power levels and considerably less distortion of amplitude modulated signals.

Published design theory for abrupt junction varactors can be used for approximate calculations of diffused varactor impedance and power handling capability, but the engineer is cautioned to use the results of such calculations for performance estimates only. Functional specifications and circuit-determined curves are included with data sheet information in order to facilitate circuit design.

The DO-4 package is well suited to varactor shunt circuits as the stud can be mounted to a chassis for ground and heat sink purposes.

GENERAL DESIGN CONSIDERATIONS:

In the design of varactor harmonic multipliers, lumped circuit techniques are useful up to 450 mc with little performance degradation provided coil and capacitor "Q" values of 200 to 300 are maintained.

Above 450 mc, coaxial, stripline, or helical coil resonators are recommended. Component values are not particularly critical; however, excessive inductance or insufficient coupling can cause low efficiency, and insufficient inductance or excessive coupling can cause poor filtering. Simple experimentation with well constructed and shielded breadboards is generally sufficient for circuit optimization. Note that an adequate tuning range must be provided to insure input match over normal varactor variations, and that spurious signals between stages should be kept below 30 db by suitable filter circuits.

If self bias is used, bias resistor values between 68K and 270K ohms are optimum. The higher values give more efficient operation, whereas the lower values permit more linear operation. Amplitude modulated signals can be passed with relatively low distortion if $R_B \approx 100K$ ohms and the varactor RF input power level is kept less than 65% of the rated maximum limit.

For all multiplications other than doubling, idler circuits should be provided in order to optimize circuit efficiencies.

In typical applications doubling efficiency is 5% greater than that for tripling and quadrupling efficiency 5% less than that for tripling. (See data sheet curves.)

1N4387

$V_R = 150\text{ V}$
 $P_O = 18\text{ W @ } 450\text{ Mc}$
 $\eta = 60\% (f_O = 450\text{ Mc})$



CASE 49
(DO-4)

cathode connected to stud

Silicon varactor diode for high-power frequency multiplication applications.

MAXIMUM RATINGS

Characteristic	Symbol	Rating	Unit
Reverse Voltage	V_R	150	Volts
RF Power Input	P_{in}	40	Watts
Total Device Dissipation @ $T_C = 75^\circ\text{C}$ (derate 0.2 W/ $^\circ\text{C}$ above 75°C)	P_D	20	Watts
Junction Temperature	T_J	+175	$^\circ\text{C}$
Storage Temperature Range	T_{stg}	-65 to +175	$^\circ\text{C}$

ELECTRICAL CHARACTERISTICS ($T_C = 25^\circ$)

Characteristic	Symbol	Condition	Min	Typ	Max	Unit
Reverse Breakdown Voltage	BV_R	$I_R = 10\ \mu\text{A dc}$	150	200	—	Vdc
Series Resistance	R_S	$V_R = 6\ \text{Vdc}$ $f = 50\ \text{mc}$	—	1.0	1.5	Ohms
Junction Capacitance	C_J	$V_R = 6\ \text{Vdc}$ $f = 50\ \text{mc}$	—	25	35	pf
Figure of Merit	Q	$V_R = 6\ \text{Vdc}$ $f = 50\ \text{mc}$	150	200	—	—

Power Output	P_{out}	TRIPLER CIRCUIT	15	18	—	Watts
Efficiency	η		$P_{in} = 30\ \text{W}$ $f_{in} = 150\ \text{mc}$ $f_{out} = 450\ \text{mc}$	50	60	—

POWER OUTPUT versus OUTPUT FREQUENCY FOR HARMONIC TRIPLING

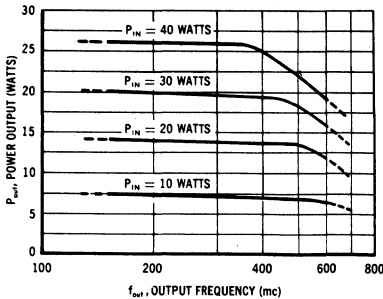

SERIES RESISTANCE AND FIGURE OF MERIT versus REVERSE VOLTAGE

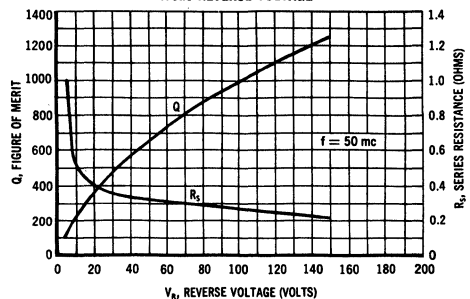

1N4388

$V_R = 100\text{ V}$
 $C_T = 10\text{ pf}$
 $\eta = 60\%$ ($f_o = 1000\text{ Mc}$)
 $P_o = 12\text{ W @ } 1000\text{ Mc}$



Silicon varactor diode for high-frequency harmonic generation applications.

CASE 49
(DO-4)

cathode connected to stud

MAXIMUM RATINGS ($T_C = 25^\circ\text{C}$ unless otherwise noted)

Characteristics	Symbol	Rating	Unit
Reverse Voltage	V_R	100	Volts
Forward Current	I_F	1	Amp
RF Power Input	P_{in}	25	Watts
Total Device Dissipation @ $T_C = 75^\circ\text{C}$ Derate above 75°C	P_D	10 0.10	Watts $\text{W}/^\circ\text{C}$
Junction Temperature	T_J	+175	$^\circ\text{C}$
Storage Temperature	T_{stg}	-65 to +175	$^\circ\text{C}$

ELECTRICAL CHARACTERISTICS ($T_A = 25^\circ\text{C}$ unless otherwise noted)

Characteristics	Symbol	Condition	Min	Typ	Max	Unit
Reverse Breakdown Voltage	BV_R	$I_R = 10\ \mu\text{Adc}$	100	150	--	Vdc
Reverse Current	I_R	$V_R = 75\text{ Vdc}$ $V_R = 75\text{ Vdc}, T_A = 150^\circ\text{C}$	--	0.5 --	2 100	μAdc
Series Resistance	R_S	$V_R = 6\text{ Vdc}, f = 50\text{ mc}$	--	1.2	2.0	Ohms
Diode Capacitance	C_T^*	$V_R = 6\text{ Vdc}, f = 50\text{ mc}$ $V_R = 90\text{ Vdc}, f = 50\text{ mc}$	--	10 5	20 10	pF
Figure of Merit	Q	$V_R = 6\text{ Vdc}, f = 50\text{ mc}$ $V_R = 90\text{ Vdc}, f = 50\text{ mc}$	200 1000	300 --	-- --	--
Power Output	P_{out}	TEST CIRCUIT (Figure 1)	11.0	12.0	--	Watts
Efficiency	η	$P_{in} = 20\text{ W}, f_{in} = 500\text{ mc}$ $f_{out} = 1000\text{ mc}$	55	60	--	%

* $C_T = C_J + C_C$

1N4388 (continued)

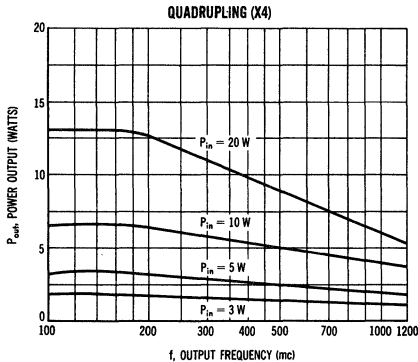
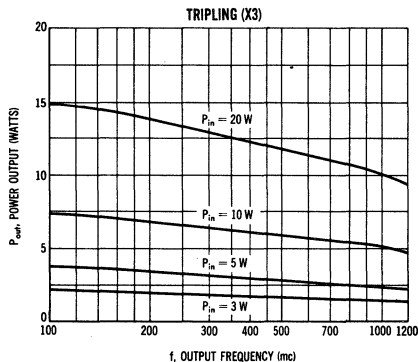
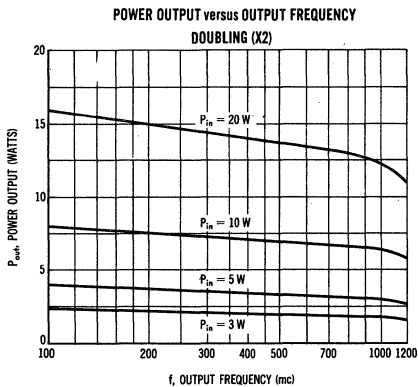
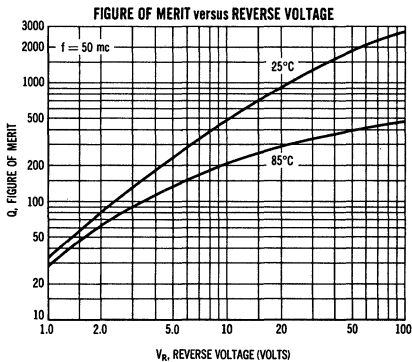
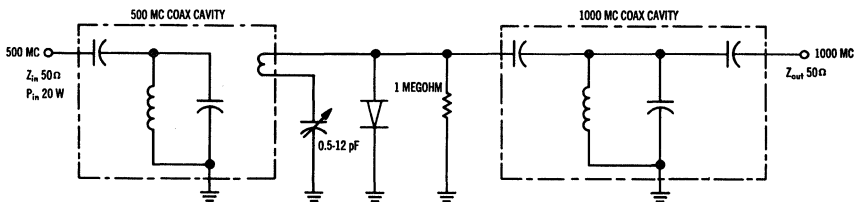

FIGURE 1 — HARMONIC DOUBLER EFFICIENCY TEST CIRCUIT



MV1808A, B, C

$V_R = 75 \text{ V}$
 $P_O = 7.2 \text{ W @ } 2 \text{ Gc}$
 $\eta = 60\% (f_o = 2 \text{ Gc})$

cathode



(pill)
 MV1808A
CASE 48

cathode



(pill w/p)
 MV1808B
CASE 46

cathode



(cartridge)
 MV1808C
CASE 47

Silicon varactor diodes for high-frequency harmonic generation applications.

MAXIMUM RATINGS ($T_A = 25^\circ\text{C}$ unless otherwise noted)

Characteristics	Symbol	Rating	Unit
Reverse Voltage	V_R	75	Vdc
Forward Current	I_F	0.25	Adc
RF Power Input	P_{in}	15	Watts
Total Device Dissipation @ $T_C = 75^\circ\text{C}$ Derate above 75°C	P_D	5.5 45	Watts mW/ $^\circ\text{C}$
Junction Temperature	T_J	200	$^\circ\text{C}$
Storage Temperature	T_{stg}	-65 to +200	$^\circ\text{C}$

ELECTRICAL CHARACTERISTICS ($T_A = 25^\circ\text{C}$ unless otherwise noted)

Characteristics	Symbol	Condition	Min	Typ	Max	Unit
Reverse Breakdown Voltage	BV_R	$I_R = 10 \mu\text{Adc}$	75	80	—	Vdc
Reverse Current	I_R	$V_R = 60 \text{ Vdc}$ $V_R = 60 \text{ Vdc}, T_A = 150^\circ\text{C}$	—	0.5 —	1 100	μAdc
Series Resistance	R_S	$V_R = 6 \text{ Vdc}, f = 50 \text{ mc}$	—	0.5	—	Ohms
Diode Capacitance	C_T^*	$V_R = 6 \text{ Vdc}, f = 50 \text{ mc}$ $V_R = 70 \text{ Vdc}, f = 50 \text{ mc}$	5.0 —	5.8 4	7.5 —	pf
Figure of Merit	Q	$V_R = 6 \text{ Vdc}, f = 50 \text{ mc}$	—	1100	—	—
Power Output	P_{out}	DOUBLER TEST CIRCUIT	6.0	7.2	—	Watts
Efficiency	η	$P_{in} = 12 \text{ W}, f_{in} = 1 \text{ gc}$ $f_{out} = 2 \text{ gc}$	50	60	—	%
Thermal Resistance	θ_J		—	19	23	$^\circ\text{C}/\text{Watt}$

* $C_T = C_J + C_C$

MV1808A, B, C (continued)

HARMONIC DOUBLER EFFICIENCY TEST CIRCUIT

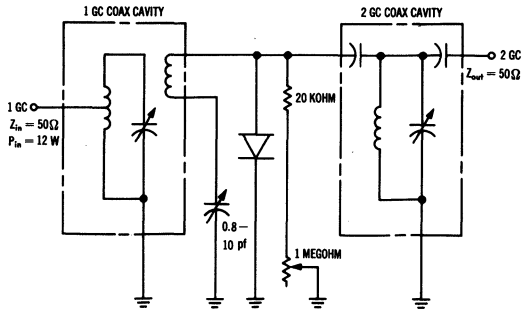

POWER OUTPUT versus OUTPUT FREQUENCY

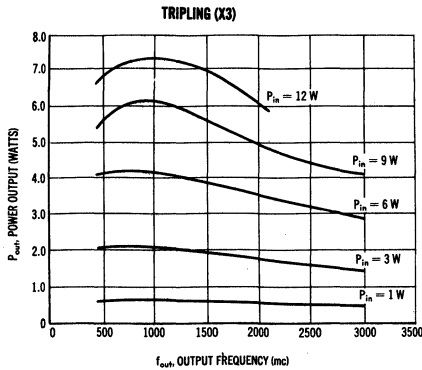
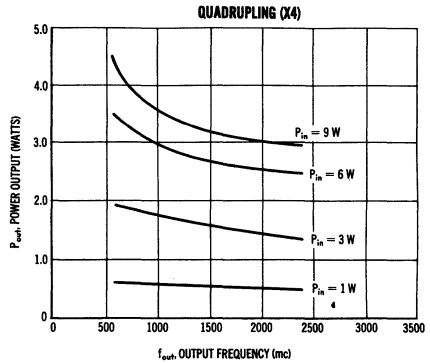
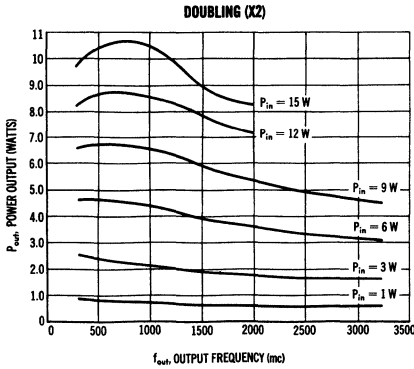

**TYPICAL CHARACTERISTICS at 25°C.
FIGURE OF MERIT versus REVERSE VOLTAGE**

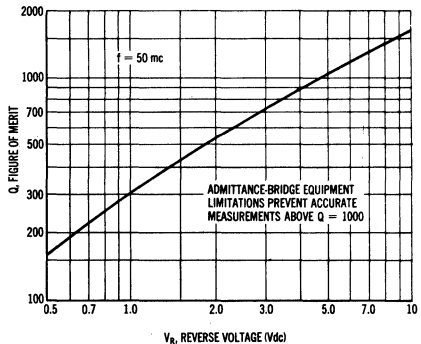

MV1864A

$C_T = 6.8 \text{ pf}$
 $V_R = 60 \text{ V}$
 $f_{CO} = 150 \text{ Gc}$
Max RF $P_{in} = 5 \text{ W}$

cathode



Silicon voltage variable capacitance diode for electronic tuning and harmonic generation applications.

CASE 48

MAXIMUM RATINGS ($T_c = 25^\circ\text{C}$ unless otherwise noted)

Characteristics	Symbol	Rating	Unit
Reverse Voltage	V_R	60	Volts
Forward Current	I_F	250	mA
RF Power Input (Note 1)	P_{in}	5	Watts
Device Dissipation @ $T_A = 25^\circ\text{C}$ Derate above 25°C	P_D	500 3.33	mW mW/ $^\circ\text{C}$
Device Dissipation @ $T_C = 25^\circ\text{C}$ Derate above 25°C	P_C	2 13.3	W mW/ $^\circ\text{C}$
Junction Temperature	T_J	+175	$^\circ\text{C}$
Storage Temperature	T_{stg}	-65 to +200	$^\circ\text{C}$

Note 1. The RF power input rating assumes that an adequate heat sink is provided.

ELECTRICAL CHARACTERISTICS ($T_A = 25^\circ\text{C}$ unless otherwise noted)

Characteristics	Symbol	Test Conditions	Min	Typ	Max	Unit
Reverse Breakdown Voltage	BV_R	$I_R = 10 \mu\text{A dc}$	60	75	--	Vdc
Reverse Voltage Leakage Current	I_R	$V_R = 48 \text{ Vdc}$ $V_R = 48 \text{ Vdc}, T_A = 75^\circ\text{C}$	--	--	0.5 10.0	$\mu\text{A dc}$

Series Inductance	L_S	See Note 1	--	0.4	1	nhy
Case Capacitance	C_C	$f = 1 \text{ mc}, L = 0$	0.6	0.8	1.0	pF
Diode Capacitance	C_T	$V_R = 4 \text{ Vdc}, f = 1 \text{ mc}$	6.1	6.8	7.5	pF
Series Resistance	R_S	$V_R = 4 \text{ Vdc}, f = 100 \text{ mc}$	--	0.5	0.9	ohm
Figure of Merit	Q	$V_R = 4 \text{ Vdc}, f = 100 \text{ mc}$ $V_R = 60 \text{ Vdc}, f = 100 \text{ mc}$	300 1000	400 1500	--	--
Cutoff Frequency	f_{co}	$V_R = 60 \text{ Vdc}, f = 100 \text{ mc}$	--	150	--	gc

Diode Capacitance Reverse Voltage Slope	α	$V_R = 4 \text{ Vdc}, f = 1 \text{ mc}$	0.33	0.35	0.37	--
Diode Capacitance Temperature Coefficient	TC_C	$V_R = 4 \text{ Vdc}, f = 1 \text{ mc}$	--	200	300	ppm/ $^\circ\text{C}$

MV1864A (continued)

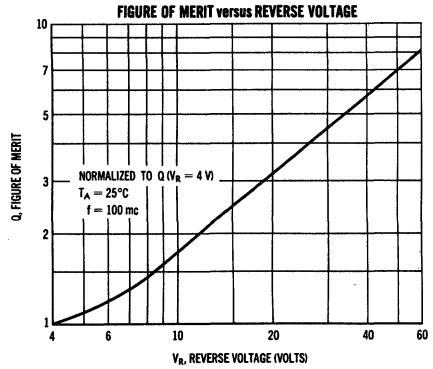
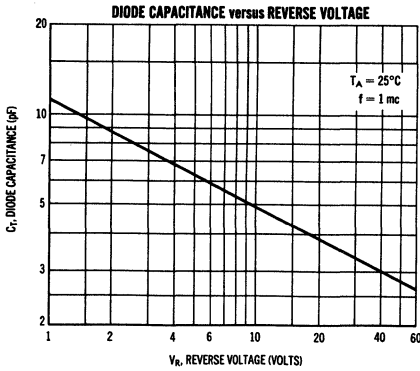
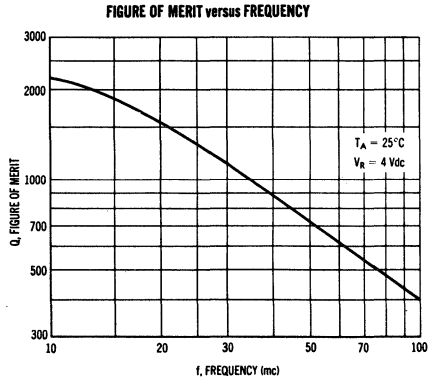
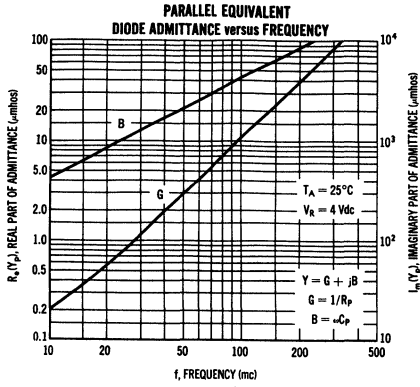

- MV1866**
- MV1868**
- MV1871**
- MV1877**

$C_T = 10\text{-}39 \text{ pf}$
 $V_R = 60 \text{ V}$
 $f_{CO} = 45 \text{ Gc}$



Silicon voltage variable capacitance diode for electronic tuning and harmonic generation applications.

CASE 51
(DO-7)

polarity band on cathode end

— Motorola Voltage-Variable Capacitance Diodes —

MV1866, MV1868, MV1871, MV1877 (continued)

MAXIMUM RATINGS ($T_C = 25^\circ\text{C}$ unless otherwise noted)

Characteristic	Symbol	Rating	Unit
Reverse Voltage	V_R	60	Volts
Forward Current	I_F	250	mA
RF Power Input	P_{in}	5	Watts
Total Device Dissipation at 25°C Ambient	P_D	400	mW
Above 25°C Derate	-	2.67	mW/ $^\circ\text{C}$
Junction Temperature	T_J	+175	$^\circ\text{C}$
Storage Temperature	T_{stg}	-65 to +175	$^\circ\text{C}$

ELECTRICAL CHARACTERISTICS ($T_A = 25^\circ\text{C}$ unless otherwise noted)

Characteristic	Symbol	Test Conditions	Minimum	Typical	Maximum	Unit
Reverse Breakdown Voltage	BV_R	$I_R = 10 \mu\text{A dc}$	60	75	-	Vdc
Reverse Current	I_R	$V_R = 48 \text{ Vdc}$	-	-	0.5	$\mu\text{A dc}$
Reverse Current	I_R	$V_R = 48 \text{ Vdc}, T_A = 75^\circ\text{C}$	-	-	10.0	$\mu\text{A dc}$
Series Inductance	L_S	$f = 250 \text{ mc}, L = 1/16''$	-	5	10	nhy
Case Capacitance	C_c	$f = 1 \text{ mc}, L \approx 1/16''$	0.20	0.25	0.30	pf
Diode Capacitance	C_T	$V_R = 4 \text{ Vdc}, f = 1 \text{ mc}$ MV1866 MV1868 MV1871 MV1877	9.0 10.8 16.2 36.1	10.0 12.0 18.0 39.0	11.0 13.2 19.8 42.9	pf
Series Resistance	R_S	$V_R = 4 \text{ Vdc}, f = 50 \text{ mc}$ MV1866 MV1868 MV1871 MV1877	-	0.80 0.76 0.65 0.33	1.18 1.01 0.98 0.50	Ohms
Figure of Merit	Q	$V_R = 4 \text{ Vdc}, f = 50 \text{ mc}$ MV1866 MV1868 MV1871 MV1877	300 300 200 175	400 350 275 250	-	-
Figure of Merit	Q	$V_R = 60 \text{ Vdc}, f = 50 \text{ mc}$	700	900	-	-
Cutoff Frequency	f_{co}	$V_R = 60 \text{ Vdc}, f = 50 \text{ mc}$	-	45	-	gc
Diode Capacitance vs Reverse Voltage Slope	α	$V_R = 4 \text{ Vdc}, f = 1 \text{ mc}$ MV1866 MV1868 MV1871 MV1877	.38 .38 .38 .43	.40 .40 .41 .45	.43 .43 .43 .47	-
Diode Capacitance Temperature Coefficient	T_C	$V_R = 4 \text{ Vdc}, f = 1 \text{ mc}$	-	200	300	PPM/ $^\circ\text{C}$

MV1870
MV1874
MV1878



polarity band on cathode end

$C_T = 15-47$ pf
 $V_R = 60$ V
 $f_{CO} = 45$ Gc

CASE 51
(DO-7)

Silicon voltage variable capacitance diode for electronic tuning and harmonic generation applications.

MAXIMUM RATINGS ($T_A = 25^\circ\text{C}$ unless otherwise noted)

Characteristic	Symbol	Rating	Unit
Reverse Voltage	V_R	60	Volts
Forward Current	I_F	400	mA
RF Power Input	P_{in}	5	Watts
Total Device Dissipation @25°C Amb.	P_D	400	mW
Above 25°C Derate	-	2.67	mW/°C
Junction Temperature	T_J	+175	°C
Storage Temperature	T_{stg}	-65 to +200	°C

ELECTRICAL CHARACTERISTICS ($T_A = 25^\circ\text{C}$ unless otherwise specified.)

Characteristic	Symbol	Test Conditions	Minimum	Typical	Maximum	Unit
Reverse Breakdown Voltage	BV_R	$I_R = 10 \mu\text{A dc}$	60	75	-	Vdc
Reverse Current	I_R	$V_R = 48$ Vdc	-	-	0.5	$\mu\text{A dc}$
Reverse Current	I_R	$V_R = 48$ Vdc, $T_A = 75^\circ\text{C}$	-	-	10.0	$\mu\text{A dc}$

See Figure 1

Series Inductance	L_S	$f = 250$ mc, $L = 1/16''$	-	5	10	nhy
Case Capacitance	C_c	$f = 1$ mc, $L \approx 1/16''$	0.2	0.25	0.3	pf
Diode Capacitance	C_T	$V_R = 4$ Vdc, $f = 1$ mc				pf
		MV1870	13.5	15	16.5	
		MV1874	24.3	27	29.7	
		MV1878	42.3	47	51.7	
Series Resistance	R_S	$V_R = 4$ Vdc, $f = 50$ mc				Ohms
		MV1870	-	1.07	1.2	
		MV1874	-	0.6	0.66	
		MV1878	-	0.35	0.38	
Figure of Merit	Q	$V_R = 4$ Vdc, $f = 50$ mc	200	250	-	-
		MV 1878	175			
Figure of Merit	Q	$V_R = 60$ Vdc, $f = 50$ mc	700	900	-	-
Cutoff Frequency	f_{co}	$V_R = 60$ Vdc, $f = 50$ mc	-	45	-	gc

See Figure 1

Diode Capacitance vs Reverse Voltage Slope	α	MV 1870 $V_R = 4$ Vdc, $f = 1$ mc MV 1874 MV 1878	.38 .43	.41 .45	.43 .47	-
Diode Capacitance Temperature Coefficient	T_C	$V_R = 4$ Vdc, $f = 1$ mc	-	200	300	PPM/°C

mv1871

For Specifications, see MV1866 Data Sheet

mv1872

$C_T = 22 \text{ pf}$
 $V_R = 60 \text{ V}$
 $f_{CO} = 45 \text{ Gc}$



polarity band on cathode end

CASE 51
(DO-7)

Silicon voltage variable capacitance diode for electronic tuning and harmonic generation applications.

MAXIMUM RATINGS ($T_c = 25^\circ\text{C}$ unless otherwise noted)

Characteristics	Symbol	Rating	Unit
Reverse Voltage	V_R	60	Volts
Forward Current	I_F	400	mA
RF Power Input (Note 1)	P_{in}	5	Watts
Device Dissipation @ $T_A = 25^\circ\text{C}$ Derate above 25 C	P_D	400 2.67	mW mW/ C
Device Dissipation @ $T_C = 25^\circ\text{C}$ Derate above 25 C	P_C	2 13.3	W mW/ C
Junction Temperature	T_J	+175	C
Storage Temperature	T_{stg}	-65 to +200	C

Note 1. The RF power input rating assumes that an adequate heat sink is provided.

ELECTRICAL CHARACTERISTICS ($T_A = 25^\circ\text{C}$ unless otherwise noted)

Characteristics	Symbol	Test Conditions	Min	Typ	Max	Unit
Reverse Breakdown Voltage	BV_R	$I_R = 10 \mu\text{Adc}$	60	75	--	Vdc
Reverse Voltage Leakage Current	I_R	$V_R = 48 \text{ Vdc}$ $V_R = 48 \text{ Vdc}, T_A = 75^\circ\text{C}$	--	--	0.5 10.0	μAdc

Series Inductance	L_S	$f = 250 \text{ mc}, L \sim 1/16"$	--	5	10	nhy
Case Capacitance	C_C	$f = 1 \text{ mc}, L \sim 1/16"$	0.2	0.25	0.3	pF
Diode Capacitance	C_T	$V_R = 4 \text{ Vdc}, f = 1 \text{ mc}$	19.8	22	24.2	pF
Series Resistance	R_S	$V_R = 4 \text{ Vdc}, f = 50 \text{ mc}$	--	0.6	0.82	ohm
Figure of Merit	Q	$V_R = 4 \text{ Vdc}, f = 50 \text{ mc}$ $V_R = 60 \text{ Vdc}, f = 50 \text{ mc}$	200 700	250 900	--	--
Cutoff Frequency	f_{CO}	$V_R = 60 \text{ Vdc}, f = 50 \text{ mc}$	--	45	--	gc

Diode Capacitance Reverse Voltage Slope	α	$V_R = 4 \text{ Vdc}, f = 1 \text{ mc}$	0.43	0.45	0.47	--
Diode Capacitance Temperature Coefficient	TC_C	$V_R = 4 \text{ Vdc}, f = 1 \text{ mc}$	--	200	300	ppm/ $^\circ\text{C}$

MV1872 (continued)

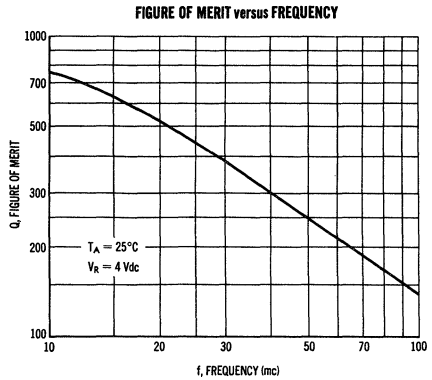
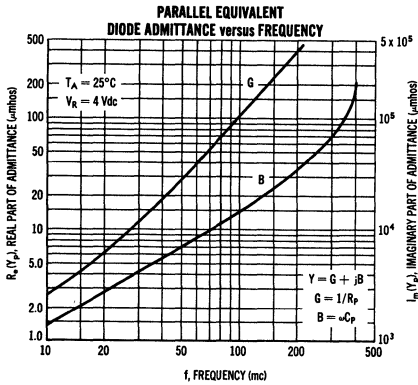
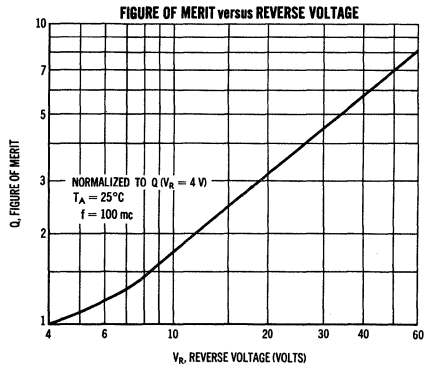
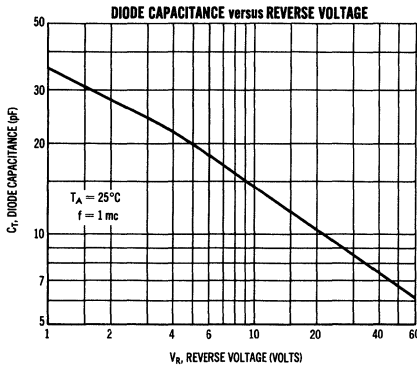

MV1874

For Specifications, see MV1870 Data Sheet

mv1876

$C_T = 33 \text{ pf}$
 $V_R = 60 \text{ V}$
 $f_{CO} = 45 \text{ Gc}$

CASE 51
(DO-7)



polarity band on cathode end

Silicon voltage variable capacitance diode for electronic tuning and harmonic generation applications.

MAXIMUM RATINGS ($T_C = 25^\circ\text{C}$ unless otherwise noted)

Characteristics	Symbol	Rating	Unit
Reverse Voltage	V_R	60	Volts
Forward Current	I_F	250	mA
RF Power Input (Note 1)	P_{in}	5	Watts
Device Dissipation @ $T_A = 25^\circ\text{C}$ Derate above 25°C	P_D	400 2.67	mW mW/ $^\circ\text{C}$
Device Dissipation @ $T_C = 25^\circ\text{C}$ Derate above 25°C	P_C	2 13.3	W mW/ $^\circ\text{C}$
Junction Temperature	T_J	+175	$^\circ\text{C}$
Storage Temperature	T_{stg}	-65 to +200	$^\circ\text{C}$

Note 1. The RF power input rating assumes that an adequate heat sink is provided.

ELECTRICAL CHARACTERISTICS ($T_A = 25^\circ\text{C}$ unless otherwise noted)

Characteristics	Symbol	Test Conditions	Min	Typ	Max	Unit
Reverse Breakdown Voltage	BV_R	$I_R = 10 \mu\text{Adc}$	60	75	--	Vdc
Reverse Voltage Leakage Current	I_R	$V_R = 48 \text{ Vdc}$ $V_R = 48 \text{ Vdc}, T_A = 75^\circ\text{C}$	--	--	10.0	μAdc
Series Inductance	L_S	$f = 250 \text{ mc}, L \sim 1/16"$	--	5	10	nhy
Case Capacitance	C_C	$f = 1 \text{ mc}, L \sim 1/16"$	0.2	0.25	0.3	pF
Diode Capacitance	C_T	$V_R = 4 \text{ Vdc}, f = 1 \text{ mc}$	29.7	33	36.3	pF
Series Resistance	R_S	$V_R = 4 \text{ Vdc}, f = 50 \text{ mc}$	--	0.4	0.55	ohm
Figure of Merit	Q	$V_R = 4 \text{ Vdc}, f = 50 \text{ mc}$ $V_R = 60 \text{ Vdc}, f = 50 \text{ mc}$	200 700	250 900	--	--
Cutoff Frequency	f_{co}	$V_R = 60 \text{ Vdc}, f = 50 \text{ mc}$	--	45	--	gc
Diode Capacitance Reverse Voltage Slope	α	$V_R = 4 \text{ Vdc}, f = 1 \text{ mc}$	0.43	0.45	0.47	--
Diode Capacitance Temperature Coefficient	TC_C	$V_R = 4 \text{ Vdc}, f = 1 \text{ mc}$	--	200	300	ppm/ $^\circ\text{C}$

MV1876 (continued)

FIGURE OF MERIT versus REVERSE VOLTAGE

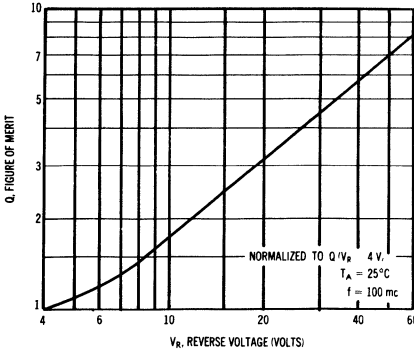

DIODE CAPACITANCE versus REVERSE VOLTAGE

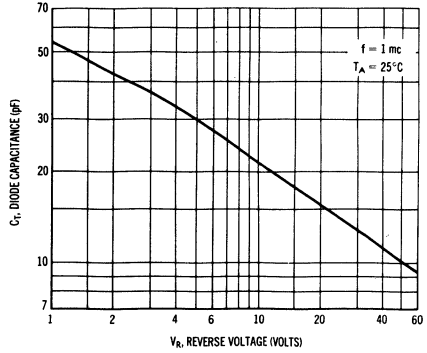

PARALLEL EQUIVALENT DIODE ADMITTANCE versus FREQUENCY

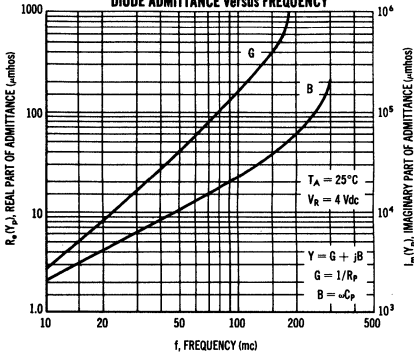
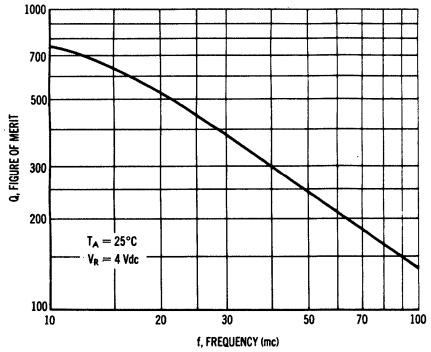

FIGURE OF MERIT versus FREQUENCY



MV1877

For Specifications, see MV1870 Data Sheet

MV1878

For Specifications, see MV1866 Data Sheet

MV1892

$V_R = 700\text{ V}$
 $I_F = 4\text{ Amps}$
 $C_T = 2.5\text{ pf}$
 $P_{SW} = 500\text{ Watts}$



cathode connected to stud

CASE 49
(DO-4)

Silicon diode for switching high-power, RF signals. Particularly well suited as a replacement for mechanical antenna and coaxial relays.

MAXIMUM RATINGS ($T_c = 25^\circ\text{C}$ unless otherwise noted)

Characteristic	Symbol	Rating	Unit
Reverse Voltage	V_R	700	Volts
Forward Current	I_F	4	Amp
RF Power Switching Capability	P_{sw}	500	Watts
Total Device Dissipation at or below 75°C Case Temperature	P_D	20	Watts
Above 75°C Derate Linearly	-	0.2	W/ $^\circ\text{C}$
Junction Temperature	T_J	+175	$^\circ\text{C}$
Storage Temperature	T_{stg}	-65 to +175	$^\circ\text{C}$

ELECTRICAL CHARACTERISTICS ($T_c = 25^\circ\text{C}$ unless otherwise noted)

Characteristic	Symbol	Test Conditions	Minimum	Maximum	Unit
Reverse Breakdown Volt.	BV_R	$I_R = 10\ \mu\text{A dc}$	700	-	Vdc
Series Resistance (See Note 1)	R_t	$I_F = 100\text{ ma}; f = 1\text{ kc}$	-	0.62	Ohms
Diode Capacitance	C_T	$V_R = 100\text{ Vdc}; f = 140\text{ kc}$	-	2.5	pf

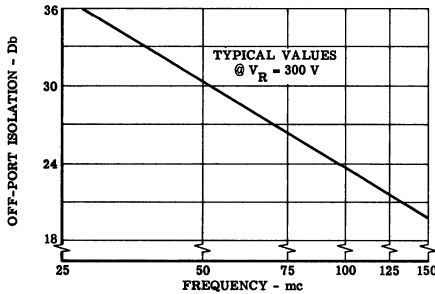

OFF-PORT ISOLATION vs FREQUENCY FOR SPDT SWITCH

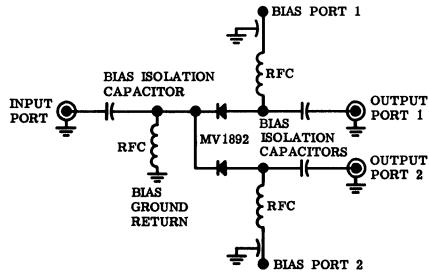

TYPICAL RF SWITCHING CIRCUIT

NOTE 1. Laboratory measurements show that R_t at 1 kc is within 15% of R_t at 50 mc.

— Motorola 4-Layer Diodes —

M4L2052
M4L2053
M4L2054

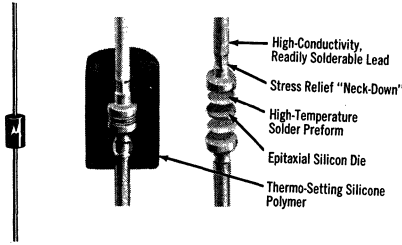

$V_{RM} = 10-12 V$
 $I_F = 500 mA$
 $V_F = 1.5 V$
 $T_{on} = 60 nsec$

CASE 59

PNPN 4-layer diodes for low-voltage switching and triggering applications.

MAXIMUM RATINGS ($T_A = 25^\circ C$ unless otherwise noted)

Characteristic	Symbol	Rating	Unit
Peak Reverse Blocking Voltage M4L2052 M4L2053 M4L2054	$V_{RM(rep)}$	10 11 12	Volts
Continuous Forward Current	I_F	500	mA
Steady State Power Dissipation	P_D	750	mW
Peak Pulse Current (10 μsec maximum pulse width)	I_{pulse}	100	Amps
Operating Junction Temperature Range	T_J	-65 to +100	$^\circ C$
Storage Temperature Range	T_{stg}	-65 to +150	$^\circ C$

ELECTRICAL CHARACTERISTICS (At $25^\circ C$ unless otherwise noted)

Characteristic	Symbol	Min	Typ	Max	Unit
Forward Breakover (Switching) Voltage M4L2052 M4L2053 M4L2054	$V_{(BR)F}$	8 9 10	— — —	10 11 12	Volts
Forward Breakover (Switching) Current	$I_{(BR)F}$	—	15	50	μA
Forward Blocking Current (Measured at 75% of $V_{(BR)F}$)	I_{FM}	—	1	5	μA
Reverse Blocking Current (at rated $V_{RM rep}$)	I_{RM}	—	—	10	μA
Holding Current	I_H	—	3	15	mA
Forward On Voltage ($I_F = 500 mA_{dc}$)	V_F	—	1.1	1.5	Volts
Turn On Time (at rated $V_{(BR)F}$, $I_F = 1 A$ peak)	t_{on}	—	60*	—	nsec
Turn Off Time ($I_F = 100 mA$, V_F applied = 5 V, V_R applied = 5 V, $dv/dt = 5 V/\mu sec$, typical I_H of units tested = 5 mA)	t_{off}	—	2*	—	μsec

*Time depends on a wide variety of circuit conditions. Consult manufacturer for further information.

M4L2052, M4L2053, M4L2054 (continued)

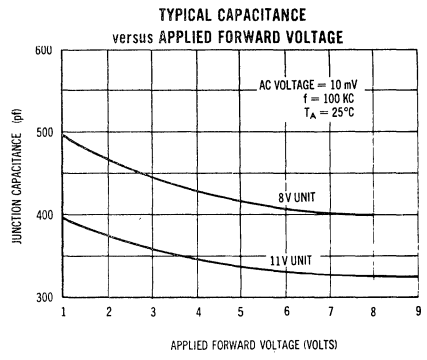
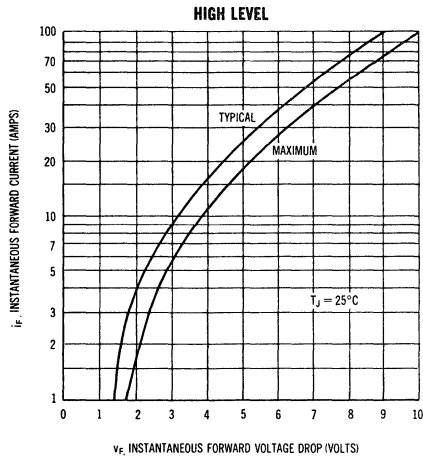
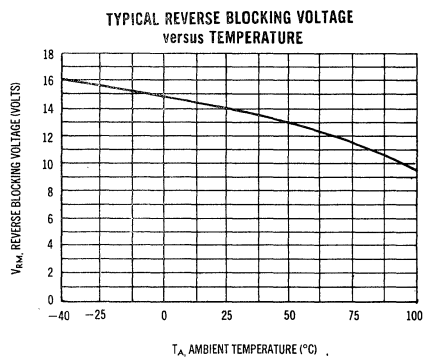
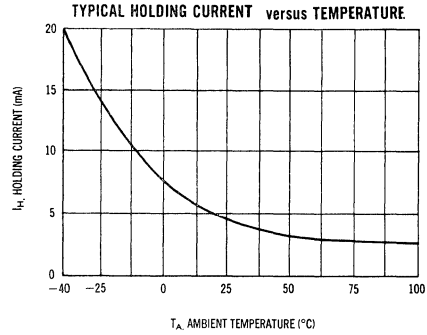
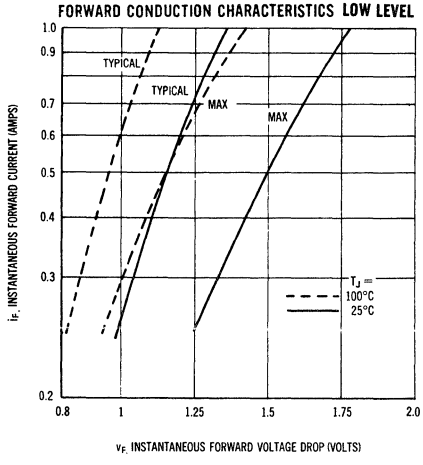
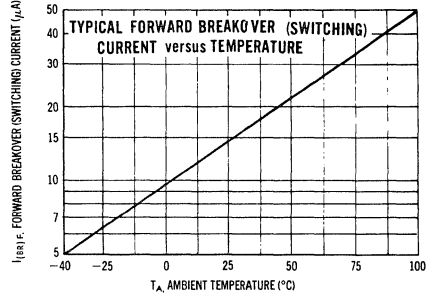
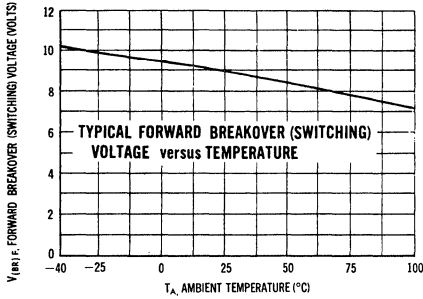

Those who are not now considering the design of electronic equipment using integrated circuits are already behind the main flow of American Technology.*

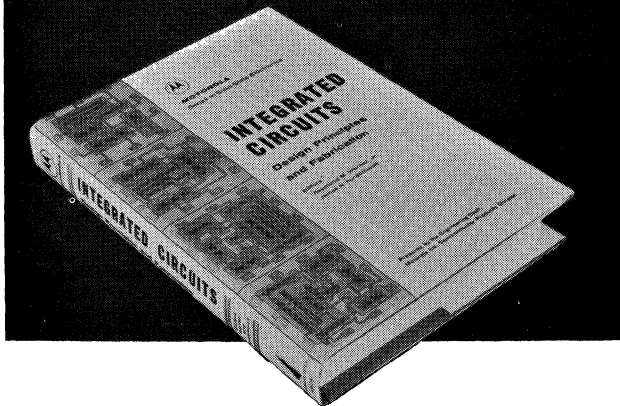

Now Off The Presses — the one indispensable text for anyone engaged in the design and applications of integrated circuits . . . the one book that covers the entire technology, both practically and theoretically.

Prepared by the engineering staff of Motorola's Semiconductor Products Division, this book is based on the celebrated Integrated Circuits Design Course presented repeatedly by Motorola, at industry request, to the engineering personnel of leading electronic equipment manufacturers the world over.

Nearly a quarter million dollars has been invested specifically for developing and up-dating the material for this book. It is not a miscellaneous collection of individual papers, but rather, a cohesive and well organized treatment covering integrated circuit design principles from the standpoint of new circuit design philosophies and practical production yields. The efforts which have gone into the Motorola Integrated Circuits Design Course, plus the subsequent editing that has turned the initial material into a highly readable engineering-level work, easily make *Integrated Circuits — Design Principles and Fabrication* one of the most authoritative and comprehensive texts ever published in the technical field.

*C. Lester Hogan, Vice President, Motorola Inc.
General Manager, Semiconductor Products Division

For your postage paid copy, send check or purchase order in the amount of \$12.50 per copy to: Motorola Semiconductor Products, Inc., Dept. TIC, Box 955, Phoenix, Arizona 85001.



MOTOROLA INTEGRATED CIRCUITS

The extensive Motorola integrated circuit line includes a variety of digital and linear circuits. In addition to the standard integrated circuit product lines described on the following pages, Motorola offers a custom fabrication capability that is presently filling many specialized requirements.

Motorola's integrated circuit fabrication capability includes monolithic construction, multi-chip techniques, and Compatible processing in which high-quality thin-film components are deposited on passivated silicon wafers.

- For devices meeting military specifications, see page 1-18.
- For case outline dimensions, see page 1-26.

MOTOROLA DIGITAL INTEGRATED CIRCUITS

Motorola Digital Integrated Circuits	Description	
Type	Logic	
MC300 Series	MECL	High-speed current-mode logic series operating over a temperature range of -55 to +125°C.
MC350 Series	MECL	High-speed current-mode logic series with an operating temperature range of 0 to +75°C for commercial applications.
MC200 Series	DTL	High-speed, low-power Diode-Transistor Logic circuits operating over a temperature range of -55 to +125°C.
MC250 Series	DTL	High-speed, low-power Diode-Transistor Logic circuits with an operating temperature range of 0 to +75°C for commercial applications.
USN ME1 Series	DTL	High-speed Diode-Transistor Logic circuits designed to meet MIL-M-23700/1-8 (NAVY).
MC1111 Series	DTL	High-speed Diode-Transistor Logic circuits operating over the temperature range of -55 to +125°C.
MC908 Series	RTL	Milliwatt Resistor-Transistor Logic circuits operating over the temperature range of -55 to +125°C.
MC400 Series	T ² L	High-speed Transistor-Transistor Logic circuits operating over the temperature range of -55 to +125°C.

MECL MC300 series

MONOLITHIC SILICON
EPITAXIAL PASSIVATED

The MECL* series of integrated logic circuits forms a versatile set of monolithic digital building blocks representing all the necessary circuitry for the arithmetic portion of a computer. MECL circuits combine extremely high speed with a systems-oriented design approach that permits implementation with the fewest possible number of individual devices. This represents both a cost saving and a potential increase in system reliability. The major features of the MECL* series are:

- 5nsec propagation delay per logic decision
- Virtually constant noise immunity with $\pm 10\%$ power supply variation, and temperature changes from -55° to $+125^\circ\text{C}$
- Simultaneous "OR"-"NOR" or "AND"-"NAND" outputs
- High fan-in and fan-out capabilities

The series is comprised of the following elements:

- MC301** — A high-speed five-input gate element that provides the positive logic "OR" function and its complement simultaneously.
- MC302** — A DC Set-Reset flip-flop with an expandable input and the power dissipation of only one gate.
- MC303** — A half-adder that provides the "SUM", "CARRY", and "NOR" function simultaneously.
- MC304** — A bias driver that compensates for changes in circuit parameters with temperature.
- MC305** — A five-input expander for use with the MC302 and the MC306,7.
- MC306,7** — A high-speed expandable three-input gate element that provides the positive logic "OR" function and its complement simultaneously.
- MC308** — A clocked J-K flip-flop for counter and shift register applications with DC Set and Reset inputs.
- MC309,10,11** — A high-speed dual two-input gate element that provides the positive logic "NOR" function.
- MC312** — A high-speed dual three-input gate element that provides the positive logic "NOR" function.

BASIC MECL CIRCUIT

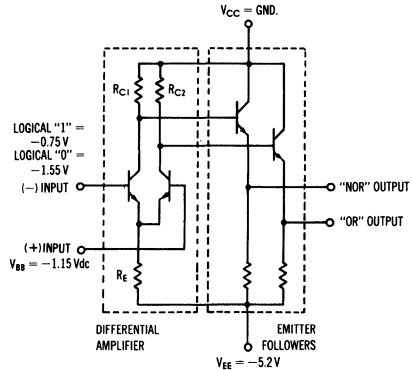

FOR LOGICAL "1" INPUT; "NOR" OUTPUT = -1.55V
"OR" OUTPUT = -0.75V

FOR LOGICAL "0" INPUT; "NOR" OUTPUT = -0.75V
"OR" OUTPUT = -1.55V

MECL — A CURRENT MODE SWITCH

The typical MECL circuit is designed with a differential amplifier input and emitter-follower output to restore dc levels. The circuit has been designed to prevent saturation of the input transistors, thus eliminating storage time and allowing for high-speed operation with non-critical transistor parameters. High fan-out operation is permitted due to the low impedance emitter-follower and the high-input impedance of the circuit. The basic gate has both the function and its complement available simultaneously. Since the current in the differential amplifier is switched from one side to the other, there is virtually no power supply noise generated.

The circuit operation is straight-forward. A fixed bias of -1.15 volts is applied to the (+) input of the differential amplifier and the logic signals are applied to the (-) input. If a logical "0" is applied to the (-) input, the current through R_e is supplied by the fixed biased transistor. A drop of 800mV occurs across R_{c1} . The "OR" output then is -1.55V , or one V_{be} -drop below 800mV . Since no current flows in the (-) input transistor, the "NOR" output is a V_{be} -drop below ground, or -0.75 volts. When a logical "1" level is applied to the (-) input, the current through R_{c2} is switched to the (-) input transistor and a drop of 800mV occurs across R_{c2} . The "OR" output then goes to -0.75 volts and the "NOR" output goes to -1.55 volts.

A bias driver is supplied to insure that the threshold point is always in the center of the transition region. The bias driver compensates for temperature changes and is designed to track with temperature.

*Trademark of Motorola Inc.

MC300 MECL series (continued)



10 PIN TO-5

CASE 71



12 PIN TO-5
(MC312G ONLY)

CASE 98

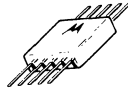

10 PIN FLAT PACKAGE

CASE 83

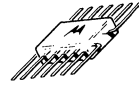

14 PIN FLAT PACKAGE
(MC312F ONLY)

CASE 72

FAMILY CHARACTERISTICS

The following information applies to all devices of the MECL family. It is intended to provide the design engineer with meaningful information for worst-case analyses. Parameters of importance are guaranteed at three temperature levels: room, and the extremes for which the family is

designed. All performance curves are based on distributional spreads and the minimum-maximum ranges can be interpreted for design purposes as 10%-90% spreads at all points on the curve except for guaranteed points on the electrical characteristics.

ABSOLUTE MAXIMUM RATINGS (at 25°C)

Characteristics	Symbol	Maximum	Unit
Logic Input Voltage	—	5	Vdc
Power Supply Voltage	—	10	Vdc
Output Source Current	I_O	10	mAdc
Operating Temperature Range	T_J	-55 to +125	°C
Storage Temperature Range	T_{stg}	-65 to +175	°C

SYSTEM LOGIC SPECIFICATIONS

Any one of the supply nodes, V_{BB} , V_{CC} , or V_{EE} may be used as ground; however, the manufacturer has found it most convenient to ground the V_{CC} node. In such a case:

$$V_{CC} = 0 \quad V_{BB} = -1.15V \quad V_{EE} = -5.2V$$

The output logic swing of 0.8V then varies from a low state of $V_L = -1.55V$ to a high state of $V_H = -0.75V$ with respect to ground.

Positive logic is used when reference is made to logical "0's" or "1's". Then

$$\left. \begin{array}{l} \text{"0"} = -1.55V \\ \text{"1"} = -0.75V \end{array} \right\} \text{ typical}$$

Dynamic logic refers to a change of logic states. Dynamic "0" is a negative going voltage excursion and a dynamic "1" is a positive going voltage excursion.

MC300 MECL series (continued)

DC CHARACTERISTICS FOR MC300 SERIES

WORST CASE TRANSFER CHARACTERISTICS

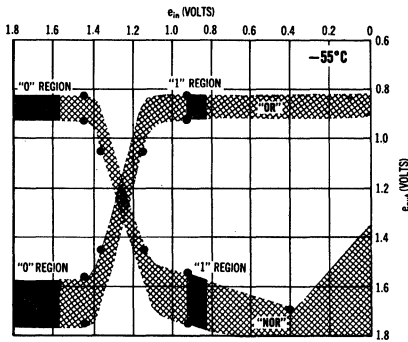
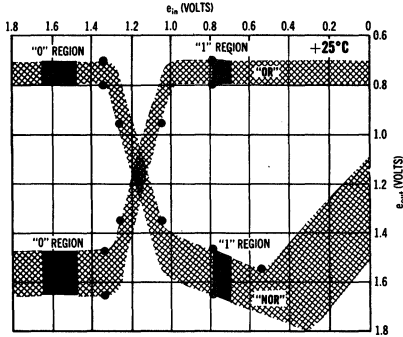

DEFINITION OF TRANSFER CHARACTERISTIC POINTS

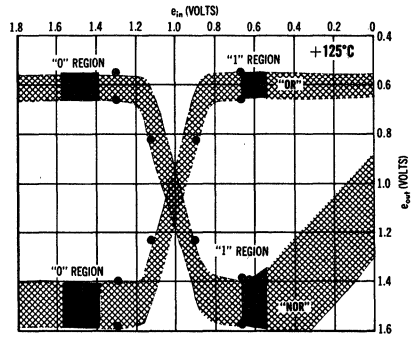
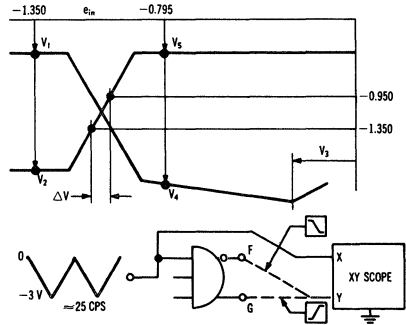

WORST CASE NOISE MARGIN

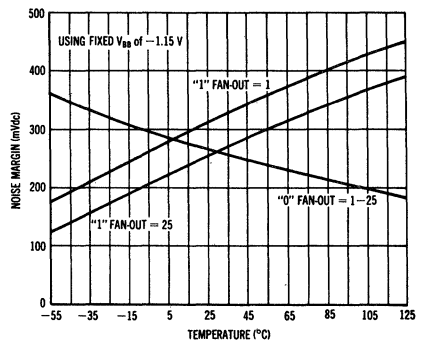
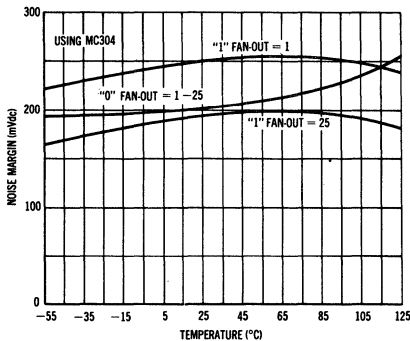

MC300 MECL series (continued)

MC304
BIAS DRIVER

A temperature compensating regulator intended for use in conjunction with the MOTOROLA MC300 "MECL" series of INTEGRATED LOGIC CIRCUITS. Insures stable and reliable operation of "MECL" logic systems over a temperature range of -55°C to $+125^{\circ}\text{C}$.

ELECTRICAL CHARACTERISTICS

Test	Conditions	Symbol	-55°C		25°C		125°C		Unit
			min	max	min	max	min	max	
Fan-Out	—	n	—	25	—	25	—	25	—
Output Voltage (No Load to Full Load)	$V_{CC} = 0, V_{EE} = -5.2 \text{ Vdc} \pm 1\%$ $I_{out} = 0 \text{ to } 2.5 \text{ mAdc}$	V_{BB}	1.19	1.32	1.09	1.22	0.95	1.08	Vdc
Power Dissipation	$V_{CC} = 0, V_{EE} = -5.2 \text{ Vdc} \pm 1\%$	P_D	—	24	—	24	—	22	mW

CIRCUIT SCHEMATIC

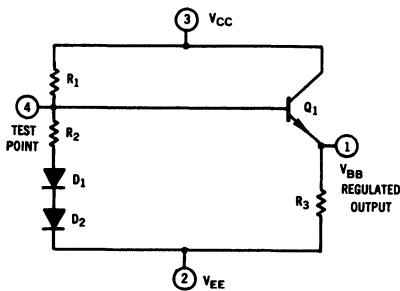

CIRCUIT DESCRIPTION

Circuit Operation:

The divider network R_1, R_2, D_1, D_2 compensates for temperature variations of the base-emitter voltages of Q_1 , and of the driven gates, producing a bias voltage for the MECL logic circuits that maintains a constant set of dc operating conditions over the temperature range of -55°C to $+125^{\circ}\text{C}$. In addition, compensation for power supply variations is achieved, since the bias output voltage is derived from the system supply.

Either of the supply voltage nodes may be used as ground, however the ground potential of the bias driver must coincide with that of the logic system. Thus, if V_{CC} is grounded in the logic system, then —

$$V_{CC} = 0; \quad V_{EE} = -5.2\text{V};$$

$$V_{BB} = -1.15 \text{ nominal output voltage at } 25^{\circ}\text{C}$$

MC300 MECL series (continued)

MC301, MC306, MC307, MC309 thru MC312
LOGIC GATES

CIRCUIT SCHEMATICS

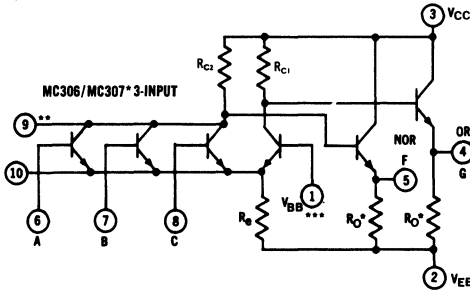
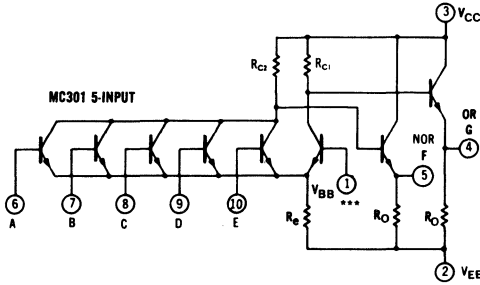

MC309 DUAL "NOR"

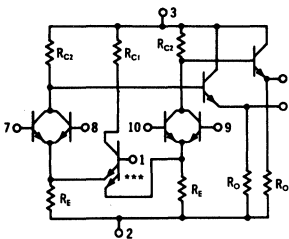

MC310 DUAL "NOR"

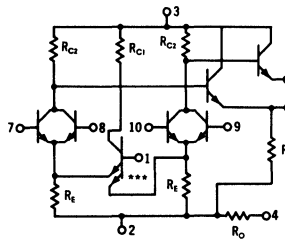

MC311 DUAL "NOR"

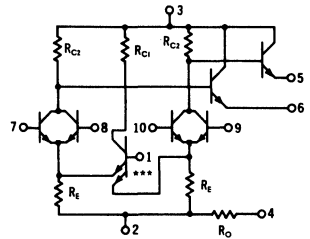

MC312F DUAL "NOR"

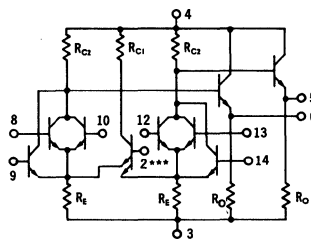

MC312G DUAL "NOR"

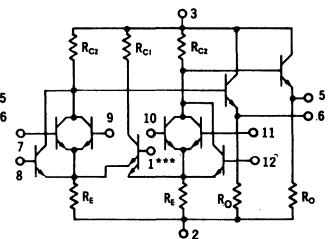

*Resistors R_O are omitted in MC307 circuits to permit reduction of Power Dissipation in systems where logic operations are performed at circuit outputs.

EXAMPLE: where (n) gates are to perform an "OR" function, one MC306 gate and (n-1) MC307 gates can be used to provide savings of Power Dissipation in (n-1) gates.

**Pins 9 and 10 are for use in conjunction with the MC305 input expander to increase the fan-in capability in increments of five.

***To be supplied from bias-driver circuit MC304 for optimum temperature stability.

NOTE: Any unused inputs can normally be left open-circuited. In cases where there may be external leakage to the unused inputs they should be connected to V_{EE} .

LOGIC SPECIFICATIONS

POSITIVE LOGIC

When V_H is defined as a logical "1" and V_L as a logical "0" the "OR"/"NOR" function is performed:



$F = \text{"NOR"} = \overline{A + B + C + D + E}$
 $G = \text{"OR"} = A + B + C + D + E$

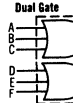

$G = \text{"NOR"} = \overline{A + B + C}$
 $H = \text{"NOR"} = \overline{D + E + F}$

NEGATIVE LOGIC

Inversely, when V_H is defined as a logical "0" and V_L as a logical "1" the "AND"/"NAND" function is performed:



$F = \text{"NAND"} = \overline{A \cdot B \cdot C \cdot D \cdot E}$
 $G = \text{"AND"} = A \cdot B \cdot C \cdot D \cdot E$

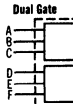

$G = \text{"NAND"} = \overline{A \cdot B \cdot C}$
 $H = \text{"NAND"} = \overline{D \cdot E \cdot F}$

MC300 MECL series (continued)

LOGIC GATES (CONTINUED)

DC ELECTRICAL CHARACTERISTICS

$V_{CC} = 0, V_{EE} = -5.2$ Volts, (all $\pm 1\%$), $V_{IH} = -1.25$ Vdc @ -55°C
 $V_{IH} = -1.15$ Vdc @ $+25^\circ\text{C}$
 $V_{IH} = -1.00$ Vdc @ $+125^\circ\text{C}$

Test	Conditions	Symbol	-55°C		25°C		125°C		Unit
			min	max	min	max	min	max	
Total Unit Power Supply Current Drain	All inputs open MC301, MC306 MC307 MC309, MC310, MC312 MC311	I_E	—	8.85	—	8.85	—	8.15	mAdc
			—	3.6	—	3.6	—	3.3	
			—	13.0	—	13.0	—	12.0	
			—	10.1	—	10.1	—	9.25	
			—	—	—	—	—	—	
Input Current	V_{1min} @ 25°C	I_{IN}	—	—	—	100	—	μAdc	
Fan-In		m	—	—	—	23	—		
Fan-Out		n	—	—	—	25	—		

"NOR" OUTPUT – All Types

"NOR" Logical "1" Output Voltage	Each Input: $V_{in} = -1.45$ Vdc @ -55°C $V_{in} = -1.35$ Vdc @ $+25^\circ\text{C}$ $V_{in} = -1.30$ Vdc @ $+125^\circ\text{C}$	V_1	0.825	0.925	—	—	—	—	Vdc
"NOR" Logical "0" Output Voltage	Each Input: $V_{in} = -0.925$ Vdc @ -55°C $V_{in} = -0.795$ Vdc @ $+25^\circ\text{C}$ $V_{in} = -0.655$ Vdc @ $+125^\circ\text{C}$	V_4	1.560	1.750	—	—	—	—	Vdc
"NOR" Saturation Breakpoint Voltage	$dv(\text{NOR}) / dV_{in} = 0$	V_3	—	0.40	—	0.55	—	0.65	Vdc
"NOR" Output Voltage Change (No load to full load)	All inputs open No load = 0 current at pin 5 Full load = 2.5 mAdc $\pm 5\%$ at pin 5	ΔV_1	—	0.055	—	0.055	—	0.060	Vdc

"OR" OUTPUT – Types MC301, MC306, MC307 only

"OR" Logical "1" Output Voltage	Each Input: $V_{in} = -0.925$ Vdc @ -55°C $V_{in} = -0.795$ Vdc @ $+25^\circ\text{C}$ $V_{in} = -0.655$ Vdc @ $+125^\circ\text{C}$	V_5	0.825	0.925	—	—	—	—	Vdc
"OR" Logical "0" Output Voltage	Each Input: $V_{in} = -1.45$ Vdc @ -55°C $V_{in} = -1.35$ Vdc @ $+25^\circ\text{C}$ $V_{in} = -1.30$ Vdc @ $+125^\circ\text{C}$	V_2	1.560	1.750	—	—	—	—	Vdc
Transition Region Slope	$V(\text{OR})$ Between: -1.450 Vdc and -1.050 Vdc @ -55°C -1.350 Vdc and -0.950 Vdc @ $+25^\circ\text{C}$ -1.220 Vdc and -0.820 Vdc @ $+125^\circ\text{C}$	ΔV	—	0.095	—	0.095	—	0.110	Vdc
"OR" Output Voltage Change (No load to full load)	No load = 0 current @ pin 1 Full load = 2.5 mAdc $\pm 5\%$ at pin 1	ΔV_5	—	0.055	—	0.055	—	0.060	Vdc

TYPICAL INPUT CHARACTERISTICS

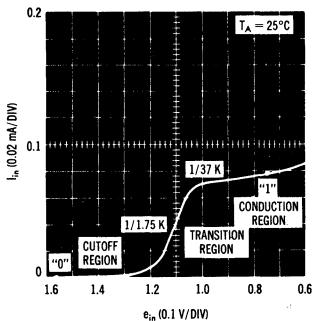

TYPICAL OUTPUT CHARACTERISTICS

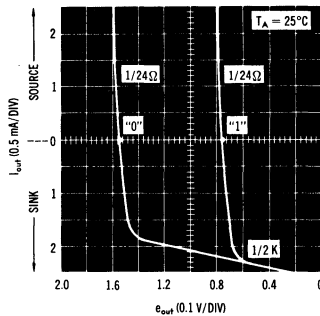

MC300 MECL series (continued)

LOGIC GATES (CONTINUED)

SWITCHING CHARACTERISTICS $V_{CC} = 0$, $V_{EE} = -5.2$ Volts, (all $\pm 1\%$)

The stray capacitance introduced by the test jig was $C_i = (n + 12)$ pf where n = number of fan-outs.

$V_{IH} = -1.25$ Vdc, $V_{IL} = -0.870$ Vdc, $V_i = -1.650$ Vdc @ -55°C
 $V_{IH} = -1.15$ Vdc, $V_{IL} = -0.750$ Vdc, $V_i = -1.550$ Vdc @ $+25^\circ\text{C}$
 $V_{IH} = -1.00$ Vdc, $V_{IL} = -0.600$ Vdc, $V_i = -1.450$ Vdc @ $+125^\circ\text{C}$

Test	Conditions	Symbol	-55°C		25°C		125°C		Unit
			min	max	min	max	min	max	
MC301									
Propagation Delay "NOR" Output	Fan-In = 1, Fan-Out = 1	t_{d1}	4.5	9.0	5.0	9.5	6.5	11.5	nsec
	Fan-In = 1, Fan-Out = 10		5.0	10.0	5.5	10.5	7.0	14.0	
"OR" Output	Fan-In = 1, Fan-Out = 1	t_{d1}	5.5	10.5	6.0	11.0	10.0	17.0	nsec
	Fan-In = 1, Fan-Out = 10		9.0	17.0	10.0	18.0	17.0	32.0	
"NOR" Output	Fan-In = 1, Fan-Out = 1	t_{d2}	6.0	11.0	6.5	14.5	8.0	16.0	nsec
	Fan-In = 1, Fan-Out = 10		10.0	18.0	11.0	20.5	20.0	31.0	
"OR" Output	Fan-In = 1, Fan-Out = 1	t_{d2}	4.0	8.0	5.0	9.0	6.0	10.0	nsec
	Fan-In = 1, Fan-Out = 10		4.5	9.5	5.5	11.0	7.0	12.0	
Rise Time "NOR" Output	Fan-In = 1, Fan-Out = 1	t_r	4.0	8.5	4.5	12.0	5.0	14.5	nsec
"OR" Output	Fan-In = 1, Fan-Out = 1		3.5	8.0	4.0	8.0	5.0	10.0	
Fall Time "NOR" Output	Fan-In = 1, Fan-Out = 1	t_f	5.5	10.0	6.0	12.0	8.5	16.5	nsec
"OR" Output	Fan-In = 1, Fan-Out = 1		5.0	10.0	6.0	12.0	9.0	15.0	

MC306, MC307 – "NOR" AND "OR" Output; MC312 – "NOR" Output only

Propagation Delay "NOR" Output	Fan-In = 1, Fan-Out = 1	t_{d1}	4.5	8.0	5.0	8.5	6.5	9.5	nsec
	Fan-In = 1, Fan-Out = 10		4.5	9.5	5.0	10.5	6.5	14.0	
"OR" Output	Fan-In = 1, Fan-Out = 1	t_{d1}	5.0	10.0	6.0	10.0	7.5	14.5	nsec
	Fan-In = 1, Fan-Out = 10		9.0	18.0	10.0	18.0	15.5	32.0	
"NOR" Output	Fan-In = 1, Fan-Out = 1	t_{d2}	5.5	9.5	6.0	10.0	8.0	13.0	nsec
	Fan-In = 1, Fan-Out = 10		9.0	16.0	10.5	20.0	15.0	29.0	
"OR" Output	Fan-In = 1, Fan-Out = 1	t_{d2}	3.5	8.0	4.0	8.0	6.0	8.5	nsec
	Fan-In = 1, Fan-Out = 10		4.0	9.5	4.5	9.5	6.0	12.0	
Rise Time "NOR" Output	Fan-In = 1, Fan-Out = 1	t_r	4.5	10.5	5.0	12.0	6.0	14.5	nsec
"OR" Output	Fan-In = 1, Fan-Out = 1		3.0	7.0	3.5	7.5	5.0	8.0	
Fall Time "NOR" Output	Fan-In = 1, Fan-Out = 1	t_f	4.5	10.0	6.0	11.5	7.5	13.5	nsec
"OR" Output	Fan-In = 1, Fan-Out = 1		4.0	9.5	5.0	11.0	7.5	14.5	

MC309, MC310, MC311 – "NOR" Output only

Propagation Delay Either Output	Fan-In = 1, Fan-Out = 1	t_{d1}	4.5	8.5	5.0	9.0	6.0	12.0	nsec
	Fan-In = 1, Fan-Out = 10		5.0	10.0	5.5	11.0	7.0	13.0	
Either Output	Fan-In = 1, Fan-Out = 1	t_{d2}	4.5	9.0	6.0	10.5	8.5	14.0	nsec
	Fan-In = 1, Fan-Out = 10		8.5	16.0	11.0	19.0	17.0	30.0	
Rise Time Either Output	Fan-In = 1, Fan-Out = 1	t_r	3.5	9.0	4.0	9.0	4.5	10.0	nsec
Fall Time Either Output	Fan-In = 1, Fan-Out = 1		t_f	5.5	12.0	6.0	14.0	9.0	

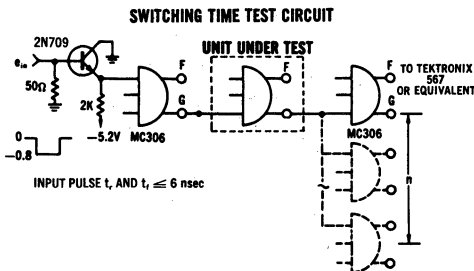

PROPAGATION DELAY

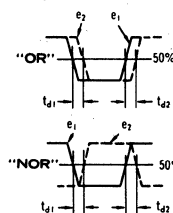

RISE AND FALL TIME

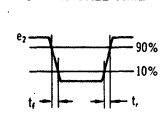

The fan-in is obtained with MC305 input expanders, with all but the driven input connected to -1.550 V.

MC300 MECL series (continued)

LOGIC GATES (CONTINUED)

SWITCHING CHARACTERISTICS
(10% to 90% distribution)

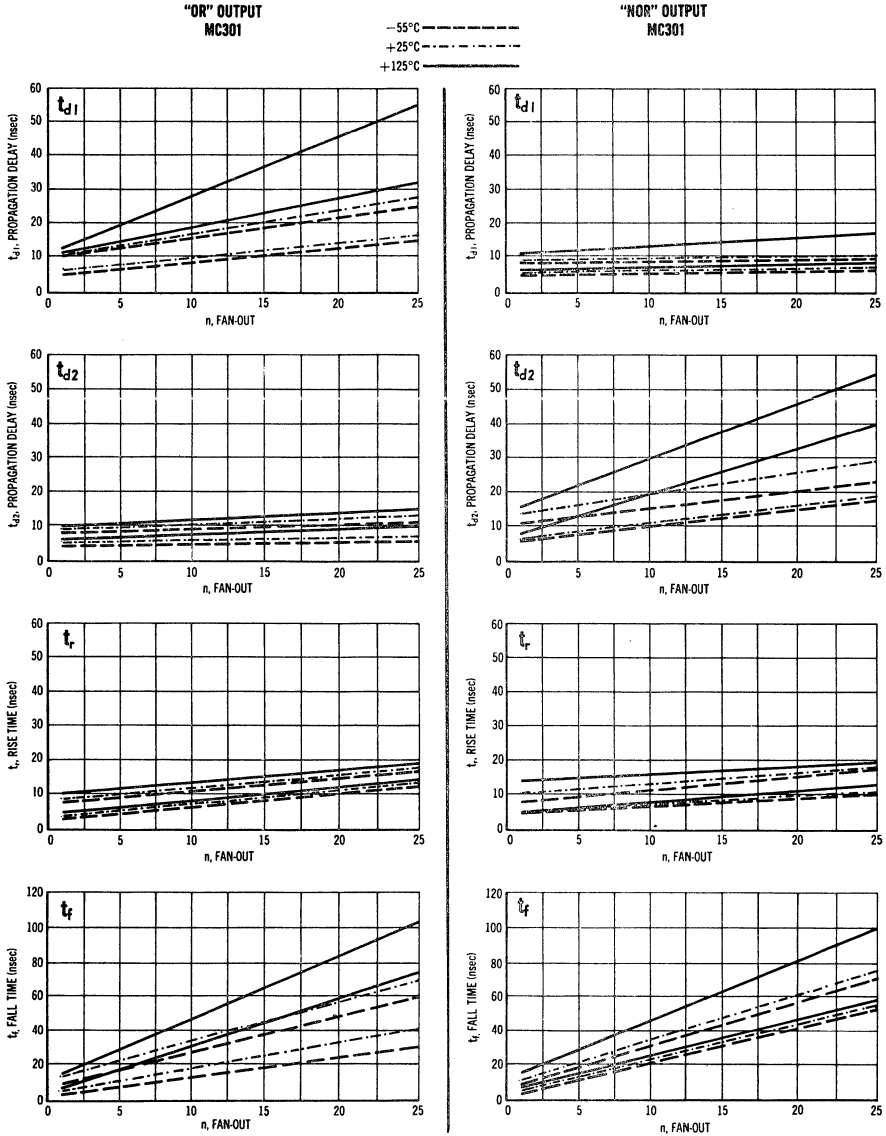

MC300 MECL series (continued)

LOGIC GATES (CONTINUED)

SWITCHING CHARACTERISTICS
(10% to 90% distribution)

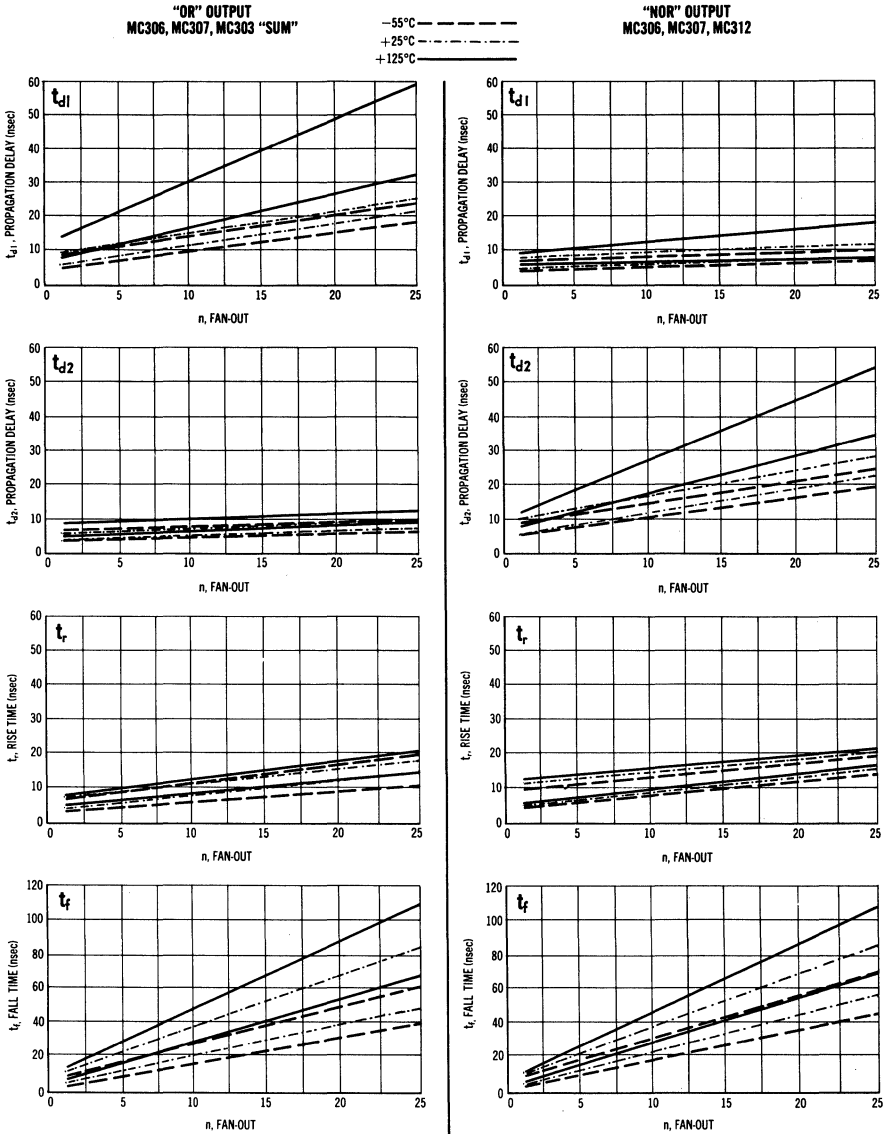

MC300 MECL series (continued)

LOGIC GATES (CONTINUED)

SWITCHING CHARACTERISTICS

(10% to 90% distribution)

"NOR"
MC309, MC310, MC311
and MC303 "NOR" and "CARRY"

--- -55°C
- - - +25°C
— +125°C

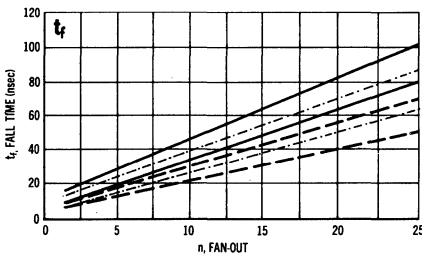
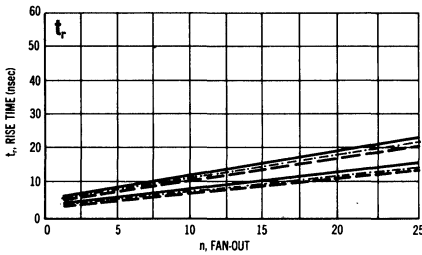
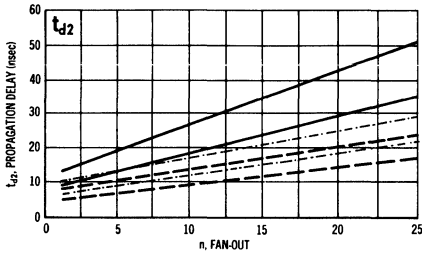
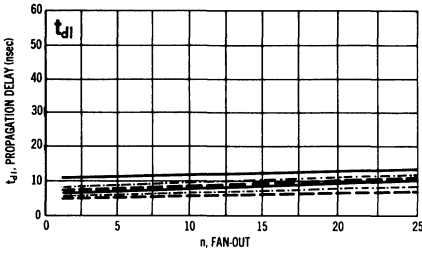

TYPICAL SWITCHING TIME VARIATIONS
MC306

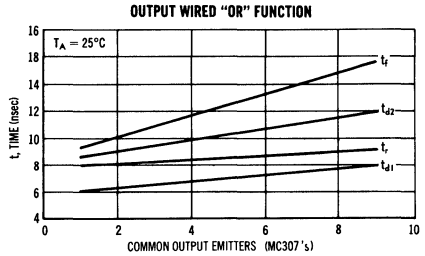
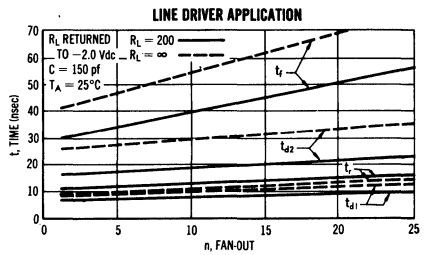
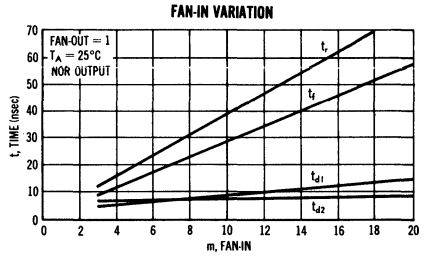
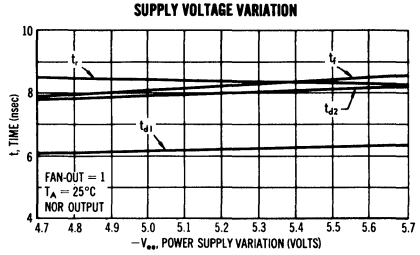

MC300 MECL series (continued)

MC303

HALF-ADDER

- Provides the "SUM," "CARRY," and "NOR" Outputs for Use in Digital Computer Circuits over a Temperature Range of -55°C to $+125^{\circ}\text{C}$.
- Average Propagation Delay — 6 nsec

CIRCUIT SCHEMATIC

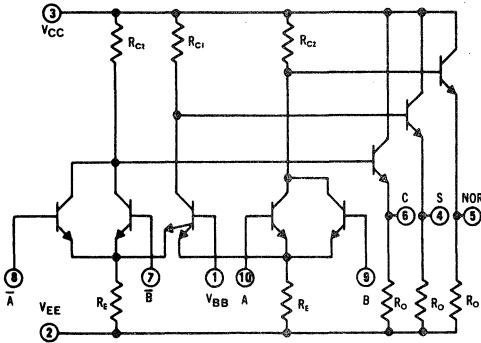

LOGIC SPECIFICATIONS

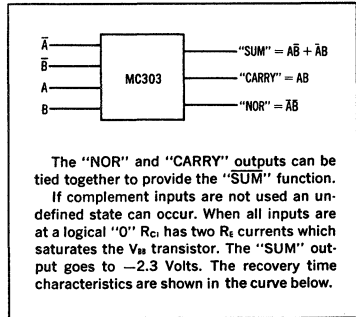

RECOVERY CHARACTERISTICS WITH SIMULTANEOUS "0" ON ALL INPUTS

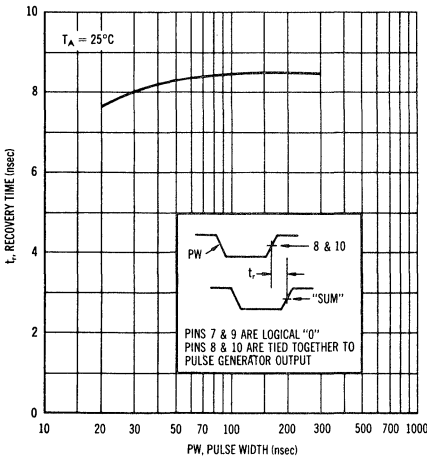

SWITCHING TIMES TEST CIRCUIT

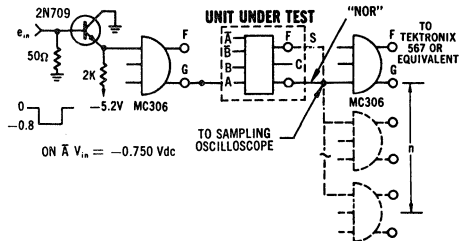

PROPAGATION DELAY TIME

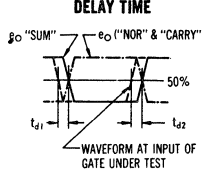

RISE AND FALL TIMES

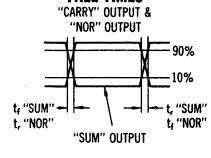

(RISE TIME = 10% TO 90% POINT OF POSITIVE GOING WAVEFORMS. FALL TIME = 90% TO 10% POINT OF NEGATIVE GOING WAVEFORMS.)

MC300 MECL series (continued)

HALF-ADDER (CONTINUED)

ELECTRICAL CHARACTERISTICS

$V_{EE} = -5.2 \text{ Vdc} \pm 1\%$, $V_{CC} = 0$ $V_{H1} = -1.25 \text{ Vdc} @ -55^\circ\text{C}$
 $V_{H1} = -1.15 \text{ Vdc} @ +25^\circ\text{C}$
 $V_{H1} = -1.00 \text{ Vdc} @ +125^\circ\text{C}$

Test	Conditions	Symbol	-55°C		25°C		125°C		Unit
			min	max	min	max	min	max	

DC CHARACTERISTICS

"NOR" Logical "1" Output Voltage	Each Input:	V_1	0.825	0.925	—	—	—	—	Vdc
	$V_{in} = -1.450 \text{ Vdc} @ -55^\circ\text{C}$		—	—	0.690	0.795	—	—	
	$V_{in} = -1.350 \text{ Vdc} @ +25^\circ\text{C}$		—	—	—	—	0.545	0.655	
"NOR" Saturation Breakpoint Voltage	$dV \text{ "NOR"}/dV_{in} = 0$ for all test temperatures	V_3	—	0.400	—	0.550	—	0.650	Vdc
			$V_{in} = -1.300 \text{ Vdc} @ +125^\circ\text{C}$	—	—	—	—	—	—
"NOR" Logical "0" Output Voltage	Each Input:	V_4	1.560	1.750	—	—	—	—	Vdc
	$V_{in} = -0.925 \text{ Vdc} @ -55^\circ\text{C}$		—	—	1.465	1.650	—	—	
	$V_{in} = -0.795 \text{ Vdc} @ +25^\circ\text{C}$		—	—	—	—	1.390	1.575	
"SUM" Logical "1" Output Voltage	Each Input:	V_5	0.825	0.925	—	—	—	—	Vdc
	$V_{in} = -0.925 \text{ Vdc} @ -55^\circ\text{C}$		—	—	0.690	0.795	—	—	
	$V_{in} = -0.795 \text{ Vdc} @ +25^\circ\text{C}$		—	—	—	—	0.545	0.655	
"SUM" Logical "0" Output Voltage	Each Input:	V_2	1.560	1.750	—	—	—	—	Vdc
	$V_{in} = -1.450 \text{ Vdc} @ -55^\circ\text{C}$		—	—	1.465	1.650	—	—	
	$V_{in} = -1.350 \text{ Vdc} @ +25^\circ\text{C}$		—	—	—	—	1.390	1.575	
Transition Region Slope	Between:	ΔV	—	—	—	—	—	—	Vdc
	$V \text{ "SUM"} = -1.050$ and $-1.450 \text{ Vdc} @ -55^\circ\text{C}$		—	0.095	—	—	—	—	
	$V \text{ "SUM"} = -0.950$ and $-1.350 \text{ Vdc} @ +25^\circ\text{C}$		—	—	—	0.095	—	—	
	$V \text{ "SUM"} = -0.820$ and $-1.220 \text{ Vdc} @ +125^\circ\text{C}$		—	—	—	—	—	0.110	
"CARRY" Logical "1" Output Voltage	Each Input:	V_1	0.825	0.925	—	—	—	—	Vdc
	$V_{in} = -1.450 \text{ Vdc} @ -55^\circ\text{C}$		—	—	0.690	0.795	—	—	
	$V_{in} = -1.350 \text{ Vdc} @ +25^\circ\text{C}$		—	—	—	—	0.545	0.655	
"CARRY" Logical "0" Output Voltage	Each Input:	V_4	1.560	1.750	—	—	—	—	Vdc
	$V_{in} = -0.925 \text{ Vdc} @ -55^\circ\text{C}$		—	—	1.465	1.650	—	—	
	$V_{in} = -0.795 \text{ Vdc} @ +25^\circ\text{C}$		—	—	—	—	1.390	1.575	
"CARRY" Saturation Breakdown Voltage	$dV \text{ "CARRY"}/dV_{in} = 0$ for all test temperatures	V_3	—	0.400	—	0.550	—	0.650	Vdc
Total Unit Power Supply Current	All Inputs Open	I_{E}	—	15.30	—	15.30	—	14.10	mAdc

LOADING CHARACTERISTICS

"NOR" Output Voltage Change Between No Load and Full Load Conditions	All inputs open No load = 0 current (pin 5) Full load = 2.5 mAdc (pin 5)	ΔV_1	—	0.055	—	0.055	—	0.060	Vdc	
			—	—	—	—	—	—		
"CARRY" Output Voltage Change Between No Load and Full Load Conditions	All inputs open No load = 0 current (pin 6) Full load = 2.5 mAdc (pin 6)	ΔV_1	—	0.055	—	0.055	—	0.060	Vdc	
			—	—	—	—	—	—		
"SUM" Output Voltage Change Between No Load and Full Load Conditions	No load = 0 current (pin 4) Full load = 2.5 mAdc (pin 4) Input (pin 9):	ΔV_5	—	0.055	—	—	—	—	Vdc	
			$V_{in} = -0.925 \text{ Vdc} @ -55^\circ\text{C}$	—	—	—	—	—		
			$V_{in} = -0.795 \text{ Vdc} @ +25^\circ\text{C}$	—	—	—	0.055	—		—
			$V_{in} = -0.655 \text{ Vdc} @ +125^\circ\text{C}$	—	—	—	—	—		0.060

SWITCHING CHARACTERISTICS

The stray capacitance introduced by the test jig was $C_s = (n + 12) \text{ pF}$ where $n =$ number of fan-outs.

$V_{H1} = -0.870 \text{ Vdc}$, $V_L = -1.650 \text{ Vdc} @ -55^\circ\text{C}$
 $V_{H1} = -0.750 \text{ Vdc}$, $V_L = -1.550 \text{ Vdc} @ +25^\circ\text{C}$
 $V_{H1} = -0.600 \text{ Vdc}$, $V_L = -1.450 \text{ Vdc} @ +125^\circ\text{C}$

Propagation Delay Time	Fan-In = 1, Fan-Out = 1	t_{d1}	6.0	12.0	7.0	12.0	11.0	17.0	nsec	
			"SUM" Output	4.5	8.5	5.0	9.0	6.0		12.0
			"NOR" Output	4.5	8.5	5.0	9.0	6.0		12.0
"SUM" Output	Fan-In = 1, Fan-Out = 1	t_{d2}	4.0	8.0	4.5	8.5	6.0	11.0	nsec	
			"NOR" Output	4.5	9.0	6.5	10.5	8.5		14.0
			"CARRY" Output	4.5	9.0	6.5	10.5	8.5		14.0
Rise Time	Fan-In = 1, Fan-Out = 1	t_r	4.0	10.0	4.5	10.5	6.0	15.0	nsec	
			"SUM" Output	3.5	9.0	4.0	9.0	4.5		10.0
			"CARRY" Output	3.5	9.0	4.0	9.0	4.5		10.0
Fall Time	Fan-In = 1, Fan-Out = 1	t_f	5.5	12.0	6.5	13.0	9.0	18.0	nsec	
			"SUM" Output	5.5	12.0	6.0	14.0	9.0		17.0
			"CARRY" Output	5.5	12.0	6.0	14.0	9.0		17.0

MC300 MECL series (continued)

FLIP-FLOPS

MC302
DC R-S FLIP-FLOP

- Performs the Binary Function of "Q" and "Q̄"
- Outputs at High Speeds over a Temperature Range of -55°C to +125°C

CIRCUIT SCHEMATIC

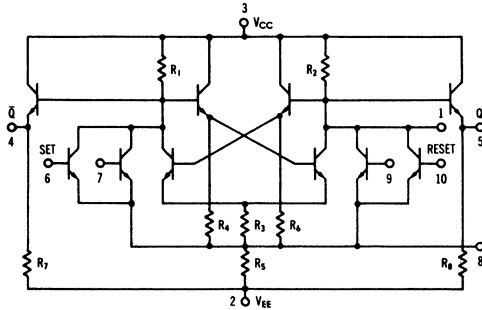

NOTE: Any unused inputs can normally be left open-circuited. In cases where there may be external leakage to the unused inputs they should be connected to V_{EE} .

LOGIC SPECIFICATIONS

When V_H is defined as a logical "1" and V_L as a logical "0", the function is as follows:

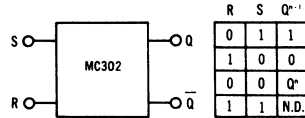

MC308
J-K FLIP-FLOP

- Performs the Single Phase Binary Function of "Q" and "Q̄" Outputs at High Speeds over a Temperature Range of -55°C to +125°C

CIRCUIT SCHEMATIC

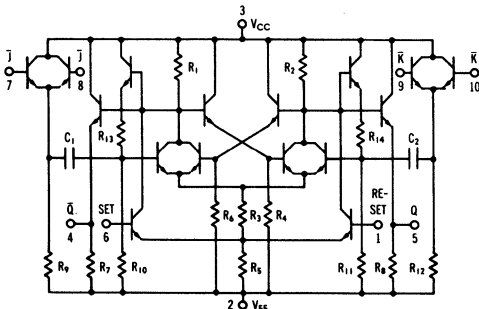

NOTE: Any unused inputs can normally be left open-circuited. In cases where there may be external leakage to the unused inputs they should be connected to V_{EE} .

LOGIC SPECIFICATIONS

When V_H is defined as a logical "1" and V_L as a logical "0", the function is as follows:

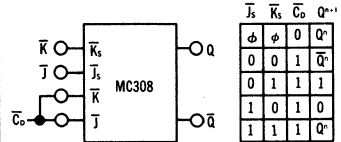

Clocked JK Operation

The \bar{J}_s and \bar{K}_s inputs refer to logic levels while the \bar{C}_o input refers to dynamic logic swings. The \bar{J}_s and \bar{K}_s inputs would be changed to a logical "1" only while the \bar{C}_o input is in a logic "1" state.

Set-Reset operation is the same as the MC302.

MC300 MECL series (continued)

FLIP-FLOPS (CONTINUED)

ELECTRICAL CHARACTERISTICS $V_{EE} = -5.2 \text{ Vdc} \pm 1\%$, $V_{CC} = 0$

(These characteristics apply to both the MC302 R-S Flip-Flop and the MC308 J-K Flip-Flop)

Test	Conditions	Symbol	-55°C		25°C		125°C		Unit
			min	max	min	max	min	max	

DC CHARACTERISTICS

"Q" or "Q̄" Logical "1" Output Voltage	Each Input: (Set Input for Q, Reset Input for Q̄) $V_{in} = -1.45 \text{ Vdc} @ -55^\circ\text{C}$ $V_{in} = -1.350 \text{ Vdc} @ 25^\circ\text{C}$ $V_{in} = -1.30 \text{ Vdc} @ +125^\circ\text{C}$	V_1	0.825	0.925	—	—	—	—	Vdc
"Q" or "Q̄" Logical "0" Output Voltage	Each Input: (Set Input for Q, Reset Input for Q̄) $V_{in} = -1.45 \text{ Vdc} @ -55^\circ\text{C}$ $V_{in} = -1.350 \text{ Vdc} @ 25^\circ\text{C}$ $V_{in} = -1.30 \text{ Vdc} @ +125^\circ\text{C}$	V_2	1.560	1.750	—	—	—	—	Vdc
"Q" or "Q̄" Saturation Breakpoint Voltage	$dV_{in}/dV_{in} = 0$; $dV_{in}/dV_{in} = 0$	V_3	—	0.50	—	0.65	—	0.75	Vdc
"Q" or "Q̄" Latch Voltage	$dV_{in}/dV_{in} = \infty$	V_L	1.17	1.33	1.09	1.21	0.94	1.06	Vdc
Total Power Supply Current Drain (MC302)	All Inputs Open	I_E	—	10.35	—	10.35	—	9.52	mAdc
Total Power Supply Current Drain (MC308)	All Inputs Open	I_E	—	16.0	—	16.0	—	14.7	mAdc

LOADING CHARACTERISTICS

"Q" Output Voltage Change	All Inputs Open, measured between no load and full load No load - 0 current (pin 5) Full load = 2.5 mAdc \pm 5% (pin 5) V_{in} (pin 6) = -0.925 Vdc @ -55°C V_{in} (pin 6) = -0.795 Vdc @ 25°C V_{in} (pin 6) = -0.655 Vdc @ +125°C	ΔV_1	—	0.055	—	—	—	—	Vdc
"Q̄" Output Voltage Change	All Inputs Open, measured between no load and full load. V_{in} at pin 10 for MC302, pin 1 for MC308 No load - 0 current (pin 4) Full load = 2.5 mAdc \pm 5% (pin 4) V_{in} = -0.925 Vdc @ -55°C V_{in} = -0.795 Vdc @ 25°C V_{in} = -0.655 Vdc @ +125°C	ΔV_1	—	0.055	—	—	—	0.060	Vdc
Output Voltage at Max I_{in}	Set "Q" to upper state: V_{in} (pin 6) = -0.925 Vdc @ -55°C V_{in} (pin 6) = -0.795 Vdc @ 25°C V_{in} (pin 6) = -0.655 Vdc @ +125°C Remove V_{in} . Then Input = 150 μ Adc \pm 1% @ -55°C 100 μ Adc \pm 1% @ 25°C 90 μ Adc \pm 1% @ +125°C	V_1	0.825	0.925	—	—	—	—	Vdc

MC302:		MC308	
Input	Output	Input	Output
1. Pin 9	Pin 4 ("Q")	1. Pin 1	Pin 4 ("Q")
2. Pin 7	Pin 5 ("Q̄")	2. Pin 6	Pin 5 ("Q̄")
3. Pin 10	Pin 4 ("Q")		
4. Pin 6	Pin 5 ("Q̄")		

TRANSFER CHARACTERISTICS

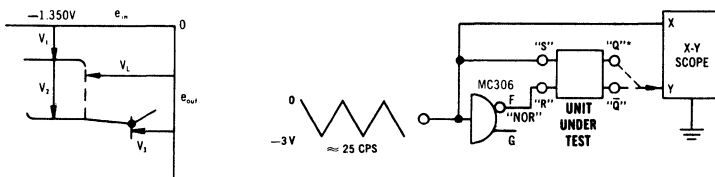

*FOR "Q" TESTS REVERSE "S" & "R" CONNECTIONS

MC300 MECL series (continued)

FLIP-FLOPS (CONTINUED)

MC302

SWITCHING CHARACTERISTICS

$V_{CC} = 0$, $V_{EE} = -5.2$ Volts, (all $\pm 1\%$), $V_{i1} = -0.870$ Vdc, $V_{i2} = -1.650$ Vdc @ -55°C
 $V_{i1} = -0.750$ Vdc, $V_{i2} = -1.550$ Vdc @ $+25^{\circ}\text{C}$
 $V_{i1} = -0.600$ Vdc, $V_{i2} = -1.450$ Vdc @ $+125^{\circ}\text{C}$
 The stray capacitance introduced by the test jig was $C_i = (n + 12)$ pf where $n =$ number of fan-outs.

Test	Conditions	Symbol	-55°C		25°C		125°C		Unit
			min	max	min	max	min	max	
Propagation Delay Time	Either Output (Fan-In = 1, Fan-Out = 1) Either Output (Fan-In = 1, Fan-Out = 1)	t_{dr} t_{df}	7.5	13.0	8.0	14.0	10.5	24.0	nsec
Rise Time	Either Output (Fan-In = 1, Fan-Out = 1)	t_r	6.0	14.0	8.0	18.0	13.0	29.0	nsec
Fall Time	Either Output (Fan-In = 1, Fan-Out = 1)	t_f	6.0	13.0	6.5	17.0	12.0	24.0	nsec

SWITCHING TIME TEST CIRCUIT

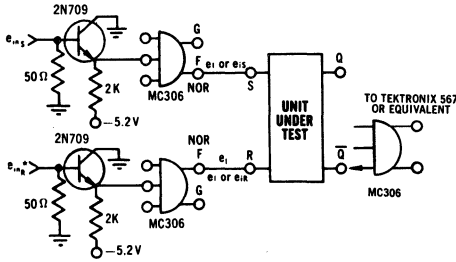

SWITCHING TIME TEST PROCEDURE

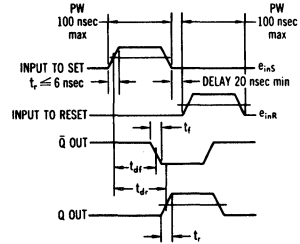

SWITCHING CHARACTERISTICS

(10% to 90% distribution)

— -55°C —
 - - - $+25^{\circ}\text{C}$ - - -
 — $+125^{\circ}\text{C}$ —

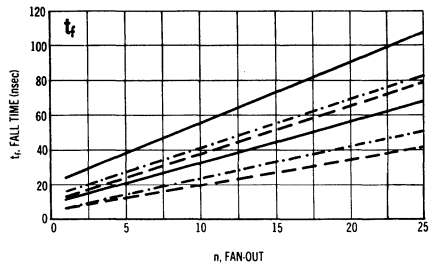
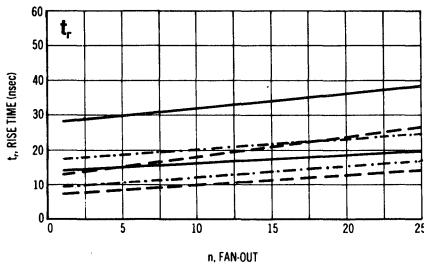
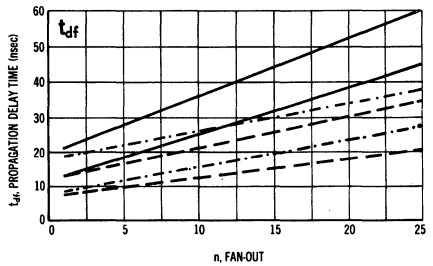
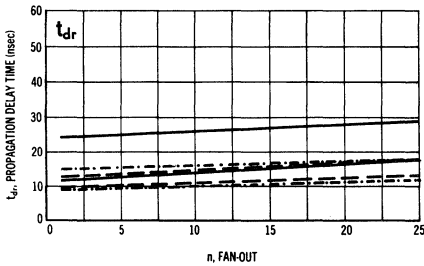

MC300 MECL series (continued)

FLIP-FLOPS (CONTINUED)

MC308

SWITCHING CHARACTERISTICS $V_{CC} = 0$, $V_{E1} = -5.2$ Volts. (all $\pm 1\%$). $V_{i1} = -0.870$ Vdc, $V_{i2} = -1.650$ Vdc @ -55°C
 $V_{i1} = -0.750$ Vdc, $V_{i2} = -1.550$ Vdc @ $+25^{\circ}\text{C}$
 $V_{i1} = -0.600$ Vdc, $V_{i2} = -1.450$ Vdc @ $+125^{\circ}\text{C}$
 The stray capacitance introduced by the test jig was $C_s = (n + 12)$ pf where n = number of fan-outs.

Test	Conditions	Symbol	-55°C		25°C		125°C		Unit
			min	max	min	max	min	max	
Propagation Delay Time	Either Output (Fan-In = 1, Fan-Out = 1) Either Output (Fan-In = 1, Fan-Out = 1)	t_{dr}	3.5	9.5	4.0	11.0	9.0	18.5	nsec
		t_{df}	5.0	13.0	7.0	14.0	8.5	17.0	
Rise Time	Either Output (Fan-In = 1, Fan-Out = 1)	t_r	6.5	15.0	7.0	16.0	11.5	24.0	nsec
Fall Time	Either Output (Fan-In = 1, Fan-Out = 1)	t_f	6.0	16.0	7.0	18.0	10.0	32.0	nsec

SWITCHING WAVEFORMS

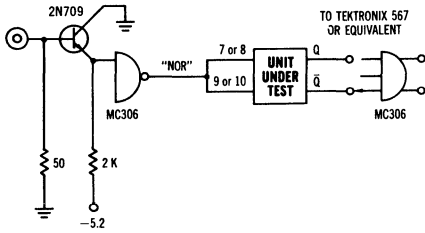

SWITCHING TIME TEST CIRCUIT

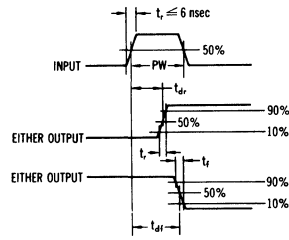

SWITCHING CHARACTERISTICS

(10% to 90% distribution)

--- -55°C
 - - - $+25^{\circ}\text{C}$
 - - - $+125^{\circ}\text{C}$

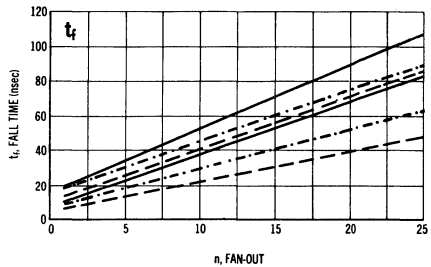
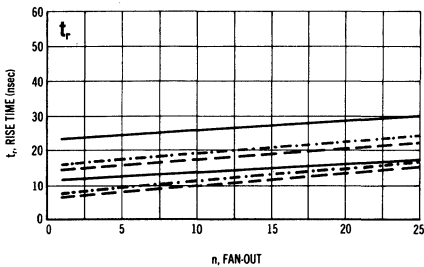
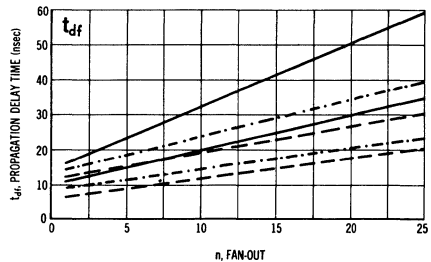
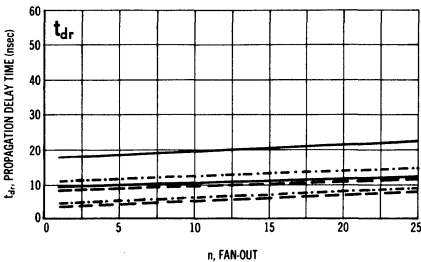

MC300 MECL series (continued)

MC305

GATE EXPANDER

Designed primarily for use in conjunction with the MOTOROLA MC306 and MC 307 "MECL" 3-INPUT LOGIC GATES. Each expander unit increases the fan-in of the basic gate by five.

ELECTRICAL CHARACTERISTICS

Test	Conditions	Symbol	-55°C		25°C		125°C		Unit
			min	max	min	max	min	max	
Base Leakage Current	$V_{EE} = 2.0 \text{ Vdc}$, $V_{CC} = 0$, $V_{BB} = -5.2 \text{ Vdc}$	I_{BL}	—	0.5	—	0.5	—	5.0	μAdc
Input Voltage	$V_{CB} = 0.7 \text{ Vdc}$, $V_B = 0$, $I_E = -1.33 \text{ mAdc}$	V_{BE}	0.810	0.870	0.680	0.720	0.490	0.530	Vdc
Collector Leakage Current	$V_{CC} = -2 \text{ Vdc}$, $V_{BE} = 0.3 \text{ Vdc}$ (all inputs), $V_{EE} = 0$	I_{CEX}	—	1.0	—	1.0	—	100.0	μAdc

SWITCHING CHARACTERISTICS (See page)

Propagation Delay		t_{d1}	3.5	8.0	4.0	8.5	5.5	9.5	nsec
		t_{d2}	4.5	9.5	5.0	10.0	7.0	13.0	nsec
Rise Time		t_r	4.5	10.5	5.0	11.5	5.5	14.5	nsec
Fall Time		t_f	3.5	10.0	4.0	11.5	5.5	13.5	nsec

SWITCHING TIME TEST CIRCUIT

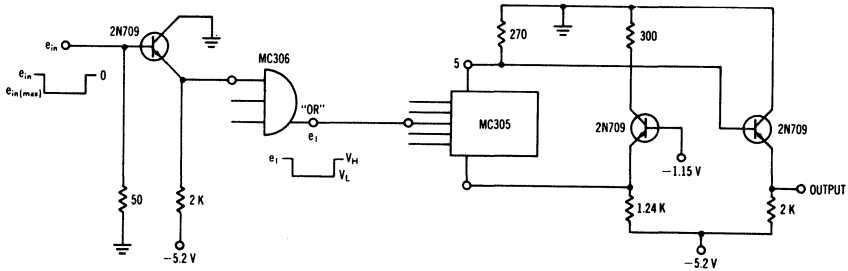

CIRCUIT SCHEMATIC AND INTERCONNECTION TO MC306 3-INPUT GATE

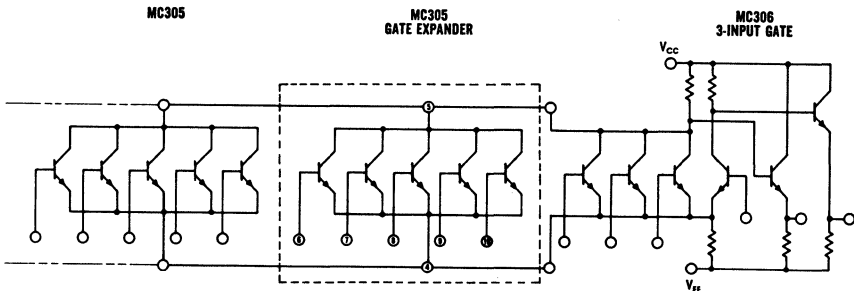

NOTE: Any unused inputs can normally be left open-circuited. In cases where there may be external leakage to the unused inputs they should be connected to V_{EE} .

MECL MC350 series

The MECL* series of integrated logic circuits forms a versatile set of monolithic digital building blocks representing all the necessary circuitry for the arithmetic portion of a computer. MECL circuits combine extremely high speed with a systems-oriented design approach that permits implementation with the fewest possible number of individual devices. This represents both a cost saving and a potential increase in system reliability. The major features of the MECL series are:

- 5 nsec propagation delay per logic decision
- Virtually constant noise immunity with $\pm 10\%$ power supply variation, and temperature changes from 0 to $+75^\circ\text{C}$
- Simultaneous "OR", "NOR" or "AND", "NAND" outputs
- High fan-in and fan-out capabilities

MECL* integrated circuits are used in various combinations to provide such intermediate system blocks as adders, counters, shift registers, decoders, multivibrators, etc. They provide a line of monolithic computer circuits designed analytically and practically to meet the stringent demands of the most advanced computer systems. The series is comprised of the following elements:

- MC351** — A high-speed five-input gate element that provides the positive logic "OR" function and its complement simultaneously.
- MC352** — A DC Set-Reset flip-flop with an expandable input and the power dissipation of only one gate.
- MC353** — A half-adder that provides the "SUM", "CARRY", and "NOR" function simultaneously.
- MC354** — A bias driver that compensates for changes in circuit parameters with temperature.
- MC355** — A five-input expander for use with the MC352 and the MC356,7.
- MC356,7** — A high-speed expandable three-input gate element that provides the positive logic "OR" function and its complement simultaneously.
- MC358** — A clocked J-K flip-flop for counter and shift register applications with DC Set and Reset inputs.
- MC359,60,61** — A high-speed dual two-input gate element that provides the positive logic "NOR" function.
- MC362** — A high-speed dual three-input gate element that provides the positive logic "NOR" function.

BASIC MECL CIRCUIT

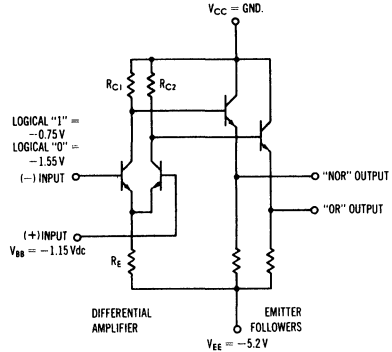

FOR LOGICAL "1" INPUT: "NOR" OUTPUT = -1.55V
"OR" OUTPUT = -0.75V

FOR LOGICAL "0" INPUT: "NOR" OUTPUT = -0.75V
"OR" OUTPUT = -1.55V

MECL — A CURRENT MODE SWITCH

The typical MECL* circuit is designed with a differential amplifier input and emitter-follower output to restore dc levels. The circuit has been designed to prevent saturation of the input transistors, thus eliminating storage time and allowing for high-speed operation with non-critical transistor parameters. High fan-out operation is permitted due to the low impedance emitter-follower and the high-input impedance of the circuit. The basic gate has both the function and its complement available simultaneously. Since the current in the differential amplifier is switched from one side to the other, there is virtually no power supply noise generated.

The circuit operation is straight-forward. A fixed bias of -1.15 volts is applied to the (+) input of the differential amplifier and the logic signals are applied to the (-) input. If a logical "0" is applied to the (-) input, the current through R_E is supplied by the fixed biased transistor. A drop of 800mV occurs across R_C2 . The "OR" output then is -1.55V , or one V_{BE} -drop below 800mV . Since no current flows in the (-) input transistor, the "NOR" output is a V_{BE} -drop below ground, or -0.75 volts. When a logical "1" level is applied to the (-) input, the current through R_C2 is switched to the (-) input transistor and a drop of 800mV occurs across R_C1 . The "OR" output then goes to -0.75 volts and the "NOR" output goes to -1.55 volts.

A bias driver is supplied to insure that the threshold point is always in the center of the transition region. The bias driver compensates for temperature changes and is designed to track with temperature.

*Trademark of Motorola Inc.

MC350 MECL series (continued)

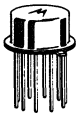

10 PIN TO-5

CASE 71



12 PIN TO-5
(MC362G ONLY)

CASE 98

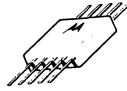

10 PIN FLAT PACKAGE

CASE 83

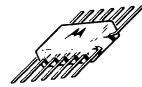

14 PIN FLAT PACKAGE
(MC362F ONLY)

CASE 72

FAMILY CHARACTERISTICS

The following information applies to all devices of the MECL family. It is intended to provide the design engineer with meaningful information for worst-case analyses. Parameters of importance are guaranteed at three temperature levels: room, and the extremes for which the family is

designed. All performance curves are based on distributional spreads and the minimum-maximum ranges can be interpreted for design purposes as 10%-90% spreads at all points on the curve except for guaranteed points on the electrical characteristics.

ABSOLUTE MAXIMUM RATINGS (at 25°C)

Characteristics	Symbol	Maximum	Unit
Logic Input Voltage	—	5	Vdc
Power Supply Voltage	—	10	Vdc
Output Source Current	I_O	10	mAdc
Operating Temperature Range	T_J	0 to +75	°C
Storage Temperature Range	T_{stg}	-40 to +150	°C

SYSTEM LOGIC SPECIFICATIONS

<p>Any one of the supply nodes, V_{B1}, V_{CC}, or V_{B2} may be used as ground; however, the manufacturer has found it most convenient to ground the V_{CC} node. In such a case: $V_{CC} = 0$ $V_{B1} = -1.15V$ $V_{B2} = -5.2V$</p>	<p>The output logic swing of 0.8V then varies from a low state of $V_L = -1.55V$ to a high state of $V_H = -0.75V$ with respect to ground. Positive logic is used when reference is made to logical "0's" or "1's". Then</p> <p align="center"> $\left. \begin{array}{l} \text{"0"} = -1.55V \\ \text{"1"} = -0.75V \end{array} \right\} \text{ typical}$ </p>	<p>Dynamic logic refers to a change of logic states. Dynamic "0" is a negative going voltage excursion and a dynamic "1" is a positive going voltage excursion.</p>
--	--	---

MC350 MECL series (continued)

DC CHARACTERISTICS FOR MC350 SERIES

WORST CASE TRANSFER CHARACTERISTICS

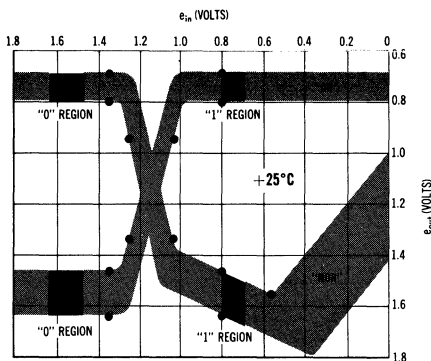
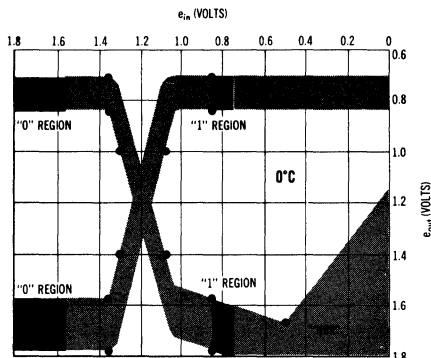

DEFINITION OF TRANSFER CHARACTERISTIC POINTS

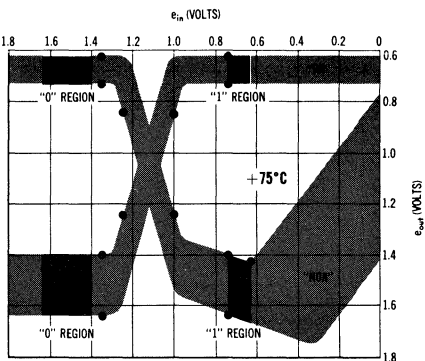
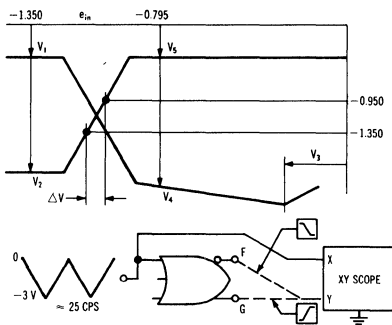

WORST CASE NOISE MARGIN

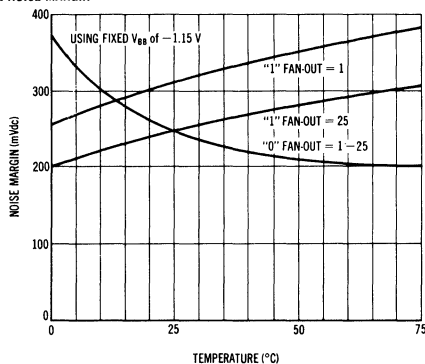
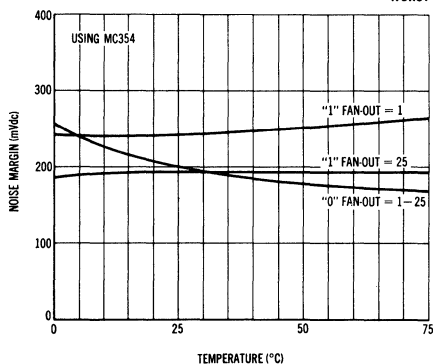

MC350 MECL series (continued)

MC354
BIAS DRIVER

A temperature compensating regulator intended for use in conjunction with the MOTOROLA MC350 "MECL" series of INTEGRATED LOGIC CIRCUITS. Insures stable and reliable operation of "MECL" logic systems over a temperature range of 0 to +75°C.

ELECTRICAL CHARACTERISTICS

Test	Conditions	Symbol	0°C		25°C		75°C		Units
			min	max	min	max	min	max	
Fan-Out	—	n	—	25	—	25	—	25	—
Output Voltage (No Load to Full Load)	$V_{CC} = 0, V_{EE} = -5.2 \text{ Vdc} \pm 1\%$ $I_{out} = 0 \text{ to } 2.5 \text{ mA dc}$	V_{BB}	1.14	1.27	1.09	1.22	1.04	1.18	Vdc
Power Dissipation	$V_{CC} = 0, V_{EE} = -5.2 \text{ Vdc} \pm 1\%$	P_D	—	25	—	24	—	22	mW

CIRCUIT SCHEMATIC

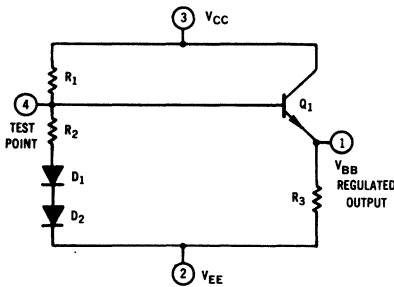

CIRCUIT DESCRIPTION

Circuit Operation:

The divider network R_1, R_2, D_1, D_2 compensates for temperature variations of the base-emitter voltages of Q_1 , and of the driven gates, producing a bias voltage for the MECL logic circuits that maintains a constant set of dc operating conditions over the temperature range of 0 to +75°C. In addition, compensation for power supply variations is achieved, since the bias output voltage is derived from the system supply.

Either of the supply voltage nodes may be used as ground, however the ground potential of the bias driver must coincide with that of the logic system. Thus, if V_{CC} is grounded in the logic system, then —

$$V_{CC} = 0; \quad V_{EE} = -5.2V;$$

$$V_{BB} = -1.15 \text{ nominal output voltage at } 25^\circ\text{C}$$

MC350 MECL series (continued)

MC351, MC356, MC357, MC359 thru MC362
LOGIC GATES

CIRCUIT SCHEMATICS

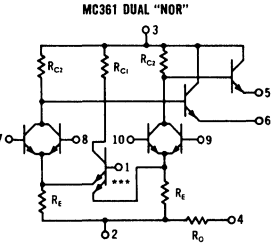
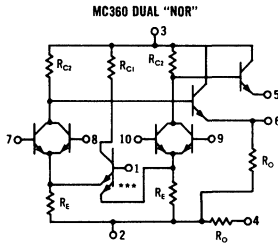
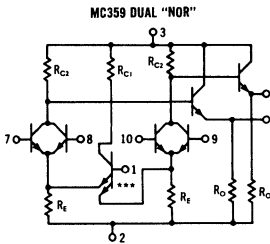
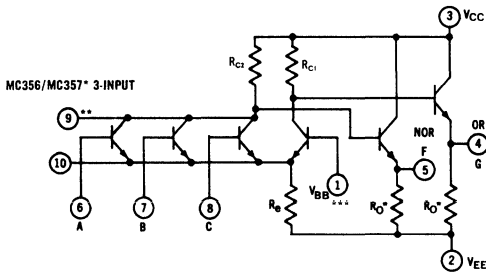
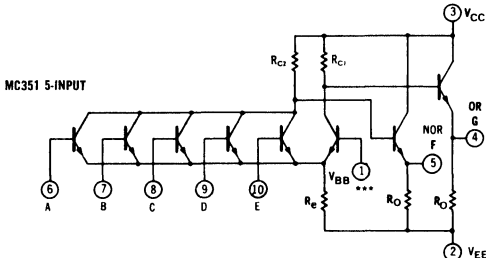

*Resistors R_o are omitted in MC357 circuits to permit reduction of Power Dissipation in systems where logic operations are performed at circuit outputs.

EXAMPLE: where (n) gates are to perform an "OR" function, one MC356 gate and (n-1) MC357 gates can be used to provide savings of Power Dissipation in (n-1) gates.

**Pins 9 and 10 are for use in conjunction with the MC355 input expander to increase the fan-in capability in increments of five.

***To be supplied from bias-driver circuit MC354 for optimum temperature stability.

NOTE: Any unused inputs can normally be left open-circuited. In cases where there may be external leakage to the unused inputs they should be connected to V_{EE} .

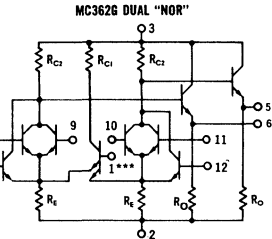
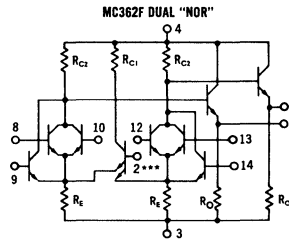

LOGIC SPECIFICATIONS

POSITIVE LOGIC

When V_{ii} is defined as a logical "1" and V_{ii} as a logical "0" the "OR"/"NOR" function is performed:

Single Gate

$$F = \text{"NOR"} = \overline{A + B + C + D + E}$$

$$G = \text{"OR"} = A + B + C + D + E$$

Dual Gate

$$G = \text{"NOR"} = \overline{A + B + C}$$

$$H = \text{"NOR"} = \overline{D + E + F}$$

NEGATIVE LOGIC

Inversely, when V_{ii} is defined as a logical "0" and V_{ii} as a logical "1" the "AND"/"NAND" function is performed:

Single Gate

$$F = \text{"NAND"} = \overline{A \cdot B \cdot C \cdot D \cdot E}$$

$$G = \text{"AND"} = A \cdot B \cdot C \cdot D \cdot E$$

Dual Gate

$$G = \text{"NAND"} = \overline{A \cdot B \cdot C}$$

$$H = \text{"NAND"} = \overline{D \cdot E \cdot F}$$

MC350 MECL series (continued)

LOGIC GATES (CONTINUED)

DC ELECTRICAL CHARACTERISTICS: $V_{CC} = 0$, $V_{EE} = -5.2$ Volts, (all $\pm 1\%$), $V_{IN} = -1.18$ Vdc @ 0°C
 $V_{IN} = -1.15$ Vdc @ $+25^\circ\text{C}$
 $V_{IN} = -1.08$ Vdc @ $+75^\circ\text{C}$

Test	Conditions	Symbol	0°C		25°C		75°C		Units
			min	max	min	max	min	max	
Total Unit Power Supply Current Drain	All inputs open MC351, MC356 MC357 MC359, MC360, MC362 MC361	I_E	—	9.25	—	8.85	—	8.15	mAdc
Input Current	V_1 min @ 25°C	I_{in}	—	—	—	100	—	—	μAdc
Fan-In		m	—	—	—	23	—	—	
Fan-Out		n	—	—	—	25	—	—	

"NOR" OUTPUT – All Types

"NOR" Logical "O" Output Voltage	Each Input: $V_{in} = -1.350$ Vdc	V_1	0.715	0.850	0.670	0.795	0.590	0.725	Vdc	
"NOR" Logical "O" Output Voltage	Each Input: $V_{in} = -0.850$ Vdc @ 0°C $V_{in} = -0.795$ Vdc @ 25°C $V_{in} = -0.725$ Vdc @ 75°C	V_4	1.570	1.830	—	—	—	—	Vdc	
"NOR" Saturation Breakpoint Voltage	$\frac{dv}{dV_{in}} = 0$	V_3	—	—	1.465	1.700	—	1.395	1.680	Vdc
"NOR" Output Voltage Change (No load to full load)	All inputs open No load = 0 current at pin 5 Full load = 2.5 mAdc $\pm 5\%$ at pin 5	ΔV_1	—	0.055	—	0.055	—	0.075	Vdc	

"OR" OUTPUT – Types MC351, MC356, MC357 only

"OR" Logical "1" Output Voltage	Each Input: $V_{in} = -0.850$ Vdc @ 0°C $V_{in} = -0.795$ Vdc @ 25°C $V_{in} = -0.725$ Vdc @ 75°C	V_5	0.715	0.850	—	—	—	—	Vdc
"OR" Logical "O" Output Voltage	Each Input: $V_{in} = -1.35$ Vdc	V_2	1.570	1.830	1.465	1.700	1.395	1.680	Vdc
Transition Region Slope	V "OR" Between: -1.400 Vdc and -1.00 Vdc @ 0°C -1.350 Vdc and -0.950 Vdc @ 25°C -1.250 Vdc and -0.850 Vdc @ 75°C	V	—	0.095	—	—	—	—	Vdc
"OR" Output Voltage Change (No load to full load)	No load = 0 current at pin 4 Full load = 2.5 mAdc $\pm 5\%$ at pin 4	ΔV_5	—	—	—	—	—	—	Vdc
	$V_{in} = -0.850$ Vdc @ 0°C $V_{in} = -0.795$ Vdc @ 25°C $V_{in} = -0.725$ Vdc @ 75°C		—	0.055	—	0.055	—	0.075	

TYPICAL INPUT CHARACTERISTICS

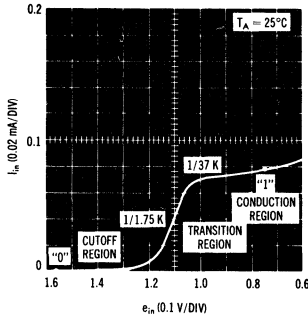

TYPICAL OUTPUT CHARACTERISTICS

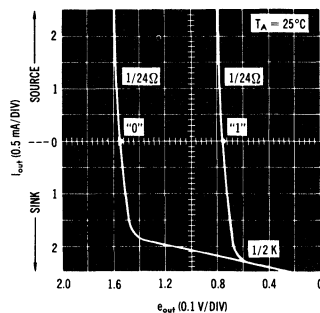

MC350 MECL series (continued)

LOGIC GATES (CONTINUED)

SWITCHING CHARACTERISTICS: $V_{CC} = 0, V_{IH} = -5.2$ Volts, (all 1%), $V_{IH} = -1.18$ Vdc, $V_{IL} = -0.790$ Vdc, $V_i = -1.640$ Vdc @ 0°C
 The stray capacitance introduced by the test jig was:
 $V_{IH} = -1.15$ Vdc, $V_{IL} = -0.750$ Vdc, $V_i = -1.550$ Vdc @ $+25^\circ\text{C}$
 $C_i = (n + 12)$ pf where n = number of fan-outs
 $V_{IH} = -1.08$ Vdc, $V_{IL} = -0.675$ Vdc, $V_i = -1.500$ Vdc @ $+75^\circ\text{C}$

Test	Conditions	Symbol	0°C		25°C		75°C		Units
			min	max	min	max	min	max	
MC351 (See curves page 7)									
Propagation Delay "NOR" Output	Fan-In = 1, Fan-Out = 1 Fan-In = 1, Fan-Out = 10	t_{d1}	3.0 4.0	10.0 13.0	4.0 5.0	11.0 15.0	5.0 6.0	13.0 17.0	nsec
"OR" Output	Fan-In = 1, Fan-Out = 1 Fan-In = 1, Fan-Out = 10	t_{d1}	3.0 8.0	12.0 20.0	4.0 9.0	12.0 21.0	5.0 15.0	17.0 58.0	nsec
"NOR" Output	Fan-In = 1, Fan-Out = 1 Fan-In = 1, Fan-Out = 10	t_{d2}	3.0 6.0	11.0 17.0	4.0 7.0	15.0 20.0	5.0 15.0	16.0 50.0	nsec
"OR" Output	Fan-In = 1, Fan-Out = 1 Fan-In = 1, Fan-Out = 10	t_{d2}	3.0 3.0	9.0 12.0	4.0 4.0	9.0 12.0	5.0 5.0	11.0 14.0	nsec
Rise Time "NOR" Output	Fan-In = 1, Fan-Out = 1	t_r	3.0	12.0	4.0	14.0	5.0	15.0	nsec
"OR" Output	Fan-In = 1, Fan-Out = 1	t_r	3.0	11.0	4.0	12.0	5.0	14.0	nsec
Fall Time "NOR" Output	Fan-In = 1, Fan-Out = 1	t_f	3.0	14.0	4.0	15.0	5.0	16.0	nsec
"OR" Output	Fan-In = 1, Fan-Out = 1	t_f	3.0	14.0	4.0	15.0	5.0	16.0	nsec

MC356, MC357 - "NOR" AND "OR" Output; MC362 - "NOR" Output only

Propagation Delay "NOR" Output	Fan-In = 1, Fan-Out = 1 Fan-In = 1, Fan-Out = 10	t_{d1}	3.0 4.0	8.0 11.0	4.0 5.0	5.0 11.0	5.0 6.0	11.0 14.0	nsec
"OR" Output	Fan-In = 1, Fan-Out = 1 Fan-In = 1, Fan-Out = 10	t_{d1}	3.0 8.0	9.0 19.0	4.0 9.0	10.0 20.0	5.0 15.0	15.0 37.0	nsec
"NOR" Output	Fan-In = 1, Fan-Out = 1 Fan-In = 1, Fan-Out = 10	t_{d2}	3.0 6.0	10.0 17.0	4.0 7.0	11.0 21.0	5.0 15.0	13.0 36.0	nsec
"OR" Output	Fan-In = 1, Fan-Out = 1 Fan-In = 1, Fan-Out = 10	t_{d2}	3.0 3.0	8.0 11.0	3.0 4.0	8.0 11.0	4.0 5.0	11.0 13.0	nsec
Rise Time "NOR" Output	Fan-In = 1, Fan-Out = 1	t_r	3.0	11.0	4.0	12.0	5.0	15.0	nsec
"OR" Output	Fan-In = 1, Fan-Out = 1	t_r	3.0	9.0	3.0	10.0	5.0	11.0	nsec
Fall Time "NOR" Output	Fan-In = 1, Fan-Out = 1	t_f	3.0	12.0	4.0	14.0	5.0	16.0	nsec
"OR" Output	Fan-In = 1, Fan-Out = 1	t_f	3.0	11.0	4.0	14.0	5.0	16.0	nsec

MC359, MC360, MC361 - "NOR" Output only

Propagation Delay "NOR" Output	Fan-In = 1, Fan-Out = 1 Fan-In = 1, Fan-Out = 10	t_{d1}	3.0 3.0	9.0 11.0	3.0 5.0	10.0 12.0	4.0 6.0	12.0 15.0	nsec
"NOR" Output	Fan-In = 1, Fan-Out = 1 Fan-In = 1, Fan-Out = 10	t_{d2}	3.0 6.0	10.0 16.0	5.0 7.0	11.0 19.0	5.0 15.0	14.0 55.0	nsec
Rise Time "NOR" Output	Fan-In = 1, Fan-Out = 1	t_r	3.0	9.0	4.0	10.0	4.0	12.0	nsec
Fall Time "NOR" Output	Fan-In = 1, Fan-Out = 1	t_f	3.0	12.0	4.0	14.0	5.0	17.0	nsec

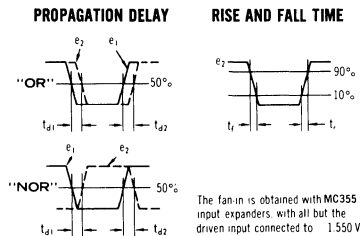
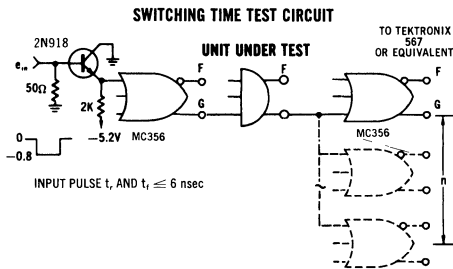

MC350 MECL series (continued)

LOGIC GATES (CONTINUED)

**SWITCHING CHARACTERISTICS
(10% to 90% distribution)**

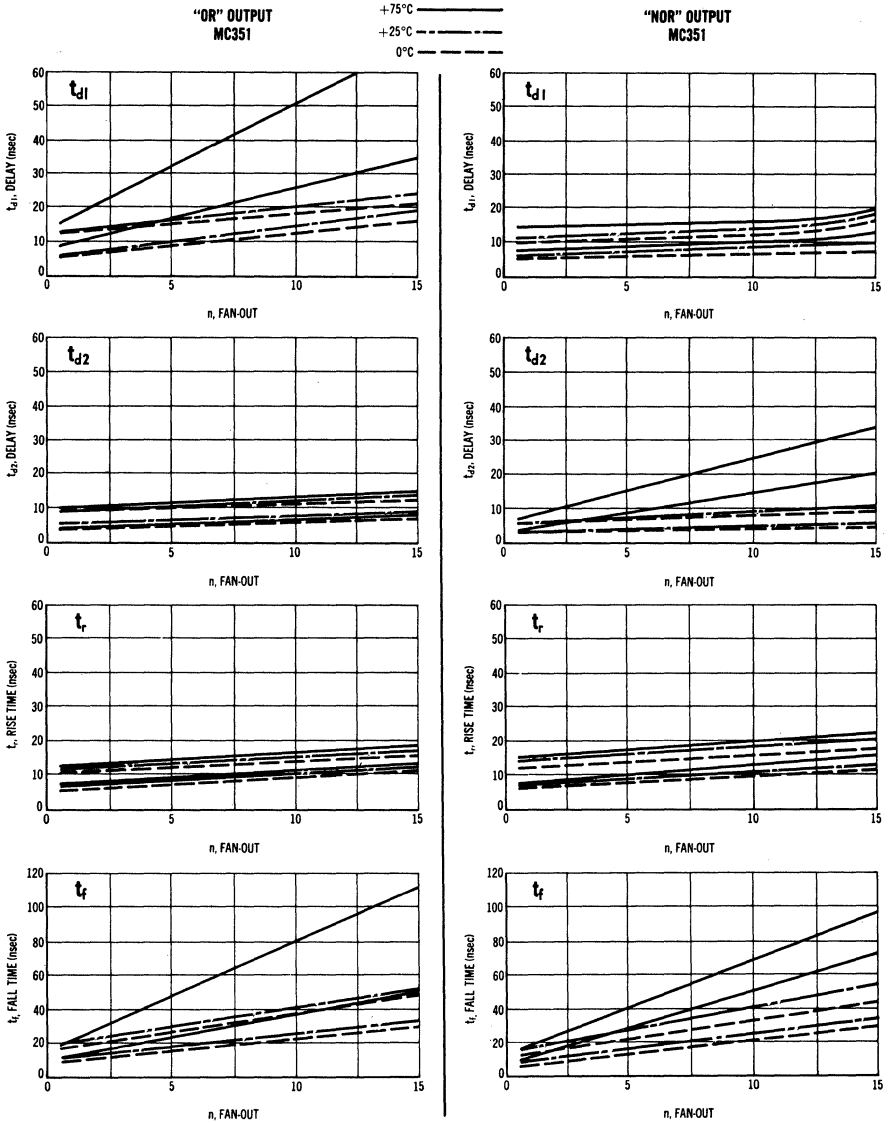

MC350 MECL series (continued)

LOGIC GATES (CONTINUED)

**SWITCHING CHARACTERISTICS
(10% to 90% distribution)**

+75°C ———
+25°C - - - -
0°C - - - -

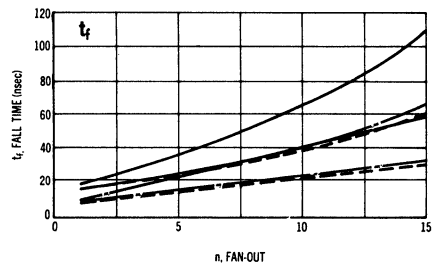
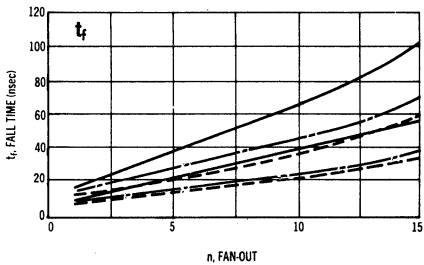
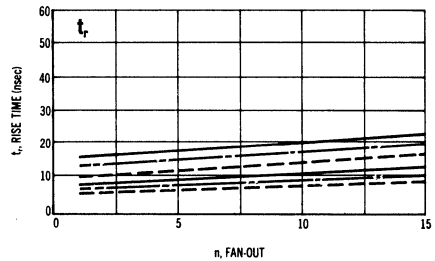
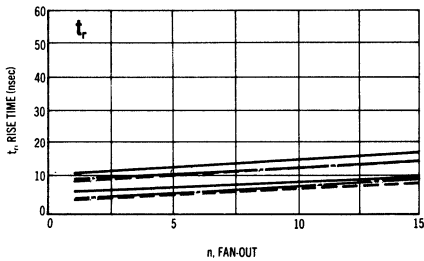
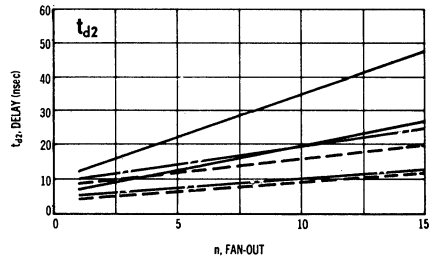
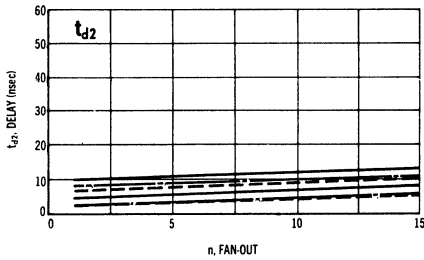
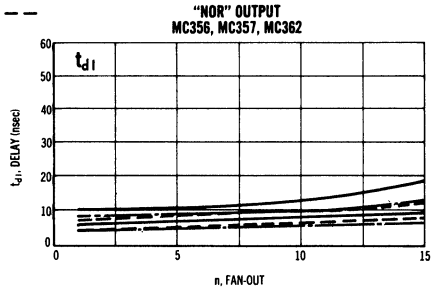
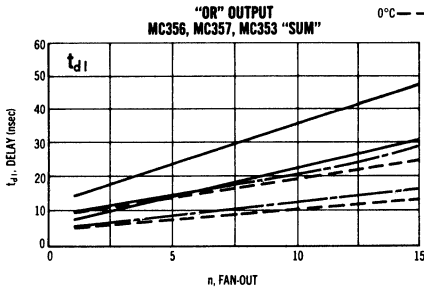

MC350 MECL series (continued)

LOGIC GATES (CONTINUED)

SWITCHING CHARACTERISTICS

(10% to 90% distribution)

"NOR"
MC359, MC360, MC361,
and MC353 "OR" and "CARRY"

+75°C ———
+25°C - - - -
0°C - - - - -

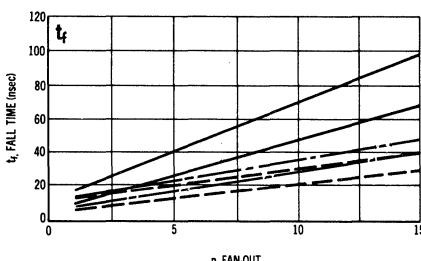
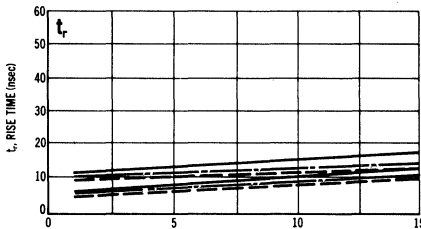
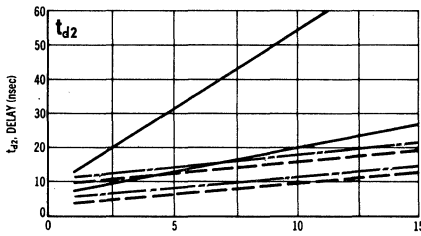
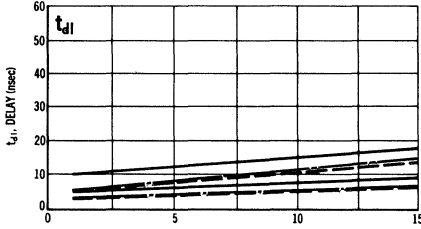

**TYPICAL SWITCHING TIME VARIATIONS
MC356**

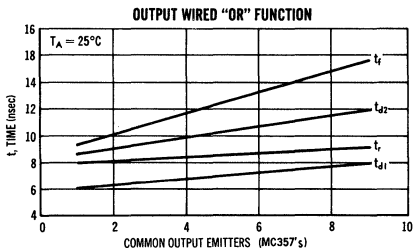
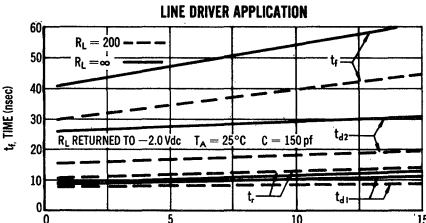
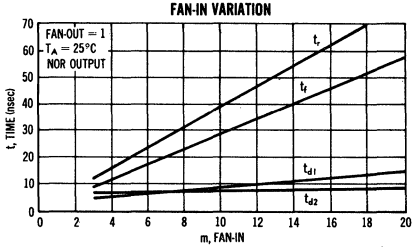
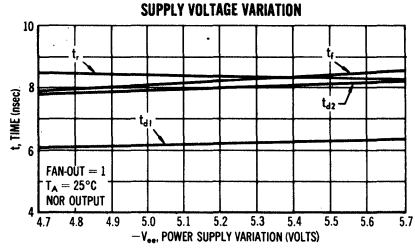

MC350 MECL series (continued)

MC353

HALF-ADDER

- Provides the "SUM," "CARRY," and "NOR" Outputs for Use in Digital Computer Circuits over a Temperature Range of 0 to +75°C.
- Average Propagation Delay — 6 nsec

CIRCUIT SCHEMATIC

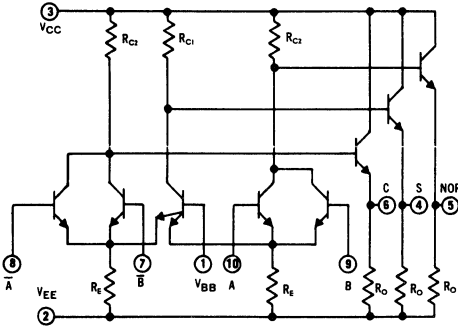

LOGIC SPECIFICATIONS

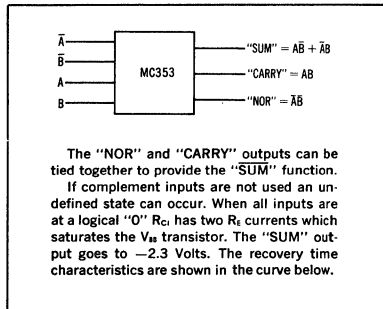

RECOVERY CHARACTERISTICS WITH SIMULTANEOUS "0" ON ALL INPUTS

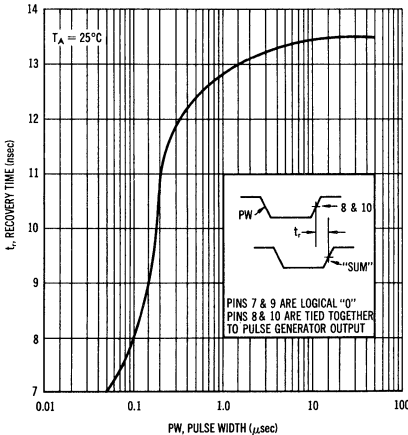

SWITCHING TIMES TEST CIRCUIT

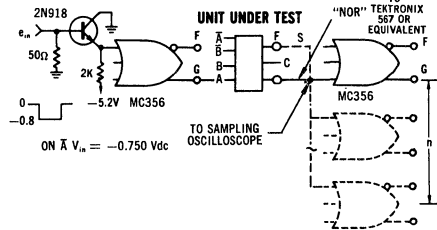

PROPAGATION DELAY TIME

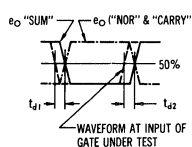

RISE AND FALL TIMES

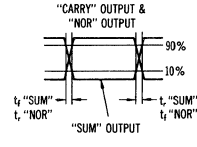

(RISE TIME = 10% TO 90% POINT OF POSITIVE GOING WAVEFORMS. FALL TIME = 90% TO 10% POINT OF NEGATIVE GOING WAVEFORMS.)

MC350 MECL series (continued)

HALF-ADDER (CONTINUED)

ELECTRICAL CHARACTERISTICS: $V_{EE} = -5.2 \text{ Vdc} \pm 1\%$, $V_{CC} = 0$ $V_{IN} = -1.18 \text{ Vdc} @ 0^\circ\text{C}$
 $V_{IN} = -1.15 \text{ Vdc} @ +25^\circ\text{C}$
 $V_{IN} = -1.08 \text{ Vdc} @ +75^\circ\text{C}$

Test	Conditions	Symbol	0°C		25°C		75°C		Units
			min	max	min	max	min	max	
DC CHARACTERISTICS									
"NOR" Logical "1" Output Voltage	$V_{in} = -1.350 \text{ Vdc}$ each input	V_1	0.715	0.850	0.670	0.795	0.590	0.725	Vdc
"NOR" Saturation Breakpoint Voltage	$\frac{dV}{dI_{in}} \text{ "NOR"} = 0$	V_3	—	0.510	—	0.550	—	0.630	Vdc
"NOR" Logical "0" Output Voltage	Each Input: $V_{in} = -0.850 \text{ Vdc} @ 0^\circ\text{C}$ $V_{in} = -0.795 \text{ Vdc} @ 25^\circ\text{C}$ $V_{in} = -0.725 \text{ Vdc} @ 75^\circ\text{C}$	V_4	1.570	1.830	—	—	—	—	Vdc
"SUM" Logical "1" Output Voltage	Each Input: $V_{in} = -0.850 \text{ Vdc} @ 0^\circ\text{C}$ $V_{in} = -0.795 \text{ Vdc} @ 25^\circ\text{C}$ $V_{in} = -0.725 \text{ Vdc} @ 75^\circ\text{C}$	V_5	0.715	0.850	—	—	—	—	Vdc
"SUM" Logical "0" Output Voltage	$V_{in} = -1.350 \text{ Vdc}$ each input	V_2	1.570	1.830	1.465	1.700	1.395	1.680	Vdc
Transition Region Slope	Between: $V_{in} \text{ "SUM"} = -1.000$ and $-1.400 \text{ Vdc} @ 0^\circ\text{C}$ $V_{in} \text{ "SUM"} = -0.950$ and $-1.350 \text{ Vdc} @ 25^\circ\text{C}$ $V_{in} \text{ "SUM"} = -0.850$ and $-1.250 \text{ Vdc} @ 75^\circ\text{C}$	ΔV	—	0.095	—	—	—	—	Vdc
"CARRY" Logical "1" Output Voltage	$V_{in} = -1.350 \text{ Vdc}$ each input	V_1	0.715	0.850	0.670	0.795	0.590	0.725	Vdc
"CARRY" Logical "0" Output Voltage	Each Input: $V_{in} = -0.850 \text{ Vdc} @ 0^\circ\text{C}$ $V_{in} = -0.795 \text{ Vdc} @ 25^\circ\text{C}$ $V_{in} = -0.725 \text{ Vdc} @ 75^\circ\text{C}$	V_4	1.570	1.830	—	—	—	—	Vdc
"CARRY" Saturation Breakpoint Voltage	$\frac{dV}{dI_{in}} \text{ "CARRY"} = 0$	V_3	—	0.510	—	0.550	—	0.630	Vdc
Total Unit Power Supply Current	All Inputs Open	I_E	—	15.9	—	15.30	—	14.10	mAdc

LOADING CHARACTERISTICS

"NOR" Output Voltage Change Between No Load and Full Load Conditions	All Inputs open No load = 0 Current (pin 5) Full load = 2.5 mAdc (pin 5)	ΔV_1	—	0.055	—	0.055	—	0.075	Vdc
"CARRY" Output Voltage Change Between No Load and Full Load Conditions	All Inputs open No load = 0 current (pin 6) Full load = 2.5 mAdc (pin 6)	ΔV_1	—	0.055	—	0.055	—	0.075	Vdc
"SUM" Output Voltage Change Between No Load and Full Load Conditions	No load = 0 current (pin 4) Full load = 2.5 mAdc (pin 4) Input (pin 9): $V_{in} = -0.850 \text{ Vdc} @ 0^\circ\text{C}$ $V_{in} = -0.795 \text{ Vdc} @ 25^\circ\text{C}$ $V_{in} = -0.725 \text{ Vdc} @ 75^\circ\text{C}$	ΔV_5	—	0.055	—	—	—	—	Vdc

SWITCHING CHARACTERISTICS

The stray capacitance introduced by the test jig was:
 $C_s (n + 12) \text{ pf}$ where n = number of fan-outs.

$V_{IN} = -0.790 \text{ Vdc}$, $V_L = -1.640 \text{ Vdc} @ 0^\circ\text{C}$
 $V_{IN} = -0.750 \text{ Vdc}$, $V_L = -1.550 \text{ Vdc} @ +25^\circ\text{C}$
 $V_{IN} = -0.675 \text{ Vdc}$, $V_L = -1.800 \text{ Vdc} @ +75^\circ\text{C}$

Propagation Delay Time	Conditions	t_{d1}	3.0	12.0	4.0	12.0	5.0	17.0	nsec
"SUM" Output	Fan-In = 1, Fan-Out = 1	t_{d1}	3.0	8.5	3.0	9.0	4.0	12.0	
"NOR" Output	Fan-In = 1, Fan-Out = 1	t_{d1}	3.0	8.5	3.0	9.0	4.0	12.0	
"CARRY" Output	Fan-In = 1, Fan-Out = 1	t_{d1}	3.0	8.5	3.0	9.0	4.0	12.0	
"SUM" Output	Fan-In = 1, Fan-Out = 1	t_{d2}	3.0	8.0	3.0	8.5	4.0	12.0	
"NOR" Output	Fan-In = 1, Fan-Out = 1	t_{d2}	3.0	9.0	4.0	10.5	5.0	14.0	
"CARRY" Output	Fan-In = 1, Fan-Out = 1	t_{d2}	3.0	9.0	4.0	10.5	5.0	14.0	
Rise Time									
"SUM" Output	Fan-In = 1, Fan-Out = 1	t_r	3.0	10.0	4.0	10.5	5.0	15.0	nsec
"NOR" Output	Fan-In = 1, Fan-Out = 1	t_r	3.0	9.0	4.0	10.0	4.0	15.0	
"CARRY" Output	Fan-In = 1, Fan-Out = 1	t_r	3.0	9.0	4.0	10.0	4.0	15.0	
Fall Time									
"SUM" Output	Fan-In = 1, Fan-Out = 1	t_f	3.0	12.0	4.0	14.0	5.0	18.0	nsec
"NOR" Output	Fan-In = 1, Fan-Out = 1	t_f	3.0	12.0	4.0	14.0	5.0	17.0	
"CARRY" Output	Fan-In = 1, Fan-Out = 1	t_f	3.0	12.0	4.0	14.0	5.0	17.0	

MC350 MECL series (continued)

FLIP-FLOPS

MC352
DC R-S FLIP-FLOP

Performs the Binary Function of "Q" and "Q̄"
Outputs at High Speeds over a Temperature
Range of 0 to +75°C.

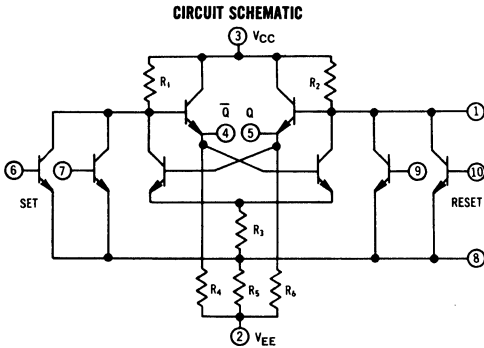

NOTE: Any unused inputs can normally be left open-circuited. In cases where there may be external leakage to the unused inputs they should be connected to V_{EE}.

LOGIC SPECIFICATIONS

When V_H is defined as a logical "1" and V_L as a logical "0", the function is as follows:

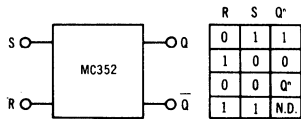

MC358
J-K FLIP-FLOP

Performs the Single Phase Binary Function of "Q"
and "Q̄" Outputs at High Speeds over a Temperature
Range of 0 to +75°C.

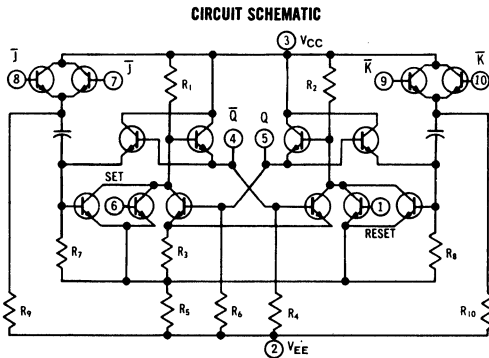

NOTE: Any unused inputs can normally be left open-circuited. In cases where there may be external leakage to the unused inputs they should be connected to V_{EE}.

LOGIC SPECIFICATIONS

When V_H is defined as a logical "1" and V_L as a logical "0", the function is as follows:

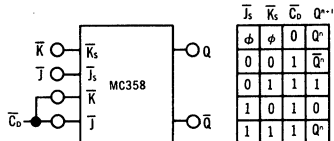

Clocked JK Operation

The J̄ and K̄ inputs refer to logic levels while the C₀ input refers to dynamic logic swings. The J and K inputs would be changed to a logical "1" only while the C₀ input is in a logic "1" state.

Set-Reset operation is the same as the MC352.

MC350 MECL series (continued)

FLIP-FLOPS (CONTINUED)

MC352, MC358

ELECTRICAL CHARACTERISTICS: $V_{EE} = -5.2 \text{ Vdc} \pm 1\%$, $V_{CC} = 0$

Test	Conditions	Symbol	0°C		25°C		75°C		Units
			min	max	min	max	min	max	

DC CHARACTERISTICS

"Q" or "Q̄" Logical "1" Output Voltage	Each Input: $V_{in} = -1.350 \text{ Vdc}$	V_1	0.715	0.850	0.670	0.795	0.590	0.725	Vdc
"Q" or "Q̄" Logical "0" Output Voltage	Each Input: $V_{in} = -1.350 \text{ Vdc}$	V_2	1.570	1.830	1.465	1.700	1.395	1.680	Vdc
"Q" or "Q̄" Saturation Breakpoint Voltage	$dV_{1}/dV_{in} = 0$; $dV_{2}/dV_{in} = 0$	V_3	—	0.61	—	0.65	—	0.73	Vdc
"Q" or "Q̄" Latch Voltage (MC352)	$dV_{1}/dV_{in} = \infty$	V_{L1}	1.11	1.34	1.09	1.30	1.02	1.23	Vdc
"Q" or "Q̄" Latch Voltage (MC358)	$dV_{1}/dV_{in} = \infty$	V_{L1}	1.11	1.25	1.09	1.21	1.02	1.14	Vdc
Total Power Supply Current	All Inputs Open	I_E	—	9.3	—	8.90	—	8.30	mAdc

LOADING CHARACTERISTICS

"Q" Output Voltage Change	All Inputs Open, measured between no load and full load V_{in} (pin 6) = -0.850 Vdc @ 0°C V_{in} (pin 6) = -0.795 Vdc @ 25°C V_{in} (pin 6) = -0.725 Vdc @ 75°C No load = 0 current (pin 5) Full load = 2.5 mAdc $\pm 5\%$ (pin 5)	ΔV_1	—	0.075	—	—	—	—	Vdc
"Q̄" Output Voltage Change	All Inputs Open, measured between no load and Full load, V_{in} at pin 10 for MC352, pin 1 for MC358 V_{in} = -0.850 Vdc @ 0°C V_{in} = -0.795 Vdc @ 25°C V_{in} = -0.725 Vdc @ 72°C No load = 0 current (pin 4) Full load = 2.5 mAdc $\pm 5\%$ (pin 4)	ΔV_1	—	0.075	—	0.075	—	0.085	Vdc
Output Voltage at Max I_{in}	Set "Q" to upper state: V_{in} = -0.850 Vdc (pin 6) @ 0°C V_{in} = -0.795 Vdc (pin 6) @ 25°C V_{in} = -0.725 Vdc (pin 6) @ 75°C Remove V_{in} . Then Input = 120 $\mu\text{Adc} \pm 1\%$ @ 0°C 100 $\mu\text{Adc} \pm 1\%$ @ 25°C and 75°C	V_1	0.715	0.850	0.670	0.795	0.590	0.725	Vdc

MC352:		MC358:	
Input	Output	Input	Output
1. Pin 9	Pin 4 ("Q")	1. Pin 1	Pin 4 ("Q")
2. Pin 7	Pin 5 ("Q")	2. Pin 6	Pin 5 ("Q")
3. Pin 10	Pin 4 ("Q")		
4. Pin 6	Pin 5 ("Q")		

TRANSFER CHARACTERISTICS

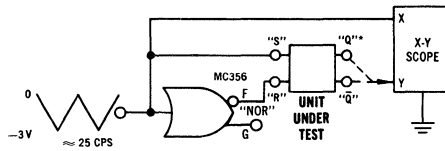
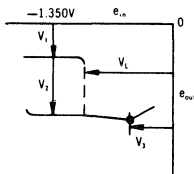

*FOR "Q" TESTS REVERSE "S" & "R" CONNECTIONS

MC350 MECL series (continued)

FLIP-FLOPS (CONTINUED)

MC352

SWITCHING CHARACTERISTICS: $V_{CC} = 0$, $V_{E1} = -5.2$ Volts, (all $\pm 1\%$), $V_{E1} = -0.790$ Vdc, $V_i = -1.640$ Vdc @ 0°C
 The stray capacitance introduced by the test jig was: $V_i = -0.750$ Vdc, $V_i = -1.550$ Vdc @ $+25^\circ\text{C}$
 $C_i = (n + 12)$ of where $n =$ number of fan-outs. $V_i = -0.675$ Vdc, $V_i = -1.500$ Vdc @ $+75^\circ\text{C}$

Test	Conditions	Symbol	0°C		25°C		75°C		Units
			min	max	min	max	min	max	
Propagation Delay Time	Either Output (Fan-In = 1, Fan-Out = 1)	t_{dr}	4.0	10.0	5.0	11.0	6.0	17.0	nsec
	Either Output (Fan-In = 1, Fan-Out = 1)	t_{df}	4.0	14.0	5.0	15.0	6.0	17.0	
Rise Time	Either Output (Fan-In = 1, Fan-Out = 1)	t_r	4.0	18.0	5.0	17.0	6.0	18.0	nsec
Fall Time	Either Output (Fan-In = 1, Fan-Out = 1)	t_f	4.0	16.0	5.0	18.0	6.0	21.0	nsec

SWITCHING TIME TEST CIRCUIT

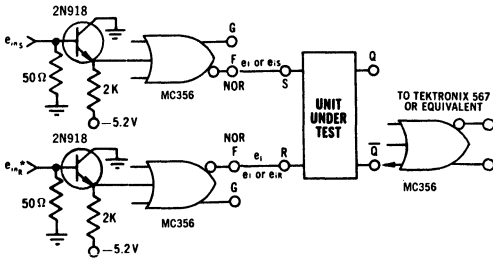

SWITCHING TIME TEST PROCEDURE

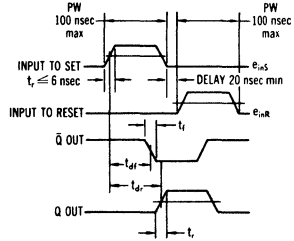

**SWITCHING CHARACTERISTICS
(10% to 90% distribution)**

— +75°C
 - - - +25°C
 - - - 0°C

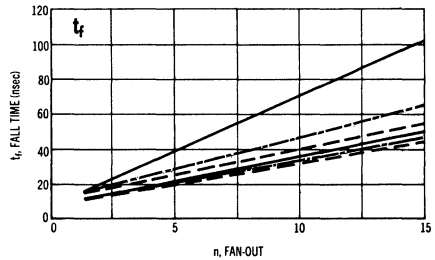
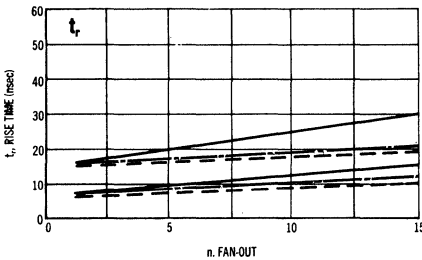
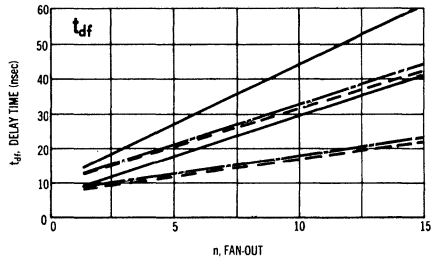
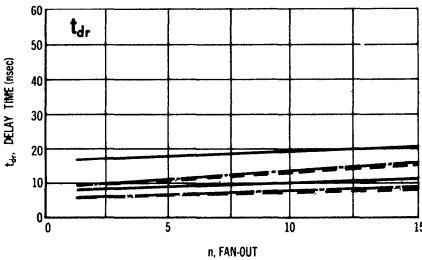

MC350 MECL series (continued)

FLIP-FLOPS (CONTINUED)

MC358

SWITCHING CHARACTERISTICS: $V_{CC} = 0$, $V_{EE} = -5.2$ Volts, (all $\pm 1\%$). $V_{IH} = -0.790$ Vdc, $V_{IL} = -1.640$ Vdc @ 0°C
 $V_{IH} = -0.750$ Vdc, $V_{IL} = -1.550$ Vdc @ $+25^\circ\text{C}$
 $V_{IH} = -0.675$ Vdc, $V_{IL} = -1.500$ Vdc @ $+75^\circ\text{C}$
 The stray capacitance introduced by the test jig was:
 $C_s = (n + 12)$ pf where n = number of fan-outs.

Test	Conditions	Symbol	0°C		25°C		75°C		Units
			min	max	min	max	min	max	
Propagation Delay Time	Either Output (Fan-In = 1, Fan-Out = 1)	t_{dr}	4.0	11.0	5.0	15.0	6.0	30.0	nsec
	Either Output (Fan-In = 1, Fan-Out = 1)	t_{df}	4.0	13.0	5.0	16.0	6.0	18.0	
Rise Time	Either Output (Fan-In = 1, Fan-Out = 1)	t_r	4.0	15.0	5.0	15.0	6.0	27.0	nsec
Fall Time	Either Output (Fan-In = 1, Fan-Out = 1)	t_f	4.0	16.0	5.0	16.0	6.0	35.0	nsec

SWITCHING TIME TEST CIRCUIT

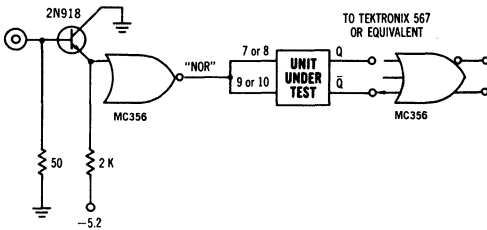

SWITCHING WAVEFORMS

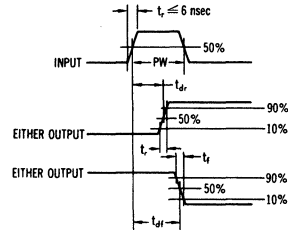

SWITCHING CHARACTERISTICS
(10% to 90% distribution)

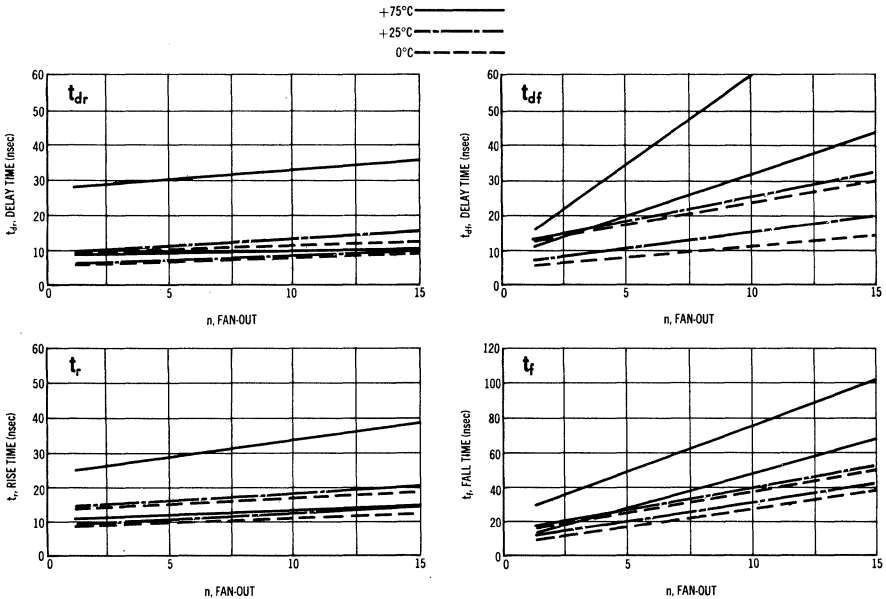

MC350 MECL series (continued)

MC355

GATE EXPANDER

Designed primarily for use in conjunction
With the MOTOROLA MC356 and
MC357 "MECL" 3-INPUT LOGIC
GATES. Each expander unit increases
the fan-in of the basic gate by five.

ELECTRICAL CHARACTERISTICS

Test	Conditions	Symbol	0°C		25°C		75°C		Units
			min	max	min	max	min	max	
Base Leakage Current	$V_{BE} = -2.0$ Vdc, $V_{CC} = 0$, $V_{BB} = -5.2$ Vdc	I_{BL}	—	0.5	—	0.5	—	2.0	μ Adc
Input Voltage	$V_{CB} = -0.7$ Vdc, $V_B = 0$, $I_E = -1.33$ mAdc	V_{BE}	0.730	0.770	0.680	0.720	0.580	0.620	Vdc
Collector Leakage Current	$V_{CC} = -2$ Vdc, $V_{BE} = 0.3$ Vdc (All inputs), $V_{EE} = 0$	I_{CEX}	—	1.0	—	1.0	—	15.0	μ Adc

SWITCHING CHARACTERISTICS

Propagation Delay	t_{d1} t_{d2}	3.0 3.0	8.0 11.0	3.0 4.0	9.0 11.0	4.0 5.0	11.0 13.0	nsec
Rise Time	t_r	3.0	12.0	4.0	13.0	5.0	15.0	nsec
Fall Time	t_f	3.0	13.0	4.0	14.0	5.0	16.0	nsec

SWITCHING TIME TEST CIRCUIT

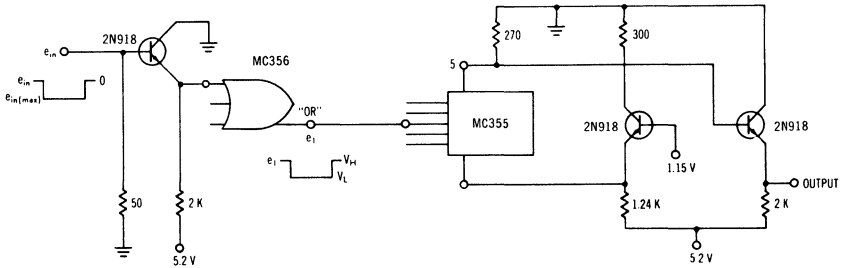

CIRCUIT SCHEMATIC AND INTERCONNECTION TO MC356 3-INPUT GATE

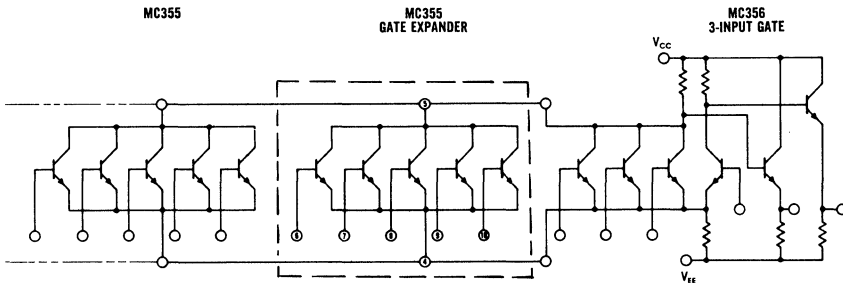

NOTE: Any unused inputs can normally be left open-circuited. In cases where there may be external leakage to the unused inputs they should be connected to V_{EE} .

MC200 DTL series



SUFFIX "F" DEVICES
CASE 72

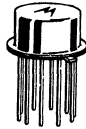

SUFFIX "G" DEVICES
CASE 71
(TO-5)

Monolithic integrated Diode Transistor Logic circuits for low-power, high-speed applications. The MC200 series provides a high noise immunity of 0.5 Volts and operates over the temperature range of -55 to +125°C.

SERIES MC200 DTL INTEGRATED CIRCUITS

Type	Description	Typical Propagation Delay (nsec)	Maximum Power Dissipation		Maximum Fan Out (-55 to +125°C)
			Output Off (mW)	Output On (mW)	
MC201	4-Input NAND/NOR Gate	30	8.5	6	5
MC202	3-Input NAND/NOR Gate	30	8.5	6	5
MC203	6-Input Diode AND Gate	—	—	—	—
MC204	3-Input Power NAND/NOR Gate	40	20	60	20
MC205	Line Driver	50	30	60	20(MC201) 15(MC209)
MC206	Dual (2-2) Input NAND/NOR Gate	30	17	12	5
MC207	Dual (3-2) Input NAND/NOR Gate	30	17	12	5
MC208	Dual (3-2) Input NAND/NOR Gate	30	17	12	5
MC209	Flip-Flop	—	16	16	8
MC212	Dual (3-3) Input NAND/NOR Gate	30	15	12	5
MC213	Dual (3-3) Input NAND/NOR Gate	30	15	30	4
MC215	Dual (3-3) Input AND Gate	—	—	—	—
MC217	Dual-Diode Array	—	—	—	—

MC201
MC202

MC200 DTL SERIES

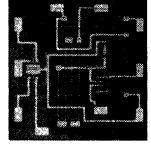

4-Input and 3-Input Diode Transistor Logic NAND/ NOR Gates.

MAXIMUM RATINGS ($T_A = 25^\circ\text{C}$ unless otherwise noted)

Characteristic	Symbol	Rating	Unit
Applied Voltage	$V_{3, 4, 6}$	+8	Volts
	V_5	-8	
	V_7 thru 10	+6	
Forward Current	I_2 thru 10	30	mA
Operating Temperature Range	T_J	-55 to +125	$^\circ\text{C}$
Storage Temperature Range	T_{stg}	-65 to +175	$^\circ\text{C}$

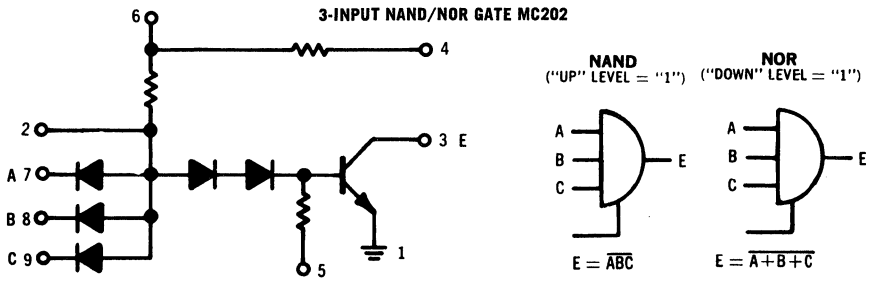
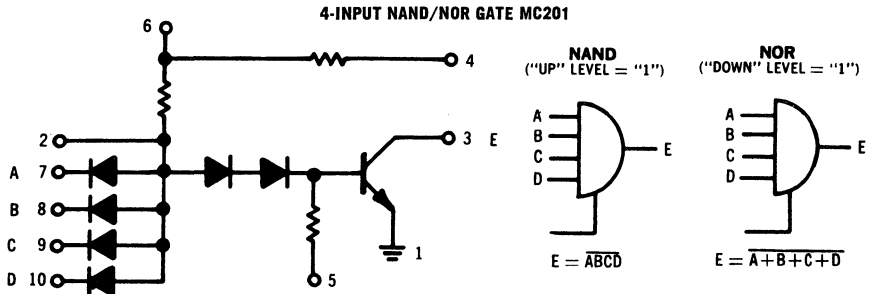

MC201, MC202 (continued)

ELECTRICAL CHARACTERISTICS

* ($V_6 = 4$ Vdc, $V_5 = 2$ Vdc, $V_1 = 0$, $T_J = 25^\circ\text{C}$ unless otherwise noted)

Characteristic	Symbol	Min	Typ	Max	Unit
Output Saturation Voltage ($I_3 = 10$ mAdc, V_7 thru $10 = 2$ Vdc, $T_J = -55$ to $+125^\circ\text{C}$)	V_3	—	—	0.6	Vdc
Output Breakdown Voltage ($I_3 = 1$ μ Adc, $V_{1,5,6} = 0$)	BV_3	8	—	—	Vdc
Output Sustaining Voltage ($I_3 = 10$ mAdc, $V_{1,5,6} = 0$)	LV_3	5	—	—	Vdc
Output Leakage Current ($V_7 = 0.7$ Vdc, $V_{8,9,10} = 2$ Vdc, $V_3 = 5$ Vdc) ($V_7 = 0.7$ Vdc, $V_{8,9,10} = 2$ Vdc, $V_3 = 5$ Vdc, $T_J = 125^\circ\text{C}$)	I_3	—	—	0.5 50	μ Adc
Input Diode Leakage Current** (Diode under test at 5 Vdc, all other inputs = 0) (Diode under test at 5 Vdc, all other inputs = 0, $T_J = 125^\circ\text{C}$)	I_7 thru 10	—	—	0.25 25	μ Adc
Turn-Off Current at Input ** (V_7 thru $10 = 0$) (V_7 thru $10 = 0$, $T_J = -55$ to $+125^\circ\text{C}$) ($V_2 = 0$)	I_7 thru 10 I_7 thru 10 I_2	-1.4 — -1.6	— — —	-1.8 -1.9 -2.4	mAdc
Load Resistor Current ($V_4 = 0$)	I_4	-1.6	—	-2.4	mAdc
Output Capacitance ($V_3 = 4$ Vdc, $V_{in} = 25$ mVrms, $f = 1$ mc, unused pins grounded)	C_3	—	—	15	pf
Input Capacitance ** (V_7 thru $10 = 4$ Vdc, $V_{in} = 25$ mVrms, $f = 1$ mc, unused pins grounded)	C_7 thru 10	—	—	8	pf
Power Consumption from Power Supply (Output "Off", $V_7 = 0$) (Output "On")		—	—	8.5 6.0	mW
Switching Time Turn-On Delay Turn-Off Delay	t_{on} t_{off}	—	—	60 50	nsec
Average Propagation Delay	pd	—	30	—	nsec
Fan-Out ($T_J = -55$ to $+125^\circ\text{C}$)	n	—	—	5	—

* Numerical subscripts refer to pin numbers. Pins not specifically referenced are left electrically open.

** Input diode at pin 10 available on MC201 only

MC201, MC202 (continued)

SWITCHING TIME TEST CIRCUIT

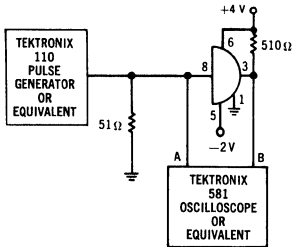

PROPAGATION DELAY MEASUREMENT CIRCUIT

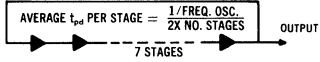

SWITCHING TIME WAVE FORMS

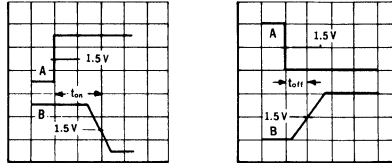

MC203

MC200 DTL SERIES

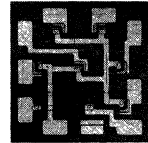

6-Input Diode Transistor Logic AND Gate.

MAXIMUM RATINGS (T_A = 25°C)

Characteristics	Symbol	Rating	Unit
Applied Voltage	V ₃ thru 8 V _{2, 9}	+8 ±8	Vdc
Forward Current	I ₂ thru 10	30	mAdc
Operating Temperature Range	T _J	-55 to +125	°C
Storage Temperature Range	T _{stg}	-65 to +175	°C

* Numerical subscripts refer to pin numbers.

MC203 (continued)

ELECTRICAL CHARACTERISTICS ($T_J = 25^\circ\text{C}$ unless otherwise noted)

Characteristics	Symbol	Min	Typ	Max	Unit
Diode Breakdown Voltage ($I_{3 \text{ thru } 8} = 10 \mu\text{Adc}$, $V_{10} = V_1 = 0$)	$V_{3 \text{ thru } 8}$	8	-	-	Vdc
Diode Forward Voltage ($I_{10} = 2 \text{ mAdc}$, $V_{3 \text{ thru } 8} = 0$)	V_{10}	-	-	0.85	Vdc
Diode Reverse Leakage Current ($V_{3 \text{ thru } 8} = 5 \text{ Vdc}$, $V_{10} = V_1 = 0$) ($V_{3 \text{ thru } 8} = 5 \text{ Vdc}$, $V_{10} = V_1 = 0$, $T_J = 125^\circ\text{C}$)	$I_{3 \text{ thru } 8}$	-	-	0.25 25	μAdc
Input Capacitance ($V_{3 \text{ thru } 8} = 2 \text{ Vdc}$, $V_{10} = V_1 = 0$, $f = 1 \text{ mc}$, $V_{\text{in}} = 25 \text{ mVrms}$, unused inputs grounded)	$C_{3 \text{ thru } 8}$	-	-	10	pf
Reverse Recovery Time ($I_{F \text{ 3 thru } 8} = I_{R \text{ 3 thru } 8} = 2 \text{ mAdc}$, $V_{10} = V_1 = 0$, recover to 0.2 mAdc)	$t_{rr \text{ 3 thru } 8}$	-	-	4	nsec
Resistor Current ($V_9 = 4 \text{ Vdc}$, $V_2 = 0$)	I_9	1.6	-	2.4	mAdc
Resistor Temperature Coefficient		-	0.1	-	%/ $^\circ\text{C}$
Diode Forward Conductance Change with Temperature	$\Delta V_F \text{ 3 thru } 8$	-	-1.7	-	mV/ $^\circ\text{C}$

* Numerical subscripts refer to pin numbers.

Pins not specifically referenced are left electrically open.

MC203 (continued)

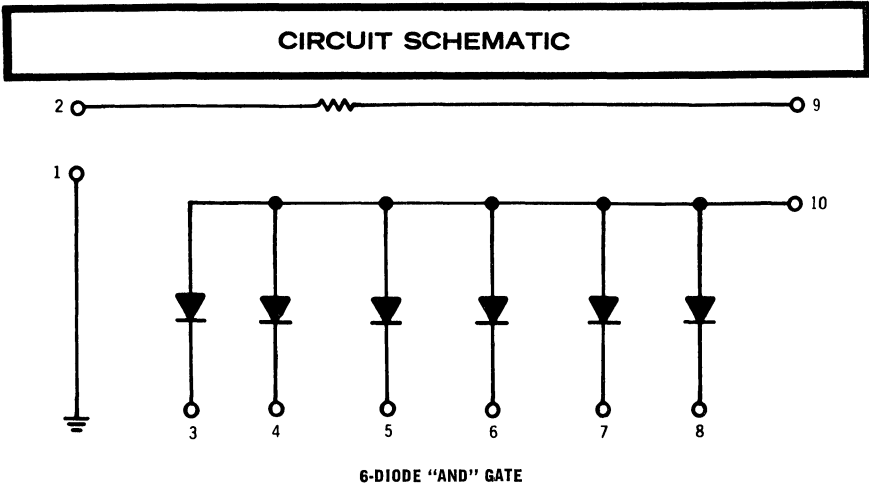

MC204

MC200 DTL SERIES



3-Input Diode Transistor Logic NAND/NOR Power Gate.

MAXIMUM RATINGS ($T_A = 25^\circ\text{C}$)

Characteristic	Symbol	Rating	Unit
Applied Voltage	$V_{3, 7, 8, 9}$	+8	Vdc
	V_5	-6	
	V_6	+6	
Forward Current	I_5 thru 10	30	mAdc
Load Current	I_3	75	mAdc
Operating Temperature Range	T_J	-55 to +125	$^\circ\text{C}$
Storage Temperature Range	T_{stg}	-65 to +175	$^\circ\text{C}$

* Numerical subscripts refer to pin numbers.

MC204 (continued)

ELECTRICAL CHARACTERISTICS

($V_6 = 4$ Vdc, $V_5 = 2$ Vdc, $V_1 = 0$, $T_J = 25^\circ\text{C}$ unless otherwise noted)

Characteristic	Symbol	Min	Typ	Max	Unit
Output Breakdown Voltage ($I_3 = 5 \mu\text{Adc}$, $V_7 = 0$)	BV_3	8	-	-	Vdc
"1" Output Current ($V_7, 8, \text{ or } 9 = 1.1$ Vdc, $V_3 = 5$ Vdc) ($V_7, 8, \text{ or } 9 = 0.7$ Vdc, $V_3 = 5$ Vdc, $T_J = 125^\circ\text{C}$) ($V_7, 8, \text{ or } 9 = 1.4$ Vdc, $V_3 = 5$ Vdc, $T_J = -55^\circ\text{C}$)	I_3	-	-	100	μAdc
"0" Output Current ($V_7, 8, \text{ or } 9 = 1.7$ Vdc, $V_3 = 0.6$ Vdc) ($V_7, 8, \text{ or } 9 = 1.3$ Vdc, $V_3 = 0.6$ Vdc, $T_J = 125^\circ\text{C}$) ($V_7, 8, \text{ or } 9 = 2.0$ Vdc, $V_3 = 0.6$ Vdc, $T_J = -55^\circ\text{C}$)	I_3	40	-	-	mAdc
Input Breakdown Voltage ($I_7 = 10 \mu\text{Adc}$, $V_8 = 0$) ($I_8 = 10 \mu\text{Adc}$, $V_7 = 0$) ($I_9 = 10 \mu\text{Adc}$, $V_7 = 0$)	BV_7 BV_8 BV_9	8.0 8.0 8.0	-	-	Vdc
Input Leakage Current ($V_7 = 5$ Vdc, $V_8 = 0$) ($V_7 = 5$ Vdc, $V_8 = 0$, $T_J = 125^\circ\text{C}$) ($V_8 = 5$ Vdc, $V_7 = 0$) ($V_8 = 5$ Vdc, $V_7 = 0$, $T_J = 125^\circ\text{C}$) ($V_9 = 5$ Vdc, $V_7 = 0$) ($V_9 = 5$ Vdc, $V_7 = 0$, $T_J = 125^\circ\text{C}$)	I_7 I_7 I_8 I_8 I_9 I_9	-	-	0.25 25 0.25 25 0.25 25	μAdc
Input Turn-Off Current (Alternately, $V_7, V_8, V_9 = 0$) (Alternately, $V_7, V_8, V_9 = 0$, $T_J = -55^\circ\text{C}$ to $+125^\circ\text{C}$) ($V_{10} = 0$)	I_7, I_8, I_9 I_7, I_8, I_9 I_{10}	-	-	-3.75 -3.9 -4.8	mAdc
Output Capacitance ($V_3 = 2.0$ Vdc, $V_{in} = 25$ mVrms, $f = 1$ mc, unused pins grounded)	C_3	-	-	15	pf
Input Capacitance ($V_7 = 2.0$ Vdc, $V_{in} = 25$ mVrms, $f = 1$ mc, unused pins grounded) ($V_8 = 2.0$ Vdc, $V_{in} = 25$ mVrms, $f = 1$ mc, unused pins grounded) ($V_9 = 2.0$ Vdc, $V_{in} = 25$ mVrms, $f = 1$ mc, unused pins grounded)	C_7 C_8 C_9	-	-	10 10 10	pf
Power Supply (Output "OFF", $V_7 = 0$) (Output "ON")		-	-	20 60	mW
Switching Times Turn-On Delay Turn-Off Delay	t_{on} t_{off}	-	-	35 90	nsec
Average Propagation Delay (Figure 2)	t_{pd}	-	40	-	nsec
Fan-Out (to MC201, $T_J = -55^\circ\text{C}$ to $+125^\circ\text{C}$)	n	-	-	20	-

*Numerical subscripts refer to pin numbers. Pins not specifically referenced are left electrically open.

MC204 (continued)

CIRCUIT SCHEMATIC

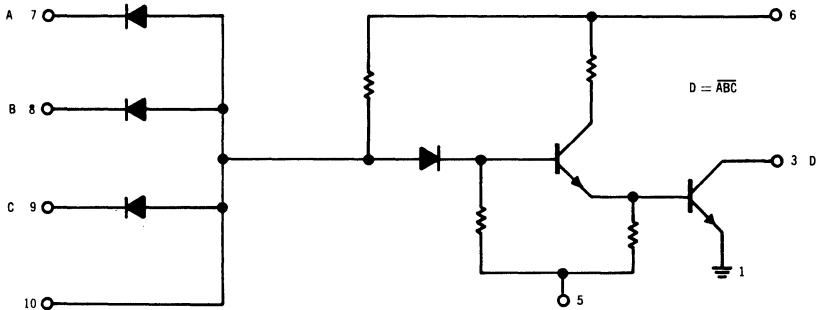

POWER GATE MC204

SWITCHING TIME TEST CIRCUIT

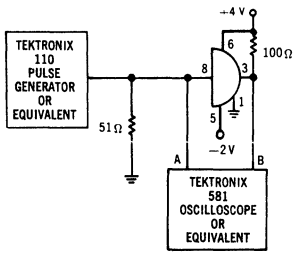

PROPAGATION DELAY MEASUREMENT CIRCUIT

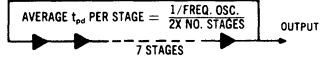

SWITCHING TIME WAVE FORMS

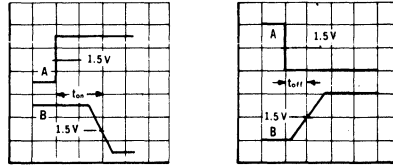

MC 205
LINE DRIVER

MC200 DTL SERIES

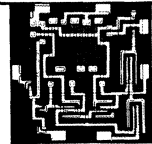

Diode Transistor Logic Line Driver.

MAXIMUM RATINGS ($T_J = 25^\circ\text{C}$)

Characteristic	Symbol	Rating	Unit
Applied Voltage	$V_{3, 4, 6}$	+6	Vdc
	V_5	-6	
	$V_{8, 10}$	+8	
Forward Current	$I_{5, 8, 10}$	30	mAdc
Load Current	$I_{3, 4, 6}$	75	mAdc
Operating Temperature Range	T_J	-55 to +125	$^\circ\text{C}$
Storage Temperature Range	T_{stg}	-65 to +175	$^\circ\text{C}$

MC205 (continued)
ELECTRICAL CHARACTERISTICS

* ($V_6 = 4$ Vdc, $V_5 = 2$ Vdc, $V_1 = 0$,
 $T_J = 25^\circ\text{C}$ unless otherwise noted)

Characteristic	Symbol	Min	Typ	Max	Unit
Output Saturation Voltage ($I_3 = 40$ mAdc, $T_J = -55^\circ\text{C}$ to $+125^\circ\text{C}$)	V_3	-	-	0.6	Vdc
Output Voltage, "Off" Level ($I_3 = 10$ mAdc, $V_8 = 0.7$ Vdc, $T_J = -55^\circ\text{C}$ to $+125^\circ\text{C}$)	V_3	2.0	-	-	Vdc
Input Breakdown Voltage ($I_8 = 10$ μ A, $V_{10} = 0$) ($I_{10} = 10$ μ A, $V_8 = 0$)	BV_8 BV_{10}	8.0 8.0	- -	- -	Vdc
Input Leakage Current ($V_8 = 5$ Vdc, $V_{10} = 0$) ($V_8 = 5$ Vdc, $V_{10} = 0$, $T_J = 125^\circ\text{C}$) ($V_{10} = 5$ Vdc, $V_8 = 0$) ($V_{10} = 5$ Vdc, $V_8 = 0$, $T_J = 125^\circ\text{C}$)	I_8 I_8 I_{10} I_{10}	- - - -	- - - -	0.25 25 0.25 25	μ A
Turn-Off Current at Inputs ($V_8 = 0$) ($V_8 = 0$, $T_J = -55$ to $+125^\circ\text{C}$) ($V_{10} = 0$) ($V_{10} = 0$, $T_J = -55$ to $+125^\circ\text{C}$)	I_8 I_8 I_{10} I_{10}	- - - -	- - - -	-3.75 -3.9 -3.75 -3.9	mA
Load Resistor	$R_6 - 4$	-	125	-	ohms
Input Capacitance ($V_8 = 2$ Vdc, $V_{in} = 25$ mVrms, $f = 1$ mc, unused pins grounded) ($V_{10} = 2$ Vdc, $V_{in} = 25$ mVrms, $f = 1$ mc, unused pins grounded)	C_8 C_{10}	- -	- -	10 10	pf
Power Consumption from Power Supply (Output "Off", $V_8 = 0$) (Output "On")		- -	- -	30 60	mW
Switching Times Turn-On Delay Turn-Off Delay	t_{on} t_{off}	- -	- -	90 50	nsec
Average Propagation Delay ($C_L = 1000$ pf)	t_{pd}	-	50	-	nsec
Fan-Out (to MC201, $T_J = -55$ to $+125^\circ\text{C}$) (to MC209, $T_J = -55$ to $+125^\circ\text{C}$)	n	- -	- -	20 15	

*Numerical subscripts refer to pin numbers. Pins not specifically referenced are left electrically open.

SWITCHING TIME TEST CIRCUIT

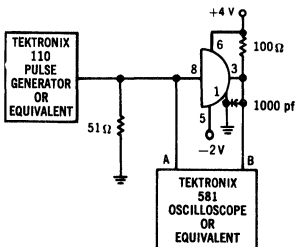

PROPAGATION DELAY MEASUREMENT CIRCUIT

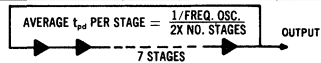

SWITCHING TIME WAVE FORMS

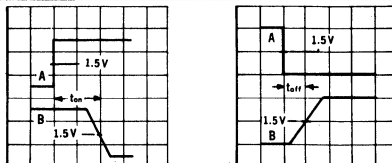

MC205 (continued)

CIRCUIT SCHEMATIC

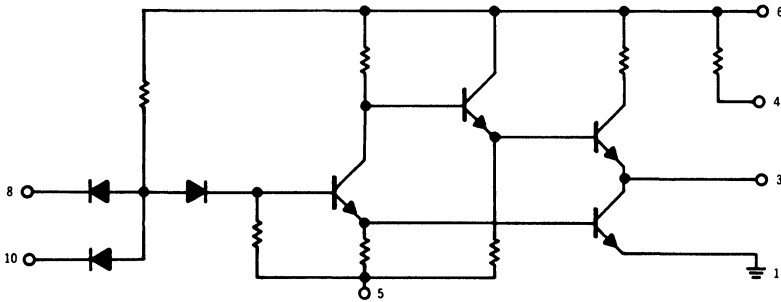

LINE DRIVER MC205

MC206

MC200 DTL SERIES

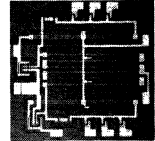

Dual (2-2) Input Diode Transistor Logic NAND/NOR Gate.

MAXIMUM RATINGS ($T_J = 25^\circ\text{C}$ unless otherwise noted)

Characteristic	Symbol	Rating	Unit
Applied Voltage	$V_{2,3,4,6 \text{ thru } 10}$	+8	Vdc
	V_5	-8	
Forward Current	$I_{2,10}$	+30	mAdc
	$I_{2 \text{ thru } 4, 7 \text{ thru } 10}$	-30	
Operating Temperature Range	T_J	-55 to +125	$^\circ\text{C}$
Storage Temperature Range	T_{stg}	-65 to +175	$^\circ\text{C}$

CIRCUIT SCHEMATIC

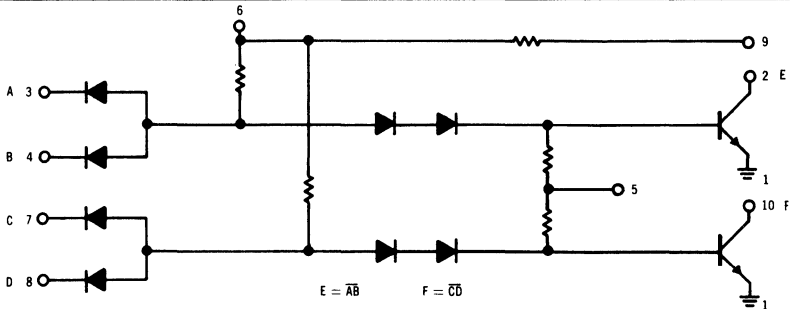

2-2 NAND/NOR GATE

MC206 (continued)

ELECTRICAL CHARACTERISTICS

* ($V_6 = 4$ Vdc, $V_5 = 2$ Vdc, $V_1 = 0$, $T_J = 25^\circ\text{C}$ unless otherwise noted)

Characteristic	Symbol	Min	Typ	Max	Unit
Output Breakdown Voltage ($I_2 = 1 \mu\text{A dc}$, $V_3 = 0$) ($I_{10} = 1 \mu\text{A dc}$, $V_7 = 0$)	BV_2 BV_{10}	8 8	- -	- -	Vdc
"1" Output Current ($V_3 = 1.1$ Vdc, $V_2 = 5$ Vdc ($V_3 = 0.7$ Vdc, $V_2 = 5$ Vdc, $T_J = +125^\circ\text{C}$) ($V_3 = 1.4$ Vdc, $V_2 = 5$ Vdc, $T_J = -55^\circ\text{C}$) ($V_3 = 1.1$ Vdc, $V_2 = 5$ Vdc) ($V_7 = 0.7$ Vdc, $V_{10} = 5$ Vdc, $T_J = 125^\circ\text{C}$) ($V_7 = 1.4$ Vdc, $V_{10} = 5$ Vdc, $T_J = -55^\circ\text{C}$)	I_2 I_2 I_2 I_2 I_{10} I_{10}	- - - - - -	- - - - - -	50 50 50 50 50 50	$\mu\text{A dc}$
"0" Output Current ($V_3 = 1.7$ Vdc, $V_2 = 0.6$ Vdc) ($V_3 = 1.3$ Vdc, $V_2 = 0.6$ Vdc, $T_J = 125^\circ\text{C}$) ($V_3 = 2.0$ Vdc, $V_2 = 0.6$ Vdc, $T_J = -55^\circ\text{C}$) ($V_7 = 1.7$ Vdc, $V_{10} = 0.6$ Vdc) ($V_7 = 1.3$ Vdc, $V_{10} = 0.6$ Vdc, $T_J = 125^\circ\text{C}$) ($V_7 = 2.0$ Vdc, $V_{10} = 0.6$ Vdc, $T_J = -55^\circ\text{C}$)	I_2 I_2 I_2 I_{10} I_{10} I_{10}	10 10 10 10 10 10	- - - - - -	- - - - - -	mA dc
Input Breakdown Voltage ($I_3 = 10 \mu\text{A dc}$, $V_4 = 0$) ($I_4 = 10 \mu\text{A dc}$, $V_3 = 0$) ($I_7 = 10 \mu\text{A dc}$, $V_8 = 0$) ($I_8 = 10 \mu\text{A dc}$, $V_7 = 0$)	BV_3 BV_4 BV_7 BV_8	8 8 8 8	- - - -	- - - -	Vdc
Input Leakage Current (Diode under test at 5 Vdc, all other inputs = 0) (Diode under test at 5 Vdc, all other inputs = 0, $T_J = 125^\circ\text{C}$)	I_3, I_4, I_7, I_8	- -	- -	0.250 25	$\mu\text{A dc}$
Input Turn-Off Current (Alternately $V_3, V_4, V_7, V_8 = 0$) (Alternately $V_3, V_4, V_7, V_8 = 0$, $T_J = -55$ to $+125^\circ\text{C}$)	I_3, I_4, I_7, I_8	- -	- -	-1.8 -1.9	mA dc
Output Capacitance ($V_2 = 2.0$ Vdc, $V_3 = 0$, $V_{in} = 25$ mVrms, $f = 1$ mc, unused pins grounded) ($V_{10} = 2.0$ Vdc, $V_7 = 0$, $V_{in} = 25$ mVrms, $f = 1$ mc, unused pins grounded)	C_2 C_{10}	- -	- -	10 10	pf
Input Capacitance ($V_3 = 2$ Vdc, $V_{in} = 25$ mVrms, $f = 1$ mc, unused pins grounded) ($V_4 = 2$ Vdc, $V_{in} = 25$ mVrms, $f = 1$ mc, unused pins grounded) ($V_7 = 2$ Vdc, $V_{in} = 25$ mVrms, $f = 1$ mc, unused pins grounded) ($V_8 = 2$ Vdc, $V_{in} = 25$ mVrms, $f = 1$ mc, unused pins grounded)	C_3 C_4 C_7 C_8	- - - -	- - - -	10 10 10 10	pf
Load Resistor Current ($V_9 = 0$)	I_9	-1.6	-	-2.4	mA dc
Power Consumption from Power Supply (Output "Off", $V_3 = V_7 = 0$) (Output "On")		- -	- -	17 12	mW
Switching Times Turn-On Delay Turn-Off Delay	t_{on} t_{off}	- -	- -	60 50	nsec
Average Propagation Delay	t_{pd}	-	30	-	nsec
Fan-Out ($T_J = -55$ to $+125^\circ\text{C}$)	n	-	-	5	

*Numerical subscripts refer to pin numbers. Pins not specifically referenced are left electrically open.

SWITCHING TIME TEST CIRCUIT

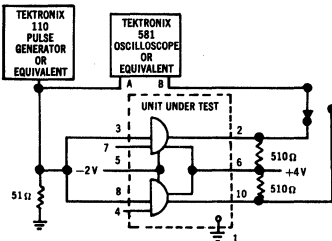

PROPAGATION DELAY MEASUREMENT CIRCUIT

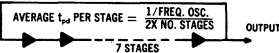

SWITCHING TIME WAVE FORMS

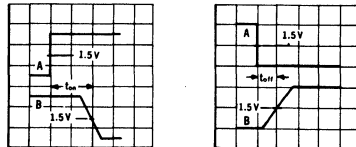

MC207

MC200 DTL SERIES

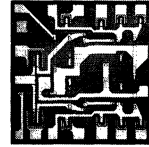

Dual (3-2) Input Diode Transistor Logic NAND/NOR Gate.

MAXIMUM RATINGS ($T_J = 25^\circ\text{C}$ unless otherwise noted)

Characteristic	Symbol	Rating	Unit
Applied Voltage	$V_{2,3,4,6}$ thru 10	+8	Vdc
	V_5	-8	
Forward Current	$I_{2,10}$	+30	mA _{dc}
	I_2 thru 4,	-30	
	7 thru 10		
Operating Temperature Range	T_J	-55 to +125	$^\circ\text{C}$
Storage Temperature Range	T_{stg}	-65 to +175	$^\circ\text{C}$

CIRCUIT SCHEMATIC

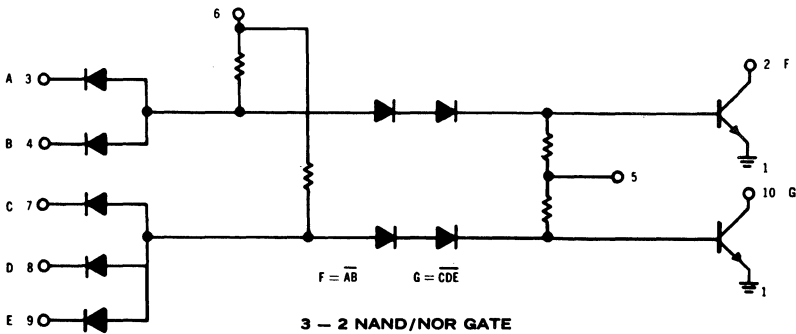

SWITCHING TIME TEST CIRCUIT

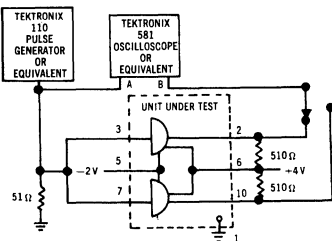

PROPAGATION DELAY MEASUREMENT CIRCUIT

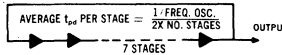

SWITCHING TIME WAVE FORMS

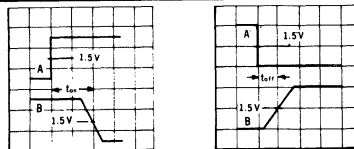

MC207 (continued)

ELECTRICAL CHARACTERISTICS *

($V_6 = 4$ Vdc, $V_5 = -2$ Vdc, $V_1 = 0$; $T_J = 25^\circ\text{C}$ unless otherwise noted)

Characteristic	Symbol	Min	Typ	Max	Unit
Output Breakdown Voltage ($I_2 = 1 \mu\text{Adc}$, $V_3 = 0$) ($I_{10} = 1 \mu\text{Adc}$, $V_7 = 0$)	BV ₂ BV ₁₀	8 8	— —	— —	Vdc
"1" Output Current ($V_3 = 1.1$ Vdc, $V_2 = 5$ Vdc ($V_3 = 0.7$ Vdc, $V_2 = 5$ Vdc, $T_J = 125^\circ\text{C}$) ($V_3 = 1.4$ Vdc, $V_2 = 5$ Vdc, $T_J = -55^\circ\text{C}$) ($V_7 = 1.1$ Vdc, $V_{10} = 5$ Vdc ($V_7 = 0.7$ Vdc, $V_{10} = 5$ Vdc, $T_J = 125^\circ\text{C}$) ($V_7 = 1.4$ Vdc, $V_{10} = 5$ Vdc, $T_J = -55^\circ\text{C}$)	I_2 I_2 I_2 I_{10} I_{10} I_{10}	— — — — — —	— — — — — —	50 50 50 50 50 50	μAdc
"0" Output Current ($V_3 = 1.7$ Vdc, $V_2 = 0.6$ Vdc) ($V_3 = 1.3$ Vdc, $V_2 = 0.6$ Vdc, $T_J = 125^\circ\text{C}$) ($V_3 = 2.0$ Vdc, $V_2 = 0.6$ Vdc, $T_J = -55^\circ\text{C}$) ($V_7 = 1.7$ Vdc, $V_{10} = 0.6$ Vdc) ($V_7 = 1.3$ Vdc, $V_{10} = 0.6$ Vdc, $T_J = 125^\circ\text{C}$) ($V_7 = 2.0$ Vdc, $V_{10} = 0.6$ Vdc, $T_J = -55^\circ\text{C}$)	I_2 I_2 I_2 I_{10} I_{10} I_{10}	10 10 10 10 10 10	— — — — — —	— — — — — —	μAdc
Input Breakdown Voltage ($I_3 = 10 \mu\text{Adc}$, $V_4 = 0$) ($I_4 = 10 \mu\text{Adc}$, $V_3 = 0$) ($I_7 = 10 \mu\text{Adc}$, $V_8 = 0$) ($I_8 = 10 \mu\text{Adc}$, $V_7 = 0$) ($I_9 = 10 \mu\text{Adc}$, $V_7 = 0$)	BV ₃ BV ₄ BV ₇ BV ₈ BV ₉	8 8 8 8 8	— — — — —	— — — — —	Vdc
Input Leakage Current (Diode under test at 5 Vdc, all other inputs = 0) (Diode under test at 5 Vdc, all other inputs = 0, $T_J = 125^\circ\text{C}$)	I_3, I_4, I_7, I_8, I_9	— —	— —	0.250 25	μAdc
Input Turn-Off Current (Alternately $V_3, V_4, V_7, V_8, V_9 = 0$) (Alternately $V_3, V_4, V_7, V_8, V_9 = 0, T_J = -55$ to $+125^\circ\text{C}$)	I_3, I_4, I_7, I_8, I_9	— —	— —	-1.8 -1.9	mAdc
Output Capacitance ($V_2 = 2.0$ Vdc, $V_3 = 0$, $V_{in} = 25$ mVrms, $f = 1$ mc, unused pins grounded) ($V_{10} = 2.0$ Vdc, $V_7 = 0$, $V_{in} = 25$ mVrms, $f = 1$ mc, unused pins grounded)	C_2 C_{10}	— —	— —	10 10	pf
Input Capacitance ($V_3 = 2$ Vdc, $V_{in} = 25$ mVrms, $f = 1$ mc, unused pins grounded) ($V_4 = 2$ Vdc, $V_{in} = 25$ mVrms, $f = 1$ mc, unused pins grounded) ($V_7 = 2$ Vdc, $V_{in} = 25$ mVrms, $f = 1$ mc, unused pins grounded) ($V_8 = 2$ Vdc, $V_{in} = 25$ mVrms, $f = 1$ mc, unused pins grounded) ($V_9 = 2$ Vdc, $V_{in} = 25$ mVrms, $f = 1$ mc, unused pins grounded)	C_3 C_4 C_7 C_8 C_9	— — — — —	— — — — —	10 10 10 10 10	pf
Power Consumption from Power Supply (Output "Off", $V_3 = V_7 = 0$) (Output "On")	—	— —	— —	17 12	mW
Switching Times (Figure 2) Turn-On Delay Turn-Off Delay	t_{on} t_{off}	— —	— —	60 50	nsec
Average Propagation Delay (Figure 3)	t_{pd}	—	30	—	nsec
Fan-Out ($T_J = -55$ to $+125^\circ\text{C}$)	n	—	—	5	—

*Numerical subscripts refer to pin numbers. Pins not specifically referenced are left electrically open.

MC208

MC200 DTL SERIES

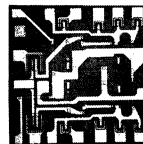

Dual (3-2) Input Diode Transistor Logic NAND/NOR Gate.

MAXIMUM RATINGS ($T_J = 25^\circ\text{C}$ unless otherwise noted)

Characteristic	Symbol	Rating	Unit
Applied Voltage	$V_{2,3,4,6 \text{ thru } 10}$	+8	Vdc
	V_5	-8	
Forward Current	$I_{2,10}$	+30	mA _{dc}
	$I_{2 \text{ thru } 4, 7 \text{ thru } 10}$	-30	
Operating Temperature Range	T_J	-55 to +125	$^\circ\text{C}$
Storage Temperature Range	T_{stg}	-65 to +175	$^\circ\text{C}$

CIRCUIT SCHEMATIC

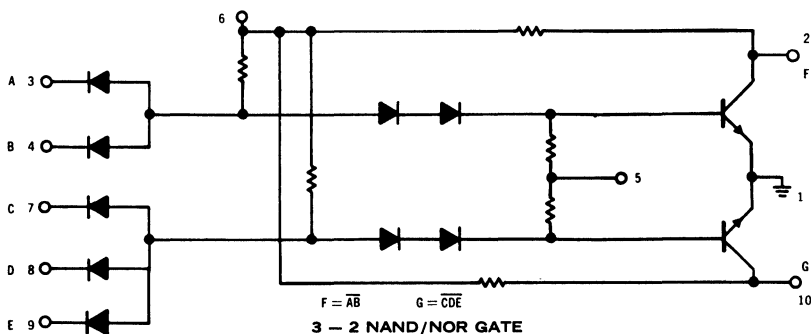

MC208 (continued)

ELECTRICAL CHARACTERISTICS

* ($V_6 = 4 \text{ Vdc}$, $V_5 = 2 \text{ Vdc}$, $V_i = 0$,
 $T_J = 25^\circ\text{C}$ unless otherwise noted)

Characteristic	Symbol	Min	Typ	Max	Unit
Output Breakdown Voltage ($I_2 = 1 \mu\text{Adc}$, $V_3 = 0$) ($I_{10} = 1 \mu\text{Adc}$, $V_7 = 0$)	BV_2 BV_{10}	8 8	— —	— —	Vdc
Output Saturation Voltage ($I_2 = 8 \text{ mAdc}$, $V_3 = V_4 = 2 \text{ Vdc}$, $T_J = -55 \text{ to } +125^\circ\text{C}$) ($I_{10} = 8 \text{ mAdc}$, $V_7 = V_8 = V_9 = 2 \text{ Vdc}$, $T_J = -55 \text{ to } +125^\circ\text{C}$)	V_2 V_{10}	— —	— —	0.6 0.6	Vdc
Output "Off" Voltage ($I_2 = 100 \mu\text{Adc}$, $V_3 = 0.7 \text{ Vdc}$, $T_J = -55 \text{ to } +125^\circ\text{C}$) ($I_{10} = 100 \mu\text{Adc}$, $V_7 = 0.7 \text{ Vdc}$, $T_J = -55 \text{ to } +125^\circ\text{C}$)	V_2 V_{10}	3.5 3.5	— —	— —	Vdc
Input Breakdown Voltage ($I_3 = 10 \mu\text{Adc}$, $V_4 = 0$) ($I_4 = 10 \mu\text{Adc}$, $V_3 = 0$) ($I_7 = 10 \mu\text{Adc}$, $V_8 = 0$) ($I_8 = 10 \mu\text{Adc}$, $V_7 = 0$) ($I_9 = 10 \mu\text{Adc}$, $V_7 = 0$)	BV_3 BV_4 BV_7 BV_8 BV_9	8 8 8 8 8	— — — — —	— — — — —	Vdc
Input Leakage Current (Diode under test at 5 Vdc, all other inputs = 0) (Diode under test at 5 Vdc, all other inputs = 0, $T_J = 125^\circ\text{C}$)	I_3, I_4, I_7, I_8, I_9	— —	— —	0.250 25	μAdc
Input Turn-Off Current (Alternately $V_3, V_4, V_7, V_8, V_9 = 0$) (Alternately $V_3, V_4, V_7, V_8, V_9 = 0$, $T_J = -55 \text{ to } +125^\circ\text{C}$)	I_3, I_4, I_7, I_8, I_9	— —	— —	-1.8 -1.9	mAdc
Output Capacitance ($V_2 = 2.0 \text{ Vdc}$, $V_3 = 0$, $V_{in} = 25 \text{ mVrms}$, $f = 1 \text{ mc}$, unused pins grounded) ($V_{10} = 2.0 \text{ Vdc}$, $V_7 = 0$, $V_{in} = 25 \text{ mVrms}$, $f = 1 \text{ mc}$, unused pins grounded)	C_2 C_{10}	— —	— —	10 10	pf
Input Capacitance ($V_3 = 2 \text{ Vdc}$, $V_{in} = 25 \text{ mVrms}$, $f = 1 \text{ mc}$, unused pins grounded) ($V_4 = 2 \text{ Vdc}$, $V_{in} = 25 \text{ mVrms}$, $f = 1 \text{ mc}$, unused pins grounded) ($V_7 = 2 \text{ Vdc}$, $V_{in} = 25 \text{ mVrms}$, $f = 1 \text{ mc}$, unused pins grounded) ($V_8 = 2 \text{ Vdc}$, $V_{in} = 25 \text{ mVrms}$, $f = 1 \text{ mc}$, unused pins grounded) ($V_9 = 2 \text{ Vdc}$, $V_{in} = 25 \text{ mVrms}$, $f = 1 \text{ mc}$, unused pins grounded)	C_3 C_4 C_7 C_8 C_9	— — — — —	— — — — —	10 10 10 10 10	pf
Power Consumption from Power Supply (Output "Off", $V_3 = V_7 = 0$) (Output "On")	—	— —	— —	17 30	mW
Switching Times Turn-On Delay Turn-Off Delay	t_{on} t_{off}	— —	— —	60 50	nsec
Average Propagation Delay	t_{pd}	—	30	—	nsec
Fan-Out ($T_J = -55 \text{ to } +125^\circ\text{C}$)	n	—	—	4	—

*Numerical subscripts refer to pin numbers. Pins not specifically referenced are left electrically open.

SWITCHING TIME TEST CIRCUIT

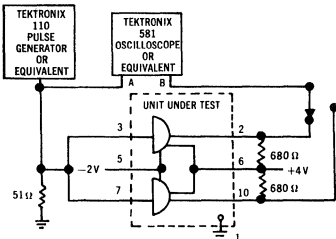

PROPAGATION DELAY MEASUREMENT CIRCUIT

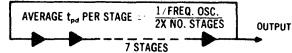

SWITCHING TIME WAVE FORMS

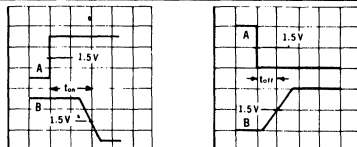

MC209

MC200 DTL SERIES

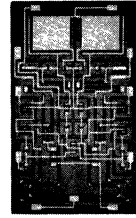

Diode Transistor Logic Flip-Flop.

MAXIMUM RATINGS ($T_J = 25^\circ\text{C}$ unless otherwise noted)

Characteristic	Symbol	Rating	Unit
Applied Voltage	$V_{2, 3, 4, 6, 7, 8, 9, 10}$	+8	Vdc
	V_5	-8	
Forward Current	$I_{3, 8}$	+50	mA _{dc}
	$I_{2, 3, 4, 7 \text{ thru } 10}$	-30	
Operating Temperature Range	T_J	-55 to +125	$^\circ\text{C}$
Storage Temperature Range	T_{stg}	-65 to +175	$^\circ\text{C}$

SWITCHING TIME TEST CIRCUITS AND WAVE FORMS

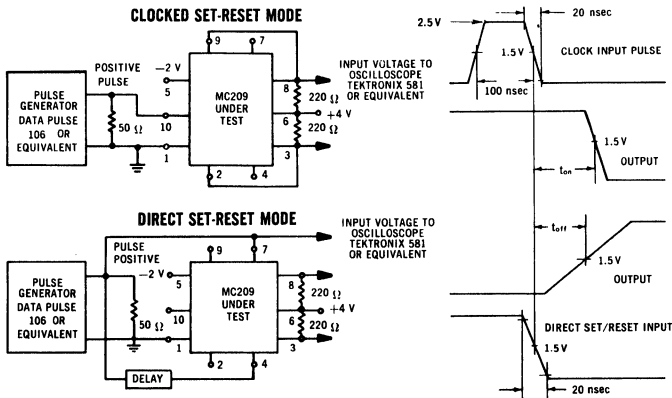

MC209 (continued)

ELECTRICAL CHARACTERISTICS

($V_6 = 4$ Vdc, $V_5 = 2$ Vdc, $V_1 = 0$, $T_J = 25^\circ\text{C}$ unless otherwise noted)

Characteristic	Logic Symbol	Logic State	Symbol	Min	Typ	Max	Unit
OUTPUT LEVEL							
“Off” Voltage ($I_8 = -200 \mu\text{A}$ dc, $V_4 = 0.6$ Vdc, $V_7 = 2.0$ Vdc) ($I_3 = -200 \mu\text{A}$ dc, $V_4 = 2.0$ Vdc, $V_7 = 0.6$ Vdc)	Q \bar{Q}	1 1	V_8 V_3	2.5 2.5	— —	— —	Vdc Vdc
“On” Voltage ($I_8 = 16$ mAdc, $V_4 = 2.0$ Vdc, $V_7 = 0.6$ Vdc) ($I_3 = 16$ mAdc, $V_4 = 0.6$ Vdc, $V_7 = 2.0$ Vdc)	Q \bar{Q}	0 0	V_8 V_3	— —	— —	0.6 0.6	Vdc Vdc
DIRECT SET-RESET INPUTS							
“Up” Voltage	S_D R_D	1 1	V_4 V_7	2.0 2.0	— —	— —	Vdc Vdc
“Down” Voltage	S_D R_D	0 0	V_4 V_7	— —	— —	0.6 0.6	Vdc Vdc
“Up” Current ($V_4 = 5$ Vdc, $T_J = 125^\circ\text{C}$) ($V_7 = 5$ Vdc, $T_J = 125^\circ\text{C}$)	S_D R_D	1 1	I_4 I_7	— —	— —	25 25	μA dc μA dc
“Down” Current ($V_4 = 0$) ($V_7 = 0$)	S_D R_D	0 0	I_4 I_7	— —	— —	-1.8 -1.8	mAdc mAdc
CLOCKED SET-RESET INPUTS							
“Down” Current ($V_9, I_0 = 0$, $T_J = 25^\circ\text{C}$) ($V_2, I_0 = 0$, $T_J = 25^\circ\text{C}$)	S_{RC} R_{RC}	0 0	I_9 I_2	— —	— —	-1.4 -1.4	mAdc mAdc
Effective Clock Input Capacitance			C_{10}	—	75	—	pf
SWITCHING TIME							
Clocked Set-Reset Mode							
Turn-On Delay			t_{on}	—	—	100	nsec
Turn-Off Delay			t_{off}	—	—	75	nsec
Direct Set-Reset Mode							
Turn-On Delay			t_{on}	—	—	100	nsec
Turn-Off Delay			t_{off}	—	—	75	nsec
FAN-OUT			n	—	—	8	—
POWER CONSUMPTION				—	16	—	mW

* Numerical subscripts refer to pin numbers. Pins not specifically referenced are left electrically open.

CIRCUIT AND LOGIC DIAGRAMS

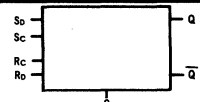
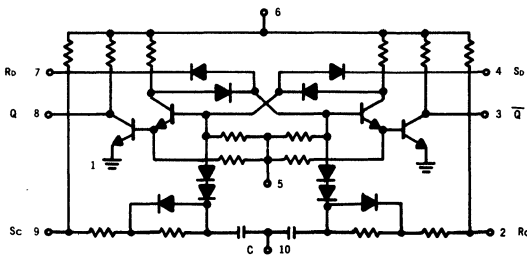

CLOCKED SET-RESET			DIRECT SET-RESET		
S_C	R_C	Q	S_0	R_0	Q
0	0	?	0	0	*
0	1	1	0	1	1
1	0	0	1	0	0
1	1	No Change	1	1	No Change

POSITIVE LOGIC DEFINITION: HIGH VOLTAGE = 1
LOW VOLTAGE = 0

* BOTH Q and \bar{Q} IN 1 STATE UNTIL EITHER S_0 OR R_0 RISES

BINARY ELEMENT MC209

MC212

MC200 DTL SERIES

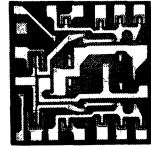

Dual (3-3) Input Diode Transistor Logic NAND/NOR Gate.

MAXIMUM RATINGS ($T_J = 25^\circ\text{C}$ unless otherwise noted)

Characteristic	Symbol	Rating	Unit
Applied Voltage	V_2 thru 10	+8	Vdc
Forward Current	$I_2, 10$	+30	mAdc
	I_2 thru 5, 7 thru 10	-30	
Operating Temperature Range	T_J	-55 to +125	$^\circ\text{C}$
Storage Temperature Range	T_{stg}	-65 to +175	$^\circ\text{C}$

SWITCHING TIME TEST CIRCUIT

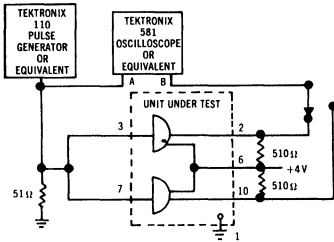

PROPAGATION DELAY MEASUREMENT CIRCUIT

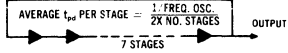

SWITCHING TIME WAVE FORMS

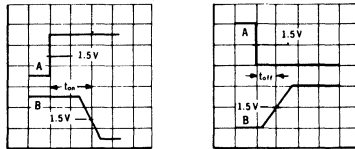

CIRCUIT SCHEMATIC

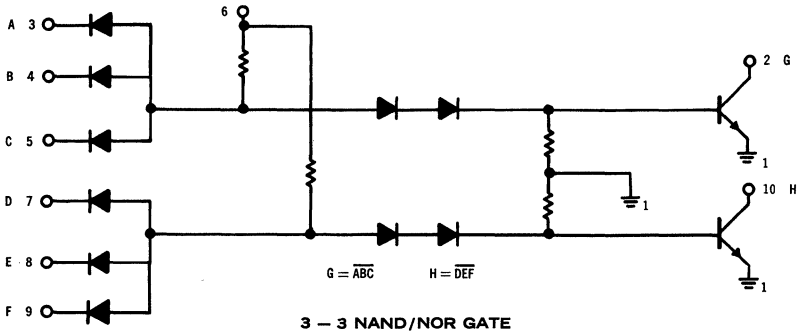

MC212 (continued)

ELECTRICAL CHARACTERISTICS * (V₆ = 4 Vdc, V₁ = 0, T_J = 25°C unless otherwise noted)

Characteristic	Symbol	Min	Typ	Max	Unit
Output Breakdown Voltage (I ₂ = 1 μAdc, V ₃ = 0) (I ₁₀ = 1 μAdc, V ₇ = 0)	BV ₂ BV ₁₀	8 8	— —	— —	Vdc
"1" Output Current (V ₃ = 1.1 Vdc, V ₂ = 5 Vdc (V ₃ = 0.7 Vdc, V ₂ = 5 Vdc, T _J = 125°C) (V ₃ = 1.4 Vdc, V ₂ = 5 Vdc, T _J = -55°C) (V ₇ = 1.1 Vdc, V ₁₀ = 5 Vdc) (V ₇ = 0.7 Vdc, V ₁₀ = 5 Vdc, T _J = 125°C) (V ₇ = 1.4 Vdc, V ₁₀ = 5 Vdc, T _J = -55°C)	I ₂ I ₂ I ₂ I ₁₀ I ₁₀ I ₁₀	— — — — — —	— — — — — —	50 50 50 50 50 50	μAdc
"0" Output Current (V ₃ = 1.7 Vdc, V ₂ = 0.6 Vdc) (V ₃ = 1.3 Vdc, V ₂ = 0.6 Vdc, T _J = 125°C) (V ₃ = 2.0 Vdc, V ₂ = 0.6 Vdc, T _J = -55°C) (V ₇ = 1.7 Vdc, V ₁₀ = 0.6 Vdc) (V ₇ = 1.3 Vdc, V ₁₀ = 0.6 Vdc, T _J = 125°C) (V ₇ = 2.0 Vdc, V ₁₀ = 0.6 Vdc, T _J = -55°C)	I ₂ I ₂ I ₂ I ₁₀ I ₁₀ I ₁₀	10 10 10 10 10 10	— — — — — —	— — — — — —	mAdc
Input Breakdown Voltage (I ₃ = 10 μAdc, V ₄ = 0) (I ₄ = 10 μAdc, V ₃ = 0) (I ₅ = 10 μAdc, V ₃ = 0) (I ₇ = 10 μAdc, V ₈ = 0) (I ₈ = 10 μAdc, V ₇ = 0) (I ₉ = 10 μAdc, V ₇ = 0)	BV ₃ BV ₄ BV ₅ BV ₇ BV ₈ BV ₉	8 8 8 8 8 8	— — — — — —	— — — — — —	Vdc
Input Leakage Current (Diode under test at 5 Vdc, all other inputs = 0) (Diode under test at 5 Vdc, all other inputs = 0, T _J = 125°C)	I ₃ , I ₄ , I ₅ , I ₇ , I ₈ , I ₉	— —	— —	0.250 25	μAdc
Input Turn-Off Current (Alternately V ₃ , V ₄ , V ₅ , V ₇ , V ₈ , V ₉ = 0) (Alternately V ₃ , V ₄ , V ₅ , V ₇ , V ₈ , V ₉ = 0, T _J = -55 to +125°C)	I ₃ , I ₄ , I ₅ , I ₇ , I ₈ , I ₉	— —	— —	-1.8 -1.9	mAdc
Output Capacitance (V ₂ = 2.0 Vdc, V ₃ = 0, V _{in} = 25 mVrms, f = 1 mc, unused pins grounded) (V ₁₀ = 2.0 Vdc, V ₇ = 0, V _{in} = 25 mVrms, f = 1 mc, unused pins grounded)	C ₂ C ₁₀	— —	— —	10 10	pf
Input Capacitance (V ₃ = 2 Vdc, V _{in} = 25 mVrms, f = 1 mc, unused pins grounded) (V ₄ = 2 Vdc, V _{in} = 25 mVrms, f = 1 mc, unused pins grounded) (V ₅ = 2 Vdc, V _{in} = 25 mVrms, f = 1 mc, unused pins grounded) (V ₇ = 2 Vdc, V _{in} = 25 mVrms, f = 1 mc, unused pins grounded) (V ₈ = 2 Vdc, V _{in} = 25 mVrms, f = 1 mc, unused pins grounded) (V ₉ = 2 Vdc, V _{in} = 25 mVrms, f = 1 mc, unused pins grounded)	C ₃ C ₄ C ₅ C ₇ C ₈ C ₉	— — — — — —	— — — — — —	10 10 10 10 10 10	pf
Power Consumption from Power Supply (Output "Off", V ₃ = V ₇ = 0) (Output "On")	—	— —	— —	15 12	mW
Switching Times (Figure 2) Turn-On Delay Turn-Off Delay	t _{on} t _{off}	— —	— —	60 50	nsec
Average Propagation Delay (Figure 3)	t _{pd}	—	30	—	nsec
Fan-Out (T _J = -55 to +125°C)	n	—	—	5	—

*Numerical subscripts refer to pin numbers. Pins not specifically referenced are left electrically open.

MC213

MC200 DTL SERIES

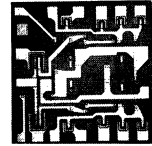

Dual (3-3) Input Diode Transistor Logic NAND/NOR Gate.

MAXIMUM RATINGS ($T_J = 25^\circ\text{C}$ unless otherwise noted)

Characteristic	Symbol	Rating	Unit
Applied Voltage	$V_{2 \text{ thru } 10}$	+8	Vdc
Forward Current	$I_{2, 10}$	+30	mAdc
	$I_{2 \text{ thru } 5, 7 \text{ thru } 10}$	-30	
Operating Temperature Range	T_J	-55 to +125	$^\circ\text{C}$
Storage Temperature Range	T_{stg}	-65 to +175	$^\circ\text{C}$

CIRCUIT SCHEMATIC

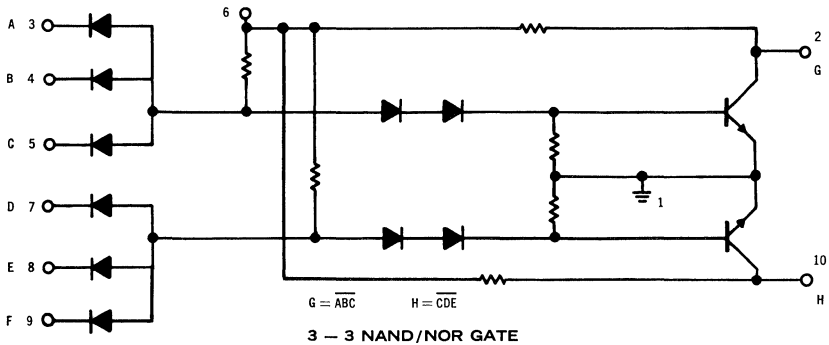

MC213 (continued)

ELECTRICAL CHARACTERISTICS ($V_6 = 4$ Vdc, $V_1 = 0$, $T_J = 25^\circ\text{C}$ unless otherwise noted)

Characteristic	Symbol	Min	Typ	Max	Unit
Output Breakdown Voltage ($I_2 = 1 \mu\text{A dc}$, $V_3 = 0$) ($I_{10} = 1 \mu\text{A dc}$, $V_7 = 0$)	BV_2 BV_{10}	8 8	— —	— —	Vdc
Output Saturation Voltage ($I_2 = 8$ mA dc, $V_3 = V_4 = V_5 = 2$ Vdc, $T_J = -55$ to $+125^\circ\text{C}$) ($I_{10} = 8$ mA dc, $V_7 = V_8 = V_9 = 2$ Vdc, $T_J = -55$ to $+125^\circ\text{C}$)	V_2 V_{10}	— —	— —	0.6 0.6	Vdc
Output "Off" Voltage ($I_2 = 100 \mu\text{A dc}$, $V_3 = 0.7$ Vdc, $T_J = -55$ to $+125^\circ\text{C}$) ($I_{10} = 100 \mu\text{A dc}$, $V_7 = 0.7$ Vdc, $T_J = -55$ to $+125^\circ\text{C}$)	V_2 V_{10}	3.5 3.5	— —	— —	Vdc
Input Breakdown Voltage ($I_3 = 10 \mu\text{A dc}$, $V_4 = 0$) ($I_4 = 10 \mu\text{A dc}$, $V_3 = 0$) ($I_5 = 10 \mu\text{A dc}$, $V_3 = 0$) ($I_7 = 10 \mu\text{A dc}$, $V_8 = 0$) ($I_8 = 10 \mu\text{A dc}$, $V_7 = 0$) ($I_9 = 10 \mu\text{A dc}$, $V_7 = 0$)	BV_3 BV_4 BV_5 BV_7 BV_8 BV_9	8 8 8 8 8 8	— — — — — —	— — — — — —	Vdc
Input Leakage Current (Diode under test at 5 Vdc, all other inputs = 0) (Diode under test at 5 Vdc, all other inputs = 0, $T_J = 125^\circ\text{C}$)	$I_3, I_4, I_5, I_7, I_8, I_9$	— —	— —	0.250 25	$\mu\text{A dc}$
Input Turn-Off Current (Alternately $V_3, V_4, V_5, V_7, V_8, V_9 = 0$) (Alternately $V_3, V_4, V_5, V_7, V_8, V_9 = 0$, $T_J = -55$ to $+125^\circ\text{C}$)	$I_3, I_4, I_5, I_7, I_8, I_9$	— —	— —	-1.8 -1.9	mA dc
Output Capacitance ($V_2 = 2.0$ Vdc, $V_3 = 0$, $V_{in} = 25$ mVrms, $f = 1$ mc, unused pins grounded) ($V_{10} = 2.0$ Vdc, $V_7 = 0$, $V_{in} = 25$ mVrms, $f = 1$ mc, unused pins grounded)	C_2 C_{10}	— —	— —	10 10	pf
Input Capacitance ($V_3 = 2$ Vdc, $V_{in} = 25$ mVrms, $f = 1$ mc, unused pins grounded) ($V_4 = 2$ Vdc, $V_{in} = 25$ mVrms, $f = 1$ mc, unused pins grounded) ($V_5 = 2$ Vdc, $V_{in} = 25$ mVrms, $f = 1$ mc, unused pins grounded) ($V_7 = 2$ Vdc, $V_{in} = 25$ mVrms, $f = 1$ mc, unused pins grounded) ($V_8 = 2$ Vdc, $V_{in} = 25$ mVrms, $f = 1$ mc, unused pins grounded) ($V_9 = 2$ Vdc, $V_{in} = 25$ mVrms, $f = 1$ mc, unused pins grounded)	C_3 C_4 C_5 C_7 C_8 C_9	— — — — — —	— — — — — —	10 10 10 10 10 10	pf
Power Consumption from Power Supply (Output "Off", $V_3 = V_7 = 0$) (Output "On")	—	— —	— —	15 30	mW
Switching Times (Figure 2) Turn-On Delay Turn-Off Delay	t_{on} t_{off}	— —	— —	60 50	nsec
Average Propagation Delay (Figure 3)	t_{pd}	—	30	—	nsec
Fan-Out ($T_J = -55$ to $+125^\circ\text{C}$)	n	—	—	4	—

*Numerical subscripts refer to pin numbers. Pins not specifically referenced are left electrically open.

SWITCHING TIME TEST CIRCUIT

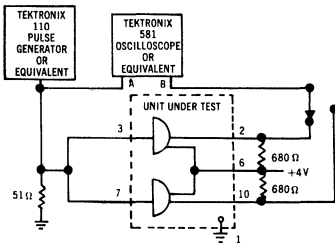

PROPAGATION DELAY MEASUREMENT CIRCUIT

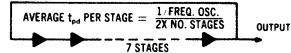

SWITCHING TIME WAVE FORMS

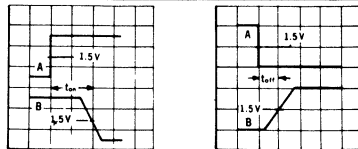

mc215

MC200 DTL SERIES

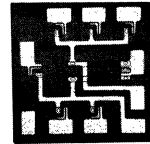

Dual (3-3) Input Diode Transistor Logic AND Gate.

MAXIMUM RATINGS ($T_A = 25^\circ\text{C}$)

Characteristics	Symbol	Rating	Unit
Applied Voltage	$V_{2, 3, 7 \text{ thru } 10}$	+8	Vdc
	V_6	± 8	
Forward Current	$I_{2 \text{ thru } 10}$	± 30	mAdc
Operating Temperature Range	T_J	-55 to +125	$^\circ\text{C}$
Storage Temperature Range	T_{stg}	-65 to +175	$^\circ\text{C}$

CIRCUIT SCHEMATIC

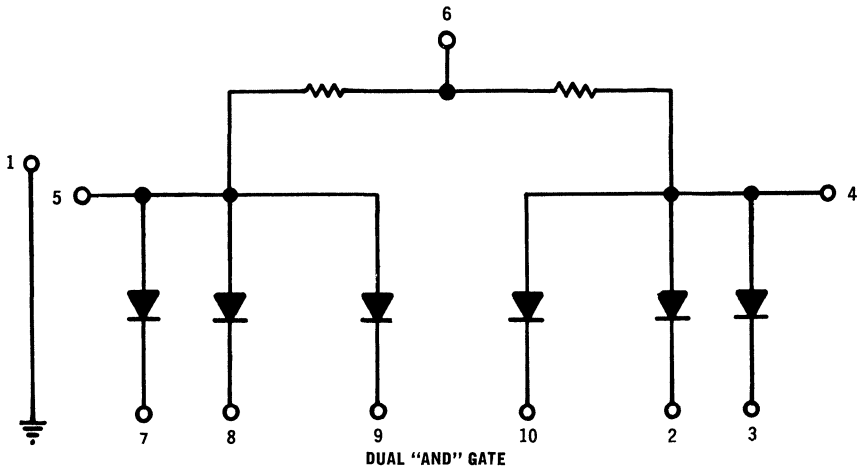

MC215 (continued)

ELECTRICAL CHARACTERISTICS ($T_J = 25^\circ\text{C}$ unless otherwise noted)

Characteristics	Symbol	Min	Typ	Max	Unit
Diode Breakdown Voltage ($I_{2, 3, 10} = 10 \mu\text{Adc}$, $V_4 = V_1 = 0$) ($I_{7, 8, 9} = 10 \mu\text{Adc}$, $V_5 = V_1 = 0$)	$V_{2, 3, 10}$ $V_{7, 8, 9}$	8 8	- -	- -	Vdc
Diode Forward Voltage ($I_4 = 2 \text{ mAdc}$, $V_{2, 3, 10} = V_1 = 0$) ($I_5 = 2 \text{ mAdc}$, $V_{7, 8, 9} = V_1 = 0$)	V_4 V_5	- -	- -	0.85 0.85	Vdc
Diode Reverse Leakage Current ($V_{2, 3, 10} = 5 \text{ Vdc}$, $V_4 = V_1 = 0$) ($V_{2, 3, 10} = 5 \text{ Vdc}$, $V_4 = V_1 = 0$, $T_J = 125^\circ\text{C}$) ($V_{7, 8, 9} = 5 \text{ Vdc}$, $V_5 = V_1 = 0$) ($V_{7, 8, 9} = 5 \text{ Vdc}$, $V_5 = V_1 = 0$, $T_J = 125^\circ\text{C}$)	$I_{2, 3, 10}$ $I_{7, 8, 9}$	- -	- -	0.25 25 0.25 25	μAdc
Input Capacitance ($V_{2, 3, 10} = 2 \text{ Vdc}$, $V_4 = V_1 = 0$, $f = 1 \text{ mc}$, $V_{in} = 25 \text{ mVrms}$, unused inputs grounded) ($V_{7, 8, 9} = 2 \text{ Vdc}$, $V_5 = V_1 = 0$, $f = 1 \text{ mc}$, $V_{in} = 25 \text{ mVrms}$, unused inputs grounded)	$C_{2, 3, 10}$ $C_{7, 8, 9}$	- -	- -	10 10	pf
Reverse Recovery Time ($I_{F2, 3, 10} = I_{R2, 3, 10} = 2 \text{ mAdc}$, $V_4 = V_1 = 0$, recover to 0.2 mAdc) ($I_{F7, 8, 9} = I_{R7, 8, 9} = 2 \text{ mAdc}$, $V_5 = V_1 = 0$, recover to 0.2 mAdc)	$t_{rr2, 3, 10}$ $t_{rr7, 8, 9}$	- -	- -	4 4	nsec
Resistor Isolation Leakage ($V_6 = 5 \text{ Vdc}$, $V_4 = V_5 = 0$)	I_1	-	-	600	nAdc
Resistor Current ($V_6 = 4 \text{ Vdc}$, $V_4 = V_1 = 0$) ($V_6 = 4 \text{ Vdc}$, $V_5 = V_1 = 0$)	I_4 I_5	1.6 1.6	- -	2.4 2.4	mAdc
Resistor Temperature Coefficient	-	-	0.1	-	%/ $^\circ\text{C}$
Diode Forward Conductance Change with Temperature	$\Delta V_{F2, 3, 10}$ $\Delta V_{F7, 8, 9}$	- -	-1.7 -1.7	- -	mV/ $^\circ\text{C}$

*Numerical subscripts refer to pin numbers. Pins not specifically referenced are left electrically open.

MC217

MC200 DTL SERIES

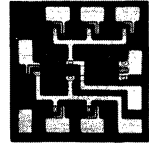

Diode Transistor Logic Dual-Diode Array.

MAXIMUM RATINGS ($T_A = 25^\circ$)

Characteristics	Symbol	Rating	Unit
Applied Voltage	$V_{2, 3, 7 \text{ thru } 10}$	8	Vdc
Forward Current	$I_{2 \text{ thru } 5, 7 \text{ thru } 10}$	30	mAdc
Operating Temperature Range	T_J	-55 to +125	$^\circ\text{C}$
Storage Temperature Range	T_{stg}	-65 to +175	$^\circ\text{C}$

CIRCUIT SCHEMATIC

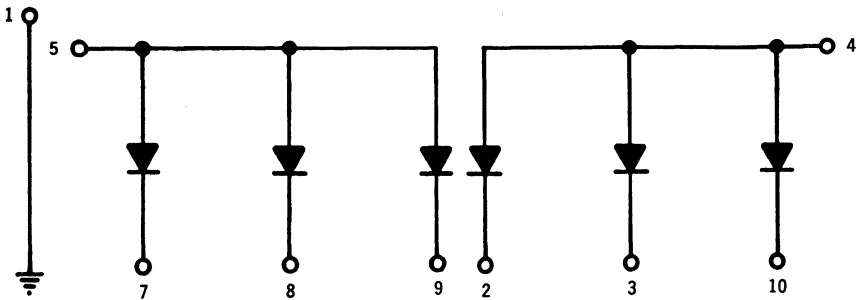

DUAL DIODE ARRAY

MC217 (continued)

ELECTRICAL CHARACTERISTICS ($T_J = 25^\circ\text{C}$ unless otherwise noted)

Characteristics	Symbol	Min	Typ	Max	Unit
Diode Breakdown Voltage ($I_{2, 3, 10} = 10 \mu\text{A dc}$, $V_4 = V_1 = 0$) ($I_{7, 8, 9} = 10 \mu\text{A dc}$, $V_5 = V_1 = 0$)	$V_{2, 3, 10}$ $V_{7, 8, 9}$	8 8	- -	- -	Vdc
Diode Forward Voltage ($I_4 = 2 \text{ mA dc}$, $V_{2, 3, 10} = V_1 = 0$) ($I_5 = 2 \text{ mA dc}$, $V_{7, 8, 9} = V_1 = 0$)	V_4 V_5	- -	- -	0.85 0.85	Vdc
Diode Reverse Leakage Current ($V_{2, 3, 10} = 5 \text{ Vdc}$, $V_4 = V_1 = 0$) ($V_{2, 3, 10} = 5 \text{ Vdc}$, $V_4 = V_1 = 0$, $T_J = 125^\circ\text{C}$) ($V_{7, 8, 9} = 5 \text{ Vdc}$, $V_5 = V_1 = 0$) ($V_{7, 8, 9} = 5 \text{ Vdc}$, $V_5 = V_1 = 0$, $T_J = 125^\circ\text{C}$)	$I_{2, 3, 10}$ $I_{7, 8, 9}$	- - -	- - -	0.25 25 0.25 25	$\mu\text{A dc}$
Input Capacitance ($V_{2, 3, 10} = 2 \text{ Vdc}$, $V_4 = V_1 = 0$, $f = 1 \text{ mc}$, $V_{\text{in}} = 25 \text{ mVrms}$, unused inputs grounded) ($V_{7, 8, 9} = 2 \text{ Vdc}$, $V_5 = V_1 = 0$, $f = 1 \text{ mc}$, $V_{\text{in}} = 25 \text{ mVrms}$, unused inputs grounded)	$C_{2, 3, 10}$ $C_{7, 8, 9}$	- - -	- - -	10 10	pf
Reverse Recovery Time ($I_{F2, 3, 10} = I_{R2, 3, 10} = 2 \text{ mA dc}$, $V_4 = V_1 = 0$, recover to 0.2 mA dc) ($I_{F7, 8, 9} = I_{R7, 8, 9} = 2 \text{ mA dc}$, $V_5 = V_1 = 0$, recover to 0.2 mA dc)	$t_{\text{rr}2, 3, 10}$ $t_{\text{rr}7, 8, 9}$	- - -	- - -	4 4	nsec
Diode Forward Conductance Change with Temperature	$\Delta V_{F2, 3, 10}$ $\Delta V_{F7, 8, 9}$	- -	-1.7 -1.7	- -	$\text{mV}/^\circ\text{C}$

*Numerical subscripts refer to pin numbers. Pins not specifically referenced are left electrically open.

MC250 DTL series



SUFFIX "F" DEVICES
CASE 72



SUFFIX "G" DEVICES
CASE 71
(TO-5)

Commercial monolithic integrated Diode Transistor Logic circuits for low-power, high-speed applications. The MC250 series operates over a temperature range of 0 to +75°C and provides guaranteed performance at 25°C.

SERIES MC250 DTL CIRCUITS

Type	Description	Typical Propagation Delay (nsec)	Maximum Power Dissipation		Maximum Fan Out (0 to +75°C)
			Output Off (mW)	Output On (mW)	
MC251	4-Input NAND/NOR Gate	30	10	7	5
MC252	3-Input NAND/NOR Gate	30	10	7	5
MC253	6-Input Diode AND Gate	-	-	-	-
MC254	3-Input Power NAND/NOR Gate	40	23	66	20
MC255	Line Driver	50	30	65	20(MC251) 15(MC259)
MC256	Dual (2-2) Input NAND/NOR Gate	30	20	12	5
MC257	Dual (3-2) Input NAND/NOR Gate	30	20	12	5
MC258	Dual (3-2) Input NAND/NOR Gate	30	20	34	4
MC259	Flip-Flop	-	16	16	8
MC260	Flip-Flop	-	16	16	8
MC262	Dual (3-3) Input NAND/NOR Gate	30	19	12	5
MC263	Dual (3-3) Input NAND/NOR Gate	30	19	33	4
MC265	Dual (3-3) Input AND Gate	-	-	-	-
MC267	Dual-Diode Array	-	-	-	-

MC251
MC252

MC250 DTL SERIES

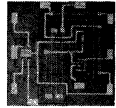

4-Input and 3-Input Diode Transistor Logic NAND/
NOR Gates.

MAXIMUM RATINGS ($T_A = 25^\circ\text{C}$ unless otherwise noted)

Characteristic	Symbol	Rating	Unit
Applied Voltage	$V_{4,6 \text{ thru } 10}$	+8	Volts
	V_5	-8	
	V_3	+6	
Forward Current	$I_2 \text{ thru } 10$	30	mA
Operating Temperature Range	T_J	0 to +75	$^\circ\text{C}$
Storage Temperature Range [*]	T_{stg}	-65 to +175	$^\circ\text{C}$

CIRCUIT AND LOGIC DIAGRAMS

4-INPUT NAND/NOR GATE MC251

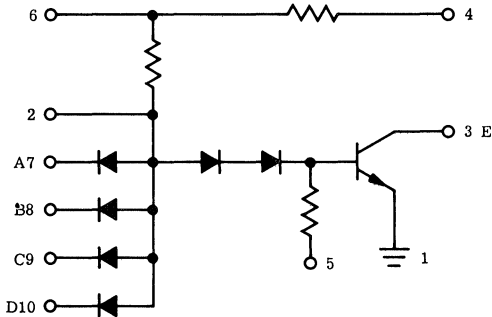

NAND ("UP" LEVEL = "1") NOR ("DOWN" LEVEL = "1")

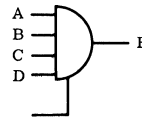

$E = \overline{ABCD}$

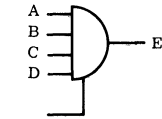

$E = \overline{A+B+C+D}$

3-INPUT NAND/NOR GATE MC252

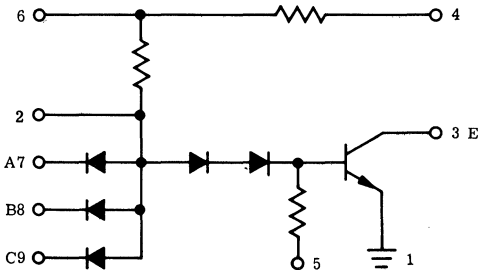

NAND ("UP" LEVEL = "1") NOR ("DOWN" LEVEL = "1")

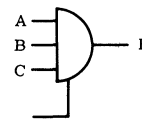

$E = \overline{ABC}$

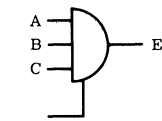

$E = \overline{A+B+C}$

MC251, MC252 (continued)

($V_6 = 4 \text{ Vdc}$, $V_5 = 2 \text{ Vdc}$, $V_1 = 0$,

ELECTRICAL CHARACTERISTICS $T_J = 25^\circ\text{C}$ unless otherwise noted)

Characteristic	Symbol	Minimum	Typical	Maximum	Unit
Output Breakdown Voltage ($I_3 = 5\mu\text{A}$, $V_5, 6, \bar{I} = 0$)	BV_3	6	-	-	Vdc
"1" Output Current ($V_{in} = 1.0\text{Vdc}$, $V_3 = 5\text{Vdc}$) ($V_{in} = 0.75\text{Vdc}$, $V_3 = 5\text{Vdc}$, $T_J = 75^\circ\text{C}$) ($V_{in} = 1.1\text{Vdc}$, $V_3 = 5\text{Vdc}$, $T_J = 0^\circ\text{C}$)	I_3 I_3 I_3	- - -	- - -	50 50 50	μA
"0" Output Current ($V_7 = 2.0\text{Vdc}$, $V_3 = 0.55\text{Vdc}$, $T_J = 0$ to 75°C)	I_3	10	-	-	mA
Input Breakdown Voltage* (Diode under test at 5Vdc , All other diodes = 0)	$BV_{7, 8, 9, 10}$	8	-	-	Vdc
Input Leakage Current* (Diode under test at 5Vdc , all other inputs = 0) (Diode under test at 5Vdc , all other inputs = 0, $T_J = 75^\circ\text{C}$)	$I_{7, 8, 9, 10}$	-	-	0.50 25	μA
Input Turn-Off Current* (Alternately $V_7, V_8, V_9, V_{10} = 0$) (Alternately $V_7, V_8, V_9, V_{10} = 0$, $T_J = 0$ to 75°C)	$I_{7, 8, 9, 10}$	-	-	-2.3 -2.5	mA
Output Capacitance ($V_3 = 2.0\text{Vdc}$, $V_7 = 0$, $V_{in} = 25\text{mVrms}$, $f = 1\text{mc}$, unused pins grounded)	C_3	-	-	15	pf
Input Capacitance* ($V_7 = 2\text{Vdc}$, $V_{in} = 25\text{mVrms}$, $f = 1\text{mc}$, unused pins grounded) ($V_8 = 2\text{Vdc}$, $V_{in} = 25\text{mVrms}$, $f = 1\text{mc}$, unused pins grounded) ($V_9 = 2\text{Vdc}$, $V_{in} = 25\text{mVrms}$, $f = 1\text{mc}$, unused pins grounded) ($V_{10} = 2\text{Vdc}$, $V_{in} = 25\text{mVrms}$, $f = 1\text{mc}$, unused pins grounded)	C_7 C_8 C_9 C_{10}	- - - -	- - - -	10 10 10 10	pf
Load Resistor Current ($V_4 = 0$)	I_4	-1.3	-	-2.85	mA
Power Consumption from Power Supply (Output "Off", $V_7 = 0$) (Output "On")		- -	- -	10 7	mW
Switching Times Turn-On Delay Turn-Off Delay	t_{on} t_{off}	- -	- -	60 60	nsec
Average Propagation Delay	t_{pd}	-	30	-	nsec

* Input Diode at pin 10 available on MC251 only

MC253

MC250 DTL SERIES

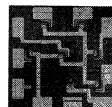

6-Input Diode Transistor Logic AND Gate.

MAXIMUM RATINGS ($T_A = 25^\circ\text{C}$)

Characteristic	Symbol	Rating	Unit
Applied Voltage	V_3 thru 8	+8	Vdc
	$V_2, 9$	± 8	
Forward Current	I_2 thru 10	30	mAdc
Operating Temperature Range	T_J	0 to 75	$^\circ\text{C}$
Storage Temperature Range	T_{stg}	-65 to +175	$^\circ\text{C}$

ELECTRICAL CHARACTERISTICS ($T_J = 25^\circ\text{C}$ unless otherwise noted)

Characteristic	Symbol	Minimum	Typical	Maximum	Unit
Diode Breakdown Voltage (I_3 thru 8 = 10 μAdc , $V_{10}=V_1=0$)	V_3 thru 8	8	-	-	Vdc
Diode Forward Voltage ($I_{10} = 2\text{mAdc}$, V_3 thru 8 = 0)	V_{10}	-	-	0.85	Vdc
Diode Reverse Leakage Current (V_3 thru 8 = 5Vdc, $V_{10}=V_1=0$) (V_3 thru 8 = 5Vdc, $V_{10}=V_1=0$, $T_J=75^\circ\text{C}$)	I_3 thru 8	-	-	0.50	μAdc
		-	-	25	
Input Capacitance (V_3 thru 8=2Vdc, $V_{10}=V_1=0$, $f=1\text{mc}$, $V_{in}=25\text{mVrms}$, unused inputs grounded)	C_3 thru 8	-	-	10	pf
Reverse Recovery Time (I_F 3 thru 8 = I_R 3 thru 8 = 2mAdc, $V_{10} = V_1 = 0$, recover to 0.2mAdc)	t_{rr} 3 thru 8	-	-	4	nsec
Resistor Current ($V_9 = 4\text{Vdc}$, $V_2 = 0$)	I_9	1.3	-	2.85	mAdc
Resistor Temperature Coefficient		-	0.1	-	$\%/^\circ\text{C}$
Diode Forward Conductance Change with Temperature	ΔV_F 3 thru 8	-	-1.7	-	$\text{mV}/^\circ\text{C}$

MC253 (continued)

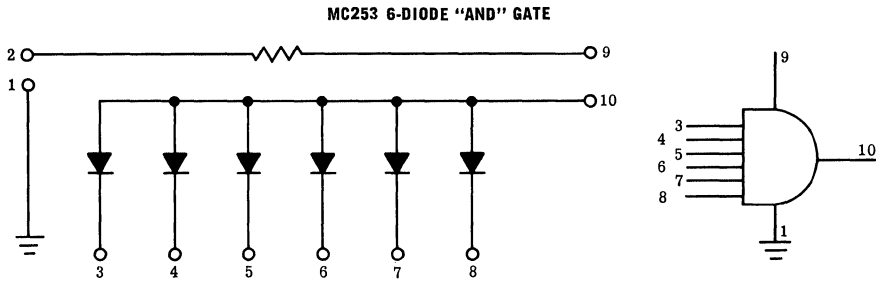

MC254

MC250 DTL SERIES



3-Input Diode Transistor Logic NAND/NOR Power Gate.

MAXIMUM RATINGS ($T_A = 25^\circ\text{C}$)

Characteristic	Symbol	Rating	Unit
Applied Voltage	$V_{7,8,9}$	+8	Vdc
	V_5	-6	
	$V_{3,6}$	+6	
Forward Current	I_5 thru 10	30	mAdc
Load Current	I_3	75	mAdc
Operating Temperature Range	T_J	0 to 75	$^\circ\text{C}$
Storage Temperature Range	T_{stg}	-65 to +175	$^\circ\text{C}$

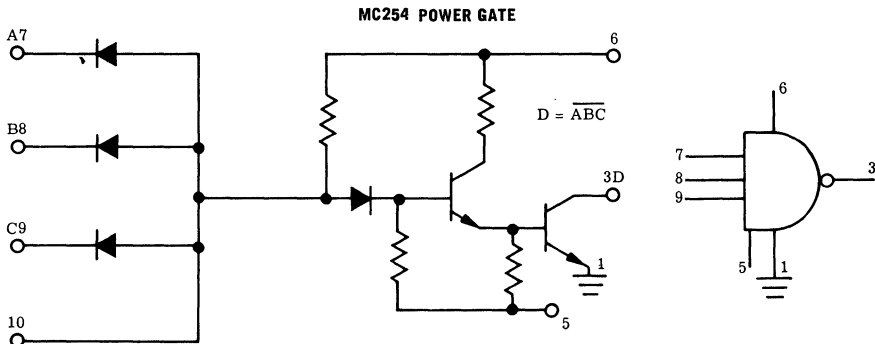

MC254 (continued)

($V_6 = 4$ Vdc, $V_5 = 2$ Vdc, $V_1 = 0$,
 $T_J = 25^\circ\text{C}$ unless otherwise noted)

ELECTRICAL CHARACTERISTICS

Characteristic	Symbol	Minimum	Typical	Maximum	Unit
Output Breakdown Voltage ($I_3 = 5\mu\text{A}$ dc, $V_7 = 0$)	BV_3	6	-	-	Vdc
"1" Output Current ($V_{7,8}$ or $9 = 1.0$ Vdc, $V_3 = 5$ Vdc) ($V_{7,8}$ or $9 = 0.75$ Vdc, $V_3 = 5$ Vdc, $T_J = 75^\circ\text{C}$) ($V_{7,8}$ or $9 = 1.1$ Vdc, $V_3 = 5$ Vdc, $T_J = 0^\circ\text{C}$)	I_3	-	-	100	μA dc
"0" Output Current ($V_{7,8}$ or $9 = 2.0$ Vdc, $V_3 = 0.55$, $T_J = 0$ to 75°C)	I_3	30	-	-	mA
Input Breakdown Voltage ($I_7 = 10\mu\text{A}$ dc, $V_8 = 0$) ($I_8 = 10\mu\text{A}$ dc, $V_7 = 0$) ($I_9 = 10\mu\text{A}$ dc, $V_7 = 0$)	BV_7 BV_8 BV_9	8.0 8.0 8.0	- - -	- - -	Vdc
Input Leakage Current ($V_7 = 5$ Vdc, $V_8 = 0$) ($V_7 = 5$ Vdc, $V_8 = 0$, $T_J = 75^\circ\text{C}$) ($V_8 = 5$ Vdc, $V_7 = 0$) ($V_8 = 5$ Vdc, $V_7 = 0$, $T_J = 75^\circ\text{C}$) ($V_9 = 5$ Vdc, $V_7 = 0$) ($V_9 = 5$ Vdc, $V_7 = 0$, $T_J = 75^\circ\text{C}$)	I_7 I_7 I_8 I_8 I_9 I_9	- - - - - -	- - - - - -	0.50 25 0.50 25 0.50 25	μA dc
Input Turn-Off Current (Alternately, $V_7, V_8, V_9 = 0$) (Alternately, $V_7, V_8, V_9 = 0$, $T_J = 0$ to 75°C) ($V_{10} = 0$)	I_7, I_8, I_9 I_7, I_8, I_9 I_{10}	- - -	- - -	-4.5 -5.5	mA
Output Capacitance ($V_3 = 2.0$ Vdc, $V_{in} = 25$ mVrms, $f = 1$ mc, unused pins grounded)	C_3	-	-	15	pf
Input Capacitance ($V_7 = 2.0$ Vdc, $V_{in} = 25$ mVrms, $f = 1$ mc, unused pins grounded) ($V_8 = 2.0$ Vdc, $V_{in} = 25$ mVrms, $f = 1$ mc, unused pins grounded) ($V_9 = 2.0$ Vdc, $V_{in} = 25$ mVrms, $f = 1$ mc, unused pins grounded)	C_7 C_8 C_9	- - -	- - -	10 10 10	pf
Power Supply (Output "OFF", $V_7 = 0$) (Output "ON")		- -	- -	23 66	mW
Switching Times Turn-On Delay Turn-Off Delay	t_{on} t_{off}	- -	- -	35 100	nsec
Average Propagation Delay	t_{pd}	-	40	-	nsec

MC255

MC250 DTL SERIES

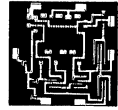

Diode Transistor Logic Line Driver.

MAXIMUM RATINGS ($T_J = 25^\circ\text{C}$)

Characteristic	Symbol	Rating	Unit
Applied Voltage	$V_{3,4,6}$ V_5 $V_{8,10}$	+6 -6 +8	Vdc
Forward Current	$I_{5,8,10}$	30	mAdc
Load Current	$I_{3,4,6}$	75	mAdc
Operating Temperature Range	T_J	0 to +75	$^\circ\text{C}$
Storage Temperature Range	T_{stg}	-65 to +175	$^\circ\text{C}$

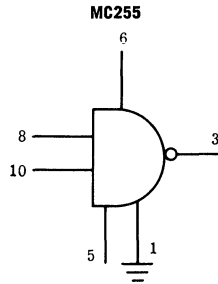

LINE DRIVER

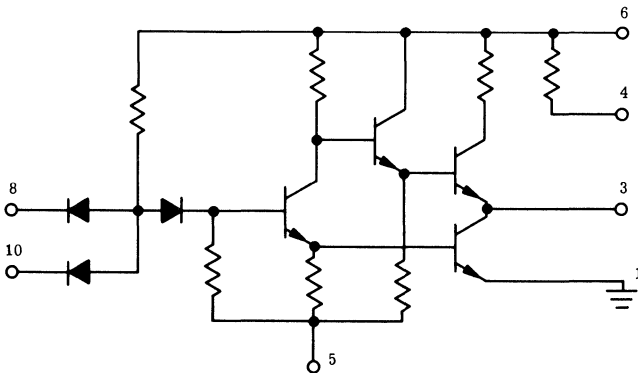

MC255(continued)

($V_6 = 4$ Vdc, $V_5 = 2$ Vdc, $V_1 = 0$,

ELECTRICAL CHARACTERISTICS $T_J = 25^\circ\text{C}$ unless otherwise noted)

Characteristic	Symbol	Minimum	Typical	Maximum	Unit
Output Saturation Voltage ($I_3 = 30\text{mA}_{dc}$, $T_J = 0^\circ\text{C}$ to $+75^\circ\text{C}$)	V_3	-	-	0.55	Vdc
Output Voltage, "Off" Level ($I_3 = 10\text{mA}_{dc}$, $V_8 = 0.7\text{V}_{dc}$, $T_J = 0$ to 75°C)	V_3	2.0	-	-	
Input Breakdown Voltage ($I_8 = 10\mu\text{A}_{dc}$, $V_{10} = 0$) ($I_{10} = 10\mu\text{A}_{dc}$, $V_8 = 0$)	BV_8 BV_{10}	8.0 8.0	- -	- -	Vdc
Input Leakage Current ($V_8 = 5\text{V}_{dc}$, $V_{10} = 0$) ($V_8 = 5\text{V}_{dc}$, $V_{10} = 0$, $T_J = 75^\circ\text{C}$) ($V_{10} = 5\text{V}_{dc}$, $V_8 = 0$) ($V_{10} = 5\text{V}_{dc}$, $V_8 = 0$, $T_J = 75^\circ\text{C}$)	I_8 I_8 I_{10} I_{10}	- - - -	- - - -	0.50 25 0.50 25	Adc
Turn-Off Current at Inputs ($V_8 = 0$) ($V_8 = 0$, $T_J = 0$ to $+75^\circ\text{C}$) ($V_{10} = 0$) ($V_{10} = 0$, $T_J = 0$ to $+75^\circ\text{C}$)	I_8 I_8 I_{10} I_{10}	- - - -	- - - -	-4.5 -4.7 -4.5 -4.7	mAdc
Load Resistor	R_{6-4}	-	125	-	Ohms
Input Capacitance ($V_8 = 2\text{V}_{dc}$, $V_{in} = 25\text{mV}_{rms}$, f=1mc, unused pins grounded) ($V_{10} = 2\text{V}_{dc}$, $V_{in} = 25\text{mV}_{rms}$, f=1mc, unused pins grounded)	C_8 C_{10}	- -	- -	10 10	pf
Power Consumption from Power Supply (Output "Off", $V_8 = 0$) (Output "On")		- -	- -	30 65	mW
Switching Times Turn-On Delay Turn-Off Delay	t_{on} t_{off}	- -	- -	90 60	nsec
Average Propagation Delay ($C_L = 1000\text{pf}$)	t_{pd}	-	50	-	nsec

MC256

MC250 DTL SERIES

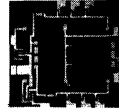

Dual (2-2) Input Diode Transistor Logic NAND/NOR Gate.

MAXIMUM RATINGS ($T_J = 25^\circ\text{C}$ unless otherwise noted)

Characteristic	Symbol	Rating	Unit
Applied Voltage	$V_{3,4,6 \text{ thru } 9}$	+8	Vdc
	V_5	-8	
	$V_{2,10}$	+6	
Forward Current	$I_{2,10}$	+30	mA _{dc}
	$I_2 \text{ thru } 4,$ $7 \text{ thru } 10$	-30	
Operating Temperature Range	T_J	0 to 75	$^\circ\text{C}$
Storage Temperature Range	T_{stg}	-65 to +175	$^\circ\text{C}$

MC256

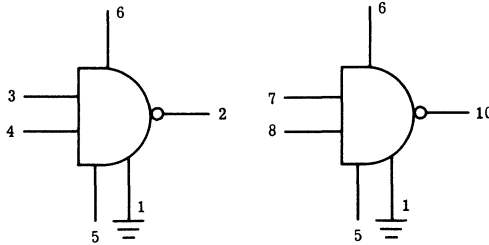

2-2 NAND/NOR GATE

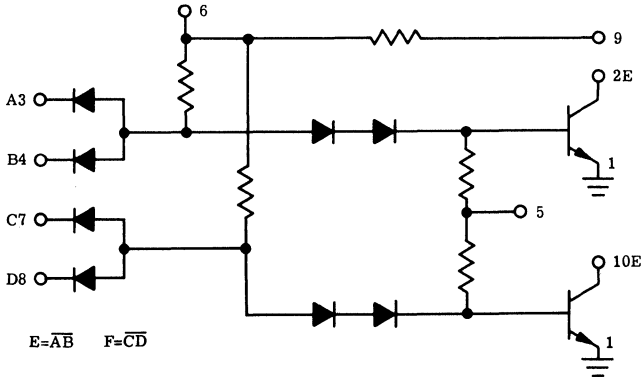

MC256 (continued)

ELECTRICAL CHARACTERISTICS

($V_6 = 4$ Vdc, $V_5 = 2$ Vdc, $V_1 = 0$, $T_J = 25^\circ\text{C}$ unless otherwise noted)

Characteristic	Symbol	Minimum	Typical	Maximum	Unit
Output Breakdown Voltage ($I_2 = 5\mu\text{A dc}$, $V_3 = 0$) ($I_{10} = 5\mu\text{A dc}$, $V_7 = 0$)	BV_2 BV_{10}	6 6	- -	- -	Vdc
"1" Output Current ($V_3 = 1.0$ Vdc, $V_2 = 5$ Vdc) ($V_3 = 0.75$ Vdc, $V_2 = 5$ Vdc, $T_J = 75^\circ\text{C}$) ($V_3 = 1.1$ Vdc, $V_2 = 5$ Vdc, $T_J = 0^\circ\text{C}$) ($V_7 = 1.0$ Vdc, $V_{10} = 5$ Vdc) ($V_7 = 0.75$ Vdc, $V_{10} = 5$ Vdc, $T_J = 75^\circ\text{C}$) ($V_7 = 1.1$ Vdc, $V_{10} = 5$ Vdc, $T_J = 0^\circ\text{C}$)	I_2 I_2 I_2 I_{10} I_{10} I_{10}	- - - - - -	- - - - - -	50 50 50 50 50 50	$\mu\text{A dc}$
"0" Output Current ($V_3 = 2.0$ Vdc, $V_2 = 0.55$ Vdc, $T_J = 0$ to 75°C) ($V_7 = 2.0$ Vdc, $V_{10} = 0.55$ Vdc, $T_J = 0$ to 75°C)	I_2 I_{10}	10 10	- -	- -	mA dc
Input BreakDown Voltage ($I_3 = 10\mu\text{A dc}$, $V_4 = 0$) ($I_4 = 10\mu\text{A dc}$, $V_3 = 0$) ($I_7 = 10\mu\text{A dc}$, $V_8 = 0$) ($I_8 = 10\mu\text{A dc}$, $V_7 = 0$)	BV_3 BV_4 BV_7 BV_8	8 8 8 8	- - - -	- - - -	Vdc
Input Leakage Current (Diode under test at 5Vdc, all other inputs = 0) (Diode under test at 5Vdc, all other inputs = 0, $T_J = 75^\circ\text{C}$)	I_3, I_4, I_7, I_8	- -	- -	0.50 25	$\mu\text{A dc}$
Input Turn-Off Current (Alternately $V_3, V_4, V_7, V_8 = 0$) (Alternately $V_3, V_4, V_7, V_8 = 0$, $T_J = 0$ to 75°C)	I_3, I_4, I_7, I_8	- -	- -	-2.3 -2.5	mA dc
Output Capacitance ($V_2 = 2.0$ Vdc, $V_3 = 0$, $V_{in} = 25\text{mV rms}$ $f = 1\text{mc}$, unused pins grounded) ($V_{10} = 2.0$ Vdc, $V_7 = 0$, $V_{in} = 25\text{mV rms}$, $f = 1\text{mc}$, unused pins grounded)	C_2 C_{10}	- -	- -	10 10	pf

MC256 (continued)

ELECTRICAL CHARACTERISTICS (continued)

Characteristic	Symbol	Minimum	Typical	Maximum	Unit
Input Capacitance ($V_3 = 2V_{dc}$, $V_{in} = 25mV_{rms}$, $f = 1mc$, unused pins grounded)	C_3	-	-	10	pf
($V_4 = 2V_{dc}$, $V_{in} = 25mV_{rms}$, $f = 1mc$, unused pins grounded)	C_4	-	-	10	
($V_7 = 2V_{dc}$, $V_{in} = 25mV_{rms}$, $f = 1mc$, unused pins grounded)	C_7	-	-	10	
($V_8 = 2V_{dc}$, $V_{in} = 25mV_{rms}$, $f = 1mc$, unused pins grounded)	C_8	-	-	10	
Load Resistor Current ($V_9 = 0$)	I_g	-1.3	-	-2.85	mAdc
Power Consumption from Power Supply (Output "Off", $V_3 = V_7 = 0$)		-	-	20	mW
(Output "On")		-	-	12	
Switching Times					nsec
Turn-On Delay	t_{on}	-	-	60	
Turn-Off Delay	t_{off}	-	-	60	
Average Propagation Delay	t_{pd}	-	30	-	nsec

MC257

MC250 DTL SERIES

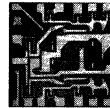

Dual (3-2) Input Diode Transistor Logic NAND/NOR Gate.

MAXIMUM RATINGS ($T_J = 25^\circ C$ unless otherwise noted)

Characteristic	Symbol	Rating	Unit
Applied Voltage	$V_{3,4,6}$ thru 9 V_5 $V_{2,10}$	+8 -8 +6	Vdc
Forward Current	$I_{2,10}$ I_2 thru 4, 7 thru 10	+30 -30	mAdc
Operating Temperature Range	T_J	-0 to +75	$^\circ C$
Storage Temperature Range	T_{stg}	-65 to +175	$^\circ C$

MC257 (continued)

ELECTRICAL CHARACTERISTICS

($V_s = 4$ Vdc, $V_5 = 2$ Vdc, $V_1 = 0$, $T_J = 25^\circ\text{C}$ unless otherwise noted)

Characteristic	Symbol	Minimum	Typical	Maximum	Unit
Output Breakdown Voltage ($I_2 = 5\mu\text{A}$ dc, $V_3 = 0$) ($I_{10} = 5\mu\text{A}$ dc, $V_7 = 0$)	BV_2 BV_{10}	6 6	- -	- -	Vdc
"1" Output Current ($V_3 = 1.0$ Vdc, $V_2 = 5$ Vdc ($V_3 = 0.75$ Vdc, $V_2 = 5$ Vdc, $T_J = 75^\circ\text{C}$) ($V_3 = 1.1$ Vdc, $V_2 = 5$ Vdc, $T_J = 0^\circ\text{C}$) ($V_7 = 1.0$ Vdc, $V_{10} = 5$ Vdc) ($V_7 = 0.75$ Vdc, $V_{10} = 5$ Vdc, $T_J = 75^\circ\text{C}$) ($V_7 = 1.1$ Vdc, $V_{10} = 5$ Vdc, $T_J = 0^\circ\text{C}$)	I_2 I_2 I_2 I_{10} I_{10} I_{10}	- - - - - -	- - - - - -	50 50 50 50 50 50	μA dc
"0" Output Current ($V_3 = 2.0$ Vdc, $V_2 = 0.55$ Vdc, $T_J = 0$ to 75°C) ($V_7 = 2.0$ Vdc, $V_{10} = 0.55$ Vdc, $T_J = 0$ to 75°C)	I_2 I_{10}	10 10	- -	- -	mA
Input Breakdown Voltage ($I_3 = 10\mu\text{A}$ dc, $V_4 = 0$) ($I_4 = 10\mu\text{A}$ dc, $V_3 = 0$) ($I_7 = 10\mu\text{A}$ dc, $V_8 = 0$) ($I_8 = 10\mu\text{A}$ dc, $V_7 = 0$) ($I_9 = 10\mu\text{A}$ dc, $V_7 = 0$)	BV_3 BV_4 BV_7 BV_8 BV_9	8 8 8 8 8	- - - - -	- - - - -	Vdc
Input Leakage Current (Diode under test at 5Vdc, all other inputs = 0) (Diode under test at 5Vdc, all other inputs = 0, $T_J = 75^\circ\text{C}$)	$I_3, I_4, I_7,$ I_8, I_9	- -	- -	0.50 25	μA dc
Input Turn-Off Current (Alternately $V_3, V_4, V_7, V_8, V_9 = 0$) (Alternately $V_3, V_4, V_7, V_8, V_9 = 0$, $T_J = 0$ to 75°C)	$I_3, I_4, I_7,$ I_8, I_9	- -	- -	-2.3 -2.5	mA
Output Capacitance ($V_2 = 2.0$ Vdc, $V_3 = 0$, $V_{in} = 25$ mVrms, $f = 1$ mc, unused pins grounded) ($V_{10} = 2.0$ Vdc, $V_7 = 0$, $V_{in} = 25$ mVrms, $f = 1$ mc, unused pins grounded)	C_2 C_{10}	- -	- -	10 10	pf

MC257 (continued)

ELECTRICAL CHARACTERISTICS (continued)

Characteristic	Symbol	Minimum	Typical	Maximum	Unit
Input Capacitance ($V_3 = 2V_{dc}$, $V_{in} = 25mV_{rms}$, $f = 1mc$, unused pins grounded) ($V_4 = 2V_{dc}$, $V_{in} = 25mV_{rms}$, $f = 1mc$, unused pins grounded) ($V_7 = 2V_{dc}$, $V_{in} = 25mV_{rms}$, $f = 1mc$, unused pins grounded) ($V_8 = 2V_{dc}$, $V_{in} = 25mV_{rms}$, $f = 1mc$, unused pins grounded) ($V_9 = 2V_{dc}$, $V_{in} = 25mV_{rms}$, $f = 1mc$, unused pins grounded)	C_3	-	-	10	pf
	C_4	-	-	10	
	C_7	-	-	10	
	C_8	-	-	10	
	C_9	-	-	10	
Power Consumption from Power Supply (Output "Off", $V_3 = V_7 = 0$) (Output "On")	-	-	-	20 12	mW
Switching Times Turn-On Delay Turn-Off Delay	t_{on} t_{off}	-	-	60 60	nsec
Average Propagation Delay	t_{pd}	-	30	-	nsec

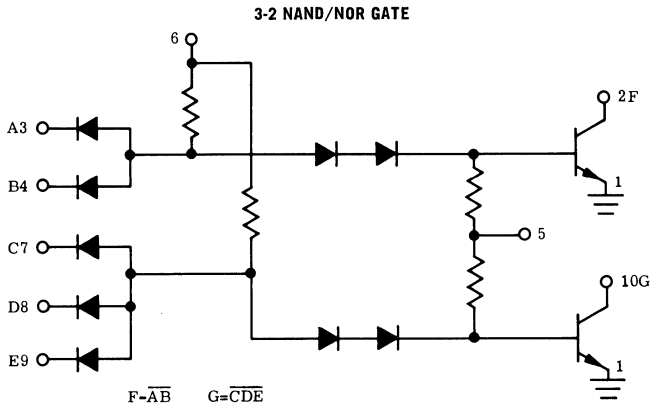
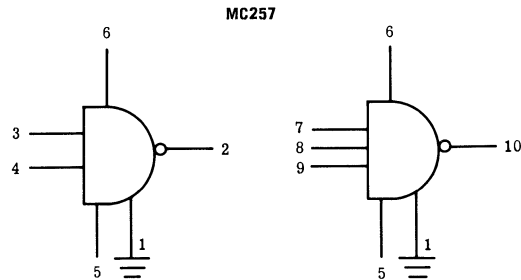

MC258

MC250 DTL SERIES



Dual (3-2) Input Diode Transistor Logic NAND/NOR Gate.

MAXIMUM RATINGS ($T_J = 25^\circ\text{C}$ unless otherwise noted)

Characteristic	Symbol	Rating	Unit
Applied Voltage	$V_{3,4,6 \text{ thru } 9}$	+8	Vdc
	V_5	-8	
	$V_{2,10}$	+6	
Forward Current	$I_{2,10}$	+30	mA _{dc}
	$I_{2 \text{ thru } 4, 7 \text{ thru } 10}$	-30	
Operating Temperature Range	T_J	0 to +75	$^\circ\text{C}$
Storage Temperature Range	T_{stg}	-65 to +175	$^\circ\text{C}$

MC258

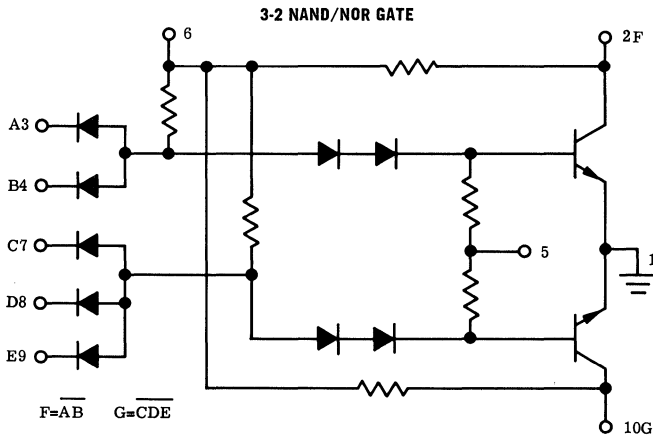
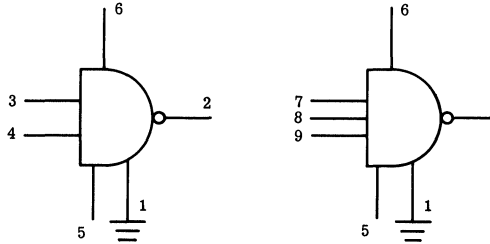

MC258 (continued)

ELECTRICAL CHARACTERISTICS

($V_6 = 4$ Vdc, $V_5 = 2$ Vdc, $V_1 = 0$, $T_J = 25^\circ\text{C}$ unless otherwise noted)

Characteristic	Symbol	Minimum	Typical	Maximum	Unit
Output Saturation Voltage ($I_2 = 8\text{mA dc}$, $V_3 = V_4 = 2\text{Vdc}$, $T_J = 0$ to 75°C) ($I_{10} = 8\text{mA dc}$, $V_7 = V_8 = V_9 = 2\text{Vdc}$, $T_J = 0$ to 75°C)	V_2 V_{10}	- -	- -	0.55 0.55	Vdc
Output "Off" Voltage ($I_2 = 100\mu\text{A dc}$, $V_3 = 1.0\text{Vdc}$ ($I_2 = 100\mu\text{A dc}$, $V_3 = 0.75\text{Vdc}$, $T_J = 75^\circ\text{C}$) ($I_2 = 100\mu\text{A dc}$, $V_3 = 1.1\text{Vdc}$, $T_J = 0^\circ\text{C}$) ($I_{10} = 100\mu\text{A dc}$, $V_7 = 1.0\text{Vdc}$ ($I_{10} = 100\mu\text{A dc}$, $V_7 = 0.75\text{Vdc}$, $T_J = 75^\circ\text{C}$) ($I_{10} = 100\mu\text{A dc}$, $V_7 = 1.1\text{Vdc}$, $T_J = 0^\circ\text{C}$)	V_2 V_2 V_2 V_{10} V_{10} V_{10}	3.5 3.5 3.5 3.5 3.5 3.5	- - - - - -	- - - - - -	Vdc
Input Breakdown Voltage ($I_3 = 10\mu\text{A dc}$, $V_4 = 0$) ($I_4 = 10\mu\text{A dc}$, $V_3 = 0$) ($I_7 = 10\mu\text{A dc}$, $V_8 = 0$) ($I_8 = 10\mu\text{A dc}$, $V_7 = 0$) ($I_9 = 10\mu\text{A dc}$, $V_7 = 0$)	BV_3 BV_4 BV_7 BV_8 BV_9	8 8 8 8 8	- - - - -	- - - - -	Vdc
Input Leakage Current (Diode under test at 5Vdc, all other inputs = 0) (Diode under test at 5Vdc, all other inputs = 0, $T_J = 75^\circ\text{C}$)	$I_3, I_4, I_7,$ I_8, I_9	- -	- -	0.50 25	$\mu\text{A dc}$
Input Turn-Off Current (Alternately $V_3, V_4, V_7, V_8, V_9 = 0$) (Alternately $V_3, V_4, V_7, V_8, V_9 = 0$, $T_J = 0$ to 75°C)	$I_3, I_4, I_7,$ I_8, I_9	- -	- -	-2.3 -2.5	mA dc
Output Capacitance ($V_2 = 2.0\text{Vdc}$, $V_3 = 0$, $V_{in} = 25\text{mVrms}$, $f = 1\text{mc}$, unused pins grounded) ($V_{10} = 2.0\text{Vdc}$, $V_7 = 0$, $V_{in} = 25\text{mVrms}$, $f = 1\text{mc}$, unused pins grounded)	C_2 C_{10}	- -	- -	10 10	pf

MC258 (continued)

ELECTRICAL CHARACTERISTICS (continued)

Characteristic	Symbol	Minimum	Typical	Maximum	Unit
Input Capacitance ($V_3 = 2V_{dc}$, $V_{in} = 25mV_{rms}$, $f = 1mc$, unused pins grounded)	C_3	-	-	10	pf
($V_4 = 2V_{dc}$, $V_{in} = 25mV_{rms}$, $f = 1mc$, unused pins grounded)	C_4	-	-	10	
($V_7 = 2V_{dc}$, $V_{in} = 25mV_{rms}$, $f = 1mc$, unused pins grounded)	C_7	-	-	10	
($V_8 = 2V_{dc}$, $V_{in} = 25mV_{rms}$, $f = 1mc$, unused pins grounded)	C_8	-	-	10	
($V_9 = 2V_{dc}$, $V_{in} = 25mV_{rms}$, $f = 1mc$, unused pins grounded)	C_9	-	-	10	
Power Consumption Power Supply (Output "Off", $V_3 = V_7 = 0$) (output "On")	-	-	-	20 34	mW
Switching Times Turn-On Delay	t_{on}	-	-	60	nsec
Turn-Off Delay	t_{off}	-	-	60	
Average Propagation Delay	t_{pd}	-	30	-	nsec

MC259

MC250 DTL SERIES



Diode Transistor Logic Flip-Flop.

MAXIMUM RATINGS ($T_J = 25^\circ C$)

Characteristic	Symbol	Rating	Unit
Applied Voltage	$V_{2,3,4,6,7}$ $V_{8,9,10}$ V_5	+8 -8	Vdc
Forward Current	$I_{3,8}$ $I_{2,3,4,7}$ thru 10	+50 -30	mA _{dc}
Operating Temperature Range	T_J	0 to +75	$^\circ C$
Storage Temperature Range	T_{stg}	-65 to +175	$^\circ C$

MC259 (continued)

ELECTRICAL CHARACTERISTICS

($V_5 = 4$ Vdc, $V_5 = 2$ Vdc, $V_1 = 0$, $T_J = 25^\circ\text{C}$ unless otherwise noted)

Characteristic	Logic Symbol	Logic State	Symbol	Minimum	Typical	Maximum	Unit
OUTPUT LEVEL							
"Off" Voltage ($I_8 = -200\mu\text{A}$ dc, $V_4 = 0.55\text{V}$ dc, $V_7 = 2.0\text{V}$ dc, $T_A = 0$ to 75°C)	Q	1	V_8	2.5	-	-	Vdc
($I_3 = -200\mu\text{A}$ dc, $V_4 = 2.0\text{V}$ dc, $V_7 = 0.6\text{V}$ dc, $T_A = 0$ to 75°C)	\bar{Q}	1	V_3	2.5	-	-	Vdc
"On" Voltage ($I_8 = 16\text{mA}$ dc, $V_4 = 2.0\text{V}$ dc, $V_7 = 0.55\text{V}$ dc, $T_A = 0$ to 75°C)	Q	0	V_8	-	-	0.55	Vdc
($I_3 = 16\text{mA}$ dc, $V_4 = 0.55\text{V}$ dc, $V_7 = 2.0\text{V}$ dc, $T_A = 0$ to 75°C)	\bar{Q}	0	V_3	-	-	0.55	Vdc
DIRECT SET-RESET INPUTS							
"Up" Voltage	S_D	1	V_4	2.0	-	-	Vdc
	R_D	1	V_7	2.0	-	-	Vdc
"Down" Voltage	S_C	0	V_4	-	-	0.55	Vdc
	R_D	0	V_7	-	-	0.55	Vdc
"Up" Current ($V_4 = 5\text{V}$ dc, $T_J = 75^\circ\text{C}$)	S_D	1	I_4	-	-	25	μA dc
($V_7 = 5\text{V}$ dc, $T_J = 75^\circ\text{C}$)	R_D	1	I_7	-	-	25	μA dc
"Down" Current ($V_4 = 0$)	S_D	0	I_4	-	-	-2.3	mA dc
($V_7 = 0$)	R_D	0	I_7	-	-	-2.3	mA dc
CLOCKED SET-RESET INPUTS							
"Down" Current ($V_{9,10} = 0$, $T_J = 25^\circ\text{C}$)	S_C	0	I_9	-	-	-1.75	mA dc
($V_{2,10} = 0$, $T_J = 25^\circ\text{C}$)	R_C	0	I_2	-	-	-1.75	mA dc
Effective Clock Input Capacitance			C_{10}	-	75	-	pf
SWITCHING TIME							
Clocked Set-Reset Mode							
Turn-On Delay			t_{on}	-	-	100	nsec
Turn-Off Delay			t_{off}	-	-	75	nsec
Direct Set-Reset Mode							
Turn-On Delay			t_{on}	-	-	100	nsec
Turn-Off Delay			t_{off}	-	-	75	nsec
POWER CONSUMPTION							
				-	16	-	mW

MC259 (continued)

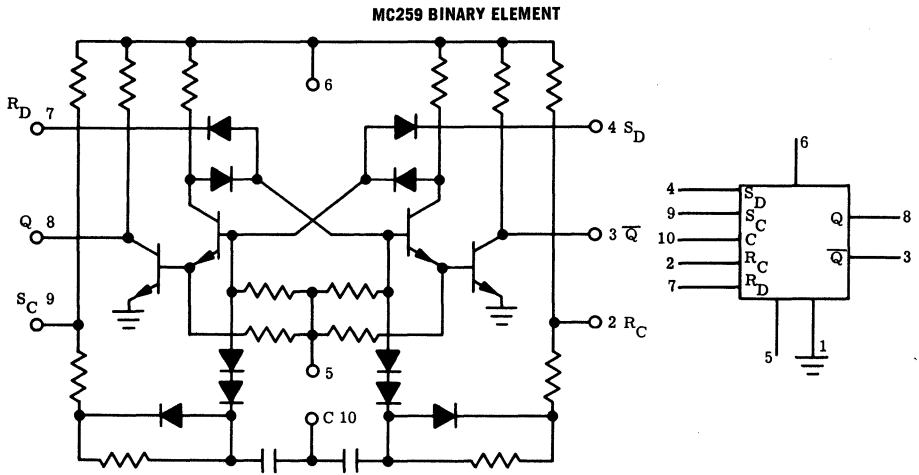

MC260

MC250 DTL SERIES

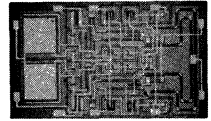

Diode Transistor Logic Flip-Flop.

MAXIMUM RATINGS ($T_J = 25^\circ\text{C}$ unless otherwise noted)

Characteristic	Symbol	Rating	Unit
Applied Voltage	$V_{2,3,4,6,7,8,9,10}$ V_5	+8 -8	Vdc
Forward Current	$I_{3,7}$ $I_{2,3,4,7}$ thru 10	+50 -30	mAdc
Operating Temperature Range	T_J	0 to +75	$^\circ\text{C}$
Storage Temperature Range	T_{stg}	-65 to +175	$^\circ\text{C}$

MC260 (continued)

ELECTRICAL CHARACTERISTICS ($V_6 = 4$ Vdc, $V_5 = 2$ Vdc, $V_1 = 0$, $T_J = 25^\circ\text{C}$)

Characteristic	Logic Symbol	Logic State	Symbol	Minimum	Typical	Maximum	Unit
OUTPUT LEVEL "Off" Voltage ($I_7 = -200\mu\text{A dc}$, $V_4 = 0.55\text{V dc}$, Momentarily connect pin 2 to -2.0V dc , $T_J = 0$ to 75°C) ($I_3 = -200\mu\text{A dc}$, $V_4 = 2.0\text{V dc}$, $T_J = 0$ to 75°C) "On" Voltage ($I_7 = 16\text{mA dc}$, $V_4 = 2.0\text{V dc}$, Momentarily connect pin 2 to -2.0V dc , $T_J = 0$ to 75°C) ($I_3 = 16\text{mA dc}$, $V_4 = 0.55\text{V dc}$, $T_J = 0$ to 75°C)	Q	1	V_7	2.5	-	-	Vdc
	\bar{Q}	1	V_3	2.5	-	-	Vdc
	Q	0	V_7	-	-	0.55	Vdc
	\bar{Q}	0	V_3	-	-	0.55	Vdc
DIRECT SET INPUT CURRENT "Up" Current ($V_4 = 5\text{V dc}$, $T_J = 75^\circ\text{C}$) "Down" Current ($V_4 = 0$)	S_D	1	I_4	-	-	25	$\mu\text{A dc}$
	S_D	0	I_4	-	-	-2.3	mAdc
CLOCKED SET-RESET INPUTS "Down" Current ($V_{8,9} = 0$, $T_J = 75^\circ\text{C}$) ($V_{2,10} = 0$, $T_J = 75^\circ\text{C}$) Effective Clock Input Capacitance ($V_9 = 2.0\text{V dc}$, $V_8 = 0\text{V dc}$) ($V_{10} = 2.0\text{V dc}$, $V_2 = 0\text{V dc}$) ($V_8 = 4.0\text{V dc}$)	S_C	0	I_8	-	-	-1.75	mAdc
	R_C	0	I_2	-	-	-1.75	mAdc
	C_9			-	75	-	pf
	C_{10}			-	75	-	pf
SWITCHING TIME Clocked Set-Reset Mode Turn-On Delay Turn-Off Delay Direct Set Mode Turn-On Delay Turn-Off Delay			t_{on}	-	-	100	nsec
			t_{off}	-	-	75	nsec
			t_{on}	-	-	100	nsec
			t_{off}	-	-	75	nsec
POWER CONSUMPTION				-	16	-	mW

MC260 (continued)

MC260

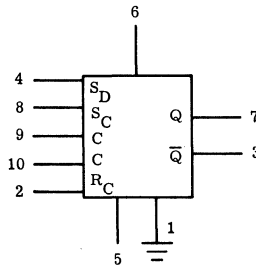
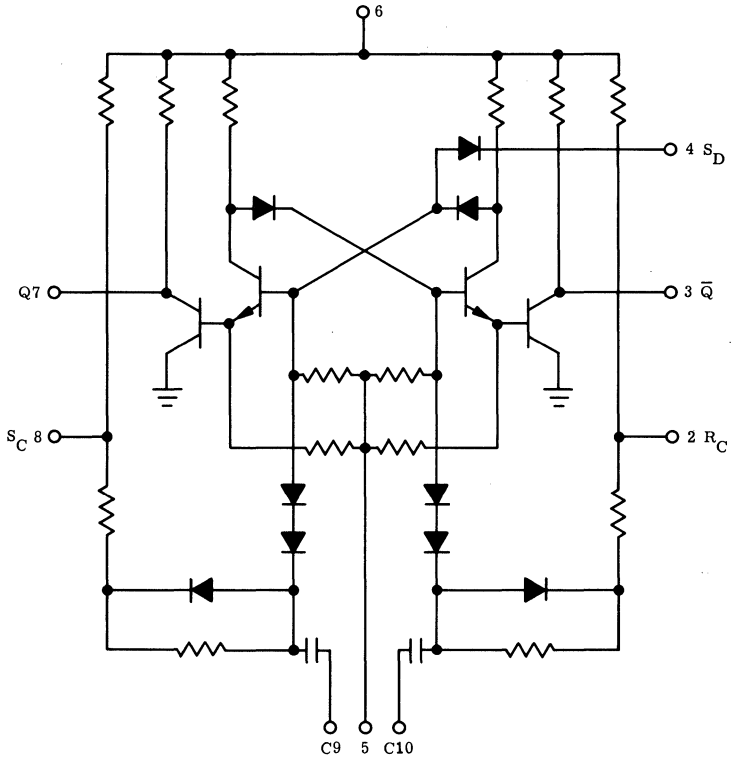

mc262

MC250 DTL SERIES



Dual (3-3) Input Diode Transistor Logic NAND/NOR Gate.

MAXIMUM RATINGS ($T_J = 25^\circ\text{C}$ unless otherwise noted)

Characteristic	Symbol	Rating	Unit
Applied Voltage	$V_{3 \text{ thru } 9}$	+8	Vdc
	$V_{2, 10}$	+6	
Forward Current	$I_{2, 10}$	+30	mAdc
	$I_2 \text{ thru } 5,$ $7 \text{ thru } 10$	-30	
Operating Temperature Range	T_J	0 to +75	$^\circ\text{C}$
Storage Temperature Range	T_{stg}	-65 to +175	$^\circ\text{C}$

MC262

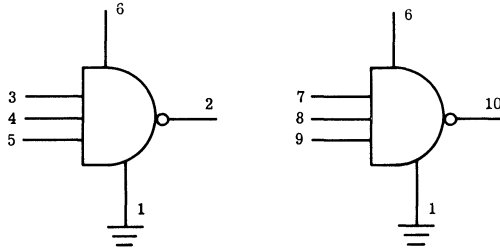

3-3 NAND/NOR GATE

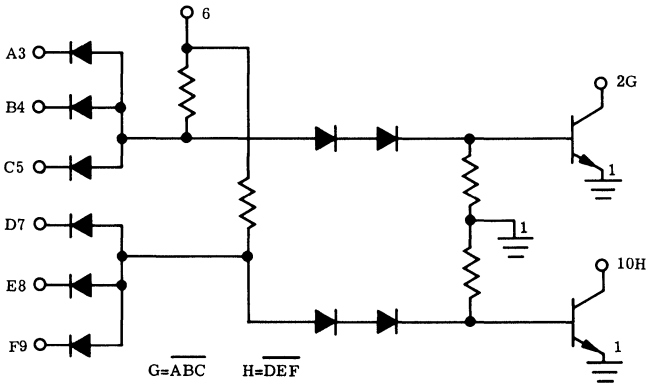

MC262 (continued)

ELECTRICAL CHARACTERISTICS

($V_6 = 4$ Vdc, $V_5 = 2$ Vdc, $V_1 = 0$, $T_J = 25^\circ\text{C}$ unless otherwise noted)

Characteristic	Symbol	Minimum	Typical	Maximum	Unit
Output Breakdown Voltage ($I_2 = 5\mu\text{Adc}$, $V_3 = 0$) ($I_{10} = 5\mu\text{Adc}$, $V_7 = 0$)	BV_2 BV_{10}	6 6	- -	- -	Vdc
"1" Output Current ($V_3 = 1.0\text{Vdc}$, $V_2 = 5\text{Vdc}$) ($V_3 = 0.75\text{Vdc}$, $V_2 = 5\text{Vdc}$, $T_J = 75^\circ\text{C}$) ($V_3 = 1.1\text{Vdc}$, $V_2 = 5\text{Vdc}$, $T_J = 0^\circ\text{C}$) ($V_7 = 1.0\text{Vdc}$, $V_{10} = 5\text{Vdc}$) ($V_7 = 0.75\text{Vdc}$, $V_{10} = 5\text{Vdc}$, $T_J = 75^\circ\text{C}$) ($V_7 = 1.1\text{Vdc}$, $V_{10} = 5\text{Vdc}$, $T_J = 0^\circ\text{C}$)	I_2 I_2 I_2 I_{10} I_{10} I_{10}	- - - - - -	- - - - - -	50 50 50 50 50 50	Adc
"0" Output Current ($V_{in} = 2\text{Vdc}$, $V_2 = 0.55$, $T_J = 0$ to 75°C) ($V_{in} = 2\text{Vdc}$, $V_{10} = 0.55$, $T_J = 0$ to 75°C)	I_2 I_{10}	10 10	- -	- -	mAdc
Input Breakdown Voltage ($I_3 = 10\mu\text{Adc}$, $V_4 = 0$) ($I_4 = 10\mu\text{Adc}$, $V_3 = 0$) ($I_5 = 10\mu\text{Adc}$, $V_3 = 0$) ($I_7 = 10\mu\text{Adc}$, $V_8 = 0$) ($I_8 = 10\mu\text{Adc}$, $V_7 = 0$) ($I_9 = 10\mu\text{Adc}$, $V_7 = 0$)	BV_3 BV_4 BV_5 BV_7 BV_8 BV_9	8 8 8 8 8 8	- - - - - -	- - - - - -	Vdc
Input Leakage Current (Diode under test at 5Vdc, all other inputs = 0) (Diode under test at 5Vdc, all other inputs = 0, $T_J = 75^\circ\text{C}$)	$I_3, I_4, I_5,$ I_7, I_8, I_9	- -	- -	0.50 25	μAdc
Input Turn-Off Current (Alternately $V_3, V_4, V_5, V_7, V_8,$ $V_9 = 0$) (Alternately $V_3, V_4, V_5, V_7, V_8,$ $V_9 = 0, T_J = 0$ to 75°C)	$I_3, I_4, I_5,$ I_7, I_8, I_9	- -	- -	-2.3 -2.5	mAdc

MC262 (continued)

ELECTRICAL CHARACTERISTICS (continued)

Characteristic	Symbol	Minimum	Typical	Maximum	Unit
Output Capacitance ($V_2 = 2.0Vdc$, $V_3 = 0$, $V_{in} = 25mVrms$, $f = 1mc$, unused pins grounded) ($V_{10} = 2.0Vdc$, $V_7 = 0$, $V_{in} = 25mVrms$, $f = 1mc$, unused pins grounded)	C_2 C_{10}	- -	- -	10 10	pf
Input Capacitance ($V_3 = 2Vdc$, $V_{in} = 25mVrms$, $f = 1mc$, unused pins grounded) ($V_4 = 2Vdc$, $V_{in} = 25mVrms$, $f = 1mc$, unused pins grounded) ($V_5 = 2Vdc$, $V_{in} = 25mVrms$, $f = 1mc$, unused pins grounded) ($V_7 = 2Vdc$, $V_{in} = 25mVrms$, $f = 1mc$, unused pins grounded) ($V_8 = 2Vdc$, $V_{in} = 25mVrms$, $f = 1mc$, unused pins grounded) ($V_9 = 2Vdc$, $V_{in} = 25mVrms$, $f = 1mc$,	C_3 C_4 C_5 C_7 C_8 C_9	- - - - - -	- - - - - -	10 10 10 10 10 10	pf
Power Consumption from Power Supply (Output "Off", $V_3 = V_7 = 0$) (Output "On")		- -	- -	19 12	mW
Switching Times Turn-On Delay Turn-Off Delay	t_{on} t_{off}	- -	- -	60 60	nsec
Average Propagation Delay	t_{pd}	-	30	-	nsec

MC263

MC250 DTL SERIES

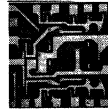

Dual (3-3) Input Diode Transistor Logic NAND/NOR Gate.

MAXIMUM RATINGS ($T_J = 25^\circ C$ unless otherwise noted)

Characteristic	Symbol	Rating	Unit
Applied Voltage	V_3 thru 9 $V_{2,10}$	+8 +6	Vdc mAdc
Forward Current	$I_{2,10}$ I_2 thru 5, 7 thru 10	+30 -30	
Operating Temperature Range	T_J	0 to 75	$^\circ C$
Storage Temperature Range	T_{stg}	-65 to +175	$^\circ C$

MC263 (continued)

ELECTRICAL CHARACTERISTICS

($V_s = 4$ Vdc, $V_5 = 2$ Vdc, $V_1 = 0$, $T_J = 25^\circ\text{C}$ unless otherwise noted)

Characteristic	Symbol	Minimum	Typical	Maximum	Unit
Output Breakdown Voltage ($I_2 = 5\mu\text{A dc}$, $V_3 = 0$) ($I_{10} = 5\mu\text{A dc}$, $V_7 = 0$)	BV_2	6	-	-	Vdc
	BV_{10}	6	-	-	
Output Saturation Voltage ($I_2 = 8\text{mA dc}$, $V_3 = V_4 = V_5 = 2\text{Vdc}$, $T_J = 0$ to 75°C) ($I_{10} = 8\text{mA dc}$, $V_7 = V_8 = V_9 = 2\text{Vdc}$, $T_J = 0$ to 75°C)	V_2	-	-	0.55	Vdc
	V_{10}	-	-	0.55	
Output "Off" Voltage ($I_2 = 100\mu\text{A dc}$, $V_3 = 0.7\text{Vdc}$, $T_J = 0$ to 75°C) ($I_{10} = 100\mu\text{A dc}$, $V_7 = 0.7\text{Vdc}$, $T_J = 0$ to 75°C)	V_2	3.5	-	-	Vdc
	V_{10}	3.5	-	-	
Input Breakdown Voltage ($I_3 = 10\mu\text{A dc}$, $V_4 = 0$) ($I_4 = 10\mu\text{A dc}$, $V_3 = 0$) ($I_5 = 10\mu\text{A dc}$, $V_3 = 0$) ($I_7 = 10\mu\text{A dc}$, $V_3 = 0$) ($I_8 = 10\mu\text{A dc}$, $V_7 = 0$) ($I_9 = 10\mu\text{A dc}$, $V_7 = 0$)	BV_3	8	-	-	Vdc
	BV_4	8	-	-	
	BV_5	8	-	-	
	BV_7	8	-	-	
	BV_8	8	-	-	
	BV_9	8	-	-	
Input Leakage Current (Diode under test at 5Vdc, all other inputs = 0) (Diode under test at 5Vdc, all other inputs = 0, $T_J = 75^\circ\text{C}$)	$I_3, I_4, I_5,$ I_7, I_8, I_9	-	-	0.500	$\mu\text{A dc}$
		-	-	25	
Input Turn-Off Current (Alternately $V_3, V_4, V_5, V_7, V_8,$ $V_9 = 0$) (Alternately $V_3, V_4, V_5, V_7, V_8,$ $V_9 = 0, T_J = 0$ to 75°C)	$I_3, I_4, I_5,$ I_7, I_8, I_9	-	-	-2.3	mA dc
		-	-	-2.3	
Output Capacitance ($V_2 = 2.0\text{Vdc}$, $V_3 = 0$, $V_{in} = 25\text{mVrms}$, $f = 1\text{mc}$, unused pins grounded) ($V_{10} = 2.0\text{Vdc}$, $V_7 = 0$, $V_{in} = 25\text{mVrms}$, $f = 1\text{mc}$, unused pins grounded)	C_2	-	-	10	pf
	C_{10}	-	-	10	

MC263 (continued)

ELECTRICAL CHARACTERISTICS (continued)

Characteristic	Symbol	Minimum	Typical	Maximum	Unit		
Input Capacitance ($V_3 = 2V_{dc}$, $V_{in} = 25mV_{rms}$, $f = 1mc$, unused pins grounded) ($V_4 = 2V_{dc}$, $V_{in} = 25mV_{rms}$, $f = 1mc$, unused pins grounded) ($V_5 = 2V_{dc}$, $V_{in} = 25mV_{rms}$, $f = 1mc$, unused pins grounded) ($V_7 = 2V_{dc}$, $V_{in} = 25mV_{rms}$, $f = 1mc$, unused pins grounded) ($V_8 = 2V_{dc}$, $V_{in} = 25mV_{rms}$, $f = 1mc$, unused pins grounded) ($V_9 = 2V_{dc}$, $V_{in} = 25mV_{rms}$, $f = 1mc$, unused pins grounded)	C_3	-	-	10	pf		
	C_4	-	-	10			
	C_5	-	-	10			
	C_7	-	-	10			
	C_8	-	-	10			
	C_9	-	-	10			
	Power Consumption from Power Supply (Output "Off", $V_3 = V_7 = 0$) (Output "On")	-	-	-		19 33	mW
	Switching Times Turn-On Delay Turn-Off Delay	t_{on} t_{off}	- -	- -		60 60	
	Average Propagation Delay	t_{pd}	-	30		-	nsec

MC263

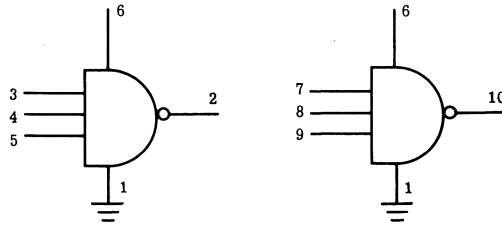

3-3 NAND/NOR GATE

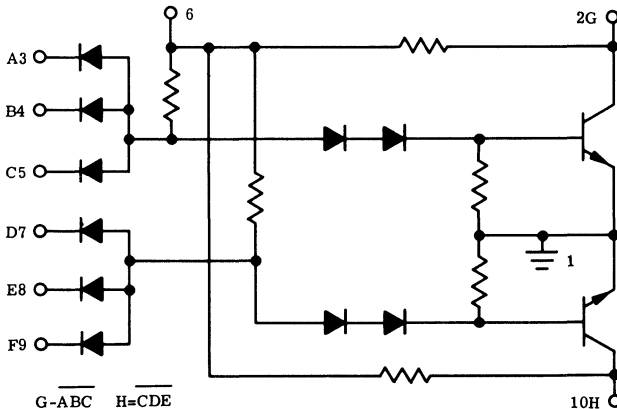

MC265

MC250 DTL SERIES

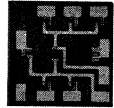

Dual (3-3) Input Diode Transistor Logic AND Gate.

MAXIMUM RATINGS ($T_A = 25^\circ\text{C}$)

Characteristic	Symbol	Rating	Unit
Applied Voltage	$V_{2,3,7,7 \text{ thru } 10}$ V_6	+8	Vdc
		± 8	
Forward Current	$I_2 \text{ thru } 10$	± 30	mAdc
Operating Temperature Range	T_J	0 to +75	$^\circ\text{C}$
Storage Temperature Range	T_{stg}	-65 to +175	$^\circ\text{C}$

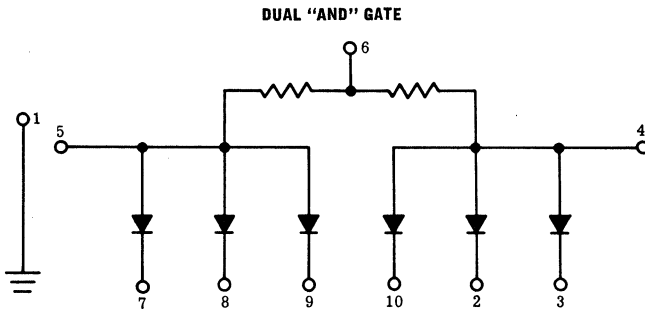
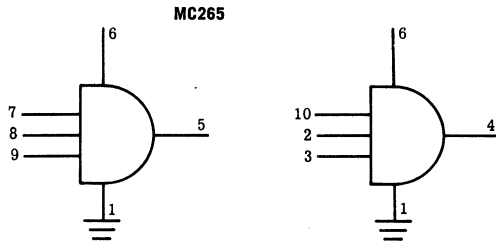

MC265 (continued)

ELECTRICAL CHARACTERISTICS

Characteristic	Symbol	Minimum	Typical	Maximum	Unit
Diode Breakdown Voltage ($I_{2,3,10} = 10\mu\text{A dc}$, $V_4 = V_1 = 0$) ($I_{7,8,9} = 10\mu\text{A dc}$, $V_5 = V_1 = 0$)	$V_{2,3,10}$ $V_{7,8,9}$	8 8	- -	- -	Vdc
Diode Forward Voltage ($I_4 = 2\text{mA dc}$, $V_{2,3,10} = V_1 = 0$) ($I_5 = 2\text{mA dc}$, $V_{7,8,9} = V_1 = 0$)	V_4 V_5	- -	- -	0.85 0.85	Vdc
Diode Reverse Leakage Current ($V_{2,3,10} = 5\text{V dc}$, $V_4 = V_1 = 0$) ($V_{2,3,10} = 5\text{V dc}$, $V_4 = V_1 = 0$, $T_J = 75^\circ\text{C}$) ($V_{7,8,9} = 5\text{V dc}$, $V_5 = V_1 = 0$) ($V_{7,8,9} = 5\text{V dc}$, $V_5 = V_1 = 0$, $T_J = 75^\circ\text{C}$)	$I_{2,3,10}$ $I_{2,3,10}$ $I_{7,8,9}$ $I_{7,8,9}$	- - - -	- - - -	0.50 25 0.50 25	$\mu\text{A dc}$
Input Capacitance ($V_{2,3,10} = 2\text{V dc}$, $V_4 = V_1 = 0$, $f = 1\text{mc}$, $V_{in} = 25\text{mV rms}$, unused inputs grounded) ($V_{7,8,9} = 2\text{V dc}$, $V_5 = V_1 = 0$, $f = 1\text{mc}$, $V_{in} = 25\text{mV rms}$, unused pins grounded)	$C_{2,3,10}$ $C_{7,8,9}$	- -	- -	10 10	pf
Reverse Recovery Time ($I_{F2,3,10} = I_{R2,3,10} = 2\text{mA dc}$, $V_4 = V_1 = 0$, recover to 0.2mA dc) ($I_{F7,8,9} = I_{R7,8,9} = 2\text{mA dc}$, $V_5 = V_1 = 0$, recover to 0.2mA dc)	$t_{rr2,3,10}$ $t_{rr7,8,9}$	- -	- -	4 4	nsec
Resistor Isolation Leakage ($V_6 = 5\text{V dc}$, $V_4 = V_5 = 0$)	I_1	-	-	600	mA dc
Resistor Current ($V_6 = 4\text{V dc}$, $V_4 = V_1 = 0$) ($V_6 = 4\text{V dc}$, $V_5 = V_1 = 0$)	I_4 I_5	1.3 1.3	- -	2.85 2.85	mA dc
Resistor Temperature Coefficient	-	-	0.1	-	$\% / ^\circ\text{C}$
Diode Forward Conductance Change with Temperature	$\Delta V_{F2,3,10}$ $\Delta V_{F7,8,9}$	- -	-1.7 -1.7	- -	$\text{mV} / ^\circ\text{C}$

MC267

MC250 DTL SERIES

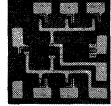

Diode Transistor Logic Dual-Diode Array.

MAXIMUM RATINGS ($T_A = 25^\circ\text{C}$)

Characteristic	Symbol	Rating	Unit
Applied Voltage	$V_{2,3,7 \text{ thru } 10}$	8	Vdc
Forward Current	$I_{2 \text{ thru } 5, 7 \text{ thru } 10}$	30	mAdc
Operating Temperature Range	T_J	0 to +75	$^\circ\text{C}$
Storage Temperature Range	T_{stg}	-65 to +175	$^\circ\text{C}$

MC267

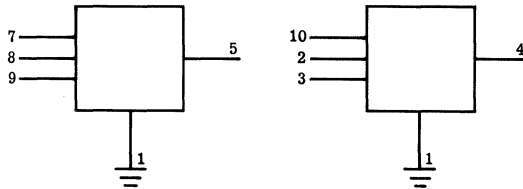

DUAL DIODE ARRAY

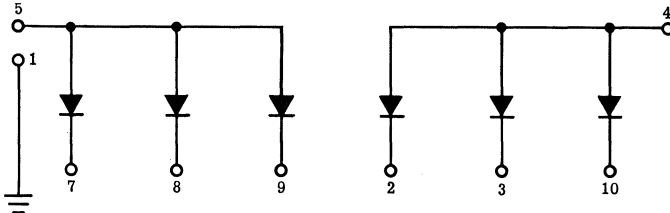

MC267 (continued)

ELECTRICAL CHARACTERISTICS ($T_J = 25^\circ\text{C}$ unless otherwise noted)

Characteristic	Symbol	Minimum	Typical	Maximum	Unit
Diode Breakdown Voltage ($I_{2,3,10} = 10\mu\text{A dc}$, $V_4 = V_1 = 0$) ($I_{7,8,9} = 10\mu\text{A dc}$, $V_5 = V_1 = 0$)	$V_{2,3,10}$ $V_{7,8,9}$	8 8	- -	- -	Vdc
Diode Forward Voltage ($I_4 = 2\text{mA dc}$, $V_{2,3,10} = V_1 = 0$) ($I_5 = 2\text{mA dc}$, $V_{7,8,9} = V_1 = 0$)	V_4 V_5	- -	- -	0.85 0.85	Vdc
Diode Reverse Leakage Current ($V_{2,3,10} = 5\text{V dc}$, $V_4 = V_1 = 0$) ($V_{2,3,10} = 5\text{V dc}$, $V_4 = V_1 = 0$, $T_J = 75^\circ\text{C}$) ($V_{7,8,9} = 5\text{V dc}$, $V_5 = V_1 = 0$) ($V_{7,8,9} = 5\text{V dc}$, $V_5 = V_1 = 0$, $T_J = 75^\circ\text{C}$)	$I_{2,3,10}$ $I_{7,8,9}$	- -	- -	0.50 25 0.50 25	$\mu\text{A dc}$
Input Capacitance ($V_{2,3,10} = 2\text{V dc}$, $V_4 = V_1 = 0$, $f = 1\text{mc}$, $V_{in} = 25\text{mV rms}$, unused inputs grounded) ($V_{7,8,9} = 2\text{V dc}$, $V_5 = V_1 = 0$, $f = 1\text{mc}$, $V_{in} = 25\text{mV rms}$, unused inputs grounded)	$C_{2,3,10}$ $C_{7,8,9}$	- -	- -	10 10	pf
Reverse Recovery Time ($I_{F2,3,10} = I_{R2,3,10} = 2\text{mA dc}$, $V_4 = V_1 = 0$, Recover to 0.2mA dc) ($I_{F7,8,9} = I_{R7,8,9} = 2\text{mA dc}$, $V_5 = V_1 = 0$, recover to 0.2mA dc)	$t_{rr2,3,10}$ $t_{rr7,8,9}$	- -	- -	4 4	nsec
Diode Forward Conductance Change with Temperature	$\Delta V_{F2,3,10}$ $\Delta V_{F7,8,9}$	- -	-1.7 -1.7	- -	$\text{mV}/^\circ\text{C}$

USN ME DTL series

CASE 71
(TO-5)



Monolithic integrated Diode Transistor Logic circuits designed to provide all of the basic logic functions in a digital computer. The ME USN Series is intended for high-speed logic applications over a temperature range of -55 to +125°C.

Series USN ME1 DTL Circuits

Type	Description	Recovery Time (nsec)	Switching Time t_{on} (nsec)		Power Dissipation (mW)
ME1	3-4 Diode AND Gate	15	—	—	200
ME2	2-2-2 Diode AND Gate	15	—	—	300
ME3	1-1-1-2 Diode AND Gate	14	—	—	400
ME4	8-Diode AND Gate	15	—	—	100
ME5	Dual Inverters	—	20	45	250
ME6	9-Diode Common-P Gate	90	—	—	—
ME7	9-Diode Common-N Gate	90	—	—	—
ME8	16-Diode Series/Parallel Matrix	90	—	—	—

SWITCHING TIME TEST CIRCUIT FOR INVERTERS (ME5)

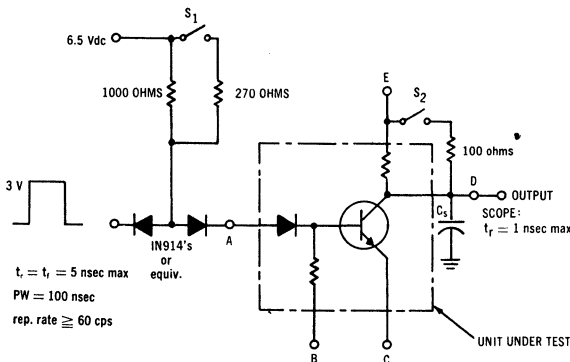

TERMINAL	Q_1	Q_2
A	6	9
B	7	8
C	5	10
D	4	1
E	3	2

NOTES

- (1) Turn-on time for the circuit is defined as the time interval from a point 10% up from the minimum amplitude on the leading edge of the input pulse to a point 90% down from the maximum amplitude on the leading edge of the output pulse.
- (2) Turn-off time for the circuit is defined as the time interval from a point 10% down from the maximum amplitude on the trailing edge of the input pulse to a point 50% down from the maximum amplitude on the trailing edge of the output pulse.
- (3) Adjust C_1 to 20 pf (includes scope and stray capacitance).

USN ME (continued)

SWITCHING TIME TEST CIRCUIT FOR DIODE GATES

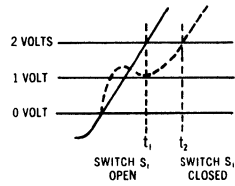
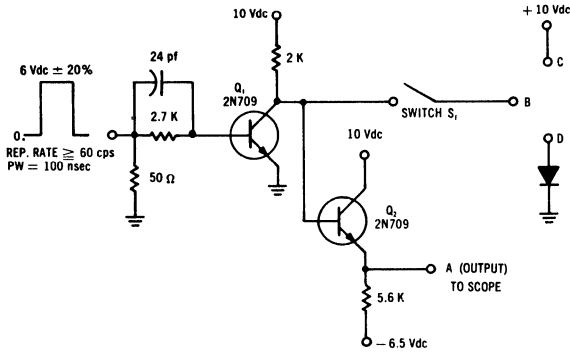

TEST PROCEDURE

- (1) Open switch S_1
- (2) Adjust input pulse of Q_1 for Q_1 fall time which will result in output at terminal A of 3 nanoseconds/volt positive slope for approximately 2.5 volts.
- (3) Note t_1 (2 volt level)
- (4) Close switch S_1
- (5) Note t_2 (2 volt level)

USN ME1
MIL-M-23700/1 (NAVY)

USN ME DTL SERIES

CASE 71
(TO-5)



3-4 Diode AND Gate.

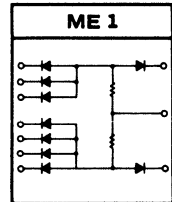

ABSOLUTE MAXIMUM RATINGS ($T_A = 25^\circ\text{C}$ unless otherwise noted)

Characteristic	Symbol	Rating	Unit
Forward Current	I_F	20	mA
Reverse Voltage	V_R	10	Volts
Total Device Dissipation Derate above 25°C	P_D	200 1.33	mW mW/ $^\circ\text{C}$
Resistor Dissipation (Each Resistor) Derate above 25°C	P_D	100 0.67	mW mW/ $^\circ\text{C}$
Operating Temperature Range	T_A	-55 to +125	$^\circ\text{C}$
Storage Temperature Range	T_{stg}	-65 to +175	$^\circ\text{C}$

USN ME1 (continued)

DIFFERENTIAL VOLTAGE AND FORWARD CURRENT TEST CIRCUIT AND TERMINAL CONNECTIONS

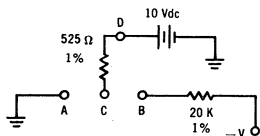

TERMINAL TEST CONNECTIONS DIFFERENTIAL VOLTAGE		
ALTERNATELY CONNECT A TO	6, 7, 8	1, 2, 9, & 10
CONNECT B TO	5	4
CONNECT C TO	3	3

TERMINAL TEST CONNECTIONS FORWARD CURRENT	
ALTERNATELY CONNECT A TO	1, 2, 4 THRU 10
CONNECT D TO	3
B NOT CONNECTED	

TABLE 1 GROUP A INSPECTION

Examination or Test	MIL-STD-750 Method	Symbol	Limits		Unit	LPTD	Max Acc Number
			Min/Max				
SUBGROUP							
Visual and Mechanical Examination	2071	—	—	—	—	20	4
SUBGROUP 2							
Forward Current (each diode - Fig. 2) V _{D-1} = 10 Vdc V _{D-2} = 10 Vdc V _{D-4 thru 10} = 10 Vdc	4011	I ₃₋₁ I ₃₋₂ I _{3-4 thru 10}	8.3	10.1	mAdc		
Reverse Current (each diode) V ₁₋₃ = 10 Vdc V ₂₋₃ = 10 Vdc V _{4 thru 10-3} = 10 Vdc	4016	I ₁₋₃ I ₂₋₃ I _{4 thru 10-3}	—	0.1	μAdc	5	4
SUBGROUP 3							
Differential Voltage (Fig. 2) V _{D-6} = 10 Vdc, I _{D-5} = 0.5 mAdc V _{D-7} = 10 Vdc, I _{D-5} = 0.5 mAdc V _{D-8} = 10 Vdc, I _{D-5} = 0.5 mAdc V _{D-8} = 10 Vdc, I _{D-5} = 0.5 mAdc V _{D-1} = 10 Vdc, I _{D-4} = 0.5 mAdc V _{D-2} = 10 Vdc, I _{D-4} = 0.5 mAdc V _{D-9} = 10 Vdc, I _{D-4} = 0.5 mAdc V _{D-10} = 10 Vdc, I _{D-4} = 0.5 mAdc		V ₅₋₆ V ₅₋₇ V ₅₋₈ V ₄₋₁ V ₄₋₂ V ₄₋₉ V ₄₋₁₀	—	0.30	Vdc	5	4
SUBGROUP 4							
Capacitance (each diode) V _{1, 2, 4 thru 10-3} = 10 Vdc, f = 100 kc	4001	C _{1, 2, 4 thru 10-3}	—	4	pf		
Reverse Recovery Time (Fig. 3) Connect Pin 3 to C. Pin 4 to D, alternately connect Pins 1, 2, 9, and 10 to B Connect Pin 3 to C, Pin 5 to D, alternately connect Pins 6, 7, and 8 to B Connect Pin 3 to C, Pin 2 to D, and Pin 4 to B Connect Pin 3 to C, Pin 6 to D, and Pin 5 to B	4031	t ₂ - t ₁	—	15	nsec	5	4

NOTE: Letter subscripts denote test circuit connection points.
Number subscripts denote device pin connections.

USN ME1 (continued)

TABLE II GROUP B INSPECTION

Examination or Test	MIL-STD-750 Method	Symbol	Limits		Unit	LTPD	Max Acc Number
			Min	Max			
SUBGROUP 1 Physical Dimensions	2066	—	—	—	—	20	5
SUBGROUP 2 Soldering Heat (1 Cycle)	2031	—	—	—	—	20	5
Temperature Cycling (T = 175°C)	1051 Condition B	—	—	—	—		
Thermal Shock (Glass Strain)	1056 Condition A	—	—	—	—		
Moisture Resistance End Points: Same As Subgroup 7	1021	—	—	—	—		
SUBGROUP 3 Constant Acceleration (10,000G, X ₁ , Y ₁ , Y ₂)	2006	—	—	—	—	20	5
Shock (500G, 1 msec, 5 blows each in orientation X ₁ , Y ₁ , Y ₂ , total of 15 blows.)	2016	—	—	—	—		
Vibration Fatigue (10G)	2046 Non-operating	—	—	—	—		
Vibration, Variable Frequency (10G)	2056	—	—	—	—		
End Points: Same As Subgroup 7							
SUBGROUP 4 (Notes 1, 2) Terminal Strength (3 leads at random)	2036 Condition E	—	—	—	—	20	5
SUBGROUP 5 (Notes 1, 3) Salt Atmosphere (Corrosion)	1041	—	—	—	—	20	5
SUBGROUP 6 High Temperature Life (T _A = 175°C) End Points: Same As Subgroup 7	1031 Non-operating	—	—	—	—	λ=20	—
SUBGROUP 7 Steady State Operation Life V _r 1, 2, 4 thru 10-3 = 10V, f = 60 cps P _D (R ₁) = P _D (R ₂) = 100 mW End Points: (Subgroups 2, 3, 6 and 7)	1026	—	—	—	—	λ=20	—
Forward Current V _{D-1} = 10 Vdc V _{D-2} = 10 Vdc V _{D-4} thru 10 = 10 Vdc	4011	I ₃₋₁ I ₃₋₂ I ₃₋₄ thru 10	7.8 7.8 7.8	10.6 10.6 10.6	mAdc —		
Reverse Current V ₁₋₃ = 10 Vdc V ₂₋₃ = 10 Vdc V ₄ thru 10-3 = 10 Vdc	4016	I ₁₋₃ I ₂₋₃ I ₄ thru 10-3	— — —	1.0 1.0 1.0	μAdc		

NOTE 1. Tests listed in these subgroups are considered destructive.

NOTE 2. At the conclusion of the testing in subgroup 4, the device shall be examined for evidence of mechanical damage.

NOTE 3. The device shall be examined for destructive corrosion and illegible marking.

USN ME2
MIL-M-23700/2 (NAVY)

USN ME DTL SERIES

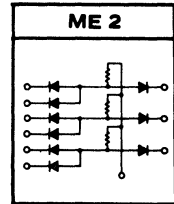

CASE 71
 (TO-5)



2-2-2 Diode AND Gate.

ABSOLUTE MAXIMUM RATINGS ($T_A = 25^\circ\text{C}$ unless otherwise noted)

Characteristic	Symbol	Rating	Unit
Forward Current	I_F	20	mA
Reverse Voltage	V_R	10	Volts
Total Device Dissipation Derate above 25°C	P_D	300 2	mW mW/ $^\circ\text{C}$
Resistor Dissipation (Each Resistor) Derate above 25°C	P_D	100 0.67	mW mW/ $^\circ\text{C}$
Operating Temperature Range	T_A	-55 to +125	$^\circ\text{C}$
Storage Temperature Range	T_{stg}	-65 to +175	$^\circ\text{C}$

DIFFERENTIAL VOLTAGE AND FORWARD CURRENT TEST CIRCUIT AND TERMINAL CONNECTIONS

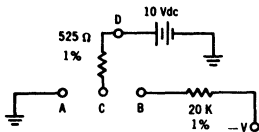

**TERMINAL TEST CONNECTIONS
DIFFERENTIAL VOLTAGE**

ALTERNATELY CONNECT A TO	9, 10	7, 8	5, 6
CONNECT B TO	1	2	4
CONNECT C TO	3	3	3

**TERMINAL TEST CONNECTIONS
FORWARD CURRENT**

ALTERNATELY CONNECT A TO	1, 2, 4 THRU 10
CONNECT D TO	3
NO CONNECTION TO B	

USN ME2 (continued)

TABLE I GROUP A INSPECTION

Examination or Test	MIL-STD-750 Method	Symbol	Limits		Unit	LTPD	Max Acc Number
			Min	Max			
SUBGROUP 1							
Visual and Mechanical Examination	2071	—	—	—	—	20	—
SUBGROUP 2							
Forward Current (each diode - Fig. 2)	4011				nAdc		
VD-1 = 10 Vdc		I ₃₋₁	8.3	10.1			
VD-2 = 10 Vdc		I ₃₋₂	8.3	10.1			
VD-4 thru 10 = 10 Vdc		I _{3-4 thru 10}	8.3	10.1		5	4
Reverse Current (each diode)	4016				μAdc		
V1-3 = 10 Vdc		I ₁₋₃	—	0.1			
V2-3 = 10 Vdc		I ₂₋₃	—	0.1			
V4 thru 10-3 = 10 Vdc		I _{4 thru 10-3}	—	0.1			
SUBGROUP 3							
Differential Voltage (Fig. 2)					Vdc		
VD-5 = 10 Vdc, ID-4 = 0.5 mAdc		V ₄₋₅	—	0.30			
VD-6 = 10 Vdc, ID-4 = 0.5 mAdc		V ₄₋₆	—	0.30			
VD-7 = 10 Vdc, ID-2 = 0.5 mAdc		V ₂₋₇	—	0.30		5	4
VD-8 = 10 Vdc, ID-2 = 0.5 mAdc		V ₂₋₈	—	0.30			
VD-9 = 10 Vdc, ID-1 = 0.5 mAdc		V ₁₋₉	—	0.30			
VD-10 = 10 Vdc, ID-1 = 0.5 mAdc		V ₁₋₁₀	—	0.30			
SUBGROUP 4							
Capacitance (each diode)	4001				pf		
V1, 2, 4 thru 10-3 = 10 Vdc, f = 100 kc		C _{1, 2, 4, thru 10-3}	—	4			
Reverse Recovery Time (Fig. 3)	4031	t _{2 - t₁}			nsec		
Connect Pin 3 to C, Pin 1 to D, alternately connect Pins 9 and 10 to B			—	15		5	4
Connect Pin 3 to C, Pin 2 to D, alternately connect Pins 7 and 8 to B			—	15			
Connect Pin 3 to C, Pin 4 to D, alternately connect Pins 5 and 6 to B			—	15			
Connect Pin 3 to C, Pin 9 to D, and Pin 1 to B			—	15			
Connect Pin 3 to C, Pin 7 to D, and Pin 2 to B			—	15			
Connect Pin 3 to C, Pin 5 to D, and Pin 4 to B			—	15			

NOTE: Letter subscripts denote test circuit connection points.
 Number subscripts denote device pin connections.

QUALITY ASSURANCE PROVISIONS

Qualification approval: Required.

Qualification inspection: Group A and group B inspections as shown in Tables I and II. Sampling shall be in accordance with Appendix D of MIL-M-23700.

Quality conformance inspection: Group A and group B inspections as shown in Tables I and II. Sampling for group A inspection shall be in accordance with procedure I, Appendix D of MIL-M-23700. Procedure IC may be used. A device having one or more defects shall be counted as one defective. Sampling for group B inspection shall be in accordance with procedure I (procedure IC may be used), of Appendix D of MIL-M-23700, except for life tests which shall be in accordance with procedure II.

Quality conformance inspection information: When specified in the contract or order, one copy of the quality conformance inspection data pertinent to the inspection lot shall accompany the shipments.

USN ME2 (continued)

TABLE II GROUP B INSPECTION

Examination or Test	MIL-STD-750 Method	Symbol	Limits		Unit	LTPD	Max Acc Number
			Min	Max			
SUBGROUP 1 Physical Dimensions	2066	—	—	—	—	20	5
SUBGROUP 2 Soldering Heat (1 Cycle)	2031	—	—	—	—	20	5
Temperature Cycling (T = 175°C)	1051 Condition B	—	—	—	—		
Thermal Shock (Glass Strain)	1056 Condition A	—	—	—	—		
Moisture Resistance End Points: Same As Subgroup 7	1021	—	—	—	—		
SUBGROUP 3 Constant Acceleration (10, 000G, X ₁ , Y ₁ , Y ₂)	2006	—	—	—	—	20	5
Shock (500G, 1 msec.; 5 blows each in orientation X ₁ , Y ₁ , Y ₂ , total of 15 blows.)	2016	—	—	—	—		
Vibration Fatigue (10G)	2046 Non-operating	—	—	—	—		
Vibration, Variable Frequency (10G) End Points: Same As Subgroup 7	2056	—	—	—	—		
SUBGROUP 4 (Notes 1, 2) Terminal Strength (3 leads at random)	2036 Condition E	—	—	—	—	20	5
SUBGROUP 5 (Notes 1, 3) Salt Atmosphere (Corrosion)	1041	—	—	—	—	20	5
SUBGROUP 6 High Temperature Life (T _A = 175°C) End Points: Same As Subgroup 7	1031 Non-operating	—	—	—	—	λ = 20	—
SUBGROUP 7 Steady State Operation Life V _{r1} 2, 4 thru 10-3 = 10V, f = 60 cps P _D (R ₁) = P _D (R ₂) = P _D (R ₃) = 100 mW End Points: (Subgroups 2, 3, 6 and 7)	1026	—	—	—	—	λ = 20	—
Forward Current (Fig. 2)	4011				m Adc		
V _{D-1} = 10 Vdc		I ₃₋₁	7.8	10.6			
V _{D-2} = 10 Vdc		I ₃₋₂	7.8	10.6			
V _{D-4} thru 10 = 10 Vdc		I ₃₋₄ thru 10	7.8	10.6			
Reverse Current	4016				μ Adc		
V ₁₋₃ = 10 Vdc		I ₁₋₃	—	1.0			
V ₂₋₃ = 10 Vdc		I ₂₋₃	—	1.0			
V ₄ thru 10-3 = 10 Vdc		I ₄ thru 10-3	—	1.0			

NOTE 1. Tests listed in these subgroups are considered destructive.

NOTE 2. At the conclusion of the testing in subgroup 4, the device shall be examined for evidence of mechanical damage.

NOTE 3. The device shall be examined for destructive corrosion and illegible marking.

USN ME3
MIL-M-23700/3 (NAVY)

USN ME DTL SERIES

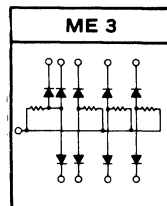

CASE 71
 (TO-5)



1-1-1-2 Diode AND Gate.

ABSOLUTE MAXIMUM RATINGS ($T_A = 25^\circ\text{C}$)

Characteristic	Symbol	Rating	Unit
Forward Current	I_F	20	mA
Reverse Voltage	V_R	10	Volts
Total Device Dissipation Derate above 25°C	P_D	400 2.67	mW mW/ $^\circ\text{C}$
Resistor Dissipation (Each Resistor) Derate above 25°C	P_D	100 0.67	mW mW/ $^\circ\text{C}$
Operating Temperature Range	T_A	-55 to +125	$^\circ\text{C}$
Storage Temperature Range	T_{stg}	-65 to +175	$^\circ\text{C}$

DIFFERENTIAL VOLTAGE AND FORWARD CURRENT TEST CIRCUIT AND TERMINAL CONNECTIONS

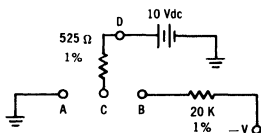

**TERMINAL TEST CONNECTIONS
 DIFFERENTIAL VOLTAGE**

ALTERNATELY CONNECT A TO	8, 9	7	6	5
CONNECT B TO	10	1	2	4
CONNECT C TO	3	3	3	3

**TERMINAL TEST CONNECTIONS
 FORWARD CURRENT**

ALTERNATELY CONNECT A TO	1, 2, 4 THRU 10
CONNECT D TO	3
B NOT CONNECTED.	

USN ME3 (continued)

TABLE I GROUP A INSPECTION

Examination or Test	MIL-STD-750 Method	Symbol	Limits			LTPD	Max Acc Number
			Min	Max	Unit		
SUBGROUP 1							
Visual and Mechanical Examination	2071	—	—	—	—	20	4
Forward Current (each diode - Fig. 2)	4011	—	—	—	nAdc	—	—
VD-1 = 10 Vdc		I ₃₋₁	8.3	10.1			
VD-2 = 10 Vdc		I ₃₋₂	8.3	10.1			
VD-4 thru 10 = 10 Vdc		3-4 thru 10	8.3	10.1		5	4
Reverse Current (each diode)							
V ₁₋₃ = 10 Vdc	4016	I ₁₋₃	—	0.1	μAdc		
V ₂₋₃ = 10 Vdc		I ₂₋₃	—	0.1			
V ₄ thru 10-3 = 10 Vdc		I ₄ thru 10-3	—	0.1			
SUBGROUP 2							
Differential Voltage (Fig. 2)					Vdc		
VD-8 = 10 Vdc, ID-10 = 0.5 mAdc		V ₁₀₋₈	—	0.30		5	4
VD-9 = 10 Vdc, ID-10 = 0.5 mAdc		V ₁₀₋₉	—	0.30			
VD-7 = 10 Vdc, ID-1 = 0.5 mAdc		V ₁₋₇	—	0.30			
VD-6 = 10 Vdc, ID-2 = 0.5 mAdc		V ₂₋₆	—	0.30			
VD-5 = 10 Vdc, ID-4 = 0.5 mAdc		V ₄₋₅	—	0.30			
SUBGROUP 4							
Capacitance (each diode)	4001	C _{1, 2, 4}			pf		
V _{1, 2, 4} thru 10-3 = 10 Vdc, f = 100kc		thru 10-3		4			
Reverse Recovery Time (Fig. 3)	4031	t ₂ - t ₁	—		nsec		
Connect Pin 3 to C, Pin 10 to D, alternately connect Pins 8 and 9 to B			—	15			
Connect Pin 3 to C, Pin 1 to D, and Pin 7 to B			—	15		5	4
Connect Pin 3 to C, Pin 2 to D, and Pin 6 to B			—	15			
Connect Pin 3 to C, Pin 4 to D, and Pin 5 to B			—	15			
Connect Pin 3 to C, Pin 5 to D, and Pin 4 to B			—	15			
Connect Pin 3 to C, Pin 6 to D, and Pin 2 to B			—	15			
Connect Pin 3 to C, Pin 7 to D, and Pin 1 to B			—	15			
Connect Pin 3 to C, Pin 8 to D, and Pin 10 to B			—	15			

NOTE: Letter denotes test circuit connection points. Number subscripts denote device pin

QUALITY ASSURANCE PROVISIONS

Qualification approval: Required.

Qualification inspection: Group A and group B inspections as shown in Tables I and II. Sampling shall be in accordance with Appendix D of MIL-M-23700.

Quality conformance inspection: Group A and group B inspections as shown in Tables I and II. Sampling for group A inspection shall be in accordance with procedure I, Appendix D of MIL-M-23700. Procedure IC may be used. A device having one or more defects shall be counted as one defective. Sampling for group B inspection shall be in accordance with procedure I (procedure IC may be used), of Appendix D of MIL-M-23700, except for life tests which shall be in accordance with procedure II.

Quality conformance inspection information: When specified in the contract or order, one copy of the quality conformance inspection data pertinent to the inspection lot shall accompany the shipments.

USN ME3 (continued)

TABLE II GROUP B INSPECTION

Examination or Test	MIL-STD-750 Method	Symbol	Limits		Unit	LTPD	Max Acc Number
			Min	Max			
SUBGROUP 1 Physical Dimensions	2066	—	—	—	—	20	5
SUBGROUP 2 Soldering Heat (1 Cycle)	2031	—	—	—	—	20	5
Temperature Cycling (T = 175°C)	1051 Condition B	—	—	—	—		
Thermal Shock (Glass Strain)	1056 Condition A	—	—	—	—		
Moisture Resistance End Points: Same As Subgroup 7	1021	—	—	—	—		
SUBGROUP 3 Constant Acceleration (10,000G, X ₁ , Y ₁ , Z ₂)	2006	—	—	—	—	20	5
Shock (500G, 1 msec, 5 blows each in orientation X ₁ , Y ₁ , Z ₂ , total of 15 blows.)	2016	—	—	—	—		
Vibration Fatigue (10G)	2046 Non-operating	—	—	—	—		
Vibration, Variable Frequency (10G) End Points: Same As Subgroup 7	2056	—	—	—	—		
SUBGROUP 4 (Notes 1, 2) Terminal Strength (3 leads at random)	2036 Condition E	—	—	—	—	20	5
SUBGROUP 5 (Notes 1, 3) Salt Atmosphere (Corrosion)	1041	—	—	—	—	20	5
SUBGROUP 6 High Temperature Life (T _A = 175°C) End Points: Same As Subgroup 7	1031 Non-operating	—	—	—	—	λ=20	—
SUBGROUP 7 Steady State Operation Life V _r 1, 2, 4 thru 10-3 = 10 V, f = 60 cps P _D (R ₁) = P _D (R ₂) = P _D (R ₃) = P _D (R ₄) = 100 mW End Points: (Subgroups 2, 3, 6 and 7)	1026	—	—	—	—	λ = 20	—
Forward Current V _{D-1} = 10 Vdc V _{D-2} = 10 Vdc V _{D-4} thru 10 = 10 Vdc	4011	I ₃₋₁ I ₃₋₂ I ₃₋₄ thru 10	7.8 7.8 7.8	10.6 10.6 10.6	mAdc		
Reverse Current V ₁₋₃ = 10 Vdc V ₂₋₃ = 10 Vdc V ₄ thru 10-3 = 10 Vdc	4016	I ₁₋₃ I ₂₋₃ I ₄ thru 10-3	— — —	1.0 1.0 1.0	μAdc		

NOTE 1. Tests listed in these subgroups are considered destructive.

NOTE 2. At the conclusion of the testing in subgroup 4, the device shall be examined for evidence of mechanical damage.

NOTE 3. The device shall be examined for destructive corrosion and illegible marking.

USN ME4
MIL-M-23700/4 (NAVY)

USN ME DTL SERIES

CASE 71
 (TO-5)



8-Diode AND Gate.

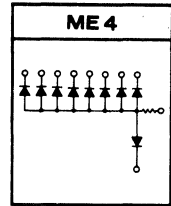

ABSOLUTE MAXIMUM RATINGS ($T_A = 25^\circ\text{C}$)

Characteristics	Symbol	Rating	Unit
Forward Current	I_F	20	mA
Reverse Voltage	V_R	10	Volts
Total Device Dissipation Derate above 25°C	P_D	100 0.667	mW mW/ $^\circ\text{C}$
Operating Temperature Range	T_A	-55 to +125	$^\circ\text{C}$
Storage Temperature Range	T_{stg}	-65 to +175	$^\circ\text{C}$

TABLE I GROUP A INSPECTION ($T_A = 25^\circ\text{C}$)

Examination or Test	MIL-STD 750 Method	Limits			Max Acc	
		Symbol	Min	Max	Unit	LTPD Number
SUBGROUP 1						
Visual and Mechanical Examination	2071	—	—	—	—	20 4
SUBGROUP 2						
Forward Current (each diode - Fig. 2) $V_{D-1} = 10$ Vdc $V_{D-2} = 10$ Vdc V_{D-4} thru 10 = 10 Vdc	4011				mAdc	
		I_{3-1}	8.3	10.1		
		I_{3-2}	8.3	10.1		
		I_{3-4} thru 10	8.3	10.1		5 4
Reverse Current (each diode) $V_{1-3} = 10$ Vdc $V_{2-3} = 10$ Vdc V_4 thru 10-3 = 10 Vdc	4016				μAdc	
		I_{1-3}	—	0.1		
		I_{2-3}	—	0.1		
		I_4 thru 10-3	—	0.1		
SUBGROUP 3						
Differential Voltage (Fig. 2) $V_{D-5} = 10$ Vdc, $I_{D-4} = 0.5$ mAdc $V_{D-6} = 10$ Vdc, $I_{D-4} = 0.5$ mAdc $V_{D-7} = 10$ Vdc, $I_{D-4} = 0.5$ mAdc $V_{D-8} = 10$ Vdc, $I_{D-4} = 0.5$ mAdc $V_{D-9} = 10$ Vdc, $I_{D-4} = 0.5$ mAdc $V_{D-10} = 10$ Vdc, $I_{D-4} = 0.5$ mAdc $V_{D-1} = 10$ Vdc, $I_{D-4} = 0.5$ mAdc $V_{D-2} = 10$ Vdc, $I_{D-4} = 0.5$ mAdc					Vdc	
		V_{4-5}	—	0.30		
		V_{4-6}	—	0.30		
		V_{4-7}	—	0.30		5 4
		V_{4-8}	—	0.30		
		V_{4-9}	—	0.30		
		V_{4-10}	—	0.30		
		V_{4-1}	—	0.30		
		V_{4-2}	—	0.30		
SUBGROUP 4						
Capacitance (each diode) $V_{1, 2, 4}$ thru 10-3 = 10 Vdc, $f = 100$ kc	4001	$C_{1, 2, 4}$ thru 10-3	—	4		pf
Reverse Recovery Time (Fig. 3) Connect Pin 3 to C, Pin 4 to D, alternately connect Pins 1, 2, 5, 6, 7, 8, 9, and 10 to B Connect Pin 3 to C, Pin 1 to D, and Pin 4 to B	4031	$t_2 - t_{11}$				nsec 5 4
			—	15		
			—	15		

NOTE: Letter subscripts denote test circuit connection points.
 Number subscripts denote device pin connections.

USN ME5
MIL-M-23700/5 (NAVY)

USN ME DTL SERIES

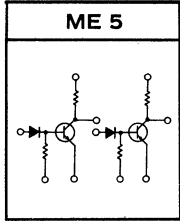

CASE 71
(TO-5)



Dual high-speed, NPN transistor inverters.

ABSOLUTE MAXIMUM RATINGS ($T_A = 25^\circ\text{C}$)

Characteristic	Symbol	Rating	Unit
Reverse Voltage	V_{10-2}	10.0	Vdc
	V_{5-3}	10.0	
	V_{5-7}	7.0	
	V_{10-8}	7.0	
Total Device Dissipation Derate above 25°C	P_D	250	mW
		1.67	mW/°C
Individual Gate Dissipation Derate above 25°C	P_D	125	mW
		0.83	mW/°C
Resistor Dissipation R_1 or R_2 Derate above 25°C R_3 or R_4 Derate above 25°C	P_D	100	mW
		0.67	mW/°C
		25	mW
		0.17	mW/°C
Operating Temperature Range	T_A	-55 to +125	°C
Storage Temperature Range	T_{stg}	-65 to +175	°C

SWITCHING TIME TEST CIRCUIT

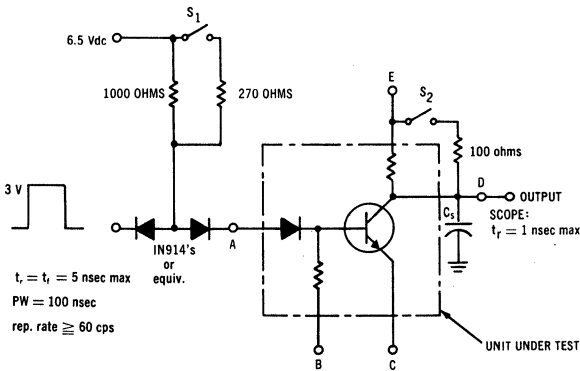

$t_r = t_f = 5 \text{ nsec max}$
 $PW = 100 \text{ nsec}$
 $\text{rep. rate} \geq 60 \text{ cps}$

TERMINAL	Q_1	Q_2
A	6	9
B	7	8
C	5	10
D	4	1
E	3	2

NOTES

- Turn-on time for the circuit is defined as the time interval from a point 10% up from the minimum amplitude on the leading edge of the input pulse to a point 90% down from the maximum amplitude on the leading edge of the output pulse.
- Turn-off time for the circuit is defined as the time interval from a point 10% down from the maximum amplitude on the trailing edge of the input pulse to a point 50% down from the maximum amplitude on the trailing edge of the output pulse.
- Adjust C_s to 20 pf (includes scope and stray capacitance.)

USN ME5 (continued)

TABLE I GROUP A INSPECTION

Examination or Test	MIL-STD-750 Method	Symbol	Limits Min/Max	Unit	LPTD	Max Acc Number
SUBGROUP 1						
Visual and Mechanical Examination	2071	—	—	—	20	4
SUBGROUP 2 - Q₁						
Static Input Voltage Drop I ₄₋₅ = 35 mA _{dc} , I ₆₋₅ = 1.5 mA _{dc}		V ₆₋₅	1.2	1.7	V _{dc}	
Collector - Emitter Saturation Voltage I ₄₋₅ = 35 mA _{dc} , I ₆₋₅ = 1.5 mA _{dc}	3071	V _{CE(sat)} 4-5	—	0.35	V _{dc}	
Base - Emitters Conduction Current V ₇₋₅ = 10 V _{dc}		I ₇₋₅	50	1.84	mA _{dc}	
Collector Resistor Current V ₃₋₄ = 3 V _{dc}		I ₃₋₄	8.82	8.35	mA _{dc}	5
Turn-On Time (Fig. 2) V ₇₋₅ = -6.5 V _{dc} , V ₃₋₅ = +3 V _{dc} , Close switch S ₂		t _{on}	—	20	nsec	4
Turn-Off Time (Fig. 2) V ₇₋₅ = -6.5 V _{dc} , V ₃₋₅ = +3 V _{dc} , Close switch S ₁		t _{off}	—	45	nsec	
SUBGROUP 3 - Q₂						
Static Input Voltage Drop I ₁₋₁₀ = 35 mA _{dc} , I ₉₋₁₀ = 1.5 mA _{dc}		V ₉₋₁₀	1.2	1.7	V _{dc}	
Collector - Emitter Saturation Voltage I ₁₋₁₀ = 35 mA _{dc} , I ₉₋₁₀ = 1.5 mA _{dc}	3071	V _{CE(sat)} 1-10	—	0.35	V _{dc}	
Base-Emitter Conduction Current V ₈₋₁₀ = 10 V _{dc}		I ₈₋₁₀	1.50	1.84	mA _{dc}	5
Collector Resistor Current V ₂₋₁ = 3 V _{dc}		I ₂₋₁	8.82	8.35	mA _{dc}	4
Turn-On Time (Fig. 2) V ₈₋₁₀ = -6.5 V _{dc} , V ₂₋₁₀ = +3 V _{dc} , Close switch S ₂		t _{on}	—	20	nsec	
Turn-Off Time (Fig. 2) V ₈₋₁₀ = -6.5 V _{dc} , V ₂₋₁₀ = +3 V _{dc} , Close switch S ₁		t _{off}	—	45	nsec	
SUBGROUP 4						
High Temperature Operation						
Collector - Emitter Cutoff Current V ₃₋₅ = 10 V _{dc} , V ₇₋₅ = -6.5V _{dc} , T _A = +85°C V ₂₋₁₀ = 10 V _{dc} , V ₈₋₁₀ = -6.5V _{dc} , T _A = +85°C	3041	I ₃₋₅ I ₂₋₁₀	— —	3 3	μA _{dc}	5
SUBGROUP 5						
Low Temperature Operation						
DC Forward Current Transfer Ratio V ₄₋₅ = 0.5 V _{dc} , I ₄₋₅ = 35 mA _{dc} , T _A = -55°C V ₁₋₁₀ = 0.5 V _{dc} , I ₁₋₁₀ = 35 mA _{dc} , T _A = -55°C		h _{FE}	15 15	— —	—	5
SUBGROUP 6						
DC Forward - Current Transfer Ratio V ₄₋₅ = 0.5 V _{dc} , I ₄₋₅ = 35 mA _{dc} V ₁₋₁₀ = 0.5 V _{dc} , I ₁₋₁₀ = 35 mA _{dc}	3076	h _{FE}	35 35	— —	—	
Collector - Emitter Cutoff Current I ₃₋₅ = 10 V _{dc} , V ₇₋₅ = -6.5 V _{dc} I ₂₋₁₀ = 10 V _{dc} , V ₈₋₁₀ = -6.5 V _{dc}	3041	I ₃₋₅ I ₂₋₁₀	— —	0.05 0.05	μA _{dc}	5
Reverse Current V ₇₋₆ = 10 V _{dc} V ₈₋₉ = 10 V _{dc}	4016	I ₇₋₆ I ₈₋₉	— —	100 100	mA _{dc}	4

QUALITY ASSURANCE PROVISIONS

Qualification approval: Required.

Qualification inspection: Group A and group B inspections as shown in Tables I and II. Sampling shall be in accordance with Appendix D of MIL-M-23700.

Quality conformance inspection: Group A and group B inspections as shown in Tables I and II. Sampling for group A inspection shall be in accordance with procedure I, Appendix D of MIL-M-23700. Procedure IC may be used. A device having one or more defects shall be counted as one defective. Sampling for group B inspection shall be in accordance with procedure I (procedure IC may be used), of Appendix D of MIL-M-23700, except for life tests which shall be in accordance with procedure II.

Quality conformance inspection information: When specified in the contract or order, one copy of the quality conformance inspection data pertinent to the inspection lot shall accompany the shipments.

USN ME5 (continued)

TABLE II GROUP B INSPECTION

Examination or Test	MIL-STD-750 Method	Symbol	Limits		Unit	LTPD	Max Acc Number
			Min	Max			
SUBGROUP 1							
Physical Dimensions	2066	—	—	—	—	20	5
SUBGROUP 2							
Soldering Heat (1 Cycle)	2031	—	—	—	—	20	5
Temperature Cycling (T = 175°C)	1051 Condition B	—	—	—	—		
Thermal Shock (Glass Strain)	1056 Condition A	—	—	—	—		
Moisture Resistance	1021	—	—	—	—		
<u>End Points:</u> Same As Subgroup 7							
SUBGROUP 3							
Constant Acceleration (10,000G, X ₁ , Y ₁ , Z ₂)	2006	—	—	—	—	20	5
Shock (500G, 1 msec, 5 blows each in orientation X ₁ , Y ₁ , Z ₂ , total of 15 blows.)	2016	—	—	—	—		
Vibration Fatigue (10G)	2046 Non-operating	—	—	—	—		
Vibration, Variable Frequency (10G)	2056	—	—	—	—		
<u>End Points:</u> Same As Subgroup 7							
SUBGROUP 4 (Notes 1, 2)							
Terminal Strength (3 leads at random)	2036 Condition E	—	—	—	—	20	5
SUBGROUP 5 (Notes 1, 3)							
Salt Atmosphere (Corrosion)	1041	—	—	—	—	20	5
SUBGROUP 6							
High Temperature Life (T _A = 175°C)	1031 Non-operating	—	—	—	—	λ=20	—
<u>End Points:</u> Same As Subgroup 7							
SUBGROUP 7							
Steady State Operation Life V ₃₋₅ = 6.3 Vdc, Pin 7 connected to pin 3, 400Ω resistor connected between pins 3 and 4, 5K Ω resistor connected between pins 3 and 6 V ₂₋₁₀ = 6.3 Vdc, pin 8 connected to pin 2, 400Ω resistor connected between pins 1 and 2, 5 KΩ resistor connected between pins 2 and 9 <u>End Points:</u> (Subgroups 2, 3, 6, and 7)	1026	—	—	—	—	λ=20	—
Collector - Emitter Cutoff current V ₃₋₅ = 10 Vdc, V ₇₋₅ = -6.5 Vdc V ₂₋₁₀ = 10 Vdc, V ₈₋₁₀ = -6.5 Vdc	3041	I ₃₋₅ I ₂₋₁₀	— —	500 500	mAdc		
Base - Emitter Conduction Current V ₇₋₅ = 10 Vdc V ₈₋₁₀ = 10 Vdc	—	I ₇₋₅ I ₈₋₁₀	1.33 1.33	2.01 2.01	mAdc		
Collector Resistor Current V ₃₋₄ = 3 Vdc V ₂₋₁ = 3 Vdc	—	I ₃₋₄ I ₂₋₁	6.06 6.06	9.09 9.09	mAdc		
Reverse Current V ₇₋₆ = 10 Vdc V ₈₋₉ = 10 Vdc	4016	I ₇₋₆ I ₈₋₉	— —	1.0 1.0	μAdc		
DC Forward Current Transfer Ratio V ₄₋₅ = 0.5 Vdc, I ₄₋₅ = 35 mAdc V ₁₋₁₀ = 0.5 Vdc, I ₁₋₁₀ = 35 mAdc	307C	hFE	25 25	— —	—		

NOTE 1. Tests listed in these subgroups are considered destructive.

NOTE 2. At the conclusion of the testing in subgroup 4, the device shall be examined for evidence of mechanical damage.

NOTE 3. The device shall be examined for destructive corrosion and illegible marking.

USN ME6
MIL-M-23700/6 (NAVY)

USN ME DTL SERIES

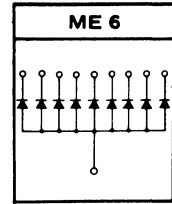

9-Diode Common-P Gate.

CASE 71
(TO-5)



MAXIMUM RATINGS (At 25°C)

Characteristic	Symbol	Rating	Unit
Reverse Voltage (Each Diode)	V_R	40	Volts
Total Device Current (Derate 2mA/°C)	I_F	300	mA
Individual Diode Current (Derate 2mA/°C)	I_F	300	mA
Operating Temperature Range	T_A	-65 to +175	°C

TABLE I GROUP A INSPECTION

Examination or Test	MIL-STD-750 Method	Symbol	Limits		Unit	LTPD	Max Acc Number
			Min	Max			
SUBGROUP 1 Visual and Mechanical Examination	2071	—	—	—	—	20	4
SUBGROUP 2 Forward Voltage $I_{F1-2 \text{ thru } 10} = 300 \text{ mAdc}$	4011	$V_{F1-2 \text{ thru } 10}$	—	1.2	Vdc	5	4
Reverse Current $V_{R2 \text{ thru } 10-1} = 20 \text{ Vdc}$	4016	$I_{R2 \text{ thru } 10-1}$	—	2.0	μAdc		
Breakdown Voltage $I_{R2 \text{ thru } 10-1} = 10 \mu\text{Adc}$		$V_{R2 \text{ thru } 10-1}$	40	—	Vdc		
SUBGROUP 3 Junction Capacitance $V_2 \text{ thru } 10-1 = 10\text{Vdc}, f = 100\text{kc}$	4001	$C_2 \text{ thru } 10-1$	—	8.0	pf	5	4
Reverse Recovery Time ($I_F = 300\text{mAdc}, I_R 10 \text{ thru } 2-1 = 60\text{mAdc}, R_L = 2.5 \Omega$, Scope Input Capacitance $\leq 4\text{pf}$)	4031 Condition B (Except t_{rr} measured at $I_R/3$)	$t_{rr} 10 \text{ thru } 2-1$	—	90	nsec		

USN ME6 (continued)

TABLE II GROUP B INSPECTION

Examination or Test	MIL-STD-750 Method	Symbol	Limits		Unit	LTPD	Max Acc Number
			Min	Max			
SUBGROUP 1							
Physical Dimensions	2066	—	—	—	—	20	5
SUBGROUP 2							
Soldering Heat (1 Cycle)	2031	—	—	—	—	20	5
Temperature Cycling (T = 175°C)	1051 Condition B	—	—	—	—		
Thermal Shock (Glass Strain)	1056 Condition A	—	—	—	—		
Moisture Resistance	1021	—	—	—	—		
<u>End Points:</u> Same As Subgroup 7							
SUBGROUP 3							
Constant Acceleration (10,000G, X ₁ , Y ₁ , Y ₂)	2006	—	—	—	—	20	5
Shock (500G, 1 msec, 5 blows each in orientation X ₁ , Y ₁ , Y ₂ , total of 15 blows.)	2016	—	—	—	—		
Vibration Fatigue (10G)	2046 Non-operating	—	—	—	—		
Vibration, Variable Frequency (10G)	2056	—	—	—	—		
<u>End Points:</u> Same As Subgroup 7							
SUBGROUP 4 (Notes 1, 2)							
Terminal Strength (3 leads at random)	2036 Condition E	—	—	—	—	20	5
SUBGROUP 5 (Notes 1, 3)							
Salt Atmosphere (Corrosion)	1041	—	—	—	—	20	5
SUBGROUP 6							
High Temperature Life (T _A = 175°C)	1031 Non-operating	—	—	—	—	λ = 20	—
<u>End Points:</u> Same As Subgroup 7							
SUBGROUP 7							
Steady State Operation Life I ₀ 2 thru 10-1 = 300 mAdc, f = 60 cps V _{r1-2} thru 10 = 32 Vdc <u>End Points:</u> (Subgroups 2, 3, 6, and 7)	1026	—	—	—	—	λ = 20	—
Forward Voltage I _{F1-2} thru 10 = 300 mAdc	4011	V _{F1-2} thru 10	—	1.5	Vdc		
Reverse Current V _{R2} thru 10-1 = 20 Vdc	4016	I _{R2} thru 10-1	—	20	μAdc		

NOTE 1. Tests listed in these subgroups are considered destructive.

NOTE 2. At the conclusion of the testing in subgroup 4, the device shall be examined for evidence of mechanical damage.

NOTE 3. The device shall be examined for destructive corrosion and illegible marking.

USN ME7
MIL-M-23700/7 (NAVY)

USN ME DTL SERIES

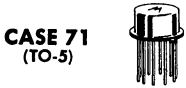
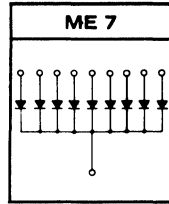

9-Diode Common-N Gate.

ABSOLUTE MAXIMUM RATINGS (At 25°C)

Characteristic	Rating	Unit	Symbol
Reverse Voltage (Each Diode)	V_R	40	Volts
Total Device Current (Derate 2mA/°C)	I_F	300	mA
Individual Diode Current (Derate 2mA/°C)	I_F	300	mA
Operating Temperature Range	T_A	-65 to +175	°C

TABLE I GROUP A INSPECTION

Examination or Test	MIL-STD-750 Method	Symbol	Limits		Unit	LTPD	Max Acc Number
			Min	Max			
SUBGROUP 1							
Visual and Mechanical Examination	2071	—	—	—	—	20	4
SUBGROUP 2							
Forward Voltage I_F 2 thru 10-1 = 300mAdc	4011	V_F 2 thru 10-1	—	1.2	Vdc		
Reverse Current V_R 1 - 2 thru 10 = 20Vdc	4016	I_R 1 - 2 thru 10	—	2.0	μ Adc	5	4
Breakdown Voltage I_R 1 - 2 thru 10 = 10 μ Adc		V_R 1 - 2 thru 10	40	—	Vdc		
SUBGROUP 3							
Junction Capacitance V_1 - 2 thru 10 = 10Vdc, f = 100 kc	4001	C_1 - 2 thru 10	—	8.0	pf		
Reverse Recovery Time (I_F = 300mAdc, I_R 1 - 10 thru 2 = 60mAdc, R_L = 2.5 Ω , Scope Input Capacitance \leq 4pf)	4031 Condition B (Except t_{rr} measured at $I_R/3$)	t_{rr1} -10 thru 2	—	90	nsec	5	4

USN ME7 (continued)

TABLE II GROUP B INSPECTION

Examination or Test	MIL-STD-750 Method	Symbol	Limits		Unit	LTPD	Max Acc Number
			Min	Max			
SUBGROUP 1							
Physical Dimensions	2066	—	—	—	—	20	5
SUBGROUP 2							
Soldering Heat (1 Cycle)	2031	—	—	—	—	20	5
Temperature Cycling (T = 175°C)	1051 Condition B	—	—	—	—		
Thermal Shock (Glass Strain)	1056 Condition A	—	—	—	—		
Moisture Resistance	1021	—	—	—	—		
<u>End Points:</u> Same As Subgroup 7							
SUBGROUP 3							
Constant Acceleration (10,000G, X ₁ , Y ₁ , Y ₂)	2006	—	—	—	—	20	5
Shock (500G, 1 msec, 5 blows each in orientation X ₁ , Y ₁ , Y ₂ , total of 15 blows.)	2016	—	—	—	—		
Vibration Fatigue (10G)	2046 Non-operating	—	—	—	—		
Vibration, Variable Frequency (10G)	2056	—	—	—	—		
<u>End Points:</u> Same As Subgroup 7							
SUBGROUP 4 (Notes 1, 2)							
Terminal Strength (3 leads at random)	2036 Condition E	—	—	—	—	20	5
SUBGROUP 5 (Notes 1, 3)							
Salt Atmosphere (Corrosion)	1041	—	—	—	—	20	5
SUBGROUP 6							
High Temperature Life (T _A = 175°C)	1031 Non-operating	—	—	—	—	λ=20	—
<u>End Points:</u> Same As Subgroup 7							
SUBGROUP 7							
Steady State Operation Life I _O 1-2 thru 10 = 300 mAdc, V _R 2 thru 10-1 = 32 V, f = 60 cps	1026	—	—	—	—	λ = 20	—
<u>End Points:</u> (Subgroups 2, 3, 6, and 7)							
Forward Voltage I _F 2 thru 10-1 = 300 mAdc	4011	V _F 2 thru 10-1	—	1.5	Vdc		
Reverse Current V _R 1-2 thru 10 = 20 Vdc	4016	I _R 1-2 thru 10	—	20	μ Adc		

NOTE 1. Tests listed in these subgroups are considered destructive.

NOTE 2. At the conclusion of the testing in subgroup 4, the device shall be examined for evidence of mechanical damage.

NOTE 3. The device shall be examined for destructive corrosion and illegible marking.

USN ME8

USN ME DTL SERIES

MIL-M-23700/8 (NAVY)

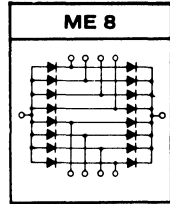

CASE 71
(TO-5)



16-Diode Series/Parallel Matrix.

ABSOLUTE MAXIMUM RATINGS (At 25°C)

Characteristic	Symbol	Rating	Unit
Reverse Voltage (Each Diode)	V_R	40	Volts
Total Device Current (Derate 2mA/°C)	I_F	300	mA
Individual Diode Current (Derate 2mA/°C)	I_F	300	mA
Operating Temperature Range	T_A	-65 to +175	°C

TABLE I GROUP A INSPECTION (At 25°C)

Examination or Test	MIL-STD-750 Method	Symbol	Limits		Unit	LTPD	Max Acc Number
			Min	Max			
SUBGROUP Visual and Mechanical Examination	2071	—	—	—	—	20	4
SUBGROUP 2 Forward Voltage I_{F2} thru 5-1 = 300 mAdc I_{F7} thru 10-1 = 300 mAdc I_{F6-2} thru 5 = 300 mAdc I_{F6-7} thru 10 = 300 mAdc Reverse Current V_{R1-2} thru 5 = 20 Vdc V_{R1-7} thru 10 = 20 Vdc V_{R2} thru 5-6 = 20 Vdc V_{R7} thru 10-6 = 20 Vdc Breakdown Voltage I_{R1-2} thru 5 = 10 μ Adc I_{R1-7} thru 10 = 10 μ Adc I_{R2} thru 5-6 = 10 μ Adc I_{R7} thru 10-6 = 10 μ Adc	4011 4016	V_{F2} thru 5-1 V_{F7} thru 10-1 V_{F6-2} thru 5 V_{F6-7} thru 10 I_{R1-2} thru 5 I_{R1-7} thru 10 I_{R2} thru 5-6 I_{R7} thru 10-6 V_{R1-2} thru 5 V_{R1-7} thru 10 V_{R2} thru 5-6 V_{R7} thru 10-6	— — — — — — — — 40 40 40 40	1.2 1.2 1.2 1.2 2.0 2.0 2.0 2.0 — — — —	Vdc μ Adc Vdc	5	4
SUBGROUP 3 Capacitance V_2 thru 5-6 = 10 Vdc, f = 100 kc V_7 thru 10-6 = 10 Vdc, f = 100 kc V_{1-2} thru 5 = 10 Vdc, f = 100 kc V_{1-7} thru 10 = 10 Vdc, f = 100kc Reverse Recovery Time I_{F6-2} thru 5 = 300 mAdc, $I_R = 60$ mAdc I_{F6-7} thru 10 = 300 mAdc, $I_R = 60$ mAdc I_{F2} thru 5-1 = 300 mAdc, $I_R = 60$ mAdc, $R_L = 2.5\Omega$, Scope input capacitance ≤ 4 pf I_{F7} thru 10-1 = 300 mAdc, $I_R = 60$ mAdc, $R_L = 2.5\Omega$, Scope input capacitance ≤ 4 pf	4001 4031	C_2 thru 5-6 C_7 thru 10-6 C_{1-2} thru 5 C_{1-7} thru 10 t_{rr} 6-2 thru 5 t_{rr} 6-7 thru 10 t_{rr} 2 thru 5-1 t_{rr} 7 thru 10-1	— — — — — — — —	16.0 16.0 16.0 16.0 90 90 90 90	pf nsec	5	4

USN ME8 (continued)

TABLE II GROUP B INSPECTION

Examination or Test	MIL-STD-750 Method	Symbol	Limits		Unit	LTPD	Max Acc Number
			Min	Max			
SUBGROUP 1 Physical Dimensions	2066	—	—	—	—	20	5
SUBGROUP 2 Soldering Heat (1 Cycle)	2031	—	—	—	—	20	5
Temperature Cycling (T = 175°C)	1051 Condition B	—	—	—	—		
Thermal Shock (Glass Strain)	1056 Condition A	—	—	—	—		
Moisture Resistance	1021	—	—	—	—		
<u>End Points:</u> Same As Subgroup 7							
SUBGROUP 3 Constant Acceleration (10,000G, X ₁ , Y ₁ , Y ₂)	2006	—	—	—	—	20	5
Shock (500G, 1 msec, 5 blows each in orientation X ₁ , Y ₁ , Y ₂ , total of 15 blows.)	2016	—	—	—	—		
Vibration Fatigue (10G)	2046 Non-operating	—	—	—	—		
Vibration, Variable Frequency (10G)	2056	—	—	—	—		
<u>End Points:</u> Same As Subgroup 7							
SUBGROUP 4 (Notes 1, 2) Terminal Strength (3 leads at random)	2036 Condition E	—	—	—	—	20	5
SUBGROUP 5 (Notes 1, 3) Salt Atmosphere (Corrosion)	1041	—	—	—	—	20	5
SUBGROUP 6 High Temperature Life (T _A = 175°C)	1031 Non-operating	—	—	—	—	λ=20	—
<u>End Points:</u> Same As Subgroup 7							
SUBGROUP 7 Steady State Operation Life Connect pins 2, 3, 4, 5, 6, 7, 8, 9, and 10 together, connect resistors from pin 6 to ground and from pin 1 to ground (0) v ₂₋₀ = 32 Vac. I ₂₋₆ = 300 mA, I ₂₋₁ = 300 mA, f = 60 cps (currents are average for 1/2 cycle)	1026	—	—	—	—	λ = 20	—
<u>End Points:</u> (Subgroups 2, 3, 6, and 7)							
Forward Voltage I _{F2} thru 5-1 = 300 mAdc I _{F7} thru 10-1 = 300 mAdc I _{F6-2} thru 5 = 300 mAdc I _{F6-7} thru 10 = 300 mAdc	4011	V _{F2} thru 5-1 V _{F7} thru 10-1 V _{F6-2} thru 5 V _{F6-7} thru 10	— — — —	1.5 1.5 1.5 1.5	Vdc		
Reverse Current V _{R1-2} thru 5 = 20 Vdc V _{R1-7} thru 10 = 20 Vdc V _{R2} thru 5-6 = 20 Vdc V _{R7} thru 10-6 = 20 Vdc	4016	I _{R1-2} thru 5 I _{R1-7} thru 10 I _{R2} thru 5-6 I _{R7} thru 10-6	— — — —	20 20 20 20	μAdc		

NOTE 1. Tests listed in these subgroups are considered destructive.

NOTE 2. At the conclusion of the testing in subgroup 4, the device shall be examined for evidence of mechanical damage.

NOTE 3. The device shall be examined for destructive corrosion and illegible marking.

MC 1111 DTL series

CASE 71
(TO-5)



Monolithic integrated Diode Transistor Logic circuits designed to provide all the basic logic functions in a digital computer. The MC1111 Series is intended for high-speed computer applications with a temperature range of -55 to +125°C.

Type	Description	Recovery Time (nsec)	Switching Time		Power Dissipation (mW)
			t_{on} (nsec)	t_{off} (nsec)	
MC1111	3-4 Diode AND Gate	15	—	—	200
MC1112	2-2-2 Diode AND Gate	15	—	—	300
MC1113	1-1-1-2 Diode AND Gate	15	—	—	400
MC1114	8-Diode AND Gate	15	—	—	100
MC1115	Dual Inverters	—	20	45	250
MC1116	9-Diode Common-P Gate	90	—	—	—
MC1117	9-Diode Common-N Gate	90	—	—	—
MC1118	16-Diode Series/Parallel Matrix	90	—	—	—

MC1111

MC1111-MC1118 DTL SERIES

3-4 Diode AND Gate.

MAXIMUM RATINGS ($T_A = 25^\circ\text{C}$ unless otherwise noted)

Characteristic	Symbol	Rating	Unit
Forward Current	I_F	20	mA
Reverse Voltage	V_R	10	Volts
Total Device Dissipation Derate above 25°C	P_D	200 1.33	mW mW/ $^\circ\text{C}$
Resistor Dissipation (Each Resistor) Derate above 25°C	P_D	100 0.67	mW mW/ $^\circ\text{C}$
Operating Temperature Range	T_A	-55 to +125	$^\circ\text{C}$
Storage Temperature Range	T_{stg}	-65 to +175	$^\circ\text{C}$

CIRCUIT SCHEMATIC

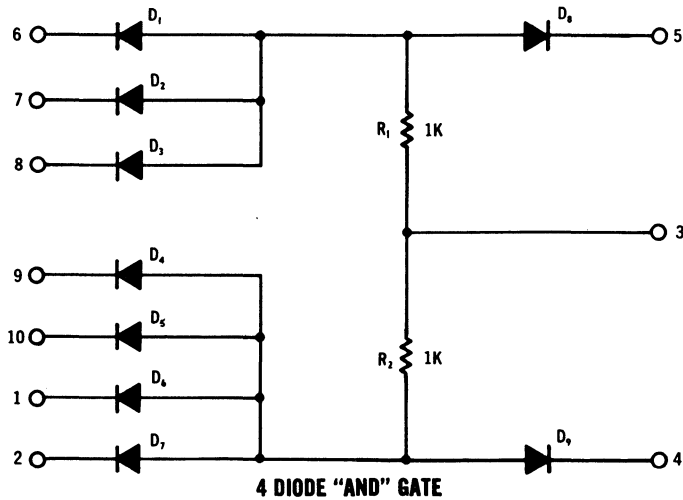

MC1111 (continued)

ELECTRICAL CHARACTERISTICS ($T_A = 25^\circ\text{C}$ unless otherwise noted)

Characteristic	Symbol	Min	Max	Unit
Forward Current (each diode - Fig. 2) $V_{D-1} = 10\text{ Vdc}$ $V_{D-2} = 10\text{ Vdc}$ V_{D-4} thru 10 = 10 Vdc	I_{3-1} I_{3-2} I_{3-4} thru 10	8.3 8.3 8.3	10.1 10.1 10.1	mAdc
Reverse Current (each diode) $V_{1-3} = 10\text{ Vdc}$ $V_{2-3} = 10\text{ Vdc}$ V_4 thru 10-3 = 10 Vdc	I_{1-3} I_{2-3} I_4 thru 10-3	— — —	0.1 0.1 0.1	μAdc
Differential Voltage (Fig. 2) $V_{D-6} = 10\text{ Vdc}$, $I_{D-5} = 0.5\text{ mAdc}$ $V_{D-7} = 10\text{ Vdc}$, $I_{D-5} = 0.5\text{ mAdc}$ $V_{D-8} = 10\text{ Vdc}$, $I_{D-5} = 0.5\text{ mAdc}$ $V_{D-1} = 10\text{ Vdc}$, $I_{D-4} = 0.5\text{ mAdc}$ $V_{D-2} = 10\text{ Vdc}$, $I_{D-4} = 0.5\text{ mAdc}$ $V_{D-9} = 10\text{ Vdc}$, $I_{D-4} = 0.5\text{ mAdc}$ $V_{D-10} = 10\text{ Vdc}$, $I_{D-4} = 0.5\text{ mAdc}$	V_{5-6} V_{5-7} V_{5-8} V_{4-1} V_{4-2} V_{4-9} V_{4-10}	— — — — — — —	0.30 0.30 0.30 0.30 0.30 0.30 0.30	Vdc
Capacitance (each diode) $V_{1, 2, 4}$ thru 10-3 = 10 Vdc, $f = 100\text{ kc}$	$C_{1, 2, 4}$ thru 10-3	—	4	pf
Reverse Recovery Time (Fig. 3) Connect Pin 3 to C, Pin 4 to D, alternately connect Pins 1, 2, 9, and 10 to B Connect Pin 3 to C, Pin 5 to D, alternately connect Pins 6, 7, and 8 to B Connect Pin 3 to C, Pin 2 to D, and Pin 4 to B Connect Pin 3 to C, Pin 6 to D, and Pin 5 to B	$t_2 - t_1$	— — — —	15 15 15 15	nsec

NOTE: Letter subscripts denote test circuit connection points.
 Number subscripts denote device pin connections.

DIFFERENTIAL VOLTAGE AND FORWARD CURRENT TEST CIRCUIT AND TERMINAL CONNECTIONS

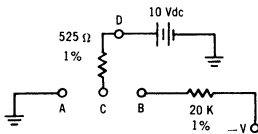

**TERMINAL TEST CONNECTIONS
DIFFERENTIAL VOLTAGE**

ALTERNATELY CONNECT A TO	6, 7, 8	1, 2, 9, & 10
CONNECT B TO	5	4
CONNECT C TO	3	3

**TERMINAL TEST CONNECTIONS
FORWARD CURRENT**

ALTERNATELY CONNECT A TO	1, 2, 4 THRU 10
CONNECT D TO	3
NO CONNECTION TO B	

MC1112

MC1111-MC1118 DTL SERIES

2-2-2 Diode AND Gate.

MAXIMUM RATINGS ($T_A = 25^\circ\text{C}$ unless otherwise noted)

Characteristic	Symbol	Rating	Unit
Forward Current	I_F	20	mA
Reverse Voltage	V_R	10	Volts
Total Device Dissipation Derate above 25°C	P_D	300 2	mW mW/ $^\circ\text{C}$
Resistor Dissipation (Each Resistor) Derate above 25°C	P_D	100 0.67	mW mW/ $^\circ\text{C}$
Operating Temperature Range	T_A	-55 to +125	$^\circ\text{C}$
Storage Temperature Range	T_{stg}	-65 to +175	$^\circ\text{C}$

CIRCUIT SCHEMATIC

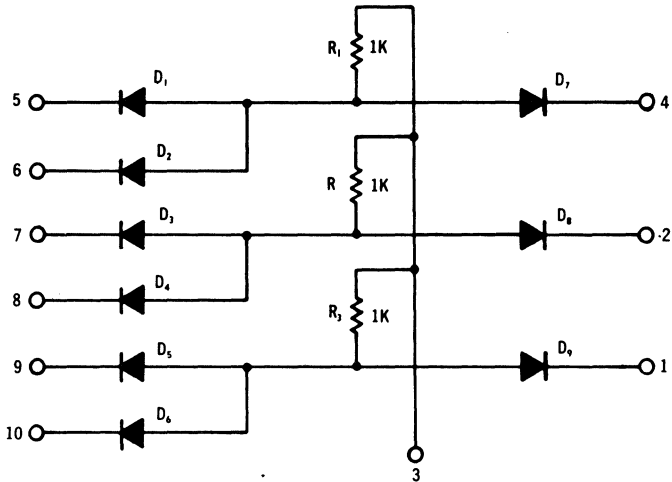

2-2-2 DIODE "AND" GATE

MC1112 (continued)

ELECTRICAL CHARACTERISTICS (T_A = 25°C unless otherwise noted)

Characteristic	Symbol	Min	Max	Unit
Forward Current (each diode - Fig. 2) V _{D-1} = 10 Vdc V _{D-2} = 10 Vdc V _{D-4} thru 10 = 10 Vdc	I ₃₋₁ I ₃₋₂ I ₃₋₄ thru 10	8.3 8.3 8.3	10.1 10.1 10.1	mAdc
Reverse Current (each diode) V ₁₋₃ = 10 Vdc V ₂₋₃ = 10 Vdc V ₄ thru 10-3 = 10 Vdc	I ₁₋₃ I ₂₋₃ I ₄ thru 10-3	— — —	0.1 0.1 0.1	μAdc
Differential Voltage (Fig. 2) V _{D-5} = 10 Vdc, I _{D-4} = 0.5 mAdc V _{D-6} = 10 Vdc, I _{D-4} = 0.5 mAdc V _{D-7} = 10 Vdc, I _{D-2} = 0.5 mAdc V _{D-8} = 10 Vdc, I _{D-2} = 0.5 mAdc V _{D-9} = 10 Vdc, I _{D-1} = 0.5 mAdc V _{D-10} = 10 Vdc, I _{D-1} = 0.5 mAdc	V ₄₋₅ V ₄₋₆ V ₂₋₇ V ₂₋₈ V ₁₋₉ V ₁₋₁₀	— — — — — —	0.30 0.30 0.30 0.30 0.30 0.30	Vdc
Capacitance (each diode) V _{1, 2, 4} thru 10-3 = 10 Vdc, f = 100 kc	C _{1, 2, 4, thru 10-3}	—	4	pf
Reverse Recovery Time (Fig. 3) Connect Pin 3 to C, Pin 1 to D, alternately connect Pins 9 and 10 to B Connect Pin 3 to C, Pin 2 to D, alternately connect Pins 7 and 8 to B Connect Pin 3 to C, Pin 4 to D, alternately connect Pins 5 and 6 to B Connect Pin 3 to C, Pin 9 to D, and Pin 1 to B Connect Pin 3 to C, Pin 7 to D, and Pin 2 to B Connect Pin 3 to C, Pin 5 to D, and Pin 4 to B	t ₂ - t ₁	— — — — — —	15 15 15 15 15 15	nsec

NOTE: Letter subscripts denote test circuit connection points.
Number subscripts denote device pin connections.

DIFFERENTIAL VOLTAGE AND FORWARD CURRENT TEST CIRCUIT AND TERMINAL CONNECTIONS

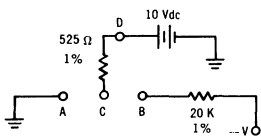

**TERMINAL TEST CONNECTIONS
DIFFERENTIAL VOLTAGE**

ALTERNATELY CONNECT A TO	9, 10	7, 8	5, 6
CONNECT B TO	1	2	4
CONNECT C TO	3	3	3

**TERMINAL TEST CONNECTIONS
FORWARD CURRENT**

ALTERNATELY CONNECT A TO	1, 2, 4 THRU 10
CONNECT D TO	3
NO CONNECTION TO B	

MC1113

MC1111-MC1118 DTL SERIES

1-1-1-2 Diode AND Gate.

MAXIMUM RATINGS ($T_A = 25^\circ\text{C}$)

Characteristic	Symbol	Rating	Unit
Forward Current	I_F	20	mA
Reverse Voltage	V_R	10	Volts
Total Device Dissipation Derate above 25°C	P_D	400 2.67	mW mW/ $^\circ\text{C}$
Resistor Dissipation (Each Resistor) Derate above 25°C	P_D	100 0.67	mW mW/ $^\circ\text{C}$
Operating Temperature Range	T_A	-55 to +125	$^\circ\text{C}$
Storage Temperature Range	T_{stg}	-65 to +175	$^\circ\text{C}$

CIRCUIT SCHEMATIC

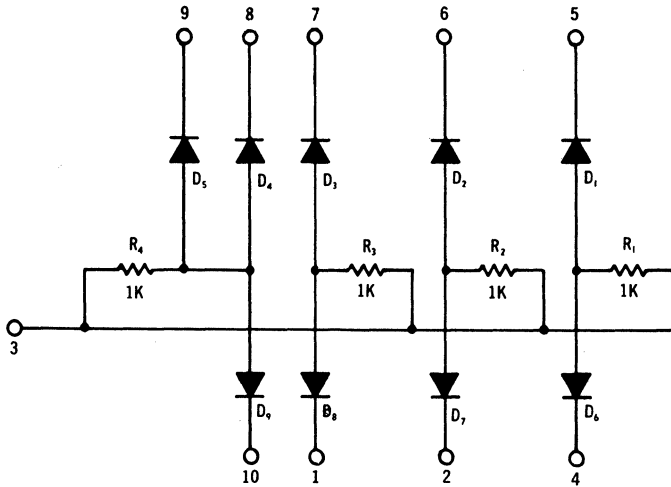

1 - 1 - 1 - 2 DIODE "AND" GATE

MC1113 (continued)

ELECTRICAL CHARACTERISTICS ($T_A = 25^\circ\text{C}$ unless otherwise noted)

Characteristic	Symbol	Min	Max	Unit
Forward Current (each diode - Fig. 2) $V_{D-1} = 10\text{ Vdc}$ $V_{D-2} = 10\text{ Vdc}$ V_{D-4} thru 10 = 10 Vdc	I_{3-1} I_{3-2} I_{3-4} thru 10	8.3 8.3 8.3	10.1 10.1 10.1	mAdc
Reverse Current (each diode) $V_{1-3} = 10\text{ Vdc}$ $V_{2-3} = 10\text{ Vdc}$ V_4 thru 10-3 = 10 Vdc	I_{1-3} I_{2-3} I_4 thru 10-3	— — —	0.1 0.1 0.1	μAdc
Differential Voltage (Fig. 2) $V_{D-8} = 10\text{ Vdc}, I_{D-10} = 0.5\text{ mAdc}$ $V_{D-9} = 10\text{ Vdc}, I_{D-10} = 0.5\text{ mAdc}$ $V_{D-7} = 10\text{ Vdc}, I_{D-1} = 0.5\text{ mAdc}$ $V_{D-6} = 10\text{ Vdc}, I_{D-2} = 0.5\text{ mAdc}$ $V_{D-5} = 10\text{ Vdc}, I_{D-4} = 0.5\text{ mAdc}$	V_{10-8} V_{10-9} V_{1-7} V_{2-6} V_{4-5}	— — — — —	0.30 0.30 0.30 0.30 0.30	Vdc
Capacitance (each diode) $V_{1, 2, 4}$ thru 10-3 = 10 Vdc, $f = 100\text{ kc}$	$C_{1, 2, 4}$ thru 10-3	—	4	pf
Reverse Recovery Time (Fig. 3) Connect Pin 3 to C, Pin 10 to D, alternately connect Pins 8 and 9 to B Connect Pin 3 to C, Pin 1 to D, and Pin 7 to B Connect Pin 3 to C, Pin 2 to D, and Pin 6 to B Connect Pin 3 to C, Pin 4 to D, and Pin 5 to B Connect Pin 3 to C, Pin 5 to D, and Pin 4 to B Connect Pin 3 to C, Pin 6 to D, and Pin 2 to B Connect Pin 3 to C, Pin 7 to D, and Pin 1 to B Connect Pin 3 to C, Pin 8 to D, and Pin 10 to B	$t_2 - t_1$	— — — — — — — —	15 15 15 15 15 15 15 15	nsec

NOTE: Letter denotes test circuit connection points.
Number subscripts denote device pin connections.

DIFFERENTIAL VOLTAGE AND FORWARD CURRENT TEST CIRCUIT AND TERMINAL CONNECTIONS

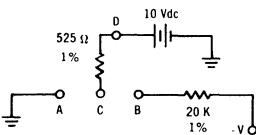

TERMINAL TEST CONNECTIONS
DIFFERENTIAL VOLTAGE

ALTERNATELY CONNECT A TO	8, 9	7	6	5
CONNECT B TO	10	1	2	4
CONNECT C TO	3	3	3	3

TERMINAL TEST CONNECTIONS
FORWARD CURRENT

ALTERNATELY CONNECT A TO	1, 2, 4 THRU 10
CONNECT D TO	3
B NOT CONNECTED.	

MC1114

MC1111-MC1118 DTL SERIES

8-Diode AND Gate.

MAXIMUM RATINGS ($T_A = 25^\circ\text{C}$)

Characteristic	Symbol	Rating	Unit
Forward Current	I_F	20	mA
Reverse Voltage	V_R	10	Volts
Total Device Dissipation Derate above 25°C	P_D	100 0.667	mW mW/ $^\circ\text{C}$
Operating Temperature Range	T_A	-55 to +125	$^\circ\text{C}$
Storage Temperature Range	T_{stg}	-65 to +175	$^\circ\text{C}$

CIRCUIT SCHEMATIC

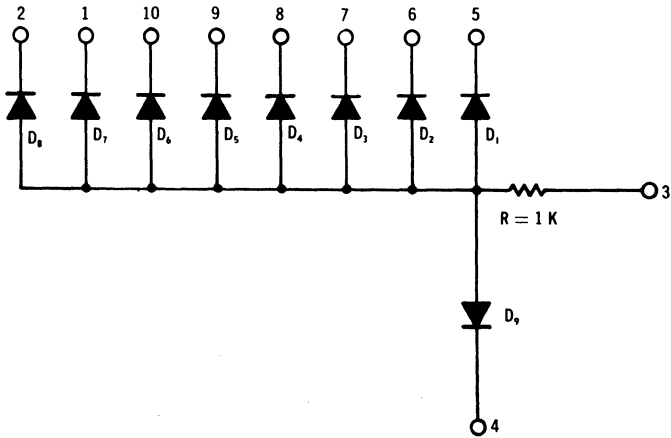

8 DIODE "AND" GATE

MC1114 (continued)

ELECTRICAL CHARACTERISTICS ($T_A = 25^\circ\text{C}$ unless otherwise noted)

Characteristic	Symbol	Min	Max	Unit
Forward Current (each diode - Fig. 2) $V_{D-1} = 10\text{ Vdc}$ $V_{D-2} = 10\text{ Vdc}$ V_{D-4} thru 10 = 10 Vdc	I_{3-1} I_{3-2} I_{3-4} thru 10	8.3 8.3 8.3	10.1 10.1 10.1	mAdc
Reverse Current (each diode) $V_{1-3} = 10\text{ Vdc}$ $V_{2-3} = 10\text{ Vdc}$ V_4 thru 10-3 = 10 Vdc	I_{1-3} I_{2-3} I_4 thru 10-3	— — —	0.1 0.1 0.1	μAdc
Differential Voltage (Fig. 2) $V_{D-5} = 10\text{ Vdc}, I_{D-4} = 0.5\text{ mAdc}$ $V_{D-6} = 10\text{ Vdc}, I_{D-4} = 0.5\text{ mAdc}$ $V_{D-7} = 10\text{ Vdc}, I_{D-4} = 0.5\text{ mAdc}$ $V_{D-8} = 10\text{ Vdc}, I_{D-4} = 0.5\text{ mAdc}$ $V_{D-9} = 10\text{ Vdc}, I_{D-4} = 0.5\text{ mAdc}$ $V_{D-10} = 10\text{ Vdc}, I_{D-4} = 0.5\text{ mAdc}$ $V_{D-1} = 10\text{ Vdc}, I_{D-4} = 0.5\text{ mAdc}$ $V_{D-2} = 10\text{ Vdc}, I_{D-4} = 0.5\text{ mAdc}$	V_{4-5} V_{4-6} V_{4-7} V_{4-8} V_{4-9} V_{4-10} V_{4-1} V_{4-2}	— — — — — — — —	0.30 0.30 0.30 0.30 0.30 0.30 0.30 0.30	Vdc
Capacitance (each diode) $V_{1, 2, 4}$ thru 10-3 = 10 Vdc, $f = 100\text{ kc}$	$C_{1, 2, 4}$ thru 10-3	—	4	pf
Reverse Recovery Time (Fig. 3) Connect Pin 3 to C, Pin 4 to D, alternately connect Pins 1, 2, 5, 6, 7, 8, 9, and 10 to B Connect Pin 3 to C, Pin 1 to D, and Pin 4 to B	$t_2 - t_1$	— —	15 15	nsec

NOTE: Letter subscripts denote test circuit connection points.
 Number subscripts denote device pin connections.

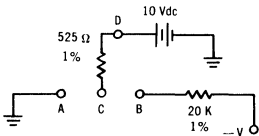

TERMINAL TEST CONNECTIONS
DIFFERENTIAL VOLTAGE

ALTERNATELY CONNECT A TO	1, 2, 5 THRU 10
CONNECT B TO	4
CONNECT C TO	3

TERMINAL TEST CONNECTIONS
FORWARD CURRENT

ALTERNATELY CONNECT A TO	1, 2, 4 THRU 10
CONNECT D TO	3
B NOT CONNECTED	

DIFFERENTIAL VOLTAGE AND FORWARD CURRENT TEST CIRCUIT AND TERMINAL CONNECTIONS

MC1115

MC1111-MC1118 DTL SERIES

Dual high-speed, NPN transistor inverters.

MAXIMUM RATINGS (T_A = 25°C)

Characteristic	Symbol	Rating	Unit
Reverse Voltage			V _{dc}
	V ₁₀₋₂	10.0	
	V ₅₋₃	10.0	
	V ₅₋₇	7.0	
	V ₁₀₋₈	7.0	
Total Device Dissipation Derate above 25°C	P _D	250	mW
		1.67	mW/°C
Individual Gate Dissipation Derate above 25°C	P _D	125	mW
		0.83	mW/°C
Resistor Dissipation R ₁ or R ₂ Derate above 25°C	P _D	100	mW
		0.67	mW/°C
		25	mW
		0.17	mW/°C
Operating Temperature Range	T _A	-55 to +125	°C
Storage Temperature Range	T _{stg}	-65 to +175	°C

CIRCUIT SCHEMATIC

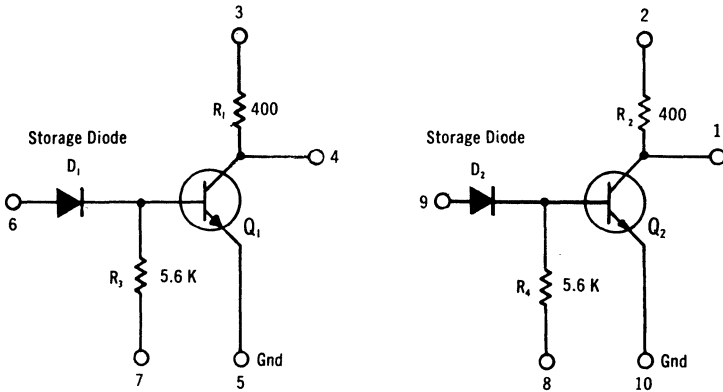

HIGH-SPEED DUAL INVERTER

MC1115 (continued)

ELECTRICAL CHARACTERISTICS ($T_A = 25^\circ\text{C}$ unless otherwise noted)

Characteristic	Symbol	Min	Max	Unit
Static Input Voltage Drop $I_{4-5} = 35 \text{ mAdc}, I_{6-5} = 1.5 \text{ mAdc}$ Q_1 $I_{1-10} = 35 \text{ mAdc}, I_{9-10} = 1.5 \text{ mAdc}$ Q_2	V_{6-5} V_{9-10}	1.2 1.2	1.7 1.7	Vdc
Collector-Emitter Saturation Voltage $I_{4-5} = 35 \text{ mAdc}, I_{6-5} = 1.5 \text{ mAdc}$ Q_1 $I_{1-10} = 35 \text{ mAdc}, I_{9-10} = 1.5 \text{ mAdc}$ Q_2	$V_{CE(sat)} 4-5$ $V_{CE(sat)} 1-10$	— —	0.35 0.35	Vdc
Base-Emitter Conduction Current $V_{7-5} = 10 \text{ Vdc}$ Q_1 $V_{8-10} = 10 \text{ Vdc}$ Q_2	I_{7-5} I_{8-10}	1.50 1.50	1.84 1.84	mAdc
Collector Resistor Current $V_{3-4} = 3 \text{ Vdc}$ Q_1 $V_{2-1} = 3 \text{ Vdc}$ Q_2	I_{3-4} I_{2-1}	6.82 6.82	8.35 8.35	mAdc
Collector-Emitter Cutoff Current $V_{3-5} = 10 \text{ Vdc}, V_{7-5} = -6.5 \text{ Vdc}$ Q_1 $V_{3-5} = 10 \text{ Vdc}, V_{7-5} = -6.5 \text{ Vdc}, T_A = +85^\circ\text{C}$ Q_2 $V_{2-10} = 10 \text{ Vdc}, V_{8-10} = -6.5 \text{ Vdc}$ Q_1 $V_{2-10} = 10 \text{ Vdc}, V_{8-10} = -6.5 \text{ Vdc}, T_A = +85^\circ\text{C}$ Q_2	I_{3-5} I_{3-5} I_{2-10} I_{2-10}	— — — —	0.05 3 0.05 3	μAdc
Reverse Current $V_{7-6} = 10 \text{ Vdc}$ Q_1 $V_{8-9} = 10 \text{ Vdc}$ Q_2	I_{7-6} I_{8-9}	— —	100 100	nA
DC Forward Current Transfer Ratio $V_{4-5} = 0.5 \text{ Vdc}, I_{4-5} = 35 \text{ mAdc}$ Q_1 $V_{4-5} = 0.5 \text{ Vdc}, I_{4-5} = 35 \text{ mAdc}, T_A = -55^\circ\text{C}$ Q_2 $V_{1-10} = 0.5 \text{ Vdc}, I_{1-10} = 35 \text{ mAdc}$ Q_1 $V_{1-10} = 0.5 \text{ Vdc}, I_{1-10} = 35 \text{ mAdc}, T_A = -55^\circ\text{C}$ Q_2	h_{FE}	35 15 35 15	— — — —	—
Turn-On Time (Fig. 2) $V_{7-5} = -6.5 \text{ Vdc}, V_{3-5} = +3 \text{ Vdc}$, close switch S_2 Q_1 $V_{8-10} = -6.5 \text{ Vdc}, V_{2-10} = +3 \text{ Vdc}$, close switch S_2 Q_2	t_{on}	— —	20 20	nsec
Turn-Off Time (Fig. 2) $V_{7-5} = -6.5 \text{ Vdc}, V_{3-5} = +3 \text{ Vdc}$, close switch S_1 Q_1 $V_{8-10} = -6.5 \text{ Vdc}, V_{2-10} = +3 \text{ Vdc}$, close switch S_1 Q_2	t_{off}	— —	45 45	nsec

NOTE: Number subscripts denote device pin connections

MC1116
MC1117
MC1118

MC1111-MC1118 DTL SERIES

Multi-diode Gates. The MC1116 is a 9-Diode Common-P Gate, the MC1117 is a 9-Diode Common-N Gate and the MC1118 is a 16-Diode Series/Parallel Matrix.

MAXIMUM RATINGS (All Types at 25°C)

Characteristic	Symbol	Rating	Unit
Reverse Voltage (Each Diode)	V_R	40	Volts
Total Device Current (Derate 2mA/°C)	I_F	300	mA
Individual Diode Current (Derate 2mA/°C)	I_F	300	mA
Operating Temperature Range	T_A	-65 to +175	°C

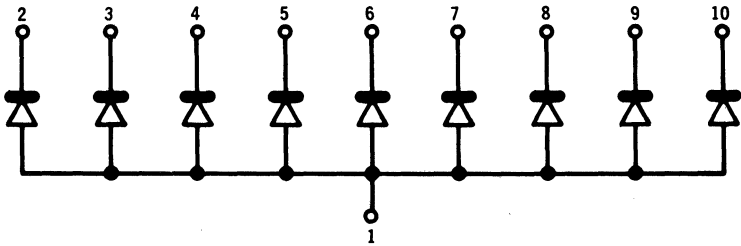

MC1116 (common P)

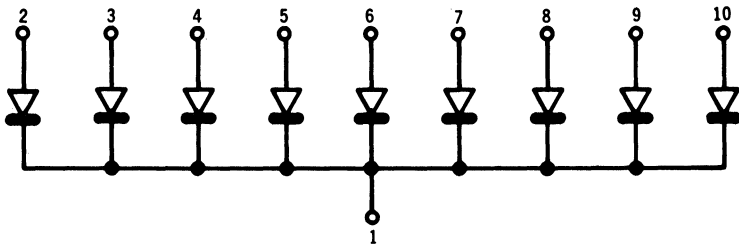

MC1117 (common N)

MC1116, MC1117, MC1118 (continued)

ELECTRICAL CHARACTERISTICS (Each Diode) - (25°C unless otherwise noted)

Characteristic	Symbol	Min	Max	Unit
Forward Voltage $I_F = 300\text{mA}$	V_F	---	1.2	Vdc
Reverse Current $V_R = 20\text{Vdc}$	I_R	---	2.0	μA
Breakdown Voltage $I_R = 10\ \mu\text{A}$	V_R	40	---	Vdc
Junction Capacitance $V_R = 10\text{Vdc}, f = 100\text{KC}$ MC1116, MC1117 MC1118*	C_j	---	8.0 16.0*	pf
Reverse Recovery Time ($I_F = 300\text{mA}$, $I_R = 60\text{mA}$, $R_L = 2.5\ \Omega$, Scope Input Capacitance $\leq 4\text{pf}$)	t_{rr}	---	90	nsec.

* The actual capacitance of the individual diodes in the MC1118 is the same as in the MC1116/7. However, the measured capacitance is higher as shown, due to the series/parallel effects of the interconnection scheme.

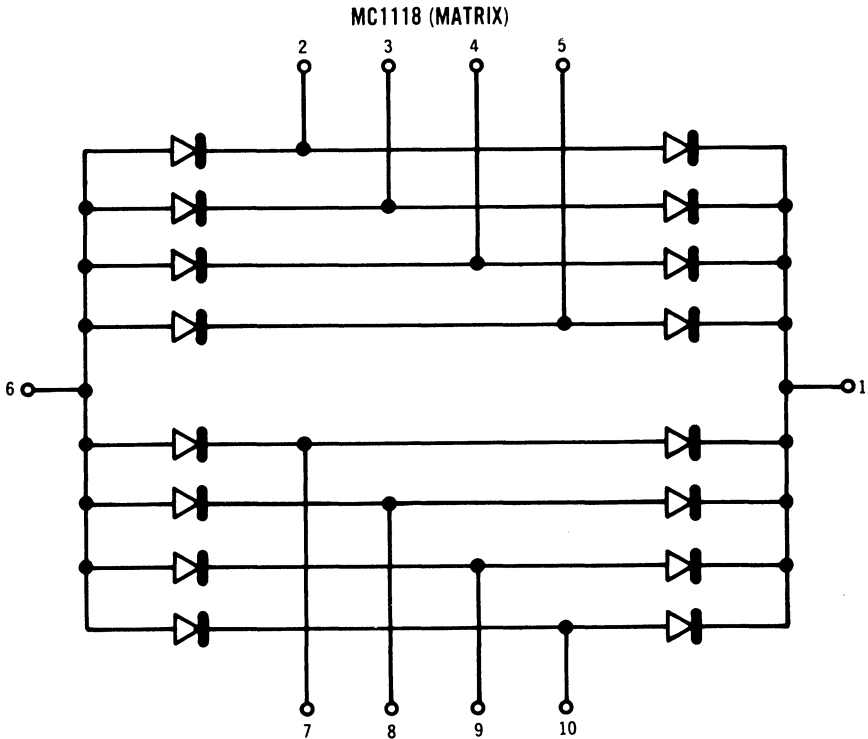

MC908 series

MC908 MILLIWATT RTL SERIES

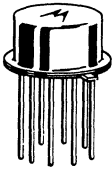

The Milliwatt RTL Line consists of seven monolithic, integrated Resistor-Transistor Logic circuits. These devices are designed for use over the full military temperature range of -55 to +125°C.

CASE 96

The mW RTL series

MC908G	Adder
MC909G	Buffer
MC910G	Dual 2-Input Gate
MC911G	4-Input Gate
MC912G	Half-Adder
MC913G	Type D Flip-Flop
MC921G	Gate Expander

MAXIMUM RATINGS (T_A = 25°C)

Characteristic	Rating	Unit
Maximum Applied Voltage to pin 8 (pulsed, ≤1 sec)	12	Vdc
Maximum Applied Voltage to pin 8 (continuous)	8	Vdc
Maximum Applied Voltage to any input	+4	Vdc
Operating Temperature Range	-55 to +125	°C
Storage Temperature Range	-65 to +150	°C
Maximum Power Dissipation	250	mW

TEST CONDITION TOLERANCES	
V _{CC} = +10mV	V _{IN} = +2mV
V _{LL} = + 2mV	V _{ON} = +2mV
V _{BOT} = +10mV	V _{OFF} = +2mV
V _{RL} = ±1%	V _{RH} = ±1%

MC908 MILLIWATT RTL SERIES

LOADING DIAGRAM (TOP VIEW)

VALID FOR $V_{CC} = 3.00 \text{ VOLTS} \pm 10\%$ AND $T_A = -55^\circ \text{ C to } +125^\circ \text{ C}$

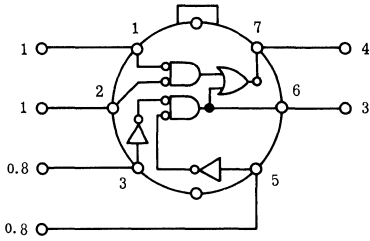

MC908G

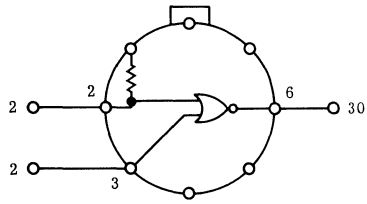

MC909G

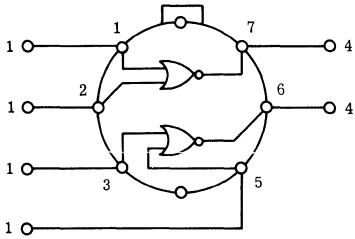

MC910G

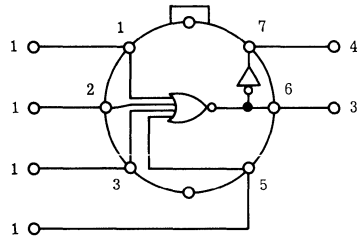

MC911G

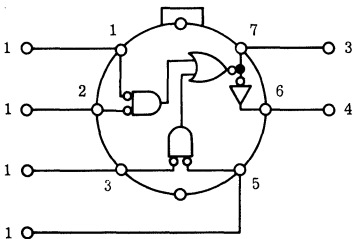

MC912G

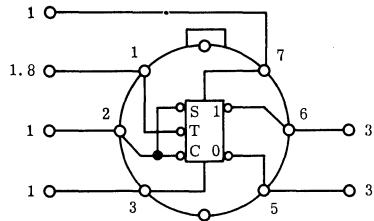

MC913G

MC908G

ADDER

mW RTL SERIES

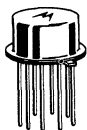

The MC908 is an RTL Adder. The binary half-adder function can be performed by connecting pin 1 to pin 3 and pin 2 to pin 5. The sum is available on pin 7 while the carry is available on pin 6. The device may also be used as a data selector by connecting pin 1 to pin 3 and using pins 2 and 5 as data inputs. A full adder can be made utilizing two MC908s and one MC911. Average power dissipation is 10mW at 25°C.

ELECTRICAL CHARACTERISTICS

		Test Condition: -55 (Volts)	-.970	.935	1.8	.650	3.00	.500	MC908G							
Characteristics	Symbol Pin No. in ()	V _{IN} Pin	V _{ON} Pin	V _{BOF} Pin	V _{OFF} Pin	V _{CC} Pin	V _{LL} Pin	Gnd. Pin	Open Pin	Test Limits						Unit
										-55°C		+25°C		+125°C		
										Min	Max	Min	Max	Min	Max	
Input Current	I _{IN} (1)	1		2		8		3, 4, 5	6, 7	125		130		110	μ Adc	
	I _{IN} (2)	2		1		8		3, 4, 5	6, 7	125		130		110	μ Adc	
	.8 I _{IN} (3)	3				8		1, 2, 4, 5	6, 7	100		104		88	μ Adc	
	.8 I _{IN} (5)	5				8		1, 2, 3, 4	6, 7	100		104		88	μ Adc	
Output Current	I _{A3} (6)	6	3, 5			8		1, 2, 4	7	350		364		308	μ Adc	
	I _{A4} (7)	7	1		3, 5	8		2, 4	6	475		494		418	μ Adc	
	I _{A4} (7)	7	2		3, 5	8		1, 4	6	475		494		418	μ Adc	
Saturation Voltage	V _{CE} (6)			3	5	8		1, 2, 4	6, 7	220		220		220	mVdc	
	V _{CE} (6)			5	3	8		1, 2, 4	6, 7	220		220		220	mVdc	
	V _{CE} (7)				1, 2	8		3, 4, 5	6, 7	220		220		220	mVdc	
	V _{CE} (7)	6		1, 2, 3, 5		8		4	7	220		220		220	mVdc	
Output Voltage	V _{OUT} (7)		6	1, 2, 3, 5		8		4	7	620		300		230	mVdc	
Leakage Current	I _L (8)						8	1, 2, 3, 4, 5	6, 7	100		100		100	μ Adc	
Switching Time	Pulse In		Pulse Out													
	Turn-On Delay	t ₃₊₇₋	3	7	2, 5	8		1, 4	6			80			nsec	
	Turn-Off Delay	t ₃₋₇₊	3	7	2, 5	8		1, 4	6			100			nsec	

SWITCHING TIME WAVE FORM

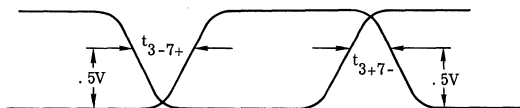

MC908G (continued)

SWITCHING TIME TEST CIRCUIT

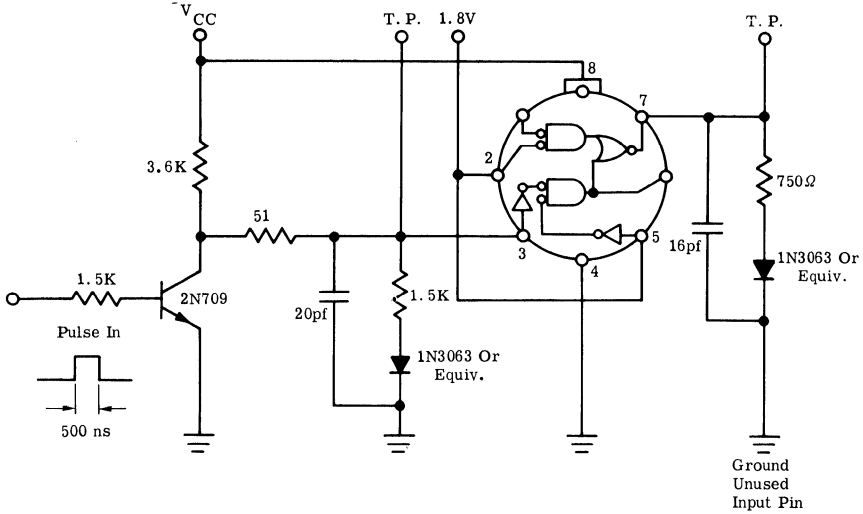

LOGIC SYMBOLS AND FUNCTIONS (PER MIL-STD-806B)

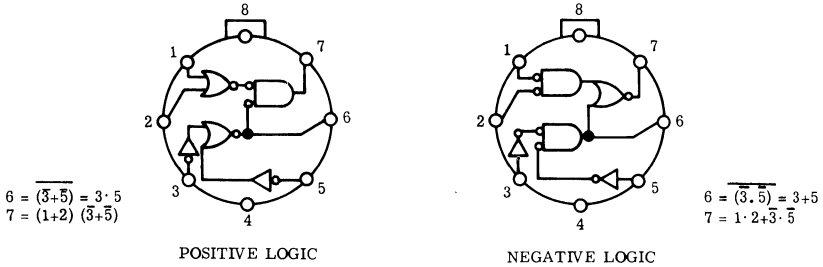

CIRCUIT DIAGRAM

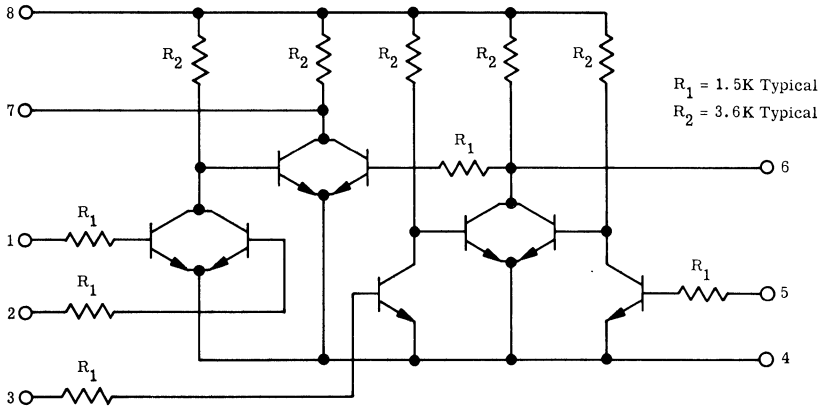

MC909G

mW RTL SERIES

BUFFER

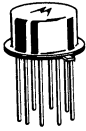

The MC909 is an RTL Buffer designed to drive a greater number of loads than the basic Resistor Transistor Logic circuit. Returning an input resistor to V_{CC} allows for capacitive coupling in multivibrator and differentiator applications. Average power dissipation at 25°C and 50% duty cycle is 10 mW.

ELECTRICAL CHARACTERISTICS

Characteristics	Symbol Pin No. in()	V_{IN} Pin	V_{ON} Pin	V_{BOT} Pin	V_{OFF} Pin	V_{CC} Pin	V_{RH}^* Pin	Gnd. Pin	Open Pin	Test Limits						Unit
										-55°C		+25°C		+125°C		
										Min	Max	Min	Max	Min	Max	
Input Current	$2I_{IN}(2)$	2		3		8		4	1, 5, 6, 7	250		260		220	μ Adc	
	$2I_{IN}(3)$	3		2		8		4	1, 5, 6, 7	250		260		220	μ Adc	
Output Current	$I_{AB}(6)$	6			2, 3	8		4	1, 5, 7	3.75		4.0		3.3	mAdc	
Output Voltage	$V_{OUT}(6)$		2			8	6	3, 4	1, 5, 7	620		300		230	mVdc	
	$V_{OUT}(6)$		3			8	6	2, 4	1, 5, 7	620		300		230	mVdc	
Saturation Voltage	$V_{CE}(6)$	2				8	6	3, 4	1, 5, 7	220		220		220	mVdc	
	$V_{CE}(6)$	3				8	6	2, 4	1, 5, 7	220		220		220	mVdc	
Leakage Current	$I_L(8)$					8		2, 3, 4	1, 5, 6, 7	100		100		100	μ Adc	
Switching Time		Pulse In	Pulse Out			*										
Turn-On Delay	t_{3-6-}	3	6			8		2, 4	1, 5, 7			90			nsec	
Turn-Off Delay	t_{3-6+}	3	6			8		2, 4	1, 5, 7			70			nsec	

* Resistor to V_{CC}

LOGIC SYMBOLS AND FUNCTIONS (PER MIL-STD-806B)

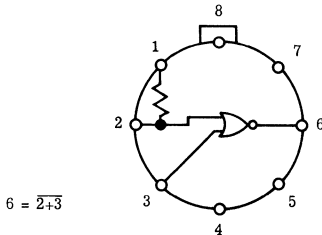

POSITIVE LOGIC

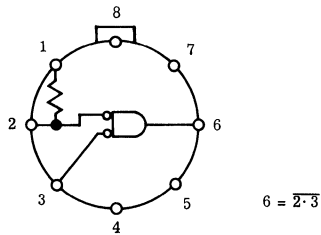

NEGATIVE LOGIC

MC909G (continued)

CIRCUIT DIAGRAM

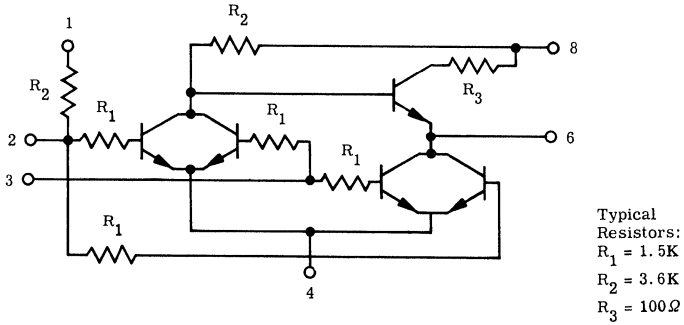

SWITCHING TIME TEST CIRCUIT

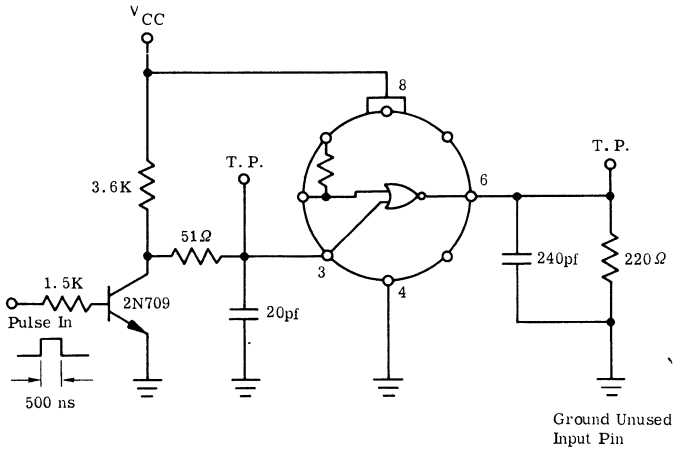

SWITCHING TIME WAVE FORM



MC910G

mW RTL SERIES

DUAL 2 — INPUT GATE

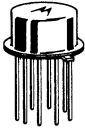

The MC910 Dual (2-2) Input Gate consists of a pair of NOR Gates. It may also be used as a pair of inverters, a double inverter or as an R-S Flip-Flop. Average power dissipation at 25°C is 4 mW.

ELECTRICAL CHARACTERISTICS

		Test Condition: +25 (Volts)	-55	.970	.935	1.8	650	3.00	.500	MC910G						
		+125	.805	.750	1.8	450	3.00	.400								
Characteristics	Symbol Pin No. in()	VIN Pin	VON Pin	V _{BOT} Pin	V _{OFF} Pin	V _{CC} Pin	V _{LL} Pin	Grounded Pin	Open Pin	Test Limits						
										-55°C		+25°C		+125°C		Unit
										Min	Max	Min	Max	Min	Max	
Input Current	I _{IN} (1)	1		2		8		3, 4, 5	6, 7		125		130		110	μA _{dc}
	I _{IN} (2)	2		1		8		3, 4, 5	6, 7		125		130		110	μA _{dc}
	I _{IN} (3)	3		5		8		1, 2, 4	6, 7		125		130		110	μA _{dc}
	I _{IN} (5)	5		3		8		1, 2, 4	6, 7		125		130		110	μA _{dc}
Output Current	I _{A4} /I _{AM} (7)	7		3	1, 2	8		4, 5	6	475	730	494	815	418	830	μA _{dc}
	I _{A4} /I _{AM} (6)	6		2	3, 5	8		1, 4	7	475	730	494	815	418	830	μA _{dc}
Output Voltage	V _{OUT} (7)		1			8		2, 3, 4, 5	6, 7		620		300		230	mV _{dc}
	V _{OUT} (7)		2			8		1, 3, 4, 5	6, 7		620		300		230	mV _{dc}
	V _{OUT} (6)		3			8		1, 2, 4, 5	6, 7		620		300		230	mV _{dc}
	V _{OUT} (6)		5			8		1, 2, 3, 4	6, 7		620		300		230	mV _{dc}
Saturation Voltage	V _{CE} (6)	3				8		1, 2, 4, 5	6, 7		220		220		220	mV _{dc}
	V _{CE} (6)	5				8		1, 2, 3, 4	6, 7		220		220		220	mV _{dc}
	V _{CE} (7)	1				8		2, 3, 4, 5	6, 7		220		220		220	mV _{dc}
	V _{CE} (7)	2				8		1, 3, 4, 5	6, 7		220		220		220	mV _{dc}
Leakage Current	I _L (8)		*			8		1, 2, 3, 4, 5	6, 7		100		100		100	μA _{dc}
Switching Time			Pulse In	Pulse Out												
	Turn-On Delay	t ₁₊₇₋	1	7		8		2, 3, 4, 5	6				40			nsec
Turn-Off Delay	t ₁₋₇₊	1	7		8		2, 3, 4, 5	6				50				nsec

SWITCHING TIME WAVE FORM



MC910G (continued)

LOGIC SYMBOLS AND FUNCTIONS (PER MIL-STD-806B)

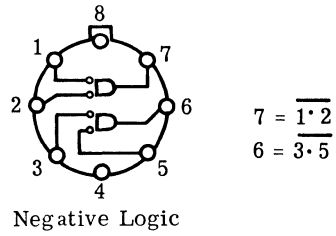
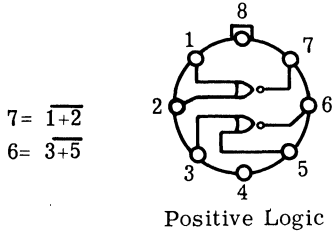

CIRCUIT DIAGRAM

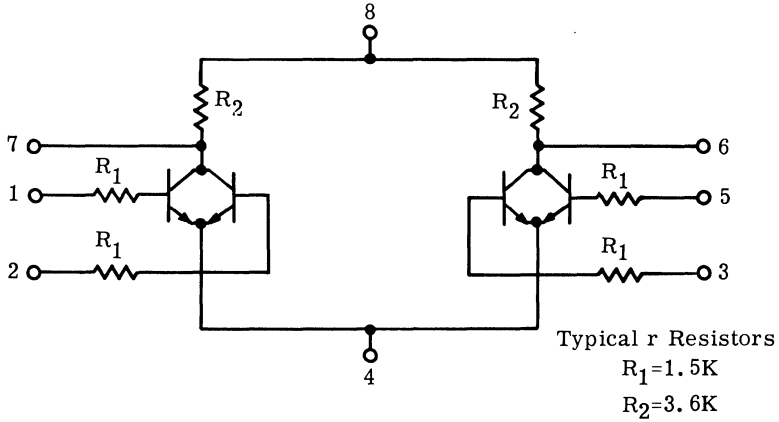

SWITCHING TIME TEST CIRCUIT

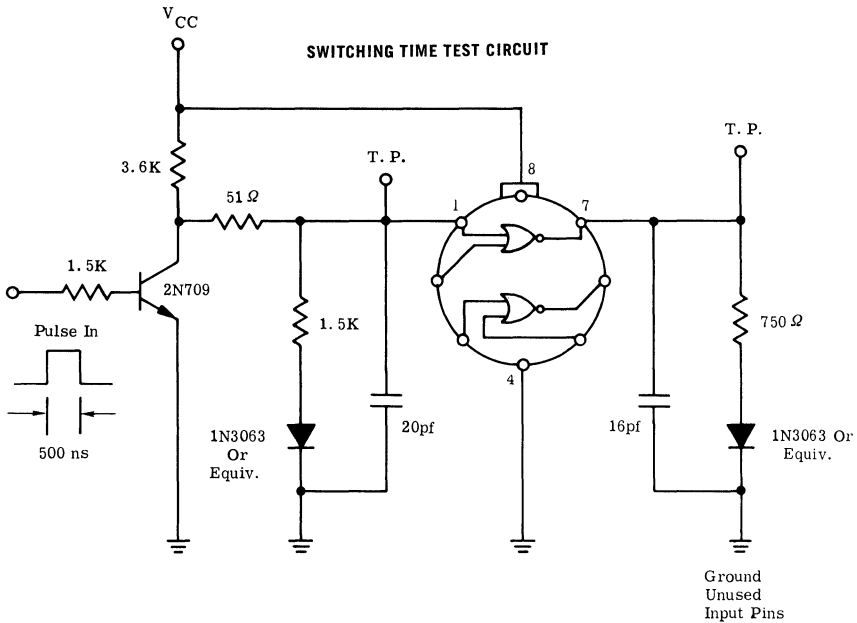

MC911G

4 INPUT GATE

mW RTL SERIES

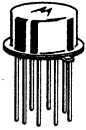

The MC911 4-Input Gate provides the NOR function on pin 6 and the OR function on pin 7. Average power dissipation at 25°C is 4 mW.

ELECTRICAL CHARACTERISTICS

		Test Condition: -55 (Volts)	-55	.970	.935	1.8	.650	3.00	.500	MC911G									
		+25	.805	.895	.750	1.8	.450	3.00	.400										
		+125	.590	.555	1.8	.260	3.00	.300	.300										
Characteristics	Symbol Pin No. in()	VIN Pin	VON Pin	V _{BOT} Pin	V _{OFF} Pin	V _{CC} Pin	V _{LL} Pin	Grounded Pin	Open Pin	Test Limits						Unit			
										-55°C		+25°C		+125°C					
										Min	Max	Min	Max	Min	Max				
Input Current	I _{IN} (1)	1		2, 3, 5		8		4	6, 7	125		130		110	μA _{dc}				
	I _{IN} (2)	2		1, 3, 5		8		4	6, 7	125		130		110	μA _{dc}				
	I _{IN} (3)	3		1, 2, 5		8		4	6, 7	125		130		110	μA _{dc}				
	I _{IN} (5)	5		1, 2, 3		8		4	6, 7	125		130		110	μA _{dc}				
Output Current	I _{A3} (6)	6			1, 2, 3, 5	8		4	7	350		364		308	μA _{dc}				
	I _{A4} , I _{AM} (7)	7			6	8		1, 2, 3, 4, 5		475	730	494	815	418	830	μA _{dc}			
Output Voltage	V _{OUT} (6)		1			8		2, 3, 4, 5	6, 7	620		300		230	mV _{dc}				
	V _{OUT} (6)		2			8		1, 3, 4, 5	6, 7	620		300		230	mV _{dc}				
	V _{OUT} (6)		3			8		1, 2, 4, 5	6, 7	620		300		230	mV _{dc}				
	V _{OUT} (6)		5			8		1, 2, 3, 4	6, 7	620		300		230	mV _{dc}				
	V _{OUT} (7)		6				8		1, 2, 3, 4, 5	7	620		300		230	mV _{dc}			
Saturation Voltage	V _{CE} (6)	1				8		2, 3, 4, 5	6, 7	220		220		220	mV _{dc}				
	V _{CE} (6)	2				8		1, 3, 4, 5	6, 7	220		220		220	mV _{dc}				
	V _{CE} (6)	3				8		1, 2, 4, 5	6, 7	220		220		220	mV _{dc}				
	V _{CE} (6)	5				8		1, 2, 3, 4	6, 7	220		220		220	mV _{dc}				
	V _{CE} (7)	6				8		1, 2, 3, 4, 5	7	220		220		220	mV _{dc}				
Leakage Current	I _L (8)						8	1, 2, 3, 4, 5	6, 7	100		100		100	μA _{dc}				
Switching Time		Pulse In	Pulse Out																
	Turn-On Delay	t ₁₋₇₋	1	7		8		2, 3, 4, 5	6					70		nsec			
Turn-Off Delay	t ₁₊₇₊	1	7		8		2, 3, 4, 5	6					90		nsec				

SWITCHING TIME WAVE FORM



MC911G (continued)

SWITCHING TIME TEST CIRCUIT

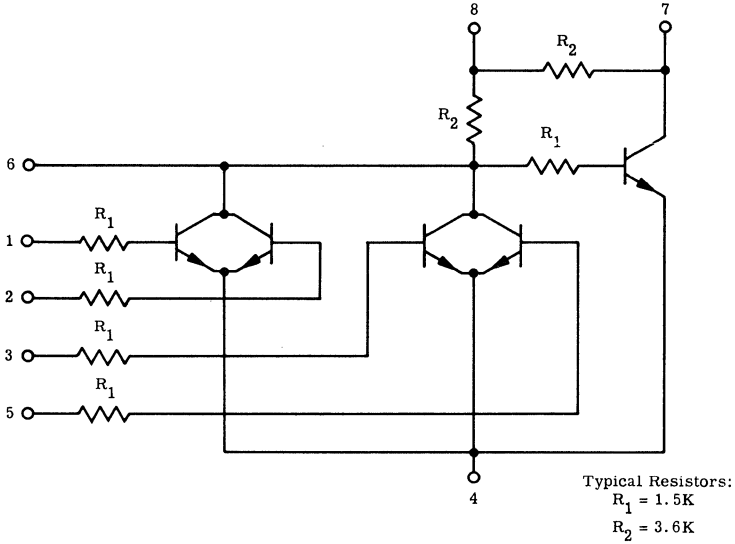
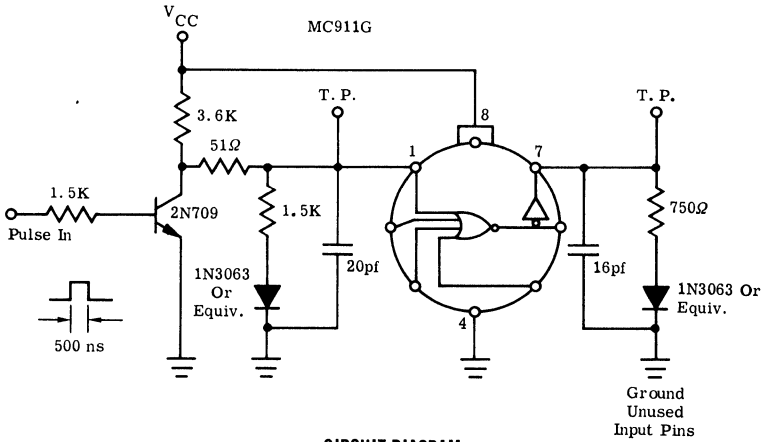

LOGIC SYMBOLS AND FUNCTIONS (PER MIL-STD-806B)

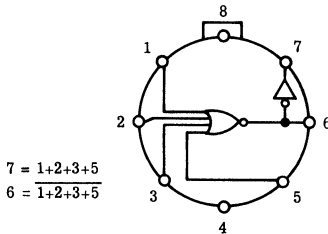

POSITIVE LOGIC

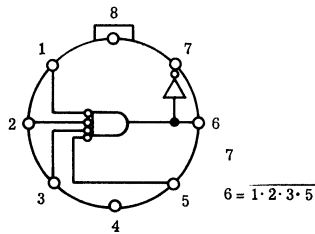

NEGATIVE LOGIC

MC912G

HALF-ADDER

mW RTL SERIES

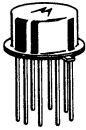

The MC912 is an RTL Half-Adder. By applying the complement of pins 1 and 2 to pins 3 and 5, the SUM and NOT SUM functions of a binary half-adder are produced on pin 7 and 6 respectively. Average power dissipation at 25°C is 8 mW.

ELECTRICAL CHARACTERISTICS

		Test Condition: -55 (Volts)	-55	.970	.935	1.8	.650	3.00	500	MC912G						
		+25	.805	.750	1.8	.450	3.00	400								
		+125	.590	.555	1.8	.260	3.00	300								
Characteristics	Symbol Pin No. in ()	V _{IN} Pin	V _{ON} Pin	V _{BOT} Pin	V _{OFF} Pin	V _{CC} Pin	V _{LL} Pin	Gnd. Pin	Open Pin	Test Limits						
										-55°C		+25°C		+125°C		Unit
		Min	Max	Min	Max	Min	Max									
Input Current	I _{IN} (1)	1		2		8		3, 4, 5	6, 7	125		130		110	μ Adc	
	I _{IN} (2)	2		1		8		3, 4, 5	6, 7	125		130		110	μ Adc	
	I _{IN} (3)	3		5		8		1, 2, 4	6, 7	125		130		110	μ Adc	
	I _{IN} (5)	5		3		8		1, 2, 4	6, 7	125		130		110	μ Adc	
Output Current	I _{A3} (7)	7	1, 3			8		2, 4, 5	6	350		364		308	μ Adc	
	I _{A3} (7)	7	2, 5			8		1, 3, 4	6	350		364		308	μ Adc	
	I _{A4} (6)	6				8		1, 2, 3, 4, 5	7	475		494		418	μ Adc	
Output Voltage	V _{OUT} (6)		7	1, 2, 3, 5		8		4	6	620		300		230	mVdc	
Saturation Voltage	V _{CE} (6)	7		1, 2, 3, 5		8		4	6	220		220		220	mVdc	
	V _{CE} (7)			3, 5	1, 2	8		4	6, 7	220		220		220	mVdc	
	V _{CE} (7)			1, 2	3, 5	8		4	6, 7	220		220		220	mVdc	
Leakage Current	I _L (8)						8	1, 2, 3, 4, 5	6, 7	100		100		100	μ Adc	
Switching Time	Pulse In	Pulse Out	1	6	5	8		2, 3, 4	7						100	nsec

LOGIC SYMBOLS AND FUNCTIONS (PER MIL-STD-806B)

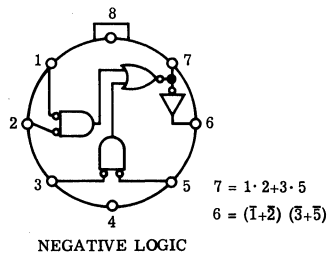
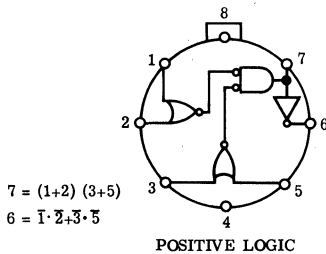

MC912G (continued)

CIRCUIT DIAGRAM

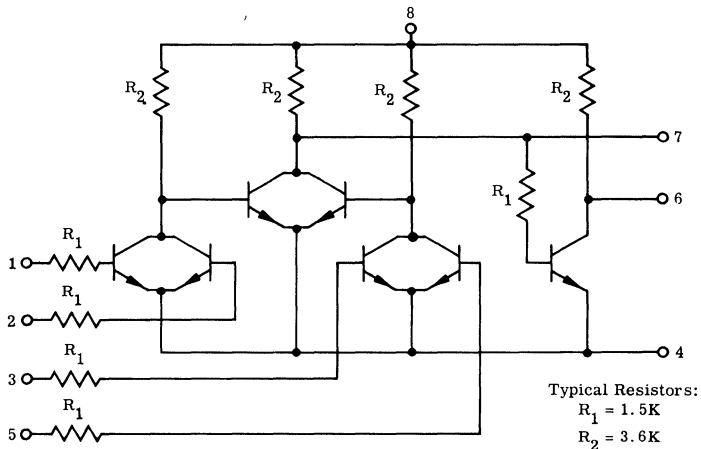

SWITCHING TIME TEST CIRCUIT

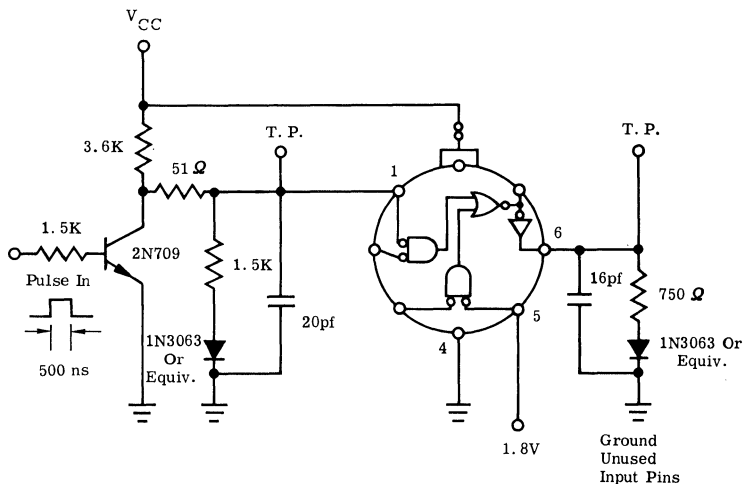

SWITCHING TIME WAVE FORM



MC913G

mW RTL SERIES

FLIP-FLOP

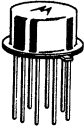

The MC913 RTL Type D Flip-Flop is a storage element that stores the state of pin 2 during negative transitions of pin 1. The flip-flop is not affected by changes of pin 2 during either the low or high state of the clock. Using pins 3 and 7 as inputs produces a standard R-S flip-flop. Average power dissipation at 25°C is 12 mW.

LOGIC SYMBOLS AND FUNCTIONS (PER MIL-STD-806B)

DIRECT INPUT (1)

3	7	6	5
L	L	NC	NC(2)
L	H	L	H
H	L	H	L
H	H	L	L

GATED INPUT (3)

t = n	t = n + 1	
2	6	5
H	H	L
L	L	H

- PIN 1 MUST BE HIGH
- NC = NO CHANGE
- PINS 3 AND 7 MUST BE LOW

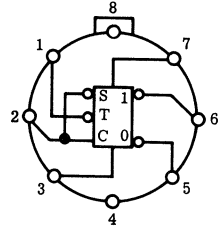

CIRCUIT DIAGRAM

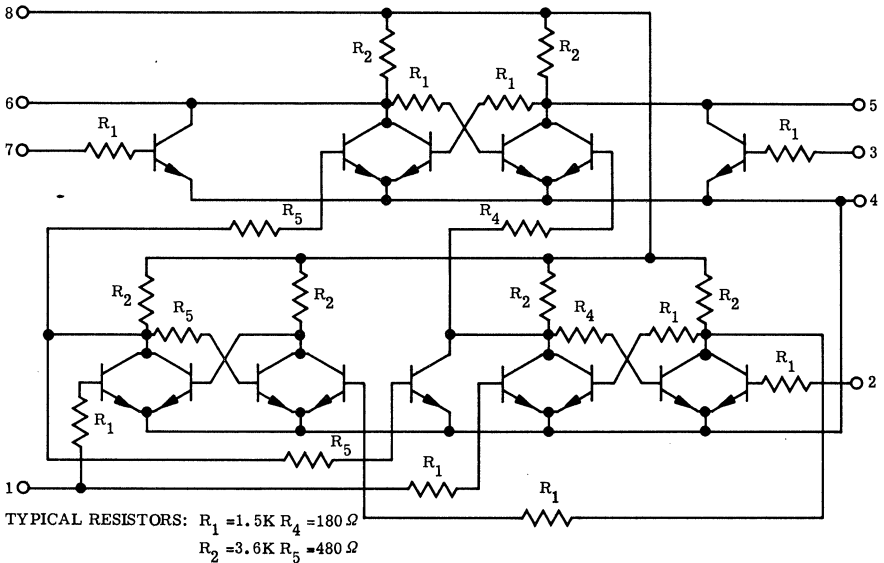

MC913G (continued)

ELECTRICAL CHARACTERISTICS

		Test Condition: -55 (Volts)	-55	.970	.935	1.8	.650	3.00	.500	MC913G						
		+25	.805	.750	1.8	.450	3.00	.400								
		+125	.590	.555	1.8	.260	3.00	.300								
Characteristics	Symbol Pin No. in ()	VIN Pin	VON Pin	V _{BOT} Pin	V _{OFF} Pin	V _{CC} Pin	V _{LL} Pin	Grounded Pin	Open Pin	Test Limits						Unit
										-55°C		+25°C		+125°C		
										Min	Max	Min	Max	Min	Max	
Input Current	I _{IN} (2) *	2			1	8		3, 4, 7	5, 6	125		130		110	μA _{dc}	
	I _{IN} (3) *	3		2	1	8		4, 7	5, 6	125		130		110	μA _{dc}	
	I _{IN} (7) *	7			1	8		2, 3, 4	5, 6	125		130		110	μA _{dc}	
	1.8 I _{IN} (1)	1				8		2, 3, 4, 7	5, 6	225		234		198	μA _{dc}	
	1.8 I _{IN} (1)	1		2		8		3, 4, 7	5, 6	225		234		198	μA _{dc}	
Output Current	I _{A3} (5)	5	1	2, 7	3	8		4	6	350		364		308	μA _{dc}	
	I _{A3} (6)	6	1	3	7	8		2, 4	5	350		364		308	μA _{dc}	
	I _{A3} (5) *	5		7	1, 3	8		2, 4	6	350		364		308	μA _{dc}	
	I _{A3} (6) *	6	2	3	1, 7	8		4	5	350		364		308	μA _{dc}	
Output Voltage	V _{OUT} (5)		3	1, 7		8		2, 4	5, 6	620		300		230	mV _{dc}	
	V _{OUT} (6)		7	1, 3		8		2, 4	5, 6	620		300		230	mV _{dc}	
	V _{OUT} (5)		5	1		8		2, 3, 4, 7	5	620		300		230	mV _{dc}	
	V _{OUT} (6)		5	1		8		2, 3, 4, 7	6	620		300		230	mV _{dc}	
Saturation Voltage	V _{CE} (5)	3		1, 7		8		2, 4	5, 6	220		220		220	mV _{dc}	
	V _{CE} (6)	7		1, 3		8		2, 4	5, 6	220		220		220	mV _{dc}	
	V _{CE} (5)	6		1		8		2, 3, 4, 7	5	220		220		220	mV _{dc}	
	V _{CE} (6)	5		1		8		2, 3, 4, 7	6	220		220		220	mV _{dc}	
	V _{CE} (5) *		2	7	1	8		3, 4	5, 6	220		220		220	mV _{dc}	
	V _{CE} (6) *		3	1, 2		8		4, 7	5, 6	220		220		220	mV _{dc}	
Leakage Current	I _L (8)						8	1, 2, 3, 4, 7	5, 6	100		100		100	μA _{dc}	
Switching Time			Pulse In	Pulse Out	Pulse 1 In	Pulse 2 In										
	t ₁₋₆₋ **	1	6			8		3, 4, 7	5			80			nsec	
	t ₁₋₆₊ **	1	6			8		3, 4, 7	5			120			nsec	
	t ₁₋₅₋ **	1	5			8		3, 4, 7	6			80			nsec	
	t ₁₋₅₊ **	1	5			8		3, 4, 7	6			120			nsec	
	t ₂₋₁₋		6	1	2	8		3, 4, 7	5		60				nsec	
	t ₁₋₂₋		6	1	2	8		3, 4, 7	5		30				nsec	
	t ₂₋₁₋		6	1	2	8		3, 4, 7	5		60				nsec	
	t ₁₋₂₊		6	1	2	8		3, 4, 7	5		30				nsec	

* The voltage applied to pin 1 will change from V_{RL} to specified value prior to making measurements.

** Tie Pin 2 to pin 5.

MC913G (continued)

SWITCHING TIME TEST CIRCUIT

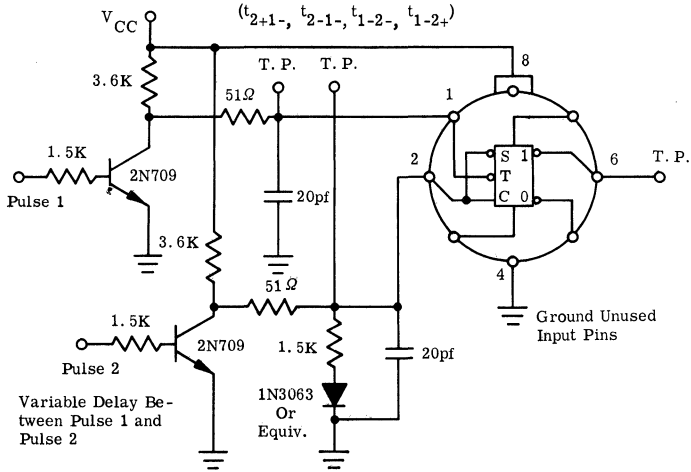

SWITCHING TIME TEST CIRCUIT

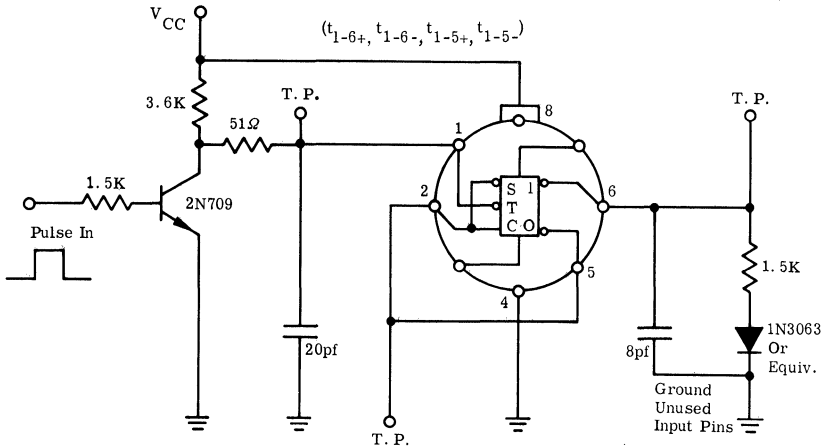

SWITCHING TIME WAVE FORM

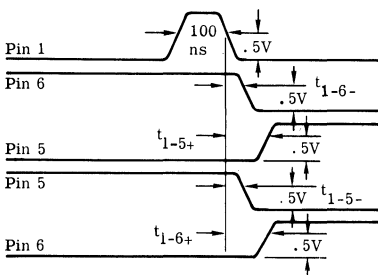

SWITCHING TIME WAVE FORM

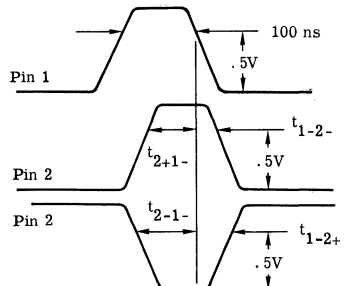

MC921G

GATE EXPANDER

mW RTL SERIES

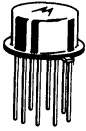

The MC921G Gate Expander is designed to increase the fan-in capability of the MC910 and MC911 Gates. Average power dissipation is considered negligible.

ELECTRICAL CHARACTERISTICS

		Test Condition: +25 (Volts)	-55	.970	.935	1.8	.650	.300	4.27K Ω	2.8K Ω	MC921G						
		+125	.805	.750	1.8	.450	.300	4.3K Ω	2.7K Ω	5K Ω							3K Ω
Characteristics	Symbol Pin No. in ()	V _{IN} Pin	V _{ON} Pin	V _{OT} Pin	V _{OFF} Pin	V _{CC} Pin	V _{RH} * Pin	V _{RL} * Pin	Grounded Pin	Open Pin	Test Limits						Unit
											-55°C		+25°C		+125°C		
			Min	Max	Min	Max	Min	Max									
Input Current	I _{IN} (1)	1		2		8	7		3, 4, 5	6	125	130	110		μ Adc		
	I _{IN} (2)	2		1		8	7		3, 4, 5	6	125	130	110		μ Adc		
	I _{IN} (3)	3		5		8	6		1, 2, 4	7	125	130	110		μ Adc		
	I _{IN} (5)	5		3		8	6		1, 2, 4	7	125	130	110		μ Adc		
Output Voltage	V _{OUT} (7)		1			8		7	2, 3, 4, 5	6	620	300	230		mVdc		
	V _{OUT} (7)		2			8		7	1, 3, 4, 5	6	620	300	230		mVdc		
	V _{OUT} (6)		3			8		6	1, 2, 4, 5	7	620	300	230		mVdc		
	V _{OUT} (6)		5			8		6	1, 2, 3, 4	7	620	300	230		mVdc		
Saturation Voltage	V _{CE} (6)	3				8		6	1, 2, 4, 5	7	220	220	220		mVdc		
	V _{CE} (6)	5				8		6	1, 2, 3, 4	7	220	220	220		mVdc		
	V _{CE} (7)	1				8		7	2, 3, 4, 5	6	220	220	220		mVdc		
	V _{CE} (7)	2				8		7	1, 3, 4, 5	6	220	220	220		mVdc		
Output Current	I _{CEX} (7)	7			1, 2	8			3, 4, 5	6	5	5	5		μ Adc		
	I _{CEX} (6)	6			3, 5	8			1, 2, 4	7	5	5	5		μ Adc		
Leakage Current	I _L (6, 7, 8)					6, 7, 8			1, 2, 3, 4, 5		100	100	100		μ Adc		

*Resistor to V_{CC}

NOTES FOR THE USE OF THE MC921G

1. The input loading factor of the expanded gate is 1. 33.
2. Pin 8 of the MC921G must be connected to V_{CC}.
3. The output loading factor of the expanded gate is decreased 0. 5 load for every added node.

MC921G (continued)

USE OF GATE EXPANDER

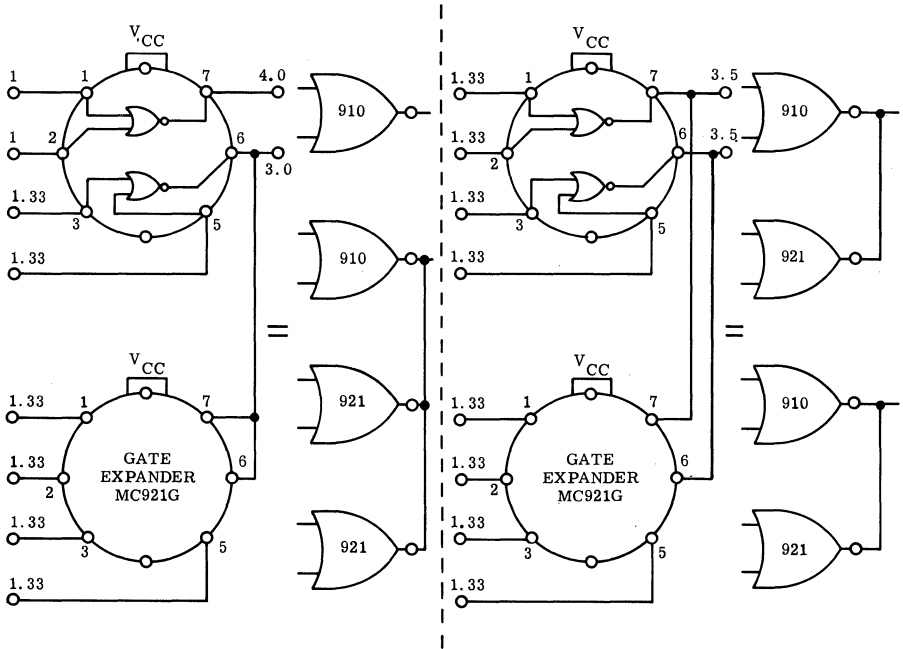

CIRCUIT DIAGRAM

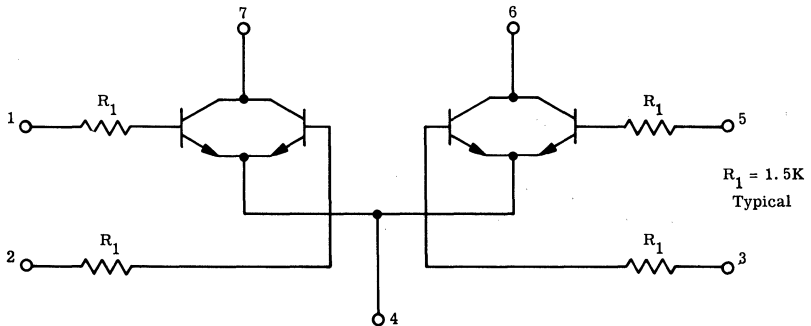

MC400 series

TTL SERIES

Monolithic integrated Transistor-Transistor Logic circuits for high-speed logic applications requiring high fan-out into high-capacitance lines. The MC400 Series operates over the full military temperature of -55 to +125°C.

Series MC400 T ² L Circuits		FAN-OUT	STORAGE TIME TYPICAL	DELAY TIME TYPICAL
MC401	8-Input NAND/NOR Gate	15	30 nsec	15 nsec
MC402	Dual 4-Input NAND/NOR Gate	15	30 nsec	15 nsec

MC401

MC400 TTL SERIES

8-Input Transistor-Transistor Logic NAND/NOR Gate.



CASE 83

8-INPUT NAND/NOR GATE

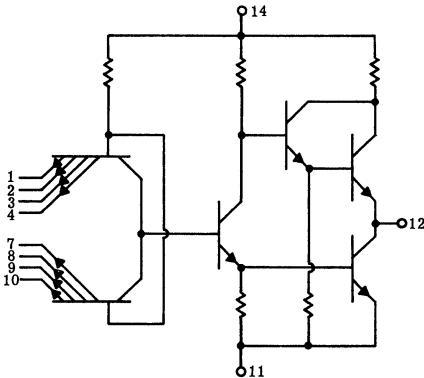

NOR GATE

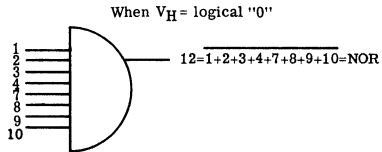

NAND GATE

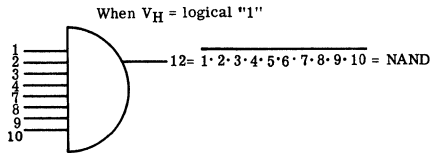

MC401 (continued)

ELECTRICAL CHARACTERISTICS

Characteristic	Minimum	Maximum	Unit
Output "On" Voltage $I_{12} = 20 \text{ mA}$ $V_1, V_2, V_3, V_4, V_7, V_8, V_9$ and $V_{10} = 2.0 \text{ V}$	--	0.5	Vdc
Output "Off" Voltage $I_{12} = -2 \text{ mA}$ $V_1, V_2, V_3, V_4, V_7, V_8, V_9$ or $V_{10} = 0.8 \text{ V}$ Unused pins = open	2.4	--	Vdc
Input Leakage Current $V_1, V_2, V_3, V_4, V_7, V_8, V_9$ or $V_{10} = 4.5 \text{ V}$ All unused pins at 0	--	150	μA
Grounded Input Current $V_1, V_2, V_3, V_4, V_7, V_8, V_9$ or $V_{10} = 0 \text{ V}$	--	-1.6	mA
Grounded Output Current $V_1, V_2, V_3, V_4, V_7, V_8, V_9$ and $V_{10}, V_{12} = 0 \text{ V}$	-20	-45	mA
Power Drain $V_1, V_2, V_3, V_4, V_7, V_8, V_9$ or $V_{10} = 0 \text{ V}$ $V_1, V_2, V_3, V_4, V_7, V_8, V_9$, and $V_{10} = \text{open}$	--	3	mA
	--	3	mA
Switching Characteristics			
Fan-Out 1 and 15 (worst Case)			
Storage Time $C_o = 150 \text{ pf}$ $C_o = 600 \text{ pf}$	--	65 100	nsec nsec
Rise Time $C_o = 150 \text{ pf}$ $C_o = 600 \text{ pf}$	-- --	45 70	nsec nsec
Delay Time $C_o = 150 \text{ pf}$ $C_o = 600 \text{ pf}$	-- --	50 80	nsec nsec
Fall Time $C_o = 150 \text{ pf}$ $C_o = 600 \text{ pf}$	-- --	35 50	nsec nsec

MC402

MC400 TTL SERIES



Dual 4-Input Transistor-Transistor Logic NAND/
NOR Gate.

CASE 83

ELECTRICAL CHARACTERISTICS

Characteristics	Minimum	Maximum	Units
Output "On" Voltage $I_2 = 20 \text{ mA}$, V_1, V_{12}, V_{13} and $V_{14} = 2.0 \text{ V}$	---	0.5	Vdc
$I_{10} = 20 \text{ mA}$, V_6, V_7, V_8 and $V_9 = 2.0 \text{ V}$	---	0.5	Vdc
Output "Off" Voltage $I_2 = -2 \text{ mA}$, V_1, V_{12}, V_{13} and $V_{14} = 0.8 \text{ V}$	2.4	---	Vdc
$I_{10} = -2 \text{ mA}$, V_6, V_7, V_8 and $V_9 = 0.8 \text{ V}$	2.4	---	Vdc
Input Leakage Current V_1, V_{12}, V_{13} or $V_{14} = 4.5 \text{ Vdc}$	---	150	μA
V_6, V_7, V_8 or $V_9 = 4.5 \text{ Vdc}$ All unused inputs at 0 V	---	150	μA
Grounded Input Current V_1, V_{12}, V_{13} or $V_{14} = 0 \text{ V}$	---	-1.6	mA
V_6, V_7, V_8 , or $V_9 = 0 \text{ V}$	---	-1.6	mA
Grounded Output Current V_1, V_{12}, V_{13} and $V_{14} = 0 \text{ V}$ $V_2 = 0 \text{ V}$	-20	-45	mA
V_6, V_7, V_8 and $V_9 = 0 \text{ V}$ $V_{10} = 0 \text{ V}$	-20	-45	mA
Power Drain V_1, V_{12}, V_{13} or V_{14} and V_6, V_7, V_8 or $V_9 = 0 \text{ V}$	--	6	mA
V_1, V_{12}, V_{13} and V_{14} and V_6, V_7, V_8 and $V_9 = \text{open}$	--	12	mA

MC402 (continued)

SWITCHING CHARACTERISTICS

Characteristic	Min	Max	Unit
Fan-Out = 1 and 15 (worst case)			
Storage Time			
$C_o = 150 \text{ pf}$	--	65	nsec
$C_o = 600 \text{ pf}$	--	100	nsec
Rise Time			
$C_o = 150 \text{ pf}$	--	45	nsec
$C_o = 600 \text{ pf}$	--	70	nsec
Delay Time			
$C_o = 150 \text{ pf}$	--	50	nsec
$C_o = 600 \text{ pf}$	--	80	nsec
Fall Time			
$C_o = 150 \text{ pf}$	--	35	nsec
$C_o = 600 \text{ pf}$	--	50	nsec

DUAL 4-INPUT NAND/NOR GATE

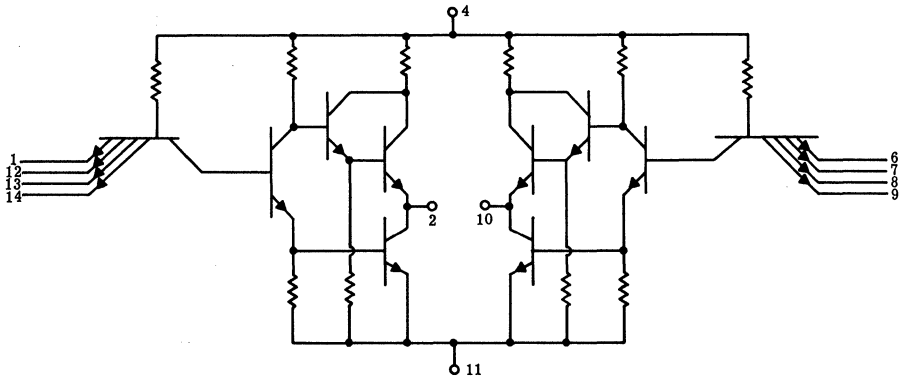

NOR GATE

When V_H = logical "0"

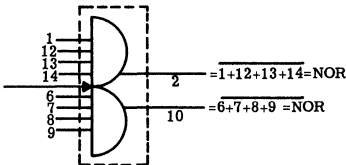

NAND GATE

When V_H = logical "1"

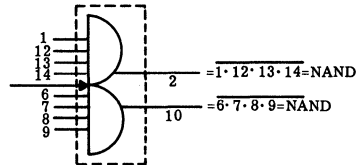

MOTOROLA LINEAR CIRCUITS

Linear Integrated Circuits

MC1110	Emitter-Coupled Amplifier
MC1513F	A/D Ladder Network
MC1519	Wideband Differential Amplifier
MC1524	1 W Power Amplifier
MC1525	NPN Differential Amplifier
MC1526	NPN Darlington-Input Differential Amplifier
MC1527	PNP Differential Amplifier
MC1528	PNP Darlington-Input Differential Amplifier

mc1110

LINEAR CIRCUIT SERIES

$G_T = 22 \text{ db @ } 100 \text{ Mc}$
 $NF = 6 \text{ db @ } 100 \text{ Mc}$

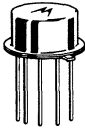

Emitter-coupled, integrated circuit linear amplifier for IF and RF applications. Frequency range is DC to 300 MC.

MAXIMUM RATINGS (at 25°C ambient)

Characteristic	Symbol	Rating	Unit
Power Supply Voltage	V_{CC}	10	Vdc
Power Supply Voltage	V_{EE}	14	Vdc
Total Power Dissipation (Derate 5 mW/°C above $T_A = 25^\circ\text{C}$)	P_D	0.5	Watt
Operating Temperature Range	T_j	-55 to +125	°C
Storage Temperature Range	T_{stg}	-65 to +200	°C
Maximum Input Level (RMS)	V_{in}	2	V (RMS)

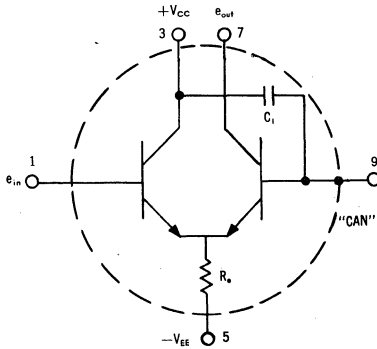

CIRCUIT SCHEMATIC

DC CHARACTERISTICS TEST CIRCUIT

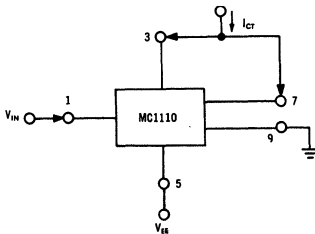

SHORT CIRCUIT ADMITTANCE TEST CIRCUIT
 (GENERAL RADIO 1607 A BRIDGE)

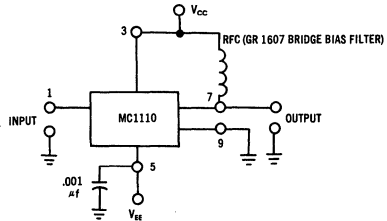

MC1110 (continued)

ELECTRICAL CHARACTERISTICS (At $T_A = 25^\circ\text{C}$ unless otherwise noted)

Characteristic	Symbol	Min	Typ	Max	Unit
----------------	--------	-----	-----	-----	------

DC CHARACTERISTICS

Input Leakage Current ($V_3 = 5\text{ Vdc}$; $I_5, I_7, I_9 = 0$)	I_1	---	---	10	nAdc	
Output Leakage Current ($V_7 = 5\text{ Vdc}$; $I_1, I_3, I_5 = 0$)	I_9	---	---	10	nAdc	
Operating Current ($V_{CC} = 5\text{ Vdc}$, $V_{EE} = -4.7\text{ Vdc}$, $V_{in} = 0$)	I_{CT}	Figure 1	3.8	4	4.2	mAdc
Input Operating Current ($V_{CC} = 5\text{ Vdc}$, $V_{EE} = -10\text{ Vdc}$, $V_{in} = 0$)	I_1	Figure 2	---	---	250	μAdc
Reference Operating Current ($V_{CC} = 5\text{ Vdc}$, $V_{EE} = -10\text{ Vdc}$, $V_{in} = 0$)	I_9	Figure 1	---	---	250	μAdc
Current Balance ($V_{CC} = 5\text{ Vdc}$, $V_{EE} = -10\text{ Vdc}$, $V_{in} = 0$) ($V_{CC} = 5\text{ Vdc}$, $V_{EE} = -1\text{ Vdc}$, $V_{in} = 0$)	I_3/I_7	Figure 1 Figure 1	0.90 0.90	---	1.10 1.10	---
Large Signal Transconductance ($V_{CC} = 5\text{ Vdc}$, $V_{EE} = -4\text{ Vdc}$, $\Delta V_{in} = 50\text{ mV}$)	G_{21}		26	28	---	m-mhos

SMALL SIGNAL CHARACTERISTICS

Small Signal Current Gain ($V_{CC} = 5\text{ V}$, $I_E = -4\text{ mA}$, $f = 100\text{ mc}$)	h_{21}		6.0	9.0	---	---
Short Circuit Admittances ($V_{CC} = 5\text{ V}$, $V_{EE} = -4\text{ V}$, $f = 100\text{ mc}$)	---	Figure 1				m-mhos
Input Admittance	$ Y_{11} $		---	2.0	---	
Reverse Transfer Admittance	$ Y_{12} $		---	0.064	---	
Forward Transfer Admittance	$ Y_{21} $		---	16.3	---	
Output Admittance	$ Y_{22} $		---	1.2	---	
Transducer Power Gain ($V_{CC} = 5\text{ V}$, $V_{EE} = -4\text{ V}$, $f = 100\text{ mc}$, $\text{BW} = 3\text{ mc}$) ($V_{CC} = 5\text{ V}$, $V_{EE} = -4\text{ V}$, $f = 200\text{ mc}$, $\text{BW} = 6\text{ mc}$)	G_T	Figure 20 Figure 21	22 15	26 18	---	db
Noise Figure ($V_{CC} = 5\text{ V}$, $V_{EE} = -4\text{ V}$, $f = 100\text{ mc}$, $R_g = R_{SO}$)	NF		---	4	6	db

MC1110 (continued)

100 MC POWER GAIN TEST SET

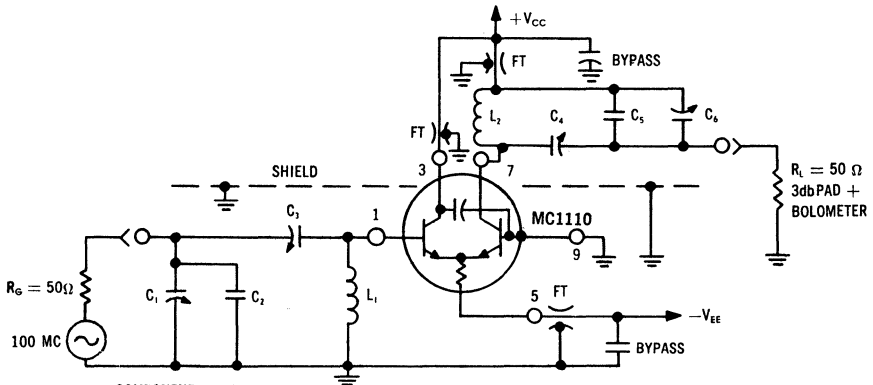

COMPONENT VALUES

C ₁ , C ₆	VARIABLE CERAMIC CAPACITOR	9-35 $\mu\mu\text{f}$
C ₂	VARIABLE CERAMIC CAPACITOR	5.5-18 $\mu\mu\text{f}$
C ₄	VARIABLE CERAMIC CAPACITOR	2-8 $\mu\mu\text{f}$
C ₂ , C ₅	FIXED MICA CAPACITOR	50 $\mu\mu\text{f}$
FT ALL	FEED THROUGH CAPACITORS	1200 $\mu\mu\text{f}$
Bypass	CAPACITORS, DISC CERAMIC	0.1 μf , 75 Vdc
L ₁	INPUT INDUCTOR, 0.15 μh Q > 50	
L ₂	OUTPUT INDUCTOR, 0.25 μh Q > 50	
V _{cc} = 5.0 Vdc		
V _{EE} = -4 VOLTS		

200 MC POWER GAIN TEST SET

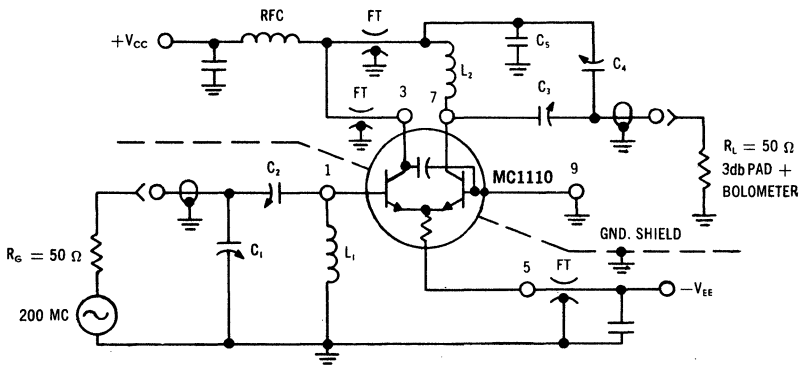

COMPONENT VALUES

C ₁ , C ₄	VARIABLE CERAMIC CAPACITOR	5.5-18 $\mu\mu\text{f}$
C ₂ , C ₃	VARIABLE CERAMIC CAPACITOR	2-8 $\mu\mu\text{f}$
C ₅	FIXED MICA CAPACITOR	300 $\mu\mu\text{f}$
FT ALL	FEED THROUGH CAPACITORS	1200 $\mu\mu\text{f}$
BYPASS	CAPACITORS, DISC CERAMIC	0.1 μf , 75 Vdc
L ₁	INPUT INDUCTOR	30 nhy Q > 100, 2T #16 AWG 1/4" FORM
L ₂	OUTPUT INDUCTOR	50 nhy Q > 100, 4T #16 AWG 1/4" FORM
RFC	JEFFERS MOLDED CHOKE	0.68 μh
V _{cc} = 5.0 Vdc		
V _{EE} = -4 VOLTS		

MC1110 (continued)

INPUT ADMITTANCE versus EMITTER CURRENT

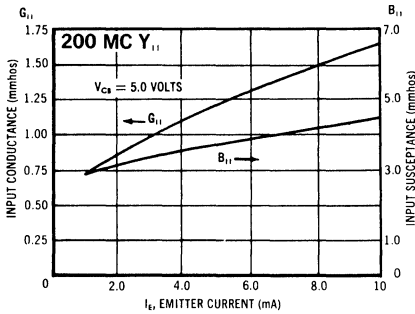

REVERSE TRANSFER ADMITTANCE versus EMITTER CURRENT

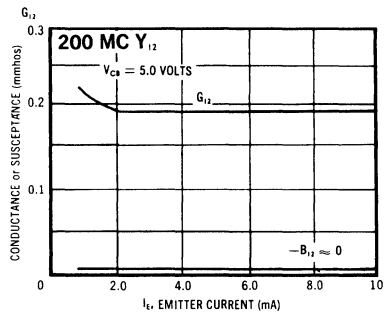

FORWARD TRANSFER ADMITTANCE versus FREQUENCY

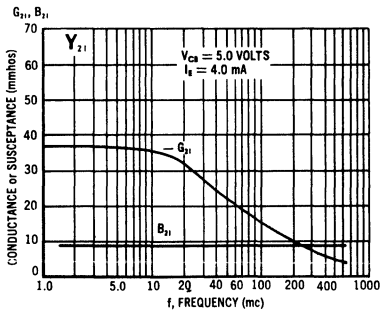

OUTPUT ADMITTANCE versus FREQUENCY

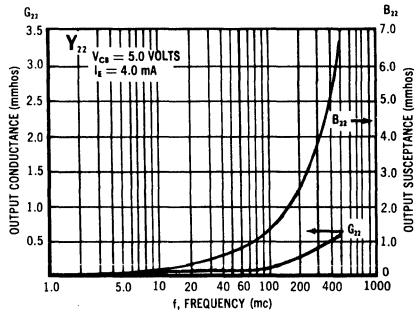

FORWARD TRANSFER ADMITTANCE versus EMITTER CURRENT

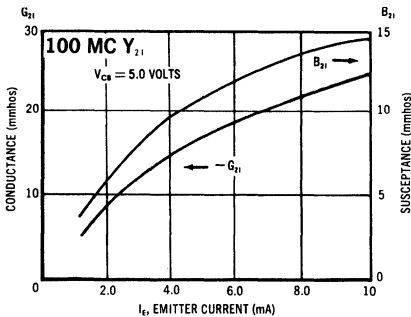

OUTPUT ADMITTANCE versus EMITTER CURRENT

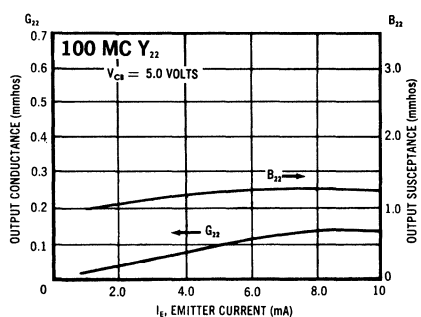

FORWARD TRANSFER ADMITTANCE versus EMITTER CURRENT

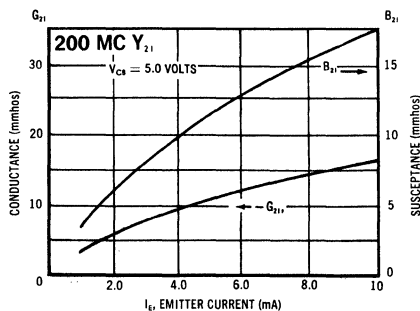

OUTPUT ADMITTANCE versus EMITTER CURRENT

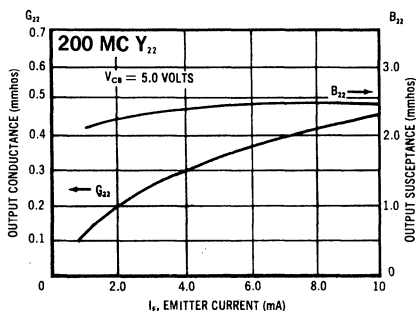

MC1110 (continued)

100 MC NOISE FIGURE vs. SOURCE RESISTANCE

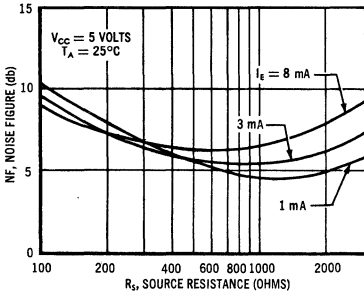

OPTIMUM NOISE FIGURE, OPTIMUM SOURCE RESISTANCE AND AVAILABLE POWER GAIN versus FREQUENCY

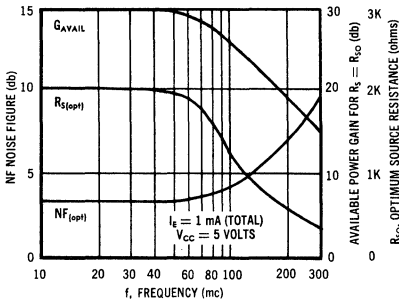

INPUT ADMITTANCE versus EMITTER CURRENT

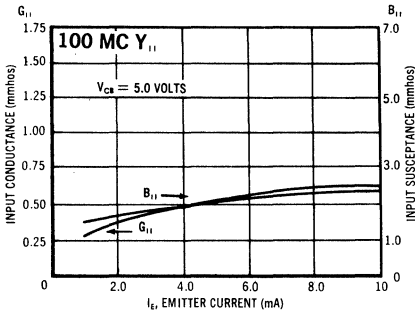

INPUT ADMITTANCE versus FREQUENCY

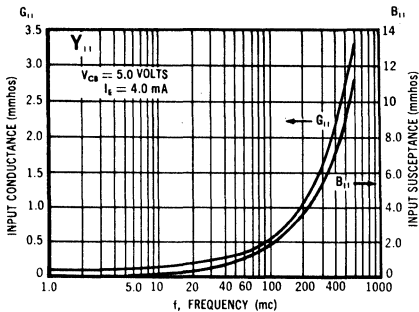

GAIN CONTROL CHARACTERISTICS

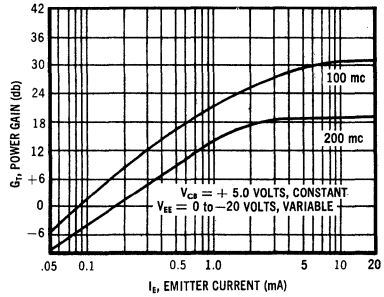

200 MC TRANSDUCER POWER GAIN (G_T) versus POWER DISSIPATION

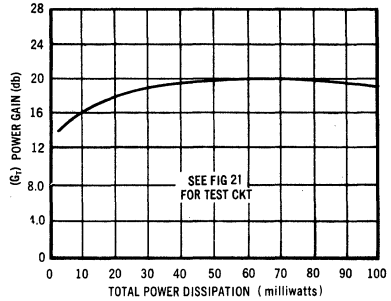

REVERSE TRANSFER ADMITTANCE versus EMITTER CURRENT

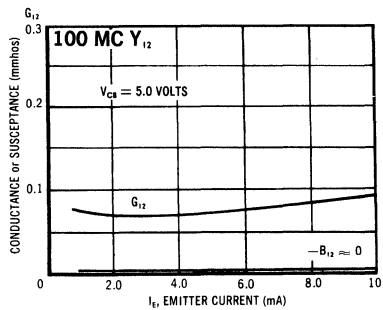

REVERSE TRANSFER ADMITTANCE versus FREQUENCY

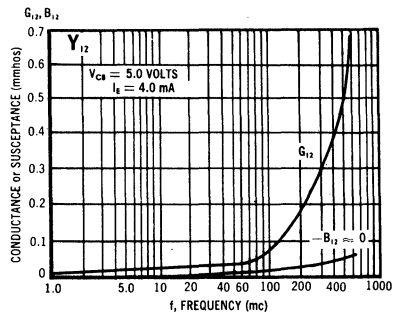

MC1513F

LINEAR CIRCUIT SERIES

P_D = 500 mW
1% ratio tolerance

Analogue/digital ladder network of thin-film resistors on passivated silicon for application as a binary reference voltage divider.

MAXIMUM RATINGS (At 25°C)

Applied Voltage	30 Vdc
Power Dissipation, Total (derate 3.3mW/°C above 25°C)	500mW
Power Dissipation, Each Resistor (derate 0.67mW/°C above 25°C)	100mW
Operating Temperature Range	-55 to +125°C
Storage Temperature Range	-65 to +175°C

ELECTRICAL CHARACTERISTICS (At 25°C)

Characteristic	Symbol	Minimum	Typical	Maximum	Unit
Resistance	R ₁ thru 8	4.4	4.7	5.0	KΩ
Resistance	R ₉ thru 15	8.8	9.4	10.0	KΩ
Voltage Ratio	V ₁ :V ₂ , V ₂ :V ₃	0.495	0.500	0.505	-
Ratio Temp. Tracking (-55 to +125°C)	$\frac{V_1:V_2, V_2:V_3}{0.500 \ 0.500}$			10	PPM/°C
Resistance Temp. Coefficient	R ₁ thru 15			100	PPM/°C

CIRCUIT SCHEMATIC

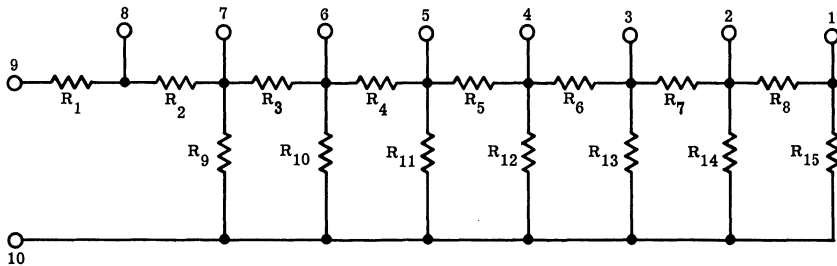

MC1519

LINEAR CIRCUIT SERIES

$A_{dd} = 67 \text{ db}$
 $V_{io} = 6 \text{ mV}$
 $CMR = 89 \text{ db}$
 $BW = 0.7 \text{ Mc}$

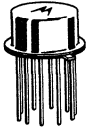

CASE 71
(TO-5)

Integrated circuit wideband differential amplifier featuring NPN inputs and PNP outputs.

MAXIMUM RATINGS ($T_A = 25^\circ\text{C}$ unless otherwise noted)

Characteristic	Symbol	Rating	Unit
Power Supply Voltage	V_{CC}	+14	Vdc
Power Supply Voltage	V_{EE}	-14	Vdc
Differential Input Signal	V_{in}	± 5	Vdc
Total Power Dissipation Derate above 25°C	P_D	300 2.0	mW mW/ $^\circ\text{C}$
Operating Temperature Range	T_J	-55 to +125	$^\circ\text{C}$
Storage Temperature Range	T_{stg}	-65 to +175	$^\circ\text{C}$

CIRCUIT SCHEMATIC

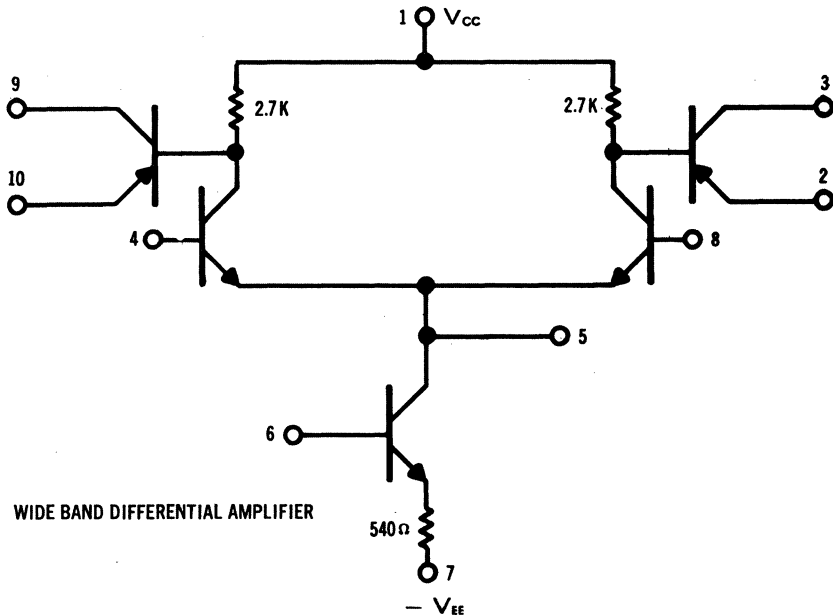

MC1519 (continued)

ELECTRICAL CHARACTERISTICS

($V_{CC} = +12$ Vdc, $V_{EE} = -12$ Vdc, $T_A = 25^\circ\text{C}$ unless otherwise noted)

Characteristic	Figure No.	Symbol	Min	Typ	Max	Unit
Differential Voltage Gain Circuit A (CE) Circuit B (CC)	3, 8	A_{dd}	67 40	73 45	79 50	db
Single Ended Voltage Gain Circuit A (CE) Circuit B (CC)	3	A_V	— —	67 38	— —	db
Maximum Output Swing Circuit A (CE) Circuit B (CC)	4	V_O	12.0 8.0	14.0 10.0	— —	$V_{(p-p)}$
Input Offset Voltage Circuit A (CE) Circuit B (CC)	5, 9	V_{IO}	— —	2.0 2.0	6.0 6.0	mVdc
Input Offset Voltage Drift Circuit A (CE) Circuit B (CC)	5, 9	V_{IOD}	— —	5.0 5.0	— —	$\mu\text{V}/^\circ\text{C}$
Input Offset Current Circuit A (CE) Circuit B (CC)	6, 10	I_{IO}	— —	1.0 2.0	4.0 8.0	$\mu\text{A}dc$
Input Current Circuit A (CE) Circuit B (CC)	6, 11	I_i	— —	40.0 60.0	70.0 90.0	$\mu\text{A}dc$
Common Mode Rejection Circuit A (CE) Circuit B (CC)	7	CM_{Rej}	— —	89.0 86.0	— —	db
Bandwidth - 3 db Circuit A (CE) Circuit B (CC)	3, 12	BW	0.70 5.0	1.0 8.0	— —	mc
Differential Input Impedance Circuit A (CE) Circuit B (CC)	2	Z_{in}	1.8 —	2.6 1.2	— —	kohms
Single Ended Output Impedance Circuit A (CE) Circuit B (CC)	2	Z_{out}	— —	2.7 0.048	— 0.120	kohms

MC1519 (continued)

CIRCUIT B COMMON COLLECTOR OUTPUT

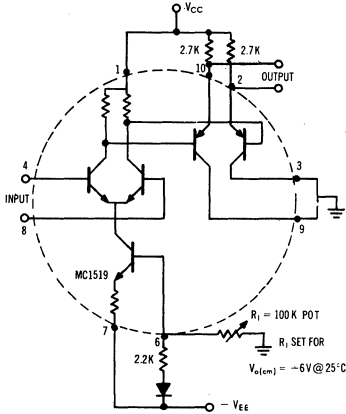

CIRCUIT A COMMON EMITTER OUTPUT

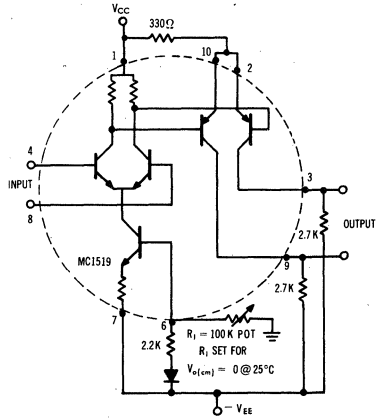

DIFFERENTIAL INPUT IMPEDANCE AND SINGLE ENDED OUTPUT IMPEDANCE

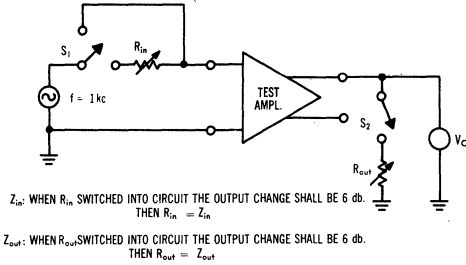

DIFFERENTIAL VOLTAGE GAIN SINGLE ENDED VOLTAGE GAIN AND BANDWIDTH

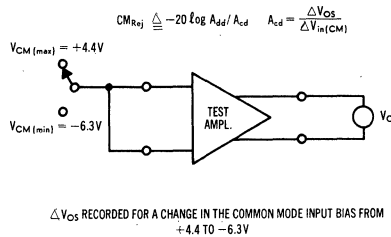
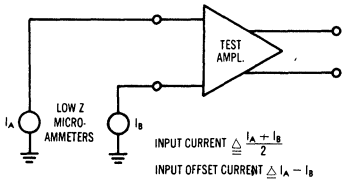
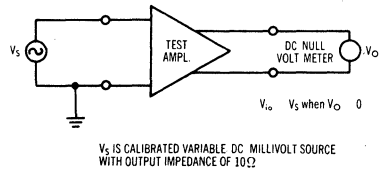
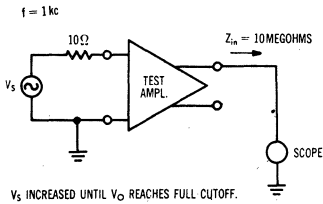
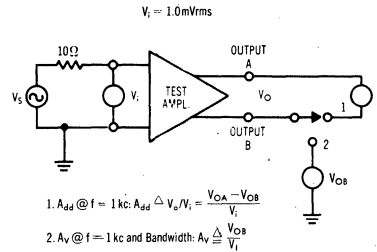

MC1519 (continued)

EFFECT OF TEMPERATURE ON CIRCUIT B CHARACTERISTICS

R_1 SET FOR $V_{O, CM} = 6V$ AT $+25^\circ C$

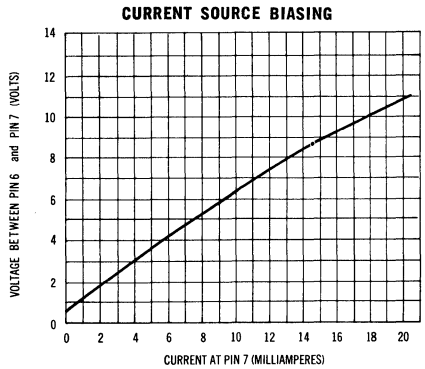
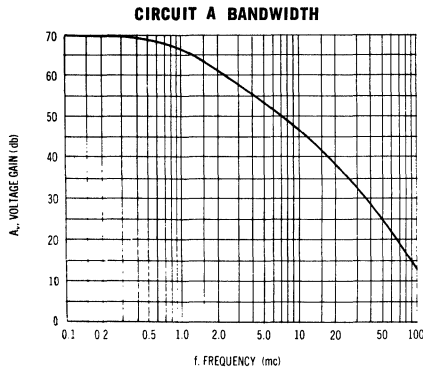
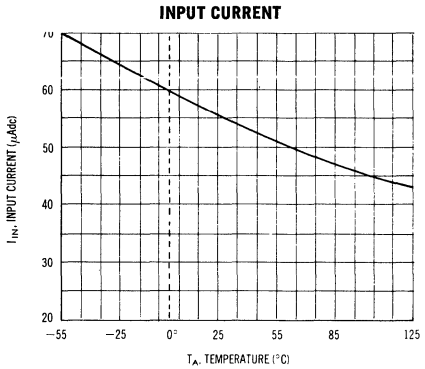
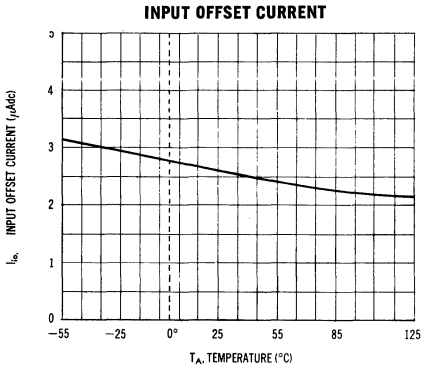
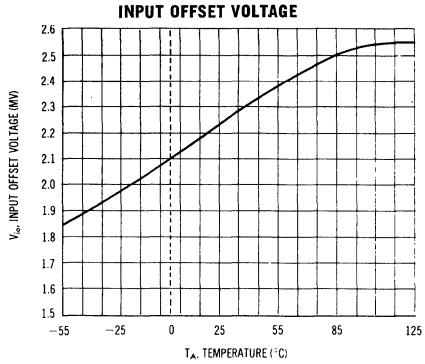
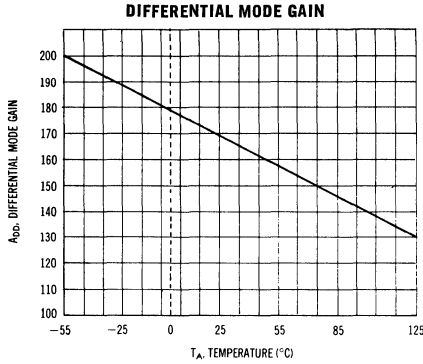

MC1524

LINEAR CIRCUIT SERIES

$Z_L = 16 - 100\Omega$
THD = 0.6% Typ
 $A_v = 10, 20 \text{ or } 30$



CASE 71
(TO-5)

Integrated circuit 1-W audio power amplifier.

MAXIMUM RATINGS ($T_A = 25^\circ\text{C}$ unless otherwise noted)

Characteristics	Symbol	Ratings	Unit
Power Supply Voltage	V_{CC}	12	Vdc
Power Supply Voltage	V_{EE}	-12	Vdc
Operating Temperature Range	T_A	-55 to +125	$^\circ\text{C}$
Storage Temperature Range	T_{stg}	-65 to +175	$^\circ\text{C}$
Maximum Audio Output Power ($T_A = -55^\circ\text{C}$ to +125 $^\circ\text{C}$)	$P_{out(max)}$	1.0	Watt

CIRCUIT SCHEMATIC

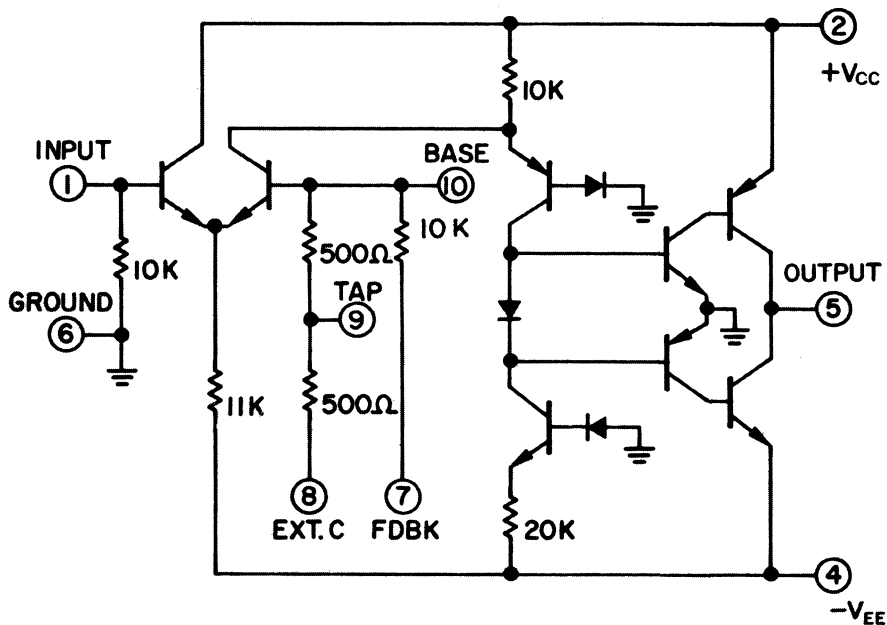

LINEAR POWER AMPLIFIER

MC1524 (continued)

ELECTRICAL CHARACTERISTICS ($V_{CC} = +6V$, $V_{EE} = -6V$, $T_A = 25^\circ C$.)

Characteristic	Load Impedance ohms	Feedback Tap ohms	Symbol	Min	Typ	Max	Units			
Maximum Peak-to-Peak Output Voltage for THD < 3% @ 1 kc	16	1000	V_{Omax}	9.0	10.0	—	$V_{(p-p)}$			
Voltage Gain @ 1 kc	16	250	A_V	—	37.9	—	—			
		500		—	20.0	—				
		1000		10.0	11.5	12.5				
	100	250		—	41.2	—				
		500		—	21.3	—				
		1000		11.0	12.3	13.5				
Input Impedance @ 1 kc	—	1000	Z_{in}	6.0	8.5	—	kohms			
Output Impedance @ 1 kc	—	1000	Z_{out}	—	0.58	0.80	ohms			
Bandwidth	16	250	BW	—	350	—	kc			
		500		—	480	—				
		1000		300	770	—				
	40	250		—	340	—				
		500		—	480	—				
		1000		—	780	—				
	100	250		—	320	—				
		500		—	480	—				
		1000		—	810	—				
	Zero Signal Current Drain (Each Supply)	16		1000	I_S	—		1.5	4.0	mA
	Low Level Total Harmonic Distortion @ 1 kc (50 mVrms in)	16		1000	THD	—		0.6	2.0	%

AC COUPLED CIRCUIT

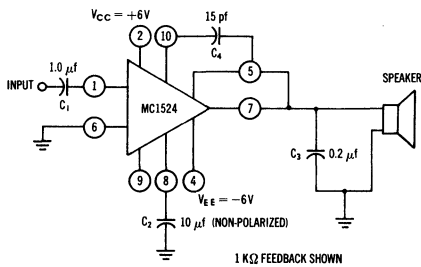

DC COUPLED CIRCUIT

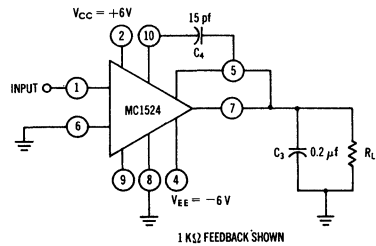

MC1524 (continued)

Notes:

- 1) R_L should be greater than 5 ohms for dc stability.
- 2) Power supplies should be balanced, have low source impedances, and should be turned on and off simultaneously. (See fig. 6 for Standby Current vs. supply unbalance.)
- 3) Capacitors C_3 and C_4 provide high-frequency stability. For most loads, at temperatures below 70°C, C_4 may be omitted.
- 4) Low frequency rolloff of AC coupled circuit is determined by C_1 and C_2 . Fig 1 is recommended for loudspeaker loads because of DC stability introduced by C_2 .
- 5) Open loop operation is not recommended. Feedback taps are connected as follows:

Feedback Tap	Pin Connection
1 K Ω	8 to C_2 (AC) or ground (DC)
500 Ω	9 to C_2 (AC) or ground (DC)
250 Ω	8 to 10; 9 to C_2 (AC) or ground (DC)

TOTAL HARMONIC DISTORTION

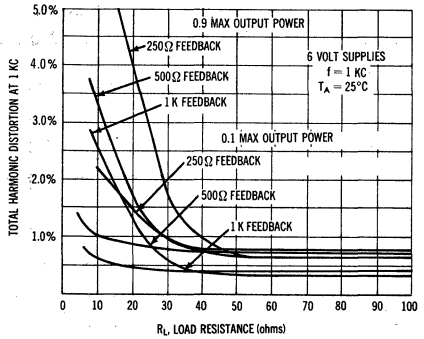

STANDBY CURRENT VARIATION DUE TO SUPPLY UNBALANCE

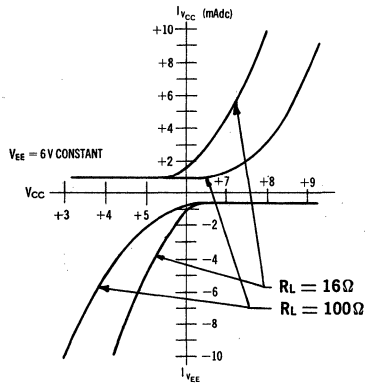
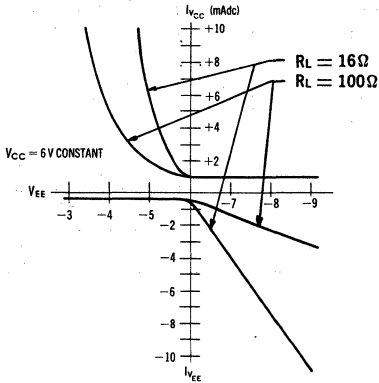

MAXIMUM AVAILABLE OUTPUT POWER

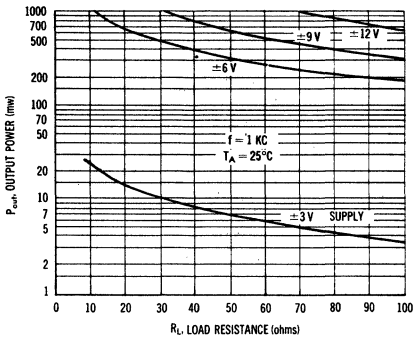

AC COUPLED FREQUENCY RESPONSE

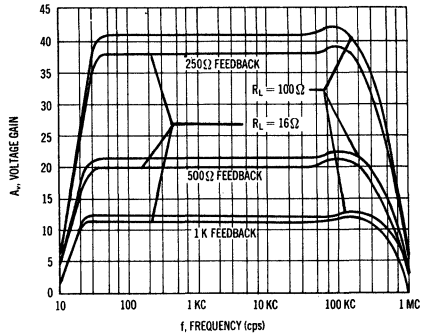

MC1524 (continued)

DC TRANSFER CHARACTERISTICS

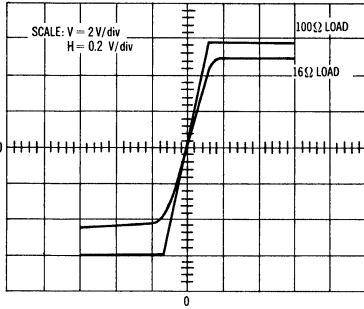

VOLTAGE GAIN versus TEMPERATURE

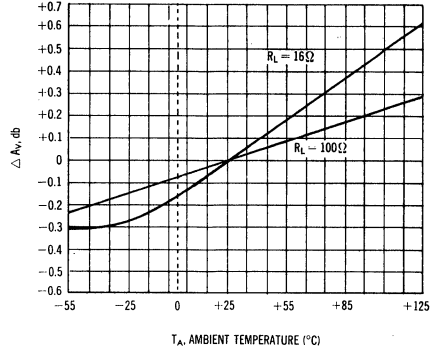

500Ω FEEDBACK TAP

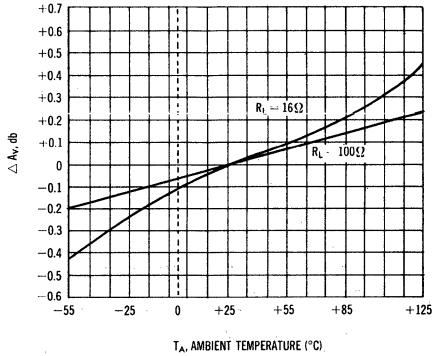
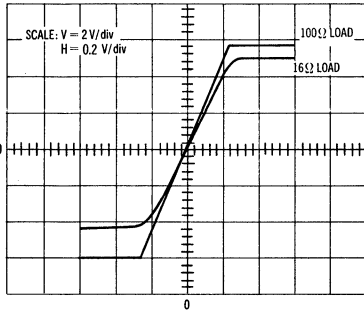

1KΩ FEEDBACK TAP

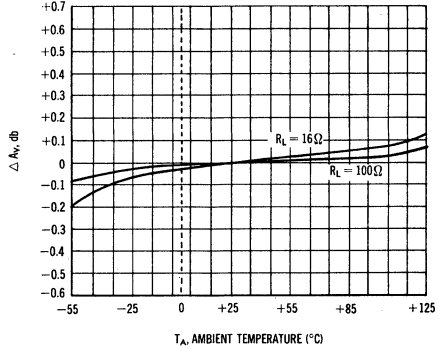
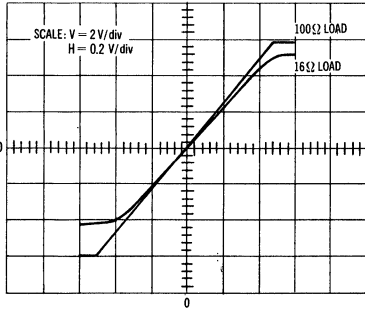

MC1525
MC1526
MC1527
MC1528

LINEAR CIRCUIT SERIES

$A_{dd} = 65-140$
 $V_{i0} = 5-7 \text{ mV}$
 $CMR = 80 \text{ db}$
 $BW = 0.3-1.4 \text{ Mc}$

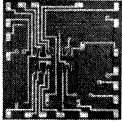

MC1525

DIFFERENTIAL AMPLIFIERS

MC1527

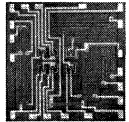

MC1526

DARLINGTON INPUT DIFFERENTIAL AMPLIFIERS

MC1528

NPN

PNP



CASE 71
(TO-5)

CASE 72

Integrated circuit complementary differential amplifiers designed to permit direct-coupled cascading for applications requiring extremely high gain.

MAXIMUM RATINGS ($T_A = 25^\circ\text{C}$ unless otherwise noted)

Characteristic	Symbol	Rating		Unit
		NPN	PNP	
Power Supply Voltage	V_{CC}	+14	-14	Vdc
Power Supply Voltage	V_{EE}	-14	+14	Vdc
Differential Input Signal	V_{in}	± 5		Vdc
Operating Temperature Range	T_J	-55 to +125		$^\circ\text{C}$
Storage Temperature Range	T_{stg}	-65 to +175		$^\circ\text{C}$
Total Power Dissipation Derate above 25°C	P_D	300 2		mW mW/ $^\circ\text{C}$

DIFFERENTIAL VOLTAGE GAIN

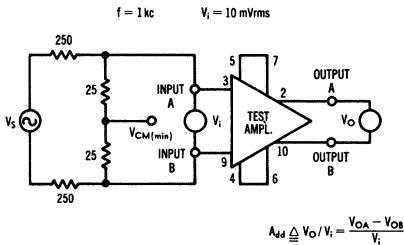

SINGLE-ENDED VOLTAGE GAIN

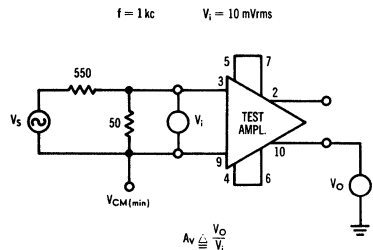

MC1525, MC1526, MC1527, MC1528 (continued)

ELECTRICAL CHARACTERISTICS

Characteristic	Fig No	Symbol	Min	Typical	Max	Unit
Differential Voltage Gain MC1525, MC1527 MC1526, MC1528	5, 15	A_{dd}	120 50	140 65	50 75	—
Single Ended Voltage Gain MC1525, MC1527 MC1526, MC1528	6	A_v	— —	75 45	— —	—
Output Voltage, Common Mode All Types	7, 16	$V_{O(CM)}$	6.0	7.0	8.0	Vdc
Maximum Output Swing All Types	8	V_o	7.0	—	—	V (p-p)
AC Unbalance All Types	8	U	—	—	300	mV (p-p)
Input Offset Voltage MC1525, MC1527 MC1526, MC1528	9, 17	V_{io}	— —	— —	5 7	mVdc
Input Offset Current MC1525, MC1527 MC1526 MC1528	10, 18	I_{io}	— — —	— — —	4 2 0.5	μ Adc
Input Current MC1525, MC1527 MC1526 MC1528	10, 20	I_{in}	— — —	— — —	20 3.5 2.0	μ Adc
Common Mode Rejection All Types	11, 19	CM_{Rej}	80	—	—	db
Bandwidth MC1525, MC1527 MC1526 MC1528	12	BW	1400 500 300	— — —	— — —	kc
Differential Input Impedance MC1525, MC1527 MC1526 MC1528	13	Z_{in}	2.0 60 80	— — —	— — —	k Ω
Single Ended Output Impedance All Types	14	Z_{out}	—	—	11	k Ω

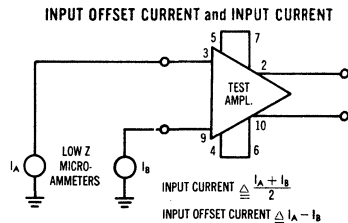
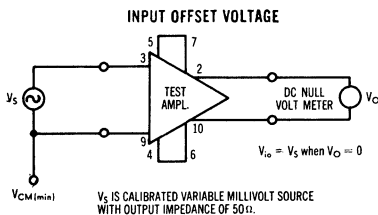

MC1525, MC1526, MC1527, MC1528 (continued)

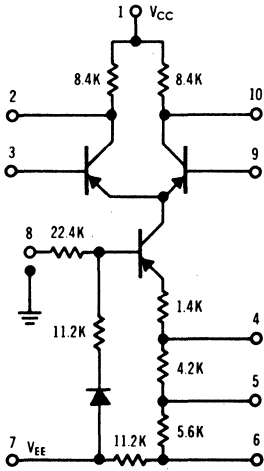

MC1527

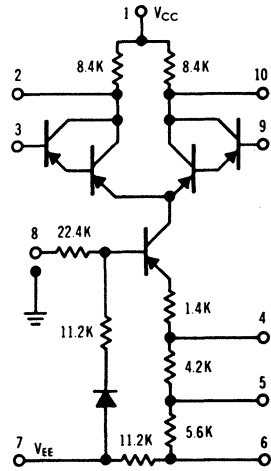

MC1528

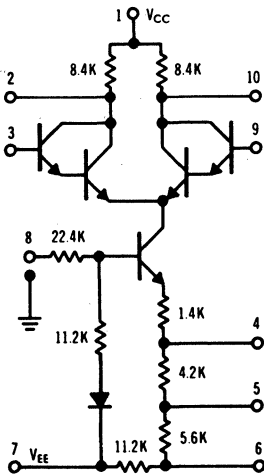

MC1526

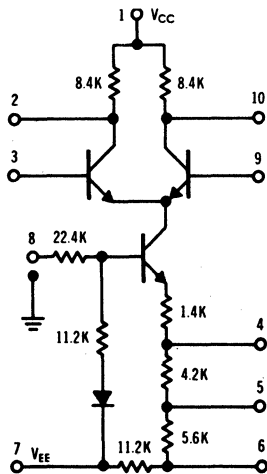

MC1525

MC1525, MC1526, MC1527, MC1528 (continued)

OUTPUT VOLTAGE — COMMON MODE

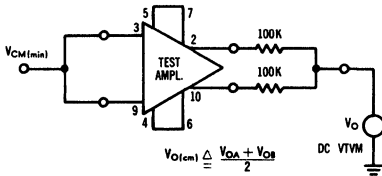

MAXIMUM OUTPUT SWING

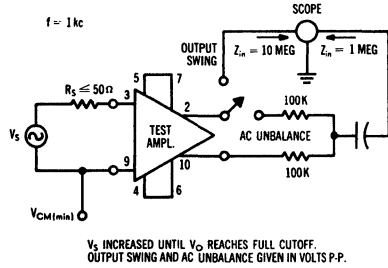

DIFFERENTIAL MODE GAIN

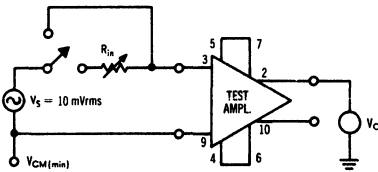

SINGLE ENDED OUTPUT IMPEDANCE

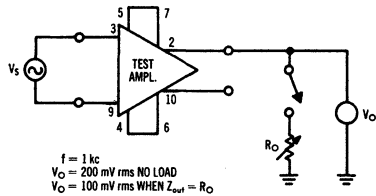

BIASING ARRANGEMENT

In the emitter of the current source transistor of each of the differential amplifiers, there are four resistors of different values which may be connected in seven ways. The resultant effective resistance in conjunction with a given V_{EE} makes provision for different current levels. For convenience, the seven methods together with their effective resistances are tabulated below.

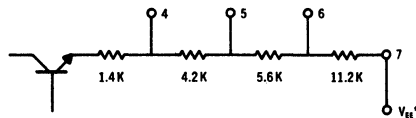

*Pin 7 is connected to the substrate and must be connected to the V_{EE} supply for proper circuit operation.

METHOD	1	2	3	4	5	6	7
PIN CONNECTIONS	4-7	4-6, 5-7	4-5, 6-7	4-6	4-5	5-6	4,5,6 OPEN
EFFECTIVE RESISTANCE	1.4 K	3.37 K	7.0 K	12.6 K	18.2 K	21.8 K	22.4 K

MC1525, MC1526, MC1527, MC1528 (continued)

EFFECT OF TEMPERATURE ON CHARACTERISTICS

DIFFERENTIAL MODE GAIN

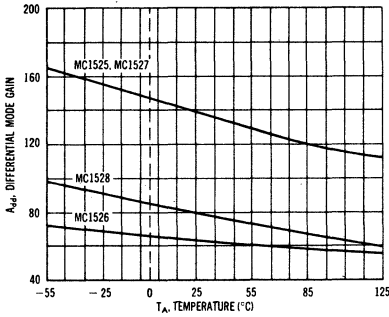

OUTPUT VOLTAGE — COMMON MODE

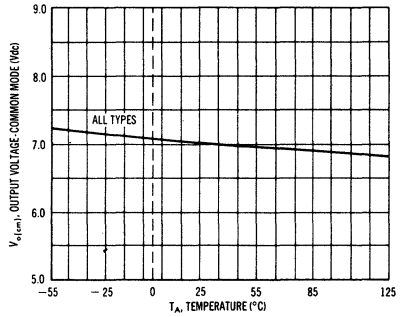

INPUT OFFSET VOLTAGE

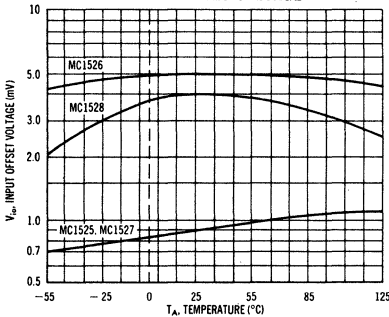

INPUT OFFSET CURRENT

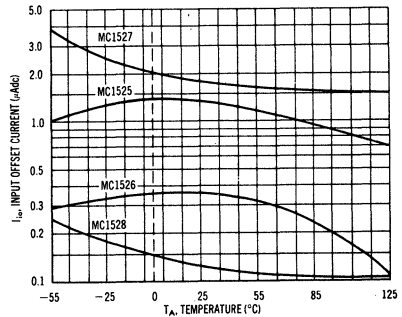

COMMON MODE REJECTION

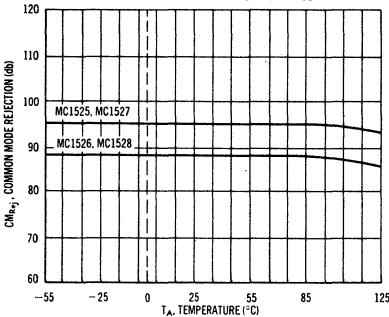

INPUT CURRENT

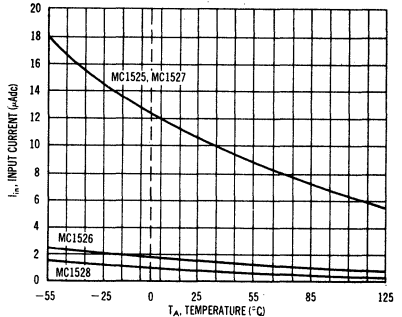

COMMON MODE REJECTION

$$CM_{Rj} \triangleq -20 \log A_{dd}/A_{cib} \quad A_{cib} = \frac{\Delta V_{OS}}{\Delta V_{in(CM)}}$$

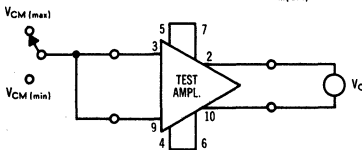

ΔV_{OS} RECORDED FOR A CHANGE IN THE COMMON MODE INPUT BIAS FROM MAXIMUM TO MINIMUM VALUES.

BANDWIDTH

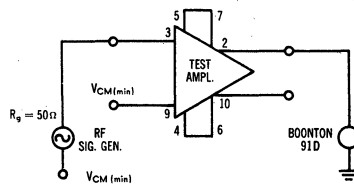



REFERENCE MATERIAL

Articles in this section:

- How to Get More Value Out of a Transistor Data Sheet
- Determining Maximum Reliable Load Lines for Power Transistors
- Factors Influencing Selection of Commercial Power Transistor Heat Sinks
- Understanding Transistor Response Parameters
- Significance of Q_T In Switching Circuits
- High-Power Varactor Diodes — Theory and Applications
- Optimizing SCR Turn-Off Parameters with Negative Bias

HOW TO GET MORE VALUE OUT OF A TRANSISTOR DATA SHEET

Engineers involved in the design of transistor circuits can gain many benefits from the proper use of transistor data sheets that have well specified characteristics. The extreme requirements of today's designs can only lead to confusion if the engineer does not have the proper limits within which to design. This report is intended to explain the relationship between published characteristics and design requirements.

A modern, well-prepared, informative data sheet should provide the design engineer with all the necessary information for selecting a transistor capable of performing a particular job. To accomplish this, the data sheet is normally divided into six general sections. A description of the device is given first, followed by sections on absolute ratings, and electrical and thermal characteristics. Mechanical data and applications information are also included.

The description of the device usually gives the broad general application which permits the designer to classify transistors according to his specific requirements. Thus, a typical power transistor description might indicate whether the unit was designed for audio work or switching applications. In addition, the power and/or current rating is specified, the polarity (whether PNP or NPN) is given, and the type of material is called out. At a glance, therefore, the engineer can determine if a particular transistor or group of transistors, is generally suitable for a particular purpose.

From here on, however, the selection of a specific transistor for a particular object becomes more involved. The unit must be considered from its various electrical ratings and characteristics to make sure that it fits the application from every conceivable standpoint. And, the engineer is generally faced with the problem of selecting the least expensive transistor which will perform adequately in his proposed circuit. This requires a comprehensive study and evaluation of the information usually given in the finer print. Only a thorough understanding of this information will permit him to do his job satisfactorily.

DISTINCTION BETWEEN RATINGS AND CHARACTERISTICS

A rating is defined as a limiting value assigned by the manufacturer which, if exceeded, may result in permanent damage to the device. On the other hand, a characteristic is a measurable property of the device under specific operating conditions for which the transistor will provide reliable performance.

ABSOLUTE MAXIMUM RATINGS

Absolute Maximum Ratings are those ratings beyond which degradation of a transistor may be expected. These ratings are established by each manufacturer based on the internal physical construction, semiconductor material and manufacturing processes. Because these are "ratings," most data sheets will not indicate test conditions under which these "ratings" are specified. Therefore, "ratings" are the extreme capabilities of a transistor and are not to be used as design conditions.

For example, under absolute maximum ratings the parameter BV_{CEO} indicates that the B when placed before a characteristic symbol usually means breakdown. Therefore, BV_{CBO} , BV_{CEO} , BV_{CES} , BV_{CEX} , and BV_{EBO} , are

the breakdown ratings of the device. It is a very well known fact in the semiconductor industry that when transistor ratings are exceeded an avalanche or breakdown condition may take place. This avalanche or breakdown condition in almost every instance will destroy a transistor. Breakdown is dependent upon temperature and a certain voltage and current condition, the combination of which can trigger an avalanching effect leading to instant destruction.

As a practical example, the graph in Figure 1 illustrates the typical output characteristics of a Motorola 2N1530 power transistor. The absolute maximum voltage BV_{CEO} is 45 volts. The absolute maximum current is 5 amps.

With an absolute maximum power rating of 90 W as shown on the data sheet for this particular transistor, it is now possible for the design engineer to calculate and plot a maximum voltage current relationship which can't be exceeded without endangering the life of the transistor.

It is obvious from the graph that the absolute maximum voltage and the absolute maximum current cannot be applied at the same time. While it is conceivable that an occasional excursion beyond this absolute maximum power for a short period of time will do no harm to the transistor, this practice is not recommended where reliability is concerned.

Thermal characteristics, also listed under the absolute maximum ratings, are expressed in degrees C per watt and define the dissipation capability of the transistor regarding the junction temperature in relation to case temperature.

ELECTRICAL CHARACTERISTICS

It is in this portion of the data sheet that the design engineer can find the limits on those electrical parameters which are most important to his particular circuit design. Whereas the absolute maximum specifications provide the limits beyond which reliable operation cannot be obtained, the electrical characteristics give the design centers around which practical circuits can evolve. When discussing any specific characteristics, the test conditions must be specified in order that a common understanding is held by both the user and the manufacturer of the transistor. Almost every parameter listed on a data sheet is subject to variation among manufacturers because of difficult test conditions. We shall now refer to the Motorola data sheet on the power transistor series from 2N1539 thru 2N1548 and discuss each parameter in order. (See Figure 2)

COLLECTOR-BASE LEAKAGE CURRENTS

I_{CBO} is a very common term loosely used by designer and manufacturer and initially used to signify the quality of a transistor. Actually, there exist three very definite I_{CBO} 's which are important to the designer. The first is the reading taken at some low collector-base voltage, in this case 2 volts, with a maximum value of I_C indicated at this voltage.

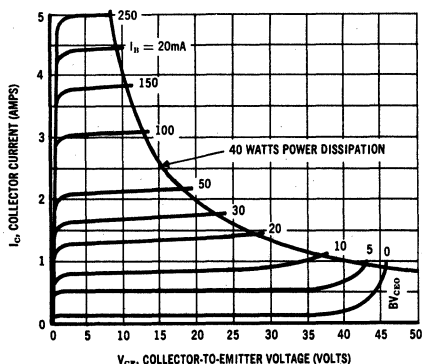

Figure 1 — Typical Output Characteristics, Motorola 2N1530

This for all practical purposes represents the thermal component of the collector current, which cannot be reduced by further decrease of V_{CB} . This is true for a given temperature and is subject to change with temperature. As the ambient temperature increases, the leakage current increases.

ELECTRICAL CHARACTERISTICS, GENERAL (At 25°C Mounting Base Temperature)

PARAMETER	SYMBOL	MIN	TYP	MAX	UNIT
Collector-Base Cutoff Current $V_{CB} = -25V$ 2N1539, 2N1544 $V_{CB} = -40V$ 2N1540, 2N1545 $V_{CB} = -55V$ 2N1541, 2N1546 $V_{CB} = -65V$ 2N1542, 2N1547 $V_{CB} = -80V$ 2N1543, 2N1548	I_{CBO}	-	-	2.0	mA
Collector-Base Cutoff Current $V_{CB} = -2V$ (all types)	I_{CBO}	-	-	200	μA
Collector-Base Cutoff Current at $T_B = +90^\circ C$ at $V_{CB} = 1/2 BV_{CES}$ rating	I_{CBO}	-	-	20	mA
Emitter-Base Cutoff Current $V_{EB} = 12V$ (all types)	I_{EBO}	-	-	0.5	mA
Collector-Emitter Breakdown Voltage $I_C = 500mA, V_{EB} = 0$ 2N1539, 2N1544 2N1540, 2N1545 2N1541, 2N1546 2N1542, 2N1547 2N1543, 2N1548	BV_{CES}	30 45 60 75 90	- - - - -	- - - - -	volts volts volts volts volts
Collector-Emitter Leakage Current $V_{BE} = 1.0V$ $V_{CE} = 40$ 2N1539, 2N1544 $V_{CE} = 60$ 2N1540, 2N1545 $V_{CE} = 80$ 2N1541, 2N1546 $V_{CE} = 100$ 2N1542, 2N1547 $V_{CE} = 120$ 2N1543, 2N1548	I_{CEX}	-	-	20 20 20 20 20	mA mA mA mA mA
Collector-Emitter Breakdown Voltage $I_C = 500mA, I_B = 0$ 2N1539, 2N1544 2N1540, 2N1545 2N1541, 2N1546 2N1542, 2N1547 2N1543, 2N1548	BV_{CEO}	20 30 40 50 60	- - - - -	- - - - -	volts volts volts volts volts
Collector-Base Breakdown Voltage $I_C = 20mA$ 2N1539, 2N1544 2N1540, 2N1545 2N1541, 2N1546 2N1542, 2N1547 2N1543, 2N1548	BV_{CBO}	40 60 80 100 120	- - - - -	- - - - -	volts volts volts volts volts

Figure 2 — Electrical Characteristics as given on a typical Motorola data sheet

ELECTRICAL CHARACTERISTICS, COMMON EMITTER (At 25°C)

PARAMETER	SYMBOL	MIN	TYP	MAX	UNIT
Current Gain $V_{CE} = -2V, I_C = 3A$ 2N1539, 2N1540, 2N1541, 2N1542, 2N1543 2N1544, 2N1545, 2N1546, 2N1547, 2N1548	h_{FE}	50 75	- -	100 150	- -
Base-Emitter Drive Voltage $I_C = 3A, I_B = 300mA$ 2N1539, 2N1540, 2N1541, 2N1542, 2N1543 2N1544, 2N1545, 2N1546, 2N1547, 2N1548	V_{BE}	- -	- -	0.7 0.5	volts volts
Collector Saturation Voltage $I_C = 3A, I_B = 300mA$ 2N1539, 2N1540, 2N1541, 2N1542, 2N1543 2N1544, 2N1545, 2N1546, 2N1547, 2N1548	$V_{CE(SAT)}$	- -	0.2 0.1	0.6 0.3	volts volts
Frequency Cutoff $V_{CE} = -2V, I_C = 3A$ 2N1539, 2N1540, 2N1541, 2N1542, 2N1543 2N1544, 2N1545, 2N1546, 2N1547, 2N1548	f_{ae}	- -	4 4	- -	kc kc
Switching Characteristics $I_C = 3A$ Delay + Rise Time 2N1539, 2N1540, 2N1541, 2N1542, 2N1543 2N1544, 2N1545, 2N1546, 2N1547, 2N1548 Storage Time 2N1539, 2N1540, 2N1541, 2N1542, 2N1543 2N1544, 2N1545, 2N1546, 2N1547, 2N1548 Fall Time 2N1539, 2N1540, 2N1541, 2N1542, 2N1543 2N1544, 2N1545, 2N1546, 2N1547, 2N1548	$t_d + t_r$ t_s t_f	- - - -	5 5 3 3 5 8	- - - -	μ sec μ sec μ sec μ sec μ sec μ sec
Transconductance $V_{CE} = -2V, I_C = 3A$ 2N1539, 2N1540, 2N1541, 2N1542, 2N1543 2N1544, 2N1545, 2N1546, 2N1547, 2N1548	g_{FE}	3.0 5.0	6.0 7.5	- -	mhos mhos

Figure 2 (continued) — Electrical Characteristics as given on a typical Motorola data sheet

With this value, the designer can easily predict what the leakage will be at some higher temperature. Using the empirical rule that the thermal component of current will double for every 10°C, the design engineer can pinpoint the temperature component of the leakage current.

COLLECTOR-BASE VOLTAGE CHARACTERISTICS

The other I_{CBO} which is important in high-temperature usage is that current due to the portion of the collector-base voltage characteristics which adds another maximum I_{CBO} to the temperature complement of the total leakage. The data-sheet indicates that V_{CB} at 25 volts on the Motorola 2N1539 power transistor gives a maximum leakage of 2 milliamps. This voltage component is not temperature sensitive. Therefore, the design engineer, wishing to determine his leakage value at some higher temperature (e.g. $T_{J75^\circ C}$), can safely assume that the maximum increase in the thermal component of leakage current (I_C) will be 32 times 200 microamps. Adding to this the 2 milliamp voltage component

he could arrive at a value of 8.4 milliamps maximum leakage at 75°C with 25 volts across the transistor. All future references to temperature in this report will refer to the transistor case temperature and not the ambient temperature.

HIGH-TEMPERATURE COLLECTOR-BASE LEAKAGE CURRENTS

Since there are many voltages and many applications to be considered, it is difficult for any manufacturer to specify leakage under all voltages at all temperatures. Motorola has led the way in specifying a guaranteed maximum leakage at 90°C at a voltage which is within reliable usage of any given transistor. In this case, it is one-half the BV_{CES} rating. The selection of the one-half BV_{CES} voltage rating for the high-temperature test is an arbitrary one, but at a point where the device will be in a reliable operating area.

EMITTER-BASE CUTOFF CURRENT (I_{EBO})

One of the least used parameters on a data sheet is I_{EBO} . It is well to know the I_{EBO} limit of any given junction within a transistor; therefore this limit is shown at a region where most design will be taking place. In most Motorola power transistors the emitter-base diode breakdown voltage rating is far greater than the 12 volts shown on the data sheet. This is indicated by the BV_{EBO} listed under the absolute maximum ratings.

COLLECTOR-EMITTER LEAKAGE CURRENT (I_{CEX})

The X in this symbol means that there is some known back-bias voltage applied to the base-emitter diode. And, for each transistor this back-bias voltage must be specified as a test condition for any given I_{CEX} or BV_{CEX} rating. This rating is very useful in the design of converters. In this switching application, while one transistor is conducting the other transistor has been back-biased on the off condition thus waiting for transformer action to turn it back on. This rating is given as I_{CEX} rather than BV_{CEX} .

It is much easier for a transistor to stand off a given voltage and guarantee that the current will not be above a certain maximum value than to apply a test current and see if the voltage will be above a certain minimum value. This test could be related to a second breakdown type of relationship. On many diodes, applying a given test current could show a voltage rating of many volts above the listed rating.

Let us assume a condition where we apply 20 milliamps to the collector from a constant current source with a one volt base-emitter back bias. In some extreme cases, the collector-emitter voltage could go to 150 or 200 volts giving an extreme power dissipation problem, putting the device into the very dangerous second breakdown region; thus, the reason for specifying I_{CEX} rather than BV_{CEX} . The reverse is true of the breakdown voltage collector to emitter (BV_{CES}), with the base and emitter short circuits.

COLLECTOR-EMITTER BREAKDOWN (BV_{CES})

The most important rating that the engineer can consider when selecting the transistor for his circuit is BV_{CES} . (See Figure 3)

Most all power transistor applications require source voltages, collector-to-emitter. This forces V_{CE} ratings to be equal to or larger than the source voltage. Inductive loads will make this requirement higher. For the design engineer, a useful rating would be BV_{CER} which falls between BV_{CES} and BV_{CEO}

in applications utilizing alloy transistors. The test current of 500 milliamps for Motorola power transistors was selected to insure an adequate range of operation under this condition. On many of these test conditions, high dissipation can be experienced with the combination of test voltage and test current. Therefore, many of these tests are specified as sweep tests or pulse tests where the duty cycle is low enough that the maximum junction temperature is not exceeded. These tests should be performed with the transistor mounted on an adequate heat sink.

COLLECTOR-EMITTER BREAKDOWN VOLTAGE WITH THE BASE OPEN (BV_{CEO})

This test is related to I_{CBO} and the gain characteristic h_{FE} . With the base open, a condition can be reached where h_{FE} will multiply the I_{CBO} at a given voltage and start an avalanche condition as the junction temperature rises due to self-heating. This can quickly reach breakdown conditions if not carefully tested by the sweep method.

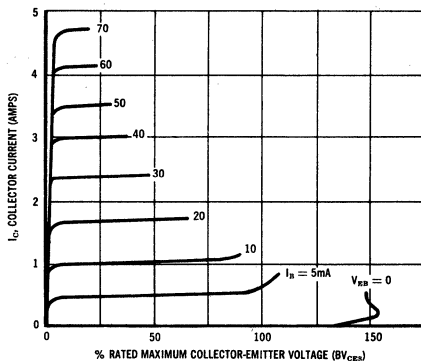

Figure 3 — Collector Characteristics, Common Emitter

Although BV_{CEO} is the most difficult of all tests to meet, especially at high voltages, it is a condition which is occasionally met in actual operation, such as in series regulated power supplies and power amplifiers. In switching circuits this condition can be met instantaneously when the transistor is switched from on to off, thus passing a region where the base has infinite resistance or is essentially open. Motorola protects for this condition by showing the BV_{CEO} rating on their data sheet and making it a part of their safe area curves.

COLLECTOR-BASE BREAKDOWN VOLTAGE (BV_{CBO})

This rating will show the limitation of the collector-base junction, but is a rating which is only occasionally used in actual circuit considerations. Many engineers make the error of selecting a transistor based on this parameter putting themselves into a high priced, low availability category, when actually the true ratings could have been defined by BV_{CES} . Circuits should be carefully analyzed to determine if BV_{CBO} or some collector-to-emitter rating is the controlling factor.

CURRENT GAIN (h_{FE})

This is the most arbitrary of all test conditions listed on a data sheet. Motorola in designing power transistors, has calculated the structure to center upon or yield a given gain at a given collector current depending upon market requirements. For alloy transistors, current-gain is a function of collector-current and in most cases will decrease when I_C increases. (See Figure 4)

It is best to design around data sheet limits. However, circuit requirement could dictate current gain spreads. Under these circumstances, it would be beneficial for the design engineer to work closely with the manufacturer to obtain a special device. This parameter is one that will vary to some degree with

life, and is therefore used as an end-of-life characteristic. It is with this realization that Motorola introduced their Meg-A-Life Program where end-of-life limits are given for both h_{FE} and I_{CBO} on industrial transistors.

BASE TO EMITTER VOLTAGE (V_{BE})

This parameter is very important to those who require knowledge of the input voltage at the specified test condition, especially to people designing converters and switching circuits. See Figure 5. The test for this parameter is usually performed with the transistor in saturation.

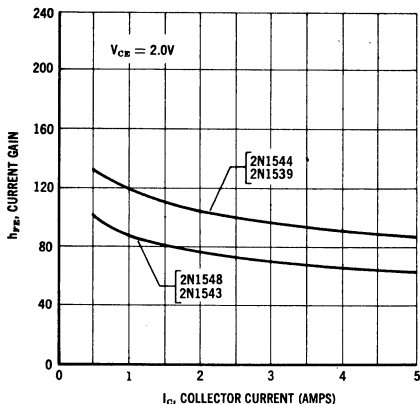

Figure 4 — Current Gain versus Collector Current

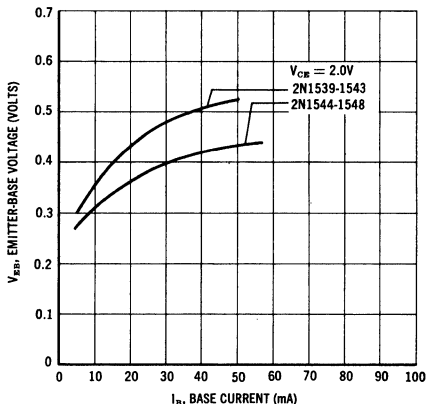

Figure 5 — Emitter-Base Voltage versus Base Current

SATURATION VOLTAGE ($V_{CE\ sat}$)

Saturation voltage, $V_{CE\ sat}$ (See Figure 6) is the minimum voltage necessary to sustain normal transistor action at a particular collector-current. At collector voltages, lower than $V_{CE\ sat}$, the base-collector diode is forward biased and the current-voltage relationship changes abruptly. Thus, the saturation voltage is the minimum collector-emitter voltage required to maintain full conduction when enough base drive is supplied. Further applications of base drive will reduce $V_{CE\ sat}$ with diminishing effect. Since the $V_{CE\ sat}$ VS I_C curve is almost a straight line, some transistor manufacturers list the characteristic as saturation resistance ($V_{CE\ sat}$). $V_{CE\ sat}$ is part of the output characteristic.

Transistor efficiency in converters is a function of switching speed and power dissipated in the fully-on condition. A very low saturation

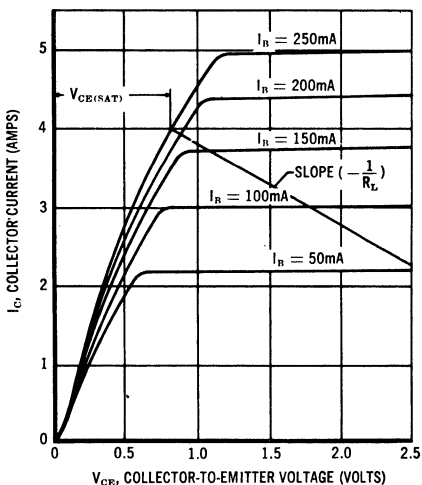

Figure 6 — Output Characteristics, Saturation Region, Motorola 2N351A

voltage is extremely desirable and is a function of the collector-current and base-current drive. Saturation voltage will increase with an increase in collector current and will also be inversely related to the gain (h_{FE}) of the transistor.

COMMON EMITTER-CUTOFF FREQUENCY (f_{ae})

Current gain frequency cutoff (f_{ae}) for the common emitter configuration, (also called the beta cutoff frequency) is the frequency where the small-signal, forward-current gain is .707 of the current gain value to be found at a given reference frequency. The .707 point represents a 3 db. reduction in current gain. The common emitter cutoff frequency F_{ab} is usually between 5 K_C and 10 K_C for power transistors. The common base frequency cutoff F_{ab} (generally not specified for power transistors) is approximately equal to h_{fe} times f_{ae} .

SECOND BREAKDOWN VOLTAGE

Second Breakdown Voltage, a destructive condition, was first observed when the first breakdown condition ($V_{BE} = 0$) was allowed to continue until point "A" was reached as illustrated by line 4 (BV_{CES}) of Figure 7. The current was allowed to increase after the curve had entered into the first negative resistance portion and a second negative resistance occurred which switched the characteristic onto Line 7 of Figure 7. Further investigation has shown that other base-emitter conditions trigger second breakdown. If the base-short-to-the-emitter ($V_{BE} = 0$) condition is used as a reference point, there exists a locus of points where second breakdown is initiated for both negative and positive base-to-emitter voltage conditions, which is shown by the dashed line. Thus, high negative base drive will cause second breakdown to be generated at much greater collector current by a lower collector voltage than at the $V_{BE} = 0$ point. When the base is positive, the locus is more difficult to determine since the trigger point lies in a negative resistance region. The exact locus varies considerably from one device to the next. However, if the collector diode breakdown and the BV_{CES} are within specifications for the transistor, the locus will always be to the right of and above lines D-E and E-F shown in Figure 8.

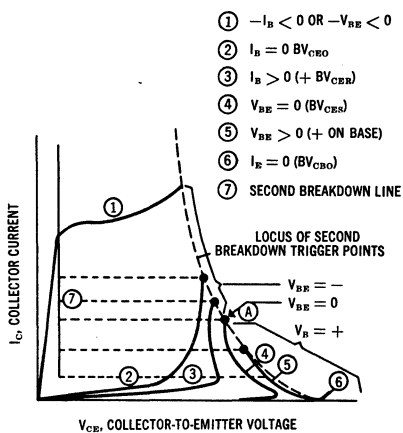

Figure 7 — Collector Current versus Collector-to-Emitter Voltage

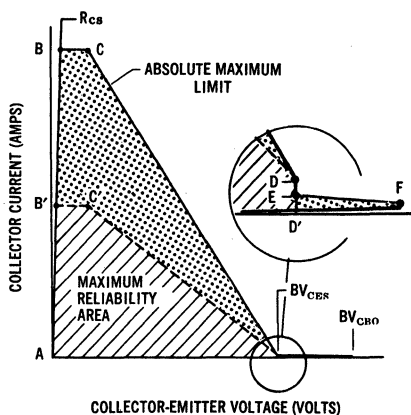

Figure 8 — Reliable $V_C - I_C$ Areas

Triggering second breakdown from positive base drive almost always results in a collector-to-emitter short or a drastically altered transistor. Negative drive action does not appear to be as drastic and usually the phenomenon can be observed repeatedly on a curve tracer.

The exact physical reaction is still somewhat of a mystery, although the results of other types of breakdown have been fully described. Second breakdown seems to result in a "channeling of current" between the collector and emitter. In second breakdown the collector-to-base junction exhibits certain instabilities when high voltage is applied. The point at which these instabilities occur is controlled by the voltage imposed on the base-to-emitter junction. This spot heating can actually melt the germanium and allow the indium of the collector and the emitter to flow together producing a collector-emitter short.

The locus of points where second breakdown occurs is independent of temperature within normal operating ranges. However, as temperature changes, a particular point on the locus will shift with a certain base-emitter condition. For instance, as temperature increases, the $V_{BE} = 0$ point will shift toward the $I_B = 0$ line. This is because more I_{CBO} flows through the internal base resistance ($R_{BB'}$) which causes the internal base-emitter junction to see a more negative voltage on the base side. In fact, high I_{CBO} current will cause the $V_{BE} = 0$ line to lose its negative resistance portion (the tail) and approach the low temperature $I_B = 0$ case.

DETERMINATION OF PEAK POWER

The peak allowable power is:

$$P_p = \frac{(T_j - T_a - \theta_{JA} P_{ss})}{\theta_{JC} \left(\frac{1}{C_r} \right) + \theta_{CA} (t_i/t)}$$

C_r is a coefficient of power as obtained from the chart. T_j is junction temperature in °C; T_a is ambient temperature in °C; θ_{JC} is junction to case thermal resistance in °C/W; θ_{CA} is case to ambient thermal resistance in °C/W; θ_{JA} is the sum of $\theta_{JC} + \theta_{CA}$; t_i is pulse width; t is the pulse period; (t_i/t) is the duty cycle; P_{ss} is a constant power dissipation and P_p is the additional allowable pulse power dissipation above the amount of P_{ss} .

The above equation is usable when a heat sink is used which has thermal capacity very much larger than the transistors thermal capacity.

The chart is normalized with respect to the thermal time constant, which is on the order of 50 milliseconds for these power transistors.

EXAMPLE

Given:

$P_{ss} = 10W$ $T_a = 40^\circ C$

Pulse width (t_i) = 1 msec

Duty Cycle = 20%

$\theta_{CA} = 3^\circ C/W$

$\theta_{JC} = 0.8^\circ C/W$ $T_{j,max} = 100^\circ C$

Solution: Enter the graph at $t_i/\tau = 1$ msec/50msec, and

Duty Cycle 20%. Find $C_r = 5$. Solve equation

$$P_p = \frac{100 - 40 - (3 + 0.8) 10}{0.8 + 3 \times 2}$$

$P_p = 29$ watts in addition to the steady 10 watts resulting in 39 watts peak.

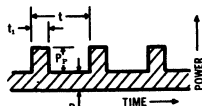

PEAK POWER DERATING CURVE

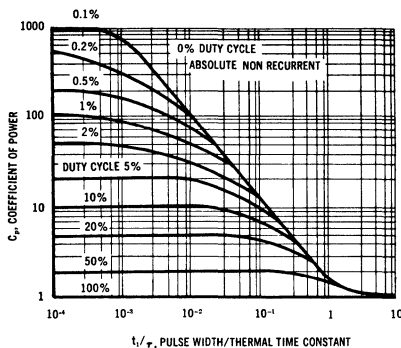

Caution In all cases the peak pulse power should stay within the Safe Operating Area.

Figure 9 — Peak Power Derating

A well specified transistor data sheet will contain all of the above information. Some designs do not require specifications other than voltage, power dissipation and gain. The extreme requirements of present day industrial equipment as well as military specifications in most cases taxes the ingenuity of the design engineer and the time available for him to design the best equipment. **TIME WHICH CAN BE SAVED DUE TO PROPER SPECIFICATION IS JUST AS IMPORTANT AS TIME SAVED DUE TO PROPER DESIGN.** Because the semiconductor industry is relatively new and because of the questions and problems that can arise involving the use of semiconductors, a design engineer can lose much valuable time if he is forced to discontinue design operations due to the lack of information. A good data sheet can clearly eliminate this delay.

DETERMINING MAXIMUM RELIABLE LOAD LINES FOR POWER TRANSISTORS

Operation of power transistors within their power-temperature ratings alone is not a sufficient safeguard to guarantee circuit reliability. An additional consideration of the allowable collector-emitter voltage vs. collector current must be taken into account, otherwise a distinctive condition termed "secondary breakdown" can occur.

To avoid this secondary breakdown condition, it is necessary to maintain the load line within safe voltage and current limits.

As described later, secondary breakdown is a function of time in addition to voltage or current and, since transistors can be operated at an infinite number of time intervals and operating points, reliable load line operation is specified by safe operating areas including time as a parameter.

SECONDARY BREAKDOWN

For a fixed bias on the base-emitter junction, as collector voltage is increased on a power transistor the collector current increases slowly to a certain point at which the increase becomes rapid and an avalanche condition exists. The collector voltage at which avalanche occurs is determined by the voltage condition across the emitter-base junction. In other words, the transistor bias condition determines the point of avalanche. Avalanche in itself is nondestructive if power dissipation is limited, but a destructive breakdown can occur if the collector current is allowed to increase to a high value. This is called "second breakdown"^{1, 2, 3}.

Second breakdown is associated with the collector-base junction, and is controlled by the emitter-base junction. The electrical interplay of the junctions is such that second breakdown is triggered at lower voltages as collector current is increased. The locus of secondary breakdown trigger points is shown in Figure 1 for a 1/2 wave 60 cps pulse.

The exact action of second breakdown is not known but seems to be associated with a sudden concentration of energy into a small area, the energy being a function of collector voltage, collector current, and time. This concentrated energy dissipates power in a very small volume which causes the temperature to exceed the melting point of the semiconductor material. The two junctions can then flow together causing a collector-to-emitter short.

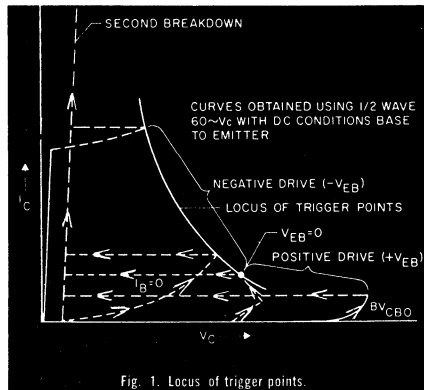

Fig. 1. Locus of trigger points.

PULSE TEST

To establish safe operating areas, through destructive testing, for various pulse widths, the test circuit shown in Fig. 2 was developed. In this circuit, a reverse bias sufficient to keep the transistor cut off until the pulse is applied, is always present between base and emitter. The 10-ohm resistor in the bias circuit is necessary to permit a negative voltage to build up and turn on the transistor when the pulse is applied.

The pulse test signal is obtained from a pulse generator and a transistor amplifier. The amplifier transistor must be a high-speed germanium device such as a 2N2832. The pulse amplitude is controlled by setting the output of the pulse generator high enough to saturate the amplifier transistor. The signal into the transistor under test is controlled by varying the collector supply voltage.

The output waveform is monitored on an XY oscilloscope across a sensing resistor which is made from Canshol type A-1 flat ribbon. A 0.1-ohm sensing resistor is used for collector currents below five amperes and a 0.01-ohm sensing resistor is used at higher collector currents.

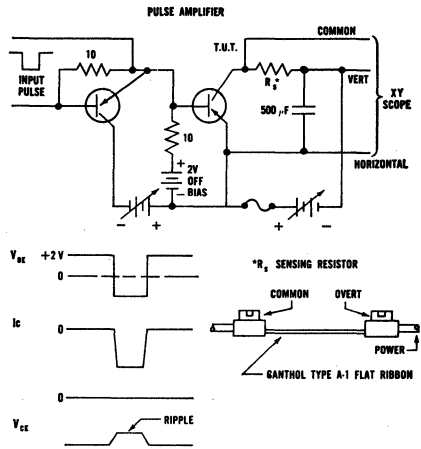

Fig. 2 Circuit used to establish safe operating areas.

To keep the voltage drop in the interconnecting wiring to a negligible value, number 10 wire is used for circuit connections and number 4 stranded cable is employed for connecting to the batteries used as the voltage source.

The 500 μf capacitor bypasses voltage transients resulting from the rapid change of current through the inductance of the connecting leads. The fuse or circuit breaker is necessary to prevent burning out the sensing resistor or other components when the transistor shorts.

The source voltage is set at a fixed level in steps of 12 volts each. Collector current is increased by increasing the base drive until second breakdown occurs. A short occurs, since no current limiting is used.

PLOT OF BREAKDOWNS

The voltage and current failure point is observed on the XY scope and recorded on a graph similar to Fig. 3. To establish a usable safe area curve, at least 5 to 10 transistors are tested and destroyed at each pulse width and voltage. To construct the safe area curve on the graph, a line is drawn connecting the worst-case points of each voltage group.

Notice that, regardless of the pulse width, as current is increased the device will withstand less voltage.

Using an average of the failure points from Fig. 3, the typical graph of energy in watt-seconds required for second breakdown is plotted in Fig. 4. The shape of these curves is logical since as current increases the effective emitter area

decreases and as voltage increases the effective base width decreases. Thus, as current and voltage increase there is a continuous shrinking of the active volume containing the energy.

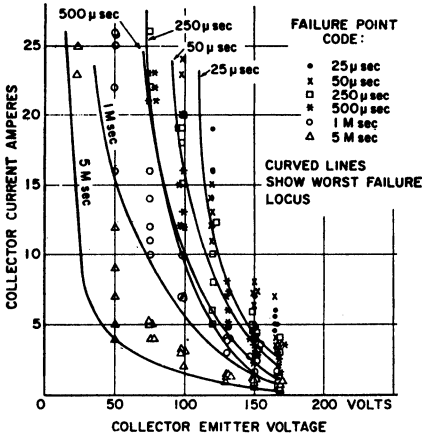

Fig. 3. Graph shows typical failure points for 2N2526 transistor.

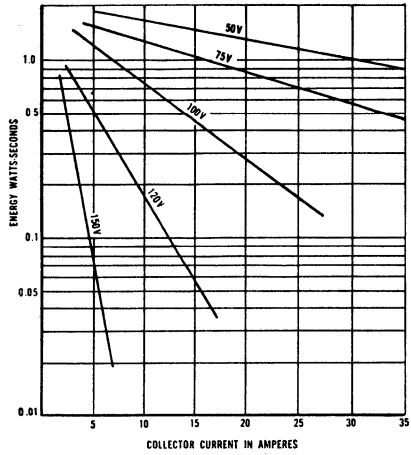

Fig. 4. Typical energy required to cause transistor failure is plotted against current with a constant voltage applied.

It is difficult to relate the results theoretically, due to all the variables which affect current crowding, although the effect of base width changing with voltage is a well-known expression. Also, since base width decreases with voltage, the effective base resistance increases due to the transverse area shrinking, which intensifies the current crowding.

DC TESTS

The test circuit used to determine failures under dc and long-time pulse conditions is shown in Fig. 5. A common-base circuit is used for this test to prevent thermal runaway.

Also, since power levels approaching 200 watts may be encountered during tests, a water-cooled heat sink is necessary. The heat sink consists of a 4" X 4" X 1/8" copper sheet with a "U" shaped copper tubing soldered to it around the transistor mounting area. Ice water is circulated through the tubing to remove heat from the copper plate.

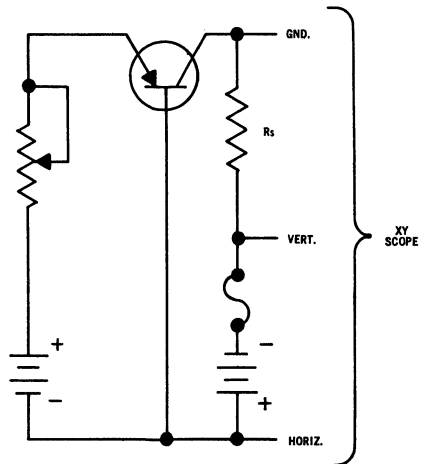

Fig. 5. Circuit used to establish dc safe operating areas.

The dc failure points were determined in a similar manner as previously described for the pulse tests.

POWER-TEMPERATURE DERATING vs SAFE AREA

This application note shows safe area curves for many Motorola Power Transistors and includes de-ratings due to temperature effects. In addition to the Safe Areas, a power dissipation curve is plotted for each device. This power curve represents the allowable average power which could be dissipated at a given case temperature (usually 25°C) without exceeding the particular maximum junction temperature. At higher case temperatures the allowable average power will be less depending on thermal resistance and the power area would be represented by a curve drawn to the left and below the one shown. In general, the allowable power at 25°C (case) is beyond the allowable dc and long-time pulse safe areas and the device is breakdown-voltage limited. However, at higher case temperatures the device may be power-dissipation limited.

In any event, both average power-temperature de-rating and safe areas must be obeyed. In addition, the switching of power causes time-dependent temperature increases which are of concern but are separate from the safe area considerations.

This temperature dependency is associated with the thermal time constant of the transistor and a discussion is included in the Motorola Power Transistor Handbook and on most data sheets under a heading of "Peak Power" or "Pulse Power".

The proper control of temperature rise and peak power will insure that the maximum junction temperature is not exceeded. In addition, the proper control of pulse load line to stay within the applicable Safe Area curve will insure that a collector to emitter short will not be caused.

EXTENSION TO COLLECTOR-BASE BREAKDOWN

Some devices have a collector-base breakdown rating greater than the collector-emitter breakdown. Operation is allowable in the region between $V_{CE(max)}$ and $V_{CB(max)}$; however, it is recommended that the current be kept as low as possible by back biasing of the base-emitter junction.

APPLICATION CHECKS

The safe areas were double checked in the following applications to see if the pulse safe area curves were meaningful: (1) audio, (2) solenoid driver, (3) power inverter, and for dc safe area, (4) low frequency audio and dc regulators.

(1) Audio

The audio application was used to test low-frequency effects which should correlate with the 5 millisecond safe areas. Devices were put into the class A circuit shown in Fig. 6, with an ac resistive load, the dc being bypassed by a shunt inductance. The input was deliberately overdriven and then the load resistor removed to obtain a reactive load line.

It was hoped that an elliptical load line could be obtained with an excursion controlled by drive voltage and with time of the excursion controlled by frequency. While this did occur, the excursion was very low at high frequencies and thus the fast pulse areas could not be probed. At frequencies between 50-200 cps, a large excursion was possible and failures were caused by exceeding the 5 msec safe area curve.

(2) Solenoid Driver

The solenoid driver consisted of controlling the load line with a suppression diode across the inductance or a zener diode across the transistor. The diode across the inductance clamps the load line excursion at the dc source voltage as indicated in Fig. 7. The zener diode method resulted in a rectangular load line as indicated in Fig. 8 and clamping occurs at the zener voltage.

A word of caution is necessary concerning this application. The fast switching can cause induced voltage in long lead lengths to the power supply. Thus, it is necessary to connect the suppression diode as close to the collector as possible and use a clamping capacitor from the emitter to the connecting point of the diode and inductance. When using the zener diode it should be soldered as close to the emitter and collector pin as possible. No failures occurred when the load line was contained within the 25- μ sec safe area curve.

(3) Power Inverters

One of the most critical operations of power transistors is in inverter circuits similar to that shown in Fig. 9. A typical inverter circuit was used to test several types of power transistors. The load line was observed while holding the peak current constant and increasing the voltage until failures occurred. Then the current was increased at a constant supply voltage until failures were encountered. Cases of failure occurred after the load line was well beyond the 25- μ sec safe area.

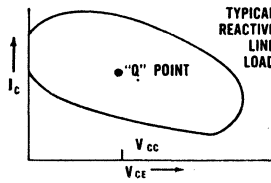
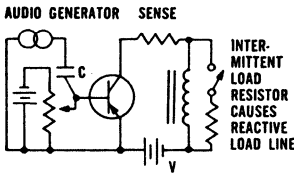

Fig. 6. Transistor arrangement for a class A audio circuit.

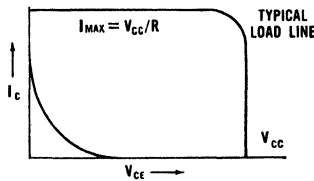
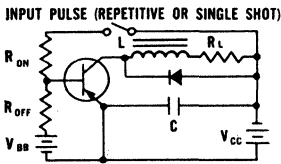

Fig. 7. Circuit for a transistor solenoid driver with diode suppression.

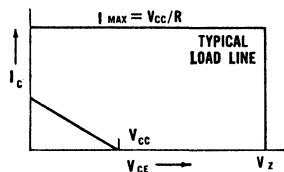
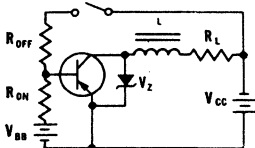

Fig. 8. Circuit for transistorized solenoid driver with zener diode.

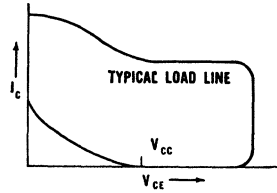
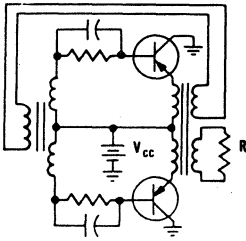

Fig. 9. Circuit arrangement for inverter.

(4) DC and Low Frequency Audio

In dc applications such as voltage regulators and in low frequency (below 100 cycle) audio circuits, the dc safe-area curve in conjunction with the power-temperature derating curve establishes reliable operating limits. Depending upon the device type and case temperature, the load line may be limited by either the power dissipation rating or the dc safe-area rating. In some instances, the dc safe limit and the power dissipation limit can cross. In this case, the load line limit would be established at low currents and high voltage by the dc safe limit and by the power dissipation limit at high current and low voltage.

The above discussion also applies to low duty cycle surge conditions such as encountered in incandescent lamp flashers where low initial resistance of the lamp permits a high-current surge for 50 to 100 milliseconds. This can trigger secondary breakdown even though succeeding current pulses are very low after the lamp resistance increases.

BIBLIOGRAPHY

1. Ralph Greenburg, Breakdown Voltage in Power Transistors, Semiconductor Products vol. 4, No. 11, November 1961, p 21-24.
2. Ralph Miller, Dependence of Power Transistor Failures on Their Energy Characteristics, Semiconductor Products, July 1962.
3. Schafft and J. C. French, Second Breakdown in Transistors, IRE Trans Electronic Devices, March 1962.

FACTORS INFLUENCING SELECTION OF COMMERCIAL POWER TRANSISTOR HEAT SINKS

Among the vast number of commercial power transistor heat sinks (over 200 catalog types), there are several factors which influence choice of types for given applications. The photograph in Figure 1 is a good illustration of the wide variety available. The results of tests compare the thermal resistance of various heat sinks with variations in weight, area, volume, shape and color and a selection chart will facilitate the best choice of heat sink.

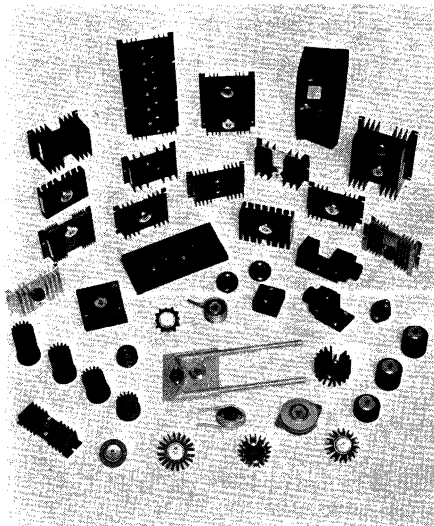

TEST PROCEDURES

Tests were organized to establish the heat sink-to-ambient thermal resistance of 31 different types, and the weight, area and volume were measured for each.

TO-3 and TO-36 power transistor packages were used depending upon the hole pattern in the samples. The bench test setup was as indicated in Figure 3. A correlation setup was also used in a closed oven, but with such close results that the open air bench test was used for convenience. All types were tested with the fins held in a vertical plane.

A constant power, usually 5 or 10 watts, was dissipated in the transistor. Regulated current and voltage were supplied from sources such as shown in Figure 4. The current and voltage were measured to an accuracy of 2 per cent. The ambient temperature was measured with a bulb type mercury thermometer at a point six inches away from the lower edge of the heat sink. The heat sink temperatures were measured by staking a thermocouple into a small silicone

grease-filled hole. The case temperature of TO-36 "door knob" transistors was measured by staking a thermocouple into a hole drilled into the stud to a depth almost level with the round mounting base. The case temperatures of the TO-3 "diamond" transistors were measured by soldering a thermocouple to a solder lug which was fastened between the case and one of the mounting screws. These methods are detailed in Figure 5. The heat sink temperatures were calculated by subtracting an estimated interface thermal resistance of $0.2^{\circ}\text{C}/\text{W}$ between heat sink and transistor.

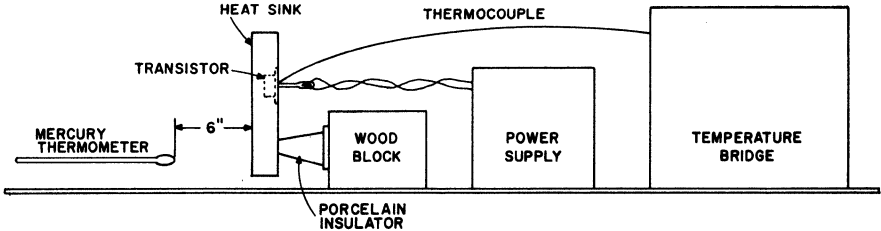

Figure 3 — Bench test set-up.

No attempt was made to investigate the various considerations of restricted air flow, surface temperature, nearby reflecting surfaces, etc. In actual practice almost each installation is unique, and transistor cases in prototype equipment should be monitored with a thermocouple under the worst conditions.

TEST RESULTS

Table Ia and Ib are comprehensive listings of test results in order of heat sink code number. From these tables important factors about a heat sink may be obtained, such as shape, size, weight, exposed surface area, and volume, which allow the designer to determine whether a particular heat sink fits into his packaging plan. The finish and thermal resistance are also included.

To compare performance of cylindrical-fin heat sinks with that of flat-fin types, the area versus thermal resistance has been plotted in Figure 6. The graph in Figure 6 shows four average slopes of thermal resistance versus total surface area for: (1) square sheets of bright 1/8 inch aluminum; (2) flat

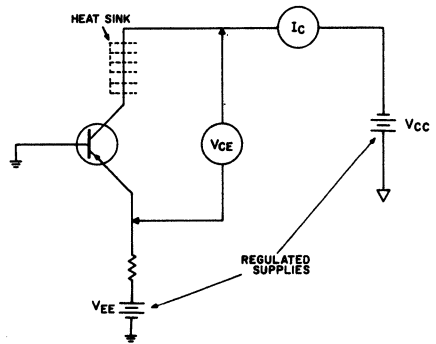

Figure 4 — Electrical circuit.

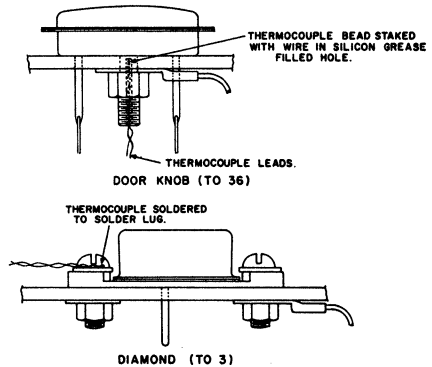

Figure 5 — Thermocouple attachment.

—Motorola Reference Material—

vertical-finned, black-finished types (these are usually aluminum extrusions); (3) vertical cylindrical fluted types, black finish (aluminum castings); (4) cylindrical horizontal fins, black finish (sheet metal rings). It should be noted that heat sinks 2, 3, 12, and 14 have flat vertical fins but are not painted black, and thus have somewhat higher thermal resistance due to less heat radiation.

TABLE Ia
FREE AIR TYPES

Code No.	Shape	Surface Area (sq. in.)	L (in.)	W (in.)	H (in.)	Vol. (cu. in.)	Weight (grams)	Finish	Thermal Resistance °C/W
1	Flat-finned Extrusion	65	3.0	3.6	1.0	10.8	114	Anod. Black	2.4
2	Flat-finned Extrusion	65	3.0	3.6	1.0	10.8	114	Bright Alum.	3.0
3	Flat-finned Extrusion	65	3.0	3.6	1.0	10.8	114	Gray	2.8
4	Flat-finned Extrusion	60	3.0	4.0	.69	8.3	123	Anod. Black	2.8
5	Flat-finned Extrusion	95	3.0	4.0	1.28	15.3	189	Anod. Black	2.1
6	Flat-finned Extrusion	64	3.0	3.8	1.3	15.0	155	Black Paint	2.2
7	Flat-finned Extrusion	83	3.0	4.0	1.25	15.0	140	Anod. Black	2.2
8	Flat-finned Extrusion	44	1.5	4.0	1.25	7.5	75	Anod. Black	3.0
9	Flat-finned Extrusion	137	3.0	4.0	2.63	31.5	253	Anod. Black	1.45
10	Flat-finned Extrusion	250	5.5	4.0	2.63	58.0	461	Anod. Black	1.10
11	Flat-finned Extrusion	130	6	3.6	1.0	21.5	253	Anod. Black	1.75
12	Flat-finned Extrusion	78	3.0	3.8	1.1	12.5	190	Gray MMI	2.9
13	Flat-finned Extrusion	62	3.0	3.8	1.3	15.0	170	Gray MMI	2.2
14	Flat-finned Extrusion	78	3.0	4.5	1.0	13.5	146	Gold Alodine	3.0
15	Cylindrical Horizontal Fin, Machined Casting	30	1.75 Dia.		0.84	2.0	40	Anod. Black	8.5
16	Cylindrical Horizontal Fin, Machined Casting	50	1.75 Dia.		1.5	3.6	67	Anod. Black	7.1
17	Cylindrical Horizontal Fin, Machined Casting	37	1.75 Dia.		1.5	3.6	48	Anod. Black	6.65
18	Cylindrical Vertical Fins, Casting	7.5	1.5 Dia.		0.9	4.4	33	Anod. Black	8.1
19	Cylindrical Vertical Fins, Casting	12	1.5 Dia.		1.4	6.9	51	Anod. Black	7.0
20	Cylindrical Vertical Fins, Casting	25	1.5 Dia.		2.9	14.2	112	Anod. Black	5.6
21	Cylindrical Vertical Fins, Casting	35	1.5 Dia.		3.4	16.7	132	Anod. Black	5.1
22	Cylindrical Vertical Fins, Casting	32	2.5 Dia.		1.5	7.4	94	Anod. Black	4.5
23	Cylindrical Vertical Fins, Casting	20	2.5 Dia.		0.5	2.45	48	Anod. Black	6.6
24	Flat-Finned Casting	23	1.86	1.86	1.2	4.15	87	Anod. Black	5.06
25	Square Vertical Fin, Sheet Metal	12	1.7	1.7	1.0	2.9	19	Anod. Black	7.4
26	Cylindrical Vertical Fin, Sheet Metal	15	2.31 Dia.		0.81	3.35	18	Black	7.1
27	Cylindrical Horizontal Fin, Sheet Metal	6	1.81 Dia.		0.56	1.44	20	Anod. Black	9.15
28	Cylindrical Horizontal Fin, Sheet Metal	55	2.5 Dia.		1.1	5.4	115	Gold Irridate	7.9

The empirical expression, $\theta_{SA} = 32.6A^{-.472}$, fits the "square aluminum" line, where A is total surface area in square inches, and θ_{SA} is in $^{\circ}\text{C}/\text{W}$. Both the flat-finned types and vertical fluted cylindrical types had almost identical slopes, compared to the single square fin, indicating for a given change in area, the change in sink-to-ambient thermal resistance would be approximately the same for both types. The ring horizontal fin types showed a much steeper slope although these were mounted with the fins in the vertical plane.

This indicates there is relatively little change in thermal resistance with variations in the surface area of the ring horizontal fin types.

Figure 7 shows the thermal resistance plotted as a function of volume displacement. According to these tests, heat sinks No. 2 (bright aluminum), No. 3 (gray finish), No. 12 (gray MMI), and No. 14 (gold alodine) have approximately 0.3 to 0.8 $^{\circ}\text{C}/\text{W}$ higher thermal resistance than the flat vertical fins with black finish. The performance of cylindrical vertical fin casting types 22, 23, flat-finned casting type No. 24, and a cylindrical vertical fin sheet metal type 25, corresponds very closely with that of the square, 1/8 inch bright aluminum heat sink with respect to volume.

Another important consideration is the heat sink weight. The thermal resistance as a function of weight is plotted in Figure 8. The correlation line for flat vertical fins is very similar to the area and volume results. This is to be expected, since all the heat sinks were made of aluminum of about the same thickness. The correlation lines for both cylindrical types (vertical and horizontal fins) are similar to the area results. However, the weight results approach the square aluminum fin performance more so that did the area re-

TABLE Ib

Fig. 1 & 2 Code No.	Conditions	Thermal Resistance
AIR COOLED TYPES		
29	10 cu ft/min of air	0.4 $^{\circ}\text{C}/\text{W}$
30	10 cu ft/min of air	1.2 $^{\circ}\text{C}/\text{W}$
WATER COOLED TYPES		
31	0.04 cu ft/min	0.45 $^{\circ}\text{C}/\text{W}$
MISCELLANEOUS TYPES - NO TEST RESULTS		

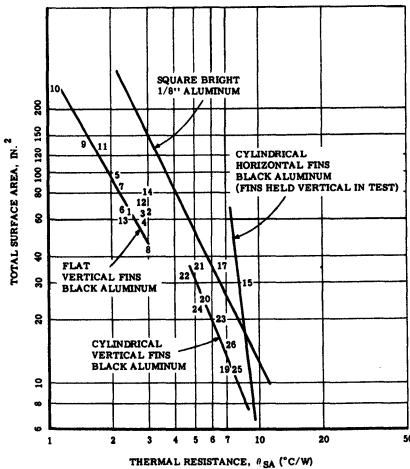

Figure 6 - Surface area vs. θ_{SA} .

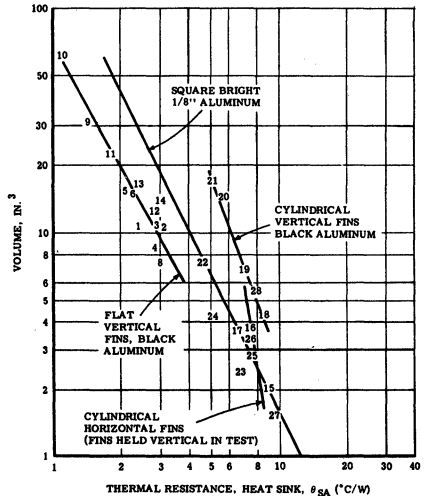

Figure 7 - Volume vs. θ_{SA} .

sults. Thus, from weight considerations there is an advantage of using the flat vertical fin design.

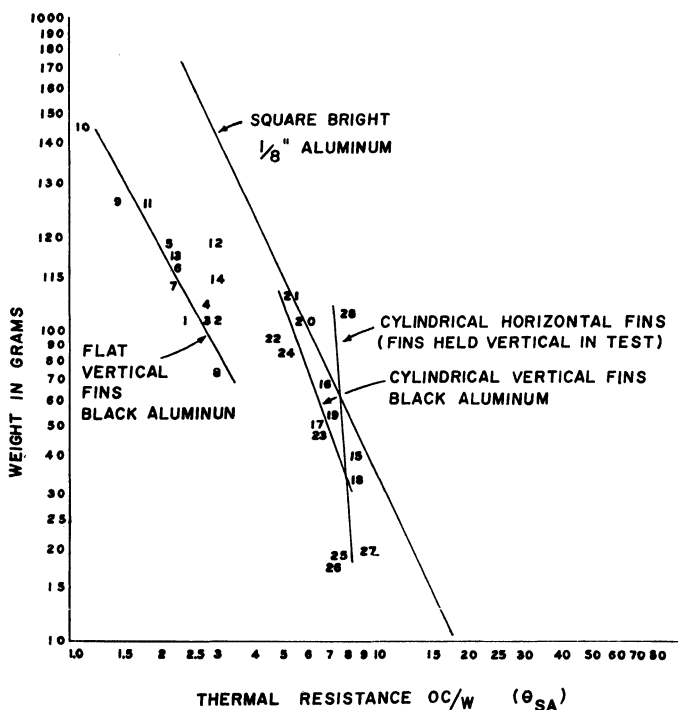

Figure 8 — θ_{SA} vs. weight.

According to Figures 6, 7, and 8, the flat extruded fin type heat sink is the most efficient for heat transfer. Of the flat fin types tested, the thermal resistance ranged from about 3°C/W with a surface area of 44 sq. in. to 1.1°C/W with an area of 250 sq. in. The same change in thermal resistance occurs with change in volume of the flat fin types. Since the slope of thermal resistance for 1/8 inch aluminum sheets is approximately the same as the black flat fins, the aluminum sheets painted black would probably offer similar performance and less cost.

Heat transfer, and consequently thermal resistance, is dependent mainly on exposed surface area, and changes in shape and volume offer relatively little advantage. The shape is important only in that it affects the final packaging configuration. Of course power level, type of chassis, and whether or not blowers or water cooling is available, must also be considered.

CHOICE OF HEAT SINK

As has been noted, many considerations affect the choice of the best heat sink to do a specific job. The value of necessary thermal resistance is, of course, the primary consideration and a designer should not exceed maximum thermal resistances in making his selection. However, it is not always easy to use one with the smallest volume and least area which would have adequately low thermal resistance. Indeed the shape factor, flat or round, etc., is the reason for so many available types.

Table II provides a logical method of selecting the best heat sink for a given application. First consideration is thermal resistance. The results listed are from tests in free air. In the equipment package there are air restrictions, chassis heat conduction, and other heat sources which were not considered in these tests. Thus several other types having a lower thermal resistance than required should be considered to assure a safety margin after packaging. A choice should also be maintained in the second consideration - shape. Three common conditions are listed - (1) the standard 3 inch chassis where the heat sink would be mounted vertically on the side of the chassis; (2) circuit card, where a small heat is useful; (3) some type of cylindrical container.

Other considerations should include availability of air or water cooling and whether or not several transistors are to be stacked. The following list of heat sink manufacturers, compiled at the time of this article, should be contacted for additional information and exact specifications.

TABLE II
Heat Sink Selection Guide

Consideration	Conditions	Heat Sink Choice (by code number - see Tables Ia & Ib & Figures 1 & 2)
Thermal Resistance	0 to 0.5°C/W	31 (water cooled)
	0.51 to 1.0	(Note 1)
	1.01 to 2.0	9, 10, 11
	2.01 to 3.0	1, 2, 3, 4, 5, 6, 7, 8, 12, 13, 14
	3.01 to 5.0	22
	5.01 to 7.0	17, 19, 20, 21, 23, 24
	7.01 to 10.0	15, 18, 25, 26, 27, 28
Shape Factor	3" Chassis	1, 2, 3, 4, 5, 6, 7, 8, 9, 13, 14
	Circuit Card	15, 18, 25, 26, 27, 28, 33
	Cylindrical Container	16, 17, 19, 20, 21, 22, 23
Blower	Self Channeled Air	29, 30, 40
	Forced Air	All except 18, 19, 20, 21, 31, 32
Water	Circulating Water	31, 32
Stacked Sinks	Easily Stacked	4, 5, 14, 30
Price & Availability	This we leave to the reader.	
1. Many of the heat sinks will fall in these lower categories if blown air is used.		

UNDERSTANDING TRANSISTOR RESPONSE PARAMETERS

THE RANGE OF FREQUENCIES over which a transistor performs a useful circuit function is limited by inherent parameters. Manufacturers' data sheets usually specify only one or two of these parameters, while the user may need others. Therefore, a clear understanding of these parameters and the relationships between them is of value evaluating transistor performance.

Typical of such parameters is h_{fb} (alpha, the common base a-c short-circuit forward current gain). As frequency is increased, h_{fb} remains approximately equal to h_{fb0} (the value of h_{fb} at 1 kc). After the upper frequency limit is reached, h_{fb} begins to decrease rapidly.

The frequency at which a significant decrease in h_{fb} occurs provides a basis for comparison of the expected high frequency performance of different transistors. The common base current gain cutoff frequency, $f_{\alpha b}$, is defined as that frequency at which h_{fb} is 3 db below h_{fb0} . Expressed in magnitude, h_{fb} at $f_{\alpha b}$, is 70.7 per cent of h_{fb0} . Power gains, current gains, and voltage gains for a few common decibel values are found in Table 1. A curve of h_{fb} versus frequency for a transistor with an $f_{\alpha b}$ of 1 mc is shown in Fig. 1.

This curve has the following significant characteristics: (1) at frequencies below $f_{\alpha b}$, h_{fb} is nearly constant and approximately equal to h_{fb0} ; (2) h_{fb} begins to decrease significantly in the region of $f_{\alpha b}$; (3) above $f_{\alpha b}$, the rate of decrease in h_{fb} with increasing frequency approaches 6 db per octave in the limit.

The curve of common base current gain versus frequency for any transistor has these characteristics, and the same general appearance as the curve of Fig. 1.

The common emitter parameter which corresponds to $f_{\alpha b}$ is $f_{\alpha e}$, the common emitter current gain cutoff frequency. By definition, $f_{\alpha e}$ is the frequency at which h_{fe} (beta, the common emitter of a-c short-circuit current gain), has decreased 3 db below h_{fe0} (the value of h_{fe} at 1 kc). A typical curve of h_{fe} versus frequency for a transistor with an $f_{\alpha e}$ of 100 kc is shown in Fig. 2.

Table 1: Conversion table for power, voltage, and current ratios into decibels.

db	Power Ratio	Current Ratio	db	Power Ratio	Voltage or Current Ratio
0	1.00	1.00	10	10.0	3.2
0.5	1.12	1.06	15	31.6	5.6
1.0	1.26	1.12	20	100	10
1.5	1.41	1.19	25	316	18
2.0	1.58	1.26	30	1,000	32
3.0	2.00	1.41	40	10,000	100
4.0	2.51	1.58	50	10^5	316
5.0	3.16	1.78	60	10^6	1,000
6.0	3.98	2.00			
7.0	5.01	2.24			
8.0	6.31	2.51			
9.0	7.94	2.82			

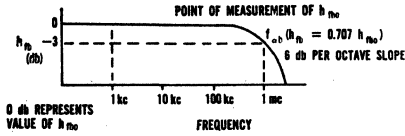

Fig. 1. Graph represents a curve of a common base current gain plotted against frequency variations.

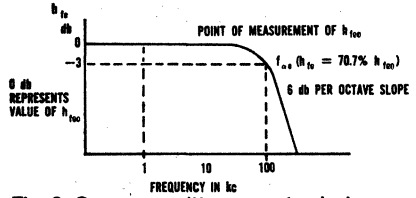

Fig. 2. Common emitter current gain is plotted against frequency in the curve shown.

This curve also has the significant characteristics listed for Fig. 1. These characteristics allow such a curve to be constructed for a particular transistor by knowing only h_{fe0} and $f_{\alpha e}$. From the curve, h_{fe} at any frequency could be determined. Furthermore, if $f_{\alpha e}$ is not known, a curve could also be constructed if h_{fe0} and h_{fe} at any frequency above $f_{\alpha e}$ were known. Thus to determine h_{fe} at any frequency, it is necessary to know only h_{fe0} and either $f_{\alpha e}$ or h_{fe} at some frequency f , where f is greater than $f_{\alpha e}$.

Sometimes, h_{fe0} is needed and only h_{fbo} is given, or vice versa. The quantities h_{fbo} and h_{fe0} are related by the following:

$$h_{fe0} = \frac{h_{fbo}}{1 - h_{fbo}} \quad (1)$$

$$h_{fbo} = \frac{h_{fe0}}{h_{fe0} + 1} \quad (2)$$

Equations 1 and 2 are plotted in Fig. 3. To further facilitate computations, the low frequency current gain scales of Fig. 7-10 contain both an h_{fbo} and an h_{fe0} scale, and may be entered with a knowledge of either quantity.

RELATIONSHIP BETWEEN $f_{\alpha e}$ AND $f_{\alpha b}$

Suppose two transistors are considered for a particular application where performance at high frequencies is of interest. The data sheets are compared and it is discovered that one specifies $f_{\alpha b}$ and the other $f_{\alpha e}$. What preliminary comparisons can be made from this without making any laboratory measurements?

Phillips¹ gives a discussion of the relationships between $f_{\alpha e}$ and $f_{\alpha b}$ with the following result:

$$f_{\alpha e} = K_{\theta} (1 - h_{fbo}) f_{\alpha b}$$

where K_{θ} is a function of excess phase value between 0.5 and 1.0. Table 2 gives approximate values of K_{θ} for a number of transistor types.

The value of 0.82 applies to all alloy junction transistors. For high-

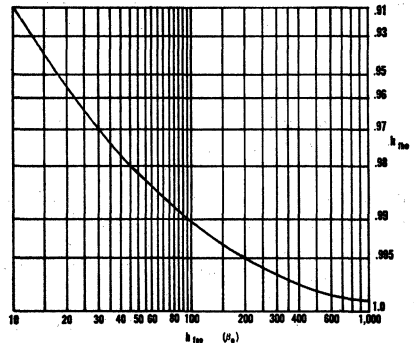

Fig. 3. The relationship between h_{fe0} and h_{fb0} is given by the graph shown.

frequency transistors, selection of K_{θ} is based on original design of the device regardless of how it may be specified later. For example, the 2N741 is a germanium mesa amplifier which is manufactured on a switching transistor production line; therefore, the germanium mesa switch K_{θ} is used for the 2N741.

The nomograms provide solutions for values of K_{θ} of 0.9, 0.8, and 0.6. These three values of K_{θ} give reasonable results for most transistor types, and if more specific information for K_{θ} is available, the results obtained from the nomograms are corrected accordingly.

The quantity $f_{\alpha e}$ is normally a much lower frequency than $f_{\alpha b}$ for the same transistor. For example, consider the Motorola 2N1141 germanium mesa amplifier. The data sheets give typical values $f_{\alpha b} = 1,000$ mc and $h_{fb0} = 0.98$. K_{θ} from Table 2 is 0.80. Substituting in Eq. 3 yields $f_{\alpha e} = 0.80 (1 - 0.98) 1,000 = 16$ mc.

Table 2: Approximate values of K_{θ}

Transistor Type	K_{θ}
Alloy Transistor (GPA, Alloy Power)	0.82
Germanium Mesa Switch	0.90 - 1.0
Germanium Epitaxial Mesa Amplifier	0.80
Germanium Non-Epitaxial Mesa Amplifier	0.70
Silicon Annular and Planar	0.80 - 1.0
MADT	0.60

This result is in approximate agreement with the h_{fe} versus frequency curve of the manufacturer's 2N1141 data sheet.

GLOSSARY OF SYMBOLS

Symbol	Definition
h_{fb}	Common base a-c forward current gain (alpha)
h_{fb0}	Value of h_{fb} at 1 kc.
h_{fe}	Common emitter a-c forward current gain. (beta)
h_{fe0}	Value of h_{fe} at 1 kc.
$f_{\alpha b}$	Common base current gain cutoff frequency. Frequency at which h_{fb} has decreased to a value 3 db below h_{fb0} . ($h_{fb} = 0.707 h_{fb0}$)
$f_{\alpha e}$	Common emitter current gain cutoff frequency. Frequency at which h_{fe} has decreased to a value of 3 db below h_{fe0} ($h_{fe} = 0.707 h_{fe0}$)
f_T	Gain bandwidth product. Frequency at which $h_{fe} = 1$ (0 db).
G_e	Common emitter power gain
f_{max}	Maximum frequency of oscillation. Frequency at which $G_e = 1$ (0 db).
K_{θ}	Excess phase shifter factor. Factor which is a function of excess phase shift of current in the base of a transistor.

For the practical application of Eq. 3, refer to Fig. 7 and 9. When any two of the quantities $f_{\alpha e}$, $f_{\alpha b}$, h_{fbo} , or h_{feo} are known, use the nomograms to find the third quantity.

A common high-frequency parameter is f_T , the gain bandwidth product and is defined as that frequency at which $h_{fe} = 1$ (0 db).

The value f_T is sometimes specified indirectly on high-frequency transistor data sheets. This is done by specifying h_{fe} at some frequency above $f_{\alpha e}$, thus, f_T is then obtained by multiplying the magnitude of h_{fe} by the frequency of measurement. This relationship arises from the 6 db per octave characteristic of the h_{fe} versus frequency curve above $f_{\alpha e}$. Since 6 db represents a current gain magnitude of 2, h_{fe} is halved each time frequency is doubled, and vice versa. Therefore, the product of h_{fe} and frequency on the sloping portion of the curve yields f_T .

For example, consider the Motorola 2N2217 silicon star planar transistor. The data sheet gives a typical h_{fe} of 4.0 at 100 mc. Multiplication of h_{fe} times the frequency of measurement yields $f_T = 4.0 \times 100 = 400$ mc. This is in agreement with the data sheet which specifies a typical f_T of 400 mc.

The parameter f_T is also equal to the product of h_{feo} and $f_{\alpha e}$, expressed by

$$f_T = h_{feo} \times f_{\alpha e} \quad (4)$$

with h_{feo} known, Eq. 4 provides a simple means of finding $f_{\alpha e}$ when f_T is known or vice versa. (See Fig. 5.)

Philips also develops the following relationship between $f_{\alpha b}$ and f_T :

$$f_T = K_{\theta} h_{fbo} f_{\alpha b} \quad (5)$$

where K_{θ} is the same quantity as in Eq. 3. Notice that since K_{θ} lies between 0.5 and 1.0, the f_T of a transistor is approximately equal to or slightly less than its $f_{\alpha b}$. (See Fig. 8 and 10.)

RULES FOR DETERMINING h_{fe}

The following rules summarize how to determine h_{fe} at some frequency f :

Rule 1. When $f < f_{\alpha e}$, $h_{fe} \approx h_{feo}$

Rule 2. When $f \approx f_{\alpha e}$, $h_{fe} \approx 0.7 h_{feo}$

Rule 3. When $f > f_{\alpha e}$, consider h_{fe} to be decreasing at 6 db per octave at frequency f and use Fig. 4 to find h_{fe} .

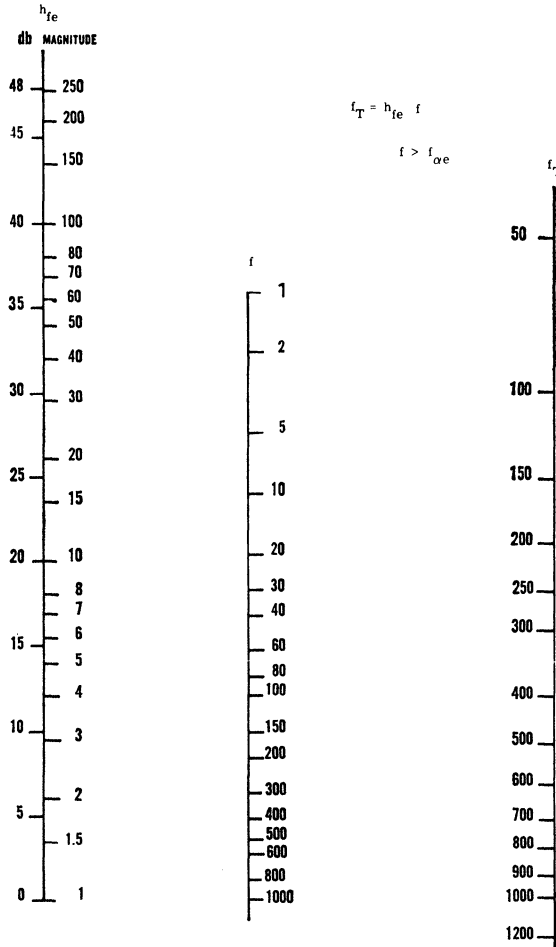
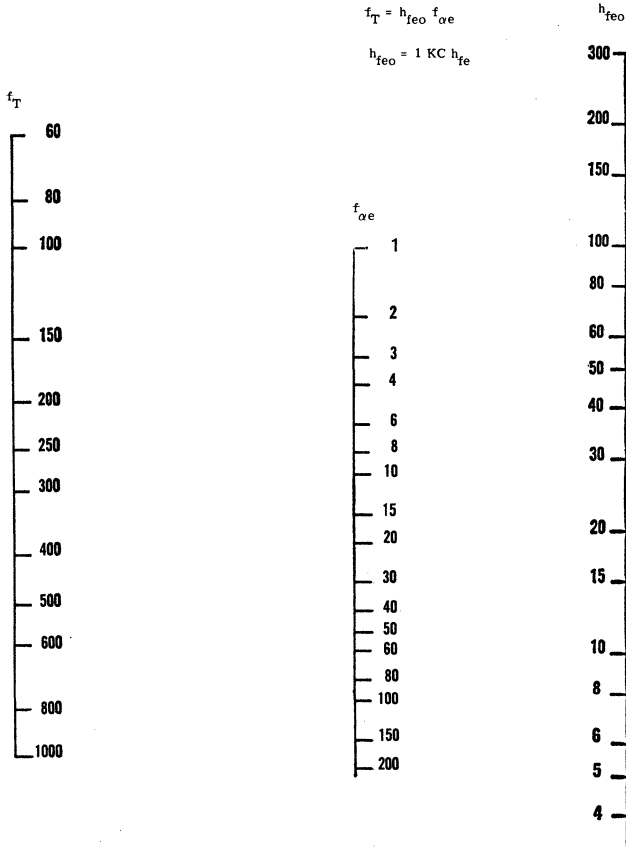

Fig. 4. This nomogram is useful in finding h_{fe} when a frequency $f > f_{\alpha e}$.

- Rule 4. (A) If h_{fb0} not h_{fe0} is known, use Fig. 3 find h_{fe0} .
- (B) If f_T is not known use Fig. 5 to find f_T if h_{fe0} and $f_{\alpha e}$ are known or Fig. 8 to find f_T if $f_{\alpha b}$ is known (Fig. 10 for MADT types).
- (C) If $f_{\alpha e}$ is not known, use Fig. 5 to find $f_{\alpha e}$ if f_T is known (Fig. 7 to find $f_{\alpha e}$ if $f_{\alpha b}$ is known (Fig. 9 for MADT types).

Though common emitter current gain is equal to 1 at f_T , there may still be considerable power gain at f_T due to different input and output impedance levels.



▲ **Fig. 5.** The quantity f_T is found from this nomogram once $f_{\alpha e}$ and h_{fe0} are known.

Thus, f_T is not necessarily the highest useful frequency of operation of a transistor, and an additional parameter, the maximum frequency of oscillation (f_{max}), is sometimes encountered. The term f_{max} is the frequency at which common emitter power gain is equal to 1, and is related to f_T by

$$f_{max} \approx \sqrt{\frac{f_T}{8 \pi r_B' C_c}} \tag{6}$$

where r_B' is the base resistance and C_c is the collector capacitance.

A plot of common emitter power gain versus frequency also has the characteristics shown in Fig. 1. This leads to another gain bandwidth product

$$f_{\max} \approx f \sqrt{\text{Power Gain}} \quad (7)$$

where f is the frequency of measurement and power gain is expressed in magnitude not in decibels. Hence, f_{\max} may be found by measuring power gain at some frequency on the 6 db per octave portion of the power gain versus frequency curve, and multiplying the square root of the power gain with the frequency of measurement (see Fig. 6). The symbol for common emitter power gain is G_e .

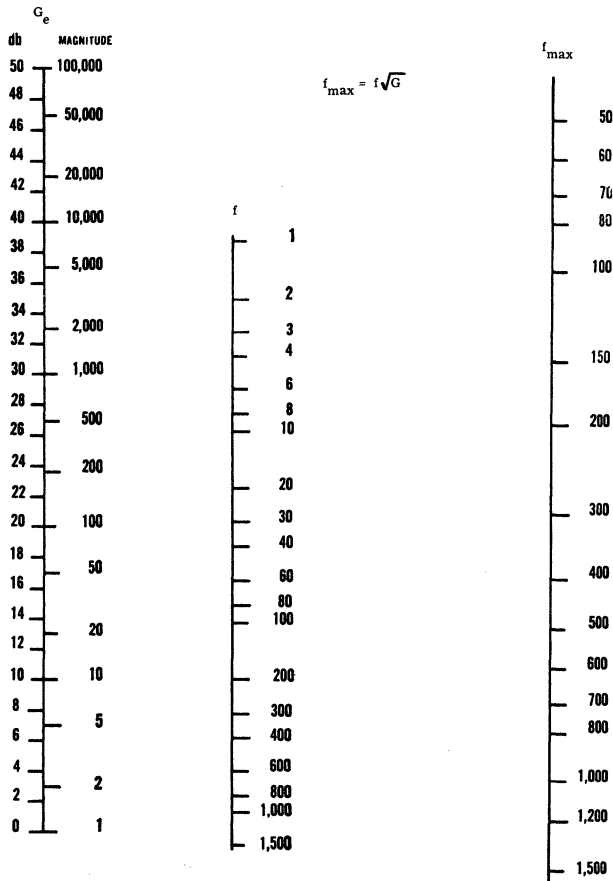

▲ Fig. 6. Maximum frequency is found from this nomogram knowing the frequency and power gain.

The parameters are voltage and current dependent, and operating point must be considered in all cases. For example, the high-frequency h_{fe} measurement at one collector voltage and current must not be used to calculate f_T directly at another voltage and/or current without considering the added effects of the different operating point. Most of the mesa data sheets have curves showing typical variations of f_T with collector voltage and current.

The parameter $f_{\alpha e}$ for present mesa transistors usually lies in the region between 10 and 50 mc. The term h_{fe} , measured at any frequency above this region is assumed on the 6 db per octave portion of the h_{fe} versus frequency curve and is used to calculate f_T directly.

Mesa transistor power gain measured at any frequency above 50 mc is assumed on the 6 db per octave portion of the power gain versus frequency curve and is used to calculate f_{max} directly.

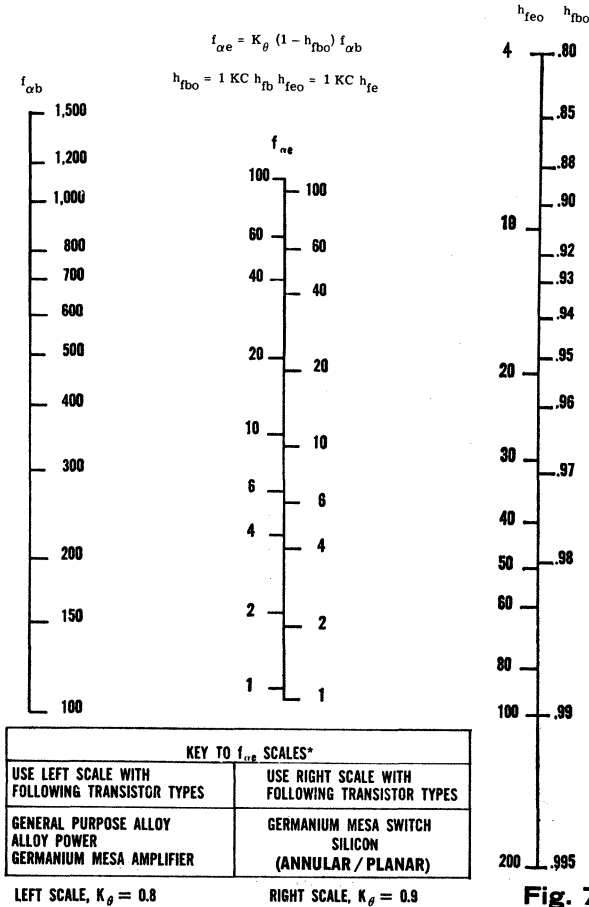

Fig. 7. Once $f_{\alpha b}$ is known this nomogram is used to find $f_{\alpha e}$.

INSTRUCTIONS FOR CURVES AND NOMOGRAMS

The nomograms assume no shift in operating point. Known parameters used to find an unknown must be measured at the same collector voltage and collector current as the desired unknown.

Frequency scales on the nomograms are calibrated in numbers only without units. Furthermore, all nomograms contain two frequency scales. Decimal points may be shifted on the frequency scales of any nomogram as long as they are shifted the same amount on both scales (i. e., both frequency scales of a nomogram must be multiplied by 10 to the same power). This enables the same nomogram to be used for both high and low-frequency transistors.

The nomograms assume that both power gain and current gain decrease with increasing frequency at a rate of 6 db per octave at high frequencies.

All power gain and current gain scales (except h_{fb0} and h_{fe0}) are calibrated in both actual magnitudes and decibel values for convenience.

EXAMPLE 1

To find h_{fe0} when h_{fb0} is known or vice versa, enter Fig. 3 with the known value and read the unknown directly. Given: $h_{fb0} = 0.96$. Find: h_{fe0} , Answer = 24.

EXAMPLE 2

Figure 4 is a nomogram of f_T and h_{fe} at some frequency f , where $f > f_{\alpha e}$. Given: h_{fe} at 100 mc is 6 db. Find: h_{fe} at 75 mc. Answer: 4, or 12 db.

EXAMPLE 3

There are no special instructions for the nomogram of Fig. 5, merely use it to find the unknown parameter when any two are known. Given: $h_{fe0} = 40$ and $f_T = 400$ mc. Find: $f_{\alpha e}$. Answer: 10 mc.

EXAMPLE 4

Figure 6 is a nomogram of f_{max} and common emitter power gain measured at some frequency f where power gain is known to be decreasing at 6 db per octave. Given: power gain at 400 mc is 6 db. Find: f_{max} . Answer: 800 mc. Given: $f_{max} = 1000$ mc. Find: power gain at 250 mc. Answer: 12 db.

EXAMPLE 5

Fig. 7 is a nomogram of $f_{\alpha b}$, $f_{\alpha e}$, and either h_{fb0} or h_{fe0} . To account for variations in this relationship with different transistor types, there are two $f_{\alpha e}$ scales, with a guide to which one to use. Given: for a GPA transistor, $f_{\alpha b} = 1$ mc and $h_{fb0} = 0.90$. Find: $f_{\alpha e}$. Answer: 80 kc. For MADT types, see Fig. 9.

EXAMPLE 6

Figure 8 is a nomogram of f_T , $f_{\alpha b}$, and either h_{fb0} or h_{fe0} . To account for variations in this relationship with different transistor types, there are two f_T

scales, with a guide to which one to use. Given: for a germanium mesa switching transistor, $f_T = 400$ mc and $h_{fb0} = 0.90$. Find: $f_{\alpha b}$. Answer: 494 mc. For MADT types, see Fig. 10.

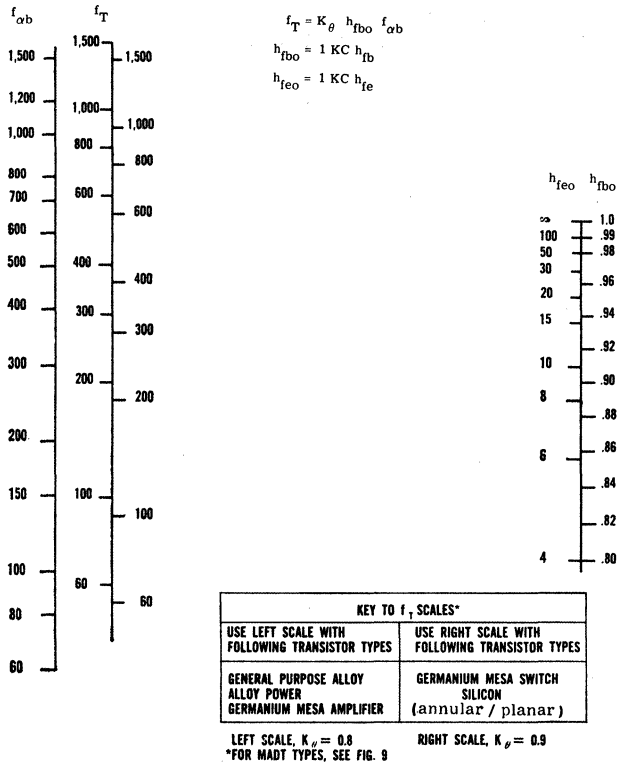

Fig. 8. This nomogram represents f_T , f_b , and either h_{fb0} or h_{feo} .

EXAMPLE 7

Figure 9 is a nomogram which is identical to Fig. 7 except that it is for use with MADT transistors (see instructions for Fig. 7).

EXAMPLE 8

Figure 10 is a nomogram which is identical to Fig. 8 except that it is for use with MADT transistors (see instructions for Fig. 8).

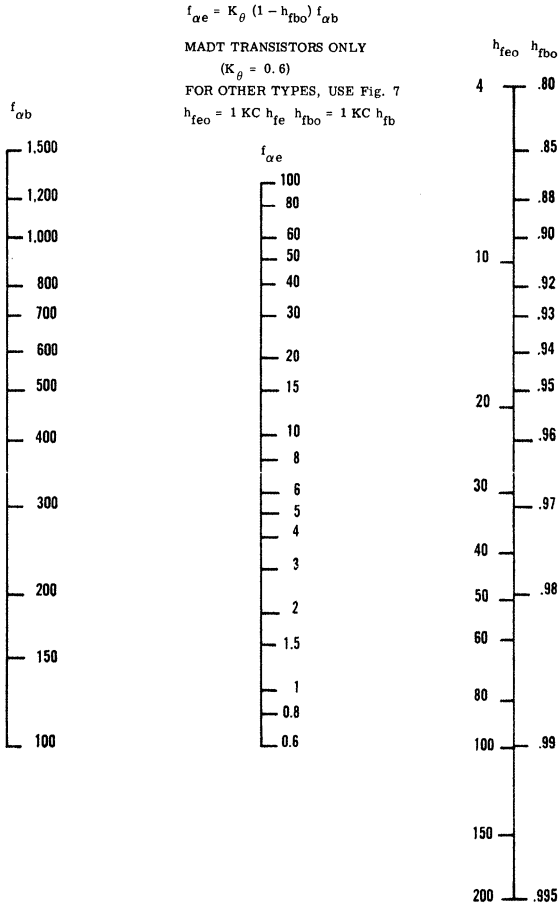

Fig. 9. This nomogram is identical to Fig. 7 but is used for MADT transistors.

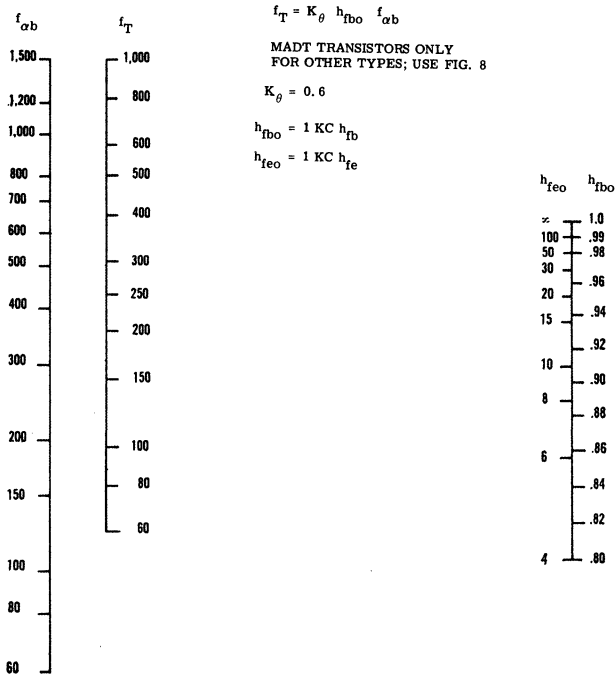

Fig. 10. Identical to Fig. 8, this nomogram is used only for MADT transistors.

REFERENCE

1. A. B. Phillips, "Transistor Engineering," McGraw-Hill Book Company, Inc., New York, N. Y., Chapter 14.

SIGNIFICANCE OF Q_T IN SWITCHING CIRCUITS

The charge factor (Q) in a transistorized pulse system is a figure of merit in much the same manner that gain-bandwidth product (f_t) is a figure of merit for an amplifier. Consider briefly a pulse transmission system where the voltage of a line must be changed by V volts. Since a finite capacity C is associated with the line, a charge $Q = CV$ must be moved in order to effect this change. To move this charge in a given time t , a certain current I is required; viz. $Q = It$. Thus with a given current, low Q is synonymous with fast switching.

The concept of total control charge, Q_T , is not only a figure of merit but is a useful tool in the design of transistor circuits particularly where capacitors are used for triggering or R-C networks are used to improve response time.

The concept is most easily understood by examining the familiar linear circuit of Figure 1. It is well known that if the time constant of the speed up network, $\tau_1 = R_1C_1$, equals the time constant, $\tau_2 = R_2C_2$, the waveform at point C will be a perfect reproduction of that at B, but reduced in amplitude according to the ratio of R_1 and R_2 . During the time that a constant level is applied at point A, charge Q_1 developed on C_1 will also equal the charge Q_2 developed on C_2 .

The impedance of this network, of course, decreases with frequency so that the signal at B may show rise time deterioration compared to the signal from the source at point A. However, there is no distortion of the signal in passing from B to C.

Several authors have shown that all frequency effects of a transistor can be represented by an R-C network from internal base to emitter. Base spreading resistance r'_b can be lumped with R_s . If a transistor were substituted for the network R_2C_2 , by adjusting τ_1 for a square wave output, the transistor input impedance could be deduced. If the transistor were driven into saturation, a square wave output would occur during turn-on regardless of the value of τ_1 , but information can be gained by observing the waveform during turn-off. Since a transistor in saturation is grossly non-linear, approximating its behavior by a linear network is not satisfactory. But the use of a speedup network to find the charge required to turn off a transistor has proven to be valuable.

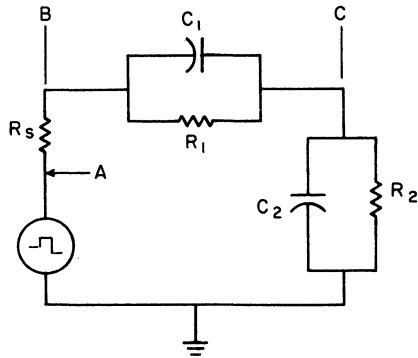

FIGURE 1
Linear Circuit Compensation

When a transistor is held in a conductive state by a base current I_B , a charge Q_S is developed or "stored" in the transistor. If I_B were suddenly removed, the transistor would continue to conduct until Q_S is removed from the active regions through an external path or through internal recombination. Since the internal recombination time is long compared to the ultimate capability of a transistor, for fast switching the designer needs to know the value of the internal charge. Q_S may be written as —

$$Q_S = Q_I + Q_V + Q_X$$

Q_I is the charge required to develop the required collector current. This charge is primarily a function of alpha cutoff frequency. Q_V is the charge required to change the collector-emitter voltage. It is primarily caused by collector-base feedback capacity. Q_X is excess charge resulting from overdrive, i. e., operation in saturation. The carriers which result compromise Q_X and are stored in the base and collector regions.

The charge required to turn a transistor "on" to the edge of saturation is $Q_I + Q_V$ but to turn it off, the full charge Q_S must be removed. Referring to the circuit of Figure 1, if the charge on the speedup capacitor Q_T equals the charge on the transistor Q_S , then when point B is grounded turn-off would be immediate if transistor r'_b were zero. In practice, point A is a more convenient place to ground and R_S and r'_b limits circuit speed.

A test circuit which measures Q_T is shown in Figure 2. C is adjusted to the minimum value which will produce a waveform similar to the one indicated by the solid trace in Figure 3. This will be where the "bumps" just disappear. It has not been established under this condition of turn-off that the charge Q_T on C actually equals the charge Q_S in the device, but Q_T certainly represents the charge necessary to control the turn-off of the transistor from a circuit designer's point of view. The charge is given by —

$$Q_T = C (V_{in} - V_{BE})$$

Using this relation, the designer may optimize C for any input voltage if Q_T at the desired operating point is known.

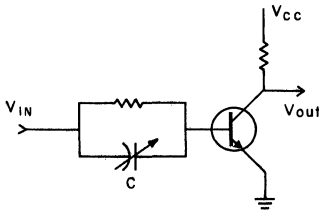

Q_T TEST CIRCUIT

FIGURE 2

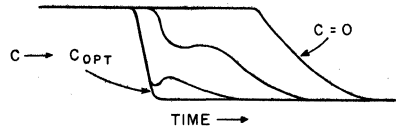

TURN-OFF WAVEFORM
(PNP TRANSISTOR)

FIGURE 3

When making measurements with this circuit it is important that the input pulse be long enough to allow carrier equilibrium to be reached. One μsec is long enough for VHF transistors. For greatest accuracy pulse instrumentation should have capability to at least 15 ns rise time and utmost care must be given to the selection and mounting of the R-C network and transistor socket. A low source impedance also makes the effects of capacitor adjustment easier to discern.

Charge measurements of representative silicon logic transistors are shown in Figure 4. It is evident that the low figures for the 2N834 permit faster switching in any given circuit since low charge means less current is required to switch the transistor in any given time. The curves also permit optimum values of speedup capacitors to be selected.

— Motorola Reference Material —

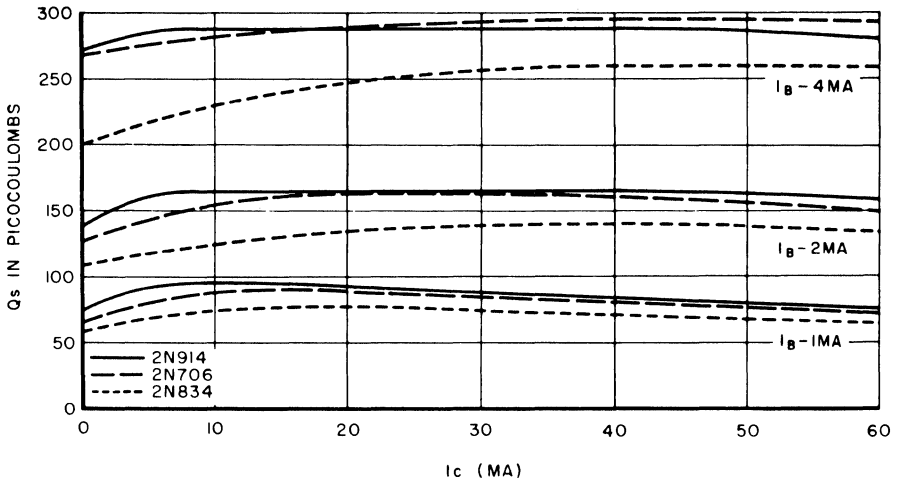

FIGURE 4
COMPARATIVE Q_s

Using too large a speedup capacitor will cause a slight reduction in response time but a heavy penalty will be paid in circuit recovery time which will limit pulse repetition frequency.

HIGH-POWER VARACTOR DIODES

THEORY AND APPLICATION

Conventionally speaking, when we refer to a semiconductor diode we normally visualize a 2-terminal p-n junction operated in the forward conduction region (as a rectifier) or in the reverse avalanche region (as a zener diode). From this standpoint, the word diode applied to a varactor is actually a misnomer — for while the varactor is indeed a 2-terminal p-n junction, it operates neither as a rectifier, nor as an avalanche device. Rather, it operates principally in the region between forward conduction and reverse breakdown — the very region in which a conventional diode is considered to be cut off.

In this operating region the p-n junction can be represented by a capacitor in series with a resistor, Fig. 1. The capacitance, known as junction capacitance, is inherently associated with all p-n junctions and, while it represents an undesirable parasitic in conventional diode operation, it is the specific mechanism that permits the device to function as a varactor, or frequency multiplier. This is true because the capacitance value, as will be seen later, actually varies as a function of applied voltage and it is this factor that encourages the generation of harmonic frequencies.

The resistor is the result of bulk and contact resistance of the semiconductor material. In varactor operation this resistance is the primary parasitic affecting varactor quality. Great pains are taken in varactor design, therefore, to hold this resistance value to an absolute minimum.

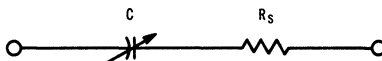

Figure 1 — Equivalent circuit of a varactor diode.

HOW THEY WORK

The cause and behavior of the junction capacitance can be determined from basic semiconductor theory, as follows:

When a junction is formed between n-type and p-type material, there is a cross-migration of charges across the junction. Electrons from the n-region cross the junction to neutralize positive carriers near the junction in the p-region, and "holes" from the p-region cross the junction to neutralize the "excess" electrons near the junction in the n-region. As a result of this migration, all free charged particles are swept out of the immediate vicinity of the junction, creating a "depletion layer" in the junction area. And, in the process, a contact potential or space charge (about 0.5V for silicon) appears across the junction, Fig. 2a.

This structure acts very much like a slightly charged capacitor, with the depletion layer representing the dielectric and the semiconductor material adjacent to the depletion layer representing the two conductive plates.

If an external voltage is connected across the p-n junction so as to reinforce the contact potential (reverse bias), the depletion layer increases, resulting in a capacitance decrease, Fig. 2b. If a forward voltage is applied, the depletion layer decreases, Fig. 2c. However, if the external forward voltage is made large enough to overcome the contact potential, forward conduction occurs and the capacitance effect is destroyed (except at very high frequencies, as discussed later).

It is obvious, therefore, that the value of the junction capacitance is a function of the externally applied voltage, so long as the junction itself remains reverse biased. This relationship is as follows:

$$C = \frac{C_0}{(1 = V/\phi)^\gamma} = \frac{\phi^\gamma C_0}{(\phi + V)^\gamma}$$

where C = capacitance at voltage V

C_0 = capacitance at zero bias

V = voltage across the diode (reverse bias)

ϕ = contact potential

γ = power law of the junction, determined by impurity gradient.

A plot of this equation, Figure 3, shows that the capacitance-voltage relationship is nonlinear. Just how this condition is useful for frequency multiplication will be seen from the following derivation.

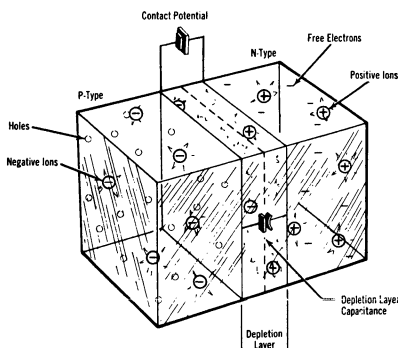

Figure 2 — (A) A representative p-n junction. The battery represents the contact potential which must be overcome before current can flow. Current carriers act as capacitor plates and the depletion layer is the dielectric.

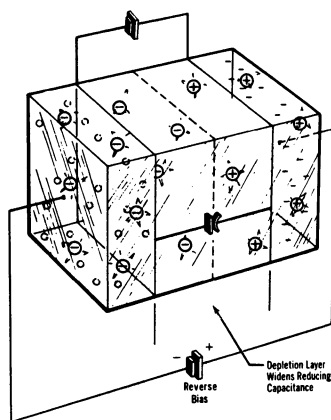

Figure 2 — (B) Reverse voltage forces carriers away from junction. This widens the depletion layer and reduces capacitance.

Assume that the voltage across a capacitor is given by the well-known relationship

$$V = \frac{Q}{C}$$

where Q = the charge on the capacitor

C = the capacitance

When a sinusoidal current is applied to a capacitance

$$\begin{aligned} Q &= \int i dt \\ &= \int I_1 \sin \omega_1 t dt \\ &= A - \frac{I_1}{\omega_1} \cos \omega_1 t \end{aligned} \tag{3}$$

where i = instantaneous current

I_1 = maximum amplitude of the input current

$\omega_1 = 2\pi f_1$

f_1 = input frequency

A = constant of integration relating to the initial charge when time (t) = zero

Substituting Equations (1) and (3) into Equation (2) yields

$$V = \frac{A - \frac{I_1}{\omega_1} \cos \omega_1 t}{\frac{\phi \gamma C_0}{(\phi + V) \gamma}} \tag{4}$$

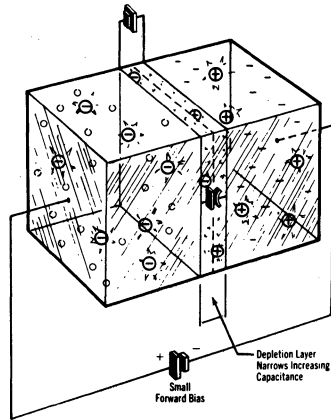

Figure 2 — (C) Forward voltage forces carriers closer to junction or across junction again changing capacitance.

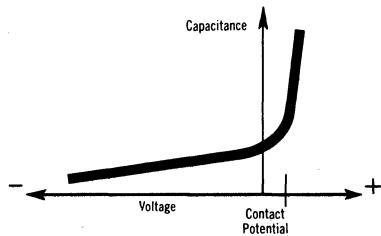

Figure 3 — Voltage-capacitance relationship for a typical varactor diode.

or, where $V \gg \phi$

$$\frac{V}{V^\gamma} = V^{1-\gamma} = \frac{A - \frac{I_1}{\omega_1} \cos \omega_1 t}{\phi^\gamma C_o} \quad (5)$$

The exponent γ is a function of the impurity gradient of the p-n junction. It may vary from approximately 1/2, for step junctions, to about 1/6 for special graded junctions. If we consider the common case of a step junction, ($\gamma = 1/2$) Equation (5) resolves to

$$V = \left(\frac{A - \frac{I_1}{\omega_1} \cos \omega_1 t}{\phi^{1/2} C_o} \right)^2 = \frac{A^2 - 2A \frac{I_1}{\omega_1} \cos \omega_1 t + \left(\frac{I_1}{\omega_1} \right)^2 \cos^2 \omega_1 t}{\phi C_o^2} \quad (6)$$

Looking at each of the terms in Equation (6) we find that the voltage (V) across the varactor consists of a dc term $\left(\frac{A^2}{\phi C_o^2} \right)$, a fundamental component

$$\left(\frac{2A \frac{I_1}{\omega_1} \cos \omega_1 t}{\phi C_o^2} \right), \text{ and the term } \frac{\left(\frac{I_1}{\omega_1} \right)^2 \cos^2 \omega_1 t}{\phi C_o^2}$$

The latter, through trigonometric identities, expands to

$$\left(\frac{I_1}{\omega_1} \right)^2 \frac{\left(\frac{1}{2} + \frac{1}{2} \cos 2 \omega_1 t \right)}{\phi C_o^2},$$

which reduces to another dc component plus a second harmonic component.

Although quite simplified, the above derivations clearly show the generation of second harmonic voltages across the varactor diode. This second harmonic voltage can be used to produce power at that frequency simply by providing a path and a load for the second harmonic current.

In the case of a step-junction device, the second harmonic is the only harmonic frequency directly available. While it is possible, through the use of graded junctions ($\gamma < 1/2$) to obtain higher harmonics directly, the second harmonic always predominates. In fact, it is normally more efficient to obtain higher harmonics by means of the doubling and mixing action of the varactor, through the use of idler circuits (see Fig. 4), than to try to obtain a desired higher harmonic directly.

(1) Penfield & Rafuse, "Varactor Applications", MIT Press, Copyright 1962.

VARACTOR CHARACTERISTICS

When operating as a frequency multiplier, the important varactor characteristics are: efficiency as a multiplier, power handling capability, and, in some applications, linearity of power output with changes in input power.

Efficiency

The efficiency of a varactor is a function of the cutoff frequency of the device which, in turn, is dependent on the diode quality factor (Q), defined as

$$Q = \frac{1}{2\pi f C R_S} \quad (7)$$

From this, it is seen that Q is a function of both R_S and C . The ability to obtain a high Q device is directly related to the ability to make R_S extremely low. The cutoff frequency is arbitrarily defined as that frequency at which $Q = 1$, or where $\frac{1}{2\pi f C} = R_S$. Accordingly, cutoff frequency is given as

$$f_c = \frac{1}{2\pi C R_S} \quad (8)$$

Since both R_S and C are voltage dependent, it is obvious that f_c , too, will vary with applied voltage. As reverse voltage increases, f_c will also increase. This is important in a comparative evaluation of devices since, in order to obtain a valid comparison, the f_c for the devices must be obtained at the same voltage.

Now, for varactors with step junctions, the maximum obtainable efficiency may be approximated from the expressions:(1)

For input frequencies of $0.01 f_c$ or less,

$$\epsilon = 1 - K \frac{f_1}{f_c} \quad (9)$$

For input frequencies of $0.2 f_c$ or higher,

$$\epsilon = B \frac{f_c^2}{f_1^2} \quad (10)$$

where f_c = cutoff frequency at V_B

f_1 = input frequency

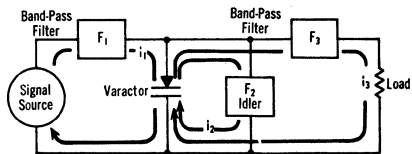

Figure 4 — Simplified multiplier circuit illustrating the use of an idler configuration to develop third and fourth harmonics.

An idler circuit is simply a tuned filter which permits the flow of a harmonic current needed to generate the desired output. If the third harmonic is desired, filter F_1 is tuned to the fundamental, idler F_2 is tuned to the 2nd harmonic, and F_3 is tuned to the 3rd harmonic. To obtain the fourth harmonic, F_1 is simply tuned to the fourth harmonic and permits the flow of the doubled 2nd harmonic current.

K and B = constants whose values depend on the desired order of the harmonic.

For doublers, K and B of Equations 9 and 10 are equal to 20 and .0039 respectively.

For triplers and quadruplers, K is equal to 35 and 62 respectively.

From these equations it is evident that the theoretical efficiency of varactors is quite high at input frequencies of 0.01 f_c or less.

Power Handling Capability

The relationship between power handling capability (P_r) and other varactor characteristics is given by

$$P_r \propto C_o V_B^2 \quad (11)$$

where V_B = voltage breakdown of the junction

C_o = junction capacity at zero bias.

The validity of this proportionality is evident from the fact that the input power is obviously proportional to the square of the input voltage swing, which is limited at one end by V_B and on the other by the permissible amount of forward conduction. If the voltage swing in the forward direction is very much smaller than V_B , it can be neglected, and the input power is approximately proportional to V_B^2 .

For large power handling capability it is desirable to make V_B as large as possible (assuming that the signal source can provide the necessary voltage swing from V_B to approximately zero). This requires that the resistivity of the material near the junction (at least on one side of the junction) be high. Yet, a high resistivity leads to a relatively high R_g which, in turn, lowers the Q of the diode and, consequently, the efficiency. Therefore, varactor diode design normally is a compromise between high power handling capability and high efficiency.

NEW VARACTOR DESIGN IMPROVES POWER HANDLING CAPABILITY

Until recently most varactors for harmonic generator applications have been designed with step junctions and their characteristics closely follow the above discussion. Some improvement in performance has been observed in varactors of the 1N4386 type whose impurity profile, Fig. 5, differs considerably from that of the customary step-junction device. These improvements include:

- 1) higher power handling capability at a given frequency,
- 2) greater linearity of power output with changes in power input.

The increase in power handling capability can be explained as follows:

To increase P_r , it is necessary to increase V_B which demands a higher resistivity material at least on one side of the junction. If one attempts to in-

crease the resistivity of a step-junction device, the value of R_S is increased significantly and efficiency is reduced accordingly. But, by employing the impurity profile shown in Fig. 5, the resistivity near the junction can be made comparatively high without changing the average resistivity. Moreover, when reverse voltage is applied, the spread of the depletion layer into the high resistivity regions actually dissipates them, leaving only the extremely low resistivity portion of the material to contribute to R_S . And, since the time that the varactor is in the reverse-voltage condition is very large compared with the time in the forward-biased condition, the average total series resistance is substantially reduced despite the increase in resistivity at the junction and a resulting increase in V_B .

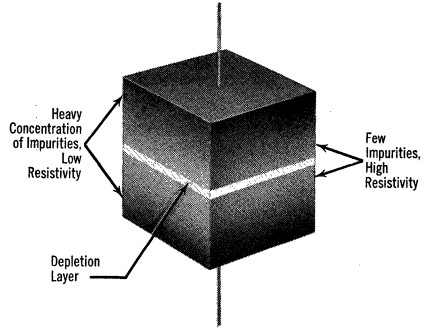

Figure 5 — Resistivity of 1N4386 is high near the junction and low near the lead contacts. When a reverse voltage is applied the depletion layer rapidly dissipates the high resistivity regions and thus, the average series resistance (R_S) is low.

By this means, it is possible to almost double the power handling capability of varactors over step-junction devices, without adversely affecting efficiency, at least as it is affected by R_S .

It might be argued that the impurity profile used in the 1N4386 type should result in lower efficiency because the capacity-voltage law (γ in Equation 1) is reduced to about a $1/5$ power, thus reducing the degree of reactive nonlinearity. Indeed, this would result in a lower efficiency of harmonic generation if it were not compensated by the reduction of series resistance described above.

In addition there appears to be an added nonlinearity resulting directly from the parabolic graded impurity profile — the phenomenon of "step-recovery". Not only does step-recovery make up for the reduced junction-capacity nonlinearity, but it leads to a linear power output advantage when driven slightly into the forward bias region at the positive peak of the signal swing.

Step-recovery is a result of charge storage — a familiar phenomenon in the application of semiconductor devices. When a p-n junction is forward biased, charged carriers from one region are injected into the other to form minority carriers in that area. If permitted to wander around in the area long enough, these minority carriers will combine with majority carriers and produce a current flow. The interval between injection and recombination is related to the minority carrier "lifetime" of the material. In the interval between the time of injection and recombination, these minority carriers are effectively stored charges contributing to junction capacitance.

If the period of the applied forward voltage is less than the carrier lifetime, as is usually the case, most of the injected carriers can be brought back to the point of origin before recombination. Step-recovery comes about when the injected minority carriers are returned to the point of origin in a compact bunch. Such a movement of carriers constitutes a current waveform as shown in Fig. 6. Because of the sudden cessation of reverse current when all of the carriers are returned to their original regions, the waveform is rich in harmonics which can be utilized as an added nonlinearity to enhance multiplier action.

The impurity profile of Fig. 7 enhances step-recovery because the electric fields set up by the steep impurity gradient a short distance away from the depletion region keep the minority carriers close to the depletion layer, rather than permitting them to wander to random depths in the opposite regions. Thus, when the voltage is reversed, they return to their point of origin in a compact bunch.

The step-recovery phenomenon, which is not as pronounced in step junctions because of the constant impurity level in such devices, provides an additional nonlinearity to the 1N4386 which contributes to harmonic generation.

Step-recovery results also in a device with more linear power characteristics because the percentage of harmonic current generation is not a function of signal level. It is only a function of the waveform and the abruptness of the decline of reverse current. And if self-biasing is employed, the shape of the current wave remains constant over a considerable power input range. This leads to a more constant efficiency of harmonic generation as a function of signal level than obtainable with devices dependent on junction-capacitance variations alone. This is an important feature when using varactors in amplitude modulated circuits.

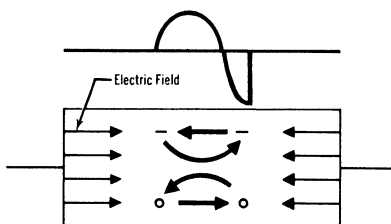

Figure 6 — When a forward voltage is applied, carriers are injected across the junction. However, before they can combine and result in a dc current flow, the applied voltage reverses and the carriers are returned to the point of origin in a bunch. This results in an abrupt cessation of reverse current and the waveform is rich in harmonics.

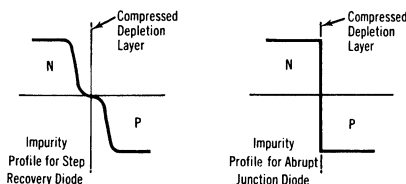

Figure 7 — Comparison of the impurity profiles for a step recovery and step junction diodes.

VARACTORS vs TRANSISTORS

In view of the fact that varactors provide no amplification, but merely convert an applied signal of one frequency to some higher frequency, one might logically ask, "Why not use transistors to directly generate the desired signal?" The answer to this is simply that there are no transistors that will provide the amount of power obtainable from varactors in the VHF and UHF regions. The best transistors today are limited to producing about 25 watts at 100 mc, and about 5 watts at 500 mc. Varactors, by contrast, can supply about three times that amount of power at those frequencies. Moreover, many VHF and UHF transmitters demand crystal control, which requires a relatively low-frequency oscillator with subsequent frequency multiplication. And, as yet, no other device operates as efficiently as a varactor for this purpose.

Even as transistors are improved, it is reasonable to assume that varactor development will keep pace, so that the latter will remain well ahead of transistors in power-frequency capabilities. As a result, it is anticipated that the varactor will become an increasingly important component in high-power, high-frequency applications.

HARMONIC GENERATOR CIRCUITS

Development of a varactor multiplier circuit is illustrated in Fig. 8. The basic premise, as shown in (a) is the conversion of a signal from a signal source to a harmonic current through the load (R_L) by means of a varactor. The necessary considerations entail 1) provisions for the necessary current paths and associated filters, 2) proper matching of source to load, and 3) development of suitable bias voltage for the varactor.

The first step in the design is the addition of suitable current paths, as shown in (b). If the output is to be the second harmonic, filter F_1 is tuned to the fundamental frequency, and F_2 is tuned to the 2nd harmonic. In designing the tuned circuits, the capacitance of the varactor must be taken into account. Since this varies over the applied signal cycle, the "average" varactor capacitance should be used. This can be approximated by the capacitance value at one-third the voltage breakdown rating of the varactor (assuming a signal voltage swing from about V_B to some small positive value) Since this average capacitance varies with signal power, some circuit detuning occurs if input power is changed appreciably. This detuning effect is less pronounced with devices of the 1N4386 structure than with step-junction devices.

If the desired load current is at the third or fourth harmonic, the configuration in (c) may be used. Here, F_1 is again tuned to the fundamental and F_2 is an idler tuned to the 2nd harmonic. This permits fundamental and 2nd harmonic current flow to mix in the varactor to provide a voltage component of F_1 , F_2 , $F_1 + F_2$, and $2F_2$ across the varactor. (Even if F_2 were omitted, there would be components of higher order harmonics, such as F_3 and F_4 across the varactor, but, as mentioned previously, it is normally more efficient to employ a suitable addition or multiple of the fundamental and second harmonic.) Filter F_3 is then tuned to the desired third or fourth harmonic so that only the desired current will flow through the load.

Bias voltage for the varactor is obtained by shunting the varactor with a high value (around 100 K Ω) bias resistor, as in (d). Bias current is provided when the varactor is driven slightly into conduction at the peaks of the applied signal.

Proper matching between source and load can be accomplished by adding matching capacitors as shown in (e). Tapped input and output coils could accomplish the same purpose.

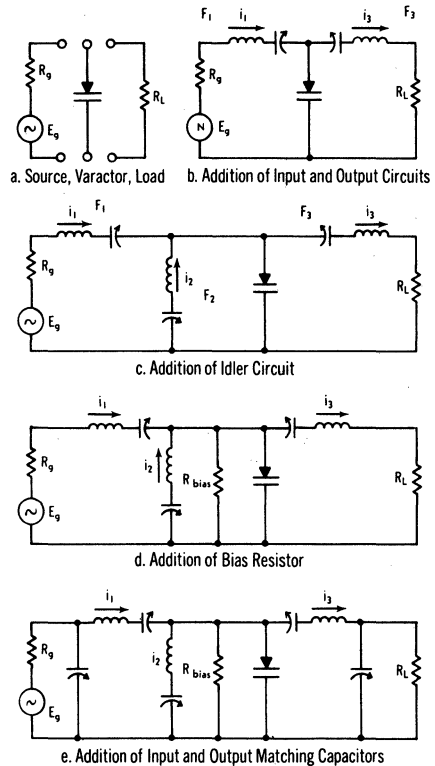

Figure 8 — Development of a harmonic generator circuit.

Obviously, the simple circuit developed in Fig. 8 can be improved upon from a performance standpoint. Higher-frequency, distributed-element circuits could be fabricated based on a circuit equivalent to Fig. 8. More complex filters, such as double-tuned circuits, may be employed for greater bandwidth and better rejection of spurious signals. In practical applications, the final circuit almost always will be more complex.

CHARACTERISTICS OF 1N4386

The 1N4386 varactor was designed to handle efficiently more than 50 watts of input power with output frequencies up to 300 mc. Typical efficiency of the device as a function of power input at 50 mc (tripler operation) is shown in Fig. 9. Additional technical information can be obtained by writing to the Technical Information Center, Motorola Semiconductor Products Inc., P. O. Box 955, Phoenix, Arizona 85001.

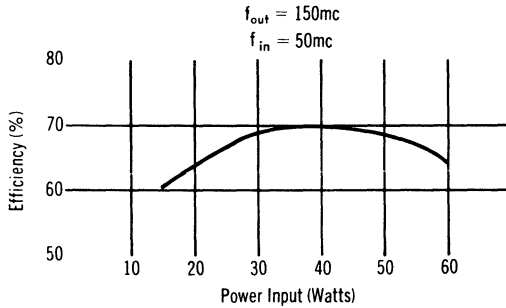

Figure 9 — Typical efficiency vs power input curve for the 1N4386 in a tripler circuit.

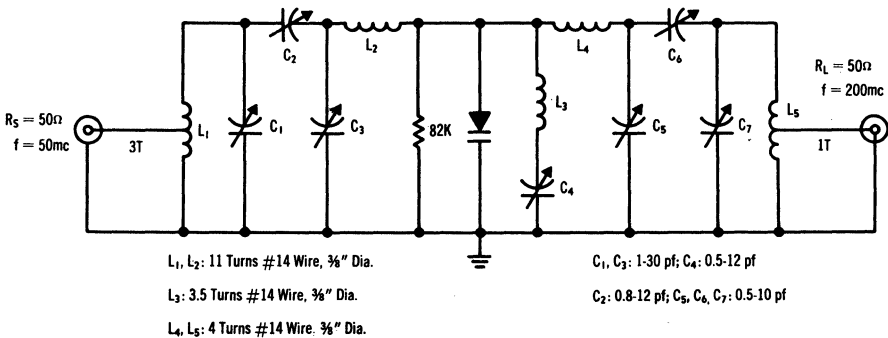

Figure 10 — 50-200 mc Varactor quadrupler

OPTIMIZING SCR TURN-OFF PARAMETERS WITH NEGATIVE BIAS

Although it is not often discussed in the literature, almost all SCR's exhibit some degree of turn-off gain.

At normal values of anode current, negative gate current will not have sufficient effect upon the internal feedback loop of the device to cause any significant change in anode current. However, it does have a marked effect at low anode current levels where it can be put to advantage to modify certain device parameters. Specifically, turn-off time may be reduced and hold current may be increased. Reduction of turn-off time and increase of hold current are useful in such circuits as inverters or in full-wave phase control circuits in which inductance is present.

Negative gate current may, of course, be produced by use of an external bias supply. It may also be produced by taking advantage of the fact that during conduction the gate is positive with respect to the cathode and providing an external conduction path such as a gate-to-cathode resistor. All Motorola SCR's are already constructed with a built in gate-to-cathode shunt, which produces a certain amount of negative gate current. Further change in characteristics, however, can be produced by use of an external shunt. Shunting does not produce as much of a change in characteristics as does negative bias, since the negative gate current, even with an external short circuit, is limited. When using external negative bias the current must be limited, and care must be taken to avoid driving the gate into the avalanche region.

All Motorola SCR lines show an improvement in turn-off time of about one-third by using negative bias up to the point where no further significant improvement is obtained. The increase in hold current by use of an external shunt resistor ranges typically between 5 and 75 percent, whereas with negative bias, the range of improvement runs typically between 2-1/2 and 7 times the open gate value.

In summary, it may be said that by use of negative gate bias, the turn-off time and hold current of Motorola SCR's may be improved significantly so that they may be used in higher frequency inverter circuits or in circuits in which higher residual currents are present.

NOTES

NOTES

NOTES

NOTES

NOTES

SILICON ZENER DIODES

SILICON RECTIFIERS

SILICON RECTIFIER ASSEMBLIES

SILICON CONTROLLED RECTIFIERS

POWER TRANSISTORS

LOW-FREQUENCY, LOW-POWER TRANSISTORS

HIGH-FREQUENCY TRANSISTORS

SPECIAL AND MULTIPLE TRANSISTORS

SPECIAL PURPOSE SILICON DIODES

INTEGRATED CIRCUITS

MOTOROLA



Semiconductor Products Inc.

BOX 955 • PHOENIX, ARIZONA 85001