

Sign Update

MAY/JUNE 2008 ISSUE 108 £2.50

4 great sign solutions from Simplex.

1 built up lettering



"high quality lettering, large or small"

2 POLE AND PLANK

by advanced sign systems

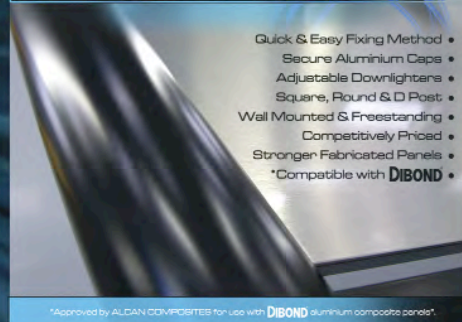

- Quick & Easy Fixing Method
- Secure Aluminium Caps
- Adjustable Downlighters
- Square, Round & D Post
- Wall Mounted & Freestanding
- Competitively Priced
- Stronger Fabricated Panels
- *Compatible with DIBOND*

*Approved by ALCAN COMPOSITES for use with DIBOND aluminium composite panels.

"exciting range of exterior systems"

3 fabrication

"bespoke systems"

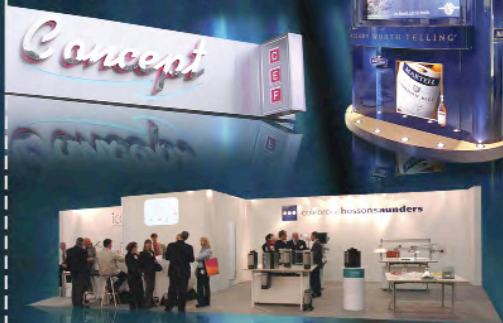

"your ideas into reality"

4 System 4

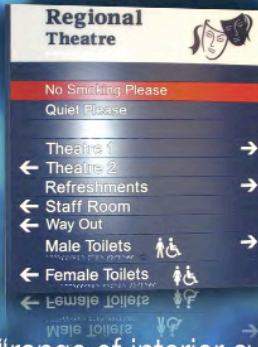

"range of interior systems compatible with braille & tactile"

for signage think
simplex LIMITED

Visit our new website at
www.simplexlimited.com
Telephone: 01903 750333
Fax: 01903 750444
Email: sales@simplexlimited.com

Your Ideas into Reality



You get more with the new Mimaki JV33



The Mimaki JV33 solvent print and cut package defines the market with its unbeatable value and endless creative possibilities. With a choice of 1,370 and 1,620mm widths, ultra low odour full or eco solvent inks (including a white) plus the JV33's ability to print to a huge range of media, you'll be getting much more.

Include a Mimaki CG-FX cutting plotter with its unique die cut feature and add a stunning array of stickers, labels, decals and graphics to your printed banners, posters and canvases. We'll get you going with over 3½ litres of ink and as Mimaki's high end RIP package and powerful cutting software is packaged free of charge, you'll be up and running in no time. You'll also get Hybrid's fully inclusive two year warranty - that's twice as much peace of mind than with more ordinary machines - making it easy to see why so many sign makers and graphics professionals have already got more with the JV33.

Printer, cutter, RIP and a 2 Year Warranty. Call Hybrid today on **01270 501 900** and we'll help you get more.

www.YouGetMore.co.uk



The NEW Mimaki JV33 Printer



Mimaki CG-FX Cutting Plotter

hybrid
Mimaki Exclusive Distributors

Published by **SignUpdate** Ltd

www.sign-update-magazine.co.uk

Allens Orchard, Chipping Warden, Banbury, Oxon, OX17 1LX.

CONTENTS

- 6 - 28 **Product News**
30 - 36 **Product Choice**
38 - 48 **Project News**
62 - 63 **Routing Focus**
70 - 76 **Durham Signmakers**
94 - 99 **Classified Adverts**
100 - 114 **Buyers Guide Directory**



Editor - **Heather Rutter**

Tel: 01525 377073

email: heather.rutter1@btinternet.com



Features Editor - **Janet Brennan**

Tel: 01582 584414

email: janetb23@tinyworld.co.uk



Publisher - **Roger Hinchliffe**

Tel: (inc. Advertising enquiries) 01295 660666

email: roger@sign-update-magazine.co.uk

Graphic Design - **Tony Hinchliffe**

Tel: 01295 660666/690862

email: tony1@masasafish.com

Advertising Manager - **Martin Hinchliffe**

Tel: (inc. Advertising enquiries) 01295 660666

email: martin@sign-update-magazine.co.uk

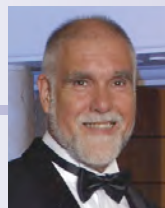

Subscriptions - Annual subscriptions are £14.00 including postage and packing • Europe €28 • Rest of world £28

Send Cheques and postal orders made payable to Sign Update Ltd to:

Subscriptions Department, Sign Update Ltd., Allens Orchard, Chipping Warden, Banbury, Oxon OX17 1LX

PRODUCTS AND EDITORIAL SUBMISSIONS

Sign Update welcomes news and information relating to new and improved products for possible coverage within the news and review pages. Sign Update however accepts no obligation to provide coverage or return unsolicited products which are sent to it.

Sign Update is always delighted to receive correspondence hints and tips for articles which should be sent in the first instance in outline form, together with the author's name and address. Manuscripts, photographs and other materials will not be returned unless accompanied by a stamped address envelope. No responsibility is accepted for any unsolicited materials. Sign Update takes every effort to ensure the accuracy of the contents of the magazine and takes all reasonable care in accepting advertisements for publication, but makes no representation as to their accuracy or quality.

Sign Update or its agents accept no liability whatsoever for any claim or complaint from any contributor or third party as a result of any advertisement or editorial coverage. Sign Update gives no warranty as to the accuracy or validity of any claim made in the magazine or in any advertisement including any relating to the specification or originality of any goods or services. Advertisements are accepted only on the basis that the advertiser indemnifies the publisher or his agents against any claim brought by a third party for infringement or alleged infringement of its rights or any defamatory or derogatory statements or claim.

Shiraz V6
www.applied-image.com

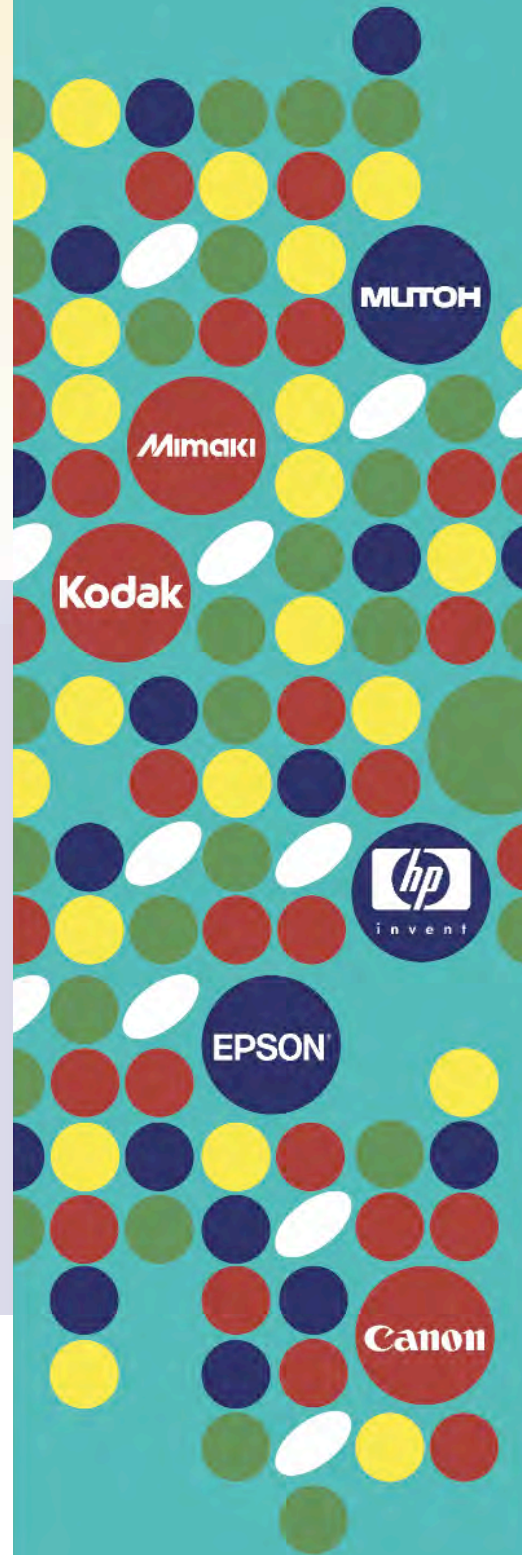

Applied Image Technology Ltd 

T +44 (0) 870 811 2370

F +44 (0) 870 811 2375

E shiraz@applied-image.com

Here today and gone tomorrow

I have noticed a slightly worrying trend over the last few years, how many 'new' small 'sign companies' seem to pop up every year and how many seem to gradually disappear.

Personally, I would not want to be starting a sign business from scratch at this time. Loan rates are high and wages are on the up, not to mention rising fuel and material costs, yet this does not seem to deter people.

Don't get me wrong, on one hand I think this new competition is a very good thing, because it keeps existing sign businesses on their toes as well as giving customers more choice. As far as I am concerned, it does not bother me at all because I know that at Simply



Stripes we can compete on all levels with these new companies. However, the worrying thing is how many of these sign companies seem to lack some basic skills, especially on material knowledge and the design side.

It's all very well being able to go out and afford to buy a small plotter or printer, a van and a few rolls of cheap vinyl, think up a quirky name and then call yourself a sign company. We have found some of these folks are good at selling their wares, and a number are good at installing signs or applying graphics, but I believe it's the whole package that customers want these days, and this type of service could be potentially damaging to the sign industry in the long term.

We frequently get customers who call into our workshop, comparing prices and we find ourselves up against two other companies which are quoting on a shop sign that might be 16 foot long and they intend making it out of 3mm foamed PVC, with poorly designed cheap vinyl graphics and maybe they plan to screw it to the shop front; sometimes the intention is to put a digitally printed image that maybe isn't laminated or even printed on the correct media on a vehicle. It makes me cringe because often customers don't realise how many corners are being cut and that the sign or livery may well end up looking shoddy within a short period of time, they look just at the price.

We have found we lose some jobs because we've been a few pounds out on price. But when you see the product that the customer ends up getting it's often substandard compared to what we would have produced for the same kind on money. That can sound just like sour grapes to the customer if you've lost the job to a competitor, but I believe substandard products have a negative effect on companies like Simply Stripes, who do know what we are talking about.

This all sounds like a bit of a rant I know, and it's only my humble opinion, but I am passionate about our products and the service we offer, and what we turn out of our own workshop. I want our customers to be happy always with what we have produced for them, and for them to recommend us to new customers when they say "wow, who did that sign for you?"

I always prefer to do any job for a customer, rather than no job at all, even if it does mean cutting a few corners ourselves. But I always try to give the customer all the options in terms of the pros and cons of materials and a design, so they can make an informed decision, but this is becoming harder and harder as the sign market becomes more crowded by people playing at sign making.

Andrew Hancock
Simply Stripes the Signmakers Limited
Email: sales@simplystripes.com

BUILT UP ACRYLIC & STAINLESS STEEL LETTERS TO THE TRADE

www.gdisigns.net
email: sales@gdisigns.net

FREEPHONE 0800 146008 FREEFAX 0800 146009

The sun is here – and so are the big wasps

Welcome to the May/June issue of Sign Update. We have all waited for the month of May to come round. I think it's the most enjoyable month of the year. Everywhere is a mass of blossom, especially this year, and the weather has turned gloriously warm with the Oxfordshire area getting the warmest temperatures, or so the television news has just announced.

Wasps seem a little bigger this year, or is it that my eyes have improved with age? No, my eyes have not improved, the larger wasps are queen wasps looking for nesting sites and as we all know but have probably forgotten, the queen wasp is a little larger than the ordinary wasp. What else do I know about wasps? Only that they sting. The reason I mention wasps is because one tried to settle into the crevice of the seat at the back of my desk chair. Luckily for me I was looking as to where I was about to put my rear and spotted the little blighter. We are now one wasp less in Chipping Warden.

I have completed my visit to the County of Durham and its sign makers, see pages 70 to 75. Having now visited two counties, I've noticed there are fewer people working from home. This is because of the amount of material and equipment now needed to produce a sign. Most one-man bands used to start from the bedroom and then move to the garage; soon they'd have outgrown that space and be looking for larger workspace.

Working from the bedroom is not ideal, yet there are a few that still struggle to run the business that way. Often they find they cannot turn the work round quick enough and are limited to what jobs they can take on.

I had one sign maker that asked me to call round to see him. When I got there he was working from home, which was just a small terraced house. My first instinct was to carry on to my next appointment, but being the softy that I am, thought, I've come this far, I may as well see it through. I ring the bell and a call came back to hang on a minute. I could have had my lunch while waiting but after some puffing and panting from behind the door it finally opened.

"Sorry, but I had to move the plotter away from the door to open it," he explained.

The reason he has his plotter by the door is because the plug socket is there. I work my way up the hallway while he rolls the plotter back up against the door. Now that should have been my cue to leave, but it was a job to get out and I had been promised a cup of tea.

We went into the computer room (this was the sitting room) where the settee was being used to store rolls of vinyl and the dining table was taken up with the computer, a small printer and a variety of teacups. The back of the house was the kitchen. Apparently he'd cleaned it up because I was coming, which made me feel like royalty. The kitchen also doubled as his stationery store. The back yard was where he kept his sheet material, under tarpaulin. This left just two bedrooms upstairs and the toilet. Again, both bedrooms were used for storing vinyl.

What really intrigued me was that he thought most sign companies work like that and was very pleased with himself that he knew where everything was. And to give him credit, he did, although we had a little trouble finding the phone when it rang. I stayed about three hours and saw his work. He had done some really clever designs, which impressed me. He had been a signwriter for years and like so many, forced to turn to the computer.

Before leaving I thanked him for the tea and helped him move the plotter along the hall so he could let me out. So keen is he that he has a part-time job to subsidise the sign making. But then he has to leave his phone switched to answer machine. Unfortunately, too often people don't leave messages; they want an answer there and then.

My next area to visit is Birmingham, to let the Brummies have their shout on how wonderful they are at making signage. So if you're a sign maker in Birmingham, email me at roger@sign-update-magazine.co.uk to say you are interested in going in that feature. I'll arrange to call round and the rest as they say, is history.

The visiting side is quite enjoyable as I don't have to sell anything, but as a travelling salesman would tell you, driving is very expensive. Everywhere you park is around a pound an hour, and a £60 fine for staying over your time. Then the dreaded traffic jams and the speeding tickets. So far I'm free from the speeding tickets. And don't start me on the price of petrol, it seems every time I go to fill up, the price has gone up!

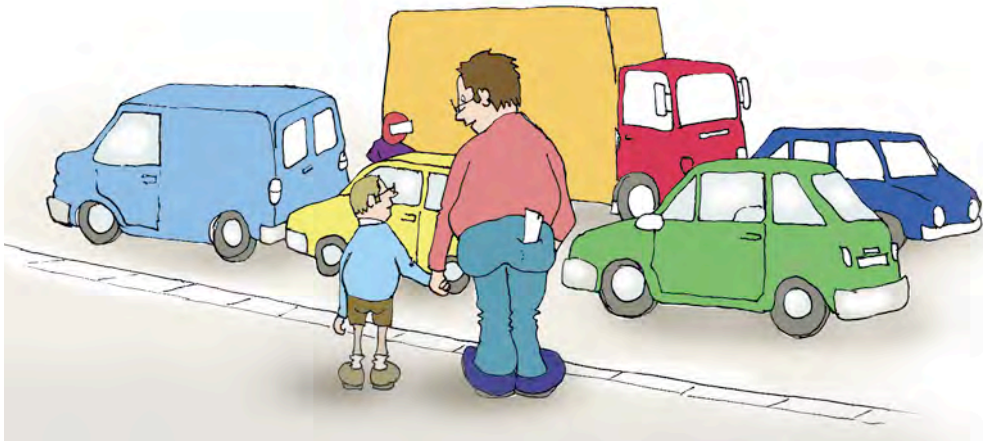

That's right son, look right, look left, look right again and if the road's not clear, then we will try again tomorrow

PRINT SYSTEM UPGRADES



WE PROVIDE NEW PRINT SYSTEMS, WITH ABILITY TO TRADE-IN YOUR OLD PRINTERS!

WE ARE ALSO THE LEADING UK SUPPLIER OF 2ND USER PRINT EQUIPMENT

CHECK OUR NEW WEBSITE FORUMS FOR OUR CURRENT STOCK LISTING

CALL US ON 01862 811379

WWW.SOLVENTPRINTER.CO.UK

Mutoh starts shipping SC-PRO 1650 cutting plotter to eager customers

Belgium-based wide-format inkjet printer and cutting plotter manufacturer Mutoh Europe nv announces that it has started shipping its latest cutting plotter model, called SC-PRO 1650. Engineered and developed at Mutoh's Research & Development Centre in Belgium, the new SC-PRO 1650 is Mutoh's first 64" (1650 mm) wide vinyl cutter for sign professionals, intended for wide-format signage, vehicle decoration, window graphics, sticker production, and more.

The new SC-PRO 1650 friction-feed cutting plotter accommodates roll and sheet media up to a width of 1850 mm (72.83"). Maximum cutting width is 1635 mm (64.37"). The machine is equipped with four repositionable pressure rollers, allowing the use of different media widths. Off-cuts down to 200 mm (7.87") can be accommodated. Long-length tracking is guaranteed thanks to matched grid roller sets per individual machine.

Equipped with a drag knife cutting head enabling cutting/plotting and automatic sheet off, the SC-PRO can cut a broad range of sign making materials ranging from self-adhesive PVC to sandblast, up to a maximum thickness of 1 mm. The automatic sheet-off feature is particularly useful when performing multiple copies of signs.

Cutting force is stepwise adjustable from 20 – 450g in order to guarantee optimum cutting results with various materials. Cutting speed is adjustable to 1000 mm/s (39.37 ips), at a maximum acceleration of 2.75 G.

The standard SC-PRO 1650 cutter is equipped with a USB and an RS-232 serial interface. It is also equipped with an Ethernet network connection. The machine's keyboard is detachable for maximum user convenience.

Built for maximum productivity, the SC-PRO 1650 is ready to produce volume cutting of repetitive jobs, corporate sign making and in-house sign making for shop chains or large grocery stores.

As standard, SC-PRO 1650 comes with a robust stand including caster wheels, a roll support system, a media basket and an EasySIGN™ Power Pack Mutoh Edition cutting software.

Apart from being a regular vinyl cutting plotter, SC-PRO also integrates Mutoh's EPOSTM technology for effortless contour cutting. As such, the SC-PRO 1650 can team up with any wide-format printer up to 64" capable of printing on self-adhesive PVC for full colour sticker production.

The new SC-PRO 1650 is being manufactured at Mutoh Europe's production site in Oostende, Belgium. The machine is distributed by Mutoh Europe all over Europe, the Middle-East and Africa through a network of dedicated authorized resellers.

For further information on Mutoh Europe and its products visit www.mutoh.be or www.mutoh.eu



The new SC-PRO 1650 Cutting Plotter.

The NEW SolJet™ PRO III XC-540 Printer/Cutter

Built for Business

High performance, flexible production

New, revolutionary Roland Intelligent Pass Control

Higher print speeds, enhanced print quality.

Smooth gradations, flawless solid colours.

XC-540 available in 6 and
4 colour using award-winning
Eco-Sol Max™ inks

XC-540W equipped with
4 colour + NEW WHITE
Eco-Sol Max™ ink

Harmonised synergy

Roland printer/cutter, VersaWorks® RIP
and Roland inks for ease of use
and reliability.

Backed up by RolandCare
training, service and support.



0845 230 90 60

customerservice@rolanddg.co.uk
www.rolanddg.co.uk

Roland[®]
Succeeding together

Stik magnetic wallpaper wins leach colour prestigious award



Stik magnetic replaceable wallpaper.

Leach Colour is reshaping the interior graphics industry with Stik, the easily changeable magnetic wallpaper, enabling customers to easily update graphics to change the environment or create a variable marketing strategy.

As a leader in the field of large format digital graphics, Leach Colour offers Stik, a magnetic wall paper system that makes removal and replacement of graphics a simple operation that can be performed by non-specialist staff and requires no tools or adhesive.

Stik presents minimal disruption and has been installed in a wide variety of organisations including the MyTravel Group head quarters. Replacement graphics can be updated to reflect a current theme or campaign, for example, a Mediterranean picture in the summer and an extreme skiing image in the winter.

The interior graphics can also be used to change an environment throughout the day, for example, day to night, a café during the day can be transformed into a restaurant during the evenings, ensuring that businesses can cater for all target markets.

"Stik gives businesses the ability to change graphics frequently and easily within their workplace," said Helen Johnson, Leach Colour Client Relations Manager. "The graphics deliver a fantastic impact and can really lift the atmosphere within the workplace for both staff and visitors."

Leach Colour has already been praised for this innovative product. The Platinum FESPA award was given to Leach for their Stik magnetic wallpaper.

Leach Colour is an innovative and forward thinking organisation in the field of large format digital graphics. With both northern and southerly based offices, the company serves customers throughout the UK and the rest of Europe.

Clients can select from a conveyor belt of new products and solutions tailored specifically to their needs. Everything, from initial site surveys to distribution and installation services, are handled in-house by a project management team, ensuring total control at every stage.

In addition to this, a £2 million pound investment in cutting edge technology means Leach Colour is capable of handling just about any project imaginable, either now or in the future.

For further information visit www.interiorgraphicsolutions.com

It all starts **here**



ALL NEW SIGNLAB 8 NOW AVAILABLE

Design enhancing, money saving sign making software. SignLab 8 is all about great design tools and sign making specific production features. Don't sell your business short by using anything but professional sign making software. If you are digitally printing signs, creating designs that need to be print and cut, SignLab is the best solution for you.

Loaded With Incredible

NEW DESIGN TOOLS...



OVER 75 PLUG-INS ADDED!

APPLY THE SAME EFFECT TO BOTH VECTOR & BITMAPS!

COMPLETE BITMAP EDITING APPLICATION ADDED

The Latest Sign Making

PRODUCTION TOOLS...

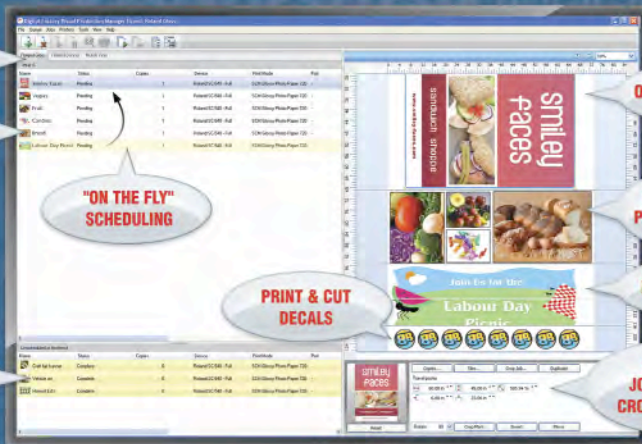

**EASY ACCESS
MULTIPLE QUEUE
TABS**

**PRINTING & PENDING
JOB ORGANIZER**

**"ON THE FLY"
SCHEDULING**

**PRINT & CUT
DECALS**

ARCHIVED JOBS

ONE JOB PER PAGE

**MULTIPLE JOBS
PER PAGE (NESTED)**

LARGE JOB TILED

**SELECTED
JOB INFO. AND
CROP, TILE, COPY**

◀ The NEW Visual Production Manager

A completely interactive, simultaneous multiple queue and printer system. Leading edge job management technology that saves time and money. VPM addresses all print, print and cut workflow scenarios that a sign maker comes across. A powerful production tool that pays for itself in no time.

**FREE
MASKING
SOFTWARE**

◀ Upgrade to SignLab Version 8 and Receive A Special CADlink Version of Fluid Mask Software (Print & Cut packages only)

**EVEN MORE
VALUE**

◀ SignLab Vinyl Now Includes Our Pro-Text Compose Features & Color Vectorization
SignLab Vinyl Pro now includes all the amazing design features previously only in our Print & Cut package

SignLab 8 Supports Windows Vista 32 or 64-bit, and is easily networked

ArtCAM software helps signmakers turn sculptural signage into successful style

With the advancements in Computer-aided Design and Manufacturing (CAD/CAM) technology and the reduction in price of CNC routers, sign-making companies can now branch out from laser printed signage and enjoy creating quick and affordable sculptural signage to give them that competitive edge.



Whether creating signage for directional, informative, commercial or brand implementation purposes Delcam's range of ArtCAM software (www.artcam.com) can create modular, custom-made, bulk or traditional signage with ease.

Currently used worldwide by award winners of the Signs of the Time, UK sign Industry, and programmes such as the Best Commercial Sign and the Best Retail Sign, ArtCAM customers are enjoying the 2D and 3D design and machining features available with ArtCAM.

To meet the diverse budgetary and design needs of each individual company, Delcam offers a range of products with a clear upgrade path for up and coming companies.

ArtCAM Express, the entry level product provides an ideal introduction to computer-based manufacturing with basic 2D drawing, and 2D and 3D machining functions.

ArtCAM's mid-range product, ArtCAM Insignia includes vector-based design, extensive 2D machining as well as basic 3D machining functionality. It can give that hand crafted look to signs, create inlays or machine a variety of textures.

ArtCAM Pro the advanced package includes all the features available within Insignia but with greater design and machining capabilities. For more complex projects, such as the featured Seagraves sign by Classic Signs, components can be designed and saved separately and then assembled into a 3D model of the complete piece.

With all products in the ArtCAM range, simulations can be run to show how the product will look prior to machining, a fantastic tool when seeking client approval.

For further information on the ArtCAM range call Delcam on 0121 683 1030 or visit www.artcam.com

Hexis awarded prize for best wide format outdoor media for solvent inkjet printers

Hexis S.A., manufacturer of self-adhesive vinyl with headquarters in France, has won the prize Best Wide Format Outdoor Media of the Year 2008 for their V3000/V3100 vinyl film for solvent inkjet printers. The prize is based on the product's "highly competitive price, compatibility and wide range of applications" says EDP (European Digital press Association) who each year select the winners of the prestigious award.

The EDP Association represents the publishers of leading European digital printing magazines and cover 15 countries, seven different languages and a readership exceeding 240,000 graphic arts professionals.

The V3000/V3100 range consists of a 100µm (3.9mil) white intermediate vinyl with a solvent-based acrylic adhesive on a 135g/m² stabilised Kraft liner. The product is available with either a grey permanent adhesive (V3000) or a black removable adhesive (V3100). Both versions come in gloss or matt finish in rolls up to 2m (80in) wide.

The two media are compatible with Mimaki, Mutoh, NUR, Roland, Scitex, Seiko and Vutek solvent and eco-solvent printers. The products are ideal for outdoor estate agent boards, building site hoardings, poster sites and other short-term promotional signage and markings.

Hexis manufactures a full line of graphic vinyl and digital printing media used for sign making and vehicle markings. The company owns two manufacturing sites and exports 40% of its turnover to over 40 countries, while enjoying sales of EUR 34 million in 2007.

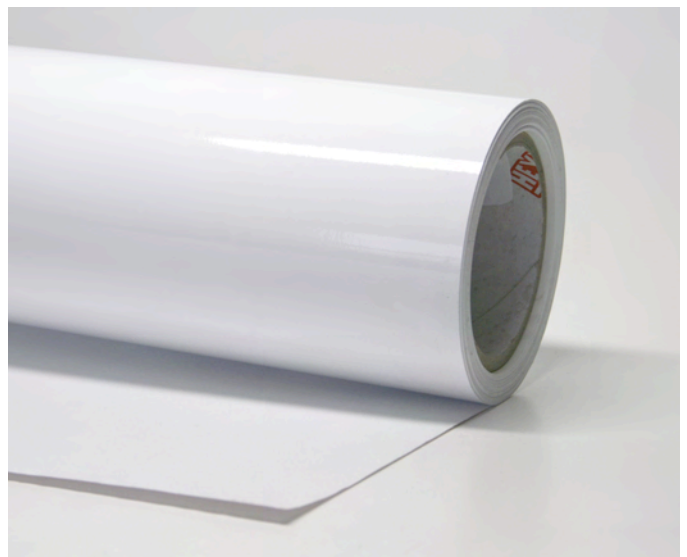

The company is based in Frontignan, near Montpellier, France and has subsidiaries in Germany and in California, USA with affiliate Hexis companies in Italy, the Netherlands and the UK.

For further information visit www.hexisgroup.com



doro tape

Your Universal Supplier

Over 400 lines stocked for next day delivery nationwide



Coloured Vinyls



Speciality Films



Digital Media



Textile Films



Accessories Galore

Phone Sales at 0845 165 1636

or buy on line at dorotape.co.uk or dorodigital.co.uk

FitzpatrickWoolmer

Creative Sign Solutions

At Fitzpatrick Woolmer we provide off the shelf and bespoke timber sign solutions in both hard and soft woods. Combining modern CNC routing facilities with traditional joinery techniques, we are able to fulfil any sign requirement from our fully equipped workshop.

We can offer advice on the most suitable material for your budget and application, and provide ongoing assistance regarding installation and maintenance.



Custom Structures



Information Displays

Noticeboards



Waymarking

For further information or to obtain a quotation please contact your local sales office or go to www.fwdp.co.uk

Kent Office:

Tel - 01634 711 771

Fax - 01634 711 761

Yorkshire Office:

Tel - 01709 878 688

Fax - 01709 878 063

Welsh Office:

Tel - 01495 793 366

Fax - 01495 793 377

info@fwdp.co.uk

www.fwdp.co.uk

Design • Manufacture • Installation

New technology offers widest colour gamut for indoor and outdoor applications

Epson used the recent Sign and Digital UK event to showcase new technology that promises higher levels of quality in the digital signage market and adds value to POS (point of sale) advertising, marketing and photo/fine art production.

The Epson Stylus Pro GS6000, a 64" large format printer with an 8-colour ink set offers the widest colour gamut to date in a printer designed for both indoor and outdoor applications. The new ink set allows production of high-impact, high-quality, durable prints enabling printers, copy-shops and sign shops to extend their business into higher quality demanding applications such as airport and exhibition graphics, as well as fine-art reproduction. Furthermore, the Epson Stylus Pro GS6000 enables operators to switch easily between a range of different coated and non-coated substrates such as vinyl, making it an ideal, flexible production solution for multiple commercial applications.

Colourgen is distributing the Epson Stylus Pro GS6000 in the UK. The company has 20 years experience of delivering printing solutions to the sign market and its unrivalled experience of working with solvent based printers will assist signmakers in maximising their investment in technology and this new printer.

Jeff Biggs, Managing Director of Colourgen, comments, "For signmakers, the key benefits of the GS6000 are its reliability and ease of use. The inks are odourless so they will not need to worry about air purification. The printer itself does not require daily cleaning or maintenance, an issue that has historically put signmakers off solvent printers. In addition, the print head is included in the warranty, adding greater overall confidence for signmakers that their investment is very well protected."

Integral to the quality and durability of print output is the new Epson UltraChrome™ GS, an 8-colour eco-solvent type ink set (cyan, magenta, yellow, black, light cyan, light magenta, plus orange and green) available in efficient 950 ml cartridges. It has an exceptionally wide colour gamut which provides enhanced support for commonly used spot colours, making the Stylus Pro GS6000 ideal for branded applications. Importantly for the environment and operators, Epson UltraChrome GS ink doesn't spread harmful VOCs (volatile organic compounds) and is the first major eco-solvent type ink set to be launched without the need for a hazard symbol.

This makes the Stylus Pro GS6000 both environmentally- and user-friendly. As additional ventilation isn't required, it can be situated in the most convenient location for the business. Furthermore, Epson has focused on significantly reducing the need for time-consuming daily operator maintenance, thus increasing available production time.

The Epson Stylus Pro GS6000 has a resolution up to 1440x1440 dpi and a smallest ink droplet size of 3.7 picolitres. Production speeds of up to 25sq.m. per hour using Epson's Variable-sized Ink Droplet and MicroWeave half-toning technologies deliver fast-drying, scratch-resistant prints that are water and UV resistant for up to 1.5 years without lamination but can be laminated for applications exposed to intensive mechanical stress or abrasion. Support for heavy rolls up to 30kg and an auto-take-up-reel enable versatile media management and standard Giga-Ethernet and USB2.0 allow high-speed connectivity. The Stylus Pro GS6000 will be supported by all major RIP vendors.

Find out more at www.epson.co.uk or tel. 08712 226702.



The award winning Epson Stylus Pro 11880.

'Best Photographic Printer of the Year'

For the second consecutive year, Epson has won the prestigious EDP award 2008 for the 'Best Photographic Printer of the Year', with the Epson Stylus Pro 11880. The award comes as Epson celebrates 40 years at the forefront of electronic printer development. EDP is the first association of digital graphic press publishers to acknowledge the value of the industry's innovation for the professional graphic arts market.

The EDP Association is made up of the publishers of leading European magazines devoted to digital printing and associated products. These publications cover more than 15 European countries with a combined circulation of approximately 120,000 and a readership exceeding 240,000 graphic arts professionals. The EDP awards identify and reward products that represent quality and innovation to enable the graphic arts community to identify the best products in the industry.

"The decision to award Epson the 'Best Photographic Printer of the Year' accolade is based on Epson's new wide format standard, its new formulation of magenta pigments, its colour stability immediately after printing, its capability of handling nine separate ink channels and superior connectivity," commented the EDP panel.



The Epson Stylus Pro GS6000 – with new technology to provide the widest colour gamut and exceptional quality.

The Secret To Quality Sign Fabrication...

CONFIDENTIAL

TOP SECRET

- Team of specialist fabricators
- Major new investment in latest 4m wide press brake and guillotine technologies
- Folded trays, panel work and general sign fabrication in aluminium and stainless steel
- Choice of specialist finishes including powdercoating
- High quality workmanship, service and discretion assured



For a quote or further information contact us:

Tel **01525 850500**
 Fax **01525 850462**
 Email **sales@signtec.co.uk**
 Web **www.signtec.co.uk**



SignTec

The Sign Industry's Best Kept Secret

Fittings available for various forms of sign illumination, including cowl lights, fluorescent uplighters, continuous troughs and floodlights.

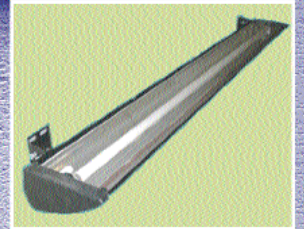

SIGN LIGHTING

Find your way out of the dark...



Manufacturers and Distributors of Commercial, Industrial, Sign Illuminating and Marine Light Fittings



• 45 Portland Place, Hull HU2 8QP.
 Phone: 01482 223353 Fax: 01482 225681
 e-mail: enquiries@sondialighting.co.uk •



NOS

BUILT UP LETTERS IN



Mirror, Brushed, Mild & Descaled Stainless Steel, Powder Coated Aluminium, Acrylic & Brass



Illuminated by Led's or Neon



CNC Aperture cut panels, Full sign systems, Digital Printing & Braille/Tactile Sign Systems



Unit 6 & 7, Stadium Ind Park, Gateshead. NE10 0XF
 T: 0191 477 3943 F: 0191 477 9700
 E: sales@newimagesigns.co.uk

Solid foundations for sign installations

One of the highlights of Sign & Digital UK was the launch of a remarkable new method for installing signs. Called GroundPlug, it is a patented steel foundation and anchor system based on a proven Scandinavian design and seems destined to become a more reliable and cost-effective alternative to conventional concrete-based sign foundations. The system is particularly suitable for the installation of tall totem signs, flagpoles, lighting columns, advertising hoardings and street furniture.

With this new solution, there are no labour-intensive and disruptive earthmoving and digging activities, no concrete, no backfill or spoil management and only minimal or frequently zero re-surfacing requirements. It is necessary only to scan the ground, make a pilot hole, drive in the GroundPlug to the required depth, activate the anchor blades by simply tightening the securing bolt and install the sign. At the end of use, it is easy to recover the anchor with much less environmental impact. In trials using a typical five metre-high pylon sign, the use of GroundPlug resulted in a 50 per cent saving on installation time and overall cost savings in excess of one third by comparison with the traditional concrete cage method.

There are four GroundPlug models to accommodate different stabilising and securing requirements, with the SK 30TV being the most appropriate for sign installation. In a recent project at Canary Wharf in London involving the installation of

a 13.5 metres high sign weighing 10 metric tonnes, use of the GroundPlug anchor system enabled the sign installation team to go 1.7 metres deeper than would have been possible using conventional concrete-based methods, with no spoil management and full compliance with all technical, life cycle and safety requirements.

Further information can be found at www.groundplug.co.uk



GroundPlug being driven into the ground prior to fixing of the sign assembly.



Sign erected using GroundPlug foundations.

Megaink launches new bio ink products

Leading ink developer innovates large-format printing industry with renewable resource based BioMGInks

Megaink recently announced that it has developed a renewable resources-based ink for large-format commercial printing use.

Made from renewable sources rather than traditional chemical solvents, BioMG Inks bring a new element of environmentalism to the ink industry. In addition to being environmentally friendly, under stringent testing, BioMGInk has proved to be notable for UV resistance, to be scratch and alcohol resistant, and to have a less abrasive odour than traditional solvent-based inks.

Commenting on the success of the new product, Megaink's Director of Business Development, Avi Bukai said "We are extremely excited to be successfully bringing a bio ink product to the market. This is a truly unique product, which is unlike others that have been tried before and we are confident that as soon as users have a chance to try the product they will be convinced, not only that this is a positive direction for the industry but that BioMGInks are superior to others in their category."

Fully compatible BioMG Inks are now available for Mimaki and Roland printers.

For further information visit www.megaink.biz



Roland SolJet Pro series profiles for KPMF digital print films

Users of the new Roland SolJet Pro III series wide format inkjet printers can now download free profiles for five of Kay Premium Marking Films' most popular self-adhesive digital media products.

The profiles, for the SolJet Pro XC-540, XJ-640 and XJ-740, are available via the Roland Japan website: www.rolanddg.com by going to the download section and selecting "Media Profiles".

The KPMF products profiled by Roland include both of the UK manufacturer's ground-breaking vehicle wrapping films: the 100-micron hybrid K88011 – better known as VWS 1 – and the 50-micron matt cast vinyl K75211, which is the printable component of VWS 2.

Also profiled are three multi-purpose 75-micron white calendered vinyls: the three-year life K42011 monomeric glossy film and the five-year K52011 and K53011 gloss and matt polymeric.

For further information on KPMF digital media products, please call UK distributor, KPMF Direct Ltd on 0870 1211 285 or visit www.kpmf.com

For information on the Roland SOLJET PRO III XJ and XC wide format printers, please contact Customer Services at Roland DG UK on 01275 335540 or visit www.rolanddg.com



Durst launches new Rho 700 UV flatbed printers

The new Rho 700 UV flatbed printers are the latest addition to the Durst Rho family and represent a new generation of modular, upgradeable flatbed printers which offer higher productivity and even finer image quality.

The outstanding performance and reliability is the result of the precision of key components developed and produced by Durst. Key to the finest quality of print combined with the highest output speed is Durst's own advanced and perfected Quadro Array inkjet technology. There is also a new concept for the print carriage which includes a linear drive system and workflow is more efficient due to the new Durst proprietary user software.

The modular build concept is unique in its class, and Durst claim that no other UV flatbed printers can be adapted to individual needs or be upgraded later in the field to the same extent.

There is a choice of ink variety which includes white and special effect varnish, also light colours for finer image quality. There are specific inks for rigid, flexible or absorbing media, ensuring the most cost efficient ink choice.

Productivity is maximised by the use of mechanical front stops which enable parallel printing of boards side by side. Printing onto corrugated boards can also be automated. Furthermore, overall speed can be increased by doubling the number of Quadro Arrays from four to eight.

The wide choice of printing applications for the Rho 700 is further increased by its ability to print both roll and rigid media. There is a heavy roll option which will enable unattended printing and there are also special features for printing heavy and/or thick boards plus a further option for printing onto corrugated boards.

Designed for high quality, industrial performance and able to be tailored to specific business requirements, the Rho 700 provides the perfect solution for screen printers, photo laboratories and digital printers.

The Rho 700 joins Durst's two other highly advanced and successful UV flatbeds, the Rho 600 Pictor, an award winning industrial standard entry level printer, and the Rho 800, the ultra high performance inkjet with a continuous board printing feature.

For further information call 0043 485 271777 or visit www.durst-online.com



The Rho 700 UV Flatbed Printer.

New Avery Quick Mount solvent inkjet film - just the job for short-life graphics

Avery Dennison Graphics and Reflective Products has added a new and versatile gloss white multi-purpose solvent inkjet film to its Avery Graphics portfolio – with a prime focus on making graphics application (and removal) quick, clean, and easy. Avery MPI 3601 Quick Mount is a prime candidate for short-life graphics where time is of the essence at the application point – for example, for bus, tram, and other public transport advertising where vehicles are only available for a very limited 'window' of time.

A benefit of Avery MPI 3601 Quick Mount's extra-thick 150-micron caliper is its 99% opacity – which makes successful overposting of existing graphics possible. The high caliper of the monomeric calendered film also makes it very easy to handle, and gives a smooth finished result on all flat surfaces.

This special facefilm is partnered with a high-specification removable adhesive, which enjoys clean removability characteristics for up to a year after application. Taken together, these benefits make the product a useful stock item for exhibition and event graphics, indoor and outdoor advertising, vehicle decoration, and whenever overposting is desirable. Developed for printing by super-wide format solvent inkjet and airbrushing, Avery MPI 3601 Quick Mount offers quality print results in addition to its physical properties. It is also compatible with Avery DOL digital overlaminating films for added durability (up to two years) and surface protection.

Avery MPI 3601 Quick Mount is available from Avery Graphics distributors throughout Europe. Got to www.europe.averygraphics.com for details



Sign-Makers-Products.co.uk

FROM £12.00
PER FT
WITH ONE ROW
OF FLUORESCENT TUBES
OPTIONAL EXTRA TWO ROWS
OF TUBES FOR DEEPER SIGNS

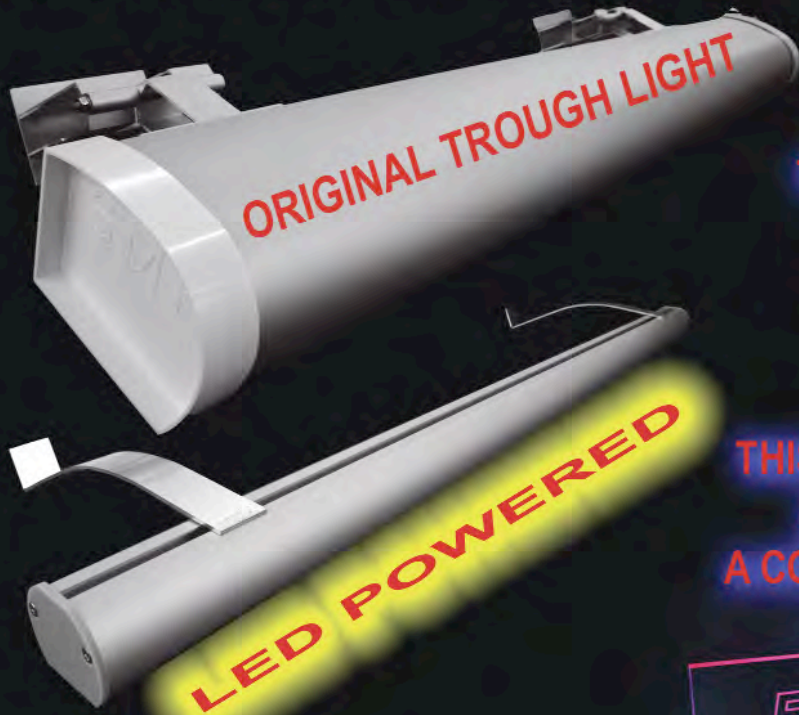

FROM £13.50 PER FT
WITH ANY ONE COLOUR LED'S
TWO COLOUR FROM £15.00 PER FT
FLASHERS FADERS & MANY
TYPES OF CONTROLLERS. CAN
FULL COLOUR CHANGE

THIS SAME SECTION IS USED AS
AN EDGE LIGHTER OR AS
A COUNTER DISPLAY UP LIGHTER



IN HOUSE
PANELS POLISHING
& ENGRAVING
FACILITY

MINI TROUGH IS POWERED
BY LED'S. ONE OR TWO COLOUR
PRICING FROM £10.00 PER FT
OPTIONAL 2 WAY FLASHER UNIT
AVAILABLE £25.00



ALL OUR TROUGH LIGHTS CAN
HAVE FULL COLOUR CHANGING
LED'S FITTED WITH MANUAL
OR REMOTE COLOUR CHANGING
CONTROLLERS

TEL:
01508
531183

HAWTHORN HOUSE
IPSWICH ROAD
LONG STRATTON
NORFOLK NR15 2XB
e-mail: smpnorfolk@aol.com

FAX:
01508
531139



New Mutoh wide-format UV printer previewed at Fespa Digital Europe

At the Fespa Digital Europe show, held in Geneva, wide-format inkjet printer manufacturer Mutoh Europe nv previewed its new wide-format UV inkjet printer, called ZEPHYR. The printer has been completely engineered and developed by Mutoh's Belgian R&D centre.

Mutoh Europe's Zephyr is a CMYK 64" (165 cm) professional UV inkjet printer for roll-to-roll printing (vinyl, flex, mesh, PVC, soft sign, etc.). The printer will also handle rigid boards up to a thickness of 20 mm. For roll printing, the machine incorporates a motorised unwinder/winder system with dancer bars for media rolls up to 100 kg. For rigid printing, media transport tables can be placed at the back and in front of the machine. Switching between rigid and roll printing is done in a trice.

The new Mutoh Zephyr printer incorporates 4 Xaar® 760 high end variable drop greyscale heads, offering high image quality combined with high productivity. The heads produce droplets as small as 8 picoliter. Small drops (8 pl) are used to deliver pin sharp text and line art, whilst larger drops (16, 24, 32 & 40 pl) ensure excellent image saturation.

Enabling six levels of greyscale, which is equivalent to six densities of CMYK, the print heads eliminate the need for extra process colours.

The printer utilises Mutoh proprietary flexible UV inks, specifically tuned for roll-to-roll printing. Still, the Zephyr UV inks were formulated to also allow printing onto a wide range of rigid substrates, such as foam board, cardboard and polyprop. Stable and reliable printing is ensured by an integrated ink conditioning and degassing system. The Zephyr's integrated bulk ink system offers a capacity of three litres of ink per colour and enables refilling whilst printing. The UV curing lamps are pre-mounted into a cassette, which can be effortlessly replaced by the printer operator.

The Zephyr UV printer produces top quality prints for close viewing distances between 10 and 20 m²/h. Prints for medium viewing distances can be produced at speeds between 20 and 30 m²/h.

For further information on Mutoh Europe and its products visit www.mutoh.be or www.mutoh.eu



Previewed at Fespa, the Zephyr wide-format UV inkjet printer.

You can do so much more...



Plastics, metals, woods or composites - our heavy duty routers make light work of them all. Turning complex fabrication processes into simple, push button operations. Making it easy for you to cut, fold, carve or engrave great looking signs and displays.

- High Performance Routers
- Servo Ballbearing Drive Systems
- Easy to Operate Controls
- Auto Tool Change Capability
- Cut to Print Camera Option
- First Class Training & Support

...with a TEKCEL router

Available in a wide range of industry standard bed sizes, our routers offer maximum versatility and deliver uncompromising quality at no extra cost. If you're looking for an affordable cnc router that your business can really depend on - you've found it.

Call us now for more information or a demonstration.

Tel: 01275 342 668 (UK Mainland)

Tel: 02828 277 013 (Ireland - Nth/Sth)



www.tekcelcnc.com



Chemical Etching

MULTItechnic



Chemical etching is all that we do, but we do more than just chemical etching.

Confusing? Not really.

Because chemical etching is all that we do, we devote all of our efforts towards being the very best, unlike other etchers who only dabble in etching as just another thing that they do.

We don't engrave, we don't screen print, and we certainly don't supply vinyl graphics. We manufacture the very best etched signs, and we only sell to the trade. Every job from a hotel installation to a simple sign gets the benefits of our expertise.

Because we don't do anything else, we spend our time developing new ways to offer more creative effects such as colours that fade into each other, adding gold plated highlights, and combinations of metal finishes.

All very simple really, well it is to us, we are the experts.



Tel: 01670 512090

Fax: 01670 503143

Email: sales@multitechnic.co.uk

www.multitechnic.co.uk

From

£12.00*

per sq.metre

24hr turnaround

* Introductory offer



just-digitalprint.co.uk
call: 0845 373 3525

no frills... we just do it!

Three new printers in the Océ CS9000 series meet different customer needs

Three new members of Océ's CS9000 series of high quality display graphics printers, all specifically designed to suit customers' varying requirements, were unveiled at Sign and Digital UK.

Building on the success of its predecessor, the 64-inch wide Océ CS9160 printer provides reliability, superior print quality and increased productivity. The ability to use 440ml cartridges increases ink capacity and productivity by halving ink change-outs and can increase print speed by 15 per cent. The environmentally safe and easy-to-use CS9160 also offers the ability to produce both indoor and outdoor durable prints. Therefore it is ideal for those just starting in the digital printing industry, and for print providers using aqueous technology that want to start offering high quality outdoor prints.



Océ CS9265.

The Océ CS9265 printer is ideal for companies that want to expand their production capacity for both indoor and outdoor jobs. It offers superior productivity at print speeds of up to 40 sq.m. per hour in production print mode, with top print speeds of up to 80 sq.m. per hour. The CS9265 also uses VariaDot imaging technology with variable ink droplet sizes to deliver superior productivity, high print quality, and excellent ink economy.

The Océ CS9050 is intended for commercial shops wanting to start offering outdoor printing, and for corporate customers who want to bring graphics production in-house. The CS9050 also uses VariaDot imaging technology, WAVE Stitching print modes and is designed for light production environments where high quality output and outdoor durability are required.

Derek Joys, Programme Manager, Display Graphics Systems, Océ UK, said: "These customers need an affordable, high quality, environmentally safe and easy-to-use system that offers indoor and outdoor versatility. All these printers in the CS9000 series suit these needs and each is specifically suited to each customer's needs."

For further information, go to www.oce.com



Océ CS9050.



Océ CS9160.

Off the shelf LED display cases

Applelec Sign Components is pleased to announce that it is now holding stock of its popular LED Display Case range "ThinLite".

"ThinLite" is an ultra thin silver anodised snap frame mechanism, perfectly mitred, with elegant rounded chrome corners. With all the benefits of LED lighting embedded within an engraved acrylic light guide plate, a bright even light is reflected across the surface of the panel illuminating the graphic. Low power consumption allows for a range of power sources including mains, battery, as well as solar technologies.

Offered in the following sizes, Din A4, A3, A2, A1 and A0, as well as the popular European sizes of 500mm x 700mm, and 1000mm x 700mm.

Applelec's "ThinLite" is now available for immediate sampling and production orders. www.applelecsign.co.uk

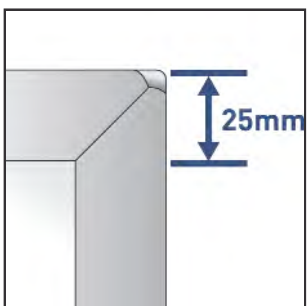
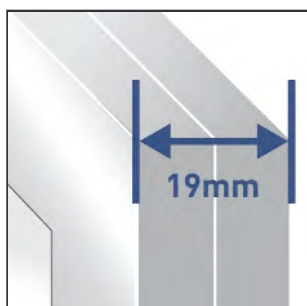

The "ThinLite" silver anodised snap frame.

Introducing new ITL wide format solvent inks

ITL are pleased to announce the launch of two new inkjet ink solutions for wide-format solvent-based digital printers. Both inks are produced in the UK at ITL's ISO9001 certified production facility; this certification ensures that ITL inks are produced with a consistency of colour, high fade-resistance and total reliability. ITL inks are an established and competitive alternative to OEM products and continue to provide cost-savings whilst enhancing critical aspects of digital print production.

ITL's EvoSol eco-solvent inks have been skilfully engineered as a low odour and non-flammable product that will improve scratch, abrasion and alcohol resistance on supported printer models when compared to the OEM supplied inks. Owners of Mimaki, Mutoh and Roland printers can convert from OEM inks to EvoSol inks without flushing out the printer, and as the inks are a true colour match users will not be required to write new ICC profiles or to adjust their existing ones. EvoSol Inks are designed to run in high-speed and high-quality printing modes and are formulated to produce a wide colour gamut, matched to the OEM inks, along with exceptional durability, fast-drying properties and outstanding reliability.

Also being launched in 2008 are ITL's JS2 inks which are designed for use with all Mimaki JV3 and JV5 printers regardless of the printer's age or firmware version. These full solvent inks are capable of printing photo-realistic images on coated and uncoated substrates giving you a wider choice of both high quality and lower cost materials to print onto. Again, JS2 inks will significantly improve alcohol, scratch and abrasion resistance when compared to the OEM ink products, improving the durability of printed output. A strong individual colour density and a simple changeover from the OEM inks, with no need for flushing, means you can immediately achieve improvements in your print production whilst also benefiting from cost savings of around 30% when compared to the OEM inks.

Both new ITL inks can be purchased in pre-filled 220ml and 440ml chipped cartridges and in bulk 500ml, 1 litre, 5 litre and 25 litre containers; ideal for use with refillable cartridge systems which ITL also supply.

For further information call 0161 495 3900 or go to www.itlgb.com

Reviving past glories at Universal

Following a period of restructuring, forward planning and inward investment (significantly its acquisition by the Cyprus-based aluminium production powerhouse Muskita), Universal Aluminium Systems of Bristol has been experiencing a kind of renaissance in the architectural, glazing and sign manufacturing industries. Under the guidance of the new General Manager Michael Jobson, ably assisted by Technical Director Carl Richards and Business Manager (Signs) Ceri Hughes, the company has now taken a giant stride forward by making significant new investment in plant, technology and human resources to reflect its true market-leading status within these industries.

A key element of the new plant installed at the 65,000 square feet facility in Bristol is what is considered to be the first 'robotic' warehouse. This incredible mobile production tool automatically monitors aluminium stock levels and delivers extrusions to the exact specifications for every customer requirement with the minimum of manual intervention and with absolute precision and faster than normal speed. There has also been additional significant investment in other plant and the progressive recruitment of a highly skilled team of additional management and production professionals, details of which will form the basis for further news releases.

At Sign & Digital UK, Universal Aluminium Systems made its first tangible step towards raising its profile in the sign industry. A comprehensive range of both new and established sign systems were on display, demonstrating the company's design innovation and the quality, durability and aesthetic appeal of its products.

Included in the products shown were Universal's Flexcase, Bannerflex and the new Wedgeflex flexible-face sign solutions. Designed for either single- or double-sided flexible-face signs, Flexcase has been developed in close collaboration with sign makers, lighting specialists and substrate manufacturers. It is available in four different formats: Standard (for single-sided signs in any shape or size), Light Duty (for smaller single-sided canopy and fascia signs up to 3,000mm in height), Double-Sided (for pole-mounted or suspended signs) and Retro-flex (for converting existing sign boxes to accept a flexible-face material or for manufacturing slim-profile wall- or fascia- mounted non-illuminated flexible-face signs).



Flexible-face solution provided by Universal.

A non-illuminated flexible-face system, Bannerflex requires only two profiles and is ideal for situations where a stronger and more durable banner assembly is required. Wedgeflex is Universal's latest incarnation for flexible-face signage applications. It is a tensioned system featuring a novel skin-retaining facility and hinged access to facilitate easier and faster replacement of the skin. It will fully complement existing flexible-face options in the Universal range.

With a depth of only 90mm, Tranicase is an illuminated system that is ideal for any situation where a narrow-profile solution is required. It has been developed from Universal's original flexible-face system and features a clip-frame facility to allow easier access when changing the graphics, posters or transparencies.

Other products from Universal include: Dualcase (for single- or double-sided illuminated signs), Panatrim (for non-illuminated panel signs), Unicase (a hinged sign case system offering for fast and easier access), the Unilight trough lighting system, the Locate Post & Panel system and the Direx reversible information and directional sign system.

For further information, visit www.universal-aluminium.co.uk



The robotic warehouse is a key element of the production facilities at Universal.



**Centre
Signs
(UK)
Ltd**

SUPPLIERS TO THE SIGN TRADE

**BUILT UP LETTERS
STAINLESS STEEL
ACRYLIC
ALUMINUM**

**FLAT CUT LETTERS
STAINLESS STEEL
ACRYLIC
ALUMINUM
FOAM PVC**

Contact Us

Tel: 01162 714247 • Fax: 01162 720260

Web: www.centresigns.co.uk • Email: graphics@centresigns.co.uk

New biodegradable foamboards offer greener option for UK signmakers

In the midst of the green revolution both large and small companies have been looking at ways of revamping everything, from packaging and P.O.S to the way we live on a daily basis.

For many years foam centred boards have been a P.O.S. favourite, large stores in particular have relied heavily on it to produce their lightweight printed signage. However, the combination of paper liners and expanded polystyrene centre has produced problems of monumental proportions when it comes to disposal. The United States, and to a lesser extent Europe, have built waste-to-heat units to burn rubbish, which generates electricity, which is then fed into the grid system. In this respect waste foam board is of value but unfortunately it seems that the UK government's ideas of "going green" has largely centred on raising taxes to reduce demand and hence the carbon footprint. Consequently, waste foamboard invariably ends up in a landfill site where it can take up to 450 years to degrade.

Now for the first time two new types of foam centred boards that go a long way to meeting the demands of the green lobby are being offered for sale in the UK. Both are biodegradable and one can also be granulated and recycled.

Insite Biodegradable is a paper faced foamboard with a biodegradable foam centre and Sustainable Forest Initiative (SFI) certified paper liners. The foam centre contains 15 per cent recycled content and is formulated with bio resins. These transform the structure of the polystyrene, which attracts micro organisms that metabolise and neutralise the plastic. It is these resins that help the discarded foamboard to degrade in a landfill or commercial composter where the foam is exposed to a bacteria-rich environment.

Only an environmentally harmless biomass compost remains after decomposition, which takes from one to five years for 100 per cent breakdown. This compares with 80 to 450 years for standard foam centred boards.

These new biodegradable foam boards contain all the characteristics of the non-biodegradable type. Faced with bright white liners formulated from wood products certified by the Sustainable Forest Initiative, it is highly warp resistant and retains its thickness during mounting, laminating, printing and die-cutting. There is no trade-off between the positive environmental attributes of Insite Biodegradable and its physical performance, and it will not begin to degrade until discarded in a landfill or similar environment.

Duraplast is a plastic biodegradable foam centred board with the same foam centre as Insite, but with smooth white or black polystyrene liners. The plastic liners offer additional dimensional stability and Duraplast is recommended for large digital printing, mounting, sign and exhibition displays. The plastic liners allow the sheet to be bent without the use of a heat bender, making it ideal for lightweight displays. It can be die-cut without loss of memory, the surface is suitable for all types of printing process and it will not start to degrade until discarded in a landfill. Duraplast can also be recycled by grinding it into pellets and then reused in the manufacture of new polystyrene sheet.

Further information and samples can be obtained from General Print Materials, telephone 01162 403216.

New range of textiles from Seal Graphics

In order that marketers can extend the gamut of applications possible from today's photo-quality dye-sublimation printers, a new range of textiles suitable for both indoor and outdoor use is now available from SEAL Graphics.

Comprising of no less than five different fabrics that have been specifically designed for use with both transfer and direct dye-sub print technologies, they are suitable for printing with solvent-, water- and oil-based dye sub inks in applications such as banners, exhibition graphics and POP displays.

One textile - which SEAL Graphics calls its 'Mirror Flag' - is particularly useful for transparent applications such as indoor and outdoor flags and room or stand dividers. It is a 100 per cent knitted, 110g/m² polyester fabric with excellent bleed-through qualities.

Another - the 'Poplin Banner' is also 100 per cent polyester and offers excellent durability and crease-resistant qualities; whilst the '3D Banner' textile has been designed for 3-dimensional advertising and therefore offers great stretchability properties.

The remaining two textiles are the 'Double Print' and 'Light Banner' fabrics. The former is a 280g/m² polyester with two different finishes: satin on one side and matt on the other. Both sides are equally printable and this material offers good long-term outdoor durability. The latter fabric also offers good long-term outdoor durability but is lighter - at 200g/m² - and has a greater degree of stretch for better use in display systems.

All fabrics have the B1 and NFPA 701 fire rating.

When used with dye-sublimation printers, these textiles are ready to handle immediately they exit the printer and deliver outstanding UV- and scratch-resistance.

For further information visit the website www.sealgraphics.com



Hardwood Magnetic Directory Systems



- Interchangeable
- Secret fixings
- Stylish Design
- Exterior/Interior
- No keys required
- Easy to install (only 4 screws)
- Changed in seconds
- Cost effective

These Systems can be manufactured from all types of hardwood
Mahogany • Oak • Beech • Cherry • Ash also available in most metals & plastics

one to one
engravers Ltd

Unit 3 Cirrus Park, Lower Farm Road,
Moulton Park, Northampton NN3 6UR

Tel: 01604
644604

Fax: 01604 644755

Email: info@onetooneengravers.co.uk

Web: onetooneengravers.co.uk



Aurora GRAPHICS

Thousands of **HUGE, HIGH RESOLUTION**
Images designed especially
for vehicle wrapping and signwriting



JUST **MB** IT!

THE WORLDS BEST
VINYL & GLUE
REMOVER

VISIT OUR WEBSITE TO
SEE THE MBX IN ACTION



Vertical Panel Saws
Improve Productivity
and Save Space



We offer the most versatile
and robust range on the market.

CALL US NOW
0118 970 1950

www.sagetechnology.co.uk



KEENCUT

*The Keencut Distributors
with the Keenest prices!*

New range of
Mobile Storage Racks for 50mm & 75mm Cores

JAG
TRADE SUPPLIES

0800 5 999 059

www.jagtradesupplies.co.uk

Come join R evolution now at Grafityp

Quality and reliability, that's what Grafityp customers say they want. Cheap inferior products are fine if you can use them, but if you start having problems, wasting bits here and there, product not performing as it should, customers rejecting work, then the small savings are quickly eroded.

Siser have been manufacturing thermo transfer materials for textiles since 1970 and have always been known for their high quality products, manufactured to the highest standards and conforming to the latest industry requirements. Grafityp UK Ltd have been successfully selling Sisers products for over 20 years, so you could say Grafityp now knows a bit about it.

The Siser range offered by Grafityp is comprehensive and includes materials for a whole host of various applications.

Standard Grafiflex is a thicker material and often described as the original flex product, Siser call this product VideoFlex. Grafiflex PU (VideoFlex PU) is a PVC free material for plotter cutting; it features a very thin layer whilst guaranteeing opacity and high covering ability. Grafiflex PU is the ideal material for multi-layering applications.

Grafiflex PS (VideoFlex PS) is very similar to the PU film but also benefits from an adhesive backing to give a little stability and less movement of graphics during application. Custom colours can also be ordered in this product subject to the minimum quantity requirement. Grafiflex Extra is a cad cut range specially developed for application onto nylon and other so called "difficult" materials, an ideal choice for sportswear items. Grafiflex fashion is a range of plotter cut materials specially developed for the fashion industry and leisure; they include glitters and special effects and the popular Electric series – ideal for speciality designs with a difference.

Elasticut is a Cad-Cut® highly stretchable material for extremely thin decorations. Specially developed for elastic fabrics (Lycra®, Elastane®, etc), it is also very suitable for normal type fabrics (Cotton, Polyester). The stretchability of this material again makes it an ideal solution for use on sportswear garments.

Away from Cad Cut Grafityp also supply a comprehensive range of Cad Print and Cut materials for textiles under the Siser C-Print banner. Available in white, clear and glitter finishes for application on to a whole host of textile products.

This range is perfect for people who use machines such as the excellent Roland VersaCMM™ and SolJet™ series or Mimaki or Mutoh print and cut systems as well as thermal print machines like the Gerber edge or Fargo and Summa.

All of the C-Print ranges are available in a choice of widths and thicknesses and offer excellent value for money.

Cad Cut and Cad Print and Cut materials are only part of what Grafityp offer for textile. There are also a whole host of other products and accessories like Flock, Teflon sheets, weeding tools, heat tape, heat presses both manual and automatic, cutting plotters in a variety of widths and transfer papers for inkjet and laser printers.

Grafityp also offer an extensive amount of other Siser garment products that are all available to special order. These include flex and flock material for screen printing, products designed especially for die cutting, Jet flock and Sublistop for use when sublimation printing, VideoFlex Perfor, which is PU flex but with either small circles or stars cut out all over the material.

People who visited the Printwear show would have also seen Grafityps latest innovative product: Evolution Cut and Evolution Print, these new products will be available imminently and there is no doubt at all that they will change the buying habits of many users of thermo textile films and vinyl's. A quick call or e-mail is all it takes to find out how your company could benefit from joining R Evolution.

Contact Grafityp now on 01827 300 500 or e-mail: sales@grafityp.co.uk





Sign installations made easy

The perfect solution for foundations



- minimise traffic congestion
- fast installation
- cost saving
- environmentally friendly
- no use of concrete
- can be driven directly into the ground without pre-digging
- minimum or no re-surfacing expenses
- accurate and precise installations

Call for a brochure on
01934 853990

GROUND PLUG®
www.groundplug.co.uk

GroundPlug (UK) Ltd Pear Tree Works,
Bath Road, Upper Langford, Bristol, BS40 5DJ

Welcoming Signs.....

*All the signs are right
for the best in
embroidery
and print
equipment*



Your Embroidery Services Ltd
Meden Road, Boughton Ind Est South, Boughton, Notts, NG22 9ZD, England
Tel: 01623 863343, Fax: 01623 863345, E-mail: sales@yesltd.co.uk, Web Site: www.yesltd.co.uk



Award-Winning AstSigns, opts for Roland DG technology and quality service

Cumbria's award-winning vehicle graphics, sign and print specialist, AstSigns, has invested in Roland DG wide format technology due to its proven ability to deliver high quality products and premium levels of service. The 30-employee company is an industry leader in the vehicle graphics arena and holds the contracts for a number of national hauliers, including the UK's most famous logistics company, Eddie Stobart.

AstSigns, which has ISO 9001 quality accreditation, recently installed a 74-inch wide Roland DG AdvancedJet AJ-740 printer that is capable of producing 80m² per hour. However, the Penrith-based company has since bolstered its Roland DG firepower with the installation of two additional 64-inch wide SolJet Pro III XJ-640s, which can print at a resolution of up to 1,440dpi. The machines have replaced others from a rival wide format manufacturer. AstSigns owner and managing director, Mark Aston, said that the reason behind the investment in Roland DG equipment was not simply down to the high quality of the wide format technology, but also the guaranteed level of service and support that Roland DG is able to offer.

Mark Aston said: "The printers use Eco-Sol Max inks and produce fantastic graphics on a variety of substrates, but the real clincher for us was the fact that Roland DG would guarantee next day service levels. As a businessman I need to know that the technology I invest in is backed with real support.

So far, we have installed three Roland DG wide format printers, which we use for all the Eddie Stobart work, and I expect that in the near future there will be more."

Roland DG (UK) managing director, Jerry Davies, said: "Today's customers expect far more than high quality technology, which is something of a given. They need to know that the manufacturer they choose to partner with has the right levels of service to support their business. Roland DG has invested heavily to ensure that it has the requisite infrastructure in place to guarantee this support. This in-the-field support is coupled with initiatives like Value Up, which allows customers to download software upgrades without charge, and means that Roland DG (UK) is the partner of choice for the business-savvy sign-maker and printer."

AstSigns has been trading for six years, since it was established by Mark Aston, who has 15 years' experience in the sign-making industry. The company wraps and produces signage for around 2,000 vehicles a year. Alongside this core business, AstSigns supplies all types of external signage, internal banners and pop-ups, as well as professional print services. Last year Mark Aston was named as businessman of the year at the Cumbria Business Awards.

For further information on Roland products visit www.rolanddg.com or to find out more about AstSigns visit www.astsigns.co.uk



GE
Lumination

MAX

Remarkably Simple.

New Tetra[®] MAX LED Lighting System
makes channel letters easier to install.

Simplify your life and streamline your entire production process with new Tetra MAX—it's the simplest LED system you'll ever install. Patent-pending 12-volt design eliminates complex wiring for time savings and reduced labor costs. Now, you can cut between any LED module and run any color with a single power supply. New Tetra MAX is the LED system you can count on for hassle-free installations that are remarkably simple. For more information contact:

Professional Sign Systems

Tel: 0191 4911908
www.pss-signs.co.uk

Specialist Neon Supplies

Tel: 01902 409205
www.amariplastics.com/amari/sns



imagination at work

Tetra[®] is a registered trademark in the U.S. and other countries. www.led.com

Stylo responds to client needs in a big way

How do graphics companies cope with shortening deadlines without reducing quality? Stylo has the answer, the new, state-of-the-art (and rare) Durst Rho 800 UV inkjet printer. A machine so big Stylo had to take apart the top floor of their premises and use a crane to install it! But the effort was worthwhile as the new machine complements Stylo's existing, extensive range of printing equipment whilst simultaneously meeting client demands of quick turnaround and high quality print at faster speeds, without compromising on quality.

"When your clients include big high street names like Vodafone and Coffee Republic, you can't afford to stand still," says Stylo's Managing Director, Simon Olley.

Olly goes on to say "As a market leader within the graphics industry, producing and supplying display and point of sale graphics, and offering the latest technology and creative solutions across sectors such as retail, exhibition and museums, a business such as ours needs to stay ahead of the game. If we are going to continue to push boundaries and further improve results then we need the most advanced equipment. This machine allows us to print on a wider variety of fabrics, acrylics and other materials with a quick turnaround, and economically.

"Stylo is all about translating interior design themes into award winning, flexible store concepts that have an impact on customers as soon as they walk through the door. The new equipment is state-of-the-art and allows Stylo to offer photographic quality printing, direct to any media, at higher speeds thus allowing more cost effective production for clients."

The German-made Durst Rho 800 is a rare breed and this is only the third of its type in existence in the UK, and the eleventh in the world.

"We knew it would be a complicated exercise to get it installed but the all round results make it well worth the effort, not just for us but also our clients", says Olley.

Helping maintain a high profile brand presence for successful companies such as Caffè Nero and Next often means that Stylo has to turn around complex projects in a short space of time, and so equipment has to reflect this requirement in terms of ease of use and reliability. The Durst 800's additional benefits include printing white and spot varnish, and the production of cardboard engineered FSDUs in conjunction with Stylo's 3m x 2m Zund digital cut and crease machine.

Furthermore, the Durst 800 is a more eco-friendly machine when compared to older inkjet printers allowing printing onto environmentally friendly substrates. It never pays to be complacent, and Stylo's continual investment in the latest machinery and the best staff has meant successful, high quality delivery to their clients.

For further information visit www.stylographics.co.uk



Up and on its way - the Durst Rho 800.

NEW

LEDLUX

...the first LED eco-friendly trough light in the UK uses half the energy of a standard fluorescent signlight

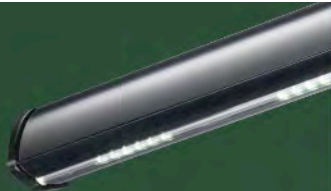

Microlux

...at only £10 per foot, the most competitive trough light in the UK

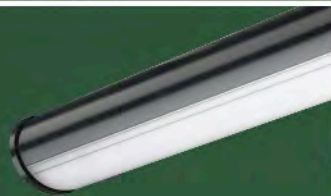

Signlux

...the UK's No.1 signlight, compact, multi-purpose trough light system

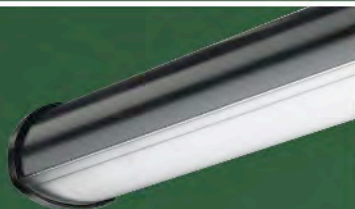

Adlux

...for optimum and even illumination over billboards and large retail and commercial signs

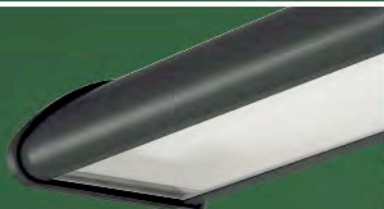

Bullet

...stylish, minimalistic, low voltage halogen light with pivotable head



For more information on any of our lighting products, call us on **01922 721133**, email sales@portlandlighting.co.uk or visit www.portlandlighting.co.uk
Portland Lighting Limited, Units A2 & A3, Walsall Enterprise Park, Regal Drive, Walsall WS2 9HQ



Productivity up by 50% for TJ's Visual Solutions

Brighton-based large format graphics and sign company, TJ's Visual Solutions, has installed an Océ Arizona 250GT helping the company increase turnover, improve efficiency and increase productivity by 50%.

TJ's Visual Solutions, a specialist in creating bespoke visual branding solutions, is already reaping the benefits since the recent installation. Productivity has increased by 50% compared to the previous solution. The printer's higher print speed allows the company to produce more output within an eight-hour period, and requires less operator input. Its significant display graphics capabilities have also opened up further business opportunities to design, advertising and marketing agencies.

Tony Jenner, Managing Director, TJ's Visual Solutions, said "We have been an Océ customer for many years now and have always found its products perfect for our visual branding needs. We initially chose the Océ Arizona 250 GT based on its ability to print high-quality images direct to substrates, however, to our delight, the printer is also exceeding our expectations in other areas. It has substantially increased our printing capacity and productivity, and our square meterage print price has been reduced considerably.

"The capability to print direct to substrate at a lower cost per metre and the photo-quality output have enabled us to compete for business more effectively, targeting customers and markets we could not previously compete in. As a result of the investment, we expect to see a sizeable increase in our turnover. The printer really is in a league of its own!"

The Océ Arizona 250 GT produces a wide variety of display graphics such as point-of-purchase displays, limited-term signage, banners, event graphics, backlit and reflective rigid displays, transit advertising, and directional signage. It uses UV curable inks and the next evolution of piezo inkjet technology that enables a print head to produce dots of variable size, delivering near-photographic image quality.

Duncan Smith, Océ UK's Wide Format Printing Systems director, said: "We are pleased that the benefits of the investment in the Océ Arizona 250 GT are already becoming apparent to both TJ's Visual Solutions and its growing client base. It enables the company to deliver an even greater range of high-quality solutions across a wide range of markets, standing out above its competitors. We are very much looking forward to continuing our long and fruitful partnership with TJ's Visual Solutions."

For further information visit www.oce.com



TJ's Visual Solutions chose the Océ Arizona 250GT.

Safety marking tape keeps Amey's highway maintenance vehicles clearly seen

William Smith has been helping leading infrastructure support services provider Amey to ensure that all its vehicles are clearly visible by day or night.

Amey is using 3M™ High Visibility Vehicle Safety Marking Tape in red and fluorescent yellow/green for both rear and side markings on all of its highway maintenance and construction vehicles throughout the UK, to ensure compliance with UN/ECE Regulation 104 Chapter 8. This regulation sets out requirements for the implementation of high visibility markings on long and heavy vehicles.

3M™ High Visibility Vehicle Safety Marking Tape is a highly reflective material offering up to nine times greater reflectivity than standard reflective film. It is visible up to 1000 metres and reflects to nearly 90 degrees. When placed in stripes on the rear,

sides and front edges of vehicles it provides enhanced visibility of vehicles at night and in poor driving conditions and increased safety for vehicle operators, other road users and pedestrians. Local Authorities and other users of this product have reported that the resulting reduction in accidents and downtime makes the application of vehicle safety marking tape a highly cost effective option.

High Visibility Vehicle Safety Marking Tape is offered as full or part rolls and same day despatch is provided on orders received up to 5.30pm. In addition, William Smith can provide bespoke designs in kit form and assist in the implementation of vehicle marking programmes.

For further information contact William Smith on 01833 694707 or visit www.amey.co.uk

new customers
SAVE 10%
off your first order

foam pvc (10mm & 19mm available in white only)

no minimum order

height	50mm	75mm	100mm	125mm	150mm	175mm	200mm	225mm	250mm	275mm	300mm	375mm	425mm	500mm	600mm	1200mm
3mm	£0.39	£0.50	£0.77	£0.96	£1.07	£1.29	£1.47	£1.98	£2.26	£2.54	£2.83	£3.73	£4.53	£5.38	£7.36	£16.98
5mm	£0.45	£0.68	£1.02	£1.36	£1.87	£2.15	£2.49	£2.94	£3.40	£4.08	£4.81	£5.66	£6.41	£7.47	£10.30	£28.09
10mm	£0.79	£1.24	£1.59	£2.38	£3.28	£4.08	£4.64	£5.66	£6.79	£7.76	£8.72	£10.75	£12.46	£15.85	£20.15	£53.15
19mm	£1.70	£2.38	£3.40	£3.96	£4.53	£6.22	£7.93	£8.78	£10.19	£11.59	£13.87	£15.85	£18.68	£21.51	£26.04	£72.12

acrylic (including gold and silver - 10mm available in black, white and clear only)

no minimum order

height	50mm	75mm	100mm	125mm	150mm	175mm	200mm	225mm	250mm	275mm	300mm	375mm	425mm	500mm	600mm	1200mm
3mm	£0.56	£0.74	£0.90	£1.13	£1.36	£1.70	£2.26	£2.83	£3.06	£3.51	£4.30	£6.40	£7.81	£9.62	£11.66	£45.28
5mm	£0.85	£1.08	£1.36	£1.70	£2.15	£2.61	£3.29	£4.18	£5.38	£5.89	£7.36	£9.06	£10.19	£13.01	£15.85	£62.26
10mm	£1.71	£2.17	£2.71	£3.40	£4.30	£5.20	£6.79	£8.38	£10.76	£11.77	£14.72	£18.11	£20.37	£26.04	£31.69	£124.51

3mm aluminium composite (Dibond, Alupanel, Reynobond)

no minimum order

height	50mm	75mm	100mm	125mm	150mm	175mm	200mm	225mm	250mm	275mm	300mm	375mm	425mm	500mm	600mm	1200mm
standard colours	£1.02	£1.42	£1.86	£2.38	£2.71	£3.17	£4.53	£5.32	£6.22	£6.79	£7.69	£9.06	£10.53	£14.72	£18.11	£54.33
chrome finish	£1.87	£2.38	£2.71	£4.00	£5.43	£6.55	£7.64	£8.83	£10.53	£12.87	£14.48	£16.39	£19.53	£24.04	£30.51	£91.70
brushed finish	£1.24	£1.59	£2.16	£2.67	£3.63	£4.36	£5.10	£5.89	£7.02	£8.60	£9.62	£10.92	£13.01	£16.02	£20.37	£61.12

exterior mdf (Medite Exterior comes in a raw form ready for painting/finishing)

no minimum order

height	50mm	75mm	100mm	125mm	150mm	175mm	200mm	225mm	250mm	275mm	300mm	375mm	425mm	500mm	600mm	1200mm
6mm	£0.34	£0.79	£1.14	£1.52	£2.26	£2.43	£2.83	£3.56	£4.08	£4.87	£6.22	£8.82	£10.19	£11.54	£13.58	£40.75
12mm	£0.85	£1.47	£1.81	£2.66	£3.63	£4.35	£5.10	£5.89	£7.02	£8.60	£9.62	£10.92	£13.01	£16.01	£18.11	£54.33
18mm	£1.47	£2.26	£2.76	£3.79	£4.69	£5.77	£7.13	£8.04	£10.19	£11.59	£13.93	£15.96	£18.68	£21.51	£26.04	£73.58

2mm stainless steel

£85 minimum order

height	50mm	75mm	100mm	125mm	150mm	175mm	200mm	225mm	250mm	275mm	300mm	375mm	425mm	500mm	600mm
brushed	£4.28	£4.61	£5.60	£6.42	£6.92	£9.72	£12.31	£14.48	£15.56	£17.20	£19.75	£28.15	£31.48	£39.50	£47.73
polished	£4.60	£4.94	£6.75	£7.24	£8.06	£11.03	£14.16	£15.48	£16.63	£19.75	£21.65	£30.37	£36.38	£42.96	£54.31

other sizes and thicknesses available - please phone for a quotation

lettering options

- add 10% - plastic locators and paper template
- add 20% - for standard extended typefaces
- add 20% - cladding template (cladding details will be required)
- add 25% - flame polishing (clear lettering only)
- add 25% - gloss finished foam pvc
- add 25% - 45° bevelled edges to mdf letters

delivery

FREE DELIVERY on orders over £280 (exc. v.a.t)
£9.25 on orders up to £280 (exc. v.a.t)

phone > 01702 308486

e-mail > sales@signright.com

fax > 0870 706 1711

We can only accept orders by fax or e-mail.
Artwork to be supplied in EPS, AI, PDF, CDR format.
Please ensure all artwork is converted to curves/outlines before sending to ensure accuracy.

157-161 west road | westcliff-on-sea | essex | ss0 9dh

flat cut letters



Terms and conditions apply. Prices subject to change without prior notice. E&OE.

ASI invests in digital print for trade buyers

Arrow Storm Ink opened its doors in February 2008. The owner, Alan Gunter, has 17 years experience in the sign and digital print industry and having built up an extensive knowledge base over this time now feels that his fledgling company, Arrow Storm Ink (ASI) and specifically ASI Trade Print, has the hardware, software and expertise to help anyone who is in the market for digital print.

Through experience in the industry, ASI has noticed that there is a huge demand for high quality, affordable prints for trade customers that can be delivered quickly and without hassle. It is for this reason they have purchased a 1604 Value Jet alongside a Pharos plotter with OposX print to cut software.

The 1.6 m wide Value Jet 1604 combines the environmental advantages of eco-friendly inks with the durability of full solvents.

The Value Jet uses a combination of the latest Epson "wide" print head technology and I2 Intelligent Interweave fast-drying, low-odour and economic Eco Ultra inks. This results in sparkling colours, high detail and the ability to print directly onto a wide range of low-cost, uncoated and coated materials. The Value Jet is easy to operate and maintain, weaving together affordability, quality & speed.

The company's overall aim is to supply digital trade print on any number of roll substrates to trade buyers. As an office based operation, they have no means to produce signage and indeed have no interest in doing so.

ASI Canvas Print also offers a trade canvas print service, taking the images supplied by customers and printing them on to 100% cotton canvas, then mounting them on to wooden stretcher frames, professionally finished with paper tape and hanging wire.

All of their services and products are specifically aimed at the trade buyer, which means keeping the costs down and the quality high. They also offer a 24 hr turn around service.

ASI trade print also have a T-Jet direct to garment printer, with which they can print any digital image direct to clothing. The T-jet has the capability of printing white as a base/prime layer first, allowing them to print white onto black.

Finally, they guarantee that you will not find a like for like quote cheaper anywhere, and if you do, they will beat it.

For further information visit www.arrowstormink.co.uk

part of the
**Arrow
Storm
Ink**
Group

asi Specialist Print Solutions

Dye sublimation 'goes large' at RA Smart

RA Smart (CAD & Machinery) have installed the first Mimaki JV5 320cm super wide printer in the UK at Image Fabrication in Crayford, Kent and only the second in Europe. The printer will be used for the production of high quality printed textiles for a range of applications including theatrical backdrops.

Peter Baker of Image Fabrication explains: "This investment will offer a new dimension to our production facility allowing us to create extremely high quality prints up to 320cm wide onto a

wide variety of textile without the need for stitching panels together." Magnus Mighall from RA Smart continues: "Having sold several JV5 160cm machines for both dye sublimation and direct to textile applications throughout the UK, it is really exciting to see the latest generation of Mimaki super wide machines capable of printing at remarkable quality up to 320cm wide."

Further details from websites www.rasmart.co.uk and www.imagefabrication.co.uk



Peter Barker and Magnus Mighall with their new Mimaki JV5.



The new website that caters for all your sign fitting needs

SUPPLIERS TO THE TRADE
FOR MORE THAN 70 YEARS



BEST PRICES

QUALITY PRODUCTS

NEXT DAY DELIVERY

FREEPHONE:
0800 032 7383

BUY ON-LINE: 
www.e-signfittings.co.uk

RECEIVE A FREE:
Comprehensive Catalogue



A versatile high resolution printer for durable graphics

- Durable indoor and outdoor prints on coated & uncoated substrates up to 1625mm (63.97") wide
- Impeccable print quality every time with Mutoh new i² technology, even with the most difficult images
- Rapid return on investment thanks to versatile performance and attractive price
- Easy to use and compact, with Eco-Solvent Ultra inks for problem-free printing in normal environments

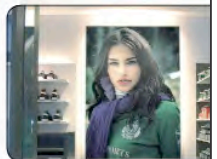

MUTOH

ArtSystems
knowledge | service | solutions

tel: 0870 224 3612
www.artsystems.co.uk/value.asp



William Smith helps CBS train attention on South Shields market

Scotchprint train graphics supplied by William Smith were part of a successful campaign devised by CBS Outdoor for South Tyneside Council in order to boost visitor numbers to South Shields market.

Explains CBS Outdoor's Account Executive, Andy Futcher, "This six month campaign was designed to encourage residents across Tyne & Wear to visit South Shields Market. As part of the total package, the train graphics were used together with other outdoor formats, including bus advertising and posters. Shops surrounding the market were also invited to place advertising inside the train."

The train was partly wrapped with a montage (27m long x 1.69m wide) showing the different types of items available at the market. It was printed using 3M™ Scotchprint™ graphics providing a five year outdoor warranted performance life against UV light fade, peeling, shrinking and cracking.

The lower half of the train featured logos and opening times, supplied as cut graphics. These were produced using 3M Scotchcal 100 Series film, giving a 10 year outdoor warranty.

"The overall campaign was targeted to all age groups, with the concept designed to highlight the variety of product offerings available at the market and to emphasise the size and scale too," concludes Andy Futcher.

"William Smith, who was specified for this work by our client, made the entire process easy from receipt of artwork to delivery of the graphics," adds CBS Outdoor Project Manager, Louise Hall. "Although I have only worked with the company on a couple of occasions, I have always found their service to be quick and efficient."

For further information contact William Smith on 01833 694707 or visit www.williamsmith.co.uk



Train graphics produced using 3M™ Scotchprint™.

Call us for...



Established for over 18 years • Fast, Friendly Service • Proven Systems • Full Support

Roland

Succeeding together

THE LATEST GENERATION PRINT & CUT SYSTEMS FROM ROLAND WILL TAKE YOUR BUSINESS TO A NEW LEVEL.

WE CAN OFFER EVERYTHING FROM 750MM WIDE TO 2.4 METRES WIDE. WE ALSO OFFER ATTRACTIVE TRADE-INS AND FINANCE PACKAGES.

PLEASE CALL US FOR THE BEST PRICES IN THE BUSINESS.



Tel: 0191 386 5222



Tel: 0191 386 5222

www.lsu.co.uk

REMEMBER! We also supply a full range of systems for:
VINYL CUTTING DIGITAL PRINTING LABELLING ENGRAVING LAMINATING SECURITY I.D.
For independent friendly advice and the best prices, call LSU today.

Impact Vehicle Library - New 2008 Edition



THE MOST COMPREHENSIVE VEHICLE RANGE AVAILABLE



New version 25 2008 Edition
The ONLY UK dedicated Vehicle Outline Library
Vans, Trucks, Buses, Cars, 4x4's Taxi cabs + more

The leading Vehicle Library since 1995

Free updates available on request for 12 months

Compatible with all leading design software

Supplied in full and 5% scale

DVD contains **Ai, CDL, EPS and PLT** formats

Fully illustrated 268 page reference manual



Visit our web site www.impactgs.co.uk
for **FREE** sample downloads & special offers

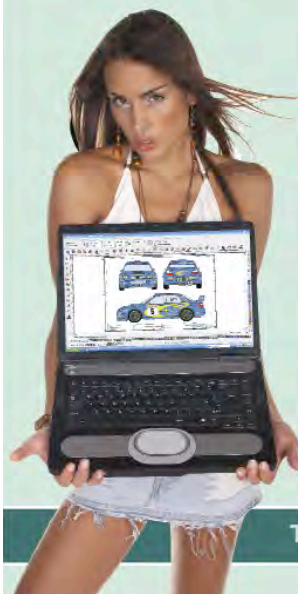

impact

graphic solutions

Tel: 0845 470 20 20 Fax: 0845 470 20 30 Email: info@impactgs.co.uk

Sign 2000 goes Nationwide

Following months of planning, Portman Building Society merged with the Nationwide Building Society in August 2007. Over that Bank Holiday weekend, there was the task of re-branding the Portman name and corporate identity to that of the Nationwide.

Nationwide had as its project managers Mace – one of the world's most diverse management and construction companies with specialist project managers in the retail sector, particularly in high street banking.

Amongst many other things, Mace was tasked with appointing the architectural sign manufacturing and installation companies that would carry out the physical re-branding.

Gareth Curtis, Mace Project Manager, explains the criteria that they were seeking to match.

"The capability to do the job. Yes, price was important but no more important than other factors such as being capable of providing a quality product; of not being overstretched by what would be a demanding task; of being able to work in partnership with other contracting specialists; and being able to deliver on time."

The selection process involved interested parties making a presentation that set how they would approach the project and providing references to other similarly logistically challenging projects.

Sign 2000, of Paddock Wood, Kent, successfully met these criteria and was awarded the contract for the South East of England area involving 32 locations.

Working closely with Mace, Sign 2000 surveyed each of the sites and produced drawings utilising CAD equipment that superimposed suggested designs on digital images of the existing properties. They confirmed quotations and provided assessments of any supporting works required. Following approval, manufacturing was commenced.

Those sites that were to be re-branded had to be completed prior to the launch date. Over a period of ten weeks Sign 2000 designed, manufactured and installed the new Nationwide identity at these Portman locations, but overlaid the new signage with temporary banners featuring the Portman name. In this way, the unveiling of the new Nationwide branding could be achieved simultaneously over the Bank Holiday weekend.

As these sites were unveiled, all internal branding was changed to reflect the change to Nationwide. In addition, all sites that had been closed, had all external signage removed and shop fronts neutralised.

The Nationwide signage was constructed from an internally illuminated fabricated aluminium fascia and projecting sign-boxes with coloured acrylic panels being laser cut and inlaid flush with a highly polished stainless steel perimeter frame.

Illuminated and non-illuminated individual letters were fabricated from satin stainless steel. Externally illuminated double sided traditional projecting signs were installed.

Although working to a tight schedule Sign 2000 achieved the objectives of delivering on time, to budget and providing the Nationwide with a quality result.

For further information call Sign 2000 on 01892 834383 or visit www.sign2000.co.uk



One of 32 locations re-branded by Sign 2000.

Stand out from the crowd...

**DELIVERY
IN 24 HOURS**
on our most
popular products

WITH OUR EXTENSIVE RANGE OF QUALITY FRAMES, SIGN HOLDERS AND STANDS



A Boards



Freestanders



Menu Boards

Locking Poster Frames



Snap Frames



Illuminated Columns



Totem Displays

Poster Grippers

**Over 300 great trade products
in our Trade Buyers Guide**



MANUFACTURERS OF QUALITY DISPLAY PRODUCTS

CALL US NOW ON: +44 (0)845 130 8091

Fax: +44 (0)845 130 8092 Email: trade@ukpos.com www.ukpos.com/trade
UK Trade Displays, Emery Court, The Embankment, Heaton Mersey, Stockport SK4 3GL

UK Trade Displays is a Division of UK Point of Sale Group Ltd



TRADE DISPLAYS

Speedy vehicle graphics from Fastsigns

Staff at FASTSIGNS® Kingston have been busy celebrating the speedy completion of a full set of colour vehicle graphics for American road rally and Gumball Rally hero Alexander Roy.



The team at Fastsigns, which is based on Ewell Road in Kingston, were called upon by Alex and his master driver and co-pilot Michael Ross, to rebrand a hired rally car at the last minute, as their own vehicle was trapped on a freighter heading for Rotterdam.

World-famous rally driver Alex has won an Xtreme Rallysport trophy seven times and Gumball 3000 trophies three years in a row. He needed the rebranded car urgently for the launch of his new book 'The Driver', in Park Lane, Mayfair which covers his life as a rally driver and his dangerous pursuit of speed.

Alex said "We were in a real fix because we needed my car for the book launch, but instead of being in London it was on its way to the Netherlands! This was a very important occasion for me and had been arranged for months. I was really worried but Fastsigns were great. We needed a really fast turnaround and they delivered a fantastic looking car right on time. Even I wouldn't have known the difference!"

Fastsigns specialises in signage and graphics products including banners, vehicle graphics and safety and identification signs. This project involved creating and wrapping the graphics on the BMW M5 series car in just 24 hours to fit in with the timescale of the book launch.

"We were really pleased that Alex and Michael asked us to help with this unusual task," said Mark Phelps, owner of Fastsigns Kingston. "We have an excellent team of experts who are able to react to any job and will do their very best to meet any deadline. This was a fun project which caused quite a stir in the local community and attracted a lot of attention from passing traffic, both by foot and car."

Fastsigns Kingston can be contacted on 0208 390 8855, or kingston@fastsigns.co.uk



FASTSIGNS pulled out all the stops to complete the BMW graphics within 24 hours.

LAMPSHADE PVC IS ILLUMINATING MEDIA FOR PRINTERS

Essex based Martin Dannel & Co Ltd, have introduced their rigid print media to the market after successful & extensive trialling. Originally designed for use in the decorative lighting industry for its ability to light well, its application as print media has proved an immediate success.

Available at 150cm wide & in two thicknesses 280 & 390 micron, this economical substrate shows many advantages. MD media has been specially engineered to give a solid vibrant print. It is strong, UV stable, flame retardant, anti-static & ideally suited for exhibition, outdoor use & numerous point of sales applications where rigid & stable substrates are required. The PVC surface has been specially calendared to give very even profile, ideally suited to print.



it extensively for outdoor posters removing the need for expensive encapsulation with the additional benefit of not wrinkling or cockling suffered by paper prints.

One groundbreaking feature is that Martin Dannel can laminate textile or decorative papers to the PVC to give an interesting, stylish & attractive look to the back of the printed product. It makes the product amazingly tactile & is an in-house process that is unique to this family run company. This level of innovation & quality is combined with the friendly & reliable service for which Martin Dannel are well known. Their print media has been on test with several companies for over a year now & has met with excellent results as illustrated in the testimonial below:

"The Dannel 300gsm and 400gsm plastic material has been an extremely useful product for us we have a Vutek Q52000 UV Flatbed printer which prints and adheres beautifully onto this particular product - we use

Martin Dannel have provided an exceptional service particularly in emergencies and consistently supply on time with a pleasant and helpful sales team."

Kim Konstantinovic, Kamset Digital

For more info: enquiries@martin-dannel.co.uk or Call David or Jamie: 01992 700311

WHY PAY PREMIUM PRICES FOR BRANDED PRODUCT?

Multi purpose rigid PVC from only £1.65 per mtr

MD Rigid PVC is a general purpose 290 micron film that offers outstanding quality and exceptional value for money.

Suitable for Digital Printing & General Signage
Posters, Column Wraps, Light Boxes,
A-Boards, Pull Up Displays



CALL FOR A FREE SAMPLE
Tel: 01992 700311

Martin Dannel & Co Ltd, MD House, Abbeymead Ind Park, Brooker Rd, Waltham Abbey, Essex, EN9 1HU
Tel: 01992 700311 Fax: 01992 769521 E-mail: enquiries@martin-dannel.co.uk www.martin-dannel.co.uk

Corby Nameplates

UNIQUE ETCHED PRODUCTS FOR THE SIGN INDUSTRY

Call for a FREE
sample pack today



Architectural signage
Nameplates
Metal business & membership cards
Event bracelets and invitations
Namebadges

Tel : 01536 266 288
WWW.CORBYNAMEPATES.CO.UK

Summer breeze!



Time for your clients to venture outdoors with their marketing message using the Voyager II or TopSail banner displays.

Indoors or outdoors, the TopSail stands tall and delivers the marketing message over a large graphic area (3x1m). Portable and lightweight (15.1kg net weight), it packs into two carry bags for storage or transport to another event. TopSail is easy to erect as the telescopic pole rises in stages to a maximum height of 5.4m.

The 2m tall Voyager II is another great way to promote your client's company outdoors.

Voyager II has a unique graphic connector rail to the base unit. This gives the banner graphic movement akin to a sail, thereby reducing the risk of being blown over in windy conditions. Base units on both system can be water-filled for extra stability.

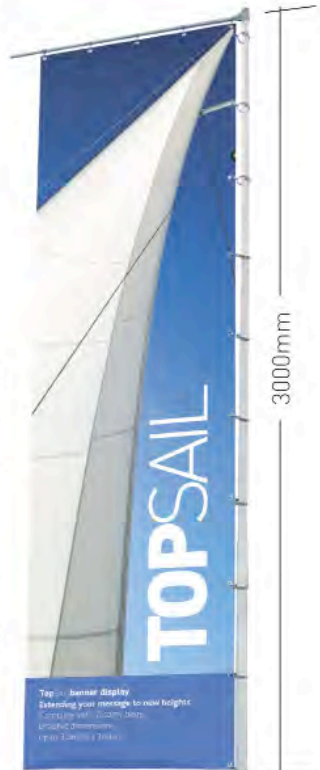

3000mm

1000mm



2000mm

700mm

Promotional price
£99
per system including carry bags (excludes graphic)

Promotional price
£59
per system including carry bag (excludes graphic)

PROMOTIONAL OFFER
ENDS 31 AUGUST 2008
Intrade prices subject to VAT and carriage

Visit eurostand display online today for more high quality great value display products.

 eurostand display

www.eurostanddisplay.com
Tel: 01277 350925

Creative partnership completes 40 site, nationwide contract for US company



A strategic partnership between two South Yorkshire companies has completed a four-month nationwide contract for US based Kaplan Financial Professional that involved the design and installation of over 3,000 different signs at 40 different sites.

Barnsley based North Star Signs and Sheffield's creative marketing house Blue Strawberry Elephant joined forces to tender for the contract in August 2006. They started work on the project in mid October with the final sign being installed in the early part of 2008.

Kaplan Financial Professional is a leading provider of professional qualifications and business training in the UK and Asia Pacific. Kaplan Financial Professional is part of Kaplan, Inc., a leading international provider of educational and career services that is subsidiary of The Washington Post Company.

MD of North Star Signs, Gary Chester is delighted with the way his team responded to the brief.

"We needed to produce straight signs and sign trays, post and wall fixed external signs with additional requirements such as etch effect window panels. We also had to create additional vinyl lettering to refurbish existing signs. The next stage was to devise an installation roll-out plan for over 3,000 signs in 40 locations from Glasgow to Southampton, Norwich to Manchester, the Welsh valleys and six locations in London, which needed a thousand signs between them.

To print and install all the signs inside four months was a big ask but our team responded superbly and the customer is really happy with the results," said Gary Chester.

Blue Strawberry Elephant Partner, Dave Atkin, says winning the contract was a major achievement for the partnership, even though they had done work for Kaplan Professional in the past.

"We had to re-produce the American parent company's new branding in a way that was sympathetic to the British locations. We worked with the client at Head Office and on location to collate information on the varying requirements. We produced artwork for over 300 different sizes and 800 different wordings of directional, identification, general notices and legally required signs. The logistics included arranging installation dates and individual site requirements for each location. It was a big contract for both partners to take on and we are really chuffed it has gone so well," said Dave Atkin.

Once Kaplan Professional had approved the designs, North Star Signs manufactured every sign to exacting standards using a range of materials including Stainless Steel, Perspex and Dibond.

Every year Kaplan provides training and development course to over 30,000 thousand professionals looking to develop their careers including ACCA, AAT and CIMA qualifications.

For further information contact North Star Signs on 01226 288 228 or visit www.northstarsigns.co.uk or Blue Strawberry Elephant on 0114 278 7000 or visit www.bluestrawberrylephant.co.uk

SOLID MOULDED RESIN LETTERS

LARGE BEVEL



'V' SECTION



STEPED



SMALL BEVEL



FLAT FACE



HALF ROUND



SOLID MOULDED RESIN letters are economically produced having a variety of styles. With these options and a wide range of colour finishes including Silver, Bronze or Gold it enables the right effect to be produced. All letters can be supplied with snap fix, grouting rod or brass locator fastenings and paper layout. A variety of standard patterns are available or we can produce special type styles.

**Check out our website
for the latest prices!!!**

**www.metalline-signs.co.uk
or ring 0117 955 5291**

- **COMMEMORATIVE PLAQUES**
- **COATS OF ARMS**
- **METAL LETTERS**



Unit 18 Barton Hill Trad Est
Barton Hill, Bristol BS5 9TE
Tel: 0117 955 5291
Fax: 0117 955 7518
www.metalline-signs.co.uk

Metalline signs

GRAPHTEC



NEW MODEL
Now includes, media basket, stand and ARMS free of charge

The latest model in Graphtec's high-end FC7000Mk2 Series has the same proven features as its big brothers, and is priced extremely favourably for a machine with all its capabilities. Perfect tracking over an enviable 15 metres and ease of use makes this 24 inch cutting plotter the ideal accompaniment to digital printing for the serious signmaker.

With typical Graphtec robustness and reliability the FC7000Mk2 cuts vinyl, window tint and screen printing films, sandblasting rubbers and other tough media with effortless ease and consistent accuracy.

Graphtec's unique Advanced Registration Mark Sensing (ARMS) system automatically compensates for more distortions than ever and prevents twisting or skewing of pre-printed data. ARMS works on four point axis alignment, instead of the usual two or three point alignment used by other systems, and the result is a noticeable improvement in cutting accuracy especially on longer length work

Graphtec GB Limited
Coed Aben Road, Wrexham Industrial Estate, Wrexham, LL13 9UH
Tel: 01978 666700 Fax: 01978 666710
www.graphtecgb.com

Dream start for Astley Signs (Southern)

Astley Sign's most recent development, aimed at strengthening their geographical coverage, is a Sales and Project Office situated in Milton Keynes. Their initial hard work is starting to pay off after securing a prestigious contract with John Lewis Plc to supply and install two sets of five metre high 3D letters for their new £45 million, 650,000 sq ft (60,386 sq m) flagship automated distribution centre at Magna Park, Milton Keynes.

Jeff Watts, General Manager for Astley Signs (Southern Office), is delighted to have won this project as one of its first major contracts "To have this opportunity to work with The John Lewis Partnership and Simons Construction Limited on this important development was a dream start for our newly opened Sales & Project Office."

With such a positive beginning, Jeff is confident that Astley Signs can continue its steady expansion with a view to enhancing the team with further recruitment in the near future.

Over the past 80 years Astley Signs have become one of the most established names in the sign industry, renowned for their cutting edge design and innovative ideas. With headquarters in Gateshead, Astley Signs also have additional facilities in Glasgow and Leeds. Working together with their key strategic partners across Europe, Astley Signs are continually expanding and becoming a highly reputable international brand. Throughout its history, the company has earned the respect of some of the world's largest blue chip organisations including Hilton,

Sainsbury's, BP, Woolworths and Bentley, to name but a few.

What attributes to Astley's success is the time and great care they take in understanding their clients' needs and objectives together with the continued commitment in providing the highest levels of service and quality products. The Milton Keynes team embrace this Astley philosophy with its own experience and reputation.

For further information telephone 01908 547826 or visit www.astleysigns.com



The new John Lewis automated distribution centre at Milton Keynes.

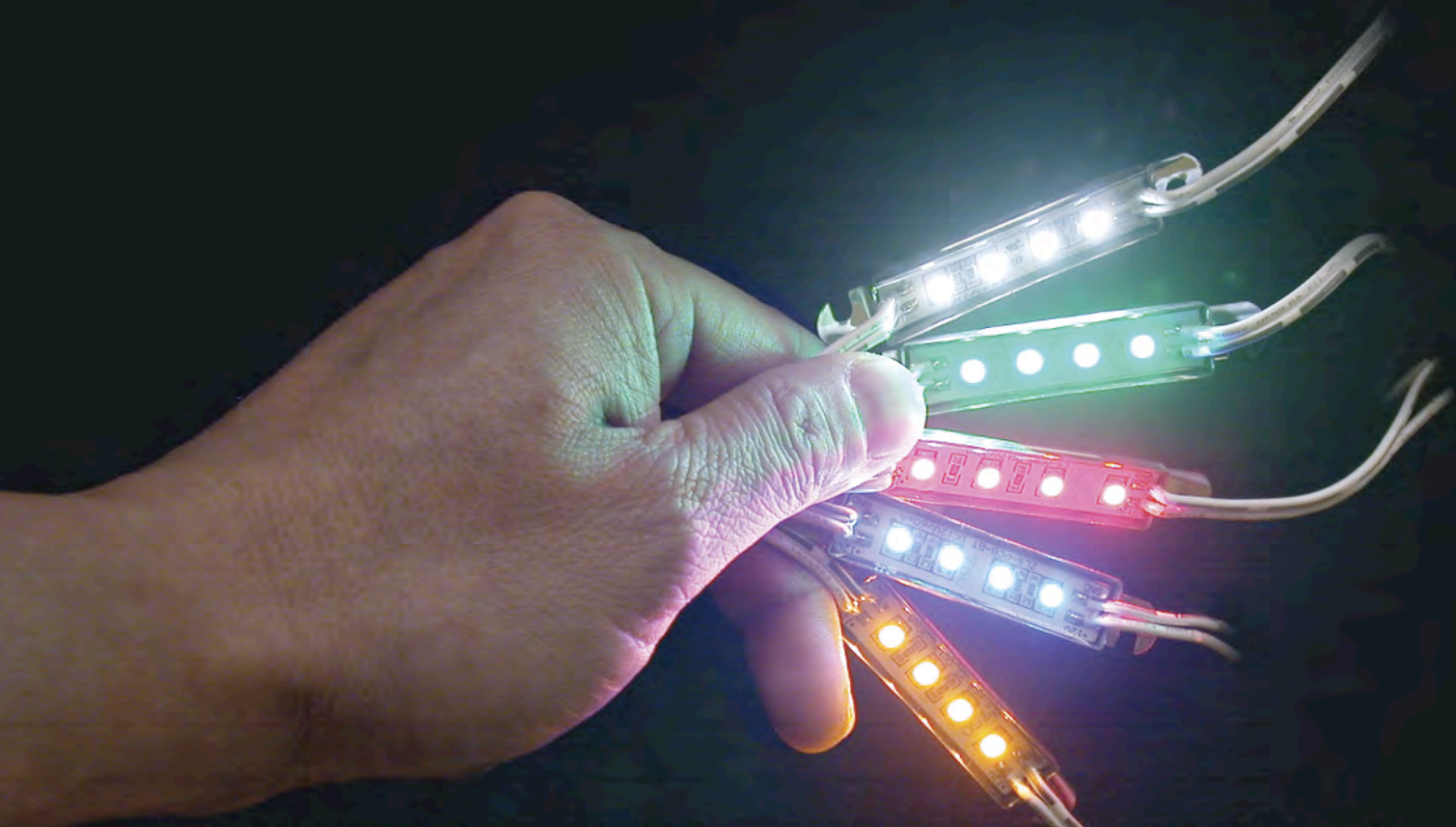

More sign makers than ever are changing to **Abacus LED** and it's easy to see why. **Abacus LED** doesn't just light brilliantly and smoothly, even for built up letters with returns as shallow as 5cm.

Thanks to its unique metal tray together with the resin encapsulation design, it eliminates overheating and achieves waterproof rating of IP68. Also with competitive prices you have no reason not to try it.

We're convinced it will convince you!

Modules, Power supplies, Flexible neon, Light ribbons / bars, RGB neon tube, Accessories

abacus
led **www.**
led
signs
and
lighting
.co.uk

FREE demo case
ask for details or
visit our website



Visit our online store at www.ledsignsandlighting.co.uk
For quotation or further information email: sales@ledsignsandlighting.co.uk
Tel: 0161 236 8828

Adbell wraps up South Yorkshire

Adbell Sign Systems has started work on a prestigious contract re-branding scores of vehicles for the South Yorkshire Passenger Transport Executive (SYPTE).

The project involves a complete re-brand, including livery design, production and installation, on buses, coaches, mini-coaches, trains and trams, for the individual transport companies that make up SYPTE.

Adbell has successfully completed many major re-branding projects and it was this experience that won the Harrogate based company the work, believes Jonathan Robson from adbell.

"We're a leader in designing and installing vehicle livery and have successfully wrapped a huge quantity of different vehicles for many clients. We're known for our quality and are extremely pleased to have been awarded this high profile contract and to be working in partnership with the SYPTE."

The brief from SYPTE was to create and develop an innovative livery design with a fresh and modern look that would work on all the vehicles involved. Each vehicle needed to be made more appealing to the general public and easily recognisable as a part of a brand. The re-branding is just one element in an ongoing strategy to improve bus services across South Yorkshire and to make bus travel more attractive to both existing and new bus users.

The first couple of design ideas adbell's creative team produced were well received; adbell won the contract and with just a few tweaks, the new look livery was given the go-ahead by SYPTE.

Simon Bell who heads up the design at adbell's explains: "We kept to the brief and using our experience and design flair we ensured that the final graphics would look good on all the differently shaped vehicles and remain looking good while they travel around all day, every day."

Avery 900 Series vinyl was chosen for the project because of its excellent conformity. The colour required was a special blue so it is delivered direct from Avery's headquarters in The Netherlands.

Vehicles are being re-branded in batches of a dozen or so at a time at adbell's Harrogate site. Currently, graphics for transport executives in Doncaster, Rotherham, Sheffield and Barnsley are being produced.

During the project, adbell has wrapped several coaches being used as community and school buses; one of which was recently featured at the Lifewise film set promoting school bus travel.



New design livery means all SYPTE vehicles are easily recognisable as one brand.

"The SYPTE contract is working out very well indeed. The customer is happy with what we've done and working on a set number of vehicles at a time means we can carry on providing our usual high standard of service to existing clients and also take on new work," says Jonathan.

On the back of the success of the SYPTE contract and to show off its talents, adbell wrapped a bus used on public service routes in and around Harrogate in its own colours and logo.

In addition to vehicle livery, adbell provides a comprehensive design, manufacture and installation service on a wide range of other sign work to customers throughout the UK.

Jonathan adds: "In an industry with such diversity it is imperative for us to be on top of our game in every aspect of the business. The market place is very competitive and we constantly strive to offer new ideas and give our clients that something extra. It is one thing to win business with great sales pitches and eye-catching designs but we always remember that it is just as important to back it up with the quality of products and service our clients receive."

For further details about adbell sign systems, go to www.adbellsigns.com or tel. 01423 885045.



This bus promotes adbell on its travels throughout the Harrogate region on public service routes.



adbell's contract involves wrapping a range of different vehicles, including mini-buses.

Aluminium and Stainless Steel direct from manufacture...



**BLACKBURNS
METALS LIMITED**

Blackburns Sign & Display materials...

- Pre-painted or Mill finish Aluminium Sheet / Extrusions
- Full range of Stainless Steel Sheet
- Full range of Sign Channels / Clips and Accessories
- Composite Sheet / Tray Manufacture
- Semi Fabricated Signs



Blackburns Metals are one of the largest UK manufacturers and stockists of Sign & Display Products specialising in component parts for the commercial and traffic sectors. With a comprehensive range of sign components together with 'kit' and 'semi fabrication' options, sign makers can choose between buying individual components such as aluminium painted sheet, rails or posts as separate items, or in kit form with bespoke fabrication to the customers finished requirements.

Contact Blackburns today to request our [Sign Product Guide](#) or further information on our Products and Services...

email: info@blackburnsmetals.com

tel. 01732 582 709

...Blackburns Metals your **reliable** stockist



Printing
Etch & Fill
Engraving
Panels
Precision
Fabrication
Overlays
Labels/Nameplates
Safety Signs
Brass, Aluminium & Stainless
Cut Out
Shapes & Lettering

With 50 years experience, Watsons has become leaders within the sign industry. We pride ourselves in supplying quality bespoke products at competitive trade prices.

- Best quality
- Fast turnaround
- Same day quotes
- Next day artwork approvals

Etching & Anodising





Introducing

SPECTRA® Speed Flex

Insight / Alumiflex Inc. Europe Patent # 0548691

Not just a pretty face, but a very sophisticated tensioning mechanism, Spectra Speed Flex is produced to the tightest tolerance possible to ensure our systems provide you, the customer, with a perfect job every time.

Speed Flex is part of the Alumiflex/Signcomp USA family, a worldwide network of trade suppliers all with matching systems protected by patents in all major countries, benefitting customers involved in pan-European contracts, while providing peace of mind that the system they are using has undergone certified wind-load testing. Very important, especially during the very windy weather, and bearing in mind insurers may not cover wind damage for systems which are not test compliant.

Bend It, Shape It, Any Way You Want It

An increasing number of flex face cases supplied by Insight are now customised by notching the extrusion as shown below, giving the outside shape of the case freedom from the standard rectangular format. This can take the form of simple radius corners, as shown above-middle, to large arcs (bottom-left), oval boxes, complicated large letter shapes, or even curved-back cases (bottom-right) to fit on to curved fascias.



Third Generation Flex Holders

Now secures a wide range of materials from 380 to 750 g. No preparation is required to the sign face, so no welded seams, no rods, no holes. Simply clip direct to the edge of the material with custom designed pliers.

Increased Tensioning

With its redesign, the tensioning channel of Speed Flex Integral now has the capability for even further tensioning of the face.



Fast, Silent Tensioning

Thanks to the new modifications, Speed Flex now accommodates the Alumiflex tensioning tool, for a more refined tensioning experience.

Available from the end of April 2008, Speed Flex Integral MkII is the first of the new MkII system, with all other variations to be upgraded during 2008.

New Spring-Loaded Cover Plate

Spring assists with opening and closing, allowing very quick and simple access, and holds lid steady when open eliminating the safety risk of having a 'loose' cover plate during maintenance.

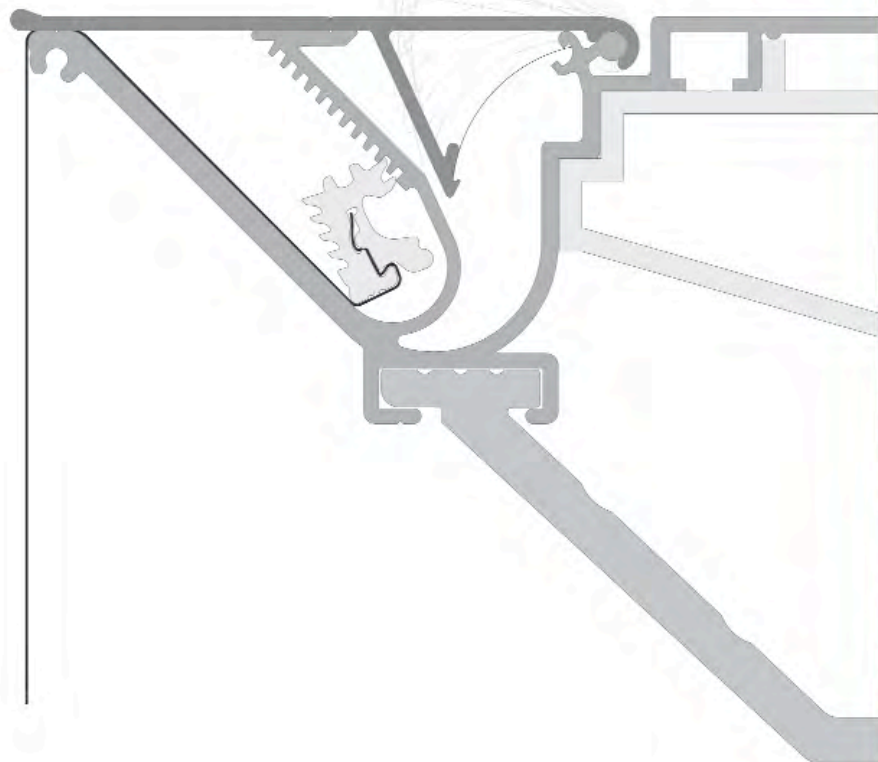

Insight Sign Systems provides a nationwide made to measure service, with cases made up to standard or bespoke shapes, powder coated to most RAL colours, supplied complete with high quality digital printed faces. The Speed Flex range has many variations, including hinged, retro-fit, and the unique Frontloader.

FAST FIX QUALITY LIGHTING

£10 PER FOOT*

**SUPPLIED READY TO INSTALL
(NO HIDDEN EXTRAS)**

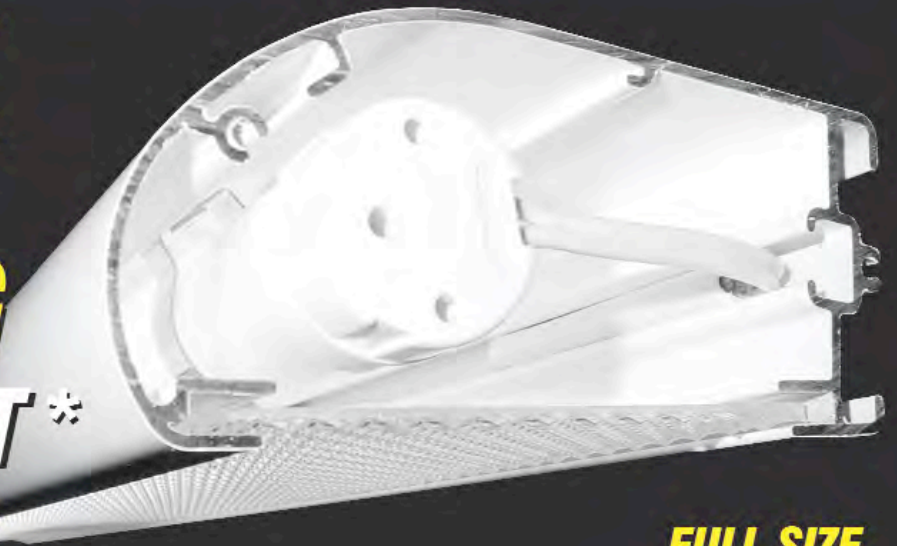

FULL SIZE

Highlight[®] BUDGET T5

Now you can purchase our small, sleek and very attractive T5 profile for £10 per foot*, offering the same high quality and ease of installation as standard T5 - the only difference being the control gear, which is standard LPF T8 rather than the expensive high output T5 gear. Output around 15% less.

* - Please note new lower price for T5 Budget in white. Units at 4' long and under are now £15 per foot for white and £18 per foot for black.

- High quality extruded aluminium profile, powder coated finish.
- Supplied and delivered made to measure within one to three working days (mainland U.K.).
- Fully made up, complete with all parts, including lamps, and fixing brackets (no hidden extras).
- Free delivery for mainland U.K. for orders over £200.00.
- Very fast installation, thanks to adjustable clip-on fit fixing brackets.

now also available in satin black, with reflectors, at £12.00 per foot!*

TERMS AND CONDITIONS

To obtain costs for in-between sizes, simply price to next foot up. For example, 16' 3" long Budget T5 would be priced at 17' 0", costing £187.00 + VAT.

Budget T5 is only available in white or black finish.

Delivery in two working days is only available for orders faxed in writing from account-holding clients by 9:30am. If you do not have an account, you can pay by credit card.

Delivery on orders under £200.00 will be charged at £15.00 + VAT.

No existing discounts or rebates will apply for this product. Discounts for orders over £2,000.00 may be available.

Budget T5 can illuminate sign depths up to 1,800mm. to any continuous length. Bracket size will vary.

Made-up units will be supplied in interlocking sections to a maximum length of 3,500mm.

Budget T5 is a downlighter only, IP rating IP65.

Tel. 0141 774 5990 • Fax. 0141 774 6653

www.insightsignsystems.com

MANUFACTURING: **Glasgow** STOCKHOLDING: **Gloucester**

INSIGHT[®]
SIGN SYSTEMS

Highlight BUDGET T5

EVERY ANGLE COVERED



Attractive, unobtrusive profile fits small areas above new or existing signs.



Also available in satin black finish, fitted with reflectors @ £12.00 per foot*.



Four sizes of fixing bracket are available, to suit signs up to 2,400 mm high. Brackets can slide to any horizontal position on the unit—essential when trying to catch high points on profile cladding.



Not all fixing surfaces are even, our brackets offer telescopic adjustment to compensate for this, unlike other 'fixed' brackets which would either require packing out, or cause stress on the fixings.

CAREFULLY DESIGNED PROFILE ELIMINATES NEED TO ANGLE LIGHT



The above photo shows Highlight in normal position (not angled). Illumination is even, and the unit blends into the background. Angling of the light is only required on sloping fascias.



The above photo shows Highlight angled inward, resulting in glare at the top, and dullness at the bottom. The profile also becomes highly noticeable.

TheMagicTouch has the WoW factor

At this year's Printwear & Promotions Excellence Awards Ceremony held in Birmingham TheMagicTouch were awarded "Technical Innovation 2008" with the introduction of the new WoW transfer paper. The company continues to develop, manufacture and distribute a range of coated papers compatible with most toner based colour copiers and printers.

WoW enables full colour images/designs/logos to be printed onto almost any garment or fabric regardless of colour or composition. The advantages of no cutting or weeding of designs, superb soft feel and fantastic washing durability confirms the recognition. WoW can be applied to Cotton, Polyester, Nylon, Denim, Leather and much more.

The new WoW was also recognised earlier this year having been awarded first prize for both "Best Transfer" and "Best Combination Print" categories in the Images Textile Awards, together with "Best Product 2007" by Corel Draw Pro Magazine.

TheMagicTouch confirm WoW transfer paper as the most significant development since the inception of garment digital transfer technology, confirming the long-term future of the image transfer business. The intellectual property of the process is protected by the European Patent No. EP 1 040936B1 and in the United States Patent No. US 6 425 324 B1.

TheMagicTouch image transfer process has become an integral part of the sign and garment decoration industry worldwide, assisting companies to add value to existing clients and helping to develop and create new ones. TheMagicTouch process is quick, clean and inexpensive.

This year has seen the introduction of new A4/A3 toner based printers with enhanced firmware and drivers for full compatibility with all TMT papers. The printers also perform on normal plain paper, at 20 colour copies per minute and are available for just a few hundred pounds.

Sign companies need to adopt TheMagicTouch as "The New Salesperson" enabling personalised product samples to be given to customers for evaluation. Consider the response from existing and new customers when receiving a "free" quality garment/product with their logo/artwork emblazoned upon it! This cost effective marketing is very rewarding and assists improving customer relations and increasing the potential business conducted.

TheMagicTouch offer sales and marketing support with a comprehensive range of image transfer solutions including all aspects of toner transfer, sublimation, consumables, heat press equipment, plotters/cutters with the relevant stocks of printable items.

For further information visit www.themagictouch.co.uk



Fastsigns present Mark with top award

Not content with simply doubling his business interests, Kingston upon Thames businessman Mark Phelps, owner of the town's Fastsigns signage and graphics franchise, has also scooped a top award for impressive sales results in 2007.

Mark, who recently acquired a second Fastsigns operation at nearby Staines, accepted his prestigious Sales Improvement Award at the company's 11th annual franchisee meeting, which was attended by senior management both from the UK and its corporate headquarters in Dallas, Texas, USA.

"I was thrilled that winning the award came so soon after taking over the business in Staines," he explained. "It's certainly been a very busy and very challenging year, but recognition like this is a real compliment to everyone who has worked so hard."

Buying the FASTSIGNS centre in Staines represented an important step in Mark's business development plan – and also helped him achieve a personal ambition.



"I always wanted to operate a second location, so when I got the chance to purchase the Staines franchise, I felt I had to seize the opportunity with both hands!" explained Mark.

"Although both locations operate independently on a day-to-day basis, a major benefit of owning two centres is that one is able to support the other if required, for example in terms of production or sales support for a big or urgent job."

Since taking over the Kingston operation in 2005, and more recently the Staines business, Mark is delighted that business has increased significantly. Both Fastsigns Kingston and Fastsigns Staines are specialists in signage and graphics products including exhibition displays and corporate and retail signage. Leading clients include Legoland at Windsor, the Chessington and Thorpe Park theme parks, and the new Heart Shopping Centre development in Walton on Thames.

Fastsigns Kingston can be contacted on 0208 390 8855, or kingston@fastsigns.co.uk. The contact number for Fastsigns Staines is 01784 455888, or by email on staines@fastsigns.co.uk

Edward Mathias & Company

Sign making solutions since 1987

**Inks
Blades
Repairs
Plotters
Printers
Training
Software
Installation
Laminators
Maintenance
Smart Knives
Router Cutters**



Smartknife

**Do you still think
we only make blades ?**

Tel: 0151 728 7221 Fax: 0151 728 8851

Email: info@blades.uk.com

sign&digital UK

Sign & Digital UK leads the way

Visitors and exhibitors at Sign & Digital UK, Screenprint and Digital Signage Showcase, the annual exhibition for the UK's sign, graphics and visual communication industry, reported a major success as the show returned to the NEC, Birmingham on 22 – 24th April 2008.

With a third of the 2009 show already booked onsite at this year's event, and many exhibitors increasing the size of their stands, Sign & Digital UK 2009 promises to be a big hit.

Newly re-branded as Sign & Digital UK, the 2008 show highlighted the equal importance of all the sign and digital technologies, modern and traditional. The re-branding enhances the position of the show as a unique, all encompassing event that once again attracted thousands of visitors.

Rudi Blackett, event director, comments: "The feedback from suppliers and visitors across the industry has been extremely positive from this year's Sign & Digital UK. Exhibitors reported the biggest number of quality enquiries ever generated, and as the show celebrated its 21st birthday this year, the vital role Sign & Digital UK plays within the industry continues to grow ever more apparent."

This year's show attracted many big name visitors from companies such as Augustus Martin, BBC, Bezier, British Airways, C3 Imaging, Debenhams, Gardners, Hawes Signs, Merson Signs, Monster Digital, Pontins, Service Graphics, Sign A Rama, Signs Express and Tesco, to name but a few.

Adrian White, manager, Chelmsford Safety Supplies: "As a first time visitor to the show, I must say that I am thoroughly impressed. A second visit next year is guaranteed!"

Dave Rowland, manager, The Sign Shop: "I have been visiting the show for about four years now, and am always pleased with the range of suppliers exhibiting. My specific interest is in Digital UV Flatbed printing, which the show has been good for.



We have some great leads and I hope to source some good suppliers following the show."

Meanwhile, some of the industry's biggest suppliers to the market reported robust trading on the show floor.

Brett Newman from Roland DG comments: "Each year the show continues to be a success for Roland, attracting exactly the type of audience we need to be speaking with. Within the first twenty minutes of the first day we had made a significant sale. This clearly demonstrates why the show is such an important event for Roland, and is the reason that we come back year on year."

Robert Horne Group's Terry Cattle says: "We've definitely seen more people on the stand this year and taken more leads compared to previous years, in fact, the amount of sales leads have doubled. We've also had good hardware sales, having sold around 20 machines from the stand."

As well as a host of exhibitors, visitors to Sign & Digital UK also had access to a wealth of free information through the Corel Workshop, Adobe Theatre, Walsall College Theatre and the newly launched Sign & Digital UK Theatre. The seminar programmes offered visitors the chance to hear a variety of industry experts discussing some of the most relevant issues facing the sector.

Sign & Digital UK, Screenprint and Digital Signage Showcase will return to the NEC, Birmingham on 28th - 30th April 2009.

Planning for the 2009 show is well underway to ensure the show continues to grow year on year, and remain the most innovative and informative show within the industry.

For further information visit www.signanddigitaluk.com. Or contact Alan Caddick, Faversham House Group, Tel: 020 8651 7074, alan.caddick@fav-house.com or visit www.signanddigitaluk.com



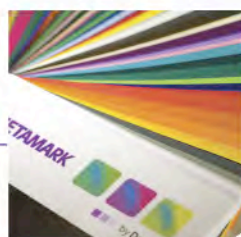
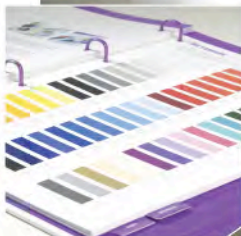

THE DIFFERENCE IS METAMARK

More businesses than ever are changing to Metamark and it's easy to see why.

Metamark doesn't just make great materials - Metamark makes sure they're available too. Digital media, SignVinyl and specialities - one call gets you what you need, when you need it, and value you won't beat anywhere.

Call, click or fax for your Metamark swatches, product guides and material selectors. Ask us about samples too.



METAMARK

by Design™

Telephone **0845 345 5645** Free Fax **0800 328 3495**
Email sales@metamark.co.uk
www.metamark.co.uk

Signing up to LED technology

With 25 years experience, Polycomp Electronic Display Systems are leaders in the manufacturing and installation of LED (Light Emitting Diode) technology.

Polycomp boasts a wealth of LED knowledge coupled with a vastly experienced team based in Hampshire. They have succeeded in innovative and cutting edge design on projects all over the world.

With a client base that are becoming increasingly more interested in cost effective signage which is ethical and environmentally friendly, LED is leading the way. Put simply, signage that requires a changeable message is an extremely effective tool for advertisers and LED is the answer. It is more energy efficient, uses less power but is also capable of being twice as bright whilst offering an amazing palette of colours.

Managing Director of Polycomp, Jeremy Harwood explains "No project is too big,

too small or too technical. We can produce a solution for all kinds of signage and have installed some intricate and difficult designs often with challenging timescales."

Some of Polycomp's projects include work undertaken for the BBC Wood Lane – the 18m display which is used for ground breaking news and high profile events,



Tom's Place – the internal signage in chef Tom Aiken's new eco-friendly Chelsea restaurant, the Countdown Clock at The Docklands to mark the start of the 2012 London Olympics and the Countdown Clock at St Pancras Station to mark the start of the Eurostar service. Other projects are the display on Reuters building overlooking the Millennium Dome, scoreboards signs at Fulham, Aston Villa Football Clubs and Murrayfield amongst many major sporting arenas. Bloomberg offices throughout Europe have installed displays showing up-to-the-minute prices and across India and Polycomp has also installed displays in rail stations as well as recent installations for London Underground.

For further information tel: 01264 400800 or visit www.polycomp.co.uk



Internal menu signage, countdown clocks and scoreboards from Polycomp Electronic Display Systems.

TRAY SIGNS FROM



We offer bespoke
trays made from
aluminium composite

(Dibond or Reynobond)

Aluminium & Stainless
Steel supplied plain or
with routed graphics
backed up or inlaid.

With or without
illumination.

Fixing angles supplied
if required.

the choice is yours!

Kings
KINGS PLASTICS LTD.

**THE
SIGNBUILD
CENTRE**

KINGSOWN HOUSE, UNITY STREET,
ST. PHILIPS, BRISTOL. BS2 0HN
Website: www.kingsplastics.co.uk

TELEPHONE 0117 922 6382
FAX 0117 925 1159
email: signbuild@kingsplastics.co.uk

Penloc Adhesive For Signmaking

Bond most Metals,
Plastics, Dibond,
Wood & Glass in any
combination.

**Channel to Dibond
Built Up Letters
Monoliths
Sign Trays
Locators**



**Quick
Clean
Easy
High Strength**



www.eurobond-adhesives.co.uk
sales@eurobond-adhesives.co.uk

Bonham Drive
Eurolink Ind. Estate
Sittingbourne
Kent ME10 3RY
Tel 01795 427888

Eurobond
ADHESIVES LIMITED



JF Series
Mimaki
JF-1610/JF-1631
Grand format UV Curing Printer

Mimaki JF1631 UV Flatbed

Book
your exclusive
appointment
to view the new
JF Printer at



Showrooms

- 1.6 x 3.1 metre wide flatbed
- Resolution of upto 1200x1200 dpi
- Includes White & Gloss Varnish!
- Prints on upto 50mm thickness
- Extremely high quality printer offering true POS capabilities!
- Prices from £76k

Cutting edge!



Mimaki Finecut System

- 610mm wide cutter
- 2 years on-site warranty as standard
- Includes finecut software for Mac or PC
- USB connection
- Die cut function for stickers & labels
- Easy to use
- 2 Models available - SL & SR*

*SR Model includes automated optical registration

From just £795 +vat

Canon IPF Range of Printers

- 17", 24", 44" & 60" Versions Available
- New 12 colour HIGH SPEED Pigment printer
- Ideal for Fine Art or Canvas prints
- Resolution of up to 2400 x 1200 dpi
- Trade-in offers available
- Call now for pricing or to book your demonstration!



Vinyl Cutting Systems

From only
£995 +vat
including stand



Visit: www.graphicdiscount.co.uk to find out more!

Consumable Catalogue
Competitive Genuine Ink Prices!

Call for your Free copy!



Mimaki NEW JV33

Solvent Printer

- 30% Faster than the JV3
- Available in widths of 54" & 60"
- Print & Cut bundles available
- Includes Rasterlink PRO RIP as standard
- Take-up Unit included
- 2 Years on-site warranty as standard

Prices From
£13,995+vat



GRANTHAM'S

GRAPHIC TECHNOLOGY

Roland SOLJET

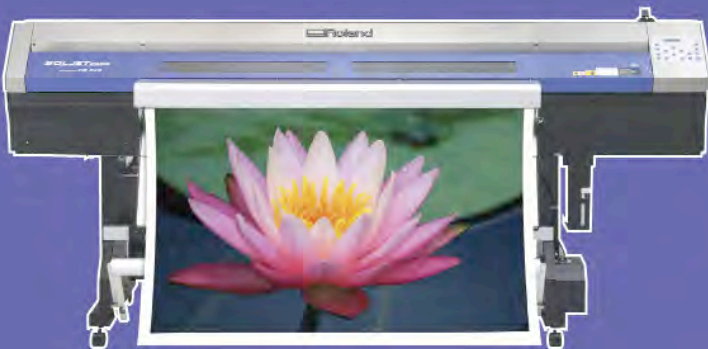

- Available in 54" Print & Cut + 64" & 74" print only models
- Ecosolvent ink available in 220ml or 440ml Cartridges
- High Speed Ecosolvent Solution
- Includes Versaworks RIP FOC
- All solutions include install & Training
- Call for BEST prices

● All Roland Solutions include 2 days FREE Training at Walsall College

Call now for further information or to arrange a demonstration

t: 0845 230 5520 • f: 0870 350 5521

e: sales@granthams.co.uk • w: www.graphicdiscount.co.uk



Pacer upgrades to increase productivity

Since the mid-1980s, Pacer Systems has been supplying British designed and built CNC routing and engraving systems to the sign industry. With more than 1,000 machines now installed worldwide, the company continues to extend the boundaries of technological possibilities.

Systems manufactured by Pacer Systems cover all routing and engraving requirements, from the entry-level Cadet series with a bed size of 600 x 700mm through to the large-format heavy-duty machines with a bed size of three x two metres. In addition to these standard machines, the company can supply customised solutions to meet special requirements.

One of this company's most popular CNC routing and engraving systems is the K series that has recently been upgraded with a number of important new design features. Apart from adding strength and increased rigidity to these machines, Pacer has introduced a raft of additional features as standard. A zoned vacuum bed enhances the hold-down capabilities of material during routing or engraving, while the fully enclosed ball screw drives have increased cutting accuracy and repeatability. New features that will help reduce production time include an automatic tool set sensor. Further options such as automatic tool change, a spray mister system for use when cutting metal and a higher-rated RPM spindle are also available.

Pacer has also introduced a Rapid Electronic Support facility for all of its machines. This will provide technical assistance, on-board diagnostics and one-to-one training at any remote location in the world. Another important machine upgrade is the new 3D Laser Scanner Option that allows reverse engineering of complex 3D shapes.



The new K series from Pacer comes with many additional features as standard.

The latest Version 3 of Pacer's XMC-E machine control software builds on the functionality and ease of use of the previous offering but now includes a new material processing feature to reduce wastage and a new cost estimating tool to take the 'educated guesswork' element out of job pricing.

For further information, visit www.pacersys.co.uk

New PanelMaster router designed specifically for nested-based manufacturing

Techno is proud to introduce the PanelMaster Pro Series CNC Router. Designed specifically to meet the demands of nested-based manufacturing, the PanelMaster Pro is constructed of large heavy tubing that is welded and stress-relieved, the perfect foundation for the company's precision drive system.

Comprised of precision ball screw drives on all three axes, THK rails and bearings, high-speed closed-loop servomotor and drives, the PanelMaster Pro's precision drive system ensures minimal maintenance, machine longevity and superior machine performance.

A unique new feature of the PanelMaster Pro Series is the double beam assembly, which includes four linear rails, 12 linear bearings, double ball nut, joined together with a welded reinforced cross beam assembly. This engineered assembly optimises the machines performance resulting in overall superior cut quality.

All models come equipped with a 10HP Automatic Tool Change Spindle with seven position tool station, six zone vacuum table, and 10HP Rotary Vane Vacuum Pump.

Additionally, this machine package includes a new computer system that has Techno's Windows PC-based CNC Interface installed and configured before the machine is shipped.



PanelMaster's new Pro Series, designed specifically for nest-based manufacturing.

The new PanelMaster Pro series follows Techno's traditional easy-to-use and operate philosophy so that customers can be up and running as quickly as possible, getting a return of their investment.

For further information tel. +1 800 819 3366 or www.technocnc.com

Bespoke routing solutions for super wide-format production

Leading manufacturer of advanced CNC routing solutions, XYZ Automation (UK) has taken the lead in the development of bespoke routing solutions for larger-format production requirements.

For most large-format applications, XYZ can provide a wide range of standard routers. These are recognised as being among the most technically advanced and competitively priced machines currently available. However, there are now an increasing number of applications where there is the need to process much larger and/or multiple sheets of material and this is invariably beyond the capabilities of other standard large-format routers.

To address this situation, XYZ has taken the lead in the development and installation of routing solutions that are achieving benchmark status wherever there is a requirement for super large-format production.

Such a requirement frequently exists in the fabrication of wider sign fascias and large display panels, billboards and outdoor advertising promotions involving the use of substrates like DIBOND aluminium composite material (ACM), acrylic, stainless steel, aluminium and medium-density fibreboard (MDF). These robust and totally reliable customised routing solutions incorporate all of the unique design features and components found on standard XYZ machines but in addition provide an enhanced capability for individual machine configuration to meet specific wider-format production requirements.

Key optional design features include the versatile Automatic Tool Change (ATC) facility and the latest Intelligent Cutting System (ICS) cut-to-print facility. The ICS function, in particular, adds a powerful new dimension to XYZ routers by enabling optimum levels of accuracy when processing both digitally-printed media and thicker sign-making materials like aluminium, aluminium composite material, PVC, acrylic, plywood and fibreboard.



Bespoke routing solutions for larger-format production from XYZ.

To further increase the speed and versatility of its routers, XYZ has recently added ArtCAM Insignia design and production software to accommodate more complex routing and engraving applications. This powerful and multi-faceted tool will help to further reduce production costs, improve quality and provide a higher and faster return on investment in CNC routing and engraving technology.

For further information, visit www.xyz.co.uk

New Braille sign making system from Gravograph

Gravograph, already a major supplier of Braille and Tactile sign making equipment, further extends its range with the launch of a fully automatic Braille system.

The new AutoBraille kit can create perfect Braille in plastic or metal signage, including stainless steel. This patented system makes Braille signmaking easier than ever before, in three simple steps.

Step 1: create raised letters or symbols that visually impaired persons not knowing Braille will be able to "read". Braille Tactile signs are created using the two layer special material GravoTac. The core layer is called substrate whilst the top layer is called profile. The top layer must feature a special self-adhesive backing that will enable the mask to be removed easily but will later permanently bond the profile letters or symbols to the substrate.

Step 2: drill the holes that will receive the beads. Gravograph's GS5 software features an advanced Braille Wizard that makes this operation as simple as two clicks, without the need to know anything about Braille signage legislation.

Step 3: a few more clicks and the new Gravograph AutoBraille kit will automatically insert the beads into the drilled holes. The complete Braille sign is now ready.

The AutoBraille kit fits on to most Gravograph engraving machines and can be left on the machine during normal engraving, eliminating any time consuming set-up operation. A spare hand-held bead insertion gun comes with the kit as well as full instruction on Braille signmaking. Beads are supplied in a variety of materials, including coloured acrylics, brass and stainless steel.

For more information contact Gravograph visit www.gravograph.co.uk or tel. 01926 884433.

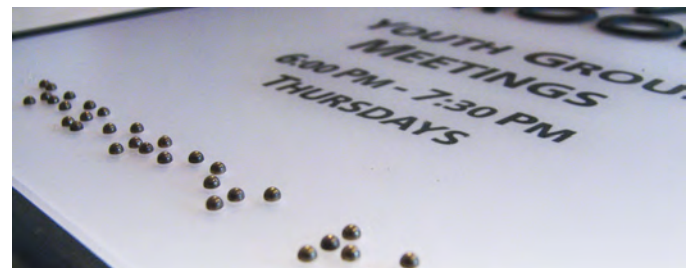

Gravograph's new AutoBraille kit can create perfect Braille into plastic or metal signage, including stainless steel.

The Techno Book of CAD

The Techno Book of CAD, CAM, CNC from Techno Inc., includes an introduction to CNC technology and useful pointers on choosing the right system for your needs.

Techno Inc, based in the United States, has supplied thousands of CNC routers in its 20+ years and through a network of dealers, offers a wide range of machines for diverse applications.

To request a copy of The Techno Book of CAD, CAM, CNC or to view pages online, go to www.technocnc.com



Traditional skills and Innovative materials

Clover Signs is one of the UK's leading makers of hand carved signs. From pub and hotel signs to ordinary house signs, the combination of old-fashioned craftsmanship with modern material technology has made them an outstanding success.

In 2006, Clover Signs manager Bernard Hibbs and his wife Rachel travelled to the United States to learn from sign makers there. Among other things, they were introduced to a new material – High Density Urethane (HDU). Although this synthetic wood was already being used extensively in the USA as well as in Canada and Australia, it had not yet made its appearance on the UK scene.

Less than two years later, Clover Signs has sold more than 1,500 HDU signs and no longer uses any other material. It's not difficult to work out why; as Floor Manager Dylan Warren puts it: "There's just no other material like it. HDU carves easier, takes paint better, and lasts far longer than wood."



Hand crafted signs from Clover Signs make this teashop stand out while retaining the character of the Grade II Listed building.



HDU has become increasingly popular over the last 30 years due largely to its phenomenal weather resistance. Wood warps and rots, and paintwork quickly cracks and peels as the grain swells and shrinks with changes in temperature or moisture. Even with the best care, a wooden sign may only last a few years. HDU, on the other hand has been proven to last up to 20 years, even in the extreme temperatures of the Australian Outback. The HDU used at Clover Signs is imported from Italy.

Clover Signs makes only premium quality handcrafted products.

"There is already an abundance of cheap signage on the market", explains Sam Hochstetler, who is responsible for sales, "we could see that many people are willing to pay that little extra for a sign that is truly a piece of art. Each process has been researched fully to ensure maximum durability and quality."

Continued on page 66

SIGN ESSENTIALS

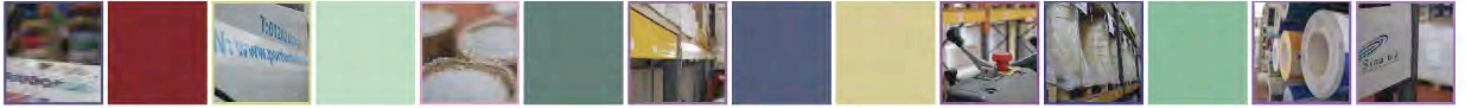

2-5 Year Gloss & Matt Vinyl

Black & White
610mm x 50m Roll
£32.00

Colours
610mm x 50m Roll
£39.00

5-7 Year Gloss Vinyl

Black & White
610mm x 50m Roll
from
£44.50

Colours
610mm x 50m Roll
from
£50.00

Application Tapes

Paper
1220mm x 100m Roll
£50.02

Clear
1220mm x 100m Roll
£51.24

Slit to your choice of widths
Free of charge



Specialities

- 5-7 Year Translucent Vinyl £57.50 p/r
- 5-7 Year Transparent Vinyl £48.00 p/r
- 3-5 Year Commercial Grade Reflective Vinyl from £5.63 p/m
- 5 Year Plain Frosted / Etched Glass Film from £1.96 p/m
- 5 Year Coloured Etched Glass Film from £8.20 p/m
- Fluorescent Vinyl from £6.67 p/m
- Metal Effect Vinyl (Gold, Silver, Copper) from £7.17 p/m
- Mosaic from £8.00 p/m
- Carbon Fibre from £8.80 p/m
- Textile Flex & Flock from £5.29 p/m

p/r: per roll p/m: per metre All Roll widths 610mm



Consumables

- Variety of Application Tapes
- Scalpel Handles & Blades
- Snitty Knives
- CAD Cam Holders & Blades
- Chalk Pencils
- Assortment of Squeegies
- Display Boards & Equipment
- Various Tapes + Dispensers
- Packaging Equipment
- Storage Systems
- Cleaning Solutions
- Swabs, Wipes & Gloves
- Genuine Ink Cartridges
- Bonding Tapes
- Welding Machines
- Cutting Equipment
- Presentation Systems
- Laminators
- Eye Press Tools & Eyelets
- Postal Solutions

Buy 3 Ink Cartridges & get the 4th half price!



Traditional skills and Innovative materials

Continued from page 64

Clover Signs decided that they would only sell hand crafted signs, so you will see no router when you enter their sign shop. All carving is done by hand with knives and chisels using conventional techniques; this makes for a noticeably sharper appearance than can be achieved using a router. Skill and experience is required to ensure that each stroke is carved to just the right depth and angle.

A large percentage of the signs feature gilded letters. By using real gold, Clover Signs ensures that the magical gleam of the lettering and designs will last for many years.

Bernard Hibbs says: "Too many companies these days use gold paint or vinyl. True it looks OK by itself, but it can't really compare with real gold leaf."

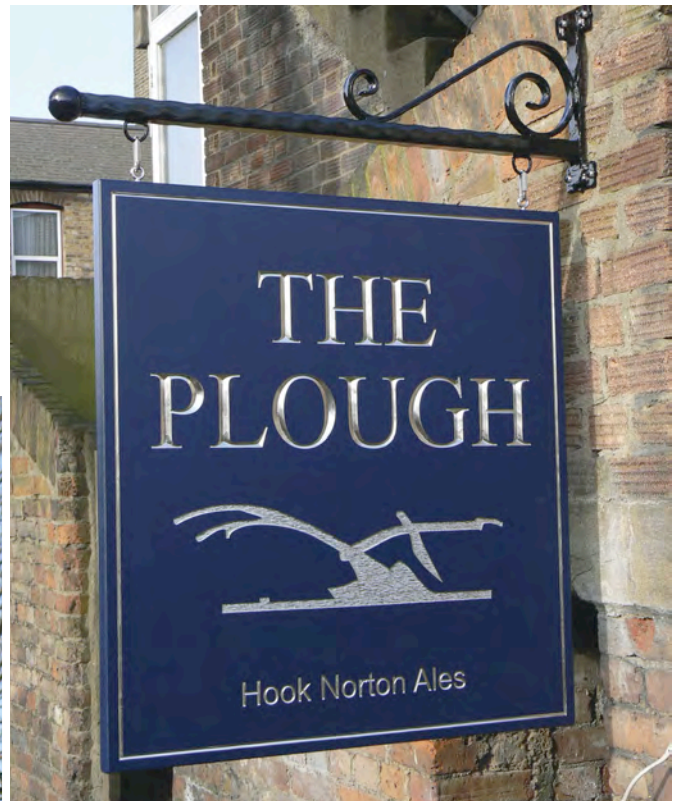

The freephone number routes callers directly through to a designer who can consult and work on their signage. Most signs are designed four hours after they are first requested.

Bernard said, "People these days don't want to wait a week for someone to get back to them. We quote over the phone if people want, and will always make a design for someone, even if we think they won't buy."

Production times have also been brought up to date. Where a traditional sign maker would take weeks or even months to make a sign, Clover Signs often makes the signs within seven working days.

Though mainly dealing directly with customers, Clover Signs also supplies the trade with signs and brackets, especially when a sign maker has been asked for a sign they can't produce. Contact Clover Signs to discuss any projects you might have.

Further information can be found at www.cloversigns.co.uk or by telephoning freephone 0800 534 5715.

Hand painted artwork is also a key element at Clover Signs. Three artists work full time in the sign shop, helping with design and production. Even complex logos are painted by hand.

Recently, Clover Signs produced a set of 14 signs for a teashop on the Isle of Wight. As picturesque as this traditional thatched cottage already looked, new owner Patricia Whybrow soon realised that it just didn't stand out. Something needed to be done to set this cottage apart from the rest, to make it special. Its Grade II listing made changes to the building impossible, so Patricia approached Clover Signs to discuss what might be done through signage.

The free design service offered by Clover Signs allowed Patricia to investigate the various options before making any payment. Using photographs of the property, the designers were able to create realistic images of the finished project. These were then sent back for comment with no limit to the number of free revisions.

Several adjustments were made before the final design could be approved (see photo on page 64), but in the words of Rachel Hibbs, a designer at Clover Signs, "Working with a customer who is inspired is easy. By combining our expertise with Patricia's ideas and objectives we were able to create something truly remarkable. This has certainly been one of our most successful projects."

Recently added to Clover Signs products are hanging signs. After a futile search to find someone to custom make sign brackets for a reasonable price, they started welding and painted the brackets themselves. Since then, hanging signs are selling everyday, and are very popular with pubs, bed and breakfasts, and larger country homes.

Even though most of Clover Signs' work comes via the internet, this doesn't stop the company providing great customer service.





**Mark
Bric[®]**

WITH FLEXIFRAME THE POSSIBILITIES ARE ALMOST ENDLESS
– FROM A SINGLE FRAME DISPLAY TO A COMPLETE TRADE SHOW STAND!

For the complete Mark Bric information pack please: - phone: 01477 537788
or e-mail: sales@markbric.co.uk website: www.markbric.com

**If you are Routing, does your finished
acrylic look like this?**

Call us on 01827 304500

email: sales@itc-ltd.co.uk or visit: www.itc-ltd.co.uk



Industrial Tooling Corporation Ltd.



**SEE US AT SIGN UK
STAND J60**

We really would have loved to show you a picture of our Canon iPF9000S production printer with a beautiful glossy print hanging out the front.

Unfortunately, with a 37.5 sq.m/hr print speed, it finished all of its printing ages ago.



Promotional Pricing

£1500 Cashback on all orders placed before June 30th 2008.

Canon

iPF S-Series

imagePROGRAF®
iPF9000S/8000S

- 37.5 sq.m/hr
- 8 Colours
- 2400dpi
- 30720 nozzles
- 4 pl drop size

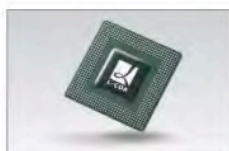

L-COA Image Processor
increases speed and control

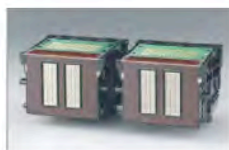

Dual 1" wide printheads
help to ensure fast output



8-colour Lucia pigment inks
for ultra-high-quality images

 FINE

 LUCIA
ink

 **Velmex**
D I S T R I B U T I O N

For your nearest Canon Reseller,
call us on **Tel: 020 8545 9570**

Win One! Go to www.winacanon.com

A business with no sign is a sign of no business

Direct Signs (northern) Ltd is a family business, founded by husband and wife team Keith and Catherine Stamp, in Sandown on the Isle of Wight in 1988.

That was in the days before computers, when general vinyl text was created and produced on a "miracle of science machine", namely a Spandex Graphic 4B Vinyl Plotter. For all other shapes and designs Direct Signs (northern) had to photocopy hand drawn images onto a clear acetate and with the use of an overhead projector, redraw the images to size and then cut out by hand.

At that point Direct Signs (northern) was introduced to a Canadian company, Thermazone Engineering and became, to the best of its knowledge, the first sign making company in the UK to run a vinyl plotter directly from a computer via what was known as a fastboard inserted into the body of the 4B. The company had the Security Dongle number 001.

Thermazone later amalgamated with Electric Studio, a company then supplying the scanning module. From this CadLink was born, now known throughout the trade for its SignLab software. Unbeknown to Direct Signs (northern), at that time, located on the same Enterprise Park as Thermazone, another new company by the name Coreldraw was being born.



Keith and Catherine's two sons, Craig and Stuart, joined the family business in 1989. A year later, the family moved to Darlington because that location offered more work opportunities, enough to keep all the family busy. Direct Signs (northern) Ltd was opened, and began trading from its current premises, a traditional walk in workshop situated on a main road where customers can interact with design and production staff.

Over the years the aim for Direct Signs (northern) has not been to get bigger but to be better than the competition. The company has kept up with new technology and state-of-the-art equipment to ensure customers have consistently good service and high quality products. Priding itself as a One Stop Sign Shop, the company slogan is "A Business with No Sign is a Sign of No Business".

In-house services at Direct Signs (northern) include routed and engraved products and full colour digital images on to most substrates. A diverse client base includes large industrial companies, the NHS, colleges, universities, MOD, local authorities and travel organisations, not forgetting sole traders, who are its "bread and butter" customers.

For further information about Direct Signs (northern), tel. 01325 351092 or go to www.direct-signs.com



Popular digital printing service – and more

Screentech, based on Nestfield Industrial Estate in Darlington, was established in 1985 in a small upstairs room in the centre of Darlington, specialising in screenprinted point of sale, t-shirts and workwear.

Within two years the need for more workspace was apparent so the business relocated to an industrial unit not far from the town centre. It was then that the company made its first move into the signage market with the purchase of a vinyl plotter. This move proved

highly successful and more employees were taken on to handle the increased workload.

Despite a couple of slow years, things picked up again and within four years the company again needed to move to larger and more modern premises.

Following this move, the company purchased its first digital printer to complement its sign and point of sale service. This enabled Screentech to offer full colour images as part of the sign package without the need to screenprint four colour process.

As time passed and digital printing technology improved the company decided to upgrade to a Roland Versacamm. Its first machine was the SP300 model but that has since been upgraded also, to the new VP540. This again increased the scope of service Screentech provides to clients, whether that is large full colour point of sale, banners or the increasingly popular vehicle wrapping.

Although Screentech has invested a lot of money in the sign side of the business, its screenprinted t-shirt and workwear service has also been enhanced with the addition of a six-head embroidery machine. This means the company can supply virtually any need when it comes to a company's image or branding requirements.

Continued on page 72



Popular digital printing service – and more

Continued from page 71

The main core of Screentech's business is with local authorities, trade suppliers of workwear and site safety signage nationally, in addition to supplying major newspaper groups with signage and point of sale displays. Screentech can print on to all kinds of substrates and even unusual items such as toilet door locks.

Screentech is regularly approached by other signmakers for its screenprinting and large format digital printing services. This is an invaluable aid to fellow signmakers who are able to increase their profits without the need to buy equipment themselves. All work is done confidentially without any contact between Screentech and the end user.

For further information regarding any Screentech service, please telephone 01325 483094 or go to www.screentech-ne.co.uk



Focus is design, safety and strength



Harrisons supplies trade customers throughout Europe, the Middle East and North America.

Almost 40 years ago an enquiry from a local vicar identified a gap in the market and Harrisons launched itself into the flag and flagpole market. Traditionally a very conservative industry where flagpoles were hard to come by and manufactured from Canadian pine, Harrisons searched for an alternative and imported Scandinavian technology using fibreglass which overall provided a much lighter, longer lasting maintenance free option.

Today, Harrisons manufactures thousands of fibreglass flagpoles a year in two facilities and supplies trade customers throughout Europe, the Middle East and North America. As the years have gone on the company has increased its range to include architectural grade aluminium and, most recently, stainless steel flagpoles up to 25 metres tall.

As customer requirements have changed Harrisons have expanded into a wider range of products and work closely with the trade on flags as well as custom and bespoke external displays including wall mounted banner brackets, steel banner poles and lamp column banners.

Demand from the trade for short-term promotional flags and poles has encouraged Harrisons to create a range of lower cost short-term products for events, the auto trade and related markets. Blade banners and Teardrop banners have really taken off along with street banners. Despite increased competition and lower quality product being imported from overseas, Harrisons have continued to focus on design, safety and strength in all its products.

Over the years Harrisons has developed a reputation for finding a solution to the most challenging of jobs. Installing a 40m tall steel flagpole on the top of a five storey hotel in Wales, designing and installing a fully rigged flagpole into the harbour bed where at high tide the bottom three metres of the pole are below sea level, are all part of the regular challenging projects the company undertakes successfully.

Every year boundaries are being pushed, clients expect something new, something eye-catching and Harrison loves the challenge of making a concept reality. The success of its business is the ability to meet those challenges by an incredibly experienced and knowledgeable team at Harrisons.

For further information, tel. 01325 355433 or go to www.flagpoles.co.uk



Harrisons work closely with the trade on flags and bespoke external displays.



Photo courtesy of IS Group.

Striking design and top customer care

Simply Stripes the Signmakers Ltd have been in business for nearly 20 years now, and have built up a very respectable regular customer base, which includes high profile blue-chip companies, as well as small and medium sized businesses and trade customers.

Simply Stripes started out by putting self-adhesive vinyl custom 'go faster' stripes and graphics onto cars and vans, and progressed quickly into signs and liveries. Andrew Hancock, Managing Director, had worked for a local sign company for a few years

Continued on page 74



Vehicle wrapping that gets the message across.

Striking design and top customer care

Continued from page 73

prior to starting the business, so establishing his own signmaking concern came as a natural progression. Then the 'Signmakers' bit was added to the company name when Simply Stripes became a limited company 15 years ago, so customer knew what the company did.

The business has expanded steadily since, investing in solvent ink digital printer (before anyone else in their area had), engraving equipment and large plotters, as well as training Simply Stripes' staff to a very high standard. Nine people are now employed at Simply Stripes, 10 if you include Andrew's 12 year old son who wants to be a trainee sign maker. Andrew says he has tried to talk his son out of it but he is adamant, and he supposes it's better than a paper round.

Andrew believes the success and growth of Simply Stripes is due to their hard work and good customer care that provides a competitive and versatile service, coupled with a high quality end product with a strong striking design, and all competitively priced.

Simply Stripes doesn't employ a dedicated salesperson, yet has work booked in for three or four weeks ahead in the production diary. Andrew believes this is down to the company's good reputation and the amount of customer recommendations and referrals it earns.



Eye-catching livery from Simply Stripes.

The company occasionally receives thank you letters from both new and existing customers, which go on to decorate its reception walls. Andrew says it is heart-warming that customers take the time to thank Simply Stripes for its enthusiasm and service, because in this day and age, customers can often be quick to complain and focus solely on the negative.

Tel. 01388 420460 or go to www.simplystripes.com for further information about Simply Stripes the Signmakers Ltd.



Simply Stripes provides a complete design, production and installation service.



Design, print and display under one roof

Spot On Displays is a company founded and based in the North-east of England within easy reach of Newcastle, County Durham and Teesside. Based in freehold premises in Stanley for more than 10 years, the company believes it is almost unique in providing all our design, print and display facilities under a single roof.

Company directors Neil and Samantha Callon have more than 50 years' experience in print, design, production and finishing between them. Creative Director Peter Redden has been designing for over 22 years and has worked for some of the top agencies in the region.

The company's display and exhibition expertise, supported by a dedicated professional staff, is based on long-term relationships with high-profile clients such as Gentoo Group, Northumbrian Water, Durham Constabulary, Arup, Cravens, Pearson Advertising, Procter & Gamble and many local and regional government agencies. A trade service is also provided to local and non local companies at competitive rates.

Spot On Displays constantly upgrades its facilities and equipment to reflect the changing needs and increasingly sophisticated demands of its clients. Materials and display equipment are sourced from the most reputable suppliers.

In-house services include:

- creative design and artwork;
- premium large format digital inkjet printing;
- premium large format solvent printing, including printed vinyl, PVC banners, canvases etc;
- cut vinyl graphics;
- full finishing department;
- exhibition and display hardware supply, hire, storage and repair;
- project management;
- account handling;
- full fitting service (H & S compliant).



Production close-up at Spot On Displays.



Facilities and equipment is regularly updated to meet client expectations.



Part of Spot on Displays' design, print and display facilities.

At Spot On Displays in-house design, production and fitting facilities ensure quality control, elimination of risk and a minimum of possible delays, enabling a quick response to a client's changing needs. Spot On Displays is proudly able to say that it has never missed a critical deadline.

Spot On Displays is also a 'Tree Appeal Partner' and will plant broadleaf trees on behalf of its clients, the bigger the project – the more trees will be planted. There are also special offers, which include additional tree planting on selected products each month.

The company appreciates that the exhibition and display industry can be hugely environmentally unfriendly, with printed graphics often only used for a few days or even hours. Being a Tree Appeal Partner helps Spot On Displays and its clients by working towards restoring the balance and putting something back.

Tel. 01207 236909 or visit www.spotondisplays.com to find out more.

Fairfield - a long term supplier with proven all-round solutions for customer demands

Customers can be extremely demanding and there never seems to be enough time to find a quick and easy solution to the demands. Sourcing new suppliers can be a lengthy and complex operation especially when so many new companies are appearing on almost a daily basis.

Searching for a product on the internet is often a quick solution or visiting a trade exhibition but that is just the start of the process. What is really important is to find a company that you can trust and work with over many years who will always come up with new and innovative ideas.

Fairfield Displays and Lighting has been in business for over 28 years and has built up a wealth of knowledge in the sign and display industry. They have served hundreds of small and large sign companies and truly understand the daily demands of busy sign makers/graphic companies.

To help clients, Fairfield has a team of highly trained consultants, many of whom have been with the company for a number of years. Customers often phone up and say, "I have a sign to create, to fit into an office complex - can you help?" The consultant will then take them through each step, advising on the best type of fixing and what material would give the best results at the most competitive price.

In today's very competitive market place, the advice on how to put the ideas together can often result in a unique design that is within budget. Many clients ring up for one particular fitting and only after a discussion, it is found that what they requested was not the ideal solution.

Once a solution is agreed upon, the client may require help in making a presentation to their customer. This is where Fairfield really starts to differentiate itself from many of its competitors. 2D and 3D drawings can be provided together with supporting photos, to make the presentation our clients need for their customers. It is one thing to present a quotation and another to close the sale but at the end of the day what really counts is the amount of business you bring in through the door. Fairfield does not stop there; they will even carry out the installation for you anywhere in the UK, under your umbrella so that your client thinks it is you who have carried out the work. All installations are covered by a full 12 month guarantee thus giving you peace of mind and saving you time to find more business.

The product range is constantly growing to meet the ever changing requirements of the market.

Cable/Rod systems from the people who live and breathe them

Fairfield has one of the largest ranges of suspended cable and rod systems in the world, available on a fast turn around even for large quantities. All fittings are made from solid brass and manufactured in a variety of finishes. Satin chrome is the most popular and should not be confused with cheaper aluminium finishes. It really makes a difference to work with a quality material. Brass does not cross thread and it is extremely hard wearing. Many clients are now becoming more creative and working with different thickness of cables and rods, options range from 1.5 & 3 mm cable or 3, 6, and 10 mm rods.

Producing large format graphics?

Forget the pop up system, add a touch of style to your graphic and suspend it from the ceiling or wall mount it with a cable/rod system. The range of fixing methods is endless from silicone acrylic, which looks like glass panels to a range of banner rails.



27 inch digital screen suspended on rods as part of an estate agency window display.



The complete cable system to meet all your requirements.

The Fairfield range can literally enhance the appearance of large and small graphics produced by printers.

Today's signs and graphics market is far more dynamic than just static graphics. Fairfield has developed illuminated ultra bright light boxes that are eco friendly with a lamp life of up to 10,000 hours. Just print on a back lit material and you can open up totally new markets with the help of the Fairfield light box range.

Go one step further – add movement - turn your designs into digital signs. Go Digital save your work into a jpeg or mpeg2 format and just drop it onto one of the unique Fairfield floating screens. To help signmakers get started in the digital market, Fairfield run regular seminars. To find out more information go to www.fairfielddisplays.co.uk and register for forthcoming events.



Fairfield cable system fixed between wall mounted channel with track lighting. The cables can easily be repositioned to take different size graphics.



Become a Signedge reseller and start making your own designer signs.

A new flexible corporate signage system – Signedge?

Signedge is one of the latest success stories for the sign trade. It gives the signmaker lots of flexibility to create signs of different sizes from a simple door sign, directory systems, to free-standing information points all using the same profile.

Signedge is an excellent product to hold in stock and it is easy to customise. It enables the signmaker to have immediate flexibility thus enabling a professional sign to be produced at highly competitive prices. The appearance of the sign can be totally transformed depending on the material used, ranging from acrylic, metal or even wood. Graphics produced from standard and large format printers can be inserted between 1 mm thick clear thermoplastic sheets.

So what makes Signedge unique

Fairfield has developed a range of standard end caps that can be used with a cleverly designed profile that can be used to make curved or flat signs. As the signs do not need a back profile it is easy to cut the profile to the required length thus making a sign to the required size. The sign can then be flat mounted directly to the wall or can be combined with the Fairfield range of components to fix at right angles or suspend from the ceiling. The profile can be screwed together to make double sided signs thus adding the flexibility of the system. The full product range can be found at www.fairfielddisplays.co.uk

To help the signmaker and graphic company present the new range to their clients, a showroom display is available at a greatly reduced price. Full details are available by contacting sales@fairfielddisplays.co.uk or by calling 0845 166 5204.

Specialist division is a new force in the flag and flagpole supply market

One Stop Promotions has launched a specialist division to concentrate on development of the Flags & Flagpoles side of their business.

With over 20 years experience in the promotional marketplace, their experience in providing solutions to the printed promotional market is unrivalled. What started out as supply of one or two bespoke flags to private companies, has grown into the supply of thousands of flags and flagpoles of varying descriptions to football & rugby clubs, house builders, sign companies, car dealerships, local authority and private and public companies.

They carry thousands of flagpoles in stock in their warehouse based in Leicestershire and receive regular shipments of the popular items throughout the year. They also carry hundreds of national flags in stock, and can make both national and corporate flags to order.

The most popular flagpoles that are kept as stock items are aimed at the showhome market, a 6 metre, 2 section white aluminium pole, supplied with rotating top arm, available in both 50mm and 60mm pole diameters. This versatile pole is also suitable for the residential and commercial market place.

The other development is the one piece fibreglass flagpole, available in 6m, 8m and 10m lengths with both internal and external halyard mechanisms.

An area that has also increased substantially for Flags and Flagpoles, is the supply of large volumes of supporters' handwaving flags, for football and rugby clubs around the UK. These flags are printed and finished in the Far East, and can be either flown or

shipped to the UK depending upon the urgency of the event. The record delivery time has been 13 days from placing the order to receiving the flags! They are proud to announce that they have never missed a deadline.

The other areas that Flags and Flagpoles specialises in is the supply of temporary and portable flagpoles, for various uses including car dealerships, outdoor events and use on exhibition stands for maximum impact.

For sales enquiries please contact the Sales Team on 01509 815155 or visit www.flagsandflagpoles.biz



Expansion a good sign for Sign 2000

Following the addition of several more blue-chip names to its client roster over the past 18 months or so, Kent based architectural sign manufacturer and installer Sign 2000, has invested in building additional production facilities to meet the growing demand for its services.

In addition to their existing 8,000 square foot manufacturing base in Paddock Wood, Kent, they have established a 5,000 square foot dedicated project management facility close by, designed initially to deal with the huge logistical requirements involved in their recently won Morrisons account. Additional storage and office accommodation is included on the new site.

All sign assembly and distribution will take place in the new facility, which is being staffed by eight new employees, with another six being taken on at the Head Office factory.

Sign 2000 has also invested in its equipment with an upgraded router and additional digital printer being part of an initial £120,000 investment in the business.

The Morrisons win comes at the end of a period which has seen Sign 2000 add many new blue chip names to its client list including: Nationwide, Abbey, Woolworths, Superdrug, O2, TK Maxx and Marks & Spencer amongst others. This is in addition to an already impressive existing client list that includes Brewers Fayre, Beefeater/Premier Inns and Bookers (Premier).

Murray Crompton, Sign 2000 Managing Director, believes the company is right on schedule in its plans for the future.

"We see this opportunity as a significant step in our long term strategy of ensuring that Sign 2000 becomes one of the leading players in the specialist sign making market. Our continued growth is a result of clients having faith in our ability to provide a quality product and excellent customer service."

For further information call Sign 2000 on 01892 834383 or visit www.sign2000.co.uk



IF YOU CAN'T CUT IT

FOAMCORE – FOREX – GATOR – DIBOND
VINYL – POP-UPS – PRINT – FILM
CORREX – MDF – FOAMEX – PAPER
BANNER – KAPPA – CARD
MATBOARD



KEENCUT CAN

KEENCUT
THE WORLD'S FINEST CUTTING MACHINES

- WIDE FORMAT JAVELIN* - PRACTIK - MAX - 1 to 5 METRES
- EXCALIBUR - VERTICAL - ALL PURPOSE - HEAVY DUTY CUTTERS
- CLASSIC ROTARY CUTTERS - ADVANCED ROTARY CUTTERS
- SABRE GENERAL PURPOSE CUTTERS 1 to 3 METRES
- BIG BENCH CUTTING CENTRES 1 to 5 METRES

- 5 YEAR GUARANTEED BUILD QUALITY
- 20 YEAR GUARANTEED BEARINGS
- GUARANTEED STRAIGHT TO 0.2MM*
- UNIQUE TO KEENCUT
- UNIQUE TO KEENCUT
- UNIQUE TO KEENCUT

AVAILABLE FROM ALL THE BEST DISTRIBUTORS

WWW.KEENCUT.CO.UK TEL: 01536 263158

prism launches at Sign and Digital UK 2008

Re-launched as “prism” the UK’s leading specialist imaging association (previously known as the DSPA), has announced exciting new member benefits and initiatives. These new initiatives are designed to support market changes and address the needs of businesses across the supply chain, ultimately, enabling prism members to increase business competitiveness, productivity, profitability and performance.

First and foremost, prism has extended its membership to include all suppliers within the digital, screen and pad printing markets throughout England, Wales, Scotland and Ireland.

Other key 2008 landmark activity includes:

- Sign & Digital UK Seminars - ‘Unveiling current wide format inkjet technology’; ‘Unleash your creative power and fuel more profit’
- Events & Exhibitions - ‘Garment & Product Decorating’; ‘Exhibiting Show’
- prism Summit - ‘Price is not the only differentiator - Value Added Solutions’
- prism Forum - ‘Take the green advantage’
- Corporate Services - Discounted energy package for every size of business

John Keith, prism business manager, comments: “While our industry is among one of the most exciting and innovative in the world, UK business challenges such as overcapacity and response to environmental concerns are seriously impacting their profitability and future success. To address this, prism is unveiling its new membership package, delivering the tools and knowledge to meet these challenges head-on and enable sustained competitiveness and growth.”

Further acknowledging the key role that prism plays within the industry, HP has committed to becoming the association’s sole Digital Technology Partner. HP is supporting prism’s presence at the show, as well as its new initiatives such as the forthcoming prism Summit and Forum.



Business Manager at prism (previously known as DSPA), John Keith, is using his wealth of blue chip commercial experience to benefit members.



Peter Kiddell, prism President, is addressing the needs of a rapidly changing market by developing a new range of services to be delivered by prism.

Association member, Graphique Media Solutions, is looking forward to benefiting from the new initiatives. Allan Hall, Business Development Manager, Graphique Media Solutions, comments, “The services offered by the DSPA, as it was previously known, have been of great assistance to our business. With the launch of prism, we expect to see the additional member benefits positively impact our bottom-line.”

The Cornwall-based large-format digital printing company is renowned for its high-quality products and followed the success of winning “gold” at the FESPA Digital Print Awards 2007, which were supported by HP, with a commendation at this year’s event.



In-house design and expertise ensures Graphique Media Solutions’ customers maximise all creative, brand and sales opportunities.

As well as representing the UK market at FESPA Digital Printing Europe, being a part of FESPA, enables the UK association to provide prism member access to a host of global resources. These include events, market reports, project funding, best practice, knowledge and training. In addition, prism has also devised a host of other member activity and support, designed to further tackle industry issues.

As the voice of the industry, prism is well placed to promote the breadth of opportunities available to print buyers and end users. It aims to do this through highlighting the creativity and unique opportunities provided by specialist imaging technology and services, which produce a host of end user applications including, POS, graphics, industrial, garment and textiles.

John Keith concludes: “Having researched, planned and developed our offering over a number of months, we are now really excited to officially launch prism and roll-out the new member benefits and initiatives. In addition to helping existing members improve their business performance, we also expect significant interest from non members, and look forward to increasing the prism community.”

For further information contact John Keith, email john.keith@dspa.co.uk or tel: 01737 240792.



engraving & etching

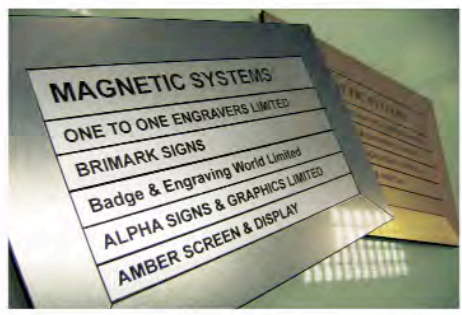

Patented Magnetic Interchangeable Directory Systems for Receptions etc..



Meeting Room Sliders

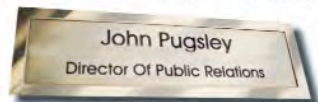

Magnetic Interchangeable Nameplates

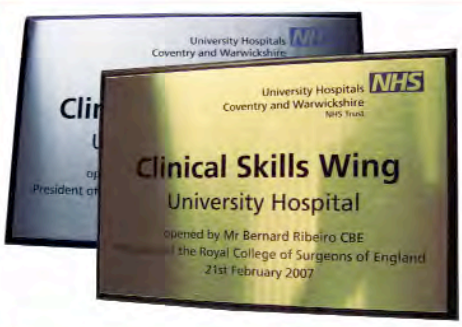

Brass or Stainless Steel opening plaques colour filled and mounted onto your choice of hardwood plinths



Brass can also be stove lacquered for extra durability

**2 to 5 DAY DELIVERY in most cases



ETCHED or ENGRAVED

Panels in Brass
Brushed Stainless
Mirror Stainless
Bronze or Aluminium



Various Colour filling, drilled/fixings or Self Adhesive



Engraving & Laser Engraving

Fast, cost effective Engraving on to a wide range of plastics



Rigid or Flexible. Colours of your choice



Brushed Stainless
Mirror Stainless
Brass

Stock Items!

Every Premises must display 'No Smoking' signs

Fire door Signs
Signs in Stainless Steel
Stock Items! 76mm dia

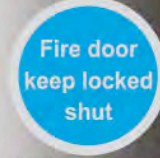

Call today for unbeatable prices !

one to one engravers ltd

Tel: 01604 644604
Fax: 01604 644755

Email: info@otoel.com
Web: www.otoel.com

Unit 3 Cirrus Park, Lower Farm Road, Moulton Park, Northampton NN3 6UR

Sign and display materials – now no need to waste these valuable materials

In this age of ever increasing environmental focus, Robert Horne Sign & Display has launched an innovative waste recovery and recycling service for its sign and display customers.

Known as the R3 process (Recover – Recycle – Reuse), the new service is based on the simple principle of the company delivering new sign and display products and taking away a customer's waste sign and display products for recycling. The collection of the waste products is undertaken by the company's licensed and UK approved waste partners, who then recycle the products at a UK facility back into a variety of recycled plastic products.

Steve Lister, Robert Horne Sign & Display's Divisional Business Development Manager, explains the reasoning behind the service: "This is a first of its kind for the sign and display market and we know from talking to customers and through the trials we have already successfully completed that it is a service of true added value. Environmental scrutiny is affecting every business and this service is a tangible and effective way to help our customers reduce their environmental impact by diverting waste away from landfill as well as demonstrating environmental responsibility."



Prior to the official launch of the service, a number of Robert Horne Sign& Display customers trialed the scheme and to date, more than 1000 tonnes of waste have already been diverted away from landfill and recycled. One of the nine companies taking part in the trials is GT Marketing Service, which has been wholly impressed by the service offered by Robert Horne and the innovative approach to recycle is easy and begins with an initial waste audit by Robert Horne to understand the starting point, in terms of volumes of materials and what a customer already recycles. A tailored solution is then offered to the customer, including the specification of materials to be collected and volumes anticipated. The next stage is to implement a Waste Pilot Solution and test the approach agreed to ensure that the customer gains maximum return from the service. The final stage is to refine the service based on feedback and implement as agreed.

Steve Lister continues: "The idea for R3 is simple and we are very proud of offering this to customers. Customer feedback has been excellent so far and we anticipate the service growing further and potentially evolving into a closed loop recycling service. Currently waste products collected are granulated, shredded and fed back into the UK polymer market to make a wide variety of recycled plastic products. Our aim for the future is to be able to offer recycled sign and display products manufactured using the waste collected via our scheme."

As well as offering a waste recovery and recycling scheme, Robert Horne Sign & Display is also able to advise customers on the appropriate sign & display products for their needs, which include the latest environmentally responsible substrates.

To find out more, go to www.roberthorne.co.uk

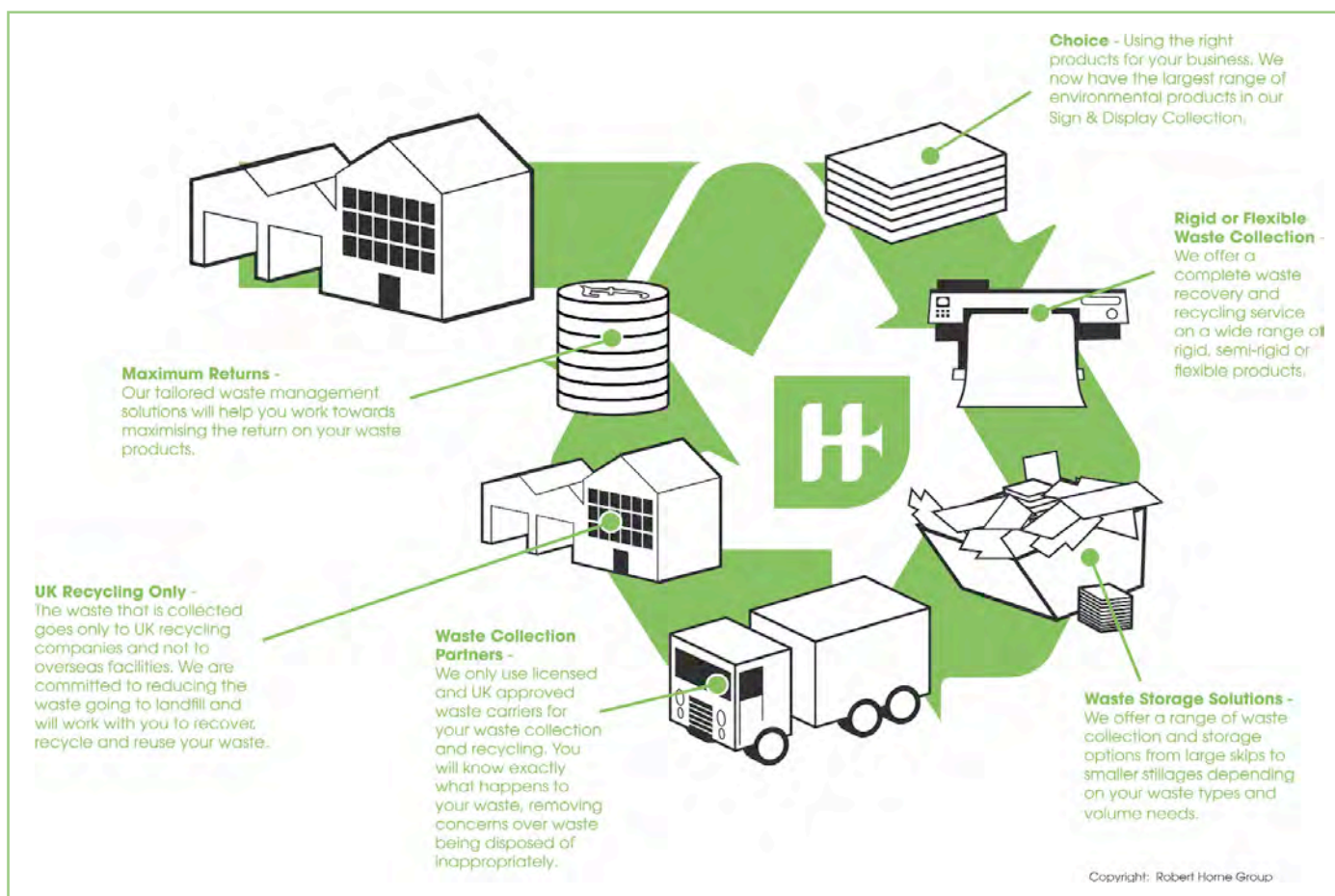



MODULAR MENU SYSTEMS

from
£145.00 + Vat

Price Includes **Photographic Transparency**

Available in Traditional or Contemporary Finish



CURVE BOX

£150.00 + Vat

Price Includes **Photographic Transparency**



EDGE LITE BOX

£175.00 + Vat

Price Includes **Photographic Transparency**

Photographic Food Transparencies



please call for a catalogue
& price list



menu
BOX



020 8345 7007

email: erol@menubox.co.uk
fax: 020 8345 7117

Five UK printers Highly Commended in Fespa Digital Print Awards 2008

UK printers picked up a total of five commendations in the FESPA Digital Print Awards 2008, across four of the eight competition categories.

Essex-based Look Digital (www.look-digital.co.uk) was singled out in the Textile category for its project FA Community Shield. This was the company's largest single printed project to date, when they were commissioned to manufacture giant photographic images for pitch display at the FA Community Shield at Wembley Stadium in August 2007. The client required two 27m x 20m pitch banners depicting images of Manchester United and Chelsea players, a 15m x 3m sponsor banner, and 36 sponsor flags. The panels were produced on EFI VUTEK FabriVu printers before stitching and finishing.



Look Digital - FA Community Shield Easibind.



Launch of L.A.M.B fragrance Mtadigital London.

Interacts (www.interface.rehabstudio.co.uk) of Northern Ireland was among three commendations in the Décor category. The entry, for client Girli Concrete, involved printing a lace design onto concrete panels. The lace was printed on the panel in one colour (using Mimaki UJF with eight print passes), the panel rotated, the image printed in another colour and the process was repeated six times.

Mtadigital London (www.mtadigital.co.uk), also printing on VUTEK equipment, was praised by the Awards jury for its entry entitled Barcardi in the hard-fought Decor category. The interior decor project for client Meadow Creative Limited involved production of a series

of mirror effect prints, printed directly to 10mm acrylic, backed with gold polish film and over-laminated to produce a hazy effect, all mounted on split batons.

In the Packaging category, a single commendation was awarded to print, packaging and prototyping specialists Easibind International of Heanor, Derbyshire (www.easibind.com), for their entry, Two-frame Lenticular Promotion.



Mixing Desk Fascia Panels.

John Keith of FESPA's UK national association DSPA comments: "It's gratifying to find so many UK printers among the commendations, and to see the creativity and innovation in their entries."

He adds: "I hope that the success of these five companies in this year's competition will inspire them and other UK printers to enter work for the FESPA Digital Print Awards 2009, and that we will see many UK entries among next year's prize winners."



Bacardi Graphique Media Solutions.

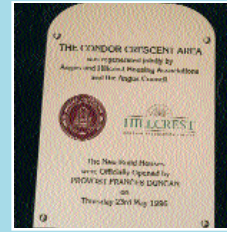
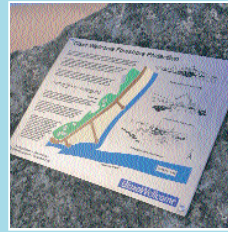

Signs and Plaques

- Sign Industries specialise in the production of fine engraved brass, bronze and stainless steel signs.
- Stringent quality control procedures are followed throughout
- Specifications can be provided without charge or obligation.
- Urgent orders can be made and delivered within 72 hours to most of the UK

Most metal is 3mm thick.
Surface areas range from matchbox sizes up to 2m diameters.
Comprehensive fitting packs, including masonry drills, are provided.

The company has full artwork facilities, and can easily work from a rough layout, incorporating logos and ornate work, as well as special shapes and fittings.

Any Pantone or BS colour can be matched.



SIGN INDUSTRIES

Tel: 01241 828 694 • Fax: 01241 828 331
www.signindustries.com
info@signindustries.com

Serving the Sign Trade

Opticool
Window Films

Because time is precious the **Opticool** range of window film has been developed as a complete range of window films available from one source.

Whatever the reason you need a window film, **Opticool** can supply it. But just as importantly, we have kept the prices low. This means that you won't pay over the odds for the convenience of having all the window films you need from one supplier.

For further details please visit our website
www.windowfilmsdirect.co.uk
or call 0845 838 6911



Opticool Solar & Glare
Reduce the build up of heat and the impact of the sun through windows, offices and conservatories.

Opticool Privacy
Black out or frost out the outside world with a range of finishes that stop people looking into the home or workplace.

Opticool Security
Protect possessions and people from burglars through to bombs. This range comes in a variety of thicknesses that protect.

Opticool Automotive
Specially designed for cars, this range offers privacy and protection.

Opticool Nano Ceramic
Using the latest nano-technology, this range offers the ultimate protection against heat, as well as providing security and privacy. It is only available in the UK from Window Films Direct.

Opticool
Window Films

Roland DG (UK) recognises next generation of graphic arts professionals with Roland Academy inter-school challenge

Illustrating its commitment to education and developing the next generation of graphic arts professionals, Roland DG (UK) has recognised the winners of the inaugural Roland Academy Inter-School Challenge, a design competition for schools in the Walsall area. Pupils were asked to design eye-catching graphics inspired by the theme "the regeneration of Walsall." A design submitted by a team of two schoolchildren aged 13 and 14 from Barr Beacon Language College was judged to be the best in its use of colour, image and clarity of message.

The winners, Kirsty Ryan and Stacey Taylor, from Barr Beacon Language College were presented with digital cameras and a framed copy of their design by Roland DG (UK) Product Manager 3D and Engraving, Peter Kettle, at a ceremony held on the company's stand at the Sign and Digital UK exhibition. The winning design will now be produced in large format and adorn banners on the perimeter of the construction site of the New Walsall College that's currently being built. The winning entry will also be reproduced and framed for display at Barr Beacon Language College.

In total, more than 60 pupils from six schools in the Walsall area, including Palfrey Girls School and Joseph Leckie Community Technology College, submitted entries. The entries were judged by a panel comprised of representatives from the organisations supporting the initiative: Walsall College, The Roland Academy, Walsall Education Business Partnership, and Roland DG (UK). The teams prepared their designs at school before attending a half-day practical session at the Roland Academy, where they amended their entries using professional software, prepared them for printing in the VersaWorks RIP, and outputted them on a Roland DG large format printer. Pupils and their teachers were also given

a tour of the Roland Academy, giving them the opportunity to learn more about wide format technologies and applications.

Barr Beacon Language College, Senior Teacher, Claire Emery, said: "I am extremely proud of our students' professional attitude throughout this competition, and have to say that this demonstrates the positive and enthusiastic way they approach a challenge."

Roland DG (UK) Managing Director, Jerry Davies, said: "We were pleasantly surprised by the overall quality of the entries. Many were produced using the latest software packages and wouldn't look out of place in a professional design agency. Roland DG is committed to supporting education and encouraging talent into the industry. I hope that the Roland Academy Inter-School Challenge has also given schoolchildren a chance to experience what a career in graphic arts can offer."

Walsall College Signwork Academy manager, Andrew Evans, said: "Picking a winner was very difficult, but Barr Beacon Language College's entry is stunning in terms of image composition, use of text, space and message. I look forward to seeing it on the site of the new college. The competition has been extremely valuable for Walsall College in that it has given more than 60 pupils approaching school leaving age first-hand experience of what a vocational course can offer them."

The Roland Academy is the largest, industry-accredited sign, engraving and large format education facility in Europe and operates from Walsall College. It runs a range of courses, which have been developed by independent industry professionals. These include programmes on digital printing, engraving, RIPs and Adobe software packages.

For further information visit www.rolanddg.com



Winning students Kirsty Ryan (left) and Stacey Taylor with Peter Kettle from Roland DG (UK).



Size:
750 x 500mm*
(*Image area)

Folding Swing Sign

This folding swing sign is easy to transport and store. Folds flat for easy storage. Manufactured from 25mm square tubing with 1.2mm zinc coated steel panel.

Available in 3 heights
1 metre high • 1.5 metre high
2 metre high

Bus Stop Sign

A useful sign for marking meeting points or giving direction. Suitable for indoor and outdoor use. Available with lightweight or located base (as shown).



Available in 2 sizes in any combination
635 x 457mm (A2)*
530 x 450mm*
(*Image area)



Handysign

This lightweight and easy to move 'A' board is manufactured in 1.2mm zinc coated steel.

- Powder coated in white as standard
- Integral carry handle

Easy to assemble.
Custom made to your own requirements and sizes.

Banner Frame

The easy way to display your banners. Fabricated from 25mm square section steel tubing, this double or single sided frame comes in a modular easy to assemble system.



Available in 3 sizes in any combination
864 x 533mm* • 876 x 635mm*
1170 x 838mm* • (*Image area)

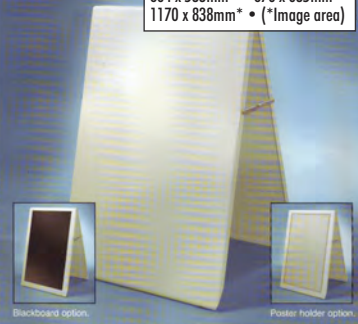

Pavement Sign

1.2mm zinc coated steel. White powder coated. Available in 3 sizes and 4 styles. i.e. Standard, poster, blackboard and poster blackboard.

Size:
915 x 610mm*
(*Image area)

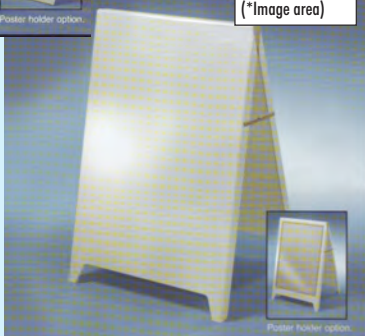

Legged Pavement Sign

- Manufactured from 1.2mm zinc coated steel.
- Powder coated in white as standard
 - Two heavy duty metal side stays and legged feet
 - Double folded sides give extra strength

DES
DES Ltd

Tel: 01663 744824
www.desltd.co.uk

CATALOGUE ON REQUEST

clearline

BRAILLE & TACTILE SIGNS

Specialised signs & labels to help companies meet the Disability Discrimination Act

Hundreds of standard signs in stock
Custom signs made to order

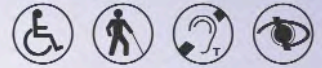

email: **clearline@nes-solutions.co.uk**

tel: **01206 848200**

www.clearlinesigns.co.uk



KIMOTO

FREEJET 320

Next Generation Flatbed Printer

- Wide range of printable materials
- Simple operation
- No RIP software necessary
- Material thickness up to 12cm
- Fast production at high resolution
- Up to 5760dpi resolution
- Maximum print size A3+ (329x483mm)
- Print products weighing up to 30kgs

Will print onto...



...and much much more!

Info-Tec Distribution

Distribution for professional solutions...

Info-Tec Distribution Limited

Unit 11B, Dawkins Road Industrial Estate
Hamworthy, Poole, Dorset BH15 4JP UK

Tel: +44 (0)1202 845 960 Fax: +44 (0)1202 845 961

Website: www.info-tec.biz

Drytac acquires Advanced Imaging Solutions

Drytac is pleased to announce the acquisition of Advanced Finishing Solutions (AFS), an OEM provider and distributor of aqueous/UV-curable coating machines and liquid coatings. This strategic move will position Drytac to leverage the growing demand for liquid laminating among users of flatbed inkjet printers, digital print-on-demand presses and photo printers, as well as operators of gicleé and fine art studios.

Advanced Finishing Solutions offers an extensive line of aqueous and UV coating equipment, with formats ranging from 3.2 M (10.5 ft) down to models the size of a copy machine. The company markets its products under such trade names as VERSA-Coater, PhotoMate, PressMate and DocuMate UV, Cyclone UV, AFC Liquid Coaters, ENDURACoat and INSTACure liquid coatings

As a world manufacturer of dry mounting tissues and Heatset® overlaminating films, Drytac is well positioned to further increase the visibility of the AFS brand in Europe, North America and Asia.

"The liquid coater line enhances our position as a one stop post print finishing resource for the graphics and display markets," says Marc Oosterhuis, President of the Drytac Group. "It will also allow us to expand into markets such as screen printing and on-demand printing."

Jim Tatum, founder and former owner of AFS and graphics industry veteran, will continue to head up the liquid products division for Drytac. "Drytac and AFS share a similar long term vision," says Tatum. "This move allows us to maintain our current level of customer service as Drytac's global infrastructure extends our geographic reach." According to Tatum, existing AFS customers can expect continued seamless service, plus an expanded product offering.

For further information call Drytac on 0845 070 0660 or visit www.drytac.co.uk



Jim Tatum founder of Advance Finishing Solutions (AFS) and Richard Kelley founder and owner of Drytac Corporation.

Antalis and Printall merge businesses

In April, Antalis Visual Communications and McNaughton Printall merged businesses, following the acquisition of MAP Merchants by Antalis Group in November 2007. This exciting new partnership will bring many service improvements by combining the strengths of both companies to provide:

- Central Conversion Facility - Same day/Next day conversion facilities using the very latest equipment from the centrally based operation in Leicestershire.
- Vast Product Range - Over 1000 screen, signage and digital products in stock for a variety of applications, including leading brand names; MACTac, Lucprint, and Kapa – many with environmental credentials.
- Dedicated Sales Team Personal and focused customer service - Internal and field sales teams with over 200 years combined industry experience.



- Local Sales Offices - UK coverage with sales desks in the North, South and Midlands.

Tony Marshall, previously sales director at McNaughton Printall has been appointed as the Divisional Director at Antalis Printall, with Colin Palazzo, previously of Antalis Visual Communications in the role of Sales Director.

For further information contact Antalis on 0870 607 3150 (midlands), 01925 837773 (North), or 0208 786 2300 (South).



BUILT UP LETTERS

**HIGHEST QUALITY PRODUCT
HIGHEST QUALITY SERVICE**

ALL STAINLESS STEEL **316 MARINE GRADE**
MIRROR OR SATIN
ALSO ALUMINIUM, BRASS, ACRYLIC
STOVE ENAMEL & POWDER COAT
(ALL ABOVE ALSO IN FLAT CUT)

email: info@impact-3d-signs.co.uk www.impact-3d-signs.co.uk

TEL : 0191 536 0 536 FAX : 0191 536 5 536

13/14 Hutton St. Boldon Colliery Ind Est. Tyne & Wear NE35 9LW

**24 & 48
Hour Service**

Available on Request

TRADE

tradesignsuk.com

SIGNS

FLAT CUT LETTERS & LOGOS

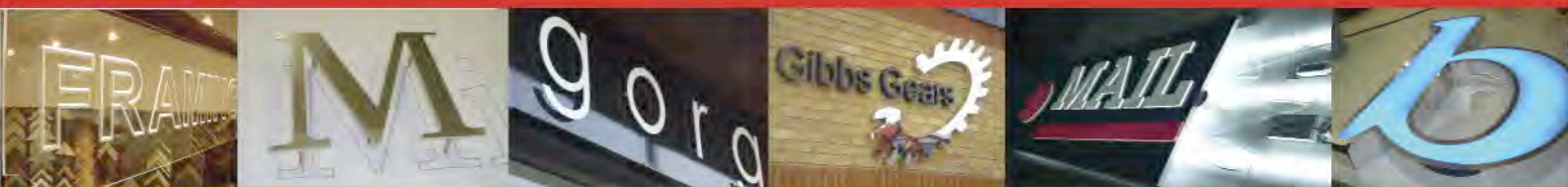

UK'S No 1 TRADE SUPPLIER

- Flat Cuts
- Laser Cut Stainless
- Built up Acrylic
- Built up Stainless
- Light Boxes
- LED illumination
- Tray Systems
- Fret Cut Systems
- V-Carved panels
- Sales Support

Call now to get your **FREE** price guide

all enquires to

sales@tradesignsuk.com

Fax **01442 828922**

Free Phone

0800 328 3050

We accept all artwork in IMB PC compatible AI or EPS vector files





Signmaster Systems Ltd

Easymount Laminator



These versatile laminators can handle materials up to 25mm thick, including card stock, foamboard, MDF or rigid PVC board. The Easymount™ can also be used as a vinyl & masking tape applicator.

- Forward and Reverse
- Variable Speed
- Foot Pedal
- Hot or Cold
- Free Installation
- On-site Warranty

GREAT VALUE From £999

Special Offer
JM 54" Laminator
 stand, delivery & £300 media
£1995.00

Graphtec Vinyl Cutters



Ring for best Price

Graphtec's most popular and affordable cutters are ideal for cutting all types of sign making vinyl

The FC7000 Cutting Pro plotters feature outstanding precision, blazing speed, brute force, bullet proof reliability, and an automatic registration mark sensor as standard equipment. The auto RMS uses a laser optical sensor to locate printed registration marks and turn printed graphics in to contour cut decals. The tangential cutting option makes precise cutting of thick, tough media easy. Whether your need is long vinyl graphics, precise decals, print & cut color graphics, sandblast stencils, or window tint cutting, there's no more capable vinyl cutter than a Pro Series Graphtec.

- Tangential Emulation for super accurate cutting.
- Free media basket
- Plug-and-Play USB connectivity
- Includes cutting software
- USB or serial connection
- Mac and PC compatible
- Fastest cutting in class
- 600gf max cutting force
- Automatic registration

Bargain Corner

Uniform Cadets



From Only **£4995** Installed

- Second User
- 30" or 54" Print & Cut
- Full Solvent

Roland Versacamm



Only **£6295** NEW

- SP300 30"
- Eco-Sol max ink
- Print & Cut
- 12 month warranty
- Inc install & training

Roland Versacamm



Only **£9495** NEW

- SP540 54"
- Eco-Sol max ink
- Print & Cut
- 12 month warranty
- Inc install & training

Signlab 8



NEW
 Upgrades From **£125**

SIGNLAB 8 brings even more design and production tools than ever before. If you are digitally printing signs or plan to in the near future, SignLab is the must have software for your business.

- New Design Tools
- 75 Plug-ins Added
- Bitmap Editing Program
- Pro Text Compose Tools
- Halfcut labels
- Vectorization Wizard

Sales line: 0845 130 55 65

All pricing subject to VAT.

Mimaki JV33 Solvent Printer and CG series Cutter

Solvent or Eco-Sol, Die-Cutting, High Speed.

JV33 Series
JV33-130 / JV33-160

- NEW high speed print head.
- 30% speed increase over JV3
- 1300mm & 1600mm print widths
- Uninterrupted Ink Supply Systems
- Includes media take-up
- 1440 x 1440 dpi photo quality
- Instantly drying printing
- No lamination required
- Triple stage intelligent heaters
- NEW ink formulation Wider Colour Gamut



AVAILABLE NOW!

Book Your Demonstration at

Signmaster Systems

Mutoh VALUEJET & UNIFORM LANCER G2 Eco-Sol



Mutoh has taken a totally new approach with i2 technology. Ink is laid down in carefully optimised wave forms, not the straight lines used by all other wide-format inkjet printers. The result is a drastic reduction or even total elimination of the typical difficulties inherent in conventional inkjet printing.

New Model Mutoh 1304 and 1614

- 1300 & 1600mm print widths
- Interweave Print (no banding)
- Eco-Sol Ultra Inks up to 14m²/h
- Space saver design
- Print & Cut bundle available

Roland VersaCMM Eco-Sol Print and Cut



Affordable and versatile colour sign production.

The instantly recognisable Roland VersaCMM™ range is the world's best-selling integrated print & cut system.

Designed to deliver precise, 1440dpi durable 4-colour inkjet printing and fast, accurate digital cutting all in a single easy-to-use device, the VersaCMM™ VP is highly versatile, very economical and seriously productive. Combined with Roland's proven Eco-Sol Max™ ink it consistently produces great images on a host of materials - making it ideal for a huge range of banner, poster, exhibition, POS, display, sign and label applications.

- 760 or 1370mm cut width
- Versaworks RIP Software
- Print to standard materials
- 1440 dpi photo quality
- Print and cut in one unit
- Instantly drying printing
- Very low running costs
- Eco-Sol Max Ink

SignLAB 8 PRINT & CUT for Versaworks ONLY £550



Mimaki

Uniform

Summa
DIGITAL IMAGING TECHNOLOGY

GRAPHTEC

Signmaster
Systems Ltd

www.signmaster.co.uk

Signs Direct

Europe Ltd

SUPPLIERS TO THE TRADE

SPECIALIST MANUFACTURES OF BUILT UP STAINLESS STEEL & ALUMINIUM LETTERS

- 3M X 2M CNC ROUTING
- IN HOUSE PAINTSHOP FACILITIES
- BESPOKE BOXWORK
- ALUMINIUM PANELS
- SPECIALIST LIGHTING FOR BUILT UP LETTERS



Tel: 01843 588 600

Fax: 01843 588 599

Email: enquiries@signsdirecteurope.co.uk

19 Leigh Road, Haine Industrial Estate

Ramsgate, Kent CT12 5EU



www.signsdirecteurope.co.uk

Velmex giving away £10,000 of Canon printers at www.winacanon.com

UK Canon distributor Velmex is offering the opportunity to win one of two Canon large format printers in the current 'Win a Canon' campaign.

The competition is a series of three questions. Knowing the answers is easier if you have a quick read of the competition website at www.winacanon.com (clue: read the page that gives the technical specifications on the prize printers).

The prizes themselves include a super little 24-inch wide A1, printer, the Canon imagePrograf 610, a combined CAD/GIS and poster printer.

Interestingly, a further promotion running alongside the Win a Canon competition has seen this printer reduced to only £995. At that price this little A1 printer is an absolute gem, easily justifiable for use in printing mock-ups in any pre-press department.

Perhaps of more interest to the production print operation is the larger and more expensive of the prize offerings, a 44" wide S-series iPF8000S.

The Canon S-series, has been specifically designed for volume production of display graphics, posters and print-for-pay.

With a production speed of up to 37.5 metres an hour, the 8-colour S-series is pitched to compete with printers from Hewlett Packard. Indeed with many users now considering upgrading their 5000-series HP printers, at three times the speed of that HP device, the Canon S-series may be worth a closer look.

The print quality and the speed of the printer in operation makes it a tempting addition to any production arsenal.

Again, as a further incentive, Velmex have announced another deal that will run alongside the competition, specifically a cash back deal of up to £1500 on an S-series printer purchased before the end of June.

For the more technically minded, the S-series printers, available in both 44" and 60" print widths, use a set of eight Lucia pigment inks with cyan, photo cyan, magenta, photo magenta, yellow, black, matt black and grey ink tones. Using a dual print head system, the S-series printer employ up to 5,120 nozzles per colour – said to be the most nozzles per colour of any printer in the industry. This is largely responsible for the S-series' blistering production speed.



With a maximum print resolution of 2400 x 1200 dpi, the new imagePrograf S-series is ideal for production print shops looking to produce posters, signage and display materials faster than ever before, as well as commercial printers, in-plant facilities, print-for-pays, tradeshow exhibit builders, and signage shops. The S-series still incorporates Canon's advanced professional features such as built-in colour calibration for colour stability, automatic clogged nozzle detection and compensation for reliability; 330ml and 700ml selectable ink capacity sizes for versatility; and a large, backlit LCD panel for ease of use.

So, whether your interest is simply in entering the 'Win a Canon' competition with a view to possibly winning one, or if you are interested in discussing the current cash back deal with a view to upgrading or investing, visit www.winacanon.com. Also there are the contact details for Velmex who can answer any questions you might have, and who can put you in touch with your nearest Canon Reseller.

For the best priced pavement signs with no compromise on quality

PromotaSigns

www.promotasigns.com

Tel: 01227 711911
Fax: 01227 711922



CLASSIFIED

Boxed classified advertising starts at £20 with unlimited wording. Will be seen by over 20,000 readers. For further details or instant quote for your advert ring

01295 660666

FOR SALE

Walker Singleton

Asset Consultants

On the instructions of the Secured Chargeholder

TENDER SALE

Pacer 1250 HD CNC Router/Engraver



- Reconditioned: 2006
- Capacity: X – 1,250mm; Y – 1,250mm; Z-130mm
- Auto 6 Station Toolchanger

Further Details Available Online

walkersingleton.co.uk

01422 430040

VACANCIES

Vehicle Livery Fitter

For 18 years, Stryz Limited has specialised in the production and application of vehicle graphics & wraps. With contracts now throughout the UK, our new subsidiary Vehicle Livery Solutions has vacancies for 2 experienced vinyl livery fitters, one being based in the North West, the other in the North East.

You will have:

- a minimum of 5 years experience fitting vehicle graphics and wraps
 - proven ability
- good communication skills enabling you to liaise with clients when on-site
 - the ability to work on-site unsupervised using your own initiative, and as part of a team
- a self motivated and flexible approach
 - a full and clean driving licence
 - no criminal convictions
 - the desire to be the best at your job

In return you will receive:

- pay of £20k per annum plus overtime
 - bonus scheme
 - a company vehicle
- 4 weeks per annum holiday plus all bank holidays
 - work wear
 - appreciation and reward

For further information please contact
Darren Roberts (Operations Director) on:

(01482) 491770

47-49 Gillett Street, Hull, East Yorkshire HU3 4JF.



SERVICES

How to avoid the hassle!

Professional sales literature increases your sales, but you're probably too busy running your business to worry about writing new brochures, producing eye-catching designs and finding reliable printers.

Tell us what you want to achieve and we'll do all the work!

- Friendly, experienced assistance to ensure that you achieve your business objectives
- Top quality results to enhance your business image and increase your sales
- Competitive prices

We've been producing KidsNeeds for over six years – why not take advantage of our experience?

Call or email us now to discuss your needs.

Tel: 01295 660922

Email: sales@thegarden-shed.co.uk



Copywriting
Design & Print

LEAFLETS
BROCHURES
NEWSLETTERS
PROGRAMMES
CATALOGUES

ANDESIGN is looking to recruit:-

Experienced VINYL GRAPHICS FITTER, DIGITAL PRINT MACHINE OPERATORS (Nur, Vutec & Seiko) and MAC OPERATORS/DESIGNERS. A full clean driving license and past experience within the sign trade an advantage.

Birmingham based, medium sized signs, graphics and large format digital print company requires enthusiastic, experienced people to join our team.

Please email your CV to sarah@andesignuk.co.uk

FOR SALE

Engraving & Signage Business For Sale

in Hampshire, due to retirement
established 40 years
Great trading location on main road
Easy access to M3 M4 & London

Owner-run with 5 staff Large Client base
Good reputation, 75% repeat work T/O £250k
£200k plus SAV 07771 527904



Future Recruitment Ltd.

Open 8 am - 8 pm

0161 485 8888

Our team of consultants cover all the UK



Sue Kirkman
Recruitment
Consultant



Jane Houghton
Managing
Director



Louise Clarke
Sign
Consultant



Hollie James
Print Management
Consultant



Helen Thomas
Board Level
Consultant

Search & Selection

Signs Screen & Digital Graphics Printing

www.futurerecruitment.com

info@futurerecruitment.com

SERVICES

hallmark

Est. 1899

ENGRAVING ETCHING & SIGNS

*A first class service based on over
a century of experience, the latest
technology and specialist professionals*



To view our complete portfolio, please visit our website:

www.hallmarksigns.co.uk

020 8686 6649

email: sales@hallmarksigns.co.uk

**DAMAGED ROLLS? UNABLE TO QUICKLY LOCATE
THE RIGHT VINYL? UNTIDY WORK AREA?**

WELL, NOT ANY MORE WITH OUR VINYL SIGN RACKS

- A simple yet unique design allows 8 x 50mtr rolls to be easily stored •
- No screws or fixings, just 4 component parts, assembled in minutes •
 - This free-standing rack can be moved easily to any location •
- But why stop at vinyl? You can load any media onto this rack, such as banner rolls, bubble wrap, application logs ... and more •
- We supply racks to fit 610mm from stock at an amazing £84.99 + VAT •

**IF YOU REQUIRE ANY OTHER SIZE OR A BESPOKE RACK,
THEN PLEASE RING ...**

0114 275 2205 TODAY!

**FREE
DELIVERY**



DOMES BY PROJECT PLASTICS

SPECIALISTS IN PLASTIC FABRICATION

- ACRYLIC DOMES AND SHAPES •
- 3MT X 2MT C.N.C. ROUTING •
- LAZER CUTTING / ENGRAVING •
- OVEN FORMING UP TO 3MT X 2MT •
- FLAT CUT ACRYLIC LETTERS •
- PROTOTYPE AND BESPOKE SPECIALISTS •
- POINT OF SALE DISPLAYS •

TEL: (01206) 868696
FAX: (01206) 793737

www.projectplastics.co.uk
 7 Grange Way Business Park,
 Colchester, Essex CO2 8HF

trade
digital print
 & cut service

1370mm x any length
 1440 dpi
 banners - vinyls - posters etc.

no minimum order charge
 active digital printing
01708 640 840
 dan@activesignsanddesigns.co.uk

General Banner company Ltd.

BLANK BANNERS

Exterior Grade 630 gsm, Welded hems
 3m wide to Any Length

3m Wide Solvent Ink Jet Printing

Now In House

BANNER FRAME KITS • WALL POLES
ROPE & BUNGEE LOOPS • SOFT BANNER VINYL IN STOCK

Ask For Free Trade Sample Pack

Tel 01845 574455 fax 01845 574433

Sales@generalbanner.co.uk
 Web www.generalbanner.co.uk

General Banner Co.Ltd Thirsk Industrial Park, York Road, Thirsk, North Yorkshire YO7 3BX

SCHOOL OF MOTORING TOP SIGNS

YOUR NAME
 S.O.M. 1
 21" x 10 1/2" x 8 1/2" High

ANDERSON
 S.O.M. 2
 21" x 10 1/2" x 8 1/2" High
 (0191) 512 00 96

F. LAING
 S.O.M. 3
 31" x 10 1/2" x 10 1/2" High
 (01792) 583434/584444

VISA MasterCard American Express SWITCH

LETTERCRAFT TOPSIGNSUK

MAGNETIC ROOF SIGNS -
 CHOOSE FROM 6 DESIGNS

- SIGNS SUPPLIED WITH OR WITHOUT ILLUMINATION
- LOWEST TRADE PRICES WITH DISCOUNTS FOR QUANTITY
- HIGHEST QUALITY SIGNS FROM THE COUNTRY'S LEADING MANUFACTURER
- BLANK SIGNS AVAILABLE FROM STOCK FOR IMMEDIATE DELIVERY

Mill House, Market Place, Houghton-le-Spring,
 Tyne & Wear DH4 8AH
 Telephone: 0191 512 0096 Fax: 0191 584 7804
 www.lettercrafttopsignsuk.co.uk

DIAMOND EDGE POLISHERS

UP TO DATE TECHNOLOGY AT AN AFFORDABLE PRICE

A bench-top machine which can handle single or multiple workpieces up to 20mm thick is now available

QUALITY WOOD & STEEL 'A' BOARDS AT A REALISTIC PRICE

PAVEMENT SIGN
 in Zinc Coated Steel with a White Finish
 Price £33.08 +VAT
 POSTER VERSION £49.53 +VAT

LARGE SIZE
 1525mm x 1000mm
 from £135.00
 SWING SIGNS £45.00

Special designs in mild/stainless steel, aluminium to your specification fabricated. Send or fax us a drawing. All colours available on our in house powder coating plant.

Delivery nationwide
 Telephone now on 01663 744824 or facsimile 01663 747733

DES Ltd
 KNOWLES INDUSTRIAL ESTATE, FURNESS VALE, HIGH PEAK, DERBYS. SK23 7PH, ENGLAND
 email: DESBOARD@aol.com
 www.desltd.co.uk

PC60 Cartridges

From Only **£5 per Cartridge**
 Quantity Price shown
 Ribbon Refills at £4

Do you need a Sample?
Ring Carol
Tel 01254 704330

New Genuine Roland Original
PrintHeads Fitted
 Ring for prices
 Independent Engineers

Exchange Cartridges XStock
 New PrintHeads XStock
 5Pack Cutter Blades XStock
 Budget 610mm Vinyl XStock
 Next Day Delivery
WHY PAY MORE?

Graphics Ready Illuminating

signBLANKS
 Trade Only Prices

Illuminating Projecting Wall & Ceiling Signs

From Only **£60 each**
 Round, Oval, Square, Oblong
HeavyWeight or LiteWeight
 Lowest

TRADE only prices
 Best Bulk Prices
 Full Warranty
 Next Day Delivery
 Ring for Catalogue
Ring Rozz or Carol
Tel: 01254 704330
WHY PAY MORE?

HEAT BENDERS

A NEW RANGE OF HIGH QUALITY MACHINES

We can offer machines to suit all needs capable of bending materials such as PMMA, PS, PP, PVC and acrylic from just 0.3mm to 20mm thick

FLAME POLISHERS

STILL THE CHEAPEST AND SIMPLEST WAY
 to apply a professional finish to cut edges of acrylic material

AWLTECH

For more information or a brochure call **AWLTECH**
Tel: 01483 569232
Fax: 01483 569263

A1 SIGNS
 Manufacturers of High Quality

NEON & COLD CATHODE

* Design * Manufacture *
 * Installation * Service & Repairs *

020 8646 9886
 Email: enquiry@a1designs.co.uk
 Unit 9a, Wandale Technology Park, Mill Green Road, Mitcham, CR4 4LZ

Manufactured and supplied to the sign industry by

A DISPLAY

Castle Trading Estate,
 Portchester, Fareham,
 Hants PO16 9SF

PAVEMENT SIGNS - READY FOR YOUR VINYL

www.a-display.co.uk

ASK FOR OUR FULL CATALOGUE - Tel: 023 9222 1222 Fax: 023 9222 1234

'A' Board
Swing Sign
Poster Board
Heavy Duty Dome



YorKut

LETTER COMPANY

YOUR FLAT CUT LETTER TRADE SERVICE

**FLAT CUT LETTERS
AT BEST PRICES**

ACRYLIC • FOAM PVC • MAGNETIC • MEDITE
STAINLESS STEEL • ALUMINIUM • DIBOND

Call 01904 690330

YorKut Letter Company, 34-36 Auster Road,
Clifton Moor, York, YO30 4XA.
email: sales@yorkut.co.uk Fax: 01904 692155

www.yorkut.co.uk

YorKut Letter Company is a subsidiary of Sign*A*Rama (York) Ltd

BETA BANNERS

BLANK BANNERS FOR YOUR GRAPHICS
TOP QUALITY BANNERS-LOW,LOW PRICES!
NEXT DAY DELIVERY
NO ACCOUNT NECESSARY
DISCOUNTS AVAILABLE
'YOU CAN'T BEAT A BETA BANNER!'

**TEL/FAX:01875
61 61 62**

MAGNETIC ROOF TOP SIGNS
for Driving Schools, Taxis etc.



A unique, brilliant, illuminated
vehicle sign that uses removable vinyl
or printed advertising inserts

GRAPHIC SERVICES Tel: 01793 542678
Fax: 01793 430788
26 Eastcott Hill, Swindon, Wiltshire SN1 3JG
www.graphicservices.uk.com

Teedy STOCK DOMES



18 SIZES 100^{mm} to 1800^{mm}
A range of clear cast acrylic domes
ready today and delivered tomorrow.
"SPECIALS" from 140 sizes

TALBOT DESIGNS LTD
TEL: 020 · 8346 8515
FAX: 020 · 8349 0294
e-mail: domes@talbotdesigns.co.uk
website: www.talbotdesigns.co.uk

White Villa LTD

Awnings, Canopies, Signwriting,
Banners, Digital Printing

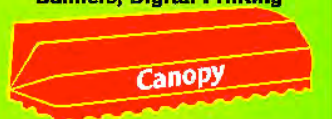

tel: 020 7237 8000
fax: 020 7237 8621
www.whitevilla.co.uk

Trade price from main distributor of no. 1 Italian awnings



The heat press is the most important part of any heat transfer system. Consistency of temperature and pressure are vital for successful results

HEAT PRESSES



xpres
Transfer Technology

www.xpres.co.uk
Tel 01332 85 50 85
Fax 01332 85 50 80

Football Shirts · T-Shirts · Bags · Polo Shirts · Caps · Jackets · Sportswear · Promotional Wear · Workwear and more



xpres
Transfer Technology

www.xpres.co.uk
Tel 01332 85 50 85
Fax 01332 85 50 80

A versatile combination of the Xpres cutter and an ink jet or sublimation printer



ULTRAGRAPHICS®



THISTLE SIGN SERVICES

FOR YOUR SCOTTISH INSTALLATION SOLUTIONS

Neon Specialist

Pole Signs

Grillages / Concrete excavations

Flexface

LED

Awnings

Vinyl Manifestations

Surveys

**Tel:01324 820230
Fax:01324 820240**

email: thistle.signs@btopenworld.com

For Peace of Mind

Call

THISTLE SIGNS LTD

The Sign Fitter's Answer



Trestles and Staging System

Scaffold Towers

STRONG • SAFE • PRACTICAL

Just some of our comprehensive range of products.
Please ask for a free copy of our Buyer's Guide

Tel: 0117 953 9533

STANFAST ACCESS EQUIPMENT

Emtage House • Brendon Road • Bedminster • Bristol • BS3 4PX



FRETSHOP TRADE CNC LETTERING

FAST, FRIENDLY RELIABLE SERVICE AT THE RIGHT PRICE!

FRETSHOP AFFORDABLE LETTERING IN ACRYLIC (PLEXIGLASS) AND DI-BOND (ADD 25%) ANY FONT (NOT EXTENDED) - US TO SET FILE OR YOUR VECTOR .eps FILE NO MINIMUM ORDER

SIZE (mm)	50	75	100	125	150	175	200	250	305	420	500	610	LOGO
3mm	62p	62	78	93	118	145	194	245	338	593	718	1014	PLUS 20%
5mm	88p	92	117	143	185	217	247	445	632	878	1112	1491	PLUS 20%

METALLIC AND OTHER RANGE ACRYLICS TO BE COSTED SEPARATELY FREE FULL SIZE NON PRICKED DRAWING

FRETSHOP AFFORDABLE LETTERING IN FOAM PVC BLACK WHITE RED BLUE GREEN YELLOW ANY FONT (NOT EXTENDED) - US TO SET FILE OR YOUR VECTOR .eps FILE NO MINIMUM ORDER - GLOSS ADD 20%

SIZE (mm)	50	75	100	125	150	175	200	250	305	420	500	610	LOGO
3mm	39	49	65	73	87	96	137	197	294	394	458	598	PLUS 20%
5mm	47p	65	84	116	144	181	214	285	395	528	748	885	PLUS 20%

10mm, 19mm and 25mm are available in white foam PVC please call for prices

ALL SALES - PAYMENT IN FULL BY MAJOR CREDIT CARD ON DESPATCH RECEIPTED INVOICE SENT TO CLIENT WE DO NOT RETAIN ANY CREDIT CARD DETAILS ON ANY FORM OF DATABASE WE DO NOT SHARE ANY DETAILS WITH ANYBODY! TOTAL CLIENT CONFIDENTIALITY GUARANTEED.

ORDERS WHERE POSSIBLE ARE DESPATCHED WITHIN 72 HOURS COSTS ARE EXCLUSIVE OF SECURE PACKAGING AND VAT. GOODS SENT BY TNT ON A NEXT DAY BASIS DELIVERY TIME UPGRADES ARE AVAILABLE AND COSTED IF REQUIRED. SAME DAY QUOTATIONS SENT BY E-MAIL OR FAX GOOD DISCOUNTS ON LARGE ORDERS VECTOR. EPS FILES REQUIRED SET AT SIZE LOCATORS AND ACCURATE FIXING DRAWINGS ARE ADDED IF REQUIRED ALL JOBS ARE SENT WITH FULL SIZE SPACING DRAWING

PLEASE NOTE WE DO NOT PRODUCE REAL METAL OR BUILT UP TEXT

ASK ABOUT OUR POLYSHOP RANGE OF CUT OUT LETTERING AND PRODUCTS IN FRA GRADE EXPANDED POLYSTYRENE FOR POS, CONFERENCES AND EXHIBITIONS A GREAT WAY TO GET THE MESSAGE ACROSS UP TO 100MM THICK AND 1830MM HIGH! NATURAL, VINYL OR PAINTED FINISH FULL DIGITAL IMAGING SERVICE BANNER STANDS, POP -UPS etc.. FULL SIGN SERVICE INCLUDING FIXING SEE OUR WEBSITE FOR FULL RANGE OF OUR SERVICES

FULL INKJET PRINT SERVICE CONFERENCE GRAPHICS A SPECIALITY

THE BEST QUALITY - THE BEST SERVICE - YOUR FRIENDS IN THE TRADE ESTABLISHED 30 YEARS FRETSHOP AND POLYSHOP BY SIGNAGRAPHIC THE COMPLETE GRAPHICS SERVICE www.signagraphic.com

THE FRETSHOP HOTLINES: Tel 01274 585511 fax 01274 585522

E-mail: steve@signagraphic.com Mobile 07831 828636.

STEVE OR MARTIN ARE WAITING FOR YOUR CALL WE VALUE YOUR BUSINESS AND SPECIALISE IN HELPING THE SMALLER SIGNMAKER WE UNDERSTAND THE TRADE AND GIVE ADVICE FREELY. WE WILL ALWAYS DO OUR BEST TO BEAT ANY GENUINE COMPETITORS QUOTED PRICES!

READY TO USE FACED UP ALUMINIUM SIGN PANELS POLES AND CLIPS AVAILABLE NEW!
FINISHED SIGN SERVICE OR YOU TO LETTER - VINYL TEXT MOST FONTS AVAILABLE
FULL CUT TO SIZE FOAMEX DI BOND OR ACRYLIC SIGN PANEL SERVICE - FROSTED & SPECIAL VINYL
WE ARE HERE TO HELP THE SMALLER SIGNMAKER CALL US WE CAN PROBABLY SUPPLY IT!
YOU DONT NEED AN ACCOUNT HERE! ALL CREDIT CARD ON DESPATCH WITH RECEIPTED INVOICE.
TEL 01274 585511 FAX 01274 585522 WE WANT YOUR BUSINESS... TRY US!

ALONG WITH OUR GREAT FLAT CUT PRODUCTS, HAVE YOU THOUGHT OF TRYING OUR FLAME RETARDANT POLYSTYRENE LETTERING AND LOGOS?

THEY ARE GREAT FOR THAT PUNCHY INTERIOR OR SHORT LIFE EXTERIOR GRAPHIC CONFERENCES EXHIBITIONS • IN STORE • THOUSANDS OF USES!
Sizes up to 1220mm HIGH and 75mm THICK
PAINTED, FACED IN VINYL OR INKJET PRINTS - YOU NAME IT, ANY TYPEFACE WITH SPACING TEMPLATES.



CALL STEVE NOW FOR ADVICE OR SAME DAY QUOTATION ON 01274 585511 OR 07831 828636

WE HAVE PRODUCED THESE FOR 25 YEARS AND WE STILL MARVEL AT THEIR APPEARANCE!



...ANOTHER GREAT PRODUCT AND SERVICE FROM THE EXPERTS...
FRETSHOP BY SIGNAGRAPHIC

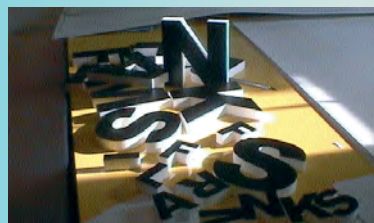

EXPERIENCED FITTERS
CSCS & IPAF
CARD HOLDERS
UNLETTERED VANS
SCAFFOLD TOWER
& HAND TOOLS

INSTALLATION TEAM FOR HIRE

FIXED PRICES
TRAVEL UK WIDE
EST. 1975

NOBLE SIGNS GLASGOW

Phone JOHN: 01698 818494

SNAPFIX Letter Fastenings

for flat-cut, built-up acrylic etc

Used by the Sign Trade for 38 years - U.V. stable
-withstand temperature variations

Medium	250	500	1000
Complete Fixing	£22	£37	£65
Sockets Only White and Black	£15	£22	£37
Studs Only	£16	£26	£38



Jumbo	250	500	1000
Complete Fixing	£33	£58	£98
Sockets Only (Black or white)	£22	£35	£60
Studs Only	£23	£38	£62

Quantity Discounts 5000 pairs-15% 10,000 pairs-20%

Nylon Locator Fixings

for wood, MDF, aluminium, steel etc

Extra strong - no shearing - excellent weathering

	250	500	1000
Complete Fixing	£33	£60	£115
Nuts Only	£22	£38	£ 75

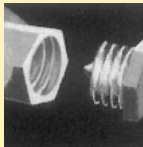

Send for samples

Prices Include Postage (add V.A.T.)

SNAPFIX

Mallow Court, Wendron, Helston, Cornwall. TR13 0NA

Telephone: 01326 561229 Fax: 01326 562796

www.snapfix.co.uk email: info@snapfix.co.uk

WANTED

Engraving Machines

manual and computerised,
most makes, in any condition

Tel: 01992 899255

Fax: 01992 899256

Evening - Tel: 01707 872991

email:

sales@ronamachines.co.uk

www.ronamachines.co.uk

signBLANKS A BOARDS

Trade Only Prices

Quality Product



From Only

£30 each

5 Allu Displays
2 sizes per model
Lowest TRADE only
prices
Best Bulk Prices
Full Warranty
Next Day Delivery

Rozz or Carol

Tel: 01254 704330

WHY PAY MORE?

NEW BLADES

£10 EACH 5 FOR £45+Vat

ROLAND GRAPHTEC
MUTOH GERBER
MIMAKI NEW STAR

HOUSTON
BLADE HOLDERS

from £40

Manufactured to EEC ISO 9003QM

01256 762999

Email: gwardave@aol.com

THE Biggest Squeegee Range

Bulk Trade Prices
All Types & Sizes
Traditional, Chislers,
Felt Edged & Felt Squeegees
Sleeves, Squeegee Holders,

Rozz or Carol
Tel: 01254 704330

Full Warranty. Highest Quality

All models ExStock
Next Day Delivery
Ring for full list
Vinyl Kit Squeegees
3M & Renown



WHY PAY MORE?

www.ispitrade.com

PAY THE REAL TRADE PRICE

SIGN FIXINGS FROM 62P

**Quality sign fixings
In Brass, Stainless
and low cost Aluminium**

**Cable Systems
Lightboxes**

**LED
All at
GENUINE TRADE PRICES**

Call Chris (local rates)
0845 241 2467
for your free brochure

MASSIVE STOCKS

FRIENDLY PROFESSIONAL SERVICE

NEXT DAY DELIVERY

New Crystal Edge Illuminated A3 & A4 ONLY 8mm Profile

ONLY 28mm depth
Counter Top Edgelit only £12.99

8mm profile lightboxes - Illuminated displays from £12.99 - Low Cost Cable Systems

LED AT THE REAL TRADE PRICE

Waterproof, 3 lamp modules
ALL Colours £1.20
White ONLY £1.50

New Products Fully CE Approved for 2008
Flame polishers Bespoke Design From Only £549

Tel 0845 241 2467

Tel 0141 764 1600

Fax 0141 778 5824

Web: www.ispitrade.com email: chrisispi@aol.com

LOWEST PRICE GUARANTEED

Lo-Call 0845 241 2467

BUYERS GUIDE

To advertise on these pages costs as little as £100 and that's for a full year's advertising!
Telephone our Buyers Guide Hotline 01295 660666 for full details of how to get your company to 22,000 Sign Update readers

3D DOMING SYSTEMS

CREATIVE PRINTERS OF LONDON

Unit B6, Burnard Rd., Dane Ind Est, Romford, Essex RM7 0HX

Tel: 01708 731294

E-mail:

creativeprinters@btinternet.com

web: www.make-a-gift.co.uk

www.print1.co.uk

Suppliers of low cost doming blanks as used in the advertising industry. We supply blank key fobs, bottle openers, cufflinks, tie slides, lapel badges, golfer's products, resins, print media, hand dispensing guns etc. Complete 'Starter Kits' also available. Details/Samples on request.

LEXICRAFT NAMEPLATES LABELS & SIGNS

Woodside Business Park, Birkenhead, Wirral CH41 1EL

Tel: +44 (0) 151 666 5400

Fax: +44 (0) 151 666 5401

E-mail: enquiries@lexicraft.co.uk

Web: www.lexicraft.co.uk

'3D-ID' Resin Domed badges provide top quality product identification attracting attention, illustrating brand names and promoting your corporate image. From short runs to mass production, call Lexicraft for more information.

MOCKRIDGE LABELS & NAMEPLATES LTD

Cavendish Street, Ashton-under-Lyne, Lancs OL6 7QL

Tel: 0161 308 2331

Fax: 0161 330 9645

E-mail: sales@mockridge.com

Web: www.mockridge.com

3D Resin Doming adds value to screen and digitally printed signs, lettering, labels and emblems. Mockridge offer a wide range of products from budget-priced starter kits to mass-production systems. Contract Doming service available. Send for samples.

3D SIGN MAKING SOFTWARE

DELCAM PLC

Small Heath Business Park, Birmingham B10 0HJ

Tel: 0121 766 5544

Fax: 0121 766 5511

E-mail: artcam@delcam.com

ArtCAM Pro is 3D Software for creative sign design and manufacture. This software takes your 2 dimensional design sketches and creates high quality 3 dimensional signs, carvings and decoration. ArtCAM Pro is very easy to use and drives almost any CNC router.

'A' BOARDS

"A" DISPLAY

Castle Trading Estate, Portchester, Fareham, Hampshire PO16 9SF

Tel: 02392 221222

Fax: 02392 221234

e-mail: sales@a-display.co.uk

Web: www.a-display.co.uk

'A-Boards, Swing Signs and Poster Boards for all retail outlets, direct from the manufacturer. Our Pavement Signs are of a heavy-duty metal construction, zinc coated for maximum durability and available in a range of colours. Try our popular PVS 2 Swing Sign with its virtually indestructible panel. Call or email for a catalogue and trade price list.'

3D DOMING SYSTEMS
3D SIGNMAKING SOFTWARE
'A' BOARDS
ACCESS EQUIPMENT
ACRYLIC DISPLAY CASES
ACRYLIC SHEET
ALKYD SCREEN PRINTING INKS
ALUMINIUM FRAMING
ALUMINIUM SIGN BLANKS
APPLICATION TAPE
BANNER FRAMES
BANNER INSTALLERS
BANNER SUPPLIES
BILLBOARDS
BRAILLE & TACTILE SIGNS
BRASS LOCATOR NUTS
BRASS REPLACEMENT
BRASS/STAINLESS BLANKS
BRONZE VITREOUS ENAMELLING
BUILT UP LETTERS ACRYLIC
BUILT UP LETTERS METAL
CAR REGISTRATION PLATES
CAST METAL NAMEPLATES
CAST METAL SIGNAGE
CHEMICAL ETCHING
CHROME PLATED LETTERS
CLOCK MECHANISMS
CNC ROUTING & ENGRAVING MACHINES
COAT OF ARMS
COMMEMORATIVE PLAQUES
COMPUTER HARDWARE
COMPUTER SOFTWARE
CUT-OUT LETTERS
DIAMOND EDGE POLISHERS
DIGITAL
DIGITAL INKJET PRINTING
DIGITAL PRINTER SUPPLIES
DIGITAL PRINTED SIGNS
DOMES & DISHES
EDGELIT SIGNS
ELECTRONIC SIGNS
ENGRAVING
ENGRAVING MACHINES
ESTIMATING SOFTWARE
FLAGS & FLAGSTAFFS
FLAME POLISHERS
FLAT CUT LETTERS METAL
FLEXIBLE FACE SIGNS
GENERAL SIGN SUPPLIERS
GLASS FIBRE (GRP) PRODUCTS
GOLD LEAF SUPPLIERS
GROUND WORKS
HEAT BENDERS
HOLOGRAPHIC VINYL
ILLUMINATED POSTER CASES
INKJET MEDIA
INSTALLATION CONTRACTORS
LARGE FORMAT DIGITAL PRINTING

LARGE FORMAT DISPLAY BOARDS
LARGE FORMAT SCREEN PRINTING
LASER CUTTING/ENGRAVING
LASER ENGRAVING MACHINES
LED ILLUMINATION
LIGHT BOXES
LIGHTING
MAGNETIC MATERIAL
METALLIZING SERVICE
MODEL MAKING
MODULAR PANEL SIGN SYSTEMS
MOULDED & FABRICATED PLASTICS
MOULDED LETTERS
NAMEPLATES
NUMBER PLATES
NEON MANUFACTURERS (TRADE)
NOTICE & DRY-WIPE BOARDS
PAVEMENT SWINGER SIGNS
PLANT HIRE
PLASTICS DISTRIBUTORS
PLOTTER BLADES
POLYSTYRENE SIGN SERVICE
POSTER HOLDERS/CASES
PRINT ON PLASTIC
PRINT/POSTER FRAMES
PROJECTING SIGNS
RECYCLED STREET NAMEPLATES
REFLECTIVE TAPES
ROAD SIGNS
ROUTING SERVICES
SCREEN INKS
SCREEN PRINTING
SCULPTORS
SHEET MATERIALS
SIGN & DISPLAY FRAMES
SIGN & DISPLAY SYSTEMS
SIGN CASES
SIGN MAINTENANCE
SIGN TRADE SUPPLIERS
SIGN SUPPORT SYSTEMS
SIGNWRITING PRODUCTS
SITE SURVEYS
SLIDERS & MAGNETIC NAMEPLATES
SPECIALITY FILMS
STENCIL MATERIAL
SUBLIMATION
TAPES & ADHESIVES
TRANSFER PAPERS/HEAT PRESSES
VANDAL RESISTANT SIGNS
VINYL
VINYL & GRAPHIC INSTALLATIONS
VINYL SUPPLIES
WAYFINDING SIGNS
WIDE FORMAT SOLUTIONS PROVIDER
WINDOW FILMS - WHOLESALE
WOODEN LETTERING
WOODEN PLAQUES
WOODEN SIGN BLANKS
WOODWORKING

ANCHOR MAGNETS LTD

Bankside Works, Darnall Road, Sheffield S9 5AH

Tel: 0114 2441171

Fax: 0114 2426612

www.anchormagnets.com

Attract more business with Anchor Signs, the versatile 'A' boards which can be used as poster frames, black boards or dry wipe boards. They feature a unique 'quick change' magnetic fixing system and transparent front panel for all weather protection. Available in a choice of colours and designs with high quality, corrosion resistant steel frames.

DES

Knowles Industrial Estate, Furness Vale,

Stockport, Cheshire SK12 7PH

Tel: 01663 744824

Fax: 01663 747733

E-mail: DESABOARD@aol.com

Web: www.desltd.co.uk

Any size, and colour, aluminium, steel or stainless steel. Standard A board display area 21" x 36" powder coated in polyester. Can be used as a poster board with a magnetic transparent cover. Swing signs also available. Fax your drawings for a quotation on special display boards.

FASTLANE SKOLABOARD

A division of WOODCON PRODUCTS LTD

Daux Road, Billingshurst, West Sussex RH14 9SR

Tel: 0800 652 8652

Fax: 01403 785353

E-mail: info@woodcon.co.uk

A comprehensive range of chalkboards, and other display and sign products to help increase turnover and profitability in all licensed trade and leisure establishments.

GLASPLAS SIGNS (GPS)

(a division of Harviglass GRP Ltd)

Alexandra Street, Hyde, Cheshire, SK14 1DX

Tel: 0161 351 4620

Fax: 0161 368 1508

Web: www.glasplas.co.uk

High quality fibreglass street signage with traditional arch top utilising the advantages of GRP signs - High gloss finish - Any colour - Vandal-resistant build - Lightweight easy set-up - Easy graphics application - Security point.

ROTOSIGNS

Pressmetal House, St Augustines Business Park,

Whitstable, Kent CT5 2QJ

Tel 01227 794490

Fax 01227 794488

E-mail sales@rotosigns.com

Website www.rotosigns.com

Extensive range of UK manufactured quality trade display boards available from stock. Range includes Budget, Chalkmaster, Heavy duty poster holders. Large range of colours available on next day delivery.

UK POINT OF SALE GROUP LTD

Emery Court, The Embankment, Heaton Mersey, Greater Manchester, SK4 3GL.

Tel: 0161 4314400, 0161 4314411

www.ukpos.com

UK Point of Sale leading manufacturers of display products Acrylic & PVC poster holders, Sign Supports, Aluminium Snap Frames, A Boards, Poster cases & Point of sale fittings.

ACCESS EQUIPMENT

ACCESS DIRECT (LONDON)

13 Conway Gardens, Enfield EN2 9AD

Mobile: 079444-01477

- Hire of 22m hydraulic platform, mounted on a 7.5 tonne lorry with fly jib & rotating basket.
- Supply labour for fitting signs
- Specialise in neon signs
- Manufacturers of neon signs

ACRYLIC DISPLAY CASES

TALBOT DESIGNS LTD

225 Long Lane, London N3 2RL

Tel: 020 8346 8515

Fax: 020 8349 0294

E-mail: sales@talbotdesigns.co.uk

Web: www.talbotdesigns.co.uk

As an established fabricator of over 50 years we know there is a demand for display cases quickly, and we stock 27 standard sizes. Ring Fax E-mail for quick details.

ACRYLIC SHEET

N E PLASTICS LIMITED

Unit 1, Ruxley Corner Industrial Estate, Edgington Way,

Sidcup, Kent DA14 5BL

Tel: 020 8308 9990

Fax: 020 8308 9995

E-mail: sales@neplastics.co.uk

Web: www.neplastics.co.uk

N E Plastics Ltd - one of the U.K.'s largest independent distributors of semi-finished plastics, supplying a fast and flexible service to the Graphics, Glazing, Exhibition, Point of Sale, Sign making and Screen printing industries.

PERSPEX® FROM LUCITE®

Lucite International UK Ltd, PO Box 34, Darwen, Lancashire BB3 1QB

Tel: 01254 874000

Fax: 01254 873300

www.lucitesolutions.com

email info@lucitesolutions.com

Perspex® from Lucite® - the UK's leading acrylic sheet - is the material of choice for sign makers, fabricators and designers the world over.

Perspex® is available in an extensive range of clear, opal, tints and solid colours as well as a range of exciting new grades and effects such as Perspex® Frost, Perspex® Pearlescent, Perspex® Fluorescent and new Perspex® Fluorescent Anti-Reflective - ideal for a range of sign, POS and display applications.

Perspex® Prismex®, Perspex® S-Lux and Perspex® D-Lux offer a range of solutions in edge-lighting technology.

Perspex® from Lucite® and Perspex® Prismex® are trademarks of Lucite International.

RIGHTON LIMITED

Righton House, Brookvale Road, Wilton,

Birmingham B6 7EY

Tel: 0121 356 1141

Fax: 0121 344 4558

Web: www.righton.co.uk

National distributors of I.R.G. extruded acrylic sheet and polircast acrylic. Available in a wide range of clear, opals and colours. Also stocked: Marlon Solid and Structured Polycarbonate, P.E.T.G., S.A.N., Foamalux, Komacel and Komadur, Octaclad, PVC, Dibond, Filon GRP, aluminium sheet (available white painted). Stainless steel sheet in various finishes, aluminium extrusions, stainless fasteners, adhesives, copper, brass and bronze. In-house cutting and coating service. 24 hour delivery service.

ROBERT HORNE SIGN & DISPLAY

Huntsman House, Mansion Close,

Moulton Park, Northampton NN3 6LA

Tel: 01604 495333

Fax: 01604 673407

Probably the largest stock range of acrylic in the UK. Wide range of Repsol cast sheet sizes for optimum efficiency, coupled with extensive colour range, textures and low minimum order quantities for special colours. UK's number one distributor for Perspex.

SILWOOD PLASTICS LIMITED

Unit F, Borough Road, Buckingham Road Industrial Estate, Brackley, Northants NN13 7BE

CENTRAL SHEET SALES

Tel: 01280 844800

FREE Fax: 0800 169 2983

Distributors of an extensive range of high quality Signage and Display Materials, which include:

CAST & EXTRUDED ACRYLIC - Clear, opals and colours

FOAM PVC - White and colours

PET PETG PC SANS HIPS

Aluminium composite sheets, Gear Trays,

Adhesive and Aluminium Sign Profiles.

All materials available in sheets or cut to size.

NATIONAL DISTRIBUTION SERVICE

TRANSPLAS

Dawkins Road, Hamworthy, Poole, Dorset BH15 4HF

Tel: 01202 670567

Fax: 01202 667768

E-mail: transplas@transdev.co.uk

Web: www.transdev.co.uk

Official regional Distributor of Perspex Cast and Extruded sheet, available in ranges of clear, opals, tints and colours as well as frosts, flourescents and pearlescents. Also stocking Palight and SS50 Foam PVC's, Alu Panel and Hoarding Panel, EZ Frame Systems, Engraving Laminate and Polycarbonate.

VISIONS IN PLASTICS

Unit 3A, Delta Court, Sky Business Park, Auckley,

Doncaster DN9 3GN

Tel: 01302 775920

Fax: 01302 760699

E-mail: sales@visionsinplastics.com

European agent for Plaskolite products, manufacturers of a wide range of mirrored plastic sheet. Extruded mirror in clear and 17 standard colours, Polycarbonate, PETG and Optix Non-mirrored Extruded Acrylic. Also, High Impact Polystyrene Mirrored and Non-mirrored manufactured by Formaterm and Foam PVC manufactured by Simona. Please telephone for further information.

VULCASCOT LIMITED

Gatwick Gate Estate, Lowfield Heath, Crawley,

West Sussex RH11 0TG

Tel: 01293 560130

Fax: 01293 537743

Braintree Road, Ruislip, Middlesex HA4 0XX

Tel: 0208 841 4211

Fax: 0208 841 3544

E-mail:

vulcascot.baz@btinternet.com

From 3 branches nationwide Vulcascot supplies a comprehensive range of plastic sheet materials including Setacryl, Vulcacrlyl, Perspex cast and extruded acrylic, Marlon, Foamalux, Foamalux Ultra, Vulcafoam, PETG, Engraving sheet, Engineering Plastics, Chalkboard, and Compact Laminates. Vulcascot also offers a wide range of decorative and industrial laminates.

ALKYD SCREEN PRINTING INKS

APOLLO COLOURS LIMITED

Unit E4, Kingfisher Business Park, Hawthorn Road,

Bootle, Liverpool L20 6PF

Tel: 0151 922 5665

Fax: 0151 933 5667

E-mail: sales@apollocolours.co.uk

Web: www.apollocolours.co.uk

Our Gloss Enamel range is thinned with White Spirit and is suitable for Water-Slide Transfers, primed metals, wood and glass. Can be air dried or stoved. Gloss Enamel is available in 17 standard colours, plus matchings and varnishes.

ALUMINIUM FRAMING

KINGS PLASTICS LTD

The signbuild Centre, Kingsown House, Unity St,

Bristol BS2 0HM

Tel: 0117 922 6382

Fax: 0117 925 1159

Our own range of aluminium extrusions for framing substrates from 3mm up to 10mm thickness, silver anodised or powder coated, supplied in lengths or made up, with or without panels.

SIGN MAKERS PRODUCTS LIMITED

Hawthorn House, Ipswich Road, Long Stratton,

Norfolk NR15 2XB

Tel: 01508 531183

Fax: 01508 531139

Manufacturers of sign boxes, frames and display cases to the trade. Fast delivery.

ALUMINIUM SIGN BLANKS

ASHBY TRADE SIGN SUPPLIES LIMITED

Unit 44, Youngs Industrial Estate,

Aldermaston, Reading RG7 4PQ

Tel: 0118 981 5343

Fax: 0118 981 5335

Nationwide, trade only suppliers of aluminium sign blanks, aluminium and steel posts, caps, finials, clips and fixings, for delivery next day. Also sign trays, shaped tops, directory systems and finger posts. Call our experienced sales team for immediate quotations 8am - 7pm. Full colour brochure available.

INSIGHT SIGN SYSTEMS

61 Dykehead Street, Queenslie Industrial Estate,

Glasgow G33 4AQ

Tel: 0141 774 5990

Fax: 0141 774 6653

Web: www.insightsignsystems.com

E-mail:

sales@insightsignsystems.com

Insight is a trade only manufacturer, offering a made to measure service, with in-house powder coating. A variety of widths of signcase are available to accept stencil-cut aluminium panels (secured by bonding) for back-lighting.

APPLICATION TAPE

ALL PRINT SUPPLIES LIMITED

79 Buckingham Avenue, Slough, Berks SL1 4PN

Tel: 01753 696977

Fax: 0800 374635

E-Mail: sales@allprint.co.uk

A complete range of application tapes including CONFORM and KLEENTEAR, to suit all needs.

KLEENTEAR tears cleanly and R Tape's CONFORM range will adhere to a wide variety of release liners. Tapes are available slit to your requirements and delivered next morning.

DORO TAPE (UK) LTD

1 Albany Court, Albany Road, Market

Harborough, Leics LE16 7QP

Tel: 0845 165 1636/

01858 431642

Fax: 01858 466992

E-Mail: sales@dorotape.co.uk

Web: www.dorotape.co.uk

Doro Tape offer a comprehensive range of application tapes that cater for almost all circumstances. With 3 different paper and 3 clear filmic application tapes, customers can choose from a variety of tack levels and qualities. Doro also supply the R Tape Conform application tape renowned for its superior adhesion to vinyl backing paper. A free roll slitting service and next day delivery is offered on all the application tapes plus a wide variety of application tools and accessories. Credit and debit cards accepted for non-account holders.

HEXIS UK LTD

70 Britannia Way, Britannia park, Lichfield,

Staffordshire WS14 9UY

Tel: 01543 411221

Free Fax: 0800 0187 111

E-mail: sales@hexis.co.uk

Web: www.hexis.co.uk

Hexis can supply a comprehensive range of application tape from all leading manufacturers such as Hexis, Poli-Tape, R-Tape, Main Tape and American Biltrite. The Hexis range includes economy and premium paper and clear tapes. The PerfecClear range tears cleanly and the R-Tape conform series has a release liner adhesion system, so it lays flat and does not wrinkle or tunnel. A new digital application tape is available for solvent ink jet printed graphics. The complete tape range can be supplied slit to your requirements for same day despatch.

BANNER FRAMES

HAMPSHIRE FLAG COMPANY LTD

Unit 11, Pipers Wood Industrial Park, Waterberry,

Waterlooville, Hampshire PO7 7XU

Tel: 0845 644 3129

Fax: 0845 644 3128

E-mail: neil@hampshireflag.eu

Web: www.hampshireflag.eu

Hampshire Flag's high quality and durable banner frames are easy to assemble and feature anodised aluminium finish and reinforced flush joints. Frames fit banners ranging from 5ft x 3ft to 30ft x 3ft.

ONE STOP PROMOTIONS LTD

Unit 38, Hayhill Ind Estate, Barrow on Soar,

Loughborough LE12 8LD

Tel: 01509 814380

Fax: 01509 814929

Email:

info@onestoppromotions.co.uk

Web:

www.onestoppromotions.co.uk
Huge stocks of steel banner frames, supplied with or without PVC or Mesh Banners. Easy to assemble, any size from 1.5m wide. Easy Pull banner systems. Heavy duty, hard wearing. TRADE PRICES - Call us for information. Also - Flags and Flagpoles, printed garments, pens, mugs, etc.

BANNER INSTALLERS

MIDA SIGN SERVICES

Gatfield House, Blandford Street, Ashton-

under-Lyne OL6 7DW

Tel: 0161 8 300 600

Fax: 0161 8 300 601

E-mail:

enquiries@midasignservices.co.uk

Web: www.midasignservices.co.uk

Specialist's installers of large format banners, Promotion, Pole and wall mounted, Multiple install, Rollout programmes. Nationwide Service. We can supply and install. Call for details.

BANNER SUPPLIERS

BETA BANNERS

110A Church Street, Tranent EH33 1BZ

Tel/Fax: 01875 616162

Blank banners for your graphics. Speedy delivery rain or shine. From Lands End to John 'O' Groats. Next day delivery usual. Over 15 colours available. All heavy duty PVC, hemmed and with brass eyelets and widths up to 3m. We also sell branding and flags. YOU CAN'T BEAT A BETA BANNER!

BIG PRINT BANNERS

Unit 2, Old Brewery Road, Wiveliscombe,
Somerset TA4 2PW

Tel: 01984 629004

Fax: 01984 624515

E-mail: info@empiresigns.co.uk

Web: www.empiresigns.co.uk

Digital Printed Banners • Supplied and finished
• 1-offs to multiples • Exterior or interior • Fast
turnaround • Nationwide delivery • Quality
guaranteed • Instant quote • Competitive
pricing.

BOLDSCAN BANNERS

Boldscan Ltd, Unit 4, Tonedale Business Park,
Wellington, Somerset TA21 0AW

Tel: 01823 665849

Fax: 01823 665850

E-mail: sales@boldscan.com

Web: www.boldscan.com

Blank banners at trade prices. Heavy duty, matt
lacquered, fire retardant PVC as standard. **27
colours now in stock.** Up to 2920mm wide
one piece in white only. Multi-coloured banners
manufactured. Specialist banners - "Road Span
Safety". Banner Frames - Freestanding and
wall mounted. Banner Poles - Post & wall
mounted. Main agents for Sign-A-Peel, the
revolutionary new inkjet print medium.
Quality with reliability in product and service.

CLEARSCORE LIMITED

Unit 1, Tudor Works, Turret Lane, Ipswich IP4 1DL

Tel 01473 212751

Fax 01473 233415

E-mail: sales@clearscore.co.uk

Web: www.clearscore.co.uk

Trade service for digitally printed banners up to
1600mm wide. Fast turnaround, high quality.
Full finishing service or print only.
Providing high quality service and products
since 1978.

CORBY CANVAS

Unit 4a, Old Gretton Road Industrial Estate,
Weldon, Corby, Northamptonshire NN17 3HW

Tel: 01536 401401

Fax: 01536 206373

E-mail:

sales@corbycanvas.fsnet.co.uk

Producers of high quality banners in rein-
forced PVC, any shape or size. Hemmed with
brass eyelets all round. Nationwide next day
delivery available.

COVERTEC

Unit 10, The Quadrangle Centre, The Drift,
Nacton Road, Ipswich IP3 9QR

Tel: 01473 272006

Fax: 01473 725050

e-mail: sales@covertec.co.uk

Manufacturers of high quality banners in poly-
ester reinforced PVC lacquer finish or matt. All
banners hemmed with nickel plated brass eye-
lets all round. Now in twelve colours. Next day
delivery available. Finishers of digital printed
banners any size any shape.

DOMINION SCREEN & DIGITAL PRINT

Carrwood House, Carrbottom Road, Bradford
BD5 9AG

Tel: 01274 309 999

Fax: 01274 309 888

Web: www.dominionprint.com

Email: sales@dominionprint.com

JUMBO SCREEN

Banners, Oversize P-O-P, Hanging boards,
Posters, Window Graphics, In-store Signage
SUPERWIDE DIGITAL
Front and backlit banners, Graphics, Posters,
Wallpaper, Building Wraps, Vehicle
graphics/advertising.

DORO TAPE (UK) LTD

1 Albany Court, Albany Road, Market
Harborough, Leics LE16 7QP

Tel: 0845 165 1646/
01858 431642

Fax: 01858 466992

E-Mail: sales@dorotape.co.uk

Web: www.dorotape.co.uk

Doro Tape can provide quality blank banners on
a 24/48-hour service at almost any size.
The 650gsm heavy-duty banner fabric is an
exterior grade PVC coated polyester. Its lac-
quered top face gives a glossier finish and
stays cleaner for longer. The banners are all
H/P welded, brass eyeleted, and flame retar-
dant and are available in over 10 colours.
Doro Tape supplies the Ri-flex soft banner vinyl
range from Ritrama in 20 colours, a must for
all banner graphics. They also stock a budget
banner on a roll at 610mm wide; plus a range
of banner accessories such as banner frame
kits, brass eyelets and rings, elasticised banner
bungees and rope.

Credit and debit cards accepted for non-
account holders.

DRYTAC EUROPE LTD

Filwood Road, Fishponds, Bristol, BS16 3RY

Tel: 0117 958 6500

Fax: 0117 965 4411

e-mail: Bristol@drytac.com

Web: www.drytac.com

The Drytac banner stand range combines the
best in design, functionality, quality and
pricing. Contact Drytac to find out about the
new eco-friendly bamboo Panda Stand™, an
earth-friendly alternative to conventional
display solutions.

D.C. HOULT LTD

The Old Print Works, 221 Lenton Boulevard,
Nottingham NG7 2BY

Tel: 0115 9550808

Fax: 0115 9780808

E-mail: sales@bannerblank.co.uk

Web: www.bannerblank.co.uk

Blank banners, high quality, fire retardant,
heavy duty 600-700gm. Hemmed all round
with choice of brass or chrome eyelets. 23
colours available. Any shape or size. Next day
delivery only £7.00 nationwide. Very
competitive prices. Free sample pack on
request.

HAMPSHIRE FLAG COMPANY LTD

Unit 11, Pipers Wood Industrial Park, Waterberry,
Waterlooville, Hampshire PO7 7XU

Tel: 0845 644 3129

Fax: 0845 644 3128

E-mail: neil@hampshireflag.co.uk

Web: www.hampshireflag.co.uk

High impact and exceptional quality,
Hampshire Flags' extensive banner service
includes blank and custom designed banners,
made from 100% polyester textile or 100%
reinforced PVC, digitally printed in colour or
lettering applied as required.

BILLBOARDS

AARON SIGNS & CONSTRUCTIONAL SERVICES LTD

Unit 16, Highlands Farm Business Park,
Highlands Hill, Swanley Village, Kent BR8 7NA

Tel: 01322 667100

Fax: 01322 664971

E-mail:

aaron.signs@btconnect.com

Company formed in 1972. Specialists in
production and erection of large format
development and advertising boards and
hoardings, for house and warehouse builders.
Suppliers and builders also of advertising
structures for the outdoor poster specialists. All
our employees are fully trained and authorised
to carry out works on Network Rail and LUL/TFI
projects.
Mows and risk assessments supplied on request.

BRILLE AND TACTILE SIGNS

CONTOUR SIGNS LTD

Dragons Wharf, Dragons Lane, Moston,
Sandbach, CW11 3PA

Tel: 01270 758787

Email:

enquiries@contoursigns.co.uk

web: www.contoursigns.co.uk

Held on the RNIB's list of manufacturers and
suppliers we specialise in the design and in-
house manufacture of Braille and tactile
signage. A full range of standard and bespoke
sign options are available to provide singular
signs through to complete sign systems. All
signs meet the requirements of the JMU/RNIB
'Sign Design Guide', the DDA (1995)
'reasonable adjustment' criteria and UK H & S
guidelines. The extensive supply to many
repeat trade customers, as well as end users, is
testament to our excellent service.

MK DESIGN

10 Footes lane, Frampton Cotterell, South
Gloucestershire BS36 2JQ

Tel: 01454 852802

Fax: 01454 852802

E-Mail:

mark.rose@mkdesign.org.uk

Web: www.mkdesign.org.uk

'One sign for all' is the philosophy promoted by
MK Design to ensure that our Braille and tactile
signs are accessible to everyone. We provide a
superior quality service of consultancy, survey,
design, manufacture and installation to a range
of clients including RNIB, NHS, Local
Authorities, universities and schools, charity
organisations as well as the trade. MK Design
is the only sign company able to offer totally
professional advice from a consultant who also
does work for the RNIB's JMU Access
Partnership, therefore ensuring that our advice,
design and end product is fully compliant to
current RNIB, British Standard and DDA
guidelines. Our bespoke signs offer flexibility in
a range of colours, styles, materials and frames
and can be individual signs, whole sign systems
or integrated into existing sign schemes.

SALTWELL SIGNS LTD (Est. 1970)

D86, Princesway North, Team Valley Trading

Estate, Gateshead, Tyne & Wear NE11 0TU

Tel: 0191 482 5555

Fax: 0191 491 0246

E-Mail: sales@saltwellsigns.co.uk

Web: www.saltwellsigns.co.uk

Specialists in the manufacture of Photo-
polymer Braille and Tactile signs. If required,
these can be reverse decorated with full colour
graphics and decorated in any colour. All
custom made to fit your requirements. There is
a 3 day service from placement of order to
delivery. Contact us for your free brochure.

SMITHBREWER LTD

Isleport Business Park, Highbridge

Somerset, TA9 4JR.

julia@smithbrewer.co.uk

www.smithbrewer.co.uk

Tel: 01934 642642

Fax: 01934 642646

E-Mail: signs@smithbrewer.co.uk

www.touchtypesigns.com

TOUCHtype signs are the industry standard for
Braille & Tactile Signs. Used by countless sign
companies, local authorities, the Health sector
and Blind associations throughout the UK,
including the RNIB.
Don't take chances in this specialist field of sign
manufacture with inferior imitations.
SmithBrewer offers you a highly competitive
first class service from design, to manufacture,
to delivery. You can rest assured that you will
receive a professional speedy reliable trade
supply, with full technical backup and no
quibble guarantee of satisfaction. Total product
solution from one-off signs to complete sign
programmes. Door signs, insert signs,
interchangeable directories, tactile plans, and
much more. All signs are custom made to any
specification.

BRASS LOCATOR NUTS

F. K. MOORE & SON LIMITED

5 Wilton Road, Haine Industrial Park, Ramsgate,
Kent CT12 5HD.

Tel: 01843 593440

Fax: 01843 585883

e-mail: sales@fkmoore.co.uk

British manufacturers of Screw/Push-in type
Brass Locator Nuts for the Sign and Shopfitting
Industries. We also manufacture Coverhead
Mirror Fasteners, either Disc, Dome, Conical or
Mushroom shape in various finishes, in
addition to the famous "Moore's Super Clips"
mirror fixings.

BRASS REPLACEMENT

HPH SIGNS

6 Kingsmead Square, Bath BA1 2AB

Tel: 01225 480555

Fax: 01225 489710

e-mail: mail@hphsigns.co.uk

Web: www.hphsigns.co.uk

HPH Signs have patented the Armourbrite™
system which offers maintenance free signs
indistinguishable from brass. There is no
applied lacquer to break down and logos can
be reproduced in fine detail.

BRASS /STAINLESS BLANKS

ONE TO ONE ENGRAVERS LTD

Unit 14 Stafford Place, Northampton NN3 6NN

Tel: 01604 644604

Fax: 01604 644755

Door nameplates 210x45x3mm complete with
radius corners and two holes. Supplied in packs
of six. Hard lacquer optional.

TRADE SIGNS UK.COM

Unit D3, 78-80 Akeman Street, Tring, Herts HP23
6AF

Tel: 0870 240 2763

Fax: 01442 828922

E-mail: sales@tradesignsuk.com

Web: www.tradesignsuk.com

We offer a 24 hour service on flat laser cut
lettering and logos in stainless steel 0.9mm -
3mm & Mild steel 0.9mm - 10mm, supplied
with or without templates and locators/studs
ready for you to install, quotations over the
phone or by e-mail/fax. Call our Sales team
today for that friendly prompt service you
require.

BRONZE VITREOUS ENAMELLING

TIS 2000 LTD

Unit 4 & 5, Partridge Court, 61 Price Street,
Birmingham B4 6JZ

Tel: 0121 359 2030

Fax: 0121 359 3040

e-mail: tis2000@netcomuk.co.uk

We are specialists in Bronze vitreous enamelled
plaques. We also offer a vitreous enamelling
only service for engraved Bronze plates; as well
as our standard range of engraving in all
metals and plastics. Castings available in
Bronze, Brass and Aluminium.

BUILT UP LETTERS ACRYLIC

APPLELEC SIGN COMPONENTS LTD

Appleby House, Walker Terrace, Bradford, West
Yorkshire, BD4 7HJ

Tel: 01274 774477

Fax: 01274 774478

E-mail: sales@applelecsign.co.uk

Web: www.applelecsign.co.uk

Trade suppliers of quality 3D built up acrylic
letters and logos, we offer colours and finishes
from a variety of different sheet manufacturers.
We also offer the built up letters with halo and
/ or face lit illumination from our award
winning and cost effective LED range, please
ask for an information pack or contact one of
our friendly experienced sales staff for
assistance. (flat cut lettering is also available).

AVENUE SIGNS LIMITED

216-222 Luton Road, Chatham, Kent ME4 5BS

Tel: 01634 841300

Fax: 01634 841420

E-mail: info@avenuesigns.co.uk
Specialists in Built up Perspex fabrication to your specification. Complete with neon / cold cathode and transformers. Supply or Installation service in the UK. CNC / Laser cut flat Perspex letters also supplied and / or fitted.

CENTRE SIGNS LIMITED

Alexander House, Iliffe Avenue, Oadby, Leicester LE2 5LH

Tel: 0116 271 4247

Fax: 0116 272 0260

E-mail: graphics@centresigns.co.uk

Web: www.centresigns.co.uk
Built up Perspex and Acrylic Letters. Router work undertaken. Trade only service.

KINGS PLASTICS LTD

The signbuild Centre, Kingsown House, Unity St, Bristol BS2 0HM

Tel: 0117 922 6382

Fax: 0117 925 1159

We supply fabricated letters and logos non illuminated or face and halo illuminated with Leds, the choice is yours.

TRADE SIGNS UK.COM

Unit D3, 78-80 Akeman Street, Tring, Herts HP23 6AF

Tel: 0870 240 2763

Fax: 01442 828922

E-mail: sales@tradesignsuk.com

Web: www.tradesignsuk.com
We offer a trade based service to sign companies all over the UK for there 3D built up acrylic lettering and logos, ranging from Neon illumination, LED illumination to No illumination. For quotes please contact our sales team by E-mail/Fax or Call our Sales team today for that friendly prompt service you require.

BUILT UP LETTERS METAL

AES (Est. 1972)

The Old Laundry, 15 Barratt Street, Easton, Bristol BS5 6DE

Tel: 0117 951 0234

Fax: 0117 952 0234

email:

avon.engraving@btconnect.com

Web: www.avonengraving.co.uk

Specialist manufacturers of built-up/flat cut letters, logos in stainless steel, brass, aluminium etc. Very competitive prices, excellent delivery, highest quality, full design service. Prompt response to all enquiries.

ALCHEMY LETTERING LTD

11-15 Wade Street, St Judes, Bristol BS2 9DR

Tel: 01179 411 800

Fax: 01179 412 800

E-mail: alchemyltd@btconnect.com

Specialists fabricators of top quality built up & flat cut letters in stainless steel, brass, aluminium, copper, paint and oxidised finishes. Neon and LED illumination also produced to your specifications. For a realistic not ballistic price, try the best in the West.

APPLELEC SIGN COMPONENTS LTD

Appleby House, Walker Terrace, Bradford, West Yorkshire BD4 7HJ

Tel: +44 (0)1274 774477

Fax: +44 (0)1274 774478

E-mail:sales@applelecsign.co.uk

Web: www.applelecsign.co.uk
Trade suppliers of quality 3D built up metal letters and logos. Offering lettering starting from as little as 50mm high, in materials such as stainless steel, brass, copper, titanium and aluminium, available in a variety of different finishes. We also offer built up letters with halo and / or face lit illumination from our award winning and cost effective LED range, please ask for an information pack or contact one of our friendly experienced sales staff for assistance. (flat cut lettering is also available).

AVENUE SIGNS LTD

216-222 Luton Road, Chatham, Kent ME4 5BS

Tel: 01634 841300

Fax: 01634 841420

E-mail:info@avenuesigns.co.uk
Specialists in stainless steel letter fabrication sprayed to your specification. Neon and transformers, etc. also made to suit.

CENTRE SIGNS LIMITED

Alexander House, Iliffe Avenue, Oadby, Leicester LE2 5LH

Tel: 0116 271 4247

Fax: 0116 272 0260

E-mail: graphics@centresigns.co.uk

Web: www.centresigns.co.uk
Specialist metal fabricators to the sign trade only. Built up letters in metal, brass, copper, aluminium and stainless steel. Fabricated boxes to any shape.

HALLMARK (Est. 1899) Engraving, Etching & Signs

116-118 Selsdon Road, South Croydon, Surrey, CR2 6PG

Tel: 020 8686 6649

Fax: 020 8760 0899

Email: sales@hallmarksigns.co.uk

Web: www.hallmarksigns.co.uk

For the very best quality built up letters and logos in brass, stainless steel and copper, finished to your specifications. Flat cut letters and logos profiled in all metals and plastics, complete with drawings and fittings. For a fast turnaround, competitive prices and a professional, reliable trade service - please give us a call.

I.C.E.

Marcon House, Wyther Lane, Leeds, LS5 3BT

Tel: 0113 2242124

Fax: 0113 2242110

Email:sales@icesigns.co.uk

Manufacturers of Built Up - Flat Cut - Rim and Return Letters and Logos in Stainless Steel, Aluminium, Copper and Brass. We also fit neon tube or LED modules within the Letters for face or halo illumination

KINGS PLASTICS LTD

The signbuild Centre, Kingsown House, Unity St, Bristol BS2 0HM

Tel: 0117 922 6382

Fax: 0117 925 1159

We supply Stainless Steel fabricated letters in polished, brushed or painted non illuminated or illuminated with leds for halo or rim and return face illumination.

LOGOTECH DISPLAY SOLUTIONS LTD

Unit 6, Atley Business Pk, North Nelson Ind Est,

Cramlington, Newcastle Upon Tyne NE23 1WP

Tel: 0191 251 7910

Fax: 0191 253 1118

E-mail:sales@logotech-ltd.co.uk

web: www.logotech-ltd.co.uk

In our fully equipped metal department we produce high quality built up letters/logos in aluminium, stainless, brass and copper. Supplied to the trade nationwide, at a very competitive price. We also manufacture boxes, post signs, gantry signs, frames and panels, which can be finished to your specifications. We have our own in-house neon department and can supply you with the complete sign service, ready for you to install. Please see our advert in Neon Manufacturers (Trade).

SIGN MAKERS PRODUCTS LIMITED

Hawthorn House, Ipswich Road, Long Stratton, Norfolk NR15 2XB

Tel: 01508 531183

Fax: 01508 531139

Manufacturers of sign boxes, frames and display cases to the trade. Fast delivery.

TRADE SIGNS UK.COM

Unit D3, 78-80 Akeman Street, Tring,

Herts HP23 6AF

Tel: 0870 240 2763

Fax: 01442 828922

E-mail: sales@tradesignsuk.com

Web: www.tradesignsuk.com

We offer a trade based service to sign companies all over the UK for there 3D built up stainless steel lettering and logos, ranging from Neon illumination, LED illumination to No illumination. For quotes please contact our sales team by E-mail/Fax or Call our Sales team today for that friendly prompt service you require.

WILSON SIGNS (BRISTOL) LTD

Unit 4b, Hayward Industrial Estate, North View,

Soundwell, Bristol BS16 4NT

Tel: 0117 956 8288

Fax: 0117 970 1484

E-mail: matt@wilsonsigns.co.uk

Specialists in metal letter fabrication. We supply built up letters in metal, brass, copper, aluminium and stainless steel. Neon illumination also produced to your requirements. Give us a call and we'll give you a price.

CAR REGISTRATION PLATES

PRESTIGE NUMBER PLATES

Unit 3, 283 Duke Street, Glasgow G3 1HX

Tel: 0141 550 1363

Fax: 0141 550 1324

Email:

info@prestigenumberplates.com

Suppliers of car registration self assembly systems. Our new product is the Laser Graphic system which can not only produce Number plates but also small signs, banners, P.O.S. and an array of other printed products.

CAST METAL NAMEPLATES

FALON NAMEPLATES LIMITED

10-13 Stephenson Court, Barrington Industrial Estate, Bedlington, Northumberland NE22 7DQ

Tel: 01670 530136

Fax: 01670 530102

E-mail: enquiries@falon-

nameplates.co.uk

www.falon-nameplates.co.uk

Manufacturers of plaques in bronze and aluminium, engraved signs/plates in various types of plastics and metals, together with chemically etched stainless steel and brass plates.

CAST METAL SIGNAGE

METALLINE SIGNS LIMITED

Unit 18, Barton Hill Trading Estate, Bristol BS5 9TE

Tel: 0117 955 5291

Fax: 0117 955 7518

E-mail: metalline@inane.com

www.metalline-signs.co.uk

Traditional manufacturers of cast bronze/ cast aluminium lettering, commemorative plaques and street nameplates. Finished in either BMA or stove enamelled effect. Metalline also produce cast resin lettering and coats of arms.

CHEMICAL ETCHING

AES (Est. 1972)

The Old Laundry, 15 Barratt Street, Easton, Bristol BS5 6DE

Tel: 0117 951 0234

Fax: 0117 952 0234

E-mail:

avon.engraving@btconnect.com

Web: www.avonengraving.co.uk

The complete sign service. Engraved/etched screen printed, signs, nameplates, etc in all materials. Very competitive prices, excellent delivery, highest quality. Full design service. Prompt response to all enquiries.

COUNTY ENGRAVERS & SIGNS LTD

Unit 5, Trent View Court, Moreland Street, Nottingham NG2 3FX

Tel: 0115 985 1171

Fax: 0115 986 1007

E-mail:

sales@countyengravers-signs.co.uk

Web:

www.countyengravers-signs.co.uk

Fine detail etching of brass and stainless steel. Engraving of all types of plaques, plates, labels and control panels in a wide range of materials. Acrylic fabrications and trophies. Full colour printing from labels to wide format.

HALLMARK ENGRAVING (Est. 1899)

116-118 Selsdon Road, South Croydon, Surrey, CR2 6PG

Tel: 020 8686 6649

Fax: 020 8760 0899

Email: sales@hallmarksigns.co.uk

Web: www.hallmarksigns.co.uk
SUPERFAST and efficient trade service for ALL commercial and industrial etching, using the latest technology and computerised equipment. One-off urgent specials or long runs no problem. Full graphics and artwork service for logos, crests and designs. Specialists for commemorative plaques, company name plates and awards in all metals and plastics. Professionally designed-drawings supplied free. Hardwood backboards can be made to any size or design and in many hardwoods. For a fast turnaround, competitive prices and a professional reliable trade service - please give us a call.

HOCKERILL ENGRAVING

Unit 2d, Willis Vean Ind. Est., Mullion, Cornwall TR12 7DF

Tel: 01326 240400

Fax: 01326 240620

www.hockerillengraving.co.uk

E-mail: hockerill@dial.pipex.com
Etchers of all metals, manufacturing signs, name-plates, data-plates and memorials, providing a high quality service to sign makers and engravers nationwide. A combination of traditional methods and the latest computer technology, enables us to achieve greater depth of etch and fine details. Now in our 24th year.

MASTERGRAVE LIMITED

65 Murdock Road, Bedford MK41 7PL

Tel: 01234 218226

Fax: 01234 269899

E-Mail: sales@mastergrave.co.uk

Website: www.mastergrave.co.uk
Trade only central engraving service, incorporating computer and laser controlled engravers, conveyer etchers, sande blasters, and lasers. Also full range of quality corporate gifts available, engraved or blank, at highly competitive prices.

MERCURY ENGRAVING & DIESINKING LIMITED

Unit A5 Bounds Green Ind Est, Ring Way, London N11 2UD

Tel: 020 8368 9017

Fax: 020 8368 9018

email:sales@mercuryengraving.co.uk

Web: www.mercuryengraving.co.uk
Over 40 Years experience, Deep etched nameplates and plaques. All Metals. Reliable trade service. Normal turn around 5-7 working days. Express service available from 1 day turn around.

MOCKRIDGE LABELS & NAMEPLATES LTD

Cavendish Street, Ashton-under-Lyne, Lancs OL6 7QL

Tel: 0161 308 2331

Fax: 0161 330 9645

E-mail: sales@mockridge.com

Web: www.mockridge.com

Specialists in chemically etched nameplates. Brass, Stainless Steel and Anodised Aluminium. Any size up to 2400 x 1200mm (8ft x 4ft). One-offs up to 5000+. trade work is totally confidential.

MULTITECHNIC LTD (Est. 1973)

Coopies Lane, Marpeth, Northumberland NE61 6JQ

Tel: 01670 512090

Fax: 01670 503143

Web: www.Multitechnic.co.uk

E-Mail: sales@multitechnic.co.uk
Chemical etching for the sign trade. We don't do anything else, just high quality etching. Because we are specialists we can offer design effects that nobody else can do. All our stainless steel is 316 marine grade, we don't use inferior grades, & our brass is Polished to the highest standards. We want your business so we will give you fast turnaround & excellent customer service to keep your business. Typical turnaround 3 - 5 days, quicker if required, just let us know.

CHROME PLATED LETTERS

SIGNTRADE LETTERS LTD

225 Long Lane, London N3 2RL

Tel: 0500 456700

Fax: 020 8349 5806

E-mail: sales@signtrade.co.uk

Web: www.signtrade.co.uk
Chromising launched at Sign UK. We offer a complete range of Chrome Plated Letters with Halo Lighting not available anywhere else. Ring Richard or Dave for details and samples.

CLOCKS

MEGA QUARTZ UK LIMITED

25 Boshers Gardens, Egham, Surrey TW20 9NZ

Tel: 01784 437072

Fax: 01784 435793

Email: megaquartzuk@aol.com

Web: www.megaquartz.co.uk
Importer and distributor of Kienzle and Hermle quartz clock mechanisms for mantle and wall clocks, pendulum or chime. Also, brass ships styled cases, barometers, dials and hands. Free brochure on request.

CNC ROUTING & ENGRAVING MACHINES

ATA ENGINEERING PROCESSES

ATA House, Unit B, Boudry Way, Hemel Hempstead, Herts HP2 7SS

Tel: 01442 264411

Fax: 01442 231383

E-Mail: sales@ataeng.com

Web: www.ataeng.com
Multicam CNC Routers and Onsrud Cutters - the complete solution for routing productivity. Multicam A, M & MG Series cover all applications from light machining to high volume production routing.

AXYZ AUTOMATION (UK) LTD

Albrighton Business Park, Newport Road, Albrighton, Wolverhampton WV7 3ET

Tel: 01902 375600

Fax: 01902 375662

E-Mail: Sales@axyz.co.uk

Web: www.axyz.co.uk
Full range of CNC routers including The Millennium (1000mm by 1000mm), The AXYZ 4008 (2590mm by 1420mm) and The AXYZ 6010 (3200mm by 2050mm). Options include vacuum bed, multiple heads and a laser cutting head.

TEKCEL CNC SOLUTIONS (IRELAND)

14 Walnut Road, Larne, Co. Antrim. BT40 2WD

Tel/Fax: +44 (0)28 2827 7013

Mobile: +44 (0)7843 089285

Email: info@tekcelcncireland.com

Web: www.tekcelcncireland.com
Latest leadscrew and servo drive technology in a range of bed sizes including 4m x 2m, 3m x 2m and 8ft x 4ft vacuum hold down beds. Complete packages including PC, choice of design packages with full on site training and technical backup. Tekcel E Series with ATC as standard. Ireland Wide Sales - Training - Support. Full range of Tooling & Accessories. Roland Desktop Engravers & 3D Scanners. CAD/CAM Software.

COAT OF ARMS

BRYAN RAWLINGS DESIGN

Unit 10, Rockhill Est., Wellsway, Keynsham, Bristol BS31 1PF

Tel: 0845 055 9369

Fax 0117 377 8816

E-mail: bryan@bryanrawlings.com
website: www.bryanrawlings.com
Designers and makers of coats of arms, emblems and all types of sculptural and decorative signage. GRP, cast resins, metals, detailed hand painting and much more. Large range of royal coats of arms available. Specialist suppliers to the sign trade

G.K. BEAULAH & CO. LTD

Heritage House, 23 Park Street, Hull HU2 8RU

Tel: 01482 223521

Fax 01482 216328

E-mail: sud@beaulah.co.uk

website: www.beaulah.co.uk
Experienced craftsmen design & manufacture unique quality products. We supply Outdoor Signage, Plaques, Coats of Arms, Heraldic Shields, Heritage Products, Screen Printing, Wooden Bases & Corporate Giftware.

METALLINE SIGNS LIMITED

Unit 18, Barton Hill Trading Estate, Bristol BS5 9TE

Tel: 0117 955 5291

Fax: 0117 955 7518

E-mail: metalline@inane.com

www.metalline-signs.co.uk
Metalline produce high quality cast aluminium, cast bronze and glassfibre, fully modelled 3D crests and coats of arms, all detail hand painted by craftsmen. Suppliers of the full range of royal warrants.

COMMEMORATIVE PLAQUES

G.K. BEAULAH & CO. LTD

Heritage House, 23 Park Street, Hull HU2 8RU

Tel: 01482 223521

Fax 01482 216328

E-mail: sud@beaulah.co.uk

website: www.beaulah.co.uk
Experienced craftsmen design & manufacture unique quality products. We supply Outdoor Signage, Plaques, Coats of Arms, Heraldic Shields, Heritage Products, Screen Printing, Wooden Bases & Corporate Giftware.

MERCURY & PHILLIPS SIGNS

51/59 Waterworks Rd. Norwich NR2 4DA

Tel: 01603 666699

Fax: 01603 616781

E-Mail: mercphil@globalnet.co.uk

Web:

www.mercuryphillipssigns.co.uk
Manufacturers of plaques in stainless steel, brass and aluminium, chemically or machine engraved, colour filled to your choice. Logos and text from artwork supplied.

MERCURY ENGRAVING & DIESINKING LIMITED

Unit A5 Bounds Green Ind Est, Ring Way, London N11 2UD

Tel: 020 8368 9017

Fax: 020 8368 9018

email:

sales@mercuryengraving.co.uk

Web: www.mercuryengraving.co.uk
Over 40 Years experience, Deep etched nameplates and plaques. All Metals. Reliable trade service. Normal turn around 5-7 working days. Express service available from 1 day turn around.

COMPUTER HARDWARE

GRAFITYP UK LTD - HARDWARE

Graftack House, 103 Mariner, Tamworth, Staffordshire B79 7UL

Tel: 01827 300500

Fax: 0800 318075

Graftityp's reliable, accurate and cost-effective range covers PC's, cutters and flatbed plotters. It includes the user friendly CSR 'S' cutters which are compatible with most systems. They deliver cutting speeds of up to 1000mm/second and offer an enlarged tacking window up to 12 metres.

ANDERSONS GRAPHICA PLUS LTD

Unit 8 Genesis Business Park, Sheffield Road, Rotherham, S60 1DX

Tel: 0870 0668661

Fax: 0870 0668662

E-Mail: louise.stables@andersons-

uk.net

Looking to upgrade your hardware or just starting out?

Anderson's are authorised resellers of Mimaki, Kala, Canon, Kodak, Epson and Shiraz, we are able to provide Plotters, Cutters, Printers, Laminators, All PC Software, Colour Management & Profiling on Most Rips / Printers We offer full installation and training at very competitive prices, please call for a free demonstration.

Anderson's are also a National Distributor of - Consumables, MACtac Digital Media, Vinyls, Laminates and Mount films. Excellent service guaranteed.

COMPUTER SOFTWARE

ROBERT HORNE SIGN & DISPLAY

Huntsman House, Mansion Close, Moulton Park, Northampton NN3 6LA

Tel: 01604 495333

Fax: 01604 673407

Robert Horne Sign & Display are authorised resellers for Roland, Mimaki, Agfa, Seal, SignLab and Onyx.

We can, through our specialised Digital Solutions team, offer everything from printers, plotters and cutters to a wide range of matching consumables including papers, vinyls and banners at competitive prices. Call to arrange a demonstration.

TOUCH SYSTEMS LTD

261 Lyndon Road, Solihull, West Midlands B92 7QP

Tel: 0121 248 2448

E-mail: sales@touchsystems.co.uk

Web: www.clarityprofessional.com

Clarity Professional is all encompassing Sign Estimating and Business Process software. It gives you a completely automated business administration system enabling you to spend more time prospecting and selling. Clarity Professional provides the complete business process in one software package including Contact Management, Estimating and Order Processing, Job Management, Price List management, Works Orders, Delivery Notes and Invoices. Also available are modules for generating Purchase Orders and Actual Job Cost Analysis. Clarity Professional links to Sage, Act, Goldmine and Microsoft Office. FREE evaluation disks are available on request. Just call or email us NOW!

CUT-OUT LETTERS

ACCENT SIGNS LIMITED

Units 1&2, Broadcott Ind. Est., Station Rd., Cradley Heath B64 6NT

Tel 0121 561 4600

Fax 0121 561 5458

Email: accsign1@aol.com

Virtually any typeface available, cut from your artwork or ours, in Acrylic, Foam PVC, Aluminium composite, or MDF. Complete Fascia Panels, and more! Samples on request.

APPLELEC SIGN COMPONENTS LTD

Appleby House, Walker Terrace, Bradford, West Yorkshire, BD4 7HJ

Tel +44 (0)1274 774477

Fax +44 (0)1274 774478

E-mail: sales@applelecsign.co.uk

Web: www.applelecsign.co.uk
Trade suppliers of flat cut letters, logos and intricate laser work. We offer lettering in a variety of materials such as acrylic, foamex, dibond, stainless steel, aluminium and MDF, available in different finishes, with or without fixings. Please ask for an information pack or contact one of our friendly experienced sales staff for assistance. (3D built up lettering is also available).

ATC

Caif Hey South, off Well'th Lane, Rochdale OL11 2JS

Tel: 01706 633043

Fax: 01706 710086

e mail: sales@apptape.co.uk
Manufacturers of flat cut acrylic letters with laser polished edges. Available in any font and in a variation of colours. Templates and locators supplied as standard. 2-3 day delivery service. For a quotation fax or e-mail the above.

I.C.E.

Marcon House, Wyther Lane, Leeds LS5 3BT

Tel: 0113 224 2124

Fax: 0113 224 2110

E-MAIL: sales@icesigns.co.uk
Manufacturers of flat cut letters in ALL materials. Incl. Acrylic, Foamex, MDF, Stainless Steel, Brass, Copper, Corian. Many finishes available- Guiding, painting, powdercoating, laquering. A special service at a competitive price.

KINGS PLASTICS LTD

The signbuild Centre, Kingsown House, Unity St, Bristol BS2 0HM

Tel: 0117 922 6382

Fax: 0117 925 1159

We supply flat cut letters in any size and style and from your own artwork in Acrylic, Foamex, Dibond/Reynobond, Aluminium, Stainless Steel and M.D.F.

MERCURY & PHILLIPS SIGNS

51-59 Waterworks Road, Norwich NR2 4DA.

Tel: 01603 666699

Fax: 01603 616781

E-mail: mercphil@globalnet.co.uk

Web:

www.mercuryphillipssigns.co.uk
A fully comprehensive service to the trade in acrylic, foam PVC, MDF, brass and aluminium. Contact us for price list or quotation.

SIGNRITE (IOM) LTD

Unit 2, Isle of Man Business Park, Braddan, Douglas, Isle of Man IM2 2QY

Tel: 01624 612244

Fax: 01624 661229

E-mail: sales@signrite-iom.com
Cut out letters and logos in acrylic, foam pvc MDF and dibond, to the sign trade. Supply us with artwork via E mail or disk. Fast delivery through out the UK and Europe. contact us for a competitive quote and a quick turnaround.

SIGNTRADE LETTERS LTD

225 Long Lane, London N3 2RL

Tel: 0500 456700

Fax: 020 8349 5806

E-mail: sales@signtrade.co.uk

Web: www.signtrade.co.uk
Plastic is our speciality including Flat Cut lettering in Perspex, foamex and Diabond. All supplied with locators and template as standard. We also offer a complete range of Moulded letters in Perspex and Chrome, offering over 50 years experience.

TRADE SIGNS UK.COM

Unit D3, 78-80 Akeman Street, Tring, Herts HP23 6AF

Tel: 0870 240 2763

Fax: 01442 828922

E-mail: sales@tradesignsuk.com

Web: www.tradesignsuk.com

We offer a 24 hour service on flat cut lettering and logos in Acrylic, Dibond, Stainless Steel, Foam PVC, MDF, Wood and many more material, supplied with or without templates and locators/studs ready for you to install, quotations over the phone or by e-mail/fax. Call our Sales team today for that friendly prompt service you require.

DIAMOND EDGE POLISHERS

AWLTECH

Unit 9 Enterprise Estate, Moorfield Road, Slyfield, Guildford, Surrey GU1 1RB

Tel: 01483 569232

Fax: 01483 569263

email: info@awltech.co.uk

Web: www.awltech.co.uk

5 models available from a small table top machine to a machine capable of polishing up to 100mm including bevelled edges. Various models on display in our showroom.

DIGITAL

all print supplies ltd

79-80 Buckingham Avenue, Slough, Berkshire, SL1 4PN

Tel: 01753 696977

Fax: 0800 374635

E-Mail: Sales@allprint.co.uk

Web: www.allprint.co.uk

One of the UK's largest suppliers of media and finishing films for Solvent and Digital printing with selected profiles available. Unique universal range available covering most media requirements. All products delivered next day before noon.

PORTLAND ADHESIVE PRODUCTS LTD

Lameshaye Bridge Mill, St Mary's Street, Nelson, Lancashire, BB9 7BA

Tel: 01282 617 818

Fax: 01282 617 718

E-Mail:

info@portlandadhesives.com

Web: www.portlandadhesives.com

Official UK Stockists for Intercoat Sign Vinyl Materials and Aslan Speciality products including materials for all sign-makers, screen-printers and large format digital printers. Next day delivery service offered. Our sales office welcomes your call to find out more about: Profiled Solvent & Water-based Digital Products • Over-Laminating Films • One Way Vision • Digital Static.

ROBERT HORNE SIGN & DISPLAY

Huntsman House, Mansion Close, Moulton Park, Northampton NN3 6LA

Tel: 01604 495333

Fax: 01604 673407

Robert Horne Sign & Display are authorised resellers for Roland, Mimaki, Agfa, Seal, SignLab and Onyx.

We can, through our specialised Digital Solutions team, offer everything from printers, plotters and cutters to a wide range of matching consumables including papers, vinyls and banners at competitive prices. Call to arrange a demonstration.

DIGITAL INKJET PRINTING

Active TRADE DIGITAL PRINTING

Unit 12c, Bates Industrial Estate, Church Road, Harold Wood, Essex RM3 0JA

Tel: 01708 640840

Fax: 01708 640877

e-mail:

dan@activesignsanddesigns.co.uk

We offer a Trade Digital Print & Cut service with no minimum order charge. From one colour to full photographic quality images up to 1370mm wide by any length printed and cut on to numerous vinyls and pvc banner materials, poster paper and photographic paper. We can take your artwork from e-mail, disk or CD in various formats.

BEL SIGN & DISPLAY

Blatchford Road, Horsham, West Sussex RH13 5QR

Tel: 01403 280850 (Pete Bedford)

Fax: 01403 280855

email: peter@belsigns.com

Web: www.belsigns.com

Screen Print and Digital Print to the trade.

Estate Agents Boards, Trade Site Boards.

Stickers & Labels cut to shape.

Plus Engraving & Etching 30 years in the Sign Trade.

CLEARSCORE LIMITED

Unit 1, Tudor Works, Turret Lane, Ipswich IP4 1DL

Tel 01473 212751

Fax 01473 233415

E-mail: sales@clearscore.co.uk

Web: www.clearscore.co.uk

Trade service for high quality digital print up to 1600mm wide. Printing on to vinyl, PVC banner, paper, lightbox material and artist canvas, also laminating and contour cutting. Providing high quality service and products since 1978.

GRAPHIC ALLIANCE EUROPE LTD

The 1844 Barn, Eltisbury Business Park, Abbotsley, Cambs PE19 6TX

Tel: 01767 679048

Fax: 01767 679015

E-mail: info@digital-interiors.co.uk

Web: www.digital-interiors.co.uk

Trade supplier of Giant-Sized Indoor or outdoor prints; Wall Art: Wallpaper & Murals. Window Decoration: Rollerblinds; Textile Drapes. Promotional Banners; Backdrops & Screening. Stretched Canvas; Signage; Front & Backlit Panels. Can supply Flatbed prints.

KOKOON LTD

Unit 12, Low Moor Business Park, Common Road, Bradford BD12 0NB

Tel: 01274 600015

Fax: 01274 600067

email: info@kokoon.co.uk

web: www.kokoon.co.uk

Trade service for Large Format Digital Printing. UV FLATBED printing up to 3000mm - print direct to substrate with no need for lamination - foamex, card, acrylic, dibond etc. SOLVENT printing, lamination and print and cut up to 1600mm. PHOTOGRAPHIC quality Pigment printing up to 1100mm. All work undertaken in house. Credit and debit card payments accepted for non account holders.

SIGNWORLD SCREEN & DIGITAL

Henson Way, Kettering, Northants NN15 6GH

Tel: 01536 527940

Fax: 01536 527944

E-mail: sales@signworld.co.uk

Web: www.signworld.co.uk

UV digital printing directly onto almost any flat substrate and roll fed media. Fade resistant prints last up to 7 years outdoors without laminating. Trade prices with plain cover deliveries guarantee you total confidentiality.

DIGITAL PRINTED SIGNS

DURABLE SIGNS UK LTD

Runways End, Lancaster Road, Carnaby Ind. Est., Carnaby, Bridlington YO15 3QY

Tel: 0871 230 1322

Fax: 0871 230 1323

E-Mail: sales@durablesigns.com

Digital printed vandal resistant signs with ten year outdoor warranty against fade from UV or air carried chemicals. Independently tested to BS3900.

PJ SIGNS LIMITED

Unit 22-24 Buckingham Square, Hurricane Way, Wickford, Essex SS11 8YQ

Tel: 01268 764874

Fax: 01268 764883

E-mail: tony.sayers@pj-signs.com

Printing at two resolutions, 720dpi and 360dpi, a high quality print service is achieved onto a wide range of medias. Also, due to our solvent based ink system PVC materials can be displayed outside for 5 years without any need for lamination. Thus keeping costs low.

VALENTINE SIGNS LTD

Based in Manchester and Nottingham

Tel: 01204 706778

Fax: 01204 575635

email:

sales@valentinesignsandlabels.com

Valentine Signs Ltd - We offer exceptional quality digital print onto all media, for example banner, vinyl, mesh and canvas. We use a unique pricing system which allows you to control your profits depending on the lead time you have available. The longer the lead time the lower the cost, see our full page advert or contact us for the latest prices. In addition we can do volume discounts on request.

DIGITAL PRINTER SUPPLIES

ALL PRINT SUPPLIES LIMITED

79 Buckingham Avenue, Slough, Berks SL1 4PN

Tel: 01753 696977

Fax: 0800 374635

E-Mail: sales@allprint.co.uk

One of the UK's largest suppliers of media and finishing films for digital printing, including printable banner, vinyl, textile, canvas, window films, reflective banner & vinyl and mount films. All products delivered next morning.

DORO TAPE (UK) LTD

1 Albany Court, Albany Road, Market Harborough, Leics LE16 7QP

Tel: 0845 165 1636/

01858 431642

Fax: 01858 466992

E-Mail: sales@dorotape.co.uk

Web: www.dorodigital.co.uk

Doro Tape under the banner of 'Doro Digital' can provide digital media for the majority of the leading makes of printers whether using solvent, eco-solvent or water based inks. Specialists in vinyls for digital printing, Doro Tape supplies products mainly from Ritrama and Aslan. Whether it's a glossy exterior vehicle graphic; a matt interior exhibition display; a floor graphic or vehicle wrap, Doro can supply the right vinyl film. These vinyls are available in various widths from 700mm to 1500mm.

For Digital printing Doro Tape also supply banners, pop up and roll up media, papers, and self-adhesive vinyl in A3 and A4 sheets for desktop and laser printers. Where print finishing is required Doro Tape have an excellent range of 7 cold laminates and 4 mounting films that cater for most circumstances.

Next day services offered on almost all products. Credit and debit cards accepted for non-account holders.

HEXIS UK LTD

70 Britannia Way, Britannia park, Lichfield, Staffordshire WS14 9UY

Tel: 01543 411221

Free Fax: 0800 0187 111

E-mail: sales@hexis.co.uk

Web: www.hexis.co.uk

Hexis are manufacturers of ink jet media direct to the trade. The range includes media for water based ink jet, media for solvent based ink jet, media for thermal transfer printing, laminating and mounting films, encapsulation films, large and grand format banner materials and ink supplies for large format printers, all available for same day dispatch.

METAMARK (UK) LTD

Moorfield Road, Slyfield Industrial Estate, Guildford GU1 1RU

Tel: 01483 571111

Fax: 01483 570540

e mail: sales@metamark.co.uk

Web: www.metamark.co.uk

Metamark manufactures the MD series of self adhesive media for solvent and eco solvent inkjet printing, which offer industry leading print quality and consistency of print output. The MD range produces excellent results on printers from Roland, Seiko, Mutoh, Agfa, Gerber, Uniform and Mimaki, and is available on a next day service either direct from Metamark or through a network of specialised digital distributors covering different segments of the market.

RITRAMA (UK) LTD

Lynwell Road, Lyntown Trading Estate, Eccles, Manchester M30 9QG

Tel: 0161 786 1760

Fax: 0161 786 1761

e mail: sales@ritrama.co.uk

Web: www.ritrama.com

Ritrama are one of the world's leading manufacturers of self-adhesive products. Materials for signmaking, digital printing, overlaminating and mounting are all available through Ritrama's UK-wide network of distributors.

DOMES & DISHES

GLASPLAS SIGNS (GPS)

(a division of Harviglass GRP Ltd)

Alexandra Street, Hyde, Cheshire, SK14 1DX

Tel: 0161 351 4620

Fax: 0161 368 1508

Web: www.glasplas.co.uk

GRP fibreglass domes, dishes, hemispheres & spheres in convex or concave finish. Many sizes available, but all sizes can be designed and originated to special order.

TALBOT DESIGNS LTD

225 Long Lane, Finchley London N3 2RL

Tel: 020 8346 8515

Fax: 020 8349 0294

E-Mail: domes@talbotdesigns.co.uk

Web: www.talbotdesigns.co.uk

We are the only company in Europe stocking clear acrylic Domes & Dishes in 18 sizes. We have over 140 other special sizes available and can make ovals, squares and oblong domes. By covering any shape with vinyl or screen printing you can have your own special sign.

EDGELIT SIGNS

KINGS PLASTICS LTD

The signbuild Centre, Kingsown House, Unity St, Bristol BS2 0HM

Tel: 0117 922 6382

Fax: 0117 925 1159

Reflex illuminated sign system using T5 lamps and integral high frequency ballast units or Miniflex using LEDs, both can be supplied with or without 8mm clear acrylic panels, plain or outline engraved to your design.

MASTER PRODUCTS LTD

Unit 51 Cutlers Road, Salt Coats Ind Estate, South Woodham Ferrers, Chelmsford, Essex CM3 5WA

Tel: 0845 838 2325

Fax: 0845 838 1634

E-mail: sales@masterproducts.co.uk

Web: www.masterproducts.co.uk
Manufacturers of edgelit signs & displays, The x-edge system combines energy efficient leds with precision laser engraving to give bright, crisp even illumination around any lettering or logo, x-edge is also highly versatile, edgelit signs can be suspended, wall mounted, ceiling mounted, projected, free standing or used as a desk top display, single, multi, or full colour images can be combined with laser engraving to give stunning results.

METALMASTER PROMOTIONS (UK) LTD

Shirburn House, Oxford Road, London SE19 3JH

Tel: 0208 670 5042

Fax: 0208 761 2745

signup@edge-lit-signs.co.uk

www.edge-lit-signs.co.uk

Offering a unique edge lighting service using A-blade(TM) with our Flat Light System and specialist panel decorations.

A-Blade (TM): 12mm overall depth, 6 panel sizes, 8 light injectors, 6 lighting colours, 16 decoration combinations & many fixing options. Allowing sign designers THOUSANDS OF DESIGN COMBINATIONS.

Call Metalmaster for further information.

ELECTRONIC SIGNS

ACTION SIGNS (VISION TEXT)

Unit 2, Mitons Yard, Pelsworth Rd, Witley, Surrey GU8 5LH

Tel: 01428 686840

Fax: 01428 687936

e-mail: info@vision-text.com

Web: www.vision-text.com
Comprehensive range of LED programmable message displays for indoor and outdoor applications. From single line to large multiline signs, clocks and reception boards. Professional and courteous service from experienced staff. National sales coverage.

ASSIGN TECHNOLOGY LTD

Unit 1, The Wadsworth Business Centre, 21 Wadsworth Road, Perivale, Middlesex UB8 7LQ

Tel: 0208 998 0806

Fax: 0208 998 1272

e-mail: info@assigntechnology.co.uk

Web: www.assigntechnology.co.uk
Design and manufacture of all types of Electronic LED signs. Our range includes single line signs, multiline signs, digital clocks, factory signs, scoreboards, time/temperature displays. both internal and external models available. Trade enquiries welcome. Call us now for more details.

FSL ELECTRONICS LTD

Sandholes Road, Cookstown, Co. Tyrone, N. Ireland BT80 9AR

Tel: 028 8676 6131

Fax: 028 8676 2414

E-Mail: info@fsl.ltd.uk

Web: www.fsl.ltd.uk
Design, manufacture and distribution of electronic displays and scoreboards, using LED and electromechanical technologies. Complete range of LED single-line, multiline signs, graphic boards, reception displays and clocks. Trade enquiries welcome.

VISIONWORX LIMITED

72 High Street, Great Dunmow, Essex CM6 1AP

Tel: 01371 876 577

Fax: 01371 874 991

E-Mail: sales@visionworx.co.uk

Web: www.visionworx.co.uk
Design, manufacture and installation of all types of Electronic Signs. Comprehensive range of message centers including single lines, multi line, graphics and video boards, forecourt pricing, scoreboards and timing, clocks, custom designs using LED technology. Digital media networks, LCD and Plasma. National coverage, trade enquiries welcome. Call for more details.

ENGRAVING

COUNTY ENGRAVERS & SIGNS LTD

Unit 5, Trent View Court, Moreland Street, Nottingham NG2 3FX

Tel: 0115 985 1171

Fax: 0115 986 1007

E-mail:

sales@countyengravers-signs.co.uk

Web:

www.countyengravers-signs.co.uk
Engravers of all types of plaques, plates, labels and control panels in a wide range of materials. Fine detail etching in brass and stainless steel. Acrylic fabrications and trophies. Full colour printing from labels to wide format.

FIRST SIGNS & LABELS

Unit 1, Raynham Close, Raynham Rd Ind Estate, Raynham Road, Bishops Cleeve, Herts CM23 5JP

Tel: 01279 467999

Fax: 01279 467888

e-mail:

sales@firstsignsandlabels.co.uk
We manufacture and engrave nameplates, Labels, Tags, Switchplates, Mimics, Brass Plates, Components, Warning Labels, Plaques, Logo's and Signs. We also produce printed fire & Safety Signs & Vinyl Graphics.

HALLMARK ENGRAVING & ETCHING

(Est. 1899)
116-118 Selsdon Road, South Croydon, Surrey CR2 6PG

Tel: 020 8686 6649

Fax: 020 8760 0899

www.hallmarksigns.co.uk

E-mail: sales@hallmarksigns.co.uk
Superfast and reliable trade service with 100 years experience for all etching, routing and profiling. Specialists for nameplate and commemorative plaques in bronze, brass, aluminium, stainless and plastics. Logos and crests. High quality graphics - drawings free of charge. Precision industrial engravers of panels, labels and moulds. Keytop specialist. Presentation silverware and glass engraving experts. Please call for Golf and Trophy catalogues. Reliable & helpful service - delivery promises always kept! - overnight deliveries nationwide. Please call for information sheet.

I.C.E.

Marcon House, Wyther Lane, Leeds LS5 3BT

Tel: 0113 224 2124

Fax: 0113 224 2110

E-MAIL: sales@icesigns.co.uk

The complete engraving service. CNC equipment ensures rapid turnaround for control panels, scales, dials, commemorative plaques, bulk labelling work etc. Enquire by fax, disk or e-mail for prompt attention.

KINGS PLASTICS LTD

The signbuild Centre, Kingsown House, Unity St, Bristol BS2 0HM

Tel: 0117 922 6382

Fax: 0117 925 1159

We supply engraved signs from tiny labels and minic panels to commemorative plaques with or without hardwood mounts.

MASTERGRAVE LIMITED

65 Murdock Road, Bedford MK41 7PL

Tel: 01234 218226

Fax: 01234 269899

E-Mail: sales@mastergrave.co.uk

Website: www.mastergrave.co.uk
Trade only central engraving service, incorporating computer and laser controlled engravers, conveyer etchers, sande blasters, and lasers. Also full range of quality corporate gifts available, engraved or blank, at highly competitive prices.

MERCURY & PHILLIPS SIGNS

51/59 Waterworks Rd. Norwich NR2 4DA

Tel: 01603 666699

Fax: 01603 616781

E-Mail: mercphil@globalnet.co.uk

Web:

www.mercuryphillippsigns.co.uk
Manufacturers of all types of plates or plaques, machine engraved or chemically etched using a variety of materials, brass, stainless steel, aluminium, plastics and wood. For high quality and intricate detail with colour infills to your choice.

MULTITECHNIC LTD (Est. 1973)

Copies Lane Industrial Estate, Morpeth,

Northumberland NE61 6JQ

Tel: 01670 512090

Fax: 01670 503143

Web: www.Multitechnic.co.uk

E-Mail: sales@multitechnic.co.uk
Specialists in photochemical etching to the trade. Multitechnic prides itself on staying ahead of the competition with leading edge research and development in photochemical etching, leading to the development of unique processes. Very fine half tones, multi colour fills and colour blends and tints. Multitechnic over the years has developed a high standard of trade customer support combined with outstanding customer service. For all your etching requirements, from design to despatch, speak to Multitechnic - serving the Trade.

ENGRAVING MACHINES

EPILOG LASER

16371 Table Mountain Parkway, Golden, CO 80403 USA

Tel: +1 303-277-1188

Fax: +1 303-277-9669

E-Mail: sales@epiloglaser.com

Website: www.epiloglaser.com
Epilog Laser manufactures the Legend EX and TT line of 35-120 watt CO2 laser engraving, cutting, and marking systems. The TT is the only compact, high-performance laser system on the market, and the EX is Epilog's top-of-the-line laser system for the highest quality engraving and cutting available.

MASTERGRAVE LIMITED

65 Murdock Road, Bedford MK41 7PL

Tel: 01234 218226

Fax: 01234 269899

E-Mail: sales@mastergrave.co.uk

Website: www.mastergrave.co.uk
Mastergrave are manufacturers and suppliers of all types of computer controlled and manual engraving machines. We also manufacture saws, bevellers, guillotines and cutters. All engraving materials stocked, including flexible and rigid laminates, brass and aluminium.

ESTIMATING SOFTWARE

TOUCH SYSTEMS LTD

261 Lyndon Road, Solihull, West Midlands B92 7QP

Tel: 0121 248 2448

E-mail: sales@touchsystems.co.uk

Web: www.clarityprofessional.com
Clarity Professional is all encompassing Sign Estimating and Business Process software. It gives you a completely automated business administration system enabling you to spend more time prospecting and selling. Clarity Professional provides the complete business process in one software package including Contact Management, Estimating and Order Processing, Job Management, Price List management, Works Orders, Delivery Notes and Invoices. Also available are modules for generating Purchase Orders and Actual Job Cost Analysis. Clarity Professional links to Sage, Act, Goldmine and Microsoft Office. FREE evaluation disks are available on request. Just call or email us NOW!

FLAGS & FLAGSTAFFS

FLAGS AND FLAGPOLES

Unit 38, Hayhill Ind Estate, Barrow upon Soar, Loughborough LE12 8LD

Tel: 01509 815155

Fax: 01509 814929

Email: sales@flagsandflagpole.biz

Web: www.flagsandflagpoles.biz

Poles - Builders, residential, aluminium, fibreglass, heavy duty, portable, exhibition, event poles - any size / specification. Flags - Printed, appliqué, any quantity, any size. Table flags, car, internal, external - for any occasion. Huge stocks in Leicestershire. Call us for information
Also - PVC Banners & Frames.

HAMPSHIRE FLAG COMPANY LTD

Unit 11, Pipers Wood Industrial Park, Waterberry, Waterlooville, Hampshire PO7 7XU

Tel: 0845 644 3129

Fax: 0845 644 3128

E-mail: neil@hampshireflag.co.uk

Web: www.hampshireflag.co.uk

From international, marine and table to feather, teardrop and digitally-printed. Hampshire Flag offers every type of flag for every occasion. Flagpoles and flagstuffs available include ceremonial, builders, heavy duty and portable.

ONE STOP PROMOTIONS LTD

Unit 38 Hayhill Industrial Estate

Barrow upon Soar, Loughborough, Leicestershire, LE12 8LD

Direct line: 0871 910 3930

Fax: 01509 814 929

Visit our website at

www.onestoppromotions.co.uk

FLAME POLISHERS

AWLTECH

Unit 9 Enterprise Estate, Moorfield Road, Slyfield, Guildford, Surrey GU1 1RB

Tel: 01483 569232

Fax: 01483 569263

email: info@awltech.co.uk

Web: www.awltech.co.uk

One quick pass of a high temperature flame produces results superior to those effected by buffing or mop polishing, and the high quality finish it produces is imparted to the surface immediately.

FLAT CUT LETTERS

APPLELEC SIGN COMPONENTS LTD

Appleby House, Walker Terrace, Bradford, West Yorkshire, BD4 7JH

Tel +44 (0)1274 774477

Fax +44 (0)1274 774478

E-mail: sales@applelecsign.co.uk

Web: www.applelecsign.co.uk

Trade suppliers of flat cut out letters, logos and intricate laser work. We offer lettering in a variety of materials such as acrylic, foamex, dibond, stainless steel, aluminium and MDF, available in different finishes, with or without fixings. Please ask for an information pack or contact one of our friendly experienced sales staff for assistance. (3D built up lettering is also available).

TRADE SIGNS UK.COM

Unit D3, 78-80 Akeman Street, Tring, Herts HP23 6AF

Tel: 0870 240 2763

Fax: 01442 828922

E-mail: sales@tradesignsuk.com

Web: www.tradesignsuk.com

We offer a 24 hour service on flat cut lettering and logos in Acrylic, Dibond, Stainless Steel, Foam PVC, MDF, Wood and many more material, supplied with or without templates and locators/studs ready for you to install, quotations over the phone or by e-mail/fax. Call our Sales team today for that friendly prompt service you require.

FLEXIBLE FACE SIGNS

INSIGHT SIGN SYSTEMS

61 Dykehead Street, Queenslie Industrial Estate, Glasgow G33 4AQ

Tel: 0141 774 5990

Fax: 0141 774 6653

Web: www.insightsignsystems.com

E-mail:

sales@insightsignsystems.com
Insight is a trade only manufacturer, offering a made to measure service, with in-house powder coating. A range of cases are available to accept flexible substrates, covering most applications. Tensioning mechanism is fast and simple to operate, and can be accessed via hinged cover plates fitted around perimeter of case. Large hinged cases can be fitted with gas struts or mechanical arms to assist opening.

MIDA SIGN SERVICES

Gatefield House, Blandford Street, Ashton-under-Lyne OL6 7DW

Tel: 0161 8 300 600

Fax: 0161 8 300 601

E-mail:

enquiries@midasignservices.co.uk

Web:

www.midasignservices.co.uk
Specialised installers of all flexible faced systems. Nationwide service. Illuminated or non-illuminated. We can supply and install. Call for details.

SIGNBASE UK LTD

Based in Nottingham and Manchester

Tel : 01773 535 356

Fax : 01773 535 153

email: sales@signbaseuk.com
Signbase Uk Ltd specialise in manufacturing flex face boxes.

We manufacture from 2 sites, Nottingham and Manchester which enables us to offer a cost effective nationwide manufacturing and installation service. All boxes are riveted and welded to ensure maximum strength. Our skins are manufactured in house and are clipped and pre tensioned prior to despatch making installation easier and more cost effective.

We will assist in every aspect of your job by offering a full site consultation with advice on access equipment and health and safety. We can work with you on the design and structure of the box and can use our in house engineers to install anywhere in the country.

SIGNTEC

Unit A, Chiltern Trading Estate, Grovebury Road, Leighton Buzzard, Bedfordshire LU7 4TU

Tel: 01525 850500

Fax: 01525 850462

Website: www.signtec.co.uk

Trade supply only - Specialists in all aspects of flexible face signage. Hinged and non-hinged systems, retros, shaped boxes, etc. Decoration of flexible face in vinyl, full colour or eradication.

GENERAL SIGN SUPPLIERS

CITY NEON SIGN CO. LTD.

Unit 4 Stephens Industrial Estate, 635 Warwick Road, Tyseley, Birmingham B11 2EZ

Tel: 0121 707 8106

Fax: 0121 707 7954

Design, install and supply of general signs, illuminated and non illuminated fascia signs. Vehicle livery, magnetic signs, vinyl signs, 'A' boards, site boards and banners, etc.

KINGS PLASTICS LIMITED

The Signbuild Centre, Kingsown House, Unity St, Bristol, BS2 0HN

Tel: 0117 922 6382

Fax: 0117 925 1159

For all types of sign. Individual letters in acrylic, vinyl and PVC. Illuminated signs, modular sign systems and frames, engraving on plastics, aluminium and brass, labels and stencils. Also material supplies cut to size. A complete service to the trade.

SIGN MAKERS PRODUCTS LIMITED

Hawthorn House, Ipswich Road, Long Stratton, Norfolk NR15 2XB

Tel: 01508 531183

Fax: 01508 531139

Manufacturers of sign boxes, frames and display cases to the trade. Fast delivery.

GLASS FIBRE (GRP) PRODUCTS

G.K. BEAULAH & CO. LTD

Heritage House, 23 Park Street, Hull HU2 8RU

Tel: 01482 223521

Fax 01482 216328

E-mail: sud@beaulah.co.uk

website: www.beaulah.co.uk

Experienced craftsmen design & manufacture unique quality products. We supply Outdoor Signage, Plaques, Coats of Arms, Heraldic Shields, Heritage Products, Screen Printing, Wooden Bases & Corporate Giftware.

GLASPLAS SIGNS (GPS)

(a division of Harviglass GRP Ltd)

Alexandra Street, Hyde, Cheshire, SK14 1DX

Tel: 0161 351 4620

Fax: 0161 368 1508

Web: www.glasplas.co.uk

80+ glassfibre GRP sign blanks ANY colour. Quality gloss in traditional styles. Weatherproof, vandal resistant + 10yr life. Sizes 300mm to 3.0M, & multiples-panel runs. Bespoke signs with CAD design service.

GOLD LEAF SUPPLIERS

HABBERLEY MEADOWS

5 Saxon Way, Chelmsley Wood, Birmingham B37 5AY

Tel: 0121 770 0103

Fax: 0121 770 6512

E-mail:

gold@habberleymeadows.co.uk

Web: www.habberleymeadows.co.uk

Best quality English Gold leaf direct from the manufacturer. "Quality Leaf for Quality Signs".

SERVICES SUPPLY COMPANY

26 Penybont Road, Pencoed, Mid Glamorgan CF35 5RA

Tel: 01656 860109/860344

Fax: 01656 862555

e-mail:

info@goldleafsupplies.co.uk

Web: www.goldleafsupplies.co.uk

Gold leaf 12 to 24ct from stock same day despatch for approved accounts. We doubt whether our prices can be bettered for comparable quality.

WRIGHTS OF LYMM LTD

t/a C. F. Stonehouse & Sons

Warrington Lane, Lymm, Cheshire WA13 0SA

Tel: 01925 754368/752226

Fax: 01925 757569

e-mail: info@wrightsoflymm.co.uk

Web: www.wrightsoflymm.co.uk
Manufacturers of finest quality English gold leaf from 24ct to 12ct at very competitive prices. Free gold size available, please ring for details.

GROUND WORKS

MIDA SIGN SERVICES

Gatefield House, Blandford Street, Ashton-under-Lyne OL6 7DW

Tel: 0161 8 300 600

Fax: 0161 8 300 601

E-mail:

enquiries@midasignservices.co.uk

Web: www.sign-maintenance.co.uk

Full excavation service for sign. Foundations, small, large and Multiples. Nationwide service

SIGNFORCE UK LTD

Unit 7 Ariane, Lichfield Road Industrial Estate,

Tamworth, Staffs, B79 7XF

Tel: 01827 312323

Fax: 01827 312323

Mob: 07766 881570

Email: info@signforceuk.com

Web: www.signforceuk.com

Nationwide service by high experienced and certified specialist crews.

Excavations / Bases / Foundations / Feature

Walls / Block Paving / Repairs

Post Signs / Road Traffic & Way Finding Signs /

Flag Poles. Friendly & efficient service.

HEAT BENDERS

AWLTECH

Unit 9 Enterprise Estate, Moorfield Road, Slyfield, Guildford, Surrey GU1 1RB

Tel: 01483 569232

Fax: 01483 569263

email: info@awltech.co.uk

Web: www.awltech.co.uk

A high quality, competitively priced, user friendly range of Heat Benders. Our range covers all application from 1/2 metre to 3 metres in length. NEW semi-automatic machines now available.

HOLOGRAPHIC VINYL

HOLOGRAPHIC VINYL

4 Selbourne Road, Havant, Hampshire PO9 1ND

Tel: 023 92 492022

Fax: 023 92 498407

e mail: mark@holographicvinyl.co.uk

Web: www.holographicvinyl.co.uk

We supply an extensive range of specialist and holographic vinyls so you can create the eye-catching signs you know your customers deserve. New 5-year outdoor durability available in a full range of colours and designs. We buy in bulk to give you the best price, so no length is too small. Cheque, credit and Switch card payments acceptable. Express delivery guaranteed. For a prompt, friendly service and competitive prices, call today.

INKJET MEDIA

DEP LTD

Frith Park, Sturts Lane, Walton-on-the-Hill, Tadworth, Surrey KT20 7NQ

Tel: 01737 813517

Fax: 01737 813442

e mail: dep@frithpark.com

Web: www.frithpark.com

In addition to manufacturing high quality films for the screen, litho and flexo industry, D.E.P Ltd supplies a wide range of versatile INKJET MEDIA from proofing papers to high quality true photo satin paper. The laminating products complement the range, available in Gloss, Satin, Matte and Sandtex.

INSTALLATION CONTRACTORS

ACCESS DIRECT (London)

13 Conway Gardens, Enfield EN2 9AD

Mobile: 079444-01477

High level fixing carried out and maintenance on signs, up to a height of 22m of our own machine. Specialists in Neon Sign installations, also manufacturers of Neon / Cold Cathode.

APPLIED IMAGING

Units 11 & 22, Brookside Centre, Sumpters Way, Southend-on-Sea SS2 5RR

Tel: 01702 462500

Fax: 01702 462503

e mail:

c.abbott@applied-imaging.co.uk

Web: www.applied-imaging.co.uk

Graphic and Signage Installation Specialists

- Fascia Signs
- Window Graphics
- Banners
- Development Hoardings
- Building Wraps

CLARENDON FLEET LIVERY

Unit 14, Churchill Way, Fleckney, Leicester

LE8 8UD

Tel: 01162 403700

Fax: 01162 402711

Mob: 07860 503710

Email: john@clarendon-fleet.com

Web: www.clarendon-fleet.com

20 applicators working nationwide, specialists in applications to large vehicle and rail fleets Sign and banner installations, building wraps Site surveys and Vehicle management. Centrally based.

LW BIRCH SIGN SERVICES

Unit 8, Charfleets House, Charfleets Road, Canvey Island, Essex, SS8 0PQ

Tel: 01268 680 899

Fax: 01268 682 676

Mobile: 07967 190089

e-mail: birchsigns@hotmail.com

web: www.birchsigns.com

"The largest independent sign installation and maintenance company in the UK." Specialists in all sign work, large or small, neon, LED, all Flexface systems, illuminated, non illuminated and vinyl. Corporate change over specialists.

MIDA SIGN SERVICES UK LTD

Gatefield House, Blandford Street, Ashton-under-Lyne OL6 7DW

Tel: 0161 8 300 600

Fax: 0161 8 300 601

www.midasignservices.co.uk

Professional installation and maintenance of all types of signage. Including, Site survey's, Illuminated signs, Flexface signage, neon etc. Nationwide service operating from Manchester. Established 1984.

NOBLE SIGNS (Glasgow)

54 Bellshill Road, Uddingston, Glasgow, G71 1LZ

tel./fax. 01698 818 494

Mobile. 07930 407 622

Email: john@noblesigns.co.uk

Web site: www.noblesigns.co.uk

Experienced sign fitting teams for hire. Fixed price contract. Will travel U.K. wide.

Unlettered vans. Scaffold tower and hand tools included. SCSC & IPAF card holders. All signwork except Neon. Specialists in Large format Vinyl application. All enquiries welcome.

PROPERTY SOLUTIONS

86 Lyde Road, Yeovil, Somerset, BA21 5DH

Tel: 01935 420699

Mobile: 07804 921322

Fax: 01935 420699

Email: enquiries@property-

solutionsonline.co.uk

Web: www.property-solution-

sonline.co.uk

Professional installation of signage and display systems. Covering flexface, illuminated, non-illuminated and vinyl signage. Any size, anywhere in the uk. Polite and presentable installation teams. All enquiries welcome.

SELECT SIGN SERVICE LIMITED

14 Spire Green Centre, Flex Meadow, Pinnacles West, Harlow, Essex CM19 5TR

Tel: 0844 412 2300

Fax: 0844 412 2231

E-mail: help@selectsignservice.com

An experienced professional trade sign and lighting contractor to undertake Surveys, Project Management, Individual or Programmed Installations, Planned or Reactive Maintenance, Illumination and Accident 'make safe' and repairs, throughout the U.K. All crews are fully trained to current Health and Safety standards including Pasma, IPAF and UKPIA Safety Passports.

SIGNFORCE UK LTD

Unit 7 Ariane, Lichfield Road Industrial Estate,

Tamworth, Staffs, B79 7XF

Tel: 01827 312323

Fax: 01827 312323

Mob: 07766 881570

Email: info@signforceuk.com

Web: www.signforceuk.com

Nationwide Installation & Maintenance Solutions
All engineers are highly experienced in all formats of Signage Installation and operate from modern plain unmarked vans.

Engineers are fully conversant with all aspects of Health & Safety and are CSCS, IPAF, PASMA & SPA certified.

Flex Face / Neon / LED / Bespoke Signage specialists.

Friendly & efficient service.

THISTLE SIGN SERVICES (SCOTLAND)

19F Winchester Ave Ind Est, Denny, Stirlingshire, FK6 6QE

Tel: 01324 820230

Fax: 01324 820240

Email:

thistle.signs@btpenworld.com

Professional installation and maintenance service throughout Scotland. We specialise in all types of sign work, excavation service for sign foundations, neon, flexface systems, vinyl. Surveys undertaken. All our crews are fully trained and hold IPAF and CSCS certification.

INSTALLATION CONTRACTORS (N.I)

GILMORE SIGNS LTD

Northern Ireland's Longest Established Sign Company

41-45 Middlepath Street, Belfast BT5 4BG

Tel: 028 9045 5419

Fax: 028 9045 8451

E-mail: martin@gilmoresigns.com

Professional installation and maintenance service throughout Northern Ireland. We also undertake surveys and individual or programmed installations. Planned or reactive maintenance, illumination and accident 'MAKE SAFE' and repair. 6,000 sq ft storage space. Rates can be negotiated down to zero.

LARGE FORMAT DIGITAL PRINTING

PRESTIGE SIGNZ LTD

28b Wellington Rd, Oldham, OL8 1RT

Tel: 0161 628 6442

Email: enquiry@prestigesignz.co.uk

web: www.prestigesignz.co.uk

Manufacturers of Large Format Digital Printing to the trade. VINYL, BANNERS, POSTERS, CANVAS, BACKLITS, CLEAR, PERFORATE and more. High quality prints up to 1370mm wide with unlimited length. Prints have 5 years outside life expectancy without lamination and can be used internal or external use.

We cover the whole UK and have a very fast turn-around. We will beat ANY price.

LARGE FORMAT DISPLAY BOARDS

AARON SIGNS & CONSTRUCTIONAL SERVICES LTD

Unit 16, Highlands Farm Business Park, Highlands Hill, Swanley Village, Kent BR8 7NA

Tel: 01322 667100

Fax: 01322 664971

E-mail:

aaron.signs@btconnect.com

Company formed in 1972. Specialists in production and erection of large format development and advertising boards and hoardings, for house and warehouse builders. Suppliers and builders also of advertising structures for the outdoor poster specialists. All our employees are fully trained and authorised to carry out works on Network Rail and LUL/TFL projects.

Mows and risk assessments supplied on request.

LARGE FORMAT SCREEN PRINTING

LLANION SIGN & GRAPHICS

Stockwell Road, West Llanion Park, Pembroke Dock, Pembrokeshire SA72 6TQ

Tel: 01646 683181

Fax: 01646 622111

E-mail:

llanionsigns@btconnect.com

Web: www.llanionsigns.co.uk

For all the high quality Signs and Screenprinting you'll ever need. We specialise in large format screen printing for the trade at very competitive trade prices.

LASER CUTTING/ENGRAVING

ATC

Calf Hey South, off Well'ith Lane, Rochdale OL11 2JS

Tel: 01706 633043

Fax: 01706 710086

e-mail: sales@apptape.co.uk

We offer a laser cutting and engraving service to the sign trade. For quotations please e-mail or fax on the above.

PJ SIGNS LIMITED

Unit 22-24 Buckingham Square, Hurricane Way, Wickford, Essex SS11 8YQ

Tel: 01268 764874

Fax: 01268 764883

E-mail: tony.sayers@pj-signs.com

Offering Laser cutting for a large range of trade work using the latest technology enabling a quick turnaround at a competitive price. Cutting Stainless Steel, Acrylic with instant polished edges and various other materials.

SJS LASER CUTTING & ENGRAVING

Craigie Cottage, North Street, Burrelton, Perthshire, Scotland PH13 9NZ

Tel: 01828 670532

FAX: 01828 670322

E-mail: Simonsellen@btinternet.com

Web: www.sjslaser.co.uk

Laser cut / engrave letters and images from a wide range of materials including up to 8mm Acrylic with Polished edges. Very competitive prices. Prompt professional service, highest quality products.

e-mail or phone for a quote

TRADE SIGNS UK.COM

Unit D3, 78-80 Akeman Street, Tring, Herts HP23 6AF

Tel: 0870 240 2763

Fax: 01442 828922

E-mail: sales@tradesignsuk.com

Web: www.tradesignsuk.com

We offer a 24 hour service on flat laser cut lettering and logos in stainless steel 0.9mm - 3mm & Mild steel 0.9mm - 10mm, supplied with or without templates and locators/studs ready for you to install, quotations over the phone or by e-mail/fax. Call our Sales team today for that friendly prompt service you require.

LASER ENGRAVING MACHINES

EPILOG LASER

16371 Table Mountain Parkway, Golden CO 80403 USA

Tel: +1 303-277-1188

Fax: +1 303-277-9669

E-Mail: sales@epiloglaser.com

Website: www.epiloglaser.com

Epilog Laser manufactures the Legend EX and TT line of 35-120 watt CO2 laser engraving, cutting, and marking systems. The TT is the only compact, high-performance laser system on the market, and the EX is Epilog's top-of-the-line laser system for the highest quality engraving and cutting available.

UNIVERSAL LASER SYSTEMS INC. / UNIVERSAL LASER SYSTEMS GMBH

7845E Paradise Lane, Scottsdale, Arizona 85260

USA / Lerchenfelder Guertel 43

A-1160 Vienna, AUSTRIA

Tel: +1 (480) 483-1214

+43 (1) 402 22 50

Fax: +1 (480) 483-5620

+43 (1) 402 22 50 10

Email: sales@ulsinc.com

eurosales@ulsinc.com

Web: www.ulsinc.com

Universal Laser Systems manufactures affordable CO2 laser engraving, cutting and marking systems. Laser systems are computer-controlled and accommodate a wide variety of materials, including plastics, wood, acrylic, glass, rubber, fabric and more.

LED ILLUMINATION

APPLELEC SIGN COMPONENTS LTD

Appleby House, Walker Terrace, Bradford, West Yorkshire BD4 7HJ

Tel: +44 (0)1274 774477

Fax: +44 (0)1274 774478

E-mail: sales@applelecsign.co.uk

Web: www.permalight.com

www.applelecsign.co.uk

Trade suppliers of proven LED lighting solutions for the Sign industry. We offer energy efficient, award winning LED lighting modules in a variety of different colours including RGB colour changing boards. Ideal for both indoor and outdoor use, the LEDs are complemented by an exclusive range of power supplies and controllers to suit your application. From 3D built up letters, to fascia trough lighting, even light boxes, Applelec offer an unrivalled service through a team of dedicated estimators, and an after sales technical support help line. Please ask for an information pack or contact one of our friendly experienced sales staff for assistance.

FIBRE OPTIC FX LTD/ LIGHTING PARADISE UK

Unit 5 Norden Court, Heys Lane Ind Est, Great

Harwood, Lancashire BB6 7UR

Tel: 01254 888809

Fax: 01254 888909

E-mail: info@fibreopticfx.co.uk

Web: www.fibreopticfx.co.uk

Suppliers of varying Led lighting for indoor and outdoor applications with a range of power supplies to suit. We also manufacture Fibre Optic point of sale display signs, side and end emitting fibre with a full range of lightsources and end fixtures.

LED SOLUTIONS

129 Humberstone Road, Leicester LE5 3AP

Tel: 0116 262 5933

Fax: 0116 262 6061

email sales@ledsolutions.co.uk

web: www.ledsolutions.co.uk

LED Solutions provides the latest in solid state lighting products for a range of professional industries. Our signage products (developed by AgiLight) combine high lumen output with low heat emission. This means you can mount our boards to any surface without the need for costly heat sinks.

We also provide SlimLight; a range of Ultra-Slim illuminated poster frames. Edge Lit technology provides profiles as narrow as 30mm.

LEDXPRESS

No.7 Helmsley Road, West Park, Leeds

LS16 5JA

Tel: 0113 274 2869

Web: www.ledxpress.co.uk

A superb range of 40 ready made LED Shop Signs. Super slim (only 17mm thick), precision engineered using the highest quality black acrylic. 8mm wide angled, super bright, anti glare LEDs. Prices from £69 to £119 + VAT. Supplied complete with hanging chains and AC/DC adapter.

Call for brochure and trade list - Est 2002

MASTER PRODUCTS LTD

Unit 51 Cutlers Road, Salt Coats Ind Estate, South Woodham Ferrers, Chelmsford, Essex CM3 5WA

Tel: 0845 838 2325

Fax: 0845 838 1634

E-mail sales@masterproducts

Web: www.masterproducts.co.uk

Suppliers of leds for halo and face lit channel letters & logos includes led neon, a genuine replacement for neon, and octoflex the flexible leds that are encapsulated in a fully waterproof pvc jacket, all products suitable for internal and external signage projects

MEGALED LTD

International Sales: 81 Chatsworth Road, Stratford, London E15 1QZ

Tel: 020 7617 7311

e-mail: info@megaled.com

Web: www.megaled.com

Megaled - make it with leds™! Specialist engineers of LED Lighting Hardware. Quality architectural internal/external lighting. Electronic Lighting Control Systems, Fixtures, LED Hardware. Complete RGB control systems and Multi-channel Controllers for BIG Installations.

MEGALED offer a completely professional LED Lighting Service.

OSHINO LAMPS (UK) LTD

Brookfield House, Brookfield Road, Arnold, Nottingham NG5 7ER

Tel: 0115 920 9513

Fax: 0115 920 9886

E-mail sales@oshino.co.uk

Web: www.oshino-lamps.co.uk

All high efficiency LED colours and RGB full colour change illuminated pucks for channel sign applications now available from our illumination partner, Oshino Lamps UK Ltd. Someone you know is using Oshino.

SIGNTRADE LETTERS

225 Long Lane, London N3 2RL

Tel: 0500 456700

Fax: 020 8349 5806

E-mail: sales@signtrade.co.uk

Web: www.signtrade.co.uk

Chromasign launched at Sign UK. We offer a complete range of Chrome Plated Letters with Halo Lighting not available anywhere else. Ring Richard or Dave for details and samples.

LIGHT BOXES

INSIGHT SIGN SYSTEMS

61 Dykehead Street, Queenslie Industrial Estate, Glasgow G33 4AQ

Tel: 0141 774 5990

Fax: 0141 774 6653

Web: www.insightsignsystems.com

E-mail:

sales@insightsignsystems.com

Insight is a trade only manufacturer, offering a made to measure service, with in-house powder coating. A range of boxes is available to cover applications including back-lit acrylic, aluminium, flex, posters and transparencies.

N E PLASTICS LIMITED

Unit 1, Ruxley Corner Industrial Estate, Edgington Way, Sidcup, Kent DA14 5BL

Tel: 020 8308 9990

Fax: 020 8308 9995

E-mail: sales@neplastics.co.uk

Web: www.neplastics.co.uk

N E Plastics Ltd - one of the U.K.'s largest independent distributors of semi-finished plastics, supplying a fast and flexible service to the Graphics, Glazing, Exhibition, Point of Sale, Sign making and Screen printing industries.

LIGHTING

INSIGHT SIGN SYSTEMS

61 Dykehead Street, Queenslie Industrial Estate, Glasgow G3 4AQ

Tel: 0141 774 5990

Fax: 0141 774 6653

Web: www.insightssignsystems.com
e-mail: sales@insightssignsystems.com
Insight is a trade only manufacturer, offering a made to measure service, with in-house powder coating. Trough lighting systems are available to cover a range of applications from shop fascias to billboards.

SIGN MAKERS PRODUCTS LIMITED

Hawthorn House, Ipswich Road, Long Stratton, Norfolk NR15 2XB

Tel: 01508 531183

Fax: 01508 531139

Manufacturers of sign boxes, frames and display cases to the trade. Fast delivery.

MAGNETIC MATERIAL

ALL PRINT SUPPLIES LTD

79-80 Buckingham Avenue, Slough, Berkshire, SL1 4PN

Tel: 01753 696977

Fax: 0800 374635

E-Mail: Sales@allprint.co.uk

Web: www.allprint.co.uk
Plain white gloss magnetic sheeting for vehicle livery and general signage. Standard thickness 0.60mm and 0.85mm with widths of 610mm and 1000mm, supplied by the metre. All products delivered next day before noon.

ANCHOR MAGNETS LTD

Bankside Works, Darnall Road, Sheffield S9 5AH

Tel: 0114 244 1171

Fax: 0114 242 6612

Web: www.anchor magnets.com
Fast ex-stock delivery of magnetic materials for vehicle livery and promotional applications. Magnetic sheet supplied in pre-cut sizes to customers specifications or 610mm/1 metre rolls, 30 metres in length. Available in plain white, gloss or a variety of attractive coloured finishes.

ARNOLD MAGNETICS

Vector 31, Waleswood Way, Wales Bar, Sheffield S26 5NU

Tel: 01909 775 724

Web: www.arnoldmagnetics.com

Email :

wmattocks@arnoldmagnetics.com
The complete range of 'Flexmag' Magnetic sheet and products from standard plain white gloss 0.85mm thick, to special materials, colour and finishes, DIRECT FROM THE MANUFACTURER AT THE LOWEST PRICES ! Call our Flexmag specialist now for samples, design advice, or a quote at the most competitive price from our factory stock.

BISBELL MAGNETIC PRODUCTS LTD.

Hillfield Lane, Stretton, Burton on Trent, Staffs DE13 0BN

Tel: 01283 531000

Fax: 01283 534000

e-mail: sales@bisbellmagnetics.com

Web: www.bisbellmagnetics.com
Maxmag magnetic sheeting is available in digitally printable standard and wide format as well as the normal finishes of plain and adhesive backed to suit all applications. Try our new PET steel film (solvent, eco-solvent and UV ink suitable) and Paper Steel display materials for Point of Sale displays. Full range of high energy magnetic tape to suit every budget and application - TESA, 3M's etc Call for samples, advice and the best prices in the industry - over 35 years experience - all materials supplied nationwide next day, as standard.

DRYTAC EUROPE LTD

Filwood Road, Fishponds, Bristol, BS16 3RY

Tel: 0117 958 6500

Fax: 0117 965 4411

e-mail: Bristol@drytac.com

Web: www.drytac.com

Use Drytac's new line of magnetic substrates, magnet-receptive primers & printable magnet compatible materials to create changeable graphic environments.

METALLIZING SERVICE

MIRROR TECHNOLOGY

Unit 4, Redwood House, Orchard Industrial Estate, Taddington, Gloucestershire GL54 5EB

Tel: +44 (0)1242 621534

Fax: +44 (0)1242 621529

Manufacturer of specialist acrylic and polycarbonate mirrors. The process used is vacuum aluminium deposition which produces a very high quality finish with no effects on the material being coated. We can process most materials from flat sheets to complex mouldings. The mirror surface is applied typically to the inside of transparent materials, requirement being a smooth surface and absolute cleanliness for the highest quality coating. Vinyl and other masks can be used with ease, it is also possible to use coloured lacquers to create a gold effect. The vacuum vessels used can handle components up to 2.0m x 1m. We also manufacture a variety of moulded plastic forms in small to medium batches. Experienced in blow and vacuum moulding and in batch fabrication of plastic components.

MODULAR PANEL SIGN SYSTEMS

APCO UNITED KINGDOM

LKH Estate, Tickhill Road, Bably, Doncaster DN4 8QG.

Tel: 01302 311121

Fax: 01302 311852

E-Mail: APCO@norking-com

APCO UK is the exclusive wholesale distributor of APCO's design award winning modular sign systems, which have been providing innovative solutions for hospitals, universities and other facilities throughout the world since 1966. APCO UK offer a complete range of interior and exterior systems, in stock length component form or pre-cut and coloured, including APCO's most comprehensive system, Accord15.

INSIGHT SIGN SYSTEMS

61 Dykehead Street, Queenslie Industrial Estate, Glasgow G3 4AQ

Tel: 0141 774 5990

Fax: 0141 774 6653

Web: www.insightssignsystems.com

E-mail:

sales@insightssignsystems.com
Insight is a trade only manufacturer, offering a made to measure service, with in-house powder coating. A range of external directional signs is available, ready to accept lettering. CAD drawings are provided with each quote, showing specifications.

RIGHTON LIMITED

Righton House, Brookvale Road, Witton, Birmingham B6 7EY

Tel: 0121 356 1141

Fax: 0121 344 4558

Righton Ltd is the UK's leading supplier of semi-finished plastics to the sign industry, our extensive range includes: ● Cast and extruded acrylic available in clear, opal and a full range of colours. ● Polycarbonate ● Foam PVC ● PET-G ● Dibond ● Painted aluminium sheet ● Aluminium extrusion ● Ultragrain stainless steel sheet. In house cutting and coating as well as 24 hour delivery service.

SIGNCONEX LIMITED

St Johns Works, Fern Street, Bury, Lancs BL9 5BP

Tel: 0161 764 9500

Fax: 0161 764 9600

E-mail: info@signconex.com

Original Product Manufacturer of the following sign-trade products: ● Stax-i (interior) and Stax-x (exterior) reversible modular sign panel systems ● Scroll: Award winning display/menu case and notice board products ● Varitex: Traditionally styled exterior & interior display cases ● Signature: State-of-the-art showcase. Non-standard sizes available ● Comprehensive range of insert and finish options for all products ● Grooved-board changeable lettering systems ● In-house powder coating and Sign Building service ● Trade only supplier. Marketing support & 'trade to retail' brochures available.

SIGNSCAPE SYSTEMS LTD

Pear Tree Works, Bath Road, Upper Langford, Bristol BS40 5DJ

Tel: 01934 852888

Fax: 01934 852816

E-mail: sales@signscape.co.uk

Web: www.signscape.co.uk

Signscape are a trade only supplier of modular sign systems including Post & Panel, Infocurve, Papyrus, Infotex, Minislats and Timberdex. Other products include the coveted range of Lynester security notice boards as well as other display units which include Posterloc, Clipframes, the Helix slimline lightbox and Vision Box. To complete its extensive range of trade services, Signscape now have a special fabrication department capable of producing bespoke signage to your specification.

SIGN MAKERS PRODUCTS LIMITED

Hawthorn House, Ipswich Road, Long Stratton, Norfolk NR15 2XB

Tel: 01508 531183

Fax: 01508 531139

Manufacturers of sign boxes, frames and display cases to the trade. Fast delivery.

MOULDED & FABRICATED PLASTICS

GLASPLAS SIGNS (GPS)

(a division of Harviglass GRP Ltd)

Alexandra Street, Hyde, Cheshire, SK14 1DX

Tel: 0161 351 4620

Fax: 0161 368 1508

Web: www.glasplas.co.uk

Complete GRP fibreglass moulding service with CAD design. We will turn your innovative ideas into reality. Towers, Totems, Fascias, Spheres, POS, Translucents, Moulded-in graphics, Street features, Retail Furniture.

MERCURY & PHILLIPS SIGNS

51-59 Waterworks Road, Norwich NR2 4DA

Tel: 01603 666699

Fax: 01603 616781

E-mail: mercphil@globalnet.co.uk

Web:

www.mercuryphillipsigns.co.uk
Suppliers of moulded acrylic pans and logos up to 2800mm x 1500mm and other types of press and vacuum forming in PVC and HIPS. Specialists in fabricated plastics for POS displays with full screen print, graphics and CNC routing capabilities.

PROJECT PLASTICS LTD

7 Grange Way Business Park, Whitehill Industrial Estate, Colchester CO2 8HF

Tel: 01206 868696

Fax: 01206 793737

E-mail:

project.plastics@btinternet.com

www.projectplastics.co.uk

Manufacturers of acrylic spheres, tubes, leaflet holders and window displays. CNC Routing ● Diamond Edge Polishing ● Blow Moulding ● Vacuum Forming ● Screen Printing.

MOULDED LETTERS

ACCENT SIGNS LIMITED

Units 1&2, Broadcote Ind. Est., Station Rd., Cradley Heath B64 6NT

Tel 0121 561 4600

Fax 0121 561 5458

Email: accsign1@aol.com

Largest range of moulded acrylic letters in the UK. Mirror effect moulded letters, LED illumination, logos, panels, complete fascia panels, blow moulding, aluminium, composite trays and more! Samples on request.

MERCURY & PHILLIPS SIGNS

51/59 Waterworks Rd. Norwich NR2 4DA

Tel: 01603 666699

Fax: 01603 616781

E-Mail: mercphil@globalnet.co.uk

Web:

www.mercuryphillipsigns.co.uk
Moulded letters and logos in all standard Perspex colours and UV stabilised gold and silver acrylics, in 8 standard sizes, bespoke sizes available on application. Press, vacuum and blow moulded pans, in acrylic and petg also available.

SIGN TRADE LETTERS LTD

225 Long Lane, Finchley London N3 2RL

Tel: 020 8346 8515

Fax: 020 8349 0294

E-mail: sales@signtrade.co.uk

Web: www.signtrade.co.uk

Moulded letters are our speciality with stock of 20 fonts 8 letter heights in coloured Perspex and 1000's of flat cut letters as well. Your own font or logo is made by our own toolmakers. With over 50 years of experience to call on.

NAMEPLATES

MERCURY ENGRAVING & DIESINKING LIMITED

Unit A5 Bounds Green Ind Est, Ring Way, London N11 2UD

Tel: 020 8368 9017

Fax: 020 8368 9018

email:

sales@mercuryengraving.co.uk

Web: www.mercuryengraving.co.uk

Over 40 Years experience, Deep etched nameplates and plaques. All Metals. Reliable trade service. Normal turn around 5-7 working days. Express service available from 1 day turn around.

MOCKRIDGE LABELS & NAMEPLATES LTD

Cavendish Street, Ashton-under-Lyne, Lancs OL6 7QL

Tel: 0161 308 2331

Fax: 0161 330 9645

E-mail: sales@mockridge.com

Web: www.mockridge.com

Specialists in chemically etched nameplates. Brass, Stainless Steel and Anodised Aluminium. Any size up to 2400 x 1200mm (8ft x 4ft). One-offs up to 5000+. Trade work is totally confidential.

NEON MANUFACTURERS (TRADE)

A1deSIGNS

Unit 9a, Wandle Technology Park, Mill Green Road, Mitcham CR4 4HZ

Tel: 020 8646 9886

Fax: 020 8646

Email: enquiry@a1designs.co.uk

Neon & Cold Cathode Manufacturers to the Trade. Fast turnaround & Delivery, Quick repair service. Installation, Fault diagnosis, Repairs & Maintenance. Confidential Service. All neon accessories, Transformers, Cable, Tube supports etc.

AVENUE SIGNS LTD

216-222 Luton Road, Chatham, Kent ME4 5BS

Tel: 01634 841300

Fax: 01634 841420

E-mail: info@avenuesigns.co.uk
Full computerised design service neon and cold cathode lighting. Fully qualified installation engineers, fault diagnosis, fast repair service. Complete sign service from vinyl through to acrylic to polished stainless steel to transformer and neon accessory supplies.

BENGE NEON

Unit 3 Moor Park Industrial Centre, Tolpits Lane, Watford, Herts WD18 9EY

Tel: 01923 255971

Fax: 01923 248190

E-mail: bengeneon@hotmail.com
Neon and Cold Cathode Tube manufacturers

CITY NEON SIGN CO. LTD.

Unit 4 Stephens Industrial Estate, 635 Warwick Road, Tyseley, Birmingham B11 2EZ

Tel: 0121 707 8106

Fax: 0121 707 7954

We are manufacturers of high quality neon to the trade. Suppliers of all neon accessories, transformers, fireman switches, HT cables etc. Instant repair service. In house computerised design and full size layout facilities available.

KEMPS NEON SIGNS

Unit 2 Matrix Court, Middleton Grove, Leeds LS11 5WB

Tel: 0113 271 5777

Fax: 0113 271 5666

E-mail: sales@kempsneon.com
Web: www.kempsneon.com
Manufacturers of Neon Signs & Cold Cathode Lighting. Design-Manufacture-Installation-Maintenance. Coverage: Signage-Nationwide. Lighting-Worldwide Suppliers of Transformers & HT Cable etc. Visit our website to view our Award Winning lighting

LOGOTECH DISPLAY SOLUTIONS LTD

Unit 6, Atley Business Pk, North Nelson Ind Est, Cramlington, Newcastle Upon Tyne NE23 1WP

Tel: 0191 251 7910

Fax: 0191 253 1118

E-mail: sales@logotech-ltd.co.uk
web: www.logotech-ltd.co.uk
Specialists in neon manufacture to the trade, all types of neon work undertaken. Quick repair service. Very competitive prices. Over 25 years experience in the sign trade.

SOUTHERN NEON SIGNS SOUTHAMPTON

The Store, 57A Rockstone Lane, Bevois Valley, Southampton, Hampshire SO14 6JA

Tel: 02380 710300

Fax: 02380 338481

E-mail: david@southernneon.co.uk
Web: southernneon.com
Neon and cold cathode manufacturing specialists. Confidential trade supply, installation and maintenance service. Transformer and neon accessory stockists.

NOTICE & DRY-WIPE BOARDS

SIGNCONEX LIMITED

St Johns Works, Fern Street, Bury, Lancs BL9 5BP

Tel: 0161 764 9500

Fax: 0161 764 9600

E-mail: info@signconex.com
Original Product Manufacturer of the following sign-trade products: • **Stax-i** (interior) and **Stax-x** (exterior) reversible modular sign panel systems • **Scroll**: Award winning display/menu case and notice board products • **Varitex**: Traditionally styled exterior & interior display cases • **Signature**: State-of-the-art showcase. Non-standard sizes available • Comprehensive range of insert and finish options for all products • Grooved-board changeable lettering systems • In-house powder coating and Sign Building service • Trade only supplier. Marketing support & 'trade to retail' brochures available.

NUMBER PLATES

TENNANTS UK LTD

Tennant House, Mount Street, New Basford, Nottingham NG7 7HX

Tel: 0115 973 8080

Fax: 0115 973 8090

Web: www.tennantsuk.com

e-mail: sales@tennantsuk.com

One of the country's largest distributors of number plate components and suppliers of the 'Print Pro' system - The UK's best selling colour number plate printer. This 'Business in a Box' comes complete with software to print Legal Plates and 'Showplates' allowing for fancy side badges and fonts to be added. This Multi-Function printer will also print full colour Health & Safety Signs direct onto self-adhesive vinyl, Business Cards, Banners, Coasters and Key Fobs! Contact us for a free on-site demonstration.

PAVEMENT SWINGER SIGNS

SIGN MAKERS PRODUCTS LIMITED

Hawthorn House, Ipswich Road, Long Stratton, Norfolk NR15 2XB

Tel: 01508 531183

Fax: 01508 531139

Manufacturers of sign boxes, frames and display cases to the trade. Fast delivery.

PLANT HIRE

BUCKLAND PLANT HIRE LTD

Flint Cottage, Buckland, Buntingford, Herts, SG9 0PY

Tel: 01763 274000

Fax: 01763 273554

For over 10 years we have been doing the ground works for the trade. Any sign base, totem, lollipop, vas, lamp post, duct work and repairs. County wide service. We do not supply signs.

PLASTICS DISTRIBUTORS

N E PLASTICS LIMITED

Unit 1, Ruxley Corner Industrial Estate, Edgington Way, Sidcup, Kent DA14 5BL

Tel: 020 8308 9990

Fax: 020 8308 9995

E-mail: sales@neplastics.co.uk

Web: www.neplastics.co.uk

N E Plastics Ltd - one of the U.K.'s largest independent distributors of semi-finished plastics, supplying a fast and flexible service to the Graphics, Glazing, Exhibition, Point of Sale, Sign making and Screen printing industries.

TRANSPLAS

Dawkins Road, Hamworthy, Poole, Dorset BH15 4HF

Tel: 01202 670567

Fax: 01202 667768

E-mail: transplas@transdev.co.uk

Web: www.transdev.co.uk

As well as being an official Perspex distributor, we stock a wide range of Display and Engineering Plastics, including: Perspex, Polycarbonate, Palight and S550 Foam PVC's, Alu Panel and Hoarding Panel, EZ Frame Systems, Engraving Laminates, Polyethelene, Nylons, Acetal, Polypropylene, ABS and PVC.

PLOTTER BLADES

EDWARD MATHIAS & CO

PO Box 216, Liverpool L69 7EB

Tel: 0151 728 7221

Fax: 0151 728 8851

E-mail: mail@blades.uk.com

Web: www.blades.uk.com

Specialist manufacturers/suppliers of tungsten carbide plotter blades and router cutters. We don't just sell blades, we are the UK's leading manufacturer. Note - we have no connection with any other company who sell or re-sharpen blades.

POLYSTYRENE SIGN SERVICE

CENTRE GRAPHICS DESIGN AND DISPLAY

Unit 2 Shawcross Court, Shawcross Business Centre, Shawcross, Dewsbury, West Yorkshire WF12 7RF

Tel: 01924 485888

Fax: 01132 527505

Email

phill_hird@centregraphics.freeserve.co.uk
Polystyrene Lettering and Logo production. We use Fire Proof grade polystyrene and can produce letters and logos small or huge. Supplied faced in card / vinyl, or plain for you to finish. Fitting templates also available. Contact us for a quote.

FONTENEYNE SIGNS & DISPLAYS

Unit 3, 181 Verulam Road, St Albans, Herts AL3 4DR

Tel: 01727 832146

Fax: 01727 898828

E-mail: studio@fonteynesigns.co.uk

Manufacturers of all types of polystyrene cut letters, graphics & 3-dimensional models. Virtually any logo, graphic or shape can be cut in polystyrene. Especially useful for short term exhibition, conference or promotional use (All polystyrene has a fire retardant additive). Polystyrene can be faced with vinyl or inkjet prints. Fitting service nationwide. Established 1976.

POLYSHOP - Lettering and Logos

Unit 1 Baildon Mills, Northgate, Baildon, Bradford, WYorks

Tel: 01274 585511

Mobile: 07831 828636

Fax: 01274 585522

E-mail: steve@signagraphic.com

Web: www.signagraphic.com

The complete Polystyrene lettering and logo creation service. There is no better way of producing punchy graphics for any corporate event. We have been producing eye-catching, impressive Poly products for 25 years and WE are still impressed by them so will you be. Call Steve for free advice and same day costs. All material is small bead FR grade. Call us for this and all other graphics products. Our templates for fixing take the headache out of on-site application. We think it through for you.

STYROTECH LTD

Unit 5, Kingfisher Ind Est., Charles Street, West Bromwich, West Midlands B70 0AT

Tel: 0121 520 6343

Fax: 0121 520 4851

email: info@styrotech.uk.com

website: www.styrotechdisplay.com

Unique 3d & 2d Polystyrene promotional items & signage, supplied to your own bespoke design. Letters, logo's & signage in polystyrene or decorative foam materials. Painted plain or faced with Foamex, board or vinyl print. 3D - Spheres, Eggs, Graphics, Columns, Arches, Logos, Display Models. All available in any size. Fast delivery throughout the UK.

POINT OF SALE FITTINGS

UK POINT OF SALE GROUP LTD

Emery Court, The Embankment, Heaton Mersey, Greater Manchester, SK4 3GL

Tel: 0161 4314400, 0161 4314411

www.ukpos.com

UK Point of Sale leading manufacturers of display products Acrylic & PVC poster holders, Sign Supports, Aluminium Snap Frames, A Boards, Poster cases & Point of sale fittings.

POSTER HOLDERS / CASES

GREEN MAGIC COMPANY

Waltham Business Park, Brickyard Road, Swanmore, Southampton SO32 2PJ

Tel: 01489 896999

Fax: 01489 895899

E-mail: info@green-magic.co.uk

Web: www.green-magic.co.uk
Easy change print frames and poster holders for all commercial and retail applications. Various styles including aluminium snap frames, low cost injection moulded frames, natural wood frames etc., all available in wall-mounted, suspended and free-standing versions. Call for our catalogue.

INSIGHT SIGN SYSTEMS

61 Dykehead Street, Queenslie Industrial Estate, Glasgow G33 4AQ

Tel: 0141 774 5990

Fax: 0141 774 6653

Web: www.insightsignsystems.com

E-mail:

sales@insightsignsystems.com
Insight is a trade only manufacturer, offering a trade to measure service, with in-house powder coating. A wide range of options is available for displaying posters and transparencies (panels not included), including back-lit or non-illuminated, wall mounted or free standing etc. Hinged opening front provides access for maintenance. Rubber gaskets and slam locks provide security. Suitable for outdoor use.

SIGNCONEX LIMITED

St Johns Works, Fern Street, Bury, Lancs BL9 5BP

Tel: 0161 764 9500

Fax: 0161 764 9600

E-mail: info@signconex.com

Original Product Manufacturer of the following sign-trade products: • **Stax-i** (interior) and **Stax-x** (exterior) reversible modular sign panel systems • **Scroll**: Award winning display/menu case and notice board products • **Varitex**: Traditionally styled exterior & interior display cases • **Signature**: State-of-the-art showcase. Non-standard sizes available • Comprehensive range of insert and finish options for all products • Grooved-board changeable lettering systems • In-house powder coating and Sign Building service • Trade only supplier. Marketing support & 'trade to retail' brochures available.

SIGN MAKERS PRODUCTS LIMITED

Hawthorn House, Ipswich Road, Long Stratton, Norfolk NR15 2XB

Tel: 01508 531183

Fax: 01508 531139

Manufacturers of sign boxes, frames and display cases to the trade. Fast delivery.

SIGNSCAPE SYSTEMS LTD

Pear Tree Works, Bath Road, Upper Langford, Bristol BS40 5DJ

Tel: 01934 852888

Fax: 01934 852816

E-mail: sales@signscape.co.uk

Web: www.signscape.co.uk
Signscape are a trade only supplier of display units including the coveted range of Lynester security notice boards (internal and external), Posterloc, Clipframes, the Helix slimline lightbox and Vision Box. Other products include modular sign systems such as Post & Panel, Infocurve, Papyrus, Infotex, Minislats and Timbertex. To complete its extensive range of services, Signscape now have a special fabrication department capable of producing bespoke signage to your specification.

SILVERCASES

A division of WOODCON PRODUCTS LTD
Daux Road, Billingshurst, West Sussex RH14 9SR
Tel: 01403 787181
Fax: 01403 785353
E-mail: info@woodcon.co.uk
An extensive range of high quality display products and signs designed for effective presentation of posters, notices and information.

UK POINT OF SALE GROUP LTD

Emery Court, The Embankment, Heaton Mersey, Greater Manchester, SK4 3GL
Tel: 0161 4314400, 0161 4314411
www.ukpos.com
UK Point of Sale leading manufacturers of display products Acrylic & PVC poster holders, Sign Supports, Aluminium Snap Frames, A Boards, Poster cases & Point of sale fittings.

PRINT ON PLASTIC

THE DEBEN PRINT CO LTD

Bailey Close, Hadleigh Road Industrial Estate, Ipswich, Suffolk IP2 0UD
Tel: 01473 210244
Fax: 01473 217299
E-mail: sales@debenprint.co.uk
Web: www.debenprint.co.uk

Full and spot colour printing onto most plastic substrates. Window and floor vinyl's, stickers, weather resistant posters, correx display boards, polypropylene folders, wallets and covers, luggage tags. Loyalty, membership, helpline, door entry and ID cards.

PRINT/POSTER FRAMES

GREEN MAGIC COMPANY

Waltham Business Park, Brickyard Road, Swanmore, Southampton SO32 2PJ
Tel: 01489 896999
Fax: 01489 895899

E-mail: info@green-magic.co.uk
Web: www.green-magic.co.uk
Easy change print frames and poster holders for all commercial and retail applications. Various styles including aluminium snap frames, low cost injection moulded frames, natural wood frames etc., all available in wall-mounted, suspended and free-standing versions. Call for our catalogue.

UK POINT OF SALE GROUP LTD

Emery Court, The Embankment, Heaton Mersey, Greater Manchester, SK4 3GL
Tel: 0161 4314400, 0161 4314411
www.ukpos.com
UK Point of Sale leading manufacturers of display products Acrylic & PVC poster holders, Sign Supports, Aluminium Snap Frames, A Boards, Poster cases & Point of sale fittings.

PROJECTING SIGNS

IRON DESIGN

PO Box 5423 Poole BH12 2ZW
Tel: 01202 463573
Fax: 01202 463564

E-mail: enquiries@ironsigns.com
Web: www.ironsigns.com
Leading trade suppliers of high quality traditional and contemporary projecting signs and brackets, offering a large range of brackets, panels and lights off the shelf, as well as a comprehensive bespoke service. Competitive prices and next day service. Please visit our website or phone for a brochure.

RECYCLED STREET NAMEPLATES

PAMA SIGN SERVICES LTD

Traffic Material Specialists.
98 Pelham Rise, Peacehaven, East Sussex BN10 8BD
Tel: 01273 581746/584295
info@pamasigns.com
www.pamasigns.com
Suppliers of High Quality Recycled Plastic Street Name plates. 80 x 80mm Black Posts and Aluminium Channel Top and Bottom. A fitted 28mm Backing to secure face plate. Available in Reflective or Non Reflective. Logos can be incorporated into the designs provided suitable artwork is supplied. For full details please visit our website www.pamasigns.com

REFLECTIVE TAPES

ATC

Call Hey South, off Well'ith Lane, Rochdale OL11 2JS
Tel: 01706 633043
Fax: 01706 710086
e mail: sales@apptape.co.uk
Suppliers of Micro prismatic reflective stripes for use on emergency vehicles. This Conspicuity tape is manufactured by Nikkalite and is one of the most reflective materials available on the market.
We can cut and seal shapes for use on Police Cars and Ambulances.

PAMA SIGN SERVICES LTD

Traffic Material Specialists.
98 Pelham Rise, Peacehaven, East Sussex BN10 8BD
Tel: 01273 581746/584295
info@pamasigns.com
www.pamasigns.com

Supplying Kivalite Reflective in all grades from Economy Grade for vehicle stripes to our Ref 2 Red which meets the new chapter 8 requirements for chevrons on Highway Maintenance Vehicles. We offer very competitive rates and accurate cuts with a tolerance of only + - 1mm

TENNANTS UK LTD

Tenant House, Mount Street, New Basford, Nottingham NG7 7HX
Tel: 0115 973 8080
Fax: 0115 973 8090

Web: www.tennantsuk.com
e-mail: sales@tennantsuk.com
As the UK's Master Distributor of Oralite Reflective and affiliate member to L.A.S.M.A. a full range of reflective vinyls are available conforming to BS EN 12899-1. Our stock range includes Class Ref 1. 3 Year Economy and 7 year Engineering grade reflectives, through to 10 year reflectives for Permanent Road Signs and Micro-Prismatic for Emergency and Highways vehicles. Overlay Films, inks, vinyl and application tape for road signs are also available ex-stock.

ROAD SIGNS

TENNANTS UK LTD

Tenant House, Mount Street, New Basford, Nottingham NG7 7HX
Tel: 0115 973 8080
Fax: 0115 973 8090

Web: www.tennantsuk.com
e-mail: sales@tennantsuk.com
Tennants are now one of the UK's largest manufacturers of Temporary Road Signs and distribute Economy Grade Zintec Road Signs through to BS EN 12899-1. Specified Permanent Signs. Many years have been spent working closely with leading Traffic Management and Construction companies enabling Tennants to supply anything from one road sign to a complete Chapter 8 traffic management layout, including Metal Frames, Cones, Barriers and Lamps! For a free on-line quote please visit www.roadsignsuk.com

ROUTING SERVICES

DTBS-CNC

39 Stoney Cross Street, Taylor Hill, Huddersfield, West Yorkshire HD4 6EY
Tel: 01484 539806
Fax: 01484 539806
E-mail: darrel@dtbs.net
Web: www.dtbs.net
Privately owned company. Providing a trade-only 3-Axis routing service at competitive rates, with a cutting bed of 8' (2.4m) x 4' (1.2m) and up to 200mm deep, cutting a wide range of materials.

PJ SIGNS LIMITED

Unit 22-24 Buckingham Square, Hurricane Way, Wickford, Essex SS11 8YQ
Tel: 01268 764874
Fax: 01268 764883
E-mail: tony.sayers@pj-signs.com
Using our flat bed CNC 3mx2m routers there is virtually nothing that can't be cut out. Also using latest 3d software a wide range of finishes can be achieved. Offering excellent trade prices and a fast turnaround.

SCREEN INKS

APOLLO COLOURS LIMITED

Unit E4, Kingfisher Business Park, Hawthorn Road, Bootle, Liverpool L20 6PF
Tel: 0151 922 5665
Fax: 0151 933 5667

E-mail: sales@apollocolours.co.uk
Web: www.apollocolours.co.uk
Apollo Colours is a family company providing the Screenprinter and Signwriter economically priced quality inks for PVC, Correx, Polypropylene, metal and various other materials.
Apollo Colours, Gloss and Matt Vinyl ink offers a wide colour range including special matches. Due to its flexibility it is particularly suitable for the production of curtain-sided vehicles and banners.
Depot also in London.

SCREEN PRINTING

3S PRINT & DISPLAY

Unit 9 Hortonwood 33, Telford, Shropshire TF1 7EX

Tel: 01952 677506
Fax: 01952 677464
E-mail: sales@3s-signs.co.uk
Web: www.3s-signs.co.uk

www.3sballoons.com
Screenprinters to the sign trade. POS, Estate Agency boards. Full colour up to 8' x 5', vinyl stickers, mark resist, Foamex. Contact us for best trade prices on large or small runs.

CLEARSCORE LIMITED

Unit 1, Tudor Works, Turret Lane, Ipswich IP4 1DL
Tel 01473 212751
Fax 01473 233415
E-mail: sales@clearscore.co.uk
Web: www.clearscore.co.uk
Trade service for high quality screen printing, large or small runs on to most substrates. Providing high quality service and products since 1978.

DOMINION SCREEN & DIGITAL PRINT

Carrwood House, Carrbottom Road, Bradford BD5 9AG

Tel: 01274 309 999
Fax: 01274 309 888
Web: www.dominionprint.com
Email: sales@dominionprint.com
JUMBO SCREEN
Banners, Oversize P-O-P, Hanging boards, Posters, Window Graphics, In-store Signage
SUPERWIDE DIGITAL
Front and backlit banners, Graphics, Posters, Wallpaper, Binding Wraps, Vehicle graphics/advertising.

G.K. BEAULAH & CO. LTD

Heritage House, 23 Park Street, Hull HU2 8RU
Tel: 01482 223521
Fax 01482 216328
E-mail: sud@beaulah.co.uk
website: www.beaulah.co.uk
Experienced craftsmen design & manufacture unique quality products. We supply Outdoor Signage, Plaques, Coats of Arms, Heraldic Shields, Heritage Products, Screen Printing, Wooden Bases & Corporate Giftware.

HOWSON SCREENPRINT

52/54 Thompson Close, Whittington Moor, Chesterfield S41 9AZ.

Tel: 01246 454676

Fax: 01246 260302

E-mail: Howsons@aol.com
Screenprinters to the trade providing large format, four colour process and general point of sale. Nominated supplier to the petroleum industry specialising in the production of price file fonts, gantry display panels associated products. Nationwide service including design manufacture, installation and project management.

HUMPHREYS SIGNS

Unit 6, Spencer Trading Estate, Denbigh, North Wales LL16 5TQ

Tel: 01745 814066

Fax: 01745 815374

E-mail: sales@humphreys-signs.co.uk
Web: www.humphreys-signs.co.uk
Trade Printers for over 25 Years. Estate agency boards a speciality. Printing on correx, pvc, vinyls, acrylics, magnetics as well as digital printing. Large and small runs. Free delivery.

LANAN ECOSSE LTD

Bankside Industrial Estate, Falkirk, FK2 7UY

Tel: 01324 623787

Fax: 01324 623040

E-mail: info@lanan.co.uk
Website: www.lanan.co.uk
Screenprinters to the sign trade since 1990. POS/POP, Estate Agency Boards, Correx, PVC, Acrylics, Glass, Decals, Nameplates, Fascia, Stickers, Banners, Posters. If you can print on it, we can do it. Large or small runs. Serving customers all over Europe. Mention "Sign Update Buyers Guide" for discount.

LLANION SIGN & GRAPHICS

Stockwell Road, West Llanion Park, Pembroke Dock, Pembrokeshire SA72 6TQ

Tel: 01646 683181

Fax: 01646 622111

We supply the sign trade with screen printing of all kinds, from small to large contracts. So for all the signs and screen printing you'll ever need, contact us for a competitive quote on the above number.

MERCURY & PHILLIPS SIGNS

51/59 Waterworks Rd. Norwich NR2 4DA

Tel: 01603 666699

Fax: 01603 616781

E-Mail: mercphil@globalnet.co.uk
Web:

www.mercuryphillipsigns.co.uk
High quality screen printing to all types of rigid and flexible base materials ie. self-adhesive vinyl, paper, plastic and metal. From single to full colour and small or large runs.

SIGNWORLD SCREEN & DIGITAL

Henson Way, Kettering, Northants NN15 6GH

Tel: 01536 527940

Fax: 01536 527944

E-mail: sales@signworld.co.uk
Web: www.signworld.co.uk
Screen and digital printing for the trade. Trade prices with plain cover deliveries guarantee you total confidentiality. Fast delivery of bespoke signs and labels printed on automatic and hand benches. Full in-house design/proofing service available at no extra cost.

SCULPTORS

BRYAN RAWLINGS DESIGN

Unit 10, Rockhill Est., Wells Way, Keynsham,
Bristol BS31 1PF

Tel: 0845 055 9369

Fax 0117 377 8816

E-mail: bryan@bryanrawlings.com

website: www.bryanrawlings.com

Designers and makers of coats of arms, emblems and all types of sculptural and decorative signage. GRP, cast resins, metals, detailed hand painting and much more. Large range of royal coats of arms available. Specialist suppliers to the sign trade.

CENTRE GRAPHICS DESIGN AND DISPLAY

Unit 2 Shawcross Court, Shawcross Business Centre,
Shawcross, Dewsbury, West Yorkshire WF12 7RF

Tel: 01924 485888

Fax: 01132 527505

Email

phill_hird@centregraphics.freeserve.co.uk
With over 14 years sculpting experience, we can provide giant centre-piece sculptures in Fire Proof Polystyrene, finished to your specifications. Anything from Giant Letters and Logos to custom designed features. Past commissions include 16' High Easter egg, 30' high ice mountain and many much smaller items. Ideal Exhibition Show Stopper! Call Phill to discuss.

SHEET MATERIALS

BRETT MARTIN SEMI-FINISHED PRODUCTS

24 Roughfort Road, Mallusk, Co Antrim BT36 4RB

Tel: 028 9083 4206

Fax: 028 9083 4235

E-mail:

semifinished@brettmartin.com

Web: www.brettmartin.com

Brett Martin's foam PVC range includes Foamalux - premium quality substrate with an excellent surface finish, Foamalux Ultra - featuring a superb gloss layer and Foamalux Xtra - double-sided Xtra hard white surfaces with a recycled core.

N E PLASTICS LIMITED

Unit 1, Ruxley Corner Industrial Estate, Edgington Way,
Sicup, Kent DA14 5BL

Tel: 020 8308 9990

Fax: 020 8308 9995

E-mail: sales@neplastics.co.uk

Web: www.neplastics.co.uk

N E Plastics Ltd - one of the U.K.'s largest independent distributors of semi-finished plastics, supplying a fast and flexible service to the Graphics, Glazing, Exhibition, Point of Sale, Sign making and Screen printing industries.

RIGHTON LIMITED

Righton House, Brookvale Road, Witton,
Birmingham B6 7EY

Tel: 0121 356 1141

Fax: 0121 344 4558

Web: www.righton.co.uk

Righton Ltd is the UK's leading supplier of semi-finished plastics to the sign industry. our extensive range includes: • Cast and extruded acrylic available in clear, opal and a full range of colours. • Dibond • Polycarbonate • Foam PVC • PET-G • Painted aluminium sheet • Aluminium extrusion • Ultragrain stainless steel sheet. In house cutting and coating as well as 24 hour delivery service.

ROBERT HORNE SIGN & DISPLAY

Huntsman House, Mansion Close, Moulton Park,
Northampton NN3 6LA

Tel: 01604 495333

Fax: 01604 673407

Through our nationwide branch network, Robert Horne offer a next day delivery for full sheets and cut panels of a wide range of sign materials (acrylic, foam PVC, polycarbonate, PET, PETG, PVC, aluminium composite, engraving laminates, mirrors) and sundries (pre-made banners, cases and frames, adhesives, pavement signs etc).

SILWOOD PLASTICS LIMITED

Unit F, Borough Road, Buckingham Road Industrial
Estate, Brackley, Northants NN13 7BE

CENTRAL SHEET SALES

Tel: 01280 844800

FREE Fax: 0800 169 2983

Distributors of an extensive range of high quality Signage and Display Materials, which include: CAST & EXTRUDED ACRYLIC - Clear, opals and colours

FOAM PVC - White and colours

PET PETG PC SANS HIPS

Aluminium composite sheets, Gear Trays, Adhesive and Aluminium Sign Profiles.

All materials available in sheets or cut to size.

NATIONAL DISTRIBUTION SERVICE

VISIONS IN PLASTICS

Unit 3A, Delta Court, Sky Business Park, Auckley,
Doncaster DN9 3GN

Tel: 01302 775920

Fax: 01302 760699

E-mail: sales@visionsinplastics.com

European agent for Plaskolite products, manufacturers of a wide range of mirrored plastic sheet. Extruded mirror in clear and 17 standard colours, Polycarbonate / PETG / See Thru and Textured. Also, mirror-faced High Impact Polystyrene (silver/gold) and non-mirrored High Impact Polystyrene manufactured by Formaterm. Please telephone for further information.

VULCASCOT LIMITED

Braintree Road, Ruislip, Middlesex HA4 0XX

Tel: 0208 841 4211

Fax: 0208 841 3544

Gatwick Gate Estate, Lowfield Heath, Crawley,
West Sussex RH11 0TG

Tel: 01293 560130

Fax: 01293 537743

The Vulcascot Mooney Group is a leading distributor of semi-finished plastics in sheet form. Our extensive range includes cast and extruded acrylic, acrylic mirror, metallic, glass lookalike, polycarbonate, Foamalux and Vulcafoam foam PVC sheet, PETG and a full range of engineering plastics. All products are available on a 24 to 48 hour delivery service to all parts of the United Kingdom. Full technical advice is available at each branch and our sales engineers cover the whole country.

SIGN & DISPLAY FRAMES

SIGNSCAPE SYSTEMS LTD

Pear Tree Works, Bath Road, Upper Langford,
Bristol BS40 5DJ

Tel: 01934 852888

Fax: 01934 852816

E-mail: sales@signscape.co.uk

Web: www.signscape.co.uk

Signscape are a trade only supplier of display units including the covered range of Lynester security notice boards (internal and external), Posterloc, Clipframes, the Helix slimline lightbox and Vision Box. Other products include modular sign systems such as Post & Panel, Infocurve, Papyrus, Infotex, Minislats and Timbertex. To complete its extensive range of services, Signscape now have a special fabrication department capable of producing bespoke signage to your specification.

SIGN & DISPLAY SYSTEMS

SIGNCONEX LIMITED

St Johns Works, Fern Street, Bury, Lancs BL9 5BP

Tel: 0161 764 9500

Fax: 0161 764 9600

E-mail: info@signconex.com

Original Product Manufacturer of the following sign-trade products: • **Stax-i** (interior) and **Stax-x** (exterior) reversible modular sign panel systems • **Scroll**: Award winning display/menu case and notice board products • **Varitex**: Traditionally styled exterior & interior display cases • **Signature**: State-of-the-art showcase. Non-standard sizes available • Comprehensive range of insert and finish options for all products • Grooved-board changeable lettering systems • In-house powder coating and Sign Building service • Trade only supplier. Marketing support & 'trade to retail' brochures available.

SIGN CASES

DES

Knowles Industrial Estate, Furness Vale, High
Peak, Derbyshire SK23 7PH

Tel: 01663 744824

Fax: 01663 747733

Web: www.desltd.co.uk

E-mail: DESABOARD@aol.com

Manufacturers of sign cases, poster holders and snap frames to the trade, available in many formats, realistic prices, for further information contact us on the above number.

INSIGHT SIGN SYSTEMS

61 Dykehead Street, Queenslie Industrial Estate,
Glasgow G33 4AQ

Tel: 0141 774 5990

Fax: 0141 774 6653

Web: www.insightsignsystems.com

E-mail:

sales@insightsignsystems.com

Insight is a trade only manufacturer, offering a made to measure service, with in-house powder coating. A wide range of aluminium signcases are available, ready to accept acrylic panels, with several trim styles to choose from, and various options including hinged opening fronts, gas strut assisted opening, stand-off brackets etc.

KINGS PLASTICS LTD

The signbuild Centre, Kingsown House, Unity St,
Bristol BS2 0HM

Tel: 0117 922 6382

Fax: 0117 925 1159

We supply illuminated boxes in Silver anodised or powder coated. Also frames with or without panels. Try us for service.

SIGN MAKERS PRODUCTS LIMITED

Hawthorn House, Ipswich Road, Long Stratton,
Norfolk NR15 2XB

Tel: 01508 531183

Fax: 01508 531139

Manufacturers of sign boxes, frames and display cases to the trade. Fast delivery.

SIGN MAINTENANCE

MIDA SIGN SERVICES

Gatefield House, Blandford Street, Ashton-
under-Lyne OL6 7DW

Tel: 0161 8 300 600

Fax: 0161 8 300 601

E-mail:

enquiries@midasignservices.co.uk

Web:

www.sign-maintenance.co.uk

Professional Maintenance and repair of all types of signage, from Emergency call outs; Reactive maintenance and repair; Illuminated signage; Flexface; Neon; Dangerous signage; Project Management; Full contracts. Nationwide service. Over 20 years experience.

THISTLE SIGN SERVICES (SCOTLAND)

19F Winchester Ave Ind Est, Denny, Stirlingshire,
FK6 6QE

Tel: 01324 820230

Fax: 01324 820240

Email:

thistle.signs@btopenworld.com

Professional installation and maintenance service throughout Scotland. We specialise in all types of sign work, excavation service for sign foundations, neon, flexface systems, vinyl. Surveys undertaken. All our crews are fully trained and hold IPAF and CSCS certification.

SIGN SUPPORT SYSTEMS

FAIRFIELD DISPLAYS & LIGHTING LTD

127 Albert Street, Fleet, Hants GU51 3SN

Tel: 01252 812211

Fax: 01252 812123

E-mail:

sales@fairfielddisplays.co.uk

Web: www.fairfielddisplays.co.uk

Sign support systems for any internal signage. Wall mounts, directory systems, hanging systems, suspended cable/rod systems, illuminated posters, light boxes and digital screens. Full range of low-voltage lighting to illuminate your signs.

Top quality, fast efficient service nationwide. Showrooms: Fleet and Shrewsbury. Call now for full colour catalogue.

UK POINT OF SALE GROUP LTD

Emery Court, The Embankment, Heaton Mersey,
Greater Manchester, SK4 3GL

Tel: 0161 4314400, 0161 4314411

www.ukpos.com

UK Point of Sale leading manufacturers of display products Acrylic & PVC poster holders, Sign Supports, Aluminium Snap Frames, A Boards, Poster cases & Point of sale fittings

SIGN TRADE SUPPLIERS

G.K. BEAULAH & CO. LTD

Heritage House, 23 Park Street, Hull HU2 8RU

Tel: 01482 223521

Fax 01482 216328

E-mail: sud@beaulah.co.uk

website: www.beaulah.co.uk

Experienced craftsmen design & manufacture unique quality products. We supply Outdoor Signage, Plaques, Coats of Arms, Heraldic Shields, Heritage Products, Screen Printing, Wooden Bases & Corporate Giftware.

NORWEST SIGN SOLUTIONS LTD

Sales Office, Flint Glass Works G3, 64 Jersey
Street, Ancoats Urban Village, Manchester, M4 6JW

TEL:- 0161 605 0844

FAX:- 0161 605 0808

Email:- carl@norwestsigns.co.uk

norsignsol@btinternet.com

Suppliers of all bespoke signage requirements, Stainless and acrylic Built Up Letters illuminated Neon or LEDs, Aluminium/Dibond Sign trays, Light Boxes, Trough light, Gear trays/tubes and more.

PJ SIGNS LIMITED

Unit 22-24 Buckingham Square, Hurricane Way,
Wickford, Essex SS11 8YQ

Tel: 01268 764874

Fax: 01268 764883

E-mail: tony.sayers@pj-signs.com
Specialist sign company where almost anything is possible. Using all latest technology as well as traditional methods to cater for all, keeping many aspects in house to achieve a competitive price.

PROFESSIONAL SIGN SYSTEMS

273 Dukesway, Team Valley Trading Est,
Gateshead, Tyne & Wear NE11 0PZ

Tel: 0191 491 1908

Fax: 0191 491 1878

E-mail: pss@redforrest.co.uk

Web: www.pss-signs.co.uk

Trade suppliers of LEDs, Built-up Letters, Troughlights, Poster Display Units, Flex-faces, Light Boxes, Edge-lit Units & Digital Printing. Supply nationwide & Europe. Quick delivery, competitive prices & highest quality products.

SIGNSCAPE SYSTEMS LTD

Pear Tree Works, Bath Road, Upper Langford,
Bristol BS40 5DJ

Tel: 01934 852888

Fax: 01934 852816

E-mail: sales@signscape.co.uk

Web: www.signscape.co.uk

Signscape are a trade only supplier of modular sign systems including Post & Panel, Infocurve, Papyrus, Infotex, Minislats and Timbertex. Other products include the coveted range of Lynester security notice boards as well as other display units which include Posterloc, Clipframes, the Helix slimline lightbox and Vision Box. To complete its extensive range of trade services, Signscape now have a special fabrication department capable of producing bespoke signage to your specification.

SIGNWRITING PRODUCTS

APOLLO COLOURS LIMITED

Unit E4, Kingfisher Business Park, Hawthorn Road,
Beale, Liverpool L20 6PF

Tel: 0151 922 5665

Fax: 0151 933 5667

E-mail: sales@apollocolours.co.uk

Web: www.apollocolours.co.uk

Apollo Colours is a family company providing the Screenprinter and Signwriter economically priced quality inks for PVC, Correx, Polypropylene, metal and various other materials.

Apollo Colours, Gloss and Matt Vinyl ink offers a wide colour range including special matches. Due to its flexibility it is particularly suitable for the production of curtain-sided vehicles and banners. Depot also in London.

PORTLAND ADHESIVE PRODUCTS LTD

Lameshaye Bridge Mill, St Mary's Street, Nelson,
Lancashire, BB9 7BA

Tel: 01282 617 818

Fax: 01282 617 718

E-Mail:

info@portlandadhesives.com

Web: www.portlandadhesives.com

Official UK Stockists for Intercat Sign Vinyl Materials and Aslan Speciality products including materials for all sign-makers, screen-printers and large format digital printers. Next day delivery service offered. Our sales office welcomes your call to find out more about: Standard Monomeric & Polymeric Sign Vinyl • Etched Glass Films • Fluorescent & Reflective Materials • Metal Effect • Laser Printable • Low, Medium & High Paper & Clear Application Tapes.

ROBERT HORNE SIGN & DISPLAY

Huntsman House, Mansion Close,
Moulton Park, Northampton NN3 6LA

Tel: 01604 495333

Fax: 01604 673407

Through our nationwide branch network, Robert Horne offer a next day delivery for a comprehensive range of signwriting materials.

WRIGHTS OF LYMM LTD

t/a C. E. Stonehouse & Sons

Warrington Lane, Lymm, Cheshire WA13 0SA

Tel: 01925 754368/752226

Fax: 01925 757569

e-mail: info@wrightsoflymm.co.uk

Web: www.wrightsoflymm.co.uk
Manufacturers of gold leaf and suppliers of traditional signwriting products including One Shop, and keeps signwriting enamels, Intenso, finest quality sable brushes, low tack tapes, airbrushes etc. Please visit our website for our full product range and online shopping facilities or call for a free catalogue.

SITE SURVEYS

MIDA SIGN SERVICES

Gatefield House, Blandford Street, Ashton-
under-Lyne OL6 7DW

Tel: 0161 8 300 600

Fax: 0161 8 300 601

E-mail:

enquiries@midasignservices.co.uk

Web: www.sign-maintenance.co.uk

Full site surveys, for shop fronts. Retail and commercial. Nationwide service. Includes digital images.

SLIDERS & MAGNETIC NAMEPLATES

ONE TO ONE ENGRAVERS LTD

19 Stafford Place, Moulton Park, Northampton
NN3 6NN

Tel: 01604 644604

Fax: 01604 644755

Sliders are manufactured from polished or satin, stainless steel, brass, bronze, ali or Eurosign. Screen printed in red and black, these items complement our magnetic slats directories and door nameplates using the same materials. Slider size: 200x75x4mm. Ask to see sample.

SPECIALITY FILMS

ATC

Call Hey South, Off Well'th Lane, Rochdale, Lancs
OL11 2JS

Tel: 01706 633043

Fax: 01706 710086

Suppliers of various speciality films including Etch glass, Reflective, Fluorescent, Crystal grade prismatic reflective, Class 1 reflective, Cast metallics, 2yr Fluorescent, Gemstone metallics, Multi lens, Transparent colours, Checker plate, Mirror colours, Prismatic colours, Glitter colours, Brushed aluminium silver and gold.

DRYTAC EUROPE LTD

Filwood Road, Fishponds, Bristol, BS16 3RY

Tel: 0117 958 6500

Fax: 0117 965 4411

e-mail: Bristol@drytac.com

Web: www.drytac.com

Drytac's speciality films & finishes include Protac Antibacterial, offering protection against MRSA & other common bacteria; Windowfac, an innovative solution for windowgraphics; steel, leather & canvas effects & many more.

STENCIL MATERIAL

LUDWIG LIMITED

19 Handley Page Way, Colney Street, St. Albans,
Hertfordshire AL2 2DQ

Tel: 0845 658 5484

Fax: 0845 658 6897

E-mail: sales@ludwig.ltd.uk

Web: www.ludwig.ltd.uk

Distributors of Regulus Stencil Papers (ReguPAC/ReguSIGN) and ReguMONT Transfer Film. Ludwig Limited have been supplying the signage industry for over 30 years. Call now for samples.

SUBLIMATION

HALLMARK

(Est. 1899)
116-118 Selsdon Road, South Croydon, Surrey,
CR2 6PG

Tel: 020 8686 6649

Fax: 020 8760 0899

Email: sales@hallmarksigns.co.uk

Web: www.hallmarksigns.co.uk

Low cost- High Quality- Tough and Durable Interior Signs, Company Nameplates, Presentation Plaques, Labels and Instruction Plates. Excellent quality full colour halftones or solid colour printed into aluminium and glass or matt substrates - permanently sealed to give tough and durable finish. Suitable for one-offs and very cost effective and profitable for volume orders. Fast turnaround from emailed artwork or we can provide graphics in our studio.

TAPE

ALL PRINT SUPPLIES LTD

79-80 Buckingham Avenue, Slough, Berkshire,
SL1 4PN

Tel: 01753 696977

Fax: 0800 374635

E-Mail: Sales@allprint.co.uk

Web: www.allprint.co.uk

A complete range of application tapes including CONFORM and KLEENTEAR, to suit all needs. KLEENTEAR tears cleanly and R Tape's CONFORM range will adhere to a wide variety of release liners. Tapes are available slit to your requirements and delivered next morning.

TAPES AND ADHESIVES

DORO TAPE (UK) LIMITED

1 Albany Court, Albany Road, Market
Harborough, Leics LE16 7QP

Tel: 0845 165 1636 /

01858 431642

Fax: 01858 466992

E-mail: sales@dorotape.co.uk

Web: www.dorotape.co.uk

Doro Tape provides a range of Double-Sided Tapes, from multipurpose, to foam, to ultra high bond, all designed to suit a variety of tasks.

Whether laminating posters, hemming banners, erecting 'for sale' signs, or dealing with short term exhibition work or high bond exterior work, there will be a tape to do the job. Next day delivery as standard, bespoke sizes on request. Credit and Debit cards accepted for non-account holders.

DRYTAC EUROPE LTD

Filwood Road, Fishponds, Bristol, BS16 3RY

Tel: 0117 958 6500

Fax: 0117 965 4411

e-mail: Bristol@drytac.com

Web: www.drytac.com

Drytac offer a range of mounting films for all applications both indoor & outdoor. Our range includes films suitable for windowgraphics, floorgraphics and much more.

TRANSFER PAPERS/HEAT PRESSES

THE MAGIC TOUCH

Unit 4, Apex Business Centre, Boscombe Road,
Dunstable LU5 4SB

Tel: 01582 671 444

Fax: 01582 671 555

E-mail: jim@themagictouch.co.uk

Web: www.themagictouch.com

www.magicut.com

Manufacturers of Transfer Papers and Materials used in conjunction with Laser Printers and Copiers (toner based) for full colour image transfer onto T-Shirts, Caps, Polo's, Mugs, Mousemats etc. Plus Magicut® film for use with Plotter/Cutter for heat transfer.

VANDAL RESISTANT SIGNS

DURABLE SIGNS

Runways End, Lancaster Road, Carnaby Ind. Est.,
Carnaby, Bridlington YO15 3QY

Tel: 0871 230 1322

Fax: 0871 230 1323

E-mail: sales@durablesigns.com

Manufacturers of Durable One vandal resistant signs and systems. All signs resistant to attack from keys, coins, naked flames; easy to clean after graffiti attack. The most cost effective answer to the vandalism of signs. Durable One signs with digital printed graphics now available with a ten year warranty against any fade including UV.

GLASPLAS SIGNS (GPS)

(a division of Harviglass GRP Ltd)

Alexandra Street, Hyde, Cheshire, SK14 1DX

Tel: 0161 351 4620

Fax: 0161 368 1508

Web: www.glasplas.co.uk

80+ glassfibre GRP sign blanks in traditional & contemporary styles. All 'brick-bouncingly' tough with zero intrinsic scrap value. Wall, post, projecting & A styles all on short delivery.

VINYL & GRAPHIC INSTALLATIONS

APPLIED IMAGING

Units 11 & 22, Brookside Centre, Sumpsters Way,
Southend-on-Sea SS2 5RR

Tel: 01702 462500

Fax: 01702 462503

e mail:

c.abbott@applied-imaging.co.uk

Web: www.applied-imaging.co.uk

Graphic and Signage Installation Specialists

- Window Graphics
- Banners
- Development Hoardings
- Building Wraps
- Vehicle Graphics

CLARENDON FLEET LIVERY

Unit 14, Churchill Way, Fleckney, Leicester LE8 8UD

Tel: 01162 403700

Fax: 01162 402711

Mob: 07860 503710

Email: john@clarendon-fleet.com

Web: www.clarendon-fleet.com

20 applicators working nationwide, specialists in applications to large vehicle and rail fleets Sign and banner installations, building wraps Site surveys and Vehicle management. Centrally based.

MIDA SIGN SERVICES

Gatefield House, Blandford Street, Ashton-
under-Lyne OL6 7DW

Tel: 0161 8 300 600

Fax: 0161 8 300 601

E-mail:

enquiries@midasignservices.co.uk

Web: www.midasignservices.co.uk

Specialist's applicators of all types of vinyl and graphics. Vehicle application, Windows graphics etc., Fleet specialists. Nationwide service.

VINYL SUPPLIES

3M COMMERCIAL GRAPHICS

3M House, 28 Great Jackson Street, Manchester
M15 4PA

Tel: 0161 237 6394

Free Fax: 0800 378127

E-mail: commgraphics.uk@mmm.com

Web: www.3m.com/uk/graphicsolutions

3M are global manufacturers of a wide variety of 'Matched Component System' Warranted graphic materials: 3M Scotchcal™, 3M Controltac™ Plus, 3M Scotchlite™, 3M Diamond Grade™, 3M Light Management™ film technologies, 3M Panaflex™ flexible substrates, Comply™ Adhesive Technology, 3m DI-NOC™, Scotchprint® Graphics™

ANDERSONS GRAPHICA PLUS LTD

Unit 8 Genesis Business Park, Sheffield Road,
Rotherham, S60 1DX

Tel: 0870 0668661

Fax: 0870 0668662

E-Mail:

louise.stables@andersons-uk.net

Suppliers of high quality self adhesive MACtac vinyls with a wide range of products and colours slit to any popular width, well established distributors of MACtac products including Digital Media, Laminates, Mount Films and Application tape, All delivered next day.

APA (UK) LTD

Unit 10 Capital Ind. Est., Crabtree Manorway South,
Belvedere, Kent DA17 6AW

Tel: 020 8311 4400

Fax: 020 8312 4777

E-mail: apauk@apaspa.com

One of Europe's main vinyl manufacturing companies supplying own brand self adhesive materials throughout the UK, Northern Ireland and mainland Europe. You name it - we make it. Also top quality bespoke banners and the original flexible banner vinyls and truck vinyls. Credit Accounts, credit card payments and next day delivery.

ATC (APPLICATION TAPE CO.)

Calif Hey South, Off Well'ith Lane, Rochdale, Lancs
OL11 2JS

Tel: 01706 633043

Fax: 01706 710086

E-mail: apptape@btinternet.com
Distributors of Ritrama (UK)'s full range of signmaking vinyls including their Pantone matched range available in 50 colours. Also in stock is a full range of application tapes from Main Tape USA. Discounts available on credit card payments.

DORO TAPE (UK) LIMITED

1 Albany Court, Albany Road, Market
Harborough, Leics LE16 7QP

Tel: 01858 431642

Fax: 01858 466992

E-mail: sales@dorotape.co.uk

Web: www.dorotape.co.uk

Doro Tape provides an extensive range of vinyls to suit all applications. From well known manufacturers such as Ritrama and Aslan, Doro Tape supplies 3/5 year monomeric vinyls, 60 and 70 micron 5/7 year polymeric vinyls as well as banner soft films and Calon II cast vinyls.

Doro Tape offer one of the most extensive ranges of specialist vinyls that include reflectives, fluorescents, glass etch effect films, Coburn holographic films, window tints, Ritrama gemstone vinyls, polyester mirror and brushed effect films and stencil masking films, to name but a few.

Doro Tape also supplies a comprehensive range of accessories, paper and clear filmic application tapes, double-sided adhesive tapes and cleaners.

Next day services offered on almost all products. Credit and debit cards accepted for non-account holders.

EUROPOINT DISPLAY

Langwood Road, Trafford Park, Manchester M17
1PZ

Tel: 0161 877 6560

Fax: 0161 877 0192

E-mail: europoint.nw@breathemail.net
Oracal plotter films renowned for quality throughout Europe, including 751 - 60 micron 7 year vinyl, the economic alternative to Premium Cast, 451 - Banner film of exceptional quality and 651 - economic 4 year vinyl - All Matan guaranteed.

GRAFITYP UK LIMITED

Grafitack House, 103 Mariner, Tamworth,
Staffordshire B79 7UL

Tel: 01827 300500

Free fax: 0800 318075

Leading manufacturers of specialist vinyls for the signmaking industry, Grafityp has a product for every application. With over 200 colours in up to 8 different widths, sprocketed and unsprocketed, product ranges span economy, budget and removable to cast, fluorescent, reflective and translucent.

HEXIS UK LTD

70 Britannia Way, Britannia park, Lichfield,
Staffordshire WS14 9UY

Tel: 01543 411221

Free Fax: 0800 0187 111

E-mail: sales@hexis.co.uk

Web: www.hexis.co.uk

Hexis are manufacturers of sign making vinyls direct to the trade. The Hexis range includes 10 year cast films, 7 year cast films, 7 year polymeric calendared films, 5 year extruded calendared films, 3-5 year monomeric calendared films, 2 year exhibition films, banner films, reflective films, fluorescent films, etch and sparkle coloured etch films, screen print vinyl roll and sheets, holographic and speciality materials, DuraCOAT & DuraMAX Gerber edge compatible refills and cartridges, DuraPRINT thermal printing media, digital ink jet media, laminating and mounting films, large format ink supplies, application tapes, magnetic material and various other speciality products, available for same day dispatch.

HOLOGRAPHIC VINYL

4 Selborne Rd, Havant, Hampshire PO9 1ND

Tel: 023 92 492022

Fax: 023 92 498407

e-mail: mark@holographicvinyl.co.uk

Web: www.holographicvinyl.co.uk

We supply an extensive range of specialist and holographic vinyls so you can create the eye-catching signs you know your customers deserve. New 5-year outdoor durability available in a full range of colours and designs. We buy in bulk to give you the best price, so no length is too small. Cheque, credit and Switch card payments acceptable. Express delivery guaranteed. For a prompt, friendly service and competitive prices, call today.

INTAGRAPH (UK) LTD

Unit 19, Roman Way, Gateway Park, Newark
Road, Lincoln LN6 9UH

Tel: 01522 705128

Fax: 01522 705129

e-mail: intagraph@btinternet.com

Web: www.intagraph.com

As an official UK stockist of Intercoat we stock the complete range. Also available for next day delivery Metal Effect Films, Holographics, Carbon Fibre, Texile Flex, Application Tapes, Waterbased, Eco-Solvent and Solvent Inkjet Films and much more. For prompt and friendly service just call or email us NOW!

MACTAC UK LTD

4-6 The Britannia Trade Centre, Ryehill Close,
Lodge Farm, Northampton NN5 7UA

Tel: 01604 595712

Fax: 01604 758150

e-mail: bridings@berus.com

Web: www.mactac-europe.com

Mactac manufacture self-adhesive materials to meet the needs of the visual communications market. Includes Macmark coloured vinyls, Macscreen and Imagin inkjet printable films and Protection Laminates. Some products are Class O fire-rated and Viacom outdoor approved.

METAMARK (UK) LTD

Moorfield Road, Slyfield Industrial Estate,
Guildford GU1 1RU

Tel: 01483 571111

Fax: 01483 570540

e-mail: sales@metamark.co.uk

Web: www.metamark.co.uk

Metamark manufactures and distributes to UK customers the Metamark 7 Series, 4 Series, T Series and 2100 Series ranges of plotter films, and exceptional range of etch glass products. From our distribution operation in Guildford via our network of regional SignVinyl Centres, Metamark also offers an extensive selection of speciality vinyls such as reflective, fluorescent and other special finishes, as well as application tapes, banners, double sided tapes and plotter accessories plotter. As one of the leading distributors in the UK we offer exceptional standards of service and next day delivery on orders placed up until 6pm.

PAMA SIGN SERVICES LTD

Traffic Material Specialists.

98 Pelham Rise, Peacehaven, East Sussex BN10 8BD

Tel: 01273 581746/584295

info@pamasigns.com

www.pamasigns.com

UK Distributor for Kwalite and ATSM products. From 3 year Reflective to 12 year REF 2 grades. Cast Vinyl and Overlay films with both paper and poly backing. Paper or Clear Application Tape. Various Speciality products see our website for full details. We are the first in the UK industry to hold a Kitemark on our Traffic Grade Reflective.

RITRAMA (UK) LTD

Lynwell Road, Lyntown Trading Estate, Eccles,
Manchester M30 9QG

Tel: 0161 786 1760

Fax: 0161 786 1761

e-mail: sales@ritrama.co.uk

Web: www.ritrama.com

Ritrama are one of the world's leading manufacturers of self-adhesive products. Materials for signmaking, digital printing, overlamination and mounting are all available through Ritrama's UK-wide network of distributors.

ROBERT HORNE SIGN & DISPLAY

Huntsman House, Mansion Close, Moulton Park,
Northampton NN3 6LA.

Tel: 01604 495333

Fax: 01604 673407

Through our nationwide branch network, Robert Horne offer a next day delivery for a comprehensive range of Avery cad cam and digital vinyls ranging from super conformable cast film, short term promotional films and 'easy apply' vehicle wrap vinyl.

SYDNEY BEAUMONT (LEEDS) LTD

Sydenham Road, Domestic Street Ind. Estate, Leeds
LS11 9RU

Tel: 0113 245 8729

Fax: 0113 242 8524

E-mail: info@sydb.co.uk

Web: www.sydb.co.uk

Distributors of Self-adhesive vinyls since 1966, we stock a wide range of vinyls from leading manufacturers; X-Film - Megarex economy (gloss and matt), Normex (matt, gloss transparents, metallics, fluorescents), Starex (premium gloss, matt translucent), Etched Glass, Anti-graffiti; Ritrama - L & M gloss and matt 3 yr, O Grade 5 year, premium Pantone colours, Cast Banner Vinyl, Tinted Glass Etch; Intercoat -9700 Series 5 yr. Add to this a range of Application Tapes, Avery Reflective Films, Double-sided tapes & foam pads, all in stock for next day delivery. All major credit cards accepted. Give our service a try - nothing is too much trouble for us!

WAY-FINDING

APPLELEC SIGN COMPONENTS LTD

Appleby House, Walker Terrace, Bradford, West
Yorkshire BD4 7HJ

Tel: +44 (0)1274 774477

Fax: +44 (0)1274 774478

E-mail: sales@applelecsign.co.uk

Web: www.permilight.com

www.applelecsign.co.uk

Trade suppliers of way-finding and aluminium display systems. This is the latest product for Applelec to embrace, in April 2007 we were appointed as the exclusive distributor for the Signal Sign Systems range in the UK and Ireland. We will be supplying way-finding sign units and frames with directories, either curved or flat faced, incorporating wall mounted, projecting, and totem signs. Also, poster display frames that have a snap side profile to allow for easy interchange of inserts will be available, as well as an exterior light box series. Please ask for an information pack or contact one of our friendly experienced sales staff for assistance.

WIDE FORMAT SOLUTIONS PROVIDER

COLOURGEN

The Amber Centre, Oldfield Road, Maidenhead,
Berkshire SL6 1TH

Tel: 01628 588722

Fax: 01628 588716

E-mail: sales@colourgen.com

Web site: www.colourgen.com

Colourgen is the UK's leading specialist distributor of large format digital colour printing solutions, consumables, bespoke software, engineering and support services. We have exclusive UK distribution for the Kodak range of wide format printers and the ColorSpan UV flatbed printer range. We also distribute EPSON's large format printers and consumables, Seal's range of laminators and finishing products and Vidar wide format scanners plus a host of consumables products.

WINDOW FILM S - WHOLESALE

DRYTAC EUROPE LTD

Filwood Road, Fishponds, Bristol, BS16 3RY

Tel: 0117 958 6500

Fax: 0117 965 4411

e-mail: Bristol@drytac.com

Web: www.drytac.com

Drytac's WindowTac™ provides an easy to apply, repositionable and bubble free solution for windowgraphics.

PSSC WINDOW FILMS

30 Crowland Road Eye Peterborough PE6 7TR

Tel 01733 222088

Fax 01733 223885

E-Mail: info@pssc.co.uk

Web: www.pssc.co.uk

Stockist of Solar, Safety, Security, Privacy, Designer Graphic, Window Films, Vinyls, and Solar Coatings for Polycarbonate Conservatory Roofs. Also Pre Cut Vehicle templates for DIY, or Professionally installed by PSSC. If you are too busy, we can also install all your window films and Vinyl Graphics for you, with our 18 years of experience. Please contact us for a quotation and brochure.

STOCKFILMS

PO Box 11, Barnet, Herts EN5 4DE

Tel: 020 8441 0449

UK Distributors of MADICO, OPALUX, V-KOOL and LUMISTY window films plus sales literature, tools and training. Solar control, energy control, architectural, safety, security, privacy, patterned, window graphics, auto tint and view control films all available from stock. Trade supply and fit service can be arranged. Phone now for our new 76-page colour brochure.

WOODEN LETTERING

NOON SIGNS

59 Twickenham Road, Isleworth,
Middlesex TW7 6AR

Tel: 020 8560 7519

Traditional Craftsman-made half-round and bevelled Wood Letters. Standard range produced in Premium-grade durable hardwood. Complex typefaces and Logo's reproduced in Laminated Timber. Letters filled with stand-off locators and complete with full-size fixing template if required.

WOODEN PLAQUES

G.K. BEAULAH & CO. LTD

Heritage House, 23 Park Street, Hull HU2 8RU

Tel: 01482 223521

Fax 01482 216328

E-mail: sud@beulah.co.uk

website: www.beulah.co.uk

Experienced craftsman design & manufacture unique quality products. We supply Outdoor Signage, Plaques, Coats of Arms, Heraldic Shields, Heritage Products, Screen Printing, Wooden Bases & Corporate Giftware.

WOODEN SIGN BLANKS

WESTERN RED CEDAR SIGN BLANKS

Field Farm Enterprises Ltd., Field Farm,
Field Lane, Solihull, West Midlands B91 2RT

Tel: 0121 705 0833

E-mail: ffcedar@fsm.net

Allwood Sign Blanks - Laminated Western Red Cedar.

Lightweight Durable Blanks Suitable for sand blasting or hand carving. Individually boxed - range of sizes available.

WOODWORKING

HALLMARK ENGRAVING ETCHING AND SIGNS (1899)

116-118 Selsdon Road, South Croydon Surrey
CR2 6PG

Tel 0208 686 6649

Fax 0208 760 0899

email sales@hallmarksigns.co.uk

www.hallmarksigns.co.uk

Quality joinery for Notice Boards, Honours Boards and Bespoke Signs. Directional signs, Finger Posts and Waymarkers made in all timbers. Backboards and Plinths can be made to any shape - singles or bulk orders. Memorial bench rails, crosses and wooden signs can all be engraved with designs and lettering. Please call for a prompt quotation or to discuss any project. Please go to our website to see examples of our work.



TRADE SUPPLIERS

'Some people think we only specialise in LEDs ..!'



Flat Cut Metal



Built Up Metal



LEDs in Letters



Sign Tray Panels



LED Trough Light



Built Up Acrylic



Projecting Signs

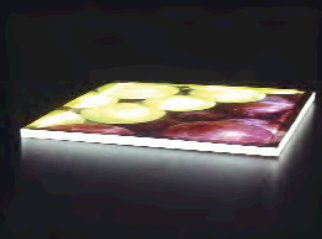

LED Light Sheet

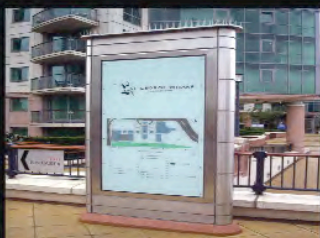

Monoliths & Totems



LED Architectural



LED Edge Lighting



Way Finding



Light Boxes



Flat Cut Acrylic

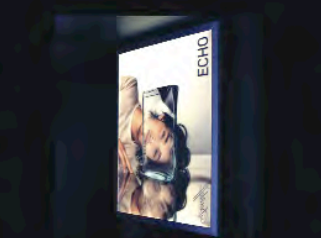

LED Display Cases



Plaques

HEAD OFFICE **MIDLANDS OFFICE** **SOUTHERN OFFICE**
T: 01274 774 477 **T: 07966 722 761** **T: 01442 500 050**
www.applelecsign.co.uk

BRIMARK SIGNS

FLAT-CUT LETTER

Trade Superstore

LOW, LOW 2008 PRICES!

The UK's Premier Flat-cut letter supplier. Est.1952

ACRYLIC (Perspex or Repsol - including gold and silver) (10mm: white black and clear)																NO MINIMUM ORDER	
height	50mm	75mm	100mm	125mm	150mm	175mm	200mm	225mm	250mm	275mm	300mm	375mm	425mm	500mm	600mm	1200mm	other sizes available on request
3mm	£0.61	£0.80	£0.93	£1.22	£1.46	£1.82	£2.42	£3.03	£3.28	£3.76	£4.61	£6.86	£8.37	£10.31	£12.49	£48.51	
5mm	£0.91	£1.15	£1.46	£1.82	£2.30	£2.79	£3.63	£4.48	£5.76	£6.31	£7.88	£9.70	£10.92	£13.94	£16.98	£66.71	
10mm	£1.83	£2.32	£2.91	£3.64	£4.61	£5.57	£7.28	£8.98	£11.53	£12.61	£15.77	£19.40	£21.83	£27.90	£33.96	£133.40	

FOAM PVC (all available sizes - 10mm & 19mm - available in white only)																NO MINIMUM ORDER	
height	50mm	75mm	100mm	125mm	150mm	175mm	200mm	225mm	250mm	275mm	300mm	375mm	425mm	500mm	600mm	1200mm	other sizes available on request
3mm	£0.42	£0.53	£0.85	£1.03	£1.14	£1.39	£1.57	£2.12	£2.42	£2.72	£3.03	£4.00	£4.85	£5.76	£7.88	£18.20	
5mm	£0.48	£0.72	£1.09	£1.46	£2.00	£2.30	£2.67	£3.15	£3.64	£4.37	£5.15	£6.07	£6.87	£8.00	£11.03	£30.32	
10mm	£0.85	£1.33	£1.70	£2.55	£3.52	£4.37	£4.98	£6.07	£7.28	£8.32	£9.34	£11.52	£13.34	£16.98	£21.59	£58.21	
19mm	£1.82	£2.55	£3.64	£4.24	£4.85	£6.67	£8.49	£9.41	£10.92	£12.42	£14.86	£16.98	£20.01	£23.05	£27.90	£78.83	

EXTERIOR MDF (MEDITE comes in its raw form for painting)																NO MINIMUM ORDER	
height	50mm	75mm	100mm	125mm	150mm	175mm	200mm	225mm	250mm	275mm	300mm	375mm	425mm	500mm	600mm	1200mm	other sizes available on request
6mm	£0.37	£0.85	£1.22	£1.63	£2.42	£2.60	£3.03	£3.81	£4.37	£5.22	£6.67	£9.46	£10.92	£12.37	£14.55	£43.66	
12mm	£0.91	£1.57	£1.94	£2.84	£3.88	£4.66	£5.46	£6.31	£7.52	£9.22	£10.31	£11.70	£13.94	£17.16	£19.40	£58.21	
18mm	£1.57	£2.42	£2.96	£4.06	£5.03	£6.18	£7.64	£8.61	£10.92	£12.42	£14.92	£17.10	£20.84	£21.83	£29.11	£87.32	

3mm ALUMINIUM COMPOSITE (Dibond, Alupanel)																NO MINIMUM ORDER	
height	50mm	75mm	100mm	125mm	150mm	175mm	200mm	225mm	250mm	275mm	300mm	375mm	425mm	500mm	600mm	1200mm	other sizes available on request
standard colours	£1.09	£1.52	£1.99	£2.55	£2.91	£3.39	£4.85	£5.70	£6.67	£7.28	£8.24	£9.70	£11.28	£15.77	£19.40	£60.71	
Chrome	£2.00	£2.55	£2.91	£4.28	£5.82	£7.01	£8.19	£9.46	£11.28	£13.79	£15.52	£17.56	£20.93	£25.76	£31.75	£98.25	
Brushed finish	£1.33	£1.70	£2.31	£2.86	£3.88	£4.67	£5.46	£6.31	£7.52	£9.22	£10.31	£11.70	£13.94	£17.17	£21.83	£65.49	

2mm 316 GRADE STAINLESS STEEL																MINIMUM ORDER £95	
height	50mm	75mm	100mm	125mm	150mm	175mm	200mm	225mm	250mm	275mm	300mm	375mm	425mm	500mm	600mm	other sizes available on request	
Satin Brush	£4.72	£5.09	£6.18	£7.10	£7.64	£10.74	£13.61	£16.01	£17.20	£19.01	£21.83	£31.11	£34.80	£43.65	£52.75		
Polished	£5.09	£5.49	£7.46	£8.00	£8.91	£12.19	£15.64	£17.10	£18.37	£21.83	£23.93	£33.59	£40.20	£47.48	£60.03		

PLEASE NOTE: All the above prices are subject to VAT at the prevailing rate. Prices are based on the capital letter height, even on lower case orders. All work carries a 2 YEAR WORKMANSHIP GUARANTEE. All materials carry the manufacturers warranty.

ADDITIONAL OPTIONS

- Add 10% to above prices if plastic locators and paper template are required
- Add 10% for VHB tape to rear
- Add 25% to price if soldered brass locators and paper template are required (Stainless steel only)
- Add 20% to price list if the typeface is extended
- Add 25% to price list if a template is required for cladding (*cladding gaps will be required*)
- Add 25% to price list for Flame Polished Edges (*clear acrylic only*)
- Add 25% to price list for Gloss Finish Foam PVC
- Add 25% to price list for a rounded or 45° edge to letter
- Additional locators** Bag of 250(M) 250(F) locators large: £51 small: £37 (100% uv stabilised)
- Additional Glue** 500ml of Adhesive £23

CARRIAGE

- £11.50 on all orders up to £60
- £14.50 on all orders up to £300
- £35 Highlands & Islands
- FREE** on orders over £300



TEL: 0151 652 6842 FAX: 0151 652 6846

We accept faxed or email orders only: sales@brimark-signs.com

When ordering we accept eps or AI files in vector format in a IBM compatible format for PC

Brimark Signs, Rosemount, Oxton Village, Wirral, Merseyside CH43 5SN



DISCOUNTS ▶	3% DISCOUNT on all orders over £200	4% DISCOUNT on all orders over £300 plus FREE carriage	5% DISCOUNT on all orders over £500 plus FREE carriage
--------------------	-----------------------------------------------	-------------------------------------------------------------------------	-------------------------------------------------------------------------