

CTB32LDg3 Deluxe

Computerized Light Controller

LOR and DMX512 Capable

Generation 3 User Manual

August 20, 2012

V3.00

Copyright © Light O Rama, Inc. 2007-2012

Table of Contents

Introduction	4
What's in the Box	6
Safety Considerations	6
CTB32LD Basic	7
CTB32LD Deluxe	7
Getting Started	7
Wiring the CTB32LD	8
General Information:	8
Power Input to the CTB32LD	9
Single Feed Configuration (20 amps max)	9
Dual Feed Configuration (40 amps max)	10
Power Output – Wiring Output Circuits	10
Power Considerations	11
CTB32LD with Single Power Feed	11
CTB32LD with Double Power Feed	12
3-Phase Power	13
Christmas Light Power Consumptions	13
Lighting Curves	14
Configuring Lighting Curves	15
Setting Multiple Channels in a Group	18
Setting Individual Channels	18
Example	18
Hardware Description	20
CTB32LD Basic Component Locations	20
Input Header	20
Resetting the controller	21
Setting the Unit ID	21
CTB32LD Deluxe Component Locations	22
Status Display	22
Assigning a DMX Address	24
Assigning a Unit ID	24
Assigning a Lighting Curve	25
Input Header	26

Resetting the Controller	26
Stand Alone Speed Control	27
Testing with the Hardware Utility.....	27
Installing LOR Software.....	28
Connecting Controller-to-PC Data Cable	28
Configuring the Communications Port.....	29
Updating Controller Firmware.....	31
Setting the Unit ID with Software.....	32
Stand Alone Operation.....	34
Triggering a Stand-Alone Sequence.....	35
Power On Mode	35
Input Control Mode.....	35
Troubleshooting	36
Autoconfigure does not find COM Port.....	36
Refresh does not find the controller.....	37
Channel 9-16 OK, Channels 1-8 No Good	38
Power OK, No Status Display	38
Warnings and Liability.....	41
Appendix A Hexadecimal to Decimal	42

Introduction

The Light O Rama (LOR) CTB32LDg3 is a 16 channel* computerized lighting controller. The “g3” indicates that it is the third generation in the model line. Depending upon how it is powered, it can handle 15/20 or 30/40 amps. This is the controller board used in the commercial LOR160xW line of controllers. It is certified to UL 508.

This controller is designed to control incandescent and line voltage LED lighting. It operates on 120 VAC (240 VAC models are available), 50/60 Hz. The 30 amp configuration can control approximately 9,000 incandescent mini-lights or 70,000 LED mini-lights or some combination of both.

There are two versions of the board. The cover page shows the deluxe version which includes the add-on display board. The display board allows local configuration and more informative status reporting. The basic version is configured using the LOR Hardware Utility on your Windows PC.

A CTB32LD can be used in many ways:

- By daisy chaining it off of an LOR1602MP3 Show-in-a-Box lighting controller with Show Director
- By connecting it to your PC running the LOR Showtime Windows software
- By connecting it to one of LOR’s Show Directors (DC-MP3 or mDM-MP3)
- By running a standalone set of commands loaded into the controller’s flash memory
- By daisy chaining it off of another controller that is either running stand alone or getting

its commands from one of the other sources listed above

The controller includes “phantom loads” which drain off charge to prevent low brightness LED glow when LEDs should be off. The “phantom loads” also permit smoother LED fading.

This controller uses higher current output components than the previous generation. These components are more tolerant of overloads and even survive some direct short circuit situations.

The controller provides greater accessory power than previous LOR controllers. This additional power is necessary for future accessories.

The controller logic has its own AC fuse so that blown fuses on the output circuits do not disable the logic.

The controller understands both LOR and DMX protocols.

The g3 firmware included with these controllers has individual channel lighting curves for smooth, glitch-free dimming and effects with LED lighting. This firmware also increases the number of brightness steps from 250 to 1000 for smoother fading with LEDs.

As with all LOR controllers, the firmware is field upgradeable so you are guaranteed compatibility with future LOR hardware and software products.

To allow your PC to communicate with this controller, you will need one of Light O Rama’s RS485 adapters. When you purchase the Generic Starter Package, you get the LOR Showtime Software, a 10’ Cat5e network cable and a choice

of RS485 adapters. The RS485 adapter will allow you to connect your PC/laptop via the Cat5e cable to your lighting controller.

*Future: the controller includes provisions to add two 8 channel daughter boards. Adding both daughter boards brings the total number of channels to 32.

What’s in the Box

In addition to your CTB32LD lighting controller you will also receive this user manual.

The latest copy of this manual is available at www.lightorama.com ► Support ► User Manuals

Safety Considerations

CAUTION: This product requires that you have an understanding of electrical wiring. It requires connections to 120/240 VAC. The board has many exposed high voltage connections which are potentially dangerous. The CTB32LD should be placed in an enclosure that will keep it dry and ensuring the safety of children and pets.

When connecting the communications cables or setting the Unit ID or other parameters, be very careful not to touch the exposed high voltage terminals.

Note that there are different versions of the board for 120 verses 240 VAC. The phantom loads for LEDs force this. Using a 120 VAC board at 240 may result in a fire and will damage the board. Using a 240 VAC board at 120 will render the phantom loads for LEDs ineffective.

CTB32LD Basic

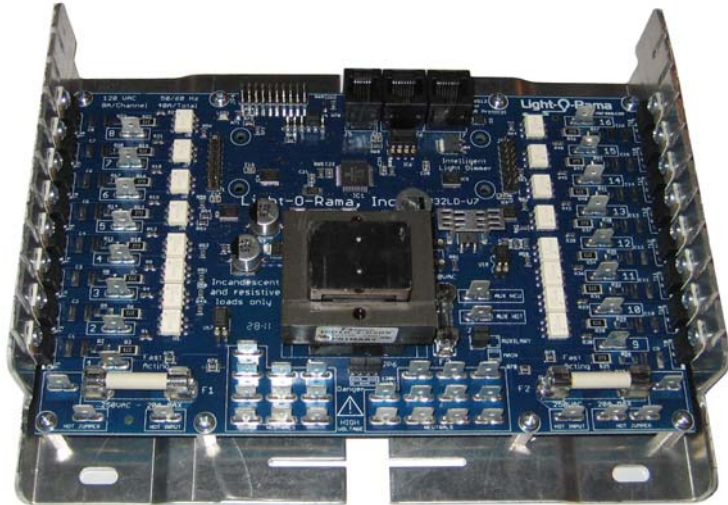

CTB32LD without Display Daughter Board

CTB32LD Deluxe

Shown on cover.

Getting Started

There are three steps to making the CTB32LD useful.

1. It must be wired to accept one or two AC power sources and wired to distribute AC power from its 16 output circuits.
2. It must be connected to a Windows PC to receive commands.
3. The LOR Hardware Utility can be used to test the controller and the LOR Sequence Editor can be used to create a “sequence” to direct the controller.

Wiring the CTB32LD

General Information:

Generally, HOT wires are BLACK or BROWN and Neutral wires are WHITE or BLUE. If you use lamp cord type wire, usually one of the wires has smooth insulation and the other wire has ribbed insulation. The wire with smooth insulation is HOT.

On a standard grounded outlet, the round hole is ground, the short slot is HOT and the longer slot is NEUTRAL.

Be sure your quick-connects are firmly crimped and that no stray wire strands are outside the crimped metal of the quick-connect.

Stray wire strands can cause short circuits that will damage the unit and pose a fire hazard. Carefully inspect all connections before applying power to insure that there are no short circuits.

The quick-connects must be pushed firmly onto the mating blades of the board. Make sure that the blade goes inside the metal of your quick-connect. It is possible to push the quick-connect on where the blade has slid between the connector and its plastic jacket. Pull on connected wires to ensure good mechanical connection. A loose wire or connector where the blade is not inside the connector can cause overheating and pose a fire hazard.

CAUTION: SHOCK HAZARD – THIS BOARD HAS MANY EXPOSED HIGH VOLTAGE CONTACTS. DISCONNECT POWER WHEN THE BOARD IS BEING WORKED ON. PLACE THE BOARD IN A SAFE OPERATING ENVIRONMENT.

Power Input to the CTB32LD

The CTB32LD can be wired with 1 or 2 power feeds. Each power feed can supply up to 20 amps, so a total power capacity of 40 amps is possible.

The CTB32LD is delivered with 15 amp fast acting fuses. You should replace them with 20 amp fast acting fuses if you intend on delivering over 15 amps per side.

Single Feed Configuration (20 amps max)

In this configuration a single power feed is connected to the board. This cable used should be 14 awg for 15 amps and 12 awg for 20 amps.

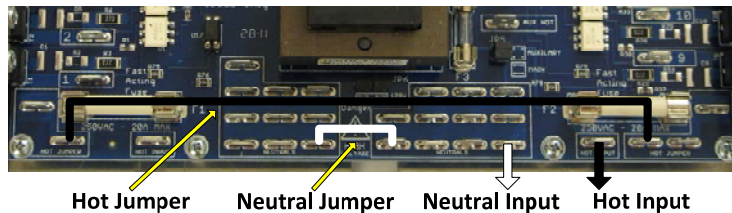

Jumpers (short wires the same gauge as the power feed cable) are used to bridge power from one side of the board to the other side. Without the jumpers in place the circuits on the left side of the card will not have power. The fuse on the right side of the card protects all 16 channels. A fuse is not required on the left side of the card.

Dual Feed Configuration (40 amps max)

In this configuration two power feeds are connected to the board. The power cable used should be 14 awg for 15 amps and 12 awg for 20 amps.

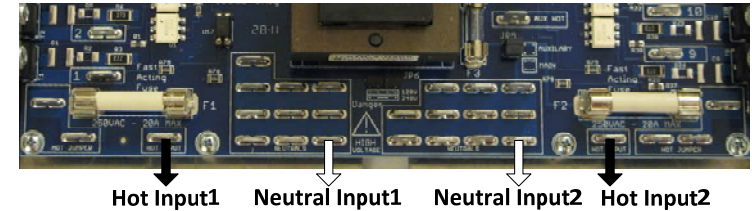

WARNING: NO JUMPERS ARE INSTALLED IN THIS CONFIGURATION

In this configuration both fuses are required. The left fuse protects channels 1-8 and the right fuse protects channels 9-16.

Power Output – Wiring Output Circuits

There are 16 numbered output quick-connect blades to be connected to the HOT side of your output sockets. There are 16 Neutral terminals where you can conveniently terminate your neutral wires. Neutrals can be connected off the board if that is more convenient.

WARNING: Connect the neutral wires for channels 1-8 on the left hand side of the card and the neutral wires for channels 9-16 on the right hand side of the card.

CTB32LD g3

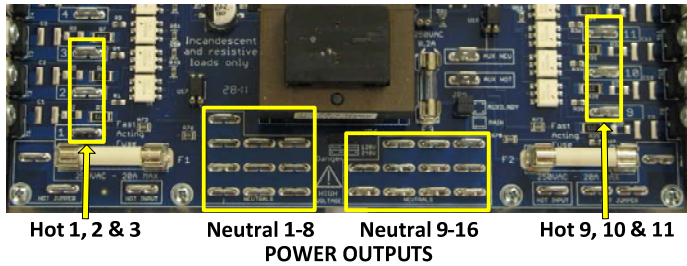

Note: Neutral wires can be placed in any of the neutral quick-connect blades on one side of the card. Order of placement is not important.

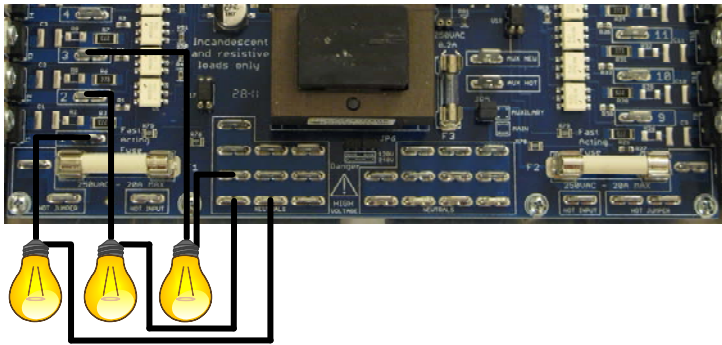

Power Considerations

This section attempts a relatively simple answer to the question “How many lights can I use?”

CTB32LD with Single Power Feed

With a single power feed, the maximum for the entire controller is 15 or 20 amps depending upon the wire gauge you used for power input to the controller. The maximum current on a single channel is 8 amps. So you have to divide up your lights on the 16 channels so you don't exceed either of these two limits.

CTB32LD g3

You could put 1 amp on 14 channels and 0.5 amps on 2 channels and that would be 15 amps. Or, you could put 0.5 amps on 14 channels, 8 amps on another channel and 0 amps on the last channel and that would be 15 amps.

CTB32LD with Double Power Feed

With two power feeds, the maximum for the controller is either 30 or 40 amps depending upon the wire gauge you used for the power inputs to the controller. The left input cord powers channels 1-8. The right power input cord powers channels 9-16 and the controller's microcomputer.

If you plug both power cords into one circuit, then the controller would have at most 20 amps available, but more likely, the circuit is a 15 amp circuit, so that's all you'll have available. If you can plug the two power cords into separate circuits, then the full 30 or 40 amp capacity of the controller will be available.

We will talk about only the right channels for now. The same discussion applies to the left channels.

The maximum current on a single channel is 8 amps. The maximum for the 8 channels is 30/40 amps. So you have to divide up your lights on the 8 channels so you don't exceed these two limits.

You could put 1 amp on 7 channels and 8 amps on the last one and that would be 15 amps. Or, you could put 2 amps on 6 channels, 1 amp on another channel and 2 amps on the last channel and that would be 15 amps.

The same computation applies to the left bank of channels. Remember, if the controller is plugged

into only one circuit in your house, then both the left and right banks' total current must not exceed what that circuit can supply.

3-Phase Power

The CTB32LD has separate sensing for the power phase on its two power input cords. This means that power phase does not matter and the controller can be plugged into two different phases in three phase commercial environments.

Christmas Light Power Consumptions

The following table gives the approximate current consumption for various types of Christmas lights.

Description	Lights/string	Amps/string
Mini-lights	50	0.17
Mini-lights	100	0.33
C7 bulbs	25	1.04
C9 bulbs	25	1.5
100 watt bulb	1	0.75
150 floodlight	1	1.25
LED mini-lights	70	0.03
LED C6 or C7	25	0.02

If you put six sets of 100 mini-lights on one channel, that would be $6 * 0.33 =$ about 2 amps. If you put six sets of 70 LED mini-lights on one channel, that would be $6 * 0.03 =$ about 0.18 amps. You can see that you can have a lot of LEDs with very little power.

Make a chart of all the lights you want to connect to the controller's channels and then work out the numbers to see if you hit any limits.

Lighting Curves

The g3 firmware supports lighting curves. These are used to allow different types of lights to behave similarly when dimming. LEDs tend to go from off to full brightness over a much narrower range of voltages than incandescent lights. This means that a fade going from 0 to 100% voltage with an incandescent light will not produce the same results with LED lights. The LED lights will come on later and reach full brightness sooner than incandescent lights.

There is a built-in Standard curve for incandescent lights which behaves as a simple, linear 0 to 100% voltage provider. This is the behavior seen with previous versions of the firmware and most DMX dimmer packs.

There is a built-in On/Off curve. This on/off 'curve' is used on a channel where the connected devices do not tolerate dimming, for example, the air blower motors in inflatables. Setting a channel configured for on/off operation to any intensity 50% or greater results in 100% intensity or 'on'. Intensities below 50% result in the channel being off.

Finally, a LED curve is provided which is the average for various LED colors and dimmable power supply configurations. This curve is provided with the software, so if you choose to change it you can recover the original. It is custom curve 1.

The g3 firmware permits the controller to accept up to eight downloaded, custom curves.

Each channel is configured with its own curve from the ten possible curves the controller may have available.

The default location for curve files is
...Light-O-Rama\DimmingCurves

The curve file names are LOR-Curve01.ldc through LOR-Curve08.ldc.

A curve file is a list of comma delimited numbers with as many numbers per line as you like. Text on a line preceded by '#' is treated as a comment.

There are 1024 numbers in a curve file. The first number represents off and the last full brightness. A number in the curve file is a value between 0 and 1023. The curve files map into the LOR brightness world for which LOR will provide a conversion utility.

Configuring Lighting Curves

Each channel on the controller is assigned a lighting curve. Initially, all channels are configured with the Standard curve. See the *Lighting Curves* section for more information on what curves are and which curves come with the controller.

The Hardware Utility is used to read current curve information from the controller, download new curves to the controller and associate curves with the output channels.

Start the Hardware Utility (see *the Assigning a Unit ID* section).

In the *Max Units* section of the Hardware Utility window, click the *Change* button. Move the slider in

the *Change Maximum Units* box so that the Max Units is set to 10 (or the maximum number of controllers you have configured.) This will limit the search for controllers to the first 10 unit IDs, otherwise 240 controllers would be searched for – taking a long time. Click the *Save* button.

Click the “Refresh” button to find your controller(s). Select a controller from the drop down menu to the right of the Refresh button. Then click the “Configure” button at the bottom of the window. You will see this window:

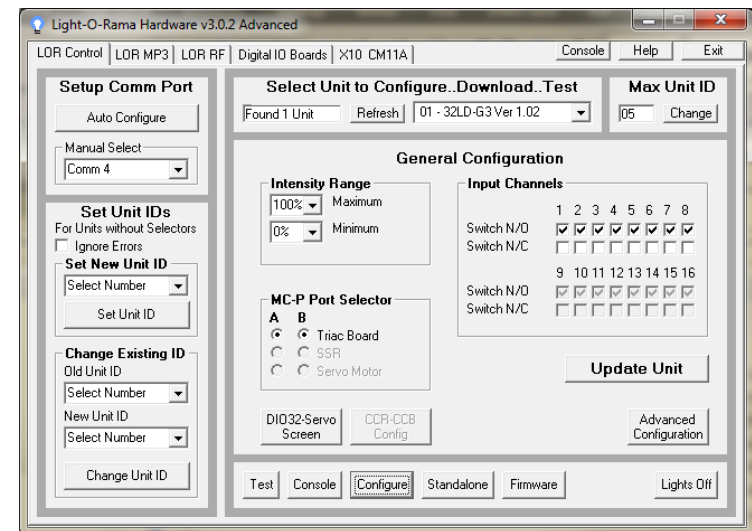

Click the “Advanced Configuration” button on the lower right. The Hardware Utility will read the current curve information from the controller, find the curve files on your PC (if any) and display this window:

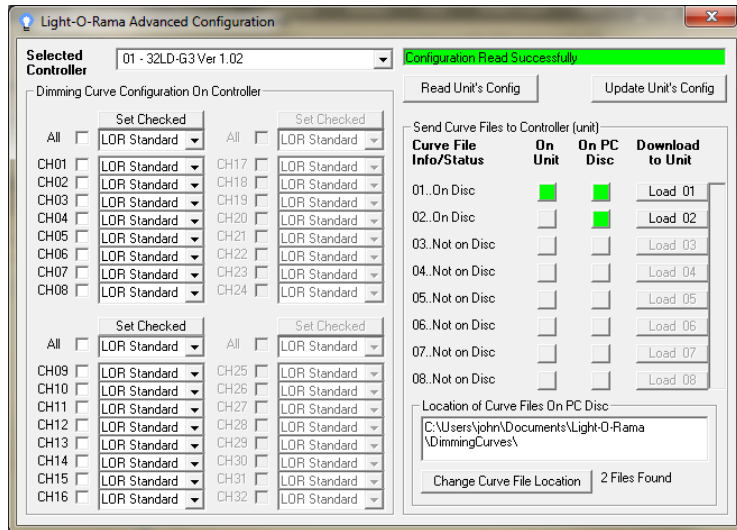

This initial configuration shows all channels configured for the Standard curve, also shown is one custom curve file loaded into the controller and two custom curve files located on the PC disk.

The CTB32LD controllers are 32 channel controllers but only the first 16 channels are currently supported so channels 17 through 32 are grayed out.

To transfer a new curve from the PC to the controller or update an existing curve on the controller from the PC, click the appropriate “*Load nn*” button. The curve file on disk will be transferred to the controller. The vertical progress bar to the right of the “*Load nn*” buttons will indicate percent transferred to controller.

The *Read Unit's Config* button will ask the controller for its channel to curve file mapping and show which custom curves are loaded into the controller.

Setting Multiple Channels in a Group

You can change the curve association for multiple channels in channel group 1-8 or channel group 9-16 using the “All” row above that channel group. If you check the “All” box, then all channels in that 8 channel group will be affected. If you only want to change some of the channels in the group, check their individual check boxes. Then use the drop down menu in the “All” row to select the curve for the checked channels and click the *Set Checked* button. Those channels will be changed to the curve selected. Finally, click the *Update Unit's Config* button to send the new curve configuration to the controller.

Setting Individual Channels

Do not check the “All” box, but do check the boxes to the left of the channels for which you want to change curves. Then use the drop down menu next to the checked box to select the curve you want for that channel. Finally, click the *Update Unit's Config* button to send the new curve configuration to the controller.

Note: If you configure a channel for a curve that does not exist in the controller, the Standard curve will be used.

Example

In the following example, channels 3 and 4 are being set to custom curve 01 and channels 15 and 16 are being set as On/Off only channels. The check boxes for channels 3, 4, 15 and 16 are checked and their drop down menus have been used to select the desired curves:

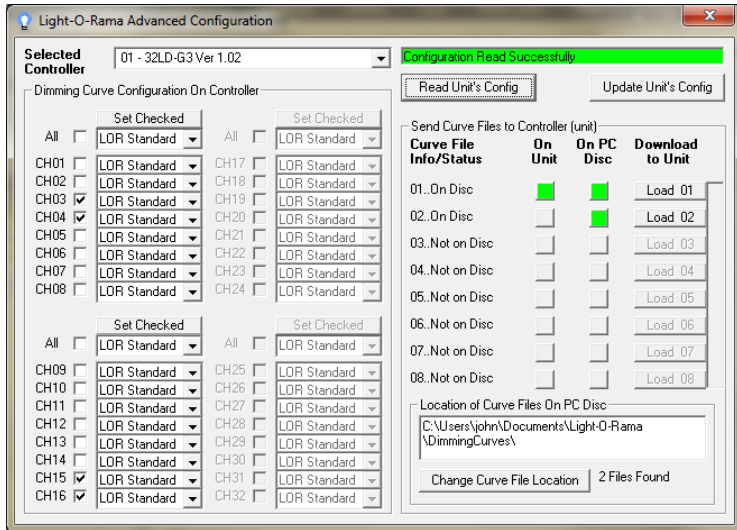

Clicking the *Update Unit's Config* button sends the new curve configuration to the controller. The controller is updated and the text in the upper right box changes to indicate this:

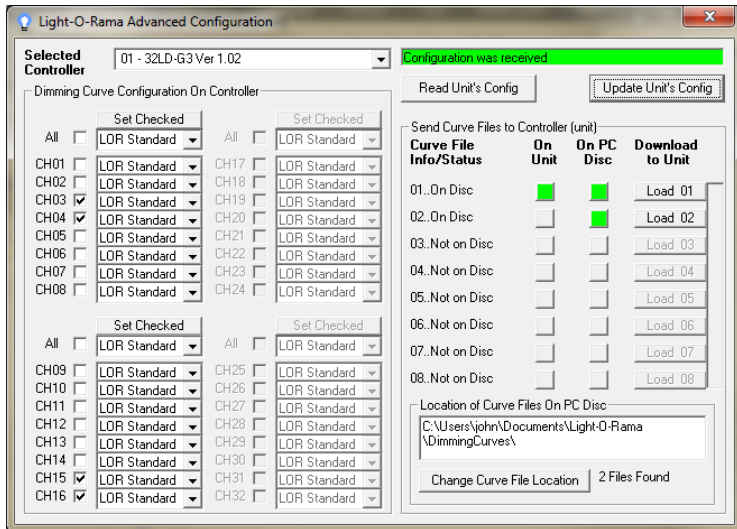

If you use the controller's Status Display (see *Assigning a Lighting Curve in the Status Display*

section) to check the lighting curves you will see that the controller is now using Hardware Utility curves as indicated by "C-HS" meaning **Hardware Utility Settings**:



Hardware Description

CTB32LD Basic Component Locations

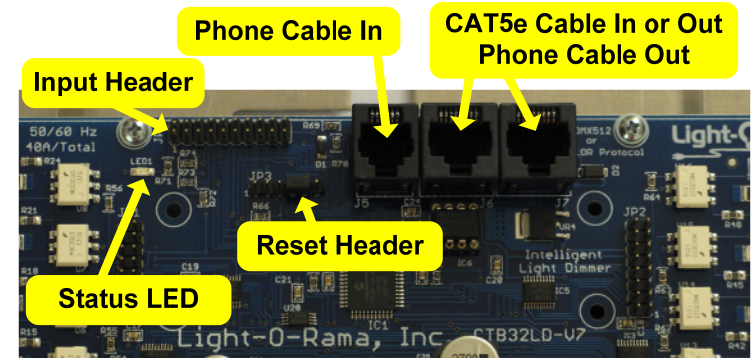

Input Header

Make no connections to unlabeled header pins.

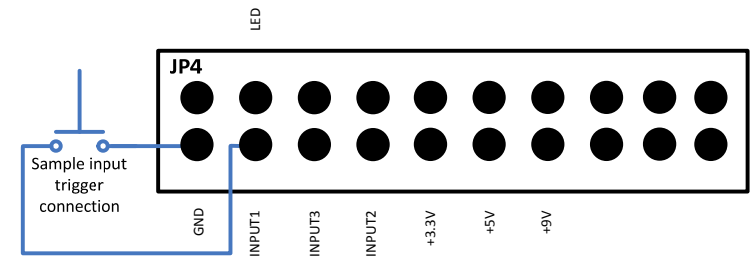

This figure shows the Input Header that is to the left of the network jacks on the main circuit board. You can connect switches here to trigger standalone sequences or provide trigger events for interactive shows. See the *Stand Alone Operation* section for more information.

Switches are simple normally open or normally closed types. No voltages may be applied to the switch inputs. You may take up to 500ma total from the 5 vdc and 9 vdc power supplies to power devices like motion sensors.

The LED output is a CPU pin. You may draw a maximum of 10ma from this pin. It will be 3.3v when the LED should be On.

Resetting the controller

1. Power the controller off
2. Remove the jumper between pins 4 & 5 of the Reset Header
3. Power the controller up, the Status LED should flash rapidly
4. Power the controller off
5. Put the reset jumper back on between Pins 4 & 5 – MAKE SURE OF ITS LOCATION
6. Power up the controller

Setting the Unit ID

See the section *Setting the Unit ID with Software*.

CTB32LD Deluxe Component Locations

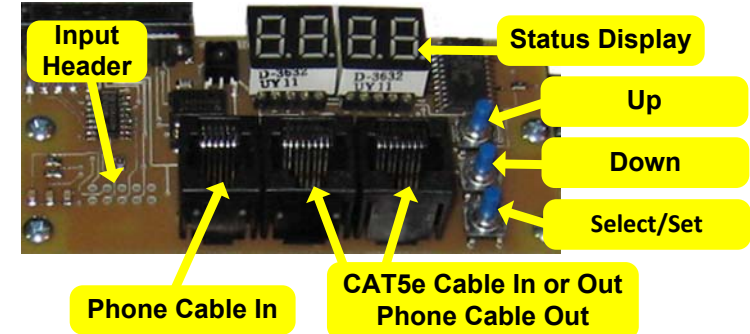

Status Display

Idle:

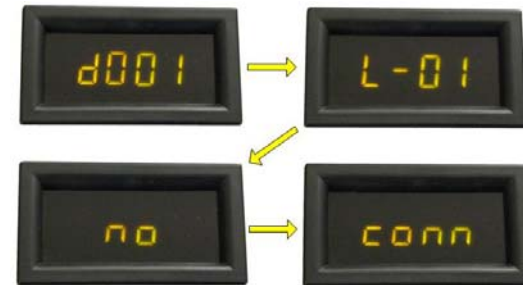

The Status Display rotates through four messages when the controller is powered but not connected to a controlling PC or Show Director and is not running a stand-alone sequence. It is displaying the LOR Unit ID, the DMX Universe address and “no conn” meaning no connection to any LOR network or DMX universe.”

Connected to LOR Network:



The display steadily shows “L-01,” meaning the controller is set to LOR Unit ID 01.

Connected to DMX Universe:



The display steadily shows “d001” meaning the controller is set to DMX address 001.

Loading Firmware:



Resetting:



“0000” is displayed for a couple of seconds while the controller is resetting. See the *Resetting the Controller* section for more information.

Running a Standalone Sequence:



Assigning a DMX Address

To set the DMX Address, press the Select/Set button until the status display flashes “dnnn” where nnn is the current DMX address. Use the ▼ and ▲ buttons to select the DMX address you want and then press the Select/Set button to save the DMX address. You can hold the ▼ or ▲ button down to scroll through addresses.

You can also set the DMX Address with the Hardware Utility. In this case you set the Unit ID which sets the DMX address to $((\text{Unit ID}) - 1) * 16 + 1$. See the *Setting the Unit ID with Software* section.

A cable that plugs into one of the controller’s RJ45 jacks and terminates with in a male XLR-3 plug is available here: www.lightorama.com ► On-line Store ► Accessories ► RJ-45 to XLR 3-Pin Male

Assigning a Unit ID

To set the Unit ID, press the Select/Set button until the status display flashes “L-nn” where nn is the current Unit ID. Use the ▼ and ▲ buttons to select the Unit ID you want and then press the Select/Set button to save the Unit ID. You can hold the ▼ or ▲ button down to scroll through IDs.

You can also set the Unit ID with the Hardware Utility. This will also set the DMX address to $((\text{Unit ID}) - 1) * 16 + 1$. See the *Setting the Unit ID with Software* section.

Each controller used in a network must have a unique ID assigned. [If two controllers are given the same unit ID, then they will both perform the same effects.] Every channel that you control in a

sequence (A sequence is a set of lighting controller commands constructed using the Showtime Windows software) has to identify a particular output circuit on a particular lighting controller (Unit.)

For example, in a sequence that you construct, a channel you call “Front door” may be assigned to Unit ID 03 circuit 10. Because the controllers are daisy chained together, every controller sees every command sent but Unit 03 will only react to commands that are marked “for Unit 03.”

See Appendix A for a conversion of Hexadecimal controller unit IDs set with the Status Display and their decimal equivalents.

Assigning a Lighting Curve

You can only assign all channels of the controller to one lighting curve through the status display. You must use the Hardware Utility program to assign individual channels to different curves. See the *Lighting Curves* and *Assigning Lighting Curves* sections for more information on curves.

To adjust lighting curves from the Status Display, press the Select/Set button until the display shows “C-xx.” Eg:



Then use the ▼/▲ buttons to select one of the following values:

- C-S Standard lighting curve for all channels
- C-Cn Lighting curve n for all channels

C-HS Hardware Utility program Set curves
C-0F On/Off lighting curve for all channels

Press the Set button to save your choice.

Input Header

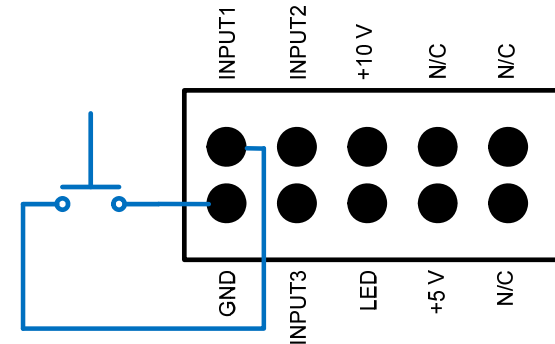

This figure shows the Input Header that is to the left of the network jacks on the Display Board. You can connect switches here to trigger standalone sequences or provide trigger events for interactive shows. See the *Stand Alone Operation* section for more information.

Switches are simple normally open or normally closed types. No voltages may be applied to the switch inputs. You may take up to 500ma total from the 5 vdc and 9 vdc power supplies to power devices like motion sensors.

You may draw a maximum of 10ma from LED pin. It will be 3.3v when the LED should be On.

Resetting the Controller

To reset the controller, press both the ▼ and ▲ buttons simultaneously and turn the controller power on. The display will show “0000.” Release the ▼ and ▲ buttons when you see the “0000.” The

controller will go into normal operation mode in about two seconds.

Stand Alone Speed Control

You can set the speed at which a standalone sequence is run. See the *Stand Alone Operation* section for more information on standalone sequences.

You can only set the standalone speed if a standalone sequence is loaded into the controller. Press the Select/Set button until the status display flashes “SPnn” where nn is the current speed:



The speed is a number between 00 and 13. When set to “06,” one second of real time equals one second of sequence time. This means the sequence runs at the same speed as it would be run by a Show Director or your PC. Lower numbers slow the sequence down.

SP00 is approximately 2.5 seconds/second sequence time. SP13 is approximately 0.33 seconds/second of sequence time.

Use the ▼ and ▲ buttons to change the speed. To save the new speed, let the display time out or press Select/Set.

Testing with the Hardware Utility

Use this section to learn how to connect your controller to your PC.

Once power has been supplied, the CTB32LD Deluxe Status Display will rotate through the “Idle” messages – see the *Status Display* section. The CTB32LD Basic will flash its Status LED twice/second. Either indicates that the Unit is functioning and that there is no communication. Once communication with a PC, Show Director or another controller is established, the Status Display will stop rotating through the “Idle” messages and steadily show its Unit ID and its Status LED will be on solid.

Installing LOR Software

You must have the LOR ShowTime software installed on your PC to proceed. Follow the instructions that came with the software to install it.

For information on using the software to create sequences (controller commands that may be choreographed to audio) see the tutorials here:

www.lightorama.com ► Support ► Video Tutorials

www.lightorama.com ► Support ► Frequently Asked Questions

Connecting Controller-to-PC Data Cable

If you want to experiment with the lighting controller using the LOR Windows Software, you will have to install an RS485 adapter so you can talk to it from your PC.

If you have an SC485 (PC serial port adapter, shown on the left in the following picture), you need only plug it into an available PC 9-pin serial port. The cable from this serial adapter to the controller is limited to 100' or less.



If you have one of the USB adapters (shown in the previous picture on the center and right), follow the installation instructions that came with the adapter to install it. If your adapter has two RJ45 jacks, you can use either.

If you are using telephone cable to connect your controller to the RS485 adapter, plug one end of the phone cable into the adapter and the other end of the cable into the *Phone Cable In jack*.

If you are using Cat5e cable to connect your controller to the RS485 adapter, plug one end of the data cable into the adapter and the other end into either of the *Cat5e In or Out*.

Configuring the Communications Port

First start the Showtime software control panel by clicking **start** ► **All Programs** ► **Light-O-Rama** ► **Light-O-Rama Control Panel**. There will be a light bulb with a red halo on the right side of the task bar at the bottom of the screen. Right-click the light bulb and select *Hardware Utility* (HWU) from the menu. You will see this window:

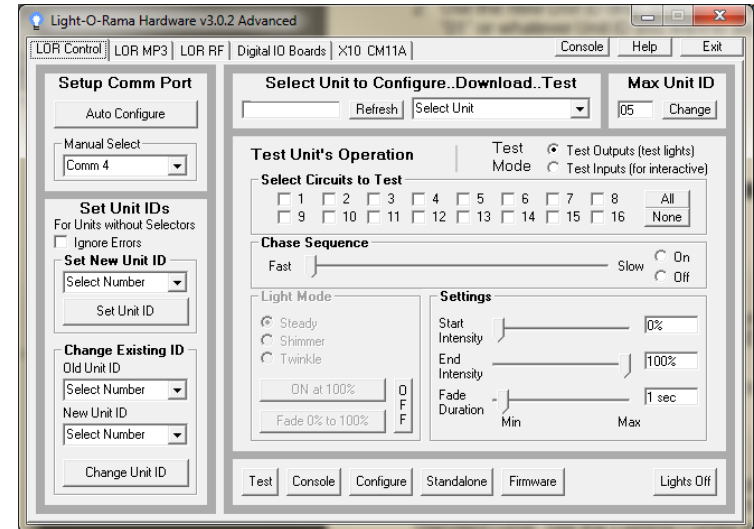

With your controller powered up and cabled to your PC, click the *Auto Configure* button on the top left. The HWU will pop up a window asking you to make sure everything is connected, click OK. It will then search through all ports on your PC looking for the port being used by Light O Rama and you will see this window like this one:

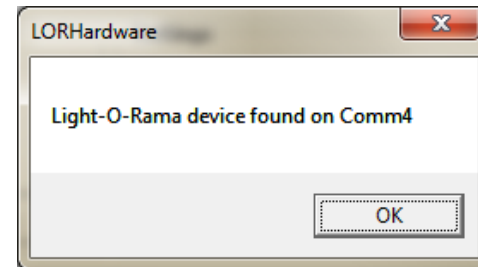

Click *OK*, your RS485 adapter has been located and is functioning properly. This will also make this port available to other LOR software, like the Sequence Editor which is used to create your lighting control sequences. See the *Troubleshooting* section if you have problems.

Tip: Under “Max Units” on the upper right, click the *Change* button and move the slider to select 10 units. This will cut down the scan time because the HWU will not have to scan for 240 controllers. Click OK.

Click the *Refresh* button (center top of window) to have the Hardware Utility scan for all controllers attached to the PC. When it finishes, the drop down menu to the right of the *Refresh* button will list all controllers found. Use this menu to select your controller. See the *Troubleshooting* section if you have problems.

You can use the “Test Unit’s Operation” portion of the window to test the controller. Make sure you have some lights plugged into the controller and use the various options to test the lights.

This is a good time to experiment with different intensities, fade rates and chase speeds. This information will be useful if you want to create your own light shows.

Updating Controller Firmware

Periodically, Light-O-Rama will distribute new firmware for your CTB32LD. If you believe you need updated firmware, use the Hardware Utility’s *Refresh* button to find your controller and check its firmware version. The drop-down menu to the right of the *Refresh* button will be filled in with the attached controllers. The right part of the controller name in this drop-down is the current firmware version.

The latest firmware can be found by going to www.lightorama.com ► **Support** ► **Firmware**. Find your controller and roll the mouse over the

Firmware button – look at the bar in the lower left of the browser window. It will show the name of the firmware file. The file name contains the version at the end. If the version number is greater than what you saw in the Hardware Utility, new firmware is available. Click the *Firmware* button to download the firmware to your PC – remember where you put it.

To load new firmware, use a data cable (not wireless) to connect the controller(s) to the PC. Start the Hardware Utility and click the *Refresh* button to find your controller(s). Select the one you want to update from the drop-down menu to the right of the *Refresh* button. Click the *Firmware* button at the bottom of the window.

In the **Firmware** section of the window, under **Step 1 – Select Unit**, select the *unit* listed above. Under **Step 2 – Select Firmware File**, use the *Open* button to browse to the firmware file you downloaded. Under **Step 3 – Press Download Button** click the *Download* button. Do not interrupt this process. Your controller will reboot after the download completes.

You can click the *Refresh* button to see that the new firmware was loaded into your controller. Repeat this process for additional controllers.

Setting the Unit ID with Software

If you have not installed the Light O Rama Windows Showtime Software, do it now.

Plug the CTB32LD power cord(s) into AC power and turn it on. The Status Display should rotate through the “Idle” messages – see the *Status Display* section and the Status LED should flash

twice/second. These mean that the controller is waiting for the PC to talk to it. Connect the controller to your PC – see the *Connecting Controller-To-Pc Data Cable* section.

Start the Hardware Utility – click **start ► All Programs ► Light-O-Rama ► Light-O-Rama Control Panel**. There will be a light bulb with a red halo on the right side of the task bar at the bottom of the screen. Right-click the light bulb and select *Hardware Utility* from the menu. Make sure the *LOR Control* tab is selected. You will see the following window:

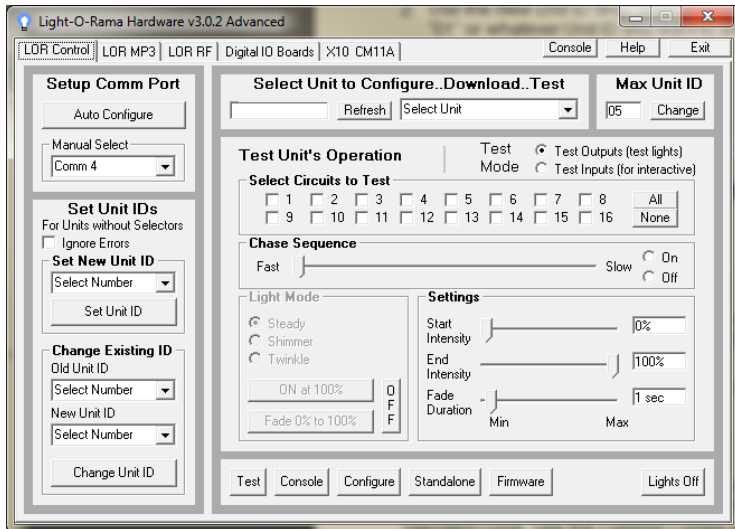

Click the *Auto Configure* button in the *Setup Comm Port* section. The Hardware Utility will search for the COM port that your RS485 adapter is plugged into and select it.

When assigning a unit ID, only one controller should be plugged into the RS485 adapter on the PC. Be sure you do not have more than one controller connected.

Steps to set/change unit ID:

1. In the *Change Existing ID* section, use the *Old Unit ID* drop down menu to select *Any Unit*, then click *OK* in the warning box for changing all unit IDs, there should only be one unit attached.
2. Use the *New Unit ID* drop down menu to select "01" or whatever Unit ID you want to assign to the attached controller.
3. Click the *Change Unit ID* button to set your CTB32LD unit ID. You will see a *Unit ID Changed* box – click *OK*.

The DMX address is set to $((\text{Unit ID}) - 1) * 16) + 1$.

Stand Alone Operation

A standalone animation sequence (sequence with no accompanying audio) can be downloaded into the flash memory of the lighting controller.

This sequence can contain approximately 10,000 lighting commands. These commands can also be for controllers other than this controller, so this controller can direct a network of controllers. There are no restrictions on the types of LOR controllers in this network.

The sequence is designed and tested using the Showtime Software Sequence Editor. When you are happy with the sequence, save it and stop the Sequence Editor.

Start the Hardware Utility and click the *Refresh* button to find the CTB32LD. Use the drop down menu next to the *Refresh* button to select the controller.

Click the *Standalone* button at the bottom of the window. Select one of “Run when power is on,” “Input (norm open switch)” or “Input (norm closed switch.)” Click the *Send Trigger info to Unit* button.

Finally, Use the *Open* button to browse to your sequence and click the *Download* button.

You also use this screen to remove downloaded standalone sequences. You can also remove a standalone sequence by resetting the controller, see the *Resetting the Controller* section.

Triggering a Stand-Alone Sequence

In the *Hardware Utility*, when you download a standalone sequence, you can specify what trigger condition will be used to start that sequence. A standalone sequence can be triggered one of two ways: *Power on* and *Input Control*.

Power On Mode

This means that the sequence will run anytime that power is supplied to the controller. You plug it in and it plays until you unplug it.

Input Control Mode

This uses Input1 on the controller to determine when the sequence will run. When the input switch is on, the sequence will run one time and then check to see if the switch is still on. For more information on trigger conditions see the help for the *Hardware Utility*.

For information on how to connect the switch to the controller, see the *Input Header* section for your controller model (Deluxe or Basic.)

Troubleshooting

Autoconfigure does not find COM Port

If the automatic method of determining the communication port used by LOR does not work, you may be able to locate the port and select it manually.

If you have an SC485 serial port RS485 adapter, you will have to examine the connection on your computer or consult the owner’s manual to determine which port it is plugged into. It is usually Comm1 or Comm2.

If you have a USB485 or USB485B serial port adapter, use the following procedure to find the communications port.

Click **start ► My Computer** or **Computer ► View System Information** or **System Properties** If there is a Hardware tab, click it. Then click “Device Manager.” You should see a *Device Manager* window like this one:

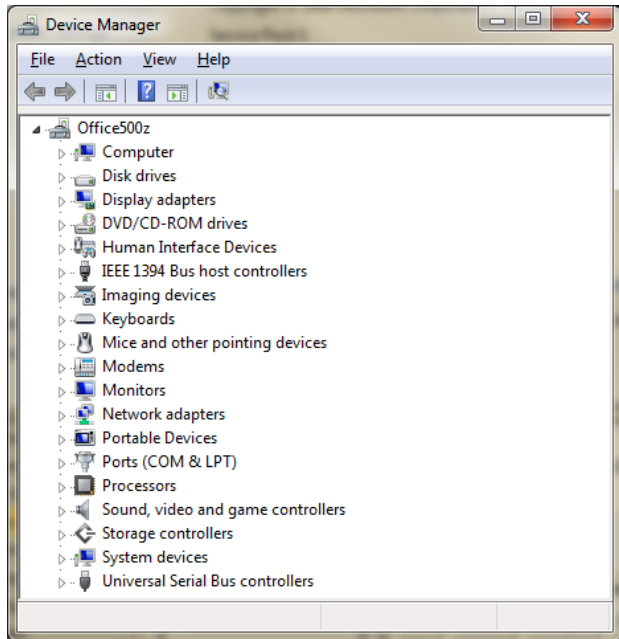

Scroll down and expand “Ports (COM & LPT).” You should see a “USB Serial Port (COMn).” This is your LOR communications port. Use the *Manual Select* drop down menu in the Hardware Utility to select this port. Proceed with your testing.

Refresh does not find the controller

You have previously successfully configured the comm port, manually selected the comm port or used another controller to Autoconfigure the comm port. In other words, you’re sure the RS485 adapter has been properly installed and is working. If this is not the case, consult the *Configuring the Communications Port* section.

When the controller is powered up but no data cable is connected to it, the Status Display should be rotating through “Idle” messages as described in

the *Status Display* section and the Status LED should be flashing twice/second. This means that the controller is working, but is not in communication with a Show Director or PC. If the Hardware Utility is running, the RS485 adapter is properly configured and you attach a cable from the RS485 adapter to the controller, this Status Display should go to steady display of “L-*nn*” where *nn* is the Unit ID and the Status LED should be on solid. If this is not the case, then either the RS485 adapter is not properly installed, the Hardware Utility is not running or some component is broken.

If the display does display steady “L-*nn*” or the Status LED is on solid, then manually type the Unit ID into the box to the right of the *Refresh* button in the Hardware Utility. Connect some lights to the controller and try clicking the ‘On at 100%’ button in the “Test Unit’s Operation’ section. If the lights come on, your controller is working. If no good at this point, contact LOR support.

Channel 9-16 OK, Channels 1-8 No Good

Channels 1-8 don’t work: If you have two power cords, make sure the left power cord is plugged into a working outlet and that the left fuse is good. If you have one power cord, check that the proper jumpers are in place and correctly located – see section *CTB32LD with Single Power Feed*.

Power OK, No Status Display

If no data cable is connected and you plug in the power cord(s), the Status Display should be rotating through the “idle” messages and the Status LED should be flashing. If neither is lit, check the outlet

into which the right power cord is plugged with a lamp that is known to be working.

If power to the right side of the board is known to be good, but there is no status display or status LED flashing, then check the Logic Fuse (see below.) If the Logic Fuse is good, then check that the jumpers for the power transformer voltage selection and the auxiliary/main power selection are in place. See below (shown for 120 VAC):

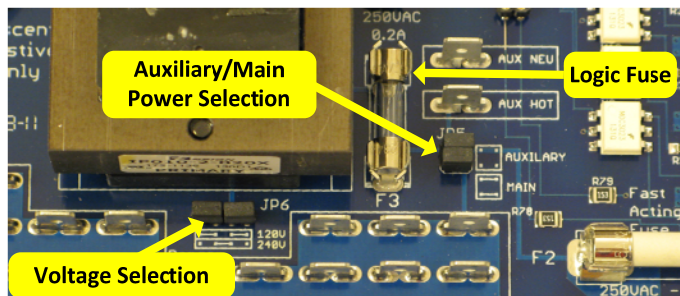

Future: The Auxiliary/Main jumpers can be set to separate the power feed for the logic from the right side power cord. This will allow the controller to be used with low AC voltages for applications like landscape lighting. The logic can be powered from 120/240 volts and the output circuits can be 12 or 24 volts.

Specifications and Features

Specifications	Features
<ul style="list-style-type: none"> • Channel Capacity: 8 amps per channel (25 amp triacs are used.) • Controller Capacity: 15 or 20 amps -single power feed, 30 or 40 amps – dual power feed. • Isolation: Opto isolators are used to isolate high and low voltage sides. Triacs are isolated. Certified to UL 508 . • Supply Voltage: 120/240 VAC 50/60 Hz • Power Connections: ¼" Quick connects • Control Input: RS485 via RJ45 or RJ11 jacks • Dimensions: With Heat Sinks: 9" w x 6 5/8" h x 2 1/8" d Without Heat Sinks: 8½" w x 5¼" h x 1½" d 	<ul style="list-style-type: none"> • Input: Unit can monitor an input to start a sequence • Unit IDs: Up to 240 controllers. Up to 3,840 channels. • Fading: 1024 levels used for smooth fading effects. Fades from 0.1 to 25 seconds. • Dimming: 100 levels (0%...100%), custom curves for LEDs for smooth dimming • Effects: Ramp, Fade, Intensity, Twinkle, Shimmer • Sequences: 5,000 command internal flash memory sequence store • Presets: High-burn and low-burn settings.

Warnings and Liability

WARNING: The CTB32LD controller can pose a dangerous electrical hazard if not used properly. Care should be taken to keep the controller dry. When the controller is directly connected to a PC via one of the RS485 adaptors, there is a direct electrical connection between the low voltage logic side of the controller and the PC. If the controller is physically damaged causing traces to short or the device is allowed to get wet either through direct contact with water or condensation, the logic side of controller can receive direct 120/240VAC. In that case damage to any connected hardware such as a PC can occur.

IN NO EVENT SHALL BUYER BE ENTITLED TO INCIDENTAL, CONSEQUENTIAL, OR SPECIAL DAMAGES, NOR SHALL LIGHT-O-RAMA'S LIABILITY EXCEED THE PURCHASE PRICE OF THE GOODS.

Appendix A Hexadecimal to Decimal

Hex	Dec	Hex	Dec	Hex	Dec	Hex	Dec
01	01	3D	61	79	121	B5	181
02	02	3E	62	7A	122	B6	182
03	03	3F	63	7B	123	B7	183
04	04	40	64	7C	124	B8	184
05	05	41	65	7D	125	B9	185
06	06	42	66	7E	126	BA	186
07	07	43	67	7F	127	BB	187
08	08	44	68	80	128	BC	188
09	09	45	69	81	129	BD	189
0A	10	46	70	82	130	BE	190
0B	11	47	72	83	131	BF	191
0C	12	48	72	84	132	C0	192
0D	13	49	73	85	133	C1	193
0E	14	4A	74	86	134	C2	194
0F	15	4B	75	87	135	C3	195
10	16	4C	76	88	136	C4	196
11	17	4D	77	89	137	C5	197
12	18	4E	78	8A	138	C6	198
13	19	4F	79	8B	139	C7	199
14	20	50	80	8C	140	C8	200
15	21	51	81	8D	141	C9	201
16	22	52	82	8E	142	CA	202
17	23	53	83	9F	143	CB	203
18	24	54	84	90	144	CC	204
19	25	55	85	91	145	CD	205
1A	26	56	86	92	146	CE	206
1B	27	57	87	93	147	CF	207
1C	28	58	88	94	147	D0	208
1D	29	59	89	95	147	D1	209

CTB32LD g3

1E	30	5A	90	96	150	D2	210
1F	31	5B	91	97	151	D3	211
20	32	5C	92	98	152	D4	212
21	33	5D	93	99	153	D5	213
22	34	5E	94	9A	154	D6	214
23	35	5F	95	9B	155	D7	215
24	36	60	96	9C	156	D8	216
25	37	61	97	9D	157	D9	217
26	38	62	98	9E	158	DA	218
27	39	63	99	9F	159	DB	219
28	40	64	100	A0	160	DC	220
29	41	65	101	A1	161	DD	221
2A	42	66	102	A2	162	DE	222
2B	43	67	103	A3	163	DF	223
2C	44	68	104	A4	164	E0	224
2D	45	69	105	A5	165	E1	225
2E	46	6A	106	A6	166	E2	226
2F	47	6B	107	A7	167	E3	227
30	48	6C	108	A8	168	E4	228
31	49	6D	109	A9	168	E5	229
32	50	6E	110	AA	170	E6	230
33	51	6F	111	AB	171	E7	231
34	52	70	112	AC	172	E8	232
35	53	71	113	AD	173	E9	233
36	54	72	114	AE	174	EA	234
37	55	73	115	AF	175	EB	235
38	56	74	116	B0	176	EC	236
39	57	75	117	B1	177	ED	237
3A	58	76	118	B2	178	EE	238
3B	59	77	119	B3	179	EF	239
3C	60	78	120	B4	180	F0	240

Light-O-Rama, Inc.
 Tel: (518) 539-9000
 Fax: (518) 538-0067
 info@lightorama.com