

VARAOSAKIRJA VUOSIMALLI 2000
RESERVDELS KATALOG ÅRSMODELL 2000
SPAREPART CATALOG MODELYEAR 2000

110	Alusta Chassi Chassie	Aisat, runkopalkit, alusta nro Ram; Dragbalkar; Chassi nr Frame side; Tension bar; Chassie nr
120	Alusta Chassi Chassie	Nokkapyörä, rengas, vanne, pölykapseli, kulmatuet, jne Stödhjul; Fälg; Däck; Navkapsel; Hörnstöb; osv Trailing wheel; Wheel; Tyre; Wheelside; Corner staeb; etc
145	Alusta Chassi Chassie	Vetokytkin PBW Påskjutsbroms PBW Overrun device PBW
146	Alusta Chassi Chassie	Vetokytkin KNOTT KF17-C Påskjutsbroms KNOTT KF17-C Overrun device KNOTT KF17-C
160	Alusta Chassi Chassie	Jarru S 2005-7 RASK Hjulbroms S 2005-7 RASK Brake system S 2005-7 RASK
161	Alusta Chassi Chassie	Jarru 250x40 KNOTT Hjulbroms 250x40 KNOTT Brake system 250x40 KNOTT
170	Alusta Chassi Chassie	Akseli BPW 1354 Enkelaxel BPW 1354 Singleaxle BPW 1354
171	Alusta Chassi Chassie	Akseli BPW 1505 Enkelaxel BPW 1505 Singleaxle BPW 1505
172	Alusta Chassi Chassie	Akseli KNOTT Enkelaxel KNOTT Singleaxle KNOTT
175	Alusta Chassi Chassie	Teliakseli PBW Boggiaxel PBW Tandemaxle PBW
210	Kori Kaross Body	Etu- & takapää Goldie 500, 530 Front & bakparti Goldie 500, 530 Front & rear Goldie 500, 530
211	Kori Kaross Body	Etu- & takapää S4 S5 S5L S5T S7 S7L S9 S10 S10L Front & bakparti S4 S5 S5L S5T S7 S7L S9 S10 S10L Front & rear S4 S5 S5L S5T S7 S7L S9 S10 S10L
214	Kori Kaross Body	Kaasupullotila Gasolkoffert Gasbottle box
215	Kori Kaross Body	Huoltoluukku Servicebox Servicebox
220	Kori Kaross Body	Ulkopuoli 500 530 Exteriör 500 530 Exterior 500 530

222	Kori Kaross Body	Ulkopuoli S4 Exteriör S4 Exterior S4
224	Kori Kaross Body	Ulkopuoli S5T Exteriör S5T Exterior S5T
226	Kori Kaross Body	Ulkopuoli S5, S5L, S7, S7L, S9, S10 Exteriör S5, S5L, S7, S7L, S9, S10 Exterior S5, S5L, S7, S7L, S9, S10
228	Kori Kaross Body	Ulkopuoli S10L Exteriör S10L Exterior S10L
240	Kori Kaross Body	Ulkopuolen päättekappaleet Ändstycken utvändigt End piece outside
245	Kori Kaross Body	Alumiinilista Aluminiumlister Lists of aluminium
250	Kori Kaross Body	Kumi- ja muovilistat Gummilister och Plastlister Lists of Rubber / Plastic
255	Kori Kaross Body	Ikkunan osat Fönsterdelar Windows parts
260	Kori Kaross Body	Kattoluukku ja kattoventtiili Tackluckor och takventiler Roof-light and roof-ventilators
275	Kori Kaross Body	Ulko-ovi Ytterdörr Exterior door
290	Kori Kaross Body	Tyyppitarrat Emblem Emblem
315	Lämmitin Värme Heating	Primus 2490 Primus 2490 Primus 2490
320	Lämmitin Värme Heating	Sähköpatruuna Elpatroner Electric heater
330	Lämmitin Värme Heating	Muut lämmittimen osat Övriga värmekomponenter Other heating parts
335	Lämmitin Värme Heating	Lämmitysjärjestelmän osat Gummislangar Rubber tubes
410	Kaasujärjestelmä Gasol Gassystem	Cramer 2-polttimoinen liesi Cramer 2-lågig spis Cramer 2-pits burner
421	Kaasujärjestelmä Gasol Gassystem	Cramer 3-polttimoinen liesi Cramer-spis Cramer-cooker

425	Kaasujärjestelmä Gasol Gassystem	Paineensäädin, kaasuletku, kaasuputki Reduceringsventiler, rör, gasfördelare Regulator valve, gas hose, gas pipe
430	Kaasujärjestelmä Gasol Gassystem	Muut kaasujärjestelmän komponentit Övriga gaskomponenter Other gas parts
435	Kaasujärjestelmä Gasol Gassystem	Jääkaappi E-lux RM 4401 L Kylskåp E-lux RM 4401 L Refrigerator RM 4401 L
510	Sähkö EI Electricity	Sisävalot Invändig belysning Inside lights
512	Sähkö EI Electricity	Ulkovalot ja heijastimet Utvändig belysning och reflexer Outside lights and reflektors
513	Sähkö EI Electricity	Muut sähkökomponentit 230 V Övriga elkomponenter 230 V Other electricity parts 230 V
515	Sähkö EI Electricity	Muut sähkökomponentit 12 V Övriga elkomponenter 12 V Other electricity parts 12 V
520	Sähkö EI Electricity	Toimintopaneli Manöverpanel Operating panel
610	Vesi Vatten Water	Puhdas vesi Färskvatten Fresh water
620	Vesi Vatten Water	Vesisäiliö Fast vattentank Watertank
650	Jätevesi Avlopp Soil water	Viemärijärjestelmä 1&2 Spillvattensystem 1&2 Spillvattensystem 1&2
655	Jätevesi Avlopp Soil water	Kasetti wc Kasettoalett Casette toilet
675	WC Toalett Toilet	Goldie 500, 530 Goldie 500, 530 Goldie 500, 530
685	WC Toalett Toilet	S4 S4 S4
695	WC Toalett Toilet	S5, S5L, S5T, S7, S7L, S9, S10, S10L S5, S5L, S5T, S7, S7L, S9, S10, S10L S5, S5L, S5T, S7, S7L, S9, S10, S10L
703	Sisäosa Inredning Interior	Goldie 500 Goldie 500 Goldie 500
706	Sisäosa Inredning Interior	Goldie 530 Goldie 530 Goldie 530

708	Sisäosa Inredning Interior	Goldie 530 Makuuhuoneversiot Goldie 530 Sovrum versioner Goldie 530 Bedroom models
710	Sisäosa Inredning Interior	Solifer S4 Solifer S4 Solifer S4
712	Sisäosa Inredning Interior	Solifer S5 S5L Solifer S5 S5L Solifer S5 S5L
714	Sisäosa Inredning Interior	Solifer S5T Solifer S5T Solifer S5T
724	Sisäosa Inredning Interior	Solifer S7 S7L S9 Solifer S7 S7L S9 Solifer S7 S7L S9
726	Sisäosa Inredning Interior	Solifer S10 S10L Solifer S10 S10L Solifer S10 S10L
733	Sisäosa Inredning Interior	Solifer S7 S7L S9 S10 S10L Tiskipöytäversiot Solifer S7 S7L S9 S10 S10L Diskbänd versioner Solifer S7 S7L S9 S10 S10L Sink models
735	Sisäosa Inredning Interior	Solifer S5 S7 S7L S9 S10 S10L Makuuhuoneversiot Solifer S5 S7 S7L S9 S10 S10L Sovrum versioner Solifer S5 S7 S7L S9 S10 S10L Bedroom models
755	Sisäosa Inredning Interior	Lukot, vetimet, saranat jne Lås, beslag, fästmaterial m.m. Lock, furniture, etc.
757	Sisäosa Inredning Interior	Helat, kannattimet, pitimet Beslag m .m. Fittings etc.
759	Sisäosa Inredning Interior	Rullaverhot, kasettiverhot, sälekaihdin Rullgardiner Rolling blind
760	Sisäosa Inredning Interior	Patjasarja G500 G530 S4 S5 S5L S5T S7 S7L S9 S10 S10L Dynor G500 G530 S4 S5 S5L S5T S7 S7L S9 S10 S10L Bolster G500 G530 S4 S5 S5L S5T S7 S7L S9 S10 S10L
780	Sisäosa Inredning Interior	Verhot G500 G530 S4 S5 S5L S5T S7 S7L S9 S10 S10L Gardiner G500 G530 S4 S5 S5L S5T S7 S7L S9 S10 S10L Curtains G500 G530 S4 S5 S5L S5T S7 S7L S9 S10 S10L
820	Korjausmateriaalit Rep.material Rep.material	Rimaprofiili Trälister Lists of wood
825	Korjausmateriaalit Rep.material Rep.material	Korikaaret Hörnbäge Corner bend
830	Korjausmateriaalit Rep.material Rep.material	Vanerit, lattiamatot, eristeet ja ruvit Faner, isolering och skruvar Playwoods, insulatedes and screws
835	Korjausmateriaalit Rep.material Rep.material	Liimat, kitit ja maalit Lim, kitt och färg Glue, cement and color

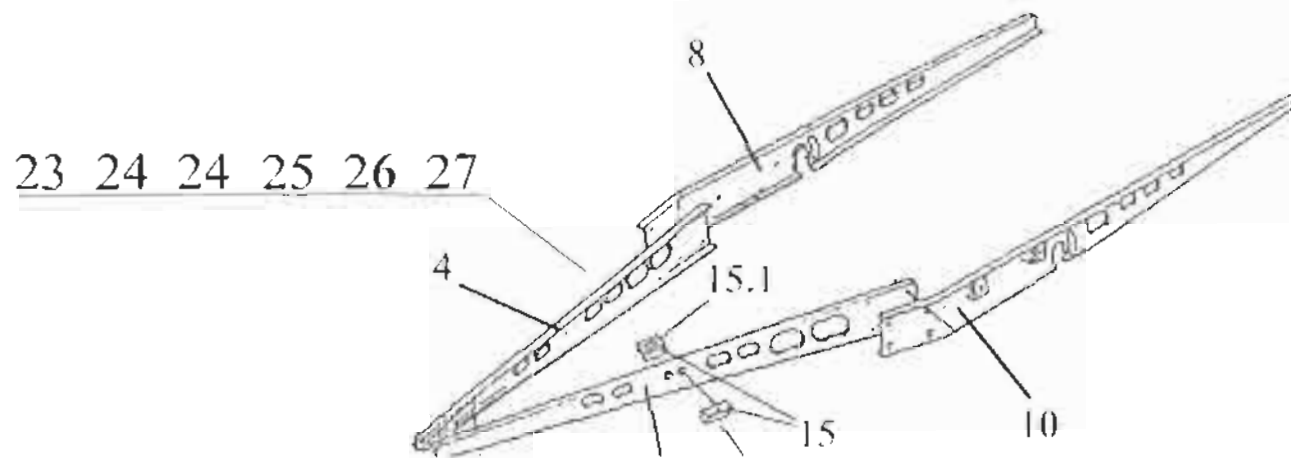
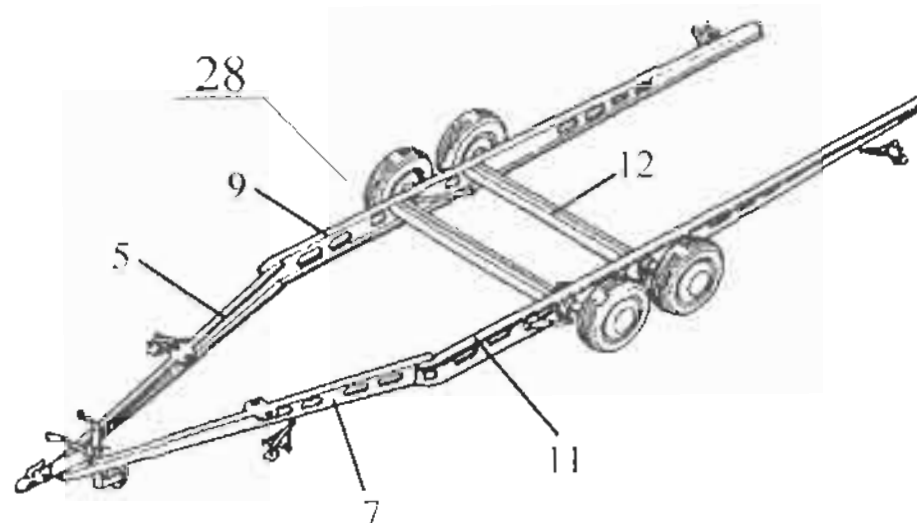
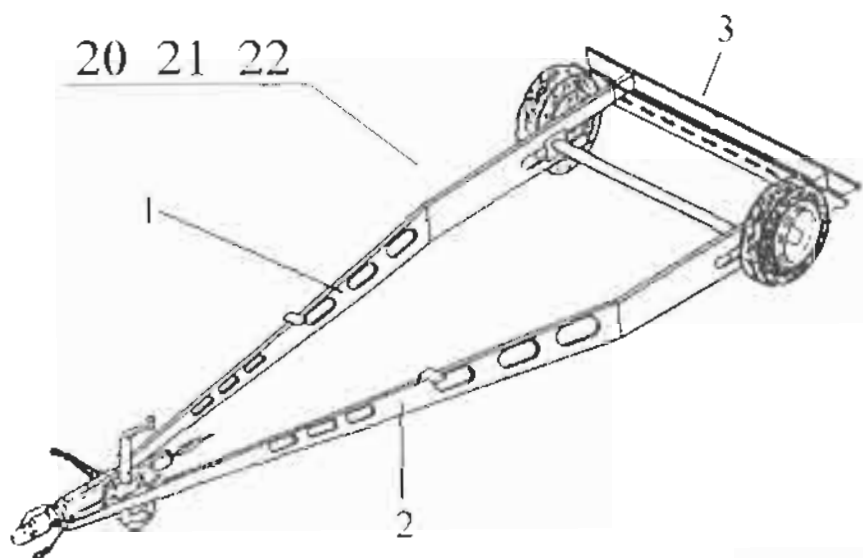

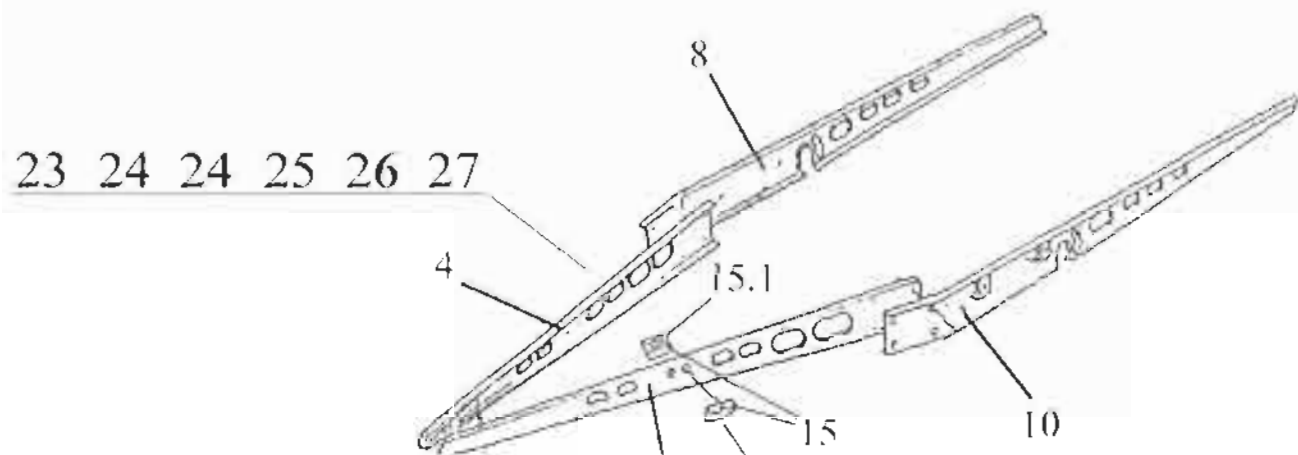
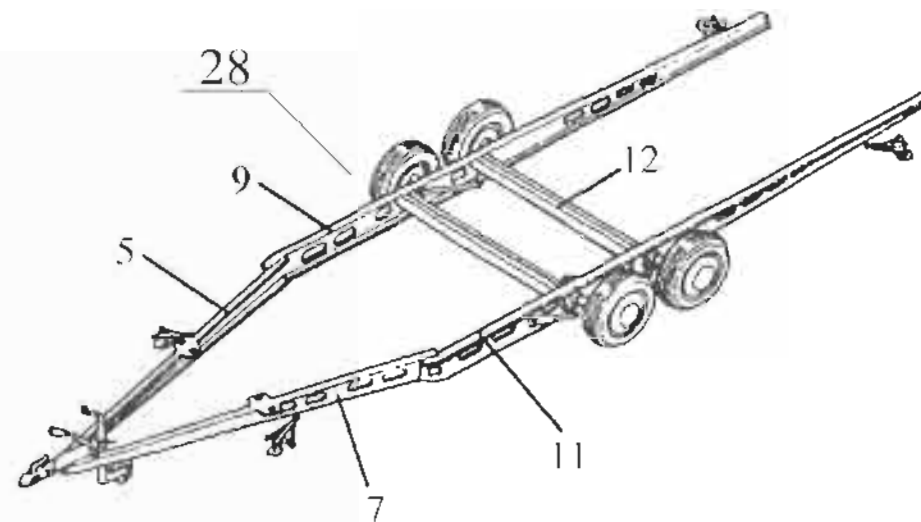
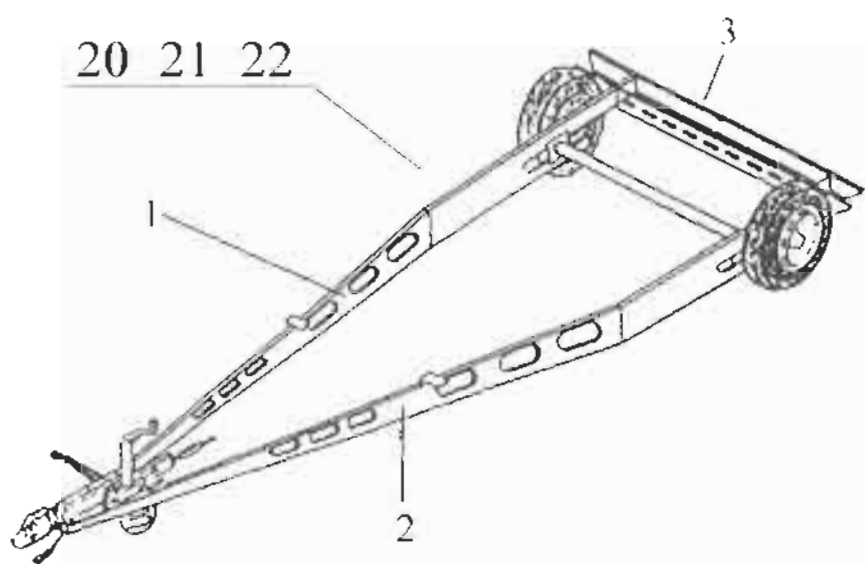

SOLIFERAlusta
Chassi
Chassie

110

Aisat, runkopalkit, alusta nro
Ram; Dragbalkar; Chassi nr
Frame side; Tension bar; Chassie nr

X=vakio/ standard

M=Menu-varustelu maasta riippuen/ Menu-utrustning beroende på land/ Menu-equipment due to country specification

2000

Kuva Pos. Fig.	Varaosan nro Del.nr. Part.nr.	Kuvaus Benämning Description																		Huom. Anm. Obs.	
12	05268-29490	Jarrupalkki	Bromsvajerbalk	Strengther girder																	
15,1	0316-003211	Aisan kiinnitin	Dragbalkens fästjärn	Fixing drawbar	x		x	x	x	x	x	x	x								
15,2	0316-003021	Aisan kiinnitin	Dragbalkens fästjärn	Fixing drawbar	x		x	x	x	x	x	x	x								
15	9001-8411	Aisan kiinnitinpari	Dragbalkens fästjärn parvis	Fixing parts drawbar																	
16	3106-010770	Vetokytkimen suojarauta	Skyddsjärn för påskjutsbromsen	Protectionbar far overrun device	x	x	x	x	x	x	x	x	x								
16	9001-8421	Vetokytkimen suojarauta	Skyddsjärn för påskjutsbromsen	Protectionbar for overrun device																	
17	0329-301290	Aisan tukirauta	Stödjärn för dragbalkar	Support for frame beam	x	x	x	x	x	x	x	x	x								
17	9001-8420	Aisan tukirauta	Stödjärn för dragbalkar	Support for frame beam																	
17	9001-8420	Aisan tukirauta	Stödjärn för dragbalkar	Support for frame beam																	
20	4425-379187	Alusta nro	Chassi nr	Chassie nr	x																1)
20	4425-379256	Alusta nro	Chassi nr	Chassie nr	x																
21	4425-379532	Alusta nro	Chassi nr	Chassie nr			x														
22	4425-379202	Alusta nro	Chassi nr	Chassie nr																	
23	4427-379041	Alusta nro	Chassi nr	Chassie nr																	1)
23	4427-379097	Alusta nro	Chassi nr	Chassie nr																	
24	4427-379090	Alusta nro	Chassi nr	Chassie nr																	
25	4427-379010	Alusta nro	Chassi nr	Chassie nr																	1)
25	4427-379092	Alusta nro	Chassi nr	Chassie nr																	
26	4427-379088	Alusta nro	Chassi nr	Chassie nr																	1)
26	4427-379091	Alusta nro	Chassi nr	Chassie nr																	
27	4427-379011	Alusta nro	Chassi nr	Chassie nr																	1)
27	4427-379089	Alusta nro	Chassi nr	Chassie nr																	
28	4416-379023	Alusta nro	Chassi nr	Chassie nr																	1)
28	4416-379027	Alusta nro	Chassi nr	Chassie nr																	

Huom./ Anm./Obs. 1) Käytössä osan mallivuotta / Användas till en del av modellår / In use partly through the model year

1) Neliö vääntöjoussi / Fyrkanting fjäderstav / Square torsional spring

(Sivu / sidan / page 170-171-175)

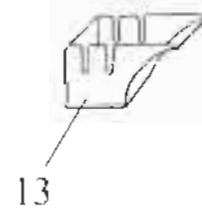
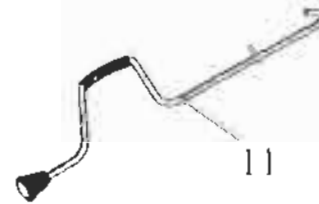
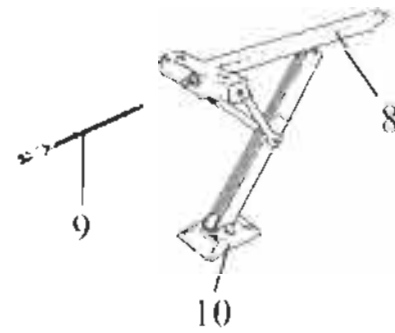
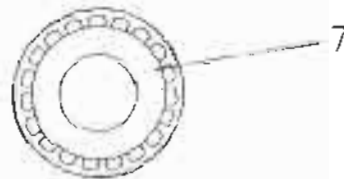
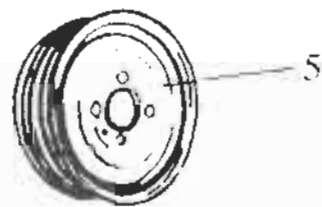
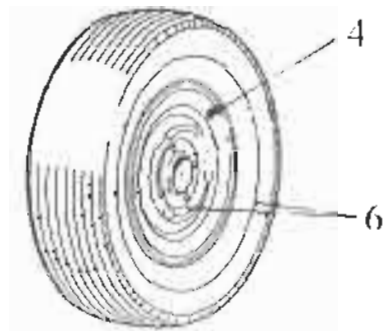
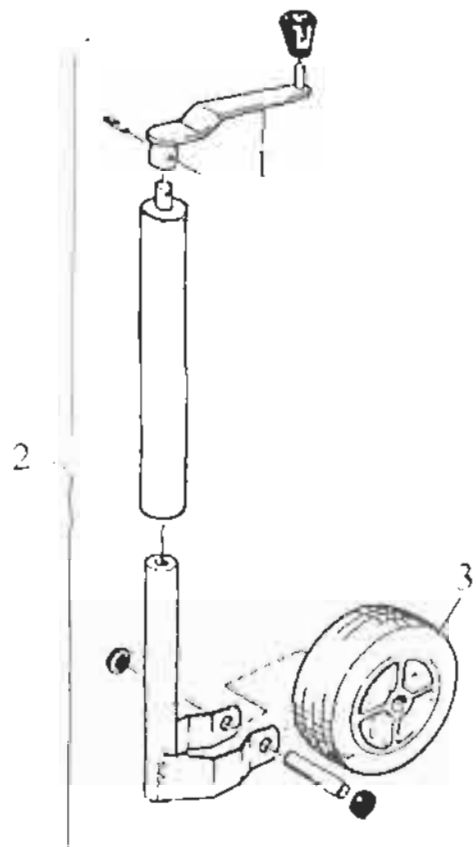



Alusta
Chassi
Chassie

120

Nokkapyörä, rengas, vanne, pöykapseli, kulmatuet, jne
Stödhjul; Fälg; Däck; Navkapsel; Hörnstöb; osv
Trailing wheel; Wheel; Tyre; Wheelside; Corner staeb; etc

2000

X=vakio/ standard

M=Menu-varustelu maasta riippuen/ Menu-utrustning beroende på land/ Menu-equipment due to country specification

Kuva Pos. Fig.	Varaosanro Del.nr. Part.nr.	Kuvaus Benämning Description																	Huom. Anm. Obs.
1	2706-0182	Nokkapyörän kampi	Vev	Crank	X	X	X	X	X	X	X	X	X	X	X	X	X	X	
2	0094-0141	Nokkapyörä, täydellinen	Stödhjul kpl.	Trailing wheel cpl.	X	X	X	X	X	X	X	X	X	X	X	X	X	X	
3	2706-0187	Nokkap. pyörä 225x75	Hjul	Wheel solid rubber	X	X	X	X	X	X	X	X	X	X	X	X	X	X	
4	0094-0005	Tubeless-venttiili	Tubeless ventili	Tubless-valve	X	X	X	X	X	X	X	X	X	X	X	X	X	X	
5	2705-3426	Levypyörä 13" x 5	Fälg 13"x5	Rim 13"x5	X	X	X												
5	2705-3431	Levypyörä 14"	Fälg 14"	Rim 14"				X	X	X	X	X	X	X	X	X	X		
5	2725-0029	Al-vanne 13"	AL-Fälg 13"	Al-wheel 13"	M	M	M											X	
6	2725-0032	Rengas + vanne 175/70 R 13	Däck + Fälg 185/70 SR 13	Wheel cpl 185/70 SR 13	X	X	X												
6	9002-5872	Rengas + AL-vanne 185/70 R13 RF	Däck + Fälg 185/70 R13 RF	Wheel cpl 185/70 R13 RF	M	M	M												
6	0094-0130	Rengas + AL-vanne 155 SR 13	Däck + Fälg 155 SR 13	Wheel cpl 155 SR 13															X
6	9001-8939	Rengas+vanne 185/75R 14 C	Däck + Fälg 185/75 SR 14 C	Wheel 185/75 SR 14 C				X	X	X	X	X	X	X	X	X	X		
6	9002-6175	Rengas+AL-vanne 185/75R 14 C	Däck + Fälg 185/75 SR 14 C	Wheel 185/75 SR 14 C				M	M	M	M	M	M						
7	9401-8601	Koristekapseli 13"	Navkapsel 13"	Wheelside 13"	X	X	X												
7	9401-8602	Koristekapseli 14"	Navkapsel 14"	Wheelside 14"				X	X	X	X	X	X	X	X	X	X		
8	9000-3165	Kulmatuki pitkällä lenkillä	Hörnstöd framre och bakre	Corner steady	X	X	X	X	X	X	X	X	X	X	X	X	X	X	
8	0094-0184	Kulmatuki lyhyellä lenkillä lattiaan	Hörnstöd bakre	Corner steady	X	X	X												
8	9001-7296	Kulmatuki lyhyellä lenkillä runkoon	Hörnstöd bakre	Corner steady				X	X	X	X	X	X	X	X	X	X		
9	2706-0501	Kierretappi 9000-3165 kulmatukeen	Hörnstödsskruv	Operating Iread	X	X	X	X	X	X	X	X	X	X	X	X	X	X	
9	2706-0310	Kierretappi 0094-0184 kulmatukeen	Hörnstödsskruv	Operating Iread	X	X	X												
9	2706-0523	Kierretappi 9001-7296 kulmatukeen	Hörnstödsskruv	Operating Iread				X	X	X	X	X	X	X	X	X	X		
10	2706-0313	Kulmatue talle + niili	Platte	Plate	X	X	X	X	X	X	X	X	X	X	X	X	X	X	
11	0094-0072	Kulmatuen kampi nupilla	Hörnstödsvev	Crank	X	X	X	X	X	X	X	X	X	X	X	X	X	X	
12	0045-4460	Rolskeläppä h=300	Stänkskydd	Protection	X	X	X	X	X	X	X	X	X	X	X	X	X	X	
13	9001-2262	Jarrukiljan pidin	Hållare till bromskloss	Socket for wheel lock wedge	X	X	X	X	X	X	X	X	X	X	X	X	X	X	
14	0090-0123	Jarrukilja	Bromskloss	Wheel lock wedge	X	X	X	X	X	X	X	X	X	X	X	X	X	X	
15	1729-1004	Varoituskolmio	Varningstriangel	Warning Iriangel	X	X	X	X	X	X	X	X	X	X	X	X	X	X	

Huom. / Anm. / Obs.

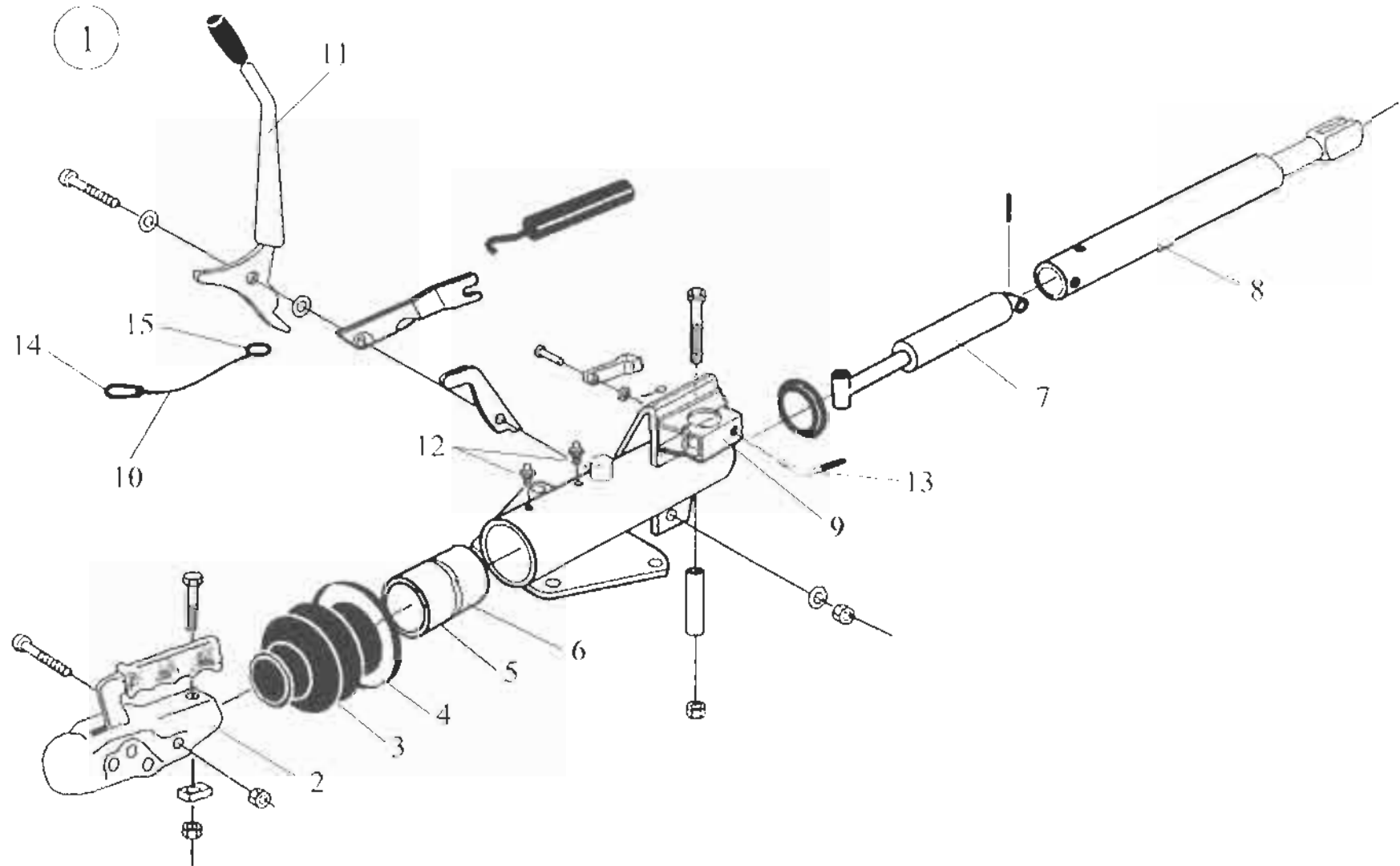

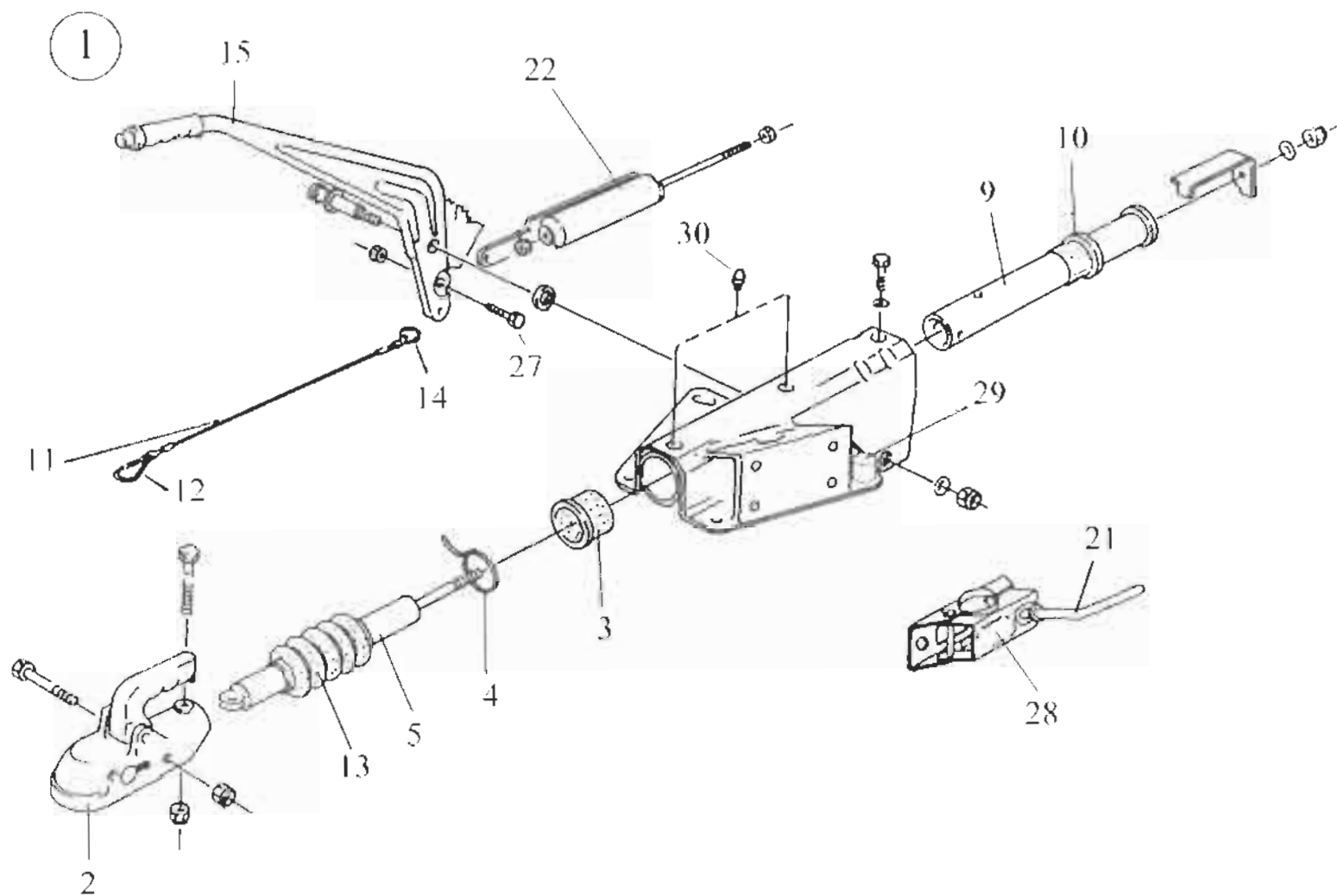

SOLIFERAlusta
Chassi
Chassis

146

Velokytkin KNOTT KF17-C
Päskjutsbrams KNOTT KF17-C
Overrun device KNOTT KF17-C

X= vakio/ standard

M= Menu-varustelu maasta riippuen/ Menu-utrustning beroende på land/ Menu-equipment due to country specification

2000

Kuva Pos. Fig.	Varaosan nro Def.nr. Part.nr.	Kuvaus Benämning Description																		Huom. Anm. Obs.	
1	9001-8422	Velopää KF17-C	Dragkoppling KF17-C	Breakgear KF17-C																	
2	9002-6337	Kulakytkin	Dragkoppling	Breakgear																	
3	9002-6338	Etumainen pusla	Bussning, främre	Bushing, front																	
4	9002-6339	Side	Fäste	Tie ring																	
5	9002-6340	Iskunvalmennin	Stötdämpare	Shock absorber																	
9	9002-6342	Työntölatko	Skjutstång	Pushrod																	
10	9002-6343	Valmenninirengas	Dämpningsring	Baffle plate																	
11	1728-0093	Hätävaljeri	Katastrofwire	Safetywire																	
12	2706-0140	Koukku	Krok	Hook																	
13	9002-6344	Suojapalje	Gummidamask	Rubber																	
14	2706-0111	Rengas	Ring	Ring																	
15	9002-6345	Käsiljarrukahva	Handbromsspak	Handlever																	
21	2706-0045	Kampi	Vred	Crank																	
22	9002-6346	Iskunvalmennin	Stötdämpare	Shock absorber																	
27	9002-6347	Alaklinnike	Fäste	Tie ring																	
28	9002-6348	Nokkapyörän kiinnitys kpl.	Noshjulets fäste	Trailing wheel fastener																	
29	9002-2001	Suojahattu	Kapsel	Cover																	
30	2706-0222	Rasvanippa	Smörjnippel	Lubricator																	

Huom./ Anm./Obs.

500 530 S4 S10L

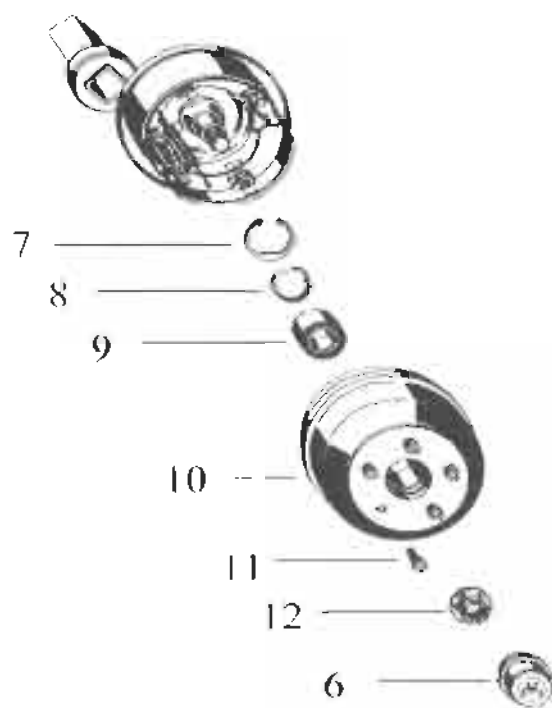
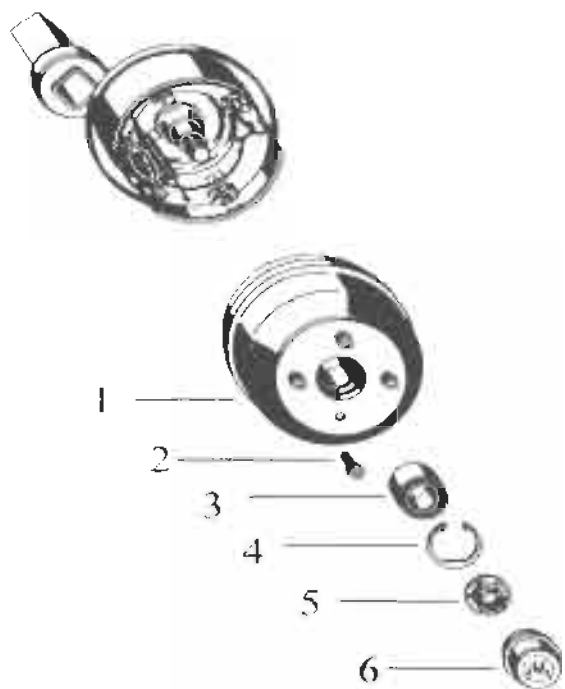

S5 S5L S5T S7 S7L S9

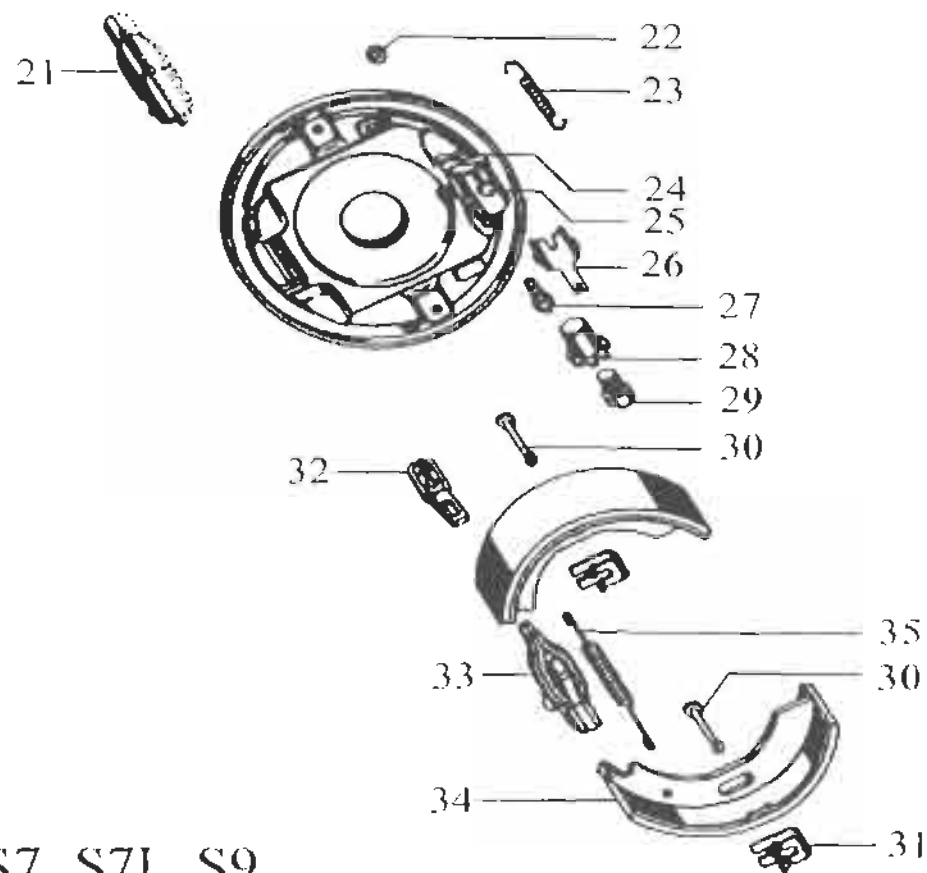

SOLIFERAlusta
Chassi
Chassie

160

Jarru S 2005-7 RASK
Hjulbroms S 2005-7 RASK
Brake system S 2005-7 RASK

X=vakio/ standard

M=Menu-varustelu maasta riippuen/ Menu-utrustning beroende på land/ Menu-equipment due to country specification

2000

Kuva Pos. Fig.	Varaosan nro Def.nr. Part.nr.	Kuvaus Benämning Description																	Huom. Anm. Obs.
1	03274-07280	Jarrurumpu 4 puittinen	Bromstrumma	Brake drum	X	X	X												X
2	02504-31100	Pyörän pultti	Hjulmutter	Wheel nut	X	X	X												X
3	02645-00200	Laakeri	Lager	Bearing	X	X	X												X
4	02560-56490	Lukkorengas	Låsring	Lock ring	X	X	X												X
5	02527-33600	Varmistuspultti M24x1.5	Kontrollmutter	Check nut	X	X	X												X
6	03211-03070	Rasvakuppi Ø 64.5	Fettkopp	Cap	X	X	X	X	X	X	X	X	X	X					X
7	02560-57390	Lukkorengas	Låsring	Lock ring				X	X	X	X	X	X	X					
8	03310-14150	Vastarengas	Ring	Ring				X	X	X	X	X	X	X					
9	02645-00400	Laakeri	Lager	Bearing				X	X	X	X	X	X	X					
10	03274-17030	Jarrurumpu 5 puittinen	Bromstrumma	Brake drum				X	X	X	X	X	X	X					
11	02504-31000	Pyörän pultti	Hjulmutter	Wheel nut				X	X	X	X	X	X	X					
12	02527-33800	Varmistuspultti M27x1.5	Kontrollmutter	Check nut				X	X	X	X	X	X	X					
21	03338-05040	Jarruväljerin pidin	Lock vid wireinfästning	Lock for brakelever	X	X	X	X	X	X	X	X	X	X					X
22	02330-10902	Varmistin	Säkring	Safety	X	X	X	X	X	X	X	X	X	X					X
23	03397-10030	Jarrujousi	Fjäder retur	Spring	X	X	X	X	X	X	X	X	X	X					X
24	03001-14800	Nokka oik	Nock H	Nose R	X	X	X	X	X	X	X	X	X	X					X
24	03001-14810	Nokka vas	Nock V	Nose L	X	X	X	X	X	X	X	X	X	X					X
25	03084-52390	Ruuvi	Skruv	Screw	X	X	X	X	X	X	X	X	X	X					X
26	03350-20120	Varmistinkristin	Säkringklämma	Safetytightener	X	X	X	X	X	X	X	X	X	X					X
27	03276-11040	Säätöruuvi	Justerskruv	Adjust screw	X	X	X	X	X	X	X	X	X	X					X
28	03263-91010	Säätömutteri	Justermutter	Adjust nut	X	X	X	X	X	X	X	X	X	X					X
29	03341-01120	Ruuvi M12x22	Skruv	Screw	X	X	X	X	X	X	X	X	X	X					X
30	03001-08140	Lukitus tappi	Lås-pinne	Lock pin	X	X	X	X	X	X	X	X	X	X					X
31	03352-00040	Lukitus pelti	Låsbleck	Lock sheet iron	X	X	X	X	X	X	X	X	X	X					X
32	03396-12020	Velohaarukka	Dragstycke	Draw yoke	X	X	X	X	X	X	X	X	X	X					X
33	05359-01020	Jarrunleviän mekanismi	Expandermekanism	Expander mechanism	X	X	X	X	X	X	X	X	X	X					X
34	05091-04430	Jarrukenkä	Bromsback	Brake shoe	X	X	X	X	X	X	X	X	X	X					X
35	03397-21160	Jarrujousi	Fjäder retur	Spring	X	X	X	X	X	X	X	X	X	X					X

Huom./ Anm./Obs.

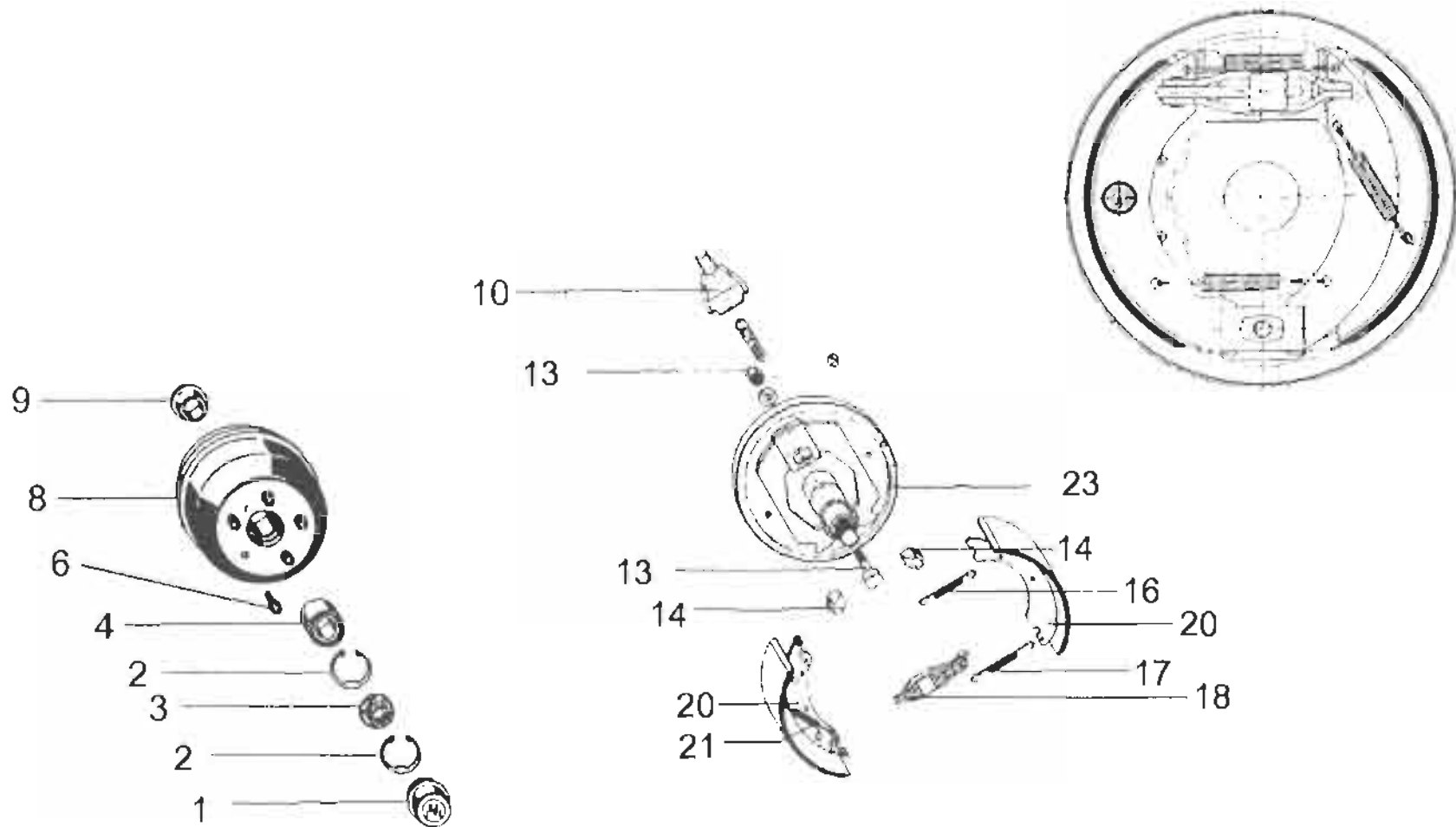

1

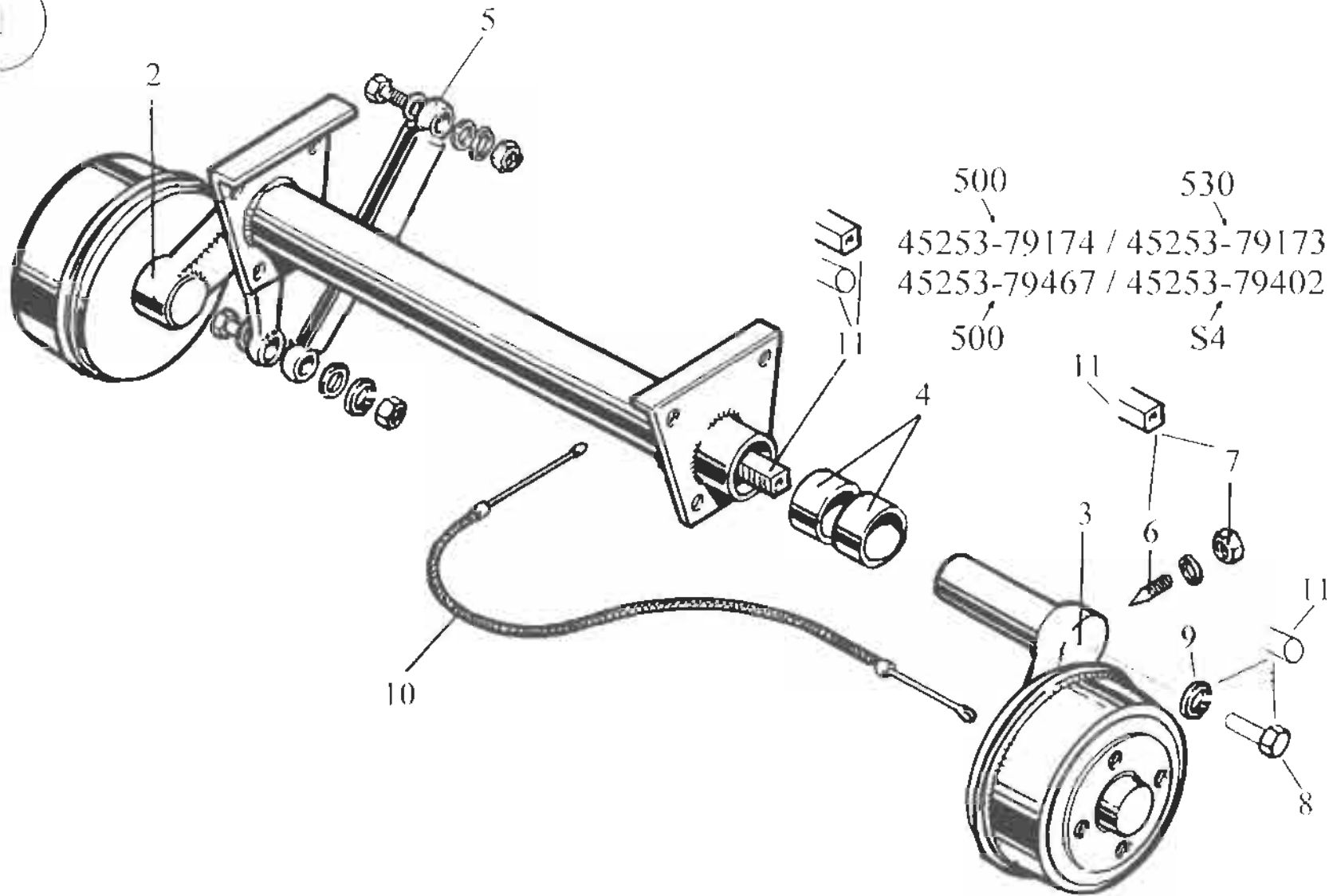

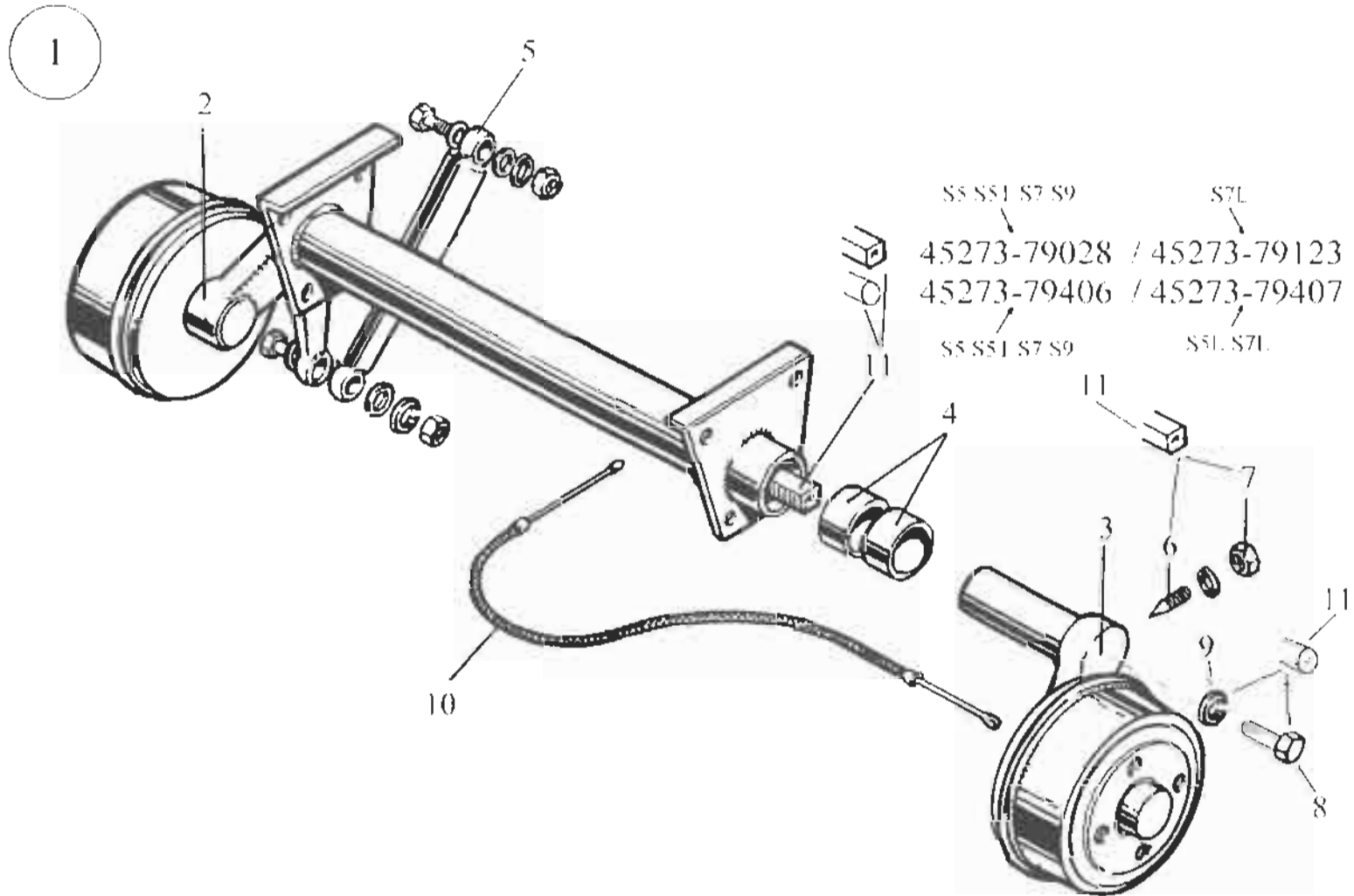

SOLIFERAlusta
Chassi
Chassie

171

Akseli BPW 1505
Enkelaxel BPW 1505
Singleaxle BPW 1505

X=vakio/ standard M=Menu-varustelu maasta riippuen/ Menu-utrustning beroende på land/ Menu-equipment due to country specification

2000

Kuva Pos. Fig.	Varaosan nro Def.nr. Part.nr.	Kuvaus Benämning Description																		Huom. Anm. Obs.
1	45273-79028	Akseli RONDO DB 1505	Axel RONDO DB 1505	Axel RONDO DB 1505																(1)
1	45273-79406	Akseli RONDO DB 1505	Axel RONDO DB 1505	Axel RONDO DB 1505																
1	45273-79132	Akseli RONDO DB 1505	Axel RONDO DB 1505	Axel RONDO DB 1505																
1	45273-79407	Akseli RONDO DB 1505	Axel RONDO DB 1505	Axel RONDO DB 1505																
2		Väntövarsi vas	Svängarm V	Swing arm L																(2)
3		Väntövarsi oik	Svängarm H	Swing arm R																(2)
4	03113-97200	Nailonhela ø 65.2/75x90	Nylonbussning	Bushing																
4	03113-97190	Nailonhela ø 65.2/75x42	Nylonbussning	Bushing																
5	02372-23900	Iskunvalmentaja S26x100	Stötdämpare	Schock absorber																
6	02501-85180	Lukitusruuvi M16x1.5x55	Låsskruv	Screw																(1)
7	02520-50824	Lukitusruuvin mutteri M16x1.5/636	Mutter	Nut																(1)
8	02503-22782	Pultti	Bult	Bolt																
9	02560-11292	Aluslevy	Bricka	Washer																
10	05089-02380	Jarruvaijeri 1275-1030	Bromswire 1240/1030	Brake Wire 1240/1030																
10	05089-02410	Jarruvaijeri 1475-1230	Bromswire 1475/1230	Brake Wire 1475/1230																
11		Väntöjousi (nelikulmainen)	Fjäderstav (fyrkanting)	Torsional spring (square)																(1 2)
11	03122-00130	Väntöjousi (pyöreä) vas	Fjäderstav (rund) V	Torsional spring (round) L																
11	03122-00140	Väntöjousi (pyöreä) oik	Fjäderstav (rund) H	Torsional spring (round) R																

Huom./ Anm./Obs. 1) Käytössä osan mallivuotta / Användas till en del av modellår / In use partly through the model year
2) Alusta nro / Chassi nr / Chassie nr (Sivu / sidan / page 110)

1

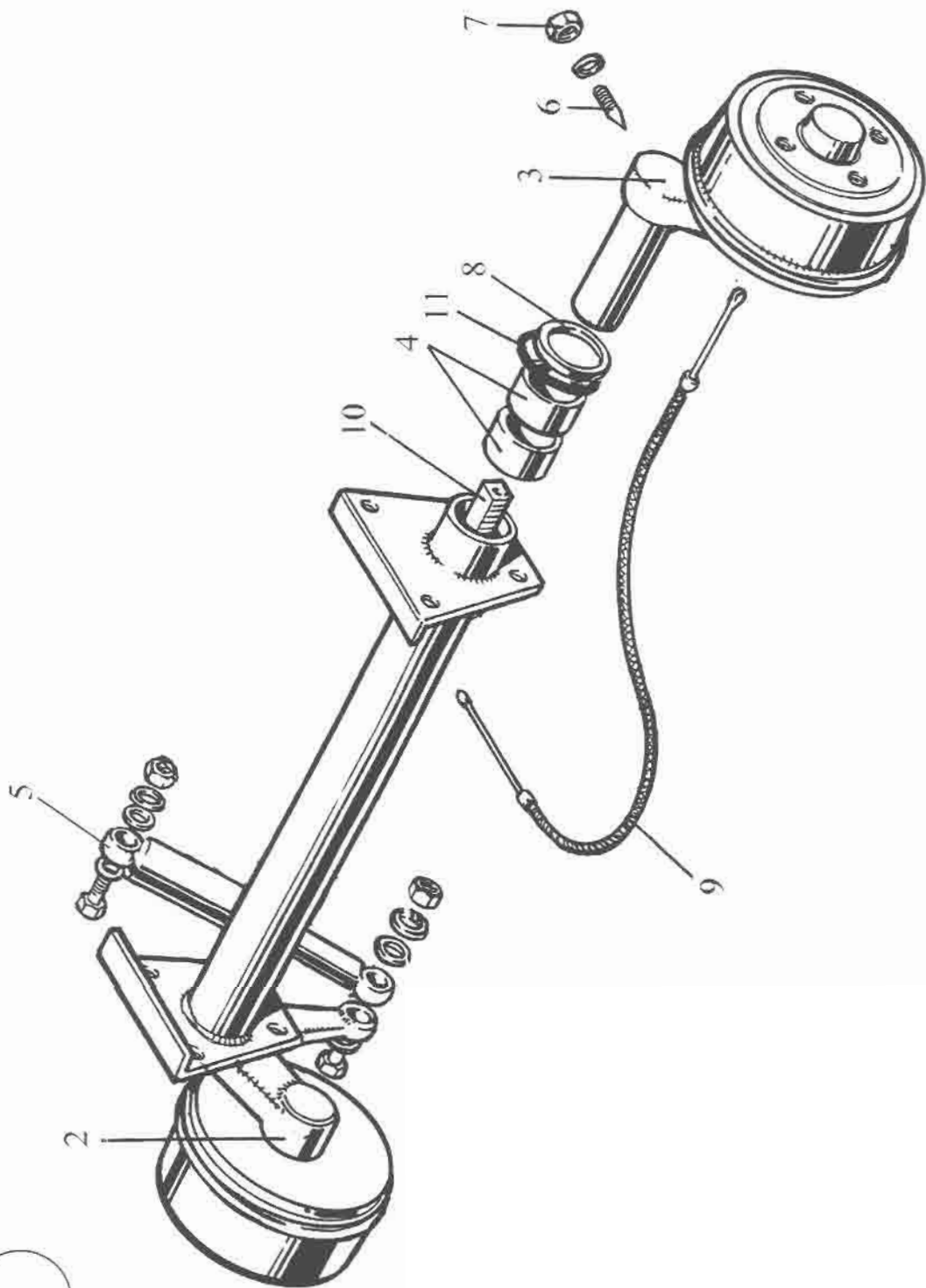

SOLIFERAlusta
Chassi
Chassie

172

Akseli KNOTT
Enkelaxel KNOTT
Singleaxle KNOTT

2000

X vakio/ standard M Menu-varustelu maasta riippuen/ Menu-utrustning beroende på land/ Menu-equipment due to country specification

Kuva Pos. Fig.	Varaosan nro Def.nr. Part.nr.	Kuvaus Benämning Description																	Huom. Anm. Obs.
1	9001-8403	Akseli DB16MV-27033	Axel DB16MV-27033	Axel DB16MV-27033															
2	2706-0549	Vääntövarsi vas.	Svängarm V	Swing arm L															
3	2706-0550	Vääntövarsi oik.	Svängarm H	Swing arm R															
4	9001-2423	Vääntövarren nollonhela	Nylonbussning	Bushing															
5	9001-8456	Iskunvalmentaja 37116	Stötdämpare	Schock absorber															
6	2706-0131	Lukitusruuvi 55 mm	Låsskruv 55mm	Screw 55mm															
7	2706-0132	Lukitusruuvin mutteri	Mutter	Nut															
8	9001-3957	Välirengas	Distansring	Ring															
9	9001-8427	Jarruvaljeri 1340/1130	Bromswire 1340/1130	Brake Wire 1340/1130															1)
10	9001-2346	Vääntöjousi	Fjäderstav	Torsional spring															
11	9000-5786	O - rengas	O-ring	O-ring															

Huom./ Anm./Obs. 1) Holkki 22 mm. Holk 22 mm. Bushing 22 mm

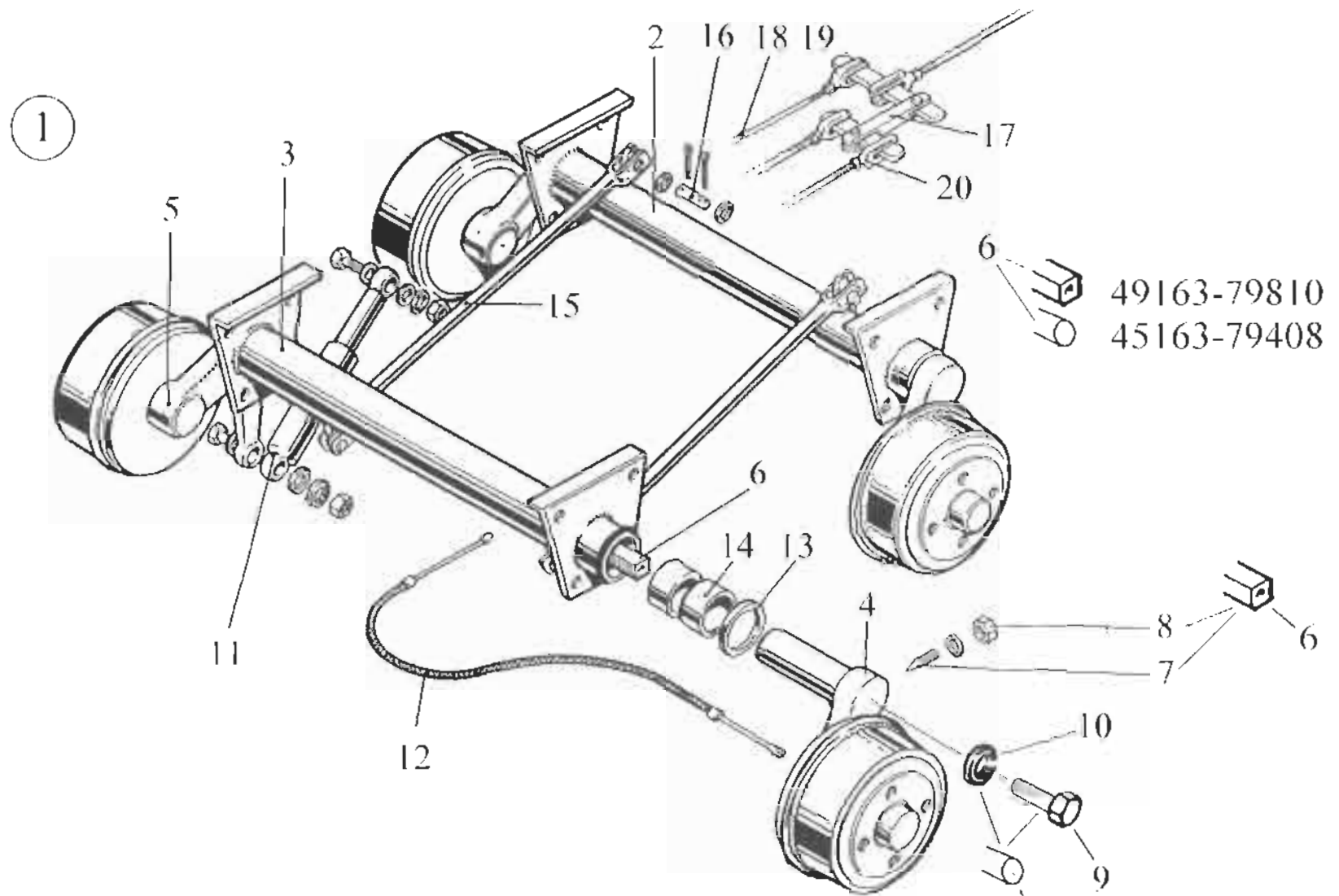

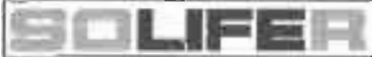

Alusta
Chassi
Chassie

175

Teliakseli PBW
Boggiaksel PBW
Tandemaksel PBW

2000

X=vakio/ standard M=Menu-varustelu maasta riippuen/ Menu-utrustning beroende på land/ Menu-equipment due to country specification

Kuva Pos. Fig.	Varaosan nro Def.nr. Part.nr.	Kuvaus Benämning Description																		Huom. Anm. Obs.		
1	49163-79810	Teliakseli RONDO DB 2/854	Boggiaksel RONDO DB 2/854	Tandemaksel RONDO DB 2/854																x	(1)	
1	45163-79408	Teliakseli RONDO DB 2/854	Boggiaksel RONDO DB 2/854	Tandemaksel RONDO DB 2/854																	x	
2		Etuakseli täyd.	Främre axel kpl	Axle cpl front																	x	(2)
3		Taka-akseli täyd.	Bakre axel kpl	Axle cpl rear																	x	(2)
4		Vääntövarsi vas	Svängarm V	Swing arm L																	x	(2)
5		Vääntövarsi oik	Svängarm H	Swing arm R																	x	(2)
6		Vääntöjousi (nelikulmainen)	Fjäderstav (fyrkanting)	Torsional spring (square)																	x	(1 (2)
6		Vääntöjousi (pyöreä) vas	Fjäderstav (rund) V	Torsional spring (round) L																	x	(2)
6		Vääntöjousi (pyöreä) oik	Fjäderstav (rund) H	Torsional spring (round) R																	x	(2)
7	02501-85211	Lukitusruuvi M16x1.5x45	Låsskruv	Screw																	x	(1)
8	02520-50824	Lukitusruuvin mutteri M16x1.5/636	Mutter	Nut																	x	(1)
9	02503-22782	Pultti	Bult	Bolt																	x	
10	02560-11292	Aluslevy	Bricka	Washer																	x	
11	02372-25300	Iskunvaimentaja S26x226	Stötdämpare	Schock absorber																	x	
12	05089-02400	Jarruvaijeri 1375-1130	Bromswire 1440/1230	Brake wire 1440/1230																	x	
13	02120-80400	O-renkas ø 4.5X180	O-ring	O-ring																	x	
14	03113-96100	Nailonhela ø 46.5/54.4x50	Nylonbussning	Bushing																	x	
15	05443-80180	Tasaustanko	Uljämningsstag	Balancing lever																	x	
16	03084-74470	Tasaustangon tappi	Lagerbult	Bolt																	x	
17		Keskivivusto	Mellanstag	Iron																	x	
18	0094-0156	Jarrutanko L = 400 mm	Bromsstag	Brake Lever																	x	
19	2706-0013	Jarrutanko L = 160 mm	Bromsstag	Brake Lever																	x	
20	2706-0032	Haarukka	Dragok	Fork																	x	

Huom./ Anm./ Obs. 1) Käytössä osan mallivuotta / Användas till en del av modellår / In use partly through the model year
2) Alusta nro / Chassi nr / Chassie nr (Sivu / sidan / page 110)

SOLFER

Kon
Karos
Body

210

Etz & tekap, Etz & tekap, Golde 500, 530
Front & bakpart Golde 500, 530
Front & rear Golde 500, 530

200

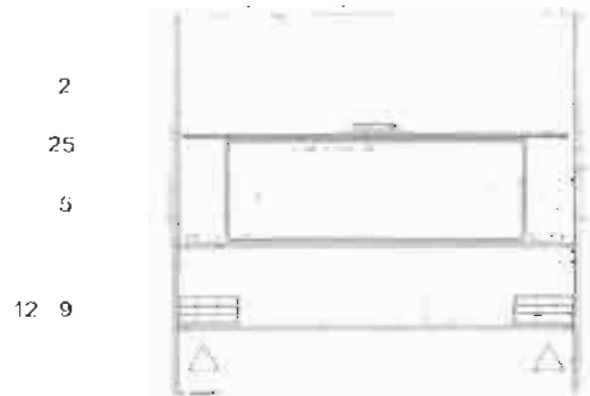

2
25
5
12 9

8 12
1
24
20
28 29

2
3
31 30
13
6
27



37 36
5
12 9
6
22

15
16
21
17

2
12 9
5
35
34
5



8 12
1
4
18
14
25 26
7
11

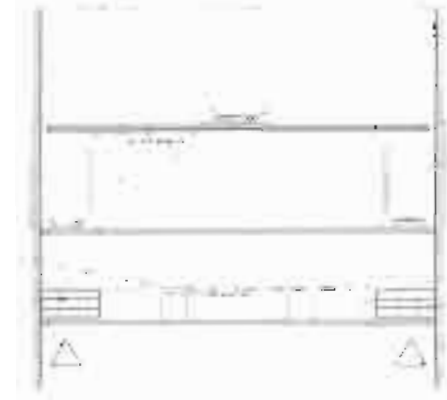

8 12
19
1
23
10
32
33
9 12



Kori
Kaross 210
Body

Etu- & takapää Goldie 500, 530
Front & bakparti Goldie 500, 530
Front & rear Goldie 500, 530

2000

X=vakio/ standard M=Menu-varustelu maasta riippuen/ Menu-utrustning beroende på land/ Menu-equipment due to country specification

Kuva Pos. Fig.	Varaosan Def.nr. Part.nr.	Kuvaus Benämning Description																		Huom. Anm. Obs.
1	9000-3752	Päätekl räystäslista oik.	Ändstycke dropplist H	End piece, drop list R	x	x														
2	9000-3753	Päätekl räystäslista vas.	Ändstycke dropplist V	End piece, drop list L	x	x														
3	9300-3773	Päätekl felttalista oik.	Ovre H hörnstycke	Corner piece R	x	x														
4	9300-3774	Päätekl kulmalista vas.	Ovre V hörnstycke	Corner piece L	x	x														
5	9500-3772	Päätekl koristelista	Dekorationslistens ändstycke	End piece	x	x														
6	9300-3775	Päätekl kpk. kiinnityslista oik.	Nedre H hörnstycke H	Corner piece R	x	x														
7	9000-3776	Päätekl kpk. kiinnityslista vas.	Nedre V hörnstycke V	Corner piece L	x	x														
8	9000-3820	Räystäslista	Dropplist	Drop list for outer door	x	x														1)
9	9001-4388	Päätylista	Ändlist	End list	x	x														2)
10	9002-2959	Takavalokotelon kiin. lista	Profil för fastsättning av ljusramp	Profil for toll light box	x	x														
11	9400-4010	Saranalista	Gångjärnlist	Hinge profil	x	x														
12	9402-4676	Keskilista harmoa	Ityllnadslis	Middle list	x	x														
13	9202-4586	Etukulmapelli oik harmoa	Fronthörn H	Front corner R	x	x														
14	9002-4587	Etukulmapelli vas harmoa	Fronthörn V	Front corner L	x	x														
15	0036-7860	Al-nauha 0.55x2203 katto	Al-plåt 0.55x2203	Al-plate 0.55x2203	x	x														
16	9001-5691	Al-nauha 0.5x633 takaylä	Al-plåt 0.5x633	Al-plate 0.5x633	x	x														
17	9401-3353	Al-nauha 0.5x1220 taka-ala	Al-plåt 0.5x1220	Al-plate 0.5x1220	x	x														
18	9300-8762	Etukunaelementti	Främre fönsterelement	Window unit front	x	x														
19	9300-9154	Ikkunaelem. kiinteä ikk. (ei sis. peiliä)	Fönsterelement, fast fönster	Window unit, fixed window	M	M														
20	9301-5266	Ikkunaelem. avatt. ikk. (ei sis. peiliä)	Fönsterelement, öppna fönster	Window unit, open window	M	M														
21	9300-8769	Takayläelem. ei takaikk. (sis. peiliä)	Ovre bakenlement	Rear unit upper	M	M														
22	9301-3355	Taka-alaelementti	Nedre bakenlement	Rear unit lower	x	x														
23	0093-0058	Ikkuna kiint. 1540x550 H	Fast framfönster 1540x550	Fixed window front 1540x550	x	x														
24	9001-5395	Ikkuna avatt. 1600x550 BIII RU/H	Öppn. fönster 1600x550 BIII	Open window 1600x550 BIII	M	M														
25	0036-8380	Vedin musta	Draghandtag svart	Grab handle black	x	x														
26	9400-3331	Vetimen korokepala	Monteringsbit under droghandtag	Add.piece for grab handle	x	x														

Huom./ Anm./Obs. 1) Jos takaikkuna / Tillsammans med fönster / If rear window
2) Ei takaikkunaa / Ingen fönster / No rear window



Van
Korpus
Body

210

Elz & bekop, Elz & bekop, Goble 500, 530
Fram & bakpan Goble 500, 530
Front & rear Goble 500, 530

100

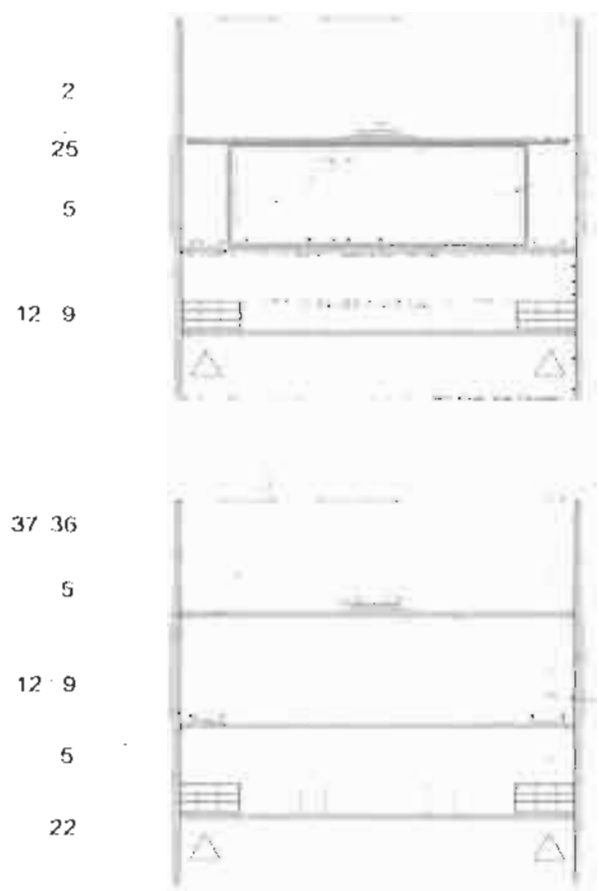

8 12
1
24
20
28 29
15
16
21
17

2
3
31 30
13
6
27
2
12 9
5
35
34
5

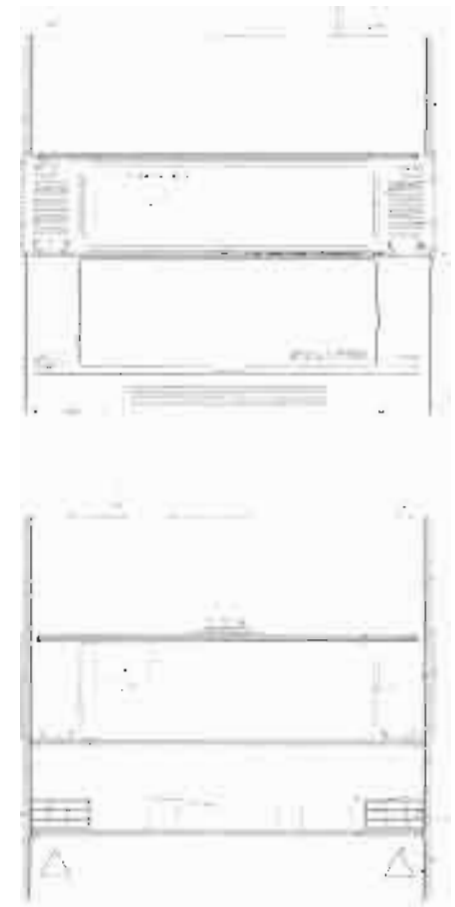

8 12
1
4
18
14
25 26
7
11
8 12
19
1
23
10
32
33
9 12

SOLIFER

Kori		Etu- & takapää Goldie 500, 530
Kaross	210	Front & bakparti Goldie 500, 530
Body		Front & rear Goldie 500, 530

X -vakio/ standard M Menu-varustelu maasta riippuen/ Menu-utrustning beroende på land/ Menu-equipment due to country specification

2000

Kuva Pos. Fig.	Varaosan nro Del.nr. Part.nr.	Kuvaus Benämning Description																	Huom. Anm. Obs.
			Goldie 500	Goldie 530	34	35	36	37	38	39	40	41	42	43	44	45	46	47	
27	0090-0078	Suorakaideheijastin	Frontreflex	Reflector front	x	x													
28	9000-3670	Kolmioheijastin	Reflextriangel	Triangel reflector	x	x													
29	0038-5470	Takahelijastimen pidin	Monteringsfot för reflextriangel	Holder for reflector	x	x													
30	0090-0168	Etuvalo Hella	Frontlampa	Front light	x	x													
31	9200-2832	Etuvalon muovikupu	Plastkåpa under frontlampa	Holder for front light	x	x													
32	9201-3333	Takavalo kotelo L=2190	Bakljusramp L=2190	Tail light box	x	x													
33	9000-3628	Takavalo oik.	Baklyckta H	Tail light R	x	x													
34	9000-9092	Takavalo vas. sumuvalolla	Baklyckta V	Tail light L	x	x													
35	0090-0028	Rekisterivalo	Nummerplåtsbelysning	Number plate light	x	x													
36	9002-4817	Lisäjarruvalo	Bromsljus	Stop light	x	x													
37	9302-4925	Lisäjarruvalon kehys	Ram till bromsljus	Frame stop light	x	x													

Huom./ Anm./Obs.

SOLIFER

Kon
Kardes
Body

211

Etz & lakap, Etz & lakap,
Frenn & Sakpart
Front & rear

54 55 55L 55T 57 57L 59 510 510L
54 55 55L 55T 57 57L 59 510 510L
54 55 55L 55T 57 57L 59 510 510L

2000

23



22

1

11

6

25



19 20

2

5 10

12

7

24



13 14

15

16 17 18

32 31

4

21

30

29

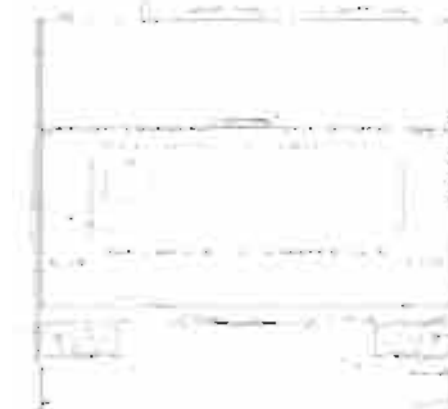

3

5 10

8

26 27

28

9



Kori		Etu- & takapää	S4 S5 S5L S5T S7 S7L S9 S10 S10L
Kaross	211	Front & bakparti	S4 S5 S5L S5T S7 S7L S9 S10 S10L
Body		Front & rear	S4 S5 S5L S5T S7 S7L S9 S10 S10L

X=vakio/ standard M=Menu-varusteita maasta riippuen/ Menu-utrustning beroende på land/ Menu-equipment due to country specification 2000

Kuva Pos. Fig.	Varaosan nro Det.nr. Part.nr.	Kuvaus Benämning Description																			Huom. Anm. Obs.	
																						S4
1	9201-7285	Päätekl etuyläkulma oik.	Ändstycke H	End piece R	x	x	x	x	x	x	x	x	x	x								
2	9201-7286	Päätekl etuyläkulma vas.	Ändstycke V	End piece L	x	x	x	x	x	x	x	x	x	x								
3	9001-5255	Päätekl räystäsilista oik.	Ändstycke H	End piece R	x	x	x	x	x	x	x	x	x	x								
4	9001-5254	Päätekl räystäsilista vas.	Ändstycke V	End piece L	x	x	x	x	x	x	x	x	x	x								
5	9002-2956	Räystäsilista	Dropplis	Drop list for outer window	x	x	x	x	x	x	x	x	x	x								
6	9301-7121	Kulmaprofiili oik	Markislist H	Drop list R	x	x	x	x	x	x	x	x	x	x								
7	9001-7122	Kulmaprofiili vas	Markislist V	Drop list L	x	x	x	x	x	x	x	x	x	x								
8	9002-2959	Takavalokotelon klin. lista	Profil för fastsättning av ljusramp	Profil for tail light box	x	x	x	x	x	x	x	x	x	x								
9	9002-2958	Saumalista	Markislist	Drop list	x	x	x	x	x	x	x	x	x	x								
10	9402-4676	Keskilista harmaa	Ifyllnadslist	Middle list	x	x	x	x	x	x	x	x	x	x								
11	9302-4592	Etukulmapeltti oik harmaa	Fronthörn H	Front corner R	x	x	x	x	x	x	x	x	x	x								
12	9002-4594	Etukulmapeltti vas harmaa	Fronthörn V	Front corner L	x	x	x	x	x	x	x	x	x	x								
13	0036-7860	Al-nauha 0.55x2203 katto	Al-plåt 0.55x2203	Al-plate 0.55x2203	x	x		x	x			x	x									
14	9002-2907	Al-nauha 0.55x2473 katto	Al-plåt 0.55x2473	Al-plate 0.55x2473				x						x								
15	9401-6203	Al-nauha 0.50x 1600 takapäätty	Al-plåt 0.5x1600	Al-plate 0.5x1600	x	x	x	x	x	x	x	x	x	x								
16	9302-4821	Takaelementti S4	Övre bakslement	Rear unit upper	x																	1)
17	9302-5882	Takaelementti S-sarja	Övre bakslement	Rear unit upper		x		x	x			x	x									1)
18	9302-3178	Takaelementti L-sarja	Övre bakslement	Rear unit upper			x			x				x								1)
19	9301-6160	Ikkuna kiint. 1600x650 H	Fast framfönster 1600x650	Fixed window front 1600x650	x	x		x	x			x	x									
20	9302-2458	Ikkuna kiint. 1870x650 H	Fast framfönster 1870x650	Fixed window front 1870x650				x				x										
21	0093-0058	Ikkuna kiint. 1540x550 H	Fast framfönster 1540x550	Fixed window front 1540x550			M	M	M	M	M	M	M	M								
22	0093-0035	Ikkuna avat. 900x550 BIII RU/H	Öppn. fönster 900x550 BIII	Open window 900x550 BIII	M																	
23	9001-5395	Ikkuna avat. 1600x550 BIII RU/H	Öppn. fönster 1600x550 BIII	Open window 1600x550 BIII		M	M	M	M	M	M	M	M	M								

Huom./ Anm./Obs. 1) Huom! Ikkunavaihtoehdot

SOLFER

Kiri
 Karoseri
 Body

211

Dtu & lakap, Eku & lakap, 8A 8B 8C, 8D 8E 8F 8G 8H 8I 8J 8K
 Papan & bakpang 8L 8M 8N 8O 8P 8Q 8R 8S 8T 8U 8V 8W 8X 8Y 8Z
 Front & rear 8AA 8AB 8AC 8AD 8AE 8AF 8AG 8AH 8AI 8AJ

1000

23



22

1

11

6

25

24



13 14

15

16 17 18

32 31

4

21

30

29



19 20

2

5 10

12

7



3

5 10

8

26 27

28

9

SOLIFER

Kori		Elu- & takapäät	S4 S5 S5L S5T S7 S7L S9 S10 S10L
Kaross	211	Front & bakparti	S4 S5 S5L S5T S7 S7L S9 S10 S10L
Body		Front & rear	S4 S5 S5L S5T S7 S7L S9 S10 S10L

X=vakio/ standard M=Menu-varustelu maasta riippuen/ Menu-utrustning beroende på land/ Menu-equipment due to country specification

2000

Kuva Pos. Fig.	Varaosanro Def.nr. Part.nr.	Kuvaus Benämning Description																		Huom. Anm. Obs.
24	0036-8380	Vedin musta	Draghandtag svart	Grab handle black																
25	2710-3786	Äärivalo etu Jokon PLR 1006	Framförlampa	Front light																
26	9202-2988	Takavalokotelo S-sarja	Profil för fastsättning av ljusramp	Profil for tail light box																
27	9202-3161	Takavalokotelo L-sarja	Profil för fastsättning av ljusramp	Profil for tail light box																
28	9001-7126	Takavalo vasen	Baklyckta V	Tail light																
29	9001-7127	Takavalo oikea	Baklyckta H	Tail light																
30	0090-0167	Rekisterikilven valo	Nummerplåtsbelysning	Number plate light																
31	9002-4817	Lisäjarruvalo	Bromsijus	Stop light																
32	9302-4925	Lisäjarruvalon kehys	Ram till bromsijus	Frame stop light																

Huom./ Anm./Obs.

GOLDIE

S & L - sarja

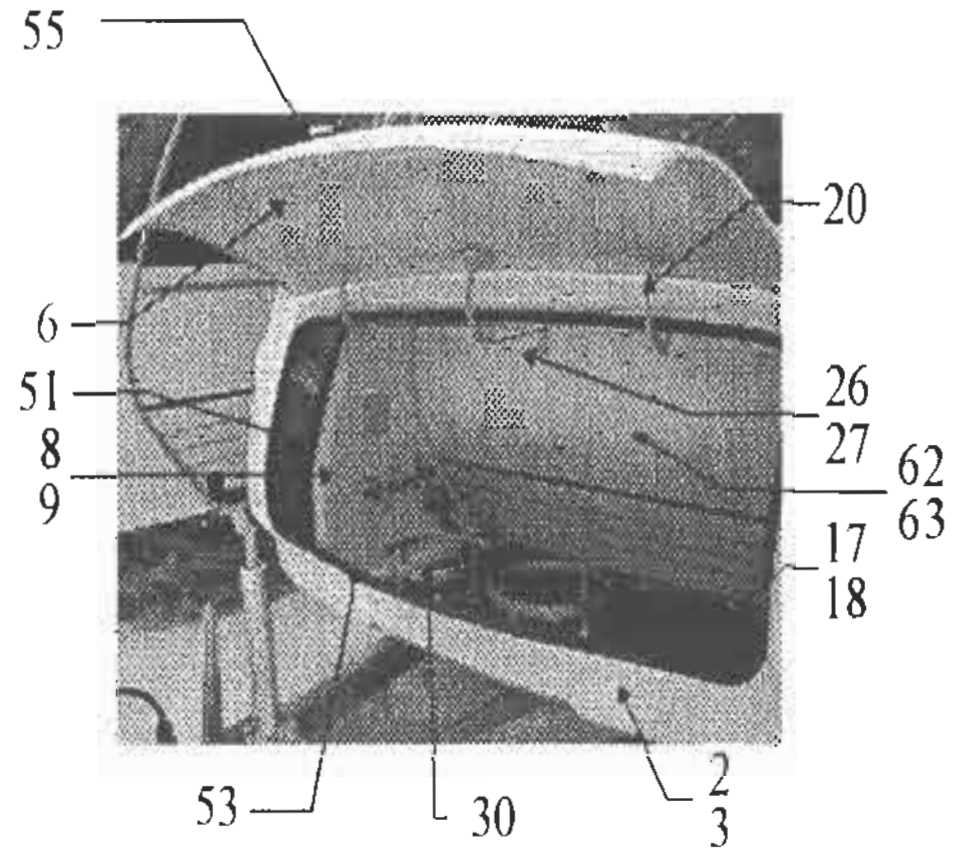
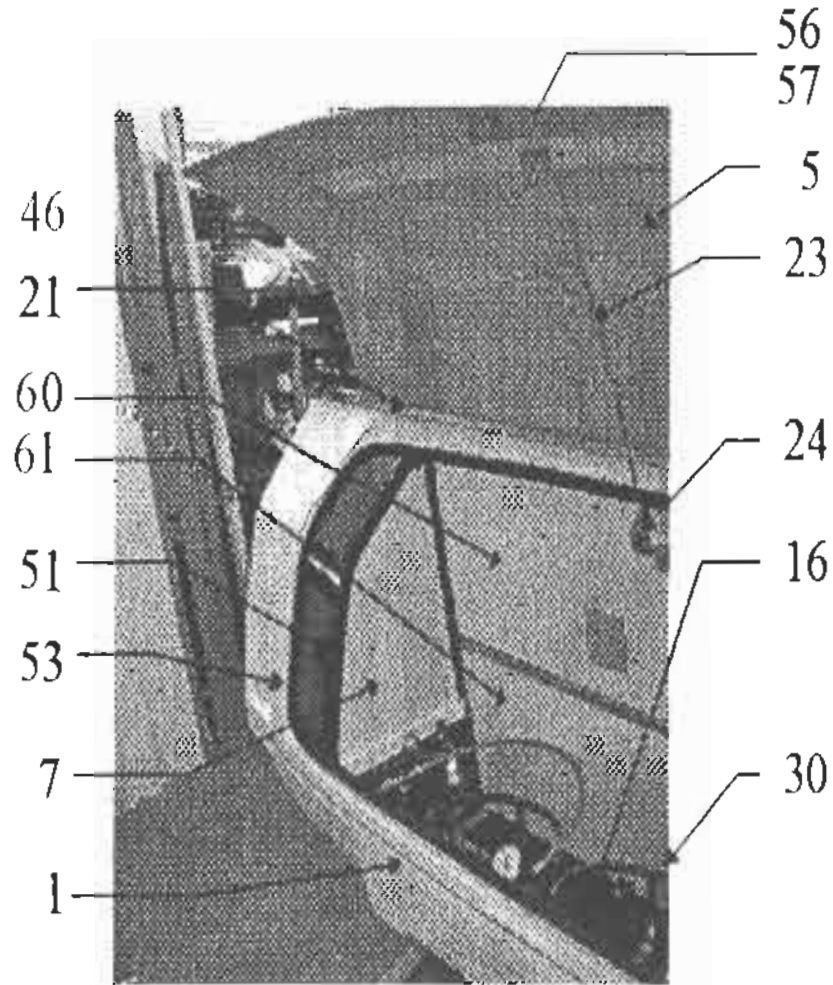

SOLIFERKori
Kaross
Body

214

Kaasupullotila
Gasolkoffert
Gasbottle box

X=vakio/ standard M=Menu-varustelu maasta riippuen/ Menu-utrustning beroende på land/ Menu-equipment due to country specification

2000

Kuva Pas. Fig.	Varaosanro Det.nr. Part.nr.	Kuvaus Benämning Description																		Huom. Anm. Obs.
			Goldie 500	Goldie 530	52	53	54	55	56	57	58	59	510	511						
1	9200-7100	Kaasupullokotelo Goldie	Gasolkoffert	Gas b. box	x	x														
2	9201-7319	Kaasupullokotelo S-sarja	Gasolkoffert	Gas b. box			x	x		x	x									
3	9202-2556	Kaasupullokotelo L-sarja	Gasolkoffert	Gas b. box					x			x								
5	2710-3921	Kaasupullokotelon kansi Goldie	Koffertlock	Gas bottle box's cap	x	x														
6	2710-3926	Kaasupullokotelon kansi S&L-sarja	Koffertlock	Gas bottle box's cap			x	x	x	x	x	x	x	x	x	x				
7	9200-3895	Kaasupullokotelon väliseinä Goldie	Mellanvägg i koffert	Partition wall (Gas box)	x	x														
8	9401-7157	Kaasupullokotelon väliseinä S-sarja	Mellanvägg i koffert	Partition wall (Gas box)			x	x		x	x				x	x				
9	9402-4389	Kaasupullokotelon väliseinä L-sarja	Mellanvägg i koffert	Partition wall (Gas box)					x			x								
16	9201-4519	Kaasupullokotelonpohja Goldie	Koffertbotten	Gasol box bottom	x	x														
17	9301-6351	Kaasupullokotelonpohja S-sarja	Koffertbotten	Gasol box bottom			x	x		x	x				x	x				
18	9302-3012	Kaasupullokotelonpohja L-sarja	Koffertbotten	Gasol box bottom					x			x								
20	0027-5100	Kp. kotelon kannen sarana	Gångjärn	Hinge for gas bottle box lid			x	x	x	x	x	x	x	x	x	x				
21	9400-3867	Kp. kotelon kannen saranalista	Gångjärnslid	Hingelid	x	x														
23	9400-3862	Aukipitolaitteen varsi	Koffertens stödpinne	Gas bottle box lid support	x	x														
24	9300-3928	Aukipitolaitteen kiinnitin	Låsdel till stödpinne	Opposite part for lock	x	x														
26	9301-6319	Aukipitolaite S-sarja	Koffertlockets öppethållare	Open holder for gas box cap			x	x		x	x				x	x				
27	9302-5423	Aukipitolaite L-sarja	Koffertlockets öppethållare	Open holder for gas box cap					x			x								
30	9000-3731	Kaasupulloteline	Gasaring	Gasoring	x	x	x	x	x	x	x	x	x	x	x	x				
51	0065-3005	Väliseinän tiiviste	Tätningsslid på mellanvägg	Packing list (middle wall)	x	x	x	x	x	x	x	x	x	x	x	x				
53	0065-3006	Kannen tiiviste	Tätningsslid på mellanvägg	Packing list (middle wall)	x	x	x	x	x	x	x	x	x	x	x	x				
55	503681	Lukko kaasupullokotelo -98	Gasolkoffert med lock	Gas b. box with lock			x	x	x	x	x	x	x	x	x					
56	0047-4570	Lukkosylinteri	Koffertlås	Cylinder lock	x	x														
56	9300-3905	Sylinterilukon kiel	Koffertlås	Cylinder lock	x	x														
57	2710-4200	Lukkosylinterin suojuus valk.	Skyddlock för låscylinder	Cover for lock cylinder	x	x														
60	9300-8767	Etukeskelementti Goldie	Främre mellanelement	Front unit middle	x	x														
61	9300-3316	Etualaelementti Goldie	Främre nedre element	Front unit lower	x	x														
62	9301-6286	Etualaelementti S-sarja	Främre nedre element	Front unit lower			x	x		x	x				x	x				
63	9302-2983	Etualaelementti L-sarja	Främre nedre element	Front unit lower					x			x								

Huom./ Anm./Obs.

BOLIFER	Kori		Huoltoalusta
	Kammi	215	Servicebox
	Body		Servicebox

500 S4 S5 S5L S5T S7 S7L S9 S10 S10L

5 4

1

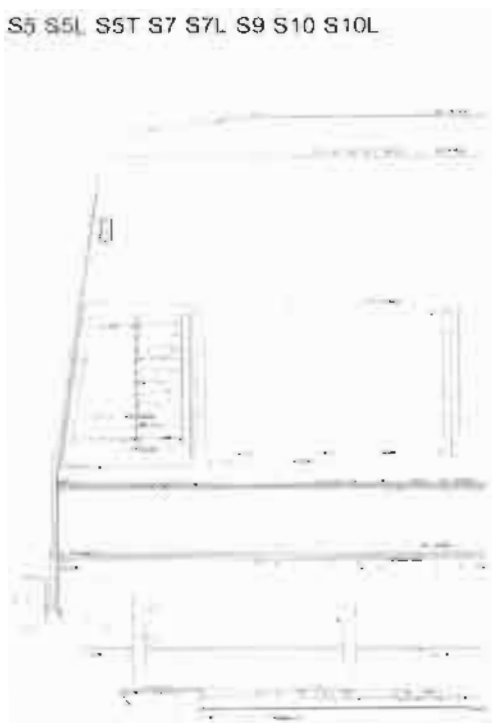

530

8
9 6
7
5 4 3
2

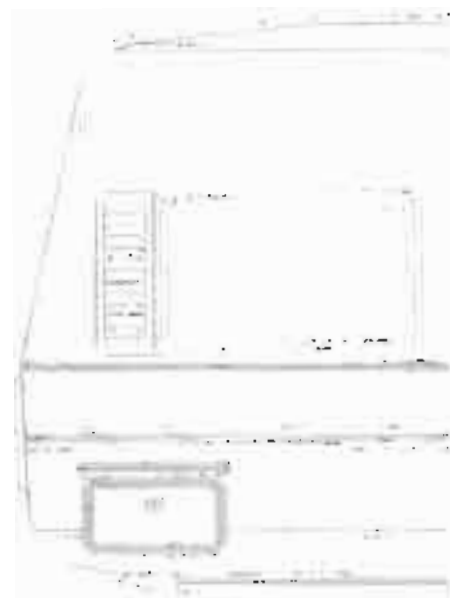

SOLIFER

Kori		Huoltoluukku
Kaross	215	Servicebox
Body		Servicebox

2000

X=vakio/ standard M=Menu-varustelu maasta riippuen/ Menu-utrustning beroende på land/ Menu-equipment due to country specification

Kuva Pos. Fig.	Varaosan nro Def.nr. Part.nr.	Kuvaus Benämning Description																		Huom. Anm. Obs.
1	9001-7318	Huoltoluukku 785x335	Servicebox	Servicebox	M	M	M	M	M	M	M	M	M	M	M	M	M	M	M	
2	9000-6271	Huoltoluukku 475x240	Servicebox	Servicebox		M														
3	9001-7522	Huoltoluukuniukko	Låscylinder servicebox	Lock cylinder servicebox		M														
4	9001-7589	Lukkosylinteri	Låscylinder	Lockcylinder	M	M	M	M	M	M	M	M	M	M	M	M	M	M	M	1)
5	9001-7590	Avain	Nyckel	Key	M	M	M	M	M	M	M	M	M	M	M	M	M	M	M	1)
6	9000-3820	Räystäslista, harmaa	Märkislst, grå	Drop list, gray		M														
7	9000-3753	Päätekl räystäslista vas.	Ändstycke droplist V	End piece, drop list L		M														
8	9000-3752	Päätekl räystäslista oik.	Ändstycke droplist H	End piece, drop list R		M														
9	9402-4676	Keskilista harmaa	Ifyllnadslst	Middle list		M														

Huom./ Anm./Obs. 1) Avaimen numero / Nyckel nummer / Key number

SOLIFER

Kao		Urloposci 500 530
Karosa	220	Exteri: 300 530
Body		Exterior: 500 530

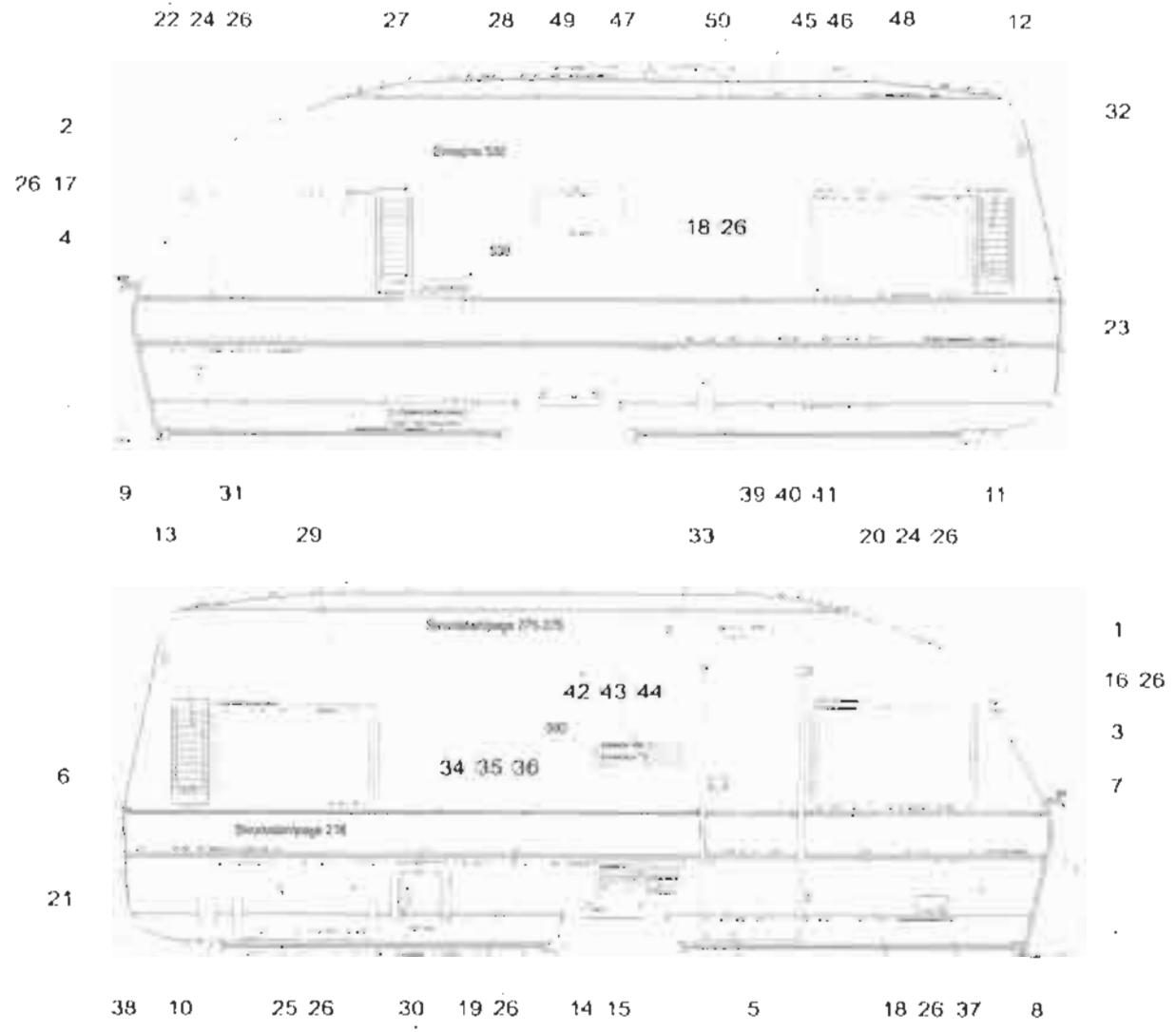

SOLIFER

Kori		Ulkopuoli 500 530
Kaross	220	Exterlör 500 530
Body		Exterior 500 530

X=vakio/ standard M=Menu-varustelu maasta riippuen/ Menu-utrustning beroende på land/ Menu-equipment due to country specification

2000

Kuva Pos. Fig.	Varaosan nro Def.nr. Part.nr.	Kuvaus Benämning Description																		Huom. Anm. Obs.
1	9300-3773	Päätekl. telftalista oik.	Övre H hörnstycke	Corner piece R	X	X														
2	9300-3774	Päätekl. kulmalista vas.	Övre V hörnstycke	Corner piece L	X	X														
3	9300-3775	Päätekl. kpk. kiinnityslista oik.	Nedre H hörnstycke	Corner piece R	X	X														
4	9000-3776	Päätekl. kpk. kiinnityslista vas.	Nedre V hörnstycke	Corner piece L	X	X														
5	9000-3784	Päätekl. seinälista oik.	Ändstycke H	End piece R	X	X														
6	9000-3785	Päätekl. seinälista vas.	Ändstycke V	End piece L	X	X														
7	9500-3772	Päätekl. koristelista	Ändstycke	End piece	X	X														
8	9302-4515	Päätekappale helmaalista etu oik.	H nedre främre ändstycke	End piece for edge list R	X	X														
9	9002-4516	Päätekappale helmaalista etu vas.	V nedre främre ändstycke	End piece for edge list L	X	X														
10	9302-4519	Päätekappale helmaalista taka oik.	H nedre bakre ändstycke	End piece for edge list R	X	X														
11	9002-4520	Päätekappale helmaalista taka vas.	V nedre bakre ändstycke	End piece for edge list L	X	X														
12	9002-4549	Tuuletussäleikkö vas. harmaa	Ventflerings galler V	Ventilations louvre L	X	X														
13	9202-4548	Tuuletussäleikkö oik. harmaa	Ventflerings galler H	Ventilations louvre R	X	X														
14	0025-7230	Lokasuoja	Hjulhus	Mud guard	X	X														
15	9202-4510	Lokasuojan kehys harmaa 1-aks	Hjulhuslist	Mud guard frame	X	X														
16	9400-3846	Ksp. kot. kiinnityslista oik.	Koffertens sidolist böjd H	Fixing list bended R	X	X														
17	9400-3847	Ksp. kot. kiinnityslista vas.	Koffertens sidolist böjd V	Fixing list bended L	X	X														
18	9000-3411	Koristelista	Dekorationslist	Decoration list	X	X														
19	9000-6329	Seinälista	Vägglist	Side wall list	X	X														
20	9000-3408	Telttalista	Tältlist	Awning list	X	X														
21	9300-8792	Taka telttalista L=1500mm, taiv.	Bak tättlist, böjd	Rear awning list, bended	X	X														
22	9000-3407	Kulmalista	Hörnlist	Corner list	X	X														
23	9300-8835	Taka kulmalista L=1500mm, taiv.	Bak hörnlist, böjd	Rear corner list, bended	X	X														
24	9400-9445	Telttalistan kumiprofili	Gummiprofil under tättlist	Rubber profile for awning list	X	X														
25	9302-4679	Helmaprofil 66 mm harmaa	Nedre plastlist	Edge list	X	X														
26	9402-4676	Keskilista harmaa	Ilyllnadslit	Middle list	X	X														

Huom./ Anm./Obs.

SOLIFER

Kor		Liftspeed 500 530
Kamrat	220	Exter'n 500 530
Body		Externa 500 530

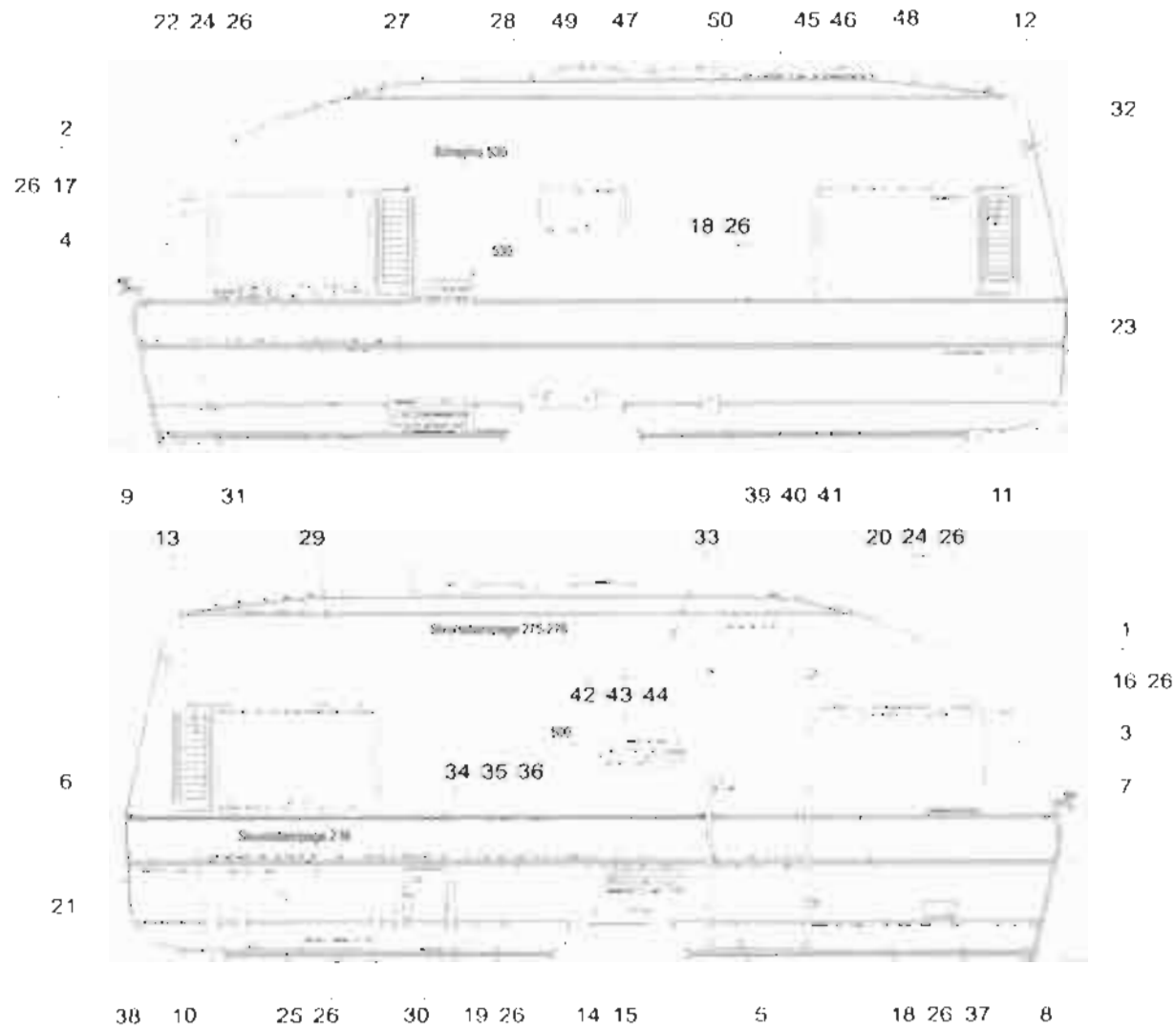



Kori	Ulkopuoli 500 530
Kaross	220 Exteriör 500 530
Body	Exteriör 500 530

2000

X-vakio/ standard M-Menu-varustelu maasta riippuen/ Menu-utrustning beroende på land/ Menu-equipment due to country specification

Kuva Pos. Fig.	Varaosan nro Det.nr. Part.nr.	Kuvaus Benämning Description																	Huom. Anm. Obs.
27	0093-0035	Avattava ikkuna 900x550	Öppningsbart sidofönster	Opening window	x	x													
28	0093-0049	Avattava ikkuna 475x240	Öppningsbart sidofönster 475*240	Opening window 475*240	M	M													
29	9402-4310	Al-nauha 0.5x1229 yläpelti	Övre sidoplat 0,5x1229	Upper al-plate 0,5x1229	x	x													
30	9402-3833	Al-nauha 0.5x800 alapelti	Nedre sidoplat 0,5x800	Lower al-plate 0,5x800	x	x													
31	9001-7305	Sivuvälo keltainen	Sidomarkeringslampa	Sidewall light	x	x													
32	9000-8654	Äärivälo pun/valk.	Breddmarkeringslampa rött/vit	Side marker light red/white	x	x													
33	0090-0166	Etuleiftavälo valk.	Ytterlampa	Awning light	x	x													
34	3816-8698	Kasetti WC:n luukku	Kasettoalett lucka	Casette toilet cover	x	x													
35	9001-7589	Lukkosylinteri	Låscylinder	Lock cylinder	x	x													
36	9001-7590	Avain	Nyckel	Key	x	x													
37	9000-6901	Kaasunulosotto	Gasöfning	Gas outlet what	M	M													
38	503460	Etuleiftapalvelu	Tätt service	Awning service	M	M													
39	9000-3664	Kojevästake MPK	230V infag	Contact box	x	x													
40	2710-4306	Kojevästakeen kansli	Lock för 230V infag	Cover for contact box	x	x													
41	2710-3925	Kojevästakeen kannen tappi	Gångjärmspinne för lock	Pin for 230V cover	x	x													
42	9001-2856	Ilmanvaihtosäleikkö	Kylskåpsgaller	Ventilation louvre	x	x													
43	9001-2855	Asennuskehys	Monterings ram	Assembly frame	x	x													
44	9001-2857	Talvisuoja	Vinterlock	Winter cover	x	x													
45	0092-0049	Tv.antennimasto ilman joht.	TV-antennenomföring	TV-antenn-bracket without cabel	x	x													
46	205516	Elektroninen TV-antenni	Elektronisk TV-antenn	Elektronic TV-antenna	M	M													
47	0097-0013	Kattoventtilli Veneta	Takventil	Ventilator	x	x													
48	0097-0024	E-Lux venttilli	E-Lux venttil	E-Lux venttil	x	x													
49	9001-8096	Kattovalkokuu 400x400	Taklucka	Roof-light	x	x													
50	9000-3661	Wc-kattovalkokuu 280x280	Toalettaklucka	Roof-light f. toiletroom	x	x													

Huom./ Anm./Obs.

SOLIFER

Kon: 180pccol 34
Kassa: 222 Exter'Y 34
Body: Exteror 34

2000

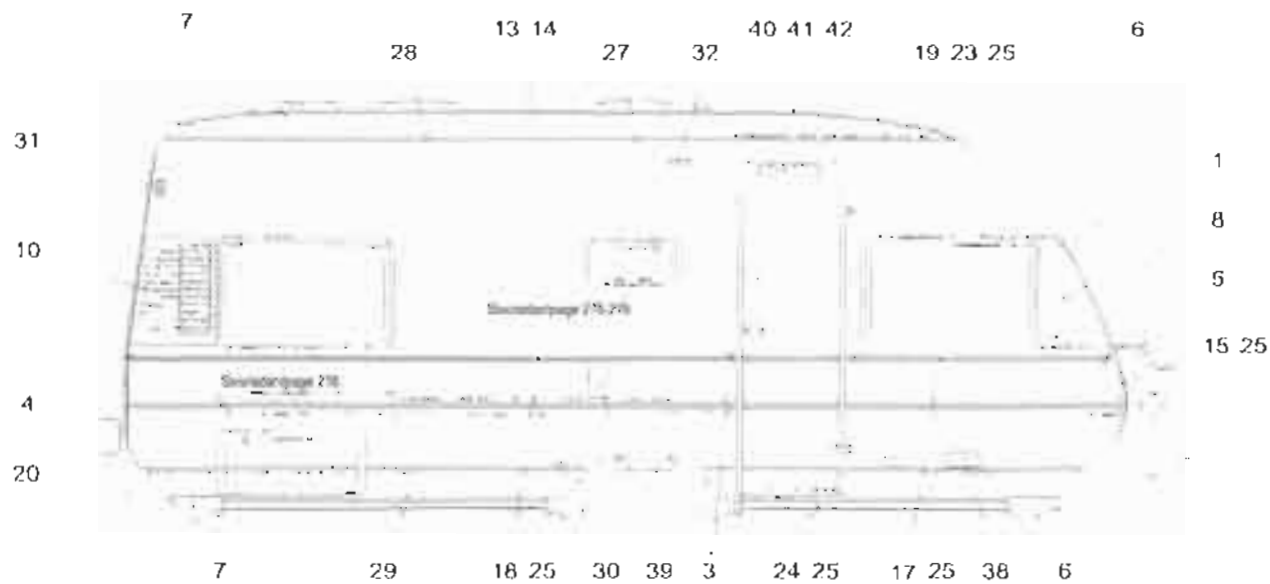
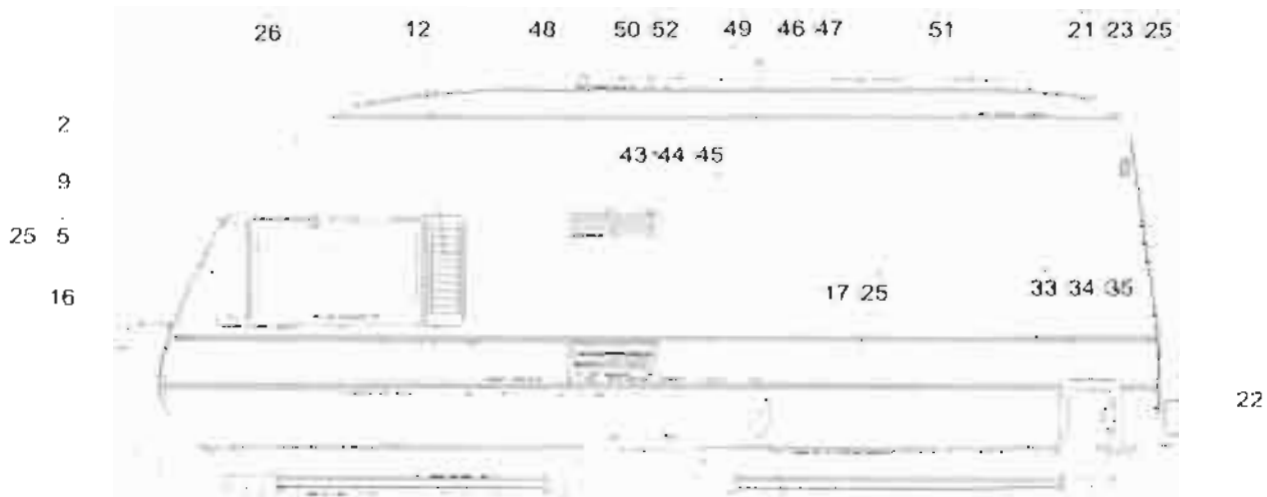

SOLIFER

Kori	222	Ulkopuoli S4
Kaross		Exteriör S4
Body		Exterior S4

2000

X=vakio/ standard M=Menu-varustelu maasta riippuen/ Menu-utrustning beroende på land/ Menu-equipment due to country specification

Kuva Pos. Fig.	Varaosan nro Def.nr. Part.nr.	Kuvaus Benämning Description		Crédite 500	Crédite 530	S4	S8	S8L	S4T	S7	S7L	S9	S10	S10L	Huom. Anm. Obs.
1	9201-7285	Päätekappale etuyläkulma oik	Övre H hörnstycke	Corner piece R		x									
2	9201-7286	Päätekappale etuyläkulma vas	Övre V hörnstycke	Corner piece L		x									
3	9000-3784	Päätekappale seinälista oik.	Ändstycke H	End piece R		x									
4	9000-3785	Päätekappale seinälista vas.	Ändstycke V	End piece L		x									
5	9500-3772	Päätekappale koristelista	Ändstycke	End piece		x									
6	9202-3892	Päätekappale helmalista oik.	Gångjärnslistens ändstycke H	End piece for edge list R		x									
7	9002-3893	Päätekappale helmalista vas.	Gångjärnslistens ändstycke V	End piece for edge list L		x									
8	9202-4544	Etukolmio oik. harmaa	Front sida trekant H	Front side triangle R		x									
9	9002-4547	Etukolmio vas. harmaa	Front sida trekant V	Front side triangle L		x									
10	9202-4537	Tuuletussäleikkö taka oik. harmaa	Ventilerings galler H	Ventilations louvre R		x									
12	9002-4549	Tuuletussäleikkö vas. harmaa	Ventilerings galler V	Ventilations louvre L		x									
13	9301-6018	Lokasuoja	Hjulhus	Mud guard		x									
14	9202-4509	Lokasuojan kehys harmaa 1-aks	Hjulhuslist	Mud guard frame		x									
15	9301-6973	Taivutettu kiinnitys lista oik.	Koffertens sidolist böjd H	Fixing list bended R		x									
16	9301-6974	Taivutettu kiinnitys lista vas.	Koffertens sidolist böjd V	Fixing list bended L		x									
17	9000-3411	Koristelista	Dekorationslist	Decoration list		x									
18	9000-6329	Seinälista	Vägglist	Side wall list		x									
19	9001-5697	Telttalista	Tällist	Awning list		x									
20	9301-6367	Taka telttalista L=1300mm, taiv.	Bak tällist, böjd	Rear awning list, bended		x									
21	9000-3407	Kulmalista	Hörnlist	Corner list		x									
22	9301-6368	Taka kulmalista L=1300mm, taiv.	Bak hörnlist, böjd	Rear corner list, bended		x									
23	9400-9445	Telttalistan kumiprofiili	Gummiprofil under tällist	Rubber profile for awning list		x									
24	9302-4674	Helmaprofiili 92 mm harmaa	Nedre plastlist	Edge list		x									
25	9402-4676	Keskilista harmaa	fyllnadslist	Middle list		x									

Huom./ Anm./Obs.



Kiri
Kanan
Body

222
222

Ulangan 34
Eksteri 34
Eksteri 34

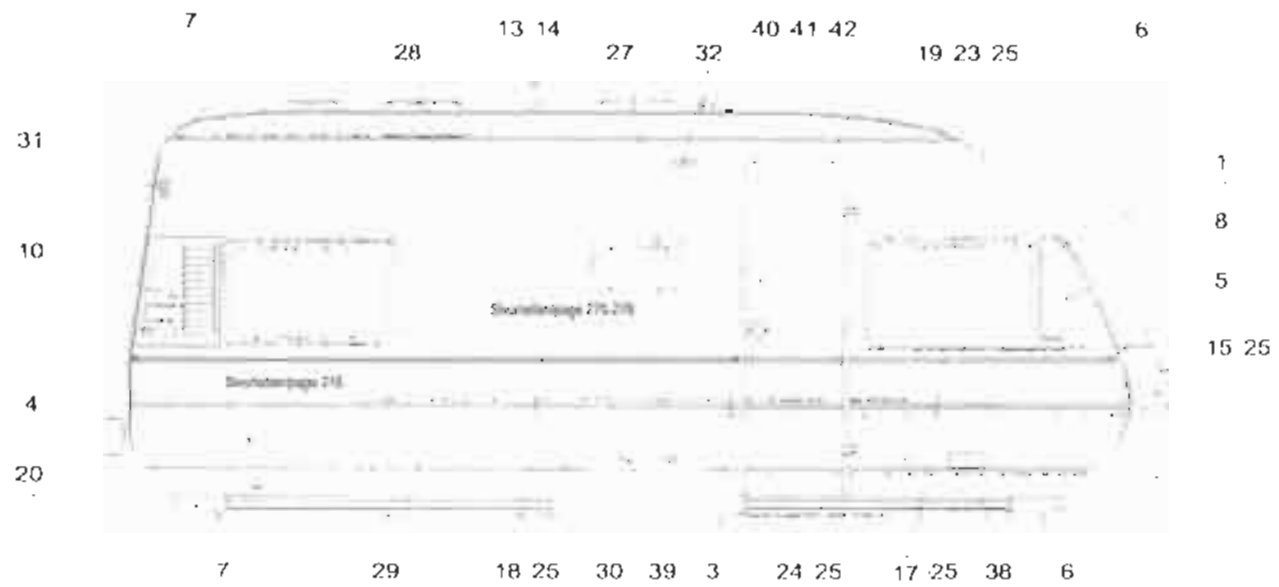
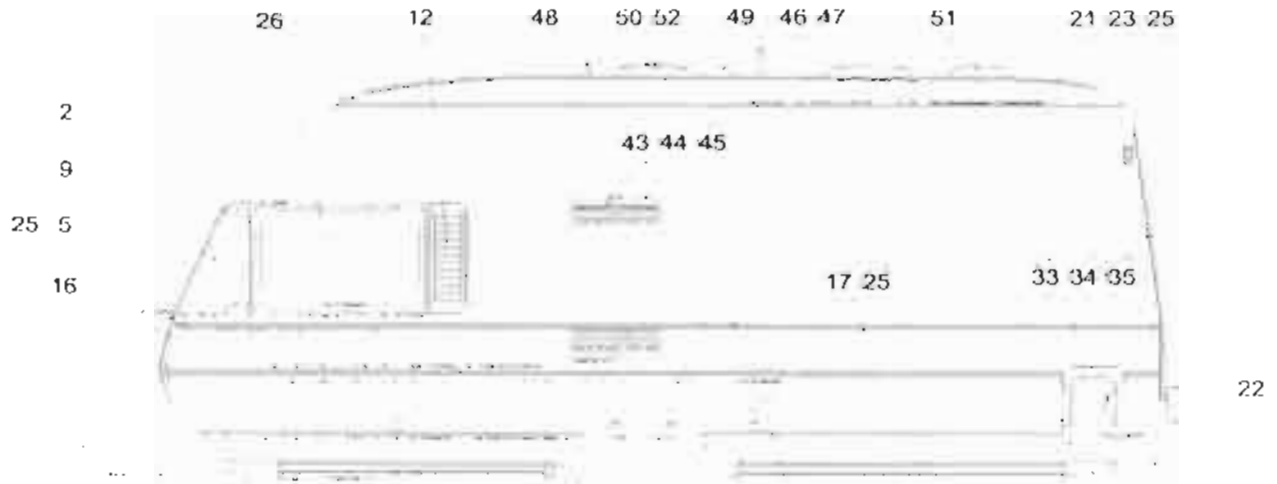

SOLIFERKori
Kaross
Body

222

Ulkopuoli S4
Exteriör S4
Exterior S4

2000

X=vakio/ standard

M=Menu-varustelu maasta riippuen/ Menu-utrustning beroende på land/ Menu-equipment due to country specification

Kuva Pos. Fig.	Varaosan nro Det.nr. Part.nr.	Kuvaus Benämning Description																	Huom. Anm. Obs.
26	0093-0035	Avattava ikkuna 900x550	Öppningsbart sidofönster	Opening window															
27	0093-0049	Avattava ikkuna 475x240	Öppningsbart sidofönster 475'240	Opening window 475'240															
28	9402-3832	Al-nauha 0.5x1323 yläpeltti	Övre sidoplat 0,5x1323	Upper al-plate 0,5x1323															
29	9402-3833	Al-nauha 0.5x800 alapeltti	Nedre sidoplat 0,5x800	Lower al-plate 0,5x800															
30	9001-7305	Sivuvato keittainen	Sidomarkeringslampa	Sidewall light															
31	9000-8654	Äärivato pun/valk.	Breddmarkeringslampa rött/vit	Side marker light red/white															
32	0090-0166	Etulettavato valk.	Ytterlampa	Awning light															
33	3816-8698	Kasetti WC:n luukku	Kosettoaleft lucka	Casettoliet cover															
34	9001-7589	Lukkosylinteri	Löscylinder	Lockcylinder															
35	9001-7590	Avain	Nyckel	Key															
38	9000-6901	Kaasunulosotto	Gaslufttag	Gas outlet whait															
39	503460	Etulettapalvelu	Tält service	Awning service															
40	9000-3664	Kojevastake MPK	230V Intog	Contact box															
41	2710-4306	Kojevastakkeen kansi	Lock för 230V intag	Cover for contact box															
42	2710-3925	Kojevastakkeen kannen tappi	Gängjärnsbinne för lock	Pin for 230V cover															
43	9001-2856	Ilmanvaihtosäleikkö	Kylskåpsgaller	Ventilation louvre															
44	9001-2855	Asennuskehys	Monterings ram	Assembly frame															
45	9001-2857	Talvisuoja	Vinterlock	Winter cover															
46	0092-0049	Tv.antennimasto ilman joht.	TV-antengenomföring	TV-antenn-bracket without cabel															
47	205516	Elektroninen TV-antenni	Elektronisk TV-antenn	Elektronisk TV-antenna															
48	0097-0013	Kattoventiili Veneta	Takventil	Ventilator															
49	0097-0024	E-Lux ventili	E-Lux ventil	E-Lux venttil															
50	9001-8096	Kattovalkoku 400x400	Taklucka	Roof-light															
51	9000-3661	Wc-kattovalkoku 280x280	Taaleftaklucka	Roof-light f. toiletroom															
52	9002-4373	Kattoikkuna HEK12	Taktönster	Roof-window															

Huom./ Anm./Obs.



Kon		Ultrapanel SST
Karcas	224	Panel SST
Body		Extens SST

7.0

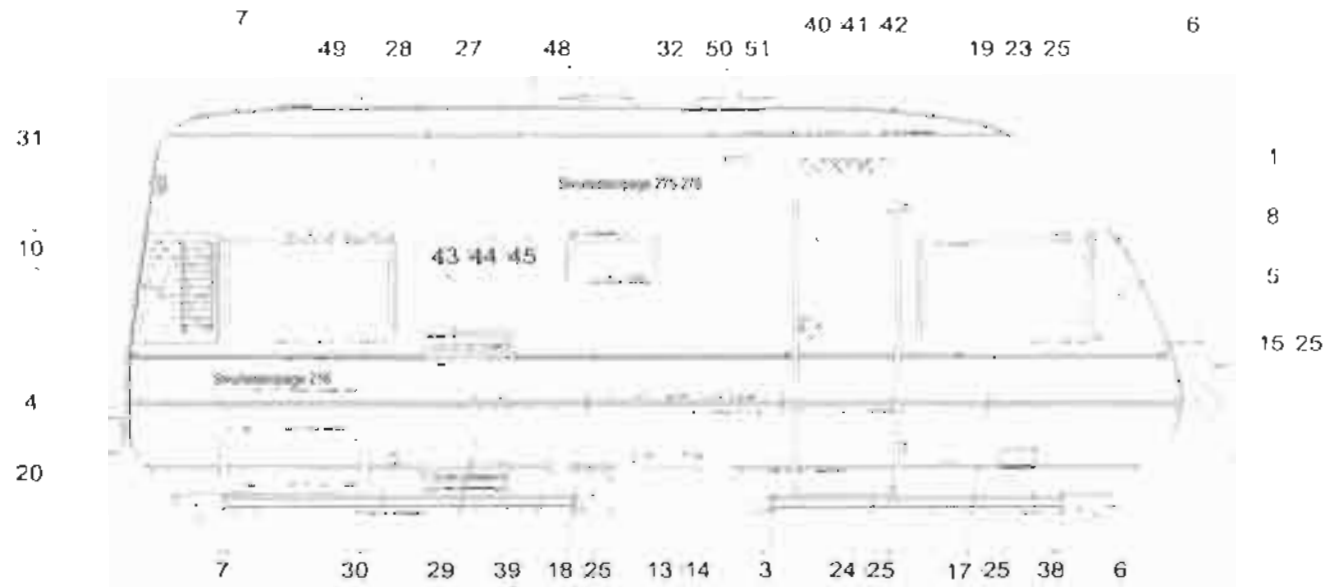
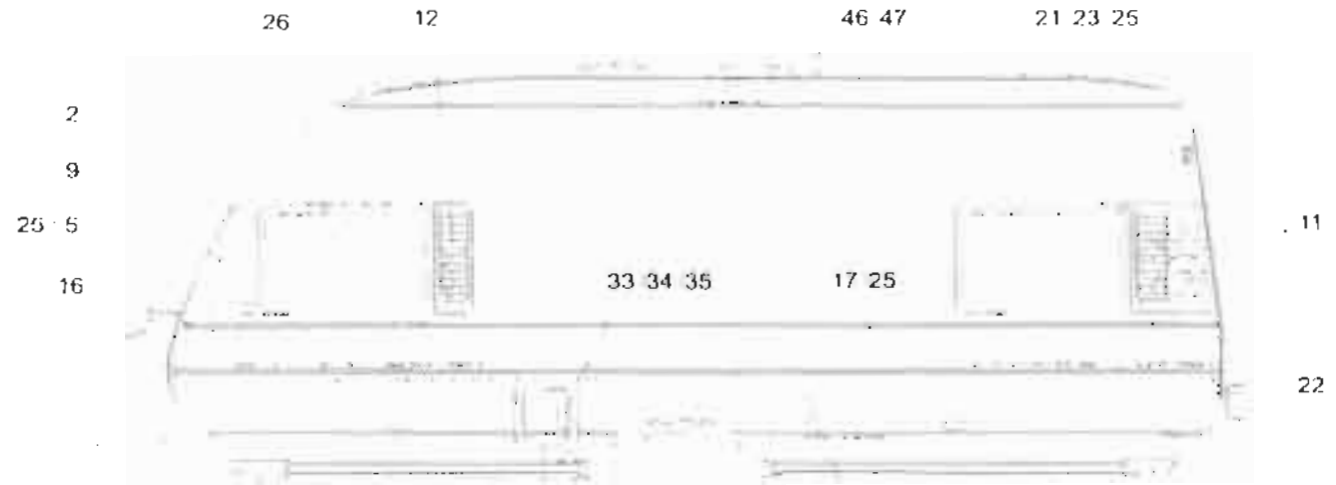

SOLIFER

Kori	Ulkopuoli S5T
Kaross	224 Exterför S5T
Body	Exterför S5T

2000

X=vakio/ standard M=Menu-varustelu maasta riippuen/ Menu-utrustning beroende på land/ Menu-equipment due to country specification

Kuva Pos. Fig.	Varaos Det.nr. Part.nr.	Kuvaus Benämning Description																		Huom. Anm. Obs.	
1	9201-7285	Päätökappale etuyläkulma oik	Övre H hörnstycke	Corner piece R																	
2	9201-7286	Päätökappale etuyläkulma vas	Övre V hörnstycke	Corner piece L																	
3	9000-3784	Päätökappale seinälista oik.	Ändstycke H	End piece R																	
4	9000-3785	Päätökappale seinälista vas.	Ändstycke V	End piece L																	
5	9500-3772	Päätökappale koristelista	Ändstycke	End piece																	
6	9202-3892	Päätökappale helmallista oik.	Gångjärnslistens ändstycke H	End piece for edge list R																	
7	9002-3893	Päätökappale helmallista vas.	Gångjärnslistens ändstycke V	End piece for edge list L																	
8	9202-4544	Etukolmio oik. harmaa	Front sida trekant H	Front side triangle R																	
9	9002-4547	Etukolmio vas. harmaa	Front sida trekant V	Front side triangle L																	
10	9202-4537	Tuuletussäleikkö taka oik. harmaa	Ventilerings galler H	Ventilationens louver R																	
11	9002-4539	Tuuletussäleikkö taka vas. harmaa	Ventilerings galler V	Ventilationens louver L																	
12	9002-4549	Tuuletussäleikkö vas. harmaa	Ventilerings galler V	Ventilationens louver L																	
13	9301-6018	Lokasuoja	Hjuthus	Mud guard																	
14	9202-4509	Lokasuojan kehys harmaa 1-aks	Hjuthuslist	Mud guard frame																	
15	9301-6973	Taivutettu kiinnitys lista oik.	Koffertens sidolist böjd H	Fixing list bended R																	
16	9301-6974	Taivutettu kiinnitys lista vas.	Koffertens sidolist böjd V	Fixing list bended L																	
17	9000-3411	Koristelista	Dekorationslist	Decoration list																	
18	9000-6329	Seinälista	Vägglis	Side wall list																	
19	9001-5697	Telttalista	Tältlist	Awning list																	
20	9301-6367	Taka telttalista L=1300mm, taiv.	Bak tältlist, böjd	Rear awning list, bended																	
21	9000-3407	Kulmalista	Hörnlist	Corner list																	
22	9301-6368	Taka kulmalista L=1300mm, taiv.	Bak hörnlist, böjd	Rear corner list, bended																	
23	9400-9445	Telttalian kumiprofiili	Gummiprofil under tältlist	Rubber profile for awning list																	
24	9302-4674	Heimaprofiili 92 mm harmaa	Nedre plastlist	Edge list																	
25	9402-4676	Keskilista harmaa	Iflylnadslis	Middle list																	

Huom./ Anm./Obs.

SOLIFER

Kon		Uitvoering SGT
Kaarsen	224	Exterieur SGT
Body		Exterieur SGT

200

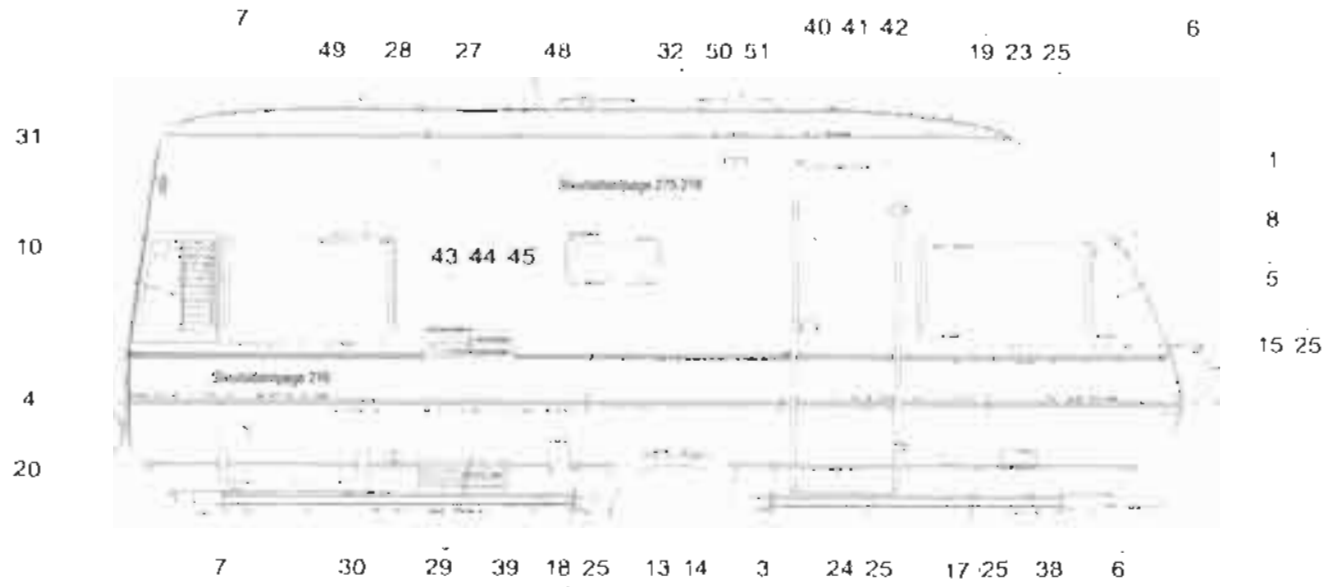
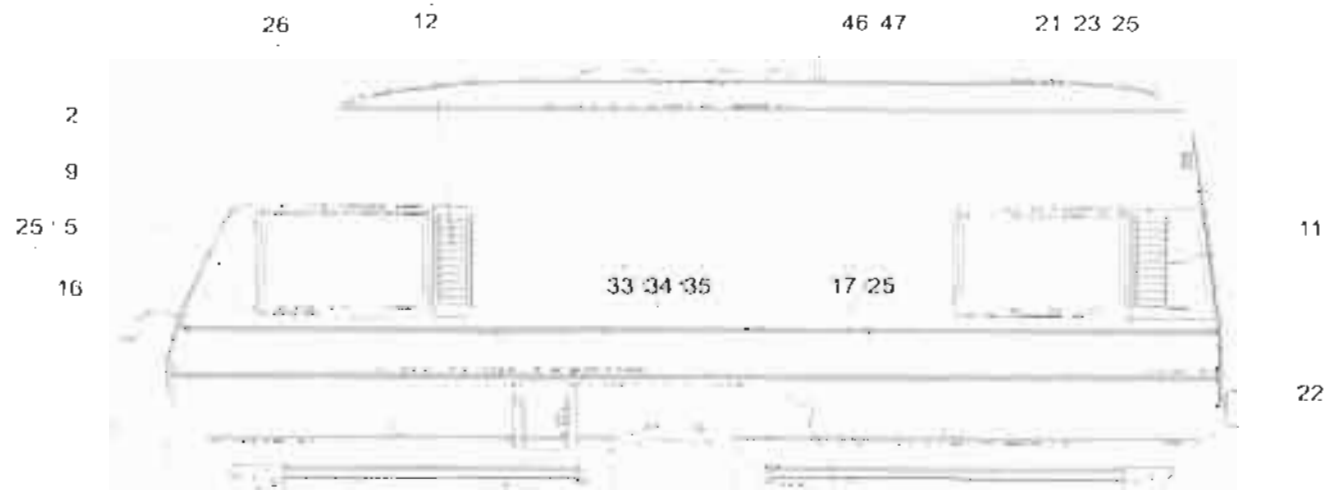

BOLIFER

Kari		Ulkopuoli 55 58L 57 57L 59 510
Karrossi	226	Extensio 55 58L 57 57L 59 510
Body		Extensio 55 58L 57 57L 58 510

220

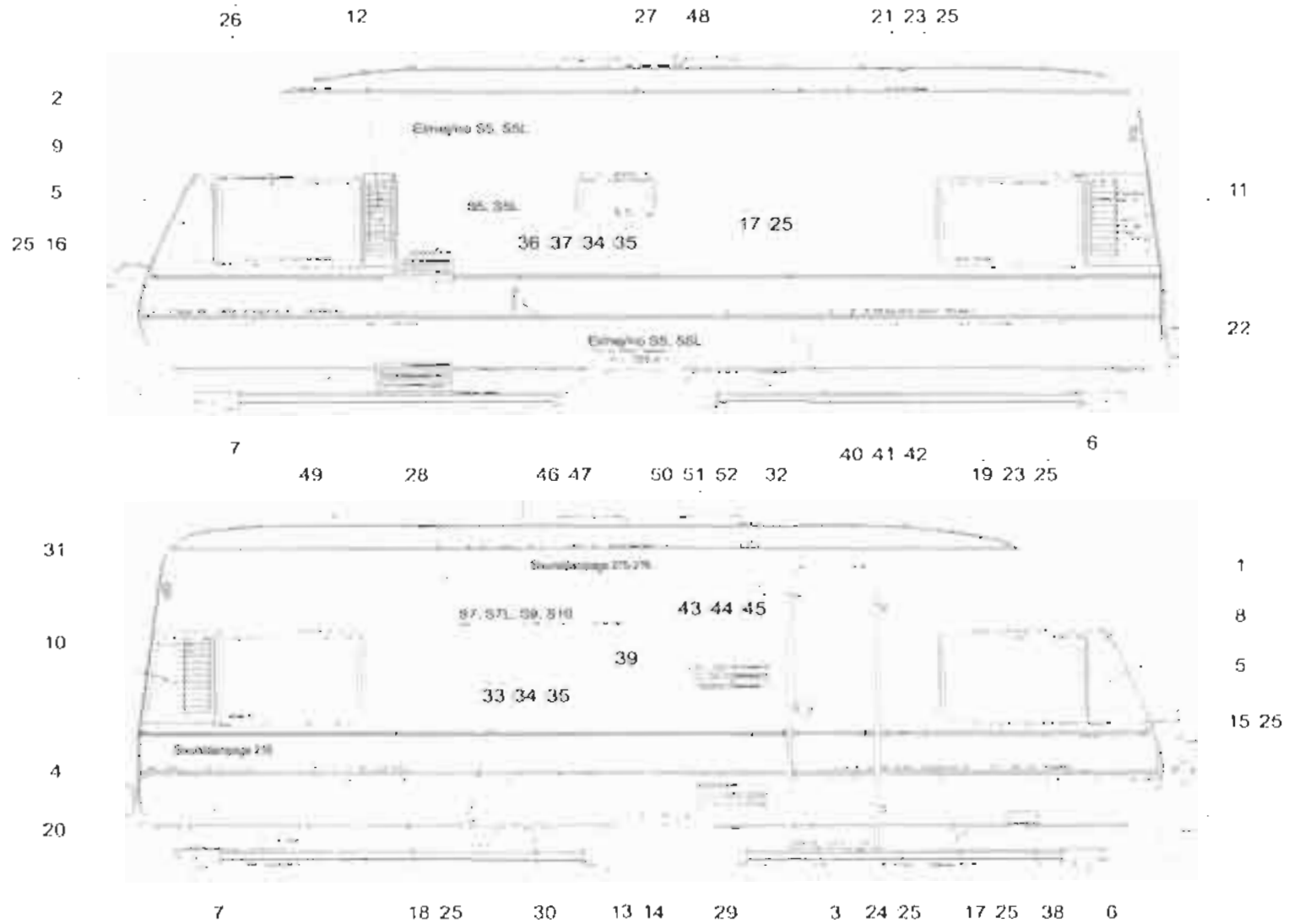

SOLIFER

Kon
Karada
Body

226

Ünvanı: 55 55L 57 57L 59 510
Eski'nin: 55 55L 57 57L 59 510
Eski'nin: 55 55L 57 57L 59 510

2000

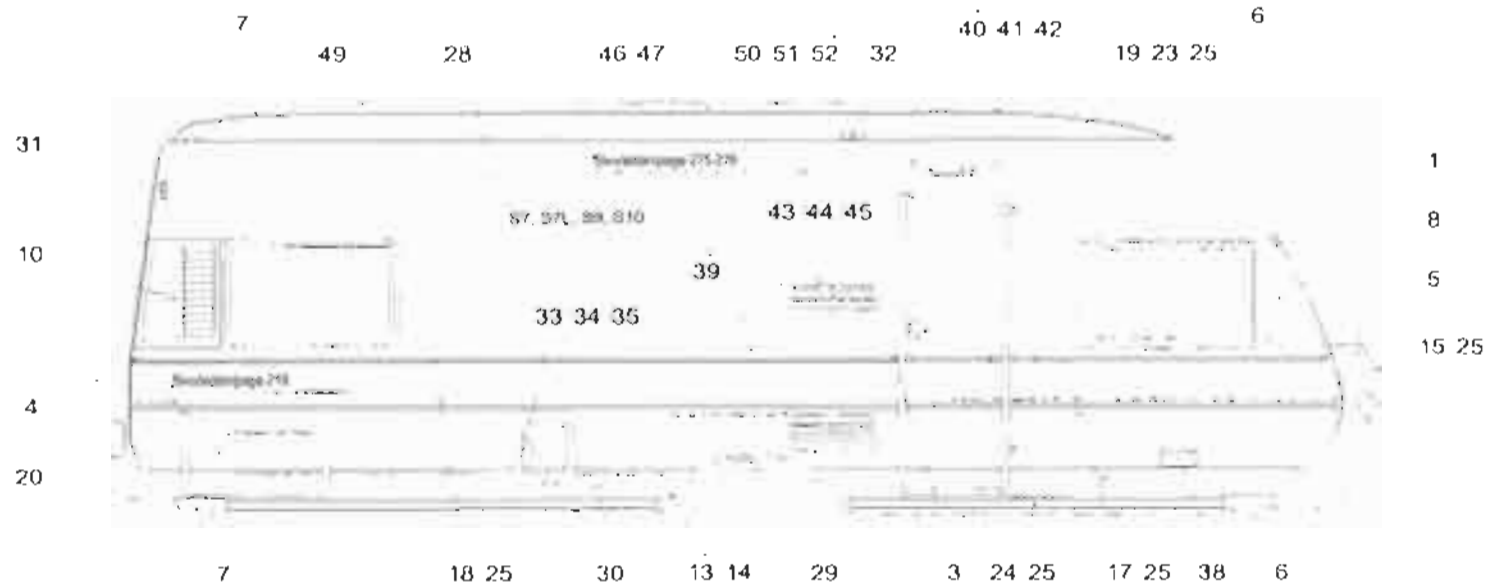

SOLIFER

Kari		Ulkopuoli S5, S5L, S7, S7L, S9, S10
Kaross	226	Exteriör S5, S5L, S7, S7L, S9, S10
Body		Exterior S5, S5L, S7, S7L, S9, S10

2000

X=vakio/ standard M=Menu-varustelu maasta riippuen/ Menu-utrustning beroende på land/ Menu-equipment due to country specification

Kuva Pos. Fig.	Varaosan nro Def.nr. Part.nr.	Kuvaus Benämning Description													Huom. Anm. Obs.
			Color 500	Color 530	S1	S2	S2L	S2R	S3	S7L	S9	S10	S1C		
26	0093-0035	Avattava ikkuna 900x550				X	X		X	X	X	X			
27	0093-0049	Avattava ikkuna 475x240				X	X		X	X	X	X			
28	9402-3832	Al-nauha 0.5x1323 yläpellii				X	X		X	X	X	X			
29	9402-3833	Al-nauha 0.5x800 alapellii				X	X		X	X	X	X			
30	9001-7305	Sivuvälo keltainen				X	X		X	X	X	X			
31	9000-8654	Äärivälo pun/valk.				X	X		X	X	X	X			
32	0090-0166	Etuleittavälo valk.				X	X		X	X	X	X			
33	3816-8698	Kasetti WC:n luukku				X	X		X	X	X	X			
34	9001-7589	Lukkosylinteri				X	X		X	X	X	X			
35	9001-7590	Avain				X	X		X	X	X	X			
36	9001-7391	Vesitankin kaulus							M	M	M	M			
37	311549	Vesitankin korkki							M	M	M	M			
38	9000-6901	Kaasunulosotto				M	M		M	M	M	M			
39	503460	Etuleittäpalvelu				M	M		M	M	M	M			
40	9000-3664	Kojevastake MPK				X	X		X	X	X	X			
41	2710-4306	Kojevastakkeen kansi				X	X		X	X	X	X			
42	2710-3925	Kojevastakkeen kannen tappi				X	X		X	X	X	X			
43	9001-2856	Ilmanvaihtosäleikkö				X	X		X	X	X	X			
44	9001-2855	Asennuskehys				X	X		X	X	X	X			
45	9001-2857	Talvisuoja				X	X		X	X	X	X			
46	0092-0049	Tv.antennimasto ilman joht.				X	X		X	X	X	X			
47	205516	Elektroninen TV-antenni				M	M		M	M	M	M			
48	0097-0013	Kattoventtiii Veneta				X	X		X	X	X				
49	0097-0024	E-Lux venttiii				X	X		X	X	X	X			
50	0097-0025	Kattoluukku MPK 403 VN											X		
51	9001-8096	Kattoluukku 400x400				X	X		X	X	X				
52	9002-4373	Kattoikkuna HEK12				M	M		M	M	M	M			

Huom./ Anm./Obs.

SOLIFER

Scat	Ultrapanel S10L
Karoseri	228
Body	Exterior S10L
	Exterior S10L

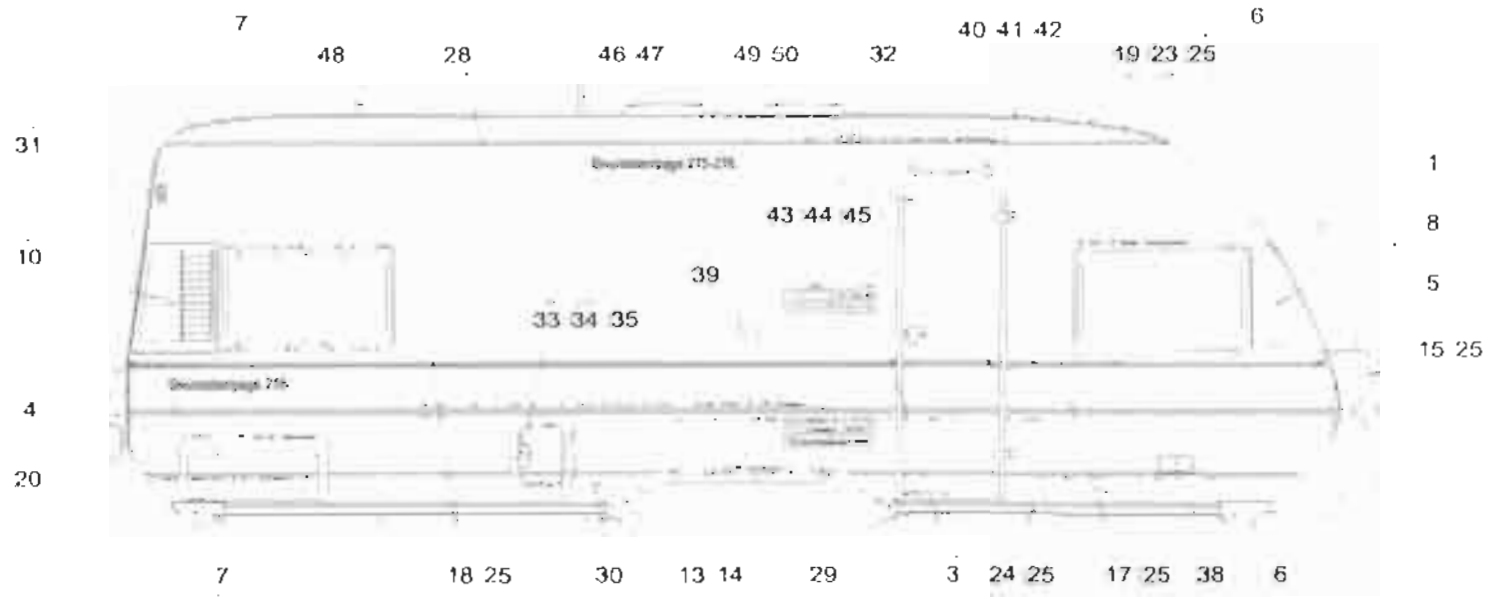
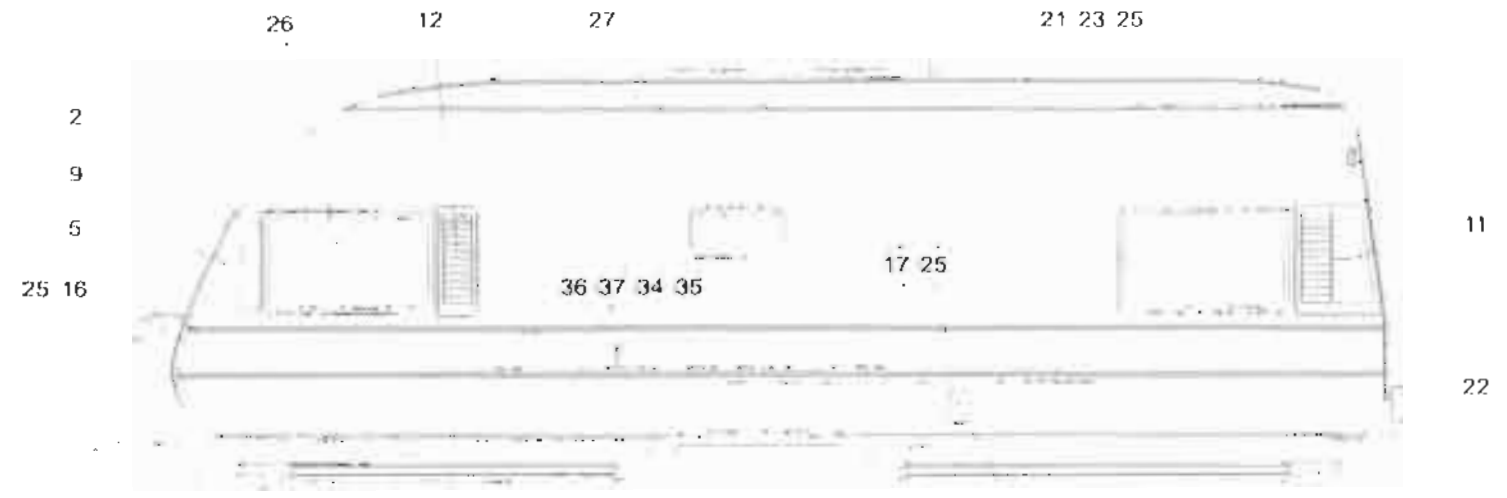

SOLIFERKori
Kaross
Body

228

Ulkopuoli S10L
Exteriör S10L
Exterior S10L

X-vakio/ standard M-Menu-varusteita maasta riippuen/ Menu-utrustning beroende på land/ Menu-equipment due to country specification

2000

Kuva Pos. Fig.	Varaosan nro Def.nr. Part.nr.	Kuvaus Benämning Description																		Huom. Anm. Obs.
1	9201-7285	Päätekappale etuyläkulma oik	Övre H hörnstycke	Corner piece R																X
2	9201-7286	Päätekappale etuyläkulma vas	Övre V hörnstycke	Corner piece L																X
3	9000-3784	Päätekappale seinälista oik.	Ändstycke H	End piece R																X
4	9000-3785	Päätekappale seinälista vas.	Ändstycke V	End piece L																X
5	9500-3772	Päätekappale koristelista	Ändstycke	End piece																X
6	9202-3892	Päätekappale helmalista oik.	Gångjärnslistens ändstycke H	End piece for edge list R																X
7	9002-3893	Päätekappale helmalista vas.	Gångjärnslistens ändstycke V	End piece for edge list L																X
8	9202-4544	Etukolmio oik. harmaa	Front sida trekant H	Front side triangle R																X
9	9002-4547	Etukolmio vas. harmaa	Front sida trekant V	Front side triangle L																X
10	9202-4537	Tuuletussäleikkö taka oik. harmaa	Ventilerings galler H	Ventilations louvre R																X
11	9002-4539	Tuuletussäleikkö taka vas. harmaa	Ventilerings galler V	Ventilations louvre L																X
12	9002-4549	Tuuletussäleikkö vas. harmaa	Ventilerings galler V	Ventilations louvre L																X
13	0025-7240	Lokasuoja	Hjulhus	Mud guard																X
14	9202-4511	Lokasuojan kehys harmaa 2-aks	Hjulhuslist	Mud guard frame																X
15	9301-6973	Taivutettu kiinnitys lista oik.	Koffertens sidolist böjd H	Fixing list bended R																X
16	9301-6974	Taivutettu kiinnitys lista vas.	Koffertens sidolist böjd V	Fixing list bended L																X
17	9000-3411	Koristelista	Dekorationslist	Decoration list																X
18	9000-6329	Seinälista	Vägglist	Side wall list																X
19	9001-5697	Telttalista	Tältlist	Awning list																X
20	9301-6367	Taka telttalista L=1300mm, taiv.	Bak tältlist, böjd	Rear awning list, bended																X
21	9000-3407	Kulmalista	Hörnlist	Corner list																X
22	9301-6368	Taka kulmalista L=1300mm, taiv.	Bak hörnlist, böjd	Rear corner list, bended																X
23	9400-9445	Telttalistan kumiprofiili	Gummiprofil under tältlist	Rubber profile for awning list																X
24	9302-4674	Helmaprofiili 92 mm harmaa	Nedre plastlist	Edge list																X
25	9402-4676	Keskilista harmaa	Ilyfnadslst	Middle list																X

Huom./ Anm./Obs.

SOLIFER

Kan		Libroport 510X
Marok	22R	Exterior 510R
Body		Exterior 510L

000

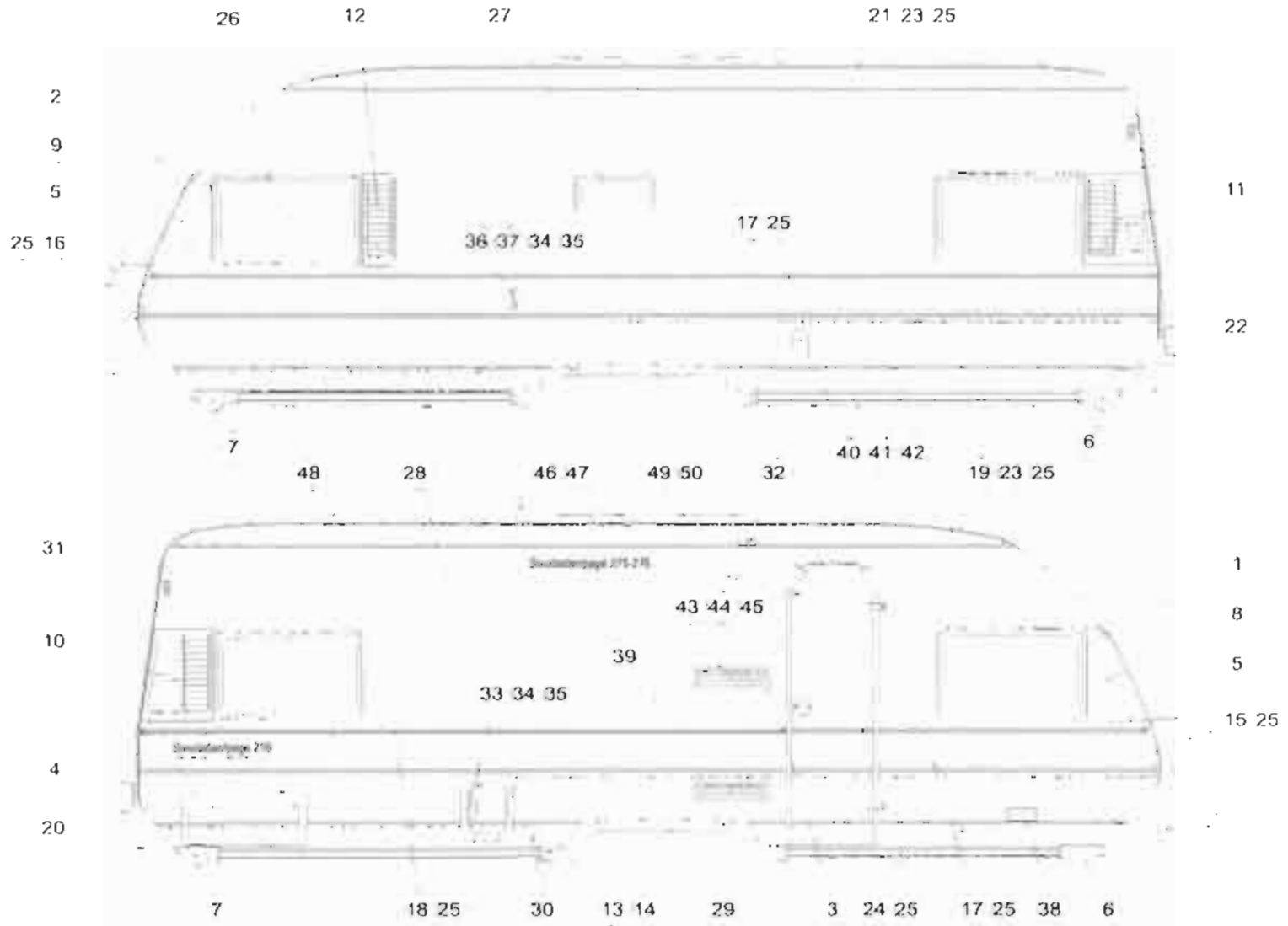

SOLIFER

Kori		Ulkopuoli S10L
Kaross	228	Exteriör S10L
Body		Exterior S10L

2000

X vakio/ standard M Menu-varusteita maasta riippuen/ Menu-utrustning beroende på land/ Menu-equipment due to country specification

Kuva Pos. Fig.	Varaosan Def.nr. Part.nr.	Kuvaus Benämning Description																	Huom. Anm. Obs.
26	0093-0035	Avattava ikkuna 900x550	Öppningsbart sidofönster	Opening window															x
27	0093-0049	Avattava ikkuna 475x240	Öppningsbart sidofönster 475*240	Opening window 475*240															x
28	9402-3832	Al-nauha 0.5x1323 yläpelti	Övre sidoplat 0,5x1323	Upper al-plate 0,5x1323															x
29	9402-3833	Al-nauha 0.5x800 alapelti	Nedre sidoplat 0,5x800	Lower al-plate 0,5x800															x
30	9001-7305	Sivuvälo keltainen	Sidomarkeringslampa	Sidewall light															x
31	9000-8654	Äärivälo pun/valk.	Breddmarkeringslampa röd/vit	Side marker light red/white															x
32	0090-0166	Etuleiftavälo valk.	Ytterlampa	Awning light															x
33	3816-8698	Kasetti WC:n luukku	Kasettoalett lucka	Casettoilet cover															x
34	9001-7589	Lukkosylinteri	Låscylinder	Lockcylinder															x
35	9001-7590	Avain	Nyckel	Key															x
36	9001-7391	Vesitankin kaulus	Flänsning	Flanging															M
37	311549	Vesitankin korkki	Kork	Plug															M
38	9000-6901	Kaasunulosotto	Gasuttag	Gas outlet whaft															M
39	503460	Etuleiftapalvelu	Tält service	Awning service															M
40	9000-3664	Kojevastake MPK	230V intag	Contact box															x
41	2710-4306	Kojevastakkeen kansli	Lock för 230V intag	Cover for contact box															x
42	2710-3925	Kojevastakkeen kannen tappi	Gångjärnspinne för lock	Pin for 230V cover															x
43	9001-2856	Ilmanvaihtosäleikkö	Kylskåpsgaller	Ventilation louvre															x
44	9001-2855	Asennuskehys	Monterings ram	Assembly frame															x
45	9001-2857	Talvisuoja	Vinterlock	Winter cover															x
46	0092-0049	Tv.antennimasto ilman joht.	TV-antengenomföring	TV-antenn-bracket without cabel															M
47	205516	Elektroninen TV-antenni	Elektronisk TV-antenn	Elektronic TV-antenna															x
48	0097-0024	E-Lux venttili	E-Lux ventfil	E-Lux ventfil															x
49	0097-0025	Kattovalkku MPK 403 VN	Taklucka	Roof-light															x
50	9002-4373	Kattoikkuna HEK12	Takfönster	Roof-window															M

Huom./ Anm./ Obs.

SOLIFER

Run
Keros
Body

240

Ulkopuolen p.,Ulkopuolen p.,Ulkopuolen p.
ndtycken str,ndtyg
Exit piece outside

1000

1

2

3

4

5

6

7

8

9



10

11

12

13

14

15

16

17

18

19



SOLIFERKori
Kaross
Body

240

Ulkopuolen pätekkappaleet
Ändstycken ulvändig
End piece outside

X=vakio/ standard

M=Menu-varustelu maasta riippuen/ Menu-utrustning beroende på land/ Menu-equipment due to country specification

2000

Kuva Pos. Fig.	Varaosan nro Det.nr. Part.nr.	Kuvaus Benämning Description	Ändstycke End piece	Ändstycke End piece	900	900	904	905	907	907	907	909	910	910	Huom. Anm. Obs.
1	9000-3753	Päättekpl räystäslista vas.	Ändstycke dropplist V	End piece, drop list L	x	x									
2	9000-3752	Päättekpl räystäslista oik.	Ändstycke dropplist H	End piece, drop list R	x	x									
3	9000-3785	Päättekpl seinälista vas.	Vägglistens ändstycke V	End piece L	x	x	x	x	x	x	x	x	x	x	
4	9000-3784	Päättekpl seinälista oik.	Vägglistens ändstycke H	End piece R	x	x	x	x	x	x	x	x	x	x	
5	9500-3772	Päättekpl koristelista	Dekorationslistens ändstycke	End piece	x	x	x	x	x	x	x	x	x	x	
6	9001-5254	Päättekpl räystäslista taka vas.	Ändstycke dropplist V	End piece, drop list L			x	x	x	x	x	x	x	x	
7	9001-5255	Päättekpl räystäslista taka oik.	Ändstycke dropplist H	End piece, drop list R			x	x	x	x	x	x	x	x	
8	9201-7285	Päättekpl etuyläkuima oik.	Ändstycke H	End piece R			x	x	x	x	x	x	x	x	
9	9201-7286	Päättekpl etuyläkuima vas.	Ändstycke V	End piece L			x	x	x	x	x	x	x	x	
10	9300-3773	Päättekpl feittalista oik.	Övre H hörnstycke	Corner piece R	x	x									
11	9300-3774	Päättekpl kulmalista vas.	Övre V hörnstycke	Corner piece L	x	x									
12	9002-4516	Päättekpl helmalista etu vas.	V nedre främre ändstycke	End piece for edge list L	x	x									
13	9302-4515	Päättekpl helmalista etu oik.	H nedre främre ändstycke	End piece for edge list R	x	x									
14	9302-4519	Päättekpl helmalista taka oik.	H nedre bakre ändstycke	End piece for edge list R	x	x									
15	9002-4520	Päättekpl helmalista taka vas.	V nedre bakre ändstycke	End piece for edge list L	x	x									
16	9002-3893	Päättekpl helmalista vas.	Gångjärnslistens ändstycke V	End piece for edge list L			x	x	x	x	x	x	x	x	
17	9202-3892	Päättekpl helmalista oik.	Gångjärnslistens ändstycke H	End piece for edge list R			x	x	x	x	x	x	x	x	
18	9300-3775	Päättekpl kpk. kiinnityslista oik.	Nedre H hörnstycke H	Corner piece R	x	x									
19	9000-3776	Päättekpl kpk. kiinnityslista vas.	Nedre V hörnstycke V	Corner piece L	x	x									

Huom./ Anm./Obs.











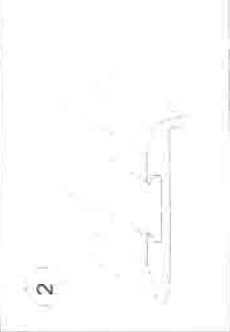



Kod
Kaross
Body

245

Aluminiolistat
Aluminiumlister
Lists of aluminium

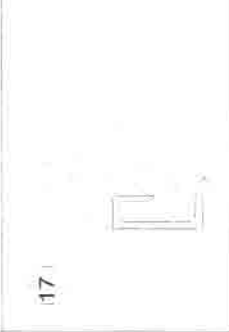
2000

 (1)	 (2)	 (3)	 (4)	 (5)
 (6)	 (7)	 (9)	 (11)	 (12)
 (16)	 (17)	 (19)	 (20)	



Kori
Kaross 245 Alumiinilista
Body Aluminiumlister
Lists of aluminium

2000

X=vakio/ standard M=Menu-varustelu maasta riippuen/ Menu-utrustning beroende på land/ Menu-equipment due to country specification

Kuva Pos. Fig.	Varaosanro Del.nr. Part.nr.	Kuvaus Benämning Description																	Huom. Anm. Obs.
1	9000-3411	Koristelista, L=6100	Dekorationslist	Decoration list	x	x	x	x	x	x	x	x	x	x	x	x	x		
2	9001-4388	Päätylista, L=2150	Ändlist	End list	x	x													
3	9000-6329	Seinälista, L=4456	Vägglist	Side wall list	x	x	x	x	x	x	x	x	x	x	x	x	x		
4	9000-3408	Telttalista, L=6200	Tältlist	Awning list	x	x													
5	9000-3407	Kulmalista, L=6300	Hörnlist	Corner list	x	x	x	x	x	x	x	x	x	x	x	x	x		
6	9001-5697	Telttalista, L=6300	Tältlist	Awning list			x	x	x	x	x	x	x	x	x	x	x		
7	9002-2956	Räystälista, L=2410	Dropplis	Drop list for outer door			x	x	x	x	x	x	x	x	x	x	x		
9	9000-3820	Räystälista, L=2099	Dropplis	Drop list for outer door	x	x													
11	9002-2958	Saunalista, L=2470	Flallist	Al-joint list	x	x	x	x	x	x	x	x	x	x	x	x	x		
12	9400-4010	Saranalista L=2040	Gångjärnlist	Hinge profil	x	x													
16	9400-3867	Saranalista k.p.k., L=1520	Gångjärnlist koffert	Hinge profil gasbox	x	x													
17	9002-2959	Takavalokot. kiinn. lista, L=2410	Profil för fastsättning av ljusramp	Profil for tail light box	x	x	x	x	x	x	x	x	x	x	x	x	x		
19	0053-2000	TV-hyllyn kannatinlista	Koffertens sidolist	Fixing list			x												
20	0053-2009	Al-profiili leikkulouta U 18x20x1	Al prof	Al list	x	x	x	x	x	x	x	x	x	x	x	x	x		

Huom./ Anm./Obs.

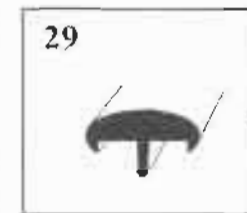
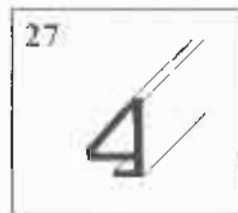
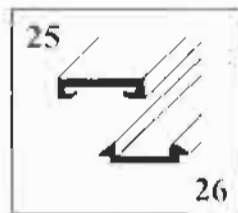
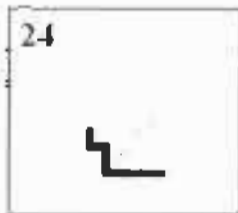
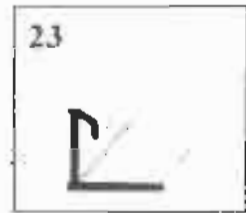
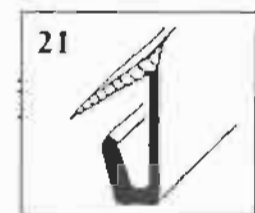
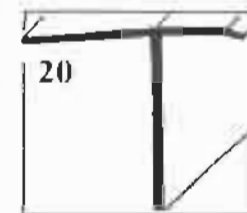
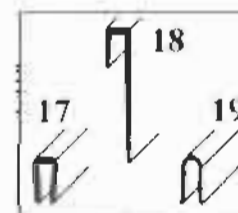
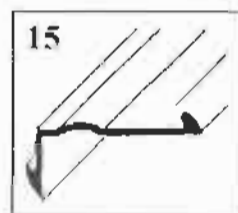
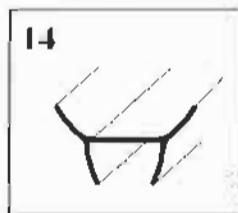
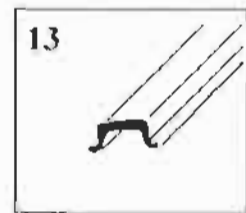
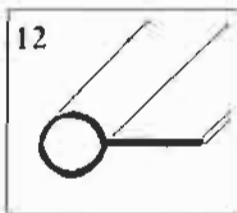
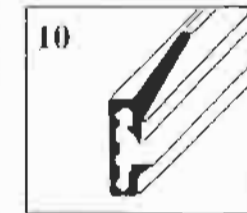
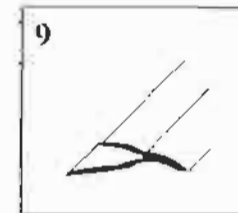
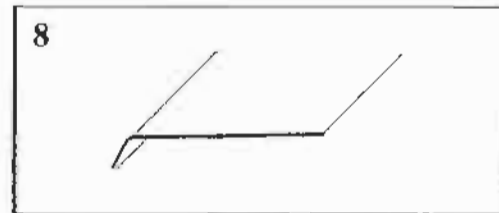
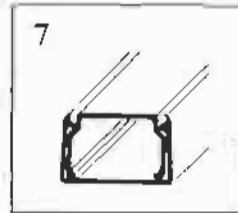
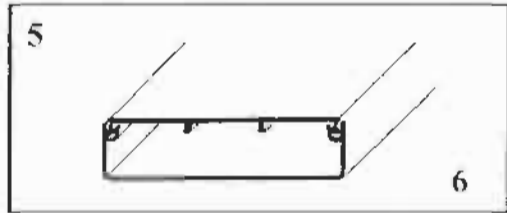
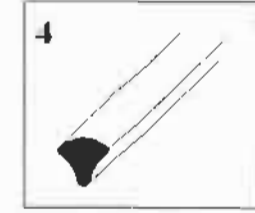
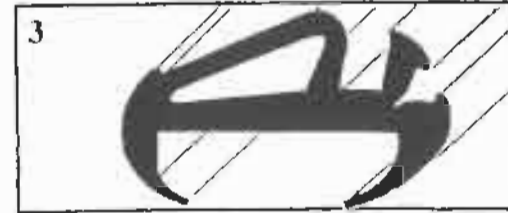
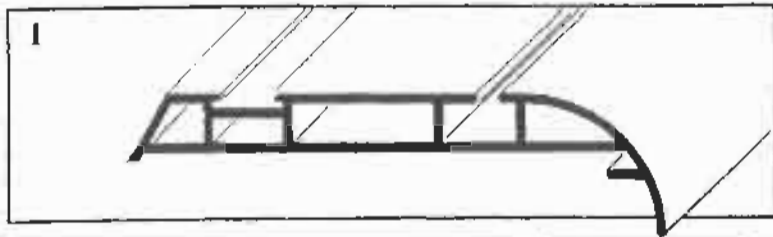



Kori
Kaross 250 Kumi- ja muovilistat
Body Gummilister och Plastlister
Lists of Rubber / Plastic

2000

X=vakio/ standard M=Menu-varustelu maasta riippuen/ Menu-utrustning beroende på land/ Menu-equipment due to country specification

Kuva Pos. Fig.	Varaosan nro Det.nr. Part.nr.	Kuvaus Benämning Description																		Huom. Anm. Obs.
1	9302-4674	Helmaprof. 92 mm harmaa	Nedre plastlist grå	Edge list grey																
2	9302-4679	Helmaprof. 66 mm harmaa	Nedre plastlist grå	Edge list grey	x	x														
3	0046-8190	Klinterän ikkunan kehyslista	Fast, fönsters tätninglist	Draught exluber window	x	x	x	x	x	x	x	x	x	x	x	x	x	x	x	
4	0063-3030	Ikkunan kiljanauha T 10/11	Killist för fönster T 10/11	Wedge list for window	x	x	x	x	x	x	x	x	x	x	x	x	x	x	x	
5	0063-4046	Sähkölista XTL 265/266 V	EL-list XTL 265/266 V	EL.lath XTL 265/266 V	x	x	x	x	x	x	x	x	x	x	x	x	x	x	x	
6	0063-4047	Sähkölista XTL 165/266 V	EL-list XTL 165/266 V	EL.lath XTL 165/266 V	x	x	x	x	x	x	x	x	x	x	x	x	x	x	x	
7	0063-4049	Sähkölista XTL 225/266 V	EL-list XTL 225/266 V	EL.lath XTL 225/266 V	x	x	x	x	x	x	x	x	x	x	x	x	x	x	x	
8	0048-6380	Tippalista kuivauskaaplin	Dropplis till torkskåp	Drop list for kitchen cupboard	x	x	x	x	x	x	x	x	x	x	x	x	x	x	x	
9	0063-3000	Muovilista T 129 valkea kulmalista	Plastlist T 129 vit hörnlist	Plastic list T 129 white cornerlist	x	x														
10	0045-8120	Ovitiiviste sisäp. harmaa	Dörrens tätninglist grå	Sealing list door grey	x	x	x	x	x	x	x	x	x	x	x	x	x	x	x	
11	0464-0020	Ovitiiviste ulkop. musta	Dörrekarmens tätning svart	Rubb. draught exci. black	x	x	x	x	x	x	x	x	x	x	x	x	x	x	x	
12	0049-9410	Pallonauha T-288 valk.	Täcklist vit	Plastic profil white	x	x	x	x	x	x	x	x	x	x	x	x	x	x	x	
12	9001-7536	Pallonauha T-288 ruskea	Täcklist brun	Plastic profil brown			x	x	x	x	x	x	x	x	x	x	x	x	x	
13	9402-4676	Keskilista harmaa	Ityllnadslis	Middle list	x	x	x	x	x	x	x	x	x	x	x	x	x	x	x	
14	9300-7264	H-profil	H-profil	H-profil			x													
15	9400-9445	Telttaistan kumiprof. kitattu	Gummiprofil under hörnlist	Rubber profile for awning list	x	x	x	x	x	x	x	x	x	x	x	x	x	x	x	
16	0065-3006	K.p.kol. kannen tiiviste	Tätninglist koffertöppning	Packning list (gas bott. box cap)	x	x	x	x	x	x	x	x	x	x	x	x	x	x	x	
17	860423	U-profil, pehmeä	Plastprofil, mjuk	Plastprofil, soft	x	x	x	x	x	x	x	x	x	x	x	x	x	x	x	
18	0063-4006	J-lista T-148K ruskea muovi	J-list T148K brun plast	J-list T148K brun plast	x	x	x	x	x	x	x	x	x	x	x	x	x	x	x	
19	0091-0356	U-profil, kova L=2050 mm	Plastprofil, hård	Plastprofil, hard	x	x	x	x	x	x	x	x	x	x	x	x	x	x	x	
20	9002-3169	Saumaprof. etu/takap. L=2400 mm	Plastprofil	Plastprofil	x	x	x	x	x	x	x	x	x	x	x	x	x	x	x	
21	0048-3750	Saumaprof. suhkuallaan	Plast-profil wc	Plastic profile for shower bas.	x	x	x	x	x	x	x	x	x	x	x	x	x	x	x	
22	0041-9480	Pöytälista ruskea	Bordlist brun	Table list brown	x															
23	300108	Pöydän kiinnityslista	Bordlist, fastning	Table list, fixing	x	x	x	x	x	x	x	x	x	x	x	x	x	x	x	
24	300420	Pöydän vastalista	Bordlist hämsko	Table list counterpart	x	x	x	x	x	x	x	x	x	x	x	x	x	x	x	
25	0063-4031	Kattoilist T 125 kansi, L=4400	Takprofil T 125 lock	Ceiling profile T 125 cover	x	x	x	x	x	x	x	x	x	x	x	x	x	x	x	
26	0063-4033	Kattoilista T 125 pohja, L=4400	Takprofil T 125 botten	Ceiling profile T 125 bottom	x	x	x	x	x	x	x	x	x	x	x	x	x	x	x	
27	0043-0640	Muovi profiili T 347	Plastprofil T - 347	Plastic profile T - 347	x	x	x	x	x	x	x	x	x	x	x	x	x	x	x	
28	9401-4193	Reunalista kalusteisiin	Plastprofil	Plastic list	x	x	x	x	x	x	x	x	x	x	x	x	x	x	x	
29	9001-6019	Reunalista kalusteisiin	Plastprofil	Plastic list	x	x	x	x	x	x	x	x	x	x	x	x	x	x	x	

Huom. / Anm. / Obs.

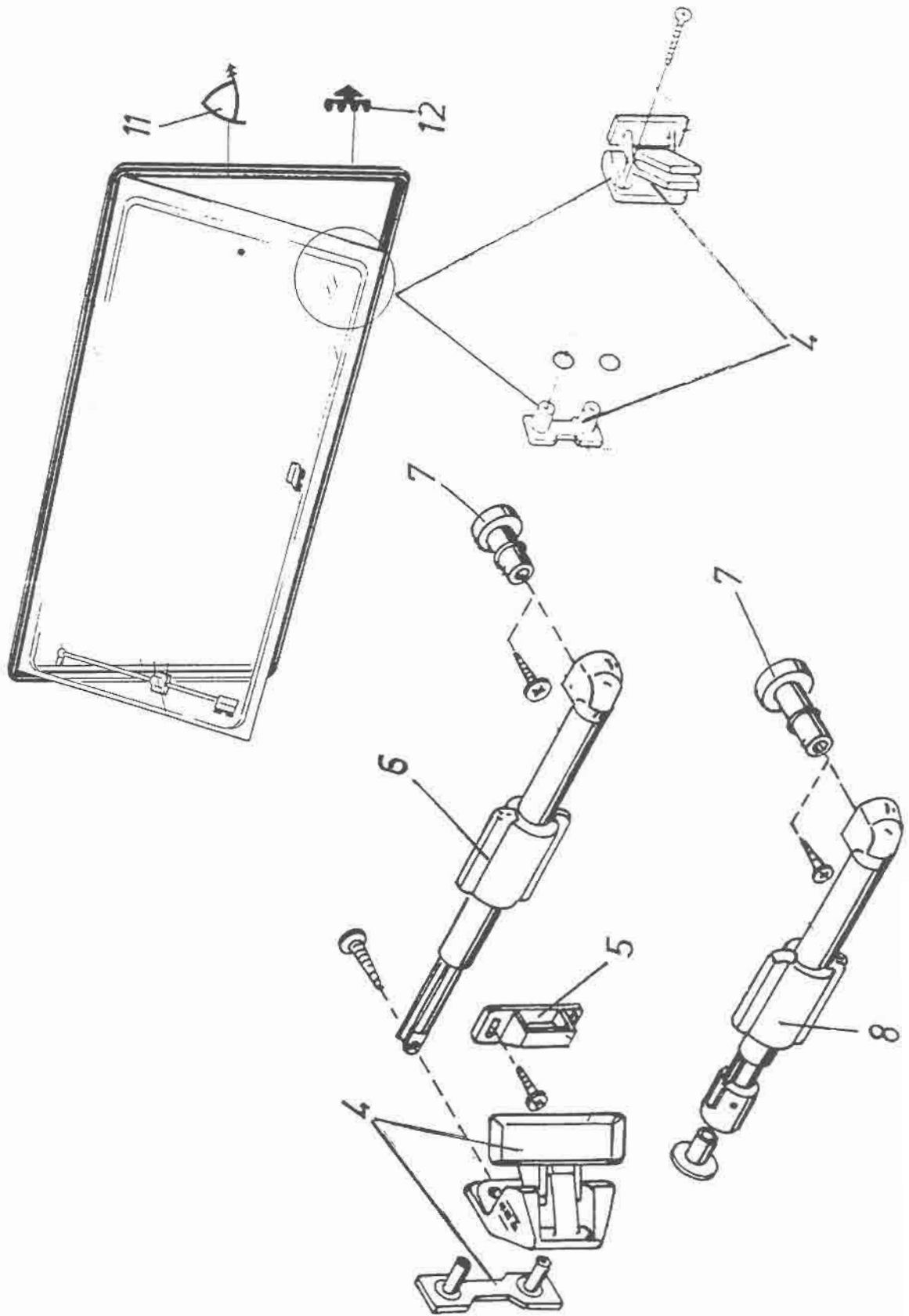



Kori
Kaross
Body

255

Ikkunan osat
Fönsterdelar
Windows parts

X=vakio/ standard M=Menu-varustelu maasta riippuen/ Menu-utrustning beroende på land/ Menu-equipment due to country specification

2000

Kuva Pos. Fig.	Varaosan nro Def.nr. Part.nr.	Kuvaus Benämning Description																		Huom. Anm. Obs.
4	2714-3024	Lukituskappale musta	Låsbeslag	Lock for window	x	x	x	x	x	x	x	x	x	x	x	x	x	x	x	
5	2714-2944	Ikkunahaan vastakappale	Motslycke	Opposite part for window lock	x	x	x	x	x	x	x	x	x	x	x	x	x	x	x	
6	2714-2938	Ikkunateleskooppi, 230mm	Teleskop	Window telescopic	x	x	x	x	x	x	x	x	x	x	x	x	x	x	x	
7	2714-2931	Nivelinuppiruuví ikk.telek. va	Fästknopp	Holding device (window telescop)	x	x	x	x	x	x	x	x	x	x	x	x	x	x	x	
8	2714-2945	Ikkunateleskooppi, 130 mm	Teleskop köksfönster	Window telescopic	x	x	x	x	x	x	x	x	x	x	x	x	x	x	x	
11	9001-5017	Tiivistelista	Tätninglist	Gasket list	x	x	x	x	x	x	x	x	x	x	x	x	x	x	x	
12	9001-5018	Tiivistelista	Tätninglist	Gasket list	x	x	x	x	x	x	x	x	x	x	x	x	x	x	x	

Huom./ Anm./Obs.

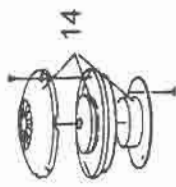
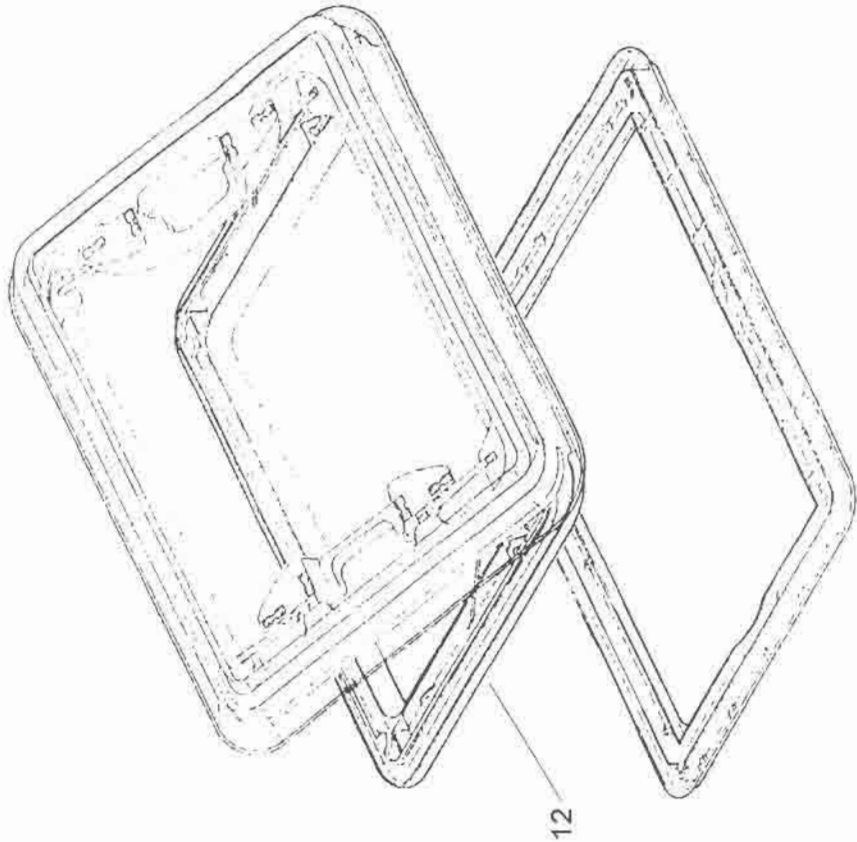
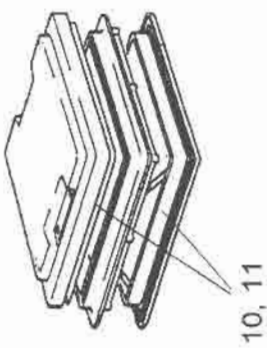
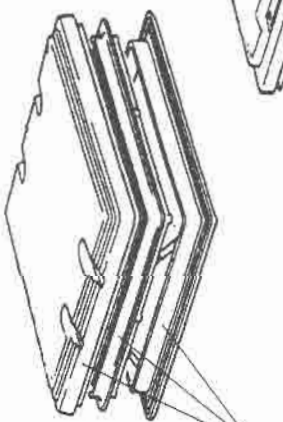
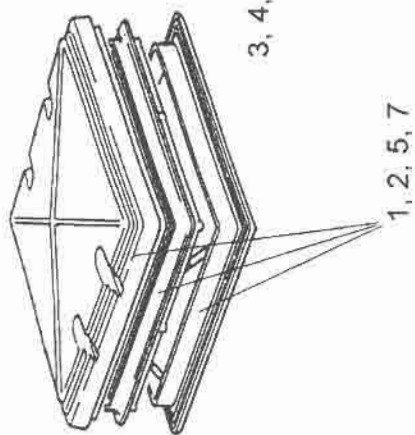

SOLIFERKori
Kaross
Body

260

Kattoluukku ja kattoventiili
Tackluckor och takventiler
Roof-light and roof-ventilators

X=vakio/ standard M=Menu-varustelu maasta riippuen/ Menu-utrustning beroende på land/ Menu-equipment due to country specification

2000

Kuva Pos. Fig.	Varaosan nro Def.nr. Part.nr.	Kuvaus Benämning Description																	Huom. Anm. Obs.
1	0097-0025	Kattoluukku 400x400 MPK paksuk.	Tacklucka kpl exkl myggnät	Roof-light exkl.mosquito net															
2	2714-2982	Hyttysverkko 400x400 MPK paksuk.	Myggnät inkl. gågjärn	Mosquito net															
3	9001-8096	Kattoluukku, 400x400 MPK	Tacklucka, 400x400	Roof-light	x	x	x	x	x	x	x	x	x	x					
4	2714-3004	Hyttysverkko 400x400 MPK	Myggnät inkl. gågjärn	Mosquito net	x	x	x	x	x	x	x	x	x	x					
5	9000-3107	Kehys + rullaverho 400*400 MPK	Ram+rullgardiner	Frame+rolling blind															
6	9001-2401	Pimennysverho 400*400 MPK	Rullgardiner	Rolling blind	x	x	x	x	x	x	x	x	x	x					
7	2714-3014	Yläkupusarja 400x400 MPK	Kupol sats	Cap set	x	x	x	x	x	x	x	x	x	x					
10	9000-3661	Kattoluukku, 280x280 MPK	Tacklucka, 280x280	Roof-light	x	x	x												
11	2714-3005	Hyttysverkko, 280x280 MPK	Myggnät inkl. gågjärn	Mosquito net	x	x	x												
12	9002-4373	Kattoikkuna HEK12	Takfönster	Roof-window			M	M	M	M	M	M	M	M	M	M	M		
14	0097-0024	E-lux ventiili, ei suljettava, Electrolux	E-luxventil kpl, stängbar	E-lux ventilator, apenable	x	x	x	x	x	x	x	x	x	x	x	x			
15	0097-0013	Kattoventiili, Veneta	Takventil	Ventilator	x	x	x	x	x	x	x	x							

Huom./ Anm./Obs.

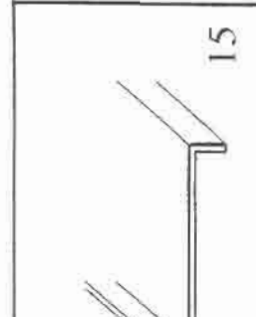
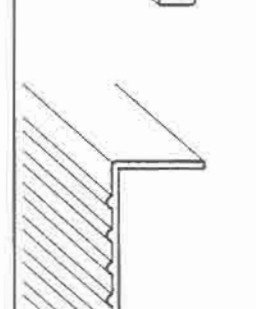
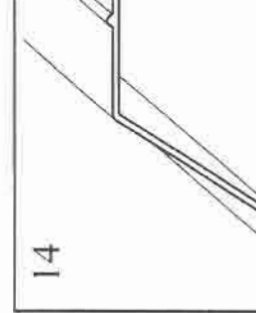
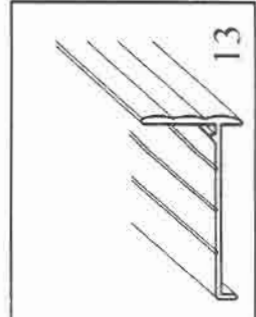
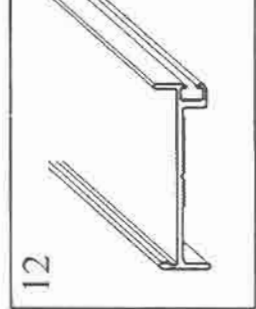
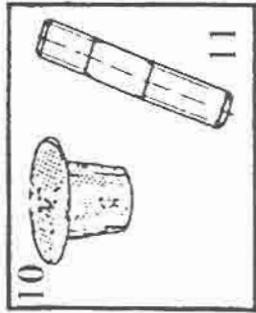
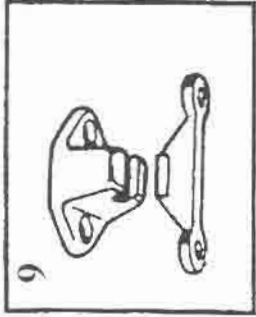
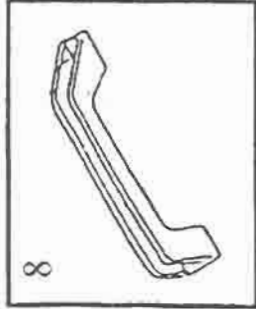
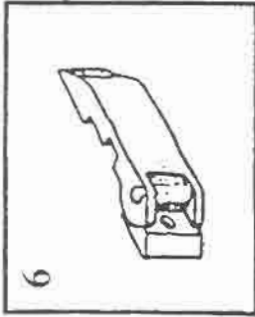
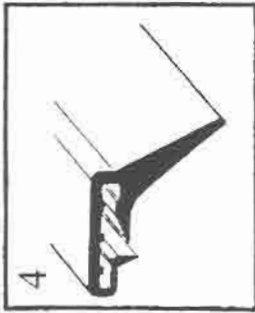
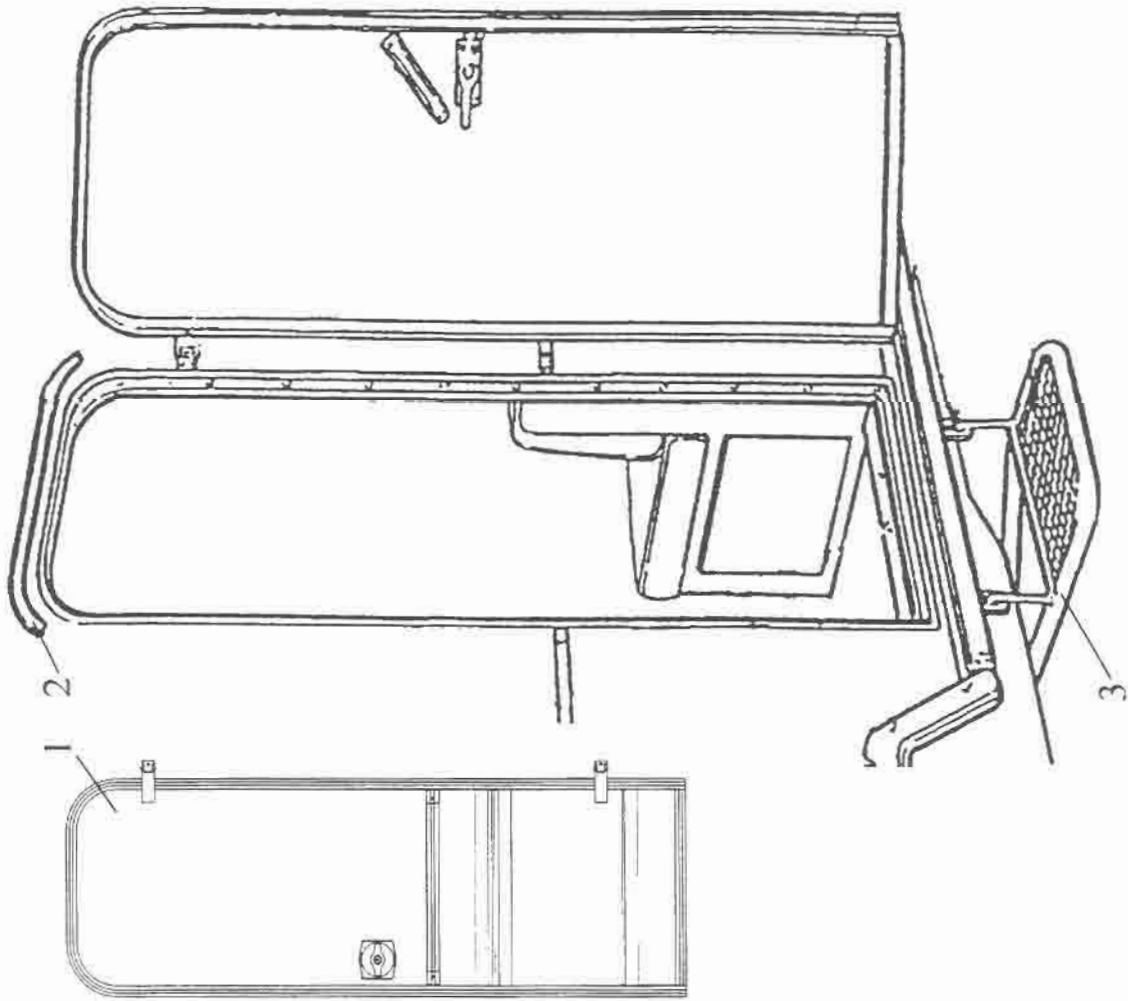

SOLIFER

Kori	275	Ulko-ovi
Kaross		Ytterdörr
Body		Exterior door

2000

X- vakio/ standard M-Menu-varustelu maasta riippuen/ Menu-utrustning beroende på land/ Menu-equipment due to country specification

Kuva Pos. Fig.	Varaos nro Def.nr. Part.nr.	Kuvaus Benämning Description																		Huom. Anm. Obs.
			Col 500	Col 530	54	55	56	57	58	59	60	61	62	63	64	65	66	67	68	
1	2711-0087	Ulko-ovi oik. käsinen	Ytterdörr högerhändig	Outdoor right-handed	x	x	x	x	x	x	x	x	x	x	x	x	x	x	x	
2	9500-3414	Räystäalusta valk.	Dropplista, vit	Drop list for outdoor, white	x	x	x	x	x	x	x	x	x	x	x	x	x	x	x	
3	9300-9700	Irtoporras	Hängtrappa	Step	x	x	x	x	x	x	x	x	x	x	x	x	x	x	x	
4	0045-8120	Ovitiiviste sisäp. harmaa	Dörrens tätningslist grå	Sealing list, Door grey	x	x	x	x	x	x	x	x	x	x	x	x	x	x	x	
5	0464-0020	Oven karmitiiviste, kumi musta	Dörrkarmens tätning svart	Sealing list, Door black	x	x	x	x	x	x	x	x	x	x	x	x	x	x	x	
6	0093-0011	Ulko-oven sarana	Ytterdörrens gångjärn	Hinge	x	x	x	x	x	x	x	x	x	x	x	x	x	x	x	
7	207061	Ulko-oven lukko, oik	Dörrlås H	Outer door lock R	x	x	x	x	x	x	x	x	x	x	x	x	x	x	x	
7	9001-7589	Lukkosylinteri	Dörrlås	Doorlock cylinder	x	x	x	x	x	x	x	x	x	x	x	x	x	x	x	1)
7	9001-7590	Avain lukkosylinteriin	Nyckel	Key	x	x	x	x	x	x	x	x	x	x	x	x	x	x	x	1)
8	1729-1203	Vedin spv muov. musta, ulko-ovi	Gavelhandtag svart	Grab handle black	x	x	x	x	x	x	x	x	x	x	x	x	x	x	x	
9	9000-8556	Ulko-oven pidin	Dörrhållare kpl.	Holder for outer door cpl.	x	x	x	x	x	x	x	x	x	x	x	x	x	x	x	
10	0072-1003	Hylsymutteri, 6mm	Hattmutter	Hat nut	x	x	x	x	x	x	x	x	x	x	x	x	x	x	x	
11	0071-1041	Ruuvi, M6x40	Pinn skruv	Stud bolt	x	x	x	x	x	x	x	x	x	x	x	x	x	x	x	
12	9200-2807	Oven karmilista L=3813	Dörrens karmlist	Al list for doorway	x	x	x	x	x	x	x	x	x	x	x	x	x	x	x	
13	0027-2720	Oven kehystilista L=3810	Dörrarm	Al list for door	x	x	x	x	x	x	x	x	x	x	x	x	x	x	x	
14	9001-3508	Kynnyskotelo L=626	Tröskellist	Threshold list	x	x	x	x	x	x	x	x	x	x	x	x	x	x	x	
15	9400-9665	Kynnysen pohjallisto L=552	Tröskellist	Threshold list	x	x	x	x	x	x	x	x	x	x	x	x	x	x	x	

Huom./ Anm./Obs. 1) Avaimen numero / Nyckel nummer / Key number

SOLIFER

Kor
Kame
Body

200

Typplanat
Erstein
Erstein

200

1

[Handwritten signature]

2

[Handwritten signature]

3

[Handwritten signature]

6

[Handwritten signature]

19

[Handwritten signature] 20

19

[Handwritten signature] 20

5

[Handwritten signature]

9

[Handwritten signature]

11

[Handwritten signature]

11

[Handwritten signature]

13

[Handwritten signature]

15

[Handwritten signature]

15

[Handwritten signature]

17

[Handwritten signature]

4

[Handwritten signature]

7

[Handwritten signature]

8

[Handwritten signature]

10

12

12

14

16

21

22

16

23

24

18

[Handwritten signature]



Kori
Kaross 290
Body

Tyypitarrat
Emblem
Emblem

2000

X vakio/standard M Menu-varustelu maasta riippuen/ Menu-utrustning beroende på land/ Menu-equipment due to country specification

Kuva Pos. Fig.	Varaosan Def.nr. Part.nr.	Kuvaus Benämning Description																		Huom. Anm. Obs.
			Emblem 500	Emblem 530	S4	S5	S5+	S7	S7+	S9	S10	S10+	S12							
1	9402-5693	Tarra "päätty 2000"	Dekal "gavel 2000"	Decal "end 2000"	x	x	x	x	x	x	x	x	x	x	x					
2	9402-5691	Tarra "sivu 2000" S-logo	Dekal "sida 2000" S-logo	Decal "side 2000" S-logo	x	x	x	x	x	x	x	x	x	x	x					
3	9402-5692	Tarra "sivu 2000" Solifer	Dekal "sida 2000" Solifer	Decal "side 2000" Solifer	x	x	x	x	x	x	x	x	x	x	x					
4	9402-5690	Tarra "Goldie"	Dekal "Ggoldie"	Decal "Goldie"	x	x														
5	9402-5687	Tarra "Classic"	Dekal "Classic"	Decal "Classic"			x	x	x	x	x	x								1)
6	9402-5688	Tarra "Finlandia"	Dekal "Finlandia"	Decal "Finlandia"												x	x			
7	9402-5674	Tyypitarra "500"	Emblem "500"	Emblem "500"	x															
8	9402-5675	Tyypitarra "530"	Emblem "530"	Emblem "530"		x														
9	9402-5676	Tyypitarra "S4" 110 mm	Emblem "S4" 110mm	Emblem "S4" 110mm			x													
10	9402-6057	Tyypitarra "S4" 75 mm	Emblem "S4" 75mm	Emblem "S4" 75mm			x													
11	9402-6471	Tyypitarra "S5" / "S5+" 110 mm	Emblem "S5" / "S5+" 110mm	Emblem "S5" / "S5+" 110mm				x	x											2)
12	9402-6472	Tyypitarra "S5" / "S5+" 75 mm	Emblem "S5" / "S5+" 75mm	Emblem "S5" / "S5+" 75mm				x	x											2)
13	9402-5697	Tyypitarra "S5T" 110 mm	Emblem "S5T" 110mm	Emblem "S5T" 110mm						x										
14	9402-6060	Tyypitarra "S5T" 75 mm	Emblem "S5T" 75mm	Emblem "S5T" 75mm						x										
15	9402-6135	Tyypitarra "S7" / "S7+" 110 mm	Emblem "S7" / "S7+" 110mm	Emblem "S7" / "S7+" 110mm							x	x								2)
16	9402-6133	Tyypitarra "S7" / "S7+" 75 mm	Emblem "S7" / "S7+" 75mm	Emblem "S7" / "S7+" 75mm							x	x								2)
17	9402-5679	Tyypitarra "S9" 110 mm	Emblem "S9" 110mm	Emblem "S9" 110mm																
18	9402-6059	Tyypitarra "S9" 75 mm	Emblem "S9" 75mm	Emblem "S9" 75mm																
19	9402-5682	Tyypitarra "S10" / "S10+" 110 mm	Emblem "S10" / "S10+" 110mm	Emblem "S10" / "S10+" 110mm																2)
20	9402-6061	Tyypitarra "S10" / "S10+" 75 mm	Emblem "S10" / "S10+" 75mm	Emblem "S10" / "S10+" 75mm																2)
21	9402-5684	Tarra kaasupullo, oik. ylä	Dekal gasolkoff H upp	Decal gas bottle box R up			x	x	x	x	x	x	x	x	x					
22	9402-5683	Tarra kaasupullo, vas. ylä	Dekal gasolkoff V upp	Decal gas bottle box L up			x	x	x	x	x	x	x	x	x					
23	9402-5686	Tarra kaasupullo, oik. ala	Dekal gasolkoff H ned	Decal gas bottle box R down			x	x	x	x	x	x	x	x	x					
24	9402-5685	Tarra kaasupullo, vas. ala	Dekal gasolkoff V ned	Decal gas bottle box L down			x	x	x	x	x	x	x	x	x					

Huom./ Anm./Obs. 1) Ei Ruotsi / Nej Sverige / No Sweden
2) Poista "+" / Ta bort "+" / Remove "+"

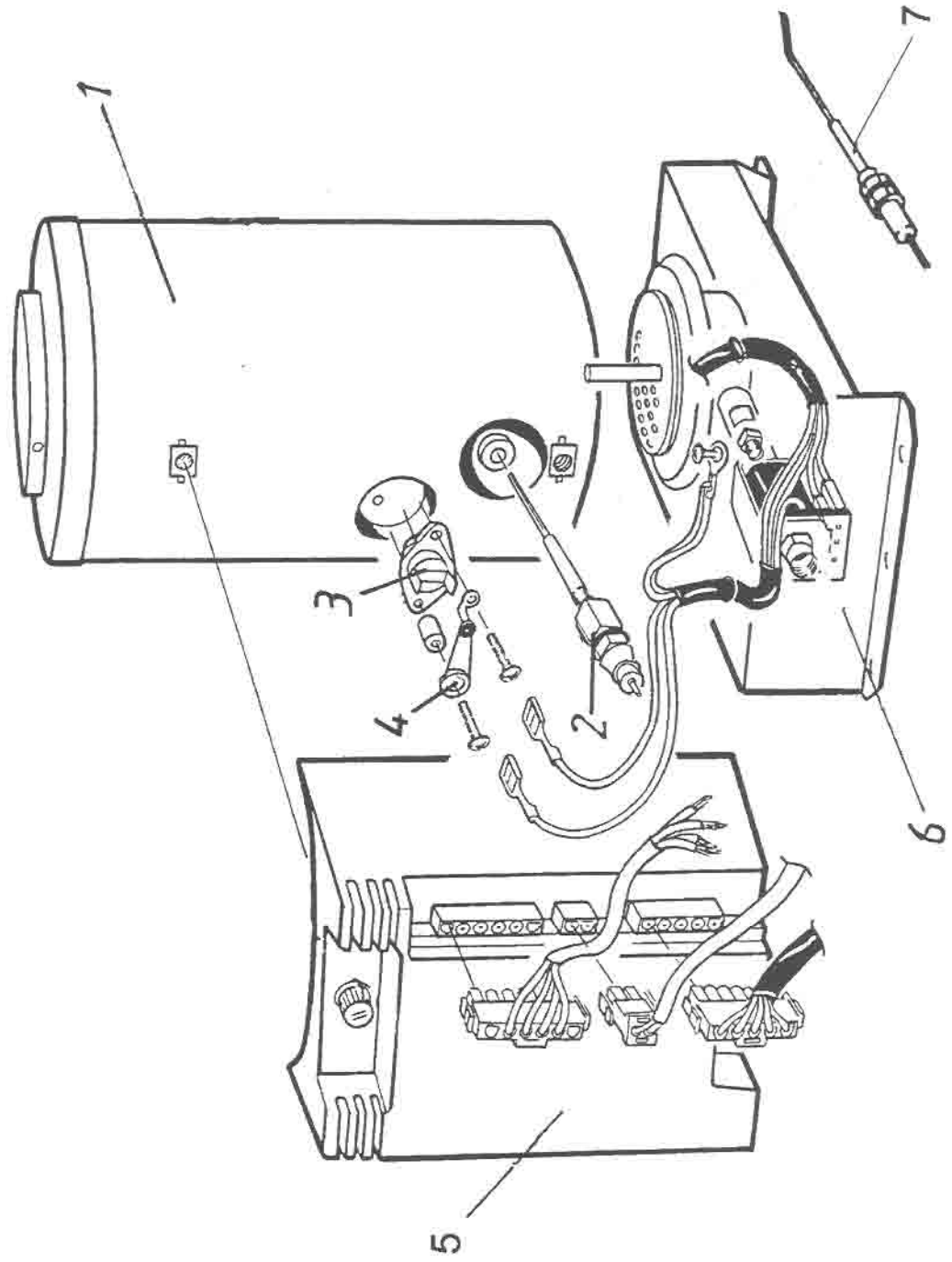

SOLIFERLämmilin
Värme
Heating

315

Primus 2490
Primus 2490
Primus 2490

2000

X=vakio/ standard

M=Menu-varustelu maasta riippuen/ Menu-utrustning beroende på land/ Menu-equipment due to country specification

Kuva Pos. Fig.	Varaosanro Def.nr. Part.nr.	Kuvaus Benämning Description																		Huom. Anm. Obs.
1	9001-6055	Lämmilin 2490 ilman pumppua	Primus värmare utan pump	Heater	X	X	X	X	X	X	X	X	X	X	X	X	X	X	X	
2	3471-9011	Liekkielektrodi	Elektrod	Electron	X	X	X	X	X	X	X	X	X	X	X	X	X	X	X	
3	3471-1031	Vesitermostaatti	Vatten termostat	Water thermostat	X	X	X	X	X	X	X	X	X	X	X	X	X	X	X	
4	3489-5901	Lämpösulake	Smältsäkring	Over heat fuse	X	X	X	X	X	X	X	X	X	X	X	X	X	X	X	
5	3471-9021	Ohjauselektronikka	Elektronik låda	Electronic box	X	X	X	X	X	X	X	X	X	X	X	X	X	X	X	
6	3471-9041	Magneettiventtiili 2490	Magnetventil	Solenoid valve	X	X	X	X	X	X	X	X	X	X	X	X	X	X	X	
7	3472-0340	Liekkielektrodi laivutettu	Elektrod, böjd	Electron, bended model	X	X	X	X	X	X	X	X	X	X	X	X	X	X	X	

Huom./ Anm./Obs.

SOLIFER

L₁mmilitin
V₁me
Heating

S. hks'patruuna
Eipatroner
Electric heater

320

2000

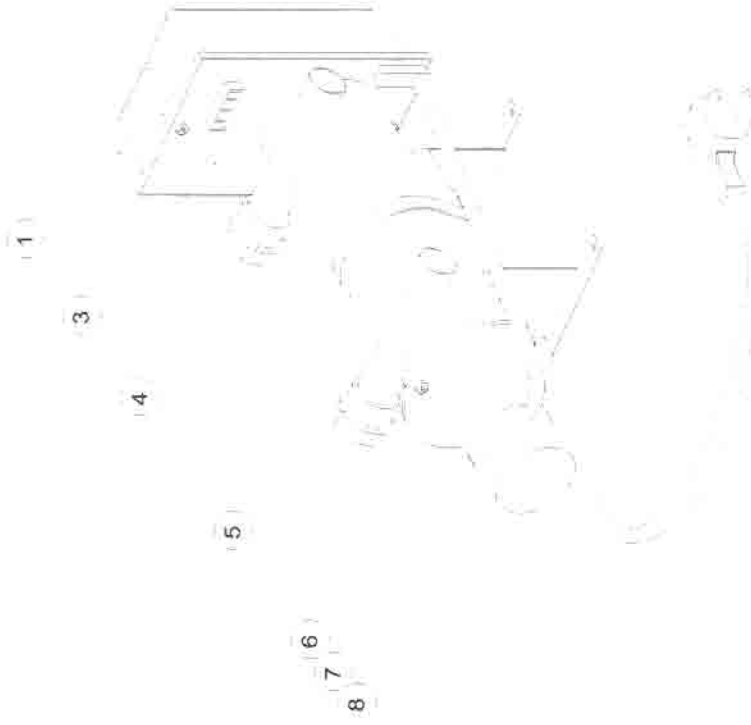

SOLIFERLämmitin
Värme
Heating

320

Sähköpatruuna
Elpatroner
Electric heater

2000

X=vakio/ standard M=Menu-varustelu maasta riippuen/ Menu-utrustning beroende på land/ Menu-equipment due to country specification

Kuva Pos. Fig.	Varaosan nro Det.nr. Part.nr.	Kuvaus Benämning Description																	Huom. Anm. Obs.
1	3425-9021	Sähköpatruuna 220 V pumpulla	Elpatron med pump	Electric heater with pump	x	x	x	x	x	x	x	x	x	x	x	x	x	x	1)
3	3471-9371	Relesarja 2590 sähköl.	Kretskort	Circuit card	x	x	x	x	x	x	x	x	x	x	x	x	x	x	1)
4	3451-0006	Sähkölämmittimen kumihylsy	Gummihylsa	Rubber sleeve	x	x	x	x	x	x	x	x	x	x	x	x	x	x	1)
5	0095-0165	Lankakiristin A19 (29.5)	Slangklänna	Clamp	x	x	x	x	x	x	x	x	x	x	x	x	x	x	1)
6	3471-6991	Moottori 259021/714821 sähköl.	230v motor	230v motor	x	x	x	x	x	x	x	x	x	x	x	x	x	x	1)
7	601345	Impeller (silipipyörä)	Impeller	Impeller	x	x	x	x	x	x	x	x	x	x	x	x	x	x	1)
8	3471-9361	Pumpunpesä sähköl.	Monteringsatts motor	Mounting kit, motor	x	x	x	x	x	x	x	x	x	x	x	x	x	x	1)

Huom./ Anm./Obs. 1) Hollanti M / Holland M / Holland M

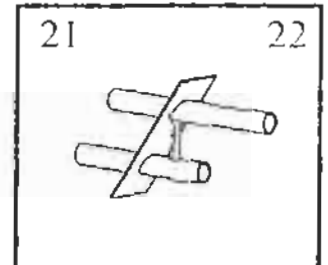
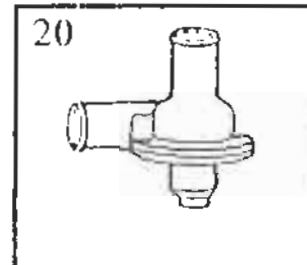
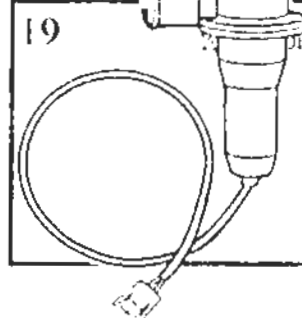
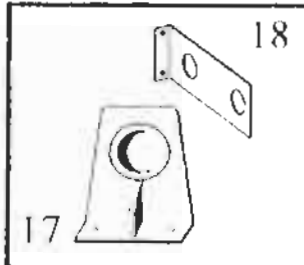
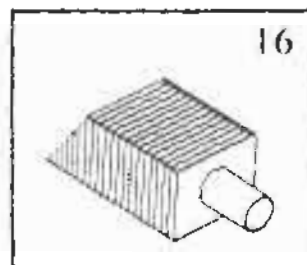
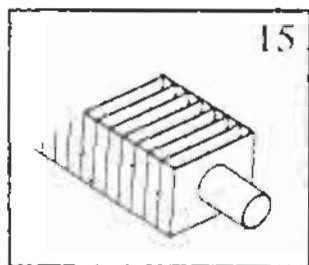
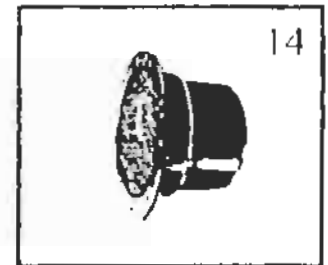
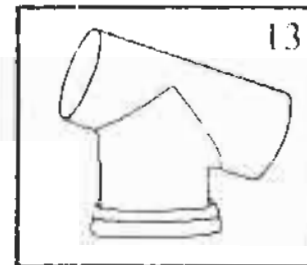
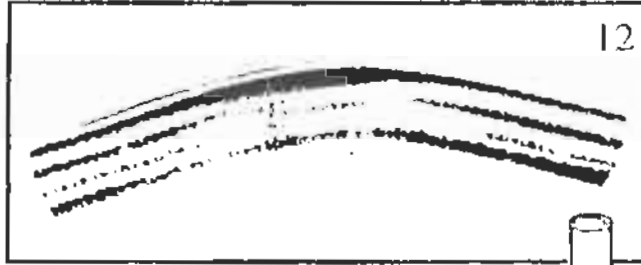
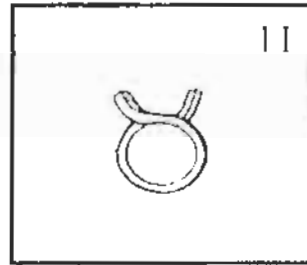
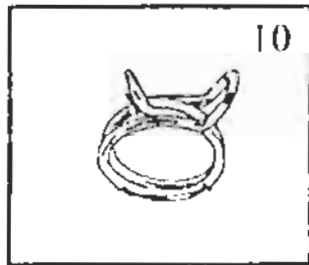
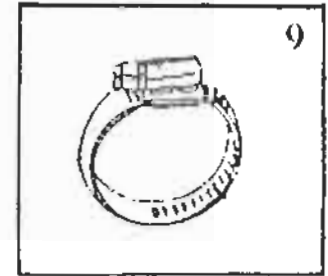
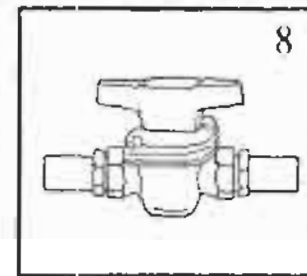
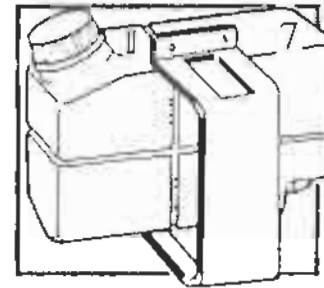
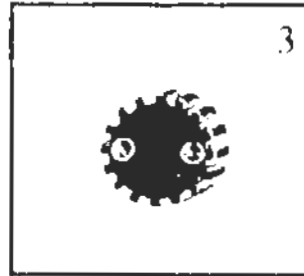
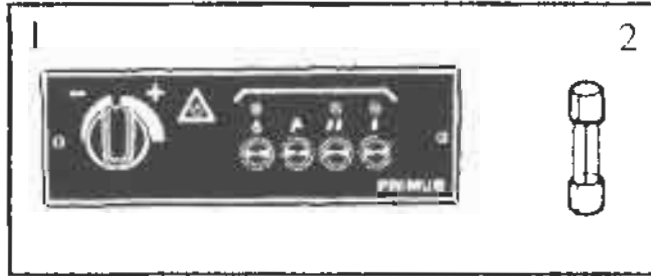

SOLIFERLämmitin
Värme
Heating

330

Muut lämmittimen osat
Övriga värmekomponenter
Other heating parts

X=vakio/standard M=Menu-varustelu maasta riippuen/ Menu-utrustning beroende på land/ Menu-equipment due to country specification

2000

Kuva Pos. Fig.	Varaosan nro Def.nr. Part.nr.	Kuvaus Benämning Description																		Huom. Anm. Obs.
1	3471-9081	Termostaattipaneli 2470 & 2490	Termostatpaneli	Thermostat panel	x	x	x	x	x	x	x	x	x	x	x	x	x	x	x	
2	3471-4092	Sulake	Säkring	Fuse	x	x	x	x	x	x	x	x	x	x	x	x	x	x	x	
3	3471-4001	Termostaatti	Termostatgivare	Thermostat distributor	x	x	x	x	x	x	x	x	x	x	x	x	x	x	x	
7	3471-5170	Paisunta-astia	Expansionskärl	Header tank	x	x	x	x	x	x	x	x	x	x	x	x	x	x	x	
8	3471-1711	Kuulaventtili 22 mm	Kulventil	Barrage valve	x	x	x	x	x	x	x	x	x	x	x	x	x	x	x	
9	0095-0074	Lokunkiristin A19-28	Slangklämma	Hose clip	x	x	x	x	x	x	x	x	x	x	x	x	x	x	x	
10	0095-0165	Lankakiristin A19 (29.5)	Slangklämma	Hose clip	x	x	x	x	x	x	x	x	x	x	x	x	x	x	x	
11	0095-0166	Lankakiristin A16 (24.5)	Slangklämma	Hose clip	x	x	x	x	x	x	x	x	x	x	x	x	x	x	x	
12	0095-0153	Hormiletku F-A D = 80 mm L = 550 mm	Flexibelt avgasrör	Flexible exhaust hose	x	x	x	x	x	x	x	x	x	x	x	x	x	x	x	
13	3471-9051	T-kappale (pakoputki primus)	T-stycke	T-piece	x	x	x	x	x	x	x	x	x	x	x	x	x	x	x	
14	9001-5192	Pakokaasun läpivihti D=154	Genomföring (avgasrör)	Exhaust part	x	x	x	x	x	x	x	x	x	x	x	x	x	x	x	
15	0095-0061	Ripaputki L = 1900 mm	Konvektor	Convector	x	x	x	x	x	x	x	x	x	x	x	x	x	x	x	
16	0095-0157	Ripaputki L = 400 mm C/C 3 mm	Konvektor C/C 3mm	Convector C/C 3mm	x	x	x	x	x	x	x	x	x	x	x	x	x	x	x	
17	0095-0007	Patterinkannatin	Konvektorläste	Convector bracket	x	x	x	x	x	x	x	x	x	x	x	x	x	x	x	
18	9401-7266	Patterinkannatin	Konvektorläste	Convector bracket	x	x	x	x	x	x	x	x	x	x	x	x	x	x	x	
19	3480-8204	Kiertovesipumppu	Cirkulationspump	Circulation pump	x	x	x	x	x	x	x	x	x	x	x	x	x	x	x	
20	3471-4951	Kiertovesipumpun pesä	Pumpphus	Housing for circulation pump	x	x	x	x	x	x	x	x	x	x	x	x	x	x	x	
21	9300-3608	Pannun läpivihti	Pannin genomföring	Boiler's lead-through	x	x														(1)
22	9301-6075	Pannun läpivihti	Pannin genomföring	Boiler's lead-through			x	x	x	x	x	x	x	x	x	x	x	x	x	(1)

Huom./ Anm./ Obs. 1) Käytössä osan mallivuotta / Användas till en del av modellår / In use partly through the model year

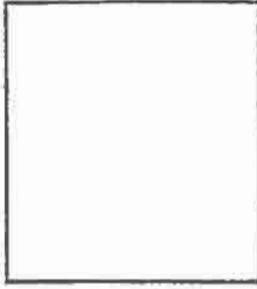
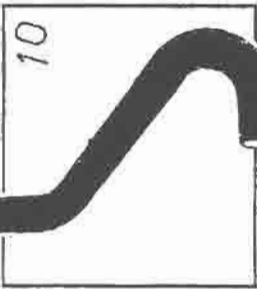
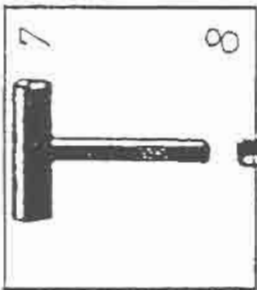
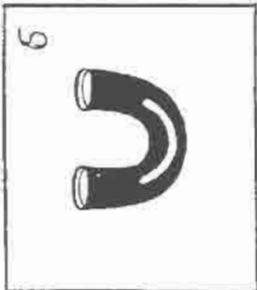
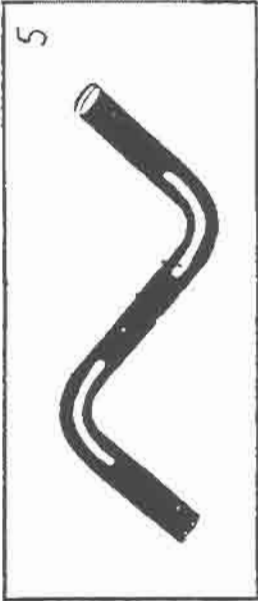
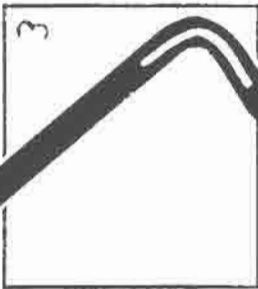



Lämmitin
Värme
Heating

335

Lämmitysjärjestelmän osat
Gummislangar
Rubber tubes

2000

X=vakio/ standard M=Menu-varustelu maasta riippuen/ Menu-utrustning beroende på land/ Menu-equipment due to country specification

Kuva Pos. Fig.	Varaosan nro Def.nr. Part.nr.	Kuvaus Benämning Description																		Huom. Anm. Obs.
1	0038-5760	Kumikulma 2 (pannun)	Gummislang 2 (värmare)	Rubber hose 2 (heater)	x	x														
2	0464-5053	Kumitetku 28/22	Gummislang 22mm	Rubber hose 22 mm	x	x	x	x	x	x	x	x	x	x	x	x	x			
3	0047-2250	Kumiputkikäyrä 100x200	Vinkelslang	Hose elbow	x	x														
4	0044-1970	Kumikulma 90° 70x130	Vinkelslang	Hose elbow	x	x	x	x	x	x	x	x	x	x	x	x	x			
5	0038-5770	S-mutka 165x265	S-slang	S-hose	x	x	x	x	x	x	x	x	x	x	x	x	x			
6	9400-2792	U-tetku 80x80	U-slang	U-hose	x	x	x	x	x	x	x	x	x	x	x	x	x			
7	0042-8460	Tyhjennys I-haara kumi	Avtappning	Drain tube	x	x	x	x	x	x	x	x	x	x	x	x	x			
8	0095-0129	Tulppa T 18/18 L=30mm	Plugg	Plug	x	x	x	x	x	x	x	x	x	x	x	x	x			
10	0038-5750	Kumikulma	Gummislang 1 (värmare)	Rubber hose 1 (heater)	x	x	x	x	x	x	x	x	x	x	x	x	x			
12	9300-3673	Tupla I-kappale 40x139 r.ilm.sis.otta	Dubbelt I-stycke (Friskluft)	Double I-piece (Fresh air)	x	x	x	x	x	x	x	x	x	x	x	x	x			
13	0410-3460	Tupla I-kappale lattia lämmitys	Dubbelt I-stycke (Golv värme)	Double I-piece (Floor heater)	x	x	x	x	x	x	x	x	x	x	x	x	x			
14	0410-3450	Kumikulma 415/12 x 103/12	Vinkelslang	Hose elbow	x	x	x	x	x	x	x	x	x	x	x	x	x			
15	9400-2533	AI-putki, lattialämmitys liittimeen	AI-rör, kopplingsrör	AI-pipe, Connection rear	x	x	x	x	x	x	x	x	x	x	x	x	x			

Huom./ Anm./Obs.

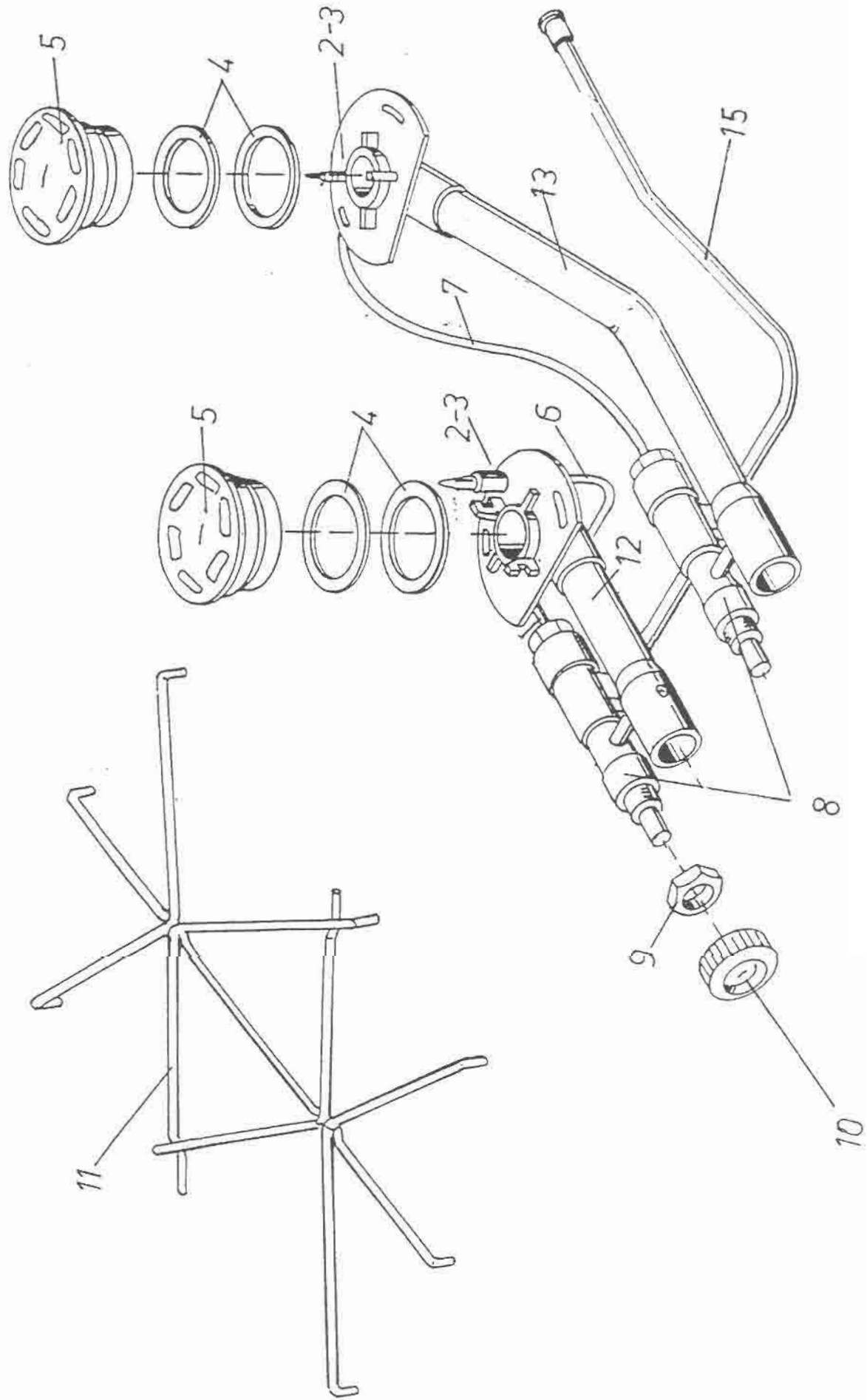



Kaasu järjestelmä
Gasol
Gassystem

410

Cramer 2-polttimoinen liesi
Cramer 2-lågig spis
Cramer 2-pits burner

2000

X-vakio/ standard M-Menu-varusteita maasta riippuen/ Menu-utrustning beroende på land/ Menu-equipment due to country specification

Kuva Pos. Fig.	Varaosan nro Def.nr. Part.nr.	Kuvaus Benämning Description																		Huom. Anm. Obs.	
1	0090-0163	Cramer polttin 2-ilekk.ek-646, 30 mbar	Spis kpl	Stove		x															
2	2713-4009	Liekinvarmistimen mutteri	Mutter	Flame monitor's nut		x															
3	2713-4012	Liekinvarmistimen tiiviste	Packning	Packing for flame monitor		x															
4	2713-4008	Polttoosan tiiviste Cramer	Brännarlockspackning	Draught excluder for burner		x															
5	2713-4005	Cramer liekinlevilin	Brännarlock	Flame spreader		x															
6	2713-4003	Cramer liekinvarm. Keski, 220 mm	Flamsäkring	Flame monitor		x															
7	2713-4004	Cramer liekinvarm. auk., 450 mm	Flamsäkring	Flame monitor		x															
8	2713-4016	Cramer lieken hana oikea	Gaskran, injektor till höger	Cramer handle right		x															
9	2713-4017	Cramer lieken hanan mutteri	Mutter för spisvred	Nut for stove handle		x															
10	2713-4018	Cramer lieken nappula	Spisvred	Handle		x															
11	0090-0198	Cramer keittinritilä ro-64 2-li	Kokunderlag	Boiling bottom		x															
12	2713-4025	Ilmansekoitusputki, 80 mm	Blandorrör	Air mixing pipe		x															
13	2713-4023	Ilmansekoitusputki, 300 mm	Blandorrör	Air mixing pipe		x															
15	2713-4024	Kaasu putki	Gasrör	Gas connection		x															

Huom./ Anm./Obs.

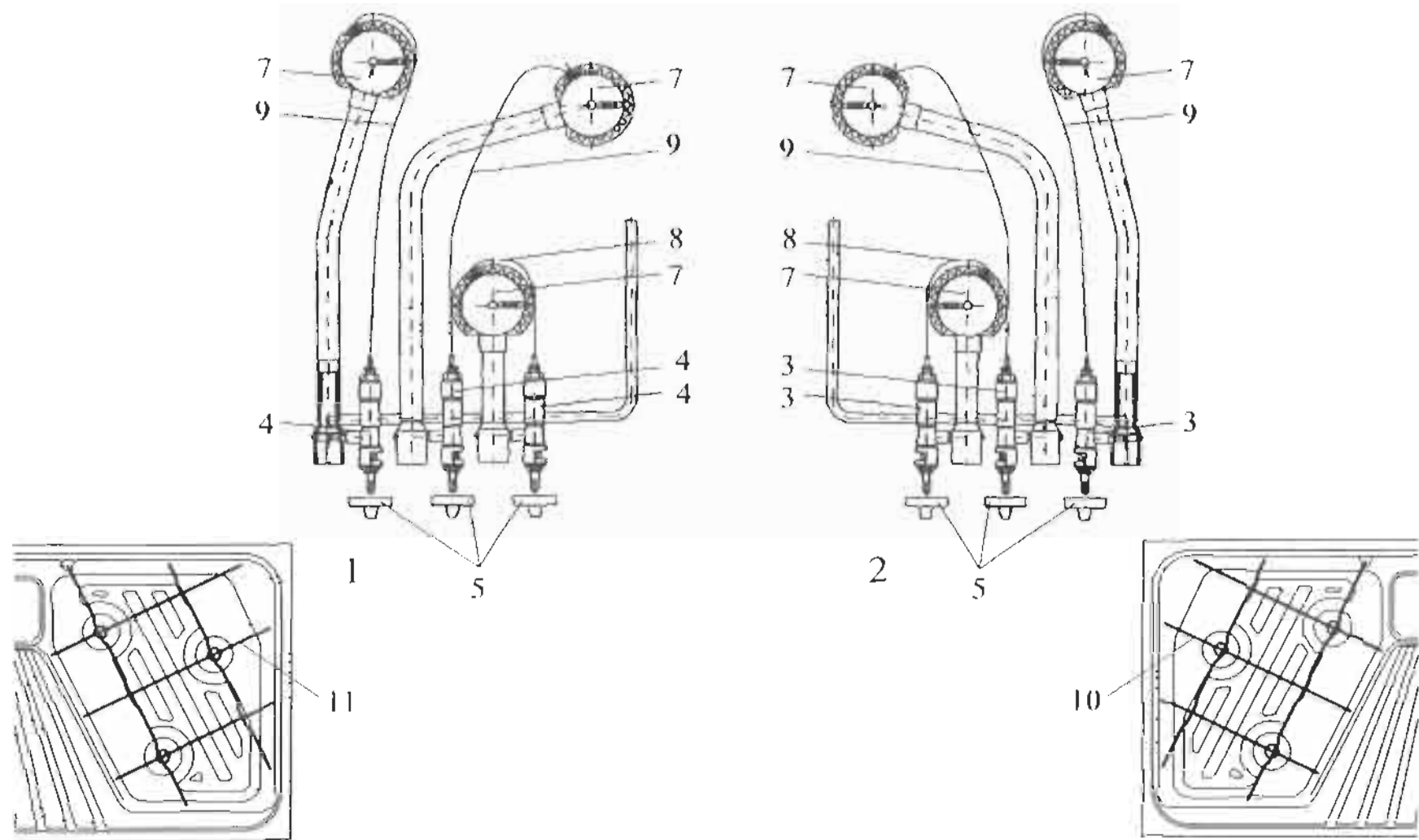

SOLIFER

Kaasujärjestelmä		Cramer 3-polttimoinen liesi
Gasol	421	Cramer-spis
Gassystem		Cramer-cooker

X=vakio/ standard M=Menu-varustelu maasta riippuen/ Menu-utrustning beroende på land/ Menu-equipment due to country specification

2000

Kuva Pos. Fig.	Varaosan Def.nr. Part.nr.	Kuvaus Benämning Description																	Huom. Anm. Obs.
1	2713-4070	Cramer poltin 3-liekk. oikea	Cramer spis, H	Cramer cooker, R															
2	2713-4071	Cramer poltin 3-liekk. vasen	Cramer spis, V	Cramer cooker, L	x	x													
3	2713-4015	Cramer lieden hana vasen	Cramer spis, V	Cramer cooker, L	x	x													
4	2713-4016	Cramer lieden hana oikea	Cramer spis, H	Cramer cooker, R															
5	2713-4072	Cramer lieden nappula	Cramer spis, gaskran	Cramer cooker, handle	x	x													
7	2713-4073	Cramer liekinlevitin	Brännarlock	Burner head	x	x													
8	2713-4074	Cramer liekinvarmistin 220 mm, 30 mbar	Flamsäkring	Flame monitor	x	x													
9	2713-4075	Cramer liekinvarmistin 450 mm	Flamsäkring	Flame monitor	x	x													
10	2713-4076	Cramer lieden ritilä vas.	Cramer spis, galler V	Cramer cooker, grating L	x	x													
11	2713-4077	Cramer lieden ritilä oik.	Cramer spis, galler H	Cramer cooker, grating R															

Huom./ Anm./Obs.

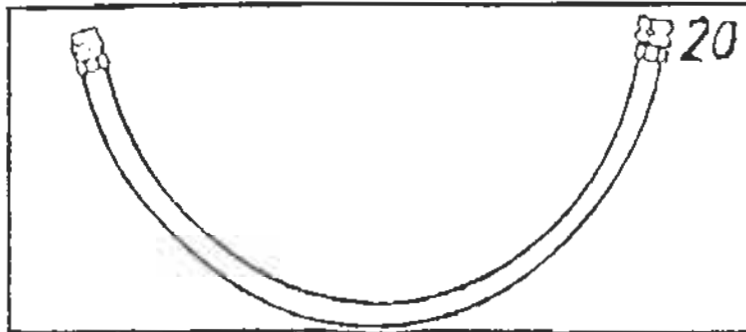
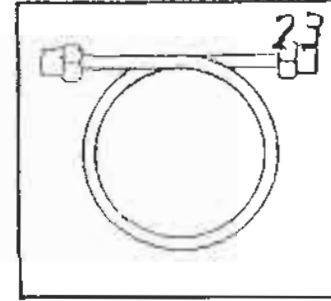
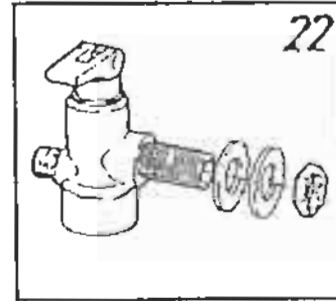
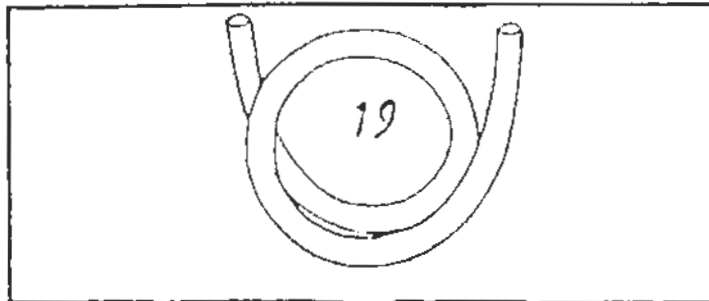
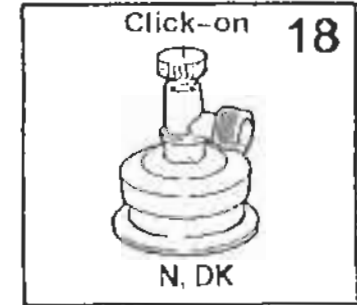
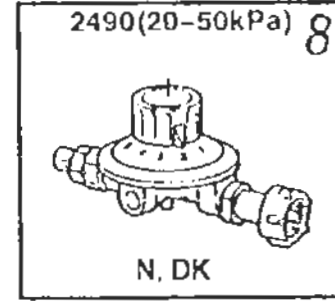
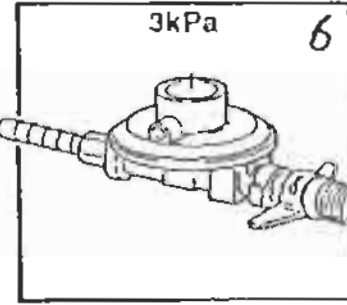
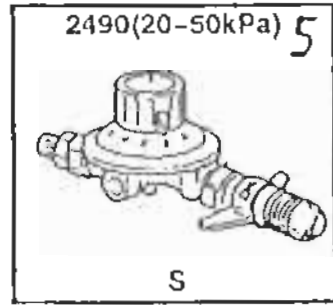
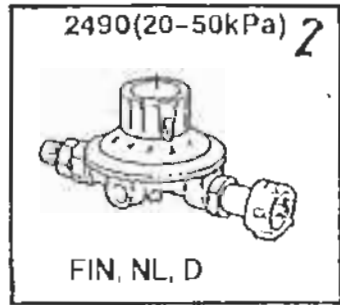



Kaasujärjestelmä
Gasol
Gassystem

425

Paineensäädin, kaasuletku, kaasuputki
Reduceringsventiler, rör, gasfördelare
Regulator valve, gas hose, gas pipe

X=vakio/ standard M=Menu-varustelu maasta riippuen/ Menu-utrustning beroende på land/ Menu-equipment due to country specification

2000

Kuva Pos. Fig.	Varaosan Det.nr. Part.nr.	Kuvaus Benämning Description	Red.ventil	Regul.valve	Click on ventil	Click on valve	S1	S2	S3	S4	S5	S6	S7	S8	S9	S10	S11	Huom. Anm. Obs.
2	3471-9061	Säädin 20-50 kPa, FIN, NL, D	Red.ventil	Regul.valve			x	x	x	x	x	x	x	x	x	x	x	9000-7791
5	3471-9001	Paineensäädin 20-50 kPa, S	Red.ventil	Regul.valve			x	x	x	x	x	x	x	x	x	x	x	9000-7792
6	3471-4231	Säädin 3kPa	Red.ventil	Regul.valve			x	x	x	x	x	x	x	x	x	x	x	0095-0079
8	3471-9091	Säädin 20-50 kPa, N, DK	Red.ventil	Regul.valve			x	x	x	x	x	x	x	x	x	x	x	9000-7793
18	3471-2201	Venttili klick-on, N, DK	Click-on ventil	Click on valve			x	x	x	x	x	x	x	x	x	x	x	
19	0464-5007	Nestekaasuletku 10 mm SFS	Gasolslang 10mm metervara	Gas hose 10mm			x	x	x	x	x	x	x	x	x	x	x	
20	3471-2650	Kaasuletku L = 700 mm	Gasolslang L=700mm	Gas hose L=700mm			x	x	x	x	x	x	x	x	x	x	x	
22	3471-4501	Kaasunjakaja	Gasfördelare	Gas manifold			x	x	x	x	x	x	x	x	x	x	x	
23	3471-0353	Kaasuputki L = 600 mm	Gasolrör	Gas pipe			x	x	x	x	x	x	x	x	x	x	x	

Huom./ Anm./Obs.

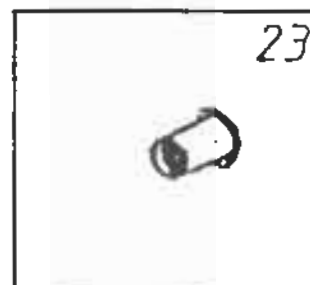
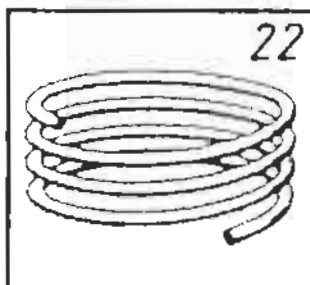
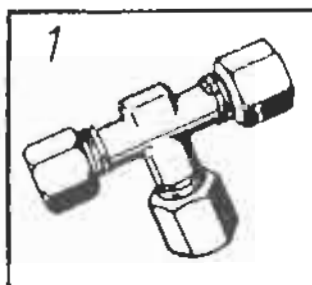
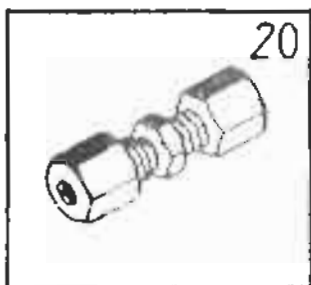
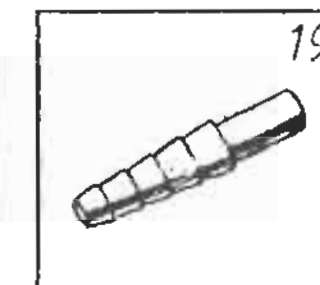
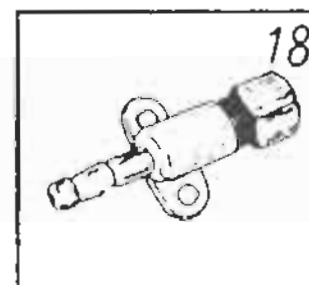
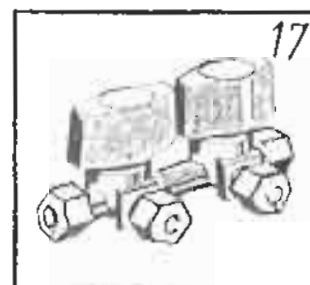
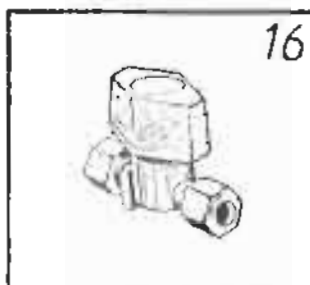
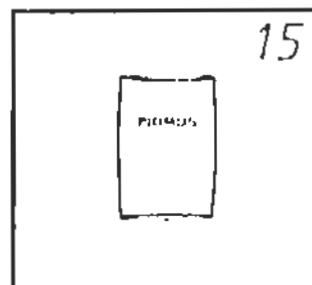
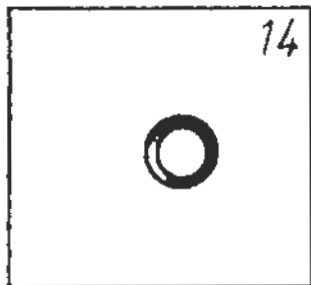
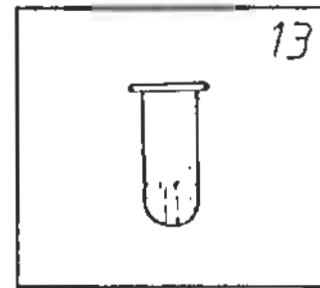
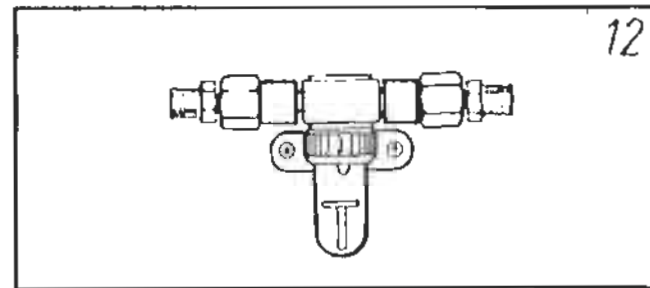
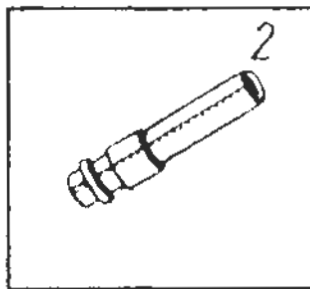
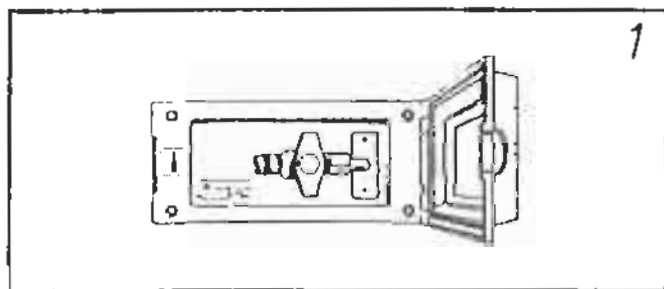

SOLIFER

Kaasujärjestelmä

Gasol

Gassystem

430

Muut kaasujärjestelmän komponentit

Övriga gaskomponenter

Other gas parts

X=vakio/ standard

M=Menu-varustelu maasta riippuen/ Menu-utrustning beroende på land/ Menu-equipment due to country specification

2000

Kuva Pos. Fig.	Varaosan nro Det.nr. Part.nr.	Kuvaus Benämning Description																		Huom. Anm. Obs.
1	9000-6901	Kaasunulosotto valk.	Gasolutfag	Gas outlet whit	M	M	M	M	M	M	M	M	M	M	M	M	M	M	M	
2	503561	Liitoskappale kaasunulosotto	Genomföring	Joint piece	M	M	M	M	M	M	M	M	M	M	M	M	M	M	M	
12	3435-8098	Kaasuvuodonilmaisim Primus	Läckindikator	Leakage indicator	x	x	x	x	x	x	x	x	x	x	x	x	x	x	x	
13	3471-2381	Säiliö	Gaskopp till läckindikator	Glastank for leakage indicator	x	x	x	x	x	x	x	x	x	x	x	x	x	x	x	
14	3471-2392	O-rengas (vuodonilmaisimeen)	O-ring till läckindikator	O-ring for leakage indicator	x	x	x	x	x	x	x	x	x	x	x	x	x	x	x	
15	3471-2021	Testausneste	Vätska till läckindikator	Fluid glycol	x	x	x	x	x	x	x	x	x	x	x	x	x	x	x	
16	0095-0145	Kaasuhana 8 mm putki/putki	Enkelkran gasol	Gas faucet	x	x	x	x	x	x	x	x	x	x	x	x	x	x	x	
17	0095-0144	Kaksoiskaasuhana 754600	Dubbelkran gasol	Double faucet	x	x	x	x	x	x	x	x	x	x	x	x	x	x	x	
18	0095-0146	Letkuistukka 73570	Slangsocket	Hose coupling	x	x	x	x	x	x	x	x	x	x	x	x	x	x	x	
19	0095-0080	Letkuistukka 91165 mess./hana	Slanganslutning för kran	Hose coupling nipple	x	x	x	x	x	x	x	x	x	x	x	x	x	x	x	
20	0095-0054	Sambra-liitin suora 8 mm	Skarvsstycke	Scarfed joint sambra	x	x	x	x	x	x	x	x	x	x	x	x	x	x	x	
21	0531-0010	T-liitin TL-8 MS kaasu	T-stycke	T-piece	x	x	x	x	x	x	x	x	x	x	x	x	x	x	x	
22	0052-4000	Kupariputki 8/6 hehkutettu	Kopparrör 8 mm	Gas pipe 8 mm	x	x	x	x	x	x	x	x	x	x	x	x	x	x	x	
23	0095-0077	Tukihoitikki 8x0.8 mm putkelle	Stödholk	Support bushing	x	x	x	x	x	x	x	x	x	x	x	x	x	x	x	

Huom./ Anm./Obs.

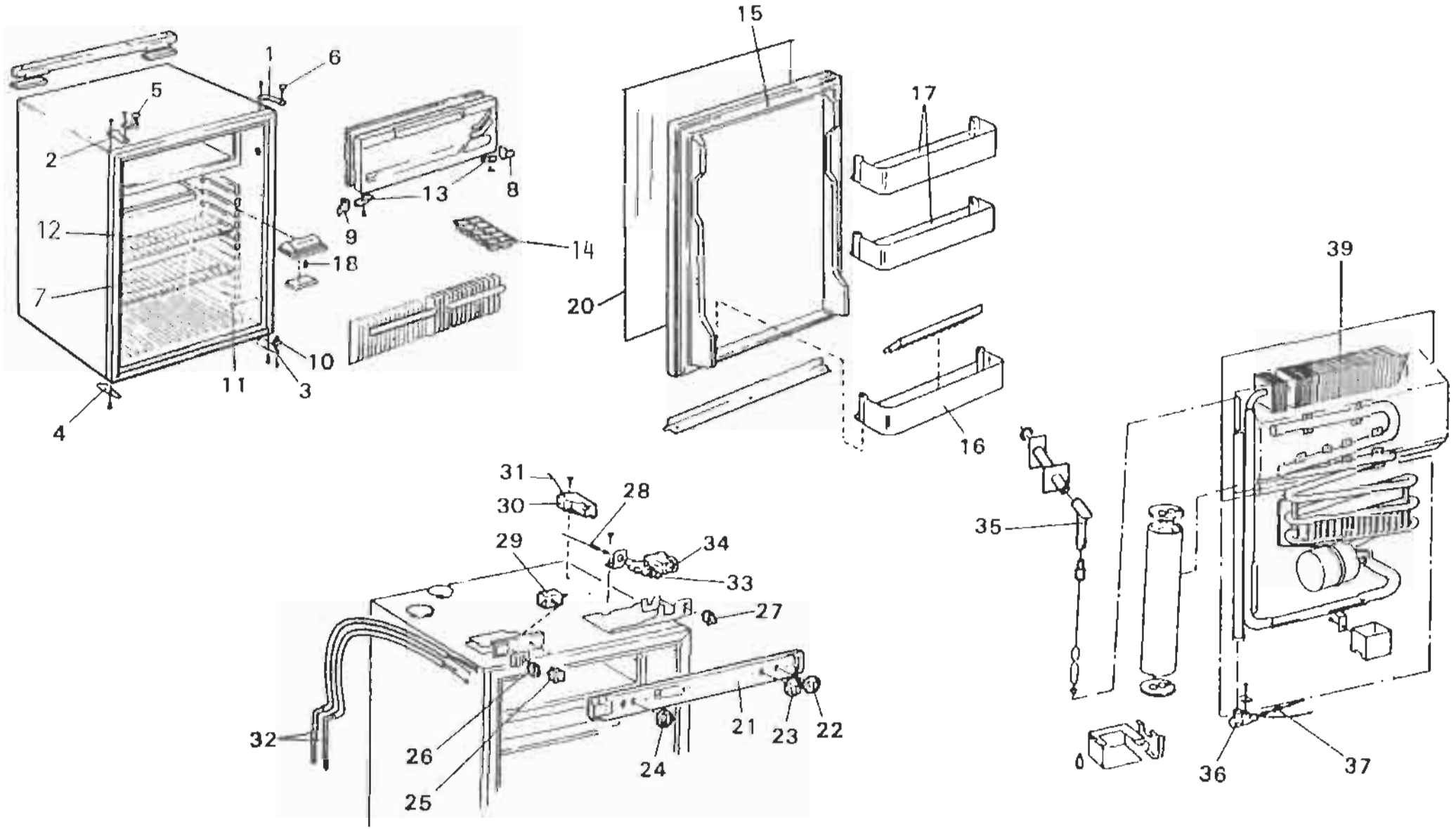

SOLIFERKaasujärjestelmä
Gasol
Gassystem

435

Jääkaappi E-lux RM 4401 L
Kylskåp E-lux RM 4401 L
Refrigerator RM 4401 L

X=vakio/ standard M-Menu-varusteita maasta riippuen/ Menu-utrustning beroende på land/ Menu-equipment due to country specification

2000

Kuva Pos. Fig.	Varaosan nro Det.nr. Part.nr.	Kuvaus Benämning Description																		Huom. Anm. Obs.
	9001-3859	Jääkaappi E-lux RM4401 3 kPa	Kylskåp kpl 230Vgasol 30 mbar (3kPa)	Refrigerator 230V/gas 30mbar(3kPa)	x	x	x	x	x	x	x	x	x	x	x	x	x	x	x	
1	6295-1246	Sarana yläoikea	Gångjärn H övre	Hinge, upper right	x	x	x	x	x	x	x	x	x	x	x	x	x	x	x	
2	6295-1247	Sarana ylävasen	Gångjärn V övre	Hinge, upper left	x	x	x	x	x	x	x	x	x	x	x	x	x	x	x	
3	6295-1248	Sarana alaoikea	Gångjärn H nedre	Hinge, lower right	x	x	x	x	x	x	x	x	x	x	x	x	x	x	x	
4	6295-1249	Sarana alavasen	Gångjärn V nedre	Hinge, lower left	x	x	x	x	x	x	x	x	x	x	x	x	x	x	x	
5	2952-7000	Ovenlukko	Transportsäkring	Door lock	x	x	x	x	x	x	x	x	x	x	x	x	x	x	x	
6	6292-3005	Saranaruuvi	Gångjärnsskruv	Screw,hinge	x	x	x	x	x	x	x	x	x	x	x	x	x	x	x	
7	6295-1414	Hylly alempi	Undre hylla	Coarse screen,lower	x	x	x	x	x	x	x	x	x	x	x	x	x	x	x	
8	9001-5008	Holkki oikea	Lagerholk H	Bearing,assy,right	x	x	x	x	x	x	x	x	x	x	x	x	x	x	x	
9	9001-5009	Holkki vasen	Lagerholk V	Bearing,assy,left	x	x	x	x	x	x	x	x	x	x	x	x	x	x	x	
10	6292-6265	Ruuvi alempi	Undre skruv	Screw,hinge,lower	x	x	x	x	x	x	x	x	x	x	x	x	x	x	x	
11	6292-1221	Pötebrikka	Täckbricka	Cover	x	x	x	x	x	x	x	x	x	x	x	x	x	x	x	
12	6295-1474	Hylly ylempi	Övre hylla	Coarse screen,upper	x	x	x	x	x	x	x	x	x	x	x	x	x	x	x	
13	6200-2244	Saranatappi	Gångjärnstapp	Hinge,cold chamber	x	x	x	x	x	x	x	x	x	x	x	x	x	x	x	
14	6295-1132	Jääalusta	Isfack	Ice tray	x	x	x	x	x	x	x	x	x	x	x	x	x	x	x	
15	6295-1404	Ovi	Dörr utan frontskiva	Door,assy,fitting	x	x	x	x	x	x	x	x	x	x	x	x	x	x	x	
16	6295-1307	Ovihylly alempi	Undre dörrhylla	Bottle,shelf lower	x	x	x	x	x	x	x	x	x	x	x	x	x	x	x	
17	6292-1308	Ylä- ja keskihylly	Övre och mellanhylly	Shelf,upper and middle	x	x	x	x	x	x	x	x	x	x	x	x	x	x	x	
18	9001-5000	Lamppu	Glödlampa	Bulb	x	x	x	x	x	x	x	x	x	x	x	x	x	x	x	
20	9401-4650	Oven vaneri	Kylskåpsfront	Front	x	x	x	x	x	x	x	x	x	x	x	x	x	x	x	
21	9002-6951	Paneli	Kylskåpspanel	Panel	x	x	x	x	x	x	x	x	x	x	x	x	x	x	x	
22	6295-1455	Nappula	Ratt gastermaslat	Button,thermostat,gas	x	x	x	x	x	x	x	x	x	x	x	x	x	x	x	
23	6295-1289	Nappula	Ratt ländsäkring	Knob for stopcock	x	x	x	x	x	x	x	x	x	x	x	x	x	x	x	
24	6295-1287	Nappula	Ratt eltermostat	Button E-thermostat	x	x	x	x	x	x	x	x	x	x	x	x	x	x	x	

Huom./ Anm./Obs:

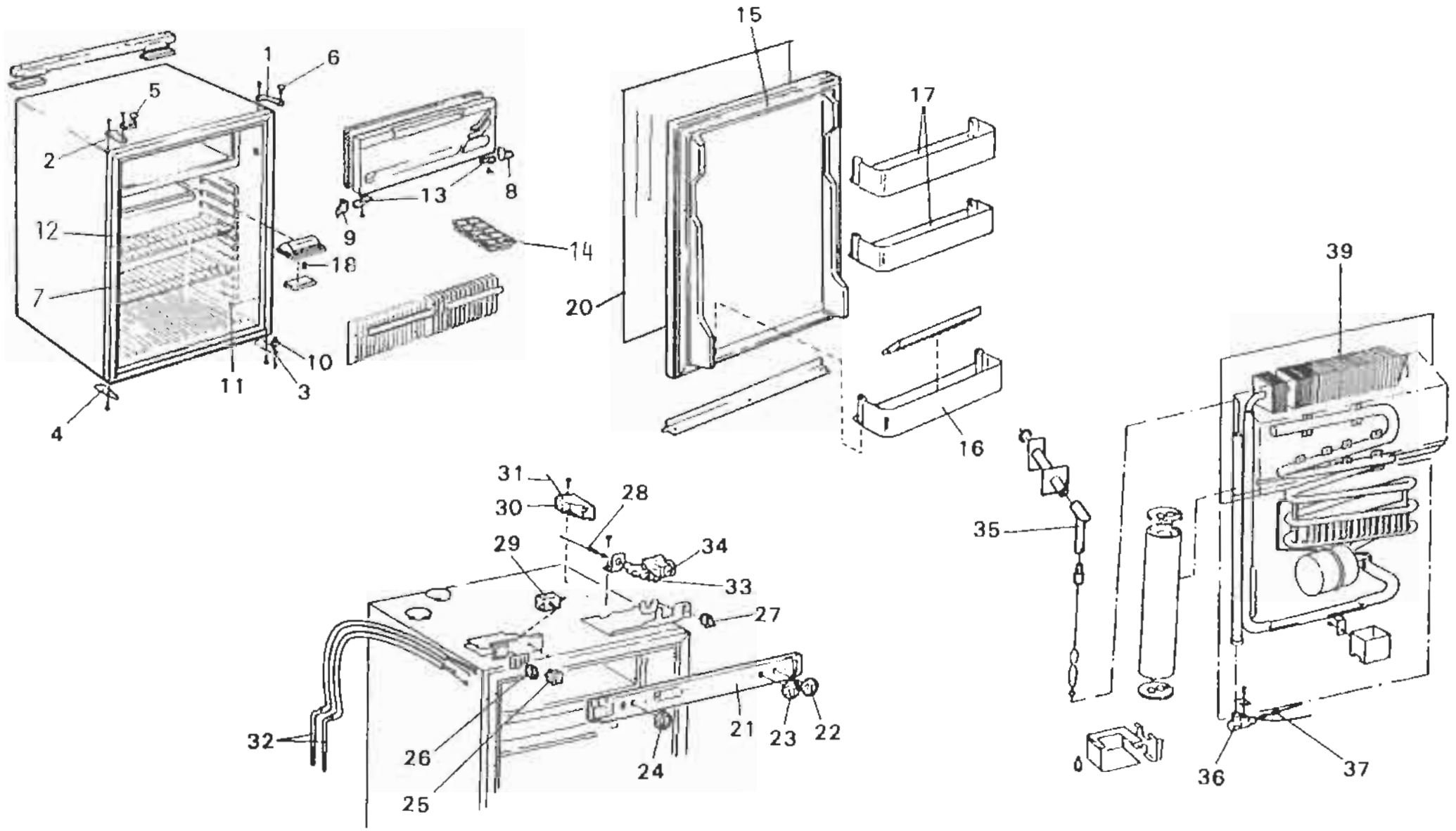

SOLIFERKaasujärjestelmä
Gasol
Gassystem

435

Jääkaappi E-lux RM 4401 L
Kyiskåp E-lux RM 4401 L
Refrigerator RM 4401 L

2000

X=vakio/ standard M=Menu-varustelu maasta riippuen/ Menu-utrustning beroende på land/ Menu-equipment due to country specification

Kuva Pos. Fig.	Varaosan nro Def.nr. Part.nr.	Kuvaus Benämning Description																		Huom. Anm. Obs.
25	6292-6274	Katkaisija 230 V	Strömställare 230V	Switch 230V	X	X	X	X	X	X	X	X	X	X	X	X	X	X	X	
26	6292-6373	Katkaisija 12 V	Strömställare 12V	Switch 12V	X	X	X	X	X	X	X	X	X	X	X	X	X	X	X	
27	6292-6275	Katkaisija	Strömställare	Switch,lighter	X	X	X	X	X	X	X	X	X	X	X	X	X	X	X	
28	6292-3435	Termoelementti LO1350 mm	Termoelement LO1350mm	Thermocouple 1350mm	X	X	X	X	X	X	X	X	X	X	X	X	X	X	X	
29	6292-3037	Termostaatti	Eltermostat	Thermostatelectro	X	X	X	X	X	X	X	X	X	X	X	X	X	X	X	
30	6292-3904	Sytytin RV 681,440	Tändare RV 681,440	Lighter RV 681,440	X	X	X	X	X	X	X	X	X	X	X	X	X	X	X	
31	6295-1105	Sytyttimen johto	Töndarkabel	Ignition cable assy	X	X	X	X	X	X	X	X	X	X	X	X	X	X	X	
32	6295-1693	Lämmityslaitte upotettu 230 V, 135 W	Elpatron 230V 135W	Immersion heater 230V,135W	X	X	X	X	X	X	X	X	X	X	X	X	X	X	X	
32	6295-1694	Lämmityslaitte upotettu 12 V, 130 W	Elpatron 12V,130W	Immersion heater 12V,130W	X	X	X	X	X	X	X	X	X	X	X	X	X	X	X	
33	6292-7657	Kaasuventtiili	Gasventil	Gas valve	X	X	X	X	X	X	X	X	X	X	X	X	X	X	X	
34	6292-3755	Kaasutermostaatti	Gasstermostat	Thermostat gas	X	X	X	X	X	X	X	X	X	X	X	X	X	X	X	
35	6292-3033	Kaasuputki	Avgasrör	Tube.assy	X	X	X	X	X	X	X	X	X	X	X	X	X	X	X	
36	6292-3877	Kaasupoltin 30 mbar	Brännare 30 mbar(3kPa)	Burner 30 mbar(3kPa)	X	X	X	X	X	X	X	X	X	X	X	X	X	X	X	
37	6292-2033	Suutin, KZ 43 30 mbar (3kPa)	Munstycke KZ 43 30 mbar(3kPa)	Jet, KZ 43 30 mbar(3kPa)	X	X	X	X	X	X	X	X	X	X	X	X	X	X	X	
39	9001-5006	Jäähdytysyksikkö 230 V / 12 V / kaasu	Kylaggregat 230V/12V/gas	Refrigerator unit 230V/12V/gas	X	X	X	X	X	X	X	X	X	X	X	X	X	X	X	

Huom./ Anm./Obs.

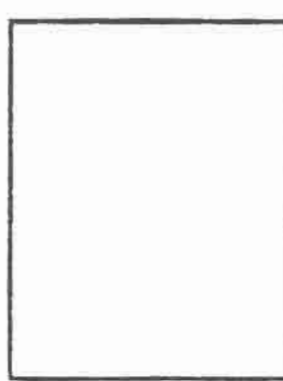
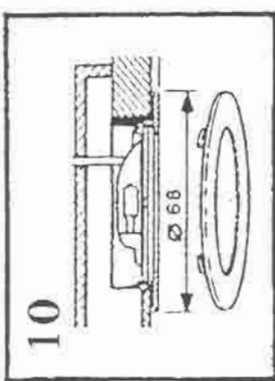
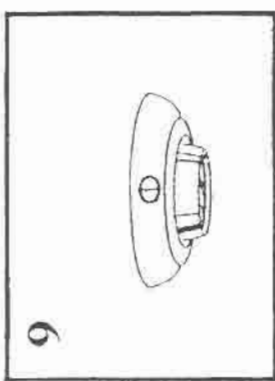
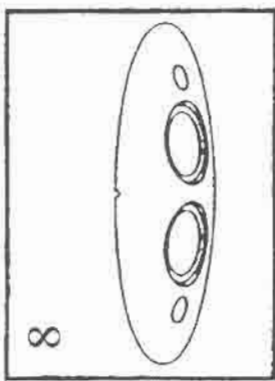
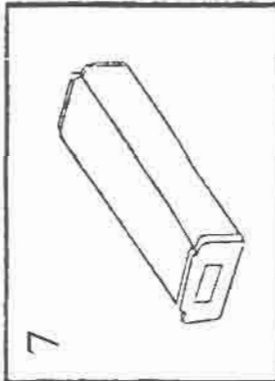
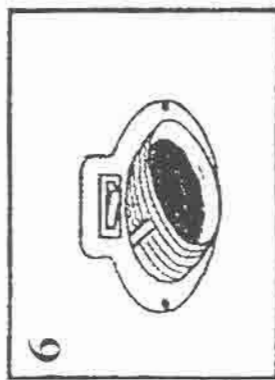
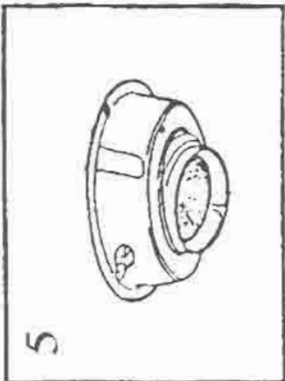
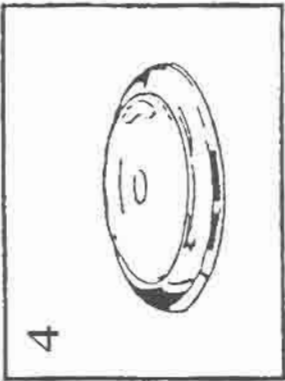
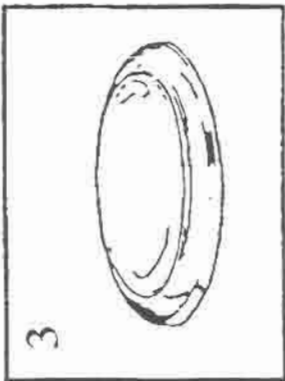
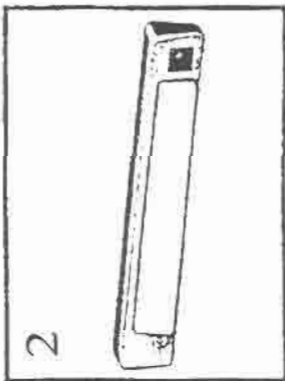
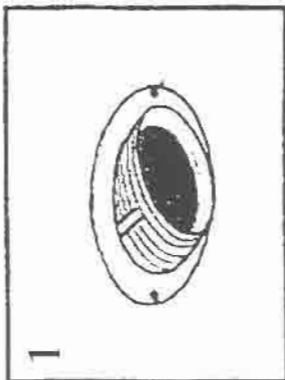

SOLIFERSähkö
El
Electricity

510

Sisävalot
Invändig belysning
Inside lights

X-vakio/ standard

M-Menu-varustelu maasta riippuen/ Menu-utrustning beroende på land/ Menu-equipment due to country specification

2000

Kuva Pos. Fig.	Varaosan nro Del.nr. Part.nr.	Kuvaus Benämning Description																	Huom. Anm. Obs.
1	9001-6315	Kulmavallo spot 8706 valk WC	Hörn lampa spot 8706 vit WC	Corner light spot 8706 white WC															
2	0091-0362	Sisävalo Talmu	Innerbelysning talmu	Inside light Talmu	x	x	x	x	x	x	x	x	x	x	x	x	x		
3	9001-3520	Valaisin Corona kulta	Taklamppa corona 200 guld	Ceiling lamp corona 200 gold	x	x													
4	9001-5543	Kattovalaisin Cirro, valkoinen	Taklamppa cirro	Ceiling lamp cirro	x	x	x	x	x	x	x	x	x	x	x	x			
5	9000-5740	Valaisin spot musta	Lampa spot svart	Lamp spot black	x	x													
6	9000-4585	Kulmavallo spot 8707/2 musta	Hörn lampa spot 8707/2 vit	Corner lamp spot 8707/2 White	x	x													
7	9001-5538	Valaisin Prolight 2x5W	Lampa Prolight 2x5W	Lamp Prolight 2x5W	x	x													
8	9301-8497	Valaisimen pohja	Armaturens botten	Bottom of fitted light			x	x	x	x	x	x	x	x	x	x			
9	9001-8507	Valaisin LD 1.8 SA+P	Lampa LD	Lamp LD			x	x	x	x	x	x	x	x	x				
10	9001-8508	Valaisin LD 1.10	Lampa LD	Lamp LD			x	x	x	x	x	x	x	x	x				

Huom./ Anm./Obs.

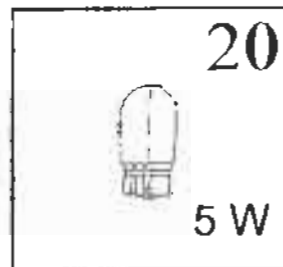
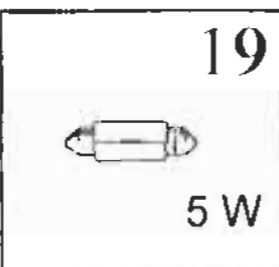
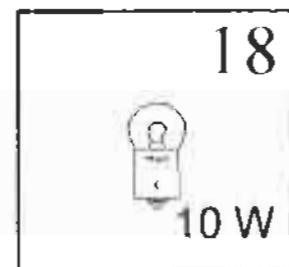
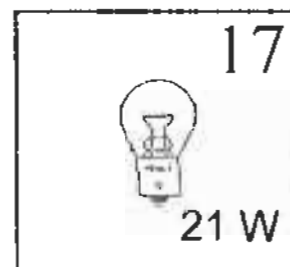
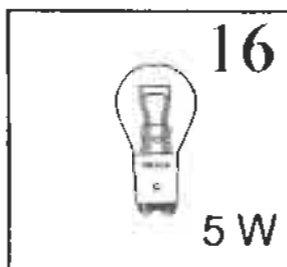
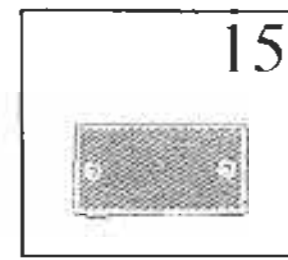
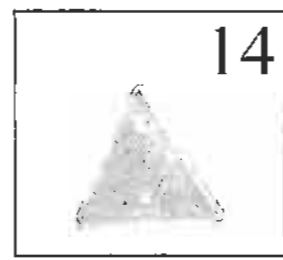
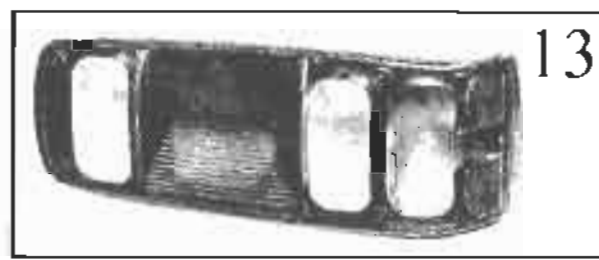
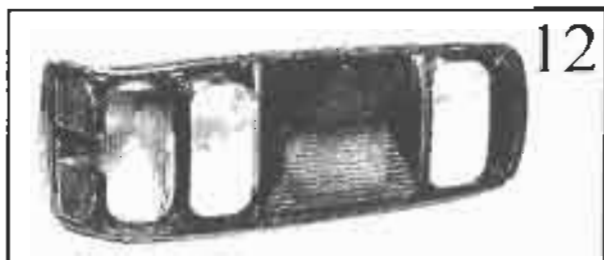
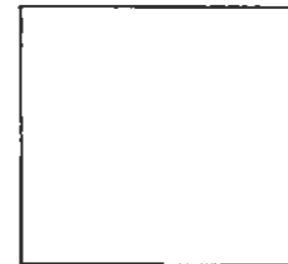
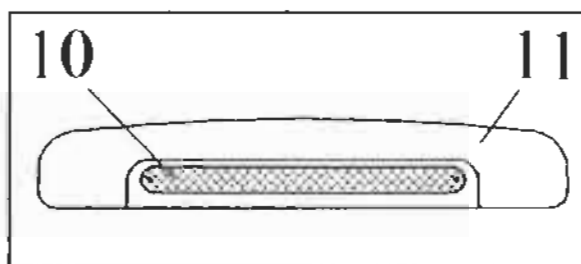
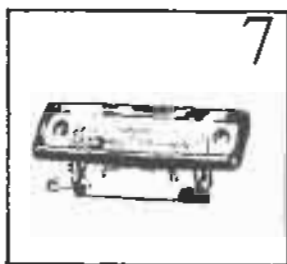
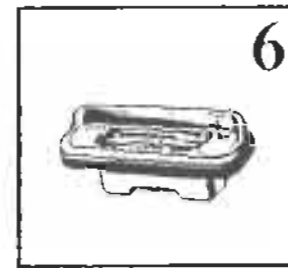
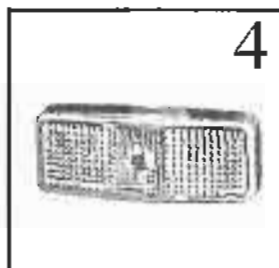
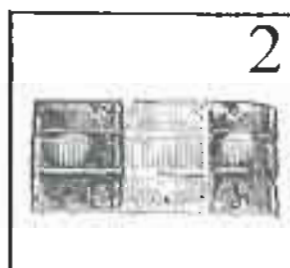

SOLIFERSähkö
El
Electricity

512

Ulkovalot ja heijastimet
Utvändig belysning och reflexer
Outside lights and reflektors

X=vakio/ standard

M=Menu-varustelu maasta riippuen/ Menu-utrustning beroende på land/ Menu-equipment due to country specification

2000

Kuva Pos. Fig.	Varaosan nro Def.nr. Part.nr.	Kuvaus Benämning Description																			Huom. Anm. Obs.
1	9000-9092	Takavalo kor. raldoin sumuv:lla vas.	Baklyckta V	Tail light	X	X															
2	9000-3628	Takavalo kor. raldoin sumuv:lla aik	Baklyckta H	Tail light	X	X															
3	0090-0168	Etuäärivalo Hella 2PF 002 747-001	Frantlampa	Front light	X	X															
4	9000-3630	Sivuvalo keltainen	Sidomarkering	sidewall light	X	X															
5	9000-8654	Äärivalo lakasivuyllä Hella 2x5 005 020-1	Breddmarkeringslyckta	Side marking light	X	X	X	X	X	X	X	X	X	X	X	X	X	X	X	X	
6	0090-0028	Rekisterivalaisin 2KA001378-04	Nummerplåtsbelysning	Light for register number plate	X	X															
7	0090-0167	Rekisterivalaisin Hella	Nummerplåtsbelysning	Light for register number plate			X	X	X	X	X	X	X	X	X	X	X	X	X	X	
8	2710-3786	Äärivalo etu kaasupullokotelaan	Ytterbelysning	Front light			X	X	X	X	X	X	X	X	X	X	X	X	X	X	
8	9001-7305	Sivuvato 12.1006-101	Sidomarkering	sidewall light			X	X	X	X	X	X	X	X	X	X	X	X	X	X	
9	0090-0166	Etulelftavalo	Ytterbelysning (tälllampa)	Awning light	X	X	X	X	X	X	X	X	X	X	X	X	X	X	X	X	
10	9002-4817	Lisäjarruvato	Brömsljus	Stop light	X	X	X	X	X	X	X	X	X	X	X	X	X	X	X	X	
11	9302-4925	Lisäjarruvaton kehys	Ram till bromsljus	Frame stop light	X	X	X	X	X	X	X	X	X	X	X	X	X	X	X	X	
12	9001-7126	Takavato -98 vasen	Baklyckta V	Tail light			X	X	X	X	X	X	X	X	X	X	X	X	X	X	
13	9001-7127	Takavato -98 oikea	Baklyckta H	Tail light			X	X	X	X	X	X	X	X	X	X	X	X	X	X	
14	9000-3670	Kolmioheijastin	Trekantreflex	Rear reflector	X	X															
15	0090-0078	Suorakaideheijastin etu	Frontreflex	Frontreflector	X	X															
16	0084-8002	Polttimo 12 V 21 / 5 W	Glödlampa 21/5W BA 15s(dim/parkijus)	Bulb 21/5W BA 15s(parkinglight)	X	X	X	X	X	X	X	X	X	X	X	X	X	X	X	X	
17	0544-3050	Polttimo 12 V 21 W kirkas	Glödlampa 21W(blink, bröms, dim)	Bulb 21W(indicator, brakes, dim)	X	X	X	X	X	X	X	X	X	X	X	X	X	X	X	X	
17	2710-3787	Polttimo 12 V 21 W keltainen	Glödlampa 21W(blink, bröms, dim)	Bulb 21W(indicator, brakes, dim)			X	X	X	X	X	X	X	X	X	X	X	X	X	X	
18	0084-8004	Polttimo 12 V 10 W BA 15 S	Glödlampa 5W(parkijus)	Bulb 5W(parkinglight)	X	X	X	X	X	X	X	X	X	X	X	X	X	X	X	X	
19	0544-3015	Polttimo 5 W (rekisterikilpi etuvato)	Spollampa 5W(nr.plåt frontlampa)	Bulb 5W(number plate's front light)	X	X	X	X	X	X	X	X	X	X	X	X	X	X	X	X	
20	2710-3780	Polttimo 5 W äärivato, sivuvato	Bajonettlampa 5W(sidomarkering)	Bulb 5W(sidewall light))	X	X	X	X	X	X	X	X	X	X	X	X	X	X	X	X	

Huom./ Anm./Obs.

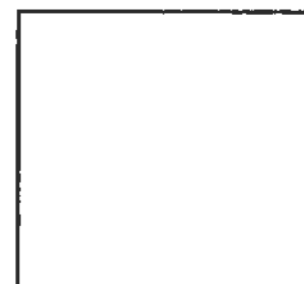
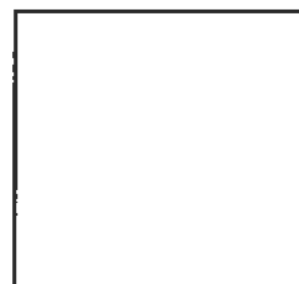
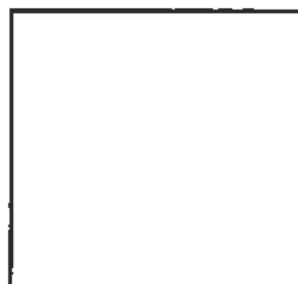
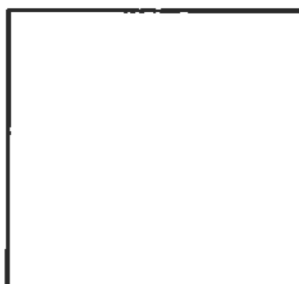
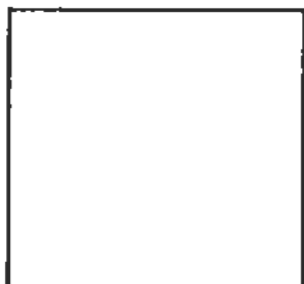
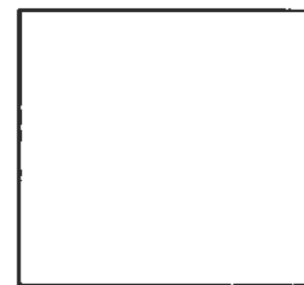
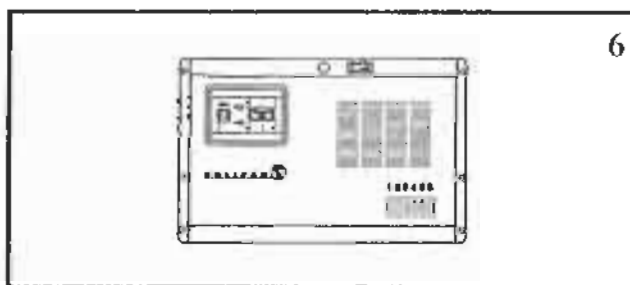
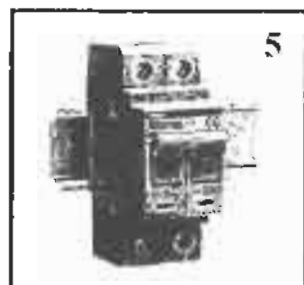
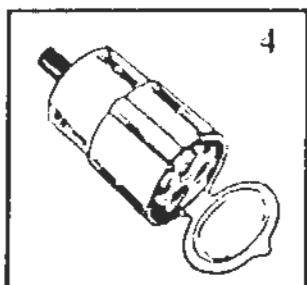
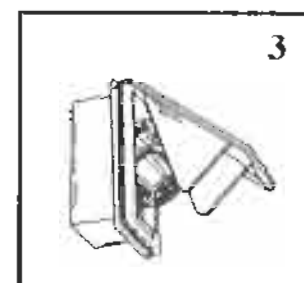
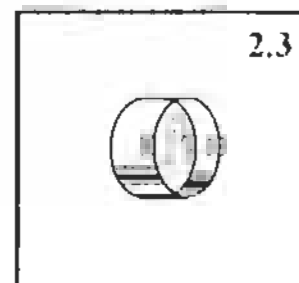
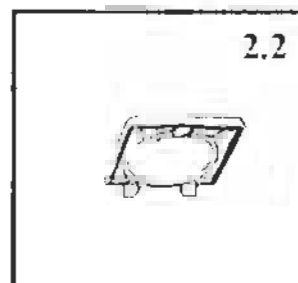
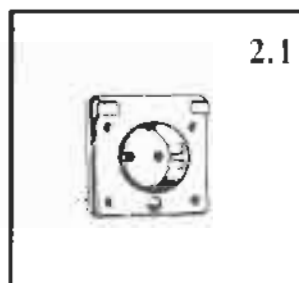
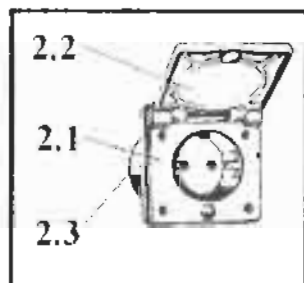
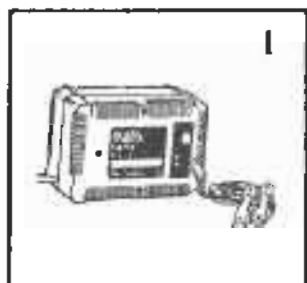



Sähkö
El
Electricity

513

Muut sähkökomponentit 230 V
Övriga elkomponenter 230 V
Other electricity parts 230 V

2000

X-vakio/ standard M-Menu-varustelu maasta riippuen/ Menu-utrustning beroende på land/ Menu-equipment due to country specification

Kuva Pos. Fig.	Varaosan nro Det.nr. Part.nr.	Kuvaus Benämning Description																		Huom. Anm. Obs.
1	0089-0087	Akkuvaraja 12/7A	Batteriladdare 12/7A	Charger 12/7A	x	x														
2,1	9000-5116	Pistorasia 230 V Berker	Väggkontakt	Wall socket 230 V Berker	x	x	x	x	x	x	x	x	x	x	x	x	x	x	x	
2,2	9000-5117	Pistorasian kanssi	Skyddslock	Cover for 230 V wall socket	x	x	x	x	x	x	x	x	x	x	x	x	x	x	x	
2,3	9000-5118	Kosketus-suoja	Beröringskydd	Contact protect	x	x	x	x	x	x	x	x	x	x	x	x	x	x	x	
3	9000-3664	Kojevastake MPK valkea	230 V inlag MPK vit	230 V contact box MPK white	x	x	x	x	x	x	x	x	x	x	x	x	x	x	x	
3	2710-4306	Kojevastakkeen kanssi	Lock för MPK	Cover of contact box	x	x	x	x	x	x	x	x	x	x	x	x	x	x	x	
3	2710-3925	Kojevastakkeen kannen tappi	Tapp för lock	Pin for cover	x	x	x	x	x	x	x	x	x	x	x	x	x	x	x	
4	0082-4000	Laitteistorasia 3-napainen	Kontakt 3-polig	Track rope coupling	x	x	x	x	x	x	x	x	x	x	x	x	x	x	x	
5	2725-0031	Automaattisulake 230 V 16A	Automatsäkring 230 V 16A	Automatic fuse 230 V 16A	x	x	x	x	x	x	x	x	x	x	x	x	x	x	x	
6	9402-6048	Sähköpääkeskus 230 V	Manövering system 230 V	Central control 230 V			x	x	x	x	x	x	x	x	x	x	x	x	x	

Huom. / Anm. / Obs.

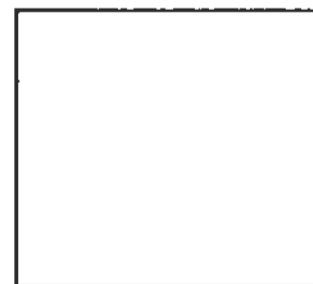
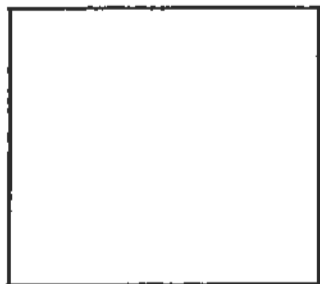
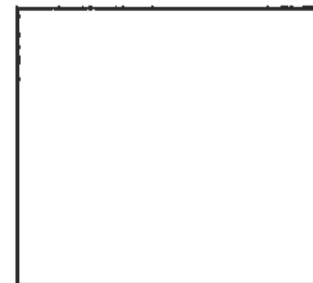
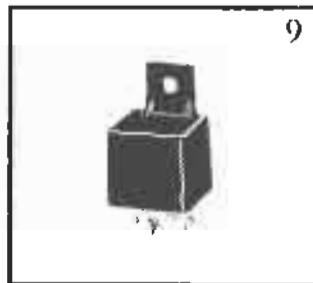
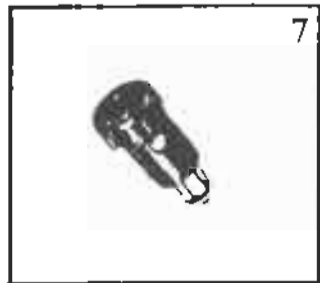
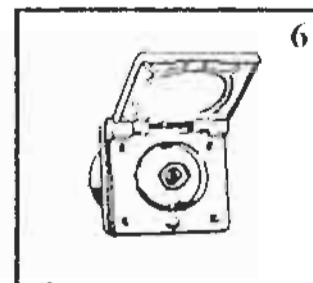
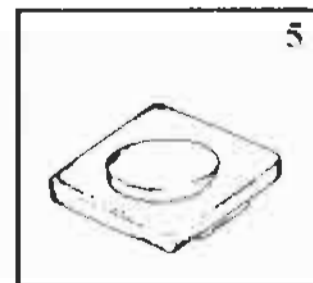
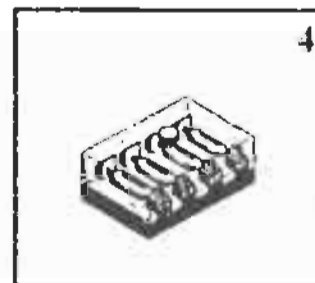
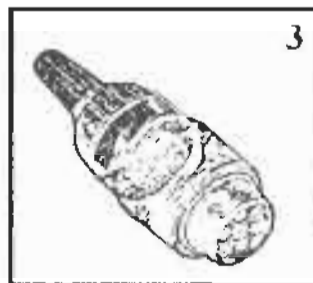
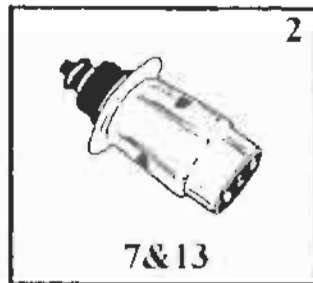
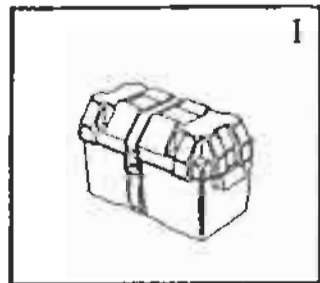



Sähkö
El
Electricity

515

Muut sähkökomponentit 12 V
Övriga elkomponenter 12 V
Other electricity parts 12 V

X -vakio/ standard

M Menu-varusteita maasta riippuen/ Menu-utrustning beroende på land/ Menu-equipment due to country specification

2000

Kuva Pos. Fig.	Varaosanro Def.nr. Part.nr.	Kuvaus Benämning Description																		Huom. Anm. Obs.
1	0090-0203	Akkukotelo	Box för batteri	Box for battery	x	x	x	x	x	x	x	x	x	x	x	x	x	x	x	
2	0082-4024	Pistotulppa 7-nap	Stickkontakt 7-pol	Plug for 7-core cable	M	M	M	M	M	M	M	M	M	M	M	M	M	M	M	1)
2	9001-2486	Pistotulppa 13-nap. Multificon	Stickkontakt 13-pol (multificon)	Plug 13-pole (multificon)	M	M	M	M	M	M	M	M	M	M	M	M	M	M	M	2)
3	9001-3958	Pistotulppa 13-nap. ISO	Stickkontakt 13-pol ISO 11446	Plug 13-pole ISO 11446	M	M	M	M	M	M	M	M	M	M	M	M	M	M	M	3)
4	0543-0012	Sulakerasia 4 sulaketta	Säkringsbox 4-pol	Safety fuse box 4-core	x	x	x	x	x	x	x	x	x	x	x	x	x	x	x	
5	0082-4019	Vipukytkin Berker 365101	Avbrytare Berker 365101	Switch Berker 365101	x	x	x	x	x	x	x	x	x	x	x	x	x	x	x	
5	9000-3704	Vipukytkin Berker (kaksos)	Avbrytare Berker (Dubbel)	Switch Berker (double)	x	x	x	x	x	x	x	x	x	x	x	x	x	x	x	
5	9000-6905	Kehys Berker 09182701	Ram till Brytare Berker	Frame for switch Berker	x	x	x	x	x	x	x	x	x	x	x	x	x	x	x	
6	9000-6904	Pistorasia 12 V 1-nap.	Väggkontakt 12V 1-pol	12 V wall socket 1-core	x		x	x	x	x	x	x	x	x	x	x	x	x	x	
7	0082-4007	Pistoke 8Ja 002 262-001 12 V	Propp 8Ja 002 262-001 12 V	Plug 8Ja 002 262-001 12 V	M	M	M	M	M	M	M	M	M	M	M	M	M	M	M	
8	0082-4016	Keinukytkin Berker WKU 850A1	Brytare Berker WKU 850A1	Switch Berker WKU 850A1	x	x	x	x	x	x	x	x	x	x	x	x	x	x	x	
9	9002-2612	Valorele 4RA 003 510-087	Relä 4RA 003 510-087	Relay 4RA 003 510-087			x	x	x	x	x	x	x	x	x	x	x	x	x	

Huom./ Anm./Obs. 1) SF, S, N 2) NL, D 3) DK

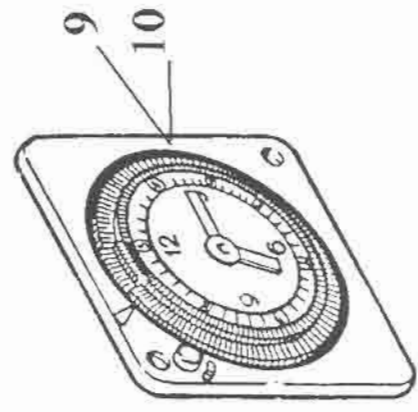
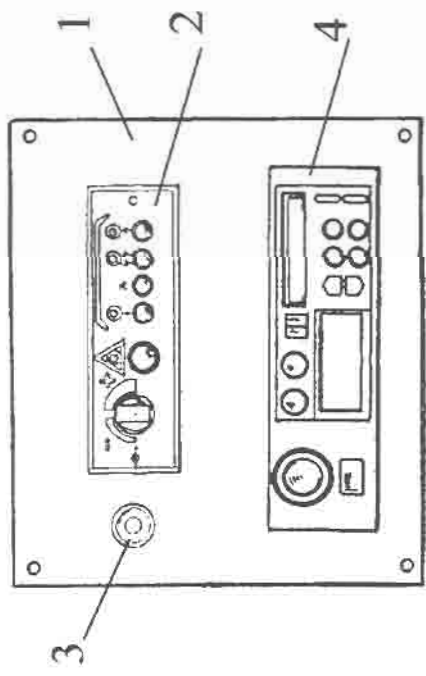
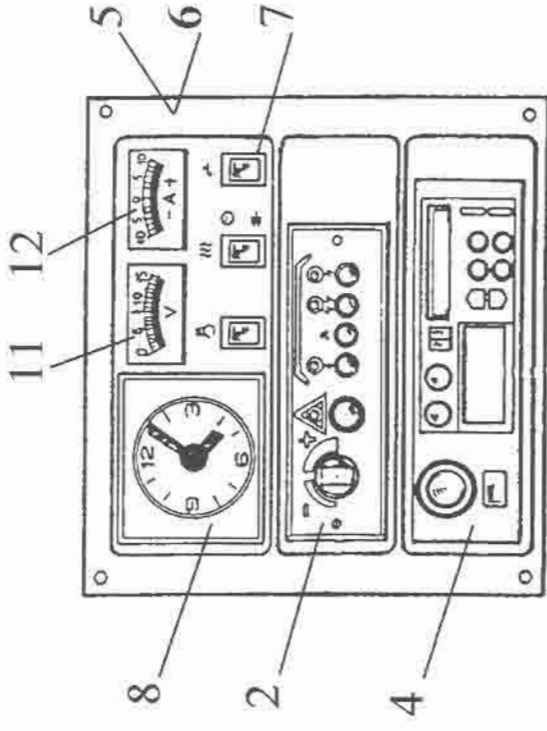

SOLIFERSähkö
El
Electricity

520

Toimintopaneli
Manöverpanel
Operating panel

X=vakio/ standard

M=Menu-varustelu maasta riippuen/ Menu-utrustning beroende på land/ Menu-equipment due to country specification

2000

Kuva Pos. Fig.	Varaosan nro Det.nr. Part.nr.	Kuvaus Benämning Description																	Huom. Anm. Obs.
1	9300-3607	Radiopaneeli	Radiopanel	Radio panel	X	X													
2	3471-9081	Termostaattipaneeli 2470&2490	Termostatpanel 2470 & 2490	Thermostat panel 2470 & 2490	X	X	X	X	X	X	X	X	X	X	X	X			
3	0082-4013	Pistorasia 8JB 002286-021	Väggkontakt 8JB	Wall socket 8JB	X	X													
4	9000-6431	Radio CD soittimejla	Bilstereo	Autostereo	M	M	M	M	M	M	M	M	M	M	M	M			
5	9302-4546	Radiopaneeli	Radiopanel	Radio panel			X	X	X	X	X	X	X	X	X	X			
6	9302-4602	Radiopaneelin johdot	Kapel serie	Capel series			X	X	X	X	X	X	X	X	X	X			
7	0082-4016	Keinukytin Berker WKU 850A1	Brytare Berker WKU 850A1	Switch Berker WKU 850A1			X	X	X	X	X	X	X	X	X	X			
8	2710-4301	Kello Scholer täyd.	Klocka Scholer kompl.	Clock scholer compl.			M	M	M	M	M	M	M	M	M	M			
9	0095-0117	Viikkokello	Veckour	Weekly clock			M	M	M	M	M	M	M	M	M	M			
10	9001-4832	Viikkokellon johto	Kapel serie till veckour	Capel series for weekly clock			M	M	M	M	M	M	M	M	M	M			
11	9400-2905	Volttimittari	Voltmätare	Voltmeter			M	M	M	M	M	M	M	M	M	M			
12	9400-2904	Ampeerimittari	Ampermätare	Amper meter			M	M	M	M	M	M	M	M	M	M			

Huom./ Anm./Obs.

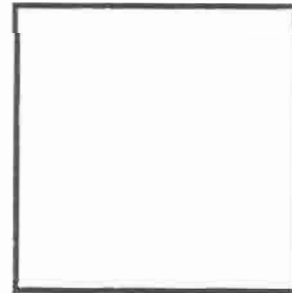
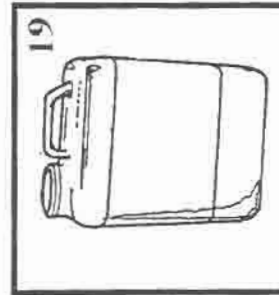
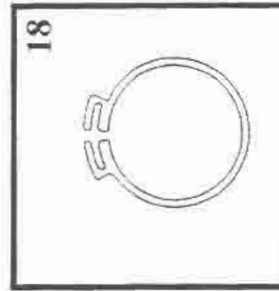
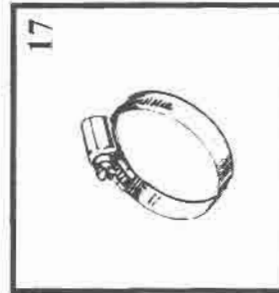
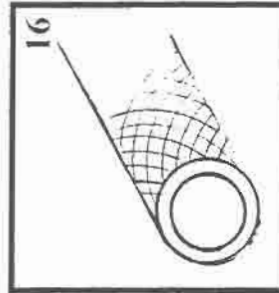
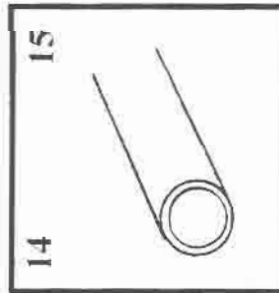
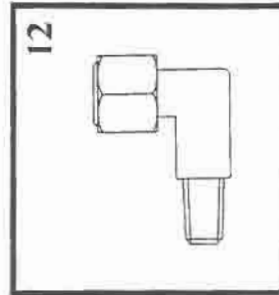
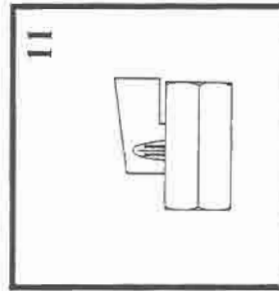
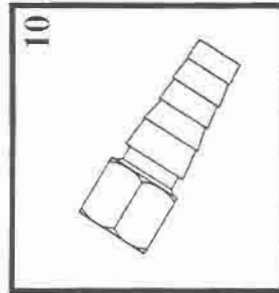
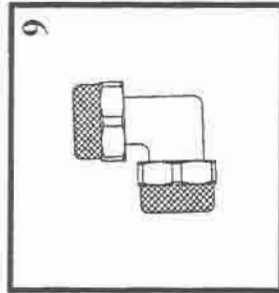
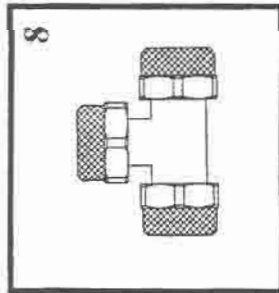
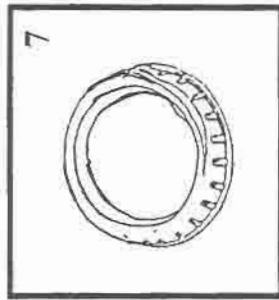
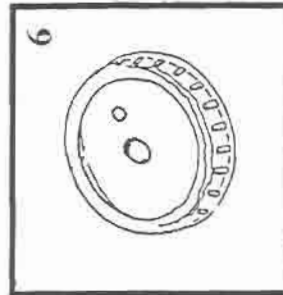
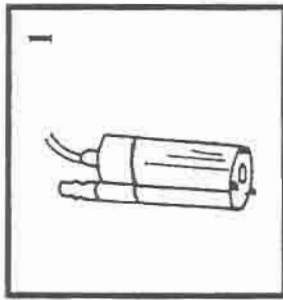

SOLIFERVesi
Vatten
Water

610

Puhdas vesi
Färskvatten
Fresh water

X=vakio/ standard

M=Menu-varustelu maasta riippuen/ Menu-utrustning beroende på land/ Menu-equipment due to country specification

2000

Kuva Pos. Fig.	Varaos nro Def.nr. Part.nr.	Kuvaus Benämning Description																	Huom. Anm. Obs.
1	0096-0096	Uppopumppu 15L Reich 511.0	Dränkbar pump 15L Reich 511.0	Pump 15L Reich 511.0	x	x	x	x	x	x	x	x	x	x	x	x	x	x	
2	9002-4758	Kylmävesihana TWIST Cr	Kallvattenskrän	Cold-water tap	M	M	M	M	M	M	M	M	M	M	M	M	M	M	
3	9002-4950	Yksiotehana TWIST Cr	Ett grepp kran	Unigrip tap	M	M	M	M	M	M	M	M	M	M	M	M	M	M	
4	9002-4953	Yksiotehana TWIST UT Cr	Ett grepp kran	Unigrip tap	M	M	M	M	M	M	M	M	M	M	M	M	M	M	
5	9002-4954	Käsisuihku WEGA Cr	Hand-dusch	Hand shower	M	M	M	M	M	M	M	M	M	M	M	M	M	M	
6	2710-3673	Vesiastian avoin korkki	Lock för vattendunk öppet	Open cap for water container	x	x	x	x	x	x	x	x	x	x	x	x	x	x	
7	2710-3672	Vesiastian umpikorkki	Lock för vattendunk läkt	Clos. cap for water container	x	x	x	x	x	x	x	x	x	x	x	x	x	x	
8	0096-0073	T-yhde 10/8	T-förgrening 10/8	T-joint 10/8	x	x	x	x	x	x	x	x	x	x	x	x	x	x	
9	0096-0092	Kulmayhde 10/8 mm	Rapidkoppling L 10/8	Coupling L 10/8	x	x	x	x	x	x	x	x	x	x	x	x	x	x	
10	3471-3021	Kartioliitin (lämminv.)	Adapler 8/10 till 10/16	Hose coupling 8/10 to 10/16	x	x	x	x	x	x	x	x	x	x	x	x	x	x	
11	0096-0086	Kuulaventtiili DG6-PN10	Kulventil DN6-PN10	Barrage valve DN6-PN10	x	x	x	x	x	x	x	x	x	x	x	x	x	x	
12	0096-0084	Kulmalliitin 10/8 ulkokierteellä	Vinkelstycke	Coupling	x	x	x	x	x	x	x	x	x	x	x	x	x	x	
13	0096-0087	Suorayhde	Rak koppling	Coupling straight	x	x	x	x	x	x	x	x	x	x	x	x	x	x	
14	9002-5877	Polyamidiletku 8/10 sininen	Plastslang 8/10 blå	Plastic hose 8/10 blue	x	x	x	x	x	x	x	x	x	x	x	x	x	x	
15	9002-5878	Polyamidiletku 8/10 punainen	Plastslang 8/10 röd	Plastic hose 8/10 red	x	x	x	x	x	x	x	x	x	x	x	x	x	x	
16	0061-4008	Juomavesiletku 10/2 Musta	Avluftnings slang	Water hose D=10 black	x	x	x	x	x	x	x	x	x	x	x	x	x	x	
17	0096-0050	Kiristin Norma SGL 10-16	Slangklämma Norma SGL 10-16	Hose clip SGL 10-16 Norma	x	x	x	x	x	x	x	x	x	x	x	x	x	x	
18	0096-0062	Letkunkiristin SNP 6	Plastklämma SNP 6	Hose clip plastic SNP 6	x	x	x	x	x	x	x	x	x	x	x	x	x	x	
19	0096-0052	Vesiastia 17 l	Vattendunk 17 l	Water container 17 l.	x	x	x	x	x	x	x	x	x	x	x	x	x	x	

Huom./ Anm./Obs.



Vesi
Vatten
Water

620

VesisäiliVesius®
Fastvattentank
Water tank

2000

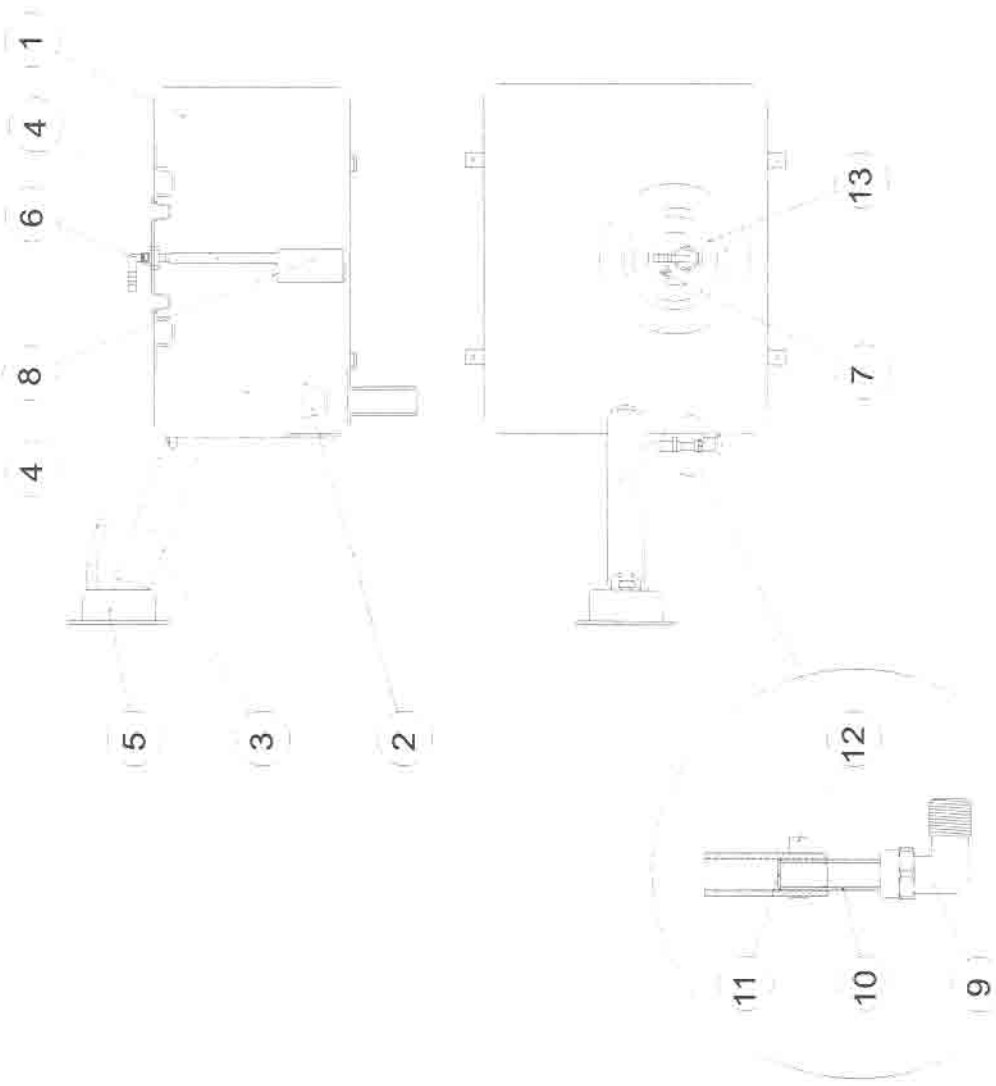

SOLIFERVesi
Vatten
Water

620

Vesisäiliö
Fast vattentank
Watertank

X=vakio/ standard M=Menu-varustelu maasta riippuen/ Menu-utrustning beroende på land/ Menu-equipment due to country specification

2000

Kuva Pos. Fig.	Varaos nro Def.nr. Part.nr.	Kuvaus Benämning Description																			Huom. Anm. Obs.	
1	9001-4343	Vesitankki -96	Vattentank -96	Watertank -96																		
2		Pohjätulppa vesitankki -96	Bottenventil	Bottom valve																		
3	0063-3029	Vesilietku D=38	Påfyllningsslang D=38	Water hose D=38																		
4	0061-4008	Juomavesilietku 10/2 Musta	Avluftningsslang	Water hose D=10 black																		
5	9001-7391	Vesitankin kaulus	Flänsning	Flanging																		
5	311549	Vesitankin korkki	Kork	Plug																		
5	9001-7589	Lukkosylinteri	Låscylinder	Lockcylinder																		1)
5	9001-7590	Avain	Nyckel	Key																		1)
6	9001-4344	Tankiliitin 90°, 2-puolinen	Tankadaptar 90°, dubbelsida	Adaptor 90°, double side																		
7	9001-4351	Läpivihti Thorsman TET 5-7	Venfil Thorsman TET 5-7	Valve																		
8	0096-0096	Uppopumppu 15L Reich 511.0	Dränkbar pump 15L Reich 511.0	Pump 15L Reich 511.0																		
9	0096-0084	Kulmaliitin 10/8 ulkakierteellä	Vinkelstycke	Caupling																		
10	9002-5877	Polyamidilietku 8/10 sininen	Plastslang 8/10 blå	Plastic hose 8/10 blue																		
11	9001-7504	Tukiholkki 8 mm putkelle	Bussning 8 mm	Bush ring 8 mm																		
12	0096-0062	Letkunkiristin SNP 6	Plastklämma SNP 6	Hose clip plastic SNP 6																		
13	3702-0005	Vesitankin korkki punainen	Vattentankfyllning kpl	Water refill																		

Huom./ Anm./ Obs. 1) Avainnumero / Nyckelnummer / Key number

Viemärijärjestelmä 1
Spillvattensystem 1
Spillvattensystem 1

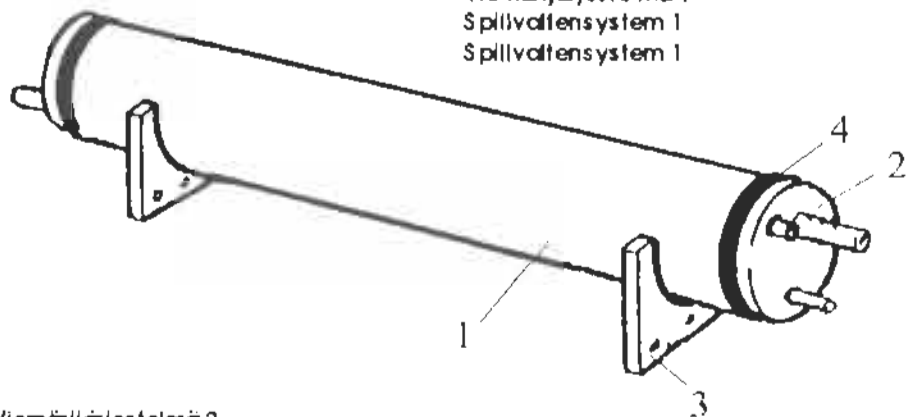

Viemärijärjestelmä 2
Spillvattensystem 2
Spillvattensystem 2

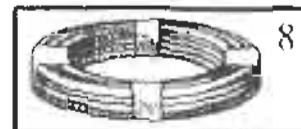
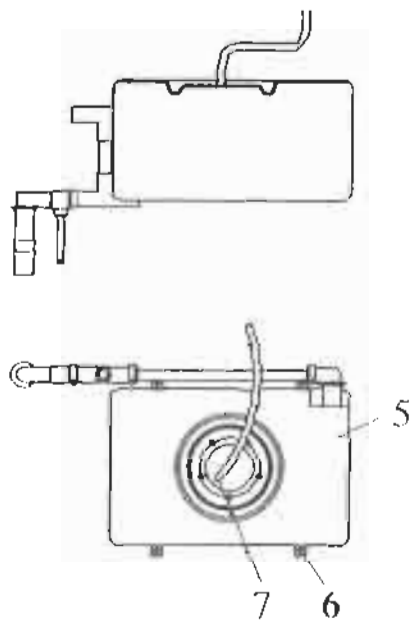

8

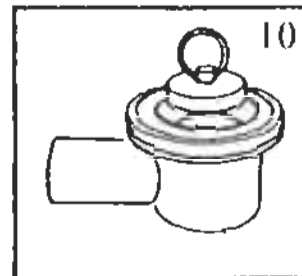

10

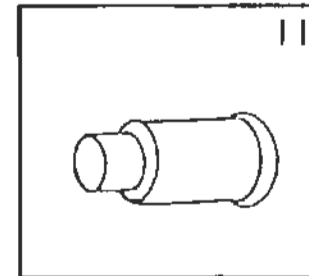

11



9



12

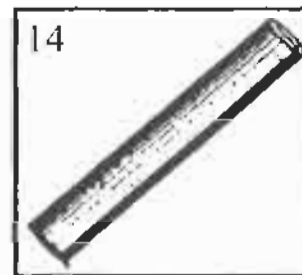

14

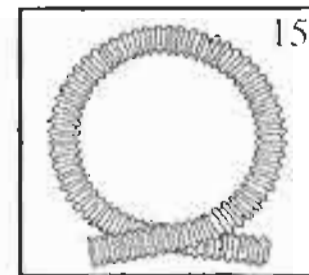

15



13

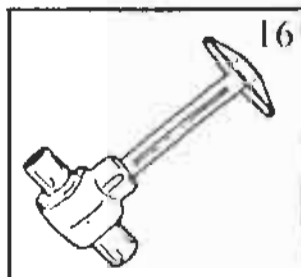

16

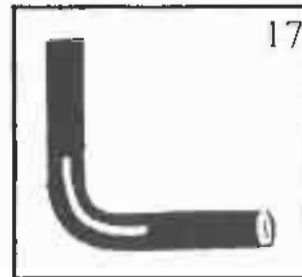

17



18



19

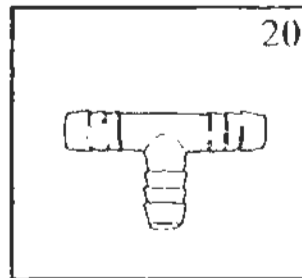

20

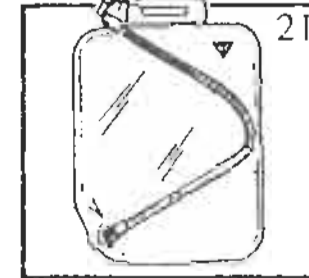

21

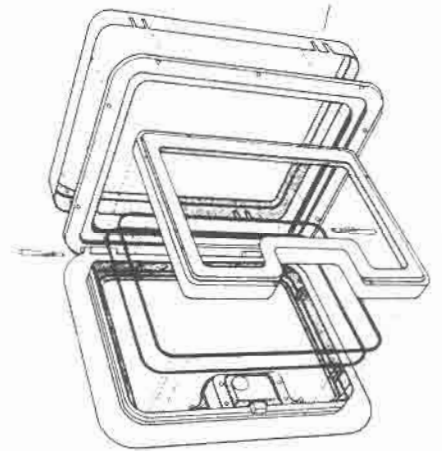
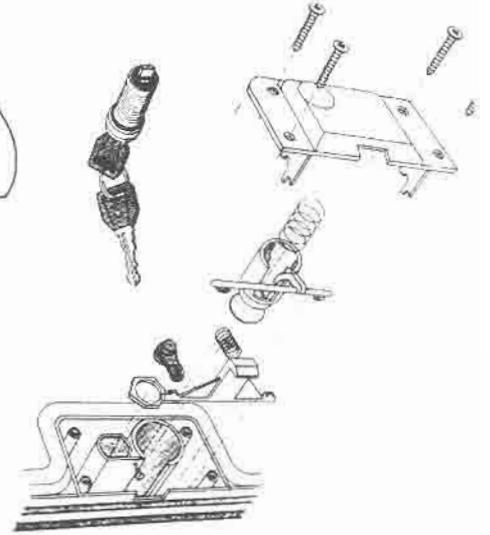
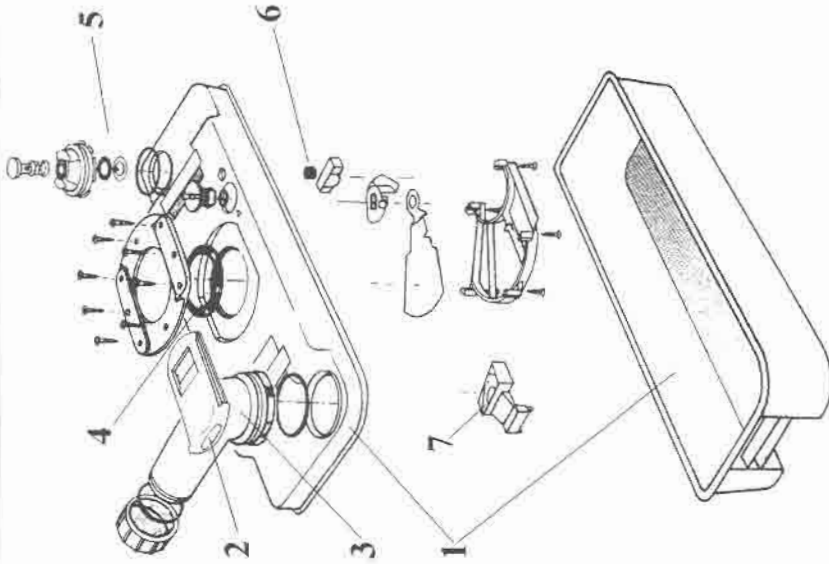
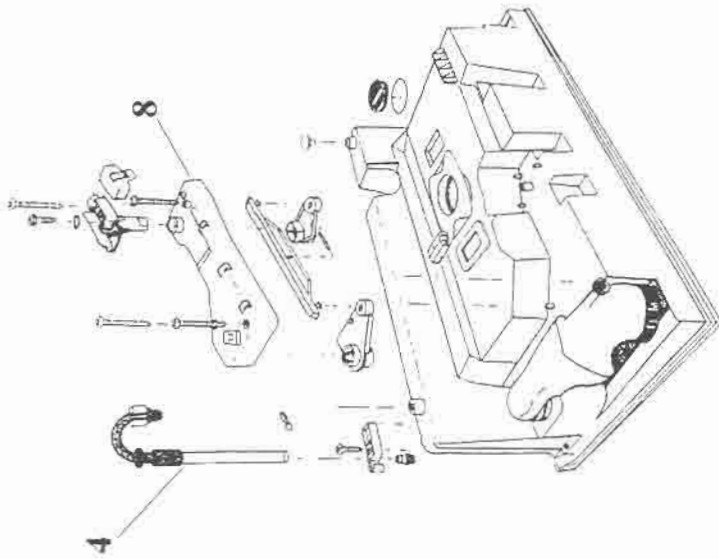
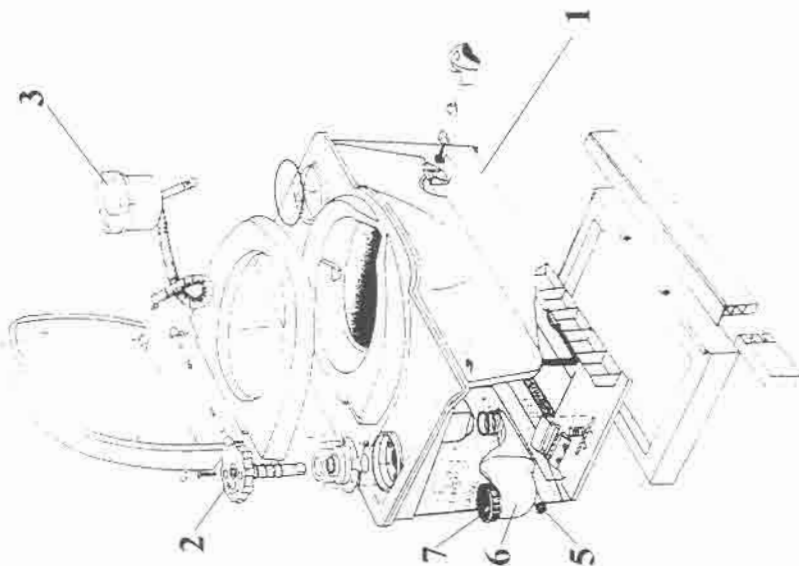



Jätevesi
Avlopp
Soil water

655

Kasetti wc
Kasettoaletti
Casette toilet

2000

X=vakio/ standard M=Menu-varustelu maasta riippuen/ Menu-utrustning beroende på land/ Menu-equipment due to country specification

Kuva Pos. Fig.	Varaosan nro Det.nr. Part.nr.	Kuvaus Benämning Description																	Huom. Anm. Obs.
			Golden 500	Golden 530	S	S	S1	S2	S3	S7L	S9	S10	S15						
1	9000-4149	P.potti Thiford valk oik.	Kasettoaletti H	Casette toilet R	x	x				x	x	x	x	x	x	x	x		
1	9001-5528	P.potti Thiford valk vas.	Kasettoaletti V	Casette toilet L							x								
2	3863-7762	Huuhtelunuppi valk.	Spolknapp	Flush knob	x	x	x	x	x	x	x	x	x	x	x	x	x		
3	3802-9162	Huuhtelunpumppu täyd. valk.	Pump	Pump	x	x	x	x	x	x	x	x	x	x	x	x	x		
4	3821-3700	Mittalasi täyd.	Mätglas	Sight glass	x	x	x	x	x	x	x	x	x	x	x	x	x		
5	3863-5878	Täyttötankin korkki	Skruvkork vattenavtappning	Drain Cap waterfillfunnel	x	x	x	x	x	x	x	x	x	x	x	x	x		
6	3863-8174	Veden täyttösuppilo	Valtenpättyllning	Waterfillfunnel	x	x	x	x	x	x	x	x	x	x	x	x	x		
7	3816-8480	Täyttösuppilon kansi	Skruvkork vattenpättyllning	Cap waterfillfunnel	x	x	x	x	x	x	x	x	x	x	x	x	x		
8	3816-3790	Tyhjennysmekanismi täyd.	Tömningsm. kompl.	Mechanism compl.	x	x	x	x	x	x	x	x	x	x	x	x	x		
9	3821-4027	Jätetankki täyd.	Tank kompl.	Tank compl.	x	x	x	x	x	x	x	x	x	x	x	x	x		
10	3821-3337	Työntölevy	Transpartlock	Sliding cover	x	x	x	x	x	x	x	x	x	x	x	x	x		
11	3861-9674	Tyhjennysputki	Tömningsrör	Poor out spout	x	x	x	x	x	x	x	x	x	x	x	x	x		
12	3816-1750	Tiiviste	Ventiltätning	Seal cover	x	x	x	x	x	x	x	x	x	x	x	x	x		
13	3861-7674	Ilmausventtill täyd.	Avluftnings ventil	Vent button	x	x	x	x	x	x	x	x	x	x	x	x	x		
14	3820-3390	Ilmausttiiviste	Packning	Vent seal	x	x	x	x	x	x	x	x	x	x	x	x	x		
15	3821-3220	Koho	Flytkropp	Float assy	x	x	x	x	x	x	x	x	x	x	x	x	x		
16	9002-3297	Kasetti WC:n luukku	Kasettoaletti lucka	Casettetoilet cover	x	x	x	x	x	x	x	x	x	x	x	x	x		
17	9001-7589	Lukkosylinteri	Låscylinder	Lockcylinder	x	x	x	x	x	x	x	x	x	x	x	x	x		1)
18	9001-7590	Avain	Nyckel	Key	x	x	x	x	x	x	x	x	x	x	x	x	x		1)

Huom./ Anm./Obs. 1) Avaimen numero / Nyckel nummer / Key number

SOLIFER

WC
Toilet
Toilet

675

Goldie 500, 530
Goldie 500, 530
Goldie 500, 530

2000

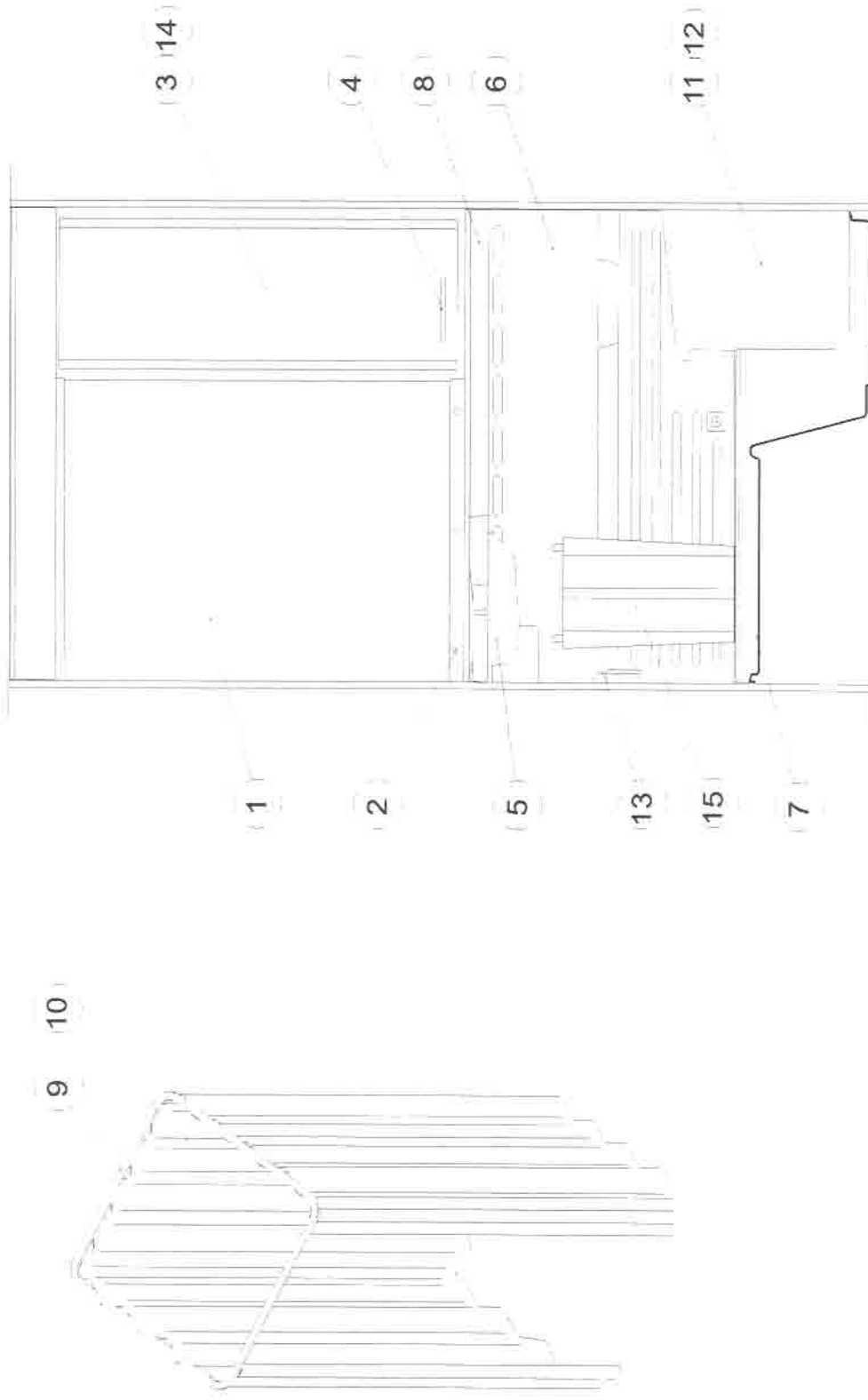

SOLIFER

WC		Goldie 500, 530
Toaletti	675	Goldie 500, 530
Toilet		Goldie 500, 530

2000

X=vakio/ standard M=Menu-varusteita maasta riippuen/ Menu-utrustning beroende på land/ Menu-equipment due to country specification

Kuva Pos. Fig.	Varaosan Def.nr. Part.nr.	Kuvaus Benämning Description		Goldie 500	Goldie 530	54	55	56	57	58	59	60	61	Huom. Anm. Obs.
1	9500-3693	Peili, 3x660x865	Spegel	Mirror	x	x								
2	0092-0187	Peiliteulppo aluslevyllä LC	Bricka med hatt 5/12	Washer for screw 5/12	x	x								
3	9301-3465	WC-kaappin ovi	Dörr för spegelskåp	Door	x	x								
4	9001-6000	Vedin Zell gold	Håndtag	Handle	x	x								
5	9201-5616	Pesualfos, valk	Tvåffställ	Sink	x	x								
6	9200-3642	WC-ohjauslevy, valk	Styrskiva	Deflection plate	x	x								
7	9000-8812	Suihkuallas	Duschtråg	Shower		x								
7	9202-2547	Suihkuallas	Duschtråg	Shower	x									
8	9401-3361	WC-taso	Hylla i toaletti	Plate for toilet	x	x								
9	9400-4906	Suihkuverhokisko	Duschgardinskena	Shower curtain bar	M	M								
10	0410-3140	Suihkuverho	Duschgardin	Shower curtain	M	M								
11	9000-4149	P.potti Thitford valk oik.	Kasettoaletti H	Cassette toilet R	x	x								
12	9202-3258	WC-luukun kehys	Plastram för lucka	Frame for cass.door	x	x								
13	0092-0119	WC-paperiteline	Ställing för toalettpapper	Holder for toilet paper	x	x								
14	9000-5877	Peilikaappi oik valk	Spegelskåp vit H	Mirror cupboard White R	x	x								
15	1723-0082	Roskakori	Papperskorg	Waste-basket	M	M								

Huom./ Anm./Obs.



NWC		04
Toilet	010	04
Toilet		04

2.6

4
1
16
20
2
5
9
18 17

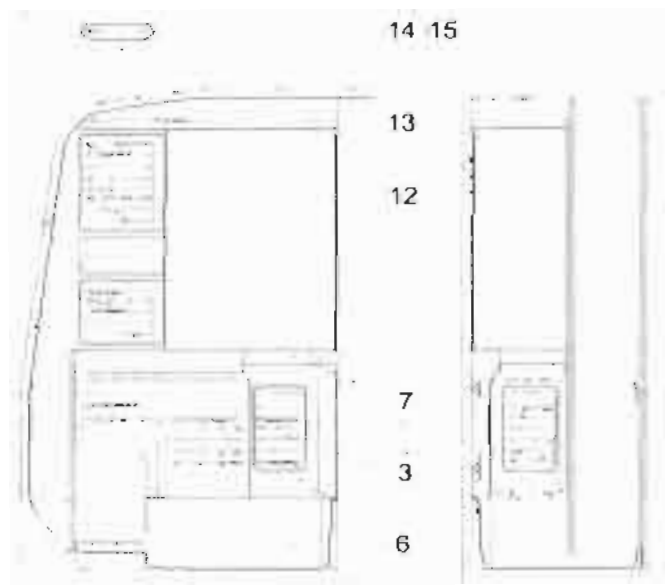

19

4
1
16
20
2
5
10
18 17

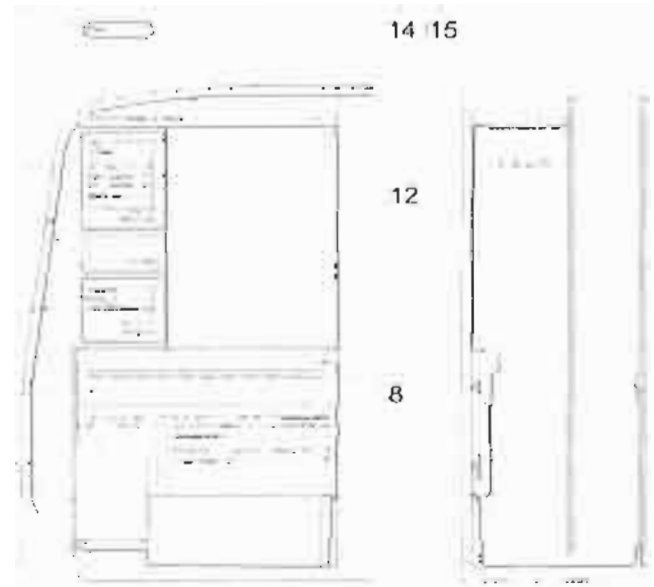

19

Pesujalas makuuhuoneessa
Tv,ttelTv,il sovrurn
Washbasin in the bedroom



SOLIFER

WC	S4
Toaletti	S4
Toilet	S4

685

S4

S4

S4

2000

X-vakio/ standard M-Menu-varustelu maasta riippuen/ Menu-utrustning beroende på land/ Menu-equipment due to country specification

Kuva Pos. Fig.	Varaosan nro Det.nr. Part.nr.	Kuvaus Benämning Description																		Huom. Anm. Obs.	
1	9302-4381	Peilikaapin ovi ylä	Spegelskåps dörr	Toilet door																	
2	9302-4395	Peilikaapin ovi ala	Spegelskåps dörr	Toilet door																	
3	93024403	Allaskaapin ovi	Skåps dörr	Cupboard door																	
4	9301-4444	Peilikaapin hylly	Hylla i toa	Plate for toilet																	
5	9302-4399	Peilikaappi	Spegelskåp	Mirror cupboard																	
6	9102-4353	Allaskaapin runko	Plastram för lucka	Frame for cass.door																	
7	9202-4344	Pesuallastaso	Tvöftställe toalet	Sink to toilet																	
8	9202-4495	Peilitaso	Spegelplan	Mirrorplane																	
9	9302-4364	Ohjauslevy, lyhyt	Styrplatta, kort	Guide plate, short																	
10	9202-4496	Ohjauslevy, pitkä	Styrplatta, lång	Guide plate, long																	
11	9102-4349	Sulhkuallas	Duschtråg	Shower basin																	
12	9002-5012	Peili 3x895x700	Spegel	Mirror																	
13	9002-5013	Peili 3x895x380	Spegel	Mirror																	
14	9302-4775	Valoramppi	Ljustramp	Lightramp																	
15	9001-8508	Valaisin LD 1.10	Lampa LD	Lamp LD																	
16	9001-3704	Vedin Golden gate	Handtag	Handle																	
17	9001-5528	P.potti Thifard valk vas.	Kasettoaletti V	Cassette toilet L																	
18	9202-3258	WC-luukun kehys	Plastram för lucka	Frame for cass.door																	
19	0092-0119	WC-paperiteline	Ställing för toalettpapper	Holder for toilet paper																	
20	9000-3364	Peitetulppa aluslevyllä	Plugg	Washer for screw																	

Huom./ Anm./Obs.

WC	85, 85L, 85T, 87, 87L, 89, 810, 810L
Toilet	89, 85L, 85T, 87, 87L, 89, 810, 810L
Total	85, 85L, 85T, 87, 87L, 89, 810, 810L

23 24

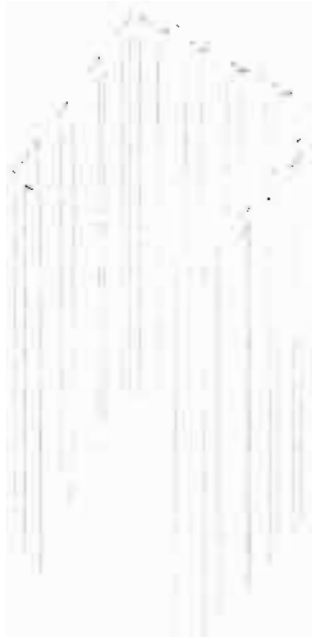

1
10
19
21
15
22



5
4
6
7
17
18
16
12
8 9

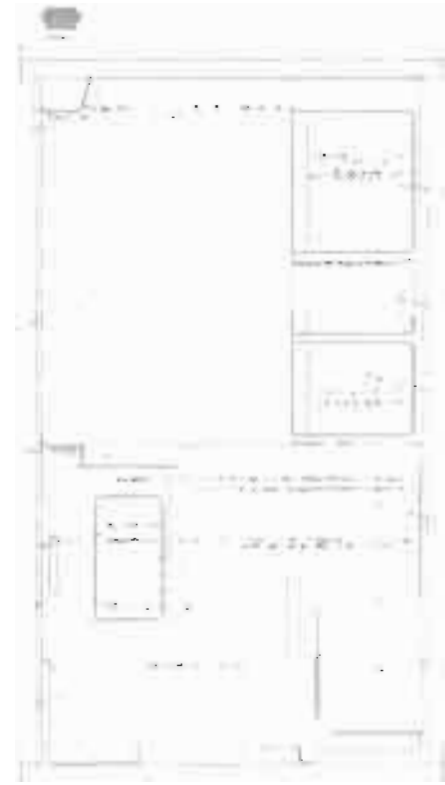

2
20
3
11
13 14

SOLIFER

WC		S5, S5L, S5T, S7, S7L, S9, S10, S10L
Toaletti	695	S5, S5L, S5T, S7, S7L, S9, S10, S10L
Toilet		S5, S5L, S5T, S7, S7L, S9, S10, S10L

X=vakio/ standard M=Menu-varustelu maasta riippuen/ Menu-utrustning beroende på land/ Menu-equipment due to country specification

2000

Kuva Pos. Fig.	Varaosan Def.nr. Part.nr.	Kuvaus Benämning Description																		Huom. Anm. Obs.
			Cassette 500	Cassette 550	S5	S5L	S5T	S7	S7L	S9	S10	S10L								
1	9301-6121	Pelikaapin ovi ylä kapea -98	Spegelskåps dörr	Toilet door				X	X	X	X	X	X	X	X	X	X	X		
2	9301-6116	Pelikaapin ovi ylä leveä -98	Spegelskåps dörr	Toilet door				X	X	X	X	X	X	X	X	X	X	X		
3	9301-6115	Pelikaapin ovi ala leveä -98	Spegelskåps dörr	Toilet door				X	X	X	X	X	X	X	X	X	X	X		
4	9301-6122	WC- valokotelo -98	Toa lysarmatur	Glasscover for toilet lamp				X	X	X	X	X	X	X	X	X	X	X		
5	9001-6315	Valaisin	Lampa	Light				X	X	X	X	X	X	X	X	X	X	X		
6	9001-6276	Peili 3x970x387	Spegel	Mirror				X	X	X	X	X	X	X	X	X	X	X		
7	9001-6277	Peili 3x970x700	Spegel	Mirror				X	X	X	X	X	X	X	X	X	X	X		
8	9301-4444	Hylly pelikaappi -98 leveä	Hylla i toa	Plate for toilet				X	X	X	X	X	X	X	X	X	X	X		
9	9301-4443	Hylly pelikaappi -98 kapea	Hylla i toa	Plate for toilet				X	X	X	X	X	X	X	X	X	X	X		
10	9001-3704	Vedin Golden gate	Handlag	Handle				X	X	X	X	X	X	X	X	X	X	X		
11	9302-3198	Ohjauslevy	Styrplatta	Guide plate				X	X	X	X	X	X	X	X	X	X	X		
12	9101-6124	Suihkuallas, valk -98	Duschtråg	Shower basin				X	X	X										
12	9102-3187	Suihkuallas	Duschtråg	Shower basin				X	X	X										
13	9000-4149	P.potti Thford valk alk.	Kasettoilett H	Cassette toilet R				X	X	X	X	X	X	X	X	X	X	X		
14	9202-3258	WC-luukun kehys	Plastram för lucka	Frame for cass.door				X	X	X	X	X	X	X	X	X	X	X		
15	0092-0119	WC-paperiteline	Ställing för toalettpapper	Holder for toilet paper				X	X	X	X	X	X	X	X	X	X	X		
16	9102-5420	Allaskaapin runko	Plastram för lucka	Frame for cass.door				X	X	X	X	X	X	X	X	X	X	X		
17	9201-6106	Pesuallastaso -98	Tvättställe toaletti	Sink to toilet				X	X	X	X	X	X	X	X	X	X	X		
18	9301-6110	Allaskaapin ovi -98	Skåps dörr -98	Cupboard door -98				X	X	X	X	X	X	X	X	X	X	X		
19	9301-6117	Pelikaappi kapea -98	Spegelskåp	Mirror cupboard				X	X	X	X	X	X	X	X	X	X	X		
20	9301-6111	Pelikaappi leveä -98	Spegelskåp	Mirror cupboard				X	X	X	X	X	X	X	X	X	X	X		
21	9000-3364	Pelitruippa aluslevyllä	Plugg	Washer for screw				X	X	X	X	X	X	X	X	X	X	X		
22	9402-4564	Al-putki U 142*574	Al-rör U 142*574	Al-tube U 142*574				X	X	X	X	X	X	X	X	X	X	X		
23	9400-4906	Suihkuverhokisko	Duschgardinskena	Shower curtain bar				M	M	M	M	M	M	M	M	M	M	M		
24	0410-3140	Suihkuverho	Duschgardin	Shower curtain				M	M	M	M	M	M	M	M	M	M	M		

Huom./ Anm./Obs.

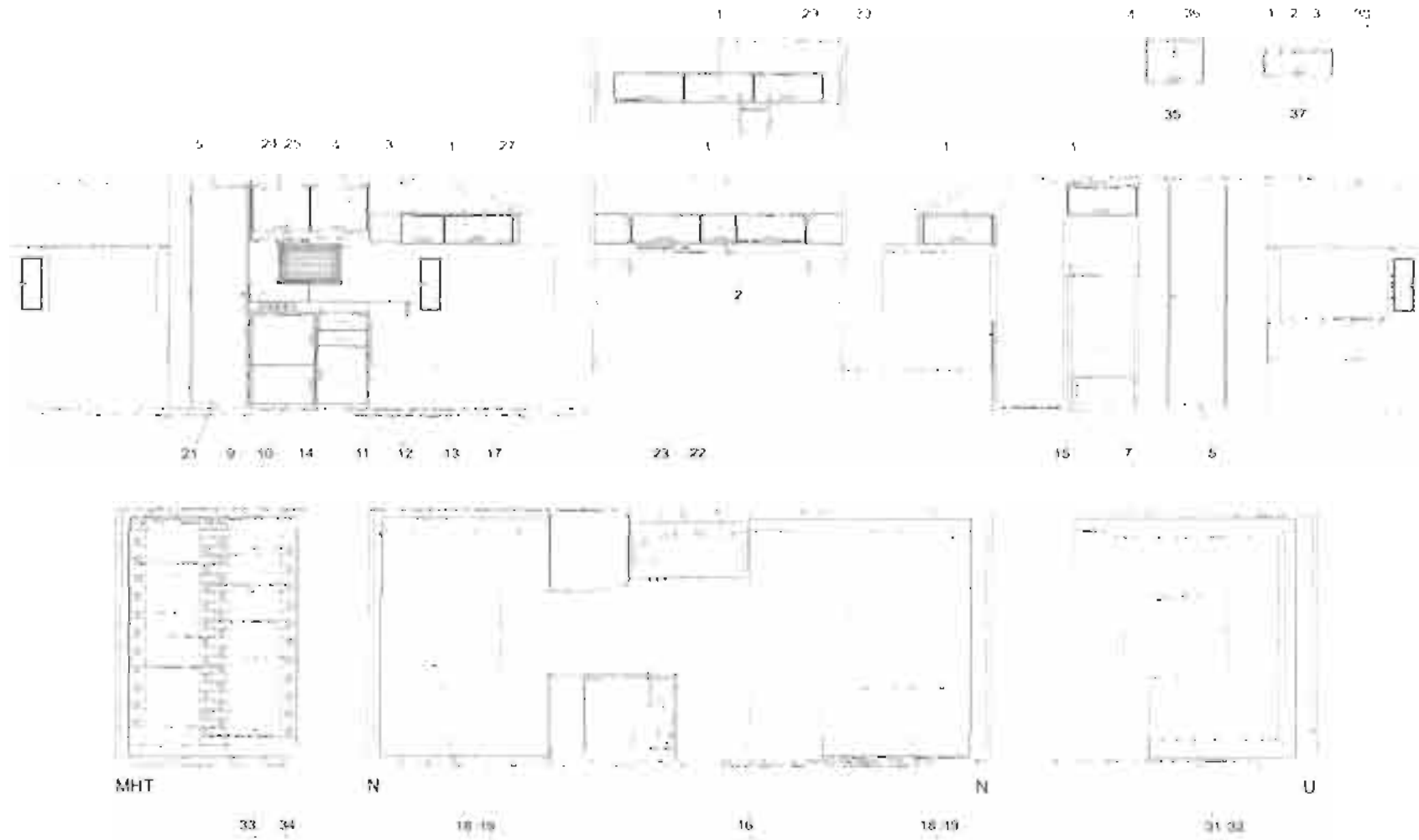

SOLIFERSisäosa
Inredning
Interior

703

Goldie 500
Goldie 500
Goldie 500

X=vakio/ standard

M=Menu-varustelu maasta riippuen/ Menu-utrustning beroende på land/ Menu-equipment due to country specification

2000

Kuva Pos. Fig.	Varaosan nro Def.nr. Part.nr.	Kuvaus Benämning Description																		Huom. Anm. Obs.
				Goldie 500	Goldie 500	S4	S5	S6	S7	S7	S7	S7	S7	S7	S7	S7	S7	S7		
1	9301-3330	Yläkaapin ovi 575x247	Överskåpslucka	Door for cupboard	x															
2	9301-3328	Yläkaapin ovi 292*247	Överskåpslucka	Door for cupboard	x															
3	9302-2703	Yläkaapin ovi 357x247	Överskåpslucka	Door for cupboard	x															
4	9301-3332	Asiakaapin ovi 480x390	Lucka pentryn överskåp	Door for cupboard in kitchen	x															
5	9301-3149	Ovi 490x1810	Dörr 490x1810	Door 490x1810	x															
7	9302-5952	Ovi 522x218	Dörr 522x218	Door 522x218	x															
9	9302-2870	Keittiön ovi vas. 541x428	Övre pentrydörr V	Left door for kitchen	x															
10	9302-2872	Keittiön ovi vas. 541x312	Nedre pentrydörr V	Left door for kitchen	x															
11	9302-2867	Keittiön ovi oik. 434x472	Nedre pentrydörr H	Door for kitchen R	x															
12	9401-5026	Vetolaatikon etulevy 434x131	Draglådans frontskiva	Front for drawer	x															
13	9401-5024	Leikkuulaudan etulevy 434x131	Skärbrädans frontskiva	Front for cutting-board	x															
14	9402-5196	Tiskikaapin etulevy 105x998	Kökets front	Frontplate	x															
15	9401-4650	Paneeli jääkaapinovi	Kylskåpsfront	Front for refrigerator	x															
16	9401-6265	Taso JK 620x620 -98	Diskbordskiva	Plate for pentry	x															
17	9402-2616	Taso tiskikaappi 380*470	Bord	Table	x															
18	9401-3334	Pöytä etu 1000x830	Främre bordskiva	Table top in front	M															
19	9000-3376	Pöydänjalatka taiteittava	Bordsben	Table support	M															
21	9301-7203	Lieden laustalevy 500*160	Stänksplåt	Back plate for stove	x															
22	9402-4641	Allas Gramer 470x1000 vasen	Diskho	Dishwashing basin	x															
23	9301-4458	Taso tiskikaappi 1000*56	Bord	Table	x															
24	9301-6225	Höyrykupu -98	Spiskåpa	Top of fan	x															
25	9000-3027	Liesifuulettimen moottori	Ventilator	Fan	x															

Huom./ Anm./ Obs.

SOLIFER

30, post
investing
interior

703

Golden 500
Golden 500
Golden 500

2003

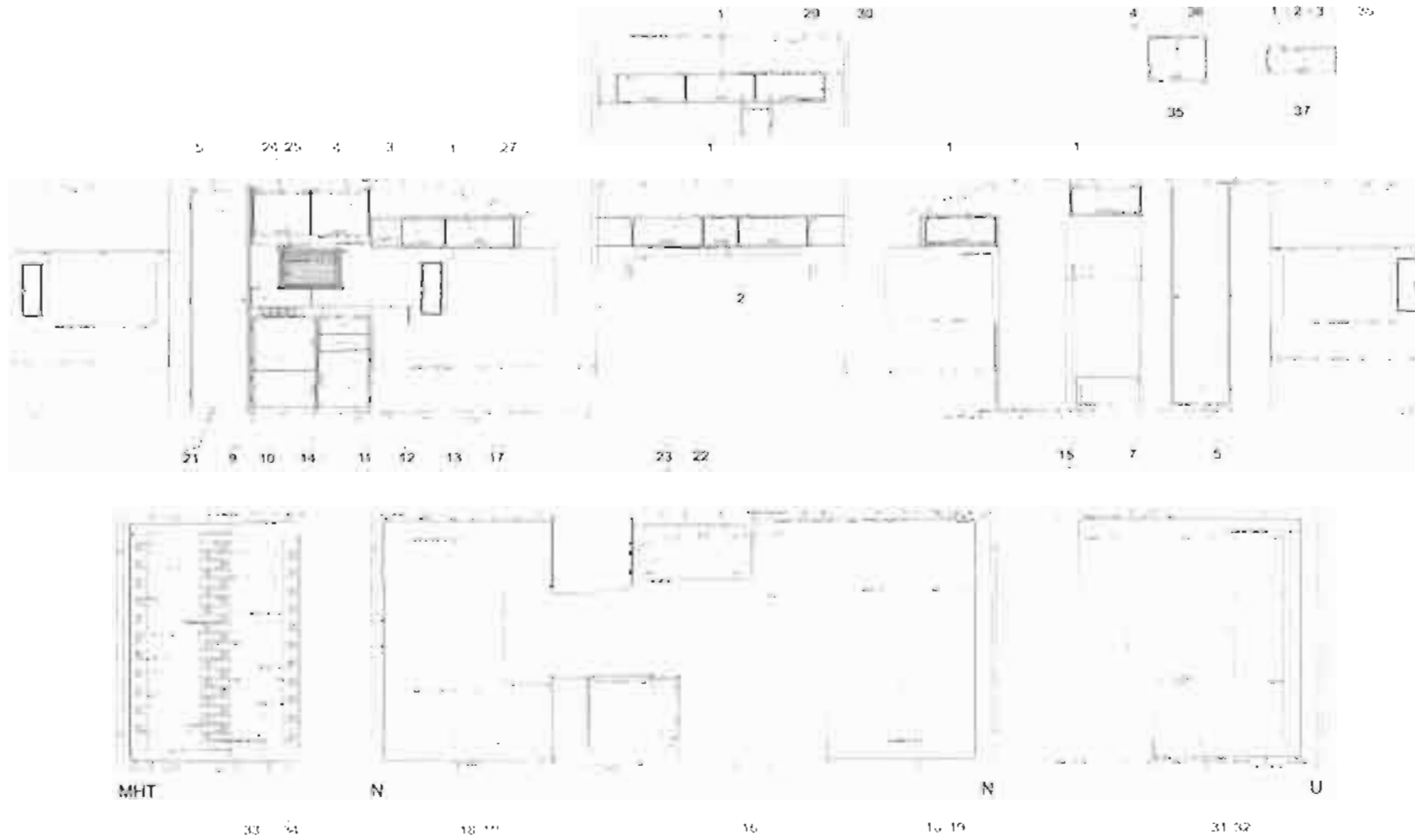

SOLIFER

Sisäosa		Goldie 500
Inredning	703	Goldie 500
Interior		Goldie 500

2000

X=vakio/ standard M=Menu-varustelu maasta riippuen/ Menu-utrustning beroende på land/ Menu-equipment due to country specification

Kuva Pos. Fig.	Varaosan nro Del.nr. Part.nr.	Kuvaus Benämning Description																	Huom. Anm. Obs.
27	9001-6000	Vedin Zell gold	Handlag	Handle	x														
29	9401-7202	Tikapuut	Lös stige	Ladder	M														
30	9301-3795	Ylävuode/kaappi paikittain	Övre säng	Upper bed	M														
31	9402-2615	Pöytälevy avaatil 900*700	Bord	Table	M														
32	0091-0027	Pöydänjalka Fawo 116/16 750mm	Bords ben	Table leg	M														
33	9000-2973	Säleen tuppi	Faststycke för ribbotten	Mattning for lath	M														
34	9001-4367	Säle 8x50x700	Spjåla till bädd	Lath for bed	M														
35	9301-3313	Luukun päätökappale	Ändstycke lucka	End piece for door	x														
36	9301-3314	Luukun tuki	Luckastöd	Support for door	x														
37	9301-3311	Luukun päätökappale	Ändstycke lucka	End piece for door	x														
38	9301-3312	Luukun tuki	Luckastöd	Support for door	x														

Huom./ Anm./Obs.

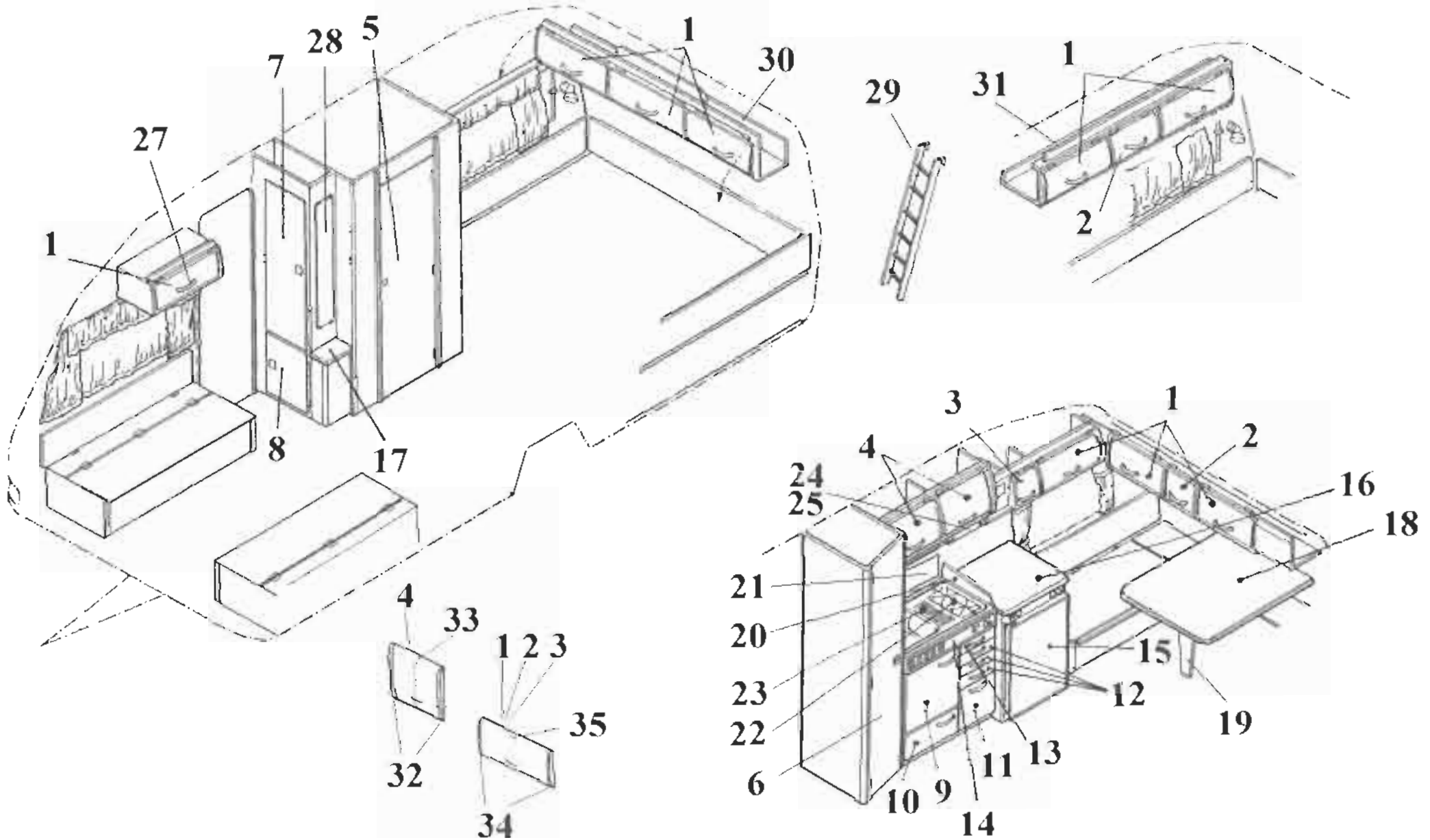

SOLIFERSisäosa
Inredning
Interior

706

Goldle 530
Goldle 530
Goldle 530

2000

X=vakio/ standard M=Menu-varustelu maasta riippuen/ Menu-utrustning beroende på land/ Menu-equipment due to country specification

Kuva Pos. Fig.	Varaosan nro Def.nr. Part.nr.	Kuvaus Benämning Description																		Huom. Anm. Obs.
			Goldle 500	Goldle 530	S1	S2	S3	S4	S5	S6	S7	S8	S9	S10	S11	S12	S13	S14		
1	9301-3330	Yläkaapin ovi 575x247	Överskåpslucka	Door for cupboard																
2	9301-3328	Yläkaapin ovi 292*247	Överskåpslucka	Door for cupboard																
3	9301-3329	Yläkaapin ovi 202x247	Överskåpslucka	Door for cupboard																
4	9301-3332	Astikaapin ovi 480x390	Lucka pentryts överskåp	Door for cupboard in kitchen																
5	9301-3149	Wc:n ovi 490x1810	Toilet dörr 490x1810	Toilet door 490x1810																
6	9301-3803	Vaatekaapin ovi 405x1810	Klädskåpsdörr	Wardrobe door																
7	9301-3802	Vaatekaapin ovi 405x1200	Övre garderobsdörr	Wardrobe door																
8	9301-3801	Vaatekaapin ovi 405x590	Klädskåpsdörr	Wardrobe door																
9	9301-3742	Keittiön vasen ovi 510x490	Övre pentrydörr V	Left door for kitchen																
10	9301-3490	Keittiön vasen ovi 510x200	Nedre pentrydörr V	Left door for kitchen																
11	9301-3739	Keittiön ovi oik. 335x351	Nedre pentrydörr H	Door for kitchen R																
12	9401-3475	Vetolaatikon etulevy 351x99	Draglådans frontskiva	Front for drawer																
13	9401-3479	Leikkuulaudan etulevy 351x40	Skärbrädans frontskiva	Front for cutting-board																
14	9200-3370	Tiskikaapin etulevy 100x859	Kökets front	Frontplate																
15	9401-4650	Paneeli jääkaapinovi	Kylskåpsfront	Front for refrigerator																
16	9401-3171	Taso jääkaap. 566x587	Skiva ovan kyl	Top over refrigerator																
17	9400-3925	Hylly 610*255	Hylla	Top																
18	9401-3334	Pöytä etu 1000x830	Framre bordskiva	Table top in front																
19	9000-3376	Pöydänjalko taitettava	Bordsben	Table support																
20	0035-4960	Tuulensuojalevy, lieden	Stänksplåt	Wind protector																
21	9301-7203	Lieden laustalevy 500*160	Stänksplåt	Back plate for stove																
22	0090-0163	Cramer polttin 2-liekk. ek 646	Spis	Cramer burner 2-flames																
23	9000-3106	Tiskipöytä Stala täyd. 900x500	Diskbänksplåt	Kitchen plate stainless																
24	9301-6225	Höyrykupu -98	Spiskåpa	Top of fan																
25	9000-3027	Liesituulettimen moottori	Ventilator	Fan																

Huom./ Anm./Obs.

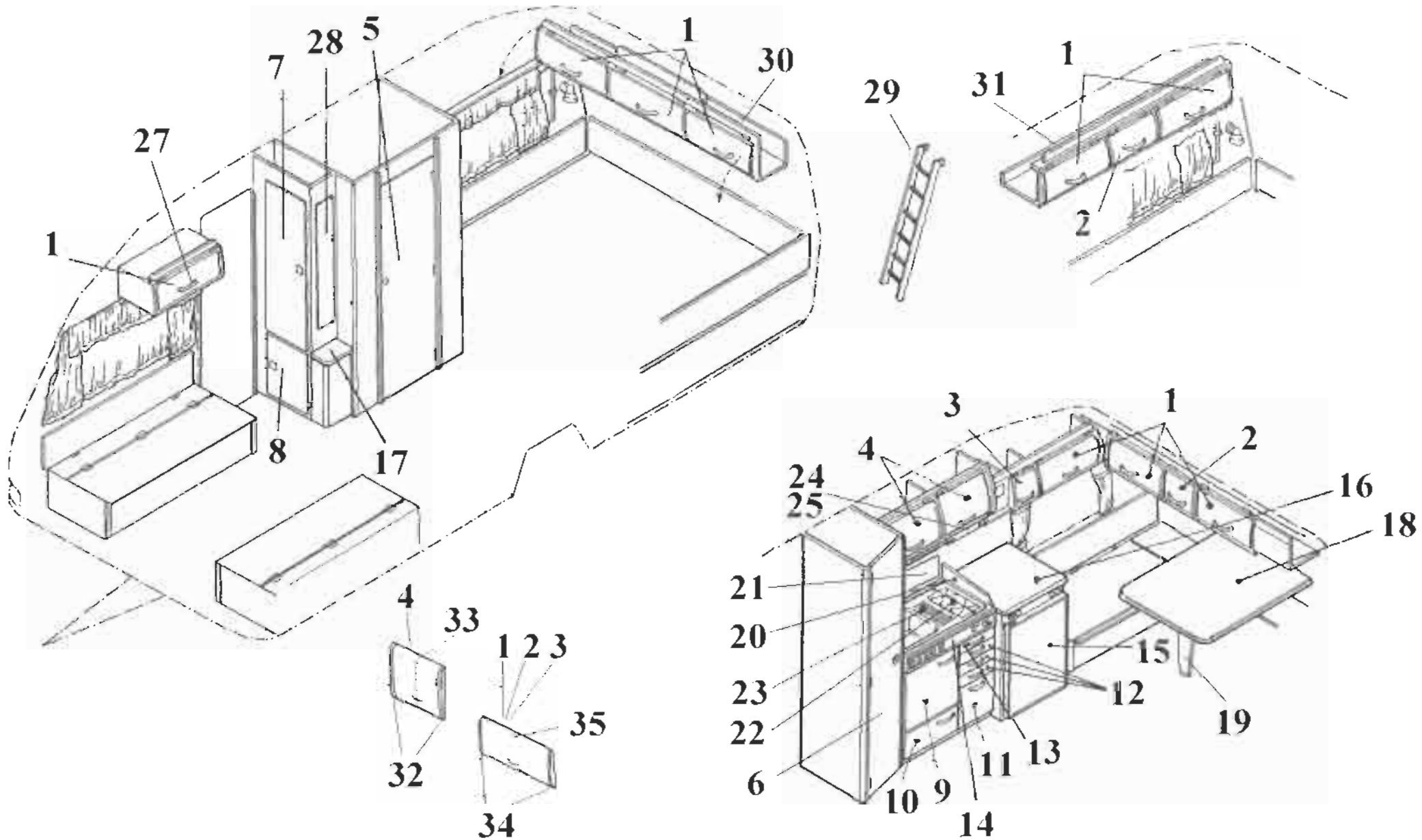

SOLIFERSisäosa
Inredning
Interior

706

Goldie 530
Goldie 530
Goldie 530

X=vakio/ standard

M=Menu-varustelu maasta riippuen/ Menu-utrustning beroende på land/ Menu-equipment due to country specification

2000

Kuva Pos. Fig.	Varaosanro Det.nr. Part.nr.	Kuvaus Benämning Description																	Huom. Anm. Obs.
27	9001-6000	Vedin Zell gold	Handtag	Handle															
28	9500-3692	Peili 3x920x235	Spegel	Mirror															
29	9401-7202	Tikapuut	Lös steg	Ladder															
30	9301-3795	Ylävuode/kaappi poikittain	Övre säng	Upper bed															
31	9301-5654	Ylävuode/kaappi pitkittäin	Övre säng	Upper bed															
32	9301-3313	Luukun päätökappale	Ändstycke lucka	End piece for door															
33	9301-3314	Luukun luki	Luckastöd	Support for door															
34	9301-3311	Luukun päätökappale	Ändstycke lucka	End piece for door															
35	9301-3312	Luukun luki	Luckastöd	Support for door															

Huom./ Anm./Obs.



Suopoli
kuvitus
interior

708

Code 530 Makuuhuoneversio
Code 530 Sovitus versio
Code 530 Bedroom models

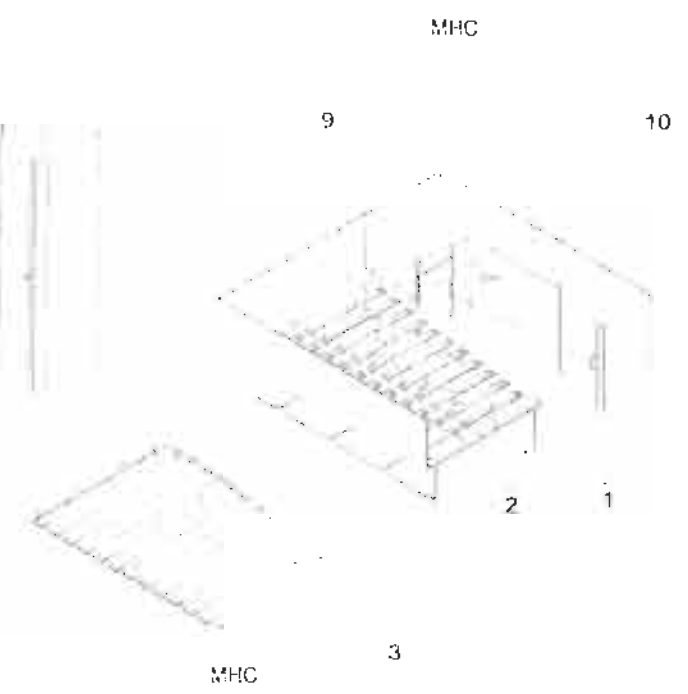
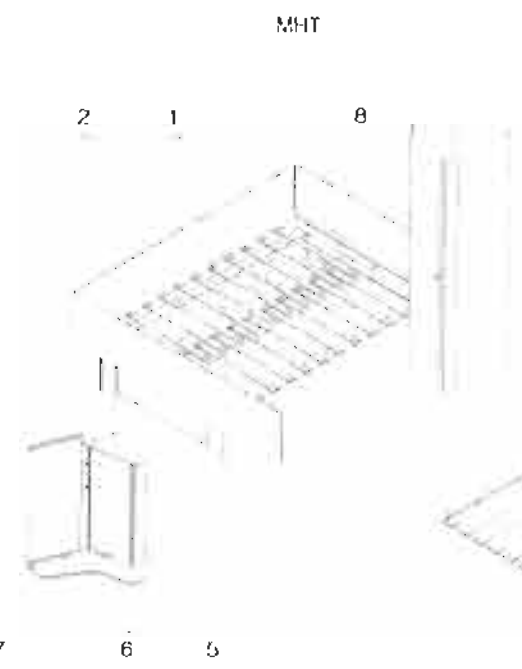
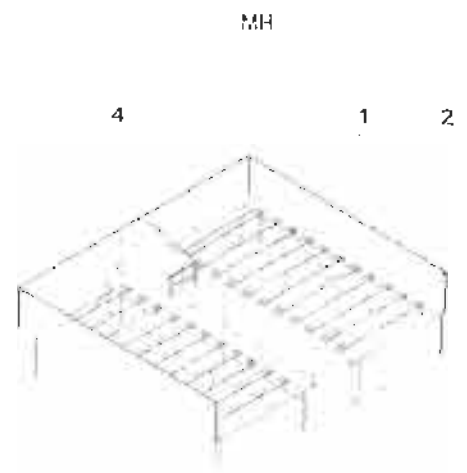

SOLIFER

Sisäpuoli Inredning Interior	708	Goldie 530 Makuuhuoneverslot Goldie 530 Sovrum versloner Goldie 530 Bedroom models
------------------------------------	-----	--

2000

X=vakio/ standard M=Menu-varustelu maasta riippuen/ Menu-utrustning beroende på land/ Menu-equipment due to country specification

Kuva Pos. Fig.	Varaosan nro Def.nr. Part.nr.	Kuvaus Benämning Description																		Huom. Anm. Obs.
1	9000-2973	Säteen tuppi	Faststycke för ribbotten	Muoting for lath																
2	9001-4367	Säle 8x50x700	Spjåla till bädd	Lath for bed																
3	9301-4171	Sälevuoteen kansi 1270/1090x1800	Locket till spjålabädd	Cover for lathbed																1)
4	9402-2441	Vetolaatikon etulevy 210x122	Draglådans frontskiva	Front for drawer																
5	9301-4142	Kulmakaappin ovi 361x830	Dörr hörnskap	Door corner cupboard																
6	9400-9584	Kampauspöydän taso	Skiva till toalettbard	Plate for dressing table																
7	0091-0398	Pelli 3x923x370	Spegel	Mirror																
8	9301-3803	Vaatekaapin ovi 405x1810	Klädskaapdörr	Wardrobe door																
9	9301-6060	Hyllyn ovi 340x581	Dörr	Door																
10	9301-6009	Kulmakaappin ovi 410x581	Dörr hörnskap	Door corner cupboard																

Huom./ Anm./Obs. 1) Käytössä osan mallivuotta / Användas till en del av modellår / In use partly through the model year

SOLIFER

Stülp
Leuchtring
Innen

710
Stülp 24
Stülp 24
Stülp 24

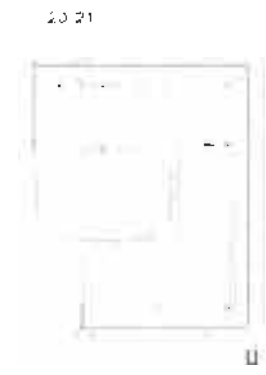
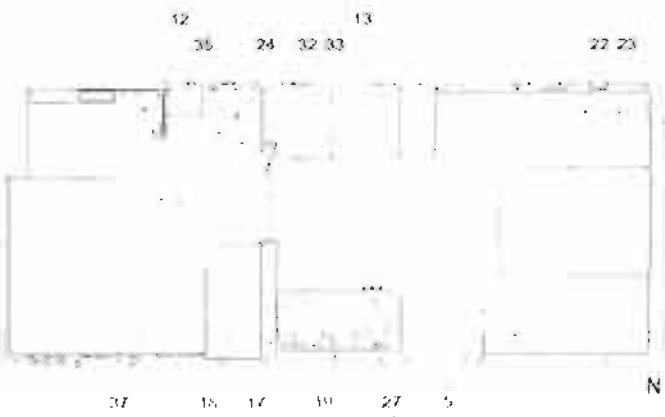
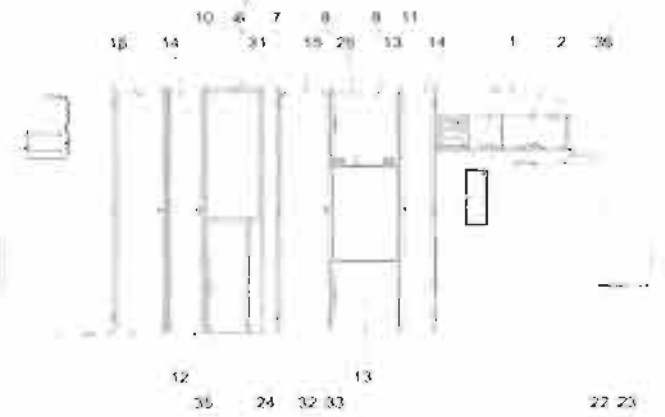
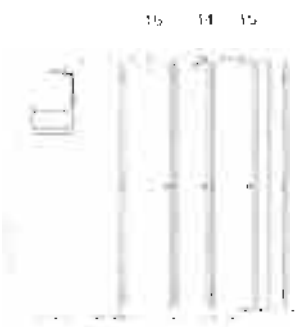
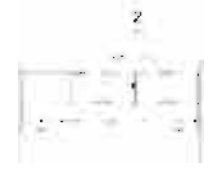
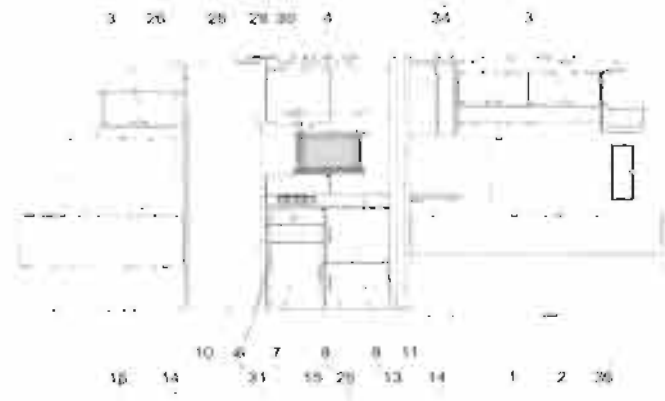
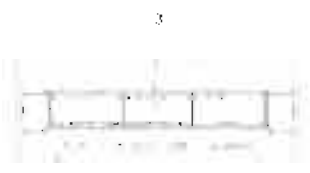

SOLIFERSisäpuoli
Inredning
Interior

710

Solifer S4
Solifer S4
Solifer S4

X=vakio/ standard

M=Menu-varusteita maasta riippuen/ Menu-utrustning beroende på land/ Menu-equipment due to country specification

2000

Kuva Pos. Fig.	Varaosan nro Det.nr. Part.nr.	Kuvaus Benämning Description																		Huom. Anm. Obs.
1	9401-7008	Luukku YK 265x270 -98	Överskåpslucka	Upper cupboard door																
2	9401-7006	Luukku YK 265x489 -98	Överskåpslucka	Upper cupboard door																
3	9401-6994	Luukku YK 265x552 -98	Överskåpslucka	Upper cupboard door																
4	9401-6998	Luukku AK 402x485 -98	Överskåpslucka	Upper cupboard door																
5	9402-4483	Etulevy lusikkalaat. 131x453	Framsida till skevlåda	Frontplate to spoonbox																
6	9401-6997	Luukku kenkäkooppi 265x374	Skokåpslucka	Shoe cupboard door																
7	9402-4478	Ovi TK 473x453	Dörr	Door																
8	9401-6342	Ovi TK 428x530 -98	Dörr	Door																
9	9401-6341	Ovi TK 312x530 -98	Dörr	Door																
10	9402-6406	Leikkuulauta	Skärbräda	Cuttingboard																
11	9302-5022	Tiskikaapin etulevy	Framsida till pentryn	Frontplate to pentry																
12	9401-6344	Ovi TK 572x390 -98	Dörr	Door																
13	9402-4423	Ovi JK/VK 515x534	Dörr	Door																
14	9401-8061	Ovi VK 1850x275	Dörr	Door																
15	9401-7095	Ovi VK 1850x415	Dörr	Door																
16	9401-7091	Ovi WC 1850x490	Dörr	Door																
17	9302-4700	Taso kiinteä	Bord	Table																
18	9302-4718	Taso kääntyvä	Bord	Table																
19	9301-4458	Taso tiskikaappi 1000*58	Bord	Table																
20	9401-5411	Pöytälevy ovaall 1080x730	Bord	Table																S4U
21	0091-0027	Pöydänjalka Fawo 116/16 750mm	Bords ben	Table leg																S4U
22	9401-6287	Pöytälevy etu 1200x875	Bord	Table																S4N
23	9000-3376	Pöydänjalka taitettava	Bords ben	Table leg																S4N
24	9302-4687	Allastaso	Bord	Table																
25	9401-4650	Paneeli jääkaapinovi	Panel till kylskåpsdörr	Panel for refrigerator door																
26	9302-4836	Ovitolppa	Sidostöd	Side plate																

Huom./ Anm./Obs.

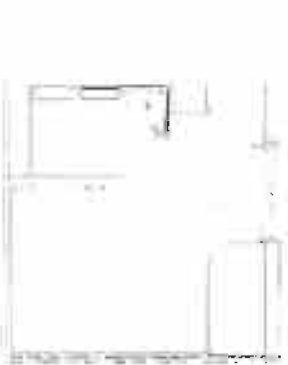
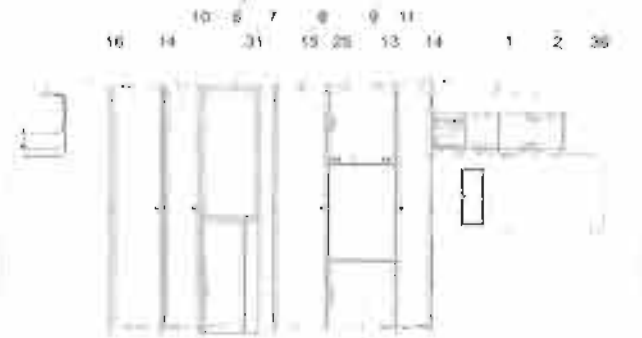
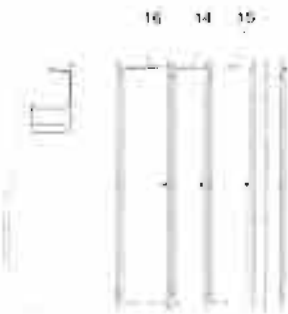
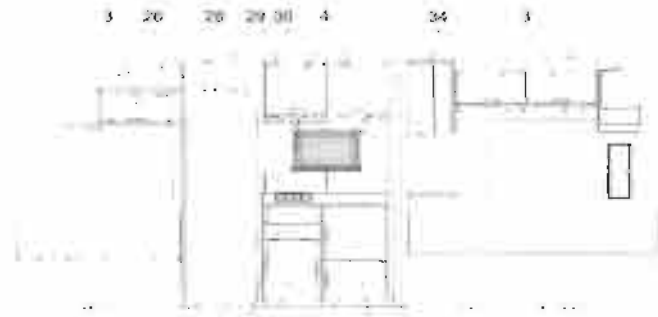

SOLIFERSisäpuoli
Inredning
Interior

710

Solifer S4
Solifer S4
Solifer S4

X- vakio/ standard M Menu-varusteita maasta riippuen/ Menu-utrustning beroende på land/ Menu-equipment due to country specification

2000

Kuva Pos. Fig.	Varaosan nro Det.nr. Part.nr.	Kuvaus Benämning Description																		Huom. Anm. Obs.	
27	9402-4641	Altas Gramer 470x1000 vasen	Diskho	Dishwashing basin																	
28	9301-7203	Lieden laustalevy	Stänk skiva	Plate for pentry																	
29	9301-6225	Höyrykupu -98	Ventilators översida	Top of fan																	
30	9000-3027	Liesituulettimen moottori	Ventilator	Fan																	
31	9001-6276	Pelli 3x970x387	Spegel	Mirror																	
32	311950	Paljeovi	Dragspelskjutdörr	Folding door																	
33	0092-0141	Paljeaven muovihihna 130x20x2	Plast rem	Plastic belt																	
34	9002-4783	Rulo-ovi	Rulo dörr	Rulo door																	
35	9302-4499	Pesuallas	Lavaar	Wash-stand																	
36	9001-6000	Vedin Zell gold	Handtag	Handle																	
37	9301-4171	Sätevuoteen kansli 1270/1090*1800	Locket till spjalabädd	Cover for lathbed																	

Huom./ Anm./Obs.

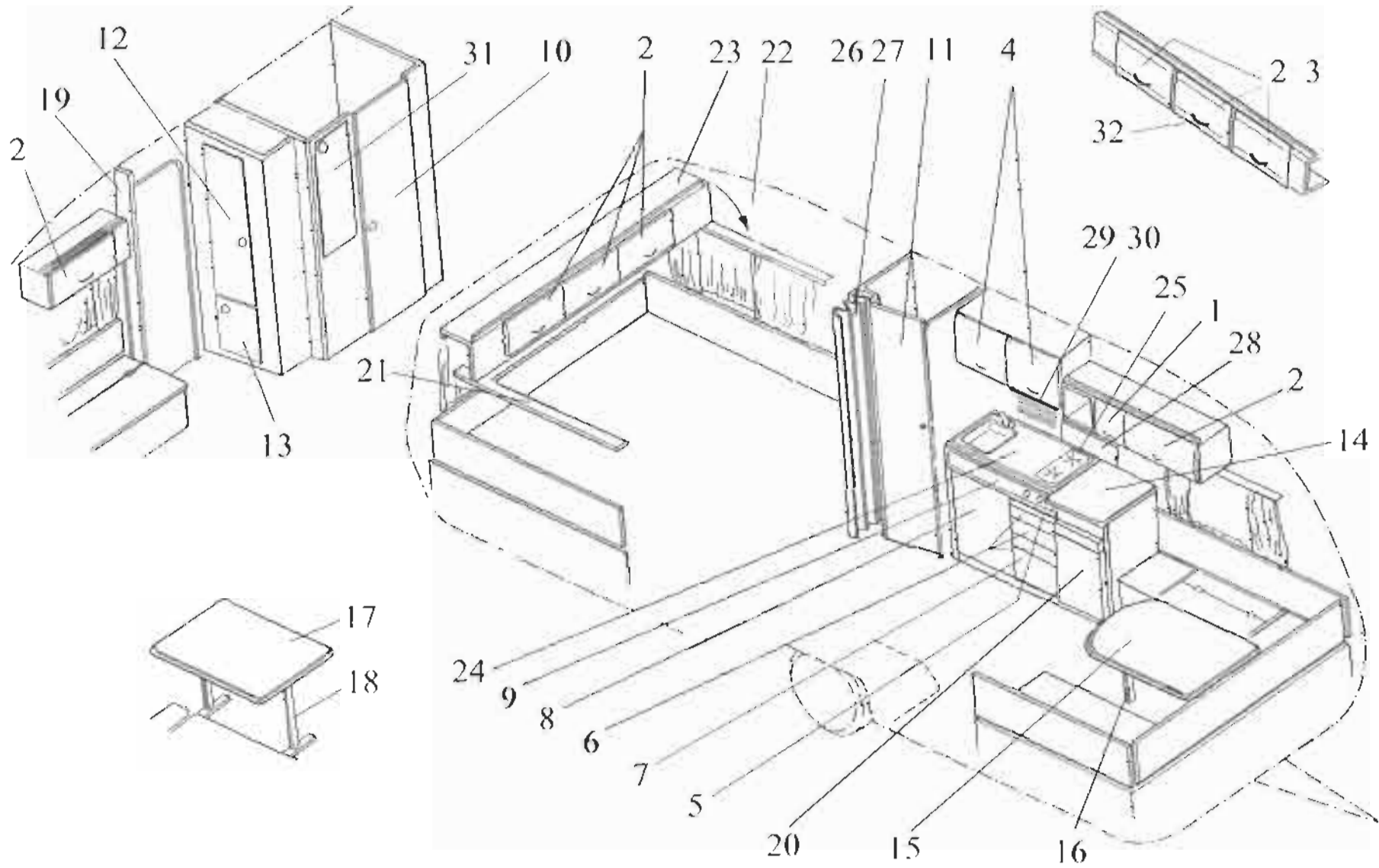

SOLIFERSisäpuoli
Inredning
Interior

712

Solifer S5 S5L
Solifer S5 S5L
Solifer S5 S5L

2000

X=vakio/ standard

M=Menu-varustelu maasta riippuen/ Menu-utrustning beroende på land/ Menu-equipment due to country specification

Kuva Pos. Fig.	Varaosa nro Def.nr. Part.nr.	Kuvaus Benämning Description																	Huom. Anm. Obs.
			General 300	General 300	31	32	33	34	35	36	37	38	39	40	41	42	43		
1	9401-7008	Luukku YK 265x270 -98	Överskåpslucka	Upper cupboard door				x											
1	9401-8089	Luukku YK 265x270	Överskåpslucka	Upper cupboard door															
2	9401-6994	Luukku YK 265x552 -98	Överskåpslucka	Upper cupboard door				x											
2	9401-8087	Luukku YK 265x552	Överskåpslucka	Upper cupboard door															
3	9402-2539	Luukku YK 265x642	Överskåpslucka	Upper cupboard door															
4	9401-6998	Luukku AK 402x485 -98	Överskåpslucka	Upper cupboard door															
4	9401-8092	Luukku AK 402x485	Överskåpslucka	Upper cupboard door				x											
5	9401-7837	Etulevy leikkuulaufa 39x349	Frontskiva skärbräda	Front for cutting board															
6	9401-7836	Etulevy luuk. laaf. 99x349	Spisfront	Front panel pentry															
7	9301-7835	Ovi TK S5 345x349	Dörr	Door															
8	9301-7834	Ovi TK S5 700x525	Dörr	Door															
9	9401-7691	Tiskikaapin etulevy	Spisfront	Front panel pentry															
10	9401-7091	Ovi WC 1850x490	Dörr	Door															
11	9401-7095	Ovi VK 1850x415	Dörr	Door															
12	9402-4485	Ovi VK 1295x415	Dörr	Door															
13	9402-4487	Ovi VK 550x415	Dörr	Door															
14	9401-3171	Taso JK 566x587	Diskbordskiva	Plate for pentry															
15	9401-7832	Pöytälevy otu 1050x875	Bord	Table															
16	9000-3376	Pöydänjalka taitettava	Bords ben	Table leg															
17	9401-5411	Pöytälevy ovaali 1080x730	Bord	Table															
17	9402-2512	Pöytälevy ovaali 1080x1000	Bord	Table															
18	0091-0027	Pöydänjalka Fawa 116/16 750mm	Bords ben	Table leg															
19	9302-4836	Ovitoippa	Sidostöd	Side plate															
20	9401-4650	Paneeli jääkaapinovi	Panel till kylskåpsdörr	Panel for refrigerator door															

Huom./ Anm./ Obs.

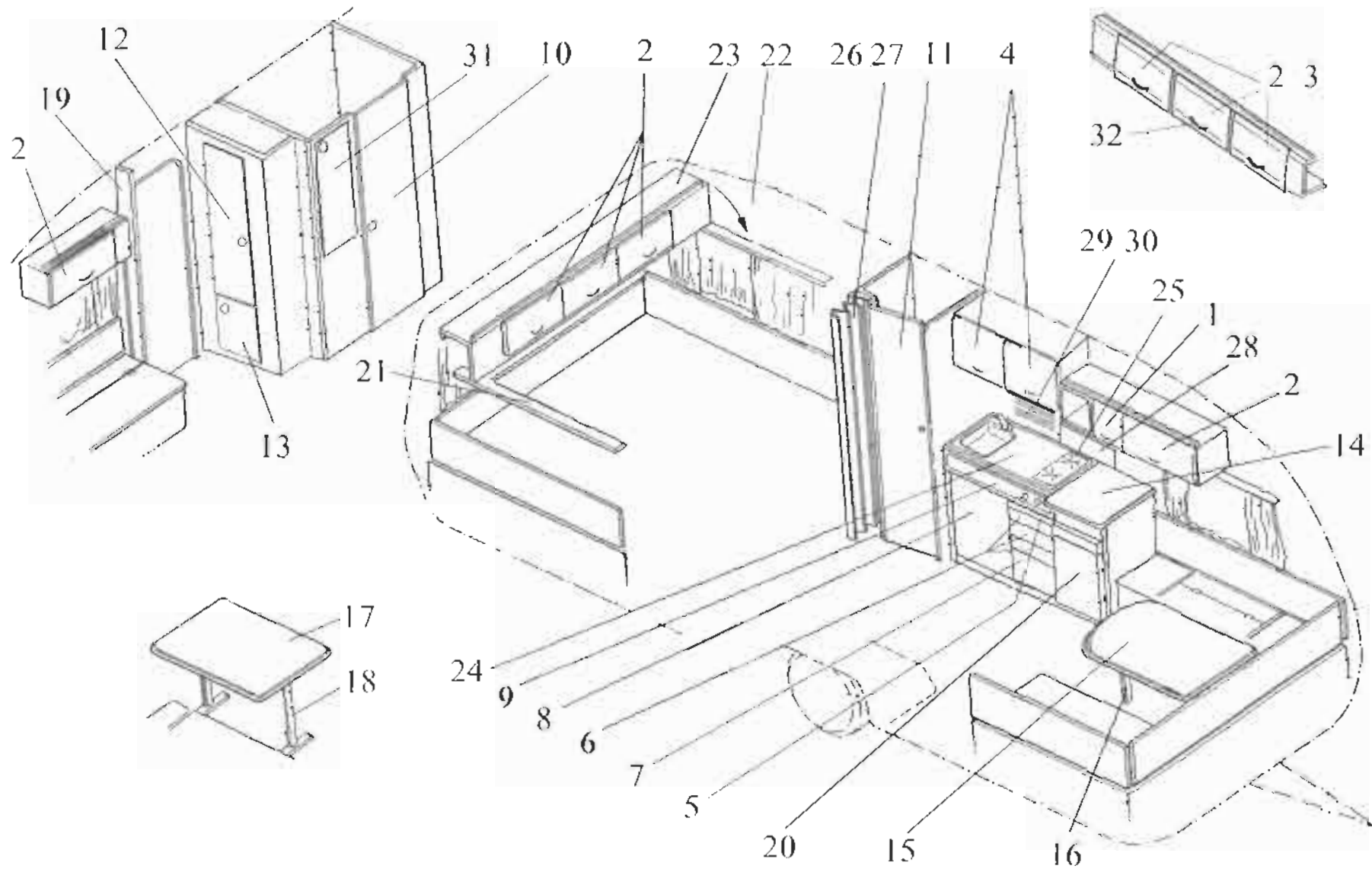

SOLIFERSisäpuoli
Inredning
Interior

712

Solifer S5 S5L
Solifer S5 S5L
Solifer S5 S5L

X=vakio/ standard M=Menu-varustelu maasta riippuen/ Menu-utrustning beroende på land/ Menu-equipment due to country specification

2000

Kuva Pos. Fig.	Varaosan nro Det.nr. Part.nr.	Kuvaus Benämning Description																	Huom. Anm. Obs.
21	9201-6358	Ylävuode / kaappi pitkittäin oik.	Övre säng H	Upper bed R															
21	9201-8399	Ylävuode / kaappi pitkittäin oik.	Övre säng H	Upper bed R															
22	9201-6358	Ylävuode / kaappi pitkittäin vas.	Övre säng V	Upper bed L															
22	9201-8399	Ylävuode / kaappi pitkittäin vas.	Övre säng V	Upper bed L															
23	9301-6984	Ylävuode / kaappi poikittain	Övre säng	Upper bed															
23	9302-6264	Ylävuode / kaappi poikittain	Övre säng	Upper bed															
24	9000-3106	Tiskipöytä Stala löyd. 900x500	Bord	Table															
25	0090-0163	Cramer pollin 2-liekk. øk 646	Spis kpl.	Slove															
26	311950	Paijeovi	Dragspeisskjutdörr	Folding door															
27	0092-0141	Paijeoven muovihihna 130x20x2	Plast rem	Plastic belt															
28	9301-7203	Lieden taustalevy	Stänk skiva	Plate for pentry															
29	9301-6225	Höyrykupu -98	Ventilators översida	Top of fan															
30	9000-3027	Liesituulettimen moottori	Ventilator	Fan															
31	9401-6311	Peili 3x920x235 valokaisilla	Spegel	Mirror															
32	9001-6000	Vedin Zell gold	Handtag	Handle															

Huom./ Anm./Obs.

SOLIFER

Sis.puoli
Inredning
Interior

714

Solifer SST
Solifer SST
Solifer SST

2000

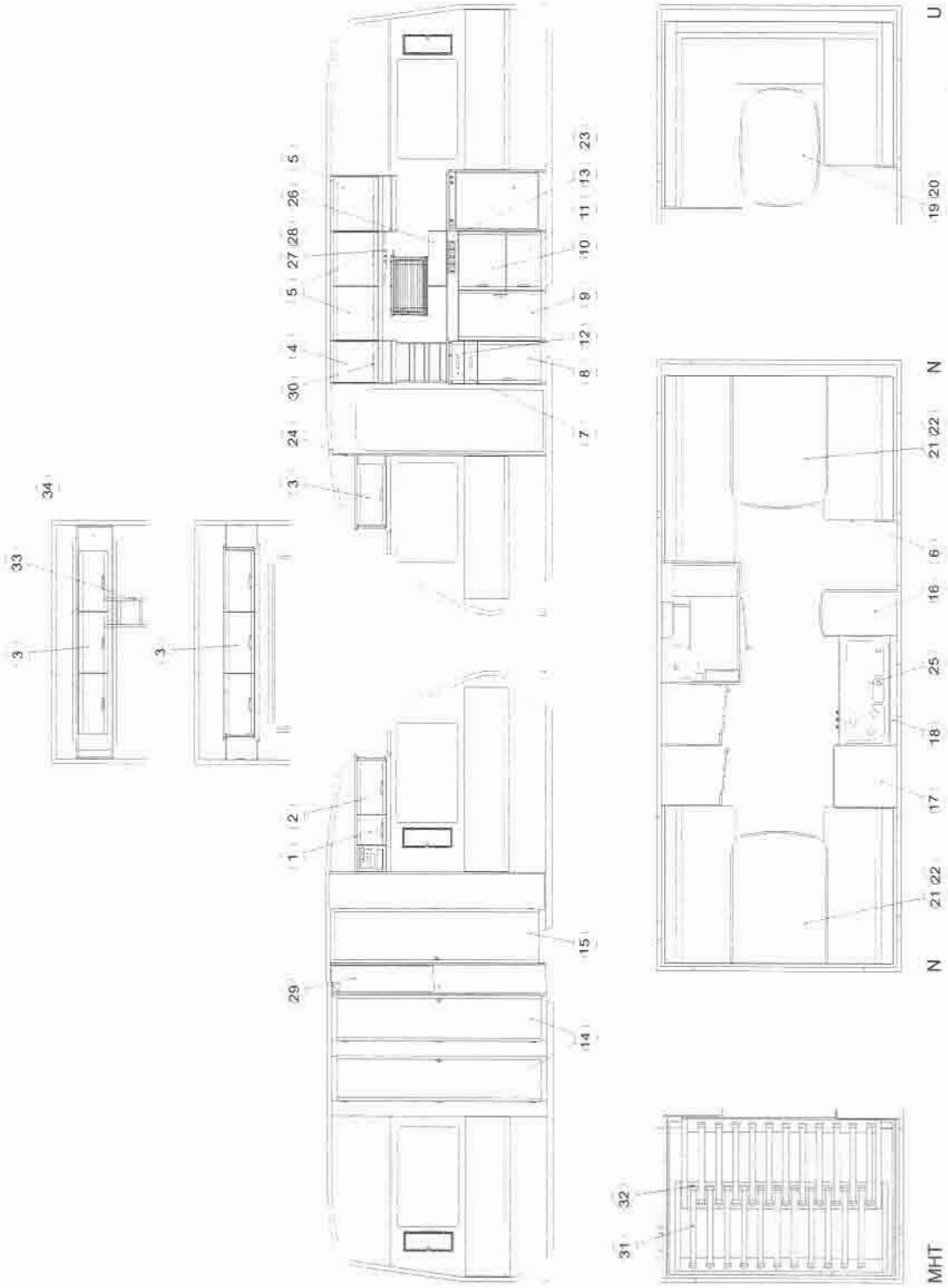

SOLIFERSisäpuoli
Inredning
Interior

714

Solifer S5T
Solifer S5T
Solifer S5T

X=vakio/ standard M=Menu-varustelu maasta riippuen/ Menu-utrustning beroende på land/ Menu-equipment due to country specification

2000

Kuva Pas. Fig.	Varaosan nro Def.nr. Part.nr.	Kuvaus Benämning Description																Huom. Anm. Obs.
1	9401-7008	Luukku YK 265x270 -98	Överskåpslucka	Upper cupboard door														
2	9401-7006	Luukku YK 265x489 -98	Överskåpslucka	Upper cupboard door														
3	9401-6994	Luukku YK 265x552 -98	Överskåpslucka	Upper cupboard door														
4	9401-7001	Luukku AK 402x374 -98	Överskåpslucka	Upper cupboard door														
5	9401-6998	Luukku AK 402x485 -98	Överskåpslucka	Upper cupboard door														
6	9401-6997	Luukku kenkäkaappi 265x374	Skokåpslucka	Shoe cupboard door														
7	9401-6345	Etulevy lusik laat. 113x390 -98	Framskena till skedlåda	Frontplate to spoonbox														
8	9401-6344	Ovi TK 572x390 -98	Dörr	Door														
9	9401-6343	Ovi TK 745x453 -98	Dörr	Door														
10	9401-6342	Ovi TK 428x530 -98	Dörr	Door														
11	9401-6341	Ovi TK 312x530 -98	Dörr	Door														
12	9301-6273	Leikkuulauta	Skärbräda	Cuttingboard														
13	9401-8739	Tiskikaapin etulevy	Framskena till pentryn	Frontplate to pantry														
14	9401-7095	Ovi VK 1850x415	Dörr	Door														
15	9401-7091	Ovi WC 1850x490	Dörr	Door														
16	9301-8672	Taso tiskikaappi 700x426	Bord	Table														
17	9301-8673	Taso JK 575x587	Diskbordskiva	Plate for pantry														
18	9301-4458	Taso tiskikaappi 1000*58	Bord	Table														
19	9401-5411	Pöytälevy ovaali 1080x730	Bord	Table														
20	0091-0027	Pöydänjalka Fawo 116/16 750mm	Bords ben	Table leg														
21	9401-6287	Pöytälevy etu 1200x875	Bord	Table														
22	9000-3376	Pöydänjalka taitettava	Bords ben	Table leg														
23	9401-4650	Paneeli jääkaapinovi	Panel till kylskåpsdörr	Panel for refrigerator door														
24	9302-4836	Ovitoippa	Sidostöd	Side plate														

Huom./ Anm./Obs.

SOLIFER

Sis.puoli
Inredning
Interior

714

Solifer S5T
Solifer S5T
Solifer S5T

2000

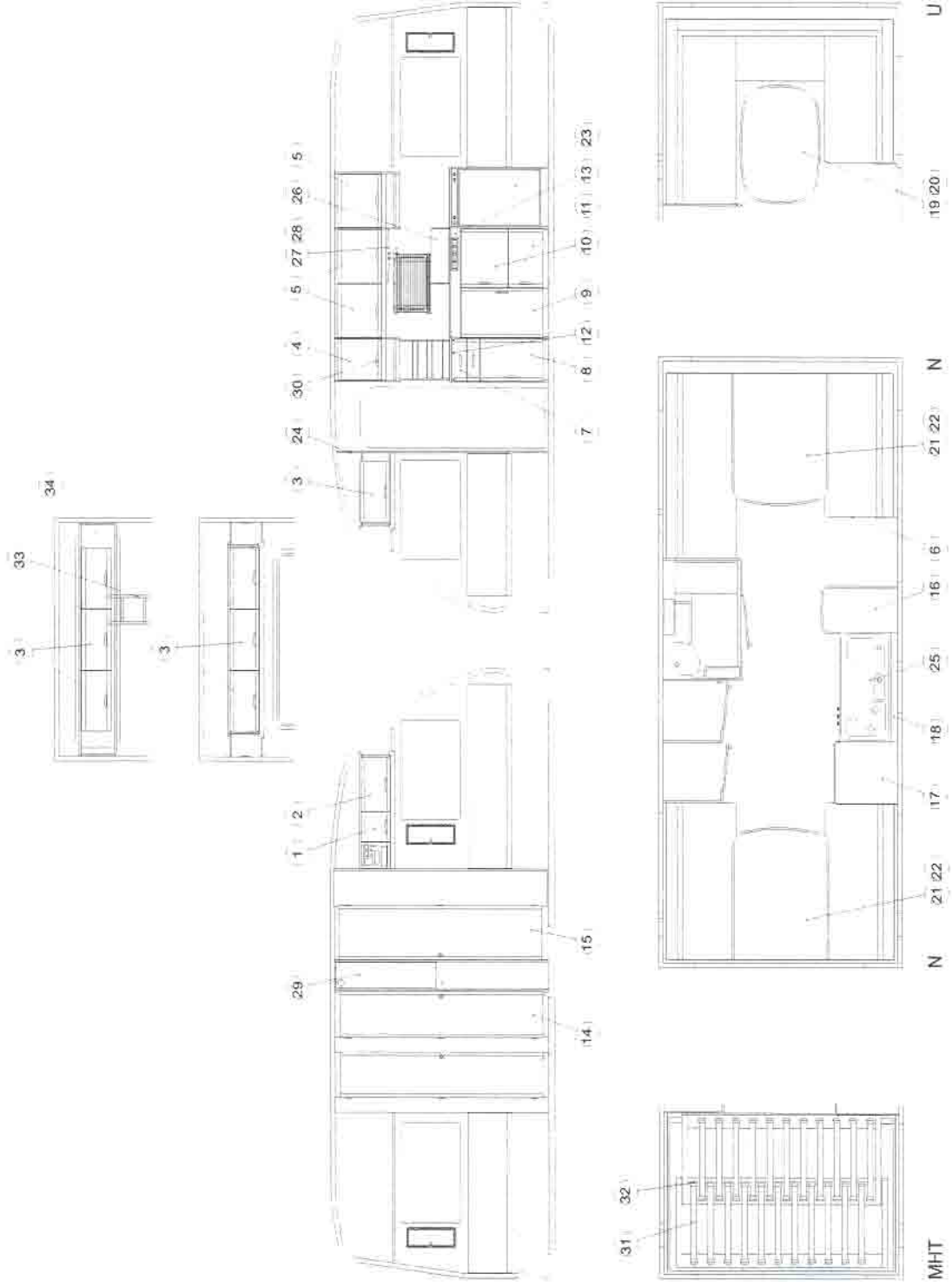

SOLIFERSisäpuoli
Inredning
Interior

714

Solifer S5T
Solifer S5T
Solifer S5T

X=vakio/ standard M=Menu-varustelu maasta riippuen/ Menu-utrustning beroende på land/ Menu-equipment due to country specification

2000

Kuva Pos. Fig.	Varaosan nro Def.nr. Part.nr.	Kuvaus Benämning Description																		Huom. Anm. Obs.
25	9402-4643	Atlas Gramer 470x1000 oikea	Diskho	Dishwashing basin																
26	9301-7203	Lieden taustalevy	Stänk skiva	Plate for pantry																
27	9301-6225	Höyrykupu -98	Ventilators översida	Top of fan																
28	9000-3027	Liesituulettimen moottori	Ventilator	Fan																
29	9401-6311	Peili 3x920x235 valooukolla	Spegel	Mirror																
30	9001-6000	Vedin Zell gold	Handtag	Handle																
31	9001-4367	Säle 8x50x700	Spjåla till bädd	Lath for bed																
32	9000-2973	Säleen luppi	Faststycke för ribbatten	Muoting for lath																
33	9401-7202	Tikapuut	Lös stige	Ladder																
34	9301-6984	Ylävuode / kaappi poikittain	Övre säng	Upper bed																

Huom./ Anm./Obs.

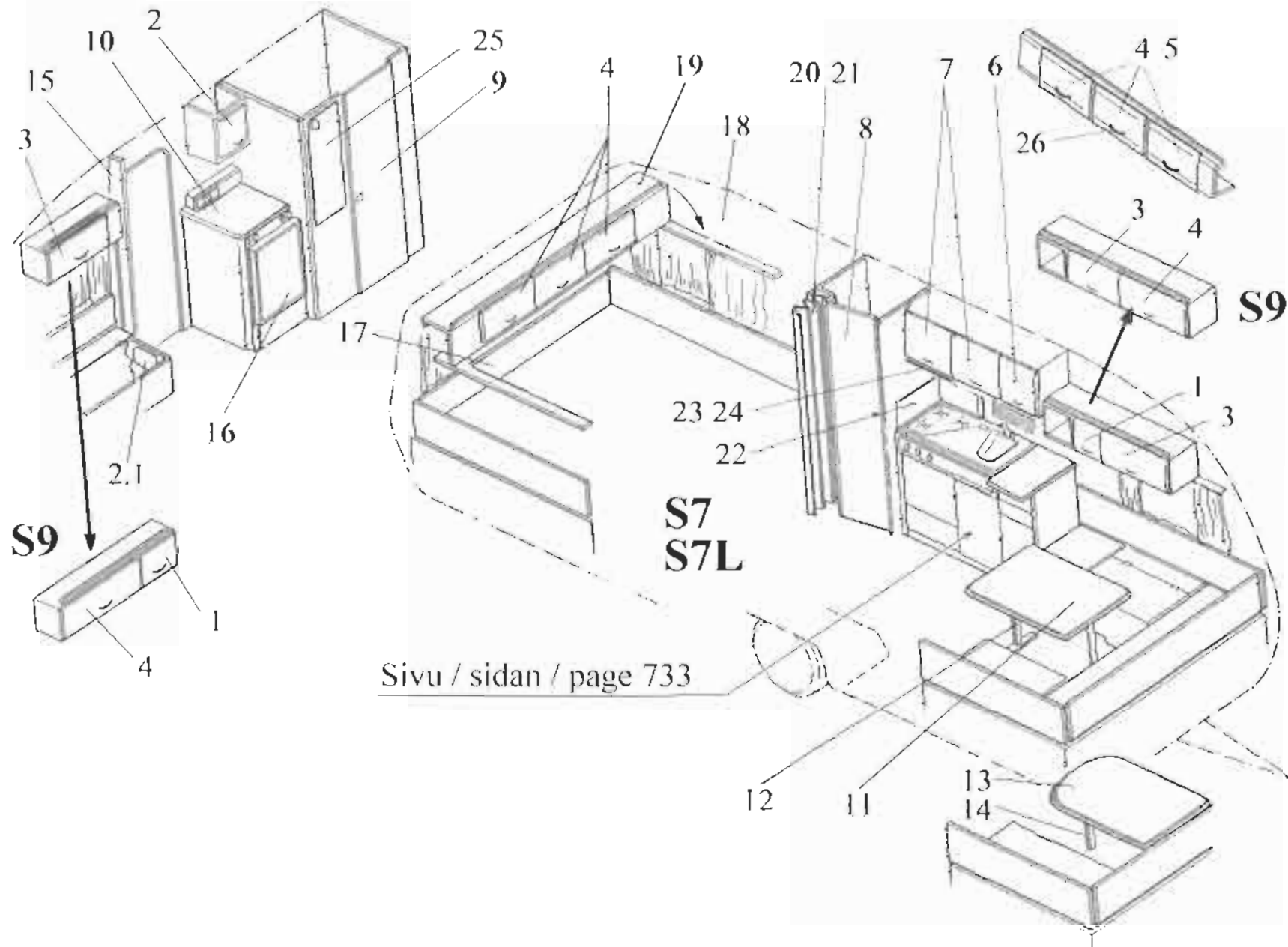

SOLIFERSisäpuoli
Inredning
Interior

724

Solifer S7 S7L S9
Solifer S7 S7L S9
Solifer S7 S7L S9

X=vakio/ standard M=Menu-varustelu maasta riippuen/ Menu-utrustning beroende på land/ Menu-equipment due to country specification

2000

Kuva Pos. Fig.	Varaosan nro Def.nr. Part.nr.	Kuvaus Benämning Description																		Huom. Anm. Obs.
1	9401-7008	Luukku YK 265x270 -98	Överskåpslucka	Upper cupboard door																
1	9401-8089	Luukku YK 265x270	Överskåpslucka	Upper cupboard door																
2	9401-6997	Luukku YK 265x374 -98	Överskåpslucka	Upper cupboard door																
2	9401-8090	Luukku YK 265x374	Överskåpslucka	Upper cupboard door																
2,1	9401-6997	Luukku kenkäkaappi 265x374	Skokåpslucka	Shoe cupboard door																
3	9401-7006	Luukku YK 265x489 -98	Överskåpslucka	Upper cupboard door																
3	9401-8088	Luukku YK 265x489	Överskåpslucka	Upper cupboard door																
4	9401-6994	Luukku YK 265x552 -98	Överskåpslucka	Upper cupboard door																
4	9401-8087	Luukku YK 265x552	Överskåpslucka	Upper cupboard door																
5	9402-2539	Luukku YK 265x642	Överskåpslucka	Upper cupboard door																
6	9401-7001	Luukku AK 402x374 -98	Överskåpslucka	Upper cupboard door																
6	9401-8091	Luukku AK 402x374	Överskåpslucka	Upper cupboard door																
7	9401-6998	Luukku AK 402x485 -98	Överskåpslucka	Upper cupboard door																
7	9401-8092	Luukku AK 402x485	Överskåpslucka	Upper cupboard door																
8	9401-7095	Ovi VK 1850x415	Dörr	Door																
9	9401-7091	Ovi WC 1850x490	Dörr	Door																
10	9401-6265	Taso JK 620x620	Diskbordskiva	Plate for pentry																
11	9401-5411	Pöytälevy ovaali 1080x730	Bord	Table																
11	9402-2512	Pöytälevy ovaali 1080x1000	Bord	Table																
12	0091-0027	Pöydänjalka Fawo 116/16 750mm	Bords ben	Table leg																
13	9401-6287	Pöytälevy etu 1200x875	Bord	Table																
14	9000-3376	Pöydänjalka taitettava	Bords ben	Table leg																
15	9302-4836	Ovitolppa	Sidostöd	Side plate																
15	9302-5415	Ovitolppa	Sidostöd	Side plate																
16	9401-4650	Paneeli jääkaapinovi	Panel till kylskåpsdörr	Panel for refrigerator door																

Huom./ Anm./Obs.

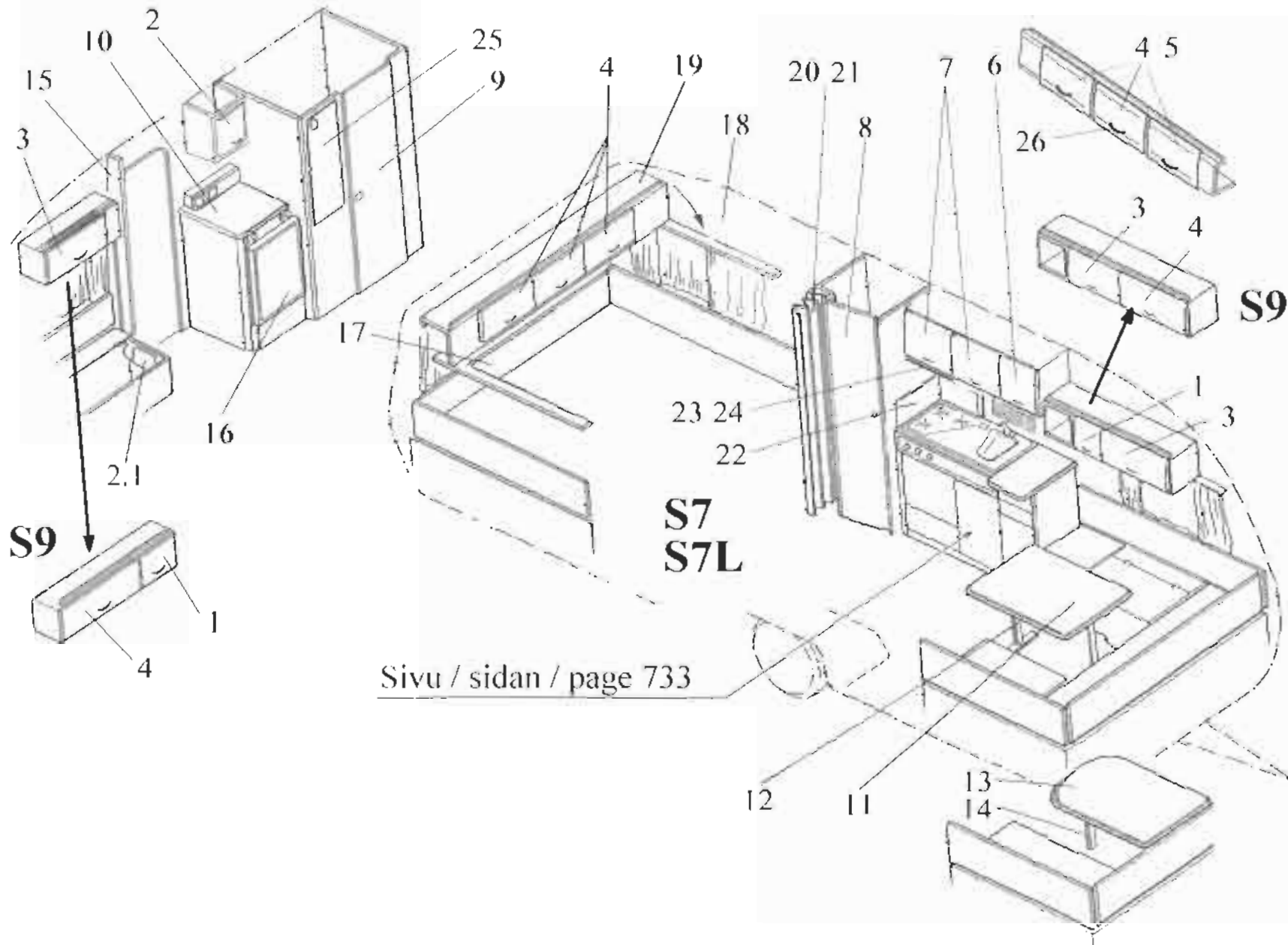

Sivu / sidan / page 733

**S7
S7L**

S9

SOLIFERSisäpuoli
Inredning
Interior

724

Solifer S7 S7L S9
Solifer S7 S7L S9
Solifer S7 S7L S9

X=vakio/ standard M=Menu-varustelu maasta riippuen/ Menu-utrustning beroende på land/ Menu-equipment due to country specification

2000

Kuva Pos. Fig.	Varaosan nro Def.nr. Part.nr.	Kuvaus Benämning Description																	Huom. Anm. Obs.
17	9201-6358	Ylävuode / kaappi pitkittäin oik.	Övre säng H	Upper bed R															
17	9201-8399	Ylävuode / kaappi pitkittäin oik.	Övre säng H	Upper bed R															
18	9201-6358	Ylävuode / kaappi pitkittäin vas.	Övre säng V	Upper bed L															
18	9201-8399	Ylävuode / kaappi pitkittäin vas.	Övre säng V	Upper bed L															
19	9301-6984	Ylävuode / kaappi poikittain	Övre säng	Upper bed															
19	9302-6264	Ylävuode / kaappi poikittain	Övre säng	Upper bed															
19	9301-8425	Ylävuode / kaappi poikittain	Övre säng	Upper bed															
20	311950	Paljeovi	Drogspelskjuddörr	Folding door															
21	0092-0141	Paljeoven muovihina 130x20x2	Plast rem	Plastic belt															
22	9301-7203	Lieden laustalevy	Stönk skiva	Plate for pentry															
23	9301-6225	Höyrykupu -98	Ventilators översida	Top of fan															
24	9000-3027	Liesituulettimen moottori	Ventilator	Fan															
25	9401-6311	Peili 3x920x235 valokaukolla	Spiegel	Mirror															
26	9001-6000	Vedin Zell gold	Handtag	Handle															

Huom./ Anm./Obs.

SOLIFER

Ein- und
Zwei- und
Drei-
Wohnung

726

Softe 510 540L
Softe 510 540L
Softe 510 540L

1000

4 19 10 11 24 25 7 6 3 4

27 1 16 2 10 26 12 18 4

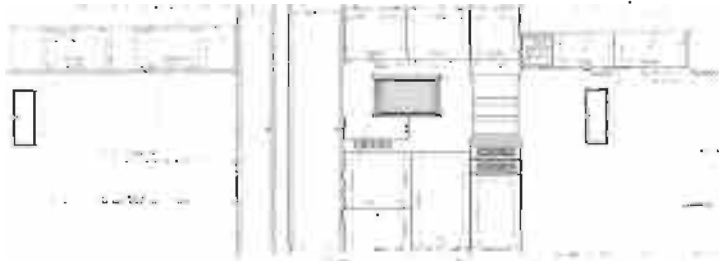

Stuhl / Stuhl / Page 733

20 4 23

21 22

9 17

4 5



13 8

14 15

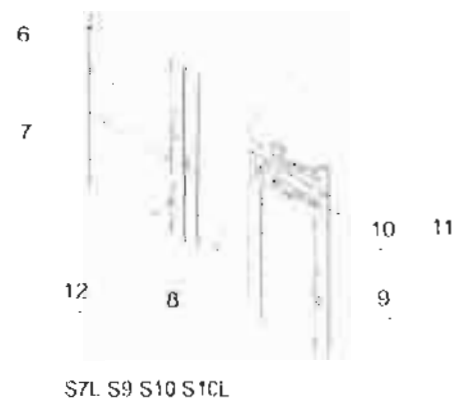
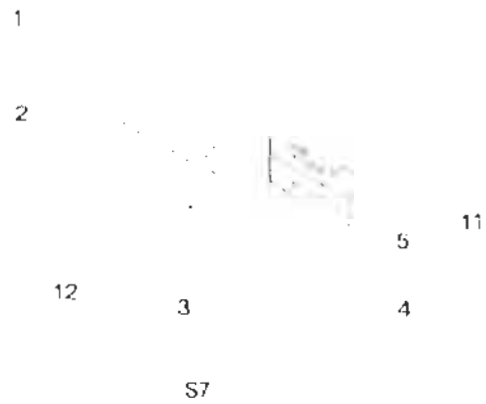
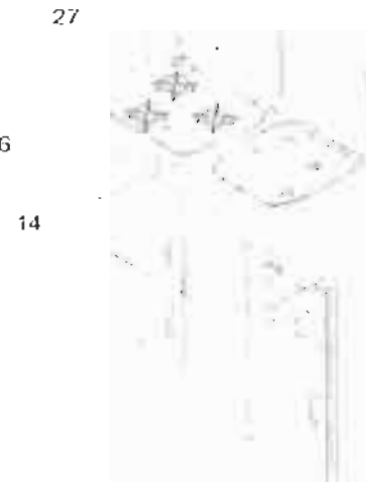
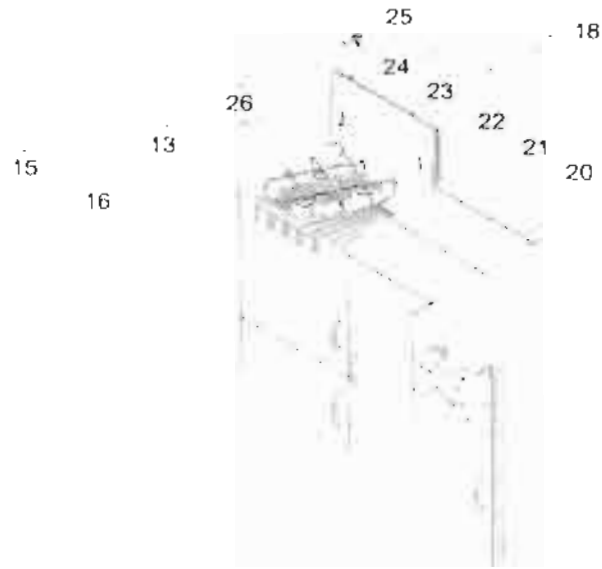
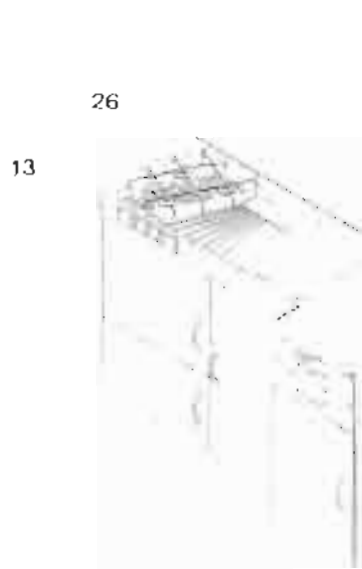

S7L S9 S10 S10L



Sisäpuoli
Inredning
Interior

733

Solifer S7 S7L S9 S10 S10L Tiskipöytäversiot
Solifer S7 S7L S9 S10 S10L Diskbänd versioner
Solifer S7 S7L S9 S10 S10L Sink models

2000

X vakio/standard M Menu-varustelu maasta riippuen/ Menu-utrustning beroende på land/ Menu-equipment due to country specification

Kuva Pos. Fig.	Varaosan nro Def.nr. Part.nr.	Kuvaus Benämning Description																		Huom. Anm. Obs.	
1	9401-6342	Ovi TK 428x530 -98	Dörr	Door																	
2	9401-6341	Ovi TK 312x530 -98	Dörr	Door																	
3	9401-6343	Ovi TK 745x453 -98	Dörr	Door																	
4	9401-6344	Ovi TK 572x390 -98	Dörr	Door																	
5	9401-6345	Etulevy lusik.laaf. 113x390 -98	Framsivja till skedlåda	Frontplate to spoonbox																	
6	9401-8097	Ovi TK 428x530	Dörr	Door																	
7	9401-8098	Ovi TK 312x530	Dörr	Door																	
8	9401-8206	Ovi TK 745x453	Dörr	Door																	
9	9401-8207	Ovi TK 572x390	Dörr	Door																	
10	9401-8099	Etulevy lusik.laaf. 113x390	Framsivja till skedlåda	Frontplate to spoonbox																	
11	9301-6273	Leikkuulauta	Skärbräda	Cuttingboard																	
12	9001-6000	Vedin Zell gold	Hondlag	Handle																	
13	9401-7153	Tiskikaapin etulevy	Framsivja till pentryn	Frontplate to pentry																	
14	9302-5067	Tiskikaapin etulevy	Framsivja till pentryn	Frontplate to pentry																	
15	9301-4458	Taso tiskikaappi 1000*58	Bord	Table																	
16	9402-5839	Taso tiskikaappi 426x700	Diskbardsivja	Plate for pentry																	
17	9302-5000	Taso tiskikaappi 1141x700	Diskbardsivja	Plate for pentry																	
18	9302-5035	Klaffikansi täydellinen	Klaffi komplett	Klaffi total																	
19	9301-4497	Klaffikansi 60x987	Klaffi	Klaffi																	
20	9402-5053	Klaffikansi 471x250	Klaffi	Klaffi																	
21	9402-5050	Klaffikansi 514x250	Klaffi	Klaffi																	
22	9402-5040	Klaffikansi 471x233	Klaffi	Klaffi																	
23	9402-5049	Klaffikansi 514x233	Klaffi	Klaffi																	
24	9001-4504	Klaffikannen sarana ø 10	Grängjörn ø 10	Hinge ø 10																	
25	0092-0028	Klaffikannen pidin	Hållare	Holder																	
26	9402-4641	Allas Gramer 470x1000 vasen	Diskbänk	Sink																	
27	90D2-5018	Liesi Gramer	Spis	Stove																	
28	9002-5020	Allas Gramer	Bassäng	Basin																	

Huom./ Anm./Obs.



Six-part
inledning
interior

735

Soffor 55 57 57L 59 510 510L Mjukhögsvenskt
Soffor 55 57 57L 59 510 510L Sömn version
Soffor 55 57 57L 59 510 510L Bedrum models

2013

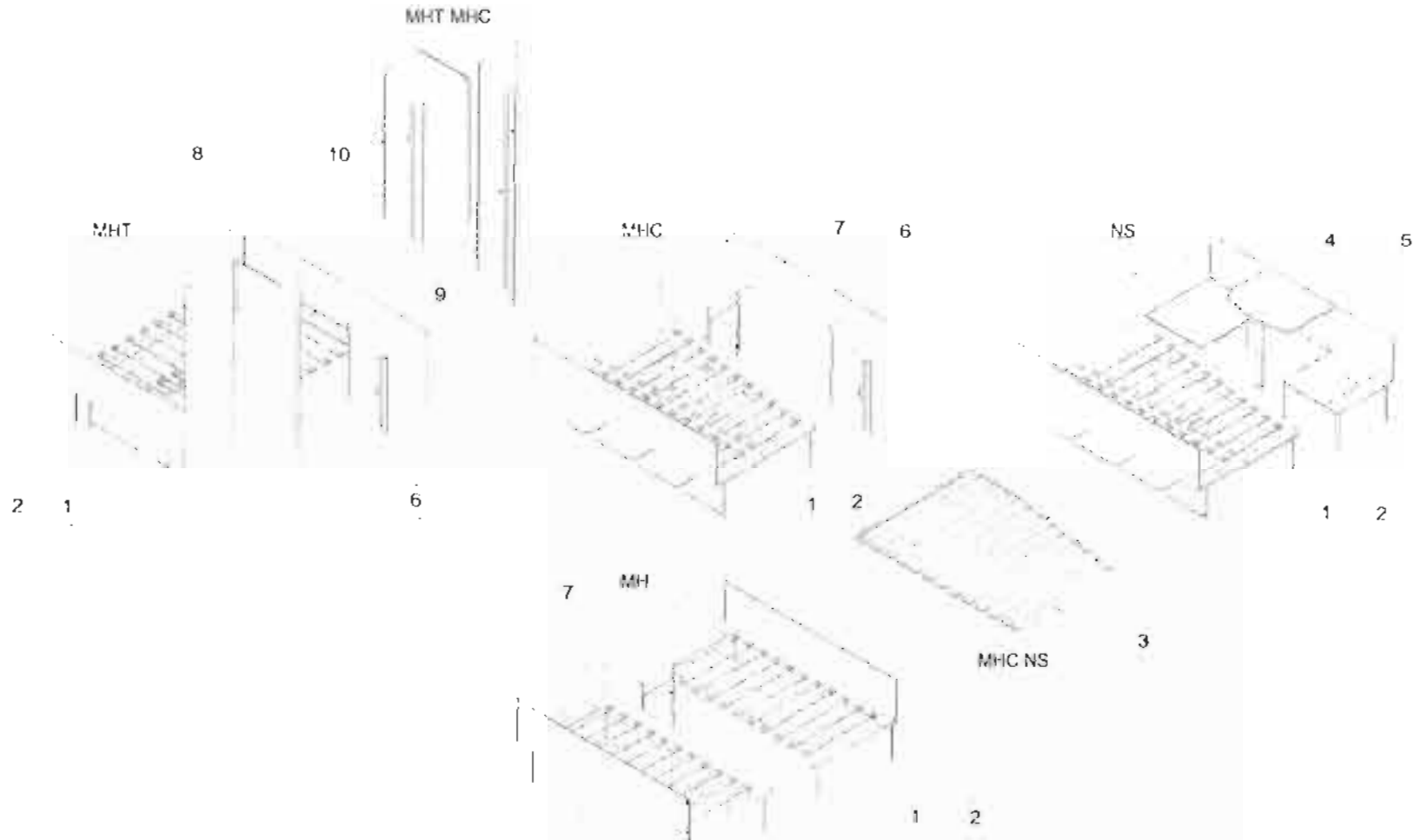

SOLIFERSisäpuoli
Inredning
Interior

735

Solifer S5 S7 S7L S9 S10 S10L Makuuhuoneversiot
Solifer S5 S7 S7L S9 S10 S10L Sovrum versioner
Solifer S5 S7 S7L S9 S10 S10L Bedroom models

X=vakio/ standard

M=Menu-varusteita maasta riippuen/ Menu-utrustning beroende på land/ Menu-equipment due to country specification

2000

Kuva Pos. Fig.	Varaosan nro Def.nr. Part.nr.	Kuvaus Benämning Description																		Huom. Anm. Obs.
1	9001-4367	Säte 8x50x700	Spjåla till bädd	Lath for bed																
2	9000-2973	Sätehen lopp	Faststycke för ribbotten	Muoting for lath																
3	9301-4171	Sätevuoteen kanssi 1270/1090*1800	Locket till spjålabädd	Cover for lathbed																1)
4	9401-6318	Pöytälevy taka 550x735	Bakbordskiva	Back table plate																
5	0092-0132	Pöydänjalka -86	Bordstativ tawa	Table support tawa																
6	9401-6288	Ovi alakaappi 635x468 -98	Skåpslucka mitten	Cupboard door																
6	9401-8209	Ovi alakaappi 635x468	Skåpslucka mitten	Cupboard door																
7	9401-7130	Ovi yöpöytä 448x316 -98	Nattbords dörr	Bedside tables door																
7	9401-8208	Ovi yöpöytä 448x316	Nattbords dörr	Bedside tables door																
8	9401-7091	Ovi VK 1850x490	Dörr	Door																
9	9401-7095	Ovi VK 1850x415	Dörr	Door																
10	9402-4485	Ovi VK 1295x415	Dörr	Door																

Huom./ Anm./Obs. 1) Käytössä osan mallivuotta / Användas till en del av modellår / In use partly through the model year

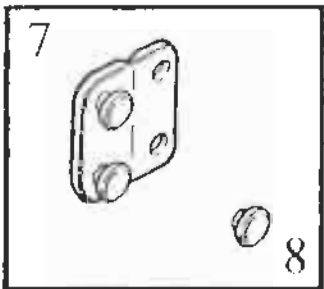
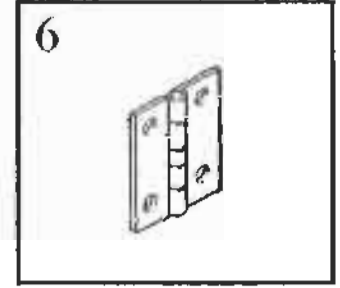
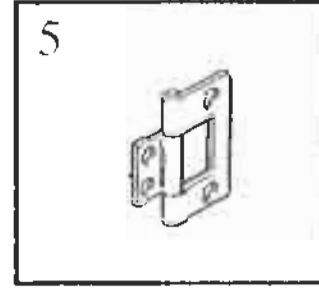
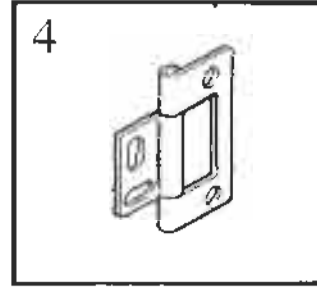
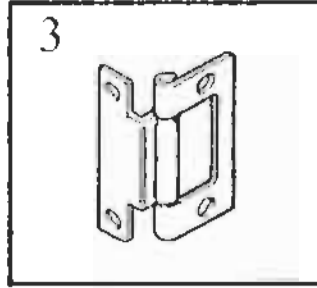
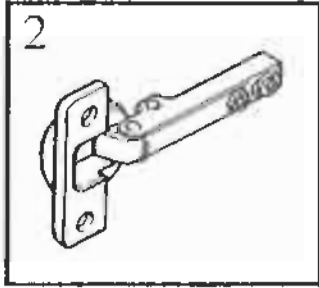
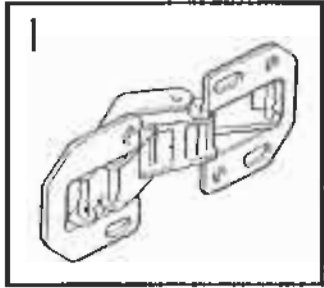

8

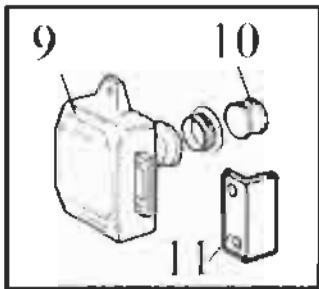

10

11

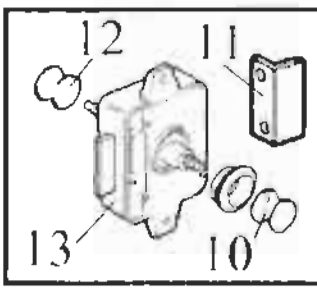

11

13

10

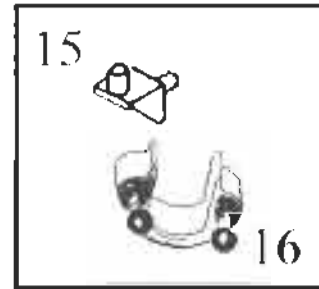
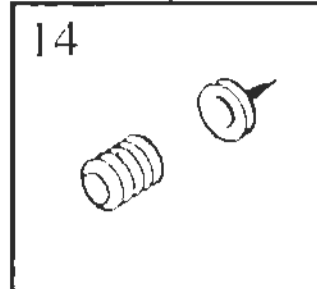

16

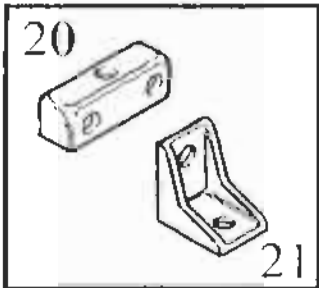
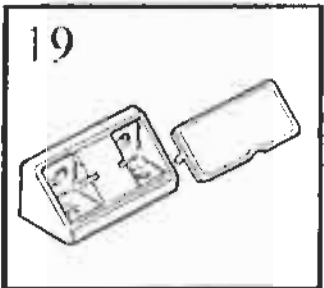
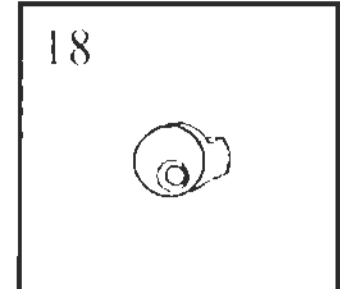

21

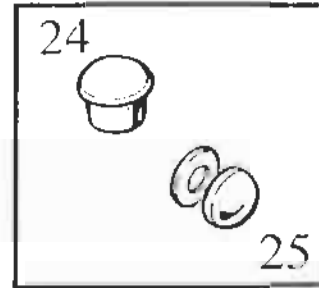
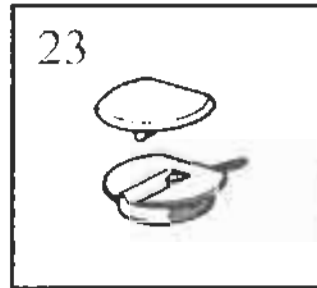
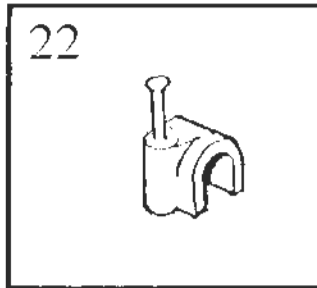

25

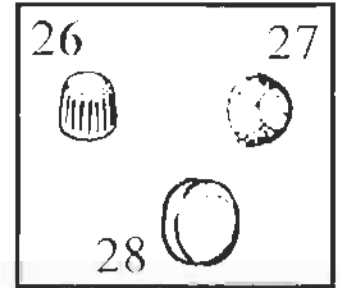

27

28

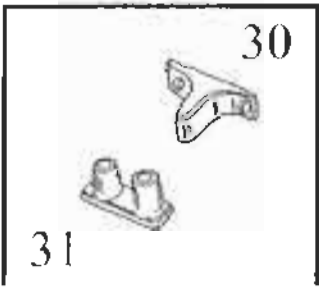
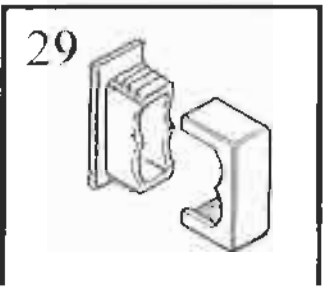

31

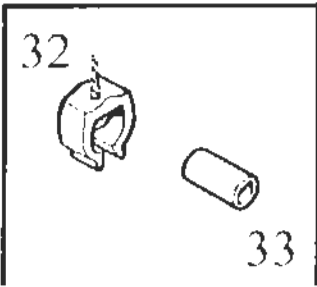

33

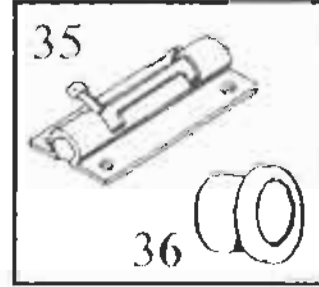
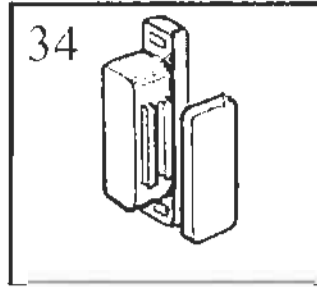

36

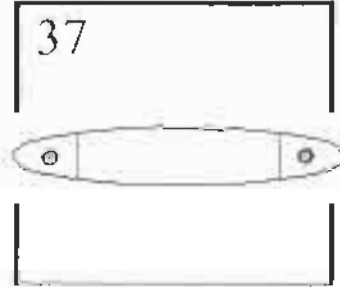

SOLIFERSisäpuoli
Inredning
Interior

755

Lukot, vetimet, sarana¹ jne
Lås, beslag, fästmaterial m.m.
Lock, furniture, etc.

X=vakio/ standard M=Menu-varustelu maasta riippuen/ Menu-utrustning beroende på land/ Menu-equipment due to country specification

2005

Kuva Pos. Fig.	Varaosan Def.nr. Part.nr.	Kuvaus Benämning Description																		Huom. Anm. Obs.	
1	860406	Yläkaapin luukun sarana	Gångjärn, överskåpslucka	Hinge, upper cupboard door																	
2	0092-0193	Peilikaapin sarana	Luckgångjärn, toas/radloskåp	Hinge, WC/radio cupboard	x	x															
3	0092-0024	Sarana	Gångjärn	Hinge	x	x	x	x	x	x	x	x	x	x	x	x	x	x	x		
4	0092-0083	Sarana 51x24	Gångjärn	Hinge	x	x	x	x	x	x	x	x	x	x	x	x	x	x	x		
5	0092-0077	Sarana 38x19	Gångjärn	Hinge	x	x	x	x	x	x	x	x	x	x	x	x	x	x	x		
6	0092-0012	Sarana 40x32	Gångjärn äverbädd	Hinge	x	x	x	x	x	x	x	x	x	x	x	x	x	x	x		
7	0526-1010	Sarana muovi ruskea 40x40	Plastgångjärn	Hinge plastic	x	x	x	x	x	x	x	x	x	x	x	x	x	x	x		
8	9500-3281	Tulpanlihti	Dubbelnit	Double rivet	x	x	x	x	x	x	x	x	x	x	x	x	x	x	x		
9	860502	Vaatekameran oven lukko	Lås	Lock	x	x	x	x	x	x	x	x	x	x	x	x	x	x	x		
10	312333	Painike metalli harmaa	Tryckknapp	Button	x	x	x	x	x	x	x	x	x	x	x	x	x	x	x		
11	0092-0061	Lukon vastakappale	Motslycke	Lock's opposite part	x	x	x	x	x	x	x	x	x	x	x	x	x	x	x		
12	860499	Painike ruskea	Tryckknapp	Button	x	x	x	x	x	x	x	x	x	x	x	x	x	x	x		
13	860498	WC oven lukko	Lås	Lock	x	x	x	x	x	x	x	x	x	x	x	x	x	x	x		
14	9000-2404	Magneettisalpa	Magnetilås	Magnetic lock	x	x															
15	312133	Kannatin ruskea 282.25.122	Stöd	Ancon	x	x	x	x	x	x	x	x	x	x	x	x	x	x	x		
16	0063-9001	Kuivaushyllyn kannatin	Torkhyllans stöd vit	Draining shelf ancon	x	x	x	x	x	x	x	x	x	x	x	x	x	x	x		
18	9500-3697	Kiinnitin peilille	Fäste för spegel	Bracket for mirror	x	x	x	x	x	x	x	x	x	x	x	x	x	x	x		
19	0092-0185	Kiinnityskpl	Fästklöss	Clamp	x	x	x	x	x	x	x	x	x	x	x	x	x	x	x		
20	0092-0039	Kiinnityskappale ruskea	Fästklöss	Clamp	x	x	x	x	x	x	x	x	x	x	x	x	x	x	x		
21	0092-0202	Kiinnityskpl muovi beige	Vinkelfäste beige	Mounting piece plastic beige	x	x	x	x	x	x	x	x	x	x	x	x	x	x	x		
22	0038-5780	Johdon kiinnike	Kabelclips	Cable clip	x	x	x	x	x	x	x	x	x	x	x	x	x	x	x		

Huom./ Anm./ Obs.

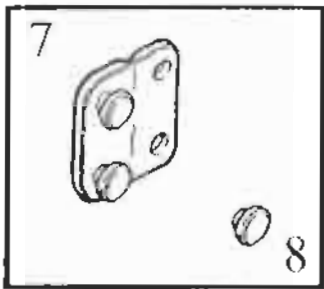
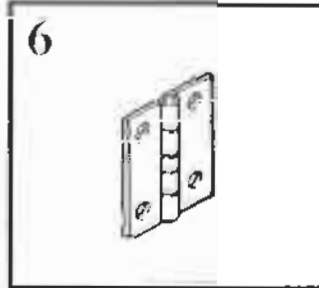
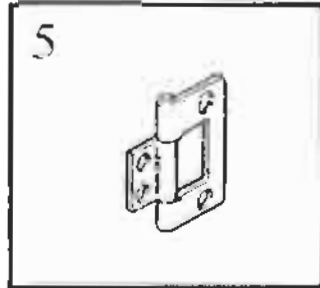
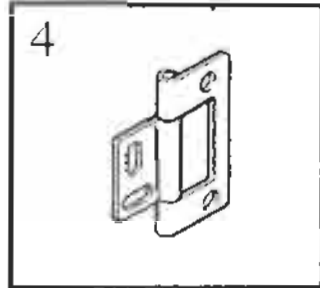
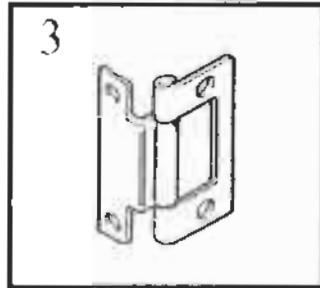
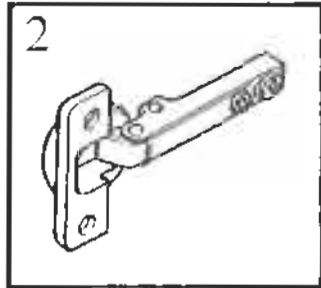
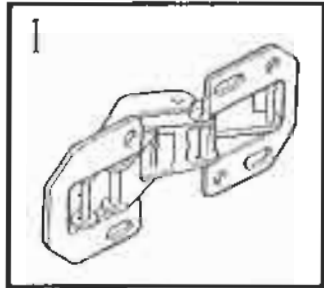

8

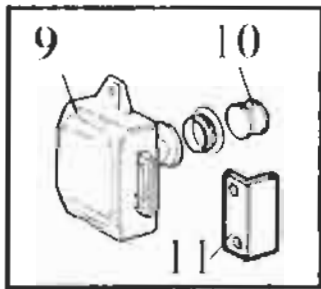

11

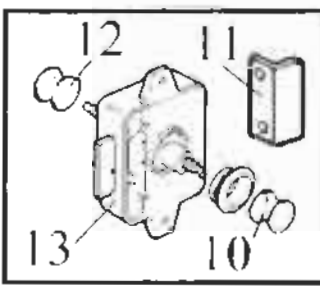

13

10

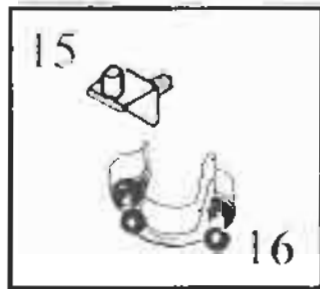
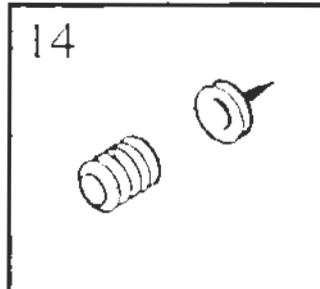

16

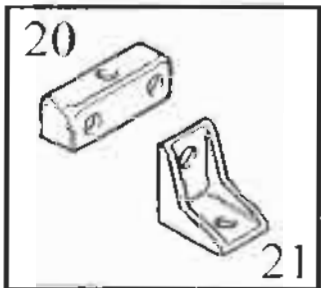
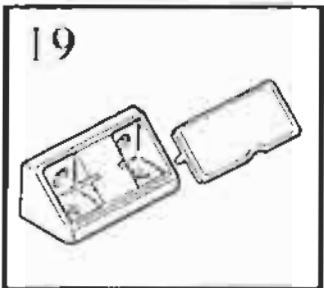
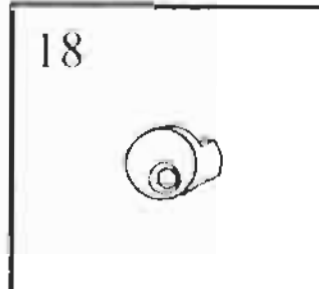

21

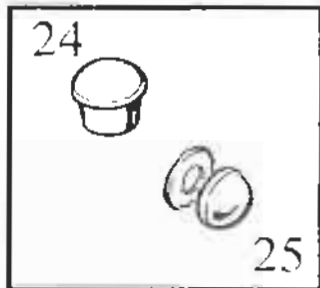
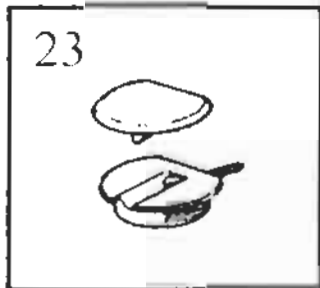
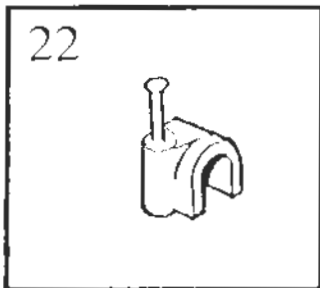

25

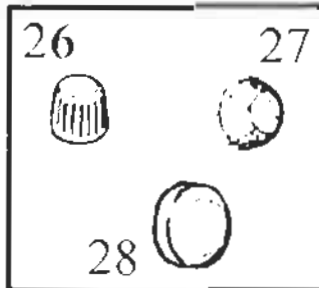

27

28

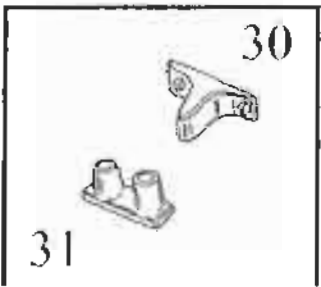
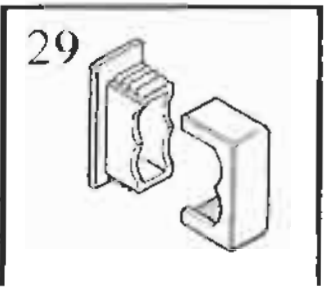

31

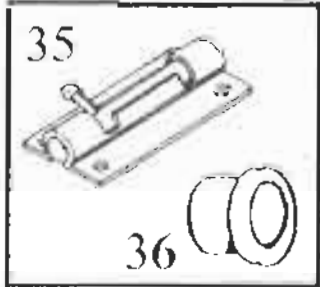
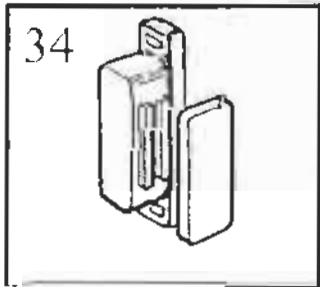
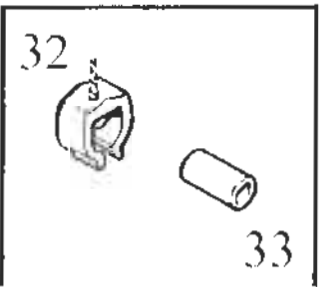

36

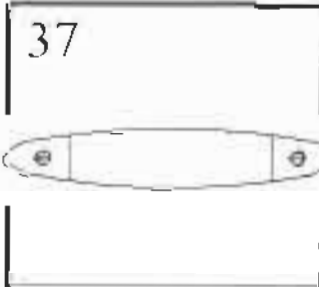

SOLIFER

Sisäpuoli
Inredning 755 Lukot, vetimet, saranat jne
Interior Lås, beslag, fästmaterial m.m.
Lock, furniture, etc.

2000

X=vakio/ standard M=Menu-varusteita maasta riippuen/ Menu-utrustning beroende på land/ Menu-equipment due to country specification

Kuva Pos. Fig.	Varaosanro Def.nr. Part.nr.	Kuvaus Benämning Description																	Huom. Anm. Obs.
23	9001-5551	Kiinnityskpl Fawo	Fäststycke	Clamp	X	X	X	X	X	X	X	X	X	X	X	X	X	X	
24	0092-0184	Pelitulppa PT 10/13 Love cherry	Plastplugg	Plug plastic	X	X	X	X	X	X	X	X	X	X	X	X	X	X	
25	0092-0187	Aluslevy hatulla 5/12mm vaal. rusk.	Plastlock+botten beige	Mounting piece beige	X	X	X	X	X	X	X	X	X	X	X	X	X	X	
25	9000-3364	Aluslevy hatulla 5/12 valk.	Plastlock+botten vitt	Mounting piece white	X	X	X	X	X	X	X	X	X	X	X	X	X	X	
26	0047-0230	Nuppi kalustokiinnitykseen	Skruvmotstycke	Nut plastic				X	X	X	X	X	X	X	X	X	X	X	
27	0092-0168	Tarratyyny yläkaap. luukkuun	Ljuddämpningsknopp	Soundproofing knob	X	X	X	X	X	X	X	X	X	X	X	X	X	X	
28	0070-0002	Salpakupu kaasupullok valk.	Täckhatt kaffert vit	Knob for gasbox cover white	X	X													
29	0096-0076	Vesitiekun kannatin	Fästklass för vatten slangar	Bracket water hose	X	X	X	X	X	X	X	X	X	X	X	X	X	X	
30	9000-8642	Lukko Fawo (yläkaap. luukkuun)	Lås	Lock	X	X	X	X	X	X	X	X	X	X	X	X	X	X	
31	9000-8643	Vastakpl (luukkuun lukon)	Plastclips han-del	Clips plastic	X	X	X	X	X	X	X	X	X	X	X	X	X	X	
32	9000-8592	Pihlisaipa kirkas	Plastclips han-del glasklar	Clips plastic transparent	X	X	X	X	X	X	X	X	X	X	X	X	X	X	
33	0092-0056	Pihlisaivan vastakpl ilm. laipp.	Plastclips han-del	Clips plastic	X	X	X	X	X	X	X	X	X	X	X	X	X	X	
34	0092-0207	Magneettisaipa	Magnetilås	Magnetic lock	X	X	X	X	X	X	X	X	X	X	X	X	X	X	
35	0524-0051	Työntösaipa 910 x 21/2 keil.	Spärrsild	Push built	X	X	X	X	X	X	X	X	X	X	X	X	X	X	
36	0526-3510	Reikätulppa valk. yläv. 13mm	Plastplugg	Plug plastic	X	X	X	X	X	X	X	X	X	X	X	X	X	X	
36	0526-3515	Reikätulppa valk. 16mm	Plastplugg	Plug plastic	X	X	X	X	X	X	X	X	X	X	X	X	X	X	
37	9001-6000	Vedin Zell gold	Handtag	Handle	X	X	X	X	X	X	X	X	X	X	X	X	X	X	

Huom./ Anm./ Obs.

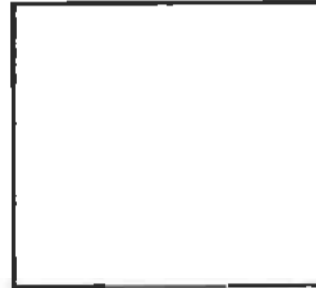
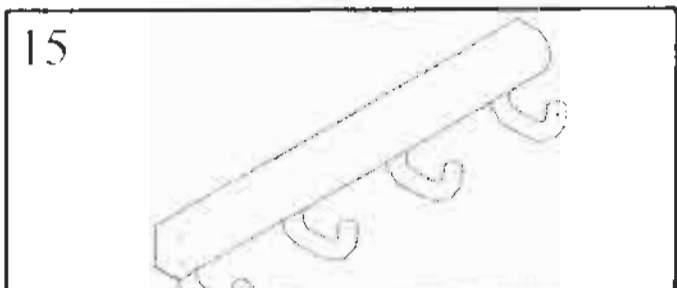
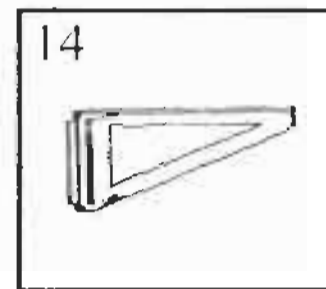
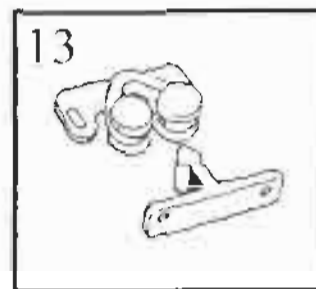
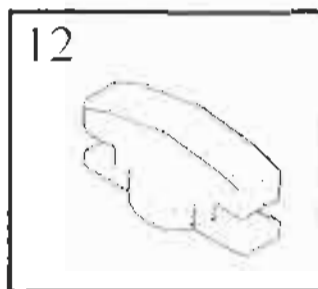
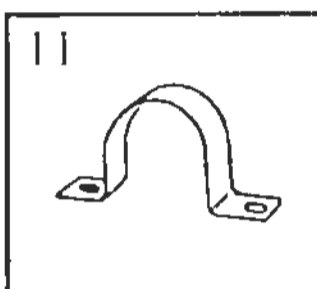
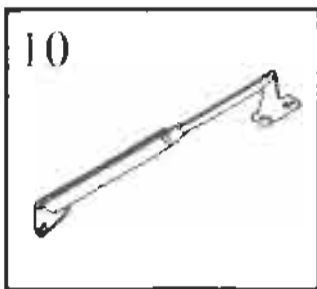
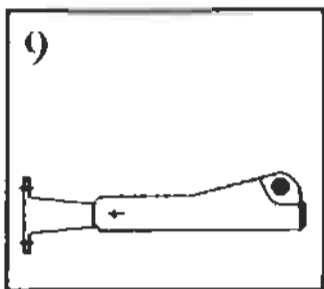
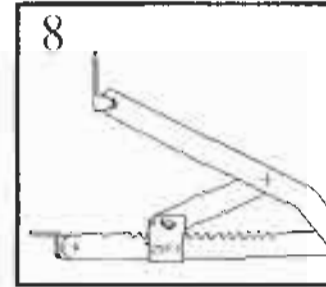
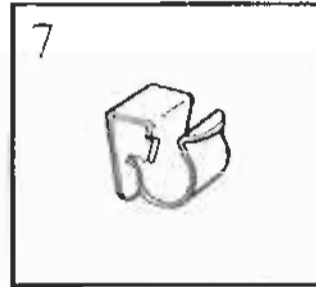
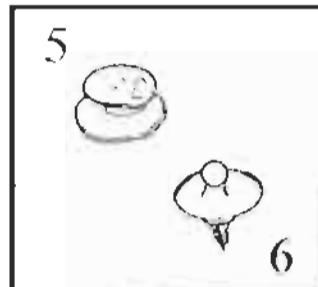
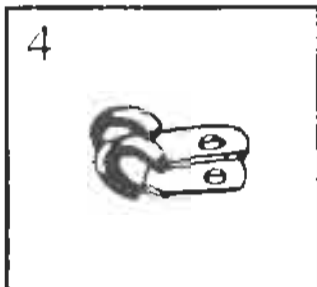
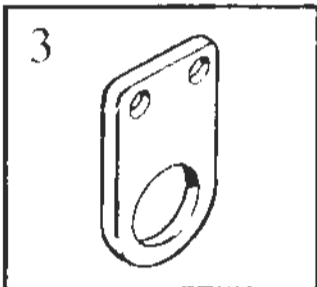
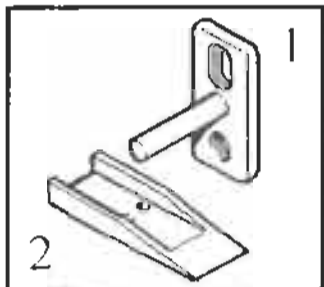



Sisäpuoli
Inredning
Interior

757

Helat, kannattimet, pitimet
Beslag m .m.
Fittings etc.

2000

X=vakio/ standard M-Menu-varusteita maasta riippuen/ Menu-utrustning beroende på land/ Menu-equipment due to country specification

Kuva Pos. Fig.	Varaosan nro Det.nr. Part.nr.	Kuvaus Benämning Description																		Huom. Anm. Obs.	
			Code 500	Code 530	51	52	53	54	55	56	57	58	59	60	61	62	63	64	65	66	
1	0045-8650	Lukkosalvan vastakpl. vefolaat.	Låsdel draglådor	Drawer holder	x	x	x	x	x	x	x	x	x	x	x	x	x	x	x	x	
2	0045-6020	Lukkosalpa vefolaafikkoon	Låsdel draglådor	Drawer holder	x	x	x	x	x	x	x	x	x	x	x	x	x	x	x	x	
3	0042-7610	Vaatetangon pidin rusk.	Garderobstängsfäste	Clothes rod holder	x	x	x	x	x	x	x	x	x	x	x	x	x	x	x	x	
4	0081-3008	Kiinnike kumipääl.	Gummiskodd klammer (gasolrör)	Robber sealed bracket	x	x	x	x	x	x	x	x	x	x	x	x	x	x	x	x	
5	0092-0139	Tenax lukko paljeoveen	Fäste för skjutsdörrrem	Holder sliding door strap			x	x	x		x	x	x	x	x	x	x	x	x	x	
6	0092-0140	Tenax laipparuuvi	Kula d.o	Ball screw, sliding door			x	x	x		x	x	x	x	x	x	x	x	x	x	
7	0081-3007	Johdon kiinnike 13-nap.	Fäste för kabel på draget	Holder towbar cable	x	x	x	x	x	x	x	x	x	x	x	x	x	x	x	x	
8	9001-5272	Sätekanen aukipitolaite	Låsdel	Holder			x	x			x	x	x	x	x	x	x	x	x	x	
9	0092-0034	Teleskooppi/nivel musta	Luckteleskoop	Teleskope cupboard			x	x	x	x	x	x	x	x	x	x	x	x	x	x	
10	0092-0084	Teleskooppi, lyhyt kirkas	Luckteleskoop kort	Teleskope cupboard short	x	x															
11	0526-2010	Kiinnike 1380/28	Klammer plåt	Bracket metal	x	x	x	x	x	x	x	x	x	x	x	x	x	x	x	x	
12	9000-3537	Tuuletusluukun salpa valk.	Ventilationsluckans vred vitt	Handle ventilation door	x	x	x	x	x	x	x	x	x	x	x	x	x	x	x	x	
13	9001-3524	Salpapari Lamp	Låsdel	Holder	x	x	x	x	x	x	x	x	x	x	x	x	x	x	x	x	
14	1729-1224	Tv-hyllyn kannatin	TV-hyllans stöd	Support TV-shelf	x	x															
15	9000-3665	Naulakko 2-haar. valkea	Kiädäkrok 2	Rack 2	x	x															
15	9000-3666	Naulakko 4-haar. valkea	Kiädäkrok 4	Rack 4	x	x	x	x	x	x	x	x	x	x	x	x	x	x	x	x	
15	9000-3667	Naulakko 6 haar. valkea	Kiädäkrok 6	Rack 6	x	x															

Huom./ Anm./Obs.

SOLIFER

Sis.puoli
Inredning
Interior

759

Rullaverhoi, kasettiverhoi, s.lekainnirnet
Rullgardiner
Rolling blind

2000

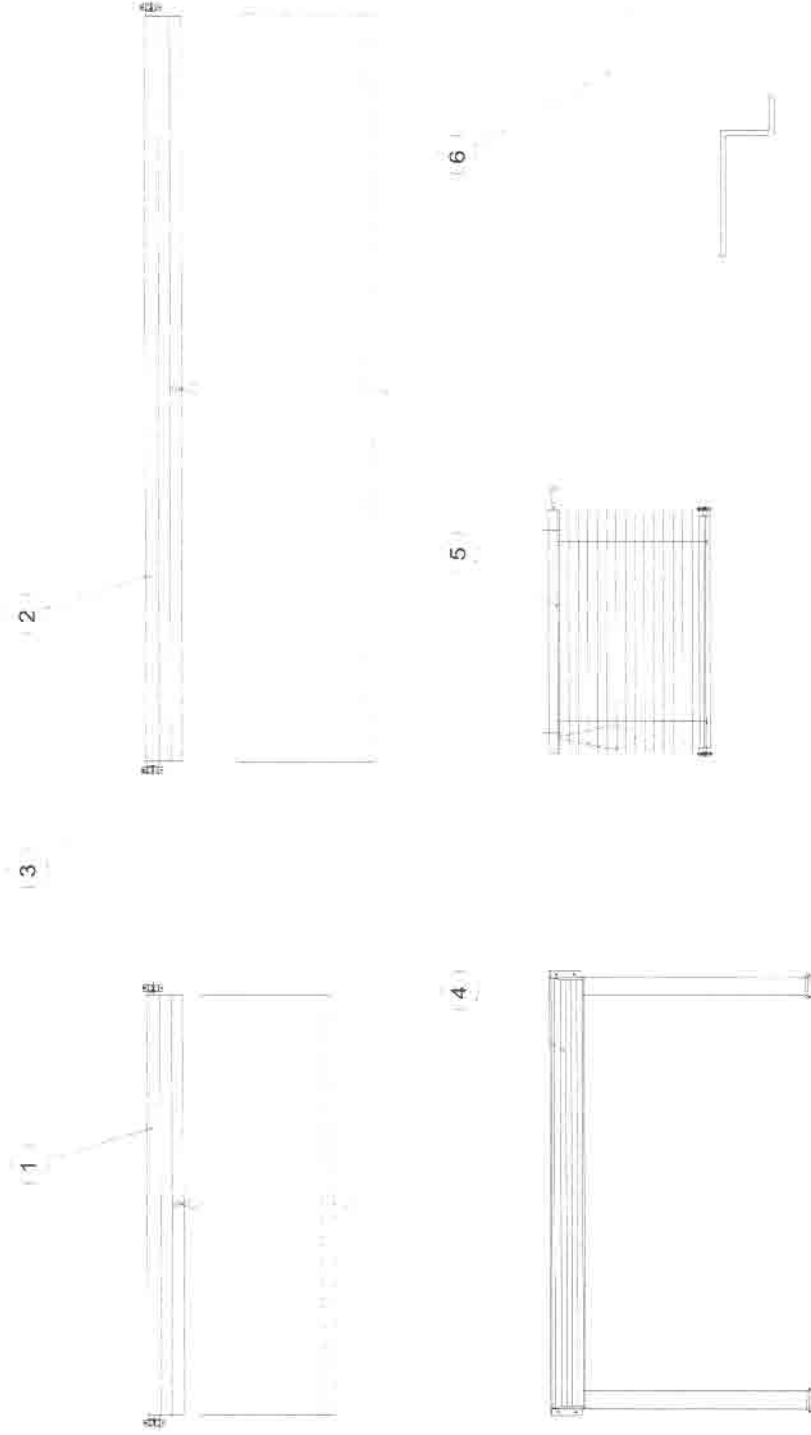

SOLIFERSisäpuoli
Inredning
Interior

759

Rullaverhot, kasettiverhot, sätekaihdin
Rullgardiner
Rolling blind

X=vakio/ standard

M-Menu-varustelu maasta riippuen/ Menu-utrustning beroende på land/ Menu-equipment due to country specification

2000

Kuva Pos. Fig.	Varaosan nro Del.nr. Part.nr.	Kuvaus Benämning Description																	Huom. Anm. Obs.
1	9001-5436	Rullaverho sivuikkunat 920x750	Rullgardin sido fönster	Rolling blind side window	x	x	x	x	x	x	x	x	x	x	x	x	x		
2	9001-5435	Rullaverho päätyikkunat 1640x750	Rullgardin fram och bak fönster	Rolling blind front & rear	x	x	x	x	M	x	x	M	x	x	M				
2	9002-3259	Rullaverho päätyikkunat 1910x750	Rullgardin fram och bak fönster	Rolling blind front & rear					x			x							
3	0091-0261	Rullaverhon kannake pari	Rullgardin stödpar	Rolling blind holders	x	x	x	x	x	x	x	x	x	x	x	x	x		
4	9001-5525	Kasettiverho 900x500	Kasetti rullgardin	Rolling blind, casette	M	M	M	M	M	M	M	M	M	M	M	M	M		
4	9001-5782	Kasettiverho 1600x550	Kasetti rullgardin	Rolling blind, casette	M	M	M	M	M	M	M	M	M	M	M	M	M		
5	9001-5443	Säleiverho 510x335 valkoinen	Spjäll	Slats of wood curtains	M	M	x	x	x	x	x	x	x	x	x	x	x		
6	9001-7538	Sivuohjaimet rulloverhoihin L=780	Sidostyrning för rullgardinerna	Sideguide for the rollos	x	x	x	x	x	x	x	x	x	x	x	x	x		
6	9001-5567	Sivuohjaimet rullaverhoihin L=670	Sidostyrning för rullgardinerna	Sideguide for the rollos	x	x	x	x	x	x	x	x	x	x	x	x	x		
6	9001-5568	Sivuohjaimet rullaverhoihin L=570	Sidostyrning för rullgardinerna	Sideguide for the rollos	x	x	x	x	x	x	x	x	x	x	x	x	x		

Huom. / Anm. / Obs.

Pos	Nimitys Namn Name	Kpl St Amount	Kankaan väri/ Tyg färg/ Bolster colour A = Punainen/ röd/ red B = Siniharmaa/ blågrå/ bluogray C = Vihreä/ grön/ green Kankaan väri/ tyg färg/ bolster colour: Jälleenmyyjä/ återförsäljare/ dealer: Malli ja vuosimalli/ modell och årsmodell/ model & modelyear : Alustanumero/ chassi nr/ chassi no:
1			
2			
3			
4			
5			
6			
7			
8			
9			
10			
11			

MHT



MHC

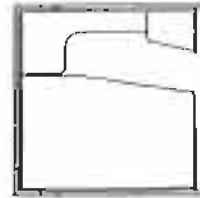

NS

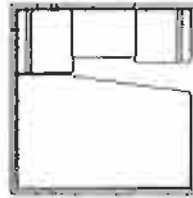

N



MH

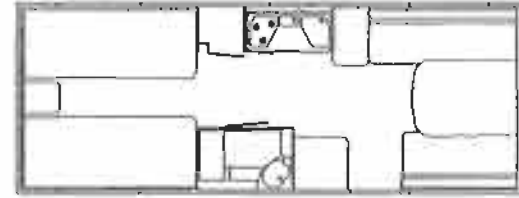

N



U

Huom./ Anm./Obs.

SOLIFERSisäpuoli
Inrednin
Interior

780

Verhot G500 G530 S4 S5 S5L S5T S7 S7L S9 S10 S10L
Gardiner G500 G530 S4 S5 S5L S5T S7 S7L S9 S10 S10L
Curtains G500 G530 S4 S5 S5L S5T S7 S7L S9 S10 S10L

2000

Pos	Nimitys Namn Name	Kpl St Amount	Kankaan väri/ Tyg färg/ Bolster colour A = Punainen/ röd/ red B = Siniharmaa/ blågrå/ bluegray C = Vihreä/ grön/ green Kankaan väri/ tyg färg/ bolster colour: Jälleenmyyjä/ återförsäljare/ dealer: Malli ja vuosimalli/ modell och årsmodell/ model & modelyear : Alustanumero/ chassi nr/ chassi no:
1			
2			
3			
4			
5			
6			
7			
8			
9			
10			
11			

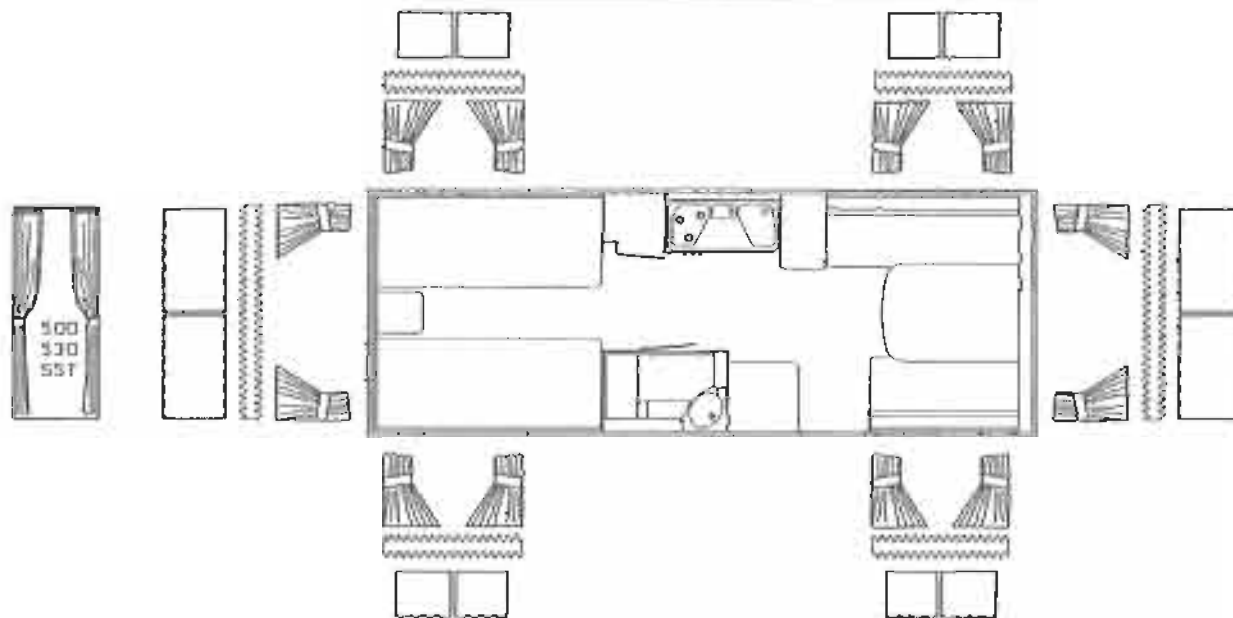

Huom./ Anm./Obs.

SOLIFER

Konsummaterial
Type material
Raw material

320

Profilprofil
Tr.Jesse
List of wood

2000

00592175
A L=2300

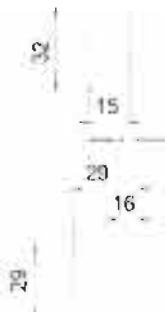

00592176
A/1 L=2100

00592177
A/2 L=2300

90013910
A/5 L=2400

90007087
A/8 L=2400

00592179
B L=1880



00592180
B/1 L=2300

94006433
B/4 L=2400

00592184
D L=2300

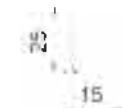

00592185
D/1 L=2300

00592186
E L=2400

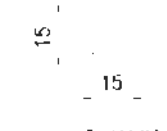

00592189
L L=2300

45

94006380
L/1 L=2400



94014140
N/1 L=1900

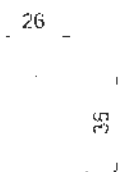

94013200
O L=2300

20.5

94016192
1 L=2400
MDF

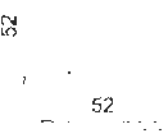

94017796
7 L=2400
MDF

16



94014356
W/1 L=2400



44

94014139
D/2 L=1900

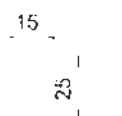

94016194
3 L=2400



17

SOLIFER

Korjausmateriaali

Rep.material

820

Rep.material

Rimaprofiili

Trällister

List of wood

X=vakio/ standard

M=Menu-varustelu maasta riippuen/ Menu-utrustning beroende på land/ Menu-equipment due to country specification

99

Kuva Pos. Fig.	Varaosan nro Def.nr. Part.nr.	Kuvaus Benämning Description																		Huom. Anm. Obs.
A	0059-2175	Rimaprofiili Abachi / Love cherry L=2300	Trällist	List of wood																
A/1	0059-2176	Rimaprofiili Abachi / Love cherry L=2100	Trällist	List of wood																
A/2	0059-2177	Rimaprofiili Abachi / Love cherry L=2300	Trällist	List of wood																
A/3	0059-2178	Rimaprofiili Abachi / Love cherry L=2300	Trällist	List of wood																
A/5	9001-3910	Rimaprofiili Abachi / Love cherry L=2300	Trällist	List of wood																
A/8	9000-7087	Rimaprofiili Abachi / Love cherry L=2400	Trällist	List of wood																
B	0059-2179	Rimaprofiili Abachi / Love cherry L=1880	Trällist	List of wood																
B/1	0059-2180	Rimaprofiili Abachi / Love cherry L=2300	Trällist	List of wood																
B/4	9400-6433	Rimaprofiili Abachi / Love cherry L=2400	Trällist	List of wood																
C	0059-2181	Rimaprofiili Abachi / Love cherry L=2300	Trällist	List of wood																
C/2	0059-2183	Rimaprofiili Abachi / Love cherry L=2300	Trällist	List of wood																
D	0059-2184	Rimaprofiili Abachi / Love cherry L=2300	Trällist	List of wood																
D/1	0059-2185	Rimaprofiili Abachi / Love cherry L=2300	Trällist	List of wood																
E	0059-2186	Rimaprofiili Abachi / Love cherry L=2400	Trällist	List of wood																
E/1	0059-2187	Rimaprofiili Abachi / Love cherry L=2300	Trällist	List of wood																
H	0059-2275	Rimaprofiili Abachi / Love cherry L=2120	Trällist	List of wood																
L	0059-2189	Rimaprofiili Abachi / Love cherry L=2300	Trällist	List of wood																
L/1	9400-6380	Rimaprofiili Abachi / Love cherry L=2400	Trällist	List of wood																
N/1	9401-4140	Rimaprofiili Abachi / Love cherry L=1900	Trällist	List of wood																
O	9401-3200	Rimaprofiili Abachi / Love cherry L=2300	Trällist	List of wood																
1	9401-6192	Rimaprofiili MDF / Jimmywood L=2400	Trällist	List of wood																
7	9401-7796	Rimaprofiili MDF / Jimmywood L=2400	Trällist	List of wood																
W/1	9401-4356	Rimaprofiili KOLC L=2400	Trällist	List of wood																
D/2	9401-4139	Rimaprofiili Abachi / Love cherry L=1900	Trällist	List of wood																
3	9401-6194	Rimaprofiili MDF / Jimmywood L=2400	Trällist	List of wood																

Huom./ Anm./Obs.

BOLIFER

Korjausmateriaalit
Rep material
Rep material

825

Korikaaret
H₁,nbHTge
Corner bend

2000





Korjausmateriaalit

Rep.material

825

Korikaaret

Hörnbåge

Rep.material

Corner bend

X=vakio/ standard

M=Menu-varustelu maasta riippuen/ Menu-utrustning beroende på land/ Menu-equipment due to country specification

2000

Kuva Pos. Fig.	Varaosan nro Det.nr. Part.nr.	Kuvaus Benämning Description																	Huom. Anm. Obs.
1	9400-3655	Kulmakaari vasen	Hörnbåge vänster	Corner bend left	x	x													
1	9400-3654	Kulmakaari oikea	Hörnbåge höger	Corner bend right	x	x													
2	9300-3480	Kulmakaari vasen	Hörnbåge vänster	Corner bend left	x	x													
2	9000-3481	Kulmakaari oikea	Hörnbåge höger	Corner bend right	x	x													
3	0048-5610	Kulmakaari oikea ja vasen	Hörnbåge höger och vänster	Corner bend right and left	x	x													
4	9400-3482	Kulmakaari oikea ja vasen	Hörnbåge höger och vänster	Corner bend right and left	x	x													

Huom./ Anm./Obs.



Korjausmateriaalit
Rep.material
Rep.material

830

Vanerit, lattiamatot, eristeet ja ruvit
Faner, Isolering och skruvar
Playwoods, insulatedes and screws

X=vakio/ standard

M=Menu-varustetu maasta riippuen/ Menu-utrustning beroende på land/ Menu-equipment due to country specification

2000

Kuva Pos. Fig.	Varaosan nro Det.nr. Part.nr.	Kuvaus Benämning Description																		Huom. Anm. Obs.
1	9001-4291	Kattovaneri bari 3x2170x1220	Poppelfaner 3x2170x1220 tak	Plywood 3x2170x1220 ceiling	X	X	X	X		X	X		X	X						
2	9002-2954	Kattovaneri bari 3x2440x1220	Poppelfaner 3x2170x1220 tak	Plywood 3x2170x1220 ceiling					X				X							
3	9000-3286	Seinävaneri bari 3x2005x1220	Väggfaner bari 3x1920x1220	Wall plywood bari 3x1920x1220	X	X	X	X	X	X	X	X	X	X	X	X	X	X	X	
4	9000-3877	Poppelivaneri wc-seinä	Poppelfaner toa-vägg	Plywood toa. wall	X	X														
5	9001-4268	Kalustevaneri 3x2135x1220 1-puol.	Möbelfaner (1) 3x2135x1220	Furnit. plywood (1) 3x2135x1220	X	X	X	X	X	X	X	X	X	X	X	X	X	X	X	
6	9001-4269	Kalustevaneri 3x2135x1220 2-puol.	Möbelfaner (2) 3x2135x1220	Furnit. plywood (2) 3x2135x1220	X	X	X	X	X	X	X	X	X	X	X	X	X	X	X	
7	9001-4270	Kalustevaneri 12x2135x1220 2-puol.	Möbelfaner (2) 12x2135x1220	Furnit. plywood (2) 12x2135x1220	X	X	X	X	X	X	X	X	X	X	X	X	X	X	X	
8	0056-1027	Havuvaneri 6,5x2440x1220	Faner 6,5x2440x1220	Plywood 6,5x2440x1220	X	X	X	X	X	X	X	X	X	X	X	X	X	X	X	
9	0056-1009	Havuvaneri 9x2440x1220	Faner 9x2440x1220	Plywood 9x2440x1220	X	X	X	X	X	X	X	X	X	X	X	X	X	X	X	
10	0056-1030	Sekavaneri 12x2440x1220	Faner 12x2440x1220	Plywood 12x2440x1220	X	X	X	X	X	X	X	X	X	X	X	X	X	X	X	
11	9001-8357	Lattiamatto	Golvatta	Floor carpet	X	X	X	X		X	X		X	X						
12	9002-6869	Lattiamatto, levy 2500	Golvatta, bredd 2500	Floor carpet, breadth 2500					X				X						X	1)
13	0063-1088	Eriste 36 mm 1200 x 2100	Isolering	Insulation	X	X	X	X	X	X	X	X	X	X	X	X	X	X	X	
14	2711-0200	Eriste 36 mm 1200 x 2100 kok. urit.	Isolering	Insulation	X	X	X	X	X	X	X	X	X	X	X	X	X	X	X	
15	0063-1057	Eriste 74 mm 1205 x 2181	Isolering	Insulation															X	
16	9001-4391	Lastulevyruuvi, Torx-kanta 3,5x30	Försänk! Torx skruv/mässingspläterad	Torx Screw /galv.	X	X	X	X	X	X	X	X	X	X	X	X	X	X	X	2)

Huom./ Anm./Obs. 1) Mallivuoden lopulla / I slutet av modellår / At the end of the model year
2) Telttälsta ruuvi / Tälttälstaskruv / Screw for tent list

SOLIFER

Korjausmateriaalit

Rep.material 835

Rep.material

Liimat, kittit ja maalit

Lim, kitt och färg

Glue, cement and color

X=vakio/ standard

M=Menu-varusteita maasta riippuen/ Monu-utrustning beroende på land/ Menu-equipment due to country specification

2000

Kuva Pos. Fig.	Varaosanro Def.nr. Part.nr.	Kuvaus Benämning Description																			Huom. Anm. Obs.
1	2707-0115	Laattaliima macroplast	Macroplast lim	Macroplast glue																	
2	2707-0100	Blanco-patruuna täyd.	Blanco-patron kompl.	Tube for uretan glue																	
3	2707-0101	Araldit liima 1 l purkki	Araldit lim 1 l bruk	Araldit glue 1 l.																	
4	2707-0102	Kovetin 0,7 l purkki	Härdare 0,7 l bruk	Hardener																	
5	2707-0103	Jauhe	Pulver	Powder																	
6	0060-5001	Tiivistemassanauha 2x20 mm beige	Tättningsband 2x20 mm beige	Sealing bond 2x20 beige																	
7	0060-5002	Tiivistemassanauha 2x20mm valk	Tättningsband 2x20 mm vit	Sealing band 2x20 white																	
8	0060-5006	Tiivistemassanauha 1,5x20 mm harm.	Tättningsband 1,5x20 mm grå	Sealing band 1,5x20 grey																	
9	0060-5008	Liimakitti pl400	Limkitt pl400	Glue putty pl400																	
10	9002-4852	Liimakitti Simson ISR 70-09 (säleiköt)	Limkitt Simson III hörnstycke	Glue putty Simson (corner piece)																	
11	0494-0720	Silikonkitti väntön	Silikonkitt utan färg	Silicone putty without colour																	
12	0060-5003	Tiivistemassa Bostik 1590 Harmaa	Karasskitt grå	Basket putty gery																	
13	2707-0105	K.p.kotelon poikkasorja	Repar.sats for gasolkoffert	Repair set f.gas bottle box																	
14	0093-0687	Paisukenauha 3x20 mm illbruck	Svällband 3x20 illbruck	Swelling band 3x20 illbruck																	
15	0063-3021	Paisukenauha 2x10 mm illbruck	Svällband 2x10 illbruck	Swelling band 2x10 illbruck																	

Huom./ Anm./Obs.

