

OVER 4000 PRODUCTS IN-STORE

ALL YOUR BUILDING PLASTICS NEEDS AND MORE!



**250
NEW
PRODUCTS**

WINDOWS

ROOFLINE

CLADDING

WATER & WASTE

INTERIOR PRODUCTS

WINDOW FINISHING

SEALANTS & FIXINGS

DOORS

HARDWARE

CONSERVATORIES

OUTDOOR LIVING

TOOLS



eurocell[®]

All together better

THREE WAYS TO SHOP



BY PHONE

Call your local branch direct
08000 77 88 88

**CALL FREE
MON-FRI
08.00-17:00**



ORDER ONLINE

eurocell.co.uk/buyonline

**COMPUTER
TABLET OR
MOBILE**



SHOP IN BRANCH

eurocell.co.uk/branchfinder

**185+
BRANCHES
NATIONWIDE**

CHOOSE YOUR DELIVERY



FREE 24-HOUR DELIVERY

We offer FREE delivery withing 24hrs* on all orders over £100** direct to your door or site, for your convenience.

*Longer lead times apply to made-to-order items. **Applies to mainland UK only and excludes Northern Scotland



FREE DELIVERY TO BRANCH

So wherever you are, you can order what you need via your smartphone, tablet or computer – and collect from your local branch.

CONTENTS

modus®

A breakthrough in design,
engineering & performance



Standard sash



Slim rebate sash



Fully flush sash

**NOW
AVAILABLE
IN BRANCH**

WINDOWS	6-13
ROOFLINE	14-41
CLADDING	42-55
WATER & WASTE	56-79
INTERIOR PRODUCTS	80-93
WINDOW FINISHING	94-111
SEALANTS & FIXINGS	112-131
DOORS	132-149
HARDWARE	150-157
CONSERVATORIES	158-177
OUTDOOR LIVING	178-197
TOOLS	198-221

FREE RETURNS

Return unused products to
any branch **FREE** of charge.



Within 14 days of purchase. Unopened packs in resellable condition only.
Proof of purchase required.



BRANCHES



All together better

185+ BRANCHES NATIONWIDE

LOCAL SERVICE

With over 185 branches across the UK (and new branches opening all the time) we can provide a local service wherever you need us.

**FIND YOUR NEAREST EUROCELL
BRANCH ON THE LIST OR VISIT**

eurocell.co.uk/branchfinder

*Monday-Friday 8am to 5pm, Saturday 8am to 12 noon, (Sunday Closed)



* Regional variations may apply, please check with your local branch

GREATER LONDON - 12 branches

BOW E16 4TG	020 7511 4850
CRAYFORD DA1 4AL	01322 553632
DARTFORD DA9 9AY	01322 387122
ENFIELD EN3 7XF	020 8804 9569
GREENFORD UB6 8UJ	020 8575 3701
HAYES UB3 1RT	020 8569 3363
MAIDSTONE ME16 8RF	01622 679727
ROMFORD RM3 8UB	01708 384059
STAPLES CORNER NW2 7LW	020 8450 7638
SYDENHAM SE26 5AQ	020 8778 6608
WIMBLEDON SW18 4NJ	020 8874 0337
WOOLWICH SE28 0EZ	020 8854 0284

THE NORTH - 52 branches

ACCINGTON BB5 1EF	01254 395220
ALTRINCHAM WA14 5DW	0161 928 3720
ASHTON-UNDER-LYNE OL6 7PP	0161 331 9994
BARNLEY S70 3NS	01226 770844
BIRKENHEAD CH41 1FH	0151 650 0090
BLACKBURN BB2 2QR	01254 693093
BLACKPOOL FY2 0LJ	01253 351515
BOLTON BL2 6QW	01204 366272
BRADFORD BD7 1JZ	01274 732101
BRADFORD COLLECT BD4 7RW	01274 722805

CARLISLE CA3 0EH	01228 513833
CHESTER CH1 4LT	01244 371700
CHESTERFIELD S41 9AJ	01246 202968
CHORLEY PR7 1QD	01257 233470
CRAMLINGTON NE23 1WD	01670 739351
DARLINGTON DL3 0XA	01325 363686
DONCASTER DN3 1QR	01302 881441
DURHAM DH1 2XU	0191 384 8294
GATESHEAD NE11 0HZ	0191 491 0860
GRIMSBY DN31 2SG	01472 340177
HALIFAX HX1 5RW	01422 344110
HARROGATE HG2 8RB	01423 879231
HUDDERSFIELD HD1 6PA	01484 518115
HULL HU3 4JF	01482 606611
HUYTON L36 6HY	0151 449 3674
KEIGHLEY BD21 3LA	01535 600121
KENDAL LA9 6LU	01539 731330
LEEDS LS27 9QS	0113 238 1387
LEEDS COLLECT LS7 1RQ	0113 249 9242
LIVERPOOL L20 6PF	0151 933 5353
MANCHESTER M17 1PS	0161 877 8888
MIDDLESBROUGH TS6 6UR	01642 430510
MORECAMBE LA3 3BN	01524 843535
NEWCASTLE-U-TYNE NE12 9FZ	0191 270 1280

NEWCASTLE WEST NE3 2EF	0191 271 3010
OLDHAM OL9 6HN	0161 621 0118
PRESTON PR1 5EJ	01772 701211
ROCHDALE OL16 5NP	01706 654020
ROTHERHAM S62 6NW	01709 525580
SCUNTHORPE DN16 1AE	01724 281195
SCARBOROUGH YO11 3XT	01723 586110
SELBY YO8 8AG	01757 210200
SHEFFIELD S9 2TW	0114 242 1666
SHEFFIELD COLLECT S3 8DG	0114 278 0230
SKEGNESS PE25 3ST	01754 769903
STOCKPORT SK5 5PG	0161 476 2025
SUNDERLAND SR2 9TW	0191 523 5892
WAKEFIELD WF1 5RN	01924 298378
WARRINGTON WA2 8NT	01925 414769
WIGAN COLLECT WN3 4DA	01942 825559
WORKINGTON CA14 3YD	01900 601261
YORK YO30 4WU	01904 479201

MIDLANDS - 35 branches

ALDRIDGE WS9 8BX	01922 452809
ALFRETON DE55 4LS	01773 545810
BIRMINGHAM B7 4RS	0121 333 3956
WEST BROMWICH DY5 1TX	01384 481263
BURTON-ON-TRENT DE13 0DW	01283 526803

WINDOWS

EUROCELL WINDOWS & DOORS

FROM EUROCELL BRANCHES



POWERED BY



GET INSTANT QUOTES

Visit your local branch today to get quotes in an instant on a full range of windows and doors.

IT'S A NO BRAINER!

6
DAYS

**READY TO COLLECT IN-BRANCH
IN JUST 6 WORKING DAYS**



SAVE TIME & MONEY

When you're buying Eurocell roofline products from your local branch, make sure you pick up your windows too! Whether you're looking for traditional casement windows, fully-engineered vertical sliding sash windows or our advanced tilt and turn windows, they're all in one place – saving you time and money!



MARKET LEADING WINDOWS – IN-BRANCH NOW!

You'll find outstanding performance right across the range. With a choice of styles, colours and finishes to suit building, our innovative windows boast A++ energy ratings and U-values as low as 0.8. In other words, they exceed the latest energy-efficiency standards.



FULLY GUARANTEED

Windows bought from your local branch are covered by a 10-year guarantee.



**FIND YOUR LOCAL BRANCH AT
eurocell.co.uk/branchfinder**

A breakthrough in design, engineering & performance

At a glance:

- ✓ Clean and contemporary looks with slimmer sight lines – different to traditional PVC-U windows.
- ✓ Advanced engineering technology – achieves the new A++ Window Energy Rating and a 0.7 U-value.
- ✓ Sustainability as standard – manufactured using 50% recycled material.
- ✓ Cost-effective alternative to aluminium.

A++

Superb
energy efficiency
performance

U0.7

U-value as low as
0.7 for improved
performance



Advanced
profile design

12
YEAR

Industry leading
12-year
guarantee

INNOVATION. INSPIRATION



Secured by Design



Official Police Security Initiative



PAS 24

Enhanced security performance for
doorsets & windows in the UK

modus[®]



Available in 3 sash styles:



Standard sash



Slim rebate sash



Fully flush sash



A complete range of windows & doors:

- Standard sash casement windows
- Slim rebate sash casement windows
- Flush sash casement windows
- Reversible windows
- Tilt & turn windows
- Entrance doors
- French doors

eurologik[®]

The leading high-performance,
sustainable window system



Superb
energy efficiency
performance



U-values as
low as 0.8



Wide range
of colour and
style options



10-year
guarantee for
peace of mind



charisma

The ultimate combination of classic design and 21st century engineering

A+

Superb energy efficiency performance

U1.3

U-values as low as 1.3



Outstanding technical performance

**10
YEAR**

10-year guarantee for peace of mind





ROOFLINE

High quality fascias, soffits, cladding and accessories help to add the essential finishing touches to any roofline project



All together better



3-IN-1 VENTILATION

This 3-in-1 solution combines an in-built felt tray, eaves comb filler and over fascia ventilator - for the ultimate time saving roofing product.

Find out more on page 21



HOLLOW SOFFIT

Our decorative hollow soffit board features in-built ventilation, helping to maintain airflow throughout your loft space.

Find out more on page 25



COMPOSITE ROOF TILES

Introducing a modern alternative to slate roof tiles - this versatile synthetic roofing slate will not shatter, crack, curl or fade. PLUS! It carries a limited lifetime warranty.

Find out more on page 32



ORDER BY PHONE

Call your local branch direct on
08000 77 88 88

ORDER ONLINE

eurocell.co.uk/buyonline

SHOP IN-BRANCH

Find your nearest branch at
eurocell.co.uk/branchfinder



ROOFLINE

FASCIA BOARDS
..... 18-20

ROOFLINE VENTILATORS
..... 21

CAPPING BOARDS
..... 22-23

SOFFIT BOARDS
..... 24-26

FIXINGS
..... 27

FINISHING TRIMS
..... 28-29

DRY VERGE
..... 30-31

COMPOSITE ROOF SLATE
..... 32-33

GRP ROOFING
..... 34-35

TIMBER
..... 36-37

ROOFLIGHTS
..... 38-39

FLASHING
..... 40-41



ROOFLINE ANATOMY

A FASCIA

For our range of direct replacement fascia and capping boards, [go to page 18](#)

B DRY VERGE

Neaten up ragged roof edges with our dry verge range [on page 30](#)

C TRIMS

From corner trims to joint trims, find all you need to complete your roofline job [on page 28](#)

D SOFFITS

Choose from our range of plain and ventilated soffit boards [on page 24](#)

For more detailed information on our roofline range, including measurements and fitting instructions, please refer to our specification guide.

Call **08000 77 88 88** to request a copy, or download at eurocell.co.uk/ebpspecguide

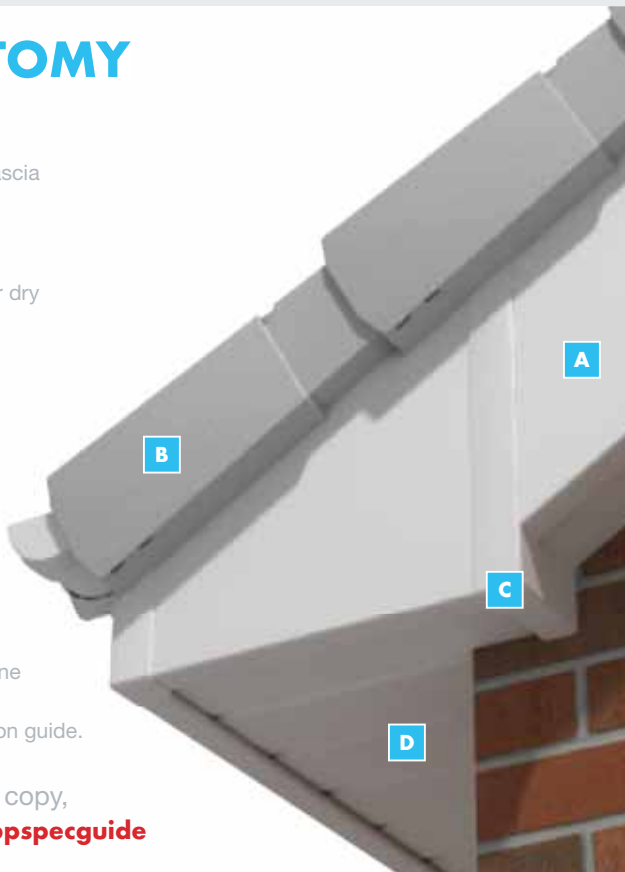

SIZE GUIDE

Our roofline products are available in various widths and thicknesses.

When we refer to **18mm** fascia board, we are talking about the **thickness** of the board.

The **width** of our fascia boards vary. In the example opposite, we show a **150mm** width board, but this particular product is available in widths up to 450mm – so you choose a size to best suit your project.



INSTALLATION EXAMPLES

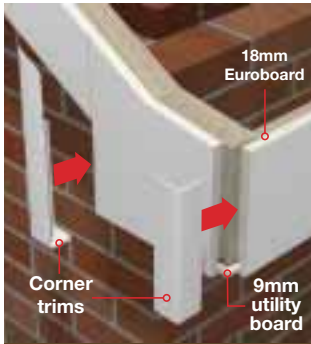

FASCIA BOARD

18mm fascia board installed on a gable box end, finished with corner (**DCBCT**) and joint trims (**DCBJT**).



SOFFIT BOARD

300mm vented hollow soffit board (**SB 300**) allows air to flow freely in the roof space. This decorative board is complemented by sculpted 18mm ogee fascia boards (**OGE 225**).



CAPPING BOARD

9mm capping board (**CB 250**) with 9mm utility board (**UB 300**) fitted to a new 6mm plywood substrate*.

*Our capping boards can be fitted over existing fascia boards, providing that they are sound

FITTING TIPS

FOILED AND LAMINATED BOARDS

All foiled and laminated boards should be fitted in lengths of 2.5m maximum, to accommodate the expansion requirements – particularly on south facing elevations. Lift protective tape for inspection before installation.

CAPPING BOARD

Capping board should only be affixed to existing timber fascias if they are sound. Where the integrity of existing fascia is compromised, replace with a timber backboard and use timber fillets for additional support.

WHICH SEALANT?

Eurocell recommends SilverSil neutral cure silicone sealants for all PVC-U roofline applications, for safe high-performance adhesion to PVC-U and masonry.

See page 112 to see the full range we stock.



FASCIA BOARDS



ATTRACTIVE DIRECT REPLACEMENT BOARDS TO SUIT EVERY PROPERTY

- ▶ Standard or decorative ogee fascia board for direct fixing to rafters
- ▶ Designed for ease of fitting and is low-maintenance, with no painting required
- ▶ Perfect for new homes and for replacing old fascias

**20-YR
GUARANTEE**

See page 222
for full details



EUROBOARD

As the flagship Eurocell fascia board, Euroboard is the perfect direct replacement board to make an attractive improvement to any home. Also ideal for new builds. Choose Ogee style for a more decorative finish.

KEY

- Available
- x Not available
- * Made to order
- † Alternative codes if short codes don't work
GY1 = GRW7016
GY2 = GRW7015
GY3 = GRW7155

COLOUR AVAILABILITY See table for colour codes and availability	Fascia board finishing trims													
	BEEB450	DEB 350	DEB 450	EB 150	EB 175	EB 200	EB 225	EB 250	EB 300	BEOGE	OGE 175	OGE 200	OGE 225	DOGE 400
WH White	•	•	•	•	•	•	•	•	•	•	•	•	•	•
CR Cream	x	x	•	•	•	•	•	x	x	x	x	x	x	x
WO Golden Oak	x	•	•	•	•	•	•	x	x	x	x	x	x	x
RO Rosewood	x	•	•	•	•	•	•	x	x	x	x	x	x	x
WL01 Irish Oak	x	x	•	•	•	•	•	x	x	x	x	x	x	x
WZ White Ash	x	x	•	•	•	•	•	x	x	x	x	x	x	x
GY1 Anthracite Grey†	x	•	•	•	•	•	•	x	x	x	x	x	x	x
WY Black Ash	x	•	•	•	•	•	•	x	x	x	x	x	x	x
WT1 Chartwell Green	x	x	•*	•*	•*	•*	•*	x	x	x	x	x	x	x
WCR Cream White	x	x	•	x	•	•	•	x	x	x	x	x	x	x
GY3 Moondust Grey†	x	x	•*	•*	•*	•*	•*	x	x	x	x	x	x	x
GY2 Slate Grey†	x	x	•*	•*	•*	•*	•*	x	x	x	x	x	x	x

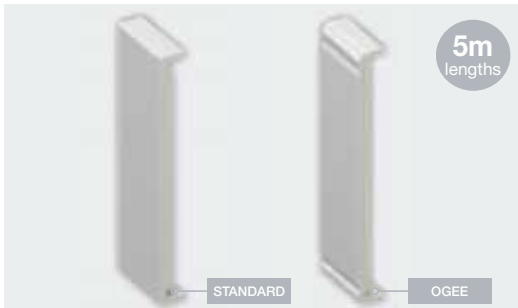
DOUBLE EUROBOARD 18mm**Standard & Ogee double euroboard**

Standard

Size	Code	Qty
350mm x 5m	DEB 350	1 pack
450mm x 5m	DEB 450	1 pack

Ogee

Size	Code	Pack Qty
400mm x 5m	DOGE 400	1 pack

Colour options: See table (left) for colour availability.

BOX END BOARD 18mm**450mm Standard & 400mm Ogee**

Standard

Size	Code	Qty
450mm x 1.25m	BEEB 450	1 pack

Colour options: 64 White

Ogee

Size	Code	Qty
400mm x 1.25m	BEOGE 400	1 pack

Colour options: 64 White

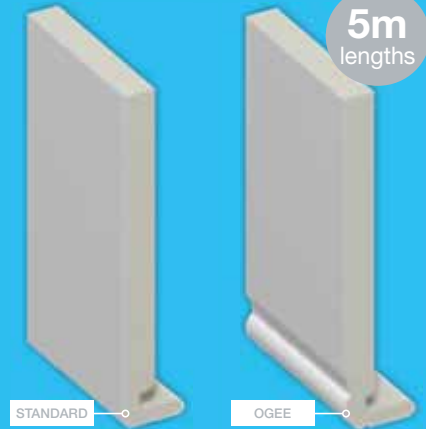
**RECOMMENDED****EUROBOARD** 18mm

Standard euroboard

Size	Code	Qty
150mm x 5m	EB 150	2 pack
175mm x 5m	EB 175	2 pack
200mm x 5m	EB 200	2 pack
225mm x 5m	EB 225	2 pack
250mm x 5m	EB 250	2 pack
300mm x 5m	EB 300	2 pack

Ogee euroboard

Size	Code	Qty
175mm x 5m	OGE 175	2 pack
200mm x 5m	OGE 200	2 pack
225mm x 5m	OGE 225	2 pack

Colour options:

See table (left) for colour availability.

DON'T FORGET YOUR

poly pins on page 27
& silicones on page 112



BULL-NOSED FASCIA BOARD 18mm

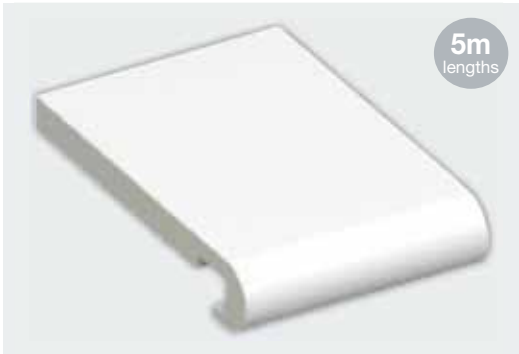

Replacement bull-nosed fascia is ideal for new build and refurbishment projects.

Size	Code	Qty
150mm x 5m	HBN 150	2 pack
175mm x 5m	HBN 175	2 pack
200mm x 5m	HBN 200	2 pack
225mm x 5m	HBN 225	2 pack
250mm x 5m	HBN 250	2 pack

Colour options: 64 White

FLAT FASCIA BOARD 16mm

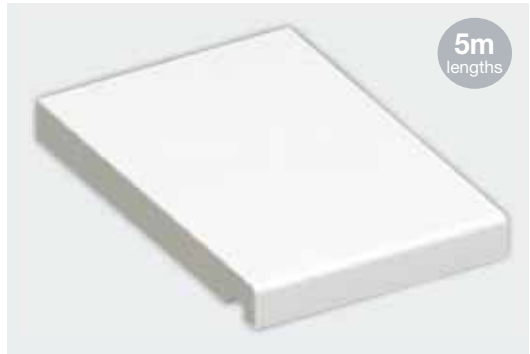

This 16mm flat fascia board is a simpler alternative to standard fascia board, and is ideal for new build and refurbishment projects.

Size	Code	Qty
150mm x 5m	FF 150	2 pack
175mm x 5m	FF 175	2 pack
200mm x 5m	FF 200	2 pack
225mm x 5m	FF 225	2 pack
250mm x 5m	FF 250	2 pack

Colour options: 64 White



HINTS & TIPS

Always use LMN silicone with roofline products.

Find out more on page 116



DOUBLE BULL-NOSED FASCIA 18mm

18mm x 405mm board

Size	Code	Qty
405mm x 5m	HBN 405	1 pack

Colour options: 64 White

FINISHING OFF

We have a range of cleaning products.

See page 122



VENTILATORS & ACCESSORIES



DISC VENTILATOR CSV 70

► Configure your roofline for optimum performance with our range of ventilators and accessories



5
x 5m

30mm panel trim

Size	Code
30mm	PT 30

Colour options:
64 White / BK Black /
WG Dark Brown / O Oak
/ BN Brown

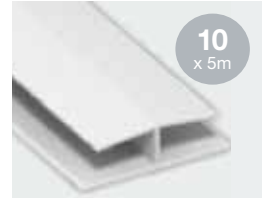

10
x 5m

40mm panel joint

Size	Code
30mm	PJ 40

Colour options: 64 White / ROF Rosewood / WY Black Ash / OF Golden Oak / CR Cream / WLO1 Irish Oak / GRW7016 Anthracite Grey / WZ White Ash / 7015 Slate Grey / WT1 Chartwell Green / LO10 Antek



10
x 5m

25mm board clip

Size	Code
25mm	BC 25

Colour options:
64 White / CR Cream
/ WLO1 Irish Oak /
GRW7016 Anthracite
Grey / WZ White Ash

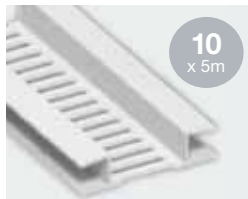

10
x 5m

10mm soffit ventilator

Size	Code
10mm	SV 10

Colour options:
64 White / BK Black /
O Oak / BN Brown



50
pack

70mm disc ventilator

Size	Code
70mm	CSVE

Colour options:
TW White / TBK Black
/ TBR Brown / BGY Grey
/ TO Oak

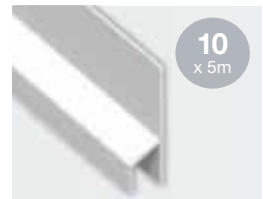

10
x 5m

40mm felt edge trim

Size	Code
40mm	FET 40

Colour options:
64 White



1.5m
long

Eaves protector

Size	Code
1.5m	GEP



20
x 1m

10mm over-fascia ventilator

Size	Code
10mm	OFV10
25mm	OFV25



0.9m
long

10mm over-fascia vent with comb

Size	Code
10mm	OFVS 10

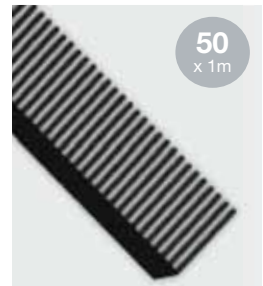

50
x 1m

Eaves comb filler

Size	Code
1m	CF1000



CAPPING BOARDS



ATTRACTIVE CAPPING BOARDS TO REFRESH TIRED TIMBER

- ▶ Stylish and cost-effective PVC-U boards designed to fit over existing timber fascias
- ▶ Standard or decorative ogee fascia board for direct fixing to existing sound fascia boards or plywood
- ▶ Designed for ease of fitting and low maintenance, with no painting required
- ▶ An attractive and easy to install solution for any replacement roofline project

**20-YR
GUARANTEE**

See page 222
for full details

COLOUR AVAILABILITY See table for colour codes and availability	Standard capping						Ogee capping					Double (std & ogee)		
	CB 150	CB 175	CB 200	CB 225	CB 250	CB 300	EOCB 150	EOCB 175	EOCB 200	EOCB 225	EOCB 300	DCB 350	DCB 450	EDOCB404
WH White	•	•	•	•	•	•	•	•	•	•	•	•	•	•
CR Cream	•*	•	x	•	x	x	x	x	x	x	x	x	x	x
WO Golden Oak	•	•	•	•	•	x	•	•	•	•	x	•	•	x
RO Rosewood	•	•	•	•	•	x	•	•	•	•	x	•	•	x
WL01 Irish Oak	•	•	•	•	•	x	•	•	•	•	x	•	•	x
WZ White Ash	•	•	•	•	•	x	x	x	x	x	x	x	x	x
GY1 Anthracite Grey†	•	•	•	•	•	x	x	x	x	x	x	x	x	x
WY Black Ash	•	•	•	•	•	•*	x	x	x	x	x	•	•	x
BW Blue White	•	•	•	•	x	x	x	x	x	x	x	x	x	x
WT1 Chartwell Green	•*	•*	•*	•*	•*	x	x	x	x	x	x	•	•*	x
WCR Cream White	•*	•	•	•	•	x	x	x	x	x	x	•	•*	x
GY3 Moondust Grey†	•*	•*	•*	•*	•*	x	x	x	x	x	x	x	•*	x
GY2 Slate Grey†	•*	•*	•*	•*	•*	x	x	x	x	x	x	•*	•*	x

KEY • Available x Not available * Made to order

CAPPING BOARD 9mm

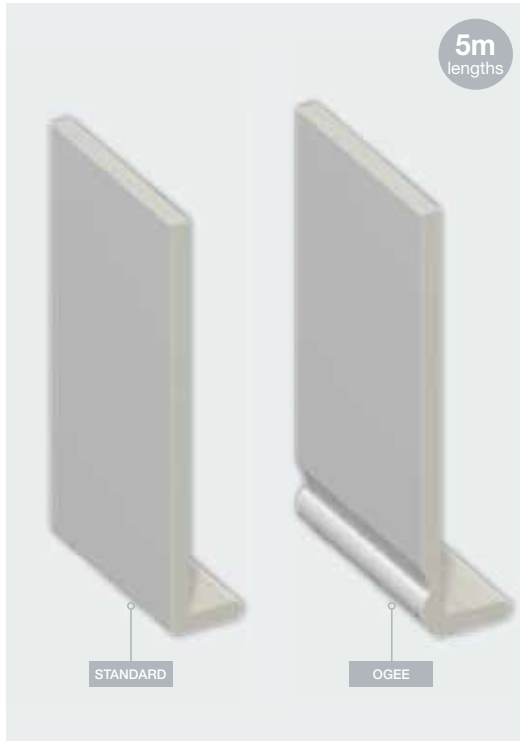

Standard & Ogee capping board

Standard

Size	Code	Qty
150mm x 5m	CB 150	4 pack
175mm x 5m	CB 175	4 pack
200mm x 5m	CB 200	4 pack
225mm x 5m	CB 225	4 pack
250mm x 5m	CB 250	4 pack
300mm x 5m	CB 300	2 pack

Ogee

Size	Code	Qty
150mm x 5m	EOCB 150	4 pack
175mm x 5m	EOCB 175	4 pack
200mm x 5m	EOCB 200	4 pack
225mm x 5m	EOCB 225	4 pack
300mm x 5m	EOCB 300	2 pack

Colour options: See table (left) for colour availability.

DOUBLE CAPPING BOARD 9mm

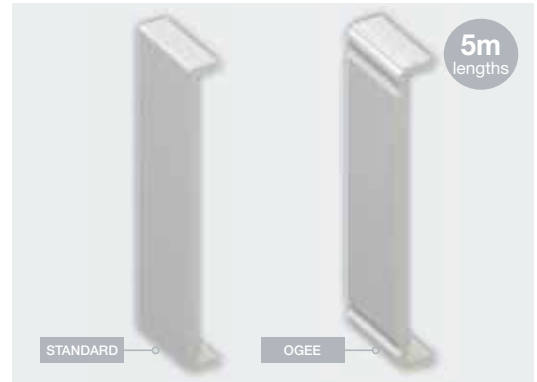

Standard & Ogee double capping board

Standard

Size	Code	Qty
350mm x 5m	DCB 350	2 pack
450mm x 5m	DCB 450	2 pack

Ogee

Size	Code	Qty
404mm x 5m	EDOCB404	2 pack

Colour options: See table (left) for colour availability.

BOX END BOARDS 9mm



450mm standard

Size	Code	Qty
405mm x 1.25m	BECB 450	1 pack

Colour options: 64 White



SOFFIT BOARDS



A COMPLETE RANGE OF SOFFIT BOARDS FOR EVERY APPLICATION

- ▶ Complete range of soffit boards are easy to fit and are fully compatible with our fascia systems for an exact colour match
- ▶ Give your roofline an attractive, clean-edged finish, available in a range of colours
- ▶ Available as standard utility board, vented Eurosoffit boards or lightweight hollow soffit boards

**20-YR
GUARANTEE**

See page 222
for full details

COLOUR AVAILABILITY See table for colour codes and availability	9mm utility board											9mm hollow soffit				
	UB 100	UB 125	UB 150	UB 175	UB 200	UB 225	UB 250	UB 300	UB 350	UB 400	UB 450	EUB 605	SB 100	SB 300	VB 100	VB 300
WH White	•	•	•	•	•	•	•	•	•	•	•	•	•	•	•	•
CR Cream	x	x	•	x	x	x	x	•	x	x	x	x	x	•	x	x
WO Golden Oak	•	x	•	x	•	•	x	•	x	•	x	x	•	•	x	x
RO Rosewood	•	x	•	x	•	x	x	•	x	•	x	x	•	•	x	x
WL01 Irish Oak	•	x	•	x	•	x	x	•	x	•*	x	x	x	•	x	x
WZ White Ash	•	x	•	x	•	x	x	•	x	•*	x	x	x	•	x	x
GY1 Anthracite Grey†	•	x	•	x	•	x	x	•	x	•	x	x	•*	•	x	x
WY Black Ash	x	x	•	x	•	x	x	•	x	•*	x	x	x	•	x	x
BW Blue White	x	x	•	x	•	x	x	x	x	x	x	x	x	x	x	x
WT1 Chartwell Green	•*	x	•*	•*	•*	x	x	•*	x	•*	x	x	x	•*	x	x
WCR Cream White	•*	x	•	•*	•	x	x	•*	x	•*	x	x	x	•	x	x
GY3 Moondust Grey†	•*	x	•*	•*	•*	x	x	•*	x	•*	x	x	x	•*	x	x
GY2 Slate Grey†	•*	x	•*	•*	•*	x	x	•*	x	•*	x	x	x	•*	x	x

KEY • Available x Not available * Made to order

UTILITY BOARDS 9mm

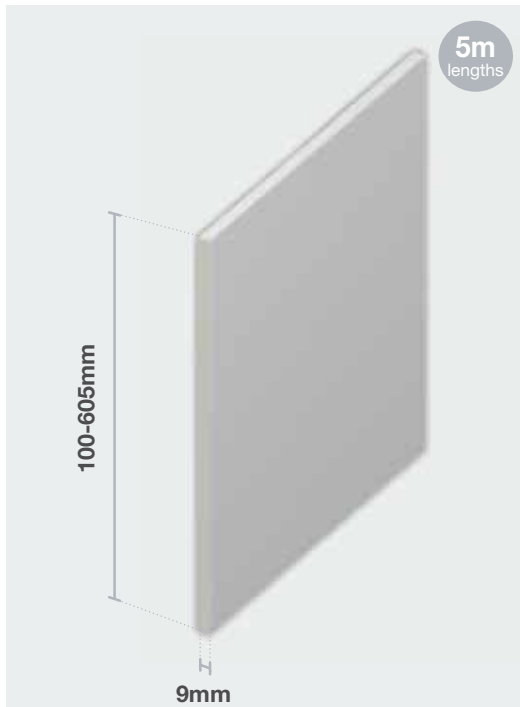

9mm utility board provides a simple, clean look and can be enhanced with separate vents and accessories to maintain airflow through your loft space

Standard

Size	Code	Qty
100mm x 5m	UB 100	4 pack
125mm x 5m	UB 125	4 pack
150mm x 5m	UB 150	4 pack
175mm x 5m	UB 175	4 pack
200mm x 5m	UB 200	4 pack
225mm x 5m	UB 225	4 pack
250mm x 5m	UB 250	2 pack
300mm x 5m	UB 300	2 pack
350mm x 5m	UB 350	2 pack
400mm x 5m	UB 400	2 pack
450mm x 5m	UB 450	2 pack
605mm x 5m	EUB 605	1 pack

Colour options: See table (left) for colour availability.



RECOMMENDED

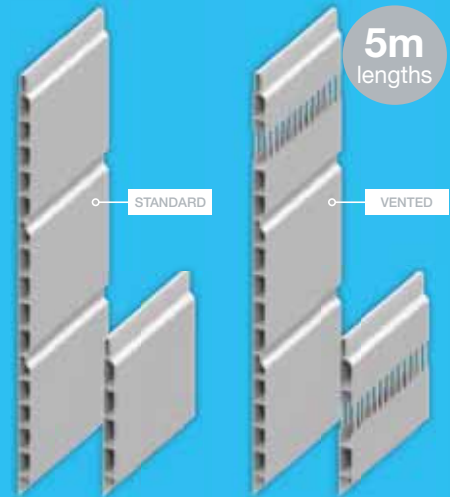

HOLLOW SOFFIT BOARD 9mm



A decorative and lightweight alternative to traditional flat soffit boards

Standard

Size	Code	Qty
100mm x 5m	SB 100	10 pack
300mm x 5m	SB 300	5 pack

Vented

Size	Code	Pack Qty
100mm x 5m	VB 100	10 pack
300mm x 5m	VB 300	5 pack

Colour options:

See table (left) for colour availability.

NEED MORE FIXINGS?

Go to page 124



EUROSOFFIT BOARDS 9mm

10 & 25mm airspace slots

10mm airspace

Size	Code	Qty
150mm x 5m	ES 150	2 pack
200mm x 5m	ES 200	2 pack
225mm x 5m	ES 225	2 pack
250mm x 5m	ES 250	2 pack
300mm x 5m	ES 300	2 pack
400mm x 5m	ES 400	2 pack
450mm x 5m	EES 450	1 pack
605mm x 5m	EES 605	1 pack

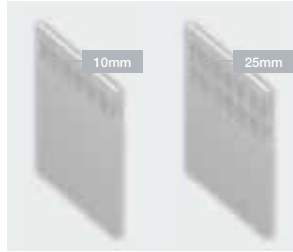

25mm airspace

Size	Code	Qty
150mm x 5m	DES 150	2 pack
225mm x 5m	DES 225	2 pack
300mm x 5m	DES 300	2 pack
450mm x 5m	DES 450	2 pack

5m lengths

A COMPLETE RANGE OF EUROSOFFIT BOARDS FOR EVERY APPLICATION

COLOUR AVAILABILITY See table for colour codes and availability	Eurosoffit (10mm airspace)								Eurosoffit (25mm airspace)				
	ES 150	ES 200	ES 225	ES 250	ES 300	ES 350	ES 400	EES 450	EES 605	DES 150	DES 225	DES 300	DES 450
WH White	•	•	•	•	•	•	•	•	•	•	•	•	•
WO Golden Oak	•	•	x	x	•	x	x	x	x	x	x	x	x
RO Rosewood	•	•	x	x	•	x	x	x	x	x	x	x	x
WY Black Ash	•	•	x	x	•	x	x	x	x	x	x	x	x
WT1 Chartwell Green	•*	•*	x	x	•*	x	x	x	x	x	x	x	x
WCR Cream White	•*	•*	x	x	•*	x	x	x	x	x	x	x	x
GY1 Anthracite Grey	•	•*	x	x	•	x	x	x	x	x	x	x	x
GY3 Moondust Grey	•*	•*	x	x	•*	x	x	x	x	x	x	x	x
GY2 Slate Grey	•	•*	x	x	•*	x	x	x	x	x	x	x	x
WZ White Ash	•*	•*	x	x	•*	x	x	x	x	x	x	x	x

COLOUR AVAILABILITY See table for colour codes and availability	Vented Soffit											
	DES225	DES300	DES450	EES450	EES605	ES150	ES200	ES225	ES250	ES300	ES350	ES400
WH White	•	•	•	•	•	•	•	•	•	•	•	•
BW Blue White	x	x	x	x	x	x	x	x	x	x	x	x
WY Black Ash	x	x	x	x	x	•	•	x	x	•	x	x
WT1 Chartwell Green	x	x	x	x	x	•*	•*	x	x	•*	x	x
CR Cream	x	x	x	x	x	x	x	x	x	x	x	x
WCR Cream White	x	x	x	x	x	•*	•*	x	x	•*	x	x
GY1 Anthracite Grey	x	x	x	x	x	•	•	x	x	•	x	x
GY3 Moondust Grey	x	x	x	x	x	•*	•*	x	x	•*	x	x
GY2 Slate Grey	x	x	x	x	x	•*	•*	x	x	•*	x	x
WO Golden Oak	x	x	x	x	x	•	•	x	x	•	x	x
WL01 Irish Oak	x	x	x	x	x	•*	•*	x	x	•*	x	x
RO Rosewood	x	x	x	x	x	•	•	x	x	•	x	x
WZ White Ash	x	x	x	x	x	•*	•*	x	x	•*	x	x

KEY • Available x Not available * Made to order

FIXINGS

FIXING PINS



250 pack

30mm & 40mm fixing pins

Size	Code
30mm	FP30
40mm	FP40

Colour options: **WH** White / **BL** Black / **BR** Brown / **O** Oak / **RW** Rosewood / **GY** Grey / **WLO1** Irish Oak / **WCR1** Cream / **WCR** Cream White* / **WT1** Chartwell Green* / **GY2** Slate Grey* (* Made to order)

FIXING NAILS

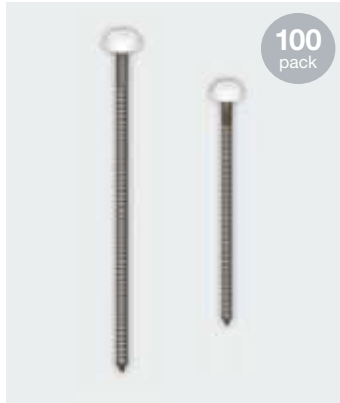

100 pack

50mm & 65mm fixing nails

Size	Code
30mm	FN50
65mm	FN65

Colour options: **WH** White / **BL** Black / **BR** Brown / **O** Oak / **RW** Rosewood / **GY** Grey / **WLO1** Irish Oak / **WCR1** Cream / **WCR** Cream White* / **WT1** Chartwell Green* / **GY2** Slate Grey* (* Made to order)

CAPPED SCREWS

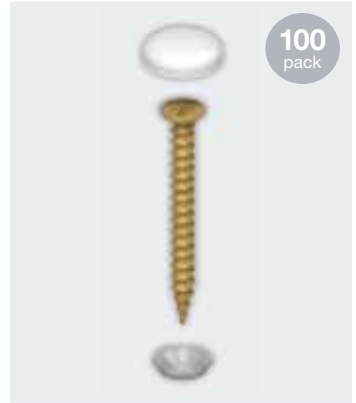

100 pack

50mm capped screws

Size	Code
50mm	CS50

Colour options:
WH White



RECOMMENDED

STOCK UP ON SILICONE

Designed for easy application, rapid curing and high performance, our silicones are essential for any PVC-U roofline installation.

See the full range on page 112



FINISHING TRIMS

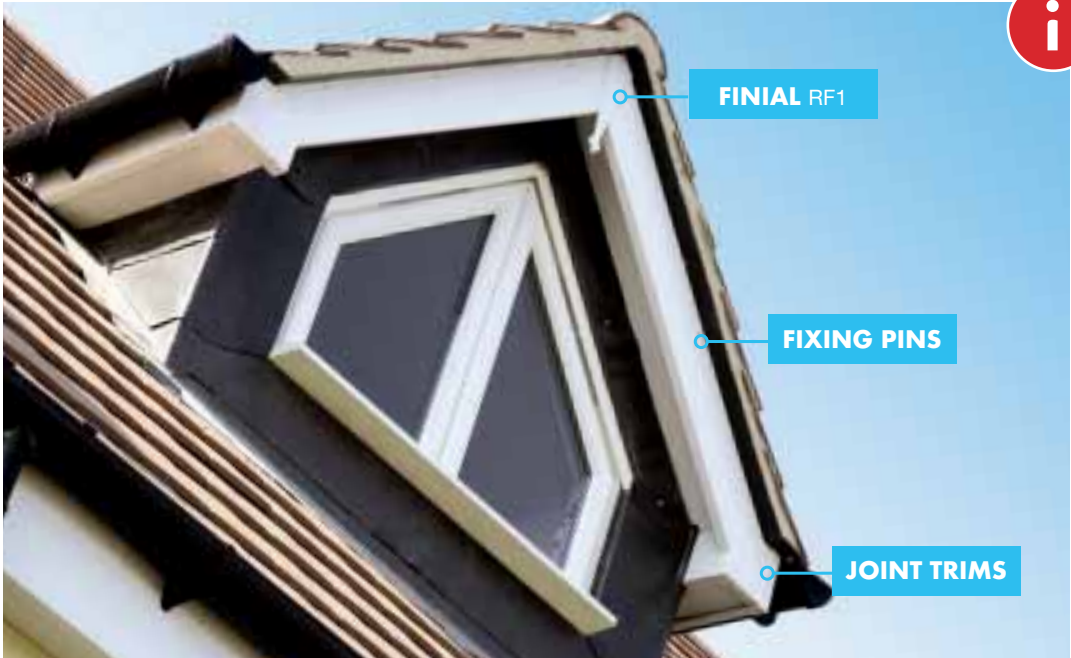

Add the right finishing touches to your roofline project with our range of finishing trims

COLOUR AVAILABILITY See table for colour codes and availability	Roofline finishing trims											
	DCBCT	DCBCT90	DCBJT	EDOGCT	EDOGICT90	EDOGJT	CBECT135	CBICT135	HBNJT	HBNCT	HBNICT	RF1
WH White	•	•	•	•	•	•	•	•	•	•	•	•
CR Cream	•	•	•	x	x	x	x	x	x	x	x	•*
WY Black Ash	•	•	•	x	x	x	•	•	x	x	x	•
WT1 Chartwell Green	•*	•*	•*	x	x	x	x	x	x	x	x	•*
WCR Cream White	•*	•*	•*	x	x	x	x	x	x	x	x	•*
GY1 Anthracite Grey†	•	•	•	x	x	x	•*	•*	x	x	x	•
GY3 Moondust Grey†	•*	•*	•*	x	x	x	x	x	x	x	x	•*
GY2 Slate Grey†	•*	•*	•*	x	x	x	x	x	x	x	x	•*
WO Golden Oak	•	•	•	•	•	•	•	•	x	x	x	•
WL01 Irish Oak	•	•	•	x	x	x	•*	•*	x	x	x	•
RO Rosewood	•	•	•	•	•	•	•	•	x	x	x	•
WZ White Ash	•	•	•	x	x	x	x	x	x	x	x	•

KEY

- Available
- x Not available
- * Made to order
- † Alternative codes if short codes don't work
GY1 = GRW7016
GY2 = GRW7015
GY3 = GRW7155

FASCIA & CAPPING FINISHING TRIMS



DCBJT
Double capping board joint trim



DCBCT
Double capping board corner trim



DCBICT90
Double 90° internal corner trim



CBECT135
Universal external 135° corner trim



DOGJT
Double Ogee joint trim



DOGCT
Double Ogee corner trim



DOGICT90
Double Ogee 90° internal corner trim



HBNJT
Double bull nosed joint trim

Colour options:
See table (left for colour availability)

TRADE DISCOUNTS ARE AVAILABLE
- why not open an account in-branch today?



HBNCT
Double bull nosed corner trim



HBNICT
Double bull nosed internal corner trim



RF1
Roofline finial



DRY VERGE

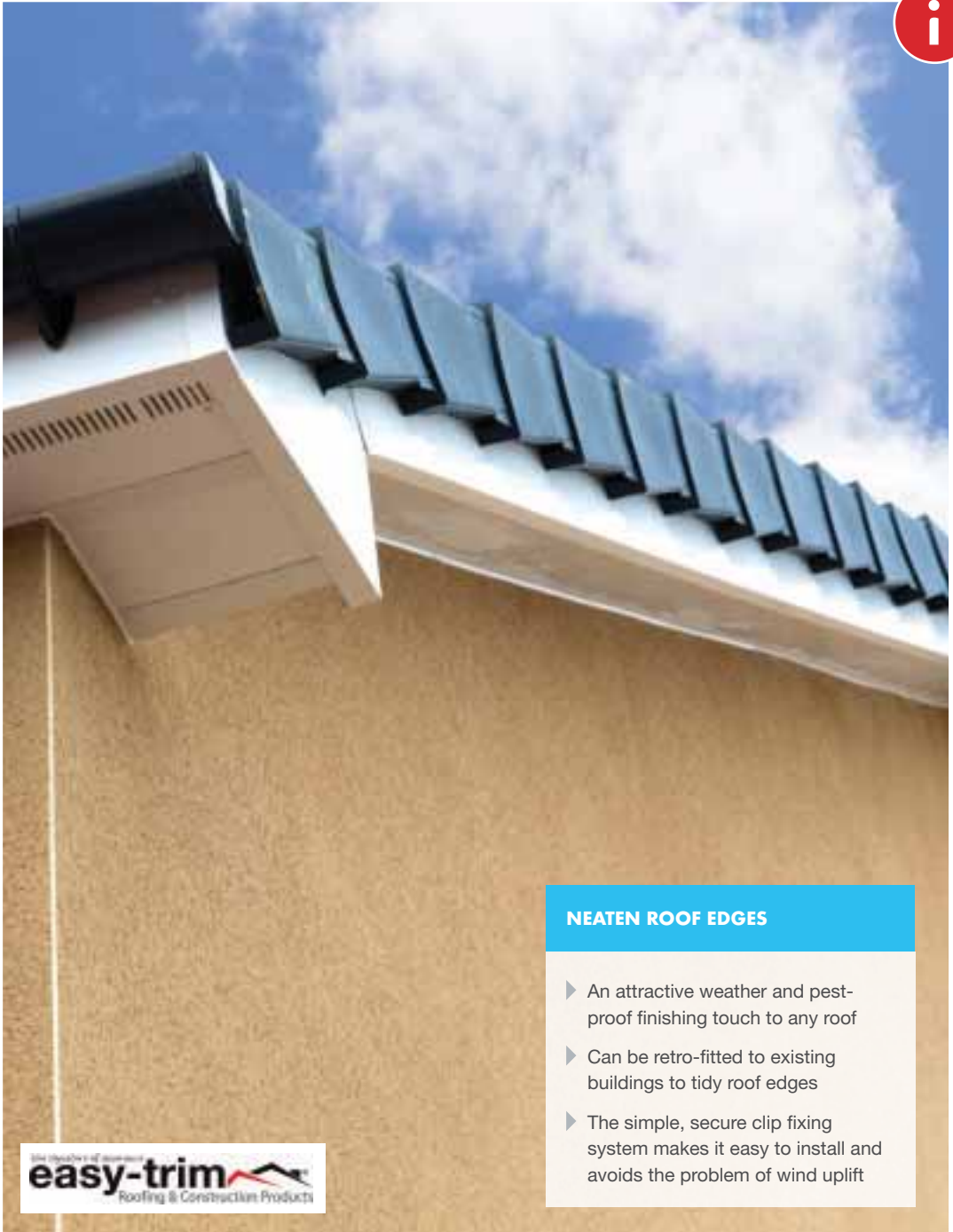

NEATEN ROOF EDGES

- ▶ An attractive weather and pest-proof finishing touch to any roof
- ▶ Can be retro-fitted to existing buildings to tidy roof edges
- ▶ The simple, secure clip fixing system makes it easy to install and avoids the problem of wind uplift

the specialists of environment
easy-trim
Roofing & Construction Products

Easyverge Half Round Ridge Cap C/W Flapcap

Code	Colour
HRRIDGECAPBLK	Black
HRRIDGECAPBRN	Brown
HRRIDGECAPGRY	Grey
HRRIDGECAPTER	Terracotta
HRRIDGECAPWHT	White



Easyverge A Ridge Cap C/W Flapcap

Code	Colour
ARIDGECAPBLK	Black
ARIDGECAPBRN	Brown
ARIDGECAPGRY	Grey
ARIDGECAPTER	Terracotta
ARIDGECAPWHT	White



Easyverge U Universal Verge System

Code	Colour
UNIVERGEBLK	Black
UNIVERGEBRN	Brown
UNIVERGEGRY	Grey
UNIVERGETER	Terracotta
UNIVERGEWHT	White



Easyverge Starter & End Cap

Code	Colour	Qty
VERGEPACKBLK	Black	2 Pack
VERGEPACKBRN	Brown	2 Pack
VERGEPACKGRY	Grey	2 Pack
VERGEPACKTER	Terracotta	2 Pack
VERGEPACKWHT	White	2 Pack

Continuous Dry Verge End Cap

Code	Colour
CDVENDBLK	Black
CDVENDBRN	Brown
CDVENDWHT	White

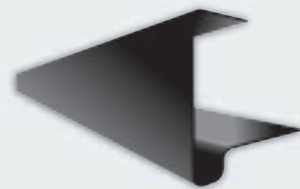

5m lengths

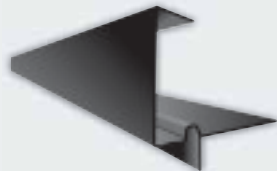

5m lengths

Slate Dry Verge Continuous

Code	Colour
SLATEDVCONTBLK	Black

R Type Continuous Dry Verge

Code	Colour
RTYPECONTBLK5M	Black
RTYPECONTBRN5M	Brown
RTYPECONTWHT5M	White

Continuous Dry Verge Connector

Code	Colour
CDVCONBLK	Black
CDVCONBRN	Brown
CDVCONWHT	White





COMPOSITE ROOF SLATE



RECYCLABLE



INTRODUCING THE PERFECT MODERN ALTERNATIVE TO NATURAL SLATE

- ▶ Great aesthetics to rival natural slate
- ▶ Will not shatter, crack, curl or fade
- ▶ Pre-marked for pitch and space allowing fast and accurate installation
- ▶ Easy-to-cut with hand tools or power saws
- ▶ Half the weight of natural slate - easier to carry and install, requires lighter roof support system
- ▶ Excellent impact strength - can be walked-on after installation

40-YR WARRANTY*

Ask in branch for details

* Conditions apply.



- Weather-resistant
- BBA certified
- Fire-tested to BS 473 Pt 3
- Choice of colours
- 100% recyclable

COLOUR AVAILABILITY

Roof slate colours

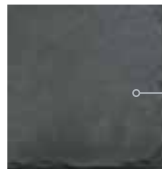

PEWTER GREY

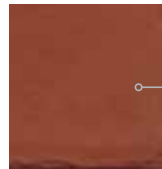

BRICK RED



STONE BLACK

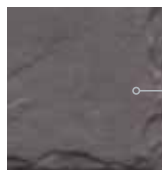

PLUM



CHESTNUT



CHARCOAL



EXCELLENT AESTHETICS



HINTS & TIPS

APPLICATIONS

This lightweight, versatile product is not only ideal for traditional roofing applications, but for a multitude of other uses too. Why not refurbish tired porches, garage or shed roofs to give them a new lease of life? Composite roof tiles are also perfect for canopies, car ports, gazebos and more.

To see examples of this product in use, go to eurocell.co.uk/roofslate



Roof slates

Size	Code	Qty
n/a	SLATE	1 pack

Colour options:

704 Pewter Grey / 706 Plum / 701 Stone Black / 712 Chestnut / 705 Charcoal / 709 Brick Red



Ridge caps

Size	Code	Qty
n/a	RIDGE	1 pack

Colour options:

704 Pewter Grey / 706 Plum / 701 Stone Black / 712 Chestnut / 705 Charcoal / 709 Brick Red

WORKING AT HEIGHT?

Make sure you have the right PPE.

See page 217 for our range.





GRP ROOFING

**NO JOINTS,
NO SEAMS,
NO LEAKS!**

**25-YR
GUARANTEE**
Conditions apply

AN ADVANCED GLASSFIBRE FLAT ROOF SYSTEM

This advanced cold-applied glassfibre flat roofing system is ideal for commercial and residential applications, offering a durable and neat finish that will look great for years to come. The product is virtually maintenance-free and is a highly economical solution for roofing projects. Plus, the surface is ideal for creating non-slip walkways.

The GRP roofing system is available in Grey to suit every job.

BOOST YOUR INCOME!

Become a trained GRP roofing installer.
Ask in branch for details.

Glassfibre flat roof system



**AVAILABLE
AT SELECTED
BRANCHES**

For more information ask a member of staff at your **local Eurocell branch today!**



HEAT
RESISTANT



FROST
PROOF



FOOT
TRAFFIC



STORM
PROOF



FIRE
RESISTANT



IMPACT
RESISTANT



TIMBER AND ROOFING



Ex Angle Fillet

Size	Code
47 x 50 x 4200mm	ANGLE47X50



OSB Boards

Size	Code
2400 x 600 x 18mm	OSB2400X600X18



CLS Timber

Size	Code
4" x 2" x 4800mm	CLS4X2



Treated Roof Battens

Size	Code
10 x 38 x 4200mm	BATTEN19X38X4.2



Easytrim Pro Breather Membrane

- ▶ Pro delivers performance and strength whilst still having a relevant price for most budgets. A 3 layer spun bond based membrane that provides excellent strength and nail tear resistance whilst being flexible. BBA certified for Warm and Cold roof application.

Code	Weight	Size
MEMBPRO20M	122gsm	1 x 20m
MEMBPRO50M	122gsm	1 x 50m



Easytrim Non Breathe Membrane

- ▶ Non-Breathe is a 2 layer, non-breathable roof membrane. This lightweight but clean and durable product provides major benefits over traditional 1F bitumen based underlays and plastic under slating membranes. It is completely waterproof and has excellent nail tear resistance. Non Breathe roofing membrane is more commonly used on re-roofing projects, garages and porches.

Code	Size
MEMBPRO45M	1 x 45m

IN A HURRY? PLACE YOUR ORDER ONLINE!

Online ordering couldn't be easier now we've introduced our new **Click & Collect** service - so wherever you are, you can order what you need via your smartphone, tablet or computer - and collect from your local branch. **EASY!**



click
& collect





ROOFLIGHTS



**10-YR
GUARANTEE**

Conditions apply

**ROOFLIGHTS ARE A SAFE & SECURE
WAY TO INCREASE NATURAL LIGHT
INTO FLAT ROOF BUILDINGS**

MAXIMUM SECURITY, EXCELLENT ENERGY EFFICIENCY

Rooflights are an ideal way to increase natural light on flat roof properties. This product range offers high security and exceptional energy efficiency - with **u-values as low as 1.8!**

The domed design offers great aesthetics, meaning they are desirable additions for residential and commercial applications.



HINTS & TIPS

APPLICATIONS

COMMERCIAL

- Schools
- Factories
- Swimming pools
- Restaurants

RESIDENTIAL

- Kitchens
- Extensions
- Garages
- Hallways



- Part L compliant
- Class 1 fire-performance
- Triple-skin polycarbonate
- 1.8 U-value

Rooflights

GLAZING OPTIONS



CLEAR

- High light transmission
- Allows unimpeded views



OPAL

- High light transmission
- Allows unimpeded views



DIFFUSED

- Maximises privacy
- Diffuses light to avoid sun glare



BRONZE

- Reduces solar heat gain
- Reduced light transmission



OTHER
DESIGNS
AVAILABLE

Choice of ventilation options - ask a member of staff at your **local Eurocell branch today!**



FLASHING



FLASHING IS AN IMPERVIOUS MATERIAL INSTALLED TO WEATHERPROOF AREAS OF A STRUCTURE.

For roofing applications, lead is traditionally used, but we also offer modern lead free alternatives, which are more environmentally friendly.

PERFECT PARTNER

If you're planning a lead installation, why not stock up on our specialist silicone designed specifically for use with lead?

See page 118 for more information.



HINTS & TIPS

OUR PRODUCTS ARE IDEAL FOR WEATHER-PROOFING THESE AREAS:

- Chimneys
- Pipes
- Roofs
- Windows
- Conservatories
- Solar panels

LEAD FLASHING



Ask in-branch for codes

Available in any width up to 1400mm (55"), cut in standard lengths of 3 and 6 metres

LEAD-FREE FLASHING



THE SUSTAINABLE, COST-EFFECTIVE ALTERNATIVE TO LEAD

- ▶ Lightweight
- ▶ Resistant to corrosion and staining
- ▶ Quick and easy to fit
- ▶ For traditional flashing applications

SELF-ADHESIVE FLASHING TAPE



75-300mm

Size	Code
75mm x 10m	LFT75
100mm x 10m	LFT100
150mm x 10m	LFT150
225mm x 10m	LFT225
300mm x 10m	LFT300



Lead-free flashing rolls

Size	Weight	Code
150mm x 12m	2kg	ULF 12150
200mm x 12m	9.6kg	ULF 12200
250mm x 12m	12kg	ULF 12250
300mm x 12m	14.4kg	ULF 12300
400mm x 12m	19.2kg	ULF 12400
500mm x 6m	24kg	ULF 6500
600mm x 6m	14.4kg	ULF 6400
1000mm x 6m	24kg	ULF 61000 *

COLOUR OPTIONS

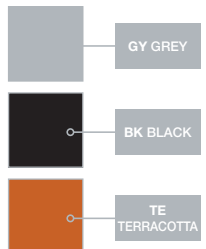

(* Not available in Terracotta)

▶ Looking for your nearest branch? Go to pages 4-5 to see the full nationwide list



CLADDING

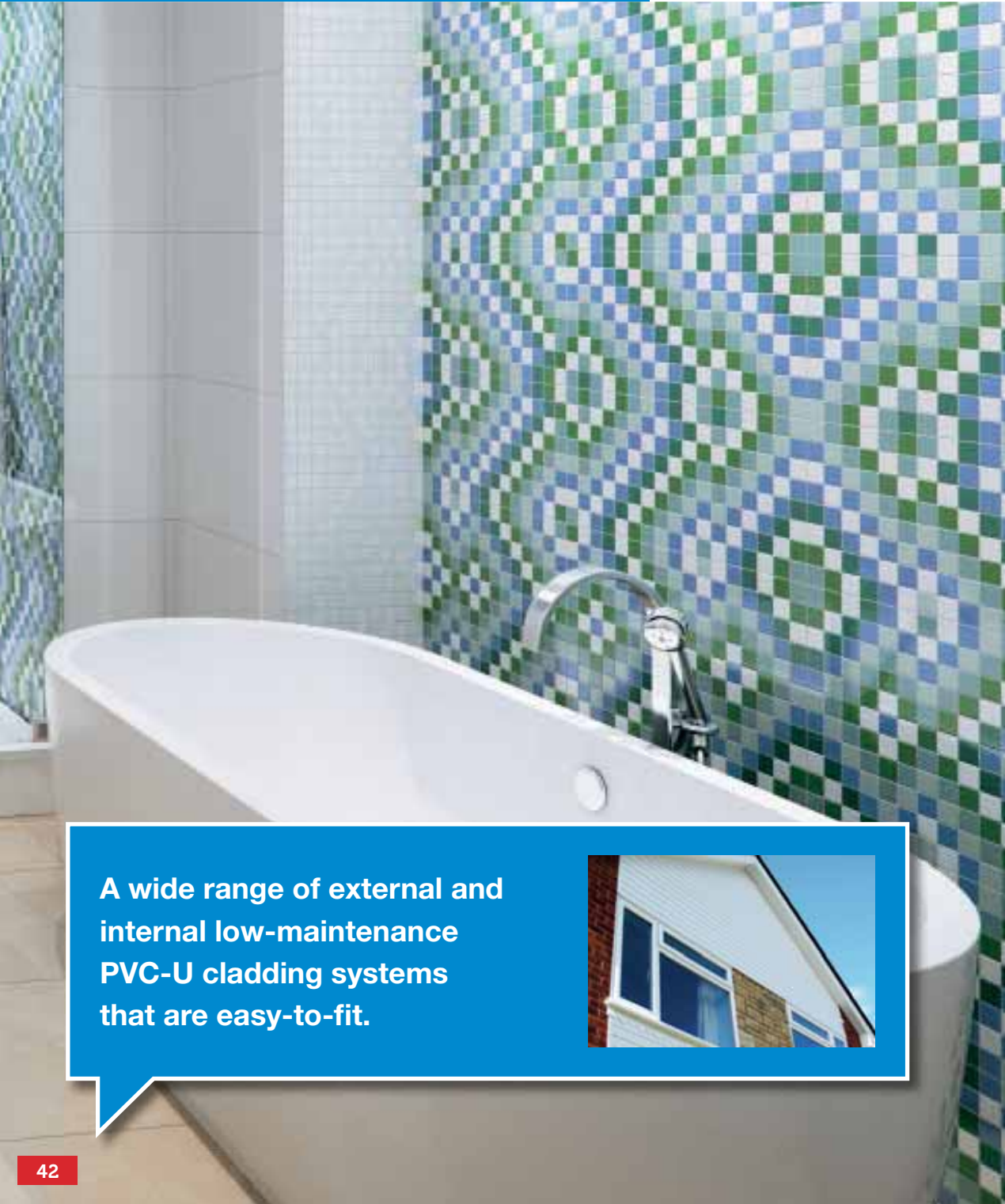

A wide range of external and internal low-maintenance PVC-U cladding systems that are easy-to-fit.



All together better



SHIPLAP CLADDING

Refresh tired brickwork or timber cladding with our range of low-maintenance PVC-U shiplap cladding.

Find out more on page 44



INTERNAL DECOR CLADDING

Check out our range of easy-fit tile-alternatives – ideal for bathrooms, kitchens and other domestic and commercial applications. Available in various styles and colours.

Find out more on page 46



LUXURY INTERNAL DECOR CLADDING

See our premium range of decorative and highly practical interior panels for bathrooms, shower and wet rooms.

Find out more on page 49



ORDER BY PHONE

Call your local branch direct on **08000 77 88 88**

ORDER ONLINE

eurocell.co.uk/buyonline

SHOP IN-BRANCH

Find your nearest branch at eurocell.co.uk/branchfinder



CLADDING

EXTERNAL CLADDING

..... 44-45

SHIPLAP CLADDING

..... 45

INTERNAL DÉCOR CLADDING

..... 46-48

LUXURY INTERNAL DÉCOR CLADDING

..... 49-50

TILE-EFFECT

..... 51

PROPLAS INTERNAL DÉCOR CLADDING

..... 52-53

HYGIENIC WALL CLADDING

..... 54

SPECIAL OFFERS

To receive information on future special offers, text the word **NEWS** followed by your **NAME** and **COMPANY NAME** to **60777**



or go to eurocell.co.uk/offers to see our latest deals



EXTERNAL CLADDING



REFRESH TIRED, OLD BRICKWORK OR TIMBER CLADDING WITH ROBUST FRESH PVC-U CLADDING

- ▶ Easy-fit clip-together PVC-U cladding to enhance any home
- ▶ Attractive, low-maintenance, weather-resistant solution
- ▶ Available in Shiplap or Open-V styles
- ▶ Open-V cladding is suitable for both horizontal and vertical use

20-YR GUARANTEE

See page 222
for full details



Add the right finishing touches to your roofline project with our range of finishing trims

COLOUR AVAILABILITY See table for colour codes and availability	Cladding			Trim					Butt joints		
	SC 125	SC 150	OV 100	ST 125	ET 125	AT 125	DT 125	JT 125	BJ 100	BJ 125	BJ 150
White	•	•	•	•	•	•	•	x	•	•	•
Golden Oak	•	•	•	x	•	•	•	•	•	•	•
Rosewood	•	•	•	x	•	•	•	•	•	•	•
Black Ash	•	x	x	x	•	•	•	x	x	•	x
Brown	x	x	x	•	x	x	x	x	x	x	x
Caramel	x	x	x	•	x	x	x	x	x	x	x
Irish Oak	x	•	x	x	x	x	x	x	x	x	x

KEY

- Available
- x Not available
- * Made to order

Colour options: See table (left) for colour availability



Shiplap cladding

Size	Code
125mm x 5m	SC 125
150mm x 5m	SC 150



Open V cladding

Size	Code
100mm x 5m	OV 100



125mm starter trim

Size	Code
125mm x 5m	ST 125



125mm edge trim

Size	Code
125mm x 5m	ET 125



125mm angle trim

Size	Code
125mm x 5m	AT 125



125mm drip trim

Size	Code
125mm x 5m	DT 125



125mm joint trim

Size	Code
125mm x 5m	JT 125

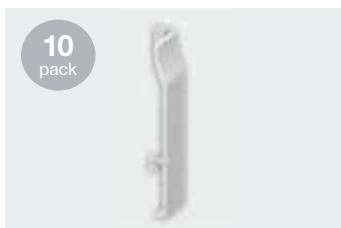

Butt joints

Size	Code
100mm	BJ 100
125mm	BJ 125
150mm	BJ 150

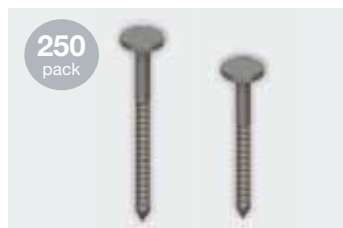

Cladding pins

Size	Code
25mm	CP 25
30mm	CP 30



INTERNAL DECOR CLADDING

**IDEAL FOR HOTELS, GUEST-HOUSES,
STUDENT ACCOMMODATION AND
SOCIAL HOUSING**

- ▶ No need for grouting!
- ▶ Water resistant
- ▶ Easy to fit
- ▶ Low maintenance
- ▶ Easy clean

For more styles and finishes
- ask a member of staff at your
local Eurocell branch today!

Mosaic

Small tile effect panel

Size	Code	Qty
25cm x 2.7m	See swatches	4 pack

COLOUR OPTIONS

PLA 65200	PLA 65201	PLA 65202	PLA 65203
			
GRISACCO	AZULADO	SABBIOSO	ALMOND



GRISACCO

AZULADO

SABBIOSO

ALMOND

2.7m
lengths**Craquele**

Elegant, high-gloss decorative panels

Size	Code	Qty
25cm x 2.7m	See swatches	4 pack

COLOUR OPTIONS & CODES

PLA 6536	PLA 6537	PLA 6538	PLA 6525
			
GREY	BLUE / BLACK	BEIGE	WHITE



GREY

BLUE / BLACK

BEIGE

WHITE

2.7m
lengths**NEED THE RIGHT TOOLS?**

We stock a range of **TOOLS** and fixings to help you complete your job in the best possible way.

See from page 198





2.7m lengths

FASTER FITTING AND LOWER MAINTENANCE THAN TILES!

Marmo
A classic marble effect panel

Size	Code	Qty
25cm x 2.7m	See swatches	4 pack

COLOUR OPTIONS & CODES

PLA 6545	PLA 6546	PLA 6547	PLA 6548
GRIGIO	AZZURO	AMARELO	VERDE
			PLA 6549
			ROSSO

CLAD SEALS



Clad seal bath pack
Code
PLACLADSEAL

INSERTS AND TRIMS

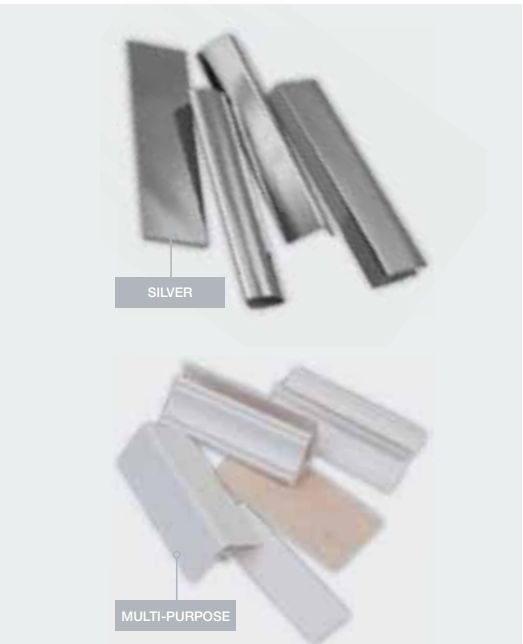

Various inserts and trims available - ask a member of staff at your **local Eurocell branch today!**

LUXURY INTERNAL DECOR CLADDING



**10-YR
GUARANTEE**

against crazing or
fading due to UV



Full range of
accessories available

- ▶ Hygienic wipe clean surface
- ▶ Easy to maintain
- ▶ Mould free
- ▶ No grouting to discolour or leak
- ▶ Quick and easy to install
- ▶ A cost-effective alternative to tiling
- ▶ Excellent insulation and sound proofing
- ▶ 100% recyclable
- ▶ All panels are: 1m (W) x 2.4m (H) x 10mm (D)

INSERTS AND TRIMS Available in black, chrome and white



PWEXTC
External Corner
Trim



PWHSEC
H Section Joiner
Trim



PWINTC
Internal Corner
Trim



PWUCHA
Edge Trim



PWUQ
Quadrant

▶ **GET IT FAST - Free next day delivery** on orders over £100



LUXURY INTERNAL DECOR CLADDING

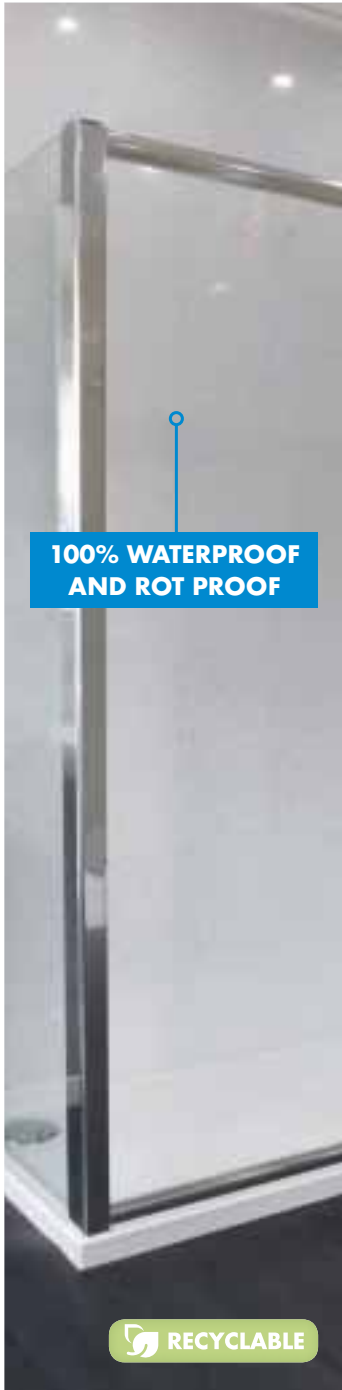

**100% WATERPROOF
AND ROT PROOF**

 **RECYCLABLE**



Shower Panels

Size	Code	Qty
1m x 2.4m x 10mm	See swatches	1 pack

COLOUR OPTIONS & CODES

PW1MBBC  BLUE / BLACK CRAQUELLE	PW1MGM  GREY MARBLE	PW1MHGW  HIGH GLOSS WHITE	PW1MPG  PERGAMON
PW1MSGM  SUBTLE GREY MARBLE	PW1MMTS  SAHARA TILE EFFECT	PW1MMTG  GREY STONE TILE EFFECT	PW1MMTPW  POLAR WHITE TILE EFFECT

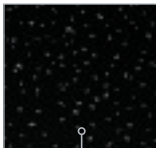
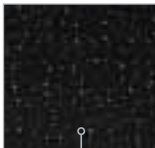
SPARKLE COLOUR OPTIONS & CODES

PW1MBS  BLACK SPARKLE	PW1MRS  RAINBOW SPARKLE	PW1MWS  WHITE SPARKLE	Please note Sparkle finishes contain a reflective sparkle effect
---	---	---	--

PERFECT PARTNER

Fix All X-Treme Grab Adhesive
290ml, and Stay Fresh Anti-Mould
Sealant 300ml

See our **SEALANT** section from
page 117



TILE-EFFECT WALL PANELS

INSTALL IN 1/3 TIME COMPARED TO CERAMIC TILES - SAVING TIME, MONEY AND LABOUR!

CREATE SANITARY ENVIRONMENTS

UP TO 40% CHEAPER THAN TRADITIONAL TILING ON AVERAGE

- ▶ Cover large areas quickly with easy-fit 1247mm x 905mm panels
- ▶ Speedy installation
- ▶ No need to remove tiles or replaster
- ▶ Invisible joints between panels - no profiles or joining strips required
- ▶ Flexible panels can fit to curved shapes

FREE DELIVERY TO BRANCH WITH CLICK & COLLECT

So wherever you are, you can order what you need via your smartphone, tablet or computer - and collect from your local branch. **EASY!**

 **click & collect**



PROPLAS INTERNAL DÉCOR CLADDING RANGE



COLOUR OPTIONS

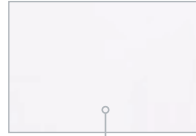

IDSPR01 - WHITE GLOSS

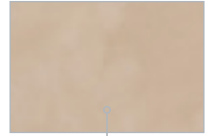

IDSPR05 - PERGAMON MARBLE HIGH GLOSS



IDSPR09 - WHITE MATT

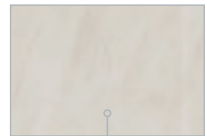

IDSPR07 - SOFT GREY MARBLE HIGH GLOSS

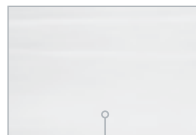

IDSPR02 - WHITE ASH



IDSPR04 - WHITE SILVER EMBEDDED HIGH GLOSS

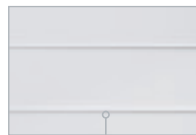

IDSPR06 - WHITE EMBEDDED HIGH GLOSS

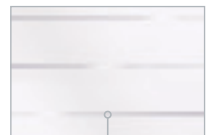

IDSPR03 - WHITE SPARKLE HIGH GLOSS

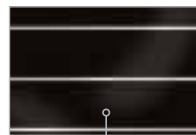

IDSPR08 - BLACK SILVER EMBEDDED HIGH GLOSS



IDSPR11 - BLACK SPARKLE HIGH GLOSS

ACCESSORIES Available in Black, White and Bight Silver.

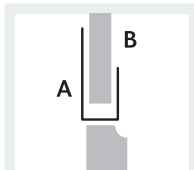

1 End U Cap
To start or end the assembly of the panels.



2 External Corner
To make an outside corner.



3 Internal Corner
To make an inside corner.

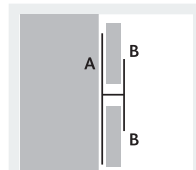

4 H Joint And Décor Strip
To make an H joint or décor strip between 2 panels.

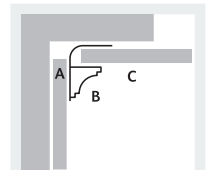

5 Scotia
To finish the corner between wall and ceiling or floor and wall.

TILE-EFFECT WALL PANELS

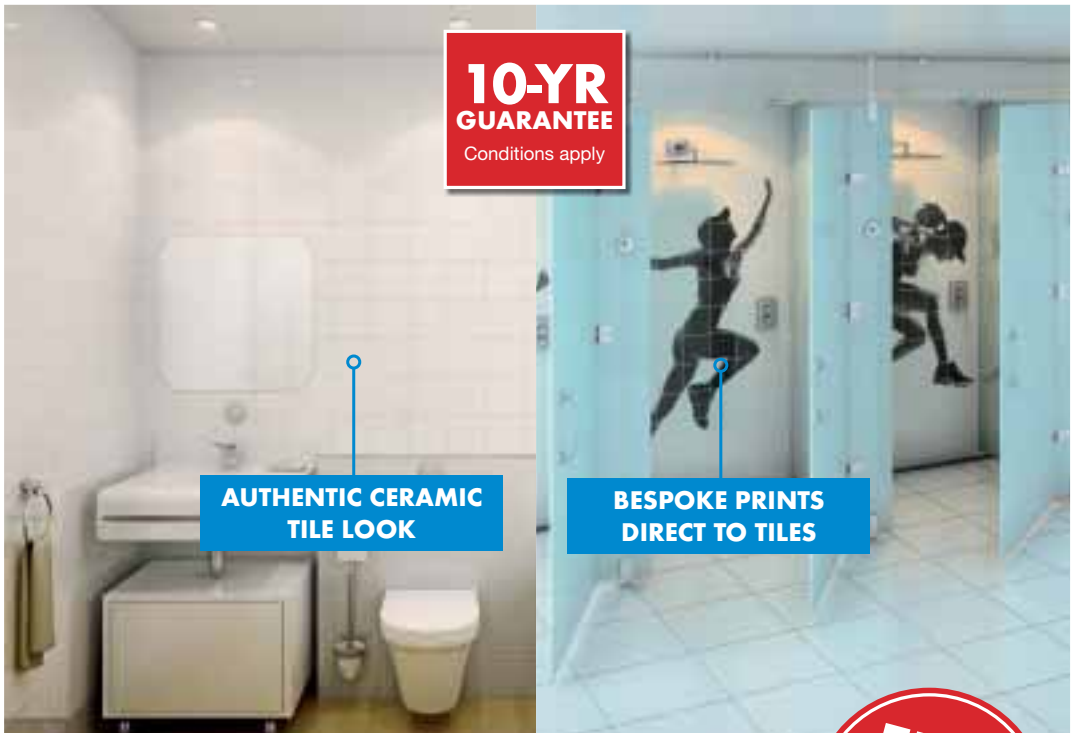

3 tile styles available: mosaic, stripes and standard

COLOURS & DESIGN

Mosaic

Small-tile mosaic effect



WHITE

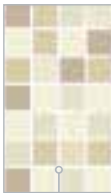

SAND



POMEGRANATE

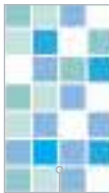

AZURE



GRANITE



ETOLIE

Stripes

Sleek and modern striped tiles can be used both horizontally and vertically



ESPRESSO



HAMMAN



MIST



SAHARA



AZURE



Plain

Our standard options include White and Sand, with other colours also available



WHITE



SAND

Bespoke also available

Any image or design can be printed directly onto panels via a unique process that ensures the print remains bonded

...samples of the product, and get expert advice from our staff



HYGIENIC WALL CLADDING

SUITABLE FOR A WIDE VARIETY OF APPLICATIONS DEMANDING HIGH LEVELS OF HYGIENE

- ▶ Ideal for commercial kitchens and food preparation areas
- ▶ Versatile and cost effective
- ▶ Hard wearing and resistant to most chemicals
- ▶ Smooth surface making the cladding easy to clean and disinfect
- ▶ Easy to install
- ▶ Highly durable



FREE DELIVERY!

Need to get this product to site fast? We can deliver direct to any UK site, for **FREE!**

To qualify for FREE DELIVERY, just spend only £100!*

*EX-VAT



Hygienic wall cladding

Size	Code
2440 x 1220mm	B-BP 3040
3050 x 1220mm	B-BP 3039

COLOUR OPTIONS



64 WHITE

HARDWARE

FOR PVC-U WINDOWS & DOORS

NEW



**3000+ PRODUCTS
INCLUDING
OBSOLETE RANGES**



**TOP SELLERS STOCKED IN
185+ LOCAL BRANCHES
NATIONWIDE**



**ORDER ONLINE FOR
SAME DAY NATIONWIDE
DISPATCH**

For more information and to order the full range of **3000+ products** online visit

eurocell-hardware.co.uk



WATER & WASTE

High-quality rainwater systems, soil drainage systems, channel drainage and underground drainage ideal for small and large scale projects





INFO

EUROCELL OFFERS A FULL RANGE OF DRAINAGE SOLUTIONS

A RAINWATER SYSTEMS

Suitable for both domestic and commercial applications, we offer a range of guttering options on page 58

B SOIL DRAINAGE

See the range of components on page 74

C CHANNEL DRAINAGE

Perfect for driveways, patios and plenty more applications. See page 79

D UNDERGROUND DRAINAGE

We offer a 110mm system which can be found on page 76

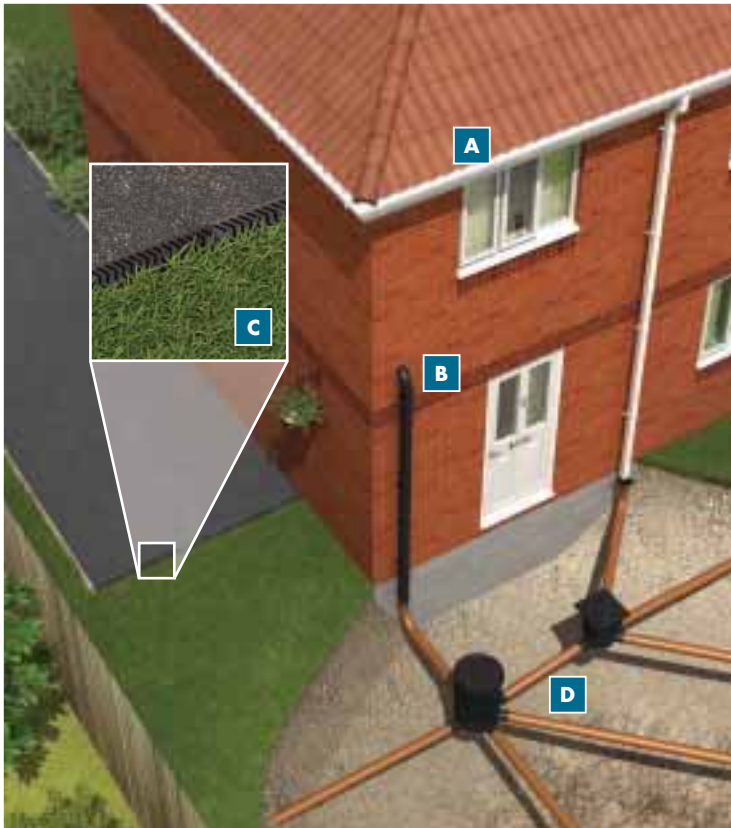

WATER & WASTE

RAINWATER SYSTEMS
..... 58-65

HEDGEHOG GUTTER BRUSH
..... 66

ELEGANCE CAST IRON EFFECT GUTTERING
..... 68-73

SOIL SYSTEMS
..... 74-75

UNDERGROUND DRAINAGE
..... 76-78

CHANNEL DRAINAGE
..... 79





RAINWATER SYSTEMS

SQUARE-LINE RAINWATER SYSTEM 114 x 59mm

► The square-line rainwater system has an easy clip design with rounded ends to ensure simple installation



COLOUR OPTIONS

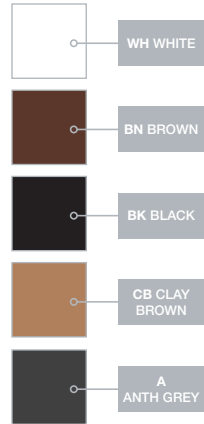

(* Not available in Clay Brown)



SQUARE-LINE

The system is suited to residential applications, and is compatible with many other existing systems

PERFECT PARTNER

Square-line guttering is compatible with **EUROCELL CONSERVATORY ROOFS.**

Find out more on page 166

HALF-ROUND RAINWATER SYSTEM 114 x 51mm

► The half-round rainwater system has an easy-clip design with rounded ends ensuring simple installation

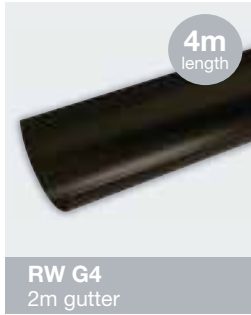

COLOUR OPTIONS

	WH WHITE
	BN BROWN
	BK BLACK
	GR GREY
	A ANTH GREY



SQUARE-LINE

The system is suited to residential applications, and is compatible with many other existing systems

TRADE DISCOUNTS ARE AVAILABLE
- why not open an account in-branch today?



PERFECT PARTNER
Need tools to complete the job? We have spirit levels, hammers, saws and more to help your guttering installation.
See our TOOLS section from page 198

► **ORDER BY PHONE** - Call now on **08000 77 88 88**



UNIVERSAL PLUS RAINWATER SYSTEM 128 x 88mm



DESIGNED TO AESTHETICALLY
COMPLEMENT ANY PROPERTY



UNIVERSAL PLUS

This system is ideal for use on larger residential buildings, smaller commercial premises and conservatory roof applications, as the system is sturdier due to the thick gutter extrusion.



RWK G4
4m gutter



RWK A1
External angle 90°



RWK A2
External angle 90°



RWK A4
Internal angle 150°



RWK A3
Internal angle 90°



RWK A5
Internal angle 135°



RWK O1
Running outlet



RWK O2
Stop end outlet RH



RWK O3
Stop end outlet LH



RWK U1
Union bracket



RWK D6*
UP TO SQ adaptor LH

Connects to square

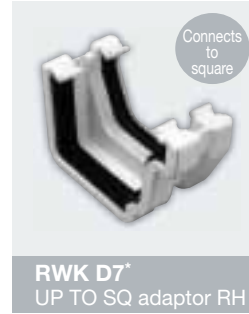

RWK D7*
UP TO SQ adaptor RH

Connects to square



RWK D8*
UP TO HR adaptor RH

Connects to half round



RWK D9*
UP TO HR adaptor RH

Connects to half round



RWK FB1
Fascia bracket



RWK FB2
Top hung fascia bracket



RWK E1
External stop end RH



RWK E2
External stop end LH

COLOUR OPTIONS

	WH WHITE
	BN BROWN
	BK BLACK
	CB CLAY BROWN
	A ANTH GREY

(* Not available in Clay Brown)

PERFECT PARTNER

Universal Plus rainwater system perfectly complements our range of decorative **OGEE FASCIA BOARDS**.

See page 18 for the full range of colours and sizes.





UNIVERSAL XL RAINWATER SYSTEM 114 x 71.5mm

- ▶ The deep elliptical shape takes an impressive capacity of rainwater meaning fewer downpipes are required



COLOUR OPTIONS

- WH WHITE
- BN BROWN
- BK BLACK
- A ANTH GREY



RUNNING OUTLETS

Will connect to either square or round down pipes

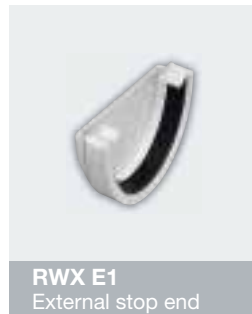
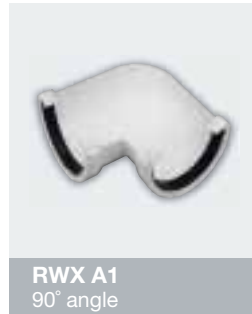

UNIVERSAL XL

This system is ideal for properties with large roof areas such as terraced / community housing and light commercial buildings



HINTS & TIPS



NEED A FITTING GUIDE?

Head over to the comprehensive Eurocell website, where you can find fixing instructions for our guttering range. Go to eurocell.co.uk/gutterfixing to view or download the guide.

SQUARE RAINWATER SYSTEM 65 x 65mm

► The square line downpipe has an easy to clip design with rounded ends to ensure simple installation



COLOUR OPTIONS

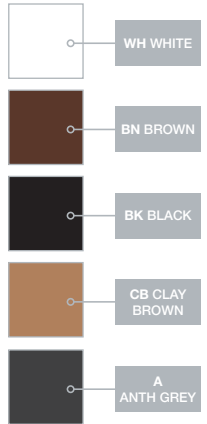

(* Not available in Clay Brown)



SQUARE

The system is suited to residential application and is compatible with many other existing systems

PERFECT PARTNER

Need tools to complete the job? We have spirit levels, hammers, saws and more to help your guttering installation.

See our **TOOLS** section from page 198

► **GET IT FAST - Free next day delivery** on orders over £100



ROUND RAINWATER SYSTEM 68mm

► The round downpipe has an easy to clip design with rounded ends ensuring simple installation



RW P25
2.5m pipe

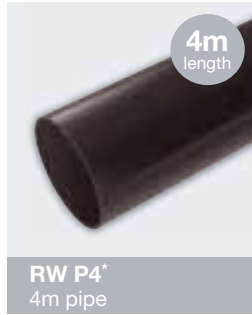

RW P4*
4m pipe



RW P55
5.5m pipe



RW B1
90° bend



RW B2
112° offset bend



RW B3
Shoe



RW S1
Pipe socket



RW Y1
112° branch



RW C1
Pipe clip



RWS C3*
Single fix downpipe clip

COLOUR OPTIONS

	WH WHITE
	BN BROWN
	BK BLACK
	CB CLAY BROWN
	GR GREY
	A ANTH GREY

(* Not available in Grey)



ROUND

The system is suited to residential applications and is compatible with other existing systems

PERFECT PARTNER

Need to repair guttering? Roof & Gutter Seal will get the job done in no time.

See our **SILICONES & SEALENTS** range from page 112

TRADE DISCOUNTS ARE AVAILABLE
- why not open an account in-branch today?

ADAPTORS



RW D2
Round cast to round
PVC adaptor



RW D3
Round to ogee
adaptor LH



RW D4
Round to ogee
adaptor RH



RWS D2
Square to round
adaptor



RWS D1
Square to round
adaptor



RWS D3
Square to ogee adaptor LH -
not suitable for universal Plus



RWS D4
Square to ogee adaptor RH -
not suitable for universal Plus

Colour options:
See table
(below)
for colour
availability

COLOUR AVAILABILITY See table for colour codes and availability	Adaptors							Brackets & accessories						
	RW D2	RW D3	RW D4	RWS D2	RWS D1	RWS D3	RWS D4	RW R1	RW R2	RW H1	RWS B4	RWO B1	RWG G1	RW D3
WH White	•	•	•	•	•	•	•	x	x	•	•	x	x	•
BN Brown	x	•	•	•	•	•	•	x	x	•	•	x	x	x
BK Black	•	•	•	•	•	•	•	x	x	•	•	•	•	x
CB Clay brown	x	x	x	•	x	x	x	x	x	•	x	x	x	x
GR Grey	x	x	x	x	x	x	x	x	x	•	x	x	x	x
GLV Galvanised	x	x	x	x	x	x	x	•	•	x	x	x	x	x
A Anthracite grey	•	•	•	•	•	•	•	x	x	•	•	•	•	x

KEY • Available x Not available * Made to order

PLUS!

We have rainwater connection kits, adaptors, diverters (round and square) and access points (round and square).

Ask in branch for full range.



BRACKETS & ACCESSORIES



RW R1
Top fix rafter bracket



RW R2
Side fix rafter bracket



RW H1
Hopper



RWO B1BK
Balloon guard



RWG G1
Gutter guard



RWS B4
Adjustable offset bend

Colour options:
See table (left) for colour
availability

HEDGEHOG

GUTTER BRUSH

Keep gutters clear from blockages all year round with the ultimate gutter guard – removing the need for costly maintenance!

4m
lengths

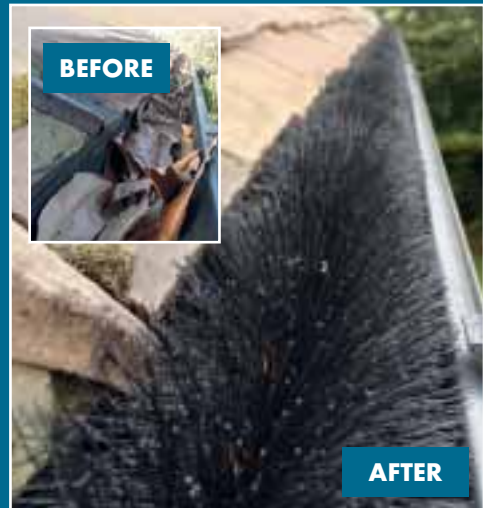

- ▶ Smart-design adapts to gutter shape
- ▶ Corner compatible and can cover down-pipe outlets
- ▶ Stops gutters and drains overflowing
- ▶ Quick fit, long lasting performance
- ▶ Compatible with most types of gutters

4m lengths gutter brush

Width	Code	Colours
100mm	HHGB4M100	WH White / BL Black / BR Brown
125mm	HHGB4M125	WH White / BL Black / BR Brown
150mm	HHGB4M150MM	BL Black
200mm	HHGB4M200MM	BL Black

Clip

Width	Code	Colours
	HHGCLIP	

COMMERCIAL PLUS RAINWATER SYSTEM 150mm

- ▶ Designed to handle large volumes of water with ease, as the outlet design encourages a vortex effect for greater water flow down the pipe



COLOUR OPTIONS



i

COMMERCIAL PLUS

The Commercial Plus system is suited to commercial or large domestic housing projects

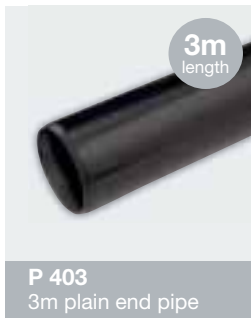



ELEGANCE CAST IRON EFFECT GUTTERING

**10-YR
COLOUR
FASTNESS**

Conditions apply

**A STYLISH RANGE
OF GUTTERING AND
DOWNPIPE PRODUCTS**

**A DECORATIVE EFFECT THAT
COMBINES THE LOOK OF A
TRADITIONAL CAST IRON SYSTEM**

- ▶ Quick to install and ready to fit without the need for painting or protective coatings
- ▶ Reduced total installation cost. (No metal primer, spanners, paint, or disc cutters required)
- ▶ Durable and long-lasting finish without the need to apply corrosion control traditionally used with cast iron systems
- ▶ UV stabilised to protect against colour fade
- ▶ Lightweight construction for easy handling, assembly and installation
- ▶ Stylish and functional, making the range suitable for new build and residential projects

ELEGANCE CAST IRON EFFECT POLYFLOW 117 x 75mm

- ▶ The Elegance Polyflow system offers a high capacity rainwater solution while still benefiting from the timeless appearance of a Cast Iron Effect rainwater system
- ▶ Its deep semi-elliptical profile means it can be used on most domestic applications



HINTS & TIPS

The Elegance range has all of the product & installation benefits of using PVC-U as the manufacturing material





- ▶ Have you seen our roofline consumer brochure? Pop in branch to find out more



ELEGANCE CAST IRON EFFECT DOWNPIPE SYSTEMS 68.5mm

► The Elegance range is designed in such a way that each profile system in the range utilises a common downpipe

	Downpipes			Offsets	
	Size	Code		Size	Code
	1.8m	CIRP18BK		75mm	CIRB4BK
	2.5m	CIRP25BK		150mm	CIRB5BK
	4m	CIRP4BK		305mm	CIRB6BK
	5.5m	CIRP55BK			



ELEGANCE CAST IRON EFFECT OGEE NOTCHED 130 x 70mm

- ▶ This system closely resembles the profiles found on original cast iron installations for that traditional look period homes
- ▶ 130mm gutters offer extra capacity

 <p>2m length</p> <p>CIROG00B 2m notched gutter</p>	 <p>4m length</p> <p>CIROG01B 4m notched gutter</p>	 <p>CIROG02B Gutter union bracket</p>	 <p>CIROG09B Gutter fascia bracket</p>
 <p>CIROG03B 90° external gutter angle</p>	 <p>CIROG13B 90° internal gutter angle</p>	 <p>CIROG04B 135° external gutter angle</p>	 <p>CIROG14B 135° internal gutter angle</p>
 <p>CIROG21B 150° external gutter angle</p>	 <p>CIROG005B Gutter running outlet</p>	 <p>CIROG15B Gutter connector to ogee cast iron LH</p>	 <p>CIROG19B Gutter connector to ogee cast iron RH</p>
 <p>CIROG07B External left hand stop end</p>	 <p>CIROG17B External right hand stop end</p>	 <p>CIRS231B Running outlet adapter</p>	 <p>CIRH720B Running outlet extension</p>



ELEGANCE CAST IRON EFFECT HALF ROUND 114 x 51mm



THE ORIGINAL AND MOST POPULAR
CAST IRON EFFECT GUTTERING RANGE



HALF ROUND

This system offers the flexibility and durability of plastic materials with the stylish, premium appearance of traditional cast iron systems.





CIRE1BK
External stop end



CIRE2BK
Internal stop end



CIRFB1BK
Fascia bracket



CIRR118B
Half round to cast iron effect ogee RH

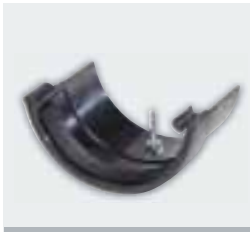

CIRR116B
Plastic to cast iron effect adaptor
(Half round to half round)



CIRR117B
Half round to cast iron effect ogee LH



RR111
Galvanised metal branch
(Fascia bracket required)



RR114
Rise and fall bracket



FREE DELIVERY!

WE CAN DELIVER YOUR ORDER DIRECT TO SITE

Get all your drainwater system and drainage delivered direct to your site (or to your premises if you prefer), along with the rest of your building plastics needs

To qualify for FREE DELIVERY, just spend only £100!*

*EX-VAT



SOIL SYSTEMS



RELIABLE SOIL SOLUTIONS

- ▶ Maximum durability
- ▶ Cost-effective
- ▶ Push-fit style is quick and easy to install
- ▶ Reliable watertight joints
- ▶ Interchangeable with leading manufacturer's products made to EN 1401



110MM SYSTEM

Ideal for domestic and commercial applications



3m length

SW 152202
3m soil pipe (single socket)



SW 152219
Double socket coupling



SW 152245
Pipe clip



SW 152275
Strap boss



SW 152250
45° soil bend (sgl socket)



SW 15231
90° soil bend (sgl socket)



SW 152270
90° angle access bend (sgl socket)



SW 152230
90° soil bend (dbl socket)



SW 152235
90° soil branch (dbl socket)



SW 152265
90° access branch (dbl socket)



SW 152245
45° soil branch (dbl socket)



SW 152255
90° soil branch (triple socket)



SW 152285
Soil boss pipe



SW 152220
Soil vent cage



SW 15216
Soil weathering collar



SW 152090
Air admittance valve



UNDERGROUND DRAINAGE



GREAT VALUE, MAINTENANCE-FREE UNDERGROUND DRAINAGE

- ▶ Easy to lay
- ▶ Flexible - to accommodate normal ground movement
- ▶ Adaptable – connects to existing drainage systems
- ▶ Suitable for commercial and residential installations
- ▶ Available in 82mm, 110mm, 160mm, 200mm, 250mm, 315mm diameters

110MM SYSTEM (160mm system available to order - ask for details)

3m also available
Code: UG432

6m
length



UG462
6m underground drain



UG401
Coupler with centre stop

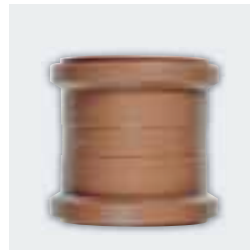

UG402
Slip coupler



UG410
15° bend (single socket)



UG468
30° bend
(single socket)



UG404
45° bend
(single socket)



UG489
87.5° bend
(single socket)



UG494
Adjustable bend
(double socket)



UG409
15° bend (double socket)



UG467
30° bend (double socket)



UG403
45° bend (double socket)



UG484
87.5° bend (dbl socket)



UG406
45° junction
(double socket)



UG424
87.5° junction
(double socket)



UG405
45° junction
(triple socket)



UG423
87.5° junction
(triple socket)



UG498
Low back P trap



UG483
Rest bend (double socket)



UG472
45° long radius bend



UG471
90° long radius bend



XDR115
Flexible adaptor



UG420
Socket plug



UG414
Square hopper & grid



UG428
Square hopper & grid



* Non stock items. Please order these in branch (longer lead times)



UG512
160-110mm invert
reducer



UG455
110mm waste
adaptor*



UG461
32-40mm waste
adaptor



UG485
Universal drain
adaptor



UG470
Gully raiser



UG413
Universal gully trap*



UG425
Bottle gully



UG427
15° bend (single socket)



UG670
160mm chamber base



450m also available
Code: **UG431**

UG438
320mm dia
raising piece



UG512
Square PVC cover
& frame



UG419
450mm dia
manhole cover



UG450
450mm dia
manhole



UG422
Aluminium rod
eye spigot



SG 500
300ml lubricant



CHANNEL DRAINAGE

A UNIQUE & EASY TO INSTALL SURFACE WATER DRAINAGE SYSTEM

- ▶ Easy to assemble, handle and install surface drainage system
- ▶ Effectively removes water from pedestrian areas
- ▶ Can withstand 5 tonne vehicle weight
- ▶ Innovative, lightweight and durable design



HINTS & TIPS

APPLICATIONS

- Driveways
- Patios
- Garage entrances
- Thresholds



UP1 MCP
Channel drainage



UP1 EC
110mm stop-end channel



UP QUADBOX
Multi-purpose quad box



INTERIOR PRODUCTS

A range of high quality
internal PVC-U products
which are low maintenance
and offer great value



All together better



PVC-U SKIRTING AND ARCHITRAVE

Roomline skirting requires no preparation or painting, so you can fit and forget it!

Find out more on page 84



UNDERFLOOR HEATING

Why not kit out your conservatory installations with underfloor heating? We offer different types that are ideal for various applications.

Find out more on page 86



UNDERFLOOR HEATING WI-FI CONTROLLER

Ensures homes are always of the right temperature and on the right tariff.

Find out more on page 87



ORDER BY PHONE

Call your local branch direct on **08000 77 88 88**

ORDER ONLINE

eurocell.co.uk/buyonline

SHOP IN-BRANCH

Find your nearest branch at eurocell.co.uk/branchfinder



INTERIOR PRODUCTS

PVC-U SKIRTING & ARCHITRAVE 84-85

UNDERFLOOR HEATING 86-91

LOFT HATCHES & LADDERS 92-93

FREE APP



YourPad

AN ESSENTIAL TOOL FOR TRADE

YourPad is designed to help you win more sales. Being able to show potential customers what home improvements products will look like on their home can help convert a sale - this app is as essential as your tape measure!

Learn more at eurocell.co.uk/YourPad



Download **FREE** on iPad and Android tablets at:



WHAT IS ROOMLINE?

ROOMLINE SKIRTING BOARDS & ARCHITRAVE

- ▶ No sanding, painting or treatment - ever!
- ▶ Glue-on fitting with standard building adhesives
- ▶ No maintenance - just wipe clean
- ▶ Durable, scratch-resistant finish
- ▶ Integral low-voltage cable tidy solution
- ▶ Manufactured from recycled PVC-U for minimal environmental impact

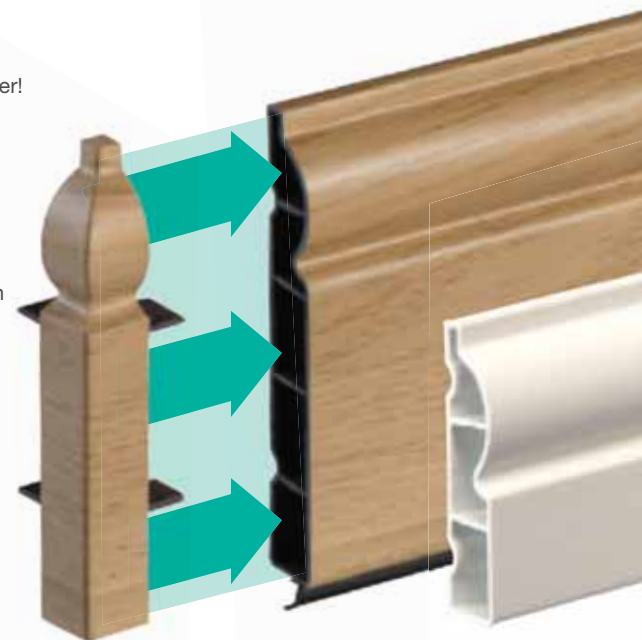

FITTING INSTRUCTIONS

You **Tube**

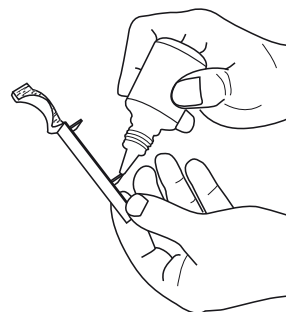

WATCH

See how to install Roomline on
[youtube.com/eurocellpvcu](https://www.youtube.com/eurocellpvcu)

DOWNLOAD

To download full PDF fitting instructions,
visit [eurocell.co.uk/roomlinefitting](https://www.eurocell.co.uk/roomlinefitting)

EXAMPLES OF USE



CORNER TRIMS

Internal and external corner trims connect skirting lengths – removing the need for mitring. They simply slot together for a perfect finish every time (adhesive required)



DOOR SURROUNDS

Our architraves perfectly frame doorways. The single door kit requires only one mitre cut, then it all fits cleverly into place. Cover trims are available if required.



LEARN MORE

Our Roomline brochure contains all the features, benefits of Roomline, plus example installations and much more.

Call **08000 77 88 88** to order your **FREE** copy, or download from our website today at eurocell.co.uk/roomlinebrochure



SKIRTING & ARCHITRAVE



NEW
NOW
AVAILABLE IN
CHAMFERED
FINISH

ROOMLINE PVC-U SKIRTING BOARDS



100mm Roomline Skirting

Size	Code	Qty
100mm x 5m	SK 100	2 pack
100mm x 5m	SKC 100	2 pack

Colour options: See table (right) for colour availability.

COLOUR AVAILABILITY See table for colour codes and availability	Roomline finishes						
	SK100/SCK100	SK 100 CTEP2/ SKC 100 CTEP2	SK 100 CTIP4/ SKC 100 CTIP4	SK 100 J/ SKC 100 J	AR60/ARC60	AR60 K6 AR60 K60	AR60 SDK
WZ1 White Satin	•	•	•	x	•	•	•
LO2 English Oak	•	•	•	x	•	•	•
RO Rosewood	•	•	•	x	•	•	•

KEY • Available x Not available * Made to order

*Chamfered finish not available in Rosewood

ROOMLINE SKIRTING TRIMS



Skirting External Corner Trims

Code	Qty
SK 100 CTEP2	2 pack
SKC100CTEP2LO2	2 pack

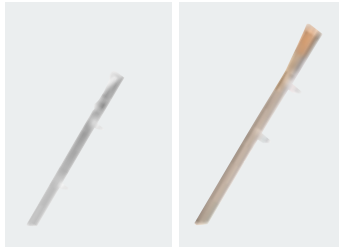

Skirting Internal Corner Trims

Code	Qty
SK100CTIP4WZ1	4 pack
SKC150CTIP4LO2	4 pack



Skirting Internal Corner Trims

Code	Qty
SK 100 J	10 pack

ROOMLINE PVC-U ARCHITRAVE & TRIMS



Architrave Single Door Kit

Code	Qty
AR60 SDK	1 kit

Contains: 2 x 2.25m architrave
1 x 1m architrave
2 x joint trims
2 x cover trims



90° Architrave Trim Kit

Code	Qty	Contains
AR60 K6	6 pack	4 x joint trims and 2 x cover trims
AR60 K60	60 pack	40 x joint trims and 20 x cover trims

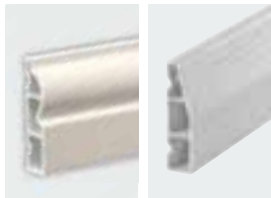

Roomline Architrave

60mm (w) x 15mm (d) x 5.5m (l)

Code	Qty
AR60	10 pack
ARC60	10 pack

MDF SKIRTING BOARDS & ARCHITRAVE

Decorative ogee-style architrave and skirting to match our range of window boards ([see page 102](#))

Architrave Door Set

70mm ogee architrave

Code	Qty
WTS 120	1 set

Contains:
2 x 2.44m and 1 x 1.22m

COLOUR OPTIONS



Ogee Skirting

4.25m (l) x 120mm (w) x 15mm (h)

Code	Qty
WTS 120	2 pack

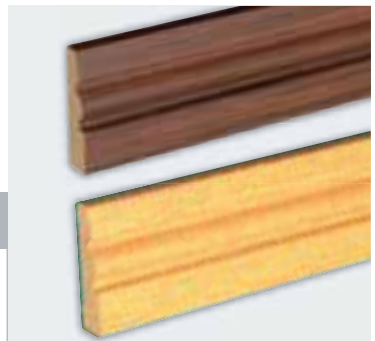



UNDERFLOOR HEATING



MODERN HEATING SYSTEMS FOR MAINTENANCE-FREE LIVING

- ▶ Perfect primary heat source throughout a house, or as a secondary heat source in kitchens and bathrooms
- ▶ Industry leading system
- ▶ European compliant & CE marked
- ▶ Even heat distribution, low running costs
- ▶ Zone control means rooms can be heated as and when required

For more information please call us on **08000 77 88 88** today!

THERMOSTAT CONTROLS



4iE Wifi Controller

Code	Colour
WU-4iE-WIFI-OB	Onyx Black
WU-4iE-WIFI-BP	Bright Porcelain



3iE Thermostat

Code	Colour
WU-3iE-PB	Piano Black
WU-3iE-CC	Classic Cream
WU-3iE-SG	Silver Grey
WU-3iE-WB	Warm Berry
WU-3iE-MB	Madison Blue
WU-3iE-LG	Leaf Green
WU-3iE-DP	Deep Pink



ELT Elements Tempo

Code	Colour
ELT- PW	Porcelain White
ELT- PB	Piano Black

150W & 200W/M² STICKY MAT SYSTEM

Suitable for new-build, retrofits and refurbishments

- ▶ Thin loose wire evenly spaced and taped to a glassfibre mesh
- ▶ The thinnest dual-fluoropolymer coated heating wire (less than 1.8mm diameter)
- ▶ Reduces installation time by 35%
- ▶ Reposition easily without losing adhesion



4IE SMART WIFI THERMOSTAT

Ensures homes are always at the right temperature and on the best tariff

- ▶ A typical home can save up to £378 on energy bills
- ▶ No programming required
- ▶ Works with smartphones
- ▶ Saves up to 25% of your heating usage
- ▶ Finds the best energy tariffs available



For more information ask a member of staff at your **local Eurocell branch today!**



INSULATION & ACCESSORIES



Dual Wire Undertile Heater

Watts	Code
300w	DWS 300
400w	DWS 400
600w	DWS 600
800w	DWS 800



Warmup Stickymat

▶ Various sizes from 1metre to 15metre

Watts	Code
150w	Ask in-branch
200w	Ask in-branch



Warmup Foil Heater Electric

▶ WLFH-140W
Various sizes from 1metre to 12metre

Watts	Code
Various	WLFH

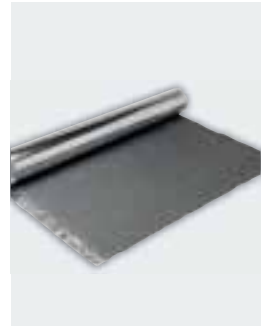

Warmup Insulated Underlay

Size	Code
2.5m ²	WIU2.5
5m ²	WIU5.0
10m ²	WIU10.0
25m ²	WIU25.0



Warmup Dual Overlay System

Size	Code
2.88m ²	WDO



6mm Warmup Insulation Board

Size	Code
Various	INS BOARD



In Screed Cable
- Ask in-branch for details

▶ Various wattage offering from WIS180 - 3370 watts



Glass Fibre Tape
90 meter roll

Size	Code
90m	INS TAPE

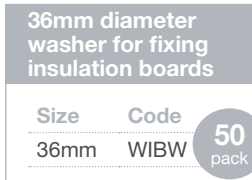

36mm diameter washer for fixing insulation boards

Size	Code
36mm	WIBW

50 pack



40mm long wood screw for fixing insulation boards

Size	Code
40mm	WIBS

100 pack

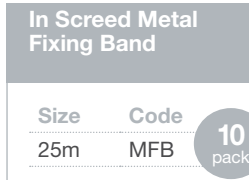

In Screed Metal Fixing Band

Size	Code
25m	MFB

10 pack

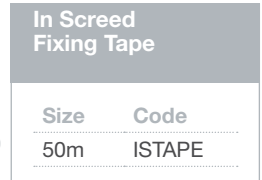

In Screed Fixing Tape

Size	Code
50m	ISTAPE

TOTAL 16



Moulded straight board including aluminium plate

Code

WHS-TOTAL16-BOARD

Moulded return board

Code

WHS-TOTAL16-RETURN

Moulded feeding board

Code

WHS-TOTAL16-FEED

70 metre 12mm coil of PEX-a Pipe

Code

WHS-P-PEXA-12 x 70



INSULATION



Celotex Insulation*

- ▶ Celotex GA4000 is a general purpose insulation board suitable for a variety of applications, including roof, wall and floor insulation. This multipurpose PIR insulation has an A+ rating when compared to the BRE Green Guide.

Celotex GA4000

Code	Size
INSUL50	2400 x 1200 x 50mm
INSUL100	2400 x 1200 x 100mm

- ▶ Celotex PL4000 is a high performance thermal insulation board where the PIR insulation is bonded to tapered edge plasterboard.

Celotex PL4000

Code	Size
INSULPL65	2400 x 1200 x 65mm + 12.5mm



Knauf Earthwool Loft Roll 44* (COMBI CUT) 150mm

- ▶ Lightweight and economic insulation quilt for pitched roofs at ceiling level and suspended timber floors. Earthwool Loft Roll 44 is a flexible low density glass mineral wool quilt which is lightweight, resilient and non-combustible. The rolls are 1140mm wide and partially perforated to produce either 2 rolls 570mm wide or 3 rolls 380mm wide or available in ready-cut version (2x570mm only).

Celotex GA4000

Code	Size
LOFTROLL44	150mm INS 9.18m ²



Gyproc 10Kg Easi-Fill*

- ▶ Two coat filler and finishing jointing compound for dry wall systems

Code	Size
EASIFILL10	10KG

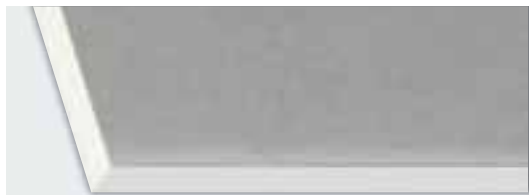

Knauf Wallboard*

- ▶ Strong and versatile, Wallboard is a cost-effective choice for partitions, linings and ceilings with standard performance requirements. Wallboard has an ivory paper face ideally suited for a plaster finish or for direct decoration.

Celotex GA4000

Code	Size
WALLBOARD125	1800 x 900 x 12.5mm

*Available in selected branches

LAMINATE FLOORING & ACCESSORIES

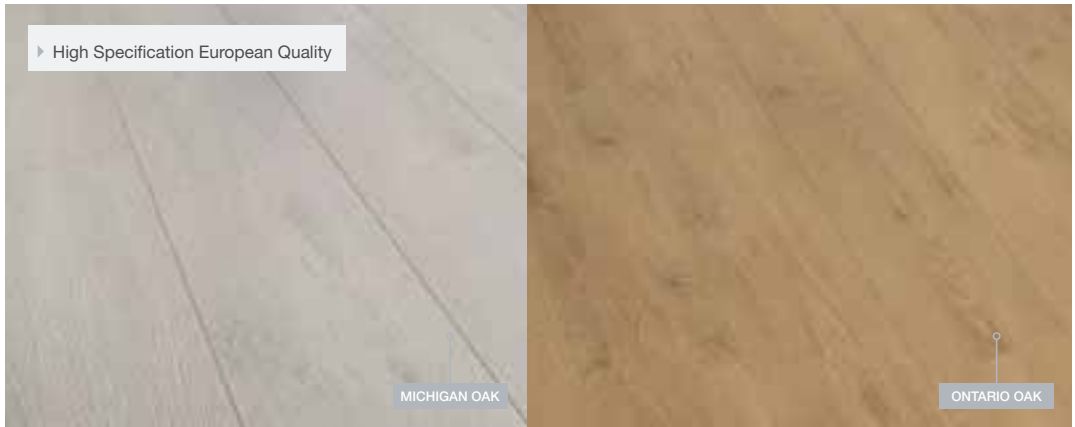

Laminate Flooring 8mm

Code	Style	Size
LAMMOAK8	Michigan Oak	8mm (2.131sqm/pk)
LAMOOAK8	Ontario Oak	8mm (2.131sqm/pk)

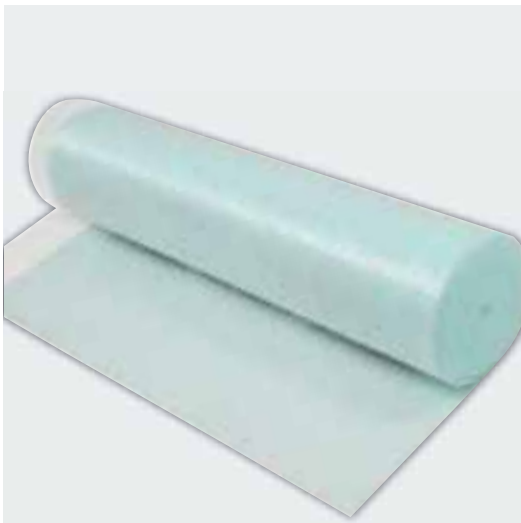

Premium DPM Underlay 15m²

Code	Size
LAMUNDERLAY	3mm x 1m x 15m (15m ²)



Combistar Profile

Code	Style	Size
LAMCBSMOAK	Michigan Oak	48mm x 19mm x 1.8m
LAMCBSOOAK	Ontario Oak	48mm x 19mm x 1.8m



Beading 16mm

Code	Style	Size
LAMBEAD20MOAK	Michigan Oak	16mm x 16mm x 2.4m
LAMBEAD20OAK	Ontario Oak	16mm x 16mm x 2.4m

► ...samples of the product, and get expert advice from our staff



LOFT HATCHES & LADDERS



Insulated 1 Hr Fire Rated
Loft Door C/W 'T' Keys

Size	Code
562 x 726mm	GL280F



Insulated Drop Down Loft Door

Size	Code
686 x 856mm	GL250



Insulated Push Up Loft White

Size	Code
660 x 660mm	MAN-LD



3 Section Aluminium Loft Ladder

Size
3.0m

Code
GLL257



WINDOW FINISHING



From cavity closers to trims to window boards, our window finishing range allows you to get the perfect finish – for every job!



All together better



CAVITY CLOSERS

Close cavities quickly and effectively with our range of Cavalok closers, whilst improving thermal efficiency for homeowners.

Find out more on page 96

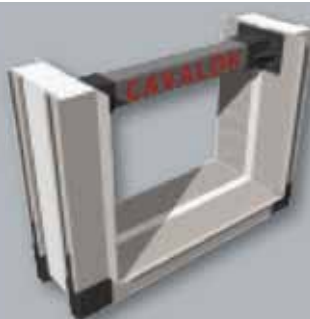

INTELLIGENT 150MM CILL

The 150mm cill system has the flexibility to create larger sizes (up to 225mm) and accommodate project tolerance discrepancies through the use of various trims.

Find out more on page 101



LAMINATED WINDOW BOARDS

These scratch-resistant boards add the finishing touch to your window installation

Find out more on page 102

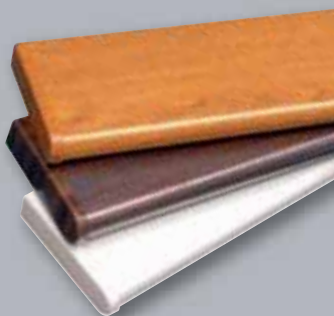

ORDER BY PHONE

Call your local branch direct on
08000 77 88 88

ORDER ONLINE

eurocell.co.uk/buyonline

SHOP IN-BRANCH

Find your nearest branch at
eurocell.co.uk/branchfinder



WINDOW FINISHING

CAVITY CLOSERS
.....96-99

WINDOW CILLS & ACCESSORIES
.....100-101

WINDOW BOARDS
.....102-104

BOW WINDOW ACCESSORIES
.....105

FINISHING TRIMS
.....106-109

COSMETIC REPAIRS
.....110

TRICKLE VENTILATION
.....110

GLASS & BRIDGE PACKERS
.....111



WHAT IS A CAVITY CLOSER?

A cavity closer is an energy-efficient aperture former which enables brick courses to be completed and creates an Air-tight receiver for windows and doors

BENEFITS

- ▶ Provides a damp proof course
- ▶ Simplifies brickwork
 - no return bricks needed
- ▶ Provides thermal break
- ▶ Stops cold bridging which can cause condensation to form inside the opening damaging internal decoration and plasterwork
- ▶ Improves heat loss at the window junction, reducing CO₂ emissions
- ▶ Meets Accredited Construction Details regulation designed to improve the heat loss at junctions
- ▶ Meets needs of Part L of the Building Regulations



Cavalok products are made from **100% recycled PVC-U**

NEED MORE INFORMATION?



Our comprehensive **Specification Guide** includes dimensions and examples of use, along with detailed information on the rest of Eurocell's product offering.

Call **08000 77 88 88** to request a copy, or download from our website today at **eurocell.co.uk/ebpspecguide**

WHICH PRODUCT IS RIGHT FOR YOU?

CAVALOK UNIVERSAL CAVITY CLOSER

- ▶ For cavity sizes 50-100mm
- ▶ Use for new build projects
- ▶ Cavity closer is assembled into a window template
- ▶ Ensures window manufacturer can produce to correct sizes without repeated surveying - saving time and money by reducing rework or snagging
- ▶ Easy to install, use with standard plastic ties to fix into coursework as you build



CAVALOK BIG BLOCK CAVITY CLOSER

- ▶ For cavity sizes 125-300mm
- ▶ Use for new build projects
- ▶ Cavity closer is assembled into a window template
- ▶ Super-insulating, specially designed to meet the Code for Sustainable Homes
- ▶ Easy to install, use with standard plastic ties to fix into coursework as you build





CAVITY CLOSER



IDEAL FOR REFURBISHMENT PROJECTS

- ▶ Slotted design allows you to cut down the product to fit your cavity width
- ▶ Just one product to hold in stock or in the van, no assembly required
- ▶ Punched flange for easy fixing
- ▶ Easy way to improve the damp proof course when replacing a window

**FOR CAVITY SIZES
50 - 100mm**

FRAME FORMING CORNERS



Cavalok corners

50mm

Code	Qty
CBP CAV 50 MOU	100/box

75mm

Code	Qty
CBP CAV 75 MOU 13	100/box



Big Blok corners

For use with both 125mm and 150mm cavity closers

Code	Qty
CBP BB MOU	200/box



Big Blok corner fillet

For use with both 125mm and 150mm cavity closers

Code	Qty
CBP BBS FIL	50 pack

CAVITY CLOSER SECTIONS



2.4m
lengths

Trade closer

- ▶ This is a stand alone product - no extra components or assembly required!
- ▶ Suitable for applications between 50mm and 100mm

Code	Qty
MCBP TDR 100 HOR	10 pack



4.8m
lengths

BigBlok closer

125mm closer (insulated)

Code	Qty
MCBP 125 HOR 48	64 pack

150mm closer (insulated)

Code	Qty
MCBP 150 HOR 48	4 pack



4.8m
lengths

Universal closer

50mm closer (insulated)

Code	Qty
MCBP 050 HOR 48	6 pack

75mm closer (insulated)

Code	Qty
MCBP 075 HOR 48	6 pack

100mm closer (insulated)

Code	Qty
MCBP 100 HOR 48	6 pack

Have you visited Cavalok's informative website?
If not, head over to www.cavalok.com

FRAME FORMING BRACING

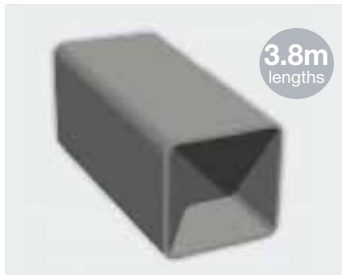

3.8m
lengths

Brace bar

For use with both Cavalok and Big Blok closer

Code	Qty
MCBP CAV BR BOX	60 pack

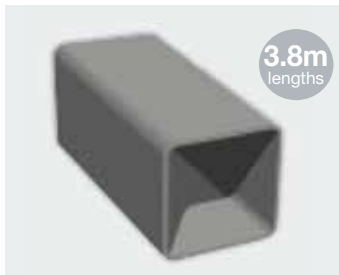

3.8m
lengths

Brace boot

For use with both Cavalok and Big Blok closer

Code	Qty
CBP BOOT 14	100/box



Brick ties

For use with both Cavalok and Big Blok closer

Code	Qty
CBP BB TIE	1000/box

▶ We can deliver your cavity closers direct to site - just ask!



WINDOW CILLS & ACCESSORIES



INTELLIGENT 150MM CILL SYSTEM

- ▶ The cill provides solutions to issues commonly found on site
- ▶ Allows flexibility to create larger sizes
- ▶ Accommodates project tolerance discrepancies through the use of cill extender and frame extension trims

COLOUR AVAILABILITY

See table for colour codes and availability

- 64 White
- 52 Warm White
- CR Cream
- WO Golden Oak
- RO Rosewood
- WL01 Irish Oak
- WZ White Ash
- 7016 Grey
- WY Black Ash
- WG Dark Brown (to match rosewood)
- O Oak
- CO Oak on caramel
- BB Brown Beige (to match irish oak)

Window cills & accessories colour finishes

	AC 150	ECA 150	AS 85	ECA 85	AC 180	ECA 180	EWS 106	EWS 136	JT 150	JTA 150	JTA 90i	JTA 90E	CR 27 P	EWS 118
64 White	•	•	•	•	•	•	•	•	•	•	•	•	•	•
52 Warm White	x	•	x	•	•	•	x	x	x	x	x	x	x	x
CR Cream	•	•	•	•	•	•	•	x	x	x	x	x	x	x
WO Golden Oak	•	x	•	x	•	x	•	•	x	x	x	x	x	•
RO Rosewood	•	x	•	x	•	x	•	•	x	x	x	x	x	•
WL01 Irish Oak	•	x	•	x	•	x	•	x	x	x	x	x	x	x
WZ White Ash	•	x	•	x	x	x	•	x	x	x	x	x	x	x
7016 Grey	•	•	x	x	x	•	•	x	x	x	x	x	x	•
WY Black Ash	•	•	•	x	•	•	•	x	x	x	x	x	x	x
WG Dark Brown (to match rosewood)	x	•	x	•	x	•	x	x	•	•	•	•	•	•
O Oak	x	•	x	•	x	•	x	x	•	•	•	•	•	•
CO Oak on caramel	•	x	•	x	•	x	x	x	x	x	x	x	x	x
BB Brown Beige (to match irish oak)	x	•	x	x	x	•	x	x	x	x	x	x	x	x

KEY • Available x Not available * Made to order

Colour options:

See table (right) for colour availability

150mm-type cill and end caps		Combinations
Cill		
Code	Qty	
AS 150	2 pack	
End caps		
Code	Qty	
ECA 150	50 pairs	

6m lengths

CILL WITH EXTENDER
SEE EWS 118 (below)

CILL WITH 25MM
EXTENDER TRIM
SEE EWS 106 (below)

CILL WITH 10MM
EXTENDER TRIM
SEE EWS 136 (below)

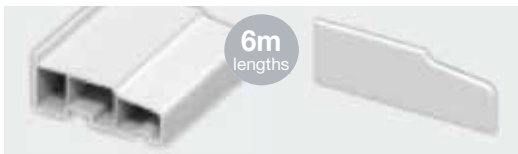

85mm A-type cill and end caps			
Cill		End caps	
Code	Qty	Code	Qty
AS 85	4 pack	ECA 85	50 pairs



180mm A-type cill and end caps			
Cill		End caps	
Code	Qty	Code	Qty
AS 180	2 pack	ECA 180	50 pairs



EWS 106
25mm x 6m knock on



EWS 136
10mm x 6m knock on

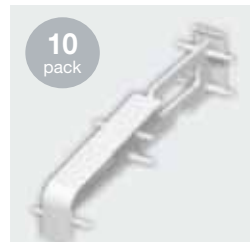

JT 150
150mm straight cill joint trim



JTA 150
150° angle cill joint trim

135° also available
Code: JTA 135



JTA 90i
90° internal angle joint trim



JTA 90E
90° external angle joint trim

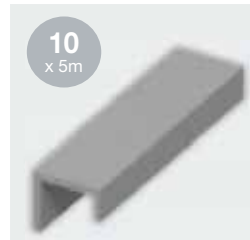

CR 27P
27mm cill reinforcement

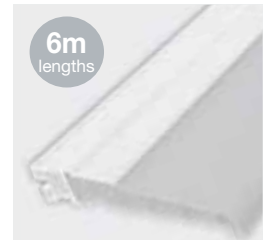

EWS 118
Cill extender



WINDOW BOARDS

23MM LAMINATED WINDOW BOARDS



GET A PERFECT COLOUR MATCH THROUGHOUT YOUR INSTALLATION WITH STYLISH 23MM LAMINATED WINDOW BOARDS

- ▶ Add style and elegance to complement any window or conservatory
- ▶ Durable and strong laminate
- ▶ Back edge and underside sealed to prevent moisture ingress
- ▶ Scratch, stain and moisture resistant
- ▶ Never needs painting and is easy to clean



23mm laminated window boards

Size	Code	Code (Light Oak Only)	Qty
100mm x 5m	WT 100	N/A	1 pack
150mm x 5m	WT 150	LOWB5000150	1 pack
180mm x 5m	WT 180	LOWB5000180	1 pack
200mm x 5m	WT 200	LOWB5000200	1 pack
225mm x 5m	WT 225	LOWB5000225	1 pack
250mm x 5m	WT 250	LOWB5000250	1 pack
300mm x 5m	WT 300	LOWB5000300	1 pack
600mm x 3m	WT 600	N/A	1 pack
600mm x 4.1m	WT 600	N/A	1 pack
900mm x 3m	WT 900	LOWB3000900	1 pack
900mm x 4.1m	WT 900	LOWB5000240	1 pack

Colour options:

64 White / **RW** Rosewood / **WO** Golden Oak / **LO** Light Oak / **CR** Cream* / **WZ** White Ash*

(*Except WT 300, WT 150 WT 180)

23MM LAMINATED TRIM



WTEC

Laminated end cap

Colour options:

64 White / **RW** Rosewood / **WO** Golden Oak / **WG** Brown / **LO2** Light Oak / **CR** Cream



WTJT

Laminated joint trim

Colour options:

64 White / **RW** Rosewood / **WO** Golden Oak / **WG** Brown / **LO2** Light Oak / **CR** Cream



WTJT

Laminated joint trim

Colour options:

64 White / **RW** Rosewood / **WO** Golden Oak / **WG** Brown / **LO2** Light Oak / **CR** Cream / **C** Caramel

DESIGNER WINDOW BOARDS

28mm textured or gloss window boards

- ▶ Durable and strong laminate
- ▶ Never needs painting
- ▶ Easy to clean
- ▶ Stylish marble effect window board to compliment windows and conservatories

Gloss

Size	Code	Qty
200mm x 1.41m	DWTG 200	1 pack
250mm x 1.41m	DWTG 250	1 pack

Textured

Size	Code	Qty
200mm x 1.41m	DWTT 200	1 pack
250mm x 1.41m	DWTT 250	1 pack



**A SOPHISTICATED
FINISH TO COMPLEMENT
CONTEMPORARY INTERIORS**



9MM WINDOW BOARDS



9mm window boards

Size	Code	Qty
160mm x 5m	WB 160	2 pack
180mm x 5m	WB 180	2 pack
210mm x 5m	WB 210	2 pack
240mm x 5m	WB 240	2 pack
260mm x 5m	WB 260	2 pack
420mm x 5m	WB 420	1 pack

Colour options:

64 White

9MM WINDOW BOARD ACCESSORIES



Window board retaining trim

Code	QTY
EWS 129	2 pairs

Colour options:
64 White / RW Rosewood / WO Golden Oak

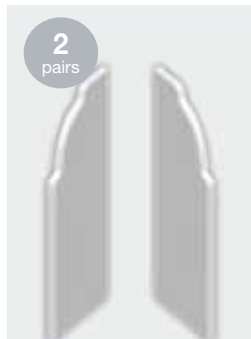

Window board retainer end cap

Code	QTY
EWS 229	2 pairs

Colour options:
64 White / RW Rosewood / CR Cream / O Oak

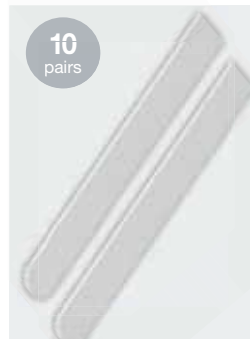

Long end caps

Code	QTY
DEC	10 pairs

Colour options:
64 White / BW Blue White / RW Rosewood / WO Golden Oak / WY Black Ash

(*Except WT 300, WT 150 WT 180)



Short end caps

Code	QTY
EWBECS	5 pairs

Colour options:
64 White / BW Blue White / RW Rosewood / WO Golden Oak / WY Black Ash

(*Except WT 300, WT 150 WT 180)

BOW WINDOW ACCESSORIES



Bow canopies

- ▶ Quick and easy installation
- ▶ One piece leak-proof moulding
- ▶ Available with lead-look top
- ▶ Made from strong rigid fibreglass
- ▶ Maintenance-free

Standard

Size	Code	Qty
1.8m	BC 18	1 pack
2.4m	BC 24	1 pack

Foam filled

Size	Code	Qty
1.8m	BC 18 FF	1 pack
2.4m	BC 24 FF	1 pack

Bow units

- ▶ Quick and easy installation
- ▶ Fully moulded GRP base unit including attached gallows bracket
- ▶ Made from strong rigid fibreglass giving a firm foundation for a bow window

Standard

Size	Code	Qty
1.8m	BA18 MK1	1 pack
2.4m	BA18 MK1	1 pack



Gallows brackets

Size	Code
7.5"	GB 7.5
10"	GB 10
13"	GB 713

COLOUR OPTIONS



WH WHITE



BR BROWN



O OAK

NEW COLOURS

EXPANDED TRIMS COLOUR RANGE

To enhance the current range of colours, our window trims* will be available in four new foiled finishes. These are: **Chartwell Green**, **Slate Grey**, **Moondust Grey** and **Anteak**

*Colour availability varies by product



EXAMPLES OF USE



PENCIL ROUND ARCHITRAVE

This flatback pencil-round architrave hides minimal plaster damage, whilst providing an attractive finish. Available in 3 sizes.



25MM D MOULDING

Conceal window joins with a 25mm D-moulding trim to improve sightlines and create a clean, colour-matched finish.



FOAM QUADRANT

Neaten joins with attractive foam quadrants, available in a variety of colours. Suitable for use around windows, floors and more.

FINISHING TRIMS



20
x 5mm

13 or 17.5mm quadrant

Size	Code
13mm	Q 13
17.5mm	Q 17.5

Colour options:

64 White / **BW** Blue White / **RW** Rosewood / **WO** Golden Oak / **CR** Cream / **WZ** White Ash / **7016** Anthracite Grey / **WLO1** Irish Oak / **WY** Black Ash / **7015** Slate Grey[†] / **WT1** Chartwell Green[†] / **LO10** Anteak[†]

(* Q17.5 only- [†]Made to order (MTO))



20
x 5mm

25mm D moulding

Size	Code
25mm	D 25

Colour options:

64 White / **BW** Blue White / **RW** Rosewood / **WO** Golden Oak / **CR** Cream / **WZ** White Ash / **7016** Anthracite Grey / **WLO1** Irish Oak / **WY** Black Ash / **7015** Slate Grey[†] / **WT1** Chartwell Green[†] / **LO10** Anteak[†]

(* [†]Made to order (MTO))



20
x 5mm

Cloaking fillet

Size	Code
20mm	C 20

Colour options:

64 White / **BW** Blue White / **RW** Rosewood / **WO** Golden Oak / **CR** Cream / **WZ** White Ash / **7016** Anthracite Grey / **WLO1** Irish Oak / **7015** Slate Grey[†] / **7155** Moondust Grey[†] / **WT1** Chartwell Green[†] / **LO10** Anteak[†]

(* [†]Made to order (MTO))

Size	Code
30mm	C 30

Colour options:

64 White / **BW** Blue White / **RW** Rosewood / **WO** Golden Oak / **CR** Cream / **WZ** White Ash / **7016** Anthracite Grey / **WLO1** Irish Oak / **7015** Slate Grey[†] / **WT1** Chartwell Green[†] / **LO10** Anteak[†]

(* [†]Made to order (MTO))



20
x 5mm

13 or 17.5mm quadrant

Size	Code
15mm	B 20

Colour options:

64 White / **BW** Blue White / **RW** Rosewood / **WO** Golden Oak / **WY** Black Ash



10
x 5mm

20mm square

Size	Code
20mm	S 20

Colour options:

64 White / **BW** Blue White / **RW** Rosewood / **WO** Golden Oak / **CR** Cream / **WZ** White Ash / **7016** Anthracite Grey / **WLO1** Irish Oak / **WY** Black Ash / **7015** Slate Grey[†] / **7155** Moondust Grey[†]

(* [†]Made to order (MTO))



ARCHITRAVES



5m lengths

Pencil round architrave
Flat

Size	Code	Qty
45mm x 5m	PF 45	10 pack
65mm x 5m	PF 65	10 pack
95mm x 5m	PF 95	10 pack

Colour options:

64 White / **BW** Blue White / **RW** Rosewood / **WO** Golden Oak / **CR** Cream / **WZ** White Ash / **7016** Anthracite Grey / **WLO1** Irish Oak / **WY** Black Ash / **7015** Slate Grey† / **WT1** Chartwell Green† / **LO10** Anteak†

(†Made to order (MTO))



5m lengths

Pencil round architrave
Castellated

Size	Code	Qty
40mm x 5m	PR 40	10 pack
60mm x 5m	PR 60	10 pack
90mm x 5m	PR 90	10 pack

Colour options:
64 White



5m lengths

Ogee architrave
Castellated

Size	Code	Qty
40mm x 5m	OGEE 50	10 pack

Colour options:
64 White

PERFECT PARTNER

Seal trims with
SILVERSIL LMN.



See page 116

ANGLES

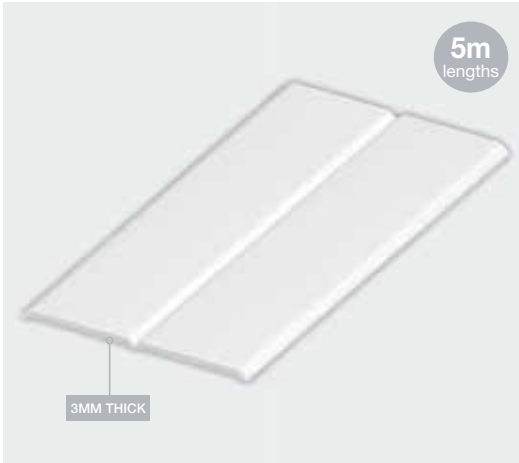

3mm thick adjustable angles

Size	Code	Qty
50mm x 5m	GAA 50	20 pack
70mm x 5m	GAA 70	20 pack
100mm x 5m	GAA 100	15 pack

Colour options:
64 White

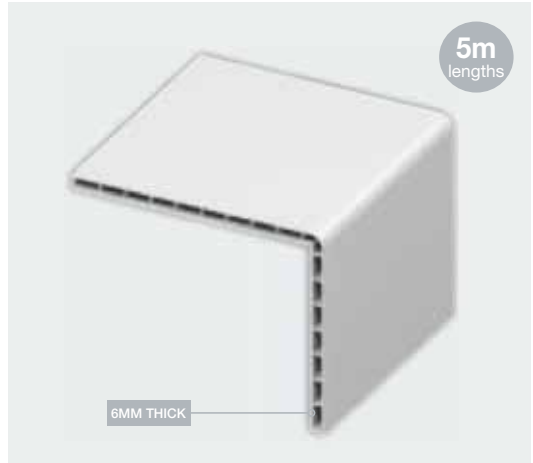

6mm thick hollow angles

Size	Code	Qty
100mm x 80mm	HA 1008	5 pack

Colour options:
64 White / RO Rosewood / WO Golden Oak



Rigid angles

Size	Code	Qty
25mm x 25mm	RA 2525	20 pack
60mm x 60mm	RA 6060	5 pack
80mm x 80mm	RA 8080	5 pack
100mm x 80mm	RA 1008	5 pack

Colour options:
64 White / RO Rosewood / WO Golden Oak
(*Except RA 6535)

White only		
Size	Code	Qty
40mm x 40mm	GRA 4040	20 pack
150mm x 35mm	RA 6535	10 pack



COSMETIC REPAIRS

COLOUR EDGING PENS



Replace missing colour on window seams, wooden flooring and more

- ▶ Unique press action
- ▶ Spare tips included
- ▶ Suitable for interior and exterior applications
- ▶ Original colour edging pen with pump action is also available

Code

CEP

WINDOW REPAIR KIT



Successfully repair minor scratches to windows

- ▶ Suitable for repairing minor scratches, dents or bruises to PVC-U and timber windows
- ▶ Contains filler for use on Mahogany, Rosewood, Golden Oak and White profile
- ▶ Original colour edging pen with pump action also available

Code

KO 614

COLOUR FILL & SOLVENT PACK



Effectively repairs laminate and melamine flooring

Code

WTCF

Colour options:

64 White / RW Rosewood / WO Golden Oak / O Oak

TRICKLE VENTILATION



23mm laminated window boards

Size	Code	Qty
XS 4400 EA ventilator (screw fix)	TS VENT	50 pack

COLOUR OPTIONS



GLASS & BRIDGE PACKERS



- ▶ Flat and bridge packers guarantee glass alignment, squareness and maintain correct weight distribution
- ▶ Moulded using prime grade material resistant to deterioration and unaffected by sealants
- ▶ Other sizes are available on request

Bridge packers		
24mm		
Size	Code	Qty
5mm	BRP 245	1000 pk
28mm		
Size	Code	Qty
3mm	BRP 283	1000 pk
4mm	BRP 284	1000 pk

24mm glass packers		
Size	Code	Qty
1mm	FLWH 24	1000 pk
2mm	FLBU 24	1000 pk
3mm	FLRE 24	1000 pk
4mm	FLYE 24	1000 pk
5mm	FLGN 24	1000 pk
6mm	FLBL 24	1000 pk
Mixed bag	PP24 GP100	100 pk

28mm glass packers		
Size	Code	Qty
1mm	FLWH 28	1000 pk
2mm	FLBU 28	1000 pk
3mm	FLRE 28	1000 pk
4mm	FLYE 28	1000 pk
5mm	FLGN 28	1000 pk
6mm	FLBL 28	1000 pk
Mixed bag	PP28 GP100	100 pk

YOU CAN NOW GET AN INSTANT PRICE FOR YOUR BESPOKE WINDOW IN BRANCH TODAY!

With the launch of our new Frameworks technology, we can provide you with an instant price at your local branch.

Ordering couldn't be easier - just let our branch staff know the window style, size, colour and quantity.

Get your quote today!

7
DAY
DELIVERY

A++
RATED
AVAILABLE

10-YR
GUARANTEE

FRAMEWORKS



SEALANTS & FIXINGS



We have a wide range of sealing and fixings, allowing you to complete a wide range of jobs to the highest standards



All together better



SILVERSIL

These popular silicones are available in various colours, and are indispensable for any PVC-U installation job.

Find out more on page 116



ALL-ROUNDER SEALANTS

Fixall offer a range of all-rounder sealants.

Find out more on page 117



GLASS CLEANER

Enhance your view with the non-smearing Silversil glass cleaner.

Find out more on page 122



ORDER BY PHONE

Call your local branch direct on
08000 77 88 88

ORDER ONLINE

eurocell.co.uk/buyonline

SHOP IN-BRANCH

Find your nearest branch at
eurocell.co.uk/branchfinder



SEALANTS & FIXINGS

SILICONES & SEALANTS

116-120

CLEANING PRODUCTS

121-123

FIXINGS

124-130

TAPES

131

STAY UP TO DATE

Keep regularly updated with news, views and offers via our social media pages.



facebook.com/eurocellofficial



twitter.com/eurocellplc



plus.google.com/+eurocell



linkedin.com/company/eurocell-plc



youtube.com/eurocellpvcu



pinterest.com/eurocell

SILICONES & SEALANTS

Eurocell stocks a variety of high-performance silicones, adhesives, expanding foams and fillers.

- ▶ Suitable for a variety of applications
- ▶ Ready to use
- ▶ Provides thermal break
- ▶ Mould-resistant
- ▶ Improved adhesion
- ▶ Tested to the highest standard
- ▶ Available in a range of colours



MAINTENANCE EXAMPLES



SILICONE SEALANTS

Our silicone sealants are ideal for window installations. Available in a variety of colours to match the window profile.

See the full range on [page 116](#)



SOLVENT-FREE CLEANERS

Revive PVC-U surfaces with solvent-free cleaners.

See [page 121](#) for more information, and to see the full cleaner range.



SILICONE SPRAY

This multi-use silicone spray spray is ideally suited for light lubrication of plastics and rubbers such as sliding doors and rubber seals.

Find out more [page 118](#).

FIXINGS

Get the right fixing for the job with permanent and secure fastening solutions in a wide range of materials, for a range of applications, including:

- ▶ Roofline installations
- ▶ Window installations
- ▶ Door installations
- ▶ DIY applications
 - shelving
 - hanging pictures
 - installing
 - blinds
 - PLUS much more



INSTALLATION EXAMPLES



CLADDING PINS

Cladding pins are available in 2 sizes, allowing you to complete your cladding installation with ease.

Find this product on [page 124](#).



FIXING PINS

Complete your roofline installation to the highest standards with 30mm and 40mm fixing pins. Available in a choice of colours to match your fascia boards.

Find this product on [page 124](#).



TRIM MOUNTING TAPE

Affix lightweight PVC-U trims with instant-adhesion trim mounting tape.

For more info, see [page 131](#).



SILICONES & SEALANTS



LMA
300ml

- ▶ Low modulus acetoxo
- ▶ General purpose sealant

Size	Code
300ml	PL 310

Colour options:
WH White / **CL** Clear / **BN** Brown
 / **BK** Black



LMN
300ml

- ▶ Low modulus neutral cure
- ▶ Ideal for sealing PVC-U products

Size	Code
300ml	PN 310

Colour options:
WH White / **CL** Clear / **BN** Brown
 / **TF** Toffee / **BK** Black / **RO**
 Rosewood / **CR** Cream



Sanitary
300ml

- ▶ For bathrooms and kitchens
- ▶ Low modulus acetoxo

Size	Code
300ml	PSS 310

Colour options:
WH White



Silirub
300ml

- ▶ Low modulus cure
- ▶ Stays permanently elastic after curing
- ▶ Ideal for sealings between PVC and glass

Size	Code
300ml	SIL12

Colour options:
WH White / **RO** Rosewood / **OK** Oak
 / **CL** Clear / **BN** Brown / **TF** Toffee
 / **CR** Cream / **BK** Black / **GY** Grey
 / **ANGY** Anthracite / **BF** Buff



Stay fresh anti-mould sealant
300ml

- ▶ Lifetime guarantee
- ▶ Low odour
- ▶ Solvent-free
- ▶ Compatible with all sanitary materials

Size	Code
300ml	STAYFRESH

Colour options:
ICYW Icy White / **CLEAR** Clear
 / **IVORY** Ivory



Fire Silicone
310ml

- ▶ Fire rated neutral cure, silicone sealant
- ▶ Solvent-free
- ▶ Virtually odourless
- ▶ Primerless adhesion on all common construction materials

Size	Code
310ml	SIL310FIRE

Colour options:
WH White



Aquafix
310ml

- ▶ Emergency repair product
- ▶ Adheres to most surface
- ▶ Seals even under water
- ▶ Transparent

Size **Code**

310ml AFIX 310

Colour options:
CL Clear



**FIX ALL IS A RANGE OF ALL-ROUNDER SEALANTS
SUITABLE FOR A WIDE VARIETY OF APPLICATIONS
– NO PRIMER REQUIRED!**



Roof & gutter seal
3010ml

- ▶ Durable, waterproof sealant
- ▶ Repairs roofing, guttering and piping
- ▶ Seals and bonds dry, damp and wet surfaces

Size **Code**

310ml GUTTERSEALANT

Colour options:
BK Black

- ▶ All-weather use
- ▶ Solvent-free
- ▶ Sanitary sealing
- ▶ High adhesive

Fix ALL High Tack

- ▶ Super strong
- ▶ 320kg/10cm²
- ▶ Ideal for heavy materials ie. mirrors and paintings

Size **Code**

290ml FIXALLHITACK

Colour options:

WH White / BK Black / GY Grey / BR Brown

Fix All Turbo

- ▶ Super fast – 20-min bond!
- ▶ End bond in 3 hours

Size **Code**

290ml FIXALLTURBO

Colour options: WH White

Fix All Flexi

- ▶ High elasticity and strength

Size **Code**

290ml FIXALLCLASSIC

Colour options:

WH White / BK Black / GY Grey / BR Brown

Fix All Ultra Tack

- ▶ Ultimate grab, 400 kg/m²
- ▶ Heavy duty bonding
- ▶ Ideal for sheet material, decor cladding, heavy objects

Size **Code**

290ml FIXALLXTR

Colour options: WH White

Fix All Crystal

- ▶ 100% crystal clear
- ▶ Ideal for kitchens, bathrooms and flooring

Size **Code**

290ml FIXALLCRYSTAL



CAULK



Decorator's caulk

- ▶ Fill gaps and cracks
- ▶ Ideal for plasterwork, skirting boards and architraves

Size	Code
300ml	PDC 310
380ml	PDC 380

Colour options:
WH White

LUBRICANT



Silicone spray 300ml

- ▶ Lubricates and protects
- ▶ Ideal for use on plastics and rubbers
- ▶ Transparent
- ▶ 360° aerosol

Size	Code
400ml	SILSPRAY

Colour options:
CL Clear

MORTAR



Bostik Cementone General Purpose Mortar

- ▶ Rapid setting waterproof cement.
- ▶ Ideal for emergency repairs, filling and patching.

Size	Code
5kgs	BST7072800G
10kgs	BST7072800F

SPECIALIST



Never Nails

- ▶ Solvent-free adhesive

Size	Code
300ml	PNN 310
380ml	PNN 380



Acrylic roof repair 5KG

- ▶ One-coat instant waterproof coating
- ▶ Dry and damp application

Size	Code
5kg	ROOFSEAL

Colour options:
GY Grey / BK Black



Lead 300ml

- ▶ Excellent adhesion to lead
- ▶ Ideal for sealing lead flashing

Size	Code
300ml	PLD310

Colour options:
GY Grey

ADHESIVES & ACTIVATORS



Stelmax 1985 adhesive

- ▶ Fast-acting vinyl adhesive
- ▶ Readily bonds to form maintenance free joints of exceptional strength

Size	Colour	Code
132g	White	1985
132g	Clear	1985 CL
132g	Mahogany	1985 WG



* Available in high or low viscosity.

Superglue

- ▶ Easy to apply
- ▶ High/low viscosity

Size	Code
20gm	SG 20 THICK
50gm	SG 50 THICK
20gm	SG 20
50gm	SG 50



Activator 200ml

- ▶ Instant cure and bonding in seconds

Size	Code
200ml	ACT 200



Superglue & activator kit 50gm/200ml

- ▶ Instant cure and bonding in seconds

Size	Code
50gm/200ml	SGKIT





PU FOAM & CLEANERS



Hand held PU foam
750ml

- ▶ Rapid curing hand held expanding foam
- ▶ For use on PVC-U, plastic, brick, stone, concrete, metals and timber

Size	Code
750ml	PHH 750



Gun PU foam
750ml

- ▶ Expanding foam, professional gun-grade
- ▶ For use on PVC-U, plastic, brick, stone, concrete, metals and timber

Size	Code
750ml	PGF 750



Gun foam cleaner
300ml

- ▶ For cleaning gun after use with PU foams
- ▶ Safely removes uncured foam from gun

Size	Code
300ml	PGFC 500

GAP FILLERS



Soudafoam FR
750ml

- ▶ Fire rated polyurethane expanding foam filler
- ▶ EN13501-1 – Reaction to fire, class E
- ▶ TAG-026 – Part 1, Part 3
- ▶ EN1366-4 – Fire resistance, up to 4 hours

Size	Code
750ml	SGF750FIRE

Colour options:
WH White



Stelmax 1965 gap filler
132g

- ▶ For use within the window frame
- ▶ Suitable for seals up to 5mm

Size	Code
132g	1965

Colour options:
WH White



Stelmax 1961 gap filler
300g

- ▶ Has a medium viscosity and flexibility suitable for seals up to 10mm
- ▶ Protects and seals
- ▶ Will not attract grime

Size	Colour	Code
300g	White	1961
300g	Mahogany	19861 M

CLEANING PRODUCTS



Soudafil Light
900ml

- ▶ An ultra lightweight filler for gaps and cracks
- ▶ Easy to tool and sand
- ▶ Sets hard with no shrinkage or sagging
- ▶ Overpaintable

Size	Code
750ml	SOUDAFIL900

Colour options:
WH White



WE'RE OPEN ON SATURDAYS*

If you're working weekends, then don't forget we open on a Saturday.

*Regional opening times vary.

WIPES



100
pack

Swipex super cleaning wipes

- ▶ Heavy-duty non-woven wipes
- ▶ Multi-purpose use
- ▶ Removes oil, sealant - and adhesive stains, grease etc. from hands

Code	Qty
113551	100 wipes per box



80
pack

Big wipes heavy duty premium wipes

- ▶ Tough on grime and kind to your hands
- ▶ Contains Vitamin E and Aloe Vera helping to nourish and protect skin
- ▶ Cleans paint, construction adhesives, wet sealants, uncured PU foam, grease bitumen and most oil-based spills from hands, tools, and surfaces

Code	Qty
HDWIPES80	80 wipes per box



CLEANERS / CLEANING PRODUCTS

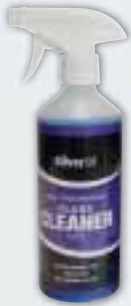

Glass cleaner

- ▶ Non-smearing glass cleaner

Size	Code
1 litre	GCLEAN1
5 litre	GCLEAN5
25 litre	GCLEAN25



Solvent cleaner

- ▶ Removes ingrained dirt, stains and pollution from PVC-U surfaces
- ▶ Suitable for PVC-U roofline, windows, doors and more

Size	Code
1 litre	SCLEAN1
5 litre	SCLEAN5



Cream cleaner

- ▶ Restore and revive PVC-U surfaces
- ▶ Solvent-free

Size	Code
1 litre	CCLEAN1



Heavy Duty Silversil Solvent Cleaner

- ▶ Professional fast acting, heavy duty industrial cleaner
- ▶ Can be used on many surfaces including Upvc windows and doors, soffits and most plastic products

Size	Code
1 litre	SCLEAN1-10



Silversil Cleaning Kit

- ▶ Contains Silversil Glass Cleaner, Cream Cleaner and J-cloth



Tissue rolls

- ▶ For use with our cleaning and restoration products
- ▶ Available in 3 sizes

Size	Code
Small (175mm x 120mm)	CTISS 200
Medium (175mm x 150mm)	CTISS 145
Large (230mm x 285mm)	CTISS 260



RECOMMENDED

MIGHTY GRIP AND AND GRAP ADHESIVE

- ▶ Incredible instant grab adhesive based on hybrid technology
- ▶ It bonds heavy objects to vertical surfaces immediately without slippage or support
- ▶ Excellent alternative fixing adhesive that replaces nails, screws and other mechanical fixings
- ▶ Can be used on damp or wet surfaces and is solvent free and cures quickly

Size	Code
290ml	SXMSGG290

SX MORTAR REPAIR CEMENT GREY

- ▶ Adheres without primer even on slightly damp surfaces
- ▶ Interior and exterior applications
- ▶ Easy to apply
- ▶ Easy to clean
- ▶ Non corrosive towards metals

Size	Code
290ml	SXMORTCE310GY

SOUDAFOAM GAP FILLER WITH GENIUS GUN

- ▶ Polyurethane foam filler
- ▶ Volume yield FEICA TM1003 - 750ml Gun Grade: 34L
- ▶ Acoustic rating ISO 717-1: 58 dB
- ▶ Thermal conductivity DIN 52612: 37mW/mK
- ▶ Application temperatures: +5C to +30C

Size	Code
600ml	130590-320069-LAB





FIXINGS

FIXING PINS



30mm & 40mm fixing pins

Size	Code
30mm	FP30
40mm	FP40

Colour options: **WH** White / **BL** Black / **BR** Brown / **O** Oak / **RW** Rosewood / **GY** Grey / **WLO1** Irish Oak / **WCR1** Cream / **WCR** Cream White* / **WT1** Chartwell Green* / **GY2** Slate Grey* (* Made to order)

FIXING NAILS



50mm & 65mm fixing nails

Size	Code
30mm	FN50
65mm	FN65

Colour options: **WH** White / **BL** Black / **BR** Brown / **O** Oak / **RW** Rosewood / **GY** Grey / **WLO1** Irish Oak / **WCR1** Cream / **WCR** Cream White* / **WT1** Chartwell Green* / **GY2** Slate Grey* (* Made to order)

CAPPED SCREWS

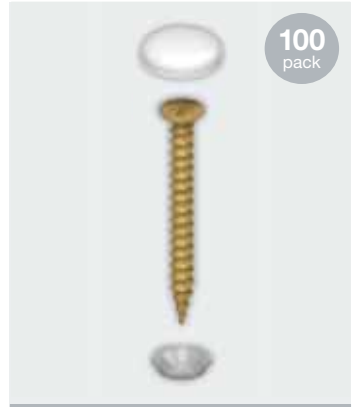

50mm capped screws

Size	Code
50mm	CS50

Colour options:
WH White

CLADDING PINS



Cladding pins

Size	Code
25mm	CP 25
30mm	CP 30



PERFECT PARTNER

Cladding pins are the perfect fixings for your cladding installation.

Choose **SHIPLAP** or **OPEN-V** style cladding, and freshen up tired properties with attractive, low-maintenance solutions from **EUROCELL**.

Find out more on page 14

SCREWS



- ▶ Hardened, yellow zinc plated, multi-purpose screws designed for use on a variety of materials such as hardwood, chipboard and MDF, without the need for pre-drilling

- ▶ Con-sert range offers the option of concrete fasteners with or without anchors
- ▶ Screw threads directly into both frame and masonry eliminating the need for a plug

Con-sert screw fixings

Size	Code	Qty
7.5 x 60mm	CS 7560	100 pack
7.5 x 80mm	CS 7580	100 pack
7.5 x 100mm	CS 75100	100 pack
7.5 x 120mm	CS 75120	100 pack
7.5 x 150mm	CS 75150	100 pack
Caps		
White	CS CAP WH	100 pack
Black	CS CAP BL	100 pack
Brown	CS CAP BR	100 pack

4mm multi-purpose screws

Size	Code	Qty
4mm x 25mm	MP 4025	200 pack
4mm x 30mm	MP 4030	200 pack
4mm x 35mm	MP 4035	200 pack
4mm x 40mm	MP 4040	200 pack
4mm x 45mm	MP 4045	200 pack
4mm x 50mm	MP 4050	200 pack
4mm x 60mm	MP 4060	200 pack
4mm x 70mm	MP 4070	200 pack

5mm multi-purpose screws

Size	Code	Qty
5mm x 20mm	MP 5020	200 pack
5mm x 25mm	MP 5025	200 pack
5mm x 30mm	MP 5030	200 pack
5mm x 40mm	MP 5040	200 pack
5mm x 45mm	MP 5045	200 pack
5mm x 50mm	MP 5050	200 pack
5mm x 60mm	MP 5060	200 pack
5mm x 70mm	MP 5070	200 pack
5mm x 80mm	MP 5080	100 pack
5mm x 90mm	MP 5090	100 pack
5mm x 100mm	MP 50100	100 pack



FIXING SCREWS



Phillips Ultimate II Screws Z&Y

5.00

Code	Size	Qty
PSZY5050	5.00 x 50mm	BOX200
PSZY5060	5.00 x 60mm	BOX200
PSZY5070	5.00 x 70mm	BOX200
PSZY5080	5.00 x 80mm	BOX200
PSZY50100	5.00 x 100mm	BOX100

4.00

Code	Size	Qty
PSZY4025	4.00 x 25mm	BOX200
PSZY4030	4.00 x 30mm	BOX200
PSZY4040	4.00 x 40mm	BOX200
PSZY4050	4.00 x 50mm	BOX200

3.50

Code	Size	Qty
PSZY3520	3.50 x 20mm	BOX200
PSZY3525	3.50 x 25mm	BOX200
PSZY3530	3.50 x 30mm	BOX200

Phillips Assortment Pack Z&Y Wood Screws



Code	Qty
WOODSCREWPK	BOX1000

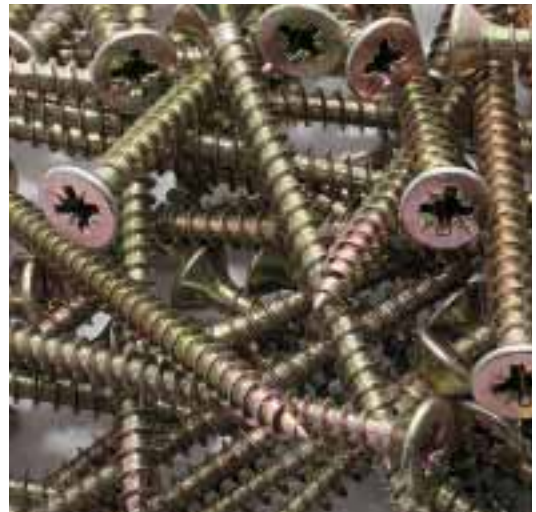

Multi Purpose Z&Y Screws

6.00

Code	Size	Qty
MPZY6080	6.00 x 80mm	BOX50
MPZY60100	6.00 x 100mm	BOX50

4.50

Code	Size	Qty
MPZY4540	4.50 x 40mm	BOX200
MPZY4550	4.50 x 50mm	BOX100
MPZY4570	4.50 x 70mm	BOX100

4.00

Code	Size	Qty
MPZY4020	4.00 x 20mm	BOX200

3.50

Code	Size	Qty
MPZY3516	3.50 x 16mm	BOX200
MPZY3520	3.50 x 20mm	BOX200
MPZY3525	3.50 x 25mm	BOX200
MPZY3530	3.50 x 30mm	BOX200
MPZY3535	3.50 x 35mm	BOX200
MPZY3540	3.50 x 40mm	BOX200

DECKING SCREWS



▶ Ideal for installing a soft wood timber deck

Decking Screws

5.00

Code	Size	Qty
DECK5070	5.00 x 70mm	200

4.00

Code	Size	Qty
DECK4050	4.00 x 50mm	500
DECK4065	4.00 x 65mm	350

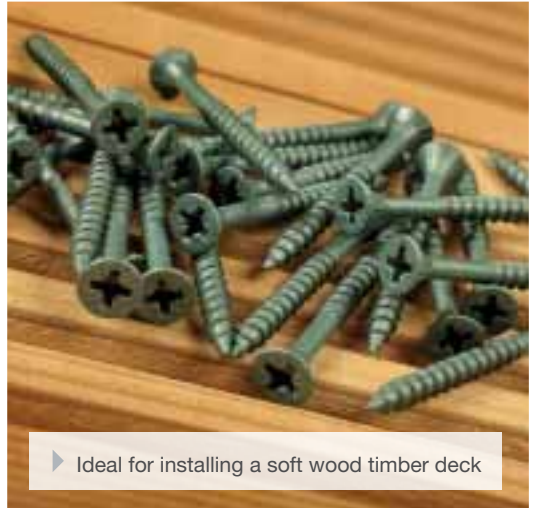

▶ Ideal for installing a soft wood timber deck

Phillips Ulti-Mate Stick-Fit Green Decking Screws

5.00

Code	Size	Qty
PSDECK5070	5.00 x 70mm	200

4.00

Code	Size	Qty
PSDECK4050	4.00 x 50mm	500
PSDECK4065	4.00 x 65mm	350

FENCING PINS

R/Neck - Fencing Pins



Code	Size	Qty
CTL9927820W	9 x 1200mm	10

Hi-Vis Orange Fencing



Code	Size
CTL9923010A	1m x 50m ROLL

▶ ...samples of the product, and get expert advice from our staff



FISCHER FRAME FIXING SCREWS

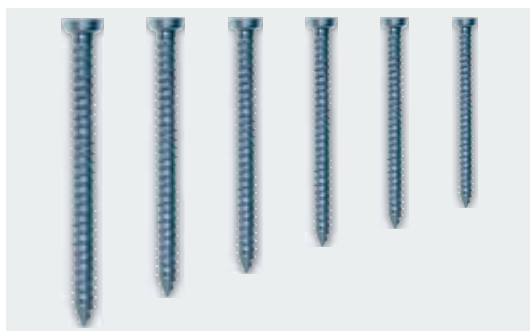

Fischer Premium FFS Frame Fixing Screws 3.5

Size	Code	Qty
7.5 x 72mm	FS72	100 pack
7.5 x 92mm	FFS92	100 pack
7.5 x 1022mm	FFS102	100 pack
7.5 x 112mm	FFS112	100 pack
7.5 x 132mm	FFS132	100 pack
7.5 x 152mm	FFS152	100 pack



BP Fischer Premium FFS Frame Fixing Screws

Size	Code	Qty
7.5 x 92mm	FFSBP92	10 pack
7.5 x 112mm	BPFFS112	10 pack
7.5 x 132mm	BPFFS132	10 pack



BP Fischer Premium SXR-Z Frame Fixing

Size	Code	Qty
8 x 60mm	FFBPSXR-Z860	16 pack
8 x 100mm	FFBPSXR-Z8100	16 pack
10 x 100mm	FFBPSXR-Z10100	12 pack



BP Fischer UPVC Window Frame Fixings With White Caps

Size	Code	Qty
8 x 100mm	FFBPPVC8100	8 pack
10 x 120mm	FFBPPVC10120	8 pack



Fischer UPVC Window Frame Fixings

Size	Code	Qty
8 x 100mm	FFWFF8100	50 pack
10 x 120mm	FFWFF10120	50 pack



BP Fischer N-Z Hammerfix

Size	Code
N6 x 60mm	FFBPNZN660
N8 x 80mm	FFBPNZN880
N8 x 1200mm	FFBPNZN8120



Fischer N-Z Hammerfix

Size	Code
N6 x 60mm	FFHFIXN660
N8 x 80mm	FFHFIXN880
N8 x 1200mm	FFHFIXN8120



BP Fischer SX Nylon High Performance Wallplug + Screws

Size	Code
6 x 30mm	FFBPSXPLUG630
8 x 40mm	FFBPSXPLUG840

NYLON FIXINGS



- ▶ Ideal for window and door frames made of wood, PVC or aluminium
- ▶ Through-fixing eliminates the need for marking, for ease and speed of installation
- ▶ Supplied with white cover caps

Nylon window anchor

Size	Code	Qty
8 x 100mm	CNWA 8100	100 pack
8 x 140mm	CNWA 8140	100 pack
10 x 75mm	CNWA 1075	100 pack
10 x 100mm	CNWA 10100	100 pack
10 x 120mm	CNWA 10120	100 pack
10 x 140mm	CNWA 10140	100 pack

Nylon hammer fixings

Size	Code	Qty
8 x 100mm	CNHF 8100	100 pack
8 x 120mm	CNHF 8120	100 pack

DRILL BITS

Drill bits

Size	Code	Qty
6.5 x 210mm	CSDB 65210	1 pack
6.5 x 260mm	CSDB 65260	1 pack

WALL PLUGS



Wall plugs

- ▶ All-purpose lightweight fixings
- ▶ Colour coded plugs for use with 3-10mm or 4-8 gauge screws
- ▶ Cost effective solution for lightweight applications

Size	Code	Qty
5mm yellow	YELLOWPLUG	100 pack
5.5mm red	REDPLUG	100 pack
7mm brown	BROWNPLUG	100 pack

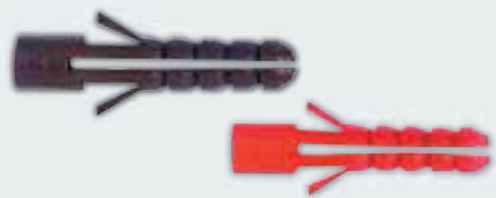

Fischer Red Plastic Plug

Red

Size	Code	Qty
6mm	FFPLUGRD	100 pack

Brown

Size	Code	Qty
7mm	FFPLUG100BN	100 pack
7mm	FFPLUG300BN	300 pack



NAILS



2.5 kg

Bright Round Wire Nails

Size	Code	Qty
75 x 3.75mm	BRW75T	2.5kg tub
100 x 4.5mm	BRW100T	2.5kg tub



2.5 kg

Galvanised Nails

Round Wire

Size	Code	Qty
50 x 2.65mm	GRW50T	2.5Kg pack
75 x 3.75mm	GRW75T	2.5Kg pack
100 x 4mm	GRW100T	2.5Kg pack

Square Twist

Size	Code	Qty
30 x 3.75mm	GST30T	2.5Kg pack



2.5 kg

Galvanised Clout Nails

ELH		
Size	Code	Qty
20 x 3mm	GEC20T	2.5Kg pack
Size	Code	Qty
40 x 2.65mm	GCN40T	2.5kg tub
50 x 2.65mm	GCN50T	2.5kg tub



1 kg

Aluminium Clout Nails

Size	Code	Qty
3.35 x 40mm	ACN40T	1Kg pack

TAPES

TRIM MOUNTING TAPE



Trim mounting tape

- ▶ Adhesive mounting tape for easy application of trims onto new PVC-U door, window and conservatory installations
- ▶ Instant adhesion
- ▶ Permanent bonding of internal lightweight plastic finishing trims on to PVC-U windows doors and conservatory profiles
- ▶ Adheres to almost all plastic surfaces

Size	Code
1mm (d) x 10mm (w) x 50m (l)	11050 WTMT

Colour options: **WH** White



RECOMMENDED



**15-YR
GUARANTEE***

*Not PE-DSP grade

DSX SECURITY TAPE

- ▶ Cost effective – replaces the internal gasket and reduces site glazing time
- ▶ High quality adhesive systems for maximum performance
- ▶ Enables externally beaded windows to satisfy the glazing security requirements of BS 7950

Black

Size	Length	Code
1mm x 10mm	50m	11050BDSX
2mm x 10mm	25m	21025BDSX
3mm x 10mm	20m	31020BDSX
4mm x 10mm	15m	41015BDSX
5mm x 10mm	12m	51012BDSX

White

Size	Length	Code
1mm x 10mm	50m	11050WDSX
2mm x 10mm	25m	21025WDSX



TRIMS FOR EVERY APPLICATION

We stock a range of **PVC-U FINISHING TRIMS**, allowing you to give the perfect finish to your installation – every time! Used with the trim mounting tape above, you get instant adhesion, so you don't need to waste time waiting for silicones to bond.

To see the full range, and tips go to **page 107**



DOORS



High security, low-maintenance and attractive composite, PVC-U and garage doors available in a range of colours and styles



All together better



**DALES COLLECTION
COMPOSITE DOORS**

Our Dales Collection composite door range is better than ever! 12 stunning styles available in 15 colours.

Find out more from page 134



ASPECT BI-FOLD DOORS

Why not open yourself up to a new business opportunity? Aspect is a new sensation in PVC-U folding sliding doors and are a hit with consumers – so why not start installing them today?

Find out more on page 146



STUDIO GLIDE BI-FOLD DOORS

StudioGlide™ isn't just a winning combination of high performance and thermal efficiency. Quality materials and advanced design make for a smooth, reliable sliding mechanism and frames that won't expand or contract, whatever extremes the weather throws at them.

Find out more on pages 148-149



ORDER BY PHONE

Call your local branch direct on
08000 77 88 88

ORDER ONLINE

eurocell.co.uk/buyonline

SHOP IN-BRANCH

Find your nearest branch at
eurocell.co.uk/branchfinder



DOORS

COMPOSITE DOORS
.....134-139

PVC-U DOORS
.....140

PVC-U DOOR CANOPIES
.....141

DOOR SURROUNDS
.....142

GARAGE DOORS
.....143-144

PATIO DOORS
.....145

BI-FOLD DOORS
.....146-149

WHAT IS THE DALES COLLECTION?

This collection of composite doors from Eurocell offers better security, better sustainability and better aesthetics

FEATURES



INSULATED RIGID
FOAM INFILL
PANEL

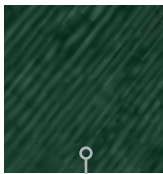

4MM TOUGH GRP
OUTER SKIN



ALUMINIUM
LOW THRESHOLD



TRIPLE-SEAL
FRAME WITH
THERMAL INSERTS



CYLINDER
LOCK



**25-YR
GUARANTEE**

On door furniture.
Conditions apply

**Doors available on a
6 day leadtime***

*This excludes doors from the Contemporary and Heritage colour ranges, doors with coloured interiors and doors with sidelights or toplights - all of which have an 11-day lead-time



VIDEOS

You Tube

WATCH

See our **composite door promotional video** and **installation overview video** - offering tips for best practice when installing your door



Watch now at [youtube.com/eurocellpvcu](https://www.youtube.com/eurocellpvcu)



THE PERFECT REPLACEMENT DOOR IN 12 STUNNING STYLES

- ▶ Triple-seal frame system ensures doors remain watertight even in the harshest weather conditions
- ▶ 3-way adjustable hinges mean they are quick and easy to install
- ▶ Selection of stainless steel door furniture, covered by a 25-year guarantee



COLOUR OPTIONS



- PAS 23/24 for improved security
- BM Trada Q-mark achieved
- B-rated doors as standard. A-rated available
- Association of Chief Police Officers' Secured by Design approved (subject to specification)

STANDARD RANGE



DOOR COLOURS

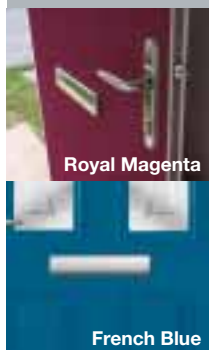

HERITAGE RANGE

Made-to-order - 11-day lead time applies



CONTEMPORARY RANGE

Made-to-order - 11-day lead time applies

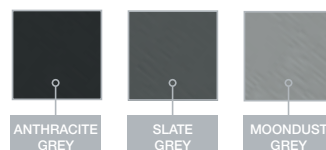



THE DALES COLLECTION STYLES includes triple-seal frame system



The Bretton
Shown with Eos glass



Solid also available

The Chatsworth
Shown with blue diamond glass



The Chelmorton
Shown with mene glass



The Hathersage
Shown with Eos glass



Solid also available

The Thorpe
Shown with clear classic glass



The Winstor
Shown with spirit glass



NEW

The Newhaven
Shown with reflections glass



THE DALES COLLECTION TRIPLE GLAZED STYLES includes triple-seal frame system



The Brassington
Shown with sunburst
glazing cassette



The Bradbourne
Shown with diamond
classic glass



The Cromford
Shown with eos glass



The Litton
Shown with lattice
classic glass



Solid also available

The Middleton
Shown with andaman
glass



The Wirksworth
Shown with diamond
classic glass



The Elton
Shown with simplicity
glass



The Hartington
Shown with simplicity
glass



THE DALES COLLECTION GLASS STYLES



Other colours available

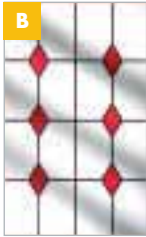

Other colours available



Other colours available

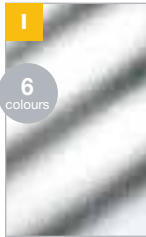
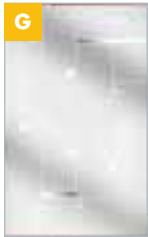

6 colours

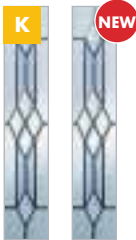

NEW



NEW



NEW

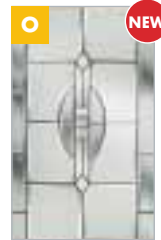

NEW



GLASS VARIATIONS See table for glass options	Options			
	DOUBLE GLAZED	TRIPLE GLAZED	LEADING COLOUR	CHOICE OF BACKING GLASS
A. Bevel Diamond	●	x	●	●
B. Diamond	●	x	●	●
C. EOS	●	x	x	●
D. Kara	x	●	● ●	x
E. Lattice	●	x	●	●
F. Murano	●	x	x	●
G. Mene	●	x	x	●
H. Spirit	●	x	●	●
I. Standard	●	x	x	●
J. Diamond Classic	x	●	●	●
K. Prestige	●	x	●	●
L. Silvaner	●	x	x	●
M. Bohemia	●	x	x	●
N. Simplicity	●	x	●	●
O. Reflections	●	x	x	●
P. Dorchester	●	x	●	●

KEY ● Available x Not available ● ● Colour



STAINLESS STEEL FURNITURE

- Our door furniture range is ideal to complement The Dales Collection, whether you're looking for a chic, modern or traditional finish

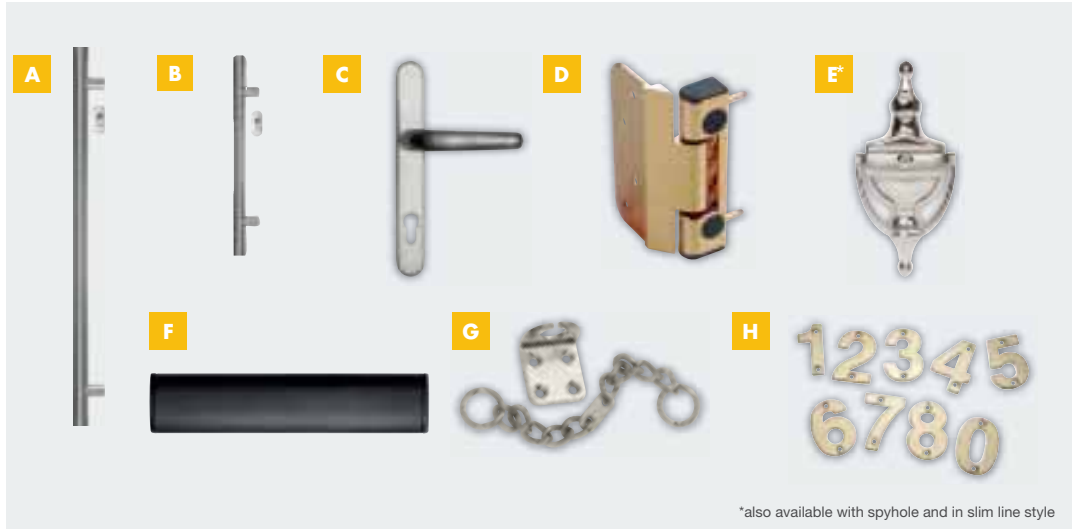

*also available with spyhole and in slim line style

- A. Long bar D. Hinges G. Door chain
B. Short bar E. Knocker H. Numbers
C. Lever/Lever F. Letterboxes

COLOUR OPTIONS

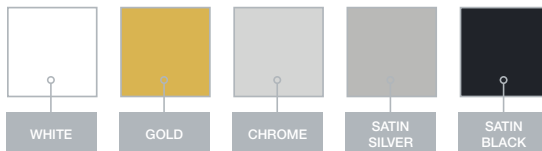

FURNITURE COLOURS



Satin Silver

Satin Black

**TRADE
DISCOUNTS
ARE AVAILABLE**

- why not open an
account in-branch
today?



PVC-U DOORS

VERSATILE DOORS THAT WILL ENHANCE ANY HOME

- ▶ Extensive choice of attractive, hard-wearing doors in a choice of styles
- ▶ High levels of security
- ▶ A range of glazing options available
- ▶ Thermally efficient
- ▶ Heat and moisture resistant
- ▶ Inverted designs also available

For more details ask a member of staff at your **local Eurocell branch today!**



COLOUR OPTIONS



WH WHITE



WO GOLDEN OAK



WL01 IRISH OAK



RO ROSEWOOD

PVC-U DOOR CANOPIES



IDEAL FOR NEW BUILD AND REFURBISHMENT PROJECTS

- ▶ Suitable for a variety of entrance doors
- ▶ Designed GRP material is low-maintenance - it will never need repainting!



The ripley

- ▶ Flat top, lead-look canopy with scalloped edge and Georgian period detailing will add prestige to any property

Size	Code
1500mm	RIP 1500
1500mm	RIP 1500

Colour options: **WH** White



3 designs

The cheltenham

- ▶ This strong, rigid GRP dual pitch canopy with tile effect roof and imitation woodgrain detailing is available with 3 design options on the gable

Style	Code
730mm std	CHELT 730
730mm fleur	CHELT 730F
730mm t-bar	CHELT 730T

Colour options: **WH** White



3 designs

The rockingham

- ▶ Elegant Victorian style GRP door canopy incorporating fully moulded brackets offers a period look for your customers

Style	Code
With brackets	ROC B
No brackets	ROC WB
Lead-top effect	ROC CL

Colour options: **WH** White

▶ Trade discounts are available - why not open an account in-branch today?



DOOR SURROUNDS

THE VICTORIAN



Add prestige to entrance doors

Code

Colours

VTPS

WH White

THE GEORGIAN



This regal design will enhance any doorway

Code

Colours

G TPS

WH White

FREESTANDING COLUMNS



The finishing touch to entrance doors

Style

Code

Flat pillar

FP

Plain column

COLPL

Fluted column

RCOLFLU

Colour options: WH White

GARAGE DOORS

STRONG, SECURE AND LIGHTWEIGHT GARAGE DOORS - SUITABLE FOR EVERY HOME!

10+
styles

- ▶ High quality, low-maintenance design
- ▶ Glazing available on certain styles
- ▶ Two-point locking as standard
- ▶ Fully bonded steel stiffeners reinforce the panel and protect against forced entry
- ▶ Corrosion resistant
- ▶ Remote control automated doors with security code technology are available
- ▶ Garage doors are available as up-and-over, side-hinged, sectional or roller type doors
- ▶ Available with or without frames
- ▶ Various range of colours available

Single garage doors available in
7', 7.6' and 8' widths

Double garage doors available in
14' wide by 6.6' or 7' high



The arden



The carlton



The sherbourne



The sherwood



FREE DELIVERY!

WE CAN DELIVER YOUR ORDER DIRECT TO SITE

Get all your drainwater system and drainage delivered direct to your site (or to your premises if you prefer), along with the rest of your building plastics needs

To qualify for FREE DELIVERY, just spend only £100!*

*EX-VAT

EUROSLIDE PATIO DOORS

SLIM AND ATTRACTIVE PATIO DOORS - A PERFECT ADDITION TO YOUR OFFERING

- ▶ 2, 3 or 4 pane options
- ▶ Internal or external door
- ▶ Separate chambers for improved drainage, thermal efficiency and strength
- ▶ Internally glazed for improved security
- ▶ Fully weather-sealed to keep out draughts
- ▶ Anti-lift device prevents panes being lifted by a would-be intruder
- ▶ Part M compliant threshold
- ▶ Available in bar lengths and kits

For more information please call us on
08000 77 88 88 today!



NEW!

**SMOOTH OPENING & SUPERIOR GLIDE
BI-DIRECTIONAL ROLLER SYSTEM**



**SUPERIOR GLIDE
FROM 8 INBUILT ROLLERS**



**INTELLIGENT
BY DESIGN**

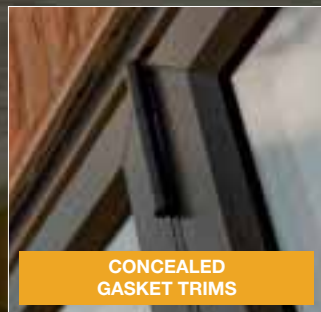

**CONCEALED
GASKET TRIMS**

**For more information visit
eurocell.co.uk/aspect**

aspect[®]

Beautifully designed, easy to install PVC-U bi-fold doors



Main image courtesy of Lissett Homes

The first bi-fold door on the UK market to achieve BBA certification and Secured by Design accreditation



AVAILABLE WITH
PART M THRESHOLD

Secured by Design
Official Police Security Initiative

BBA BRITISH BOARD OF AGREEMENT
TECHNICAL APPROVALS FOR CONSTRUCTION

Certificate number
13/5043

GREENBUILD 2012

DOCUMENT Q COMPLIANT

For more information call us
on **08000 77 88 88** today.

NEW!

DESIRABLE.

SCALABLE. DURABLE.

STUDIOGLIDE™ BI-FOLD DOORS

U1.3

ENVIRONMENTAL PERFORMANCE

U-values as low as 1.6W/m²k for double glazing and 1.3 W/m²k for triple glazing



INCREASED SCALABILITY

Endless possibilities with a maximum frame height of 2.5m and width of 6.5m and individual sashes that can be up to 1.2m wide



MINIMAL SIGHT LINES

Minimal profiles for a modern look and inline system with sash and outer frame of the same depth

10
YEAR

PEACE OF MIND

10-year guarantee. Tested to BS6375 2015. PAS 24 accredited for security

STUDIO

Glide™



THE HIGH-PERFORMANCE ALUMINIUM BI-FOLD.

StudioGlide™ isn't just a winning combination of high performance and thermal efficiency. Quality materials and advanced design make for a smooth, reliable sliding mechanism and frames that won't expand or contract, whatever extremes the weather throws at them.



For further information visit studioglide.co.uk



HARDWARE

Eurocell offers a wide selection of Door Hardware, Window Hardware, Additional Security, Architectural Ironmongery and Tools for repair and maintenance.



THE KEY TO HASSLE-FREE LOCK REPLACEMENT IS IN YOUR HANDS

**10-YR
GUARANTEE**

Don't let your customers fall victim to insurance company small print

- ▶ Quick and easy replacement
- ▶ Insurance recognised
- ▶ Sold Secure SS312Diamond Standard (endorsed by the Master Locksmith Association)
- ▶ Secured By Design Standard

**ANTI
DRILL**

**ANTI
SNAP**

**ANTI
PICK**

**ANTI
BUMP**

**EURO DOUBLE
CYLINDER**

**EURO SINGLE
CYLINDER**

**EURO TURN
CYLINDER**

3 SEPARATE LINES OF DEFENCE

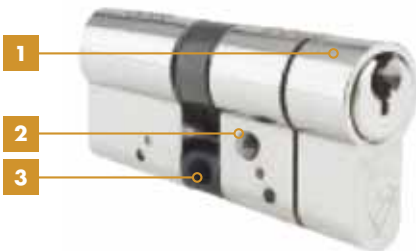
**IN STOCK
AT YOUR
LOCAL
BRANCH**

DETER'S THE MOST DETERMINED ATTACK!

It's a fact that more insurance companies are now specifying that high performance locks such as **Schlosser Anti-Snap Cylinder** are fitted before paying out claims. Just look at the great built-in security features opposite:

1 SNAP-OFF FRONT SECTION

If attacked, the cylinder will come away, giving the intruder less of the cylinder to grip.

2 HARDENED GRIP DEFLECTORS

Make gripping the rest of the cylinder difficult

3 HARDENED REINFORCED BAR

This is designed not to snap, but to flex in a way that will defeat the majority of intruders



LOCKS

REPLACEMENT CYLINDER LOCKS

For budget-conscious customers, there is the Euro Profile Cylinder. Available with single cylinder, double cylinder and turn cylinder

- ▶ 6-pin Euro profile cylinder
- ▶ Quick and easy replacement for existing cylinder
- ▶ Tested to BS EN 1303:2005
- ▶ Available in polished brass and nickel

Euro Profile Cylinder



2-YR
GUARANTEE



RECOMMENDED

REVOLUTIONARY MULTI-POINT REPLACEMENT LOCKS

Doormaster™

- ▶ Doormaster™ replacement locks utilise the latest patented technology to ensure secure and reliable installation. There are three locks available to meet your requirements
- ▶ Easy to install
- ▶ Compatible with 80% of doors

Universal

- ▶ Standard security
- ▶ Central hook protects against attack
- ▶ 1-piece easy adjustment rollers
- ▶ Compatible with PVC-U doors

Adjustable

- ▶ High security
- ▶ Secured By Design approved
- ▶ Central hook protects against attack
- ▶ Adjustment rollers
- ▶ 3-hooks for high security anti-separation
- ▶ Compatible with PVC-U doors

Professional

- ▶ High security
- ▶ Secured By Design approved
- ▶ Central hook protects against attack
- ▶ Adjustment rollers
- ▶ 3-hooks for high security anti-separation
- ▶ Compatible with PVC-U doors, composite and timber doors



AVAILABLE
AT SELECTED
BRANCHES
ONLY

10-YR
GUARANTEE

HARDWARE



Sparta sprung door handle

Size	Code
122mm fixing crs/92mm PZ	ST-DH4636TS
210mm fixing crs/92mm PZ	ST-DH4645TS

Colour options: CH Chrome, GO Gold, WH White



Schlosser sprung door handle

▶ Apto L/L 70 Sprung - 180 Fix Crs 205 O/A

Size	Code
180mm	ST-DH4720

Colour options: CH Chrome, GO Gold, WH White



Ideal Flag hinge

▶ Ideal Flag hinge to suit sash rebate

Size	Code
14-25mm	ST-HIN6114

Colour options: BR Brown, WH White



Butt Hinges 115mm

Style	Code
0 degree	ST-HIN6115
15 degree	ST-HIN6116

Colour options: BR Brown, WH White



Letterplates

▶ Letterplate with BLACK ABS frame

Style	Code
aluminium 10"	ST-LP4600
aluminium 12"	ST-LP4602

Colour options: GO Gold, SI Chrome, WH White



HARDWARE



Centre striker

► Adjustable centre striker with plastic packer

Style	Code
Left hand	ST-MPA3240LH
Right hand	ST-MPA3240RH



Centre Cases

Style	Size	Code
Lockmaster PL LDB 2 Followers Centre Case only	35/92/62	ST-MPL3113
Lockmaster PL LDB 1 Followers Centre Case only	35/92	ST-MPL3114
Milla Centre Case with LDB 1 Follower	35/92	ST-MPL3151
GU Old Type Centre Case with CPB 1 Follower	35/92	ST-MPL3213



Schlosser Technik Sash Blocker Non-Locking

Code

ST-SJ5171N

Colour options: **BR** Brown, **WH** White



Screws

Style	Size	Code
Pan Head friction stay screws	3.9x16mm	ST-SC39X16PDBAG
Countersunk Reinforced screws	3.9x25mm	ST-SC39X25PDBAG
Countersunk Reinforced screws	3.9x38mm	ST-SC39X38CDBAG
Countersunk UPVC screws	4.3x25mm	ST-SC43X25CGBAG
Countersunk UPVC screws	4.3x40mm	ST-SC43X40CGBAG
Countersunk Repair screws	4.8x25mm	ST-SC48X25CGBAG
Countersunk Repair screws	4.8x38mm	ST-SC48X38CGBAG



Apto Cockspur handle 9mm-21mm

Style	Colour	Code
Left hand	Gold	ST-WCH1801PLGO
Left hand	Chrome	ST-WCH1801PLSI
Left hand	White	ST-WCH1801PLWH
Right hand	Gold	ST-WCH1801PRGO
Right hand	Chrome	ST-WCH1801PRSI
Right hand	White	ST-WCH1801PRWH

Colour options: **GO** Gold, **SI** Chrome, **WH** White



Apto Cockspur Wedge Kit

Size	Code
(1x2mm, 1x3mm, 1x4mm & 1x5mm)	ST-WCH1803

Colour options: **BL** Black, **WH** White



Friction Stay Hinges with 17mm packer (pair)

Style	Size	Code
Top Hung Friction Stay	13mm x 8"	ST-WFS5200
Top Hung Friction Stay	13mm x 10"	ST-WFS5201
Top Hung Friction Stay	13mm x 12"	ST-WFS5202
Top & Side Hung Stay	13mm x 16"	ST-WFS5203
Top Hung Friction Stay	13mm x 20"	ST-WFS5204
Top Hung Friction Stay	13mm x 24"	ST-WFS5205
Egress Friction Stay with	10.3" x 13mm	ST-WFS5240
Egress Friction Stay with	16" x 13mm	ST-WFS5241



Window espag handle (43mm)

Style	Code
In-Line locking	ST-WEH5440-40SP

Colour options: **GO** Gold, **CH** Chrome, **WH** White



Concealed Window Restrictor 11.5mm

Style	Code
Left Hung with Stud Plate	ST-WR5160LSIKIT-11.5
Right Hung with Stud Plate	ST-WR5160RSIKIT-11.5



MINI Cable Restrictor 200mm

Code
ST-WR7210
Colour options: BR Brown, WH White



Schlosser Technik Snap-Safe Euro Cylinder

► Dual Finish - EN 1303 - 3 Keys

Size	Code
30mm/30mm	UE6 3030 D
35mm/35mm	UE6 3535 D
35mm/40mm	UE6 3540 D
35mm/45mm	UE6 3545 D
35mm/55mm	UE6 3555 D
40mm/40mm	UE6 4040 D
40mm/45mm	UE6 4045 D
40mm/50mm	UE6 4050 D
40mm/55mm	UE6 4055 D
40mm/60mm	UE6 4060 D
45mm/45mm	UE6 4545 D
45mm/50mm	UE6 4550 D
45mm/55mm	UE6 4555 D
50mm/50mm	UE6 5050 D

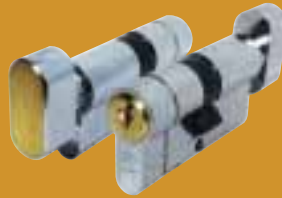

Schlosser Technik Snap-Safe Thumbturn Euro Cylinder

► Dual Finish - EN 1303 - 3 Keys

Size	Code
35mm /35mm	UE635T35D
40mm /40mm	UE640T40D
50mm /50mm	UE650T50D



SCHLOSSER TECHNIK SNAP SAFE EURO CYLINDER

Don't let your customers fall victim to insurance company small print – choose insurance-backed Schlosser replacement locks – in-branch now!

HARDWARE

MORE FOR PVC-U WINDOWS & DOORS

NEW



**3000+ PRODUCTS
INCLUDING
OBSOLETE RANGES**



**TOP SELLERS STOCKED IN
185+ LOCAL BRANCHES
NATIONWIDE**



**ORDER ONLINE FOR
SAME DAY NATIONWIDE
DISPATCH**

For more information and to order the full range of **3000+ products** online visit

eurocell-hardware.co.uk



CONSERVATORIES



A superb selection of conservatory roofs to suit every home, plus conservatory accessories and canopies



All together better



EQUINOX TILED ROOFS

Transform your customers' conservatories from an under-used room into a cosy, welcoming space that provides complete comfort all year round.

Find out more from page 161



SKYPOD SKYLIGHTS

With a **NEW** acute design option now available, Skypod skylights have never looked better. Why not offer your customers sleek, contemporary design with Skypod today?

Find out more on page 170



POLYCARBONATE ROOF GLAZING

Polycarbonate offers a great cost saving solution to traditional glass options.

Find out more on page 174

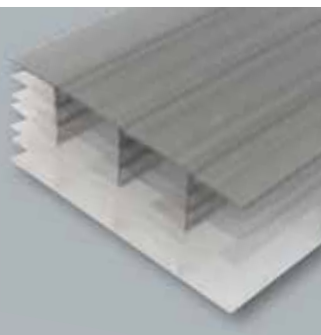

ORDER BY PHONE

Call your local branch direct on
08000 77 88 88

ORDER ONLINE

eurocell.co.uk/buyonline

SHOP IN-BRANCH

Find your nearest branch at
eurocell.co.uk/branchfinder



CONSERVATORY
ROOF SYSTEMS

**EQUINOX TILED
ROOF SYSTEM**
.....161-164

**CONSERVATORY
ROOFS**
.....166-167

MODULAR ROOFS
.....168-169

**SKYPOD
SKYLIGHTS**
.....170-173

ROOF GLAZING
.....174-176

**CONSERVATORY
PVC-U PANELS**
.....177

CANOPIES
.....177

**185+
BRANCHES**



Nationwide coverage & with new branches opening all the time we can provide a local service wherever you need us.

to locate your
nearest branch
see pages 4-5



CONTEMPORARY CONSERVATORY DESIGN



CONSERVATORIES DON'T NEED TO BE CONSERVATIVE

Need something different to standard out-of-the-box solutions like the Edwardian or Victorian styles? Give your customers a contemporary alternative – we can help you design a solution that really has the wow factor.

Design options are endless, and with a range of new and special colours like Irish Oak and Chartwell Green, you can offer your customers more choice than ever before.

SPECIAL COLOUR OPTIONS



WT1
CHARTWELL
GREEN



WO GOLDEN
OAK



WL01 IRISH
OAK



RO
ROSEWOOD

Request your roof kit quotation at your **local Eurocell branch today!**

TILED ROOF SYSTEM

TRANSFORM UNDER-USED
CONSERVATORIES INTO USABLE LIVING
SPACES - 24/7, 365 DAYS A YEAR

equinox[®]
THE DIFFERENCE IS NIGHT & DAY

**10-YR
GUARANTEE**
Conditions apply



TILED ROOF SYSTEM TILE OPTIONS

Steel tiles

▶ Steel tiles come as standard, and are lightweight and available in a choice of colours to suit many house styles

COLOUR OPTIONS

CHARCOAL	ANTIQUÉ RED	BURNT UMBER	MOSS GREEN	EBONY

Composite slate tiles

▶ Composite tiles offer the authentic look of traditional slate tiles without the risk of shattering, fading, warping or cracking

COLOUR OPTIONS

BRICK RED	PEWTER GREY	STONE BLACK	CHESTNUT	PLUM

NEW

SLATESKIN GRP SHEET SLATE TILES

This authentic slate-effect sheet tile allows you to tile an Equinox roof upto 50% faster than composite slate tiles.

- VARIABLE PITCHES = MORE CONVERSIONS
- PRECISION-ENGINEERED
- 25 YEAR GUARANTEE +AA FIRE RATED
- NO CONDENSATION

slateskin[®]

INSTALL A TRADITIONAL SLATE-EFFECT TILE SYSTEM IN 50% LESS TIME



**COMING
OCTOBER
2017**



**COMPONENTS SUPPLIED
PRE-CUT TO SIZE**

TILED ROOF SYSTEM ROOF WINDOWS

- ▶ A choice of high-quality, market-leading roof windows are available and can be fitted into the roof system.



For more details ask a member of staff at your **local Eurocell branch!**



PLUS

EQUINOX IS ALSO SUITABLE FOR:

- Flat roofs - Extensions - Porches



COLOUR OPTIONS

FASCIA COLOURS

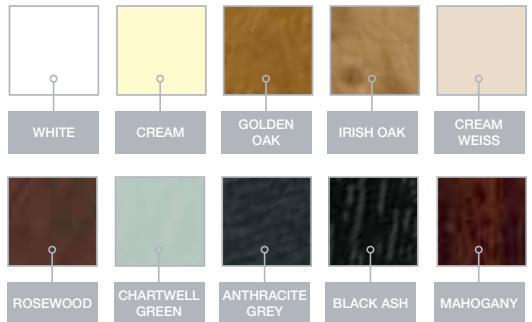

GUTTERING COLOURS

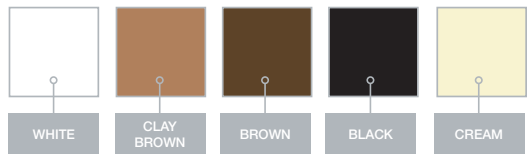

HINTS & TIPS

COMPATIBLE WITH ALL ROOF STYLES

- Victorian - Edwardian - Gable-ended - P-shaped - Lean-to

- ▶ Got a technical question? Our branch staff are here to help – just ask!



HINTS & TIPS

You Tube

WATCH

See our **Equinox tiled roof system** installation video at youtube.com/eurocellpvcu



The leading system - eurocell designed, manufactured & distributed

equinox[®]
THE DIFFERENCE IS NIGHT & DAY

**DELIVERED
IN 7-10
WORKING
DAYS**



VARIABLE PITCHES
MEANS MORE
CONVERSIONS
POSSIBLE



GREATER
STRUCTURAL
STRENGTH



EASY AND QUICK
INSTALLATION IN
2 DAYS



DESIGN-ENGINEERED
FOR OUTSTANDING
TECHNICAL
PERFORMANCE

0.15
U-VALUE

U-VALUES AS
LOW AS 0.15



BETTER VALUE
FOR MONEY
- HELPS INCREASE
YOUR SALES



0.15
U-VALUE



**JOIN EUROCELL SELECT
AND GET FULLY BACKED**

eurocell

SELECT

THE FIRST TILED ROOFS APPROVED INSTALLER SCHEME WITH SUBSTANCE

- ✔ 2 year workmanship warranty - competitive edge
- ✔ Independent certification - customer peace of mind
- ✔ Free marketing support - more opportunities

I WANT TO BE SELECTED!



Find out how you can be selected
www.eurocell-select.co.uk
or call **0845 988 3047**

eurocell

SELECT



CONSERVATORY ROOFS

FIT QUICKER, MORE EFFICIENTLY AND SMOOTHLY BY REDUCING MITRING, SCRIBING AND SEALING

- ▶ Compatible with all Eurocell systems, including Eurologik and most other window systems
- ▶ Adjustable ridge and eaves beam providing a pitch range of 2.5° up to 45°
- ▶ One standard capping for 25mm, 32mm polycarbonate and 24mm glass
- ▶ Foam ridge sealing assembly
- ▶ The ridge cap with finial and cresting is fitted before the polycarbonate
- ▶ Lead flashing channel on the starter bar and flashing trim
- ▶ Easy to fit bolt on jack rafters
- ▶ Adhesive polycarbonate support trim
- ▶ Lusso orangery-style internal finish also available

For more information please call us on
08000 77 88 88 today!

**FREE
QUOTATION -
ASK IN-BRANCH
FOR DETAILS**



HINTS & TIPS

COMPLETE THE JOB



RAINWATER SYSTEMS

Take a look at the range on page 58



BI-FOLD & PATIO DOORS

Find out more on page 146



COMPOSITE DECKING

Find out more on page 188



POLYCARBONATE SHEETS

Choose from our range of polycarb on page 174

Conservatory roof system

- ▶ Eurocell's conservatory roof system is designed to eliminate common problems experienced by installers at a price that doesn't penalise you for wanting to fit the best

STUNNING STYLES TO SUIT ALL HOMES

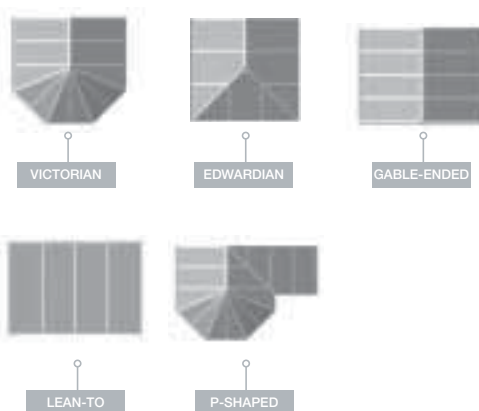

▶ Got a big project? We can deliver your items direct to site – just ask for more details



MODULAR ROOFS



THE SMARTEST CHOICE

- ▶ With a choice of 2.5°, 5°, 7.5° or 10° roof pitches
- ▶ 750mm glazing bar centres create more light and allow continuous sight lines between the roof and doors
- ▶ Fast and easy to fit with modular kits eliminating on-site cutting, sawing or adjusting
- ▶ Fully sculptured eaves beam trim and rafter end caps
- ▶ Components organised in packs with simple and easy to follow instructions

For more information ask in-branch for a **technical brochure**

AVAILABLE WITH IMMEDIATE STOCKS AND FREE DELIVERY



ROSEWOOD FINISH



HINTS & TIPS

FINISHING OFF



SCULPTURED EAVES
BEAM TRIM



PATENTED RAFTER
END CAPS



FAST-FIT SQUARE-LINE
GUTTER BRACKET

IQ750 FIRRING PACKS



Furring

- ▶ Furring packs include ring beam to allow side door locations

Size

- 2 x 2m furring (ring beam and 2 x 3m furring)
- 2 x 2.5m furring (ring beam and 2 x 3m furring)
- 2 x 3m furring (ring beam and 2 x 3m furring)
- 2 x 3.5m furring (ring beam and 2 x 4m furring)
- 2 x 4m furring (ring beam and 2 x 4m furring)

Colour options: WH White / RO Rosewood

IQ750 BOX CUTTERS

Made
to order



Image for illustration
purposes only

Box gutters

- ▶ Box gutters for IQ750 roofs are made to order - ask in branch for more details

IQ750 BRACKETS

3m
lengths



Fascia fixing brackets

Code	Qty
CRS8594	2 pack

NOW INCLUDES
skypod^{ACUTE}

NEW!

**NOW EVEN MORE FLEXIBILITY WITH
FOUR STYLES AVAILABLE**

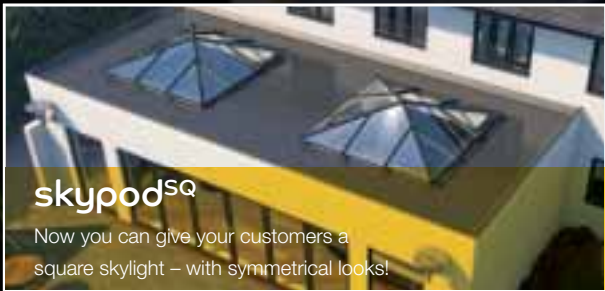

For more information visit
eurocell.co.uk

skypod®

Eye-catching, affordable and easy to install pitched PVC-U lantern roofs



There are lots of ways to add light to buildings, but none are as stylish as Skypod pitched PVC-U lantern roofs



For more information call us
on **0800 988 3045** today.



Pitched skylights

WHY CHOOSE SKYPOD?

Great looks, energy efficient, easy installation and a more cost-effective solution than conservatory roof systems or aluminium skylights - Skypod brings a stylish new living space that's flooded with natural light.

NEW Skypod Acute

And now, thanks to Skypod Acute - you can increase the natural light of your home in a purposed-designed skylight!



**DELIVERED
IN 5 WORKING
DAYS - ORDER
ONLINE
TODAY!**

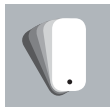

A CHOICE OF
FRAME AND GLASS
COLOURS



FAST, ACCURATE
INSTALLATION



DESIGNED FOR
SUPERIOR
PERFORMANCE



U-VALUES AS
LOW AS 1.0*



CHEAPER THAN
ALUMINIUM
ALTERNATIVES



FREE BROCHURE

See the great benefits of Skypod for yourself in our **NEW Skypod brochure**.



**PICK ONE UP
IN-BRANCH TODAY!**



SIZE OPTIONS

Rectangle

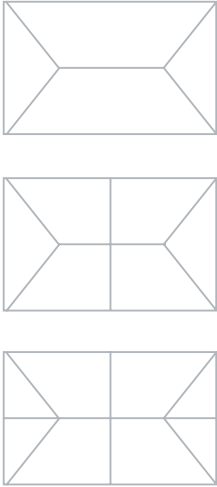

- UP TO 1.5M X 2.75M
- UP TO 1.5M X 7.45M
- UP TO 2.75M X 8.7M

skypod^{SQ}

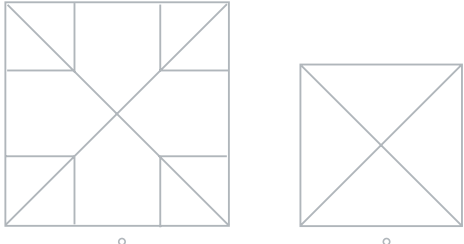

- UP TO 2.75M X 2.75M
- UP TO 1.5M X 1.5M

skypod acute



ALL SKYPODS AVAILABLE IN 20° AND 35° FIXED PITCHES

NEW

COLOUR OPTIONS

Frame

COLOUR OPTIONS



- WHITE
white interior
- ANTHRACITE GREY
white interior
- ANTHRACITE GREY
anthracite interior
- MOONDUST GREY
white interior
- ROSEWOOD
white interior
- GOLDEN OAK
white interior

Glass

COLOUR OPTIONS

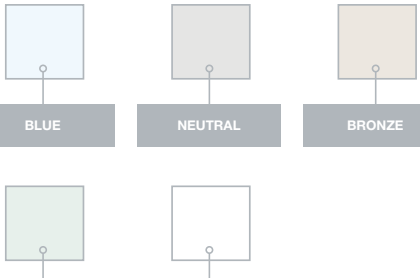

- BLUE
- NEUTRAL
- BRONZE
- AQUA
- CLEAR



ROOF GLAZING

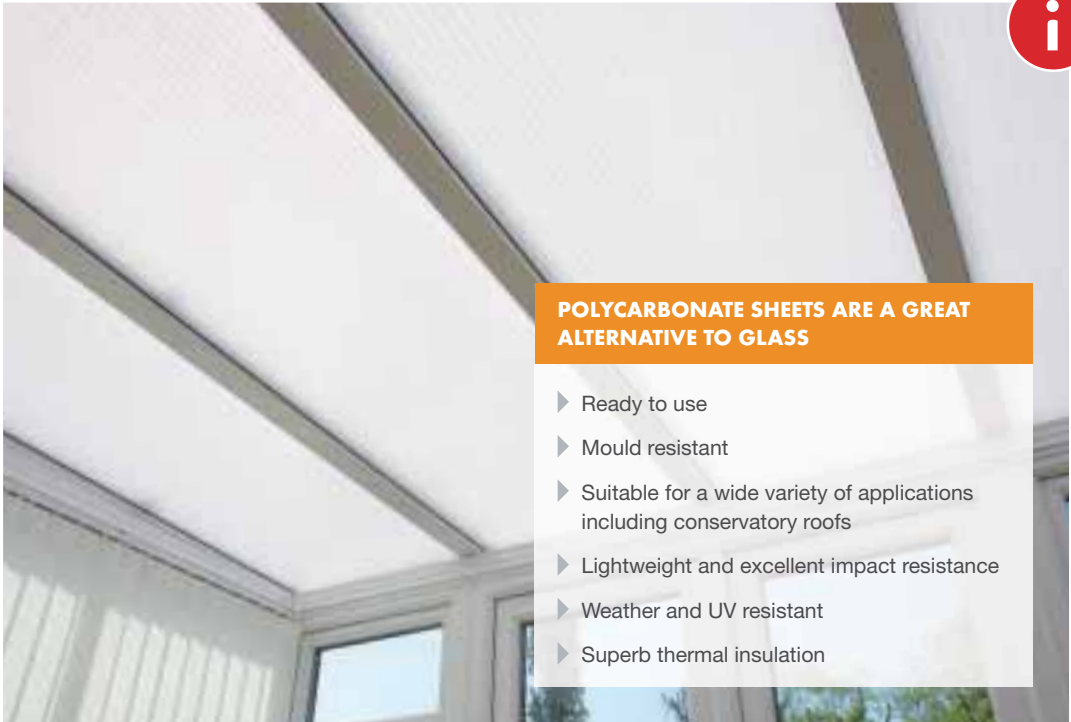

POLYCARBONATE SHEETS ARE A GREAT ALTERNATIVE TO GLASS

- ▶ Ready to use
- ▶ Mould resistant
- ▶ Suitable for a wide variety of applications including conservatory roofs
- ▶ Lightweight and excellent impact resistance
- ▶ Weather and UV resistant
- ▶ Superb thermal insulation



EUROBOARD

Available in varying colours and thicknesses so you can choose the right fit for your project

Class 1 BS 476/7
fire rating



RECOMMENDED

MULTI-WALL POLYCARBONATE HEAT-GUARD OPAL

HEAT
guard

- ▶ A multi-layered dual colour sheet with a co-extruded heat reflective layer in the outer surface reducing the solar transmission by up to 50% compared with standard tint material

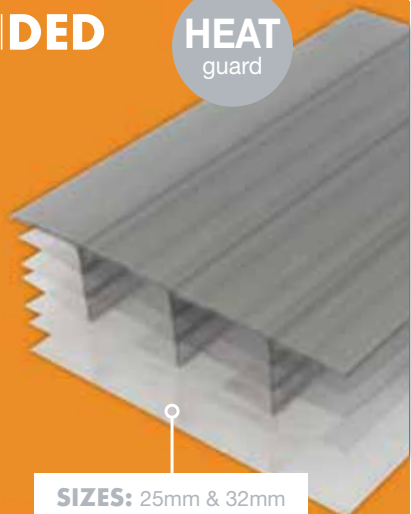

SIZES: 25mm & 32mm

POLYCARBONATE

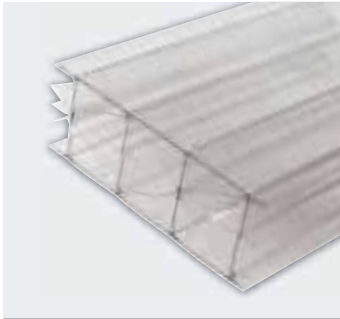

Multi-wall polycarbonate

Sizes	Colour
25mm	Clear
32mm	Clear

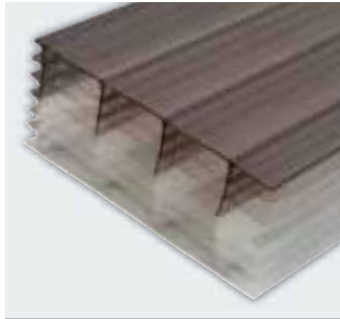

Multi-wall polycarbonate

- ▶ Multi-wall offers extra heat and noise insulation, whilst the bronze tint reduces sun glare

Sizes	Colour
10 & 32mm	Bronze/Opal

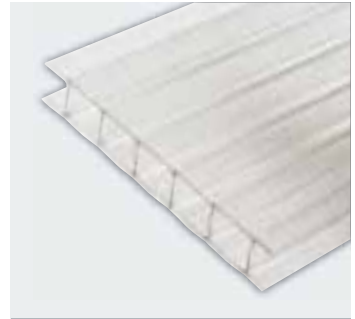

Twin-wall polycarbonate

- ▶ Choose clear twin-wall polycarbonate when maximum light transmission is required

Size	Colour
10mm	Clear

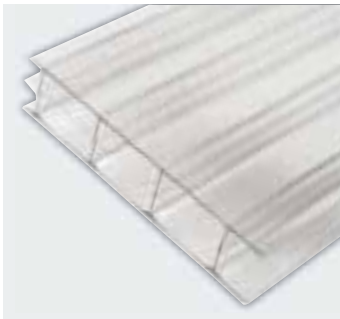

Triple-wall polycarbonate

- ▶ Choose clear triple-wall polycarbonate when maximum light transmission is required

Size	Colour
16mm	Clear

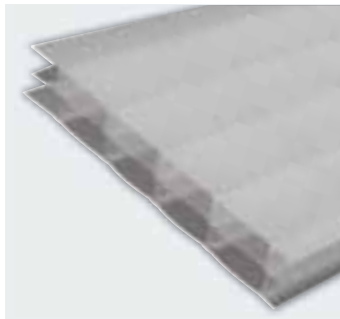

Triple-wall polycarbonate

- ▶ Opal polycarbonate offers protection from sun glare, whilst providing extra privacy

Size	Colour
16mm	Opal

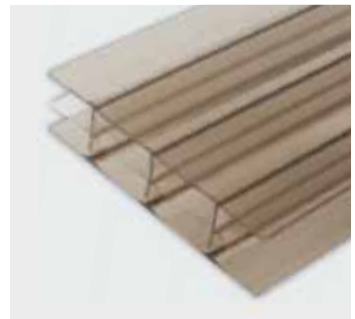

Triple-wall polycarbonate

- ▶ Bronze polycarbonate has a tinted effect for protection from sun glare

Size	Colour
16mm	Bronze

PERFECT PARTNER

Our NYLON HAMMER is perfect to hammer those end caps into place once you have your polycarbonate in position.

Find this on page 203





POLYCARBONATE ACCESSORIES



Snaptyte glazing bars

- ▶ Join polycarbonate sheets with easy fit glazing bars

Glazing bars

Size	Code
1 x 2.5m	ND 25ST 25
1 x 3m	ND 25ST 30
1 x 4m	ND 25ST 40

Curled roof edge strip

Size	Code
1 x 3m	ND 25ST RE3
1 x 4m	ND 25ST RE4

Colour options: **WH** White / **B** Brown



F profiles

- ▶ F profiles offer support on a side wall, or act as a neat outside roof trim

10mm

Size	Code
3m x 10mm	ND 10F 1030
4m x 10mm	ND 10F 1040

16mm

Size	Code
3m x 16mm	ND 10F 1630
4m x 16mm	ND 10F 1640
6m x 16mm	ND 10F 1660

Colour options: **WH** White / **B** Brown

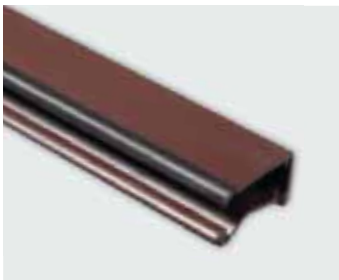

Sheet closures

- ▶ Fit onto polycarbonate ends to prevent water from getting into the roof space

Size	Code
2.1m x 10mm	ND10 SCB
2.1m x 16mm	ND16 SCB
2.1m x 25mm	ND25 SCB

Colour options:
WH White / **B** Brown



Fixing buttons

- ▶ For securing polycarbonate sheets when required

Size	Code
10mm	PGFB 10
16mm	PGFB 16
25mm	PGFB 25

Colour options:
WH White / **B** Brown



Tapes

Solid

Size	Code
45m	ANO3 ST 45MM

Vented

Size	Code
16mm	ANO3 ADT 45MM

CONSERVATORY PVC-U PANELS



DON'T WANT TO BUILD A DWARF WALL, OR GO FOR A FULLY GLAZED CONSERVATORY?

THEN CHOOSE PVC-U CONSERVATORY PANELS INSTEAD.

- ▶ Low-maintenance
- ▶ Perfectly colour-matched to windows and roof

CANOPIES



A VERSATILE RANGE OF STYLISH CANOPIES PROVIDE ADDITIONAL SHELTER.

IDEAL FOR:

Residential use

- ▶ Car ports
- ▶ Covered walkways
- ▶ Patio/garden areas

Commercial use

- ▶ Smoking areas
- ▶ School playgrounds



OUTDOOR LIVING



Help customers enhance their outdoor living space with composite decking, fencing and balustrade.





RECOMMENDS

All together better



COMPOSITE FENCING

Transform gardens with stylish, low-maintenance composite fencing.

Find out more on page 180



COMPOSITE DECKING – HOLLOW RANGE

Hollow profile wood composite decking with the warmth and look of solid wood combined with the unique properties of PVC-U.

Find out more on page 188



COMPOSITE DECKING – SOLID RANGE

With its clean, deep grains, the solid core ensures great performance whilst giving a real wood look and feel.

Find out more on page 192



BALUSTRADE

Finish off your decking with a stylish balustrade.

Find out more on page 194



ORDER BY PHONE

Call your local branch direct on **08000 77 88 88**

ORDER ONLINE

eurocell.co.uk/buyonline

SHOP IN-BRANCH

Find your nearest branch at eurocell.co.uk/branchfinder



OUTDOOR LIVING

COMPOSITE FENCING
.....180-185

COMPOSITE FENCING HOLLOW
.....186-187

COMPOSITE DECKING HOLLOW
.....188-189

COMPOSITE BALUSTRADE
.....190-191

COMPOSITE DECKING SOLID
.....192-193

BALUSTRADE SYSTEM
.....194-195

PVC-U PICKET FENCING
.....196

GARDEN ROOMS
.....197





COMPOSITE FENCING

**TRANSFORM GARDENS WITH
STYLISH, LOW-MAINTENANCE
COMPOSITE FENCING**



For more information please call us on
08000 77 88 88 today!

**20-YR
GUARANTEE**

See previous page
for full details

FEATURES & BENEFITS OF ECO FENCING



CAN BE CUT WITH A HANDSAW

Because composite fencing is so easy to cut, gravel boards can be easily trimmed to suit popular European fence panels which are 1.8m wide.



USE WITH TIMBER PANELS

Composite fencing posts and gravel boards can also be used in conjunction with wooden panels.



LOOKS AND FEELS LIKE WOOD

Composite fencing's unique finish will add beauty and complement gardens for years to come. Unlike most traditional fencing, Wood-Grain's dual face means you can also share the cost with neighbours.



COMPOSITE FENCING HAS STRENGTH

In independent testing, Wood-Grain proved that it has a much greater tensile strength than concrete posts, as the combined weight of 56 stones demonstrates! It will even flex in strong winds.



REPLACE ROTTEN OLD PANELS

Simply remove the old panels from the concrete posts and then slot the composite fencing gravel boards in place. In an instant you have a maintenance free fence which not only looks good but is easy to install and never needs treating.



INCREDIBLY LIGHT

At around 5 kgs, composite fencing is a pleasure to work with. It is incredibly light and strong, making general handling and transportation easy. The health and safety risks ever present with concrete fence posts are eliminated.



ENVIRONMENTALLY FRIENDLY

Wood-Grain is manufactured from 75% recycled materials. In using Wood-Grain you can be assured that you are protecting the world's natural resources and helping the environment.



USE WITH EXISTING POSTS

Simply remove the old wooden panels from the concrete posts and then slot the composite fencing gravel boards in place. In an instant you have a maintenance-free fence which not only looks good but is easy to install and never needs treating



ACCEPTS SCREWS

Wood-Grain will also accept screws to secure the fence into position.

20-YEAR GUARANTEE



All composite fencing products come with a 20-year manufacturing guarantee against rotting. Variations in colour, shade or pigment are NOT covered under our guarantee. These variations in no way affect the longevity of the product.

*Guarantee terms and conditions

The Company or seller offer a 20-year manufacturing guarantee against rotting. In the event of proven manufacturing defect, the Company or seller's total liability shall under no circumstances exceed the price of the defective item. The company or seller shall not in any way be responsible for additional, consequential costs or losses. The company or seller accepts no responsibility for defects to products caused by incorrect fitting, misuse or abuse. This guarantee does not cover any changes to the colour of the product due to natural weathering, shade or colour variations, storm damage or acts of God.

For more information, call **0800 988 3047** or visit **or visit eurocell.co.uk/fencing**



SAVE MONEY

Composite fencing will work out much cheaper over time compared to timber panels, which would need to be maintained every couple of years. **Compare the facts!**

Savings based on 10-year maintenance cost for 10 No 6'x6' timber panels

*Figures based on a timber panel which would need treating a minimum of four times over a 10-year period, using 14 tins of preserver @ £22.49 each, 50 hours of your customers' time at minimum wage of £7.20 (From 01/04/16).

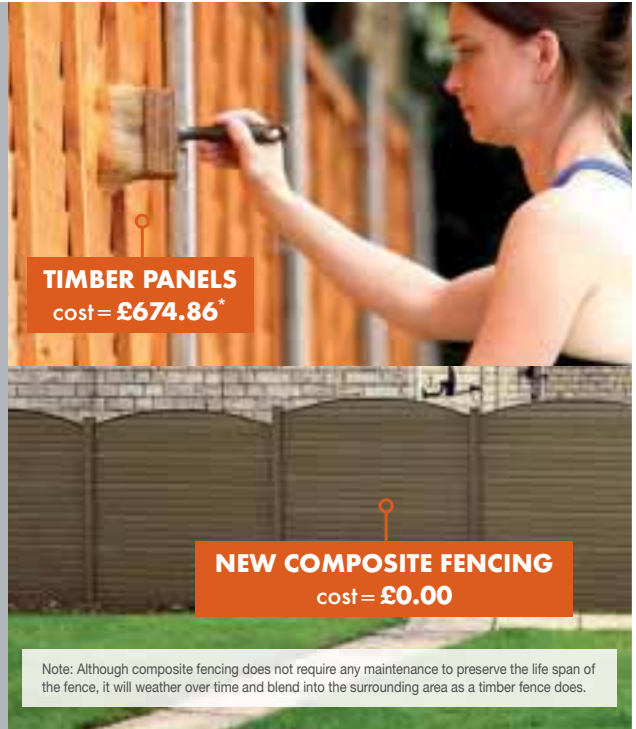

TIMBER PANELS
cost = **£674.86***

NEW COMPOSITE FENCING
cost = **£0.00**

Note: Although composite fencing does not require any maintenance to preserve the life span of the fence, it will weather over time and blend into the surrounding area as a timber fence does.

Composite fencing is quick & easy



TOUGH AND HARD-WEARING – MUCH GREATER TENSILE STRENGTH THAN CONCRETE POSTS



LOOKS AND FEELS LIKE WOOD – THE FENCING'S UNIQUE FINISH WILL ADD BEAUTY AND COMPLEMENT GARDENS FOR YEARS TO COME



SAVES TIME AND MONEY – COMPOSITE FENCING WILL WORK OUT MUCH CHEAPER OVER TIME COMPARED TO TIMBER PANELS, WHICH WILL NEED TO BE MAINTAINED



MAINTENANCE-FREE – NO MORE PAINTING AND REGULAR MAINTENANCE TO KEEP FENCES LOOKING LIKE NEW



UK MANUFACTURED – ALL COMPOSITE FENCING PRODUCTS ARE MANUFACTURED IN OUR UK FACTORIES

WHY CHOOSE COMPOSITE FENCING?

The unique finish of composite fencing will add beauty and complement a gardens' natural surroundings. These incredibly light fencing panels are incredibly strong, making general handling and transportation easy.



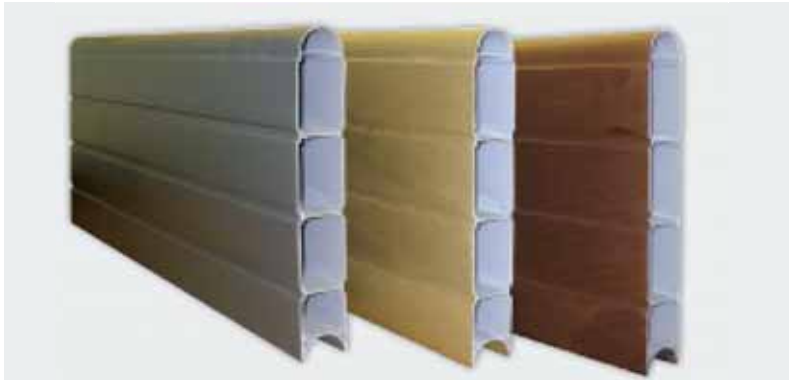

COLOUR OPTIONS



NATURAL

WALNUT

GRAPHITE

Composite fencing panels

Length	Height	Qty
1.829m	300mm	1 pack
2.438m	300mm	1 pack



Composite fencing posts**

Height	Includes	Qty
1.8m		1
2.4m	Steel Insert	1
2.7m	Steel Insert	1



Decorative caps

Description	Qty
Flat Cap	1
Acorn Cap [†]	1
Globe Cap [†]	1

[†]Acorn & Globe, require a flat cap also to sit on

**Fencing posts are designed to flex and from our experience over the years, we would advise that for fences over 6ft tall a cement grout is poured down the inside of the posts to reduce excess flex. When fitting a gate, a timber post will need to be fixed to the eco posts to provide a square edge for the hinges and catch.

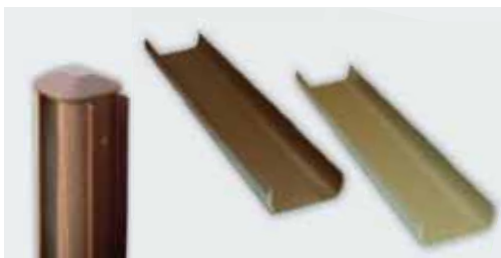

3-Way Utility Strip

Description	Length
Corner/End Attachment	2.1m

The unique finish of composite fencing will add beauty and complement a gardens' natural surroundings. These incredibly light fencing panels are extremely strong, making general handling and transportation easy.



BEFORE



AFTER

**EASILY
REPLACE
ROTTEN
OLD
PANELS**



**ADD A
SHAPED
TOP FOR A
PREMIUM
LOOK**

Shaped tops

Length	Height	Qty
1.829m	140mm	1
2.438m	140mm	1



Anti theft clip

- ▶ Protect the fencing against theft



**MADE TO
MEASURE**

Eco gate

- ▶ Available in all colours opposite



Supaspike and bolt down

- ▶ The Supaspike is incredibly easy to install, just drive it into the ground and place the post over the top of the spike. For solid surfaces such as driveways and pavements, use the Supaspike Bolt Down.



COMPOSITE FENCING – HOLLOW RANGE

FENCING

Composite fencing is low maintenance with no need for painting, staining or sealing. The UV stabiliser in the fencing means that the colour won't fade in the sunlight. The fencing range is tough and can withstand all weather conditions.



Composite Fencing Boards – Hollow
Size: 163mm x 20mm x 1830mm

Colour	Code
Ancient Black	CWFS-FC-03-A
Antique Ash	CWFS-FC-03-D
Salt Lake Silver	CWFS-FC-03-C
Wild Brown	CWFS-FC-03-B

THE FEATURES & BENEFITS OF FENCING AND BALUSTRADE ARE:

- ▶ Long lasting strong railing
- ▶ Safe and secure
- ▶ Easy to clean
- ▶ Low Maintenance
- ▶ Quick installation
- ▶ No painting or staining

COLOUR OPTIONS



ANCIENT BLACK

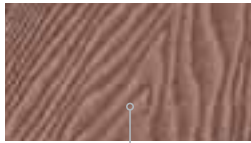

WILD BROWN

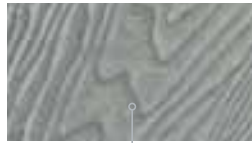

SALT LAKE SILVER



ANTIQUÉ ASH

Fencing Accessories

Fence Panel Adapter

These adapters are designed to be inserted into existing posts. They come in pairs with every fence panel.





COMPOSITE DECKING – HOLLOW RANGE



THE FEATURES & BENEFITS OF HOLLOW DECKING ARE:

- ▶ Great value
- ▶ Natural Look
- ▶ Eco Friendly
- ▶ Low Maintenance
- ▶ Waterproof and Stain Resistant
- ▶ Durable and Long Lasting
- ▶ Slip Resistant
- ▶ Seamless installation with Hidden Fixings

COLOUR OPTIONS



ANCIENT BLACK

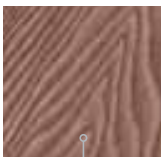

WILD BROWN



SALT LAKE SILVER

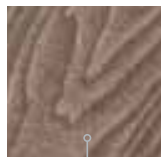

ANTIQUÉ ASH

DECKING BOARDS

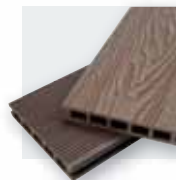

WOODGRAIN

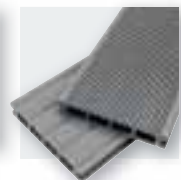

GROOVED

Hollow Grooved Decking – Size: 3.66m

Colour	Code
Ancient Black	CWD-FS-DEK-04-A
Antique Ash	CWD-FS-DEK-04-D
Salt Lake Silver	CWD-FS-DEK-04-C
Wild Brown	CWD-FS-DEK-04-B



Hollow Woodgrain Decking - Size: 3.66m

Colour	Code
Ancient Black	CWD-FS-DEK-NW-B
Antique Ash	CWD-FS-DEK-NW-A
Salt Lake Silver	CWD-FS-DEK-NW-D
Wild Brown	CWD-FS-DEK-NW-C

Step & Edge Nosing – Size: 95x45mmx3.66m

Colour	Code
Ancient Black	CWD-SC-01-A
Antique Ash	CWD-SC-01-D
Salt Lake Silver	CWD-SC-01-C
Wild Brown	CWD-SC-01-B



STEP & EDGE NOSING



Edging Trim – Size: 65x38x3.66m

Colour	Code
Ancient Black	CWD-WEC-02-A
Antique Ash	CWD-WEC-02-D
Salt Lake Silver	CWD-WEC-02-C
Wild Brown	CWD-WEC-02-B



EDGING TRIM



STARTER CLIP

Capping Strip – Size: 15x25x1830mm

Colour	Code
Ancient Black	CWD-FC-05-A
Antique Ash	CWD-FC-05-D
Salt Lake Silver	CWD-FC-05-C
Wild Brown	CWD-FC-05-B



STAINLESS STEEL CLIP

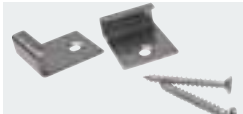

STARTER CLIP

Hollow decking accessories

Product	Code	Qty
Stainless Steel Clip	CWD-KK-07	12
Starter Clip	CWD-KK-06	12
Wood Grain PE Clip	CWD-KK-NW-03	12
PE Clip	CWD-KK-03	12



WOOD GRAIN PE CLIP



PE CLIP



COMPOSITE BALUSTRADE – HOLLOW RANGE



BALUSTRADE KITS

Components list

-
- Rails x2
-
- Balusters x9
-
- Black Plastic Connectors x22
-
- Railing End Cover Inserts between Balusters x20
-
- Railing End Cover
-
- Railing End Cover Bottom Post
-
- Black Plastic Connectors x22
-
- Railing End Cover Top Post (CWC-NRL-K-03)



RAILING KIT

COLOUR OPTIONS



ANCIENT BLACK

CWD-NRL-K-03-A

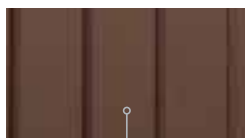

WILD BROWN

CWD-NRL-K-03-B

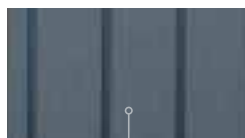

SALT LAKE SILVER

CWD-NRL-K-03-C

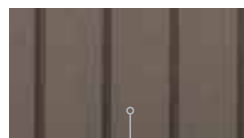

ANTIQUE ASH

CWD-NRL-K-03-D

COMPONENTS

BALUSRADE FINISH AND ACCESSORIES

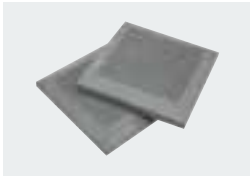

POST CAP



POST

Post Cap – Size: 145x145mm

Colour	Code
Ancient Black	CWD-PC-05-A
Antique Ash	CWD-PC-05-D
Salt Lake Silver	CWD-PC-05-C
Wild Brown	CWD-PC-05-B



STEEL POST MOUNT

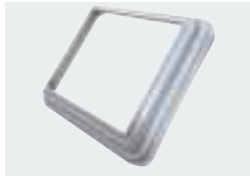

POST SKIRT

Post – Size: 2.4m

Colour	Code
Ancient Black	CWD-NRL-01-A
Antique Ash	CWD-NRL-01-D
Salt Lake Silver	CWD-NRL-01-C
Wild Brown	CWD-NRL-01-B



END COVER

Steel Post Mount – 800mm

CWD-CWC-POS-MT

Post Skirt – Size: 170x170mm

Colour	Code
Ancient Black	CWD-PC-06-A
Antique Ash	CWD-PC-06-D
Salt Lake Silver	CWD-PC-06-C
Wild Brown	CWD-PC-06-B

▶ This is a connector which is part of the fixing kit for the railing kits. This product is supplied with the kit at no charge.

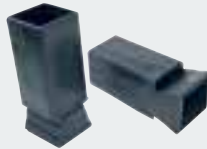

FIXING KITS

Railing Kit

Colour	Code
Ancient Black	CWD-NRL-K-03-A
Antique Ash	CWD-NRL-K-03-D
Salt Lake Silver	CWD-NRL-K-03-C
Wild Brown	CWD-NRL-K-03-B

End Cover – Size: 2.4m

Colour	Code
Ancient Black	CWD-NRL-04-03-A
Antique Ash	CWD-NRL-04-03-D
Salt Lake Silver	CWD-NRL-04-03-C
Wild Brown	CWD-NRL-04-03-B



COMPOSITE DECKING – SOLID RANGE



**25-YR
GUARANTEE**
Conditions apply*

For more details ask a member of staff
at your **local Eurocell branch!**

**IMAGINE A DECK THAT WON'T
FADE, STAIN, ROT OR SPLIT...**

- ▶ High-performance shell that resists fade, stain, scratches and mold
- ▶ Beautiful realistic wood look - does not warp, split or crack
- ▶ Low maintenance - never needs staining, sanding or painting
- ▶ Made from recycled content - good for the environment
- ▶ 25-year stain & fade limited guarantee

COLOUR OPTIONS

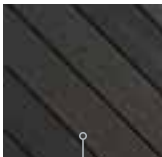

EARL GREY

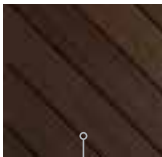

ESPRESSO

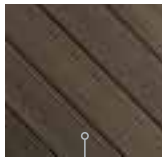

LATTE

DECKING BOARDS

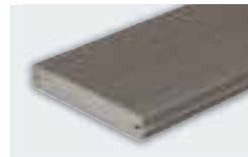

GROOVED

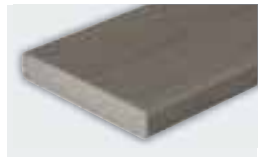

SQUARE

Decking Boards - Grooved

Colour	Code	Qty	Size	Length	Per
Latte	DEFDSGRLAT366	1 per pack	133 x 24mm	3.66m	Linear Metre
Espresso	DEFDSGRES366	1 per pack	133 x 24mm	3.66m	Linear Metre
Earl Grey	DEFDSGREGY366	1 per pack	133 x 24mm	3.66m	Linear Metre

Decking Boards - Square

Colour	Code	Qty	Size	Length	Per
Latte	DEFDSSQLAT244	1 per pack	133 x 24mm	2.44m	Linear Metre
Espresso	DEFDSSQESP244	1 per pack	133 x 24mm	2.44m	Linear Metre
Earl Grey	DEFDSSQEGY244	1 per pack	133 x 24mm	2.44m	Linear Metre



STARTER SCREWS



DECKING CLIPS

Decking accessories

Product	Code	Qty
Screw Grey	DECDTGREYSS	100
Screw Brown	DECDTDBROWNSS	100
Clips	DEFDOBRACLIPSB90	90

Screw size: 4.8 x 63mm. Clip fits 4sq m



BALUSTRADE SYSTEM

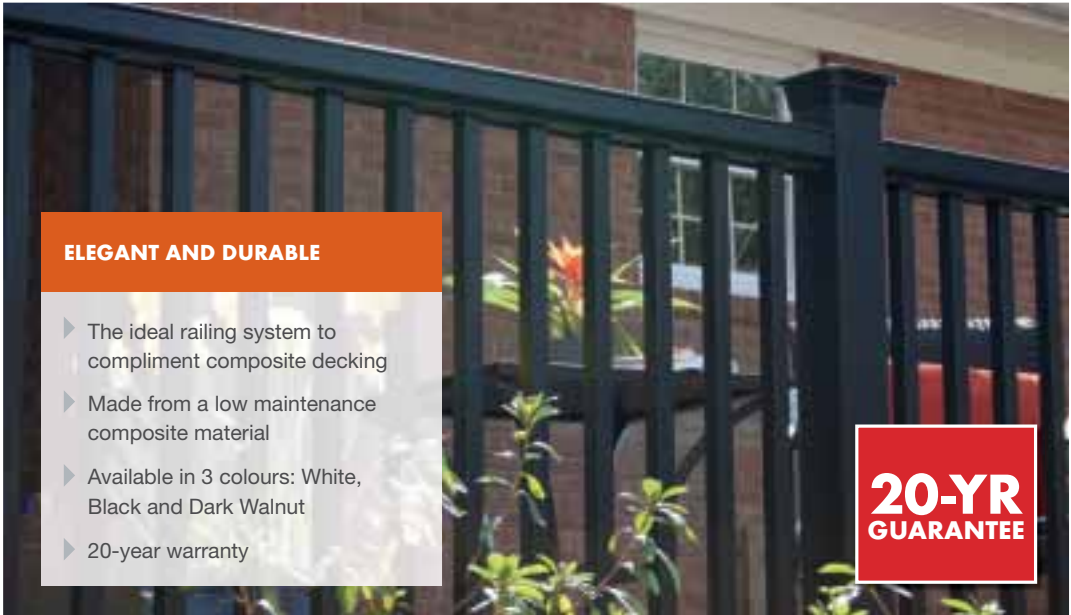

ELEGANT AND DURABLE

- ▶ The ideal railing system to compliment composite decking
- ▶ Made from a low maintenance composite material
- ▶ Available in 3 colours: White, Black and Dark Walnut
- ▶ 20-year warranty

**20-YR
GUARANTEE**



Line Kit Bracket Kits

Colour	Code	Qty
White	BKTLINEKITPK4	4
Dark Walnut	RAILKITLINE182DW	4
Black	BKTLINEKITPK4BL	4



Clear Vision Panel Adaptor Kit

Colour	Code	Qty
White	RCVSKIT182MWH	2
Black	RCVSKIT182MBL	2

6mm Acrylic Panel

Clear & Bronze	MTO	2
----------------	-----	---

Pack: Pack of 2 (30mm wide) / **Size:** 1.82mbl

COMPONENTS

BALUSRADE ACCESSORIES



Top & Bottom Rail Kit

Colour	Code	Qty
White	RAILSECTN182MWH	Each
Dark Walnut	RAILKITLINE182DW	Each
Black	RAILKITLINE182BL	Each

Size: W92 X D64mm / Length: 1.82m



Top & Bottom Rail Kit

Colour	Code	Qty
White	RAILSECTN244MWH	Each
Dark Walnut	RAILKITLINE24MDW	Each
Black	RAILKITLINE24MBL	Each

Size: W92 X D64mm / Length: 2.44m



Post Cap

Colour	Code	Qty
White	POSTCAPHARBOURWHI	Each
Dark Walnut	POSTCAPHARBOURDKW	Each
Black	POSTCAPHARBOURBL	Each

Size: 110mm sq.



Post Sleeve

Colour	Code	Qty
White	POSTSLEEVE27MTR	Each
Dark Walnut	POSTSLEEVE27MDKW	Each
Black	POSTSLEEVE27MBL	Each

Size: 110mm sq. / Length: 2.7m

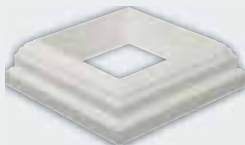

Baluster Pole

Colour	Code	Qty
White	BALUSTER100MWH	Each
Dark Walnut	BALUSTER100MDW	Each
Black	BALUSTER100MBL	Each

Size: 950mm High 30x30mm sq. / Length: 1m



PVC-U PICKET FENCING



FEATURES & BENEFITS

- ▶ Strong, self-supporting system does not require wood inside to hold them up
- ▶ Quick and easy to install, simply slide and lock into place (No need for brackets)
- ▶ No painting or staining
- ▶ Won't blister, peel, corrode or rot as it doesn't absorb moisture
- ▶ UV-inhibitors and impact modifiers to help stop colour change

Picket Fencing By Vinyl Fencing

Colour	Code	Description	Size
White	PICKFENWHT48	Straight Picket Fence PVC White 48x72"	48x72"
White	PICKFENWHT36	Straight Picket Fence PVC White 36x72"	36x72"
White	PICKFENWHT30	Straight Picket Fence PVC White 30x72"	30x72"
White	PICKPOST48	Post & Cap for 48" Fence	48"
White	PICKPOST36	Post & Cap for 36" Fence	36"
White	PICKPOST30	Post & Cap for 30" Fence	30"
White	PICKGATEWHT3636	Gate PVC White 36x36"	36x36"
White	PICKGATEWHT3648	Gate PVC White 36x48"	36x48"
White	PICKGATEWHT3660	Gate PVC White 36x60"	36x60"
White	PICKGATEWHT3030	Gate PVC White 30x30"	30x30"
White	PICKGATEWHT4836	Gate PVC White 48x36"	48x36"
White	PICKGATEWHT4848	Gate PVC White 48x48"	48x48"
White	PICKGATEWHT4860	Gate PVC White 48x60"	48x60"

GARDEN ROOMS

FEATURES & BENEFITS

- ▶ Full insulation for all year use
- ▶ BBA certified roof waterproofing system
- ▶ Designs and colours to create your perfect garden room
- ▶ Choice of windows and door styles including french doors

COMING
SOON



▶ ...samples of the product, and get expert advice from our staff



TOOLS & ACCESSORIES



A range of high-quality, professional tools, attachments and PPE to help complete your building project



All together better



PREDATOR PVC-U SAW

This precision saw is specially designed to cut PVC-U, making it ideal for cutting down fascias and soffits on-site.

Find out more on page 204



POWER PRO SEALANT GUN

Complete your window installations with this heavy duty gun for cartridges up to 400ml, complete with hook end, swivel action barrel and extra pull trigger.

Find out more on page 212



GASKET SHEARS

An ideal tool for window fitters, these gasket shears cut neatly through rubber gaskets and small PVC-U trims.

Find out more on page 213



ORDER BY PHONE

Call your local branch direct on **08000 77 88 88**

ORDER ONLINE

eurocell.co.uk/buyonline

SHOP IN-BRANCH

Find your nearest branch at eurocell.co.uk/branchfinder



TOOLS

STANLEY SCREWDRIVERS
.....200

CHISELS
.....201

HAMMERS
.....202-203

DEMOLITION BARS
.....203

SPIRIT LEVELS
.....203

SAWS & BLADES
.....204-205

TAPE MEASURES & POWER WINDERS
.....206

WOODWORKING CLAMPS
.....207

PALLET, PUTTY & CUTTING KNIVES
.....207-208

POWER TOOL ACCESSORIES
.....209-210

STAPLE GUNS & STAPLES
.....211

WINDOW FITTER'S TOOLS
.....212-213

MISCELLANEOUS
.....214-216

PERSONAL PROTECTION ITEMS
.....217-218

ACCESS EQUIPMENT
.....221



SCREWDRIVERS



Fatmax

Ogee

Size	Code	Qty
3mm x 150mm	STA 064 979	1
4mm x 100mm	STA 065 017	1

Flared tip

Size	Code	Qty
6.5mm x 150mm	STA 065 141	1

Pozi tip

Size	Code	Qty
PZ1 x 100mm	STA 065 335	1
PZ1 x 250mm	STA 065 336	1



Screwdriver set

Code	Qty
KEN5726010K	1x Set of 8 screwdrivers



Mains testing screwdriver

Size	Code
63mm	KEN5150500K

WOODWORKING



Wood chisel set

Size	Code
6, 13, 19 & 25mm	SEN5972970K



Wood chisels

Size	Code
12mm	KEN5972320K
20mm	KEN5972480K
26mm	KEN5972640K

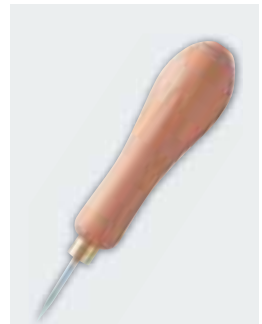

KEN5977250K
75mm Carpenters AWL

CHISELS ideal for cutting and carving hard materials

1/2 inch



Cold chisel **STANLEY**

Size	Code
1/2"	STA 418 287

1 inch



Cold chisel **STANLEY**

Size	Code
1"	STA 418 291

2 1/2 inch



Bolster **STANLEY**

Size	Code
2 1/2"	STA 418 295



Cold chisel

Size	Code
19 x 200mm	KEN5054840K
19 x 450mm	KEN5054890K
25 x 250mm	KEN5056460K
25 x 300mm	KEN5054840K



Brick bolster

Size	Code
75 x 220mm	SSF5051300K



Brick bolster & guard

Size	Code
75 x 220mm	SSF5051310K



RECOMMENDED

ADJUSTABLE WRENCH



Size	Code
200mm	SEN5014080K



HAMMERS & MALLETS



Hickory club hammer
4lb

Size	Code
1.8kg/4lb	KEN5255400K



Hickory club hammer
2.2lb

Size	Code
1kg/2.2lb	KEN5255250K



Club hammer
44oz

Size	Code
44oz	STA 154 923



Hickory sledge hammer
3.2kg

Size	Code
3.2kg/7lb	KEN5256070K



Fibreglass sledge hammer
1.8kg

Size	Code
1.8kg/4lb	KEN5255840K



Fibreglass sledge hammer
3.2kg

Size	Code
3.2kg/7lb	KEN5256180K



Basics claw hammer
16oz

Size	Code
450g/16oz	SEN5254060K



Blue strike claw hammer
20oz

Size	Code
20oz	STA 151 489



Rubber mallet
24oz

Size	Code
720g/24oz	KEN5259180K



Fibreglass club hammer
2.2lb

Size	Code
1kg/2.2lb	KEN5255720K



Fibreglass club hammer
1.8lb

Size	Code
1.8kg/4lb	KEN5255760K



Rubber hammer
54mm

Size	Code
54mm	EL THO 952 W



RECOMMENDED THOR NYLON HAMMER

▶ Ideal for window fitting, when sustained blows without recoil

2 sizes



Size	Code
Small	THO 710 (small)
Large	THO 712 (large)



For use with Thor nylon hammer opposite

Replacement face

Code	Qty
THO 712 NF	1 pack

DEMOLITION BARS



3 sizes

14" Fatmax demolition bar



Size	Code
14"	STA 155 101
24"	STA 155 102
36"	STA 1455 104

SPIRIT LEVELS



3 sizes

Stanley Pro levels



Size	Code
600mm	STA 143 024
1200mm	STA 143 048
1800mm	STA 143 072



SAWS & BLADES



RECOMMENDED

20" PREDATOR PVC-U SAW

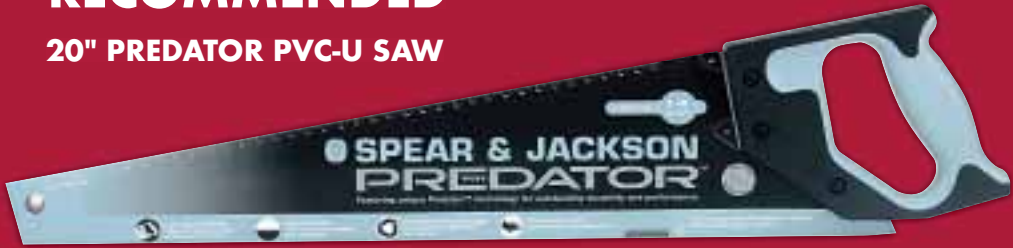

PREDATOR™

Size

Code

20"

B98 UPVC

- ▶ Ideal for cutting PVC-U and other hard plastics
- ▶ Precision cut for a fine finish
- ▶ Comfort handle
- ▶ Rigid blade
- ▶ Duralife technology



B9822

20" Predator universal saw



B98 LAMINATE

20" Predator laminate saw



2 sizes

22" also available
Code: STA 520 096

STA 520 094

Stanley 20" hard-point fine saw



JAK 990 PLUS

Irwin 22" hardpoint saw





BAH 30014
Bahco toolbox saw



BAH SE22
22" Bahco hand saw



JAK 880 UN 20
Irwin 20" panel saw



JAK 1300 HP 325
Irwin 13" floorboard saw



STA 015 218
Stanley junior hacksaw



STA 120 110
Stanley heavy duty hacksaw



SEN5380300K
Junior Hacksaw



KEN0400620K
Junior Hacksaw Blades

10 pack

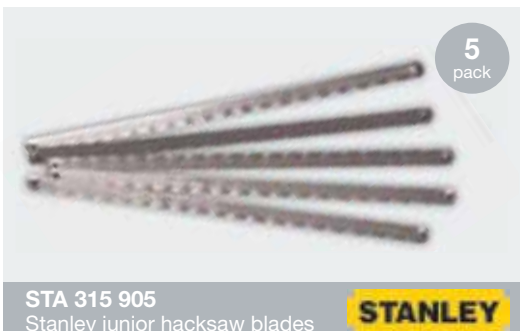

STA 315 905
Stanley junior hacksaw blades



5 pack



STA 015 906
Stanley HD hacksaw blades



2 pack



TAPE MEASURES & POWER WINDERS



RECOMMENDED STANLEY TAPE MEASURE

- ▶ Corrosion resistant tylon coated blade
- ▶ Comfortable contour case with improved grip
- ▶ True zero end hook moves to compensate for accurate inside and outside measurement
- ▶ Belt-clip on reverse



Size	Code
5m	STA 030 696



2 lengths

STANLEY

Fatmax tape measures

Code	Size
STA 033726	8m
STA 033719	5m



Tape Measure (19mm)

Code	Size
SEN5366050K	5m



30m length

STANLEY

Power-winder tape measure

Code	Size
STA 234 771	30m



30m length

Power-winder chalk reel

Code	Size
STA 047 460	30m

WOODWORKING CLAMPS



2 sizes

Irwin quick-grip clamp **IRWIN.**

Size	Code	Qty
6"	Q / G506 QC	1 pack
12"	Q / G512 QC	1 pack



12" trigger clamp **STANLEY**

Size	Code	Qty
12"	STA 083 003	1 pack

PALLET, PUTTY & CUTTING KNIVES



EL PALL KNDC
Don Carlos pallet knife



1 1/4 inch
EL PUTT KN
1 1/4" putty knife



10 pack
STA 211 921
10 blades (carded)



STA 210 122
Titan retractable knife



STA 210 099
Retractable blade knife



STA 510 810
Quick slide knife



RECOMMENDED

DON CARLOS SPRUE KNIFE

- ▶ Enables easy removal of glazing beads
- ▶ Allows quick and easy replacement of sealed glass units

Code

EL SPRUE KNDC



Basics Trimming Knife

Code

SEN5370500K



14" Fatmax demolition bar

Code

KEN5331990K

Size

125mm

SCRAPERS



R/Neck - Mutt Multi Scraper Blade

Code

CTL5124392C

Size

200 x 100mm



Site Safe Roofing Scraper

Code

SSF5227120A

Size

240 x 170mm



Wire Brush & Scraper

Code

KEN9066450K



Site Safe Floor Scraper

Code

SSF5223863A

Size

200 x 100mm

POWER TOOL ACCESSORIES



DEWALT

25 pack

DP 40
PZ2 25mm screwdriver bits



DEWALT

25 pack

DP 41
PH2 25mm screwdriver bits



RECOMMENDED
DRILL AND DRIVER BIT BOX

90 pieces

DEWALT

- ▶ High quality 90-piece drill and driver bits set
- ▶ Hard wearing carry case



Code
DT 9296



SDS-plus extreme drill bits

DEWALT

- ▶ Optimised flute design allows efficient debris removal
- ▶ New tip design ensures better bit penetration, longer life, faster drilling and greater durability

Size	Code	Qty
6.5 x 210mm	DT 9521 QZ	1 pack
6.5 x 260mm	DT 9522 QZ	1 pack



HSS-G long series

HSS-G long series drill bits

- ▶ Precision ground extra long twist drill for rapid drilling of deep hole

Size	Code	Qty
4 x 119mm	DT 9521 QZ	10 pack
3 x 100mm	DT 5717 QZ	10 pack



Reciprocating saw blades



► For fast cuts in wood with nails and tough plastics

Size	Code	Qty
305mm	DT 2350 QZ	5 pack
305mm	DT 2321 QZ	100 pack
305mm	DT 2320 QZ	100 pack



Trimsaw blade

Size	Code
165x10x16mm	DT 1203 QZ



Demolition blade

► For fast cutting of metals, plastics and 'sandwich materials'

Size	Code
152mm	DT 2301 QZ



5 pack



Wood cutting blade

► For coarse, fast cuts in wood
► High carbon steel construction

Size	Code
240mm	DT 2352 QZ



100 pack



Metal cutting blade

► Fast cutting of ferrous and non ferrous metal, sheet metal, pipes and profiles

Size	Code
305mm	DT 2322 QZ

STAPLE GUNS & STAPLES

Heavy duty staple gun & HD staples

- ▶ With anti-jam mechanism and easy-squeeze handle

Code

STA 0TR 150 HL

HD staples

Size	Code	Qty
10mm	STA 0TR A70 6T	1000 per box
14mm	STA 0TR A70 9T	1000 per box



Heavy Duty Staple Gun

- ▶ Aluminium cast housing. Push lock-down handle for storage. Easy access staple insertion. Ergonomic soft handle and head

Code

AVN8380010K



Hammer Tacker

- ▶ Suitable for a variety of applications including roof felting and carpet fitting

Code

AVN8380020K

Heavy Duty Staple Gun Staples

Code	Size	Qty
RPD8380030K	6mm	2000
RPD8380040K	8mm	2000
RPD8380050K	10mm	2000
RPD8380055K	12mm	2000

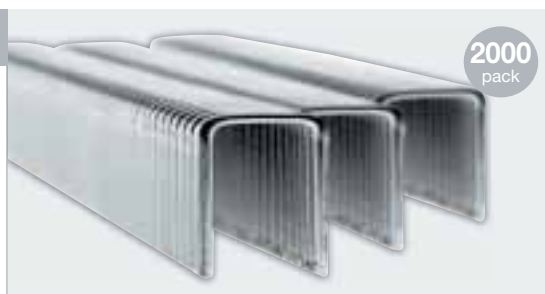



WINDOW FITTER'S TOOLS



Economy gun

- ▶ For 300ml cartridges

Code

PEGUN



Professional cox gun

- ▶ Heavy duty skeleton gun
- ▶ For 400ml cartridges

Code

PPCOX 400



Power pro sealant gun

- ▶ Heavy duty gun with extra pull trigger, hook end and swivel action barrel for both
- ▶ 310ml and 400ml cartridges

Code

SGPOWER



Design foam gun

- ▶ Heavy duty metal foam gun
- ▶ Professional quality

Code

PFGUN

PERFECT PARTNER

Keep your **FOAM GUN** clean after use with this specially developed product. It safely removes any uncured foam from your gun.



Find out more
on page 116



Double pad suction lifter

- ▶ Ideal for lifting glass, marble, granite, plastic or any smooth surface
- ▶ Maximum lift 70KG

Code

EL LIFT DOUB



Glazing shovel

- ▶ Allows controlled vertical lift for wedging and 'heel and toe' on double glazed units

Code

GLSHOVEL

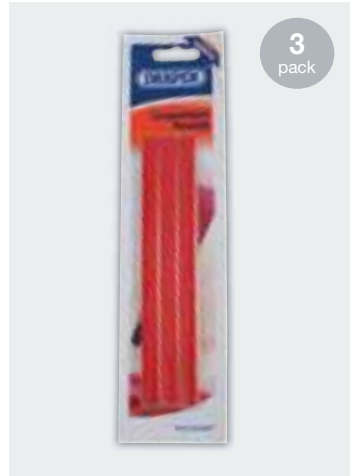

3 pack

Carpenters pencils

Code

PENCIL PC3



RECOMMENDED

LÖWE 45° GASKET SHEARS

- ▶ 45° faces
- ▶ Cuts neatly through rubber gaskets and small PVC-U trims
- ▶ Ideal for cutting synthetic, duxex, PVC and leather
- ▶ Replaceable blade

Code

ELGASKSHLO



Also available -
Get replacement blade (Code: EL GASK SHBL)
sheer wings (Code: EL GASK SHWING)



ACCESSORIES

MISCELLANEOUS



STA 046 529
Plastic sliding bevel



ANGLESETLEV
Digital angle setter



Wipe clean tarpaulins

Size	Code
12' x 9'	1TARP9
18' x 12'	1TARP12



MON 748
Bossing stick



MON 734
Beechwood lead dresser

CLEANING SUNDRIES



PMHB1101
11" Soft hand brush



Sweeping broom complete

Stiff	
Size	Code
12"	PMST1201C
Soft	
Size	Code
12"	PMS01201C

REFUSE & RUBBLE SACKS



DPS
Dust pan & brush set in red



Roll prodex sacks

Rubble	
Qty	Code
10	FFJHDS10
Refuse	
Qty	Code
50	FFJRS50

DECORATING SUPPLIES



60
grit

80
grit

120
grit

Prodec Ali-Oxide GRIT

Size	Code
60 Grit x 5m	PAALV60
80 Grit x 5m	PAALV80
120 Grit x 5m	PAALV120



Cotton dust sheets

► Minimise mess with washable dust sheets

Size	Code
12' x 9'	BFT 129



ELDECT6IN1
6 In 1 decorators tool



5
pack

FFJCP530
FFJ All purpose clam brush set



PSET
FFJ 9" Roller & tray kit



PRTRDSH
12'x9' Plastic backed dust sheet



243SQB
24'x3' Cotton twill dust sheet



129TRDS
12'x9' Cotton dust sheet

► Need project advice? Talk to our knowledgeable staff in-branch!



ROOFING



CTL5124382K
Slaters Ripper



CTL5122067A
Left hand slaters axe



CTL5122067C
Right hand slaters axe

TUBS & BUCKETS



Yellow flexible rhino tubs

- ▶ Tough, sturdy yet flexible, Light-weight and versatile, Moulded handles allow for easy lifting and transport

Size	Code
12 Litres	BM5/12/Y
40 Litres	BM5/40/Y
75 Litres	BM5/75/Y



RBUCKET
Rubble bucket



Heavy duty yellow bucket

- ▶ Wide pouring spout, Hand grip at base, Galvanized steel handle

Code
BB69YW

3
gallon

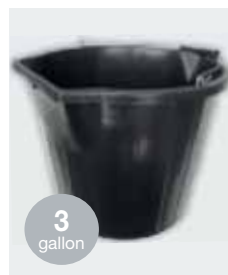

Heavy duty pour & scoop black bucket

- ▶ Slope Feature for Accurate Pouring, Extra Thick Ribs for a Stronger Bucket, Finger Recesses for Improved Handling

Code
BB4BK

3
gallon



Heavy duty green bucket

- ▶ Calibrated in litres and gallons, Galvanized steel handle and plastic grip, Tough and durable

Code
BM10

10
litres

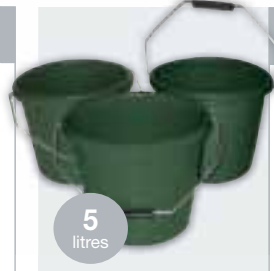

LDPE Green Bucket

Code
BM7/G

5
litres

PERSONAL PROTECTION ITEMS

WE UNDERSTAND THAT HEALTH AND SAFETY IS VERY IMPORTANT IN THE WORKPLACE

▶ We stock a range of quality personal protection equipment to help you keep your standards high



First Aid Kit Pouch
10 Person

Size	Code
10 Person	FIRSTAIDKIT





SAFETY SPECTACLES



SCASSE 001
Goggles



GOGGLEVENT
Clear lens safety vented goggles



SPECSPIT
Spitfire Clear Lens Safety Spectacles



SPECJAG
Jaguar Clear Lens Safety Spectacles

DISPOSABLE GLOVES & SHOES



Blue Nitrile Powder Free Disposable Glove

Code	Qty
GLOVENITDISPBL	100



CPE Blue Overshoes

Size	Code	Qty
14"	OVERSHOEPK100	100

EAR DEFENDERS



SCASSE 003
Ear defenders



EARDEFBLUE
Blue cyclone ear defender SNR27



EARPLUGBAND
3M Banded Semi
Aural Ear Plugs



EARPLUG5PK
3M Classic Ear
Plugs Pack



EARDEFRED
Red/black standard ear defender SNR24

MASKS



SCASSE 066
Cup mask

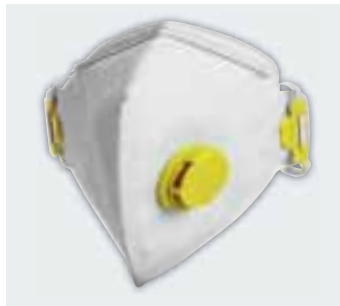

DUSTMASK
PK1 Foldflat P2 valved dust mask

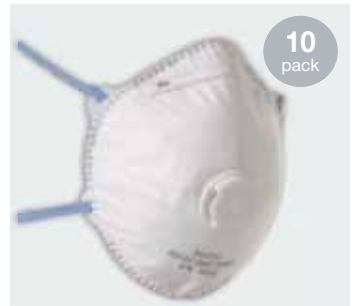

VALVEDMASKPK10
FFP2 valved mask EN149:2001



GLOVES



SCAG LOGG
Ribbed gloves



GLOVECROSSYL
Yellow criss cross gloves



KEVLAR GLOVE
Kevlar-cut gloves



SCAG LOHD RIG
Rigger gloves



GLOVERIGGER
Superior rigger gloves



GLOVEPVCRED
Red PVC knitwrist gloves



GLOVEPUX3
PU coated palm coated
cut level 3 gloves



GLOVELATEXGR
Green latex palm builders
grip gloves



GLOVELATEXOR
Orange latex palm builders
grip gloves



GLOVEPUX5
Pu coated palm coated cut
level 5 gloves



GLOVEPUKNITBK
Black pu palm coated
knitwrist gloves



GLOVENITFOAMBK
Black nitrile foam coated
knitwrist gloves

ACCESS EQUIPMENT

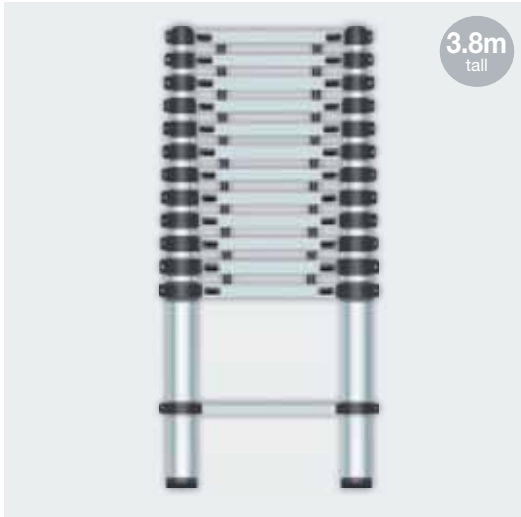

3.8m tall

Click 'n' climb telescopic ladder

Size	Code
3.8m	CCTL38



Platform ladder
1202-007

Size	Code
1.46 x 2.16m	TBD9391920R



Zarges Roof Rack Clamps
CW Padlocks (1 Pair)

Code
ZARGEROOFRACK



Stand off
1400-001

Code
TBD9395400B



Aluminium
workstand

Size	Code
825mm	DWDK608



RECOMMENDED HOP-UP STEPS

2 sizes

Size	Code
Large hop-up steps	HOP90
Small hop-up steps	HOP80



▶ Safe working load: 150kg*

* Applies to HOP90. HOP80 has safe working load of 115kg



OUR PRODUCTS

CHECK US OUT ON OUR YOUTUBE CHANNEL



Watch now at: youtube.com/eurocellpvcu



Can't find what you need online?
Tell us!
Email: marketing@eurocell.co.uk

Visit Eurocell's YouTube channel for the latest content available to **STREAM DIRECT** to your computer, laptop, tablet or smartphone!

▶ INSTALLATION VIDEOS

Watch our range of installation overview videos – available for conservatories, Aspect bi-fold doors, windows, Roomline skirting and arc hitrave, Equinox tiled roofs, Skypod pitched skylights and The Dales Collection composite doors.

▶ PRODUCT PROMOS

Why not show your customers the WOW factor of Aspect doors, or the green credentials Eurocell products have?

▶ LATEST NEWS AND MUCH MORE!

ROOFLINE PRODUCT GUARANTEES

Roofline products are supplied with up to 20-year guarantee against discolouration, warping and cracking.

Plus, we have a unique colour-match promise across our entire range of products including windows, doors and conservatories as well as fascias, soffits and guttering for a consistent look across your home.



ALL EUROCELL
WHITE PROFILES
CARRY A 20-YEAR COLOUR
FASTNESS GUARANTEE*



ALL EUROCELL
LAMINATED BOARDS
CARRY A 10-YEAR COLOUR
FASTNESS GUARANTEE*

*The above guarantees relate to Eurocell foam and rigid profiles only and are subject to the product being fitted to the manufacturer's installation recommendations.



A		E		P		V	
Adhesives	119	Equinox Tiled Roof System	161-164	Panels & Canopies	177	Ventillator & Accessories	
B		F		R		W	
Balustrade Systems	190-191 & 194-195	Fascia Boards		Rainwater Systems		Window Boards	
Bow Window Accessories		Euroboard	18	Square line	58	Laminated boards	102
Canopies	105	Double Euroboard	19	Half round	59	Laminated trims	103
Bow units	105	Box end board	19	Universal	60-62	Window boards	104
Gallow brackets	105	Bull-nosed board	20	Square	63	Window Cills	
C		Flat fascia board	20	Round	64	Cills & end caps	101
Capping Boards		Double bull nosed fascia	20	Adaptors	65	Joint trims	101
Standard & ogee	23	Finishing Trims		Brackets	66	Extender & reinforcements	101
Double capping board	23	Fascia & capping	29	Commercial plus	67	Windows	
Box end board	23	Finishing Trims		Cast iron effect	68-73	In-branch	6-7
Caulk	118	Trims	107	Soil systems	74-75	Modus	8-11
Cavity Closer		Architraves	108	Underground drainage	76-78	Eurologik	12
Frame corners	98	Angles	109	Channel drainage	79	Charisma vertical slider	13
Closer sections	99	Fixings		Roof Glazing	174-176		
Forming & bracing	99	Pins	27	S			
Cladding		Nails	27	Silicones & Sealants	116-117		
External cladding	45	Screws	27	Skirting & Architrave			
Internal décor	46	Fixings		Roomline skirting	84		
Clad seals	48	Pins	124	Trims	85		
Inserts & trims	48	Capped nails	124	Architrave	85		
Wall panels	53	Capped screws	124	MDF boards	85		
Cleaning Products	121-122	Cladding pins	124	Skypod	170-173		
Composite Decking		Screws	125	Soffit Boards			
188-189 & 192-193		Fixing screws	126	Utility board	25		
Composite Doors		Decking screws	127	Hollow soffit boards	25		
Dales Collection	134-137	Fencing pins	127	T			
Glass styles	138	Frame fixing screws	128-129	Tools			
Furniture	139	Wall plugs	129	Screwdrivers	200		
Composite Fencing	180-187	Nails	130	Chisels	200-201		
Composite Roof Slate		Tape	131	Brick Bolster	201		
Roof slate	33	Foam	120	Hammer & mallets	202-203		
GRP roofing	34	G		Demolition bar	203		
Roofing timber	36	Gap Filler	120	Spirit level	203		
Roofing membrane	37	Garden Rooms	197	Saws	204-205		
Rooflight	38	Glass & Bridge Packers	111	Tape measure	206		
Flashing	40-41	H		Clamps	207		
Conservatory Roofs	166-167	Hardware		Knives	207-208		
Cosmetic Repairs	110	Locks	152	Scrapers	208		
D		Handles	153	Power tool accessories	209-210		
Doors		Hinges	153	Staple guns	211		
Canopies	141	Letterplate	153	Sealant guns	212		
Surrounds	142	Center case & striker	154	Cleaning sundries	214		
Garage doors	143	Cockspur handle	155	Buckets	216		
Patio doors	145	Espag hinges	155	PPE	217-220		
Aspect bi-fold doors	146-147	Restrictors	156	Access equipment	221		
Studio Glide bi-fold doors	148-149	Technik snap safe lock	156	Trickle Ventilation	110		
Dry Verge		L		U			
Ridge caps	31/33	Loft Hatches & Ladders	92-93	Underfloor Heating			
End caps	31	Lubricant	118	Thermostats	86		
Universal & continuous	31	M		Sticky mat system	87		
		Modular Roof	168-169	Insulation	88/90		
		Mortar	118	Laminate flooring	91		

ACCREDITATIONS

Our products are manufactured to the highest standard in both foam and rigid composition.

Our foam profiles are co-extruded and this superior production process offers the advantages of a sealed cellular structure, durability and better surface quality with no pitting.

Rigid profiles are manufactured using high quality window grade rigid PVC-U material.



Assessment report number 01/3783. The Eurocell roofline system



Assessment report number 01/3784. The Eurocell cladding system



Assessment report number 13/5043. The Eurocell Aspect bi-fold door system



BSI Registered

TERMS & CONDITIONS

Eurocell Building Plastics reserves the right to amend prices and products without prior notice. Product specifications are subject to change without notification. See your local branch for full trading terms and conditions.

Please also note that colours shown in this catalogue are illustrative only, as the printing process does not

allow 100% accurate colours to be reproduced. Images are for illustration purposes only.

FREE DELIVERY

Free delivery available on orders over £100 excluding VAT. Free delivery covers mainland UK and excludes northern Scotland.

PEACE OF MIND!



All together better

By using Eurocell products across a property (ie windows, doors, conservatories and roofline) **will ensure you get a perfect colour match - every time!**

Our products are offered in the following colour options:

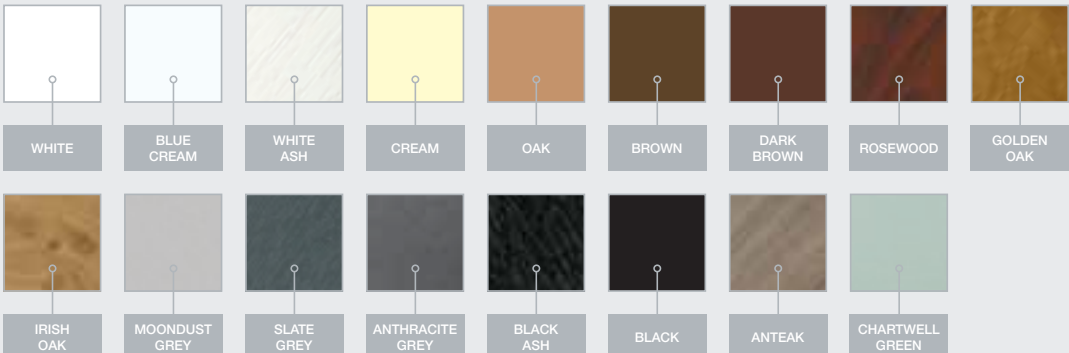

NOTE: not every colour is available for every product, see product descriptions for specific colour availability

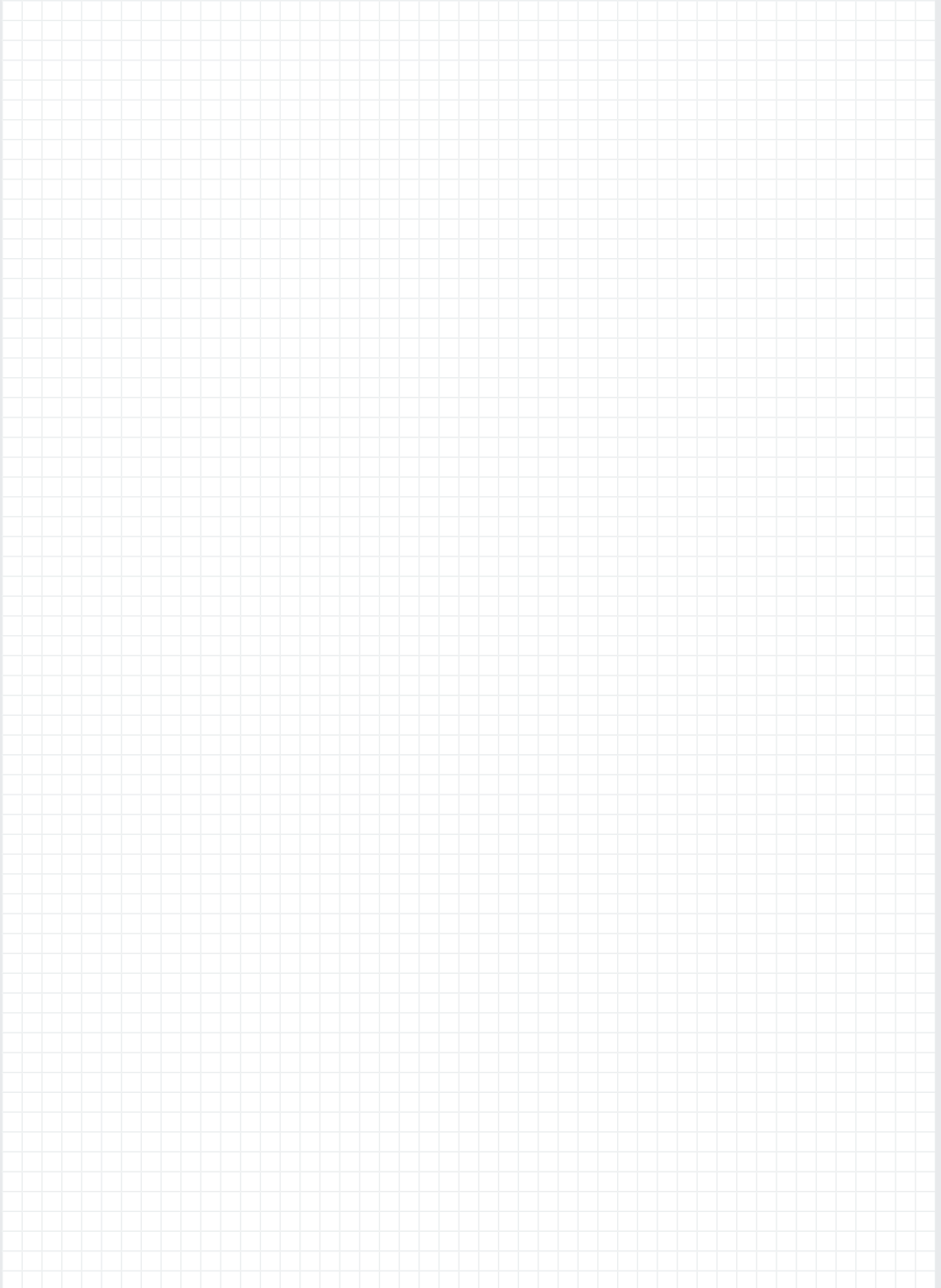

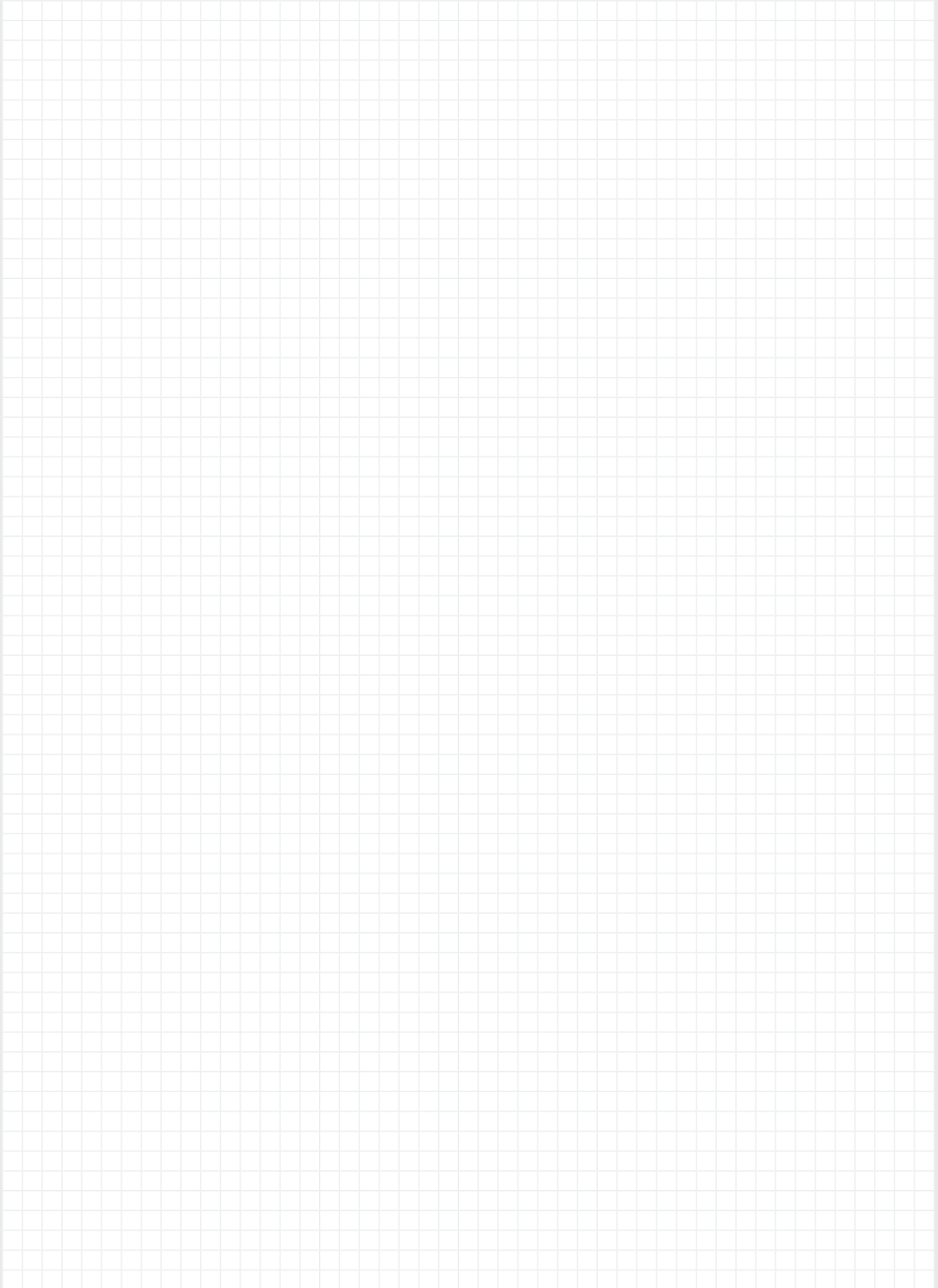

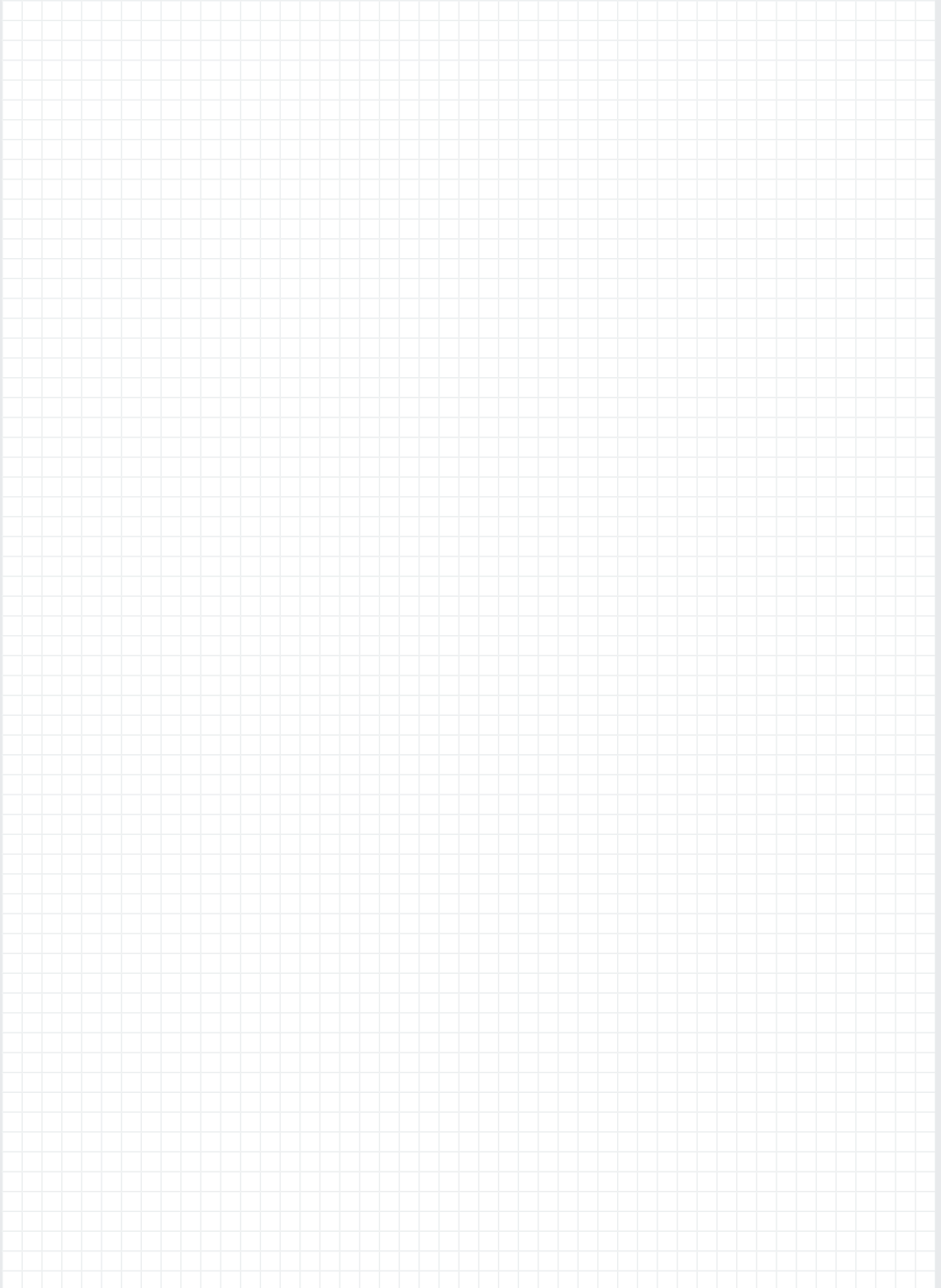

WHY CHOOSE EUROCELL?



FULL QUALITY CONTROL

We manufacture,
deliver and recycle



LARGEST STOCKED RANGE

available in every
branch



FREE 24-HOUR DELIVERY

direct to your site or in-branch
for your convenience

**PRODUCT & SERVICE EXPERTS
IN EVERY BRANCH**

185+

**BRANCHES NATIONWIDE
LOCAL SERVICE**

ORDER TODAY



ONLINE

at
eurocell.co.uk/buyonline



BY PHONE

Call your local branch direct
on 08000 77 88 88



IN BRANCH

Find your local branch at
eurocell.co.uk/branchfinder

For news, views and offers,
connect with us online



eurocell®

All together better

Product specifications are subject to change without notification. Please also note that colours shown are illustrative only, as the printing process does not allow 100% accurate colours to be reproduced.