

# ASCOT

Supply Corporation

## B U Y E R ' S   G U I D E



**ASCOT**  
Supply Corporation

*Service Equipment and Supplies for the Automobile,  
Tire Service and Retreading Industries*

## Accessory Kits Assortments & Tools

### Ascot Accessory Kit Assortments

- Contain all the parts you will need when servicing tires and wheels that are equipped with Schrader Original Equipment pressure monitoring transmitter valves. All components are individually packaged for easy identification by vehicle application and are stored in a handy plastic box

Ascot No.	Mfg. No.	Description
469-20097	20097	30 Bags (5 Ea.) Accessory Kits for Each Transmitter Size, 25 Plastic Valve Caps and Core Tool
469-20179	20179	60 Bags (10 Ea.) Accessory Kits for Each Transmitter Size, 50 Plastic Valve Caps and Core Tool



469-20097



469-20179



### Schrader TPMS Transmitters



Ascot No.	Mfg. No.	Description
461-20028	20028	Chrysler OE 5208-8990AC
461-20034	20034	Mitsubishi OE MN103081
461-20064	20064	Nissan OE 40700-CD001
461-20066	20066	Chrysler OE 5605 3036AA, 5605 3030AB, 6800 16966AA, Siemens SE57770
461-20069	20069	Nissan OE 40700-CK002
461-20076	20076	GM OE 25758220
461-20081	20081	Subaru OE 28103 AG 00A
461-20082	20082	Daewoo OE 96484045
461-20096	20096	Ford OE 4L2T 1A150-BA
461-20107	20107	GM OE 15114379
461-20115	20115	GM OE 15136883
461-20116	20116	GM OE 25774006
461-20117	20117	GM OE 25773946
461-20131	20131	Hummer OE 15122618
461-20135	20135	Ford OE 5L1Z 1A150-AA
461-20153	20153	GM OE 70503153
461-20156	20156	Volvo OE 8651700
461-20158	20158	GM OE 15268606, 10394110
461-20161	20161	Nissan OE 40700-CK001
461-20335	20335	Chrysler OE 04727392AD, 5127 335AB, 5127 335 AD, Siemens SE57243
461-28004	28004	Chrysler OE 04815132AB
461-28006	28006	Chevrolet Corvette OE 10438853
461-28981	28981	Acura and Honda OE 06421-S3V-A02
461-28982	28982	Honda OE 06421-S9V-A01
461-28983	28983	Hyundai OE 958104D100

### Valve Core Torque Tool



Preset torque guarantees correct setting every time on all cores!

- Calibrated to 4 in.-lbs. of torque
- Meets the Tire & Rim Association (TRA) specifications for installing valve cores on TPMS applications
- Can be used to install and remove cores in standard valve stems

Ascot No.	Mfg. No.
469-10347	10347

### Core Removal Tool

Ascot No.	Mfg. No.
469-20250	20250



### TPMS Torque Wrench - 1/4" Drive

- Perfect for tightening grommet nut to manufacturer specifications



168-01501

169-01002



167-12110

Ascot No.	Mfg. No.	Description
168-01501	1501MRMH	1/4" Drive 20-150 in.-lbs. Torque Wrench
169-01002	1002E	1/4" Drive x 2" Chrome Extension
167-12110	1211D	1/4" Drive x 11mm x 12mm Chrome Flip Socket



### 1/2" DR 13 Piece SAE Set

- Contains the following sizes: 7/16", 1/2", 9/16", 5/8", 11/16", 3/4", 13/16", 7/8", 15/16", 1", 1-1/16", 1-1/8", 1-1/4"

Ascot No.	Mfg. No.
163-01150	1150



### 1/2" DR 29 Piece Metric and SAE 6 Point Deep Impact Socket Set

- Contains 7/16", 1/2", 9/16", 5/8", 11/16", 3/4", 13/16", 7/8", 15/16", 1", 1-1/16", 1-1/8" and 1-1/4" deep sockets
- 10, 11, 12, 13, 14, 15, 16, 17, 18, 19, 21, 22, 26 and 27mm deep sockets
- 3/4" x 13/16" deep and 19mm x 21mm deep flip sockets

Ascot No.	Mfg. No.
163-05153	1153DD



### 1/2" DR 13 Piece Deep Set

- Contains the following sizes: 7/16", 1/2", 9/16", 5/8", 11/16", 3/4", 13/16", 7/8", 15/16", 1", 1-1/16", 1-1/8", 1-1/4"

Ascot No.	Mfg. No.
163-01151	1151D



### 1/2" DR 5 Piece Deep Thin Wall Flip Set

- Contains the following sizes: 3/4" x 13/16", 19mm x 21mm, 7/8" x 15/16", 17mm x 19mm, 3" extension

Ascot No.	Mfg. No.
167-12050	1205D



### 1/2" DR 14 Piece Metric Standard Set

- Contains the following sizes: 10mm, 11mm, 12mm, 13mm, 14mm, 15mm, 16mm, 17mm, 18mm, 19mm, 21mm, 22mm, 26mm, 27mm

Ascot No.	Mfg. No.
163-01152	1152M



### 3/4" DR 10 Piece Truck Set

- Contains the following sizes: 13/16" Square Socket, 1-1/16", 1-1/8", 1-1/4" Thin Wall Deep Sockets, 1-1/2" Budd Wheel Socket, 17mm & 21mm Square Socket, 33mm, 35mm & 41mm Deep Sockets

Ascot No.	Mfg. No.
164-02110	2110



### 1/2" DR 14 Piece Metric Deep Set

- Contains the following sizes: 10mm, 11mm, 12mm, 13mm, 14mm, 15mm, 16mm, 17mm, 18mm, 19mm, 21mm, 22mm, 26mm, 27mm

Ascot No.	Mfg. No.
163-01153	1153MD



### 3/4" DR 8 Piece SAE Deep Set

- Contains the following sizes: 1", 1-1/16", 1-1/8", 1-1/4", 1-5/16", 1-3/8", 1-7/16", 1-1/2"

Ascot No.	Mfg. No.
164-02181	2181D



### 3/4" DR 5 Piece Metric Standard Truck Set

- Contains the following sizes: 4 pts. budd wheel standard length, 17mm, 27mm, 30mm, 33mm, 35mm standard



Ascot No.	Mfg. No.
164-02185	2185M

### 1" DR 5 Piece Budd Wheel Socket Set

- Contains the following sizes: 1-1/2" hex x 13/16" square budd wheel impact socket, 35mm x 17mm square budd wheel impact socket, 38mm x 20mm square budd wheel impact socket, 41mm x 21mm square budd wheel impact socket and 33mm deep

Ascot No.	Mfg. No.
165-05626	5626



### 3/4" DR 4 Piece Budd Wheel Socket Set

- Contains the following sizes: 1-1/2" hex x 13/16 square budd wheel impact socket, 35mm x 17mm square budd wheel impact socket, 41mm x 21mm square budd wheel impact socket and 33mm deep



Ascot No.	Mfg. No.
164-04626	4626

### 1" DR 7 Piece Metric Truck Set

- Contains the following sizes: 17mm, 21mm, 4 pts. budd wheel standard length, 27mm, 33mm, 36mm, 41mm deep



Ascot No.	Mfg. No.
165-03197	3197M

### 1" DR 10 Piece Truck Set

- Contains the following sizes: 13/16" square, 1-1/16", 1-1/8", 1-1/4" thin wall deep, 1-1/2" deep with inside lip, 17mm & 21mm square with inside lip, 33mm, 35mm & 41mm deep



Ascot No.	Mfg. No.
165-03110	3110

### #5 Spline DR 9 Piece SAE Truck Set

- Contains the following sizes: 13/16", 4 points budd wheel standard length, 7/8", 15/16", 1", 1-3/16", 1-1/2" deep with inside lip, 1-1/16", 1-1/8", 1-1/4" thin wall deep

Ascot No.	Mfg. No.
165-04191	4191



### 1" DR 9 Piece SAE Truck Set

- Contains the following sizes: 13/16", 4 points budd wheel standard length, 7/8", 15/16", 1", 1-3/16", 1-1/2" deep with inside lip, 1-1/16", 1-1/8", 1-1/4" thin wall deep



Ascot No.	Mfg. No.
165-03190	3190

**Easier to identify and find right impact socket with new & improved laser etching**



### 1/2" DR Master 39 Piece SAE Impact Socket Set

- CR-MO alloy steel for long life
- Fully guaranteed
- Heavy duty blow mold case
- 19 Standard Sockets: 3/8", 7/16", 1/2", 9/16", 5/8", 11/16", 3/4", 13/16", 7/8", 15/16", 1", 1-1/16", 1-1/8", 1-3/16", 1-1/4", 1-5/16", 1-3/8", 1-7/16" and 1-1/2"
- 19 Deep Sockets: 3/8", 7/16", 1/2", 9/16", 5/8", 11/16", 3/4", 13/16", 7/8", 15/16", 1", 1-1/16", 1-1/8", 1-3/16", 1-1/4", 1-5/16", 1-3/8", 1-7/16" and 1-1/2" Universal

Ascot No.	Mfg. No.
163-02668	2668



### 1/2" DR Master 39 Piece Metric Impact Socket Set

- CR-MO alloy steel for long life
- Fully guaranteed
- Heavy duty blow mold case
- 19 Standard Sockets: 9mm, 10mm, 11mm, 12mm, 13mm, 14mm, 15mm, 16mm, 17mm, 18mm, 19mm, 20mm, 21mm, 22mm, 23mm, 24mm, 26mm, 27mm and 30mm
- 19 Deep Sockets: 9mm, 10mm, 11mm, 12mm, 13mm, 14mm, 15mm, 16mm, 17mm, 18mm, 19mm, 20mm, 21mm, 22mm, 23mm, 24mm, 26mm, 27mm and 30mm Universal Joint

Ascot No.	Mfg. No.
163-02669	2669



### 1/2" DR Extra Thin Wall 9 Piece SAE & Metric Wheel Protector Socket Set

- Durable outer sleeve and insert protects high polished wheels and lug nuts from damage
- CR-MO alloy steel for long life
- Fully guaranteed
- Heavy duty blow mold case
- 6 SAE Sockets: 3/4" (light green), 13/16" (purple), 7/8" (green), 15/16" (brown), 1" (silver) and 1-1/16" (black)
- 3 Metric Sockets: 17mm (blue), 19mm (yellow) and 21mm (red)

Ascot No.	Mfg. No.
163-02849	2849

### Replacement Sockets for 2849 Set

Ascot No.	Mfg. No.	Description
163-28492	28492	1/2"x3/4"
163-28494	28484	1/2"x13/16"
163-28496	28496	1/2"x7/8"
163-28498	28498	1/2"x15/16"
163-28910	284910	1/2"x1"
163-28912	284912	1/2"x1-1/16"
163-28917	284917	1/2"x17mm
163-28919	284919	1/2"x19mm
163-28921	284921	1/2"x21mm



### 8-Piece Professional Screwdriver Set

- Includes 5 flat tip drivers and 3 Phillips tip drivers
- Slotted: 3/8" x 8", 5/16" x 6", 1/4" x 4", 3/16" x 3", 1/4" x 1-1/2"
- Phillips: #2 Phillips x 4", #1 Phillips x 3", #2 Phillips x 1-1/2"
- Fluorescent yellow handles
- Hardened chrome vanadium shafts
- Vapor blasted magnetic tips
- Packaged in molded plastic tray for storage
- Hex bolsters for extra turning power

Ascot No.
319-19800



### 1/2" Super Duty Air Impact Wrench-Tire Tool

- Patented spring hammer clutch for smooth operation and extended durability
- Add low air consumption and high torque makes this tool very efficient
- Comfort and control with new ergonomic grip and trigger
- Applications: suspension, shock, frame and engine work
- Ultimate Torque: 550 ft.-lbs.



Ascot No.	Mfg. No.	Description
153-07492	CP-7733	1/2" Impact Wrench
153-17492	CP-7733-2	2" Extended Anvil

### 1" Heavy Duty Air Impact Wrench

- High performance clutch provides longer life under tough conditions
- High-efficiency 6 vane motor for maximum performance
- Bottom exhaust directs exhaust away from the operator
- Three position power regulator with directional control
- Ultimate Torque : 1,450 ft.-lbs.



Ascot No.	Mfg. No.	Description
155-07778	CP-7778	1" Short Shank
155-77786	CP-7778-6	6" Extended Anvil
155-17786	CP-7778SP-6	#5 Spline with 6" Extended Anvil

### Marvel Air Tool Oil

- Specially formulated for use in all piston type rotary air tools and in-line air lubricators
- Prevents rust formation while providing positive lubrication for smooth starting and longer tool life
- Assures maximum performance by dissolving gum and sludge



Ascot No.	Mfg. No.	Description
181-00085	MM085	32 oz.

### 7 Piece Spare Tire Tool Set

- Allows anyone to quickly remove difficult to reach spare tires
- No more digging through the customer's vehicle to locate the spare tire removal kit
- Color-coded wall bracket allows user to quickly identify the correct removal tool
- Applications include many trucks & SUV's where the spare tire is located under the vehicle

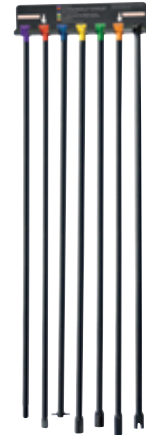

Ascot No.	Mfg. No.	Description
319-96090	96090A	7 Piece Spare Tire Tool Kit

### Individual Spare Tire Tools

Ascot No.	Mfg. No.	Description
319-96091	96091	Spare Tire Tool - Flat Head - Red <i>(For Use on Late Model S10 trucks, Explorers, Blazers, Jimmys, F150s, Expeditions, Older Dakota 2-Wheel Drives and McGuard Lock Systems)</i>
319-96092	96092	Spare Tire Tool - Pin Head - <i>(Blue For Use on Import Trucks)</i>
319-96093	96093	Spare Tire Tool - Hex Head - Yellow <i>(For Use on Dodge Full Size and Stake Bodies, '98-'01 Dodge Full-Size 4-Wheel Drive)</i>
319-96094	96094	Spare Tire Tool - 12mm Square Head - Green <i>(For Use on All Late Model GMs, Remaining '98-'03 Dodge Trucks)</i>
319-96095	96095	Spare Tire Tool - Std. Square Head - Orange <i>(For Use on Older Ford Trucks)</i>
319-96096	96096	Spare Tire Tool - Slotted Square Head - Black <i>(For Use on Dodge Durango, Inside the Hatch)</i>
319-96097	96097	Wall Mount Bracket for Spare Tire Tool Set <i>(Color-coded to allow user to quickly identify the correct removal tool)</i>
319-96098	96098	Spare Tire Tool - 3/8" Square Head - Purple <i>(For Use on New Ford Models)</i>

### Personal Safety Equipment



Ascot No.	Mfg. No.	Description
396-02003	GLO2003	Men's Large Latex Gloves - 100 per Box
396-40314	924G	Hot Mill Glove - Gauntlet Cuff - 12 Pairs per Box
396-40316	924	Hot Mill Glove - Short Cuff - 12 Pairs per Box
396-55220	7533	Leather Palm Glove - 12 Pairs per Pkg.



### Rim Clamp Bead Lifting Tool

- Designed for ease of lifting the bead during the tire changing operation
- Made from a durable chrome-vanadium material
- 20" overall length
- Equivalent to COATS 181354

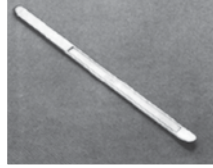

Ascot No.	Mfg. No.	Item
444-81354	TC181354	Rim Clamp® Bead Lifting Tool

### Drop Center Tool

- Assists in mounting high performance tires by holding the bead in the drop center
- Will not scratch aluminum rims
- Equivalent to COATS 435685

Ascot No.	Mfg. No.	Length	Stock	Weight
402-31568	T68	14"	7/16"	1.3 Lbs.

### Tire and Wheel Measuring Tool



Ascot No.	Mfg. No.	Description
454-00599	595	Tire Tread Depth Gauge. Used To Measure Tire Tread Depth In 1/32" Increments: 0-1"

### TPMS Countertop Displays

This display promotes replacing the TPMS components when service is performed on the customer's tires.



Ascot No.	Mfg. No.	Description
469-61589	61589	TPMS Countertop Display w/ Dummy Transmitter
469-61599	61599	Spanish TPMS Countertop Display w/ Dummy Transmitter

### Valve Core Insertion and Removal Tools



Ascot No.	Mfg. No.	Description
469-00607	607	Has Plastic Screwdriver Handle For Better Grip And Leverage
469-00612	TL-612	Standard Bore Core Tool. With An Overall Length Of 8" And Oversized Handle

### Band Transmitter Accessories

- TPMS Band is adjustable to accommodate 14"- 26" wheels
- Plastic clip included with TPMS Cradle
- For use on vehicles equipped with banded transmitters



Ascot No.	Mfg. No.	Description
469-01426	TPSTRAP	Universal TPMS Band
469-02723	TPCRADLE	Band Transmitter Cradle and Clip

### Electric Tire Brander

- 110 volt and 220 volt electric versions available
- Propane brander also available
- 1" letters (A-Z) & numbers (0-9) sold separately
- Hardwood handle

Ascot No.
452-01200



Tire Brander Letters



Tire Brander Numbers

### Mitchell TPMS Guide

- Contains current learn procedures for all domestic and import vehicles currently equipped with tire pressure monitoring systems
- Includes a quick reference to determine service requirements
- Provides detailed system operation for manufacturer specific systems
- E-Book Guide Available



Ascot No.	Description
469-22006	TPMS Consumer Brochure

### Digital Hand Held Tire Inflator

- Inflation range 0-174 PSI
- Accuracy +/- .2 PSI
- 6' Hose
- Lightweight shock resistant design
- High specification ceramic sensor
- Long life, easily replaceable battery
- Available in custom hose lengths and chuck styles



**This Gauge Provides More Accurate Air Pressure Readings Which is Essential with TPMS**

Ascot No.	Mfg. No.
477-10001	Accura 1

### Hand Held Tire Inflator

- Inflation range 0-138 PSI
- Accuracy +/- 2.0 PSI
- Cast aluminum body
- Proven linear spring gauge
- High flow valve for fast inflation
- Available in custom hose lengths and chuck styles



Ascot No.	Mfg. No.	Description
477-10003	MK3	Heavy Duty Hand Held Inflator Gauge w/ Dual Foot Chuck

### Air Line Inflators

- Ideal for gauging and inflating dual tires on trucks and buses as well as passenger cars and light trucks
- Solid brass indicator bar
- Allows operator to stand away while inflating and deflating tires
- Bleeder valve allows user to adjust tire pressure without touching either the tire or valve stem
- Any hose length and/or chuck style available. CALL FOR DETAILS



Ascot No.	Description
477-00001	Safety Inflator Gauge. 12" Hose With Dual Foot Chuck. 10 To 120 PSI
477-00002	Safety Inflator Gauge. 3' Hose With Clip-On Foot Chuck. 10 To 120 PSI. Bleeder Valve
477-00003	Safety Inflator Gauge. 3' Hose With Straight Lock-On Chuck. 10 To 120 PSI. Bleeder Valve
477-00004	Safety Inflator Gauge. 6' Hose With Clip-On Ball Foot Chuck. 10 To 120 PSI. Bleeder Valve
477-00005	Safety Inflator Gauge. 6' Hose With Straight Lock-On Chuck. 10 To 120 PSI. Bleeder Valve
477-00008	Safety Inflator Gauge. 9' Hose With Clip-On Ball Foot Chuck. 10 To 120 PSI. Bleeder Valve
477-00009	Safety Inflator Gauge. 9' Hose With Straight Lock-On Chuck. 10 To 120 PSI. Bleeder Valve
477-00010	Safety Inflator Gauge. 12' Hose With Clip-On Ball Foot Chuck. 10 To 120 PSI. Bleeder Valve
477-00012	Safety Inflator Gauge. 12' Hose With Straight Lock-On Chuck. 10 To 120 PSI. Bleeder Valve
477-01117	Safety Inflator Gauge. 3' Hose with European-Style Clip-On Chuck
477-01116	Safety Inflator Gauge. 6' Hose with European-Style Clip-On Chuck
477-01119	Safety Inflator Gauge. 9' Hose with European-Style Clip-On Chuck

**WARNING:** Never inflate a tire on a multi-piece rim (a rim made up of 2 or more separate pieces) unless the tire and rim are mounted in OSHA regulation 29-CFR Part 1910.177 or D.O.T. approved tire inflation cage. OSHA Regulations require that an inflator gauge must be equipped with a lock-on chuck and have a hose extension sufficiently long for the operator to stand clear of the possible trajectory of a multi-piece rim.





## Tire Swabs and Brushes



Ascot No.	Mfg. No.	Description
437-00001	TS-1	11" OAL x 2" Swab Diameter
437-00002	TS-2	15" OAL x 2" Swab Diameter
437-00003	TS-3	18" OAL x 3" Swab Diameter
437-40006	40006	Tire Lubricating Brush

## Adhesive Wheel Weight Remover



- One piece composite construction can be hit with a hammer
- Removes emblems, body side moldings and stick-on wheel weights
- Scrape off stickers without scratching paint or glass and gaskets from aluminum parts
- Resharpen with a file when needed

Ascot No.	Mfg. No.
486-71510	71510

## Angled Neck Lube Bucket for Center-Post Tire Changers

- Designed for holding tire lubricants on Center-Post tire changers
- Compatible with COATS 4040, 4040SA & 4050
- Made from a durable plastic material
- Equivalent to COATS 106572

Ascot No.	Mfg. No.	Description
844-16572	LB106572	Angled Neck Lube Bucket

## Tire Shelving

Three adjustable tiers - perfect for tires alone or wheel-mounted. Used mainly to store small numbers of tires or store customers' tires. Allows storage of 330 tires in a 40-foot container. Fasteners for walls, floors and additional sections are included.



- Holds 10-12 tires per level
- Rails are tilted to hold tires properly
- Each section is designed to stand alone

Ascot No.	Mfg. No.	Capacity	Dimensions	Weight
751-00922	MTS-92	30 to 36 tires	92" x 92" x 18"	110 Lbs.
751-00924	MTS-924	40 to 48 tires	92" x 120" x 18"	140 Lbs.
751-00925	MTS-925	50 to 60 tires	92" x 150" x 18"	170 Lbs.

## Wheel Cover Pullers/Replacers

- Remove wheel covers quickly and easily without gouging or scratching
- Rubber head T1 1RH prevents damage to hubcap and is replaceable



Ascot No.	Mfg. No.	Length	Stock	Weight
402-31568	T68	14"	7/16"	1.3 Lbs.

## Heavy Duty Wheel Weight Hammer

- Heavy duty construction
- Replaceable plastic head available
- Designed for use on coated wheel weights
- Will not mar alloy wheels



Ascot No.	Mfg. No.	Description
486-33580	113175	Heavy Duty Wheel Weight Hammer
486-33584	113176	Replaceable Head

## Straight Lube Bucket for Rim Clamp Tire Changers

- Designed for holding tire lubricants on Rim Clamp tire changers
- Compatible with COATS RC15, RC20, 5060 & 5070 tire changers
- Made from a durable plastic material
- Equivalent to COATS 106259

Ascot No.	Mfg. No.	Description
844-16259	LB106259	Straight Lube Bucket

## Deluxe Showroom Display Unit

Perfect for displaying your tires for customers, this unit will hold eight tires up to 29" in diameter (740 mm). Includes a folder display and bookmarks providing information on 15 different makes of tire. Packed in a box with all necessary assembly hardware.



Ascot No.	Mfg. No.	Holds	Size
751-00008	MSTD	8 Tires	35" x 98" x 34"

### Wall-Mount Rack

Get tires away from your workspace! With this wall-mount tire rack, you can store 8 tires on the wall to get them off your floor. Easy to assemble and mount on wood or concrete walls.



Ascot No.	Mfg. No.	Holds	Size
751-00066	MWM-66	8 Tires	66" Long

### 60" Passenger & Light Truck Folding Racks

This versatile modular storage system offers extraordinary flexibility in outfitting your tire warehouse. Pallets can be moved and stacked for fast shipment. Removable posts can reduce space requirements by 80%, allowing you to stack them when empty to free up space.



Ascot No.	Mfg. No.	Holds	Size
751-06060	MSR-6060	28-35 Tires	60" x 60" x 60"

### Passenger & Light Truck Folding Racks

This flexible mobile storage system allows you to reduce tire handling to a minimum while providing unparalleled versatility. Large numbers of tires can be stored by load stacking and smaller quantities can be kept on treads in tires. Very sturdy steel construction ensures superior durability.



Ascot No.	Mfg. No.	Holds	Size
751-03260	MLTFD	32-60 Tires	72" x 50" x 66"

### Dolly for Tire Displays

Required to handle tire display units. Only one is necessary even if you have several display units. Compatible with all other makes of display units.

Ascot No.	Mfg. No.
751-00172	MD



### Tire Cart

Easy to maneuver... even with a full load of tires. Can carry tires up to 35" in diameter. Simply press down on the pedal, slide the dolly under the pile and release the pedal. The frame will align the tires! Good for tire diameters from 16" to 35" (406-890 mm).



Ascot No.	Mfg. No.	Holds	Size
751-00810	MTC	8-10 Tires	Max O.D. 35"

### Deluxe Tire Display

This display unit is an excellent compromise between strength and light weight. It has four wheels for fast, easy moves with no need for a dolly. It will hold 14-18 tires up to 31" (790mm) outside diameter. Front wheels are equipped with a brake, and a nameplate measuring 48" x 12" (1200 x 300mm) is provided to display your logo.



Ascot No.	Mfg. No.	Holds	Size
751-00072	MTD-72	14-18 Tires	72" x 75" x 20"

### Truck Tire Folding Rack

For greater ease of use in storing and handling your tires for heavy trucks or farm machines, this folding rack offers vertical tire storage for easy access. Each rack holds 8 tires and can be stacked 4 high, or 20 high when folded. Fits easily in a trailer for shipping.

Ascot No.	Mfg. No.	Holds	Size
751-08010	MTFR	8-10 Tires	94" x 44" x 52"



## AIR SYSTEMS

### Air Compressors



Air Compressor Selection Guide . . . . .	15
Air Compressor . . . . .	16 - 23
Nitrogen Generators . . . . .	24 - 27
Nitrogen Accessories . . . . .	26, 141, 155
Air Tank . . . . .	42

### Air Line Components



Air Dryers . . . . .	19
Filter/Regulators/Lubricators Accessories . . . . .	29
Filter/Regulators/Lubricators . . . . .	30 - 32
Air Hose Reels . . . . .	33 - 36
Air Hose . . . . .	37
Air Line Couplers/Plugs/Fittings . . . . .	38 - 40
Coupler Cross Reference . . . . .	41
Air Hose Adapters and Fittings . . . . .	42 - 44

## AIR TOOLS

### Chicago Pneumatic



Impact Wrenches . . . . .	47 - 50
Sanders . . . . .	50
BlueTork . . . . .	51, 74
Ratchets . . . . .	51 - 52
Grinders . . . . .	53
Drills . . . . .	54
Air Hammer Chisel Kits . . . . .	55
Air Tool Accessories . . . . .	54 - 55

### Ingersoll-Rand



Impact Wrenches . . . . .	56 - 58
Hammers . . . . .	59
Grinders . . . . .	59 - 60
Drills . . . . .	60
Cordless Tools . . . . .	61
Air Tool Accessories . . . . .	62

### Tire Repair Air Tools

Tire Buffers . . . . .	52, 60, 311
Workstation . . . . .	62

## WHEEL SERVICE PRODUCTS



### Impact Sockets

Impact Socket Sets . . . . .	64 - 66
Individual Impact Sockets, Adapters and Extensions . . . . .	67 - 68



### Wheel Torque Products

Torque Sockets and Extensions . . . . .	69 - 71
Wheel Centering Products . . . . .	72
Tire and Wheel Accessories . . . . .	73
Torque Wrenches and Accessories . . . . .	74 - 75
Wheel Attaching Hardware . . . . .	76 - 78
Tire and Wheel Service Tools . . . . .	79 - 80

## LIFTING EQUIPMENT

### Jacks & Lifts



Bottle Jack . . . . .	83 - 85
Service Jacks . . . . .	85 - 92
Jack Stands . . . . .	93 - 95, 102
Specialty Jacks . . . . .	96 - 97
Transmission Jacks . . . . .	98 - 100
Wheel Dollies . . . . .	101
Hydraulic Shop Presses . . . . .	103
Heavy Duty Equipment and Shop Cranes . . . . .	104

## TIRE & WHEEL SERVICE

### Tire Service Supplies



Tire Lubricants . . . . .	107
Tire Service Supplies . . . . .	108
Tire Sealant . . . . .	109 - 110

### Bead Seating



Bead Breakers . . . . .	111 - 112
Hydraulic Rams and Accessories . . . . .	113
OTR Service Tools . . . . .	114 - 115
Bead Seating Devices . . . . .	115 - 116
Chloride Pumps . . . . .	117

## TIRE & WHEEL SERVICE (Cont.)

### Wheel & Rim Dismounting

Tubeless Tire Irons . . . . .	118
Mount/Demount Tools . . . . .	119 - 120
Portable Bead Breakers and Lock Ring Tools . . . . .	121
Wedges and Hammers . . . . .	122 - 123
Shop Service Tools & Wrenches . . . . .	124 - 125
4-Way Lug Wrenches . . . . .	126
Tire Service Tools . . . . .	127 - 130

### VALVE HARDWARE



#### Tire Pressure Monitoring Systems

TPMS Training Materials . . . . .	135, 149
TPMS Activation Tools . . . . .	136 - 138
TPMS Accessory Kits & Assortments . . . . .	139 - 140
TPMS Accessories and Tools . . . . .	141 - 144
TPMS Sensors . . . . .	145 - 146
TPMS Cabinets . . . . .	147
TPMS Retrofit Kits . . . . .	148

#### Valve Hardware



Passenger & Truck Valves . . . . .	150 - 155
Special Application Products and Valve Extension . . . . .	156 - 157
Air/Liquid Valves . . . . .	158
Large Bore Valves . . . . .	159 - 163
Super Large Bore Valves . . . . .	163 - 165
Z-Bore Valve System . . . . .	166
PT Valve System . . . . .	167

#### Tools



Valve Service Tools . . . . .	167 - 169, 173
-------------------------------	----------------

#### Gauges & Chucks

Passenger Air Gauges . . . . .	169
Truck Air Gauges . . . . .	170 - 171
Passenger & Truck Air Chucks . . . . .	172 - 173
Large Bore Air Gauges and Chucks . . . . .	173
Inflation Gauges . . . . .	174

## SERVICE EQUIPMENT



#### Tire Changers

Passenger . . . . .	177 - 181
---------------------	-----------

Heavy Duty Truck . . . . .	180 - 181, 185 - 187
Tire Changer Accessories . . . . .	182 - 185, 188

#### Wheel Balancers

Passenger . . . . .	189 - 191, 193
Heavy Duty Truck . . . . .	191 - 192
Wheel Balancer Accessories . . . . .	192 - 200

#### Brake Lathes

Brake Lathes . . . . .	201 - 202
Accessories . . . . .	203 - 213

#### Lifts

Two-Post Lifts . . . . .	214 - 215
Four-Post Lifts . . . . .	216
Rolling Jacks and Workstation . . . . .	217
Specialty Lifts . . . . .	218

## WHEEL BALANCING SUPPLIES



#### Lead Wheel Weights

Coated & Uncoated . . . . .	221 - 224
Adhesive Wheel Weights . . . . .	230 - 232
Truck Wheel Weights . . . . .	234 - 236
Wheel Weight Assortments . . . . .	237 - 238

#### Alternative Lead Wheel Weights

Zinc & Steel Passenger Wheel Weights . . . . .	226 - 229
Adhesive Wheel Weights . . . . .	232 - 233
Truck Wheel Weights . . . . .	236
Wheel Weight Assortments . . . . .	238

#### Wheel Weight Tools

Wheel Weight Hammers . . . . .	239
Adhesive Wheel Weight Remover and Rim Gauges . . . . .	239

Tire Balancing Compounds . . . . .	240 - 242
------------------------------------	-----------

## ALIGNMENT



#### Alignment Tools & Equipment

Alignment Racks . . . . .	216 - 217
---------------------------	-----------

Aligners ..... 255  
 Turntables ..... 258

**Passenger Car Alignment**

Rear Wheel Alignment Shims ..... 244  
 Camber/Caster Adjustment Shims ..... 244 - 245  
 Camber/Caster Adjusting Kits ..... 246 - 248  
 Rear Camber & Toe Kits ..... 249 - 253  
 MacPherson Strut Tools ..... 259

**Light Truck Alignment**

Alignment Bushing, Sleeves and Cams ..... 246 - 248  
 Suspension Parts ..... 248 - 253  
 2WD and 4WD Service Tools ..... 258

**Medium & Heavy Duty Truck Alignment**

Alignment Shims ..... 254 - 257

**AUTOMOTIVE & FLEET SERVICE EQUIPMENT**



**Battery Chargers/Starters**

Battery Chargers/Starters ..... 263 - 265  
 Battery Testers ..... 266

**Exhaust Accessories**

Hose and Adapters ..... 266 - 267  
 Exhaust Removal Systems ..... 281

**Mechanics Tools**

Bench Grinders ..... 267  
 Bench Vises ..... 268  
 Pliers and Screwdrivers ..... 268  
 Drop Lights ..... 271

**Shop Supplies**

Shop Supplies and Equipment ..... 269  
 Shop Cleaners and Brushes ..... 270  
 Tire Carts and Service Stickers ..... 271  
 Tire Racks ..... 272 - 273  
 Car Protectors ..... 274  
 Studding Equipment ..... 275

**Lubrication**

Drain ..... 276, 278 - 280  
 Grease Gun and Fluid Pumps ..... 276 - 277  
 Oil Accessories ..... 282

**Safety Products**

Safety Products ..... 283  
 Mechanics Gloves ..... 284

**FLUID EXCHANGE EQUIPMENT**



A/C Refrigerant Handling Systems ..... 286 - 287  
 Fluid Exchange and Flushers ..... 288  
 A/C Cooling System Accessories ..... 289 - 292

**TIRE REPAIR MATERIALS & TOOLS**



**Cements & Chemicals**

Bead Sealant and Vulcanizing Fluids ..... 296, 303, 306, 310  
 Retreaders Cement ..... 303 - 304

**Tire Repair Equipment**

Tire Buffers ..... 52, 60, 311  
 Extruders ..... 305  
 Electric Spotter & Vulcanizers ..... 305  
 Monoflex System ..... 307  
 Flexible Shaft Buffer ..... 329

**Rubber Vulcanizing Materials ..... 304**

**Tire Repair Tools**

Cement Brusher/Dispensers ..... 304  
 Buffing Stones/Wheels ..... 312, 314 - 317  
 Tungsten Carbide Rasps ..... 312, 316 - 317  
 Burrs/Drills Bits ..... 317  
 Stitchers ..... 317  
 Knives ..... 318

**Tire Repair Materials**

Nail Hole Repair Units ..... 294 - 295, 299, 302, 306, 308 - 309  
 Center (Tread & Shoulder) Units ..... 294, 297 - 302, 306, 308 - 309



## TIRE REPAIR MATERIALS & TOOLS (Cont.)

Sidewall Units.....297 - 298, 300 - 301, 309  
 EM, Grader, OTR Units .....297 - 298, 300 - 301, 309  
 Knives ..... 318

### Special Application Patches

Blue Triangle Section ID Patches ..... 302  
 Envelope Repair..... 307

### Tire Inspection

Inspection Awls/Rasps..... 313, 317  
 Tire Vacuum ..... 316  
 Tire Spreaders..... 319  
 Manual Tire Spreaders ..... 320

## RETREADING



### Buffing

Rasp Blades and Retread Shop Accessories ... 322 - 327

### Building

Casing Venting Materials..... 327  
 Tire Appearance ..... 328  
 Retreading Accessories ..... 329

### Curing

Envelopes ..... 330 - 331

**Measurement Conversion Chart..... 332**

**Product Index..... 333**

**Numeric Index..... 343**

Ascot Supply Corp. is not responsible for inadvertent typographical errors or omissions.

- Tire and Rim Servicing can be dangerous, and should be done by trained personnel using proper tools and procedures. The Occupational Safety and Health Administration has a safety standard for the servicing of single-piece and multi-piece rim wheels (OSHA std 29 CFR 1910.177) to include requirements for the safe servicing of rims used on passenger, truck, trailers, buses and off-road vehicle equipment. Properly trained personnel should perform all tire servicing. Failure to comply with these procedures as well as procedures recommended by Tire Manufacturers and Wheel and Rim Manufacturers may result in faulty positioning of the tire and or rim and may cause the assembly to burst with explosive force sufficient to cause serious physical injury or death.
- The sole intent of this catalog is to aid the Ascot Distributors and their customers in the resale of automotive related parts. This catalog, or any part thereof, may not be reproduced in any form without written consent from Ascot Supply Corp.
- Ascot and the "Ascot Logo" are marks of Ascot Supply Corporation. The products in this catalog are manufactured for distributors of Ascot Supply Corp. and their customers.
- Caution and Warning statements appear throughout this catalog. Use of products in this catalog contrary to specifications and directions may result in personal injury and/or property damage.
- **WARRANTY DISCLAIMER:** Ascot Supply Corp. has made a diligent effort to illustrate and describe the products in this catalog accurately; however, illustrations, photos and descriptions are for the sole purpose of identification and do not express or imply a warranty that the products are merchantable, or fit for a particular purpose, or that the products will necessarily conform to the illustrations, photos or descriptions. Ascot Supply Corporation or its Distributors make no warranty or affirmation of fact, express or implied
- **O.S.H.A. HAZARDOUS SUBSTANCE AND CALIFORNIA PROPOSITION 65 PRODUCT INFORMATION:** Material Data Safety Sheets for products containing OSHA defined hazardous substances and a list of products known to the state of California to cause cancer, birth defects, or other reproductive harm are available upon request from Ascot Supply Corp.
- Ascot Supply Corp. disclaims all express and implied warranties, including the implied warranties of merchantability and fitness for a particular purpose. Ascot Supply Corp. also disclaims liability for personal injury, property damage or consequential damages.
- **IMPORTANT:** Snap-In passenger valve stems are safe for tire pressures up to a maximum of 60 psi (cold tire pressure) and for a maximum rim thickness of .156" (3.96mm). If greater pressure or rim thickness is required, metal clamp-in valve stems are recommended.
- Ascot Supply Corp. Does Not recommend "temporary" tire repairs. All repairs should perform the function of filling or replacing the injured section as recommended by the RMA and other industry associations.
- Always wear eye protection when using air tools, wheels, cups and rasps.
- **Warning:** Always wear safety goggles when using striking or struck tools. Never use one hammer to strike another hammer. Never use a striking tool with a loose or damaged handle. Discard any striking or struck tool if it shows dents, cracks, chips or mushrooming.
- **CAUTION:** Use all chemicals and cements in a well ventilated area. Avoid prolonged breathing or inhalation of vapors.
- Lead is harmful if ingested. Wash thoroughly after handling and before eating, drinking or smoking. Keep away from children and pets.
- For best results, check tire pressure when tires are cold or when the vehicle has not been driven for several hours. Readings taken after prolonged driving at high speeds will increase tire pressure causing a false reading. Check tire pressure at least once a week or as necessary.

# AIR SYSTEMS

AIR COMPRESSORS  
NITROGEN TIRE FILLING SYSTEMS  
AIR HOSE & REELS  
AIR PREPARATION PRODUCTS  
COUPLERS & PLUGS  
DRY AIR SYSTEMS  
HOSE FITTINGS



## Meet the Compressors You Can Depend on for the Long Haul

### Advantage Series Simplex

*Loaded with the Essentials!*

- Magnetic Motor Starter
- Automatic Tank Drain
- Low Oil Level Monitor
- Air Cooled Aftercooler
- (Select models)



### Advantage Series Duplex

*Need More Air?*

- Double the Compressors
- Double the Quality
- Double the Air!



### Engine Driven

*Take It On The Road!*

- 8–25 hp
- Gas or Diesel Driven
- Kohler & Honda Engines



### Evolution

*The Solution for a Quiet Compressor*

- 5–15 hp
- Noise Levels as low as 67 dBA
- Powder Coated Steel Enclosure



All Advantage, R-Series, and Evolution Compressors include the Legendary Heavy Duty Two-Stage R-Series Pump

Serving Compressed Air Users  
for 91 Years!!



## Compressor Selection Guide

### Terminology

#### GENERAL DEFINITIONS

**Compressors** are machines for compressing air or gas from an initial intake pressure to a higher discharge pressure.

**Single-Stage Compressors** are those in which compression from initial to final pressure is completed in a single step or stage.

**Two-Stage Compressors** are those in which compressions from initial to final pressure is completed in two distinct steps or stages.

**Intercoolers** are devices for removing the heat of compression of the air or gas between consecutive states of multistage compressors.

**Load Factor** is the ratio of average compressor output during a period of actual use to the continuous rated output of the machine.

**Piston Displacement (PD)** is determined by precisely measuring a volume of air which has been raised to a specific pressure and is expressed in conditions existing at the compressor discharge. This flow rate is generally stated in terms of actual cubic feet per minute (CFM).

#### ACCESSORIES

**Magnetic Starters** provide thermal overload protection for motors and are recommended for 3 HP and larger motors.

**Aftercoolers/Dryers** remove moisture from the air line as air cools from compressor.

**Automatic Tank Drain** automatically removes water that has accumulated in the compressor tank as air cools.

**Low Oil Switch** prevents the air compressor from operating when oil is low.

### Sizing an Air Compressor

1. List the types of pneumatic devices/equipment to be used and how many will be used at the same time.
2. Add total of air volume (SCFM) required by pneumatic tools being used. Utilize the chart below.
3. Add additional 25% to compensate for air line leaks and pressure drops.
4. Identify the air compressor that will provide necessary SCFM. The following professional electric 2-stage compressors provide the listed.

SCFM:

HP	SCFM	HP	SCFM
5 HP	17.2 SCFM	15 HP	42 SCFM
7.5 HP	24 SCFM	25 HP	97 SCFM
10 HP	35 SCFM	30 HP	106 SCFM

5. Once the correct HP rating has been selected based on the air volume requirements, you will need to know the type of available electric service to determine the need for a single phase or three phase compressor.

#### EXAMPLE

Tools Being Used	SCFM
Tire Changer	5.5 SCFM
1/2" Impact Wrench	3.5 SCFM
3/4" Impact Wrench	7.5 SCFM
Hydraulic Lift	6.0 SCFM
SUBTOTAL	22.5 SCFM
	X 1.25%
<b>TOTAL SCFM</b>	<b>28.125 SCFM</b>

#### ANSWER

Customer will need an air compressor that produces a minimum of 28.125 SCFM @ 175 PSI. Customer will need a 10 HP compressor or two 5 HP compressors.

## Compressor Selection Guide

After listing all the air operated devices to be supplied by the air compressor, determine from the chart, pressure range and volume of air required by each device. The air compressor must maintain a minimum pressure at least equal to the highest of the pressure ranges. Always use free air (CFM) and pressure (PSI) from the nameplate on device or from manufacturer. Free air figures in the table are averages and should not be considered accurate for any specific brand.

PSI	TOOL	CFM
<b>PORTABLE TOOLS</b>		
70-100	Air Filter Cleaner	3
70-100	Body Polisher	20
70-100	Body Sander	10
70-100	Brake Tester	4
70-100	Carbon Remover	3
90-100	Dusting Gun (Blow Gun)	3
70-100	Panel Cutter	4
70-90	Drill 1/16" - 3/8"	4
70-90	3/8" Impact Wrench	3
70-90	1/2" Impact Wrench	4
70-90	5/8" Impact Wrench	5
70-90	3/4" Impact Wrench	8
70-90	1" Impact Wrench	12
70-90	Die Grinder	5
90-100	Vertical Disc Sander	20
90-100	Small File/Saw Machine	3
90-100	Large File/Saw Machine	5
90-100	Burring Tool	5

PSI	TOOL	CFM
<b>SPRAY GUNS</b>		
90-100	Engine Gun	5
90-100	Paint Gun - Production	8
90-100	Paint Gun - Touch Up	4
125-150	Rim Stripper	6
125-150	Tire Changer	1
125-150	Tire Inflation Line	2
125-150	Tire Spreader	1
125-150	Vacuum Cleaner	7
<b>HAMMERS</b>		
90-100	Air Hammer	4
90-100	Tire Hammer	12
125-150	Pneumatic Garage Door	3
90-100	Radiator Tester	1
90-100	Spark Plug Cleaner	5
90-100	Spark Plug Tester	1
70-100	Transmission/Differential Flusher	3
70-100	Fender Hammer	9
70-100	Car Washer	9

## Air Compressors

### Advantage Series - Reciprocating Air Compressor

The Advantage Series is a fully packaged unit with all of the additional accessories customers need included. Advantage series compressors are typically shipped from the factory in 24 hours or less. Compressors are shipped ready to install and operate. Each new assembled unit comes with a five-year limited warranty.

#### Specifications and Features:

- 5 – 25 HP
- Maximum Pressure up to 175 PSIG
- 17.3 – 90.1 ACFM at 175 PSIG
- Two Stage, Splash Lubricated
- Tank Mounted, Simplex and Duplex Models
- Vertical or Horizontal Configurations
- Package comes standard with up to six pre-installed options
- Factory filled with ChampLub lubricant



Ascot No.	Mfg. No.	HP or HPD	Variants STD	Variants CA	Pump Model No.	Volts	Tank Capacity (Gal.)*	175 PSI Rating CFM Del'y	RPM	Dimensions LxWxH	Approx. Ship Weight (Lbs.)
101-00058	VR5-8	5	CASRSA01	CASRSA39	R-15B	230/1	80V	17.3	710	33x24x77	535
101-00158	VR5-8	5	CASRSA126	CASRSA128	R-15B	230/1	80V	17.3	710	33x24x77	565
101-00078	VR5-8	5	CASRSA05	CASRSA45	R-15B	208/3	80V	17.3	710	33x24x77	535
101-01012	VR5-8	5	CASRSA03	CASRSA40	R-15B	230/3	80V	17.3	710	33x24x77	535
101-11012	VR5-8	5	CASRSA148	CASRSA154	R-15B	230/3	80V	17.3	710	33x24x77	565
101-02512	HR5-8	5	CASRSA07	CASRSA46	R-15B	230/1	80H	17.3	710	66x23x49	535
101-40580	HR5-8	5	CASRSA146	CASRSA152	R-15B	230/1	80H	17.3	710	66x23x49	565
101-40581	HR5-8	5	CASRSA11	CASRSA81	R-15B	208/3	80H	17.3	710	66x23x49	535
101-40582	HR5-8	5	CASRSA09	CASRSA48	R-15B	230/3	80H	17.3	710	66x23x49	535
101-40583	HR5-8	5	CASRSA147	CASRSA153	R-15B	230/3	80H	17.3	710	66x23x49	565
101-40780	VR7F-8	7.5	CASRSA168	CASRSA167	R-15B	208/1	80V	23.1	990	33x24x77	545
101-40781	VR7F-8	7.5	CASRSA13	CASRSA42	R-15B	230/1	80V	23.1	990	33x24x77	545
101-40782	VR7F-8	7.5	CASRSA17	CASRSA53	R-15B	208/3	80V	23.1	990	33x24x77	545
101-40783	VR7F-8	7.5	CASRSA15	CASRSA44	R-15B	230/3	80V	23.1	990	33x24x77	545
101-41012	VR10-12	10	CASRSA21	CASRSA75	R-30D	208/3	120V	34.8	740	47x30x81	890
101-41112	VR10-12	10	CASRSA19	CASRSA74	R-30D	230/3	120V	34.8	740	47x30x81	890
101-42112	HR10-12	10	CASRSA25	CASRSA49	R-30D	208/3	120H	34.8	740	72x24x55	890
101-43112	HR10-12	10	CASRSA29	CASRSA64	R-30D	208/3	120H	34.8	740	72x24x55	920
101-44112	HR10-12	10	CASRSA23	CASRSA41	R-30D	230/3	120H	34.8	740	72x24x55	890
101-45112	HR10-12	10	CASRSA27	CASRSA50	R-30D	230/3	120H	34.8	740	72x24x55	920
101-41512	HRA15-12	15	CASRSA33	CASRSA59	R-40A	208/3	120H	53.7	770	74x28x62	1110
101-42512	HRA15-12	15	CASRSA31	CASRSA43	R-40A	230/3	120H	53.7	770	74x28x62	1110
101-43512	HRA15-12	25	CASRSA37	CASRSA65	R-70A	208/3	120H	90.1	770	74x27x64	1365
101-44512	HRA15-12	25	CASRSA35	CASRSA47	R-70A	230/3	120H	90.1	770	74x27x64	1365

\* V: Vertical, H: Horizontal Configuration

## Air Compressors

### Advantage Series - Duplex Compressors

**Fully Packaged Compressors:** Compressors equipped with all of the desired options: Mounted Magnetic Starter, Low Oil Level Monitor, Automatic Tank Drain, Air-Cooled Aftercooler and Vibration Isolators.

**Duplex Fully Packaged Compressors:** Two (2) Compressors and accessories supplied in one package provides the flexibility of single operations, alternating between compressors, or duplex operations to meet high air demands. Includes Automatic Tank Drain, Vibration Isolators, Two (2) Mounted Magnetic Starters plus alternator, Low Oil Level Monitors and Air Cooled Aftercoolers.



Ascot No.	Mfg. No.	HP	Voltage/ Phase	Tank Size	Tank Conf	Pump Mfg. No.	ACFM @175 PSIG	ACAC
101-51120	HR5D-12	5	230/1	120	Horiz.	R-15B	33.0	STD
101-53120	HR5D-12	5	208/3	120	Horiz.	R-15B	33.0	STD
101-54120	HR5D-12	5	230/3	120	Horiz.	R-15B	33.0	STD
101-75120	HR7D-12	7.5	230/1	120	Horiz.	R-30D	51.6	STD
101-75320	HR7D-12	7.5	208/3	120	Horiz.	R-30D	51.6	STD
101-75420	HR7D-12	7.5	230/3	120	Horiz.	R-30D	51.6	STD
101-10325	HR10D-25	10	230/3	250	Horiz	R-30D	69.6	STD

### Champion Gasoline Air Compressors

- Truck Bed Mountable. Ideal for Field Service Applications
- Heavy Duty Two Stage Compressors
- V-Belt Drive with Totally Enclosed Belt Guard
- Centrifugal unloader for loadless start – prolongs motor life
- Gasketless Design
- Vibration Isolators Included on 30 gallon models
- Each new assembled unit comes with a five-year limited warranty



Ascot No.	Mfg. No.	HP or HPD	Tank Size	Tank Conf	Engine Type	ACFM @175 PSIG	RPM	Approx. Ship Weight
102-11530	HGR5-3H	11	30	Horiz.	Honda	20.1	895	409 Lbs.
102-11560	HGR5-6H	11	60	Horiz.	Honda	20.1	895	475 Lbs.
102-11880	HGR5-8H	11	80	Horiz.	Honda	20.1	895	514 Lbs.
102-13730	HGR7-3K	13	30	Horiz.	Kohler	23.2	1025	409 Lbs.
102-13760	HGR7-6K	13	60	Horiz.	Kohler	23.2	1025	475 Lbs.
102-13780	HGR7-8K	13	80	Horiz.	Kohler	23.2	1025	514 Lbs.

## Air Compressors

### Evolution – Quiet Enclosed Recip

- Sound levels as low as 67dBA
- 12 Gauge Steel Enclosure
- Separate compressor and motor chambers with dedicated cooling circuits provide cooler operation and long-life
- Separate Inner Base reduces vibration and noise
- Oil-Site Gauge and Filter maintenance indicator provide notification of routine maintenance
- Innovative Belt-tensioning system

Ascot No.	Mfg. No.	HP	Tank Configuration	Tank Size (Gal.)	Pump Model Number	RPM	Approx. Ship Weight
101-58000	HER5-8	5	Horiz.	80	RP-15B	734	733 Lbs.
101-78000	HER7F-8	7.5	Horiz.	80	RP-15B	990	762 Lbs.



### Centurion II Reciprocating Air Compressors

- 5 - 15 hp
- Up to 175 PSIG
- 17.3 - 49 ACFM at 175 PSIG rating
- Tank mounted, vertical or horizontal configuration
- Two-stage, splash lubricated compressor pump
- Automatic start/stop operation
- Factory filled with ChampLub AC lubricant
- Mounted Magnetic Starters standard on all Centurion II models (Except for 5 HP models with 3450 RPM motors)



Ascot No.	Mfg. No.	HP	Tank Size	Pump Mfg. No.	Dimensions (LxWxH)	Shipping Weight (Lbs.)	125 PSI Rating*			175 PSI Rating*		
							RPM	CFM Displ.	CFM Del'y	RPM	CFM Displ.	CFM Del'y
101-65600	HRV5-6	**5	60	RV-15A	51.5" x 22.75" x 47.25"	445	805	23.5	19.1	734	21.4	17.3
101-65800	HRV5-8	**5	80	RV-15A	66.5" x 22.75" x 47.25"	530	805	23.5	19.1	734	21.4	17.3
101-65120	HRV5-12	**5	120	RV-15A	72.25" x 24" x 54"	760	805	23.5	19.1	734	21.4	17.3
101-65601	VRV5-6	**5	60	RV-15A	32.5" x 24.5" x 76"	450	805	23.5	19.1	734	21.4	17.3
101-65801	VRV5-8	**5	80	RV-15A	33" x 26-5/8" x 76"	530	805	23.5	19.1	734	21.4	17.3
101-65121	VRV5-12	**5	120	RV-15A	42.5" x 30" x 79"	760	805	23.5	19.1	734	21.4	17.3
101-67560	HRV7F-6	7.5	60	RV-15A	51.5" x 22.75" x 47.25"	510	990	28.7	23.9	990	28.7	23.1
101-67580	HRV7F-8	7.5	80	RV-15A	66.5" x 22.75" x 47.25"	595	990	28.7	23.9	990	28.7	23.1
101-67512	HRV7F-12	7.5	120	RV-15A	72.5" x 24" x 53-5/8"	820	990	28.7	23.9	990	28.7	23.1
101-67561	VRV7F-6	7.5	60	RV-15A	32.5" x 24.5" x 76"	515	990	28.7	23.9	990	28.7	23.1
101-67581	VRV7F-8	7.5	80	RV-15A	33" x 26-5/8" x 76"	595	990	28.7	23.9	990	28.7	23.1
101-67513	VRV7F-12	7.5	120	RV-15A	42.5" x 30" x 79"	820	990	28.7	23.9	990	28.7	23.1
101-67582	HRV7-8	7.5	80	RV-30A	66.5" x 22.75" x 48.5"	595	670	39.6	30.0	575	33.5	25.8
101-67514	HRV7-12	7.5	120	RV-30A	72.5" x 24" x 54"	820	670	39.6	30.0	575	33.5	25.8
101-67583	VRV7-8	7.5	80	RV-15A	33" x 26-5/8" x 76"	595	670	39.6	30.0	575	33.5	25.8
101-67515	VRV7-12	7.5	120	RV-30A	42.5" x 30" x 79"	820	670	39.6	30.0	575	33.5	25.8
101-61080	HRV10-8	10	80	RV-30A	66.5" x 22.75" x 47.25"	675	810	47.3	37.3	740	43.1	34.8
101-61212	HRV10-12	10	120	RV-30A	72.5" x 24" x 54"	890	810	47.3	37.3	740	43.1	34.8
101-61081	VRV10-8	10	80	RV-30A	42.5" x 30" x 66.75"	675	810	47.3	37.3	740	43.1	34.8
101-61012	VRV10-12	10	120	RV-30A	42.5" x 30" x 79.75"	910	810	47.3	37.3	740	43.1	34.8
101-61580	HRV15F-8	15	80	RV-30A	66.5" x 22.75" x 48.5"	740	1045	60.9	50.2	1045	60.9	47.0
101-61512	HRV15F-12	15	120	RV-30A	72.5" x 24" x 54"	960	1045	60.9	50.2	1045	60.9	47.0
101-61513	VRV15F-12	15	120	RV-30A	46-3/8" x 30" x 79.75"	980	1045	60.9	50.2	1045	60.9	47.0

\*Units tested in accordance with CAGI/PNEUROP Acceptance Test Code PH2CPTC2

\*\*Available with either 1750 or 3450 RPM. 3450 RPM motors come with built-in TOLP (Starter not included).

## Refrigerated Dryers

### Refrigerated Air Dryers

- Effective moisture removal at all flow rates
- Combination separator/filter
- Ideal for air compressors equipped with an air cooled aftercooler

Ascot No.	Mfg. No.	Flow	Voltage	In/Out Connection	Dimensions LxWxH	Approx. Ship Weight
105-00015	CRN15	15	115/1/60	3/8" OD	15x12.6x12.6	69 Lbs.
105-00025	CRN25	25	115/1/60	1/2" NPT	26x19x21	142 Lbs.
105-00035	CRN35A1	35	115 or 230/1/60	1/2" NPT	26x19x21	146 Lbs.
105-00050	CRN50A1	50	115 or 230/1/60	1/2" NPT	26x19x21	152 Lbs.
105-00075	CRN75A1	75	115 or 230/1/60	3/4" NPT	33x25x26	209 Lbs.
105-00100	CRN100A1	100	115 or 230/1/60	1" NPT	38x29x20	251 Lbs.
105-00125	CRN125A1	125	115 or 230/1/60	1" NPT	38x29x20	273 Lbs.
105-00150	CRN150A1	150	115 or 230/1/60	1" NPT	38x29x20	279 Lbs.



**Call for more information on Maintenance Kits for Air Compressors and Refrigerated Dryers.**

### Sizing 3-in-1 High Inlet Dryer

Follow the below steps to size your dryer:

1. Use the table that identifies your inlet temperature to your dryer.
2. In the chart select the inlet pressure that will be entering your dryer.
3. Determine SCFM.

**RULE of THUMB CALCULATION**

Rotary Screw Air Compressor

SCFM = Compressor HP x 4.5

Reciprocating Air Compressor

SCFM = Compressor HP x 3.5

4. Select the SCFM requirement for your dryer based on the SCFM coming out of the air compressor.

### EXAMPLE: WHAT SIZE DRYER SHOULD BE USED?

Customer has a 20 HP reciprocating compressor. The inlet temperature to the dryer is approximately 120°F. The pressure entering the dryer is 140 PSI.

1. Identify the table that shows 120°F (in this example it would be table 3).
2. From the same table (table 3) select the inlet pressure of dryer. In this example (140 PSI).
3. Use Rule of Thumb Calculation to determine SCFM.  
 $20\text{HP} \times 3.5 = 70 \text{ SCFM}$
4. Locate 70 SCFM under 140 PSI column. Follow across to dryer part number.

**ANSWER - Customer needs part number 3530.**

### Champion CRH Series High Inlet Temperature Refrigerated Air Dryer

**TABLE 1 - 180° INLET**

Mfg. No.	100 PSIG	150 PSIG	175 PSIG
CRH20	18	22	23
CRH25	23	27	29
CRH35	32	38	41
CRH50	45	54	58
CRH75	68	81	87
CRH100	91	108	116
CRH125	114	135	145

**TABLE 2 - 150° INLET**

Mfg. No.	100 PSIG	150 PSIG	175 PSIG
CRH20	21	25	26
CRH25	26	31	33
CRH35	37	44	47
CRH50	52	62	67
CRH75	78	93	100
CRH100	105	124	133
CRH125	131	155	167

**TABLE 3 - 120° INLET**

Mfg. No.	100 PSIG	140 PSIG	175 PSIG
CRH20	23	29	30
CRH25	30	35	38
CRH35	42	49	53
CRH50	59	70	75
CRH75	88	105	113
CRH100	118	140	151
CRH125	148	176	189

## Industrial Air Compressors

### Electric Start Gas Engine

- Aluminum head for maximum operating temperatures
- Automotive-style rings allows less than 5 ppm oil carryover
- Finned intercooler dissipates excess heat
- Two-piece connecting rod for serviceability
- Stainless steel reed valves with controlled lift for maximum efficiency
- Balance counter-weighted crankshaft for smooth, trouble-free operation
- Cast-iron cylinder, crankcase and flywheel for dependability
- American made designed, manufactured and assembled since 1920



Ascot No.	Mfg. No.	HP	Engine Brand	Low Oil Shutdown	Tank Configuration	Unit Tank Size	Gas Fuel Tank Size	Pump Model	ACFM @175 PSIG	Wt. (Lbs.)
102-21131	G211H30HCB	11	Honda	Yes	Horizontal	30	1.72 Gal.	QT-5	18.7	490
102-21130	G211K30HCD	11	Kohler	No	Horizontal	30	1.25 Gal.	QT-5	18.7	515
102-21330	G213H30HCB	13	Honda	Yes	Horizontal	30	1.72 Gal.	QT-7.5	23.6	490
102-21230	G212K30HCD	13	Kohler	No	Horizontal	30	1.25 Gal.	QT-7.5	23.6	515
102-21860	G218K60HCA	18	Kohler	Yes	Horizontal	60	6 Gal.	QT-15	37.4	900

### Pro Unit

#### Pro Unit Standard Features:

- Two-Stage Compressor
- Splash-Lubricated
- 5 to 30HP Electric ODP Motor
- Single Phase or Three Phase
- Honda or Kohler Gas Engine
- Motor Overload Protection
- True Blue 5 Year Warranty
- Ball Valve-Style Tank Drain

#### Pro Unit Optional Features:

- 5 to 7.5HP Horizontal Units
- Pressure-Lubricated
- Duplex Tank Configurations
- Yanmar Diesel Engines



Ascot No.	Mfg. No.	HP	Phase	Volt	Tank Configuration	Unit Tank Size	Starter Type	Pump Model	ACFM @175 PSIG	RPM	Wt. (Lbs.)
101-24160	2V41C60VC	5	1	230	Vertical	60	Capacitor Start	QT-54	15.2	1310	475
101-08251	251CP80VCB	5	1	230	Vertical	80	Combo	QT-5	17.2	942	660
101-18251	251CS80VCB	5	1	230	Vertical	80	Magnetic	QT-5	17.2	942	680
101-25323	253DS80VCB23	5	3	230	Vertical	80	Magnetic	QT-5	17.2	942	680
101-25346	253DS80VCB46	5	3	460	Vertical	80	Magnetic	QT-5	17.2	942	680
101-08271	271CS80VCB	7.5	1	230	Vertical	80	Magnetic	QT-7.5	22.6	1026	720
101-27323	273DS80VCB23	7.5	3	230	Vertical	80	Magnetic	QT-7.5	22.6	1026	720
101-27346	273DS80VCB46	7.5	3	460	Horizontal	80	Magnetic	QT-7.5	22.6	1026	720
101-02110	P2101CS12VCB	10	1	230	Vertical	120	Magnetic	QT-10	31	859	1000
101-02112	P2101CS12HCB	10	1	230	Horizontal	120	Magnetic	QT-10	31	859	850
101-02103	P2103DS12VCB20	10	3	208	Vertical	120	Magnetic	QT-10	35	968	1000
101-12103	P2103DS12HCB20	10	3	208	Horizontal	120	Magnetic	QT-10	35	968	850
101-12230	P2103DS12VCB23	10	3	230	Vertical	120	Magnetic	QT-10	35	968	1000
101-12231	P2103DS12HCB23	10	3	230	Horizontal	120	Magnetic	QT-10	35	968	850
101-12460	P2103DS12VCB46	10	3	460	Vertical	120	Magnetic	QT-10	35	968	1000
101-12461	P2103DS12HCB46	10	3	460	Horizontal	120	Magnetic	QT-10	35	968	850
101-15320	2153DS12HCA20	15	3	208	Horizontal	120	Magnetic	QT-15	51	923	995
101-15323	2153DS12HCA23	15	3	230	Horizontal	120	Magnetic	QT-15	51	923	995
101-15346	2153DS12HCA46	15	3	460	Horizontal	120	Magnetic	QT-15	51	923	995
101-20320	2203DS12HC20	20	3	208	Horizontal	120	Magnetic	QT-30	75	687	1925
101-20323	2203DS12HC23	20	3	230	Horizontal	120	Magnetic	QT-30	75	687	1925
101-20346	2203DS12HC46	20	3	460	Horizontal	120	Magnetic	QT-30	75	687	1925
101-12232	2253DS12HC23	25	3	230	Horizontal	120	Magnetic	QT-30	92.4	833	1940
101-23246	2253DS12HC46	25	3	460	Horizontal	120	Magnetic	QT-30	92.4	833	1940
101-30346	2303DS12HC46	30	3	460	Horizontal	120	Magnetic	QT-30	105.9	958	1965

## Industrial Air Compressors

### Fully Loaded Max Unit

#### Max Unit Standard Features:

- Two-Stage Compressor
- Splash-Lubricated
- 5 to 15HP Electric ODP Motor
- Single Phase or Three Phase
- Motor Overload Protection
- Air Cooled Aftercooler
- Low Oil Level Switch
- Automatic Tank Drain

- Isolator Pads (Horizontal units)
- Dual Controls on 10 to 15HP
- True Blue 5 Year Warranty

#### Max Unit Optional Features:

- 5 to 7.5HP Horizontal Units
- 20 to 30HP Horizontal Units
- Pressure-Lubricated
- Duplex Tank Configurations



Ascot No.	Mfg. No.	HP	Phase	Volt	Tank Configuration	Unit Tank Size	Starter Type	Pump Model	ACFM @175 PSIG	RPM	Wt. (Lbs.)
101-51800	251C80VCBM	5	1	230	Vertical	80	Magnetic	QT-5	17.2	942	730
101-53823	253D80VCB23M	5	3	230	Vertical	80	Magnetic	QT-5	17.2	942	730
101-53846	253D80VCB46M	5	3	460	Vertical	80	Magnetic	QT-5	17.2	942	730
101-80271	271C80VCBM	7.5	1	230	Vertical	80	Magnetic	QT-7.5	22.6	1026	770
101-73823	273D80VCB23M	7.5	3	230	Vertical	80	Magnetic	QT-7.5	22.6	1026	770
101-73846	273D80VCB46M	7.5	3	460	Vertical	80	Magnetic	QT-7.5	22.6	1026	770
101-21230	2101C12VCBM	10	1	230	Vertical	120	Magnetic	QT-10	31	859	1050
101-21232	2101C12HCBM	10	1	230	Horizontal	120	Magnetic	QT-10	31	859	950
101-21208	2103D12HCB20M	10	3	208	Horizontal	120	Magnetic	QT-10	35	968	950
101-21231	2103D12HCB23M	10	3	230	Horizontal	120	Magnetic	QT-10	35	968	950
101-24621	2103D12HCB46M	10	3	460	Horizontal	120	Magnetic	QT-10	35	968	950
101-53208	2153D12HCA20M	15	3	208	Horizontal	120	Magnetic	QT-15	51	923	1050
101-53230	2153D12HCA23M	15	3	230	Horizontal	120	Magnetic	QT-15	51	923	1050
101-53460	2153D12HCA46M	15	3	460	Horizontal	120	Magnetic	QT-15	51	923	1050



### Xtreme Unit

When you want the advantages of a rotary screw but the application requires a reciprocating compressor, Quincy's Xtreme is the right choice. Xtreme units come standard with motor overload protection, sound attenuating canopy for low noise operation, air-cooled aftercooler, removable front and back panel, 175 PSI working pressure and Quincy's industry leading 5-year True Blue Warranty.



Ascot No.	Mfg. No.	HP	Phase	Volt	Tank Configuration	Unit Tank Size	Starter Type	Pump Model	ACFM @175 PSIG	RPM	Wt. (Lbs.)
101-80230	251CS80HCBX	5	1	230	Horizontal	80	Magnetic	QT-5	17.2	942	980
101-80231	253DS80HCB23X	5	3	230	Horizontal	80	Magnetic	QT-5	17.2	942	980
101-80460	253DS80HCB46X	5	3	460	Horizontal	80	Magnetic	QT-5	17.2	942	980
101-80234	271CS80HCBX	7.5	1	230	Horizontal	80	Magnetic	QT-7.5	22.6	1026	1020
101-80232	273DS80HCB46X	7.5	3	230	Horizontal	80	Magnetic	QT-7.5	22.6	1026	1020
101-80461	273DS80HCB23X	7.5	3	460	Horizontal	80	Magnetic	QT-7.5	22.6	1026	1020
101-12023	2101CS12HCBX	10	1	230	Horizontal	120	Magnetic	QT-10	31	859	1185
101-12208	2103DS12HCB20X	10	3	208	Horizontal	120	Magnetic	QT-10	35	968	1185
101-12221	2103DS12HCB23X	10	3	230	Horizontal	120	Magnetic	QT-10	35	968	1185
101-12222	2103DS12HCB46X	10	3	460	Horizontal	120	Magnetic	QT-10	35	968	1185
101-20812	2153DS12HCB20X	15	3	208	Horizontal	120	Magnetic	QT-15	51	923	1320
101-23530	2153DS12HCB23X	15	3	230	Horizontal	120	Magnetic	QT-15	51	923	1320
101-23531	2153DS12HCB46X	15	3	460	Horizontal	120	Magnetic	QT-15	51	923	1320

## Air Compressors

### Two-Stage Gasoline Engine Driven

Ideal for fleet or field service applications with truck bed mounting design. Idle engine control and electronic ignition for easier starting. Powder coat paint finish to protect against outdoor elements. 30 gallon ASME receiver and OSHA fully enclosed belt guard for worker safety.

Ascot No.	Mfg. No.	HP	Engine	ACFM @175 PSIG	Tank
102-24125	2475F12.5G	13	Kohler	25	30 Gallon Horizontal
102-24212	2475F13.GH	13	Honda	25	30 Gallon Horizontal



### Two-Stage Electric "Value Package"

Priced right and designed for the most demanding applications where a dependable air supply is required. Each package includes a two-stage cast iron compressor pump, ODP electric motor, magnetic motor starter (mounted and wired), automatic start and stop pressure switch control, mounted on an ASME rated receiver tank. Available voltages: 230/1/60 (5-7.5 HP), 200/3/60, 460/3/60. Pressure up to 175 PSIG. Oil sight glass included on 10-15 HP Packages.

Ascot No.	Mfg. No.	HP	ACFM @175 PSIG	Tank
101-23451	2340L5-V	5	14.7	60 Gallon Vertical
101-24705	2475N5-V	5	16.8	80 Gallon Vertical
101-24751	2475N7.5-V	7.5	24	80 Gallon Vertical
101-25452	2545E10-V	10	35	120 Gallon Horizontal
101-71150	7100E15-V	15	50	120 Gallon Horizontal

### Two-Stage Electric "Fully Packaged"

Everything you need for a dependable air supply with minimal maintenance. Fully packaged compressors include magnetic motor starter, air cooler and electric drain valve which removes harmful moisture, plus, the added protection of a low oil level shutdown switch. Available voltages: 230/1/60 (5-7.5 HP), 200/3/60, 460/3/60.

Ascot No.	Mfg. No.	HP	ACFM @175 PSIG	Tank
101-27550	2475N5-P	5	16.8	80 Gallon Vertical
101-27551	2475N7.5-P	7.5	24	80 Gallon Vertical
101-27552	2545K10-P	10	35	120 Gallon Vertical
101-27553	2545E10-P	10	35	120 Gallon Horizontal
101-71153	7100E15-P	15	50	120 Gallon Horizontal



### Ingersoll-Rand Start-Up Maintenance Kits

All the parts needed to maintain your compressor for a full year, plus the added protection of extended warranty coverage are two very distinct advantages you'll gain with the All Season Select synthetic pump lubricant and replacement air filter elements. Kits for gasoline engine driven compressors also include engine air filter, oil filter and engine oil.



Ascot No.	Mfg. No.	Compressor HP
106-24305	3230580	5 & 7.5
106-24710	32305898	10 & 15
106-30020	32305906	20, 25 & 30
106-24712	32305872	12.5 (Kohler)



## Air Compressors

### Rotary Screw Compressors

- Engineered for high performance, efficiency and reliability, Chicago Pneumatic's new line of QRS rotary screw air compressors meet the compressed air requirements of the most demanding shops, providing a complete compressed air installation. The compressor and dryer, when included, is tank mounted, prepiped, wired and tested. All air connections have been optimized to minimize pressure drop and reduce the potential for air leaks
- Low sound enclosure and innovative cooling fan, the CP QRS series offers the lowest noise levels available, allowing you to install it virtually anywhere in the shop
- Combined with efficient rotary screw technology and a high efficiency TEFC (Totally Enclosed Fan Cooled) motor, the QRS offers low energy consumption. Pulse free air is ideal for paint and body applications
- Simple compression concept and continuous contact cooling, the QRS rotary screw compressor can operate fully loaded- 24 hours a day/7 days a week. All reciprocating compressors are designed to cycle for intermittent operation
- Can easily be installed just about anywhere in the shop. It's integrated design provides clean, cool, dry, quality air that protects your air tools, shop equipment and body work from harmful moisture, dirt and heat. The QRS oil cooling system, A-T-L starter, TEFC motor, optional air dryer, low sound enclosure and receiver tank are all factory assembled and tested
- The CP QRS offers increased reliability, reduced maintenance and trouble-free operation. No need to worry about rings, valves, rod inserts, bushings and pistons. Extended service intervals save time and money. Convenient service panel allows easy access to all internal components
- QRS 3.0, 5.0 & 7.5 are available 1/60/220V
- All QRS are available with tri-voltage motors and starters for 3/60/208-230-460V
- QRS 20-30 are also available as base mounted



HPD Models Include Dryer



HP Model



Ascot No.	Mfg. No.	HP or HPD	CFM @Max PSI	Max Pressure (PSIG)	Horizontal Tank (gal.)	dBA Enclosed	Dimensions	Net Wt. (Lbs.) (w/o & w/ Dryer)
101-50000	QRS5.0HPD	5	16.6	150	60	62	56"x22"x50"	463/485
101-75000	QRS7.5HPD	7.5	21.2	150	60	64	56"x22"x50"	468/490
101-10000	QRS10HPD	10	37/33	125/150	120	66	73"x24"x58"	775/845
101-15000	QRS15HPD	15	52/47	125/150	120	68	73"x24"x58"	815/885
101-20000	QRS20HPD	20	84/76	125/150	120	63	53"x31"x48"	1325/1425
101-25000	QRS25HPD	25	101/92	125/150	120	66	53"x31"x48"	1400/1500
101-30000	QRS30HPD	30	119/107	125/150	120	68	53"x31"x48"	1475/1575

## Nitrogen Tire Filling Systems

### How Nitrogen Works and What it Does:

Studies of nitrogen tire filling show that car owners can improve gas mileage by up to 10% and extend tire life by as much as 25%! Tire filling with 95% minimum purity nitrogen helps keep tires at optimum inflation levels, which in turn delivers fuel savings and improved tread wear compared to under inflated tires. And properly inflated tires improve safety and handling as well. Nitrogen tire filling is one of the fastest growing segments in the auto service industry as more car owners seek ways to save money and improve gas mileage.



### Nitrogen Tire Filling Systems

- Robust plastic bezel design eliminates any potential for damage from accidental contact with vehicle. Minimizes weight for easy portability
- Heavy duty Parker Hannifin (4) stage filtration provides contaminant-free compressed air. Includes carbon adsorption filter, a must have in any generator installation
- Built-in sample port for testing the purity of your nitrogen. Generators are set for 95% purity in tires, but produce purities up to 99%
- Built-in auto inflator purges and fills up to 6 tires simultaneously. Operator simply puts chucks on tires and sets pressure, then is free to do other work
- Includes nitrogen membrane produced by Cleveland, OH based Parker Hannifin, with expertise from over 10,000 nitrogen generator installations worldwide
- Includes 30 gallon storage tank with every portable generator
- Built-in counter to keep track of your nitrogen business
- Easy installation. Simply pipe in compressed air and pipe out nitrogen
- Rugged nitrogen inflated tires provide effortless portability in garage environments



Mfg. No.	TS021	TS051	TS076	TS123
Ascot No.	119-00021	119-00051	119-00076	119-00123
N2 Flow @ 97% purity, 145 PSIG, SCFM	1.39	3.28	4.9	7.89
N2 Flow @ 95% purity, 145 PSIG, SCFM	2.1	5.1	7.6	12.3
N2 Flow @ 97% purity, 101.5 PSIG, SCFM	0.98	2.3	3.43	5.5
N2 Flow @ 95% purity, 101.5 PSIG, SCFM	1.51	3.62	5.43	8.77
Compressed air pressure requirement, PSIG	100-145	100-189	100-189	100-189
Maximum compressed air pressure, PSIG	145	189	189	189
Compressed air temperature range	50°F-104°F	50°F-104°F	50°F-104°F	50°F-104°F
Ambient temperature	68°F	68°F	68°F	68°F
Nitrogen dew point	-50°	-50°	-50°	-50°
Ambient operating temperature	33°F-110°F	33°F-110°F	33°F-110°F	33°F-110°F
Max compressed air requirement, SCFM	5.5	13	20	31
Compressed air prefiltration	2 stage including carbon adsorption	4 stage including carbon adsorption	4 stage including carbon adsorption	4 stage including carbon adsorption
Wall mount dimensions and weight	54"H x 18"W x 11"D, 140 Lbs.	54"H x 18"W x 11"D, 140 Lbs.	54"H x 18"W x 11"D, 140 Lbs.	54"H x 18"W x 11"D, 140 Lbs.
Tank (floor) mount dimensions	56"H x 26"W x 34"D, 300 Lbs.	56"H x 26"W x 34"D, 300 Lbs.	56"H x 26"W x 34"D, 300 Lbs.	56"H x 26"W x 34"D, 300 Lbs.
Portable dimensions	60"H x 20"W x 34"D, 250 Lbs.	60"H x 20"W x 34"D, 250 Lbs.	60"H x 20"W x 34"D, 250 Lbs.	60"H x 20"W x 34"D, 250 Lbs.
Inlet/Outlet connection	1/2" NPT, 1/2" NPT	1/2" NPT, 1/2" NPT	1/2" NPT, 1/2" NPT	1/2" NPT, 1/2" NPT
Noise Level	<45 dBA	<45 dBA	<45 dBA	<45 dBA
Required Annual Maintenance	Filters	Filters & Carbon	Filters & Carbon	Filters & Carbon
Application	Motorcycles & Mini Cars	Cars & Light Trucks	Cars & Trucks	Full Vehicle Service
Annual Maintenance Kit	MKTS021	MKTS123	MKTS123	MKTS123

## Nitrogen Tire Filling Systems

### RTI NTF-60 Plus Nitrogen Tire Filling System

- The NEW RTI NTF-60 Plus generates nitrogen on demand and stores it on-board for quick nitrogen tire service. The exclusive RTI tire deflation and vacuum system increases speed and ensures higher nitrogen purity in tires. A purity tester quickly checks nitrogen purity. The NTF-60 provides your customers with better tire pressure, increased safety, superior handling, improved fuel economy and longer tire life! Purity tester 436050 included.
- Service Time\* – <7 minutes average (per vehicle)
- Maximum Services\* – 8 tires (per hour including tank refill)
- Tank Size – 60 gallon (227 L)

\*Average tire size for data: 225/60/R15

Ascot No.	Mfg. No.	Nitrogen Capacity
119-00060	NTF-60 Plus	5.1CFM



### RTI NTF-15 Plus Nitrogen Tire Filling System

- The NEW RTI NTF-15 Nitrogen Tire Filling System generates nitrogen on demand and stores it on-board for quick nitrogen tire service. The exclusive RTI tire deflation and vacuum system increases speed and ensures higher nitrogen purity in tires. A purity tester quickly checks nitrogen purity. The NTF-15 provides your customers with better tire pressure, increased safety, superior handling, improved fuel economy and longer tire life! Purity tester 436050 included.

Ascot No.	Mfg. No.	Nitrogen Capacity
119-00015	NTF-15	2.1CFM
119-00115	NTF-15 Plus	5.1CFM

### NitroPRO® NTF-515 Nitrogen Tire Filling System

RTI's NEW NitroPRO® NTF-515 is the professional's choice for nitrogen tire inflation with more nitrogen tire fill capability and variable nitrogen purity level flexibility. Major features include:

- Application flexibility - dual setting provides either 95% or 98% N2 purity of the outlet with the twist of a wrist
- Superior productivity - automatic operation, up to six tire simultaneous fill
- Super-fast service times - about 5 minutes for four 225/60R15 tires simultaneously
- Use anywhere - battery powered fill controller provides superior unit portability
- Fill versatility - programmable control head easily accommodates variable pressure settings
- Single tire operation (deflate, vacuum & fill or simply fill) - perfect for new tire installation & top-offs
- 5.1CFM large-bore membrane - high throughput and efficiency

Ascot No.	Mfg. No.	Nitrogen Capacity
119-00215	NTF-515	5.1CFM



## Nitrogen Tire Filling Systems

### Green Valve Caps for Nitrogen Inflated Tires

Ascot No.	Mfg. No.	Description
468-00207	46800207	Green Plastic Nitrogen Cap
468-00307	46800307	Green Valve O-ring
468-00607	46800607	Nitrogen Sleeve
468-43607	436075	High Quality Green Stamped Chrome
468-59021	590021	Chrome Nitrogen Valve Cap (100/Box)
468-59019	590019	Aluminum Nitrogen Valve Cap (100/Box)



468-00207



468-00607



468-00307



468-43607



468-59019

### Haltec Air & Nitrogen Inflation System

Ideal for:

- Fleet Operations
- Tire Service Centers
- Auto Dealerships

89TRL offers a mobile solution for single tire nitrogen inflation. The all-new nitrogen software will purge the air out of any tire size, re-inflate with nitrogen, maintaining its accuracy of .3 PSI. Designate the number of purge cycles to guarantee the purity level needed to obtain the benefits of nitrogen inflation over standard air inflation. Systems also work for standard air inflation.

Ascot No.	Mfg. No.
119-08914	89RTI4B



### Parker TS018 Tiresaver Nitrogen Top-Off Inflator

- 1.6 CFM
- Digital PSIG readout
- 1/4" NPT Inlet
- Replaceable membrane cartridge
- Nitrogen replacement hose

Ascot No.	Mfg. No.
119-00018	TS018

## Nitrogen Tire Filling Systems

### Branick 120A Nitrogen Cylinder Inflation System

The Branick 120A is the solution for a low volume shop that only plans to service one or two vehicles a day or one that's looking to test the nitrogen market.

**Features include:**

- Fully automatic nitrogen delivery cart
- New plug and battery are industrial grade, built for a tough environment
- Comes standard with 4 lock-on chucks
- Pressure range up to 145 PSI

Ascot No.	Mfg. No.	Working Pressure Range
119-00120	120A	0 - 145 PSI



### Branick 485 Nitrogen Inflation System

- The 485 is totally automatic and completely mobile, enabling the operator to wheel the unit directly to any vehicle
- Zero installation costs
- No electrical requirements to operate
- Industrial grade HD battery
- Efficient membrane
- Low maintenance cost
- Connect to any air-line and you're inflating tires. Plug and Play

Ascot No.	Mfg. No.	Nitrogen Capacity
119-00485	485	4.0CFM

### Branick 685 Nitrogen Inflation System

- The 685 has all the features of the Model 485 with added capacity to easily handle SUV and light truck applications
- Retractable hose reels
- Automatic and completely mobile enabling the operator to wheel the unit directly to any vehicle
- No installation costs and no electrical requirements to operate
- Equipped with an industrial grade HD battery

Ascot No.	Mfg. No.	Nitrogen Capacity
119-00685	685	8.0CFM



## Building An Efficient Air System

Water and dirt cause more problems in compressed air lines than anything else. A typical 7.5 HP compressor brings in an average of 3 gallons of water from the atmosphere per day along with dust and dirt. It is important to eliminate water and dirt from your air system. A good filtration system will extend the life of your tools and eliminate downtime and unnecessary service calls on your equipment.

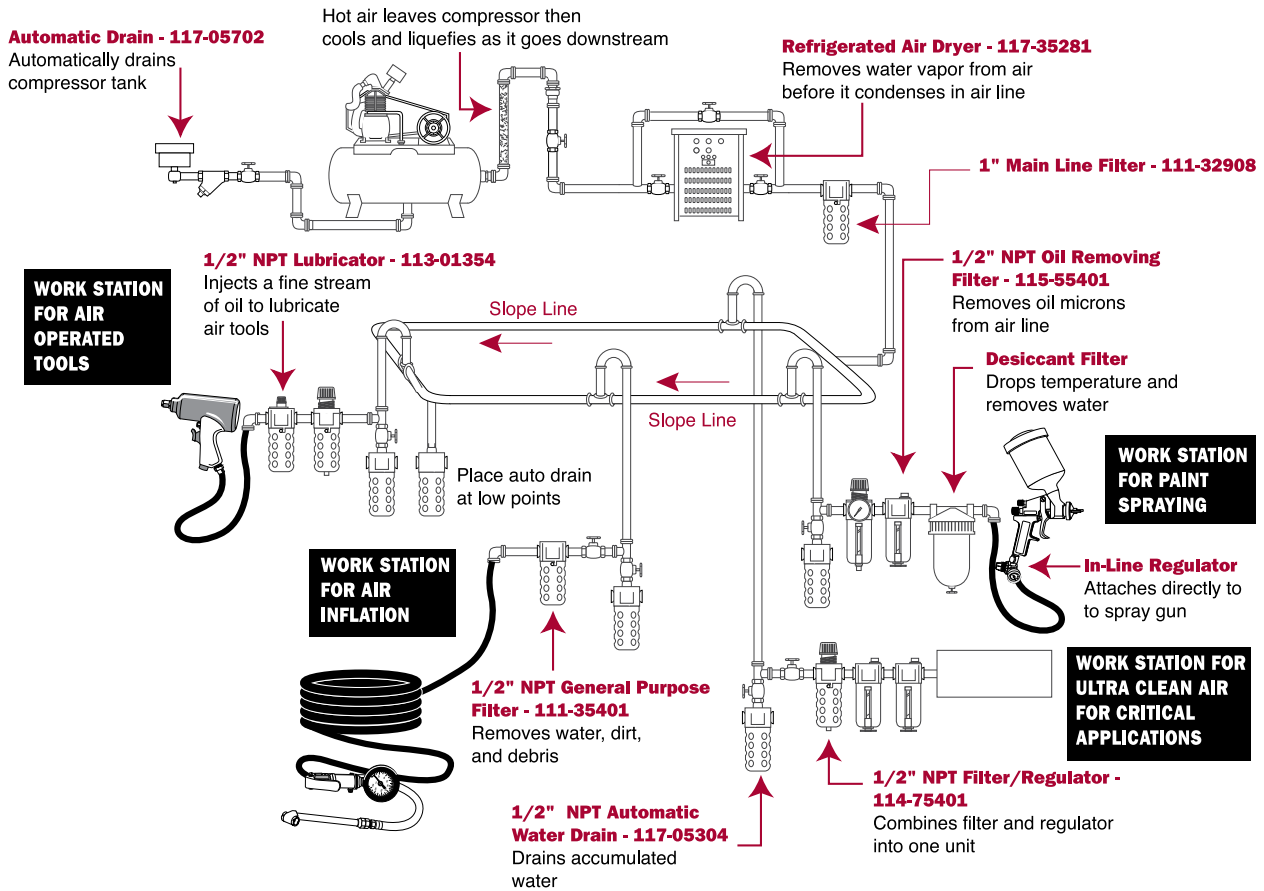

### 5 Important Steps to a Work Station Drop

1. Main line filter and regulator should be placed at least 20 feet from the compressor. The air will cool down, allowing much of the water vapor to condense naturally for removal by filtration.
2. Main line piping should slope down from point of origin by 1/8" per foot. Any water in the line will flow down to the lowest point for draining.
3. All line drops (work stations) should be taken from the top of the main line. This prevents water which forms in the main line from flowing into branch lines.
4. Galvanized pipe is recommended when building an air system.
5. Follow illustration when building a work station drop.

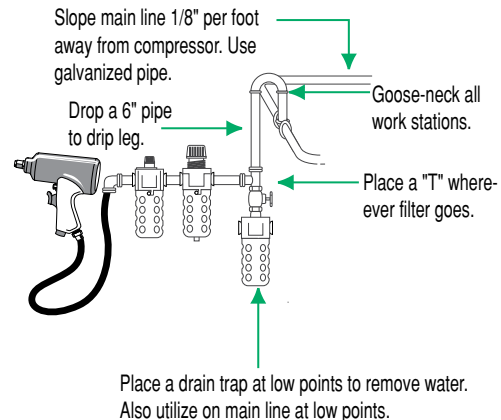

## Air Preparation Accessories

### Electric Automatic Compressor Drain

- Automatically drains filters, compressor tanks, drip legs, aftercoolers and receivers
- Opens and closes valve in 1 to 60 minute cycle times and 1 to 30 second blow down time
- 1/4" NPT connection
- Includes Y-strainer



### Automatic Compressor Drain

- Automatically expels liquids from piping network in compressed air systems
- Use in low spots in an air system where water accumulates
- Float type drain features a protective stainless steel screen with umbrella baffle, providing large sump area for oil, sludge and dirt
- 1/2" NPT top threaded port



Ascot No.	Mfg. No.	Description
117-05702	5702S	Electric Automatic Compressor Drain

Ascot No.	Mfg. No.	Description
117-05304	T53-04W	Automatic Drain

### Mini In-Line Disposable Desiccant Dryer

- Point-of-use, patented, disposable, mini in-line desiccant dryer removes water vapor, oil vapor and dirt
- Point-of-use on blow guns or spray guns as final protection for critical parts during blow off and paint spraying
- See-through housing shows desiccant bead color change from blue to pink indicating dryer needs to be replaced
- 1/4" NPT connection



### In-Line Air Tool Filter

- In-line filter protects air tools from dirt and debris
- 1-9/16" length, 1/2 oz.
- 40 micron sintered bronze element
- Inlet can be attached directly to pneumatic tools
- 1/4" male x 1/4" female NPT



Ascot No.	Mfg. No.	Description	Qty.
117-00010	DFD-10	Disposable Desiccant Dryer	2

Ascot No.	Mfg. No.	Description
117-09132	9132	In-Line Air Tool Filter

Follow the steps below to determine the gallons of water accumulated by a compressed air system per 8 hours of use:

1. Determine the ambient temperature (outside temperature surrounding the dryer) and relative humidity.
2. Locate ambient temperature in first column of water factor chart.
3. Follow the row over to percent of humidity. This indicates the number of gallons accumulated by your air compressor in an 8-hour period.

#### EXAMPLE

25HP air compressor delivers 100 SCFM.  
 Ambient Temperature = 100°F  
 Relative Humidity = 60%

Water factor chart number is 31.2

**COMPRESSED AIR SYSTEM ACCUMULATES 31.2 GALLONS OF WATER PER 8 HOURS OF USE.**

### Gallons of Water per 8 Hours @ 100 SCFM

Ambient Air Temperature	20% Humidity	30% Humidity	40% Humidity	50% Humidity	60% Humidity	70% Humidity	80% Humidity	90% Humidity	100% Humidity
120°F	18.6	27.9	37.2	46.5	55.8	65.1	74.4	83.7	93.0
110°F	14.1	21.0	27.9	35.1	42.0	48.9	55.8	63.0	69.9
100°F	10.5	15.6	20.7	26.1	31.2	36.6	41.7	46.8	52.2
90°F	7.8	11.4	15.3	19.2	23.1	26.7	30.6	34.5	38.4
80°F	5.7	8.4	11.1	13.8	16.8	19.5	22.2	24.9	27.9
70°F	3.9	6.0	7.8	9.9	12.0	13.8	15.9	18.0	19.8
60°F	2.7	4.2	5.7	6.9	8.4	9.9	11.1	12.6	14.1
50°F	2.1	3.0	3.9	4.8	6.0	6.9	7.8	8.7	9.9
40°F	1.2	2.1	2.7	3.3	3.9	4.8	5.4	6.0	6.6
30°F	.9	1.2	1.8	2.1	2.7	3.0	3.6	3.9	4.5
20°F	.6	.9	1.2	1.5	1.7	1.9	2.1	2.4	2.7
10°F	.3	.5	.7	.8	1.0	1.2	1.4	1.5	1.8

## Filters, Regulators, Lubricators

### Filter/Regulator Combination Units

- Combines filter and pressure regulator into one space saving unit
- Output performance equal to an individual filter and regulator
- Reduced pressure outputs of 0-125 PSIG
- Features three position non-rising knob—push to lock, pull to adjust, detach to make tamper resistant
- Available in metal bowl or polycarbonate bowl with metal bowl guard



114-75301

\*NOTE: Gauge not included. Sold separately. Ascot part number indicated.



Ascot No.	Mfg. No.	Pipe Size	Adjustment Type	Max. Flow SCFM	Bowl Capacity	Bowl Type	Drain	Gauge Part No.	Operating Temperature	Max. Pressure
114-75200	B752T	1/4"	T-Handle	50	5 Oz.	Poly	Manual	117-01481*	40-125°F	150 PSIG
114-75201	B752WT	1/4"	T-Handle	50	6 Oz.	Metal	Manual	117-01481*	40-175°F	250 PSIG
114-75202	B752FW	1/4"	Knob	50	6 Oz.	Metal	Float Auto	117-01481*	40-125°F	175 PSIG
114-75203	B752Z	1/4"	Knob	50	5 Oz.	Poly	Piston Auto	117-01481*	40-125°F	150 PSIG
114-75300	B753T	3/8"	T-Handle	80	5 Oz.	Poly	Manual	117-01481*	40-125°F	150 PSIG
114-75301	B753WT	3/8"	T-Handle	80	6 Oz.	Metal	Manual	117-01481*	40-175°F	250 PSIG
114-75302	B753FW	3/8"	Knob	80	6 Oz.	Metal	Float Auto	117-01481*	40-125°F	175 PSIG
114-75303	B753Z	3/8"	Knob	80	5 Oz.	Poly	Piston Auto	117-01481*	40-125°F	150 PSIG
114-00754	B754GW	1/2"	Knob	100	6 Oz.	Metal	Manual	Included	40-175°F	250 PSIG
114-75400	B754T	1/2"	T-Handle	100	5 Oz.	Poly	Manual	117-01481*	40-125°F	150 PSIG
114-75401	B754WT	1/2"	T-Handle	100	6 Oz.	Metal	Manual	117-01481*	40-175°F	250 PSIG
114-75402	B754FW	1/2"	Knob	100	6 Oz.	Metal	Float Auto	117-01481*	40-125°F	175 PSIG
114-75403	B754Z	1/2"	Knob	100	5 Oz.	Poly	Piston Auto	117-01481*	40-125°F	150 PSIG



114-03354

### Modular Units

- Units include a filter, regulator and lubricator and/or filter, regulator and oil removing filter
- Units equipped with or without OSHA safety lock-out valves
- Gauge included
- Screwdriver only tool needed to connect or disconnect units
- Insert interlocking feature allows simple installation in any location

Ascot No.	Mfg. No.	Pipe No.	Max. Flow Size	Bowl SCFM	Bowl Capacity	Type	Lockout Drain	Operating Valve	Max. Temperature
114-03352	C33352W	1/4"	100	6 Oz.	Metal	Manual	Not Included	40-175°F	250 PSIG
114-13352	VC33352W	1/4"	100	6 Oz.	Metal	Manual	Included	40-175°F	250 PSIG
114-03353	C33353W	3/8"	100	6 Oz.	Metal	Manual	Not Included	40-175°F	250 PSIG
114-13353	VC33353W	3/8"	100	6 Oz.	Metal	Manual	Included	40-175°F	250 PSIG
114-03354	C33354W	1/2"	100	6 Oz.	Metal	Manual	Not Included	40-175°F	250 PSIG
114-13354	VC33354W	1/2"	100	6 Oz.	Metal	Manual	Included	40-175°F	250 PSIG



## Filters

### General Purpose Filters

- Removes harmful water condensate, pipe scale, dirt and rust from your compressed air system
- Prevents corrosive damage to compressed air equipment and finished products
- Protects components and air tools from premature failure
- Installed upstream of regulators to prevent valve failure
- Also used as pre-filters to oil removing and coalescing filters to ensure high efficiency and long element life in applications such as paint spraying, instrumentation and pharmaceuticals
- Porous sintered bronze element



111-30002

111-35201

111-32908



Ascot No.	Mfg. No.	Pipe Size	Max. Flow SCFM	Bowl Capacity	Bowl Type	Operating Drain	Max. Temperature	Filter Flow	Element
111-30002	F300-02	1/4"	27	1 Oz.	Poly	Manual	40°-125°F	150 PSIG	20 micron
111-35200	F352	1/4"	48	5 Oz.	Poly	Manual	40°-125°F	150 PSIG	40 micron
111-35201	F352W	1/4"	48	6 Oz.	Metal	Manual	40°-160°F	250 PSIG	40 micron
111-35202	F352Z	1/4"	48	5 Oz.	Poly	Piston Auto	40°-125°F	150 PSIG	40 micron
111-35203	F352FW	1/4"	48	6 Oz.	Metal	Float Auto	40°-120°F	175 PSIG	40 micron
111-35300	F353	3/8"	75	5 Oz.	Poly	Manual	40°-125°F	150 PSIG	40 micron
111-35301	F353W	3/8"	75	5 Oz.	Metal	Manual	40°-160°F	250 PSIG	40 micron
111-35302	F353Z	3/8"	75	6 Oz.	Poly	Piston Auto	40°-125°F	150 PSIG	40 micron
111-35303	F353FW	3/8"	75	6 Oz.	Metal	Float Auto	40°-120°F	175 PSIG	40 micron
111-35400	F354	1/2"	100	5 Oz.	Poly	Manual	40°-125°F	150 PSIG	40 micron
111-35401	F354W	1/2"	100	6 Oz.	Metal	Manual	40°-160°F	250 PSIG	40 micron
111-35402	F354Z	1/2"	100	5 Oz.	Poly	Piston Auto	40°-125°F	150 PSIG	40 micron
111-35403	F354FW	1/2"	100	6 Oz.	Metal	Float Auto	40°-120°F	175 PSIG	40 micron
111-37600	F376W	3/4"	230	10 Oz.	Metal	Manual	40°-160°F	250 PSIG	40 micron
111-37601	F376FW	3/4"	230	10 Oz.	Metal	Float Auto	40°-120°F	175 PSIG	40 micron
111-32908	F329-08	1"	300	29 Oz.	Metal	Manual	40°-160°F	250 PSIG	40 micron



115-55301



115-57601

### Coalescing/Oil Removing Filters

- Removes submicron particles, particularly oil
- Applications include paint spraying, pneumatic control instrumentation, printing and protection of air bearings
- For maximum efficiency, a pre-filter needs be to installed upstream of oil-removing filter
- Bonded end seals eliminate aerosol leakage past the element
- Inner and outer support ribs are chemical resistant and strengthen element structure
- Drain layers allow filtered elements to drop to bottom of filter with barrier to prevent reentry of drops to downstream air

Ascot No.	Mfg. No.	Pipe Size	Max. Flow SCFM	Bowl Capacity	Bowl Type	Drain	Operating Temperature	Max Pressure	Filter Element
115-55200	F552FW	1/4"	24	6 Oz.	Metal	Float Auto	40°-120°F	175 PSIG	.03 micron
115-55201	F552W	1/4"	24	6 Oz.	Metal	Manual	40°-160°F	250 PSIG	.03 micron
115-55300	F553FW	3/8"	37	6 Oz.	Metal	Float Auto	40°-120°F	175 PSIG	.03 micron
115-55301	F553W	3/8"	37	6 Oz.	Metal	Manual	40°-160°F	250 PSIG	.03 micron
115-55400	F554FW	1/2"	37	6 Oz.	Metal	Float Auto	40°-120°F	175 PSIG	.03 micron
115-55401	F554W	1/2"	37	6 Oz.	Metal	Manual	40°-160°F	250 PSIG	.03 micron
115-57601	F576W	3/4"	60	10 Oz.	Metal	Manual	40°-160°F	250 PSIG	.03 micron
115-50508	F508-08W	1"	300	29 Oz.	Metal	Manual	40°-160°F	250 PSIG	.03 micron
115-50810	F508-10W	1-1/4"	300	60 Oz.	Metal	Manual	40°-160°F	250 PSIG	.03 micron
115-50812	F508-12W	1-1/2"	400	60 Oz.	Metal	Manual	40°-160°F	250 PSIG	.03 micron

## Regulators & Lubricators

### Regulators

- Specialized control valve reduces upstream supply pressure level to a specified constant downstream pressure
- Regulates air pressure of the air line
- Self-relieving style units
- Available in T-handle or adjustment knob
- Adjustment knob features three position non-rising knob - push to lock, pull to adjust, detach to make tamper resistant
- Reinforced diaphragm for repeated accuracy



112-00378\*



112-00352\*



112-00262



Ascot No.	Mfg. No.	Pipe Size	Max. Flow SCFM	Adjustment Type	Pressure Gauge Part No.	Gauge Part	Operating Temperature	Operating Pressure
112-00162	R162	1/4"	25	Adjustment Knob	117-01681*	1/8" NPT	40°-120°F	5 to 125 PSIG
112-00262	R262**	1/4"	25	Adjustment Knob	117-01681*	1/8" NPT	40°-120°F	5 to 125 PSIG
112-00352	R352	1/4"	50	Adjustment Knob	117-01481*	(2) 1/4" NPT	40°-120°F	5 to 125 PSIG
112-00353	R353	3/8"	80	Adjustment Knob	117-01481*	(2) 1/4" NPT	40°-120°F	5 to 125 PSIG
112-00354	R354T	1/2"	100	T-Handle	117-01481*	(2) 1/4" NPT	40°-120°F	5 to 125 PSIG
112-00376	R376T	3/4"	220	T-Handle	117-01481*	(2) 1/4" NPT	40°-120°F	5 to 125 PSIG
112-00378	R378T	1"	250	T-Handle	117-01481*	(2) 1/4" NPT	40°-120°F	5 to 125 PSIG
112-03910	R3910	1-1/4"	700	T-Handle	117-01481*	(2) 1/4" NPT	40°-120°F	5 to 125 PSIG
112-03912	R3912	1-1/2"	700	T-Handle	117-01481*	(2) 1/4" NPT	40°-120°F	5 to 125 PSIG

\*NOTE: Gauge not included. Sold separately. Ascot part number indicated.

### Lubricators

- Injects a fine stream of oil into the air stream to automatically lubricate air operated tools and other devices
- Extends life of downstream components
- Precise control of oil feed with needle valve adjustment knob
- Adds minimal pressure drop to the air system
- Features three position non-rising knob - push to lock, pull to adjust, detach to make tamper resistant
- High air flow
- Precise visual adjustment control
- Low flow to establish drip rate
- "W" is with sight glass and metal bowl



113-00353



113-01353

Ascot No.	Mfg. No.	Pipe Size	Max. Flow SCFM	Bowl Capacity	Bowl Type	Operating Temperature	Max Pressure	Oil Delivery
113-00352	L352	1/4"	16	5 Oz.	Poly	40°-125°F	150 PSIG	2 SCFM
113-01352	L352W	1/4"	16	5 Oz.	Metal	40°-175°F	200 PSIG	2 SCFM
113-00353	L353	3/8"	82	5 Oz.	Poly	40°-125°F	150 PSIG	2 SCFM
113-01353	L353W	3/8"	82	5 Oz.	Metal	40°-175°F	200 PSIG	2 SCFM
113-00354	L354	1/2"	142	5 Oz.	Poly	40°-125°F	150 PSIG	2 SCFM
113-01354	L354W	1/2"	142	5 Oz.	Metal	40°-175°F	200 PSIG	2 SCFM
113-00376	L376W	3/4"	142	10 Oz.	Metal	40°-125°F	150 PSIG	2 SCFM

**CALL FOR DETAILS ON REPLACEMENT PARTS ON ALL AIR PREPARATION PRODUCTS.**

## Hose Reels

### High Pressure Hose Reels

- Compact design allows reels to fit into tight locations
- Corrosion resistant powder coated paint
- Extended service life due to permanently lubricated bearings and swivels
- Versatile applications include easy mounts on wall, floor, ceiling or truck
- Air/Water hose included



Ascot No.	Mfg. No.	Hose ID	Hose OD	Hose Length	Hose PSI
124-04435	44350LP	1/4"	.500	35'	300
125-04625	46250LP	3/8"	.640	25'	300
125-05450	54500LP	1/4"	.500	50'	300
125-05635	56350LP	3/8"	.640	35'	300
125-05650	56500LP	3/8"	.640	50'	300
126-05850	A58500LP	1/2"	.781	50'	300

### Heavy Duty Industrial Reels

- Compact design
- Substantial support
- Air/Water (OLP), Oil (OMP) or Grease (OHP)
- All steel construction with engineered ribs/forms
- Baked-on powder coat finish provides corrosion resistance



Ascot No.	Mfg. No.	Hose ID	Hose OD	Hose Length	Hose PSI
125-07650	76500LP	3/8"	.688	50'	300
125-07670	76700LP	3/8"	.688	70'	300
126-07850	78500LP	1/2"	.844	50'	300
125-07651	76500MP	3/8"	.690	50'	2250
126-07851	78500MP	1/2"	.815	50'	2000
124-07450	74500HP	1/4"	.590	50'	5000
125-07652	76500HP	3/8"	.750	50'	4000

### Nitrogen Hose Reels

- Adjustable guide arm locates to seven positions
- Oversized main shaft increases support
- Long life drive spring
- Easy to mount due to slotted mounting holes for safer and easier installation
- Air/Water hose included
- Model RT650-OLPG specifically designed for dispensing nitrogen gas



Ascot No.	Mfg. No.	Hose ID	Hose OD	Hose Length	Hose PSI
124-04500	RT450-OLP	1/4"	.500	50'	300
125-06350	RT635-OLP	3/8"	.640	35'	300
125-06500	RT650-OLP	3/8"	.640	50'	300
126-08500	RT850-OLP	1/2"	.781	50'	300
125-06501	RT650-OLPG	3/8"	.640	50'	300
126-08501	RT850-OLPG	1/2"	.781	50'	300

### Side Mounted Reels/Series RT

- Main drive spring completely containerized and permanently sealed
- Stainless steel torsion spring
- Widened ratchet and latch pawl design greatly reduces wear and increases service life
- High quality brass hose crimpings
- Air/water hose included



Ascot No.	Mfg. No.	Hose ID	Hose OD	Hose Length	Hose PSI
124-45014	RT450-OLPSM	1/4"	.500	50'	300
125-65038	RT650-OLPSM	3/8"	.640	50'	300
125-83512	RT835-OLPSM	1/2"	.500	35'	300
125-85012	RT850-OLPSM	1/2"	.640	50'	300
124-65138	RT650-OMPMSM*	3/8"	.640	50'	1000

\*Medium pressure for oil.

## Hose Reels (Cont.)

### General Industrial Air/Water

- Full flow swivel and heavy gauge steel frame
- All-bolted unitized construction with no welds to fatigue
- Hand Crank (CA) and 12VDC Electric Motor (EA) driven



Ascot No.	Mfg. No.	Hose ID	Hose OD	Hose Length	Hose PSI
126-21120	CA32112L	1/2"	.845	200'	1000
126-31120	CA33112L	3/4"	1.188	100'	1000
126-31180	CA33118L	3/4"	1.188	175'	1000
126-21121	EA32112L12D	1/2"	.845	200'	1000
126-31121	EA33112L12D	3/4"	1.188	100'	1000

### Nitro-Pro Nitrogen Reel

- EZ-Coil controlled retraction for greater safety
- Special "Nitrogen green" proprietary "CPC" powder-coated finish for long lasting durability
- Factory-matched lubricated containerized spring motor for trouble free, enduring performance
- 50' of green 3/8" I.D. nitrogen hose & adjustable hose stop
- Nitrogen quality seals in the solid brass, 360-degree swivel inlet



Ascot No.	Mfg. No.	Hose ID	Hose Length	Hose PSI
127-05880	CP-0588	3/8"	50'	300

### Low Pressure Hose Reels for Air and Water

- High quality epoxy powder coated steel construction
- Sturdy 1" solid steel axle with 1" self-lubricated precision bearings
- Steel base plate and support post add stiffness reducing vibration
- Multi-position guide arm adjusts to 10 different mounting positions
- 8-position locking ratchet secures hose at desired length
- Self-retracting spring return reels
- Factory balanced cartridge-style spring motor provides safe maintenance
- Solid brass NPT swivel with stainless steel stud bolts to reel
- Made in the U.S.A.



Ascot No.	Mfg. No.	Hose ID	Hose OD	Hose Length	Hose PSI
124-13500	P-LP-135	1/4"	1/2"	35'	250
124-15000	P-LP-150	1/4"	1/2"	50'	250
124-33500	P-LP-335	3/8"	21/32"	35'	250
125-35004	P-LP-350	3/8"	21/32"	50'	250
126-42500	P-LP-425	1/2"	27/32"	25'	250
126-43500	SH-N-435	1/2"	27/32"	35'	250
126-45000	SH-N-450	1/2"	27/32"	50'	250
126-52500	SH-N-525	3/4"	1-5/32"	25'	250

### C-Series Low Pressure Hose Reels

- Reels ideally suited for plant maintenance, service trucks or other industrial functions
- Standard hose for air and water
- Single set screw to access spring casing
- Drive spring mechanism lubricated for life
- One piece combination latch, spring arbor, main bearing and spool support for fewer moving parts
- Brass swivel reduces corrosion potential
- Durable powder coated finish



### HOSETRACT

Ascot No.	Mfg. No.	Operating Pressure	Hose ID	Hose Length	Ship Weight
125-35000	LC-350	300 PSI	3/8"	50'	54 Lbs.
125-55000	LC-550	300 PSI	1/2"	50'	60 Lbs.

## Hose Reels (Cont.)

### Safety Series Hose Reels

- Equipped with the EZ-COIL™ Rewind Safety System
- 80% Slower Retraction than that of conventional hose reels
- Controlled retraction reduces workplace accidents
- EZ-COIL™ requires no electricity
- 0-1 ft.-lbs. of impact at end of the recoil cycle and 0-1 ft.-lbs. "Whipping Radius"
- Auto-rewind for fast easy pay out and take up
- High-quality heavy duty steel construction
- Durable on-corrosive electrostatic powder coat finish
- Adjustable hose stop
- Sturdy double supported solid steel 1" axle
- Multi-position arm guide adjusts for wall, ceiling or floor mounting
- Available in low, medium and high pressure
- "Safe-Replace" factory balanced cartridge style spring motor
- Multi-position locking ratchet secures hose at desired length
- Made in the U.S.A.



Ascot No.	Mfg. No.	Hose ID	Hose Length	Hose PSI	Max. Temp.
125-00325	EZ-P-LP-325	3/8"	25'	300	150°F
125-00350	EZ-P-LP-350	3/8"	50'	300	150°F
126-00425	EZ-P-MP-425	1/2"	25'	2500	250°F
126-00450	EZ-MP-450	1/2"	50'	2500	250°F
126-01450	EZ-SH-450	1/2"	50'	250	150°F

### Medium Pressure Hose Reels for Air, Water & Oil

- High quality epoxy powder coated steel construction
- Sturdy, double supported 1" solid steel axle with 1" self-lubricated precision bearings
- 8-position locking ratchet secures hose at desired length
- Multi-position guide arm adjusts to 10 different mounting positions
- 1/4" steel base plate and support post
- Self-retracting spring return reels
- Factory balanced cartridge-style spring motor
- Solid brass NPT swivel with stainless steel stud bolts to reel for non-corrosive, long lasting strength and performance



Ascot No.	Mfg. No.	Hose ID	Hose OD	Hose Length	Hose PSI
125-32500	P-MP-325	3/8"	5/8"	25'	3000
125-33502	P-MP-335	3/8"	5/8"	35'	3000
125-35002	MP-N-350	3/8"	5/8"	50'	3000
126-42501	P-MP-425	1/2"	3/4"	25'	2500
126-43000	P-MP-430	1/2"	3/4"	30'	2500
126-43501	MP-N-435	1/2"	3/4"	35'	2500
126-45003	MP-N-450	1/2"	3/4"	50'	2500

### Cord Reels Open Style

- For indoor, non-weather-tight applications only
- All models UL listed at 115 volt 60 hz single phase; reels without cord suitable for 220 volt
- Incandescent bulb 75 watt maximum
- Cord Included

Ascot No.	Mfg. No.	Wire Size AWG	No. of Wires	Cord Length	Volts	Max Amps
Incandescent						
312-40351	L40351631	16	3	35'	115	13
312-40501	L40501631	16	3	50'	115	13
Florescent						
312-40352	L40351622	16	2	35'	115	0.3
312-40502	L40501622	16	2	50'	115	0.3
Single Outlet						
312-40353	L40351633	16	3	35'	115	13
312-40503	L40501633	16	3	50'	115	13
312-45453	L45451233	12	3	45'	115	25



## Hose Reels (Cont.)

### Lightweight, Durable, PVC Reels

- Lightweight, easy to handle
- Standard pivot bracket so the reel can swing from side to side
- Made of corrosion proof, tough polypropylene
- Design both protects the hose and allows easy cleaning of both hose and reel
- Hose included



Ascot No.	Mfg. No.	Hose ID	Hose PSI	Hose Length	Application
125-03650	SGA36500LP	3/8"	232	50'	Air/Water
125-03665	SGA36650LP	3/8"	232	65'	Air/Water
126-03850	SGA38500LP	1/2"	232	50'	Air/Water
126-03851	SWA38500LP	1/2"	145	50'	Water
126-03852	SHA38500LP	1/2"	232	50'	Hot Water
126-03853	SCA38500LP	1/2"	232	50'	Chemical

## Hose Products

### Blow Guns

- Non-restricted, full pressure performance
- Sturdy, high-tech composite material
- Light weight ergonomic design
- Variable air flow
- 1/4" Female NPT



128-72025

128-72021

128-72023

Ascot No.	Mfg. No.	Nozzle	Description
128-72021	27202OSH	Venturi	High-output, OSHA-Compliant
128-72022	27202SIL	Silent	Quiet, OSHA Compliant
128-72023	27202PRE	Standard	Standard, Non-Scratch Nozzle
128-72024	27202ECR	Air Shield	Unique Air Shield Nozzle
128-72025	27202MTL	Metal	Durable Metal Nozzle

### Hose Cutter

- Hand tool for straight, even, clean cut on heater, air conditioning and braided rubber or plastic hose up to 1-1/8" diameter

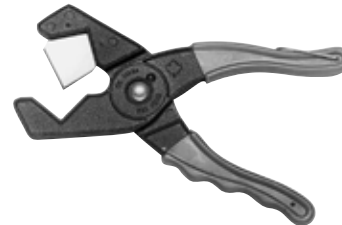

Ascot No.	Mfg. No.	Description
137-10010	10010	Hose Cutter
137-10011	10011	(2) High Grade Carbon Steel Replacement Blades

### Hose Stops & Guards

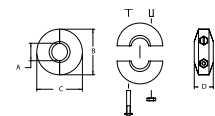

Ascot No.	Mfg. No.	Hose Guard Fitting	Hose ID	OD
127-01310	131	237-1	1/4"	1/2"
127-01313	131-3	237-1	3/8"	21/32"
127-01314	131-4	398-1	1/2"	3/4"

## Air Hoses

### Heavy Duty Air Hose

- Smooth red rubber with NPT fittings
- Lightweight and flexible
- Versatile and oil resistant
- Crimped ends
- Rated at 300 PSI working pressure



Ascot No.	Mfg. No.	Hose ID	NPT	Hose Length
121-51225	512-25	1/4"	1/4"	25'
121-51250	512-50	1/4"	1/4"	50'
121-51210	512-100	1/4"	1/4"	100'
121-51255	512-500	1/4"	---	500'
121-51450	514-500	3/8"	---	500'
121-55225	552-25	3/8"	1/4"	25'
121-55250	552-50A	3/8"	1/4"	50'
121-55210	552-100A	3/8"	1/4"	100'
121-55525	555-25*	3/8"	1/4"	25'
121-55550	555-50A*	3/8"	1/4"	50'
121-55510	555-100*	3/8"	1/4"	100'
121-51525	515-25	1/2"	1/2"	25'
121-51550	515-50	1/2"	1/2"	50'
121-51510	515-100	1/2"	1/2"	100'
121-51500	515-500	1/2"	---	500'

\*NOTE: Gauge not included. Sold separately. Ascot part number indicated.

\*500 ft. reels (bulk) do not have fittings.

### Premium Rubber Air Hose

- Smooth cover
- 300 PSI W.P. - 1,200 PSI burst pressure
- For heavy duty service



Ascot No.	Mfg. No.	Hose ID	Hose Length	NPT	Weight
127-04425	W44RJ25VSL	1/4"	25'	1/4"	4 Lbs.
127-04450	W44RJ50VSL	1/4"	50'	1/4"	8 Lbs.
127-44100	W44RJ100VSL	1/4"	100'	1/4"	15 Lbs.
127-06425	W64RJ25VSL	3/8"	25'	1/4"	5 Lbs.
127-06450	W64RJ50VSL	3/8"	50'	1/4"	9 Lbs.
127-64100	W64RJ100VSL	3/8"	100'	1/4"	17 Lbs.
127-08425	W84RJ25VSL	1/2"	25'	1/2"	6 Lbs.
127-08450	W84RJ50VSL	1/2"	50'	1/2"	12 Lbs.
127-84100	W84RJ100VSL	1/2"	100'	1/2"	24 Lbs.

### Light Weight Premium PVC Air Hose

- Smooth cover
- 300 PSI W.P. - 1,200 PSI burst pressure
- Applications: automotive, paint & body shops, construction, general industry



Ascot No.	Mfg. No.	Hose ID	Hose Length	NPT	Weight
127-04625	W46DBLJ25VSL	1/4"	25 ft.	1/4"	3 lbs.
127-04650	W46DBLJ50VSL	1/4"	50 ft.	1/4"	6 lbs.
127-46100	W46DBL100VSL	1/4"	100 ft.	1/4"	12 lbs.
127-06625	W66TBLJ25VSL	3/8"	25 ft.	1/4"	4 lbs.
127-06650	W66TBLJ50VSL	3/8"	50 ft.	1/4"	7 lbs.
127-66100	W66TBLJ100VSL	3/8"	100 ft.	1/4"	13 lbs.

### Whip Hose

- Flexible neoprene hose
- Rated at 300 PSI
- Coupled 1/4" male NPT ball swivel at one end and 1/4" female NPT fitting at the other end
- Used between quick coupler and air tool to protect coupler from harmful impact
- Reduces kinking and twisting of air hose



Ascot No.	Mfg. No.	Description
127-37240	596-6	3/8" x 24" (1/4" x 1/4") Lead-In
127-37720	597-6	3/8" x 72" (1/4" x 1/4") Lead-In
127-59820	598-2	1/2" x 24" (1/2" x 3/8") Lead-In
127-59920	599-2	1/2" x 24" (1/2" x 1/2") Lead-In
127-59720	597-2	1/2" x 24" (1/2" x 1/4") Lead-In

### Safe Coil Hoses

- Stretches and recoils like a telephone cord
- Full 360° swivel at each end
- Rated for working pressures up to 300 PSI



Ascot No.	Mfg. No.	Hose ID	Hose Length	NPT	Std. Pack
123-00412	4-12	1/4"	12'	1/4"	1
123-00425	4-25	1/4"	25'	1/4"	1
123-00450	4-50	1/4"	50'	1/4"	1
123-00625	6-25A	3/8"	25'	1/4"	1
123-00650	6-50A	3/8"	50'	1/4"	1



## Air Line Couplers and Plugs

### 1/4" Lincoln Long Nose

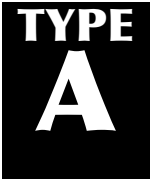

- Brass plated couplers with hardened steel balls and stainless steel springs
- Plugs heat-treated to reduce wear on critical mating surfaces
- Interchange with Lincoln "Long Nose Series" as well as units produced by other manufacturers



131-61486

131-61548

131-61550

Ascot No.	Schrader No.	Dill No.	Amflo No.	Thread	NPT
<b>Couplers</b>					
131-61486	3527	N/A	C27	Male	1/4"
131-61548	3528	123	C28	Female	1/4"

Ascot No.	Schrader No.	Dill No.	Amflo No.	Thread	NPT
<b>Adapter Plugs</b>					
131-61550	3531	126	CP27	Male	1/4"
131-61551	3532	125	CP28	Female	1/4"

### 1/4" Aro Series

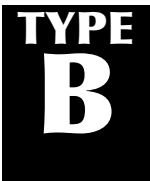

- Brass plated couplers with hardened steel balls and stainless steel springs
- Plugs heat-treated to reduce wear on critical mating surfaces
- Interchange with Aro 210 series as well as units produced by other manufacturers
- Maximum working pressure 300 PSI

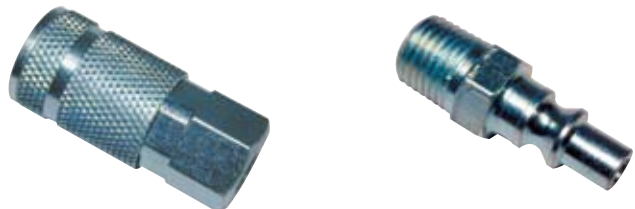

131-61526

131-61528

Ascot No.	Schrader No.	Dill No.	Amflo No.	Thread	NPT
<b>Couplers</b>					
131-61526	3526	8888	C38	Female	1/4"
131-61527	3525	N/A	C37	Male	1/4"
131-08888	Dill 8888	Push- to-Connect		Female	1/4"

Ascot No.	Schrader No.	Dill No.	Amflo No.	Thread	NPT
<b>Adapter Plugs</b>					
131-61529	3530	8889	CP38	Female	1/4"
131-61528	3529	88891	CP37	Male	1/4"

### 1/4" Automotive Standard (Tru-Flate)

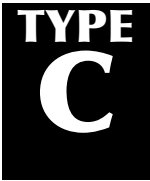

- Brass plated couplers with hardened steel balls and stainless steel springs
- Plugs heat-treated to reduce wear on critical mating surfaces
- Interchange with Tru-Flate 10 and 100 type series as well as units produced by other manufacturers
- Maximum working pressure 300 PSI

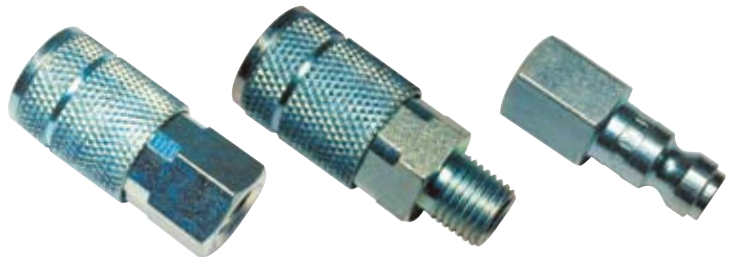

131-61523

131-61524

131-61539

Ascot No.	Schrader No.	Dill No.	Amflo No.	Thread	NPT
<b>Couplers</b>					
131-61523	3504	D-13	C2	Female	1/4"
131-61524	3503	D-12	C1	Male	1/4"

Ascot No.	Schrader No.	Dill No.	Amflo No.	Thread	NPT
<b>Adapter Plugs</b>					
131-61539	3507	D-3C	CP2	Female	1/4"
131-61538	3506	D-2C	CP1	Male	1/4"



## Air Line Couplers and Plugs

### 1/4" Industrial Interchange Series

#### TYPE D

- Brass plated couplers with hardened steel balls and stainless steel springs
- Plugs heat-treated to reduce wear on critical mating surfaces
- Interchange with Aro, Foster, Milton as well as units produced by other manufacturers
- Maximum working pressure 300 PSI



131-61573

131-61574

131-61579

Ascot No.	Schrader No.	Dill No.	Amflo No.	Thread	NPT
<b>Couplers</b>					
131-61573	5142-12	102	C20	Female	1/4"
131-61574	5141-12	103	C21	Male	1/4"

Ascot No.	Schrader No.	Dill No.	Amflo No.	Thread	NPT
<b>Adapter Plugs</b>					
131-61579	5139-11	109	CP20	Female	1/4"
131-61578	5138-11	110	CP21	Male	1/4"

### 1/2" Automotive Series

#### TYPE F

- Brass plated couplers with hardened steel balls and stainless steel springs
- Plugs heat-treated to reduce wear on critical mating surfaces
- Maximum working pressure 300 PSI



131-61563

131-61471

131-61569

Ascot No.	Schrader No.	Dill No.	Amflo No.	Thread	NPT
<b>Couplers</b>					
133-61563	3512	D-17	C10	Female	1/2"
133-61564	3511	D-16	C9	Male	1/2"

Ascot No.	Schrader No.	Dill No.	Amflo No.	Thread	NPT
<b>Adapter Plugs</b>					
133-61569	3514	D-3F	CP10	Female	1/2"
133-61568	3513	D-2F	CP9	Male	1/2"
133-61474	3537	D-0F	CP9-03	Male	3/8"
133-01855	1855	N/A	N/A	Male	1/4"

Ascot No.	Dill No.	Description	Thread	NPT
131-61471	D-17R	Steel Coupler w/ Sleeve Ring	Female	1/2"

### 3/8" Automotive Series

#### TYPE G

- Brass plated couplers with hardened steel balls and stainless steel springs
- Plugs heat-treated to reduce wear on critical mating surfaces
- Maximum working pressure 300 PSI



131-61476

131-61478

131-61480

Ascot No.	Schrader No.	Dill No.	Amflo No.	Thread	NPT
<b>Couplers</b>					
132-61476	3521	D-15C	C8	Female	1/4"
132-61478	NA	N/A	C7	Male	1/4"
132-61553	3516	D-15C	C6	Female	3/8"
132-61554	3515	N/A	C5	Male	3/8"

Ascot No.	Schrader No.	Dill No.	Amflo No.	Thread	NPT
<b>Adapter Plugs</b>					
132-61481	3520	D-1E	CP8	Female	1/4"
132-61480	3519	D-0E	CP7	Male	1/4"
132-61559	3518	D-3E	CP6	Female	3/8"
132-61558	3517	D-2E	CP5	Male	3/8"

## Air Line Couplers and Plugs (Cont.)

### 1/4" Retreader Series



134-61544

134-61545

134-61543

Ascot No.	Description	Schrader No.	Amflo No.
134-61544	Female 1/4" NPT Steel Plug (.302-32 Std.)	3508	CP12
134-61545	Female 1/4" NPT Brass Coupler With Sleeve	N/A	C2RB
134-61487	Female 1/4" NPT Steel Coupler	3505	C2R
134-61552	Female 1/4" NPT Plug (.482 - 26-3/4")	3510	61-552
134-61543	Male 1/4" NPT Plug (.302-32 inner & outer thread)	3533	CPI-302

### Combo Coupler®

- One coupler fits 1/4" Aro Style, 1/4" Automotive Standard and 1/4" Industrial Interchange plugs



135-61260

Ascot No.	Description	Schrader No.	Mfg. No.
135-61240	1/4" Series, 1/4" NPT Female	—	C60
135-61241	1/4" Series, 1/4" NPT Male	—	C61

### Parker E-Z to Connect/Disconnect Coupling

- E-Z-Mate is an exhaust type coupler designed to exhaust air pressure prior to disconnection
- Valve sleeve acts as integral shut-off valve
- Meets ISO 4414 requirements
- Built-in sleeve-lok mechanically locks the valve sleeve

#### Female Couplers

Ascot No.	Part No.	Body Size	Thread Size
131-02514	EZ-251-4FP	1/4"	1/4-18
131-02516	EZ-251-6T	1/4"	3/4-18
132-03716	EZ-371-6T	3/8"	3/8-18
132-03718	EZ-371-8T	3/8"	1/2-14
133-05018	EZ-501-8T	1/2"	1/2-14
133-05012	EZ-501-12T	1/2"	3/4-14
133-75112	EZ-751-12T	3/4"	3/4-14
133-75116	EZ-751-16T	3/4"	1-11-1/2

### Hansen Universal Auto-Flo Couplings

- High flow coupling designed for use with compressed air
- First automatic universal coupling designed to operate with industrial, ARO 210 and Tru-Flate Interchange plugs



Ascot No.	Mfg. No.	Description
135-00023	B23AS-25F	Female 1/4" NPT Coupler
135-00123	B23AS-25M	Male 1/4" NPT Coupler

### Hi-Flo/HVLP Coupler

- Designed for air tools and paint spray equipment
- Provides up to 50% more air flow than conventional couplers
- Hi-Flo couplers/plugs for use with sanders, grinders and high air usage tools
- HVLP couplers for use with paint spray guns



135-00910



135-00901

Ascot No.	Amflo No.	Description
135-00900	C90	1/4" FNPT Hi-Flo/HVLP Coupler-Brass
135-00910	C91	1/4" MNPT Hi-Flo/HVLP Coupler-Brass
135-00980	C98	1/4" FNPT Hi-Flo Coupler-Steel
135-00901	CP90	1/4" FNPT Hi-Flo Plug-Steel
135-00911	CP91	1/4" MNPT Hi-Flo Plug-Steel



#### Nipples

Ascot No.	Part No.	Body Size	NPT	Thread
131-17000	CP17	1/2"	1/2"	Male
131-18000	CP18	1/2"	1/2"	Female
133-17030	CP1703	1/2"	3/8"	Male

## Air Line Couplers and Plugs (Cont.)

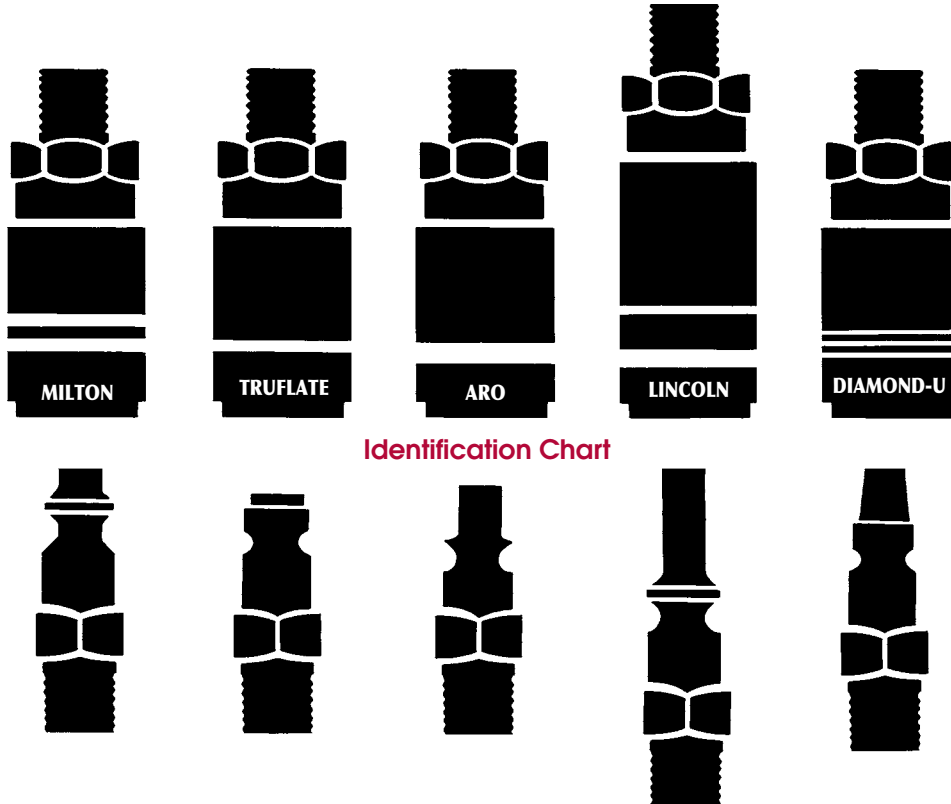

Identification Chart

Schrader	Amflo	Camel	Dill	Milton
<b>1/4" Tru-Flate Automotive Type</b>				
3503	C1	61-524	D-12	786
3504C-D	-	-	-	-
3504	C2	61-523	D-13	785
3505	C2R	61-487	D-13R	787
3506	CP1	61-538	D-2C	783
3507	CP2	61-539	D-3C	784
3508	CP12	-	D-6C	779
3510	CP14	61-552	D-7CR	481
3533	CP1-302	61-544	D-5C	-
<b>1/4" "ARO" Speed Series Type</b>				
3526	C38	61-526	8888	775
3529	CP37	61-528	8891	777
3530	CP38	61-529	8889	778
<b>1/4" Industrial Interchange Type</b>				
5138-11	CP21	61-578	110	727
5138-12	-	-	-	-
5139-11	CP20	61-579	109	728
5139-12	-	-	-	-
5140-12	C21-103	-	-	719
5141-12	C21	61-574	103	716
5142-12	C20	61-573	102	715
5142C-D	-	61-572	-	711
5223-11	CP21-42	-	-	736
5263-11	CP21-103	61-535	115	733
5263-12	C20-23	-	-	718

Schrader	Amflo	Camel	Dill	Milton
<b>1/4" Lincoln Long Stem Type</b>				
3528	C28	61-548	123	790
3531	CP27	61-550	126	791
3532	CP28	61-551	125	792
<b>3/8" Tru-Flate Type</b>				
3515	C5	61-554	-	1806
3516	C6	61-553	D-15	1805
3517	CP5	61-558	D-2E	1807
3518	CP6	61-559	D-3E	1808
3519	CP7	61-480	D-03	1809
3520	CP8	61-481	-	1810
3521	C8	61-476	D-15C	1803
<b>3/8" Industrial Interchange Type</b>				
3541	C26	61-482	117	1835
3542	CP25	61-484	122	1837
3543	CP26	61-485	121	1837
<b>1/2" Tru-Flate Type</b>				
3511	C9	61-564	D-16	1818
3512	C10	61-563	D-17	1815
-	C10R	61-471	D-17R	-
3513	CP9	61-568	D-2F	1817
3514	CP10	61-569	D-3F	1818
3537	CP9-03	61-474	D-0F	1819

## Air Tank, Blow Gun & Hose Adapters

### Air Tanks

- Patented built-in pressure by-pass valve
- Easy to read pressure gauge
- Heavy-gauge steel construction
- Maximum pressure up to 125 PSI
- Portable design with easy carrying handle
- 4 foot rubber hose
- Durable valve chuck



Ascot No.	Mfg. No.	Description	Shipping Wt.
129-01010	W-1010A	10-Gallon Air Tank	26 Lbs.

### Standard Blow Gun

- Rugged construction with hang hook
- Accepts a full range of accessories



Ascot No.	Mfg. No.
128-20000	200K

### Solid Brass Female Crosses

- Excellent for running several air lines from a common supply hose



Ascot No.	Mfg. No.	NPT Thread
136-00344	344X	1/4"
136-00366	366X	3/8"

### Solid Brass Female Tees

- Use to run two lines from a common feed



Ascot No.	Mfg. No.	NPT Thread
136-01344	344T	1/4"
136-01366	366T	3/8"

### Solid Brass Swivel

- Simple design is excellent to stop hoses from kinking or for use in pneumatic equipment applications



Ascot No.	Mfg. No.	NPT Thread
136-34490	344R90	1/4" Male/Female Swivel

### Brass In-Line Swivels

- Simple design is excellent to stop hoses from kinking or for use in pneumatic equipment applications



Ascot No.	Mfg. No.	Description
136-02344	344R	1/4" Male/Female NPT
136-02366	366R	3/8" Male/Female NPT

### Uniswivel

- Features a full 360° swivel to keep hose from twisting when using air operated tools and while paint spraying



Ascot No.	Mfg. No.	Description
136-03344	344U	1/4" NPTF x 1/4" NPTM

### Standard Male Hose Barb Fittings

- Select fitting to match hose ID
- Fittings must be secured to hose with either a hose clamp or crimped-on ferrule



Ascot No.	Mfg. No.	NPT Thread	Hose ID
136-00403	403	1/4"	3/16"
136-00398	398	3/8" -24"	1/4"
136-00401	401	1/4"	1/4"
136-00604	604	3/8"	1/4"
136-00406	406	1/4"	3/8"
136-00606	606	3/8"	3/8"
136-00806	806	1/2"	3/8"
136-00408	408	1/4"	1/2"
136-00608	608	3/8"	1/2"
136-00808	808	1/2"	1/2"
136-00813	813	3/4"	1/2"
136-00812	812	1/2"	3/4"
136-00818	818	1"	1"

## Hose Adapters

### Reusable Hose Repair Fittings

- Makes air tight connection without using hose clamps
- Must closely match hose OD (outer diameter) and ID (inner diameter) accurately before ordering
- Minimum order is box of ten

### Male Pipe Thread



Ascot No.	Mfg. No.	Hose OD	Hose ID	NPT
137-00418	418	1/2"	1/4"	1/4"
137-00439	439	9/16"	1/4"	1/4"
137-00419	419	19/32"	1/4"	1/4"
137-00420	420	5/8"	1/4"	1/4"
137-00520	520	5/8"	5/16"	1/4"
137-00620	620	5/8"	3/8"	1/4"
137-00621	621	21/32"	3/8"	1/4"
137-00623	623	23/32"	3/8"	1/4"
137-00624	624	21/32"	3/8"	3/8"
137-00625	625	23/32"	3/8"	3/8"
137-00828	828	7/8"	1/2"	1/2"

### Female Pipe Thread



Ascot No.	Mfg. No.	Hose OD	Hose ID	NPT
137-01418	418F	1/2"	1/4"	1/4"
137-01439	439F	9/16"	1/4"	1/4"
137-01520	520F	5/8"	5/16"	1/4"
137-01621	621F	21/32"	3/8"	1/4"
137-01623	623F	23/32"	3/8"	1/4"
137-01624	624F	21/32"	3/8"	3/8"

### Hose Splicers



Ascot No.	Mfg. No.	Hose OD	Hose ID
137-11520	520S	5/8"	5/16"
137-11621	621S	21/32"	3/8"
137-11623	623S	23/32"	3/8"

### Male Pipe Couplings

- Solid Brass NPT



Ascot No.	Mfg. No.	Male NPT	Male NPT
137-00324	324	1/8"	1/4"
137-00344	344	1/4"	1/4"
137-00346	346	3/8"	1/4"
137-00366	366	3/8"	3/8"
137-00388	388	1/2"	1/2"
137-00389	389	3/4"	3/4"

### Bushings and Adapters

- Solid Brass



Ascot No.	Mfg. No.	Male NPT	Female NPT
137-01324	324F	1/4"	1/8"
137-01342	342F	1/8"	1/4"
137-01346	346F	3/8"	1/4"
137-01348	348F	1/2"	1/4"
137-01364	364F	1/4"	3/8"
137-01368	368F	1/2"	3/8"
137-01389	389F	3/4"	1/2"

### Pipe Coupling Female NPT

- Solid Brass



Ascot No.	Mfg. No.	Male NPT
137-01344	344F	1/4" x 1/4"

### Standard Hose Crimper

- Provides production capability and "big tool" crimping advantages at a much lower cost
- Heavy duty ductile iron casting and hardened steel dies for long service life and positive crimping
- With five dies for crimping 1/4" single braid to 3/8" double braided hose



Ascot No.	Mfg. No.	Description
137-08550	855	Standard Hose Crimper
137-08551	855A	Same Tool As Crimper Above Except Largest Die Is Replaced By 7/16" For Crimping 3/16" Hose

## Hose Fittings

### Hose Crimper Replacement Dies

- Replacement dies for Hose Crimper (Ascot No. 137-08550 and Ascot No. 137-08851)

Ascot No.	Mfg. No.	Die Size
137-08561	856-1	5/8"
137-08532	856-2	37/64"
137-08563	856-3	17/32"
137-08564	856-4	31/64"
137-08565	856-5	11/16"
137-08567	856-7	7/16"
137-08568	856-8	3/4"
137-08569	856-9	13/16"
137-85610	856-10	3/8"



137-08563

### Hose Crimper Kit

- Kit is complete with standard crimper ferrules, hose barbs, splicer & directions needed to make up hoses in the field
- Organized in a plastic tote
- Contents: Hose Barbs: 10; Hose Splicers: 10; Ferrules: 20; Standard Crimper: 1



Ascot No.	Mfg. No.
137-00855	855K

### Oetiker 2-Ear Clamps

- Especially suited for industrial or heavy vibrating equipment
- Medium pressure clamp that is used for maintenance and OEM applications
- Rubber hose, plastic tubing, coaxial and electrical cable, rope are easily clamped
- For air, fluid, gas, steam line



Ascot No.	Mfg. No.	Nominal Size	Inches Closed-Open	MM Closed-Open	Inner Inches	Width of Ear
316-00507	507	1/4"	.197-.276"	5-7 mm	.236"	6.0 mm
316-00709	709	5/16"	.276-.354"	7-9 mm	.276"	7.0 mm
316-00911	911	7/16"	.355-.433"	9-11 mm	.276"	7.0 mm
316-01113	1113	1/2"	.433-.512"	11-13 mm	.276"	7.0 mm
316-01315	1315	9/16"	.512-.591"	13-15 mm	.295"	7.5 mm
316-01518	1518	5/8"	.591-.708"	15-18 mm	.315"	8.0 mm
316-01720	1720	3/4"	.669-.787"	17-20 mm	.335"	8.5 mm
316-01922	1922	13/16"	.748-.866"	19-22 mm	.354"	9.0 mm
316-02023	2023	7/8"	.787-.905"	20-23 mm	.354"	9.0 mm
316-02225	2225	15/16"	.866-.984"	22-25 mm	.394"	10.0 mm
316-02327	2327	1"	.905-1.063"	23-27 mm	.394"	10.0 mm

### Brass Ferrules

- For use with hose barb fittings
- Use with hose crimper (Ascot No. 137-08550)
- 50 per box



137-73255

Ascot No.	Mfg. No.	Ferrule I.D.
137-73215	7321-50	.478"
137-73225	7322-50	.500"
137-73235	7323-50	.527"
137-73255	7325-50	.562"
137-73265	7326-50	.593"
137-73275	7327-50	.625"
137-73285	7328-50	.656"
137-73295	7329-50	.687"
137-73305	7330-50	.718"
137-73315	7331-50	.750"
137-73325	7332-50	.781"
137-73335	7333-50	.812"
137-73345	7334-50	.825"
137-73355	7335-50	.850"
137-39525	3952-50	.875"
137-50291	5029A-50	.900"
137-72421	7242A-50	.937"

### Oetiker 2-Ear Clamp Service Kit

- Service kit contains the following sizes: (15) 5/16"; (15) 7/16"; (15) 1/2"; (15) 9/16"; (12) 5/8"; (12) 3/4"; (12) 7/8"; (12) 15/16"; (12) 1"; and (1) pair straight jaw pincers



Ascot No.	Description
316-91098	Complete Kit
316-01098	Pincer Only

# AIR TOOLS

IMPACT WRENCHES

AIR RATCHETS

HAMMERS

SANDERS

GRINDERS

AIR TOOL ACCESSORIES



# *Can You Afford to Ignore the Future?*



## **CP7600 BLUE TORK**

Less noise. Less vibration. Less human error. A new concept in air wrenches delivers the ultimate in torque control and regulation-compliant ergonomics for critical tightening applications.



**4-TORQUE PRESET  
SELECTOR**  
(also available in Single  
Torque Preset Selector)

**REVERSABLE**  
For un-tightening and budd  
wheels. (also available in  
Non-Reversible)

*Proper cleaning helps to eliminate wheel-offs*



Clean the drum and studs with a  
**CP7562 Mini Angle Grinder**



Clean the wheel with a  
**CP7202 Mini Disc Sander**



Tighten the nuts with a  
**CP7749 1/2" Impact Wrench**



## Impact Wrenches/Quick Reference Chart

CP No.	Ascot No.	Sq. Drive (mm)	Std Bolt Size (mm)	Net Weight Lbs. (kg)	Average Air Cons. (cfm)	Air Inlet (NPTF)	Min. Hose Size	Working Torque Range ft.-lbs. (NM)	Max Torque ft.-lbs. (NM)
CP-7735	152-07735	3/8" (10)	3/8" (10)	2.55 (1.15)	3.7	1/4"	1/4"	19-220 (28-300)	300 (407)
CP-7722	152-07722	3/8" (10)	3/8" (10)	2.09 (0.95)		1/4"	1/4"	5-65 (7-88)	90 (120)
CP-7749	153-07749	1/2" (13)	5/8" (16)	4.37 (1.98)	4.8	1/4"	3/8"	75-580 (102-428)	725
CP-7749-2	153-77492	1/2" (13)	5/8" (16)	4.5 (2.04)	4.8	1/4"	3/8"	75-580 (102-428)	725
CP-749	153-07492	1/2" (13)	5/8" (16)	5.25 (2.5)	5.5	1/4"	3/8"	50-450 (68-610)	625 (827)
CP-749-2	156-07992	1/2" (13)	5/8" (16)	5.5 (2.5)	5.75	1/4"	3/8"	50-450 (68-610)	625 (827)
CP-7733	153-00733	1/2" (13)	9/16" (15)	5.6 (2.5)	4.75	1/4"	3/8"	25-400 (34-542)	475 (644)
CP-7733-2	153-00733	1/2" (13)	9/16" (15)	5.6 (2.5)	4.75	1/4"	3/8"	25-400 (34-542)	475 (644)
CP-734H	153-00734	1/2" (13)	9/16" (15)	5.1 (2.31)	3.75	1/4"	3/8"	25-310 (34-420)	425 (576)
CP-772H	154-00772	3/4" (18)	1-1/8" (28)	10.1 (4.8)	6	3/8"	1/2"	150-700 (203-949)	1000 (1356)
CP-772H-6	154-01772	3/4" (18)	1-1/8" (28)	11.63 (5.28)	6	3/8"	1/2"	150-700 (203-949)	1000 (1356)
CP-7763	154-07763	3/4" (18)	1-1/8" (28)	11.57 (5.25)	7.5	3/8"	1/2"	100-950 (136-1288)	1200 (1627)
CP-7763-6	154-77636	3/4" (18)	1-1/8" (28)	13.85 (6.28)	7.5	3/8"	1/2"	100-950 (136-1288)	1201 (1627)
CP-796	155-00796	1" Square	1-1/4" (32)	20 (9.07)	13	1/2"	1/2"	300-1400 (407-1,898)	2000 (2712)
CP-796SP	155-07633	1" Square	1-1/4" (32)	20 (9.07)	13	1/2"	1/2"	300-1400 (407-1898)	2000 (2712)
CP-7774	155-07774	1" Square	1-1/4" (32)	22.2 (10.1)	8.25	1/2"	1/2"	100-1300 (136-1763)	1750 (2373)
CP-7774-6	155-77746	1" Sq. 6" Ext.	1-1/4" (32)	25.5 (11.6)	8.25	1/2"	1/2"	100-1100 (136-1491)	1550 (2102)
CP-7775	155-07775	1" Square	1-1/4" (32)	22.2 (10.1)	8.75	1/2"	1/2"	100-1200 (136-1627)	1550 (2102)
CP-7775-6	155-77756	1" Sq. 6" Ext.	1-1/4" (32)	25.4 (11.5)	8.75	1/2"	1/2"	100-1200 (136-1627)	1550 (2102)
CP-7775SP-6	155-17756	1" Sq. 6" Ext.	1-1/4" (32)	25.4 (11.5)	8.75	1/2"	1/2"	100-1200 (136-1627)	1550 (2102)
CP-7778	155-07778	1" Square	1-1/4" (32)	22.5 (10.1)	-	1/2"	1/2"	100-1100 (136-1491)	1450 (1966)
CP-7778-6	155-77786	1" Sq. 6" Ext.	1-1/4" (32)	25.4 (11.5)	-	1/2"	1/2"	100-1100 (136-1491)	1450 (1966)
CP-7778SP6	155-17786	#5 Spl. 6" Ext.	1-1/4" (32)	25.4	-	1/2"	1/2"	100-1100 (136-1491)	1450 (1966)
CP-797	155-07971	1" Square	1-1/4" (32)	27 (12.3)	12	1/2"	1/2"	600 (816) @90-170psi*	1400 (1898)
CP-797-6	155-07976	1" Sq. 6" Ext.	1-1/4" (32)	29.75 (13.5)	10	1/2"	1/2"	150-900 (200-1225)	1400 (1898)
CP-797-SP6	155-79716	#5 Spl. 6" Ext.	1-1/4" (32)	29.75 (13.5)	10	1/2"	1/2"	150-900 (200-1225)	1400 (1898)
CP-5000	155-50000	1" Square	1-1/4" (32)	30.5 (13.83)	22.5	1/2"	1/2"	370-1600 (502-2169)	2,000 (2712)
CP-897-6	155-08676	1" Square	1-1/4" (32)	19 (8.62)	6.5	1/2"	1/2"	150-800 (203-1085)	1300 (1763)

## 3/8" Impact Wrenches

### 3/8" Heavy Duty Air Impact Wrench

- Push button forward & reverse
- Twin hammer clutch with MgDriven™ Technology for superior torque and reliability
- Lightweight, compact & powerful
- Ultimate Torque: 300 ft.-lbs.

Ascot No. 152-07735  
Mfg. No. CP-7735



### 3/8" Heavy Duty Air Impact Wrench

- One hand push button forward/reverse power regulator
- Handle exhaust directs air away from the work area
- 360° air inlet swivel prevents hose kinks
- Applications include: general repair, transmission work, exhaust systems and body shops
- Ultimate Torque: 200 ft.-lbs.

Ascot No. 152-00724  
Mfg. No. CP-724H



## 1/2" Impact Wrenches

### 1/2" Heavy Duty Air Impact Wrench

- Side-To-Side (S2S) forward/reverse functionality
- Perfectly balanced to reduce strain on wrist and forearm
- Twin hammer clutch with MgDriven™ Technology
- Ultimate Torque: 725 ft.-lbs.

Ascot No.	Mfg. No.	Description
153-07749	CP-7749	1/2" Impact Wrench
153-77492	CP-7749-2	2" Extended Anvil



### 1/2" Heavy Duty Air Impact Wrench

- One hand push button forward/reverse power regulator. 4 positive power setting. Ultimate power in reverse
- Differential regulator allows the operator to match the required power to the job
- Patented oil bath Dyna-Pact clutch delivers smooth operation and extended durability
- Handle exhaust with 360° air inlet swivel to prevent kinks
- Power and economy for general repair, transmission work, exhaust systems and body shops
- Ultimate Torque: 425 ft.-lbs.

Ascot No.	Mfg. No.	Description
153-00734	CP-734H	1/2" Impact Wrench
153-01734	CP-734HK	Kit Includes: CP734H, (1) Set of 5 SAE Sockets: 1/2", 5/8", 3/4", 7/8", 15/16"



### 1/2" Super Duty Air Impact Wrench

- Tackle the tough jobs with the power and speed of this true workhorse
- Patented clutch provides smooth operation and extreme durability
- One hand push button forward reverse power regulator. 4 positive power settings in forward and ultimate power in reverse
- Compact design with comfortable contoured handle
- Ultimate Torque: 625 ft.-lbs.



Ascot No.	Mfg. No.	Description
153-07492	CP-749	1/2" Impact Wrench
153-17492	CP-749-2	2" Extended Anvil

### 1/2" Super Duty Air Impact Wrench-Tire Tool

- Patented spring hammer clutch for smooth operation and extended durability
- Add low air consumption and high torque makes this tool very efficient
- Comfort and control with new ergonomic grip and trigger
- Applications: suspension, shock, frame and engine work
- Ultimate Torque: 550 ft.-lbs.



Ascot No.	Mfg. No.	Description
153-00733	CP-7733	1/2" Impact Wrench
153-07332	CP-7733-2	2" Extended Anvil

## 3/4" Impact Wrenches

### 3/4" Heavy Duty Air Impact Wrench

- Smoothest operating 3/4" impact on the market
- One hand push button forward/reverse power regulator
- Handle exhaust with 360° air inlet swivel
- Applications: spring work, truck and bus maintenance, farm machines & construction equipment
- Ultimate Torque: 1,000 ft.-lbs.

Ascot No.	Mfg. No.	Description
154-00772	CP-772H	3/4" Impact Wrench
154-01772	CP-772H-6	6" Extended Anvil



### 3/4" Super Duty Air Impact Wrench

- Compact size with excellent power
- Twin hammer clutch for power and durability
- Combined power regulator with forward/reverse lever
- Applications: spring work, pinion nut and tractor pad removal, truck tire work and major engine tear downs
- Ultimate Torque: 1,200 ft.-lbs.

Ascot No.	Mfg. No.	Description
154-07763	CP-7763	3/4" Impact Wrench
154-77636	CP-7763-6	6" Extended Anvil



## 1" Impact Wrenches

### 1" Super Duty Air Impact Wrench

- Best power to weight ratio in a 1" air wrench
- Compact housing design for ease of use in tight areas
- Industrial quality and durability in an automotive tool
- Applications: spring work, tractor pad removal and off road equipment repair
- Ultimate Torque: 2,000 ft.-lbs.



Ascot No.	Mfg. No.	Description
155-00796	CP-796	1" Short Shank
155-07633	CP-796SP	#5 Spline

### 1" Heavy Duty Air Impact Wrench

- High performance clutch provides longer life under tough conditions
- High-efficiency 6 vane motor for maximum performance
- Bottom exhaust directs exhaust away from the operator
- Three position power regulator with directional control
- Ultimate Torque : 1,450 ft.-lbs.



Ascot No.	Mfg. No.	Description
155-07778	CP-7778	1" Short Shank
155-77786	CP-7778-6	6" Extended Anvil
155-17786	CP-7778SP-6	#5 Spline with 6" Extended Anvil

## 1" Impact Wrenches (Cont.)

### 1" Heavy Duty Air Impact Wrench

- Three position power regulator to match the power to the job
- Compact design for easy use in tight areas
- Handle exhaust directs air away from the work area
- Ideal for spring work, tractor pad removal and off road equipment repair
- Ultimate Torque: 1,750 ft.-lbs.



Ascot No.	Mfg. No.	Description
155-07774	CP-7774	1" Short Shank
155-77746	CP-7774-6	6" Extended Anvil

### 1" Heavy Duty Air Impact Wrench

- At only 25.4 Lbs., reduces operator fatigue
- Directs air away from work area
- Four position power control in forward and reverse
- Ultimate Torque: 1,550 ft.-lbs.



Ascot No.	Mfg. No.	Description
155-07775	CP-7775	1" Short Shank
155-67775	CP-7775-6	6" Extended Anvil
155-77756	CP-7775SP-6	6" Extended Anvil and #5 Spline

### 1" Super Duty Air Impact Wrench

- Rocking dog clutch for smooth operation and extreme durability
- Teasing throttle for easy bolt starting
- Convenient reverse valve for easy directional changes
- Choice of professional mechanics for high volume tire work on trucks, buses and heavy equipment
- Ultimate Torque: 1,400 ft.-lbs.



Ascot No.	Mfg. No.	Description
155-07971	CP-797	1" Short Shank
155-07976	CP-797-6	6" Extended Shank
156-79716	CP-797SP-6	6" Extended Shank and #5 Spline

## Sanders

### Heavy Duty High-Speed Sander

- Built-in regulator and variable speed throttle for precise speed control
- Rugged, energy efficient 1/2 HP motor
- Ideal for small jobs or hard to reach spots. Including: paint removal, shaping filler patches, welding, smoothing and rust removal
- Free Speed: 14,000 RPM



Ascot No.	Mfg. No.
158-00778	CP-778

### Mini Disc Sander Kit

- Kit includes: CP7202 Mini Disc Sander plus (1) 3" backing pad, (10) 3" 80, 100 & 120 grit sanding discs, (1) 3" fine, medium and coarse surface prep disc & a spindle wrench packed in a heavy duty carrying case
- Free Speed: 15,000 RPM



Ascot No.	Mfg. No.
158-07202	CP-7202D



## BlueTork

### 1" Non Impact Wrench

- Two pneumatic motor for rundown and final tightening
- Preset and adjustable shut off for torque control
- **Ergonomics**
  - Very low noise level
  - Virtually no vibration
- **Efficiency**
  - Precise and accurate tightening
  - Less fatigued operators
- **Environment Improvements**
  - By increasing durability of the tools, we reduce waste
- **Quality**
  - Precise, accurate tightening to the manufacturer's recommended torque and angle specifications
- **Maximum Torque: 660 ft.-lbs.**



Training Required Prior to Use

Ascot No.	Mfg. No.	Description
168-07600	CP-7600	Non-Reversible Single Torque Preset
168-07601	CP-7600-4P	Non-Reversible 4 Torque Preset Selector
168-07602	CP-7600-R	Reversible Single Torque Preset
168-07603	CP-7600-R4P	Reversible 4 Torque Preset Selector

## CP Quick Reference Chart

### Air Ratchets

CP No.	Ascot No.	Sq. Drive (mm)	Std Bolt Size (mm)	Net Weight (kg.)	Average Air Cons. (CFM)	Air Inlet (NPTF) In.	Min. Hose Size (inch)	Working Torque Range (ft.-lbs.)	Max. Torque (ft.-lbs.)
CP-826	151-00826	1/4" (6)	1/4" (6)	1.13 (0.51)	3.5	1/4"	1/4" (4)	5-15 (7-20)	15 (20)
CP-7823	151-07823	1/4" (6)	1/4" (6)	1.0 (.45)	4.5	1/4"	1/4" (4)	5-15 (7-20)	15 (20)
CP-7824	152-07824	3/8" (10)	3/8" (10)	1.0 (.45)	4.5	1/4"	3/8" (10)	5-15 (7-20)	16 (20)
CP-825	151-00825	1/4" (6)	1/4" (6)	1-7/8 (.85)	2-3/4	1/4"	1/4" (4)	5-15 (7-16)	15 (20) 200 RPM
CP-828	152-00828	3/8" (10)	3/8" (10)	2-5/8 (1.2)	4	1/4"	3/8" (10)	10-50 (14-68)	50 (68) 150 RPM
CP-828H	153-00828	1/2" (13)	3/8" (10)	2-5/8 (1.2)	4	1/4"	3/8" (10)	10-50 (14-68)	50 (68) 150 RPM
CP-7830Q	153-07828	3/8" (10)	3/8" (10)	2.7 (1.2)	5 (142)	1/4"	3/8" (10)	10-90 (14-136)	90 (122)

## 1/4" Air Ratchets

### 1/4" Super Duty Air Ratchet

- Exceptional durability with an advanced head design that virtually eliminates slippage
- Urethane grip for comfort and control
- Extended length-designed for greater reach in confined areas
- Faster rundown with 250 RPM
- Applications: Under-dashboard work, small engine repair and body shops
- Ultimate Torque: 15 ft.-lbs.



Ascot No.	Mfg. No.
151-00826	CP-826

### 1/4" Heavy Duty Air Ratchet

- 250 RPM of free speed
- 4 position swivel head for easy access and maneuverability
- Rear exhaust directs air away from work area
- Applications: Under-dashboard work, small engine repair and body shops
- Ultimate Torque: 15 ft.-lbs.



Ascot No.	Mfg. No.
151-07823	CP-7823

### 3/8" Heavy Duty Air Ratchet

- 4 position swivel head for easy access and maneuverability
- 250 RPM of free speed
- Compact and lightweight. Fits in the palm of your hand
- Rear exhaust
- Ultimate Torque: 15 ft.-lbs.

Ascot No.	Mfg. No.
152-07824	CP-7824

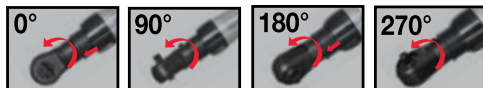

**Chicago Pneumatic**



## 3/8" Air Ratchets

### 3/8" Quiet Air Ratchet

- Applications: exhaust systems, small engines, water and fuel pumps and radiator and air conditioner removal and replacement
- New advanced, patented head design
- Patented ergonomic square-handle design for a comfortable grip
- Efficient 1/2 HP motor and triple idler planetary gear system
- Ultimate Torque: 50 ft.-lbs.

Ascot No.	Mfg. No.	Description
152-00828	CP-828	3/8" Super Duty Ratchet
153-08281	CP-828H	1/2" Super Duty Ratchet



### 3/8" Quiet Air Ratchet

- Quiet Operation
- Compact, yet packed with power and speed
- Features CP's Patented TriSpring anti-slip head design which virtually eliminates slippage
- Easy Touch Variable Speed Trigger for speed control on all types of work
- Ultimate Torque: 60 ft.-lbs.

Ascot No.	Mfg. No.	Description
152-07828	CP-7828	3/8" Super Duty Ratchet
153-07828	CP-7828H	1/2" Super Duty Ratchet



### 3/8" Extreme Duty Air Ratchet

- Adjustable noise level - as low as 79 dBA
- Highest torque available on the market
- Patented TriSpring ratchet head
- Lightweight and well balanced
- Ultimate Torque: 90 ft.-lbs.

Ascot No.	Mfg. No.	Description
152-07830	CP-7830Q	3/8" Super Duty Ratchet
153-07830	CP-7830HQ	1/2" Super Duty Ratchet



## Tire Buffers

### High Speed Tire Buffer Kit

- Jacobs chuck for holding buffing accessories
- Lock-off throttle
- Applications: tire patchwork, roughing areas for recapping and cleaning tire moldings
- Free Speed: 22,000 RPM



Ascot No.	Mfg. No.	Description
158-00871	CP-871K	Includes Over Hose

### Low Speed Tire Buffer Kit

- Quick change slip chuck for fast and easy change of buffing wheel
- Adjustable speed regulator for precise control
- Lock off throttle to prevent accidental start ups
- Rear exhaust directs air away from work area
- Free Speed: 2,800 RPM



Ascot No.	Mfg. No.	Description
158-00873	CP-873K	Includes Over Hose

## Needle Scaler and Cut-Off Tool

### Needle Scaler

- Ideal for surface preparation work
- Adjustable sleeve to fit the protrusion of the needles to the task to be performed
- 19 1/8" steel needles with high resistance to wear
- Easily converts into a chisel scaler
- Blows Per Minute: 4,800



Ascot No.	Mfg. No.
157-07120	CP-7120

### High Speed Cutter

- Adjustable speed regulator for precise control
- Lock off throttle to prevent accidental start up
- Rear exhaust directs air away from work area
- Max RPM: 22,000



Ascot No.	Mfg. No.
157-00874	CP-874

## Grinders

### 2" Angle Grinder Kit

- Kit includes: Pin Wrench, Spanner, (3) each 2" 60, 80 & 120 Grit Grinding Wheels, (5) each 2" Cutting Wheels and Protective Glasses packed in a heavy duty carrying case
- Free Speed: 22,000 RPM



Ascot No.	Mfg. No.
157-07500	CP-7500DK

### Mini 120° Angle Grinder

- Powerful .25 HP high performance motor
- Easy access speed regulator for precise power and control
- Insulated grip for greater operator comfort
- Rear exhaust vents air away from the work area
- Applications: blending, smoothing, porting and deburring in confined areas
- Free Speed: 23,000 RPM



Ascot No.	Mfg. No.
157-07563	CP-7563

### Mini Angle Die Grinder

- Compact, lightweight design for easy maneuverability
- 90° angle head allows flexibility in confined areas
- Complete with 1/4" and 6mm collet
- Applications: high speed blending, smoothing, porting, and deburring in confined areas
- Max RPM: 22,500



Ascot No.	Mfg. No.
157-00875	CP-875

### Mini Angle Die Grinder Kit

- Kit includes: (1) 2" backing pad, (2) 2" coarse surface prep pads, (2) 2" medium surface prep pads, (2) 2" fine surface prep pads, (2) 2" 50 grit sanding discs, (2) 2" 36 grit sanding discs, (2) 2" 24 grit sanding discs paced in a heavy duty carrying case
- Max RPM: 22,500



Ascot No.	Mfg. No.
157-01875	CP-875K

### 5" Heavy Duty Angle Grinder

- Powerful .7 HP high performance motor for fast, effective grinding in tight quarters
- Aluminum alloy housing is rugged yet lightweight for maximum operator comfort
- Spiral bevel gearing in angle head provided extended life and smooth low vibration
- Applications: weld preparation and smoothing, rust removal, deburring and blending of steel, cast iron and aluminum
- Max RPM: 12,000



Ascot No.	Mfg. No.
157-07554	CP-7554

### Mini 90° Angle Grinder

- Powerful .25 HP high performance motor
- Easy access speed regulator for precise power and control
- Insulated grip for greater operator comfort
- Rear exhaust vents air away from the work area
- Applications: blending, smoothing, porting and deburring in confined areas
- Free Speed: 23,000 RPM



Ascot No.	Mfg. No.
157-07562	CP-7562

### Mini Straight Angle Grinder

- Powerful .25 HP high performance motor
- Easy access speed regulator for precise power and control
- Insulated grip for greater operator comfort
- Rear exhaust vents air away from the work area
- Applications: blending, smoothing, porting and deburring in confined areas
- Free Speed: 28,000 RPM



Ascot No.	Mfg. No.	Description
157-07556	CP-7556	Angle Grinder
157-07856	CP-7856-ES	3.5" Extended Shaft

### Mini Die Grinder

- Compact, lightweight design for easy maneuverability
- Adjustable speed regulator for precise control
- Complete with 1/4" and 6mm collet
- Applications: high speed blending, smoothing, porting, and deburring in confined areas
- Max RPM: 30,000



Ascot No.	Mfg. No.
157-00876	CP-876

## Drills

### 1/4" Mini Air Drill

- Ergonomic grip for comfort and control
- Jacob's chuck 1/4" capacity
- Planetary gearing with brass bushings for low wear and long life
- Adjustable exhaust
- Applications: Drilling, honing, reaming and hold sawing
- Free Speed: 2,800 RPM

Ascot No.	Mfg. No.
157-07300	CP-7300



### 1/4" Reversible Mini Air Drill

- General purpose reversible drill
- Compact and lightweight for easy handling
- Planetary gearing with brass bushings for low wear and long life
- Jacob's chuck 1/4" capacity
- Applications: Drilling, honing, reaming and hold sawing
- Free Speed: 2,700 RPM

Ascot No.	Mfg. No.
157-07301	CP-7300R
157-07302	CP-7300RQC w/Keyless Chuck



### 3/8" Reversible Angle Drill

- Compact, low profile head for confined areas
- Reverse valve for easy directional changes
- Teasing throttle for control from start up through run down
- Ideal for screwdriving and drilling in hard to reach areas
- Free Speed: 1,800 RPM

Ascot No.	Mfg. No.
157-00879	CP-879



### 3/8" Reversible Drill

- Teasing throttle for precise control
- Oil free operation
- Needle bearing gearing for improved durability
- Applications include screwdriving, honing and heavy drilling
- Free Speed: 2,600 RPM

Ascot No.	Mfg. No.
157-78926	CP-789-R26



### 1/2" Reversible Drill

- Teasing throttle for precise control
- Needle bearing gearing for improved durability
- The right tool for heavy drilling, reaming, hole sawing and jobs requiring a lot of torque
- Free Speed: 500 RPM

Ascot No.	Mfg. No.
157-00789	CP-789-HR



## Air Tool Accessories

### Protecto-Lube Air Tool Oil

Ascot No.	Mfg. No.	Description
181-00046	CA-000046	20 Oz.
181-14966	CA-149661	4 Oz.

### Pneu-Lube Clutch Grease

Ascot No.	Mfg. No.	Description
181-58455	8940158455	3.5 Oz.
181-58457	8940158457	7 Oz.

### PVC Cushion-Coat Protective Covers

Tool No.	Ascot No.	Mfg. No.
CP-734H	177-12940	CA-129405
CP-749, CP-749-2	177-15553	CA-155537
CP-772H	177-12474	CA-124745
CP-7733 -2	177-77332	8940158949
CP-797, CP-797-6	177-13988	CA-139818
CP-7775	177-17775	8940162416
CP-7778, CP-7778-6	177-17778	8940163099



## Air Tool Accessories

### Tune-Up Kits

Tool No.	Ascot No.	Mfg. No.
CP-721	176-18880	CA-118880
CP-7735	176-67479	8940167479
CP-724H	176-55218	CA-155218
CP-749	176-14861	8940158635
CP-749-2	176-14866	CA-148616
CP-7749/7749-2	176-89481	8940167481
CP-7733/7733-2	176-89860	8940158860
CP-796	176-26992	CA-126992
CP-7778/ 7778-6	176-89816	8940162816
CP-7774/CP-7774-6	176-62693	8940162693
CP-7775/7775-6/7775SP-6	176-62206	8940162206

### Repair Kits

Tool No.	Ascot No.	Mfg. No.
CP-7735	176-89480	8940167480
CP-724H	176-55310	CA-155310
CP-749	176-58636	8940158636
CP-749-2	176-15597	CA-155967
CP-7749/7749-2	176-88482	8940167482
CP-7733	176-88861	8940158861
CP-7733-2	176-88862	8940158862

### Blaster 404-ATC Air Tool Conditioner

- Restores & prolongs tool life
- Provides a coating & lubrication for tools while in use
- Inhibits rust
- Increases RPM's
- Use for normal maintenance

Ascot No.	Mfg. No.	Description
181-00404	404	18 Oz.



### Hammer Accessories



Index No.	Ascot No.	Mfg. No.	Description
1	171-47050	A-047050	Rivet Cutter
2	171-47051	A-047051	Wide Cutting Chisel
3	171-47052	A-047052	Bushing Splitter
4	171-47057	A-047057	U-Joint & Tie Rod Rod
5	171-47059	A-047059	1" Separator Fork
	171-47060	A-047060	3/4" Separator Fork
	171-47061	A-047061	1-1/4" Separator Fork
6	171-47071	A-047071	Twin Blade Cutter
7	171-47073	A-047073	Cold Chisel
8	171-47074	A-047074	Straight Punch
9	171-47078	A-047078	Tapered Punch
10	171-47091	A-047091	1-1/4" Smoothing Hammer
11	171-47095	A-047095	Quick-Change Retainer
12	171-47096	A-047096	Bee-Hive Retainer
	171-47270	CA-047270	2' Leader Hose
	171-47300	CA-047300	Quick Change Coupler
	171-47032	CA-047302	Nipple

### Marvel Air Tool Oil

- Specially formulated for use in all piston type rotary air tools and in-line air lubricators
- Prevents rust formation while providing positive lubrication for smooth starting and longer tool life
- Assures maximum performance by dissolving gum and sludge

Ascot No.	Mfg. No.	Description
181-00085	MM085	32 Oz.



## Impact Wrenches/Quick Reference Chart

### IR Quick Reference Chart

I-R No.	Ascot No.	Sq. Drive	Std. Bolt Size	Net Weight (lbs.)	Average Air Cons. (CFM)	Air Inlet (NPTF)	Min. Hose Size	Working Torque Range (ft.-lbs.)	Max. Torque (ft.-lbs.)
IR-2115Ti	152-02115	3/8"	7/16"	2-1/2	4	1/4"	3/8"	25-230	250
IR-212	152-00212	3/8"	7/16"	2-3/4	2.5	1/4"	3/8"	20-150	180
IR-231HA	152-00231	1/2"	9/16"	5.8	4.2	1/4"	3/8"	25-350	590
IR-244A	153-0244	1/2"	9/16"	5-5/8	4.2	1/4"	3/8"	40-350	500
IR-2135TiMax	153-02135	1/2"	9/16"	4	5.0	1/4"	3/8"	50-600	625 (700 rev)
IR-2135QTiMax	153-12135	1/2"	9/16"	4.05	5.0	1/4"	3/8"	50-600	625
IR-259	154-00259	3/4"	7/8"	8.8	6.0	3/8"	3/8"	200-800	1050
IR-261	154-00261	3/4"	1"	11-1/16	9.5	3/8"	1/2"	200-600	1100
R-2141	154-02141	3/4"	1"	7	9.5	3/8"	1/2"	200-900	1100 (1200)
IR-271	155-00271	1"	1-1/4"	11-9/16	9.5	3/8"	1/2"	100-750	1200
IR-285B	155-00285	1"	1-1/4"	27-1/3	10.0	1/2"	1/2"	100-1000	1600
IR-290	155-00290	1"	1-1/4"	19-3/4	10.0	1/2"	1/2"	150-1000	1600
IR-293	155-00293	1"	1-3/8"	22-7/8	12.0	1/2"	1/2"	1000-1600	2000
IR-295	155-00295	1"	1-1/4"	22	10.0	3/8"	1/2"	100-1000	1450
IR-2161XP	155-02161	1"	1"	11.3	10.0	3/8"	1/2"	300-1000	1250

### 3/8" and 1/2" Impact Wrenches

#### 3/8" Super Duty Air Impact Wrench

- Titanium hammer case
- 280 ft.-lbs. of torque will remove even the toughest nuts and bolts
- Applications: transmissions, brakes, exhaust, body repair and underhood



Ascot No.	Mfg. No.
152-02115	IR-2115Ti

#### 1/2" Super Duty Air Impact Wrench

- Most popular tool in its class
- Offers the sheer power and performance features to tackle the toughest of jobs
- Durable and economical
- Torque Range: 25-300 ft.-lbs.



Ascot No.	Mfg. No.	Description
153-00231	IR-231HA	Standard Anvil
153-02312	IR-231HA-2	2" Extended Anvil

#### 3/8" Super Duty Air Impact Wrench

- Tremendous power and longer life
- Popular choice of professional mechanics for under car, under hood and bench work
- Handle exhaust directs air away from work
- Torque Range: 20-150 ft.-lbs., 180 max.



Ascot No.	Mfg. No.
152-00212	IR-212

#### 1/2" Super Duty Air Impact Wrench

- For fire-changing, shock and spring work, front-end work and other heavy automotive and truck work
- Pumps out 500 ft.-lbs. of torque at a free speed of 7,000 RPM
- IR-244A-2 with a two-inch extended anvil for use with flip sockets



Ascot No.	Mfg. No.	Description
153-00244	IR-244A	Standard Anvil
153-02442	IR-244A-2	2" Extended Anvil



## 1/2" and 3/4" Impact Wrenches

### 1/2" Ultra Duty Titanium Air Impact Wrench

- Titanium weighs less and provides greater durability
- Enhanced Twin Hammer mechanism for fast removal of frozen bolts
- Push button forward/reverse controls for one-handed operation
- Torque Range: 50-600 ft.-lbs., 625 ft.-lbs. max (forward), 700 ft.-lbs. max (reverse)



Ascot No.	Mfg. No.	Description
153-02135	IR-2135TiMax	Standard Anvil
153-21352	IR-2135TiMax-2	2" Extended Anvil
153-21350	IR-2135QTiMax	Quiet Version
153-21353	IR-2135QTiMax-2	Quiet Version with 2" Extended Anvil

### 3/4" Ultra Drive Air Impact Wrench

- Lightest, most compact impact tool
- 4 power positions
- Twin Hammer Plus™ Mechanism
- 1200 ft.-lbs. of torque

Ascot No.	Mfg. No.
154-02141	IR-2141



### 3/4" Super Duty Air Impact Wrench

- Powerful 3/4" wrench
- Combines compact size with high output
- Ideal for everything from spring work to pinion nut and track pad removal and major engine teardowns
- Jumbo hammer mechanism delivers up to 1,100 ft.-lbs. of torque smoothly, with less vibration

Ascot No.	Mfg. No.	Description
154-00261	IR-261	Standard Anvil
154-02613	IR-261-3	3" Extended Anvil
154-02616	IR-261-6	6" Extended Anvil



### 3/4" Super Duty Air Impact Wrench

- Non-biased motor delivers 1,050 ft.-lbs. of maximum torque in both forward and reverse
- Two power settings in forward and reverse
- Variable speed trigger
- Lighter than other 3/4" impacts in its class
- Handle-vented exhaust directs air away from the operator
- Silenced exhaust reduces tool noise while in use

Ascot No.	Mfg. No.
154-00259	IR-259



### 3/4" Ultra Duty Air Impact Wrench

- Offers all of the ergonomic, power and durability enhancing features as the IR-2161 but with a 6" extended anvil for those hard to reach applications
- Jumbo hammer mechanism
- Up to 1,200 ft.-lbs. of torque
- Trouble-free, longer performance aided by the pressure-feed lube system
- Compact and only 7-5/8" long
- Handle exhaust

Ascot No.	Mfg. No.
154-21617	IR-2161X-6



## 1" Impact Wrenches

### 1" Heavy Duty Air Impact Wrench

- Perfect for the demanding world of truck tire and service work
- Combines exceptional power, durability and operator convenience
- Delivers 1450 ft.-lbs. of maximum torque, with a 5000 RPM free speed and four-position power regulator
- 360° swivel inlet
- Available in 6" extended anvil and 6" extended #5 spline drive anvil for high production truck tire changing



Ascot No.	Mfg. No.	Description
155-28560	IR-285B	Standard Anvil
155-02856	IR-285B-6	6" Extended Anvil
156-28566	IR-285BS-6	#5 Spline Super Duty Anvil

### 1" Super Duty Air Impact Wrench

- 1" drive wrench with 1,000 ft.-lbs. torque to handle tough jobs in cramped spaces
- Built-in pressure-feed lube system, adjustable side handle and built-in oil reservoir that provides continuous misting of the air motor
- Available in 6" extended anvil and 6" extended #5 spline drive anvil for high production truck tire changing



Ascot No.	Mfg. No.	Description
155-00280	IR-280	Standard Anvil
155-02806	IR-280-6	6" Extended Anvil
156-28006	IR-280-S6	#5 Spline Super Duty Anvil

### 1" Super Duty Air Impact Wrench

- Designed specifically for tire changing
- Chainsaw handle provides comfortable control for the operator
- Delivers devastating torque in a lightweight package
- 1200 ft.-lbs. of torque



Ascot No.	Mfg. No.	Description
155-02190	IR-2190TI	Standard Anvil
155-21906	IR-2190DTI-6	6" Extended Anvil/D-Handle
155-21916	IR-2190TI-6	6" Extended Anvil

### 1" Super Duty Air Impact Wrench

- Designed for getting into cramped spaces with three-way adjustable handle
- Ideal for spring work, tractor pads, bus maintenance and off-road/farm equipment
- Torque Range: 150-1000 ft.-lbs. (1600 maximum)



Ascot No.	Mfg. No.	Description
155-00290	IR-290	Standard Anvil
156-02901	IR-290-S	#5 Spline

### 1" Ultra Duty Air Impact Wrench

- High power-to-weight ratio
- Full power reverse
- 3-position power regulator
- 360° swivel inlet
- Maximum Torque: 1250 ft.-lbs.



Ascot No.	Mfg. No.	Description
155-21710	IR-2171XP	Standard Anvil

### 1" Ultra Duty Air Impact Wrench

- Most powerful 1" wrench for spring work, tractor pads, bus maintenance and off-road/farm equipment
- Maximum Torque: 2000 ft.-lbs.



Ascot No.	Mfg. No.	Description
155-00293	IR-293	Listed Above
156-02931	IR-293-S	#5 Spline Drive

### 1" Heavy Duty Air Impact Wrench

- Improved 1" drive tool perfect for truck and heavy equipment maintenance
- Offers power and convenience at an affordable price
- Compact, lightweight and perfect for working on suspension components
- Torque Range: 100-1000 ft.-lbs.



Ascot No.	Mfg. No.	Description
155-00295	IR-295	Listed Above
156-02951	IR-295-S	#5 Spline Drive



## Air Hammers



### Super Duty Air Hammer

- For front-end and heavy exhaust work, riveting, king pin removal, bushing driving and bolt shearing
- Controls starting strokes precisely with an extra-sensitive tease throttle
- Super duty power, at up to 1,725 blows per minute
- Chisel Shank Diameter: .401"

Ascot No.	Mfg. No.
159-00132	IR-132



### Needle Scaler

- For surface preparation work involving the cleaning or removal of paint, rust, dirt or weld slag
- Durable, dependable and economical

Ascot No.	Mfg. No.
157-00125	IR-125

### Air Hammer Kits

- Five-piece chisel set in a plastic pouch with .401" shank diameters
- Includes: edging tool, tail pipe cutter, straight chisel, cutting chisel and pouch



Ascot No.	Mfg. No.	Description
171-01151	IR-115K	IR-115 Air Hammer Kit
171-01161	IR-116K	IR-116 Air Hammer Kit
171-01171	IR-117K	IR-117 Air Hammer Kit

## Die Grinders

### Heavy Duty Angle Air Die Grinder

- For work in confined areas
- Features a right angle head
- For grinding, porting, polishing, de-burring, breaking sharp edges
- Self-locking throttle lever
- Positive grip 1/4" capacity collet chuck



Ascot No.	Mfg. No.
157-00302	IR-302A



### Heavy Duty Air Die Grinder

- 25,000 RPM
- Designed for porting, light weld grinding and breaking sharp edges
- Self-locking throttle lever
- Positive grip 1/4" capacity collet chuck with two collet wrenches



Ascot No.	Mfg. No.
157-00308	IR-308A

### Super Duty Mini Air Die Grinder

- For grinding, edge-breaking, de-burring, porting and polishing
- Right-angle configuration
- Compact, lightweight and easy to handle



Ascot No.	Mfg. No.
157-00307	IR-307A

## Finishing Tools

### IR Quick Reference Chart - Finishing Tools & Air Drills

Ascot No.	Mfg. No.	Description
157-03012	IR-301-2MK	Surface Conditioning Kit
158-00311	IR-311A	Heavy Duty Dual Action Quiet Air Sander 6" Pad
157-00326	IR-326	Heavy Duty 2-7/8" Air Cut-Off Tool
157-00313	IR-313A	Heavy Duty Angle Air Sander 7" Pad
158-00317	IR-317A	Heavy Duty High Speed Air Sander 5" Pad
158-00319	IR-319A	Heavy Duty Vertical Air Sander 7" Pad

See Page 62 for IR Tune-Up Kits and Repair Kits!

### Heavy Duty Dual Action Quiet Air Sander 6" Pad

- A built-in silencer muffles noise as you work
- Quality sander used for feather edging, metal preparation and finish work on body filler



Ascot No.	Mfg. No.
158-00311	IR-311A

### Surface Conditioning Kit

- Includes a IR301 1/4" angle head die grinder in a blow molded plastic case with two coarse and two medium grit 3" 3M Rolco™ surface conditioning pads, two coarse, two medium grit 2" 3M Rolco™ surface conditioning pads and a disc holder



Ascot No.	Mfg. No.
158-03012	IR-301-2MK

## Air Drills

### 3/8" Heavy Duty Air Drill

- Planetary gear reduction balances the load on bearings and gears-increasing tool life
- Variable speed throttle makes starting holes easy
- Positive action trigger stop reduces maximum speed at any time



Ascot No.	Mfg. No.	Description
157-07802	IR-7802A	Standard Air Drill
157-17802	IR-7802RA	Reversible Air Drill

### 1/2" Heavy Duty Air Drill

- Designed for drilling, hole sawing, cylinder honing and other jobs that call for a 1/2" size
- Industrial grade 1/2" chuck, ball and needle bearing construction and double reduction planetary gearing for longer life
- No-load speed of 500 RPM and auxiliary side handle



Ascot No.	Mfg. No.	Description
157-07803	IR-7803A	Standard Air Drill
157-17803	IR-7803RA	Reversible Air Drill

### High Speed Tire Buffer

- Lever style tease trigger with lock-off for easy operation
- Quick change chuck for easy buffing



Ascot No.	Mfg. No.
157-00327	IR-327HS

### Heavy Duty Air Low Speed Tire Buffer

- For quick work of patchwork and roughing up low areas for recapping, tire scuffing and cleaning tire moldings
- Free speed up to 3,000 RPM
- 1/2 hp motor



Ascot No.	Mfg. No.	Description
157-00327	IR-327LS	Includes Over Hose



## Cordless Tools

### IR Quick Reference Chart - Cordless Tools

I-R No.	Ascot No.	Drive Type	Speed (RPM)	Weight (Lbs.) No Battery	Weight (Lbs.) Li-ion	Length (In.)	Sound dBA	Voltage
D650	153-00650	3/8"	0-360/1300	3.2	4.7	9.2	76.1/87.1	19.2
R380	153-00380	3/8"	225	2.8	4.3	12.4	80.8	14.4



### 1/2" Cordless Drill

- 650 in.-lbs. stall torque
- Less than 4.5 Lbs. with Lithium Ion battery
- 0-360/1300 RPM
- Engineered composite housing with patent pending metal subframe for unbreakable strength
- Two speed all metal gear train for the ultimate in power and durability



Ascot No.	Mfg. No.
153-00650	D650

### 3/8" Cordless Ratchet

- The R380 cordless ratchet delivers the perfect combination of power, durability, and convenience. More powerful than any other ratchet in its class and increased mobility for hard-to-reach areas. Features the patent pending IQv Grip twist to lock mounting that grips the battery into the tool for the strongest, most secure design available
- Compatible with all 14.4v IQv batteries including NiCd and Lithium Ion



Ascot No.	Mfg. No.
153-00380	R380

### 1/2" Cordless Drill Kit

- Includes W360 1/2" Square Dr. Cordless Drill, BC10 battery charger and (2) BL192 Lilon Batteries in a hard case



Ascot No.	Mfg. No.
153-03602	W360-KL2

### IR Quick Reference Chart - Li-ion Battery

I-R No.	Ascot No.	Weight (Lbs.)	Voltage	Battery Life	Dimensions LxWxH (in.)
BL144	319-00144	1.31	14.4	Min. 100 recharges	5 x 3.25 x 4
BL192	319-00192	1.5	19.2	Min. 100 recharges	5 x 3.25 x 4

### Cordless Battery Charger

- Charges all IQv Series Batteries
- Optimizes charge through digital communication with IQv batteries
- Constant monitoring for safe trickle charge
- Onboard charge level gauge displays charge of both Li-Ion IQv batteries
- Advanced Diagnostics identifies and alerts user of memory effect or degradation
- Renew Feature restores dead batteries to like new capacity. Extends pack life up to 3 times longer
- Separate power cord and internal voltage switch



Ascot No.	Mfg. No.
319-00010	BC10

### IQV SERIES 14.4V Lithium Ion Battery

- Battery charge level gauge displays exactly how much charge is left in the battery
- More than 35% lighter than 18v NiCd or 28v and 36v Li Ion packs
- At 2.4 hrs., up to 30% higher capacity than NiCd and most competitive Li-Ion batteries
- No memory effect or fading power



Ascot No.	Mfg. No.
319-00144	BL144

### IQV SERIES 19.2V Lithium Ion Battery

- Battery charge level gauge displays exactly how much charge is left in the battery anytime
- More than 35% lighter than 18v NiCd or 28v and 36v Li Ion packs
- At 2.4 hrs., up to 30% higher capacity than NiCd and most competitive Li-Ion batteries
- No memory effect or fading power



Ascot No.	Mfg. No.
319-00192	BL192

## Air Tool Accessories

### Hammer Mechanism Tune-Up Kit

- Contains the anvil, hammer (or pins) and gaskets for the impact mechanism
- 110-TK1 includes only the cam ball, two anvil pins and anvil spring



IR Tool No.	Ascot Tool No.	Kit No.
211	176-00111	111-THK1
231C, 244A	176-00231	231-THK1
231-2HA-2, 244A-2	178-01231	231-THK2
2135TI	178-02135	2135-THK1

### Motor Tune-Up Kits

- Contains the vanes, gaskets and seals for a complete tune-up
- 231-TK3, also includes ball bearings

IR Tool No.	Ascot Tool No.	Kit No.
211	176-10211	211-TK2
212	176-10212	212-TK2
231C, 231HA-2	176-10221	231-TK3
235	176-12313	235-TK3
244A, 244A-2	176-10244	244-TK2
261, 271	176-10261	261-TK2
280 Series	176-10280	280-TK2
2135TI	176-12135	2135-TK1
7803A, 7803RA	176-17803	7803-TK1
285-6	176-10285	285TK1

### Lubricants



Ascot No.	Mfg. No.	Description
181-10510	105-LBK1	4 Oz. IR 105 Grease, 4 Oz. IR10 Oil & Grease Gun Head
181-10540	105-4T	(6) 4 Oz. Tubes - IR 105 Grease Refills
181-11510	115-LBK1	4 Oz. IR 115 Grease, 4 Oz. IR10 Oil & Grease Gun Head
181-11540	115-4T	(6) 4 Oz. Tubes - IR 115 Grease Refills
181-12228	R000A2-228	Grease Gun
328-10001	100-1	1 Lb. Grease for Impact Wrenches

## Ergonomic Workstation

### Mobile Wheel Work Station

- Features gas-strut assisted boom that supports the weight of those heavy impact wrenches
- The suspended impact wrench is capable of rotating to the operator desired position
- Features side and rear storage compartments designed to organize sockets, tire irons, lubricants, hoses and various wheel parts
- Air wrench is supported and held in desired position
- Air wrench suspension boom allows for directional freedom and reduces damage

Ascot No.	Mfg. No.
515-00555	WS-05



### Retaining Rings

Ascot Tool No.	IR Tool No.	Kit No.
176-31425	231-425A	Socket Retainer for IR231, 231-2
176-01590	R1A-159	Retainer O-Ring for IR 231, 231-2
176-91425	291-425	Socket Retainer for IR-281, 285
176-81426	291-426	Retainer O-Ring for IR-281, 285

### Air Tool Covers

- Vinyl boots also absorb some of the tool vibration and protect air impact ratchets, wrenches and drills free from external damage

IR Tool No.	Ascot Tool No.	Kit No.
212	177-20232	202-P32
211	177-21132	211-P32
231C, 231HA-2	177-23132	231-P32
2135	177-21335	2135-P32
244A, 244A-2	177-24432	244-P32
258	177-25832	258-P32
261, 261-2, 271	177-26132	261-P32
285B-6, 285BS-6, 285B	177-28132	285-P32

### Tire Tool Station

- Organize your tools
- Universal top tray with slots for torque sockets, etc.
- Dual cradles for impact guns, 1/2" airline connections
- Includes (2) 25' x 3/8" recoil hoses with 1/4" swivel fittings



Ascot Tool No.	IR Tool No.
515-02400	2400





# WHEEL SERVICE PRODUCTS

SOCKETS  
SOCKET SETS  
WHEEL ATTACHING HARDWARE  
STUD SETTERS AND REMOVERS  
TORQUE TOOLS



## Impact Sockets

### 1/2" DR 13 Piece SAE Set

- Contains the following sizes: 7/16", 1/2", 9/16", 5/8", 11/16", 3/4", 13/16", 7/8", 15/16", 1", 1-1/16", 1-1/8", 1-1/4"



Ascot No.	Mfg. No.
163-01150	1150

### 1/2" DR 13 Piece Deep Set

- Contains the following sizes: 7/16", 1/2", 9/16", 5/8", 11/16", 3/4", 13/16", 7/8", 15/16", 1", 1-1/16", 1-1/8", 1-1/4"



Ascot No.	Mfg. No.
163-01151	1151D



### 1/2" DR 14 Piece Metric Standard Set

- Contains the following sizes: 10mm, 11mm, 12mm, 13mm, 14mm, 15mm, 16mm, 17mm, 18mm, 19mm, 21mm, 22mm, 26mm, 27mm



Ascot No.	Mfg. No.
163-01152	1152M

### 1/2" DR 14 Piece Metric Deep Set

- Contains the following sizes: 10mm, 11mm, 12mm, 13mm, 14mm, 15mm, 16mm, 17mm, 18mm, 19mm, 21mm, 22mm, 26mm, 27mm



Ascot No.	Mfg. No.
163-01153	1153MD



### 1/2" DR 29 Piece Metric and SAE 6 Point Deep Impact Socket Set

- Contains 7/16", 1/2", 9/16", 5/8", 11/16", 3/4", 13/16", 7/8", 15/16", 1", 1-1/16", 1-1/8" and 1-1/4" deep sockets
- 10, 11, 12, 13, 14, 15, 16, 17, 18, 19, 21, 22, 26 and 27mm deep sockets
- 3/4" x 13/16" deep and 19mm x 21mm deep flip sockets



Ascot No.	Mfg. No.
163-05153	1153DD



### 1/2" DR 5 Piece Deep Thin Wall Flip Set

- Contains the following sizes: 3/4" x 13/16", 19mm x 21mm, 7/8" x 15/16", 17mm x 19mm, 3" extension



Ascot No.	Mfg. No.
167-12050	1205D

### 3/4" DR 10 Piece Truck Set

- Contains the following sizes: 13/16" Square Socket, 1-1/16", 1-1/8", 1-1/4" Thin Wall Deep Sockets, 1-1/2" Budd Wheel Socket, 17mm & 21mm Square Socket, 33mm, 35mm & 41mm Deep Sockets



Ascot No.	Mfg. No.
164-02110	2110

### 3/4" DR 8 Piece SAE Deep Set

- Contains the following sizes: 1", 1-1/16", 1-1/8", 1-1/4", 1-5/16", 1-3/8", 1-7/16", 1-1/2"



Ascot No.	Mfg. No.
164-02181	2181D



## Impact Sockets (Cont.)

### 3/4" DR 5 Piece Metric Standard Truck Set

- Contains the following sizes: 4 pts. budd wheel standard length, 17mm, 27mm, 30mm, 33mm, 35mm standard

Ascot No.	Mfg. No.
164-02185	2185M



### 1" DR 5 Piece Budd Wheel Socket Set

- Contains the following sizes: 1-1/2" hex x 13/16" square budd wheel impact socket, 35mm x 17mm square budd wheel impact socket, 38mm x 20mm square budd wheel impact socket, 41mm x 21mm square budd wheel impact socket and 33mm deep

Ascot No.	Mfg. No.
165-05626	5626



### 3/4" DR 4 Piece Budd Wheel Socket Set

- Contains the following sizes: 1-1/2" hex x 13/16" square budd wheel impact socket, 35mm x 17mm square budd wheel impact socket, 41mm x 21mm square budd wheel impact socket and 33mm deep

Ascot No.	Mfg. No.
164-04626	4626



### 1" DR 7 Piece Metric Truck Set

- Contains the following sizes: 17mm, 21mm, 4 pts. budd wheel standard length, 27mm, 33mm, 36mm, 41mm deep

Ascot No.	Mfg. No.
165-03197	3197M



### 1" DR 10 Piece Truck Set

- Contains the following sizes: 13/16" square, 1-1/16", 1-1/8", 1-1/4" thin wall deep, 1-1/2" deep with inside lip, 17mm & 21mm square with inside lip, 33mm, 35mm & 41mm deep

Ascot No.	Mfg. No.
165-03110	3110



### #5 Spline DR 9 Piece SAE Truck Set

- Contains the following sizes: 13/16", 4 points budd wheel standard length, 7/8", 15/16", 1", 1-3/16", 1-1/2" deep with inside lip, 1-1/16", 1-1/8", 1-1/4" thin wall deep

Ascot No.	Mfg. No.
165-04191	4191



### 1" DR 9 Piece SAE Truck Set

- Contains the following sizes: 13/16", 4 points budd wheel standard length, 7/8", 15/16", 1", 1-3/16", 1-1/2" deep with inside lip, 1-1/16", 1-1/8", 1-1/4" thin wall deep

Ascot No.	Mfg. No.
165-03190	3190



**Easier to identify and find right impact socket with new & improved laser etching**

## Impact Sockets (Cont.)

### 1/2" DR Master 39 Piece SAE Impact Socket Set

- CR-MO alloy steel for long life
- Fully guaranteed
- Heavy duty blow mold case
- 19 Standard Sockets: 3/8", 7/16", 1/2", 9/16", 5/8", 11/16", 3/4", 13/16", 7/8", 15/16", 1", 1-1/16", 1-1/8", 1-3/16", 1-1/4", 1-5/16", 1-3/8", 1-7/16" and 1-1/2"
- 19 Deep Sockets: 3/8", 7/16", 1/2", 9/16", 5/8", 11/16", 3/4", 13/16", 7/8", 15/16", 1", 1-1/16", 1-1/8", 1-3/16", 1-1/4", 1-5/16", 1-3/8", 1-7/16" and 1-1/2" Universal

Ascot No.	Mfg. No.
163-02668	2668



### 1/2" DR Master 39 Piece Metric Impact Socket Set

- CR-MO alloy steel for long life
- Fully guaranteed
- Heavy duty blow mold case
- 19 Standard Sockets: 9mm, 10mm, 11mm, 12mm, 13mm, 14mm, 15mm, 16mm, 17mm, 18mm, 19mm, 20mm, 21mm, 22mm, 23mm, 24mm, 26mm, 27mm and 30mm
- 19 Deep Sockets: 9mm, 10mm, 11mm, 12mm, 13mm, 14mm, 15mm, 16mm, 17mm, 18mm, 19mm, 20mm, 21mm, 22mm, 23mm, 24mm, 26mm, 27mm and 30mm Universal Joint

Ascot No.	Mfg. No.
163-02669	2669



### 1/2" DR Extra Thin Wall 9 Piece SAE & Metric Wheel Protector Socket Set

- Durable outer sleeve and insert protects high polished wheels and lug nuts from damage
- CR-MO alloy steel for long life
- Fully guaranteed
- Heavy duty blow mold case
- 6 SAE Sockets: 3/4" (light green), 13/16" (purple), 7/8" (green), 15/16" (brown), 1" (silver) and 1-1/16" (black)
- 3 Metric Sockets: 17mm (blue), 19mm (yellow) and 21mm (red)

Ascot No.	Mfg. No.
163-02849	2849

### Replacement Sockets for 2849 Set

Ascot No.	Mfg. No.	Description
163-28492	28492	1/2"x3/4"
163-28494	28484	1/2"x13/16"
163-28496	28496	1/2"x7/8"
163-28498	28498	1/2"x15/16"
163-28910	284910	1/2"x1"
163-28912	284912	1/2"x1-1/16"
163-28917	284917	1/2"x17mm
163-28919	284919	1/2"x19mm
163-28921	284921	1/2"x21mm





## Impact Sockets (Cont.)

### INDIVIDUAL IMPACT SOCKETS



#### 1/2" DR Standard Impact Sockets

Ascot No.	Mfg. No.	Description
<b>METRIC</b>		
163-10100	1010M	1/2" Drive x 10mm Std.
163-10111	1011M	1/2" Drive x 11mm Std.
163-10120	1012M	1/2" Drive x 12mm Std.
163-10130	1013M	1/2" Drive x 13mm Std.
163-10142	1014M	1/2" Drive x 14mm Std.
163-10150	1015M	1/2" Drive x 15mm Std.
163-10162	1016M	1/2" Drive x 16mm Std.
163-10170	1017M	1/2" Drive x 17mm Std.
163-10182	1018M	1/2" Drive x 18mm Std.
163-10190	1019M	1/2" Drive x 19mm Std.
163-10210	1021M	1/2" Drive x 21mm Std.
163-10221	1022M	1/2" Drive x 22mm Std.
163-10262	1026M	1/2" Drive x 26mm Std.
163-10270	1027M	1/2" Drive x 27mm Std.
<b>SAE</b>		
163-10140	1014	1/2" Drive x 7/16" Std.
163-10160	1016	1/2" Drive x 1/2" Std.
163-10180	1018	1/2" Drive x 9/16" Std.
163-10200	1020	1/2" Drive x 5/8" Std.
163-10220	1022	1/2" Drive x 11/16" Std.
163-10240	1024	1/2" Drive x 3/4" Std.
163-10260	1026	1/2" Drive x 13/16" Std.
163-10280	1028	1/2" Drive x 7/8" Std.
163-01030	1030	1/2" Drive x 15/16" Std.
163-10320	1032	1/2" Drive x 1" Std.
163-10340	1034	1/2" Drive x 1-1/16" Std.
163-10360	1036	1/2" Drive x 1-1/8" Std.
163-10400	1040	1/2" Drive x 1-1/4" Std.

#### 1/2" DR Extra Thin Wall Impact Sockets

Ascot No.	Mfg. No.	Description
<b>METRIC</b>		
163-10172	1017MEDT	1/2" Drive x 17mm Extra Thin Wall
163-10191	1019MEDT	1/2" Drive x 19mm Extra Thin Wall
163-10211	1021MEDT	1/2" Drive x 21mm Extra Thin Wall
163-10223	1022MEDT	1/2" Drive x 22mm Extra Thin Wall
163-10230	1023MEDT	1/2" Drive x 23mm Extra Thin Wall
<b>SAE</b>		
163-10241	1024EDT	1/2" Drive x 3/4" Extra Thin Wall
163-10261	1026EDT	1/2" Drive x 13/16" Extra Thin Wall
163-10282	1028EDT	1/2" Drive x 7/8" Extra Thin Wall

#### 1/2" DR Deep Impact Sockets

Ascot No.	Mfg. No.	Description
<b>METRIC</b>		
163-10101	1010MD	1/2" Drive x 10mm Deep
163-10121	1012MD	1/2" Drive x 12mm Deep
163-10131	1013MD	1/2" Drive x 13mm Deep
163-10143	1014MD	1/2" Drive x 14mm Deep
163-10151	1015MD	1/2" Drive x 15mm Deep
163-10163	1016MD	1/2" Drive x 16mm Deep
163-10171	1017MD	1/2" Drive x 17mm Deep
163-01018	1018MD	1/2" Drive x 18mm Deep
163-01019	1019MD	1/2" Drive x 19mm Deep
163-01021	1021MD	1/2" Drive x 21mm Deep
163-10222	1022MD	1/2" Drive x 22mm Deep
163-10263	1026MD	1/2" Drive x 26mm Deep
163-10271	1027MD	1/2" Drive x 27mm Deep
163-01032	1032MD	1/2" Drive x 32mm Deep
163-01033	1033MD	1/2" Drive x 33mm Deep
<b>SAE</b>		
163-10141	1014D	1/2" Drive x 7/16" Deep
163-10161	1016D	1/2" Drive x 1/2" Deep
163-10181	1018D	1/2" Drive x 9/16" Deep
163-10201	1020D	1/2" Drive x 5/8" Deep
163-01024	1024D	1/2" Drive x 3/4" Deep
163-01026	1026D	1/2" Drive x 13/16" Deep
163-10281	1028D	1/2" Drive x 7/8" Deep
163-10300	1030D	1/2" Drive x 15/16" Deep
163-01034	1034D	1/2" Drive x 1-1/16" Deep
163-01036	1036D	1/2" Drive x 1-1/8" Deep
163-10401	1040D	1/2" Drive x 1-1/4" Deep
163-01048	1048D	1/2" Drive x 1-1/2" Deep

#### 1/2" DR Flip Impact Sockets

Ascot No.	Mfg. No.	Description
<b>METRIC</b>		
167-12179	1271DT	1/2" Dr. x 17mm x 19mm Deep Thin Flip
167-12910	1291	1/2" Dr. x 19mm x 21mm Std. Flip
167-12911	1291D	1/2" Dr. x 19mm x 21mm Deep Flip
167-12912	1291DT	1/2" Dr. x 19mm x 21mm Deep Extra Thin Flip
<b>SAE</b>		
167-12460	1246D	1/2" Dr. x 3/4" x 13/16" Deep Flip
167-12461	1246DT	1/2" Dr. x 3/4" x 13/16" Deep Extra Thin Flip
167-12490	1249D	1/2" Dr. x 7/8" x 15/16" Deep Flip
167-12510	1251D	1/2" Dr. x 1" x 1-1/16" Deep Flip

#### 3/4" DR Impact Sockets

Ascot No.	Mfg. No.	Description
164-02017	2017MS	3/4" Drive x 17mm Square
164-02019	2019MS	3/4" Drive x 19mm Square
164-02020	2020MS	3/4" Drive x 20mm Square
164-02021	2021MS	3/4" Drive x 21mm Square
164-02024	2024D	3/4" Drive x 3/4" Deep
164-02026	2026S	3/4" Drive x 13/16" Square
164-02028	2028D	3/4" Drive x 7/8" Deep
164-02030	2030	3/4" Drive x 15/16" Std.
164-02032	2032D	3/4" Drive x 1" Deep
164-02033	2033MD	3/4" Drive x 33mm Deep
164-02034	2034DT	3/4" Drive x 1-1/16" Deep Thin Wall





## Impact Sockets (Cont.)

### 3/4" DR Impact Sockets

Ascot No.	Mfg. No.	Description
<b>METRIC</b>		
164-20270	2027M	3/4" Drive x 27mm Std.
164-20271	2027MD	3/4" Drive x 27mm Deep
164-20301	2030M	3/4" Drive x 30mm Std.
164-20330	2033M	3/4" Drive x 33mm Std.
164-02035	2035M	3/4" Drive x 35mm Std.
164-20350	2035MD	3/4" Drive x 35mm Deep
164-20360	2036MD	3/4" Drive x 36mm Deep
164-02041	2041MD	3/4" Drive x 41mm Deep
<b>SAE</b>		
164-20260	2026D	3/4" Drive x 13/16" Deep
164-20300	2030D	3/4" Drive x 15/16" Deep
164-02036	2036DT	3/4" Drive x 1-1/8" Deep Thin Wall
164-20401	2040D	3/4" Drive x 1-1/4" Deep
164-20402	2040DT	3/4" Drive x 1-1/4" Deep Thin Wall
164-02038	2038D	3/4" Drive x 1-3/16" Deep
164-02042	2042D	3/4" Drive x 1-5/16" Deep
164-02044	2044D	3/4" Drive x 1-3/8" Deep
164-02046	2046D	3/4" Drive x 1-7/16" Deep
164-20480	2048	3/4" Drive x 1-1/2" Std.
164-20481	2048D	3/4" Drive x 1-1/2" Deep
164-20482	2048DR	3/4" Drive x 1-1/2" Limited Depth
164-02052	2052D	3/4" Drive x 1-5/8" Deep
164-02056	2056D	3/4" Drive x 1-3/4" Deep
164-02060	2060D	3/4" Drive x 1-7/8" Deep
164-02323	2323C	3/4" Drive x 1-1/2" Hex x 13/16" Square



### 1" DR SAE Impact Sockets

Ascot No.	Mfg. No.	Description
165-03026	3026S	1" Drive x 13/16" Square
165-03030	3030S	1" Drive x 15/16" Square
165-03034	3034DT	1" Drive x 1-1/16" Thin Wall Deep
165-03042	3042D	1" Drive x 1-5/16" Deep
165-03044	3044D	1" Drive x 1-3/8" Deep
165-03046	3046D	1" Drive x 1-7/16" Deep
165-03052	3052D	1" Drive x 1-5/8" Deep
165-03054	3054D	1" Drive x 1-11/16" Deep
165-03056	3056D	1" Drive x 1-3/4" Deep
165-03060	3060D	1" Drive x 1-7/8" Deep
165-03323	3323C	1" Drive 1-1/2" Hex x 13/16" Square
165-30280	3028	1" Drive x 7/8" Std.
165-30281	3028D	1" Drive x 7/8" Deep
165-30300	3030	1" Drive x 15/16" Std.
165-30301	3030D	1" Drive x 15/16" Deep
165-30320	3032	1" Drive x 1" Std.
165-30321	3032D	1" Drive x 1" Deep
165-30361	3036D	1" Drive x 1-1/8" Deep
165-30362	3036DT	1" Drive x 1-1/8" Deep Thin Wall
165-30380	3038D	1" Drive x 1-3/16" Deep
165-30401	3040D	1" Drive x 1-1/4" Deep
165-30402	3040DT	1" Drive x 1-1/4" Deep Thin Wall
165-30420	3042DT	1" Drive x 1-5/16" Deep Thin Wall
165-30481	3048D	1" Drive x 1-1/2" Deep w/Inside Lip
165-30482	3048DR	1" Drive x 1-1/2" Deep - Standard
165-30483	3048	1" Drive x 1-1/2" Std.

### 1" DR Metric Impact Sockets

Ascot No.	Mfg. No.	Description
165-03017	3017MS	1" Drive x 17mm Square
165-03019	3019MS	1" Drive x 19mm Square
165-03020	3020MS	1" Drive x 20mm Square
165-03021	3021MS	1" Drive x 21mm Square
165-03027	3027MD	1" Drive x 27mm Deep
165-30302	3030MD	1" Drive x 30mm Deep
165-03033	3033MD	1" Drive x 33mm Deep
165-03035	3035MD	1" Drive x 35mm Deep
165-30381	3038MD	1" Drive x 38mm Deep
165-30410	3041MDT	1" Drive x 41mm Deep Thin Wall
165-03041	3041MD	1" Drive x 41mm Deep
165-03321	3321MC	1" Drive 41mm x 21mm Square
165-03517	3517MC	1" Drive x 35mm Deep x 17mm Sq.
165-03820	3820MC	1" Drive x 38mm Deep x 20mm Sq.



### #5 Spline DR Impact Sockets

Ascot No.	Mfg. No.	Description
<b>METRIC</b>		
166-04033	4033MD	#5 Spline x 33mm Deep
166-04035	4035MDT	#5 Spline x 35mm Deep Thin Wall
166-04041	4041MDT	#5 Spline x 41mm Deep Thin Wall
<b>SAE</b>		
166-04026	4026S	#5 Spline x 13/16" Square
166-04034	4034DT	#5 Spline x 1-1/16" Deep Thin Wall
166-40360	4036D	#5 Spline x 1-1/8" Deep
166-40361	4036DT	#5 Spline x 1-1/8" Deep Thin Wall
166-04038	4038	#5 Spline x 1-3/16" Std.
166-04040	4040DT	#5 Spline x 1-1/4" Deep Thin Wall
166-04042	4042DT	#5 Spline x 1-5/16" Deep Thin Wall
166-04048	4048D	#5 Spline x 1-1/2" Deep w/Inside Lip
166-40480	4048DT	#5 Spline x 1-1/2" Deep Thin Wall
166-04323	4323C	#5 Spline x 13/16" Square x 1-1/2" Hex



### Impact Extensions & Adapters

Ascot No.	Mfg. No.	Description
169-01003	1003E	1/2" Drive x 3" Extension
169-01005	1005E	1/2" Drive x 5" Extension
169-01020	1020A	1/2" Drive Female x 3/4" Male Adapt.
169-02006	2006E	3/4" Drive x 6" Extension
169-02010	2010A	3/4" Drive Female x 1/2" Male Adapt.
169-02030	2030A	3/4" Drive Female x 1" Male Adapt.
169-20100	2010E	3/4" Drive x 10" Extension
169-02013	2013E	3/4" Drive x 13" Extension
169-03006	3006E	1" Drive x 6" Extension
169-03010	3010E	1" Drive x 10" Extension
169-03013	3013E	1" Drive x 13" Extension
169-03020	3020A	1" Drive Female x 3/4" Male Adapt.
169-04010	4010A	#5 Spline Female x 3/4" Male Adapt.
169-04020	4020A	#5 Spline Female x 1" Male Adapt.



## Wheel Torque Products

### Medium/Heavy Duty Torque Sockets

- Originally patented AccuTorq® sockets properly torque wheel nuts to exact factory specs
- Prevents warping of rotors, which causes brake pulsation
- Eliminates broken studs and nuts
- Avoids damage to aluminum alloy wheels
- Stops customer complaints about over-tightened lug nuts
- Strobe marks stop turning at the CORRECT torque
- Plus heavy duty case



Ascot No.	Mfg. No.	Description
495-00103	10-0103	AccuTorq® Torque Chart
495-03915	20-3915	5 Piece AccuTorq® Med. Duty Truck Set. Set Includes: MD Purple, MD Tan, MD Olive, MD Burgundy & HD Orange
495-04000	20-4000	4 Piece AccuTorq® 1" DR Heavy Duty Truck Set. Set Includes: HD Red, HD Yellow, HD Brown & HD Black, plus Heavy Duty Case
495-04100	20-4100	4 Piece AccuTorq® 3/4" DR Heavy Duty Truck Set. Set Includes: HD Red, HD Yellow, HD Brown & HD Black, plus Heavy Duty Case

Ascot No.	Mfg. No.	Description	Drive	Size	Torque	Other
495-03045	20-3045	HD Unpainted	1"	30mm	330 Ft.-lbs.	
495-03360	20-3360	HD Unpainted	1"	33mm	440 Ft.-lbs.	
495-03900	20-3900	MD Purple	1/2"	1"	140 Ft.-lbs.	Deep Well
495-03901	20-3901	MD Tan	1/2"	1-1/16"	140 Ft.-lbs.	Deep Well
495-03902	20-3902	MD Olive	1/2"	1-1/8"	140 Ft.-lbs.	
495-03903	20-3903	MD Burgundy	1/2"	1-1/4"	140 Ft.-lbs.	
495-03904	20-3904	HD Orange	3/4"	1"	175 Ft.-lbs.	
495-03918	20-3918	HD Red	3/4"	1-1/4"	250 Ft.-lbs.	
495-03919	20-3919	HD Brown	3/4"	33mm (1-5/16")	475 Ft.-lbs.	
495-03920	20-3920	HD Black	3/4"	1-1/2"	475 Ft.-lbs.	
495-03921	20-3921	HD Yellow	3/4"	13/16" Square	475 Ft.-lbs.	
495-03908	20-3908	HD Red	1"	1-1/4"	250 Ft.-lbs.	
495-03909	20-3909	HD Brown	1"	33mm (1-5/16")	475 Ft.-lbs.	
495-03910	20-3910	HD Black	1"	1-1/2"	475 Ft.-lbs.	
495-03911	20-3911	HD Yellow	1"	13/16" Square	475 Ft.-lbs.	

### Clikker Torque Wrench

- Loud click tells you when you've reached the torque setting
- Feature ratchet-style heads, all metal construction, permanently roll-marked scales and soft-grip rubber handles
- Molded plastic carrying case



Ascot No.	Mfg. No.	Drive	Length	Torque/Range/Graduations
495-07375	7375	3/8"	15-1/8"	150-750 in.-lbs./10 in.-lbs.
495-07377	7377	1/2"	17-3/4"	30-150 ft.-lbs./2 ft.-lbs.
495-07378	7378	1/2"	19-3/8"	50-250 ft.-lbs./2 ft.-lbs.
495-07379	7379	3/4"	42-1/4"	100-600 ft.-lbs./10 ft.-lbs.

### Heavy Duty Truck Torque Extensions

- Heavy duty truck extensions can convert sockets into Torque Sockets
- Available in 3/4" and 1" drives



Ascot No.	Mfg. No.	Description
495-16000	1600-M	3/4" Dr. Truck Torque Extension - 475 Ft.-lbs.
495-16001	1600-N	3/4" Dr. Truck Torque Extension - 250 Ft.-lbs.
495-16002	1600-Q	3/4" Dr. Truck Torque Extension - 175 Ft.-lbs.
495-16003	1600-U	3/4" Dr. Truck Torque Extension - 350 Ft.-lbs.
495-16004	1600-P	1" Drive Truck Torque Extension - 475 Ft.-lbs.
495-16005	1600-R	1" Drive Truck Torque Extension - 250 Ft.-lbs.
495-16006	1600-S	1" Drive Truck Torque Extension - 350 Ft.-lbs.
495-16007	1600-T	1" Drive Truck Torque Extension - 175 Ft.-lbs.

## Wheel Torque Products (Cont.)

### Passenger Car and Light Truck Torque Sockets

- Originally patented AccuTorq® sockets properly torque wheel nuts to exact factory specs
- Prevents warping of rotors, which causes brake pulsation
- Eliminates broken studs and nuts
- Avoids damage to aluminum alloy wheels
- Stops customer complaints about over-tightened lug nuts
- Strobe marks stop turning at the CORRECT torque



Ascot No.	Mfg. No.	Description
495-00315	10-0315	4 Piece AccuTorq® Automotive Set. Set Includes: Gray, Brown, Blue, & Yellow
495-00321	10-0321	8 Piece AccuTorq® Auto & Mini Van Set. Set Includes: Yellow, Red, Blue, Brown, Green, Lt. Brown, Gray & Turquoise
495-00322	10-0322	10 Piece AccuTorq® Auto & Lt. Truck Set. Set Includes: Yellow, Red, Blue, Brown, Green, Lt. Brown, Gray, Turquoise, White & Lt. Green
495-00450	10-0450	4 Piece AccuTorq® Lt. Truck Set. Set Includes: White, Turquoise, Lt. Green & Charcoal
495-00455	10-0455	5 Piece AccuTorq® Lt. Truck Set. Set Includes: White, Turquoise, Lt. Green, Charcoal & Lt. Purple

### Kit Contents

Ascot No.	Mfg. No.	Description	Drive	Size	Torque	Other
495-00304	10-0304	Green	1/2"	17mm	55 Ft.-lbs.	
495-00305	10-0305	Red	1/2"	17mm	80 Ft.-lbs.	
495-00306	10-0306	Yellow	1/2"	19mm (3/4")	65 Ft.-lbs.	Deep Well
495-00307	10-0307	Blue	1/2"	19mm (3/4")	80 Ft.-lbs.	Deep Well
495-00308	10-0308	Gray	1/2"	19mm (3/4")	100 Ft.-lbs.	
495-00309	10-0309	Black	1/2"	21mm	60 Ft.-lbs.	
495-00310	10-0310	Lt. Brown	1/2"	21mm	80 Ft.-lbs.	
495-00311	10-0311	Brown	1/2"	21mm (13/16")	100 Ft.-lbs.	
495-00312	10-0312	White	1/2"	22mm	120 Ft.-lbs.	Deep Well
495-00313	10-0313	Turquoise	1/2"	22mm	140 Ft.-lbs.	Deep Well
495-00327	10-0327	Lt. Blue	1/2"	22mm	100 Ft.-lbs.	
495-00328	10-0328	Charcoal	1/2"	21mm	147 Ft.-lbs.	Deep Well
495-00329	10-0329	Off White	1/2"	17mm	90 Ft.-lbs.	
495-00334	10-0334	Lt. Yellow	1/2"	17mm	113 Ft.-lbs.	
495-00336	10-0336	Orange	1/2"	22mm	75 Ft.-lbs.	
495-00337	10-0337	Dark Green	1/2"	22mm	60 Ft.-lbs.	
495-03898	10-3898	Lt. Purple	1/2"	21mm	160 Ft.-lbs.	Deep Well
495-03899	10-3899	Lt. Green	1/2"	24mm (15/16")	140 Ft.-lbs.	Deep Well

### 10 Pc. 1/2" Drive Torque Limiting Socket Set

- Contains the most popular torque sockets to service the majority of passenger cars and light trucks
- Set includes all 10 torque sockets listed below
- Lifetime warranty
- Heavy duty blow molded case

Ascot No.	Mfg. No.	Description
168-02880	12880	10 Pc. Torque Limiting Socket Set

### Kit Contents

Ascot No.	Mfg. No.	Description
168-21755	121755M	1/2" Drive 17mm - 55 Ft.-lbs. Torque Socket - Green
168-21780	121780M	1/2" Drive 17mm - 80 Ft.-lbs. Torque Socket - Red
168-21910	121910M	1/2" Drive 19mm (3/4") - 100 Ft.-lbs. Torque Socket - Gray
168-21965	121965M	1/2" Drive 19mm (3/4") - 65 Ft.-lbs. Torque Socket - Yellow
168-21980	121980M	1/2" Drive 19mm (3/4") - 80 Ft.-lbs. Torque Socket - Blue
168-22180	122180M	1/2" Drive 21mm - 80 Ft.-lbs. Torque Socket - Light Brown
168-22212	122212M	1/2" Drive 22mm (7/8") - 120 Ft.-lbs. Torque Socket - White
168-22214	122214M	1/2" Drive 22mm (7/8") - 140 Ft.-lbs. Torque Socket - Turquoise
168-22610	122610	1/2" Drive 13/16" - 100 Ft.-lbs. Torque Socket - Brown
168-23014	123014	1/2" Drive 15/16" - 140 Ft.-lbs. Torque Socket - Light Green







## Wheel Torque Products (Cont.)

### Ascot Wheel Torque Wrench Sets

- One-way, not bi-directional
- +/- 4% accuracy
- Cushioned ratchet head
- Color coded presets



Ascot No.	Description
168-16000	6-Piece Preset/Adjustable (5 Preset - 1 Adjustable) Wheel Torque Wrench Set

#### Kit Contents

Ascot No.	Description
168-12065	65 Ft.-lbs. Preset Torque Wrench—Yellow
168-12080	80 Ft.-lbs. Preset Torque Wrench—Blue
168-12100	100 Ft.-lbs. Preset Torque Wrench—Gray
168-12120	120 Ft.-lbs. Preset Torque Wrench—White
168-12140	140 Ft.-lbs. Preset Torque Wrench—Aqua
163-91217	1/2" Dr. x 17mm Chrome Socket
163-91219	1/2" Dr. x 19mm Chrome Socket
163-91221	1/2" Dr. x 21mm Chrome Socket
163-91234	1/2" Dr. x 3/4" Chrome Socket
163-91236	1/2" Dr. x 13/16" Chrome Socket
163-91278	1/2" Dr. x 7/8" Chrome Socket
163-91278	1/2" Dr. x 6" Chrome Extension
168-12250	250 Maximum Ft.-lbs. Single Direction Micro-Adjustable Torque Wrench
169-12006	1/2" Dr. x 6" Chrome Extension Wall Board

Ascot No.	Description
168-13000	4-Piece Preset Wheel Torque Wrench Set

#### Kit Contents

Ascot No.	Description
168-12080	80 Ft.-lbs. Preset Torque Wrench—Blue
168-12100	100 Ft.-lbs. Preset Torque Wrench—Gray
168-12120	120 Ft.-lbs. Preset Torque Wrench—White
168-12140	140 Ft.-lbs. Preset Torque Wrench—Aqua
163-91217	1/2" Dr. x 17mm Chrome Socket
163-91219	1/2" Dr. x 19mm Chrome Socket
163-91221	1/2" Dr. x 21mm Chrome Socket
163-91234	1/2" Dr. x 3/4" Chrome Socket
163-91236	1/2" Dr. x 13/16" Chrome Socket
163-91278	1/2" Dr. x 7/8" Chrome Socket
169-12006	1/2" Dr. x 6" Chrome Extension Wall Board

### 1/2" DR 5 Piece Torque Extension Set



Ascot No.	Mfg. No.	Description
168-12450	2450	5 Pc. Torque Limiting Socket Set

#### Kit Contents

Ascot No.	Description
168-12465	65 Ft.-lbs. Extension - Yellow
168-12480	80 Ft.-lbs. Extension - Blue
168-12410	100 Ft.-lbs. Extension - Gray
168-12412	120 Ft.-lbs. Extension - White
168-12414	140 Ft.-lbs. Extension - Aqua



### High-Temp Wheel Check

- Designed to withstand heat of up to 450 degrees
- Orange in color to designate high-temperature
- Used to identify a loose wheel nut with a simple visual inspection
- When placed in a uniform position, the wheel check will appear out of sequence when nut is loose
- 100 per bag
- The use of wheel checks does not guarantee wheel-offs will not occur

Ascot No.	Mfg. No.	Description
402-10133	WCHT-B	33mm High Temp Wheel Check



### Wheel Check Loose Wheel Nut Indicators

- Used to identify a loose wheel nut with a simple visual inspection
- When placed in a uniform position, the wheel check will appear out of sequence when nut is loose
- Also used to detect excessive heat in the event of a binding brake or seized bearing
- 100 per bag
- The use of wheel checks does not guarantee wheel-offs will not occur

Loose and Unsafe

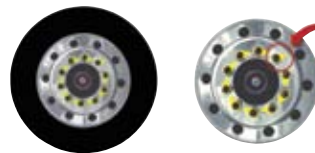

Ascot No.	Mfg. No.	Description
402-10001	WLCH-G	Wheel Check Loose Wheel Nut Indicator - 1"
402-10015	WLCH-AA	Wheel Check Loose Wheel Nut Indicator - 1-1/2"
402-10033	WLCH-B	Wheel Check Loose Wheel Nut Indicator - 33mm
402-10078	WLCH-C	Wheel Check Loose Wheel Nut Indicator - 7/8"

## Wheel Torque Products (Cont.)

### Lug Lock Wheel Nut Retainers

Improve the safety of your fleet, prevent lug nut loss, wheel damage and potential wheel loss by securing your lug nuts together with Lug Lock Wheel Nut Retainers.

- Use the resistance between two nuts to minimize their ability to rotate and loosen
- Flexible and easy to install - fits over two adjacent nuts
- Field tested at high and low rotation levels
- Lab tested in severe vibration conditions
- Designed to be used on wheels with 33mm nuts on 3.5" stud centers
- Compatible with a complete wheel mounting safety program
- Other sizes and colors available



Ascot No.	Mfg. No.	Description
402-62600	62600	3 1/2" Spacing, 350 degrees



## Wheel Centering Products

**Wheel Vibrations? Erratic Tire Wear?  
Wheel Hop? Brake Pedal Pulsations?  
Excessive Fuel Consumption?**

If you are experiencing these problems, it may be because your wheels aren't centered on the hub. And if your wheels aren't centered, you will continue to experience these problems. With **Specialty Products' Wheel Centering Products**, you can re-center your wheel, and eliminate all of these problems.

### Benefits...

**Increases fuel mileage • Increases tire life • Decreases tire vibration • Reduces tire cupping  
Cuts rebalancing costs • Reduces "wheel-off" condition**

### Perfect for...

*Semi Trucks and Trailers • Heavy & Medium Duty Trucks • Parcel Package Trucks  
Emergency Vehicles • Commercial Buses • School Buses • Motor Coaches*



### "EZ On" Wheel Centering Tool Set

Simply slide the 3 centering tapered tools over the wheel studs at the 12, 8, and 4 o'clock positions; mount wheel and add lugnuts; remove the tools and replace remaining lugnuts, torquing to manufacturer specifications. The wheel is now completely centered. Problem Solved!

- Threadless Design
- Saves Installation Time
- Tapered Nose
- Eases Wheel Mounting
- Single Set
- For Steer, Drive & Trailer Axles



Ascot No.	Mfg. No.
491-32111	32111

### Tru Balance

- Threaded Design
- Steer and Drive axles
- Extended Length (1" longer than A-1339)
- 22.50/24.50 steel & aluminum wheels
- 22mm threads
- 16,000 & 18,000 Lb. axles
- Also used for dual drive axle wheel centering
- Reusable tool
- Hardened steel
- Sold in sets of 3

Ascot No.	Mfg. No.
491-01573	A-1573

### "EZ On" Wheel & Brake Drum Centering Sleeves

These sets center both steer axle HD wheels and brake drums to minimize wheel vibrations, brake pedal pulsations and wheel hop. For both Aluminum and Steel steer wheels and a variety of brake drum types.

Ascot No.	Mfg. No.	Description
491-32120	32120	Aluminum 1.25" hole/.5" depth
491-32121	32121	Aluminium 1.25" hole/.25" to .3125" depth
491-32124	32124	Steel 1.25" hole/.5" depth



491-32120



491-32121



491-32124

## Tire & Wheel Accessories

### 7 Piece Spare Tire Tool Set

- Allows anyone to quickly remove difficult to reach spare tires
- No more digging through the customer's vehicle to locate the spare tire removal kit
- Color-coded wall bracket allows user to quickly identify the correct removal tool
- Applications include many trucks & SUV's where the spare tire is located under the vehicle

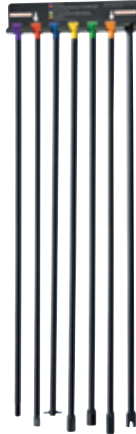

Ascot No.	Mfg. No.	Description
319-96090	96090A	7 Piece Spare Tire Tool Kit

### Individual Spare Tire Tools

Ascot No.	Mfg. No.	Description
319-96091	96091	Spare Tire Tool - Flat Head - Red (For Use on Late Model S10 trucks, Explorers, Blazers, Jimmys, F150s, Expeditions, Older Dakota 2-Wheel Drives and McGuard Lock Systems)
319-96092	96092	Spare Tire Tool - Pin Head - (Blue For Use on Import Trucks)
319-96093	96093	Spare Tire Tool - Hex Head - Yellow (For Use on Dodge Full Size and Stake Bodies, '98-'01 Dodge Full-Size 4-Wheel Drive)
319-96094	96094	Spare Tire Tool - 12mm Square Head - Green (For Use on All Late Model GMs, Remaining '98-'03 Dodge Trucks)
319-96095	96095	Spare Tire Tool - Std. Square Head - Orange (For Use on Older Ford Trucks)
319-96096	96096	Spare Tire Tool - Slotted Square Head - Black (For Use on Dodge Durango, Inside the Hatch)
319-96097	96097	Wall Mount Bracket for Spare Tire Tool Set (Color-coded to allow user to quickly identify the correct removal tool)
319-96098	96098	Spare Tire Tool - 3/8" Square Head - Purple (For Use on New Ford Models)

### 3 Piece Twist Socket Lug Nut Removal System



492-04300



492-04200

- Removal of damaged 3/4" and 19mm, 13/16" and 21mm lug nuts
- Two dual-sided twist sockets have a fluted design which gives the sockets a tight grip to remove the most difficult locking and damaged lug nuts from the socket
- Works with 1/2" impact gun or breaker bar for service calls
- Includes an extractor punch

Ascot No.	Mfg. No.	Description
492-04300	4300	3 Piece Twist Socket Lug Nut Removal System
492-04200	4200	Dual Sided Twist Socket Lug Nut Remover

### Wheel Lock Removal Kit

- Includes: GM Hubcap Lock Remover, GM Sprocket Hubcap Remover, Ford and Chrysler Hubcap Lock Remover, Large Universal Locking Lug Nut Remover, Large Wheel Cover Lock Remover, Fits Stripped 18mm Lug Nuts, Oversize Wheel Lock Remover, GM "M" and "F" Body Wheel Lock Remover, Lug Nut Remover Punch
- Durable Plastic Carrying Case



Ascot No.	Mfg. No.	Description
401-02840	2840	Deluxe Hubcap Wheel Lock Removal System

### Twist Socket Removal Kit

- This kit easily removes damaged nuts, studs, pipe nipples and bolts. Comes mounted on a 1/2" rail, individually packaged

Ascot No.	Mfg. No.	Description
492-04400	LT4400	1/2" Drive 6 Piece Twist Socket Removal Kit



## Lug Nut Removal Products

### Sav-A-Stud Rethreader

- Damaged studs can be renewed in minutes without removing the caliper rotor or stud
- For disc brake, four wheel drive and front wheel drive vehicles

Ascot No.	Mfg. No.	Description
493-30100	30100	Passenger Car/Light Truck Save-A-Stud Rethreader Kit
493-30200	30200	Heavy Duty Truck Save-A-Stud Rethreader
493-30300	30300	Metric Save-A-Stud Rethreader



### Truck Sav-A-Stud Rethreader

- Repairs wheel studs, spindles and standard threaded studs

Ascot No.	Mfg. No.	Description
493-30125	31250	3/4" - 16" Right, 3/4" - 16" Left, 22mmx1.5mm



## Wheel Service Items

### BlueTork 1" Non Impact Wrench

- Two pneumatic motor for rundown and final tightening
- Preset and adjustable shut off for torque control
- **Ergonomics**
  - Very low noise level
  - Virtually no vibration
- **Efficiency**
  - Precise and accurate tightening
  - Less fatigued operators
- **Environment Improvements**
  - By increasing durability of the tools, we reduce waste
- **Quality**
  - Precise, accurate tightening to the manufacturer's recommended torque and angle specifications



Training Required Prior to Use

Ascot No.	Mfg. No.	Description
168-07600	CP-7600	Non-reversible Single Torque Preset
168-07601	CP-7600-4P	Non-Reversible 4 Torque Preset Selector
168-07602	CP-7600-R	Reversible Single Torque Preset
168-07603	CP-7600-R4P	Reversible 4 Torque Preset Selector

### Preset Truck Clicker Style Torque Wrench

- Preset at 475 ft.-lbs.
- Designed for fleet applications
- Massive 4-1/2' length for high torque applications
- Designed for fleet applications
- Supplied with handy storage bag for sockets and extensions
- Both the wrench and the bag have reflective strips for safe highway night use



Ascot No.	Mfg. No.	Description
168-47501	1-475	1" Drive x 475 Ft.-lbs. Preset Torque Wrench
168-47534	3/4-475	3/4" Drive x 475 Ft.-lbs. Preset Torque Wrench

**Contact us for information  
Regarding our Torque Recalibration  
and Repair Program.**

## Wheel Service Items

### Chrome Lug Nut Cover Remover



402-03014

402-03606

Ascot No.	Mfg. No.	Description
402-03014	03014	Heavy Duty
402-30606	30606	Professional

### Flex Hinge Torque Wrench

- Robust construction achieves accurate results to +/- 4%
- Flex hinge design provides unmistakable signal
- Flex angle makes it virtually impossible to overtorque
- Torques both right and left-handed threads
- Calibrated and certified to ISO Standards
- Scale reads in ft.-lbs.
- 3/4" or 1" drive x 13" extension available



Ascot No.	Mfg. No.	Description
168-60034	600-34	3/4" Drive 600 Ft.-lbs. Capacity
168-60001	600-1	1" Drive 600 Ft.-lbs. Capacity
168-75034	750-34	3/4" Drive 750 Ft.-lbs. Capacity
168-75001	750-1	1" Drive 750 Ft.-lbs. Capacity
169-02013	2013E	3/4" Drive x 13" Extension
169-03013	3013E	1" Drive x 13" Extension





## Torque Wrenches

### Torque Multipliers

- Increase the range of your torque wrench as much as 14 to one with a Central Torque Multiplier
- Designed with four pinion gears in a compact housing, these multipliers expand your torque wrench range by their stated ratio



Ascot No.	Mfg. No.	Rate	Drive Input	Drive Output	Max. Output Cap	Weight (Lbs.)	Body Length	Total Length
495-06380	6380	4:1	1/2"	3/4"	1,000 In.-lbs.	7	6.6"	22"
495-06382	6382	4.33:1	1"	1-1/2"	4,000 In.-lbs.	35	9.7"	30"
495-06383	6383	4.6:1	1"	1-1/2"	8,000 In.-lbs.	47	12.1"	32"
495-06384	6384	6:1	1"	2-1/2"	12,000 In.-lbs.	78	11.5"	30"
495-06386	6386	14.3:1	3/4"	1-1/2"	3,000 In.-lbs.	30	9.7"	30"
495-06387	6387	4:1	3/4"	1"	2,000 In.-lbs.	14	6.6"	25"

### Micrometer Torque Wrenches

- Set desired torque on micrometer type scale by rotating hand grip
- Automatically indicates desired torque by feel and sound
- No need to worry about getting a reading
- Wrench torques left or right and resets in seconds
- Accurate throughout entire torque range. Dual scale - English and international Metric. Chrome finish
- Accuracy +/-4%CW and +/-6%CCW
- 20% - 80% of capacity
- Metal hand grip is resistant to damage from striking or automotive fluids such as gasoline, oil and kerosene
- Ratchet Head. The 45-tooth ratchet is designed for speedy torquing and operating in restricted areas



Ascot No.	Mfg. No.	Range (Increment)	Drive	Length	Weight (Lbs.)
495-96351	96351	25-250 In.-lbs. (1 In.-lbs.)	3/8" Ratchet	12.6 inches	1.4
495-96352	96352	10-100 In.-lbs. (5 In.-lbs.)	3/8" Ratchet	17.3 inches	1.9
495-96353	96353	25-250 In.-lbs. (1 In.-lbs.)	1/2" Ratchet	20.0 inches	2.0
495-96355	96355	100-600 In.-lbs. (5 In.-lbs.)	3/4" Ratchet	38.5 inches	0.5
495-96361	96361	20-200 In.-lbs. (1 In.-lbs.)	1/4" Ratchet	12.4 inches	1.5
495-96395	96395	10-80 In.-lbs. (In.-lbs.)	3/8" Flexhead	17.6 inches	2.2

### Micrometer Torque Wrenches

- Extremely Accurate - within 3% of reading from 20% of full scale to full scale clockwise and counterclockwise
- Exclusive Patented Calibration Mechanism - This patented mechanism allows for calibration in both the clockwise and counterclockwise directions, plus with regard to spring rate, without the disassembly of the wrench. This protects against contamination of the working mechanism, and make calibration quick and easy
- Exclusive Patented Roller-Release - This patented feature removes over 95% of the friction inherent in other click wrenches thereby extending life and providing for more reliable operation.
- All "M" Series meets or exceeds all applicable requirements of: ANSI / ASME B107.14M, GGG-W-00686C, BS6073: 1988, ISO6789

Ascot No.	Mfg. No.	Description
168-01200	M1R200H	1/4" Drive
168-02101	M2R100F	3/8" Drive
168-03252	M3R250F	1/2" Drive

### Split-Beam Click Torque Wrenches

- Extremely accurate - within 4% of reading from 20% of full scale to full scale
- Setting torque on adjustable wrenches is fast and easy because there is no spring tension on the adjustment knob
- Torque setting locks on adjustable wrenches for repetitive applications
- Wrench length designed to provide the leverage required for maximum torque applications. Also provides the needed reach for those hard to get at places

Ascot No.	Mfg. No.	Description	Ft.-Lbs.
168-02100	C2FR100F	3/8" Drive	100
168-03250	C3FR250F	1/2" Drive	250
168-03251	CP3F250F	1/2" Preset	250
168-04400	C4D600F	3/4" Drive	600
168-05600	C5D600F	1" Drive	600

## Wheel Attaching Hardware

### Grade 8 Disc Wheel Hardware-Inner Cap Nuts



491-01001



491-01003



491-01011

Ascot No.	Sirco No.	Ascot No.	GLP No.	Similar To:			
491-00708	708AR	491-01001 (RH)	GL-1001	Budd 10708	Euclid 7895R	Leland W-11	Steel/Steel
491-00709	709AL	491-01002 (LH)	GL-1002	Budd 10709	Euclid 7895L	Leland W-12	Steel/Steel
491-00896	896R	491-01003 (RH)	GL-1003	Budd 35336	Euclid 7896R	Leland W-620	Steel /Alum
491-01896	896L	491-01004 (LH)	GL-1004	Budd 35337	Euclid 7896L	Leland W-621	Steel/Alum
491-00897	897R	491-01005 (RH)	GL-1005	Budd 22621	Euclid 7897R	Leland W-616	Steel/Alum
491-01897	897L	491-01006 (LH)	GL-1006	Budd 22622	Euclid 7897L	Leland W-617	Steel/Alum
491-00978	988R	491-01011 (RH)	GL-1011	Alcoa 5988R	Euclid 5988R	Leland W-486	Alum/Alum
491-01978	988L	491-01012 (LH)	GL-1012	Alcoa 5988L	Euclid 5988L	Leland W-487	Alum/Alum

#### METRIC

491-00306	306R	491-01009 (RH)	GL-1009	Hino 900423101	Isuzu 1-42335005 - Zinc		
491-01306	306L	491-01010 (LH)	GL-1010	Hino 900424101	Isuzu 1-42336005 - Zinc		

### Grade 8 Disc Wheel Hardware-Outer Cap Nuts



491-02001



491-02301



491-02202

Ascot No.	Sirco No.	Ascot No.	GLP No.	Similar To:			
491-00891	891AR	491-02001 (RH)	GL-2001	Budd 37891	Euclid 5552R	Leland W-13	
491-00892	892AL	491-02002 (LH)	GL-2002	Budd 37892	Euclid 5552	Leland W-14	
491-00888	888R	491-02101 (RH)	GL-2101	Budd 37888	Euclid 5652R	Leland W-15	
491-00889	889L	491-02102 (LH)	GL-2102	Budd 37889	Euclid 5652L	Leland W-16	
491-00995	995R	491-02103 (RH)	GL-2103	Alcoa 5995R	Euclid 5995R	Leland W-506	
491-01995	995L	491-02104 (LH)	GL-2104	Alcoa 5995L	Euclid 5995L	Leland W-507	
N/A	891BR	491-00054	GL-0054	GMC-3988631			
N/A	891BL	491-02203	GL-2203	Budd 95188	Euclid 9022R	Dodge 3637720	
N/A	N/A	491-02204	G-2204	Budd 95189	Euclid 9022L	Dodge 3637719	
N/A	N/A	491-02202	GL-2202	Budd 81269	Euclid 5734	GMC 3771410	
N/A	N/A	491-02205	GL-2205	Budd 84608	Euclid 5704	Ford C3TZ-1120A	
N/A	N/A	491-02303	GL-2303	Alca 389928	Ford E4tZ-1012A	N/A	

#### METRIC

491-00304	304R	491-02009	GL-2009	Hino 900421112	Isuzu 1-42333023	N/A	
491-01304	304L	491-02010	GL-2010	Hino 900421104	Isuzu 1-42334023	N/A	
491-00033	333B	491-02301	GL-2301	Budd 106333	Euclid 6000A	Leland W-498	
491-00881	881M	491-02302	GL-2302	MW 88881	Euclid 5991	Leland W-492	

### Hub Centric Nut

- Metric 2-pc. hub centering nut
- Designed to eliminate imbalance in truck wheels
- Elongated neck for centering the wheel to the hub
- Stamped 450-500 ft.-lbs.



Ascot No.	Description
491-00133	33mm Hex X 1.5mm Thread

## Wheel Attaching Hardware (Cont.)

### Spoke Wheel Hardware



491-03005



491-03002

Ascot No.	Sirco No.	Ascot No.	GLP No.	Thread	Similar To:
<b>RIM CLAMP NUTS</b>					
491-00149	149	491-03004	GL-3004	5/8-11	Dayton 5149 Euclid 4962 Leland W-7
491-00716	716	491-03005	GL-3005	3/4-10	Dayton, 5716 Euclid 4963 Leland W-8
<b>RIM STUDS (GRADE 8)</b>					
491-00654	654	491-03001	GL-3001	5/8-11x2-3/4	Dayton 6654 Euclid 4958 Leland W-5
N/A	N/A	491-03002	GL-3002	3/4-10x3	Dayton 5715 Euclid 4956-A Leland W-6

### Locking Back Nuts



491-02408

Ascot No.	Mfg. No.	Size	Similar To:
491-06023	GL-6023	5/8"-18	MW 85643
491-02408	GL-2408	3/4"-16	Budd 41073-71
491-02431	GL-2431	7/8"-14	Budd 41073-8 Euclid 1835
491-02445	GL-2445	1"-14	Budd 44672-9 Euclid 1828

### Oil Seal Hubcaps and Gaskets



491-04009

Ascot No.	Mfg. No.	Description
491-04009	GL-4009	Standard 6-Hole Hubcap
491-04012	GL-4012	6-Hole Gasket for Above
491-04013	GL-4013	Universal Gasket - 5 or 6 Hole
491-04020	GL-4020	Replaceable Window Kit
491-04021	GL-4021	Rubber Plug for Bolt-On Cap
491-09013	GL-4913	Fruehauf/Propar Cap
491-09014	GL-4974	O-Ring for Screw-On Cap
491-09015	GL-4975	Rubber Plug for Screw-On Cap

### Cone Wheel Nuts



491-00014

Ascot No.	Mfg. No.	Size	Description
491-00014	GL-0014	7/16"-20 (3/4" Hex, 9/16" High)	G.M.
491-00016	GL-0016	1/2"-20 (13/16" Hex, 5/8" High)	Ford
491-00027	GL-0027	1/2"-20 (3/4" Hex, 9/16" High)	Chrysler
491-00062	GL-0062	12mm-1.5 (19mm Hex, 14mm High)	G.M.
491-00066	GL-0066	12mm-1.5 (21mm Hex, 16mm High)	Toyota
491-00065	GL-0065	12mm-1.25 (21mm Hex, 16mm High)	Nissan
491-00064	GL-0064	12mm-1.25 (19mm Hex, 16mm High)	Nissan
491-00052	GL-0052	9/16"-18 (7/8" Hex, 3/4" High)	G.M.
491-00055	GL-0055	R.H. 5/8"-18 (1" Hex, 21/32" High)	Budd 67147
491-00056	GL-0056	L.H. 5/8"-18 (1" Hex, 21/32" High)	Budd 67147

### Brake Drum Mounting Hardware



491-06014

Ascot No.	Mfg. No.	Size	Description
491-06012	GL-6012	5/8-18 x 2"	5/8" Brake Bolt/Washer/Assembly
491-06014	GL-6014	3/4-16 x 2"	3/4" Brake Bolt/Washer/Assembly
491-06020	GL-6020	5/8-18 x 2"	Brake Bolt Only
491-06021	GL-6021	3/4-16 x 2"	Brake Bolt Only
491-06025	GL-6025	5/8"	Flat Washer
491-06026	GL-6026	3/4"	Flat Washer
491-06023	GL-6023	5/8"-18"	Lock Nut Only
491-06024	GL-6024	3/4"-16"	Lock Nut Only

## Wheel Attaching Hardware (Cont.)

### Rim Clamps



491-03097

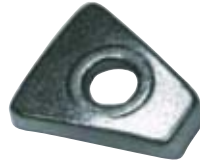

491-03113

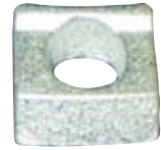

491-06115

Ascot No.	GLP No.	Ascot No.	Sirco No.	A Dim.	B. Dim.	C. Dim.	Similar To:
491-03083	GL-3083	491-00399	399	N/A	N/A	N/A	Dayton 8399 Euclid 5927 Leland W-124
491-03087	GL-3087	491-00729	729	N/A	N/A	N/A	Dayton 09-729514 Euclid 5838 Leland W-407
491-03096	GL-3096	491-00123	123	1-1/8"	2-7/8"	2-11/32", 3/4" Stud	Dayton 6123 Euclid 5571A Leland W-3
491-03097	GL-3097	491-00235	235	1-3/4"	2-7/8"	2-11/32", 3/4" Stud	Dayton 6235 Euclid 5572A Leland W-4
491-03098	GL-3098	491-00993	993	1-1/2"	2-7/8"	2-11/32", 3/4" Stud	Dayton 6993 Euclid 5040A Leland W-120
491-03099	GL-3099	N/A	N/A	2-1/8"	2-7/8"	2-11/32", 3/4" Stud	Dayton 705317 Euclid 5786 Leland W-403
491-03101	GL-3101	N/A	N/A	1-7/8"	2-7/8"	2-11/32", 3/4" Stud	Dayton 851817 Webb 16124 Leland W-404
491-03103	GL-3103	N/A	N/A	1-1/4"	2-7/8"	2-11/32", 3/4" Stud	Dayton 8708 Euclid 5784 Leland W-405
491-03104	GL-3104	491-00053	053	2"	2-7/8"	2-11/32", 3/4" Stud	Dayton 870917 Euclid 5785 Leland W-406B

Ascot No.	GLP No.	Ascot No.	Sirco No.	Similar To:
491-03113	GL-3113	491-00257	257	Mack 15QJ-17P1 Euclid 5828 Leland W-450
491-03271	GL-3271	491-00238	238	Mack 15QJ-223BP8 Euclid 5781 Leland W-448
491-03279	GL-3279	491-00233	233	Mack 15QJ-223BP3 Euclid 5821 Leland W-467
491-06115	GL-6115	N/A	N/A	Kelsey 79954 N/A N/A

### Rimlock Wheel Clamps

- Designed to replace original equipment clamps on steering axle, single rear axle and cast spoke wheels using multi-piece demountable rims
- Makes it virtually impossible for the lock ring to separate from the rim
- Reduces the problem of losing a tire or lock-ring during sudden tire deflation while driving
- Tires can be inflated without removing the rim



Ascot No.	Mfg. No.	Description
491-03960	960	Up to 9,000 lb. axles (Universal Clamp)

### Truck Wheel Guard

- Stop rust, scale, corrosion and galvanic electrolysis on disc wheels
- Nylon separator plate, placed between the hub or drum and the wheel and/or between the two wheels on dual applications

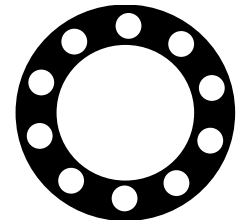

Ascot No.	Mfg. No.	Description
402-60100	61000	1-1/8", 7/8" Diameter Studs, 10-Hole, 11-1/4" B.C.
402-60101	61010	3/4" Diameter Studs, 10-Hole, 11-1/4" B.C.
402-60102	61020	22mm Diameter Studs, 10-Hole, 285.75mm B.C.
402-60104	61040	22mm Diameter Studs, 10-Hole, 335mm B.C.
402-60105	61050	20mm Diameter Studs, 8-Hole, 275mm B.C.

### Standard Wheel Rim Guard

- Protects aluminum, chrome and painted truck rims/wheels during stud and nut removal
- Inexpensive
- Tough polymer design



Ascot No.	Mfg. No.
402-50301	53010

### Aluminum Wheel Shields

- Covers entire wheel while changing tires
- Protects aluminum wheel surface from ground
- Torque sequence imprint



Ascot No.	Mfg. No.
402-50200	52000



## Tire & Wheel Service Tools

### Wheelok Systems for Heavy Duty Vehicles

- For trucks, tractors or trailers with spoke (Dayton) Wheels



401-10431

401-10430

Ascot No.	Mfg. No.	Description
401-10431	X10-DN43Z	Wheelok Nut & Free Spinning Sleeve - 2 Recommended For Each Wheel to Replace 2 Regular Nuts
401-10430	X10-DK43Z	Wheelok Key With Replaceable Pin - "Combination" Determined By Position Of Pins

### Wheelok Systems for Heavy Duty Vehicles - Front Wheels

- For trucks, tractors or trailers with disc (Budd) Wheels
- For truck or tractor front wheels

Ascot No.	Mfg. No.	Description
401-10160	X10-BN16Z	Wheelok Nut & Free Spinning Sleeve - Right-Hand Thread - 2 For Each Wheel to Replace 2 Regular Nuts
401-10170	X10-BN17Z	Wheelok Nut & Free Spinning Sleeve - Left-Hand Thread - 2 for Each Wheel to Replace 2 Regular Nuts

### Wheelok Systems for Heavy Duty Vehicles - Rear Wheels

- For trucks, tractors or trailers with disc (Budd) Wheels
- For truck or tractor rear wheels

Ascot No.	Mfg. No.	Description
401-10280	X10-BN28Z	Wheelok Nut Only - Right Hand Thread - 2 For Each Wheel To Replace 2 Regular Nuts
401-10290	X10-BN29Z	Wheelok Nut Only - Left Hand Thread - 2 For Each Wheel To Replace 2 Regular Nuts
401-10810	X10-BK81Z	Wheelok Key With Replaceable Pin - "Combination" Determined By Position Of Pins

### Wheelok Systems for Heavy Duty Vehicles

- For trucks, tractors or trailers with Budd Unimount™ Wheels— 22mm thread or equivalent



Ascot No.	Mfg. No.	Description
401-10220	X10-UN22Z	Wheelok Nut, Flange and Free Spinning Sleeve - Combined Into One Single Unit
401-10221	X10-UK22Z	Wheelok Key with Replaceable Pin - "Combination" Determined By Position Of Pins

### Rib Nut Salvage Tool Kit

- Consists of (1) Drift Pin, (1) Salvage Cylinder, (1) LH Thread Bolt, (1) RH Thread Bolt



Ascot No.	Mfg. No.
499-10150	X10-LS15B

### Wheelok Systems for Autos & Light Trucks

- Each kit consists of 4 nuts (1 for each wheel) and 1 key
- Available for American vehicles and imports
- Combination determined by order of pins



Ascot No.	Mfg. No.
401-10000	X10-SS00C

Note: Also specify year, make and model of vehicle

### Wheel Nut Chamfer Wear Gauge

- New disc wheel measuring tool kit shows you when wheel and inner and outer cap nuts are worn out
- Provides a guide to visually detect excessive wear in .875R spheric chamfers of bolt holes in disc wheels
- Designed for use with stud-piloted steel wheels which have .875R spherical bolt holes 3/8" to 1/2" disc thickness

Ascot No.	Mfg. No.
401-60929	60929



## Tire & Wheel Service Tools (Cont.)

### Stud Installers



495-10134

492-10158

Ascot No.	Mfg. No.	Description
492-10134	X10-SI34Z	For 3/4" Studs. Fits 1-3/4" Socket
492-10158	X10-SI58Z	For 5/8" Studs. Fits 1-1/4" Socket
492-10159	X10-SI59Z	For 5/8" x 18 Studs. Fits 1-1/4" Socket
492-10196	X10-SI96Z	For 9/16" x 18 studs. Fits 1-1/4" Socket

### Stud Removers

Ascot No.	Mfg. No.	Description
492-10340	X10-SR34B	For 3/4" Studs. Fits 1-3/4" Socket
492-10580	X10-SR58B	For 5/8" Studs. Fits 1-1/4" Socket
492-10180	X10-SR18B	For 1-1/8" Studs. Fits 1-1/4" Socket
492-10780	X10-SR78B	For 7/8" Studs. Fits 1-1/4" Socket

### 13/16" Square Head Adapter



Ascot No.	Mfg. No.	Description
499-10130	X10-SA13B	Fits 1-1/2" Socket Wrench to Speed Up Installing Or Removing Budd Wheel Inner Cap Nuts
499-10171	X10-SA17B	17mm Stud Adapter
499-10210	X10-SA21B	21mm Stud Adapter

### Portable Truck Wheel Stud Remover & Installer

- Power of a 10-ton shop press
- Remove and install studs without removing the hub
- Two-hour job is done in twenty minutes without risk of damaging seals or bearings
- Any mechanic can use it to get the job done right in minutes
- Stand available separately



Ascot No.	Mfg. No.	Description
492-10001	1-PPF	Pak-Press Kit "Frame Only"
492-10002	1-PPK	Pak-Press Kit w/ Hydraulics
492-06427	6427	Stand Only

### Heavy Duty Drive-On Rib-Grip Lug-Off Kits



Ascot No.	Mfg. No.	Description
499-10200	X10-LT20B	For Removing Damaged Inner Cap Nuts (1-1/8" Dia. - 13/16" Square Head) Consists of (1) Drive-On Tool And (1) Rib Nut
499-10340	X10-LT34B	For Removing Damaged 3/4" Lug Studs. Consists Of (1) Drive-On Tool And (1) Rib Nut.
499-10580	X10-LT58B	For Removing Damaged 5/8" Lug Studs. Consists Of (1) Drive-On Tool, (1) Rib Nut
499-10660	X10-LT66B	Triple Duty Tool For Removing Damaged Budd Wheel Inner Cap Nuts, 3/4" And 5/8" Lug Studs. Consists Of (1) Drive-On Tool and (3) Rib Nuts

### Replacement Rib Nuts



Ascot No.	Mfg. No.	Description
499-10180	X10-LN18B	For Budd Wheel Inner Cap Nuts
499-10341	X10-LN34B	For 3/4" Lug Studs
499-10581	X10-LN58B	For 5/8" Lug Studs
499-10211	X10-LN21B	For 21mm Lug Studs
499-11171	X10-LN17B	For 17mm Lug Studs
492-10151	X10-LP15Z	Drive Pin

### Hex Nut Remover Kits 3-Piece



Ascot No.	Mfg. No.	Description
492-15000	X10-NR15B	1-1/2" Hex Nut Remover Kit - 3 Piece
492-14000	X10-NR14B	1-1/4" Hex Nut Remover Kit - 3 Piece

**For Penetrants See  
Tire & Wheel  
Service Section.**



# LIFTING EQUIPMENT

BOTTLE JACKS  
SERVICE JACKS AND STANDS  
TRANSMISSION JACKS  
HYDRAULIC SHOP PRESSES  
WHEEL DOLLIES





Winntec smart frames ensure fast and cost effective maintenance. Replacing the heart of the jack takes just **10 minutes!**



'LIFTING WITH HIGHER STANDARDS'



**Y420300 Turbo Lifter garage jack**  
 3 Tons. Equipped with TURBO LIFTER system, rubber saddle and handle bumper. The pump pistons (protected with jacket to prevent from intrusion of dirt) are placed at a 45° angle so a complete pumping stroke will always be utilized.

**Y420302 Economy jack**  
 3 Tons. Economy model with single pump. This model combines reliable Winntec quality with a very competitive price. Great for smaller commercial shops.



Capacities in Metric tons (20 tons Metric equates to 22 tons US)



**Y432020 Air/manual bottle jack** 20 Tons. This unit includes a welded base to prolong service. Chrome main ram and aluminum air motor guarantee optimum life-time. Air filter, connected to hose, included. Y432003 comes on trolley. **Air regulator included (prolongs life of air motor by reducing air pressure inflow)**

**Y432001 Air service jack**  
 20 Tons. Heavy duty model, designed for servicing jobs in the truck industry. Comes with extension screw, 3 adapters, chrome main ram and aluminum air motor. Air filter connected to hose. **Air regulator included (prolongs life of air motor by reducing air pressure inflow)**



**GHP-01 Handle Protector: "protect your shop by reducing unnecessary insurance claims"**  
 Every Winntec floor jack includes a free Handle Protector



## Portable Bottle Jacks

### 2, 3, 5 and 8-Ton Capacity Bottle Jacks

- For automotive, industrial, agricultural, marine, recreation and construction applications
- Two-piece zinc plated handle
- Prevent rust with "Parkerized" pump piston, ram and extension screw
- No lead "uniweld" construction
- 50% safety overload factor
- Longer wear life due to internally machined oil passages, smooth bearing surfaces and close tolerances



Ascot No.	Mfg. No.	Capacity	Min. Height	Max. Height	Lifting Handle
301-76502	76502A	2-Ton	7-1/8"	14-1/2"	No
301-76503	76503A	3-Ton	7-1/2"	15 19/16"	No
301-76505	76505A	5-Ton	9-1/16"	18-7/8"	No
301-76508	76508A	8-Ton	9-1/16"	18-3/4"	Yes



### 12 and 20-Ton Capacity Bottle Jacks

- Contains same features as the 2, 3, 5 and 8-ton capacity bottle jacks
- Carrying handles

Ascot No.	Mfg. No.	Capacity	Min. Height	Max. Height	Lifting Handle
301-76412	76412	12-Ton	9-7/16"	18-7/8"	Yes
301-76512	76512	12-Ton	6-11/16"	13-13/16"	Yes
301-76520	76520	20-Ton	10-13/16"	20-3/16"	Yes
301-76820	76820	20-Ton	8-1/4"	14-15/16"	Yes

### 30 and 50-Ton Capacity Bottle Jacks

- Contains same features as the 2, 3, 5 and 8-ton capacity bottle jacks
- Features a safety overload system which prevents the jack from being used beyond its rated capacity
- Removable plug so a gauge or remote pump can be adapted to the jack
- 39-1/2" long handle allows ease of pumping

Ascot No.	Mfg. No.	Capacity	Min. Height	Max. Height	Lifting Handle
301-76530	76530A	30-Ton	11"	17-3/8"	Yes
301-76550	76550	50-Ton	12"	18-11/16"	Yes

### 12 and 22-Ton Capacity Low Forged Steel Base Bottle Jacks

- Welded steel construction throughout - reduces metal fatigue allowing for longer use life
- Unique base forging method increases resistance to high pressure and gives a degree of durability
- Special type of steel resists rust
- Needle valve allows for controlled lowering of the ram
- Casing, cylinder and base are joined by electric welding for greater strength and are leak proof
- Heat treated extension screw provides low pickup height adjustment, maximum lift height and extra strength



Zinko Hydraulic Jacks



Ascot No.	Mfg. No.	Capacity (Tons)	Min. Height	Max. Height	Ram Lift	Screw Ext.	Base Area	Ship Wt.
<b>Standard</b>								
301-01220	ZN-12	12	9-1/2"	18-1/2"	5-7/8"	3-1/8"	4-1/8" x 6-1/2"	18 Lbs.
301-02200	ZN-22	22	10-5/8"	20-1/8"	6-1/4"	3-1/4"	5" x 7-1/8"	30 Lbs.
<b>Low</b>								
301-01201	ZNB-12	12	6-3/4"	13-3/8"	3-3/4"	3"	4-1/8" x 6-1/2"	15 Lbs.
301-02201	ZNB-22	22	7-1/8"	12"	3-3/8"	1-1/2"	5 x 7-1/8"	27 Lbs.

## Portable Bottle Jacks (Cont.)

### Hydraulic Side Pump Bottle Jacks

- Hydraulic system is protected from internal damage by a patented bypass mechanism
- Machined and polished cylinders with die-cut threads provide non-abrasive leak-free, durable performance
- Fabricated from hard-cast steel with heat-treated critical stress areas
- Unique cross-type forged release valve assures positive control
- A wide, rugged base provides stability and strength

301-10125  
12-Ton



301-1025  
20-Ton



Ascot No.	Mfg. No.	Capacity	Min. Height	Max. Height	Hyd. Height	Ext. Screw	Base Size Length	Base Size Width	Weight (Lbs.)
301-10125	10125C	12-Ton	9-1/2"	18-5/8"	6"	3-1/8"	5-1/4"	5-1/8"	18
301-10129	10129C	12-Ton	6-1/8"	10-5/8"	3"	1-5/8"	5-1/4"	5-1/8"	14
301-10205	10205C	20-Ton	9-1/2"	18-5/8"	6"	3-1/8"	6-1/4"	5-7/8"	27
301-10209	10209C	20-Ton	6-1/2"	11-1/4"	3-1/8"	1-5/8"	6-1/4"	5-7/8"	21

### Hydraulic In-Line Bottle Jacks

- Heat-treated extension screw allows low pick-up height adjustment and maximum lift height
- A wide, rugged base provides stability and strength
- Easiest accessible pumping system eliminates off-center pumping force for the most efficient operation
- U.S. Patented built-in by-pass device protects hydraulic system from over pumping damage
- Unique cross-type forged release valve assures positive control

301-10120  
12-Ton



301-10208  
20-Ton



Ascot No.	Mfg. No.	Capacity	Min. Height	Max. Height	Hyd. Height	Ext. Screw	Base Size Length	Base Size Width	Weight (Lbs.)
301-10120	10120	12-Ton	9-1/2"	18-5/8"	6"	3-1/8"	7"	4-1/4"	19
301-10128	10128	12-Ton	6"	10-3/4"	3-1/8"	1-5/8"	7"	4-1/4"	16
301-10200	10200	20-Ton	9-1/2"	18-5/8"	6"	3-1/8"	7-3/4"	5"	28
301-10208	10208	20-Ton	6-1/2"	11-1/4"	3-1/8"	1-5/8"	7-3/4"	5"	23

### 2 to 30-Ton Capacity Bottle Jacks

- All models have a chrome main ram and a chrome pump piston
- The extension screws have a pressed thread
- These units can be used horizontally and vertically

Ascot No.	Mfg. No.	Capacity	Min. Height	Max. Height	Ext. Screw
301-41020	G410200	2-Ton	6-1/4"	11-3/4"	2"
301-41040	G410400	4-Ton	7-1/2"	14-1/2"	2"
301-41060	G410600	6-Ton	7-3/4"	14-3/4"	2"
301-41080	G410800	8-Ton	9"	18"	3-1/4"
301-41150	G411500	15-Ton	9-3/4"	19-1/4"	3-1/4"
301-41200	G412000	20-Ton	9-1/2"	18-1/2"	3-1/4"
301-41201	G412001	20-Ton Short	6-1/2"	11-1/4"	1-1/2"
301-41300	G413000	30-Ton	9-1/2"	18-1/2"	3"



### 20-Ton Air/Hydraulic Bottle Jack

- Unit includes a welded base to prolong service and return springs
- Chrome main ram and aluminium air motor guarantee optimum lifetime
- Air filter, connected to hose, included

Ascot No.	Mfg. No.	Capacity	Min. Height	Max. Height	Ext. Screw
301-43220	G432200	20-Ton Air/Hydraulic Bottle Jack	9-3/4"	18-3/4"	3-1/4"



## Portable Bottle Jacks (Cont.)

### Hydraulic Air-Actuated Bottle Jacks

- Effortless air operation will greatly reduce operator fatigue and speed up the efficiency of garage work
- All air bottle jacks come with chrome plated rams
- A compact, yet powerful Air Turbo
- The motor is equipped to raise the load to the desired height efficiently, effortlessly and safely
- Versatile "Quick Connector" design provides for easy removal of air hose from air motor allowing compact storage or remote operation



**301-18202**  
20-Ton

Ascot No.	Mfg. No.	Capacity	Min. Height	Max. Height	Hyd. Height	Ext. Screw	Base Size Length	Base Size Width	Weight
301-18122	18122C	12-Ton	9-1/2"	18-1/2"	5-1/2"	3-1/2"	7-5/8"	6-1/2"	31 Lbs.
301-18125	18125	12-Ton	9-1/2"	18-5/8"	5-1/2"	3-1/2"	8-7/8"	5-3/4"	29 Lbs.
301-18202	18202C	20-Ton	9-1/2"	18-5/8"	5-1/2"	3-1/2"	9-1/4"	6-3/4"	40 Lbs.
301-18205	18205	20-Ton	9-1/2"	18-5/8"	5-1/2"	3-1/2"	8-7/8"	5-3/4"	39 Lbs.
301-18209	18209	20-Ton	8-1/8"	15-1/2"	4"	3-3/8"	8-1/2"	7-1/4"	35 Lbs.
301-18302	18302C	30-Ton	11"	18"	7"	N/A	10-1/4"	8-1/4"	63 Lbs.

### Titan Jack Plates

- Each unit has non-skid surface to prevent jacks from sliding under wet or oily conditions
- Complies with OSHA regulation 29 CFR 1926.305 when it is necessary to provide a firm foundation, the base of the jack shall be blocked or cribbed
- Each unit has non-skid surface to prevent jacks from sliding under wet or oily conditions

Ascot No.	Mfg. No.	Dimensions (LxWxH)	Capacity	Weight
309-14464	14464	12"x12"x1"	30-Ton	5 Lbs.
309-14465	14465	12"x12"x1.5"	100-Ton	8 Lbs.



**309-14464**



**309-14465**

## Service Jacks

### Magic Lift Service Jacks & Long Chassis Service Jacks

- Innovative design of Magic Lift offers a quicker lift for professional performance
- Metered release system allows for precise load control
- After the first pump reaches the lifting point, the jack continues with extraordinary lifting speed to raise the load to the desired height
- Heavy gauge construction with rugged universal joint release valve for professional performance
- U.S. Patented built-in by-pass device protects hydraulic system from over pumping damage
- 25025A & 25037 come with a one-piece handle



**302-25025**

**302-25025**

**302-25030**

Ascot No.	Mfg. No.	Capacity	Min. Height	Max. Height	Handle Length	Saddle Diameter	Jack Size Length	Jack Size Width	Jack Size Height	Weight
302-25025	25025	2-1/2-Ton	3-3/4"	20"	49-7/8"	5-1/2"	29-3/4"	13-1/4"	6-1/4"	95 Lbs.
302-25125	25025A	2-1/2-Ton	3-3/4"	20"	49-7/8"	5-1/2"	29-3/4"	13-1/4"	6-1/4"	95 Lbs.
302-25037	25037	3-Ton	4"	23"	49-7/8"	6-1/4"	31-7/8"	15-3/8"	7-3/8"	143 Lbs.
302-25030	25030	3-Ton	5-3/4"	20"	42-1/8"	5-1/2"	27-3/4"	13-3/8"	6-3/4"	91 Lbs.
302-25057	25057	5-Ton	6-1/2"	22-1/4"	40-5/8"	6-1/2"	52-5/8"	16-7/8"	11"	198 Lbs.
302-27037	27037	3-1/2-Ton	4"	22"	50"	4-3/4"	30-7/8"	14-7/8"	7-1/4"	109 Lbs.
302-29025	29025	2-Ton	2-1/2"	19-5/8"	52"	4-7/8"	30"	13-5/8"	30"	91 Lbs.

## Service Jacks (Cont.)

### 1-1/2, 2 and 5-Ton Capacity Hydraulic Service Jacks

- Overall construction of steel for durability and long life
- Light and compact design for easy and efficient operation even in a limited area
- Rear wheels fixed to balance the total weight of the jack
- Built-in automatic safety valve prevents overloading and also protects the ram plunger from being pushed up beyond maximum limit
- Handle can be locked in one of three positions
- Foot pedal with pump to raise jack to desired level



**Zinko Hydraulic Jacks**



**302-00030**

Ascot No.	Mfg. No.	Capacity	Low Pickup Height	High Lifting Point	Power Raise	Cap Size Diameter	Handle Length	Chassis Length	Shipping Weight
302-00015	ZSJ15T	1-1/2-Ton	5-1/8"	32"	26-7/8"	5-1/2"	6-3/4"	27"	92 Lbs.
302-00020	ZSJ20S-2	2-Ton	4-3/4"	18-7/8"	14-1/8"	5-1/2"	6-1/4"	25-4/5"	80 Lbs.
302-00030	ZSJ-30H	3-Ton	4-7/8"	23-7/8"	18-5/8"	5-1/2"	7-1/2"	51-3/5"	143 Lbs.
302-00050	ZSJ-50H	5-Ton	5-7/8"	22"	16-1/8"	5-1/2"	7-7/8"	55-1/2"	187 Lbs.

### 2-Ton Low-Rider Floor Jack

- Built with our traditional AFF quality, perfect for today's lower-profile "tuner" vehicles
- Universal joint technology and precision release valve for a more controlled release
- Pinned steel saddle (1" stud) with rubber pad for added vehicle protection
- Tough UV powder-coated frame for greater protection and durability
- One-piece, foam-covered 50" handle for ease of positioning, pumping and storage



**302-20000**

Ascot No.	Mfg. No.	Capacity	Low Height	High Height	Length	Overall Width (rear)	Shipping Wt.
302-20000	200T	2-Ton	2-3/4"	20"	27"	15"	99 Lbs.

### 3-1/2-Ton Capacity Professional Heavy Duty Floor Service Jacks

- Designed and built for the professional user
- Universal joint technology for precision control of release valve
- Flanged side plates for increased strength and stability
- Rear mounted swivel casters for easy maneuverability
- Automatic safety valve prevents jack from overload
- 302-35002 equipped with a double pump design to increase speed



**302-35001**

Ascot No.	Mfg. No.	Capacity	Low Height	High Height	Length	Overall Width (rear)	Shipping Wt.
302-35000	350	3-1/2-Ton	4"	19-1/2"	28"	14-1/2"	112 Lbs.
302-35001	350GT	3-1/2-Ton	4"	19-1/2"	29"	15"	119 Lbs.
302-35002	350SS	3-1/2-Ton	4"	19-1/2"	29"	15"	120 Lbs.

*SERVICE JACKS are for lifting vehicles only. Support the vehicle with vehicle stands immediately after lifting. Do not move or dolly the vehicle with the jack. Use only on a hard level surface. Always follow the instructions accompanying the product for safe and proper use.*



## Service Jacks (Cont.)

### 2 and 3-Ton Service Jacks

- One-piece handle
- Flanged side plates increase strength
- In-line pump provides efficient pumping operation
- Full swivel rear casters for easy positioning
- Sealed hydraulic pump for durability
- Pressure relief valve prevents overloading
- Cast iron lift arm for heavy duty loads
- U-joint release mechanism for precise load control
- 2 Year Warranty



302-93642



302-93652

Ascot No.	Mfg. No.	Capacity	Low Pickup Height	Max. Height	Power Raise	Saddle Diameter	Handle Length	Chassis Length	Chassis Height	Chassis Width	Ship Weight
302-93642	HW93642	2-Ton	3-3/4"	20"	16-1/4"	6-5/8"	50"	26-3/4"	6-3/4"	11-1/2"	96 Lbs.
302-93652	HW93652	3-Ton	4"	23"	19"	6-3/4"	50"	30-3/4"	7-1/4"	11-1/2"	110 Lbs.

### 2-1/4 and 5-Ton Capacity Floor Service Jacks

- Steel hydraulic block assembly includes dust seals to prevent oil contamination
- Long, removable two-piece handle
- Safety bypass system protects cylinder
- Safety overload system prevents jack from being used beyond rated capacity



302-71232



302-71500



Ascot No.	Mfg. No.	Capacity	Min. Height	Max. Height	Handle Length
302-71202	71202A	2-Ton	3-1/5"	20-3/8"	40"
302-71232	71232	2 -1/4-Ton	3-3/4"	20"	49"
302-71500	71500E	5-Ton	6-1/4"	27-1/4"	42-1/2"

### Garage Jacks

- The professional universal joint release valve makes it possible to lower the jack with load very precisely
- The pump piston (protected with jacket to prevent from intrusion of dirt) is placed at a 45° angle so a complete pumping stroke will always be utilized
- The jack has a chrome main ram



302-42225



302-42030



302-42032



Ascot No.	Mfg. No.	Capacity	Min. Height	Max. Height	Ship Weight
302-42030	G420300	3-Ton Fast Lift - Double Piston	4"	19-1/2"	110 Lbs.
302-42032	G420302	3-Ton (Economic)	5"	19-1/2"	94 Lbs.
302-42250	G422500	2.5-Ton Low Profile	3-1/4"	18-1/2"	104 Lbs.
302-42225	G420225	2.25-Ton Long Chassis Low Profile	3-1/2"	20-1/4"	124 Lbs.

### Handle Protector

- Made of a durable synthetic rubber
- Fits multiple jack manufacturers' handles and popular tire tools
- Unique design ensures a tight fit on jack/tool handle without slippage
- Protects vehicles from scratches or dents caused by falling jack handles and unstable tools in the shop
- Patent Pending design absorbs the dent/scratch-causing force as the handle contacts an adjacent vehicle

Ascot No.	Mfg. No.
448-01101	GHP-01



## Service Jacks (Cont.)

### 5, 10 and 20-Ton Capacity Long Chassis Service Jacks

- Ideal for lifting heavy trucks, buses, agricultural and heavy construction equipment with hard to access lift points
- Heavy gauge, sturdy frame helps prevent distortion or twisting
- Foot pedal operation provides quick, no load lifts to load point
- 302-22051 uses standard shop air



302-22050



302-22051

Ascot No.	Mfg. No.	Description	Capacity	Min. Height	Max. Height	Handle Length	Saddle Dia.	Jack Size Length	Jack Size Width	Jack Size Height	Weight
302-22050	22050C	Long Chassis Service Jack	5-Ton	7"	27"	42-1/8"	6-5/8"	55-1/2"	16-7/8"	7-5/8"	233 Lbs.
302-22051	22051C	Long Chassis Service Jack with Air	5-Ton	7"	27"	42-1/8"	6-5/8"	55-1/2"	16-7/8"	7-5/8"	237 Lbs.
302-22100	22100C	Heavy Duty Hydraulic Service Jack	10-Ton	7"	27"	42-1/8"	7-3/8"	55-1/2"	20"	12-3/4"	436 Lbs.
302-22101	22101C	Heavy Duty Air Actuated Service Jack	10-Ton	7"	27"	42-1/8"	7-3/8"	55-1/2"	20"	12-3/4"	441 Lbs.
302-22201	22201C	Long Chassis Service Jack	20-Ton	7-1/2"	28"	48"	6-1/8"	62-1/4"	20-3/8"	11-3/4"	550 Lbs.

### 4 and 10-Ton Long Chassis Service Jacks



- Dual piston action provides speed to contact and power to lift
- Long chassis for hard to reach points
- Handle adjusts to three pumping positions
- Heavy gauge, steel frame helps prevent distortion
- "T" handle with release knob for exact positioning of load
- 2 Year Warranty



302-93662

Ascot No.	Mfg. No.	Capacity	Low Pickup Height	Max. Height	Power Rate	Saddle Length	Handle Length	Chassis Length	Chassis Height	Jack Width	Weight
302-93657	HW93657	4-Ton	5-1/4"	26"	20-3/4"	7-1/2"	48"	48-1/2"	7-1/2"	12"	222 Lbs.
302-93667	HW93667	4-Ton	5-1/4"	26"	20-3/4"	7-1/2"	48"	48-1/2"	7-1/2"	12"	222 Lbs.
302-93660	HW93660	10-Ton	5-7/8"	26"	20-1/8"	7-1/2"	50"	55-3/8"	9-3/4"	12"	222 Lbs.
302-93662	HW93662	10-Ton	5-7/8"	26"	20-1/8"	7-1/2"	50"	55-3/8"	9-3/4"	12"	222 Lbs.

### 20-Ton Capacity Air Operated Hydraulic Floor Jacks

- Intended for heavy duty truck, agricultural and heavy construction equipment
- Long handle with 45-1/2" reach helps in positioning of jack under vehicles with low overhang
- Removable handle for shipment or storage
- Hand grip also works as a stand to store the jack in a vertical position
- Compact design fits easily between tandem wheels
- Fast efficient air pump reduces lifting time and has a built-in relief mechanism which prevents the jack from being used beyond its maximum capacity

Ascot No.	Mfg. No.	Capacity	Min. Height	Max. Height	Weight
302-72081	72080A	20-Ton	11-1/5"	22-2/3"	66 Lbs.
302-72091	72090A	20-Ton	8-5/8"	22-1/2"	60 Lbs.



302-72091



## Service Jacks (Cont.)

### 20-Ton Truck Jacks

- Patented "Speed Pak" provides effortless lift
- Large rubber wheels enhance mobility
- Automatic valve prevents overloading
- Extension screw permits pickup height adjustment
- 2 Year Warranty



Ascot No.	Mfg. No.	Capacity	Min. Height	Max. Height	Power Raise	Handle Length	Base Size	Ext. Screw	Operating Pressure	Weight
302-93731	HW93731	20-Ton	9-1/2"	17-1/2"	5-1/2"	50"	8" x 5-1/2"	2-1/2"	140	69 Lbs.

### 20-Ton Air/Hydraulic Service Jacks with Cart

- Unit includes a welded base to prolong service
- Chrome main ram and aluminium air motor guarantee optimum lifetime
- Air filter, connected to hose, included
- Comes on trolley



Ascot No.	Mfg. No.	Capacity	Min. Height	Max. Height
302-43202	G432020	20-Ton Air/Hydraulic Bottle Jack with Cart	9-2/3"	8-1/2"

### 20-Ton Capacity Air/Hydraulic Service Jacks

- Compact, powerful design quickly lifts rated capacity
- Large 8" rubber wheels
- Low height allows lifting from axle or suspension
- Pressure relief valve prevents overloading
- Rapid two-speed air hydraulic action quickly advances ram to load
- Chrome plated plunger for extended jack life
- Optional height adapters HW93265
- 2 Year Warranty



Ascot No.	Mfg. No.	Capacity	Min. Height	Max. Height	Power Raise	Handle Length	Base Size	Ext. Screw	Operating Pressure	Weight
302-93733	HW93733	20-Ton	9"	19-3/4"	6"	45"	8" x 17"	4-3/4"	90-150	87 Lbs.

## Service Jacks (Cont.)

### 22-Ton Capacity Air Operated Hydraulic Floor Jacks

- All steel-welded construction built for heavy duty use
- Long 50" T-handle for easy positioning of jack under vehicles with low overhang
- Quick-lift mechanism allows for substantially shortened ram-lifting time when no load is involved
- Spring return for self retraction
- Extension screw for fine adjustment beyond rated capacity or lifting limit
- Built-in safety valve prevents use beyond rated capacity
- Specially processed air pump for low-noise operation

Ascot No.	Mfg. No.	Capacity	Min. Height	Max. Height	Height of Frame	Cylinder Lift	Screw Ext.	Weight
302-00224	ZATJ-22S-4	22-Ton	8"	15-7/8"	7-1/4"	4-1/4"	3-5/8"	82 Lbs.



Zinko Hydraulic Jacks

### 20-Ton Air Service Trolley Jacks



- Heavy duty model designed for servicing jobs in the truck industry
- Jack has an extension screw in addition to 3 saddles that can be placed on top of each other for added height
- Chrome main ram and aluminium air motor guarantee optimum lifetime
- Air filter, connected to hose, included

Ascot No.	Mfg. No.	Capacity	Min. Height	Max. Height	Ext. Screw
302-43201	G432001	20-Ton Air Service Jack	6-3/5"	11-1/5"	1-1/5"



### 20-Ton Truck Ramps

- Specifically designed for heavy-duty tasks
- 33" Long T-handle increase mobile efficiency
- Sold in set of two only



Ascot No.	Mfg. No.	Capacity	Frame Width	Frame Length	Wheel Diameter	Handle Length	Weight
302-93200	93200	20-Ton	13-1/2"	47"	5"	33"	230 Lbs.

## Service Jacks (Cont.)

### 22-Ton Capacity Air/Hydraulic Floor Jacks

- Long "T" handle helps in positioning jack under vehicles with low overhang
- Jack load release top mounted at "T" handle and allows operation at any handle position
- Handle locking lever secures handle in either vertical, horizontal or 45° position
- Compact design fits easily between tandem wheels
- Rust inhibitive coating on ram and extension screw
- Large diameter wheels for easy maneuverability
- Self-retracting ram eliminates manual lowering of jack
- Includes 3-piece extension set



Ascot No.	Mfg. No.	Capacity	Min. Height	Max. Height	PSI Range	Weight
302-72200	72200C	22-Ton	9"	18"	85-200	102 Lbs.

### Hydraulic Air Actuated Single Stage Truck Jacks

- Three handle angles choices for space saving storage, easy carrying move and easy access to lifting point
- Large steel wheels for easy positioning and smooth motion
- Sturdy one-piece handle assembly is standard on all Omega Truck Jacks
- Chrome plated rams
- Heat-treated extension screw allows low pick-up height adjustment and maximum lift height
- U.S. Patented built-in by-pass device protects hydraulic system from over pumping damage



302-23221



302-23401

Ascot No.	Mfg. No.	Capacity	Min. Height	Max. Height	Ext. Screw	Handle Length	Base Length	Base Width	Weight
302-23221	23221	22-Ton	9-7/8"	20-1/4"	4"	48-3/4"	22-7/8"	12-1/2"	96 Lbs.
302-23222	23222	22-Ton	8-1/4"	21-7/8"	3-7/8"	48-3/4"	22-7/8"	13-1/4"	96 Lbs.
302-23301	23301	30-Ton	11"	18"	N/A	48-3/4"	22-7/8"	12-1/2"	122 Lbs.
302-23401	23401	40-Ton	7-1/4"	20-1/8"	N/A	51-1/8"	78-3/4"	6-1/4"	149 Lbs.
302-23501	23501	50-Ton	12"	19"	N/A	48-3/4"	22-7/8"	13-3/4"	174 Lbs.

### 25-Ton Truck Jacks

- Compact, powerful design quickly lifts rated capacity
- 8" low height allows lifting from axle or suspension
- Pressure relief valve prevents overloading
- Specially coated ram prevents rust and extends jack life
- 3" adapter available, Part number 735-002-001
- Air assisted ram retract



Includes 3" Extension



Ascot No.	Mfg. No.	Capacity	Min. Height	Max. Height	Handle Length	Base Size	Ext. Screw
302-93735	HW93735	25-Ton	8"	18"	53"	12"x20"	4-7/8"

**WARNING:** Service Jacks are for lifting vehicles only. Support the vehicle with vehicle stands immediately after lifting. Do not move or dolly the vehicle with the jack. Use only on a hard level surface. Always follow the instructions accompanying the product for safe and proper use.

## Service Jacks (Cont.)

### 44-Ton Capacity Air/Hydraulic Floor Jacks

- Long "T" handle helps in positioning jack under vehicles with low overhang
- Jack load release top mounted at "T" handle and allows operation at any handle position
- Handle locking lever secures handle in either vertical, horizontal or 45° position
- Compact design fits easily between tandem wheels
- Rust inhibitive coating on ram and extension screw
- Large diameter wheels for easy maneuverability



302-72244  
Wheels concealed

Ascot No.	Mfg. No.	Capacity	Min. Height	Max. Height	PSI Range	Weight
302-72244	72244	44-Ton	9-1/4"	18"	130-175	149 Lbs.

Ascot No.	Mfg. No.	Description
302-72204	72204	4" Extension Adapter
302-72206	72206	2-3/4" Diameter Lifting Saddle

### 30, 50 and 55-Ton Capacity Air/Hydraulic Telescopic Floor Jacks

- Long "T" handle for positioning jack under vehicles with low overhang
- Handle locking lever secures handle in either vertical, horizontal or 45° position
- Safety overload system prevents cylinder damage
- Rust inhibitive coating on rams
- Integrated filter protects air motor
- Double acting pump raises ram more quickly to the load
- Suspension loaded axle prevents wheel damage



302-72225

302-72218

302-72212

Ascot No.	Mfg. No.	Lifting Capacity	Low Height	Stroke	High Height	Chassis Width	Chassis Length	Wheel Diameter	PSI Range	Weight
302-72212	72212	55-Ton	5.9"	9.5"	15.4"	8.6"	39.3"	7"	100-175	233 Lbs.
302-72218	72218	33-Ton	5.9"	7.3"	12.71"	8.5"	49.2"	8-1/2"	120-175	106 Lbs.
302-72225	72225	50-Ton	8.7"	7.9"	16.6"	8.6"	39.3"	7"	120-175	235 Lbs.

### 22-Ton Aluminum Service Jacks

- Lightweight compact telescopic jack comes with a handle that folds down
- First stage 238mm & 25 Tons. Second stage 230mm & 10 Tons
- 2-piece extended handle



Ascot No.	Mfg. No.	Capacity	Min. Height	Max. Height	Ext. Screw	Frame Width	Frame Length	Wheel Dia.	Handle Length	Weight
302-43225	G432025	22-Ton Aluminum Service Jack	6-1/2"	18"	5"	12-1/2"	21"	6"	46"	64 Lbs.

## Jack Stands

### 3, 6, 10 and 12-Ton Capacity Stands

- Four legged base with foot pads for added strength and more secure footing
- Common machine bolt secures lifting column to stand and provides stability
- Recessed column saddle for acceptance of vehicle panel rail



Ascot No.	Mfg. No.	Capacity	Low Height	High Height	Height Intervals	Base Size	Saddle Size	Weight Per Pair
302-81004	81004C	3-Ton	12"	17-1/2"	9/16"	7-1/2" x 7-7/8"	1-1/8" x 4-9/16"	19 Lbs.
302-81006	81006D	6-Ton	16-1/4"	24-7/8"	5/8"	10-1/16" x 11-1/16"	1-1/8" x 4-7/8"	28 Lbs.
302-81007	81012	12-Ton	19-5/8"	29-3/8"	1-1/4"	13" x 15"	1-5/8" x 4-3/4"	86 Lbs.
302-81208	81208	10-Ton	10-1/2"	17"	4"x1-1/2"	12-1/2"x12-1/2"	3"x5"	60 Lbs.
302-81209	81209	10-Ton	18-1/2"	30"	7"x1-1/2"	17"x17"	3"x5"	80 Lbs.
302-81210	81210	10-Ton	28"	47"	10"x2"	16"x16"	3"x5"	106 Lbs.

### 3, 6 and 12-Ton Capacity "Ratchet Style" Stands

- Counter-weighted pawl serves as a safe, secure locking device to prevent the load from accidentally disengaging
- Sturdy, welded steel construction for superior safety and strength
- One piece, multi-position ductile ratchet bar provides super strength and durability, and quick adjustment mechanism that securely lock into desired location
- Sold and to be used only in pairs



Ascot No.	Mfg. No.	Capacity	Min. Height	Max. Height	Saddle Size	Base LxW	Weight
302-32035	32035	3-Ton	11-1/2"	17"	3-1/2" x 1"	6-3/4" x 7-3/4"	23 Lbs.
302-32065	32065	6-Ton	15-3/8"	24-1/4"	4-1/4" x 1-1/4"	8-7/8" x 10-7/8"	32 Lbs.
302-32125	32125	12-Ton	17-1/2"	27-1/4"	4-5/8" x 1-1/2"	12" x 10-3/4"	61 Lbs.

302-32035

### 6 and 12-Ton Magic Lift™ Jack Stands

- Innovative design of Magic Lift offers a fast lift for professional performance
- Rack bar quickly raises to desired support point
- Heavy gauge, steel frame helps prevent distortion and twisting
- Counter-weighted pawl locks ratchet bar securely in place



302-32066



302-32126

Ascot No.	Mfg. No.	Capacity	Min. Height	Max. Height	Base LxW	Weight
302-32066	32066	6-Ton	15-3/4"	24-3/8"	11" x 9-3/4"	35 Lbs.
302-32126	32126	12-Ton	19-3/4"	30-1/4"	14-3/4" x 12-3/4"	75 Lbs.

## Jack Stands (Cont.)

### 10-Ton Pin Style Jack Stand

- Pin style column adjusts in 2" height intervals
- Heavy duty square tubing
- Large saddle securely supports load
- Ideal for fleet, agricultural and construction maintenance
- Sold in pairs



Ascot No.	Mfg. No.	Capacity	Min. Height	Max. Height	Base Size	Weight
302-93511	HW93511	10-Ton	30"	52"	19" x 19"	144 Lbs.

### 10-Ton Jack Stands

- Heavy duty pin style height adjustment
- Wide, square tubing construction and base for maximum load stability
- Adjusts from 19-1/2" to 31-1/2" in 2" intervals
- Large saddle secures load
- Integrated carrying handle
- Ideal for fleet, agricultural and construction maintenance
- Sold and to be used in pairs



Ascot No.	Mfg. No.	Capacity	Min. Height	Max. Height	Adjustments	Base Size	Weight
302-93512	HW93512	10-Ton	19-1/2"	31-1/2"	2" Increments	16"x16"	92 Lbs.

### 10 and 22-Ton Capacity "Pin-Style" Jack Stands

- Sturdy, welded steel construction for superior safety and strength
- Heavy gauge, steel frame helps prevent distortion or twisting
- Sold and to be used only in pairs



302-32225



Ascot No.	Mfg. No.	Capacity	Min. Height	Max. Height	Saddle Size	Base LxW	Weight
302-32075	32075	7-Ton	9-3/8"	14-1/8"	3-1/2" x 2-3/8"	8-3/4" x 8-3/4"	23 Lbs.
302-32105	32105	10-Ton	18-5/8"	30-1/2"	5-5/8" x 6-3/8"	16" x 16"	96 Lbs.
302-32107	32107	10-Ton	28"	47"	5-5/8" x 6-3/8"	16" x 16"	98 Lbs.
302-32225	32225	22-Ton	12-1/8"	19-7/8"	3-1/8" x 2-3/4"	9-3/4" x 9-3/4"	67 Lbs.

### 12-Ton Jack Stand with Pin and Wheels

- All stands have a heavy duty robot welded frame, and a multi-position ductile ratchet bar
- The quick adjustment mechanism securely locks into the right location
- Includes counter-weighted pawl for safe securing



Ascot No.	Mfg. No.	Capacity	Min. Height	Max. Height	Base Size	Weight
302-45125	G451205	12-Ton	11-4/5"	18-1/10"	19"x19"	144 Lbs.



## Jack Stands (Cont.)

### 25-Ton Heavy Duty Jack Stand

- Pin style column adjusts in 2" height intervals
- Heavy duty square tubing
- Large saddle securely supports load
- Ideal for fleet, agricultural, and construction maintenance
- Sold in pairs



Ascot No.	Mfg. No.	Capacity	Min. Height	Max. Height	Adjustment	Base Size	Weight Per Pair
302-93526	HW93526	25-Ton	12"	20"	2" Intervals	10" x 10"	62 Lbs.

### 22-Ton Capacity Jack Stands

- Intended for fleet and maintenance garages where low profile stands are used to support loaded trailers
- Pin-type support column adjusts to four different height positions
- Adjustment pin is secured to stand to prevent loss
- Handle provides ease of positioning and carrying
- 3/8" thick solid steel base plate for stability



Ascot No.	Mfg. No.	Capacity	Low Height	High Height	Height Intervals	Base Size	Saddle Size	Weight Per Pair
302-81222	81222	22-Ton	12"	20"	3" x 3"	10" x 10"	2-1/4" x 3-1/4"	66 Lbs.

### 3 and 6-Ton Jack Stands

- Saddle column provides ratchet action height adjustment
- Dual purpose handle serves as carry handle and saddle column release
- Multi position ratchet bar provides strength and durability
- Formed base adds stability and helps reduce sinkage into pavement



302-93503

302-93506

Ascot No.	Mfg. No.	Description	Min. Height	Max. Height	Height Intervals	Base Size	Saddle Size	Weight
302-93503	HW93503	3-Ton Jack Stands	11-1/2"	17"	11/16"	7-5/8" x 8-2/4"	1-3/16" x 4-1/4"	16 Lbs.
302-93506	HW93506	6-Ton Jack Stands	15-1/2"	24-3/4"	5/8"	11" x 11-3/4"	1-1/4" x 4-5/8"	40 Lbs.

### 7-Ton Forklift Stand

- Low profile muscle work for forklifts and heavy machinery
- Wide, square base for maximum load stability
- Adjusts from 9-1/2" to 14" at 2" intervals
- Heavy duty holding pins for adjustable heights
- Lightweight for portability and ease of positioning



Ascot No.	Mfg. No.	Description	Min. Height	Max. Height	Height Intervals	Base Size	Saddle Size	Weight
302-93524	HW93524	7-Ton Forklift Stands	9-1/2"	14"	2"	7-3/4" x 7-3/4"	2-1/2" x 3-1/2"	40 Lbs.

## Specialty Jacks

### 4-Ton Floor Forklift Jack

- Specially designed seals and strong steel construction
- Low pick up height
- Removable handle and compact size
- 2 Year Warranty



Ascot No.	Mfg. No.	Capacity	Min. Height	Max. Height	Power Rise	Handle Length	Base Size	Weight
302-93659	HW93659	4-Ton	2-1/4"	16"	13-3/4"	24"	8" x 26-1/2"	56 Lbs.



### 4 to 5-Ton Capacity Forklift Jack

- Two lift points for numerous lifting applications
- 2-1/4" low lift height at scissors end
- 40" removable "T" handle
- Short pump arc provides faster rising action
- Additional foot pedal pumping provides fast saddle raising to the load

TWO-POSITION SADDLE @ SCISSORS END



Lifts at edge

Lifts flat surfaces

Ascot No.	Mfg. No.	Type	Maximum Capacity	Maximum Height	Height	Length	Width	Wheel Dia. Front	Wheel Dia. Rear	Ship Weight
302-72036	72036C	Scissors	5-Ton	2-1/2"	18-1/4"	34"	7-7/8"	2"	3-18"	104 Lbs.

### 4-Ton Capacity Forklift Jack

- Dual lift points for various lifting applications. The lower point is for forklift truck lifts and the higher point is for most farm equipment lifts
- Precision control of lifting and lowering functions



### 4-Ton Capacity Air-Hydraulic Forklift Jack

- Dual lift points for various lifting applications. The lower point is for forklift truck lifts and the higher point is for most farm equipment lifts
- Precision control of lifting and lowering functions



Ascot No.	Mfg. No.	Capacity	Lifting Height Min.	Lifting Height Max.	Shipping Weight
302-28045	28045	4-Ton	2-1/8"	17-1/8"	91 Lbs.

Ascot No.	Mfg. No.	Capacity	Lifting Height Min.	Lifting Height Max.	Shipping Weight
302-28047	28047	4-Ton	2-1/8"	17-1/8"	96 Lbs.

## Specialty Jacks (Cont.)

### 2-1/2-Ton Capacity Air Lift Jacks

- For fast lifting and easy lowering of automobiles, vans, pick-up trucks and light service vehicles
- Ideal for repair bays and service stations
- Three-way heavy duty air valve provides fine control when lifting or lowering a vehicle
- Automatic safety lock engages in five different height positions
- Designed for lifting entire front or rear of a vehicle
- Front swivel caster wheel and two 8" pneumatic rear tires for maneuverability
- Adjustable lifting saddles can be raised and extended



Ascot No.	Mfg. No.	Capacity	Low Pickup Height	High Lifting Point	Min. PSI for Rated Load	Weight
308-82925	82925	2-1/2-Ton	8-3/8"	35-1/2"	175	203 Lbs.

### 10-Ton Capacity Air Lift Jacks

- Intended for use with truck and equipment dealer garages, heavy duty construction repair shops and bus company garages
- Features six automatic safety lock positions and two 12" diameter rear pneumatic tires
- Three-way heavy duty air valve provides fine control when lifting or lowering a vehicle
- Automatic safety lock engages in five different height positions
- Designed for lifting entire front or rear of a vehicle
- Adjustable lifting saddles can be raised and extended to desired position



308-82950

308-82999

Ascot No.	Mfg. No.	Capacity	Low Pickup Height	High Lifting Point	Min. PSI for Rated Load	Weight
308-82950	82950	5-Ton	12-1/2"	47-1/2"	175	534 Lbs.
308-82999	82999	10-Ton	12-1/2"	50"	200	638 Lbs.

### 10-Ton Capacity Lift Jacks

- Removable handle and 10 foot air hose for safe position and operation
- 10-ton capacity when used separately, 20-tons when used in pairs
- Completely air-operated
- Doubles as a support stand
- 2 Year Warranty



308-93737



308-93690



Ascot No.	Mfg. No.	Capacity	Min. Height	Max. Height	Power Raise	Saddle Spread	Min. PSI for Rated Load	Lifting to Front Saddle Distance	Height Intervals	Weight
308-93737	HW93737A	10-Ton	17"	52-1/2"	10"	N/A	200	N/A	2-1/2"	139 Lbs.
308-93690	HW93690	10-Ton	12-1/2"	50-1/2"	28"	25" to 53"	200	13"	N/A	586 Lbs.

### 10-Ton Air Operated Wheel Lift System

- Lifts engage wheels without needing to remove panels on vehicle
- Raise front or rear end of vehicle using a single controller
- Load retention pin allows lifts to function as stands in six different positions
- Completely air operated
- 2 Year Warranty
- Sold as pairs



Ascot No.	Mfg. No.	Capacity	Min. Height	Max. Height	Power Raise	Min. Wheel Diameter	Max. Wheel Diameter	Frame Size (WxDxH)	Operating Pressure	Weight
308-93693	HW93693	10-Ton	Floor Level	24"	24"	19-1/2"	24-1/2"	41-5/8"x39-1/2"x53-1/4"	160 PSI	1,234 Lbs.

## Transmission Jacks

### 1/2-Ton Capacity Hydraulic Transmission Jacks

- Fully adjustable universal saddle
- Safety bypass prevents damage to cylinder
- Safety overload system prevents jack from being used beyond rated capacity
- Full 360° rotating pump handle operates in any position
- Four full-swivel ball bearing caster wheels for easy positioning

Ascot No.	Mfg. No.	Capacity	Min. Height	Max. Height	Weight
371-72050	72050C	1/2-Ton	7-3/4"	30-3/8"	138 Lbs.



### 1-1/2-Ton Capacity Truck Transmission Jacks

- For heavy truck transmissions
- Fully adjustable universal saddle with adjustable arms to position the transmission
- Heavy duty chain with convenient chain tensioner secures load to saddle
- Safety bypass system prevents damage to the hydraulic cylinder



371-72000

Ascot No.	Mfg. No.	Capacity	Low Lift	High Lift	Caster Wheel Dia.	Chassis Width	Chassis Length	Saddle Width	Saddle Length	Weight
371-72001	7200Di	1-1/2-Ton	7-3/4"	35-2/4"	4"	26-1/2"	44-1/2"	10-1/4"	15-1/4"	302 Lbs.
371-72000	72000D	1-1/2-Ton	7-3/4"	36-1/2"	4"	25"	45"	10-1/4"	11"	310 Lbs.

### 1-1/2-Ton Capacity Under Hoist Transmission Jacks

- Fully adjustable universal saddle with adjustable corner brackets and safety chain
- Safety overload system prevents jack from being used beyond rated capacity
- Foot operated pump and lowering pedals
- Two-stage flash chromed rams inhibit rust from entering hydraulic system
- 371-72550 same as 371-72500 but with 2 times faster rising action without the load and 2 times faster rising action with a load up to 400 Lbs.

Ascot No.	Mfg. No.	Capacity	Min. Height	Max. Height	Ship Weight
371-72501	72500E	1/2-Ton	38-1/2"	75"	176 Lbs.
371-72550	72550B	1/2-Ton	38-1/2"	75"	178 Lbs.



371-72501  
(1/2 Ton)

371-72550  
(1/2 Ton)

## Transmission Jacks (Cont.)

### 1-Ton Capacity Hydraulic Transmission Jack

- Designed for the removal, installation and transportation (in the lowered position) of heavy duty truck transmissions that are raised by an above-ground lift
- Air/hydraulic foot pump for hands free operation
- Fully adjustable universal saddle with adjustable arms
- Heavy duty chain with chain tensioner to secure load to saddle



371-72701

Ascot No.	Mfg. No.	Capacity	Min. Height	Max. Height	Ship Weight
371-72701	72701	1-Ton	41-1/4"	69-3/8"	273 Lbs.

### Transmission Jack Adapters

- Adapters fit transmission jacks 72050C, 72500E and 72550B



309-72508



309-72525



309-72507

Ascot No.	Mfg. No.	Capacity
309-72501	72501B	Adapter For Use On GMC 4-Wheel Drive Transmission Case. Weight 18 Lbs.
309-72502	72502B	Adapter For Use On 4 and 5 Speed Truck Transmissions. Weight 13 Lbs.
309-72504	72504B	Adapter For Use On GMC Front Wheel Drive Transmissions. Weight 24 Lbs.
309-72505	72505B	Adapter For Use On GMC Front Wheel Drive Transmissions (X, J and A Bodies) 3T40. Weight 15 Lbs.
309-72506	72506B	Adapter For Use On GMC 440 Metric Transmissions 4T60-E. Weight 11-1/2 Lbs.
309-72507	72507A	Adapter For Use On Ford 640E & 4R100 (4WD) Truck & Van Transmissions
309-72517	72507B	Adapter For Use On Ford E40D Truck Transmissions. Weight 34 Lbs.
309-72508	72508	Fuel Tank Adaptor
309-72525	72525	Optional Saddle That Replaces the Four Adjustable Corner Brackets Found on Standard and Universal Saddle

### 1-Ton Floor Style Transmission Jack

- Wishbone design allows unit more mobility
- Wide stance tubular steel frame equipped with a 4 ball bearing 360° swivel casters
- Two heavy cast adjustable mounting plates and load restraint chain
- Built in relief valves prevent overloading
- 2 Year Warranty



Ascot No.	Mfg. No.	Capacity	Min. Height	Max. Height	Chassis Length	Chassis Width	Forward Tilt	Rear Tilt	Sideway Tilt	Weight
371-93718	HW93718	1-Ton	10"	44"	48"	29-7/8"	40°	15°	10° L & R	309 Lbs.

## Transmission Jacks (Cont.)

### Telescopic Transmission Jack

- First stage utilizes air for a quick initial rise
- Second stage uses hydraulic hand pump for precise control
- Four ratcheting brackets fit transmission pan flanges
- Hefty nylon safety strap helps anchor transmission
- Wide spread casters for smooth maneuverability
- Head adjustments made easy with big easy-to-grip crank handles
- Optional adapters available
- 2 Year Warranty



Ascot No.	Mfg. No.	Capacity	Min. Height	Max. Height	Lifting Head Height	Chassis Length	Chassis Width	Forward Tilt	Rear Tilt	Sideway Tilt	Weight
371-93720	HW93720	1/2-Ton	34-1/2"	75"	11-1/2" x 11-1/2"	41"	41"	50°	20°	10° L & R	118 Lbs.

### Telescopic Transmission Jack

- Chrome-plated rams maximize its high reach operated by a user friendly foot pedal
- Extra-wide base lowers center of gravity and promotes stability
- Rugged steel wheels and full swivel ball bearing caster
- Adjustable ratchet style saddle (Model 41000 and 41001)
- A unique release pedal provides safety in lowering the load
- Model 41000 and 41001 are 2 stage manual
- Model 41001 is Air Actuated and requires 90 – 175 PSI



371-42003



Ascot No.	Mfg. No.	Capacity	Min. Height	Max. Height	Saddle Base	Min. Exp. Saddle Area	Max. Exp. Saddle Area	Jack Size	Weight
371-41000	41000	1/2-Ton	37-7/8"	77-5/8"	8-7/8" x 7-1/8"	11-1/2" x 11-1/2"	21" x 21"	34-1/8" x 36-1/8"	180 Lbs.
371-41001	41001	1/2-Ton	37-7/8"	77-5/8"	8-7/8" x 7-1/8"	11-1/2" x 11-1/2"	21" x 21"	34-1/8" x 36-1/8"	196 Lbs.
371-42003	42003	1-Ton	48-5/8"	77-3/8"	15-1/2" x 12-5/8"	15-1/2" x 12-5/8"	24-1/2" x 18-7/8"	42-1/2" x 39-1/2"	306 Lbs.

### Floor Style Telescopic Transmission Jack

- The adjustable head can be tilted forward, backward and side to side for optimum alignment of transmission bolt pattern and pins
- Hydraulic system is protected from internal damage by a patented by-pass mechanism
- Load-restraining chain is vital for raising and lowering safety
- Four wheel casters allow easy movement, positioning of transmission jack
- Rugged steel wheel and full swivel ball bearing caster
- User friendly 360° rotating pumping socket for maximum in directional operation



371-42000

Ascot No.	Mfg. No.	Capacity	Min. Height	Max. Height	Saddle Base	Handle Length	Exp. Saddle Area	Jack Size	Weight
371-42000	42000	1-Ton	7-7/8"	33-1/2"	8-7/8" x 7-1/8"	22-1/2"	17" x 15-3/4"	39-3/8" x 18-1/8"	198 Lbs.
371-43000	43000	1-1/2-Ton	7-7/8"	37-1/4"	8-7/8" x 7-1/8"	29-1/2"	24-7/8" x 19"	46-3/4" x 25-5/8"	377 Lbs.

## Wheel Dollies

### 3/4-Ton Capacity Hydraulic Wheel Dolly

For the removal and installation of single, tandem and duplex tires and wheels which are mounted on trucks that are supported above ground level.

- Heavy duty lift arms made with ball bearing conveyor rollers which allow easy rotation of wheels for alignment with bolt pattern
- 7-1/2" of side-to-side lift arm adjustment eliminates the trial and error method of aligning the rim's lug holes with the wheel drum
- A 1500 pound capacity heavy duty winch with 5 to 1 gear ratio provides ease of operation
- The winch gear design acts as a brake and allow the load to be lowered incrementally if desired and without the need of constant hand pressure against the crank handle
- A hydraulic jack tilts the lift arms in order to match the angle of the spindle
- Safety chain provided to secure tires and wheels to the dolly
- Maneuverability is made easy by means of two rear mounted ball bearing swivel caster wheels. The caster wheels include a locking mechanism which can prevent the dolly from moving
- 82304 has the same great features as the 82302B but also includes and air-operated pump that allows the unit to lift the load effortlessly



407-82304



407-82302

Ascot No.	Mfg. No.	Description
407-82302	82302B	Wheel Dolly
407-82304	82304	Wheel Dolly-Includes Air-Operated Pump

### 3/4-Ton Wheel Dolly

- For handling of dual wheels and large single wheels
- Handles up to 52" diameter tires and wheels
- Load levelers aid alignment
- Carriage arm rollers with self-lubricating bearings
- 2 swivel ball bearing casters for easy positioning
- Wide frame and lifting carriage
- Handy tool/parts tray on frame
- 2 Year Warranty



407-93765



Ascot No.	Mfg. No.	Capacity	Lift Range	Arm Length	Arm Spread	Overall Length	Overall Width	Overall Height	Weight
407-93765	HW93765	3/4-Ton	2-3/8" x 7-7/8"	23"	24"	37-1/2"	36-1/2"	31"	118 Lbs.

### Super Single Truck Dolly

- Easy installation and de-installation of truck wheel assemblies
- 1 man control
- Heavy-duty industrial bearings
- 3 positions for rollers depending on size of wheel
- Great tool for every service truck
- Avoid damage to wheel bolts and expensive modern rims
- For all wheels from 6.5 – 22.5"



Ascot No.	Mfg. No.	Cap. kg/lbs.	G.W. kg/lbs.	N.W. kg/lbs.
407-47115	G471105	250/551	12/26.5	11.2/24.7

### Truck Wheel Dolly

- Tire/wheel is rotated left or right on tiltable roller pads for perfect stud alignment
- Perfect for 8-10 hole Budd type wheels
- Removes truck wheels and tires fast and easy
- Increases productivity
- Reduces manpower needs
- Saves time and money - maintenance free
- Heavy duty tubular construction lifts 280 Lbs.
- 3" caster wheels roll the truck wheels for effortless removal or replacement

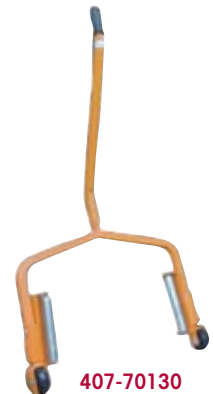

407-70130

Ascot No.	Mfg. No.	Description
407-70130	70130	Truck
407-70132	70132	Super Single

## Underhoist Stands

### Underhoist Stands

- Sturdy, welded steel construction for superior safety and strength
- Ideal to support the exhaust system, shock absorber and other vehicle components during an under vehicle repair. Not designed to support vehicle
- Acme screw allows for precise height adjustment



Ascot No.	Mfg. No.	Capacity	Min. Height	Max. Height	Saddle Size	Base Size
302-31500	31500	3/4-Ton	53-5/8"	79-1/8"	5-1/4" x 1-5/8"	12" Diameter
302-31501	31501	3/4-Ton	53-5/8"	79"	5-1/4" x 1-5/8"	12" Diameter
302-33020	33020	2-Ton	67"	76"	5-1/4" x 1-5/8"	24" x 24" x 24"

### 20-Ton Capacity Trailer Stabilizing Stands

- Meets OSHA requirements for supporting trailers when loaded or unloaded
- 14" diameter base provides maximum leveling stability
- Quick adjust spin handle for ease of turning
- Large diamond plate saddle to grip the load



Ascot No.	Mfg. No.	Capacity	Low Height	Extended Height	Base Size	Saddle Size	Shipping Weight
302-81022	81022A	20-Ton	39"	50-5/8"	14" Diameter	4-1/2" x 5"	52 Lbs.

### 3/4-Ton Under Trailer Hoist Stands

- Lightweight, slender design
- Quick adjust spin handle with thrust bearing eliminates wear and provides ease of turning load
- Foot pedal (81034A only) generates 1" additional stroke and 400 Lbs. of force at the saddle
- Pedal may be locked in vertical position for storage or shipment 1-1/4" diameter acme threaded screw has 26-1/4" travel



Ascot No.	Mfg. No.	Capacity	Low Height	Extended Height	Base Size	Saddle Size	Shipping Weight
302-81033	81033A	3/4-Ton	55-1/4"	81-1/2"	12" Diameter	1-5/8" x 5-1/4"	35 Lbs.
302-81034	81034A	3/4-Ton	55-1/4"	81-1/2"	12" Diameter	1-5/8" x 5-1/4"	39 Lbs.
302-81035	81035A	1-1/2-Ton	48-7/8"	85-3/8"	12"x12"x12"	3-1/4" x 3-1/4"	39.5 Lbs.

## Lifting Equipment Accessories

### Hydraulic Jack Oil

Ascot No.	Mfg. No.	Description
309-93291	93291	Hydraulic Jack Oil - 1 Quart
309-93294	93294	Hydraulic Jack Oil - 1 Gallon





## Hydraulic Shop Presses

### 12 and 20-Ton Capacity Hydraulic Shop Press

- Manual pump power unit with access hole to adapt optional models
- Gauge, hydraulic pump, hose and fittings are included
- Pair of beds included
- Shielded heavy duty ram return springs
- Hydraulic power unit is bearing mounted for horizontal movement on head channel
- Zero distortion, heavy duty structural steel frame



317-78022

Ascot No.	Mfg. No.	Capacity	Ram Travel	Throat Min.	Height Max.	Throat Width	Bed Height Adjustment	Between Uprights	Between Bed Rails	Weight
317-78013	78013A	12-Ton	5-7/8"	5"	38-1/4"	25"	8 x 4-3/4"	5"	6"	266 Lbs.
317-78022	78022D	20-Ton	6-5/8"	7-1/8"	35-1/2"	30"	7 x 3-3/4"	6"	7"	394 Lbs.

### Arbor Plates

- For use with Norco 12 and 20-ton shop presses only
- 1" x 4" x 10" long steel plates with "V" cutout on one edge and circle cutout on the other



Ascot No.	Mfg. No.	Weight
317-78000	78000	20 Lbs.



### Hydraulic Gauge With Fitting

- For use with Norco 12 and 20-ton capacity shop presses only
- 4" diameter face
- Dial indicates internal pressure (PSI) and corresponding pounds of force at ram end
- Accurate within 2-1/2%
- 1/4" NPT fitting



Ascot No.	Mfg. No.	Weight
317-78021	78021	2 Lbs.

### 50 and 100-Ton Capacity Hydraulic Shop Press

- For heavy duty use in truck garages and industrial work shops
- Manually operated two speed pump provides quick ram travel to load
- Hand operated winch raises and lowers press bed
- Liquid filled gauge measures ram force in pounds and tons
- Self-retracting ram is bearing mounted for lateral movement on head channel
- 78057A features air/hydraulic foot pump and 10' hose
- 78058A and 78110B feature electro/hydraulic pump



317-78058

Ascot No.	Mfg. No.	Capacity	Ram Travel	Throat Min.	Height Max.	Throat Width	Bed Height Adjustment	Between Uprights	Between Bed Rails	Weight
317-78055	78055A	50-Ton	6-1/4"	7-1/2"	32-5/8"	34-1/2"	7 x 5"	5-5/8"	7-3/8"	804 Lbs.
317-78057	78057A	50-Ton	6-1/4"	7-1/2"	32-5/8"	34-1/2"	7 x 5"	5-5/8"	7-3/8"	801 Lbs.
317-78058	78058A	50-Ton	6-1/4"	7-1/2"	32-5/8"	34-1/2"	7 x 5"	5-5/8"	7-3/8"	814 Lbs.
317-78110	78110B	100-Ton	10-1/4"	18-1/4"	45-3/4"	40-1/4"	8 x 4-1/2"	5-5/8"	9"	1,777 Lbs.

Ascot No.	Mfg. No.	Capacity
317-78056	78056A	50-Ton Capacity Pair Of Arbor Plates. Weight: 108 Lbs.
317-78111	78111A	100-Ton Capacity Pair Of Arbor Plates. Weight: 153 Lbs.

## Heavy Duty Equipment

### Brake Drum Handler

- Ideal for removing and installing truck brake drums
- Works with 15" and 16-1/2" drums
- Includes detachable handle for convenient storage

Ascot No.	Mfg. No.
407-46000	46000



### Back Buddy II

- Designed to prevent injuries from awkward lifting
- Rolls under and bolts on to heavy brake drum and hub assemblies, then rolls the assembly out and lays it over for servicing
- Re-assembly is quick and precise because the Back Buddy II angles for perfect hub alignment, eliminating seal damage and costly fixes
- Handles all hub and drum assemblies with Universal Receiver and Adapter Sets. A simple change of adapters transforms the tool in seconds from an inboard hub/drum lifting device to an outboard drum or spoke lifting device

Ascot No.	Mfg. No.
407-00350	350B



### Brake Drum Handler

- Designed for removing and installing and transporting outboard mounted brake drums and inboard mounted drums with disc wheel hubs
- Reduces lost-time injuries
- Handles 15" and 16-1/2" drums
- Machine rotating handle provides ease of raising and lowering drum
- Ball bearing wheels, semi-pneumatic tires and 3/4" diameter axle provide easy maneuverability and balance of the drum
- Adjustable angle bracket secures both outboard and inboard mounted drums with disc wheel hubs to the drum handler's carriage
- Detachable handle for convenient storage

Ascot No.	Mfg. No.	Low Lift Height	High Lift Height	Overall Width	Overall Length	Wheel Diameter	Weight
407-72040	72040A	10-1/4"	15-1/4"	21"	62-1/2"	8"	58 Lbs.



## Shop Cranes

### 1/2, 2 and 3-Ton Capacity Shop Cranes

- Four adjustable legs provide greater stability
- 1/2 and 2-ton are boom retracted
- 3-ton available in either air/hydraulic or electro/hydraulic
- Designed to raise, lower and transport engines, transmissions, differentials and other heavy loads with minimal effort
- 1/2-ton truck crane mount in the bed of truck or on loading dock



331-78106



331-78204



331-78600

Ascot No.	Mfg. No.	Boom Capacity @ Length	Boom Height Minimum	Boom Height Maximum	Leg Extension	Overall Dimensions (HxWxL)	Weight
331-78106	78106A	2-Ton @ 44-3/4"	0"	90-1/2"	83-1/2"	80-3/4" x 45-1/4" x 83-1/2"	366 Lbs.
331-78204	78204A	1/2-Ton @ 46-1/4"	0"	68-1/2"	N/A	64" x 14" x 46-1/4"	180 Lbs.
331-78600	78600B	3-Ton @ 65"	13"	149-1/2"	49", 65", 81"	90-1/2" x 51" x 75"	1,150 Lbs.
331-78605	78605A	2-1/2-Ton @ 81"	13"	149-1/2"	49", 65", 81"	90-1/2" x 51" x 75"	1,182 Lbs.

# TIRE & WHEEL SERVICE

Mounting Compounds  
Bead Breaking Equipment  
Bead Seating and Inflation Devices  
Tire Service Supplies  
Tire Specialty Tools





**TOOLS DESIGNED BY TIRE PROFESSIONALS  
FOR TIRE PROFESSIONALS**



11010



11000



11070



15920



15001



15000



## Tire Lubricants

### Ascot Tire and Tube Mounting Compound

- Now with rust inhibitor
- Makes tire mounting and dismounting faster and easier
- Approved by major rubber companies
- Lubricates all rubber parts—stops rubber squeaks



432-02028

432-02029



Ascot No.	Mfg. No.	Description
432-02028	2028	Tire/Tube Mounting Compound, 8 Lbs. Pail
432-02029	2029	Tire/Tube Mounting Compound, 25 Lbs. Pail
432-02035	2035	Tire/Tube Mounting Compound, 40 Lbs. Pail
432-02012	2012	Tire/Tube Mounting Compound, 125 Lbs. Drum
432-02022	2022	Tire/Tube Mounting Compound, 445 Lbs. Drum
437-00491	-	Swab - For All Center Posts And Rim Clamps
437-20366	-	Swab - For Models 5000, 6000, 9000
437-00001	TS-1	Swab - 11" OAL x 2" Diameter
437-00002	TS-2	Swab - 15" OAL x 2" Diameter
437-00003	TS-3	Swab - 18" OAL x 3" Diameter

### No Rim Rust

- Protects tires. Tire bead won't fuse to rim
- Helps prevent corrosion on rims and rigs
- Helps you comply with OSHA Regulation 3086



Ascot No.	Mfg. No.	Capacity
435-00015	FL4-1	4-1/2 Lbs. Pail
435-00125	FL25-1	25 Lbs. Pail
435-01120	FL120-1	120 Lbs. Drum



### Universal Mounting Paste

- Makes mounting and demounting tires easier and faster and helps alleviate stress on and damage to the bead area of tires
- Tire mounting paste applies with a sponge and will not corrode or discolor aluminum or alloy wheels, won't freeze or harden
- Rubber Lubricant is a liquid concentrate that makes one gallon of rust-inhibiting water-based mounting lubricant

Ascot No.	Mfg. No.	Description	Units/Box
432-00720	72	Rema Rubber Lubricant, 16 Oz. Can, Concentrate	12
432-00730	73	Mounting Paste Brush for Car/Light Truck	1
432-00731	73T	Mounting Paste Brush for Trucks	1
432-00740	74	Universal Mounting Paste, 22 Lbs.	1
432-00750	75	High Profile Universal Mounting Paste, 7.7 Lbs.	1
432-01750	75N	Low Profile Universal Mounting Paste, 7.7 Lbs.	1
432-00751	75B	Bracket For Mounting Paste	1
437-00001	TS-1	Swab - 11" OAL x 2" Diameter	1
437-00002	TS-2	Swab - 15" OAL x 2" Diameter	1
437-00003	TS-3	Swab - 18" OAL x 3" Diameter	2



### Murphy's Non-Rust Rim-Kote

- Contains no petroleum - prevents rim rust and scale
- Acts as tire mounting lubricant - prevents tire bead "freezing"
- Great for seating tubeless bias, belted and radial tires
- Recommended for mounting tires on heavy duty trucks, buses and off-the-road vehicles



Ascot No.	Mfg. No.	Description
434-02020	2020	Liquid-Lube, 1-Gallon
434-02105	2105	Non-Rust Rim-Kote, 7 Lbs. Can
434-02110	2110	Non-Rust Rim-Kote, 25 Lbs. Pail
434-02120	2120	Non-Rust Rim-Kote, 40 Lbs. Pail

### Black Rim Rust Retardant & Tire Lube



Ascot No.	Mfg. No.	Description
435-06001	065-2539	Black Rim Rust Retardant Tire Lube (6 - 5 Lbs.)
435-06002	025-2539	Black Rim Rust Retardant Tire Lube (25 Lbs.)
435-06003	040-2539	Black Rim Rust Retardant Tire Lube (40 Lbs.)
435-06004	120-2539	Black Rim Rust Retardant Tire Lube (120 Lbs.)
435-07001	041-2541	Tire Mounting & Rubber Lubricant (4 Gal.)
435-07002	005-2541	Tire Mounting & Rubber Lubricant (5 Gal.)
435-08001	048-2540	Tire Mounting & Rubber Lubricant Paste (8 Lbs.)
435-08002	025-2540	Tire Mounting & Rubber Lubricant Paste (25 Lbs.)
435-08003	040-2540	Tire Mounting & Rubber Lubricant Paste (40 Lbs.)

## Tire Service Supplies

### Paintstik® Markers



- Real paint in stick form
- Ideal for coding tire casings
- Marks are long lasting, water resistant and weather resistant
- Marks will withstand vulcanizing and recap temperatures
- Non-toxic, contains no lead
- Marking range -50°F to 150°F (-46°C to 66°C)
- 12 sticks per box, 12 boxes per case

Ascot No.	Color	Ascot No.	Color
459-80257	White	459-80227	Pink
459-80258	Yellow	459-80228	Purple
459-80222	Red	459-80229	Brown
459-80223	Black	459-80230	Gray
459-80271	Orange	459-80231	Gold
459-80225	Blue	459-80232	Aluminum
459-80226	Green		

### Markal Crayon

- Ideal for temporary marking of tires
- Marks easily on wet or cold surfaces
- Lead-free, zinc-free marks can be painted over
- Size: 1/2" X 4-5/8"
- Marking range: -20°F to 130°F (-29°C to 24°C)
- 12 sticks per box, 12 boxes per case



Ascot No.	Mfg. No.	Description
459-54221	51422	Red Crayon
459-54222	51421	Yellow Crayon
459-54220	51420	White Crayon

### B Hex White Tire Paintstick

- Ideal for temporary marking of tires
- Marks easily on wet or cold surfaces
- 12 sticks per box, 12 boxes per case



Ascot No.	Mfg. No.	Description
459-80250	80250	B Hex White Tire Paintstick

### Paintstik® Marker Holder



Ascot No.	Mfg. No.	Description
459-85000	85000	5" Metal Holder for Paintstik Marker
459-85100	85100	6" Push-Button Metal Holder for B-Paintstik

### E-Z Break Anti-Seize Compound-Copper Grade

- Prevents lug nuts from rusting to wheel studs
- Prevents seizing of aluminum wheels to steel brake drums or rotors
- Will not wash off in rain or snow
- Other applications include head bolts, exhaust manifolds and muffler connections, brackets and engine bolts
- Withstands temperatures to 1800°F (982°C)



Ascot No.	Mfg. No.	Description
494-01010	08910	10 Oz. Can With Brush in Cap
494-08916	08916	14 Oz. Aerosol Can
494-08907	08907	16 Oz. Can with Brush in Cap
494-08930	08930	2.25 Oz. Stick

### Penetrants/Air Leak Detector

- PB Blaster quickly breaks loose the surface tension of frozen parts and protects against further and corrosion



Ascot No.	Mfg. No.	Description
408-00016	16PB	Blaster Penetrating Catalyst, 11 Oz.
328-05001	022-1071	Ultra Pen Lube 2000 Penetrant Lubricant, 1- 22 Oz.
328-05003	001-1071	Ultra Pen Lube 2000 Penetrant Lubricant, 1 Gal.
328-05005	005-1071	Ultra Pen Lube 2000 Penetrant Lubricant, 5 Gal.
433-35805	35805	Detecto Mist Air Leak Locator, 1 Qt.

### Sure Shot Pressure Sprayers

- Air pressurized and refillable
- Environmentally safe - eliminates aerosol usage
- For brake and parts cleaner, penetrating oils, lubricants, degreasers, solvents
- Made in USA



Ascot No.	Mfg. No.	Description
632-01002	A1002	Black Enameled Steel Sprayer With Adjustable Plastic Nozzle
632-02000	A2000	Plated Brass Sprayer
632-10001	A1000R	Enameled Steel Sprayer - Red
632-10002	A1000G	Enameled Steel Sprayer - Green
632-00005	K-5	Partial Repair Kit For Model A
632-00010	K-10	Complete Repair Kit For Model A

## Tire Sealants

### STS Tire Sealant

Ascot No.	Mfg. No.	Capacity
<b>STS TIRE SEALANT</b>		
451-00248	STS-CS24-8	(24) 8 Oz. Cartridges
451-04128	STS-CS4-128	(4) 1-Gallon/Case
451-00640	STS-640	5-Gallon Pail
451-00006	STS-6G	6-Gallon Pail
451-00055	STS-55G	55-Gallon Drum
<b>STS CONCENTRATE TIRE SEALANT</b>		
451-01248	STS-CON-CS24-8	(24) 8 Oz. Cartridges
451-14128	STS-CON-CS4-128	(4) 1-Gallon/Case
451-01640	STS-CON-640	5-Gallon Pail
451-00026	STSCON-6G	6-Gallon Pail
451-00155	STS-CON-55G	55-Gallon Drum
<b>STS OTR TIRE SEALANT</b>		
451-24128	STS-OTR-CS4-128	(4) 1-Gallon/Case
451-02640	STS-OTR-640	5-Gallon Pail
451-00036	STSOTR-6G	6-Gallon Pail
451-00255	STS-OTR-55G	55-Gallon Drum

### Chemical Bead Boss

- Very slippery for easy mounting or dismounting
- Contains anti-rust chemicals for preventing rim rust at the bead area
- Easy release of the bead for removing the tire
- Can be diluted with water up to 1 to 8 (1:8) for lubricant purposes only
- Does not damage the bead
- Used as a sealant to seat and seal bead on tire beads



Ascot No.	Mfg. No.	Capacity
504-10080	CS-80	(4) 1-Gallon Plastic Containers
504-10085	CS-85	5-Gallon Pail
504-10090	CS-90	55-Gallon Drum

### Chemical Flat Stop

- Instant puncture protection-repairs any pneumatic, tubeless or tube tire
- Prevents flats from cactus needles, thorns, stickers and most small nails
- Prevents high pressure and rim leaks
- Not harmful to rubber or cord and will not affect wheel balance



Ascot No.	Mfg. No.	Capacity
504-30035	FS-35	(4) 1-Gallon Plastic Containers
504-30050	FS-50	5-Gallon Pail
504-30065	FS-65	55-Gallon Drum
504-30010	FS-15	Applicator Pump w/1 6" Hose
504-20505	MR-50-5	Pump Fits 5-Gallon Pail With 1 Ft. Hose
504-20050	MR-50	Barrel Pump Fits 55-Gallon Drum

### STS Tool and Accessories



Ascot No.	Mfg. No.	Capacity
451-00101	ST-XM-1	1-Gallon Hand Pump
451-00440	ST-XM-44	5-Gallon Hand Pump
451-00005	5-FAVA-5	5-Gallon Pneumatic Pump
451-00550	5-FAVA-55	55-Gallon Pneumatic Pump
469-02311	VCR-A	Auto Valve Core Tool
469-02312	VCR-F	Farm Valve Core Tool
451-00707	ST-TTS-WW	STS Display Stand

### Chemical Shur Seal

- For tubeless tires
- Seals rim, bead leaks, hard-to-find slow leaks
- Reduces ply separation in new and recapped tubeless tires
- Ends need for tubes in recapped tubeless tires
- Helps keep tires fully inflated



Ascot No.	Mfg. No.	Capacity
504-20024	SS-24	(24) 4 Oz. Bottles
504-20060	SS-60	(4) 1-Gallon Plastic Containers
504-20053	SS-53	5-Gallon Pail
504-20070	SS-70	55-Gallon Drum
504-20010	CR-10	Applicator Pump w/1 6" Hose & Choke Valve
504-20505	MR-50-5	Applicator Pump Fits 5-Gallon Pail With 1 Ft. Hose
504-20050	MR-50	Barrel Pump Fits 55-Gallon Drum

**Tire Sealants (Cont.)**

**EcoSeal**

- Permanently seals punctures up to 1/4"
- Prevents wheel corrosion
- Uses recycled rubber and 100 percent biodegradable ingredients
- Non-combustible by NFPA standards (flashpoint over 700°F)
- Low freeze point (-10°F)
- Freeze/thaw stable

Ascot No.	Mfg. No.	Description
504-00005	ECO5G	5-Gallon Pail
504-00055	ECO55G	55-Gallon Drum
504-00275	ECO275G	275-Gallon Tote
451-05510	ST-XM55	5-Gallon EcoSeal Hand Pump



**Tire Brander**

**Electric Tire Brander**

- 110 volt and 220 volt electric versions available
- Propane brander also available
- 1" letters (A-Z) & numbers (0-9) sold separately
- Hardwood handle

Ascot No.  
452-01200



Tire Brander Letters



Tire Brander Numbers

**Tire Brander End-Lock**

Ascot No.  
452-00300



**Serial Number Removal Tool**



531-95001



531-95002



Ascot No.	Mfg. No.	Description
531-95001	TTHB-1	Serial Number Remover Tool
531-95002	RRB-1	12-Pack Replacement Blades

**Tire Regrooving Tools & Accessories**



455-12500



455-00003



Ascot No.	Mfg. No.	Description
455-00003	RC400	Rubber Cut 400 Rema Regroover
455-00401	W-1	Regroover Blades 20-Pack
455-00402	W-2	Regroover Blades 20-Pack
455-00403	W-3	Regroover Blades 20-Pack
455-00404	W-4	Regroover Blades 20-Pack
455-00405	W-5	Regroover Blades 20-Pack
455-00406	W-6	Regroover Blades 20-Pack

Ascot No.	Mfg. No.	Description
455-12500	125	Heavy Duty Pistol Grip Tire Groover
455-00444	No. 4 Head	Replacement Head for No. 125 Groover
455-04444	No. 4 Bld.	Replacement Blades for 125 Groover



## Bead Breakers

### "Combi" Tire Bead Breaker

- Works on a single, two and three-piece truck, agricultural and earthmover tire/rim
- Breaks beads in seconds using 10,000 Lbs. of force
- No screws, bolts or attachments
- "Combi" bead breaker will not work on five-piece earth mover giant wheel/rim



422-12000



422-12020



422-16200

422-11010

Ascot No.	Mfg. No.	Description
422-11010	11010	Bead Breaker
422-16200	16200	Conversion Kit for Combi Bead Breaker
422-12000	12000	Bead Breaker Kit includes: 11010 Bead Breaker, 15000 Pump and 16040 Hose Assembly
422-12020	12020	Bead Breaker Kit includes: 11010 Bead Breaker, 15920 Pump and 16040 Hose Assembly

### Giant Tire/Earthmover Tire Bead Breaker

- Use on 5-piece rims 15" to 51" without pry bar/bead loosening pockets
- Model 15000, 1520 or 15040 air/hydraulic pump recommended for operation
- Replaces Goodyear TO-100-HA

Ascot No.	Mfg. No.
422-11040	11040



### Giant Tire/Earthmover Tire Bead Breaker

- Use on 5-piece rim 25" to 51" with pry bar/bead loosening pocket
- Replaces Goodyear TO-1600-HA
- 4-1/4" stroke, 14-ton ram will break the toughest beads
- Same as IMT-1800
- Model 15000, 15020 or 15040 air/hydraulic pump recommended



422-11000

Ascot No.	Mfg. No.	Description
422-11000	11000	Bead Breaker
422-12070	12070	Bead Breaker Kit includes: 11000 Bead Breaker, 15000 Pump, 16040 Hose Assembly
422-12090	12090	Bead Breaker Kit includes: 11000 Bead Breaker, 15920 Pump, 16040 Hose Assembly

### Dual Agricultural Tractor Tire Bead Breaker

- Heavy duty - 10-tons of force breaks the toughest beads
- Breaks inside bead on outside dual farm tractor tires
- Requires just 3" of operating space between dual tractor tires
- Use with 10,000 PSI air/hydraulic pump
- No need to remove outside wheel to change tire on outside dual

Ascot No.	Mfg. No.
422-11060	11060



### Giant Tire/Earthmover Tire Bead Breaker

- Use on all 39", 45", 49", 51", 57" and 63" wheel sizes
- In most cases you must first use Model 10105 or 10100 bead breaker to start the movement of the rim flange. Model 11030 can then be used
- Model 15020 or 15040 air/hydraulic pump recommended for operation
- Replaces Goodyear TO-2000-HA



Ascot No.	Mfg. No.	Description
422-10103	11030	Giant Tire Earthmover Bead Breaker
422-12110	12110	Kit Contains 11030 Bead Breaker, 15040 Pump And 16020 Hose Assembly

## Pumps & Bead Breakers

### Economy Air Hydraulic Pump

- Provides up to 10,000 PSI with standard shop air supply
- Reservoir made of durable aluminum
- Built-in pressure bypass system to prevent overload of operation
- User-friendly foot-actuated design for easy control of moving fluid



Ascot No.	Mfg. No.	Description
422-22903	22903	1.39 Quart Capacity
422-22905	22905	1.75 Quart Capacity



### "Maxi" Bead Breaker

- Newly redesigned bead breaker, works on ALL 3-piece wheels that replace older 5-piece wheels
- Designed to work on front or back of wheel with no attachments or accessories
- Unit clamps easily to wheel – no setup time



Ascot No.	Mfg. No.
318-11020	11020



### Turbo II Air Hydraulic Pump-3.5-Quart Oil Capacity

- Rugged polyglass reservoir with sight gauge
- 10,000 PSI hydraulic pressure
- Easily works on rams and bead breakers with oil to spare
- Unique design easily fits truck storage bins
- Turbo II pump-fastest pump available
- Redesigned air motor is inexpensive to service



Ascot No.	Mfg. No.	Capacity
318-15000	15000	3.5-Quart Air Hydraulic Pump
318-15010	15010	Above Pump With Hydraulic Hose
318-15020	15020	5-Quart Air Hydraulic Pump

### Stinger Bead Breaker

- OTR Bead Breaker for heavy duty 3-piece rims that replace standard 5-piece rims
- Works on both front and back of wheel without dismounting wheel from vehicle
- Works on all new 3 piece 25" wheels or larger
- Works on all wheels with CAT "Shur-Lok" safety feature



Ascot No.	Mfg. No.	Description
318-11090	11090	Stinger Bead Breaker



### Air Hydraulic Pump 5-Quart Oil Capacity

- Rugged 5 quart metal reservoir
- Air inlet filter keeps air clean
- All metal air motor
- 10,000 PSI hydraulic pressure



Ascot No.	Mfg. No.	Capacity
318-15920	15920	5-Quart Air Hydraulic Pump
318-15930	15930C	Air Hydraulic Pump w/Hose & Coupler

### "Maxi-Lite" Bead Breaker

- Lightweight Aluminum reduces weight by 40%
- Adjustable clamp allows for a perfect fit – regardless of the size of the wheel
- Unit delivers 10 Tons of force
- 2.75" (7 cm) stroke breaks beads, often with only one "bite"
- Model 11071 has increased length on jaws
- Model 11070-041 needed for some wheels with little clearance
- Weight – 31 Lbs. (14 kg)

Ascot No.	Mfg. No.
422-11070	11070



11070-041

### Air Hydraulic Pump 2-Gallon Oil Capacity

- Rugged 2-gallon metal reservoir
- 10,000 PSI hydraulic pressure
- Air inlet filter keeps air clean
- All metal air motor



Ascot No.	Mfg. No.	Capacity
318-15940	15940	2-Gallon Air Hydraulic Pump
318-15950	15950C	2-Gallon Air Hydraulic Pump w/Hose & Coupler

**Ask About Our Tire Bead Breaker and Hydraulic Pump Repair Program.**

## Hydraulic Rams and Accessories

### Hydraulic Rams

- Used to push off rear rim flange and tire bead on earthmover wheels
- For all earthmover tires, trucks and perfect for construction



Ascot No.	Mfg. No.	Capacity (Tons)	Stroke	Retracted Height
422-13010	13010	10	2-1/8"	4-3/4"
422-13020	13020	10	4"	6-3/4"
422-13030	13030	10	6-1/8"	9-3/4"
422-13040	13040	10	8"	11-3/4"
422-13050	13050	10	10-1/8"	13-3/4"
422-13060	13060	30	2-7/16"	4-5/8"
422-13090	13090	25	8-1/4"	12-3/4"
422-13100	13100	25	6-1/4"	10"

### Hydraulic Hose Assemblies

- 8 or 10 feet in length
- Swivel fittings, hose won't kink
- Reinforced with 2 layers of braided steel
- Use with any 10,000 PSI pump, ram and bead breaker



Ascot No.	Description
318-04960	8 Ft. with Half Coupler
318-04120	10 Ft. with Half Coupler



### 55-Ton and 100-Ton Aluminum Rams

- Lightweight yet durable
- For use with 10,000 PSI pumps
- Ships completely assembled with valve, coupler and base
- Perfect for off highway truck work
- The preferred jack for road service



318-13080

318-13120

318-13000

318-13140

Ascot No.	Mfg. No.	Recommended Pump	Weight Capacity	Collapsed Height	Extended Height	Weight
318-13080	13080	15930C	55-Tons	12"	18"	32 Lbs.
318-13120	13120	15930C	55-Tons	12-1/4"	18-1/4"	29 Lbs.
318-13000	13000	15930C	100-Tons	11-3/4"	17-3/4"	38 Lbs.
318-13140	13140	15930C	100-Tons	16-1/4"	26-1/4"	53 Lbs.

### Hy-Flo Hydraulic Coupler

- Lightweight yet durable
- Includes ram and hose portions
- Interchanges with OTC, Power Team and ESCO hydraulic products



135-10606

135-10605

135-16000

Ascot No.	Mfg. No.	Description
135-16000	16000	Hy-Flo Hydraulic Coupler
135-10606	16060	Ram Female Half Coupler
135-10605	16050	Hose Male Half Coupler

### Quick Couplers

- Precision built and designed for high pressure
- Permits disconnecting without loss of oil
- 3/8" NPTF

Ascot No.	Mfg. No.	Description
318-09795	9795	Complete Quick Coupler
318-09796	9796	Ram Half Coupler And Dust Cap
318-09797	9797	Ram Half Coupler Dust Cap Only
318-09798	9798	Hose Half Coupler Only
318-09799	9799	Hose Half Coupler Dust Cap Only
318-09866	9866	Hose or Ram Half Dust Cap



319-09795



319-09796



319-09798



319-09797



319-09866

## OTR Service Tools & Accessories

### Flange Ring Puller

- Lifts the rim base and bead seat band from the tire
- Aids in bead seating during inflation
- Attaches to a standard boom style service truck
- 4 point hook/chain assembly for optimal lifting
- Chain lengths of 30" (76.2 cm)
- Includes 2 flat hooks and 2 tapered hooks to allow use on all rim styles
- Weight - 32 Lbs.

Ascot No.	Mfg. No.	Capacity
402-08029	93000	5,000 Lbs.



### 2-Way Push Bar

- Two-way push bar allows for quick and easy depression of the bead seat band flange ring and rim for removal of the lock ring and O-ring
- Can also be used to retain the tire during inflation

Ascot No.	Mfg. No.	Capacity
429-08837	92000	25" to 51"
429-06661	92005	33" to 57"



### Bead Hooks



429-00441

429-01601

Ascot No.	Mfg. No.	Description	Capacity
429-00441	B0441PC	Bead Hook	12,000 Lbs.
429-01601	D1601PC	Bead Hook	16,000 Lbs.

### Earthmover Tire Bead Hook

- Used to connect with hydraulic boom on tire service truck for transport of tires
- Model 94000 has slim design which will fit inside all tires – even ones that have been stacked
- Model 94000 – 5,000 Lbs. (2,260 kg) capacity
- Model 94020 – 12,000 Lbs. (5,400 kg) capacity
- Model 94010 – 16,000 Lbs. (7,250 kg) capacity



429-90403

429-90402

429-90401

Ascot No.	Mfg. No.	Capacity
429-90403	94000	4,000 Lbs.
429-90402	94020	12,000 Lbs.
429-90401	94010	16,000 Lbs.

### Bead Push Off Tool

- Lightweight tool for removing combine and tractor tires after breaking the bead
- Pushing force of 8,000 Lbs. and a 5.5" stroke, a removable handle for compact storage and uses hydraulic pressure to force the tire off the rim. Hooks between the rim and the tire bead



Ascot No.	Mfg. No.	Description
429-10108	11080	Bead Push Off Tool

### Tire Sling

- Adjustable locking sling for dismantling single or dual assembly tires
- With locking mechanism so tires don't rotate



Ascot No.	Mfg. No.	Capacity	Description
402-06662	91000	6,500 Lbs.	Small Sling Assembly

## Cribbing Sets

### Cribbing Set for 55-Ton Ram Nestling

Ascot No.	Mfg. No.	Description	Size
429-08075	15012	Cribbing Set	3"
429-08076	15022	Cribbing Set	6"
429-08077	15032	Cribbing Set	9"



429-08075

### Steel Crib Kit

- Durable Steel Cribbing – will not bend or warp
- Model 15002 is a complete set – 3", 6" and 9" stands
- Units can be nested together for 18" of total lift
- Recessed area on cribbing fits 7" square plate on 55 Ton Cylinders
- Each unit has carry handle

Ascot No.	Mfg. No.
429-08074	15002



### Super Stacker Cribbing

- Industrial cribbing blocks made from 100% Recycled plastic
- Provide superior strength compared to hardwood or softwood
- Provide visual warning of overload
- Interlocking and aggressive non-slip surfaces
- Non conductive plastic construction
- Carry lanyards provided on all 6x7 and 4x4 blocks
- Rated up to 198,000 Lbs. (depending on configuration)
- Testing paperwork available and can be filed on service truck

Ascot No.	Mfg. No.	Description
429-15255	15255	Kit includes (6) 15230, (3) 15210 and (1) 14465
429-15250	15250	Kit includes (3) 15230, (3) 15220 and (3) 15200
429-15260	15260	Kit includes (12) 15230 (140T capacity when used in 3 block configuration, pyramid mating)



429-15250



429-15255

## Bead Seating Devices

### 5-Gallon Cheetah Bead Seater

- Makes seating the most difficult bead safe and simple
- 5-gallon capacity
- Designed for commercial use on large truck tires, passenger and ATV tires to 24.5"
- Fill tank from any service station chuck or service truck air compressor

Ascot No.	Mfg. No.	Description
473-00500	CH-5	Cheetah Bead Seater - 5-Gallon
473-00501	CH5AL	Same As Above With Aluminum Tank



### 13-Gallon Cheetah Bead Seater

- 13-gallon capacity - ASME certified tank
- Seats bead on tractor & heavy equipment tires from 24.5" to 54"
- Includes a straight barrel, new Magnum barrel (for larger tires) and safety goggles as standard equipment
- Extends tire service capability not possible with portable unit

Ascot No.	Mfg. No.	Description
473-00012	CH-13	13-Gallon
473-00013	CH-13AL	13-Gallon With Aluminum Tank



### 10-Gallon Cheetah Bead Seater

- 10-gallon capacity with ASME certified tank
- Designed for small rear agri/grader or smaller tires
- Standard for fleet work, farm and service trucks

Ascot No.	Mfg. No.	Description
473-00010	CH-10	10-Gallon
473-00011	CH-10AL	10-Gallon With Aluminum Tank



## Bead Seating Devices (Cont.)

### Boa Constrictor

- Hammerless bead breaking system
- Uses a high pressure vacuum to literally "squeeze" the tire away from the wheel
- Eliminates the need for a hammer in the tire break-down process
- Ideal for aluminum & steel wheels
- Connects to any standard air line - perfect for on-the-road service



Ascot No.	Mfg. No.	Description
421-00004	BC-04	Bead Breaking System

### Tubeless Truck Bead Sealer O-Ring Type

- Helps seat beads that will not properly seat
- One-piece rubber tubes that fit over the rim between the beads and the rim flange, making a seal which allows the tire to be inflated
- Models available for both tubeless truck and passenger tires



Ascot No.	Mfg. No.	Description
471-20100	20100 (PC-1)	For Passenger Rim Size 13"-14"
471-20101	20101 (PC-2)	For Passenger Rim Size 14"-15"
471-20200	20200 (TC-50)	For Truck Rim Size 16.5"-17.5"
471-20202	20202 (TC-60)	For Truck Rim Size 19.5"
471-20204	20204 (TC-70)	For Truck Rim Sizes 22.5"-24.5"

### Bead Seater

- Provides an efficient and quick way to seat the beads of truck tires
- Easy to operate-twist valve with man-size handle
- Includes 8 feet of 1" diameter hose, hand-operated valve and choice of one ring-specify ring part number

Ascot No.	Mfg. No.	Description
473-00880	GB-8A	Bead Seater

### Pneumatic Bead Expanders

- Fits most bias ply passenger tires
- Pliable neoprene rubber tube encased in tough nylon cover
- Withstands contact with oil, grease, solvents and acid



Ascot No.	Mfg. No.	Min./Max. Dia.	Tube Dia.	Weight
471-31432	31432	24"-34"	2-1/4"	2.8 Lbs.
471-31433	31433	22"-32"	3/4"	.75 Lbs.

### B&J Standard Duty Bead Seating System

- Provides an efficient and quick way to seat the beads of truck tires
- Easy to operate-twist valve with man-size handle
- Includes 8 feet of 1" diameter hose, hand-operated valve and choice of one ring-specify ring part number

Ascot No.	Mfg. No.	Description
474-21373	31212	For Rim Sizes 14.5" To 16.5"
474-21372	31211	For Rim Sizes 17.5" To 19.5"
474-21371	31210	For Rim Sizes 20" To 24.5"
474-21374	31213	For Rim Sizes 17.5" Only
474-21375	31214	For Rim Sizes 22.5" Only
474-31701	31701	20 Gallon Surge Tank
474-31303	31303	8 Ft. Hose
474-31401	31401	1" Valve



## Chloride Pumps

### "Mini-Mite" Chloride/Methanol Pumper

- Double diaphragm 1/2" capacity pump
- No lubrication required - self-priming - non-stalling
- Aluminum alloy casting
- Simple, yet highly effective operating principal
- Muffler enclosed in body
- On/off ball valve - 1/2" brass quick couplers for fast flow reversal
- Two 10' hoses (250 Lb. rated)
- Air/water adapter and stainless steel strainer



**MOV-IT TIRE PRODUCTS** ○ ○ ○

Ascot No.	Mfg. No.	Description
475-00010	10A	Chloride/Methanol Pumper

### Calcium Chloride Pump

- Now available with polyvinyl valve (Model #10509) or anodized aircraft aluminum valve (Model #10509M)
- Pumps 34 gallons of calcium chloride per minute
- Newly designed valve will not leak
- Spring reinforced hoses for fill and evacuate
- Comes complete with valve adapters for all valves (large bore and standard)
- Gauges are protected
- Unit is portable or can be mounted in tire service trucks
- Double diaphragm pump, 1 to 1 ratio
- 10' hoses gives plenty of room to operate
- Includes hoses & calcium tire filled gun
- USA made pump



Ascot No.	Mfg. No.	Description
475-10509	10509	Calcium Chloride Pump with Polyvinyl Valve
475-11590	10509M	Calcium Chloride Pump with Aircraft Aluminum Valve

### "Wonder Pump" Pneumatic Double Diaphragm Calcium Chloride Pump

- No lubrication required
- Self-priming; non-stalling; low noise level
- Diaphragms have no stress points and "less flex" for longer life
- No gradual loss of pump performance due to wear
- Can run dry indefinitely
- Protected by an air filter/regulator
- 4-way valve - 1/4 turn reverses the flow - no need to change hoses
- 35 gallon per minute free flow



Ascot No.	Mfg. No.	Description
475-18001	30A Plus	1" Capacity Standard Package

### Valve Adapter Gun

- 1/2" female pipe thread
- Will attach to any calcium tire filling pump
- Will extract valve core from a standard bore valve or core housing from tractor valve
- Securely holds valve core or core housing up in the gun body during the filling or evacuation of liquid from tire

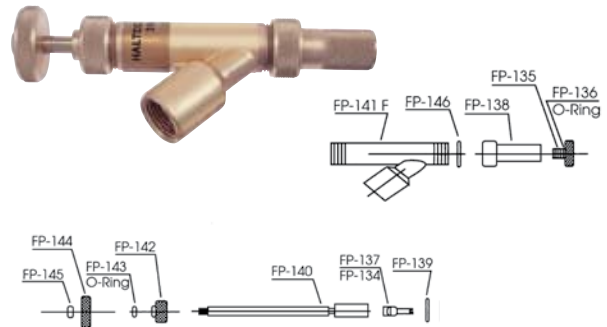

Ascot No.	Mfg. No.	Description
464-00310	310	Valve Adapter Gun
464-00134	FP-134	Large Bore Core Remover
464-00135	FP-135	Adapter For Standard Valve
464-00136	FP-136	O-Ring For FP-135
464-00137	FP-137	Standard Valve Core Remover
464-00138	FP-138	Ejector Union With FP-136 O-Ring
464-00139	FP-139	Gasket
464-00140	FP-140	Stem
464-00141	FP-141F	Adapter Body
464-00142	FP-142	Stem Sealing Nut
464-00143	FP-143	O-Ring For FP-142
464-00144	FP-144	Hand Wheel
464-00145	FP-145	Lock Nut
464-00146	FP-146	Teflon Gasket

## Tubeless Tire Irons

### Gaither's Bead Saver System

- Patented design
- By using simple principles of leverage, the Bead Saver System actually works with tire and rim to do the work for you
- Safest, fastest, easiest way ever invented to change tubeless truck tires
- Guaranteed not to damage tire beads



Ascot No.	Mfg. No.	Description
448-12880	12880	Bead Saver System

Ref. No.	Ascot No.	Description
1	448-12902	Clevis (Demounting Tool)
2	448-12883	Right Wing For Clevis
3	448-12884	Left Wing For Clevis
4	448-12897	Bolts For Clevis Wing (Set Of 2)
5	448-12903	Rollers For Clevis (Black & White Roller Including Pins)
6	448-12909	Wire Handle For Clevis (Includes Screws)
7	448-12892	On/Off Plate
8	448-12893	Wedge
9	448-12899	Beavertail
10	448-12901	Rollers For Beavertail (Set Of 2 Includes Screws)
11	448-12886	Lever Bar
12	448-22886	Crook End For Lever Bar
13	448-32886	Spoon End For Lever Bar
14	448-12894	Beadkeeper (1 Included In Standard Set)
15	448-12898	Clevis Assist (Not Included In Standard Set)
16	448-12900	Heavy Duty Carrying Case
17	448-12904	Gaither's Super Slick'em (Replacement Sold by The Case) - 4 Gallons w/Applicator
18	448-12905	Instructional Video (Available in PAL Also)

### Beadkeepers

- Old reliable beadkeeper with a new heavy duty plastic cover to protect aluminum wheels during the tire mounting process



448-12894 448-32894

Ascot No.	Mfg. No.	Description
448-22894	12894	Steel Beadkeeper
448-12894	12894-C	Rubber Head Beadkeeper
448-32894	12894-CS	Blue Wide Mouth Rubber Head Beadkeeper

### Golden Tool Tubeless Truck Tire Mount/Demount Tool

448-00202

- Demounts most tubeless tires in 8 seconds with ease - remount them in 20 seconds with equal ease - all without the need to lift tire and rim to remove rear bead
- Demounts/mounts 17.5" to 24.5" tires
- Use on all tubeless truck tires including super single/duplex tires, radial and bias
- For Dayton-type wheels (centerless) and Budd type disc wheels
- Eliminates the need to lift tire and rim to remove the bottom bead, preventing possible strain or even serious injury



Ascot No.	Mfg. No.	Description
448-00100	TNT-100	Tire Mount/Demout Tool Complete
448-00101	TNT-100-1	Demount Tool Only
448-01008	TNT-100-8	Roll Pins for TNT-9 (Need 2)
448-01009	TNT-100-9	Small Tire Roller (Need 2)
448-10010	TNT-100-10	Main Roller
448-10011	TNT-100-11	Roll Pin For TNT-100-1 (Need 1)
448-00200	TNT-200	Super Single Tire Mount/Demount Tool
448-00201	TNT-200D	Super Demount Tool
448-00202	TNT200M	Single Mount Tool
448-00301	TNT-300-1	New 445 Super Single Demount Tool

### Easy-Way™ Tubeless Truck Tire Demounting System

- Demount tubeless truck tire in 8 seconds
- Never lift tire to demount rear or bottom bead
- Eliminates bead damage
- Handles all tubeless truck tires 16.5"-24.5" diameter and some super single "floats"
- No damage to aluminum or painted wheels

Ascot No.	Mfg. No.	Description
402-70100	70100	Complete Kit
402-70101	70101	Top Bead Tool
402-70102	70102	Bottom Bead Tool
402-70103	70103	Rim Protector





## Mount/Demount Tools

### 37" Classic Tubeless Tire Iron

- Ken-Tool's patented designs offer one-piece construction and assure long life for many tire changing applications
- Tip ends insert easily and will not cut or rip bead or sidewall. These designs make it easier to mount and demount tires without changing the way the tool is used
- Mount end: Precision-forged knob grips rim. Tip designs won't slip during tire mounting. Special curve design always grabs the bead edge
- Demount end: Precision-forged angled tip slides between bead and rim easily. Forged design won't slip when demounting the second bead



Ascot No.	Mfg. No.	Length	Stock	Weight
402-34645	T45AC	37"	3/4"	4.6 Lbs.

### Tire Mount/Demount Irons

- Many sizes for use on truck, agricultural and industrial tires
- Straight and offset tire irons for use on large, wide-base tires
- T45 series for use on standard truck tires
- New 402-45005 allows the professional to lift the bead over the rim with less effort than conventional methods



402-45005

Ascot No.	Mfg. No.	Length	Stock	Weight
402-45003	T45A	37"	3/4"	4.6 Lbs.
402-45005	T45A-2000K	38"	3/4"	5 Lbs.
402-45004	T45HD	41"	7/8"	7 Lbs.
402-45006	T47A	52"	1"	11 Lbs.

### Tire Demount Tool

- Demounts both beads on most truck tires with the need for lifting the tire/wheel assembly off the ground and then dropping it
- Heat-treated alloy steel for maximum durability and strength

Ascot No.	Mfg. No.	Length	Stock	Weight
402-02001	T2001	39"	3/4"	6.5 Lbs.

### Tire Mount Tool

- Wing shaped designed to stop against rim, remove itself from between rim and bead
- Small end gets under stretched bead for last pull

Ascot No.	Mfg. No.	Length	Stock	Weight
402-02002	T2002	38"	1 1/16"	4 Lbs.

### Super Serpent Mount Tool

- It may seem funny looking, but every inch of this innovative design is purely serious
- Delivers Twice the leverage of any "Straight-type" tire mounting tool



Ascot No.	Mfg. No.	Length	Stock	Weight
402-02005	T2005	37"	3/4"	6.6 Lbs.

### Super Serpent Demount Tool

- At only 5-1/2 pounds, this unique, lightweight demount tool for super singles can be lugged around on a fingertip
- Delivers incredible leverage right where it's needed

Ascot No.	Mfg. No.	Length	Stock	Weight
402-02006	T2006	37"	3/4"	5.5 Lbs.

### Tire Spoons

- General purpose tire irons for all mounting and demounting needs
- Use 18" and 24" spoons to mount or demount passenger car, motorcycle, ATV and light truck tires
- 30" spoons provide enough strength and leverage to work on large truck, bus, off-road vehicle, tractor and aircraft tires



STRAIGHT

Ascot No.	Mfg. No.	Length	Stock	Weight
402-32101	T1X	18"	1 1/16"	1.8 Lbs.
402-32119	T19	24"	1 1/16"	2.5 Lbs.
402-33219	T19A	30"	1 1/16"	3 Lbs.
402-33022	33022	30"	3/4"	3.4 Lbs.
402-33238	T38	30"	7/8"	4.8 Lbs.



DROP-CENTER

Ascot No.	Mfg. No.	Length	Stock	Weight
402-02100	T21R	18"	1 1/16"	1.8 Lbs.
402-02101	T21F	24"	1 1/16"	2.5 Lbs.
402-33020	33020	30"	1 1/16"	3.1 Lbs.
402-33024	33024	30"	3/4"	3.4 Lbs.
402-02102	T21HD	30"	7/8"	4.5 Lbs.



CURVED

Ascot No.	Mfg. No.	Length	Stock	Weight
402-32102	T2X	18"	1 1/16"	1.8 Lbs.
402-32120	T20	24"	1 1/16"	2.4 Lbs.
402-33220	T20A	30"	1 1/16"	3.1 Lbs.
402-31820	31820	18"	1 1/16"	1.8 Lbs.
402-32420	32420	24"	1 1/16"	2.5 Lbs.
402-33021	33021	30"	1 1/16"	3.1 Lbs.
402-33052	33052	30"	3/4"	3.1 Lbs.
402-33062	33062	30"	7/8"	3.4 Lbs.
402-33239	T39	30"	7/8"	4.5 Lbs.

## Mount/Demount Tools (Cont.)

### Tubeless Tire Iron Sets

- Sets provide all irons necessary for a variety of tire changing applications
- Use C bar with the B extension bar for easier use on large, wide-base truck tires
- Use on standard and large truck tires, including industrial, farm, buses and tractors



Ascot No.	Mfg. No.	Description	Length	Stock	Weight
<b>Adapter Plugs</b>					
402-46000	T46	Tire Iron Set. Includes T46A, T46B, T46C	—	3/4"	12 Lbs.
402-46001	T46A	Med. Duty Mount/Demount Iron	36"	3/4"	4.5 Lbs.
402-46002	T46B	Mount/Demount Iron	36"	3/4"	4.5 Lbs.
402-46003	T46C	Offset Bar For Deep Well Tires	22"	3/4"	4.5 Lbs.
<b>Heavy</b>					
402-47000	T47	Tire Iron Set. Contains: T47A, T47B, T47C	—	1"	29 Lbs.
402-47001	T47A	Ultra Duty Mount/Demount Iron	52"	1"	11 Lbs.
402-47002	T47B	Mount/Demount Iron	49-1/2"	1"	11 Lbs.
402-47003	T47C	Offset Bar For Deep Well Tires	27"	1"	6.6 Lbs.

### Small Mount/Demount Tools

- Design based on popular European styles
- Extended length of the flat curved sliding surface provides comparable mounting ability of much longer traditional tire irons

#### Tire Irons - Small Tire



- Pro tire changing tools for small tires
- Ideal for mounting and demounting motorcycle, ATV, lawn, golf cart and small tires by hand
- Rounded ends will not pinch tube

Ascot No.	Mfg. No.	Length	Stock	Weight
402-00900	T9A	9"	7/16"	.4 Lbs.
402-00160	T16A	16"	7/16"	.7 Lbs.
402-01900	T9C	2 Piece Set - Contains (2) T9A 9" Bars		
402-01160	T16C	2 Piece Set - Contains (2) T16A 16" Bars		

#### Tire Irons - Small Tire



- Pro tire changing tools for small tires
- Sturdy, comfortable plastic handles
- Ideal for mounting and demounting motorcycle, ATV, lawn tractor, golf cart and small tires by hand
- Rounded ends will not pinch tube

Ascot No.	Mfg. No.	Length	Stock
402-00050	T5	16" (41 Cm)	.8 Lbs
402-00080	T8	16" (41 Cm)	.8 Lbs

#### Tire Irons - Small Tire



- Pro tire changing tools for small tires
- Ideal for mounting and demounting motorcycle, ATV, lawn, golf cart and small tires by hand
- Rounded ends will not pinch tube

Ascot No.	Mfg. No.	Length	Stock	Weight
402-00060	T6A	16-1/2"	5/8"	1.5 Lbs.

#### Motorcycle/Small Wheel



Ascot No.	Mfg. No.	Length	Stock	Weight
402-04311	T43A	15"	3/4"	1.8 Lbs.

#### European Style Tools

- Use on car, motorcycle, truck and agricultural tires
- Designed for mounting and demounting tires
- Best if used in pairs



Ascot No.	Mfg. No.	Length	Stock	Weight
402-04300	T43C	21"	7/8"	3.1 Lbs.
402-04301	T43D	30"	7/8"	4.5 Lbs.
402-04401	T44	31"	7/8"	5.3 Lbs.

## Bead Breakers

### Impact Bead Breaker

- Loosens the most stubborn beads with floating bead breaking foot and ram bar
- Forces wedge foot between head and rim flange
- Delivers blow directly to the tip
- Designed for shop or road use



Ascot No.	Mfg. No.	Description	Length	Length Ext.	Weight
427-35924	T24B	Economy	46"	72"	13.5 Lbs.
427-35926	T26B	Heavy Duty	50"	80"	23 Lbs.

### Floor Type Bead Breaker

- Use on custom wheels, without center holes, wide based motorcycle tires, ATV tires
- Used to prevent bending of wheels



Ascot No.	Mfg. No.	Description	Tread Width	Weight
421-00098	T98	Deluxe	Up to 11"	28.5 Lbs.

### Portable Bead Breaker

- Breaks beads on most sizes of passenger tires & light trucks



Ascot No.	Mfg. No.	Handle Length	Weight
421-00100	T100	36"	5.2 Lbs.

### Driving Iron

- Used for loosening rusted truck and bus beads



Ascot No.	Mfg. No.	Length	Stock	Weight
427-26000	T26A	11-3/4"	1-1/4"	4.4 Lbs.

### "Swan Neck" Bead Breaking Tools

- Portable tools - great alternative to handled bead breaking wedges or hydraulic bead breakers

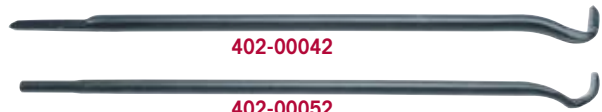

Ascot No.	Mfg. No.	Length	Stock	Weight
427-00041	T41	30"	7/8"	5.3 Lbs.
427-00042	T42	30"	7/8"	4.8 Lbs.
427-00052	T52	33"	7/8"	5.5 Lbs.

## Lock Ring Tools

### Truck Lock Ring Remover

- Designed for small diameter wheels



Ascot No.	Mfg. No.	Length	Diameter	Weight
402-32123	T23	24"	1 1/16"	2.4 Lbs.
402-33223	T23A	30"	1 1/16"	3.1 Lbs.



### Special Lock Ring Tool

- Long tapered curved end for continuous side rings



Ascot No.	Mfg. No.	Length	Diameter	Weight
402-32127	T27	18"	1 1/16"	1.8 Lbs.

### Combination Rim/Ring Tool

- Flat tapered end ideal for all around ring and rim work



Ascot No.	Mfg. No.	Length	Diameter	Weight
402-33224	T23B	23-1/2"	1 1/16"	2.4 Lbs.

### Lock Ring Tool

- Removes continuous side rings on two-piece truck rims



Ascot No.	Mfg. No.	Length	Diameter	Weight
402-32128	T27A	18"	1 1/16"	1.8 Lbs.

### Rim Lock Tool

- For servicing wide base rims



Ascot No.	Mfg. No.	Length	Diameter	Weight
402-32125	T25	18"	5/8"	1.8 Lbs.

### Heavy Duty Lock Ring Tool

- Use for multi-piece wheels, especially hub type



Ascot No.	Mfg. No.	Length	Diameter	Weight
402-34648	T48A	37"	3/4"	4.6 Lbs.

## General Purpose Hammers

### Wooden Handle Hammers

- Designed for tire service in variety of sizes



Ascot No.	Mfg. No.	Handle No.	Length	Weight
426-35311	T11B	T11BH	14-1/2"	4.5 Lbs.
426-35317	T33R	T11HN	14"	2.3 Lbs.

### Fiberglass Handle Hammers



Ascot No.	Mfg. No.	Handle No.	Length	Weight
426-35411	TG11B	TG11BH	16"	4.8 Lbs.
426-35417	TG33R	TG31H	16"	2.5 Lbs.

## Heavy Duty Hammers

### Wooden Handle Hammers

- Used for mounting and demounting tires
- Makes tire changing easier for passenger car, truck, bus, farm tractor and aircraft tires



Ascot No.	Mfg. No.	Handle No.	Length	Head Weight	Weight
425-35321	T34	T11CH	17"	4.8 Lbs.	5.4 Lbs.
425-35323	T35	T11CH	16-1/2"	5.5 Lbs.	6.1 Lbs.
425-35325	T36	T11CH	16-1/2"	5.8 Lbs.	5.3 Lbs.
425-35105	T34RH	Rubberhead Replacement			

### Fiberglass Handle Hammers



Ascot No.	Mfg. No.	Handle No.	Length	Head Weight	Weight
425-35421	TG34	TG11CH	18"	5.5 Lbs.	6 Lbs.
425-35423	TG35	TG11CH	18"	4.8 Lbs.	6.6 Lbs.
425-35425	TG36	TG11CH	18"	5.8 Lbs.	6 Lbs.

## Replacement Handles

### Fiberglass Replacement Handles



Ascot No.	Mfg. No.	Handle No.	Length	Weight
429-35206	TG31H	TG11R, TG31, TG33R	16"	1 Lb.
429-35211	TG11BH	TG11B	16"	1.3 Lbs.
429-35219	TG11CH	TG11C, TG34, TG35, TG36	18"	2.5 Lbs.
429-35227	TG11DH	TG11D	18"	1.2 Lbs.
429-35229	TG11EH	TG11E	32"	2.3 Lbs.



### Aluminum Replacement Handles



Ascot No.	Mfg. No.	For Hammer No.	Length	Head Weight	Weight
429-35529	T11AH	T11E, TG11E	32"	4.3 Lbs.	6 Lbs.

### Hickory Replacement Handles



Ascot No.	Mfg. No.	For Hammer No.	Length	Weight
429-35111	T11BH	T11B	15"	.75 Lbs.
429-35113	T11HN	T11R, T31, T33R	15"	.75 Lbs.
429-35119	T11CH	T11C, T34, T35, T36	17"	.75 Lbs.
429-35127	T11DH	T11D	17"	.75 Lbs.
429-35129	T11EH	T11E	30"	1.2 Lbs.

## Wedges & Hammers

### Duck Billed Bead Breaking Wedges - Wood Handled



Ascot No.	Mfg. No.	Handle No.	Length	Weight
424-35327	T11D	T11DH	17"	4.8 Lbs.
424-35329	T11E	T11EH	30"	9.2 Lbs.

### Duck Billed Bead Breaking Wedges- Fiberglass Handled

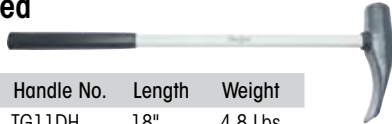

Ascot No.	Mfg. No.	Handle No.	Length	Weight
424-35427	TG11D	TG11DH	18"	4.8 Lbs.
424-35429	TG11E	TG11EH	32"	9.1 Lbs.

### Duck Billed Polymer Handled Bead Breaking Wedge



- Hump design prevents tool from wedging between rim and bead
- Breaks bead with little or no prying
- New polymer handle design with fiberglass core

Ascot No.	Mfg. No.	Handle No.	Length	Weight
424-35460	T11K	T11KH	32"	10.5 Lbs.

Ascot No.	Mfg. No.	Description
429-35230	T11KH	Replacement Handle for T11K

### Double Faced Sledge Hammer



- High carbon steel, heat treated. Machined, polished face
- Top grade U.S. hickory handle

Ascot No.	Mfg. No.	Handle Length	Face	Eye Size	Weight
428-37302	84H-2	15"	1-1/2"	3/4" x 1"	2 Lbs.
428-37304	84H-4	15"	1-3/4"	3/4" x 1"	4 Lbs.
428-37308	84H-8	32"	2"	1" x 1-3/8"	8 Lbs.
428-37310	84H-10	36"	2-1/8"	1" x 1-3/8"	10 Lbs.
428-37312	84H-12	36"	2-1/8"	1" x 1-3/8"	12 Lbs.
428-37316	84H-16	36"	2-3/8"	1" x 1-3/8"	16 Lbs.
428-37320	84H-20	36"	3"	2" x 1-1/2"	20 Lbs.

### 2 Lb. Rubber Mallet



- Rubber head prevents marring surfaces

Ascot No.	Mfg. No.	Handle Length	Weight
426-35310	T32	17"	2 Lbs.

### Cross-Pein/Blacksmith Hammer



Ascot No.	Mfg. No.	Handle Length	Face	Eye Size	Weight
426-37103	85H-3	16"	1-5/8"	1" x 1-3/4"	3 Lbs.

### New England Pattern Hand-Drilling Hammers



Ascot No.	Mfg. No.	Handle Length	Face	Face Size	Weight
426-37003	80H-3	10-1/2"	1-1/2"	1" x 3/4"	3 Lbs.
426-37004	80H-4	10-1/2"	1-5/8"	1" x 3/4"	4 Lbs.

### Tire Knocker



Ascot No.	Mfg. No.	Handle Length	Face	Eye Size	Weight
426-35110	35110	18"	.7 Lbs.	1" x 3/4"	3 Lbs.

### Dead Blow Hammers

- Economy version for DIYers or home workshops
- One-piece polypropylene outer jacket provides a lifetime of use
- Head is shot-filled for maximum force with no bounce effect

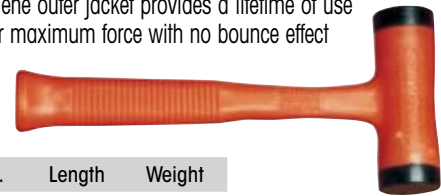

Ascot No.	Mfg. No.	Length	Weight
426-35335	T335	12"	1.5 Lbs.

### Professional Dead Blow Hammers



Ascot No.	Mfg. No.	Description	Length	Weight
426-35331	TG331	1 lb. Head	12-1/4"	1.8 Lbs.
426-35332	TG332	2 lb. Head	13-1/2"	1.9 Lbs.
426-35333	TG333	3 lb. Head	14-1/2"	2.7 Lbs.
426-35334	TG334	4 lb. Head	15-1/2"	3.4 Lbs.
426-35337	TG337	Steel Face/Soff Face	13-1/2"	2.2 Lbs.

## Shop Service Tools

### Wheel Cover Pullers/Replacers

- Remove wheel covers quickly and easily without gouging or scratching
- Rubber head T11RH prevents damage to hubcap and is replaceable



Ascot No.	Mfg. No.	Length	Stock	Weight
402-31567	T67	17-1/2"	9/16"	1.8 Lbs.
402-31568	T68	14"	7/16"	1.3 Lbs.

### Center Cap Removers



Ascot No.	Mfg. No.	Length	Stock	Weight
402-31565	T65	7-3/4"	5/16"	.2 Lbs.
402-31566	T66	7-3/4"	5/16"	.2 Lbs.

### Bead Holder

- Holds the bead in place against the wheel when mounting the tire on the wheel



Ascot No.	Mfg. No.	Length	Stock	Weight
472-31710	31710	Solid Brass	1.4 Lbs.	1.8 Lbs.

### Aluminum Wheel Protector

- Protects wheel rims from damage
- U.S. Patent No. 6,991,018



Ascot No.	Mfg. No.	Weight
472-31810	31810	12 Lbs. (5.4 kg)

## Wrenches

### KenTool Porkchop™ Wrenches

- Holds outer cap nut on dual wheels while turning inner nut
- Lip fits in hole to secure wrench in place
- Fits standard and metric cap nuts



Ascot No.	Mfg. No.	Description	Size	Weight
406-30609	TX9	SAE	1-1/2"	.4 Lbs.
406-30610	TX10	Metric	35mm	.4 Lbs.
406-30612	TX12	Metric	41mm	.4 Lbs.

### Combination Cap Nut Wrenches

- Combination wrench offers you the versatility of two wrenches in one
- Fit one end onto the outer cap nut with other end through center hole
- Slides underneath center disc of wheel reducing slipping during nut removal



Ascot No.	Mfg. No.	Description	Size	Weight
406-30620	TX50	SAE & Metric	41mm	1.3 Lbs.

### Heavy Duty Nut Wrenches

- Heavy duty design will not slip out of position
- Rests snugly against the center hole reducing the possibility of rim damage
- Great for aluminum rims

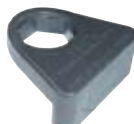

Ascot No.	Mfg. No.	Description	Size	Weight
406-30618	TX200	SAE	1-1/2"	2.6 Lbs.
406-30619	TX241	Metric	41mm	2.6 Lbs.

### Budd Nut Wrenches

- New design won't slip out of rim hole
- Will not damage aluminum/chrome rim
- Holds outer cap nut securely
- This adaptation of an old product solves the problem of damage to wheels, as well as broken toes and injuries to the feet
- Model 60301 has a replaceable polymer covered tail that locks the tool securely in place



Ascot No.	Mfg. No.	Description
406-60301	60301	Budd Nut Wrench
406-60302	60302	Budd Nut Wrench - 35mm
406-60303	60303	Budd Nut Wrench - 41mm
406-60908	60908	Replaceable Polymer Tail

### Budd Nut Wrenches

- Eliminates the need for hand and foot aid in separating the nuts, therefore reducing needless injury
- Reduces the work and potential for back strain because there is no need to lay down the tire
- Will not lose its grip on the outer cap nut so there is no loss of torque, which will give the impact wrench maximum power and efficiency



Ascot No.	Mfg. No.
406-60300	60300

## Lug Wrenches

### Power Wrench

- Designed for dual nut systems
- Has 13/16" square end to hold inner nut, with a 1-1/2" hex drive to spin outer nut off

Ascot No.	Mfg. No.	Length
404-34543	TR43	Basic Set Consists Of Power Drive And Two Handles (Solid Bar - 20-1/2" Long And Tube - 20" Long)
404-34545	TR44X	Budd Wheel Set Contains Power Drive, One Bar, One Tube Handle, A 3/4" Service Adapter And One 13/16" Square Adapter
404-34547	TR44SW	Universal Set Consists of Power Drive, One 20-1/2" Bar, One 36" Tube Handle, A 3/4" Service Adapter, A 13/16" Square Adapter, And Six 3/4" Impact Sockets (7/8", 15/16", 1-1/16", 1-1/8", 1-3/16", 1-1/2")



404-34547

### Double End Truck Wrenches

- Double end truck wrenches for on-the-road service
- Sizes available for all standard lug nuts
- Constructed from 1" high quality steel for greatest strength and durability
- All will take our standard TR5 (ASCOT Order No. 405-32318) leverage handle. Handle hex opening: 3/4"
- Length: 16"; Weight: 4-1/2 Lbs.



Ascot No.	Mfg. No.	Socket Size	Weight
<b>SAE</b>			
405-32501	TR1	1-1/8", 13/16" Square, 1-1/2"	4.6 Lbs.
405-32502	TR2	1, 1-1/4", 5/8" Square	4.3 Lbs.
405-32504	TR2X	15/16", 7/8"	4.5 Lbs.
405-32503	TR3	7/8", 1-1/16"	4.5 Lbs.
405-32505	TR3A	1-1/8", 1-1/16"	4.5 Lbs.
405-32506	TR3X	1-1/16", 1-3/16"	4.5 Lbs.
405-32509	TR9	1-1/4", 1-1/16"	4.5 Lbs.
405-32508	TR98	1-1/2", 13/16" Square	4.5 Lbs.

<b>METRIC</b>			
405-32551	TRM1	35mm Sq. x 17mm Square	4.5 Lbs.
405-32552	TRM2	24mm x 33mm	4.4 Lbs.
405-32553	TRM3	27mm x 30mm	4.5 Lbs.
405-32556	TRM6	41mm x 21mm Square	4.5 Lbs.
405-32557	TRM7	33mm x 30mm Square	4.5 Lbs.

### Heavy-Duty Truck Wrenches

- Use for off-the-road Budd-type wheels
- Use TR11 handle



Ascot No.	Mfg. No.	Length	Stock	Weight
405-34401	TR10	29-1/2"	1-3/4" Hex x 15/16" Square	12.2 Lbs.
402-34402	TR11	30"	1-1/4"	6.5 Lbs.



404-34545



### Dual Wheel Lug Stud Remover

- Special self-tapping splines provide maximum grip to remove stripped lug studs
- Use with TR1 and TR98 truck wrenches
- Also used with open end wrench
- Use with soft-faced hammer



Ascot No.	Mfg. No.	Length	Weight
492-30165	30165	Fits 13/16" Sq. Inner Nut	1 Lb.

## Lug Wrenches (Cont.)

### Professional Lug Wrenches

- Most popular 4-way lug wrench - polished sockets
- For passenger cars

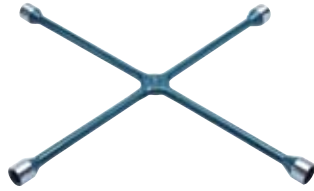

Ascot No.	Mfg. No.	Length	Stock	Weight	Socket Size
403-35657	T57	23"	5/8"	4-1/2 Lbs.	3/4", 13/16", 7/8", 15/16"
403-35656	T56	20"	5/8"	4 Lbs.	17, 19, 21, 22mm

### Standard Lug Wrenches

- Welded center construction for strength and durability
- Premium grade, special bar quantity steel for extra strength
- T59 series for passenger cars and T90 series for light truck



Ascot No.	Mfg. No.	Length	Stock	Weight	Socket Size
403-35659	T59	22"	5/8"	4.5 Lbs.	3/4", 13/16", 7/8", 15/16"
405-35690	T90	25"	3/4"	7.2 Lbs.	7/8", 15/16", 1", 1-1/16"

### Economy Lug Wrenches

- Designed with welded centers which stand up to everyday use
- For passenger cars



Ascot No.	Mfg. No.	Length	Stock	Weight	Socket Size
403-35620	T9520	20"	9/16"	3.4 Lbs.	3/4", 13/16", 7/8", 17mm
403-35661	T61	22"	9/16"	3.8 Lbs.	3/4", 13/16", 7/8", 17mm
403-35662	T62	18"	9/16"	3.2 Lbs.	3/4", 13/16", 7/8", 17mm
403-35663	T63	18"	9/16"	3.2 Lbs.	17, 19, 21, 22mm



### Heavy Duty Truck Four-Way Lug Wrenches

- Drop-forged center
- Heavy duty truck, bus, tractor four-way
- Center hole for leverage bar
- T96 with heavy duty solid center



Ascot No.	Mfg. No.	Length	Stock	Weight	Socket Size
403-35695	T95	27-1/2"	1"	13.8 Lbs.	1-1/16", 1-1/4", 1-1/2", 13/16" Sq.
403-35795	TM95	27-1/2"	1"	13.5 Lbs.	24, 27, 30, 33mm

- 3/4" service arm that will take any standard 3/4" drive socket



Ascot No.	Mfg. No.	Length	Stock	Weight	Socket Size
403-35697	T95A	27-1/2"	1"	13.5 Lbs.	1-1/4", 1-1/2", 13/16" Sq., 3/4" Service Arm



Ascot No.	Mfg. No.	Length	Stock	Weight	Socket Size
403-35696	T96	27-1/2"	1"	13.5 Lbs.	1-1/16", 1-1/4", 1-1/2", 13/16" Sq.



Ascot No.	Mfg. No.	Length	Stock	Weight	Socket Size
403-35595	TC95	27-1/2"	1"	14.2	1-1/2", 13/16" Sq., 30, 33mm



## Tire Service Tools

### Small Tire Snake



- Included with T600 Tire Changer

Ascot No.	Mfg. No.	Length	Stock	Weight
402-34672	34672	22"	5/8"	2 Lbs.

### Medium Tire Snake



- Included with T601 Tire Changer
- Designed for wheels from 4" to 13"
- Longer length provides greater strength

Ascot No.	Mfg. No.	Length	Stock	Weight
402-34674	34674	28"	5/8"	2.5 Lbs.

### Large Tire Snake



- Included with T600 Tire Changer

Ascot No.	Mfg. No.	Length	Stock	Weight
402-34678	34678	40"	3/4"	5.3 Lbs.

### Air Blast Bead Seater for Small Tires

- Fast and easy way to seat beads in one simple operation
- Seat the bead on most small tubeless tires with rims ranging from 4" to 12"
- One-man operation—just point and release



Ascot No.	Mfg. No.	Weight
473-31440	31440	5.6 Lbs.

### ATV Bead Breaker

- Constructed of heavy duty steel
- Works with any center-post tire changing machine and adjusts to sizes of 6" to 12" ATV rims
- No hammers, wrenches or additional tools required



Ascot No.	Mfg. No.	Weight
421-38620	38620	7 Lbs.

### Floor Mount Manual Tire Changer

- Mounts and demounts a full range of tires on rim diameters from 4" to 15"
- Tapered bearing guide positively centers straight shaft hubs of all diameters
- Built-in adjustable bead breaker works on rims up to 13" in diameters and 24" in width without disassembly
- Includes a 28" tire snake mount/demount tool

Ascot No.	Mfg. No.	Height	Weight
441-38601	T601	32"	31 Lbs.



### Bench Mount Rim-Clamp Manual Tire Changer

- Mounts and demounts a full range of tires on rim diameters from 4" to 12"
- Mounts easily to a bench or in any standard, four-position rim-clamp tire changer
- Built-in, three-fin centering device mounts standard lug-type rims with 2" and larger center hole
- Square base prevents turning in the changer during use
- Includes a 22" tire snake mount/demount tool

Ascot No.	Mfg. No.	Height	Weight
441-38600	T600	16.5"	21.7 Lbs.



### Multi Tire Changer

- For changing small tires and wheels
- Includes everything needed to change 4" to 16.5" tires including rim
- Rim clamp mechanism
- 2 center posts (for open or hub type wheels and bearing type wheels)
- Also includes the CH-4 Mongoose tire tool
- Can be mounted on a bench, tire stand or tire changer

Ascot No.	Mfg. No.	Description	Weight
441-00220	CH-22	Multi-Tire Changer	23 Lbs.
441-00230	CH-23	Tire Stand	70 Lbs.



## Tire Service Tools (Cont.)

### Automatic Tire Inflation Systems

All systems feature an operating range of 5-145 PSI, accurate within .3 PSI. Units are housed in weather resistant aluminum casings. All provide an easy to use and affordable way to assure precise inflation. Units available with 110 volt AC electric or battery hook up. Optional heater available for outdoor units.

#### Multiple Tires

For Fleet Operations, Service Centers, or Mounters

- For 19.5" and larger rims
- Capable of inflating four 22.5" tires from 5 to 100 PSI in 5 minutes



Ascot No.	Mfg. No.
475-89003	89 XDB

#### Multiple Tire Inflation Hoses and Accessories



478-00360

Ascot No.	Mfg. No.	Description
475-00891	89HKC-LM	Straight Hose w/CH-3605 Air Chuck
475-00892	89HKT-LM	Straight Hose w/Coupler & CH-330-LO Air Chuck
475-00893	89HKI-25	Straight Hose w/Coupler & IN-20 Tool (Single Tire)
475-00894	89-HMVN	4-Way Manifold
475-00895	89-3W	Air Flow Control Valve
478-00360	CH-360S	Chip-On Style Air Chuck (Closed) w/Spring
478-03300	CH-330-LO	Lock-On Style Air Chuck (Dual Wheels)
475-00896	STAND-4	4' Mounting Steel Stand w/Square Base

*Specify Hose length when ordering. Components available separately.*

#### Portable Tire Inflator

Easy to maneuver. Perfect in service bay or on truck. High capacity battery means long life between recharges. Walk right up to the point of inflation!



Ascot No.	Mfg. No.
475-01891	89 PIU

#### Single Tire

For Dealerships, Rental Facilities, Service Centers and Quick Lubes



Ascot No.	Mfg. No.
475-89001	89 XDA

#### Single Tire Inflation Hoses and Accessories



475-01898

Ascot No.	Mfg. No.	Description
475-01892	89HKC-L	Straight Hose w/Coupler & CH3600P Chuck
475-01893	89HKC-LC	Coil Hose w/Coupler & CH-360CP Chuck
475-01894	89HKT-L	Straight Hose w/Coupler & CH 330-LO-OP Chuck
475-01895	89HK1-25	Straight Hose w/Coupler & IN-20 Tool
475-01896	89-2 WASV	2 Way Automatic Switching Valve (2 Hoses)
475-01897	89-3 WASV	3 Way Automatic Switching Valve (3 Hoses)
475-01898	89-3 WTK	3 Way Automatic Switching Valve Kit
475-00896	STAND-4	4' Mounting Steel Stand w/Square Base

*Components available separately. Specify hose length - 50 foot maximum.*

#### Over Inflation and High Volume

For Retreaders, Fleets or Mounters

- Inflate multiple tires to a preset over-pressure setting
- Unit then performs a leak test for "zipper leaks"
- Deflates to final preset required PSI setting
- Features 3 preset PSI settings



Ascot No.	Mfg. No.
475-89004	89 XDZ

#### Nitrogen Tire Inflation System

- For any service center inflating with nitrogen
- Use with any nitrogen generator
- Convert up to 4 tires at once
- Optional heater available



Ascot No.	Mfg. No.
475-59005	89 XDB-G

#### Mobile Inflation

- Nitrogen or air
- Trolley design provides mobility
- Nitrogen software will purge the air out of any size tire, re-inflate with nitrogen, while maintaining .3 PSI accuracy
- Designate the number of purge cycles needed to obtain the benefits of nitrogen



Ascot No.	Mfg. No.
475-89106	89 TRL-6B

## Tire Service Tools (Cont.)

### Blue Cobra™ Truck Tire Demount Tool

- Ergonomic shaped steel handle with no-slip grip for optimum leverage
- Change nearly any 20", 22.5" and 24.5" tube-type and tubeless truck tires, up to a 13" wide one-piece wheel



Ascot No.	Mfg. No.	Length	Weight
402-35440	35440	54"	22 Lbs.

### Easy-Lift™ Bead Seating Stand

- With hub facing out, simply roll mounted tire and wheel assembly to front of stand
- Push assembly onto crown – tire and wheel will automatically fall onto center of stand and rest with bead centered on bottom wheel flange
- Seat beads by inflating tire to 4 PSI (max.)
- Step around stand and easily lift assembly into vertical position
- Roll assembly into tire inflation safety cage for final inflation
- Portable for field service, or can be bolted to the floor
- 24"H x 26"W x 27"L
- Made of high grade steel



Ascot No.	Mfg. No.	Description	Weight
473-36016	36016	Std. Crown for 8-3/4" Dia. Hubs	36 Lbs.
473-36017	36017	Large Crown for 11" Euro Hubs	37 Lbs.

### Ironman™ Ergonomic Wheel Lifting Bar

- Easily and safely lift heavy, awkward truck tire and wheel assemblies
- Extremely useful in outdoor conditions – when truck tire and wheel assemblies can become wet & slippery
- Protect your workers and yourself – reduce injuries & claims – keep insurance premiums down
- Specially designed forged ends work from either side of the wheel assembly as it lays flat
- Lift all sizes and types of small and large heavy truck wheels: Standard sizes including 22.5" and 24.5" wheels, plus European (which have 1" lug holes), Super Wide and even the Super Single (a 340 Lb. assembly) size



Ascot No.	Mfg. No.	Length	Weight
402-34950	34950	58"	10 Lbs.

### Nineteen-Five™ Tire Mounting & Demounting Tool Set for 19.5" Truck Tires

- New tire bar uniquely designed to work on hub side of wheel - where hub protrudes above rim
- Specially designed ends manipulate tire with less effort
- Tools are powder coated to protect from rust and corrosion
- Forged from high-grade carbon steel and heat-treated for longlasting strength and durability
- Specially designed Bead Holder to hold bead on 19.5" aluminum wheels
- Solid brass Bead Holder for steel wheels
- Aluminum Wheel Protector - thick leather pad helps protect rims from marring and scratching

Ascot No.	Mfg. No.	Description
402-33195	33195	Nineteen-Five™ Tire Mounting and Demounting Set



#### Set Includes:

Ascot No.	Mfg. No.	Description	Length	Weight
402-33199	33199	Tire Mounting/ Demounting Tool	38"	7 Lbs.
402-33196	33196	Bead Holder for 19.5" Aluminum Wheels	7-1/2"	1 Lb.
402-31710	31710	Bead Holder for Steel Wheels - Solid Brass	4-1/2"	1 Lb.
402-31810	31810	Aluminum Wheel Protector - Leather	6"	.35 Lbs.

### Industrial Wheel Lock Ring Tool Set

- Helps prevent injury – easier to keep hands safely outside of press cage
- Tools are powder coated to protect from rust and corrosion; bright orange color helps prevent lost tools
- Forged from high-grade carbon steel and heat-treated for long lasting strength and durability



Ascot No.	Mfg. No.	Description
402-32129	32129	2 Pc. Industrial Wheel Lock Ring Set

#### Set Includes:

##### #3130 Mount/Demount Tool

- Demount end lifts split ring progressively around wheel until fully demounted
- Mount end used to mount split ring

##### #3132 Demount Prep Tool

- Separator end separates split ring from solid flange ring to form gap
- Pry-out end reaches behind slotted end of split ring to pry in out and over the flange of the wheel

Ascot No.	Mfg. No.	Description	Length	Width
402-32130	32130	Mount/Demount Tool	15-3/4"	1.8 Lbs.
402-32131	32131	Demount Prep Tool	15-1/2"	1.5 Lbs.

## Safety Inflation Cages

### Safety Inflation Cages

A safety inflation cage is mandatory in any shop for tubeless and multi-piece rims. Ascot offers a size and design for all your needs. Constructed of heavy gauge steel welded to a steel base. Guards against blown lock rings, exploding rims and ruptured tire explosions when used properly. These cages meet OSHA safety requirements (29-CFR Part 1910.177).



479-36001



479-36006



479-02130



479-36003



479-36004



479-36002



479-36005



479-02260



479-36011

Ascot No.	Mfg. No.	Description	Handles Tires	Base Plate	Inside Height	Inside Dimensions	Weight
479-36001	MIC-2	Portable 2-Bar Safety Cage	12"- 24"	6" x 21-1/2"	54"	41" H x 16" W	60 Lbs.
479-36011	MIC-2WB	Portable 2-Bar Safety Cage (Super Single)	12"- 24"	-	43"	-	70 Lbs.
479-36006	MIC-3	3-Bar Safety Cage	14"- 24"	26" x 22"	43-1/2"	43-1/2" H x 20-1/2" W	134 Lbs.
473-36004	T104	3-Bar Safety Cage for Off Road	-	30" x 27"	65"	65" H x 24" W	158 Lbs.
479-02130	2130	3-Bar Passenger/Light Truck Cage	Up to 27"	-	-	-	100 Lbs.
479-36002	MIC-4	4-Bar Safety Cage (Super Single)	-	31-1/2" x 26"	43-1/2"	43-1/2" H x 20-1/2" W	146 Lbs.
479-36003	T103	3-Bar Safety Cage/Light Truck Cage	-	21-1/2" x 22"	30"	30" H x 16" W	80 Lbs.
479-36005	MIC-5	5-Bar Safety Cage	-	41" x 26"	43-1/2"	43-1/2" H x 20-1/2" W	182 Lbs.
479-02260	2260	6-Bar Safety Cage	14"- 24" or 54" Super Single	-	-	-	275 Lbs.

Work safely. Always use an inflation cage when inflating tires. Follow OSHA regulation 29-CFR Part 1910.177 whenever changing tires.

### Truck Tire Changing Stand

- Handles wheels or open rims 16.5" to 24"
- Double-slide adjustment with locking device prevents twisting so it stays aligned with the wheel or rim
- Ideal height for driving off beads or demounting tire



Ascot No.	Mfg. No.	Description
479-36015	T115	Truck Tire Changing Stand

### Heavy Duty Inflation Chamber

- Fast accurate inflation using pressure limiter
- Liquid filled pressure gauges
- Automatic shut-off when desired pressure is reached
- Bleed valve for releasing air in the tire if defect is found while inflating
- Complies with federal law covering the service of single or multi-piece wheels
- Max. tire diameter: 51"; Max. tire width: 23"



Ascot No.	Mfg. No.	Description
479-06160	6160	Heavy Duty Inflation Chamber



# VALVE HARDWARE

TPMS Accessories & Tools  
Passenger & Truck Valves  
Air/Liquid Valves  
Large Bore  
Valve Service Tools  
Tire Gauges & Air Chucks



# SUCCESS with TPMS!

- ✓ Re-learn Tools
- ✓ Mechanical Tools
- ✓ Training Programs
- ✓ Online clinics
- ✓ Technical Support

Bartec understands that TPMS is more than tools!



Bartec USA





**Air  
Controls  
Products**



**Your Complete Tire Valve and  
Valve Hardware Supplier**



**Leading the industry  
with US Design,  
Manufacturing,  
Testing, and  
Warehousing**

## EZ-Sensor

Introducing...



# EZ-sensor™

*Programmable Tire Pressure Monitoring Sensor*



- Eliminate lost sales
- Manage inventory of slow moving sensors
- Reduce risk of installing the wrong part
- No need to purchase additional costly programming tools
- Works with the Schrader and Bartec OBD learn tools you already own
- Allow consumers to own a second set of wheels and tires that will not require a relearn after exchange

## Always Have the Right Part, Right Away

Two EZ-to-program snap-in sensors will eventually replace over 90% of OEM SKUs. Capable of having ASIC ID learned using a hand held MLF (Modulated Low Frequency) tool. Capable of having RF Protocol and sensor timings, learned using a hand held MLF tool. Can be programmed with Schrader 21230 and Bartec Tech400 learn tools.

First sensor SKU for Toyota, Lexus and Subaru applications to be launched at a later date. Additional applications and additional sensor to be available at a later date.



## TPMS Relearn Chart

# Want the Best TPMS Relearn Chart On the Market? This Is It!



WORKING FOR THE INDUSTRY...WORKING FOR YOU.

Forget the competitor's TPMS relearn information. The **TIA Tire Pressure Monitoring System (TPMS) Relearn Chart** serves as a valuable, comprehensive, and quick reference guide that technicians can easily navigate through to service any vehicle – Foreign **AND** Domestic – equipped with TPMS.

**Your organization won't want to be without one! It will save you time and money the first time you use it.**

The **TIA Tire Pressure Monitoring System (TPMS) Relearn Chart** is divided into

two sections: domestic and imported vehicles. In each section, vehicles are listed by make, model, and year.

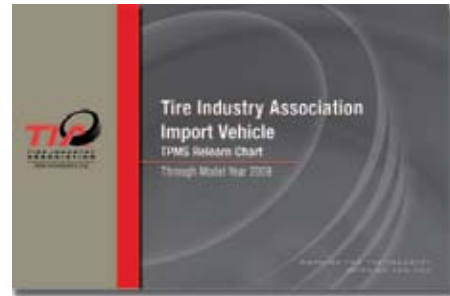
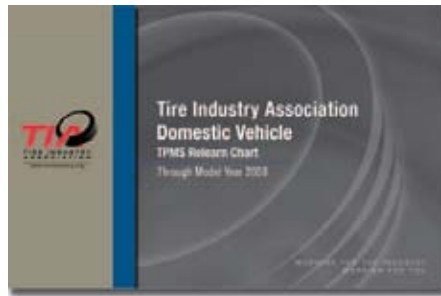

Make	Model	Year	Direct Indirect TPMS	Relearn Required After			Relearn Summary	Sensor Brand	OEM Sensor Part#	Schrader Sensor Part#	Schrader Service Pack#	Dill Sensor Part#	Dill Kit or Band #	NAPA Sensor Part#	NAPA Service Pack#	Torque Specifications (ft. lbs.)					
				Change Air Pres.	Rotation	Front Wheel Service										Sensor Nut	Tire Bolt	Worm Gear	Lug Nut Ft. lbs. (lb.in)		
Buick	Allure	2006	I	✓	✓	✓	GM-3													100(140)	
		2007	D	✓	✓	✓	GM-4														100(140)
	Allure	2006	D	✓	✓	✓	GM-11														100(140)
		2009	D	✓	✓	✓	GM-11														100(140)
Century	1999-05	I	✓	✓	✓	GM-1														100(140)	
		2006	I	✓	✓	✓	GM-2														100(140)

The **TIA TPMS Relearn Chart** includes:

- The type of TPMS, whether direct or indirect.
- Three columns of data that indicate when a system relearn is necessary, i.e. after a change in air pressure, tire rotation, or tire/sensor replacement.
- A relearn summary – this includes a reference number that corresponds to the vehicle's procedure for initiating sensor relearn mode. The vehicle relearns are located in the back of the corresponding section, either domestic or import.
- The sensor manufacturer.
- OEM sensor part number, Schrader replacement sensor part and service pack numbers, Dill replacement sensor part and kit and band numbers, Continental replacement sensor part and kit and band numbers, and NAPA replacement sensor part and service pack numbers.
- The torque specifications for the sensor nut, torx bolt, worm gear, and lug nuts are listed.

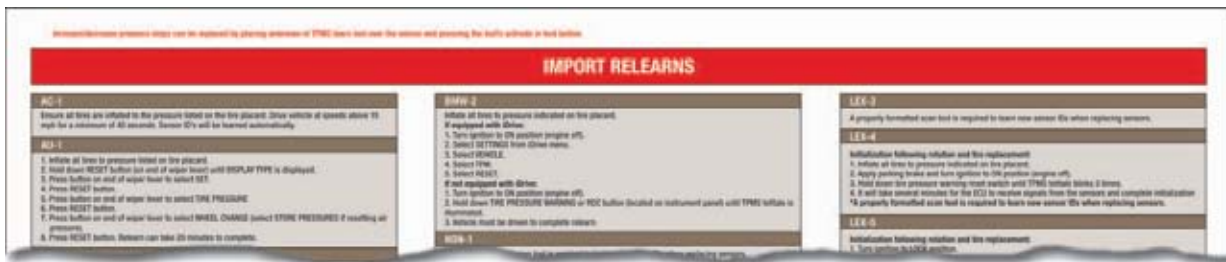

**Order the TIA Tire Pressure Monitoring System (TPMS) Relearn Chart Today!**

Ascot No.: 469-02010

## Sensor Activation Tools

### Bartec Wheelrite Tech 400 Plus Kit

- Large, easy to read display
- Make - model - year vehicle look up
- Downloads TPM data directly to the vehicle
- Rechargeable battery
- Decodes and displays sensor data including: Sensor ID, PSI, battery state, temperature
- Displays the replacement part number
- Audit Mode - easily download TPMS sensor data to a PC or laptop for printing
- Compact and ergonomic
- Most complete sensor coverage
- Upgradable via USB port



**Compliant with Asian Vehicle Manufacturers such as: Toyota, Lexus, Nissan, Honda, Kia & more.**

**Tool Kit Includes:**

- Tech 400 Plus Tool
- Magnet
- OBD Cable
- User Guide
- Training CD
- USB Cable
- Power Supply
- All in a custom case

Ascot No.	Mfg. No.
469-40001	Tech 400 Plus

**Software Updates:**

- 1 year WRT400SUL1
- 2 year WRT400SUL2
- 3 year WRT400SUL3

**The Certificate Includes:**

- Update Certificate (w/Activation Code) 4 1/2" X 4 1/2" certificate, packaged in a CD jacket
- Instruction Sheet included in the package



### Bartec Wheelrite Tech 300 Plus Kit

- Decodes and displays sensor data including: sensor I.D., PSI, battery state, temperature
- Bright, high resolution display
- Make-model-year vehicle look up
- If a failed sensor is detected, the tool displays the replacement part no.
- Audit mode – easily download TPMS sensor data to a PC or laptop for printing
- Compact and ergonomic
- Most complete sensor coverage
- Upgradable

**Tool Kit Includes:**

- Standard USB Cable
- Magnet
- Protective rubber boot

Ascot No.	Mfg. No.
469-30001	Tech 300 Plus

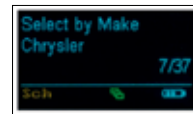

### Schrader Learn and Test Tool with OBD Adapter

- Enables TPMS relearn on imports such as Toyota, Nissan, Hyundai, Kia, Honda, Mitsubishi, Subaru and more
- SD Card Slot upgradable
- Comes with a universal OBD connector and cable to write sensors ID's directly to the VCM on vehicles that require OBD programming
- Will not allow duplicate or wrong ID's to be written. No manual typing needed
- One simple-to-use tool

**Tool Kit Includes:**

- 21230 DBL plus learn and test tool
- Hard plastic case - PN 21222
- One USB cable - PN 21219
- Magnet (necessary to activate some sensors) - PN 20143
- Protective rubber boot - PN 21216
- Rechargeable 9-volt battery - PN 21216
- Charger - PN 21218
- OBD connector and cable
- User guide

Ascot No.	Mfg. No.
469-21230	21230



## Sensor Activation Tools (Cont.)

### TIPS Pro – KTI P.S.T.

The Pro and P.S.T. models allow you to manually select the desired electronic triggering protocol or you may simply activate the tool and allow the "hunting" feature to automatically choose the correct solution. These tools are digital and can be upgraded with new pulse modulated protocols as they become available in the future.

- Quick Reference Guide and Application Quick Start Flip Chart included with TIPS 003B & KTI 71990A



Ascot No.	Mfg. No.	Description
469-71990	TIPS003B	TIPS Pro.
469-71991	71990A	KTI P.S.T.



Programming Interface Module



Holster

Ascot No.	Mfg. No.	Description
469-71993	TIPS004/71991	P.I. Module
469-71992	TIPS05/71992	Holster

### Complete Kit for TIPS Pro & KTI P.S.T.

Contains sensor activation tool, programming module and holster, 1 year of upgrades, flip chart, poster, sign valve core torque tool and 4-way valve tool. Includes training DVD and Quick Reference Guide.

Ascot No.	Mfg. No.	Description
469-71998	71998	TIPS Pro
469-71999	71999	KTI P.S.T.

### ATEQ VT55 OBDII TPMS Tool Kit

The only tool which needs updates by software instead of purchasing other tools to comply with future TPM Systems.

- RF range adjustable from 300 to 900 Mhz by software to accommodate future sensors
- Duplicate sensor warning to prevent displaying or writing incorrect information to vehicle ECU
- Visual, audible and physical feedback when VT55 receives sensor information
- Rewrite sensor information directly to TPMS ECU
- USB port to print decoded sensor information and update VT55 with PC
- Large, fluid resistant tool reference guide
- Useful remote keyless entry option to test battery/signal strength
- Test and diagnose all TPM sensors
- Kit includes VT55, protective pouch, USB cable, CD manual and software, power supply, magnet, OBDII connector, reference guide



Ascot No.	Mfg. No.
469-05500	VT55OBD

### TPMS Transmitter Check Box

- Identify a difference between gauge and your vehicle dash reading
- Helps eliminate possible transmitter defects or failures before mounting and inflating transmitter on wheel
- An ideal device to ensure quality service
- Designed for use with all styles of direct TPMS transmitters
- Portable and easy to use
- Equipped with a regulator and gauge to ensure proper functionality



Ascot No.	Mfg. No.
469-03200	OCB

### Nissan Reset Tool

Designed to extinguish the Tire Pressure Warning Light on 2003 & newer Nissan vehicles with TPM Reset Connector

Ascot No.	Mfg. No.
469-71985	71985



## Sensor Activation Tools (Cont.)

### Genisys™ Heavy-Duty Standard Deluxe Kit

Includes Genisys™ Scan Tool, OBD II Smart Cable, Automated System Test™, Heavy-Duty Standard software, USA 2007 Domestic with Pathfinder, Repair-Trac™, Fast Fixes™, USA 2007 Asian, InfoTech 2006, USA 2004 ABS/Air Bag software, manuals, adapters, and domestic OBD I vehicle cables (for GM, Ford, Chrysler, Jeep, Saturn) and carrying case.

Ascot No.	Mfg. No.
351-03860	3860HD



### OTC Tire Pressure Monitor Kit

- Displays sensor data, such as ID and pressure. Sensor activation and data display are dependent upon system type
- Updatable via serial cable to PC to keep up with changing vehicle requirements
- Maintains "last vehicle" use history
- Three "C" batteries provide hours of continuous use (Auto shutdown is after three minutes of inactivity)

Ascot No.	Mfg. No.
496-03833	3833



### OTC TPR

- Works on all known TPMS sensors through 2009
- Bright graphic display and simple navigation buttons enable vehicle selection for fast activation
- Automatically adjusts activation output power to eliminate cross activation of near sensors
- Easily updated with a wireless connection to the Genisys™ scan tool when new software is installed on the Genisys™
- Compatible with the entire Genisys™ family of scan tools
- Register new sensor ID's on Asian vehicles
- Use the TPR to activate and decode sensor ID's and transmit them to the Genisys™ wirelessly
- Bluetooth wireless communication adapter included
- Quick reference reset procedures can be quickly accessed on the Genisys™

Ascot No.	Mfg. No.
469-03866	3866TPR





## Accessories and Kits

### Schrader Accessory Kits

The OEM requires that the four sealing components be replaced when re-installing a TPMS sensor. The replacement components are supplied in TPMS accessory kits, which are sensor specific. Each TPMS accessory kit contains: 1 Nut, 1 Valve Core, 1 Cap, 1 Grommet

Ascot No.	Mfg. No.	Description
469-20002	20002	Accessory Kit For Ford Transmitters - Replaces 469-29601 & 469-23501
469-20003	20003	Accessory Kit For Chrysler Transmitters - Replaces 469-21701 & 469-22801
469-20004	20004	Accessory Kit For GM Transmitters - Replaces 469-20701 & 469-21601
469-20005	20005	Accessory Kit For Steel Wheel Nissan Transmitters
469-20006	20006	Accessory Kit For Hummer Transmitters
469-20007	20007	Accessory Kit For Alloy Wheel Nissan Transmitters
469-20008	20008	Replacement Snap-In Valve for Schrader 20153 Transmitter, Box of 50
469-20009	20009	Accessory Kit for Suzuki Replacement Transmitter
469-20010	20010	Accessory Kit for Prowler Replacement Transmitter
469-20011	20011	Accessory Kit for Subaru Replacement Transmitter
469-20012	20012	Accessory Kit for Corvette Replacement Transmitter
469-20013	20013	Accessory Kit for Dodge Nitro Transmitters
469-20014	20014	Accessory Kit for Nissan Transmitters
469-20015	20015	Accessory Kit for GM/TRW Transmitters
469-20016	20016	Accessory Kit for Mercedes Transmitters
469-20017	20017	Accessory Kit for Volkswagen/Siemens Transmitters
469-20018	20018	Replacement Snap-In Valve Ford 20315 Transmitter, Box of 50
469-20019	20019	Accessory Kit for Honda/Acura Transmitters
469-20020	20020	TPMS Service Pack - Stem Only - Chrysler, Dodge, Jeep
469-20030	20030	Accessory Kit for Chrysler/Siemens Transmitters
469-20031	20031	Accessory Kit for Pacific Transmitters
469-20032	20032	Accessory Kit for Toyota/Pacific Transmitters
469-20035	20035	Accessory Kit for TRW Long Valve Transmitters
469-20036	20036	Accessory Kit for TRW Short Valve Transmitters
469-22008	22008	Assembled Chrome Replacement Snap-In Valve for Schrader 20153 Transmitter



VALVE HARDWARE

### Accessory Kit Assortments

Contain all the parts you will need when servicing tires and wheels that are equipped with Schrader Original Equipment pressure monitoring transmitter valves. All components are individually packaged for easy identification by vehicle application and are stored in a handy plastic box.

Ascot No.	Mfg. No.	Description
469-20097	20097	30 Bags (5 ea.) Accessory Kits for Each Transmitter Size, 25 Plastic Valve Caps and Core Tool
469-20597	20597	8 Each of Accessory Kits 20002-20007, 20030-20031, 4 Each of 20035 & 20036, 100 Cores and 25 Plastic Caps



## Accessories and Kits (Cont.)

### Dill TPMS Accessory Kits

Ascot No.	Mfg. No.	Description
469-01030	1030K	Siemens Kit for VW (Fits 1053 Sensor)
469-01031	1031K	VW Kit for Special Wheel Package
469-01040	1040K	Siemens Mercedes Assembled Valve
469-01050	1050K	Siemens Kit for Chrysler
469-01060	1060K	Compatible with Schrader 20001/20002/ 20135AK/20096AK
469-01070	1070K	Compatible with Schrader 20004/20116AK/ 20115AK/20107AK
469-01080	1080K	Compatible with Schrader 20003/20007/ 20117AK/20028AK
469-01090	1090K	Compatible with Beru Sensors
469-01096	1096	Entire Valve (Schrader 20036) for Hyundai, Kia, Honda
469-01097	1097	Entire Valve (Schrader 20035) for Hyundai, Kia, Honda
469-01098	1098K	Dodge Sprinter Replacement Valve
469-01100	1100K	Compatible with Pacific Sensors for Toyota/Lexus
469-01110	1110K	Compatible with Pacific Sensors for Toyota
469-11120	1120K	Compatible with Pacific Sensors for Lexus
469-01130	1130K	Compatible with Schrader 20005
469-20025	2000K	Compatible with Entire Sensors
469-20010	2010K	Compatible with Schrader Sensors for Volvo
469-20020	2020K	Early 2007 GM Kit for Entire Sensors
469-20030	2030K	Compatible with Schrader Sensors for Chrysler, Dodge
469-02040	2040K	Kit for Honda Civic
469-09250	VS-925A	Aluminum Metal Replacement Valve for GM Snap-In
469-09252	VS-925B	Black Nut/Black Cap Metal Replacement Valve for GM
469-09251	VS-925C	Chrome Replacement Valve for GM Snap-In
469-09304	930-SC-4	4-Pack of Chrome Sleeves & Caps That Fit the TPMS Snap-In Valve
469-09305	VS-930	Rubber Snap-In Replacement Valve for GM Transmitters. Box 25
469-00950	VS-950	Rubber Snap-In Replacement Valve for GM & Ford Transmitters. Box 25



469-09250



469-09251



469-09304



469-09305



469-00950

### Dill TPMS Master Accessory Assortment

- Contains 76 kits, 3 tools, 20 cores, 20 caps and 4 chrome sleeves
- Tools included are a Torque Screwdriver, a Fishing Tool and a 4-Way TPMS tool
- Includes 6 kits each of the following: 1050K, 1060K, 1070K, 1080K, 1100K, 1110K, 1130K, 2000K and VS-930
- Includes 4 kits each of the following: 1030K, 1090K, 2010K, 2020K, 2030K and 2040K

Ascot No.	Mfg. No.
469-07100	7100



### Universal Master TPMS Transmitter Hardware & Tool Service Set

- Versatile 152 piece assortment (15 unique kits) covers over 55 different OEM sensor models and 90% of US vehicles
- Tools included are a Sensor Service Tool, Ratcheting Torque Wrench, 2 Deep Sockets, 2 Torque Drivers and bits

Ascot No.	Mfg. No.	Description
469-30000	30000	Universal Master TPMS Set



## Accessories

### Schrader TPMS Valve Caps



468-00050    468-20495    468-20595    468-59019

Ascot No.	Mfg. No.	Description	Qty./Box
468-00050	20395	Plastic Valve Caps	100
468-20495	20495	Aluminum Valve Caps	100
468-20595	20595	Black TPMS Plastic Sealing Valve Caps for Snap-In Transmitters	100
468-20695	20695	Green TPMS Plastic Sealing Valve Caps for Snap-In Transmitters	100
468-59019	59-0019	Green Nitrogen Indicating Aluminum Valve Cap	100
468-59021	59-0021	Chrome-Plated Brass Valve Caps	100
468-59023	59-0023	Universal Nitrogen Caps	100

### Rubber TPMS Snap-In Replacement Valves

- Rubber stem & attaching screw for Schrader 20153 snap-in transmitter
- Cap & core included
- Requires T-10 Torx Tool for assembly/disassembly



Ascot No.	Mfg. No.	Description	Qty./Box
469-09305	VS-930	Dill Rubber Snap-In Replacement Valve for GM Transmitters	25
468-09305	VS-930SC	TPMS Snap-In Valve Chrome Sleeve & Cap Kit	25
469-00950	VS-950	Rubber Snap-In Replacement Valve for GM & Ford Transmitters	25
469-20008	20008	Replacement Snap-In Valve for Schrader 20153 Transmitter	50
469-20018	20018	Replacement Snap-In Valve for Schrader Ford 20315 Transmitter	50

### Schrader TPMS Valve Core

- Electroless Nickel-Plated valve core
- All valve caps packaged 100/box

Ascot No.	Mfg. No.
468-20055	20055



### Beru TPMS Valve Inserts

- Original equipment valve insert for the Beru Tire Safety System
- Each Insert comes complete with cap, core, grommet & grommet nut
- Colored bottom to differentiate inserts
- Applications - Audi, Bentley, BMW, Ferrari, Land Rover, Maserati, Maybach, Mercedes-Benz, Porsche, Volkswagen
- Requires TX-20EZ torx tool for assembly/disassembly

Ascot No.	Mfg. No.	Description
461-59307	59.0342	Green Insert
461-59337	59.0340	Silver Insert
461-59357	59.0346	Orange Insert
461-59387	59.0344	Black Insert
469-02020	TX-20EZ	Torx Screwdriver



### Dill TPMS Valve Caps & Cores

- All valve caps and cores packaged 100/box



Ascot No.	Mfg. No.	Description
468-01001	100-TP	Electroless Nickel Plated Valve Core
468-06300	630N	Plastic TPMS Valve Cap
468-00635	635	Plastic Cap for VS-930 TPMS Snap-In Valve
468-00650	650	Small Plastic TPMS Valve Cap
468-00680	680	N2 Aluminum Cap for TPMS
468-00690	690	N2 Plastic Cap for TPMS

## Tools

### TPMS Torque Wrenches and Sockets

- Perfect for tightening grommet nut to manufacturer specifications
- Periodic calibration recommended

Ascot No.	Mfg. No.	Description
168-01501	1501MRMH	1/4" Drive 20-150 In.-lbs. Torque Wrench
167-12110	1211D	1/4" Drive x 11 mm x 12 mm Chrome Flip Socket
169-01002	1002E	1/4" Drive x 2" Chrome Extension
168-72100	72100	3/8" Drive, 20 - 200 In.-lbs.
168-72120	72120	3/8" Drive, 25 - 250 In.-lbs.
162-27211	27211	3/8" Drive x 11mm Socket
162-27212	27212	3/8" Drive x 12mm Socket



168-01501



167-12110



169-10022



168-72100

### Electronic TPMS Torque Wrench

- Range 12–120 in.-lbs. Accuracy  $\pm 2\%$ . Green light for power on/red light and buzzer for reaching target signal. Red flash for overload signal. Torque set quickly with unique slide bar on the scale. Indexing head allows for use straight (screwdriver position) to spin nut down quickly. Rotate to 90° position to torque and leverage. Torque limit LED flashes with audible beep. Power switch with LED indicator. Uses coin style batteries. Approximately 8.5" long

Ascot No.	Mfg. No.
168-38325	3833-25



### Core/Cap Removal Tool



469-20250

### Grommet Installation/Removal Tool

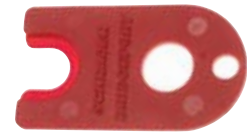

469-20144

### 1/4" Socket Driver

- Made in the USA. 6" Overall Length, 2-1/2" Shank Length
- Durable screwdriver handle and a chrome vanadium shank
- Ideal for use with the TPMS 11 mm x 12mm flip socket

Ascot No.	Mfg. No.
319-72521	7252100



### 3 Way TPMS Tool



469-89111

Ascot No.	Mfg. No.	Description
469-20250	20250	Core/Cap Removal Tool
469-20144	20144	Grommet Installation/Removal Tool
469-89111	8911-10	3 Way TPMS Tool

### Valve Core Torque Tool

- Preset torque guarantees correct setting every time on all cores
- Calibrated to 4 in.-lbs. of torque
- Meets the Tire & Rim Association (TRA) specifications for installing valve cores on TPMS applications
- Can be used to install and remove cores in standard valves

Ascot No.	Mfg. No.
469-00044	TPMS-4VC





## TPMS Accessories and Tools

### TPMS Valve Stem Fishing Tool

- Secures TPMS sensor to wheel during demount
- One handle end can be used as a deflator; the other as a core remover
- 3" Overall length

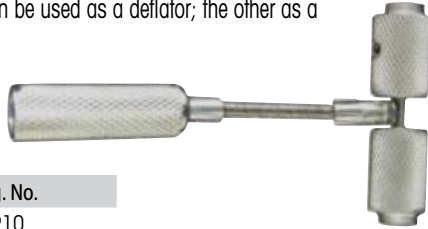

Ascot No.	Mfg. No.
469-08910	08910

### Tire Deflator/Valve Core Remover

- Screws on TPMS valve stems to deflate the tire without removing the valve core

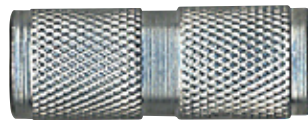

Ascot No.	Mfg. No.
469-00021	TL-615

### Tire Deflator Set for TPMS Valve Stems

- Simply replace a standard sized valve cap with this handy tool and the special design will depress the pin in the valve core. Large openings on the sides of the tool allow air to escape quickly from the tire. Tools are marked so tires can be returned to their original position on the vehicle so TPMS will not need to be reset. Also saves time since the valve core has not been removed from the sensor
- Set of 4

Ascot No.	Mfg. No.
469-19860	19860

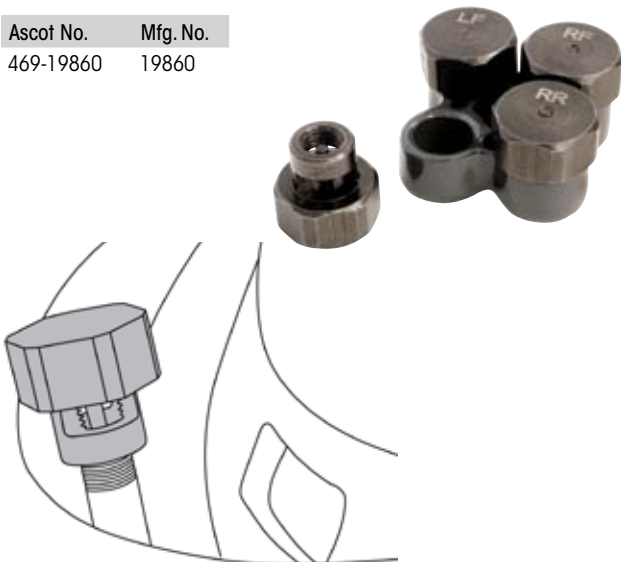

### T-10 Torque Tools

- Installs replacement snap-in valve to Schrader 20153/20315 transmitter
- Preset to 12 in.-lbs. (1.3 nM)



469-05415

469-20140

Ascot No.	Mfg. No.	Description
469-20140	20140	T-10 Torque Tool
469-05415	5415	T-10 Torque Tool w/ Replaceable Tip
469-54151	5415-1	Replacement T-10 Tip

### Dill TPMS Master Tool Kit

- Includes all the mechanical tools needed to properly remove and install TPMS sensors. This complete tool kit includes a 3/8" torque wrench, 2 sockets, a valve core torque tool, a torque screwdriver, a 3-way valve stem fishing tool, a valve nut wrench and grommet seating tool, plus 20 valve cores and 20 valve caps

Ascot No.	Mfg. No.
469-08100	8100



## Convert Vehicles with Valve Transmitters to Band Type!

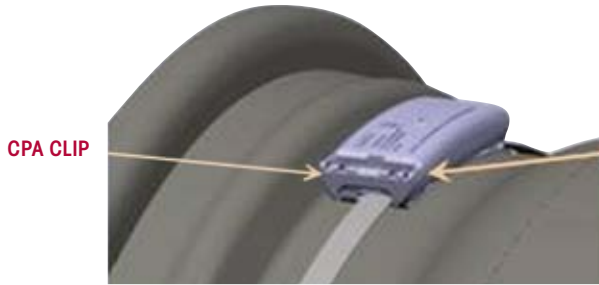

CPA CLIP

BANDED TRANSMITTER ASSEMBLY  
(Sensor in Cradle)



### Band Transmitter Complete Packages

- Includes band, cradle, clip and 1048 transmitter
- 469-15105 includes the above but with the 1048-HP high pressure transmitter

Ascot No.	Mfg. No.	Description
469-05105	5105	Complete Banded Transmitter Package
469-15105	5105-HP	High Pressure Complete Banded Transmitter Package



### Band Transmitter for Ford

Ascot No.	Mfg. No.	OE Part No.	Description
461-01048	1048	6F2Z1A189A	Lear Ford Banded Transmitter
461-11048	1048-HP	8C2Z1A189A	Lear High Pressure Ford Branded Transmitter



14" to 26" One Size Fits All

### Band Transmitter Accessories

- TPMS Band is adjustable to accommodate 14" - 26" wheels
- Plastic clip included with TPMS Cradle
- For use on vehicles equipped with banded transmitters

Ascot No.	Mfg. No.	Description
469-01426	TPSTRAP	Universal TPMS Band
469-02723	TPCRADLE	Band Transmitter Cradle and Clip



469-02723

### Replacement Clip

- Plastic replacement clip for TPMS replacement cradle

Ascot No.	Mfg. No.	Description
469-01026	1026	Plastic Replacement Clip for TPMS Replacement Cradle



### Dill OEM Replacement Bands

Ascot No.	Mfg. No.	Description
469-19318	1193-18	18" OEM Replacement Band
469-19320	1193-20	20" OEM Replacement Band
469-19322	1193-22	22" OEM Replacement Band



## Schrader TPMS Transmitters



### Schrader TPMS Transmitters

Includes transmitter, grommet, nut, cap & core

Ascot No.	Mfg. No.	O.E. Part No.	Description
461-20028	20028	5208-8990AC	Chrysler Replacement Transmitter
461-20034	20034	MN103081	Mitsubishi Replacement Transmitter
461-20064	20064	40700-CD001	Nissan Replacement Transmitter
461-20066	20066	5605-3036AA, 5605-3030AB, 6800-16966AA, SE57770	Chrysler Gen J Replacement Transmitter
461-20069	20069	40700-CK002	Nissan Replacement Transmitter For Vehicles With Steel Wheels
461-20076	20076	25758220	GM 2006 Cadillac & Corvette Replacement Transmitter
461-20081	20081	28103-AG00A	Subaru Replacement Transmitter
461-20082	20082	96484045	Daewoo Replacement Transmitter
461-20087	20087	4313054J20	Suzuki Replacement Transmitter
461-20096	20096	4L2T-1A150-BA	Ford Small Truck Replacement Transmitter
461-20107	20107	15114379	GM Large Truck Replacement Transmitter
461-20115	20115	15136883	GM 2004 Large SUV Replacement Transmitter
461-20116	20116	25774005	GM Small Truck Replacement Transmitter
461-20117	20117	25773946	GM Cadillac & Corvette Replacement Transmitter
461-20131	20131	15122618	Hummer Replacement Transmitter
461-20135	20135	5L1Z-1A150-AA	Ford Large Truck Replacement Transmitter
461-20153	20153	70503153	GM Snap-In Type Replacement Transmitter - Complete Unit
461-20156	20156	8651700	Volvo Replacement Transmitter
461-20158	20158	15268606, 10394110	GM 2006 Replacement Transmitter
461-20161	20161	40700-CK-001	Nissan Replacement Transmitter For Vehicles With Alloy Wheels
461-20315	20315	9L3Z1189A	Ford 2009/2010 Snap-In Style Replacement Transmitter Complete Unit
461-20335	20335	04727392AD, 5127-335AB, 5127-335AD, SE57243	Chrysler Siemens Replacement Transmitter
461-20398	20398	56029398AA	Chrysler Snap-In Replacement
461-28004	28004	04815132AB	Chrysler Prowler Replacement Transmitter
461-28006	28006	10438853	97-00 Corvette Replacement Transmitter
461-28078	28078	24437708	Saab Replacement Transmitter
461-28129	28129	4250A030	Mitsubishi Replacement Transmitter
461-28154	28154	56029319AA	Chrysler DCA Replacement Transmitter
461-28155	28155	56029359AA	Chrysler Replacement Transmitter
461-28167	28167	40700JA01A	Nissan Replacement Transmitter O.E. 40700-JA01A
461-28203	28203	28103AG01A	Subaru Snap-In Replacement Transmitter OE 28103AG01A
461-28204	28204	40700JA01B	Nissan Replacement Transmitter O.E. 40700-JA01B
461-28210	28210	40700JK00B	Nissan/Infiniti Replacement Transmitter
461-28214	28214	0045421518	Mercedes Gen Alpha WALA Replacement Transmitter
461-28291	28291	56029400AB	Chrysler Replacement Transmitter
461-28300	28300	426070C010	Toyota Replacement Transmitter
461-28305	28305	426070C020	Toyota Replacement Transmitter
461-28310	28310	4260724010	Lexus Replacement Transmitter
461-28315	28315	4260724020	Lexus Replacement Transmitter
461-28320	28320	4260724030	Lexus Replacement Transmitter
461-28325	28325	0426724040	Lexus Replacement Transmitter
461-28335	28335	0426724040	Lexus & Toyota Replacement Transmitter
461-28345	28345	4260735010	Lexus & Toyota Replacement Transmitter
461-28355	28355	42607AD020	Toyota Replacement Transmitter
461-28360	28360	4260706011	Toyota Replacement Transmitter
461-28365	28365	4260733011	Lexus, Scion, Toyota Replacement Transmitter
461-28370	28370	4260733021	Lexus & Toyota Replacement Transmitter
461-28380	28380	42607AD010	Toyota Replacement Transmitter
461-28395	28395	8C2Z1A189A	Ford Banded Replacement Transmitter
461-28670	28670	426070C050	Toyota Replacement Transmitter
461-28720	28720	42753SNAA83	Honda & Acura Replacement Transmitter
461-28849	28849	529332F000	Hyundia & Kia Replacement Transmitter
461-28982	28982	06421-S9V-A01	Honda Replacement Transmitter
461-28983	28983	958104D100	Hyundai Replacement Transmitter



VALVE HARDWARE

## Dill TPMS Transmitters

### Dill TPMS Transmitters

- Includes transmitter, grommet, nut, cap & core



Ascot No.	Mfg. No.	O.E. Part No.	Description
461-01027	1027	36236779490	Lear BMW Replacement Transmitter
461-01028	1028	529334D200	Lear Hyundai/Kia Replacement Transmitter
461-01029	1029	529332F000	Entire Kia Spectra/Rio Replacement Transmitter
461-01041	1041	Check VIN	Volkswagen Replacement Transmitter w/O-Ring Nut
461-01042	1042	68006771AA	Dodge Sprinter Replacement Transmitter
461-01043	1043	68001698AA	Siemens 2008 Chrysler Replacement Transmitter
461-01044	1044	30666931_6G92-1A159-BB	2007-2008 Volvo Replacement Transmitter
461-01046	1046	Check VIN	Siemens Land Rover/Jaguar Replacement Transmitter - 433 MHz
461-01047	1047	10394110	Siemens 2007 - 2008 Clamp-In Replacement Transmitter
461-01048	1048	6F2Z1A189A	Lear Ford Banded Transmitter
461-11048	1048-HP	8C2Z1A189A	Lear High Pressure Ford Banded Transmitter
461-01049	1049	Check VIN	Siemens Mercedes Replacement Transmitter - 433 MHz
461-01051	1051	4250A225	Siemens Chrysler Replacement Transmitter
461-01052	1052	Check VIN	Siemens 2004 Chrysler Replacement Transmitter
461-01053	1053	Check VIN	Siemens Volkswagen Replacement Transmitter
461-01054	1054	Check VIN	Siemens Mercedes Replacement Transmitter
461-01055	1055	Check VIN	Siemens Land Rover/Jaguar Replacement Transmitter
461-01056	1056	GN3A-37-140B	Siemens Mazda Replacement Transmitter
461-01057	1057	06421-S3V-A02	Entire Acura/Honda Replacement Transmitter
461-01058	1058	06421SCVA00	Entire Hyundai/Kia Replacement Transmitter
461-01059	1059	06421S9VA01	Entire Honda Replacement Transmitter
461-01068	1068	52933-2G200	Hyundai/Kia Replacement Transmitter
461-01203	1203	42607-0C010/AD010	Toyota Replacement Transmitter - OE No. 42607-0C010
461-11204	1204	42607-0C020	Toyota Replacement Transmitter - OE No. 42607-0C020
461-01204	1204A	42607-33021	Aftermarket Pacific Replacement Transmitter for Toyota
461-01205	1205	42607-35010	Toyota Older 4Runner, Lexus GX-470 Replacement Transmitter
461-01206	1206	42607-0C050	Toyota Replacement Transmitter - OE No. 42607-0C030/0C050
461-01207	1207	42607-0C060	Toyota Replacement Transmitter - OE No. 42607-0C040/0C060
461-01208	1208	42753-SWA-316	Honda Accord/CRV/Fit Replacement Transmitter
461-01209	1209	42753-STK-A04	Honda Pilot/Some Acura Replacement Transmitter
461-01210	1210	42753-SHJ-A82	Honda Odyssey, Can Use 1058 with TRW Enable Function
461-01211	1211	42753-SHJ-853	Odyssey Touring, Can Use 1057 with TRW Enable Function
461-01212	1212	42753-SNA-A83	Honda Civic Replacement Transmitter
461-09001	9001	A0008223306	Beru RDE 001 Transmitter for Audi, Mercedes (433 MHz)
461-09002	9002	36118378682	Beru RDE 002 Transmitter for BMW 3/5/7 Series (433 MHz)
461-09003	9003	36146752128	Beru RDE 003 Transmitter for BMW X5 / Land Rover (433 MHz)
461-09004	9004	A0008223406	Beru RDE 004 Transmitter for Mercedes Benz
461-09005	9005	7L0907275	Beru RDE 005 Cayenne/Touareg Replacement Transmitter - 433 MHz
461-09007	9007	4F0907275	Beru RDE 007 Audi A6 Replacement Transmitter - 433MHz
461-09011	9011	4F0907275D	2010 Audi Transmitter
461-09012	9012	3610679 054	2010 BMW, Mini Cooper



Siemens - Entire - Pacific - Beru



### Beru TPMS Transmitters

- Valve insert & transmitter sold separately
- Two-piece design to adapt to rim configurations

Ascot No.	Mfg. No.	Description
461-10001	RDE001	Audi, MB Replacement Transmitter
461-10002	RDE002	BMW Replacement Transmitter
461-10003	RDE003	Land Rover Replacement Transmitter
461-10005	RDE005	Select Porsche & VW Transmitter
461-10007	RDE007	Audi A4 Replacement Transmitter



## Beru Tire Safety System (TSS)

For use with most European vehicles equipped with TPMS. Call for application information.

## TPMS Cabinets

### TPMS Cabinet - Stocked and Ready!

This fully stocked cabinet includes the following:

- 3 of each Sensors: 20028, 20064, 20069, 20076, 20096, 20107, 20115, 20116, 20117, 20131, 20135, 20158, 20161
- 50 of each Service Packs: 20002, 20003, 20004, 20005, 20006, 20007
- 100 TPMS Electroless Nickel Plated Cores (#20055)
- 100 TPMS Plastic Sealing Caps (#20395)
- 100 TPMS Metal Sealing Caps (#20495)
- Current Mitchell 1 Protocol Manual (#20136)



Ascot No.	Mfg. No.	Description	Dimensions
469-20190	20190	TPMS Cabinet	30.25" x 26.5" x 10"



### TPMS Cabinets

- Dill cabinets are shipped empty

Ascot No.	Mfg. No.	Description	Dimensions
469-05112	5112	Counter Top Style TPMS Cabinet	12" x 15" x 3.5"
469-32755	32755	Lockable Medicine Cabinet Style TPMS Cabinet	42" x 35" x 11"
469-32756	32756	Lockable Top TPMS Cabinet	43.5" x 35" x 11"



469-32755



469-32756



469-05112

## TPMS Retrofit Kit

### Schrader TPMS Retrofit Kits

- For installation on vehicles not equipped with OE TPMS Systems
- Stand alone kit includes dash mounted display
- Four wheel mounted transmitters and installation instructions
- 20256 includes two AA batteries

Ascot No.	Mfg. No.	Description
469-20256	20256	Battery Operated
469-20257	20257	Hard Wired



### Dill Trailer TPMS System

- Designed to be installed directly into trailer tires
- Provides accurate trailer tire air pressures and temperatures
- A warning will trigger if pressure falls below the set pressure
- Ability to set baseline pressure to desired PSI level
- Valve options for 0.453", 0.625", and 9.7mm rim holes
- Cigarette lighter adapter or hard-wired options

Ascot No.	Mfg. No.	Description
469-01502	1502-453	Dill Trailer TPMS System With Two Sensors
469-01504	1504-453	Dill Trailer TPMS System With Four Sensors



Ability to Set Baseline Pressure



Valve Options for 0.453", 0.625", and 7.7mm Rim Holes



Transmitters

## Training and Promotional Materials

### TPMS Training Package



491-11111



491-21355

### TPMS Countertop Displays

This display promotes replacing the TPMS components when service is performed on the customer's tires.



Training Package Includes:

- 90 minute, in-depth TPMS Training DVD
- Mitchell TPMS Service Guide
- TPMS Course Book (with test & certification application)
- CD Video Demos of each Bartec TPMS Tool

Ascot No.	Mfg. No.	Description
491-11111	WRTRKIT	TPMS Training Package

### Schrader TPMS Training DVD

Available in both English and Spanish versions - call for more details

Ascot No.	Mfg. No.	Description
491-21355	21355	Training DVD - English Version
491-21357	21357	Training DVD - Spanish Version

Ascot No.	Mfg. No.	Description
469-61589	61589	TPMS Countertop Display w/ Dummy Transmitter
469-61599	61599	Spanish TPMS Countertop Display w/ Dummy Transmitter

### Mitchell TPMS Guide



### Consumer Brochure & Holder



### Consumer Awareness Counter Mat



Call for details on a complete line of TPMS point-of-purchase displays and training materials.

- Contains current learn procedures for all domestic and import vehicles currently equipped with tire pressure monitoring systems
- Includes a quick reference to determine service requirements
- Provides detailed system operation for manufacturer specific systems
- E-Book Guide Available

Ascot No.	Description
469-22006	TPMS Consumer Brochure
717-00400	Plastic Brochure Holder
469-07011	Consumer Awareness Counter Mat

## Passenger Valves - Tubeless

### Snap-In Tubeless Tire Valves

- Schrader, Dill or equivalent available



Ascot No.	TR No.	Effective Length
FOR .453" VALVE HOLES		
461-00412	412	7/8"
461-00413	413	1-1/4"
461-00414	414	1-1/2"
461-00418	418	2"
461-00423	423	2-1/2"
FOR .625" VALVE HOLES		
461-00415	415	1-1/2"
461-00425	425	2"

### Chrome-Sleeve Snap-In Type Tubeless Tire Valves

- Standard snap-in type tubeless tire valves are fitted with an attractively designed hexagon valve cap and chrome sleeve to cover the valve stem area
- Available in two lengths to fit .453" valve holes

Ascot No.	Mfg. No.	Effective Length
461-41211	412SC	7/8"
461-41311	413SC	1-1/4"
461-41811	418SC	2"



### High Pressure Snap-In Valves

- Tubeless snap-in type valves for high pressure applications
- Maximum cold inflation pressure is 80 PSI
- For .453" or .625" rim holes
- Do not use on tire rims that exceed .205" in thickness



Ascot No.	TR No.	Effective Length	Valve Hole Dia.
461-00600	600HP	1.27"	.453"
461-00602	602HP	2"	.453"
461-00801	801HP	1.25"	.625"
461-00802	802HP	2"	.625"

**IMPORTANT:** Snap-in passenger valve stems are safe for tire pressures up to a maximum of 65 PSI (cold tire pressure) and for a maximum rim thickness of .156" (3.9mm). If greater pressure or rim thickness is required, metal clamp-in valve stems are recommended.

### Clamp-In Tubeless Tire Valves

- Nickel plated metal valves can be installed in all passenger cars, light trucks and industrial rims with .453" or .625" valve holes
- Rubber grommet forms a seal when valve is clamped to rim by tightening hex nut
- Maximum inflation pressure is 130 PSI
- Includes 2 rubber grommets

Ascot No.	TR No.	Effective Length
462-00416	416	1-1/4"
461-01416	416L	2"



### Replacement Grommets

- Replacement grommets for .453" and .625" valve holes

Ascot No.	TR No.	Effective Length
468-59765	RG-54	Grommet for .453" Hole
468-99393	RG-39	Grommet for .625" Hole



### High Performance Valve

- Chrome plated clamp-in valves are easily installed in all types of passenger car wheels
- For .453" or .625" valve holes

Ascot No.	Mfg. No.
462-00800	5991B



### Enkei Valves

- A high performance "No Show" type chrome plated valve that installs from the outside
- A rubber washer and nut are on the inside
- Fits .453" diameter hole

Ascot No.	Mfg. No.	Description
462-06010	TV-6010	3/4" Length, Standard
462-06020	TV-6020	Bent at 45° Angle
462-06030	TV-6030	1-1/4" Length, Standard
462-06040	TV-6040	1-3/4" Length, Standard



### High Pressure Chrome Sleeve Tire Valve

- Used to 80 PSI cold inflation pressure
- Fits 453" diameter valve hole, maximum rim thickness .205" at valve hole
- Chrome sleeve

Ascot No.	Mfg. No.
461-01600	600HPC





## Truck Valves - Tubeless

### 570 Series Truck & Bus Tubeless Tire Valves - 570 Series

- Used on both demountable and non-demountable rims with standard 5/8" (.625") side hole valve mountings
- Heavy duty rubber grommet forms airtight seal when valve is clamped in rim by tightening the hex nut
- Eight valves cover all truck rim requirements
- Available in custom bends
- Schrader, Dill or equivalent available

Ascot No.	TR No.	Effective Length
463-00575	575	1-1/8"
463-00501	501	1-1/2"
463-00500	500	2"
463-00570	570	3-1/8"
463-00571	571	3-3/8"
463-00572	572	3-3/4"
463-00573	573	4-3/8"
463-00574	574	5"



### Alcoa Truck Tubeless Tire Valves - 540 Series and 550 Series

- Designed for use with 9.7mm (.382") rim hole
- Rubber O-ring forms a seal when valve is clamped to rim by tightening hex nut
- Designed specifically for use in aluminum wheels
- 550 Series equipped with rubber grommet
- Schrader, Dill or equivalent available

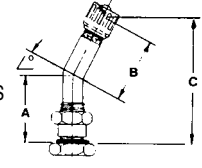

Ascot No.	TR No.	Ascot No.	TR No.	A	B	C
463-00542	542	463-00552	552	1.25"	-	-
463-00543	543	463-00553	553	2.31"	-	0°
463-05433	543C	463-01553	553C	0.93"	1.43"	45°
463-05434	543D	-	-	0.98"	1.38"	60°
463-05435	543E	463-03553	553E	0.98"	1.38"	75°
463-00544	544	-	-	2.86"	-	0°
463-01544	544C	-	-	0.86"	1.94"	45°
463-05444	544D	463-02554	554D	0.98"	1.94"	60°
463-00545	545	-	-	3.50"	-	0°
463-05454	545D	463-01555	555D	0.98"	2.60"	60°
463-15454	545E	463-02555	555E	0.98"	2.60"	75°
463-00546	546	-	-	4.25"	-	-
463-05464	546D	-	-	0.98"	3.35"	60°
463-05465	546E	-	-	0.98"	3.35"	75°
463-05474	574D	-	-	0.98"	3.78"	60°
463-54636	546-36	-	-	0.98"	3.35"	36°
468-10060	RG-60	-	-	Replacement O-Ring TR-540 Series		
468-10070	RG-70	-	-	Grommet for 550 Series		

### Replacement Valve Components

- Packaged 100 per Box

Ascot No.	Mfg. No.	Description
468-07572	7572V	Schrader Replacement Cap
468-00765	765	Dill Replacement Dome Cap
468-05405	5405V	Schrader Replacement Core
468-00103	100-TB	Dill Replacement Core
468-05954	595-4	Replacement Hex Nut
468-05952	595-2	Replacement Washer
468-05953	595-3	Replacement Grommet
468-00462	462G	Dill Green High Temp Grommet

### Tubeless Valves for Aluminum Disc Wheels

- For drop-center aluminum disc wheels with 5/8" bottom valve hole



Ascot No.	TR No.	Effective Length
463-00509	509	4-3/4"
463-00510	510	5-1/2"
463-00511	511	4-1/4"
468-05093	509-3	Replacement Rubber Grommet

### Nitrogen O-Ring & Sleeves

- Fits 540 and 570 Truck Valves
- Nitrogen use in truck tires



Ascot No.	TR No.	Effective Length
468-00307	TS-OR	O-Ring
468-00607	NITSLV	Indicator Sleeves

### Metric Rim Hole Valves (9.7mm Valve Hole)

- Some imported trucks will have steel wheels that incorporate the 9.7mm valve hole (.382")
- Most popular valves for this application
- Other sizes available upon request



Ascot No.	TR No.	ETRTO	Bend	A	B
462-06027	60 MS-27	-	27°	1-3/16"	1-3/16"
462-07025	70 MS-27	V3-20-5	27°	1-3/16"	1-9/16"
462-08027	80 MS-27	V3-20-7	27°	1-3/16"	2"
462-09027	90 MS-27	V3-20-4	27°	1-3/16"	2-3/8"
462-11527	115 MS-27	V3-20-6	27°	1-3/16"	3-3/8"
462-04100	41 MS-00	V3-20-1	STR	1-3/16"	-
468-00707	70 MS-7	-	7°	-	-

## Truck and Specialty Valves

### Radial Commander Valve for 15° Disc Wheels

- 23° bend clamp-down valve for .625" valve hole
- Bend allows clearance of brake drum for tire service

Ascot No.	Part No.	Description
462-01147	VS-1223R	Radial Commander Valve
462-01224	VS-1224R	Longer Radial Commander Valve for Equal Applications



462-01224

### Valve for 16 X 6KS with Oval Hole

- Oval rim slot valve for 16 x 6KS and 16 x 6-1/2LS rim contours
- Allows a positive seal in this special valve hole
- Check the valve hole for metal burrs prior to installation

Ascot No.	TR No.	Description
462-05010	H5010V	Oval Rim Slot Valve



### Truck/Bus Screw-On Repair Valves



463-01078

- Replace damaged cured-in or cured-on valves without cutting out old valve base
- 1-1/16" horizontal diameter

Ascot No.	TR No.	Eff. Length
463-01177	1177A	3-3/4"
463-01175	1175A	4-1/2"
463-01078	1078A	5"

### Tractor Front Wheel Valves

- Low profile valve offers minimum protrusion above the rim
- 9/16" effective length with chrome finish
- Fits .453 or .625 valve holes



Ascot No.	Part No.	Description
462-06008	TV-6008C	Tractor Front Wheel Valve With Chrome Finish
462-16008	TV-6008	Tractor Front Wheel Valve With Brass Finish

### Tubeless Motorcycle Valve

- Has O-ring seal
- Fits .327" valve holes
- Effective length is 1-13/16"
- TR430

Ascot No.	Part No.	Description
462-00430	TV-430	Tubeless Motorcycle Valve



### Alloy Valve

- Light alloy valve used on racing and light alloy wheels
- Fits .453" valve hole
- Has O-ring seal

Ascot No.	Part No.	Description
462-00523	H-523MS	Alloy Valve



## Truck and Specialty Valves (Cont.)

### Special Clamp-In Tire Valve

- Designed for front wheel drive Toronado ('66-'78) and Eldorado ('67-'78) cars

Ascot No.	TR No.
462-00417	417



### Ford "F" Series Truck Valve

- Ford "F" series with dual wheels
- Accuride steel 16" x 16"
- Front and rear wheels
- Nickel finish
- Includes dual seal cap

Ascot No.	Part No.	Description
462-02416	TV-416MC	Ford "F" Series Valve



### Valve Breaker

- Removes valves quickly
- Slide hammer with an internal spring absorbs the shock of impact
- Easy to use
- Designed to shear the bottom flange off the valve with one or two blows



Ascot No.	Mfg. No.	Description
469-35934	35934	27" Valve Breaker
469-35936	35936	45" Valve Breaker
469-35935	35935	Valve Breaker Parts Kit

### Ford "F" Series Truck Valve

- Ford "F" series with dual wheels
- Alcoa aluminum 16"
- Front and rear wheels
- Chrome finish
- Includes dual seal cap

Ascot No.	Part No.	Description
462-01600	N-1600	Ford "F" Series Truck Valve



### Nut Splitter

- Removes brass tire valves from truck rims
- Available in manual and pneumatic

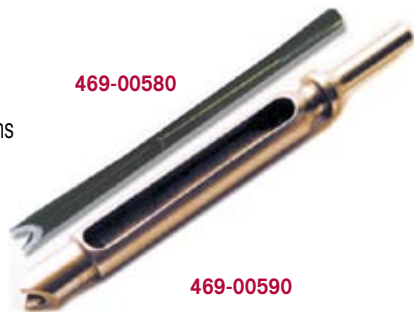

469-00580

469-00590

### Ford "F" Series Valve

- Ford "F" series with dual wheels
- Accuride steel 19.5"
- Front and rear wheels
- Nickel finish
- Includes dual seal cap

Ascot No.	Part No.	Description
462-03416	TV-416/DS-1	Ford "F" Series Valve



Ascot No.	Part No.	Description
469-00580	NS58B	Manual Nut Splitter
469-00590	NS59B	Pneumatic Nut Splitter. Attaches To Pneumatic Hammer

## Truck and Specialty Valves (Cont.)

### Valve Nut Torque Wrench

- For use on the valve nut for TR540 & TR570 series truck valves
- Red indicator "pops up" when setting is reached
- 9/16" (preset to 42 in.-lbs.) & 5/8" (preset to 100 in.-lbs.) wrenches available individually or combined with the tool pouch as a kit
- 168-10042 kit includes 9/16" & 5/8" wrenches and tool pouch
- Tool pouch (736-10002) also available separately



168-01942



168-10042

Ascot No.	Description
168-01942	9/16" Valve Nut Torque Wrench - Preset at 42 In.-lbs.
168-10042	Valve Nut Torque Wrench Kit - Includes 9/16" & 5/8" Wrenches & Tool Pouch
168-10100	5/8" Valve Nut Torque Wrench - Preset at 100 In.-lbs.
736-10002	Tool Pouch for Valve Nut Torque Wrenches

### O-Ring Seal Silicone Truck Valves

- Operating temperature from -67°F to 500°F
- Handles any type of high temp application
- Seals between the rim and valve more effectively
- Replacement O-rings available - RG-150 (468-30015)

Ascot No.	Part No.	Description
463-01571	VS-571-EQ	O-Ring Silicone Truck Valve For TR571
463-01572	VS-572-EQ	O-Ring Silicone Truck Valve For TR572
463-01573	VS-573-EQ	O-Ring Silicone Truck Valve For TR573



463-01572

### High Temperature Brass Valves w/ Viton O-Rings

- Perfect for all applications
- Does not need changed between tire changes (Green product for the environment)
- Can be bent after installation without O-ring damage
- Operating temperature from -130°F to 4000°F
- Replacement brass grommets with o-rings available AS100-1 (fits all TR valves)
- Replacement O-rings available AS100-OR
- Eliminates the labor of removing wheels in order to re-tighten a valve stem nut
- Eliminates flat repair charges due to leaking valve stem grommets
- Less time spent maintaining air pressure



Ascot No.	Part No.	Description
463-10572	AS-100-572	TR572 w/Brass Grommet & Viton O-Ring
463-10573	AS-100-573	TR573 w/Brass Grommet & Viton O-Ring
463-10001	AS-100-1	Brass Grommet w/Viton O-Rings (Fits all TR Valves)
468-10002	AS-100-OR	Replacement Viton O-Rngs for AS100

### Ford "Cut-Away" Series Valve

- Ford "cut-away" series with dual wheels
- Accuride steel 16" x 16" wheels
- Front and rear wheels
- Nickel finish
- Includes dual seal cap

Ascot No.	Part No.	Description
462-01416	TV-416LF	Ford "F" Series Valve



### Ford "Cut-Away" and Cargo Van Series Valve

- Ford "cut-away" and Cargo van series with single rear wheels
- Accuride steel 16" x 7" wheels
- Front and rear wheels
- Chrome Finish
- Includes dual seal cap

Ascot No.	Part No.	Description
462-01575	TV-575HP/DS-1	Ford "Cut-Away" & Cargo Van Series



## Valve Caps & Cores

### Standard Valve Cores

- Valve cores all have .206"-36 threads and are compatible with existing U.S.A. and E.T.R.O. housing standards as well as proposed I.S.O. standards -meets specification ZZ-V-25 and TR C-1
- 5405V recommended for all truck, bus and commercial applications; general purpose heat-resistant applications
- 8500TV for general purpose valve use
- Standard pack - 100



Ascot No.	Mfg. No.	Operating Pressure Range	Operating Temp Range (F°)	Operating Pressure	Plug Sealing Material	Plunger Sealing Material
468-05405	5405V	0-200 PSI-Peaks Of 300	-65° To +300°F-Peaks Of +400°F	90 PSIG	Red Teflon	White Silicone
468-08500	8500TV	0-200 PSI-Peaks Of 300	-40° To +225°F	60 PSIG	Green Teflon	Black Nitrile
468-00103	100-TB	Dill Replacement	-65° To +250°F	80 PSIG	Teflon	Silicone

### Passenger Valve Caps

- Fits .305"-32 Threads on standard type valves



Ascot No.	Mfg. No.	Description	TR No.	Pack Size	Finish
468-05005	2413CS	Combination Cap/Sleeve for TR413	TR413	-	Chrome
468-00207	CAP-PG	Green Plastic Nitrogen Cap	-	100	Plastic
468-00660	VC8	Standard Black Plastic Valve Cap	VC8	-	Plastic
468-00680	680	N2 Aluminum Cap for TPMS With Adhesive Green Ring	-	100	Chrome
468-00690	690	N2 Plastic Painted Metallic Silver Cap for TPMS With Adhesive N2	-	100	Plastic

### Truck Valve Caps



Ascot No.	Mfg. No.	Description	TR No.	Sealing Washer Material	Operating Pressure	Operating Temp Range (F°)	Pack Size	Finish
468-07572	7572V	Dome-Shaped Top & Guide On Skirt For Easy Application	VC3	Nitrile	0-200 PSI	-40° To +165°F	100	Nickel Plated
468-00440	440V	High Temperature Truck/Bus Valve Cap	-	100	Plastic	-	-	-
468-00102	6300V	All Purpose Cap With Screwdriver Top For Removing/Inserting Valve Cores	VC2	Nitrile	0-200 PSI	-40° To +165°F	100	Black
468-00765	765	Dill Dome Cap	VC3	Nitrile	0-200 PSI	-40° To +165°F	100	Nickel Plated
468-00632	632	Dill High Temp Dome Cap	VC3	100	Plastic	-40° To +250°F	100	Nickel Plated

### Double Sealing Valve Caps

- Light weight design uses both high temperature and low temperature resistant airtight seals at extension tip and valve mouth
- External grooves accommodate all industry standard air chucks and gauges
- Knurled surface for easy hand installation
- Nickel plated for better appearance and improved corrosion protection



Ascot No.	Mfg. No.	Description
468-06541	6541N	Double Seal Valve Cap, Box 50
468-16541	6541N	Double Seal Valve Cap, Box 250
468-26541	6541N2	Double Seal Cap for Nitrogen, Box 250



**Full Line of TPMS Products Available - See Page 134-149**

## Special Application Products

### High-Pressure Inflating Connections

- Connections attach securely by hand or wrench to the valve cap threads of high-pressure valves



Ascot No.	Mfg. No.	Description
468-00556	H-556	Fits .305"-32" Thread Size With 1/8" NPT Male Connection. Has Core Depressor Pin, Copper Sealing Washer. Max. Working Pressure: 3000 PSI
468-06116	H-6116B	Fits .305"-32" Thread Size With 1/8" NPT Female Connection With 70° Bend. Equipped With Hard Fiber Sealing Washer. Max. Working Pressure: 3000 PSI

### High-Pressure Shock/Strut Valves

- Constructed of stainless steel bodies for use in high pressure shock absorber units, hydraulic pressure accumulator, surge cylinders and high pressure pneumatic systems
- 1/2" - 20 U.N.F. - 3A threads for connection to container



Ascot No.	Mfg. No.	Oper. Pressure	Conforms To
468-07607	H-7607	2000 PSI	AN-812-1
468-04361	H-4361	3000 PSI	AN-6287-1
468-00798	H-798	5000 PSI	MS-28889-2

### Tank Valves

- Use on pressure containers where gauging or service may be required
- Used with various gases, fluids and operating pressures



Ascot No.	Mfg. No.	OAL	Base Thread	Cap Thread	Hex Size
468-00399	TV-399	1-5/16"	1/8" NPT	.305"-32	7/16"
468-00400	TV-400	1-5/16"	1/4" NPT	.305"-32	9/16"
468-00401	TV-401	27/32"	1/8" NPT	.305"-32	7/16"
468-00402	TV-402	1-5/16"	1/8" NPT	.305"-32	7/16"

### Crossfire Dual™ Tire Pressure Equalization System

#### How Crossfire Works:

Crossfire is a pressure equalizing and monitoring valve that is mounted between dual tires. It bolts easily to the lug, hub cap, or drive axle end. Properly mounted, air freely flows from one tire to the other, maintaining equal tire pressure and load distribution.

- Maximizes tire life
- Decreases rolling resistance for increased fuel mileage
- Cuts maintenance time due to single-point inflation and the visual pressure gauge
- Improves stability, braking and overall safety
- Installs in minutes and requires little maintenance
- Pays for itself in less than a year
- American-made and guaranteed for two years



**Under-inflation**  
20% under-inflation can cause a minimum 30% loss of tire life expectancy



**Over-inflation**  
20% over-inflation can cause a minimum 10% loss of tire life expectancy



**Proper-inflation**  
Mounted correctly, Crossfire's yellow indicator verifies that air is flowing freely from one tire to the other, equalizing the load

**Call with Specific Application Information**

## Valve Extensions

### Truck Valve Extensions

- Available in various lengths
- Extensions screw onto the standard .305" valve cap threads of the valve stem and make valve mouth accessible for air service

#### STRAIGHT METAL EXTENSIONS

Ascot No.	Mfg. No.	Eff. Length
468-00347	347	3-1/16"
468-00348	348	5-1/16"
468-00349	349	6-1/16"
468-00346	346	1"
468-00356	356	1-13/32"
468-00350	350	2-7/32"
468-00331	331	3-1/8"
468-00330	330	4-1/8"
468-00341	341	4-7/16"



#### BENT METAL EXTENSIONS

Ascot No.	Mfg. No.	Bend Angle	Eff. Length
468-08028	8028	45°	1-3/8"

### Valve Accessories



#### HEX NUTS

Ascot No.	TR No.	Fits Thread	For Uses On
468-10013	HN-13	.406"-28	TR570 Series
468-10004	HN-4	.406"-28	TR416
468-10117	HN-17	.406"-28	TR509, 510
468-00808	RW-8	.406"-28	TV500 & TV570 Series

#### GROMMETS

Ascot No.	TR No.	Fits Thread	For Uses On
468-10015	RG-15	.625"	TR570 Series
468-11700	G-170S	.625"	Heat Resistant for TV570
468-10046	RG-46	.625"	TR509, 510
468-10039	RG-39	.625"	TR416
468-10054	RG-54	.453"	TR416

#### O-RING

Ascot No.	TR No.	Fits Thread	For Uses On
468-10060	RG-30	.328"	TR540 Series

### Passenger Car Extensions

- Provides a seal against contaminants while extending the valve mouth for convenient access



Ascot No.	Mfg. No.	Description	Eff. Length
468-36801	3680C	Metal	3/4"
468-36803	3680G	Metal	1-1/4"
468-50661	5066C	Nylon	3/4"
468-50663	5066G	Nylon	1-1/4"

### Dual Wheel Extensions

- For convenient air service access to inner rear dual wheels
- Fit standard valve cap threads and include a clip to secure the extension to the wheel cutout
- Can be used on campers, recreational vehicles and light trucks

Ascot No.	Mfg. No.	Eff. Length
468-10017	1001-7	7"
468-10019	1001-9	9"
468-10011	1001-11	11"

### Dual Wheel Flexible Valve Extensions

- Provide easy access to the inner dual fire found on campers, recreational vehicles and light trucks
- Fit standard valve cap threads
- Come with clamp to secure extension to wheel cutout
- 2 extensions per pack and available in steel braided hose



Ascot No.	Mfg. No.	Description	Eff. Length
468-30007	FE-300	Flexible Extension	7"
468-30010	FE-300-9	Flexible Extension	9"
468-40007	SFE-400-7	Steel Braided Extension	7"
468-40010	SFE-400-10	Steel Braided Extension	10"

### Truck Valve Extensions

- HE-370 Series - Lightweight Extensions have the short collar for use on tube-type valves or tubeless lightweight valves. Has a double seal feature to assure positive seal
- HE-390 Series - Lightweight Extensions are the same as the HE-370 series except with a long collar
- HE-380 Series - Standard Style Extensions screw on the standard valve stem (.305-32 cap thread) and make valve mouth accessible
- Extensions & stabilizers available for Alcoa wheels **468-00370**

Ascot No.	Mfg. No.	Collar Type	Eff. Length
468-00370	HE-370	Short 3/8"	2"
468-00371	HE-371	Short 3/8"	2-15/16"
468-00372	HE-370	Short 3/8"	3-15/16"
468-00373	HE-373	Short 3/8"	5-1/8"
468-00389	HE-389	Long 1"	1-1/16"
468-00390	HE-390	Long 1"	2"
468-00391	HE-391	Long 1"	2-15/16"
468-00392	HE-392	Long 1"	5-1/8"
468-00393	HE-393	Long 1"	6"
468-00394	HE-394	Long 1"	8"
468-00395	HE-395	Long 1"	10"
468-00396	HE-396	Long 1"	12"
468-00397	HE-397	Long 1"	14"
STANDARD STYLE			

468-00381	HE-381	Long 1"	3-1/16"
468-00382	HE-382	Long 1"	5-1/16"
468-00383	HE-383	Long 1"	6-1/16"



## Air/Liquid/Agricultural Valves

### Air/Liquid Valves for Tractor and Road Grader Service



Ascot No.	TR No.	A	B	Bend Angle	Valve Hole
464-00618	TV-618A	1-7/8"	—	—	.625"
464-01618	TV-618B	1-1/2"	—	—	.625"
464-00718	TR-618RB	1-7/8"	—	—	.625" Rubber
464-00621	TV-621A	1-1/2"	3"	65°	.625"
464-00622	TV-622A	1-3/4"	4-1/2"	90°	.625"
464-00623	TV-623A	1-1/2"	2-1/4"	65°	.625"
464-00619	TR-619A	1-7/8"	—	—	.812"

### Tractor and Grader Tube Valve

- Valve assemblies with removable core housing for liquid fill
- Vulc-on back to allow field repair



Ascot No.	TR No.	Base Dia.	Core Housing	Vertical Height	Valve Hole
467-00218	TR-218A	2-1/2"	TV-CH-3	1-7/8"	.625"
467-00220	TR-220A	2-1/2"	TV-CH-3	2-15/16"	.625"
467-00916	TR-916A	3-1/4"	R-372	1-7/8"	.812"

### Air/Liquid Extension

- Use with tractor or grader valve stems
- 90° angle for more accessible valve



Ascot No.	TR No.
464-05905	TV-5905

### Rim Nuts and Bushings



Ascot No.	TR No.	Description
468-00010	LN-10	Plastic Rim Nut. For Tractor Tube Valves TR-218A, TR-220A
468-00009	B-9A	Bushing Assembly. Fits Over TR-218A, TR-220A Valves For Use In 13/16" Valve Hole. Includes B9 Bushing And LN-13 Nut
468-00006	B-6	Bushing. Fits Over TR-13 Tube Valve When Used In 5/8" Valve Hole

### Rim Hole Plugs



Ascot No.	TR No.	Description
464-00015	P-15	For Tube-Type Wheels. Used To Plug 5/8" Rim Hole And Avoid Tube Pouching
464-01025	N-1012S	Used To Seal 5/8" Rim Hole When Relocating Valve
464-00030	T-30	Used To Seal 13/16" Rim Hole When Relocating Valve

### Core Housings



Ascot No.	TR No.	Description
468-00201	TV-CH-1	Fits Old Style TR-218, TR220 Valves
468-00203	TV-CH-3	Fits All Fast Flow Air-Liquid Valves Except Super Large Bore
468-00216	TR-CH-16	Fits SP816 Tube Spud and T-81, C-100

### Valve Adapter Gun

- 1/2" female pipe thread and attaches to any calcium tire filling pump
- Extracts valve core from standard bore valve or core housing from tractor valve
- Securely holds valve core or core housing up in the gun body during tire filling or evacuation of liquid from a tire

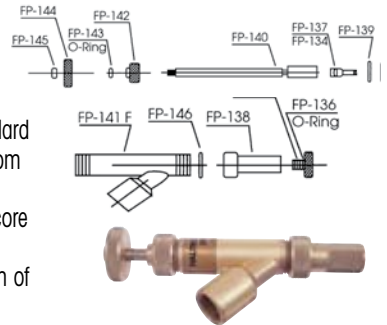

Ascot No.	Mfg. No.	Description
464-00310	310	Valve Adapter Gun
464-00134	FP-134	Large Bore Core Remover
464-00135	FP-135	Adapter For Standard Valve
464-00136	FP-136	O-Ring For FP-135 Adapter
464-00137	FP-137	Standard Valve Core Remover
464-00138	FP-138	Ejector Union
464-00139	FP-139	Gasket
464-00140	FP-140	Stem
464-00141	FP-141F	Adapter Body
464-00142	FP-142	Stem Sealing Nut
464-00143	FP-143	O-Ring For FP-142
464-00144	FP-144	Hand Wheel
464-00145	FP-145	Lock Nut
464-00146	FP-146	Teflon Gasket

### Liquid Fill Tools



Ascot No.	Mfg. No.	Description
464-01091	N-1091	Water Adapter For Liquid Fill Tires
464-10912	N-1091-2	For Water Adapter
464-10913	N-1091-3	For Water Adapter
464-01451	N-1451	1/2" FNPT Coupler for Fluid Use
464-01452	N-1452	1/2" MNPT Nipple for Fluid Use

### Aqua Quick Fill

- To fill a tractor tire or off-the-road tire with liquid without supervision
- Automatically vents excess pressure through side port while tire is filled
- Indicates tire is filled by water escaping through vent hole

Ascot No.	Mfg. No.
464-10001	AQF-1





## Large Bore Valves

### Single Bend Swivel Valves

- Any other lengths may be ordered
- All valves equipped with core and hex cap
- On lengths over 6", 2 lock nuts are furnished
- Large bore swivel valves can be used with any of the spuds on this



Ascot No.	Mfg. No.	TR No.	Bend Angle	Length	Height
465-01418	N-1418	-	74°	1-3/4"	1-5/64"
465-00650	WH-300-J-650	J-650	80°	3-1/8"	1-5/64"
465-00653	WH-300-J-653	J-653	80°	2-1/2"	1-5/64"
465-00657	WH-300-J-657	J-657	80°	4"	1-5/64"
465-30045	WH-300-4-1/2	-	80°	4-1/2"	1-5/64"
465-00658	WH-300-J-658	J-658	80°	5-1/2"	1-5/64"
465-03009	WH-300-9	-	80°	9"	1-5/64"
465-00446	WH-44-6	-	Strt.	6"	1-5/64"
465-40001	WH-45-2-1/2	J-4000-2-1/2	90°	2-1/2"	1-5/64"
465-00454	WH-45-4	-	90°	4"	1-5/64"
465-40002	WH-45-4-1/2	J-4000-4-1/2	90°	4-1/2"	1-5/64"
465-00455	WH-45-5	-	90°	5"	1-5/64"
465-40003	WH-45-6	J-4000-6	90°	6"	1-5/64"
465-40004	WH-45-7-1/2	J-4000-7-1/2	90°	7-1/2"	1-5/64"
465-00458	WH-45-8	-	90°	8"	1-5/64"
465-40005	WH-45-9	J-4000-9	90°	9"	1-5/64"
465-04510	WH-45-10	-	90°	10"	1-5/64"
465-45105	WH-45-101/2	-	90°	10-1/2"	1-5/64"
465-04512	WH-45-12	-	90°	12"	1-5/64"
465-04513	WH-45-13	-	90°	13"	1-5/64"
465-04524	WH-45-24	-	90°	24"	1-5/64"
465-40006	WH-45-28	J-4000-28	90°	28"	1-5/64"
465-40007	WH-45-29-1/2	J-4000-29-1/2	90°	29-1/2"	1-5/64"
465-04530	WH-45-30	-	90°	30"	1-5/64"
465-04532	WH-45-32	-	90°	32"	1-5/64"
465-04536	WH-45-36	-	90°	36"	1-5/64"
465-00651	WH-46-J-651	J-651	90°	4-11/16"	1-17/64"
465-04645	WH-46-4-1/2	-	90°	4-1/2"	1-17/64"
465-00652	WH-47-J-652	J-652	86°	5-1/2"	1-5/64"
465-04745	WH-47-4-1/2	-	86°	4-1/2"	1-5/64"
465-00479	WH-47-9	-	86°	9"	1-5/64"
465-00655	WH-48-J-655	J-655	74°	3-1/8"	1-5/64"
465-00654	WH-49-J-654	J-654	60°	3-1/8"	1-5/64"
465-00659	WH-50-J-659	J-659	90°	3-1/2"	1-57/64"
465-00660	WH-50-J-660	J-660	90°	8-3/4"	1-57/64"
465-00506	WH-50-6	-	90°	6"	1-57/64"
465-00507	WH-50-7-1/2	-	90°	7-1/2"	1-57/64"
465-00668	WH-51-J-668	J-668	90°	4-11/16"	5-1/8"
465-00522	WH-52-2	-	25°	2"	1-5/64"
465-00535	WH-53-5-1/2	-	80°	5-1/2"	1-21/64"
465-00546	WH-54-6	-	90°	6"	2-25/64"
465-00552	WH-55-2-1/2	-	90°	2-1/2"	2-25/64"
465-00558	WH-55-8-1/2	-	90°	8-1/2"	2-25/64"
465-00563	WH-56-3	-	65°	3"	1-5/64"
465-00573	WH-57-3	-	80°	3"	1-5/64"
465-00582	WH-58-2-1/2	-	30°	2-1/2"	2-1/8"
465-00656	WH-59-J-656	J-656	90°	3-11/16"	2-5/8"

### Single Bend Swivel Valves



465-00702



465-00710



465-00431

Ascot No.	Mfg. No.	Description
465-00702	H-41	TR-SP-2 Tubeless Spud. Fits 13/16" Rim Hole Used With All Large Bore Swivel Valves
465-00710	C-10	TR-C-10 Large Bore Screw-In Spud. Screws Into 1/2" NPT Tapped Hole In The Rim. Can Be Replaced Without Dismounting Tire
465-00431	K-431	Clamp-In Type Spud. Grommet increases The Sealing Area. Can Be Removed And Replaced Without Dismounting The Tire. Do Not Use In Continuous Service. Temporary Use Only

### Double and Triple Bend Swivel Valves

- These valve stems can be used with any of the spuds above
- Any other lengths can be ordered
- All valves equipped with core and hex cap
- On lengths over 6", 2 lock nuts are furnished



Double Bend Swivel Valve



Triple Bend Swivel Valve

### DOUBLE BEND SWIVEL VALVES

Ascot No.	Mfg. No.	TR No.	Bend Angle	Length	Height
465-00661	WH-70-J661	J-661	82°-8°	4-1/2"	1-5/64"
465-70255	WH-70-J661-10-1/2	—	82°-8°	10-1/2"	1-5/64"
465-70285	WH-70-J661-25-1/2	—	82°-8°	25-1/2"	1-5/64"
465-70280	WH-70-J661-28	—	82°-8°	28"	1-5/64"
465-00664	WH-70-J664	J-664	90°-13°	8-3/4"	1-5/64"
465-70125	WH-70-J664-12-1/2	—	90°-13°	12-1/2"	1-5/64"
465-00667	WH-70-J667	J-667	90°-11°	7-1/2"	1-5/64"
465-71090	WH-71-J-9	—	55°-35°	9"	1-33/64"
465-72212	WH-72-J-21-1/4	—	70°-20°	21-1/4"	1-5/64"
465-72280	WH-72-J-28	—	70°-20°	28"	1-5/64"
465-73212	WH-73-J-21-1/4	—	60°-30°	21-1/4"	1-3/8"

### TRIPLE BEND SWIVEL VALVES

Ascot No.	Mfg. No.	TR No.	Bend Angle	Length	Height
465-00662	WH-75-J662	J-662	90°-20°-20°	14"	1-5/64"
465-75610	WH-75-J662-10-1/2	-	90°-20°-20°	10-1/2"	1-5/64"
465-00663	WH-75-J663	J-663	90°-8°-8°	25"	1-5/64"
465-00665	WH-75-J665	J-665	90°-13°-13°	32"	1-5/64"
465-00666	WH-75-J666	J-666	84°-6°-31°	20-1/8"	1-5/64"

## Large Bore Valves (Cont.)

### Special Hydroflating Valves

- For faster filling of tires with liquid
- Does not contain valve core
- Straight-through 5/16" opening sealed with special O-ring cap, No. A-151
- Used on loader tire in conjunction with similar large bore air valve

### Air Water Valve

- Used in conjunction with WH-330-J-694 large bore valve



Ascot No.	Mfg. No.	TR No.	Angle Bend	Horizontal Length	Cap
465-00994	WH-JF-994	JF-994	28°	3.5" (88.9mm)	A-151

### Turret Valve for Planetary Gear Wheels



465-00691

465-00690

Ascot No.	Mfg. No.	TR No.	Angle Bend	Offset Inches	Length
465-00690	WH-330-J-690	J-690	2 Bends	9/16"	4-11/16"
465-00691	WH-330-J-691	J-691	18°	-	3-5/16"
465-06911	WH-330-J-691B	J-691	18°	-	8-1/2"
465-00692	WH-330-J-692	J-692	28°	9/16"	4-11/16"
465-00693	WH-330-J-693	J-693	60°	1"	5"
465-00694	WH-330-J-694	J-694	28°	-	3-1/2"
465-00695	WH-330-J-695	J-695	50°	1"	4-1/8"
465-00696	WH-330-J-696	J-696	42°	29/32"	4-1/4"

### Large Radius, High-Bend Air-Valve Used with 977S

- All valves fit 13/16" valve hole
- Includes A-145 valve core and A-149 cap



Ascot No.	Mfg. No.	Bend	Length	Height
465-11455	114S-5-1/2	90°	5-1/2" (139.7mm)	2" (50.8mm)
465-11411	114S-11	90°	11" (279.4mm)	2" (50.8mm)

### Super Large Bore Air/Liquid Valve for Tractor & Grader



464-00208

464-50910

Ascot No.	Mfg. No.	TR No.	Angle Bend
464-00216	R-372	CH-16	Fits T-81, C-100 & TR SP 816 Tube Spud
464-00208	T-81	SP-8	Fits 13/16" Dia. Rim Hole
466-50910	H-50	TR-F-910	Straight, Valve Assembly Components T-81 Spud and R-372 Core Housing

### Large Radius, High-Bend Air/Liquid Valve

- Uses super large bore T-81 spud (TR-SP-8)
- Uses A-151 cap



465-97755

Ascot No.	Mfg. No.	Bend	Length	Height
465-97755	977S-5-1/2	90°	5-1/2" (139.7mm)	2" (50.8mm)
465-97711	977S-11	90°	11" (279.4mm)	2" (50.8mm)

### Double Spud Valves



456-00400



465-00385

Ascot No.	Mfg. No.	Description
465-00400	DS-400	Large Bore Double Spud Valve. Eliminates Most Of The Plugging Of Large Bore Valves Which Occurs At The Bend Of The Swivel Type Large Bore Valve
465-00385	DS-385	Rigid Extension For Double Spud. For Rims With Valve Hole Counterbore On O.D. Of Rim
465-00390	DS-390	Rigid Extension For Double Spud. For Rims With 1/2" Tapered Pipe Thread Rim Hole

## Large Bore Valves (Cont.)

### Miscellaneous Valves



465-00670    465-00671    465-06702    465-06703

Ascot No.	Mfg. No.	TR Number	Description
465-00670	T-670	—	Loader Tire Valve. Complete With Core, Hex Cap & O-Ring Seal. Thread Size: 1-1/16-12. Height: 1-25/32"
465-00671	H-47	TR-J-671	Tank Valve. Screw-In Type With 1/4" Male Pipe Thread. Complete With Core And Cap. 1-19/32" Length
465-00702	H-41	SP-2	Tubeless Spud. Used With All Large Bore Swivel Valves. Fits 13/16" Rim Hole
465-06702	H-42	TR-J-670-2	Straight Valve. Equipped With Core And Hex Cap. Height Is 1-1/2"
465-06703	H-45	TR-J-670-3	Spud and Valve Complete. Consists Of H-41 & H-42. Height Is 1-5/8"

### Large Bore Caps and Cores



465-00145    465-00148    465-00149    465-00151

Ascot No.	Mfg. No.	Description
465-00145	A-145	Large Bore Core (Short). Fits 305-32" Threads
465-00144	A-144	Large Bore Core (Long). Fits .305-32" Threads
465-00148	A-148	Screwdriver Valve Cap. Fits .482-26" Threads
465-00149	A-149	Hex Valve Cap. Fits .482-26" Threads
468-00151	A-151	Air-Water Valve Cap (TR-FC-1). O-Ring Sealing Cap. Used With 465-00994, 465-97755, 465-97711

### Valve Adapters



468-00100    468-08007

Ascot No.	Mfg. No.	Description
468-00100	AD-1	Adapts Large Bore Valve Down To Standard Valve Bore. Fits .305-32" Valve Core Threads
468-08007	8807N-4	Adapts Large Bore Valve Down To Standard Valve Bore. Fits .485-26" Valve Cap Threads

### Standard O-Rings for Tubeless Rims

- Packaged 2 per poly bag, 24 O-rings per case
- Made of high quality polysoprene rubber
- Manufactured to major OEM specifications
- Arctic style O-ring available



Ascot No.	Mfg. No.	Size
471-80001	OR-20-JM	Hwy (JM Rim) 20"
471-80002	OR-22-JM	Hwy (JM Rim) 22"
471-80003	OR-24-JM	Hwy (JM Rim) 24"
471-80004	OR-21-T	Hwy 21"
471-80009	OR-321-T	EM 21"
471-80008	OR-25-T	EM 25"
471-80010	OR-325-T	EM 25"
471-80011	OR-329-T	EM 29"
471-80024	OR-232-T	EM 32"
471-80012	OR-333-T	EM 33"
471-80014	OR-335-T	EM 35"
471-80015	OR-339-T	EM 39"
471-80025	OR-239-T	EM 39"
471-80016	OR-343-T	EM 43"
471-80017	OR-345-T	EM 45"
471-80018	OR-349-T	EM 49"
471-80019	OR-351-T	EM 51"
471-80021	OR-451-T	EM 51"
471-80020	OR-357-T	EM 57"
471-80022	OR-457-T	EM 57"
471-80023	OR-463T	EM 63"
471-80005	OR-217-L	Grader 17"
471-80006	OR-220-TG	Grader 20"
471-80007	OR-224-TG	Grader 24"
471-80215	OR-215-H	Grader 15"
471-80225	OR-225-T	Grader 25"
471-80449	OR-449-T	EM 49"
471-80451	OR-451-OVM	EM 51"
471-80457	OR-457-OVM	Titan OVM 57"
471-80463	OR-463-OVM	MEM 63"
471-80469	OR-469T	RM 69"

### L-Rings for Earthmovers

- Creates an air seal where the tire bead and rim seat are not completely compatible
- Not a cure for damaged beads nor damaged wheels and rims  
Caution: Should be used during fitments - do not install where a broken bead is suspected

Ascot No.	Mfg. No.	Size
471-80125	LR-25	25"
471-80129	LR-29	29"
471-80133	LR-33	33"
471-80135	LR-35	35"
471-80139	LR-39	39"
471-80145	LR-45	45"
471-80149	LR-49	49"
471-80151	LR-51	51"
471-80157	LR-57	57"
471-80163	LR-63	63"
471-80169	LR-69	69"



## Large Bore Extensions

### Rigid Brass Large Bore Extensions

- All-brass extensions used when mounted in straight line with valve
- Full length deflector pin opens core in valve when servicing
- Equipped with hex cap, 2 lock nuts on extensions over 5" in length

Ascot No.	Mfg. No.	Effective Length
465-86032	867- 1-1/4	1-1/4"
465-86015	867- 1-1/2	1-1/2"
465-86020	867- 2	2"
465-86025	867- 2-1/2	2-1/2"
465-86030	867- 3	3"
465-86033	867- 3-3/8	3-3/8"
465-86040	867- 4	4"
465-86045	867- 4-1/2	4-1/2"
465-86050	867- 5	5"
465-86059	867- 5-9/16	5-9/16"
465-86060	867- 6	6"
465-86067	867- 6-7/8	6-7/8"
465-86072	867- 7-1/4	7-1/4"
465-86077	867- 7-3/4	7-3/4"
465-86080	867- 8	8"
465-86085	867- 8-1/2	8-1/2"
465-86090	867- 9	9"
465-86100	867-10	10"
465-86107	867- 10-3/4	10-3/4"
465-86120	867-12	12"
465-86125	867- 12-1/2	12-1/2"
465-86160	867- 16	16"
465-86187	867- 18-7/8	18-7/8"
465-86225	867- 22-1/2	22-1/2"
465-86245	867- 24-1/2	24-1/2"



### Hand Bendable Large Bore Extensions

- Equipped with 2 lock nuts and 3/4" hex sealing nut
- Teflon gasket seals on end of valve; the lead seal in the sealing nut is forced into the threads for a second seal, locking extension to valve
- Cap and core not included
- Should be removed from valve and transferred to extension

Ascot No.	Mfg. No.	Effective Length
465-75035	753S-3-1/2	3-1/2"
465-75040	753S-4	4"
465-75045	753S-4-1/2	4-1/2"
465-75080	753S-8	8"
465-75090	753S-9	9"
465-75010	753S-10	10"
465-75115	753S-11-1/2	11-1/2"
465-75120	753S-12	12"
465-75135	753S-13-1/2	13-1/2"
465-75160	753S-16	16"
465-75170	753S-17	17"
465-75175	753S-17-1/2	17-1/2"
465-75180	753S-18	18"
465-75185	753S-18-1/2	18-1/2"
465-75190	753S-19	19"
465-75205	753S-20-1/2	20-1/2"
465-75210	753S-21	21"
465-75215	753S-21-1/2	21-1/2"
465-75225	753S-22-1/2	22-1/2"
465-75235	753S-23-1/2	23-1/2"
465-75245	753S-24-1/2	24-1/2"
465-75250	753S-25	25"
465-75295	753S-29-1/2	29-1/2"
465-75320	753S-32	32"



### Custom Bent Swivel Valves and Extensions

Ascot No.	Mfg. No.	Overall Length	No. of Bends	Type
465-00585	WHD-0585EC	17-15/16"	4	Extension
465-05008	WHD-5008EC	17-13/16"	4	Extension
465-07103	WHD-7103EC	16-1/4"	4	Extension
465-09903	WHD-9903EC	16-7/8"	4	Extension
465-00570	WHG-0570VC	19-31/32"	5	Valve
465-01450	WHG-1450VC	32-7/8"	5	Valve
465-04985	WHG-4985VC	19-3/4"	4	Valve
465-05200	WHG-5200VC	27"	5	Valve
465-05410	WHG-5410VC	31-9/16"	5	Valve
465-05420	WHG-5420VC	33"	5	Valve
465-08018	WHG-8018VC	26-3/4"	4	Valve
465-08019	WHG-8019VC	8"	1	Valve
465-09440	WHG-9440VC	27"	5	Valve
465-09470	WHG-9470VC	31-1/2"	5	Valve
465-05112	WHG-5112VC	28-3/8"	5	Valve
465-07601	WHG-7601EC	16-3/4"	4	Extension
465-07602	WHG-7602EC	14-1/4"	4	Extension
465-08852	WHG-8852VC	18-9/16"	4	Valve
465-05922	WHD-5922EC	15-1/4"	5	Extension
465-07940	WHD-7940EC	19"	5	Extension
465-07949	WHD-7949EC	28-7/8"	4	Extension

### Flexible Large Bore Extensions

- Made with tough rubber hose and reusable hydraulic type fittings
- Equipped with 2 lock nuts and 3/4" hex sealing nut. A Teflon gasket seals on end of valve. The lead seal in the sealing nut is forced into the threads for a second seal, positively locking extension to valve



Ascot No.	Mfg. No.	Effective Length
465-81080	810F-8	8"
465-81090	810F-9	9"
465-81100	810F-10	10"
465-81200	810F-20-1/2"	20-1/2"
465-81250	810F-25	25"
465-81320	810F-32	32"
465-81400	810F-40	40"

## Large Bore and Super Large Bore Valves

### Large Bore Screw-On Repair Valves for Inner Tubes

- Supplied in straight or bent form ready for installation on tubes
- Equipped with valve core and A-149 hex cap
- Used with SP-1000 tube spud



465-10781

Ascot No.	Mfg. No.	TR Number	A-Angle Bend	B-Vertical Height	C-Horizontal Length
465-01014	LB-216	J-1014	Straight	1-29/32"	-
465-10760	LB-217	J-1076A	Straight	4-5/32"	-
465-10761	LB-218	J-1076B	86°	1-1/8"	3-1/4"
465-10762	LB-219	J-1076C	90°	1-1/2"	2-7/8"
465-10763	LB-220	J-1076D	90°	2-1/16"	2-5/16"
465-10764	LB-221	J-1076E	88°	1-3/8"	3"
465-11750	LB-223	J-1175A	Straight	5-9/32"	-
465-11751	LB-224	J-1175B	82°	1-1/4"	4-1/4"
465-11752	LB-225	J-1175C	88°	1-3/8"	4-1/8"
465-10780	LB-226	J-1078A	Straight	5-25/32"	-
465-10781	LB-227	J-1078B	82°	1-3/8"	4-5/8"
465-10782	LB-228	J-1078C	90°	1-1/8"	4-7/8"
465-11790	LB-229	J-1179A	Straight	6-13/32"	-
465-11791	LB-230	J-1179B	88°	1-3/8"	5-1/4"
465-11792	LB-231	J-1179C	86°	1-1/8"	5-1/2"

### Large Bore Screw-On Repair Valve Adapters for Inner Tubes

Ascot No.	Mfg. No.	TR Number
465-40000	H-4000	Adapter Converts Tubes having SP-1000 Type Spud To Accept Large Bore Swivel Valves. Equipped With BW-18 Washer And Used With Rim Slots
465-40011	H-40001	Same As H-4000 Except Without Bridge Washer And Hex Nut



465-40000

465-40011

### Clamp-In Rim Spud

- Fits 13/16" dia. valve hole
- Can attach to any super large bore valve to the rim through a standard valve hole (13/16" diameter)



464-00208

Ascot No.	Mfg. No.	TR Number	Description
464-00208	T-81	TR-SP8	Clamp-In Rim Spud

### Screw-In Rim Spuds

- Used to attach any of the super large bore valves to the rim and is designed to screw into a 1/2" NPT tapped rim hole
- Can be changed without dismantling the tire



Ascot No.	Mfg. No.	TR Number	Description
464-00209	T-82	-	Effective Length 1/4" Longer

### Screw-In Rim Spuds

- 85° bend angle



466-00851

466-00850

Ascot No.	Mfg. No.	Description
466-00850	S-85	Fits 1/2" NPT Tapped Rim Hole
466-00851	S-85-D	Furnished With A Locking Nut With A Teflon Seal So Direction Can Be Reversed

**Large Bore Gauges and Chucks**  
See Page 173



## Super Large Bore Valves (Cont.)

### Core Housing

- Complete with core and cap
- Designated at Tire and Rim as the CH-8
- Integral part of the system as the CH-8 is removed from the valve assembly with the IN-80A adapter to utilize the larger opening and the fullest flow of the 6185 check valve



Ascot No.	Mfg. No.	TR No.	Description
466-00918	R-520	TR-CH-8	Core Housing

### Check Valve

- Complete with cap
- Permits rapid inflation and deflation
- Eliminates need for core housing and inflation adapter
- Used with 6190 air chuck



Ascot No.	Mfg. No.	TR No.	Description
466-00860	6185	TR-L-860	Check Valve

### Quick Connection Inflation Chuck

- Designed specifically for use with 6185 check valve
- Sliding sleeve locks air chuck onto check valve and permits unrestricted air flow
- Gauging can be done through valve on chuck
- Positive air line shut off-valve must be installed in back of air chuck



Ascot No.	Mfg. No.	TR No.	Description
466-06190	6190	-	Quick Connection Inflation Chuck

### Super Large Bore Inflator Adapter



- 1/2" pipe thread for easy air hose connection. During inflation, air pressure in the tire can be checked through the stem knob with a tire pressure gauge
- Reduces inflation time 60%, deflation time 80%
- Core housing held in a stainless steel extractor by a snap ring
- Extractor is rugged enough so that the core housing can be loosened or tightened without being damaged
- Fast inflation or deflation of a tire - after removing the valve cap, inflator is screwed onto the valve stem. Inflator stem is pushed in to engage the flats on the core housing. By rotating the stem counter/clockwise, the core housing can be removed without any danger to the person removing it. The core housing is pulled up into the inflator body and held there during inflation or deflation

Ascot No.	Mfg. No.	Description
466-05310	IN-80A	Super Large Bore Inflator Adapter

### Swivel Angle Connectors

- Component two of the super large bore system is generally a swivel connector that screws onto the spud
- Connectors of various angles and lengths are available
- Other end of the connector accommodates a MT-3000 flexible extension which attaches to the R-520 core housing of the 6185 check valve



466-00675

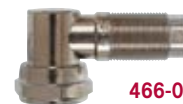

466-00525

Ascot No.	Mfg. No.	Bend Angle
466-00525	R-525	90°
466-00685	R-685	85°
466-00625	R-625	80°
466-00675	R-675	75°
466-00660	R-660	60°
466-00529	R-529-5-1/4	90°

### Flexible Extension Series

- Flexible extensions are made up in any length to allow the extension to fit the wheel configuration
- Specially designed fittings and thermoplastic hose will not fatigue or crush during service
- Corrosion problems are eliminated
- Able to customize your extension in the field
- The R-969-K and R-969K-1 kits available to field assemble your own flexible extensions with the T-620 assembly tool (not shown)



Ascot No.	Mfg. No.	Description
466-03000	MT-3000	Flexible Extension

### Assembly Kit for Super Large Bore Valves-Field Service



Ascot No.	Mfg. No.	Description
466-96901	R-969K-1	Consists Of R-762S Swivel Connector, R-763 Straight Tubing Connector, R-764R (2) Tubing Connector Sleeves And B-222 Nuts (3)
466-96900	R-969-K	Consists Of The Above Plus The R-520 Core Housing Complete With Core And Cap
466-76000	R-760	Extension Tubing Available In 50' And 100' Lengths

## Super Large Bore Valves (cont.)

### Rigid Metal Swivel Valves



Ascot No.	Mfg. No.	Description
466-00800	MR-800	Swivel Valve. MR-800-Length. Rigid Metal Swivel Valve With R-520 Core Housing And 2B-222 Lock Nuts
466-01850	MR-850	Swivel Valve. MR-850. Same As MR-800 Except With A T-81 Rim Spud
466-00890	MR-890	Turret Valve. MR-890. Rigid Metal Turret Type Valve With R-520 Core Housing & (3)B-222 Lock Nuts
466-00200	M-2000	Swivel Valve Assembly. 90° Swivel Valve - 3-1/8" Horizontal Length

### Rigid Metal Swivel Valves



Ascot No.	Mfg. No.	Description
466-00296	DS-296	Super Large Bore Double Spud Valve Assembly (with Flexible Extension). Designed For Use Where Above Rim Is 7/8". Consists Of DS-210 Double Spud, DS-215 Plug And MT-4000 Flexible Extension
466-04000	MT-4000	Flexible Extension. Used With DS-296 And PB-210. Consists Of: DS-226 Connector, R-763 Connector, (2) R-764R Sleeves, R-760 Tubing
466-07910	S-7910	Valve Support For Super Large Bore
466-08860	S-8860	Valve Support For Large Bore

### Super Large Bore Turret Valves

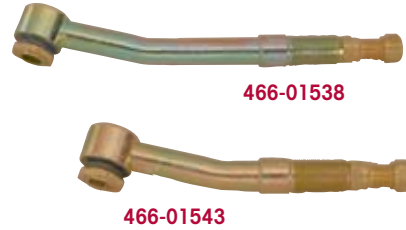

- Long super large bore turret valve with 15° bend
- Used on Caterpillar applications

Ascot No.	Mfg. No.	Description
466-01538	N-1538B	7-7/8" Long Super Large Bore Turret
466-01543	N-1543A	6-1/8" Long Super Large Bore Turret

### Super Large Bore Valves



Ascot No.	Mfg. No.	Description
466-01066	N-1066	Super Large Bore Loader Valve. Accepts R-520 Core Housing Or Other Super Large Bore Swivel Fittings. Thread Size is 1-1/16"-12. Super Large Bore Version Of T-670
466-05000	M-5000	Straight Valve Assembly. Screw-In Type Spud With O-Ring Seal. R-521 Core Housings Not Interchangeable In Other SLB Spuds. Thread Size Is 3/4-16"
466-01870	M-1870	Straight Valve Assembly. Super Large Bore Straight Valve Assembly Consists Of R-520 Core Housing And T-81 Spud
466-01050	N-1050	Same as M-1870 but with T-82 Spud

### Super Large Bore Air/Liquid Valves for Tractor and Grader



Ascot No.	Mfg. No.	Description
464-00208	T-81	Fits 13/16" Dia. Rim Holes
466-50910	H-50	Components T-81 Spud And R-372 Core Housing
464-00216	R-372	Fits T-81, C-100, TRSP 816 Tube Spuds

## Z-Bore Valve System

There are three spud types available: the standard clamp-in spud, a screw-in spud and an angle screw-in spud. There is no temporary outside-in clamp-in spud for Z-Bore. The Z-Bore Valve System is very similar to the Super Large Bore System. By using an O-Ring to seal the clamp-in spud to the rim, a greater flow diameter is created without sacrificing strength or performance. Flows 370 CFM compared to 240 CFM on the Z-Bore Valve System.

### Z-1 Screw-In Spud

- The screw-in spud is used to attach any Z-Bore valves to the rim
- Designed to screw into a 1/2" NPT-tapped rim hole
- Can be changed without demounting the tire



Ascot No.	Mfg. No.	Description
466-70001	Z-1	Screw-In Spud

### Z-13 Screw-In Spud

- The Z-13 screw-in spud screws into the 3/4" NPT-tapped rim hole and converts Mega Bore to Z-Bore

Ascot No.	Mfg. No.	Description
466-70013	Z-13	Screw-In Spud

### Angle Connector

- Connectors of various angles and lengths are available
- The connector accommodates a flexible extension which attaches to the Z-10 core housing



466-70390

Ascot No.	Mfg. No.	Description
466-70375	Z3-75	75° Angle
466-70390	Z3-90	90° Angle
466-70380	Z3-80	80° Angle

### Z-10 Core Housing

- Complete with core and cap
- Integral part of the system as the Z-10 is removed from the valve assembly with the Haltec Z-12 inflator to utilize the larger opening and the fullest flow



Ascot No.	Mfg. No.	Description
466-70010	Z-10	Core Housing w/ Core & Cap

### Z-2 Clamp-In Spud

- Fits a 13/16" diameter valve hole.
- Can attach any Z-Bore valve to the rim through a standard valve hole (13/16")
- Tire must be dismounted to change spud



Ascot No.	Mfg. No.	Description
466-70002	Z-2	Clamp-In Spud

### Z-4 Angle Screw-In Spud

- Fits 1/2" NPT-tapped rim hole. 85° bend angle



Ascot No.	Mfg. No.	Description
466-70004	Z-4	Angle Screw-In Spud

### Z-Bore Flexible Extensions

- Made up in any length to allow extension to fit the wheel configuration
- Specially designed fittings and thermoplastic hose will not fatigue or crush during service
- Corrosion problems are eliminated
- Able to customize extension in the field
- ZFAK field assembly kit available to assemble your own

Ascot No.	Mfg. No.	Description
466-70700	ZBFE-Length	Flexible Extension
466-70701	ZFAK	Assembly Kit For Z-Bore Valves - Contains Z-8 Swivel Connector, Z-7, Straight Tubing Connector, 2 - Z2-2 Nuts, 2 - Z-9 Tubing Connector Sleeves, Z-10 Core Housing. Z-100 Tubing Is Ordered Separately

### Z-12 Inflator

- To maximize air flow, a Z-12 inflator is used to remove core housing during inflation and deflation
- Operates like the IN-80A Super Large Bore inflator

Ascot No.	Mfg. No.	Description
466-70012	Z-12	Inflator





## PT Valve System

The best way to insure maximum tire life is through proper tire inflation. Using a PT valve and gauge assembly, tire pressure monitoring has never been easier. Use the proper PT gauge for daily checks and a separate master gauge for weekly checks which will prevent air loss before it can cause permanent tire damage. The PT valve and gauge can be used on most Large Bore and Super Large Bore applications.

### PT Valves



- Designed with trouble-free, urethane O-rings on the valve barrel
- Other valves and sizes available
- Assemble the valve to the tire and wheel assembly before installing the PT gauge to the PT valve

Ascot No.	Mfg. No.	Description
465-30060	PT-300-J-650	WH-300-J-650 With PT Grooves & O-Rings
465-00456	PT-45-6	WJ-45-6 With PT Grooves & O-Rings
465-33069	PT-330-J-690	WH-330-J-690 With PT Grooves & O-Rings
465-00042	PT-H-42	H-42 With PT Grooves & O-Rings
465-07536	PT-753S-6	753S-6 With PT Grooves & O-Rings
465-00520	PT-R-520	R-520 With PT Grooves & O-Rings For Super Large Bore
465-33031	PT-330-3-1/2	Turret Style Valve With 3-1/2" Effective Length
465-00524	PT-EX	Large Bore Extension w/1-5/8" Effective length to allow PT Gauge installation on existing valves

### Large Bore Valve Tools

Ascot No.	Mfg. No.	Description
469-01710	N-1710	Large Bore Core Tool. Valve Core Screwdriver Tool. Sliding Sleeve Allows Positive Grip On Valve Core For Hard To Reach Valves
469-01610	N-1610	Large Bore Core Tool
469-01910	N-1910	Large Bore Core Remover. Plastic Handle For Positive Grip. 5 - 6" OAL
469-00631	TL-631	Super Large Bore Rethreading Tool. Used To Rethread 1 1/16-24" Thread On Any Super Large Bore Valve
469-01810	N-1810	Large Bore Hex Cap Remover. Plastic Handle For Positive Grip. 10" OAL
469-00680	TL-680	Three-Way Large Bore Tool. For Removing Large Bore Cores, Hex Caps And Screwdriver Caps
469-00010	ASP-10	Tube Deflation Aspirator. For Large Bore
469-06950	TL-695	Four-Way Tool. Repairs Internal And External Threads On Air/Liquid Spuds. Also Large Bore Valve Core Insertion Tool
469-06900	TL-690	Four-Way Large Bore Core Tool. Thread Repair For Core And Cap Threads And Core Remover For Large Bore And Super Large Bore
469-08909	8909-C	Large Bore Valve Fishing Tool

### PT Gauges

- Easy-to-read dial gauge attaches to the valve
- Includes gauge and nut
- Calibrated 0-160 PSI
- Has an all-anodized aluminum body and is totally sealed to prevent moisture from fogging the glow-in-the-dark dial



Ascot No.	Mfg. No.	Description
468-00101	PT Gauge	Digital Passenger Gauge

### PTC Block-Off Collar

- For PT valves when gauge is not attached
- Can be installed to prevent air leakage



Ascot No.	Mfg. No.	Description
468-00580	PTC	5/8" Hex

### PT Valve Tool

- Tightens nut to hold PT gauge on valve assembly
- Also tightens A-150 cap and PTC collar

Ascot No.	Mfg. No.	Description
468-00634	TL-634	



### Valve Cap

- Valve cap used on PT-style valves
- 5/8" hex



Ascot No.	Mfg. No.	Description
468-00150	A-150	

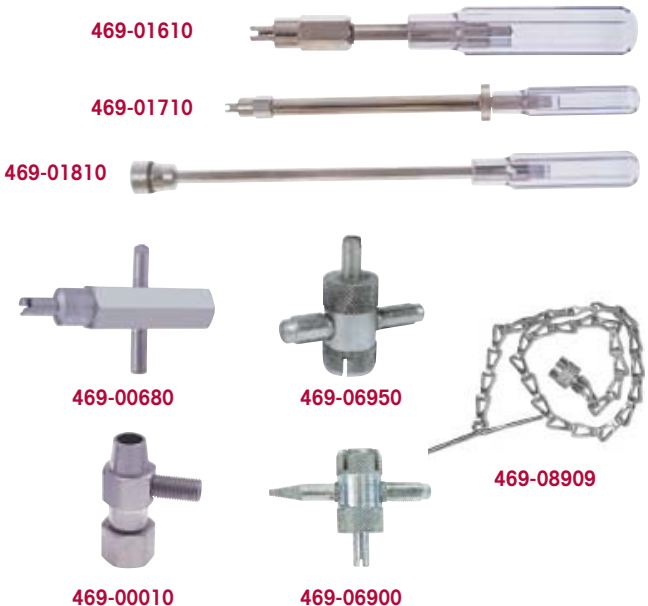

## Valve Tools

### Valve Insertion and Removal Tools

Ascot No.	Mfg. No.	Description
469-00992	992	Tubeless Tire And Tire Valve Inserting And Removing Tool. For All Sizes Of Snap-In Passenger Car Tire Valves
469-01124	VT-1124	Tubeless Tire Valve Service Tool. Pull-A-Stem Tool Pulls Old Valves Or Inserts New Valves. Tool Fits All Sizes Or Lengths
469-43002	43002	Plastic Valve Puller
469-00033	VT-33	No-Mar Valve Stem Remover & Installer. Installs And Removes Tubeless Valves Without Marring Or Scratching Chrome And Alloy Wheels
469-00040	00040R	Valve Stem Puller with Rubber Boot
469-03333	VT-03P	Plastic Valve Puller with Metal Rod Insert



### Valve and Core Tools

Ascot No.	Mfg. No.	Description
469-00567	567A	Core Removing Tool. Screwdriver Grip. Easy Out For Removing Broken Cores
469-01115	VT-1115	Valve Core Tool. For Inserting And Removing. Valve Cores. Long Hex Body For Easy Access.
469-00021	VT-21	Double-Use Tool. Removes Valve Cores. Screws On Valve Mouth To Open Core
469-05262	5262	Tube Deflating Aspirator. Screwing Aspirator Onto Valve Mouth And Applying Air Chuck To Threaded Inlet Creates Vacuum That Siphons Air From Tube
469-00609	TL-609	Chain Valve Fishing Tool. Guides Valve Smoothly Through Rim Hole While Mounting Tire & Tube
469-00011	VT-11	Cable Valve Fishing Tool. Valve Core Wrench And Deflating Pin With Flexible Cable For Fishing Valve Through Rim Hole. 24"
469-00002	CT-2	Black Heat Treated Heavy Duty Tire Valve Repair Tool. 4-in-1 Standard Valve Tool Repairs Cap Threads, Repairs Core Threads. Easy-Out Feature For Removing Damaged Cores & Removing Standard Caps
469-00004	CT-4	Economy Standard Bore 4-Way Tool
469-00018	VSW18	Valve Stem Ratchet. For TR570 Series Valves
469-00020	VSW20	Valve Stem Ratchet. For TR540 Series Valves
469-23430	VG8	Tube Deflator. Removes Air Completely, Quickly After The Valve Core Is Moved. Fits On Every Type Of Standard Bore Valve
469-00081	TVT-81	Heavy Duty 4-Way Valve Core Tool



### Valve Core Insertion and Removal Tools

Ascot No.	Mfg. No.	Description
469-00001	CT-1	Pocket-Size Valve Core Remover
469-00003	CT-3	Heavy Duty Standard Valve Core Remover
469-00005	CT-5	For Both Standard and Large Bore Valves
469-00607	607	Has Plastic Screwdriver Handle For Better Grip And Leverage
469-15407	15407	Angled Tubeless Tire Valve Inserting And Removing Tool



## Valve Tools

### Standard Bore Valve Tools

Ascot No.	Mfg. No.	Description
469-01440	1440	Valve Cap Tool. Length 9". Accommodates 440/1046 Valve Caps With Knurled Sockets
469-00632	TL-632	Truck Extension Service Tool. Tightens Both Metric European And Domestic Type Extensions. Broached To Engage The Metric Hex At The Extension Top And Will Reach The Hex On A 7" U.S.A. Type Extension
469-00630	TL-630	Hex Nut Driver. For 500 Series Truck. For Tubeless Clamp-In Metal Valves. For All Lengths of Tubeless Truck Valves
469-00625	TL-625	Standard Bore Core Tool. With Recessed Probe. Fits In Pocket
469-00612	TL-612	Standard Bore Core Tool. With An Overall Length Of 8" And Oversized Handle
469-00633	TL-633	Valve Cap Tool. Easy To Remove And Install Valve. Caps On Inside Dual Wheels. For Aluminum Wheels
469-52000	5-2	Inner Dual Valve Core/Cap Tool
469-52001	5-2-DIS	Inner Dual Valve Core/Cap Display



469-52000 - Valve Capper Tool  
469-52001 - Valve Capper Display



469-00625



469-00632



469-01440



469-00612



469-00633

### Tire Tread Depth Gauges

Ascot No.	Mfg. No.	Description
454-00599	595	Tire Tread Depth Gauge. Used To Measure Tire Tread Depth In 1/32" Increments: 0-1"
454-05124	5124	Color Coded Tread Depth Gauge
454-01420	N1420H	Truck Tire Depth Gauge. Calibrated In MM And 1/32nd of Inch. Measures Shoulder Wear And Tread Depth. Durable Metal Construction



454-00599



454-01420



454-05124

## Tire Gauges

### Automotive Tire Gauges

- Pencil, chrome tire gauges with nylon indicator bars



Ascot No.	Mfg. No.	Range	Type
476-10105	GA-150	10-50 PSI	Passenger Gauge
476-10115	GA-115	20-120 PSI	High Pressure Gauge
476-10100	GA-100	1-20 PSI	Low Pressure Gauge
476-10110	GA-110M	10-50 PSI	Passenger Gauge 75-340 kPa Calibrated in PSI & kPa
476-10120	GA-120M	20-120 PSI	High Pressure Gauge 150-280 kPa Calibrated in PSI & kPa
476-10125	GA-125	5-45 PSI	Air/Liquid Gauge
476-10145	GA-145	10-75 PSI	Mid-Range Gauge 70-500 kPa Calibrated in PSI & kPa

**Note: Imprinted Gauges Available with Your Name**

### Master Test Gauge

- Used to check accuracy of gauges
- Calibrated 10 -160 PSI



Ascot No.	Mfg. No.	Description
476-10140	GA-140	Master Test Gauge

### Pocket Truck Gauges



476-10160

Ascot No.	Mfg. No.	Description
476-10150	GA-150	Straight-On/Angled Gauge. 20 -120 PSI. Chrome Plated
476-10160	GA-160	Straight-On/Angled Gauge. 20 -120 PSI. Black Baked Epoxy Protective Finish
476-10130	GA-130	Dual Foot Angled Pencil Gauge. 20 -120 PSI

## Tire Gauges

### Truck Service Gauges

- Wide variety of service gauges to accommodate the numerous tire and wheel configurations encountered by tire service personnel
- Available in chrome plated or protective black epoxy finish as indicated
- Calibrated from 10-150 PSI in 2 pound increments
- Nylon or metal indicator bars



476-10135



476-10155



476-10165



469-10185

Ascot No.	Mfg. No.	Range
476-10135	GA-135	Angle Chuck With Nylon Bar
476-11135	GA-135S	Same As Above, Angle Chuck With Metal Bar
476-10155	GA-155	Straight-On With 30° Reverse Chuck
476-10165	GA-165	Same As Above, Straight-On With 30° Reverse Chuck, Black Epoxy Finish
476-11155	GA-155S	Same As Above, Straight-On With 30° Reverse Chuck, Metal Bar
476-11048	1048-ADJ	Internal Adjustable Field Service Gauge
476-10185	GA-185	Dual Foot Service Gauge With Nylon Bar, 180° Chuck, Chrome Plated
476-11185	GA-185S	Same As Above, Dual Foot Service Gauge. Metal Bar

### Digital Tire Gauges

- Large, easy-to-read LCD numbers for precise readings
- Features pinpoint accuracy, convenient air bleed, protective casing
- Features dual foot chuck
- Reads 3 to 160 PSI

Ascot No.	Mfg. No.	Description
476-10500	DT-105	Digital Passenger Gauge
476-15038	DT150-38CV	Digital Truck Gauge PSI



476-10500



476-15038

### Digital Tread Depth Gauge

- Made from strong carbon fiber composite
- Zero setting in any position
- Metric, decimal inch and fraction inch toggle
- Large LCD display



Ascot No.	Mfg. No.	Description
454-05800	5800	Digital Tread Depth Gauge

### Dial Gauge

- Calibrated 0 to 160 PSI in 5 PSI units and 150 to 1100 in kPa metric scale
- 14" flexible hose
- Holds pressure readout until released



Ascot No.	Mfg. No.	Description
476-00274	GA-274	Dial Gauge. 0 -160 PSI

### Standard and Large Bore Air/Liquid Master Gauge

- Straight-on air chuck fits both standard and large bore valves
- Calibrated to 0 to 160 PSI in 1 PSI increments and 0-1100 in kPa metric scale
- Has recalibration feature and replaceable filters



Ascot No.	Mfg. No.
476-00290	GA-290

### Dial Gauge Without Hose

- Calibrated 0 to 160 PSI in 5 PSI increments and 0 to 1100 in kPa Metric Scale



Ascot No.	Mfg. No.	Description
476-00289	GA-289	Dial Gauge without Hose. 0 -160 PSI

## Tire Gauges (Cont.)

### Dial Gauge with Rigid Extension

- Calibrated 0 -160 PSI in 1 PSI increments. 0 to 1100 in kPa metric scale



Ascot No.	Mfg. No.	Description
476-00285	GA-285	Dial Gauge with Rigid Extension

### Dill Adjustable Truck Tire Gauges



476-07275

Ascot No.	Mfg. No.	Description
476-07285	7285R	Dual Foot Service Gauge With Reverse Angle Chuck (Internally Adjustable)
476-17285	7285E	External Adjustable Truck Service Gauge
476-07275	7275RB	Recalibrate Truck Service Gauge With 25° Offset Chuck Angle Chuck (Internally Adjustable)

### Adjustable Field Service Gauges

- Field adjustable truck service gauges
- Adjustable calibration
- Chrome finish



476-01046



476-11048



476-00541

Ascot No.	Mfg. No.	Description
476-01046	1046-ADJ	Screwdriver Adjustable Calibration Gauge
476-11048	1048-ADJ	Internal Adjustable Metal Bar Gauge
476-00541	A541-ADJ	Externally Adjustable Plastic Bar Truck Gauge

### Master Test Gauge



- For checking accuracy of service and pencil gauges
- Has dual foot chuck and a retaining valve to hold pressure reading after gauge is removed from valve to within +/- 2% of total dial reading
- Protective case



Ascot No.	Mfg. No.	Description	Range
476-08860	8860C	Master Test Gauge	0 - 160 PSI

### Dill Air Gauge Checking Station

- Use for checking air gauges for accuracy



Ascot No.	Mfg. No.
476-08500	8500

### Economy Passenger Gauges

- 10 - 75 PSI
- Available with your company logo



Ascot No.	Mfg. No.	Description
476-05601	5600	Chrome Barrel
476-05600	5600ST	Aluminum Barrel

### Gauge Displays

- 941-DIS for SUVs, trucks and other high pressure applications
- 211-DIS for general use
- Gauges calibrated in 2 Lb. increments
- Aluminum barrel
- Made in the USA



Ascot No.	Mfg. No.	Description
476-00941	941-DIS	Gauge Display, 20 - 120 PSI
476-00211	211-DIS	Gauge Display, 10 - 50 PSI



## Air Chucks

### Ball Foot Chucks



Ascot No.	Mfg. No.	Description
478-00305	CH-305	Ball Foot Chuck. 1/4" Female Thread (Normally Closed)
478-00315	CH-315	Ball Foot Chuck With Lock-on Clip. 1/4" Female Thread (Normally Closed)
478-00325	CH-325	Ball Foot Chuck With Lock-on Clip. 1/4" Female Thread (Normally Open)
478-05451	-	Ball Foot Chuck With Lock-on Clip. 1/4" Female Thread (Normally Closed - Alligator)
478-00707	-	Replacement Washer. For 478-05451 Ball Foot Chuck
478-04500	-	Air Chuck Clip. For All Ball Foot Chucks



478-00305



478-00315



478-04500



478-00001



478-02985

### European-Style Clip-On Chucks



Ascot No.	Mfg. No.	Description
478-02985	CH-360	European-Style Clip-On Chuck. 1/4" Female Fitting. Silver Clip (Normally Closed)
478-02995	CH-360-OP	European-Style Clip-On Chuck. 1/4" Female Fitting. Black Clip (Normally Open)
478-00001	N-1200	European-Style Clip-On Chuck. Serrated Shank For 1/4" I.D. Hose. Silver (Normally Closed)



478-05265



478-00340

### Lock-On Air Chucks



Ascot No.	Mfg. No.	Description
478-05265	H-5265	Lock-On Air Chuck. Specially Designed To Lock Onto The Cap Of A Standard Bore Valve Stem When The Sliding Sleeve Is Pushed To Forward Position
478-00340	CH-340	Lock-On Air Chuck. 1/4" NPT Female Thread. Securely Locks Onto Valve When Sleeve Is Pushed Forward
478-01340	CH-340-OP	Lock-On Air Chuck. Available For Use With Tire Changers

### Dual Foot Air Chucks



Ascot No.	Mfg. No.	Description
478-01350	CH-350-LO	Straight-On/Angled Chuck. Protective Black Epoxy Finish (Normally Closed)
478-00335	CH-335	Angled Chuck. Plated Finish (Normally Closed)
478-01335	CH-335-OP	Angled Chuck. Plated Finish (Normally Open)
478-03300	CH-330-LO	Straight-On/Angled Chuck. With Lock-On Threads (Normally Closed)
478-03301	CH-330	Straight-On/Angled Chuck (Normally Closed)
478-03330	CH-333-LO	Straight-On/Angled Chuck. 1 1/4" Long (Normally Closed)
478-03370	CH-370-LO	Straight-On/180° Chuck. 1/4" NPT (Normally Closed)
478-06585	6585LB	Large and Standard Bore Chuck. 1/4" NPT (Normally Closed)



478-01350



478-03300



478-00335



478-06585

## Large Bore Gauges & Chucks

### Large Bore Gauges

Ascot No.	Mfg. No.	Description
476-10255	GA-255S	Swivel Gauge. Nickel Plated Brass. Metal Slide Bar. Calibrated 10 - 150 PSI In 2 Lb. Units. Swivels 360° For Those Hard-To-Reach Valves
476-10250	GA-250S	Swivel Gauge. Nickel Plated Brass. Plastic Bar. Calibrated 10 - 150 PSI In 2 Lb. Units. Swivels 360° For Those Hard-To-Reach Valves
454-01410	N-1410	Off-Highway Tire Tread Depth Gauge. Calibrated With 32nds And MM. Magnified Sight Glass For Easy Readability
476-10240	GA-240	Straight-On Gauge. 20 - 120 PSI
476-07233	7233	Dill Swivel Gauge
454-05131	5131	Large Bore Tread Depth Gauge



### Large Bore Air Chucks

Ascot No.	Mfg. No.	Description
478-00326	326	Screw-On Air Chuck. .458"-26 Internal Thread. 1/2" NPT External Thread. Full Flow For Seating Of Tire Beads
478-00328	328	Short Lock-On Air Chuck. Locks On Valve When Cocked On Threads. Greater Air Flow And Seat Cannot Be Blown Out If Seal Fails. 1/4" NPT Thread
478-00377	377	Long Lock-On Air Chuck
478-10013	10013	Large Bore Screw-On Chuck. Fits 3/8" ID Air Hose
478-00322	322	Large Bore Dual Foot Air Chuck. 45° Chuck For Easy Access To Valve. 1/4" NPT Female Thread
478-06190	6190	Quick Connection Inflation Gauge. For Use With 6185 Check Valve. Sliding Sleeve Locks Chuck Onto Check Valve. Permits Unrestricted Air Flow
478-04660	H-4660A	Clip-On Air Chuck. Locks Onto Valve When Sleeve Is Pushed Forward, Releases When Sleeve Is Pulled Back. 1/4" NPT Female Thread



### Sur-Lock Valve Tools

- Special design allows the valve core to stay attached to the tool after it is removed from the valve
- Great tool to keep the valve core from getting dropped or lost

Ascot No.	Mfg. No.	Description
469-00131	TL-131	For Bicycles
469-00132	TL-132	For Cars. 1-3/4" Length
469-00133	TL-133	For Trucks. 8-1/4" Length
469-00134	TL-134	For Large Bore Cores. 10-1/2" Length

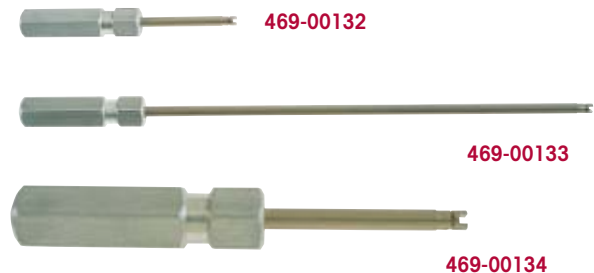



## Inflator Gauges

### Digital Hand Held Tire Inflator

- Inflation range 0 - 174 PSI
- Accuracy +/- .2 PSI
- 6' Hose
- Lightweight shock resistant design
- High specification ceramic sensor
- Long life, easily replaceable battery
- Available in custom hose lengths and chuck styles



**This Gauge Provides More Accurate Air Pressure Readings Which is Essential with TPMS.**

Ascot No.	Mfg. No.
477-10001	Accura 1

### Hand Held Tire Inflator

- Inflation range 0 - 138 PSI
- Accuracy +/- 2.0 PSI
- Cast aluminum body
- Proven linear spring gauge
- High flow valve for fast inflation
- Available in custom hose lengths and chuck styles



Ascot No.	Mfg. No.	Description
477-10003	MK3	Heavy Duty Hand Held Inflator Gauge w/ Dual Foot Chuck

### Air Line Inflators

- Ideal for gauging and inflating dual tires on trucks and buses as well as passenger cars and light trucks
- Solid brass indicator bar
- Allows operator to stand away while inflating and deflating tires
- Bleeder valve allows user to adjust tire pressure without touching either the tire or valve stem
- Any hose length and/or chuck style available. CALL FOR DETAILS



477-00001



477-00002, 477-00004, 477-00008, 477-00010



477-00003, 477-00005, 477-00009, 477-00012

Ascot No.	Description
477-00001	Safety Inflator Gauge. 12" Hose With Dual Foot Chuck. 10 - 120 PSI
477-00002	Safety Inflator Gauge. 3' Hose With Clip-On Foot Chuck. 10 - 120 PSI. Bleeder Valve
477-00003	Safety Inflator Gauge. 3' Hose With Straight Lock-On Chuck. 10 - 120 PSI. Bleeder Valve
477-00004	Safety Inflator Gauge. 6' Hose With Clip-On Ball Foot Chuck. 10 - 120 PSI. Bleeder Valve
477-00005	Safety Inflator Gauge. 6' Hose With Straight Lock-On Chuck. 10 - 120 PSI. Bleeder Valve
477-00008	Safety Inflator Gauge. 9' Hose With Clip-On Ball Foot Chuck. 10 - 120 PSI. Bleeder Valve
477-00009	Safety Inflator Gauge. 9' Hose With Straight Lock-On Chuck. 10 - 120 PSI. Bleeder Valve
477-00010	Safety Inflator Gauge. 12' Hose With Clip-On Ball Foot Chuck. 10 - 120 PSI. Bleeder Valve
477-00012	Safety Inflator Gauge. 12' Hose With Straight Lock-On Chuck. 10 - 120 PSI. Bleeder Valve
477-00033	Safety Inflator Gauge. 3' Hose with European-Style Clip-On Chuck
477-00066	Safety Inflator Gauge. 6' Hose with European-Style Clip-On Chuck
477-00099	Safety Inflator Gauge. 9' Hose with European-Style Clip-On Chuck

**WARNING:** Never inflate a tire on a multi-piece rim (a rim made up of 2 or more separate pieces) unless the tire and rim are mounted in OSHA regulation 29-CFR Part 1910.177 or D.O.T. approved tire inflation cage. OSHA Regulations require that an inflator gauge must be equipped with a lock-on chuck and have a hose extension sufficiently long for the operator to stand clear of the possible trajectory of a multi-piece rim.

## Large Bore Inflator Gauges

### Large Bore Inflation Gauge

- Large bore inflation unit with in-line gauge
- Equipped with H-4660A chuck and 6' hose
- Gauge calibrated 10-120 PSI (70-800 kPa) in 2 PSI increments



Ascot No.	Mfg. No.	Description
477-00409	I-409	Large Bore Inflation Gauge

### Dual Tire Inflator Gauge

- Features 5' hose to a tee connection, 2' of hose on each side with 12" sliding sleeve
- Lock-on chuck for easy access to inner dual and dual foot lock-on chuck for outer dual tire
- Allows user to engage and disengage chuck quickly



Ascot No.	Mfg. No.	Description
477-00408	I-408	Dual Tire Inflator Gauge



# SERVICE EQUIPMENT

TIRE CHANGERS  
WHEEL BALANCERS  
BRAKE LATHES  
LIFTS  
ACCESSORIES



# America's Workhorses

## Forging Capability.

When the world's best techs step into the shop each morning, they reach for their front-line Coats® equipment. And the models more shops trust are the Coats **70X Series** tire changer and the **1250-3D** wheel balancer. This powerful team has been upgraded to deliver even more productivity, protection, and capability than ever before. And they are so easy to use, they'll keep your shop running without a hitch. That's what makes them America's Workhorses. Only from Coats, the leader in the wheel service industry for over 65 years.



Coats. We're changing more than tires!

**AMMCO** **GOATS**  
Hennessy Industries

## Passenger Tire Changers

### 50X Series High Volume Rim Clamp® Tire Changer

- Exclusive pedal-actuated X-shaped tabletop provides support for the most delicate wheels
- Handles broad range of wheels and tires, from 6" to 26" in diameter and rims up to 14" wide
- 1.5 HP air drive system provides plenty of power plus infinite wheel control
- Built-in bead sealing jets and tabletop inflation for faster work
- Also available in electric versions



Ascot No.	Mfg. No.	Description
443-50181	50XAH-1	Air Drive, Hand Operated Bead Loosener, Basic Accessory Set
443-50182	50XAH-2	Air Drive, Hand Operated Bead Loosener, Extended Accessory Set
443-50183	50XAH-3	Air Drive, Hand Operated Bead Loosener, Premium Accessory Set

### 5035E Series High Volume Rim Clamp® Tire Changer

- For alloy and steel wheels
- Electric Drive System for the turn table to reduce noise
- Air powered side bead loosener for power
- Exclusive X-shaped tabletop
- Includes bead seating jets to aid in inflation
- 3.4 gallon air surge tank built into the tower to reduce floor space required
- Made in the USA



Ascot No.	Mfg. No.
443-50350	5035E

### RC200 Series Rim Clamp® Tire Changer

- Robo-Arm Equipped - Provides extra power for flexing stiff sidewalls without damaging tire or rim
- New 3-Position Motorcycle Rim Clamps - Specifically designed for motorcycle rims to provide the grip and protection you need for wider wheels
- New Gear Reduction Turntable - Protects expensive rims and gives operator more torque at lower RPMs for more precise control over larger installs
- New Rim Clamp Pressure Control System - Indicates amount of pressure being applied to the motorcycle rim



Ascot No.	Mfg. No.
443-20000	RC200

### 70X Series Rim Clamp Tire Changers

- With complete robotics and exclusive Rim Clamp® for run-flat tire changing speed and power
- Robotic arm used to assist in top bead mounting of stiff sidewall, low profile and run-flat tires
- Manual bead roller used to assist in holding the tire bead down to lube both the tire and wheel
- Robotic arm used to hold tires in the up position to reduce the effort in second bead removal
- Handles up to 22" wheels clamping with option for 24" wheels
- Also available in electric versions



Ascot No.	Mfg. No.	Description
443-70181	70XAH-1	Air Drive, Hand Operated Bead Loosener, Basic Accessory Set
443-70182	70XAH-2	Air Drive, Hand Operated Bead Loosener, Extended Accessory Set
443-70183	70XAH-3	Air Drive, Hand Operated Bead Loosener, Premium Accessory Set

### 5040 Series High Volume Rim Clamp® Tire Changers

- Clamps Wheels Externally Up to 21"
- Conveniently-placed foot pedals that give you precise control over every step of the changing process
- Provides protection for wheels at every step of the process
- Optional bead loosener socks, clamp booties and lift tool protection prevent metal-to-metal contact that causes scratching or marring



Ascot No.	Mfg. No.	Description
443-50400	5040A	Air Drive System
443-50401	5040E	Electric Drive System

### Single-Stage Center-Post Tire Changer

- Represents the most tried-and-true technology in the business
- Featuring single-stage operation
- All operations - bead loosening, demounting, mounting and inflation - are performed in the same position
- Equipped with 7.5 gallon surge tank, 50% larger than competitive models
- Features a contoured tabletop for proper rim support and state-of-the-art components for quality performance



Ascot No.	Mfg. No.
442-04050	4050A

**COATS**

## Tire Changers (Cont.)

### Coats Pro Guard High Performance Tire Changer

- Leverless Power Duckhead® - The leverless design replaces traditional tire tools that can mar wheel surfaces due to application difficulties or operator error
- Built-in Adjustable Wheel Lift - The wheel lift places the tire on the pedestal with the push of a pedal, reducing operator fatigue
- Protective Pedestal & Center Lock Design - Lock the wheel into place at its stringest point, while protecting both conventional and reverse mount wheels
- RoboArm® Helper Device - Effortlessly keeps the top bead of even the most stubborn tires in the drop center during the mounting process

Ascot No.	Mfg. No.
443-85606	85606688

**COATS**



### APX90 Passenger Tire Changer

- Externally clamps wheels up to 30" or as small as 9" to maximize service flexibility
- Hi-Torque Electric Turntable - High start-up torque gives you the power you need for tough applications
- Integrated Wheel Lift - Lifts heavy assemblies, reducing both wheel damage risk
- RoboArm® - Applies pressure to create bead lock and hold top bead in drop center when mounting
- RoboRoller® - Extra leverage for large diameter runflat and low-profile tires
- Available in Air and Electric

Ascot No.	Mfg. No.	Description
443-90101	APX90E	Electric Tire Changer
443-90102	APX90A	Air Tire Changer

**COATS**

### APX80 Passenger Tire Changer

- Large Clamping Capacity - Externally clamps wheels up to 30" or as small as 9" to maximize service flexibility
- Hi-Torque Electric Turntable - High start-up torque gives you the power you need for tough applications
- Three Position Bead Loosener - Provides complete control, reducing wait time and minimizing risk of wheel damage
- Duckhead Roller - Prevents top bead from flipping over Duckhead® on large stiff sidewall tires
- Ergonomically Positioned Foot Pedals & Helper Controls - Operator controls located at point of helper use
- Available in Air and Electric

Ascot No.	Mfg. No.	Description
443-80101	APX80E	Electric Tire Changer
443-80102	APX80A	Air Tire Changer

**COATS**





# Tire Changers

## Tire Changer Specifications

FEATURE TO BE COMPARED	Model 50X	Model 70X	Model 5040 A&E	Model 4050A	Pro Guard
<b>Operation</b>	Two Wheel Positions 1st - Loosen Bead 2nd - Mount/Demount	Two Wheel Positions 1st - Loosen Bead 2nd - Mount/Demount	Two Wheel Positions 1st - Loosen Bead 2nd - Mount/Demount	One Wheel Position Loosen Bead/Mount & Demount	
<b>Wheels Handled</b>	Steel & Alloy	Steel, Alloy, Performance, Run Flat	Alloy & Steel	Alloy & Steel	Alloy, Performance, Run Flat
<b>Mount/Demount Mechanism</b>	Swing Arm	Swing Arm	Swing Arm	Separate Tool Engages Center Post Key	Leverless
<b>Tool Head Offset Adjustment</b>	Manual	Manual	Manual	N/A	Tilt Back
<b>Shape Of Tabletop</b>	"X-Shaped" for Perimeter Support of the Wheel	"X-Shaped" for Perimeter Support of the Wheel	"X-Shaped" for Perimeter Support of the Wheel	Contoured for Perimeter Support of the Wheel	N/A
<b>Wheel Clamping Method</b>	Four Clamps In Table Top Actuated by One 3.75" Fiber Reinforced Composite Cylinder	Four Self-Center Constant Force Clamp by Single Carbon Fiber Cylinder	Four Clamps In Table Top Actuated by One 3.75" Fiber Reinforced Composite Cylinder	Centering Cone Mounts on Center	Center Post Lock
<b>Bead Loosening System</b>	Foot Control Actuates 7" Dual Action, Fiber Cylinders that Handle Wheels 2" - 17" Wide	Foot Control Actuates 7" Dual Action, Fiber Cylinders that Handle Wheels 2" - 17" Wide	Foot Control Actuates 7" Dual Action, Fiber Cylinders that Handle Wheels 2" - 12" Wide	Foot Control Operates Both 7" and 5" Cylinders that Loosens Both Beads on Wheels up to 19" Wide	Built-in Roller Disk and Tower
<b>Air Drive System</b>	1.5 HP - Air (Air Version Only)	1.5 HP - Air (Air Version Only)	1.5 HP - Air (Air Version Only)	Powered By Dual Chrome Plated Air Cylinders	N/A
<b>Electric Drive System</b>	1HP 110V - 1 Phase - 60 Cycle (Electric Version Only)	1HP 110V - 1 Phase - 60 Cycle (Electric Version Only)	1HP 110V - 1 Phase - 60 Cycle (Electric Version Only)	N/A	1.5HP 220V (Electric Version Only)
<b>Pressure Limiter</b>	Standard	Standard	Standard	Standard	Standard
<b>Bead Seating Reservoir</b>	Located in the Vertical Tower with a 3.8 Gal. Capacity	Located in the Vertical Tower with a 3.8 Gal. Capacity	Located in the Vertical Tower with a 3.4 Gal. Capacity	Enclosed ASME Tank with a 7.5 Gal. Capacity	Optional ABS
<b>Inflation Gauge</b>	Easily Calibrated 0 to 60 PSI Gauge W/ Damage Resistant Lexan® Faceplate	Easily Calibrated 0 to 60 PSI Gauge W/ Damage Resistant Lexan® Faceplate	Easily Calibrated 0 to 60 PSI Gauge W/ Damage Resistant Lexan® Faceplate	Easily Calibrated 0 to 60 PSI Gauge W/ Damage Resistant Lexan® Faceplate	Easily Calibrated 0 to 60 PSI Gauge W/ Damage Resistant Lexan® Faceplate
<b>Oiler/Lubricator</b>	Standard	Oil Injection	Standard	N/A	Standard
<b>Storage Tray</b>	Post	Standard	Optional	Top Only	
<b>Rim Diameter</b>	6"-22" Ext., 8"-24" Int.	6"-22" Ext, 8"-24" Int.	10"-21" Ext. 17"-24" Int.	10" x 17.5"	10"-34" Ext. 16"-47" Int.
<b>Rim Width</b>	14" Maximum	14" Maximum	10.5" Maximum	19" Maximum	16" Maximum
<b>Tire Diameter</b>	50" Max. Outside	50" Max. Outside	40" Max. Outside	38" Max. Outside	47" Maximum
<b>Required Air Source</b>	110 to 175 PSI, 5 SCFM for E Models, 14SCFM for A Models	110 to 175 PSI, 5 SCFM for E Models, 14SCFM for A Models	110 to 175 PSI, 5 SCFM for E Models, 14SCFM for A Models	110 to 175 PSI, 5 SCFM for E Models, 14SCFM for A Models	115 to 145 PSI, 5 SCFM
<b>Chassis Footprint</b>	35"W x 44"D x 75"H	35"W x 44"D x 89"H	32"W x 40"D x 70"H	53"W x 17.5"D x 42"H	46"W x 77"D x 83"H
<b>Shipping Wt.</b>	585 Lbs.	700 Lbs.	685 Lbs.	575 Lbs.	940 Lbs.

SERVICE EQUIPMENT

## Tire Changers (Cont.)

### SM915 Maxi Swing Arm Passenger & Light Truck Tire Changer

- Air tank in tower
- Dual clamping cylinders
- Semi-automatic swing arm
- Inflator jets on each clamp
- Inserts protect aluminum wheels
- Adjustable bead breaker
- Low profile mounting helper (Pressarm version only)
- Bead suppressing tool (Pressarm version only)
- Comes fully assembled

Ascot No.	Mfg. No.
443-91500	SM915Maxi



### SM915 Jumbo Swing Arm Passenger & Light Truck Tire Changer

- Air tank in tower
- Dual clamping cylinders
- Semi-automatic swing arm
- Inflator jets on each clamp
- Inserts protect aluminum wheels
- Adjustable bead breaker
- Low profile mounting helper (Pressarm version only)
- Bead suppressing tool (Pressarm version only)
- Comes fully assembled

Ascot No.	Mfg. No.
443-91501	SM915



### Corghi AM50 Tire Changer

- Handles all rims 12" - 30" including UHP, runflat, light truck and more
- A revolutionary bead lifter eliminates the need for tire bar, reducing operator risk and torn beads
- Powerful two-speed transmission for precision and speed
- Sleek design with sturdy pneumatic locking swing-arm uses less floor space
- Precision bead breaker disk gently loosens both beads
- Center cone clamping with plastic protector means no metal ever touches the fact of the rim

Ascot No.	Mfg. No.
443-00500	AM50



### SM56T Universal Tire Changer for Truck, Bus, Agriculture and Earth Moving Vehicles 14" - 56"

- Mobile cable control unit
- Two speed hydraulic pump motor
- Bi-directional rotation
- Self centering universal wheel chuck
- Rim pliers and rim lever standard
- Optional: alloy wheel protectors
- Optional: tubeless roller

Ascot No.	Mfg. No.
446-56000	SM56T



**Call for Details  
on Full Range  
of Cemb Truck  
Tire Changers**

## Tire Changers (Cont.)

### AM26 Artiglio Master

- Automatic mount/demount
- Computerized system
- Push-button technology
- 12" to 26" rim diameter
- No pry bars or tire tools
- No damage to wheels, tires or operator
- Pneumatic wheel lift

Ascot No.	Mfg. No.
443-26000	AM26



### A2024TI-20 Super Power Unit

- Pneumatic-powered upper disc holds bead into the wheel drop for mounting
- Designed for low-profile, EMT and high-performance tires and wheels
- Loosening upper bead for demounting
- Push down upper bead for lubrication and tire tool insertion
- Lowering upper bead for inspection between bead and demount head
- Lowering upper bead for inserting the bead clamp; this clamp makes it possible to lift the bead over the mount/demount head
- Shipping weight 815 Lbs.

Ascot No.	Mfg. No.
443-20242	A2024TI-20

### Monster AG TT

- Significant reduction in strain
- High protection of rims and tires
- High performance
- Maximum safety
- Universal application
- 14" to 48" and tilt up to 58"

Ascot No.	Mfg. No.
446-10000	AG TT





## Tire Changer Accessories

### Tire Changer Accessory Matrix

Model No.	Clamps as Manufactured *1	22" External Clamps	24" External Clamps	26" External Clamps	28" External Clamps	30" External Clamps	Motorcycle & ATV	Grip Max Service Items	Steel Mount Demount Head (Duckhead)	Plastic Inserts
5030/5035	8181677	N/A	N/A	N/A	N/A	N/A	8184414 MC, 8183585 ATV *7	N/A	81827881 Standard, 8183355 Motorcycle	Std. 8182961 (2), 8182963 (12), Motorcycle 8183373 (2), 8183374 (12)
5040	8182247									
5050A/E										
5060A/E	8181677									
5065A/E										
5050AX/EX		8184926, 85000758	8184327 *7	85606361 Grip Max *7	85606361 Grip Max *7	N/A	81845744 MC *7, ATV 6" reach standard	Grips 8500059408, Rebuild Kit 85000768w teeth or 85600314 w/o teeth		
5060AX/EX	8184926									
5065AX/EX										
7050AX/EX	8500758 Grip Max									
7060AX/EX										
7065AX/EX										
9024	83002297	8184262 *2	83002297	8184262 *2	8185590 or 8185531 *3*7	8184262 & 8185590 or 8185531 *4*7		N/A	N/A	N/A
APX 80	85000758 (std.) or 85600345 (opt.*7)	85000758 or 85600345 (opt.*7)	85000758 (std.) or 85600345 (opt.*7)	85000758 (std.) or 85600345 (opt.*7)	85000758 (std.) or 85600345 (opt.*7)	85000758 (std.) or 85600345 (opt.*7)	N/A	Grips 8500059408, Rebuild Kit 85000768w teeth or 85600314 w/o teeth	81827881 (requires shaft reversal) *5	8182961 (2), 8182963 (12)
APX 90										

### Tire Changer Accessory Matrix (Cont.)

Model No.	Standard Plastic Mount Demount Head (Black)	High Spoke Plastic Mount Demount Head (Grey)	Wheel Lifts	Clamp Sock	Bead Loosener Shoe Sock	Bead Lift Tool Sock	Bead Lifting Tool	Lube Swab	Lube Bucket	Paste Lube Bracket & Brush
5030/5035	8183061 (1), 8184410 (25)	8184432 (1), 85000372 (25)	N/A	8183604				85000850 (Past Lube) 80004911 (Liquid Lube)	8183710 (Past Lube) 8106259 (Liquid Lube)	850009048
5040										
5050A/E										
5060A/E										
5065A/E										
5050AX/EX										
5060AX/EX										
5065AX/EX										
7050AX/EX										
7060AX/EX										
7065AX/EX										
9024			N/A	N/A						N/A
APX 80	N/A	N/A	85000440	8183604						Standard
APX 90			Standard	8183604						Standard

\*1 As Manufactured today; older versions of the same model may be different and require conversions to meet current specifications

\*2 Carrier Extensions, bolt in, move clamps out 2" total

\*3 8183550 increase clamping 4": 8185531 reversible either increase 4" or decrease 2"

\*4 Carrier Extensions and clamp extensions required to be used in conjunction to reach maximum extension

\*5 The vertical shaft that the mount head attaches to must be turned 180 degrees for conversion to a steel head

\*7 External Clamping only. No teeth for internal clamping





## Tire Changer Accessories (Cont.)

### Tire Changer Accessories & Wheel Protecting Items

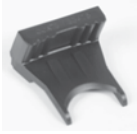

444-83604



444-83606



444-83605



444-84432



444-83061



444-01221

Ascot No.	Mfg. No.	Item	Description
444-83604	183604	Clamp Sock	Quilted Clamp Sock, RC-TC. 10 Pack
444-83605	183605	Lift Tool Sock	Lift Tool Sock, RC-TC. 10 Pack
444-83606	183606	Shoe Sock	Bead Loosener Shoe Sock, RC-TC. 2 Pack
444-84432	1844322	Duckhead	Raised Spoke Gray Plastic Duckhead. For 5000, 6000 & 7000 Series
444-08043	3008403	Duckhead	Black Plastic Duckhead for 9010/9024/APX-90
444-83061	183061	Nylon Mount/Demount Head	Rim Clamp® Tire Changers For 5000, 6000 And 7000 Series
444-01221	1221	Nylon Mount/Demount Head	Hunter Style
444-82963	182963	Plastic Inserts	Plastic Inserts for 182788 Metal Mount/Demount head for 50 & 7065 Series. Quantity of 12

### Tire Changer Accessories - Rim Clamp®

Ascot No.	Mfg. No.	Item	Description
444-89408	800059408	GRIP MAX	Laminated Clamp Replacement Kit
444-56345	5600345	6" - 22" GRIP MAX Laminated Clamp Set	Includes 4 Clamps, 4 Plungers, 1 Extra Set of Grips
444-56361	5606361	16" - 28" GRIP MAX Clamp Set	Without teeth, 4 Pk, Fits X Model Ramp Clamp Tire Changers (not for use on APX series)
444-81257	181257	Motorcycle Adapter	Set of 4 Clamps. Handles Wheels From 15" To 23". For Short (1") Table Clamps Used On Some Of The RC-1, RC-15, And RC-20's And All RC-5
444-83401	183401	Motorcycle Adapter	For Tall (1.75") Table Clamps Used On Some RC-1, RC-15, And RC-20's And All 5060 And 5070's.
444-83275	183275	Motorcycle Adapter	Single Clamp. Same As Above
444-83585	183585	ATV Adapter	8 Jaw ATV Adapters. Set Of 4. Fits "Tall" Clamp Carriers. Not Model 9010
444-82788	182788	Demount Head	Stainless Steel Mount/Demount Head Assembly For Models 5030 and 5060 Series Rim Clamp® Tire Changers
444-81329	181329	Rim Clamp® Spreader Adapter	Allows Use Of Manual Tire Spreader No. 00347 Or Adjustable Tire Spreader On All Rim Clamp® Tire Changers
444-81354	181354	Rim Clamp® Bead Lifting Tool	Designed For Ease Of Lifting the Head During The Tire Changing Operation
444-35685	435685	Drop Center Tool	Assists In Mounting High Performance Tires By Holding Bead In Drop Center
444-18312	183120	Inflation Guard Kit	For 50 Series Rim Clamp® Tire Changers
444-81131	8113125	Extended X-Clamp	Externally Clamp Wheels Up To And Including 22". For Coats "X" Model Rim Clamp® Tire Changers
444-84958	184958	28" X-Out Clamp	28" Clamps for 7065/5065X
444-84590	184590	4" Ext Clamp	4" Clamps for 9024/9010
444-84926	184926	Extended X-Clamp	3 Positions Enable External Wheel Clamping on 6" Through 22" Diameter Wheels
444-56462	5606462	Duckhead Roller	For 50/60/70 series rim clamps



444-56345



444-56361



444-56345



444-83585

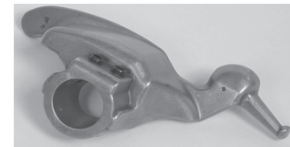

444-82788



444-81329



444-81354



444-18312



444-35685

## Tire Changer Accessories (Cont.)

### Tire Changer Accessories Center-Post



Ascot No.	Mfg. No.	Item	Description
444-00312	000312	Small Hold Down Cone	1.12" x 5" Secures Wheel To Center-Post Tire Changer During Mount/Demount Operation
444-01701	101701	Deep Hub Adapter	For All COATS Center-Post Tire Changers. Extended Shank Lets You Service Import Cars, Especially Sports Cars—Even With Spoked Wheels
444-81891	108276	Hold Down Cone	4040SA & 4050. To Secure Wheel To Tire Changer During Bead Loosening And Mount/Demount Operations
444-02927	102927	Shim Adapter .25"	Used To Adjust Lower Shoe For Wheels With Large Rim Flanges On All Center-Post Changers
444-08311	108311	Center-Post Short Adapter	4040SA And 4050. Short Extension For Center-Post
444-08313	108313	Center-Post Long Adapter	4040SA And 4050. Long Extension For Center-Post
444-07686	107686	Speed Mag Adapter Kit	For Changing Expensive High Hub, Cast Aluminum Mag Wheels. It Uses A Spring-loaded Backcone For Centering. A Cast Metal Dish With A Rubber Cushion That Distributes The Load Around The Wheel Structure And The Standard Hold Down Cone. Can Only Be Used With The 4050, 4040SA, 4040A, 4030A, 30-40A, 3030A, 2020A, 2020, 1010A And 1010 Tire Changers
444-07764	107764	Speed Mag Short Adapter Kit	Same Function As Above. For Use With 40-40SA And 4050 Only
444-00347	000347	Manual Tire Spreader	Action Range From 4" To 10". Fits All Rim Clamps®
444-81329	181329	Spreader Adapter	Optional Adapter For 000347 Spreader.
444-06637	106637	Wheel Bead Loosener	Manual Hand-Operated For Servicing Custom Mag And Decorative Style Wheels. Handles Custom Wheels 13" To 16" Diameter And 4" to 10" Width. Can Be Used With COATS 3040A, 3030A, 2020A, 2020 And 1010A Tire Changers
444-00768	000768	Combo Tool	Designed Specifically To Mount And Demount Tire Effortlessly And Damage Free On 4050, 4040SA, 3040A, 3030A, 2020A, 2020, 1010A & 1010
444-07156	107156	Combo Tool	For All Manual Tire Changers. Used When Servicing Custom Wheels And With Any Tire Changer Requiring A Manual
444-06568	106568	Custom Wheel Protector Set	Prevents Marring And Scratching of Custom Mag And Decorative-Style Wheels On Center-Post Tire Changers. Set Consists of Plastic Combo Tool and Polyurethane Bead Loosener Boots
444-07790	107790	Protector Boot Set	Set Of 10 Mount/Demount Plastic Booties For 4050, 4040SA Combo Tool. Prevents Combo Tool From Marring Wheel Finish
444-08397	108397	Bulk Pack Protectors	Mount End Package Of 500 Protective Booties For Mount End Of No. 000768 Combo Tool For 4050, 4040SA And Any Other Center-Post Changer
444-08398	108398	Bulk Pack Protectors	Demount End Package Of 500 Protective Booties For Mount End Of No. 000768 Combo Tool For 4050, & 4040SA And Any Other Center-Post Changer

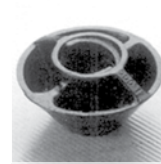

444-00312

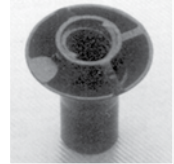

444-01701

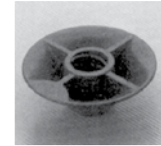

444-81891

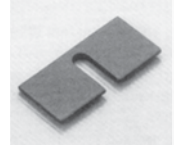

444-02927

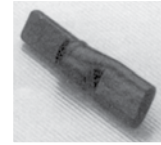

444-08311

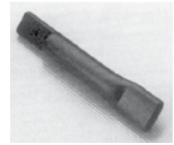

444-08313



444-07686



444-07764

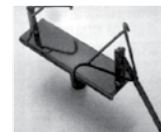

444-00347



444-06637



444-07156



444-00768



444-06568

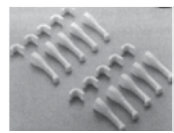

444-07790

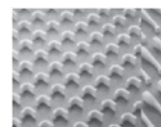

444-08397

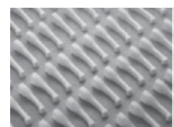

444-08398

## Tire Changer Accessories (Cont.)

### Tire Changer Lube Bottles and Swabs



844-16572

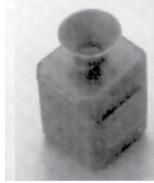

844-16259



437-00001

Ascot No.	Mfg. No.	Description
844-16572	106572	Lube Bottle. Center-Post. Fits 4040, 4040SA And 4050 Tire Changers
844-16259	106259	Lube Bottle. Rim Clamp®. Fits RC-15, RC-20, 5060 And 5070 Series Tire Changers
437-00001	TS-1	11" OAL x 2" Swab Diameter
437-00002	TS-2	15" OAL x 2" Swab Diameter
437-00003	TS-3	18" OAL x 3" Swab Diameter

### Bead Sealer Accessory Kit

- Kit Includes: Auxiliary Bead Sealer, for Rim Clamp Tire Changer, Taps off the Tire Changer surge tank, pkg.



Ascot No.	Mfg. No.
447-85545	85606545

### Mag/Chrome/Alloy Wheel Mount/Demount Tool

- Eliminates damage to mag, chrome and alloy wheels
- Fits all center-post tire changers
- Replaceable polymer inserts get 500 to 700 mount/demounts when used correctly
- Eliminates "booties" that slip off "combo" tool
- Changes inserts in seconds
- Not for use on steel wheels

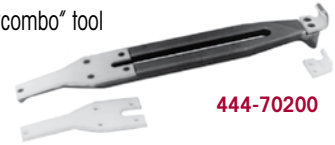

444-70200

Ascot No.	Mfg. No.	Description
444-70200	72000	Mount/Demount Tool
444-70201	72010	One Set Of Replacement Inserts For 70200 Mount/Demount Tool
444-70205	72000-005	Replacement Screw - Demount
444-70206	72000-006	Replacement Screw - Mount

### Storage Cabinet

- Board Storage
- Keep tools, valve stems, TPMS, ect. conveniently at the machine



Ascot No.	Mfg. No.	Description
444-83621	8113621	Storage Cabinet

## Heavy Duty Tire Changers

### HIT 5000 Heavy Duty Tire Changer

- These heavy duty changers can accommodate tube or tubeless tires with rim diameters from 15" to 38" (5000) and 15" to 44" (9000)
- Easy-to-use swing-arm houses all hydraulic controls, with a dedicated lever for each powered function
- Self-centering hydraulic clamping chuck
- Adjustable pressure regulator ensures proper matching of chuck pressure to rim strength
- Heavy, tapered roller bearings and a dual direction hydraulic motor provide smooth torque
- Roller-type tire spreader standard

Ascot No.	Mfg. No.
446-05000	5000



446-05000

## Heavy Duty Tire Changers

### HIT 6000 Heavy Duty Tire Changer

- The Coats Model 6000 tire changer is designed for servicing tubeless tires. It can change tubeless truck tires in a matter of minutes without the use of adapters, as well as loosen tube-type tire beads
- Handles wheel widths of 6" to 15" and diameters of 16.5" to 24.5"
- Changes all 15-degree single-piece highway rims, including demountable Dayton wheels, reverse disc Budd wheels and standard disc wheels
- One control stick for pivoting the tabletop and clamping the rim chuck
- Bead loosening, mounting and demounting are activated by dedicated two-way pedals
- Optional #183945 nylon head combo tool available for aluminum wheels

**COATS**



Ascot No.	Mfg. No.
446-06000	HIT 6000



### CHD-9551 Heavy Duty Tire Changer

- Our top-of-the-line changer is designed for high-volume shops. The CHD-9551 makes it easy to handle the toughest super-single, skidder, agricultural and off-road tires on the market
- Offers the most automated features and widest range of fittings in the CHD line
- Remote control rotating tool head/arm for the fastest, easiest tool changes in the business
- Optical wireless remote gives you freedom to move around the machine without cumbersome cables
- Handles rims from 14" to 46" (up to 56" with clamp extensions) and tires up to 95" in diameter and 51" wide

Ascot No.	Mfg. No.
446-09551	CHD-9551

### CHD-9043 Heavy Duty Tire Changer

- The clear choice for high volume shops that deal with both a variety of applications and large wheel fittings
- Solid, single-piece frame for added capacity and dependability
- Remote control hydraulically operated tool arm saves operator effort and speeds tire-changing turnaround time
- Handles rims from 14" to 46" (up to 56" with clamp extensions) and tires up to 90.5" in diameter and 43" wide

Ascot No.	Mfg. No.
446-09043	CHD-9043



## Heavy Duty Tire Changers (Cont.)

### CHD-6330 Heavy Duty Tire Changer

- It's the most compact of the jaw-style clamping machines available today. This easy-to-learn model is designed for shops with moderate to high volume with a wide range of applications
- Four-jaw chuck allows fast and easy clamping of virtually all rim styles, including de-mountable, reverse disc, standard disc and off-road style wheels
- Floating jaws match wheel contours for excellent grip and safety
- Solid, single-piece frame for added capacity and reliability
- Portable wired control unit lets you work from the best angle at all times
- Handles rims from 13" to 27" and tires up to 36" in diameter and 30.5" wide



Ascot No.	Mfg. No.
446-06330	CHD-6330



### Heavy Duty Tire Changer Features & Specifications

FEATURES TO COMPARE	CHD 9551	CHD 9043	CHD 9041	HIT 5000	CHD 6330	HIT 6000	CHD 4730
Operation	4 Jaw Chuck	4 Jaw Chuck		3 Jaw Chuck	4 Jaw Chuck	Lay Back, Center Mount	Front Plate or Cone
Wheel Handled	Budd & Dayton, Tube & Tubeless	Budd & Dayton, Tube & Tubeless		Budd & Dayton, Tube & Tubeless	Budd & Dayton, Tube & Tubeless	Budd & Dayton Tubeless	Budd Tubeless
Mount Demount	Hook & Roller on Reversible Mount	Hook & Roller on Reversible Mount		Independent Hook & Roller	Hook & Roller on Reversible Mount	Center Post	Roller on Sliding Mount, Hook Optional
Tool head Offset	Automatic Permanent Mounted	Automatic Permanent Mounted	Foot Release Permanent Mounted	Independent Removable, Mount in Table	Hand Release Permanent Mounted	Independent Removable, Mount in Table	Hand Release Permanent Mounted
Table	Moving Table Side Mounted	Moving Table Side Mounted		Moving Table Centered in Frame	Moving Table Side Mounted	Lay Back	Moving Table Side Mounted
Wheel Clamping Method	4 Jaw Chuck	4 Jaw Chuck		3 Jaw Chuck	4 Jaw Chuck	Lay Back, Center Mount	Front Plate or Cone
Wheel Lift	Clamp Arm Lifting	Clamp Arm Lifting		Clamp Arm Lifting	Clamp Arm Lifting	Tilt Back	Clamp Face Plate Lifting
Frame Structure	Full Frame	Full Frame	Open Frame	Center Carriage	Open Frame	Tilt Table	Open Frame
Max. Tire Diameter	95"	90.5"	90.5"	76"	63"	44"	47"
Max. Tire Width	51"	43"	42"	25"+	30.5"	16"	30.5"
Rim Diameter Range	14-46 (47"-56" with Clamping Extensions)	14-46 (47"-56" with Clamping Extensions)		15"-38"	13-27	16.5"-24.5"	14"-26"
Electric Specifications	208-230VAC, 3ph, 60Hz, 22Amp	208-230VAC, 3ph, 60Hz, 15Amp		220v / 1 ph or 220v / 3ph, 60Hz	208-230VAC, 3ph, 60Hz, 15Amp	220v / 1 ph or 220v / 3ph, 60Hz	208-230VAC, 3ph, 50/60Hz, 12Amp
Air Required				No		Yes	
Max. Overall Dimension	112"(w)x81"(d) x75"(h)	96,5"(w)x85"(d) x73"(h)	88"(w)x79"(d) x59"(h)	96"(w)x108"(d) x66"(h)	69"(w)x68,5"(d) x50"(h)		62"(w)x59"(d) x46"(h)
Max Wheel Weight	3300 lbs.	3500 lbs.	3300 lbs.	-	3300 lbs.	-	2800 lbs.
Weight with Standard Accessories (shipping)	2282 lbs.	1874 lbs.	1698 lbs.	1400 lbs.	1245 lbs.	1150 lbs.	981 lbs.

## Tire Changer Accessories

### Heavy Duty Tire Changer Accessories for HIT



447-10843



447-20082



447-09249



447-09764



447-09346



447-10843



447-83945



447-09342



447-20564



447-09344



447-20334



447-09345



447-09343

Ascot No.	Mfg. No.	Item	Description
447-10843	110843	Jaw Extensions	Optional for HIT 5000 & Standard for HIT 9000.Used For Mounting Large Wheels Up To 44" . 3 Required
447-83803	183803	Bolt Circle Adapter	10" x 11.25" for "Budd" Hub Piloted Wheels. For Use On 5000/9000 Tire Changers
447-83945	183945	Combo Tool	Nylon Head Combo Tool For 6000 Tire Changer
447-83950	183950	Nylon Head	Replacement Nylon Head For 183495 Combo Tool
447-20082	120082	Combo Tee	For Model 6000 Tire Changer To Hold Mount/Demount Tool
447-20564	120564	Combo Tool/Duplex	Optionally Used On 6000 For Mounting/Demounting Duplex Style Tires With Thick Beads
447-09342	109342	Tubeless Tire Iron	37" Long; Standard Accessory For Models 5000 And 9000
447-09343	109343	Lock Ring Tool	24" Long; Standard Accessory For Models 5000 And 9000
447-09344	109344	Drop Center Tool	18" Long; Standard Accessory for Models 5000 And 9000
447-09345	109345	Bead Starting Tool	Standard Accessory For Models 5000/9000 Used For Starting Beads Into Drop Centers On Tubeless Wheels
447-09249	109249	Combo Tee	Standard Accessory For Models 5000/9000, Used For Mounting Tubeless And Some Tube-Type Tires. For Units Before 1/1/93
447-10449	110449	Combo Tee	Standard Accessory for Models 5000/9000 Used For Mounting Tubeless And Some Tube-Type Tires. For Units After 1/1/93
447-10851	110851	Combo Tee	Optional Accessory For 5000/9000 For Tractor Tires & Mounting Large Off-Road/Agricultural Style Tires. For Units Before 1/1/93
447-09764	109764	Offset Disc	For Models 5000/9000. Optional Accessory For Mounting/ Tool Holder Demounting Tires On Dayton Style Wheels, Super Singles And Off-Road Type Tires. For Units Before 1/1/93
447-10852	110852	Offset Disc	For Models 5000/9000. Optional Accessory For Demounting Tool Holder Tires On Dayton Style Wheels, Super Singles And Off-Road Type Tires. For Units After 1/1/93
447-09346	109346	Vise Grip	Standard for Models 5000/9000. For Starting Tire Beads Into Drop Centers on Tubeless Wheels
447-20334	120334	Bead Lift Tool	57" Long. Standard For Models 5000/6000/9000. Extra Long Bar For Bead Lifting Tires
447-10842	110842	Ramp	Optional Accessory For Model 5000. Allows Easy Roll Up Of Large Tires

## Wheel Balancers

### Ride Management System

- Accuracy: Our drive systems are self-calibrating and complete diagnostic suite for radial runout, lateral runout and other key issues to solve difficult vibration problems. Adding just 2-3 seconds to cycle time, it's fast enough to use with every balance
- Real-time 3-D animated graphics and visual cues provide a simple user interface that promotes proper balancing techniques and faster floor-to-floor times
- 12 balancing modes with several alloy options, plus patch balance and PAX
- Highly accurate sensor system replaces an outer arm, increasing productivity and reducing machine wear

Ascot No.	Mfg. No.	Description
481-01800	XR1800	Ride Management System
481-01850	XR1850	Includes Lateral Runout



### Medium Duty Wheel Balancer

- Color LED Matrix Information Box - Easy-to-read visual cues, critical information at a glance and promote proper balancing techniques and faster bay turnaround times
- 10 Balancing Modes - Multiple static, dynamic and alloy modes
- Automatic Distance & Diameter Entry - Automatic measurement of two parameters with manual control back-ups
- Direct Tape-A-Weight Placement - Audible beep guides you to perfect placement

Ascot No.	Mfg. No.
481-01175	1175

### Premium High Volume Laser Balancer

- LED display operators provide needed information for all 8 balancing modes. Simultaneous display of static and dynamic data identifies excess residual static imbalance
- Laser Guidance eliminates error by displaying exact Tape-A-Weight placement and behind the spoke weight placement locations
- Automatic offset and diameter measurement with manual control backups
- Five second (avg.) balancing cycle begins when you lower the hood
- Static, dynamic, four alloy options, behind the spoke (on all modes with inside weight), plus patch balance
- Can be ordered in 28mm or 40mm configurations
- No belts to slip or pulleys to wear out
- Adapter set not included



Ascot No.	Mfg. No.	Description
481-00950	1250-2D28	Premium High Volume Balancer, 28mm
481-00951	1250-2D40	Premium High Volume Balancer, 40mm
481-00952	1250-3D	With AC Vector Drive System, 40mm Only
481-00953	1250-3DV	With AC Vector Drive System, 40mm Only (Video Display)



## Wheel Balancers (Cont.)

### Economy Balancer

- Ideal balancer for cost-conscious shops and service stations performing fewer than 20 balancing jobs per day
- Handles standard OEM tires up to 40" diameter and 100 Lbs.
- Digital readouts and data entry
- Ten balancing modes - dynamic, alloy and static-ensure accuracy
- Cycle time is just 10 seconds
- Adapter set not included
- 110V, 1PH



Ascot No.	Mfg. No.
481-00775	775

### C71 Digital Wheel Balancer

- High Volume Computerized Balancer for cars and light trucks
- C71 balances steel & light alloy wheels of cars, light trucks, motorcycles & scooters (with optional adaptors)
- Self-Diagnosis and Self-Calibrating
- Menus for quick selection of ounces to grams; inches to millimeters; and unbalanced thresholds 0.1 or 0.035 ounces (1-5g)
- Almost twice as fast as other balancers
- Optimization program for compensation of rim and tire unbalance
- "Static" Program - plus 4 ALU programs for PAX, light alloy or special shaped rims
- Standard Quick Nut Mounting
- One Button Split & Hidden Weight Program
- Automatic Distance and Diameter Entry
- Direct Weight Location Program (no repositioning of stick-on weights)
- Foot Brake for easy weight placement
- Standard Splash Guard



Ascot No.	Mfg. No.
481-00071	C71

### C88 Premium Video Wheel Balancer

- High Volume Video Balancer for cars and light trucks
- C88 balances steel & light alloy wheels of cars, light trucks, motorcycles & scooters (with optional adaptors)
- HD High Definition Flat Screen Video Monitor with Touch Screen
- "Intelligent" averaging system for residual static in-balance
- Optimization Program for compensation of rim and tire unbalance
- "Static" program - plus 4 ALU programs for PAX, light alloy or special shaped rims
- Pneumatic Locking Shaft
- One Button Split & Hidden Weight program
- Automatic Distance and Diameter Entry
- Automatic Width Sonar
- Radial Run-Out (EMS Sonar) and Lateral Run-Out
- Direct Weight Location Program no repositioning of stick-on weights
- Electronic Brake for easy weight placement
- Printer Standard (prints and records best wheel location and weights used)



Ascot No.	Mfg. No.
481-00088	C88



## Wheel Balancers (Cont.)

### C212 Motorized Digital Truck Wheel Balancer with Pneumatic Lift

- Digital Truck Wheel Balancer that operates at high precision on truck, bus, light commercial and car wheels thanks to a 40mm shaft and to a rich standard equipment including cones and adapters
- Pneumatic stationary brake useful during wheel mounting and counterweight application. The powerful and ergonomic (soft) type lift enables excellent centering accuracy of the wheel on shaft
- C212 balances steel & light alloy wheels of cars, light & heavy commercial trucks and bus
- Pedal Operated Pneumatic Lift
- Shows Static and Dynamic Unbalance
- Optimization Program to compensate the tire unbalance with the rim unbalance
- One Button Split & Hidden Weight Program
- Automatic Distance and Diameter Entry
- Direct weight location program (no repositioning of stick-on weights)
- Hood optional



Ascot No.	Mfg. No.
481-00212	C212

### Electronic Strobe Balancer

- Companion to the Model 525 spinner
- Delivers fast precision balancing on-the-vehicle
- No special wheel attachments are required
- The flashing strobe indicator pin-points exact placement of wheel weights
- 110-115 Volt



Ascot No.	Mfg. No.
481-00501	501A

### Low Profile Heavy Duty Spinner

- Allows for easy access under today's lower body style cars and trucks
- Completely portable, this heavy duty spinner will handle passenger cars and heavy duty truck tires, including rear wheels and drive duals
- Available in 7.5 HP, 220 Volt, 3 Phase or 5 HP, 220 Volt, Single Phase



Ascot No.	Mfg. No.
481-00525	525

### Portable Tire/Wheel Balancer

- Rugged die-cast aluminum head cone
- Plated steel guide rods with zinc chromate helper springs
- Hardened cast-in place pivot seat
- Recessed circular level bubble



Ascot No.	Mfg. No.
481-00061	M61



### Heavy Duty Mobile Hand Spin Balancer

- With a reduced overall size, the Coats 6275 hand spin balancer is a portable, easy to move balancer
- No lift is required - simply roll the balancer into position
- A handle operated mechanical reduction gear makes hand spinning easier
- An intuitive menu featuring self-diagnosis and self-calibration allows for quick and easy balance for almost any type of rim

Ascot No.	Mfg. No.	Description
481-06275	6275	Hand Spin Balancer



## Wheel Balancers (Cont.)

### Truck Wheel Balancer

- Ideal for every heavy duty balancing job
- Exclusive direct drive power
- One moving part, resulting in extremely accurate balancing for tires up to 46" in diameter and rims up to 16" minimum and 26" maximum diameter and from 4.5" to 18" wide
- Large dial indicator knobs enter data and bright LED displays indicate weight locations and amounts
- Balances full range of heavy duty, RV and light truck tires using single-spin dynamic, static and RV balancing modes
- Features fully interlocked hood guard and emergency stop button for safety
- Average cycle time for truck tires is 12 seconds
- Incorporates an automatic hub nut loosening feature, a back/front cone mounting system and a removable stub shaft
- New 8K 6401 Packages include: 501 Lift, 143935 Adapter Plates & 109877 adapter plates

**COATS**



Ascot No.	Mfg. No.	Description
481-06401	6401	Truck Wheel Balancer-Direct Drive
481-86401	8K6401KT1P	220V Single Phase Truck Wheel Balancer Package
481-86403	8K6401KT3P	220V 3 Phase Truck Wheel Balancer Package

### Adapters & Cones for Model 6401 Heavy Duty Balancer

Ascot No.	Mfg. No.	Item	Description
482-43935	143935	Adapter	Large Budd Wheels
482-10785	110785	Adapter	Speedy Dayton
482-10786	110786	Adapter Accessories Kit	Speedy - For 22"-24.5" Wheels
482-09877	109877	Cone Kit	Hub Centered Wheels, Truck
482-08630	308630	Cone	Large 2.98"-5.06" Center Holes
482-08629	308629	Cone	Medium 2.78"-3.46" Center Holes
482-08628	308628	Cone	Small 2.44"-3.12" Center Holes
482-08631	308631	Cone	Truck 4.52"-6.95" Center Holes
482-00501	501	Lift	Hydraulic - Roll Around
482-08639	308639	Spring	Back Cones
481-86401	8K6401KT3P	Kit	220/3P Kit includes 3PH Balancer, Budd Plate Adapter 8143935, Hub Centered Truck Cone Kit 8109877 & 501 Wheel Lift
481-86403	8K6401KT1P	Kit	220V/1P Kit includes 1PH Balancer, Budd Plate Adapter 8143935, Hub Centered Truck Cone Kit 8109877 & 501 Wheel Lift

## Wheel Balancer Accessories

### Miscellaneous Heavy Duty Wheel Balancer Accessories



482-09618



482-00501



482-08642

Ascot No.	Mfg. No.	Item	Description
482-09618	09618	Hub Nut Assembly	Replacement Hub Nut For 6401 Balancer Shaft
482-00501	501	Hydraulic Roll Around Lift	Optional Accessory For 6401. Allows Operator To Lift Large Truck Tires Onto The 6401
482-08642	308642	Large Pressure Drum	Used To Properly Clamp Or Decorate Wheels On 6401 Balancer When Using The Preferred Back Cone Balancing Technique. 5.75" Diameter
482-08605	308605	Replacement Shaft	Replacement Shaft For 6401 Balancers
482-09608	309608	Heavy Duty Assembly Caliper	Measures Rim Widths In Inches. For Use With 6401 Balancers
482-43622	143622	Spacer Plate	Spaces Wheel Out From 6401 Balancer Chassis To Prevent Interference With Chassis When Balancing Some Wide Base And Offset Tires
482-08645	308645	Long Hub Nut Wrench	Standard Accessory For 6401 Balancer. Fits No. 309618 Hub Nut Assembly
482-08646	308646	Short Hub Nut Wrench	Standard Accessory For 6401 Balancer. Fits No. 309618 Hub Nut Assembly

## Wheel Balancers (Cont.)

### Blue Light

- High resolution touch-screen monitor
- Wheel data acquisition with automatic laser triangulators
- Image/data processing using a personal computer microprocessor
- Rim lighting for acquiring images with the blue light system
- Automatic weight position search
- Automatic wheel clamping with ELS shaft assembly
- Radial and lateral run-out measurement
- Slide slip measurement
- Laser pointer to indicate weight position
- Weight management (integrated software suite)

Ascot No.	Mfg. No.
481-00101	Blue Light

SPECIFICATIONS	
Voltage	Switching Power Supply 100-230V 50-60Hz
Rim diameter	10" - 32"
Maximum wheel diameter	44"
Maximum wheel width with guard	600mm
Maximum wheel weight	165 Lbs.
Rotation Speed	70-85-98 RPM
Shipping weight	736 Lbs.



### Basic Automotive Accessory Group Standard with EM Balancers

- Conical Spring
- Rubber Guard for alloy Wheels
- Wheel Attaching Cap
- Spacer Cap
- Small Cone 1.6" – 2.7"
- Medium Cone 2.6" – 3.4"
- Large Cone 3.3" – 4"
- Quick-Release Speed Nut
- Wheel Weight Hammer
- Calibration Weight/3.5 Oz.
- Tire Caliper

### EM430

- Large LCD display
- Wide cabinet on three legs
- Wheel guard up to 44"
- Automatic date entry for distance and diameter
- Accurate - 1 gram
- Self-calibration
- Shift plane capability
- Quick-release speed nut

Ascot No.	Mfg. No.
481-00430	EM430

SPECIFICATIONS	
Voltage	110V 1Ph
Tire Diameter	Up to 35"
Rim Width	1.5" - 20"
Rim Diameter	1" - 23"
Spin Time	9 sec.
Shaft Diameter	40mm
Max. Tire Weight	144 Lbs.
Shipping Weight	330 Lbs.

# COATS®

## Sometimes The Hole Isn't The Center

- Aftermarket and a few OE wheels are designed so one model can fit many brands of vehicle. To do this, they enlarge the middle hole and center off the bolts.
- These wheels are called lug-centric or bolt centric.
- **It is critical for accurate balancing that the wheel centers on the balancer the way it centers on the car.**

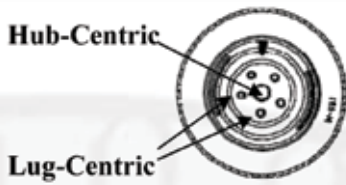

### FIXED FINGER PLATES

- Each plate is set to one size and locked.
- Offers fast set up on the balancer.
- Ideal for very high volume shops with a full set or get just a few plates for fleet applications.



### PIN PLATES

- The most popular option.
- Four plates cover more than 95% of vehicles on the road.
- Faster set up than stud plates or combi adapters.
- Fewer plates than fixed finger plates to provide maximum coverage.
- Changeable pins allow for upgrading when new wheel styles come out.



### STUD PLATES

- Each plate is set to one size and locked.
- Plates are bolted to the wheel and the assembly is mounted on the balancer.
- Used when maximum accuracy is needed.

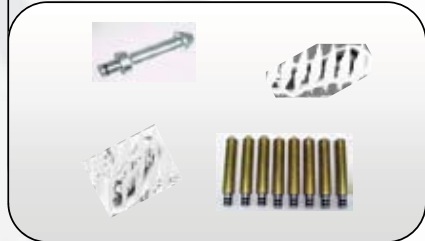

### COMBI ADAPTER

- A wide range of sizes in one unit.
- Can be time consuming to set up.
- Used in very low volume specialty applications or wheels without center holes.

8309060      28mm  
8112784      40mm



### WALL STORAGE

- Gets adapters up off the floor
- Easy to see and select



### BALANCER MATE

- Mobile Storage
- Position where you need it when you need it.

## Wheel Balancer Accessories

### Pin-Plate System

- Will cover over 90% of all passenger car and light truck applications
- Applies to both hub & lug centric wheels
- Most consistent method for providing accurate mountings
- System includes: pin-plate numbers 1 through 4, choice of adapter storage basket, hole gauge, application chart, video, instructions
- Intuitive bolt pattern arrangements on plates for easy pin placement
- Color coded pins for quick identification
- Available in 28mm and 40mm



**COATS**



Ascot No.	Mfg. No.	Description
482-13465	8113465	Pin-Plate System 28mm I.D. Plates 1 Through 4, Pins Storage Panel, Video, Application Chart, Hole Gauges, Instructions
482-13113	8113113	Hole Gauge For Pin-Plates
482-13210	8113120	8 Pack Of Pins 24 x 80mm, Bullet Nose
482-13121	8113121	8 Pack Of Pins 24 x 70.5mm, Funnel Nose, Long
482-13122	8113122	5 Pack Of Pins, 22 x 60mm, Funnel Nose, Short
482-13637	8113637	Pin-Plate System 40mm, I.D., Plates 1 Through 4, Pins Storage Panel, Video, Application Chart, Hole Gauges, Instructions
482-82800	8KPPBM28	Pin-Plate System, 28mm I.D., Plates 1 Through 4, Pins, Balancer Mate, Video, Application Chart, Hole Gauge, Instructions
482-84000	8KPPBM40	Pin-Plate System, 40mm I.D., Plates 1 Through 4, Pins, Balancer Mate, Video, Application Chart, Hole Gauge, Instructions
482-13224	8113224C	Storage Panel, 11 Hook For COATS Wheel Balancing Solutions, Wall Mount

### The Complete Balancing System for the 1250 Series

- Kits must be purchased with the 1250 series balancer
- Basic, Extended & Premium Kits: Coverage for most OE passenger cars and some light truck wheels (Premium includes aftermarket cars also)
- Optional Accessory Storage: Peg kit (8111480 Included in kit when ordered with balancer)



482-12099



482-12100



482-12101



482-12107



482-12420



482-88095



482-88820



482-89011

Ascot No.	482-14335	482-14337	482-14338	482-14339	482-14341	482-14343
Mfg. Part No.	8114335	8114337	8114338	8500997401	85009976	85009977
Description	Basic Kit 28mm	Extended Kit 28mm	Premium Kit 28mm	Basic Kit 40mm	Extended Kit 40mm	Premium Kit 40mm
Small Cone (1-2/4" x 2-1/4")	8110410	8110410	8110410	8112098	8112098	8112098
Medium Cone (2-1/4" x 3")	8110411	8110411	8110411	8112099	8112099	8112099
Large Cone (3" x 3-1/8")	8110412	8110412	8110412	8112100	8112100	8112100
Light Truck Back Cone	8308095	8308095	8308095	8112101	8112101	8112101
Calipers	8309011	8309011	8309011	8309011	8309011	8309011
Premium Wheel Weight Hammer	8113175	8113175	8113175	8113175	8113175	8113175
Hub Nut	8110543	8110543	8110543	8112103	8112103	8112103
Small Pressure Cup & Rubber Lip	8110542	8110542	8110542	8112106	8112106	8112106
Spring	8308820	8308820	8308820	8112107	8112107	8112107
Stub Shaft	8113166	8113166	8113166	8500920401	8500920401	8500920401
Short Cone	-	8112420	8112420	-	8112421	8112421
Light Cone Kit (4.8" x 6.8")	-	8113276C	8113276C	-	8113277C	8113277C
Faceplate Extension	-	8111935	8111935	-	8111935	8111935
Pin Plate System with Balancer Mate	-	-	8KPPBM2B	-	-	8KPPBM40
Storage Peg Kit	811148	811148	811148	811148	811148	811148



## Wheel Balancer Accessories (Cont.)

### Fixed Finger Plates



- Each plate is set to one size and locked
- Offers fast set up on the balancer
- Ideal for very high volume shops with a full set or get just a few plates for fleet applications

Ascot No.	Mfg. No.	Item
482-13206	8113206C	Fixed Finger Plate, ffp1a, 4x100mm & 4x108mm, 4 Tapered Fingers, 28mm I.D.
482-13207	8113207C	Fixed Finger Plate, ffp2a, 4x114.3mm & 4x108mm, 4 Tapered Fingers, 28mm I.D.
482-13208	8113208C	Fixed Finger Plate, ffp3a, 5x100mm & 5x108mm, 5 Tapered Fingers, 28mm I.D.
482-13209	8113209C	Fixed Finger Plate, ffp4a, 5x114.3mm & 5x108mm, 5 Tapered Fingers, 28mm I.D.
482-83210	8113210C	Fixed Finger Plate, ffp5a, 5x115mm & 5x120.65mm, 5 Tapered Fingers, 28mm I.D.
482-13211	8113211C	Fixed Finger Plate, ffp6a, 5x112mm & 5x130mm, 5 Ball Seat Fingers, 28mm I.D.
482-13212	8113212C	Fixed Finger Plate, ffp7a, 5x120mm & 5x127mm, 5 Tapered Fingers, 28mm I.D.
482-13689	8113689C	Fixed Finger Plate, ffp8a, 6x4.5" & 6x5.5", 6 Tapered Fingers, 28mm I.D.
482-13695	8113695C	Fixed Finger Plate, ffp9a, 5x5.5" & 5x6.5", 5 Tapered Fingers, 28mm I.D.
482-13714	8113714C	Fixed Finger Plate, ffp10a, 5x135mm & 5x4.25", 5 Tapered Fingers, 28mm I.D.
482-13702	8113702C	Fixed Finger Plate, ffp11a, 8x6.5" & 6x127mm, 8 Tapered Fingers, 28mm I.D.
482-13708	8113708C	Fixed Finger Plate, ffp12a, 8x170mm & 6x135mm, 8 Tapered Fingers, 28mm I.D.
482-13720	8113720C	Fixed Finger Plate, ffp13a, 5x150mm & 5x110mm, 5 Tapered Fingers, 28mm I.D.
482-13213	8113213C	Fixed Finger Plate, ffp1b, 4x100mm & 4x108mm, 4 Tapered Fingers, 40mm I.D.
482-13214	8113214C	Fixed Finger Plate, ffp2b, 4x114.3mm & 4x108mm, 4 Tapered Fingers, 40mm I.D.
482-13215	8113215C	Fixed Finger Plate, ffp3b, 5x100mm & 5x108mm, 5 Tapered Fingers, 40mm I.D.
482-13216	8113216C	Fixed Finger Plate, ffp4b, 5x114.3mm & 5x108mm, 5 Tapered Fingers, 40mm I.D.
482-13217	8113217C	Fixed Finger Plate, ffp5b, 5x115mm & 5x120.65mm, 5 Tapered Fingers, 40mm I.D.
482-13218	8113218C	Fixed Finger Plate, ffp6b, 5x112mm & 5x130mm, 5 Ball Seat Fingers, 40mm I.D.
482-13219	8113219C	Fixed Finger Plate, ffp7b, 5x120mm & 5x127mm, 5 Tapered Fingers, 40mm I.D.
482-13692	8113692C	Fixed Finger Plate, ffp8b, 6x4.5" & 6x5.5", 6 Tapered Fingers, 40mm I.D.
482-13699	8113699C	Fixed Finger Plate, ffp9b, 5x5.5" & 5x6.5", 5 Tapered Fingers, 40mm I.D.
482-13717	8113717C	Fixed Finger Plate, ffp10b, 5x135mm & 5x4.25", 5 Tapered Fingers, 40mm I.D.
482-13705	8113705C	Fixed Finger Plate, ffp11b, 8x6.5" & 6x127mm, 8 Tapered Fingers, 40mm I.D.
482-13711	8113711C	Fixed Finger Plate, ffp12b, 8x170mm & 6x135mm, 8 Tapered Fingers, 40mm I.D.
482-13723	8113723C	Fixed Finger Plate, ffp13b, 5x150mm & 5x110mm, 5 Tapered Fingers, 40mm I.D.
482-13791	8113791	Pin, Fixed Finger Bullet 16 & 94mm
482-13792	8113792	Pin, Fixed Finger Tapered 16 & 94mm



### Fixed Finger Plates, Kits & Systems

Ascot No.	Mfg. No.	Item
482-81028	8K1FFP28	Essential Balancing Solutions Package: Plates 1-7, Short Cone, Gage & Balancer Mate (Passenger Car Coverage) 28mm
482-82028	8K2FFP28	Preferred Balancing Solutions Package: Kit 1 Plus Balancer Chuck & Light Truck Cone Kit (Car, Light Truck, & SUV Coverage), 28mm
482-83028	8K3FFP28	Premium Balancing Solutions Package: Kit 1 plus Deep Offsets, Light Truck Cone Kit, Stud Plates 1-5 & 2 Balancer Mates (Car, Light & Medium Truck, & SUV Coverage), 28mm
482-80285	8KFFP285	Fixed Finger Plates 1-5, 28mm
482-80287	8KFFP287	Fixed Finger Plates 1-7, 28mm
482-80140	8K1FFP40	Essential Balancing Solutions Package: Plates 1-7, Short Cone, Gage & Balancer Mate (Passenger Car Coverage), 40mm
482-82040	8K2FFP40	Preferred Balancing Solutions Package: Kit 1 Plus Balancer Chuck & Light Truck Cone Kit (Car, Light Truck, & SUV Coverage), 40mm
482-83040	8K3FFP40	Premium Balancing Solutions Package: Kit 1 plus Deep Offsets, Light Truck Cone Kit, Stud Plates 1-5 & 2 Balancer Mates (Car, Light & Medium Truck, & SUV Coverage), 40mm
482-80405	8KFFP405	Fixed Finger Plates 1-5, 40mm
482-80407	8KFFP407	Fixed Finger Plates 1-7, 40mm

## Wheel Balancer Accessories (Cont.)

### Pin Plate, Kits & Systems

Ascot No.	Mfg. No.	Item
482-13835	8113835	Pin-Plate System, Plates 1-4, Four Pin Styles, Training Video, Application Measuring Tool, 28mm
482-13836	8113836	Pin-Plate System with Wall Board Storage, 28mm
482-80028	8KPPBM28	Pin-Plate System with Balancer Mate, 28mm
482-80128	8K1PP28	Essential Balancing Solutions Package with Pin-Plates, (Passenger Car Coverage), 8KPPBM** Plus Short Cone, 28mm
482-80228	8K2PP28	Preferred Balancing Solutions Package with Pin Plates, (Passenger Car, Light Truck & SUV Coverage), Kit 1 Plus a Balancer Chuck & Light Truck Cone Kit, 28mm
482-80328	8K3PP28	Premium Balancing Solutions Package with Pin Plates (Passenger Car, Light & Medium Truck, & SUV Coverage), Kit 1 Plus Deep Offsets, Light Truck Cone Kit, Stud Plates 1-5 Plus an Extra Balancer Mate, 28mm
482-13841	8113841	Pin-Plate System, Plates 1-4, Four Pin Styles, Training Video, Application Measuring Tool, 40mm
482-13842	8113842	Pin-Plate System with Wall Board Storage, 40mm
482-80040	8KPPBM40	Pin-Plate System with Balancer Mate, 40mm
482-81040	8K1PP40	Essential Balancing Solutions Package with Pin-Plates, (Passenger Car Coverage), 8KPPBM** plus short cone, 40mm
482-82140	8K2PP40	Preferred Balancing Solutions Package with Pin Plates, (Passenger Car, Light Truck & SUV Coverage), Kit 1 plus a Balancer Chuck & Light Truck Cone Kit, 40mm
482-83140	8K3PP40	Premium Balancing Solutions Package with Pin Plates (Passenger Car, Light & Medium Truck, & SUV Coverage), Kit 1 Plus Deep Offsets, Light Truck Cone Kit, Stud Plates 1-5 Plus an Extra Balancer Mate, 40mm

### Pin Plate, Extra Pins



482-13120

482-85087



Ascot No.	Mfg. No.	Item
482-13120	8113120	8 Pack of Pins, 24x80mm, Bullet Nose, 28mm
482-13122	8113122	5 Pack of Pins, 22x60mm, Funnel Nose - Short, 28mm
482-13807	8113807	8 Pack of Pins, Turner Style, 19x96mm, 28mm
482-85087	85000087	5 Pack of Pins, 38x66.5mm, Large End Funnel Nose, 28mm
482-13120	8113120	8 Pack of Pins, 24x80mm, Bullet Nose, 40mm
482-13122	8113122	5 Pack of Pins, 22x60mm, Funnel Nose - Short, 40mm
482-13807	8113807	8 Pack of Pins, Turner Style, 19x96mm, 40mm

### Slide Nuts, Spacers & Shafts



482-59998



482-56394

Ascot No.	Mfg. No.	Item
482-59998	85009998	Nut, Slide, 2 Jaw, 40mm, with Drum. 28mm Available
482-56467	85606467	Hub Nut, Slide, 40mm, Nut Only, XR Models. 28mm Available
482-14392	8114392	Nut, Hub, with Pressure Cup, Solid for XR Series. 28mm Available
482-56394	85606394	Spacer, Light Truck Back Cone. Allows Back Coning of Wheels Up To 5.20" Center-Holes

### Wheel Balancer Shafts



483-13082

Ascot No.	Mfg. No.	Item	Description
483-13343	8113343	Slide Nut	Quick Slide-Nut Release For 40mm I.D., 28mm
483-13167	8113167	Shaft	7" Balancer Shaft, Full Diameter, 1.125" (28mm Balancer Shaft)
483-13082	8113082	40mm Conversion Balancer Shaft	Kit Includes Shaft And Coupler. 7" Of Usable Thread Length

### Wheel Balancer Miscellaneous Accessories

Ascot No.	Mfg. No.	Item	Description
482-11021	8111021	Caliper Hanging Bracket	Provides A Handy Place To Hang The No. 309011 Wheel Width Measuring Caliper
482-09011	8309011	Caliper	Measures Wheel Width In Inches. For Use With All COATS Automotive Wheel Balancers
482-10400	8110400	Accessory Pegs	Add Four Pegs To Your 850 Balancer For Storage Of Cones Or Accessories. Easy Installation
482-10905	8110905	Hood Kit	For Model 700
482-11087	8111087	Accessory Pocket	Provides A Convenient Place To Store Small Adapters And Extra Boxes Of Wheel Weights On The COATS Model 950 And 1050 Balancers
482-11088	8111088	Accessory Peg Kit	(1 Rail/2 Pegs) Convenient Storage For Frequently Used Cones And Adapters On The COATS Model 700, 850, 950 And 1050 Balancers
482-11480	8111480	Accessory Peg Kit	(2 Rails/2 Pegs)-Convenient Storage For Frequently Used Cones And Adapters On The COATS Model 850, 950 And 1050 Balancers
482-11515	8111515	Wheel Weight Tool	Steel Hammer With Molded Rubber Grip. Use One Side To Remove Weights And Wheel Covers And The Other Side To Add New Weights
482-44064	8144064	Truck Wheel Weight Tool	Heavy Duty Construction Includes A Plier-Type Hook For Weight Removal And Hammer Head For Installation. Soft, Comfortable Plastic Grip
482-11934	8111934	Wheel Lift	For Balancers; Pneumatic And Self-Centering

# COATS

## The Center Isn't What it Used to Be

- Many alloy wheels do not have a simple tapered center any more.
- There are a number of different taper angles being used.
- Plus, after the structural part of the center, the wheel may have a narrow cosmetic front.
- It is critical for accurate balancing that the cone supports the wheel on the structural taper.
- Incorrect contact can allow the wheel to move while on the balancer, giving false readings or chasing weights.

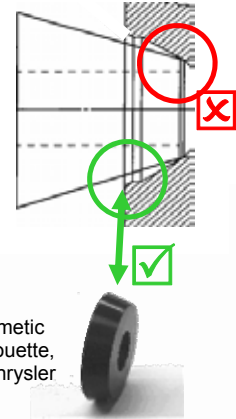

### Back Cone Spacer

Allows for the standard "D" cone to be used as a back one on an 850 through XR Series Balancers. Often needed for applications using the #4 pin plate. **Different Part Number for use on 775 / 875 / 1175.**



### Short Cone

Required to prevent contact with the cosmetic face found on Cadillac Seville, Olds Silhouette, Pontiac Grand Prix & Trans Sport and Chrysler LH Chassis models.



### Ford ULA Cone

The Ultra Low Angle Cone is specified by Ford to be used on 2003 and newer F150, Expedition & Navigator wheels in conjunction with a pin plate or finger plate.



8111539

### Light Truck Back & Tacoma Cones

These cones are designed to allow for back coning of some light truck wheels. Can be used on any balancer but are required for light truck back coning on 775/875/1175.

## Specialty Cones and Spacers

482-83687



482-82420



Ascot No.	Mfg. No. 28mm	Ascot No.	Mfg. No. 40mm	Description	Range
482-84444	81144441	482-81821	81141821	Ultra Low Angel Cone, Ford	TBA
482-82420	8112420	482-81242	8112421	Short Cone	2.65" - 3.025"
482-81539	8111539	-	-	Light Truck Back Cone	3.281" - 4.05"
482-83520	8500035201	482-83687	81136871	Tacoma Cone	3.281" - 4.44"
482-81935	8111935	482-82935	8111935	Light Truck Back Cone Spacer*	Straight 5.25"
-	-	482-83940	8560639401	*Spacer for 775/875/1175 Balancers	Straight 5.25"

## In Between Cones (Tweener)

- Supplemental set for wheels with shallow wheel centers
- Shallow cone angles provide more accurate mounting
- Example vehicles requiring these cones include Ford Edge and Chevy Malibu



482-85340  
(Cone Set)

Ascot No.	Mfg. No. 28mm	Ascot No.	Mfg. No. 40mm	Description	Range
482-85340	85000340	482-83795	8113795	Cone Set (4)	1.62" - 3.45"
482-85336	8500033601	482-83796	8113796	Miniature	1.62" - 2.33"
482-85337	8500033701	482-83797	8113797	Small	2.05" - 2.76"
482-85338	8500033801	482-83798	8113798	Medium	2.44" - 3.15"
482-85339	8500033901	482-83799	8113799	Large	2.8" - 3.45"



## Wheel Balancer Accessories (Cont.)

### Light Truck Cone Kit

- Used for front coning light truck wheels
- Cone mounting is quick and easy
- Steel backing plate spaces out medium offsets and ensures wheels are held solidly
- Good for most light truck wheels including some duallies

**COATS**



482-83276

Ascot No.	Mfg. No. 28mm	Ascot No.	Mfg. No. 40mm	Description	Range
482-83276	8113276	482-83277	8113277	Cone Kit	4.8" - 6.8"
482-83279	8113279	482-83280	8113280	Cone Only	4.8" - 6.8"
482-83060	8113060C	482-83061	8113061	Backing Plate Only	8"

### Balancer Chucks

- Balancing some light truck wheels on a cone can be challenging. The greater the offset, the greater the challenge. If the wheel is not sitting straight on the cone, balancers will give false readings
- The 3-jaw chuck eliminates issues with cone seating providing the MOST ACCURATE balancing



482-83326

Ascot No.	Mfg. No. 28mm	Ascot No.	Mfg. No. 40mm	Ascot No.	Mfg. No. 2"	Description	Range
482-83326	8113326	482-83330	8113330	-	-	Standard Balancer Chuck w/Plate	3.13" - 7.13"
482-85085	85000856	482-85856	85000856	-	-	Extension Jaws for Standard Chuck	Extended to 9.125"
482-81828	8111828	482-81850	8111850	-	-	Front Plate, Optional for Extended Jaws	10"
-	-	482-85908	85009088	482-85906	85009086	Heavy Duty Balancer Chuck w/Plate	8" - 12"
-	-	482-85909	85009089	482-85907	85009087	Front Plate	12"

### Pressure Drums, Rings

Ascot No.	Mfg. No.	Item	Description
483-10542	8110542	Small Pressure Drum	4.625" Diameter, 1.125" I.D.
483-12106	8112106	Small Pressure Drum	4.625" Diameter, 40mm I.D.
483-10544	8110544	Large Pressure Drum	5.75" Diameter, 1.125" I.D.
483-12102	8112103	Large Pressure Drum	5.75" Diameter, 40mm I.D.
483-11433	8111433	Pressure Drum	For Speed Lock-Replacement Pressure Drum For No. 111405 Speed Lock Kit, 4.75" Diameter. Snaps Onto Quick Release Hub Nut No. 111423
483-13308	8113308C	XL Pressure Drum	(8.375") O.D. Rubber Lip To Help Prevent Marring The Wheel. 28mm I.D.
483-13309	8113309C	XL Pressure Drum	(8.375") O.D. Rubber Lip To Help Prevent Marring The Wheel. 40mm I.D.
483-12382	8112382	ALU-Cup-Extra Large	Same As 111518 Except With 40mm I.D.
483-11434	8111434	No-Mar Ring	Replacement No-Mar Ring For Use With No. 111405 Speed Lock Kit. Intended To Prevent Finish Damage On Wheels With Small Diameter Pilot Hole And A Raised Center
483-08105	8308105	No-Mar Ring	To Prevent Damaging The Finish On Wheels With A Small Diameter Pilot Hole And A Raised Center. Used In Place Of Pressure Cup With Standard Hub No. 110543. 1.125" I.D.
483-12012	8112102	No-Mar Ring	Same As 308105 Except With 40mm I.D.
483-60639	8560639401	Spacer	Light Truck Back Cone for Coats 775/875/1175 Balancers



483-10542

483-10544



483-11433

483-13308

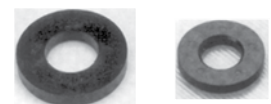

483-11434

483-08105



## Wheel Balancer Accessories (Cont.)

### Deep Offset Adapters

- For fleet operators needing the accuracy of a chuck and the speed of a cone
- For specific center sizes found on some Ford 19.5" & 16" or GM & Chrysler 16" wheels
- Customers must check wheel center sizes closely



Ascot No.	Mfg. No. 28mm	Ascot No.	Mfg. No. 40mm	Ascot No.	Mfg. No. 2"	Description	Range
482-82982	8112982	482-82984	8112984	-	-	Fed-Ex Plate with Backing	-
482-82952	8112952	482-82985	8112985	-	-	Fed-Ex Plate	8.627" - 8.7"
482-82828	8112828	482-81850	8111850	-	-	Backing Plate	10"
482-83041	8113041C	482-83042	8113042	482-83042	8113043	Deep Offset Plate Set (3)	-
482-83032	8113032	482-83033	8113033	482-83034	8113034	Ford Double Sided Plate	4.922" & 6.693"
482-83057	8113057	482-83058	8113058	482-83059	8113059	GM/Chrysler Double Sided Plate	4.561" & 4.766"
482-83160	811306C	482-83061	8113061	482-83062	8113062	Backing Plate	8"
-	-	482-85945	85009945	-	-	Toyota Kit with Fixed Finger Plate and 2 Direct off-set Plates	-
-	-	482-89950	85009950	-	-	Pin - Finger Set of 6 for Toyota Truck	-

### Baby Budd Cone



Ascot No.	Mfg. No. 28mm	Ascot No.	Mfg. No. 40mm	Ascot No.	Mfg. No. 2"	Description	Range
482-81829	8111829C	482-81853	8111853C	482-81987	8109877	Cone and Backing Plate Kit	8.52" - 8.89"
482-81827	8111827	482-81851	8111851	482-81984	8109844	Cone Only	8.52" - 8.89"
482-81828	8111828	482-81850	8111850	482-81983	8109832	Backing Plate	10"

(For Hub Piloted Budd Style Wheels Including 19.5")

### Dayton Adapters for Heavy Duty Balancers

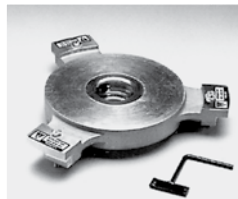

Ascot No.	Mfg. No.	Description	Range
482-80785	8110785	Standard Center Adapter	20" - 22.5"
482-80786	8110786	Extension Kit for Standard Adapter	24.5" - 26"

### Budd Adapter for Heavy Duty Balancers

- Standard center adapter stud piloted wheel patterns 8x275mm, 10x335mm



Ascot No.	Mfg. No.	Range
482-84393	8143935	22.5" & 24.5"

### Heavy Duty Adapters

Ascot No.	Mfg. No.	Description	Range
482-09791	109791	Balancer Adapter Kit	Standard On Current 6100C, Optional On Pre-12/89. Fits Hub-Piloted Wheels With Bolt Patterns: 8 Hole-275mm (10.84" Motor Wheels), 10 Hole-335mm (13.20" Mercedes, Accurides, Etc.), 2-Ton Chevrolet And Ford Wheels
482-10785	110785	Speedy Dayton Adapter	Optional Accessory For Model 6401. Fits 20" And 22.5" Dayton Demountable Rims, Including Most Front Steer Axle Super Single Wheels
482-10786	110786	Speedy Adapter Extension Kit	Optional Accessory Kit For 110785 Adapter Allows Mounting Of 22" And 24.5" Demountable Rim
482-43935	143935	Large Budd Wheel	Optional Accessory For 6401. Allows Mounting Of Stud Centered Budd Style Wheels With Bolt Patterns: 8/ Bolt-275mm, 10/Bolt - 11.25" (285.75mm) And 10/Bolt-133/16" (335mm)
482-19877	109877	Cone Kit	Cone Kit, Hub Centered Wheels - Truck - For 6401

## Brake Lathes

### 4100B Medium Duty Combination Drum/Disc Lathe



- Must be ordered with either an "A", "B", "C", "E" or "F" adapter kit
- All of the rugged construction and features of the legendary Model 4000B plus: extended spindle travel to machine drums up to 8.875" deep; and equipped with Model 7900 twin-cutter featuring independent boring bars to enable machining larger diameter rotors and "spider" hubbed rotors found on some school buses and medium trucks
- Massive spindle, supported on wide centers by oil fed bronze journal bearings, dampens vibration, contributes to service life
- Variable spindle speed and feed rates for optimum surface finish on diverse applications
- Translating spindle for drum machining also provides faster rotor set up by quickly positioning rotor horizontally
- Large diameter, tubular cross-slide on wide centers
- Double tapered arbor gives maximum support and quick change to optional arbors if desired
- Fast change-over from rotors to drums



Ascot No.	Mfg. No.
414-04100	4100B

### 4000E Brake Lathe



- Custom Digital Finishes
- Shift On The Fly 3 Speed - The 4000E is the first lathe with an integrated synchronous gearbox and shifter
- Forged Alloy Steel Arbor - Two tapered mounting surfaces add stability and handle up to 200 Lbs.
- Feed Slide Protection - Keeps travel surfaces free of dirt and chips
- Patented Floating Spindle Design - Extra large bronze bearings reduce pressure and wear. Larger drive gear adds life



Ascot No.	Mfg. No.
414-04002	4000E

### 4000B Combination Drum/Disc Lathe

- Must be ordered with either an "A", "B", "C", "E" or "F" adapter kit
- Massive spindle, supported on wide centers by oil fed bronze journal bearings, dampens vibration and contributes to legendary service life
- Variable spindle speed and feed rates for optimum surface finish on diverse applications
- Translating spindle for drum machining also provides faster rotor set up by quickly positioning rotor horizontally
- Large diameter, tubular cross-slide, on wide centers, for maximum vibration dampening and minimal service requirements
- Double tapered arbor gives maximum support and quick change to optional arbors if desired
- Fast change-over from rotors to drum
- Motor enclosed in mainframe for maximum service life
- Optional accessory make it easy to customize
- Can be equipped to machine some flywheels



Ascot No.	Mfg. No.
414-04000	4000B

## Brake Lathes (Cont.)

### 4000SP Single Pass Disc/Drum



- Must be ordered with either an "A", "B", "C", "E" or "F" adapter kit
- Designed for speed, it cuts rotors in one pass, with a high-quality finish
- Positive rake tool bits allow for precision turning that produces superior machined surfaces every time
- Twin cutter dials and depth of cut are clearly marked, and even new operators can quickly turn rotors like seasoned professionals
- Precision tool that cuts to one-thousandths of an inch tolerances
- Massive "floating spindles" offer superior weight support, and a unique patented system provides a constant oil feed to bearings
- Fast change-over from rotors to drum
- Motor enclosed in mainframe for maximum service life
- Optional accessory make it easy to customize
- Can be equipped to machine some flywheels



Ascot No.	Mfg. No.
414-04001	4000SP

FEATURES TO BE COMPARED	414-04100	414-04002	414-04000	414-04001
Model No.	4100B	4000E	4000B	4000SP
Volume	High	High	High	Medium
Application	Car - Medium Truck	Car - Medium Truck	Car/ Lt. Truck	Car/ Lt. Truck
Rotors	Yes	Yes	Yes	Yes
Drums	Yes	Yes	Yes	Yes
Flywheel Service Capable	Yes	Yes	Yes	Yes
Spindle Bearings	Bronze Sleeve	Bronze Sleeve	Bronze Sleeve	Bronze Sleeve
Motor	1 HP	1 HP	1 HP	1 HP
Tool Bits (shipped with)	Negative Rake	Both	Negative Rake	Positive Rake
Double Taper Arbor	Yes	Yes	Yes	Yes
Max Rotor Diameter	19"	14.5" 1	14.5" 1	14.5" 1
Max Rotor Face Width	3.75"	3.75"	3.75"	3.75"
Max Rotor Thickness	4"	1.875"2	1.875"	1.875"
Max Arbor Capacity - A: Standard	A. 100 Lbs.	A. 200 Lbs.	A. 100 Lbs.	A. 100 Lbs.
Max Arbor Capacity - B: Heavy Duty	B. 200 Lbs.	B. N/A Lbs.	B. 200 Lbs.	B. 200 Lbs.
Spindle Speed	60, 80, 115 RPM	100, 150, 200 RPM	100, 200 RPM	100 RPM
Drum Feed Rate	.002" to .020"/REV	Variable	.002" to .020"/REV	.005"/REV
Rotor Feed Rate	.002"/.010"/REV	Variable, .001" to .018"/REV	.002"/.010"/REV	.002"/REV
Drum Depth	Up to 9.875 "	Up to 9.875"	Up to 6.875"	Up to 6.875"
Shipping Weight	480 Lbs.	410 Lbs.	365 Lbs.	385 Lbs.

## Drum and Rotor Silencers, Cutters

### Drum Silencer Bands

- Extra long, premium grade rubber silencer band for automotive and wider truck drums
- Dampens vibrations which occur during the machining operation



Ascot No.	Mfg. No.	Description	Shipping Wt.
416-05280	5280	1-3/4" Drum Silencer Band for Automotive Drums	1 Lb.
416-05290	5290	2-3/4" Drum Silencer Band for Truck Drums	1 Lb.

### Ventilated Rotor Silencer Bands

- Easily wraps around ventilated rotors to dampen machining vibrations
- Made of premium grade rubber with seven lead weights



Ascot No.	Mfg. No.	Description	Shipping Wt.
416-06920	6920	Ventilated Rotor Silencer Band	2 Oz.
416-09800	9800	Spring Type Vent Rotor Silencer Band	3 Oz.

### Solid Rotor Silencer Bands

- For thin, solid rotors
- Package of 2

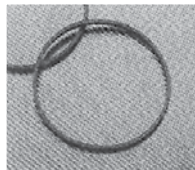

Ascot No.	Mfg. No.	Description	Shipping Wt.
416-06921	6921	6.500" Diameter (165.10mm)	2 Oz.
416-06922	6922	9.250" Diameter (234.95mm)	3 Oz.

### Heavy Duty Ventilated Rotor Silencer Band

- Easily wraps around ventilated truck rotors to dampen machining vibrations
- Made of premium grade rubber, twice as wide as the No. 6920
- With twenty-four weights for effective dampening



Ascot No.	Mfg. No.	Description	Shipping Wt.
416-06930	6930	Heavy- Duty Ventilated Rotor Silencer Band	8 Oz.

### Magnetic Silencer



- Firmly attaches to flywheels to dampen vibrations which occur during machining
- Sometimes used to dampen a rotor when machining one side at a time
- Standard with No. 9381 facing & grinding set
- Has hole and lock screw for mounting a No. 3229 diamond nib
- Cannot be used with No's 6900 and 7900 twin-cutters



Ascot No.	Mfg. No.	Description	Shipping Wt.
416-07670	7670	Magnetic Silencer	1 Lb., 14 Oz.

### Deluxe Bench Lathe Clip-On Rotor Silencers



- Adjust clamping pressure simply by changing spring position on handle
- Essential to silence those hard to dampen, thin, composite, solid rotors (example: GM W-body rear rotors)
- Reduced vibration improves surface finish

Ascot No.	Mfg. No.	Description
416-01180	1180	Deluxe Lathe Clip-On Rotor Silencer For 6900 & 6950
416-01175	1175	Lathe Clip-On Rotor Silencer For 6900 & 6950
416-90980	909800	Lathe Clip-On Rotor Silencer For 8000 OTV

### Optional Twin-Cutter Tools

- Optional for lathe Models 4000B and 7500
- Independent boring bars can be positioned to cut rotors up to 4" thick and from 6" to 22" OD on Models 4000, 4100 and 7500
- Boring bars have built-in inch/millimeter micrometers for depth-of-cut settings
- Chip shield included
- Standard equipment on Model 4100

Ascot No.	Mfg. No.	Description
416-07900	7900	Twin-Cutter Tool On 4100B
416-06950	6950	Standard Twin For 3860, 4000 And 7500

### Environmental Lathe Enclosure

- An enclosure for most brake lathes, but is specifically designed for AMMCO bench lathe models 1000, 3000, 3850, 4000, 4100 and 7000
- Lathe sold separately
- 48" L x 62" H



Ascot No.	Mfg. No.	Description
416-02800	2800	Environmental Lathe Enclosure



## Brake Lathe Accessories

### Safety Shield

- Clear plastic shield provides added eye protection
- Deflects metal chips downward, while permitting an unobstructed view of the work
- Attaches to the No. 6900 twin-cutter with the thumb screw provided
- Can be quickly moved out of the way for rotor mounting and demounting



### Tool Holder Replacement Kit

- Increases tool bit reach of early design No. 6900 twin-cutters to allow machining of thin solid rotors
- Replaces worn parts in all 6900's
- Includes: One No. 10650 LH tool bit holder; one No. 10651 RH tool bit holder; one No. 10701 RH and one No. 10702 LH tool bit assembly; two return Springs; one spring tool

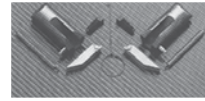

416-08899



416-10650

Ascot No.	Mfg. No.	Description	Shipping Wt.
416-09481	9481	Safety Shield	2 Lbs.
416-11154	11154	Replacement Shield	-

Ascot No.	Mfg. No.	Description	Shipping Wt.
416-08899	8899	Tool Holder Replacement Kit	1 Lb., 2.5 Oz.
416-10650	10650	LH Tool Bit Holder	8 Oz.
416-10651	10651	RH Tool Bit Holder	8 Oz.
416-09249	9249	Square Head Screw Set For 10650 And 10651	2 Oz.

## Brake Lathe Parts & Accessories

Ascot No.	Mfg. No.	Item	Description
416-05393	5393	Grinding Wheel	For Model 4850 Brake Drum Grinder And Obsolete 4650 Brake Drum Grinder, 2-1/2" x 1/2"
416-03085	3085	Polyethylene	Replaces Front/Rear Spindle Boots On 3000/4000 Spindle Boot Lathes. Damaged Boots Should Be Replaced To Protect The Spindle And Bearings From Metal Chips And Grinding Dust. Replaces Discontinued Spindle Boot 10401 On Models 4100 And 7700
416-23682	23682	Spindle Ring	For Replacing A Rubber Boot On The Front Of The Spindle In Order To Mount The Boot To The Spindle
416-03086	3086	Feed Screw Boot	Used On Lathes 3000, 4000 And 7000.
416-03087	3087	Cross Feed Boot	Used On Lathes 3000, 4000, 4100, 7000, 7700
416-03148	3148	Oil Level Stick	Standard On Lathes 3000, 4000, 4100, 7000, 7700
416-04282	4282	Bearing Protector	Mounts Between The Lathe And The Drum Or Rotor, On The Arbor, To Keep Chips And Grinding Dust Out Of The Hub. Fits Any Arbor Up To 2.25" (57.15mm)
416-06936	6936	Cross Feed Extension	To Relocate The No. 6900 Twin Cutter On 4000 & 4100 Lathes To Accommodate Rotor Diameters Up To 17-15/16" (455.61mm)
416-07996	7996	Shear Gear and C-Clip	Replacement For The "Fail Safe" Gear. Protects Cross Feed Gear Box In The Event Of Operator Error During Rotor Machining
416-09590	9590	Spindle Lock Kit	Parts Needed To Easily Add A Spindle Lock To An Older Drum/Disc Lathe That Does Have This Feature
417-02760	2760	Mechanical Rotor Micrometer	Range: 0 To 2.25". English & Metric Display
417-02761	2760-50	Mechanical Metric Rotor Micrometer	Range: 0 To 60.9mm. English & Metric Display
417-02780	2780	Digital Rotor Micrometer	Deep Throat Design Allows Measurement Within Rotor Brake Surfaces. For Checking Rotor Wear, Thickness Variation, And Depth of Scoring. For All Automotive And Truck Applications. Range: 0 To 2.4"



416-03085

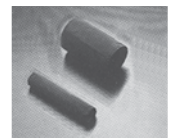

416-03086  
416-03087

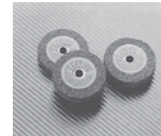

416-05393

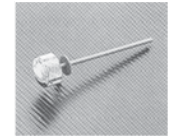

416-03148

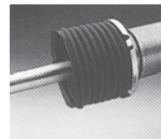

416-04282



416-06936

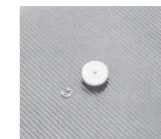

416-07996



416-09590



416-02780



## Brake Lathe Parts & Accessories (Cont.)

Ascot No.	Mfg. No.	Item	Description
417-08500	8500	Brake Drum Micrometer	Measures Drum Diameters On Or Off The Lathe. Can Be Used To Check Out-of-Roundness. Dial Is Graduated By 0.005". Range: 6" To 16.125"
417-09582	9582	Checking Gauge	For Brake Drums
417-08501	8500-50	Metric Brake Drum Micrometer	Graduated By 0.1mm. Range: 15 To 41cm
417-08539	8539	Micrometer Extension Shaft	Increases 8500 Micrometer Range To 6" To 26"
417-85391	8539-50	Micrometer Extension Shaft	Increases 8500-50 Micrometer Range From 39 To 66cm
417-02780	2780	Digital Rotor Micrometer	Range 0"-2.4"
417-08545	8545	Digital Drum Micrometer	Range 5"-15". Stands Up In Drum
417-94127	941270	Three Jaw Chuck	Heavy Duty Three Jaw Chuck for 1-7/8" Arbor



417-94127



417-08545

## Adapters, Arbors and Nuts

### Encore/Alliance Rear Drum Adapter

- Fits inside the bearing to mount the drum on an 11/16" arbor
- Also requires a No. 3127 step-down adapter and a No. 3904 centering cone

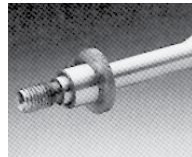

Ascot No.	Mfg. No.	Description	Shipping Wt.
416-02170	2170	Encore/Alliance Rear Drum Adapter	4.5 Oz.

### Step-Down Adapter

- Permits the use of 1" adapters on the 11/16" arbor
- 1" x 11/16"
- Not standard with the No. 9708 11/16" arbor set

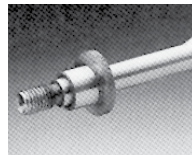

Ascot No.	Mfg. No.	Description	Shipping Wt.
416-03127	3127	Step-Down Adapter	4.5 Oz.

### 1" Arbor and Nut

- For drums and rotors up to 100 Lbs.
- Standard with lathe Models 2002, 3000, 4000, 4100, 7000 and 7700



416-03101

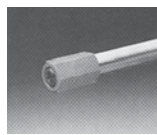

416-03102

Ascot No.	Mfg. No.	Description	Shipping Wt.
416-03101	3101	1" Arbor	6 Lbs.
416-03102	3102	1" Arbor Nut	8 Oz.

### 1 1/16" Arbor Set

- Used to mount drums and rotors with splined hubs, or with center holes less than 1" in diameter
- Used on 2002, 3000, 4000, 4100, 7000, 7700 Lathes
- Includes centering cone, 3 spacers and 11/16"



Ascot No.	Mfg. No.	Description	Shipping Wt.
416-09708	9708	1 1/16" Arbor Set	8 Lbs.

### 1 1/16" Arbor Nut

- Needed with older No. 9708 11/16" arbor sets to provide a 1-1/4" hex nut to drive the Model 8750 swirl finisher
- (LH thread for Models 2002, 3000, 4000)

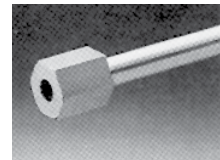

Ascot No.	Mfg. No.	Description	Shipping Wt.
416-25882	25882	1 1/16" Arbor Nut	8 Oz.

### Double Chuck Adapter Set

- Range 2.125" - 5.750"
- Hubless Rotors & Drums through 1 ton vehicles
- Double chuck
- 4 Backings



Ascot No.	Mfg. No.	Description
416-41412	41412	Double Chuck Adapter Kit

## Brake Lathe Adapter Sets & Accessories

### 1" Centering Cone Set

- For mounting some splined hubbed drums and some drums and rotors with unusual hub designs
- Standard with Models 2002, 3000, 4000, 4100, 7000 and 7700 lathes
- Consists of: one No. 3902 centering cone; one No. 3903 centering cone

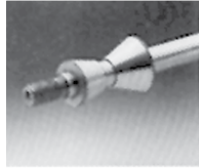

Ascot No.	Mfg. No.	Description	Shipping Wt.
416-03900	3900	1" Centering Cone Set	1 Lb., 2.5 Oz.

### 1" Splined Hub Adapter Set

- Used to mount rear drums and some rotors with splined hubs on 1" arbors, such as: Subaru front rotors, Subaru 4 x 4 drums and older VW drums
- May also be used as spacer

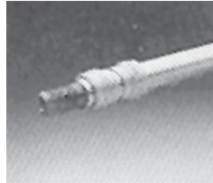

Ascot No.	Mfg. No.	Description	Shipping Wt.
416-05795	5795	1" Splined Hub Adapter Set	6 Oz.

### Hubless Rotor Adapter Set

- Easiest, fastest hubless rotor mounting available
- Used on 1" arbors to mount rigid-center hubless rotors
- Centering cone easily locates and solidly clamps hubless rotors against the rugged faceplate for fast, accurate mounting with minimal chatter
- Can also mount Chrysler, Ford and GM composite rotors with the optional No. 8888 clamping plate set for automotive composite rotors and the No. 8889 clamping plate set for light truck composite rotors



Ascot No.	Mfg. No.	Description	Shipping Wt.
416-08800	8800	Hubless Rotor Adapter Set	18 Lbs.

### Clamping Plate Set

- Used with No. 8800 hubless rotor adapter set to quickly and easily mount Chrysler, Ford and GM automotive composite rotors
- Clamping plates apply clamping pressure to the rotor centers

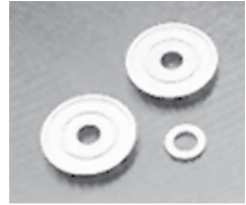

Ascot No.	Mfg. No.	Description	Shipping Wt.
416-08888	8888	Clamping Plate Set Includes 2 Clamping Plates, 2 Locating Rings	14 Lbs.
416-08889	8889	Clamping Plate Set Includes 2 Clamping Plates, 1 Locating Rings	18 Lbs.

### 1" Double Taper Adapter Truck Set

- For mounting larger hubbed drums and rotors on 1" arbors
- Fits bearing face diameters from 2.828" to 3.560" (71.83 to 90.42mm)
- Some Ford and Chrysler truck drums and many Ford 4 x 4 front rotors require two No. 9195 double taper adapters
- Includes one No. 9195 1" double taper adapter 2.828" x 3.185" and one No. 9196 1" double taper adapter 3.203" x 3.560"



Ascot No.	Mfg. No.	Description	Shipping Wt.
416-09233	9233	1" Double Taper Adapter Truck Set	8 Lb., 8 Oz.

### Self-Aligning Spacer

- Prevents arbor distortion when properly tightening 1" arbor nuts
- Standard with all Ammco automotive lathes

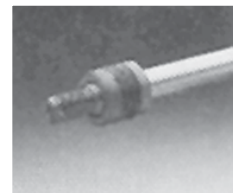

Ascot No.	Mfg. No.	Description	Shipping Wt.
416-09492	9492	Self-Aligning Spacer	11 Oz.







## 1" Adapters

Ascot No.	Mfg. No.	Item	Description
416-02160	2160	Ford Probe Adapter	For 1" Arbors. Slips Into The Hub In Place Of The Bearings Of Rear Probe Drums And Rotors
416-03125	3125	1" Spacer	1/2" (12.70mm) Long
416-01080	1080	Mazda Adapter	Mounts Mazda Drums Without Center Holes On Ammco. Model 1000 Lathe. Includes: Two Hex Head Cap Screws
416-03106	3106	1" Centering Cone	3.421" x 4.031" (86.89 x 102.39mm)
416-03107	3107	1" Centering Cone	2.890" x 3.500" (73.41 x 88.90mm)
416-03108	3108	1" Centering Cone	2.328" x 2.968" (59.13 x 75.39mm)
416-03109	3109	1" Hubless Adapter	5.650" (143.52mm) O.D.
416-03110	3110	1" Centering Cone Spring	Presses The Centering Cone Into The Center Hole When Mounting A Hubless Drum Or Rotor
416-03123	3123	1" Hubless Adapter	5.750" (146.05 mm) O.D.
416-03178	3178	1" Centering Cone	2.650" x 3.224" (67.31 x 81.89 mm). Fits Many In-Between Center Hole Diameters On Some European Hubless Rotors
416-03902	3902	1" Centering Cone	1.250" x 1.750" (31.75 x 44.45mm)
416-03903	3903	1" Centering Cone	1.187" x 2.250" (30.16 x 57.15mm)
416-03904	3904	1" Centering Cone	1.703" x 2.750" (43.26 x 69.85mm)
416-04790	4790	Step-Down Adapter Set	Permits The Use Of 1-7/8" Adapters On A 1" Arbor. Set Of 3
416-09192	9192	1" Double Taper Adapter	1.711" x 2.073" (43.46 x 52.65mm)
416-09193	9193	1" Double Taper Adapter	2.074" x 2.440" (52.68 x 61.98mm)
416-09194	9194	1" Double Taper Adapter	2.441" x 2.897" (62.00 x 73.58mm)
416-09195	9195	1" Double Taper Adapter	2.828" x 3.185" (71.83 x 80.90mm)
416-09196	9196	1" Double Taper Adapter	3.203" x 3.560" (81.36 x 90.42mm)
416-09232	9232	1" Double Taper Adapter Set	For Mounting Automobile And Light Truck Hubbed Drums And Rotors On 1" Arbors. Fits All Bearing Race Diameters From 1.322" To 2.897" (33.58 to 73.58mm). Standard With Lathe 1000, 2002, 3000, 4000, 4100, 7000 And 7700. Consists Of: 9192, 9193, 9194, 9921, 9922
416-09263	9263	1" Hubless Adapter	Three Pad, 4.500" (114.30 mm) OD. Used On Outside Of Drums & Rotors For Stable Mounting
416-09265	9625	1" Hubless Adapter	Five Pad, 5.625" (142.88 mm) OD. Used On Outside Of Drums & Rotors For Stable Mounting
416-09489	9489	1" Hubless Adapter	For Mounting Smaller Hubless Drums And Rotors. Permits Boring Bar And Tool Bit Clearance Inside Small Diameter Drums. 3.625" (92.08 mm) O.D. Standard With Models 1000, 2002, 3000, 4000, 4100, 7000 And 7700
416-09490	9490	1" Hubless Adapter	For Mounting Corvette Rear Rotors, Some Eldorado/Toronado Front Rotors And Import Hubless Rotors. 4.500" (114.30 mm) OD. Standard With Models 1000, 2002, 3000, 4000, 4100, 7000 And 7700
416-09921	9921	1" Double Taper Adapter	1.322" x 1.670" (33.58 x 42.42 mm). Needed On Older Lathes. Smaller Size Allows Accurate Mounting Of Current Smaller Rotors
416-09922	9922	1" Double Taper Adapter	1.362" x 1.710" (34.59 x 43.43mm)

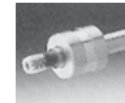

416-02160

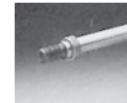

416-03125



416-03109

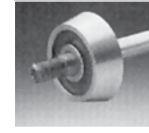

416-03106

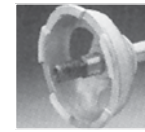

416-03123

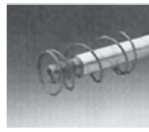

416-03110

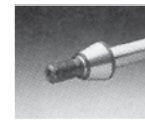

416-03902

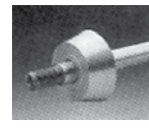

416-03178



416-09192



416-03903



416-09232

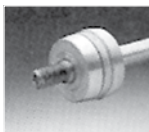

416-09195



416-09265



416-09263

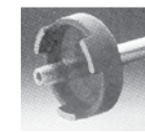

416-09490

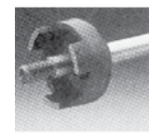

416-09489



416-09922



416-09921

SERVICE EQUIPMENT



## Outboard Support, Adapter and Arbor Sets

### 1-7/8" Hubbed and Hubless Adapter Set

- Used with 1-7/8" Arbors, Nos. 1081 and 3481A

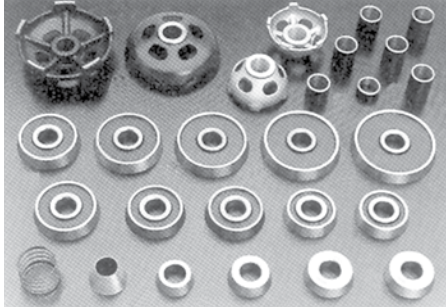

Ascot No.	Mfg. No.	Description	Shipping Wt.
416-04775	4775	1-7/8" Hubbed And Hubless Adapter Set	90 Lbs.

### 1-7/8" Medium Duty Adapter Set

- Used with Nos. 1081 and 3481 1-7/8" arbors
- Standard with No. 4775 hubbed and hubless adapter set

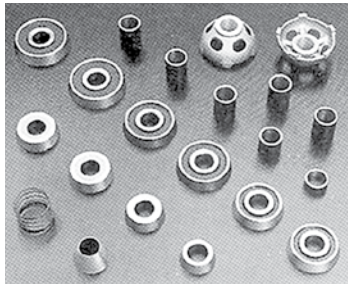

Ascot No.	Mfg. No.	Description	Shipping Wt.
416-08994	8994	1-7/8" Medium Duty Adapter Set	52 Lbs.

### 1-7/8" Heavy Duty Adapter Set

- Used with Nos. 1081 and 3481 1-7/8" arbors
- Standard with No. 4775 hubbed and hubless adapter set

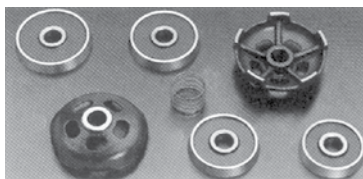

Ascot No.	Mfg. No.	Description	Shipping Wt.
416-08995	8995	1-7/8" Heavy Duty Adapter Set	51 Lbs.

### 1-7/8" Ford Light Truck Adapter Set

- Needed to mount late model Ford 3/4 and 1-ton, large center, hubless drums
- Used with 1-7/8" arbors

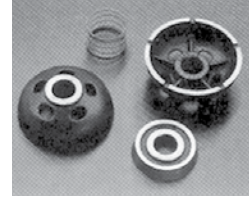

Ascot No.	Mfg. No.	Description	Shipping Wt.
416-09399	9399	1-7/8" Ford Light Truck Adaptor Set	18 Lbs.

### 1-7/8" Light Truck Adapter Set

- Mounts most light 3/4 and 1-ton truck drums on the standard 1" or 1-7/8" arbors
- Standard with Model 4100 lathe

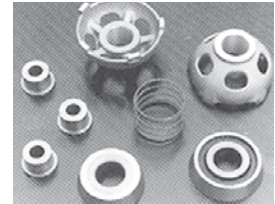

Ascot No.	Mfg. No.	Description	Shipping Wt.
416-09499	9499	1-7/8" Light Truck Adapter Set	12 Lbs., 10 Oz.

### 1-7/8" Arbor Set

- Used with all 1-7/8" Adapter Sets to mount a wide range of hubbed and hubless truck drums and rotors up to 200 Lbs.
- For Model 3860 lathe
- Consists of one 1-7/8" arbor nut wrench, one arbor nut, one arbor



Ascot No.	Mfg. No.	Description	Shipping Wt.
416-03491	4391	1-7/8" Arbor Set	28 Lbs.

### 1-7/8" Arbor Set

- Used with all 1-7/8" adapter sets to mount a wide range of hubbed and hubless truck drums and rotors up to 200 Lbs.
- For Lathe Models 2002, 3000, 4000, 4100, 7000 and 7700
- Consists of one No. 3198 1-7/8" arbor, one No. 3460 1-7/8" arbor nut, one No. 5722 1-7/8" arbor nut wrench

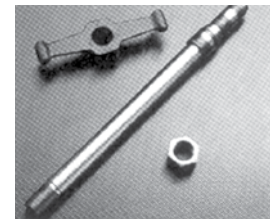

Ascot No.	Mfg. No.	Description	Shipping Wt.
416-03481	3481	1-7/8" Arbor Set	38 Lbs.

## 1-7/8" Adapters

Ascot No.	Mfg. No.	Item	Description
416-03191	3191	1-7/8" Spacer	1" (25.40mm) Long
416-03192	3192	1-7/8" Spacer	2" (50.80mm) Long
416-03193	3193	1-7/8" Spacer	3" (76.20mm) Long
416-03194	3194	1-7/8" Centering Cone	2.000" x 3.375" (50.80 x 85.73mm)
416-03460	3460	1-7/8" & 2-1/2" Arbor Nut	For All 1-7/8" Arbors Used On Lathe Models 2002, 3000, 4000, 4100, 7000 and 7700
416-03577	3577	1-7/8" Hubless Adapter	6.250" (158.75mm) O.D.
416-03578	3578	1-7/8" Hubless Adapter	7.813" (198.45mm) O.D.
416-03581	3581	1-7/8" Hubless Adapter	9.625" (244.48mm) O.D.
416-03590	3590	1-7/8" Centering Cone Spring	Presses The Centering Cone Into The Center Hole When Mounting Hubless Drum or Rotor
416-04732	4732	1-7/8" Centering Cone	4.656" x 5.250" (118.26 x 133.35mm)
416-04776	4776	1-7/8" Centering Cone	2.750" x 3.344" (69.85 x 84.93mm)
416-04777	4777	1-7/8" Centering Cone	3.281" x 3.891" (83.34 x 98.82mm)
416-04778	4778	1-7/8" Centering Cone	3.828" x 4.421" (97.20 x 112.30mm)
416-04779	4779	1-7/8" Centering Cone	4.359" x 4.968" (110.70 x 126.20mm)
416-04781	4781	1-7/8" Centering Cone	4.891" x 5.500" (123.46 x 139.70mm)
416-04782	4782	1-7/8" Centering Cone	5.438" x 6.031" (138.11 x 153.19mm)
416-04783	4783	1-7/8" Centering Cone	5.969" x 6.563" (151.61 x 188.69mm)
416-04784	4784	1-7/8" Centering Cone	6.500" x 7.438" (165.10 x 188.91mm)
416-04785	4785	1-7/8" Centering Cone	7.031" x 7.641" (178.59 x 194.07mm)
416-04786	4786	1-7/8" Centering Cone	7.578" x 8.172" (192.48 x 202.57mm)
416-05722	5722	1-7/8" & 2-1/2" Arbor Nut Wrench	
416-09197	9197	1-7/8" Double Taper Adapter	2.828" x 3.185" (71.83 x 80.90mm)
416-09198	9198	1-7/8" Double Taper Adapter	3.203" x 3.560" (81.36 x 90.42mm)
416-09234	9234	1-7/8" Double Taper Adapter Set	For Use With Nos. 1081 And 3481 1-7/8" Arbors. Standard With Model 4100 Lathe. Consists Of: (1) No. 9197 1-7/8" Double Taper Adapter 2.828" x 3.185" And (1) No. 9198 1-7/8" Double Taper Adapter 3.203" x 3.560"
416-03229	3229	Diamond Nib	For The No. 5380 Grinding Wheel Dresser And No. 7670 Magnetic Silencer
416-05380	5380	Grinding Wheel Dresser	Clamps On The Drum To Dress The Grinding Wheel Parallel To The Brake Surface. Standard With Model 4850 Brake Drum Grinder. Includes Diamond Nib.
416-08756	8756	Abrasive Pads	Package Of 6 Adhesive Backed Abrasive Pads For Model 8750 Swirl Finisher

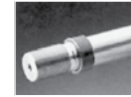

416-03191



416-03194



416-03460



416-03577



416-03578



416-03581

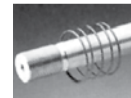

416-03590



416-04732

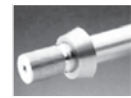

416-04776

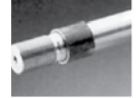

416-04779

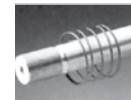

416-05772



416-09197



416-09234



416-03229



416-05380



416-08756

## ADAPTEK® Brake Lathe Adapters

- Most versatile collection of brake lathe adapters. Self-centering and augmented for stability for better results with less chatter
- Reduces adapters needed to handle most car and light truck applications, or specify one of the four application-oriented sets
- Engineered for use with most lathes with 1" arbors including Ammco, Accu-Turn, FMC and Performance

Ascot No.	Mfg. No.	Description	Min.	Max.
416-09310	9310	Auto & Truck Set	1.84"	3.85"
416-09311	9311	Auto Set	1.84"	3.30"
416-09312	9312	Light Truck Set	3.20"	3.85"
416-09313	9313	Truck Set	3.75"	5.23"



416-0910



416-09311



416-09312



416-09313



## Tool Bits/Carbide Inserts

SERVICE EQUIPMENT

Ascot No.	Mfg. No.	Item	Description
418-40410	940410	Carbide Insert Triangular	Positive Rake, For FMC Lathes, 10 Pack
418-40415	940415	Carbide Insert Triangular	Positive Rake, For Kwik-Way Lathes, 10 Pack
418-40420	940420	Carbide Insert Triangular	Negative Rake, For Hunter Lathes, 10 Pack
418-40430	940430	Carbide Insert Triangular	Negative Rake, For Performance Lathes, 10 Pack
418-40435	940435	Carbide Insert Triangular	Positive Rake For Accuturn Lathes, 10 Pack
418-40608	40608	Tool Bit Assembly	Right-Handed Tool Holder For Round Inserts
418-40609	40609	Tool Bit Assembly	Left-Handed Tool Holder For Round Inserts
418-40610	40610	Carbide Insert Round	Positive Rake, 10 Pack. Requires Tool Holder
418-40630	40630	Tool Holder Set	Right- And Left-Handed Tool Holder For Round Inserts
418-04114	4114	Positive Rake Tool Bit	For Drum Turning On Ammco Lathe Models 2002, 3000, 4000, 4100 And 7700. Brazed Carbide Tip Easily Resharpended By Grinding Top Flat. Shank: 3/8" (9.525 mm) Square
418-04725	4725	Positive Rake RH Heavy Duty Tool Bit	Used For Drum Turning On Ammco Lathe 2002, 3000, 4000, 4100 And 7700
418-04728	4728	Positive Rake RH Heavy Duty Tool Bit Set	Package Of 3 No. 4725 RH Tool Bits
418-05392	5392	Positive Rake Small Drum Tool Bit Assembly	For Turning Small Diameter Drums On Ammco Lathes. Shank: 5/8" x 3/4" x 5" (15.875 x 19.050 x 127mm) Long For Standard Boring Bars
418-06999	6999	Negative Rake Tool Bit Set	Replacement LH And RH Tool Bit Assemblies For The No. 6900 Twin-Cutter. Includes: One No. 10701 RH Tool Bit And One No. 10702 LH Tool Bit With Carbide Inserts
418-06914	6914-10	10 Carbide Inserts	Negative Rake 10 Pack
418-69142	6914-2	2 Carbide Inserts	Negative Rake 2 Pack
418-69146	6914-6	6 Carbide Inserts	Negative Rake 6 Pack
418-76812	7681-2	2 Carbide Inserts	Positive Rake 2 Pack
418-76816	7681-6	6 Carbide Inserts	Positive Rake 6 Pack
418-07692	7692	Duplex Tool Bit	Used With No. 9381 Facing And Grinding Set. Replacement Carbide Inserts No. 416-07681
418-07999	7999	Positive Rake Tool Bit Set	Permits Up To .100" Maximum Depth-Of-Cut (Total Of Two Sides, One Pass) When Turning Rotors With A No. 6900 Twin Cutter. Includes: One No. 25968 RH Tool Bit And One No. 25969 LH Tool Bit With Carbide Inserts. Replacement Carbide Inserts No. 416-07681
418-09872	9872	Negative Rake Tool Bit Assembly	For Drum Turning. Order Replacement Carbide Insert 418-06914. Standard With Lathe Models 2002, 3000, 4000, 4100, 7700
418-10701	10701	RH Negative Rake Tool Bit Assembly	For The No. 6900 Twin Cutter. Includes: One 418-06914 Six-Cutting-Edge Carbide Insert
418-10702	10702	LH Negative Rake Tool Bit Assembly	For The No. 6900 Twin Cutter. Includes: One 418-06914 Six-Cutting-Edge Carbide Insert
418-41410	40410	Carbide Insert, Pos. Rake	For FMC Lathes (John Bean Co.), 10 Pack
418-41415	40415	Carbide Insert, Pos. Rake	For KWIK-WAY Lathes, 10 P Pack
418-41420	40420	Carbide Insert, Neg. Rake	For Hunter Lathes, 10 Pack
418-40425	40425	Extend Offset Toolholder	Right And Left, 3/8"
418-41430	40430	Carbide Insert, Neg. Rake	For Performance Lathes, 10 Pack
418-41435	40435	Carbide Insert, Pos. Rake	For ACCUTURN Lathes, 10 Pack
418-06610	06610	Carbide Brake Lathe Insert	Round Carbide Bits For All Tool, Ammco, Hunter, Performance Rels Lathes, 10 Pack

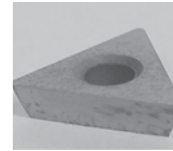

418-40410



418-40435



418-40415



418-40610



418-40630

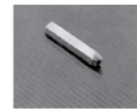

418-04114



418-04725

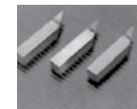

418-04728



418-05392



418-06914



418-07999



418-06999



418-69142



418-07692



418-09872



418-10701



418-40425

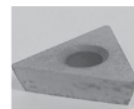

418-40410

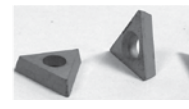

418-40415





## Tool Bits/Carbide Inserts (Cont.)

Ascot No.	Mfg. No.	Item	Description
418-06610	06610	Carbide Brake Lathe Insert	Round Carbide Bits For All Tool, Ammco, Hunter, Performance Rels Lathes, 10 Pk.
418-06700	06700	Brake Drum Tool, Right And Left Hand Tool Holders	Fits All Tool, Ammco, Hunter Performance, And Rels. Complete With Carbide Insert No. 06610. Number 06700 Includes 2 Holders, One Right Hand And One Left Hand, With Bits



## Tool Bits/Carbide Inserts Quick Reference Chart

DRUM					ROTOR			
Lathe Model	Tool Bit Assembly	Rake	Carbide Insert	Screw	Tool Bit Assembly	Rake	Carbide Insert	Screw
4000B	4114	0	N/A	N/A	10701 (RH)	-	6914	6499
	4725	+	N/A	N/A	10702 (LH)	-	6914	6499
	5392	-	7681	6499	25968 (RH)	+	7681	6499
	9872	-	6914	6499	25969 (LH)	+	7681	6499
4000B-SP	4114	0	N/A	N/A	10701 (RH)	-	6914	6499
	4725	+	N/A	N/A	10702 (LH)	-	6914	6499
	5392	-	7681	6499	25968 (RH)	+	7681	6499
	9872	-	6914	6499	25969 (LH)	+	7681	6499
4100	4114	0	N/A	N/A				
	4725	+	N/A	N/A	See 6950 Or			
	5392	-	7681	6499	7900 Twin Cutter			
	9872	-	6914	6499				
7500	N/A	N/A	N/A	N/A	See 6950 Or			
					7900 Twin Cutter			

Accessory No.	Tool Bit Assembly	Rake	Carbide Insert	Screw
6950 Twin Cutter	40608 (RH)	+	40610 (Round)	N/A
	40609 (LH)	+	40610 (Round)	N/A
	10701 (RH)	-	6914	6499
	10702 (LH)	-	6914	6499
	25968 (RH)	+	7681	6499
	25969 (LH)	+	7681	6499
7900 Twin Cutter	25761 (LH)	-	6914	6499
	25762 (RH)	-	6914	6499
	4120 (RH/LH Set)	+	7681	N/A
9381 Facing & Grinding Set	7692 (Duplex)	0	7681	6499

## Swirl Finisher

- Hand-held, low rpm grinder produces a "non-directional" finish on machined rotors when recommended by the manufacturer
- Finisher is driven by the lathe arbor nut of 1" and 1 1/16" arbors
- Note: No. 25882 nut must be used with older 1 1/16" arbor sets
- Includes six abrasive pads

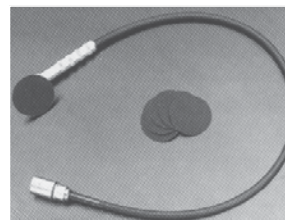

Ascot No.	Mfg. No.	Description
416-08740	8740	Swirl Finisher - Non-Driven
416-08750	8750	Swirl Finisher - Driven
416-08756	8756	Replacement Abrasive Pads. Package Of 6

## Brake Bleeders and Reservoir Adapters

### Pressure Brake Bleeder

- 4-gallon (1.5 L) reservoir eliminates frequent refilling
- 12 foot (3.65 m) quick coupler hose with automatic shut-off
- Diaphragm separates brake fluid from pressurized air
- Dual-scale pressure gauge: 0 to 31 PSI and 0 to 2 kg/cm<sup>2</sup> for 7300
- 7300 includes: No. 7330 universal adapter for open-top dual reservoir master cylinders
- 3-1/2" x 6-1/4" (89 x 159mm); automatic fill nozzle with quick coupler; fill funnel; syringe; cup; 1/4" & 3/16" ID fluid collection hoses

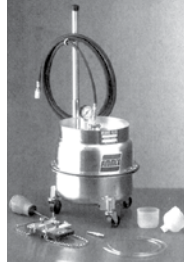

Ascot No.	Mfg. No.	Description	Weight
417-07300	7300	Pressure Brake Bleeder	24 Lbs.

### High Pressure ABS Brake Bleeder

- For bleeding high pressure anti-lock brake systems
- Includes same features as T300
- Pressure gauge: 0 to 60 PSI
- Max. recommended bleeding pressure of 45 PSI
- 48 PSI safety relief valve prevents over-pressurization
- Automatic fill nozzle with quick coupler fill funnel, syringe and cup
- 1/4" and 3/16" ID fluid collection hoses

Ascot No.	Mfg. No.	Description	Weight
417-07301	7301	High Pressure ABS Brake Bleeder	24 Lbs.

### High Pressure ABS Brake Bleeder Adapters

Ascot No.	Mfg. No.	Description	Description
417-07304	7304	Small Reservoir Adapter Set	Consists Of: (1) No. 7309 Large VW Reservoir Adapter; (2) No. 7313 Reservoir Adapters; (2) No. 7314 Expanding Plug Reservoir Adapter Sets; (1) No. 7315 Small VW Reservoir Adapter; (1) No. 7326 Universal Dual Reservoir Adapter
417-07306	7306	Ford Teves ABS Reservoir Adapter	For Ford Products With The Integrated Teves Anti-Lock Brake System
417-07307	7307	GM Reservoir Adapter	For GM Step Master Cylinders In Vans, Mini Vans
417-07308	7308	Chrysler Reservoir Adapter	Required For 1982 To 1991 Chrysler Cars. Can Be Used With 7300 & 7301
417-07309	7309	Large VW Reservoir Adapter	Screws Onto Reservoir Threads
417-07313	7313	2-1/2" Reservoir Adapter	For Plastic Open-Top Reservoirs Up To 2-1/2" Dia
417-07314	7314	Expanding Plug Reservoir Adapter Set	Seven Expanding Rubber Seals To Fit A Wide Range Of Reservoir Openings
417-07326	7326	Universal Dual Reservoir Hose Adapter	For Supplying Fluid To Separate Front And Rear Reservoirs Simultaneously, 7313, 7314 Adapters
417-07330	7330	Universal Reservoir Adapter	For Open-Top Dual Reservoir Master Cylinders, 3-1/2" x 6-1/4" (89x159mm). Standard W/7300
417-07331	7331	Universal Round Reservoir	For Round Open-Top Reservoirs To 4-1/8" (104.2mm) Diameter
417-07332	7332	GM By-Pass Reservoir Adapter	For GM Plastic Reservoirs
417-07335	7335	GM/Ford Reservoir	For Large Open-Top Dual Reservoirs For GM, Ford Trucks & Buses (1969-78) 3-3/4" x 7-3/4"
417-07374	7374	Brake Bleeder Adapter	Permits Brake Bleeders To Be Used With Ammco Reservoir Hose Adapters. Has Quick Coupler

### Drainman Bleeder

- Adaptable to most recycling systems
- Medium size brake bleeder with automatic refill, large capacity, long suction hose and universal drain valve for convenient brake service
- Bleeds and flushes hydraulic brake and clutch systems
- 25" continuous vacuum for easy and complete service
- 2.6 quart canister for more service time between draining
- Long 8" vacuum hose for technician convenience, hands free
- Tripod canister legs give enhanced stability even when connected to air line
- Drain valve allows emptying canister with disassembly
- Brass, nickel plated internal components allow for field maintenance
- Master cylinder refiller one man system—no need for troublesome adapters
- Working pressure: 80-174 PSI
- Maximum air consumption: 4.6 cfm/87 PSI
- Air connection: 1/4" NPT
- Temperature range: -4° to 140°F
- Canister volume: 2.6 Quarts



Ascot No.	Mfg. No.	Description	Weight
417-18989	18-9989	Drainman Bleeder	5.5 Lbs.



417-07304



417-07306 417-07307 417-07308



417-07309



417-07313



417-07314



417-09326



417-07330



417-07331



417-07332



417-07374

## Fluid Evacuators and Brake Washers

### Deluxe Brake Washer

- OSHA preferred method
- Low pressure pneumatic pump offers convenience and durability with no electric hazards
- Preset and tamper-proof air pressure regulator to control incoming air supply



Ascot No.	Mfg. No.	Description
419-01450	1450	Deluxe Brake Washer

### Fluid Evacuator

- Extracts fluids cleanly and quickly
- Ideal for motor, rear axle oil, transmission fluid changes
- Automatic self-drain capability for clean, quick fluid disposal



Ascot No.	Mfg. No.	Description	Shipping Wt.
417-15107	15-1071	Fluid Evacuator	21 Lbs.

## Brake Measuring Devices

### Measuring Devices

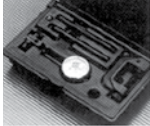

417-02850

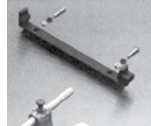

417-09582

Ascot No.	Mfg. No.	Description
417-02850	2850	Dial Indicator Set. Set For Testing Rotor Runout
417-09582	9582	Drum Micrometer Checking Gauge
417-08650	8650	Brake Shoe Setting Gauge

### Brake Drum Wear Limit Gauges

- A must for every state inspection station
- Available with pointed contacts for pre-inspecting scored brake drums to determine if they can be safely machined



Ascot No.	Mfg. No.	Description
417-06456	6456	6" - 14.350" (150mm - 365mm)
417-06478	6478	6" - 22" (150mm - 560mm)

### Digital Brake Drum Gauge

- Quickly and accurately measures brake drums up to 14.350"
- 3.25" depth allows measurement of the full drum
- Inch and metric digital readout



Ascot No.	Mfg. No.	Description
417-06469	6469SA	6" - 14.350" (150mm - 365mm)

### Digital Rotor Gauges

- Developed to eliminate doubt in diagnosing rotor wear
- Easy to use
- Includes clear digital gauge display, inch and metric readout and is self-calibrating



Ascot No.	Mfg. No.	Description
417-06459	6459A	Brake Force Digital Rotor Gauge 0" - 2.250" (0mm - 58mm)
417-06479	6479A	Brake Force Digital Rotor/Ball Joint Gauge

### Wheels-On Rotor Gauge

- Measure rotor wear without removing the wheel
- Measure all rotors with digital accuracy
- Easy access between the car dust shield and rotor
- Ideal for bus and fleet safety inspections
- Range: 0" - 3.25" (0mm - 80mm)
- 1" measuring depth
- Made in the U.S.A.



Ascot No.	Mfg. No.	Description
417-06496	6496SA	Wheels-On Rotor Gauge

## Challenger Two-Post Lifts

### CL10 Series— 10,000 Lb. Capacity Two Post Lift

- Maximize service capabilities and revenue potential
- Reduces stress on equalization system and increases cable life
- Decreases load on bearing
- Allows lift to be placed in standard service bay with 12' ceiling
- Prevents vehicle damage from being raised too high
- Reduces column deflection
- Allows technician to disengage both columns simultaneously

- **Complete Productivity**  
(CL10) - Conventional Power Controls, Versymmetric® offset 2-stage front and rear arms

Ascot No.	Mfg. No.
304-00010	CL10



### CL10 Offset Two-Stage Arm

- Wide arm sweep with excellent arm retraction and reach
- Meets OEM recommended pick up points of most vehicles
- Offset front arms provide single sweep spotting of virtually any vehicle
- Lifts vehicles with a symmetric center of gravity



Ascot No.	Mfg. No.
309-02002	B2002

### 2 Lifts in One

Why should you be forced to decide what type of vehicles you service the most?

- Asymmetric Lifts accommodate 70% of top 20 selling vehicles
- Symmetric Lifts accommodate 30% of the top 20 selling vehicles
- Versymmetric® Lifts accommodate 100% of the top 20 selling vehicles, properly lifts cars, trucks, vans and SUVs with one lift

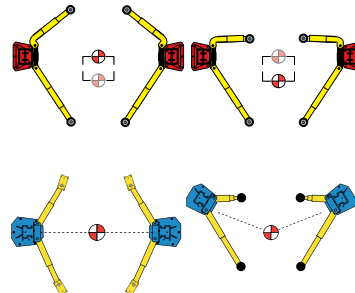

Symmetric on right side  
Asymmetric on left

### Maximum Productivity

(CL10V3) - Conventional Power Controls, Versymmetric® Plus offset 3-stage front + 3-stage rear arms



Ascot No.	Mfg. No.
443-02520	CL10V3

### Max Plus Productivity

(CL10V3DPC) - Dual Pendant Power Controls, Stack Adapter Kit and Document Caddy with Versymmetric® Plus offset 3-stage front + 3-stage rear arms



Ascot No.	Mfg. No.
304-01103	CL10V3DPC



## Challenger Two-Post Lifts (Cont.)

### E10 – 10,000 Lb. Capacity Two Post Lift

- Versymmetric® 3-stage front arms for asymmetric or symmetric lifting in the same service bay
- Standard height fits in 12' ceiling
- Double Telescoping Screw Pads
- Padded overhead shut off system
- Single-point mechanical lock release system allows technician to disengage both column locks simultaneously
- ALI/ETL certified



Ascot No.	Mfg. No.
304-00110	E10



### CLFP9 – 9,000 Lb. Capacity Floor Plate Lift

- 10'-7/8" overall column height is ideal for servicing vehicles in a low ceiling height
- Low profile drive-over floor plate for easy vehicle positioning
- 3-stage front + 3-stage rear arms provide excellent reach and retraction to lift a variety of vehicles
- Electric/hydraulic heavy-duty chain lifting operation with cable equalization
- Dual point mechanical pull-lock cable release system

Ascot No.	Mfg. No.
304-00009	CLFP9

### E12 – 12,000 Lb. Capacity Two Post Lift

- Heavy-Duty 2-stage telescoping arms provide excellent reach and retraction to accommodate vehicle lifting points
- 13'-10" or 14'-7" adjustable column height accommodates higher profile vehicles and provides maximum headroom to work underneath vehicles
- Heavy-Duty telescoping Screw Pads
- Padded overhead shut off system
- Single-point mechanical lock release system allows technician to disengage both column locks simultaneously
- ALI/ETL certified



Ascot No.	Mfg. No.
304-00120	E12



Ascot No.	Mfg. No.	Max. Capacity (Lbs.)	Overall Width	Between Columns	Drive-Thru Width	Overall Height	Under Bar Clearance	Front Arm Length	Rear Arm Length	Max. Lift Height	Power Reg.
304-00110	E10	10,000	10' 11-3/4"	110-1/4"	98-3/8"	11' 11-7/8"	11' 5"	21 3/4" to 39-1/4"	38-1/4" to 55-3/8"	75-3/4"	2HP, Single Phase, 60HZ
304-00120	E12	12,000	11' 7-3/4"	115"	103"	13' 10" or 14' 7"	13' 3-1/2" or 14'-1/2"	35 3/4" to 54-1/4"	35-3/4" to 54-1/4"	78-1/8"	2HP, Single Phase, 60Hz
304-00009	CLFP9	9,000	11' 5-1/2"	109"	98-3/16"	N/A	N/A	24 1/2" to 44-1/2"	24-1/2" to 44-1/2"	79-1/8"	2HP, Single Phase, 60Hz
304-00010	CL10	10,000	11' 6-1/2" to 11' 11"	10" to 114-1/2"	100-1/2" to 105"	11' 11"	11' 2-1/2"	27" to 41"	42" to 59"	74-5/8"	2HP, Single Phase, 208V-230V
304-00103	CL10V3	10,000	11' 6-1/2" to 11' 11"	10" to 114-1/2"	100-1/2" to 105"	11' 11"	14' 2-1/2"	19-13/16" to 42"	37-5/8" to 60"	74-5/8"	2HP, Single Phase, 208V-230V
304-01103	CL10V3-DPC	10,000	11' 6-1/2" to 11' 11"	10" to 114-1/2"	100-1/2" to 105"	11' 11"	11' 2-1/2"	19-13/16" to 42"	37-5/8" to 60"	74-5/8"	2HP, Single Phase, 208V-230V

## Four-Post Lifts

### 4P12EFX & 4P12XFX – 12,000 Lb. Capacity Four Post Lift

- The highest rise in the industry provides more working room underneath vehicles
- Louvered approach ramps for positive vehicle traction
- Solid piece column construction provides rigidity and stability
- Oversized solid machined steel pulleys for prolonged pulley and cable life
- Adjustable runways to accommodate a variety of tread widths
- 14 level locking positions for a variety of general service tasks
- ALI/ETL certified

#### Optional Accessories Inset:

- Optional 6,000 Lb. rolling jacks for brake and tire work
- Optional bolt on alignment kit converts general service application into alignment rack

Ascot No.	Mfg. No.
305-41200	4P12EFX



### 4015 Series – 15,000 Lb. Capacity General Service and Alignment Rack Four Post Lifts

- The highest rise in the industry provides more working room underneath vehicles
- Large 9-1/2" heavy-duty pulleys and 1/2" cable diameter reduces wear on cable equalization system
- Compatible with the industry's latest camera imaging alignment systems
- Recessed stainless steel turning radius gauges provide accurate readings
- 14 level locking positions for a variety of alignment and general service tasks
- Durable non-skid surfaces for positive vehicle traction and technician safety
- Fully gusseted base plate and top shroud reduces column deflection and is less sensitive to uneven floors
- 80" rear recessed free floating slip plates offer a wider range of 4 wheel alignment capacities
- Alignment Rack models include a package of two 7.5K Lb. rolling jacks, flush mount stainless steel turning radius gauges and rear slip plates, internal air line system for the dual rolling jacks, multi-position work-steps and automatic wheel stops

Ascot No.	Mfg. No.	Description
305-40150	AR4015	Open Front
305-40151	AR4015EFX	Close Front



305-40150



305-40151

### 40EFX – 12,000 Lb. Surface Mounted Four Post Lift

- 78" rise height provides more working room underneath vehicles
- Durable non-skid surfaces for positive vehicle traction and technician safety
- Grease fittings located on arm pin bushings minimize corrosion to keep arms swinging freely
- Oversized solid machined steel pulleys for prolonged pulley and cable life
- ALI/ETL certified

Ascot No.	Mfg. No.
305-40001	AR40EFX



Ascot No.	Mfg. No.	Max. Capacity (Lbs.)	Overall Width	Length Overall	Inside Columns	Height of Columns	Height of Runways	Width of Runways	Width Between Runways	Max. Lift Height	Power Reg.
305-41200	4P12EFX	12000	10" 10' 3/4"	20" 4-1/2"	116"	90-1/2"	7"	20"	40" - 43"	78"	2HP
305-40150	AR4015 (Open Front)	15000	142" front - 134-1/2" rear	249" - 276"	120"	99-1/2" front - 93-1/2" rear	7"	20"	43"	78"	2HP
305-40151	AR4015EFX (Closed Front)	15000	134-1/2"	244-1/2" - 272"	120"	90-1/2"	7"	20"	40" - 43"	78"	2HP
305-40001	AR40EFX	15000	134-1/2"	244-1/2"	120"	90-1/2"	7"	20"	40" - 43"	78"	2HP

## Rolling Jacks and Work Stations

### Rolling Jacks

- Optional 6,000 Lb. capacity rolling jack allows brake and wheel access
- Available for 40 Series lifts



Ascot No.	Mfg. No.	Description
218-00060	RJ6	Air/hydraulic Operation, 40 Series, 4P12 Series and AR40 Series
309-61240	JABJ6	Air Only Operation, 40 Series, 4P12 Series and AR40 Series
309-94418	RJ9A	Air Operated with Capacity for 44018AR



### Air Electric Work Stations

- Air and Electric workstation with filter, lubricator and regulator for four post car and truck lifts
- Increase productivity with air supply and electric outlets on the four post automotive lift column
- Convenient power source for extension lights and other tools needed when servicing cars and trucks

Ascot No.	Mfg. No.	Description
309-10310	10310	Air Electric Work Station for Four Post Lifts
309-10264	B10264	Air/Electric with Filter/Lubricator/Regulator for Two Post Lifts
309-99700	B99700	Tire Tool Manager Work Station with Filter Lubricator/Regulator

### Rolling Jacks

- Heavy duty air/hydraulic rolling jack with telescoping mounting brackets
- Fits many of the popular lifts
- Narrow width allows access tool area of vehicle being serviced
- Spring-loaded mounting bracket allows jack to be easily positioned, then automatically locks in place when weight is applied
- 6,000 Lbs. capacity - specify lift brand
- 9,000 Lbs. capacity available



**Branick®**

Ascot No.	Mfg. No.	Description	Drive-Over Clearance	Min. Air Pressure	Max. Air Pressure	Min. Lift	Max. Lift	Shipping Weight
218-08610	8610	Rolling Jack - Rotary	3-1/2"	80 PSI	120 PSI	33"	50"	350 Lbs.
218-08620	8620	Rolling Jack - JBC/FMC	3-1/2"	80 PSI	120 PSI	33"	50"	350 Lbs.
218-08630	8630	Rolling Jack - Hunter	3-1/2"	80 PSI	120 PSI	33"	50"	350 Lbs.
218-08640	8640	Rolling Jack - Wheeltronics	3-1/2"	80 PSI	120 PSI	33"	50"	350 Lbs.

**Lifts**

**CS1020WV – 10,000 Lb. Capacity In Ground Lift**

- 87" drive-thru. Widest industry drive-thru eases vehicle spotting and reduces potential tire pinching damaging
- Double Telescoping Screw Pads
- 50% taller bearing contact than competitor provides increased stability
- Mechanical lock engages every 3" allowing technicians to work at their ergonomic working height to increase productivity and minimize fatigue
- Stainless Steel air lock release cylinder promotes longer working life with its corrosion resistant design
- Optional bench mounted controls – part #BMC
- ALI/ETL certified

Ascot No.	Mfg. No.
307-01020	CS1020WV



**MR6 – 6,000 Lb. Capacity Mid Rise Lift**

- Portable mid-rise lift with Heavy-Duty tow dolly provides flexibility to service vehicles anywhere, inside or out
- 7 locking positions allow technician to work at an ergonomic height to increase productivity and minimize fatigue
- Electric motor mounted on tow dolly provides convenience and ease of maneuverability
- Single push button power unit with release valve provides convenience when lifting and lowering vehicles
- Slip-on rubber pad adapter kit with height extension accommodates high profile vehicles
- Sliding/rotating arm design accommodates meeting pick-up points on a wider range of vehicles

Ascot No.	Mfg. No.
307-00006	MR6



**SRM10 – 10,000 Lb. Capacity Short Rise Lift**

- Standard with 4 two-position adapter blocks for increased vehicle spotting versatility
- Standard storage trays are conveniently placed on each side of the lift to prevent lug nuts and other small parts from being misplaced
- Dual cylinders provide stable 10,000 Lb. lifting capabilities to accommodate a wide range of vehicles
- Floor mounted diamond plated approach ramps help to prevent slipping
- 3 locking positions
- ALI/ETL certified

Ascot No.	Mfg. No.
303-00010	SRM10



**CLM16 and CLM18 – Heavy Duty Mobile Column Lifts**

- CLM16series capacity to 96,000 Lbs. for Heavy-Duty lifting
- CLM18series capacity to 108,000 Lbs. for Heavy-Duty lifting
- Low friction recirculating ball screw lifting system for high efficiency
- 3 separate operating modes (All Mode, Single Mode and Group Mode - any combination)
- Electronic self diagnostics
- Automatic synchronization and communication between columns
- Automatic leveling of asymmetric loads
- Fail safe independent safety device with automatic obstacle contact shutoff
- Mobile power supply unit with no master column
- ALI/ETL certified

Ascot No.	Mfg. No.
308-00016	CLM16
308-00018	CLM18



# WHEEL BALANCING SUPPLIES

PASSENGER WHEEL WEIGHTS  
TRUCK WHEEL WEIGHTS  
ADHESIVE WHEEL WEIGHTS  
WHEEL WEIGHT TOOLS  
BALANCING COMPOUNDS



# EQUAL<sup>®</sup>

THE ORIGINAL BALANCING COMPOUND

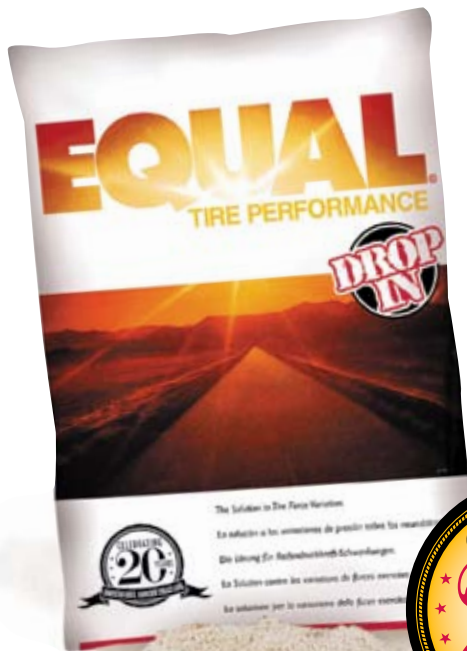

20 years of superior balancing and dampening delivered by EQUAL.

**Why use anything else?**



## Weights for Passenger Car Alloy Wheels

- Ascot Wheel Protector™ Coated Wheel Weights for alloy wheels have a special dry polymer coating that prevents the wheel from being stained by the weight
- Designed to meet or exceed all OEM specifications to protect the finish from lead staining for the life of the vehicle
- Coated weights have been original equipment on new cars since 1985. Use as a replacement on these vehicles
- To avoid damage to the coating, a soft headed hammer should be used to install weights

### "MCS" Series - Coated Wheel Weights



- "MC" is an economical alternative to OEM quality coated weights
- Coated weights should be used on all vehicles having alloy wheels  
"MCS" Coated-25 pc. box. "MC" Uncoated-50 pc. box

#### APPLICATIONS - MC/MCS Series

Ford: All from 1985; Chrysler-All from 1990 to 1997; some models changed to LHS in 1998; GM-Increasingly used starting in 1988; as of 2000 only C5 Corvette remains AWS.  
NOTE: MCS = MCN = ALCMC

### "AWS" Series - Coated Wheel Weights



- "AW" is an economical alternative to OEM quality coated weights
- Coated weights should be used on all vehicles having alloy wheels  
"AWS" Coated-25 pc. box. "AW" Uncoated-50 pc. box

#### APPLICATIONS - AWS/AW Series

Ford-All up to 1984; Chrysler-All up to 1989; GM-All up to 1987; decreasingly used from 1988-2000.  
NOTE: AWS = AWN = ALC

### "FNS" Series - Coated Wheel Weights



- Designed for the thicker flange alloy wheels now being used on many Japanese vehicles
- 25 per box

#### APPLICATIONS - FNS Series

Toyota-All since 1990; Lexus-All since 1990; Honda-All since 1989; Acura-All since 1990; Nissan-All since 1990; Infiniti-All since 1990; Isuzu-All since 1997; Mazda-All since 1990; Daewoo-All since 1999.

NOTE: FNS = FN = ALCFN

### "MCS" Coated

Ascot No.	Mfg. No.	Weight
488-19025	MCS025	0.25 Oz.
488-19050	MCS050	0.50 Oz.
488-19075	MCS075	0.75 Oz.
488-19100	MCS100	1.00 Oz.
488-19125	MCS125	1.25 Oz.
488-19150	MCS150	1.50 Oz.
488-19175	MCS175	1.75 Oz.
488-19200	MCS200	2.00 Oz.
488-19225	MCS225	2.25 Oz.
488-19250	MCS250	2.50 Oz.
488-19275	MCS275	2.75 Oz.
488-19300	MCS300	3.00 Oz.
488-19325	MCS325	3.25 Oz.
488-19350	MCS350	3.50 Oz.
488-19375	MCS375	3.75 Oz.
488-19400	MCS400	4.00 Oz.

### "MC" Uncoated

Ascot No.	Mfg. No.	Weight
487-18025	MC25	0.25 Oz.
487-18050	MC50	0.50 Oz.
487-18075	MC75	0.75 Oz.
487-18100	MC100	1.00 Oz.
487-18125	MC125	1.25 Oz.
487-18150	MC150	1.50 Oz.
487-18175	MC175	1.75 Oz.
487-18200	MC200	2.00 Oz.
487-18225	MC225	2.25 Oz.
487-18250	MC250	2.50 Oz.
487-18275	MC275	2.75 Oz.
487-18300	MC300	3.00 Oz.

### "AWS" Coated

Ascot No.	Mfg. No.	Weight
488-17025	AWS25	0.25 Oz.
488-17050	AWS50	0.50 Oz.
488-17075	AWS75	0.75 Oz.
488-17100	AWS100	1.00 Oz.
488-17125	AWS125	1.25 Oz.
488-17150	AWS150	1.50 Oz.
488-17175	AWS175	1.75 Oz.
488-17200	AWS200	2.00 Oz.
488-17225	AWS225	2.25 Oz.
488-17250	AWS250	2.50 Oz.
488-17275	AWS275	2.75 Oz.
488-17300	AWS300	3.00 Oz.

### "AW" Uncoated

Ascot No.	Mfg. No.	Weight
487-16025	AW25	0.25 Oz.
487-16050	AW50	0.50 Oz.
487-16075	AW75	0.75 Oz.
487-16100	AW100	1.00 Oz.
487-16125	AW125	1.25 Oz.
487-16150	AW150	1.50 Oz.
487-16175	AW175	1.75 Oz.
487-16200	AW200	2.00 Oz.
487-16225	AW225	2.25 Oz.
487-16250	AW250	2.50 Oz.
487-16275	AW275	2.75 Oz.
487-16300	AW300	3.00 Oz.

### "FNS" Coated

Ascot No.	Mfg. No.	Weight
488-23005	FNS05	5 Grams
488-23010	FNS10	10 Grams
488-23015	FNS15	15 Grams
488-23020	FNS20	20 Grams
488-23025	FNS25	25 Grams
488-23030	FNS30	30 Grams
488-23035	FNS35	35 Grams
488-23040	FNS40	40 Grams
488-23045	FNS45	45 Grams
488-23050	FNS50	50 Grams
488-23055	FNS55	55 Grams
488-23060	FNS60	60 Grams
488-23065	FNS65	65 Grams
488-23070	FNS70	70 Grams
488-23075	FNS75	75 Grams
488-23080	FNS80	80 Grams

NOTE: Ask us about application Wall Charts for Coated Alloy Wheel Weights



## Weights for Passenger Car Alloy Wheels

### "ENS" Series - Coated Wheel Weights



- Designed for VW & Audi alloy wheels 1997 and up
- For vehicles manufactured prior to the 1989 model year
- 25 per box

Ascot No.	Mfg. No.	Weight
488-22010	ENS10	10 Grams
488-22015	ENS15	15 Grams
488-22020	ENS20	20 Grams
488-22025	ENS25	25 Grams
488-22030	ENS30	30 Grams
488-22035	ENS35	35 Grams
488-22040	ENS40	40 Grams
488-22045	ENS45	45 Grams
488-22050	ENS50	50 Grams
488-22055	ENS55	55 Grams
488-22060	ENS60	60 Grams

#### APPLICATIONS - ENS Series

Audi-All from 1997; VW-All from 1997; used on many aftermarket alloy wheels with thin rim flanges.  
 NOTE: FNS = FN = ALCFN

### "LHS" Series - Coated Wheel Weights for Dodge/Chrysler



- Weights are coated and specially contoured with unique clip design
- For use with aluminum wheels
- 25 per box

#### "LHS" Coated

Ascot No.	Mfg. No.	Weight	Ascot No.	Mfg. No.	Weight
488-24025	LHS025	.25 Oz.	488-24175	LHS175	1.75 Oz.
488-24050	LHS050	.50 Oz.	488-24200	LHS200	2.00 Oz.
488-24075	LHS075	.75 Oz.	488-24225	LHS225	2.25 Oz.
488-24100	LHS100	1.00 Oz.	488-24250	LHS250	2.50 Oz.
488-24125	LHS125	1.25 Oz.	488-24275	LHS275	2.75 Oz.
488-24150	LHS150	1.50 Oz.	488-24300	LHS300	3.00 Oz.

#### APPLICATIONS - LHS Series

Chrysler-Used on LH platform (Intrepid, Concorde, LHS, 300M) and all Mini Van models since 1998. Also used on 2000 Neon, 2001 PT Cruiser and 2001 Sebring & Stratus sedans and convertibles.  
 NOTE: LHS = LH = ALCLH

### "IAWS" Series - Coated Wheel Weights



- Used on many import car alloy wheels
- Replaces the two piece alloy wheel weights commonly found on vehicles manufactured in Europe
- 25 per box

#### APPLICATIONS - IAWS Series

Audi-Up To 1996; VW-Up To 1996; BMW, Catera, Geo Hyundai, Jaguar, Kia, Mitsubishi, Subaru, Suzuki, Volvo  
 NOTE: IAWS = IAW = ALCIW

#### "IAWS" Coated

Ascot No.	Mfg. No.	Wt.
488-20005	IAWS5	5 Grams
488-20010	IAWS10	10 Grams
488-20015	IAWS15	15 Grams
488-20020	IAWS20	20 Grams
488-20025	IAWS25	25 Grams
488-20030	IAWS30	30 Grams
488-20035	IAWS35	35 Grams
488-20040	IAWS40	40 Grams
488-20045	IAWS45	45 Grams
488-20050	IAWS50	50 Grams
488-20055	IAWS55	55 Grams
488-20060	IAWS60	60 Grams

#### "IAWU" Uncoated

Ascot No.	Mfg. No.	Weight
487-21005	IAWU005	5 Grams
487-21010	IAWU010	10 Grams
487-21015	IAWU015	15 Grams
487-21020	IAWU020	20 Grams
487-21025	IAWU025	25 Grams
487-21030	IAWU030	30 Grams
487-21035	IAWU035	35 Grams
487-21040	IAWU040	40 Grams
487-21045	IAWU045	45 Grams
487-21050	IAWU050	50 Grams
487-21055	IAWU055	55 Grams
487-21060	IAWU060	60 Grams

### CC Series - Coated Contoured Weights

- High quality coated contoured adhesive weights
- Designed for original equipment and aftermarket alloy wheels without an outside clip-on flange
- Attractive finish for applications where they will be highly visible
- No breaking or cutting necessary
- Available in sizes from 5-50 grams in 5 gram increments
- 25 per box



Ascot No.	Mfg. No.	Weight
488-25005	CC05	5 Grams
488-25010	CC10	10 Grams
488-25015	CC15	15 Grams
488-25020	CC20	20 Grams
488-25025	CC25	25 Grams
488-25030	CC30	30 Grams
488-25035	CC35	35 Grams
488-25040	CC40	40 Grams
488-25045	CC45	45 Grams
488-25050	CC50	50 Grams





## Weights for Passenger Car Alloy Wheels

### "PCAS" Series - Precontoured Adhesive Coated Wheel Weight with CW

- Available from 5 g to 80 g
- Width 20 mm (~3/4")
- Offered in boxes of 25 pieces



Ascot No.	Mfg. No.	Weight
488-81005	PCAS-05-CW	5 Grams
488-81010	PCAS-10-CW	10 Grams
488-81015	PCAS-15-CW	15 Grams
488-81020	PCAS-20-CW	20 Grams
488-81025	PCAS-25-CW	25 Grams
488-81030	PCAS-30-CW	30 Grams
488-81035	PCAS-35-CW	35 Grams
488-81040	PCAS-40-CW	40 Grams
488-81045	PCAS-45-CW	45 Grams
488-81050	PCAS-50-CW	50 Grams
488-81055	PCAS-55-CW	55 Grams
488-81060	PCAS-60-CW	60 Grams
488-81065	PCAS-65-CW	65 Grams
488-81070	PCAS-70-CW	70 Grams
488-81075	PCAS-75-CW	75 Grams
488-81080	PCAS-80-CW	80 Grams

### "NTS" Series - Coated Wheel Weights



- Coated wheel weights for alloy wheels on Ford Explorer and Mercury Mountaineer from 2002, as well as, 2003 Lincoln Aviator

Ascot No.	Mfg. No.	Weight
488-30050	NTS 50	.5 Oz.
488-30075	NTS 75	.75 Oz.
488-30100	NTS 100	1 Oz.
488-30125	NTS 125	1.25 Oz.
488-30150	NTS 150	1.5 Oz.
488-30175	NTS 175	1.75 Oz.
488-30200	NTS 200	2 Oz.
488-30225	NTS 225	2.25 Oz.
488-30250	NTS 250	2.5 Oz.
488-30275	NTS 275	2.75 Oz.
488-30300	NTS 300	3.00 Oz.

### Mercedes-Benz 2-Piece Wheel Weights

- Coated wheel weights for Mercedes-Benz alloy wheels
- 25 pieces per box
- 10 - 80 Grams



Ascot No.	Mfg. No.	Weight	Ascot No.	Mfg. No.	Weight
488-45010	MBN 100	10 Grams	488-45035	MBN 350	35 Grams
488-45015	MBN 150	15 Grams	488-45040	MBN 400	40 Grams
488-45020	MBN 200	20 Grams	488-45045	MBN 450	45 Grams
488-45025	MBN 250	25 Grams	488-45050	MBN 500	50 Grams
488-45030	MBN 300	30 Grams	488-45055	MBN 550	55 Grams
			488-45060	MBN 600	60 Grams

### Mercedes-Benz Wheel Weight Tool



Ascot No.	Mfg. No.	Description
486-10500	6410500	Clip Tool For "MBN" Series Weights
486-14604	6414604	"MBN" Series Tire Compressor

**Contact us for a current year wheel weight application guide.**

## Weights for Passenger Car Alloy Wheels

### "BMN" Series - Coated Wheel Weights

- Designed to meet or exceed all OEM specifications
- Feature a highly resistant polyester coating which completely encapsulates the weight, assuring the protection of the wheel from lead staining
- 25 per box



Ascot No.	Mfg. No.	Weight
488-46010	BMN 10	10 Grams
488-46015	BMN 15	15 Grams
488-46020	BMN 20	20 Grams
488-46025	BMN 25	25 Grams
488-46030	BMN 30	30 Grams
488-46035	BMN 35	35 Grams
488-46040	BMN 40	40 Grams
488-46045	BMN 45	45 Grams
488-46050	BMN 50	50 Grams
488-46055	BMN 55	55 Grams
488-46060	BMN 60	60 Grams

## Steel Wheel Weights

### Wheel Weights for Passenger Car Steel Wheels

- "P" Series-For use on all passenger car rims with 13"-15" steel wheels
- "P" series replaces the two piece (steel wheel) design commonly found on vehicles manufactured in Europe
- Designed with "dovetail" clip to insure double retention of the clip to the wheel
- Clips are plated and batch salt spray tested to assure compliance to demanding OEM specifications
- Use rim gauge number RGP1 to verify correct application
- Available in coated & uncoated

NOTE: P=N - Passenger Weights Now Available in Nylon Coating. Call for Details



Ascot No.	Mfg. No.	Weight	Qty./Box
487-12025	N25	0.25 Oz.	50
487-12050	N50	0.50 Oz.	50
487-12075	N75	0.75 Oz.	50
487-12100	N100	1.00 Oz.	50
487-12125	N125	1.25 Oz.	50
487-12150	N150	1.50 Oz.	50
487-12175	N175	1.75 Oz.	50
487-12200	N200	2.00 Oz.	50
487-12225	N225	2.25 Oz.	50
487-12250	N250	2.50 Oz.	50
487-12275	N275	2.75 Oz.	50
487-12300	N300	3.00 Oz.	50
487-12325	N325	3.25 Oz.	25
487-12350	N350	3.50 Oz.	25
487-12375	N375	3.75 Oz.	25
487-12400	N400	4.00 Oz.	25
487-12450	N450	4.50 Oz.	25
487-12500	N500	5.00 Oz.	25
487-12550	N550	5.50 Oz.	25
487-12600	N600	6.00 Oz.	25

### Passenger Car Steel Wheel Weights



Ascot No.	Mfg. No.	Weight
488-82025	REGS-0.25	.25 Oz.
488-82050	REGS-0.50	.50 Oz.
488-82075	REGS-0.75	.75 Oz.
488-82100	REGS-1.00	1.00 Oz.
488-82125	REGS-1.25	1.25 Oz.
488-82150	REGS-1.50	1.50 Oz.
488-82175	REGS-1.75	1.75 Oz.
488-82200	REGS-2.00	2.00 Oz.
488-82225	REGS-2.25	2.25 Oz.
488-82250	REGS-2.50	2.50 Oz.
488-82275	REGS-2.75	2.75 Oz.
488-82300	REGS-3.00	3.00 Oz.



plombco

turning *lead-free* for a brighter future

# let's get the lead out!



Our **steel** weights...  
**a new standard of excellence**

## Weights for Passenger Car Alloy Wheels

### MC/ALCMC Type



Plombco



Perfect



Plombco



Bada



Perfect

### Zinc

Ascot No.	Plombco MCZS Series No.	Perfect MCZ Series No.	Weight
488-28025	MCZS-0.25	MC025Z	.25 Oz.
488-28050	MCZS-0.50	MC050Z	.50 Oz.
488-28075	MCZS-0.75	MC075Z	.75 Oz.
488-28100	MCZS-1.00	MC100Z	1.00 Oz.
488-28125	MCZS-1.25	MC125Z	1.25 Oz.
488-28150	MCZS-1.50	MC150Z	1.50 Oz.
488-28175	MCZS-1.75	MC175Z	1.75 Oz.
488-28200	MCZS-2.00	MC200Z	2.00 Oz.
488-28225	MCZS-2.25	MC225Z	2.25 Oz.
488-28250	MCZS-2.50	MC250Z	2.50 Oz.
488-28275	MCZS-2.75	MC275Z	2.75 Oz.
488-28300	MCZS-3.00	MC300Z	3.00 Oz.

### Steel

Ascot No.	Plombco MCFe Series No.	Bada MCFE Series No.	Perfect MCST Series No.	Weight
488-29025	MCFe-0.25	MCFE025	MC025ST	.25 Oz.
488-29050	MCFe-0.50	MCFE050	MC050ST	.50 Oz.
488-29075	MCFe-0.75	MCFE075	MC075ST	.75 Oz.
488-29100	MCFe-1.00	MCFE100	MC100ST	1.00 Oz.
488-29125	MCFe-1.25	MCFE125	MC125ST	1.25 Oz.
488-29150	MCFe-1.50	MCFE150	MC150ST	1.50 Oz.
488-29175	MCFe-1.75	MCFE175	MC175ST	1.75 Oz.
488-29200	MCFe-2.00	MCFE200	MC200ST	2.00 Oz.
488-29225	MCFe-2.25	MCFE225	MC225ST	2.25 Oz.
488-29250	MCFe-2.50	MCFE250	MC250ST	2.50 Oz.
488-29275	MCFe-2.75	MCFE275	MC275ST	2.75 Oz.
488-29300	MCFe-3.00	MCFE300	MC300ST	3.00 Oz.

### APPLICATIONS - MC/ALCMC Series

Ford: All from 1985; Chrysler-All from 1990 to 1997; some models changed to LHS in 1998; GM-Increasingly used starting in 1988; as of 2000 only C5 Corvette remains AWS.

### AW/ALC Type



### Zinc

Ascot No.	Perfect AWZ Series No.	Weight
488-78025	AW025Z	.25 Oz.
488-78050	AW050Z	.50 Oz.
488-78075	AW075Z	.75 Oz.
488-78100	AW100Z	1.00 Oz.
488-78125	AW125Z	1.25 Oz.
488-78150	AW150Z	1.50 Oz.
488-78175	AW175Z	1.75 Oz.
488-78200	AW200Z	2.00 Oz.
488-78225	AW225Z	2.25 Oz.
488-78250	AW250Z	2.50 Oz.
488-78275	AW275Z	2.75 Oz.
488-78300	AW300Z	3.00 Oz.



Plombco



Bada

### Steel

Ascot No.	Plombco AWFe Series No.	Bada ALFE Series No.	Weight
488-77025	AWFe-0.25	ALFE025	.25 Oz.
488-77050	AWFe-0.50	ALFE050	.50 oz
488-77075	AWFe-0.75	ALFE075	.75 Oz.
488-77100	AWFe-1.00	ALFE100	1.00 Oz.
488-77125	AWFe-1.25	ALFE125	1.25 Oz.
488-77150	AWFe-1.50	ALFE150	1.50 Oz.
488-77175	AWFe-1.75	ALFE175	1.75 Oz.
488-77200	AWFe-2.00	ALFE200	2.00 Oz.
488-77225	AWFe-2.25	ALFE225	2.25 Oz.
488-77250	AWFe-2.50	ALFE250	2.50 Oz.
488-77275	AWFe-2.75	ALFE275	2.75 Oz.
488-77300	AWFe-3.00	ALFE300	3.00 Oz.

### APPLICATIONS - AW/ALC Series

Ford-All up to 1984; Chrysler-All up to 1989; GM-All up to 1987; decreasingly used from 1988-2000.

## Weights for Passenger Car Alloy Wheels

### FN/ALCFN Type



Plombco



Perfect



Plombco



Bada



Perfect

### Zinc

Ascot No.	Plombco FNZS Series No.	Perfect FNZ Series No.	Weight
488-34005	FNZS-05	FN005Z	5 Grams
488-34010	FNZS-10	FN010Z	10 Grams
488-34015	FNZS-15	FN015Z	15 Grams
488-34020	FNZS-20	FN020Z	20 Grams
488-34025	FNZS-25	FN025Z	25 Grams
488-34030	FNZS-30	FN030Z	30 Grams
488-34035	FNZS-35	FN035Z	35 Grams
488-34040	FNZS-40	FN040Z	40 Grams
488-34045	FNZS-45	FN045Z	45 Grams
488-34050	FNZS-50	FN050Z	50 Grams
488-34055	FNZS-55	FN055Z	55 Grams
488-34060	FNZS-60	FN060Z	60 Grams

### Steel

Ascot No.	Plombco FNFe Series No.	Bada FNFE Series No.	Perfect FNST Series No.	Weight
488-33005	FNFe-05	-	FN005ST	5 Grams
488-33010	FNFe-10	FNFE10	FN010ST	10 Grams
488-33015	FNFe-15	FNFE15	FN015ST	15 Grams
488-33020	FNFe-20	FNFE20	FN020ST	20 Grams
488-33025	FNFe-25	FNFE25	FN025ST	25 Grams
488-33030	FNFe-30	FNFE30	FN030ST	30 Grams
488-33035	FNFe-35	FNFE35	FN035ST	35 Grams
488-33040	FNFe-40	FNFE40	FN040ST	40 Grams
488-33045	FNFe-45	FNFE45	FN045ST	45 Grams
488-33050	FNFe-50	FNFE50	FN050ST	50 Grams
488-33055	FNFe-55	FNFE55	FN055ST	55 Grams
488-33060	FNFe-60	FNFE60	FN060ST	60 Grams

### APPLICATIONS - FN/ALCFN Series

Toyota-All since 1990; Lexus-All since 1990; Honda-All since 1989; Acura-All since 1990; Nissan-All since 1990; Infiniti-All since 1990; Isuzu-All since 1997; Mazda-All since 1990; Daewoo-All since 1999.

### EN/ALCEN Type



Plombco



Perfect



Plombco



Bada



Perfect

### Zinc

Ascot No.	Plombco ENZS Series No.	Perfect ENZ Series No.	Weight
488-42005	ENZS-05	-	5 Grams
488-42010	ENZS-10	EN010Z	10 Grams
488-42015	ENZS-15	EN015Z	15 Grams
488-42020	ENZS-20	EN020Z	20 Grams
488-42025	ENZS-25	EN025Z	25 Grams
488-42030	ENZS-30	EN030Z	30 Grams
488-42035	ENZS-35	EN035Z	35 Grams
488-42040	ENZS-40	EN040Z	40 Grams
488-42045	ENZS-45	EN045Z	45 Grams
488-42050	ENZS-50	EN050Z	50 Grams
488-42055	ENZS-55	EN055Z	55 Grams
488-42060	ENZS-60	EN060Z	60 Grams

### Steel

Ascot No.	Plombco ENFe Series No.	Bada ENFE Series No.	Perfect ENST Series No.	Weight
488-32005	ENFe-05	-	-	5 Grams
488-32010	ENFe-10	ENFE10	EN010ST	10 Grams
488-32015	ENFe-15	ENFE15	EN015ST	15 Grams
488-32020	ENFe-20	ENFE20	EN020ST	20 Grams
488-32025	ENFe-25	ENFE25	EN025ST	25 Grams
488-32030	ENFe-30	ENFE30	EN030ST	30 Grams
488-32035	ENFe-35	ENFE35	EN035ST	35 Grams
488-32040	ENFe-40	ENFE40	EN040ST	40 Grams
488-32045	ENFe-45	ENFE45	EN045ST	45 Grams
488-32050	ENFe-50	ENFE50	EN050ST	50 Grams
488-32055	ENFe-55	ENFE55	EN055ST	55 Grams
488-32060	ENFe-60	ENFE60	EN060ST	60 Grams

### APPLICATIONS - EN/ALCEN Series

Audi-All from 1997; VW-All from 1997; Used on many aftermarket alloy wheels with thin rim flanges.

## Weights for Passenger Car Alloy Wheels

### IAW/ALCIW Type



Plombco



Perfect



Plombco



Bada



Perfect

### Zinc

Ascot No.	Plombco IAWZS Series No.	Perfect IAWZ Series No.	Weight
488-27005	IAWZS-05	IAW005Z	5 Grams
488-27010	IAWZS-10	IAW010Z	10 Grams
488-27015	IAWZS-15	IAW015Z	15 Grams
488-27020	IAWZS-20	IAW020Z	20 Grams
488-27025	IAWZS-25	IAW025Z	25 Grams
488-27030	IAWZS-30	IAW030Z	30 Grams
488-27035	IAWZS-35	IAW035Z	35 Grams
488-27040	IAWZS-40	IAW040Z	40 Grams
488-27045	IAWZS-45	IAW045Z	45 Grams
488-27050	IAWZS-50	IAW050Z	50 Grams
488-27055	IAWZS-55	IAW055Z	55 Grams
488-27060	IAWZS-60	IAW060Z	60 Grams

### Steel

Ascot No.	Plombco IAWFe Series No.	Bada IWFE Series No.	Perfect IAWST Series No.	Weight
488-26005	IAWFe-05	-	-	5 Grams
488-26010	IAWFe-10	IWFE10	IAW010ST	10 Grams
488-26015	IAWFe-15	IWFE15	IAW015ST	15 Grams
488-26020	IAWFe-20	IWFE20	IAW020ST	20 Grams
488-26025	IAWFe-25	IWFE25	IAW025ST	25 Grams
488-26030	IAWFe-30	IWFE30	IAW030ST	30 Grams
488-26035	IAWFe-35	IWFE35	IAW035ST	35 Grams
488-26040	IAWFe-40	IWFE40	IAW040ST	40 Grams
488-26045	IAWFe-45	IWFE45	IAW045ST	45 Grams
488-26050	IAWFe-50	IWFE50	IAW050ST	50 Grams
488-26055	IAWFe-55	IWFE55	IAW055ST	55 Grams
488-26060	IAWFe-60	IWFE60	IAW060ST	60 Grams

### APPLICATIONS - IAW/ALCIW Series

Audi-Up to 1996; VW-Up to 1996; BMW, Catera Geo, Hyundai, Jaguar, Kia, Mitsubishi, Subaru, Suzuki, Volvo

### T/TTC Type



### Zinc

Ascot No.	Perfect TZ Series No.	Weight
489-29025	T025Z	.25 Oz.
489-29050	T050Z	.50 Oz.
489-29075	T075Z	.75 Oz.
489-29100	T100Z	1.00 Oz.
489-29125	T125Z	1.25 Oz.
489-29150	T150Z	1.50 Oz.
489-29175	T175Z	1.75 Oz.
489-29200	T200Z	2.00 Oz.
489-29225	T225Z	2.25 Oz.
489-29250	T250Z	2.50 Oz.
489-29275	T275Z	2.75 Oz.
489-29300	T300Z	3.00 Oz.



Plombco



Bada



Perfect

### Steel

Ascot No.	Plombco TFe Series No.	Bada TFE Series No.	Perfect TST Series No.	Weight
489-19025	TFe-0.25	TFE025	T025ST	.25 Oz.
489-19050	TFe-0.50	TFE050	T050ST	.50 Oz.
489-19075	TFe-0.75	TFE075	T075ST	.75 Oz.
489-19100	TFe-1.00	TFE100	T100ST	1.00 Oz.
489-19125	TFe-1.25	TFE125	T125ST	1.25 Oz.
489-19150	TFe-1.50	TFE150	T150ST	1.50 Oz.
489-19175	TFe-1.75	TFE175	T175ST	1.75 Oz.
489-19200	TFe-2.00	TFE200	T200ST	2.00 Oz.
489-19225	TFe-2.25	TFE225	T225ST	2.25 Oz.
489-19250	TFe-2.50	TFE250	T250ST	2.50 Oz.
489-19275	TFe-2.75	TFE275	T275ST	2.75 Oz.
489-19300	TFe-3.00	TFE300	T300ST	3.00 Oz.

### APPLICATIONS - T/TTC Type

Chevrolet - Full Size Pick Up, Suburban, Yukon, Tahoe from 2000; FORD - Expedition from 1997, F-100, F-150 from 1997; Lincoln - Lincoln Navigator with alloy & steel wheels from 1998



# Zinc and Steel Wheel Weights

WHEEL BALANCING SUPPLIES

## Weights for Passenger Car Alloy Wheels

### P/T Type



Zinc



Zinc

Ascot No.	Plombco PZS Series No.	Weight
488-14005	PZS-05	5 Grams
488-14010	PZS-10	10 Grams
488-14015	PZS-15	15 Grams
488-14020	PZS-20	20 Grams
488-14025	PZS-25	25 Grams
488-14030	PZS-30	30 Grams
488-14035	PZS-35	35 Grams
488-14040	PZS-40	40 Grams
488-14045	PZS-45	45 Grams
488-14050	PZS-50	50 Grams
488-14055	PZS-55	55 Grams
488-14060	PZS-60	60 Grams

Ascot No.	Coated Perfect PZ Series No.	Ascot No.	Uncoated Perfect PZU Series No.	Weight
488-15025	P025Z	487-25025	P025ZU	.25 Oz.
488-15050	P050Z	487-25050	P050ZU	.50 Oz.
488-15075	P075Z	487-25075	P075ZU	.75 Oz.
488-15100	P100Z	487-25100	P100ZU	1.00 Oz.
488-15125	P125Z	487-25125	P125ZU	1.25 Oz.
488-15150	P150Z	487-25150	P150ZU	1.50 Oz.
488-15175	P175Z	487-25175	P175ZU	1.75 Oz.
488-15200	P200Z	487-25200	P200ZU	2.00 Oz.
488-15225	P225Z	487-25225	P225ZU	2.25 Oz.
488-15250	P250Z	487-25250	P250ZU	2.50 Oz.
488-15275	P275Z	487-25275	P275ZU	2.75 Oz.
488-15300	P300Z	487-25300	P300ZU	3.00 Oz.

### Steel

Ascot No.	Plombco PFe Series No.	Bada PFE Series No.	Perfect PST Series No.	Weight
488-13025	PFe-0.25	PFE025	P025ST	5 Grams
488-13050	PFe-0.50	PFE050	P050ST	10 Grams
488-13075	PFe-0.75	PFE075	P075ST	15 Grams
488-13100	PFe-1.00	PFE100	P100ST	20 Grams
488-13125	PFe-1.25	PFE125	P125ST	25 Grams
488-13150	PFe-1.50	PFE150	P150ST	30 Grams
488-13175	PFe-1.75	PFE175	P175ST	35 Grams
488-13200	PFe-2.00	PFE200	P200ST	40 Grams
488-13225	PFe-2.25	PFE225	P225ST	45 Grams
488-13250	PFe-2.50	PFE250	P250ST	50 Grams
488-13275	PFe-2.75	PFE275	P275ST	55 Grams
488-13300	PFe-3.00	PFE300	P300ST	60 Grams
488-13325	-	PFE325	-	-
488-13350	-	PFE350	-	-



Plombco



Bada



Perfect

**APPLICATIONS - PT Series**  
Standard passenger car with 13" to 15" steel wheels

### LH/ALCLH Type



Perfect



Bada

**APPLICATIONS - LH/ALCLH Series**  
Chrysler-Used on LH platform (Intrepid, Concorde, LHS, 300M) and all Mini Van models since 1998. Also used on 2000 Neon, 2001 PT Cruiser and 2001 Sebring & Stratus sedans and convertibles

### Zinc

Ascot No.	Perfect LHZ Series No.	Weight
488-74025	LH025Z	.25 Oz.
488-74050	LH050Z	.50 Oz.
488-74075	LH075Z	.75 Oz.
488-74100	LH100Z	1.00 Oz.
488-74125	LH125Z	1.25 Oz.
488-74150	LH150Z	1.50 Oz.
488-74175	LH175Z	1.75 Oz.
488-74200	LH200Z	2.00 Oz.
488-74225	LH225Z	2.25 Oz.
488-74250	LH250Z	2.50 Oz.
488-74275	LH275Z	2.75 Oz.
488-74300	LH300Z	3.00 Oz.

### Steel

Ascot No.	Bada LHFE Series No.	Weight
488-64025	LHFE025	.25 Oz.
488-64050	LHFE050	.50 Oz.
488-64075	LHFE075	.75 Oz.
488-64100	LHFE100	1.00 Oz.
488-64125	LHFE125	1.25 Oz.
488-64150	LHFE150	1.50 Oz.
488-64175	LHFE175	1.75 Oz.
488-64200	LHFE200	2.00 Oz.
488-64225	LHFE225	2.25 Oz.
488-64250	LHFE250	2.50 Oz.

## Adhesive Wheel Weights

### Perfect Quik-Stik™ Segmented Adhesive Style Wheel Weights

- Only pre-cut pre-taped weight
- No cutting, no pre-contouring and no waste
- Each segment is stamped with the actual weight in ounces and grams
- Available in 1/2", 3/4" low profile and 3/4" truck weight design
- Wheel weight for racing/off road performance applications

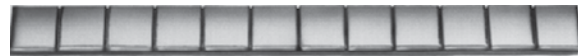
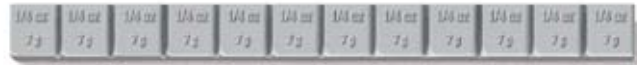

### Perfect Lead Adhesive

Ascot No.	Mfg. No.	Weight	Description
484-11360	100360	3 Oz.	Pre-Taped Weight 30 Strips of .25 Oz. Segments
484-10720	100720	3 Oz.	Pre-Taped Weight 60 Strips of .25 Oz. Segments
484-13360	200624	3 Oz.	Pre-Taped Weight 52 Strips of .25 Oz. Segments
484-00012	200624S	3 Oz.	Pre-Taped Weight 48 Strips of .25 Oz. Segments
484-20624	200624HP	3 Oz.	High Performance Pre-Taped Weight 52 Strips of .25 Oz. Segments
484-21624	200624N	3 Oz.	Low Profile Pre-Taped Weight - Coated
484-10361	100360B	3 Oz.	Pre-Taped Coated Weight-Black 30 Strips of .25 Oz. Segments
484-10362	100360S	3 Oz.	Pre-Taped Coated Weight-Silver 30 Strips of .25 Oz. Segments
484-10363	100360BL	3 Oz.	Pre-Taped Coated Weight-Blue 30 Strips of .25 Oz. Segments
484-10364	100360G	3 Oz.	Pre-Taped Coated Weight-Green 30 Strips of .25 Oz. Segments
484-10365	100360M	3 Oz.	Pre-Taped Coated Weight-Magenta 30 Strips of .25 Oz. Segments
484-10366	100360R	3 Oz.	Pre-Taped Coated Weight-Red 30 Strips of .25 Oz. Segments
484-10367	100360W	3 Oz.	Pre-Taped Coated Weight-White 30 Strips of .25 Oz. Segments
484-10368	100360C	3 Oz.	Pre-Taped Chrome Weight 30 Strips of .25 Oz. Segments
484-40300	400300	75 Gram	5/10 Gram Pre-Taped Adhesive 30 Strips of 5 Gram/10 Gram Segments
484-50300	500300	60 Gram	5/10 Gram Pre-Taped Adhesive 25 Strips of 5 Gram/10 Gram Segments
484-50301	500300C	60 Gram	5/10 Gram Pre-Taped Adhesive 25 Strips of 5 Gram/10 Gram Segments
484-30360	300360	6 Oz.	Pre-Taped Truck Weight 30 Strips of 1 Oz. Segments
484-30361	300360HP	6 Oz.	High Performance Pre-Taped Weight 30 Strips of 1 Oz. Segments



484-13360



484-21624

### Bada Tape-A-Weights for RVs & Light Trucks



484-07127

Ascot No.	Mfg. No.	Description
484-07127	7127	Break-A-Way Weights, 16 Piece, .5 Oz. Segments, 3/4" x 12", 384 Segments
484-03101	3101	Cut-A-Way Weights, 12 Piece, 1 Oz. Segments, 1" x 12", 216 Segments
484-06001	6001	16 Piece, 1 Oz. Segments, 3/4" x 12", 192 Segments



## Adhesive Wheel Weights (Cont.)

### Bada Tape-A-Weights for Passenger Cars

Ascot No.	Mfg. No.	Description
484-07025	7025	Break-A-Way Weights, 15 Pieces, .25 Oz. Segments, 1/2" x 12", 360 Segments
484-07125	7125	Break-A-Way Weights, 30 Pieces, .25 Oz. Segments, 1/2" x 12", 720 Segments
484-07026	7026	Low Profile, 48 Pieces, .25 Oz. Segments, 3/4" x 6", 576 Segments
484-07126	7126	Low Profile, 348 Pieces, .25 Oz. Segments, 3/4" x 6", 4176 Segments
484-05101	5101	Cut-A-Way, 15 Pieces, .5 Oz. Segments, 1/2" x 12", 180 Segments
484-09101	9101	Cut-A-Way, 30 Pieces, .5 Oz. Segments, 1/2" x 12", 360 Segments
484-09165	9101-65	Cut-A-Way, 174 Pieces, .5 Oz. Segments, 1/2" x 12", 2088 Segments
484-09405	9405 Chrome	Cut-A-Way, 12 Pieces, .5 Oz. Segments, 1/2" x 12", 144 Segments (For Use on Chrome Plated Wheels)
484-09901	9901	Low Profile, 24 Pieces, .5 Oz. Segments, 3/4" x 12", 288 Segments
484-09065	9901-65	Low Profile, 174 Pieces, .5 Oz. Segments, 3/4" x 12", 2088 Segments
484-09025	9902-500	High Performance Racing, 24 Pieces, .5 Oz. Segments, 3/4" x 12", 144 Segments (Used by NASCAR and suppliers of Firestone Racing CART, Indy Light and IRL)



484-07026



484-05101



484-09901

### Bada Tape-A-Weights for Motorcycles



484-01201

Ascot No.	Mfg. No.	Description
484-01201	1201	Cut-A-Way Weights, 15 Piece, .5 Oz. Segments, 3/8" x 12", 180 Segments
484-02101	2101	Cut-A-Way Weights, 30 Piece, .5 Oz. Segments, 3/8" x 12", 360 Segments

### Plombco Lead Adhesive

Ascot No.	Mfg. No.	Tape Type	Description
484-31430	314-30	Rubber Tape	30 - 6" Bars - 1/4 Oz. Segments - 1/2" Wide
484-31460	314-60	Rubber Tape	60 - 6" Bars - 1/4 Oz. Segments - 1/2" Wide
484-31230	312-30	Rubber Tape	30 - 6" Bars - 1/4 Oz. Segments - 3/4" Wide
484-31231	312-30BCW	Cold Weather	30 - 6" Bars - 1/4 Oz. Segments - 3/4" Wide, Black
484-31248	312-48	Rubber Tape	48 - 6" Bars - 1/4 Oz. - 3/4" Wide Uncoated
484-31252	312-52	Rubber Tape	52 - 6" Bars - 1/4 Oz. Segments - 3/4" Wide
484-41215	412-15	Rubber Tape	15 - 6" Bars - 1/2 Oz. Segments - 3/4" Wide
484-41230	412-30	Rubber Tape	30 - 6" Bars - 1/2 Oz. Segments - 3/4" Wide
484-51215	512-15	Rubber Tape	15 - 6" Bars - 1 Oz. Segments - 3/4" Wide
484-61215	612-15	Rubber Tape	15 - 6" Bars - 2 Oz. Segments - 1-1/4" Wide
484-61280	612-8	Rubber Tape	8 - 6" Bars - 2 Oz. Segments - 1-1/4" Wide
484-21430	214-30	Rubber Tape	Low Profile 5-10 Gram Segments, Width 3/4", Length 5"



312 - Rubber Tape



412 - Rubber Tape



314 - Rubber Tape



612 - Rubber Tape



## Adhesive Wheel Weights (Cont.)

### Plombco Lead Adhesive

Ascot No.	Mfg. No.	Tape Type	Description
484-31431	314-30R	Red Tape	30 - 6" Bars - 1/4 Oz. Segments - 1/2" Wide
484-31461	314-60R	Red Tape	60 - 6" Bars - 1/4 Oz. Segments - 1/2" Wide
484-31232	312-30R	Red Tape	30 - 6" Bars - 1/4 Oz. Segments - 3/4" Wide
484-32252	312-52R	Red Tape	52 - 6" Bars - 1/4 Oz. Segments - 3/4" Wide
484-42215	412-15R	Red Tape	15 - 6" Bars - 1/2 Oz. Segments - 3/4" Wide
484-41231	412-30R	Red Tape	30 - 6" Bars - 1/2 Oz. Segments - 3/4" Wide
484-52215	512-15R	Red Tape	15 - 6" Bars - 1 Oz. Segments - 3/4" Wide
484-62215	612-15R	Red Tape	15 - 6" Bars - 2 Oz. Segments - 1-1/4" Wide



312 - Red Tape and Cold Weather



412 - Red Tape and Cold Weather

### Plombco Lead Adhesive

Ascot No.	Mfg. No.	Tape Type	Description
484-31432	314-30CW	Cold Weather	30 - 6" Bars - 1/4 Oz. Segments - 1/2" Wide
484-31462	314-60CW	Cold Weather	60 - 6" Bars - 1/4 Oz. Segments - 1/2" Wide
484-31233	312-30CW	Cold Weather	30 - 6" Bars - 1/4 Oz. Segments - 3/4" Wide
484-33252	312-52CW	Cold Weather	52 - 6" Bars - 1/4 Oz. Segments - 3/4" Wide
484-43215	412-15CW	Cold Weather	15 - 6" Bars - 1/2 Oz. Segments - 3/4" Wide
484-41232	412-30CW	Cold Weather	30 - 6" Bars - 1/2 Oz. Segments - 3/4" Wide
484-53215	512-15CW	Cold Weather	15 - 6" Bars - 1 Oz. Segments - 3/4" Wide
484-63215	612-15CW	Cold Weather	15 - 6" Bars - 2 Oz. Segments - 1-1/4" Wide
484-61281	612-8CW	Cold Weather	8 - 6" Bars - 2 Oz. Segments - 1-1/4" Wide



314 - Red Tape and Cold Weather



612 - Red Tape and Cold Weather

### Perfect Steel Adhesive Wheel Weights

Ascot No.	Mfg. No.	Tape Type	Description
484-00300	SST300N	3 Oz. Segments	Pre-Taped Steel Weight (Ounce Segments)
484-00060	SSG060N	60 Gram Segments	Pre-Taped Steel Weight (Gram Segments)
484-00288	SST288PC	3 Oz. Segments	Pre-Taped Steel Weight (Ounce Segments)
484-20624	200624ST	3 Oz. Segments	Pre-Taped Steel Weight (Ounce Segments)
484-30360	300360ST	6 Oz. Segments	Pre-Taped Steel Weight (Ounce Segments)



484-00300

### Perfect Steel Rolls

Ascot No.	Mfg. No.	Size	Description
484-03200	SST32000N	1/4 Oz. Segments	Pre-Taped Steel Weight Roll (Ounce Segments)
484-07500	SSG7500N	5 Gram Segments	Pre-Taped Steel Weight Roll (Gram Segments)





## Adhesive Wheel Weights (Cont.)

### Bada Steel Coated Tape-A-Weights Segments

Ascot No.	Mfg. No.	Weight
484-00005	SEGFE05	5 Grams
484-00010	SEGFE10	10 Grams
484-00015	SEGFE15	15 Grams
484-00020	SEGFE20	20 Grams
484-00025	SEGFE25	25 Grams
484-00030	SEGFE30	30 Grams
484-00035	SEGFE35	35 Grams
484-00040	SEGFE40	40 Grams
484-00045	SEGFE45	45 Grams
484-00050	SEGFE50	50 Grams

### Bada Steel Coated Tape-A-Weights Strips



Ascot No.	Mfg. No.	Description
484-70261	7026FE	Low Profile Strips: .25 Oz. Segments, 3.4" x 5", 200 Segments

### Bada Steel Coated Tape-A-Weights 5KG Roll

Ascot No.	Mfg. No.	Description
484-70262	7026FER	Roll Only
484-70263	7026FERB	Roll & Bracket
484-70264	7026FEB	Bracket Only

### Plombco Steel Adhesive Wheel Weights



484-41226

Ascot No.	Mfg. No.	Tape Type	Description
484-31230	312Fe-30	Rubber Base Tape	30 * 6" Bars Precut in .25 Oz. Segments of .75" Wide
484-35252	312Fe-52	Rubber Base Tape	52 * 6" Bars Precut in .25 Oz. Segments of .75" Wide
484-31210	312Fe-10	Rubber Base Tape	10 Lb. Roll of Adhesive (624 Segments)
484-31220	312Fe-20	Rubber Base Tape	20 Lb. Roll of Adhesive (1200 Segments)
484-32230	312Fe-30CW	Cold Weather	30 * 6" Bars Precut in .25 Oz. Segments of .75" Wide
484-32252	312Fe-52CW	Cold Weather	52 * 6" Bars Precut in .25 Oz. Segments of .75" Wide
484-33230	312Fe-30R	3M Tape	30 * 6" Bars Precut in .25 Oz. Segments of .75" Wide
484-33252	312Fe-52R	3M Tape	52 * 6" Bars Precut in .25 Oz. Segments of .75" Wide
484-34230	312Fe-30OE	OE Adhesive	30 * 6" Bars Precut in .25 Oz. Segments of .75" Wide
484-34252	312Fe-52OE	OE Adhesive	52 * 6" Bars Precut in .25 Oz. Segments of .75" Wide
484-30836	308Fe-36	Rubber Base Tape	2 Oz. strips (1/4 Oz.) - 36 Strips/Box
484-41226	412Fe	OE Adhesive	6", Bars Precut in .5 Oz. Segments of .75" Wide

### Plombco Steel Rolls

Ascot No.	Mfg. No.	Tape Type	Description
484-35210	312Fe-10R	3M Tape	10 Lb. Roll of Adhesive (624 Segments)
484-35220	312Fe-20R	3M Tape	20 Lb. Roll of Adhesive (1200 Segments)
484-35310	310Fe	Rubber Base Tape	10 Lb. Roll - 636 Segments (1/4 Oz.)
484-35320	320Fe	Rubber Base Tape	20 Lb. Roll - 1272 Segments (1/4 Oz.)
484-32210	312Fe-10CW	Cold Weather	10 Lb. Roll of Adhesive (624 Segments)
484-32220	312Fe-20CW	Cold Weather	20 Lb. Roll of Adhesive (1200 Segments)
484-34210	312Fe-10OE	OE Adhesive	10 Lb. Roll of Adhesive (624 Segments)
484-34220	312Fe-20OE	OE Adhesive	20 Lb. Roll of Adhesive (1200 Segments)



484-35210

## Truck Wheel Weights

### "LT1" Series - Wheel Weights

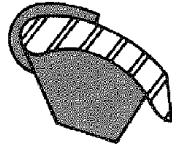

- For light trucks, 3/4 & 1 ton vehicles with either tube or tubeless rims where such rims are too thick for "P" series weights
- For use on heavier trucks with thin rim flanges
- Use "P" series weights on 1/2 ton vehicles
- Use rim gauge RG2 to verify correct application
- 25 pieces per box

Ascot No.	Mfg. No.	Weight
489-05005	LT1 50	0.5 Oz.
489-05010	LT1 100	1.0 Oz.
489-05015	LT1 150	1.5 Oz.
489-05020	LT1 200	2.0 Oz.
489-05025	LT1 250	2.5 Oz.
489-05030	LT1 300	3.0 Oz.

Ascot No.	Mfg. No.	Weight
489-05035	LT1 350	3.5 Oz.
489-05040	LT1 400	4.0 Oz.
489-05045	LT1 450	4.5 Oz.
489-05050	LT1 500	5.0 Oz.
489-05060	LT1 600	6.0 Oz.

NOTE: LT1 = BTS

### "LT2" Series - Wheel Weights

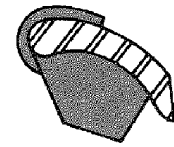

- Used on Budd duo 16 x 5.50 split side ring (use LT1 series on rim base)
- Used on light duty trucks and RVs with rims too thick for LT1 series
- Use rim gauge RG2 to verify correct application
- 25 pieces per box

Ascot No.	Mfg. No.	Weight
489-06010	LT2 100	1.0 Oz.
489-06020	LT2 200	2.0 Oz.
489-06030	LT2 300	3.0 Oz.

Ascot No.	Mfg. No.	Weight
489-06040	LT2 400	4.0 Oz.
489-06050	LT2 500	5.0 Oz.
489-06060	LT2 600	6.0 Oz.

NOTE: LT2 = BTST

### "R" Series - Wheel Weights

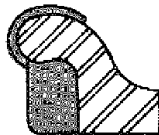

- Used on heavy duty trucks with Firestone or Accu ride, Radial Commander rims
- Can be used with new strip steel rims with curved edges
- Use rim gauge RG2 to verify correct application
- 25 pieces per box except 10 and 12 Oz. are 20 per box

Ascot No.	Mfg. No.	Weight
489-09020	RC 020	2.0 Oz.
489-09030	RC 030	3.0 Oz.
489-09040	RC 040	4.0 Oz.
489-09060	RC 060	6.0 Oz.

Ascot No.	Mfg. No.	Weight
489-09080	RC 080	8.0 Oz.
489-09100	RC 100	10.0 Oz.
489-09120	RC 120	12.0 Oz.

NOTE: RC = BTRC

### "CT" Series - Wheel Weights

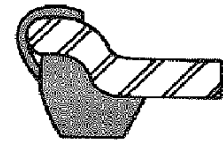

- Used on heavy duty trucks with Firestone or Accuride, Budd or Goodyear tubeless rims (except steel rims with curved edges)
- Primarily used on rim widths of 6.75", 7.50" and 8.25"
- 25 per box

Ascot No.	Mfg. No.	Weight
489-02020	CT 200	2.0 Oz.
489-02030	CT 300	3.0 Oz.
489-02040	CT 400	4.0 Oz.
489-02060	CT 600	6.0 Oz.
489-02080	CT 800	8.0 Oz.

Ascot No.	Mfg. No.	Weight
489-02100	CT 1000	10.0 Oz.
489-02120	CT 1200	12.0 Oz.
489-02140	CT 1400	14.0 Oz.
489-02160	CT 1600	16.0 Oz.

NOTE: CT = BTLT

## Truck Wheel Weights (Cont.)

### "19" Series - Wheel Weights

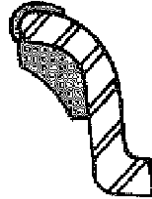

- Thin style weight used on heavy duty trucks where there may be interference with steering parts
- For use on rims too thick for "17" series weights
- Basic rim sizes 7.50 and 8
- Use rim gauge RG2 to verify correct application
- 25 per box except 10 Oz. and 12 Oz.; 20 per box

Ascot No.	Mfg. No.	Weight
489-04020	19-020	2.0 Oz.
489-04030	19-030	3.0 Oz.
489-04040	19-040	4.0 Oz.
489-04060	19-060	6.0 Oz.
489-04080	19-080	8.0 Oz.
489-04100	19-100	10.0 Oz.
489-04120	19-120	12.0 Oz.

### "17" Series - Wheel Weights

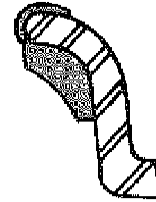

- Most popular weight for the medium duty truck
- Used on most trucks with tube type tires
- 25 per box except 10 & 12 Oz.; 20/box & 14 & 16 Oz.; 10/box

Ascot No.	Mfg. No.	Weight	Ascot No.	Mfg. No.	Weight
489-55010	17100	1.0 Oz.	489-55080	17800	8.0 Oz.
489-55020	17200	2.0 Oz.	489-55100	171000	10.0 Oz.
489-55030	17300	3.0 Oz.	489-55120	171200	12.0 Oz.
489-55040	17400	4.0 Oz.	489-55140	171400	14.0 Oz.
489-55050	17500	5.0 Oz.	489-55160	171600	16.0 Oz.
489-55060	17600	6.0 Oz.			

NOTE: 17 = BTLM + E

### "TS" Series - Wheel Weights for Light Truck Alloy Wheels



- All 1997 and newer Ford trucks with alloy and steel wheels use the "TS" series wheel weight
- For use on many domestic trucks with decorative steel wheels, Ford truck new alloy wheels
- Weights fit new domestic full size trucks equipped with wheels using thicker flanges and chrome or powder coatings
- Weights larger and use different clip configurations
- 25 per box

Ascot No.	Mfg. No.	Weight	Ascot No.	Mfg. No.	Weight
489-08025	TS 25	0.25 Oz.	489-08275	TS 275	2.75 Oz.
489-08050	TS 50	0.50 Oz.	489-08300	TS 300	3.0 Oz.
489-08075	TS 75	0.75 Oz.	489-08325	TS 325	3.25 Oz.
489-08100	TS 100	1.00 Oz.	489-08350	TS 350	3.50 Oz.
489-08125	TS 125	1.25 Oz.	489-08375	TS 375	3.75 Oz.
489-08150	TS 150	1.50 Oz.	489-08400	TS 400	4.0 Oz.
489-08175	TS 175	1.75 Oz.	489-08425	TS 425	4.25 Oz.
489-08200	TS 200	2.0 Oz.	489-08450	TS 450	4.50 Oz.
489-08225	TS 225	2.25 Oz.	489-08475	TS 475	4.75 Oz.
489-08250	TS 250	2.50 Oz.	489-08500	TS 500	5.0 Oz.

#### APPLICATIONS - TS Series

Chevrolet - Full Size Pick Up, Suburban, Yukon, Tahoe from 2000; Ford - Expedition from 1997, F-100, F-150 from 1997; Lincoln - Lincoln Navigator with alloy & steel wheels from 1998

NOTE: TS=TN=TTC

## Truck Wheel Weights (Cont.)

### "TAL" Series - Wheel Protectors® Weights

- Special weight for all Alcoa and Accuride (from 1983) aluminum tubeless heavy truck wheels; fits both sides of the wheel
- Replace the "OS-TAL" and "DS-TAL" series
- Use rim gauge RG2 to verify correct application (either OS-TAL or DS-TAL slot)
- "TALU" an economical alternative to OEM quality coated weights
- Recommend coated weights on all vehicles having alloy wheels
- 25 pieces per box



Ascot No.	Mfg. No.	Weight	Ascot No.	Mfg. No.	Weight
489-10020	TAL-S200	2.0 Oz.	489-10060	TAL-S600	6.0 Oz.
489-10030	TAL-S300	3.0 Oz.	489-10080	TAL-S800	8.0 Oz.
489-10040	TAL-S400	4.0 Oz.			

NOTE: Uncoated Available; TAL = BTCAL

## Zinc Truck Wheel Weights

### LT1 Type



Plombco



Perfect

Ascot No.	Plombco LT1Z Series No.	Perfect LT1Z Series No.	Weight
489-21050	LT1Z-0.50	LT1Z-005	.5 Oz.
489-21100	LT1Z-1.00	LT1Z-010	1.0 Oz.
489-21150	LT1Z-1.50	LT1Z-015	1.5 Oz.
489-21200	LT1Z-2.00	LT1Z-020	2.0 Oz.
489-21250	LT1Z-2.50	LT1Z-025	2.5 Oz.
489-21300	LT1Z-3.00	LT1Z-030	3.0 Oz.
489-21350	LT1Z-3.50	LT1Z-035	3.5 Oz.
489-21400	LT1Z-4.00	LT1Z-040	4.0 Oz.
489-21450	-	LT1Z-045	4.5 Oz.
489-21500	-	LT1Z-050	5.0 Oz.

NOTE: LT1 = BTS

### CT Type



Ascot No.	Plombco CTZ Series No.	Weight
488-24200	CTZ-2.00	2.0 Oz.
488-24300	CTZ-3.00	3.0 Oz.
488-24400	CTZ-4.00	4.0 Oz.
488-24500	CTZ-5.00	5.0 Oz.
488-24600	CTZ-6.00	6.0 Oz.

NOTE: CT = BTLT

### TAL Type



Plombco



Perfect

Ascot No.	Plombco TALZ-S Series No.	Perfect TALZ Series No.	Weight
489-23100	-	TALZ-010	1.0 Oz.
489-23200	TALZS-2.00	TALZ-020	2.0 Oz.
489-23300	TALZS-3.00	TALZ-030	3.0 Oz.
489-23400	TALZS-4.00	TALZ-040	4.0 Oz.
489-23500	TALZS-5.00	TALZ-050	5.0 Oz.
489-23600	TALZS-6.00	TALZ-060	6.0 Oz.

### I7 Type



Plombco



Perfect

Ascot No.	Plombco I-7Z Series No.	Perfect I7Z Series No.	Weight
489-22100	-	I7Z-010	1.0 Oz.
489-22150	-	I7Z-015	1.5 Oz.
489-22200	I7Z-2.00	I7Z-020	2.0 Oz.
489-22250	-	I7Z-025	2.5 Oz.
489-22300	I7Z-3.00	I7Z-030	3.0 Oz.
489-22350	-	I7Z-035	3.5 Oz.
489-22400	I7Z-4.00	I7Z-040	4.0 Oz.
489-22500	I7Z-5.00	I7Z-050	5.0 Oz.
489-22600	I7Z-6.00	-	6.0 Oz.

NOTE: I7 = BTLM + E



## Wheel Weight Assortments

### Professional Wheel Weight Kit

- Ultimate kit for the professional tire dealer
- Contains a wide assortment of seven styles of polyester-coated wheel weights plus regular weights for steel wheels
- System includes 74 pre-labeled, color-coded bins, wheel weights, coated wheel weight installation/removal tool, application chart and application gauge
- 2,100 wheel weights
- Free standing floor display
- Empty display is also available

Ascot No.	Mfg. No.	Description
486-02000	2000	Professional Wheel Weight Kit

#### Kit Includes

P 025 To P 250	250 Pieces	AWS 025 To AWS 250	250 Pieces
IAWS 10 To IAWS 55	200 Pieces	MCS 025 To MCS 250	250 Pieces
FNS 10 To FNS 55	200 Pieces	ENS 10 To ENS 55	200 Pieces
TS 025 To TS 250	250 Pieces	LHS 025 To LHS 250	250 Pieces



### Basic Wheel Weight Kit

- Basic kit for the professional tire dealer
- Contains an assortment of seven styles of polyester-coated wheel weights plus regular wheel weights for steel wheels
- System includes 40 pre-labeled color-coded bins, coated wheel weights, coated wheel weight installation/removal tool, application chart and application gauge
- 1,120 wheel weights, 1 box of adhesive weights
- Empty display is also available

Ascot No.	Mfg. No.	Description
486-01000	1000	Basic Wheel Weight Kit

#### Kit Includes

P 025 To P 200	130 Pieces	AWS 025 To AWS 200	150 Pieces
IAWS 5 To IAWS 55	130 Pieces	MCS 025 To MCS 200	150 Pieces
FNS 10 To FNS 55	130 Pieces	ENS 10 To ENS 55	130 Pieces
TS 25 To TS 200	150 Pieces	LHS 025 To LHS 200	150 Pieces



### Wheel Weight Assortments

- All metal floor rack includes dividers for increased flexibility while accommodating a minimum of 64 weight locations
- Metal design simplifies rack assembly
- Header card displays product description and application information for quick reference
- Color coded channel cards for easy inventory and selecting the correct weights
- Each rack contains printed channel cards for common weight styles
- Additional cards provided for flexibility in displaying other weights
- Empty display is also available

Ascot No.	Mfg. No.	Description
486-21280	5201205	Metal Weight Storage Rack Only. Includes Header Card, Channel Cards, Planogram And Rim Gauges
486-21285	201275	All Vehicle Assortment. Includes Metal Wheel Weight Storage Rack, Header Card, Channel Cards, Planogram, Rim Gauges, Wall Chart, Tape-A-Weight Scraper And Premium Wheel Weights. Weight Assortment Consists Of 25 Pieces Each Of The AWN, MCN, TN In .25-2.00 Ounce Sizes, 25 Pieces Of The IAW, FN, EN In the 10-55 Gram Sizes And 50 Pieces Of The Pin .25-2.00 Ounce Sizes



## Wheel Weight Assortments (Cont.)

### Specialty and Introductory Wheel Weight Kits

- Seven kits primarily for the dealer that specializes in one type of vehicle or an introductory kit for alloy wheels
- Contains an assortment of ten wheel weights of ten sizes for each series coated wheel weight series
- Each kit includes a divided plastic organizer, 100 wheel weights, condensed application chart and application gauge
- P-Kit NTS 050 to 275 Pieces
- Empty display is also available

Ascot No.	Mfg. No.	Contents	Qty.
486-17110	P-Kit AWS	0.25 To 2.50 Oz.	100 Pieces
486-19110	P-Kit MCS	0.25 To 2.50 Oz.	100 Pieces
486-20110	P-Kit IAWS	5 To 50 Grams	100 Pieces
486-23110	P-Kit FNS	5 To 50 Grams	100 Pieces
486-22110	P-Kit ENS	5 To 50 Grams	100 Pieces
486-08110	P-Kit TS	0.50 To 2.75 Oz.	100 Pieces
486-09110	P-Kit LHS	0.25 To 2.50 Oz.	100 Pieces

### Professional Truck Wheel Weight Management System

- Professional assortment of truck wheel weights
- Contains an array of wheel weights to fit all trucks
- Pre-labeled bins supported on a bench mount display
- Includes 24 pre-labeled bins, 420 truck wheel weights and a heavy duty installation/removal tool
- Empty display is also available



Ascot No.	Mfg. No.	Contents
486-00360	420	Truck Wheel Weight Assortment

#### Kit Includes

Wheel Weight	Qty.	Description
LT1 050 To LT1 400	200 Pcs.	3/4 & 1 Ton Tube Or Tubeless Rims
LT2 100 To LT2 40	100 Pcs.	Budd Duo 16 x 15.50 Split Ring, Light Trucks And Some RV & Radial Commander Wheels
CT 200 To CT 800	40 Pcs.	Heavy Duty Trucks With Firestone, Budd, Accuride Or Goodyear Tubeless Wheels With Straight Rim Flanges
I7 200 To I-7 800	40 Pcs.	Medium And Heavy Duty Trucks With Tube Type Tires
TAL-S 200 To TAL-S 800	40 Pcs.	Polyester Coated For Alcoa Or Accuride Tubeless Alloy Wheels

NOTE: Ask us about Application Guides for Truck Wheel Weights.

### Lead Free Professional Wheel Weight Kit

- Lead free kit
- Ultimate kit for the professional tire dealer
- Contains a wide assortment of seven styles of polyester-coated wheel weights plus regular weights for steel wheels
- System includes 74 pre-labeled, color-coded bins, wheel weights, coated wheel weight installation/removal tool, application chart and application gauge
- 2,100 wheel weights
- Free standing floor display



Ascot No.	Mfg. No.	Description
486-02001	2000LF	Lead Free Professional Wheel Weight Kit

#### Kit Includes

PFe	250 Pieces	AWFe	250 Pieces
IAWFe	200 Pieces	MCFe	250 Pieces
FNFe	200 Pieces	ENFe	200 Pieces
TSFe	250 Pieces	LHFe	250 Pieces

### Perfect Alternative Lead Assortment



Ascot No.	Mfg. No.	Contents
484-00075	CWW075NL	Non-Lead Master Assortment - Contains 2625 Total Pcs. in Both Steel and Zinc
484-01500	CWW150NL	Non-Lead Master Assortment - Contains 836 Total Pcs. in Both Steel and Zinc
484-00250	CWW250NL	Non-Lead Master Assortment - Contains 1600 Total Pcs. in Both Steel and Zinc
484-00275	CWW275NL	Non-Lead Master Assortment - Contains 2325 Total Pcs. in Both Steel and Zinc
484-00175	CWW075Z	Zinc Master Assortment - Contains 2625 Total Pcs.
484-00150	CWW150Z	Zinc Table Top Assortment - Contains 732 Total Pcs.
484-01250	CWW250Z	Zinc Master Assortment - Contains 1600 Total Pcs.



## Wheel Weight Tools

### Heavy Duty Wheel Weight Hammer

- Heavy duty construction
- Replaceable plastic head available
- Designed for use on coated wheel weights
- Will not mar alloy wheels



Ascot No.	Mfg. No.	Description
486-33580	113175	Heavy Duty Wheel Weight Hammer
486-33584	113176	Replaceable Head

### Specialty Wheel Weight Hammers



486-07500      486-07129

Ascot No.	Mfg. No.	Description
486-07500	51470	Coated Wheel Weight Tool
486-07129	51400	Truck Wheel Weight Hammer

### Coated Wheel Weight Tool

- Protects valuable wheels from damage
- Features replaceable plastic head



Ascot No.	Mfg. No.	Description
486-00233	P3-B	Coated Wheel Weight Tool
486-00133	P3-H	Replaceable Head For P3-B Tool

### Adhesive Wheel Weight Remover



- One piece composite construction can be hit with a hammer
- Removes emblems, body side moldings and stick-on wheel weights
- Scrape off stickers without scratching paint or glass and gaskets from aluminum parts
- Resharpen with a file when needed

Ascot No.	Mfg. No.
486-71510	71510

### Passenger Car Wheel Weight Tool

- The industry standard for passenger car wheel weight tools



Ascot No.	Mfg. No.
486-00011	P1

### Rim Gauges

- Convenient and economical gauges that guide you to the correct wheel weight application
- Helpful with alloy wheels and thinner high strength steel wheels that have numerous new rim configurations

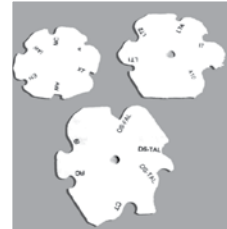

Ascot No.	Mfg. No.	Description
486-75003	RG1	Complete Set Of 3 Rim Gauges For Cars And Trucks
486-75002	RG2	Set Of 2 Rim Gauges For Trucks
486-75001	RGP1	Rim Gauge For Passenger Car Wheels

### Wheel Cleaner

- Water-Based
- Biodegradable
- Non-Petroleum
- Non-Toxic



Ascot No.	Mfg. No.	Description
486-75032	WC-32	Wheel Cleaner – 32 Oz. Spray Bottle
486-75017	WC-1G	Wheel Cleaner – 1 Gallon Bottle

**See Pages 221-233 for a Complete Line of Coated and Uncoated Wheel Weights for Passenger Cars and Light Trucks**

## Tire Balancing Compounds

### EQUAL Tire Performance

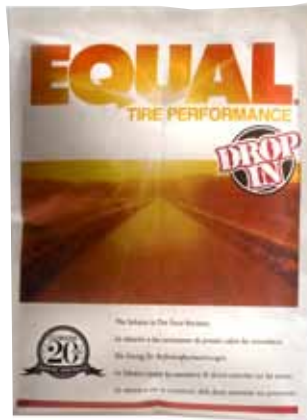

- Provides you with an accurate, continuous, maintenance free solution to tire force variation and imbalance within the complete tire and wheel assembly
- Installed by placing a self-opening bag containing a specified amount of the product tailored to the tire size - inside the tire at the time of the tire mounting. It can also be installed through the valve stem using a special installation tool after initial tire mounting

Includes filtered valve cores and EQUAL I.D. sleeves

Ascot No.	Mfg. No.	Description
451-00040	EQCS40AD	EQUAL Drop-In Bags (40) A Pkgs. (12 Oz.), (40) AirX Cores
451-00041	EQCS40BD	EQUAL Drop-In Bags (40) B Pkgs. (10 Oz.), (40) AirX Cores
451-00042	EQCS40CD	EQUAL Drop-In Bags (40) C Pkgs. (8 Oz.), (40) AirX Cores
451-00043	EQCS40DD	EQUAL Drop-In Bags (40) D Pkgs. (6 Oz.), (40) AirX Cores
451-00044	EQCS40ED	EQUAL Drop-In Bags (40) E Pkgs. (4 Oz.), (40) AirX Cores
451-00045	EQCS40FD	EQUAL Drop-In Bags (40) F Pkgs. (3 Oz.), (40) AirX Cores

### XACTBalance 180s

- Each strip covers half the wheel (two strips per wheel)
- Vibration reduction = as much as 2X (or more) better than balance rings on all wheels
- World-standard adhesive used to secure exterior vehicle components
- Extruded aluminium containing free-moving steel particles, sealed with hydraulically-pressed plugs and metal-bonding epoxy
- Available with a maintenance free anodized brite-dipped OR a mill finish that can be polished to a mirror shine



Ascot No.	Mfg. No.	Description
484-18022	XBAL180-22.5A	2 Aluminum 180's for 22.5 Wheels - Anodized
484-18024	XBAL180-24.5A	2 Aluminum 180's for 24.5 Wheels - Anodized

### XACTBalance



Low Profile

Standard Profile



XACTBalance is the first and only weight that is truly dynamic. XACTBalance wheel weights rely on dynamic steel media moving inside a thermoplastic cartridge, targeting the exact location of the imbalance and correcting it. This patented dynamic balancing method can reduce vibrations 40-60 percent beyond standard wheel weights. The result is a more precise and long-lasting balance, adding value for you and your customers.

- Better balance = fewer comebacks
- Contains NO lead
- Proven performance for hard-to-balance wheel assemblies
- Does not mar or damage wheel surface
- Available in standard and low profile

Ascot No.	Mfg. No.	Description
451-07001	XB-Starter	Start-Up Kit
451-07003	XB-Cleaner	32 Oz. Adhesive Wheel Cleaner



# Tire Balancing Compounds

## EQUAL Quantity Chart

Tire Size		Wheel Position	
		Single	Dual
7.50	R18	E-4 oz.	E-4 oz.
8.00	R19.5	D-6 oz.	C-8 oz.
9.00	R19.5	D-6 oz.	C-8 oz.
18.00	R19.5	B+C=18 oz.	
225/70	R19.5	D-6 oz.	C-8 oz.
245/70	R19.5	D-6 oz.	C-8 oz.
265/70	R19.5	D-6 oz.	C-8 oz.
275/70	R19.5	C-8 oz.	B-10 oz.
285/70	R19.5	C-8 oz.	B-10 oz.
295/70	R19.5	C-8 oz.	B-10 oz.
305/70	R19.5	B-10 oz.	A-12 oz.
280/75	R19.5	C-8 oz.	
445/65	R19.5	B+C=18 oz.	
525/65	R20.5	B+B+C=26 oz.	
615/65	R20.5	A+A+B=34 oz.	
7.50	R20	C-8 oz.	C-8 oz.
8.25	R20	C-8 oz.	C-8 oz.
9.00	R20	B-10 oz.	B-10 oz.
10.00	R20	B-10 oz.	B-10 oz.
11.00	R20	A-12 oz.	A-12 oz.
12.00	R20	A-12 oz.	A-12 oz.
12.50	R20	A-12 oz.	A-12 oz.
13/80	R20	A-12 oz.	B+E=14 oz.
14/80	R20	B+E=14 oz.	C+C=16 oz.
14.00	R20	C+C=16 oz.	
16.00	R20	B+B=20 oz.	
10.00	R22	B-10 oz.	B-10 oz.
11.00	R22	A-12 oz.	A-12 oz.
9.00	R22.5	C-8 oz.	B-10 oz.
10.00	R22.5	B-10 oz.	A-12 oz.
11.00	R22.5	B-10 oz.	A-12 oz.
12.00	R22.5	A-12 oz.	A-12 oz.
275/50	R22.5	B-10 oz.	A-12 oz.
235/70	R22.5	D-6 oz.	C-8 oz.
255/70	R22.5	C-8 oz.	B-10 oz.
11/70	R22.5	B-10 oz.	A-12 oz.
265/70	R22.5	C-8 oz.	B-10 oz.
295/60	R22.5	B-10 oz.	A-12 oz.
275/70	R22.5	B-10 oz.	A-12 oz.
305/70	R22.5	B-10 oz.	A-12 oz.

Tire Size		Wheel Position	
		Single	Dual
245/75	R22.5	C-8 oz.	B-10 oz.
265/75	R22.5	C-8 oz.	B-10 oz.
285/75	R22.5	B-10 oz.	A-12 oz.
295/75	R22.5	B-10 oz.	B-10 oz.
315/75	R22.5	A-12 oz.	A-12 oz.
345/75	R22.5	A-12 oz.	
350/75	R22.5	B+E=14 oz.	
235/80	R22.5	D-6 oz.	C-8 oz.
255/80	R22.5	C-8 oz.	B-10 oz.
275/80	R22.5	B-10 oz.	B-10 oz.
295/80	R22.5	A-12 oz.	A-12 oz.
305/85	R22.5	A-12 oz.	B+E=14 oz.
315/80	R22.5	A-12 oz.	A-12 oz.
365/80	R22.5	B+E=14 oz.	
445/50	R22.5	C+C=16 oz.	
455/50	R22.5	C+C=16 oz.	
385/65	R22.5	A-12 oz. hwy	C+C=16 oz. flotation
425/65	R22.5	B+C=18 oz.	
435/45	R22.5	B+E=14 oz.	
445/55	R22.5	C+C=16 oz.	
445/65	R22.5	B+C=18 oz.	
495/45	R22.5	B+C=18 oz.	
15.00	R22.5	A-12 oz. hwy	C+C=16 oz. flotation
16.50	R22.5	B+C=18 oz.	
18.00	R22.5	B+C=18 oz.	
11.00	R24	A-12 oz.	B+E=14 oz.
12.00	R24	B+E=14 oz.	
14.00	R24	B+C=18 oz.	
285/75	R24.5	B-10 oz.	A-12 oz.
305/75	R24.5	A-12 oz.	B+E=14 oz.
315/75	R24.5	A-12 oz.	B-10 oz.
275/80	R24.5	B-10 oz.	A-12 oz.
295/80	R24.5	B-10 oz.	A-12 oz.
11.00	R24.5	B-10 oz.	A-12 oz.
12.00	R24.5	A-12 oz.	B+E=14 oz.

For EQUAL quantities for tire sizes not listed, please contact your local Ascot Distributor.

WHEEL BALANCING SUPPLIES

## Tire Balancing Compounds (Cont.)

### Counteract Balancing Beads



- Perfect balance - perfect wear
- Clean, trouble free balancing micro-beads provide continuous self-adjusting balance
- No clumping
- Just open the outside package and throw the inside bag into the tire
- Method allows the use of an air blaster to seat the tire on the rim without contaminating the seating area
- Air blaster pressure inside the tire will collapse the bag containing Counteract Balancing Beads or the package will break open and release its contents soon after driving
- Available in application sizes from passenger vehicles to heavy trucks
- All packaging is color coded to tire size on application chart

Ascot No.	Qty./Case	Description
451-00201	160	Throw-In Bag, 1 Oz.
451-00202	128	Throw-In Bag, 2 Oz.
451-00203	96	Throw-In Bag, 3 Oz.
451-00204	92	Throw-In Bag, 4 Oz.
451-00205	76	Throw-In Bag, 5 Oz.
451-00206	64	Throw-In Bag, 6 Oz.
451-00208	52	Throw-In Bag, 8 Oz.
451-00210	40	Throw-In Bag, 10 Oz.
451-00212	36	Throw-In Bag, 12 Oz.
451-00214	32	Throw-In Bag, 14 Oz.
451-00216	28	Throw-In Bag, 16 Oz.

### Advanced Technology Tire Balancing

# MAGNUM

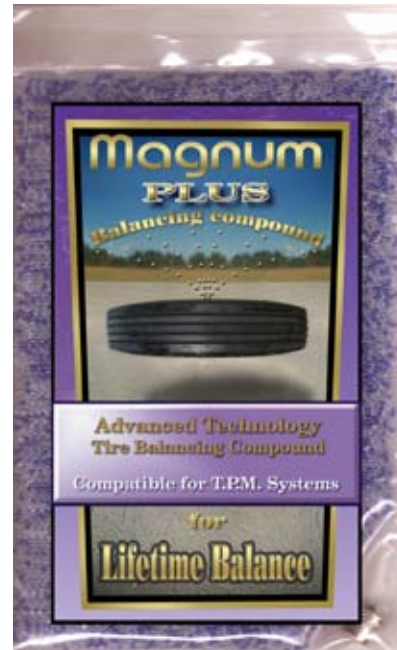

- An advanced technology dry tire balancing compound, with superior tire balancing properties
- Formulated from specially-processed multiple-density materials
- Magnum Plus provides continuous and lasting tire balancing for standard, low-profile and wide-base medium truck tires and heavy duty light truck tires
- No more time-consuming and expensive mechanical balancing, perfect self-adjusting balance in all your tires, less vehicle wear and tear, easier maintenance and less driver fatigue

Ascot No.	Mfg. No.	Qty./Case	Sample Tire Size
451-00150	LT150	36	LT215/75/R15
451-00200	LT200	24	LT235/85R16
451-00250	LT250	24	33x12.50R15
451-00300	MT300	18	245/75R22.5
451-00400	MT400	12	11R22.5/11R24.5
451-00500	MT500	12	12R24.5
451-06000	DP6000	6	365/80R22.5
451-07000	DP7000	6	425/65R22.5
451-09000	DP9000	6	445/65R22.5





# ALIGNMENT

ALIGNMENT SYSTEMS  
ALIGNMENT TOOLS & EQUIPMENT  
SHIMS & BUSHINGS FOR CARS & TRUCKS



## EZ-Shims & EZ-CAM™ XR Camber Kits

### Full Contact Dual Angle EZ Shims™

- Full contact/dual angle
- Corrects toe and camber with one shim
- Total of three shims cover most shimable FWD vehicles
- Estimated installation time - .5/hr. side

Ascot No.	Mfg. No.	Description
221-75200	75200	Blue
221-75400	75400	Grey
221-75800	75800	Red



#### APPLICATIONS - BLUE 221-75200

Audi, Chevrolet/Geo, Chrysler, Dodge, Eagle, Isuzu, Plymouth, Volkswagen

#### APPLICATIONS - GREY 221-75400

Acura, Audi, Buick, Chevrolet, Chrysler, Dodge, Ford, Honda, Mercury, Nissan, Oldsmobile, Plymouth, Pontiac

#### APPLICATIONS - RED 221-75800

Buick, Cadillac, Chevrolet, Geo, Lexus SP, Oldsmobile, Pontiac, Toyota

### EZ-CAM™ XR - Camber Kits for Domestic/Import Two Bolt Struts (Pair)

- Designed for non-slotted struts
- Allows both positive and negative camber changes up to approximately 1.75° (depending on vehicle) by replacing the upper O.E. strut/spindle bolt
- Easy to use adjuster provides built-in adjustment over the life of a vehicle just by rotating the head of the bolt
- Each kit contains two cam bolt assemblies, enough for both sides of the vehicle
- Estimated installation time - .4 hr/side



#### APPLICATIONS - 223-03545 for 17mm Bolts

Geo, Lexus, Toyota

#### APPLICATIONS - 223-81280 for 16mm Bolts

Buick, Cadillac, Chevrolet, Chrysler, Dodge, Eagle, Ford, Lincoln, Mercury, Oldsmobile, Pontiac: This kit may also be used on GM vehicles equipped with aftermarket slotted struts with the addition of our new adapter plate, #81286

#### APPLICATIONS - 223-81270 for 15mm Bolts

Geo, Lexus, Toyota

#### APPLICATIONS - 223-81260 for 14mm Bolts

Chevrolet, Chrysler, Daewoo, Dodge, Hyundai, Infiniti, Mitsubishi, Nissan, Plymouth, Saturn, Subaru, Toyota, Volvo

#### APPLICATIONS - 223-81250 for 12mm Bolts

Chevrolet, Cadillac, Daihatsu, Daewoo, Dodge, Eagle, Ford, Geo, Hyundai, Infiniti, Isuzu, Mazda, Mercury, Mitsubishi, Nissan, Plymouth, Pontiac, Porsche, Renault, Saab, Saturn, Suzuki, Toyota, Volkswagen, Volvo, Yugo

#### APPLICATIONS - 223-81240 for 10mm Bolts

Alfa Romeo, Fiat, Lancia

Ascot No.	Specialty No.	Ascot No.	Ingalls No.	Description
223-81240	81240	223-03540	I-81250	Replacement 10mm Bolts
223-81250	81250	223-03541	I-81280	Replacement 12mm Bolts
223-81260	81260	223-03542	I-81260	Replacement 14mm Bolts
223-81270	81270	223-03543	I-81270	Replacement 15mm Bolts
223-81280	81280	223-03544	I-81280	Replacement 16mm Bolts
223-81290	81290	223-03545	I-81290	Replacement 17mm Bolts

### Focus, Mazda 3, Celica Camber Arm

These high strength forged rear arms are perfect for tuners or installers that need extended camber ranges on these popular platforms. Complete with OE style bushings installed for a factory type ride.



Ascot No.	Mfg. No.	Description
225-67420	67420	Focus, Mazda 3 Camber Arm
225-67440	67440	Toyota Celica Camber Arm

#### APPLICATIONS - 225-67420 Focus, Mazda 3 Camber Arm

Ford - 2000 & Up Focus, Mazda - 2004 & Up Mazda 3, 2006 & Up Mazda 5, Volvo - 2004 & Up S40, 2004 & Up V50 67440, Toyota - 2000 - 05 Celica

#### APPLICATIONS - 225-67440

Celica - 2000 to 2005

### Honda, Acura EZ Arm

These rear arms are for Accords, Pilots and more. An O.E. ball joint is integrated into this arm. Perfect for stock height and lowered vehicles.



Ascot No.	Mfg. No.	Description
225-67290	67290	Honda, Acura EZ Arm

#### APPLICATIONS 225-67290 Honda, Acura EZ Arm

Acura - 2001 & Up MDX, 2003 & Up TSX, Honda - 2003 & Up Accord, 1999 - 04 Odyssey, 2003 & Up Pilot

**\*Call for current application chart**

## Passenger Car Alignment Accessories

### Light Truck/SUV Sleeve Assortment Board Set

This great new board set includes the most popular parts for aligning today's trucks and SUVs. Don't be caught without the part that you need. Shipped with our polymer display board.



Board includes One each of the following:

- 23755 Dodge 4x4 - 2002 & Up Camber/Caster kit for 4 Wheel Drive BR1500s
- 23765 Dodge 4x2 - 2002 & Up Camber/Caster kit for 2 Wheel Drive BR1500s
- 86140 Ford Explorer Front Kit - For 2002 & Up Explorers and Mountaineers
- 86240 Ford F150 Camber/Caster Kit - Front kit for the 2004 & Up F150s
- 86640 Expedition Front Kit - For 2002 & Up Expeditions & 2003 & Up Navigators
- 87310 Explorer Front Camber/Caster Kit - Cams for 1995 - 01 Explorers and Mountaineers along with 1998 & Up Rangers
- 87385 Ford F150 Front Camber - Cam bolt assemblies for 1997 - 03 F150s and F250(LD)s
- 87400 GM 2WD & 4WD Camber/Caster Kit - For 1988 - 99 C & K 1500, 2500 and 3500s
- 86350 GM 1/2 & 3/4-Ton Camber Bushings - For 2002 & Up C & K 1500s, Suburbans and more
- 86320 GM 1/2 & 3/4-Ton Cam Lock Plates - For 2002 & Up C & K 1500, 2500 and 3500s
- 86325 GM 1/2 & 3/4-Ton Alignment Pins - For 2002 & Up C & K 1500, 2500 and 3500s
- 86330 GM 1/2 & 3/4-Ton Camber Bushings - For 2002 & Up C & K 2500 and 3500s
- 87520 Nissan Camber/Caster Kit - For 2004 & Up Titan and 2005 & Up Pathfinder, Xterra and more

Ascot No.	Mfg. No.	Description
251-88270	88270	Light Truck/SUV Sleeve Assortment Board

### Passenger Car Assortment Board Set

- Board set includes the most popular shims, cam kits and adjustable strut plates
- A "must have" for any shop performing 4 wheel alignments on passenger cars
- Shipped with high-strength polymer display board



Board includes One each of the following:

- 75200, 75400, EZ Shims - a patented full contact, dual angle shim set that corrects toe and camber with one shim. These shims cover many rear shimmable FWD vehicles on the road today
- 75915 EZ Shim Cutter - A necessary tool for properly cutting EZ Shims
- 75970 EZ Shim Caliper Spacer Set - Aligns caliper to rotor after installing our EZ Shims on some FWD cars with hub mounted rear brakes
- 10408 Hub Replacement Bolt Set - to be used when installing rear shims
- 81250, 81260, 81270, 81280, 81290 EZ Cams XR - Camber kits for domestic and imported vehicles with two bolt non-slotted struts. Sizes include 12mm, 14mm, 15mm, 16mm and 17mm. Each kit contains two cam bolt assemblies, enough for both sides of the vehicle
- 71720, 71721, 71730 Chrysler and Dodge Mini Van Rear Camber and Toe Shims. The shim you need to align this very popular platform
- 71520, 71521, 71530 VW Beetle, Jetta, Golf Rear Camber and Toe Shims. Includes our 87530 wrench to make installing these shims easy and profitable
- 81340 VW Beetle, Jetta, Golf Front Camber/Caster adjustable upper strut plate assembly
- 81310 Ford Focus Rear Camber Kit
- 81320 Ford Focus Front Camber/Caster adjustable upper strut plate

Ascot No.	Mfg. No.	Description
251-88260	88260	Passenger Car Assortment Board Set

## Light Truck/SUV Camber/Caster Sleeve Sets

### Ford 4WD Camber/Caster Sleeve Set

- Change camber, caster or both at the same time. Remove the tire, cotter pin and upper ball joint stud nut and break the taper free between the stud and sleeve
- To adjust camber/caster, the sleeve may be lifted and rotated 1/8 turn
- Sized in 1/4° increments through 2°
- One sleeve covers one side of the vehicle
- Estimated installation time – .5 hr/side



Ascot No.	Mfg. No.	Description
231-23100	23100	Complete Set

#### SET CONTENTS

Ascot No.	Specialty No.	Ascot No.	Ingalls No.	Total	Change
231-23101	23101	231-66501	I-23101	.25°	(1/4°)
231-23102	23102	231-66502	I-23102	.50°	(1/2°)
231-23103	23103	231-66503	I-23103	.75°	(3/4°)
231-23104	23104	231-66504	I-23104	1.00°	(1°)
231-23105	23105	231-66505	I-23105	1.25°	(1-1/4°)
231-23106	23106	231-66506	I-23106	1.50°	(1-1/2°)
231-23107	23107	231-66507	I-23107	1.75°	(1-3/4°)
231-23108	23108	231-66508	I-23108	2.00°	(2°)
231-23109	23109	231-66509	I-23109	0.00°	(0°)
231-23111	23111*	231-66511	I-23111	2.25°	(2-1/4°)
231-23112	23112*	231-66512	I-23112	2.50°	(2-1/2°)
231-23113	23113*	231-66513	I-23113	2.75°	(2-3/4°)

\* Extended range sold separately.

### APPLICATIONS - 232-23100 Series

**Ford 4WD:** 1980 & Up F250, F350, E250, E350, Full Size Bronco w/Ball Joints, 1980-96 F150, F250 (L/D)

### Ford 4WD Camber/Caster Sleeve Set

- Same features as the 23100 series
- Estimated installation time – .5 hr/side

Ascot No.	Mfg. No.	Description
231-23120	23120	Complete Set



#### SET CONTENTS

Ascot No.	Mfg. No.	Total	Change
231-23121	23121	.25°	(1/4°)
231-23122	23122	.50°	(1/2°)
231-23123	23123	.75°	(3/4°)
231-23124	23124	1.00°	(1°)
231-23125	23125	1.25°	(1-1/4°)
231-23126	23126	1.50°	(1-1/2°)
231-23127	23127	1.75°	(1-3/4°)
231-23128	23128	2.00°	(2°)
231-23129	23129	0.00°	(0°)

### APPLICATIONS - 232-23120 Series

**Ford 4WD:** 1983-89 Ranger, Bronco II

### Ford & Dodge Camber/Caster Sleeve Set

- Sleeves change camber, caster or both at the same time
- Remove the upper ball joint stud nut and break taper free between the stud and sleeve
- Calculate the change and install correct sleeve
- Sized in 1/4° increments
- One sleeve covers one side of the vehicle
- Estimated installation time – .5 hr/side

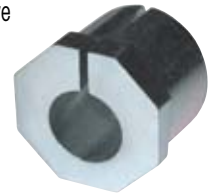

Ascot No.	Mfg. No.	Description
231-23130	23130	Complete Set

#### SET CONTENTS

Ascot No.	Specialty No.	Total	Change
231-23131	23131	.25°	(1/4°)
231-23132	23132	.50°	(1/2°)
231-23133	23133	.75°	(3/4°)
231-23134	23134	1.00°	(1°)
231-23135	23135	1.25°	(1-1/4°)
231-23136	23136	1.50°	(1-1/2°)
231-23139	23139	1.75°	(1-3/4°)

### APPLICATIONS - 232-23130 Series

**Dodge:** 1994-99 BR2500 4WD, BR3500 2WD/4WD Ford 4WD: 1992 & Up F350 Crew Cab Pickup, Some F250 4WD w/Straight Axle, 1999 & Up Super Duty 250, 350, 450, 550

#### ALIGNMENT TERMS

##### Caster

**Definition** The forward or backward tilt of the upper ball joint, or top of the strut, relative to the lower ball joint

**Purpose** Caster affects steering stability and steering wheel returnability

**Methods of Adjustment** (1) Shimms; (2) Cams; (3) Slotted Frame; (4) Strut Rod; (5) Strut Rotation; (6) Cradle Movement; (7) Offset Ball Joint; (8) Sliding Ball Joint

**0 Caster** The upper ball joint or top strut bearing and lower ball joint are in the same plane as viewed from the side of the vehicle

**Pos. Caster** The upper ball joint or top strut bearing is toward the rear of the vehicle in relation to the lower ball joint as viewed from the side of the vehicle

**Neg. Caster** The upper ball joint or top strut bearing is toward the front of the vehicle in relation to the lower ball joint as viewed from the side of the vehicle

##### Camber

**Definition** Inward or outward tilt of the top of the wheel

**Purpose** Adjustment centers the vehicle's load on tire, eliminating pull. Proper adjustments reduce camber tire wear and pulling

**Methods of Adjustment** (1) Shimms; (2) Cams; (3) Slotted Frame; (4) Strut Rod; (5) Wedges; (6) Ball Joint Rotation; (7) Offset Bearing Plates; (8) Cam Bolts; (9) Eccentrics; (10) Offset Ball Joints

**0 Camber** When wheel and tire assembly are in exact vertical position

**Pos. Camber** When the top of the wheel and tire assembly is tilted out, or away from the engine

**Neg. Camber** The top of the wheel and tire assembly is tilted in toward the engine





## Light Truck/SUV Camber/Caster Sleeve Sets

### 23220 & 23230 Sleeve Sets

Ford changed the axle design in 2005 on their Heavy Duty trucks. These sleeves correct camber and caster on the new 4x4 F250 and F350 Super Duty trucks.

Ascot No.	Mfg. No.	Description
231-23220	23220	Complete Set



#### SET CONTENTS

Ascot No.	Mfg. No.	Camber	Change
231-23221	23221	.25°	(1/4")
231-23222	23222	.50°	(1/2")
231-23223	23223	.75°	(3/4")
231-23224	23224	1.00°	(1")
231-23225	23225	1.25°	(1-1/4")
231-23226	23226	1.50°	(1-1/2")
231-23227	23227	1.75°	(1-3/4")
231-23228	23228	2.00°	(2")
231-23229	23229	0.00°	(0")
231-23211	23211	2.25°	(2-1/4")
231-23212	23212	2.50°	(2-1/2")

#### APPLICATIONS - 231-23220 Series

**Ford 4WD:** 2005 & Up F250, F350 Super Duty

**Ford RWD:** 2005 & Up F250, F350 Solid Axle/Coil Spring

Ascot No.	Mfg. No.	Description
231-23230	23230	Complete Set



#### SET CONTENTS

Ascot No.	Mfg. No.	Camber	Change
231-23231	23231	.25°	(1/4")
231-23232	23232	.50°	(1/2")
231-23233	23233	.75°	(3/4")
231-23234	23234	1.00°	(1")
231-23235	23235	1.25°	(1-1/4")
231-23236	23236	1.50°	(1-1/2")
231-23237	23237	1.75°	(1-3/4")
231-23238	23238	2.00°	(2")
231-23239	23239	0.00°	(0")

#### APPLICATIONS - 231-23230 Series

**Ford RWD/4WD:** 2005 & Up F450, F550 Coil Springs

**Chevy/GMC 4WD:** 2005 & Up Kodiak K4500, Topkick K5500

### Ford 2 & 4WD Camber/Caster Truck Sleeves

- Sleeves are widely used to adjust caster and/or camber on many Ford 2WD/4WD trucks
- To install, simply loosen and remove upper ball joint pinch bolt. Remove top snap ring if one is present
- Sleeves allow for larger caster and camber changes which may be required on lowered and raised trucks
- Set contains nine of the XR™ Camber/Caster truck sleeves

Ascot No.	Mfg. No.	Description
231-23180	23180	Complete Set

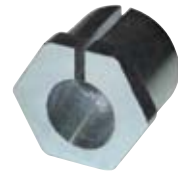

#### SET CONTENTS

Ascot No.	Specialty No.	Ascot No.	Ingalls No.	2WD Adj. Total Change	4WD Adj. Total Change
231-23181	23181	231-56501	I-23181	.25° (1/4")	.20°
231-23182	23182	231-56502	I-23182	.50° (1/2")	.40°
231-23183	23183	231-56503	I-23183	.75° (3/4")	.60°
231-23184	23184	231-56504	I-23184	1.00° (1")	.75°
231-23185	23185	231-56505	I-23185	1.25° (1-1/4")	.90°
231-23186	23186	231-56506	I-23186	1.50° (1-1/2")	1.10°
231-23187	23187	231-56507	I-23187	1.75° (1-3/4")	1.25°
231-23188	23188	231-56508	I-23188	2.00° (2")	1.40°
231-23189*	23189	231-56509	I-23189	2.25° (2-1/4")	1.60°
231-23190*	23190	231-56510	I-23190	2.50° (2-1/2")	1.80°
231-23191*	23191	231-56511	I-23191	2.75° (2-3/4")	2.00°
231-23192*	23192	231-56512	I-23192	3.00° (3")	2.25°
231-23193*	23193	231-56513	I-23193	3.25° (3-1/4")	2.50°
231-23194*	23194	231-56514	I-23194	3.50° (3-1/2")	2.75°
231-23199	23199	231-56500	I-23199	0°	0°

\* Extended range sold separately.

#### APPLICATIONS - Chamber/Caster Truck Sleeves

**Ford 2WD:** 1987 & Up F350, 1987-96 F150, F250 (L/D), 1989-90 Bronco II, 1992 & Up E150, E250, E350, 1991-94 Explorer, 1989-97 Ranger, 1999 & Up F250, F350 Super Duty; **Mazda 2WD:** 1991-97 Navajo, Pickup; **Ford 4WD:** 1991-94 Explorer, 1990-97 Ranger; **Mazda 4WD:** 1991-97 Navajo, Pickup

## Light Truck/SUV Camber/Caster Kits

### Thrust Alignment Plates

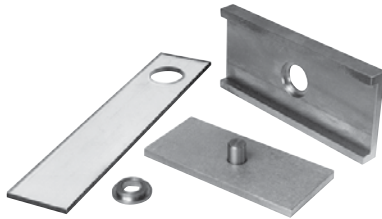

- Allows for corrections of setback and thrust angle on most vehicles with rear leaf springs
- Install by loosening the U-bolts holding the leaf spring to the axle, installing the alignment plate between the axle and leaf spring and re-tightening the U-bolts
- Kit includes multiple parts to provide coverage of most vehicles with rear leaf springs, including all early model passenger cars
- One kit covers one side of the vehicle
- Estimated Installation Time - .3 hr/side
- NOTE: Allow extra time for rusted bolts - new, longer U-Bolts may be required

Ascot No.	Mfg. No.	Description
231-63020	63020	2-3/8" Width
231-63030	63030	3" Width

#### APPLICATIONS - 232-63020 2-3/8" Width

Vehicles with 2-3/8" wide to 2-3/4" wide leaf springs including 60mm, 65mm and 70mm leaf springs of import trucks; all passenger vehicles with rear leaf springs

#### APPLICATIONS - 232-63030 3" Width

Vehicles with 3", 3-1/2" and 3-5/8" wide leaf springs including 80mm, 90mm and 100mm wide leaf springs

#### APPLICATIONS - 232-63040 4" Width

Vehicles with 4" - 5" wide leaf springs

### Explorer Camber/Caster Kit

- Set of 4 cams for quick installation without having to remove the upper control arm bolt
- Change camber and caster up to  $\pm 1.75^\circ$
- One kit covers both sides of the vehicle
- Estimated installation time - .3 hr/side

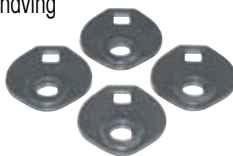

Ascot No.	Mfg. No.	Description
231-87310	87310	Explorer Camber/Caster Kit

#### APPLICATIONS

**Ford**-1995-01 2WD & 4WD Explorer, 1998-02 2WD & 4WD Ranger; **Mercury**-1995-01 & up 2WD & 4WD Mountaineer; **Mazda**-1998 2WD & 4WD B-Series Pickup

### F150/250 (L/D) 2/4WD Camber/Caster Kit

- Used to change caster and/or camber on the new F150, F250 (L/D), Expedition and Navigator
- Replace the existing upper control arm mounting bolts with these cam bolts for caster/camber changes up to  $2.0^\circ$
- One kit covers both sides of the vehicle
- Estimated installation time - .5 hr/side



Ascot No.	Specialty No.	Ascot No.	Ingalls No.	Description
231-87385	87385	231-00290	I-87385	F150/250, 2/4WD Camber Caster Kit

#### APPLICATIONS

**Ford**-1997-03 F150, F250 (L/D), 1997-02 2WD & 4WD Expedition; **Lincoln**-1997-02 2WD & 4WD Navigator

### GM 2WD & 4WD Camber/Caster Kit

- Replaces the upper control arm mounting bolts
- Remove the O.E. bolts and replace with these cams, rotating them to provide up to  $2^\circ$  camber and/or caster adjustment
- One kit covers both sides of the vehicle
- Estimated installation time - .5 hr/side



Ascot No.	Specialty No.	Ascot No.	Ingalls No.	Description
231-87400	87400	231-00288	I-87400	GM 2/4WD Camber Caster Kit

#### APPLICATIONS

**GM**-1988-99 1500, 2500, 3500 C & K series 2WD/4WD trucks, 1990 & up Safari AWD Van; **Chevrolet**-1990 & up Astro AWD Van

### Ford Explorer Camber/Caster Kit

- Kit will provides up to  $2^\circ$  positive or negative camber/caster adjustment
- Replace the O.E. upper control arm mounting bolts with the #87500 cam bolts for fast and efficient adjustment
- One kit covers both sides of the vehicle
- Estimated installation time - .5 hr/side passenger side
- Estimated installation time - .7 hr/side driver side



Ascot No.	Specialty No.	Ascot No.	Ingalls No.	Description
231-87500	87500	231-00286	I-87500	Ford Explorer Camber/Caster Set

#### APPLICATIONS

**Ford**: 1995-01 2WD & 4WD Explorer, 1998 & up 2WD & 4WD Ranger; **Mercury**: 1995-01 2WD & 4WD Mountaineer; **Mazda**: 1998 2WD & 4WD B-Series Pickup

## Camber/Caster/Ball Joints

### Jeep and Dodge Offset Ball Joint

- Offset ball joint replaces the O.E. upper ball joint to provide up to 2° camber/caster change on several previously non-adjustable Jeep and Dodge vehicles
- Comes with an installation template for accurate changes



Ascot No.	Mfg. No.	Description
237-23510	23510	1/2° Positive Or Negative Change
237-23520	23520	1° Positive Or Negative Change
237-23530	23530	1-1/2° Positive Or Negative Change
237-23540	23540	2° Positive Or Negative Change

#### APPLICATIONS

**Jeep:** 1984 & up 2WD/4WD Cherokee, Comanche, 1987 & up Wrangler; 1990 & up Renegade, 1984 & up 2WD/4WD downsize Wagoneer; 1993 & up Grand Cherokee, **Dodge:** 1994 -2001 BR1500 4WD & BR2500 (L/D) Pickups

### Ball Joint Press Sleeves

- These specially designed sleeves make installation of the #23510-40 ball joints easy and profitable for the installer
- Sleeves are designed to match the angle of the yoke on the axle housing to insure proper ball joint



Ascot No.	Mfg. No.	Description
231-23580	23580	Bushing Sleeves For Ball Joints 23510, 23520, 23530, 23540

### Dodge Truck Camber/Caster Kits

- Heavy duty bolts and brackets replace the upper control arm mounting bolts giving you both camber and caster adjustments for this popular series of Dodge trucks
- Caster adjustments from -1.5° to +1.5° and camber adjustments from -1.0° to +1.0°
- Kit includes 4 cam and bolt sets to cover both sides of the vehicle



Ascot No.	Mfg. No.	Description
231-23755	23755	Dodge Camber/Caster Kit, 4 Wheel Drive
231-23765	23765	Dodge Camber/Caster Kit, 2 Wheel Drive

#### APPLICATIONS -231-23755

**Dodge:** 2002 & Up 1500 Series - 4 Wheel Drive

#### APPLICATIONS - 231-23765

**Dodge:** 2002 & Up 1500 Series - 2 Wheel Drive

### Ford Pinch Bolt Axle Adjustable Bushing

- Camber adjustment up to +/- 2-1/2° on full size and 1-3/4° on downsize
- .5 hours per side installation time
- 1 bushing per wheel



Ascot No.	Mfg. No.	Description
231-00594	59400	Ford Pinch Bolt Axle Adjustable Bushing

#### APPLICATIONS

**Ford:** 1989-1990 2WD and 4WD Bronco II; 1989-1997 2WD and 4WD Ranger; 1991-1994 2WD and 4WD Explorer; 1992-1999 2WD E150, E250, E350; 1987-1996 2WD F150; 1987-2000 F250 and F350

**Mazda:** 1994-1999 Pickup; 1991-1994 Navajo

### Ford F150 Kit

This innovative cam nut and sturdy bracket saves time and money. Easily adjust camber and caster on F150s from '04 and up (including late model) and '07 & up Expeditions. Save time since you don't have to remove the O.E. bolt or stabilizer bar. The sturdy guide bracket allows for live adjustment. This product is a must have every time these vehicles enter your shop!



Ascot No.	Mfg. No.	Description
231-86250	86250	Ford F150 Kit

#### APPLICATIONS

**Ford:** 2004 & Up F150, 2007 & Up Expedition

**Lincoln:** 2006 & Up Mark LT, 2007 & Up Navigator

### Honda/Acura Adjustable Front Camber Kit

- 223-03570 and 223-03572 equipped with polyurethane for performance vehicles
- 223-03571 and 223-03573 with O.E. style rubber bushing for factory-like ride
- .5 hours per side installation time
- 1 kit per wheel



Ascot No.	Mfg. No.	Description
223-03570	35700	Polyurethane Bushings, -5/8° To +1°
223-03571	35710	Rubber Bushings, -5/8° To +1°
223-03572	35720	Polyurethane Bushings, +1-1/4° To 3°
223-03573	35730	Rubber Bushings, +1-1/4° To 3°

#### APPLICATIONS

**Acura:** 1990-2000 Integra; 1991-1995 Legend; 1992-1994 Vigor; 1996-2000 Acura 3.5 RL; 1997-1999 Acura 3.0 CL;

1996-2000 Acura 3.2 TL; 1995-1998 Acura 2.5 TL. **Honda:** 1988-1991 CRX; 1988-1995 Civic; 1993-1997 Del Sol; 1990-1997 Accord; 1992-1996 Prelude; 1995-1998 Odyssey; 1992-2000 Prelude (Rear). **Izuzu:** 1996-1998 Oasis

## Alignment Kits

### Chrysler, Dodge, Mitsubishi and Eagle Adjustable Front Camber Kit

- 223-03575 and 223-03577 equipped with polyurethane for performance vehicles
- 223-03576 and 223-03578 with O.E. style rubber bushing for factory-like ride
- .5 hours per side installation time
- 1 kit per wheel



Ascot No.	Mfg. No.	Camber Range
223-03575	35750	Polyurethane Bushings, -3/4° To 1°
223-03576	35760	Rubber Bushings, -3/4° To 1°
223-03577	35770	Polyurethane Bushings, +1-1/4° To 3°
223-03578	35780	Rubber Bushings, +1-1/4° To 3°

#### APPLICATIONS

**Chrysler, Dodge, Mitsubishi and Eagle Front Camber Kit**

**Chrysler:** 1995-2000 Sebring (exc. Convertible)

**Dodge:** 1995-2000 Avenger

**Eagle:** 1995-1998 Talon

**Mitsubishi:** 1995-1999 Eclipse; 1999-2000 Galant

### Adjustable Upper Control Arm

- Camber adjustment from -1° to +4°
- .8 hours per side installation time
- 1 control arm per wheel



Ascot No.	Mfg. No.	Description
236-00100	CA100	Adjustable Upper Control Arm

#### APPLICATIONS

**Honda:** 1996-2000 Civic, 1997-2000 CRV

### Honda/Acura EZ Arm XR™

- Installation time: .5 hours
- Applications: Acura: Integra Honda: Civic, Del Sol, CRV, CRX
- 67230 Applications: 2001 and up Civic



Ascot No.	Mfg. No.	Adjustment Range
226-67030	67030	-2.00° To +3.40°
226-67230	67230	-4.00° To +6.00°

## Performance Alignment Catalog Available Call for Details

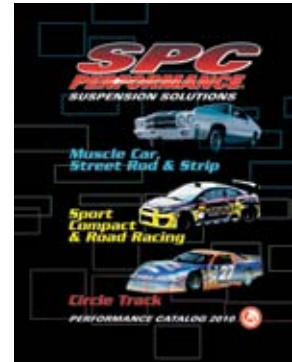

### Hyundai/Kia Rear EZ Arm XR™

- These adjustable rear upper control arm and toe cam kits, for many Hyundai and Kia models, will provide up to ±2° camber and toe change
- Rear Adjustment range: Camber and Toe ±2.00°
- Installation time: .3 Hrs./side
- Required: 1 per wheel

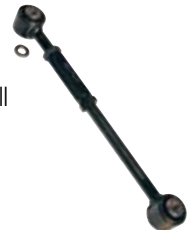

Ascot No.	Mfg. No.	Description
226-67410	67410	Hyundai/Kia Rear EZ Arm XR™

#### APPLICATIONS

**Hyundai:** 2007 & Up Elantra

**Kia:** 2007 & Up Optima, 2007 & Up Rondo

### Honda EZ Arm XR™

- Adjustment range: -2.00° to +4.00°
- NOTE: An O.E. style ball joint is integrated in this arm
- Installation time: .8 hours
- 67090 Applications: **Honda:** 1998-2002 Accord. **Acura:** 2001 3.2CL, 1999-2002 3.2TL 1996 & Up 3.5RL



Ascot No.	Mfg. No.	Description
226-67090	67090	Honda/Acura EZ Arm XR™
226-67290	67290	Honda EZ Arm XR™

### Honda Front Camber/Caster Control Arm

- O.E. style control arm now makes it possible to adjust camber and caster on newer Honda Civics
- Arm may be used on vehicles that have retained their stock ride height and vehicles that have been lowered for performance and appearance

Ascot No.	Mfg. No.
222-62010	62010

#### APPLICATIONS

**Honda:** 1996-2000 Civic



## Camber Kits

### Camber Adjusting "Magna Cam" Bolt Kits

- Fast and easy alternative to adjust camber on vehicles utilizing standard 2 bolt (upper and lower) strut-to-knuckle mounting bolt design
- Unique design incorporates an offset internal sleeve working in conjunction with a full-size/high strength O.E. diameter bolt (with matching internal offset) which allows camber to be increased or decreased by a simple turn of a bolt
- Allows technician to accurately adjust camber with the weight of the vehicle on its front wheels. Available in 12mm, 14mm, 15mm, 16mm and 17mm sizes



Ascot No.	Mfg. No.	Description
223-41147	41-147	12mm 12.9 High-Strength Bolts
223-41158	41-158	14mm 12.9 High-Strength Bolts
223-41149	41-149	15mm 10.9 High-Strength Bolts
223-41160	41-160	16mm 10.9 High-Strength Bolts
223-41151	41-151	17mm 10.9 High-Strength Bolts

### GM "Quick Cam" Adjusters

- The unique design allows fast and easy "on-vehicle" camber/caster adjustment with an easy to access Allen wrench slot



Ascot No.	Mfg. No.	Description
223-44257	44-2507	4 Per Pack - Fits 2004-2006 Chevrolet Colorado, GMC Canyon, Hummer H3, and Isuzu I35/I28
223-44256	44-2506	2 Per Pack - Fits 2003-2006 Chevrolet Express Van and GMC Savanna Van

### Dodge/Chrysler/Jeep Camber Adjustment Kits

- The unique design allows fast and easy "on-vehicle" camber/caster adjustment with an easy to access Allen wrench slot



Ascot No.	Mfg. No.	Description
223-44792	44-792	4 Per Pack - This Kit Provides Precise, Controlled Camber and Caster Adjustments. 2002-2005 Dodge Ram 1500
223-41825	41-8256	Pair - This Kit Adjusts Caster and the Front Pinion Angle on Jeep Vehicles That Have no Such Adjustment From the O.E. 1997-2006 Jeep Wrangler, 1993-1998 Jeep Grand Cherokee, 1994-1998 Dodge Ram Truck (36mm Cams)

### Rear Full Contact Camber/Toe Shim



Ascot No.	Mfg. No.	Description
221-46121	46-1121	.25° Green
221-46122	46-1122	.5° Green
221-46123	46-1123	.75° Green
221-46124	46-1124	1° Green
221-46120	46-1120A	Contains 2 Each Size Shims - Green
221-46151	46-1501	.25°
221-46152	46-1502	.5°
221-46153	46-1503	.75°
221-46154	46-1504	1°
221-46150	46-1500A	Contains 2 Each Size Shims
221-46521	46-1521	.25°
221-46522	46-1522	.5°
221-46523	46-1523	.75°
221-46524	46-1524	1°
221-46520	46-1520A	Contains 2 Each Size Shims

**46-1120 Series Applications:** 1998-Newer **Toyota** Sienna, **Chrysler** Town & Country Van (exc. AWD), **Dodge** Caravan (exc. AWD)

**46-1500 Series Applications:** **Pontiac** Vibe 2003 & Newer, **Toyota:** Matrix & Corolla 2003 & Newer, **Scion:** XA & XB

**46-1520 Series Applications:** **Chevrolet** Cobalt 2005-2006, **Saturn** Ion 2003-2006, **Chevrolet** HHR 2005-2006

### Ford Truck Cam Bolt Kits

- These kits provide adjustment for camber and caster on Ford light-duty trucks/SUVs where no O.E. adjustment is available



Ascot No.	Mfg. No.	Description
223-42778	42-778	Pair - 1997-2003 Ford F150, 1997-2002 Ford Expedition and Lincoln Navigator
223-44789	44-789	4 Per Pack - 2004-2006 Ford F150
223-44786	44-786	4 Per Pack - 2003-2006 Ford Expedition and Lincoln Navigator
223-44768	44-768	Pair - 1995-2001 Ford Explorer, 1998-2001 Ford Ranger
223-44773	44-773	2 Cam Guides - 2002-006 Ford Explorer, Mercury Mountaineer, and Lincoln Aviator

### Nissan Light Truck Cam Bolt Kit

- This Cam Bolt Kit makes Nissan light-duty trucks with no O.E. adjustment fully adjustable for camber and caster



Ascot No.	Mfg. No.	Description
223-44820	44-820	4 per pack - Fits 2004-2006 Nissan Titan 2005-2006 Nissan: Armada, Frontier, Pathfinder, and Xterra

## Camber/Caster Tools & Bushings

### Ford Truck Fixed Camber/Caster Bushings

- Fits the same applications as 5032 on the right. Adjust caster/camber or a combination of both from 0° to 2.75° either positive or negative, with easy to adjust "Multi-Slot" bushings



Ascot No.	Mfg. No.	Description
231-44499	44-4099	0°
231-44501	44-5001	.25°
231-44502	44-5002	.5°
231-44503	44-5003	.75°
231-44504	44-5004	1°
231-44505	44-5005	1.25°
231-44506	44-5006	1.5°
231-44507	44-5007	1.75°
231-44508	44-5008	2°
231-44509	44-5009	2.25°
231-44510	44-5010	2.5°
231-44511	44-5011	2.75°

### Inner Tie Rod Tool

- Unique design allows for fast and easy replacement of inner tie rod ends without removing the rack and pinion
- Fits domestic and foreign vehicles with inner tie rods up to 42mm outer diameter. Adjusts to fit all styles of inner tie rods (round, square, flat or hex) without slipping



Ascot No.	Mfg. No.	Description
227-88731	88-7301	Inner Tie Rod Tool

### Dodge Truck Adjusting Tool

- 2002-2005 Dodge Ram 1500
- Allows for fast and easy camber/caster adjustment on Dodge trucks without removing any bolts or the wheel
- Easy-to-adjust tool jaws allow for a smooth controlled adjustment



Ascot No.	Mfg. No.	Description
236-88928	88-8928	Dodge Truck Adjusting Tool

### Taurus/Sable Ball Joint Adapter Set

- Unique Design Easily removes Ford Taurus ball joints
- Even Removes the most Stubborn Ball Joints
- Prevents arm from being damaged while removing ball joint
- 4 Piece set fits for both removal and installation



Ascot No.	Mfg. No.	Description
227-88787	88-7870C	Taurus Sable Ball Joint Adapter Set



### Adjustable Light Truck Bushings

- This New "DUAL AXIS" design allows for up to 25% greater range of adjustment and a "Tech Friendly" adjustment feature makes on-site vehicle adjustments a snap (standard socket fits easily & securely over inner hex adjuster for fast & accurate settings)
- The universal adjustable design allows technician to make any camber/caster or combination adjustment needed with just one part number, even True Zero

Ascot No.	Mfg. No.	Description
231-44532	44-5032	0° to ± 3.25°, Ford: F-150 4x4 1980-96 F-250 4x4 1980-97, F-350, F-450, F-550 4X4 1992-96, F-250, F-350, F-450 4X4 1998-04, F-550 Super Duty 4x4 Dodge: 1994-02 - Ram 2500, 3500 4x4 1994-99 - Ram 2500, 3500 4x2 1994-02
231-44535	44-5035	0° to ± 3.25°, Ford: 1983-89 Ranger & Bronco II 4X4
231-44536	44-5036	0° to ± 2.5°, Ford: 2005-06 F-250 & F-350 4X4
231-44537	44-5037	0° to ± 2.5°, Ford: 2005-06 F-450 & F-550 4X4 & 4X2, Chevy: Kodiak (2005-06), GMC: Top Kick (2005-06)
231-44594	44-5094	0° to ± 4°, Ford: Explorer 4x4 & 4x2 1991-94 Ranger 4x4 & 4x2 1990-97 F-150, F250, F350 4X2 1987-96 Econoline Van 1992-05 Excursion 4x2 2000-05, F250, F350 Super Duty 4x2 1998-05, Mazda: Navajo 4x4 & 4x2 1991-94, Pickup 4x4 & 4x2 1994-99

### Ford Truck Fixed Camber/Caster Bushings

- Adjust caster/camber or a combination of both from .25° to 3.5° either positive or negative with easy to adjust "Hex-Head" bushings (Fits same applications as 44-5094 above)



Ascot No.	Mfg. No.	2WD	4WD
231-42949	42-949	0°	0°
231-42951	42-951	.25°	.25°
231-42952	42-952	.5°	3/8°
231-42953	42-953	.7°	.5°
231-42954	42-954	1°	.75°
231-42955	42-955	1.25°	7/8°
231-42956	42-956	1.5°	1°
231-42957	42-957	1.75°	1.25°
231-42958	42-958	2°	1.5°
231-42959	42-959	2.25°	1.75°
231-42960	42-960	2.5°	2°
231-42961	42-961	2.75°	2.25°
231-42962	42-962	3°	2.5°
231-42963	42-963	3.25°	2.75°
231-42964	42-964	3.5°	3°

## Caster/Camber Accessories

### Adjustable Ball Joint

- Adjustable upper ball joints make front camber/caster adjustments easy on late model Honda and Acura
- Sliding ball joint allows for greater camber changes than previously available
- Sliding plate assembly is perfect for vehicles that have been lowered for performance or retain the factory ride
- Adjustment:  $-1.50^{\circ}$  to  $+1.50^{\circ}$
- Installation time: .6 hours



Ascot No.	Mfg. No.	Description
226-67125	67125	Honda/Acura Adjustable Ball Joint
226-67165	67165	Honda/Acura Adjustable Ball Joint

#### APPLICATIONS: 226-67125 - Standard Range

**Acura:** 1996 - 97 2.2CL, 1998 - 99 2.3CL, 1996 - 99 3.0CL, 2001-04 3.2CL, 1999 -2004 TSX; 1996-98 2.5 TL; 3.2 TL;  
**Honda:** 1998 - 02 Accord, 1989 - 91 Civic & CRX, 1995 - 98 Odyssey

#### APPLICATIONS: 226-67165 - Standard Range

**Acura:** 1995 - 98 2.5TL, 1992 - 94 Vigor (front); **Honda:** 1992 - 02 Prelude (Rear) 1992 - 1996 Prelude (Front)

### Honda/Acura Uprights

- New uprights incorporate a sliding mechanism for easy camber changes
- O.E. bushing eliminates squeaking and no special tools are required



Ascot No.	Mfg. No.	Description
222-84945	84945	Up To $+1.5^{\circ}$
222-84955	84955	$+1.75^{\circ}$ To $+3.25^{\circ}$

#### APPLICATIONS:

**Acura:** 1990 - 99 Integra, 1991 - 96 Legend, 1992 - 94 Vigor, 1996 - 97 2.2CL, 1998 & up 2.3CL, 1996 - 98 2.5 TL, 1996 - 99 3.0CL, 3.5RL; **Honda:** 1990 - 97 Accord, 1988 - 91 Civic SW & 4WD, 1988 - 95 Civic, 1988 - 92 CRX, 1992 - 96 Prelude, 1995 - 98 Odyssey, 1992 - 94 Del Sol, Prelude 4WS; Isuzu: 1995 - 98 Oasis

### Performance Ball Joint Press Set

- Specifically designed to remove the original equipment ball joints on smaller cars such as Hondas and Acuras when installing SPC Performance's sliding ball joints
- Can remove the ball joint from the front upper control arm without removing the arm from the vehicle, saving time and cost
- Packaged in a convenient blow-molded plastic case this set comes complete with adapters for both removing and installing stock or Specialty Product's sliding ball joints



Ascot No.	Mfg. No.	Description
227-40920	40920	Performance Ball Joint Set

### FasTrax™ Complete Adjustable Camber/Caster Gauge

- Portable, hands-free alignment can be done quickly and easily with the FasTrax™ Adjustable Camber/Caster Gauge

Ascot No.	Mfg. No.	Wheel Size
223-91000	91000	13" - 18"



### FasTrax™ Camber/Caster Gauge

- Add quick alignment checks to your fleet PMS. Save tire wear & fuel costs

Ascot No.	Mfg. No.	Wheel Size
223-91040	91040	21" - 26"



### Ford/Dodge Truck Adjustable Camber/Caster Bushing

- Camber and caster adjustment up to  $\pm 2-3/4^{\circ}$
- .5 hours per side installation time
- 1 bushing per wheel



Ascot No.	Mfg. No.	Description
231-00532	532	Ford/Dodge Truck Adjustable Camber/Caster Bushing
231-00535	535	Ford Downsize Truck Adjustable Camber/Caster Bushing
233-23120	23120	SET (9) 4WD CAM/CAS Sleeves. Set 23120 contains 23121 thru 23129
233-23130	23130	SET (9) 4WD & RWD SLEEVES. Set contains one each of 23131 thru 23139

#### APPLICATIONS - 231-00532

**Ford:** 1980-1985 4WD F150 and Bronco, 1980-2000 4WD F250 and F350; **Dodge:** 1994-1999 2WD/4WD 2500 Trucks, 1994-1999 4WD 3500 Trucks

#### APPLICATIONS - 231-00535

**Ford:** 1983-1990 4WD Downsize Trucks

#### APPLICATIONS - 231-23120

**Ford 4WD:** 1983 - 89 Bronco II; 1990 (Early) Bronco II; 1983 - 89 Ranger

#### APPLICATIONS - 231-23130

**Ford 4WD:** 1997 - 98 F250 (H/D), 1999 - 04 F250, F350, F450, F550, Super Duty 2000 - 05 Excursion, 1992 - 98 F350 Crew Cab; **Ford RWD:** 1999 - 04 F450, F550 Super Duty; **Dodge 4WD:** 1994 - 99 BR2500, BR3500; **Dodge RWD:** 1994 - 02 BR3500 w/Mono Beam

### Ford Combination Sleeve Puller

- Pulls both O.E. and most aftermarket camber/caster sleeves quickly and efficiently without damaging the ears of the sleeve
- Heat treated high strength steel
- Single-unit design with no loose parts

Ascot No.	Mfg. No.
247-77880	77880

#### APPLICATIONS:

**Ford:** Twin I-Beam w/ Upper And Lower Ball Joints



## Heavy Duty Truck Alignment Shims

### Truck Axle Shims (Heavy Duty Zinc Alloy)

- Twice the coverage with half the inventory, these truck axle shims fit a variety of 2WD and 4WD vehicles with solid axles from full size Blazers to school buses
- Measure the spring pad, break the shim off at the correct width and insert between the spring and axle
- Available in 1/2° changes up to a 4° caster change, either positive or negative
- Packaged 6 per box
- Any solid axle 2 or 4 wheel drive vehicle

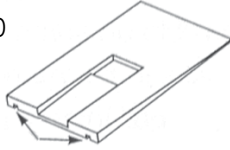

Ascot No.	Mfg. No.	Width	Degree Taper
243-00891	89199	3"-3-1/2"-4"	1/2°
243-00892	89299	3"-3-1/2"-4"	1°
243-00893	89399	3"-3-1/2"-4"	1-1/2°
243-00894	89499	3"-3-1/2"-4"	2°
243-00895	89599	3"-3-1/2"-4"	2-1/2°
243-00896	89699	3"-3-1/2"-4"	3°
243-00897	89799	3"-3-1/2"-4"	3-1/2°
243-00898	89899	3"-3-1/2"-4"	4°

### Truck Axle Shims (Heavy Duty Zinc Alloy)

- One part number gives you six shims in a box

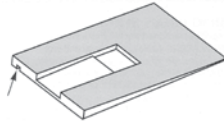

Ascot No.	Mfg. No.	Degree	Width	Box Wt.
243-00841	84199	1/2°	2-1/4"- 2-1/2"	1-1/2 Lbs.
243-00842	84299	1°	2-1/4"- 2-1/2"	1-1/2 Lbs.
243-00843	84399	1-1/2°	2-1/4"- 2-1/2"	2 Lbs.
243-00844	84499	2°	2-1/4"- 2-1/2"	2-1/4 Lbs.
243-00845	84599	2-1/2°	2-1/4"- 2-1/2"	2-3/4 Lbs.
243-00846	84699	3°	2-1/4"- 2-1/2"	2-3/4 Lbs.
243-00847	84799	3-1/2°	2-1/4"- 2-1/2"	3-1/4 Lbs.
243-00848	84899	4°	2-1/4"- 2-1/2"	3-1/4 Lbs.

### Truck Axle Shims

- Packaged six per box
- Spring pad length and width is needed when placing orders
- Installation time – .5 hr./side

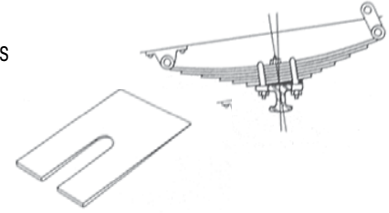

Ascot No.	Mfg. No.	Ascot No.	Mfg. No.	Width	Degree	Length
Bronze	Bronze	Aluminum	Aluminum			
241-04050	T10405	241-04051	AL10405	2-1/2"	1/2°	5"
241-10410	T1041	241-10411	AL1041	2-1/2"	1°	5"
241-10420	T1042	241-10421	AL1042	2-1/2"	1-1/2°	5"
241-10430	T1043	241-10431	AL1043	2-1/2"	2°	5"
241-10440	T1044	241-10441	AL1044	2-1/2"	2-1/2°	5"
241-10450	T1045	241-10451	AL1045	2-1/2"	3°	5"
241-10460	T1046	241-10461	AL1046	2-1/2"	3-1/2°	5"
241-10470	T1047	241-10471	AL1047	2-1/2"	4°	5"
241-05050	T10505	241-05051	AL10505	3"	1/2°	6"
241-10510	T1051	241-10511	AL1051	3"	1°	6"
241-10520	T1052	241-10521	AL1052	3"	1-1/2°	6"
241-10530	T1053	241-10531	AL1053	3"	2°	6"
241-10540	T1054	241-10541	AL1054	3"	2-1/2°	6"
241-10550	T1055	241-10551	AL1055	3"	3°	6"
241-10560	T1056	241-10561	AL1056	3"	3-1/2°	6"
241-10570	T1057	241-10571	AL1057	3"	4°	6"
241-06050	T10605	241-06051	AL10605	3-1/2"	1/2°	6-1/4"
241-10610	T1061	241-10611	AL1061	3-1/2"	1°	6-1/4"
241-10620	T1062	241-10621	AL1062	3-1/2"	1-1/2°	6-1/4"
241-10630	T1063	241-10631	AL1063	3-1/2"	2°	6-1/4"
241-10640	T1064	241-10641	AL1064	3-1/2"	2-1/2°	6-1/4"
241-10650	T1065	241-10651	AL1065	3-1/2"	3°	6-1/4"
241-10660	T1066	241-10661	AL1066	3-1/2"	3-1/2°	6-1/4"
241-10670	T1067	241-10671	AL1067	3-1/2"	4°	6-1/4"
241-07050	T10705	241-07051	AL10705	4"	1/2°	6-1/2"
241-10710	T1071	241-10711	AL1071	4"	1°	6-1/2"
241-10720	T1072	241-10721	AL1072	4"	1-1/2°	6-1/2"
241-10730	T1073	241-10731	AL1073	4"	2°	6-1/2"
241-10740	T1074	241-10741	AL1074	4"	2-1/2°	6-1/2"
241-10750	T1075	241-10751	AL1075	4"	3°	6-1/2"
241-10760	T1076	241-10761	AL1076	4"	3-1/2°	6-1/2"
241-10770	T1077	241-10771	AL1077	4"	4°	6-1/2"
241-10780	T1078	241-10781	AL1078	4"	5°	6-1/2"

### Kenworth Air Glide Spacer for Eight Baggers



Ascot No.	Mfg. No.	Thickness	Qty.
241-35001	35001	1/32"	6
241-35002	35002	1/16"	6
241-35003	35003	1/8"	6
241-35004	35004	1/4"	6
241-35005	35005	1/2"	6
241-35006	35006	3/4"	6
241-35007	35007	1"	6

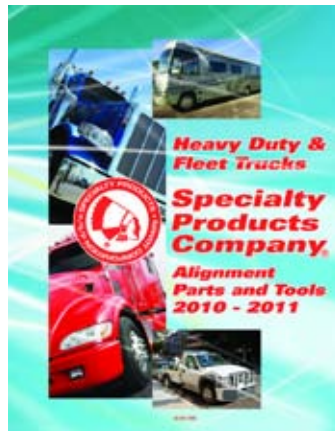

**SPECIALTY PRODUCTS  
HEAVY DUTY & FLEET  
TRUCKS CATALOG  
NOW AVAILABLE.  
CALL TO ORDER!**





## Alignment Systems

### DWA 1000 Compact Wheel Alignment System

- 8 sensor CCD technology
- DSP processing
- MEMS static accelerometers provide the latest in measuring technology
- Linux based software running on standard hardware provides years of trouble free service and low cost ownership
- Four shock resistant blue tooth wireless rechargeable alignment heads with lithium ion batteries for long life
- Four standard wheel clamps
- Color printer
- 19" flat screen monitor
- Large mobile console



Ascot No.	Mfg. No.
203-10001	DWA1000

### DWA 1000LT Compact Wheel Alignment System

- Four Bluetooth Wireless Rechargeable Alignment Heads
- Lithium Ion Batteries for long life
- Laptop Computer and Storage Cabinet
- Accelerometers (newest measuring technology)
- PC Based Software with multiple languages
- 24" Wheel Clamping Range (30" optional)
- Power Supply and USB Bluetooth Antenna
- Vehicle and Customer Database
- Alignment Specification 30 years
- User Friendly Software to guide technician

Ascot No.	Mfg. No.
203-10002	DWA1000LT



## Tandem Alignment Set

### Tandem Alignment Set - GREAT STARTER KIT!

These alignment angle shims are now available in a heavy duty metal box to help you organize all of your shims. Packaged with a large variety of shims (listed below) and an organization chart inside the lid to make reordering and organization of shims quick and easy.

Ascot No.	Mfg. No.	Description
246-36000	36000	Tandem Alignment Set



### Set Includes

Ascot No.	Mfg. No.	Description	Qty.
246-35001	35001	Kenworth Airglide space 1/32"	6
246-35002	35002	Kenworth Airglide space 1/16"	6
246-35003	35003	Kenworth Airglide space 1/8"	6
246-35004	35004	Kenworth Airglide space 1/4"	6
246-35005	35005	Kenworth Airglide space 1/2"	6
246-35006	35006	Kenworth Airglide space 3/4"	6
246-35007	35007	Kenworth Airglide space 1"	6
246-35010	35010	Peterbilt Air Leaf Shim 1/32"	2
246-35011	35011	Peterbilt Air Leaf Shim 1/16"	4
246-35012	35012	Peterbilt Air Leaf Shim 1/8"	6
246-35020	35020	Freightliner FAS I Air Ride 1/32"	2
246-35021	35021	Freightliner FAS I Air Ride 1/16"	4
246-35022	35022	Freightliner FAS I Air Ride 1/8"	6
246-35030	35030	Volvo/White 4-Spring Susp 1/32"	2
246-35031	35031	Volvo/White 4-Spring Susp 1/16"	4
246-35033	35033	Volvo/White 4-Spring Susp 1/8"	6
246-35040	35040	Navistar IHC Torque Arm 1/32"	2
246-35041	35041	Navistar IHC Torque Arm 1/16"	4
246-35042	35042	Navistar IHC Torque Arm 1/8"	6
246-35060	35060	Freightliner Airliner Susp 1/32"	2
246-35061	35061	Freightliner Airliner Susp 1/16"	4
246-35062	35062	Freightliner Airliner Susp 1/32"	6
246-35070	35070	Freightliner Air Glide Susp 1/32"	2
246-35071	35071	Freightliner Air Glide Susp 1/16"	4
246-35072	35072	Freightliner Air Glide Susp 1/8"	6
246-36010	36010	Peter/KW Flex-Air Torque Arm 1/32"	2
246-36011	36011	Peter/KW Flex-Air Torque Arm 1/16"	4
246-36012	36012	Peter/KW Flex-Air Torque Arm 1/8"	2

## Heavy Duty Truck Alignment

### Peterbilt Air Leaf Adjusting Shim

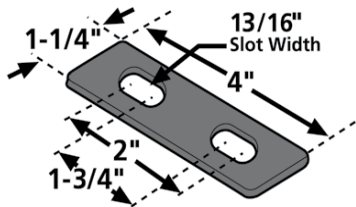

Ascot No.	Mfg. No.	Description	Qty.
241-35010	35010	1/32"	6
241-35011	35011	1/16"	6
241-35012	35012	1/8"	6

### Single Slot Tandem Truck Shims

- Universal shims are installed at the ends of torque rod to change toe and/or thrust angles on Freightliner, Hendrickson and Navistar heavy duty tandem trucks and trailers



Ascot No.	Mfg. No.	Description	Qty.
246-35060	35060	1/32"	6
246-35061	35061	1/16"	6
246-35062	35062	1/8"	6

### Freightliner Adjusting Shims

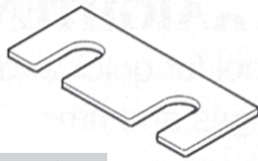

Ascot No.	Mfg. No.	Description	Qty.
241-35020	35020	1/32"	6
241-35021	35021	1/16"	6
241-35022	35022	1/8"	6

### Freightliner Shims for Air Glide Suspension

- Over-the-road heavy duty adjusters for fast and accurate means to align front or rear axles of popular tandem trailers and trucks
- Reliable means to complete total heavy duty truck alignments

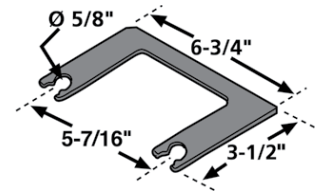

Ascot No.	Mfg. No.	Description	Qty.
241-35070	35070	1/32"	6
241-35071	35071	1/16"	6
241-35072	35072	1/8"	6

### Volvo/White Tandem Shims

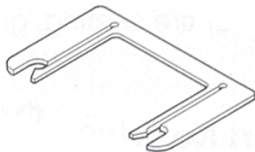

Ascot No.	Mfg. No.	Description	Qty.
246-35030	35030	1/32"	6
246-35031	35031	1/16"	6
246-35032	35032	1/8"	6

### Peterbilt/Kenworth Flex Air Suspension Shims

- Adjust thrust angle and toe by shimming the torque arms

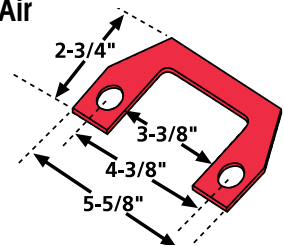

Ascot No.	Mfg. No.	Description	Qty.
241-36010	36010	1/32"	6
241-36011	36011	1/16"	6
241-36012	36012	1/8"	6

### I.H.C. Torque Arm Shims

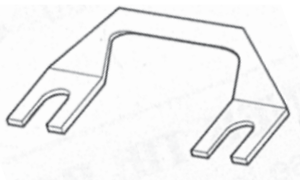

Ascot No.	Mfg. No.	Description	Qty.
246-35040	35040	1/32"	6
246-35041	35041	1/16"	6
246-35042	35042	1/8"	6

## Heavy Duty Truck Alignment (Cont.)

### Hendrickson Walking Beam Shims

- O.E. style shims recommended by Hendrickson
- Offers three adjustments of 0, 3/16" and 3/8"

Ascot No.	Mfg. No.	Qty.
241-36080	36080	2
241-36085	36085	2



### Hendrickson HD Shims

- Shim kit will adjust the thrust angle on Hendrickson's "walking beam" rear tandem axle suspension
- Improves tire wear and handling by adjusting thrust angle from 0" to 3/8" in precise 1/32" increments
- Includes 2 (two)-five piece kits
- Requires one set per wheel

Ascot No.	Mfg. No.
241-36087	36087

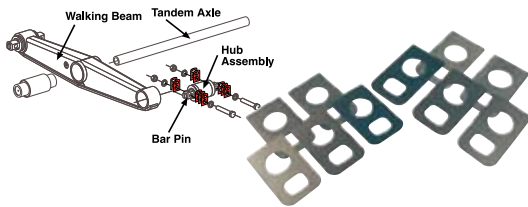

### Tire Mating Square

- Checks for variance in dual tire mating
- Compare tire size by placing long arm against the side wall and short arm against tread

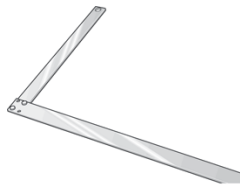

Ascot No.	Mfg. No.	Description
247-18440	91844	Length: Long Arm 48" ; Short Arm: 26" length

### Toe Bar with Scribe

- Gives toe readings (in 1/32 of an inch increments) by measuring distances between marks scribed at the center of the tire treads
- Includes 8 ft. bar, 17 in. pointers, 5 in. stands and #WA516 scribe
- Reliable means to complete total heavy duty truck alignments



Ascot No.	Mfg. No.	Description
246-51100	99511	For Cars and Light Trucks
247-51200	99512	For Trucks, Buses, RVs, Vans

### Truck Front Slip Plate Set (Pair)

- Used in conjunction with the WA515 toe gauge
- Steel slip plates allow the tire to move freely while the technician sets the toe



Ascot No.	Mfg. No.	Description
247-18410	91841	16" x 24" x 3/8"

### Trailer Tandem Tracker

- Used to aid in measuring the tracking of tandem axles in relationship to the kingpin suspensions and the front and rear axles on the tandem
- Establishes a measuring point from the center of the wheel



Ascot No.	Mfg. No.	Description
246-18880	91888	Trailer Tandem Tracker Set (Pair)

### Tandem Axle Caliper

- Used to check the spacing between the axles of tractors or trailers for alignment and tracking
- Easy to read scale in both metric and inches, with a range of 72"

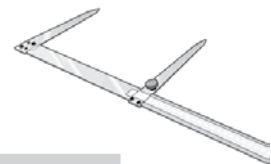

Ascot No.	Mfg. No.	Description
246-18910	91891	Tandem Axle Caliper

## Alignment Tools

### GM Upper Control Arm Punch

- For removing the alignment inserts on the upper control arm alignment brackets without damaging the alignment bracket
- Lubricate before use
- Not for use with impact wrenches (air tools)

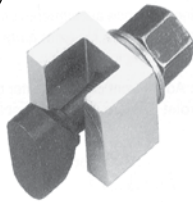

Ascot No.	Mfg. No.
247-74910	74910

#### APPLICATIONS

**Chevrolet/GM:** 1989 - 1998  
2WD/4WD C & K Series 1/2, 3/4 & 1  
Ton Trucks, 1991 & Up AWD Astro  
Vans & AWD Safari Vans

### Canyon/Colorado Socket

Aligning these trucks can be difficult because it is impossible to access the head of the cam bolt to adjust alignment angles. This special grooved socket fits over the end of the bolt allowing the technician to turn the alignment cams to change alignment angles after loosening the lock nut. This socket makes aligning these 4WD trucks much quicker and easier.



Ascot No.	Mfg. No.
236-45938	45938

### Ford Super Duty Tie Rod Sleeve Adjuster

- Designed for use on the new Ford Super Duty chassis as well as most other light trucks and vans
- Extra long bar gives you maximum leverage to loosen rusted sleeves without injuring your knuckles
- 8-position tool allows 360° rotation without removing the adjuster block from the sleeve



Ascot No.	Mfg. No.
236-77350	77350



### Air Bladder Camber Adjusting Tool

- Air-assisted, multiple camber adjustment tool makes camber adjustment on many GM and Chrysler vehicles easier
- Simply loosen the strut mount bolts, place the adjuster between the tire and strut, and inflate. To adjust camber slowly release the air until the wheel retracts to the specified alignment setting. Tighten bolts and the alignment is done
- Includes a specially designed, puncture resistant air bladder, 2' air hose, a low pressure pop-off valve to prevent overinflating and an air control valve for inflating and controlled deflating

Ascot No.	Mfg. No.
228-61400	DOWTC614



### H/D Steel Wheel Rim Straightening Tool

- For quick and easy removal of indentations on wheel flanges and rims of most vehicles
- Allows proper tire seating, giving greater tire protection and durability
- Powder coated for added durability



Ascot No.	Mfg. No.
247-08130	83109

### Inner Tie Rod End Wrench Set

- Set Includes: **#89105** - Dual socket inner tie rod removal tool, fits 1-3/16" or 1-5/16" hex inner tie rod ends. **#89106** - A 1-3/16" hex tool for inner tie rod ends on Ford Escort, Tempo, Topaz, Lynx. **#89107** - A 1-5/16" hex tool designed for inner tie rod ends on 1986 & up Taurus/Sable. **#89108** - A 1-7/16" hex tool designed for GM Saginaw rack and pinions



CAUTION: Not for use with impact wrenches (air tools)

Ascot No.	Mfg. No.
227-89000	89000

### Turntables (Pair)

- Full floating with enclosed ball bearings
- Large, easy to read dial is quickly adjusted to zero
- Ideal for racks, pits, floor units or stands
- For cars and light trucks
- Dimensions: 11" x 15-1/2" x 2"; Weight Limit: 5,000 Lbs./wheel
- Range: 100°



Ascot No.	Mfg. No.
217-00750	99750

## Alignment Tools (Cont.)

### Tire/Wheel Runout Gauge Set

- Gauge checks tire and wheel runout, disc brake rotor run out and ball joint wear
- Flex-Arm for easy positioning
- Clamping pliers securely attach anywhere on your balancer
- Gauge has a large contact for checking radial run out and a roller contact for checking wheels and sidewalls. Six-inch extension provides added reach
- Retaining ring prevents indicator from falling out
- Enclosed in a fitted case



Ascot No.	Mfg. No.
226-06454	6454

### 2WD/4WD Ball Joint Press

- Remove and replace universal joints without "brute force" methods that can cause costly damage
- A forcing screw-powered press, used with proper adapters, easily removes and installs all press-fit ball joints (inc. GM plastic pin C.V. type joints)
- Comes in a durable plastic case
- Package includes:
  - #4437 - press
  - #29503 - receiver tube, 3" OD x 2-3/4" ID
  - #29504 - receiver tube, 2-1/2" OD x 2-1/4" ID
  - #29505 - receiver tube, 2" OD x 1-3/4" ID
  - #38354 - 4WD receiving cup
  - #38355 - installing cup
  - #204508 - 4WD installing adapter
  - #305227 - installing adapter
  - #305228 - removing adapter



Ascot No.	Mfg. No.
227-07250	7250

### Camber Tool

This turnbuckle design tool attaches to the front lower control arms and allows the technician to easily change camber on these popular SUVs. The tool range is from 36" to 44".

Ascot No.	Mfg. No.
247-83795	83795

#### APPLICATIONS

- Buick:** 2004 & Up Rainier
- Chevrolet:** 2003 & Up SSR, 2002 & Up Trail Blazer
- GMC:** 2002 & Up Envoy
- Isuzu:** 2003 & Up Ascender
- Olds.:** 2002 - 04 Bravada
- Saab:** 2005 & Up 9-7X

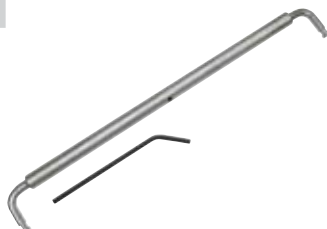

### OTC Strut Tamer

- For MacPherson strut springs
- Safe compressor for handling virtually any straight, conical or offset spring
- Adjustable arm and four point locking jaws
- Adjustable center screw that floats from side to side to keep strut straight during compression



Ascot No.	Mfg. No.	Description	Weight
228-06580	6580	Master StrutTamer	81 Lbs.
228-06581	6581	Master StrutTamer with Stand	142 Lbs.
228-06582	6582	StrutTamer Stand	61 Lbs.

### Branick Strut Spring Compressor

- You know the problems...small springs with tight coils, new models with short springs and steeper helix angles
- The answer for yesterday, today and tomorrow's struts
- Wall mount brackets standard



Ascot No.	Mfg. No.	Description
228-07400	7400	Strut Spring Compressor
228-00741	741	Bench Mount
228-00744	744	Strut Tool Cart

### Radial Runout Gauge

Radial runout is an out of round condition in which the radius of the wheel or tire is not consistent from the wheel center to any point on the rim or the tread. Tire and wheel radial runout are often factors in troubleshooting ride and handling and in maintaining correct wheel balancing to reduce vibration.

- Measures vehicle vibration sensitivity
- Measures out of round condition
- Easy to use - only 2 adjustments
- Pinpoints high or low spots in the tire
- Determines accurate centering of tire and wheel mounting

Ascot No.	Mfg. No.
247-33173	33173



## Alignment Tools (Cont.)

### Alignment Tool Board

- New board set gives technicians the tools needed to complete today's modern alignments quickly and efficiently

Ascot No.	Mfg. No.	Description
251-87910	87910	Complete Board

#### BOARD CONTENTS (Includes 1 of each)

Mfg. No.	Description
7023	Tie Rod Tool
7195, 7196, 7197, 7198, 7199	Tie Rod Tools
8113	Mag. Adj. Camber Gauge
8370	Tie Rod Puller
31010	10" Power Grip Jaws
45938	Colorado/Canyon 4WD Alignment Socket
74910	GM Upper Control Arm Punch
77880	Ford OE Sleeve Puller
83775	Cas/Cam Tool - 93 & Up F-Body
87145	22mm Mini-Van Wrench
78155	Ford 4x4 Wrench
83820	Ford F150 Cam Kit Adj. Wrench
88325	Camber/Caster Wrench
83850	GM "W" Toe Tool



### Mini-Van Wrenches

- Designed specifically to make front wheel alignments
- L-design of the wrench permits easy access to the bolt
- Full contact wrench that prevents slipping when adjusting eccentric toe cams



### GM/Ford Mini-Van Wrench Set

- Set contains the most popular 3/4", 13/16" and 18mm wrenches to make camber and caster adjustments on Mini-Vans and GM rear wheel drive turbo passenger cars
- Full contact wrench that prevents slipping when adjusting eccentric toe cams

Ascot No.	Mfg. No.	Description
223-87125	87125	GM/Ford Mini-Van Wrench Set

Ascot No.	Mfg. No.	Description
223-87130	87130	13/16" Ford Aerostar Van Wrench
223-87135	87135	3/4" GM Mini-Van Wrench

#### APPLICATIONS: 223-87130

**Ford RWD & 4WD:** 1995 - 01 Explorer, 1998 - 00 Ranger, 2101 - 02 Sport Trac

**Mercury RWD & 4WD:** 1995 - 01 Mountaineer

**Mazda RWD & 4WD:** 1998 & Up B-Series Pickup

#### APPLICATIONS: 223-87135

**GM:** Astro Van 1973-87, GM 2WD Pickups

# AUTOMOTIVE & FLEET SERVICE EQUIPMENT

LUBRICATION

EXHAUST, ENGINE & TRANSMISSION SERVICE

BATTERY & ELECTRICAL

SHOP EQUIPMENT

SAFETY PRODUCTS

MECHANICS GLOVES



# NEED HELP?

with tire storage

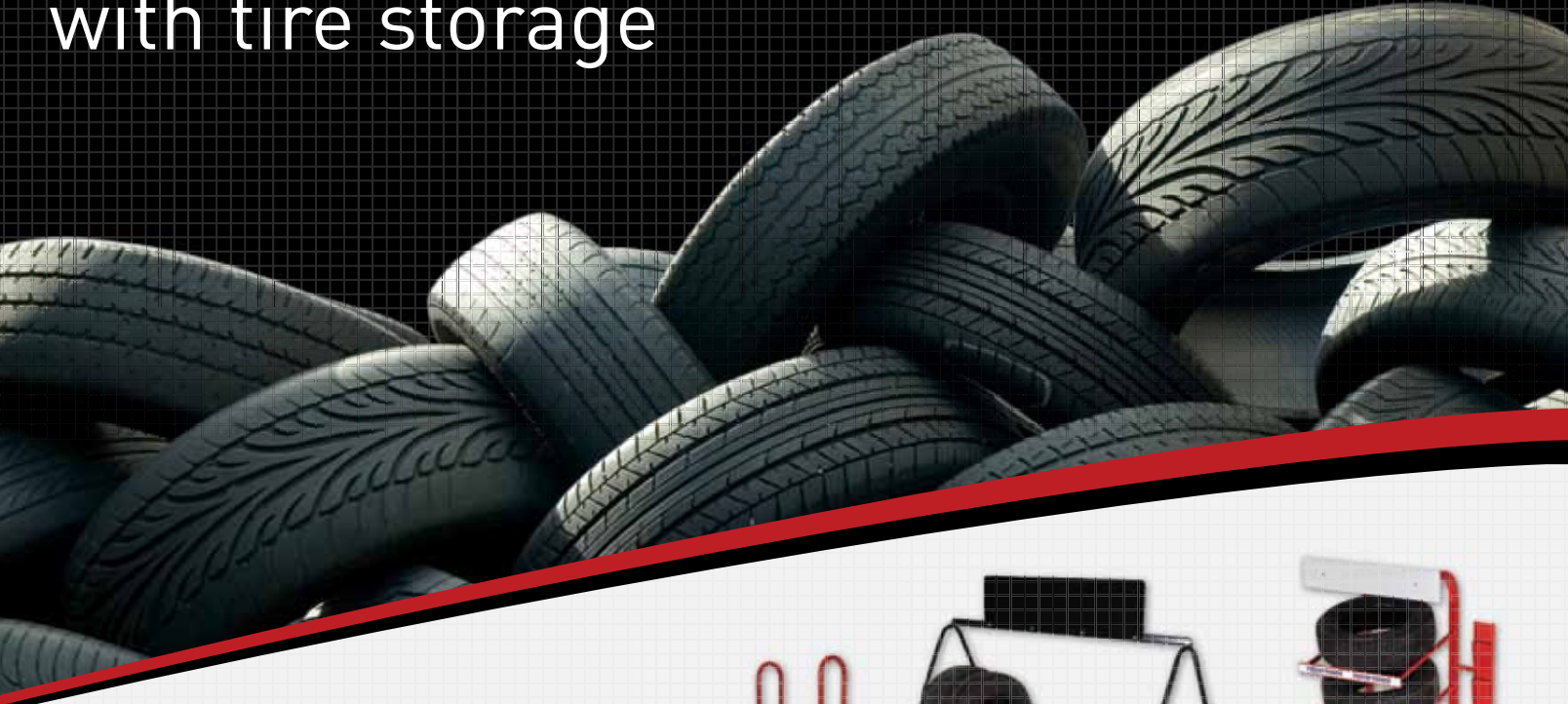

MANUFACTURER OF TIRE RACKS, TIRE DISPLAYS AND TIRE HANDLING SOLUTIONS



**MARTINS**  
INDUSTRIES



## Battery Charger/Starters

### Schumacher PSC12500A

- Charges 6 and 12 volt batteries
- Fully automatic, microprocessor controlled
- 125 Amp 12V Engine Start-for emergency starting
- 15->40 Amp 6 and 12V rapid charge with self adjusting, variable charge rates and float-mode monitoring
- 2 Amp 12V Trickle charge for small batteries
- 12V regular automotive, deep-cycle, AGM/Gel Cell and 6V regular batteries
- Built in digital volt meter/alternator tester

Ascot No.	Mfg. No.
341-12500	PSC12500A



### Schumacher SE-3000

- For heavy-duty fleet and industrial use. Charges a variety of batteries: 6, 12, 18 and 24 volt. No need to separately charge 18 and 24 volt batteries. Full power engine start available in each volt range. Fan cooled
- 200 amp 12 or 24 volt/180 amp 6 volt engine start – for emergency starting under severe conditions
- Single rotary switch – addresses all volt ranges
- "Hold" position on timer switch – for continuous charging

Ascot No.	Mfg. No.
341-03000	SE3000

UL Rating: 80/60/44/30 amp  
 Discharge Rating: 35/60/70/100 amp  
 CUL Listed: Model SF-3000



### Schumacher SE-6030

- Ideal for big fleet operations and industrial use. Perfect for situations that need a lot of power (including diesel engines). Two fast charge settings. Very high-output engine start assists batteries in cranking most engines under severe weather conditions. For 6 and 12 volt batteries. Fan cooled
- "Hold" position – for continuous charging
- Durable construction with tubular handle

Ascot No.	Mfg. No.
341-06030	SE6030

UL Rating: 30 amp and 60 amp continuous, 300 amp start  
 Discharge Rating: 40/80 amp  
 CUL Listed: Model SF-8050



### Schumacher INC-7A-OBD

- On board diagnostics connector (OBDII) plugs directly into vehicles OBDII Port
- Preserves stored fault codes and programmed electronic settings
- 7 amp hour battery
- Easy to ready battery status LED's - tell when internal battery is at full power, 75% charged or 50% or less and needs charging
- Built-in charger for automatic charging of internal battery
- Charging and charged LED indicators - indicates charging status of internal battery

Ascot No.	Mfg. No.
341-70000	INC-7A-OBD



### Schumacher INC-12B-OBD

- This accessory connector plugs the OBD II head into the car's OBD II source
- Protects vehicle fault codes, driveability codes, keyless entry codes and digital radio settings

Ascot No.	Mfg. No.
343-12000	INC-12B-OBD



### Schumacher PSJ1812

- 1800 peak amps
- 18 Ah professional grade, high output AGM Battery
- 12 volt DC power outlet
- 4 gauge, 28 inch cables
- Built-in automatic charger
- Charging and charged status LEDs
- Battery status LED

Ascot No.	Mfg. No.
341-81200	PSJ1812



### Schumacher PSJ2212

- 2200 Peak Amps, 330 Cranking Amps & 275 Cold Cranking Amps
- 22 Ah Professional-Grade, High-Output AGM Battery
- 3-Amp Built-in, Automatic Charger
- Two-Function Digital Display
- 12V DC Power Outlet
- 4-Gauge, 50-inch Cables

Ascot No.	Mfg. No.
341-22120	PSJ2212





## Battery Chargers/Starters (Cont.)

### Associated 6/12 VOLT Charger

- Highest performance fast charger on the market
- Designed to meet the needs of the most demanding professional with 16 rates of charge and 75 amp continuous charge with 375 amps crank assist at 12 volts
- 25% more engine start than previous model
- UL and CSA listed for indoor and outdoor use "SAFE IN ANY WEATHER"

Ascot No.	Mfg. No.
341-06001	6001A



### Associated 6/12/18/24 VOLT Charger

- Highest performance fleet charger on the market has 80 amps continuous charge with 400 amp crank assist at 12 volts
- 33% more engine start than previous model
- Heavy duty vacuum impregnated Transformer, patented "Sub-Sil" multi-diode rectifiers, longer AC cord and DC leads are standard features for higher performance
- UL and CSA listed for indoor and outdoor use, "SAFE IN ANY WEATHER"

Ascot No.	Mfg. No.
341-06002	6002B



### Associated 6/12/24 VOLT Charger

- Fleet charging power with a cranking assist rating higher than any other charger in its classification
- Increased starting power
- Heavy duty fleet charger rejuvenates all standard and maintenance-free 6, 12 and 24 volt batteries with five charging positions
- 10% more starting power than previous model

Ascot No.	Mfg. No.
341-06006	6006



### Associated 6/12 VOLT Charger

- 40/20/10 amp CSA continuous charge rate
- 200 amp cranking assist
- CSA and CSA US listed for indoor and outdoor use
- Automatic 90 minute timer with "Hold"
- Convection cooled, fewer moving parts
- Heavy duty chrome hoop handle
- Made in USA

Ascot No.	Mfg. No.
341-06019	6019



## Booster Pacs

### Kwikstart 425 Booster Pac

- Rechargeable 12 volt DC power supply is equipped with a UL listed 12 volt DC battery
- Ideal for jump-starting cars, trucks, boats, RVs and tractors
- Operator can also use up to 50 hours of portable DC power for cell phone, power tools, work lights and more
- Patented clamp on bars make it easy for stowing the clamps when not in use
- Comes equipped with a 120 volt charger with overload protection

Ascot No.	Mfg. No.
341-06225	6225



### Kwikstart 650 Booster Pac

- Rechargeable 12 volt DC power supply is equipped with a UL listed 12 volt DC battery
- Ideal for jump-starting cars, trucks, boats, RV's and tractors
- Has 44% more cranking power than Kwikstart 425
- Operator can also use up to 50 hours of portable DC power for cell phones, power tools, work lights and more
- Patented clamp on bars make it easy for stowing the clamps when not in use
- Comes equipped with a 120 volt charger with overload protection

Ascot No.	Mfg. No.
344-06250	6250



### Battery Load Tester

- Perform diagnostic tests: state of charge, battery load test, starter test, charging system test
- Lightweight and easy to use

Ascot No.	Mfg. No.
344-06026	6026



### Battery Load Tester

- Carbon pile tester that handles all 6/12 volt batteries
- Two large 4.5" analog meters that display amperes and volts. DC test leads that are 2.5' and 4 AWG

Ascot No.	Mfg. No.
344-06034	6036B



## Battery Chargers/Starters (Cont.)

### Boost Wheel Charger & Power Supply

- Electrical Stability System (ESS™) technology turns 6007A into a stable power supply for extended service procedures or re-flashes. Nominal 13.7V DC Output
- Program for deep discharge recovery of flooded batteries
- Patented diagnostics indicate weak or defective battery
- Charges all types of 12 volt batteries
- Designed for AGM, Gel Cell, Sealed and Standard Flooded batteries including Spiral cell, Orbital or Optima batteries
- "Safe In Any Weather" Operation
- UL Listed
- MADE IN USA



Ascot No.	Mfg. No.
341-06007	6007A

### Automatic Charger/Analyzer 12 Volt

- Micro-processor controlled and fully automatic
- Analyzes battery condition and automatically selects proper charging techniques
- Voltage controlled charging
- Suitable for flooded and sealed batteries
- Utilizes three color LED's to monitor charging status
- Program for deep discharge recovery of flooded batteries
- Capable of charging both small and large batteries
- Switch for selecting battery type
- Maintains battery charge, can be left connected to battery
- Models 9520 and 9510 available in 230VAC, 50/60 Hz
- PATENTED. MADE IN USA



Ascot No.	Mfg. No.
341-09410	9410

### Automatic Charger/Analyzer 8V/12V/16V

- Fully automated microprocessor controlled charger capable of charging Flooded, Deep Cycle, AGM and Gel Batteries – a simple switch determines the battery type
- A rotary switch is used to select the battery size: 8V for monoblock batteries used on many golf carts, 12V standard battery or 16V high performance batteries
- After the battery is fully charged; the unit will proceed to a float charge, keeping the battery ready and fully charged
- MADE IN USA



Ascot No.	Mfg. No.
341-06058	6058

### Automatic Charger/Analyzer 12 Volt

- Micro-processor controlled and fully automatic
- Voltage controlled charging
- Suitable for flooded or sealed batteries and gel-cell capable
- UL Listed for indoor and outdoor use
- LCD Display showing voltage, charging rate, type of battery (sealed or flooded) and the condition of the battery being charged
- Reverse polarity protected
- Anti-sparking protection
- Weak battery detection and rejuvenation program
- Switch for selecting battery type
- Switch for manual start of batteries below limit
- PATENTED. MADE IN USA

Ascot No.	Mfg. No.
341-06003	6003



### Output Bench Charger/Power Supply

- Electrical Stability System (ESS™) technology turns 9425 into a stable power supply for extended service procedures or re-flashes. Nominal 13.7V DC Output
- Program for deep discharge recovery of flooded batteries
- Patented diagnostics indicate weak or defective battery
- Charges all types of 12 volt batteries
- Designed for AGM, Gel Cell, Sealed and Standard Flooded batteries including Spiral Cell, Orbital or Optima batteries
- MADE IN USA

Ascot No.	Mfg. No.
341-09425	9425



## Battery Tester

### NEW! Midtronics HYB Hybrid Battery System Analyzer

- The HYB provides technicians with the capability to perform battery service maintenance testing on several leading Hybrid vehicles
- Simply connect the wireless convergence communication module to the vehicle's on-board diagnostics port and follow the menu instructions on the HYB tester. One person test –easy to use for any technician level. Consistent test across all vehicle manufacturers
- Safe – no exposure to dangerous high voltage
- Preventative maintenance: Find problem packs and cells before they cause system performance issues or failure
- Drive Test - Interactive, menu-driven test that uses live vehicle sensor information while performing an accelerated drive test
- Test 12 volt Auxiliary battery
- Read & Clear DTC Codes
- Live Data—Run Chart



Ascot No.	Mfg. No.	Description
342-10000	HYB-1000	Tester
342-10001	HYB-1000KIT	Kit (Includes Printer)

## Exhaust Hoses

### Crushproof Exhaust Ventilation System

Ascot No.	Mfg. No.	Description
391-00125	DF25	2-1/2" Rubber Door Port
391-00130	ADF30	3" Aluminum Door Port
391-00140	ADF40	4" Aluminum Door Port
391-00225	RY25	2-1/2" Rubber Y-Connector
391-00230	RY30	3" Rubber Y-Connector
391-00240	AY40	4" Aluminum Y-Connector
391-20030	AC30	3" Aluminum Splice Connector
391-20040	AC40	4" Aluminum Splice Connector
391-20050	AC50	5" Aluminum Splice Connector
391-20060	AC60	6" Aluminum Splice Connector
391-21025	SP25	2-1/2" Splice Connector
391-21030	SP30	3" Splice Connector
391-21040	SP40	4" Splice Connector
391-00325	AEL25	2-1/2" Aluminum Elbow
391-00330	AEL30	3" Aluminum Elbow
391-00340	AEL40	4" Aluminum Elbow
391-00350	AEL50	5" Aluminum Elbow
391-00425	EB25	2-1/2" Rubber Elbow
391-00430	EB30	3" Rubber Elbow
391-22150	OC50D	5" Overhead Duct Connector W/Damper
391-22160	AC-60-OC	6" Overhead Duct Connector
391-22030	OC30	3" Overhead Duct Connector
391-22040	OC40	4" Overhead Duct Connector
391-22050	OC50	5" Overhead Duct Connector
391-52500	YA250	2-1/2" Y-Assembly
391-53000	YA300	3" Y-Assembly
391-54000	YA400	4" Y-Assembly



Door Ports



Y-Connectors



Splice



Elbows



Overhead Duct



Y-Assembly

### Flarelock Hose

- For use with cars and small trucks
- Flared end on each length to permit connection of two or more lengths of same size hose

Ascot No.	Mfg. No.	Description
391-15250	FLT250	2-1/2" x 11' Flarelock Hose
391-15300	FLT300	3" x 11' Flarelock Hose
391-15350	FLT350	3-1/2" x 11' Flarelock Hose
391-15400	FLT400	4" x 11' Flarelock Hose



## Tailpipe Adapters

### Tailpipe Adapters

- Crushproof offers a complete line of accessory items



Ascot No.	Mfg. No.	Description	Tailpipe Style	Tailpipe Size	Hose ID
391-93000	TPA3000	Split Adapter	Separated	Up To 2-1/2"	3"
391-90250	F250	Straight W/ Hook & Chain	Single	Up To 2"	2-1/2", 3", 3-1/2"
391-90300	F300	Straight W/ Hook & Chain	Single	Up To 2-1/2"	2-1/2", 3", 3-1/2"
391-90350	F350	Straight W/ Hook & Chain	Single	Up To 3"	2-1/2", 3", 3-1/2"
391-90400	F400	Straight W/ Hook & Chain	Single	Up To 3-1/2"	3-1/2", 4", 5"
391-90600	DSR600	Stack Adapter	Diesel Stack	Up To 5-1/2"	4", 5"
391-90606	DSR600-6	Stack Adapter	Diesel Stack	Up To 5-1/2"	5", 6"
391-91000	UNA1000	Plug-n Unihose	All	All	3"
391-90475	F475	Oval Adapter (2.5" x 6")	Twin Oval	2", 5-1/2"	3", 4"
391-90575	F575	Oval Adapter (3.5" x 8.5")	Twin Oval	2", 5-1/2"	3", 4"
391-91250	RA250	Bell W/Snaps	All	All	3"
391-91300	RA300	Bell W/Snaps	All	All	3"

## Bench Grinders

### Industrial Bench Grinders

- UL listed motor
- Pre-lubricated and enclosed ball bearings
- Cast iron wheel guards and dust vents
- One piece quick adjusting spark guards
- Large eye shields with quick adjustment
- Adjustable tool rests
- Heavy duty guarded toggle switch on 8" and 10"
- Fine and coarse vitrified wheels included
- Rubber mounts prevent movement
- 3-conductor cord with 3-prong plug



Ascot No.	Mfg. No.	Description
311-77101	577101	JBG-6A - Bench Grinder, 6" Wheel
311-77102	577102	JBG-8A - Bench Grinder, 8" Wheel
311-77103	577103	JBG-10A - Bench Grinder, 10" Wheel
311-77172	577172	JPS-2 - Optional Pedestal

SPECIFICATIONS:	311-77101	311-77102	311-77103
Overall Dimensions (LxWxH)	18"x10.5"x8.5"	19"x12.5"x13"	24.5"x12.25"x13"
Wheel Size (DxWxB)	6"x7.5"x5"	8"x1"x5.75"	10"x1"x1"
Motor	1/2 HP 1 Phase 115V	1 HP 1 Phase 115V	1-1/2 HP 1 Phase 115V
Amperage			
Full Load:	5-1/2	8-1/2	10-1/2
No Load:	4	5	7
Cycle	60	60	60
RPM	3,450	3,450	1,725
Wheels Included	36/60 Grit	36/60 Grit	24/46 Grit
Net Weight	32 Lbs.	54 Lbs.	110 Lbs.
Shipping Weight	38 Lbs.	68 Lbs.	119 Lbs.



## Shop Vises

### Professional Shop Vises

- Cast iron jaw with heavy internal ribs for added strength. Pipe jaws are permanently cast in for greater channel strength
- Cast iron back jaw designed for exceptional alignment with the front jaw
- "V" notched, replaceable/reversible jaws made of carbon steel and heat treated for extra strength
- Specially designed spring loaded handle and screw guarantees quick jaw response
- Front jaw beam covers and protects screws
- Steel handle balls forged from handle stock



**Ken-Tool**

Ascot No.	Mfg. No.	Jaw Width	Jaw Opening	Throat Depth	Pipe Capacity	Weight
311-64055	64055	5-1/2" (14 cm)	6-1/2" (17 cm)	3-3/16" (8 cm)	1/8" (.3 cm)	30 Lbs. (14 kg)
311-64065	64065	6-1/2" (17 cm)	7-1/2" (19 cm)	3-3/4" (10 cm)	1/8"-2-1/2" (.3 - 6 cm)	41 Lbs. (19 kg)
311-64650	64650	6-1/2" (17 cm)	7"-10" (18 - 25 cm)	3-3/16" (8 cm)	1/8"-2-1/2" (.3 - 6 cm)	50 Lbs. (23 kg)
311-64800	64800	8" (20 cm)	8"-11" (20 - 28 cm)	3-3/4" (9 cm)	1/8"-3" (.3 - 8 cm)	74 Lbs. (34 kg)

### 5" Tradesman Vise

- Wider jaws provide greater clamping surface
- Fully enclosed spindle and nut increases the life of the vise
- Made from 60,000 PSI tensile ductile iron
- Precision turned sidebar
- 360° swivel base with double lockdowns
- Opening capacity max: 5"



Ascot No.	Mfg. No.	Jaw Width	Throat Depth	Pipe Capacity	Weight
311-63200	63200	5-1/2"	3-3/4"	1/4 - 3"	51.55 Lbs.

### 6" Swivel Base Bench Vise

- Heavy duty 30,000 PSI castings for long life and added strength
- Swivel bar rotates 360 and has double lockdowns ensuring maximum stability
- Powder coat paint resists scratches and provides a tough durable finish
- Replaceable hardened steel top and pipe jaws



Ascot No.	Mfg. No.	Jaw Width	Throat Depth	Pipe Capacity	Weight
311-21500	21500	6"	4-1/8"	1/4 - 3-1/2"	69.35 Lbs.

## Pliers & Screwdrivers

### 7" Cutting Plier with End Cutter

- Perfectly mated cutter, heat treated to hold its edge
- Polished high carbon drop forged steel
- CHANNELLOCK BLUE comfort grips



Ascot No.	Mfg. No.
319-00357	357

### 5" Cutting Plier Box Joint

- Perfectly mated cutters, scientifically heat treated to hold their edge
- Precision made of fine polished, high carbon drop forged steel
- Distinctive CHANNELLOCK BLUE comfort grips



Ascot No.	Mfg. No.
319-00435	435

### 6" Diagonal Cutting Plier - Box Joint

- Perfectly mated cutter, heat treated to hold its edge
- Polished high carbon drop forged steel
- Distinctive CHANNELLOCK BLUE comfort grips



Ascot No.	Mfg. No.
319-00436	436

### 6" Slip Joint Plier - Wire Cutting Shear

- Thick Nose Pliers
- Shear-type wire cutter
- Precision made of fine polished, high carbon drop forged steel
- Patented PermaLock® fastener eliminates nut and bolt failures
- CHANNELLOCK BLUE® comfort grips



Ascot No.	Mfg. No.
319-00526	526

### 8-Piece Professional Screwdriver Set

- Includes 5 flat tip drivers and 3 Phillips tip drivers
- Slotted: 3/8" x 8", 5/16" x 6", 1/4" x 4", 3/16" x 3", 1/4" x 1-1/2"
- Phillips: #2 Phillips x 4", #1 Phillips x 3", #2 Phillips x 1-1/2"
- Fluorescent yellow handles
- Hardened chrome vanadium shafts
- Vapor blasted magnetic tips
- Packaged in molded plastic tray for storage
- Hex bolsters for extra turning power

Ascot No.
319-19800



## Shop Supplies & Equipment

### Imprinted Paper Floor Mats

- High bulk 60 pound paper imprinted with a "Thank You" message
- Excellent protection for the plush interior of today's cars
- Size: 17" x 22"
- 1,000 per box



Ascot No.	Description
399-00003	Imprinted Paper Floor Mats

### Waffle Paper Floor Mats

- Mat designed for wet applications
- Made from a very durable packing material
- Size: 17" x 22"
- 500 per bundle



Ascot No.	Description
399-00004	Waffle Floor Mats

### Personalized Paper Floor Mats

- Either insert your logo where the footprints are or totally design a new layout
- The stock is a high bulk 60 pound white sheet, size 17" x 22", with a one color imprint
- Minimum order of 3,000
- Camera ready art must be supplied for all logos - one time artwork charge

Ascot No.	Description
399-00005	Personalized Floor Mats

### Metal Ring Key Tag

- Save valuable time looking for customer keys - keys can be immediately identified with this inexpensive 2-1/2" x 1-3/8" manila reinforced tag
- Plenty of room for name and license plate number



Ascot No.	Description
399-00010	Metal Ring Key Tag

### Plastic Arrow Key Tag

- Unique one piece key tag that attaches easily to the key ring with a hole for hanging on a board
- Packaged 40 perforated sheets with 25 tags each
- 1000 per pack

Ascot No.	Description
399-00011	Plastic Arrow Key Tag



### Tire Labels

- 2-1/2" x 6" label for easy identification of new, used and retreaded tires
- Packed 500 per roll



Ascot No.	Description
601-00101	Tire Labels

### Heavy Duty Tubeless Truck Tube/Tire Dunkers



- Space saving design requires 40% less space
- New design fits in left or right corners
- Entire rim and tire are checked for air leaks simultaneously
- One man operation: Safe and easy to operate. No lifting
- 360° turn in water - easy and fast inspection
- Uni-quick ratchet type adapter adjusts from 15" dia. to 52" dia. and instantly lifts up to 400 lbs. RVs to super singles
- Optional inner tube adapter allows you to check tubes up to 50" in diameter

Ascot No.	Mft. No.	Description
517-00100	100TTD	E-Z Dunk Truck Tire Dunker, Range 15" - 50" Diameter
517-00039	39ED	39" Dia. x 24" Depth Passenger & RV Tube & Tire Dunker With Polyethylene Tank
517-00055	55T	T & G 55" Dia. x 24" Depth Truck & Grader Tube Dunker With Polyethylene Tank



517-00039



517-00055

## Shop Cleaners & Brushes

### GOJO SUPRO MAX™ 2000

- Removes tough, sticky soils while being gentle on the skin
- A unique blend of cleaners, skin conditioners and gentle scrubbers
- Does not leave a residue or dry out the skin



395-72722

Ascot No.	Mfg. No.	Description
395-72722	7272-D2	PRO™ 2000 Starter Kit 1 Dispenser/ 1 Refill
395-72724	7272-04	PRO™ 2000 Refill - Qty. 4 Per Case

### Floor Squeegees

- Black neoprene rubber blade designed for rough, heavy use
- Handle not included, order separately



395-45507

Ascot No.	Mfg. No.	Description
395-45507	45507	24" Straight Squeegee
395-45509	45509	Blade Refill for 45507
395-44020	44020	Handle

### GOJO Natural Orange Pro

- Quickly removes most common medium to heavy soils
- Contains pumice scrubbing particles to help loosen stubborn dirt
- Natural citrus ingredient leaves pleasant scent
- 2000mL capacity



395-72552

395-72554

Ascot No.	Mfg. No.	Description
395-72552	7255-D2	Orange PRO™ Starter Kit 1 Dispenser/ 1 Refill
395-72554	7255-04	Orange PRO™ Refill - Qty. 2 Per Case

### Palmyra Fill Garage Brushes/Brooms

- Excellent for heavy duty sweeping of concrete, sidewalks and garage floors
- Can be used for wet or dry sweeping



Ascot No.	Mfg. No.	Description
395-42023	42023	24" Garage Brush-Palmyra

### GOJO Natural Orange 1 Gallon Pump Bottle



Ascot No.	Mfg. No.	Description
395-09552	0955-02	2 - 1 Gallon Pump Bottles

### Super Tough Hand Scrub

- Commercial size for 768 washes
- Recommended for shops under 10 users



Ascot No.	Mfg. No.	Description
395-06400	TS6400	64 Ounce Container

### Hand Wire Brush

- Cleans rust from rims and wheels



Ascot No.	Mfg. No.	Length	Weight
535-00150	T15	14"	5 Oz.



## Tire Carts, Shop Lights, Service Stickers

### EZ-1F Tire Cart

- Clamps on and holds
- Tire stack handling cart greatly improves moving tire stacks
- With an adjustable range of 14" including 12" passenger through largest RVs
- Cart's adjustable clamping arms grip bottom tire and holds on - no lost loads while moving stacks of tires
- Modernize your tire handling operation
- Positive lock - instant release
- 69" H x 28" W (including 10" solid wheels), weight: 101 lbs.
- 14" adjustable range: 12" passenger thru 33 x 12.50 R16.5LT



**MOV-IT TIRE PRODUCTS** ○ ○ ○

Ascot No.	Mfg. No.	Description
703-00001	EZ-1F	EZ Tire Cart-For Passenger Tires (12"), Pickup and RV Tires

### Tire Cart

- Features a gas spring that automatically closes the arms and grips the tires
- Tires won't work loose
- Handles 20" through 37" outside diameter tires



Ascot No.	Mfg. No.
703-00103	TC

### Static Cling Reminder Stickers

- Excellent item to promote repeat business
- Keeps your name, the service to be done and the time to do it in constant view of the customer
- More effective than a door jam sticker
- Static cling vinyl will cling to almost any smooth surface
- No adhesive residue and they can be removed for cleaning and replacing
- Silk screen printing process for a high quality image and a writing strip that won't allow the ink to fade
- Generic design stickers as well as personalized stickers

Ascot No.	Mfg. No.
399-00101	Air Pressure/Tire Rotation Static Cling Sticker
399-00102	Oil Change Static Cling Sticker
399-00103	Service Reminder Static Cling Sticker

### Bounce Lite

- Bounces instead of breaking
- Patented rough service bulb for superior impact resistance
- 18/2 SJTOW cord for longer cord life
- Fully enclosed safety switch



312-12010

Ascot No.	Mfg. No.	Description
312-12006	12006	Bounce Light 25' Cord
312-12010	12010	Bounce Light on 40' Reel
312-11006	11006-17	Replacement Rough Service Bulb

### Static Cling Printer

- Full feature Reminder Sticker Solution takes professionalism to a new level
- Zebra Printer pre-programmed to work out of the box
- Zebra Keyboard Display Unit
- 1 year parts and labor warranty (6 months on print head)
- 1 ribbon - Zebra CD with Drivers for printer and Create-A-Label Software

Ascot No.	Mfg. No.
399-11111	Static Cling Printer

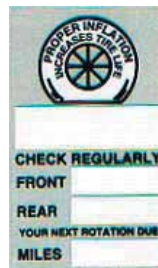

399-00101

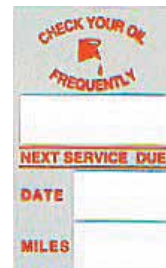

399-00102

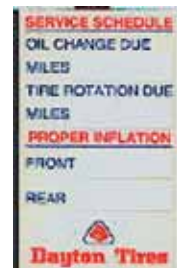

399-00103

## Tire Racks

### Passenger & Light Truck Folding Racks

This flexible mobile storage system allows you to reduce tire handling to a minimum while providing unparalleled versatility. Large numbers of tires can be stored by load stacking and smaller quantities can be kept on treads in tires. Very sturdy steel construction ensures superior durability.

Ascot No.	Mfg. No.	Holds	Size
751-03260	MLTFD	32-60 Tires	72" x 50" x 66"



### 60" Passenger & Light Truck Folding Racks

This versatile modular storage system offers extraordinary flexibility in outfitting your tire warehouse. Pallets can be moved and stacked for fast shipment. Removable posts can reduce space requirements by 80%, allowing you to stack them when empty to free up space.



Ascot No.	Mfg. No.	Holds	Size
751-06060	MSR-6060	28-35 Tires	60" x 60" x 60"

### Wall-Mount Rack

Get tires away from your workspace! With this wall-mount tire rack, you can store 8 tires on the wall to get them off your floor. Easy to assemble and mount on wood or concrete walls.



Ascot No.	Mfg. No.	Holds	Size
751-00066	MWM-66	8 Tires	66" Long

### Tire Shelving

Three adjustable tiers - perfect for tires alone or wheel-mounted. Used mainly to store small numbers of tires or store customers' tires. Allows storage of 330 tires in a 40-foot container. Fasteners for walls, floors and additional sections are included.



- Holds 10-12 tires per level
- Rails are tilted to hold tires properly
- Each section is designed to stand alone

Ascot No.	Mfg. No.	Capacity	Dimensions	Weight
751-00922	MTS-92	30 to 36 tires	92" x 92" x 18"	110 Lbs.
751-00924	MTS-924	40 to 48 tires	92" x 120" x 18"	140 Lbs.
751-00925	MTS-925	50 to 60 tires	92" x 150" x 18"	170 Lbs.

### Truck Tire Folding Rack

For greater ease of use in storing and handling your tires for heavy trucks or farm machines, this folding rack offers vertical tire storage for easy access. Each rack holds 8 tires and can be stacked 4 high, or 20 high when folded. Fits easily in a trailer for shipping.



Ascot No.	Mfg. No.	Holds	Size
751-08010	MTFR	8-10 Tires	94" x 44" x 52"

## Tire Racks (Cont.)

### Standard Tire Display

This display unit mounted on two fixed wheels can hold 10-14 tires with rims. Handling requires a dolly designed specifically for wheel-mounted tire display units. It is 60" long (1524mm) and ideally suited for heavier loads and uneven ground.



Ascot No.	Mfg. No.	Holds	Size
751-00060	MTD-60	10-14 Tires	60" x 72" x 20"

### 3-Tier Tire Display

This display unit mounted on two fixed wheels can hold 21-30 tires with rims. Handling requires a dolly designed specifically for wheel-mounted tire display units. It is 60" long (1524mm) and ideally suited for heavier loads and uneven ground. Comes with a logo plate (48" x 12") painted black to put your logo.



Ascot No.	Mfg. No.	Holds	Size
751-00272	MTD-3T	21-30 Tires	60" Long

### Deluxe Tire Display

This display unit is an excellent compromise between strength and light weight. It has four wheels for fast, easy moves with no need for a dolly. It will hold 14-18 tires up to 31" (790mm) outside diameter. Front wheels are equipped with a brake, and a nameplate measuring 48" x 12" (1200 x 300mm) is provided to display your logo.



Ascot No.	Mfg. No.	Holds	Size
751-00072	MTD-72	14-18 Tires	72" x 75" x 20"

### Dolly for Tire Displays

Required to handle tire display units. Only one is necessary even if you have several display units. Compatible with all other makes of display units.

Ascot No.	Mfg. No.
751-00172	MD



### Wheel Display

This wheel rim display unit will hold eight rims 27" in diameter (685mm) and 12" wide (300mm). Made with 1 1/2" (28mm) round tube with brushed stainless steel finish. Fully adjustable in height.



Ascot No.	Mfg. No.	Holds	Size
751-00093	MWD	4-8 Tires	24" x 24" x 78"

### Standard Showroom Display

This showroom display holds 6 tires and is just right for limited spaces. You can display your logo at the top as a mounting is already provided for the sign. An inexpensive way to display your tires for customers. Baked powder enamel with metallic silver finish.



Ascot No.	Mfg. No.	Holds	Size
751-00773	MSSD	6 Tires	90" High

### Deluxe Showroom Display Unit

Perfect for displaying your tires for customers, this unit will hold eight tires up to 29" in diameter (740 mm). Includes a folder display and bookmarks providing information on 15 different makes of tire. Packed in a box with all necessary assembly hardware.



Ascot No.	Mfg. No.	Holds	Size
751-00008	MSTD	8 Tires	35" x 98" x 34"

### Tire Cart

Easy to maneuver... even with a full load of tires. Can carry tires up to 35" in diameter. Simply press down on the pedal, slide the dolly under the pile and release the pedal. The frame will align the tires! Good for tire diameters from 16" to 35" (406-890 mm).



Ascot No.	Mfg. No.	Holds	Size
751-00810	MTC	8-10 Tires	Max O.D. 35"

**Car Protectors**



Steering Wheel Cover

Floor Mat

Tire Storage Bag

Worn Parts Bag  
Seat Covers

- Protection system provides total protection for customer's car while being serviced
- Cover holds fast to the upholstery
- A patented process laminates two distinctly different plastics together - the top layer allows a person to easily slide into and out of the vehicle and the bottom, or gripping layer, keeps the seat cover in place
- Unique process eliminates static electric clinging and wrinkling
- Complete line of vehicle interior protection products available with service center roll dispenser

**Plastic Seat Covers**

- Unique patented two-sided, double ply seat covers that cling to the seat while allowing service personnel to freely slide in and out without rumpling or moving the protective cover
- Two covers will protect a bench seat with plenty of room for center overlap

Ascot No.	Mfg. No.	Description
399-94315	P9943-15	Valve Seat Cover - 500/Roll
399-94314	P9943-14	Premium Seat Cover - 250/Roll

**Plastic Floor Mats**

- Large plastic mats 19" x 21", fit all cars
- Stay in place with unique clinging feature
- Rugged plastic, won't tear or soak through like paper
- 500 per roll

Ascot No.	Mfg. No.
399-60091	P9943-02

**Parts Return Bag**

- Heavy plastic bag for holding old removed parts you've replaced
- Keeps customer's vehicle and hands clean

Ascot No.	Mfg. No.	Description
399-60098	P9943-56	14" x 22"

**Steering Wheel Cover**

- Reusable/disposable steering wheel covers are made of clear polyethylene with stretch elastic grip feature
- Protects steering wheel from grease and other shop chemicals
- 500 per box

Ascot No.	Mfg. No.
399-60099	P9943-33

**Tire Storage Bags**

- Large multi-use bags
- Made from clear polyethylene
- Protects the interior of your customer's car when they want to take old tires home with them
- 250 per roll

Ascot No.	Mfg. No.	Description
399-94329	P9943-29	Standard Tire Bags - White (250 per Roll)
399-93392	P9933-92	Large Tire Bags - White (250 per Roll)

**Product Dispenser System**

- Promotes your professional image by displaying your complete line of car interior protection products where your customers can see you putting them in their car
- Convenient roll dispenser work station provides organized storage, helps save employee time and shows your customers you care about their car

Ascot No.	Mfg. No.
399-60000	P9833-89A



## Studding Equipment

### Studding Equipment



Ascot No.	Mfg. No.	Description
458-00010	10-G	Stud Gun. Standard Of The Industry. Automatic, Light Weight
458-00002	KFP2	Stud Feeder. Fully Automatic With 110 Volt Motor, Fast Loading. Provides Positive Stud Orientation. Feeds Up To 225 Studs Per Minute
458-04048	4048	Feederboy Stud Gun. Designed For Fast Feeding Studs Of The AS-9 Gun Attaches With Screw Clamp. Operates By Manually Turning The Feeder Cap
458-00005	K-5	Stud Feeder. Includes Shield For Gun. Welded Steel Construction With Saddle
458-00500	K-500	Studding Equipment Kit. Consists of K-5 Stand, AS-9 Gun, KFP2 Automatic Stud Feeder

### Stud Gun Parts Breakdown

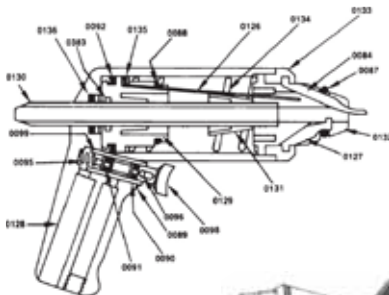

Part No.	Description
0084	External Finger
0087	O-Ring
0088	O-Ring
0089	O-Ring
0090	O-Ring
0091	O-Ring
0092	Piston Cup
0095	Trigger Spring
0096	Trigger Pin
0098	Trigger
0099	Trigger Sleeve
0126	Pressing Spring

Part No.	Description
0127	Internal Finger
0128	Handle Body
0129	Piston
0130	Feed Tube
0131	Tapered Sleeve
0132	Head (Steel)
0133	Ring Nut
0134	Compression Spring
0135	Ring
0136	O-Ring
0383	Piston Cup

### Model KFP2 Parts Breakdown

Part No.	Description
0169	Deflector Spring
0172	Snap Ring
0173	Screw
0174	Washer
0175	Clamp
0180	Drive Shaft Pin
0428	Washer
0519	Feed Wheel
0520	Base Plate
0521	Retaining Ring
0522	Feed Tube
0523	Screw
0524	Shaft
0525	Hex Bolt

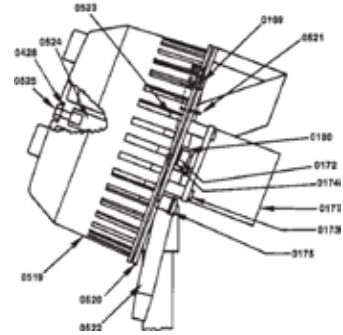

### Ugigrip®, Self-Adjusting Carbide Tire Stud

- Delivers full-time traction, increases the safety, convenience and security
- To order studs to best fit your customers' tire, use the TSMI number recommended by the tire manufacturer



#### SINGLE FLANGE STUDS

TSMI Size	11	12	13	15	169	17	19
Overall Length	.345"	.375"	.470"	.520"	.585"	.515"	.635"
Jacket Dia.	.197"	.197"	.197"	.197"	.197"	.197"	.250"
Bottom Dia.	.354"	.354"	.354"	.354"	.354"	.354"	.354"
Nearest 32" to Hole Depth	11/32"	12/32"	13/32"	15/32"	16/32"	17/32"	19/32"

### Studding Equipment

- Lightweight, reduces road wear. Steel 125L, 135L & 165L meet requirements for Washington, Oregon and Idaho

Ascot No.	Studding Gun	Use with Studs Numbered
458-00010	10G	TSMI-11-12-13-15-16-17
458-00011	10T	TSMI-19-21

### Stud Gun Repair and Conversion Kits

Ascot No.	Studding Gun	Use with Studs Numbered
458-03810	0381	Tire Stud Mini Repair Kit. Includes (3) 0084 External Fingers; (1) 0087 O-Ring; (1) 0088 O-Ring; (3) 0126 Pressing Springs
458-03820	0382	Tire Stud Gun Large Repair Kit. Includes: (6) 0126 Pressing Spring; (3) 0084 External Fingers; (2) 0087 O-Ring; (2) 0088 O-Ring; (1) 0092 Piston Cup; (1) 0136 O-Ring
458-00911	00911	Conversion Kit. Converts AS-9 Gun To AS-11 Truck Model. Includes: (1) 0401 Truck Feed Tube; (1) 0400 Truck Stud Gun Head; (3) 0127 Truck Stud Gun Internal Finger

**Drains**

**Used Oil System**

- Used Oil Kit - When used with Balcrank's diaphragm pump 1120-013, this kit provides suction evacuation for the 4110-010 Spillguard Drain. Includes wall bracket, air hose, suction hose and fluid hose with dry-break coupler

Ascot No.	Mfg. No.	Description
322-30015	4140-015	Used Oil System
322-41110	4110-010	Spillguard Drain
324-11213	1120-013	1" Diaphragm Pump
329-11211	1121-011	1" Outfit Kit Includes: 1120-013 & 4140-015
329-11212	1121-012	Kit includes: 1120-019 (Diaphragm Pump), 4140-026 (Oil Kit)

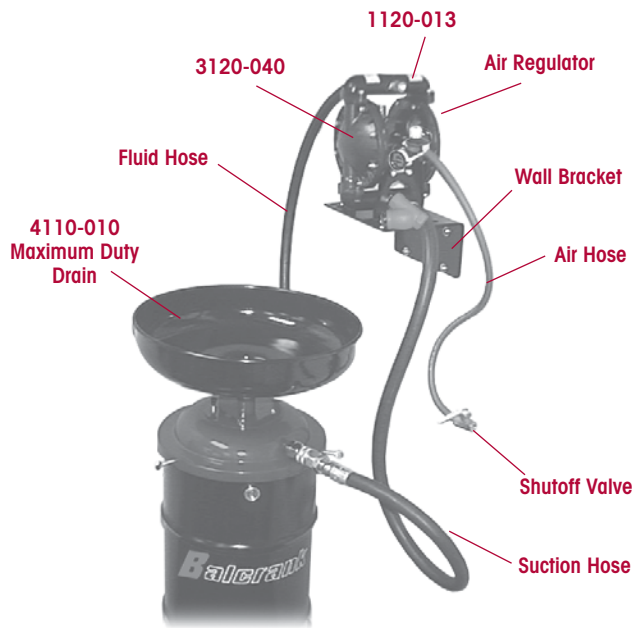

**Roughneck II™ Series Self Evacuating Drains**

Drain used oil or antifreeze into the 23 gallon reservoir, then connect to low pressure air hose to evacuate oil or antifreeze into any bulk storage tank. No pump required. Features 19.25" bowl, quick height adjustment, sight gauge, patented automatic evacuation valve, regulated air inlet with safety valve, tank handle, large carriage wheels and durable powder coat finish. Antifreeze drains painted with green powder coat.

Ascot No.	Mfg. No.	Description
322-10022	4110-022	Used Oil Drain
322-10023	4110-023	Used Antifreeze Drain



322-10023



322-10022

**Grease Guns**

**Grease Guns**

- 14 oz. capacity

Ascot No.	Mfg. No.	Description
323-52006	5200-006	Lever style
323-52007	5200-007	Pistol Style
323-52008	5200-008	Air Operated



323-52006



323-52007



323-52008

**A Complete Line of Oil and Grease Reels Available. Call for Details.**

## Fluid Pumps

### Balcrank 3:1 Tank Package

**Includes:**

- Panther 3:1 Pump
- Inlet hose
- PGM-40 mechanical handle with flex extension
- Pressure Relief Kit
- FRL
- Bung Adapter

Ascot No.	Mfg. No.	Description
322-32006	1132-006	1/2" x 30' Signature Series Hose Reel
329-11329	1132-009	1/2" x 50' Signature Series Hose Reel

### Balcrank 5:1 Tank Package

**Includes:**

- Panther 5:1 Pump
- Inlet hose
- PGM-40 mechanical handle with flex extension
- Pressure Relief Kit
- FRL
- Bung Adapter

Ascot No.	Mfg. No.	Description
322-32007	1132-007	1/2" x 30' Signature Series Hose Reel
322-32010	1132-010	1/2" x 50' Signature Series Hose Reel

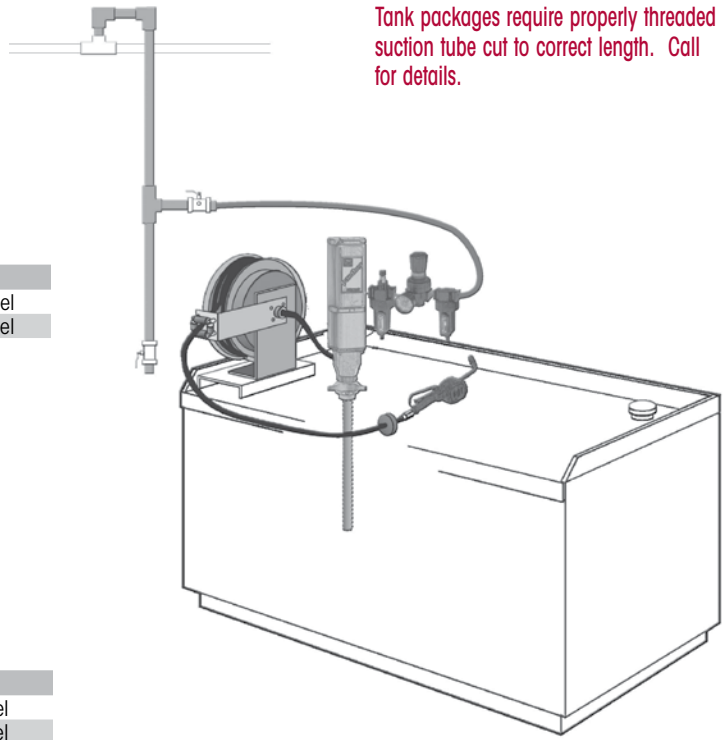

Tank packages require properly threaded suction tube cut to correct length. Call for details.

### Balcrank PGE-55 Convertible Electronic Control Handle

- Heavy duty construction
- Two outlet nozzle position (in-line or pistol grip)
- Oval gears for optimum accuracy
- Resettable batch totalizer; non-reset-table totalizer
- Resettable third totalizer to track daily or weekly usage
- Free-moving, ball bearing swivel
- Up to 8 gallons per minute (bare handle)
- Trigger guard included
- Models available with automatic and semi-automatic tip



Ascot No.	Mfg. No.	Description	Tip
322-30054	3330-054	Rigid	Automatic
322-30055	3330-055	Flex	Automatic
322-30056	3330-056	Elbow	Automatic
322-30057	3330-057	Flex 90	Automatic
322-30058	3330-058	Bare	-
322-30059	3330-059	Straight*	Automatic
322-30063	3330-063	Rigid	Semi-automatic
322-30064	3330-064	Straight	Semi-automatic
322-30065	3330-065	Flex	Semi-automatic
322-30066	3330-066	Elbow	Semi-automatic
322-30067	3330-067	Flex 90	Semi-automatic

\*Pistol Grip

### Balcrank Panther® 3:1 Pumps

- Double acting, true pump ratio
- Balanced flow displacement
- Positive trip air valve prevents stalling
- Heavy duty air motor with thick wall housing and long stroke design
- Enlarged flow passages
- High performance check valves
- Smooth, quiet operation
- Five year warranty, high value price point
- Used for distribution to 500 Ft. and up to 3 reel simultaneous service - medium to high usage
- Pumps available up to 50:1



Ascot No.	Mfg. No.
322-20015	1120-015

## Waste Oil Drains

### Super Truck Drain on Wheels

- Rugged heavy duty plastic tub for draining a large capacity crankcase
- Resistant to corrosives found in oils
- Holds 60 quarts to the rim
- Heavy duty casters fit into built-in fasteners for maneuverability
- Sturdy formed wire handle for easy moving
- Overall height 10", width 24" I.D. and length 43"



Ascot No.	Mfg. No.
322-19452	19452

### Transmission Drain Funnel

- 22" by 23" heavy duty plastic lift drain funnel
- Extends the catch area of any lift drain
- Funnel catches any loose parts
- Prevents parts from falling through drain



Ascot No.	Mfg. No.
322-17892	17892

### Dunk Tank

- Heavy duty plastic tire and tube test tank
- Features pyramid type ribs for extra support to prevent bowing
- Handles passenger tire sizes to wide oval and light duty truck tires



Ascot No.	Mfg. No.	Application
322-19822	2400-10	Passenger Car
322-02444	240044	SUV/Light Truck

### Multi-Drain Tub

- 30-quart, all purpose, heavy duty, plastic drain tub
- For draining radiator, crankcase, transmission differential
- Accommodate autos and trucks
- Apron for washing and sorting parts

Ascot No.	Mfg. No.
322-17922	17922



### Collection Spill-Proof Recovery Drain Pan

- Holds 4-1/2 gallons
- Heavy duty construction and an outstanding new concept for transfer of liquids
- For auto, home and industry
- Resistant to chemicals & solvents
- Made of durable high-density polyethylene
- 3 large openings lead liquid into 1" wide diameter spout for quick and easy pouring



323-17892



323-17952

Ascot No.	Mfg. No.	Description
322-17942	17892	Black
322-17952	17952	Green

### Evacuation Caddy (Gas)

- Safest, easiest way to evacuate or fill a gas tank
- Constructed of cross-linked polyethylene with a molded-in baffle
- 28-gallon capacity
- Equipped with industrial grade rotary hand pump with a 3/4" ID UL approved 10' hose with 3/4" ball and flexible siphon hose
- UN/DOT approved



Ascot No.	Mfg. No.	Description
329-24031	34031PQD	Evacuation Caddy, 28 Gallon

### Single Wall UL-142 Cube Lube Tank

- UL listed tanks - double and single Wall
- If tank is for used oil, a high level tank monitor is recommended



Ascot No.	Mfg. No.	Dimensions HxWxD	Thickness	Approx. Weight
322-00125	SW125	38"x32"x26"	12 Gauge	170 Lbs.
322-00200	SW200	36"x60"x22"	12 Gauge	220 Lbs.
322-00201	SW200V	60"x36"x22"	12 Gauge	220 Lbs.
322-00250	SW250	34"x60"x28"	12 Gauge	290 Lbs.
322-00251	SW250V	60"x34"x28"	12 Gauge	290 Lbs.
322-00300	SW300	38"x60"x31"	12 Gauge	325 Lbs.
322-00301	SW300V	60"x38"x31"	12 Gauge	325 Lbs.
322-00350	SW350V	60"x41"x31"	12 Gauge	350 Lbs.
322-00500	SW500	60"x60"x33"	12 Gauge	450 Lbs.
322-00650	SW650	60"x78"x33"	10 Gauge	730 Lbs.
322-00750	SW750	60"x90"x33"	10 Gauge	820 Lbs.
322-01000	SW1000	60"x118"x33"	10 Gauge	1,025 Lbs.



## Waste Oil Drains (Cont.)

### 8-Gallon Oil Lift Drain

- 8-gallon capacity
- Spout for evacuation
- Hand grips on bottom and top for ease in evacuation
- Four 3-1/2" ball bearing wheels
- Height adjusts from 48" to 71"
- Polyethylene body is translucent for easy viewing of oil level



Ascot No.	Mfg. No.	Capacity	Max. Height	Min. Height
322-24020	2400-20	8-Gal.	71"	48"

### 18-Gallon Oil Lift Drain

- 18-gallon capacity
- Four 3-1/2" ball bearing wheels
- 3/4" evacuation valve
- Spout for evacuation
- Hand grips on bottom and top
- Height adjusts from 48" to 71"
- Polyethylene body is translucent for easy viewing of oil level



Ascot No.	Mfg. No.	Capacity	Oil Drain Pump	Max. Height	Min. Height
322-24019	2400-19	18-Gal.	Not Included	71"	48"
322-24026	2400-26	18-Gal.	Not Included	71"	48"

### Low Boy Oil Drain

- Rolls under trucks or buses to drain oil or antifreeze with ease
- Constructed of heavy duty polyethylene that will resist rust, dents, automotive fluids and other chemicals
- Gravity drain valve is recessed to protect it from damage and a wire screen in the pan prevents foreign matter from entering into the reservoir



Ascot No.	Mfg. No.	Capacity	Description
322-24034	2400-34	17 Gallon	Low Boy Oil Drain
322-24037	2400-37	17 Gallon	Low Boy Oil Drain w/115V Evac

### Double Drum Containment Vessel

- Perfect solution for storing your chemical drums
- Drum pallets are designed so that hazardous spills can be safely contained in pallet basin, not on your floors or in the soil
- Pallets hold two 55 gallon drums
- Convenient forklift entry
- Designed for in-plant use, not for transport



Ascot No.	Mfg. No.	Capacity
322-24016	SP1006A	Chemical Drum Storage Unit

### Drum Funnel

- Eliminates overspills while pouring
- Large surface area permits drainage of multiple containers simultaneously
- Highly durable - will resist rust, dents and other chemicals and will give many years of trouble-free service
- Fits all types of 55-gallon drums
- Patented design
- Color: yellow



Ascot No.	Mfg. No.	Description
322-24014	2400-14	Drum Funnel

### Oil Lift Caddy

- Unique new way to drain an oil or hydraulic fluid tank
- 28-gallon capacity
- Molded-in baffle for strength and durability
- Rolls easily on pneumatic tires with nylon bearings
- Designed for easy balance and movement
- Orange polyethylene body is translucent for easy viewing of oil level
- 18" diameter funnel height adjusts from 47" to 72"
- Drains through 3/4" faucet



Ascot No.	Mfg. No.	Description
329-93249	932409IP	Oil Lift Caddy, 28-Gallon

**Waste Oil Drains (Cont.)**

**8-Gallon Poly Portable Oil Drain**

- 8-gallon red translucent poly tank allows for easy viewing of oil level
- 18" diameter funnel with strainer
- 2-1/2" heavy-duty, swivel casters
- Spout for evacuation
- JDI-8DCP adjusts from 48" to 67"
- Weight: 12 Lbs.

Ascot No.	Mfg. No.
322-00800	JDI-8DCP



**25-Gallon Heavy-Duty Self Evacuating Oil Drain**

- 25-gallon capacity steel tank
- 16" deep-drawn, offset steel funnel with expanded metal screen
- 360° swivel base on funnel makes positioning easy
- Height adjustment from 50" to 70"
- Molded tray for convenient tool storage
- Heavy-duty 4" swivel casters provide stability and mobility
- 6' quick-disconnect discharge hose can be permanently attached to a storage tank
- Built-in sight tube shows fluid level
- Weight: 85 Lbs.

Ascot No.	Mfg. No.
322-02500	JDI-25HDC



**27-Gallon Portable Poly Oil Drain**

- Gravity drain or pump evacuation system
- Optional male coupler No. HA-15242-00 for pump evacuation
- 27-gallon poly tank
- 16" deep drawn, offset steel funnel with expanded metal screen
- Positive height adjustment from 45" to 70"
- Built-in sight tube shows fluid level
- Handles on all four sides for easy maneuverability
- Heavy-duty 4" swivel casters provide stability and mobility
- Weight: 55 Lbs.

Ascot No.	Mfg. No.
322-02700	JDI-27GFD



**Pro 25-Gallon Steel Gas Caddy**

Makes fuel transfer safe and easy. Ideal for auto repair shops, motorcycle shops, salvage yards and marinas where fuel tanks need to be drained before repair or removal.

- FM Approved, complies with OSHA Guidelines
- Heavy-Duty FM Approved Cast Iron pump with carbon vanes
- Two-way operation for either siphoning or dispensing
- 1 gallon for every 12 revolutions
- Fill level gauge
- Ground wire and clamp
- Fire-screened vent and filler neck combination
- Dolly handle for ease of moving
- Decal set for contents identification
- Weight: 88 Lbs.

Ascot No.	Mfg. No.
322-02501	JDI-25GC



**17-Gallon Low-Profile Portable Oil Drain with Optional Self-Evacuation Kit**

- 25-gallon measured capacity (17-gallon evacuation capacity)
- Low-profile drain (9") fits under most trucks
- Size 48"L x 25"W x 9"H
- 6" industrial casters for easy handling
- 38" T-handle folds down flat for easy storage
- Expanded metal shield reduces splash
- Drain can be emptied by gravity, evacuation pump or air evacuation
- Weight: 144 Lbs.

Ascot No.	Mfg. No.	Description
322-00500	JDI-LP5	Includes Self-Evacuation Kit



**Air Evacuation Kit for JDI-LP4**

- Converts the JDI-LP4 into a self-evacuating drain
- Using regular shop air, oil is easily transferred from the drain to the storage tank
- Kit includes air regulator and safety relief valve, 10' evacuation hose, drain plug and mounting hardware
- Weight: 2 Lbs.

Ascot No.	Mfg. No.
322-00100	JDI-EK





## Portable Exhaust Removal System

### Portable Exhaust Removal System

This easy to use portable exhaust extraction system is a practical and affordable solution for effectively removing toxic exhaust fumes from auto repair facilities, motorcycle shops, small engine repair shops and other work areas where toxic fume removal is needed.

#### Features & Benefits:

- Positioned next to the vehicle, the high-output suction fan captures fumes and discharges them safely up to 30' away
- 3/4 HP fan produces 330 CFM air flow
- Uses standard 100V current
- Fan is mounted in tough, integrally molded polyethylene "flow thru" case
- Mobile base makes the EV-5100 easy to position behind the vehicle or move around the shop
- Height position is controlled by a quick-release spring-loaded cam lock
- 30' discharge hose stores easily and neatly when not in use

Ascot No.	Mfg. No.	Dimensions	Motor	Hose	Weight
391-05100	EV-5100	24"W x 24"D x 35"H	3/4 HP 330 CFM	30'	86 Lbs.



## Rail Systems

### Above Ground/Rail System

#### Limitless Flexibility

- Streamlined, euro-style design will enhance the appearance of your service area
- Modular design uses an extruded aluminum exhaust rail and a sliding ventilation crab
- Sliding crab is equipped with an exhaust hose and tailpipe adapter and rolls along the rail
- Easily sized to fit any workspace and adapts quickly to changing needs

#### Maximum Efficiency, Minimal Operation Costs

- High-efficiency exhaust fan quietly and effectively removes fumes
- Fewer outlets required to cover all of the service bays
- Slides easily out of the way when not in use
- Fewer hose drops and a smaller exhaust fan saves money and reduces energy consumption

#### Virtually Maintenance Free

- Rugged aluminum rail design is virtually maintenance free and holds up under heavy use
- No PVC or cast iron pipes to flood, freeze or break

#### Ease of Use

- Sliding crab system makes it easy to position a drop at any service bay and attach it to the vehicle
- Hoses retract easily when not in use

#### Reduces Installation Time

- Most systems can be engineered using eight basic components
- The "bolt-together" design significantly reduces installation time

#### Enhanced Professional Image

- Retractable hoses create an organized professional workspace



## Oil Accessories

### Measuring Containers

- Heavy duty helpers to handle the most demanding jobs
- Large handle and wide base
- 5-quart capacity



Ascot No.	Mfg. No.	Capacity
329-18110	18110	5-Quarts

### Water/Anti-Freeze Bibb

- Durable, full volume dispense nozzle for water, windshield wash and antifreeze
- 1/4" NPT female inlet



Ascot No.	Mfg. No.	Description
329-18685	180 685	Water/Anti-Freeze Bibb

### Radiator Fillers

- Long curved spout, balanced shape and handle positions
- Weather resistant plastic
- 12-quart capacity



Ascot No.	Mfg. No.	Description
329-00505	505BX	Black Plastic Radiator Filler

### Flow Control Crankcase Fillers



- Extra long spouts for hard to reach places
- Non-spill top
- One hand operated flow control valve that locks open
- Top and side handles
- Clear drain recessed bottom
- Marked with quart and liter measurements
- Black enamel finish

Ascot No.	Mfg. No.	Capacity	Spout
329-61101	6110-001	5-Quarts	17" Flex
329-61102	6110-002	8-Quarts	18" Flex

### Oil Waste Cans

- Features foot level operation
- Unique shape for stability
- Rugged steel construction
- Ventilated bottom
- Closed cover
- Designed for safe disposal of oily rags and other material subject to spontaneous combustion
- Listed and labeled by Underwriters' Laboratories Inc. Factory Mutual approved
- Meets OSHA requirements

Ascot No.	Mfg. No.	Capacity
329-64105	6410 005	6-Gallon Capacity
329-64102	6410 002	10-Gallon Capacity

### 10-Ton Air Operated Oil Filter Crusher

- Crushes up to four automotive filters at one time, in just 20 seconds
- 100% air operation eliminates electrical connections. The generous size crushing chamber (9" high) easily accommodates the largest automotive spin-on filters on the market

Ascot No.	Mfg. No.	Description
322-01821	1821	Air Operated Oil Filter Crusher



## Safety Products

### Eye and Face Protection

Ascot No.	Description
396-31844	Jackson Clear Visor. 12" x 8" x .04". Bound Acetate
396-33461	Crews Tomahawk Glasses. Red, Blue, White. Clear Lens
396-01318	Headgear. Lightweight Thermoplastic. Snap-On Adjustable Suspension And Crown Strap. Spark Deflector
396-81095	Particulate Respirator. Adjustable Noseclip For Secure Fit And Secure Seal (Not Pictured)



396-31844



396-01318

396-33461

### Hearing Protection

Ascot No.	Description
396-27231	E-A-R Classic Plug. Pillow Pack. 200 Box
396-27233	E-A-R Muff. Three Position Muff Can Be Worn Over The Head, Behind the Head Or Under The Chin
396-27521	Airsoft Earplug. With Vinyl Cord. 100/DS



396-27231



396-27233



396-27521

### First Aid Product

Ascot No.	Description
396-61316	Healer Eyewash Station. W/2-16 Oz. Bottles
396-30100	First Aid Kit, 10 Unit Kit. Meets AINSI Standards For Size And Color Coding. Red Tear Strip For Quick, Efficient Opening



396-61316



396-30100

### Safety and Traffic Control Products

Ascot No.	Description
396-20100	Safety Vest. Orange Mesh Style Safety Vest With Reflective Strips
396-30000	Highway Warning Triangle Kit. Reflective And Easy To Set Up. Contains 3 Triangles In Plastic Case
396-10100	Rubber Wheel Chock With Chain. Designed For Traction On Any Surface, Wet Or Dry. Will Not Cut Or Gouge Tires



396-30000



396-10100



396-20100

### Driveway Signal and Hose

- Know when you have a customer at the pumps with this 6" diameter driveway signal bell

Ascot No.	Mfg. No.	Description
392-00803	803	Driveway Signal - 110V 6" Dia. Bell
392-00812	812	50' Coil of Driveway Signal Hose
392-00813	813	100' Coil of Driveway Signal Hose
392-00814	814	250' Coil of Driveway Signal Hose



392-00803

## Mechanics Gloves

### Original Glove

- Authentic, genuine Mechanix Glove
- Streamlined elastic cuff with adjustable hook and loop closure for perfect fit
- Reinforced thumb and fingertips increase protection, reduced wear



Ascot No.	Mfg. No.	Capacity
396-01010	MG-01-010	Yellow Original Glove
396-02010	MG-02-010	Red Original Glove
396-03010	MG-03-010	Blue Original Glove
396-05010	MG-05-010	Black Original Glove
396-06010	MG-06-010	Green Original Glove
396-09010	MG-09-010	Orange Original Glove
396-03901	MG-39-010	Purple Original Glove
396-07101	MG-71-010	Camo Original Glove

### M-Pact II Glove

- Wide elastic cuff
- Molded TPR shock-absorbing bumpers on wrist, top panel and fingers
- Rubberized Clarino® on thumb and fingertips for improved grip
- High-density accordion knuckle panel deadens sharp impact



Ascot No.	Mfg. No.	Capacity
396-21010	MP2-01-010	Yellow M-Pact II Glove
396-22010	MP2-02-010	Red M-Pact II Glove
396-23010	MP2-03-010	Blue M-Pact II Glove
396-25010	MP2-05-010	Black M-Pact II Glove
396-26010	MP2-06-010	Green M-Pact II Glove
396-29010	MP2-09-010	Orange M-Pact II Glove

### Gojo Dipped Gloves

- Chemtrile™ nitrile coating - liquid/oil repellent palm coat
- Maxflex™ Multi-directional weave - breathable and lightweight stretch weave for comfort
- Ergonomic design - shaped fingers for excellent fit and dexterity
- Extended Cuff - provides a snug fit and additional wrist protection
- Excellent Value - machine washable/ reusable, more economical than latex or nitrile gloves



Ascot No.	Description
396-02005	Dipped Gloves

### Latex Protective Gloves

- Size-large
- Protect sensitive or irritated hands
- Box of 100



Ascot No.	Mfg. No.
396-02003	Latex Protective Gloves - Size Large

### Nitrile Protective Gloves

Ascot No.	Mfg. No.
396-02004	Nitrile Pro Gloves - Size Large



### Hand Protection

Ascot No.	Mfg. No.
396-40314	Hot Mill Glove. Gauntlet, Domestic
396-40315	Hot Mill Glove. Gauntlet Starched Cuff. Rayon Lining.
396-40316	Hot Mill Glove. Band Top Cuff With Knuckle Strap. 100% Cotton
396-40317	Power Grip. With Latex Premium Grip
396-55220	Leather Palm Glove. Safety Cuff, Elastic
396-06780	Wet Grip Neoprene Glove. Protects Against Acids, Caustics, Oils, Greases And Many Solvents. 5-Piece Flannel Liner



396-40314



396-40316



396-40317



396-06780



396-55220

**NOTE: ALL GLOVES ARE AVAILABLE IN SMALL, MEDIUM, LARGE, X-LARGE AND XX-LARGE. PLEASE INDICATE SIZE WHEN ORDERING.**



# FLUID EXCHANGE EQUIPMENT

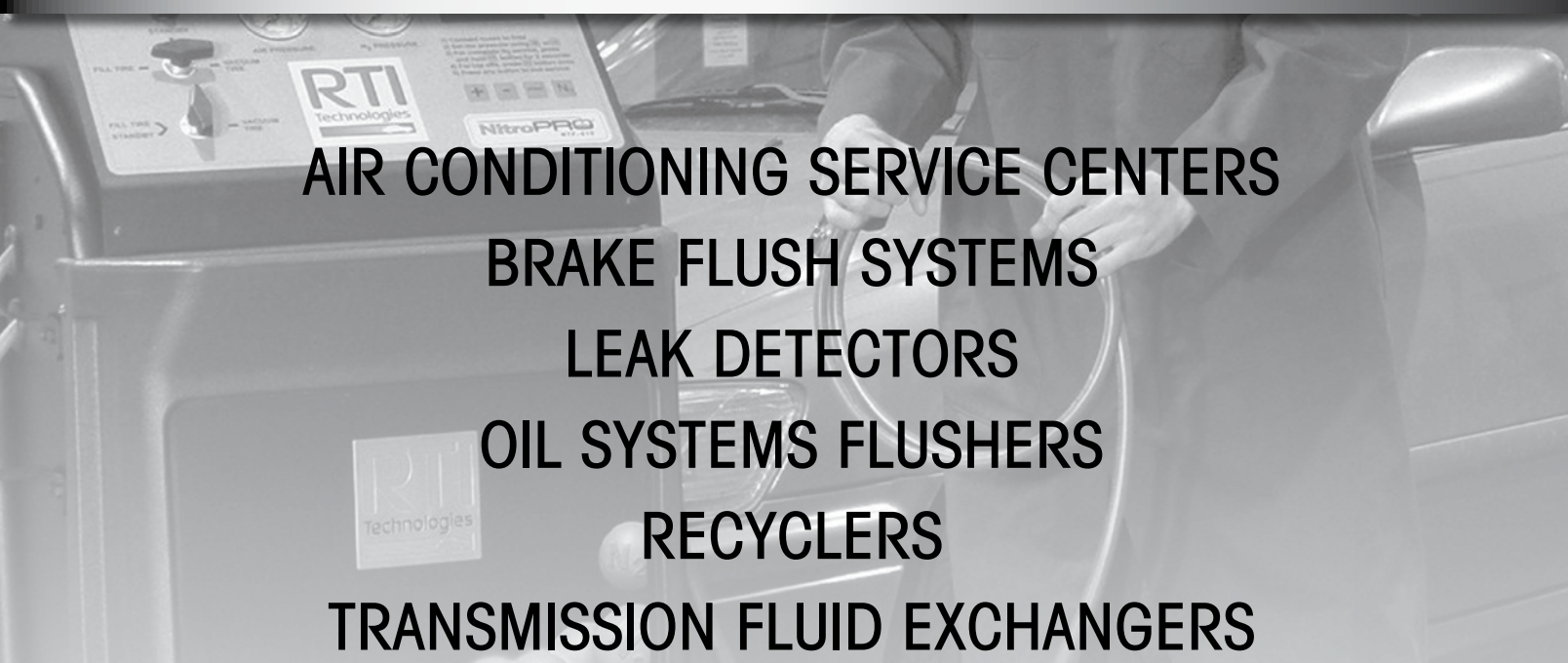

AIR CONDITIONING SERVICE CENTERS  
BRAKE FLUSH SYSTEMS  
LEAK DETECTORS  
OIL SYSTEMS FLUSHERS  
RECYCLERS  
TRANSMISSION FLUID EXCHANGERS



## Refrigerant Recovery/Recycling Systems

### Cool-Tech 34288 Recovery/Recycling System

- The Cool-Tech 34288 combines simple operation with superior accuracy. It recovers, recycles, evacuates, leak tests and recharges R-134A quickly and accurately. Meets SAE J-2788 standards for accuracy: 95% refrigerant recovery and charging to +/- 1/2 Ounce
- Automatic Air Purge
- Refrigerant charging and refrigerant management
- Vacuum Function
- New 4x20 multilingual display



Ascot No.	Mfg. No.	Description	Dimensions	Shipping Weight
361-34288	34288	Recovery/Recycling System	50" H x 34" W	225 Lbs.

### Cool-Tech 34788 Recovery/Recycling System

- The Cool-Tech 34788 combines simple operation with superior accuracy. It recovers, recycles, evacuates, leak tests, and recharges R-134a quickly and accurately. Fully automatic function lets you recover, vacuum, leak test, charge, and then walk away
- Recovers 20% more refrigerant
- Charge Accuracy +/- 1/2 Ounce
- Control panel offers flat storage feature when not in use
- Database expansion slot
- Two large tool storage areas
- Change between traditional & hybrid vehicle systems without fear of cross contamination with improved oil injection
- New 2X larger display makes the 34788 easier than ever to use
- Built-in storage for extra filter and on-board storage for compressor oils
- With Automated A/C Service



Ascot No.	Mfg. No.	Description	Shipping Weight
361-34788	34788	Recovery/Recycling System	235 Lbs.

### Premium A/C RRR Machine

- Fully-Automatic Function: Program to recover, vacuum, leak test, and charge without operating panel valves
- Automatic Dye Inject: Gives the user the ability to use the machine to inject UV dye into a vehicle's A/C system
- Automatic Oil Measure & Inject
- A/C System Plus
- Indicator light and notification alarm
- Oil Inject: Less than 1% cross-contamination
- Refrigerant & Oil Database: For North American market vehicles 1994 - 2008
- Vacuum Leak Test: Monitors level after evacuation; informs of possible leak



Ascot No.	Mfg. No.	Description	Shipping Weight
361-34988	34988	Recovery/Recycling System	232 Lbs.

### Recycling Filter-Driers

- Specially blended for maximum acid and moisture removal

364-34430



Ascot No.	Mfg. No.	Description
364-16912	16912	Refrigerant Identifier Filter For 34200 And Refrigerant Identifiers
364-17630	17630	Inlet Filter For 17625A
364-17663	17663	Inlet Filter For 34650, 17650A
364-17678	17678	XH-9 Filter Drier For 17800A, 17800-2K
364-34430	34430	Quick Change Filter For Older 17700A, 17700A, 34450, 34700 Series
364-34724	34724	Spin-On Filter For 17700A, 1770-2K, 34134A, 34134-2K, 342000, 34234, 34234-2K, 34700, 34700-2K, 34800, 34800-2K, 34900, 34700Z Series



## Refrigerant Handling Systems

### ArcticPRO™ RHS980 Digital A/C Refrigerant Handling System

- Control panel mounted on a revolving turret-the turret rotates 90 degrees in either direction for unrestricted viewing capability-this eliminates machine repositioning for the technician
- Intuitively easy-to-use function input and display. Extra large character (4 x 20) LCD display
- TechALERT™ compatible-boosts workshop productivity by remotely signaling the technician when RTI equipment completes automated service operations
- Dual stage, 7.0 CFM vacuum pump, large industrial duty cooling fan, integrated oil change function accelerate operation cycle time
- 30 lb. refrigerant recovery cylinder mounted inside cabinet to minimize load cell re-calibration
- Recovers 95% of auto refrigerant with 30 minutes, minimizes refrigerant loss, saves money
- Recharge accuracy is +/- 1/2 ounce-saves money, eliminates call-backs
- Pre-assembled, 100% pre-tested patent-pending KWIK-CHANGE "block" manifold assembly eliminates defects before final unit assembly. Virtually eliminates all potential leak points



Ascot No.	Mfg. No.
361-00980	RHS980

### Maintenance Kits

- Maintenance kit for recovery and recycling units
- Contains one quick change filter-drier to be used on both R-12 and R-134A station, and (1) 16 Oz. bottle of high vacuum pump oil



Ascot No.	Mfg. No.	Description
361-78012	RHS780-R12	Refrigerant Handling System For R-12
361-78134	RHS780-R134A	Refrigerant Handling System For R-134A

### ELF-1 EVAP Leak Finder

- The latest advancement in EVAP Leak Detection. Superior ability to find a wider variety of automotive system leaks
- NO Heat and NO Smoke! One-of-a-kind technology utilizes patented, safe, non-flammable, smoke-free process to find leaks. It just looks like smoke
- NO Nitrogen Required – Use air or nitrogen
- Meets OBDII Test Requirements
- Higher generation rates fill systems quickly and reduce service time
- Multiple Pressure Settings (1-15 PSI with safety default) - find more types of leaks than other systems



Ascot No.	Mfg. No.	Description
369-10001	ELF-1	Leak Finder

## Fluid Exchangers and Flushers

### FluidPRO™ ATX Automatic Transmission Fluid Exchangers

- RTI's ATX series automatic transmission fluid exchangers offer more benefits to the service organization than any other brand
- Easy Operation - Electronic keypad, logical intuitive command functions
- Superior Productivity – fully automatic operation, multi-fluid exchange capability, transmission pressure diagnostics
- Extremely Fast Process Times – high volume fill pump, precision fluid measurement to minimize technician input
- Professional Service – digital weight scale technology for precise fluid flow measurement & accurate fluid exchange, proportional motor control maximizes exchange percentage
- Application Flexibility – comprehensive color-coded adapter set with reference guide
- Peace-of-Mind – patented bypass circuit for vehicle protection if power is interrupted



Ascot No.	Mfg. No.	Description
372-00100	ATX	Automatic Transmission Fluid Exchanger

### FluidPRO™ PSX-2 Power Steering Fluid Exchangers

- Increasing productivity to generate additional profit comes naturally for the handy, versatile and easy-to-operate PSX-2
- Easy-to-Use – insert control wand into reservoir & flip switch to begin extraction or fill process, control switch mounted on wand provides remote machine activation
- Enhanced Productivity – provides thorough fluid exchange, high-mobility cart includes 4 HD swivel casters
- Extremely Fast Process Times – dual pump process, PSX-2 uses two positive displacement diaphragm pumps, no priming required
- Professional Service – clear dual channel hose provides excellent new/used fluid visual, professional compact design saves valuable shop space & assists in selling OEM recommended service
- Application Flexibility – fast & easy changeover between multiple power steering fluid types



Ascot No.	Mfg. No.	Description
368-00202	PSX-2	Power Steering Fluid Exchanger

### FluidPRO™ BFX-2 Brake Flush System

- Routine interval brake fluid exchanges are now being recommended by a growing number of OEMs and MAP (Motorist Assurance Program) and the efficient way to provide this service today is with the BFX-2
- Efficient & Simple – 3 step process...extracts old brake fluid from master cylinder; fills new fluid into master cylinder; automatically performs OEM specified single sequential wheel end bleeding procedure all in less than 10 minutes
- Easy Service to Sell – now specified by OEMs & MAP to maintain safe vehicle operation
- User-Friendly Operation – universal master cylinder adapters w/quick reference guide for EZ hook-up & includes pistol wand for convenient & accurate fill. EZ wheel end bleeder hose hook-up and storage
- Effective and Professional – unique push/pull process ensures optimal fluid exchange, eliminates system contamination, purges harmful air simultaneously. Isolates each wheel end & performs OEM recommended bleeding sequences. Compatible with both ABS & non-ABS systems
- Durable Design & Construction - Rugged cabinet w/ special powder coated steel to resist brake fluid corrosiveness



Ascot No.	Mfg. No.	Description
368-00201	BFX-2	Brake Flush System

### FluidPRO™ VCX II Vacuum Coolant Exchange

- When expert high-demand coolant flush service is required, RTI's VCX II Vacuum Coolant System Exchanger is the natural choice
- Extremely Fast Service Cycles – vacuum extraction & pressure fill process provides rapid process times, perfect for quick lube operations
- Easy Service to Sell – customers can visually see dirty fluid being removed and replaced with clean new coolant
- Simple Hook-Up & Operation – shop air operation, insert Cone Adapter, select process and go
- Many Makes Compatibility – simplicity and versatility of service hose is adaptable to most makes and models without modification
- Robust Design & Construction - high strength fiberglass composite coolant cylinders, rugged chassis & cushioned, no-inflate wheel
- Good Exchange Efficiency – can remove up to 60% of used coolant in single pass



Ascot No.	Mfg. No.	Description
367-00100	VCX-II	Vacuum Coolant Exchangers

## Robinair Accessories

### Refrigerant Identifier

- Visual hydrocarbon alarm
- Displays percent of air in the A/C system or tank

Ascot No.	Mfg. No.
366-16900	16900



### Refrigerant Charging Scale

- Touch Key controls
- Three display modes – Lbs./Oz.; Decimal Lbs., Kilograms
- Very High Resolution – 0.1 Oz./0.005 Lbs./2 Grams
- Extreme Accuracy
- 110 Pound/50KG capacity
- Auto Zero
- Compact design, completely portable
- Can be used with all refrigerants
- Removable control box with prop stand/hanging hook
- Compatible with TIF 9020 for automatic capability

Ascot No.	Mfg. No.
361-09010	TIF 9010A



### Refrigerant Identifier Plus

- Displays the actual percent of R-12, R-134A, R-22 and air in the system or tank
- Air purge
- Visual and audible hydrocarbon alarm
- On-board printer port

Ascot No.	Mfg. No.
366-16910	16910



### R134a Manifold Hose Kit

- R12/R134G gauges, PSI and °F Temp
- ½" ACME bottom ports
- Rear R134A and ½" ACME fittings for holding hoses
- 90° manual couplers
- 72" R134A Hose Set (1/2" ACME x 14mm)
- Brass manifold with easy-to-grip handles

Ascot No.	Mfg. No.	Description
366-45111	45111	134A Manifold Gauge Set with 72" Hose and Couplers



### Infrared Thermometer PRO

- SoC (System-on-a-Chip) Technology – Complete IR design incorporated on a single chip, creating compact and lightweight design
- Innovative optical lens – high accuracy measurements over wide temperature ranges. 10:1 distance to spot (D:S) ratios available
- Laser pointer – Simply point at desired target and press the trigger for temperature reading
- High and low pass filters with audible alarms for out of range measurements
- Temperature modes - Maximum (MAX)
- Visual low battery indicators; requires two AAA batteries



Ascot No.	Mfg. No.
369-07610	TIF7610

## Tracer Accessories

### PRO-Alert 2791™ Electronic Refrigerant Leak Detector

- Optimum sensitivity detects leaks down to 0.1 Oz./Year
- User selectable, three-position sensitivity switch minimizes false triggering and allows for easy diagnosis of small, medium and large leaks
- Sensitive to R-12, R-134A and all other HFC refrigerants
- High-efficiency air sampling pump provides quicker response and clearing
- Audible alarm and multiple LEDs help locate leaks fast
- NiMH battery provides over six hours of use between charges. Detector also works with AC and DC power adapters (included)
- On-board diagnostics indicate battery charging status, low battery condition or sensor failure
- Includes sensor, replacement filters, rechargeable NiMH battery, AC power adapter, DC power adapter with cigarette lighter plug and rugged carrying case. AC adapter available in 120V, 230V, 240V and 100V versions

Ascot No.	Mfg. No.
366-09364	TP-9364



### PRO-Vac™ Vacuum/Micron Gauge

- Large LCD displays readings in microns, pascal or millibars
- Wide display range from atmosphere (760,000 microns) down to 1 micron
- Industry-first inline filter protects sensor from contaminants, eliminating need for cleaning
- Low-battery warning indicator
- Auto shut-off conserves battery life
- Works with any vacuum pump
- Includes 9V battery, spare filter and compact storage case

Ascot No.	Mfg. No.
366-09365	TP-9365



### PRO-DigiScale™ Refrigerant Scale

- Handles cylinders up to 220 pounds
- Measures in Lbs./Oz., KG/G or decimal Lbs.
- "Best in class" load cell accurate to +/- .25 Oz., with no drift
- Automatic and manual "zeroing"
- Low-battery and over-range warning indicators
- Auto shut-off conserves battery life
- Includes weighing platform, control head, communication cable, 9V battery and rugged carrying case

Ascot No.	Mfg. No.
366-09366	TP-9366



### BigEZ™ Universal A/C Dye Injection Kit

- BigEZ cartridges are prefilled with co-solvent free A/C dye, certified to meet SAE J2297 and calibrated for exact dosing
- Includes: BigEZ assembly and R-134G hose with R-12 fitting; BigEZ 4 Oz. universal A/C dye cartridge for servicing up to 32 vehicles

Ascot No.	Mfg. No.
369-09742	TP-9742CS



### EZ-Ject™ Universal A/C Dye Injection Kit

- 9841CS EZ-Ject Universal A/C Dye Injection Kit
- Easiest, most accurate and most compact method of injecting A/C dye
- Cartridge prefilled with co-solvent free A/C dye, certified to meet SAE J2297
- Packaged in full-color hanging clamshell
- Includes: EZ-Ject steel assembly and R-134A hose with R-12 adapter/purge fitting; EZ-Ject universal A/C dye cartridge, services up to 14 vehicles

Ascot No.	Mfg. No.
369-09841	TP-9841CS



### EZ-Shot™ A/C Dye Injection Gun

- Quickly introduces dye into vehicle's A/C system
- Works with all 4 and 8 Oz. dye cartridges

Ascot No.	Mfg. No.
369-09749	TP-9749



## Tracer Accessories (Cont.)

### EZ-Shot™ Universal A/C Dye Injection Kit

- EZ-Shot quickly introduces dye into a vehicle's A/C system
- BigEZ™ cartridges are pre-filled with co-solvent free A/C dye, certified to meet SAE J2297 and calibrated for exact dosing
- Includes: EZ-Shot dye injection gun and R-134a hose with R-12 fitting; BigEZ 8 Oz. universal dye cartridge services up to 64 vehicles; Hoses, couplers for low-side injection for all A/C systems

Ascot No.	Mfg. No.
369-09790	TP-9790



### OPTIMAX Jr™ Cordless, Ultra-Compact Blue Light LED Leak Detection Flashlight

- High-intensity LED bulb with 100,000-hour service life
- Power comparable to high intensity 75-watt lamps
- Inspection range of up to 6 feet (1.8 mm) or more
- 3 AA batteries and fluorescence-enhancing glasses included
- Packaged in full-color hanging clamshell

Ascot No.	Mfg. No.
366-08640	TP-8640CS



### OPTI-Lite™ Cordless Economy 6-LED Leak Detection Flashlight

- Power comparable to 50-watt lamps
- Inspection range of up to 2 feet (0.6m) or more
- 100,000-hour bulb life
- Powered by 3 AA batteries (included)
- Fluorescence-enhancing glasses
- Packaged in full-color hanging clamshell



Ascot No.	Mfg. No.
366-08620	TP-8620CS

### OPTIMAX™ 3000 Cordless Blue Light LED Leak Detection Flashlight

- 15 times brighter than regular LED lights
- Power comparable to super-high intensity 150-watt lamps
- Inspection range of up to 20 feet (6.1 m) or more
- Compatible with all leak detection dyes
- 50,000-hour bulb life
- Powered by rechargeable NiMH battery (included)
- AC charger
- Fluorescence-enhancing glasses

Ascot No.	Mfg. No.
366-08690	TP-8690CS



### Complete LeakFinder™ Kit

#### Kit Includes:

- TP-8620CS OPTI-Lite™ 6-LED, economy leak detection flashlight
- TP-9881 Syringe A/C dye injector with hose for R-134A and R-12 adapter/purge fitting
- TP-3840-001CS - 1 Oz. bottle co-solvent free universal A/C dye, services up to 4 vehicles
- TP-3405CS - 1 Oz. bottle Dye-Lite™ All-In-One™ standard oil dye, services 1 vehicle
- TP-3900-0001CS - 1 Oz. water-based bottle Dye-Lite coolant dye, services 1 vehicle
- 120884 - 8 Oz. bottle of GLO-AWAY™ dye cleaner
- TP-9940 fluorescence-enhancing glasses
- TP-1140 plastic carrying case

Ascot No.	Mfg. No.
366-08621	TP-8621



### Complete OPTIMAX Jr™ /EZ-Ject™ Kit

#### Kit Includes:

- TP-8640CS OPTIMAX Jr cordless, ultra-compact high-intensity blue light LED leak detection flashlight
- EZ-Ject injector with universal A/C dye cartridge for servicing up to 14 vehicles
- 1 Oz. (30 ml) bottle Dye-Lite™ All-In-One™ standard dye for oil, fuel, ATF, PS and hydraulic leaks, services 1 vehicle
- 1 Oz. (30 ml) bottle Dye-Lite coolant/auto body leak dye, services 1 vehicle
- Fluorescence-enhancing glasses and plastic case

Ascot No.	Mfg. No.
366-08647	TP-8647



## Tracer Accessories (Cont.)

### OPTI-Lite™/EZ-Shot™ A/C Kit

**Kit Includes:**

- TP-8620CS OPTI-Lite economy, 6-LED leak detection flashlight
- TP-9790 EZ-Shot A/C dye injection kit with:
  - TP-9747 hose/coupler for R-134a systems with R-12 adapter/purge fitting
  - TP-9770-0108 - 8 Oz. universal A/C dye cartridge for servicing up to 64 vehicles
- 120884 - 8 Oz. spray bottle of GLO-AWAY™ dye cleaner
- TP-9940 fluorescence-enhancing glasses
- TP-1140 plastic carrying case

Ascot No.	Mfg. No.
366-08626	TP-8626



### Complete OPTI-Lite™/EZ-Ject™ Kit

- EZ-Ject dye injector is the easiest, most accurate and most compact method of servicing a vehicle's A/C system with dye

**Kit Includes:**

- TP-8620CS OPTI-Lite 6-LED, economy flashlight
- EZ-Ject injector with universal A/C dye cartridge for servicing up to 14 vehicles
- 1 Oz. bottle Dye-Lite™ All-In-One™ standard dye for oil, fuel, ATF, PS and hydraulic leaks, services 1 vehicle
- 1 Oz. bottle Dye-Lite coolant/auto body leak dye, services 1 vehicle
- Fluorescence-enhancing glasses and plastic case

Ascot No.	Mfg. No.
366-08627	TP-8627



## A/C & Coolant System Accessories

### 946Kit Professional Super Seal Premium

- Seals leaks fast and is easily installed in minutes
- Permanently seals leaks in compressor, evaporator, accumulator, condenser, gaskets, O-Rings, metal and rubber hoses
- For all mobile air conditioning systems R-134A and R-12/R-22



Ascot No.	Mfg. No.	Description
366-00946	946Kit	Professional Super Seal Premium

### Retrofit-Stick™

- Reduces time, effort and cost because there is no need to open the system; no need to replace O-Ring seals, hoses or the receiver drier; no need to remove existing mineral oil in the A/C system, PAG Plus is compatible with all existing lubricants present in the system
- Includes: 1 retro-fit conditioner injector; 1 low side 1/4" retrofit fitting; 1 high side 3/8" retrofitting; 1 retro label



Ascot No.	Mfg. No.	Description
366-00715	715	Retrofit-Stic

### Roc Oil

- Quick "pull down" times & lower vent temperatures
- Reduced compressor load and run times
- Improved compressor durability - less noise
- Highly refined synthetic lubricant with an operating range of -90°F to 599°F that will not break down over extended use



Ascot No.	Mfg. No.	Description
366-51105	51105	500 ML
366-51110	51110	1 Liter

### 930Kit 1-2-3 Shot Canister

- 30 shot UV dye injector for R-134a systems
- UV dye in a can



Ascot No.	Mfg. No.	Description
366-00930	930Kit	Super Chill

# TIRE REPAIR MATERIALS & TOOLS

TUBE PATCHES  
BIAS & RADIAL TIRE REPAIR  
CEMENTS & CHEMICALS  
TIRE REPAIR EQUIPMENT  
RUBBER VULCANIZING MATERIALS  
TIRE REPAIR TOOLS  
TIRE SPREADERS



## Radial Tire Repairs

### Tube Repairs and Replacement Valves

- Manufactured with soft Prematack cushion gum rubber that provides maximum green tack. Use a repair at least 1/2 inch (12mm) larger than the injury on each side
- Install with Prema Ultra Fast dry vulcanizing cement

Ascot No.	Mfg. No.	Description	L	W	L (mm)	W (mm)	Qty./Unit
541-00501	PT-1	Mini Round Repair	1-1/2"	-	38	-	50
541-00502	PT-2	Small Round Repair	1-3/4"	-	44	-	40
541-00522	PT-2T	Small Round Repair	1-3/4"	-	44	-	160 (tub)
541-00503	PT-3	Medium Round Repair	2-1/4"	-	57	-	40
541-00533	PT-3T	Medium Round Repair	2-1/4"	-	57	-	100 (tub)
541-00504	PT-4	Large Round Repair	3"	-	76	-	25
541-00544	PT-4T	Large Round Repair	3"	-	76	-	75 (tub)
541-00505	PT-5	Maxi Round Repair	4-1/2"	-	114	-	10
541-00506	PT-6	Giant Round Repair	5"	-	127	-	10
541-00507	PT-7	Small Oval Repair	3"	1-1/2"	76	38	25
541-00508	PT-8	Medium Oval Repair	3-3/4"	1-3/4"	95	44	20
541-00509	PT-9	Large Oval Repair	6"	3"	152	76	10
541-00510	PT-10	Giant Oval Repair	7-1/2"	3-3/4"	191	95	10
541-00511	PT-11	Giant Rim Oval Repair	9-1/2"	3-1/2"	241	64	10
541-00513	PTR-13	Tube Repair Valve	2" Dia.	-	-	-	10
541-05218	PTR-218A	Air/Liquid Repair Valve	3-3/8" Dia.	-	-	-	10



State of the Art Soft Gum Tire Repair



### Universal Bias/Radial Repairs

- Designed for repairing nail hole injuries in tubeless Bias & Radial injuries in the crown area only
- Available in either round or square versions
- Installs with Prema Ultra Fast dry Vulcanizing Cement

Ascot No.	Mfg. No.	Description	L	W	L (mm)	W (mm)	Qty./Unit
550-00501	PUR-1	Universal Rd. 1	-	-	1-1/4"	32	100
550-00502	PUR-2	Universal Rd. 2	-	-	2"	55	50
550-00503	PUR-3	Universal Rd. 3	-	-	3"	75	50
550-00522	PUS-2	Universal Sq. 2	1-3/4"	1-3/4"	-	-	100
550-00533	PUS-3	Universal Sq. 3	2-3/4"	2-1/4"	-	-	100



### Emergency Inserts

- Install with Prema Insert Cement

Ascot No.	Mfg. No.	Description	Injury Size		Qty./Unit
			(in.)	(mm)	
585-00501	PRI-1	PremaFill-Passenger/Light Truck Thin Orange	3-3/4"	95	50
585-00502	PRI-2	PremaFill-Passenger/Light Truck Regular Blue	3-3/4"	95	50
585-00503	PRI-3	PremaFill-Truck Blue	5-1/8"	130	40
585-00504	PRI-4	PremaFill-Earthmover Blue	7-1/2"	191	25

### Combi Units and Stems

- Combi repairs can be used for crown injuries only

Ascot No.	Mfg. No.	Description	Cutter	Injury Size		Qty./Unit
				(in.)	(mm)	
582-00501	PC-1	Combi 1	PCC-1	1/8"	3	40
582-00502	PC-2	Combi 2	PCC-2	1/4"	6	15
582-00503	PC-3	Combi 3	PCC-3	5/16"	8	10
582-00504	PC-4	Combi 4	PCC-4	3/8"	10	10
582-00522	PCS-2	Stem 2 w/Guide Wire	PCC-2	1/4"	6	20
582-00533	PCS-3	Stem 3 w/Guide Wire	PCC-3	5/16"	8	20
582-00544	PCS-4	Stem 4 w/Guide Wire	PCC-4	3/8"	10	20





## Tire Repair Cabinet & Kits



### Prema Cabinets

- Custom Design Passenger Kits, Truck Kits and Cabinets are available upon request

Ascot No.	Mfg. No.	Description
518-00502	PCAB-2	Pre-Packaged Cabinet Kit

#### Contents: 440 Assorted Repairs

2 PT-2 Small Round Tube	1 PCS-2 Wire Lead Stem
1 PT-3 Medium Round Tube	1 PCS-3 Wire Lead Stem
1 PT-4 Large Round Tube	1 PC-2 Wire Lead Combi
2 PR-110 Radial	1 PC-3 Wire Lead Combi
2 PR-112 Radial	1 PC-4 Wire Lead Combi
1 PR-120 Radial	1 PCC-2 Cutter
1 PUR-2 Universal Round	1 PCC-3 Cutter
1 PUS-3 Universal Round	1 PCC-4 Cutter
1 PPC-16 Spray Pre-Buff	1 Prema Cabinet
1 PLOS-16 Liner Sealant	2 PFC-8 Cement Fast Dry
1 PLD-32 Leak Detector	1 PBS-32 Bead Sealer

### PremaFill Passenger/Light Truck Kit

- Contents: 50 PRI-1 inserts, 50 PRI-2 inserts, Prema insert cement with flip top bottle, spiral cement tools, valve core tool, dual foot air gauge, white crayon and one pistol grip inserting tool. All items come in a durable plastic case

Ascot No.	Mfg. No.	Description
518-00522	PRI-2K	PremaFill-Passenger/Light Truck Kit



### PremaFill Truck Kit

- Contents: 40 PRI-3 inserts, Prema insert cement with flip top bottle, spiral cement tool, valve core tool, dual foot air gauge, white crayon and one truck pistol grip inserting tool. All items come in a durable plastic case

Ascot No.	Mfg. No.	Description
518-00503	PRI-3K	PremaFill Truck Kit



### PremaFill ATV/Motorcycle Kit

- Contents: One each split eye insert tool, reamer tool, rubber cement (tube), microflate inflator, two each 16 gram CO<sub>2</sub> cartridges and 8 each PRI-2 inserts. All items are packed in a nylon zippered bag

Ascot No.	Mfg. No.	Description
518-00504	PATVP	PremaFill ATV/Motorcycle Kit with CO <sub>2</sub> Cartridges

## Chemicals/Cements

### Ultra Fast Dry Vulcanizing Cement

- Formulated to provide outstanding performance when used in conjunction with PREMATAACK materials
- Contains no ozone depleting chemicals

Ascot No.	Mfg. No.	Description	Size		Qty./Box
			Fl. Oz.	MI	
501-00504	PFC-4	Vulcanizing Cement	4	118	24
501-00508	PFC-8	Vulcanizing Cement	8	237	24
501-00532	PFC-32	Vulcanizing Cement	32	946	6
501-00518	PIV-8FT	Insert Cement - Flip Top	8	237	12



### Black Vulc Cement

- Designed for use in HEAT CURE applications with rope rubber and cushion gum
- Contains no ozone depleting chemicals

Ascot No.	Mfg. No.	Description	Size		Qty./Box
			Fl. Oz.	MI	
501-05321	PBV-32	Black Vulc Cement (Flammable)	32	946	6



### Heavy Duty Giant Vulcanizing Cement

- Designed for use with Prema Giant OTR chemical units
- Contains no ozone depleting chemicals

Ascot No.	Mfg. No.	Description	Size		Qty./Box
			Fl. Oz.	MI	
502-00532	PFCG-32	H.D. Giant Vulcanizing Cement (Flammable)	32	946	10
502-00501	PFCG-1G	H.D. Giant Vulcanizing Cement (Flammable)	128	3600	1

### Pre-Buff Cleaner

- Formulated to remove contaminants (such as silicone and mold lubricants) from the innerliner of the tire prior to buffing. Available in either liquid or aerosol
- Contains no ozone depleting chemicals

Ascot No.	Mfg. No.	Description	Size		Qty./Box
			Fl. Oz.	MI	
505-00516	PPC-16	Pre-Buff Cleaner "Aerosol" (Flammable)	16	473	12
505-00532	PPC-32	Pre-Buff Cleaner (Flammable)	32	946	12
505-05160	PPG-16	Pre-Buff Cleaner (Flammable)	128	3800	1



### Innerliner Overbuff Sealant

- Designed to restore air retention qualities to the buffed innerliner around the repair after installations. It can be used in both COLD and HOT vulcanizing systems
- Contains no ozone depleting chemicals

Ascot No.	Mfg. No.	Description	Size		Qty./Box
			Fl. Oz.	MI	
505-05320	PLOS-16	Innerliner Overbuff Sealant	31	946	6



### Tire Talc

- Use when repairing or changing tube type tires. Helps prevent tubes from sticking, chaffing and pinching

Ascot No.	Mfg. No.	Description	Size		Qty./Box
			Fl. Oz.	MI	
507-00501	PTT-1	Tire Talc	16	464	12



## Radial Tire Repairs

### Radial Repairs - Passenger and Truck

- Manufactured with soft PREMATAK cushion gum rubber that provides maximum green tack. Use a repair at least 1/2 inch (12mm) larger than the injury on each side
- Install with PREMA Ultra Fast dry vulcanizing cement

Ascot No.	Mfg. No.	Description	L (in.)	W (in.)	L (mm)	W (mm)	Qty./Unit
575-05109	PR-109	Radial	3"	2"	77	50	20
575-05119	PR-109T	Radial	3"	2"	77	50	80
575-05110	PR-110	Radial	3-1/4"	2-1/4"	83	57	20
575-05111	PR-110T	Radial	3-1/4"	2-1/4"	83	57	80
575-05112	PR-112	Radial	4-3/4"	3"	121	76	10
575-15112	PR-112T	Radial	4-3/4"	3"	121	76	40
575-05113	PR-113	Radial	5"	3-1/4"	127	83	10
575-05114	PR-114	Radial	5-1/4"	3-1/4"	133	89	10
575-05115	PR-115	Radial	3-1/4"	3"	95	76	10
575-05120	PR-120	Radial	5"	3-1/4"	127	83	10
575-05122	PR-122	Radial	7"	3-1/4"	178	83	10
575-05124	PR-124	Radial	8-3/4"	3-1/4"	222	83	10
575-05125	PR-125	Radial	5-1/4"	4-3/4"	133	121	10
575-05126	PR-126	Radial	10-3/4"	3-1/4"	273	83	10
575-05135	PR-135	Radial	7-1/2"	5-1/2"	191	140	10
575-05137	PR-137	Radial	7-1/4"	5-1/2"	184	140	5
575-05140	PR-140	Radial	7-3/4"	4-3/4"	197	108	10
575-05142	PR-142	Radial	10-3/4"	5-1/2"	273	140	5
575-05144	PR-144	Radial	13-1/4"	5-1/2"	337	140	5



- PR115 is used in place of PR110 in heavy duty applications
- PR113 is used in place of PR112 in heavy duty applications



### Radial Repairs - Agricultural

- Designed for the extreme flexing of radial rear farm tires. These repair units can be used for repairing crown, shoulder and sidewall injuries
- Install with PREMA Ultra Fast dry vulcanizing cement or use PREMA Black Vulc cement for hot vulcanizing

Ascot No.	Mfg. No.	Description	L (in.)	W (in.)	L (mm)	W (mm)	# Plies	Qty./Unit
574-05180	PR-180	Radial Ag	8"	6-1/4"	203	159	2	5
574-05182	PR-182	Radial Ag	9-3/4"	7-3/4"	248	197	3	5
574-05184	PR-184	Radial Ag	12"	8-3/4"	305	222	3	2
574-05186	PR-186	Radial Ag	13-3/4"	10"	349	254	3	1

### Radial OTR Repairs - Cloth Black (Heat Cure Only)

- Manufactured with full body ply construction and special rubber compounds designed for OTR tires
- The construction of the repair body with no pre-applied bonding gum results in extended shelf-life and makes them an excellent choice for use in retreading operations
- Must be installed using PREMA uncured Cushion Gum and PREMA Black Vulc Cement as well as PREMA uncured Cushion Gum or PREMA Rope Rubber to properly fill the injury channel

Ascot No.	Mfg. No.	Description	L (in.)	W (in.)	L (mm)	W (mm)	# Plies	Qty./Unit
577-05146	PR-146	Radial Cloth Black	17-1/2"	7-1/4"	440	180	4	1
577-05150	PR-150	Radial Cloth Black	23-1/4"	7-1/4"	580	180	5	1
577-05152	PR-152	Radial Cloth Black	23-1/4"	9-1/2"	580	240	5	1
577-05155	PR-155	Radial Cloth Black	13-1/4"	10-1/2"	330	260	5	2
577-05156	PR-156	Radial Cloth Black	28-3/4"	10-3/4"	720	270	7	2
577-05160	PR-160	Radial Cloth Black	34-1/2"	10-3/4"	860	270	7	1
577-05162	PR-162	Radial Cloth Black	41-1/4"	13"	1030	325	7	1
577-05165	PR-165	Radial Cloth Black	16-3/4"	13-1/4"	420	330	6	2
577-05168	PR-168	Radial Cloth Black	30-1/2"	14"	760	350	7	2
577-05175	PR-175	Radial Cloth Black	21-1/4"	18"	530	450	8	2



## Radial Tire Repairs (Cont.)

### Giant Radial OTR Repairs (Chemical Cure)

- Can be used in both chemical (cold cure) and heat & pressure (heat cure) vulcanizing systems. The repairs are manufactured with full body ply construction and specially formulated rubber compounds designed to provide excellent performance for the life of the OTR tire
- Constructed with a "chemical" bonding gum for extended shelf-life
- To be installed with PREMA Grey Sulf-Vulcanizing Floater Gum applied on the back of the repair using PREMA Giant OTR Cement
- For cold cure process, use PREMA Giant OTR Chemical Cement
- For heat cure process, use PREMA Black Vulc Cement
- PREMA Cut-Resistant Rope Rubber should be used to properly fill the injury on all installations

Ascot No.	Mfg. No.	Description	L (in.)	W (in.)	L (mm)	W (mm)	# Plies	Qty./Unit
577-15146	PRG-146	Giant Radial	17-1/2"	7-1/4"	440	180	4	5
577-15150	PRG-150	Giant Radial	23-1/4"	7-1/4"	580	180	5	5
577-15152	PRG-152	Giant Radial	23-1/4"	9-1/2"	580	240	5	5
577-15155	PRG-155	Giant Radial	13-1/4"	10-1/2"	330	260	5	2
577-15156	PRG-156	Giant Radial	28-3/4"	10-3/4"	720	270	7	2
577-15160	PRG-160	Giant Radial	34-1/2"	10-3/4"	860	270	7	1
577-15162	PRG-162	Giant Radial	41-1/4"	13"	1030	325	7	1
577-15165	PRG-165	Giant Radial	16-3/4"	13-1/4"	420	330	6	2
577-15168	PRG-168	Giant Radial	30-1/2"	14"	760	350	7	2
577-15175	PRG-175	Giant Radial	21-1/4"	18"	530	450	8	2



### Bias Repairs - Passenger and Truck

- Designed with large ply construction for repairing all bias-ply tube and tubeless tires. These repairs can be used for repairing crown, shoulder and sidewall injuries
- Install with PREMA Ultra Fast Dry Vulcanizing Cement or Black Vulcanizing Cement in hot curing systems



Ascot No.	Mfg. No.	Description	L (in.)	W (in.)	L (mm)	W (mm)	# Plies	Qty./Unit
562-00501	PB-1	Bias	2-1/4"	-	57	-	1	25
562-00502	PB-2	Bias	3-1/4"	-	83	-	2	10
562-00503	PB-3	Bias	3-3/4"	3-3/4"	96	96	2	10
562-00504	PB-4	Bias	4-3/4"	4-3/4"	121	121	2	10
562-00505	PB-5	Bias	4-3/4"	4-3/4"	121	121	4	10
562-00506	PB-6	Bias	6-1/2"	6-1/2"	165	165	4	10
562-00507	PB-7	Bias	9-3/4"	9-3/4"	248	248	6	5
562-00508	PB-8	Bias	11-3/4"	11-3/4"	298	298	6	5
562-00509	PB-9	Bias	13-3/4"	13-3/4"	349	349	6	5
562-00510	PB-10	Bias	15-3/4"	15-3/4"	400	400	8	2
562-00511	PB-11	Bias	17-3/4"	17-3/4"	451	451	8	2

### Bias Repairs - Agricultural

- Designed for use in all types of farm implement bias tires. These repair units can be used for repairing crown, shoulder and sidewall injuries
- Install with PREMA Ultra Fast Dry Vulcanizing Cement or use Black Vulc Cement in hot curing systems

Ascot No.	Mfg. No.	Description	L (in.)	W (in.)	L (mm)	W (mm)	# Plies	Qty./Unit
568-00500	PBT-0	Bias	7-3/4"	7-3/4"	197	197	4	5
568-00501	PBT-1	Bias	8-3/4"	8-3/4"	222	222	4	5
568-00502	PBT-2	Bias	10-3/4"	10-3/4"	273	273	4	5
568-00503	PBT-3	Bias	14-1/4"	14-1/4"	362	362	4	5
568-00504	PBT-4	Bias	8-3/4"	8-3/4"	222	222	6	5
568-00505	PBT-5	Bias	10-3/4"	10-3/4"	273	273	6	5
568-00506	PBT-6	Bias	14-1/4"	14-1/4"	362	362	6	2
568-00507	PBT-7	Bias	20-1/2"	20-1/2"	521	521	6	2



## Tire Repair & Tube Patches



### Rema Red Edge Tube Patches

- Feature double-scalloped feathered edges to ensure perfect bonding and complete vulcanization
- A unique rubber compound allows the patch to stretch evenly and equally in all directions
- Use vulcanizing fluid 203 or 204

Ascot No.	Mfg. No.	Description	Units/Box
541-00400	0	1-1/4" Round Tube	100
541-00410	1	1-1/2" Round Tube	30
541-00420	2	1-3/4" Round Tube	30
541-00430	3	2" Round Tube	30
541-00440	4	3" Round Tube	30
541-00450	5	3-3/4" Round Tube	10
541-00460	6	4" Round Tube	10
541-00470	7	3" x 1-1/2" Oval Tube	30
541-00471	7A	4" x 1" Oval Tube	30
541-00472	7B	6" x 2" Oval Tube	10
541-00473	7C	7-1/4" x 3-1/2" Oval Tube	10
541-00474	7D	9" x 4-3/4" Oval Tube	10
541-00480	8	9" x 2-1/4" Oval Tube	10



### Rema Minicombi Repair Units & Accessories

- Part of Rema's exclusive Blue Bonding System™
- Features a metal pilot blue for easy installation and seating
- Specially designed for tread area punctures on both radial and bias-ply tires
- Minicombi should used with Special Cement BL

Ascot No.	Mfg. No.	Description	Units/Box
581-67050	A3	1/8" Minicombi	50
581-67010	A3-R	1/8" Minicombi	10
581-67045	A4.5	3/16" Minicombi	40
581-67340	A6	1/4" Minicombi	40
581-67345	A6B	1/4" Minicombi	100
581-67308	A6-R	1/4" Minicombi	8
581-68008	B8-MC	5/16" Minicombi	20
581-68020	B8-MC-R	5/16" Minicombi	8
581-68418	B10	3/8" Minicombi	18
581-68406	B10-R	3/8" Minicombi	6

### Radial RemaStem™ Stems & Accessories

- Perfect for two-piece nail hole repair of radial passenger, light truck, agricultural and off-the-road tires
- Self-vulcanizing, pre-cured RemaStems™ are specially contoured for easy application using Rema's Special Cement BL and high quality carbide cutters

Ascot No.	Mfg. No.	Description	Units/Box
582-19310	193	1/4" Radial RemaStem™	10
582-19410	194	5/16" RadialStem™	10
582-19420	RS-10	3/8" Radial RemaStem™	20
468-01120	VT-1120L	Insertion Pulling Wires (626)	-



### Universal Patch

- The Hole Solution™ - the only patch you'll ever need for making a nail hole repair
- For radial and bias-ply passenger to truck tires
- Use Special Cement BL with Universal Patch

Ascot No.	Mfg. No.	Size	Qty.
550-26707	UP-3	1/8"	100
550-26714	UP-4.5P	3/16"	300 in Pail
550-26721	UP-6	1/4"	50
550-26738	UP-6P	1/4"	200 in Pail
550-26745	UP-8	5/16"	50
550-26752	UP-8P	5/16"	150 in Pail

## Radial Tire Repairs



### RAD-100 Series Radial Repair Unit

- Includes 30 different sizes of patches which repair every radial injury from passenger car up through EM tires
- Each unit has a special "shock absorber" construction which absorbs and disperses the high flex forces designed into radial tires
- Unique construction, combined with the use of Special Cement BL, gives patch twice the adhering power of most systems
- When applied to properly prepared surfaces using Special Cement BL, cure chemically to a permanent repair bond - also can be used with hot-cure repair methods to allow curing of filled skive and patch in one operation

Ascot No.	Rema No.	Patch Size	Ply	Qty.
575-00110	RAD-110	2" x 2-3/4"	1	20
575-00112	RAD-112	2-3/8" x 4-1/8"	1	10
575-00114	RAD-114	3" x 4-3/4"	1	10
575-00115	RAD-115	3-1/2" x 2"	1	20
576-00120	RAD-120	4-7/8" x 3"	2	10
576-00122	RAD-122	6-7/8" x 3"	2	10
576-00124	RAD-124	8-1/2" x 3"	2	10
576-00125	RAD-125	4-1/2" x 4-7/8"	3	10
576-00126	RAD-126	2-7/8" x 10-1/2"	3	10
576-00128	RAD-128	2-7/8" x 13-1/8"	3	10
576-00135	RAD-135	5-1/4" x 7-1/4"	4	10
576-00140	RAD-140	7-7/8" x 3-15/16"	3	10
576-00142	RAD-142	10-1/4" x 5"	4	10
576-00144	RAD-144	13" x 5"	4	10
577-00145	RAD-145	7-3/4" x 9-1/8"	4	5
577-00146	RAD-146	17-1/4" x 17-1/4"	4	5
577-00150	RAD-150	23" x 7-1/4"	5	5
577-00152	RAD-152	23" x 9-1/2"	5	3
577-00155	RAD-155	10-1/4" x 13-1/8"	5	3
577-00156	RAD-156	29" x 10-1/2"	7	3
577-00160	RAD-160	40" x 10-1/4"	7	3
577-00162	RAD-162	13" x 41-1/4"	7	3
577-00165	RAD-165	13-1/8" x 16-3/4"	6	3
577-00168	RAD-168	14" x 30-3/8"	7	3
577-00175	RAD-175	18" x 21-3/4"	8	5
577-00180	RAD-180	7-3/4" x 6"	2	5
577-00182	RAD-182	10" x 7-1/2"	3	5
577-00184	RAD-184	11-1/2" x 8-1/2"	3	5
577-00185	RAD-185	28-3/4" x 20-7/8"	—	1
577-00186	RAD-186	13-1/2" x 9-3/4"	2	5

### RAD-500 Series Steel Reinforced Radial Repair Unit

- Newest member of the Blue Bonding System™
- Specifically designed for low profile tires
- Curved design reduces heat buildup and allows for ultimate flexibility
- Steel reinforced units are designed for medium/heavy truck and bus tire applications
- Reduces bulging up to 40% over textile reinforced repair units
- Has twice the adhesion power of most other repair systems
- Ideal for commercial tire retreaders, fleets and dealers
- Can be cold or hot-vulcanized

Ascot No.	Rema No.	Patch Size	Ply
575-00225	RAD-225	4-1/2" x 4-7/8"	10
575-00235	RAD-235	5-1/4" x 7-1/4"	10
575-00240	RAD-240	7-7/8" x 3-15/16"	10
575-00245	RAD-245	7-1/8" x 9-1/16"	5
575-00531	RAD-531	88mm x 16mm	10
575-00533	RAD-533	4-3/8" x 8"	10
575-00535	RAD-535	4-3/8" x 10"	10
575-00537	RAD-537	4-3/8" x 11-1/4"	10
575-00539	RAD-539	4-1/2" x 12-3/4"	1
575-00541	RAD-541	5" x 14-3/8"	10
575-00543	RAD-543	5-5/16" x 17-1/2"	5
575-00545	RAD-545	5-5/16" x 20"	5
575-00547	RAD-547	5-3/4" x 22-7/8"	5
575-00549	RAD-549	7-7/8" x 22-7/8"	3

**Aramid Reinforced  
Radial Repair  
Units Available**

## Bias Tire Repairs



### Agricultural and OTR Tires/PN Series Bias Ply Repair Units

- 90° cord angle of the plies provides greater compatibility with the flexing action of the tire as it operates under load, plus it also makes the patch more flexible for easier installation
- A new concept in rubber compounding of the ply-end cover strip eliminates cord breakout at the end of the plies
- Two different ply levels for each size patch provide better compatibility of the repair unit to the ply rating of the tire
- Flexibility in patch/injury size optimization for improved performance
- Eliminates need for "S" (Sidewall) patches in the smaller sizes
- Reduced buffing requirement due to the smaller size of the patch
- Use Blue Bonding cement

Ascot No.	Rema No.	Patch Size (mm/in.)	Ply	Qty./Box
568-05000	PN-50	240mm/9-1/2"	4	3
568-05010	PN-050+	240mm/9-1/2"	6	3
568-05200	PN-052	360mm/14"	6	3
568-05210	PN-052+	360mm/14"	8	3
568-05400	PN-054	480mm/19"	8	2
568-05410	PN-054+	480mm/19"	10	2
568-05600	PN-056	660mm/26"	10	2
568-05610	PN-056+	660mm/26"	12	2
567-05620	PN-056S	660mm/26"	10	2
567-05621	PN-056S+	660mm/26"	12	2
568-05800	PN-058	810mm/32"	12	1
568-05810	PN-058+	810mm/32"	14	1
567-05820	PN-058S	810mm/32"	12	1
567-05821	PN-058S+	810mm/32"	14	1
567-06000	PN-60	393mm/15-1/2"	14	1
567-06010	PN-60+	393mm/15-1/2"	16	1



### PN Units-Tread & Shoulder Injuries/ Passenger, Light Truck & Truck

Ascot No.	Rema No.	# of Plies	Patch Size (in.)	Patch Size (mm)	Qty.
562-26006	PN-0	1	1-7/16"	31.75	50
562-26013	PN-1	1	2-1/2"	63.50	30
562-26020	PN-2	2	3-1/4"	82.55	20
562-26037	PN-3	2	4"	101.60	10
562-26044	PN-4	2	5-3/4"	146.00	10
562-26051	PN-5	4	6-1/2"	165.00	10
562-26068	PN-6	6	9-1/4"	235.00	10
562-26075	PN-7	6	11-3/4"	298.50	10
562-26082	PN-8	6	13-1/2"	343.00	5
562-26099	PN-9	8	15-1/2"	393.00	3
562-26109	PN-10	8	17-3/4"	450.80	3

### PN Units-Sidewall Injuries Only/ Passenger, Light Truck & Truck

Ascot No.	Rema No.	# of Plies	Patch Size (in.)	Patch Size (mm)	Qty.
563-26116	PN-5S	4	6-1/2"	165.00	10
563-26123	PN-6S	6	9-1/4"	235.00	10
563-26130	PN-7S	6	11-3/4"	298.40	10
563-26147	PN-8S	6	13-1/2"	343.00	5
563-26154	PN-9S	8	15-1/2"	393.70	3
563-26160	PN-10S	8	17-3/4"	450.80	3

### PN Units-Tread, Shoulder Injuries Agricultural Tires

Ascot No.	Rema No.	# of Plies	Patch Size (in.)	Patch Size (mm)	Qty.
563-00200	PN-20T	4	10"	10	10
563-00210	PN-21T	4	14-1/2"	5	10
563-00220	PN-22T	4	20"	3	10
563-00230	PN-23T	6	10"	10	5
563-00240	PN-24T	6	14-1/2"	5	3
563-00250	PN-25T	6	20"	3	3

## Patches and Tire Repair Kits

### Radial RX Reinforced Patches

- Specially designed for small nail hole repair on radial passenger, performance, light truck and truck tires
- Perfect for tread area and sidewall repair



Ascot No.	Mfg. No.	Description	Size	Qty.
571-00100	RAD-00	Reinforced Nail Hole Patch	1-3/8" x 1-3/8"	10
571-00010	RAD-0	Reinforced Nail Hole Patch Non-Reinforced Passenger	1-9/16" x 1-9/16"	10
572-00001	RAD-1	Patch for Sidewall and Tread	2-3/4" X 1-5/8"	20

### Section Repair ID Patches

- Universally accepted method for marking section repairs on radial truck tires
- Blue triangle identification patches are a must for any dealer, retreader or fleet performing sidewall, shoulder or tread area section repairs



Ascot No.	Mfg. No.	Description	Qty.
569-00090	90	Section ID Patches	50



### Rubber Base Replacement Valves

Ascot No.	Mfg. No.	Description
467-00009	9	5/8" Rim Hole Tube Valve Repair Unit
467-00914	9-14	.453" Rim Hole Tube Valve Repair Unit
467-00019	9T-LB	Agricultural/OTR Tube Valve Repair Unit, Fast Flow Valve

### Radial Tire Repair Specialist Service Cabinet

- Large 20" x 20" cabinet, heavy gauge metal with three full shelves and hinged door
- Included in the cabinet is everything needed to service radial or bias-ply tires and tubes:
  - (1) box each of No. 1, 2, 3, and 7 patches
  - (10) of each RAD110, RAD112, RAD-0
  - (5) of RAD 114 radial tire patches
  - (1) corrugated ball bearing stitcher
  - (1) hand buffer with replacement blade
  - (1) of each 8-Oz. container Cold Vulcanizing Fluid, 16 Oz. spray can of Pre-Buffer Cleaner



Ascot No.	Mfg. No.	Description
518-00264	26R	Passenger/Light Truck Tire Repair Cabinet
518-00263	26NT	Truck Tire Repair Cabinet
518-00261	27E	Replacement Wall Mount Steel Cabinet Only

### Seal-Elastic™ Temporary Repairs



- Kits include Seal-Elastic™ cement, inserting tool and repair plugs

Ascot No.	Mfg. No.	Description
569-00560	560	50 Repair Plugs for Bias-Ply Passenger Tires Only, (1) Can Seal Elastic Cement, (1) Insertion Tool
569-00561	561	Replacement Pack Of 50 Repair Plugs
565-00570	570	20 Repair Plugs for Bias-Ply Medium/Heavy Truck Tires Only, (1) Can Seal-Elastic Cement, (1) Insertion Tool
569-00571	571	Replacement Pack Of 20 Repair Plugs
566-00580	580	20 Repair Plugs for Bias-Ply OTR Tires Only, (1) Can Seal Elastic Cement, (1) Insertion Tool
569-00581	581	Replacement Pack Of 20 Repair Plugs



## Tire Cements and Sealants

### Cold Vulcanizing Fluid

- For the vulcanization of tube patches



Ascot No.	Mfg. No.	Description
501-00201	201	Cold Vulc Fluid 25 Gm. Tube
501-00202	202	Cold Vulc Fluid 50 Gm. Tube w/Brush
501-00203	203	Cold Vulc Fluid 8 Oz. Can w/Brush
501-00204	204	Cold Vulc Fluid 32 Oz. Can
501-00205	205	Cold Vulc Fluid 1 Gallon

### Pre-Buff Cleaner



- Quick and easy cleaning and buffing of tubes; provides a perfect bonding surface
- Dissolves mold-release lubricant and loosens other contaminants so they can be removed using the rubber scraper, creating a clean, solid surface for any repair unit
- Perfect solution for crayon marks, grease and oil smears and rubber skid marks on equipment
- Flammable Pre-Buff Available - F Series

Ascot No.	Mfg. No.	Description
505-00070	70	Pre-Buff Rubber Cleaner 16 Oz. Spray Can
505-00071	71	Pre-Buff Rubber Cleaner 1 Qt. Spout Top Can
505-00028	28	Rubber Scraper
505-00027	27	Replacement Blades for Rubber Scraper
532-06020	6020	16 Oz. Aluminum Cement Dispenser with Brush Top
505-00170	70F	Pre-Buff Cleaner (Flammable) - 16 Oz.

### Rema Tire Talc

- For installing tubes and liners to prevent folding, sticking and heat-causing friction between tube and tire

Ascot No.	Mfg. No.	Description
507-00063	63	Rema Tire Talc, 1 Lb. Shaker Top



### Special Cement BL™

- The lynchpin of Rema's exclusive Blue Bonding System™
- Creates a nearly indestructible bond between tire and repair unit
- Specially formulated for use in all types of tire repair, special accelerator solution that can be used equally well in both cold and hot vulcanization
- Flammable Version Available - F Series



Ascot No.	Mfg. No.	Description
502-50339	BL-5	Special Cement BL, 30 Gm. Tube
502-50340	BL-8	Special Cement BL - 8 Oz. Brush Top Can
502-50388	BL-32	Special Cement BL - 32 Oz. Can
502-50389	BL-G	Special Cement BL - 1 Gallon
502-40541	BL-8F	Special Blue Cement (flammable), 8 Oz. Brush Top Can
502-51388	BL-32F	Special Blue Cement (flammable), 32 Oz. Can

### OTR Special Cement BL™

- Specially formulated to deliver reliable and complete adhesion in even the toughest operating conditions
- Can be used for both cold and hot vulcanizing



Ascot No.	Mfg. No.	Description
502-05576	5576	OTR Special Cement, 32 Oz. Can
502-05577	5577	OTR Special Cement, 1-1/2 Gallon
532-06020	6020	16 Oz. Aluminum Cement Dispenser

### Rim/Bead Sealer and Innerliner Repair Sealant

- Rema Rim and Bead Sealer (non-flammable) - seals minor leak between bead of tire and wheel rim
- Designed for use around the edges of repair units, overbuff areas and on porous innerliners
- Creates an air-tight seal, improving the integrity and reliability of any repair solution for hot vulcanizing uncured rubber
- Flammable Version Available - F Series
- No Drip Version available - ND Series



Ascot No.	Mfg. No.	Description
504-00960	960	Rim And Bead Sealer in Brush Top Can - 1 Qt.
508-00076	76	Repair Sealant in Brush Top Can - 16 Oz.
508-00176	76-G	Repair Sealant - 1 Gallon
505-00176	76F	Innerliner Sealer Can (Flammable) - 16 Oz.
504-09600	960-F	Rim & Bead Sealer w/Brush Cap. CFC-Free Formula (Flammable) 32 Oz.
504-09601	960ND	Rim & Bead Sealer w/Brush Cap. No Drip Formula - 32 Oz. Can

## Vulcanizing Materials

### Thermopress MTR & Thermopress Solution

- Designed specifically for hot vulcanization of repairs, especially on truck, agricultural and OTR tires
- Fast curing and ideal for use with uncured rubber
- Rema's Thermopress MTR Solution delivers a solid, durable bond
- Rema's original Thermopress Solution is a fast-curing heating solution for hot vulcanizing uncured rubber



Ascot No.	Mfg. No.	Description
501-05575	5575	Thermopress Solution - 1 Pint (500 G)
501-05578	5578	Thermopress MTR Solution - 32 Oz. Can
501-05579	5579	Thermopress MTR Solution - 1-1/2 Gallon

### SV Blue Bonding Rubber



- Chemical vulcanizing gum for the hot or cold lamination of all kinds of tire patches

Ascot No.	Mfg. No.	Description
525-05570	5570	SV Blue Bonding Rubber 1/32"x 20", 11 Lbs.
525-05571	5571	SV Blue Bonding Rubber 1/32" x 7", 4-1/2 Lbs.
525-05550	5550	Heat-Resistant Foil 3" x 6", 1000 Pcs. Keeps Heating Plates Clean

### Cement Brushes & Dispensers

- Cement brush that meets every need and a sealable cement dispenser with a built-in brush



Ascot No.	Mfg. No.	Description
532-06020	6020	16 Oz. Aluminum Cement Dispenser With Brush Top
532-06021	6021	Vulcanizing Brush 9"

532-06020

### A+B Vulc Compound - for Cold Vulcanization



- Components A and B have to be mixed in equal quantities to achieve vulcanization

Ascot No.	Mfg. No.	Description
501-00050	50	A+B Compound Kit 2 Lbs. Ea., 2 Cans Special Cement BL
501-00051	51	Compound Kit 1 Lb. Ea., 1 Can Special Cement BL

### Rema MTR Rubber



- The easy-to-extrude MTR Rope Rubber provides excellent green tack, has good flow properties and delivers improved adhesion
- MTR Cushion Gum Rubber is designed for hot vulcanization lamination of patches
- Should only be used with Rema's Thermopress-MTR Solution
- For applications with long waiting times between the repair and hot vulcanization

Ascot No.	Mfg. No.	Description
526-55610	5561	MTR Cushion Gum, 1/32" x 10", 24' Roll, 5.5 Lbs.
526-55630	5563	MTR Cushion Gum, 1/8" x 1-1/4", 8' Roll, 2.2 Lbs.
526-55672	5567-26.5	MTR Rope Rubber, Pail, for OTR Repairs, 26.5 Lb. Pail
502-55780	5578	Thermopress-MTR Solution, 32 Oz. Can

**Caution:** Use all tire repair chemicals in a well ventilated area. Avoid prolonged breathing or inhalation of vapors.

## Thermopress & Extruders

### EM Thermopress I



- Designed especially for bias and radial agricultural and OTR tires in sizes ranging from 14.00" to 29.5"
- Can be used on the tread, shoulder and sidewalls of bias and radial truck tires from size 11.00"
- High impact casters allow easy movement of the EM Thermopress I anywhere in the shop
- Precise automatic temperature and digital time controls assure proper cures
- Extended cure cycles up to 24 hours are possible
- Curing temperature adjustable up to 320°F; pneumatic pressure system adjustable up to 145 PSI

Ascot No.	Mfg. No.	Description
512-06580	6580	EM Thermopress I

### EM Thermopress II

- For the repair of large bias or radial agricultural and OTR tires
- Completely portable
- Precision electronics adjust and monitor pressure, temperature and cure time, while reliable loading/latching mechanisms help assure safe operation
- Curing temperature adjustable up to 320°F and hydraulic pressure system up to 2,275 PSI
- Extended curing cycles up to 24 hours is possible



Ascot No.	Mfg. No.	Description
512-06575	6575	EM Thermopress II with Stand

### EM Thermopress III

- For the repair of large bias and radial tires (size 30.00" - 51" and larger)
- Completely portable
- Curing temperature adjustable up to 320°F and hydraulic pressure system up to 2,275 PSI



Ascot No.	Mfg. No.	Description
512-06595	6595	EM Thermopress III
512-06585	6585	OTR Tire Repair Stand

### Thermopress Duplex

- Deluxe model for the economic repair of car, truck and EM tires up to 20.5" - 25"
- Equipped with swiveling top heating plate for more convenience
- Package includes: table support clamp, pressure equalizing pad, car adapter set, heat control/timer unit
- Requires a 110V power source

Ascot No.	Mfg. No.	Description
512-06750	6750	Thermopress Duplex



### Thermopress II

- For the economic repair of radial and bias-ply passenger, light truck, truck and small agricultural and OTR tires
- Delivers quick, safe vulcanization of sidewall, shoulder and tread area repairs up to 4" in size
- Unique C-clamp design allows for the vulcanization between the legs of rear agricultural and large OTR tires
- Low operating temperature and precise controls assure no deformation of the tire

Ascot No.	Mfg. No.	Description
512-06701	6701	Thermopress II
512-06700	6700	Thermopress II with Stand



### Extruders

- Compact construction and economical in power consumption
- Perfect for filling skives and for section repair buildup
- Feature Bosch drives, variable heat control from 32° to 248°F
- Complete with different nozzle configuration



Ascot No.	Mfg. No.	Description
511-06792	6792	Bench Top Nail Hole Extruder 1/4 HP Drive, 110V, 5 Nozzle Sizes, Bosch Drive, Heating Unit, Variable Heat Control from 32° to 248°F, Extrudes 11 Lbs.-Hour
511-06790	6790	Mini-Extruder, 110V, Self-Heating, 1/2 hp Bosch Drive, Variable Heat Control from 32° to 248°F, Extrudes 40 Lbs.-Hour
511-06794	6794	OTR Extruder, 110V, Self-Heating, 3/4 hp Bosch Drive, Variable Heat Control from 32° to 248°F, Extrudes 66 Lbs.-Hour

**Extruder Repair Service Available!**

## Tire Repair Patches & Chemicals

### Chemicals & Cements



504-90032



505-90016



501-90032



501-90008



521-90008

Ascot No.	Mfg. No.	Description
504-90032	ABS32	Black Bead Sealer, quart
501-90032	ASV32	Self-Vulc Cement, quart
505-90018	ASV8	8 Oz. Cement
505-90016	ABU16S	Spray Cleaner/Buffer, Citrus Scent, 16 Oz.
501-90008	ASV8BL	Blue Fast Dry Cement, 8 Oz.
521-90008	ARS8	Butyl Liner & Repair Sealer



### Lead Wire Pull Through Patch/Plug

- Easiest and most popular method to fill a nailhole and apply a patch in one simple step
- Lead-wire guides the rubber stem through injury
- Stem coated with self vulcanizing material and patch features Versacure bonding gum
- For tread area of bias and radial passenger and truck tires



Ascot No.	Description	Qty./Box
587-01303	1/8" Stem	48
587-01306	1/4" Stem	24
587-01309	3/8" Stem	24

### Push Through Patch/Plug

- One-piece molded rubber patch/plug unit with a metal quill that protects the stem from damage during insertion
- For tread area of bias and radial passenger and truck tires



Ascot No.	Description	Qty./Box
587-01151	1/4" (6mm) Stem	24
587-01152	1/4" (6mm) Stem	48
587-01150	1/8" (3mm) Stem	48

### Tire Repair Patches

Ascot No.	Mfg. No.	Description
<b>Standard Tube and Tubeless Tire Repairs</b>		
541-90040	ARB40D	Small Round (1-9/16") Box/40
541-90030	ARB30D	Medium Round (2-1/8") Box/30
541-90020	ARB20D	Large Round (3-1/8") Box/20
<b>Square Universal Radial/Bias Repairs (Black Gum/Blue Plastic Backed)</b>		
550-90007	AWR7	Small Square (1-3/4" width) 1/8" Injury Box/35
550-90008	AWR8	Medium Square (2-1/4" width) 1/4" Injury Box/25
550-90009	AWR9	Large Square (2-2/4" width) 3/8" Injury Box/15
<b>Round Universal Radial/Bias Repairs</b>		
550-90000	AWR0	Small Round (1-9/16") Box/35
550-90004	AWR4	Medium Round (2-1/8") Box/18
550-90005	AWR5	Large Round (3-1/8") Box/18
550-90006	AWR6	Giant Round (4-1/8") Box/10



Standard Tube & Tubeless Tire Repairs



Square Universal Radial/Bias Repairs (Black Gum/Blue Plastic Backed)



Round Universal Radial/Bias Repairs

## Monaflex Tire Repair System

### Monaflex Tire Repair System

**TRUFLEX/PANG**

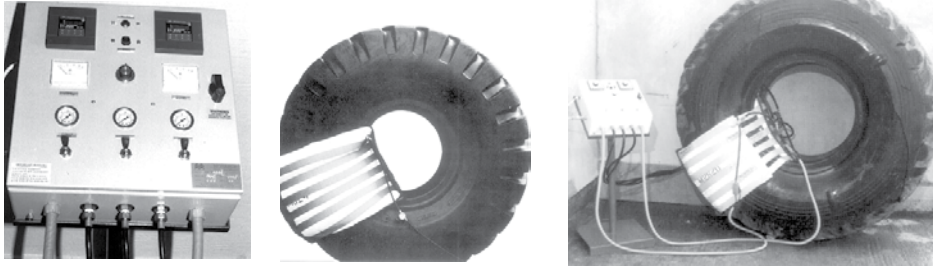

- A small Monaflex System can be purchased initially then expanded when required to cover up to 4200 tire section
- Flexible rubber heat pads and air bags conform to the profile of radial, cross-ply, wide base, low profile and skidder/flotation tires to provide distortion-free repairs
- Inside and outside heat and pressure vulcanize patch and plug in one operation to provide first class cures with maximum patch adhesion
- Handles up to 28" x 28" cross-ply patch and 35" x 10" radial patch
- The elastic windows incorporated in air bag covers allow the air bag to expand further into the sidewall areas of the tire ensuring even pressure over the patch area
- Control panel fitted with digital temperature displays, timer, self-relieving air differential control, air gauges and fail-safe features
- Maximum of 45 PSI air pressure required

Tractor/OTR Wide Base	Tire Section	Max. Injury	Patch Dim.	Cylinder Air Bag	Inside Flat Air Bag	Outside Flat Air Bag	Inside Heat Pad	Outside Heat Pad	Control Harness	Panel
9.5-32	825 900	2"	10" x 10"							
11.2-38	1000 1100	2.5"	12" x 12"	TR911/13	TR2213 TR2213E	WITH PACK	TR2213HP TR2213E	WITH PACK 4 OFF	TROC (1)	M100
12.4-3 9.5-32 11.2-38 12.4-38	1200 RADIAL LOW PROFILE TRUCK	3"	13" x 13" 16" x 10"	TR911/13	TR2210W WINDOW BAG	AS ABOVE	TR2210HP	AS ABOVE	TROC (1) 4 OFF	M100
9.5-32 11.2-38 12.4-38	SUPER SINGLE TRUCK	3"	16" x 10"	TR1214/20 LOW PROFILE	TR2210W WINDOW BAG	AS ABOVE	TR2210HP	AS ABOVE	TROC (1) 4 OFF	M100
14.4-24	1300 1400 15.5 RADIAL 1600	4"	15" x 15"	M1220	M2820	M2316	M2519 M3015	M1616	M45/6	M100
16.9-24 18.4-38	17.5 1800 20.5 2100 RADIAL	4" 5"	19" x 19"	M1518/24	M3624	M2820	M2626	M2519	M45/6	M100
20.8-38 23.1-34 24.5-32 28.1-26	23.5 2400 RADIAL 26.5 2700	5" 6"	22" x 22" 23" x 23"	M2124	M4824	M3624 M3015	M2626	M2519	M45/6	M100
30.5-32	295 33.25 3300 RADIAL	8"	25" x 25"	M2427/32	M5432	M4824	M2626	M2519	M45/6	M100
65/35-33	3600 3700 37.5 38-39 4200 RADIAL 6700	9" 10"	25" x 25" 28" x 28"	M3336/32	M6732	M5432	M3132	M2626	M45/6	M100
65/40-39 65/45-45		10"	28" x 28"	M6036	M12636	M12636	M4215 M3636	M3132	M46-5	M100

## Universal Tire Repair Units

### Euro-Style Universal Repair Units

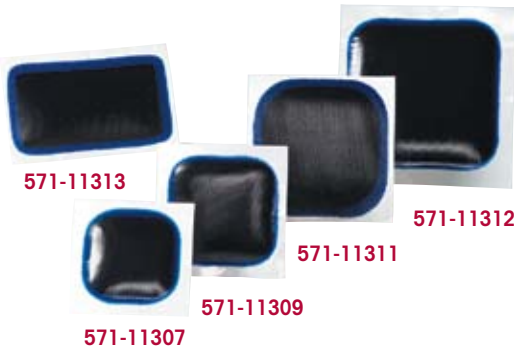

- Rubber reinforced repairs that can be applied in any repairable area of a radial or bias-ply passenger tire
- Repairs a maximum injury of 1/4" when following industry recommended repair procedures
- Vulcanizes either chemically or with heat

Ascot No.	Mfg. No.	Description	Size (in.)	Size (mm)	Box Qty
571-11307	11-307	Mini Square	1-1/2	38	50
571-11309	11-309	Small Square	2	50	50
571-11311	11-311	Medium Square	2-3/8	60	50
571-11312	11-312	Large Square	2-3/4	70	50
571-11313	11-313	Small Rectangle	1-3/4 x 3	45 x 76	10

### USA Style Universal Repair Units



- For nail hole repairs in radial or bias-ply passenger tires
- Chemical vulcanization only
- Available with red or blue poly backing

Ascot No.	Mfg. No.	Description	Size (in.)	Size (mm)	Box Qty
571-11321	11-321	Small Round	1-3/4	45	30
571-11322	11-322	Medium Round	2-1/4	57	25
571-11323	11-323	Large Round	3-1/8	79	15
571-11324	11-324	Small Oval	1-1/2 x 2-1/2	38 x 64	25
571-11325	11-325	Medium Oval	1-7/8 x 3-7/8	48 x 98	15
571-11115	11-115	Small Square	1	45	25
571-11116	11-116	Medium Square	2-1/8	54	15

### Feather-Edge Tube Repairs



- Designed for repairing inner tubes (chemical vulcanization only)
- Twice as strong as tube being repaired, yet, extremely flexible

Ascot No.	Mfg. No.	Description	Size (in.)	Size (mm)	Box Qty
541-11000	11-000	Mini Round	1-1/4	32	100
541-11001	11-001	Small Round	1-5/8	43	40
541-11002	11-002	Medium Round	2-1/4	57	30
541-11003	11-003	Large Round	3-1/8	79	20
541-11004	11-004	Small Oval	1-3/8 x 2-3/8	35 x 60	30
541-11005	11-005	Medium Oval	1-7/8 x 3-3/4	48 x 95	20
541-11006	11-006	Large Oval	2-1/2 x 5-3/4	64 x 146	20
541-11007	11-007	Giant Round	4	102	10
541-11008	11-008	Giant Oval	4 x 6-1/4	102 x 159	10

### USA Style Universal Repair Units

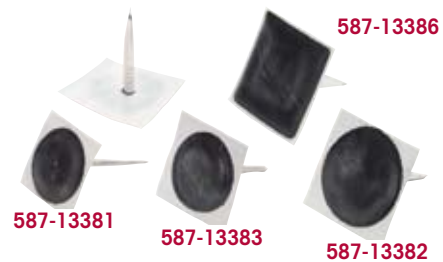

- Feature rubber reinforced patch heads
- Multi-directional and can be used in any repairable area of radial or bias-ply tires (tread, shoulder or sidewall)
- Black repair unit with black vulcanizing gum
- Both stem and repair unit will vulcanize chemically
- Stem of combination unit is equipped with a metal quill

Ascot No.	Mfg. No.	Patch Size	Stem Size	Box Qty.
587-13381	13-381	Round, 1-3/4"	Round, 3/16"	20
587-33810	13-381SQ	Round, 42mm	Round, 5mm	20
587-13382	13-382	Square, 1-1/2"	Round, 3/16"	15
587-33811	13-382SQ	Square, 40mm	Round, 5mm	15
587-13386	13-386	Round, 2-1/4"	Round, 5/16"	15
		Round, 57mm	Round, 8mm	15
		Square, 2-1/4"	Round, 5/16"	15
		Square, 57mm	Round, 8mm	15
		Square, 2-1/4"	Flat, 7/16"	10
		Square, 57mm	Flat, 1mm	10

## Radial & Bias-Ply Repair Units

### Lead-Wire Inserts



581-13621      581-13622      581-13623

- Designed to fill the injury in passenger and truck, radial or bias-ply tires
- Will vulcanize chemically or in the presence of a heat curing system, becoming a permanent part of the tire
- Requires no special insert tool for installation

Ascot No.	Mfg. No.	Description	Injury Size	Box Qty.
581-13621	13-621	1/4" Lead Wire Insert	1/8" (3mm)	20
581-13622	13-622	3/8" Lead Wire Insert	1/4" (6mm)	20
581-13623	13-623	7/16" Lead Wire Insert	3/8" (10mm)	20
581-13624	13-624	1/2" Pull-Thru	3/8" (10mm)	5

### "BN" Bias-Ply Repair

- Designed to be applied in any repairable area of tube or tubeless bias-ply tire
- Designed for use in puncture, reinforcing or section repairs
- Will vulcanize chemically or in high heating curing systems
- Repairs are a unit molded style with premium blue vulcanizing gum on white Mylar backing
- Fine feather-edge eliminates chaffing



561-11492      561-11489      561-11488  
561-11491      561-11490

Ascot No.	Mfg. No.	Description	Size (in.)	Size (mm)	Box Qty.
561-11488	11-488	BN1, 1-Ply	2-1/8"	55	30
561-11489	11-489	BN2, 2-Ply	3"	76	20
561-11490	11-490	BN3, 2-Ply	3-1/2"	89	20
561-11491	11-491	BN4, 2-Ply	4-1/2"	114	10
561-11492	11-492	BN5, 2-Ply	5-1/2"	140	10
561-11493	11-493	BN7, 3-Ply	7"	178	10
561-11494	11-494	BN8, 3-Ply	8-1/4"	210	10
561-11495	11-495	BN9, 4-Ply	9"	228	10
561-11496	11-496	BN10, 6-Ply	10"	254	5
561-11497	11-497	BN12, 6-Ply	12"	305	5
561-11498	11-498	BN15, 8-Ply	15"	381	3
561-11499	11-499	BN20, 8-Ply	20"	508	3

### USA Style C-O-I Radial Repair

- Designed for use in puncture, reinforcement or section repairs in any repairable area of passenger, truck, agricultural or earthmover radial tires
- Repair is black with gray vulcanizing gum on a blue poly backing
- Each reinforced ply is individually end-wrapped to deflect tire flexing stresses in a unique manner
- New tie-gum construction eliminates the potential for delamination common in competitive brands
- Will vulcanize chemically or in low temperature (pre-cure) systems



Ascot No.	Mfg. No.	Description	Size (in.)	Size (mm)	Box Qty.
571-11808	11-808	Radial 10, 1-Ply	1-3/4" x 3"	45 x 76	20
571-11810	11-810	Radial 10, 1-Ply	2-1/4" x 3"	57 x 76	20
571-11812	11-812	Radial 12, 1-Ply	2-1/4" x 4"	57 x 102	10
571-11814	11-814	Radial 14, 1-Ply	3-3/4" x 4"	95 x 102	10
571-11820	11-820	Radial 20, 2-Ply	3" x 5"	76 x 125	10
571-11822	11-822	Radial 22, 2-Ply	3" x 6"	76 x 150	10
571-11824	11-824	Radial 24, 2-Ply	3" x 8-1/2"	76 x 215	10
571-11825	11-825	Radial 25, 3-Ply	4-1/2" x 5"	115 x 125	10
571-11835	11-835	Radial 35, 3-Ply	5-1/4" x 7-1/4"	133 x 185	10
571-11840	11-840	Radial 40, 3-Ply	4" x 7-1/2"	102 x 190	10
571-11842	11-842	Radial 42, 4-Ply	5" x 10"	125 x 254	10
571-11844	11-844	Radial 44, 4-Ply	5" x 13"	125 x 330	10
571-11845	11-845	Radial 45, 4-Ply	7-3/4" x 9"	197 x 228	5

### Lead-Wire Combination Units

- Requires no special wire pulling tools—just insert lead wire into the injury from the inside of the tire and pull the repair unit through from the outside
- Stem and repair unit are gum-coated to provide the most complete bond, both inside the injury and on the innerliner
- Will vulcanize chemically or in a heat cure system
- 13-673 and 13-674 are black with gray vulcanizing gum and both the stem and repair unit are protected by a blue poly wrap

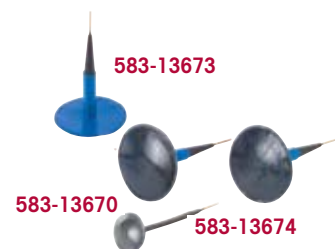

583-13673  
583-13670      583-13674

Ascot No.	Mfg. No.	Patch Size	Stem Diameter	Injury Size	Box Qty.
583-13670	13-670	1"	1/8" (3mm)	1/16" (16mm)	20
583-13673	13-673	2"	1/4" (6mm)	1/8" (3mm)	24
583-13674	13-674	2"	3/8" (10mm)	1/4" (6mm)	24

## Cement, Buffers and Sealers

### Buffing Solution



505-14110



505-14102

Ascot No.	Mfg. No.	Description	Type	Size
505-14100	14-100	Buffing Solution	Flammable	32 Oz.
505-14102	14-102	Aerosol Buff	Non-Flammable	16 Oz.

### Sealers



504-14101



504-14128

Ascot No.	Mfg. No.	Description	Type	Size
504-14101	14-101	Bead Sealer	Flammable	32 Oz.
504-14100	14-101	Bead Sealer	Flammable	1 Gal.
504-14104	14-104	Bead Sealer	Flammable	5 Gal.
504-14128	14-128	Inner-Liner Sealer	Noan-Flammable	16 Oz.

### Chemical Vulcanizing Cement

- Offering both flammable and non-flammable cements
- Flammable cements tend to dry faster
- In certain regions, non-flammable cements required by law or regulation
- Contains accelerators which, when coming into contact with the face gum on any "X-tra Seal™" repair unit, will begin the vulcanization process



Ascot No.	Mfg. No.	Description	Type	Size
501-14008	14-008	Vulcanizing Cement	Flammable	8 Oz.
501-14032	14-032	Vulcanizing Cement	Flammable	32 Oz.
501-14511	14-511	HD Supr-Blu Cement	Flammable	8 Oz.
501-14512	14-512	HD Supr-Blu Cement	Flammable	32 Oz.
501-14513	14-513	Vulcanizing Cement	Non-Flamm.	8 Oz.
501-14514	14-514	Vulcanizing Cement	Non-Flamm.	32 Oz.
501-14515	14-515	Black Vulc. Cement	Flammable	32 Oz.

### Safety Seal +Plus+ The Liquid Patch™

- Temporary tire repair system combines two state of the art components; The Liquid Patch and The Original Safety Seal® Repair to create the perfect tire repair system while reducing labor, equipment and inventory costs
- Kit includes: 60-4" Temporary repairs; Prep & primer (Qt.); The liquid patch (16 Oz.); A metal T-handle insertion tool; Spiral probe tool; and Special lube



Ascot No.	Mfg. No.	Description
571-23929	LPKA	Auto
571-23930	LPKT	Truck

### ATV "On The Wheel Truck Tire Repair Kit"

- Designed for outdoor enthusiasts to repair, inflate and go!
- Kit includes: (1) Needle insertion tool; (6) Self-vulcanizing repairs, (1) CO<sub>2</sub> inflator w/ two cartridges; and Instructions
- Packed in a water tight display tube package that hang on a peg hook
- Can repair all tubeless tires with NO cement needed



Ascot No.	Mfg. No.
571-22928	SSKATVI

### Safety Seal® Truck Tire Repair Kit

- Includes everything to make temporary repairs to most flats caused by nails or other objects up to 1/4"
- Kit includes: 30-8" (20cm) temporary repairs, Metal T-handle insertion tool, Metal T-handle spiral probe, Special lube, Extra insertion needle, Cutting blades, Allen wrench, and Instructions
- Packed in a sturdy carrying case to fit easily under the seat of a truck



Ascot No.	Mfg. No.
571-22926	SSKTPX

### Safety Seal® Deluxe Tire Repair Kit

- For autos and light trucks
- "On the Wheel" design for the professional who wants to fix a flat quickly and easily
- Repairs punctures up to 1/4" and seals entire puncture from tread to inner liner
- Also available in other sizes: truck, off-road and heavy equipment



Ascot No.	Mfg. No.
571-22960	SS-KAP60



## Air Buffers and Drills

### High-Speed Tire Buffer with Quick Change Chuck

- Equipped with a quick change chuck to allow for rapid changes to a variety of tire repair tasks
- Ideal for scuffing, grinding, cleaning and many other uses requiring high speed and is equipped with safety throttle lever
- Includes one quick-change adapter



Ascot No.	Mfg. No.	Description
157-06010	SLP-6010	High-Speed Tire Buffer with Quick Change Chuck
157-16010	SLP-6010REK	Above with Rear Exhaust Hose Kit

### High-Speed Tire Buffer with Jacobs Chuck

- Provides plenty of power with it's .5 horsepower motor and 20,000 RPM, rear exhaust performance
- Ideal for general purpose drilling, scuffing or to grind down steel belts
- Equipped with safety throttle lever



Ascot No.	Mfg. No.	Description
158-00871	CP-871K	Includes Over Hose

### High Speed Tire Buffer Kit

- Jacobs chuck for holding buffing accessories
- Lock-off throttle
- Applications: tire patchwork, roughing areas for recapping and cleaning tire moldings
- Free speed: 22,000 RPM



Ascot No.	Mfg. No.	Description
157-04038	SLP-4038	High-Speed Tire Buffer with Jacobs Chuck
157-14038	SLP-4038REK	Above with Rear Exhaust Hose Kit

### Heavy Duty Skiving Tool

- Excellent for skiving work due to the more substantial gear package which contributes to durability
- Features 3,200 RPM, rear exhaust performance
- Equipped with safety throttle lever
- Includes one quick-change adapter



Ascot No.	Mfg. No.	Description
157-06550	SLP-6550	Heavy Duty Skiving Tool

### Heavy Duty Air Low Speed Tire Buffer

- For quick work of patchwork and roughing up low areas for recapping, tire scuffing and cleaning tire moldings
- Free speed up to 3,000 RPM
- 1/2 HP motor



Ascot No.	Mfg. No.	Description
157-00327	IR-327LS	Includes Over Hose

### Low Speed Tire Buffer Kit

- Quick change slip chuck for fast and easy change of buffing wheel
- Adjustable speed regulator for precise control
- Lock-off throttle to prevent accidental start ups
- Rear exhaust directs air away from work area
- Free Speed: 2,800 RPM



Ascot No.	Mfg. No.	Description
158-00873	CP-873K	Includes Over Hose

### Lighted Low-Speed Buffer with Quick-Change Chuck



- Provides light inside the tire without the use of batteries or other external power sources
- Volt-Aire patented technology turns the motor into a working generator to bring electricity and light to the work surface for enhanced visibility, safety and productivity
- Geared design provides high torque but low speed to prevent burning of work surface
- Quick-change chuck allows operator to make rapid changes to a variety of tool accessories



Ascot No.	Mfg. No.	Description
157-06520	SLP-6520L	Lighted Low-Speed Tire Buffer with Quick Change Chuck
157-16520	SLP-6520REK	Above with Rear Exhaust Hose Kit

## Tire Repair Tools

### Slotted Finishing Rasps



Ascot No.	Mfg. No.	Description
539-02203	2203	36-Grit, 2" x 3/16"
539-02204	2204	16-Grit, 2" x 3/16"
539-02205	2205	36-Grit, 2" x 3/8"
539-02206	2206	16-Grit, 2" x 3/8"
539-02207	2207	36-Grit, 2" x 1/2"
539-02208	2208	16-Grit, 2" x 1/2"
539-02209	2209	36-Grit, 2" x 3/4"
539-02210	2210	16-Grit, 2" x 3/4"
539-02241	2241	36-Grit, 2" x 1"

### Contour Cup Rasps

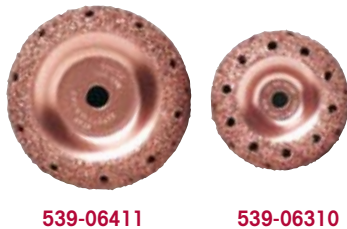

Ascot No.	Mfg. No.	Description
539-06261	TCW210	36-Grit, 2"x1-3/8" - 3/8" Arbor Hole
539-06260	TCW210	16-Grit, 2"x1-3/8" - 3/8" Arbor Hole
539-06360	TCW310	36-Grit, 3" x 1" - 3/8" Arbor Hole
539-06361	TCW310	16-Grit, 3" x 1" - 3/8" Arbor Hole
539-06310	TCW315	36-Grit, 3" x 1-1/2" - 3/8" Arbor Hole
539-06311	TCW315	16-Grit, 3" x 1-1/2" - 3/8" Arbor Hole
539-06312	TCW315	36-Grit, 3" x 1-1/2" - 1/2" Arbor Hole
539-06313	TCW315	16-Grit, 3" x 1-1/2" - 1/2" Arbor Hole
539-06314	TCW315	36-Grit, 3" x 1-1/2" Vented - 3/8" Arbor Hole
539-06315	TCW315	16-Grit, 3" x 1-1/2" Vented - 3/8" Arbor Hole
539-06316	TCW315	36-Grit, 3" x 1-1/2" Vented - 1/2" Arbor Hole
539-06317	TCW315	16-Grit, 3" x 1-1/2" Vented - 1/2" Arbor Hole
539-06410	TCW415	36-Grit, 4" x 1-1/2" - 1/2" Arbor Hole
539-06411	TCW415	16-Grit, 4" x 1-1/2" - 1/2" Arbor Hole
539-06412	TCW415	36-Grit, 4" x 1-1/2" - 5/8" Arbor Hole
539-06413	TCW415	16-Grit, 4" x 1-1/2" - 5/8" Arbor Hole
539-06414	TCW415	36-Grit, 4" x 1-1/2" Vented - 1/2" Arbor Hole
539-06415	TCW415	16-Grit, 4" x 1-1/2" Vented - 1/2" Arbor Hole
539-06416	TCW415	36-Grit, 4" x 1-1/2" Vented - 5/8" Arbor Hole
539-06417	TCW415	16-Grit, 4" x 1-1/2" Vented - 5/8" Arbor Hole

### B&J



Ascot No.	Mfg. No.	Grit	Description
539-15616	332056-16	16 Grit	Flat Faced Buffout Wheel 2" x 3/16" (50 x 5mm)
539-15636	332056-36	36 Grit	Flat Faced Buffout Wheel 2" x 3/16" (50 x 5mm)
539-15816	332058-16	16 Grit	Flat Faced Buffout Wheel 2" x 1/4" (50 x 7mm)
539-15836	332058-36	36 Grit	Flat Faced Buffout Wheel 2" x 1/4" (50 x 7mm)
539-16316	332063-16	16 Grit	Flat Faced Buffout Wheel 2" x 3/8" (50 x 10mm)
539-16336	332063-36	36 Grit	Flat Faced Buffout Wheel 2" x 3/8" (50 x 10mm)
539-16416	332064-16	16 Grit	Round Faced Buffout Wheel 2" x 1/2" (50 x 13mm)
539-16436	332064-36	36 Grit	Round Faced Buffout Wheel 2" x 1/2" (50 x 13mm)
539-16516	332065-16	16 Grit	Round Faced Buffout Wheel 2" x 3/4" (50 x 19mm)
539-16536	332065-36	36 Grit	Round Faced Buffout Wheel 2" x 3/4" (50 x 19mm)
539-17616	232076-16	16 Grit	Round Faced Buffout Wheel 2" x 7/8" (50 x 22mm)
539-17636	232076-36	36 Grit	Round Faced Buffout Wheel 2" x 7/8" (50 x 22mm)



Ascot No.	Mfg. No.	Grit	Description
539-10116	332001-16	16 Grit	2" x 1" Cooper Contour Wheel (50 x 25mm) AH 3/8"
539-10136	332001-36	36 Grit	2" x 1" Cooper Contour Wheel (50 x 25mm) AH 3/8"
539-10160	332001-60	60 Grit	2" x 1" Cooper Contour Wheel (50 x 25mm) AH 3/8"
539-11016	332010-16	16 Grit	3" x 1" Cooper Contour Wheel (76 x 25mm) AH 3/8"
539-11036	332010-36	36 Grit	3" x 1" Cooper Contour Wheel (76 x 25mm) AH 3/8"
539-11060	332010-60	60 Grit	3" x 1" Cooper Contour Wheel (76 x 25mm) AH 3/8"
539-10916	332009-16	16 Grit	3" x 1.5" Cooper Contour Wheel (76 x 38mm) AH 3/8"
539-10936	332009-36	36 Grit	3" x 1.5" Cooper Contour Wheel (76 x 38mm) AH 3/8"
539-10960	332009-60	16 Grit	3" x 1.5" Cooper Contour Wheel (76 x 38mm) AH 3/8"
539-10416	332004-16	16 Grit	4" x 1.5" Cooper Contour Wheel (102 x 38mm) AH 3/8"
539-10436	332004-36	36 Grit	4" x 1.5" Cooper Contour Wheel (102 x 38mm) AH 3/8"
539-10460	332004-60	16 Grit	4" x 1.5" Cooper Contour Wheel (102 x 38mm) AH 3/8"

## Tire Repair Tools and Accessories

### Scrapers, Rasps and Inserting Tools

- Rubber must be cleaned and hole injuries must be cleaned and roughened before inserting repair units



Ascot No.	Mfg. No.	Description
537-00027	27	Replacement Blades For Rubber Scraper
537-00028	28	Rubber Scraper
537-36560	190	Awl
537-95893	199	Rasp-Roughens Nail Holes
537-10565	565	Car Repair Insertion Tool
537-00575	575	Truck Repair Insertion Tool
537-00585	585	EM Repair Insertion Tool
537-02240	6003	Radial Tire Repair Specialist Rasp
537-02241	6003T	Radial Tire Repair Specialist Rasp For Truck Tires

### Tire Related Hand Tools



Ascot No.	Mfg. No.	Description
537-06010	6010	Geared Side Cutter For Steel Cords
537-06012	6012	8" Steel Nippers
537-06014	6014	Brass Brush For Cleaning Repair
537-06019	6019	Scissors For Cutting Rubber
537-06022	6022	9" Whetstone
537-00045	45	Retreaders Brush

### Professional Heavy Duty Tire Reamers



Ascot No.	Mfg. No.	Description
537-17276	1-R	3/16" Diameter - Blade Length 7"
537-17277	2-R	1/4" Diameter - Blade Length 8-3/4"

### Tire Probes



Ascot No.	Mfg. No.	Description
537-15224	15-224	Super-Grip Open-Eye Needle
537-15225	15-225	Super-Grip Tire Probe
537-15226	15-226	Super-Grip Closed-Eye Needle
537-15227	15-227	Super-Grip Spill-Eye Needle
537-15230	15-230	Heavy Duty Metal Closed-Eye Needle
537-15232	15-232	Super-Grip Heavy Duty Tire Probe

### Tire Repair Air Tool Accessories

Ascot No.	Mfg. No.	Description
173-09150	SLP-9150	Jacobs 3/8" Precision Chuck And Key
173-09165	SLP-9165	Quick-Change Chuck
173-09201	SLP-9201	1-1/16" x 3/8"-24 Chuck Adapter W/Washer & Nut
173-09202	SLP-9202	2-3/4" x 3/8"-24 Chuck Adapter W/Nut & Wheel Spacer
173-09211	SLP-9211	1-7/8" x 3/8"-24 Threaded Adapter W/Washer & Nut
173-09212	SLP-9212	2-1/4" x 3/8"-24 Threaded W/ Nut & Wheel Spacer
173-09213	SLP-9213	1-15/16" Adapter W/Set Screw for 1/8" Shank
173-09214	SLP-9214	1-15/16" Adapter W/Set Screw for 3/16" Shank
173-09215	SLP-9215	1-15/16" Adapter W/Set Screw for 1/4" Shank
173-09216	SLP-9216	1-15/16" Adapter W/Set Screw for 5/16" Shank
173-09400	SLP-9400	Overhose Kit



## Rubberhog®

### Rubberhog® Tire Repair Tools

The controlled wide-open structure provides generous cutting clearance between the "SSG" teeth allowing them to easily penetrate and cut off small, cool chips of rubber without loading. "SSG" teeth are also manufactured so that the teeth operate at a uniform cutting radius, resulting in a rubber surface that is minutely roughened and free of coarse grooves, ridges or closed cuts.

This combination of features explains why Rubberhog® wheels provide a cool efficient cutting action, which produces an even, scorch-free surface with an ideal texture for obtaining the strongest rubber to rubber bonds.

Rubberhog® tools are for texturing and removing rubber rapidly with a highly efficient, cool, smokeless cutting action that requires no coolants at all. They leave a prepared rubber surface that is physically and chemically clean, evenly textured and entirely free from any defects caused by abrading and rasping.

### "Mini-Cup" Flared Contour Wheels

- Innerliner buffer
- Available in grit or "SSG" coating



538-13000

Ascot No.	Mfg. No.	Description
538-13000	130	2" FCW Mini Cup, 60 Grit (Black)
538-13017	130-170	2" FCW Mini Cup, SSG 170
538-13023	130-230	2" FCW Mini Cup, SSG 230

### Polyplugs For Flared Contour Wheels

- Made for flared contour wheels and are reusable
- Make the wheels run true, protect them from damage and provide a flywheel effect for better control



538-15200

Ascot No.	Mfg. No.	Description
538-00150	150	1-3/4" Polyplug
538-15100	151	2" Polyplug
538-15200	152	2-1/2" Polyplug
538-15400	154	3" Polyplug, 3/8" Bore
538-15412	154-12	3" Polyplug, 1/2" Bore
538-15600	156	3-1/2" Polyplug, 3/8" Bore
538-15612	156-12	3-1/2" Polyplug, 1/2" Bore

### Flared Contour/Precision Contour Wheels



538-10700    538-11200    538-12200    538-12900

- Redesigned to most effectively use their "SSG" tooth armors
- Working faces of the wheels are at an angle to the shaft, which makes it easy to clear the handpiece for working inside and outside of casings
- Wide and nearly flat working face radius produces the ideal texture over a wider contact area for a more even textured surface

Ascot No.	Mfg. No.	Description
538-10700	107	2-1/2" Contour Wheel 3/8" Bore, SSG 170
538-10760	107-60	2-1/2" Contour Wheel 3/8" Bore, 60-Grit
538-10900	109	2-1/2" Contour Wheel 3/8" Bore, SSG 230
538-10936	109-36	2-1/2" Contour Wheel 3/8" Bore, 36-Grit
538-11100	111	2-1/2" Contour Wheel 3/8" Bore, SSG 390
538-10000	100	1-3/4" Flared Contour Wheel, SSG 170
538-10200	102	1-3/4" Flared Contour Wheel, SSG 230
538-10400	104	1-3/4" Flared Contour Wheel, SSG 390
538-15000	1-500	2" Cup, 3/8"-24 Thread, SSG 170
538-15020	1-502	2" Cup, 3/8"-24 Thread, SSG 230
538-15040	1-504	2" Cup, 3/8"-24 Thread, SSG 390
538-11200	112	3" Contour Wheel 3/8" Bore, SSG 170
538-11400	114	3" Contour Wheel 3/8" Bore, SSG 230
538-11600	116	3" Contour Wheel 3/8" Bore, SSG 390
538-11800	118	3-1/2" Contour Wheel 3/8" Bore, SSG 170
538-12000	120	3-1/2" Contour Wheel 3/8" Bore, SSG 230
538-12200	122	3-1/2" Contour Wheel 3/8" Bore, SSG 390
538-12600	126	4" x 1/2" Bore Contour Wheel, SSG 230
538-12658	126-5/8	4" x 5/8" Bore Contour Wheel, SSG 230
538-12800	128	4" x 1/2" Bore Contour Wheel, SSG 390
538-12858	128-5/8	4" x 5/8" Bore Contour Wheel, SSG 390
538-12900	129	4" x 3/4" Bore Contour Wheel, SSG 390

### Flared Contour/Precision Contour Wheels

- For skiving and texturing of larger exterior section repairs



538-30400

Ascot No.	Mfg. No.	Description
538-30200	302	2" x 1/4" Buzzout, SSG 390
538-30400	304	2" x 3/8" Buzzout, SSG 230
538-30600	306	2" x 3/8" Buzzout, SSG 390
538-30800	308	2" x 1/2" Buzzout, SSG 230
538-31000	310	2" x 1/2" Buzzout, SSG 390
538-31200	312	2" x 3/4" Buzzout, SSG 230
538-31400	314	2" x 3/4" Buzzout, SSG 390

## Rubberhog®

### Tapered Cones

- For skiving and texturing of larger exterior section repairs

538-50100



Ascot No.	Mfg. No.	Description
538-50100	501	5/8" x 1-3/8" Cone, 3/8"-24, SSG 230
538-50300	503	5/8" x 1-3/8" Cone, 3/8"-24, SSG 390
538-50500	505	7/8" x 2" Cone, 3/8"-24, SSG 230
538-50700	507	7/8" x 2" Cone, 3/8"-24, SSG 390
538-50900	509	7/8" x 4" Cone, 3/8"-24, SSG 230
538-51100	511	7/8" x 4" Cone, 3/8"-24, SSG 390



### Small and Medium Balls

- Medium balls for skiving/texturing of larger exterior section repairs
- Small balls for skiving/texturing of medium exterior section repairs



538-53300



538-60100

Ascot No.	Mfg. No.	Description
538-55100	551	1-1/8" Ball, 3/8-24, SSG 230
538-55300	553	1-1/8" Ball, 3/8-24, SSG 390
538-60100	601	5/8" Ball, 1/4" Shank, SSG 330
538-60160	601-6mm	5/8" Ball, 6mm Shank, SSG 330
538-60300	603	7/8" Ball, 1/4" Shank, SSG 330
538-60360	603-6mm	7/8" Ball, 6mm Shank, SSG 330

### Small Tapers

- For small section repairs of tread and sidewall

538-61100



Ascot No.	Mfg. No.	Description
538-61100	611	5/8" Taper, 1/4" Shank, SSG 330
538-61300	613	7/8" Taper, 1/4" Shank, SSG 330
538-61360	613-6mm	7/8" Taper, 6mm Shank, SSG 330

### Rotor Saws

- For small buzzout repairs of tread and sidewall

538-61900



Ascot No.	Mfg. No.	Description
538-61900	619	1-3/8" Rotor Saw, 1/4" Shank, SSG 330
538-62000	620	1-5/8" Rotor Saw, 1/4" Shank, SSG 330
538-62100	621	2" Rotor Saw, 1/4" Shank, SSG 330

### Shank Kits

- For extremely small defect repairs



538-63500

Ascot No.	Mfg. No.	Description
538-63500	635	1/8" Shank Tool Kit, SSG 170
538-63530	635-3mm	3mm Shank Tool Kit, SSG 170

### Nail Hole Reamers

- For extremely small defect repairs



538-62500

Ascot No.	Mfg. No.	Description
538-62500	625	1/4" x 3" NHR, 1/4" Shank, SSG 230
538-62600	626	1/4" x 3" NHR, 1/4" Shank, SSG 330
538-62700	627	3/8" x 3" NHR, 1/4" Shank, SSG 230

### Donut Wheels

- For Marangoni, Collman and other sidewall buffers



538-70600

Ascot No.	Mfg. No.	Description
538-70600	706	5" x 1" x 1-1/2" Donut Wheel, SSG 390
538-70650	706-50mm	5" x 1" x 50mm Donut Wheel, SSG 390
538-70800	708	6" x 1-1/4" x 1-1/2" Donut Wheel, SSG 390
538-70850	708-50mm	6" x 1-1/4" x 50mm Donut Wheel, SSG 390

### Disc Wheels/Disc Sidewall Wheels

- For angle head machines; section repair and cosmetics



538-00150

Ascot No.	Mfg. No.	Description
538-71400	714	4" Disc Wheel, 5/8" Bore, SSG 390
538-71600	716	4" Disc Wheel, 5/8" Bore, SSG 230
538-01150	1150	4" Disc, 5/8" Bore, SSG 390
538-01152	1152	4" Disc, 5/8" Bore, SSG 230
538-01160	1160	7" Disc, 7/8" Bore, SSG 390
538-01162	1162	7" Disc, 7/8" Bore, SSG 230

### Rotary Knife Blade

- For cutting precured tread
- Carbide coated sides combined with a sharp cutting edge structure provides an efficient cutting and long lasting blade - 10-20 times the life of standard blades



538-10011

Ascot No.	Mfg. No.	Description
538-10013	100-GE138	6" x 1-3/8" Rotary Knife Blade
538-10011	100-GE	6" x 2" Rotary Knife Blade
538-20011	200-GE	180mm x 32mm Rotary Knife Blade

## Buffing Wheels, Brushes & Rasps

### Buffing Wheels



539-00033



539-00788

Ascot No.	Mfg. No.	Description
539-00033	33	3/8"-24 Arbor For Mounting Buffing Wheels
539-00788	788	(2) No. BC-1 Buffing Wheels Mounted Back-to-Back On No. 33 Arbor

### Power Brushes

Ascot No.	Mfg. No.	Description
535-70179	70179	3" Brush
535-13533	13533	Medium Face Standard Twist Knot Wire Wheel



### Power and Hand Tube Brushes



Ascot No.	Mfg. No.	Description
535-21072	21072	1/4" Diameter, Wire Size: .004", OAL 3-1/2"
535-21073	21073	3/8" Dia, .004", OAL 3-1/2"
535-21074	21074	1/2" Diameter, Wire Size: .005", OAL 3-1/2"
535-21076	21076	3/4" Diameter, Wire Size: .006", OAL 3-1/2"

### Vacuum Cleaners

- Air operated wet or dry
- Easy hook up, efficient suction
- Ideal for use on mobile service trucks



Ascot No.	Mfg. No.	Description
537-00795	795	Air Vacuum, Wet Or Dry, Bag Included
537-00798	798	Air Vacuum With Water Hose Attachment

### Wire Brushes



535-35240



535-15443



535-00014

Ascot No.	Mfg. No.	Dia.	Wire Size	RPM	Arbor Hole
Polyflex® Encapsulated Wheels-Burgundy Elastomer (Standard)					
535-35240	35240	2"	.0104"	20,000	1/2"
535-35070	35070	2"	.014"	20,000	1/2"
535-35250	35250	3"	.0118"	20,000	1/2"
Copper Center® Wire Wheel Brushes-Wire Fill					
535-15322	15322	1-1/2"	.0104"	20,000	3/8"
535-15443	15443	2"	.008"	20,000	1/2"
535-15463	15463	2"	.0118"	20,000	1/2"-3/8"
535-15533	15533	3"	.006"	20,000	1/2"
535-15543	15543	3"	.008"	20,000	1/2"
535-15563	15563	3"	.0118"	20,000	1/2"-3/8"
Dualife® Knot Type Wire Wheel Brushes-Standard Twist					
535-08014	08014	3"	.014"	20,000	1/2"-3/8"
535-08034	08034	4"	.0118"	20,000	1/2"-3/8"
535-08044	08044	4"	.014"	20,000	1/2"-3/8"
535-08075	08075	6"	.0118"	20,000	5/8"-1/2"
535-08085	08085	6"	.014"	20,000	5/8"-1/2"

### Cone Pencil Rasps



539-02218



539-02217



539-02212



539-02211



539-02214



539-02213

Ascot No.	Mfg. No.	Description
539-02211	2211	36-Grit, 2" x 1" Cone Rasp
539-02212	2212	16-Grit, 2" x 1" Cone Rasp
539-02213	2213	36-Grit, 4" x 3/4" Cone Rasp
539-02214	2214	16-Grit, 4" x 3/4" Cone Rasp
539-02217	2217	36-Grit, 1/4" x 2-1/2" Pencil (Non-Regrittable)
539-02218	2218	16-Grit, 1/4" x 2-1/2" Pencil (Non-Regrittable)

## Tire Repair Tools

### Carbide Cutting Tools



Ascot No.	Mfg. No.	Description
533-01120	BU12B	1/2" Ball Burr
533-01140	BU14R	1/4" Router Burr
533-01141	BU14T	1/4" Long Taper Burr
533-01180	BU18R	1/8" Router Burr
533-01181	BU18T	1/8" Taper Burr
533-01381	BU38T	3/8" Tree Burr
533-01516	BU516N	5/16" Long Taper Burr
533-01716	BU716N	7/16" Long Taper Burr
533-01732	BU732N	7/32" Long Taper Burr

### Buffing Stones for Steelbelted Tires



Ascot No.	Mfg. No.	Description
534-80001	A-1	Large Cone - 3/4" Stone Diameter
534-80005	A-5	Small Cone - 3/4" Stone Diameter
534-80015	A-15	Pencil Point - 1/4" Stone Diameter
534-80024	A-24	Round Head Pencil - 1/4" Stone Diameter
534-80036	A-36	Stone Disc - 1-3/4" Diameter
534-80037	A-37	Stone Disc - 1-1/4" Stone Diameter
534-80115	A-15B	Pencil Point - 1/4" Stone Diameter-Brown
534-80136	A-36B	Stone Disc - 1-3/4" Diameter -Brown
534-80137	A-37B	Stone Disc - 1-1/4" Diameter-Brown

### Tire Probe Awl

- Used to inspect injuries in tires and to remove small stones and debris

Ascot No.	Mfg. No.	Description
537-00001	AWL-1	Black Handle Awl
537-00005	SC5C	Wooden Handled Awl



### Professional Stitcher

- Corrugated ball bearing stitcher with hardened steel wheel and varnished wooden handle

Ascot No.	Mfg. No.	Description
536-00001	CS-1	1-1/2" Diameter x 1/16" Face
536-02910	MRO-2910	2" Diameter x 1/4" Face

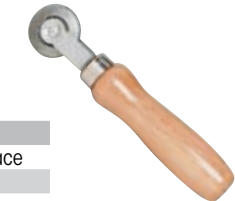

### Innerliner Scraper

- This tool is a must for professional tire repairs
- Eliminates power buffing on many tire repairs
- Scraper removes material that might contaminate buffing wheels, ensuring a better repair every time

Ascot No.	Mfg. No.	Description
537-00004	S-4	Black Handle Innerliner Scraper



### Buffing Wheel

- Coarse grit, round nose
- Tungsten carbide
- 2-1/2" diameter
- For use on tires or tubes

Ascot No.	Mfg. No.	Description
539-10001	BC-1	Buffing Wheel



### Cutting Plier - Box Joint

- Perfectly mated cutters, scientifically heat treated to hold their edge
- Precision made of fine polished, high carbon steel
- Distinctive CHANNELLOCK BLUE comfort grips

Ascot No.	Mfg. No.	Length	Weight	Jaw Length	Joint Thickness	Joint Width	Cutter Length
319-00437	437	7" 175mm	7.84 Oz. 222 Gr.	1" 25.5mm	31/64" 12.5mm	15/16" 24mm	1" 25.5mm



### Curved Diagonal Cutting Plier - Lap Joint

- Curved diagonal for maximum pulling leverage
- Perfectly mated cutter, heat treated to hold its edge
- Polished high carbon drop forged steel
- CHANNELLOCK BLUE comfort grips

Ascot No.	Mfg. No.	Length	Weight	Jaw Length	Joint Thickness	Joint Width	Cutter Length
319-00447	447	7-3/4" 195mm	10.67 Oz. 302 Gr.	1-1/32" 26mm	1/2" 12.5mm	1-1/16" 27mm	1-1/32" 26mm



## Tire Knives

### Tire Repair Knife

- High carbon steel, taper point, glaze finish, round burnt finish handle (riveted)



Ascot No.	Mfg. No.	Blade Length	Box
531-75190	X2T	4" (102mm)	12

### Tire Repair Knife

- High carbon steel, round point, thin skiver, glaze finish, round burnt finish handle



Ascot No.	Mfg. No.	Blade Length
531-75310	X3N	4-7/8" (124mm)

### Tire Repair Knife

- High carbon steel, square point, glaze finish, round burnt finish handle (riveted)



Ascot No.	Mfg. No.	Blade Length
531-75200	X1S	2-1/2" (64mm)
531-75170	X2S	3" (76mm)
531-75330	X3S	3-5/8" (93mm)
531-75370	X4S	3-7/8" (99mm)
531-75440	X5S	4-1/4" (108mm)

### Rubber Knife

- High carbon steel, square point, glaze finish, round burnt finish handle (riveted)



Ascot No.	Mfg. No.	Blade Length
531-60070	X4x1S	4" x 1" (102 x 26mm)
531-60090	X5x1S	5" x 1" (127 x 26mm)
531-60130	X6x1S	6" x 1" (152 x 26mm)
531-60150	Xx11/8S	8" x 1-1/8" (203 x 29mm)
531-60170	X10x11/4S	10" x 1-1/4" (254 x 32mm)

### Flexible Tire Repair Knife

- High carbon steel, round point skiver, glaze finish, round burnt finish handle (riveted)



Ascot No.	Mfg. No.	Blade Length	Box
531-75150	X2RF	4" (102mm)	12

### Tire Repair Knife

- High carbon steel, hawk bill notch, glaze finish, round burnt finish handle (riveted)



Ascot No.	Mfg. No.	Blade Length
531-60570	X751N	2" (51mm)

### Skiving Knife



Ascot No.	Mfg. No.	Description
531-70030	70030	Blade Handle
531-71050	71050	10 Replacement Blades

### Trimmer Blade

- High carbon steel, 9" trimmer, 1/4" notch
- Used by tire manufacturers and recappers for trimming vents

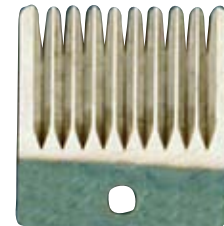

Ascot No.	Mfg. No.	Blade Length	Box
531-60500	60500	1-7/8" x 2" (48 x 51mm)	12



## Tire Spreaders & Repair Stations

### All Purpose "eF" Full Circle Tire Spreader

- Expose tire defects immediately
- Handles passenger, truck, bus and tractor tires with 12" thru 28" bead diameters and 4" thru 11" cross sections
- Revolve the tire 360° for inspection, repair and buffing or installing tubes, flaps and air bags inside curing rims
- Operates on 150-200 PSI
- Air-operated lift raises tire to inspection position



Ascot No.	Mfg. No.	Description
602-60210	eF	All Purpose Full Circle Tire Spreader

### Heavy Duty "eF/HD" Full Circle Tire Spreader

- Designed to lift and spread truck, bus, tractor and some aircraft tires 14" thru 24", 20-ply, including steel radial tires
- Revolves 360°, while spread, for easy excellent inspection
- Conveniently located floor-mount controls
- Diameter arms easily slide into position to hold inner beads before spreading



Ascot No.	Mfg. No.	Description
602-60211	eF-HD	Heavy Duty Full Circle Tire Spreader

### 5500 Tire Spreader

- Tool Tray pivots to either side
- Tire spread control conveniently located on the Tool Tray
- Foot controls for raising/lowering platform located on both sides
- 5-1/4" air cylinder lift platform using as little as 75 PSI



Ascot No.	Mfg. No.	Description
602-05500	5500	Tire Spreader w/Tool Tray

### LREF Tire Spreader

- Air powered tire spreader with tire lift
- Handles passenger and truck tires from 13" through 24" rim diameter
- Tubeless truck tires from 16.5" through 24.5" rim diameter



Ascot No.	Mfg. No.	Description
602-60212	BR-LREF	Tire Spreader w/ Tire Lift

### Inverting Tire Spreader/Repair Station

- Spreads and inverts passenger, truck and bus tires with ease for inspection and repair
- Foot control valve conveniently located at base of machine
- Adjustable lamp swings in and out of tire



Ascot No.	Mfg. No.
604-05120	5120

**Branick®**

### Adjustable Height Inspector/Repair Station

- Air operated model lifts, spreads, revolves and inverts passenger and truck tires
- Lift, spreading and inverting functions are controlled by valves mounted on a pivoting control panel
- Foot-operated valve controls variable speed tire revolution for thorough inspection of any area - includes reverse
- Air-powered cylinder inverts tread for sectional repairs



Ascot No.	Mfg. No.
603-60331	AH/RI/R

### Tire Repair Station

- Designed for servicing and repairing passenger, light truck, medium/heavy truck and small agricultural and OTR tires up to 23.5-25" size
- Extremely low eight-inch working platform, lifting power up to 660 Lbs.
- Adjustable spreading jaws that are shorter on the operator's side for improved access and safety
- Integrated lifting device with a lifting height of 17-1/2"
- Integrated lighting, a ramp that automatically retracts as tire is lifted
- Dimensions: 45" x 30-1/2" x 35"
- Weight: 375 Lbs.



Ascot No.	Mfg. No.
603-06551	6551

## Manual Tire Spreaders

### Lever Tire Spreaders

- Low cost tire spreader
- Includes tire back rest—tire is controlled during inspection and repair process
- Spreads passenger, RV and light truck tires up to 11"
- Two ball bearing rollers
- Three adjustable height settings
- Heavy duty self supporting base
- Spread control—no buckling
- Improved positive hold on spreader arm
- Flex arm light—optional



Ascot No.	Mfg. No.	Description
603-00050	EZM-50	Lever Tire Spreader
603-00014	EZ-14	Flex Arm Light for Spreader

### Passenger/Light Truck Manual Tire Spreader

- Handles all passenger and most light truck tires, 13" thru 16.5" diameter
- Adjustable spread hooks adapt to varying sidewall heights and tire widths for easy innerliner inspection and repair
- Hooks flip up and out of the way when not in use
- Shock absorber cushions tire release
- Tire rollers with sealed bearings for easy tire rotation
- 60 watt rough-service light, mounted on flexible arm for illumination

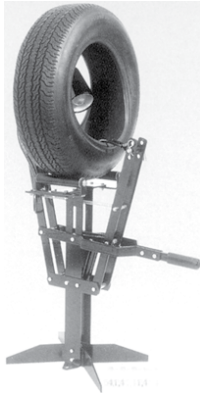

Ascot No.	Mfg. No.
604-05040	5040

### TS 24 Tire Dunker

- Easy lift and dunk
- Mounted truck tires
- Handles mounted tires up to 24.5" duplex
- Tire is lifted by actuating foot valve
- Checks tubes just as easily



Ascot No.	Mfg. No.	Description
517-00024	TS24	Tire Dunker

### Repboy Spreader

- The economical Rep Boy provides easy access for repairing passenger and light truck tires
- Adjustable tire spreader can accommodate all tires from garden service through light truck

Ascot No.	Mfg. No.	Description
604-03050	3050-RB	Tire Spreader
604-51770	5177084	Base Plate



### Adjustable Center-Post Tire Spreader

- Easy to use
- Durable
- Adjustable from 0" to 10"

Ascot No.	Description
605-08208	Adjustable Center-Post Tire Spreader



### Manual Tire Spreader

- Lightweight and easy to use
- Special locking pin for safety
- Made from durable materials
- Locks both beads open for easy tire inspection and repair

Ascot No.	Description
605-14191	Manual Tire Spreader



### Manual Tire Spreaders

605-31554



605-31553

Ascot No.	Mfg. No.	Description
605-31553	T53	Simple, Fast Operation. Locks Both Beads Open For Easy Tire Inspection And Repairs. Use Two For A Portable Section Repair Spreader. Weight: 3 Lbs.
605-31554	T54	For Large Truck Tires Used In Pairs. Spreads Tires Up To 17" Span. Spreading Power Of A Car Jack. Heavy Duty Construction. Weight: 4-1/4 Lbs.

# RETREADING

ENVELOPES  
TIRE PAINT  
RASP BLADES  
STAPLES & STAPLERS



## Retreading Rasp Blades

### Pincott® Air Cooled Spacers

Single Section  
1/8", 5/32", 3/16"

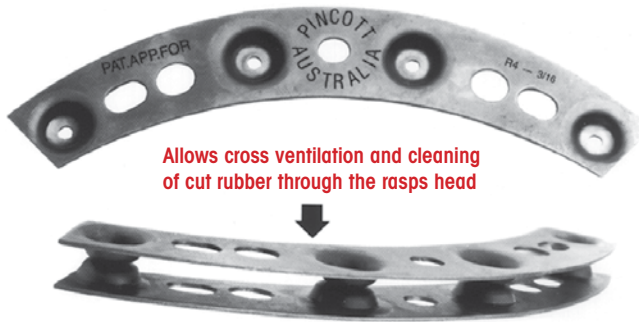

- Progressive development of blades capable of higher rates of rubber removal and the use of more powerful and higher speed machines imposed increasingly severe temperature conditions on rasp blades, giving rise to the need for effective cooling to avoid loss of temper in the blade material
- Lower cost per buffed tire
- Engineered by a company with over 65 years in the retreading industry
- Designed to fit all U.S. and European buffing machines, manufactured with multiple stampings to allow interchangeability between two or three pin hubs
- Benefits include: reduced heat and smoke, cleaner buffer, cooler running and faster buffing
- 6 precision sizes
- Heavy duty quality steel blade
- Cross ventilation
- Special heat treatment for long life
- Increases blade life - keeps blades running cooler, improves buff texture and prevents premature blade breakage

Ascot No.	Mfg. No.	Description
<b>SPACERS FOR 9" 4-SEGMENT</b>		
613-00418	R4S18S	1/8" Single
613-04532	R4S532S	5/32" Single
613-04316	R4S316S	3/16" Single
613-00414	R4S14D	1/4" Double
613-04516	R4S516D	5/16" Double
613-00438	R4S38D	3/8" Double
<b>SPACERS FOR 11.5" 5-SEGMENT</b>		
613-00518	R5S18S	1/8" Single
613-00514	R5S14D	1/4" Double
613-53165	R5S316S	3/16" Single
613-00538	R5S38D	3/8" Double
<b>SPACERS FOR 11.5" 6-SEGMENT</b>		
613-00618	R6S18S	1/8" Single
613-06532	R6S532S	5/32" Single
613-06316	R6S316S	3/16" Single
613-00614	R6S14D	1/4" Double
613-06516	R6S516D	5/16" Double
613-00638	R6S38D	3/8" Double

\* Available for contoured hubs.

### Pincott® Standard Series Buffing Rasp Blades

- R4 Series • 28 Blades per Set

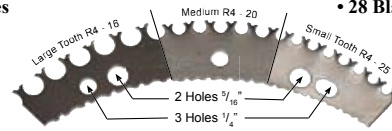

- R115, 5 Segments Series • 25 Blades per Set

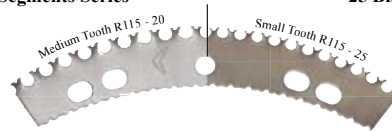

- P3, 6 Segments Series • 30 Blades per Set

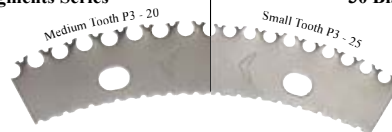

- Exclusive heat treating process
- Reduced tooth breakage
- Cooler running
- Faster material removal
- No blade warpage
- Lower cost per buffed tire

Ascot No.	Mfg. No.	Description
616-11520	PTR115-20	Fits All 11.5" 5-Segment Hubs
616-00420	PTR4-20	Fits All 9" 4-Segment Hubs
616-00320	PTP3-20	Fits All 11.5" 6-Segment Hubs
616-11525	PTR115-25	Fits All 11.5" 5-Segment Hubs
616-00425	PTR4-25	Fits All 9" 4-Segment Hubs
616-00325	PTP3-25	Fits All 11.5" 6-Segment Hubs

\* Other Sizes Available for Contoured Hubs and Use with Smart Blades



### How to Order Buffing Hubs

1. Model/Make of Buffer
2. Arbor Hole Size
3. Keyway Size - If Any
4. Pin Length
5. Rasp Blade Type
6. Hub Type: Non-Spiral, Heavy-Duty, All Purpose or Regular

## Rasp Blades & Retread Shop Accessories

### Pincott® Rasp Blades - Ultra Series

- Pincott® buffing rasp blades are designed to fit all U.S. and European buffing machines and are manufactured with multiple stampings to allow interchangeability between two or three pin hubs
- Exclusive heat treating process
- Reduced tooth breakage
- Faster material removal
- Cooler Running
- No blade warpage
- Lower cost per buffed tire

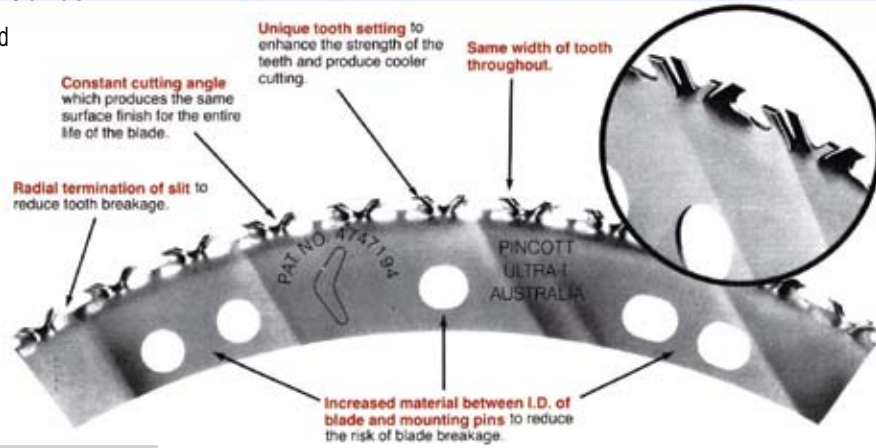

Ascot No.	Mfg. No.	Description
616-00111	Ultra I	Fits All 11.5", 5-Segmented Hubs
616-00222	Ultra II	Fits All 9", 4-Segmented Hubs
616-00333	Ultra III	Fits All 11.5", 6-Segmented Hubs



### Pincott® Rasp Blades - Smart Series

- Manufactured with a unique sinusoidal (wave-like) form which introduces a multidirectional cutting action
- Wave-like form creates greater strength in the blade and its teeth
- Cutting action produces less drag on the rasp motor, saving you energy

Ascot No.	Mfg. No.	Description
616-01155	Smart I	Fits all 11.5", 5-Segmented Hubs
616-00944	Smart II	Fits all 9", 4-Segmented Hubs
616-01156	Smart III	Fits all 11.5", 6-Segmented Hubs



616-01155



616-00944



616-01156



## B&J Rasp Blades & Spacers

### Eagle I and Eagle II Buffing Blades



- Fast cutting and long lasting rasps for the best texture in all tire buffing operations
- Tested under all conditions with outstanding results

Ascot No.	Mfg. No.	Description	Blades Per Set
616-11274	11-274	Eagle I Refill	Eagle I refills 25 for set
616-11275	11-275	Eagle II Refill	Eagle II refills 28 per set

### Pins for Eagle II Hubs



- Special convex style hubs used on buffers must be returned to factory for pin replacement

Ascot No.	Mfg. No.	Description	Length
613-16436	16-436	Eagle II Long Pins 5/16"	4"

### Hubs for Eagle I and II

- Eagle I for use on Matteuzzi RAS90 and RAS98 Buffers
- Eagle II for use on all other Bandag buffers



Ascot No.	Mfg. No.	Description
613-12908	12-908	Eagle I 2" W., 1-1/8" Arbor
613-12900	12-900	Eagle II 9" Dia., 4" W., 1-1/2" Arbor

### Replacement Spacers for Eagle II Hubs

Ascot No.	Mfg. No.	Description	Spacer Width
613-16575	16-575	Eagle II Spacer	3/16"
613-16574	16-574	Eagle II Spacer	1/4"
613-16576	16-576	Eagle II Spacer (Standard)	3/8"



### Buffing Blades



Jet Series



Apollo Series

- Proven to be the fastest cutting, longest lasting rasps with the best texture for all buffing operations
- Refills have been tested under all conditions and used on all types of tire buffing equipment with outstanding results
- Can be used in existing Saturn II or R4 hub assemblies
- Fast cutting, long life. Same texture from start to finish

Ascot No.	Mfg. No.	Description	Type	Blades Per Set
616-43912	43912	Apollo II	Refill	25
616-43914	43914	Apollo III	Refill	30
616-43920	43920	S115-25		30
616-43921	43921	S115-20		28
616-00420	R4-20	Rocket Jet	Refill	28
616-11520	R1-1520	Rocket Jet	Refill	25
616-11525	R1-1525	Rocket Jet	Refill	25
616-43928	43928	Patriot II		28
616-43940	43940	Gemini II		28

Packed 50 sets per case.



## Rasp Blades & Retread Shop Accessories

### Replacement Spacers for Rocket Hubs

- I-Beam aluminum spacers available in 3/16", 1/4", and 3/8"

Ascot No.	Mfg. No.	Hub Type	Spacer Width
613-43855	43855	R4	3/8"
613-43856	43856	R115	3/16"
613-43587	43857	R115	1/4"
613-43858	43858	R115	3/8"

Note: For optimum performance replace spacers and pins as a set



### Replacement Pins for Rocket Hubs



Ascot No.	Mfg. No.	Hub Type	Spacer Width
613-43934	43934	5/16"	2-1/2"
613-43935	43935	5/16"	3"
613-43936	43936	5/16"	3-1/8"
613-43937	43937	5/16"	3-1/4"
613-43938	43938	5/16"	3-3/8"
613-43939	43939	5/16"	3-1/2"
613-43940	43940	5/16"	3-3/4"
613-43941	43941	5/16"	4"
613-43924	43924	5/16"	4-1/2"
613-43943	43943	5/16"	5"
613-43944	43944	5/16"	5-3/4"
613-43945	43945	5/16"	6"
613-43946	43946	5/16"	6-1/2"
613-43831	43831	5/16"	8"
613-43813	43813	1/4"	3"
613-43812	43812	1/4"	3-3/8"
613-43897	43897	1/4"	3-3/4"
613-43814	43814	1/4"	4"
613-43811	43811	1/4"	6"
613-43815	43815	1/4"	8"

### Rocket Rasp Rotary Gouges



616-10605      616-11612      616-10610



616-11612      616-10603

Ascot No.	Mfg. No.	Description
616-11605	11-605	2" Dia. Heavy Wall No Notch 1/2" AH
616-11606	11-606	2" Dia. Heavy Wall No Notch 1/2" AH
616-11610	11-610	2" Dia. Thin Wall No Notch 3/8" AH (2/Set)
616-16101	11-610-1	2" Dia. Thin Wall No Notch 1/2" AH (2/Set)
616-16102	11-610-2	2" Dia. Thin Wall No Notch 3/8" 24 THD (2/Set)
616-11612	11-612	2" Dia. Thin Wall Notched 3/8" AH (2/Set)
616-16121	11-612-1	2" Dia. Thin Wall Notched 1/2" AH (2/Set)
616-16122	11-612-2	2" Dia. Thin Wall Notched 3/8" 24 THD (2/Set)
616-11603	11-603	1-1/4" Dia. Mini No Notch 3/8" 24 THD (3/Set)
616-11604	11-604	1-1/4" Dia. Mini No Notch 3/8" AH (3/Set)

### Squiggly



Ascot No.	Mfg. No.	Description
616-20104	20-104	Squiggly 2" Dia. 3/8" AH (Replaces 2"x1/2" Gritted Carbide Wheel) Box of 24

## Retread Shop Accessories

### Precure Shop Accessories

We stock many brands of staples and staplers. Call for details!



Ascot No.	Mfg. No.	Description
639-00027	T27SB	Stanley-Bostitch Pneumatic Stapler
639-50002	50002	Paslode PW50 Staple Gun
639-05038	PW5038	Paslode 3/8" Staples (10,000)
639-00312	T312SBNK	Bostitch Staple Gun
639-02338	SBNK402338	Bostitch 3/8" Staples (10,000)
639-23516	SBNK4023516	Bostitch 5/16" Staples (10,000)
639-00814	8/14	Atro (Bea Style) Staple Gun
639-00808	80/8	Bea 5/16" Staples (10,000)
639-00810	80/10	Bea 3/8" Staples (10,000)
639-10800	10800F	Fasco Stapler For 80/8
639-05010	5010C	Duofast 5/16" Staples (10,000)
639-05012	5012C	Duofast 3/8" Staples (10,000)

### Couplers/Plugs



645-21192



645-01604



645-03524



645-00321



645-16171

Ascot No.	Mfg. No.	Description
645-01000	1000	1/4" Bandag-Type Coupler
645-00011	11E	Plug Tire Valve Stem Steel Fits 5/16"-32 Ft.
645-03000	W-300OHT	High Temperature Washer for 1000 Above
<b>HANSEN SPECIAL COUPLER FOR PRESS TYPE MATRIX</b>		
645-00321	B3HD21Y	Coupler (Brass)
645-21192	B3K21192	Plug (Brass)
<b>1/4" BANDAG-TYPE COUPLERS/ADAPTERS</b>		
645-00017	CST17B	Chamber Exhaust Coupler (Brass)
645-00117	CPST17B	Chamber Envelope Adapter (Brass)
645-02014	2014EPR	Thin Replacement O-ring
645-02110	2110EPR	Wide Replacement O-ring
<b>PARKER SPECIAL COUPLER MRT</b>		
645-01604	BH1-60Y4FP	Coupler Vacuum Seal
645-16171	BH1-61-711	MRT Coupler Adapter
<b>BAIRD STYLE COUPLERS AND ADAPTERS</b>		
645-08476	874-6	Straight Thru With 90° Side Exhaust Coupler For Envelope Use
645-00874	874	90° Hose Inlet Coupler For Tube
645-00812	812	.302 Valve Steam Adapter
645-00814	814	.482 Envelope Adapter

### Teflon Hose Assemblies for Precure Retreading Systems

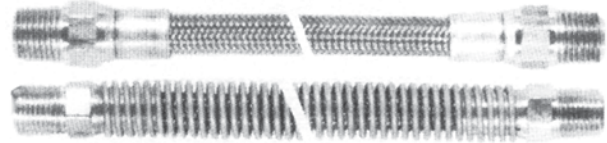

- Teflon hose assemblies in any length are available for all precure tire retreading equipment including Bandag, Harrelson, Vulcan, etc.
- Hoses are used inside the chamber for inflating the tire and evacuating the air from the envelope
- Hoses are made of an innercore of extruded Teflon and covered with stainless steel braid reinforcement
- All hoses have permanent swage-type brass end fittings 1/4"-18 male pipe (NPT)

**Call Us For Ordering Information!**

### Portable Spraying Equipment

- Portable sprayer includes pump, 25' x 1/4" airless hose, gun swivel, silver spray gun and tip of choice
- Recommended Graco tip #163-415



Ascot No.	Mfg. No.	Description
651-32437	232-437	23:1 Cement Sprayer
651-35462	235-462	Silver Airless Spray Gun Only
651-63415	163-415	Silver Tip, .015" Orifice, 8-10" Fan Width

### Jet-It Airless Cement Sprayer

- Controlled spray patterns direct the cement onto the tire without overspray
- Can run on one or more spray stations
- Agitates cement in a whirlpool motion eliminating the need to mechanically stir the cement
- 115/230V 60 cycle

Ascot No.	Mfg. No.	Description
632-00015	AS5G	5-Gallon Unit





## Retread Shop Accessories

### Poly Ease Retread Release Liner

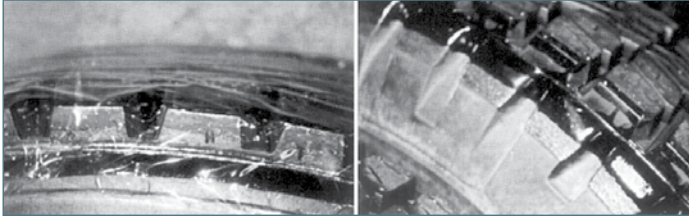

- American made perforated polypropylene film is specified to soften at 311°F and melt at 328°F
- For low temp bonding chambers
- Custom widths are also available

Ascot No.	Mfg. No.	Width	Length	Thickness	Per Box
634-12027	PP12HD	12"	2700'	.002"	2
634-12036	PP12SD	12"	3600'	.0015"	2
634-14027	PP14HD	14"	2700'	.0015"	2
634-14036	PP14SD	14"	3600'	.0015"	2
634-15027	PP15HD	15"	2700'	.002"	2
634-15036	PP15SD	15"	3600'	.0015"	2
634-18027	PP18HD	18"	2700'	.002"	1
634-18036	PP18SD	18"	3600'	.0015"	1

### High Temperature Film - Nylon

- Allows the envelope to penetrate to the bottom of the tread pattern
- Protects envelope from tearing/wearing out in a short time period
- Can be reused many times and still retain good lubrication for the envelope to reach the bottom of the tread patterns
- Retains non-stick properties even after several module of chamber cures at 300°F, letting the envelope release from the tires without ripping or tearing
- 0.75 mil. thickness

Ascot No.	Description
634-12757	12" Wide x .75 Mil., 2,700 Feet
634-15757	15" Wide x .75 Mil., 2,700 Feet
634-18757	18" Wide x .75 Mil., 2,700 Feet
634-12754	12" Wide x .75 Mil., 4,000 Feet
634-14754	14" Wide x .75 Mil., 4,000 Feet
634-16754	16" Wide x .75 Mil., 4,000 Feet
634-18754	18" Wide x .75 Mil., 4,000 Feet
634-12756	12" Wide x .75 Mil., 6,000 Feet
634-15156	15" Wide x .75 Mil., 6,000 Feet

### Woven Roll Wicking

- For use with non-valve type processes
- Full rolls only
- Treated with a special release agent to prevent adhesion to the cushion gum

Ascot No.	Description	Size
634-05586	Woven Roll Wicking - Green	1-1/2" x 180'
634-05587	Woven Roll Wicking - Green	2" x 180'



### Stretch Wicking Products

- For use with valve-type envelopes - All 4-ply

Ascot No.	Size	Qty./Case
634-00812	8" x 12"	24
634-00815	8" x 15"	24
634-00820	8" x 20"	24

\* Available for Michelin. Please specify.



## Tire Appearance

### Spray Booths

- Spray booth is a must for any paint shop or maintenance department
- Overspray and fumes are quickly and safely removed

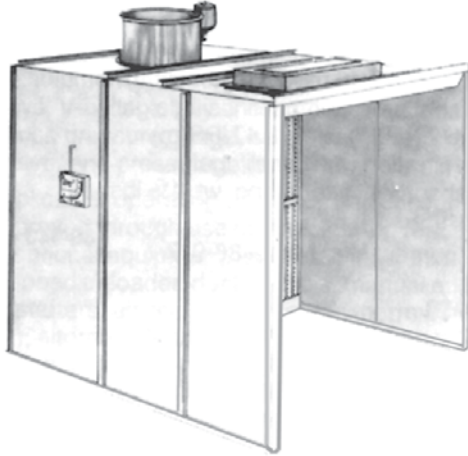

**Call Us For More Detailed Information About Spray Booths!**

### Black Tire Paint

- Water based, premixed or concentrated
- Specially formulated black paint for improved appearance, coverage and tire adhesion
- Makes retread and used tires look like new
- Creates a clean black satin finish
- Covers crayon marks and dirt
- Dries quickly with low odor, will not rub off, even when wet
- Available premixed and ready for use, or in economical concentrate which dilutes with water



Ascot No.	Mfg. No.	Description
497-83901	E839	Premixed - 1-Gallon. Siphon Fed Paint Systems
497-83905	E839	Premixed - 5-Gallon. Siphon Fed Paint Systems
497-83955	E839	Premixed - 55-Gallon. Siphon Fed Paint Systems
497-84101	E841	Premixed - 1-Gallon. Pump Fed Paint Systems
497-84105	E841	Premixed - 5-Gallon. Pump Fed Paint Systems
497-84155	E841	Premixed - 55-Gallon. Pump Fed Paint Systems
497-84401	E844	Concentrate - 1-Gallon
497-84405	E844	Concentrate - 5-Gallon
497-84455	E844	Concentrate - 55-Gallon

### Mold Lubricant (Concentrated)

- Release molded retreads with ease and keep molds clean at the same time
- This non-flammable, odorless formula allows rubber to flow freely and prevents carbon buildup
- Produces a superior satin finish with no staining
- Economical concentrate may be diluted with up to 20 parts water to one part lubricant



Ascot No.	Description
647-24501	Mold Lubricant - 1-Gallon
647-24505	Mold Lubricant - 5-Gallon

### Sure-Shot Sprayer

- One quart pressure sprayer is perfect for mold lubricants, tire paint, etc.
- Hold up to 200 Lbs. of pressure safely
- Shoots a wide-area mist spray or an effective jet stream up to 20'
- Fast, easy refilling with standard air chuck, hand pump or CO2 cartridge



Ascot No.	Mfg. No.	Description
632-02000	A-2000	1 Qt. Rust Resistant Chrome Plated Brass Tank
632-01952	A-2600	1 Qt. Enamel Steel Tank
632-00325	325	6" Extension Nozzle
632-00010	K-10	Repair Kit

**Call for all your Retread Supply Items**

### Robbins Envelope Lube

- Spray on inside of the envelope
- Spray on while envelope is hot to dry faster
- Spray after first cure and then every 30 cures or as needed
- Quart container is a convenient spray bottle
- Ready to use, no dilution required

Ascot No.	Mfg. No.	Description
647-05611	5611	1-Quart
647-05612	5612	1-Gallon
647-05613	5613	5-Gallon



## Retreading Accessories

### Tack Bands for Smooth, Fine Texture



539-80013    539-80012    539-80003    539-80002

Ascot No.	Mfg. No.	Description
539-80013	OX3-R	1-1/2" OD x 5/8" W
539-80012	OX2-R	2-1/2" OD x 1" W
539-80003	H11	Hub Units, 1-1/2" OD x 5/8" W
539-80002	H12	Hub Units, 2-1/2" OD x 1" W

### Expandable Hub Replacement Stems

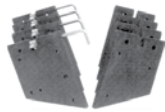

Ascot No.	Mfg. No.	Description
613-29617	729617	Steel-Inserted Plain Stem
613-29618	729618	Steel-Inserted Plain Locking Stem
613-00512	900512	Garter Spring

### Wheel Arbor-Adapters

- Require a wheel arbor for using grinding wheels or wire brushes
- Have 9/16"– 18 female thread to fit Wyco handpieces

#### FOR GRINDING WHEELS AND OTHER ACCESSORIES

Ascot No.	Mfg. No.	Wheel Width	Male Thread
516-00305	305	5/8"	3/8"-24
516-00405	405	1"	1/2"-20
516-00505	505	1-1/2"	1/2"-20
516-00605	605	1-1/2"	5/8"-18

#### FOR ROTARY RASPS

Ascot No.	Mfg. No.	Description
516-01305	305R	Threaded 3/8" – 16 To Fit Rasps
516-01405	405R	Threaded 1/2" – 13 To Fit Rasps

### Wyco Flexible Shaft Machines

- Versatile Wyco Flexible Shaft Machines are offered for the various needs in foundries, steel welding shops, sheet metal fabricators, maintenance departments, forging plants, tire shops
- Typical applications include: wood or metal finishing, rust or paint removal, auto body sanding, tire buffing, etc.
- Many types of accessories are used with these machines, including edge-type grinding wheels, wire brushes, sanding discs, depressed center wheels, tire rasps, sanding drums

Ascot No.	Mfg. No.	Core Casing & Handpc. No.	Length in Feet	Core No.	Casing	Straight Handpc.
516-00491	49-1	10R	5	C-10	K-10	3500
516-00492	49-2	10R	5	C-10	K-10	3500
516-00493	49-3	2R	6	C-2	K-2	3500
516-00494	49-4	2R	6	C-2	K-2	3500
516-00495	49-5	30R	7	C-30	K-30	551
516-00496	49-6	30R	7	C-30	K-30	551
516-04914	49-14	4R	7	C-4	K-4	551



### Expandable Rim Assemblies and Replacement Belts



Ascot No.	RIMS Mfg. No.	Rim Size	Bead Width	Ascot No.	Mfg
613-39020	309020	12-14"	5"	613-28260	728260
613-00436	309030	13-16"	6-3/8"	613-00660	700660
613-33379	309962	13-16"	7-1/2"	613-33382	733382
613-28081	309963	13-16"	11-3/8"	613-28160	728169
613-32769	309942	14-17"	6"	613-32773	732773
613-00937	309140	14-17"	7-1/8"	613-02701	702701
613-28313	309150	14-17"	9-1/4"	613-02821	702821
613-00938	309952	14-17"	11-3/8"	613-02702	702702
613-00465	309040	17-20"	6-1/2"	613-01653	701653
613-32774	309202	17-20"	8-1/4"	613-32778	732778
613-28271	3092211	18-20"	7-5/8"	613-33717	733717
613-00470	309220	18-20"	13-1/4"	613-01332	701332
613-00674	309230	18-20"	16-3/8"	613-02092	702092
613-23800	309602	20-22.5"	8-1/4"	613-33092	733092
613-00466	309050	20-22.5"	9"	613-01715	701715
613-32822	309183	20-22.5"	11-3/4"	613-32826	732826
613-33162	309021	20-22.5"	14-1/2"	613-33007	733007
613-25718	309190	22-24.5"	7-1/2"	613-25839	725839
613-33093	309282	22-24.5"	8-1/4"	613-33094	733094
613-00846	309060	22-24.5"	9"	613-02533	702533
613-00467	309070	22-24.5"	13-3/8"	613-01955	701955
613-33564	309912	22-24.5"	14-1/2"	613-33568	733568
613-00839	309913	22-24.5"	18-1/2"	613-02516	702516
613-00699	309490	23-25"	13-3/8"	613-11955	701955
613-00705	309890	27-29"	14"	613-02184	702184

### Nailhole Detector Machine

- New digital detector to improve accuracy
- Find more flaws than any other NDT
- Reduce inspection time up to 43%
- Self diagnostic electronics
- Ergonomic design increases speed



Ascot No.	Mfg. No.	Description
606-00303	NTD-III	Nailhole Detector Machine

## Envelopes

### 750 Envelope Expander

- Designed to fit under your monorail
- Designed so that the tire can pass through the envelope expander into the chamber
- Note double fingers and foot valve so envelope can be loaded from either side of machine
- As tire passes along the monorail, it is positioned above the lift, which raises to remove the tire from the hook to install the envelope sealer



Ascot No.	Mfg. No.	Description
643-00750	750	Model 750 Envelope Expander
643-30121	3012-1	Spool-Kit - Treadle Valve
643-03012	3012	Tread Valve For 750
643-04001	4001L	Cylinder
643-04005	4005	Grease Zerk 3/16"
643-04007	4007	Silencer 1/4"
643-04010	4010	Straight Connector 6" x 4"
643-04012	4012	Rigid 90° Connector 6" x 4"
643-04013	4013	Presto Lock Branch Tee 6" x 4"
643-04014	4014	Swivel Connector 6" x 4" x 90°
643-04019	4019OL	Half Moon Key
643-04028	4028	Lever Valve - Norgren - Lift & 700 Exp
643-04034	4034	Control Valve, 600 & 700
643-04048	4048	3/8" Airline, Red
643-04049	4049	5/32" Airline, White
643-04050	4050	5/32" Airline, Red
643-04111	4111	Nylock Nut 3/8" x 16
643-04112	4112	USS Bolt 3/8" x 1-1/4" for Alum. Bushing
643-04113	4113	Flat Washer 3/8"
643-04114	4114	Lock Washer 3/8" for Alum. Bushing
643-04153	4153	Spool Kit for 4034 & 4028
643-04160	4160	Spring
643-05004	5004OL	Bushing, Aluminum
643-05020	5020	Short (Lower) Shaft W/Keyway
643-05021	5021	Long (Upper) Shaft W/Keyway
643-05129	5129	O-Ring (Surgical Tubing)
643-06004	6004OL	Arm
643-06017	6017OL	O-Ring Assembly
643-06018	6018	Cylinder W/Fittings
643-06020	6020	Cylinder W/Plugs
643-06022	6022	Valve Assembly
643-06024	6024	Valve, Norgren (700 Exp, 4028 Valve)
643-06063	6063	Double Finger Short W/Nut
643-06064	6064	Double Finger Long
643-06068	6068	Valve Assembly, Treadle
643-09026	9026	Cylinder Repl. Kit (8 #4001)
643-09027	9027	FRL Replacement Kit
643-09031	9031	Finger Extension Kit - Removable
643-09032	9032	Upper Finger Stop Kit

### Accu Fit II/Innerlope Inside Envelopes

Ascot No.	Mfg. No.	Description
643-40001	40x8-24.5	305/75R24.5 Deep Lug
643-40002	-	305/75R24.5
643-40003	38x8-24.5	285/75R24.5, 275/80R24.5
643-40004	42x8-24.5	12R24.5
643-40005	40x8-24.5	11R24.5
643-40006	44x10-24.5	12.00R24
643-40007	42x10-24.5	11.00R24
643-40008	42x10-22.5	455/55R22.5
643-40009	44x12-22.5	445/65R22.5 18R22.5
643-40010	40x8-22.5	445/50R22.5, 315/80R22.5, 305/85R22.5
643-40011	44x10-22.5	425/65R22.5 16R22.5
643-40012	42x10-22.5	385/65R22.5 15R22.5
643-40013	38x8-22.5	305/75R22.5, 305/70R22.5, 295/80R22.5, 295/75R22.5, 275/80R22.5
643-40014	35x8-22.5	275/70R22.5, 265/75R22.5, 255/80R22.5, 255/70R22.5, 245/75R22.5, 235/80R22.5
643-40015	40x8-22.5	12.75R22.5, 12R22.5, 10.00R22
643-40016	38x8-22.5	11R22.5, 10R22.5
643-40017	35x8-22.5	9R22.5
643-40018	42x8-22.5	11.00R22
643-40019	42x10-20	365/80R20
643-40020	42x8-20	14/80R20
643-40021	44x12-20	14.00R20
643-40022	40x8-20	13/80R20, 11.00R20, 10.00R20
643-40023	42x10-20	12.00R20
643-40024	38x8-20	9.00R20
643-40025	35x8-20	8.25R20
643-40026	35x8-19.5	305/70R19.5
643-40027	32x8-19.5	285/70R19.5, 265/70R19.5
643-40028	29x7-19.5	245/70R19.5, 225/70R19.5
643-40029	32x8-19.5	8R19.5
643-40030	29x7-17.5	245/70R17.5, 215/75R17.5
643-40031	35x8-17.5	11R17.5
643-40032	32x8-17.5	10R17.5, 9.5R17.5, 9R17.5
643-40033	29x7-17.5	7.50-17
643-40034	29x7-16	245/75R16, 235/85R16, 215/85R16, 7.50R16
643-40035	27x5-16	225/75R16
643-40036	10.00-15 HB	10.00R15
643-40037	8.25-15 HB	8.25R15
643-40038	7.50-15 HB	7.50R15



## Envelopes (Cont.)

### Popular Tire Envelopes

#### Selection

Base envelope selection on the outside of the diameter and bead-to-bead measurement of the built retread unit. Many published charts show suggested envelope-to-tire size fitment. They are useful as a general guide. Variations to tire sizes from one tire manufacturer to another - plus the many precure tread designs and thickness available - make it necessary to measure the built retread tire unit to determine the correct envelope to use.

Ascot No.	Tire Size	Rimless
643-22001	225/70R16.5	2910-25
643-22002	10R16.5	3211-27
643-22003	12R16.5	3511-30
643-22004	8.0R16.5	2913-22
643-22005	8.75R16.5	2910-25
643-22006	9.5R-16.5	3211-27
643-22007	750-17	3211-27
643-22008	8R17.5	3111-24
643-22009	9R17.5	3513-28
643-22010	10R17.5	3511-30
643-22011	11R17.5	3812-32
643-22012	215/75R17.5	3213-25
643-22013	225/75R17.5	3211-27
643-22014	235/75R17.5	3211-27
643-22015	245/70R17.5	3211-27
643-22016	8R19.5	3515-25
643-22017	9R19.5	3513-28
643-22018	15R19.5	4413-40
643-22019	16.5R19.5	4814-44
643-22020	18R19.5	4814-44
643-22021	225/70R19.5	3213-25
643-22022	235/70R19.5	3213-25
643-22023	245/65R19.5	3213-25
643-22024	245/70R19.5	3513-28
643-22025	265/70R19.5	3513-28
643-22026	285/70R19.5	3511-30
643-22027	305/70R19.5	3812-32
643-22028	445/65R19.5	4513-44
643-22029	6.5R20	3515-25
643-22030	7.0R20	3515-25
643-22031	7.5R20	3816-28
643-22032	8.25R20	3812-32
643-22033	9.0R20	4012-34
643-22034	10.00R20	4213-37
643-22035	11.00R20	4415-38
643-22036	12.00R20	4413-40
643-22037	13/80R20	4213-37
643-22038	14.00R20	58X13
643-22039	14/80R20	4413-40
643-22040	10.00R22	4416-36
643-22041	11.00R22	4415-38
643-22042	12.00R22	4413-40
643-22043	8R22.5	3818-26
643-22044	9R22.5	3814-30

#### Steps to Determine Correct Envelope Size

1. Identify your envelope sealing method.
2. Measure built retread tire diameter.
3. Locate the tire size on our Application Chart.
4. Measure the built retread from sealing point to sealing point and add 2".
5. Compare the above measurement to the bead-to-bead dimensions on the envelope for proper fit. If your measurement falls between two bead-to-bead envelope sizes, use the larger size.

Ascot No.	Tire Size	Rimless
643-33002	11R22.5	4217-34
643-33003	11R22.5 D.L.	4215-35
643-33004	12R22.5	4416-30
643-33005	12.75	4416-36
643-33006	15R22.5	4413-40
643-33007	16.5R22.5	4513-44
643-33008	18R22.5	4513-44
643-33009	235/80R22.5	3816-28
643-33010	245/75R22.5	3818-26
643-33011	255/70R22.5	3816-28
643-33012	265/70R22.5	3814-20
643-33013	265/75R22.5	3814-30
643-33014	275/70R22.5	3814-30
643-33015	275/80R22.5	4214-32
643-33022	315/80R22.5 OPT.	4418-38
643-33023	365/80R22.5	58X12
643-33024	385/65R22.5	4415-38
643-33025	385/65R22.5 D.L.	4415-38
643-33026	385/75R22.5	58X12
643-33027	425/65R22.5	4515-41
643-33028	445/50R22.5	4415-38
643-33029	445/65R22.5	4814-44
643-33030	455/55R22.5	4515-41
643-33031	11.00R24	4415-38
643-33032	12.00R24	4515.41
643-33033	12.00R24 D.L.	55.5X15
643-33034	13.00R24	55.5X14
643-33035	14.00R24	63X13
643-33036	11R24.5	4418-34
643-33037	11R24.5 D.L.	4416-35
643-33038	12R24.5	4416-36
643-33039	275/80R24.5	4217-34
643-33040	285/75R24.5	4217-34
643-33041	295/80R24.5	4418-34
643-33042	305/75R24.5	4418-34

# Measurement Conversion Chart



## Conversion Chart Showing Millimeter, Decimal and Fractional Inch Sizes

MEASUREMENT CONVERSION

MM	Decimal Equiv.	Fraction Equiv.	MM	Decimal Equiv.	Fraction Equiv.	MM	Decimal Equiv.	Fraction Equiv.	MM	Decimal Equiv.	Fraction Equiv.	MM	Decimal Equiv.	Fraction Equiv.
.10	.0039		1.70	.0670		3.90	.1540		6.60	.2610		11.00	.4330	
.15	.0059		1.75	.0689		3.97	.1562	5/32"	6.70	.2638		11.11	.4375	7/16"
.20	.0079			.0700			.1570		6.75	.2656	17/64"	11.50	.4528	
.25	.0098		1.80	.0709		4.00	.1575		6.75	.2657		11.51	.4531	29/64"
.30	.0118		1.85	.0728			.1590			.2660		11.91	.4687	15/32"
	.0135			.0730			.1610		6.80	.2677		12.00	.4724	
.35	.0138		1.90	.0748		4.10	.1614		6.90	.2716		12.30	.4843	31/64"
	.0145			.0760		4.20	.1654			.2720		12.50	.4921	
.39	.0156	1/64"	1.95	.0767			.1660		7.00	.2756		12.70	.5000	1/2"
.40	.0157		1.98	.0781	5/64"	4.25	.1673			.2770		13.00	.5118	
	.0160			.0785		4.30	.1693		7.10	.2795		13.10	.5156	33/64"
.45	.0177		2.00	.0787			.1695			.2811		13.49	.5312	17/32"
	.0180		2.05	.0807		4.37	.1719	11/64"	7.14	.2812	9/32"	13.50	.5315	
.50	.0197			.0810			.1730		7.20	.2835		13.89	.5469	35/64"
	.0200			.0820		4.40	.1732		7.25	.2854		14.00	.5512	
	.0210		2.10	.0827			.1770		7.30	.2874		14.29	.5625	9/16"
.55	.0217		2.15	.0846		4.50	.1771			.2900		14.50	.5709	
	.0225			.0860			.1800		7.40	.2913		14.68	.5781	37/64"
.60	.0236		2.20	.0866		4.50	.1771			.2950		15.00	.5906	
	.0240		2.25	.0885			.1800		7.50	.2953		15.08	.5937	19/32"
	.0250			.0890		4.60	.1811		7.54	.2968	19/64"	15.48	.6094	39/64"
.65	.0256		2.30	.0905			.1820		7.60	.2992		15.50	.6102	
	.0260		2.35	.0925		4.70	.1850			.3020		15.88	.6250	5/8"
	.0280			.0935		4.75	.1870		7.70	.3031		16.00	.6299	
.70	.0276		2.38	.0937	3/32"	4.76	.1875	3/16"	7.75	.3051		16.27	.6406	41/64"
	.0292		2.40	.0945		4.80	.1890		7.80	.3071		16.50	.6496	
.75	.0295			.0960			.1910		7.90	.3110		16.67	.6562	21/32"
	.0310		2.45	.0964		4.90	.1929		7.94	.3125	5/16"	17.00	.6693	
.79	.0312	1/32"		.0980			.1935		8.00	.3150		17.06	.6719	43/64"
.80	.0315		2.50	.0984			.1960			.3160		17.46	.6875	11/16"
	.0320			.0995		5.00	.1968		8.10	.3189		17.50	.6890	
	.0330			.1015			.1990		8.20	.3228		17.86	.7031	45/64"
.85	.0335		2.60	.1024		5.10	.2008			.3230		18.00	.7087	
	.0350			.1040			.2010		8.25	.3248		18.26	.7187	23/32"
.90	.0354		2.70	.1063		5.16	.2031	13/64"	8.30	.3268		18.50	.7283	
	.0360			.1065			.2040		8.33	.3261	21/64"	18.65	.7344	47/64"
	.0370		2.75	.1082		5.20	.2047		8.40	.3307		19.00	.7480	
.95	.0374		2.78	.1094	7/64"		.2055			.3320		19.05	.7500	3/4"
	.0380			.1100		5.25	.2067		8.50	.3346		19.45	.7656	49/64"
	.0390		2.80	.1102		5.30	.2086		8.60	.3386		19.50	.7677	
1.00	.0394			.1110		5.40	.2126			.3390		19.84	.7812	25/32"
	.0400			.1130			.2126		8.70	.3425		20.00	.7874	
	.0410		2.90	.1141			.2130		8.73	.3437	11/32"	20.24	.7969	51/64"
1.05	.0413			.1160		5.50	.2165		8.75	.3445		21.00	.8268	
	.0420		3.0	.1181		5.56	.2187	7/32"	8.80	.3465		21.03	.8281	53/64"
	.0430			.1200		5.60	.2205			.3480		21.43	.8437	27/32"
1.10	.0433		3.10	.1220			.2210		8.90	.3504		21.50	.8465	
1.15	.0452		3.18	.1250	1/8"	5.70	.2244		9.00	.3543		21.83	.8594	55/64"
	.0465		3.20	.1260		5.75	.2263			.3580		22.00	.8661	
1.19	.0469	3/64"	3.25	.1279			.2280		9.40	.3701		22.23	.8750	7/8"
	.0472			.1285		5.80	.2283		9.50	.3740		22.50	.8858	
1.25	.0492		3.30	.1299		5.90	.2323		9.53	.3750	3/8"	22.62	.8906	57/64"
1.30	.0512		3.40	.1338			.2340			.3770		23.00	.9055	
	.0520			.1360		5.95	.2344	15/64"	9.60	.3780	15/64"	23.02	.9062	29/32"
1.35	.0531		3.50	.1378		6.00	.2362		9.70	.3819		23.42	.9219	59/64"
	.0550			.1405			.2380		9.75	.3838		23.50	.9252	
1.40	.0551		3.57	.1406	9/64"	6.10	.2401		9.80	.3858		23.81	.9375	15/16"
1.45	.0570		3.60	.1417			.2420		9.90	.3898		24.00	.9449	
1.50	.0591			.1440		6.20	.2441		9.92	.3906	25/64"	24.21	.9531	61/84"
	.0595		3.70	.1457		6.25	.2460		10.00	.3937		24.50	.9646	
1.55	.0610			.1470		6.30	.2480			.3970		24.61	.9687	31/32"
1.59	.0625	1/16"	3.75	.1476		6.35	.2500	1/4"		.4040		25.00	.9843	
1.60	.0629			.1495		6.40	.2520		10.32	.4062	13/32"	25.03	.9844	63/64"
	.0635		3.80	.1496		6.50	.2559			.4130		25.40	1.000	1"
1.65	.0649			.1520			.2570		10.50	.4134				

INCH X 25.40 = MM  
MM X 0.03937 = INCHES

**A**

Above Ground Lifts ..... 214-218	Recycling Equipment ..... 286-287	Air Line,
ACCUTORQ ..... 69-71	Super Seal ..... 292	Filters ..... 24, 29-31
Adapttek Brake Lathes ..... 209	Air Operated,	Lubricators ..... 32
Adapters,	Buffers ..... 52, 60, 311	Regulators ..... 32
Air Line ..... 36-41	Cutter ..... 52, 59	Air-Liquid,
Balancer ..... 194-197	End Lift ..... 97	Grader Valves ..... 158-160, 165
Brake Lathe ..... 203-209	Hydraulic Pumps ..... 112	Master Gauges ..... 169, 171
Buffing Wheel ..... 312, 314-317	Jacks ..... 83-92	Valve Accessories ..... 158-160
Flexible Shaft ..... 329	Tire Filling Pumps ..... 128	Valve Extensions ..... 158, 160
Hydraulic ..... 113	Tire Spreaders ..... 319-320	Valves ..... 158, 160, 165
Hydro-Inflation ..... 158, 164	Air Tools,	Air Pressure Regulators ..... 32
Impact Socket ..... 67	Cut-Off Tools ..... 53-59	Air Pressure Gauges,
Jacobs Chuck ..... 312	Die Grinders,	Digital ..... 170
Quick Change ..... 313	CHICAGO PNEUMATIC ..... 46	Dual Foot ..... 169, 171, 173, 174
Spud ..... 158-160, 163, 165, 166	INGERSOLL-RAND ..... 59	Large Bore ..... 173
Adhesive Style	Drills,	Master Test ..... 171
Weights ..... 222, 223, 230-233	INGERSOLL-RAND ..... 60	Air/Hydraulic,
Adhesive Weight Remover ..... 239	Hammers,	Pumps ..... 112
Adjustment Cams,	INGERSOLL-RAND ..... 59	Service Jacks ..... 84-92
Camber ..... 244 - 252	Impact Wrenches,	Air Tanks ..... 42
Adjustment Sleeves ..... 246, 247, 252	CHICAGO PNEUMATIC ..... 47-49	Portable ..... 42
Aftercoolers, Compressor ..... 19	INGERSOLL-RAND ..... 56-58	Air Tool,
Agricultural,	Ratchets,	Conditioner ..... 55
Bead Breakers ..... 111-113	CHICAGO PNEUMATIC ..... 51-52	Oil ..... 55
Tire Cage ..... 130	Repair Kits,	Whip Hose ..... 37
Tire Filling Pumps ..... 117	CHICAGO PNEUMATIC ..... 55	Air Water Tractor Gauges ..... 169
Tire Spreaders ..... 319-320	INGERSOLL-RAND ..... 62	Air Wrenches,
Valves ..... 158-167	Sanders,	CHICAGO PNEUMATIC ..... 42, 47-50
Air,	INGERSOLL-RAND ..... 60	NGERSOLL-RAND ..... 56-58
Adapters ..... 38-41, 326	CHICAGO PNEUMATIC ..... 47-53	Aligners ..... 255
Blow Guns ..... 42	Tire Buffers ..... 52, 60, 311	Alignment,
Chucks ..... 172	Tool Hose ..... 33	CEMB ..... 255
Chucks, Large Bore ..... 173	Tool Lubricants ..... 62	Equipment ..... 255
Chucks, Clip-on Large	Tool Protective Covers ..... 62	Plates ..... 257-258
Gauges ..... 169-171, 173-174	Air Hose,	Racks ..... 216
Chucks, Standard Bore ..... 172	Accessories ..... 42-44	Shim Assortments ..... 245
Couplers ..... 38-41, 326	All Purpose ..... 37	Shims ..... 244, 245
Gauges, Metal ..... 169-171	Barb Fittings ..... 42	Sleeves ..... 246-247, 252
Hammers ..... 59, 122, 123	Bulk ..... 37	Tester Portable ..... 264
Air Compressors,	Clamps ..... 44	Tool Board ..... 260
Accessories ..... 29	Coil ..... 37	Tool ..... 252-253, 257-260
ARROW ..... 29-32	COXREELS ..... 34-35	Truck Axle Shims ..... 254-257
Drain ..... 29	Connectors ..... 42-43	Alloy,
Dryers ..... 19	Hosetract ..... 34	Light-Weight Valves ..... 152
Gas & Electric ..... 16-23	Oil Resistant ..... 37	Wheel Weights ..... 221-224
Magnetic Starter ..... 17, 18, 22	PVC Hose ..... 37	Aluminum,
Maintenance Kit	Recoil ..... 37	Alloy Truck Shims ..... 254-256
INGERSOLL-RAND ..... 22	Reels ..... 33-36	Rams ..... 113
QUINCY ..... 20-21	Reelcraft ..... 33-36	Jack, 55-fTon ..... 113
Selection Guide ..... 15	Repair Parts ..... 43-44	AMMCO ..... 201-212
Air Compressor Drain ..... 29	Splicer ..... 43-44	Brake Bleeders ..... 212
Dryers ..... 19	Whip Hose ..... 37	Brake Lathes ..... 201-202
Air Conditioning,	Air Hose Crimpers ..... 43-44	Brake Washer ..... 213
Accessories ..... 292	Cutter ..... 36	Lifts ..... 214-216, 218
Evacuation, Recharging	Air Line Couplers ..... 38-41	Swirl Grinder ..... 211
System ..... 286-287	Adapters ..... 38-41	Wheel, Inner/Outer Nuts ..... 77
Leak Detector ..... 287	Bandag ..... 326	Angle Die Grinder ..... 53, 59
	Smooth Body ..... 38-41	Anti-Seize & Lubricating
	Sleeve Body ..... 38-41	Compound ..... 108
	Schrader ..... 38-41	

Antifreeze/Coolant Management..... 286-288  
 Arbor Kit, Brake Lathe..... 205-209  
 Arbors, Wheel..... 313  
 ARROW..... 29-32  
 ASCOT,  
 Impact Sets & Sockets..... 64-68  
 Paintstiks..... 108  
 Tire Gauges..... 169-171, 173-174  
 Tire Lube..... 107  
 Tire Labels..... 269  
 Tire Mounting Compound..... 107  
 Tire Repair Materials..... 294-320  
 Tire Valve Hardware..... 152, 155  
 Wheel Weights..... 221-224  
 Aspirator, Deflating..... 168  
 Asymmetric Lifts..... 214  
 ATV Adapter..... 183  
 ATV Repair Kit..... 310  
 Automotive,  
 Composite Rotor Adapters . 205-209  
 Interior Protection..... 269-274  
 Lift, Portable..... 218  
 Style, Coupler/Adapter..... 38-40  
 Tools, Air Hammer..... 59  
 Automatic,  
 Air Line Lubricators..... 30, 32  
 Hose Reel..... 33-36  
 Stud Feeder..... 275  
 Tank Drain..... 29  
 Tire Inflator, Remote..... 128  
 Auxiliary Stand..... 102  
 Awls..... 313, 317  
 Axle Stands..... 84, 93-95

**B**

Bags,  
 Parts..... 274  
 Tire Storage..... 274  
 Balancers, Wheel..... 189-193  
 CEMB..... 190-191  
 CORGHI..... 193  
 Adapter Kits..... 194-200  
 Motorcycle Wheel..... 190  
 Passenger Wheel..... 189-193  
 Truck Wheel..... 191, 192  
 Ball Bearing Stitchers..... 317  
 Ball Joint Service Kit..... 259  
 Bandag-Type Couplers..... 326  
 Battery,  
 Charger..... 263-265  
 Starters..... 263-265  
 Testers..... 264, 266  
 Bead,  
 Breaker, Truck..... 111-112  
 Breaker, KEN-TOOL..... 121-123  
 Breakers, Pumps..... 112  
 Breaking Wedge..... 121

Dressing..... 107  
 Driver..... 123  
 Expanders, Prevention..... 116  
 Knocker..... 123  
 Looseners..... 111-112, 116, 121  
 Lubricant..... 107  
 Push-Off Tool..... 114  
 Saver System..... 118  
 Sealer..... 303, 306, 310  
 Sealant..... 109-110  
 Seating Devices..... 115-116  
 Sealant – Inner Liner..... 296, 303  
 Bead Keeper..... 118  
 Bench,  
 Grinders..... 267  
 Lathe..... 201-202  
 Vise..... 268  
 Bent Truck Valves..... 151-153  
 Bias Ply Tire Repairs.... 298, 301, 309  
 Bin System..... 237-238  
 Bits, Brake Lathe..... 210  
 Black,  
 Putty..... 304  
 Tire Paint..... 328  
 Blaster,  
 Air Tool Oil..... 55  
 PB Penetration Catalyst..... 108  
 Bleeder, Brake..... 212  
 Block..... 283  
 Blow Gun..... 36, 42  
 Blue Cement..... 303  
 BlueTork..... 51, 74  
 Bolt,  
 Hole Chamfer Wear Gauge..... 79  
 Bottle Jacks..... 83-85  
 Braided Flexible Extensions..... 159  
 Brake,  
 ABS Bleeders..... 212  
 Accessories..... 203-211  
 Adapters..... 205-209  
 Adapters, ADAPTEK..... 209  
 Benches..... 203  
 Bleeder Adapters..... 212  
 Bleeders..... 212  
 Caliper..... 213  
 Drum Gauges..... 213  
 Drum Wear Gauge..... 213  
 Gauges..... 213  
 Lathes..... 201-202  
 Lathe Accessories..... 203-211  
 Lathe Bits..... 210-211  
 Micrometer, Drum..... 213  
 Rotor Gauge..... 213  
 Swirl Finisher..... 211  
 Service Tools..... 212-213  
 Washers..... 213  
 BRANICK..... 27, 130, 259, 319  
 Nitrogen Fillers..... 27  
 Strut Compressors..... 259  
 Tire Spreaders..... 319-320  
 Broken,

Budd Nut Remover..... 80  
 Core Remover..... 167-169  
 Stud Removers..... 80  
 Brooms..... 270  
 Brushes,  
 Hand..... 270, 313  
 Inertube Buffing..... 316  
 Plastic Encapsulated..... 316  
 Rim..... 270  
 Sidewall..... 270  
 Stem..... 316  
 Tube..... 313  
 Twisted Wire..... 316  
 Wheel..... 316  
 Wire..... 316  
 Wire Wheel..... 316  
 Bubble Balancer..... 191  
 Budd,  
 Nut Remover..... 80  
 Nut Wrenches..... 124-125  
 Nuts, Disc Wheels..... 76  
 Wheel Combination Sockets .. 65-68  
 Wheel Stud Remover..... 125  
 Buffers,  
 Flexible Shaft..... 329  
 Tire Repair..... 52, 60, 311  
 Buffing,  
 Rasp Blades..... 322-323  
 Stones..... 315  
 Wheels..... 314, 316-317  
 Buffing/Skiving Tools..... 318  
 Bulk Air Hose..... 37  
 Bus Tire Valves..... 151-154  
 Bushings..... 150, 157  
 Butyl Innerliner Sealer..... 296, 303  
 Buzzout Extruder Gun..... 305

**C**

Cages, Inflation..... 130  
 Calcium Chloride Pump..... 117  
 Camber,  
 Adjusters..... 244, 246-252  
 Adjusting Kit..... 244-246, 252  
 Camber/Caster Bushings... 246-247  
 Camber/Caster  
 Correction..... 244, 248-251  
 Camber/Caster Kit..... 244, 248-251  
 Camber/Casters,  
 Sleeves..... 244, 248-251  
 Correction..... 244, 248-251  
 Gauge..... 259  
 Shims..... 244  
 Sleeves..... 244, 248-251  
 Caps & Core Tool..... 167-169, 173  
 Caps, Tire Valve..... 155, 157, 161  
 Carbide,  
 Cutting Tools..... 317  
 Rasps..... 316





Carts, Tire ..... 271-273  
 Caster Camber,  
 Gauge..... 259, 253  
 Kits..... 244, 248-251  
 Tools..... 253, 258-259  
 CATERPILLAR SHUR-LOCK..... 111-112  
 Cement,  
 Brush Type  
 Vulcanizing 296, 303, 306, 310  
 Brushes..... 304  
 Chemical  
 Vulcanizing 296, 303, 306, 310  
 Dispenser..... 304  
 Dispensing Cans..... 304  
 Fast Drying Self-  
 Vulcanizing 296, 303, 306, 310  
 Non-Flammable..... 303  
 Self-Vulcanizing 296, 303, 306, 310  
 Spray Booth..... 328  
 Sprayers..... 326  
 Center-Over-Injury ..... 297-298, 300  
 Center-Post Tire Changer..... 127, 177  
 Center Sleeves- Truck..... 72  
 CHALLENGER Lifts..... 214-216  
 Chamfer Wear Gauge..... 79  
 Changing Stand, Truck Tire..... 130  
 Charger, Battery..... 263-265  
 Charging Starter Analyzer..... 264, 266  
 Chassis Lube Pump..... 276  
 Cheetah Bead Seater..... 115  
 Chemical,  
 Vulcanizing  
 Fluid..... 296, 303, 306, 310  
 Cure Section Patches..... 300  
 Gum..... 304  
 Vulcanizing  
 Cement..... 296, 303, 306, 310  
 Tire Sealant..... 109  
 Chloride Pumps..... 117  
 CHICAGO PNEUMATIC..... 47-54  
 Chrome,  
 Low Profile Valves..... 150  
 Nut Cover Remover Tool..... 74  
 Sleeve Snap-In Valves..... 150  
 Truck Valves..... 151-153  
 Chucks,  
 Air..... 172-173  
 European..... 172  
 Jacobs..... 313  
 Quick Change..... 313  
 Clamp-In,  
 Tubeless Tire  
 Valves . 151-153, 157-161, 163  
 165, 167.....  
 Valve Tool..... 167-169  
 Valve, Light Truck..... 150, 152-153  
 Clamps,  
 Oetiker Hose..... 44  
 Tire Changer..... 183  
 Clip-On Air Chucks..... 172  
 Cliplight..... 292

COATS.....  
 177-179, 184-190, 194, 195-201  
 Coated Wheel Weight..... 221-224  
 Coil Spring Compressor..... 259  
 Cold Patching Cement..... 303  
 COMBI Adapter..... 195  
 COMBI Tire Bead Breaker..... 111  
 Compressor,  
 Accessories..... 29-32  
 ARROW..... 29-32  
 CP..... 23  
 CHAMPION..... 16-19  
 Drain..... 29  
 Dryers..... 19  
 Gas & Electric..... 18-23  
 INGERSOLL-RAND..... 22  
 Maintenance Kits,  
 INGERSOLL-RAND..... 22  
 QUINCY..... 20-21  
 Selection Guide..... 15  
 Service Truck..... 20-22  
 Strut..... 259  
 Computer Wheel,  
 Aligner..... 255  
 Balancer..... 189-193  
 Cone Rasps..... 316  
 Connector, Air Hose..... 42-43  
 Contamination Detector..... 289  
 Coolant Recyclers..... 286-288  
 Coolant Systems..... 286-288  
 Cords, Power..... 35  
 Core, Ejectors..... 158-164  
 Housing, Super Large Bore 163-165  
 Cores, Tire Valve..... 139-141  
 Counteract..... 242  
 Coupler Cross Reference Guide..... 41  
 Couplers,  
 Air Line..... 39-41  
 Retread..... 40, 326  
 Covers,  
 Air Tools..... 62  
 COXREELS..... 34-35  
 Crayon, Tire Marking..... 108  
 Cribbing..... 115  
 Crushproof..... 266-267  
 Cup Rasps..... 312, 314-317  
 Cure Gum..... 304  
 Curved Knives..... 318  
 Curved Spoon Tire Irons..... 119-120  
 Cushion Gum..... 304  
 Custom Tire Racks..... 272  
 Cut-Off Tool..... 52

**D**

Dayton Nuts & Studs..... 78  
 Dead Blow Hammer..... 123  
 Deep Hex Impact Sockets..... 64-68  
 Deflating Aspirator..... 167-168

Deflator,  
 Large Bore Tube..... 167  
 Tire Valve..... 168  
 Tube..... 168  
 Depth Gauges, Tread..... 169-170  
 Detection, A/C Leak..... 287, 289-292  
 Dexter Knives..... 318  
 Dial Indicator Set, Brake..... 213  
 Dial Gauges..... 170-171  
 Die Grinders..... 53, 59  
 Digital,  
 Air Pressure Gauge..... 170  
 Brake Drum Gauge..... 213  
 Disc,  
 Brake Rotor Gauges..... 213  
 Drum Silencer Bands..... 203  
 Rotor Micrometer..... 213  
 Rotor Silencer..... 203  
 Rotor Thickness Gauge..... 213  
 Disc Wheel,  
 Budd Nuts..... 76-77  
 Inner Cap Nuts..... 76  
 Outer Cap Nuts..... 76  
 Shoulder Studs..... 77  
 Studs..... 77  
 Dispenser,  
 Cement..... 304  
 Dispensing Cans..... 304  
 Disposable,  
 Ear Plugs..... 283  
 Filter Masks..... 283  
 Dolly, Wheel..... 101  
 Double,  
 Bent Large Bore Valves..... 159  
 Entry Tire Racks..... 272-273  
 Sealing Valve Cap..... 155  
 Drain, Waste Oil..... 276-280  
 Drain/Flush/Fill System..... 276-282  
 Drills, Air Operated..... 54  
 Drill Bits..... 317  
 Drop Center Tire Iron..... 118-121  
 Drum,  
 Brake Micrometer..... 204-205  
 Disc Lathe..... 201-202  
 Disc Silencer Bands..... 203  
 Dolly..... 104  
 Dryer,  
 Disposable Desiccant..... 29  
 Refrigerated Air..... 19  
 Dual,  
 Angle Shims..... 244  
 Bead Breaker..... 111-112  
 Foot Air Chucks..... 172-173  
 Foot Gauges..... 169  
 Tire Inflator..... 174  
 Wheel Flexible Extension..... 157  
 Wheel Vehicle Extensions.. 157-158  
 Dunker, Tube/Tire..... 269  
 Dunk, Tire Tank..... 269  
 Duo-Fast Staples..... 326

Duplex,  
Compressors ..... 17  
Tire Iron..... 185

**E**

Ear Plugs ..... 283  
Earth Mover,  
Bead Breaker ..... 111-112  
L-Rings & O-Rings..... 161  
Repair Units..... 301  
Tire Tools ..... 120-123  
Economy Tire Paint ..... 328  
ECOSEAL..... 110  
EF Tire Spreader ..... 319  
Enkei Valve ..... 150  
Ejectors, Core ..... 158, 164, 166  
Electronic Leak Detector ..... 290  
Emergency Patches,  
Dual Cure ..... 301  
Emergency Wheel Lock Remover .... 73  
End Lift ..... 97  
Engine Cranes ..... 104  
Envelope Expanders ..... 330  
Equal ..... 240  
European Style Tire Changers 177-181  
Evacuation,  
A/C System ..... 286-287  
Exhaust,  
Hose ..... 266  
Hose Adapters..... 266  
Expandable Rim Assemblies ..... 329  
Expanding Hub Assemblies..... 329  
Extension,  
Large Bore..... 162  
Socket..... 68  
Tire Valve..... 157  
Torque..... 69  
Extruder Guns..... 305  
Extruder Rope ..... 304

**F**

Face Shields ..... 283  
Fast Dry Self Vulcanizing  
Cement ..... 296, 303, 310  
Feeder, Stud ..... 275  
Fiberglass Hammer Handles . 122-123  
Filters, Air Line ..... 30-31  
Filters, Lubricators, Regulators  
& Gauges ..... 29-32  
Finishing Rasps ..... 312  
Finishing Tools ..... 52-53, 60  
Filter Masks ..... 283  
First Aid Kits ..... 283  
Fishing Tool, Valve ..... 167-168  
Fleet Battery Charger..... 263-265

Flexible,  
Large Bore Extensions..... 162  
Shaft Adapters..... 329  
Shaft Buffers ..... 329  
Skiving Knife..... 318  
Stems, Super Large Bore ..... 165  
Valve Extensions ..... 157  
Flip-Flop Stand ..... 130  
Flip Sockets..... 64, 67  
Floor,  
Crane..... 104  
Jacks ..... 85-92  
Mats ..... 269, 274  
Flow Through Chucks ..... 172  
Fluid Ballast Pumps ..... 117  
Fluid Exchangers ..... 288  
Fluid Leak Detection ..... 290-292  
Fluorescent Utility Lights..... 271  
Foot Pumps..... 111-112  
Forklift Jacks ..... 96  
Four-Post Lifts ..... 216  
Four-Way Lug Wrenches..... 126  
Four-Way Valve Tools ..... 167-168  
Frame Contact Lifts..... 218  
FreyLube ..... 107  
Front Camber Kits ..... 246-253  
Front Wheel Drive Service  
Tools..... 258-260  
Full Contact/Dual Angle Shims..... 244  
Funnel Lift Drains ..... 276, 278-280

**G**

Garage,  
Broom..... 270  
Exhaust Hose..... 266  
Gas Air Compressors..... 17, 20, 22  
Gauges,  
Air ..... 169-171, 174  
Brake Drum ..... 205, 213  
Dual Foot ..... 169-171, 174  
DIAL..... 170-171  
Large Bore..... 173-174  
Rim ..... 239  
Tire Pressure ..... 169-171, 174  
Tire/Wheel Run-Out..... 259  
Toe ..... 257  
Tread Depth ..... 169-170, 173  
Glasses ..... 283  
Gloves,  
GOJO ..... 284  
Latex..... 284  
M-PACT ..... 284  
MECHANIX..... 284  
Nitrile ..... 284  
GOJO ..... 270  
Golden Tool..... 118  
Grader Valves ..... 158-167  
Grease Guns ..... 276

Grinders,  
Bench ..... 267  
Die ..... 53, 59  
Tire ..... 53  
Grinding Stones ..... 317  
Gun,  
Extruder..... 305  
Grease ..... 276  
Safety Blow..... 36, 42  
Staple ..... 326  
Stud..... 275

**H**

HALTEC..... 150-174  
Hammer,  
Air ..... 59  
Handles ..... 122  
Sledge..... 123  
Tire ..... 123  
Wheel Weight ..... 239  
Hand,  
Bendable Extensions..... 162  
Brush ..... 270  
Cleaner ..... 270  
Operated Tire Spreader ..... 319-320  
Handle Protector ..... 87  
Handle Protector, Jack..... 87  
Handles, Tire Hammer ..... 122  
Hand Spin Balancer ..... 191  
Hands-Free Budd Nut Wrench ..... 124  
Hansen Couplers ..... 40, 326  
Hardware, Wheel Attaching ..... 76-78  
Hearing Protection..... 283  
Heat Resistant Foil ..... 304  
Heat Resistant Valve Caps..... 155  
Heavy Duty,  
Lifting Equipment..... 104  
Tire Changers..... 185-187  
Wheel Service ..... 97  
HEIN-WERNER..... 87-101  
High,  
Performance Valve..... 150  
Pressure Valve ..... 150, 156  
High Speed,  
Air Cutter ..... 52  
Grinding Stones..... 317  
Tire Buffer Ascot..... 311  
Tire Buffer  
CHICAGO PNEUMATIC ..... 52  
INGERSOLL- RAND ..... 60  
Hoist, Automobile..... 98, 102  
Holders, Paint Stick ..... 108  
Hot Mill Gloves ..... 284  
Hose,  
Air ..... 33-37  
Cutter ..... 36  
Crimper ..... 43  
Exhaust..... 266

Couplers..... 38-41, 326  
 Fittings..... 42-43  
 Reels..... 33-36  
 Stop..... 36  
 Whip..... 37  
 Hosetract..... 34  
 Hub,  
 Cap Puller..... 124  
 Expandable..... 329  
 Hub Centric Nut..... 76  
 Hubless Adapters..... 206  
 Hubcap Lock Removal Kit..... 73  
 Hydraulic,  
 Bead Breakers..... 111-113  
 Couplers..... 113  
 Hose..... 113  
 Jacks..... 83-92  
 Jack Oil..... 102  
 Lifts, Automotive..... 214-218  
 Tire Removing Tools..... 111-113  
 Press..... 103  
 Pumps..... 111-113  
 Rams..... 113  
 Service Jack..... 85-92  
 Transmission Jacks..... 98-100  
 Truck Jacks..... 85-92  
 Wheel Dolly..... 101

**I**

Impact,  
 Sockets..... 67-68  
 Socket Sets..... 64-66  
 Wrenches..... 47-50, 56-58  
 Impact Wrenches,  
 Accessories..... 55, 62  
 CHICAGO PNEUMATIC..... 47-50  
 Cordless..... 61  
 Grease..... 54, 62  
 INGERSOLL-RAND..... 56-58  
 Protective Covers..... 54, 62  
 Tune-Up Kits..... 55, 62  
 Inflate-Through Valve Cap..... 155  
 Inflation Cages..... 130  
 Inflation Gauges..... 169-171  
 Inflator,  
 Dual Foot..... 169-172  
 Large Bore..... 174  
 Nitrogen..... 24-27  
 Safety..... 174  
 Straight Chuck..... 172  
 Truck Tire..... 169-170  
 INGERSOLL-RAND  
 Air Compressors..... 22  
 Air Tools..... 56-61  
 Inner,  
 Budd Nut, Cap Nuts..... 76  
 Budd Nut Guard..... 78  
 Budd Nut Remover..... 80

Tie Rod Tool..... 252  
 Innerliner,  
 Buffer..... 314  
 Cleaners..... 296, 303, 306, 310  
 Repair..... 309  
 Scraper..... 317  
 Sealants..... 296, 303, 306, 310  
 Inserting Tools..... 313  
 Inspection Tools,  
 Brake Drum..... 213  
 Light..... 291  
 Rotor Gauge..... 213  
 Tire Spreaders..... 319-320  
 Tube/Tire Dunker..... 269  
 Irons, Tire..... 118-121

**J**

Jacks,  
 Automotive..... 83-92  
 Bottle..... 83-85  
 Floor..... 85-92  
 Oil, Hydraulic..... 102  
 Specialty..... 97  
 Stands..... 93-95, 102  
 Rolling..... 217  
 Transmission..... 99-100  
 Truck..... 85-92  
 Truck Plates..... 85  
 Jacobs Chuck..... 313

**K**

KEN-TOOL..... 119-130  
 Knife,  
 Rotary Blades..... 315  
 Skiving..... 318  
 Tire..... 318  
 KWIKSTART..... 264

**L**

L-Rings..... 161  
 Labels, Tire..... 269  
 Large Bore,  
 Air Chucks..... 173  
 Air Pressure Gauges..... 173  
 Dual Inflation..... 174  
 Extensions..... 162  
 Screw-On Valves..... 163  
 Spuds..... 160, 163  
 Spud Adapters..... 163  
 Swivel Gauge..... 173  
 Swivel Valves..... 159  
 Tire Valves..... 159-165

Tire Valve Tools..... 167  
 Tube Deflator..... 167  
 Valves, Caps & Cores..... 161  
 Latex Gloves..... 284  
 Lathe,  
 Accessories..... 203-211  
 Adapters..... 205-209  
 Bits..... 210-211  
 Brake..... 201-202  
 Silencer Band..... 203  
 Lawn Tractor Tire Irons..... 120  
 Leak Detector,  
 Refrigerant..... 287, 289  
 Tire..... 108  
 Leather Gloves..... 284  
 Lever Grease Gun..... 276  
 Lifts..... 214-218  
 Light Truck,  
 Alignment Parts..... 246-255  
 Lathe Adapters..... 205-209  
 Wheel Balancer  
 Accessories..... 194-200  
 Valves..... 150-154  
 Wheel Weights..... 234-236  
 Light, Bounce..... 271  
 Liquid,  
 Air Inflators..... 158  
 Fill Tools..... 158  
 Loader Tire Valves..... 158  
 Tire Pump..... 117  
 Valves..... 158, 160  
 Lock-On Air Chucks..... 172  
 Lock Removal Set..... 73  
 Lock Ring Tools..... 121  
 Low,  
 Pressure Gauges..... 169-171  
 Profile Valve..... 150  
 Speed Buffer..... 52, 60, 311  
 Lube Bottles/Applicators..... 185  
 Lube Pumps..... 277  
 Lubricants,  
 Air Conditioning..... 292  
 Air Tool..... 55, 62  
 Multi-Purpose..... 107-109  
 Rubber..... 107-109  
 Swab..... 107, 185  
 Tire..... 107, 109  
 Tire Mold..... 328  
 Lubrication Accessories..... 282  
 Lubrication Equipment..... 278-282  
 Lubricators, Dry Air..... 32  
 Lug Nut,  
 Cover Removal Tools..... 74  
 Removal Tools..... 73-75  
 Axle Shimms..... 254  
 O-Rings..... 161  
 Valves, Replacement..... 151-154  
 Lug Lock Retainers..... 72

**M**

Magnum ..... 242  
Mallet ..... 123  
Manual,  
    Spring Compressor ..... 259  
    Tire Changer ..... 127  
    Tire Spreaders ..... 320  
MARKAL ..... 108  
Markers, Tire ..... 108  
MARTIN Tire Racking ..... 272  
Master Dial Gauge ..... 170-171  
Master Test Gauge ..... 169  
Material Handling ..... 271-273  
Measurement Conversion Chart .... 332  
Mechanix Gloves ..... 284  
Metal,  
    Clamp-in Tire Valves ..... 150-154  
    Dome Valve Caps ..... 141, 155  
    Screwdriver Caps ..... 155  
    Valve Extensions ..... 157  
Metric,  
    Cap Nuts ..... 76-77  
    Socket Sets ..... 64-66  
    Valves ..... 151  
    Valve Tools ..... 154  
    Wrenches ..... 126  
Micrometer,  
    Digital ..... 204, 213  
    Torque Wrenches ..... 69, 75  
Mini-Extruder ..... 305  
Mini-Rasps ..... 312, 314 - 316  
Mold Gloves ..... 284  
Mold Lubricant ..... 328  
Monoflex Tire Repair ..... 307  
Mount/Demount Tools ..... 118-121  
Mounting Compound ..... 107  
MURPHY'S Tire Lube ..... 107

**N**

Nail Hole Extruder ..... 305  
    Repair Tools ..... 312-318  
    Repairs ..... 294-306  
Nitrogen,  
    Hose Reels ..... 33-34  
    Valves ..... 151  
    Valve Caps ..... 141, 155  
    Tire Filling  
        Systems ..... 24-27, 141, 155  
    Tire Inflation System ..... 24-27  
        Double Seal Cups ..... 155  
Non-Flammable Cement ..... 303, 310  
NORCO 83, 87-88 91-93, 95, 96-104  
Nuts, Wheel & Rims ..... 76-77  
Nylon Valve Extensions ..... 157

**O**

O-Rings ..... 161  
Bead Seater ..... 116  
Nitrogen ..... 26, 151  
Off-the-Road,  
    O & L-Rings ..... 161  
    Valves ..... 151  
Section Repair  
Equipment ..... 305, 307  
Service Tools ..... 111-115  
Tire Repairs, PREMA... 297, 298  
Tire Repairs, REMA..... 300, 301  
Tire Sealant ..... 109-110  
Valves ..... 159-167  
Oil,  
    Air Tool ..... 55, 62  
    Drains ..... 276, 278-280  
    Filter Crushers ..... 282  
    Hose Reels ..... 33-36  
    Hydraulic Jack ..... 102  
OMEGA .....  
    84, 85, 88, 90, 91, 93, 94, 96, 100,  
    102, 104  
OTC,  
    TPMS Kit ..... 138  
    Strut Tamer ..... 259  
    Outer Cap Nut ..... 76

**P**

Pad Lift ..... 218  
Paint,  
    Booth ..... 328  
    Markers ..... 108  
    Sprayer ..... 108, 328  
    Tire Paint ..... 328  
Paintstik ..... 108  
PARKER,  
    Nitrogen Filling System ..... 24, 26  
Parts Return Bag ..... 274  
Passenger Car,  
    Alignment Accessories ..... 245, 253  
    Stud Rethreader ..... 73  
    Tire Changers.. 177, 178, 180, 181  
    Tire Valves ..... 150, 152, 153  
    Wheel Balancers 189, 190, 191, 193  
    Wheel Torque Sockets ..... 70-71, 75  
    Wheel Weights ..... 221-233  
Patches,  
    Bias-Ply ..... 298, 301, 309  
    Cement ..... 296, 303, 306, 310  
    Heat Cured ..... 297, 298, 300, 301  
    Nail Hole .....  
        294, 299, 306, 308, 309, 310  
    Off-The-Road .. 297, 298, 300, 301  
Patch Plugs ..... 299, 306, 308, 309

Radial .....  
    294, 297-300, 302, 306, 308, 309  
    Universal ..... 294, 299, 306, 308  
PB Blaster ..... 108  
Penetrating Lubricants ..... 108  
Perforated Sheets ..... 327  
PINCOTT Blades ..... 322-323  
Plastic Drains ..... 278, 279, 280  
Plastic Floor Mats/Seat Covers ..... 274  
Plastic Valve Caps ..... 26, 141, 155  
Plug,  
    Ear ..... 283  
    Insert Tool ..... 313  
    Repairs . 294, 299, 306, 308, 309  
    Rim Hole ..... 158  
Pneumatic,  
    Bead Seater ..... 115, 116  
    Buffers ..... 52, 60, 311  
    Nut Splitter ..... 153  
    Oil ..... 55, 62  
    Pump ..... 117  
Polypropylene Film ..... 327  
Pork Chop Wrench ..... 124  
Portable,  
    Air Tank ..... 42  
    Bead Breakers ..... 111, 112, 121  
    Bottle Jacks ..... 83-85  
    Lift ..... 218  
    Tire/Wheel Balancer ..... 191  
    Wheel Stud Remover ..... 80  
Precure Accessories ..... 326  
PREMA ..... 294-298  
Press, Hydraulic ..... 103  
Pressure Gauges ..... 169-171, 173  
Probe Rasp Tools ..... 313, 317  
Probing Awls ..... 313, 317  
Protective,  
    Eyewear ..... 283  
    Eyewash Stations ..... 283  
    Gloves ..... 284  
    Tool Covers ..... 54, 62  
PT Valves ..... 167  
Pull-A-Stem ..... 168  
Pullers,  
    Flange Ring ..... 114  
    Lugnut Cover ..... 74  
    Sleeve ..... 253  
    Valve ..... 168  
    Wheel Cover ..... 124  
    Wire ..... 299  
Pumps,  
    Calcium Chloride ..... 117  
    Hydraulic ..... 111-112  
Puncture Repair Kit ..... 295, 302  
PVC Hose Reels ..... 36

**Q**

QRS Compressor ..... 23  
Quick Change Chuck ..... 313



Quick Couplings ..... 38-40  
 Quick Fill Valve ..... 158  
 QUINCY ..... 20-21

**R**

R134A Recyclers ..... 286-287  
 R134A Detector ..... 289-290  
 Racks,  
 Alignment ..... 216  
 Tire ..... 272-273  
 Radial Tire Repairs ..... 294-310  
 Rams, Hydraulic ..... 113  
 Rasps,  
 Blades ..... 322-324  
 Cone ..... 316  
 Contour Cup ..... 312  
 Finishing ..... 312  
 Pencil ..... 316  
 Ratchet,  
 Air ..... 51, 52, 61  
 Stands ..... 93-95  
 Recoil Air Hose ..... 37  
 Recycling ..... 286-287  
 Recharging System ..... 286-287  
 Reels, Air Hose ..... 33-36  
 REELCRAFT ..... 33-36  
 Retreading Rasp Blades ..... 322-325  
 Refrigerated Dryers ..... 19  
 Refrigerant,  
 Accessories ..... 290-292  
 Identifier ..... 289-290  
 Leak Detectors ..... 289-290  
 Recovery/Recycling ..... 286-287  
 Regulator ..... 30-32  
 REMA ..... 299-305  
 Removers,  
 Core ..... 167-169, 173  
 Chrome Lug Nut ..... 74  
 Stud ..... 80  
 Valve Stem ..... 153  
 Wheel Cover ..... 124  
 Wheel Lock ..... 79  
 Wheel Weight ..... 239  
 Repair for  
 EM Tires . 297, 298, 300, 301, 304  
 Rethreaders ..... 73  
 Retread Release Liner ..... 239  
 Rim,  
 Bushings ..... 158  
 Clamps ..... 78  
 Gauges, Wheel Weight ..... 239  
 Guards ..... 78  
 Protector ..... 78  
 Spuds ..... 159-161, 163, 165, 166  
 Straightener ..... 258  
 Tire Brush ..... 270  
 Rollers & Stitchers ..... 317  
 Rolling jacks ..... 217  
 Rope Rubber ..... 304

Rotary Gouges ..... 325  
 Rotary Knife Blades ..... 315  
 Rotary Screw Compressors ..... 23  
 Rotor,  
 Brake Lathe ..... 201, 202  
 Digital Gauge ..... 204, 213  
 Digital Micrometer ..... 213  
 Silencer ..... 203  
 Router Burrs ..... 317  
 RTI ..... 287-288  
 Rubber,  
 Air Hose ..... 37  
 Beadkeeper ..... 118  
 Innerliner Scraper ..... 313, 317  
 Lubricants ..... 107  
 Mallets ..... 123  
 Wheel Chock ..... 283  
 RUBBERHOG Tools ..... 314-315

**S**

Safety,  
 Blow Gun ..... 36, 42  
 Couplings ..... 43  
 Glasses ..... 283  
 Inflation Cages ..... 130  
 Inflation Devices ..... 26, 27, 28  
 Inflation Gauges ..... 174  
 Safety Seal ..... 310  
 Triangles ..... 283  
 Vests ..... 283  
 SAETZ Tire Sealants ..... 109  
 Save-A-Stud Rethreader ..... 73  
 SCHRADER ..... 150-154  
 Couplers & Adapters ..... 38-40  
 Valve Caps & Cores ..... 155  
 SCHUMACHER ..... 263  
 Scissors ..... 313  
 Scrapers ..... 313, 317  
 Screw-On Repair Valves ..... 152, 163  
 Scribe ..... 257  
 Scribe Toe Gauges ..... 257  
 Sealer,  
 Bead ..... 296, 303, 306, 310  
 Butyl Innerliner ..... 303  
 Repair ..... 296, 303, 306, 310  
 Tubeless Tire ..... 109, 110  
 Seat Covers ..... 274  
 Section Air Bags ..... 307  
 Section ID Patches ..... 302  
 Section Repair Patches .....  
 ..... 297, 298, 300, 301, 304  
 Self-Vulcanizing  
 Cement . 296, 299, 303, 306, 310  
 Semi-Flexible RV Extensions ..... 157  
 Serpent Mount Tool ..... 119  
 Service,  
 Gauges ..... 169-171, 173  
 Jacks ..... 85-92

Station Air Pressure,  
 Gauges ..... 169, 170, 171, 173  
 Truck Air Compressors ... 17, 20, 22  
 Truck Hose Reels ..... 33-36  
 Shaft, Flexible ..... 329  
 Shields, Face ..... 283  
 Shims,  
 Rear Wheel Alignment ..... 244, 251  
 Shop,  
 Cranes ..... 104  
 Equipment & Supplies ..... 263-292  
 Presses ..... 103  
 Shoulder Studs, Disc Wheel ..... 77  
 Silencer Bands, Brake Lathe ..... 203  
 Silicone Mold Lubricant ..... 328  
 Skirt Style Nut ..... 76  
 Skiver Buffers ..... 52, 60, 311  
 Skiving Knives ..... 318  
 Sledge Hammers ..... 123  
 Sleeve,  
 Alignment ..... 246, 247, 249, 252  
 Slotted Angle Tire Racks ..... 272  
 Snap-In Tubeless Tire Valves ..... 150  
 Socket,  
 Adapters ..... 68  
 Extensions ..... 68  
 Metric ..... 64-68  
 Sets, Impact ..... 64-66  
 Spline ..... 65, 68  
 Standard ..... 64, 67, 68  
 Socket Set Protector ..... 66  
 Solid Carbide Cutting Tools ..... 317  
 Special Alignment Tools 253, 257-260  
 SPECIALTY PRODUCTS ..... 244-250  
 Alignment Adjustment  
 Parts ..... 244-260  
 Alignment Tools ..... 253, 257-260  
 EZ Shims ..... 244-245  
 Splicer, Air Hose ..... 43  
 Spline Drive Sockets ..... 65, 68  
 Spline Drive Wrenches,  
 CHICAGO PNEUMATIC ..... 49-50  
 INGERSOLL-RAND ..... 58  
 Spoon, Tire Irons ..... 119  
 Spray Booths ..... 328  
 Sprayers ..... 108, 326  
 Spreaders, Tire ..... 319-320  
 Spring Guard, Teflon ..... 326  
 Spring Compressor Tool ..... 259  
 Spuds, Large  
 Bore ..... 159, 160, 163, 165, 166  
 Squeezegee ..... 270  
 Standard Bore,  
 Valve Tools ..... 168-173  
 Tire Valves ..... 150-154  
 Stands ..... 93-95  
 Staplers & Staples ..... 326  
 Steam,  
 Adapters ..... 326  
 Couplers ..... 326  
 Hoses ..... 326

Steel,  
 Radial Grinding Stones..... 317  
 Wheel Weights..... 224, 226-233  
 Steering Wheel Cover..... 274  
 Steering Alignment  
 & Suspension Tools .. 253, 257-260  
 Stem Brushes..... 316  
 Stickers, Static Cling..... 271  
 Stitchers, Ball Bearing..... 317  
 Stones,  
 Buffing..... 317  
 High Speed Grinding, Wire..... 317  
 Storage,  
 Bags..... 274  
 Tank, Oil..... 278  
 Tire..... 272-273  
 Strut Spring Compressor..... 259  
 STS Tire Sealant..... 109  
 Stud,  
 Accessories..... 275  
 Feeders..... 275  
 Guns..... 275  
 Installers..... 80  
 Removers..... 80  
 Stud Remover & Installer..... 80  
 Studding Equipment..... 275  
 Super Large Bore,  
 Check Valves..... 164  
 Core Housing..... 164-165  
 Flexible Extensions..... 164-165  
 Tube Spuds..... 165  
 Valves..... 164-165  
 Sure-Shot Sprayers..... 108, 328  
 Surface Conditioning Kit..... 50, 53, 60  
 Surface Mounted Lifts..... 214-216  
 Swabs, Tire Lubricating..... 107, 185  
 Swirl Grinder..... 211  
 Swivel,  
 Large Bore Gauge..... 173  
 Large Bore Valves..... 159  
 Type Valve Spuds..... 159

**T**

Tack Bands..... 329  
 Tags, Tire..... 269  
 Tailpipe Hose Adapters..... 267  
 Tandem Alignment Set..... 255  
 Tandem Axle Caliper..... 257  
 Tandem Truck Alignment Shims..... 256  
 Tank,  
 Air..... 42  
 Tubeless Tire Dunkers..... 269, 278  
 Oil Storage..... 277-279  
 Packages..... 277  
 Valve..... 156  
 Taper Point Knife..... 318  
 Tapered Carbide Cutting Tools..... 317  
 Tapered Cones..... 315

Tapered Funnel  
 Lift Drains..... 276, 279-280  
 Tapered Rasps..... 316  
 Teflon Hose Assemblies..... 326  
 Test Gauge, Master..... 169, 171  
 Test Station, Air Gauge..... 171  
 Testers,  
 Battery..... 264, 266  
 Tank, Tubeless Tire..... 269, 278  
 Thermopress & Extruders..... 305  
 Thin Wall Impact Sockets..... 67-68  
 Tie Rod Adjusting Tool..... 252, 258  
 Tire,  
 Air Wrenches,  
 CHICAGO PNEUMATIC..... 47-50  
 INGERSOLL-RAND..... 56-58  
 Alignment Tools..... 258-260  
 Appearance..... 328  
 Balancers..... 189-193  
 Balancer Accessories..... 195-200  
 Balancing Compound..... 240-242  
 Bead Holder..... 124  
 BeadSaver..... 118  
 Bead Seaters..... 115-116  
 Branders & Accessories..... 110  
 Brush..... 270, 313, 316  
 Buffers,  
 CHICAGO PNEUMATIC..... 52  
 INGERSOLL-RAND..... 60  
 ASCOT..... 311  
 Cages..... 130  
 Carts..... 271  
 Dollies..... 101  
 Cements and Sealants.....  
 ..... 109, 296, 303, 306, 310  
 Changer Accessories 182-185, 188  
 Changer Specifications..... 179, 187  
 Changers..... 177-181  
 Changers, Heavy Duty..... 185-187  
 Changing Tools..... 118, 120  
 Dolly, Wheel..... 101  
 Demounting Tool-Truck..... 118-120  
 Dunker..... 269, 278  
 Filling Pumps..... 117  
 Filling Systems, Nitrogen..... 24-27  
 Gauge Display..... 171  
 Gauges, Large Bore..... 173  
 Gauges, Passenger..... 169-171  
 Gauges, Truck..... 169-171  
 Hammers..... 122-123  
 Inflation Cages..... 130  
 Inflation Systems..... 128  
 Inflators, Digital..... 174  
 Inflators, Hand Held..... 174  
 Inflator, Dual..... 174  
 Inflator, Safety..... 174  
 Inflator, Straight Chuck..... 174  
 Inspectors..... 319-320  
 Irons..... 119-121  
 Knives..... 318  
 L-Rings..... 161

Labels..... 269  
 Leak Detector..... 108  
 Leak Tanks..... 269, 278  
 Lube Concentrate..... 107  
 Lubricants..... 107  
 Lubricating Swabs..... 107, 185  
 Marking Crayons..... 108  
 Mating Square..... 257  
 Mold Lubricant..... 328  
 Mounting Compound..... 107  
 O-Rings..... 161  
 Paint, Black..... 328  
 Plug Insert Tools..... 313  
 Pressure Equalizer..... 156  
 Pressure Gauges..... 169-171  
 Pressure Monitoring Systems  
 (See TPMS)  
 Probing Awls..... 313, 317  
 Racks & Displays..... 272-273  
 Rasps, Repair..... 313  
 Reamers..... 313  
 Regroovers & Accessories..... 110  
 Repair Cabinets..... 295, 302  
 Repair Patches..... 294-309  
 Repair Tools..... 318, 318  
 Rim Brushes..... 270  
 Sealants..... 109-110  
 Sealant Pump..... 109  
 Service Supplies..... 107-110  
 Service Tools..... 119-127  
 Sling..... 114  
 Spoons..... 119-120  
 Spreaders..... 319-320  
 Stands..... 130  
 Storage Bags..... 274  
 Studs..... 275  
 Swabs..... 107, 185  
 Tags..... 269  
 Talc..... 296, 303  
 Tire Repair..... 294-320  
 Tester Tanks..... 269, 278  
 Tool Station..... 62  
 Tread Depth Gauges..... 169, 173  
 Tube Patches .. 294, 299, 306, 308  
 Vacuums..... 316  
 Valve Caps..... 141, 155  
 Valve Caps, Large Bore..... 161  
 Valve Cores..... 141, 155  
 Valve Cores, Large Bore..... 161  
 Valve Extensions..... 167-169, 173  
 Valve Tools..... 132-134  
 Valves..... 150-167  
 Tire Dunker – CORGHI..... 320  
 TIRESAVER Nitrogen Top-Off Inflator. 26  
 TNT Tire Changing Tools..... 118  
 Toe Bar w/Scribe..... 257  
 Tool Covers,  
 Impact Wrenches..... 54, 62  
 Hand..... 268  
 Large Bore Valve..... 167  
 Probe Rasps..... 313, 317

Serial Number Removal..... 110  
 Sets, Spare Tire ..... 73  
 Station ..... 62  
 Valve Cores ..... 141, 155  
 Wheel Weight ..... 239  
**Tools,**  
 Alignment..... 258-260  
 Bits/Carbide Cutters ..... 210-211  
 Carbide Cutters..... 317  
 Tire Changing ..... 118-127, 129  
 Torque Extensions ..... 71  
 Torque Sockets ..... 69-70  
 Torque Wrenches ..... 69, 71, 74-75  
 Tough Scrub ..... 270  
**TPMS,**  
 Activation Tools ..... 136-138  
 Accessory Kits  
 Assortments ..... 139-140  
 Accessories ..... 141-144  
 Cabinets..... 147  
 Relearn Chart..... 135  
 Retrofit Kits ..... 148  
 Sensors/Transmitters..... 145-146  
 Trailer Systems..... 148  
 Training &  
 Promotional Materials ..... 149  
**TRACER PRODUCTS..... 290-292**  
**Tractor,**  
 Air/Liquid Valves..... 158  
 Tire Filling Pumps..... 117  
 Tire Pressure Gauges ..... 169  
 Tire Repair ..... 297-298, 301  
 Wheel Valve..... 158  
**Traffic Control Products ..... 283**  
**Trailer Alignment..... 255-256**  
**Trailer Tandem Tracker..... 257**  
**Transmission Jacks..... 98-100**  
**Tread Depth Gauges..... 169, 173**  
**Trim Knives ..... 318**  
**Trouble Lights..... 271**  
**TRU BALANCE..... 72**  
**Truck & Bus,**  
 Tubeless Tire Valves..... 151-154  
**Truck,**  
 4-Way Wrenches ..... 126  
 Air Compressors ..... 16-18, 20-23  
 Alignment..... 254-257  
 Automatic Hose Reels ..... 33-36  
 Axle Shims ..... 254  
 Brake Washer ..... 213  
 Centering Sleeves ..... 72  
 Cone Kits..... 195, 198-200  
 Drum & Disc Lathes..... 201-202  
 Impact Wrenches,  
 CHICAGO PNEUMATIC ..... 49-50  
 INGERSOLL-RAND ..... 57-58  
 Jacks..... 87-92  
 Lock Ring Removers..... 121  
 O-Rings..... 161  
 Oil Filter Crusher..... 282  
 Rim Clamps..... 78

Sav-A-Stud Rethreader ..... 73  
 Socket Sets &  
 Individual Sockets..... 64-65, 68  
 Turntables ..... 258  
 Valve Caps ..... 155  
 Valves, Replacement..... 151-154  
 Wheel Balancers ..... 191-193  
 Wheel Weights..... 234-236  
**Truck Tire,**  
 Balancers ..... 191-193  
 Bead Seaters..... 115-116  
 Cages ..... 130  
 Changers..... 180-181, 185-187  
 Changing Stand ..... 130  
 Hammers ..... 122-123  
 Inflators..... 174  
 Manual Spreaders ..... 320  
 Tools..... 118-127  
 Valve Tools ..... 167-169  
 Valve Extensions ..... 157, 162, 164  
 Truck Valve Extensions 157, 162, 164  
 Truck Wheel Dollies..... 101  
 Truck Wheel Weights ..... 234-236  
**TRUFLEX/PANG ..... 307**  
**Tube,**  
 Brushes..... 316  
 Buffers ..... 52, 60, 311  
 Deflators..... 167-169  
 Dunkers ..... 269, 278  
 Patches..... 294, 299, 306, 308  
**Tubeless,**  
 Tire Bead  
 Sealer..... 396, 303, 306, 310  
 Tire Changing Tools .. 118-127, 129  
 Tire Irons ..... 119-121  
 Tire Snap-In Valves ..... 150  
 Tire Tester Tanks..... 269, 278  
 Tire Valves, Large Bore..... 159-161  
 Truck Valves ..... 151-154  
 Truck Tire Mount/Demount  
 Tools..... 118-120, 129  
 Valve Tools ..... 167-169  
**Tune-Up and Repair Kits,**  
 Air Tools ..... 55, 62  
**Tungsten Carbide**  
 Rasps ..... 312, 316-317  
 Turntables ..... 258  
 Twisted Wire Brush..... 316  
 Twistsocket Kits ..... 73  
 Two-Post Lift..... 214-215

**U**

Uncoated Wheel Weights ..... 221-222  
 Under Hoist Stands..... 102  
 Uni-Wedge Shims ..... 254, 256  
 Universal Mounting Paste..... 107  
 Universal Patches 294, 299, 306, 308  
 UV Inspection Light..... 290-292

**V**

Vacuum Cleaner and Accessories . 316  
 Valve Accessories,  
 Air/Liquid..... 158  
 Adapter Gun, Chloride Pump..... 117  
 Adapters ..... 161  
 Breaker ..... 153  
 Caps..... 141, 155  
 Cores..... 141, 155  
 Chrome..... 155  
 Extensions..... 157, 162, 164  
 Fishing Tool..... 167-168  
 High Pressure ..... 150  
 Metric Truck ..... 151  
 Nut Torque Wrenches..... 154  
 Service Tools..... 167-169, 173  
 Snap-In..... 150  
 Truck & Bus ..... 151-154  
 Truck Breakers ..... 153  
 TPMS..... 145-146  
**Valve Caps,**  
 Air Water ..... 161  
 Chrome..... 155  
 Dome..... 155  
 Double Sealing..... 155  
 Heat Resisting..... 155  
 Hex Chrome..... 155  
 Inflate Through..... 155  
 Large Bore..... 161  
 Metal Dome ..... 155  
 Metal Screwdriver ..... 155, 161  
 Nitrogen ..... 26, 141, 155  
 Standard ..... 155  
 Tools..... 169  
 Truck ..... 155  
 TPMS..... 141  
**Valve Cores,**  
 Heat Resisting..... 155  
 Large Bore..... 161  
 Removing Tools ..... 167-169  
 Screwdrivers ..... 167-169  
 Wrench Large Bore ..... 167  
 TPMS..... 141  
**Valve Extensions,**  
 Bent..... 162  
 Flexible ..... 162  
 Straight ..... 157, 162  
**Valve Tools,**  
 Four-Way ..... 167-168  
 Large Bore..... 167  
 Rethreading ..... 167-168  
 Standard ..... 168-169  
 Tire ..... 167-169  
 Truck ..... 167-169  
 TPMS..... 141-142  
 Valve Nut Torque Wrench ..... 154  
 Variable Speed,  
 Buffer Grinders ..... 52, 60, 311  
 Drills..... 54, 60

Vehicle Lifts ..... 214-216  
 Vehicle Stands ..... 93-95  
 Ventilation/Exhaust  
 Removal Systems ..... 281  
 Vises ..... 268  
 Vulcanize-On Valves ..... 158, 294  
 Vulcanizers ..... 305  
 Vulcanizing Fluid .....  
 ..... 296, 303-304, 306, 310

**W**

Washers, Brake ..... 213  
 Waste Oil Drains ..... 276-280  
 Water Adapter Set ..... 158  
 Water Based Black Tire Paint ..... 328  
 Wedges ..... 123  
 Weights (See Wheel Weights)  
 Wheel,  
 Accessories ..... 76-80  
 Alignment Equipment ..... 255  
 Alignment Shims ..... 254-256  
 Arbor Adapters ..... 313, 316  
 Attaching Hardware ..... 76-78  
 Balancer Accessories ..... 195-200  
 Balancers ..... 189-193  
 Bolt & Nut Assortments ..... 76-78  
 Brushes ..... 270, 313, 316  
 Centering Tool Set ..... 72  
 Chocks ..... 283  
 Clamps ..... 78  
 Cover Pullers ..... 74, 124  
 Dollies ..... 101  
 Guards ..... 78  
 Lock Removal Set ..... 73  
 Lock Systems ..... 79-80  
 Rim Nuts ..... 76-77  
 Rim Studs ..... 76-77  
 Stud Accessories ..... 275  
 Studs ..... 275  
 Torque Products ..... 69-71, 74-75  
 Weights ..... 221-238  
 Weights, Adhesive ..... 230-233  
 Weights, Adhesive Remover ..... 239  
 Weights, Coated 221-224, 226-229  
 Weights,  
 Passenger ... 221-224, 226-229  
 Weights, Scraper ..... 239  
 Weights, Steel ... 226-229, 232-233  
 Weights, Truck ..... 234-236  
 Weights, Zinc ..... 226-229, 236  
 Weight Assortments ..... 237-238  
 Weight Tools ..... 239  
 Wheel & Brake Drum  
 Centering Sleeves ..... 72  
 Wheels, Tungsten Carbide ... 312, 317  
 Wheel Work Station ..... 62  
 WHEELCHECK ..... 71  
 Whip Hoses ..... 37

White Sidewall, Tire Brush ..... 270  
 Wicking Products ..... 327  
 WINNTEC ..... 90, 92  
 Wire,  
 Brushes ..... 270, 313, 316  
 Buffing Stones ..... 317  
 Carbide Tools ..... 317  
 Cord Grinders ..... 316  
 Grinding Stones ..... 317  
 Pull-Through ..... 299  
 Wooden Hammer Handles ..... 122  
 Work,  
 Gloves ..... 284  
 Station, Lifts ..... 217  
 Wrenches,  
 4-Ways ..... 126  
 Cap Nut & Pork Chop ..... 124  
 Truck ..... 125  
 Impact,  
 BlueTork ..... 51, 74  
 CHICAGO PNEUMATIC ..... 47-50  
 INGERSOLL-RAND ..... 56-58  
 Budd Nut ..... 124  
 Caster/Camber ..... 260  
 Lug ..... 126  
 Socket Valve Cap, Large Bore ... 167  
 Torque ..... 69, 71, 74-75  
 Woven Roll Wicking ..... 327  
 WYCO Flexible Shaft Buffers ..... 329

**X**

XTRA Seal ..... 308-310

**Z**

Zafety Locks ..... 72  
 Z-Bore Valve System ..... 166  
 Zinc Wheel Weights ..... 226-233  
 Zip Gun,  
 INGERSOLL-RAND ..... 59  
 Accessories ..... 55, 59





**101-00000**

101-00058	16	101-27553	22	101-71153	22	112-00162	32
101-00078	16	101-30000	23	101-73823	21	112-00262	32
101-00158	16	101-30346	20	101-73846	21	112-00352	32
101-01012	16	101-40580	16	101-75000	23	112-00353	32
101-02103	20	101-40581	16	101-75120	17	112-00354	32
101-02110	20	101-40582	16	101-75320	17	112-00376	32
101-02112	20	101-40583	16	101-75420	17	112-00378	32
101-02512	16	101-40780	16	101-78000	18	112-03910	32
101-08251	20	101-40781	16	101-80230	21	112-03912	32
101-08271	20	101-40782	16	101-80231	21	113-00352	32
101-10000	23	101-40783	16	101-80232	21	113-00353	32
101-10325	17	101-41012	16	101-80234	21	113-00354	32
101-11012	16	101-41112	16	101-80271	21	113-00376	32
101-12023	21	101-41512	16	101-80460	21	113-01352	32
101-12103	20	101-42112	16	101-80461	21	113-01353	32
101-12208	21	101-42512	16	102-11530	17	113-01354	32
101-12221	21	101-43112	16	102-11560	17	114-00754	30
101-12222	21	101-43512	16	102-11880	17	114-03352	30
101-12230	20	101-44112	16	102-13730	17	114-03353	30
101-12231	20	101-44512	16	102-13760	17	114-03354	30
101-12232	20	101-45112	16	102-13780	17	114-13352	30
101-12460	20	101-50000	23	102-21130	20	114-13353	30
101-12461	20	101-51120	17	102-21131	20	114-13354	30
101-15000	23	101-51800	21	102-21230	20	114-75200	30
101-15320	20	101-53120	17	102-21330	20	114-75201	30
101-15323	20	101-53208	21	102-21860	20	114-75202	30
101-15346	20	101-53230	21	102-24125	22	114-75203	30
101-18251	20	101-53460	21	102-24212	22	114-75300	30
101-20000	23	101-53823	21	105-00015	19	114-75301	30
101-20320	20	101-53846	21	105-00025	19	114-75302	30
101-20323	20	101-54120	17	105-00035	19	114-75303	30
101-20346	20	101-58000	18	105-00050	19	114-75400	30
101-20812	21	101-61012	18	105-00075	19	114-75401	30
101-21208	21	101-61080	18	105-00100	19	114-75402	30
101-21230	21	101-61081	18	105-00125	19	114-75403	30
101-21231	21	101-61212	18	105-00150	19	115-50508	31
101-21232	21	101-61512	18	106-24305	22	115-50810	31
101-23246	20	101-61513	18	106-24710	22	115-50812	31
101-23451	22	101-61580	18	106-24712	22	115-55200	31
101-23530	21	101-65120	18	106-30020	22	115-55201	31
101-23531	21	101-65121	18	111-30002	31	115-55300	31
101-24160	20	101-65600	18	111-32908	31	115-55301	31
101-24621	21	101-65601	18	111-35200	31	115-55400	31
101-24705	22	101-65800	18	111-35201	31	115-55401	31
101-24751	22	101-65801	18	111-35202	31	115-57601	31
101-25000	23	101-67512	18	111-35203	31	117-00010	29
101-25323	20	101-67513	18	111-35300	31	117-05304	29
101-25346	20	101-67514	18	111-35301	31	117-05702	29
101-25452	22	101-67515	18	111-35302	31	117-09132	29
101-27323	20	101-67560	18	111-35303	31	119-00015	25
101-27346	20	101-67561	18	111-35400	31	119-00018	26
101-27550	22	101-67580	18	111-35401	31	119-00021	24
101-27551	22	101-67581	18	111-35402	31	119-00051	24
101-27552	22	101-67582	18	111-35403	31	119-00060	25
		101-67583	18	111-37600	31	119-00076	24
		101-71150	22	111-37601	31	119-00115	25



NUMERIC INDEX

119-00120	27	125-83512	33	128-72025	36	135-00980	40
119-00123	24	125-85012	33	129-01010	42	135-16000	113
119-00215	25	126-00425	35	131-02514	40	135-16050	113
119-00485	27	126-00450	35	131-02516	40	135-16060	113
119-00685	27	126-01450	35	131-08888	38	135-61240	40
119-08914	26	126-03850	36	131-17000	40	135-61241	40
121-51210	37	126-03851	36	131-18000	40	136-00344	42
121-51225	37	126-03852	36	131-61471	39	136-00366	42
121-51250	37	126-03853	36	131-61486	38	136-00398	42
121-51255	37	126-05850	33	131-61523	38	136-00401	42
121-51450	37	126-07850	33	131-61524	38	136-00403	42
121-51500	37	126-07851	33	131-61526	38	136-00406	42
121-51510	37	126-08500	33	131-61527	38	136-00408	42
121-51525	37	126-08501	33	131-61528	38	136-00604	42
121-51550	37	126-21120	34	131-61529	38	136-00606	42
121-55210	37	126-21121	34	131-61538	38	136-00608	42
121-55225	37	126-31120	34	131-61539	38	136-00806	42
121-55250	37	126-31121	34	131-61548	38	136-00808	42
121-55510	37	126-31180	34	131-61550	38	136-00812	42
121-55525	37	126-42500	34	131-61551	38	136-00813	42
121-55550	37	126-42501	35	131-61573	39	136-00818	42
123-00412	37	126-43000	35	131-61574	39	136-01344	42
123-00425	37	126-43500	34	131-61578	39	136-01366	42
123-00450	37	126-43501	35	131-61579	39	136-02344	42
123-00625	37	126-45000	34	132-03716	40	136-02366	42
123-00650	37	126-45003	35	132-03718	40	136-03344	42
124-04435	33	126-52500	34	132-61476	39	136-34490	42
124-04500	33	127-01310	36	132-61478	39	137-00324	43
124-07450	33	127-01313	36	132-61480	39	137-00344	43
124-13500	34	127-01314	36	132-61481	39	137-00346	43
124-15000	34	127-04425	37	132-61553	39	137-00366	43
124-33500	34	127-04450	37	132-61554	39	137-00388	43
124-45014	33	127-04625	37	132-61558	39	137-00389	43
124-65138	33	127-04650	37	132-61559	39	137-00418	43
125-00325	35	127-05880	34	133-01855	39	137-00419	43
125-00350	35	127-06425	37	133-05012	40	137-00420	43
125-03650	36	127-06450	37	133-05018	40	137-00439	43
125-03665	36	127-06625	37	133-17030	40	137-00520	43
125-04625	33	127-06650	37	133-61474	39	137-00620	43
125-05450	33	127-08425	37	133-61563	39	137-00621	43
125-05635	33	127-08450	37	133-61564	39	137-00623	43
125-05650	33	127-37240	37	133-61568	39	137-00624	43
125-06350	33	127-37720	37	133-61569	39	137-00625	43
125-06500	33	127-44100	37	133-75112	40	137-00828	43
125-06501	33	127-46100	37	133-75116	40	137-00855	44
125-07650	33	127-59720	37	134-61487	40	137-01324	43
125-07651	33	127-59820	37	134-61543	40	137-01342	43
125-07652	33	127-59920	37	134-61544	40	137-01344	43
125-07670	33	127-64100	37	134-61545	40	137-01346	43
125-32500	35	127-66100	37	134-61552	40	137-01348	43
125-33502	35	127-84100	37	135-00023	40	137-01364	43
125-35000	34	128-20000	42	135-00123	40	137-01368	43
125-35002	35	128-72021	36	135-00900	40	137-01389	43
125-35004	34	128-72022	36	135-00901	40	137-01418	43
125-55000	34	128-72023	36	135-00910	40	137-01439	43
125-65038	33	128-72024	36	135-00911	40	137-01520	43



137-01621	43	153-00828	51	155-07774	47	157-14038	311
137-01623	43	153-01734	48	155-07775	50	157-16010	311
137-01624	43	153-02135	56	155-07778	47	157-16520	311
137-08532	44	153-02135	57	155-07971	47	157-17802	60
137-08550	43	153-02312	56	155-07976	50	157-17803	60
137-08551	43	153-02442	56	155-08676	47	157-78926	54
137-08561	44	153-03602	61	155-17756	47	158-00311	60
137-08563	44	153-07332	48	155-17786	47	158-00317	60
137-08564	44	153-07492	47	155-21710	58	158-00319	60
137-08565	44	153-07492	48	155-21906	58	158-00778	50
137-08567	44	153-07749	47	155-21916	58	158-00871	52
137-08568	44	153-07749	48	155-28560	58	158-00871	311
137-08569	44	153-07828	51	155-50000	47	158-00873	52
137-10010	36	153-07828	52	155-67775	50	158-00873	311
137-10011	36	153-07830	52	155-77746	47	158-03012	60
137-11520	43	153-08281	52	155-77756	47	158-07202	50
137-11621	43	153-12135	56	155-77786	47	159-00132	59
137-11623	43	153-17492	48	155-79716	47	162-27211	142
137-39525	44	1153-21350	57	156-02901	58	162-27212	142
137-50291	44	153-21352	57	156-02931	58	163-01018	67
137-72421	44	153-21353	57	156-02951	58	163-01019	67
137-73215	44	153-77492	47	156-07992	47	163-01021	67
137-73225	44	153-77492	48	156-28006	58	163-01024	67
137-73235	44	154-00259	56	156-28566	58	163-01026	67
137-73255	44	154-00259	57	156-79716	50	163-01030	67
137-73265	44	154-00261	56	157-00125	59	163-01032	67
137-73275	44	154-00261	57	157-00302	59	163-01033	67
137-73285	44	154-00772	47	157-00308	59	163-01034	67
137-73295	44	154-00772	49	157-00313	60	163-01036	67
137-73305	44	154-01772	47	157-00326	60	163-01048	67
137-73315	44	154-01772	49	157-00327	60	163-01150	64
137-73325	44	154-02141	56	157-00327	60	163-01151	64
137-73335	44	154-02141	57	157-00327	311	163-01152	64
137-73345	44	154-02613	57	157-00789	54	163-01153	64
137-73355	44	154-02616	57	157-00874	52	163-02668	66
137-85610	44	154-07763	47	157-00875	53	163-02669	66
151-00825	51	154-07763	49	157-00876	53	163-02849	66
151-00826	51	154-21617	57	157-00879	54	163-05153	64
151-00828	52	154-77636	47	157-01875	53	163-10100	67
151-07823	51	154-77636	49	157-03012	60	163-10101	67
152-00212	56	155-00271	56	157-04038	311	163-10111	67
152-00231	56	155-00280	58	157-06010	311	163-10120	67
152-00724	47	155-00285	56	157-06520	311	163-10121	67
152-00828	52	155-00290	56	157-06550	311	163-10130	67
152-02115	56	155-00290	58	157-07120	52	163-10131	67
152-07722	47	155-00293	56	157-07300	54	163-10140	67
152-07735	47	155-00293	58	157-07301	54	163-10141	67
152-07824	51	155-00295	56	157-07302	54	163-10142	67
152-07828	52	155-00295	58	157-07500	53	163-10143	67
152-07830	52	155-00796	47	157-07554	53	163-10150	67
153-00231	56	155-00796	49	157-07556	53	163-10151	67
153-00244	56	155-02161	56	157-07562	53	163-10160	67
153-00380	61	155-02190	58	157-07563	53	163-10161	67
153-00650	61	155-02806	58	157-07802	60	163-10162	67
153-00733	48	155-02856	58	157-07803	60	163-10163	67
153-00734	48	155-07633	49	157-07856	53	163-10170	67



NUMERIC INDEX

163-10171	67	164-02044	68	165-30321	68	168-12065	71
163-10172	67	164-02046	68	165-30361	68	168-12080	71
163-10180	67	164-02052	68	165-30362	68	168-12100	71
163-10181	67	164-02056	68	165-30380	68	168-12120	71
163-10182	67	164-02060	68	165-30381	68	168-12140	71
163-10190	67	164-02110	64	165-30401	68	168-12250	71
163-10191	67	164-02181	64	165-30402	68	168-12410	71
163-10200	67	164-02185	65	165-30410	68	168-12412	71
163-10201	67	164-02323	68	165-30420	68	168-12414	71
163-10210	67	164-04626	65	165-30481	68	168-12450	71
163-10211	67	164-20260	68	165-30482	68	168-12465	71
163-10220	67	164-20270	68	165-30483	68	168-12480	71
163-10221	67	164-20271	68	166-04026	68	168-13000	71
163-10222	67	164-20300	68	166-04033	68	168-16000	71
163-10223	67	164-20301	68	166-04034	68	168-21755	70
163-10230	67	164-20330	68	166-04035	68	168-21780	70
163-10240	67	164-20350	68	166-04038	68	168-21910	70
163-10241	67	164-20360	68	166-04040	68	168-21965	70
163-10260	67	164-20401	68	166-04041	68	168-21980	70
163-10261	67	164-20402	68	166-04042	68	168-22180	70
163-10262	67	164-20480	68	166-04048	68	168-22212	70
163-10263	67	164-20481	68	166-04323	68	168-22214	70
163-10270	67	164-20482	68	166-40360	68	168-22610	70
163-10271	67	165-03017	68	166-40361	68	168-23014	70
163-10280	67	165-03019	68	166-40480	68	168-38325	142
163-10281	67	165-03020	68	167-12050	64	168-47501	74
163-10282	67	165-03021	68	167-12110	142	168-47534	74
163-10300	67	165-03026	68	167-12179	67	168-60001	74
163-10320	67	165-03027	68	167-12460	67	168-60034	74
163-10340	67	165-03030	68	167-12461	67	168-72100	142
163-10360	67	165-03033	68	167-12490	67	168-72120	142
163-10400	67	165-03034	68	167-12510	67	168-75001	74
163-10401	67	165-03035	68	167-12910	67	168-75034	74
163-91217	71	165-03041	68	167-12911	67	169-01002	142
163-91219	71	165-03042	68	167-12912	67	169-01003	68
163-91221	71	165-03044	68	168-01200	75	169-01005	68
163-91234	71	165-03046	68	168-01501	142	169-01020	68
163-91236	71	165-03052	68	168-01942	154	169-02006	68
163-91278	71	165-03054	68	168-02100	75	169-02010	68
163-91278	71	165-03056	68	168-02101	75	169-02013	68
164-02017	67	165-03060	68	168-02880	70	169-02013	74
164-02019	67	165-03110	65	168-03250	75	169-02030	68
164-02020	67	165-03190	65	168-03251	75	169-03006	68
164-02021	67	165-03197	65	168-03252	75	169-03010	68
164-02024	67	165-03321	68	168-04400	75	169-03013	68
164-02026	67	165-03323	68	168-05600	75	169-03013	74
164-02028	67	165-03517	68	168-07600	51	169-03020	68
164-02030	67	165-03820	68	168-07600	74	169-04010	68
164-02032	67	165-04191	65	168-07601	51	169-04020	68
164-02033	67	165-05626	65	168-07601	74	169-12006	71
164-02034	67	165-30280	68	168-07602	51	169-20100	68
164-02035	68	165-30281	68	168-07602	74	171-01151	59
164-02036	68	165-30300	68	168-07603	51	171-01161	59
164-02038	68	165-30301	68	168-07603	74	171-01171	59
164-02041	68	165-30302	68	168-10042	154	171-47032	55
164-02042	68	165-30320	68	168-10100	154	171-47050	55





NUMERIC INDEX

231-23191	247	231-44511	252	241-10430	254	243-00848	254
231-23192	247	231-44532	252	241-10440	254	243-00891	254
231-23193	247	231-44535	252	241-10450	254	243-00892	254
231-23194	247	231-44536	252	241-10460	254	243-00893	254
231-23199	247	231-44537	252	241-10470	254	243-00894	254
231-23211	247	231-44594	252	241-10510	254	243-00895	254
231-23212	247	231-56500	247	241-10520	254	243-00896	254
231-23220	247	231-56501	247	241-10530	254	243-00897	254
231-23221	247	231-56502	247	241-10540	254	243-00898	254
231-23222	247	231-56503	247	241-10550	254	246-18880	257
231-23223	247	231-56504	247	241-10560	254	246-18910	257
231-23224	247	231-56505	247	241-10570	254	246-35001	255
231-23225	247	231-56506	247	241-10610	254	246-35002	255
231-23226	247	231-56507	247	241-10620	254	246-35003	255
231-23227	247	231-56508	247	241-10630	254	246-35004	255
231-23228	247	231-56509	247	241-10640	254	246-35005	255
231-23229	247	231-56510	247	241-10650	254	246-35006	255
231-23230	247	231-56511	247	241-10660	254	246-35007	255
231-23231	247	231-56512	247	241-10670	254	246-35010	255
231-23232	247	231-56513	247	241-10710	254	246-35011	255
231-23233	247	231-56514	247	241-10720	254	246-35012	255
231-23234	247	231-63020	248	241-10730	254	246-35020	255
231-23235	247	231-63030	248	241-10740	254	246-35021	255
231-23236	247	231-66501	246	241-10750	254	246-35022	255
231-23237	247	231-66502	246	241-10760	254	246-35030	255
231-23238	247	231-66503	246	241-10770	254	246-35031	255
231-23239	247	231-66504	246	241-10780	254	246-35032	256
231-23580	249	231-66505	246	241-35001	254	246-35033	255
231-23755	249	231-66506	246	241-35002	254	246-35040	255
231-23765	249	231-66507	246	241-35003	254	246-35041	255
231-42949	252	231-66508	246	241-35004	254	246-35042	255
231-42951	252	231-66509	246	241-35005	254	246-35060	255
231-42952	252	231-66511	246	241-35006	254	246-35061	255
231-42953	252	231-66512	246	241-35007	254	246-35062	255
231-42954	252	231-66513	246	241-35010	256	246-35070	255
231-42955	252	231-86250	249	241-35011	256	246-35071	255
231-42956	252	231-87310	248	241-35012	256	246-35072	255
231-42957	252	231-87385	248	241-35020	256	246-36000	255
231-42958	252	231-87400	248	241-35021	256	246-36010	255
231-42959	252	231-87500	248	241-35022	256	246-36011	255
231-42960	252	233-23120	253	241-35070	256	246-36012	255
231-42961	252	233-23130	253	241-35071	256	246-51100	257
231-42962	252	236-00100	250	241-35072	256	247-08130	258
231-42963	252	236-45938	258	241-36010	256	247-18410	257
231-42964	252	236-77350	258	241-36011	256	247-18440	257
231-44499	252	236-88928	252	241-36012	256	247-33173	259
231-44501	252	237-23510	249	241-36080	257	247-51200	257
231-44502	252	237-23520	249	241-36085	257	247-74910	258
231-44503	252	237-23530	249	241-36087	257	247-77880	253
231-44504	252	237-23540	249	243-00841	254	247-83795	259
231-44505	252	241-04050	254	243-00842	254	251-87910	260
231-44506	252	241-05050	254	243-00843	254	251-88260	245
231-44507	252	241-06050	254	243-00844	254	251-88270	245
231-44508	252	241-07050	254	243-00845	254		
231-44509	252	241-10410	254	243-00846	254		
231-44510	252	241-10420	254	243-00847	254		

301-00000



301-01201	83	302-25057	85	302-93511	94	311-64650	268
301-01220	83	302-25125	85	302-93512	94	311-64800	268
301-02200	83	302-27037	85	302-93524	95	311-77101	267
301-02201	83	302-28045	96	302-93526	95	311-77102	267
301-10120	84	302-28047	96	302-93642	87	311-77103	267
301-10125	84	302-29025	85	302-93652	87	311-77172	267
301-10128	84	302-31500	102	302-93657	88	312-11006	271
301-10129	84	302-31501	102	302-93659	96	312-12006	271
301-10200	84	302-32035	93	302-93660	88	312-12010	271
301-10205	84	302-32065	93	302-93662	88	312-40351	35
301-10208	84	302-32066	93	302-93667	88	312-40352	35
301-10209	84	302-32075	94	302-93731	89	312-40353	35
301-18122	85	302-32105	94	302-93733	89	312-40501	35
301-18125	85	302-32107	94	302-93735	91	312-40502	35
301-18202	85	302-32125	93	304-00009	215	312-40503	35
301-18205	85	302-32126	93	304-00010	214	312-45453	35
301-18209	85	302-32225	94	304-00110	215	316-00507	44
301-18302	85	302-33020	102	304-00120	215	316-00709	44
301-41020	84	302-35000	86	304-01103	214	316-00911	44
301-41040	84	302-35001	86	305-40001	216	316-01098	44
301-41060	84	302-35002	86	305-40150	216	316-01113	44
301-41080	84	302-42030	87	305-40151	216	316-01315	44
301-41150	84	302-42032	87	305-41200	216	316-01518	44
301-41200	84	302-42225	87	307-00006	218	316-01720	44
301-41201	84	302-42250	87	307-01020	218	316-01922	44
301-41300	84	302-43201	90	308-00016	218	316-02023	44
301-43220	84	302-43202	89	308-00018	218	316-02225	44
301-76412	83	302-43225	92	308-82925	97	316-02327	44
301-76502	83	302-45125	94	308-82950	97	316-91098	44
301-76503	83	302-71202	87	308-82999	97	317-78000	103
301-76505	83	302-71232	87	308-93690	97	317-78013	103
301-76508	83	302-71500	87	308-93693	97	317-78021	103
301-76512	83	302-72036	96	308-93737	97	317-78022	103
301-76520	83	302-72081	88	309-02002	214	317-78055	103
301-76530	83	302-72091	88	309-10264	217	317-78056	103
301-76550	83	302-72200	91	309-10310	217	317-78057	103
301-76820	83	302-72204	92	309-14464	85	317-78058	103
302-00015	86	302-72206	92	309-14465	85	317-78110	103
302-00020	86	302-72212	92	309-61240	217	317-78111	103
302-00030	86	302-72218	92	309-72501	99	318-04120	113
302-00050	86	302-72225	92	309-72502	99	318-04960	113
302-00224	90	302-72244	92	309-72504	99	318-09795	113
302-20000	86	302-81004	93	309-72505	99	318-09796	113
302-22050	88	302-81006	93	309-72506	99	318-09797	113
302-22051	88	302-81007	93	309-72507	99	318-09798	113
302-22100	88	302-81022	102	309-72508	99	318-09799	113
302-22101	88	302-81033	102	309-72517	99	318-09866	113
302-22201	88	302-81034	102	309-72525	99	318-11020	112
302-23221	91	302-81035	102	309-93291	102	318-11090	112
302-23222	91	302-81208	93	309-93294	102	318-13000	113
302-23301	91	302-81209	93	309-94418	217	318-13080	113
302-23401	91	302-81210	93	309-99700	217	318-13120	113
302-23501	91	302-81222	95	311-21500	268	318-13140	113
302-25025	85	302-93200	90	311-63200	268	318-15000	112
302-25030	85	302-93503	95	311-64055	268	318-15010	112
302-25037	85	302-93506	95	311-64065	268	318-15020	112



NUMERIC INDEX

318-15920	112	322-24026	279	341-22120	263	371-72001	98
318-15930	112	322-24034	279	341-70000	263	371-72050	98
318-15940	112	322-24037	279	341-81200	263	371-72501	98
318-15950	112	322-30015	276	342-10000	266	371-72550	98
319-00010	61	322-30054	277	342-10001	266	371-72701	99
319-00144	61	322-30055	277	343-12000	263	371-93718	99
319-00192	61	322-30056	277	344-06026	264	371-93720	100
319-00357	268	322-30057	277	344-06034	264	372-00100	288
319-00435	268	322-30058	277	344-06250	264	391-00125	266
319-00436	268	322-30059	277	351-03860	138	391-00130	266
319-00437	317	322-30063	277	361-00980	287	391-00140	266
319-00447	317	322-30064	277	361-09010	289	391-00225	266
319-00526	268	322-30065	277	361-34288	286	391-00230	266
319-19800	268	322-30066	277	361-34788	286	391-00240	266
319-72521	142	322-30067	277	361-34988	286	391-00325	266
319-96091	73	322-32006	277	361-78012	287	391-00330	266
319-96090	73	322-32007	277	361-78134	287	391-00340	266
319-96092	73	322-32010	277	364-16912	286	391-00350	266
319-96093	73	322-41110	276	364-17630	286	391-00425	266
319-96094	73	323-52006	276	364-17663	286	391-00430	266
319-96095	73	323-52007	276	364-17678	286	391-05100	281
319-96096	73	323-52008	276	364-34430	286	391-15250	266
319-96097	73	324-11213	276	364-34724	286	391-15300	266
319-96098	73	328-05001	108	366-00715	292	391-15350	266
322-00100	280	328-05003	108	366-00930	292	391-15400	266
322-00125	278	328-05005	108	366-00946	292	391-20030	266
322-00200	278	328-10001	62	366-08620	291	391-20040	266
322-00201	278	329-00505	282	366-08621	291	391-20050	266
322-00250	278	329-11211	276	366-08626	292	391-20060	266
322-00251	278	329-11212	276	366-08627	292	391-21025	266
322-00300	278	329-11329	277	366-08640	291	391-21030	266
322-00301	278	329-18110	282	366-08647	291	391-21040	266
322-00350	278	329-18685	282	366-08690	291	391-22030	266
322-00500	278	329-24031	278	366-09364	290	391-22040	266
322-00650	278	329-61101	282	366-09365	290	391-22050	266
322-00750	278	329-61102	282	366-09366	290	391-22150	266
322-00800	280	329-64102	282	366-16900	289	391-22160	266
322-01000	278	329-64105	282	366-16910	289	391-52500	266
322-01821	282	329-93249	279	366-45111	289	391-53000	266
322-02444	278	331-78106	104	366-51105	292	391-54000	266
322-02500	280	331-78204	104	366-51110	292	391-90250	267
322-02501	280	331-78600	104	367-00100	288	391-90300	267
322-02700	280	331-78605	104	368-00201	288	391-90350	267
322-10022	276	341-03000	263	368-00202	288	391-90400	267
322-10023	276	341-06001	264	369-07610	289	391-90475	267
322-17892	278	341-06002	264	369-09742	290	391-90575	267
322-17922	278	341-06003	265	369-09749	290	391-90600	267
322-17942	278	341-06006	264	369-09790	291	391-90606	267
322-17952	278	341-06007	265	369-09841	290	391-91000	267
322-19452	278	341-06019	264	369-10001	287	391-91250	267
322-19822	278	341-06030	263	371-41000	100	391-91300	267
322-20015	277	341-06058	265	371-41001	100	391-93000	267
322-24014	279	341-06225	264	371-42000	100	392-00803	283
322-24016	279	341-09410	265	371-42003	100	392-00812	283
322-24019	279	341-09425	265	371-43000	100	392-00813	283
322-24020	279	341-12500	263	371-72000	98	392-00814	283







NUMERIC INDEX

416-01175	203	416-06920	203	417-02761	204	418-40608	210
416-01180	203	416-06921	203	417-02780	204	418-40609	210
416-02160	207	416-06922	203	417-02780	205	418-40610	210
416-02170	205	416-06930	203	417-02850	213	418-40630	210
416-02800	203	416-06936	204	417-06456	213	418-41410	210
416-03085	204	416-06950	203	417-06459	213	418-41415	210
416-03086	204	416-07670	203	417-06469	213	418-41420	210
416-03087	204	416-07900	203	417-06478	213	418-41430	210
416-03101	205	416-07996	204	417-06479	213	418-41435	210
416-03102	205	416-08740	211	417-06496	213	418-69142	210
416-03106	207	416-08750	211	417-07300	212	418-69146	210
416-03107	207	416-08756	211	417-07301	212	418-76812	210
416-03108	207	416-08756	209	417-07304	212	418-76816	210
416-03109	207	416-08800	206	417-07306	212	419-01450	213
416-03110	207	416-08888	206	417-07307	212	421-00004	116
416-03123	207	416-08889	206	417-07308	212	421-00098	121
416-03125	207	416-08899	204	417-07309	212	421-00100	121
416-03127	205	416-08994	208	417-07313	212	421-38620	127
416-03148	204	416-08995	208	417-07314	212	422-10103	111
416-03178	207	416-09183	203	417-07326	212	422-11000	111
416-03191	209	416-09192	207	417-07330	212	422-11010	111
416-03192	209	416-09193	207	417-07331	212	422-11040	111
416-03193	209	416-09194	207	417-07332	212	422-11060	111
416-03194	209	416-09195	207	417-07335	212	422-11070	112
416-03229	209	416-09196	207	417-07374	212	422-12000	111
416-03460	209	416-09197	209	417-08500	205	422-12020	111
416-03481	208	416-09198	209	417-08501	205	422-12070	111
416-03491	208	416-09232	207	417-08539	205	422-12090	111
416-03577	209	416-09233	206	417-08545	205	422-12110	111
416-03578	209	416-09234	209	417-08650	213	422-13010	113
416-03581	209	416-09249	204	417-09582	213	422-13020	113
416-03590	209	416-09263	207	417-09582	205	422-13030	113
416-03900	206	416-09265	207	417-15107	213	422-13040	113
416-03902	207	416-09310	209	417-18989	212	422-13050	113
416-03903	207	416-09311	209	417-85391	205	422-13060	113
416-03904	207	416-09312	209	417-94127	205	422-13090	113
416-04282	204	416-09313	209	418-04114	210	422-13100	113
416-04732	209	416-09399	208	418-04725	210	422-16200	111
416-04775	208	416-09481	204	418-04728	210	422-22903	112
416-04776	209	416-09489	207	418-05392	210	422-22905	112
416-04777	209	416-09490	207	418-06610	210	424-35327	123
416-04778	209	416-09492	206	418-06610	211	424-35329	123
416-04779	209	416-09499	208	418-06700	211	424-35427	123
416-04781	209	416-09590	204	418-06914	210	424-35429	123
416-04782	209	416-09708	205	418-06999	210	424-35460	123
416-04783	209	416-09800	203	418-07692	210	425-35105	122
416-04784	209	416-09921	207	418-07999	210	425-35321	122
416-04785	209	416-09922	207	418-09872	210	425-35323	122
416-04786	209	416-10650	204	418-10701	210	425-35325	122
416-04790	207	416-10651	204	418-10702	210	425-35421	122
416-05280	203	416-11154	204	418-40410	210	425-35423	122
416-05290	203	416-23682	204	418-40415	210	425-35425	122
416-05380	209	416-25882	205	418-40420	210	426-35110	123
416-05393	204	416-41412	205	418-40425	210	426-35310	123
416-05722	209	416-90980	203	418-40430	210	426-35311	122
416-05795	206	417-02760	204	418-40435	210	426-35317	122



426-35331	123	432-00751	107	444-00312	184	447-09343	188
426-35332	123	432-01750	107	444-00347	184	447-09344	188
426-35333	123	432-02012	107	444-00768	184	447-09345	188
426-35334	123	432-02022	107	444-01221	183	447-09346	188
426-35335	123	432-02028	107	444-01701	184	447-09764	188
426-35337	123	432-02029	107	444-02927	184	447-10449	188
426-35411	122	432-02035	107	444-06568	184	447-10842	188
426-35417	122	433-35805	108	444-06637	184	447-10843	188
426-37003	123	434-02020	107	444-07156	184	447-10851	188
426-37004	123	434-02105	107	444-07686	184	447-10852	188
426-37103	123	434-02110	107	444-07764	184	447-20082	188
427-00041	121	434-02120	107	444-07790	184	447-20334	188
427-00042	121	435-00015	107	444-08043	183	447-20564	188
427-00052	121	435-00125	107	444-08311	184	447-83495	188
427-26000	121	435-01120	107	444-08313	184	447-83803	188
427-35924	121	435-06001	107	444-08397	184	447-83950	188
427-35926	121	435-06002	107	444-08398	184	447-85545	185
428-37302	123	435-06003	107	444-18312	183	448-00100	118
428-37304	123	435-06004	107	444-35685	183	448-00101	118
428-37308	123	435-07001	107	444-56345	183	448-00200	118
428-37310	123	435-07002	107	444-56361	183	448-00201	118
428-37312	123	435-08001	107	444-56462	183	448-00202	118
428-37316	123	435-08002	107	444-70200	185	448-00301	118
428-37320	123	435-08003	107	444-70201	185	448-01008	118
429-00441	114	437-00001	185	444-70205	185	448-01009	118
429-01601	114	437-00002	107	444-70206	185	448-01101	87
429-06661	114	437-00002	185	444-81131	183	448-10010	118
429-08074	115	437-00003	185	444-81257	183	448-10011	118
429-08075	115	437-00491	107	444-81329	184	448-12880	118
429-08076	115	437-20366	107	444-81329	183	448-12883	118
429-08077	115	441-00220	127	444-81354	183	448-12884	118
429-08837	114	441-00230	127	444-81891	184	448-12886	118
429-10108	114	441-38600	127	444-82788	183	448-12892	118
429-15250	115	441-38601	127	444-82963	183	448-12893	118
429-15255	115	442-04050	177	444-83061	183	448-12894	118
429-15260	115	443-00500	180	444-83275	183	448-12897	118
429-35111	122	443-02520	214	444-83401	183	448-12898	118
429-35113	122	443-20000	177	444-83585	183	448-12899	118
429-35119	122	443-20242	181	444-83604	183	448-12900	118
429-35127	122	443-26000	181	444-83604	183	448-12901	118
429-35129	122	443-50350	177	444-83605	183	448-12902	118
429-35206	122	443-50400	177	444-83606	183	448-12902	118
429-35211	122	443-50401	177	444-83621	185	448-12903	118
429-35219	122	443-50650	177	444-84432	183	448-12904	118
429-35227	122	443-50651	177	444-84590	183	448-12905	118
429-35229	122	443-50651	177	444-84926	183	448-12909	118
429-35229	122	443-70600	177	444-84958	183	448-22886	118
429-35230	123	443-70601	177	444-89408	183	448-22894	118
429-35529	122	443-70650	177	446-05000	185	448-32886	118
429-90401	114	443-70651	177	446-06000	186	448-32894	118
429-90402	114	443-80101	178	446-06330	187	451 00203	242
429-90403	114	443-80102	178	446-09043	186	451-00005	109
432-00720	107	443-85606	178	446-09551	186	451-00006	109
432-00730	107	443-90101	178	446-10000	181	451-00026	109
432-00731	107	443-90102	178	446-56000	180	451-00036	109
432-00740	107	443-91500	180	447-09249	188	451-00040	240
432-00750	107	443-91501	180	447-09342	188	451-00041	240



NUMERIC INDEX

451-00042	240	455-12500	110	461-01055	146	461-20398	145
451-00043	240	458-00002	275	461-01056	146	461-28004	145
451-00044	240	458-00005	275	461-01057	146	461-28006	145
451-00045	240	458-00010	275	461-01058	146	461-28078	145
451-00055	109	458-00011	275	461-01059	146	461-28129	145
451-00101	109	458-00500	275	461-01068	146	461-28154	145
451-00150	242	458-00911	275	461-01203	146	461-28155	145
451-00155	109	458-03810	275	461-01204	146	461-28167	145
451-00200	242	458-03820	275	461-01205	146	461-28203	145
451-00201	242	458-04048	275	461-01206	146	461-28204	145
451-00202	242	459-54220	108	461-01207	146	461-28210	145
451-00204	242	459-54221	108	461-01208	146	461-28214	145
451-00205	242	459-54222	108	461-01209	146	461-28291	145
451-00206	242	459-80222	108	461-01210	146	461-28300	145
451-00208	242	459-80223	108	461-01211	146	461-28305	145
451-00210	242	459-80225	108	461-01212	146	461-28310	145
451-00212	242	459-80226	108	461-01416	150	461-28315	145
451-00214	242	459-80227	108	461-01600	150	461-28320	145
451-00216	242	459-80228	108	461-09001	146	461-28325	145
451-00248	109	459-80229	108	461-09002	146	461-28335	145
451-00250	242	459-80230	108	461-09003	146	461-28345	145
451-00255	109	459-80231	108	461-09004	146	461-28355	145
451-00300	242	459-80232	108	461-09005	146	461-28360	145
451-00400	242	459-80250	108	461-09007	146	461-28365	145
451-00440	109	459-80257	108	461-09011	146	461-28370	145
451-00500	242	459-80258	108	461-09012	146	461-28380	145
451-00550	109	459-80271	108	461-10001	146	461-28395	145
451-00640	109	459-85000	108	461-10002	146	461-28670	145
451-00707	109	459-85100	108	461-10003	146	461-28720	145
451-01248	109	461-00412	150	461-10005	146	461-28849	145
451-01640	109	461-00413	150	461-10007	146	461-28982	145
451-02640	109	461-00414	150	461-11048	144	461-28983	145
451-04128	109	461-00415	150	461-11048	146	461-41211	150
451-05510	110	461-00418	150	461-11204	146	461-41311	150
451-06000	242	461-00423	150	461-20028	145	461-41811	150
451-07000	242	461-00425	150	461-20034	145	461-59307	141
451-07001	240	461-00600	150	461-20064	145	461-59337	141
451-07003	240	461-00602	150	461-20066	145	461-59357	141
451-09000	242	461-00801	150	461-20069	145	461-59387	141
451-14128	109	461-00802	150	461-20076	145	462-00416	150
451-24128	109	461-01027	146	461-20081	145	462-00417	153
454-00599	169	461-01028	146	461-20082	145	462-00430	152
454-01410	173	461-01029	146	461-20087	145	462-00523	152
454-01420	169	461-01041	146	461-20096	145	462-00800	150
454-05124	169	461-01042	146	461-20107	145	462-01147	152
454-05131	173	461-01043	146	461-20115	145	462-01224	152
454-05800	170	461-01044	146	461-20116	145	462-01416	154
455-00003	110	461-01046	146	461-20117	145	462-01575	154
455-00401	110	461-01047	146	461-20131	145	462-01600	153
455-00402	110	461-01048	144	461-20135	145	462-02416	153
455-00403	110	461-01048	146	461-20153	145	462-03416	153
455-00404	110	461-01049	146	461-20156	145	462-04100	151
455-00405	110	461-01051	146	461-20158	145	462-05010	152
455-00406	110	461-01052	146	461-20161	145	462-06008	152
455-00444	110	461-01053	146	461-20315	145	462-06010	150
455-04444	110	461-01054	146	461-20335	145	462-06020	150



462-06027	151	464-00139	117	465-00522	159	465-05112	162
462-06030	150	464-00139	158	465-00524	167	465-05200	162
462-06040	150	464-00140	117	465-00535	159	465-05410	162
462-07025	151	464-00140	158	465-00546	159	465-05420	162
462-08027	151	464-00141	117	465-00552	159	465-05922	162
462-09027	151	464-00141	158	465-00558	159	465-06702	161
462-11527	151	464-00142	117	465-00563	159	465-06703	161
462-16008	152	464-00142	158	465-00570	162	465-06911	160
463-00500	151	464-00143	117	465-00573	159	465-07103	162
463-00501	151	464-00143	158	465-00582	159	465-07536	167
463-00509	151	464-00144	117	465-00585	162	465-07601	162
463-00510	151	464-00144	158	465-00650	159	465-07602	162
463-00511	151	464-00145	117	465-00651	159	465-07940	162
463-00542	151	464-00145	158	465-00652	159	465-07949	162
463-00543	151	464-00146	117	465-00653	159	465-08018	162
463-00544	151	464-00146	158	465-00654	159	465-08019	162
463-00545	151	464-00208	160	465-00655	159	465-08852	162
463-00546	151	464-00208	163	465-00656	159	465-09440	162
463-00570	151	464-00208	165	465-00657	159	465-09470	162
463-00571	151	464-00209	163	465-00658	159	465-09903	162
463-00572	151	464-00216	160	465-00659	159	465-10760	163
463-00573	151	464-00216	165	465-00660	159	465-10761	163
463-00574	151	464-00310	117	465-00662	159	465-10762	163
463-00575	151	464-00310	158	465-00663	159	465-10763	163
463-01078	152	464-00618	158	465-00664	159	465-10764	163
463-01175	152	464-00619	158	465-00665	159	465-10780	163
463-01177	152	464-00621	158	465-00666	159	465-10781	163
463-01544	151	464-00622	158	465-00668	159	465-10782	163
463-01571	154	464-00623	158	465-00670	161	465-11411	160
463-01572	154	464-00718	158	465-00671	161	465-11455	160
463-01573	154	464-01025	158	465-00690	160	465-11750	163
463-05433	151	464-01091	158	465-00691	160	465-11751	163
463-05434	151	464-01451	158	465-00692	160	465-11752	163
463-05435	151	464-01452	158	465-00693	160	465-11790	163
463-05444	151	464-01618	158	465-00694	160	465-11791	163
463-05454	151	464-10001	158	465-00695	160	465-11792	163
463-05464	151	464-10912	158	465-00696	160	465-30045	159
463-05465	151	464-10913	158	465-00702	159	465-30060	167
463-05474	151	465-00042	167	465-00702	161	465-33031	167
463-10001	154	465-00144	161	465-00710	159	465-33069	167
463-10572	154	465-00145	161	465-00994	160	465-40000	163
463-10573	154	465-00148	161	465-01014	163	465-40001	159
463-15454	151	465-00149	161	465-01418	159	465-40001	163
463-54636	151	465-00385	160	465-01450	162	465-40002	159
464-00015	158	465-00390	160	465-03009	159	465-40003	159
464-00030	158	465-00400	160	465-04510	159	465-40004	159
464-00134	117	465-00431	159	465-04512	159	465-40005	159
464-00134	158	465-00446	159	465-04513	159	465-40006	159
464-00135	117	465-00454	159	465-04524	159	465-40007	159
464-00135	158	465-00455	159	465-04530	159	465-45105	159
464-00136	117	465-00456	167	465-04532	159	465-70125	159
464-00136	158	465-00458	159	465-04536	159	465-70255	159
464-00137	117	465-00479	159	465-04645	159	465-70280	159
464-00137	158	465-00506	159	465-04745	159	465-70285	159
464-00138	117	465-00507	159	465-04985	162	465-71090	159
464-00138	158	465-00520	167	465-05008	162	465-72212	159



NUMERIC INDEX

465-72280	159	465-86187	162	468-00006	158	468-00650	141
465-73212	159	465-86225	162	468-00009	158	468-00660	155
465-75010	162	465-86245	162	468-00010	158	468-00680	141
465-75035	162	465-97711	160	468-00050	141	468-00680	155
465-75040	162	465-97755	160	468-00100	161	468-00690	141
465-75045	162	465-00661	159	468-00101	167	468-00690	155
465-75080	162	465-00667	159	468-00102	155	468-00707	151
465-75090	162	466-00200	165	468-00103	151	468-00765	151
465-75115	162	466-00296	165	468-00103	155	468-00765	155
465-75120	162	466-00525	164	468-00150	167	468-00798	156
465-75135	162	466-00529	164	468-00151	161	468-00808	157
465-75160	162	466-00625	164	468-00201	158	468-01001	141
465-75170	162	466-00660	164	468-00203	158	468-01120	299
465-75175	162	466-00675	164	468-00207	26	468-04361	156
465-75180	162	466-00685	164	468-00207	155	468-05005	155
465-75185	162	466-00800	165	468-00216	158	468-05093	151
465-75190	162	466-00850	163	468-00307	26	468-05405	151
465-75205	162	466-00851	163	468-00307	151	468-05405	155
465-75210	162	466-00860	164	468-00330	157	468-05952	151
465-75215	162	466-00890	165	468-00331	157	468-05953	151
465-75225	162	466-00910	165	468-00341	157	468-05954	151
465-75235	162	466-00918	164	468-00346	157	468-06116	156
465-75245	162	466-01050	165	468-00347	157	468-06300	141
465-75250	162	466-01066	165	468-00348	157	468-06541	155
465-75295	162	466-01538	165	468-00349	157	468-07572	151
465-75320	162	466-01543	165	468-00350	157	468-07572	155
465-75610	159	466-01850	165	468-00356	157	468-07607	156
465-81080	162	466-01870	165	468-00370	157	468-08007	161
465-81090	162	466-03000	164	468-00371	157	468-08028	157
465-81100	162	466-04000	165	468-00372	157	468-08500	155
465-81200	162	466-05000	165	468-00373	157	468-09305	141
465-81250	162	466-05310	164	468-00381	157	468-10002	154
465-81320	162	466-06190	164	468-00382	157	468-10004	157
465-81400	162	466-07910	165	468-00383	157	468-10011	157
465-86015	162	466-08860	165	468-00389	157	468-10013	157
465-86020	162	466-50910	160	468-00390	157	468-10015	157
465-86025	162	466-70001	166	468-00391	157	468-10017	157
465-86030	162	466-70002	166	468-00392	157	468-10019	157
465-86032	162	466-70004	166	468-00393	157	468-10039	157
465-86033	162	466-70010	166	468-00394	157	468-10046	157
465-86040	162	466-70012	166	468-00395	157	468-10054	157
465-86045	162	466-70013	166	468-00396	157	468-10060	151
465-86050	162	466-70375	166	468-00397	157	468-10060	157
465-86059	162	466-70380	166	468-00399	156	468-10070	151
465-86060	162	466-70390	166	468-00400	156	468-10117	157
465-86067	162	466-70700	166	468-00401	156	468-11700	157
465-86072	162	466-70701	166	468-00402	156	468-16541	155
465-86077	162	466-76000	164	468-00440	155	468-20055	141
465-86080	162	466-96900	164	468-00462	151	468-20495	141
465-86085	162	466-96901	164	468-00556	156	468-20595	141
465-86090	162	467-00009	302	468-00580	167	468-20695	141
465-86100	162	467-00019	302	468-00607	26	468-26541	155
465-86107	162	467-00218	158	468-00607	151	468-30007	157
465-86120	162	467-00220	158	468-00632	155	468-30010	157
465-86125	162	467-00914	302	468-00634	167	468-36801	157
465-86160	162	467-00916	158	468-00635	141	468-36803	157



468-40007	157	469-01097	140	469-20008	141	469-89111	142
468-40010	157	469-01098	140	469-20009	139	471-20100	116
468-43607	26	469-01100	140	469-20010	139	471-20101	116
468-50661	157	469-01110	140	469-20010	140	471-20200	116
468-50663	157	469-01115	168	469-20011	139	471-20202	116
468-59019	26	469-01124	168	469-20012	139	471-20204	116
468-59019	141	469-01130	140	469-20013	139	471-31432	116
468-59021	26	469-01426	144	469-20014	139	471-31433	116
468-59021	141	469-01440	169	469-20015	139	471-80001	161
468-59023	141	469-01502	148	469-20016	139	471-80002	161
468-59765	150	469-01504	148	469-20017	139	471-80003	161
468-99393	150	469-01610	167	469-20018	139	471-80004	161
469-00001	168	469-01710	167	469-20018	141	471-80005	161
469-00002	168	469-01810	167	469-20019	139	471-80006	161
469-00003	168	469-01910	167	469-20020	139	471-80007	161
469-00004	168	469-02010	135	469-20020	140	471-80008	161
469-00005	168	469-02020	141	469-20025	140	471-80009	161
469-00010	167	469-02040	140	469-20030	139	471-80010	161
469-00011	168	469-02311	109	469-20030	140	471-80011	161
469-00018	168	469-02312	109	469-20031	139	471-80012	161
469-00020	168	469-02723	144	469-20032	139	471-80014	161
469-00021	143	469-03200	137	469-20035	139	471-80015	161
469-00021	168	469-03333	168	469-20036	139	471-80016	161
469-00033	168	469-03866	138	469-20097	139	471-80017	161
469-00040	168	469-05105	144	469-20140	143	471-80018	161
469-00044	142	469-05112	147	469-20144	142	471-80019	161
469-00081	168	469-05262	168	469-20190	147	471-80020	161
469-00131	173	469-05415	143	469-20250	142	471-80021	161
469-00132	173	469-05500	137	469-20256	148	471-80022	161
469-00133	173	469-06900	167	469-20257	148	471-80023	161
469-00134	173	469-06950	167	469-20597	139	471-80024	161
469-00567	168	469-07011	149	469-21230	136	471-80025	161
469-00580	153	469-07100	140	469-22006	149	471-80125	161
469-00590	153	469-08100	143	469-22008	139	471-80129	161
469-00607	168	469-08909	167	469-23430	168	471-80133	161
469-00609	168	469-08910	143	469-30000	140	471-80135	161
469-00612	169	469-09250	140	469-30001	136	471-80139	161
469-00625	169	469-09251	140	469-32755	147	471-80145	161
469-00630	169	469-09252	140	469-32756	147	471-80149	161
469-00631	167	469-09304	140	469-35934	153	471-80151	161
469-00632	169	469-09305	140	469-35935	153	471-80157	161
469-00633	169	469-09305	141	469-35936	153	471-80163	161
469-00680	167	469-11120	140	469-40001	136	471-80169	161
469-00950	140	469-15105	144	469-43002	168	471-80215	161
469-00950	141	469-15407	168	469-52000	169	471-80225	161
469-00992	168	469-19318	144	469-52001	169	471-80449	161
469-01026	144	469-19320	144	469-54151	143	471-80451	161
469-01030	140	469-19322	144	469-61589	149	471-80457	161
469-01031	140	469-19860	143	469-61599	149	471-80463	161
469-01040	140	469-20002	139	469-71985	137	471-80469	161
469-01050	140	469-20003	139	469-71990	137	472-31710	124
469-01060	140	469-20004	139	469-71991	137	472-31810	124
469-01070	140	469-20005	139	469-71992	137	473-00010	115
469-01080	140	469-20006	139	469-71993	137	473-00011	115
469-01090	140	469-20007	139	469-71998	137	473-00012	115
469-01096	140	469-20008	139	469-71999	137	473-00013	115

473-00500	115	476-10115	169	478-03300	128	482-09877	192
473-00501	115	476-10120	169	478-03300	172	482-10400	197
473-00880	116	476-10125	169	478-03301	172	482-10785	192
473-31440	127	476-10130	169	478-03330	172	482-10785	200
473-36004	130	476-10135	170	478-03370	172	482-10786	192
473-36016	129	476-10140	169	478-04500	172	482-10786	200
473-36017	129	476-10145	169	478-04660	173	482-10905	197
474-21371	116	476-10150	169	478-05265	172	482-11021	197
474-21372	116	476-10155	170	478-05451	172	482-11087	197
474-21373	116	476-10160	169	478-06190	173	482-11088	197
474-21374	116	476-10165	170	478-06585	172	482-11480	197
474-21375	116	476-10185	170	478-10013	173	482-11515	197
474-31303	116	476-10240	173	479-02130	130	482-11934	197
474-31401	116	476-10250	173	479-02260	130	482-13113	195
474-31701	116	476-10255	173	479-06160	130	482-13120	197
475-00010	117	476-10500	170	479-36001	130	482-13121	195
475-00891	128	476-11048	170	479-36002	130	482-13122	195
475-00892	128	476-11048	171	479-36003	130	482-13122	197
475-00893	128	476-11135	170	479-36005	130	482-13206	196
475-00894	128	476-11155	170	479-36006	130	482-13207	196
475-00895	128	476-11185	170	479-36011	130	482-13208	196
475-00896	128	476-15038	170	479-36015	130	482-13209	196
475-01891	128	476-17285	171	481-00061	191	482-13210	195
475-01892	128	477-00001	174	481-00071	190	482-13211	196
475-01893	128	477-00002	174	481-00088	190	482-13212	196
475-01894	128	477-00003	174	481-00101	193	482-13214	196
475-01895	128	477-00004	174	481-00212	191	482-13215	196
475-01896	128	477-00005	174	481-00430	193	482-13216	196
475-01897	128	477-00008	174	481-00501	191	482-13217	196
475-01898	128	477-00009	174	481-00525	191	482-13218	196
475-10509	117	477-00010	174	481-00775	190	482-13219	196
475-11590	117	477-00012	174	481-00950	189	482-13224	195
475-18001	117	477-00408	174	481-00951	189	482-13465	195
475-59005	128	477-00409	174	481-00952	189	482-13637	195
475-89001	128	477-01116	174	481-00953	189	482-13689	196
475-89003	128	477-01117	174	481-01175	189	482-13692	196
475-89004	128	477-01119	174	481-01800	189	482-13695	196
475-89106	128	477-10001	174	481-01850	189	482-13699	196
476-00211	171	477-10003	174	481-06275	191	482-13702	196
476-00274	170	478-00001	172	481-06401	192	482-13705	196
476-00285	171	478-00305	172	481-86401	192	482-13708	196
476-00289	170	478-00315	172	481-86403	192	482-13711	196
476-00290	170	478-00322	173	482-00501	192	482-13714	196
476-00541	171	478-00325	172	482-08605	192	482-13717	196
476-00941	171	478-00326	173	482-08628	192	482-13720	196
476-01046	171	478-00328	173	482-08629	192	482-13723	196
476-05600	171	478-00335	172	482-08630	192	482-13791	196
476-05601	171	478-00340	172	482-08631	192	482-13792	196
476-07233	173	478-00360	128	482-08639	192	482-13807	197
476-07275	171	478-00377	173	482-08642	192	482-13835	197
476-07285	171	478-00707	172	482-08645	192	482-13836	197
476-08500	171	478-01335	172	482-08646	192	482-13841	197
476-08860	171	478-01340	172	482-09011	197	482-13842	197
476-10100	169	478-01350	172	482-09608	192	482-14335	195
476-10105	169	478-02985	172	482-09618	192	482-14337	195
476-10110	169	478-02995	172	482-09791	200	482-14338	195





482-14339	195	482-83040	196	483-13309	199	484-21430	231
482-14341	195	482-83041	200	483-13343	197	484-21624	230
482-14343	195	482-83042	200	483-60639	199	484-30360	230
482-14392	197	482-83057	200	484-00005	233	484-30360	232
482-19877	200	482-83058	200	484-00010	233	484-30361	230
482-43622	192	482-83059	200	484-00012	230	484-30836	233
482-43935	192	482-83060	199	484-00015	233	484-31210	233
482-43935	200	482-83061	199	484-00020	233	484-31220	233
482-44064	197	482-83061	200	484-00025	233	484-31230	231
482-56394	197	482-83062	200	484-00030	233	484-31230	233
482-56467	197	482-83140	197	484-00035	233	484-31231	231
482-59998	197	482-83160	200	484-00040	233	484-31232	232
482-80028	197	482-83210	196	484-00045	233	484-31233	232
482-80040	197	482-83276	199	484-00050	233	484-31248	231
482-80128	197	482-83277	199	484-00060	232	484-31252	231
482-80140	196	482-83279	199	484-00075	238	484-31430	231
482-80228	197	482-83280	199	484-00150	238	484-31431	232
482-80285	196	482-83326	199	484-00175	238	484-31432	232
482-80287	196	482-83330	199	484-00250	238	484-31460	231
482-80328	197	482-83520	198	484-00275	238	484-31461	232
482-80405	196	482-83687	198	484-00288	232	484-31462	232
482-80407	196	482-83795	198	484-00300	232	484-32210	233
482-80785	200	482-83796	198	484-01201	231	484-32220	233
482-80786	200	482-83797	198	484-01500	238	484-32230	233
482-81028	196	482-83798	198	484-02101	231	484-32252	232
482-81040	197	482-83799	198	484-03101	230	484-32252	233
482-81242	198	482-83940	198	484-03200	232	484-33230	233
482-81539	198	482-84000	195	484-05101	231	484-33252	232
482-81821	198	482-84393	200	484-06001	230	484-33252	233
482-81827	200	482-84444	198	484-07025	231	484-34210	233
482-81828	199	482-85085	199	484-07026	231	484-34220	233
482-81828	200	482-85087	197	484-07125	231	484-34230	233
482-81829	200	482-85336	198	484-07126	231	484-34252	233
482-81850	199	482-85337	198	484-07127	230	484-35210	233
482-81850	200	482-85338	198	484-07500	232	484-35220	233
482-81851	200	482-85339	198	484-09025	231	484-35252	233
482-81853	200	482-85340	198	484-09065	231	484-35310	233
482-81935	198	482-85856	199	484-09101	231	484-35320	233
482-81983	200	482-85906	199	484-09165	231	484-40300	230
482-81984	200	482-85907	199	484-09405	231	484-41215	231
482-81987	200	482-85908	199	484-09901	231	484-41226	233
482-82028	196	482-85909	199	484-10361	230	484-41230	231
482-82040	196	482-85945	200	484-10362	230	484-41231	232
482-82140	197	482-89950	200	484-10363	230	484-41232	232
482-82420	198	483-08105	199	484-10364	230	484-42215	232
482-82800	195	483-10542	199	484-10365	230	484-43215	232
482-82828	200	483-10544	199	484-10366	230	484-50300	230
482-82935	198	483-11433	199	484-10367	230	484-50301	230
482-82952	200	483-11434	199	484-10368	230	484-51215	231
482-82982	200	483-12012	199	484-10720	230	484-52215	232
482-82984	200	483-12102	199	484-11360	230	484-53215	232
482-82985	200	483-12106	199	484-13360	230	484-61215	231
482-83028	196	483-12382	199	484-18022	240	484-61280	231
482-83032	200	483-13082	197	484-18024	240	484-61281	232
482-83033	200	483-13167	197	484-20624	230	484-62215	232
482-83034	200	483-13308	199	484-20624	232	484-63215	232



NUMERIC INDEX

484-70261	233	487-16150	221	488-14055	229	488-22020	222
484-70262	233	487-16175	221	488-14060	229	488-22025	222
484-70263	233	487-16200	221	488-15025	229	488-22030	222
484-70264	233	487-16225	221	488-15050	229	488-22035	222
486-00011	239	487-16250	221	488-15075	229	488-22040	222
486-00133	239	487-16275	221	488-15100	229	488-22045	222
486-00233	239	487-16300	221	488-15125	229	488-22050	222
486-00360	238	487-18025	221	488-15150	229	488-22055	222
486-01000	237	487-18050	221	488-15175	229	488-22060	222
486-02000	237	487-18075	221	488-15200	229	488-23005	221
486-07129	239	487-18100	221	488-15225	229	488-23010	221
486-07500	239	487-18125	221	488-15250	229	488-23015	221
486-08110	238	487-18150	221	488-15275	229	488-23020	221
486-09110	238	487-18175	221	488-15300	229	488-23025	221
486-10500	223	487-18200	221	488-17025	221	488-23030	221
486-14604	223	487-18225	221	488-17050	221	488-23035	221
486-17110	238	487-18250	221	488-17075	221	488-23040	221
486-19110	238	487-18275	221	488-17100	221	488-23045	221
486-20110	238	487-18300	221	488-17125	221	488-23050	221
486-21280	237	487-21005	222	488-17150	221	488-23055	221
486-21285	237	487-21010	222	488-17175	221	488-23060	221
486-22110	238	487-21015	222	488-17200	221	488-23065	221
486-23110	238	487-21020	222	488-17225	221	488-23070	221
486-33580	239	487-21025	222	488-17250	221	488-23075	221
486-33584	239	487-21030	222	488-17275	221	488-23080	221
486-71510	239	487-21035	222	488-17300	221	488-24025	222
486-75001	239	487-21040	222	488-19025	221	488-24050	222
486-75002	239	487-21045	222	488-19050	221	488-24075	222
486-75003	239	487-21050	222	488-19075	221	488-24100	222
486-75017	239	487-21055	222	488-19100	221	488-24125	222
486-75032	239	487-21060	222	488-19125	221	488-24150	222
487-12025	224	488-02075	238	488-19150	221	488-24175	222
487-12050	224	488-13025	229	488-19175	221	488-24200	222
487-12075	224	488-13050	229	488-19200	221	488-24200	236
487-12100	224	488-13075	229	488-19225	221	488-24225	222
487-12125	224	488-13100	229	488-19250	221	488-24250	222
487-12150	224	488-13125	229	488-19275	221	488-24275	222
487-12175	224	488-13150	229	488-19300	221	488-24300	222
487-12200	224	488-13175	229	488-19325	221	488-24300	236
487-12225	224	488-13200	229	488-19350	221	488-24400	236
487-12250	224	488-13225	229	488-19375	221	488-24500	236
487-12275	224	488-13250	229	488-19400	221	488-24600	236
487-12300	224	488-13275	229	488-20005	222	488-25005	222
487-12325	224	488-13300	229	488-20010	222	488-25010	222
487-12350	224	488-13325	229	488-20015	222	488-25015	222
487-12375	224	488-13350	229	488-20020	222	488-25020	222
487-12400	224	488-14005	229	488-20025	222	488-25025	222
487-12450	224	488-14010	229	488-20030	222	488-25030	222
487-12500	224	488-14015	229	488-20035	222	488-25035	222
487-12550	224	488-14020	229	488-20040	222	488-25040	222
487-12600	224	488-14025	229	488-20045	222	488-25045	222
487-16025	221	488-14030	229	488-20050	222	488-25050	222
487-16050	221	488-14035	229	488-20055	222	488-26005	228
487-16075	221	488-14040	229	488-20060	222	488-26010	228
487-16100	221	488-14045	229	488-22010	222	488-26015	228
487-16125	221	488-14050	229	488-22015	222	488-26020	228



488-26025	228	488-32010	227	488-45055	223	488-78225	226
488-26030	228	488-32015	227	488-45060	223	488-78250	226
488-26035	228	488-32020	227	488-46010	224	488-78275	226
488-26040	228	488-32025	227	488-46015	224	488-78300	226
488-26045	228	488-32030	227	488-46020	224	488-81005	223
488-26050	228	488-32035	227	488-46025	224	488-81010	223
488-26055	228	488-32040	227	488-46030	224	488-81015	223
488-26060	228	488-32045	227	488-46035	224	488-81020	223
488-27005	228	488-32050	227	488-46040	224	488-81025	223
488-27010	228	488-32055	227	488-46045	224	488-81030	223
488-27015	228	488-32060	227	488-46050	224	488-81035	223
488-27020	228	488-33005	227	488-46055	224	488-81040	223
488-27025	228	488-33010	227	488-46060	224	488-81045	223
488-27030	228	488-33015	227	488-50000	238	488-81050	223
488-27035	228	488-33020	227	488-64025	229	488-81055	223
488-27040	228	488-33025	227	488-64050	229	488-81060	223
488-27045	228	488-33030	227	488-64075	229	488-81065	223
488-27050	228	488-33035	227	488-64100	229	488-81070	223
488-27055	228	488-33040	227	488-64125	229	488-81075	223
488-27060	228	488-33045	227	488-64150	229	488-81080	223
488-28025	226	488-33050	227	488-64175	229	488-82025	224
488-28050	226	488-33055	227	488-64200	229	488-82050	224
488-28075	226	488-33060	227	488-64225	229	488-82075	224
488-28100	226	488-34005	227	488-64250	229	488-82100	224
488-28125	226	488-34010	227	488-74025	229	488-82125	224
488-28150	226	488-34015	227	488-74050	229	488-82150	224
488-28175	226	488-34020	227	488-74075	229	488-82175	224
488-28200	226	488-34025	227	488-74100	229	488-82200	224
488-28225	226	488-34030	227	488-74125	229	488-82225	224
488-28250	226	488-34035	227	488-74150	229	488-82250	224
488-28275	226	488-34040	227	488-74175	229	488-82275	224
488-28300	226	488-34045	227	488-74200	229	488-82300	224
488-29025	226	488-34050	227	488-74225	229	489-02020	234
488-29050	226	488-34055	227	488-74250	229	489-02030	234
488-29075	226	488-34060	227	488-74275	229	489-02040	234
488-29100	226	488-42005	227	488-74300	229	489-02060	234
488-29125	226	488-42010	227	488-77025	226	489-02080	234
488-29150	226	488-42015	227	488-77050	226	489-02100	234
488-29175	226	488-42020	227	488-77075	226	489-02120	234
488-29200	226	488-42025	227	488-77100	226	489-02140	234
488-29225	226	488-42030	227	488-77125	226	489-02160	234
488-29250	226	488-42035	227	488-77150	226	489-04020	235
488-29275	226	488-42040	227	488-77175	226	489-04030	235
488-29300	226	488-42045	227	488-77200	226	489-04040	235
488-30050	223	488-42050	227	488-77225	226	489-04060	235
488-30075	223	488-42055	227	488-77250	226	489-04080	235
488-30100	223	488-42060	227	488-77275	226	489-04100	235
488-30125	223	488-45010	223	488-77300	226	489-04120	235
488-30150	223	488-45015	223	488-78025	226	489-05005	234
488-30175	223	488-45020	223	488-78050	226	489-05010	234
488-30200	223	488-45025	223	488-78075	226	489-05015	234
488-30225	223	488-45030	223	488-78100	226	489-05020	234
488-30250	223	488-45035	223	488-78125	226	489-05025	234
488-30275	223	488-45040	223	488-78150	226	489-05030	234
488-30300	223	488-45045	223	488-78175	226	489-05035	234
488-32005	227	488-45050	223	488-78200	226	489-05040	234



NUMERIC INDEX

489-05045	234	489-21200	236	491-00066	77	491-04020	77
489-05050	234	489-21250	236	491-00123	78	491-04021	77
489-05060	234	489-21300	236	491-00133	76	491-06012	77
489-06010	234	489-21350	236	491-00149	77	491-06014	77
489-06020	234	489-21400	236	491-00233	78	491-06020	77
489-06030	234	489-21450	236	491-00235	78	491-06021	77
489-06040	234	489-21500	236	491-00238	78	491-06023	77
489-06050	234	489-22100	236	491-00257	78	491-06024	77
489-06060	234	489-22150	236	491-00304	76	491-06025	77
489-08025	235	489-22200	236	491-00306	76	491-06026	77
489-08050	235	489-22250	236	491-00399	78	491-06115	78
489-08075	235	489-22300	236	491-00654	77	491-09013	77
489-08100	235	489-22350	236	491-00708	76	491-09014	77
489-08125	235	489-22400	236	491-00709	76	491-09015	77
489-08150	235	489-22500	236	491-00716	77	491-11111	149
489-08175	235	489-22600	236	491-00729	78	491-21355	149
489-08200	235	489-23100	236	491-00881	76	491-21357	149
489-08225	235	489-23200	236	491-00888	76	491-32111	72
489-08250	235	489-23300	236	491-00889	76	491-32120	72
489-08275	235	489-23400	236	491-00891	76	491-32121	72
489-08300	235	489-23500	236	491-00892	76	491-32124	72
489-08325	235	489-23600	236	491-00896	76	492-04200	73
489-08350	235	489-29025	228	491-00897	76	492-04300	73
489-08375	235	489-29050	228	491-00978	76	492-04400	73
489-08400	235	489-29075	228	491-00993	78	492-06427	80
489-08425	235	489-29100	228	491-00995	76	492-10001	80
489-08450	235	489-29125	228	491-01304	76	492-10002	80
489-08475	235	489-29150	228	491-01306	76	492-10134	80
489-08500	235	489-29175	228	491-01306	76	492-10151	80
489-09020	234	489-29175	228	491-01573	72	492-10158	80
489-09030	234	489-29200	228	491-01896	76	492-10159	80
489-09040	234	489-29225	228	491-01897	76	492-10180	80
489-09060	234	489-29250	228	491-01978	76	492-10196	80
489-09080	234	489-29275	228	491-01995	76	492-10196	80
489-09100	234	489-29300	228	491-02408	77	492-10340	80
489-09120	234	489-55010	235	491-02431	77	492-10580	80
489-10020	236	489-55020	235	491-02445	77	492-10780	80
489-10030	236	489-55030	235	491-03001	77	492-14000	80
489-10040	236	489-55040	235	491-03002	77	492-15000	80
489-10060	236	489-55050	235	491-03004	77	492-30165	125
489-10080	236	489-55060	235	491-03005	77	493-30100	73
489-19025	228	489-55080	235	491-03083	78	493-30125	73
489-19050	228	489-55100	235	491-03087	78	493-30200	73
489-19075	228	489-55120	235	491-03096	78	493-30300	73
489-19100	228	489-55140	235	491-03097	78	494-01010	108
489-19125	228	489-55160	235	491-03098	78	494-08907	108
489-19150	228	491-00014	77	491-03099	78	494-08916	108
489-19175	228	491-00016	77	491-03101	78	494-08930	108
489-19200	228	491-00027	77	491-03103	78	495-00103	69
489-19225	228	491-00033	76	491-03104	78	495-00304	70
489-19250	228	491-00052	77	491-03104	78	495-00305	70
489-19275	228	491-00053	78	491-03113	78	495-00306	70
489-19300	228	491-00055	77	491-03271	78	495-00307	70
489-21050	236	491-00056	77	491-03279	78	495-00308	70
489-21100	236	491-00062	77	491-03960	78	495-00308	70
489-21150	236	491-00064	77	491-04009	77	495-00309	70
		491-00065	77	491-04012	77	495-00310	70
				491-04013	77	495-00311	70





NUMERIC INDEX

532-06020	304	537-06012	313	538-30600	314	539-06313	312
532-06021	304	537-06014	313	538-30800	314	539-06314	312
533-01120	317	537-06019	313	538-31000	314	539-06315	312
533-01140	317	537-06022	313	538-31200	314	539-06316	312
533-01141	317	537-10565	313	538-31400	314	539-06317	312
533-01180	317	537-15224	313	538-50100	315	539-06360	312
533-01181	317	537-15225	313	538-50300	315	539-06361	312
533-01381	317	537-15226	313	538-50500	315	539-06410	312
533-01516	317	537-15227	313	538-50700	315	539-06411	312
533-01716	317	537-15230	313	538-50900	315	539-06412	312
533-01732	317	537-15232	313	538-51100	315	539-06413	312
534-80001	317	537-17276	313	538-55100	315	539-06414	312
534-80005	317	537-17277	313	538-55300	315	539-06415	312
534-80015	317	537-36560	313	538-60100	315	539-06416	312
534-80024	317	537-95893	313	538-60160	315	539-06417	312
534-80036	317	538-00150	314	538-60300	315	539-10001	317
534-80037	317	538-01150	315	538-60360	315	539-10116	312
534-80115	317	538-01152	315	538-61100	315	539-10136	312
534-80136	317	538-01160	315	538-61300	315	539-10160	312
534-80137	317	538-01162	315	538-61360	315	539-10416	312
535-00150	270	538-10000	314	538-61900	315	539-10436	312
535-08014	316	538-10011	315	538-62000	315	539-10460	312
535-08034	316	538-10013	315	538-62100	315	539-10916	312
535-08044	316	538-10200	314	538-62500	315	539-10936	312
535-08075	316	538-10400	314	538-62600	315	539-10960	312
535-08085	316	538-10700	314	538-62700	315	539-11016	312
535-13533	316	538-10760	314	538-63500	315	539-11036	312
535-15322	316	538-10900	314	538-63530	315	539-11060	312
535-15443	316	538-10936	314	538-70600	315	539-15616	312
535-15463	316	538-11100	314	538-70650	315	539-15636	312
535-15533	316	538-11200	314	538-70800	315	539-15816	312
535-15543	316	538-11400	314	538-70850	315	539-15836	312
535-15563	316	538-11600	314	538-71400	315	539-16316	312
535-21072	316	538-11800	314	538-71600	315	539-16336	312
535-21073	316	538-12000	314	539-00033	316	539-16416	312
535-21074	316	538-12200	314	539-00788	316	539-16436	312
535-21076	316	538-12600	314	539-02203	312	539-16516	312
535-35070	316	538-12658	314	539-02204	312	539-16536	312
535-35240	316	538-12800	314	539-02205	312	539-17616	312
535-35250	316	538-12858	314	539-02206	312	539-17636	312
535-70179	316	538-12900	314	539-02207	312	539-80002	329
536-00001	317	538-13000	314	539-02208	312	539-80003	329
536-02910	317	538-13017	314	539-02209	312	539-80012	329
537-00001	317	538-13023	314	539-02210	312	539-80013	329
537-00004	317	538-15000	314	539-02211	316	541-00400	299
537-00005	317	538-15020	314	539-02212	316	541-00410	299
537-00027	313	538-15040	314	539-02213	316	541-00420	299
537-00028	313	538-15100	314	539-02214	316	541-00430	299
537-00045	313	538-15200	314	539-02217	316	541-00440	299
537-00575	313	538-15400	314	539-02218	316	541-00450	299
537-00585	313	538-15412	314	539-02241	312	541-00460	299
537-00795	316	538-15600	314	539-06260	312	541-00470	299
537-00798	316	538-15612	314	539-06261	312	541-00471	299
537-02240	313	538-20011	315	539-06310	312	541-00472	299
537-02241	313	538-30200	314	539-06311	312	541-00473	299
537-06010	313	538-30400	314	539-06312	312	541-00474	299



541-00480	299	561-11498	309	568-05400	301	575-00531	300
541-00501	294	561-11499	309	568-05410	301	575-00533	300
541-00502	294	562-00501	298	568-05600	301	575-00535	300
541-00503	294	562-00502	298	568-05610	301	575-00537	300
541-00504	294	562-00503	298	568-05800	301	575-00539	300
541-00505	294	562-00504	298	568-05810	301	575-00541	300
541-00506	294	562-00505	298	569-00090	302	575-00543	300
541-00507	294	562-00506	298	569-00560	302	575-00545	300
541-00508	294	562-00507	298	569-00561	302	575-00547	300
541-00509	294	562-00508	298	569-00571	302	575-00549	300
541-00510	294	562-00509	298	569-00581	302	575-05109	297
541-00511	294	562-00510	298	571-00010	302	575-05110	297
541-00513	294	562-00511	298	571-00100	302	575-05111	297
541-00522	294	562-26006	301	571-11115	308	575-05112	297
541-00533	294	562-26013	301	571-11116	308	575-05113	297
541-00544	294	562-26020	301	571-11307	308	575-05114	297
541-05218	294	562-26037	301	571-11309	308	575-05115	297
541-11000	308	562-26044	301	571-11311	308	575-05119	297
541-11001	308	562-26051	301	571-11312	308	575-05120	297
541-11002	308	562-26068	301	571-11313	308	575-05122	297
541-11003	308	562-26075	301	571-11321	308	575-05124	297
541-11004	308	562-26082	301	571-11322	308	575-05125	297
541-11005	308	562-26099	301	571-11323	308	575-05126	297
541-11006	308	562-26109	301	571-11324	308	575-05135	297
541-11007	308	563-00200	301	571-11325	308	575-05137	297
541-11008	308	563-00210	301	571-11808	309	575-05140	297
541-90020	306	563-00220	301	571-11810	309	575-05142	297
541-90030	306	563-00230	301	571-11812	309	575-05144	297
541-90040	306	563-00240	301	571-11814	309	575-15112	297
550-00501	294	563-00250	301	571-11820	309	576-00120	300
550-00502	294	563-26116	301	571-11822	309	576-00122	300
550-00503	294	563-26123	301	571-11824	309	576-00124	300
550-00522	294	563-26130	301	571-11825	309	576-00125	300
550-00533	294	563-26147	301	571-11835	309	576-00126	300
550-26707	299	563-26154	301	571-11840	309	576-00128	300
550-26714	299	563-26160	301	571-11842	309	576-00135	300
550-26721	299	565-00570	302	571-11844	309	576-00140	300
550-26738	299	566-00580	302	571-11845	309	576-00142	300
550-26745	299	567-05620	301	571-22926	310	576-00144	300
550-90000	306	567-05621	301	571-22928	310	577-00145	300
550-90004	306	567-05820	301	571-22960	310	577-00146	300
550-90005	306	567-05821	301	571-23929	310	577-00150	300
550-90006	306	567-06000	301	571-23930	310	577-00152	300
550-90007	306	567-06010	301	572-00001	302	577-00155	300
550-90008	306	568-00500	298	574-05180	297	577-00156	300
550-90009	306	568-00501	298	574-05182	297	577-00160	300
561-11488	309	568-00502	298	574-05184	297	577-00162	300
561-11489	309	568-00503	298	574-05186	297	577-00165	300
561-11490	309	568-00504	298	575-00110	300	577-00168	300
561-11491	309	568-00505	298	575-00112	300	577-00175	300
561-11492	309	568-00506	298	575-00114	300	577-00180	300
561-11493	309	568-00507	298	575-00115	300	577-00182	300
561-11494	309	568-05000	301	575-00225	300	577-00184	300
561-11495	309	568-05010	301	575-00235	300	577-00185	300
561-11496	309	568-05200	301	575-00240	300	577-00186	300
561-11497	309	568-05210	301	575-00245	300	577-05146	297











Catalog No. 360



*Serving the Transportation Needs of North America*