

THE SHORT WAVE

Magazine

VOL. XXXVIII

FEBRUARY 1981

NUMBER 12



TRIO

pacesetter in amateur radio



R-1000 "hear there and everywhere"

The R-1000 is an amazingly easy-to-operate, high performance, communications receiver, covering 200 kHz to 30 MHz in 30 bands. This PLL synthesized receiver features a digital frequency display and analog dial, plus a quartz digital clock and timer.

R-1000 FEATURES:

- Covers 200 kHz to 30 MHz continuously.
- 30 bands each 1 MHz wide.
- Five-digit frequency display with 1-kHz resolution and analog dial with precise gear dial mechanism.
- Built-in 12-hour quartz digital clock with timer to turn on radio for scheduled listening or control a recorder through remote terminal.
- Step attenuator to prevent overload.
- Three IF filters for optimum AM, SSB, CW. 12-kHz and 6-kHz (adaptable to 6-kHz and 2.7-kHz) for AM wide and narrow, and 2.7-kHz filter for high-quality SSB (USB and LSB) and CW reception.
- Effective noise blanker.
- Terminal for external tape recorder.
- Tone control.
- Built-in 4-inch speaker.
- Dimmer switch to control intensity of S-meter and other panel lights and digital display.
- Wire antenna terminals for 200 kHz to 2 MHz and 2 MHz to 30 MHz. Coax terminal for 2 MHz to 30 MHz.

OPTIONAL

- SP-100 matching external speaker.
- HS-5 and HS-4 headphones.

R-1000 receiver £285.20 inc. VAT
 matching speaker £23.45 inc. VAT
 Securicor carriage £4.50

LOWE ELECTRONICS Ltd.

CHESTERFIELD ROAD, MATLOCK, DERBYSHIRE DE45LE

TEL. 0629 2430/2817

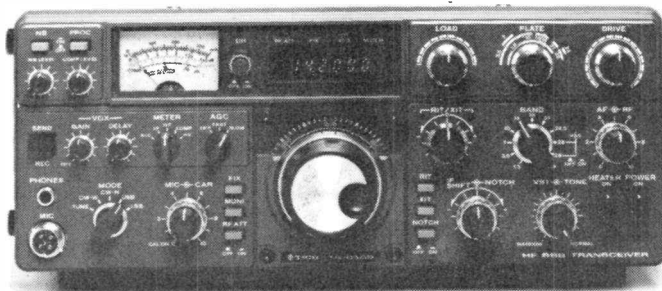

TS830S *V.B.T. notch, IF shift, wide dynamic range*

Now most Amateurs can afford a high-performance SSB/CW transceiver with every conceivable operating feature built in for 160 to 10 metres (including the three new bands). The TS-830S combines a high dynamic range with variable bandwidth tuning (VBT), IF shift, and an IF notch filter, as well as very sharp filters in the 455-kHz second IF. Its optional VFO-230 remote digital VFO provides five memories.

TS-830S FEATURES:

- **160-10 metres, including three new bands**
Covers all Amateur bands from 1.8 to 30MHz (LSB, USB, and CW), including the new 10, 18, and 24MHz bands. Receives WWW on 10MHz.
- **Wide receiver dynamic range**
Junction FETs (with optimum IMD characteristics and low noise figure) in the balanced mixer, a MOSFET RF amplifier operating at low level for improved dynamic range (high amplification level not needed because of low noise in mixer), dual resonator for each band, and advanced overall receiver design result in excellent dynamic range.
- **Variable bandwidth tuning (VBT)**
Continuously varies the IF filter passband width to reduce interference. VBT and IF shift can be controlled independently for optimum interference rejection in any condition.
- **IF notch filter**
Tunable high-Q active circuit in 455kHz second IF, for sharp, deep notch characteristics.
- **IF shift**
Shifts IF passband toward higher or lower frequencies (away from interfering signals) whilst tuned receiver frequency remains unchanged.

- **Various IF filter options**
Either a 500Hz (YK-88C) or 270Hz (YK-88CN) CW filter may be installed in the 8.83MHz first IF, and a very sharp 500Hz (YG-455C) or 250Hz (YG-455CN) CW filter is available for the 455kHz second IF.
- **Built-in digital display**
Six-digit large fluorescent tube display, backed up by an analogue dial. Reads actual receive and transmit frequency on all modes and all bands. Display Hold (DH) switch.
- **Adjustable noise-blanker level**
Built-in noise blanker eliminates pulse-type (such as ignition) noise. Front-panel threshold level control.
- **6146B final with RF NFB**
Two 6146B's in the final amplifier provide 220W PEP (SSB)/180W DC (CW) input on all bands. RF negative feedback provides optimum IMD characteristics for high-quality transmission.
- **More flexibility with optional digital VFO**
VFO-230 operates in 20-Hz steps and includes five memories. Also allows split-frequency operation. Built-in digital display. Covers about 100kHz above and below each 500kHz band.
- **Built-in RF speech processor**
For added audio punch and increased talk power in DX pileups.
- **RIT/XIT**
Receiver incremental tuning (RIT) shifts only the receiver frequency, to tune in stations slightly off frequency. Transmitter incremental tuning (XIT) shifts only the transmitter frequency.
- **SSB monitor circuit**
Monitors transmit IF signal whilst transmitting, to determine audio quality and effect of speech processor.

TRIO TS-830S £639.52 inc VAT.

MATCHING STATION ACCESSORIES

SP230 EXTERNAL SPEAKER WITH SELECTABLE AUDIO FILTERS	£33.14 inc VAT
VFO 230 EXTERNAL DIGITAL VFO WITH 5 MEMORIES	£194.45 inc VAT
AT 230 ANTENNA TUNER	£106.75 inc VAT
YK 88C 500Hz C.W. FILTER	£26.45 inc VAT
CARRIAGE BY SECURICOR	£4.50

LOWE ELECTRONICS Ltd.

CHESTERFIELD ROAD, MATLOCK, DERBYSHIRE TEL 0629 2430/2817





TR8400 *70 cm is on the move*

The TR 8400 synthesized 70 cm UHF FM mobile transceiver covers 430-440MHz in 25KHz steps and includes five memories, automatic memory and band scan, UP/DOWN manual scan, and two VFOs.

TR 8400 FEATURES

- Synthesized coverage of 430-440MHz in 25KHz steps.
- Five memories and memory backup terminal on rear panel.
- Two VFOs.
- Offset switch for ± 1.6 MHz.

transmit offset and simplex operation. Fifth memory allows any other offset by memorising receive and transmit frequencies independently.

- Automatic scan of memories and of 430-440MHz band (in 25KHz steps). Locks on busy channel and resumes when signal disappears. HOLD or mic PTT button cancels scan.
- Up/down manual band scan in 25KHz steps with UP/DOWN microphone supplied with TR 8400.

- Only 5 3/4 inches wide, 2 inches high, and 7 5/8 inches deep.
- TONE switch.
- Four-digit frequency display and S/R/F bar meter. Other LEDs indicate BUSY, ON AIR, and REPEATER operation.
- HI/LOW (10 W/1 W) RF output power switch.

TRIO TR 8400 £279 inc. VAT. Securicor carriage £4.50.

TR7800 *the only 2 metre FM mobile rig*

Frequency selection with the TR 7800 2 metre FM mobile transceiver is easier than ever. The rig incorporates new memory developments for repeater shift, priority, and scan.

TR 7800 FEATURES

- 15 multification memory channels, selected with a rotary switch. M0 to M12 memorize frequency and offset (± 600 KHz or simplex). M13, 14 memorize transmit and receive frequencies independently for nonstandard offset.
- Internal backup for all memories, by installing four AA NiCd batteries (not Trio supplied) in battery holder.

- Priority channel (memory 14) and priority alert.
- Covers 144-146MHz, in 25KHz or 5KHz steps
- Front-panel keyboard for selecting frequency, transmit offset, programming memories, and controlling scan.
- Automatic scan of entire band (5KHz or 25KHz steps) and memories.
- Manual scan of band and

memories, with UP/DOWN microphone (standard).

- Repeater REVERSE switch.
- Selectable power output 25W (HI)/5 (LOW).
- LED S/R/F bar meter.
- TONE switch.

TRIO TR 7800 £268 inc. VAT. Securicor carriage £4.50.



LOWE ELECTRONICS Ltd.

CHESTERFIELD ROAD, MATLOCK, DERBYSHIRE TEL 0629 2430/2817



THE SHIMIZU SS 105S 80 - 10 metres ssb/cw transceiver



This super new transceiver covers 80-10 metres, gives 10W out and is smaller than anything else we have seen so far. Ideal for transverter driving, the SS 105S has FM transmit and receive options as well as excellent performance on SSB/CW for HF band use. The SS 105S is supplied in semi kit form so as to keep down the price, but all the RF and mixer boards are ready built and aligned so no test equipment is required. All the cabinet work has been carried out so all you have to do is assemble the IF strip, xtal oscillator, and fit them to the completed chassis. Great idea and it brings back the flavour of home brew with the added advantage that the rig will work when you've finished it. For more info, just ask or come along and see it. It's a great little rig.

		Inc. VAT	Carr
SS105S	80-10m solid state SSB/CW/FM transceiver. Semi kit form	£258.75	£4.50
SE-NB	Noise blander kit	£7.76	£0.50
SE-FMrx	RX FM discriminator kit	£17.25	£1.00
SE-FMtx	TX FM generator kit	£12.65	£1.00
SE-MK	RX marker kit	£11.04	£0.50
0.5 CWF	500Hz CW filter	£22.43	£0.50
Optional band crystals		£3.45	£0.25

PLEASE SPECIFY ANY PARTICULAR INTEREST AND WE WILL SEND FULL INFORMATION.

**THE WAY TO HAVE
TOMORROW'S EQUIPMENT
TODAY**

WRITE FOR FULL DETAILS TODAY

OPEN TUES - FRIDAY 9-5.30; SAT 9-5.00. CLOSED FOR LUNCH 12.30-1.30

For personal attention on the South Coast contact John G3JYG, 16 Harvard Road, Ringmer, Lewes, Sussex. Ringmer B12071.
For equally helpful attention in Scotland contact Sim, GM3SAN, 19 Ellismuir Road, Baillieston, Nr. Glasgow. 041-771 0364.

SEND 48p IN STAMPS FOR COMPLETE CATALOGUE AND ANTENNA BOOK



AR 245 2 metre hand held FM synthesized transceiver

"A staggering technical achievement"; "How can they get it into such a small size"; "Outperforms any rig I've ever had"; these are typical of the comments made by amateur radio operators after seeing and using the remarkable AR 245 2 metre FM handheld transceiver. What does it mean to you? Well, at last you can really take your amateur radio with you, anywhere you want to go, because in this handheld unit, you have a complete synthesised 2 metre FM transceiver covering 144-146MHz in 5KHz steps. Also included are + and - 600KHz repeater shifts, crystal controlled tone burst unit and nicads.

Operation of the AR 245 is very simple indeed. You simply select the frequency required on the direct reading frequency decade switches, switch on the transceiver, pull out the telescopic whip and speak into the microphone. Repeater shift is selected by a switch on the rear panel and tone burst activated by a secondary button on the PTT bar.

If you are considering a handheld 2 metre unit, there is nothing to compare with the AR 245.

AR 245 5 watts/1 watt £179 inc. VAT carriage £1.50.

AR 240A 1½ watts £158 inc. VAT carriage £1.50.



LOWE ELECTRONICS Ltd.

CHESTERFIELD ROAD, MATLOCK, DERBYSHIRE TEL 0629 2430/2817



Whether you are: just starting, taking an R.A.E. course, just licensed, or an old timer, SMC has something for you. . . . And at very good prices. Adverised **PRICES** on this and the following four pages **INCLUDE VAT at 15%, INCLUDE SECURICOR** speedy delivery and **INCLUDE A TWO YEAR WARRANTY** (remember as Yaesu Musen UK distributors our guarantee is **FACTORY BACKED**).

We take **ACCESS AND BARCLAYCARD OVER THE PHONE**, offer **HP** (including a **FREE FINANCE SCHEME** on many regular priced items) written quotations provided upon application, and have branches and agents conveniently situated across the country plus the biggest mail order department right here in Totton.

SMC YOUR CHOICE, FOR CHOICE, IN GENERAL COVERAGE RECEIVERS



FRG7

The FRG7 is an economically priced general purpose communications receiver employing all solid state construction for reliability and performance. It uses a Wadley-loop drift cancellation system for high sensitivity, stability and image rejection. Listen to Radio Amateurs, shortwave broadcasts, BBC and commercial medium wave stations, CB and much more.

A side by side comparison between the FRG7 and any of the mass of "all singing and dancing" transistor portables, possibly costing much more, will soon reveal why the FRG7 is a most popular choice.

- ★ "Industry standard" receiver.
- ★ 0.5-3MHz.
- ★ SSB (LSB/USB), CW, AM.
- ★ Selectivity of ± 3 kHz at -6dB.
- ★ Wadley-loop triple conversion.
- ★ 10kHz Direct dial readout.
- ★ Well calibrated "sharp" preselector.
- ★ AM Automatic noise suppression circuit.
- ★ Antenna Hi to 1.6MHz, 50ohm to 30MHz.
- ★ 3 position RF Antennuator.
- ★ 3 position AF (LP, WBP, NBP).
- ★ 110-240Vac and 12Vdc.
- ★ Internal Battery holder option.
- ★ Illuminated edge type "S" meter.
- ★ Optional Battery holder £5.00.

£ 199 INC. VAT @ 15%
& SECURICOR

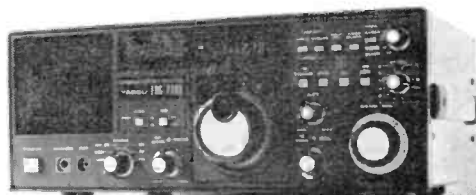

FRG7700

The FRG7700 is a deluxe all purpose communications receiver using the latest in large scale integration, phase locked loops and bandpass filters for superb performance. It uses an up conversion circuit with 48MHz first IF with professional quality crystal filter. The receiver can be used for listening to all normal HF services, and the inclusion of FM allows reception of 10m FM, and with a converter VHF Amateur and Marine bands. The FM detector, the clock/timer, and the optional 12 channel memory (instant write in recall of frequencies anywhere in the tuning range) places the FRG7700 head and shoulders above similar priced receivers.

- ★ Incredible new receiver.
- ★ 0.15-30MHz.
- ★ SSB (LSB/USB), CW, AM, FM.
- ★ 2.7kHz, 6kHz, 12kHz, 15kHz, @ -6dB.
- ★ Up conversion 48MHz first IF.
- ★ 1kHz digital plus analogue display.
- ★ No preselector, auto selected LPF's.
- ★ Advanced noise blanker fitted.
- ★ Antenna 500ohm to 2MHz, 50ohm to 30MHz.
- ★ 20dB pad plus continuous attenuator.
- ★ Constantly variable tone control.
- ★ 110 and 240V ac and 12V dc option.
- ★ 12 channel memory option.
- ★ Signal meter calibrated in "S" and SIMPO.
- ★ FRG7700M £389. Memory option £83.95.

£ 309 INC. VAT @ 15%
& SECURICOR

SOUTH MIDLANDS COMMUNICATIONS LTD



S.M. HOUSE, OSBORNE ROAD, TOTTON, SOUTHAMPTON SO4 4DN, ENGLAND

Tel: Totton (0703) 867333, Telex: 477351 SMCMM G. Telegram: "Aerial" Southampton



South Midlands

SMC FOR CHOICE IN HYBRID HF TRANSCEIVERS



FT101ZD

The "Z" series is base station design at its best, a no compromise, go anywhere unit of the highest quality. The FT101ZD is an all new design using today's technology backed with the 101 name — the name of the world's most popular amateur transceiver.

The FT101ZD is a complete, value for money, yet uncompromising, HF station. It includes such state-of-the-art features as variable IF bandwidth for "digging out" the real dx and an advanced noise blanker, which for optimum results has front panel adjustable threshold level.

The FT101ZD transceiver, provides USB, LSB, AM and CW and covers from top band to ten metres (including the new 'Warc' bands). It combines a sensitive receiver, with a good front end with a powerful, spurious free transmitter featuring a pair of rugged 6146's with negative feedback in the PA.

Ergonomically designed throughout, the transceiver is aesthetically completed by a pleasant bright orange LED display.

The 101ZD is fully compatible with all the '902 accessories, hence as the budget allows, you can expand your station with such matching items as an external VFO, transverter (4, 2, 70m in one box), RTTY/CW reader, keyboard, VDU, linear, ATU, monitorscope, external speaker.

- ★ 160-10 metres including new allocations.
- ★ Variable IF bandwidth 2.4kHz down to 300Hz.
- ★ 8 pole filters for razor edge selectivity.
- ★ Selectable CW fixed bandwidth CW-W and CW-N*.
- ★ Semi-break in with sidetone for excellent CW.
- ★ Digital plus analogue frequency displays.
- ★ 6146B PA's with 6dB of negative feedback.
- ★ 180W PIP and — 31dB 3rd order intermod.
- ★ RF speech processor fitted — adjustable level.
- ★ VOX built-in and is adjustable from the front panel.
- ★ Wide dynamic range for big signal handling.
- ★ High usable sensitivity, for those weak ones.
- ★ Superb noise blanker — adjustable threshold.
- ★ Attenuator; 0-10-20dB, front panel switch.
- ★ AGC; slow-fast-off, front panel switchable.
- ★ Clarifier (RIT) switchable on TX, RX or both.
- ★ Heater switch for battery conservation.
- ★ Low level transverter drive output facility.
- ★ Ergonomic design and position of controls.
- ★ Universal power supply 110-234V AC and 12V DC.*

*Option.

£515 inc. VAT @ 15%
& SECURICOR



FT902DM

The FT902DM transceiver offers unparalleled receiver performance combined with state of the art transmitter design for 10 to 160 metres including the new allocations. The FT902DM is an all mode radio — and all means all — SSB, AM, FSK, CW and FM.

The FT902DM is feature packed not gimmick ridden, for instance; the internal Curtis IC keyer (designed for amateur radio applications) provides immunity to RF interference and false keying through contact bounce. The full size digital plus clear analogue frequency display and memory circuitry provide the ultimate in versatility and operating efficiency. In addition to numerous band stop filters, crystal filters* of 350Hz or 600Hz*, 2.4kHz*, 6.0kHz* and 12kHz define the IF bandwidth. Selectivity is continuously variable from the normal 2.4kHz right down to 300Hz without even having the CW Filter installed! Other filters worthy of note are the Rejection Tune, tunable notch (for removing unwanted narrow signals from the IF passband) and the Audio Peak Filter A.P.F., a razor sharp filter, without ringing, which produces a dramatic increase in signal to noise ratio and QRM rejection on CW. All these features, including an advanced noise blanker, are standard equipment on the 'DM', not costly extras.

- ★ 160-10 metres including new allocations.
- ★ Variable IF bandwidth 2.4kHz down to 300Hz.
- ★ Audio Peak and independent notch controls.
- ★ AM, FSK, USB, LSB, CW, FM, (TX and RX).
- ★ Semi-break in, inbuilt Curtis IC Keyer.
- ★ Digital plus analogue frequency displays.
- ★ 6146B's with negative feedback.
- ★ VOX built-in and adjustables.
- ★ Instant write in memory channel.
- ★ Tune up button (10 sec, of full power).
- ★ Curtis Keyer — lmbic, single or straight.
- ★ Switchable AGC and RF attenuator.
- ★ Optional 350 or 600 Hz CW, 6kHz, AM filters.
- ★ Clarifier (RIT) switchable on TX, RX or both.
- ★ Audio Peak and tunable notch filter.
- ★ Plug in modular, computer style constructor.
- ★ Fully adjustable RF Speech processor.
- ★ Ergonomically designed with necessary LEDS.
- ★ Incredible range of matching accessories.
- ★ Universal power supply 110-234V AC and 12V DC.

*Option.

£ 799 inc. VAT @ 15%
& SECURICOR

SOUTH MIDLANDS COMMUNICATIONS LIMITED

OSBORNE ROAD, TOTTEN,
SOUTHAMPTON SO4 4DN
9-5.30 Mon-Fri 9-1.30 Sat.



Head Office Showrooms
Cables Aerial Southampton
Telex 477351 SMCOMM G
Tel: Totton (0703) 867333

AGENTS DEMONSTRATIONS, STOCKS AND SALES

G3ZUL	Brian	Stourbridge	(03843)	5917
G13DR	John	Bangor	(0247)	55162
GMB8EC	Jack	Edinburgh	(031665)	2420
G13WVY	Mervyn	Tandragee	(0762)	840656
GW3TMP	Howarth	Pontyvodkin	(035287)	846 324
GW8EBB	Peter	Swansea	(0792)	872525
GJ4CD	Geoff	St. Saviour	(0634)	26788

Communications Ltd



SMC FOR CHOICE IN SOLID STATE HF TRANSCEIVERS



FT107

If you have been searching for an all solid state HF transceiver with a "broad band" output that will deliver 75 per cent of maximum power into a 3:1 load, then look no further than this Yaesu. The FT 107M covers 160-10M inc. new bands and is fully equipped with: variable IF bandwidth, audio peak/notch filter, RF speech processor, variable threshold noise blanker, full metering — including SWR, and boasts a schottky diode ring mixer for excellent receiver dynamic range. The all new memory system provides 12 stored channels (with fine tuning), scanning from the optional microphone and the exclusive DMS — digital memory shift. This system using a photo interruptor (with fine tuning) to control the 100kHz synthesizer to provide any offset up to 500kHz, from the memory channel (almost the equivalent of 13 VFOs).

- ★ 160-10 metres plus WWV plus 2 auxiliary bands.
- ★ USB-LSB-CW-FSK-AM multi-mode.
- ★ Full broad band "no tune" power amplifier.
- ★ 240W PIP. 75 per cent power output at 3:1 VSWR.
- ★ 12 memory channels with clarifier on memory.*
- ★ Digital Memory Shift gives offset from memory.*
- ★ Up/down scanning control from microphone.*
- ★ Variable IF bandwidth — 16 poles of selectivity.
- ★ Bandwidths: 6kHz*, 2.4kHz-300Hz, 600Hz-300Hz.*
- ★ Selectable CW "fixed" widths CW-W and CW-N.*
- ★ Tunable Audio Peak (AFP) and Notch filter.
- ★ Diode ring mixer for very high Rx dynamic range.
- ★ Noise blanker — front panel adjustable threshold.
- ★ AGC; slow-fast-off switchable from the front panel.
- ★ Attenuator 0-20dB, plus RF gain on front panel.
- ★ RF speech processor fitted — front panel adjustable.
- ★ Digital (100Hz) plus analogue frequency displays.
- ★ Meter Reads; Vcc, Ic, ALC, Compression and SWR.
- ★ Semi-break in with side tone. Vox built in.
- ★ Choice of built-in or separate power supply units.

*Option.

£ 690 inc. VAT @ 15%
& SECURICOR

SMC (Jack Tweedy) LTD.

Roger Baines, G3YBO
79 Chatsworth Road,
Chesterfield, Derby.
Tel.: Chesterfield (0246) 34982
9-5 Tuesday-Saturday.

SMC (Leeds)

Collin Thomas, G3PSM
257 Otley Road,
Leeds 16, Yorkshre.
Tel.: Leeds (0532) 782326
9-5.30 Monday-Saturday

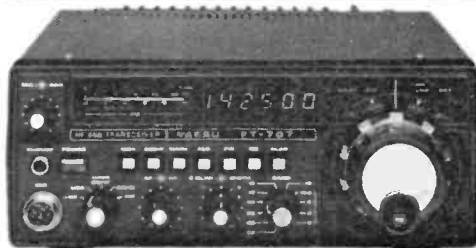

FT707M

The FT707 'The Wayfarer' is an ultra-compact transceiver ideally suited for the home station or as a travelling companion. The FT707 is THE radio of the eighties: 80-10m, including 30, 17 and 12m — all factory installed — 100W output (10W's* model) 50% developed in 3:1 VSWR — Digital, bright LED's in mode sensitive counter and analogue readout — Transceiver status at a glance, from string LED and single displays — 16 poles of crystal filtering provides continuously adjustable IF bandwidth 2.4kHz to 300Hz (N.B. This is true 'variable bandwidth' that minimises much of the adjacent channel interference not 'IF shift') — Noise blanker of most advanced design using local AGC loop — Schottky diode ring module, power transistor buffers, ultra clean, low noise local oscillator are combined to produce, size and price notwithstanding — a remarkable Rx.

- ★ 80-10 metres (including 10, 18 and 24MHz bands).
- ★ USB-LSB-CWW-CWN-AM (Tx and Rx operation).
- ★ 100W PEP. 50% power output at 3:1 VSWR.
- ★ Full "broad band" no tune output stage.
- ★ Excellent Rx dynamic range, power transistor buffers.
- ★ Rx Schottky diode ring mixer module.
- ★ Local oscillator with ultra-low noise floor.
- ★ Variable IF bandwidth — 16 crystal poles.
- ★ Bandwidths 6kHz*, 2.4kHz-300Hz (600-350)Hz*-300Hz.*
- ★ AGC; slow-fast switchable from the front panel.
- ★ VOX built-in and adjustable from the front panel.
- ★ Semi-break in with side tone for excellent CW.
- ★ Digital (100Hz) plus analogue frequency display.
- ★ LED Level meter reads: S, PO and ALC.
- ★ Convenient concentric AF/FR gain controls.
- ★ Indicators for: calibrator, fix, Int/ext VFO.
- ★ Receiver offset tuning (RIT-clarifier) control.
- ★ Advanced noise blanker with local-loop AGC.
- ★ 25kHz crystal calibrator feature.
- ★ Internal, xtal or external VFO control.

*Option.

£ 529 inc. VAT @ 15%
& SECURICOR

SMC (Jack Tweedy) LTD.

Jack Tweedy, G3ZY
150 Horncastle Road,
Woodhall Spa, Lincs.
Tel.: Woodhall Spa (0526) 52793
9-5 Tuesday-Saturday (+ appoint.)





South Midlands

SMC FOR CHOICE IN 2 m MULTIMODES



FT480R

- ★ 144-146MHz (143.5-148.5 MHz possible).
- ★ USB-LSB-CW-FM (A3, A1, F3).
- ★ Special linear PA module fitted.
- ★ 12V dc (13.8V dc) operation negative earth.
- ★ 30W PIP A3, 30W dc A1 and F3.
- ★ A1 and F3, 10W or 1W output switches.
- ★ Bandpass filter no tune design.
- ★ Excellent receiver dynamic range.
- ★ Outstanding sensitivity on SSB and FM.
- ★ 3SK 59 Mosfet RF, 3SK 51 mixer.
- ★ Bandwidth 2.4kHz and 14kHz at -6dB.
- ★ Semi break in with side tone.
- ★ Very bright blue 100Hz digital display.
- ★ Display shows Tx and Rx freq (inc RIT).
- ★ String LED display for "S" and PO.
- ★ Convenient Concentric AF and squelch.
- ★ Digital receiver offset tuning.
- ★ Advanced effective noise blanker.
- ★ FM; 100, 25 (12½), 1kHz steps.
- ★ SSB; 1,000, 100, 10Hz steps.
- ★ Dual digital VFO system.
- ★ Any TX Rx split with A and B VFO's.
- ★ ±600kHz standard repeater split.
- ★ Four easy write-in memory channels.
- ★ Memory kept alive with 12V supply.
- ★ Memory scanning with slot location display.
- ★ Up/down tuning/scanning from mic.
- ★ Priority channel on any memory slot.
- ★ "F set" clears non step component.
- ★ Lock on tuning controls on Tx.
- ★ Satellite mode allows tuning on Tx.
- ★ Scanning for busy or clear channels.
- ★ Size (Case): 8.3" D, 2.3" H, 6.9" W.
- ★ Size (Projections): 10.1" D, 3.0" H, 7.0" W.
- ★ Size (Bracket): 10.1" D, 3.5" H, 8.5" W.
- ★ Weight 5½lb (2.6kg).
- ★ Generous 2W audio output.
- ★ Indicator for FM modulation level.
- ★ LED's; "On Air" Clarifier, Hi/Low.
- ★ Matching FP80 Mains PSU available.

£ 359 inc. VAT @ 15%
& SECURICOR

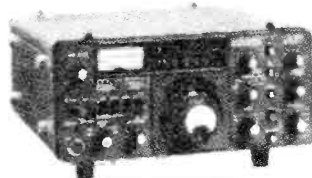

FT225RD

- ★ 144-148MHz inclusive Coverage.
- ★ Multimode SSB-LSB-FM-AM-CW.
- ★ AC mains or 12V dc working.
- ★ Smooth Dual speed VFO.
- ★ Digital readout to 100Hz.
- ★ Mode sensitive digital readout.
- ★ Analogue readout to 1kHz.
- ★ 22 Fix Channels (2 x 11) (2MHz).
- ★ Memory Option S or split use.
- ★ "S"/centre zero/P output meter.
- ★ Switchable 20dB RF attenuator.
- ★ Switchable Xtal cont tone burst.
- ★ Switchable Meter function on Rx.
- ★ Accessory rear panel DIN socket.
- ★ Front Panel FM power control.
- ★ Front Panel VOX/MOX/Control.
- ★ Front Panel SSB Mic Gain control.
- ★ Switchable effective noiseblanker.
- ★ Switchable AGC - Slow or fast.
- ★ Switchable lights/readout brightness.
- ★ Semi Break in CW with side tone.
- ★ Clarifier on Rx or Rx + Tx.
- ★ Clarifier works on VFO, xtal & mem.
- ★ ALC external phono socket.
- ★ Normal/Reverse repeater split.
- ★ Auxiliary repeater shift option.
- ★ Relay make-break-common sockets.
- ★ Front panel adjustable squelch.
- ★ Plug in board construction.
- ★ 11.8" D x 11.1" W x 4.8" H (case).
- ★ 14.2" D x 11.5" W x 5.6" H (projections).
- ★ Weight 20lb (9kg).
- ★ LED's for; MEM, Burst, NB & Attn.
- ★ LED's for; RPT, CLAR, VFO, MEM, On Air.
- ★ Front panel headphone jack.
- ★ PLL (VCO) At 130MHz for clean signal.
- ★ 25W + PEP A3, 25W + F3.
- ★ 2W of AF to inbuilt speaker.
- ★ Highly sensitive and selective.
- ★ Conservatively rated PA for low IMD.

£ 565 inc. VAT @ 15%
& SECURICOR

SOUTH MIDLANDS COMMUNICATIONS LIMITED

OSBORNE ROAD, TOTTON
SOUTHAMPTON SO4 4DN
9-5.30 Mon-Fri 9-1.30 Sat



Head Office Showrooms
Cables Aerial Southampton
Telex 477351 SMCOMM G
Tel: Totton (0703) 867333

AGENTS STOCK AND SALES

G32UL Brian	Stourbridge	(03843)	5917
G13KDR John	Bangor	(0247)	55162
G4M6GEC Jack	Edinburgh	(031665)	2420
G13WVV Mervyn	Tandragee	(0762)	840656
GW3TMP Howarth	Pontybockin	(035287)	846324
G-V8EBB Peter	Swansea	(0792)	872525
G 4CD Geoff	St Saviour	(0534)	26788

Communications Ltd

SMC FOR CHOICE IN VHF/UHF FM

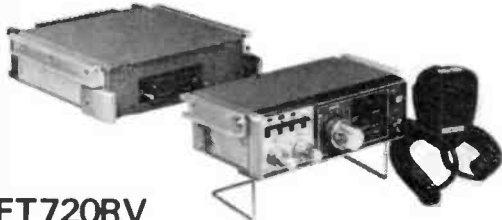

FT720RV

- FT 720 Control Head. £ 120.00 inc.
- ★ Four easy write-in memory channels
 - ★ Rx priority channel (auto check)
 - ★ Scanning of band or memory channel
 - ★ Up/down tuning/scanning from mic.
 - ★ Scanning for empty or occupied channels
 - ★ Optically coupled tuning control
 - ★ Easy selection of up/simplex/down
 - ★ Manual and automatic tone burst
 - ★ String LED's for 'S' and PO
 - ★ Seven status report LEDs
 - ★ Convenient concentric AF and squelch
 - ★ 1½ W of audio to internal/external speaker
 - ★ 3.3 (4.3)" D x 6" W x 2 (2.2)" H
- MMB3 Bracket for deck option. £5.00 inc.
- 720RV 10W, 2M deck. £133.00 inc.
- 720RVH 25W, 2M deck. £143.00 inc.
- ★ 144-146MHz (144-148MHz possible)
 - ★ 12½ KHz synthesizer steps
 - ★ ±600KHz repeater offset
 - ★ 0.3µV for 20dB quieting
 - ★ Rx 0.5A, Tx RV 3.5A, RVH 6.5A
 - ★ 10.7MHz & 455KHz double conversion
 - ★ 5.8 (6.5)" D x 6" W x 2 (2.2)" D
 - ★ 720RU 10W, 70cm. deck. £ 156.00 inc.
 - ★ 430-434MHz
 - ★ 25KHz synthesizer steps
 - ★ 1.6MHz repeater shift
 - ★ 0.5µV for 20dB quieting
 - ★ Rx 0.5A, Tx 4.5A
 - ★ 16.9MHz + 455KHz double conversion
 - ★ 5.8 (6.5)" D x 6" W x 2 (2.2)" D
 - ★ E72S Extension cable 200cms. £ 23.00 inc.
 - ★ E72L Extension cable 400cms. £28.00 inc.
 - ★ S72 Switching box. £56.00 inc.
 - ★ Permits control head with two decks
 - ★ Single button change of band
 - ★ Auto change of synthesizer steps
 - ★ Auto change of repeater split

£253 inc. VAT @ 15% & SECURICOR

- ★ 144-148MHz (144-148 possible)
- ★ 12.5KHz synthesizer steps
- ★ 4 bit CPU chip for freq. control
- ★ Keyboard entry of frequencies
- ★ Keyboard lockout safety features
- ★ Digital display to hundreds of Hertz
- ★ Display auto shutdown times
- ★ Four Channels of memory
- ★ Memory back up disable
- ★ Up/down manual tuning
- ★ Bandscan for busy or clear channels
- ★ Memory scanning feature



FT207R

- ★ ±600KHz split built in
- ★ Any split + or - programmable
- ★ Easy change Ni Cad packs
- ★ BNC antenna connector
- ★ "On Air" and "Channel Busy" LEDs
- ★ Built in condenser microphone
- ★ 200mW AF to internal/external speaker
- ★ External speaker/mic available
- ★ 2.5/0.2W of RF output
- ★ Rx; 35mA squelch, 150mA full vol.
- ★ Tx; 250mA low, 800mA high
- ★ 0.3µV for 20dB quieting
- ★ Double conversion 10.7MHz and 455KHz
- ★ Two tone encoder built in
- ★ 1.7 (2.2)" D x 2.5 (2.7)" W x 6.7 (7.2)" H
- ★ C/w Ni Cads, helical and case
- ★ YM24A External speaker Mic. £ 16.85 inc.
- ★ PA2 12V DC adaptor. £ 13.40 inc.
- ★ MMB10 Mobile Bracket £ 5.75 inc.
- ★ NC9C Mini Charger £ 7.65 inc.
- ★ NC1A Mains Charger £ 19.15 inc.
- ★ NC2/3 Mains quick charger/eliminator. £39.50 inc.
- ★ NC3 Charger/eliminator/12V adaptor. . £42.55 inc.
- ★ NBP9 Ni Cad pack (spare). £ 16.85 inc.
- ★ FLC2 Heavy Duty leather case. £20.70 inc.
- ★ WMT207R Workshop Manual £4.00 inc.

£195 inc. VAT @ 15% & SECURICOR



SMC (Jack Tweedy) LTD.

Roger Baines, G3YBO
79 Chatsworth Road,
Chesterfield, Derby
Tel. Chesterfield (0246) 34982
9-5 Tuesday-Saturday

SMC (Leeds)

Colin Thomas, G3PSM
257 Otley Road,
Leeds 16, Yorkshire.
Tel. Leeds (0532) 782326
9-5.30 Monday-Saturday

SMC (Jack Tweedy) LTD.

Jack Tweedy, G3ZY
150 Horncastle Road,
Woodhall Spa, Lincs
Tel.: Woodhall Spa (0526) 52793
9-5 Tuesday-Saturday (+ appoint.)



AMATEUR ELECTRONICS UK

AEUK — Your number one

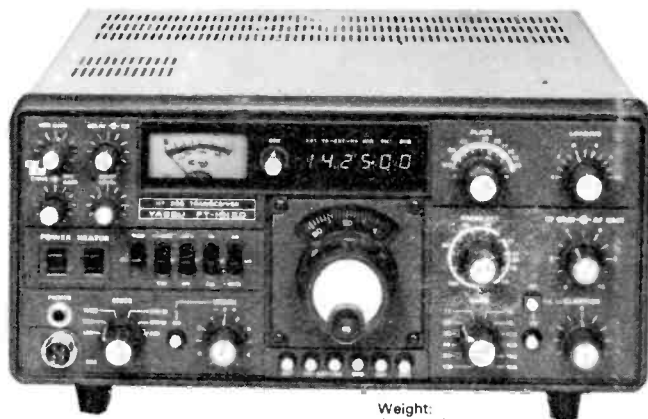

FT-101ZD SPECIFICATIONS

GENERAL

Frequency coverage:

160m 1.8-2.0 MHz, 80m 3.5-4.0 MHz, 40m 7.0-7.5 MHz, 30m 10.0-10.5 MHz, 20m 14.0-14.5 MHz, 17m 18.0-18.5 MHz, 15m 21.0-21.5 MHz, 12m 24.5-25.0 MHz, 10m 28.0-29.9 MHz.

Operating modes:

LSB, USB, CW, AM.

Power requirements:

100 110/117/200 220 234 volts AC, 50/60 Hz, 13.5 volts DC (with optional DC-AC converter).

Power consumption:

AC 117V: 75 VA receive (65 VA HEATER OFF), 285 VA transmit, DC 13.5V: 5.5 amps receive (1.1 amps HEATER OFF), 21 amps transmit.

Size

345 (W) x 157 (H) x 326 (D) mm.

Weight:

Approx. 15 kg.

TRANSMITTER

PA input power:

180 watts DC (SSB/CW), 50 watts DC (AM).

Carrier suppression:

Better than 40 dB.

Unwanted sideband suppression:

Better than 40 dB @ 1000 Hz, 14 MHz.

Spurious radiation:

Better than 40 dB below rated output.

Third order distortion products:

Better than -31 dB.

Transmitter frequency response:

300-2700 Hz (-6 dB).

Stability:

Less than 300 Hz in first 30 minutes after 10 min. warmup; less than 100 Hz after 30 minutes over any 30 min. period.

YAESU FT-101ZD (WARC)

Here is the brand new FT 101ZD which now comes complete with the new WARC bands and retains all the superb features which have made this the finest value for money HF Transceiver ever available to the discerning amateur.

Negative feedback:

6 dB @ 14 MHz.

Antenna output impedance:

50-75 ohms, unbalanced.

Microphone input impedance:

500-600 ohms.

RECEIVER

Sensitivity:

0.25 μ V for S/N 10dB (SSB/CW) 0.5 μ V for S/N 10 dB (AM).

Selectivity:

2.4 kHz at 6 dB down, 4.0 kHz at 60 dB down (1.66 shape factor); Continuously variable between 300 and 2400 Hz (-6 dB); CW (with optional CW filter installed); 600 Hz at 6 dB down, 1.2 kHz at 60 dB down (2:1 shape factor).

Image rejection:

Better than 60 dB (160-15 metres); Better than 50 dB (10 metres).

IF rejection:

Better than 70 dB (160, 80, 20-10m); Better than 60 dB (40m).

Audio output impedance:

4-16 ohms.

Audio output power:

3 watts @ 10% THD (into 4 ohms).

Specifications subject to change without notice.

The brand new FL-2100Z Linear Amplifier matching in style of course to the FT-101ZD and FT-902DM, and now incorporating the new WARC bands also.



Access or attractive H.P. terms readily available for on-the-spot transactions. Full demonstration facilities. Free Securicor delivery.



HOW TO REACH US (EASY PRIVATE PARKING ON OUR 90ft. FORECOURT)

FROM SOUTH AND EAST. We are located approximately two miles from Junction 5 of the M6 from which follow signposts to Birmingham. Within ¼ mile turn right at Clock Garage and proceed towards city. After one mile look for traffic lights at Fox & Goose and immediately over the lights take minor left fork into Alum Rock Road. We are located one mile from this point.

FROM NORTH. Leave M6 at Junction 6 (Spaghetti) and follow left fork down to traffic island beneath motorway complex. Take third turning off to Lichfield. One mile further on follow A4040 to the right and within 100 yds veer again to the right, approximately one mile further on brings you to the Fox & Goose. Turn right and see preceding directions.

FROM THE WEST AND SOUTH-WEST. Follow M5 then M6 to Spaghetti Junction (see above). Alternatively, leave M5 at junction 4 or 3 and proceed to inner ring road. Turn South on ring road and leave on A47 (East). We are located three miles from this point.

Hours: 9.30-5.30 Continuous including Saturdays — Early closing Wednesday, 1 pm

AMATEUR ELECTRONICS UK

source for YAESU MUSEN



A NEW BREAKTHROUGH IN RECEIVER TECHNOLOGY!

Last but not least, here is the very latest in receivers by Yaesu Musen — the brand new FRG-7700 which sets new standards for general coverage receivers, and has features not found on any competitive product regardless of cost. This is truly a new breakthrough in receiver technology.

The exciting new FRG-7700 GENERAL COVERAGE RECEIVER from YAESU MUSEN, the world's largest manufacturer of Amateur Radio equipment, will satisfy the demands of the most critical Short Wave Listener or Licensed Operator with its superb performance and incredible specification — just consider the following condensed details:



Frequency coverage 150 KHz-29.999 MHz.

Modes AM (fitted Narrow, Medium and Wide Filters).
 USB, LSB, CW and FM.
 Memory option with twelve channels and automatic band selection.
 CPU Digital Clock and Timer.

State-of-the-Art Noise Blanker.
 FM Squelch Control.
 Mains or Battery operation.
 Digital and Analogue read-out.



For full details of these new and exciting models, send today for the latest YAESU CATALOGUE and LEAFLETS. All you need to do to obtain the latest information about these exciting developments from the world's No. 1 manufacturer of amateur radio equipment is to send 36p in stamps and as an added bonus you will get our credit voucher value £3.60p — a 10 to 1 winning offer.



AGENTS: NORTH WEST — THANET ELECTRONICS LTD, GORDON, G3LEO, KNUTSFORD. (0565) 4040.
 WALES & WEST — ROSS CLARE, GW3NWS, "GLENVIEW", NEWPORT ROAD, MAGOR, GWENT.
 (0633) 880146
 EAST ANGLIA — AMATEUR ELECTRONICS UK — EAST ANGLIA, Dr T. THIRSK (Tim) G4CTT,
 NORWICH 06925 865
 NORTH EAST — NORTH EAST AMATEUR RADIO, DARLINGTON. 0325 55969.
 SOUTH EAST — AMATEUR ELECTRONICS, UK — COASTAL, CLIFTONVILLE, KENT.
 KEN McINNES, G3FTE, THANET. (0843) 291297, 9 a.m.-10.30 p.m.



508-514 ALUM ROCK ROAD
BIRMINGHAM 8

021-327 1497
 Telex 337045 6313



Western

ANOTHER **Western** WINNER!

The 30ft. **ULTIMAST**

Slim, unobtrusive

One-winch operation

For VHF & HF antennas Telescopic & Tilt-over

Simple ground fixing Self-supporting

THIS IS THE TELESCOPIC

YOU *CAN* AFFORD!

Ultmast, UM-1 £215.00
 Reducer head, UHD-1 (reduces to 2"
 dia stub) £13.25
 Rotor head, UHD-2 (takes up to Emoto
 100SAX) £31.06

PRICES INCLUDE DELIVERY AND
 VAT AT 15%

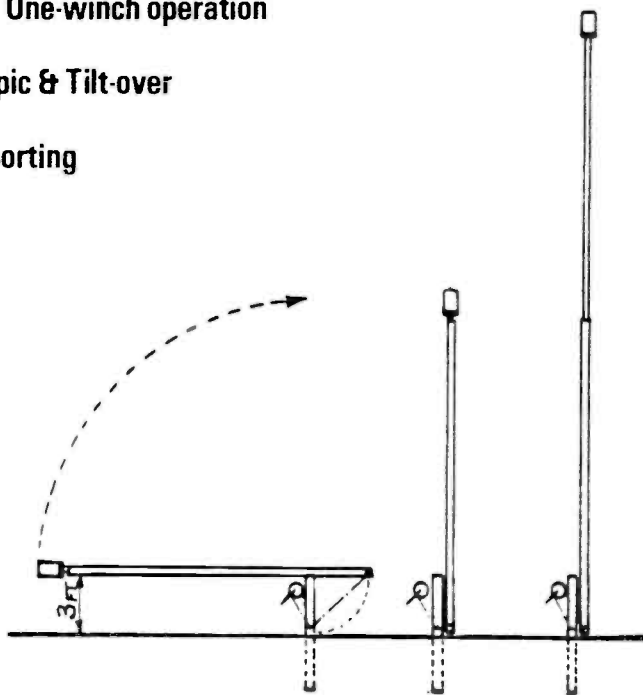

ALSO MANUFACTURED BY **Western**
WESTOWER — **ALUMAST** — **DX-ANTENNAS**

CALL US AT **Western** FOR ALL YOUR AMATEUR RADIO NEEDS

EMOTO ROTATORS
 WESTERN ANTENNAS
 HUSTLER ANTENNAS
 PANORAMA ANTENNAS
 DUMMY LOADS
 ANTENNA SWITCHES
 SWR/PWR METERS
 COAX, PLUGS, SOCKETS



SCANNING RECEIVERS
 ANTENNA TUNERS
 MICROWAVE MODULES
 VIBROPLEX KEYS
 STANDARD MORSE KEYS
 HEADPHONES, MICROPHONES
 SHACK CLOCKS
 RIGGING ACCESSORIES

Electronics (UK) Ltd



Western

FOR THAT NEW RIG!



WRITE OR PHONE FOR DETAILS/PRICES

NEW

TS-830S

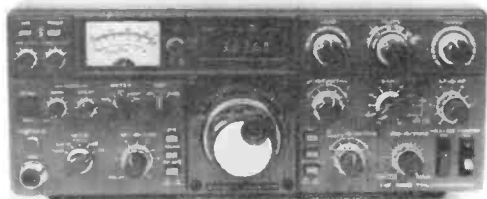

The TS-830S is a high-performance, very affordable, HF SSB/CW transceiver with every conceivable operating feature built in for 10-160 metres (including the three new bands). The TS-830S combines a high dynamic range with variable bandwidth tuning, IF shift, and an IF notch filter, as well as very sharp filters in the 455kHz second IF.

TS-830S FEATURES

- ★ 160-10 metre coverage, including 3 New Bands
- ★ 220W PEP input (SSB); 180W DC input (CW)
- ★ Wide Receiver Dynamic Range
- ★ Variable Bandwidth Tuning (VBT)
- ★ IF Shift and IF Notch Filter
- ★ Built-in Digital Readout
- ★ 6146Bs in the PA, with RF negative feedback
- ★ PLL frequency control system for stability
- ★ RF Speech Processor, Noise Blanker and other desirable operating features
- ★ New compact size — only 333(W) x 333(D) x 133(H) mm

NEW

TS-130S



The TS-130S series is an incredibly compact, full-featured, all solid-state HF SSB/CW transceiver for both mobile and fixed operation. It covers 3.5 to 29.7MHz (including the three new amateur bands!) and is loaded with optimum operating features such as digital display, IF shift, speech processor, narrow/wide filter selection (for both SSB and CW modes), and optional (DFC-230) digital frequency controller.

TS-130S FEATURES

- ★ 80-10 metre coverage, including 3 New Bands
- ★ 200W PEP input (SSB), 160W DC input (CW) on 80-15m
- ★ 160W PEP input (SSB), 140W DC input (CW) on 12 and 10m
- ★ Built-in Speech Processor
- ★ CW Narrow/Wide filter selection (with optional filter)
- ★ SSB Narrow (1.8kHz) selection (with optional filter)
- ★ Automatic Sideband Selection according to Band
- ★ All solid-state; IF Shift; built-in Digital Readout
- ★ Compact package — ideal for /M or /P operation

NEW

YAESU FRG-7700

A HIGH-PERFORMANCE COMMUNICATIONS RECEIVER

The short-wave listener's dream is now a reality in the FRG-7700 — an advanced all-mode communications receiver featuring significant advances in circuit design and operating convenience.



FRG-7700 FEATURES

- ★ Full General Coverage, 0.15 to 29.999MHz
- ★ All Modes, AM, SSB, CW, FM
- ★ Digital Frequency/Time Display
- ★ 12 Memory Channels (option) with backup
- ★ LSI Clock/Timer, for unattended recording
- ★ Wide Dynamic Range
- ★ Many other Convenience Features

2M HB9CV ANTENNAS IN STOCK!

IDEAL FOR DF OR PORTABLE
ONLY £8.75 Inc. Post and VAT

ACCESS — VISA ACCEPTED — H.P. ARRANGED (WRITTEN QUOTATIONS ON REQUEST)
ALL ABOVE LISTED PRICES INCLUDE VAT AT 15% AND CARRIAGE

Western Electronics (UK) Ltd

Our Agents:

Southern: Alan Paxton, G4BZ, Southampton, Hants.
(0703) 582182

Scotland: Jim Henderson, GM4HKW, Falkirk
(0324) 255669

N. Ireland: Les Lyske, G13CDF, Newtownards
(0247) 812449

Opening Hours:

LOUTH: 9-12, 1-5pm Mon-Fri. By appointment Sat 9-12

LEICESTER: May's Hi-Fi, Churchgate (Tel: 0633 586652)
Mon-Sat 9-6pm; closed Thurs.

HEAD OFFICE (All Mail/Enquiries)

FAIRFIELD ESTATE
LOUTH, LINCNS LN11 QJH

Tel: Louth (0607) 604955 Telex: 56121 WEST G



STEPHENS-JAMES LTD.

47 WARRINGTON ROAD, LEIGH, LANCS. WN7 3EA **G3MCN**
Telephone (0942) 676790

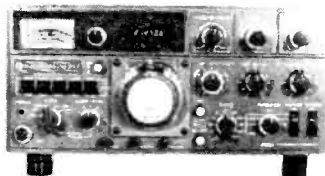

R820 RECEIVER

THE ULTIMATE IN RECEIVERS

Frequency coverage 160-10m plus SW Broadcast Bands. All modes CW-USB-LSB-RTTY Digital Readout. Noise Blanker Fully variable. I.F. Bandwidth, plus Bandpass tuning, plus rejection notch filter. £690.00



TR2300

TR2300 2m Synthesised Portable Transceiver. We have lost count of the number of this model we have sold over the last 12 months. Hikers, campers, climbers, you can hear them all over the country and reliability which is the essence of TRIO equipment. £166.75

JAYBEAM

5Y/2M 5 element yagi	£11.27
8Y/2M 8 Element yagi	£14.49
10Y/2M 10 Element	£31.06
PBM/14/2m. 14 element Parabeam	£44.80
5XY 2m. 5 element crossed yagi	£22.77
8XY 2m. 8 element crossed yagi	£28.40
10XY 2m. 10 element crossed yagi	£37.72
Q4 2m. 4 element Quad	£23.89
Q6 2m. element Quad	£31.39
D5 2m. 5 over 5 slot fed yagi	£20.12
D8 2m. 8 over 8 slot fed yagi	£27.40
UGP 2m. ground plane	£10.12
M8M48 70cms. Multibeam	£28.76
MBM88 70cms. Multibeam	£38.33
TAS 2m. Whip mobile	£15.29
C5/m. Colinear	£44.27
C8/70cm. Colinear	£60.00
D15 1296 23cm. Antenna	£34.04

Carriage on Antennas £3.00

TR9000



The TR9000 is a compact lightweight 2 mt. FM-USB-LSB-CW Transceiver with an outstanding array of functions. FM1 for 25 KHz steps (for mobile use) FM2 for precise 100Hz steps (for base station use). Microcomputer control giving many advanced features. Built in 5-channel memory. New type microphone with UP/DOWN switching. Built in high performance N. Blanker. Side tone for CW. ALL THIS PLUS MUCH MORE FOR £345.00 inc. VAT

TRIO	
R820 Receiver	£690.00
SP820 Speaker	£37.95
SM220 Monitorscope	£197.80
TL922 Linear Amplifier	£595.00
PS-20 AC power supply for TS120V	£44.85
MB100 Mobile mounting bracket	£17.25
R1000 Receiver	£298.00
TR2300 2m. Portable Transceiver	£166.75
TR2400 Hand held 2m Transceiver	£198.00
TL120 Linear Amplifier	£128.80
HS5 Headphones	£21.85
HS4 Headphones	£10.35
MC50 Desk Microphones	£24.15
MC30S Hand Microphone 50K	£13.80
TS130V HF Transceiver	£404.34
TS130S HF Transceiver	£491.06
AT130 Antenna Tuner	£72.89
PS30 Power Supply	£85.10
SP100 Speaker	£28.46
AT230 Antenna Tuner	£106.72
SP230 Speaker	£33.14
SP40 Mobile Speaker Unit	£28.89



TRIO R1000

R1000 Receiver £285.20

The latest general coverage from Trio. Frequency coverage 200 KHz to 30 MHz in 30 bands. Using an advanced PLL system. Full digital readout. Three filters 12 KHz for AM -6KHz narrow AM and 2.7 KHz SSB. Also incorporates a noise blanker. Operation is from 100-240 V AC or 12 V DC.



TS 180S

TS 180s. HF Transceiver. An all solid state Transceiver with Digital Frequency Control. A rig that has the facilities that DXer, Contest operator or any Amateur would desire for maximum flexibility on the 160 through 10 metre bands. Up to 200 watts PEP input. No tune final amplifier. £679.65

J.R.C. NRD515D

General coverage receiver 100KHz to 30MHz fully synthesised. Digital readout PLL synthesiser with rotary type encoder pass band tuning - modular construction. £949.00

ACCESS & BARCLAYCARD facilities. Instant HP service Licensed Credit Broker - quotations upon request

Try our new "Overnite" service for £5.00. Guaranteed 24 hour service if order placed before 11 a.m. (except North GM).

Part exchange always welcome. Spot cash paid for good clean equipment. If you have equipment surplus to your requirement we would be pleased to sell this on commission for you.

Shop Hours: 9.30 to 5.30 Monday to Friday.
5 p.m. Saturday

No parking problems. Turn at the Greyhound Motel on the A580 (East Lancs.) Road, S.A.E. with all enquiries. 25p will bring you latest information and prices, credited to your first purchase over £5. Postage carriage extra.

ALL OUR PRICES INCLUDE VAT



TR7800

Continuing TRIO's policy of presenting the Radio Amateur with the finest equipment available, we are pleased to announce the NEW TR7800 2m FM Mobile Transceiver. 15 memory channels - Priority channels with simplex \pm 600 KHz or non-standard operation - "Priority alert" bleeps when signal on M14 priority channel. Frequency coverage 144.00, 145.955 in switchable 5 KHz or 25 KHz steps. Front keyboard for selecting frequencies, programming memories and controlling scan function. ALL THIS and MORE for £268.50.

HF SSB TRANSCEIVER AROUND £640 inc VAT

carriage by Securicor £4.50

The new TS830S, the latest from TRIO. A high performance, very affordable HF SSB/CW transceiver with every conceivable operating feature built in for 160 through 10 metres (including the new three bands). The TS830S combines a high dynamic range with variable bandwidth tuning (VBT), IF shift and an IF notch filter, as well as very sharp filters in the 455 kHz second IF. Together with the optional VFO230 (remote digital display VFO) which provides split frequency operation and 5 memories for frequency hold, the amateur has available today's advanced technology linked to the proven reliability and exceptional linearity of a valve PA.

- * VBT variable bandwidth tuning
- * IF notch filter
- * IF Shift
- * Various filter options
- * Built in digital display
- * 6146B final with RF negative feed-back
- * Optional Digital VFO for increased flexibility
- * Innovative PLL system of frequency generation
- * RF speech processor
- * Adjustable noise blanker level
- * Adjustable audio tone
- * RF attenuator
- * RIT/XIT
- * SSB monitor circuit
- * Expanded frequency coverage



TS830S

ROTATORS	CABLE
DR7500X £98.04	UR43 24p metre
DR7500R £107.98	UR67 80p
ART300C £97.50	300 ohm Ribbon
Sky King SU200. £40.40	12p metre
Sky King SU400. £75.00	75 ohm low loss 24p
DR7600X £135.00	

SRX-30
Solid state Receiver 550 kHz-30 MHz £158.00

Mobile Antenna Range	
5/8th Whip PL259 fitting	£8.50
Magnetic Mount PL 259 fitting	£8.00
7/8th Whip	£13.00
Basemount and lead	£3.50
Gutter mounts	£3.15

Accessories	
2 way Antenna Switch 50 ohm-200 watt	£6.60
3 way Antenna switch SWL push button type	£4.60
3 way Antenna Switch 2 kW PEP 0.500MHz	£10.60
4 way Antenna Switch 50 ohm 200 watt PEP	£10.60

Single Meter SWR Wall type	£10.87
Single Meter SWR Desk type	£11.00
Twin Meter SWR Desk type	£13.55
T345N Thru Line Wattmeter 140-435 MHz	£34.45
DL50 50 watt 50 ohm Dummy Load	£7.50
DL-1000 1kW Dummy Load 50 ohm	£37.95
Morse Keys Light weight	£3.25
Oscerblock SWR200B Twin Meter	£40.19
HyMount HK 708.	£10.50
Katsumi EK 150 Electronic Keyer	£79.00
Bencher IAMBIC keying paddle	£29.75
DX-008 Programmable Frequency Counter	£116.25
HP3A High Pass Filter	£3.50
Twin Keying Paddle Chrome plated with heavy base. Precision Unit	£26.50
KX2-SWL Antenna Tuner	£29.90
Mk II SWL Antenna Multituner.	£32.50
Full Range	

Mini Products	
C4X 3 band Vertical	£48.00
HQ1 Mini Beam	£96.00

Hy Gain	
12AVG 3 band Vertical	£43.12
14AV7/WB 4 band Vertical	£60.37
18AV7/WB 5 band Vertical	£87.40
Diawa 144 Mhz and 70 cms Antennas in stock	

F.D.K.	
Multi-750E Transceiver	£299.00
Multi-700EX Transceiver	£199.00

R517 Hand Held Tunable 118.144MHz plus Crystal Control on three Fixed Frequencies. UNDER £50 inc. VAT



£258.75

BEARCAT 220 FB
Specifications.
Frequency range:
66 - 88 MHz
118 - 136 MHz
144 - 148 MHz
148 - 174 MHz
420 - 450 MHz
450 - 470 MHz
470 - 512 MHz

STANDARD
C8800 2M FM Mobile Transceiver £252.00

G-WHIP

Tribander Helical 10-15-20m	£24.72
LF Coils for Tribander	£6.55
LF Telescopic Whip Section	£3.35
Basemount standard type	£4.48
Multimobile 7B, 10-15-20m	£28.75
MM Coils	£6.55
MM Telescopic whip section	£3.33
Flexiwhip basic 10 metres section	£17.25
Basemount standard	£4.48
Ball type Basemount	£6.32
Coils for Flexiwhip	£6.55
Base thread adaptor USA/G Whip	£0.75
Extendard 40"	£11.50

DRAKE

TR7 Digital Transceiver	£1035.00
PS7 Power supply	£207.00
RV7 Remote VFO	£138.00
MS7 Speaker	£29.90
R7 Digital Receiver	£989.00
Filters for TR7	£39.10
FA7 Fan for TR7	£20.70
MN7 ATU/RF Meter 250 Watts	£124.20
MN2700 ATU 2 KW	£207.00
DL300 Dummy Load 300watts	£20.70
DL1000 Dummy Load 1 KW	£37.95
TV3300 Low Pass Filter	£18.40
AK75, Doublet Antenna 132" top with 470 ohm Feeder	£23.00

MICROWAVE MODULES

MMT 1296/144 1296 MHz Lin/Transverter	£184.00
MMT 70/144 4m Lin/Transverter	£115.00
MMA 1296 Receiver pre-amp	£29.90
MML 144/40 40 watt Linear Amplifier	£69.00
MMA 144V 2m RF Switched preamplifier	£29.90
MML432/20 Lin Amp and Pre-amp	£69.00
MMT 144/28 2m Transverter	£99.00
MMT432/28S 70cm Transverter	£136.85
MMT432/144R 70cm Transverter	£173.65
MMT 70/144 4m Transverter	£115.00
MML 144/25 2m 25 watt Linear	£48.30
MML 144/100 2m 100 watt Linear	£142.60
MMC70/28 4m Converter	£24.90
MMC 144/28LO 2m Converter	£26.90
MMC432/28S 70cm Converter	£29.90
MMC 1296/144 23cm Converter	£32.20
MMO50/500 500MHz freq. conter	£69.00

ANTENNA RANGE

HG5 Vertical 10-80m	£48.50
HFR Ground Plane Kit	£28.00
GDX-2 Oiscone 50-480MHz	39.50

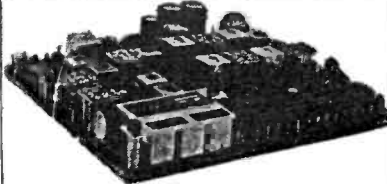

AR20. 12 channel FM receiver 144-146MHz. Input impedance 50-75 ohm. AM-FM modes. Sensitivity 0.2uV AF output 3 watts. 12v DC operation
Price £50.00

RECEIVERS AND TRANSCEIVERS
(Inc. VAT and Postage)

SR9 Tunable 144-146MHz Receiver	£46.00
AMR217B Scanner Receiver. AC or DC operation	£113.50
R512 Aircraft Band Scanning Receiver	£135.00
Regency Digital Flight Scan Synthesised Aircraft Band Receiver	£215.00
Phillips FM321 70cms FM Transceiver	£264.00
Yaesu FRG7 Receiver	£199.00
FDK TM563 Scanning 2m Receiver	£109.00
'Sky ACE' Hand held Aircraft Band Receiver.	£49.50
Bearcat 220 Scanning Receiver.	£258.75
AR22 2m Hand Hold Receiver	£83.00

SECONDHAND EQUIPMENT
We have a very rapid change over of secondhand equipment, especially in receivers. Our lists are updated each day, please send SAE for latest or telephone. Here are a few of the items from our range. All prices include VAT.

Drake TR4C HF Transceiver MS4S Speaker/power supply	£396.00
NRD 505 Synthesised Receiver	£1,400.00
KW202 Receiver	£165.00
Drake R4C + CW Filter	£400.00
Eddystone 830/7 Receiver.	£396.00
Drake TR7 Transceiver + PSU 7	£896.00
Trio TS 700S Transceiver	£425.00
ICOM IC701 Transceiver + PSU	£575.00
Yaesu FRG700 Receiver	£200.00

SOLID STATE STABILISED POWER SUPPLIES
Maximum ratings quoted. Prices include postage.

Model 122 12.6V 2.5A	£15.55
Model 125 10-15V 5 amp	£29.50
Model 156S 4-15V 5 amp Twin Meter	£40.00
Model 1210S 4-20V 10 amp Twin Meter	£85.00
Model 1210/1 10amp 13v	£68.00
Model 1220-1 13.5V 20 amp	£90.00
Model 1220/2 13.5V 12 amp	£80.00

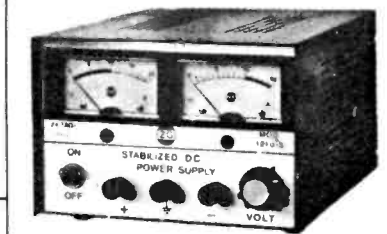

Mod. 1210 S

STEPHENS-JAMES LTD.
47 WARRINGTON ROAD, LEIGH, LANCs. WN7 3EA
Telephone (0942) 676790



WATERS & STANTON ELECTRONICS

RADIO COMMUNICATIONS SPECIALISTS

Largest Stocks in the South



Prices correct as 1/1/81

	£	£
TRIO		
TS830S	160-10m transceiver	639.52 (4.50)
VFO230	Digital VFO	194.45 (1.50)
AT230	All band ATU	106.72 (1.50)
SP230	External speaker	33.14 (1.50)
DS2	Dc pack for TS830S	36.90 (1.50)
DRC230	Digital frequency controller	163.13 (1.50)
YK89C	500Hz CW filter	28.75 (1.00)
YK89CN	270Hz CW filter	28.62 (1.00)
TS530	180-10 metre transceiver	1.6 a (4.50)
DC5	Digital readout	103.50 (1.50)
SP520	Speaker	17.25 (1.50)
VFO520S	External VFO	96.90 (4.50)
YG3395C	CW filter 8 pole	37.95 (0.60)
DK520	Conversion kit	10.36 (0.75)
AT200	160-10m antenna tuner	82.80 (1.50)
SM220	Station monitor scope	197.60 (4.50)
BSB	Panoramic display	48.30 (0.50)
BS5	Scan board	48.30 (0.50)
RB20	Amateur band receiver	680.00 (4.50)
YG455C	500Hz CW filter	58.65 (0.50)
YG455CN	250Hz CW filter	60.95 (0.50)
YGB8A	60Hz AM filter	34.50 (0.50)
TS180S	160-10m solid state trans.	675.85 (4.50)
VFO180	External VFO	96.90 (1.50)
SP180	External speaker unit	36.80 (1.50)
AT180	Matching 200W ant. tuner	95.45 (4.50)
YK89C	500Hz CW filter	28.75 (1.00)
YK89S	Second SSB filter option	28.75 (1.00)
PS30	AC power sply for TS180S	85.10 (4.50)
TS130S	8 band 200W mobile trans.	491.05 (4.50)
TS130V	8 band 200W mobile trans.	404.34 (4.50)
DCR230	Digital frequency controller	163.13 (1.50)
TS120S	80-10m 200W mobile trans.	432.40 (4.50)
TS120V	80-10m 200W mobile trans.	319.00 (4.50)
TL130	200W pep linear	128.80 (1.50)
MB100	Mobile mount	17.25 (1.00)
YK89C	500Hz CW filter	28.75 (1.00)
YK89CN	270Hz CW filter	28.62 (1.00)
SP120	External speaker unit	89.70 (4.50)
SP40	Mobile speaker unit	25.30 (1.25)
AT130	100W antenna tuner	72.89 (1.50)
PS20	AC pwr sply for TS120/130V	44.85 (4.50)
PS30	AC pwr. sply for TS120/130S	86.10 (4.50)
MA5	5 band mobile aerial system	74.75 (4.50)
TL922	160-10m 2KW linear	596.70 (4.50)
MC50	Deluxe desk microphone	24.15 (1.50)
MC35S	Fist mic 50K impedance	13.80 (1.00)
MC30S	Fist mic 500 ohm impedance	13.80 (1.00)
LF30A	HF lowpass filter	18.40 (1.00)
RD300	1KW dummy load	48.30 (1.50)
TS730E	2m 70m dual band trans.	730.25 (4.50)
SP70	External speaker	18.40 (1.00)
TR900	2m multimode mobile	345.00 (4.50)
B09	Base plinth for TR900	32.20 (4.50)
TR7800	2m FM syntsd mobile 25W	288.00 (4.50)
RM76	Microprocessor control	60.95 (1.50)
TR2300	2M FM syntsd portable	166.75 (4.50)
V92300	10W amplifier for TR2300	49.45 (1.50)
MB2	Mobile mount	17.25 (1.00)
RA1	Rubber flex. antenna	6.90 (0.50)
PS1200	AC power unit and charger	29.50 (1.50)
TR2400	2M FM syntsd handheld	198.95 (4.50)
ST1	Base stand and quick chgr.	43.70 (1.50)
BC5	12V quick charger	17.25 (1.50)
SC3	Soft carrying case	11.50 (0.50)
LH1	Hard leather holster	18.50 (0.50)
PB24	Spare battery pack	14.26 (1.50)
TR3200	70cm FM portable	164.45 (4.50)
PL1	Power power/charge lead	1.30 (0.15)
R1000	Gen. Coverage Receiver	235.20 (4.50)

YAESU		
FT101Z	160-10m 9band trans.	486.75 (n/c)
FT1012Z	as above with digital	569.25 (n/c)
DCT101Z	Digital kit	86.25 (n/c)
DCT101Z	12V DC adaptor	34.50 (1.00)
FV101Z	Remote VFO	126.50 (n/c)
FT107M	160-10m band trans.	680.00 (n/c)
FV107	Remote VFO for FT107	92.00 (n/c)
FC107	160-10m atu.	97.75 (1.50)
FP107E	230V AC power supply	106.95 (2.50)

E. & O. E.	£	£
FP107	Internal model	97.75 (2.50)
FTV107	Transverter main frame	110.40 (n/c)
FTV107Z	Transverter	207.00 (n/c)
144V107V901	Transverter	101.20 (n/c)
50V107V901	Transverter	89.00 (n/c)
144V107V901	Transverter	178.25 (n/c)
SP107P	External speaker	55.20 (2.50)
SP107	External speaker	27.80 (2.00)
DMST107	12 channel memory	100.05 (n/c)
CW	CW filter for FT107	23.00 (0.50)
AM	AM filter for FT107	23.00 (0.50)
YM34	Desk mic for FT707/FT107	21.28 (1.50)
YM35	Up/down for FT107	12.85 (0.75)
YM36	500 ohm noise canclg. mic	13.80 (0.75)
YM37	500 ohm mic for FT707/FT107	8.63 (0.75)
FT707S	160-10m 9band trans. 100w	465.75 (n/c)
FT707	160-10m 9band trans. 100w	463.00 (n/c)
FP707	230V AC PSU	109.25 (2.50)
FC707	160-10m atu.	74.75 (1.50)
FV707DM	Digital vfo for FT707	178.25 (n/c)
MH7	Metal rack	14.95 (1.50)
MNB2	Mobile mount	14.95 (1.50)
FRB707		21.85 (1.00)
FL2100Z	160-10m 1200 watt linear	362.25 (n/c)
YP150	150w dummy load/meter	63.25 (1.75)
YH55	8 ohm comm. headphones	10.35 (1.25)
NP	Low pass filter	19.95 (0.75)
TR24D	24 hour quartz clock	24.95 (1.50)
S72	230V AC 12 amp DC	78.20 (2.50)
FP4	230V AC 4 amp DC	41.40 (2.50)
FSP1		9.95 (1.00)
FRG7	0.5-30 MHz comm. receiver	189.00 (n/c)
BHGR7	Battery holder	5.00 (1.00)
FRG7000	0.2-30 MHz	P. O. A.
YC7000	Frequency counter	189.75 (n/c)
YC5025		270.25 (n/c)
YC500E		346.00 (n/c)
FRG7000	1981 version of FRG7000.	309.00 (n/c)
FRG7700	MEM with frequency memory	360.00 (n/c)
FT207R	144-146 MHz handheld 2 watt	199.00 (n/c)
NC1A	230V AC charger	18.98 (1.50)
NC2	230V AC charger	38.88 (1.50)
NC9	230V AC charger	7.48 (0.75)
NB99	Ni-cad battery pack	16.88 (0.75)
FLC2	Heavy duty case	20.70 (0.75)
PA2	12v PSU	16.88 (1.00)
FBA1	Ni-cad pack charging adaptor	2.59 (0.35)
FT225R	144-146 MHz Base station	449.00 (n/c)
FT225RD	With digital readout	499.00 (n/c)
MEMT225	Memory option module	92.00 (n/c)
DIST225	Readout for FT225R	57.50 (1.00)
FT480R	2m 10W SSB CW/FM trans	369.00 (n/c)
FT720R	2m/4m 70cm control head	149.50 (n/c)
S	Switching box	55.20 (n/c)
E72S	2m of connecting cable	23.00 (1.00)
E72L	4m of connecting cable	27.20 (1.00)
720V9	10W 2m module	166.75 (n/c)
720V9H	25W 2m module	172.50 (n/c)
720R	10W 70cm module	201.25 (n/c)
MMBR3	Mobile mounting bracket	5.00 (1.50)

FDK VHF/UHF EQUIPMENT		
M700EX	2m FM 25w 12v/25kHz trans	198.00 (n/c)
M750E	2m FM/SSB/CW 144-146 trans	299.00 (n/c)
Expander	70cm transceiver	168.00 (n/c)
PS750	230V AC 6 amp psu	89.00 (2.50)
Palm II	2m FM 6 channel portable	89.00 (n/c)
Palm IV	70cm FM 6 channel portable	149.00 (n/c)
TB1	1750Hz tone burst	10.00 (n/c)
PalmSizer	2m FM 40 channel handheld	149.00 (n/c)
BT1	2m FM/SSB CW 10w base str	398.00 (n/c)
TM56B	2m FM monitor	79.00 (n/c)
FDM40SP	Speaker/mic for PalmSizer	11.00 (0.50)
CC2	Case for Palm II/IV	5.75 (0.50)
CC2	230V AC battery charger	4.50 (0.50)
SC2	Case for Palmizer	9.75 (0.50)
EB2	External battery case	5.00 (0.50)
B22	Ni-cad battery pack	12.00 (0.50)
Xtals	For Palm II and Palm IV	3.00 (0.15)
Xtals	For TM56B	2.50 (0.15)

MICROWAVE MODULES	£	£
MMT28/144	10m linear transverter	99.00 (1.75)
MMT144/28	2m linear transverter	99.00 (1.75)
MMT432/28S	70cm linear transverter	149.00 (1.75)
MMT432/144R	70cm linear transverter	194.00 (1.75)
MMT70/28	4m linear transverter	115.00 (1.75)
MMT70/144	4m linear transverter	115.00 (1.75)
MMT1296/144Z	23cm linear transverter	194.00 (2.25)
MML144/25	2m 25 watt linear amplifier	59.00 (1.75)
MML144/40	2m 40 watt linear amplifier	77.00 (1.75)
MML432/100	2m 100 watt linear amplifier	142.80 (1.75)
MML144/100P	2m 100 watt linear amplifier	142.80 (1.75)
MML432/70	70cm 70 watt linear amplifier	77.00 (1.75)
MML432/100	70cm 100 watt linear amplifier	119.00 (2.75)
MM200	RITTY to TV converter	169.00 (1.75)
MML28/144	10m converter	27.90 (0.65)
MML50/28	6m converter	27.90 (0.65)
MML70/28	4m converter	27.90 (0.65)
MML70/28LO	4m converter	29.90 (0.65)
MML144/28	2m converter	27.90 (0.65)
MML144/28LO	2m converter	29.90 (0.65)
MML432/28S	70cm converter	34.90 (0.65)
MML432/144S	70cm converter	34.90 (0.65)
MML435/51	70cm ATV converter	34.90 (0.65)
MML435/600	70cm ATV converter	27.90 (0.65)
MML1296/28	23cm converter, 10m output	32.20 (0.65)
MML1296/28	23cm converter, 2m output	59.80 (1.75)
MMD050/500	500MHz digital frequency meter	69.00 (0.65)
MMD800P	800 MHz prescaler	23.00 (0.65)
MMDP1	Frequency counter probe	11.50 (0.65)
MMA28	10m preamplifier	14.95 (0.65)
MMA1144	2m RF switched preamplifier	34.90 (0.65)
MMA1296V	23cm preamplifier	29.90 (0.65)
MMF144	2m filter	9.90 (0.65)
MMF432	70cm filter	9.90 (0.65)
MML1296	70cm to 23cm varactor tripler	34.50 (0.65)
MMS384	384mhz frequency source	27.60 (0.65)
MMR1510	15b atten. BNC terminations	5.75 (0.65)

JAYBEAM ANTENNAS		
TB3	HF 3 element Tribander	167.90 (4.50)
VR3	HF Vertical Tribander	42.50 (3.00)
4 metre Antennas		
4Y/4M	4 element yagi	20.70 (3.00)
PMH4/2M	2 way phasing harness	12.20 (1.00)
2 metre Antennas		
DL1WB	Wide band discone (10D-470MHz)	41.40 (2.50)
LR1/2M	Vertical colinear	24.15 (2.50)
C5/2M	5db glass fibre colinear	44.30 (3.50)
5Y/2M	5 element	11.25 (2.00)
8Y/2M	8 element	14.50 (2.50)
10Y/2M	10 element	31.00 (3.50)
PBM10/2M	10 element Parabeam	36.80 (3.50)
PBM14/2M	14 element Parabeam	44.85 (4.50)
XY/2M	Crossed 5 element	22.75 (3.00)
8X/2M	Crossed 8 element	28.40 (3.50)
10X/2M	Crossed 10 element	37.70 (4.00)
X6/2M X 12/70cm	Dual band	38.50 (4.50)
10Y/2M	2 way phasing harness	7.50 (0.75)
Q4/2M	4 element quad	23.70 (2.50)
Q6/2M	6 element quad	31.40 (4.50)
DS/2M	Double 5 slot-fed	20.15 (2.50)
DB/2M	Double 8 slot-fed	27.15 (4.00)
SVHK/2M	Kit for vertical col.	7.25 (1.50)
UGP/2M	Ground plane	10.15 (1.50)
HO/2M	Mobile halo (head only)	4.50 (1.00)
HM/2M	Mobile halo with mast	5.40 (1.75)
PMH4/2M	2 way phasing harness	9.90 (1.00)
PMH4/2M	4 way phasing harness	23.00 (1.75)

70cm Antennas		
CB/70cm	8dB colinear	50.00 (3.50)
DB/70cm	Double 8 slot-fed	20.70 (2.50)
PBM18/70cm	18 element Parabeam	25.30 (2.50)
MMLM48/70cm	48 element Multibeam	28.75 (3.00)
MMLM89/70cm	89 element Multibeam	39.30 (4.50)
8X/70cm	Crossed 8 element	34.15 (3.50)
12M/70cm	Crossed 12 element	42.32 (4.50)
PMH4/70cm	2 way phasing harness	8.50 (1.00)
PMH4/70cm	4 way phasing harness	18.00 (1.50)

WATERS & STANTON ELECTRONICS

FAST MAIL ORDER SERVICE ANYWHERE IN UK FULL MANUFACTURERS WARRANTY

Prices include VAT & Insurance

Carriage shown in brackets

23cm Antenna			
D15/1296 Double 15 slot-fed	34.00	(1.50)	
PMH2/23cm 2 way phasing harness	25.40	(1.00)	

Matching Transformer			
MT75/50 75/50 ohms	3.60	(0.50)	

Chimney Lashing Kit			
DL Double lashing kit	8.25	(2.00)	

Wall Brackets			
W6 6" wall bracket	2.65	(1.00)	
W21 21" wall stand-off bracket	10.35	(3.00)	
W24HD 24" wall stand-off bracket	14.70	(4.50)	

Masts (Aluminium)			
SPM 16' x 1" Portable Mast	15.15	(3.00)	
PME 4' extension	2.50	(2.00)	
A4 4'6" x 1 1/2" straight	3.80	(1.50)	
A5 5' x 1" straight	2.30	(1.50)	
A9 9' x 1 1/2" straight	6.50	(2.50)	
A10 10' x 2" straight	12.55	(2.50)	
A12 12' x 2" straight	14.95	(3.00)	
A14 14' x 2" straight	17.40	(3.00)	

Accessories			
CP1 Cross-over plate 2" x 2"	3.36	(1.50)	
JBL59/15 15" jointing sleeve	6.80	(1.50)	
JBL29 Universal clamp	1.80	(0.75)	
JBL30 Universal clamp	1.80	(0.75)	
JBL53 Universal clamp	1.45	(0.75)	
JBL58 3hook guy wire clamp	1.50	(0.75)	
JBL63 Universal clamp	1.40	(0.75)	
JBL64 Die-cast clamp	1.20	(0.75)	
JBL65 Die-cast clamp	1.30	(0.75)	
JBL73 Heavy duty	2.10	(1.00)	
MBP Mast base plate	3.60	(1.50)	

PCZEN PRODUCTS			
PCS 3000 2 metre 25w transceiver	199.00	(n/c)	
PCS 2800 10metre 10w transceiver	169.00	(n/c)	
Remote cable kit	19.50	(n/c)	

G-WHIP MOBILE ANTENNA RANGE			
Tribander HEICAL 10/15/20 metres	24.75	(2.00)	
LF40m Coil for above	6.55	(0.50)	
LF80m Coil for above	6.55	(0.50)	
LF180m Coil for above	6.55	(0.50)	
LF telescopic resonator whip	3.35	(0.75)	
Base mount + 3m cable	4.50	(0.50)	

AERIAL ROTATORS (complete with control boxes)			
CDE AR30 (5 core cable)	47.00	(1.50)	
CDE AR40 (5 core cable)	59.80	(1.50)	
Channelmaster 9502 (3 core)	42.00	(2.00)	
Sky King SU400 (6 core)	75.00	(2.50)	
Jaybeam KR400 (6 core)	105.00	(2.00)	
CDE alignment bearing	7.75	(1.00)	
Channelmaster alignment bearing	11.75	(1.00)	

HF ANTENNAS (various manufacturers)			
Mini-Prts HC1 20 15/10m 2 ele.	96.50	(2.50)	
Mini-Prts C4 20 15/10m vertical	48.00	(2.00)	
Mosley TD3JR 20 15/10m wire dipole	34.50	(1.50)	
Mosley "Mini-Beam" 20 15/10m 2 ele. 600w	99.00	(2.00)	
Mosley "Mini-Beam" 20 15/10m 2 ele. 2Kw	129.00	(2.00)	
Mosley TA32 20 15/10m 2 ele. 600w	88.70	(2.00)	
Mosley TA33 20 15/10m 3 ele. 600w	133.40	(2.50)	
Mosley Mustang 20 15/10m 3 ele. 2Kw	166.75	(2.00)	
Hy-Gain 12AVQ 20 15/10m vertical	43.00	(2.00)	
Hy-Gain 14AVQ 40 10m vertical	80.00	(2.00)	
Hy-Gain 18AVT/WB 80 10m vertical	87.00	(2.50)	

HF580 10m vertical 200w	48.00	(2.00)
Radial Kit for HF5	28.00	(2.00)
Sagant EL40X 60 40 dipole (79' long)	36.00	(1.50)
Jaybeam TB3HF 3 element 2Kw	167.90	(4.50)
Jaybeam VR3HF vertical 2Kw	42.50	(3.00)

DENTRON		
MLA2500B 6 band 180 10m 2Kw linear	695.00	(n/c)
Clipperton-L 6 band 180 10m 2Kw linear	469.00	(n/c)
DTR-1200L 5 band 80 10m 1.2Kw linear	t.b.a.	(n/c)
GLA-1000B 5 band 80 10m 1Kw linear	295.00	(n/c)
DTR-3K 1.8-30MHz ATU 2Kw	t.b.a.	(n/c)
MT-3000A 1.8-30MHz ATU 3Kw	275.00	(n/c)
AT-1K 1.8-30MHz ATU 1Kw	99.00	(n/c)
HF200A 80 10m transceiver 100w	399.00	(n/c)
Spare set of D50A tubes	24.00	(n/c)
All band Doublet 1.8-30MHz	22.50	(2.00)
100T1. 470 ohm semi-air spaced	12.00	(1.00)

ADONIS MICROPHONES		
AM202G Mobile safety mic.	20.95	(n/c)
AGM202S Mobile safety mic.	20.95	(n/c)
AM202H Mobile safety mic.	29.00	(n/c)
AM502S Base station comp. mic.	38.00	(n/c)
AM802G Base station 3 outputs	59.00	(n/c)

The above model numbers may confuse you with regard to which model suits your equipment. Please telephone or write for free advice.

SEM PRODUCTS		
2 metre power amplifier 5w/30w	50.00	(1.00)
2 metre power amplifier 16w/50w	86.70	(1.50)
2 metre power amplifier Rf sensing 16w		
120w out 16w/10w	126.50	(1.50)
2 metre converters 28.30 4/6 2/4	23.00	(0.35)
2 metre Auto pre-amplifier	21.73	(0.35)
70cm Auto pre-amplifier	24.73	(0.35)
2 metre pre-amplifier	14.95	(0.35)
70cm pre-amplifier	17.73	(0.35)
2.40MHz pre-amplifier	18.66	(0.35)
2.40MHz pre-amplifier	11.73	(0.35)
PA3 2 metre pre-amplifier	8.00	(0.35)
PA70 70cms. pre-amplifier	10.00	(0.35)
Z Match ATU 3.5-30MHz 500watts	47.15	(1.50)
EZTune Aerial tuning aid	30.48	(0.75)
IAMBIC Keyer	34.50	(0.75)

2 METRE PORTABLES		
SB2M 2m SSB portable	99.00	(1.50)
AR245 (previously AR240A) 2m FM 5w	178.00	(1.50)
AR245 carrying case	4.10	(0.50)
AR245 optional helical	4.10	(0.50)
AR245 12v DC car adaptor	4.10	(0.50)

VHF/UHF MONITORS		
TM568 FM Scanner 12v DC/230v AC	79.00	(n/c)
Q08 8 channel FM monitor	69.00	(n/c)
M161 16 channel FM monitor	59.00	(n/c)
MF083 Marine/Broadcast scanner	85.00	(n/c)
BEARCAT 220FB 66 512mHz	258.00	(n/c)
SX 200 26-512mHz	240.00	(n/c)
SRS Tuneable 144-148 or 156-162mHz	46.00	(n/c)
AR22 2m FM synthesized handheld	13.25	(n/c)
AR22 flexible antenna	3.00	(n/c)

VHF/UHF MOBILE AERIALS		
ASP201 2m 1/2 wave	3.50	(1.25)
ASP2008 2m 1/2 wave	9.25	(2.00)
ASP2009 2m 1/2 wave	8.25	(1.25)
ASP462 70cm co-linear	9.75	(2.00)
Magnetic base adaptor	8.50	(0.75)
ASP677 2m 1/2 wave	14.96	(2.00)
ASP667 70cm co-linear	17.95	(1.25)

ASPM125 27mHz 1/2 wave	18.50	(2.00)
Magnetic base adaptor for above	8.50	(0.75)
ASP boot mount adaptor	3.75	(0.50)
2NE 2m 1/2 mobile whip	13.00	(2.00)
RG4M Base for above aerial	3.50	(0.75)
G5S Gutter/boot mount	3.15	(0.50)
MBS Magnetic mount	7.95	(1.00)
10SE 28mHz whip 1.72m long	11.50	(1.25)
15SE 21mHz whip 1.72m long	11.50	(1.25)
20SE 14mHz whip 1.72m long	13.80	(1.25)

WELZ PROFESSIONAL POWER/SWR METERS		
SW2A 1.8-180mHz 20w-200w-1Kw	49.95	(n/c)
SP300 1.8-500mHz 20w-200w-1Kw	89.95	(n/c)
SP400 130-500mHz 5w-20w-150w	49.95	(n/c)

SHORT WAVE LISTENER AERIALS		
3-30mHz Inverted "L"	9.95	(1.00)
3-30mHz Broad band dipole	29.00	(1.00)
Mosley RD5 all-band dipole	40.00	(1.00)

AIR BAND PORTABLE MONITORS		
Sharp FX213 tuneable	13.50	(0.75)
INGERSOLL MW/FM/Airband monitor	12.95	(0.75)
R517 Professional Air Monitor	49.50	(0.75)

SPECIAL OFFER!		
5 Band TS120S Brand New	399.00	(4.50)

MISC. STATION ITEMS		
SEIF 13.8v 4 amp AC power supply	22.95	(1.50)
PS125 5amp AC power supply	29.00	(2.00)
EK121 Katsumi Electronic Keyer	29.00	(0.75)
EKM12 Matching side tone	10.95	(0.50)
SW2A Morse code oscillator	8.95	(0.50)
Telegraph CW key	10.50	(0.75)
YW3 TWIN SWR/Power meter 3.5-150mHz	11.50	(0.50)
MF210 Self powered 2M FM monitor	12.95	(0.50)
FX1 Station wavemeter	29.00	(1.00)
DM801 70Hz-250MHz dip meter	51.75	(1.00)
Station log books	1.95	(0.50)
12BY7A driver valves	2.75	(0.50)
6146B/S2001A P.A. valves	8.00	(0.50)
6JS6C P.A. valves. Matched pairs	9.95	(0.50)
PL259 plugs	0.63	(n/c)
PL259 reducers	0.17	(n/c)
SO239 chassis sockets	0.80	(0.10)
PL259 joiners	0.85	(0.10)
N. Plugs cable entry	2.00	(n/c)
N. Plugs UR43 cable entry	2.00	(n/c)
4 pin mic plugs	0.85	(0.10)
3 pin mic plugs	0.65	(0.10)
6 pin mic plugs (FDK 75)	0.85	(0.10)
3 pin chassis socket	0.85	(0.10)
4 pin chassis socket	0.85	(0.10)
BNC plugs (bayonet)	0.90	(0.05)
Pen Cell Ni-cads (HP7 size)	1.20	(0.05)
Clear lighter plugs	0.85	(0.05)
UR67 cable 50 ohm per metre	0.89	(0.10)
UR43 cable 50 ohm per metre	0.23	(0.05)
5 core rotator cable per metre	0.30	(0.05)
BL40X balun 50 ohm	11.25	(0.35)
3 core rotator cable	0.22	(0.05)
Ferrite rings 1 1/2" diameter	0.35	(0.05)
Mosley aerial insulators	0.30	(0.05)
KX25SWL aerial tuner. 5-30MHz	29.00	(1.50)
APM11 Audio Peak/notch filter	33.00	(1.00)
HP3A TV high pass filter	3.50	(0.50)
Drake TV3000 LP low pass filter	19.40	(1.25)
Shure 444 high impedance desk mic	27.50	(1.50)
Shure 201 high impedance hand mic	11.75	(1.00)
Trio HCM 10 digital word clock	56.20	(1.00)

ORDER WITH CONFIDENCE

Callers welcome. We are open 9-5.30 p.m. Monday - Saturday Ex. Wednesday 9-1.00 p.m.
 Telephone orders - Simply phone in your Barclaycard or Access number and we will despatch goods within 24 hours.
 Mail orders - Send cheque or postal order for correct amount and print clearly name and address - we will do the rest!
DEPT. 3, 18-20 MAIN ROAD, HOCKLEY, ESSEX. Tel. 0702 206835/204965. Telex 995895 HDSG

OUR REPUTATION IS YOUR GUARANTEE

AZDEN — THE "2 WAY" RADIO!

144 or
28mHz
FM

PCS 3000 25w 2M

PCS 2800 10w 10M



COMPUTER CONTROL
DETACHABLE CONTROL HEAD
8 MEMORIES
MEMORY/BAND SCANNING

WHY 2 WAY?

A unique feature of the Azden FM transceivers is the ability to detach the control head from the main body and so enable the control module to be mounted even in the smallest of spaces. This can be achieved in seconds and a flexible cable kit is available to permit boot mounting of the unit. This feature will help solve the problem of mounting the transceiver in some of today's modern cars.

WHO IS AZDEN?

Azden began life back in 1953 specialising in audio products on which their business has been built. Now they employ over 400 employees of which 50 are licensed amateurs. Several years ago they began marketing communications products, including amateur radio transceivers for their home market. Now they have decided to expand into the World market and the PCS 2800 and PCS 3000 are the first European models to be released. Other products are already on the drawing board and the name of Azden should become familiar in the next few years.

SPECIFICATION

5 watts/25 watts output — 144-146mHz — 25/12½ kHz steps — 0.2uv for 12db NQ — LED Bar S-meter — 8 channel memory — Simplex/-600kHz/+600kHz — 1750Hz tone burst — boot mount option — Quick release computer control head — Band scanning (full or partial) — Memory scanning — 4 digit frequency display — Remote control microphone — Ni-cad memory back-up (ni-cad fitted) — Illuminated key pad buttons — mobile mount and hardware supplied — 12 month Warranty.

DEALER ENQUIRIES INVITED

As sole U.K. distributors for Azden products, we are looking for bona fide amateur radio dealers in the U.K. to stock and sell both the PCS 2800 and PSC 3000. Limited stocks will be available during February 1981.

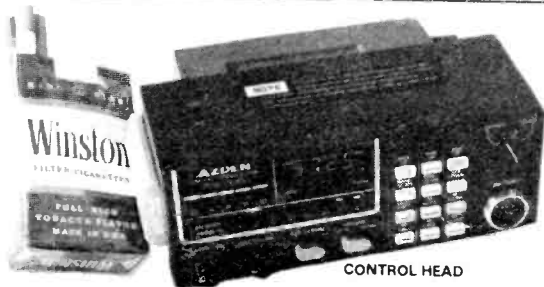

2M 25 watts £ 199 inc. VAT

10M 10 watts £ 169 inc. VAT

Another fine product from: —

WATERS & STANTON ELECTRONICS, 18-20 Main Road, Hockley, Essex.

Retail and Trade Sales.

SHORT WAVE MAGAZINE

(GB3SWM)

ISSN: 0037-4261

ADVERTISERS' INDEX

	Page
Aero & General Supplies ...	795
Amateur Electronics UK ...	748, 749
Amateur Radio Exchange ...	783
Amcomm Services ...	791, 796
J. Birkett ...	802
Bredhurst Electronics ...	788
British National Radio and Electronics School ...	804
Cambridge Kits ...	800
Catronics Ltd. ...	794
C.B. Electronics ...	796
Colomor Electronics Ltd. ...	804
Crayford Electronics ...	800
Datong Electronics Ltd. ...	789
Gemini Communications ...	804
G2DYM Aerials ...	800
G3HSC (Rhythm Morse Courses) ...	804
Heathkit ...	797
D. P. Hobbs Ltd. ...	803
Leeds Amateur Radio ...	799
Low Electronics <i>front cover, inside front cover, 741, 742</i>	
Merseyside Amateur Radio Supplies ...	804
M.H. Electronics ...	804
Northern Communications	802
Northern Radio Societies Association ...	801
Partridge Electronics Ltd. ...	794
P.M. Electronics Services ...	793
Quartslab Marketing Ltd. ...	795
Radio Shack Ltd. ...	758
R. T. & I. Electronics Ltd ...	801
S.E.M. ...	790
Small Advertisements	797, 798, 799, 800
South Midlands Communications Ltd. ...	743, 744, 745, 746, 747
Spacemark Ltd. ...	803
Stephen-James Ltd. ...	752, 753
S.W.M. Publications	<i>back cover, inside back cover, 798</i>
Thanet Electronics Ltd.	784, 785, 786, 787
T.M.P. Electronics ...	803
Uppington Tele/Radio (Bristol) Ltd. ...	795
Reg Ward & Co. Ltd. ...	803
Waters & Stanton Electronics	754, 755, 756
Geoff Watts...	798
Western Communications (Galway) Ltd. ...	792
Western Electronics (UK) Ltd.	750, 751
W. H. Westlake ...	800

Vol. XXXVIII

FEBRUARY, 1981

No. 448

CONTENTS

	Page
VHF Bands , by N. A. S. Fitch, G3FPK.....	759
Hints and Tips on the K2RIW Amplifier , by Geoff Brown, GJ4ICD.....	764
Two-Metre 'Aide Memoire' , by Peter Lloyd, C.Eng., MIEE, G8XGH.....	764
Clubs Roundup , by "Club Secretary".....	766
1980 "Magazine" Club Contest	769
The Rabbit Patch, Part VI , by "Buck".....	771
"A Word in Edgeways" — Letters to the Editor.....	775
A Simple Tuning Aid for Blind Operators , by Brian Castle, G4DYF.....	778
"It's The Second Biggest Thing Since '46" , by Jack Hum, G5UM.....	776
Communication and DX News , by E. P. Essery, G3KFE.....	779
New QTH's	782

Editor: PAUL ESSERY, G3KFE/G3SWM

Advertising: Charles Forsyth

Published at 34 High Street, Welwyn, Herts. AL6 9EQ, on the last Friday of the month, dated the month following. Telephone: 04-3871 5206 & 5207

Annual Subscription:

Home: £7.50, 12 issues, post paid
Overseas: £7.50 (\$17.00 U.S.), post paid surface mail

Editorial Address: Short Wave Magazine,
34 High Street, Welwyn, Herts. AL6 9EQ, England.

Prices shown in advertising in this issue do not necessarily constitute a contract and may be subject to change.

AUTHORS' MISS

Articles submitted for Editorial consideration must be typed double-spaced with wide margins on one side only of quarto or foolscap sheets. Photographs should be lightly identified in pencil on the back with details on a separate sheet. All drawings and diagrams should also be shown separately, and tables of values prepared in accordance with our normal setting convention — see any issue. Payment is made for all material used, and it is a condition of acceptance that full copyright passes to the Short Wave Magazine, Ltd., on publication.

Short Wave Magazine Ltd.

E. & O. E. VAT Reg. No. 239 4864 25

RADIO SHACK for

THE BEST OF EVERYTHING IN AMATEUR RADIO



DRAKE

TR-7 TRANSCEIVER, R-7 RECEIVERS, AND ALL ACCESSORIES

**HY-GAIN ANTENNAS
HUSTLER ANTENNAS
CDE ROTATORS**

BEARCATS

*With 4m, 2m &
70cm FM
Amateur Bands*



**COLLINS KWM-380 TRANSCEIVER
AVANTI ANTENNAS
TRS-80 COMPUTERS
VIDEO GENIE
HAL RTTY EQUIPMENT
J-BEAM ANTENNAS
ASTATIC MICROPHONES
TELEX HEADPHONES**

**HAVE YOU
GOT YOUR
RADIO SHACK
CHARGE CARD
YET?**

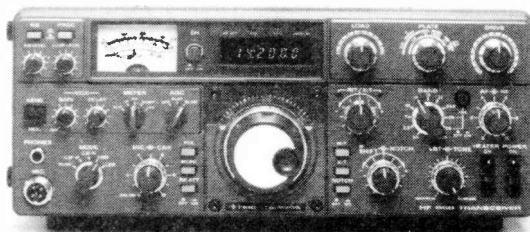

**TRIO HF
& VHF
RECEIVERS &
TRANSCEIVERS**

**LOTS & LOTS
MORE**

**MACROTRONICS RTTY — TEN-TEC
AEA MEMOMATIC KEYERS,
BENCHER PADDLES, VIBROPLEX**

**(ONE DAY WE MAY EVEN
HAVE EVERYTHING
LISTED!!!)**

ACCESS



SALES



SERVICE



BARCLAYCARD



RADIO SHACK LTD.

188 BROADHURST GARDENS, LONDON NW6 3AY

Giro Account No. 588 7151

Telephone: 01-624 7174

Cables: Radio Shack, NW6

Telex: 23718



VHF BANDS

NORMAN FITCH, G3FPK

Awards and Tables

GEOFFREY Grayer, G3NAQ, is the 11th. reader to receive a 2m. QTH Squares Century Club award with 101 squares credited. Almost all the cards came *via* the bureau and seemed to take a long time. 97 contacts were *via* tropo., 2 *via* E's and one each *via* MS and *Auroral* propagation. Geoff is currently operating from the Newbury area in Berkshire. The QTHCC was dated Dec. 16, 1980.

A sticker for 175 squares confirmed was issued to John Hunter, G3IMV, on Dec. 31 for QTHCC No. 3. His latest additions included 2 E's, 1 Ar, 5 MS, 16 tropo., and one QSO by a tropo./MS mixture. John's total of 2m. squares worked was 247 after the *Quadrantids* and only a few more cards are needed for the 200 sticker landmark. He is glad that our squares awards are on-going ones and do not come to a grinding halt at 100 as do the *RSGB* ones.

Congratulations to Clive Morton, G4CMV, outright winner of the Annual Three Band Table in 1980, with a total of 215 points. That is a record since the current administrative counties and regions have been used, starting in 1975. Clive also heads the 4m. table with 50 counties and 6 countries. Jack Kay, G3CO, and Arthur Breese, GD2HDZ, share second place with 45 counties and 6 countries.

On 2m., Bryn Llewellyn, G4DEZ, was the only reader to reach triple figures last year. At the beginning of 1980, he stated his target to work 30 countries in the year and just managed it by working YO2IS at the eleventh hour. Bill Hodgson, G3BW, who is now a dedicated MS operator, also worked 72 counties which, with 26 countries, earned him 2nd. place. Ken Osborne, G4IGO, notched up 28 countries and is another keen MS buff who achieved 3rd. place. Last year ten participants worked 20 or more countries on 2m.

The 70cm. section of the table produced a photo finish with Gary Allitt, G4HNS, in top place just one point ahead of Tony Collett, G4GXE. G4CMV came third. One third of the participants worked ten or more countries in 1980 and mention must be made of the 17 worked by GJ4ICD and the 15 by G8GXE. Will anyone work 20 countries on 70cm. this year?

The 1981 Annual Table will break new ground in that it will be a four band competition including 23cm. for the first time. It is anticipated that there will be increased use of this band for various reasons. These include the ready availability of more, excellent commercial gear, such as aerial arrays, low noise Rx preamplifiers, transverters, etc. There is evidence that some 2m. operators are getting thoroughly fed up with the increasing anarchy on the band, with FM stations operating in the CW, beacon, SSB and satellite sub-bands. They are now concentrating more on 70cm. and 23cm.

The inclusion of 23cm. in the Annual Table will allow Class B licensees to enter on three bands and Class A folk on all four although only the highest three of the four band scores will be used to calculate the points. Finally, henceforth both The Shetlands Islands, GM, and Sicily, IT9, will be counted as countries for the tables.

Beacon News

There is a new 2m. beacon on the air from Austria. Its call sign is OE5FO, the QRG being 144.955 MHz and the QTH Locator G177a. The power is 15 watts and the aerial a 5-over-5 array beaming northwest. Keying is F1 and the *a.s.l.* 600 metres. Several readers have heard this during recent tropo. lifts. During the *Quadrantids* meteor shower, several operators heard EA3XS on 144.153 MHz. G4IRX received some S9 bursts lasting up to 30 seconds. EA3XS is the call of an amateur station in the Barcelona region and this "beacon" could be a private or unofficial one, perhaps for a specific research purpose, like MS. Perhaps EA3LL could enlighten us?

Both Roger Thorn, G3CHN, and Dave Sellars, G3PBV, report reception of a weak burbly carrier on 144.003 MHz when beaming south from Devon. It was audible as a continuous carrier on Dec. 30, possibly with some form of undecipherable modulation.

Contest Notes

Results;— The 12th. VHF-UHF contest organised by the BARTG took place on Sept. 13 and 21 last year. Rough conditions kept activity down and only one QSO over 350 kms. was made. On 2m., 63 U.K. and 31 Continentals took part and on 70cm., 21 and 10 respectively. In the Single Operator section, G4ARD/A, operated by G3VZV, was the winner, with DC1ZN/P just a few points less for 2nd. place. In the Multi-Operator part, GW3UUP/P, the Ealing Club, were the winners with G3NNG second.

Coming attractions;— The BATC has organised an Activity Contest this year, split into seven sessions of which a maximum of four will count for points. The dates are;— Jan. 31, Feb. 8, 16 and 24, and Mar. 4, 12 and 20. The times are 2000-2300 GMT. The Secretary of the BATC is G8HUA, whose address appears in our *Clubs Roundup* feature from time to time.

Feb. 8 sees the 432 MHz Fixed Contests, a five hour event starting at 1000.

Satellite News

There is now a Sunday evening UHF net for AMSAT members and satellite users. This is on 432.21 MHz from 1800 local time, chaired by G4CUO in Cheltenham. On 2m. G8CSI still runs the Sunday net on 144.28 MHz from 1930 local time. Your scribe tries to check in, beaming north from the Surrey hills, and AMSAT-UK Secretary, G3AAJ, usually calls in. The rather hastily promoted *Activity Week* for satellite users attracted only 20 entries and Andrej Ovarac, OK3AU, won the transmitting section with 558 points. In the *s.w.l.* section, Berger Lindholm from Finland scored 173 points. G3AAJ described activity as "disappointing", so perhaps when another such event is proposed, the details will be available well in advance for greater publicity.

Repeater News

It was announced in a recent *GB2RS* news broadcast that another eleven UHF repeaters had been licensed. They are;—GB3CW on RB6 in Powys; GB3GR/RB11/Grantham; GB3GY/RB11/Grimsby; GB3LS/RB2/Lincoln; GB3MT/RB12/Bolton, an RTTY relay; GB3NF/RB11/Southampton; GB3PU/RB0/Perth; GB3SW/RB6/Salisbury; GB3TD/RB13/Swindon; GB3VS/RB13/Glastonbury and GB3WG/RB6/Port Talbot.

The South London 2m. repeater, GB3SL, was taken out of service by the operating group at Christmas and was still silent on Jan. 12. The Home Office requires that when a repeater is taken out of service for any prolonged period, the operating group informs the licensee — the RSGB — of the fact and reasons. Your scribe spoke to Dave Evans, G3OUF, at RSGB HQ and he seemed to recall the reason for shut down was given as "technical". No doubt, by the time these notes are read, it will be back serving its clientele of licensed amateurs, pirates and frustrated CB-ers.

Band Plan

During a contact with Tim Douglas, G3BA, the topic of the DX/Local SSB concept was discussed. It seems that reactions range from those who fully support the idea that local and DX QSOs should be conducted in separate parts of the SSB sub-band on 2m., to strong opposition from those using limited coverage gear that cannot tune much above 144.33 MHz. However, such equipment can usually be modified so as to extend its range — as with the *Belcom* Liner-2. It does seem unrealistic to expect to evolve a sensible band plan for the 1980s if we are to plan it around the capabilities of a diminishing number of restricted range sets. If that approach was continued, we would still be transmitting SSB around 145.41 MHz!

A disturbing feature of the 2m. band is the growing "invasion" of the beacon, satellite, SSB and CW sub-bands by FM stations. While some are obviously pirates using "borrowed" call signs, many are genuine amateurs. A few of the latter behave in a rude manner when asked to QSY to the appropriate part of the band, but others are genuinely ignorant of any band plan. It seems a great mistake that the RSGB's *Call Book* no longer includes any mention of band plans. Perhaps those running R.A.E. courses could be persuaded to acquaint their students with this aspect of the hobby at the end of the course. Better still if successful candidates could be sent a copy of the current band plans with their pass slips. Meantime, all we can do is to politely ask folk to QSY and explain the reasons.

It continues to amaze your scribe how reluctant many operators are to stray more than 20 or 30 kHz from the SSB calling frequency on 2m. Why not, "Boldly go where no man has gone before", to quote from *Star Trek*, and explore the wastes of 144.40 to 144.50

MHz? History tells us we have explored the uncharted seas of the World in past ages, so why not colonise this part of the band with SSB operators.

The Aurora

December 19 will certainly be remembered for a long time as it saw one of the best periods of *Auroral* propagation for a long time. Chris Reed, G8MFP, noticed a solar prominence at 1300 on the 17th. which he reckons lasted some 14 hours. At Bolder, Colorado, the "A" index shot up to 50, on the 19th. The event seems to have started around 1330 and went on continuously till 2051. In much of mainland Britain, it was pouring with rain and blowing a gale, but in Ulster, it appears a visual *Aurora* was observed from horizon to horizon.

From written and verbal reports, it seems that at least 27 countries were worked from Britain and that the reflecting curtain was much further south than usual enabling southern stations to "get in" using quite low power. A fine example was the effort of Nick Button, G4IRX, (Beds.) who contacted 9 stations using just 3 watts from an *Icom* IC-202S to a 9-ele. *Yagi* at 20ft. on a portable mast. His first QSO was with G3BW on CW at 1459. After a break for Christmas shopping, he returned to the fray at 1555 and added 4 new GM regions and 3 new squares — YP, YQ and DF70G (FM) on SSB.

Bill Hodgson, G3BW, (Cumbria) was an enormous signal without and worked 76 stations, adding several new squares. As so often has been the case, Bill's friendly rival Arthur Breeze, GD2HDZ, missed it all. (Never mind, Arthur, you beat him in the Annual Table). John Hunter, G3IMV, (Bucks.) operated from 1520 to 1915 and made 55 QSOs, including YO2IS (KF), YU2EZA (IG), OK3AU (KI), HG8CE and BLG in KG, HG0HO and KLZ in KH and HG0KLW

FOUR-METRE ANNUAL TABLE

Final Placings
at December 31, 1980

Station	Counties	Countries	Total
G4CMV	50	6	56
G3CO	45	6	51
GD2HDZ	45	6	51
G4HNS	42	6	48
G3FIJ	40	6	46
GW3MHW	40	5	45
G4FKI	38	5	43
G4BYP	36	5	41
G4ARI	27	4	31
G3EKP	22	5	27
GW3CBY	20	5	25
G3PBV	18	4	22
G4ERX	15	2	17
G4BWG	13	3	16
G8VR	7	1	8

70-CENTIMETRE ANNUAL TABLE

Final Placings
at December 31, 1980

Station	Counties	Countries	Total
G4HNS	59	11	70
G8GXE	54	15	69
G4CMV	55	12	67
G4JCD	47	17	64
G8TFI	52	12	64
G8OPR	51	10	61
G3PBV	45	10	55
G8IFT	44	10	54
G8HHI	42	11	53
G8VLQ	43	10	53
G8FMK	43	9	52
G3BW	40	8	48
GD2HDZ	41	7	48
G8KGF	35	8	43
G8KAX	31	8	39
G8MFI	31	8	39
G3KPU	28	6	34
G8JJR	27	7	34
G4BWG	23	8	31
G4BYP	23	4	27
G4ERX	18	8	26
G3CO	17	6	23
G4FKI	15	7	22
G3FIJ	17	4	21
GW3CBY	10	5	15
G3EKP	8	5	13
G8VR	8	1	9
GM8TSI	5	2	7
GM8MNG	2	2	4
G8VJJ	2	1	3

(LH), 6 SPs, 2 SM6s, 3 OZs, 4 Ys, 21 DLs, etc. QTFs were between 50° and 80°.

Colin Desborough, G3NNG, (Berks.) had 58 QSOs including an LA in EU square, an SM in HU, 7 SPs, an RQ2 in KQ, a UC2 in NN and a UA3 in PP19a, but Des could not get the full call due to QRM. His QTF was 40° for the most part. Dave Sellars, G3PBV, (Devon) only came into the event at 2010 for it to fade out at 2031, but with a brief final fling at 2051. At that time, all he heard were GB3GI, G3BW, GM3XNE, G3XDY and F6EOQ. Dave has yet to make an *Ar* contact from his present QTH. He mentions that G8KBQ in Glastonbury heard a UB5 in RN square.

Mike Kipp, G4FBK, (London) was also a late comer to the affair and worked GM3XNE at 2040 at a QTF of 355°, a sure sign the *AR* was about to switch off. John Wilkinson, G4HGT, (Liverpool) was only on for 45 mins. so only made a few G contacts, plus DL6BF (DM), PEICKI (CM) and F9XG (AJ). John Pilags, G8HHI, (Hants.) was on from 1800 till 1915 and worked a few German and Dutch stations in CM, DK, DL and DM squares at QTF 45°, plus GI5MPS (WO) and GM4JEJ (YQ) at 5° and finally FIKBF (BI) at 45°.

Welcome to Len Challis, G8SKG, (Lincs.) who enjoyed his first ever *Ar* experienced and whose haul included 5 Germans in DK, EM and FM, 2 Fs in BH and BI, a PA in CL, a GM in XP and a G in ZL square. Chris Easton, G8TFI,

(London) discovered the event at 1520 and worked some GM's in new Regions. He reports it still in progress at 2010. Steve Cottis, G8TFR, (N. Yorks.) contacted F1BUU at 1857, and who is in ZE08a.

A phone call from G41YA brought G8VR hurrying to the shack for what turned out to be the biggest *Auroral* event ever heard at Ken's Hartley, Kent, QTH. He wasted a lot of time just listening to the incredible number of stations on the band, but nevertheless worked 4 GMs, 3 OZs, EI6DN, LA3RU and a host of German stations. Ken heard UC2, UQ2, UR2, SP and numerous SMs, but the event was interesting since it appeared to favour stations in more southern locations. Very few northern stations were heard whereas strong signals were received from as far south as HB9MY and LX1S1. This conclusion is supported by the fact that SK4MPI (HU) did not surface at all at G8VR, during the three or four times he listened for it.

Mike Lee, G3VYF, (Essex) was on the 20m. VHF net setting up an MS sked with SM7DLZ when a DL broke in with news of the *Ar*. Subsequently, Mike worked many stations in some new squares. QSOs included SP5AD (KM), YO2IS (KF), SP8AOV (LL), SP9CVF (JJ), OK2STK (JJ), UP2BFR (LP), UC2AAB and ABT in NN, at QTFs between 80 and 100 degrees — further east than others reported. Also heard were Y22ME, SP2DX and HB9RO.

From Midlothian, GM8MNG added a further six countries to his 1980 total, viz:— DL, F, ON, PA, SM and Y. (Incidentally Chris, there is no DM prefix for East Germany any more; for a year now they have used the Y2 to Y9 series.) Chris's haul comprised 31 DLs, 2 Ys, 26 PAs, 2 OZs, 3 Fs, 2 ONs and an SM7, along with many British stations. From Swansea, Roy Webb, GW3CBY, worked Y23FG (FM) and a French station with his 14-ele. *Parabeam* erected at the beginning of December.

Mike Allmark, (Leeds) caught the last part of the event and heard F6FOE (YI), HB9MMC, F6DZG (BG), FIAGO (AG), F8ZW (DI), DC7OH (GM), Y25CD (GM), OZ6KV (EQ), OZ1DPR (EP), and F1BUU, together with lots of locals and PA and DL stations. Due to the high winds, the beam at G3FPK was "parked" at 30° which was not the best direction for the most easterly DX. The affair was accidentally discovered at 1705 and signals seemed best up to 1740 when the evening meal was ready.

THREE BAND ANNUAL VHF TABLE
Final Placings
at December 31, 1980

Station	FOUR METRES		TWO METRES		70 CENTIMETRES		TOTAL Points
	Counties	Countries	Counties	Countries	Counties	Countries	
G4CMV	50	6	72	20	55	12	215
G4HNS	42	6	63	13	59	11	194
GD2HDZ	45	6	60	14	41	7	173
GJ4CD	—	—	67	25	47	17	156
G8TFI	—	—	70	21	52	12	155
G8GXE	—	—	65	19	54	15	153
G8OPR	—	—	69	23	51	10	153
G3PBV	18	4	58	16	45	10	151
G3BW	—	—	72	26	40	8	146
G8VLO	—	—	70	17	43	10	140
G3CO	45	6	46	12	17	6	132
G8IFT	—	—	61	14	44	10	129
G4BYP	36	5	49	11	23	4	128
G8HHI	—	—	59	16	42	11	128
G8FMK	—	—	62	14	43	9	128
G3FIJ	40	6	46	12	17	4	125
G4BWG	13	3	56	20	23	8	123
G8MFI	—	—	64	19	31	8	122
G8KGF	—	—	51	15	35	8	109
G4DEZ	—	—	72	30	—	—	102
G8VR	7	1	56	24	8	1	97
G8KAX	—	—	46	11	31	8	96
G4FKI	38	5	23	7	15	7	95
G4IGO	—	—	65	28	—	—	93
GW3CBY	20	5	41	11	10	5	92
G4ARI	27	4	48	12	—	—	91
G8JJR	—	—	42	15	27	7	91
G3FPK	—	—	69	21	—	—	90
G4ERX	15	2	30	10	18	8	83
G4HAO	—	—	71	12	—	—	83
G4HGT	—	—	64	13	—	—	77
G8RWG	—	—	61	14	—	—	75
GM8TSI	—	—	53	13	5	2	73
G3KPU	—	—	33	5	28	6	72
G8TIN	—	—	55	15	—	—	70
G8VJJ	—	—	50	14	2	1	67
GM8MNG	—	—	49	12	2	2	65
G8VJV	—	—	49	9	—	—	58
G8RZA	—	—	44	11	—	—	55
G8JGK	—	—	35	13	—	—	48
GW3MHV	40	5	—	—	—	—	45

Without doubt, this *Ar* was the most widespread one heard by your scribe since 1969 and gave an insight into what they sound like in the more northerly latitudes. The band was dominated by hundreds of German stations, all S9 plus, which made it very difficult to hear the weaker signals from further afield. Many British operators were disappointed at not being able to work the real DC. Doug Parker, G4DZU, (Leeds) called "CQ U" repeatedly, only to be called by dozens of DLs. He got so fed up that he packed up and QSY-ed to the local ale house! It does seem quite ridiculous that stations which can be worked during any slight tropo. opening insist on calling when a station is obviously trying to work DX.

This event was characterised by being very far south. For example, 16WJB in HC square heard an F stations in AI and many YUs took part in the event. YU3ES (GF) had 14 QSOs and heard a further 10 stations, including some Gs, while YU7BCU (KF?) heard G3NSM, G3VYF and a G in ZN square. UA3LBO (QO) says he did *not* work any G stations. All-in-all, a memorable

event; will there have been a replay around Jan. 15?

Meteor Scatter

At their sixth attempt, Paul Turner, G4IJE, (Essex) and Pete Etheridge, G4ERG, (Hull) completed an MS contact *via* back scatter by pointing their aerials to EO square and eliminating all direct path signals. Paul got 18 pings and 9 bursts from Pete, one being of 28 seconds.

Majority opinions seems to suggest that the *Geminids* shower was not as good as last year. G3IMV had QSOs with SM6CMU (FR) and LA1K (FX) and G3VYF also worked the latter, plus YU2IQ (HE). G4HGT heard SP7GPW and OK1MBS (HK) on the random SSB frequency, but 'flu and a throat infection kept John quiet! G4IJE also worked YU2IQ and completed asked on SSB with F1JG (CD).

G8VR only completed one sked out of more than a dozen, but fared better on the random CW QRG where he worked LA3VU and OK1LG. At the peak of the shower, Ken monitored SK4MPI (HU) and the Gdansk FM broadcast station

(JO) on 70.31 MHz, simultaneously but found absolutely no correlation between the two. The bursts on 70 MHz were much longer and the signal strength much greater. (This is to be expected as the BC station runs 40 kW.)

Darrell Mawhinney, ex-G18JPG, is now G14KSO and worked SM0EJY (IT), DH4DAB (DL), DF5JJ (DL), PA3BBI (CM) and SM5CHK (HS), all on SSB. Mike Allmark heard F, I, OE, OK, OZ, SM and YU stations in many squares.

On Jan. 1, G3IMV worked LA8AK (DS) for a new square but heard nothing at all in the peak of the *Quadrantids* on Jan. 3 from UO5OGX. Several readers have queried whether anyone has ever heard anything from this chap. It seems some of the Russians say they have much better stations than they really have, just to get some skeds. John did complete with EA3LL (AB) on SSB and later, on CW, with OH7TN/4 (OV) and HG8ET (KG) for another three new squares. The sked with UR2RQT (MS) was incomplete and only a few brief reflexions were received from OH7RJ (NW).

Clive Penna, G3POI, (Kent) added just one more square, making it 299, in

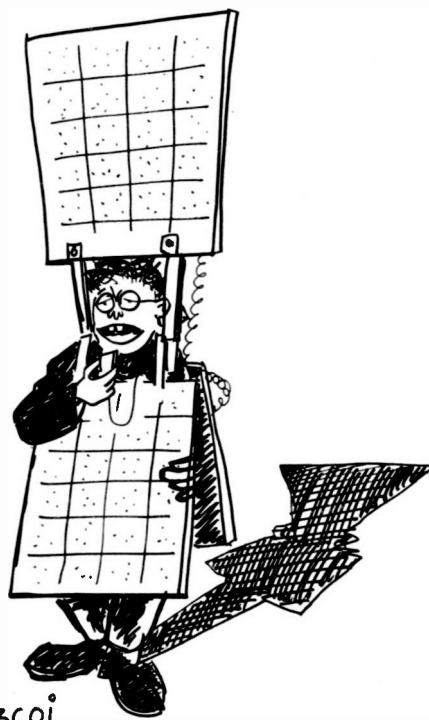

GW3COI

"... glad to be your first solar-powered pedestrian mobile, OM ..."

TWO-METRE ANNUAL TABLE

Final Placings
at December 31, 1980

Station	Countries	Countries	Total
G4DEZ	72	30	102
G3BW	72	26	98
G4IGO	65	28	93
GJ4ICD	67	25	92
G8OPR	69	23	92
G4CMV	72	20	92
G8TFI	70	21	91
G3FPK	69	21	90
G8VLQ	70	17	87
G8GXE	65	19	84
G8MFJ	64	19	83
G8HAO	71	12	83
G8VR	56	24	80
G4HGT	64	13	77
G4BWG	56	20	76
G8FMK	62	14	76
G4HNS	63	13	76
G8HHI	59	16	75
G8IFT	61	14	75
G8RWG	61	14	75
G3PBV	58	16	74
GD2HDZ	60	14	74
G8TIN	55	15	70
G8KGF	51	15	66
GM8TSI	53	13	66
G8VJJ	50	14	64
GM8MNG	49	12	61
G4ARI	48	12	60
G4BYP	49	11	60
G3CO	46	12	58
G3FIJ	46	12	58
G8VJV	49	9	58
G8JJR	42	15	57
G8KAX	46	11	57
G8RZA	44	11	55
GW3CBY	41	11	52
G8JGK	35	13	48
G4ERX	30	10	40
G3KPU	33	5	38
G4FKI	23	7	30
G3EKP	18	6	24

the shape of OK2BFH (JJ). Due to a faulty grid bias supply to his amplifier, G4HGT was unable to keep skeds with OH3YW, YU7BCX and SM3COL, while operating from G4HAO's QTH. The only success was OE5XDL (HI) with whom he exchanged 37/46 reports. G4IRX went to Mark Turner's, G8OBS, QTH in Luton and took his IC-202 and 20 watts PA, using Mark's G4CIK keyer and 4-ele. *Quad*. Their two skeds came off on Jan. 3 with OZ1EYX (GQ) in 95 mins., and SM3COL (IW) in 105 mins.

G8SKG stayed up all night on Jan. 3/4 for the shower and worked OE5KE and F6GGF, with YU3ULM heard. G14KSO is claiming the first G1/OY 2m. QSO following his contact with OY5NS (WW) between 1100 and 1140 on Jan. 3. Other *Quadrantids* successes were OZ1DSK (EP), OZ4VV (EQ), LA2PT (FT), all on SSB. Mike Allmark did not think this shower was as good as previous years and his best DX heard was OY5NS, also OH3MF (MU).

Four and Six Metres

On Dec. 14, VS6BE and VS6FX on 6m. were worked by G4BPY, G3COJ

and G3UUT on 10m. EI6AS worked VS6BE direct on 6m. for a "first". On Dec. 27, Mike Allmark heard VE1AVX on 6m. at S9-plus working stations on 10m. He also heard F6CTT (ZH) on the band on Jan. 1! John Baker, GW3MHW, (Dyfed) reports that ZD8TC often leaves his Tx on auto-keying on 50.110 MHz. On Dec. 12, FY7THF was S9-plus-40 dB for over an hour from 1150. John has had 262 10/6m. crossband QSOs so far this "season". During the Dec. 19 *Ar* he heard the auto-CQ signal from PA0RYS on 50.027 MHz but could not find him on 10m.

On 4m. GW3MHW's nightly skeds with G2AOK seem no longer possible probably due to a higher roof at the latter's QTH now. During the *Ar*, John heard many strong signals but complains that operators will not spread out enough to avoid QRM. John worked GM3WOJ, GM3ZXE, GM4DIJ, G6WR, G3FDW, G4FXW, and G4BPY G2AOK and GM3YOR were also heard. SM6PU on 10m. worked G4BPY, GM3WOJ and GW4BCD on 4m. in this event. In an attempt to stir up activity on 4m. John runs an automatic

transmission near 70.2 MHz over-riding it with "QSX NW" when listening.

G8VR has worked a few new countries on 4m. and says that DK1PZ (FL22h) has converters for 4m. and 6m. with aerials and is interested in 10m. crossband working. He can often be found on the 20m. VHF net.

Two Metres

On Dec. 29-31, Mike Allmark and Kevin Jackson, were out portable in AN21j with Andy Cole, G8MJD, and Dave Shaw, G8MDG, during what proved to be reasonable tropo. conditions, both on 2m. and 70cm. Best DX was to FN square. From Devon, G3PBV heard, on Dec. 24, the HB9HB beacon on 144.125 MHz but found activity very low with DD3UD (EI) the best DX. On the 30th, this beacon was again heard, along with a couple of EAs and some Fs as far as DI and CF squares. The Brittany folk were working into SM and OZ at the time.

On Christmas Eve, Tony Collett, G8GXE, (Berks.) heard Germans in EJ and EK squares but could not raise them. He did contact DK8VR (DJ), DF61Y (EI) and FIEGS (DI), which latter was a new square. The end of year lift produced a QSO with DD3UD (EI) at 1037 on the 31st. for G8HHI.

Brian Morrison, G8SEZ, (London) has received a QSL from 13DDS/1 whom he worked on tropo. in late Nov. or early Dec. 1979. The Italian was near Aosta, 5,000m. *a.s.l.*, which is remarkable as Mt. Blanc is only 4,810m! Brian wonders if anyone else worked this station who is not listed in the 1980 *Call Book*, by the way? In the latter part of 1980, G8SKG moved to a better QTH in Lincoln and now has a 16-ele. *Tonna Yagi*. On Dec. 24, Len had a ball and worked 23 Germans in several D and E squares, along with 5 PAs, 4 ONs and 5 Fs.

Geoff Brown, GJ4ICD, enjoyed some nice ducting to the northeast on Dec. 30 and, when he had this beam to SM, he heard EA1CR (XD) off the back of the beam. After a 15 min. QSO, chaos reigned as half of Scandinavia was trying to work Rubén. The time was 2330. Geoff's best DX was to HR and HS squares.

Seventy Centimetres

The aforementioned "AN" operation by G8MJD, G8MDG and party worked 31 squares on Dec. 30. The gear comprised a *Trio* TS-120V and

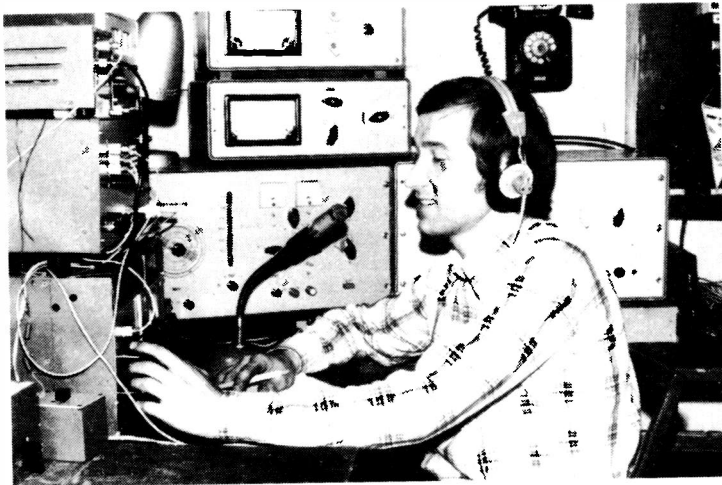

The mostly home-brew station of Lothar Wilke, Y24UK.

Microwave Modules 10 watts transverter with a 19-ele. *Yagi*. The 50 watts PA blew up and they suffered a lot of *Syledis* QRM. G8MJD/P provided another new square for G3VYF, along with DK6AS (FM), on Dec. 30. During the Dec. 19 *Ar*, Mike worked DF1OH (EM) on 70cm. exchanging 51A/52A reports.

G3PBV found conditions poor in both the Dec. 24 and 30 events but did copy HB9F on the 30th. and worked DF1EQ (DL) with deep, slow QSB. On Dec. 24, G8GXE was on and heard F9NL (AD) and worked DK8VR (DJ) and F6CBC/P (ZD). On the 30th. Tony contacted DJ3ZU and DF1EQ in DL square together with GW8GKF and G8MJD/P, the latter being more consistent on 70cm. with 10 watts than they were with 150 watts to four 9-ele. *Yagis* on 2m.

Ian Gordon, G8IFT, (Birmingham) writes that he has a 4CX250B amplifier on its way when he can find time to finish the power supply. The Dec. 30 lift brought two new squares for GJ4ICD in the shapes of DK2NH (FN) and DF2OO (EM) to make it 84.

Twenty-three Centimetres

In the Dec. 30 lift, G8GXE was copying DJ3ZU's signal at up to S4 but could not be detected by the German, who was running 300 watts to a 2m. dish. G8IFT's best three sessions in the *Cumulatives* produced 41 QSOs worth 3,920 points, best DX being 220 kms. to G3XDY and G8HPU in Ipswich. N. Yorks. was a new county on the band,

thanks to G8SFI/G4KCT at 184 kms. GJ4ICD is now QRV on the band, the gear consisting of a *Yaesu* FT-480R, feeding a *Microwave Modules* transverter, driving a rebuilt *S.O.T.A.* 70cm., amplifier, driving a YD 1302 PA giving 300 watts output, hopefully, when completed. Eight 15-over-15 aerials are promised which should certainly provide Geoff with the proverbial big mouth!

Final Miscellany

Peter Burden, G3UBX, writes that a group of Midlands VHF operators is planning a VHF Convention at the Wolverhampton Polytechnic on Oct. 10 from 1100 to 1800. A lecture stream is proposed and simple catering at a reasonable tariff is promised. As attendance must be limited to 400, attendance will be by ticket only. More information later.

It seems that the long silent Lannion beacon, FX3THF, could be operating again from the old site, in the 2m. band on 144.905 MHz. This information via Roger Thorn, G3CHN, who has offered to pass on any definite details from F5ZA.

Deadlines

All your copy for the new, bigger *S.W.M.*, starting with the March issue, by Feb. 4 please and for the following month, by March 4. As usual, everything to;— "VHF Bands", *SHORT WAVE MAGAZINE*, 34 High Street, Welwyn, Herts., AL6 9EQ. 73 de G3FPK.

HINTS AND TIPS ON THE K2RIW AMPLIFIER

GEOFF BROWN, GJ4ICD

AS most readers who operate on 432 MHz will know, Dick Knadle, K2RIW, designed an amplifier for the band using a parallel pair of 4CX250B's some years ago (see "A Strip-line Kilowatt Amplifier for 432 MHz", *QST* April and May 1972, pp 49-55 and 59-62). During the past few years UK amateurs have been building this QRO device with some success, but the odd intending constructor or two have tried to take short cuts, or have been 'conned' at rallies into buying the wrong valve bases or "used and tested tubes". Unfortunately, this has led prospective builders to believe that the design is in some way deficient. GJ4ICD is now producing a modified version of this unit, after two years of testing, and a few tips on the "beast" which follow will ensure a very stable and powerful amplifier.

Firstly referring to the original article, or to the ARRL *VHF Manual*, it is noted that the original valve bases used were the SK 610 type. It has, however, come to light through extensive tests that the SK 620A sockets are the correct ones for use in this amplifier (see *Part I* of the article by J. H. Nelson, G4FRX, in January *Short Wave Magazine* for further explanation), the main difference being in the screen decoupling capacitor. The SK 620A is readily available from *Cambrian Electronics*, P.O. Box 10, Stanmore, Middlesex, who also stock valves to match.

In the course of building several parallel 432 MHz amplifiers of this type, slight modifications have been incorporated as follows. Firstly, the grid line length is reduced by ½-in. — this gives a better resonance curve, better input VSWR and improved efficiency. Next, for easier tuning of the anode tank circuit, the plate line length should be reduced to 8¾ inches from its original 9 inches, still with the corners rounded off. Also with reference to the anode line (L1), the writer has tried three different double-sided epoxy p.c.b. lines; standard p.c.b., silver plated and gold plated. A comparison between the standard and the gold plated line revealed an 8% increase for the latter which must make it very cost effective.

The next item is the usual problem of obtaining the phosphor-bronze or beryllium-copper required for the anode "flapper" capacitor. The correct thickness is hard to come by, but 22 gauge phosphor-bronze should be available from a good sheet metalwork shop: this, however, would mean a change from the "fish line" tuning system to a brass or steel wire system, as otherwise the fish line would break under the added stress. When, however, a brass wire system was tried, the *Teflon* rod in the under-chassis started to burn, probably due to RF finding its way down the wire to earth! So if 22 gauge, or thicker, phosphor-bronze is used, along with a brass or steel wire, the ¼-in. *Teflon* rod in the under-chassis should be replaced with ¼-in. brass rod — which will ensure a good DC earth to the anode end of the "flapper" capacitor and, incidentally, give a better tuning range.

Finally, to ensure maximum stability, two ferrite beads should be fitted between the screen grid connections on the valve base and the inner box leadthroughs (which should be p.t.f.e. only and should also be decoupled with a 1000 pF 750VW capacitor, available from *RS Components*).

If all the above modifications are carried out and the correct bases used, it will be practically impossible for the amplifier to be unstable — but note that a well-regulated screen and bias supply *must* be used.

TWO-METRE BAND "AIDE MEMOIRE"

PETER LLOYD, C.ENG., MIEE, G8XGH

MANY of those would-be 'hams' who received the good news during last August of their success in the RAE will have, by now, been granted their Class-B licence. This new batch of G8's will be keen to get on the air as soon as possible, and with the range of multimode transceivers now available, will have a wide choice of operating frequencies and emissions.

It is with the needs of these newcomers to the band in mind that the "2-Metre Aide Memoire", Fig. 1, has been devised. Intended for quick reference desk use, a suitable format dictated the splitting of the band scale into two sections covering 144 to 145 MHz, and 145 to 146 MHz, respectively. This division is also convenient, as the upper scale deals with CW, SSB and 'all-mode' allocations, whilst the lower portion is mainly devoted to FM channelled transmissions; IARU allocations for moonbounce, meteor scatter and TV have not been shown. (Operators are reminded that the licence does not permit use of 144.00 and 144.54 MHz which are aeronautical frequencies).

The major scale divisions are indicated at 0.1 MHz (100 KHz), with sub-divisions every 50 KHz; in the channelled FM section of the band the scale is further divided into 25 KHz steps, with the appropriate channel numbers adjacent. Repeater input R0 to R9 are shown, as are their outputs shifted by the fixed 600 KHz increment. Within the Simplex channels, S10 to S24, there is a section described as 'basic' which covers the most commonly used frequencies of S20 to S24. When purchasing transceiver crystals (in the case of non-synthesised equipment) these channels should be considered, next to those used by local 'repeaters', the minimum with which to start. With reference to S9 and S33, it has been proposed that these should be phased out in Europe and used for satellites.

Also shown on the scale are the major calling frequencies such as 144.05 MHz (CW), 144.30 MHz (SSB), and 145.50 MHz (FM) etc. The number of repeater stations has increased to such an extent in recent years that it has been impossible to include all but a fraction of them. Those listed are considered to be of interest to users whose QTH is in the central part of the country, and an abbreviated form of location is used, e.g. GB3MH Malvern Hills is MAL. Where the name of the repeater QTH is not too familiar, the county abbreviation is given: hence GB3PI Barkway has-HERTS only after the callsign.

It should be noted that, to save space, the repeater callsigns are only listed once, either under input or output frequency. For example, GB3BM Birmingham has its input on R5, but against its output channel (S29) will be found GB3SN Fourmarks (Hants.) — which uses the same input and output frequencies at 145.125 and 145.725 MHz, respectively.

It is hoped that the novice will find the "Aide Memoire" helpful in obtaining a perspective on two-metres, and a device which he can readily modify for use in other parts of the UK.

Publications recommended for further information on Band Plans for 2-metres are: *A Newcomer's Guide to FM Simplex Operation on Two Metres*, by Anthony Askew G4BPC, published by the UK FM Group (London); and *Amateur Radio Operating Manual*, edited by R. J. Eckersley G4FTJ, published by RSGB (obtainable from S.W.M Publications Dept.).

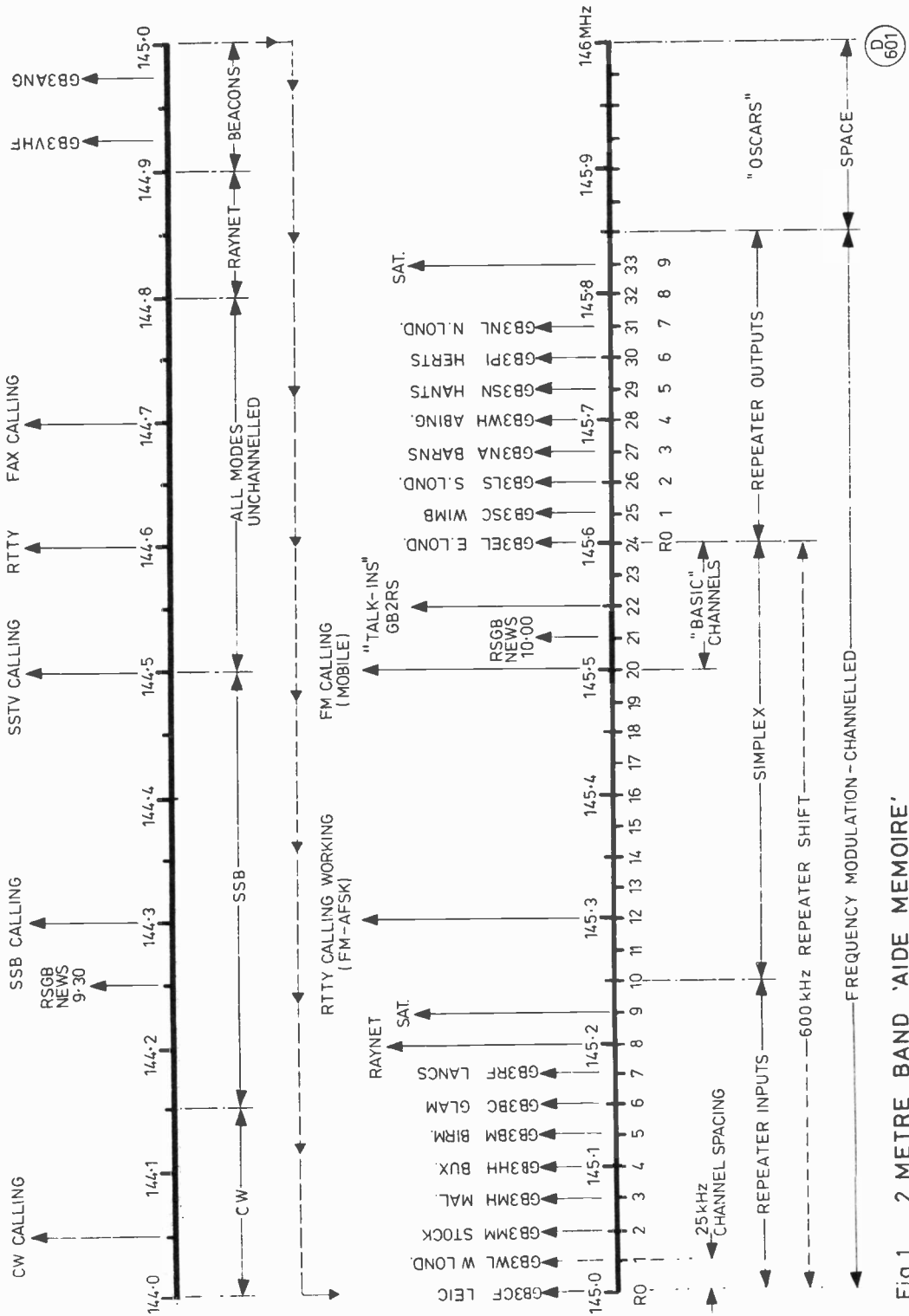

Fig. 1 2 METRE BAND 'AIDE MEMOIRE'

D
601

CLUBS ROUNDUP

BY "Club Secretary"

The Mail

Acton Brentford & Chiswick stick to, as they have done for so many years, the old routine of sending a letter every month, come hell or high water. On February 17, George Grzbeieniak will be talking to them about the reception of DX TV signals. This is something we've not heard much of in recent years although at one time there was a fair-sized group up north who used to report results.

A.R.M.S. is the club for the mobile operators, and a very good one too; detail from the Hon Sec — see the panel for his address.

Now to **Ashford** (the Kentish one) where the HQ is at the top of Hart Hill, which in its turn is near Charing, so — up the hill it is, every Tuesday evening.

B.A.R.T.G. have had an AGM, and sundry members have changed round, but not the Hon Sec — see Panel for his address. For those who don't already know, BARTG is the specialist group covering the use of an amateur station for radio teletype.

Next we have **Bournemouth**, based as ever on the Dolphin Hotel, Holdenhurst Road, where they have February 6 as a project night, and on 20th a film show covering the manufacture of thin film microcircuits and the manufacture of junction transistors. Incidentally they recently had an auction sale for RAIBC, and raised some £250 which will have helped no end — other clubs going to follow suit?

Still on the South Coast, at **Brighton** they foregather at 47 Cromwell Road, Hove, on alternate Wednesdays, the start being sharp at 7.45pm.

We got a newsletter with nary a mention of which club generated it, let alone the address! However, it did have across the top something which gave it away, which was the after-end of the club call sign: Bromsgrove it turned out to be. Our own records could then tell us they have the second Friday at the Avongate Art Centre, and we also note an informal now appears on the lists for fourth Tuesdays at the Parkgate Inn. However, we recommended a contact with the Hon Sec to be sure — see Panel.

With a paid-up membership of 107, **Bury** must now rate as one of the big 'uns — however, they can still get in their room at the Mosses Community Centre, Cecil Street. Their "secret of success" is that although they are to be found on every Tuesday evening, the second Tuesday is always given over to a formal meeting with a talk or whatever. The club also has a policy of buying quality accurate test-gear for members use (we hope they have a facility for keeping it calibrated within spec!). They have a bit of nostalgia on February 9, when G2AKR will be talking about The Good Old Days.

Over to **Cheltenham** and the Old Bakery, Chester Walk, Clarence Street, on the first Thursday and the third Friday in each month, with the first of these being the "formal" evening, which for February means a talk on radio controlled models.

Pressing on, we come next to **Coventry** who mention they are based on Baden-Powell House, Radford, Coventry; they do not say which evening, although we believe it to be a Friday each week — but check with the Hon Sec and be sure. He will also give some guidance on how to find the HQ address — see the Panel for his name and telephone number.

Chiltern are booked for February 25, for an auction junk sale, at the canteen of the John Hawkins furniture factory, Victoria Street, off Wycombe Road, High Wycombe.

On to **Colchester** now, where the venue is the Colchester Institute, Sheepen Road; February 5 is down for G4JIE to talk about power supplies, and on 19th they have a selection of films, RSGB, ARRL and other.

It's the first Wednesday in each month for the **Congleton** gang, who have a place each month at Congleton Library — latest details from the Hon Sec at the address in the Panel, or just pop along and join!

Deadline for "Clubs" for the next three months—

March issue — January 30th

April issue — February 27th

May issue — March 27th

June issue — April 24th

Please be sure to note these dates!

Down in the West Country, one eventually comes to **Cornish**; but once there, the club is well worth the trouble of a visit. Find them in the SWEB Clubroom, Pool, Camborne, on Thursday, February 5, when there will be three different members speaking on propagation at, respectively, VHF, UHF, and HF. They also have a section meeting separately who are "home-computer" addicts, as well as members of the main group.

Unfortunately our information about the **Crawley** programme is not quite up to date, but we do know they are based on Trinity United Reformed Church, Ifield, on the second Wednesday each month; there is also an informal each month at a member's home.

Now for **Cray Valley** we have a bit of a problem, because they in their turn also have a problem, due to over-booking at Christchurch Centre, Eltham High Street, SE9. No alternative dates were offered either, all of which sounds somewhat like a polite way of applying the frozen mitt. So — we refer you to the Hon Sec for the latest situation, and hope that they can find something to suit a membership of 125.

Crystal Palace have Saturday February 21 at Emmanuel Church Hall, Barry Road SE22, starting at 8pm for the Annual General Meeting. It is nice to hear that this is another club where the membership is rising.

We have details of the **Denby Dale** group mobile rally from their Hon Sec — so we can refer you to him for all the details.

Regular as clockwork, we get an update from **Derby** as to what's going on at 119 Green Lane, where they have the whole top floor, and make it work for them. The "proper"

Names and Addresses of Club Secretaries reporting in this issue:

- ACTON, BRENTFORD & CHISWICK: W. G. Dyer, G3GEH, 188 Gunnersbury Avenue, Acton, London W3 8LB. (01-992 3778).
- A.R.M.S.: N. A. S. Fitch, G3FPK, 40 Eskdale Gardens, Purley Surrey CR2 1EZ.
- ASHFORD: J. A. Clarke, G3TIS, Yeomans Cottage, The Street, Brook, Ashford, Kent. (Wye 812888).
- B.A.R.T.G.: J. Binning, G3AJS, 293 Perry Street, Billericay, Essex.
- BRIGHTON: J. Trimmer, G4JDM, 7 Dale Crescent, Paicham, Brighton.
- BOURNEMOUTH: G. T. Lloyd, G8GTB, 4 Gorleston Road, Parkston, Poole, Dorset.
- BURY: M. Bainbridge, G4GSY, 7 Rothbury Close, Bury, Lancs. BL8 2TT. (061-761 5083).
- CHELTENHAM: G. Cratchley, G41L1, 47 Golden Miller Road, Prestbury, Cheltenham. (Cheltenham 438911).
- CHILTERN: B. Catteral, G41WC, 78 Fairacres, Prestwood, Gl. Missenden, Bucks. (Gl. Missenden 4504).
- COLCHESTER: G. W. Caswell, G4DK1, 112 St John's Road, Colchester, Essex CO4 4JH. (Colchester 67512).
- CONGLETON: N. R. Clayton, G8UYT, 2 Moorfields, Leek, Staffs. (Leek 385992).
- CORNISH: S. T. S. Evans, G3VGO, "Glengormley," Cannon Downs, Truro, Cornwall. (Devoran 864255).
- COVENTRY: J. E. Beech, G8SEQ, 14 Hollow Crescent, Radford, Coventry CV6 1NT. (0203 598186).
- CRAWLEY: D. L. Hill, G4IQM, 6 Reigate Close, Pound Hill, W. Sussex RH10 3TZ. (Crawley 882641).
- CRAY VALLEY: P. J. Clark, G4FUG, 42 Shooters Hill Road, London SE3. (01-858 3703).
- CRYSTAL PALACE: G. M. C. Stone, G3FZL, 11 Liphook Crescent, London SE23 3BN. (01-699 6940).
- DARTFORD HEATH D/F: A. R. Burchmore, G4BWV, 49 School Lane, Horton Kirby, Dartford, Kent DA4 9DQ.
- DENBY DALE: J. Clegg, G3FQH, 8 Hillside, Leak Hall Lane, Denby Dale, Huddersfield HD8 8QZ. (Huddersfield 862390).
- DERBY: Mrs J. Shardlow, G4EYM, 19 Portreath Drive, Darley Abbey, Derby DE3 2BJ. (0332 556875).
- DOVER: P. Chamberlain, G8EFT, 59 Capel Street, Capel-le-Ferne, Folkestone, Kent CT18 7LY. (Folkestone 42387).
- EAST ANTRIM: J. Welch, G14XM, c/o 20 Bryantang Brae, Doagh, Ballyclare, Co. Antrim BT39 0R.J. (Ballyclare 40384).
- EAST KENT: N. Gerolamo, G8PFE, 63 Cobblers Bridge Road, Herne Bay, Kent.
- EDGWARE: D. L. Lisney, G3MNO, 119 Draycott Avenue, Kenton, Harrow HA3 0DA. (01-907 1237).
- G-QRP: Rev. G. C. Dobbs, G3RJV, 17 Aspen Drive, Chelmsley Wood, Birmingham B37. (021-770 5918).
- GUILDFORD: L. Bright, G4GHQ, 4 Dagley Farm, Shalford, Guildford, Surrey. (Guildford 76375).
- HASTINGS: D. Edwards, G4KMJ, 214 Hillside Road, Hastings, Sussex. (Hastings 752383).
- HEREFORD: S. Jesson, G4CNY, 181 Kings Acre Road, Hereford. (Hereford 3237).
- IPSWICH: J. Tootill, G4IFF, 76 Fircroft Road, Ipswich, Suffolk IP1 6PX. (Ipswich 44047).
- I.R.T.S.: C. Yeates, E17AAB, 126 Beech Park, Lucan, Co. Dublin, Eire.
- ISLE OF WIGHT: T. Fallick, G4FYI, "Harmony," Main Road, Chiller-ton, Newport, I.O.W. (Chillerton 328).
- KIDDERMINSTER: R. Manton, G4ILQ, 7 Osborne Close, Offmore Farm Estate, Kidderminster, Worcs. DY10 3YY. (Kidderminster 4930).
- LIVERPOOL: R. Simmons, G3PNS, 62 Daneville Road, Liverpool L4 9RG.
- MEDWAY: P. J. Poole, G4EYV, 5 River Drive, Strood, Rochester, Kent ME2 3JW. (Medway 76463).
- MEIRION: Mrs J. Jones, GW8SYX, 25 Fford Dyfrig, Tywyn, Gwynedd. (Tywyn 710-402).
- MELTON MOWBRAY: R. Winters, G3NVK, 32 Redwood Avenue, Leics. LE13 1TZ (Melton Mowbray 3369).
- MENBOROUGH: I. Abel, G3ZHI, 9 Grove Terrace, Maltby, Rotherham, Yorks. (0709 814911).
- MID-LANARK: D. Smillie, G4MFKD, 27 Easter Crescent, Cambus Court, Wishaw, Lanarkshire.
- MIDLAND: N. Gutteridge, G8BHE, 68 Max Road, Quinton, Birmingham B32 2AN (021-422 9787).
- NORTHERN HEIGHTS: M. Topham, G8NUC, 1200 Great Horton Road, Bradford (Bradford 73271).
- PETERBOROUGH: D. Wilson, G4KSW, 4 Conway Avenue, Peterborough.
- R.A.I.B.C.: Mrs F. Woolley, G3LWY, 9 Rannoch Court, Adelaide Road, Surbiton KT6 4TE.
- SCUNTHORPE: J. A. Sheardun, G8TIY, 5 Witheringham Lane, West Halton, Scunthorpe, S. Humberside DN15 9AX (0724 732438).
- SILVERTHORN: C. J. Hoare, G4AJA, 41 Lynton Road, South Chingford, London E4 9EA (01-529 2282).
- SOUTHDOWN: R. E. Holtham, G4EKS, 2 Benbow Avenue, Eastbourne, E. Sussex BN23 6AB (Eastbourne 31620).
- SOUTHGATE: J. Fitch, G8EWG, 16 Kent Drive, Cockfosters, EN4 0AP (01-440 7353).
- STEVENAGE: E. Godfrey, 94 Common View, Letchworth, Herts (Letchworth 72184).
- STOURBRIDGE: C. Williamson, G4IEB, 14 Lawn Street, Stourbridge (Stourbridge 2006).
- SURREY: R. Howells, G4FFY, 7 Betchworth Close, Sutton, Surrey (01-642 9871).
- SUTTON & CHEAM: G. Brind, G4CMU, 26 Grange Meadow, Binstead.
- THURROCK: A. M. Taylor, G4KJI, 11 Kathleen Close, Stanford-le-Hope, Essex (Stanford-le-Hope 5057).
- TYNESIDE: J. Dingwall, G4ILW, 10 Loweswater Road, Gateshead, Tyne & Wear NE9 6TN.
- VERULAM: G. N. Dale, G3PZF, 16 Pulfrey Close, St. Albans
- WAKEFIELD: R. C. Sterry, G4BLT, 1 Wavell Garth, Sandal Magna, Wakefield (Wakefield 255515).
- WEST KENT: B. P. Castle, G4DYF, 6 Pinewood Avenue, Sevenoaks, Kent (0732 56705).
- WIRRAL: G. O'Keefe-Wilson, G8VPF, 20 South Drive, Upton, Wirral (051-677 1531).
- WISBECH: D. Dunn, G8RZN, Five Bells, Parson Drove, Wisbech, Cambs.
- WORCESTER: M. Tittensor, G4EKG, 16 Durcott Road, Evesham, Worcs WR11 6EQ (0386 41105).
- YEOVIL: D. L. McLean, G3NOF, 9 Cedar Grove, Yeovil, Somerset.
- YORK: K. R. Cass, G3VVO, 4 Heworth Village, York.

meetings are on Wednesdays: a Junk Sale on 4th, and a slide show by G8KSW on 11th. February 18 is a natter evening, and on 25th G3WFU will be talking about line transmission systems — he is from British Telecom.

The **Dover** chaps are at the YMCA, Godwyne Road, Dover on Wednesday evenings — hint to their Hon Sec to the effect that we need an up-date!

Over in GI, the **East Antrim** lads are based on Carnall Hall which is near Mossley — details on dates generally, and how to get to the talk on aerials on February 10 from the Hon Sec — see Panel.

Now it's **East Kent**, where they have a nice new newsletter; the last chairwoman, G3ZZZ, did the first issue and then said "find yourselves an editor", which they did — and with quite a good standard too. The only snag from our point of view is that they seem to have several places to meet. February 5 is down for films at the Dominican Hall, Canterbury, and on 19th they have a pub evening at "The Sun," St Nicholas at Wade; a glance at the map to find

where this fascinatingly named village is, shows it to be almost at Thanet.

Edgware have the second and fourth Thursdays of each month at Watling Community Centre, 145 Orange Hill Road, Burnt Oak, Edgware. On February 12 they are to hear the G2FKZ tape-and-slide lecture on Radio Aurora, while February 26 is down for an informal.

Our next on the clip is the latest issue of the **G-QRP Club** magazine; and some degree of reorganisation helps to cope with the now 1,000 members. Incidentally, member number 1,000 was John Bazley, G3HCT, Past President of RSGB and a real DX'er; and five members in Austin, Texas have formed a section of this UK club, which has grown to have members in all continents and both sides of the Iron Curtain.

Over to **Guildford** where there is a report that a member has joined as a result of reading this piece (thus proving to sceptics that we have at least one reader!). The gang are to be found at the Guildford Model Engineers HQ in Stoke

Park on the second and fourth Fridays of each month; February 13 is down for a talk by G8PHG. We don't know how much of their banter to take seriously but there is a statement that the Construction Contest entries included a QRP rig in a bottle!

Every third Wednesday in the month, **Hastings** have a formal 'do' at West Hill Community Centre, Croft Road, Hastings; they also have their own clubroom at 479 Bexhill Road, St Leonards-on-Sea, which is in use most evenings of the week for one thing or another, Fridays being the chat night.

On to **Hereford**, where the venue is the County Control, Civil Defence Headquarters, Goal Street, Hereford, where they are to be found on the first and third Fridays of each month; we aren't quite up to date on the newsletter to hand, albeit it does mention the Annual Dinner on February 14.

A change of venue for most meetings occurs at **Ipswich**; the second and last Wednesdays will be taken at the "Rose and Crown" in the upstairs clubroom. This is 77 Norwich Road, and looking at the map with the current edition of *QUA*, it would appear to be the junction of the A45 Norwich and Bramford Road, the latter being on the left as one heads for Norwich. The dates are February 11, when they have a talk on cacti — an unusual subject and a change from Amateur Radio; with February 25 for a talk on oscilloscopes by G3NYK.

The **I.R.T.S.** news is still coming out, thanks to the work of the President; and there are some hints in his editorial that someone may have offered to remove some of the load from him. IRTS is, of course the EI national society, and so any queries about club life in EI that are aimed at the Hon Sec — see Panel — will be dealt with or re-directed as may be necessary.

The **Isle of Wight** group has another aerial up, and so the G8 types are getting to know a bit more about the lower bands as the club station, G3SKY, has now aerials for 80 and 20 metres. Listen out for them around 3.170 MHz, on Friday evenings, from the Unity Hall, which is near the Sloop Inn, Wootton Bridge.

The **Kidderminster** membership list has gone up to no less than 48 — quite remarkable; they can be found on alternate Tuesday evenings at the Aggborough Community Centre, Hoo Road, Kidderminster, which is adjacent to the Harriers football ground. We believe that in between the fortnightly affairs just mentioned they also have informals at another venue. To revert to the Aggborough sessions, the one on February 3 will be graced by a visit from a GPO gentleman but our list doesn't cover February 17.

Up to **Liverpool** now, where they have February 3 for a quiz, and a "mystery guest speaker" on February 10. February 17 will be taken up with a dissertation by a Mr B. Emmanuel on canal cruising; February 24 is set for the surplus sale where everyone gets rid of their ham gear to buy a boat! The Hq is at the Conservative Rooms, Church Road, Wavertree.

Another group to find themselves a new home are **Medway**, who now get together on Friday evenings at St. Luke's Church Hall, King William Road, Gillingham; the new venue is understood to be about half a mile from the previous place and quite easy to find. Details from the acting Hon Sec — see Panel.

GW amateurs and SWLs within reach of Dolgellau will no doubt be aware that the **Meirion** group are to be found

at the Ship Hotel on the first Thursday in each month; on February 5, SWL Bob Smith will be talking about power station instrumentation.

It is every Friday for the **Mexborough** crowd, and they are to be found at Harrop Hall, Dolcliffe Road. Latest details from the Hon Sec — see Panel.

February 20 at **Melton Mowbray** is down for a talk on Raynet, by G3STG, at the St John Ambulance Brigade Hall, Asfordby Hill, Melton Mowbray.

Another "every Friday" group is the one known as **Mid-Lanark**; they get together at the Wrangholm Hall Community Centre, Jerviston Street, New Stevenson, Motherwell.

After reading the current issue of the **Midland** newsletter we feel you should contact the Hon Sec at the address in the Panel, as it is not clear at the time of writing whether or no the new Hq in Broad Street is being put into use on schedule.

Northern Heights newsletter carries the weekly programme data until January-end, but they will no doubt have something going on each week: Wednesdays at the Bradshaw Tavern, Bradshaw, Halifax.

Peterborough continue their merry way, with their regular sessions on the third Friday of each month at the Scout Hut, Lincoln Road, Peterborough. Details from the new Hon Sec — they will doubtless have the programme all settled by the time this comes to be read.

The Radio Amateur Invalid and Blind club is better known as **RAIBC**; and we commend to your attention the thought, that, quite apart from pointing any suitable candidates for full membership in the right direction, much can be done by supporters and representatives, and a fund-raising effort is always well appreciated. All the 'gen' from the Hon Sec — see Panel.

At **Scunthorpe** they have booked February 3, 10, 17, and 24. In order, the activity will be first a talk on "my favourite QSLs" by G4GZB, a natter evening, a junk sale, and a talk on Ceefax and Teletext by G8XMP. Find them at the Shack, Grange Farm Hobbies Centre, Franklin Crescent, Scunthorpe.

Nice to see **Silverthorn** club newsletter again after an interval; they are still based on Friday Hill House, Simmons Lane, Chingford, where they are in session each Friday evening, with some quite remarkable facilities available to them.

Down South again to **Southdown** — there must be something in the South Coast air that causes radio clubs to form spontaneously! This group meet at Chaseley Home for Disabled Ex-Servicemen, Southcliff, Eastbourne, on the first Monday of each month; as they have, at the time of writing, just had their AGM, we will no doubt hear next time of the detailed programme. Meantime, either go along or contact the Hon Sec at the address in the Panel.

On now to **Southgate** at the Scout Hut, Wilson Street, Winchmore Hill Green on the second Thursday of the month. Details from the Hon Sec — see Panel.

At **Stevenage** we see February 5 for a talk by G4BGP, on microwave communication, and February 19 for a talk by a representative of the Lea Valley Water Board. The meetings are held in the canteen of the British Aerospace Dynamics Group (ex-De Havilland, ex-HSD) in Gunnels Wood Road.

A very abbreviated newsletter from **Stourbridge**, and also minus the rather nice cover they used to have. It tells us

that the Hq is at Longlands School, Brook Street, Stourbridge, but for all the rest of it we must refer you to the Hon Sec — see Panel.

Surrey members are still getting used to the change of meeting night; but February 2 is down for a talk on "Electronics in the Home and Shack Security", while there is an informal on February 16, both at *T. S. Terra Nova*, 34 The Waldrons, South Croydon.

Sutton and Cheam have two meeting-places; on February 13, at Sutton College of Liberal Arts, G3FZL will be giving a talk on VHF, operating and other aspects. Then on February 27, at Banstead Institute, G4CQR will be telling them how a photocopier works.

Every Tuesday evening sees the local lads heading for the **Thurrock** Hq on the top floor of Grays Park Hall, Orsett Road, Grays. Details from the Hon Sec.

Up at **Tyneside**, the group are based on Vine Street, Community Centre, Wallsend, where they are to be found on Monday evenings. Operating must be a major interest, as we understand a tri-band beam has been put up for use with the club station. Details from the Hon Sec at the address in the Panel.

Verulam have moved themselves out of St Albans to Hq at the Charles Morris Memorial Hall, Tyttenhanger Green, Tyttenhanger; details from the Hon Sec — see Panel.

A long list of dates come to us from **Wakefield**, and from it we gather that on February 10 there will be some Post Office films, and on 24th the club will be on the air and nattering; the venue is Room 2, Holmfield House, Denby Dale Road, Wakefield.

On we go now to **West Kent**, at the Adult Education Centre, Monson Road, Tunbridge Wells, on the first and third Friday. February 13 is down for a series of ten-minute talks on subjects germane to contesting, and on 27th, G4GTN will be giving a talk on optics.

"Time marches on", says the man from **Wirral** in his editorial, which caused your scribe a fast backward look to see how he lay for time to deadline! This club are nicely set up in the Sportscentre, Grange Road West, Birkenhead, where they can be met on the first and third Wednesdays of each month. Details from the Hon Sec — see Panel.

Wisbech foregather fortnightly at the "Five Bells", Parson Drove — again details from the Hon Sec at the address in the Panel.

The **Worcester** lot seem to have forgotten us — but against this eventuality (which arises because of their newsletter coming out irregularly) we have a standing message from them which says that they will be in the Old Pheasant in New Street on the first Monday in the month. More from the Hon Sec if you need it — see Panel.

Every Thursday evening at Building 101 of Houndstone Camp the **Yeovil** group foregather, but we do not at the time of writing have details for February, but no doubt the Hon Sec would be pleased to tell you what is to go on.

We always like to see the **York** letter, partly because it's usually the bottom of the pile, but more because two successive scribes have had the gift of putting into words the atmosphere of the club — we feel almost members ourselves. They have Hq at the United Services Club, 61 Micklegate, York, and one day we will drop in and see just how accurate our imaginary crowd is! Be careful though, as they are booked in on all Fridays of every month except the third Friday in each month — it sometimes confuses them as well as us!

More Mail

Just as this piece was enveloped up and ready to go, your scribe received a missing "Special Delivery" packet, with apologies from our friends in the Post Office. In it were letters from: **Mexborough, Dartford Heath D/F, Crawley, Midland, G-QRP**, all of which will be taken in next time; plus news of the formation of a new club at **Chesham** — the contact is G8PUC on 02-405 5625. Also a letter from *Tolworth Venture Scouts*, who will be having an auction of surplus equipment of G3DQT, from 11am till 4pm on Saturday, February 7, the venue being the Berryfields Scout and Guide Hq, Stirling Walk, Surbiton. For more details on this one, Contact: R. P. Abbott, 151 Beresford Avenue, Surbiton.

QRT

Which is where we pull the Big Switch on *Clubs Roundup* for another month; deadline dates are in the 'box', and if you miss a bus, you'll go into the next one anyway!

Address, as ever, to "Club Secretary", SHORT WAVE MAGAZINE, 34 High Street, Welwyn, Herts AL6 9EQ. Cheers for now!

1980 "MAGAZINE" CLUB CONTEST

THIRTY-FOURTH ANNUAL EVENT

THE contest this year was fun for those who entered, and pretty well every station who sent in a log managed at least one QSO outside the UK. From that point at least it served its purpose; on the other hand, while the clubs who entered had, in general, a good time the snag was not enough clubs putting in logs.

The winner was quite out of the blue as far as the pre-contest forecasts of the invigilators went — none of us won the pint of bitter! *Tyneside* remembered words of yesteryear in the context of MCC, and thought about the wild blue yonder — hence the big booming signal from GM3ZQM/P just north of the Border, some 20 km southwest of Jedburgh, on "nice muddy farmland with trees in all the right places" — they certainly were the biggest signal on the band, and that on an end-fed aerial is quite something even if it was $\frac{3}{4}$ -wavelength long with "vertical" in the right place. At times they were knocking up a scoring rate of one a minute for most of the time and, believe it or not, sitting crystal-controlled on 1.9114 MHz all through the contest, leaving the VFO of the Trio TS-520SE to make the best use on receive of the crystal filters (they had the 250 Hz one for CW).

Dundee were second placers, but at no time were they of the booming strength of the *Tyneside* lads, despite their half-wave at 180 feet at the feedpoint as an inverted-vee, with FT-101B down below. We know their spot pretty well and would have thought they too would have been a big signal with their take-off to the South, but it seems they weren't to be lucky; we doubt if they lost out due to equipment or aerials but rather to the skip — and the chance that gave *Tyneside* a fine site to go with the best location from the skip point of view. Certainly



Winners of MCC 1980 were Tyneside A.R.S., signing GM3ZQM/P. Seen here 'on location' in Scotland are the Contest operators, left to right, G4ILW, G4HUX, G8CYW, G4JGL and SWL Teddy Tomiak. The other operator, G4AZB, took the photograph.

Dundee weren't putting in their usual signal strength at the writer's operating shack.

On the debit side, there was little to find. One club didn't know how to calculate their results. To clarify: add up the sum of the QSO points for the first evening; add up the total number of multiplier points for counties and countries; multiply the first by the second. Ditto the second evening. Add first evening and second evening totals. In our case of course, the CW total needed to receive also the 1.5 multiplier, and for some entrants the total score needed a further multiplier for location — nobody got the last two bits wrong, save for the incurable optimist who said "we thought you'd left our part of the country out of the list of those to receive the extra multiplication, so we've multiplied it anyway!"

However, perhaps we should consider the multiplier situation more closely for next time. But, for this year, the rules are the rules, and everyone must abide by them.

Now, as to the operating; by and large it was very good, and certainly the stations were better spread out with very few huddled in the lee of a coast station as used so often to occur. Conditions were more difficult for your invigilators to assess, as there can be no doubt that the local noise level in built-up areas has risen greatly of late years, but by halfway through the session on each evening one was finding typical Top Band evening propagation. Talking of noise, the IOI Contest Group who had a half-wave top at 200 feet(!) between two tower blocks of flats, fed by another quarter-wave zig-zagged up the side of one, found the snag of such a set-up — TV timebase noise at S9 plus; they know that several stations called them and could not be worked due to this problem. We would like to have been present to see this wondrous wire being worked up the building!

On the equipment side everyone who reported their gear was using transceivers, and among these were some novelties, like a KW-2000B with one 6146 plugged in — it sounded OK to us.

For the rest, Yaesu's FT-101 and variants thereof predominated, with several Trio TS520S's and SE's. One of the invigilators was having fun with his Trio TS-830B and its outboard VFO, monitoring his outgoing signal by listening to the second harmonic as heard by his TS-520 — quite a tangle, if his check log is anything to go by. One thing that does bother us a bit is the question of *how* one gets one of these Japanese transceivers to give a real 10 watts input as required by the licence conditions; we accept that it was done, because we have the declarations, and because we could do it on our old KW machine. But it does require some messing about and the obvious alternative, namely to make the licence conditions the same for CW and SSB, would make it ever so much easier.

It is interesting to notice the effect of the "opposition contest" on the CW evening, as reflected in the winner's score. On SSB, it was the mainland UK plus the Channel Isles and GD, with just one other country in UP2. On the CW evening there were twelve countries outside UK — but it is clear after going through all the logs that we will have to *define* countries in the rules for next year — after all, the UK comprises G, GI, GD, GM, GW, GU, GJ as separate countries, and some logs were not scored with this in mind. So — we had to rescore all the logs to be sure of correct totals.

Thirty-Fourth MCC — Results

Place	Club name & Call	Points
1.	Tyneside, GM3ZQM/P	21944
2.	Dundee, GM4AAF	13602
3.	Shefford 'C', G4IRX	9864
4.	Sutton & Cheam 'A', G2DMR/ G3MES/A	8645
5.	Maidstone YMCA, G3TRF	8024
6.	BSC Port Talbot, GW4NZ	7854
7.	Edgware, G3ASR	7302
8.	IOI Contest, GW4IOI	7227
9.	Wimbledon, G3WIM	6993
10.	Acton, Brentford & Chiswick, G4HIO	4646
11.	Sutton & Cheam 'B', G4BFJ	4615
12.	N. Staffs, G4BEM	3473
13.	Grimsby, G3CNX/A	2433
14.	Sunderland RSGB, G3ZOG	2304
15.	Silverthorn G3SRA	2150
16.	Bromsgrove, G4IVJ	1904

The present format seems to please the majority; but how about some more clubs coming back for the 1981 MCC? Start thinking about it *NOW*, since you'll have had time to break your New Year Resolutions and will need something to cling to for the rest of 1981! We'll be there — will YOU?

As a final, we might note that part of the fun is overcoming the problems. Acton, Brentford & Chiswick lost their Hq in a fire some time ago, it will be recalled; and the new place doesn't permit use of an aerial system. So they negotiated with the London Transport Amateur Radio Club for their aerial and site at the new sports ground in Acton. Thus, the deal was that the boys used their own gear and put up the aerial, but used the LT callsign of G4HIO instead of their own. An interesting bonus for them was to find they had such an electrically quiet site, infinitely better than their old place.

So — that's it for 1980. See you in MCC 1981!

THE RABBIT PATCH, PART VI

THE FOURTH OF FOUR PARTS DESCRIBING THE CONSTRUCTION OF A MULTI-TEST UNIT

By "Buck"

On the rotary switch (S2) the unused tags can be utilised as a 'tag-strip' to accommodate any resistors that are used to make up a particular value. The loudspeaker is fixed by four solder tags held to the panel by 6BA nuts and bolts and which grip the edge of the speaker; in the area under the speaker cone the front panel is drilled with $\frac{1}{8}$ " holes to form an acoustic grille. The remainder of the construction is simple. The components are mounted on the panel and the interwiring soldered in as shown in Fig. 21. The sub-chassis is made up and fixed in position, and the 10 leads joined into the rest of the circuit. After checking all connections the CMOS IC can be inserted into its socket — making sure that it is the right way round!

Operation: Test out the continuity side to begin with by using flying leads to join the following terminals together: positive output to speaker positive, continuity output to speaker input. Using a piece of wire to short out the two continuity probe terminals should cause an audible note to be heard in the loudspeaker. If not, check the connections and wiring on the continuity half of the circuit, including the voltage supply to the IC: there will be a dry joint, or a wrong or missed-out connection lurking in the undergrowth. When the continuity section functions satisfactorily remove the flying lead from the continuity output terminal and reconnect it to the capacitor output terminal. Set the range switch (S2) to position no. 1 (0-0.001 μ F). If a faint whistle is heard in the loudspeaker at this point — rejoice! The circuit is thus indicating that it is sensitive enough to react to the tiny capacitance that exists between the capacitor probe terminals.

Whether the whistle is there or not, connect the capacity substitution box between the capacitor probe terminals and select any value between 100 pF and 1,000 pF. This should produce a definite audible result. Varying the value of the capacitor will vary the note produced, and — *Voila!* — an electronic organ as a spin-off. Testing up through the ranges by means of an assortment of capacitor values will establish the fact that there comes a point in each range where the note in the loudspeaker degenerates into a series of clicks, and finally ceases when the C value is too high for the R value chosen. As an indication of capacitor serviceability clicks will serve as well as a musical note, of course; but as experience is obtained in using the tester a shrewd idea of the possible value of an unknown capacitor can be obtained from knowing the range selected and the kind of note it produces. However, the limits of each range will probably be:—

- Range 1: 0 — 0.001 μ F
- Range 2: 0.001 — 0.01 μ F
- Range 3: 0.01 — 0.1 μ F
- Range 4: 0.1 — 1 μ F
- Range 5: 1 — 100 μ F

When making the legend to go around the range switch (S2), it is convenient to show just the upper limit of each range (as demonstrated in Fig. 15) even though there will inevitably be

some overlap between ranges and Range 5 will operate at well over 100 microfarads.

Section 'D' — Transistor and Diode Tester

This section of the Tester can conveniently be considered in two parts. Firstly, the part that demonstrates whether the transistor is PNP or NPN; and secondly the part enabling the performance of the transistor to be tested. When diodes are being tested, both parts can be used to provide information.

PNP-NPN Determination: The basic circuit for the determination of NPN or PNP characteristics is given in Fig 22(a). Light Emitting Diodes (LEDs) are designed to produce light when the diode anode is made positive with respect to the cathode (*i.e.* under forward bias); a current limiting resistor must be included in the circuit to prevent damage from overheating, and anything from 1.5 to 2.5 kilohms will serve. LEDs are made in several colours, but red is the cheapest and most efficient.

Two LEDs are connected in parallel with alternate polarity and from part of a circuit which allows for a transistor to be inserted and for a 9v. supply to be switched from one polarity to the other. With the switch set to 'PNP' and with a transistor in circuit the LED marked 'PNP' will glow if the transistor is indeed a serviceable PNP type allowing current to pass through it; the LED will not glow if the transistor is (a) unserviceable, or (b) an NPN type. Turning the switch to the NPN mode will cause the LED marked 'NPN' to glow if the device is a serviceable NPN type; but not otherwise. This test is all that is needed if only a "go — no go" answer is required. But there are times when transistors need to be balanced in performance to operate as a matched pair; or the comparative merits of a number of similar transistors weighed so that the best performance can be selected. For this purpose the second half of the Tester is used.

Testing Transistor Performance: Take a look at the basic circuit shown in Fig 22(b). Here a transistor (which happens to be an NPN type although PNP types can be tested in a similar way) is in circuit with a switch, two resistors, a milliammeter, and a 3v. power supply. With S1 open, the meter will only measure the current which is allowed to flow by the series impedance between the emitter and the collector junctions. This is the 'leakage current' and, in good transistors, is very small or non-existent. By closing S1, the base voltage is brought closer to the collector voltage. This causes the transistor impedance to be less thus increasing the collector current which, in turn, increases the meter deflection. The amount of increase is a measure of the gain of the transistor.

Testing Diode Performance: To test the performance of a diode a circuit as shown in Fig 22(c) is required. Here a diode is connected in series with a meter and a power supply in such a way that the diode is 'forward biased' (positive of circuit to positive anode of diode). In this situation, the forward impedance of the diode will be low and the meter deflection quite high. By 'reverse biasing' (positive of circuit to negative cathode of diode), the diode is caused to present a high impedance to the current and the meter deflection drops. Comparing the difference in current flow in the 'forward' situation to that in the 'reverse' situation gives a measure of the diode's performance. For a simple "go-no go" test, which also determines which end of the

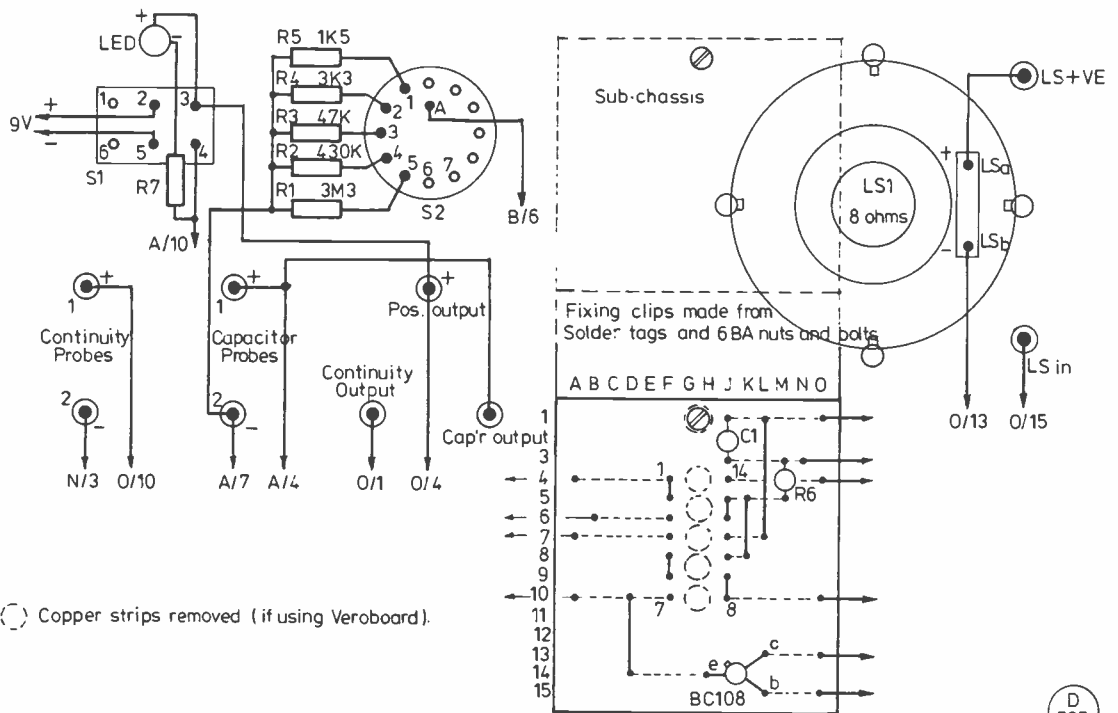

diode is the anode and which the cathode, see "Operation".

The circuit for the Tester follows the above mentioned principles but will have a few extras put in by way of 'on-off' warning lights, and switching arrangements, etc. Fig 23 gives the details.

Construction: The wiring diagram in Fig 24 follows the circuit diagram, and the front panel layout is shown in Fig 15. From left to right the controls are: three terminals for collector, emitter and base leads of transistors under test (the 'c' and 'e' terminals being also used for diode testing); the "PNP — NPN — Test" switch (S2) which allows the

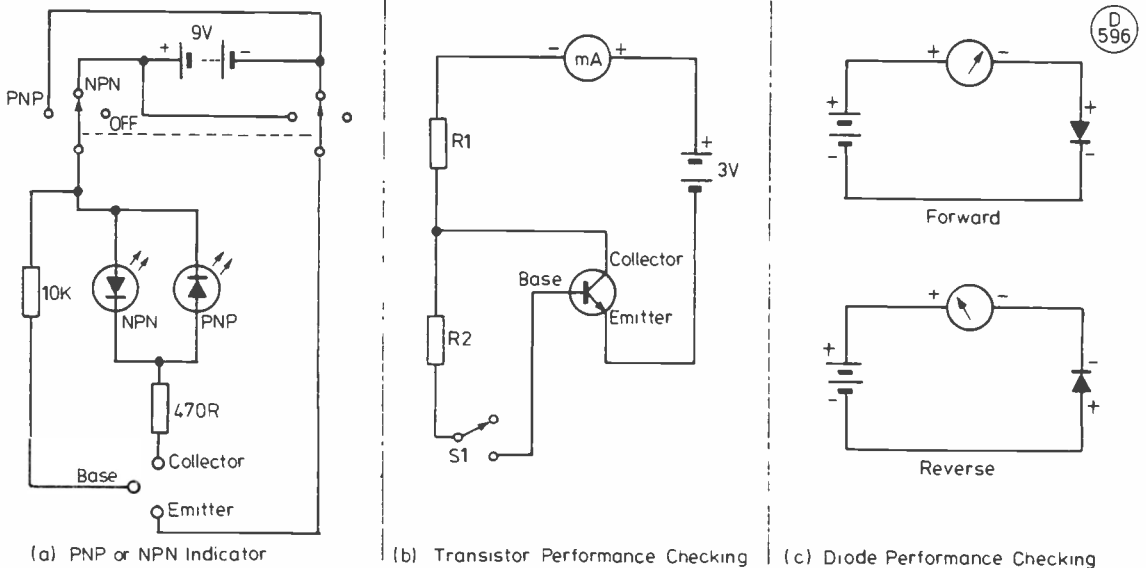

Fig 22 BASIC THEORY CIRCUITS FOR TRANSISTOR AND DIODE TESTING

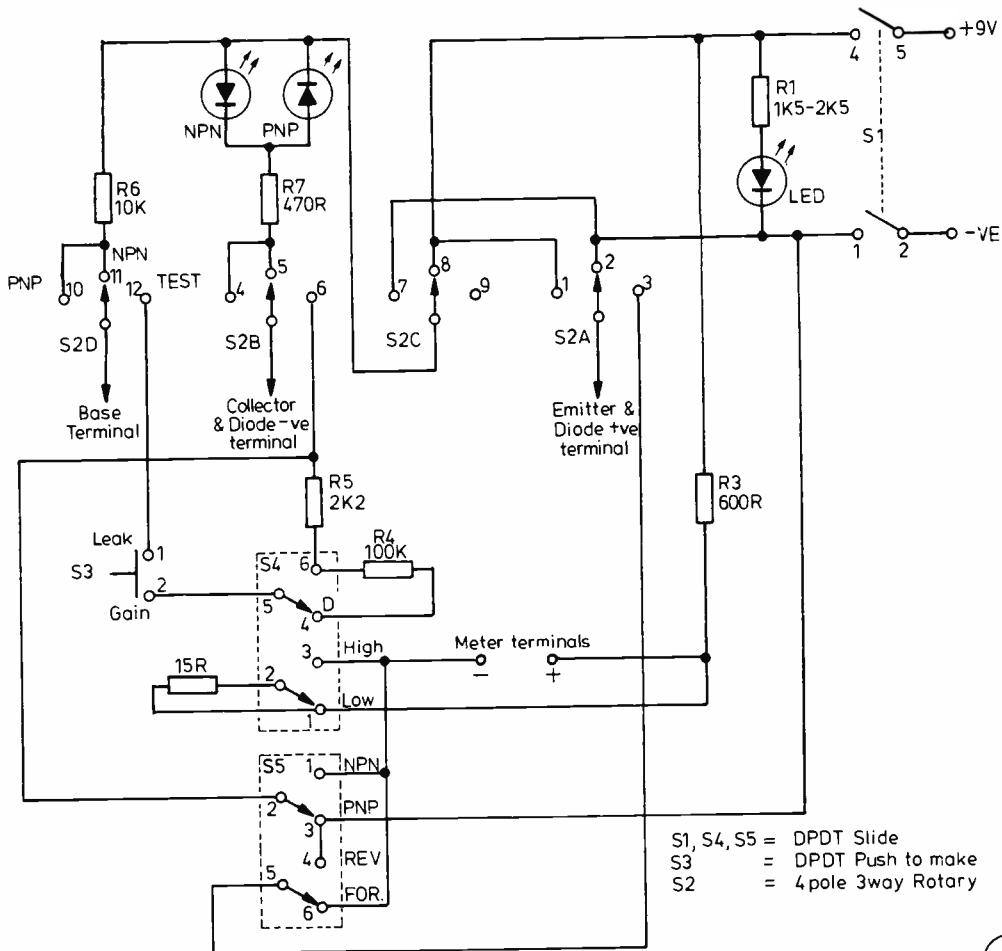

Fig. 23 CIRCUIT DIAGRAM OF TRANSISTOR AND DIODE TESTER

D
597

type of transistor to be checked before going into the 'test' position; the "Leak — Gain" push-to-make switch (S3), normally in the 'leak' position (being spring-biased it cannot be inadvertently left in the high-current-producing 'gain' position); the "High — Low" switch (S4) which should be in the 'low' position when diodes are to be tested (hence this position is marked "Low/Diode"); the "PNP — NPN" switch (S5), which determines the voltage polarity when measuring the gain of the transistor also determines whether the bias on a diode under test is 'forward' or 'reverse' (switch is marked "PNP/Forward" and "NPN/Reverse"); the "on — off" switch (S1), with its associated LED: and the positive and negative output terminals to allow a meter to be connected into circuit.

The components are mounted on the panel and then wired as shown in Fig 24. A partial view of the wiring is given in the bottom half of Fig 16, though this is somewhat obscured by the sub-chassis (mounted on a single 40 mm. stand-off pillar) which carries the resistors R2 to R7 inclusive. Care is needed in the inter-switch wiring, and for this reason the tag points have been numbered in both the

circuit and the wiring diagrams to reduce the chances of confusion. Patient cross-checking as the wiring is done will pay dividends in saving heart- and headaches later.

Operation: (Diode Testing). Switch on S1 and check that the 'on-off' light glows, then set S2 to 'PNP', S4 to 'diode' and S5 to 'forward'. Connect flying leads to meter terminals, observing the terminal polarity; select a 50mA. range on the meter. Next, connect diode leads to the 'emitter' and 'collector' terminals: if the PNP LED glows, the polarity of the diode is as you have it, i.e. diode anode to 'emitter' and diode cathode to 'collector' as indicated by the symbol legend at the side of the terminals. If the light does not glow, reverse the diode leads: the PNP LED should glow this time. If it doesn't, the diode is open-circuited (o/c) and can be discarded.

With the PNP LED glowing, switch S2 to 'test'; the meter should now read some value or other. If necessary, adjust meter range to give nearly f.s.d. Switch S5 to 'reverse', whereupon the meter reading should fall considerably. If there is no change in the reading the diode is short-circuited (s/c) and can be discarded.

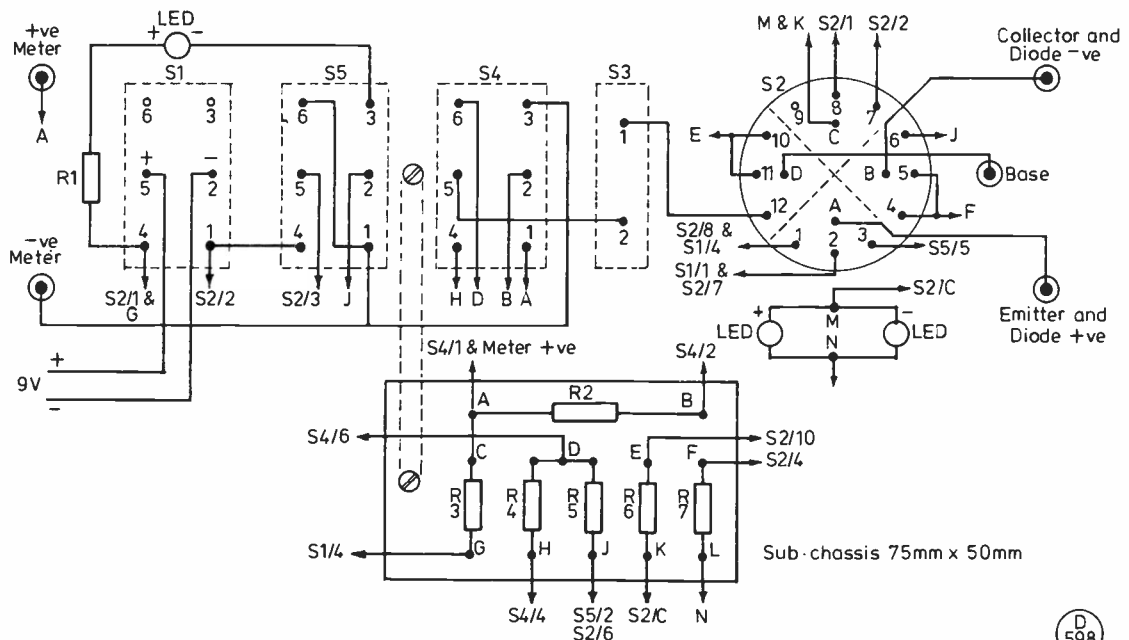

Fig. 24 WIRING DIAGRAM OF TRANSISTOR AND DIODE TESTER

Note that silicon and germanium diodes have a comparatively low resistance and will give a higher meter reading than selenium or copper oxide types which, having roughly twice the resistance, will only give about half the meter reading values of the first category.

Operation: (Transistor Testing). To test a transistor it is first necessary to know which of the three transistor leads belongs to the base junction. If, for any reason, the lead-out details cannot be found from charts, an ohmmeter must be used.

Select the "ohms" range on Meter 2 and connect a black flying lead to the red terminal, and a red flying lead to the black terminal. The colour of the flying leads will now be in accord with the polarity of the voltage they carry; knowing the true polarity of the leads is an essential part of the process.

Work methodically round the leads of the transistor measuring the resistance between each pair. Actual values are not important, only the relative values being significant. Find a pair of junctions which are of relatively high resistance no matter which way round the meter leads are connected to them; the base junction will be the remaining, third lead.

PNP or NPN action can be established by the ohmmeter once the base connection is known. With a positive connection to base, and a negative connection to either of the other two junctions, a low resistance reading indicates the base is a P-type and that the transistor is, therefore, an NPN type; the reverse case is true for PNP varieties. Type determination — and distinction between collector and emitter junctions — will be revealed by the test procedure.

When the base junction of the transistor has been identified the steps in the testing process are as follows. Switch on S1 and check that the 'on-off' light glows, then set S2 to 'PNP', S4 to 'low' and S5 to 'PNP'. Connect flying leads

to meter terminals, observing polarity, and select a 50 m/A. range on the meter. Next, connect the transistor base lead to the 'base' terminal, and connect the other two transistor leads to the remaining terminals in any order. One or other of both of the 'PNP' and 'NPN' LEDs may glow; and one may glow more brightly than the other when the switch (S2) is varied between 'PNP' and 'NPN'. Changing over the 'collector' and 'emitter' connections will result in only one light glowing in either the 'PNP' or the 'NPN' as the switch is altered. When this condition has been established the transistor type and lead-out details have been determined. Provided that the base junction has been correctly identified, failure to produce the single light condition indicates that the device is unserviceable, and that it can be discarded.

Leaving the transistor in circuit, set S2 to 'test', and set S5 to 'PNP' or to 'NPN' according to the type determined. The meter will now read the leakage current value. If the meter reading goes to f.s.d. the transistor is s/c and useless; no reading at all may only signify that the leakage current is too tiny to be measured on that particular range of the meter.

Push S3 to the 'gain' position and note any increase in meter reading that occurs: the increase in meter deflection indicates the gain that can be obtained from the device. No increase at all in the meter reading (provided the correct meter range has been selected) means that the transistor is o/c or is such a poor performer that it can be thrown away.

The Multi-Test Unit performed well up to standard, and continues to earn its keep. Almost immediately the Unit had been completed, however, another need clamoured for attention. There had to be some way of determining the precise values of capacitors, to a lesser degree resistors, and to a lesser degree still, inductors. So an RC(L) Bridge had to be made.

to be continued

“A WORD IN EDGEWAYS”

Letters to the Editor

The views expressed here are not necessarily those of the Editor, nor should they be taken to represent any particular SHORT WAVE MAGAZINE policy.

Dear Sir — One often hears arguments, both on the bands and at club meetings, as to when SSB first came into use. The general opinion seems to be either just before or just after the last war but how wrong can a guess be!

Whilst glancing through a recent addition to the archives of the National Wireless Museum, I found the following: “The Western Electric Company has devised a system in which the carrier wave and one sideband are filtered out, and only the second sideband is radiated. In order to render the speech intelligible, however, the carrier wave must be re-introduced at the receiving point, and this is accomplished by employing an oscillating detector, the frequency of the heterodyne oscillation being the same as that of the carrier wave suppressed at the transmitting point. Since the sideband amplitude is only one-half that of the carrier wave, the total power to be radiated is only one-quarter of that required with the ordinary system, while the band of wavelength required is considerably reduced”.

This paragraph is taken from *Radio Engineering* by J. H. Reyner, published in September 1925 — in the era of bright emitter valves and horn loudspeakers!

Truly, there is nothing new under the sun.

*Douglas Byrne, G3KPO/GB3WM.
Hon. Curator, National
Wireless Museum, Isle of
Wight*

Dear Sir — When things are ‘dead’ on 28 MHz, I often tune down that odd one meg. to 27 MHz — and my mind boggles!

Why does that small change in frequency bring forth such enthusiasm *and* organisation? I am sure that at any one time in the UK, there are more ‘good buddies’ using that bit of the spectrum than all the amateurs on 160 to 10 metres put together.

Could the answer be, as I heard one CB-er say, that “I only enjoy CB because it’s illegal”. Perhaps we would get more fun from amateur radio if we dropped the next licence renewal fee demand down the nearest drain! Or is it simply that the 27 MHz operators are the new breed of radio amateurs and we, the “come day go day, operate on Sunday” types, should take our Tony Hancock image and quietly tiptoe away.

We could, of course, actually use that ‘dead’ 28 MHz band. It certainly makes you think — rather like taxing your car for a year and then using it only on Sunday mornings!

Nev Kirk, G3JDK

Dear Sir — I am a short wave listener and keen on entering for awards open to SWL’s; also I hope to receive a full licence this year.

I would like to take up the matter of QSL cards. To obtain an award it is necessary to forward QSL cards for

confirmation of the contact, and I wonder if other SWL readers are experiencing the same problem as myself, namely, failure to receive a return QSL card when dealing with some ‘managers’.

The return is about 25%, against 90% when sent direct to the address given in the *Call Books*. It would appear that managers do not treat reports and cards from SWL’s with the same respect as they do licensed operator’s QSL’s — even though they are sent addressed envelopes, IRCs and return Air Mail stamps. This causes resentment and is a poor reflection on the Amateur scene generally. It should be remembered that a keen SWL is a future licensed operator, becoming a member of the ‘club’, hoping to enter for awards and contests, and expecting replies to his QSL cards.

This failure to reply does not occur very much when correspondence takes place direct with a station operator himself, so it seems that this must be the way to overcome the problem; however not all operators have QSL cards available, having delegated the job to their manager. Of course there is always the QSL bureau, but the years pass before enough of the necessary cards are collected.

B. Woodcock, Leeds

Dear Sir — Most two-metre operators will by now have heard about the proposal to divide up the SSB section of the band, with DX working below 144.40 MHz and local working above it.

There must be a few thousand rigs, such as Liner-2’s, which are only capable of tuning up to about 144.330 MHz and these are most likely to be used for local and mobile contacts. DX operators, on the other hand, are more likely to be equipped to work anywhere on the band. I therefore propose that 144.150 to 144.300 MHz be used for local working, and 144.300 to 144.500 MHz for DX; this would give limited-coverage equipment access to the full local/mobile sub-band and a small part of the DX segment. It would also keep the DX clear of those reactionaries who will never move no matter what the band plan says.

I must state my personal view that there is already too much ‘bureaucracy’ on 2m. in the form of calling channels etc. People still manage to work DX on the more crowded HF bands without all this band planning. I don’t advocate a free-for-all with satellites, repeaters and SSB all in there together, it is simply a matter of degree. I think some of the people making the rules forget that amateur radio is supposed to be a hobby.

In any case, I think it is wrong that a handful of influential amateurs in their ivory tower should be able to make hundreds of rigs obsolete overnight. This plan should either be forgotten, or modified as I have suggested.

Julian Moss, B.Sc., AMBCS, G4ILO

Dear Sir — Could we use your pages to offer thanks to the following people and companies who have helped us so much in the last six months. We are involved in the care and rehabilitation of young men who wish to be helped with their drug, alcohol or other problems, some of whom have spent time in prison or borstal. We use amateur radio as one of our hobby projects as it encourages diligence and co-ordination,

and brings our lads into contact with people all over the world.

A Trio 9R-59DS was donated by Lowe Electronics Ltd. Our other receiver is an RX-80, designed by A. L. Bailey G3WPO, the circuitry for which was donated by Roy Stevens of the IARU. Decca and Cable & Wireless donated equipment and funds to enable us to build a very efficient antenna system, using an 18-AVQ vertical and a 108-ft. trap dipole. Amcomm provided the ATU; Heathkit and C. Bowes provided kits for the Morse code oscillator and wideband pre-amp., respectively. We have also been encouraged by Dr. Tong's gift of a Datong Morse Tutor, and Mr. F. L. Curtis's gift of the G3SVK Morse Course.

We would like to thank *Short Wave Magazine* and the RSGB for their generous gifts of books and subscriptions; and last but not least, Mr. Geoff Stone G3FZL and all the other radio experts who have helped us so much.

Two of this household are attending evening classes at Ferndale and hope to sit the RAE next May.

Thank you all for your help.

Arthur (BRS44147) and Susie McBryan,
house parents, Pye Barn Ltd.

Address your letters for this column to "A Word in Edgeways", *SHORT WAVE MAGAZINE*, 34 High Street, Welwyn, Herts. AL6 9EQ.

"IT'S THE SECOND BIGGEST THING SINCE '46"

Jack Hum, G5UM

ANOTHER clubnight had come and gone. The members drifted off into the chill of the night, and as Old Fangler, standing in the doorway of the clubroom, watched their figures merge into the darkness, an old church bell from somewhere down in the city below tolled the knell of passing day and registered 2200 hours logging time.

At that moment Old Fangler suddenly realised he was not alone. There was still somebody behind him in the clubroom. He turned round to look. Now why, thought Old Fangler, was that member whom he knew as the Sceptic At The Club hanging around? Why was he lurking? Had he been indulging in a furtive draining of the teapot in the kitchen? Wasn't he feeling well?

It was none of these things, explained the SATC when Old Fangler asked him. The reason he was delaying his home going, he said, was that he had one or two important things to ask of Old Fangler.

"H'm", thought the O.F., "This sounds a bit portentous . . . after all, he's been in amateur radio a long time and there's not much you can tell him . . . in fact, he's the one who usually does the telling. Many's the young squirt who has caught the sharp edge of his tongue by daring to ask for his 'handle'. It was said he replied 'It's in the smallest room in the house'. And it's a standing club joke how he put down a chap who kept on saying on the air 'We this' and 'We that' by asking him if he customarily used the Royal plural and did he have a coat of arms!

All these thoughts flashed through Old Fangler's mind at 186K/per sec; he shook himself clear of them and asked the

Sceptic At The Club what he could do to help.

Came the reply from SATC: "Do you remember a few weeks ago we had a most interesting conversation about getting going on the metre waves, and we'd reached the point where I'd asked you about repeaters (see "SWM," *August 1980, page 367*). You shut up like a clam at this and said it was another story for another time. How d'you feel about giving me the lowdown on it now?"

Seeing he was cornered, metaphorically if not physically, Old Fangler observed that a draughtily doorway at the clubroom (which he was trying hard to close) was no place to hold a dissertation. "Home to a last cuppa" he suggested, feeling that his chances of a quiet diddle-dee-dah before he went to bed were rapidly becoming subject to inexorable QSB.

Fourteen minutes and four cuppas later, Old Fangler stretching out in his armchair said:

"Now, repeaters . . . they are the second best thing to have hit amateur radio since the Great Resumption back in 1946".

The SATC couldn't help asking what the First Thing was if repeaters were the second.

"Why, single sideband" replied Old Fangler: "It revolutionised the amateur radio scene as nothing else before it had ever done. Think of the chaos we'd be in today if it hadn't been for those dedicated chaps who pioneered the A3J mode for amateurs about a quarter of a century ago . . . yet, d'you know, it wasn't new? The professionals had it across the Atlantic well before the war but the amateurs didn't".

Fidgeting slightly, because the hour was late, the SATC reminded Old Fangler that it wasn't SSB he'd come to talk about but repeaters.

"Oh yes" replied the O.F.: "H'm, repeaters . . . the second best thing to hit amateur radio . . . I'll tell you all about them in just a few short swift sentences".

What Old Fangler had to say went something like this:

In the Sixties and Seventies the British amateur radio scene experienced a growth in VHF activity which could only be described as explosive, maybe exponential and certainly quite extraordinary (the advent of the Class B licence in 1964 was only one of several reasons for this trend). Along with this growth went an equally emphatic expansion of mobile operation. Yet herein lay a snag: on the metre waves you get best results not only when you can cover a line of sight path but also when you can obey that dictum uttered times without number over the last three decades in *Short Wave Magazine*: get as much antenna metal high up and in the clear as you possibly can.

Quite evidently no mobile installation can obey these two dicta of high antenna and lots of it: mobiles by definition operate at ground level and the antennas fixed to them are not much higher than that. At the same time they must be smallish enough to attach to a vehicle.

Result: mediocre performance at VHF, with contacts limited to those stations (fixed or mobile) who coincidentally happen to be within electronic line of sight with you when you put out that optimistic CQ.

The remedy? To instal a VHF repeater station on a high spot overlooking known areas of vehicular activity. Equip it with a receiver for accepting signals from those same vehicles, and a transmitter which automatically re-radiates your call on another frequency where you hope someone will be listening and waiting to talk with you.

Nothing new in that: the professionals had done it for years, asserted Old Fangler. But when a handful of professionals holding amateur call-signs noted the shortcomings of mobile VHF operation they came up with the suggestion that there could be amateur operated repeaters, too. And now, not quite ten years after the initial thought, there are a hundred-plus repeaters covering most the British Isles on either the 145 MHz band or the 433 MHz band — and from some sites, both.

The Old Fangler went on to describe the operational technique of bleeping up a repeater when you wanted to talk through it, of always checking the input to determine if, hearing your correspondent's signal, a simplex contact might be possible, of getting off the repeater a.s.a.p. lest others should be waiting to use it — and most important of never, never using it from the home site if direct communication was viable, remembering always that repeaters were for the disadvantaged and not for people sitting comfortably at home (unless they honestly could say that communication by any other means was impossible). Old Fangler waxed especially vehement about so-called nets forming up on repeaters, thus inhibiting their intended use (which, as he said, was for the electronically disadvantaged).

All of which seemed to make a positive impression on the SATC: "I've been in this amateur communications game a long time, as you know, but a lot of this is new to me" he said. Then a thought struck him:

"If you talk through repeaters isn't it rather like cheating? After all it's the magic box that's doing the work and you're not having a real QSO at all!"

"Point taken, chum", replied Old Fangler, adding: "What's more, when there's a bit of a lift on the band and the distant stuff is coming through, perhaps laced with a foreign body or two, you have to keep a sense of balance and remember that it's the automatic box up on that hill that's doing the work, not you. I find it quite pathetic when you hear chaps begging for a QSL for what they call a QSO . . . it's nothing more than a proxy QSO if it's done through a repeater, and the QSL anyway should logically go to the repeater and not to the person you talk to".

With a glint in his eye the Old Fangler murmured: "You won't get a card back in return if you do QSL a repeater. The thing can hear and it can talk, but it can't write!"

At this point the Sceptic At The Club muttered something about a lot of room being taken up in the bands by all these repeaters, what with space in which they can listen for calls and more space in which to reply. Back came Old Fangler with a quick answer: "Just 175 kHz input on the 2m band plus another 175 kHz output, a total of 350 kHz devoted to repeaters . . . not much when you consider that the 2m band is 2000 kHz wide. There's an enormous amount of room left to for your own thing if you don't like repeaters".

Quickly he apologised: "I shouldn't have said 'Don't like repeaters'. That's negative thinking. I should've said 'If I choose not to work *via* repeaters'. After all, it's every operator's free choice whether he wants to use them or not. I always like to think of a repeater as an electronic motor car: it's a marvel of complex engineering which will take you places when you want it to, but there *are* other modes of travel".

The SATC thought this a nice analogy and he capped it by saying: "Yes, and like the motor car it depends on how

they are used". Which could almost have been the last aphorism of the evening until a final thought occurred to The Sceptic: "You still haven't fully explained why you think repeaters are the second best thing to have hit amateur radio".

Smiling wryly, Old Fangler excused himself for this lapse, and, pouring out the final-final cuppa, gave it as his opinion that rarely before in British amateur radio had so many people been so inspired by a technical project as they had shown themselves to be about the repeater concept. All those repeaters dotting the map of the country came about because of the dedication of often small groups of local enthusiasts firm in their belief that a repeater in their vicinity would be of benefit not just to themselves but to all others who were passing that way on their lawful occasions. These enthusiasts were prepared to find the cash to buy the parts to make the things, they were prepared to submit their technical expertise to the scrutiny of the central body (the Repeater Working Group) which co-ordinated all UK repeater activity; and thirdly, added the O.F., they accepted the responsibility that their repeater, once authorised, must, come heck or high water, give a 24-hour service.

"Service" . . . that's what amateur radio is all about" said the SATC quietly, as he reached for his raincoat.

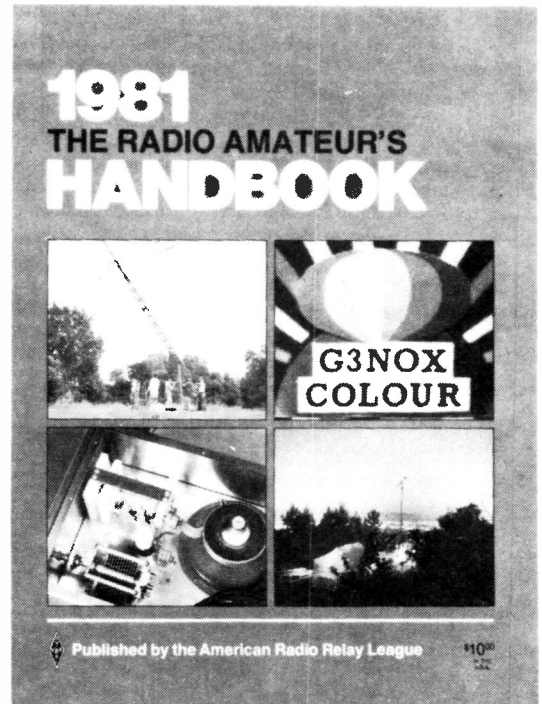

The front cover of the 1981 edition of the radio amateur's 'bible': ARRL's "The Radio Amateur's Handbook". Revised each year to reflect changes in the state of the art, this 58th edition has much useful added material as well as several new construction projects, while retaining its long-established reputation as perhaps the finest standard reference book in its field. Obtainable from *Short Wave Magazine Publications Dept.*, it is available in both soft and hard cover, at £7.80 and £10.80 respectively, including post/packing.

A SIMPLE TUNING AID FOR BLIND OPERATORS

BRIAN CASTLE, G4DYF

THE device described in this article was developed from one which appeared a few years ago in *Ham Radio*. It is intended for use by blind or partially sighted operators, and affords some assistance in tuning the transmitter output stage and the coupling to the aerial. It is not recommended for use with a solid state PA which might be damaged by a small mismatch or might give much reduced output under these conditions.

These simple devices are in daily use at the stations of at least three well known British "white stick" operators on the HF bands. They use rigs having the rather delicate TV sweep tube PAs and tune them in this way without problems.

Circuit Operation

The tuning aid works by detecting a fraction of the RF present at the aerial socket of the transmitter and using it to power an audio oscillator. The tone varies according to the amount of RF present and with experience is interpreted by the operator as he tunes the PA and aerial matching circuit. The device is switched out of circuit by SW1 when the operator is satisfied with result.

The circuit is shown in Fig. 1. The variable potential divider formed by R1, R2 and RV1 is adjusted for maximum sensitivity to changes in the RF. Diode D1 rectifies the signal and C1, L1 and C2 remove the ripple so that DC is passed on to the oscillator. This consists of an astable multivibrator which will work down to about 0.4 volt (at 1.5 volts it takes only about 300 μ V). The audio transducer is a crystal microphone insert or crystal earpiece connected between the collectors of the two transistors. One collector is at maximum positive when the other is at minimum, and *vice versa*. An earpiece of lower impedance, say 200 ohms, might give satisfactory results if connected in place of one of the collector resistors R3 or R6, but then the circuit would draw a larger current; an 8 ohm earpiece would not be satisfactory.



The device is connected in parallel with the aerial socket of the transmitter. The easiest way to make this connection if the rig has an SO-329 socket is to use a PL-259 T-connector and to plug the aerial into one side of the 'T' and the tuning aid into the other, *via* coaxial cable. Otherwise the aid can be fitted with a socket similar to the rig, wired *via* coaxial cable to a suitable plug.

Switch SW1 can be a cheap slide-switch type in spite of the RF present. The circuit can be made on stripboard provided that the full RF voltage does not reach it; resistor R1 should be connected directly between the input terminal and the switch. The whole circuit, including the crystal transducer, should be fitted in a fully screened enclosure, *i.e.* aluminium box, diecast box, tobacco tin or suchlike; this is to prevent RF bypassing the filter, C1, L1, C2. If unscreened, the tuning aid may produce very weird noises even when switched off. Holes will have to be drilled in the box through which to hear the tone.

When a tuning aid is constructed for a blind operator it is desirable to assist him initially by tuning up visually while the aid is in circuit so that the squeaks and squawks which it makes can be related to the correct tuning, loading and matching settings. Much more sophisticated circuits to make it possible for blind operators to carry out all operations unaided have been designed but the little gadget described here is simple and, with its limitations, undoubtedly serves the purpose.

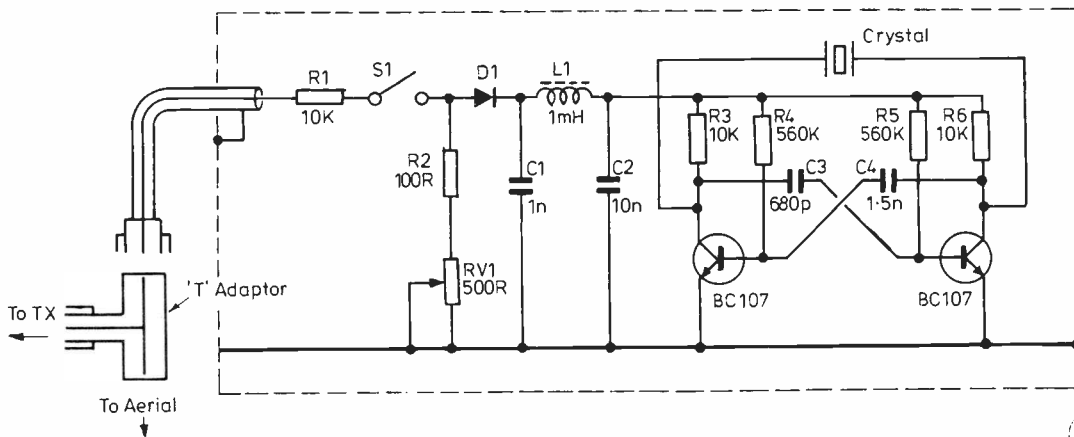

Fig. 1 BLIND TUNING AID

COMMUNICATION and DX NEWS

E. P. Essery, G3KFE

AS FAR as the writer is concerned, the month in review has seen quite a bit of "playing with wireless" but not much operating activity! And indeed, operating isn't all the hobby has to offer, even for the "appliance user" so-called. In my own case it has been questions of aerial design, for example, which have kept me amused, not to mention mending the machinery, and some constructional work.

Events

Perhaps the most important news is that of the BY situation; the Chinese authorities are on record as saying it will soon be possible to work BYs. Now, your old scribe has two comments to make on this; they won't let loose any amateurs until they are sure their operating will be a credit to BY as a country and, having said it will in due course be possible to work BY, it *will happen*. We have had occasion to deal with Chinese, and IT is a part of the Chinese code of things that a public statement like this will be honoured, particularly when the statement has been made at international level. To be a bad operator, or to fail to keep a promise, involves loss of face and no Chinese will happily let this happen to him. All we can say is "welcome back, BYs".

There is, of course, an interesting corollary to this, which is that most of the crackpot republics which think of amateur radio as a way of aiding dissension in their country are receiving aid from the West, from the Russians, or from the Chinese — so there will be the possibility that whoever is giving out the aid will also be able to think of screwing down the issue of amateur licences as part of the price of aid. An interesting thought?

Lloyd and Iris Colvin were last heard of from French St. Martin, signing FG0FOL/FS; it seems they have a liking for trying to work all continents in the shortest possible time — so far Iris holds the record, with just *three minutes*, Twenty SSB to 4Z4, EA9, SP, W2, VK, and YV!

An interesting thought for those who reckon CB is a good thing; FCC finally caught up with one outfit in New Orleans, running *5000 watts* into a

6-element beam. The set-up included two stations, a legal one down below, and a string of amplifiers in series driven by a 4-watt rig and an echo reverb box(!). When the FCC chaps got hold of the rig and tried to fire it up in their lab., they got to 5000 watts and no further because the 40 amp circuit breakers tripped out the mains! Already we are seeing many of the UK 27 MHz pirates who are using things like FT-901 transceivers, as is made very clear by

We hear of a visit to Nepal being planned for April by a group from JA. We also hear that the proposal by P29JS to activate Heard Is. is up against the wall, partly because Jim has moved to Norfolk Is. as VK9NS but rather more by the lack of support for his activity by others. This one, if it comes off, will cost a bomb; indeed VK9NS himself has a lot tied up in it. He repeats that any donations will be returned if the trip does not materialise. None of the big DX groups has committed any money to it, but donations are still welcome. By the time this is in print, the operations *may* have begun, or be about to do so, but the writer has to admit to a feeling that this one won't happen for a while yet.

South Birmingham Radio Society are the inventors of an award called the Birmingham Postal Zone Award; you have to get either 25, 50, or 75 points for the different classes. A first qualification is to work either G3OHM or G8OHM, for five points; you must have a QSO with one or the other (not both) to qualify for any of the awards. Work members of the club for two points, or non-members for one point, one contact in each postal zone (of which there are some 98 in the city and surrounding districts). All QSOs to be direct, and all from the same station (*i.e.* all from home, all from one /A place, all /M, or all /P). An exception to the rule about direct contacts is made if you work them *via* OSCAR — but you need the lot to be on OSCAR and the award is suitably endorsed. For full details, get in touch with J. Harvey, G4IVJ, 38 Bodenham Road, Birmingham B31 5DS, W. Midlands. As for the cost of the award, it is £1, or 6 IRCs, or three dollars. An S.a.e. is required.

The RSGB 7 MHz contest comes up

soon; Phone over the weekend February 7/8, CW February 28/March 1. This is a good one on which to test the station out — and a good contest into the bargain. Entries: Phone to be received by April 4, CW by April 25, to the RSGB HF Contest committee, c/o P. A. Miles, 28 Scotch Orchard, Lichfield, Staffs WS13 6DE. Note that in the Phone section you will have to be able to work split-frequency, as the Ws are up above 7.1 MHz.

QRP merchants should note that February 28/March 1 is also the date for the G-QRP Club Activity Weekend. Look on 3560, 7030, 14060, 21060 and 28060 kHz, starting at 0900 on the Saturday through to 2359 on Sunday, the band change being hourly in accordance with propagation. Details from G3RJV, QTHR.

Some results: the CQ WW 160 1980 contest. The World Trophy goes to K1PBW — a nice way to bow out indeed! For Europe the winner was G3XWZ/A, although G3SZA had more points and QSOs — this is doubtless the rule about holding the Trophy for one year only. K1PBW found 555 QSOs, G3XWZ/A 227 QSOs and G3SZA 343. It is of some interest that KV4FZ only managed 303 contacts.

1981 is the 25th anniversary of the founding of the Duke of Edinburgh Award. The commemoration as far as our hobby is concerned will be from *HMS Belfast*, planned for 6/7/8 February. Details from P. Carey, G3UXH, 99 Bells Lane, Hoo St., Rochester, Kent, or Medway (0634) 250562. He particularly wants to hear from anyone who has been active in the scheme, either as a helper or a participant.

In the past we have on occasion mentioned the YL/YL QSOs of G4EZI (she is Hon. Sec. of BYLARA, incidentally, if any YL reader is interested), and by way of a note in the Geoff Watts *DXNS* we see Diana has now worked YL/YL contacts with 193 countries — which must be a top score.

Some people who report to this piece seem to be having rig troubles: G4EZA (Colchester) lost the coupling capacitor between PA anode and pi-tank, after a little fire and smoke. G4HZW (Knutsford) has an FT-75, which has

been back a couple of times to the supplier, each time with the same fault, and each time the fault has recurred within a short time. We're not very surprised, as there is a tendency in "servicing" engineers to assume that if a valve, say, is u/s, that's the fault, instead of asking themselves what wrote it off in the first place! (Indeed, when TV sets were full of valves, at least one maker in a paper on reliability was quite blunt that almost all valve failures were attributable to their being used as means of isolating stages, and his graphs showed the spectacular differences in mortality rate for wire-ended valves.) Still with the wreckers, Bill of G2ADZ (Chessington) has had an attack of Murphy's mice who ate the rotator cable clean through in several places and then added insult to injury by eating the speaker cone! Finally (we hope) the writer's autokeyer; he thought his problem was in the ALC circuit of the cassette recorder and tore it to bits looking for the fault before spotting the AF Gain control had not been turned to the right level since the thing had previously been used to play music.

Top Band

The writer has been listening quite a bit on the band at the CW end for DX. There are several European countries around in the mid-evening, but the lack of inter-G activities is really quite saddening — can't we have a few more amateur radio noises made, lest we lose a good band?

Talking of this band G4BUE (Upper Beeding) sends in his six-band score for QRO and QRP, the latter being a maximum of five watts input; the score shows full power and a longer time produced 30 countries on the band, and QRP, mostly from the small garden of the present QTH, gave 21 countries — the point is made!

Now for G2HKU (Sheppey): for him Phone met PAOPN, while the CW yielded OK1DFF, OZ1LO, EA2OP, DZ1W, 4N3P, EI9J, UC2ABT, SR1ADM, UK1AAA, OZ7YY, SP3FLR, OH3XT, OL6BAB/P, UK5CAP, YU3RTW, F3FN, UT5AB, and UD6DMR. That last one is real DX in any band list.

Eighty

For the writer, it has been a case of a listening watch while working, on the QRP frequencies mainly; on 3560 kHz, one can pick out most of the old lags in

the course of a day. If a cynic should enquire as to why only listening, the answer is the difficulty of not having three hands, not to mention in any spare(?) time having other commitments.

For G2HKU (Sheppey) the Argonaut has been the prime mover in everything, and three watts of CW have made it to OK1DKW, I1XHV, DJ6ZB, and OZ7YL.

'CDXN' deadlines for the next three months—

March issue — February 5th

April issue — March 5th

May issue — April 2nd

Please be sure to note these dates.

The letter from G3CED/G3VFA (Broadstairs) got snarled up in the mail and missed us for last time. George has been trying his new *Joyframe*, and has worked a few, as we will see. Perhaps the most interesting was the one with YO4WJ/MM, going from Broadstairs to Felixstowe; George just sent a couple of Vs to check tuning, the YO came back to those for a five-minute session, then again called CQ, but with no replies to several calls.

Now G4BUE's activities on Eighty. Using the Argonaut at 500 milliwatts input, there was a QSO with G3SYC who was also running QRP. At the five watt level, the Argonaut managed to latch on to G3HIS, G4DVW, G3JU, G3GW1, OK2BMA, PAOGHS, OK1DKW, G3RJV, G4CQK, G3NTD, G2FWP, G4DQP, OR5AG, G4IYE, G3YCC, ON6QZ, G3HQQ, G2HKU, G4IKI, G3KKQ, G4FAI, D3DRP, G3GBD, F9YZ, OR7JC, and G3GMI/A. Just goes to show how QRP activity has grown, world-wide, since 1976 — most of the above were QRP-QRP contacts.

G2NJ (Peterborough), has taken to late evening operating, on account largely of the local QRM from electrical gadgetry around neighbouring houses. An interesting one for an OT was with OH2BWR who came back "Pse QRS, this is my first QSO" — which lasted 35 minutes. To work G6LD in Huddersfield was another surprise, the latter having been QRT since seven years earlier; G2NJ recalls regular QSOs back in the thirties between them. Then there was the G2 + 3 in a mobile home, where

all aeriels are banned, a superb signal as always from an "invisible" aerial. G5LD has an indoor dipole on this band too, and was a good signal at teatime from Newcastle. Another odd one was to work DK9XT shortly after midnight and to receive a prompt SWL report from an old colleague of wartime days — a small world!

Forty

It is well said that "if you can't hear 'em, you can't work 'em". This simple fact puts many people off operating the band.

G4EZA (Colchester) says he *must* get up early and go after something interesting — but his evening look around resulted in a QSO with K2VV on CW.

On to G2HKU where the ear trouble continues to reduce enthusiasm, and so on 7 MHz there was just CW to UA0AG and K4YF.

G4BUE used the Argonaut at five watts to work other QRP stations, like G3PKQ, GM3OXX, G3GBD, G3RJV, HB9ASJ, G4DQP, OK1DKW, G4JRE, GM3MXN, and GD3FXN. He tried an early start (0400) to raise WB3AVN on the inverted-vee — a pity the W was QRO.

At the G3CED/G3VFA establishment, the surge of 50 watt operating soon gave way to the usual two watts, and of course the little comments still abound. For example, about a contest: first, "pea-shelling contest"; second, to a 599 report, "liar!"; and third, "don't these guys know log books cost money?". Further down the log there was a little gem, "never give up — there is *always* a UA3!".

Twenty

Where it all happens — whether by "happens" you mean DX, or noise, or QRM or whatever, the word still applies!

Let's start with a look at G3VFA and his Joyframe and two watts input; OZ8AA, OE6CTG, Y57SH, DL8AN, DL1HAK, DL2CT, GW4DZE — plenty enough to show that he is getting out with the low power, but the big effort concentrated on 21 and 28 MHz as we will see.

G4BUE operated QRO to reach the J20AA expedition to Abu Ail to give overall country number 294; with the Argonaut, he worked other QRP stations, namely GM3OXX,

DL7MAM, OK1DKW, HB9ASJ, OZ5XW, SM6AWA, and GM3MXN.

G3EZA simply says he had several looks at the band, heard the rumpus and hastily cranked the bandswitch!

For G2HKU, Twenty was in the main the ZL skeds; ZL1VN, ZL1SV, ZL3SE, and ZL3FV. As a matter of interest Ted has made 1000 QSOs with G6AB, and well over 900 with ZL1VN; it is of interest to note that the latter has a TA33 and a delta-loop up, and the delta is always a better signal than the beam by quite a bit.

21 MHz

This is the place to be, pronounces G4EZA, and Tim then offers his CW contacts with lots of JAs, K6ORT/7 KV4AA, UJ8JAS, UK8MAA, VE6HH, VK2NAV, VK3NWN, VK7NRT who was running two watts to a two-element quad for an S6 signal, YV1AD, YV2BE, 4Z4NUT; and SSB to JA1SHC, JE2CHJ, OE5GML/YK, SV0AM/SV5 in the Dodecanese, VK3VDW, and 9K2FO.

Steps of power about sums up the G4BUE activity on the band. At 350 milliwatts input, WA1JVV (two watts) and AA9N (five watts) were worked, than a lift to 500 mW brought a QSO with KA9J who was QRO. Next comes the 750 mW, and it managed to work WA7ZBL in Oregon who was running five watts; finally the five watts input level, which brought in QRP stations like WB3BDQ (2w.), WB8RUT (5w.), W7DJU (5w.), W2OWJ (2w.), WA7SGZ (2w.), VE7CGO (5w.), WB2QOT (2w.), and G3BOK (5w.), plus I7CCF, HB9XX, OK2BMA, GM3RFR, SM6AWZ, SM5KQS, OK1DKW, SM0FSM, YO3BIZ, SM2JSN, and SM6JWR all of whom were QRP. Of the QRO stuff, VK4AGW, VK1KB, G13OLJ/W7, ZK2VU for country 211 on QRP, and KP4EMX.

For George at G3CED, two watts and the Joystick yielded I0ESK, UQ2PQ, I6ANZ, SMOCC, an assortment of YU and UAIs in the contest, OH3CW, YU3TVB, EA7BMH, SP8KDF, SM2JAC, OH1KA, OE3RE, and HA1VF — all these being on the Joyframe.

28 MHz

To G4BUE first, and the weekend of the ARRL 10-metre contest: 3½ volts on the PA and 214 mA made 750 milliwatts input, and with the 4-element

beam some 149 QSOs were made with North America among 41 states, including most of the difficult ones. The G-QRP Club Winter Sports produced a QSO with DK5RY/LX on all five bands — his 180 metre long-wire made him easy on the LF bands but it was a real struggle on 21 and 28 MHz. Another interesting QSO was at 750 mW input with WB2RZU who was running his PA at 500 milliwatts; less than a watt either way for a solid contact. Other QRP stations included K9XL, EA8EY, PY2EGM, KB9K, WA2SON, WD0DGU, WB8OWM — a long time since we last heard from Skip — G3VXJ, SP9AAB, UB5QGC, and UA3ACB who was running an output of 100 mW.

On to G2HKU, who also stuck to the Argonaut and three watts, with which the CW got over to W7WA, WOONM (Minn.) VE3BMV, W7CB (Oregon), K6EWL, K6OQA, K0ZZ (South Dakota), WD9DCL, W9OA, and WDOBWH (South Dakota).

G4HZW, as already recounted, has had more than a share of rig problems, but when it was working his 25 watts went to a two-element quad at 24 feet. So Tony offers (we believe SSB, as he doesn't say) VE3HFN, KA3CHD, W2HBC, WB6JE, W6ZNL, W7WKB (Idaho), WB6GEN, WB2OKB, VE5JN, KA0CUQ, W6NSU, WB0CVM (Iowa), W6IH, KOGND (Nebraska), WD8JWF; then in the ARRL ten-metre shindy OH1ZE, UW6DR, HA9RE, UK9UAA, UR2KEB, UA9AED, UK7PAL, plus hordes of Ws including such as K3HPB (Delaware), AA5B (New Mexico), W1CTM (Vermont), N7DD (Arizona), VE7CUM, N7AOS (Delaware), K1IK (Vermont), K6JHV, K7CA/HCI, UA0SEL, PY3CB by long path(!), UA0SAU, GM3RAO by back-scatter, UL7OAA, PJ2FR, HK3TF, HH2MC, VO2CW, W6LH (Arizona, believe it or no!), KA1EHR (Rhode Island), WB0MWJ (S. Dakota). Then after the contest we find FP8HL, WD9DRM, WD6CBX, W9SNZ/M/9, VP8QG, VK8UK, W0DQ, WB0NMD, K7ZCR, WD4KKG/P/VE4, WB7SMU, VE6SP, VE1-7 in the Canada Day contest, VE5DB who had 12 watts to a vertical, XL3ON, VP2AZE, W9MMZ, KB4WX, and JA5OKY, and then — the rig died!

G2ADZ (Chessington), apart from his Murphy's mice problems, had his fair share of chores over the holidays, which restricted activity. Never mind,

Bill stuck to his 28 MHz CW last, and found TU20JB, OA8CP, VK3MR, VK4AIN, VK5MD, VK6NLU and others, FG7AS, CO7FM, 8P6JD, 3B8CF, 5T5NC, 5N0MAS, VP8AI, VU2BK, 9M2KG, HZ1HZ, AP2TN, and CE3WD, plus some W6-7 and VE7.

G4EZA says he heard a JA talking to a G on Ten, saying the JAs weren't going to be allowed 10 and 24 MHz, and as a result some JAs were going to make a fuss with their authorities. Turning to the QSOs, Tim comments that a bigger proportion of QSOs were on Phone on this band, and wonders why — lower noise levels maybe? Anyway CW gobbled up DL8NU/OH0, ZS3A, while the SSB dealt with AA6AA/3B8, JA8CIJ, JY9XK, LU3MCJ, UJ8JCO, VE6EO, VK6MV, VK6NE, VP2AZE, VP2VDH, YB2SV/9, ZZ5OW (a PY in a contest), 4X6CW, 9Y4VU, and lots of Gotaways of course.

G3CED found UK5EDF, UT5YV, LZ2KSU, UC2FI, UA3PDE, U22CFH, W3ARK, OH6NH, W9MYD, UB5INK who came back to a CQ QRP call, UA3AHI, UA3DNU, UB5QHJ, UA9CPJ, UA3DMJ, UK9CCI, UC2AFI, W2BAI, IT9AF, VE3DFM, WA6CIL who disappeared "in all that Californian fog" says the log, WB8NVX, UK5EEZ who was using AM (crikey!), and YU4FST.

No doubt about it, there is a certain fascination about this QRP lark, which grows on you; George, G3CED/G3VFA has donated a cup to the G-QRP Club, aimed at "the ordinary mortals using backyard aerials" for which entries are to be in by February 1 — and we bet there will be quite a few entries for it.

Time-Out

Which is where we say our farewells for another month — the dates are in the 'box', and we can always use more reports. Thanks to those who make time to find pen and paper, to the *DX Bulletin*, and of course to Geoff Watts' *DX News Sheet*. Now your scribe sits back to await for reports known to be in transit but which will arrive too late — notably from G3NOF and G3PKS, two of our closest observers of activity. It's a great pity they missed the bus, but deadlines, like time and tide, wait for no man! Address everything to "CDXN", SHORT WAVE MAGAZINE, 34 High Street, Welwyn, Herts. AL6 9EQ. Cheers!

NEW QTH's

This space is for the publication of the addresses of holders of new callsigns, or change of address, in EI, G, GJ, GU, GD, GI, GM and GW of stations not already listed. All addresses published here will appear in the U.K. section of the American "CALL BOOK" in preparation. Please write clearly and address on a separate slip to QTH Section. Be sure to give correct County designation and post-code. In the case of direct subscribers needing Change of Address, please state for card index adjustment. Address items for this space to: "New QTH Page", *SHORT WAVE MAGAZINE*, 34 HIGH STREET, WELWYN, HERTS., AL6 9EQ.

EI3DV, G. M. Murphy, 49 Lavarna Grove, Terenure, Dublin. 6. (Tel: 01-909639).
EI5DR, E. F. Kelly, Cregganavar, Breaffy, Castlebar, Co. Mayo.
EI6DP, G. P. Fitzgerald, 40 Maigue Way, John Carew Park, Limerick.
EI7DY, M. Conroy (G15DOR), West End, Bundoran, Co. Donegal.
EI8DZ, P. Conboy, 29 Lisbrack, Longford.
EI9DZ, G. E. Birkhead (ex-EI4APB), 103 Roselawn Road, Castleknock, Co. Dublin.
G2GC, G. W. R. Field (ex-G4IJZ), 2 Lovaine Grove, Sandal, Wakefield, W. Yorkshire. (Tel: Wakefield 250103).
G2DHI, Dr. S. Bockner, 41-B Lansdowne Crescent, Kensington, London. W11 2NT. (Tel: 01-727-1767).
G3GZQ, W. J. Roberts (ex-G8WNZ), 34 Barn Park, Buckfastleigh, Devon. TQ11 0AS. (Tel: 036-44-3608).
G3KQS, E. G. Simpson (ex-ZS6BGS), 5 Cottingham Grove, Bletchley, Milton Keynes. MK3 5AA. (re-issue). (Tel: 0908-647076).
G3YAA, G. S. Dunn, 5 Eden Close, Beverley, N. Humberside. HU17 7HE. (re-issue). (Tel: 0482-883465).
GM3ZTA, W. Curnie, 4-E Raplach Crescent, Fairley, Glasgow. (re-issue).
G4HVV, B. A. Kac, 33 Upper Clapton Road, London. E5 8AY.
G4IQN, R. E. Espiau (ex-G8OGC), 40 Empire Court, North End Road, Wembley Park, Wembley, Middlesex. HA9 0AG. (Tel: 902-4732).
G4IYX, R. J. Martin (ex-G8SNS), 4 East Elloe Avenue, Holbeach, Spalding, Lincs. PE12 7NB.
G4JHY, K. Kelso, 66 Paisley Street East, Stoke, Plymouth, Devon.
GW4JQQ, M. G. J. Smith, 26 Rhosmaen Street, Llandelilo, Dyfed. SA19 6LW.
GW4JPC, G. Woods, 87 Frampton Road, Gorseinon, Swansea, W. Glamorgan. SA4 2XZ.
G4JPL, P. Morgan (ex-G8VWY), 13 Dickenson Road, Weston-super-Mare, Avon. BS23 1YW. (Tel: 0934-26903).
G4JPM, J. Nicol (ex-G8TGW), "Sunnydene", School Lane, South Croxton, Leics. LE7 8RT.
G4JQG, J. H. Lockeyear, 70 Stapleton Hall Road, London. N4 4QA.
G4JSG, D. I. Harrison, 95 Lindsay Drive, Kenton, Harrow, Middlesex. HA3 0TH.
G4JSW, H. Butler, 6 Allen Road, Great Bookham, Surrey. KT23 4SL.
G4JVB, R. Macmillan (ex-G8PAO), 11 Napier Terrace, Mutley, Plymouth, Devon. PL4 6ER.

G4JVG, S. E. Lowe (ex-EP2SL/G8FEO), 15 Malvern Court, Addington Road, Reading, Berks. RG1 5PL. (Tel: 0734-67873).
G4JZM, C. Makin, 61 Gleneagles Drive, Ainsdale, Southport, Merseyside. PR8 3TJ. (Tel: 0704-79079).
G4JZO, M. J. D. Watts, 22 Queens Road, Wellington, Somerset. TA21 9AW. (Tel: 082-347-2104).
G4KAC, B. A. Kac, o/b/o Clapton Builders Merchants Ltd., 33 Upper Clapton Road, London. E5 8AY.
GW4KAW, A. B. Radford, "The Bungalow", Albert Street, Pentre, Rhondda, CF41 7JX.
G4KDF, North Lincs. Repeater Group Club Station, (c/o G4IPE, R. D. Wilson QTHR), The Shack, Kenwick Bar, Poverty Lane, Louth, Lincs.
G4KEE, V. A. Tomkins (ex-G8VKK), 56 Springfield Road, Exeter. EX4 6JL. (Tel: Exeter 51843).
G4KFD, B. Wilson, 24 Feniscliffe Drive, Cherry Tree, Blackburn, Lancs. BB2 2UF. (Tel: 0254-28585).
G4KHF, D. Wilkinson, "Leon", Luton Gowts. Long Sutton, Spalding, Lincs. PE12 9LQ. (Tel: 0406-362588).
GW4KHH, J. R. S. Craige, "Bryn Haul", Hill Street, Newbridge, Wrexham, Clwyd.
G4KKZ, K. Robinson, 13 Race Hill, Launceston, Cornwall. PL15 9BB. (Tel: 0566-3012).
GW4KOE, R. J. Lines, 12 Hydrangea Close, Cyncoed, Cardiff. S. Glamorgan. CF2 7HT.
G8WMG, J. A. Bassnett, 105 Edgemoor Drive, Thornton, Liverpool. L23 9UF.
G8WOE, Miss S. Gabriel, 71 Albert Road, Ilford, Essex. IG1 1HS. (Tel: 01-478-5031).
G8WQK, G. E. Smith, 11 Hare Lane, Hatfield, Herts.
G8WRD, T. M. Hackwill, 59 Rivermead Road, Woodley, Reading. RG5 4DH.
G8WRY, G. G. Brock, 6 Lord Haddon Road, Ilkeston, Derbyshire. DE7 8AW.
G8WUJ, C. M. Bracher, 2 Square Close, Moot Gardens, Downton, Salisbury, Wilts. SP5 3LQ.
G8WXZ, B. J. Harding, 19 Oakwell Drive, Bury, Lancs. BL9 8LB.
G8WZK, D. J. Collins, 71 Trench Road, Tonbridge, Kent. TN10 3HG.
G8WZN, W. G. Dimery, 81 Sandbeck House, Grove Place, Doncaster. DN1 3AT.

GM8XDV, Lt. S. G. Huyton, 266 Colinton Road, Edinburgh. EH14 1DS. (Tel: 031-441-2117).
G8XDZ, P. A. Long, Flat No. 30, Deanswood, 32 Maidstone Road, London. N11 2TL. (Tel: 01-888-8810).
GM8YFY, R. Maslen, "Broomie Knowe", Dulaish Bridge, Grantown-on-Spey.
G8YGP, S. R. Tyler, 2 John Court, Hoddesdon, Herts. EN11 9LZ. (Tel: Hoddesdon 42106).
G8YWF, E. Appleby, 60 Willow Garth, Newby, Scarborough, N. Yorkshire. YO12 5HY.

Change of Address

G2LD, H. F. M. Baker, "Priorswood", 64 Front Road, Woodchurch, Ashford, Kent.
G3AVD, R. Harden, 14 Ferriers Way, Epsom Downs, Surrey.
G3AXS, R. A. Collins, High Elms, Julian Bower, Louth, Lincs. LN11 9QW.
GW3CBA, J. Kellaway, 50 Winston Road, Barry, S. Glamorgan.
G3FYF, H. G. Gosling, 209 Belconnen Road, Heathwood Estate, Nottingham. NG5 5JB.
G3KDP, A. G. Bounds, 52 Porthia Road, St. Ives, Cornwall. TR26 2JB.
G3PRC, Plymouth Radio Club, c/o 46 Beatrice Avenue, Saltash, Cornwall.
G3SQH, D. Reffold, 12 Woodlands Rise, North Ferriby, Hull, N. Humberside.
G3UZB, J. R. Shewan, 42 Stirling Road, Redcar, Cleveland.
G3WHQ, J. M. Kelly, "Sunnyfield", Glopel Lane, Friskney, Boston, Lincs.
G3YRW, J. A. van Walwyk, 30 Elstree Park, Elstree, Boreham Wood, Herts. WD6 2RW.
G3ZDW, R. Hyde, 72 Oakapple Close, St. Michael's Estate, Colchester, Essex. CO2 9QJ.
G4AI, G. H. Blake, "Cedar End", Carleen, Breeze, Helston, Cornwall.
G4BEZ, J. Phillipson, 9 Hatherley Lane, Cheltenham, Glos. GL51 6PN.
G4DIE, I. A. R. Dredge, 8 Winkins Lane, Great Somerford, Chippenham, Wilts.
GM4GIF, B. Lyons, 63 James Street, Helensburgh, Dunbartonshire. G84 8XG.
G4HKE, L. R. Woodings, 119 Hoo Marina, Hoo, Rochester, Kent. ME3 9LE.
GM4JAP, D. H. Stewart, Drumbuie, Newmains, Kirkbean, Dumfries.
G5ZN, P. Nicoll, 8 Egrons Lane, Withernsea, N. Humberside. HU19 2LZ. (Tel: 09642-3244).
G8AED, D. J. Emmett, Listensheils Hostel, Bierley Lane, Bierley, Bradford, 4. W. Yorkshire. (Tel: Bradford 682331/681352).
G8OFY, S. J. Bishop, 68 Lingforest Road, Mansfield, Notts. NG18 3NJ. (Tel: 0623-36006).
G8PRC, Plymouth Radio Club, c/o 46 Beatrice Avenue, Saltash, Cornwall.
G8RY, F. E. Wyer, 12 Coven Farm Park, Brewood Road, Coven, S. Staffs. WV9 5DB. (Tel: 0902-790364).

AMATEUR RADIO EXCHANGE



Brenda (G8SXY) and Bernie (G4AOG) invite you to visit the only shop in London where you can see and try ALL the leading makes of Amateur Radio equipment under one roof . . . YAESU, ICOM, TRIO/KENWOOD . . . compare them all, and choose the rig that's right for you. The only make you can't choose is the coffee . . . that's "instant Brenda"!!



FRG-7

Still the finest value-for-money communications receiver on the market at only **£185** inc. VAT and free Heliscan aerial worth £15.



R-1000

Trio/Kenwood's successful new receiver with the PLL system that has proved so popular **£285** inc. VAT and free Heliscan aerial worth £15.

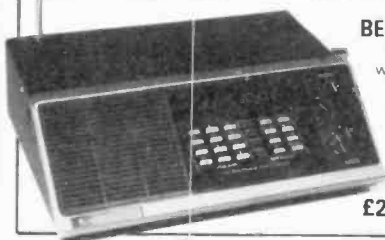

BEARCAT 220FB

The super scanner which brings you all the excitement of the VHF and UHF frequencies . . . aircraft, marine, amateur, plus so much more.

£258.75 inc. VAT

FRG-7700

Yaesu's latest receiver with FM right across the band and optional memory facility plus excellent filtering.

£299 inc. VAT and free Heliscan aerial worth £15 (Memory extra)



MR-1000A

The finest-value pocket VHF scanning receiver ever offered. 10 channels, with scan or manual tune across selected crystal-controlled channels. Complete with Nicads and charger.

£39 inc. VAT (2m amateur band crystals £2 per channel)

MR-110

VHF scanning receiver. 10 channel capability, with lock-out facility. Superb sensitivity. 12v operation so ideal for mobile work.

£39 inc. VAT (2m amateur band crystals £2 per channel)



ARE YOU A G8 ABOUT TO TAKE YOUR 'A' LICENCE? OR ARE YOU TAKING YOUR G4 STRAIGHT AWAY?

Either way, why not start listening right now on a Yaesu FT-101 transceiver? It really knocks spots off the average general coverage receiver, with better selectivity, better sensitivity, better stability . . . And remember, cooling fans and microphones come FREE with 101s from A R E !! So, buy your rig now, and claim your mic and fan when you get your G4.

FT-101Z **£488** inc. VAT FT-101ZD **£569** inc. VAT



Closed Wednesday, but use our 24-hour Ansafone service.
INSTANT HP FOR LICENSED AMATEURS AND 6 MONTH NO INTEREST HP TERMS AVAILABLE.

LICENSED CREDIT BROKERS ★ Ask for written quotation.
Credit card sales by telephone.



2 NORTHFIELD ROAD, EALING, LONDON W13 9SY. Tel. 01-579 5311

So easy for Overseas visitors. Northfields is just seven stops from Heathrow on the Piccadilly Line.

Thanet Electronics for ICOM the amateur's professional friends

This month we are showing you:

IC-451 UHF Base Station
IC-720A – ICOM's new 9 band HF Transceiver.
Theta 7000E – An outstanding communications computer.
IC202S – A pair of magnificent sideband portables.
IC402 – A pair of magnificent sideband portables.

On these, and all our other products:

- we offer a full year's warranty on all parts and labour
- Free delivery for all transceivers, using registered first class post

IC-451 UHF Base Station



£579 inc. V.A.T.

Also available from our shop in Herne Bay are:

- | | | |
|---------------------|-----------|-------------------------|
| * MICROWAVE MODULES | * WESTERN | * ANTENNA SPECIALISTS |
| * J-BEAM | * G-WHIP | * YAESU MUSEN |
| * RSGB PUBLICATIONS | * BEARCAT | * VIDEO GENIE COMPUTERS |

IMPORTANT

We would like you to phone, or write to us so that we can give you as much detailed information as possible on any particular product. Use our 24 hour ansafone when calls are cheap.

IC2E – Probably the smallest made, extra sensitive handy talkie.

IC251E – Must be the best value in 2M base stations.

IC255E – A great value 25W mobile transceiver.

IC260E – The ideal choice for multimode mobile.

- All prices including V.A.T.
- H.P. and Part Exchange welcome.

ICOM are proud to announce the introduction of the 70cm version of their famous 2m base station – the IC-251. Of course, it is engineered to the usual high ICOM standards and includes such features as:-

- 3 memory channels
- Automatic repeater shift on switch-on
- Additional selectable shift for European DX
- Selectable channel steps for FM (supplied with 25KHz – others are diode programmable)
- Full power control on SSB/CW/FM
- Superb receiver performance using MOSFETS
- Multipurpose scanning
- Covers 430-440 MHz
- Xtal controlled Toneburst
- Cool running chopper power supply

SEND FOR TECHNICAL DETAILS

Thanet for



ICOM

143 RECVLVER RD.,
BELTINGE,
HERNE BAY, KENT.
Tel: 02273/63859



All over the World they haven't been able to get enough! (But things are getting better)



ICOM's new 9-band HF Transceiver – the IC-720A beats the lot!

IC-720A
£795 incl

Some features.

- 9 Bands Top to Ten including new ones!
 - General Coverage Receiver – 100KHz to 30MHz.
 - Tuning down to 10Hz steps – YES! 10Hz – yet stable as a rock!
 - Built-in Speech Compressor which really gets excellent reports.
 - The famous ICOM Band Pass Tuning.
 - Memory – it even does all the band changing for you.
 - Self cancelling RIT.
 - 3 rates of Tuning.
 - Two Independent VFOs (in band duplex possible).
 - 100 W Output.
 - Modes AM, SSB, CW and RTTY.
- A lot in a small packet for £795 inc. VAT (13.6V operation – matching mains PSU £100)
- Solid State 500W linear available shortly.

**FOR ONLY
£640.00
INCL.**

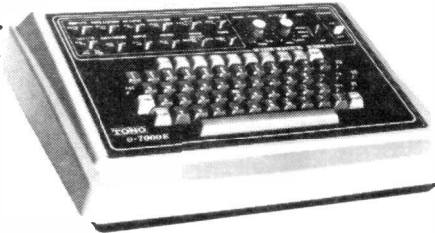

Tono Theta 7000E A great computer on offer from Thanet

The new THETA 7000E means that every Amateur can enjoy the visual display of CW, RTTY and ASCII in both transmit and receive modes. Just connect the TONO to any TV set via the antenna terminals or to a page printer from the parallel port provided. Bring up your CW speed in receiving or sending by either watching receiver sent or from recorded cassettes. Connection to the transceiver is via the key, phone and mic sockets.

Some of the Outstanding Features
COMMUNICATIONS COMPUTER THETA 0-7000E

UHF and Composite Video Output * Printer interface * Wide range of transmitting and receiving speeds – 10CW speeds + 8RTTY * Built-in demodulator for high performance for 170, 425 and 820 Hz shift * Crystal controlled modulator for ASFK – Hi or Lo tone * Convenient ASCII key arrangement * Large capacity display memory

– 2 pages 32chr x 16 lines split screen for Rx & Tx if required * Automatic transmit/receive switch * Anti-noise circuit * Battery backed-up memory 7 channels of 64chrs * Send function * Buffer memory – 53 character type ahead, rub out function * Simultaneous access of the memory – 53 character type ah
LF (line feed) cancel function * Cursor control function * Word mode operation * Automatic CR/LF (72, 60 or 80 chrs per line) * Echo function

* Word Wrap around function * Transmit/receive in ASCII mode or RTTY * CW identification function * Mark and break (space and break) system * Monitor circuit & CW practice function * Variable CW weights * Cross pattern checking output terminal * Log computer output provided * Test message function (Ry and Q8F).

Phone or write for the price list of accessories for this unit.

IC-202S
£169 INCL.

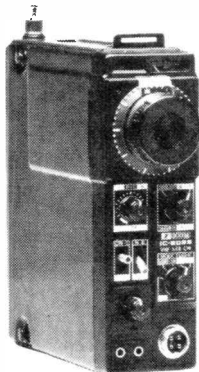

The IC-202S is a very well designed 2m SSB portable. It offers: 3W pep output on USB, LSB and CW. * Large Battery capacity (HP11 type) or Nicads if you wish * A special VXO circuit to provide smooth tuning and crystal stability needed for SSB operation on 2m * Each of the four 200kHz band positions allows operation anywhere in 2m. (Supplied with 144.144.2 and 144.2-144.4) * Top of the band Oscar xtals available for "cross-pond working" * It has a DC socket and SO239 sockets for mobile or base station working, barefoot or as a prime mover * Mobile mounting brackets, Nicad packs, chargers, cases all available options. You must agree, a very versatile well proved rig.

Their versatility is well worth an enquiry.

IC-402
£242 INCL.



The 70cm twin of the 202S having very similar features, covering the frequency range of 432-435.2 MHz.

SEND FOR TECHNICAL DETAILS

Thanet for



ICOM

TELEX: 965179



ICOM in small packages

IC-2E HandyTalky £159^{INCL.}

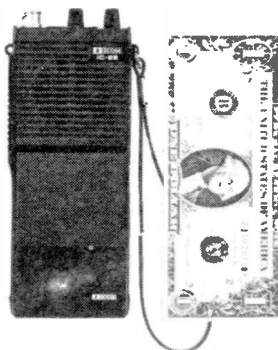

CHECK THE FEATURES

FULLY SYNTHESIZED – covering 144-145.995 in 400 5kHz steps.
 POWER OUTPUT – 1.5W with the 9V rechargeable battery pack as supplied – but lower or higher output available with the optional 6V or 12V packs.
 BNC ANTENNA OUTPUT SOCKET – 50 ohms for connecting to another antenna or use the Rubber Duck supplied.

SEND/BATTERY INDICATOR – Lights during transmit, but when battery power falls below 6V it doesn't light indicating the need for a recharge.
 FREQUENCY SELECTION – by thumbwheel switches, indicating the frequency.

+5kHz SWITCH – adds 5kHz to the indicated frequency.

DUPLX SIMPLEX SWITCH – gives simplex or plus 600kHz or minus 600 kHz Transmit.

HI-LOW SWITCH – reduces power output from 1.5W to 150mW reducing battery drain.

EXTERNAL MICROPHONE JACK – If you do not wish to use the built-in electret condenser mic an optional microphone/speaker with PTT control can be used. Useful for pocket operation.

EXTERNAL SPEAKER JACK – for speaker or earphone.
 This little beauty is supplied ready to go complete with nicad battery pack, charger, rubber duck.

IC2E OPTIONS

BATTERY PACKS		CHARGERS ETC	
ICBP3	9 VOLT PACK (AS FITTED) REPLACEMENT	£15.50	IC-DC1 9 VOLT REGULATOR PACK £7.50
ICBP2	(7.2 VOLT) (1 WATT)	£22.00	IC-CP1 CAR CHARGER LEAD WITH CIGAR PLUG £2.75
ICBP4	EMPTY CASE (WILL TAKE SIX 'AA' SIZE NI-CADS)	£5.00	IC-BC25 CHARGER FOR BP3 AS SUPPLIED £3.70
ICBP5	11 VOLT PACK (2-3 WATTS)	£30.50	IC-BC30 DESK CHARGER FOR ALL NI-CAD PACKS FAST FOR IC-BP5 + BP2 (1½ hours) £34.00

It will seduce you in it's own way
 the ICOM IC 251E

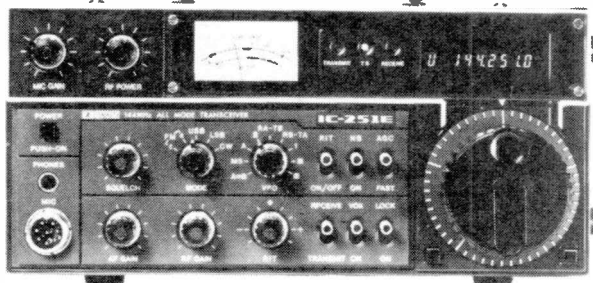

only
 £479^{INCL.}

SEND FOR TECHNICAL DETAILS

Thanet for



ICOM



for only
£255
INCL.

IC-255E

An experts mobile choice

NOW WITH
IMPROVED
FRONT-END

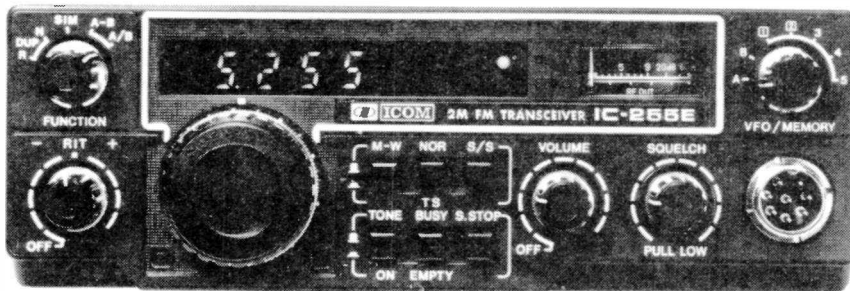

**25 Watts – 5 Memories – Scanning – 600kHz
AND User Selectable Repeater Shift – Full Coverage in 5kHz or 25kHz Steps.**

- Crystal controlled Tone Burst
- Full band coverage – extendable to 148MHz if required
- Four digit LED display
- 25 Watts output or 1W low power
- A superb receiver using grounded gate FET front end
- Scanning over a user programmable range
- Memory scan
- Stop on empty or busy channels
- Tuning in 25kHz or 5kHz steps
- 5 Memories – retained while the power is connected to the rig
- Built-in 600kHz Repeater Shift
- Alternative programmable shift
- Reverse Repeater facilities
- RIT (± 3kHz for those off channel stations)
- Scan control from the microphone (optional mic available)
- Good loud audio
- Optically coupled tuning between control knob and CPU
- Multiway 24 pin socket on back for touchpad, computer, or external control
- Rugged modular PA (Guaranteed of course!)
- Mobile mount which can be padlocked
- Up-down scanning microphone available

CAN YOU RESIST SUCH A TEMPTATION

Enjoy VHF mobile at it's best-IC-260E

The IC-260E offers such extras as full frequency read out, upper and lower sideband, and scanning as well as FM and CW. Thus, it makes an ideal base station, when used with a DC power supply, as well as a mobile. Now supplied with up-down scanning mic.



£339 INCL.

SEND FOR TECHNICAL DETAILS

AGENTS (PHONE FIRST – All evenings and weekends only, except Burnley)

Scotland	Jack GM8GEC (031-665-2420)	Midlands	Tony G8AVH (021-329 2305)
Wales	Tony GW3FKO (0874 2772)	North West	Gordon G3LEQ (Knutsford (0565) 4040)
Burnley	(0282 38481)		



Bredhurst electronics

HIGH ST., HANDCROSS, W. SUSSEX

0444 400786

**BREDHURST STOCK TRANSCEIVERS, RECEIVERS AND MANY, MANY ACCESSORIES —
START THE NEW YEAR BY TRYING THE EFFICIENT BREDHURST SERVICE —**

GLOBAL SHORT WAVE RECEIVING AERIALS

Global short wave antennas are designed for the serious short wave listener who requires general coverage capability throughout the short wave spectrum. Two models are available, either the broad band dipole or the inverted "L" model. Full details of these antennas are available on receipt of a stamped addressed envelope. The inverted "L" is £9.95 and the dipole is £29. Both come with full instructions, hardware, etc. and the dipole model includes 50ft of 50 ohm coax feeder.

VHF ANTENNAE — BASE STATION

The Ringo Ranger is an omni-directional vertical providing a 6dB gain over a ¼ wavelength whip. Ideal for extending the range of F.M. communications. Frequency coverage 137-160 MHz. Only £25 inc. VAT & carriage.

FM MONITOR RECEIVER AR22

AT A NEW LOW PRICE

- ★ Full band coverage, 141.000-149.995MHz
- ★ Direct frequency reading in 5 KHz steps by digital thumbwheel and slide switch
- ★ Automatic electronic RF tuning system for wide band coverage
- ★ Compact and lightweight
- ★ Rugged, reliable double sided glass epoxy printed circuit board
- ★ High performance mini rubber flexible antenna £3 extra
- ★ Includes nicads and charger

£83

OF
inc. VAT,
carriage
N.B. available
soon
150-160MHz
version.



BEARCAT 220 FB

£258 inc. VAT, carriage

Coverage 66-88 MHz
118-136 MHz
144-148 MHz
148-174 MHz
420-512 MHz

A receiver which covers all these bands and offers scanning, lockout of unwanted signals, search,

programmable memories, priority, etc.

THE FABULOUS BEARCAT

LISTEN TO VHF ON YOUR HF RECEIVER, using Micro-wave Modules Converters

For 2m MMC 144.28 £24.90

For 70cm MMC 432.28 £29.90 inc. VAT and carriage.

For improved reception on HF use KX2 Listeners A.T.U. £29.95 (carriage £1)

TRIO R 1000



£285

inc. VAT & carriage

TRANSCEIVERS

H.F.

Trio TS 130V	£404.00
Trio TS 130S	£491.00
Trio TS 520 SE	£437.00
Yaesu FT 707	£499.00
Yaesu FT 101Z with new bands	£488.00
Yaesu FT 101ZD with new bands	£569.00
Trio TS R30 S	£639.00
Trio TS 180S	£679.00
Yaesu FT 107M	£859.00

2 M MOBILES

Icom IC 240	£159.00
FDK Multi 700EX	£199.00
Standard C8800	£250.00
Icom IC 255E	£255.00
Trio TR 7800	£295.00

2 M HANDHELD

FDK Palm II	£99.00
Icom IC 2E	£159.00
Trio TR 2300	£166.00
AOR AR 245	£178.00
Trio TR 2400	£198.00
Yaesu FT 270R	£199.00

2 M MULTIMODES

FDK Multi 750	£295.00
Icom IC 260E	£339.00
Trio TR 9000	£345.00
Yaesu FT 480R	£359.00
Icom IC 251	£479.00

RECEIVERS

H.F.

Lowe SRX 30	£158.00
Yaesu FRG 7	£189.00
Trio R 1000	£285.00
Yaesu FRG 7700	£309.00

2 METRE F.M.

Search 9	£45.00
AR22	£83.00
FDK TM56B	£79.00
Bearcat 220	£258.00

MARINE V.H.F.

Search 9	£45.00
TM56B	£79.00
Bearcat 220	£258.00

2M HANDY TALKIE

ICOM IC2E

- Fully synthesised
- Power output 1.5W
- BNC Antenna Socket
- Weight 450gms
- Hi Low power switch
- Ext. Mic. jack

£159 inc. VAT & carriage



ACCESSORIES

Headphones Yaesu YH55	£10.35	(£0.50)
Headphones Trio HS4	£10.35	(£0.50)
Headphones Trio HS5	£21.85	(£0.50)
Clocks Yaesu QTH 24D	£24.50	(£0.60)
Clocks Trio HC 10	£56.00	(£0.60)
Power Supplies 13.8v 3A	£19.95	(£1.00)
Power Supplies 13.8v 4A	£22.95	(£1.00)
Power Supplies 13.8v 5-6A	£29.95	(£1.50)
Power Supplies 13.8v 5-7A	£46.00	(£1.50)
SWR-Power Meter YW3 (2M)	£11.50	(£0.50)
SWR-Power Meter JD 110 (2M)	£13.00	(£0.50)
SWR-Power Meter Daiwa SW 110A (2M)	£35.00	(£0.75)
SWR-Power Meter Daiwa CN 620A (2M)	£52.00	(—)
SWR-Power Meter Daiwa CN 630A (70CM)	£71.00	(—)
Problems with T.V.I.) Yaesu Low Pass Filter (1KW) High Pass Filter (T.V. Lead) Ferrite Rings FX-1 Wave Meter (250 MHz) Trio DM 801 Dip Meter Helical Antennas 2M BNC/PL259 7 MHz Traps (Pair)	£19.95 (£0.75) £3.50 (£0.25) £0.45 (—) £28.00 (£0.75) £51.00 (£0.75) £4.50 (£0.25) £6.95 (—)	

PLEASE PHONE YOUR ENQUIRY FOR ANY OTHER ITEMS

ACCESS ● BARCLAYCARD ● PART EXCHANGE

MID SUSSEX HOUSE ● HIGH ST. ● HANDCROSS ● WEST SUSSEX RH17 6BW

Mail Order

Tel.: 0444 400786 9 am - 5.30 pm

Retail Callers

TO ORDER ANY OF THE ABOVE ITEMS SIMPLY WRITE ENCLOSING A CHEQUE OR PHONE YOUR CREDIT CARD NUMBER



DATONG ELECTRONICS LIMITED

Not just a pretty fascia!

Multi-mode Audio Filter Model FL 2

Adds variable selectivity to existing communications receivers without internal modifications. Gives extremely sharp pass-band edges for truly exceptional filtering performance on all modes but especially for SSB. Its 10 poles of full variable low and high pass filtering give sharper filter edges even than normal crystal filters. A separate manually tuned notch filter is also fitted. In "cw" mode all 12 poles of filtering are combined to give exceptional skirt selectivity. Connects in series with loudspeaker.

General Coverage Converter Model PC1

Model PC1 converts any good two metre SSB receiver or transceiver into a superb general coverage communications receiver. Coverage is 0 to 30 MHz in thirty synthesised bands of 1 MHz and no receiver modifications are required.

Advanced parametric mixer and LSI frequency synthesiser ensure that the overall performance is limited only by that of the main receiver.

Also usable with 28-29 MHz receivers via a conventional 2-metre converter.

Automatic r.f. Speech Processor Model ASP

Makes your transmitted speech louder and clearer for a given transmitter power. The 'Rolls-Royce' of r.f. speech processors Model ASP adjusts itself to suit your voice level and your microphone. Simply select the degree of r.f. clipping in steps of 6 db from 0 to 30 db. Connects in series with the microphone.



The Answer to the Morse Test Model D70

The Datong Morse Tutor (Model D70) is your passport to a full licence. Compact, with internal battery and speaker plus personal earphone it provides unlimited random Morse for practice.

With Model D70 you can practice Morse anywhere, anytime, and at your own pace. With the Morse Tutor practice becomes a pleasure because you get results quickly.

Active Receiving Antennas Models AD270, AD370

Ultra-compact receiving antenna systems giving wideband coverage from 200kHz to over 30 MHz at high sensitivity.

Models AD270 and AD370 give similar receive performance to large conventional antenna systems yet are only 3 metres in overall length. The balanced dipole configuration also gives good rejection of local interference. Model AD270 (an upgraded version of Model AD170) is for indoor mounting.

Model AD370 is waterproofed for outdoor use. Model AD370 & AD270 head units only are also available separately for upgrading earlier AD170 systems.



Very Low Frequency Converter Model VLF



If your communications receiver gives poor results below 500 kHz Model VLF is the answer. It also adds MW and LW coverage to amateur bands-only receivers for news, time checks etc.

It connects between antenna and receiver input, and converts signals from 0 to 500 kHz to the range 28 to 28.5 MHz with low noise and high sensitivity. Useable to 1 MHz with reduced sensitivity.

NEW PRODUCT

Available shortly - a dual purpose 2 metre converter with 3SK68 input stage and high level Schottky mixer.

Designed for full compatibility with Model PC1, the new unit makes an excellent stand-alone 2 metre converter for 28-30 MHz receivers, or when used with Model PC1 (see above). It adds full 0-30 MHz general coverage reception to a 28-29 MHz receiver

Products not shown in this advertisement

- Model FL1, Self-tuning notch/peak audio filter.
- Model D75, R.F. Speech Processor
- Model RFC/M, R.F. Speech Processor P.C.B. Module
- Model MPU, Mains Power Unit.
- Accessory Leads.

PRICES: All prices include delivery in U.K. Basic prices in £ are shown with VAT-inclusive prices in brackets.

FL1	59.00	(67.85)	AD270	33.00	(37.95)
FL2	78.00	(89.70)	AD370	45.00	(51.75)
PC1	105.00	(120.75)	AD270 + MPU		
ASP	69.00	(79.35)		37.00	(42.55)
VLF	22.00	(25.30)	AD370 + MPU		
D70	43.00	(49.45)		49.00	(56.35)
D75	49.00	(56.35)	MPU	6.00	(6.90)
RFC/M	23.00	(26.45)			

DATONG ELECTRONICS LIMITED

Spence Mills, Mill Lane, Bramley, Leeds LS13 3HE, England. Telephone: (0532) 552461

S.E.M.

P.O. BOX 6, CASTLETOWN, ISLE OF MAN

Tel: MAROWN (0624) 851277

BUY WITH CONFIDENCE FROM YOUR LEADING MANUFACTURER

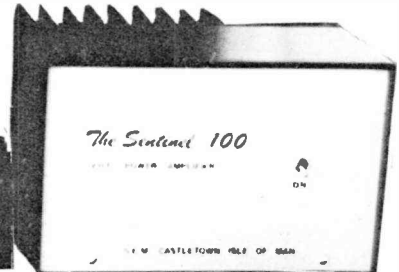

THE NEW SENTINEL AUTO 2 METRE PRE-AMPLIFIER
In the five years since we first thought of the principle of r.f. switched automatic pre-amplifiers, we have learned a lot about them. The benefit of all this experience has been put into the Sentinel Auto Mk II. These include NEW PROTECTION circuit to give MAXIMUM LEGAL through power rating. Completely new (and unique) third generation DUAL GATE MOSFET pre-amplifier giving 1db N.F. and 20db gain with GAIN CONTROL and OFF switch (straight through when OFF). The r.f. switch has a delay for use on ANY MODE.

High Q tuned circuits for high selectivity.

12V 25mA Size 1½" x 2¼" x 4"

£25.00* 2metres and 4metres. 70cm version £28.80*
All ex stock.

PA5. Same as above plus 240V A.C. supply. £30.00*
ex Stock.

SENTINEL STANDARD 2 METRE PRE-AMPLIFIER

Same performance as above less r.f. switch. £15.00* 2 and 4 metres. £17.50* 70cm version. All ex stock.

PA3. Same new circuit as above in about 1 cubic inch to fit inside your transceiver. £7.50. 70cm version £10.70
Ex stock.

NEW! SENTINEL L.F. CONVERTER. 10Khz-2MHz IN. 28-30MHz OUT. 9-12V. 5mA. £28.80 Ex stock.

SENTINEL DUAL GATE MOSFET 2 or 4 METRE CONVERTERS. IFs: 2-4, 4-6 or 28-30MHz. 2db N.F. 30db gain. £24.73 Ex stock. 4M. IF. 28-28.7 MHz.

SENTINEL X 2 or 4 METRE CONVERTER. Same as above plus mains power supply. £28.80 Ex stock.

SENTINEL TOP BAND CONVERTER. 1.8 - 2.3MHz IN. 14-14.5MHz OUT. 9-12V. 5mA. £20.80 Ex stock.

SENTINEL 70 70cm CONVERTER 432-434MHz IN. 28-30MHz OUT. 12V. 20mA. £28.80 Ex stock.

SENTINEL 2 METRE POWER PRE-AMPLIFIERS

From the inventors of combined Power/Pre-amps. ULTRA LINEAR — ALL MODES. Switch STRAIGHT THROUGH when OFF. R.F. switch operates at .1W. Fully SWR protected transistors. Provide same power gain at lower drive powers. Supply 13.8V (12-16V). Receive pre-amp. 1db N.F. 18db gain. SO239s. Three models to suit your transceiver. These units have all been re-designed to make use of the latest techniques for highest reliability and performance.

SENTINEL 35. 3W IN 35W. Maximum drive 5W. 3.5 amps. 6" x 2¼" front panels, 4½" deep. £50.00 Ex stock.

SENTINEL 50. 5 times power gain. 10W IN 50W OUT. Maximum drive 16W 6amps. Same size as the Sentinel 30. Ex stock.

SENTINEL 100. 10 times power gain. 10W IN 100W OUT. Max. drive 16W. Size: 6½" x 4" front panel, 3½" deep. 12 amps. Price: £126.50 Ex stock. All available less pre-amp for £8.00 less.

MAINS POWER SUPPLIES FOR SENTINEL POWER/ PRE-AMPLIFIERS.

6amps for the 30 and 50. £34.50. 12amps for the 100 £47.00. Both Ex stock.

SENTINEL H.F. WIDEBAND PRE-AMPLIFIERS

2-40MHz. 15db gain. Ideal for 15 and 10 metres and OSCAR or an ACTIVE AERIAL. 9-12V Size: 2¼" x 1½" x 3". Two versions.

1. SENTINEL STANDARD H.F. PRE-AMPLIFIERS

Performance as above £10.00* Ex stock.

2. SENTINEL AUTO H.F. PRE-AMPLIFIERS

Same performance as above with a change over relay, r.f. operated by your transceiver for direct connection in your aerial co-ax. £16.93* Ex stock.

S.E.M. IAMBIC KEYS

Undoubtedly the best keyer circuit. It uses the CURTIS custom designed CMOSLSI chip. Sidetone, tunes, etc. As users say "I've never been able to use one before". £34.50 Ex stock.

The Worlds first CMOS Twin Paddle Morse Key Gold plated touch contact paddles with CMOS technology and no mechanical adjustments for only £15.00. Ex stock. No supply is required when used with the S.E.M. Keyer.

S.E.M. TRAN Z MATCH has had a few changes too. NOW covers 160-10M. The most VERSATILE transmatching system. Will match from 15 to 5000 Ohms BALANCED or UNBALANCED at up to 1KW. Link coupled balun means no connection to the equipment, which can cure TVI both ways. 160-10M TRAN Z MATCH £57.00. 80-10M £50.00. EZITUNE built in for £19.50 extra. SO239 and 4mm connectors for co-ax or wire feed.

S.E.M. EZITUNE — JOIN THE RUSH

Makes SWR Bridges obsolete. Noise generator and 50 Ohms SWR Bridge and R.F. Switch combine to allow you to tune up your transmatch etc. without transmitting. Saves your P.A. Stops Q.R.M. £28.75* Ex stock.

S.E.M. FORWARD/ REFLECTED POWER METER — £28.80 Ex stock.

12 MONTHS COMPLETE GUARANTEE.

Prices include VAT and delivery. C.W.O. or credit cards. Phone card number for same day service. Items marked * have Belling Lee sockets. Add £1.73 for SO239s or BNC. It's impossible to put everything in here but RING or WRITE for more information.

MAIL ORDER

FROM



by two way
FREEPOST

MORSE KEYS		
HK 707	Straight Up/Down keyer	£11.44
BK 100	Semi-automatic mechanical bug	£17.88
MK 702	Up/Down keyer on marble base	£22.43
MK 702	Manipulator	£22.43
MK 704	Squeeze paddle	£14.38
MK 705	Squeeze paddle on marble base	£22.43
EKM 1A	Morse code practice oscillator	£8.63
MK 1024	Automatic memory keyer	£135.13
EK 150	Semi/Automatic keyer	£74.75

LINEAR AMPLIFIERS		
2M10-80P	144MHz 10W input/80W output with 9dB preamp	£138.00
2M25-150P	144MHz 25W input/150W output with 9dB preamp	£184.00
2M10-150P	144MHz 10W input/150W output with 9dB preamp	£209.88
2M3-150P	144MHz 3W input/150W output with 9dB preamp	£209.88

G. WHIP Mobile Antennas		
Tribander 10-20 Slide		£24.73
L. F. Coil 40/80/160 MTS		£6.56
L. F. Whip Telescopic		£3.34
Multimobile 10-20 Auto		£28.75
M/Mobile Coil 40/80/160		£6.56
M/Mobile Whip Telescopic		£3.34
Flexiwhip 10M Mast		£17.25
F/Whip Coils 40/80/160		£6.56
Base Standard		£4.49
Base Heavy Duty		£5.75
Extenarod		£11.50

SHURE MICS		
201	Hand ceramic omnidirectional high impedance	£14.49
202	Hand ceramic noise reducing high impedance	£15.18
401A	Hand controlled magnetic high impedance	£16.56
401B	Hand controlled mag. low impedance (200 ohms)	£16.56
444	Desk adjustable height controlled magnetic	£32.43
526T	Desk controlled response transistor preamp	£39.33

DUMMY LOADS		
DL20	30W DC-150MHz with PL259 connector	£6.33
T-80	80W DC-500 MHz with SO239 connector	£22.94
T-150	150W DC-500MHz with SO239 connector	£32.78

STILL HELPING WHERE IT HURTS

Here's a list below to make buying easier for you — Work it out yourself — You'll see — It really is easy!

Product	List Price	12 Pmt's
Yaesu FT 902DM	£799	£312
Yaesu FT 7700-S	£309	£120
Yaesu FRG 7700S/2M	£315	£120
Yaesu FRG 7700M	£389	£189
Yaesu FRG 7700M/2M	£399	£199
Yaesu FT 101ZD	£569	£223
Yaesu FT 101Z	£488	£190
Yaesu FT 225RD	£499	£194
Yaesu FL 2100Z	£362	£180
Yaesu FT 707	£500	£200
Yaesu FT 480R	£359	£175
Trio R 1000	£298	£115
Standard C8800	£252	£99
Standard C7800	£275	£109

Many Other Items Available on Similar Terms
Call for Details

MICROWAVE MODULES		
MMT 432/28S		£149.00
MMR 432/144R		£184.00
MMT 28/144		£199.00
MMT 144/28		£99.00
MMC 28/136		£27.90
MMC 28/156		£27.90
MMC 28/144		£27.90
MMC 144/anyIF		27.90
MMC 144/28LO		£29.90
MMC 70/anyIF		£27.90
MMC 432/28S		£34.90
MMC 432/144S		£34.90
MMC 1296/anyIF		£32.20
MMC 050/500		£69.00
MMA 28preamp		£14.95
MMA 144V preamp		£34.90
MMV 1296 28		£32.20
MML 144/100linamp		£142.60
MML 432/100linamp		£228.85
MML 144/25linamp		£59.00
MML 432/50linamp		£119.00
MM 2000		£169.00

UNADILLA/REYCO		
Antenna Traps — Precision moulded coil forms stainless - hardware - Aluminium tube irridit finish - Coated aluminium wire. Fully waterproofed.		
Available 7/14/21MHz		£10.99

WZAU BALUN		
3.5/30 MHz 2.5 Kw with Lightning Arrestor — Suitable Veas, Yagis, Doublets, Quadsetc.		
		£10.99

STANDARD		
C8800 2m Tcvr		£252.00
C7800 70cms Tcvr		£275.00

DENTRON		
GLA 1000 Linear Amp 10/80 1Kw		£295.00
MLA 2500 Linear Amp 10/160 2Kw		£699.00
MT 3000 3Kw Tuner/SWR/Dummy Load		£275.00

FDK Multi 700EX		£199.00
FDK Multi 750E		£299.00
Send 30p for our bumper bundle literature		
No Quibble Guarantee Same Day Despatch All Items Advertised		

Choose your AMTECH here		
Amtech 100 Mobile Match		£16.95
Amtech 200 Random Wire ATY 10-160m		£29.95
Amtech 300 Random and Coax Fed ATU		£39.95
Amtech CW 250 — The most outstanding CW filter available		£24.90
Amtech Channelguard — A plug in device to eliminate those unwanted stations	Decoder	£15.25
	Sender	£7.25
Amtech FM7: FM Demodulator for FR 7		£11.90

MONITOR RECEIVERS		
SX 200 Scanning Receiver		£240.00
STANDARD c800 10ch + 1 low power transmit CH		£79.00
AR 22 Pokcer Receiver 144-150 MHz		£91.50

AR 245		
5/1 watt transceiver		£179.00
ICOM IC2E handheld		£155.00

ROTATORS		
Skyking SU 4000		£79.00
Emoto 502CXX		£139.75
KR 400		£105.00
AR 40		£59.00
KR 9502A		£50.00
Rotor Bearing		£12.00

SWR/RF POWER METERS		
SWR 25 3.5/170 MHz		£12.94
LEADER LPM 885-HF 1Kw		£58.00
HANSON 3.5/150MHz 200w		£28.75
REECE UHF 74 144/432		£16.28
HANSON FS 500H 1.8/60MHz 2Kw		£67.85
OSKAR SWR 200 3.30 MHz 2Kw		£40.00

ANTENNAS		
Wide range in stock including JAYBEAM — HYGAIN — CUSHCART — ASP TELECON — HOKUSHIN etc.		
Bantex 5/B whip complete antenna		£8.99
Bantex 1/4 w whip complete antenna		£3.50

AMCOMM SERVICES
194 NORTHOLT ROAD, SOUTH HARROW, MIDDY.
Telephone: 01-864 1166, 01-422 9585
Opposite South Harrow Tube Station on Piccadilly Line

Showroom Opening Hours	
Tuesday to Saturday	9 — 5.30
Sunday	by Appointment

All items over £100 available on easy terms at List Price

NO POSTAGE REQUIRED **AMCOMM SERVICES, FREEPOST, HARROW HA2 0BR.**

Please send me

at enclosed cheque/P.O. for

..... or charge my VISA / ACCESS

Nr.....

Name

Address

..... Post Code.....

EIØCL

EI8DC

G4CIV

WESTERN COMMUNICATIONS (Galway) LTD.

KILCOLGAN, GALWAY, IRELAND

Tel. Within the State: 091-65166 or 65208.

U.K. Callers: 0009-65166/65208.

Telex: 28933 MHTC EI

Mon. 8.30 a.m. — 6.00 p.m. Fri.

Importers — Exporters — Factors *Distributors of Telecommunication Equipment*

*Your nearest AGENT West, Midlands &
South for:*

DANCOM Landmobile — MPT + P&T
approved. — Agents required.

YAESU MUSEN; STANDARD; DRAKE
TR7/DR7/L7
note our Drake Tx/Rx, full cover 0.30ML
RX, 1.5 — 30ML TQX.

QUARTZ — Crystals — fastest delivery.
Microwave Modules Products Stocked.

BEARCAT. 210/22FB/250FB.

LUNAR — Amps and Pre Amps.

Distributor for: Wescom Commercial,
Marine, Amateur Antennas.
Agents required.

SPECTRUM — Repeaters — Duplexers
Commercial — to order

Distributor for: G. WHIP of Wales — full
line in stock.

DANCOM — Marine, Type Approved.

SYT. Land line, interface equipment.

SAXTON — RG&u + 5&u — Cable.

Stockists of: J. Beam, Cushcraft

*We also have all the accessories and hard-to-get plugs, sockets, etc.
Suppliers and Manufacturers — Note.*

P.M. ELECTRONIC SERVICES

PROFESSIONAL COMPLETE CRYSTAL SERVICE AMATEUR

Prices shown exclude VAT — UK Customers please add 15%.

70 CM CRYSTALS

Due to the much higher multiplication involved (3 times that on 2m) all our stock 70cm crystals are to much higher tolerances than our standard range. We are stocking the following channels: RB0 (434.60/433.00), RB2 (434.65/433.05), RB4 (434.70/433.10), RB6 (434.75/433.15), SU8 (433.20), RB10 (434.85/433.25), RB11 (434.875/433.275), RB13 (434.925/433.325), RB14 (434.95/433.35), SU18 (433.45), SU20 (433.50) — TX & RX for use with: — PYE UHF Westminster (W15U), UHF Cambridge (U10B), Pocketfone (PF 1) AND UHF PF70 Range, and STORNO CQL/CQM 662 all at £2.32. For the U450L Base Stn we have the TX crystals for the above channels. The RX crystals for the U450L Base Stn together with TX and RX crystals for any other 70cm channel (eg RB/SU12 (434.90/433.30) RTTY, SU16 (433.40), SU22 (433.55) etc.) for most UHF equipments are available at £4.48 for crystals up to 63MHz, and £5.16 for 63 to 105MHz to amateur spec or £5.26 for up to 63MHz and £6.06 for 63 to 105MHz to the same closer spec as our stock items. Delivery approx. 5/6 weeks.

TWO METRE CRYSTALS

CRYSTALS MANUFACTURED TO ORDER

Prices shown are for one off, to our amateur spec., closer tolerances are available, please send us details of your requirements.

A Low frequency fundamentals in HC13/U or HC6/U

Adj. tol. ±50ppm. Temp. tol. ±100ppm 0 to + 70°C.

6.0 to 19.999kHz	£28.12	80 to 99.999kHz	£10.06
20 to 39.999kHz	£17.74	100 to 159.99kHz	£9.25
40 to 79.999kHz	£12.40	160 to 499.99kHz	£6.19
		500 to 799.99kHz	£7.30

B High frequency fundamentals/overtones in HC6/U, HC18/U or HC25/U

Adj. tol. ±20ppm. Temp. tol. ±30 ppm - 10 to 60°C.

*800 to 900.9kHz (fund)	£9.75	*21 to 24.99MHz (fund)	£6.73
*1.0 to 1.499MHz (fund)	£10.36	*26 to 30MHz	£6.28
*1.5 to 2.599MHz (fund)	£4.93	*15 to 62.99MHz (30/T)	£4.48
*2.6 to 20.99MHz (fund)	£4.48	*60 to 105MHz (50/T)	£5.16
*3.4 to 3.999MHz (fund)	£6.21	*105 to 125MHz (50/T)	£7.76
*4.0 to 5.999MHz (fund)	£4.53	125 to 180MHz (0/T)	£7.50
*6.0 to 20.99MHz (fund)	£4.48	180 to 25MHz (0/T)	£12.49

Delivery *Normally 5/6 weeks (express available), all other frequencies 7/8 weeks. Holders: Low frequencies HC 13/U or HC 6/U dependent on frequency. High frequencies are available in HC 6/U, HC 18/U or HC 25/U unless marked † only available in HC 6/U or ‡ only available in HC 18/U and HC 25/U, HC 17/U (replacement for FT 243) and HC 33/U (wire end HC 6/U) available as per HC 6/U above at 30p extra on HC 6/U price. Unless otherwise specified, fundamentals will be supplied to 30pf circuit conditions and overtones to series resonance.

CRYSTALS FOR PROFESSIONAL USE

We can supply crystals to most commercial and MIL specifications, with an express service for that urgent order. Also for commercial use, eg TV or computer crystals, etc., we can supply at very competitive prices. Please send S.A.E. for details or telephone between 4.30-7pm and ask for Mr. Norcliffe.

EXPRESS SERVICES

Many types made to order crystals are available on our EXPRESS SERVICE with a delivery of three days on our class "A" service. Telephone or Telex for details.

TERMS: CASH WITH ORDER — MAIL ORDER ONLY — S.A.E. WITH ALL ENQUIRIES — PRICES INCLUDE P.P. (BRITISH ISLES) EXCEPT WHERE STATED — OVERSEAS CHARGED AT COST.

CRYSTAL FREQUENCY RANGE USE (Tx or Rx) and HOLDER	4 MHz-TX-HC6/U	6 MHz-TX-HC25/U	8 MHz-TX-HC6/U	10 MHz-RX-HC6/U	11 MHz-RX-HC6/U	12 MHz-TX-HC25/U	14 MHz-RX-HC25/U	18 MHz-TX-HC25/U	44 MHz-RX-HC6/U	44 MHz-RX-HC25/U	52 MHz-RX-HC25/U
144.4 (433.2)	b	b	b	b	b	b	b	b	b	b	b
144.480	b	b	b	b	b	b	b	b	b	b	b
144.800	b	b	b	b	b	b	b	b	b	b	b
144.850	b	b	b	b	b	b	b	b	b	b	b
145.000/ROT	c	c	c	c	c	c	c	c	c	c	c
145.025/R1T	a	a	a	a	a	a	a	a	a	a	a
145.050/R2T	a	a	a	a	a	a	a	a	a	a	a
145.075/R3T	a	a	a	a	a	a	a	a	a	a	a
145.100/R4T	a	a	a	a	a	a	a	a	a	a	a
145.125/R5T	a	a	a	a	a	a	a	a	a	a	a
145.150/R6T	a	a	a	a	a	a	a	a	a	a	a
145.175/R7T	a	a	a	a	a	a	a	a	a	a	a
145.200/R8T	a	a	a	a	a	a	a	a	a	a	a
145.300/S12	a	a	a	a	a	a	a	a	a	a	a
145.350/S14	a	a	a	a	a	a	a	a	a	a	a
145.400/S16	a	a	a	a	a	a	a	a	a	a	a
145.425/S17	a	a	a	a	a	a	a	a	a	a	a
145.450/S18	a	a	a	a	a	a	a	a	a	a	a
145.475/S19	a	a	a	a	a	a	a	a	a	a	a
145.500/S20	a	a	a	a	a	a	a	a	a	a	a
145.525/S21	a	a	a	a	a	a	a	a	a	a	a
145.550/S22	a	a	a	a	a	a	a	a	a	a	a
145.575/S23	a	a	a	a	a	a	a	a	a	a	a
145.600/R0R	a	a	a	a	a	a	a	a	a	a	a
145.625/R1R	a	a	a	a	a	a	a	a	a	a	a
145.650/R2R	a	a	a	a	a	a	a	a	a	a	a
145.675/R3R	a	a	a	a	a	a	a	a	a	a	a
145.700/R4R	a	a	a	a	a	a	a	a	a	a	a
145.725/R5R	a	a	a	a	a	a	a	a	a	a	a
145.750/R6R	a	a	a	a	a	a	a	a	a	a	a
145.775/R7R	a	a	a	a	a	a	a	a	a	a	a
145.800/R8R	a	a	a	a	a	a	a	a	a	a	a
145.950/S38	a	a	a	a	a	a	a	a	a	a	a

PRICES: (a) £1.95; (b) £2.32; (c) £2.50; (e) £4.48.

AVAILABILITY: (a), (b), (c) stock items, normally available by return (we have over 5000 items in stock). (e) 4/6 weeks normally but it is quite possible we could be able to supply from stock.

N.B. Frequencies as listed above but in alternative holders and/or non stock loads are available as per code (e).

ORDERING. When ordering please quote (1) Channel; (2) Crystal frequency; (3) Holder; (4) Circuit conditions (load in pf). If you cannot give these, please give make and model of equipment and channel or output frequency required and we will advise if we have details.

4M. CRYSTALS FOR 70.26 MHz — HC6/U

Tx 8.7825 MHz and Rx 6.7466 MHz or 29.780 MHz £2.32.

10.245 MHz 'ALTERNATIVE' IF CRYSTALS £2.32. For use in Pye and other equipment with 10.7 MHz and 455 kHz IF's to get rid of the "birdy" just able 145.0 MHz in HC6/U, HC18/U and HC25/U.

CRYSTAL SOCKETS — HC6/U, HC13/U and HC25/U (Low loss) 16p each

CONVERTER/TRANSVERTER CRYSTALS — HC18/U

All at £3.00, 38.6666 MHz (144/28), 42 MHz (70/28), 58 MHz (144/28), 70 MHz (144/4), 71 MHz (144/2), 95 MHz (342/52), 96 MHz (1,296/432/144), 101 MHz (432/28), 101.50 MHz (434/28), 105.6666 MHz (1,296/28) and 116 MHz (144/28).

TEST EQUIPMENT FREQUENCY STANDARD CRYSTALS

200 KHz and 455 KHz in HC6/U £3.50
100 KHz in HC13/U and 1 MHz in HC6/U £2.95
5 MHz in HC6/U and 10 MHz + 10.7 MHz in HC6/U + HC25/U £2.80

CRYSTALS FOR MICROPROCESSOR USE

Please let us know your requirements eg 4 MHz HC 18/U 1 off £2.00, 100 off £1.10, 1000 off 90p, 25,000 off 50p.

ANZAC MD-108 DOUBLE BALANCED MIXER

5-500 MHz supplied with full details for only £6.95.

Buy your TRIO Rig from a Specialist Trio Dealer — CATRONICS

Because CATRONICS specialise in TRIO, YOU GET A BETTER DEAL —

- (1) SALES: Only a TRIO specialist such as Catronics knows and stocks the full TRIO range of equipment and accessories.
- (2) SERVICE: Only a TRIO specialist such as Catronics can offer the servicing arrangements required for today's microprocessor controlled equipment. We have probably the best equipped service workshop in the south of England with trained engineers who know how to use the equipment.

ALL OUR TRIO PRICES INCLUDE VAT

TS820	160-10m transceiver 200W PEP	£669.30
DG1	Digital readout to 100Hz	£121.90
VFO820	External VFO	£118.45
YG88C	CW filter 8 pole	£36.80
R820	The ultimate matching receiver to the TS820	£690.00
YG455C	CW filter 500Hz	£58.65
YG455CN	CW filter 250Hz	£60.95
YG88A	AM filter 6kHz	£34.50
TS520SE	160-10m Transceiver	£437.00
SP520	Speaker	£17.25
YG3395C	8 pole CW filter	£37.95
DG5	Digital display/counter	£103.50
TS130S	80-10m transceiver 200W PEP with new bands	£491.00
TS130V	80-10m transceiver 20W PEP with new bands	£404.00
PS20	AC power supply for TS 130V	£44.85
MB100	Mobile mounting bracket	£17.25
YK88C	500Hz CW filter	£28.75
SP120	External speaker	£25.30
VFO120	External VFO	£89.70
AT120	Antenna tuner (100W)	£55.20
PS30	AC PSU for TS 130S	£85.10
AT200	1.8-30MHz antenna tuner	£82.80
SM220	Monitor scope	£197.80
BS8	TS820 scanboard for SM220	£48.30
TL10	80-10m 200W linear	£128.80
TL922	HF linear amp 160-10m/2kW PEP 2x 3 500Z tubes	£595.00
HS4	Communications headphones, tailored response	£10.35

TS830S	160-10m transceiver with the new bands	£639.52
VFO230	Digital VFO with memories and digital readout	£194.45
AT230	All band ATU and power meter. Matches TS830S	£106.72
SP230	External speaker unit with switched filters	£33.14
DS2	Optional dc pack for TS830S	£39.90
DFC230	Dgtl frequency rem. controller. 4 memories etc.	£163.13
TS770E	2m/70cm all mode dual bander	£730.25
SP70	Matching speaker	£18.40
TR7800	2m Synthesised mobile/fixd transceiver 25 watt	£268.00
TR2300	2m FM portable transceiver PLL with all 80 FM channels	£166.75
MB2	Mobile mount	£17.25
RA1	Helical rubber antenna	£6.90
TR2400	2 meter synthesised handheld transceiver	£198.95
ST1	Base stand and quick charger	£43.70
BC5	12V quick charger	£17.25
SC3	Carrying case	£11.50
TS180S	160-10m solid state transceiver	£589.95
TS180S	As above but with digital frequency control	£679.65
VFO180	External VFO	£96.60
SP180	Speaker	£36.80
DF180	Digital frequency control	£104.65
AT180	1.8-30MHz antenna tuner	£95.45
PS30	AC power unit for TS180S	£85.10
TR8300	70cm FM mobile 10W transceiver fitted 4 channels	£225.00
TR3200	70cm FM handy transceiver fitted 3 channels	£164.40
R1000	0.2-30MHz receiver	£285.20
SP100	External speaker	£26.45



CATRONICS ARE 300 yards from Wallington Railway Station (London Bridge or Victoria). Frequent buses from Croydon and Sutton. Three large car parks within 100 yards. Hire purchase facilities available on all equipment. Credit cards accepted. Mail orders are normally dealt with on day of receipt. All our prices INCLUDE VAT.



CATRONICS LTD., Dept 112, Communications House, 20 Wallington Square, Wallington, Surrey SM6 8RG

Tel: 01-869 6700, Shop/Showroom open Mon to Fri 9am to 5.30pm. Closed for lunch 12.45 to 1.45pm. Sat 9am to 1pm.

From the World-Record JOYSTICK people!

A REVOLUTIONARY ANTENNA THEY CALLED "IMPOSSIBLE"

THE JOYFRAME (Patent Applied for)

Amateur bands 3 · 5-30MHz, plus 27MHz and "New" bands — ALSO 2m. band RECEIVE

The ultimate in small package, poor QTH, versatile antennas. Comes in easily assembled package which makes up to a 21 x 21 (inches) triangle. The unit JUST STANDS ON TOP OF TX/RX! Two knob control — and is rotated by hand for directivity on 80m. Is omni-directional on higher freq. 's and for many SW BC stations. Incredible low angle radiation. Tested at 2 watts (only) CW at our works — world wide contacts! "Soak test" with G2VF using only 30 watts has satisfyingly filled his log with world wide QSO's. Loop TRANSMISSION performance with such a small unit has, we believe, never been seriously contemplated before, but rather written off as "impossible". Years of research from the firm that produced the JOYSTICK VFA and related systems now offers the JOYFRAME to the amateur fraternity and is the answer to the "maidens prayer" to everyone with a space problem. All the benefits of JOYSTICK products; substantially harmonic free, low angle, efficiency, compact.

COMPLETE JOYFRAME (incl. ATU) £60.00

(or write — 14p — or phone for literature)

TRANSCEIVERS ETC.
We reckon we're offering the

LOWEST YAESU PRICES!!

Try phoning us for your PERSONALISED quote with or without Partridge antennas. For example: ● FT101ZD — only £559 ● FT902DM — only £795 ● FT7B — only £395.



JUST TELEPHONE YOUR CARD NUMBER 0843 62536 (Ext. 4). After office hours 0843 62839 or send 14p stamp for FREE literature on "too numerous to mention" alternative ANTENNAS, leading RECEIVERS with competitive COMPLETE RADIO STATION bargains, VHF BUSINESS RADIO, etc., etc. Prices correct as at press, NOTE our prices are always INCLUSIVE of VAT, carriage. Prompt service too, goods usually despatched WITHIN 48 HOURS.

4 Partridge House, Prospect Road, Broadstairs, Kent CT10 1LD (Callers by appointment)





**FOR QUALITY CRYSTALS—AT COMPETITIVE PRICES.
POPULAR FREQUENCIES IN STOCK—MADE TO ORDER 10kHz to 225MHz.**

OSL leads the field in supplying crystals world wide to major communications companies, broadcasting authorities and posts and telecommunications administrations. As a result we can supply the amateur with a high quality, competitively priced product over a frequency range from 10kHz to 225MHz. Get the power of the professionals in crystal supply behind you!

2 METRE STOCK CRYSTALS. Price £1.83 for one crystal. £1.74/crystal when two or more purchased.

	HC6/U 30pF TX	HC6/U 30pF TX	HC25/U 30pF and 40pF TX	HC25/U 20pF and 30pF RX	HC25/U 25pF and 20pF TX	HC6 & 25/U SR RX
RO	4.0277	8.0555	12.0833	14.9888	18.1250	44.9666
R1	4.0284	8.0569	12.0854	14.9916	18.1281	44.9750
R2	4.0291	8.0583	12.0875	14.9944	18.1312	44.9833
R3	4.0298	8.0597	12.0895	14.9972	18.1343	44.9916
R4	4.0305	8.0611	12.0916	15.0000	18.1375	45.0000
R5	4.0312	8.0625	12.0937	15.0027	18.1406	45.0083
R6	4.0319	8.0638	12.0958	15.0055	18.1437	45.0166
R7	4.0326	8.0652	12.0979	15.0083	18.1468	45.0250
S8	—	—	12.1000	14.9444	18.1500	44.8333*
S9	—	—	12.1020	14.9472	18.1531	44.8416*
S10	—	—	12.1041	14.9500	18.1562	44.8500*
S11	—	—	12.1062	14.9527	18.1593	44.8583*
S12	—	—	12.1083	14.9555	18.1625	44.8666*
S13	—	—	12.1104	14.9583	18.1656	44.8750*
S14	—	—	12.1125	14.9611	18.1687	44.8833*
S15	—	—	12.1145	14.9638	18.1718	44.8916*
S16	—	—	12.1167	14.9667	18.1750	44.9000*
S17	—	—	12.1187	14.9694	18.1781	44.9083*
S18	—	—	12.1208	14.9722	18.1812	44.9166*
S19	—	—	12.1229	14.9750	18.1843	44.9250*
S20	4.0416	8.0833	12.1250	14.9777	18.1875	44.9333
S21	4.0423	8.0847	12.1270	14.9805	18.1906	44.9416
S22	4.0430	8.0861	12.1291	14.9833	18.1937	44.9500
S23	4.0437	8.0875	12.1312	14.9861	18.1968	44.9583

SR = Series Resonance *HC25 only

Also in stock: RO to R7 for FT221 RO to R7 and S8 to S23 for following: Belcom FS1007, FDK TM56, Multi 11 Quartz 16 and Multi 7, Icom IC2F, 21, 22A and 215, Trio Kenwood 2200, 7200, Uniden 2030 and Yaesu FT2FB, FT2 Auto, FT224, FT223 and FT202.

Also in stock 4 and 8 MHz TX in HC6/U for 145.8 MHz. Icom crystals TX for 145.8 MHz (RR0). 44 MHz RX crystals in HC6 for 145 (RR0). All at above price.

4 METRE CRYSTALS for 70.26 MHz in HC6/U at £2.25. TX B.78250 MHz. RX 6.7466 or 29.78 MHz in stock.

70cm CRYSTALS in stock B.0222 and 12.0333 in HC6 £1.85. Pvc Pocketfone PF1, PF2, PF70 and Wood and Douglas £4.50 a pair or TX £2.25, RX £2.50, SU8(433.2) RBO, RB2, RB4, RB6, RB10, RB11, RB13 and RB14.

CONVERTER CRYSTALS in HC18/U at £2.85. In stock 38,666, 42,000, 70,000, 96,000, 101,000, 101,500, 105,666 and 116,000 MHz.

STONE BURST AND I.F. CRYSTALS in HC18/U at £2.25 in stock. 7.168 MHz for 1750 kHz and 10.245 MHz for 10.7 MHz IF's.

FREQUENCY STANDARDS in stock £2.75. HC6 200 kHz, 455 kHz, 1000 kHz, 5.000 MHz and 10.000 MHz. HC13 100 kHz, HC18 1000 kHz, 7.000 MHz, 10.700 MHz, 48.000 MHz and 100.00 MHz.

QuartzLab MARKETING LTD
P.O. Box 73
London SE18 3LR

FORMERLY C&C ELECTRONICS

Telephone: 01-690 4889 24 hr. Ansafone: (03224) 30630
Telex: 912881 CWUKTX-G (Attention QUARTSLAB)
Cables: QUARTSLAB London SE18

PRICES ARE EX VAT. PLEASE ADD 15%.

MADE TO ORDER CRYSTALS SINGLE UNIT PRICING

	Price Group	Adjustment Tolerance ppm	Frequency Ranges	Price and Delivery		
				A	B	
Fundamentals	1	200 (total)	10 to 19,999 kHz	—	£23.00	
	2	200 (total)	20 to 29,999 kHz	—	£16.50	
	3	200 (total)	30 to 99,999 kHz	—	£10.50	
	4	200 (total)	100 to 999,999 kHz	—	£6.00	
	5	50	1.00 to 1.499 MHz	£9.00	£6.00	
	6	10	1.50 to 1.999 MHz	£4.75	£4.20	
	7	10	2.00 to 2.599 MHz	£4.75	£4.00	
	8	10	2.60 to 3.999 MHz	£4.55	£3.70	
	9	10	4.00 to 20,999 MHz	£4.55	£3.60	
	10	10	21.00 to 24,000 MHz	£6.00	£5.40	
	3rd OVT	11	10	21.00 to 59,999 MHz	£4.55	£3.60
	5th OVT	12	10	60.00 to 99,999 MHz	£5.00	£4.00
	5th, 7th & 9th OVT	13	10	100.00 to 124,999 MHz	£6.15	£5.20
		14	20	125.00 to 149,999 MHz	—	£6.00
	15	20	150.00 to 225.00 MHz	—	£7.50	

Unless otherwise requested fundamentals will be supplied with 30pF load capacity and overtones for series resonance operation.

HOLDERS — Please specify when ordering — 10 to 200 kHz HC13/U, 170 kHz to 170 MHz HC6 or HC33/U, 4 to 225 MHz, HC18 and HC25.

DELIVERY Column A 3 to 4 weeks (this service is subject to availability), Column B 6 to 8 weeks.

Please note that it is not always possible to provide the A delivery service but a telephone call will confirm its availability.

Any orders received for A delivery when it is not available will automatically be placed on B delivery and a credit note issued for the difference in price.

DISCOUNTS. 5% mixed frequency discount for 5 or more crystals at B delivery. Price on application for 10 or more crystals to same frequency specification. Special rates for bulk purchase schemes including FREE supply of crystals used in UK repeaters.

EMERGENCY SERVICE SURCHARGES (to be added to A delivery prices). 4 working days £12, 6 working days £7, 8 working days £5, 13 working days £3 (maximum of 5 crystals on 4 day delivery).

CRYSTAL SOCKETS HC6/U and HC25/U 16p.

MINIMUM ORDER CHARGE £1.50.

COMMERCIAL USERS. Crystals can be supplied for industrial control, etc. in the range 4-21 MHz fundamental and 3rd OVT 18 to 60 MHz at £1.15 for 100 off. This is only a limited example of our capabilities. Please enquire about other quantities, frequency ranges, watch and sub-carrier crystals. We can supply crystals for marine and land mobile radio telephone use. Send for details.

MPU Crystals available at competitive prices please contact us for details.

TERMS. Cash with order, cheques and postal orders payable to OSL Ltd. All prices include postage to UK and Irish addresses. Please note Southern Irish cheques and postal orders are no longer acceptable. Please send bank draft in pounds Sterling.

ROBOT BARGAINS

'400' Demo. Full Warranty	£565
'800' Demo. Full Warranty	£545
'70A' Monitor — Mint	£195
'80A' Camera & Macro Lens — Clean	£145
'61' Viewfinder — Mint	£65
Package Deal: — 70A + 80A + 61	£350

All prices inclusive of V.A.T. & Delivery.
Please phone to reserve your bargain.

AERO AND GENERAL SUPPLIES
Building 33, East Midlands Airport,
Castle Donington, Derby.
Tel: (0332) 812446 or (0602) 397588.

**G2BAR HAM BAND
AERIALS**

2 element YAGI 10 metres	£31.68	£4.00 p.p.
2 element YAGI 15 metres	£39.80	£4.00 p.p.
3 element YAGI 10 metres	£49.45	£4.50 p.p.
3 element YAGI 15 metres	£59.80	£4.50 p.p.

Beams include Boom and Standard type Gamma Match System.

For descriptive leaflets please send 30p in stamps.

UPPINGTON TELE-RADIO (BRISTOL) LTD.
12-14 Pennywell Road, Bristol BS5 0TJ.
Telephone: 0272 557732.

C.B. ELECTRONICS

UNIT 3, 771 ORMSKIRK ROAD, PEMBERTON, WIGAN, WN5 8AT

Telephone: Wigan (0942) 216567

THE BEST IN THE NORTH-WEST

HOW TO FIND US — From M6 junction 26 follow signs for Wigan A577 at first traffic lights (T junction) turn right towards Wigan. At next traffic lights you are there, *BUT* turn left and 10 yards further turn right by telephone kiosk. Premises are slightly to your right. Plenty of parking space. Mileage from motorway ½ mile. From Wigan follow the A577 Skelmersdale to traffic lights at Fleet Street, Pemberton (Ye Olde White Swan on your left). Turn right then 10 yards right again. By Co-op. Mileage from Wigan 2½ miles.

YAESU		Morse keys		Emotator		HF Antennas	
FT901DM	£799.25	Standard	£3.15	103L BX	£98.00	HQ1 mini beam	£96.50
FT101Z	£488.75	Nye King	£12.00	502CXX	£145.12		
FT101ZD	£589.25	Nye King heavy duty	£13.50	1102	£239.00		
FL2100Z	£362.25					Cushcraft Verticals	
FT 7B	£389.00			ASP Antennas		ATV3	£43.00
FC902	£128.50	F.D.K.		2009 5/8 wave		ATV4	£76.00
FRG7	£199.00	Multi 750E	£299.00	201 1/4 wave		ATV5	£79.00
FRG 7000	£299.00	Muti UII	£249.00	397 Low Band			
FRG 7700	£309.00	Palmiszar	£159.00	E462 UHF		Hi Gain	
FT225RD	£489.00	Palm IV	£159.00	677 5/8 wave		12AVQ	£43.00
FT227RB	£263.35	TM56B	£104.00	462 5/8 wave		14AVQ	£80.37
FT202	£99.00	Multi 700EX	£199.00	Magnetic Base		18AVQ	£89.70
FT207R	£199.00			Boot mount		TH3MK3	£186.00
FT107M	£890.00	CDR Rotators		High Pass Filter			
FT707	£500.25	AR30	£47.15	Headphones		2m Colinear	
FP707	£109.25	AR40	£59.00	PTT mics		Ringo Ranger	£22.00
FC707	£74.75	CD44	£109.25			GPV5	£22.00
FC107	£97.75	CD45	£113.85	STANDARD			
Charger	£18.87	Ham IV	£166.75	C800	£252.45		
QTR24	£18.40			C7800	£275.45		
YP150	£67.27						

TERMS: ACCESS, C.W.O. (CARRIAGE AND POST EXTRA AT COST)

BUSINESS HOURS
Mon, Tues, Thurs, Fri 9.30-5.30
Sat 9.30-4.30
Closed Wednesday

S.A.E. ALL ENQUIRIES

SOUND ADVICE — SOUND VALUE

A GOOD START is essential to short wave listening and expert advice is important in achieving this — So here's some — If you've made up your mind to buy a receiver you should be aware it will perform only as well as the antenna it sees. The old adage regarding wire antennas "As long and as high as you can" is still good, but at best is only good for PEAK PERFORMANCE on one or two frequencies, at worst none.

Whichever frequency you tune your receiver to, for PEAK PERFORMANCE on all frequencies you need good matching between your Receiver and Antenna to hear the best from it. If you plan to listen on the high frequency bands up to 30MHz then you know you can't have an antenna for every frequency! Or can you? — Well, not quite! BUT we can offer you MUCH IMPROVED PERFORMANCE from your receiver by using an antenna tuning unit, that will electrically change the length of your antenna to match the frequency you select — In other words — A MATCH AT ALL FREQUENCIES.

You'll see many antennas being advertised under gimmicky names, but when it comes down to it they're only random wires or odd configurations. At the end of the day, if you're expecting the performance the manufacturers specified, then you'll still have to buy an antenna tuning unit.

Tell you what we'll do — we'll prove it to you — we'll give you one ABSOLUTELY FREE when you buy your FRG 7 or FRG 7700 and we'll give you complete advice on an antenna to suit your available space, which should only cost you a couple of pounds!

So let's put the offer in big print for you!

1 YAESU FRG7 + AMTECH 200 ATU	£199.00
1 YAESU FRG 7700 + AMTECH 300 ATU	£309.00
VAT included	

What's the difference between the Amtech 200 and Amtech 300? Well both will tune any random length of wire but the Amtech 300 will do a little extra — it will also tune co-axial fed antennas — Their normal selling price? The Amtech 300 £39.95 — The Amtech 200 £29.95 — What can you lose?

So get cracking MAKE A GOOD START! HAVE PEAK PERFORMANCE FROM THE OFF.

JAYBEAM — HYGAIN — BANTEX — AMTECH — CUSHCRAFT — SWAN — ATLAS
and 50 other major lines — all ex stock



AMCOMM SERVICES

194A NORTHOLT ROAD, SOUTH HARROW, MIDDX.

Tels: 01-864 1166 & 01-422 9585

Opening hours: Tues-Sat 9.00-5.30, Sundays by appointment. Closed Monday.



("SITUATIONS" AND "TRADE")

20p per word, minimum charge £2.40. No series discount. All charges payable with order. Insertions of radio interest only accepted. Add 50 per cent for Bold Face (Heavy Type). No responsibility accepted for transcription errors. Box Numbers 40p extra. Replies to Box Number should be addressed to the Short Wave Magazine, Ltd., 34 High Street, Welwyn, Herts., AL6 9EQ.

TRADE

Pre-war onwards valves, wireless (SW's); send s.a.e. — Sole Electronics, 37 Stanley Street, Ormskirk, Lancs.

Morse code tuition cassettes, £2.50 (state speed required). — M. Smith (factors agent), High Wiend, Appleby, Cumbria.

VHF converter, 45-220 MHz (varicap), 28-30 MHz tunable IF, highly sensitive unit, £9 inc. p/p. TVDX monitor sporadic-E conditions with my VHF-UHF converter, produces Band 1 over ch. 35-38 UHF, very low conversion loss, £10.50 inc. p/p. Send s.a.e. for data on both items. — H. Cocks, Cripps Corner, Robertsbridge, Sussex. (Tel: 058083-317).

March issue: Due to appear February 27th. Single copies at 75p post paid will be sent by first class mail for orders received by Wednesday, February 25th, as available. — Circulation Dept., Short Wave Magazine Ltd., 34 High Street, Welwyn, Herts. AL6 9EQ.

Good second-hand equipment always wanted. Come to AMATEUR RADIO EXCHANGE for the best deal. — 2 Northfield Road, Ealing, London W13 9SY. (Tel: 01-579 5311.)

SX-200 scanning receiver covers most bands from 26-512 MHz, AM/FM, £208.00 + VAT. Send s.a.e. for data. — W. H. Westlake, Clawton, Holsworthy, Devon.

QSL cards. Sample pack and price list forwarded on receipt of 20p stamp. — Derwent Press, 69 Langstone Drive, Exmouth, Devon EX8 4HZ.

Radio Amateur Examination City and Guilds. Pass this important Examination and obtain your G8 Licence with an RRC Home-Study Course. For details of this and other courses (GCE, professional examinations etc.) write or phone: THE RAPID RESULTS COLLEGE, Dept. JV1, Tuition House, London SW19 4DS. Careers Advisory Service, 01-947 7272 or ring 01-946 1102 for Prospectus (24-hr. Recordacall.)

TVI/AFI? Cure it with ferrite rings, 67p each including postage. — TMP Electronics, Britannia Stores, Leeswood, Mold, Clwyd CH7 4RU.

Aerial wire, 14 s.w.g. hard-drawn copper: 70 ft. coils £5.50; 140 ft. coils, £8.90. Including postage. — TMP Electronics, Britannia Stores, Leeswood, Mold, Clwyd CH7 4RU.

The Quality choice.



VF 7401-2 2 Metre Digital Scanning Transceiver

Fully synthesized, 15 watt solid-state rig. Scanning Capability. Mobile or fixed station use.



HW-8 QRP CW Transceiver.
80m through 15m. 3.5W DC power input. Operates from car battery or mains pack.



IM-2400 Hand-held Frequency Counter

Measures 50Hz to 512MHz in two ranges. 7 digit LED Display. Crystal-controlled 10MHz time base.

Operates on nickel-cadmium batteries or line current with optional eliminator charger. Swivelling Telescopic Antenna optional.

Make Heathkit your first choice for building Amateur Radio Kits of Quality. Easy to build. And superb value for money.

Full details are available in the Heathkit catalogue. Send for your copy and see the Quality choice now.

To: Heath Electronics (UK) Limited, Dept. (SW2), Bristol Road, Gloucester, GL2 6EE.

Please send me a copy of the Heathkit catalogue. I enclose 25p in stamps.

Name

Address

Soldering
Iron offer
FREE

NB: If you are already on the Heathkit mailing list you will automatically receive a copy of the latest

Heathkit catalogue without having to use this coupon.

When you receive your catalogue you will get details of this free offer.

HEATHKIT

HEATH
ZEPHYR

CALL BOOKS

INTERNATIONAL:

RADIO AMATEUR CALL BOOKS (1981)	
Foreign ("DX") Listings.....	£9.80
U.S. Listings.....	£10.30
U.K. Callbook, 1981 Edn, (RSGB).....	£4.25

A few 1980DX Listings still available at a special sale price of £6.50 each including p/p.

MAPS

"SHORT WAVE MAGAZINE" DX ZONE MAP (GREAT CIRCLE) In colour, <i>New 9th Edition!</i>	£3.35
AMATEUR RADIO MAP OF WORLD Mercator Projection — Much DX Information — in colour <i>Latest 14th edition</i>	£1.10
RADIO AMATEUR MAP OF THE U.S.A. AND NORTH AMERICA State Boundaries and Prefixes, size 24" x 30", paper <i>Latest 6th edition</i>	95p.
RADIO AMATEUR'S WORLD ATLAS In booklet form, Mercator projection, for desk use. Gives Zones and Prefixes <i>Latest 11th edition</i>	£1.65

LOG BOOKS

Amateur Radio Logbook.....	£2.80
Receiving Station Log.....	£2.60
Mobile Logbook.....	£1.10

(The above prices include postage and packing)

Available from:

Short Wave Magazine

Publications Dept.,

34 High Street, Welwyn, Herts. AL6 9EQ

Tel: Welwyn (043871) 5206/7

(Counter Service, 9.30-5.00 Mon. to Fri.)

(Giro A/c No. 547 6151)

READER'S ADVERTISEMENTS

10p per word, minimum charge £1.50 payable with order. Add 25 per cent for Bold Face (Heavy Type). Please write clearly, using full punctuation and recognised abbreviations. No responsibility accepted for transcription errors. Box Numbers 40p extra. Replies to Box Number should be addressed to the Short Wave Magazine, Ltd., 34 High Street, Welwyn, Herts., AL6 9EQ.

READERS

Selling: Realistic DX-302 receiver, 10 kHz to 30 MHz, digital display, switched selectivity, two months old, boxed, mint, £195. — Ring Logan, Hereford 760073 after 6 p.m.

For sale: FT-101E, £375. Magnum four-metre transverter, £75. G-Whip, 160m., £5. — Ring Thurlow, G3WBN, 01-654 2761.

For sale: FDK Palm IV, with all accessories, xtal'd SU20, SU8, RB2, RB4, RB6, RB14, only one month old (having tried 70cm. am going for something better), £130. — Ring Stanway, Huntingdon 52451 ext. 429 evenings.

Wanted: Mizuho AP-11 audio processor, — Ring 01-5500855, 6-9 p.m.

Sale: Trio R-1000, immaculate in all respects, 8 months old, £200. — Robson, 8 Shebster Court, Thurso, Caithness KW14 7ES.

For sale: Trio 120V with TL-120 linear, £350 or near offer. — Ring Rochford, G5DQA, 01-856 4123.

Selling: Pye Vanguard AM radiotelephone, complete. Offers, or exchange for oscilloscope. — Ring Forshaw, 061-766 9218.

For sale: Magnum II high-power transverter, 10-2m., complete with all connecting leads, excellent condition, £95. — Ring Dane, G8TFE, Oxted 4888.

Wanted: Homebrew SSTV monitor in good working order, up to £80 paid. All letters answered. — Stockwell, 45 Maple Road, Grays, Essex RM17 6LB.

For sale: Dual beam 'scope, 10 MHz, good clean condition, with manual, no probe, £70. — Ring Baker, 061-653 5275.

Selling: Eddystone 940 receiver, general coverage, with handbook, mint condition, £200. — Ring Draper, Hornchurch 43676 after 7 p.m.

Sale: AR88D receiver with instruction manual, £45. Buyer collects. — Ring Williams, 03542-56625 (Cams).

For sale: Sommerkamp FT-227ZD transceiver (de-luxe model of Yaesu FT-101ZD), with new WARC bands, mint condition, 4 weeks old, £500. Buyer collects. — Ring Smith, 051-928 8020.

RADIO AMATEUR PREFIX-COUNTRY-ZONE LIST

published by GEOFF WATTS
Editor of "DX News-Sheet" since 1962

The List you have always needed, the list that gives you everything, and all on one line! For each country: —

- | | |
|---------------------------------------|----------------------|
| a. its DXCC "status" | e. the continent |
| b. the normal prefix | f. the "CQ" Zone No. |
| c. the special prefixes | g. the ITU Zone No. |
| d. the ITU call sign block allocation | |

Full information on Antarctic stations, USSR Klub-stations, obsolete prefixes used during the past 10 years, and much more, and the List can be kept always up-to-date because ample space has been provided for adding every new prefix, each new ITU allocation, etc.

Everything arranged alphabetically and numerically in order or prefix. Ideal for Contest operators and SWL's.

Tell your Club-members about it. Order an extra copy for that overseas friend. 15 pages. Price 55p (UK), Overseas (air mail) \$2.00 or 6 IRCs.

GEOFF WATTS

62 BELMORE ROAD, NDRWICH NR7 0PU, ENGLAND

Selling: FRG-7700 with memory, new (unwanted gift), original packing, manual, plus Amtech 300 antenna tuning unit, £300. — Ring Ingrebourne 45945.

Sale: Hallicrafters S.19R with manual and circuit, good condition, £32. Buyer collects. — Ring Tapping, Colchester 5561.

For sale: Marconi "Oceanspan V1" Tx, 405 kHz to 22 MHz crystal controlled (ships' main transmitter), £25. Marconi TF-867 signal generator, 20 kHz to 32 MHz, in good working order, £25; also scrap TF-867, £1. Airmec Type 784 RF millivoltmeter, in good working order, £10. No. 1 MkII Class-D wavemeter, 400 kHz to 19 MHz (World War II vintage), for use with Wireless Stations No. 19 and No. 12, in good working order, £8. Two No. 31 Wireless Sets, £3. Type CT-44 AF absorption wattmeter, 2.5 ohm to 20 kilohm load, 200 µW to 6W, £10. Television alignment and pattern generator, 7-70 MHz, £3. — Ring Watson, Bristol 38822 after 6 p.m.

Selling: Drake R4-C receiver, £295. — Ring Carling, Lympington 73269.

Selling: Trio R.820 receiver, as new, £580. Drake SPR-4, general coverage plus three amateur bands, provision for more, excellent condition, £360. Buyers collect. — Ring Ahmed, 01-272 3437, 5-9 p.m.

Sale: Codar CR-45 TRF valve receiver, CW/AM, £35. — Ring Mathewson, Standford-le-Hope 79801 evenings.

Wanted: Trio BPF-2A. Details and price please. — Singleton, 15 St. Martins Approach, Russlip, Middlesex.

For sale: Sullivan and Griffiths universal inductance meter, one micro-H to one Henry, £350. Precision Wheatstone bridge, £250. — Ring Cottrell, G3PSY, Tenterden 4531.

Selling: BC-221M, £25. LM-14, £30. W1649 wavemeter, £4. CT-53 signal generator, 8-300 MHz, new, £25; 1-30A, £8. TS47/APR, £35. Type 339 oscilloscope, £15. Hewlett Packard 200A audio generator, brand new, £25. TF-340 output meter, £6. PR7 NA/Ray-5 receiver, £5. HRO 110v., rack mounting, with PSU, £5. Carriage extra. Also disposing of many manuals. — Reynolds, 5 Headland Way, Lingfield, Surrey RH7 6DH. (Tel: 0342-834288).

Sale: Microwave Modules converters 432/28, 1296/28, and Varactor tripler 1296/432, £15 each. Telford TC-9 TX, 10 watts, Fm, VFO controlled, 144-146 MHz continuous coverage, £25. Compact xtal calibrator, £5. — Ring Mash, G8JAO, Malvern (06845) 63270 evenings/weekends.

March issue: due to appear February 27th. Single copies at 75p post paid will be sent by first class mail for orders received by Wednesday, February 25th, as available. — Circulation Dept., Short Wave Magazine Ltd., 34 High Street, Welwyn, Herts. AL6 9EQ.

For sale: Trio 9R-59DS receiver, LSB/USB, antenna trim, hardly used, £80. — Ring Roberts, Waltham Cross 26651.

LAR

THE SHORT WAVE WIZARDS



Trio R1000 PLL C&L SWL Communications Receiver 200 KHZ to 30 MHz. £285.00

TRIO EQUIPMENT

R 820 The ultimate S.W.L. Receiver	£690.00
SP 820 Matching Extension Speaker	£37.95
HS 5 Communications Headphones	£21.85
HS 4 Communications Headphones	£10.35
Full Range of Trio Transceivers in Stock.	

COMMUNICATIONS RECEIVERS

Lowie SRX 30 Still the Best Value	£158.00
YAESU FRG 7 General Coverage	£199.00
YAESU FRG 7000 Digital Readout	£299.00
FGR 7700 Receiver	£309.00
All YAESU Transceivers available.	

ICOM AMATEUR EQUIPMENT

LAR are Yorkshire's largest stockists of the full ICOM range of transceivers.

V.H.F. AMATEUR RECEIVERS

Search SR9 V.F.O. or crystal control 2M F.M. 144-146 MHz . . .	£46.00
(Marine 156 to 162 MHz also available)	
AMR 2178B 2M F.M. Scanner 144-146 MHz. Fitted 8 crystals battery/mains. The best and most popular 2m. monitor	£120.00
Extra crystals for the above receiver	£2.50

TUNERS, SWITCHES AND SHACK CLOCKS

K x 2 SWL Antenna Tuner 500KHZ to 30MHz	£29.90
LAR OMNI Match (HF VHF Mobile & Linear. Send 20p for details)	
Cx/3 SWL 3 way antenna switch	£5.80
LAR 1 KW P.E.P. Feeder Switch (Switch to Quality)	£16.95
COPAL 24 hour Digital clock mains operated	£12.95

AIR BAND RECEIVERS

Sharp FX 213AU Hand held portable	£16.00
SKY ACER 517 VFO and crystal control	£49.50
SIGNAL R 512 Scanner Fitted 5 Channels	£138.00
Crystals for R 517 or R 512	£2.80
Regency Digital flight scan (no crystals required)	£230.00
BEARCAT 220FB. Scanner 66 to 512 MHz	£258.75
SX 2000 Scanner 26-514 MHz	£239.20

(All prices include VAT. Securicor delivery arranged on request)

Buy by post or phone your Barclaycard, Access, or LAR Creditcard number. Alternatively, call in for a chat. The shop is just 10 minutes from Leeds City Station, and there's easy parking if you travel by car. * Instant HP for licensed Amateurs * Extended Credit Terms Available * Send 50p for Catalogue and Price List.



Leeds Amateur Radio
27 Cookridge Street, Leeds, LS2 3AG.
Tel: 782224

TRIO DISTRIBUTOR. LAR are area distributors for Jay Beams, Antenna Specialists, Hilomast, Icom, Microwave Modules and Ascot Products.

CRAYFORD ELECTRONICS

GBAYN

G81WX

**FLEXIBLE HELICAL AERIALS FOR HAND PORTABLES
VHF—UHF**

Frequency	Connector/Fitting	Price
70MHz (4m)	2BA, BNC, PL259	£6.00
145MHz (2m)	2BA, BNC, PL259, Pye PF70, 2200GX, 2300, IC215, IC202S	£4.20
	Right angle BNC, PL259, TNC	£5.35
	Storno 500, Pye Bantam	£5.00
433MHz (70cm)	4BA (use on PFI)	£2.65
	BNC, min BNC, Pye PF70, 3200, Storno 500	£3.35

Prices inclusive of VAT and carriage, most items ex-stock. Many others available, including commercial, marine etc.

ACCESS SAE all enquiries BARCLAYCARD

**6 LOVELACE CLOSE, WEST KINGSDOWN,
SEVENOAKS, KENT TN15 6DJ**
24hr Answer Service 047485 2577

ANTI-TVI TRAP DIPOLES

1981 Range: Shortwave Listener
Indoor models £14.50 & £27.50.
Outdoor models £30.00 & £36.00.

Tx-into models £52.50 & £59.75.

Lists 10x8in 17p SAE. Aerial Guide 50p.

Publication "Indoor and Invisible Aerials
for S.W.L.s" — £3.50.

Callers Welcome. Tel: 03986-215.

G2DYM, UPLOWMAN, TIVERTON, DEVON**ANTENNA FAULT?**

LOSING DX? Storm Damage? Check it FAST with an Antenna Noise Bridge, MEASUR resonance 1-150MHz and radiation resistance 2-1000 ohms, get ANSWERS, £11.80.

RARE DX UNDER QRM? DIG it OUT with a Tunable Audio Notch Filter, between your receiver and speaker, BOOST your DX/QRM ratio, 40dB notch, hear WEAK DX, £10.90

MISSING DX? Make them HEAR YOU with a Speech Compressor, between your microphone and transmitter, BOOST your POWER up to 4 times, MORE DX, £9.90.

Each fun-to-build kit includes all parts, printed circuit, case, postage, etc., instructions, money back assurance, so GET yours NOW.

CAMBRIDGE KITS**45 (SP) Old School Lane, Milton, Cambridge.****CO-AXIAL CABLES**

UR43 50 ohms. The most popular standard Coax. 5mm dia. 20p per Metre (post 2½p)

UR76 50 ohms. About the same spec as UR43 and the same size but a stranded inner conductor. 22p per Metre (2½p)

UR95 50 ohms. Miniature. Polythene & Nylon 2.3 dia. 25p per Metre (1p)

UR67. The thick low loss 50 ohm ½" dia. Coax. 60p per Metre (4½p)

UR70 75 ohm standard Coax. Stranded 6mm dia. Stranded inner conductor 20p per Metre (2½p)

UR39. Low Loss 75 ohm about ¼" dia. 35p per Metre (3p)

CX4007 75 ohm. Low loss UHF TV Feeder, good quality. Price 18p per Metre (2½p)

300 Ohms. Twin ribbon feeder PVC Polarity coded. A very popular line @

11p per Metre (1½p)

Mains. 3 core White PVC Mains to carry about 3-5a @ below trade price.

14p per Metre (3p)

Mains. Twin Mains 3-5 amp flat. 8p per Metre (2p)

Mains. Twin transparent. Light twisted @ 4p per Metre (1½p)

Multicore Screened: 8 core screened in up to 10m coils @ 15p per Metre

(3p); 20 core screened in up to 10m coils @ 26p per Metre (5p).

SAE for Full Lists.

W. H. WESTLAKE, Clawton, Holsworthy, Devon

Selling: Sony CRF-160 portable 13-band Rx, VHF/SSB, wide and narrow bandwidth, mains/battery, £50. — Harling, 3 Holly Street, Burnley BB10 4AN (Tel: 0282-38284).

Sale: BC-221 with power pack, £30. TS-174U with power pack, 20-250 MHz, £45. Racal SSB converter, £75. Transistor/diode tester, £25. FM tuner with power unit, £15. VHF receiver and PSU, £30. Carriage extra, s.a.e. with enquiries. — Hayward, Sunnyfields, Lighthouse Road, St. Margaret's Bay, Dover, Kent.

Sell or exchange: Eddystone 680X, best offer secures. Or exchange for low band receiver, 66-512 MHz. — Ring James, 0872-820182 (Cornwall).

Sale: KW-1000 linear, £175. K. W. Victor, £50. AR88LF, £30. BL-221, £20. Fuller phone test set, ex-W.W.II, £35 — Ring Cottrell, G3PSY, Tenterden 4531.

Selling: Heathkit SB-401 Tx, SB-303 Rx, SB-600 speaker, SB-610 monitor 'scope, HM-102 RF power meter, complete with manuals, £250 or near offer. — Ring Black, G8HPD, QTHR. (Tel: Wheathampstead 3307 after 6.30 p.m.).

For sale: Microwave Modules 432/144 MHz, brand new, £135. 70cm. Yagi, new. FR-DX400, £150. TC-10 Tx, £80. Complete Nikon outfit in case, with Kaiser copying stand, 5 lens, electric flash, filters, £400. — Coutey, G4KXX, Wilton, Grove Road, Hindhead, Surrey. (Tel: 042873-5947).

Selling: KW-77 Rx, £50. Star SR-550 Rx, £100. KW-204 Tx, £150. Codar AT-5 Tx with 250S PSU, £40. Standard SR-C826MB VHF/FM transceiver with PSU and SR-CMP14 mic., £100. All with manuals. Carriage extra. — Ring Plimmer, Findon (Sussex) 2317.

Sale: Yaesu FR-101D, as new, £200. U.S. Army RA-20, £20. R.C.A. 88D, £60. — Ring Kiryluk 0787-78460.

For sale: AR-40 rotor, TA-31 Jr dipole, only 6 months old (cost £108), accept £70. Western Electronics 40-ft. Alimast, telescopic, £30. Two 21-in. stand-off wall brackets, £10. First offer of £99 secures the lot. — Ring Ginger, Leicester 302430.

Selling: FT-101B, mint, £330. Gem-Quad 2-ele quad, requires new spider, good condition otherwise, £30. Hy-Gain 204BA 4-ele beam, requires new hardware, £50. — Ring Menzies 041-639 2173.

Sale: FRG-7, used very little, £150. — Ring George, Narborough 337630 (Norfolk).

Sale: Heathkit DX-40U and VF-1U VFO, with handbooks, £30. **Wanted:** FR-100B Rx and ATU. — Ring Williamson, Deeside 816435.

Wanted: 19 Set and ancillary equipment, any condition. — Ring Wuille, Worthing (0903) 41810 after 6 p.m.

Wanted: Any of the following receivers: Collins R388/51J-3/4, R.390/391, National HRO-500, G.E.C. BRT-400K, Hammarlund SP-600JX, Eddystone 730/4, Collins 51S-1. — Clappison, 190 Victoria Avenue, Hull HU5 3DY (Tel: 0482-43353).

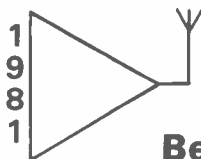

NORTHERN RADIO SOCIETIES ASSOCIATION

**Belle Vue Radio and Electronics Exhibition
in the Lancaster Hall**

on Sunday, 29th March, 1981
Doors Open at 11.00 a.m.

The North's Premier Amateur Radio and Electronics Event

Inter-Club Quiz
Construction Contest
R.S.G.B. Book Stall

Features
Grand Raffle
Amateur Computer
Stands

Radio Society's Stands
and Trophy
Morse Code Challenge

Home Office and Raynet Stands

Traders Stands who have booked space:

EUROVA LTD.
M & B RADIO
J BIRKETT
THE AMATEUR RADIO SHOP
RADIOTRONICS
LOWE ELECTRONICS LTD.
BREDHURST ELECTRONICS
CRAYFORD ELECTRONICS
S.M.C. (JACK TWEEDY) LTD.
J.M.C. ELECTRONICS
SOTA COMMUNICATION SYSTEMS LTD.

AMATEUR RADIO EXCHANGE
RICHARD WHITE
JOHN RADIO
N.W. REPEATER GROUP (Bring & Buy)
S.G. ELECTRONICS
GH, ENTERPRISES
WILSONS VALVES
MECHANEELEC LTD.
W. H. WESTLAKE
D.S. ELECTRONICS
MICRODIGITAL LTD.

ARROW ELECTRONICS LTD.
TELECOM
ROYD ELECTRONICS
F.R. GALKA
CONTOUR ELECTRONICS
TANDY CORPORATION (UK)
ACE MAILTRONIX LTD.
SOUND SERVICE
MARCO TRADING
MINICOST TRADING LTD.
JEWELL & POWERS

Belle Vue has ample car parks

F.M. Talk in on GB3NRS & GB8NRS/A on 145MHz Chs S22, R, & R,
and on 433MHz Chs SU8, RB4 & RB14

ADMISSION 40p. BY RAFFLE TICKET AND EXHIBITION PLAN
ENTER AT REAR OF BELLE VUE OPPOSITE MAIN CAR PARK OFF HYDE ROAD A57

R. T. & I. ELECTRONICS LTD.

where equipment is fully overhauled

EDDYSTONE EC10Mk. 1. Receiver	£131.10
EDDYSTONE EC10Mk. 2. Receiver	£165.60
EDDYSTONE 840C. Receiver	£109.25
EDDYSTONE 940. Receiver	£236.90
EDDYSTONE 990S. 230-870MHz. AM/FM	P.O.A.
DRAKE. SPR4 Receiver	£405.75
TRIO JR310 Amateur B.S. Receiver	£131.10
HAMMARLUND HQ170 Amateur B.S. Receiver	£213.90

We are MAIN DISTRIBUTORS for AVO, MEGGER, TAYLOR and SULLIVAN INSTRUMENTS

THE LATEST AVO AND TAYLOR METERS IN STOCK

AVO Digital Multimeter Model DA211	£51.75
AVO Digital Multimeter Model DA212	£74.75
AVO Digital Multimeter Model DA116	£122.93
AVO Digital Multimeter Model DA117	£155.25
Taylor Analogue Multimeter Model 131	£15.20
Taylor Analogue Multimeter Model 132	£21.85

Cases for AVO, TAYLOR & MEGGER instruments in stock.
Send for Details

We also repair all types of instruments
Trade and Educational enquiries invited

S. G. BROWN'S HEADPHONES. Type "F" 120 ohm, 2000 ohm, 4000 ohm, £29.95. Rubber Earpads for same, £3.26 per pr.: Standard Jack plugs, 50p.

ALL PRICES INCLUDE VAT AND CARRIAGE. *Terms:*
C.W.O., Approved Monthly Accounts, Hire Purchase and Part Exchange. Special facilities for export.

SINCLAIR EQUIPMENT	£58.99
DM235 Digital Multimeter	£10.92
Carrying Case for DM235	£5.17
Mains Adaptor for DM235	£35.59
PDM35 Pocket Digital Multimeter	£58.42
PFM200 Pocket Digital Frequency Meter	£204.75
YAESU MUSEN FRG-7 Receiver	£344.75
YAESU MUSEN FRG-7000 Receiver	£309.00
YAESU MUSEN FRG-7700 Receiver	£83.95
Memory Unit for above

At R. T. & I.

- ★ We have full H.P. facilities.
- ★ Part exchanges are a pleasure.
- ★ We purchase for cash.
- ★ We offer a first-class overhaul service for your electronic equipment, whether you are an amateur or professional user.
- ★ We have EASY PARKING facilities.
- ★ We welcome your enquiries for specific items which although not advertised, may very well be in stock.

PARTRIDGE "JOYSTICK". New improved VFA, £29.00. JOYMATCH IIIIB, £22.55. LO-Z500, £28.62. JOYMATCH A.T.U. Kit, £10.50. A.T.U. Kit assembled, £12.75. Artificial earth and bandswitch, £10.50.

TRIO EQUIPMENT.

New Trio R-300 Receiver, in stock, £193.89
All Bands with xtal calibrator.

SHURE MICROPHONES, 526, T £35.42; 444, £29.21; 401A, £14.95; 202, £13.80; 201, £13.11; 414A, £22.43; 414B, £22.43. Full details on request.

SCOPEX OSCILLOSCOPES IN STOCK.

VALVES. Please state your requirements.

TMK METERS: Model TP10S, £18.05. Model 500T-U-B, £33.23. Model TW20CB, £39.56. Model TP5SN, £21.27. Model 700, £68.42. Also in stock Leather cases for above.

Model 700B, £72.16. Model 3020E (Digital) £115.00. Full details on request.

In present conditions we regret that all prices are subject to alteration without notice.

R. T. & I. ELECTRONICS LTD.

Ashville Old Hall, Ashville Road, London E11 4DX Tel. 01-539 4986

NEAREST STATION: LEYTONSTONE (Central Line)

HOURS—9.30 am - 5.30 pm MON.-FRI. CLOSED SATURDAYS



NORTHERN COMMUNICATIONS

AMATEUR ★ COMMERCIAL ★ MARINE

YAESU, FDK, ATLAS, DENTRON, STANDARD, JAYBEAM
NAG, ASP, SWAN, G WHIP, MM, CDE, SEM



CUSHCRAFT Power and Performance ANTENNAS

ATV3 - Vertical 10/15 20	(a)	£35.40
ATV5 - Vertical 80/10m	(b)	£76.00
A144-7 - 7 element 10db Yagi 144Mhz	(a)	£24.95
A144-11 - 11 element 11.3db Yagi 144Mhz	(a)	£27.85
2148 - Junior Boomer 14 element 15db Yagi 144Mhz	(c)	£45.00
A3219 - 19 element "Boomer" 16.5db long Yagi 144Mhz	(c)	£64.00
ARX2 - Ringo ranger 6db Vertical 144Mhz	(a)	£26.50
AR10 - Ringo Ranger Vertical 10metres	(a)	£22.00
A10/3 - 3 element Yagi 7.6db 10metres	(b)	£52.00
A15/3 - 3 element Yagi 7.6db 15metres	(b)	£72.00
A20/3 - 3 element Yagi 7.6db 20metres	(c)	£139.75
AT834 - 3 Band HF Yagi 7.5db 10/15/20metres	(*)	£235.75

Prices include VAT, *carriage extra. (a) £1.50; (b) £2.50; (c) £3.50
M700E £199.00 M750 £299.00

OR our very own 2 metre 12 element ZL SPECIAL
ZL-12 13db gain from a 10ft 6in long boom (a) £28.75

NEW Portable, Compact 8 element ZL SPECIAL
ZL-8 9.5db gain only 6ft 0in long split boom (a) £17.25



303 CLAREMOUNT ROAD, HALIFAX HX3 6AW, West Yorkshire
VISIT OUR SHOWROOM - Tues-Sat inc. 9.45a.m. - 5.30p.m.
Tel: (0422) 40792 and 24-hour answering service G3UGF



NEW! - WIDEBAND ANTENNA - NORCONE

The new "NORCONE DISC 512" is a wideband, unity gain antenna, specially developed for coverage of 66Mhz to 512Mhz. An ideal partner for the BEARCAT and other scanning monitor receivers. It may also be used for transmission. Full coverage of 70, 144, 432 Mhz Amateur bands, Aircraft, Marine and Public Services (a) £24.95

SWAN 100MX HF TRANSCEIVER - Now at a Price You Can Afford

80-10 metre Solid State, compact HF rig for mobile and fixed operation. 2.5watts input. Send for details of this amazing rig! Including VAT £420.00

Mains PSU also available.

FDK - MULTI 700EX & 750EX

In the very best traditions of FDK the new M700EX (2m FM25 watts) and M750EX (2m Multimode Mobile SSB/FM) are here to offer you the very best in 2 metre operating at economic prices.

If you liked the Multi 700E then you'll love the EX version! The new M750EX makes it possible to work the SSB DX, without breaking the bank! Contact us for details.

J. BIRKETT

Radio Component Suppliers

25 THE STRAIT · LINCOLN · LN2 1JF

Telephone: 20767

405-475 MHz 3 PORT CIRCULATORS AND ISOLATOR with Conhex Sockets type HGA3552-2 By Microwave and Electronic Systems at £17.50.

SINCLAIR AA NICAD BATTERY CHARGER at £3.30.

MULLARD SUB - MINIATURE 1000pf 63w.w. DISCS at 25p doz.

4500 PIV 2 AMP SILICON DIODES at £1.50.

VHF CHOKES WIRE ENDED 10U.H., 30U.H., 330U.H. All at 7p each

FERRANTI WIRE ENDED SILICON DIODES 900 PIV 750mA at 12 for £1.

FET SIMILAR TO MPF 106 TEXAS TIS14 at 4 for £1.

MULLARD TRIMMER 8.9 Type 1 To 3.5pf, 1.8 To 10pf, 2 To 18pf All at 15p each.

EDDYSTONE TRANSMITTING VARIABLE 30 + 30pf (60pf) at £2.20.

SOLID SILVER WIRE ENDED TRANSMIT RECOVER AIRIAL SWITCHING PIN DIODES with circuits at 40p each.

B9A VALVE 9 PIN PLUG AND SOCKET at 25p A Pair.

SUB - MINIATURE CERAMIC TUBULAR TRIMMERS 0.5 To 3pf at 15p.

H.P. HOT CARRIER DIODES 5082 - 2800 at 40p each.

FERRITE BEADS FX1115 at 15p doz. 1/2" Long Type at 6 for 10p.

800 MHz NPN STRIPLINE TRANSISTORS BF 362 at 25p.

POWER TRANSISTORS BU127 at 60p, BU128 at 55p.

ITT BFY 16 T05 NPN TRANSISTORS at 6 for 50p.

80M CRYSTALS 10X Type 3642 5KHz, 3750 KHz Both 40p each.

X BAND GUNN DIODES with data at £1.65.

X BAND TUNING VARACTOR DIODES with data at £1.65.

X BAND SCHOTTKY BARRIER DETECTOR DIODES at 30p.

RADAR WIDE BAND AMPLIFIER I.C.'s with data untested at 5 for 60p.

3/16" COIL FORMERS with core at 6 for 25p.

TRANSISTORS 2N 2894, 2N 3947, 2N 930 All at 6 for 50p.

9 VOLT ITRON 9N DIGIT SEVEN SEGMENT DISPLAY TYPE FG95A at £1.80.

BECKMAN 3 DIGIT SEVEN SEGMENT GAS DISCHARGE ORANGE DISPLAY SP 363 at £1.95.

PLASTIC TRANSISTORS BC 548 or BC 549 at 6 for 65p.

COMMUNICATION SERIES OF I.C.'s untested with data, consisting of R.F., I.F., VOGAD, AGC., MIKE AMP, MIXER, All I.C.'s at 27p each.

FERRITE RINGS approx. size Ext. Dia. 24mm, Int. Dia. 11mm at 35p.

VHF FETS J304 at 30p, BF 256C at 4 for 75p.

SOLDER - IN FEED THRU'S 6 B, 27, 51, 300, 1000pf All 20p doz.

BELLING LEE SUB - MINIATURE CO - AX CONNECTORS Type L1403

Chassis Socket at 60p, L1403R Angle Plug at 60p.

GREENPAR BNC 50 OHM PLUG at 60p.

BELLING LEE BNC CONNECTORS L1637 Fixed Socket at 60p, L1637

Free Socket at 50p, Double Screen Types L1647 Free Socket at 50p, L1647 Fixed Socket at 50p, L1647 Nut Fixing Inboard Socket at 50p.

SPECIAL BFY90 TRANSISTORS In Stripline Form at £1 each.

CAPACITORS 10uF 370V A.C. 5/4" x 3/4" x 1/4" at £1.50.

BSF 21 MATCHED PAIR OF FETS at 50p pair.

BSV 81 INSULATED GATE VHF FET (MOST) at 30p.

N CHANNEL FETS 2N 3822 at 30p, 2N 3823 at 25p.

BA X53 HIGH SPEED BRIDGE TO92 Can 40 PIV 200mA at 40p.

DISCS 1uf 18v.w., 1uf 25v.w., 22uf 8v.w., .5uf 25v.w., All 5p each.

HIGH POWER VHF TRANSISTOR 175MHz 45v.w., FM or SSB 5 watt

Drive type 570BLY 28v with data at £8.30.

UHF POWER BFR64 470MHz: 12 - 24 Volt, 4 watt with data at £4.

UHF POWER Bt W82 13v 30 watt 470MHz at £9.80.

QUAD COMPARATOR LM 339 with data at 50p.

500 METRE REEL OF PVC CABLE 13 strands .019 at £10.

455 KHz CRYSTAL FILTERS B.W. ± 7.5KHz at 50p.

METAL FILM RESISTORS Tol. 0.5% 33, 39, 39.2, 65.7, 68, 82, 82.5,

100, 121, 123, 150, 240, 270, 274, 326, 330, 332, 360, 365, 470,

562, 619, 620, 680, 681, 700, 730, 750, 820, 856, 909, 910, 1K

All at 5p each.

Please add 30p for post and packing. Orders over £3 post free.

G4DSG D. P. HOBBS LTD. G3HEO

THE RADIO COMPONENT SPECIALISTS

YAESU FRG 7700, 150 KHz-30 MHz Gen. Cov. Rec. Dig. Readout and Clock £309.00
 YAESU FRG 7, .5-30MHz Gen. Cov. Rec. 1MHz Segments £199.00
 LOWE SRX30, .5-30MHz Gen. Cov. Rec. 1MHz Segments £158.00
 FDK 700EX 2mtr. FM, TCVR, Dig. Readout, Scan, Etc. £199.00
 FDK 750E 2mtr. FM, SSB, CW, TCVR, Dig. Readout £299.00
 DAIWA SR9 2mtr. Monitor Rec., VFO + 11 Fixed Positions £46.00
 R517 Aircraft Band Monitor Rec., VFO + 3 Fixed Positions £49.75
 REGENCY Digital Flight Scan Air Band Rec. with Memory £215.00
 REGENCY M100 Digital FM Scanning Rec. 66-90 MHz, 144-174 MHz, 440-512 MHz. £199.00
 DM350 50K P.T.T. Mics. £4.83 + 30p p&p
 DL20 Dummy Loads 15Watt (30W Peak) PL259. £6.04 + 30p p&p
 AY 3-8500 T.V. Games Chips £2.00
 FND500 Com. Cath. Displays £1.00
 40KHz Transducers £4.25 Pr.
 Electrolytics ideal for Linears, 400MFD, 400V. and 700MFD, 350V.

£1.20 each + 30p p&p

Microwave Modules, 2 mtr, 70 cm, 23 cm Converters, 2 mtr and 70 cm Transverters, Ascot, Bantex and Jaybeam Aerials.
 Vero Products, Ally and Plastic Boxes, Res., Caps., ICs., Transformers Etc., Bernards and R.S.G.B. Technical Books.

Prices include VAT. All Mail Orders to Luton. Access Barclaycard.

11 Kings Street, Luton, Beds. Tel. 20907

Open 9 am - 5.30 pm Mon - Sat. Closed all day Wednesday

Also visit **D. P. HOBBS NORWICH LTD.**

13 St. Benedict's St., Norwich. Tel. 615786

Closed all day Thursday

YAESU MUSEN

FT-101Z		FT-101ZD
FT-901		FRG-7
FRG-7000		FT225RD
FT227RB		CPU-2500R
FT-7B		FT207R
FT707		FT107
FT-101Z		

All ex-stock and FREE SECURICOR DELIVERY

APPOINTED JAYBEAM DISTRIBUTOR FOR NORTH WALES
 ASP MOBILE ANTENNAS. SEM PRODUCTS STOCKED
 FULL RANGE OF AMIDON TOROIDAL CORES IN STOCK

COPPER AERIAL WIRE 14swg Hard Drawn. 140'	£8.84
Same as above 70'	£5.34
POWER SUPPLIES 12v @ 4 amp.	£25.00
LOW PASS FILTERS 1 KW. 5db loss.	£19.50
SEM Z MATCH 160-10m.	£50.00
MULTIMETERS 1000V AC/DC 500K resistance.	£17.00
BALUN KITS 1:1 or 4:1 LF 160, 80, 40, 20m.	£5.86
HF 20, 15, 10m.	£7.05
SWR METERS 3.5-150 MHz TWIN METER.	£14.00
144 & 432MHz.	£17.00
QUAD SPIDERS.	£25.00
SR9 2m FM RECEIVERS.	£48.00
AIR BAND RECEIVERS + MW.	£15.00

Plus lots of other items inc. plugs, sockets, coax.

 *
 * **SEE THE NEW FRG-7700 IN STOCK NOW***
 * **ONLY £309 - two year warranty**
 *
 *

TMP ELECTRONIC SUPPLIES

Britannia Stores, Leeswood, Mold, Clwyd CH7 4SD
 Tel: Pontybodkin 846 (036287)

Shop hours: Mon, Wed, Thurs, Fri, 9.30-5 pm; Tues & Sat. 9.30-1 pm

SAMSON ETM-3C C-MOS KEYS

1µA battery drain - Why switch off?

● Self-completing dots/dashes/spaces ● Can be used either as normal electronic keyer or as an iambic mode squeeze keyer ● 8-50 wpm ● Constant 3:1 dash-dot ratio ● 6 C-MOS ICs and 4 transistors ● Plug-in PCB ● Long battery life - typically 1µA drain when idling - Built-in battery holder for 4 x 1.5 v. batteries (but will work over 3-10 v. range) ● PCB has both a reed relay (250 v., 0.5 amp., 25 w. max.) and a switching transistor (300 v., 30 mA max.) - either keying method can be used ● Has the well-known fully-adjustable Samson precision twin keying lever assembly ● Operate/Tune button ● Sidetone oscillator ● Grey case 4" x 2" x 6". ETM-3C, £66.86.

ETM-4C MEMORY KEYS: Has ETM-3C features plus 4 memories of 22 characters each (for 2 of 44). Erase/Rewrite memories as needed - Send CQ's etc. by pressing button. £124.95.

BUILT FOR DEPENDABLE MARINE AND COMMERCIAL SERVICE

JUNKER PRECISION HAND KEY: A superbly engineered straight key used for many years by professionals afloat and ashore. With this key you can't help but send good morse. Free-standing - no screwing down. Front and back contacts - fully adjustable gaps/tension. Key-click filter. Hinged grey cover, £39.87

BAUER KEYING PADDLE: Single-paddle unit on 1 1/2" x 2" base for home-built El-bugs. Adjustable gaps/tensions, £13.85.

All prices post paid UK and include 15% VAT
 Please send stamp with enquiries

SPACEMARK LTD.
 THORNFIELD HOUSE, DELAMER ROAD
 ALTRINCHAM, CHESHIRE
 (Tel: 061-928 8458)

REG WARD & CO. LTD G2BSW YAESU

FT901DM	£799.25	FT225RD	£489.00
FT901D	£724.50	FT225R	£449.00
FC902	£126.50	FT480R	£359.00
FT301D	£660.00	CPU2500RK	£322.25
FP301D	£140.00	FT227RB(Stl)	£281.75
FT101ZD	£569.25	FT207R	£199.00
FT101Z	£488.75	FT202R	£99.00
FT707	£500.25	YO101	£180.00
FP707	£109.25	YC500J	£189.75
FC707	£74.75	YC601	£120.00
FT73	£399.00	YP150	£63.25
FT200B/FP200	£399.00	FP12	£78.20
FR101DD	£690.00	FP4	£41.40
FR101S	£454.25	SD901	£28.75
FRG7700	£309.00	YD148	£21.27
FRG7000	£299.00	YD844	£21.27
FRG7D	£249.00	YE7A	£8.62
FRG7	£199.00	YH55	£10.00

SWAN

ASTRO 102BX	£798.00	PSU 6 (for 102)	£142.00
ASTRO 150	£613.00	PSU S (for 150/100)	£135.00
100MX	£418.00	ST3 ATU	£122.00

KDK FM202SE £225.00

Valves: Most types available. All valves for Yaesu and KW equipment stocked. We also stock: Shure microphones, Hy-Gain, Jaybeam, Ascot, Cushcraft. Agents for G2DYM Antennas. SEM equipment. Rotators and Rotator control cable. Co-ax and Twin Feeders. 'Co-ax' and Antex Antenna Switches. Aerial Wire and Hardware.

HP Available. Please check prices and availability before ordering. VAT at 15%, included in all prices.

ACCESS/BARCLAY CARD/TRUSTCARD.
 GEORGE STREET, AXMINISTER, DEVON EX13 5DP.
 Telephone: 33163 (Std 0297).

We give you the world.

Enrol in TUTORCOURSE and we'll take you step by step towards a full Amateur Radio Operator's Licence. Clip the coupon and discover the world.

FREE
BROCHURES

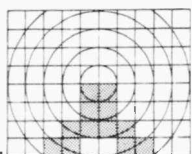
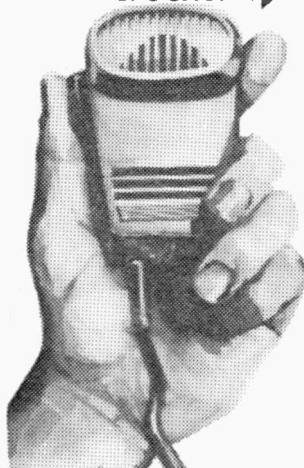

TUTORCOURSE Amateur Radio Operator

Please rush me details of your
AMATEUR RADIO COURSE

Name _____

Address _____

Block Caps Please

Post now, without obligation to
SWT/2

**British National Radio
& Electronics School.**

P.O. Box 156 Jersey Channel Isles

TRIO — YAESU

**MERSEYSIDE
AMATEUR
RADIO
SUPPLIES**

117 OXFORD RD
WATERLOO
LIVERPOOL L22
051 920 7483.

TUESDAY TO SATURDAY
10.00 — 17.00

**IN STOCK
NOW**

**YAESU
FT-480R**

**SOMMERKAMP
TS802**

**YAESU
FRG-7700**

ANTENNAS & ACCESSORIES

PART EXCHANGE WELCOME

ACCESS — BARCLAYCARD

**YOUR
SOMMERKAMP
IMPORTER**



1 Railway Road, Blackburn, Lancs. Telephone 51842
(Telephone Evenings, Bolton 592929 G4GHE.)



THE LATEST SOMMERKAMP — FRG7700 COMMUNICATION RECEIVER. 150KHz — 30MHz multimode, digital frequency readout, 12 programmable memories, variable bandwidth, built-in clock/timer. Price £389.00.

SOMMERKAMP 2 METRE RIGS

TS802 Hand held 80ch, 2watt. with battery charger £129. TS280 Mobile 80 ch. 50 watt £198.00. Low power version 10 watt £159.00. FT480 Mobile 30 watt £359.00.

SOMMERKAMP H.F. RIGS.

FT2772D (= FT101 with extras) £589.00. FT307 (= FT107 with extras) £899.00 FT767 (= FT707 with extras) £499.00

ROTATORS, ANTENNAS, GENUINE SOMMERKAMP SWR BRIDGES AND 12 VOLT POWER SUPPLIES.

All prices include VAT. Barclaycard and Access welcome. H.P. terms available. Part Exchange. S.A.E. for details

MORSE MADE EASY BY THE RHYTHM METHOD!

FACT NOT FICTION • No expensive equipment required only a turntable

If you start RIGHT you will be reading amateur and commercial Morse within a month. (Most students take about three weeks). That's why after 25 YEARS we still use three scientifically prepared special records with which you cannot fail to learn the MORSE RHYTHM automatically. It's as easy as learning a tune. 18 w.p.m. in 4 weeks guaranteed. Complete course comprising 2 x 12" + 1 x 7" multi-speed records + books. £5.50 plus (U.K. p.p. + 75p. Overseas, sufficient for 750 grms.) Despatch by return from: — S. Bennett, G3HSC. (Box 14), 46 Green Lane, Purley, Surrey CR2 3PQ. 01-880 2896

**ALL
VALVES
& TRANSISTORS**

Call or phone for a
most courteous quotation
01-749 3934

We are one of the largest
stockists of valves etc. in the U.K.

COLOMOR ELECTRONICS LTD. 170 GOLDHAWK ROAD
LONDON W12

MORSE CODE RECEIVING AND SENDING

Receiving: C-90 Cassettes. CASSETTE A for Amateur Radio examination preparation. Speed slowly increasing from 1-12w.p.m. CASSETTE B for Professional examination preparation. Computer produced morse from 12-24w.p.m. incl. international procedure signs and symbols and their incorporation into messages.

Sending: Morse Key and Buzzer Unit for sending practice and own tape preparation. Phone output. Prices: each cassette, incl. booklets, £4.75. Morse key and buzzer unit, £4.75.

Prices incl. postage, etc. Overseas Airmail £1.50 extra
M H ELECTRONICS (Dept. 3, 12 Longshore Way, Milton, Portsmouth PO4 8LS)

"CALLBOOKS" 1981 ARE NOW IN STOCK!

Foreign ("DX") Listings £9.80

U.S. Listings £10.30



The above prices include postage and packing

Publications Dept.,

Short Wave Magazine

34 High Street, Welwyn, Herts. AL6 9EQ

Tel: Welwyn (043871) 5206/7

THE RADIO AMATEUR'S HANDBOOK, 1981 (ARRL)

58th Edition

NOW AVAILABLE!

Soft cover, £7.80 inc. p/p

Hard cover, £10.80 inc. p/p

Publications Dept.

SHORT WAVE MAGAZINE LTD.

34 HIGH STREET, WELWYN,
HERTS. AL6 9EQ

SIMPLE, LOW-COST WIRE ANTENNAS

by William Orr, W6SA1

This excellent and thoroughly recommended handbook is the publication on the practical approach to building aerials. After starting with aerial fundamentals there are discussions and descriptions of ground-plane, end-fed, DX dipole, vertical and wire beam antennas, plus coverage on a universal HF antenna system and working DX with an "invisible aerial"; the SWR meter and coaxial cable also have chapters to themselves.

The whole book is presented in an authoritative, immensely clear, readable and enjoyable manner with the emphasis on the practical throughout — to the extent that even the chap who can hardly strip a piece of co-ax need not feel at all left out! Just as practical for the SWL, too!

192 pages

£3.50 inc. post

Order from

Publications Dept.

Short Wave Magazine Ltd.

34 High Street, Welwyn, Herts. AL6 9EQ

"S.W.M." DX ZONE MAP

New 9th Edition!

Great Circle projection on durable, quality, paper for wall mounting, 33¾ in. wide by 24½ in. deep. Giving essential DX information — bearing and distance of all parts of the world relative to the U.K., the Zone areas into which the world is divided for Amateur Radio purposes, with major prefixes listed separately. Distance scale in miles and kilometres. Time scale in GMT. Marking of Lat./Long. close enough for accurate plotting. Hundreds of place names, mainly the unusual ones, and most of the rare islands.

Zones and Prefixes corrected to August 1980

Price £3.35

including postage and special packing in postal tube to avoid damage in transit.

Publications Dept.

Short Wave Magazine Ltd.,

34 High Street, Welwyn, Herts. AL6 9EQ.

Tel: Welwyn (043871) 5206/7

Technical Books and Manuals

(ENGLISH AND AMERICAN)

AERIAL INFORMATION

Antenna Handbook (Orr and Cowan)	£4.10
Practical Aerial Handbook, 2nd Edition (King)	£7.90
Beam Antenna Handbook	£3.15
Cubical Quad Antennae, 2nd Edition	£3.15
Simple Low Cost Wire Antennas, by Orr	£3.50
73 Vertical Beam and Triangle Antennas (E. M. Noll)	£4.00
73 Dipole and Long-Wire Antennas (E. M. Noll)	£4.00
Antenna Book (ARRL) 13th Edition	£3.60
The ARRL Antenna Anthology	£2.75
Two-metre Antenna Handbook, F. C. Judd G2BCX	£4.35

BOOKS FOR THE BEGINNER

Questions and Answers on Amateur Radio, by F. C. Judd G2BCX	£2.05
Transistors Q & A, new 4th Edition (Newnes)	£2.05
Elements of Electronics, Book 1	£2.50
Elements of Electronics, Book 2	£2.50
Elements of Electronics, Book 3	£2.50
Solid State Short Wave Receivers for Beginners (R. A. Penfold)	£1.50
Beginners Guide to Radio (8th Edition)	£3.70
Beginners Guide to Electronics	£3.70
Beginners Guide to Microprocessors and Computing Course in Radio Fundamentals, ARRL	£2.05
Guide to Amateur Radio (new 18th Edition) (RSGB)	£2.95
Ham Radio (A Beginners Guide) by R. H. Warring	£3.95
Morse Code for the Radio Amateur (RSGB)	£1.20
Understanding Amateur Radio (ARRL)	£3.65
Radio Amateur's Examination Manual, 8th Edition (new syllabus) RSGB	£2.70

GENERAL

How to Build your own Solid State Oscilloscope (Rayer)	£1.75
Projects in Radio and Electronics (Newnes)	£2.60
How to Make Walkie Talkies (Rayer)	£1.75
How to Build Advanced Short Wave Receivers (Penfold)	£1.40
Better Short Wave Reception, 4th Edition	£3.00
FM & Repeaters for the Radio Amateur (ARRL)	£3.20
Easibinder (to hold 12 copies of "Short Wave Magazine" together)	£2.70
Oscar - Amateur Radio Satellites	£4.30
World Radio & TV Handbook 1981 Edition <i>available shortly</i>	
World DX Guide	£5.40
Guide to Broadcasting Stations (new 18th Edition)	£3.40
Radio Stations Guide	£1.75
Long Distance Television Reception (TV-DX) for the Enthusiast (revised edition)	£2.25
Solid State Basics for the Radio Amateur (ARRL)	£3.35
Counter Driver and Numeral Display Projects, Rayer	£2.05

Electronic Test Equipment Construction (Rayer)	£2.05
Power Supply Projects (Penfold)	£2.05

HANDBOOKS AND MANUALS

Radio Communication Handbook, Vol 1 (5th Edition) (RSGB)	£9.75
Radio Communication Handbook Vol. II (5th Edition) (RSGB)	£8.40
TVI Manual (2nd Edn.) (RSGB)	£1.85
Radio and Electronic Laboratory Handbook by Scroggie-Johnstone, 1980 (9th) Ed.	£19.05
RTTY Handbook (73 Magazine)	o/s
Slow Scan Television Handbook (73 Magazine)	o/s
Working with the Oscilloscope	£4.05
The Radio Amateur's Handbook 1981 (ARRL) soft cover	£7.80
The Radio Amateur's Handbook 1981 (ARRL) hard cover	£10.80
Shortwave Listener's Handbook	£3.30
Learning to Work with Integrated Circuits (ARRL)	£1.70
Weather Satellite Handbook	o/s
Single Sideband for the Radio Amateur (ARRL)	£2.95
Test Equipment for the Radio Amateur (RSGB)	£4.60
Amateur Radio Operating Manual (RSGB)	£4.90

USEFUL REFERENCE BOOKS

Solid State Design for the Radio Amateur (ARRL)	£5.00
Foundations of Wireless and Electronics, 9th Edition (Scroggie)	£5.85
Amateur Radio Techniques, new 7th Edn (RSGB)	£6.00
U.K. Call Book 1981 (RSGB)	£4.25
Hints and Kinks (ARRL)	£2.85
Radio Data Reference Book (RSGB)	£4.80
Electronics Data Book (ARRL)	£3.25
Radio Frequency Interference (ARRL)	o/s
Amateur Radio Awards, RSGB	£3.40

VALVE AND TRANSISTOR MANUALS

Towers' International Transistor Selector 1980 Edition (Up-Date No. 2)	£10.40
Radio Valve and Semiconductor Data (10th Edition)	£4.35

VHF PUBLICATIONS

VHF Handbook, Wm. 1 Orr	o/s
VHF Manual (ARRL)	£3.30
VHF/UHF Manual (RSGB) 3rd Edition	£8.20

O/P (Out of print)

THE ABOVE PRICES INCLUDE POSTAGE AND PACKING

O/S (Out of stock)

Many of these titles are American in origin

(Terms C.W.O.)

Prices are subject to alteration without notice.

Available from

SHORT WAVE MAGAZINE

Publications Dept.

34 High Street, Welwyn, Herts. AL6 9EQ - Welwyn (043871) 5206/7

(Counter Service. 9.30-5.00 Mon. to Fri.)

(GIRO A/C No. 5476151)