

Only  
£2.00

# Hi-Fi WORLD

APRIL 1994 £2.00

**NAIM NAC82 &  
NAP180  
AMPLIFIERS**

*See Supplement*

**NAD 501  
CD PLAYER**

**CASTLE HOWARD  
TRANSMISSION  
LINE 'SPEAKER**

**DIY SUPPLEMENT  
No. 7  
banded to this issue**

**SCOOP!**

**CYRUS  
SENSATION !**

**NEW MISSION  
TUNER AND  
AMPLIFIER**

**DENON  
DRM-540  
CASSETTE DECK**

**COMPETITION - PINK TRIANGLE DA CAPO  
CD CONVERTOR TO BE WON**



The truth,  
the whole truth,  
and nothing but the truth . . .



. . . so help me DPA!

It is a truth universally acknowledged, that clarity of sound allows true involvement with music.

Recognised Hi-Fi critics throughout the world have consistently praised DPA's products for their unrivalled clarity and transparency of sound reproduction. This inevitably leads to more profound musical experiences.

After years of development, the 200S pre and power amplifiers have been perfected. The amplifiers share the technology that has so inspired reviewer's praise in the past. The 200S combination at £1,250 gives state of the art performance at a reasonable price.

If you crave musical truth, contact DPA so we can help.

dpa

DPA Digital Ltd., Unit 7, Willowbrook Tech. Units, Crickhowell Rd., St. Mellons, Cardiff CF3 0EI Tel (0222) 795621 Fax (0222) 794267



# EXPERIENCE MUSICAL TRUTH



45 High Street, Hounslow, Middx.  
TW3 1RH  
Tel: 081 569 5802  
(Also at Edgware, Middx,  
Tel. 081 952 5535)



41 Victoria Road,  
Cambridge.  
CB4 3BW.  
Tel: 0223 68305

## NEW 200S PRE POWER £1250

### audible difference

Scale, Diss, Norfolk.  
IP21 4DX.  
Tel : 0379 740227

### Doug Brady Hi-Fi

Kingsway Studios,  
Kingsway North,  
Warrington.  
Tel: 0925 828009  
(Also at Liverpool, London  
and Otley, Nr Leeds)



Tel/Fax: 0252 377952



Royal London Buildings,  
Wulfruna Street,  
Wolverhampton.  
WV1 1LY.  
Tel/Fax: 0483 504801



Chantry Walk,  
16/18A Eldon Street,  
Tuxford, Nr Newark,  
Notts NG22 0LH.  
Tel: 0777 870372

### Audio Suite

42 St. Andrews Street,  
Aberdeen AB1 1JA.  
Tel: 0224 625 635



152A High Street,  
Bloxwich,  
West Midlands.  
Tel: 0922 493499



3 Bridge Street,  
Guildford,  
Surrey.  
Tel: 0483 504801

### SHROPSHIRE HI-FI

St. Michael's Street,  
Shrewsbury,  
Shropshire SY1 2ES.  
Tel: 0743 232317



41 Victoria Road,  
Cambridge.  
CB4 3BW.  
Tel: 0223 68305

### ZEUS AUDIO

2/4 Great Victoria Street  
Belfast BT2 7BA  
Northern Ireland.  
Tel: 0232 332522



### KJ WEST ONE

26 New Cavendish  
Street,  
London W1M 7LH.  
Tel: 071 486 8262

## AT OUR KEY DEALERS

# dpa digital ltd

Unit 7, Willowbrook Technical Units,  
Crickhowell Road, St. Mellons, Cardiff CF3 0EF, Wales, UK  
Phone: 0222 795621 Fax: 0222 794267

# THIS MONTH'S REVIEWS



Cover Photograph by  
Paul Hartley Studio 071-482 3768

## AMPLIFIERS

**MISSION CYRUS III** 14  
Can Mission build on the success of the previous Cyrus amps? Robert Wilson gets to grips with their latest offering.

**NAIM NAC82/NAP180** 24  
Naim bring the luxury of remote control to their new NAC82 preamplifier. Naim expert Malcolm Steward has a listen, and so does new boy Robert Wilson.



**AUDIO INNOVATIONS ALTO** 34  
Can valve experts make solid-state devices give a smooth sound? Dominic Baker listens intently.

**CAMBRIDGE P25 II** 48  
Noel Keywood and Robert Wilson take a look at both past and present of this most studios of amplifier manufacturers

## COMPACT DISC

**NAD 501** 18  
A new bitstream player using Philips' chips and Levi's number, but not in denim finish. Our man in Scarborough finds out if it's a rugged performer.

**ROKSAN ATTESSA** 28  
Eric Braithwaite samples the latest three-box CD player from the turntable specialists.

**QED REFERENCE DAC** 41  
Having made an impressive debut with their budget Digit DAC, Dominic Todd finds out if QED can go one better with the Reference.



**AMERICAN  
and  
CANADIAN  
SUBSCRIPTIONS**  
- see page 68

## LOUDSPEAKERS

**CASTLE HOWARD** 21  
Can a quarter wavelength design give really powerful bass? Did the earth move for Dominic Baker?



**JAMO CORNET** 33  
Will this budget offering from Denmark bring home the bacon? Robert Wilson investigates.

**NEAT CRITIQUE** 50  
Following in the footsteps of the Petite, Robert Wilson asks if the new Critiques can Boogie like their big brother.

## TURNTABLES

**MICHELL GYROPOWER QC** 57  
Has the gorgeous Gyrodec learned to lingo? Eric Braithwaite gets powered up.

**ORIGIN LIVE REGA ARM** 60  
Dominic Todd listens to an improved tonearm. A further fix for the vinyl addict.

## TUNERS

**MISSION CYRUS FM7** 14  
Does Mission's latest tuner sound as good as it looks. Robert Wilson scans the airwaves to find the answer.

**YAMAHA TX-670 RDS** 58  
Noel Keywood investigates the technicalities of a high performance RDS tuner from the experts, Yamaha.

## CASSETTE

**DENON DRM 540** 36  
Will this latest machine from Denon continue their excellent recording tradition? Noel Keywood gives it a close inspection.

**Editor**  
Noel Keywood

**Assistant Editor**  
Dominic Baker

**Editorial Assistant**  
Robert Wilson

**Production Editor**  
Ferewini T. Michael

**General Manager**  
Mark Winfield

**Marketing Manager**  
Richard Johnson

**Advertising Director**  
Caroline Knott  
Advertising Tel: 071-266 0969

**Design Engineer**  
Andy Grove

**Technical Assistant**  
Nick Lucas

**Contributors**  
Eric Braithwaite  
Richard Brice  
Giovanni Dadomo  
Peter Herring  
Simon Hopkins  
Dominic Todd

**Cartoonist**  
Freddy Ahmet

**Distributed by:**  
COMAG Tavstock Road, West  
Dorset, Dorchester, BH7 7QE  
Tel: 01258 441055

**Origination by:**  
Aldford Scoring  
2 Hatfield Drive  
Faywood Industrial Park,  
Aldford, Kent TN23 2FB  
Tel: 0233 622042

**Printed by:**  
Southprint, Pease, Dorset  
Tel: 01202 62216

**AUDIO PUBLISHING LTD.,**  
64 Castellon Road, Maid Vale,  
London W5 1LX  
Tel: 071 266 3533  
Fax: 071 269 5230  
Our lines cannot be answered  
by telephone

**MAIL ORDER**  
Tel: 071-266 0461 (24 hours)

**Subscription Rates:**  
UK: £22.  
Overseas Surface: £39. Airmail:  
£42 (Europe & Middle East).  
£62 (USA, Japan & China).

No material may be reproduced  
from this magazine without  
the publisher's written  
permission.  
© Audio Publishing Ltd

## REGULARS

**NEWS** 7  
All that's new in the wonderful world of hi-fi.

**LETTERS** 38  
More informed comment from our ever growing post bag.

**COLUMNS** 61,62,63,64.  
The world of hi-fi put into context by our resident experts.

**NEXT ISSUE** 60  
There's bound to be something in our May issue to get you dancing around the Maypole.

**SUBSCRIPTIONS** 68  
Guarantee that your copy of Hi-fi World is delivered to your doorstep hot off the presses.

**ACCESSORIES** 92  
All those little bits and pieces required to get your system into tip top condition.

**DIAL-A-DEALER** 81  
Go on, pick up the 'phone and book a demonstration. They'll be pleased to see you.

**WORLD AUDIO DESIGN** 89  
Fabulous products for those of you with soldering irons at the ready.

**WORLD FAVOURITES** 110  
A list of the equipment that really caused a buzz around the office.

**QUERIES** 115  
Help is at hand for those of you who are bewildered or lost in the hi-fi jungle.

**CLASSIFIEDS** 125  
Whether you're buying or selling, there's always a bargain or two on offer here.

**ADVERTISERS INDEX** 130

## FEATURES

**VALVES Vs TRANSISTORS** 52  
Noel Keywood plays devil's advocate as he canvasses people's views on this thorny subject.

**VDH FIRST AND SECOND** 31  
Using technology borrowed from Grand Prix motor racing, will Dominic Baker find carbon fibre has something to offer to music lovers.

## DIY SUPPLEMENT

**DIY SUPPLEMENT NO.7**  
This month's return to DIY features a phono head amplifier, kit transmission line loudspeaker from IPL, a feature on rare and exotic power valves for audio amplifiers, two excellent computer design packages for loudspeakers and much, much more.

## MUSIC

Our guide to some of the best new releases.

**ROCK RECORD OF THE MONTH:**  
Therapy? : Troublegum

**CLASSICAL RECORD OF THE MONTH:**  
Franz Schubert: String Quartets - The Hungarian Quartet

**ROCK AND POP** 73

**CLASSICAL** 76

**JAZZ** 85

## COMPETITION

**DA CAPO COMPETITION** 66  
Those clever gentlemen at Pink Triangle give you a chance to win the fabulous Da Capo CD convertor, one of the most advanced today.



# CONTENTS



## THERE'S A FIRST TIME FOR EVERYONE

An integrated amplifier from Meridian? It's true!  
The new Meridian 551 is our first time – but this is no ordinary integrated.

Just look at it and what do you see?

Power, elegance, simplicity, quality. What else would you expect from Meridian?  
It's what you don't see that makes this product a true thoroughbred and your best start to a Meridian system. Dual mono construction, a massive twin-wound toroidal transformer, four layer circuit boards to aerospace standard and a unique feedback topology with precision local error correction.

If it's your first time to try Meridian, discover the real audiophile quality is now within reach.

BOOTHROYD STUART  
**MERIDIAN**

Just clip this coupon and send it to Meridian Audio Ltd 14 Clifton Road Huntingdon Cambridge PE18 7EJ Tel 0480 52144 and we'll send you our new brochure.

Name \_\_\_\_\_ Age \_\_\_\_\_ Address \_\_\_\_\_

Postcode \_\_\_\_\_ Current system \_\_\_\_\_

Ref 04 94

## MORE FROM MISSION

Things have been busy in Huntingdon of late, as Mission expands its Cyrus range. Latest additions to the family include an integrated CD player, the DAD-7, a modular amplifier system, and some new speakers (jumping on the Home Theatre band wagon).

The 752 Reference Tower, which made its debut at the Las Vegas CES is a 2-way, reflex loaded floorstander using a 30 litre, time aligned enclosure. Technological innovations include the use of an 'Aerogel' bass/mid unit.

Catering for the Home Theatre market is the new 73 series, consisting of the 73C centre channel speaker and the 73I compact 2-way monitor.

The CD player uses some of the technology from the range topping two box machine, such as the top-loading transport (Philips CDM9) and the 18 bit DAC with 8x oversampling filter. All this in the standard Cyrus die-cast 'shoe-box' chassis.

Ease of upgradeability (and brand loyalty) is the key feature of the amplifier system. The pre-amp offers seven analogue inputs including plug-in phono modules for MM/MC. The 50watt per channel power amp can be mono'd at the flick of a switch to give double the power and high current delivery, when used with the PSX-R supply. All the other new electronics can also be upgraded with this 'intelligent' power supply.

Prices for the electronics and the Home Theatre speakers are, as yet, unavailable as we go to press. However, the 752 Reference Towers will shortly be on sale at £499.

Mission Group, Huntingdon, Cambridgeshire, PE18 6ED. Tel: 0480 451777.



## ROGERS INTRODUCE A NEW STUDIO

For almost 50 years Rogers have been producing loudspeakers for both the professional and domestic market.

The latest addition to the range is the Studio 5, a mid-sized, two-way bass reflex design, housed in a 20 litre veneered cabinet. The bass/mid-range unit is a 165mm polypropylene driver mounted in a rigid die-cast magnesium chassis which crosses over to the treble unit at 3kHz, this being a 19mm soft dome with a vented voice coil former and ferro fluid damping.

The Studio 5s are available in a choice of walnut, black ash and rosewood veneers. Prices start at £699.

Swisstone Electronics Ltd, 310  
Commonside East, Mitcham,  
Surrey, CR4 1HX.  
Tel: 081 640 2172.



D E S E R V E S  
C L O S E R I N S P E C T I O N



## NAD 302. European Amplifier of the Year '93-'94

“An amazing design which can bring true Hi-Fi performance to those unable, or unwilling, to spend a fortune.”



BRITISH BY DESIGN

NAD MARKETING LTD. NAD BUILDING, 401-405 NETHER STREET, LONDON N3 1QG. TELEPHONE 081-343 3240

World Radio History



## QUAD ESL-63 UPGRADE FROM EAR

Hot news from Tim de Paravicini of EAR, terror of Huntingdon and valve genius extraordinaire. He's decided to embark upon hi-fi's equivalent of climbing Mount Everest without oxygen. Tim has announced his intention to build a valve direct-drive amplifier for the Quad ESL-63 electrostatic loudspeaker. Yes, it has been done, in the States by Dynaco, but Tim claims he can do it better. It's a fantastic idea, in the broadest sense of the word.

At one go, a valve direct drive amplifier rids the ESL-63 of its input transformers and protection electronics. Needing to swing no less than 3,000volts at a rate of up to 1000V/ $\mu$ sec, the engineering involved seems unusually dangerous, but in fact it amounts to transmitter design practice, so it is not without

precedent. However, the amplifier must be integrated with the loudspeaker in one box for safety, so it will sit within a plinth that acts as a base for the Quad. By eliminating the internal circuits



of the Quad, as well as any need for a conventional external high current power amplifier, the valve amp idea offers an apparently near-perfect solution to the driving of electrostatic loudspeakers. Only a pre-amp is needed to feed each loudspeaker.

When contacted, Ross Walker, managing director of Quad said: "\*\*\*\*????!!+++++".

Sound quality is likely to be awesome, just like the engineering involved. Price will be fairly awesome too: around £3,400 per pair, including installation. Tim says the units should be ready by the end of the summer, 1994.

Additionally, he will be producing a self-powered subwoofer for the ESL-63, valve driven. Price will be around £1000/pair. Wistful transmitter designers should contact -

Tim de Paravicini, EAR Ltd., Unit 11, Stukely Meadows Industrial Estate, Huntingdon, PE18 6ED. Tel: 04804 53791.

## MOREL PUT MUSIC FIRST

Morel, manufacturer of high-tech loudspeaker drive units, has introduced some new high-end speakers. The Music First 705 is the first to be launched in the forthcoming 700 series.

The 705 is a three-way floorstanding design, engineered using all-Neodymium magnets. The enclosures are finished in satin black oak veneer.

Unique linearising technology promises clear, accurate reproduction in the bass and mid-range, as well as three tweeters per channel handling the highs.

All this high technology can be yours for £1,495 per pair including integral stands.

Real Music Distribution, Unit B12, Riverside Business Centre, Bendon Valley, Garrett Lane, London, SW18 4LZ. Tel: 081 875 9388



## WHARFEDALE RECRUIT

A surprise appointment in the revitalisation of Wharfedale was the recent recruitment of Malcolm Blockley as Managing Director. He brings enormous experience from running Hi-Fi Markets and NAD, which he helped start. Malcolm joins Stan Curtis, ex-Cambridge Audio, and John James, from Mission, on the board at Wharfedale.

Malcom Blockley's primary responsibility will be to oversee sales, we were told. And sales, it seems, are not a problem for Wharfedale nowadays. "We are shipping container loads of Karaoke loudspeakers to the Pacific Basin countries", Stan Curtis, Technical Director, told us. "There's more demand for our Modus Vivendi AV loudspeakers than we can easily satisfy, and a new range of Modus Vivendi hi-fi speakers are due onto the market within the next few months."

Wharfedale are now run by the Verity Group, whose chief executive is Farad Azima, founder and managing director of Mission. All the same, there is no management crossover between the two companies and Wharfedale operate independently although, needless to say, the group pools its buying power. Wharfedale does not now build loudspeaker cabinets; they come from Touchwood cabinets, also a part of the group. However, the company does still manufacture its own drive units, and will continue to do so.

There are plans for a range of electronics, and doubtless the company will in due course produce CD players and such like. Also due for revival as a top-end brand is the Leak name and we believe there has been discussion about a short run of replica Troughline valve tuners. Unfortunately, it was felt that if manufacture was recommenced, demand would be so great that it could not easily be stopped, forcing Leak to carry on where it left off thirty years ago.

Wharfedale Loudspeakers,  
Sandless Way,  
Crossgates, Leeds, LS15 8AL.  
Tel: 0532-601222



# **Try me & see** **For the very best** **DEALS for 1994!**

***on any current Hi-Fi, A/V,  
Home Cinema unit or VCR -  
AND all Award Winners***

**AMAZING PRICES GUARANTEED**  
***PHONE NOW - you'll get first-class  
service, savings and support.***

- ▶ Budget, Regular and Esoteric Equipment.
- ▶ Insured Overnight Delivery, anywhere in the U.K.
- ▶ Major Credit Cards, Switch/Connect accepted.
- ▶ All goods carry full Manufacturers' Warranty.
- ▶ TMS Warranty covering collection and delivery provided FREE.
- ▶ Extended Warranties up to 5 years available.

*You can always buy from TMS with the complete confidence that we will never let you down.  
We ever put our customers first and constantly upgrade and update our systems in order to improve our service.*

**081-563 0003**  
**Fax 081-563 0300**

**Try Me & See Ltd,**  
**5 Rocks Lane, Barnes,**  
**London SW13 0DB**

## MORDAUNT-SHORT ENTERTAINS AT HOME



"What?" I hear you ask - a hi-fi Hostess trolley. Well, no, actually. Those clever men (and women) at Mordaunt-Short have come up with some new speakers for their home entertainment series.

The stand mounted HT30 uses Mordaunt's 200mm MCS (Moulded Cone and Surround) bass/mid unit and the newly designed 25mm aluminium dome tweeter. The larger HT50 also uses the new tweeter with two 200mm woofers in a floorstanding enclosure. Both speakers feature magnetic shielding so you can put them next to your TV without sending it crazy, and also Mordaunt's Positec overload protection circuit, so that Mr Bond won't blow up your speakers along with everything else at the end of the film.

Prices are £149.99 for the small ones and £279.99 for the big ones.

Mordaunt-Short, 3 Ridgway, Havant, Hampshire, PO9 1JS. Tel: 0705 407722.

## ELECTROCOMPANIET

Esoteric Audio Imports have been awarded the sole U.K. distribution for the Electrocompaniet range of high quality amplifiers. These are designed by Rock musician Per Abrahamsen and have been built in Norway since 1977.

The range comprises two dual-mono power amps (250 and 100watts) two phono pre-amps, one line level pre-amp, a separate phono stage and an integrated amplifier.

Prices range from £561 for the phono stage to

£4,972 for the exquisite limited edition Anniversary pre-power models.

Esoteric Audio Imports, 6 Castleman Road, Chichester, West Sussex, PO19 4TL. Tel: 0243 533030.

## HARMAN TAKE A GAMBLE

The Las Vegas CES show was the venue chosen by Harman Kardon to introduce three new additions to its range of hi-fi separates - the FL8400 five disc CD player (£399), the AVR15 audio/video receiver (£699) and the HK3350 stereo receiver (£299).

The CD changer, as Harman want us to call it, features bitstream technology and a heavy duty mechanical chassis. For those of us wishing to join the Home Theatre revolution, the AVR15 provides Dolby Pro-Logic, multiple audio and video inputs and an integral AM/FM tuner, while the HK3350 receiver caters for the more traditional hi-fi user, providing a 30watt amp and a digitally-synthesised AM/FM tuner in a compact package.

Harman Audio, Unit 2, Borehamwood Industrial Park, Rowley Lane, Borehamwood, Herts, WD6 5PZ. Tel: 081 207 5050.

## BASS FOR MINIS AND MIDIS

Jamo has just launched a subwoofer loudspeaker system aimed the owners of smaller hi-fis.

The SW8 bass reflex subwoofer and Sidekick satellite speakers will retail for £149.99 (the Sidekicks are available separately for £54.99).

The subwoofer uses two 4" drivers in a 14 litre enclosure. Frequency range is quoted at 50 to 200 Hz for an 8 ohm load. The Sidekick's come with a built-in mounting bracket for ease of placement and feature a 3" drive unit spanning the frequencies from 100Hz-20kHz.

JAMO UK Ltd, 5 Faraday Close, Drayton Fields, Daventry, Northants. NN11 5RD. Tel: 0327 301300.



# Attesa

## SELECTED NATIONWIDE ROKSAN STOCKISTS

 <p><b>Roksan Attesa</b> CD Player</p> <p><b>AudioScene</b> 132 Chatsworth Road, Brampton, Chesterfield. Tel: 0246 204005</p>	<p><b>Q</b> WHERE CAN YOU HEAR A ROKSAN ROCK?</p> <p><b>A</b> HI-FI EXCELLENCE 293 UNION GROVE ABERDEEN AB1 6TD Tel: 0224 322520</p>	<p><b>Oxford Audio Consultants</b></p> <p>Specialist dealers in Roksan and other systems</p> <p>APOGEE, AUDIO RESEARCH, CASTLE, HEYBROOK, JPW, KRELL, MARANTZ, MICHELL, MUSICAL FIDELITY, NAKAMICHI, NAD, ONIX, PIONEER, ROTEL, ROGERS, RUARK, SD, SME, SONJUS FABER, STAX, TDL, THORENS, WADIA, WHARFEDAILE, etc.</p> <p><b>Cantay House, Park End St, Oxford OX1 1JE</b> Telephone: Oxford (0865) 790879</p>
 <p>For the most exciting range of equipment available in the Midlands. Now supplying</p> <p><b>ROKSAN</b></p>	<p>351 Hagley Road Edgbaston Birmingham B17 8DL Tel: 021-429 2811 Fax: 021-434 3298</p>	 <p><b>ROKSAN ATTESSA</b></p>
<p>156-157 Lower Bridge Street Stourbridge West Midlands Tel: 0384-444184</p>	 <p><b>AUDIO</b></p> <p>HI-FI FOR ENTHUSIASTS 41 VICTORIA ROAD CAMBRIDGE (0223) 68305</p>	<p><b>ROKSAN ATTESSA</b></p>



The Attesa ATT-DP2 CD Transport, ATT-DA2 D/A Converter, ATT-DS5 power supply

<p><b>THE LEICESTER HI-FI COMPANY</b> OF ST. MARTINS SQ. EST 1971</p> <p>"Isn't it brill that you can go into one shop and choose from all the leading brands of Hi-Fidelity equipment and guess what? We know what we're talking about, and we care!"</p> <p><b>Leading Roksan Specialists</b> 6 Silver Walk, Leicester Tel: 0533 539753 Fax: 0533 626097</p>	<p><b>kj</b></p> <p>CENTRAL LONDON'S ROKSAN CENTRE</p> <p><b>KJ WEST ONE</b></p> <p>26 NEW CAVENDISH STREET, LONDON W1M 7LH Tel: 071-486 8262/8263 Fax: 071-487 3452 Open: Mon-Sat 10am-6pm Thurs until 7pm</p>
<p><b>THE ROKSAN ATTESSA</b> on demonstration at</p> <p><b>mike manning</b> the hi-fi specialists audio</p> <p>WE STOCK, DEMONSTRATE &amp; INSTALL THE BEST RANGE OF QUALITY HI-FI IN THE SOMERSET AREA AND OUR PROFESSIONAL ADVICE &amp; AFTER SALES SERVICE IS SECOND TO NONE</p> <p><b>Our reputation is your Guarantee</b> 110 Middle Street Yeovil Phone: 0935-79361</p> <p>Interest Free Credit Please phone for details</p>	<p><b>THE MOST EXCLUSIVE INDEPENDENT HI-FI STUDIO</b></p> <p>Largest stockist of Roksan in the Midlands - 3 demo rooms Open 6 days a week Enquiries welcome for interest free (APR 0%) Evening demonstrations by appointment (Share the ASDA car park) just off the High Street, near Walsall, West Midlands, W53 3JT</p> <p>Tel: 0922 493499 and 473499</p> <p>Just call in or phone Richard or Dorian for a demonstration</p> <p><b>Solo ACADEMY</b> EST 1981</p> <p><small>ALBARRY • AUSTIN ENERGY • AUDIO LAB • AUDIO ALCHEMY • AUDIO QUEST • BSW • BOSE • CABLE TALK • CHORD • CYRUS • DPA • ENSEMBLE • EROS • INFINITY • JPW • KEF REFERENCE • MARANTZ • MERIDIAN • MICROMEGA • MISSION • NAD • MUSICAL FIDELITY • NAKAMICHI • ORTOFON • QJAD • PROJECT • ROKSAN • RYGGERS • ROTEL • SPENDOR • SUMKO • SYSTEMDEK • TDL • THORENS • TRIANGLE • TUBE TECHNOLOGY • VAN DEN HUL • VANDERSTEEN • YBA</small></p>

**ROKSAN** ROKSAN LIMITED Stockley Close, Stockley Road.  
West Drayton Middlesex UB7 9BB U.K.  
Tel: 0895 436384 Fax: 0895 436 385

# Atessa

SELECTED NATIONWIDE ROKSAN STOCKISTS

**Q** WHERE CAN YOU  
HEAR A ROKSAN  
ROCK?

**A** HI-FI EXCELLENCE  
293 UNION GROVE  
ABERDEEN AB1 6TD  
Tel: 0224 322520



## Doug Brady Hi-Fi

KINGSWAY STUDIOS  
KINGSWAY NORTH  
WARRINGTON, CHESHIRE

TEL: (0925) 828009 FAX: (0925) 825773

ALSO AT LIVERPOOL,  
OTLEY - YORKS, AND  
LONDON - COVENT GARDEN



7 St. Pancras, Chichester, West Sussex PO19 1SJ  
Telephone 0243 776402 Closed Mondays

## the powerplant

Brighton's Leading Hi-Fi Shop  
in ROKSAN EQUIPMENT  
Comfortable listening room, knowledgeable and approachable staff

Roksan, Micromega, Audiolab, Exposure, Epos,  
B&W, Ruark, Tannoy, Ratel, Marantz, Yamaha  
and other fine equipment.

66 Upper North Street,  
Brighton.  
Telephone 0273 775978



The Atessa ATT-DP2.P CD Player

## West Midlands Audio

158 OMBERSLEY ROAD, WORCESTER WR3 7HA  
TELEPHONE 0905 58046 • FAX 0905 57585

**ATESSA • TMS • DA1/DS1  
ALL ON DEM**

On demonstration - the three  
best CD players available:  
Naim CDI, Micromega CD3  
& Roksan Atessa

## Infidelity

9 High Street, Hampton Wick,  
Kingston upon Thames, Surrey KT1 4DA.  
Tel: 081-943 3530  
Open Tues - Fri 10.30 - 7.00, Sat 10.00 - 6.00

## The NORFOLK/SUFFOLK High End Dealer *audible difference*

Near DISS, NORFOLK

ATESSA + ALSO A WIDE VARIETY OF C.D. PLAYERS  
AND DACS ON DEMONSTRATION

PLEASE RING FOR AN APPOINTMENT  
0850 983233/0379 740227

For the great sound of sound:

### The Cornflake Shop

37 Windmill Street London W1P 1HH  
+071 631 0472 +071 436 7165

We are the UK's No. 1 Roksan Dealer. Excellent  
demonstration facilities with the world's best performance  
HiFi. Global mail-order service.

# ROKSAN

ROKSAN LIMITED Stockley Close, Stockley Road.  
West Drayton Middlesex UB7 9BB U.K.  
Tel: 0895 436384 Fax: 0895 436 385

# CYRUS THE KING

**Mission recently introduced their new Cyrus range of electronics. We first caught a glimpse of their complex and expensive die-cast alloy casework whilst visiting a sub-contractor about our own chassis work. Impressed, we've been pursuing them ever since! Noel Keywood tracked them down and tested them. Robert Wilson - a Cyrus fan - had a long listen.**

## MISSION CYRUS FM7 TUNER

A good tuner can bring music and information from around the globe into our living rooms. I listen to the radio a lot as a result; it has so much to offer compared to the TV. For me a good tuner is a Godsend and that's what the Cyrus is - a very good tuner.

Mission's build quality is superb. The casing of the Cyrus just oozes class - and for a very good reason. Whilst a majority of manufacturers use a particular build method that is satisfactory and, of course, cost effective, Mission break the mould. They use an expensive and complex diecast chassis possessed of curves and forms not possible using any other method. Castings are extremely strong and rigid too; as a result this tuner feels unusually sturdy. The soft green backlit display was soothing on the eye and ergonomically a dream, like the rest of the Cyrus' facilities.

Tuning can be carried out either automatically or manually. The lazy only have to press 'seek', and for those of us who still prefer to use clutch pedals and the like, Mission have provided a wonderfully weighted rotary tuning knob. When you reach your desired station the signal meter bar-graph pans across the

display until the lock indicator lights up, as does the stereo symbol (if the broadcast is transmitted in stereo). Pressing the 'Fine' button the display changes to Magic Eye Mode so that you can accurately tune-in using 10kHz steps. It's easier to do than explain, and so is using the seven presets, but all this is clearly laid out in Mission's excellent instruction manual. Don't worry if you're one of those people who need their five year old to programme the video, because your toddler will be able to master this tuner easily.

Once all the operational niceties were sorted out the listening began. Let's just say the Cyrus had a tough act to follow as I'd previously been using Noel's Leak Troughline, in a system based around Audiolab's 8000 pre-amp and monoblocks and the very revealing Heybrook Sextets.

What greeted me as I locked in to Radio 1 was a tight, full and dynamic bass, with loads of verve and punch. Jingles used to lead into the hourly news bulletins blasted forth from between the speakers with an impressively full and dynamic sound which couldn't fail to grab the attention. As the news editor switched to an outside broadcast from



## MISSION CYRUS III AMPLIFIER

With all the success that Mission has had with the Cyrus I and II amplifiers in the past, it was with bated breath that I awaited our review sample of the all new Cyrus III.

Like its predecessors, it comes in Mission's shoe-box-sized enclosure, being 215mm wide, 73mm high and 360mm deep. However, as usual, the casing is gorgeous. A magnesium alloy inverted diecast chassis endows the little Mission with both solidity and the appearance of being hewn from solid metal ingot.

The latest Cyrus has an opening trick up its sleeve too. Mimicking the Hewlett Packard test equipment used at Hi-Fi World and at Mission, it goes through a power-up routine. This constitutes a display of flashing lights. On HP equipment, it signifies the on-board computer is performing checks and calibrations. Doubtless as intrigued and perhaps awed by this sort of NASA technology as we are, Mission have built the same facility into the Cyrus. Turn on the mains power and it flashes every front panel LED in fast sequence. After that, the front panel power switch glows red, showing the amp is in stand-by.

The ergonomics of the Cyrus are a lesson in clarity. The volume control is a

bit unusual - possibly gimmicky - but in a very useful way. Around the rotary dial are fifteen equally-spaced green LEDs, the first one glowing red to show the control's minimum. As you move the knob, the green LEDs progressively illuminate. 'Big deal', I hear you say, but this comes in handy when using a remote from twenty feet away!

This, however, is not the cunning part, nor the most exhibitionist. That occurs when you press the balance button. Suddenly, the volume control acts to set balance and, in doing so, lights up all the LEDs, except the one showing balance control position. Whereas volume is shown by one illuminated LED, balance is shown by one extinguished LED - and the LEDs extinguish sequentially as balance is adjusted. Neat, eh!

Other switches include selection for four line level sources, an MM phono stage and tape inputs. These are delicate micro-processor controlled push-buttons, as are the Mute and Stand-by switches. The main on/off switch is around the back, alongside the gold-plated phono sockets, pre-amp output sockets (handy for bi-amping) and a DIN socket for connection to the Cyrus PSX-R power supply upgrade.



**Cyrus FM7, continued . . .**

the USA I was transported to a New York street, the Cyrus capturing all the ambient information and layering it into a wide, deep image of a place thousands of miles away. There were cars driving past the mic., people hailing taxis and milling around all within, of course, a large open space - one the Mission conveyed beautifully. With my eyes closed I found it totally captivating.

Voices were crystal-clear and tonal variations were concisely and beautifully portrayed, even if the Mission did make them slightly more 'chesty' than the Leak. Variations of emphasis, inflections and pauses in the spoken word were perfect, the ability of this tuner to

communicate was truly excellent. Our aural discrimination with human speech is considerable, so when a tuner places a DJ right into the living room, as this one did, then you know it's good.

Emma Freud was a dream come true! She was vivacious and enthusiastic, if a little rougher around the edges than through the Troughline. Fine detail like the 'pop' and 'thump' one hears when an announcer gets too close to the mic became incredibly evident with the

Mission, as was background studio noise, papers rustling, doors opening and the general ambience of a small enclosed space.

I couldn't believe my luck when a track by the gorgeous Aretha Franklin came on air. The intro was delicious as the cymbals sparkled alongside a tingling hi-hat, all the better for the ribbon tweeter of the Heybrooks. If pushed, I'd have to say that the Cyrus was possessed of a slightly better bass than the

*Variations of emphasis, inflections and pauses in the spoken word were perfect, the ability of this tuner to communicate was truly excellent.*

Troughline. The extension (for a tuner) was superb, as was its overall musical quality, which I'd describe as tight, punchy and full of life; I believe Scots refer to that as 'tuneful'.

The mid-range was so open, like French windows on a balmy summer's eve, that Ms. Franklin was there with bags of emotion, real Soul Music with just a hint of a lisp around the edge, as it were. This was due to over-compression after the studio, which always leads to breathy

vocals. Listening to a Kate Bush CD, the same breathy effect on her vocals was evident, but it was again due to Optimod compression, which is applied to the audio signal before it is broadcast. Tuning in to Classic FM, the Mission locked on to a huge soundstage, stretching right across the room with rigid central placement of images and great atmospheric depth. Image placement was concise, all the parts panned to their respective places in the mix. Instrumental timbre was very good too, if a little darkened when compared to a reference. Brass enjoyed a metallic rasp and string sections positively soared.

As you may have already guessed, I came to adore this tuner; it's musical,

communicative, incredibly detailed and an absolute steal at £299. The Cyrus isn't quite a Troughline, but then again to build a similar valve tuner these days would probably cost three, if not four times the price of the Mission. The fact that the build quality is exemplary and that it looks exquisite make the drawback of having 'only' 7 presets pale into insignificance. If it wasn't for the latest NAD tuner, then the Cyrus FM7 would be the unchallenged broadcast bargain of the year ●

**Cyrus III, continued . . .**

The Cyrus pumps its 50 watts per channel (65watts when PSX'd) into the loudspeakers via a set of 4mm banana sockets; there are no terminals for bi-wiring.

Well, I suppose I'd better come clean, and nail my colours to the mast - I'm a Mission Cyrus fan. There's something about their sound that is particularly endearing. I have a Cyrus I at home, to use as a budget reference, and I've yet to find anything to touch it at the price as far as sound and build quality are concerned. So I was hoping that the 'III' would improve on this, and it did - marvellously!

The sound was astonishingly lively and free, like a breath of fresh air. The incredible fluency and poise of the Cyrus was blatantly obvious from the first few bars of Steve Earl's 'Copperhead Road', where the crisp metallic resonance of a National guitar blended perfectly with a damped snare, before the powerful impact of the kick drum brought passion and rage to the track.

Using a highly analytical and revealing system of a TEAC CD Transport sync-locked to a DPA PDM-II/III two-box convertor and a pair of Heybrook Sextets the little Cyrus more than held its own, never sounding out of place in this esoteric company.

With a much-used example of Mr.

Knopflers' 'Love over Gold' the resulting image height was extraordinarily lifelike, the sonic dimensions being perfectly proportioned with pin-point placement and nothing seeming unduly out of place. 'Private Investigations' is a very dynamic track and the Cyrus left no doubt of this, drums blasting out of the soundstage, pinning me to the sofa after I'd been stunned by the explicit attack of the acoustic guitar in all its glorious purity. The

*For one so small, the Cyrus can really pack a punch.*

whole studio acoustic was resolved with a wealth of detail and ambient information.

Other tracks gave tantalisingly solid portrayals of Hammond organ sounds; I could picture their Leslie speakers rotating. Piano arrangements positively sparkled as did the treble. Hi-hats were so sharp they cut through the mix like a diamond edged blade. This amp is very enthusiastic, sounding fast and agile, if sometimes a little too hasty with vocals. Put simply, the Cyrus loves to rock and roll.

For one so small, the Cyrus can really pack a punch. Those 50 watts are certainly very powerful ones. They gave the bottom end great presence, with astounding

weight and speed. The Mission made mincemeat of the torture tracks that I threw its way, playing the acoustic bass on Fairground Attraction's album as if it was standing on its head.

Temptation got the better of me and I had to try the Cyrus' phono input, especially as I had Andy's prototype phono stage (see DIY supplement) sitting next to Noel's wonderfully modified Garrard/SME turntable. The sound

remained pretty much the same. With the latest Lemonheads album the bass was slightly lighter, but just as quick and agile. In fact, overall, the sound was marginally laid back with the treble and mid band a little

warmer, and although the treble was deliciously sweet with the metallic ringing of the ride cymbal, it didn't quite have the incisive nature of Andy's pre-amp. One thing is certain, the phono input isn't an afterthought, even if it does have perceptibly light bass, with little real slam.

Mission really have managed a double whammy. The tuner is a delight and the amp is amazing. It's coherent and fluent, images beautifully and has a neutral, detailed presentation way beyond its price point. If I had £500 in my pocket to blow on a new amp, then this would be the one I'd buy ●



## MEASURED PERFORMANCE

The new FM7 possesses a wide, flat audio frequency response that reaches up to 14kHz (-1dB), as our response analysis shows, before filtering suppresses pilot tone at 19kHz and sub-carrier at 38kHz. As Mission claim, output from these products, plus intermodulation of programme around them, was well suppressed, ensuring low levels of unwanted products above 15kHz.

Channel separation was very high at -50dB in the midband and -46dB at high frequencies (10kHz), so low levels of crosstalk are present, always a good sign.

Actual distortion levels were also very low - around 0.1% - on the main sum (mono) signal and in the difference channel. This compares with the best. Our distortion analysis shows the presence of a small amount of third harmonic, which is unlikely to have much subjective impact.

Mission have managed to ensure the FM7 is subjectively hiss-free at full quieting, possessing -75dB hiss level. For this it needs a signal of 1.2mV from the aerial, or more.

The signal strength meter isn't good enough to show how an aerial is really performing, which is a pity. All the same, Mission's indicator looked good and worked well enough to be useful.

Sensitivity was a little lower than usual,

measuring 30µV, but this would barely be noticeable in use, except to someone trying to capture very distant, weak stations. Station rejection (selectivity) was unusually well balanced either side of the IF passband, measuring an impressive 85dB, so the FM7 is very selective and will pick out weak stations even when very strong ones are close by.

The new Mission FM7 performed very well all round under test. It offers a high standard of performance and is completely free of foibles or unusual behaviour. The superbly controlled IF passband characteristic indicates that Mission's advanced test facilities result in a better product, in this case from good design and accurate, repeatable final alignment. **NK**

### TUNER TEST RESULTS

Frequency response	3Hz-14kHz
Stereo separation	50dB
Distortion (50% mod.)	0.1%
Hiss (CCIR)	-75dB
Signal for minimum hiss	1.2mV
Selectivity (at 0.4MHz)	85dB
Sensitivity	
mono	1.6µV
stereo	30µV

Signal strength meter

50% = 40µV  
100% = 500µV

### Distortion

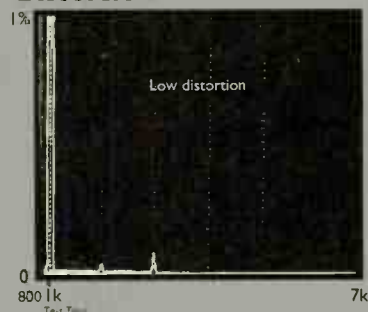

### Frequency Response

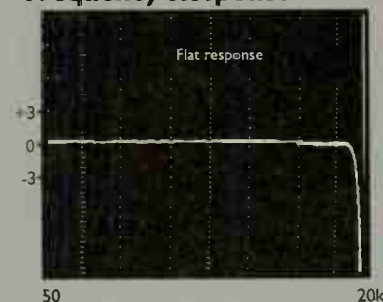

## MEASURED PERFORMANCE

For such a small package, the Cyrus turns out a lot of power - 66watts into 8ohms and no less than 100watts into 4ohms. It is unaffected by reactive loads too, so it will drive most loudspeakers with ease.

The new Cyrus is microprocessor controlled and its push buttons are message senders; they do not switch the audio signal directly. Likewise the volume control, which is a rotary transmitter that tells a solid-state attenuator to operate, rather than controlling volume directly. This brings an unusual operating law to the volume control, since it rotates continuously, having no end stops, and the degree of rotation for a volume change is much greater than usual. Or in other words, more twiddling than usual is needed to change volume. Putting everything under electronic control allows remote control to be applied.

The CD input has a wide frequency response: 9Hz-60kHz within 1dB. There's enough bass extension to do justice to CD and treble starts to roll off slowly above 20kHz, which is wise, becoming -1dB at 60kHz. The unequalised inputs, including CD, are sensitive enough to accept low output sources, needing just 230mV for full output power to be achieved. Distortion was low and our analysis shows that

innocuous second harmonic prevailed at high frequencies, indicative (but not proof positive) of clean-sounding treble. The Cyrus measures well through its CD and 'flat' inputs, as it always has done.

Like earlier models, I seem to remember, the Cyrus III has a curious disc stage performance characterised by slowly falling response below about 600Hz, culminating in a roll-off in deep bass that starts high up at 50Hz and reaches 12dB/octave attenuation, which is steep. This whole filter results in very light bass from LP; I was taken aback at just how anaemic the Cyrus sounds in this department. There's a little hiss, but it isn't very obvious. A curious form of distortion, dependent on attenuator position, set in at inputs above 50mV too, which was most unusual. The disc stage was described as 'unimpressive' by three listeners, including myself. This is in contrast to the line inputs, for which the Cyrus receives acclaim, from Dominic Baker and Robert Wilson on our staff, as one of the best going. **NK**

### TEST RESULTS

Power	66watts
CD/tuner/aux.	
Frequency response	9Hz-60kHz
Separation	88dB
Noise	-90dB
Distortion	0.004%
Sensitivity	230mV
dc offset	2/14mV
Disc (MM)	
Frequency response	50Hz-52kHz
Separation	50dB
Noise	-75dB
Distortion	0.006%
Sensitivity	3.2mV
Overload	50mV

### Distortion



# BARGAIN

# BASEMENT

**Dominic Todd, temporarily on a tight budget after buying several pairs of the other 501s, tries out NAD's new low-cost CD player with the Levi's number on it.**

Technics player that could get close as far as sound quality is concerned, in my opinion.

The modifications to the basic Philips set-up centre mainly around the power supplies. So, for example, the DAC has a dedicated power supply, the analogue

**J**ust as NAD's competitors feel it's safe to come out of hiding, after a spate of superb budget equipment releases, NAD have gone and done it again. This time it's the CD market that's going to take a knock



from NAD's extraordinary ability to produce giant slaying electronics at near farcical prices.

It obviously wasn't enough for NAD to already have a highly rated 502 CD player right in the midst of the ultra-competitive £200+ price category, priced at £219.95. Rather than upgrading this existing player and fielding a £300 player, as is the norm these days, NAD have gone to the other extreme and produced a player for a mere £179.95.

The biggest surprise of all, though, is

that NAD have ditched the usual Technics-based MASH system and, for the first time ever, chosen a Philips mechanism and Bitstream conversion. As with all NADs, there's nothing particularly fancy or frivolous about the new 501 compact disc player. The basic layout is quite similar to most of the older budget Philips machines and others such as the £230 Rotel RCD 945. The CDM-4 transport is a little old-fashioned by today's standards, but it's nothing to be ashamed of, as even players such as the £1400 two-box Orelle still use such a mechanism.

As is often the case with NAD, the basic specification is nothing special, but what makes their equipment sound so good is the care with which the technology is implemented. Although the previous machines were based on Technics chipsets and transports, you wouldn't be able to find a similarly priced

sections have separate, regulated power supplies, and there is complete separation of the digital and analogue stages.

You'd have to be a dedicated Nadophile to spot the differences between this and previous machines. The only physical differences between this model and the 502 are a slightly smaller drawer (to accommodate the new transport), Philips-type transport locks underneath and the addition of a 'pause' key. Other than that it's pure NAD, which means lightweight build quality, matt grey front panel, small and dim display, and good ergonomics, partly due to the fact there are so few features on offer.

Where's the catch then? It's simple, there's no remote control, although you can control it via the remote on a NAD 701 or 705 receiver.

Using Bjork's Debut album, I put the 501 through its paces to see if it was capable of pulling off the same star performance as other NADs have recently. Needless to say, I was highly impressed. The sound was full-bodied in a way that even the occasionally thin sounding 502 couldn't hope to emulate. This gave more presence to Bjork's vocals

which can sound decidedly anorexic on lesser machines.

NADs have never been ones for a 'laid back' balance, tending to favour a more forward balance with plenty of detail. The 501 is no different here. The Commitments' second album could occasionally sound edgy in places, but this was compensated for by a real enthusiasm and verve shown for the music. Vocals could sound a bit larger than life, but once again showed improvements over previous NADs in having a warmer balance and less of a tendency to 'shout' at the listener. Yet traditional NAD values of fine articulation and detail were still present. Complex bass lines, which can overcome some budget (and even mid price) CD players, were handled competently, with only a mild degree of muddle and bass overhang.

Sound quality showed some of the qualities of the QED Digit, in that it was very clean and precise, with good separation between the vocalists and backing instruments. No doubt this is something to do with the attention shown to power supplies in both cases.

An expansive and deep soundstage was prominent, although the slightly too powerful vocals and warm bass created this impression somewhat artificially. Nonetheless, the sound was involving without too many of the harsh constraints, such as compression, that

budget players can often portray.

With classical music, the 501 didn't quite manage the same success it achieved with rock and pop. Although the fine separation and broad soundstage suited large scale orchestras, there wasn't the sheer dynamic scale to the sound that can make all the difference. Having said that, I'd be hard-pushed to name another player under £260 that can create the required dynamics effectively. More delicate violin and flute solos suffered from a lack of subtlety and delicacy, lacking fluidity and sounding a little stilted, with occasional hardening.

Although some of the sound quality observations may seem to be less than flattering this is still an excellent machine, and the criticisms are part and parcel of all machines at this sort of price anyway. So, considering it's £180, the 501 offers a superb sound quality capable of rivalling, or even exceeding, machines costing up to £260 (and even the odd duffer above that). I'd even go as far as to say that it sounds comprehensively better than the more expensive 502, giving only a little away in terms of bass articulation and mid range clarity. The 501 offers a much more rounded sound that allows it to be less fussy about the choice of music or system that it's to be matched with. Music bubbles with enthusiasm, and the lively, detailed balance with rock, pop and even jazz and folk, belies the player's dowdy grey appearance.

Don't expect the last word in truthfulness, though. The 501 has a distinctive character that does colour the sound and can be rather off-putting on material that requires more than guts. It's here where more expensive players such as the Rotel 965 Discrete and Arcam Alpha 5 show just what the extra money is being spent on. Anybody who predominantly listens to chamber music or classical soloists, will find that the more expensive machines really score here.

The 501 can't quite claim the awesome ability of its sister 402 tuner. This isn't the best-sounding CD player at under £400, as most £300+ players will show an improvement. Unlike the jeans from which it takes its name, the 501 is unlikely to become a legend. Yet it is an excellent value-for-money CD player, with no real rivals at the price and an enjoyable sound quality that will disappoint few.

Long may NAD continue their winning formula of gimmick free products that offer arguably the best sound quality for money ●

**NAD 501 CD Player** **£179.95**  
**NAD Marketing Ltd.,**  
**Adastra House,**  
**401-405 Nether Street,**  
**London, N3 1QG.**  
**Tel. 081 343 3240**

**MEASURED PERFORMANCE**

NAD have traditionally used the Japanese low-bit NEC/Technics MASH convertor in their CD players, unlike most occidental manufacturers, who have traditionally gravitated to Philips. Now NAD have joined them, using a Philips one-bit convertor, the SAA7323. When not used doubled up in distortion-cancelling differential mode, this gives a little distortion, but not much - typically around the 0.02% figure when well applied. The 501 produced just this amount at -30dB music level on disc, which is very low. Our analysis shows it comprised just a few low-order components, so I would not expect any sign of sharpness or coarseness in the sound. However, distortion rises significantly to nearly 1% at -60dB, and this just may have some slight impact upon the sound.

Frequency response has been tilted downward at high frequencies by the output filters, suggesting the NAD501 is likely to have a warm-ish or smooth sound; it certainly shouldn't come across as sharp in any way.

With low noise, wide channel separation and very high output at nearly 3V, this player measured well. It produced little spurious output above 21kHz too, which is always a good sign.

NAD have engineered the 501 well,

obviously aiming for a smooth or warm sound free from the harshness that can afflict budget players. Whether it will have a little more get-up-and-go than most MASH players only listening tests can tell. **NK**

**TEST RESULTS**

Frequency response	4Hz-20.6kHz	
Distortion %		
-6dB	0.005	0.008
-30dB	0.02	0.03
-60dB	0.96	0.97
-90	40	40
-90dB dithered	19	21
Separation dB	left	right
1kHz	92	101
20kHz	91	95
Noise	-94.5dB	
with emphasis	-98dB	
Dynamic range	101dB	
Output	2.9V	

**Distortion**

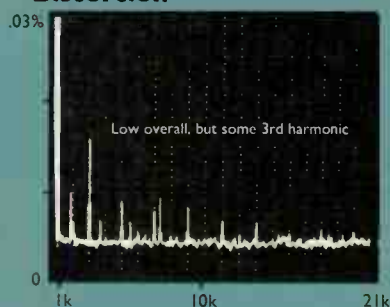

**Frequency Response**

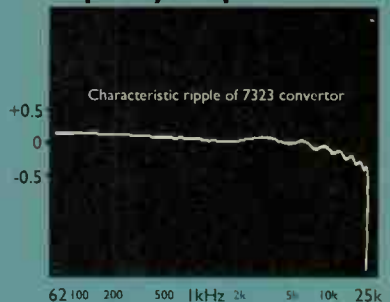



**PREMIER MARBLE LTD.**

**PRESENTS  
A SOUND REVELATION**

Uncover the true sound quality and potential of your system. Use the natural benefits of granite and marble, cut and polished by craftsmen. These natural materials offer better base definition, clarity and natural sound staging capabilities. CD/Turntable slates/platforms, custom made stands, shelves or anything you desire cut and polished to any shape or size required, all to enhance the beauty of your audio and visual environment. Trade enquiries welcomed.

For technical services ring John Walker  
0603 38752 Fax 0603 721948.

3 Dewing Road (off Wendover Road),  
Rackheath Ind Est, Rackheath, Norwich.  
Telephone: (0603) 721995.

Tesserac Audio.

We make them  
the way they said  
you just can't make  
them anymore.

For full details of the Tesserac range of head amplifiers, pre-amplifiers, power amplifiers, turntable power supplies and dealer list contact: Tesserac Research Ltd, Sutton Business Centre, Restmor Way, Hackbridge Road, Wallington, Surrey, SM6 7AH Telephone: 081-669 0011 Fax: 081-773 0406



**TESSERAC AUDIO**  
The Best of British High End

# Don't trip up on your speaker cable!

When you invest in good quality hi-fi equipment, why skimp on the cable?

Especially now that Ortofon can offer 3 types of top-quality cable for under £10.

Each cable is made up of very fine core copper strands rated at 6-Nines (that's a copper purity of 99.9999% - it doesn't come much better), is flat and flexible for easy installation and features a 'tack-rack' for panel-pin fixing.

Cable Type	Description
SPK 100	Twin-core white cable, each core with 130 copper strands (total 260 strands).
SPK 200	Triple-core grey cable for bi-wiring with twin-core treble (260 strands) and 3-core bass (390 strands).
SPK 300	7-core blue cable having 13 strands per core (each strand laminated). Requires soldering.

You'd better hound us for the name of your nearest stockist.

## ortofon

Ortofon (UK) Limited, Chiltern Hill, Chalfont St Peter,  
Bucks SL9 9UG. Tel: 0753 889949.





in principle) is traditionally known for giving floor shaking low organ notes, for example, but performance depends much upon details of its physical implementation, such as the sort of line damping material used and the nature of the chamber behind the drive unit.

Castle are known for their fine in-house cabinet work. They've made the Howards appear elegant, rather than overpowering, by using tall, slim proportions and swept-curve grilles. The cabinet work is excellent, with real wood used for comers and a deep rich shine. This gives the speakers a quality 'crafted' feel-and they're heavy, which also suggests that these aren't mass-produced items.

The drive unit in the top of the cabinet, the port in the base and the special plinth that has to be screwed firmly into place underneath also suggest that the Howards aren't a simple box loudspeaker either. There are more expensive 'speakers in Castle's range, but these are their

current treasures, at least for the time being. The 6 inch doped-paper drive unit in the top of the cabinet, firing upwards towards the ceiling, drives the quarter-wave line in order to provide bass. It does, surprisingly, cover part of the midrange too, rather than being committed only to bass frequencies. This is almost certainly responsible for the spacious sound the Howards have, but unfortunately explains the slightly vague imagery and occasional muddle they suffered.

More conventionally mounted is a second identical unit, accompanied this

# Towers Of Strength

**Dominic Baker enjoys Castle's latest floorstander - the towering Howards.**

**T**he Castle Howards are a quarter-wave resistive horn-loaded design. This is a loading technique that

demands a big cabinet, but in theory offers very strong and even-sounding deep bass. Transmission-line bass (similar

# Doug Brady Hi-Fi

*"You really must hear this"*



*Also available:*

Arcam, Meridian, Naim, Pink Triangle, Exposure, Roksan, Audio Innovations, Tube Technology, Mission, Lyra Cartridges, Michel Engineering etc...

**MAKE FRIENDS AT DOUG BRADY HI-FI**

Kingsway Studios, Kingsway North, Warrington, Cheshire (0925) 828009 Open six days. Fax: (0925) 825773	401 Smithdown Road, Liverpool L15 3JJ Merseyside (051) 733 6859 Closed on Wednesday.	14/18 Monmouth Street, Covent Garden, London WC2H 9HB (071) 379 4010 (071) 497 1346 Open seven days Fax: (071) 497 9205	The Forge Cottage, 19 Crossgate, Otley, Leeds, West Yorks LS21 1AA (0943) 467689 Closed Sunday & Monday.
--	---	---	---

*Listen Inn*

## HI-FI SPECIALISTS

Linn, Naim, Epos, Heybrook, Arcam, Mission, Royd, Audiolab, Creek, Cyrus, Quad, Denon, Rotel, NAD, Marantz, Kef, Chord Company (Naim and Epos Northampton only).

**LISTEN INN Northampton**  
Appointed REGA Agent

**32 GOLD STREET, NORTHAMPTON**  
TEL: 0604 37871  
**6 HOTEL STREET, LEICESTER**  
TEL: 0533 623754

# Great tracking

Ortofon is famed the world over for the tracking capability of its cartridges. Cartridges which will breathe new life into a cherished LP collection, divulging detail as never before.

The cartridge is always the key factor in the reproduction of music from records and Ortofon has dedicated nearly 50 years to the manufacture of the finest pick-ups possible. Enjoying constant critical acclaim along the way.

So if you want to bring more out of your records than ever imagined, an Ortofon Cartridge will have you hot on the scent.



**500 Series**  
Moving magnet cartridges from £30-£100



**MC Series**  
Moving coil cartridges from £80-£110



**Q Series**  
Moving coil cartridges from £140-£500



**1000 Series**  
Moving coil cartridges from £800-£1500

# ortofon

Ortofon (UK) Limited, Chiltern Hill, Chalfont St Peter, Bucks SL9 9UG.  
Tel: 0753 889949.



time by a 25mm metal dome tweeter, which is smooth in nature and manages to keep its identity extremely well suppressed. No out-of-tune squeaks from this one!

The Howards need plenty of breathing space. Pushed too far back into the corners of a room they have a tendency to produce a hollow boom; I found they needed at least three feet of clear space around them to deliver tuneful and natural bass. This immediately puts small rooms out of bounds, unless your musical tastes revolve around heavy reggae. A solid floor is also an advantage, as low frequencies vent from the narrow gap between the plinth and the main 'speaker cabinet, flowing out across the carpet.

An advantage of using lightweight paper drive units and quarter-wave resistive line loading is good sensitivity. Castle quote 90dB, and I certainly had no problem at all driving them with a 30watt valve amplifier. In fact, this was the best match for them, as any hardness or grit is ruthlessly revealed by the midrange unit. I suspect that, even though doped quite heavily, the bass/mid unit starts to break up just before crossing over to the tweeter. This gives the midband just a slight coarseness, not enough to worry about, but a smooth valve amplifier was just the medicine needed to banish it from my attention. A slight hardness, or coldness, did remain, but this is far more desirable than a soft, mushy quality.

The Howards, contrary to what I'd expect knowing transmission line loudspeakers (being well acquainted with IMFs and TDLs) had quite a dry, lean and well controlled bass. It was far less pronounced than any of TDL's designs, for example. That's not to say it isn't good, in fact it does remarkably well at staying tuneful and powerful, but without becoming overblown. It has none of the artificial richness of, say, some heavier polypropylene bass units, but instead gave a very real and uncoloured presentation. Large kick drums retained the hollow thud that characterises them at a live concert, and bass guitars played scales evenly, individual notes only becoming more prominent when the guitarist chose to pluck harder.

James' new album 'Laid', sorrowful in character apart from the couple of inevitable singles, was given suitable treatment. It is quite a 'dark' recording and with loudspeakers that sound veiled in any way it can become 'withdrawn'. The Howards, however, are quite forthright in their delivery, revealing detail and exposing it to the listener. As Tim Booth stepped forwards the band moved back, the soundstage being given the depth it needed to sort out who was who. This album was imbued with some of the attack it so desperately needed to become clearer, more precise and more enjoyable. The acoustic set and twangy country-style guitars of Grant Lee Buffa'o's Fuzzy were also given the atmosphere

and fast, clean delivery needed to recreate a realistic performance. And although they are normally a pet hate of mine, the metal dome tweeters did a fine job, giving the steel-strung guitars just enough sharpness and edge to make them realistic without becoming grating. In fact, on all of the albums I tried, this unit always managed to steer clear of the faults commonly attributed to metal dome tweeters, revealing a pleasant crispness within most recordings.

On the same album 'The Hook' displayed just how well the speakers could cope with reproducing the atmosphere of a recording. The soundstage was wide open, seemingly unlimited in size, yet without sounding unnatural.

The Howards, I found, imaged well within this stage, with exceptions in certain areas. There was a range in the midband that became ill-defined in terms of position and had an almost phasey quality to it. Just when you were sure of a performer's position, a changed note or new instrument caused the image to disperse across the stage. This, I'm sure, is a result of the separate upward and forward firing midrange units, combining to produce strange effects.

Their image quality and focus could be improved by placing a light pillow on top

of each of the Howards, which effectively absorbs the majority of the upwardly firing midrange. A little spaciousness was lost, but it's artificially produced anyway and the result was a more cohesive delivery. My ceiling is nine feet high; perhaps in rooms a couple of feet higher the effect of bouncing the midrange off it would not be so noticeable.

Having said that, these loudspeakers do so many things right in areas that others surrender to, they deserve credit. If you're not particularly bothered about precise imagery and focus, but enjoy an open and airy presentation, the Howards do a lot to please. They are revealing and truthful about the programme material they are fed, making them both insightful and clean. Definitely worth careful auditioning, they have strengths that others lack-and that may well prove to be a deciding factor. You do get a lot of loudspeaker for the price ●

**Castle Howard**  
**Castle Acoustics Ltd,**  
**Park Mill,**  
**Shortbank Road,**  
**Skipton, N. Yorks,**  
**BD23 2TT.**  
**Tel: 0756 795335**

**£1000**

## MEASURED PERFORMANCE

Castle's new Howards are an interesting loudspeaker. From the front they appear to be a conventional two-way floorstander, using a 6inch doped-paper bass/midrange unit and a metal dome tweeter. However, on top of the cabinet there is a second bass unit whose job is to drive the 1/4 wave line.

The midrange output from this upward-firing bass unit has an effect upon the measured performance of the Howards, producing cancellation suck-outs in the midband caused by mutual interference between the units, because their outputs overlap. Placing a pillow, or similar absorbent material, over this top unit resulted in a much flatter response, by absorbing the midrange energy.

So our response plot shows the frontal response, which is largely what will be heard at the listening position, albeit with some slight modification from room reflections. The tweeter rolls gently down towards 20kHz, which is probably responsible for the speaker's apparently smooth sound. The roll-off isn't quite enough for the Howards to sound dull, but it is enough to prevent it sounding conspicuously sharp or bright. The rest of the response is very even, with just a small lift around 160Hz which tends to add a little speed and punch in the bass.

The Castles are not quite as sensitive as I had thought from usage, measuring a mediocre 85.5dB at 1m, for a nominal watt input. This means that they will not go particularly loud unless a powerful (60W)

amplifier is used. However, the overall impedance is high at 11Ω and the impedance curve well controlled - staying high through the mid and treble. This explains why I was able to get such good results from our 300B no feedback power amp; the Howards are a prime candidate for this kind of amplification.

Overall the Castle Howards are well engineered and suitable for a wide range of amplifiers. The midrange content ideally needs to be eliminated from the top bass unit, but the effects of this will vary from room to room. If you don't like it, a couple of cushions should do the trick! **DB.**

### Frequency Response

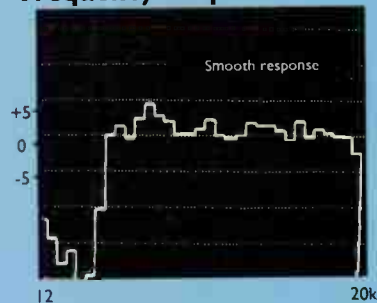

### Impedance

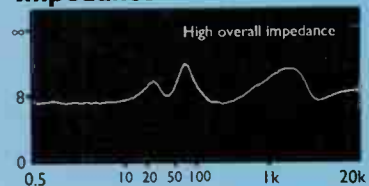

**M**y system has always been Naim-powered. It began as a Linn Sondek with Basik arm and cartridge driving an original Nait amplifier and Linn Kan speakers, but has progressed to a NAC52 pre-amplifier driving a brace of NAP250 power amplifiers via an electronic crossover into Naim's active SBL loudspeakers. The turntable is still a Sondek, albeit a Pink Triangle-modified, battery-powered version with Naim ARO tone-arm (and a pre-production cartridge about whose origins I'm currently sworn to secrecy). The system's development adequately reflects the fact that although I've changed speakers and source components-even to the point of embracing Compact Disc-I've yet to discover another electronics package that delivers what I want from music.

As a long-standing user I've always appreciated the way that Naim Audio takes care of its customers by making its amplifier range easy to upgrade. This tradition continues with the models reviewed here, the £898 NAP180 power amplifier and the £1880 NAC82 remote control pre-amplifier.

The NAC82 is a minimalist design with six inputs. Inputs 2 and 3 are standard line level connections; inputs 4, 5 and 6 are similar, but with record-output facilities; input 1 is configurable for line-level or phono duties provided by small, interchangeable boards that plug into the main circuit board. Each input has independent record and listen selectors, enabling users to record one source while listening to another. Each bank of selectors also has a mute and mono facility. The only other controls are for volume and balance. This amplifier does, however, have one convenience feature-full remote control. The handset supplied



## RHYTHM

**When it comes to conveying rhythm, Malcolm Steward and Robert Wilson agree that new remote control NAC82 preamplifier**

will also control Naim's CDI and CDS CD players, or any others that are Philips RC-5 compatible.

The NAP180 power amplifier is another minimalist product. All you get is an on/off switch on the front panel, one input and one set of outputs on the rear. The 90watts into 4-ohms output is via 4mm sockets, so speaker cables terminated with banana plugs are mandatory.

The input is a four-pin DIN connector and this connection also supplies DC power to the pre-amplifier, which means that you must use the supplied leads to connect the pre and power amplifiers.

Naim designs its power amplifiers specifically to work with its own pre-amplifiers and interconnects. I recognise that this isn't what most audiophiles expect, but you need to shelve your paranoia. Over the years I've wasted countless hours toying with custom leads and I've yet to find an arrangement that betters the original.

As supplied (i.e. with no additional power supplies) the NAC82 and NAP180 system delivered a supremely confident performance, even with difficult loudspeakers. I used various models including Naim's own passive SBLs, Epos ES1 Is, and Neat Petites, which are

diminutive but difficult-they reveal weaknesses in amplifiers that work satisfactorily with all manner of other speakers. The NAC82/NAP180 sounded unwaveringly consistent throughout.

The amplifiers gave a lucid, highly engaging insight into a wide selection of music and proved typically critical, in true Naim fashion, of source components. Consequently, I did all my listening with my own turntable. Naim and Micromega CD players.

The amplifiers' most outstanding characteristic proved to be their facility for involving you in the music. During a week of testing amplifiers prior to sitting down





# MASTER

**nothing quite matches up to a big Naim amplifier. Here's what they thought about the and NAPI80 power amplifier.**

with the NAC82/NAPI80, I'd bought Gabrielle's Find Your Way CD and after numerous plays I remained unimpressed by it; after playing it once through the Naims I realised it had been a worthwhile purchase. Does that girl's voice sound enticing through these amplifiers or what!

The same thing happened with Van Morrison's Too Long In Exile, which went from having a so-so rating, judged on other electronics, to being permanently stationed next to the CD player.

The NAC82/NAPI80 cut through music's cosmetics and unearthed the elements within it that stir your emotions and trigger subconscious reactions. Lyrics,

phrasing, instrumental lines that passed unnoticed before assumed a significance that changed the way I felt about particular pieces of music. That might sound spooky and metaphysical, but I reckon that the reason for this is quite mundane; the insight and cogency with which the Naims presented music simply allowed me to gain a much better appreciation of what was happening within recordings.

Consider the way that musicians can dramatically alter the feel of a song by quite subtle devices—a bass player dropping marginally behind a drummer's beat, for example—and it's logical that

listening to an amplifier capable of revealing such nuances is going to be a more stimulating experience. Their portrayal of music didn't entertain any muddle or opacity, yet they weren't detailed in a sterile hi-fi fashion. The acoustic guitar and percussion on the intro of 'Gabrielle's Dreams', for instance, were scrupulously etched, but not exaggerated or conspicuous. The amplifiers allowed me to delve into the deepest recesses of a mix while they maintained a wholly natural perspective on the music.

Their musical faithfulness and ability to convey the emotional impact of

# Soundcraft Hi-Fi

## Your Place or Ours?



Hear the difference whilst relaxing in our Traditional Kent Style Listening Room.....

.....or let us deliver and set up your chosen system in the comfort of your own home.

For your convenience we offer an appointment service, where you can hear the best equipment available to-day. You are welcome to bring your own records or CDs, and by arrangement, any part of your existing system for comparison.

We guarantee that you will be thrilled with your music, not just for the first few months but over many years of listening.

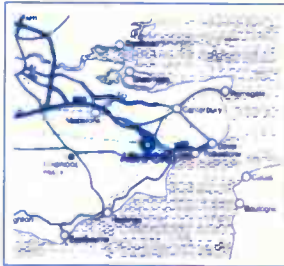

Delivery and installation service



Soundcraft Hi-Fi, The New Musical Experience  
40 High Street Ashford Kent TN24 8TE  
TEL:0233 64033 Fax:0233 640333



# EXPENSIVE TUNER??

## THEN HAVE THE AERIAL IT DESERVES

You spend many hours and quite a lot of money choosing that new tuner, so don't ruin the whole effect by fiddling with bits of wire or old aerials. Have the full benefit of the multipath-free, clean signal which only a well designed and properly installed unit can achieve. If D.X. is your scene, then go for the ultimate in rotating high gain narrow beam systems like our G.23 with 19dB Forward gain, 38dB F. to B. and Acc. Ang. down to 15 Degrees or have a "one off" special built, up to 32 elements.

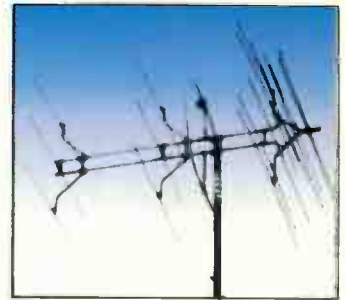

GALAXIE CIRCULAR 17-ELEMENT STEREO  
GAIN 15.9dB F. TO B.33.7dB. L.74"

## WE DESIGN, MANUFACTURE, SUPPLY AND FIT

- ★ FM arrays from 4 to 23 Elements. TV from 10 to 92 Element.
- ★ British-built and designed to withstand our weather.
- ★ Interested D.I.Y. advice freely given, backed by our complete range of masts, brackets, rotors, cables and aerials. Systems available for chimney, loft, wall, or through roof mounting.
- ★ Professional installation service available within a nominal 200-mile radius of LUTON. Full details of this service available on receipt of a large S.A.E. which will bring you our complete "Aerial Guide" which is more than just a list of our products and prices, and carries details of all our services, including MAIL ORDER and site surveys.

CONTACT US ON 0582 36561 or WRITE To:

RON SMITH AERIALS

98, ASH ROAD, LUTON, BEDS, LU4 8AQ

Personal Callers: Shop Hours Mon. Fri. Sat. 9.00 to 6.00. Lunch 12.30.1.00  
Tuesday & Thursday 9.00 to 10.30 Wednesday Closed

(On Tue/Wed/Thurs we are often available: Phone to check. Mon/Fri/Sat we are always open).

NAIM AUDIO U.K. RECOMMEND OUR FM AERIALS AND THEIR DEALERS CAN OBTAIN YOUR CHOSEN MODEL WITHIN 48 HOURS, OR SUPPLY EX STOCK.

# Steve Boxshall **AUDIO**

## OFFERS YOU THE BEST HI-FI IN CAMBRIDGE



Use our expertise to invite real music into your home

- BEST CHOICE IN HI-FI
- INTEREST FREE CREDIT
- THREE DEMONSTRATION ROOMS
- VISITING CAMBRIDGE...?... VISIT US

41 VICTORIA ROAD  
CAMBRIDGE  
(0223) 68305

performances, however, stemmed from their exceptional aptitude for conveying intonation and timing clues. This was due in no small part to the remarkable control the NAC82/NAP180 exerted over the frequency extremes. The low end was notably powerful, but taut. I've heard it described as dry, but that suggests a tonal flatness, which isn't justifiable; the Naim's didn't, for example, rob a double bass of its resonance or tonal colour, nor did they confuse sampled basses with the genuine article. Their upper registers appeared equally informative. Like other amplifiers from the Naim stable, they demonstrated a lightning response to leading edges that were followed by the exposition of the full note envelope; their resolution of, say, the different timbres in a drummer's range of cymbals was exemplary.

Previous encounters with the NAC82 have shown that adding one or two HI-CAPs to it, as you inevitably will, doesn't alter the system's signature, but enhances its already considerable ability to communicate. However, that's another story. In its basic configuration the NAC82/NAP180 rivals any similarly priced combination; within the context of an appropriately well-sorted system it buries them in my view.

Malcolm Steward

### Back at Hi-Fi World Towers, this is what we thought of Naim's new amplifier ...

With Heybrook Sextet loudspeakers hooked to the Naims, I settled down into the sofa with remote control in hand. Knowing the dynamic nature of the 'Naim sound' I decided to let it get to grips with some big, dramatic drum recordings.

The beginning of Phil Collins' 'Another day in Paradise' uses a heavily gated drum and the Naims showed this specific technique to perfection. It was easy to discern the speed of the gate 'closing' on the reverb produced by the drum. The initial notes played on an acoustic guitar cut through the mix with power and confidence, conveying the musician's performance with unerring insight, although the sound of the guitar was a little too metallic and lacked the finest harmonic details that fill out the woody timbre of the instrument. As the track built up, the Naims followed suit, taking hold of the Sextets by the scruff of the neck and making them take charge of the rhythm section with military-like precision.

These amps were crying out for the Rolling Stones and all the percussion that they always layer onto their up-beat numbers, which lesser amplifiers fail to resolve into a cohesive performance. Again, the Naims didn't disappoint, relishing the tight, punchy drums, endowing them with terrific dynamics allowing me to really appreciate the amount of air that a tight 'skin' can move. If you love drums and percussion, then

you'll love these Naims.

Bass guitar fared almost as well. However, it did lack that last ounce of weight and the laser sharp leading-edge definition afforded by Naim's better amps (especially in an active system), as well as the big American Krells and the UK Chords. The 'tune' was always evident and made listening to my all-time favourites, those Fab Liverpudlians, an absolute joy. Paul's melodic bass lines shone through, allowing me to bask in the man's sheer genius.

The Naims aren't perfect though, noticeably in the mid-range where they do lose out to some of the finer valve amps that I've heard. The tenacity with which they handle rhythm can sometimes be a touch overpowering with vocals, as they do tend to add a little glare. There is a distinct sonic trademark which firmly imprints the word 'transistor' in your mind. This is not to say that vocals were poor-far from it; the way that these amps can communicate a singer's emotions is at times breathtaking, from Jagger to Joplin, Lennon to Lee Hooker.

The ability of an amplifier to unravel the complex strands of a multitrack mix is something that I especially look out for. The Naims certainly possess this, although not in abundance. They lay a sound stage out quite beautifully, solid and tangible between the speakers, although depth is very much constrained. But they do allow you to follow the intricacies of the music, which maintains listening interest. You will find yourself enthralled in the discovery of musical minutiae and harmonic timbres which these amps portray quite delicately, if in a slightly dry overall presentation.

I've certainly enjoyed listening to music with the Naims. They are fun and give music life and dynamism, making other amps sound pale in comparison. Although they don't possess the last word in sonic purity or smoothness, or even neutrality, they do allow you to enjoy the music, which is not always the case with other amplification, even at this high price level. From me, they receive recommendation ●

Robert Wilson

### MEASURED PERFORMANCE

The NAP180 power amplifier produces 55watts per channel into 8ohms, enough to make most loudspeakers go loud in most rooms. All the same, it is not quite the powerhouse its dimensions would suggest, so party levels are out. As usual, power output into low loads increases, 90watts being delivered into 4ohms. Naim rate their amps into 4ohm loads, the '180' model number representing the total output of the two stereo channels. Tests showed that the power amplifier is load tolerant, so it will drive most loudspeakers.

Naim like to band limit their pre-amplifiers: they roll the NAC82 off as soon as possible, making it -1dB down at 20kHz. This is quite drastic and, in most amplifiers, it produces a noticeably warm sound. However, in this one it does not, although over a weekend's use I did notice that upper treble seemed a little dilatory. The reason for band limiting, by the way, is to prevent 'transient intermodulation distortion', or in other words, it is meant to produce a cleaner sound. Low frequency output extended down to 10Hz (-1dB), low enough to get good bass power and a firm, deep bass line from CD.

Channel separation was mediocre at 40dB, but this actually enhances centre images and strengthens stage presence in vocalists in particular. Hiss was satisfactorily low at -82dB, if not as low as usual. However, this is because Naim use buffered inputs, which provides optimal source matching. Input overload occurs at 7V.

Distortion was not detectable at low levels in the midband, but started to appear on our analyser screen at high frequencies. However, levels were low at

0.01% worst case (-1dB below full output at 10kHz). The spectrum analysis shows harmonics extended up 5th order at 50kHz, suggesting the presence of crossover artefacts.

The NAP180 is a big beastie for a 50watt per channel amplifier (using the conventional power rating standard), but it measures well enough. The NAC82 preamplifier imposes band limiting on the system, which has some impact upon its sound. The two in combination turn in a competent measured performance free from major flaws. **NK**

### TEST RESULTS

Power	55watts
CD/tuner/aux.	
Frequency response	10Hz-20kHz
Separation	40dB
Noise	-82dB
Distortion	0.03%
Sensitivity	70mV
dc offset	15/13mV

### Distortion

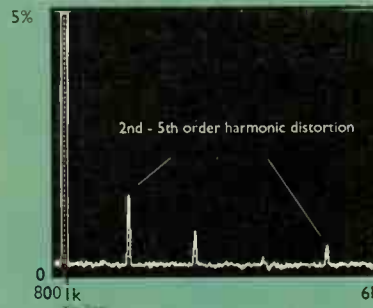

# ROKSAN RHYTHM



Eric Braithwaite listens to the rhythm of a Roksan Attesa CD transport and convertor.

The hot news a month or so back was that Roksan, doyen of turntable builders for several years, have given up making them - apart from the Signature, that is. The company is obviously going to concentrate on activities more in keeping with its new name: Roksan Digital.

A number of moves have probably concentrated the digital mind at Roksan, resulting in the disappearance of the Rok DP1/DA-1 transport and DAC and its replacement with the new, cheaper, Attesa transport, eponymous DAC and power supply.

As it so happens, I've been digitally spoilt for the last few weeks, having been living with both Counterpoint's DA-10 multi-module DAC (which has the Crystal Delta-Sigma the Attesa uses as a plug-in

option) and Trichord's Pulsar. Some familiar resemblance might be expected, since both companies now have ex-Roksan personnel, but not a bit of it.

Counterpoint's transport and DAC have rack-mount width and slimline looks, the transport using the Philips 12.1 mechanism. The Pulsar adopts the latest Burr-Brown surface-mount PCM-69 chip, with an awe-inspiring range of user-options in 18-bit or 20-bit filtering, phase inversion, adding dither and jitter-reducing options.

Roksan, by way of contrast, have opted for multi-inputs: the Attesa DAC will take four digital sources. The review sample was supplied with BNC sockets which, since using them on the Sugden SDT-1 and SDA-1 transport and DAC, I've come to favour. Optical terminations are an option.

Two power supplies cater for the penurious, or those with a smiling bank manager. There's the basic DSU, which comes in a plain black, oblong metal box, and there's the grander Attesa PSU, matching the DAC in size, colour, slope-fronted shape and powder-grey finish. Both link to the DAC with a dedicated umbilical, and the warning in the manuals that the amplifier should be turned down before switching on is justified: there's a fair power-on thump.

The DSU is very much a stop-gap. Superficially, it gave a tight sound, narrowed in width between the speakers, with the images projected out towards the apex of a triangle before the listener. It was, however, rather coarse and gritty, especially in the upper-midrange. By comparison, plugging in the Attesa PSU

broadened the stage, freeing it from the speakers, while fleshing out and smoothing the tonal colour.

Crystal's Delta-Sigma has a distinct signature. It can sound vivacious and lively in the mid-range, very tonally clean and accurate, but sometimes almost a-rhythmical in the bass. It can offer a sharp focus with an exceptional amount of inner definition - but sometimes the degree of sharpness can vary with frequency. I've begun to call this 'Crystal cracked horn syndrome' since I first noted it on a Sony 20-bit recording of Haydn symphonies, where a horn note sounded as though it had cracked. It can afflict vocals as well, in this case making Janis Joplin's voice somewhat screechier than usual in places, coarsening 'Ball and Chain' almost to sandpaper abrasiveness.

Where it becomes a virtue is on songs like Björk's 'Human Behaviour' or Suede's 'Breakdown', when the vocal line is that much more distinct from the backing that sometimes obscures it. But it does mean that some recordings are enhanced while others become a curse. One that was unusually enhanced was The Nelson Brothers' Hometown. (Regular readers will recognise the name from my using a live 96kHz sampled DAT recording of this country-world-music-rock band. Hometown is the studio-recorded CD.) This amalgam of mandolins, acoustic instruments, five-string bass and (reall!) drums came across with astonishing breadth and deep bass. It was deliberately

mixed 'after Daniel Lanois' and the Roksan squeezed every aspect of that kind of sound out of the CD - Crystal clear and highly developed.

Odd, therefore, that the Atessa pairing couldn't perform the same feat consistently throughout the Chicago Symphony Orchestra's Beethoven on EMI or Steven Issleris' new RCA recording of Taverner's Eternal Memory. At one point in the Taverner tremolo, strings become very agitated against a strong but deliberate cello melody. The Roksan lost control and it all became a muddle.

Beethoven's Eighth is an airy, danceable piece; but the Roksan couldn't quite get it to fly, the orchestral sections seeming undirected. Some electronics and speakers suffer 'one-note bass'; this odd effect (which it has to be said is evident in both Dacula and the Quad 67, but better-controlled and therefore impinging less) is best described as 'one speed rhythm'. It leads to a degree of dynamic sluggishness.

Partly, this may be attributable to the transport as well as the DAC. With the Atessa linked to the Sugden DAC, images were a little more clear, rhythm and beat tighter, but the overall gauzy soft-focus effect remained. At just a couple of hundred pounds more, Counterpoint's DA-11 transport has a much sharper focus and unerring - almost uncanny - dynamic control.

Equally, at around £1200, Trichord's Pulsar is a tough act to beat. It has breadth, depth, three-dimensional imaging,

remarkable dynamic speed and that rare ability to establish nuances of expression in every part of a recording. While the Roksan could give a flavour of subtle vocal and instrumental expression, a neutral tonal colour and physical width that was nearly the equal of the Counterpoint's exceptional spread, it was more recording-dependent than I find entirely comfortable. Acoustic instruments or electric guitar-driven music seemed to fare best, least affected by the Crystal foibles.

Finally, too, I have a couple of mechanical niggles. The Atessa took nine seconds to reach track 18 on one CD against the Sugden's six and the manual disc clamp is an inconvenience, although one imposed by others such as Naim. I don't mind the Atessa's unusual styling - I thought it quite attractive and certainly distinctive. The player is fascinating, but I feel it is also a little flawed in contrast to some effective competition

<b>Atessa transport</b>	<b>£1295.00</b>
<b>DAC &amp; Atessa PSU</b>	<b>£995.00</b>
<b>DAC &amp; budget PSU</b>	<b>£595.00</b>
<b>DAC/no PSU</b>	<b>£550</b>
<b>Atessa PSU</b>	<b>£550</b>
<b>Basic PSU</b>	<b>£135</b>
<b>Roksan Digital Ltd.,</b>	
<b>Stockley Close,</b>	
<b>Stockley Road,</b>	
<b>West Drayton,</b>	
<b>Middlesex, UB7 9BB.</b>	
<b>Tel: 0895 436384</b>	

## MEASURED PERFORMANCE

Roksan have put their faith in the U.S. Crystal chip with this player, a key item the Atessa shares with Quad and Creek CD converters/players, to name but two. The Crystal chip is easy to apply and comes with its own distinctively punchy sound that has certainly made a lot of Quad owners happy, we are told.

In the Atessa convertor though, Roksan place it into a different environment, one without a transport and with an external power supply. Under these conditions the Crystal proved itself to be a very low distortion device, as in the other products that I have tested previously. At normal music levels our analysis shows there's no distortion to be seen at all. At low levels it still barely makes an appearance, measuring just 0.4% at -60dB for example. Distortion lurked beneath noise with a -90dB dithered signal, being revealed only by synchronous linear time averaging, used in astronomy to strip away noise from radio stars. We use it to strip away dither noise to reveal underlying distortions, which in this case measured just 2.2%, a very good result at -90dB, where digital signals are usually horrendously distorted.

Frequency response of the Atessa can be seen in the analysis. It has a peculiar inverted saucer shape to it, suggesting

restrained bass and smooth, spit-free treble. However, listening tests must be the final arbiter of this aspect of the player's subjective performance.

Noise levels were unusually low due to noise muting at digital zero I suspect, which makes the measurement effectively invalid. Channel separation was good and spurious outputs low, but audio output was unusually low too, measuring just 1.4V. So the Atessa will sound distinctly lacking in any uncompensated A/B demonstration - something that's worth bearing in mind.

**NK**

## TEST RESULTS

Frequency response	4Hz-21.2kHz	
Distortion %		
-6dB	0.006	0.006
-30dB	0.008	0.008
-60dB	0.4	0.4
-90	32	31
-90dB dithered	2.2	2.5
Separation dB	left	right
1kHz	111	110
20kHz	88	88
Noise		116dB
	with emphasis	116dB
Dynamic range		105dB
Output		1.4V

## Distortion

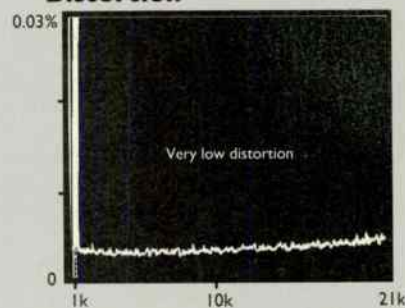

## Frequency Response

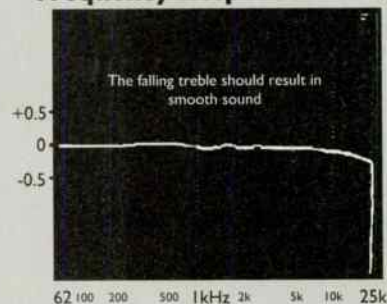



# Experience live music

*in your home.*

Experience a personal service second to none.

At Sound Gallery we will help you tailor a hi-fi system that sounds exactly the way you want it, not the way you've been told it should sound.

Experience the options in the neutral conditions of our demonstration room, and the professional home installation of your desired system.

**FOR A SOUND EXPERIENCE  
AND SOUND ADVICE, CALL**

**THE SOUND  
GALLERY**

**0494 531682**

65 CASTLE STREET • HIGH WYCOMBE • BUCKS HP13 6RN

World Radio History

# CLEAR AS CARBON!

## Dominic Baker finds van den Hul's new carbon interconnect has a clear advantage

It's not often that we review cables here at Hi-Fi World. They're so system dependent that it is often hard to say exactly what the cable itself sounds like. And what is a good cable anyway? One that has a character that can be usefully used to tame either brightness or dullness in your system, or one that is neutral and reveals the faults? The purists would opt for the latter, but not everyone can afford a purist hi-fi system, nor do they want faults put under a spotlight.

Those cables which are neutral add or take away little from the sound of the basic hi-fi equipment, but those which are 'coloured' in some way or other can usefully tame an unwanted trait of the system to give a balanced and more natural overall sound. Of course, if you find you need a dull cable to tame vicious treble, you haven't been all that careful with your choice of equipment, but sometimes this is unavoidable.

The two cables we're interested in here are by no means budget items, so you would expect the systems they're likely to turn up in to be fairly transparent and neutral. So the cable ideally should also be transparent and neutral.

And this is the claim made for van den Hul's linear structured carbon interconnects, The First and Second. Both use non-metallic conductors, carbon in fact, and so aspire to be completely free from the colourations associated with various metals, such as copper and silver.

The First is a carbon cable with a carbon screen. The Second is similar, but has two signal conductors and a triple screen made up of a layer of carbon, aluminium foil and silver-plated copper braid, to give an option of balanced operation and reduce interference to a minimum. There was a rumour that the First could suffer hum problems, but I've been using it for around eight months now with some of the

weirdest valve amplifiers around and haven't heard a whisper yet.

At first I was unsure about the sound of these carbon interconnects. They seemed to be hiding detail when compared to a similarly-priced metal cable. They sounded a little too soft, and the more forward, brighter balance of, say, DPA's Black Slink was certainly more impressive to listen to.

However, after a week or so I was having second thoughts. I spent hours experimenting using a mixture of carbon and metal interconnects, all-carbon and all-metal, including solid silver between the source and pre-amp and on to power-amp. The metal cables I used had a harder, brighter balance than the van den Hul carbon cables, but was this the character of the metal, or were the carbon cables just less revealing?

To confuse matters further the carbon cables were changing as they ran in. Fine detail was appearing in delicate layers, all there, but not forced to the front in the same way as the metal cables I normally use.

After months of listening I came to the conclusion that neither metal nor carbon interconnects are the 'be all and end all' of hi-fi interconnects. Both have their qualities, the carbon having a smooth, almost darkly detailed quality, and metal cables a more up-front dynamic sound. Van den Hul's carbon interconnects aren't as impressive to listen to, but have a more reserved, classy quality.

The basic character of each of the two cables—First and Second—is very similar, as you might expect, but the Second, for whatever reason, does have a little more weight behind it, more dynamic punch in the bass. Lately I have been using First from CD to pre-amp (it removes a little of the 'edge' from poorly recorded CDs) and Second from the turntable head amp, to give a little more punch in the bass on vinyl. This gives me a similar balance from both CD and vinyl, and certainly makes for a musical and listenable presentation from both sources.

The Second is a little more expensive, £20 more than the equivalent 1m length of First, but it does have just a little more oomph behind it. Both are excellent cables, but be prepared to re-adjust, they do things quite differently and certainly don't sound as impressive in an A-B comparison as a good metal cable. But they grow on you and can give one of the most musically relaxing and enjoyable presentations of any cable ●

van den Hul First (1m) £179.99

van den Hul Second (1m) £199.99

Van den Hul UK,  
P.O. Box 304,  
Maidstone,  
Kent.  
ME16 8TS  
Tel: 0622 721636

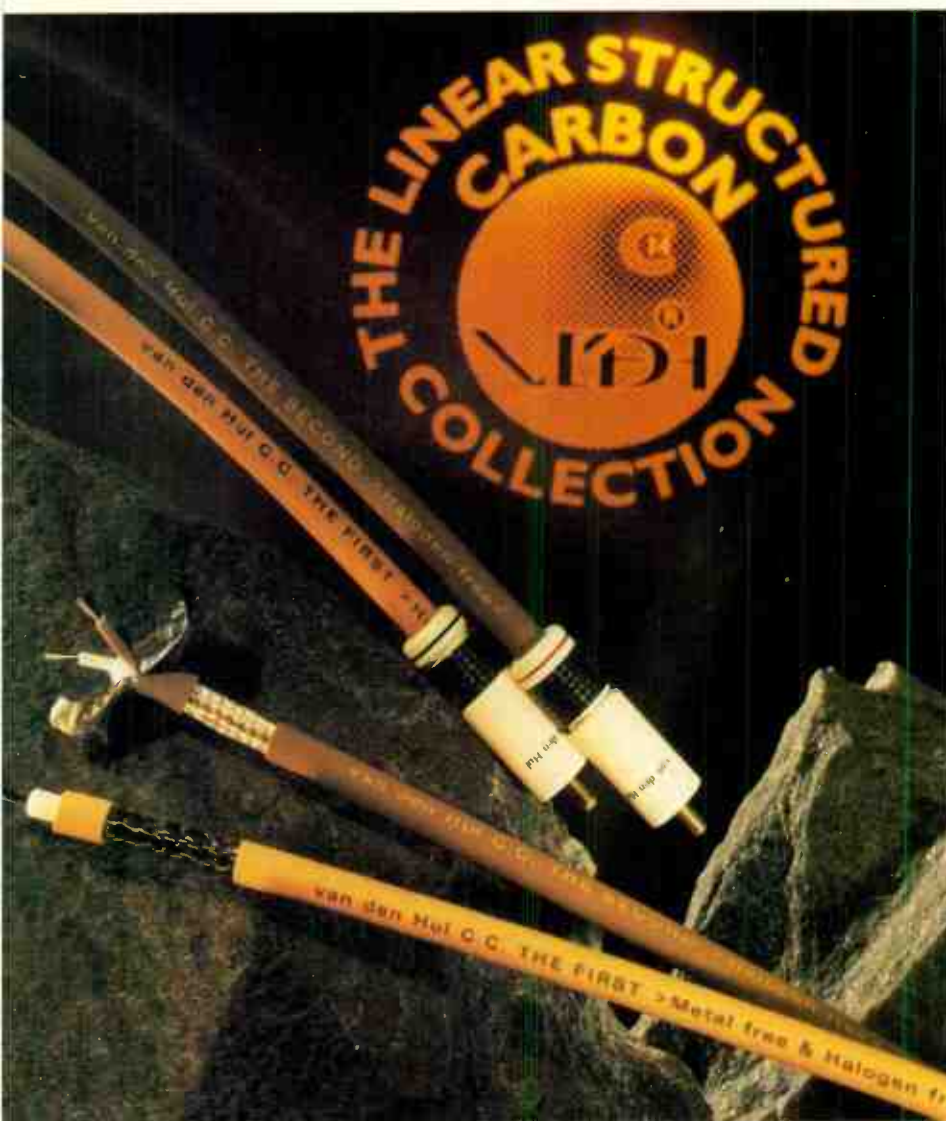



# D.P.A

## The Power

Available for several years, and still widely regarded as probably the ultimate filter: fit to each component or use one for the whole system.

**ONLY  
£125**

D.P.A were one of the first manufacturers to recognise the importance of filtering frequencies way beyond the range of other filters and their unit is correspondingly more complex and effective.

Fitted with male and female IEC connectors and provided with a rewirable plug, the unit is rated at 6A (1400W)

## SILTECH

### HF6 DIGILINK

**FROM  
£99**

From Siltech, acknowledged as world leaders in cable technology, the HF6 pure silver digilink represents the ultimate way to link your CD Transport to your Digital to Analogue Converter.

Once you hear the difference this Silver/Teflon link makes to your CD combination you will be tempted to invest in Siltech interconnects as well!

0.5m Digilink - £99 1.0m Digilink - £148



**ORDER THESE KJ PRIZE WINNING ACCESSORIES  
TODAY VIA OUR MAIL ORDER SERVICE**

Telephone Orders - welcome when paying by Visa/Access/Amex  
Post & Packing - FREE OF CHARGE



# TOWNSHEND

## SEISMIC SINK

Isolation platforms are now an accepted part of any good system. But did you realise there was a huge difference between the best and the worst?

**FROM  
£170**

Treat your CD or amp to the best platform available and realise your components full potential.

The SEISMIC SINK is the ultimate. What Hi-Fi agreed and gave it an award.

Standard model takes up to 15kg and measures 430 x 360mm. Other models available, please phone.

**NEW**

## Remove the Ghost in the Machine

From Gryphon, established High-end amplifier manufacturer, a beautifully crafted accessory ready to take the market by storm.

The EXORCIST when used regularly removes a layer of haze from the sound of your amplifier.

D.C. present at start up combines with constant low levels of D.C. leakage to gradually affect magnetisable materials in or near the signal path.

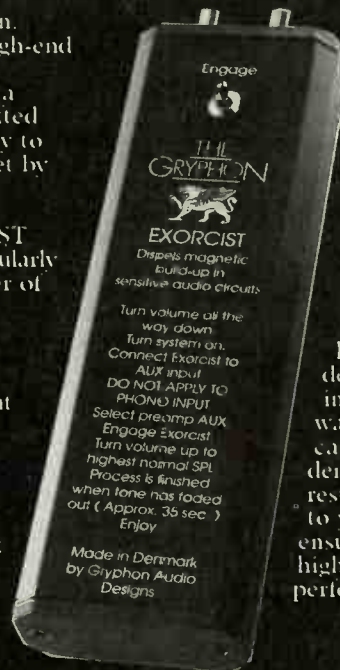

**ONLY  
£80**

EXORCIST demagnetises in the same way as a cartridge demagnetiser, restoring clarity to your amp and ensuring the highest level of performance.

## KJ WEST ONE

26 New Cavendish St; London W1M 7LH  
(close to Marylebone High Street)

TEL: 071 - 486 8262/8263

FAX: 071 - 487 3452

We are open Mon to Sat 10 am to 6 pm.

make you wonder how you managed without it!

Many of our customers regularly come back to purchase more; we think this says more than anything we could write here!

## TWEEK

**ONLY  
£18.95**

A contact enhancer (not cleaner) originally developed in conjunction with N.A.S.A.

This high-tech fluid will enhance the metal contacts everywhere in your system and





# Danish Cream Cornet

**Budget it may be, but Robert Wilson finds this loudspeaker from Jamo is neither brassy nor brash**

**D**anish loudspeaker manufacturer Jamo has certainly set its stall out for the budget market with this aggressively priced package. For the 'special' price of £129.99 you can purchase the Cornets with a mahogany finish, plus a pair of Jamo's own AP 20 stands, which normally retail separately at £40.

The speakers are nicely finished in a vinyl wrap with classy designer curved edge to the front baffle.

The main drive unit is a 4.5 inch woofer supplemented by a small soft dome tweeter. Both are tightly screwed to the enclosure which measures 320x195x220mm, and the cabinet is vented by a rear facing port whose edges are rounded to reduce the 'chuffing' noise that is all too often present when a ported speaker is working hard. The Cornets present the amp with a 6ohm impedance, the makers claim, and sturdy, gold-plated binding posts are provided, although the speakers cannot be bi-wired. Unfortunately, the Jamo stands were not supplied for the review so I used them with heavy, twin column Targets which complemented the Cornets quite well. First disc into the CD transport was an old

Dire Straits favourite - Love Over Gold.

Initial impressions were of a gentle, self-effacing speaker which retained a laid back, slightly reserved character. The acoustic guitar and Mark Knopfler's voice were well positioned, just slightly behind the plane of the speakers as was the marimba on the left, although the piano further back in the mix was noticeably lacking in space and sounded quite tinkly.

Generally speaking, the whole image was a little lacking in dimensionality. No 'out of box experiences' here! With percussive tracks the reserved nature impaired the musical drive and with some Stones numbers, like 'Undercover', sounded disjointed, failing to blend the various elements of the mix. Mick was his usual infectious self, jumping all over the place and although the Cornets didn't fully capture the dynamic swings as he moved on and off the mic, you could certainly picture him dancing around it. Fellow glimmer twin 'Keef' was nicely rounded out with plenty of raw power when the speakers were driven hard.

It was the rhythm section, however, that let the speakers down, for the bass was anaemic and lacking in pace. Luckily, proximity to the wall didn't cause the port too much stress, allowing bass reinforcement.

These speakers would certainly tame the brash top-end of many Midi systems. Even when listening to over-the-top Disco mixes with a persistent over EQ'd high frequency content the Cornets still remained composed, but alternatively some may find them a little too understated.

As usual with speakers, it's horses for courses. If you have a system that is too aggressive, especially at the top, then the Cornets will certainly calm things down and add some relaxation to your listening ●

## MEASURED PERFORMANCE

The Cornet 30.111s are one of the least expensive loudspeakers we have ever reviewed. If you discount the stands from the price they come out at around £90. But, nonetheless, Jamo being a large company with good test equipment and a large engineering department, they still manage to turn in a very respectable measured performance.

Flat within  $\pm 2$ dB across the majority of their frequency range, the Cornets show that respectable results can be obtained even with cheap drive units. There is also a slight hump in the midband which will push vocals forwards, and although quite lumpy, the treble is free from any prominent spikes that could be heard as sharpness. The bass doesn't go particularly deep, but I could hear no undue whistling from the rear firing reflex port.

The Cornets have a high overall impedance of 10 $\Omega$  and the impedance curve doesn't dip below 8 $\Omega$  across the whole audio band. This is quite important for a budget loudspeaker, which is likely to be driven by low power amplifier unable

to supply massive current. They are of average sensitivity, 86dB, and so should go reasonably loud with a 30watt minimum transistor integrated DB.

### Frequency Response

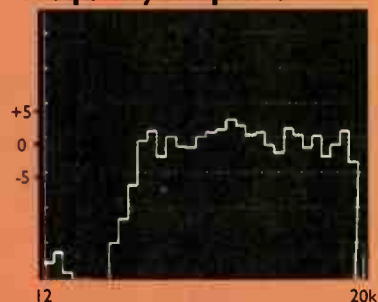

### Impedance



**T**here was no way Audio Innovations could produce an integrated amplifier for £300 and use valves. The need for costly output transformers and the price of the valves themselves prohibit such an exercise. So, the company that claims to be the world's largest manufacturer of hi-fi valve amps decided to use transistors. The only reminder of valves comes in the Alto's exterior, whose Sixties styling harks back to when the valve was king.

The result is a transistor amplifier shaped much like an imaginary flying saucer of the period, with the addition of a large Cyclops eye in the centre of the front panel.

A conscious attempt has been made to style this amplifier more strongly than others in the range, to the extent that whilst the more expensive pre-amplifiers rely on off-the-shelf control knobs, those on the Alto are custom-made. The styling is definitely in one of those 'love it or

hate it' idioms, but either way, it does feel solidly built, which should appeal to all.

Audio Innovations are certainly hoping that visual impact is going to sell this amplifier. Whilst the front panel carries custom knobs and a blue LED indicator - expensive items on a £299 integrated amplifier - the internal components, which determine sound quality and performance, are fairly standard.

I found the Alto was well suited to light acoustic/vocal music such as Grant Lee Buffalo's Fuzzy album. On 'The Hook' it gave a snappy, crisp sound with a light and open balance. It had a relaxing sound

at low levels although there was a little unwanted rasp to the treble.

The Alto imaged well, placing performers firmly between the 'speakers and the soundstage grew outwards to give a good sense of atmosphere. It didn't have a great deal of depth to it, but a wide sideways spread gave the amp an open and expansive sound.

Moving on to 'Soft Wolf Tread', on the same album, gave an altogether different impression. The increased complexity and addition of a bass line

floored the Alto. It became quite coarse in the mid, confused by the extra instruments and increased tempo. And the bass was dry to the extent of sounding hollow with no real ability to move any reasonable volume of air.

I was lucky to catch an early EP of the forthcoming Blue Aeroplanes album as it passed through the office a few weeks ago, and this was the next to highlight the

#### MEASURED PERFORMANCE

Audio Innovations like to engineer their amplifiers subjectively, on the basis that if it sounds right, then it is right. This approach hangs together up to a point: who decides what sounds right, and by what standard? It is possible to engineer an amp this way, but extreme care and diligence are needed, because of the adaptability of the human cognitive system. The Decca London cartridge phenomenon is the most cogent example I know of how our ears can be fooled and just how measurement, properly interpreted, acts as a useful guide to prevent this happening.

The Alto produces large amounts of

distortion and, much above one watt, the harmonics are extended up to fifth order components and higher - see the spectrum analysis at 12watts. In the midband distortion measured 0.6% at 1watt, but 0.3% just below (-1dB) full output. Interestingly, there was little change at high frequencies: 0.7% at 1kHz and 0.4% at 10kHz.

This appears to be a low feedback amplifier where the designer has hoped to avoid the suspected sins of feedback. In my experience, you cannot get away with these levels of distortion unless it is mainly second harmonic in nature; CD has shown us just

how higher orders are noticeable and in what way they affect sound quality. The Alto only fares well in consistency of level with frequency. But whether this will redeem the Alto I somehow doubt.

The other most-curious feature is fast bass roll off (-12dB/octave) below 40Hz. The impact of this is well known: it produces clean, fast bass, but also a sound lacking weight or slam. The complete absence of DC on the output suggested the use of output coupling capacitors and lifting the lid confirmed this. The upper response limit was high at 150kHz.

# Flying Back

Dominic Baker listens to the Alto

Audio Innovation



# to the Sixties

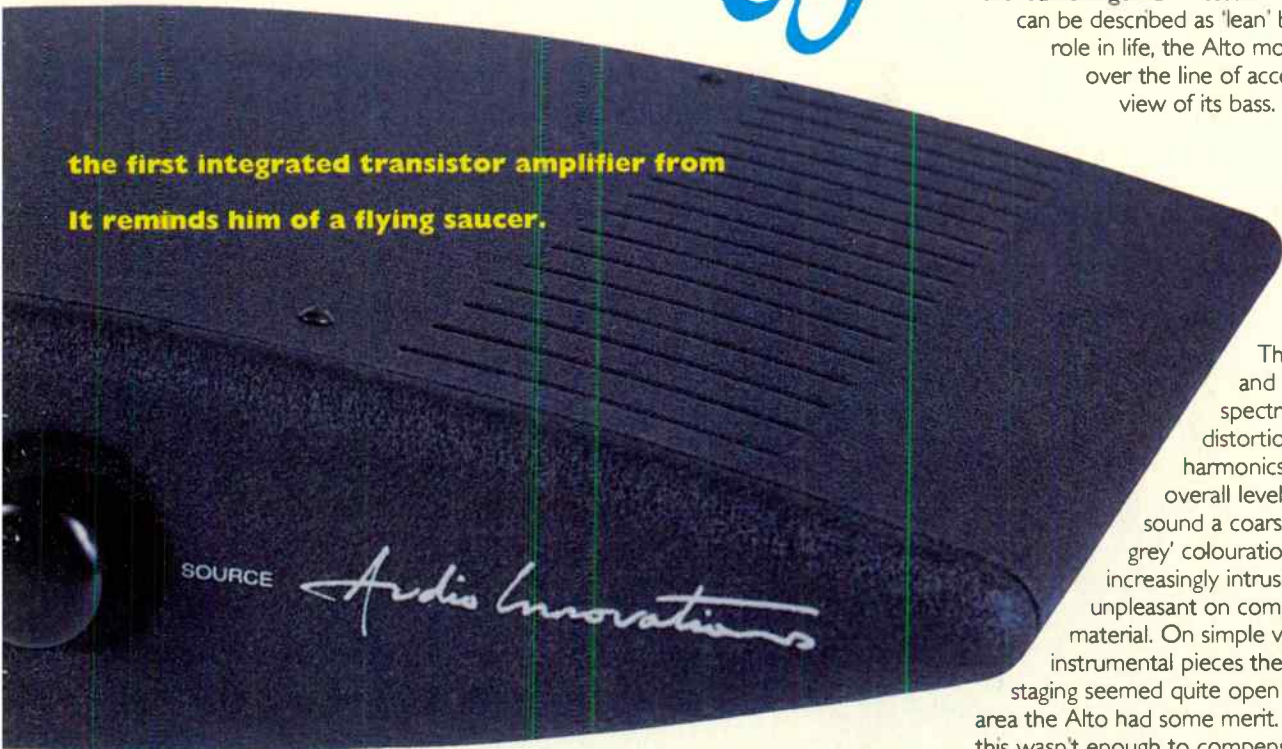

**the first integrated transistor amplifier from  
It reminds him of a flying saucer.**

Overall? Questionable. If you fall in love with the styling and listen to simple acoustic music at low levels, the Alto can turn in a respectable result. Otherwise, there are just too many compromises that come through in its sound quality.

**Noel says:**

After measuring the Alto I listened to it to see what degree of correlation existed between the measured performance, which was poor, and sound quality. The bass was unacceptably light in my view, lacking even a hint of bottom end power. Whilst amplifiers like the Cambridge P25 II tested in this issue can be described as 'lean' but find a role in life, the Alto moved just over the line of acceptability in view of its bass.

The complex and extended spectrum of distortion harmonics at a high overall level gave the sound a coarse and 'dark grey' colouration that was increasingly intrusive and unpleasant on complex material. On simple vocals or instrumental pieces the sound staging seemed quite open and in this area the Alto had some merit. However, this wasn't enough to compensate for its problems, I felt ●

Alto's shortcomings. The title track 'Broken and Mended' is a full blown rock track, lead guitar, bass, drumkit, all full of energy. Played at any reasonable level it sounded compressed and thin. The treble became splashy, unable to differentiate between the drum stick hitting the cymbals and the following ring from the brass. It was fast, but too light by far. Plugging in a REL subwoofer rectified

some of the problems, but this adds £500 to the price, and the midband and top end still grated.

Moving back to simpler recordings the Alto was more comfortable. Suzanne Vega, Texas and Belly all achieved enjoyable results, but even then, the character of the Alto over-ride that of the vocalists. And every now and again, as their voices rose in level, they had an unexpected tendency to shout.

**Alto** £299  
**Audio Innovations,**  
**Albany Court, Albany Rd.,**  
**Gramby Ind. Est.,**  
**Weymouth, Dorset.**  
**DT4 9TH**  
**Tel. 0305 761017**

Otherwise, the Alto was conventional enough, producing a useful 32watts into 8ohms and 42 into 4ohms, having a normal sensitivity of 300mV and low noise and hum, but a somewhat poor (24dB) channel separation at high levels that improved to a useful 42dB at average signal levels.

I would expect the strong distortion with extended and varying harmonic structure to make itself known, especially with a high upper response limit of 150kHz. The lack of deep bass will be heard too. To my way of thinking, this amplifier is the result of a peculiar and extreme design philosophy. **NK**

**TEST RESULTS**

Power	32watts
CD/tuner/aux.	
Frequency response	37Hz-150kHz
Separation	42dB
Noise	-93dB
Distortion	0.6%
Sensitivity	300mV
dc offset	none
Disc	none

**Distortion**

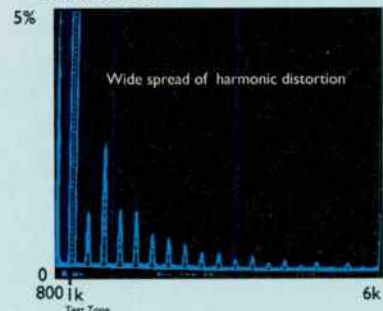

Denon have traditionally done a fine job with cassette: their decks have consistently been amongst the best available at any price point. But with the budget DRM-540 I wondered whether, nowadays, it was realistic to try and market a deck at £159.99. With Japanese material and labour costs rocketing, their budget cassette decks have been suffering in particular; I'd have guessed £200 was a minimum figure for a good machine these days. Would the DRM-540 prove me wrong?

It looks smart enough, that's for sure. Denon adopted clean lines and restrained styling, free from meaningless 'turbo' legends, many moons ago. The DRM-540 carries a neat array of transport controls, with large, clearly marked buttons. The tape compartment window gives a clear view of the tape but, of course, at this price no back-lighting is provided. There's some noise from the mechanism as it reels tape (slowly!) and some sloppy

clanking noises when Stop is pressed. The reel brakes could have done with servo-assistance it appeared, since the reels came to a halt none too sharply, paying out spare tape into the cassette shell.

All the same, our sample worked adequately and suffered no jams. Its performance is about what I'd expect, and Denon do in fact fit a two-motor transport with a dedicated capstan motor, which is a good sign. A large, legible, blue fluorescent display shows recording level, with 0VU set at a normal level - neither high nor low. Metal tapes can be taken to around +3 or so on music peaks, high performance ferrics and chromes just a little higher.

There's a four-digit tape counter with zero-stop (memory), track search, return to record start position, automatic tape type selection and an MPX filter, used when recording stereo VHF/FM broadcasts. Denon also include bias adjustment - and it works with metal tape,

as well as ferrics and chromes. Adjusting bias matches-in tapes by altering their high-frequency response, bringing it flat so as to avoid either emphasised or dull treble. It also removes amplification of errors by the Dolby system, this deck possessing Dolby B and C noise reduction, as well as HX Pro treble headroom improvement.

The Denon's case was a remarkable one-piece plastic moulding; the tooling for this sort of thing would cost a fortune, but the cases themselves mere pennies as a result. This is the way volume production can lower build costs; NAD in contrast use a veritable jigsaw of stamped metal parts for their rival 602 deck (£200). Denon do, however, fit a real-alloy extruded fascia and a flimsy steel top access plate.

The main circuit board inside possesses adjusters for overall bias level, playback gain and record gain, so this deck can be tweaked as well, but be warned



# LITTLE DEMON DENON

**As tape decks below a couple of hundred pounds become a rarity, Noel Keyword tests a new example from Denon.**

that circuit data, experience and test equipment are needed. And finally, a legend on the front says: Remote Sensor. Believe it or not, the deck can be remote controlled, but the handset is not supplied - it is available as an extra.

Unfortunately, the DRM-540 greeted me with a problem. Casually making a recording on TDK AR ferric tape of The Pretender's 'Show Me' - not a demanding track - I was confronted by opening guitar notes that shook and trembled badly. It was a gruesome demonstration of random drift, something the spectrum analyser had warned of, although I hadn't quite expected anything so obvious.

Subsequently, this blemish became less obvious. Piano certainly had slightly 'cracked pitch', as I call it, but sustained notes seemed to hold satisfactorily, without blatant wow. I'd been caught by the randomness of a budget transport with a weak motor, making it cassette dependent. The AR cassette I used must have been primarily responsible. Swapping to Maxell MX metal - and all Maxell tapes run well - the same notes held reasonably well. So the transport generally manages well enough, until faced with a less than perfect tape. I had to bang some cassettes hard on their side before they'd reel properly, because of limited torque (this flattens an uneven tape pancake).

The same Maxell MX tape provided good recordings, with especially clear treble. However, the deck does rather lack bass slam, which gave metal tape a light sound. This was something I noticed with pre-recorded tapes too. However, using only Dolby B in order to preserve sound quality, there was little hiss from MX and, with bias increased a little and recording level kept to +3 on peaks, recording quality proved good - I heard little muddle, there was an even tonal balance (ignoring light bass) and a general sense of clarity prevailed. So the DRM-540 does work reasonably well with metals - not always the case with budget decks.

Ferric tapes came over as a little muddled, doubtless by treble overload (saturation), when recording level was pushed up to lessen hiss. I suspect bass distortion was creeping in, affecting everything. The Denon was a little less at ease with ferrics than expected, I found.

Maxell XL-II chrome ran well and gave firm bass, yet reasonably clean treble. Neither ferrics nor chromes can match metals for clean, fast transients and lack of treble muddle, yet XL-II offered a high standard of recording quality all round. The drawn-out slide guitar intro to Roy Rogers 'Bad Situation' held steady, the drums sounded fast and lean and his nasal vocals were well etched. The DRM-540 showed it could give good enough recordings.

There's a certain air of unpredictability to budget cassette decks; they're victim to many problems, some transitory. The DRM-540 generally worked well, even if it

did seem a little uncertain about itself at times. Used to the confident stability of a dual-capstan Nakamichi, I find budget cassette decks can be a little unsettling - as this one was. Yet it gave good recording quality on chromes and metals in particular and it replayed pre-recorded tapes without muffling them. It leaves me thinking that budget decks now have to make some dubious compromises to reach price levels of the sort that existed a year or two back and that, if possible, a

little more needs to be spent for more stable and predictable results. However, amongst the dwindling band of decks priced at less than £200, the DRM-540 is as good as any ●

**Denon DRM-540** £159.99  
**Hayden Labs Ltd.,**  
**Hayden House,**  
**Chiltern Hill, Chalfont St. Peter,**  
**Bucks. SL9 9UG**  
**Tel: 0753 888447**

**MEASURED PERFORMANCE**

The tape head of a budget deck is an item that needs close attention. If the manufacturer has been too stingy here, there's little chance of success. Denon's tape head on the DRM-540 just holds up. It suffers more distortion than usual - 7% instead of 3% on bass notes for example - and it has a ragged low frequency performance, due to head contour effects, so I wouldn't expect the cleanest nor the most even-sounding bass from this machine. However, its high frequency extension was adequate, metal tape hitting 20kHz, and its overload headroom was reasonable too, being a few dB above IEC 0dB reference level for all tape types - a good result. Ferrics, chromes and metals can be taken above 0VU when recording, to about +3dB - +5dB or thereabouts.

Denon had set the head azimuth of our review sample well. On replay it reached up to 20kHz on one channel, although curiously not on the other. This would skew images toward one side of the sound stage with pre-recorded tapes. However, the deck should also sound bright and clear with commercial pre-recordeds, although a little bass light too, since bass output falls away below 50Hz. The transport ran at the correct speed and replay hiss measured low at -60dB so, all round, this deck will handle commercial pre-recordeds reasonably well.

The transport possessed some slow random drift under analysis, although short term wow and flutter variations were quite low. I'd expect some random pitch changing to be occasionally evident, but not so much warble from capstan wow or roughness from flutter.

The Dolby system worked satisfactorily, although Dolby C was 2dB short of its full noise reduction potential and some low level motor drone components were obvious under spectrum analysis. Whether this would be audible only listening tests can tell.

Denon fit user-adjustable bias and tests showed it worked with metals, as well as with ferrics and chromes. Denon have biased the deck so that metals accept strong treble signals, at some loss further down the audio band, so expect clear, clean treble from metal, but not high overall recording levels. Quality ferric tapes are often the best choice for budget decks and the DRM-540 looked good with them under test.

Budget cassette decks these days show their compromises. In the DRM-540 Denon use their expertise to balance them well. **NK**

**TEST RESULTS**

**REPLAY** (pre-recorded tapes)  
 Frequency response (-2dB) 30Hz-20kHz  
 Speed accuracy +0.6%  
 Hiss (70uS, Dolby out) -60dB

**RECORDING** (blank tapes)  
 Frequency response (IEC Primary Refs.)  
 ferric (IECI) 20Hz-16.5kHz  
 chrome (IECII) 20Hz-18kHz  
 metal (IECIV) 20Hz-20kHz  
 Separation (1kHz) 48dB  
 Distortion (315H) 1.4%  
 Hiss (70uS, Dolby out) -56dB  
 Speed variations (DIN total) 0.06%  
 Flutter energy (3-3.13kHz) -26dB  
 MOL/SAT (IEC Refs) 315/10k  
 IEC I (ferric) 4dB/-5dB  
 IECII (chrome) 2dB/-3.5dB  
 IECIV (metal) 2dB/+1.5dB

**Frequency Response**

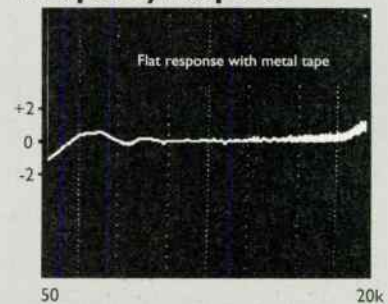

**Speed Stability**

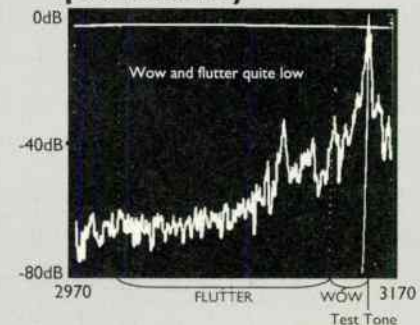



# World

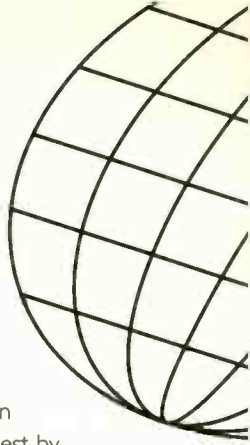

## CURSE OF THE PYRAMIDS

I am writing this letter to try and find out what is actually happening at Hi-Fi World at the moment.

Over the past few months I have noticed that you have a policy of putting coloured backgrounds on the pages where equipment is being reviewed. Sometimes it is hard to make out the words (Vol 3 No. 12, page 48). Also wrong photographs have been printed to equipment reviewed. (Vol 3 No. 12 page 34 and 36) but there are some amusing new things about Hi-Fi World.

The new photo of Noel Keywood (Reflections) looks like the Editor has either sat on a very warm valve amp or a rather large Krell has just been dropped on his hand.

And Mr Dominic Baker does not get away with anything either. The photo (dB On The Level) looks like an advert for Head and Shoulders.

So come on chaps, lets get

back to basics. Good reviews, the right photos, and no silly coloured backgrounds.

**M. A. Golden  
Chadderton,  
Lancs.**

We're trying to find out what is happening at Hi-Fi World too! The answer lies with Fifi, our layout artist. Why she chose to change pics and why she likes such colour schemes are mysteries as great as the Pyramids. But then, since Fifi is Egyptian, perhaps this is to be expected. Your letter has been passed on . . . **NK**



Fifi - the culprit

## SCOTS THRIFT

I am a member of a newly founded Hi-Fi Club on the North Coast of Scotland. We

are an enthusiastic bunch wanting to up-grade our systems. If you could hear the very best of our systems you would understand why. We are all unemployed (yes, it's bad up here too) and therefore can only spend a fiver or so each on the up-

grading.

My own system is best by far. It has home-made speakers, one comprising an 18" Goodmans unit and a pair of 2" mid-range units (obtained from Fishermans Tales, who lives up the road, I

## Letter of

What a welcome innovation Dominic Todd's turntable review was in your December 1993 issue. Anyone with his system based around a Manticore Mantra, moving coil cartridge, Pioneer A400 and Celestion SL600s, but with much customised tweaking, is clearly an enthusiastic and full-spirited iconoclast, immune to the vagaries of fashion! Amidst manufacturer talk of 'total one-stop system solutions' his is no accident and a breath of fresh air. This is not a man who wears his equipment lightly; and his writing provides the perfect antidote to some of Hi-Fi World's wilder technospeak.

It was amongst the technospeak that I found myself delving, looking for a cheap skate RIAA head-amp when I came across this from D.B. 'opening up £600 amplifiers to find them populated with 50p chips makes us groan'. Elsewhere, he and I share disappointment in the lack of innovation in the Hi-Fi industry and its belief in

competitive pricing, of which the £600 amplifier above is a perfect example: it's priced at £600 because that's where its competitors are priced, not because there's anything like £600 worth of bits inside. But was it ever otherwise?

To my mind this is another fascinating side of our hobby, perhaps a microcosm of British Industry. The hi-fi business is driven by 'innovative' niche products.

Picture the scene - our lonely inventor sits up late into the night soldering up amplifiers on the kitchen table, in time for delivery to a shop the following morning. Aside from the fact that these early models are actually no more than working prototypes, he actually manages to sell a few, and by the end of the second month, a friend of a friend, who just happens to be a hi-fi journalist gets to hear one. . . .

The rest, as they say is history, but after a couple of years and a business expansion scheme, a talk with the bank manager over

### WIN HI-FI WORLD SILVER PLATED COPPER

#### INTERCONNECT CABLES

(1 metre pair)

The writer of the most interesting or funniest letter will receive a free set of Hi-Fi World's silver plated copper interconnect cables, worth £69.95.



Send your letters to Hi-Fi World Letter Page,

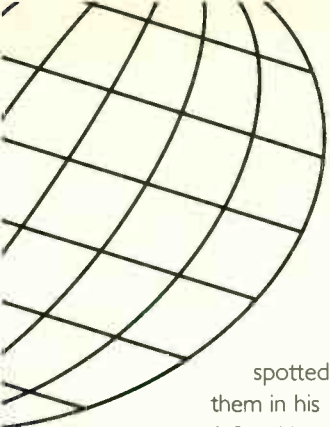

# writes

spotted them in his garage) fitted into a sealed chipboard enclosure.

Eat your hearts out boys! The other speaker is a more compact unit comprising a 6.5" Goodmans woofer (£2 from a car boot sale) into an

enclosure of unknown make which was found in Billy's back garden complete with a working tweeter! This unit has made a great improvement to my overlay sound definition and is light years ahead of the blown car speakers it replaces.

My amplifier is the real

heart of this system though - a Sony receiver/tapedeck. This was obtained from Brian in Helmsdale, who had given up on it and was about to fling it out due to the expired tape deck and the machine-gun-like background noise emitted from the amplifier. If it wasn't

for the painfully harsh mid-range I would be more than happy with it.

The tapedeck is a good old Triumph TC-400 which is in fairly good working order considering it has spent twelve months on a filthy bench in Fred's goat shed, subjected to horrifically damp conditions.

Corrosion, thankfully, had not gone too deep and apart from having to remove the lid every so often to free the mechanism, it has performed superbly. Although the sound quality of this piece of equipment leaves a little bit to be desired it has proved to be a real work-horse (since I have no other source, it needs to be).

As you can see, we are in need of some slightly better equipment up here for the desired upgrading to take place. We can't afford to be too fussy as we are more or less dependent on contributions. If anyone would like to contribute any un-used, inferior or discarded equipment to our worthy cause, we would be more than happy to receive it. Seriously now - we are not joking.

**Rob,**  
**The Cottage,**  
**Charleston Farm,**  
**Dunnet**  
**Nr John-O-Groats**  
**Caithness**  
**Scotland KW14 8SY**

Was this written tongue-in-cheek or screwdriver in 'Sony receiver tape deck' (whatever that is)? We don't know, but if any other hi-fi clubs want to investigate and offer a bit of charity, contact Rob - he and Fred's goat sound deprived. **NK**

## the Month

roller-coaster cash flow problems yields a business plan and a marketing scheme. Those amps always had a good reputation for reliability and what with the glossy brochures as well - recession? What recession?

However, something important has happened on the back of this 'burgeoning British success story'. The amplifier company became BIG - sure, the range and the company expanded, but in inverse proportions to its capacity to innovate. The company needed to maintain its entrepreneurial flare and crucially, to be able to borrow money for its next innovative breakthrough. Unlikely in the present climate, hence the cynicism of the new model change for next year and competitive pricing.

What's to be done? UK manufacturing appears to be on the slide, but Hi-Fi World is to be applauded for its own innovation in the publishing world, with your DIY supplements, which in turn allow us to build low-cost innovations into our own systems. Although I

won't be following you down the Single-Ended path (with high efficiency speakers), an MC cartridge with head amp does appeal. But can I learn to solder before the next supplement?

**Chris Moorhouse**  
**Poole,**  
**Dorset.**

I'd say your perceptive analysis of a typical company start up and ossification cycle is spot on! Beyond a certain size, sales and marketing become formalised into the company structure, as current commercial wisdom dictates and, at that point the outlook of the time takes over from the sort of gut instincts or perhaps niche interests of the company's founder(s). This can be both good or bad, but it is more often the latter.

As you say, the product range has to be 'rationalised' and renewed at regular intervals to stimulate demand. It is at this point that real innovation flees; change is then made for change's sake. This is the safest and most comfortable

position for management, who are under the gaze of both their accountants, who have a statutory reporting duty, and the bank. Adopting the same sort of approach and policies as everyone else is easiest to justify. Luckily, there are always dissenters who retain their own unique vision and can see past marketing hype through to genuine and worthwhile product development that can in turn result in very buoyant trading. At present, some of Britain's best hi-fi companies are doing great business, yet at the same time others are experiencing a lot of difficulty - that's the way the market is at present.

We are having fun developing new projects. The 300B amplifier now has no feedback at all, because it has been improved and now sounds best without it. A feedbackless amplifier is an almost unique animal and we are proud of it. However, we will be offering simple, solid-state projects in the future, of the sort you request. **NK**

64, Castellain Road, Maida Vale, London W9 1EX.

**CATHODE FEEDBACK**

I have read with great interest details of your circuits for valve amplifiers. I am nearly 80 years old and many of my pre-war memories in radio service public address work was with valves such as PX4, PX25, KT66, KT75, KT88, EL34, including 807s, many in parallel push-pull.

Hi-Fi World is taken regularly each month; it confirms what I have always been sure of - that valve sound quality is the best.

I used to work in a factory lab with a large company after war service in radar. I am sending you this extract from Practical Wireless 1962 on ultra-linear cathode loading because it has not been mentioned in your article. I believe it was published by Practical Wireless as subject to patent. It is of course a cathode-loading method and was highly thought of at the time as low in distortion.

**C. Wright Skegness, Lincs.**

Thanks for the circuit. We are always interested in innovations that might have been forgotten. However, in this case we recognise distributed loading, pioneered by Peter Walker and Theo Williamson and used in the output stage of the Quad II power amplifier. Independent low impedance windings provide feedback into the cathode and it does give good results. **NK**

**CIRKUS**

I am certain that the Cirkus modification has substantially improved my Linn LP12 turntable in every conceivable area, including timing, musicality and authority, and all the areas where the deck was previously criticised, like accuracy and imaging. The surface noise has dropped by an unbelievable amount, in spite of this being one of the LP12's many virtues, and loath

though I am to admit it, it even renders some digitally recorded material acceptable for the first time.

Best of all it has again and again allowed the meaning behind the music or lyrics to shine through where previously they were unintelligible or just bland. The staggering increase in 'solidity' and authority imparted by the Cirkus gives me the uncanny impression that the 'needle' must have been bouncing around out of its groove before. If Lingo advances the LP12 by one order of magnitude, then Cirkus advances it by two. I am just extremely grateful that Linn didn't price it that way!

In spite of its ability, I search in vain for an intelligent

perhaps it doesn't like his glass top.

The Cirkus has not excited an acid note in any of my records and has, on the contrary, demonstrated a tremendous smoothness, even though the dynamic range has dramatically increased. Indeed it has rendered my harshest records listenable without removing any of their bite. Jonathan Kettle's '74 Sondek vs '93 Sondek hardly mentions the Cirkus - and where the devil is Malcolm Steward's review, or have I missed something?

I've had my Cirkus update since June this year and have yet to read a review that begins to do this massive upgrade the justice that it deserves. Please, in fairness to

of the Cirkus.

**Richard Hatton East Sussex.**

For readers not acquainted with this modification, the Linn Cirkus comprises new inner platter and spindle, main bearing housing, sub-chassis, arm board, replacement of springs, grommets & drive belt, cost: £285 fitted.

The Cirkus and Klyde are victims of Linn's change of direction. They now have a sales area in Harrods which, we are assured, costs a fortune. From such a venue, and from other prestige outlets around Britain, Linn told me they hope to move into what they believe is a more affluent and less critical market than the one of their

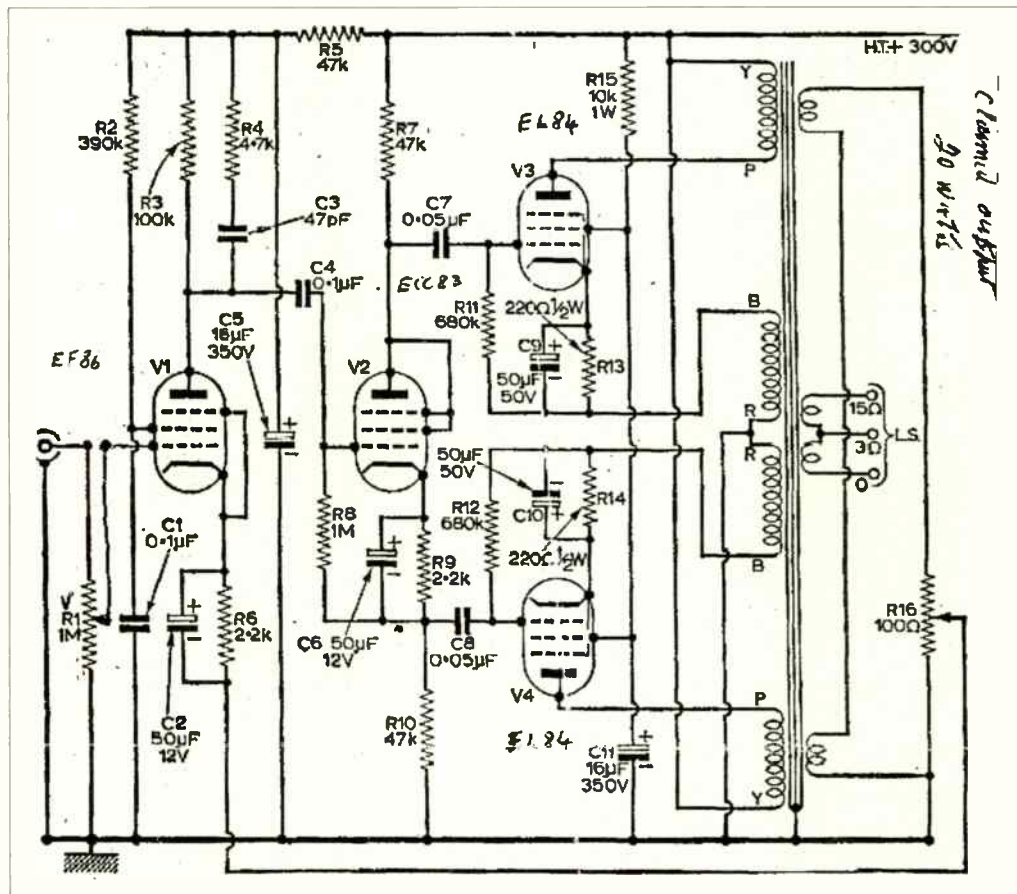

Ultra-linear cathode loading - Practical wireless 1962.

review of the Cirkus (or the Klyde for that matter). The Hi-Fi News review by Chris Breunig was acceptable, but hardly did the Cirkus justice, and Paul Messenger's review in Hi-Fi Choice was really disappointing; it works brilliantly with the Naim,

Linn who have done so much for both audio and British industry, for the benefit of those who are crazy enough to believe what they read in hi-fi magazines, and for the satisfaction of those who have heard and already know, let someone do a proper review

beginnings. The conspicuous wealth they hope to be able to capture, commonly referred to as the 'B&O market', demands a different approach to marketing of product (glib expression,

continued on page 45...



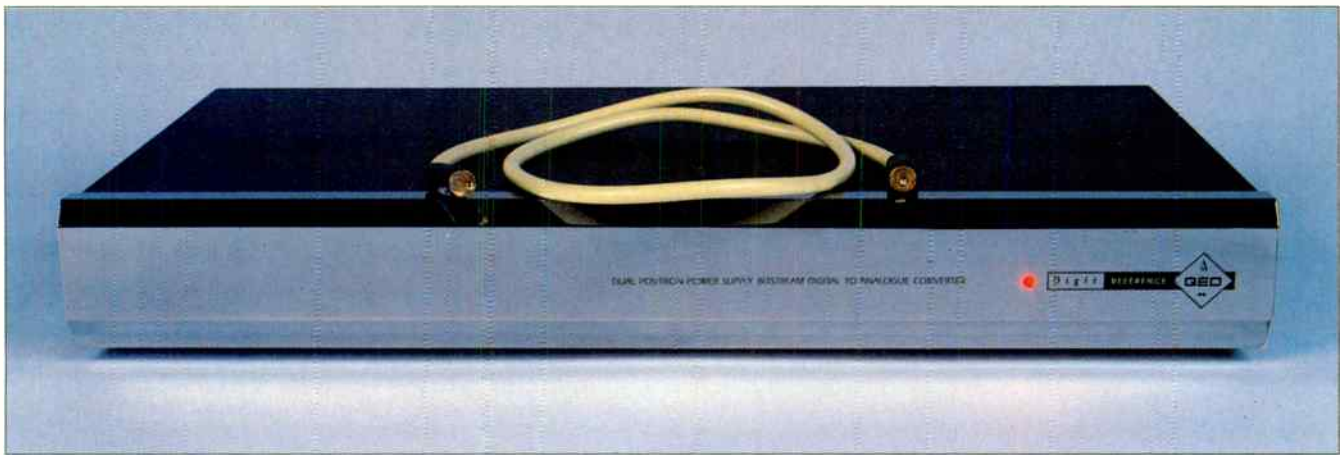

**W**here QED got their idea of a twin-power-supply Digit from, I can't possibly imagine! Regular readers will remember that when Hi-Fi World tested the Digit and the then-new, Positron power supply a year or so ago, we found that the performance could be usefully improved by the addition of a second Positron. Now QED have brought out their own twin-power-supply DAC, the Digit Reference housed in a single full-width case, complete with *de rigueur* chrome front panel and understated graphics. This came as quite a shock after the usual plastic boxes, more reminiscent of a £4.99 alarm clock, that QED products are often housed in. This marks a move by QED up-market, and is matched by an equally up-market price of £450.

There's stiff competition at this price point. QED will have to trade punches with the excellent DPA Little Bit II (£450), the well established Arcam Black Box (£450) and Select Systems' keenly priced Dacula (£395).

The technical specification and inclusion of good quality Digiflex and Optiflex digital and optical cables goes some way to justify the price. With twin power supplies, the digital and analogue circuits built into the Digit have separate feeds. This should help reduce distortion and improve resolution. Additionally the circuit board does at least feature a complete ground plane, and a vertical brass shield to reduce distortion and prevent digital noise entering the audio output stage.

I was interested to see if the new QED would show noticeable improvements over my own Cambridge DAC, which is getting rather long in the tooth now. The Digit Reference was most at home with sparser music such as early Prefab Sprout. The over-riding impression was of a DAC that was in firm control of the music. The separate power supplies certainly appear to be effective as far as separation is concerned. Vocals were distinctly separated from the rest of the mix, although, against some of the competition, they could sound a little two-dimensional. The QED demonstrated fine detail, and instruments were always cleanly reproduced. So far so good. But the 7323-based DAC showed up its weaknesses

# A NEW QED REFERENCE

**Dominic Todd listens to the dual-Positron powered  
Digit Reference, in new shiny chrome case.**

against newer DAC-7 and Crystal convertor designs. Although the bass was tidy, it was never particularly deep or extended, giving the sound a somewhat lightweight balance.

With All About Eve's *Touched by Jesus*, there was an occasional muddying of vocals that detracted somewhat from the clarity shown elsewhere. One characteristic of the original Digit that has certainly been carried through to the Reference, is its ability to really strip a recording down and give it 'bite' and attack. For example, the electric guitar was vividly portrayed, and each riff clearly distinguishable. However this can also materialise as a slight hardening in the mid range, especially if the recording isn't as good as it could be.

Despite the Reference's clean and punchy balance, it lacked any real dynamics, a characteristic that did little to help the rather too analytical nature of the DAC. With some types of music it could sound thin and wearing in the long term. Albums such as Mike Oldfield's *Crisis* are brightly recorded, relying on a deep and tight bass to avoid the sound becoming ear-splitting. Here the QED fell down somewhat.

Zachary Breaux's 'Groovin', recorded live at Ronnie Scott's Jazz Club, was produced with a believable 'live' atmosphere, and Breaux's guitar work really bubbled with enthusiasm. Once again though, the bass tended to lack grunt at the bottom end, which prevented the music from becoming really involving.

Chamber music, such as Corelli, showed the QED in a good light. It gave each individual instrument a sense of space, the end result being a broad and realistic sound stage. Violins could occasionally sound harsh, though; another area where more modern digital techniques used in the Digit's competitors show up its slight lack of refinement. Otherwise, the lack of really deep bass wasn't a problem here, as neither cello nor chamber organ demanded it.

QED's full-width case with chrome front panel is light years ahead of what QED usually turn out. It was also nice to see that QED had gone to the trouble of supplying decent quality coax and optical cables as standard. These also turned in a good performance and you'd need to spend at least £40 on either to see much of an improvement.

Yet the sound isn't quite so impressive. It has all the qualities that make the Digit and Positron such excellent value for money, but at nearly twice the price fails to make a comprehensive enough improvement. It's fine with sparser Pop, Jazz and Chamber music, but can become trying with anything more complex. It's not only refinement it lacks; comparing the DAC to my own Cambridge, I felt that it was reluctant to produce really deep and extended bass.

My advice is to stick with the superb value Digit and Positron, or if you're in the market for a DAC of this price take a look at what DPA and Select Systems have to offer ●

# On the Eighth Day...



These CD collection systems, hi-tec in design, will enhance the quality and sophistication within the hi-fi world.

In a variety of styles and finishes this is the ultimate to compliment your CD compilation and complete your sound galaxy.



**AMPHIS**®

**Lourens**®  
**Fisher**

**FRED'S CAPACITOR CRISIS**

Dear Val,  
When I first switch on my system one of my speakers produces a little noise, not unlike a cross between an Intercity train and Brian Blessed belching. Obviously, I would like to solve this problem, as when guests visit they invariably think it is me. Fred Kenners Macclesfield.

**A spot of noise suggests the capacitors need replacing in your power amp. However, I would suggest you eat less bran - just to be on the safe side. VV**

**NEIL'S CRANKY CABLES**

Dear Val,  
I recently bought an enormous length of cable from my local dealer. It was a copper stranded affair with a sensible price tag, so I thought I'd done quite well. However, once at home I connected it up and went to switch on - nothing happened. It was then that I realised I don't actually own a system. What do you suggest I do?  
Neil Sharples  
New Malden, Surrey.

**You obviously need cables with a sweet treble and clear midrange. Van den Hul do an excellent silver plated oxygen free cable. Try it - Oh... and don't forget to buy a system. VV**

**GRANNIE'S WINTER WARMERS**

Dear Val,  
My poor gran's ears suffer terribly from the cold in winter so I decided to buy her some smart 'phones to wear whilst shopping and going about her daily business in general. I opted for Beyerdynamic's DT331s which have particularly large circular ear cushions which can be comfortable and warm. However, she wears a lot of silver jewellery and these particular 'phones require gold plated jacks. Help!  
Donald Gregory  
Eltham, London.

**Poor gran, I suggest**



**VAL-VAMP'S PROBLEM PAGE**

Problems with your front end?

Maybe you can't get your cross over?

Basically imbalanced?

...well don't fret, you're not on your own. Write in with your problem to Val Vamp, aka Caroline Knott, Hi-Fi World's very own resident agony aunt, and she will endeavour to solve it - or at least offer some practical advice (a problem shared and all that. . .)

**Vivanco's IR 9001s.** They're slightly more expensive, retailing at £119.19 but they are infra red headphones that receive music from a transmitter. Failing that, Woolworths do a lovely range of candy striped fur hats at £2.99 each which should suffice. VV

**OFF THE RECORD**  
Dear Val,  
I recently aquired some 'Sunsplash' storage units for my extensive vinyl collection and have found I can only fit two or three albums in each one. What am I doing wrong? I have enclosed one for your inspection.  
John Wilson  
Scarborough, W. Yorks.

**This is the 'Sunsplash Orb'. You need the 'Sunsplash Cube'. The orb is shaped like a goldfish bowl and is therefore unsuitable for anything much other than goldfish. VV**

**A CD SILENCE**  
Dear Val,  
I recently bought an expensive CD player which I took home to use. It was extremely quiet and I returned it, presuming it was faulty. The dealer had a good laugh at my expense when he pointed out the fact that there was no plug on it. Needless to say I was a tad embarrassed, but not half as embarrassed as him when he realised he'd sold me a sandwich toaster in error! Just goes to show you, eh?  
Johnny Fletch,  
Sidcup, Kent.

**It certainly does Johnny. If any other readers have an amusing or embarrassing experience relating to the purchasing of their Hi-Fi, please write in and we can ALL have a good laugh at their expense. VV**

**PLUGGING BANANAS**  
Dear Val,  
I've always been a little on the forgetful side but this

recent experience really does take the biscuit. When a friend informed me I needed to improve my connections with some banana plugs, I dashed out to my local dealer to buy some. A while later my friend passed the local estate agents where he spotted me drinking bubbly and celebrating the purchase of a rather large banana plantation in Honduras. Have any other readers had a problem of a similar nature?  
Andrew Lynch  
Stevenage, Herts.

**No Andrew, I shouldn't think so. But, if any readers ARE particularly scatty or forgetful, write to us (NOT your local gas showroom) and tell us of your experiences. VV**

**A TIP OR TWO**

- 1) Fool neighbours and friends in to thinking you own the latest esoteric system by throwing a brief but wild party during a home dem. Ask the demonstrator if he wouldn't mind serving drinks.
- 2) For a cleaner sound from your valve amp, clean all valves with Windolene prior to play.
- 3) Always keep Isopropyl Alcohol and haemorrhoid ointment well separated in your bathroom cabinet.
- 4) To combat the frustration of listening to other people's loud, hissy walkmans, travel on the tube or train with a blank tape playing on your own walkman at full volume.
- 5) Forget multiroom installation. Purchase wall to wall mirrors throughout your home and hey presto! A reflection of your system from anywhere at which you can aim your remote control.
- 6) Whatever you do, do NOT attempt to wash CDs with cheap washing up liquid. "Fairy may cost that little bit more but it also lasts that little bit longer. 50% LONGER in fact etc., etc.●"

...the best in  
sound reproduction?

Then look no further than the new  
Yamaha LSI Catalogue...

Yamaha has captured sound as digital information and created its own sound-orientated Semiconductor Technology. By combining its experience in building electronic musical instruments with high-tech R&D work, Yamaha has mastered the art of making sophisticated LSI chips for Graphics processing communications, and full-custom & semi-custom applications.



For further information, contact: Keith Kelly on 0525 853071



**Polar Electronics Ltd**  
Cherrycourt Way, Leighton Buzzard,  
Bedfordshire LU7 8YY  
Telephone: 0525 377093  
Fax: 0525 378367



# Infidelity

indecently good hi-fi



Buying hi-fi should be fun, we guarantee to make it so. Listen to a well chosen selection of quality hi-fi equipment in our comfortable and relaxed listening room. Bring along your own records or CDs, we'll provide the coffee, and hear the difference we can make to your enjoyment of music.

**MICROMEGA's fantastic new STAGE CD players now on demonstration**

ARCAM, EPO, HEYBROOK, MICROMEGA, NAI, NAKAMICHI, NEAT, REGA, ROKSAN, ROTEL, ROYD, TEAC and YAMAHA

9 High Street, Hampton Wick, Kingston upon Thames, Surrey KT1 4DA  
Telephone: 081-9433530. Open: Tues - Fri 10.30am - 7pm, Saturday 10am - 6pm.

## Connections



Tel: 081 348 5676 (2.00-7.00pm)  
Fax: 081 341 9368

## Esoteric High Fidelity CABLES

Dealers in: Absolute, Audio Note, Audioquest, Deltec, Harmonix, Kimber, Mandrake, MIT, Siltech, Symo, Van den Hul, WBT, and others

...the RIGHT cable  
...in YOUR system  
...for YOUR ears  
...in YOUR home

Contact us by phone, fax, or letter and we'll do our best to help you achieve your goal.

(Auditions may be subject to a handling charge)

**CONNECTIONS** 13 John Prince's St, London W1M 9AH (A division of Connection 90' Travel Ltd.)

# THE MICHELL CONNECTION

"The ultimate connectors for all quality speaker cables"

AN ORIGINAL MICHELL PRODUCT

Made in England

WARNING: Beware of inferior copies!

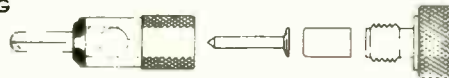

SURE-LOC: Rhodium or Gold Plated Expanding Plug

Details from:

**J.A. Michell Engineering Ltd.**

2 Theobald Street, Borehamwood, Hertfordshire, England. Telephone: 081-953 0771

...continued from page 40

that), one not really in tune with the likes of specialist hi-fi magazines.

Consequently, Linn are not overly fussed about providing products for review, except where they can be assured of a friendly and uncritical reception - which counts us out! We have asked for the Klyde for review many times, but Linn refuse to supply it. In truth, of course, it would probably receive a favourable review, since Linn moving coils have always been amongst the best. However, the Kremlin tuner was a pretty lacklustre device, which I stated was easily bettered by a Leak Troughline, and that seems to have upset them.

Linn are not interested in supplying product into what they perceive as 'hostile territory' such as Hi-Fi World (you need to understand that many manufacturers genuinely believe their products are perfect and believe that any criticism of them in the press derives solely from spite - or some other irrational factor). So don't hold your breath for a thorough Cirkus review, 'cos Linn aren't interested. All the same, I'm glad you feel this upgrade is worthwhile. Other readers with Linn turntables (which we like) will doubtless take note.

Personally, I believe Linn won't find a pot of gold at the end of the 'lifestyle' rainbow they're currently pursuing and that they'll return to dedicated and high spending enthusiasts like yourself in the near future. **NK**

#### CHARITY HI-FI

The nucleus of my system is a Leak 2000 AM/FM receiver - yes, the Rank era - but it still sounds nice driving a pair of Leak 'sandwich' speakers. I bought them at the beginning of last year, separately, from our local charity shop for £25.00 and £30 respectively! This is a curious week-by-week

affair in a 16th century cottage - different charities each week!

Some two months later a '2001 Transcription Unit' turntable appeared in the same place - it shows design influences from everywhere, but nothing definite: belt-drive, suspended sub-chassis, unipivot arm, with 'Patent Sphere dynamic' suspension, cost - £110. I secured a new set of balls for £20 - one had split and the other two perished, plus a belt and manual. They were very easily installed and, fitted with an ADC QLM III cartridge, this turntable sounds very well indeed.

My next purchase - yes, again from the same emporium - was a Leak 2002 cassette machine (alias Nakamichi, I'm informed), again £15, and this needs serious attention to the RH relay channel - advise me, please.

After a seven month hiatus, a big box in a corner of the same place proved to be a Revox G86 open-reel recorder - for £25.00. A tweak of the variable impedance inputs and all my 20+ year old tapes made on my old Ferrograph came back into playability - my wife didn't even object to its being on permanent display - could that be said of a Ferrograph?

A second-hand cheapo Fidelity CD player (£40) completes the ensemble, oh with a pair of Audio-Technica Headphones I won in a Church Raffle (10p).

Total cost, to date, £140.10, with my own design of MDF, spiked floor stands being made now, and decent FM aerial and quality interconnects pending perhaps another £100, a fair-value system for a ludicrous price!

Your advice would be appreciated over repairs to the cassette machine and a replacement cartridge, crossover components etc. to keep the system as original as possible, since performance is already more than adequate for my surroundings (and purse). Would it be too much

to ask for a suggestion of approx. value for insurance purposes as well?

**Mike Dent  
Cottingham,  
East Yorks.**

The unique feature of the Leak 2001 turntable was four suspension balls filled with energy absorbing silicon fluid. I remember a demonstration at a press reception by Dr Barlow, where he thumped the table supporting the 2001 with a large mallet - and the arm didn't so much as tremble. It certainly looked effective as a suspension system, yet the turntable seemed to have a short commercial life. I don't know where you managed to find new balls for it, because Mr Escot at Leak/Wharfedale, who was there at the time as they say, tells me the company making them no longer exists, so they are now unobtainable. Mr Escot confirmed that the 2002 cassette deck was made by Nakamichi and that it can be serviced, but yet again spares are limited. Contact him at Wharfedale on 0532-601222. And by the way, Wharfedale are now in effect owned by Mission, although they are to become a totally independent operation in engineering, staff and product terms. After a disastrous few years however, business is now booming and Mr Escot in the service department can help on all Leak/Wharfedale matters, spares permitting.

The value of a system like yours is, generally, minimal. Only certain vintage items, like Quad Electrostatics, can consistently command high-ish prices. However, if you value it highly, then insure it appropriately. **NK**

#### SINGLE MINDED

I write with reference to Dominic Baker's article 'DB On The Level' appearing in the October issue of Hi-Fi World in which he describes the highly desirable and efficient

coupling of single-ended amplifiers with high sensitivity speakers.

Could you please list suitable choices of each of the above. I am about to invest in these items and having taken heed of the warning 'These are expert kits, not for the inexperienced' on page 63 of your magazine; I feel obliged to go for the 'off-the-peg' variety and stay away from the idea of building my own.

And how do these 'commercially' available items compare with your KLS-1 3-way floor stander the 300B 28W amp and the soon to be published single-ended, integrated amplifier kit?

Having been 'dizzied' by so much hardware and incomprehensible 'software' talk in hi-fi shops, it is good to see that someone has espoused a single idea to the fullest extent.

I look forward to hearing from you and thank you for your kind assistance.

**Hayder Al-Hassan  
London.**

There are very few commercial single-ended amplifiers available at present. Audionote make the Oto and Soro valve single-endeds, which are designed and built in Britain - and are affordable! The Oto SE uses paralleled EL84s and provides 12W; the Soro SE uses paralleled 6L6s to give 18W. Prices range from £1149 up to £1999, according to whether you want a valve phono stage, a line-only amp or a power amp. The Soro is most flexible, due to its extra power. Contact Audionote at 0273-220511 to find where these amps are on demonstration.

Not on demo at dealers, but available for audition at the factory unit in Hove (near Brighton) are the Japanese-made Neiro, Kassai, Kagiki, Ongaku, Kego and Gaku-on (push-pull). Handbuilt only when a full moon appears

continued on page 47... ▶▶

# The Audiolab 8000A Integrated Amplifier



The Audiolab product range:  
 8000A Integrated amplifier  
 8000C Pre-amplifier  
 8000P Stereo power amplifier  
 8000T FM/AM tuner  
 8000M Monobloc power amplifier  
 8000DAC digital-analogue convertor

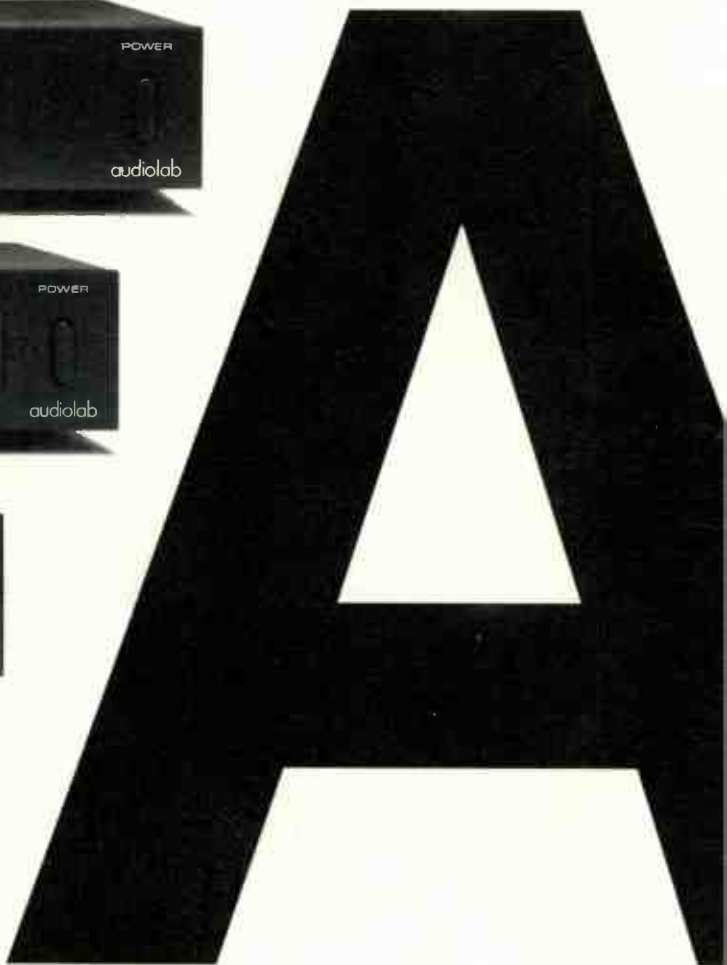

**Winners**



*Audiolab 8000A  
 Best Integrated Amplifier  
 Audiolab 8000T Best Tuner  
 Audiolab 8000DAC  
 Best Digital Component  
 Audiolab 8000C & 8000P  
 Best Hi-Fi Separates*

**AUDIOLAB**

Cambridge Systems Technology Limited, Spitfire Close, Ermine Business Park, Huntingdon, Cambs. PE18 6XY. Tel 0480 52521

...continued from page 45

during the grasshopper mating season, these range in price from £10,000-£138,375.

We haven't, as yet, designed any equivalents. Our own single-ended offers 4W at around £390 and should be available soon. The 300B amp is push-pull, but a paralleled 300B single-ended monoblock will be made available by the end of the summer - but it won't be cheap. The transformers required are absolutely huge and the metalwork is heroic in scale. Most of the components will be custom-made though; off-the-shelf components are just not of an appropriately high quality for true hi-fi work we are finding. **NK**

### USING GRADIENT SUBWOOFERS

I much enjoyed the "Quad Supplement" but, having used an ESL-63/Gradient SW-63 combination for about two years now, I did not feel that either Eric Braithwaite or Dominic Baker did them justice in their separate evaluations. I was warned by John Smith of K.J. West One, the first importers of the Gradients, that they took time to sound their best. This was good advice; after six months use they were appreciably fuller and more open, and they combined even more closely with the ESL-63s. I remain convinced that they represent a good investment for anyone owning ESLs, particularly if they have a spare amplifier.

The opening out of the sound of the ESL-63 which the crossover provides is as much an advantage in my view as the extra bass. The combination competes favourably with the highly expensive U.S. made panels and the sub-woofer match is rather better than some of the competing hybrids. My sub-woofers have been transformed since I followed the advice of the US magazine "Stereophile" and began using them with a

Bryston 4 NRB amplifier and (almost to the same extent!) since I changed their spiked feet to a more substantial floor penetrating variety.

Dominic Baker put his finger on the real weakness of the Gradient conversion when he drew attention to the cheap and rather nasty crossover. Having tailored the sound of the ESL and matched it to the sub-woofer so brilliantly, Gradient (who produce some noteworthy loudspeakers themselves and should know better) sold their own design short. At the last Penta I asked the Gradient representative whether an upgrade was planned. I got an equivocal reply which I took to mean "no".

Now that Quad have taken over the distribution of the ESL-63 from K.J., might they not produce a crossover with a bit more class? While I have never been a fan of Quad amplifiers since the demise of the 22/11 (a splendid piece by Haden Boardman by the way) the Maplin-type tin box and its contents hardly matches the beautifully designed and made 66 Tuner or CD player or Quad's "armchair control" image.

While the real solution for Quad fanatics would, of course, be an ESL-94 along the lines of the Sound-Lab A-3, but with Quad know-how and its legendary after sales service (and sensible U.K. pricing), I would settle for a Quad designed and made crossover keeping within Gradient's superbly judged parameters.

**Jim Hastings  
Oxfordshire.**

PS: By the way, if you find an amp that takes a real grip on the sub-woofers you may find, as I have done, that separating them from the ESL 63s in order to find their optimum position in the room does not really work since it emphasises the split between the two units which, in their normal position, is virtually imperceptible once the system has "settled in".

Thanks for your observations. Other readers will, I'm sure, be interested to learn from your experiences. However, we still protest that open baffle, dipole subwoofers cannot simply be pointed at a listener, as they have to be with the Gradient, and give optimum results. I developed a crossover to integrate Quad ESL-63s with Celestion SL6000 dipole sub-woofers some time ago and worked through the problems, gathering a lot of experience with dipole orientation and placement in a wide variety of rooms, and Dominic runs the system today.

As Celestion pointed out initially with their SL6000s, they must be orientated to match a room, as well as positioned ideally relative to the wall. In general, whilst such subwoofers can be placed in the usual loudspeaker position and sound approximately correct, we find that in most cases for the bass to sound smooth and deep, they have to point outwards. This sort of positioning is impossible with the Gradients. Pointing dipole subwoofers inward has, in all cases we have come across, resulted in overblown and loose sounding bass. A fascinating aspect of dipole bass is the way it changes in character as you walk around the room; the corollary is that there is an optimum listening position for such subwoofers.

All this might seem unduly complex - and it is! Celestion used a computer to work out optimum room positioning for owners of the SL6000, for example. We've spent an enormous amount of time on the subject, trying to find more empirical room matching rules to eliminate this necessity and we believe it is possible, but need to experiment more to determine whether they are widely applicable. I think you can understand our cynicism toward manufacturers who

market products whose theory of operation they seem to understand poorly.

The crossover is a different matter again and, to integrate a Quad into a subwoofer, some subtle psycho-acoustic work has to be done. Because of the dimensions of the Quad panel it starts to lose bass output through cancellation up at many hundreds of Hertz. The high pass filter that feeds the Quad needs to gently correct this loss, for example.

Furthermore, at worst the crossover should be based around a very high quality silicon chip, not a cheap NE5534 or TL071. Personally, I couldn't stand the thought of using yet another chip in my crossover and found, after experiment with our FFT and a test jig, an ultra high current gain FET that would do the job on its own with minimal distortion and massive headroom (130dB), due to ultra low noise and a high operating voltage. This particular FET always oscillates and tries to destroy itself unless all sorts of precautions are used, but it is a transparent device audio wise and an elegant and correct solution. Stuffing metal boxes full of ICs isn't clever at all, I have to say; there are far better ways of designing hi-fi products.

However, in real life, products we may frown upon technically can still work well enough to provide pleasure, as your letter proves. If the proof of the pudding is in the eating, then Gradient's culinary efforts are good enough it seems.

We will soon, I hope, be able to publish my own crossover in a DIY Supplement, to better illustrate the nature of these problems, as well as providing technically effective solutions for experimenters so they can make their own. Also, see our News section for Tim de Paravicini's - ahem! - radical solution to this problem. **NK**

# Studying Cambridge

**"I** designed the first one back in 1986" Stan Curtis told me on the 'phone from Wharfedale in Leeds, "but it was discontinued when the P40 came out. Then Hi-Fi Markets revived the P25 when they bought the Cambridge name, putting its manufacture out to the Far East, but using an updated version of my original design. Wharfedale then bought the name, but when Mission in turn bought Wharfedale, Cambridge was sold to Richer Sounds, who have kept its manufacture in the East. That's the history of the P25 and the origins of MkII version, which is really MkIII! It explains why the version you are testing follows my design principles, rather than those commonly used in the East, but they've probably been modified by others."

The history of this amplifier reflects the labyrinthine politics of the UK audio industry, through the commercially choppy seas of the late Eighties and early Nineties. Once upon a time Cambridge products bore the distinctive stamp of Stan Curtis (he's now Technical Director at Wharfedale), whose skills became widely appreciated in unusual products like the Cambridge CD-1, and CD-2 CD players and the Cambridge P40 amplifier. Testing the new P25II I realised that although it bore most of his hallmarks, such as high frequency band limiting (rolling off treble above 20kHz, the limit of human hearing), it also possessed early bass roll off, which seemed uncharacteristic.

"You didn't design in bass cut on the CD input did you?" I enquired. "No, I believe in extended deep bass for CD" Stan assured me.

I was trying to determine just how

**A British integrated amplifier for £120? You must be joking! Robert Wilson and Noel Keywood investigate this Richer Sounds bargain.**

much of this new Cambridge P25, built in Taiwan for Richer Sounds and priced at just £119.95, was attributable to the original designer, and how much had been tacked on later by way of modification or addition by persons unknown. What I was really trying to establish, I suppose, was its pedigree: was the new P25II a thoroughbred or a mongrel? Its lineage has been watered down a bit, it seems, but much of the original animal remains. All the same, the changes have had an impact.

The new P25II is interesting technically, as well as commercially. It has limited-action tone controls that finely trim spectrum extremes, rather than upset the entire audio band. This makes them subtle, but precise in their trimming action, offering just enough variation to suppress tweeter/cartridge treble peaks for example, whilst not upsetting the overall tonal balance of the system and they can be switched out if desired.

The low case profile and control knobs with a shallow dish, both style features of the Cambridge brand, have been retained, albeit in palid form. Nevertheless, build quality was good enough, the chassis being a complex jigsaw of stamped metal parts with a well finished front extrusion forming the fascia, as is common nowadays. Inside, the board and components are of normal grade, but

the number of discrete transistors suggested this was the original Cambridge circuit, rather than an Oriental substitute.

There's no shortage of inputs and, surprisingly at the price, a disc stage that can accept moving magnet and moving coil cartridges has been included. Tests showed that the moving coil option is a simple one where  $\times 10$  gain is switched in downstream from the input, so the loading conditions remain MM at 47k with around 220pF in parallel.

Sitting down, preparing myself for that warm, punchy, almost meaty sound that I remember from my youth as a Cambridge sonic trade mark, the first few bars from the P25II came as a slight disappointment. Just as the lightweight build quality of this latest model does not resemble the heavyweight construction of the old P40s I fondly recall, neither did the lean bass. This modern-day Cambridge is a dry, slightly hard-sounding amplifier, coming across as academic in comparison to the muscular sound that I know so well and had anticipated.

The lack of low-end grunt led to a rather constrained overall presentation; I got the impression that something was missing from the original studio mix, as if a couple of channels had been lost on the multitrack. This leaves the mid-range very prominent, which isn't always a bad thing as vocals and solo instruments are on the

## MEASURED PERFORMANCE

The P25II has a distinctive measured performance, reminiscent of earlier Cambridge designs, which bore the distinctive stamp of Stan Curtis, a long time UK audio designer of repute. However, the P25II departs from earlier Cambridge products too, possessing bass roll off below 24Hz on CD, something not in Stan's design repertoire at all. So others have contributed their little piece to this design. Rolling off bass on CD is neither common nor especially useful, but at least the P25II covers bass fundamentals well enough, but it certainly will not have earth shaking subsonics.

Very typical of Stan Curtis though is a high frequency roll off above 20kHz to lessen various distortions that result from a budget design. This gives a warm or smooth sound,

but one that is generally relaxing to listen to. In fact, the P25II starts to roll off above 10kHz and is -1dB down at 19kHz at all positions of the volume control, which is a bit drastic. It is normal to prevent the actual audio band from drooping.

Both the MM and MC cartridge stages were band limited too, warp filtering setting the lower response limit to 40Hz, whilst high frequencies extended to 23kHz.

The amplifier produced very little distortion and what there was comprised second harmonic, with a small amount of third. There was little increase at high frequencies - a good sign. It suggests the amplifier will have clean sounding treble, free from obvious harshness.

I was surprised to find the tone controls

work in perfect Cambridge fashion, lifting only higher treble or low bass by 3dB or so, producing just a subtle but useful adjustment at frequency extremes. They can be switched out.

Power output measured 40watts, or 64watts into 4ohms. A 4ohm switch resets the mains transformer secondary to give less volts but more current when working with low loads, improving transient current delivery. The P25II gives plenty enough output to go loud with ordinary loudspeakers of around 86dB sensitivity.

In spite of its low price, the P25II has both MM and MC disc stages. The MM input was very quiet, sensitive and possessed a high overload margin. The MC was sensitive, needing just 0.25mV for full output, but it was



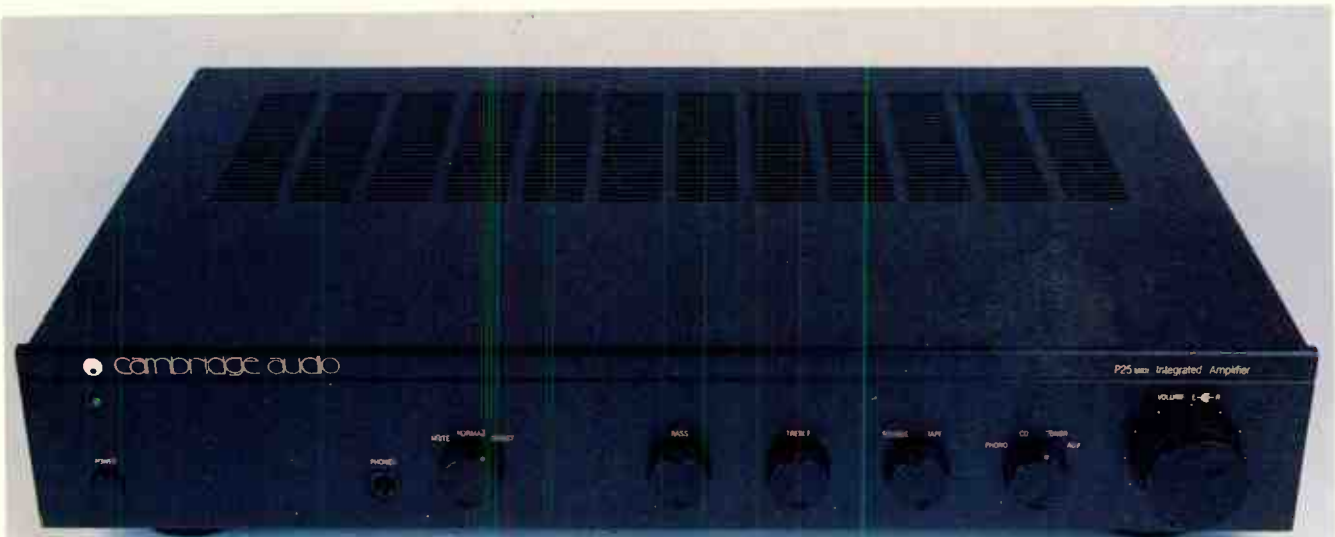

whole portrayed well, being projected forward from the speakers, making them both clear and intelligible.

Male vocals, such as those from John Lee Hooker, Gerry Rafferty and Eric Clapton were certainly communicative, although the amp sometimes tended to add a hard quality to some of the more mellow ballads. The effect was tolerable on rough, forceful rock or heavy blues numbers, but quieter moments did tend to show this fault up, giving singers a hard 'electronic' edge.

Instrumental timbre was differentiated well, making it easy to appreciate differing tonal colours, as well as the textures of solo guitars, both electric and acoustic; their images were solidly placed too. The delightful woody quality of Hammond organ and Fender-Rhodes piano also sounded good, but unfortunately acoustic piano again tended towards an upper midband hardness, becoming a little metallic. It was also dynamically restrained, reducing the insight into musical expression, perceived through the use of an instrument's dynamic range.

The budget limitations of the P25 were highlighted in the upper midband

where female vocals took on a shouty quality; Mariah Carey didn't so much sing as force me to listen! I was rather taken aback. This was also true of the percussive blasts of brass: they became overpowering. The P25II had a cold, steely top end, but it wasn't as gritty or coarse as that of so many budget amplifiers, even if it didn't shimmer like the better amps can either.

I suppose I was disappointed that the Cambridge 'sound' has gone from the P25II, and that in its place comes a presentation less to my taste. However, this latest version offers good power output, a clean midband and satisfactorily smooth treble free from budget coarseness. Matched with speakers possessing heavy, underdamped bass and healthy treble output, like B&W 620 is, it will sound balanced and persuasive. So here's a budget amplifier with good potential, only it must be approached with care.

### MM SOUND QUALITY

Following on from my initial disappointment with certain aspects of the P25's sound, I decided to try it in a

system with some speakers that would counter the bass-light character present in the amp. Using the B&W 620is and now feeding the amp with quality signals from a Garrard/SME/Goldring vinyl system into the MM input, I was greeted by an appreciable increase in bass output and quality. On the whole it was fuller and rounder, although still lacking a bit in extension.

The MM input was certainly quiet and most definitely didn't sound like a cheap afterthought. In fact the more lucid treble and slightly softer mid, which had a tendency to shout before, did increase listening pleasure quite significantly. Part of this was almost certainly due to the smoother character of vinyl, but the Cambridge had to have a good phono stage in order to exploit this. The inclusion of such a good MM/MC input at this price is certainly great value ●

**CAMBRIDGE P25II** £119.95  
**Richer Sounds,**  
**2 London Bridge Walk,**  
**London, SE1 2SX.**  
**Tel: 071 403 1201**

not especially quiet, so low output moving coils would not be an ideal match. Also, it shares its input impedance with the MM stage, meaning 47kΩ is presented to the MC cartridge. The MM input had a low input capacitance of around 200pF, which loads cartridges correctly. So the MM disc input measured very well and MC was good enough to do the job, but you wouldn't run a Koetsu through it.

This amplifier has a good measured performance, but with some peculiarities, notably curtailed bass on CD and treble that starts to roll off in the audio band. I'd expect it to have light bass, plus a warm but smooth presentation with clean treble. The MM disc stage in particular should give fine results with LP. NK

### TEST RESULTS

Power	40watts
CD/tuner/aux.	
Frequency response	24Hz-19kHz
Separation	72dB
Noise	-93dB
Distortion	0.01%
Sensitivity	200mV
dc offset	4/1mV
Disc (MM)	
Frequency response	40Hz-23kHz
Separation	56dB
Noise	-80dB
Distortion	0.01%
Sensitivity	2.5mV
Overload	150mV
Disc (MC)	

Frequency response	40Hz-23kHz
Separation	57dB
Noise	-63dB
Distortion	0.01%
Sensitivity	0.25mV
Overload	15mV

### Distortion

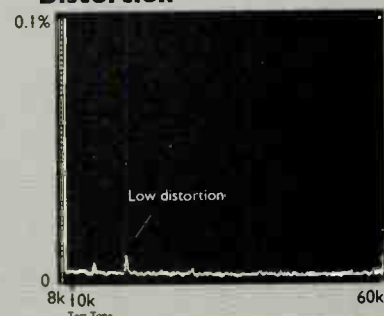



**N**orth Eastern Audio Traders (NEAT) jumped into the boiling cauldron of 'speaker manufacture a couple of years ago with the rather cheekily named Neat Petite. These were very well received as a superbly communicative, musically involving and coherent piece of kit. The only trouble with the Petites was their appetite for rather tasty amplifiers, which tend to cost large amounts of the folding stuff! Therefore it seemed sensible to produce a similar speaker which was both enjoyable and easier to drive.

With this in mind the second member of the Neat family has just been released. The Critique is a small two-way design, like its older brother, bass reflex loaded by a very small diameter rear port. Finished in a glossy textured covering the enclosure measures 320x220x230mm (hwd) and seems to be very sturdily put together, built in mirror-image pairs with the tweeter offset to one side. This is a 28mm treated fabric dome unit with the company logo neatly (yes, I know!) moulded into the surround, crossing over to Neat's own custom-made 160mm bass/mid unit. They can also be bi-wired. I mounted them on heavy stands, quite near to the rear wall with the tweeters towards the inside, for best imaging. The Critiques have a very business-like

appearance, functional in the mould of a studio monitor, but would they have the analytical presence of a professional speaker?

Neat Acoustics stand firmly by the fact that the main design method employed during the development of the Critiques was subjective, even to the point of only taking test measurements after the designers were satisfied with the performance in the listening room. This is certainly represented by the absence of grandiose technical claims made about the speakers with an emphasis on the use of materials and components chosen purely for their effect on the music.

Bob Surgeoner, Neat's designer, says of this approach that 'In the end it's the music that counts'; so, with the music in

mind we shall begin.

Initially the Critiques were played-in using the Naim NAC82/NAP180 set-up, this dynamic and musically coherent amplifier ideal at highlighting the designer's claim of an involving loudspeaker. I find that small affordable speakers most noticeably lack dynamics. The ability to resolve the important transient content of a musical signal is crucial in allowing the listener to determine the various individual strands of instrumentation used by the performers and composers, to convey their own artistic ideas, as well as the creative intentions encapsulated in the music.

Listening to well-recorded drumming from Phil Collins the Critiques gave me a valuable insight into the sonic signature

## *Musical Critique*

**A new small speaker from the Darlington designers of the NEAT Petite faces up to the critical ear of Robert Wilson.**

which marks out a typical Collins track, that dry tight rhythm punctuated with loads of gated reverb and machine-like consistency produced by even compression of the kick drum. However, the Neats still allowed the emotive human character of the drummer to prevail through all of this signal processing, making it child's play to spot the difference between the authentic Mr Collins and a computerised pattern on a sampler.

The Critiques come across initially as a slightly warm speaker, the bass being a little enclosed as if the small reflex port was restricting the freedom of the drive unit, which seemed at odds with the expressive dynamics available from the drums. This tended to unbalance the speaker to a small degree, leaving the bass marginally detached. However, this snapped back into place when the volume control was wound round. The Critiques are certainly hungry and come into their own when driven hard. They also take a fair bit of running-in to loosen up.

An absolute killer album for small speakers is Fairground Attraction's 'First of a Million Kisses' which relies heavily on a mix evolved from acoustic instruments, particularly solid, deep double-bass, something which the Naims also relish. The Neats made a very good stab at this producing a rounded sound with plenty of texture possessing much of the woody timbre of the acoustic bass, if at times resorting to a faint grumble.

Higher up the frequency range things became very interesting. The Critiques captured the recorded acoustic of a performance well, especially when I switched over to Audiolab monoblocks. For example, using a track from Graceland by Paul Simon where he orchestrates

Ladysmith Black Mambazo into a panoramic spread of voices across the soundstage, the depth and accuracy the Neats conjured up was very impressive. As was the vibrant, deep, chesty quality of bass vocals whose enunciation was precise and succinct. Other tracks on this album showed how adept the Critiques were with a good brass section, the notes beginning with a sharp blast and retaining their vibrancy throughout, accentuated by terrific little off-beats on the kick drum. All this was beautifully layered by engineer Roy Halee's artistic use of reverb, providing space and atmosphere where the Neats again displayed their fondness for ambient detail.

As I mentioned earlier, the Critiques are a slightly warm loudspeaker and they have a darkened tonal quality in the midband which is very gentle, but quite noticeable, particularly with the Naims which also sound a little darkened. This tended to be most obvious with female vocals; for instance, Chrissie Hynde took on a nasal character which thickened her voice although fortunately it didn't impair the musical content, just made it a bit less truthful. Swapping back to the Audiolabs gave vocals less colour, Winwood, Clapton and Collins retaining their forced, strained upper note delivery.

Upper mid and top-end frequencies were well integrated, at times appearing quite seamless. Sade's 'Smooth Operator' was just that, the top being detailed and informative without resorting to the obvious harsh tweeter definition of some speakers. Delicate hi-hat strokes were gently handled by the Critiques, where they were part of the musical picture, not something that was thrust forth into your face. This, along with a gorgeously reedy sax, combined to capture the mood of

the track.

Back to the Pretenders again. On this album, recorded at AIR studios, the cymbals had a wonderful ring and decay (pop into a music store and tap a Zildjian, then you'll know what I mean) very spacious with lots of air (pun intended) around the kit.

To finish off my listening out came a copy of Abbey Road and Jimmy Hendrix's Electric Ladyland. During 'Come Together' the Neats really put the performance across well, especially the ethereal guitar mixed into the middle eight where the Fender-Rhodes and bass open up. Macca was his playful self on 'Maxwell'; you could almost imagine him there all thumbs-up and wide-eyed grin. The Critiques easily encompassed the diverse musical styles in the Beatles repertoire. As for Hendrix, it was all wah-wah pedals, phasing and flanging with a good measure of valve amp distortion thrown in. The intro to 'Voodoo Chile' was a real 'out of box' experience.

The Critiques certainly possess a persuasive character even if it is one that is a little coloured at times. However, they also like a good amp and at £335 will require one with the pedigree of Audiolab's 8000A, a Naim pre/power, or the John Sheame Phase 2 integrated. Anything less will be ruthlessly exposed ●

**NEAT Critique** £335.00  
**NEAT Acoustics,**  
**62 High Northgate,**  
**Darlington,**  
**Co. Durham DL1 1UW**  
**Tel: 0325 460812**

## MEASURED PERFORMANCE

NEAT claim to have developed the Critique using only listening tests - and it shows. All too often when this approach is adopted the result is a loudspeaker that performs only to the designer's tastes. You get a loudspeaker that is ideal for the select few, but of less appeal to the majority.

The Critiques are far from flat: there is a strong (+5dB) lift in the midrange, centred around 1kHz, that will tend to push vocals forwards out of the box, as Robert heard. Robert also commented on the 'dark' nature of the Critiques, which is explained by the low treble output compared to the midrange. There is also a suck-out between the midrange and treble, which means that the crossover isn't integrating the two properly. Whilst measuring with pink noise I heard a phasey effect between the midband and treble which probably explains the dip.

Driving the Critiques should be reasonably easy, they are of average

sensitivity, measuring 86dB output for one nominal watt input (2.8V), and overall impedance is high. The impedance curve is a reasonably smooth one and stays above 6Ω, giving a high 9.5Ω overall, so the Critiques aren't current hungry. The sharp notch around 4kHz also suggests that there is a phase problem with the crossover network, explaining the effects I noticed with pink noise.

Overall, the Critiques are a bit of a mixed bag. The lift in the midband will give them an 'out of box' sound and they certainly won't sound sharp. But they aren't particularly accurate either, likely appealing strongly to some listeners, but less to others. **DB**

### Frequency Response

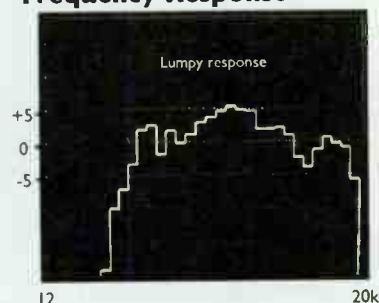

### Impedance

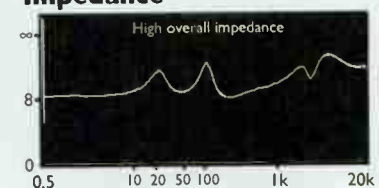

# Sound Differences

Roger Canute,  
Anstey,  
Norfolk.

Dear Hi-Fi World,

I was interested in your comments about the accuracy of valve amps, since I am currently being told by many people (perhaps they are behind the times) that solid state amplifiers cannot be matched for accuracy and low noise, even though everybody accepts valves have a fine sound stage.

In order to reduce costs and overwarmness (I'm aware some valve amps are now not so warm) I am considering a valve pre-amp and solid state power amp, but most industry people try to revert me to solid state pre-amp and valve power amp. What do you think?

*Roger Canute*

**Prompted by one of your numerous letters on the subject, Noel Keyword, with the help of a few others, explores the differences between valve and transistor amplifiers.**

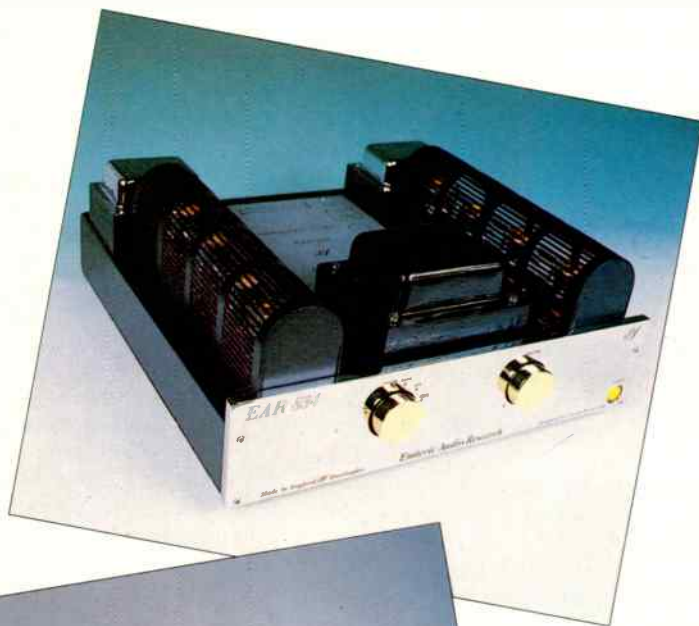

EAR's 834. It is easy to build-in "warmth" and many designers do this, believing it's what people want from valves. The EL34 output valve is known for its "warmth" and is used to provide a soft sound. The 6L6, which can be used in the 834

amplifier, and its

military derivative the 5881, are known for having a brighter, clearer sound.

It is most common to run a valve power amplifier from a solid state pre-amp. The primary reason is that valve pre-amps have traditionally lacked clarity. However, this is not the case anymore either; modern valve pre-amps, when well designed, are very clear sounding. Audio Innovations' L2 (line) and P2 (phono) are fine pre-amps, and so is the EAR834P valve phono stage. Then there's the Rose RV-23S, which is a hybrid of valves and solid state (phono). At this point you may like to know that Rose make a solid state power amplifier to go with their valve pre-amp.

Generally, a solid state power amplifier run from a valve pre-amp is for those who would like to tame solid state a little. The other way around, you get far more of the valve sound, but with a soupçon of transistor thrown in.

Many readers have asked us to explain differences between transistors and valves. As you've found, there are some peculiar misunderstandings flying around on this subject. Here are our views, as well as those of enthusiasts and retailers. I hope they will give you a helpful and informative cross section of opinion on differences in sound quality and personal preferences, as well as our own experiences, for as regular readers know, we design, build and sell a range of valve amps, from budget to esoteric. This gives us first hand knowledge of the problems, as well as the benefits. But perhaps it makes us a little - er - biased? To try and get a balance, we gave our own K5881 20watt design to an ardent Naim enthusiast (our front cover photographer) and asked him to tell us what he thought the essential differences were and why he preferred transistors.

## OUR VIEW

The only objective way in which a valve amplifier can be less accurate than a transistor design is in the way varying loudspeaker impedance can upset its frequency response. But this is not a problem with the majority of valve amplifiers, which have overall feedback and a low output impedance. Otherwise, any apparent inaccuracy can only be a subjective view.

Noisy? No - not this either. An EF86 has  $2\mu\text{V}$  of input noise (hiss), which is very low. It gives our budget K5881 valve

amplifier lower noise (-103dB) than most solid state amplifiers. It is, however, true that valve amplifiers hum to a greater or lesser degree, but good engineering can suppress this down to an extremely low level, one so low that the hum will not be heard at normal listening distances (6ft minimum) from any loudspeaker. Each model must be judged on its own merit here, but a generally accepted guideline in the industry is 1mV of hum output maximum. Because valve amps are expensive, expect a demo in which you can make your own assessment of hum.

Valve amps vary in their sound balance, just like solid state amps. Well designed, modern units do not necessarily sound dull or warm: two examples of bright, clear sounding amps are our own K5881 and



### **LUIGI (Hi-fi salesman, Hi-Fi Confidential)**

**What's the essence of the difference between valves and transistors?**

I suppose it's the warmth and naturalness of valves that I like really. I'm more interested in midband than treble and bass; so long as they are good I can accommodate it. But I hate a midband that is unnatural or not as it should be - and that's the area where valves are best. You get a lovely openness and naturalness, with detail and information, but you don't get the kind of edge to everything that transistors have, if that's how to describe it.

**How about the benefits of solid state. Do you think it generally has better bass, for example?**

I suppose that's most peoples' way of looking at it, yet I use EAR 509s and I've yet to find a transistor amp that has better bass. If you have a well designed tube amp there's no reason why it can't have bass on par with transistors amps

**Do you demo transistor against valve amplifiers?**

Yes, we've done quite a few comparisons on that basis. Customers have gone through all the top pre/powers in the £1200 region and afterwards I've plonked an EAR834 in front of them as a closing demo, 'cos it's got the same bass, but the rest is nicer. Almost without exception everyone who's heard that, whether they want to buy valves or not, have said "Oh, that's better!"

**Has anyone come in and said "No, I don't like that, I prefer the transistor sound"?**

No one has said that. Some people are reluctant because they look at tubes and say "I have to change them", or they want to put the amp into a cabinet and they generate heat, or something. Most people who simply want to listen to music, rather than run a disco in the home, have not said they don't like the sound of valves as such.

I've just had a chap who came in and he listened to seven transistor amps. At the end he was unsure, so I said "OK, try this 'cos you can just about afford it compared to what you have been listening to" - and he'd been listening to things with 40-60watts of power. I put on this little 12watt Audio Innovations and he loved it. The

warmth, naturalness and flow appealed to him - and that's what he ended up with.

So people are put off by practical things: you can't guarantee tube life - most last for years but some can go in a week - but no one has ever been put off by the sound. Mostly, it's the other way around: once they've heard, they're convinced.



### **ERIC (Freelance hi-fi reviewer)**

**How would you describe the essential differences between transistor and valve amplifiers?**

In the right circuits they've both got merits, but the essence of valve amplification I would term as 'air, space and depth'; it's not dynamics. A valve amp will nearly always deliver a better idea of space and air around performers - and in between them. It has taken something like thirty years for transistors to come close, and there are still very few of them.

**What do you think are the benefits of transistors? You use one of the best, the Michell Alecto, so you are well versed in their best qualities.**

The Michell Alecto exhibits nearly all of the best properties of solid state. It has amazingly fast dynamics, and a very, very wide dynamic range.

It is the speed with which transients go from a ting to a boom and beyond that a good transistor amp can handle so well. The Alectos have the most effective reproduction of breadth, depth and an almost holographic size to instrumentalists and vocalists. The latter is something valve amps do, the old Leaks being a good case in point. But the classic valve amps of the sixties never managed to gain the spread from left to right that modern solid state amps get today, although they do have amazing depth - especially the Leak amps it always seemed to me.

**Do you like the bass quality of solid state?**

Yes, because it drives down faster and it drives down firmer. Sometimes it is too clean and is curiously too dynamically restrained or 'tight' it often seems. Valves can stay clean and firm all the way down, Tim de Paravicini's designs among them, but they're rare.

The impact of timpani is always a problem - for both types of amp. Transistor amps produce the initial impact, but the timbral quality of the resonances are

suppressed; you get the attack but not enough of the decay, as it were. On valve amps you get the decay qualities better resolved, but less of the initial attack. Few amplifiers yet seem to offer both, but modern valve amplifiers seem to get a better balance in this respect and so do some exceptional transistor amps, so there seems to be some coming together of the two technologies these days.

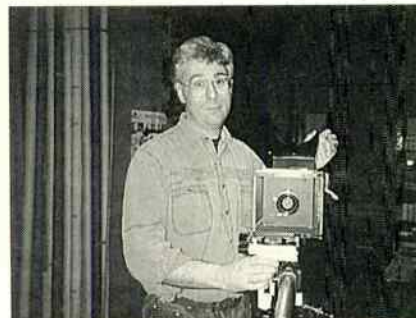

### **PAUL (Our front cover photographer and a hi-fi enthusiast)**

When I first heard an Audio Innovations I thought it was running at low speed. It had a big, walk through sound stage, but I was falling asleep. Your K588I was initially pleasant to listen to, but the more I listened to complex bass rhythms the more I realised the valve amp didn't keep up with the transistor; the Naim was quicker and more textured in the bass. There was a bigger sound stage from the valve amp as you would expect - big and lush. The Naim was smaller but better focussed. Altogether, it sounded faster, but the valve amp had better staging.

**How would you generalise the differences?**

Yours did not sound like a valve amp as I know it. It sounded more like a transistor amp in clarity - and a good one, but without the bass clarity of a Naim.

**So you like the fast and well textured bass of a good transistor amp?**

Mmm. But the vocals on the valve amp were very well textured across the midband. I played two tracks: a Michael McDonald track with Patti Labelle singing with two voices over-dubbed, plus Philip Yama and there were some complex rhythms going on there. There was a lot more bass - more deep bass - from the valve amp initially. It was big and generous sounding. But once I listened closely I found that it was not so well defined. I prefer something with a bit more snap and grip in the bass. Tonally treble was sweeter from the valve amp, without a doubt.

Generally, in my experience valve amps tend not to play the music that taxes them. Curiously, your valve amp didn't sound soft and shy and it didn't sound like "Oh dear I've got some music to play here - can I do it?" It acquitted itself well - especially for the

# Audiofreaks

FOR the **LOVE**  
of music

To hear the beauty of music, your Hi-Fi comes from Audiofreaks.

Cartridges from **BENZ-MICRO** · Tonearms from **KUZMA** and **WHEATON** · Turntables from **KUZMA** and **VPI** · Step up transformers from **EXPRESSIVE TECHNOLOGIES** · CD Transports, D/A converters and integrated CD players from **ENLIGHTENED AUDIO DESIGNS** · Valve and FET pre-amplifiers and power amplifiers from **conrad-johnson** · Solid state pre-amplifiers and power amplifiers from **MUSE** · Cables from **STRAIGHT WIRE** · Electrostatic speakers from **SOUND-LAB** and **AUDIOMATIC**.

Music making at its best.

## AUDIOFREAKS

15, Link Way, Ham, Surrey TW10 7QT.  
Tel: 081. 948 4153 Fax: 081. 948 4250.



# D I V A

audio fidelity

Experience just how good your LPs and CDs really can sound by listening to them through one of our hi-fi systems.

*analogue replay*  
Project  
Michell  
Townshend  
Wilson Benesch  
Basis  
Kuzma  
SME  
Sumiko  
Lyra  
Transfiguration

*digital replay*  
TEAC  
Aura  
Micromega  
Counterpoint  
Mark Levinson  
Accuphase

*valve amplification*  
Audio Innovations  
Trilogy  
Audionote  
Tube Technology  
Conrad Johnson  
Lumley Reference  
Counterpoint  
Sonic Frontiers

*solid state amplification*  
Rotel  
Aura  
Adcom  
John Shearne  
Audiogram

Alchemist  
LFD  
Michell  
Chord  
Primare  
Mark Levinson  
Tesseract Audio

*loudspeakers*  
JPW  
Monitor Audio  
Sequence  
B&W  
Triangle  
Audionote  
SD Acoustics  
Impulse  
REL  
Audiostatic  
Thiel  
Klipschorn  
Townsend

*cables & accessories*  
XLO  
Audioquest  
Audionote  
Cogan Hall  
Silver Sounds  
Seismic Sink  
Tripod  
Frameworks  
Leider

*audio-visual*  
Harman  
Lexicon  
JBL

From £50,000 to £500 we put together the finest hi-fi to suit every budget. Call us or pop in to arrange a musical experience you'll never forget.

Workshop 30, Royal Victoria  
Patriotic Building, Fitzhugh Grove,  
Wandsworth Common, London SW18  
0 8 1 8 7 5 9 5 9 3

LOUGHTON AUDIO VISUAL SERVICE	"THE SOUND CLINIC" AUDIO ACCESSORIES FOR HIFI ENHANCEMENT
<p><b>Interconnect/Cables</b></p> <p><b>Van Den Hul</b> The first 1.0m.....£179.99 The second 1.0m.....£199.99 Thunderline 1.0m.....£99.99</p> <p><b>The Chord Company</b> Chameleon.....£68.00 Cobra.....£49.00</p> <p><b>Sonic Link</b> Violet 0.5m.....£75.00 Pink 1.0m.....£25.00 Many other variations Cable Talk, Monster, Desk adel</p>	<p><b>Loudspeaker Cables</b></p> <p><b>Cable Talk</b> Talk 3, Talk 3 Bi-wire Concert 3, Concert 3 Bi-wire</p> <p><b>Van Den Hul</b> D352, The Magnum, The Wind. Others available-please ring for length, prices etc Free plugs with non terminated Michell Sureloc.....£18.95 Mains, Audio, Loudspeaker connectors available.....</p>
<p><b>Digital Audio Converters</b> Dracula.....£399.99 "The best under £500" Perfect Connect.....£25.00 Q.E.D. Digit.....£139.00 Q.E.D. Positron.....£84.95</p>	<p><b>Furniture and Supports</b> Townshend Seismic Sink.....£169.00 Wonda-pet Set.....£10.00 Soundstyle Goldring Perfect Sound Sound Organisation Please ring for details</p>
<p>Francstien.....£150.00 Stereo enhancement system Van Den Hul cartridges inc. the Grasshopper series Cartridge repairs Please ring for details</p>	<p>Others by Townshend, Q.E.D., Michell, Beyer Select, System, Goldring, Sennheiser</p>
<p>All prices include VAT and free carriage in the U.K Mail order to your door</p>	<p>Telephone: 081 508 6000 Fax: 081 508 2112 106 Colson Road, Loughton, Essex, IG10 3RF</p>

money it is fantastic. There's not much to touch it.

**It's a rough, early prototype with random components. A new, built sample I listened to the other day before it went off to Switzerland was much tidier and cleaner in its sound.**

It plays loud too, doesn't it. I like to play at realistic levels and it did not run out of steam. That was the first surprise. Pitting it against the NAP250, which is three times the price, it didn't sound three times less expensive, which was a shock.



**ROY (A vintage valve amplifier enthusiast)**

**How would you describe the sound of a valve amp?**

They should sound open, sweet in the top and, most of all, there should be space around instruments. They should allow you to listen for a whole evening without being

pinned to the wall by a sound that is initially impressive, but fatiguing in the long term.

**Would you say they are bright or bassy?**

Most valve amps I have heard haven't had the tightest bass, but I quite like that - a full, round sound, but one that is open and with a big sound stage.

**How would you describe a transistor amplifier?**

A good transistor amp can come close in many areas, but they don't have the depth. I'm not saying they are bad. Recently I had a Mark Levinson and a pair of Leak TL12 originals. In my opinion the Leaks were every bit as good, even if they didn't have the welly.

It's price as well. You can pick up a good second-hand valve amp for £120, for example. The Leak Stereo 20 is a brilliant amp; I've never heard anything under £1500 that is made now that comes near it.

**Do you think transistor amps have benefits?**

Yes, definitely: bass and power. Also, valve amps seem more prone to mains problems. They seem to have sweet periods, whereas transistor amps don't seem so dependent.

**Do you find valve amps more difficult to use?**

Yes, but they look better without a doubt! I first realised I love valves - up until that point I'd had all the transistor amps through the eighties, like NAD, Pioneer, Marantz, Quad - when I got a Croft Series IV. We all have an idea of the perfect sound - well, I found I had exactly that sound.

Other valves amps I found had that space too, that realism. I think that's the thing valves will always have over transistors. I went to the Penta Show and some of the price tags on modern transistor amps were outrageous for what they do, in my opinion.

**It's usually valve amps that are seen as more expensive though.**

Well, they are if you buy the newer type, but you can still pick up a good Leak or RCA for little.

The pride of owning a valve amp is there too. They are far more interesting, but even if they sounded the same as transistors, I'd prefer them! They are alive and glowing - they're not bland, black boxes.

**Would you say you'd rather have the depth of sound stage than the dynamic bass of a transistor amp then?**

Yes, because the music I listen to is not heavy rock. With that you might be better off with a transistor amp, but if you listen to acoustic music, with less slam and more ambience, then valve amps are far better.

## Valve Amplifiers - The Facts

Upon their introduction, transistor amps seemed to offer a wonderful escape from the domestic intrusion and difficulty of the valve. Do today's valve amps suffer the same problems as those of yesteryear?

### 1) Reliability

Modern electronic components are extremely reliable, but modern valves vary greatly in reliability. Consequently, fit a reliable valve into a modern valve amp and you will have an amplifier that will run for years before the valves need replacing.

Of valves currently in production, there is unanimity that Russian types are very reliable; Chinese valves are variable in quality. Of valves not now in production, U.S. and European types are generally considered best.

### 2) Cost

Valve amplifiers are much more expensive to produce than solid state designs, so they will always cost more. There is a move to cheapen them, but watch out: cheap output transformers give mushy bass and warm, smeared treble. Listen

before buying.

Running costs depend upon the valves. Rugged types in current production, like the Russian 5881, cost little (£8-£10 each) and will last for years. Rare obsolete types can cost £50-£1000. Low volume, high quality modern production types like the 300B cost £70-£80.

### 3) Behaviour

A properly designed valve amplifier should be as civilised and even more robust than a transistor amplifier. Only poorly designed valve amps are temperamental.

A good valve amplifier should remain unperturbed by being switched on and off rapidly, even when hot; it should run without difficulty with the speakers disconnected, but this could in some cases cause internal flashover, so it is not recommended. A valve amp should not squeal with the inputs disconnected and it should easily survive the outputs shorted for a short time (1 minute or so) when running flat out. There should be no significant noise at switch on or off, or significant mechanical or electrical hum. It

should be able to handle all loudspeaker loads, including electrostatics, without going unstable and squealing. However, specialised low feedback types may not suit certain "difficult" speakers, sounding tonally unbalanced with them. In such a case, the loudspeaker must be chosen with care.

### 4) Safety and convenience

Valve amplifiers have high voltages inside, so they must be earthed. Otherwise, they differ little in fundamental safety to any piece of mains powered equipment. They need good ventilation, in order to dissipate around 250watts of power and to ensure the cathode bias resistors don't overheat.

Currently, most designs are large, but it is possible to get valves into a normal size case, albeit with difficulty (see the AMC CVT3030). However, since modern valve amplifiers are something of a visual spectacle, this is a little self-defeating.

Finally, valves run very hot and they can bum, so beware of exposing them to pets and children.



Prophet

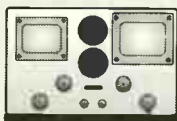

Genesis

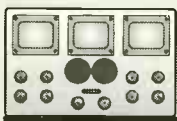

Unisis

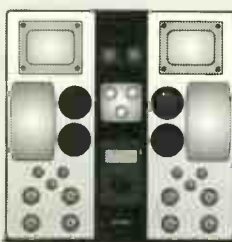

Synergy



*A Sense of Rhythm*

Tube Technology, Design & Manufacturers of High Quality Tube Amplification & Distributors of Gold Aero Vacuum Tubes. Please enquire for further information on our range of amplifiers and Vacuum Tubes. ~ Hatch Farm, Chertsey Road, Addlestone, Surrey, KT15 2EH, England.  
Tel: 0932 850361 Fax: 0932 850354 ~ Pictured; *The Genesis 100 watt All Tube Monoblocs.*

## CLEAR • CRYSTAL • SYSTEMS

### WANTED: EARLY HI-FI

Loudspeakers and Units:

Tannoy Gold and Red units, IILZ, Lancaster, York, GRF etc. Western Electric/Westrex drivers and Cinema speakers. Lowther, Voigt, Axiom 80, RCA, Parmeko, Seimans, Vitavox, Lockwood, Altec, Quad, JBL, Dual Concentric units etc.

Turntables:

Garrard 301, 401, BBC, EMT 927/930  
Thorens TD124 and TD224

Pickup Arms and Heads:

SME 12" Arms, Ortofon Arms and Heads,  
FR-64 and FR-66, Decca FFSS, EMT

Valve Amplifiers:

Dynatron, Quad, Radford, McIntosh, Leak,  
BTH, AEI, Western Electric, Pye, RCA etc.

Valves:

Audio Valves: DA30, DA60, KT66, KT88, KT77  
ECC83, GZ34, PX4, PX25, PP5/400, WE300 etc.

Interesting early Hi-Fi and Valves Bought and Sold.

John Petrie-Baker,

CLEAR CRYSTAL SYSTEMS

Flat 2, 18 Canfield Gardens, London NW6 3JY

Tel: 071-328 9275 - Fax: 071-833 3008

Mobile: 0831-860499.

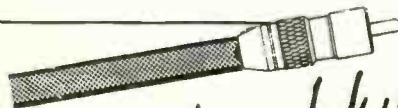

*van den Hul*

by  
**MAIL**

### INTERCONNECTS (Pairs - terminated RCA Phonos)

- STORM** An inexpensive 75ohm coax cable with silver plated central conductor. Good for most general applications at an economical price.  
Lengths: 0.8m - £25.00 1.2m - £30.00
- D300/3** A rather more sophisticated version of Storm. Very low resistance coax and sounds better. General applications.  
Lengths: 0.6m - £47.50 1.0m - £52.00
- D102/3** Classic cable for both balanced and unbalanced applications. Firm bass, smooth treble.  
Lengths: 0.6m - £68.00 1.0m - £77.00 1.2m - £81.50
- THE FIRST** Metal free (World patents) this special carbon conductor coax cable is quite unique. The benefits of the cable are that it requires no "running in", exhibits no "ageing", has no preferred direction and sounds incredibly clear without a trace of harshness. (Between pre & power use THE SECOND).  
Lengths: 0.6m - £120 0.8m - £150 1.0m - £180 1.2m - £210
- THE SECOND** A carbon cable like THE FIRST but with metal screen suited to situations requiring more screening or a balanced format. (Can be supplied fitted with XLR Connectors if specified)  
Lengths: 0.6m - £130 0.8m - £165 1.0m - £200 1.2m - £233

### SPEAKER CABLES (Stereo pairs terminated with 4mm plugs)

	2m	3m	4m	5m	6m	7m	Cable/m
SNOWLINE	£29.80	£36.90	£43.90	£50.90	£57.90	£64.90	£3.50
CLEARWATER	£35.00	£45.00	£55.00	£65.00	£75.00	£85.00	£5.00
SNOWTRACK*	£55.00	£71.00	£87.00	£103.00	£119.00	£135.00	£8.00
THE WIND	£79.00	£110.00	£141.00	£172.00	£203.00	£234.00	£15.50

\* Snowtrack is a bi-wire cable and is made up for use in this manner.

NB. Revelation, Revolution and other VDH speaker cables by quotation.

TELEPHONE ORDERS - are welcome when paying by Access/Visa & Amex  
POST & PACKING - £3.50 per order (over £60 post free)



**KJ WEST ONE** (DEPT HFW)

26 NEW CAVENDISH STREET, LONDON W1M 7LH

TEL: 071-486 8262/8263 Fax: 071-487 3452

Open: Mon-Sat 10am-6pm Thurs until 7pm



# Power in the Round

**Styled to match the shape of  
Michell electronics, the  
Gyropower QC power supply  
for the Gyrodec finds a willing  
advocate in Eric Braithwaite**



I fell in love with the Gyrodec's looks from the beginning, so I bought one because I wanted a sculpture for a turntable - and I couldn't afford an Oracle. It was then I discovered it was a hell of a good turntable - with two provisos. One, the better the arm, the better it sounds; and the better the cartndge in the arm, the better it sounds again.

While John Michell has been steadily making Gyrodecs in Borehamwood, year in, year out, until recently it has been left in the shadow of a certain Scottish turntable. It's gradually achieved a higher profile - to the extent that three British reviewers now use one.

With the new Gyropower QC power supply, it should achieve an even higher profile. Other companies have made much fuss about dedicated power supplies, but Michell - being a very traditional engineering company, despite having a knack for coming up with avant-garde visual designs - has stuck to just a couple of options. Until now, the choice was either a plug-in transformer (the sort that comes with an answering machine) or the Gyropower, a fairly simple, though elegantly acrylic-encased power supply.

The reasoning at Borehamwood has largely been pricing, Michell being reluctant to let the cost of the Gyrodec rise beyond a thousand pounds. Even with the release of the Gyropower QC and a special offer which throws the QC in with the turntable for just under a grand, saving fifty pounds, the magic price point has been held. And what magic it is!

Readers of the reviews of the Alecto power amplifiers will have gathered that they perform a particular kind of magic. Primarily it is a very natural, realistic sound, with broad dynamics, three-dimensional space, and a great deal of free air around and enveloping performers. It shouldn't come as a surprise, then, to hear that the Gyropower QC creates exactly this 'sound' for the turntable.

It surprised me, though. After all, all a turntable has to do is revolve at the right speed. A strobe disc on the platter proved it went round at 33 1/3 even with the bog-standard psu. So where is all the extra magic coming from?

Partly, it's a cleaned and smoothed current; partly because the power is controlled by two separate quartz crystal oscillators which provide a precise waveform for each speed, either 45 or 33. Yes, the Gyropower QC is electronically switchable. No more need to mess about moving the drive belts (two on a Gyrodec) up one step on the pulley to play Ian McNabb's Truth and Beauty on vinyl.

On Dave Grusin's 'Mountain Dance' on GRP, the piano suddenly increased its dimensions and took on an extra firmness and precision below Middle C that gave the impression it was deeper. The whole recording expanded, putting more depth between the players - it was that same 'walk in and around' effect that is so marked on the Alectos. The percussionist tinkles a triangle, just on the fringes of consciousness; extraordinarily, it was possible to tell he was striking all three sides in turn. QC-equipped, the Gyrodec/SME IV and Morch da Capo retrieved even that most subtle and delicate information.

Most startling of all was tangible proof that the motor was now running with utter stability, because the beat and timing became remarkably crisp. In the same Grusin piece, woodblocks tapped out an unerringly metronomic beat, one you could click your fingers to with the kind of precision that's normally the province of piano teachers. Not a trace of hesitation or irregularity.

That sort of rhythmic ability lifts this

turntable right into the upper league. And it underpins every genre of

music. Transients are sharp in attack, and very slow in decay - dying notes seem to be held forever, instead of being cut off. It makes rock faster and sharper, while focusing detail with pinpoint precision. On classical music it increases the emotional content. Ricci's violin in Tchaikovsky's Violin Concerto (Decca SXL) acquires an additional nuance that draws the concentration almost exclusively to his bowing, his expression, as one would be drawn into it live. While, all the time, the orchestral sections inhabit that extra dimension of space so that there is even more of an illusion of reality.

No doubts? Well, some may not like its styling - it looks like a miniature Alecto. For them, Tesseract make a power supply for the Gyro in more conventional shape, which is fifty quid more. That too, turns the Gyrodec into something extraordinary - but it has, would you believe, a different sound. Exquisitely detailed, splendidly airy, somewhat sweeter and delicate rather than speedy and muscular.

Eight years on, and the Michell Gyrodec is still with us. The new power supply turns this excellent turntable into a superb one. It doesn't need the silver tongue of a Queen's Counsel - it's its own advocate. ●

**Michell Gyropower QC**  
**J.A. Michell Engineering,**  
**2 Theobald Street,**  
**Borehamwood,**  
**Herts. WD6 4SE.**  
**Tel: 081 953 0771**

**£349**

# Naming Names

**Putting a name to a station is still difficult. Yamaha help solve the problem with their RDS capable TX-670RDS tuner, Robert Wilson found.**

**T**hey're steadily growing more complex, these modern tuners. And describing how a new function works in English gets no easier for the Japanese instruction books authors of as a result. With Yamaha's TX-670 RDS synthesiser tuner 'You can store a station with a name of your own giving' we are told. That might not be quite how most people would put it, but so what! Yamaha have been clever all the same: the '670 is a good,

high performance tuner fitted with an enhanced Radio Data System (RDS) and priced at £239.95.

An unfortunate feature of RDS - a system for passing data from broadcast transmitter to radio receiver - is that at present only the majors use it. So a tuner like the TX-670 RDS will efficiently tell you what you probably know already - that you've just tuned into Radio 1 - whilst remaining resolutely mute as the Caribbean colour of Sunrise pours in. So just as

that last snatch of Dub fades out, you'll be left wondering who or what the station is.

The Yamaha can't crack this little difficulty, but it can prevent it from recurring, because the name SUNRISE can be entered into a memory so it will pop up as the station is selected. I pity the poor Japanese in having to deal with European languages though, for in addition to the standard 26-letter alphabet they've had to include no fewer than 33 special accents, from France, Germany, Scandinavia and Greece, and there are numerals as well. Up to eight characters can be displayed.

Possessing high sensitivity and excellent selectivity, our tests showed, the Yamaha is a good choice for anyone wanting to pluck as many stations as possible from our increasingly crowded airwaves. Our own high-gain aerial in Central London now provides access to around thirty stations at any one time, but the Yamaha could cope, storing no fewer than forty. That's more than most tuners and each one can be named, so here's a tuner for inveterate wave riders who are afraid they might be missing something, somewhere. In addition to VHF/FM, there's also Medium Wave (531kHz-1611kHz), but not Long Wave.

Like all modern synthesiser tuners this one tunes in fixed steps, either manually or automatically. The idea is, however, to save a station frequency into memory and then call it up by push button. With up to forty in store, the memory needs to be non-volatile and Yamaha's lasts for up to one year without power applied.

Wide or Narrow IF selectivity is provided, but in fact this tuner offers high selectivity on Wide and very high



selectivity on Narrow our tests showed. The purpose of Wide is to offer best sound quality with least compromise. 'Narrow' sacrifices some distortion and channel separation in order to yield maximum ability to pick out weak stations.

Yamaha build and finish this tuner well enough, but in this respect it differs little from the norm, being satisfactory rather than anything better.

I thought it fitting to tune in to Auntie's young person's channel to begin listening. As the legend 'BBC 1 FM' appeared in a soft orange glow on the dot matrix display panel I was greeted with a lively, detailed sound which was definitely in keeping with Simon Mayo's manic 'Zoo Radio' style of presentation. This aspect of the Yamaha's performance nicely complemented the rest of the system (Naim 82/180 and the Neat Critiques) which itself was very involving.

When the first single was played - a particularly upbeat new track by The Inspiral Carpets - the Yamaha latched on to the wonderful arrangement of jangling guitars, giving them plenty of body and solidity at the heart of the soundstage, the downside being that this confident presentation didn't extend further down the frequency range. Like a lot of modern tuners, the Yamaha lacked the ability to fill out the lower registers, thus denying the music its coherence. This fundamental flaw leaves the listener having to concentrate, albeit subconsciously, on filling in the blanks, so to speak, which does distract from the rest of the performance.

However, this is not a damning criticism of the Yamaha, but one that can be broadly aimed at modern tuners in general. That said, what bass there was did have a tight nature, being reasonably quick and communicative - and let's face it, communication is what radio is all about!

Moving on up to the mid-range brings us to this tuner's forte. Voices come over with a fair degree of authority, giving just the right amount of intonation to a newscaster's delivery, though sometimes clipping certain vowel sounds on one rather enthusiastic correspondent. But it was with music, especially live sessions, where the Yamaha came alive, providing insight into a solid, quite centralised soundstage which only tended to become diffuse towards the extreme outer edges.

Live vocals were very tangible, if just a little too sibilant, the tuner tending to over emphasise the breathy content of some female vocals - Toni Amos in particular.

With music from either Radio 3 or Classic FM the stereo depth made the orchestral image pan out nicely behind the line of the speakers, layering the instrumentation well, although it was a little more compressed than the best available.

While on the subject of compression the quiet background of the Yamaha did ruthlessly expose programme hiss, which is a general problem as more and more

signal compression is forced upon us.

The ability of this tuner to recreate the treble content of a programme with some emphasis was a little disappointing, particularly on Jazz FM and Kiss FM where it was rather splashy, and although not harsh or overly bright, the TX-670RDS did become 'tizzy' when pushed and never managed to give delicately played cymbals that glorious shimmer that sends a tingle down your spine. So here's a tuner that eschews balance in its sound for detail and insight. It's a great wave

rider, our tests proved, being unusually effective at picking weak stations out of a crowded ether. So the Yamaha has a good stock of ability, but a few weaknesses too ●

**YAMAHA TX-670RDS** £239.95  
**Yamaha Electronics UK Ltd.,**  
**Yamaha House,**  
**200 Rickmansworth Road,**  
**Watford, Herts., WSD1 7JS.**  
**Tel: 0923 233166**

**MEASURED PERFORMANCE**

The TX-670 RDS has a frequency response tilted upward slightly toward high frequencies. This characteristic, taken in conjunction with a bass roll off, is liable to make the sound dry but detailed and bass light. Channel separation on stereo was good at 39dB or thereabouts right across the audio band; there was little deterioration at high frequencies.

Low distortion levels have been achieved, but this is not uncommon nowadays, due to refined chip technology. The '670 turned in a figure of 0.13% at 50% modulation level, on a par with other quality tuners. Where it was not on a par though, but ahead, was in hiss level. I measured a -78dB hiss floor at full quieting, which is around 5dB lower than usual and about the best the test equipment can measure. Few tuners are so quiet; -73dB or so being usual. The benefit of this isn't so great, because radio stations struggle to keep modulation levels up and silences minimal specifically to drown out hiss, because it gives them better theoretical range and audience figures (absurd!). However, ardent Radio 3 listeners can be assured that the Yamaha won't hiss annoyingly during silences or low level passages providing, as always, it is given enough signal by the aerial.

And what a surprise to find that Yamaha have actually fitted a signal strength meter capable of indicating whether this is so. It reads right up to 1.6mV, much higher than usual, so owners really can tell whether they are getting an adequately strong aerial signal. Worried, as always, that a display that doesn't show maximum might unsettle users, giving them cause to think the tuner isn't sensitive enough, Yamaha have ensured that 80% of the display lights up with just 100µV of signal - far too little for good results. In truth it is necessary to get the very highest sector to light before the tuner is truly in full quieting, giving least hiss.

Audio output was satisfactorily high at 500mV. Radio frequency sensitivity was good too, which is unusual for an RDS tuner; early models were both hissy and insensitive. The Yamaha also had excellent selectivity and - unusually - the Narrow/Wide IF facility worked well, rather than being a cosmetic addition, as is so common. This is certainly a good tuner

for use on crowded airwaves, where a weak station nesting close to a strong one needs to be picked up.

The Yamaha proved a good all-rounder in terms of its measured performance, but I would expect it to sound bright and possibly a little thin. **NK**

**TEST RESULTS**

Frequency response	44Hz-15kHz
Stereo separation	39dB
Distortion (50% mod.)	0.13%
Hiss (CCIR)	-78dB
Signal for minimum hiss	1.6mV
Selectivity (W/N)	78/90dB
Sensitivity	
mono	1.2µV
stereo	20µV
signal strength meter	0.3µV - 1.6mV

**Distortion**

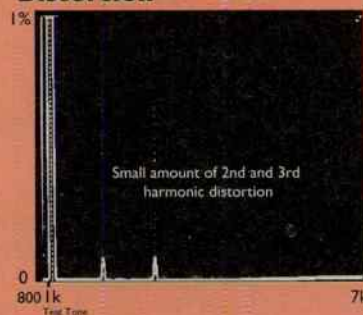

**Frequency Response**

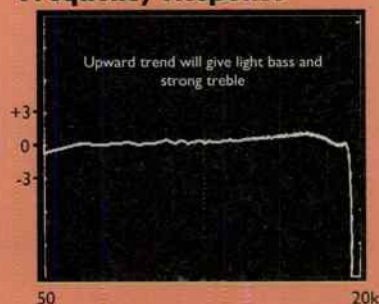

# REGA REVISED

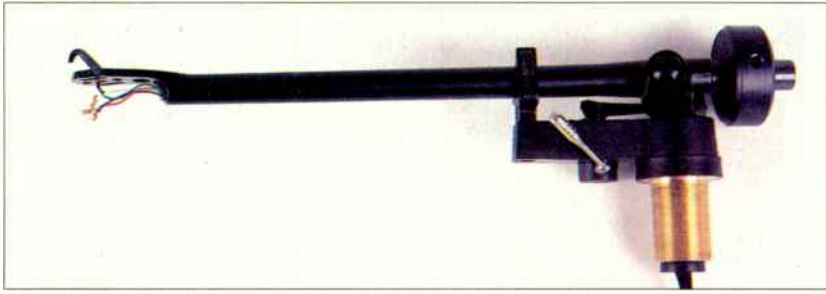

## Dominic Todd tries a modified Rega RB250 from Origin Live.

**W**ith the collapse of Revolver, and turntable sales well and truly in the doldrums, the last thing you'd expect is yet another modified Rega arm. Yet Origin Live have gone against the grain of fashion and produced one. The basic Rega arm itself is a sound, rigid, design which lends itself to modification. An old trick is to replace the extremely cheap cable used to wire the RB250. Origin offer such an upgrade, but here we take a look at another of their modifications. For £75, Origin Live replaces the counterweight with a smooth, non-threaded variety. It is modified too, to allow it to simply slide up and down the tube (and be held by a hex screw) rather

than twisted along a screw thread. Even accounting for the fact that the price includes VAT and return carriage, I think £75 is a bit steep considering how simple the modification is. But if the modification is as successful as Origin suggest (they claim it can rival a Roksan Tabriz), then it's good value.

Changing from a standard RB250 arm to the modified version did show noticeable improvements. It has to be said that they weren't huge, but they were certainly in keeping with the cost of the upgrade. Overall, the sound was more articulate. The RB250 has always been something of a let-down at the frequency extremes, with a rather woolly bass and

soft treble. It was in the the latter region that the Origin-modified Rega showed the greatest improvement, with a notably crisper treble leading to better definition on instruments such as the saxophone. The bass gained a little added 'weight', but overall depth wasn't improved.

Instruments were better separated than the original, but the slightly limited stereo width of the RB250 was unchanged. Finally, the smooth and musical mid-range (the best feature of the Rega arm) fortunately hasn't suffered from the 250's new-found articulation. This is hardly something for the mass-market, but if you've already got a turntable equipped with a Rega RB250 (or RB300 for that matter), and would like vinyl replay to be spiced up a little bit, without going to great expense, then Origin's RB250 comes recommended ●

## IN THE MAY ISSUE

Spring's nearly here, so with a spring in your step get down to your local newsagents for a copy of the MAY issue of Hi-Fi World packed with exciting reviews, features, letters, Q&A and much, much more. Here's a short list of what we hope to be able to bring you:

### ORTOFON MC7500 ANNIVERSARY MOVING COIL CARTRIDGE

To celebrate 75 years in the business, Ortofon have something special on offer. The MC7500 uses a stylus 25% finer than that of the excellent MC3000 and MC5000 cartridges. The coils of this new model are wound with 99.999999% pure copper, promising to reveal more than any other cartridge.

### LUMLEY ST70 VALVE AMPLIFIER

Reputedly one of the best-built valve amplifiers around, Dominic Todd listens to this awesome 70watt power amplifier to see if the sound matches up to its build.

**ROTEL RA960BX2 AMPLIFIER**  
Rotel's latest integrated amplifier has been aimed firmly at the audiophile. Polypropylene capacitors are just one of the high grade components used inside.

### HEYBROOK INTEGRA AMPLIFIER

The first integrated amplifier from Plymouth-based Heybrook. This is the beastie that our lucky June competition winner named, and they've been promising to launch it for months.

### TEAC VRDS-7 CD PLAYER

Following the success of the VRDS-10, TEAC have launched a more affordable version, the VRDS-7. We hope to bring you this as an exclusive in our MAY issue.

### ORIGIN LIVE OLAV

The latest small speaker from the respected manufacturer of equipment supports and turntables.

Hi-Fi World is still only £2, but with more editorial than most rivals. With the most enthusiastic and expert editorial team in hi-fi journalism, can you afford to miss it? Make sure you don't by filling in this order form and handing it to your newsagent.





Please reserve/deliver\* Hi-Fi World on a regular basis, commencing with the next issue, until further notice.

Name: \_\_\_\_\_

Address \_\_\_\_\_

\_\_\_\_\_

\_\_\_\_\_

\_\_\_\_\_

Signed: \_\_\_\_\_ Date: \_\_\_\_\_

• Delete as appropriate

Distributed to the news trade by  **COMAG**  
MAGAZINE MARKETING

There always were ways of improving the performance of cassette that remain easy to implement, cheap and practicable, yet retain all its benefits and, perhaps most importantly, stand a chance of being accepted by music stores. Those options are rarely discussed. Sony and Philips have been too obsessed by the lure of capturing the world-wide cassette market with some dazzling new technology - DCC and MD - only to end up fighting each other to a standstill whilst consumers looked on bemused and uninterested.

I suspect that the cassette is a satisfactory medium as far as most people are concerned, at least in broad outline, if not in fine detail. By this I mean that it's satisfactorily durable, given the price of cassettes, it is robust in use - you can throw them around - it is conveniently small and it does its job adequately well. To hi-fi enthusiasts, this last point is contentious of course: it doesn't do very well at all, but it does record music and speech so that they are intelligible. There are some surprisingly simple ways of usefully improving its sound though.

The cassette overloads prematurely for music purposes, especially at high frequencies. This causes treble dullness and muddle, due to magnetic saturation. Raising the overload ceiling increases dynamic range and lessens hiss, so both hiss and treble quality would improve from raised maximum recording level. The easiest way to do this is simply to raise the tape speed. Philips set it at a low 1 7/8 ips (4.75cms/sec) back in 1963 to give plenty of time for dictation use, for that was the original role of the Compact Cassette. Raising speed to, say, 8cms/sec, would take dynamic range from around 64dB (on a Nakamichi) up to 68-70dB-and that's without noise reduction. It would give much cleaner treble too. This was the sort of result Sony's Elcassette gave way back in the Seventies - and very

impressive it sounded.

Increasing speed would also lessen the problem of holding speed steady, reducing all forms of speed variations. It would give a large improvement in sound quality too, reduced flutter and modulation noise, which increases clarity and reduces that peculiar form of flat, papery colouration that afflicts the medium. Reducing wow - especially capstan wow - gives purer tones, noticeable with sustained notes from simple instruments, like flute, in particular. Finally, lessening drift, or low-rate



## Reflections from Noel Keywood kaleidoscope

speed variations, gives music that rock-steady feeling of pitch, or tight timing.

The other blight of cassette is head azimuth error, where the head is not upright, or at least is not aligned with the modulation slant on the tape. By increasing recorded wavelengths, increasing cassette speed lessens this problem as well.

So raising tape speed could, at a stroke, upgrade the performance of cassette to that of a medium much more in keeping, quality wise, to late twentieth century requirements. There are two big drawbacks though: reduced playing time and incompatibility through loss of standardisation. It's here that I have to make a few assumptions. The major one is that much of the reduced playing time could be clawed back by using thinner tape. We already have C120s which give 60 minutes a side; my suggestion would be to use the same film, or one slightly thinner, and run the cassette not at double speed, but at - say - 6cms/sec, to get better

sound quality and adequate playing time. People expect to be able to record an entire CD on one side of a tape, suggesting 45-48minutes a side.

It would be a difficult technology to introduce, demanding stronger base film from tapes and better tape handling from machines, but the idea would have to rely in any case on a two-tier system, the new updated specification being compatible with the old one so they can run side by side in the market.

Some of you may already be exclaiming that it's already been done and that there's nothing new in this idea. Quite! I believe a U.S. company produced a double-speed deck a few years ago and, doubtless, they would have received a stiff letter from Philips about it, who demand the original standard isn't broken, so that the medium retains perfect compatibility; a double speed tape won't play on a conventional deck.

But Philips broke this rule when they introduced DCC, for it isn't fully compatible with cassette

either. Compatibility could be built into upmarket high-speed recorders by making them two-speed, so they could play original-standard tapes, just as DCC plays old analogue cassettes.

The music business and the retail stores would have to be left to decide for themselves what to do about the new high-speed standard. What retailers dislike in particular is what they call 'multiple inventory', or the same piece of music on three or more carriers, typically LP, CD and cassette. A new

high-speed cassette standard that was compatible with low-speed cassette wouldn't demand new software and this may well be the best way of bringing a better system onto the market - slowly!

Retailers, as always, have been reluctant to stock DAT, then DCC and MD. Those that do have slapped a premium price of £14.99 on pre-recordeds, an action Philips claim has come about due to industry politicking. Irrespective of the merits of DCC and MD, the cost and rarity of both blank tapes and pre-recordeds is alone enough to prevent the medium gaining popularity, in my view. Faced with this degree of opposition to new formats, the only way to bring about any quality improvement in recording media is likely to be by the sort of approach I'm suggesting. One which doesn't rely so heavily upon the retailers stocking another medium, in this case high-speed cassette, at least until it has slowly gained popularity and acceptance by the buying public and obvious demand exists ●



It's back! Our DIY Supplement has made a welcome return this month, bringing you hi-fi projects and information to drool over. We'll be producing one every other month throughout the coming year and the projects planned are exciting. Not only will there be more valve amplifiers, but we hope to be able to offer loudspeakers too, knowing they are also popular. There will be some simpler projects to entice the less experienced to get involved, plus some solid-state designs, we hope, and a little light but practical theory.

The DIY Supplements proved to be immensely popular last year. Strangely, even those who wouldn't actually consider building anything for themselves seemed to find them an interesting read. It seems that there is a strong desire to understand how hi-fi actually works, something that is normally kept secret or confused by long winded technical explanations.

This desire to understand how things work, but not to actually put the knowledge to any practical use, I find quite odd. The UK's hi-fi enthusiasts have been pushed steadily away from tweaking and DIY for one reason or another. They have gone from being DIY enthusiast builders-and-tweakers of the Sixties, to being passive black-box listeners of the Eighties.

In the States it has been quite different, or so I am led to believe by some of the US readers I've been talking to recently. One I spoke with recently couldn't stop telling me about the improvements he had made to his Quad electrostatics by stripping them down and completely re-wiring them with higher quality cable and components. This is no job for the faint hearted though: a few kilovolts is enough to terminate anyone's fun - so it's not a wise tweak for the

amateur.

However, should a washer in a tap need replacing, he told me he wouldn't hesitate to pick up the 'phone and ring for a repair man. His argument was that anyone can fix a tap, but there was no chance they were going to get near his pride and joy with a soldering iron - that was his territory.

The Americans trust someone to do a relatively simple task and get it right, but anything complex they would rather learn about and do themselves. We, in the UK, are completely



Dominic Baker

## dB on the level

different. We are very trusting of the things we don't understand and weary of the things we do. If a builder comes round to do some work we are the first to tell him he's doing it wrong, or the other man didn't do it that way. However, the engineer in the hi-fi shop who tells us that he had to replace the output and driver transistors in the amplifier to fix it, is likely to get a blank stare.

It seems that we are prepared to take on domestic DIY to save money much more readily than tweak our hi-fis for higher performance. Whereas in the States, it is commonplace for enthusiasts to completely re-wire their amplifiers, or upgrade the components in their loudspeakers, in the UK this is rarely seen, done or talked about.

The 1994 Mintel Marketing Intelligence report on British Lifestyles shows our interest in home DIY. In fact we are becoming more and more a DIY nation and the Mintel report shows a massive £5.6bn was spent on DIY in 1993. Obviously, this includes a wide range of

DIY activities, painting, decorating and furniture taking the biggest chunk, but it shows that people are prepared to do things for themselves. And the skills needed for these DIY activities are similar to those needed for kit loudspeakers.

Further on in the Mintel report there is a break-down of the DIY tasks people feel confident about doing. One figure that I find staggering is that 19% of the population feel confident about re-wiring their own homes. Here, a knowledge of electricity, an understanding of circuit diagrams and a very practical nature are necessities; I'm amazed that so many people believe they have these skills. This indicates that there is a large proportion of people out there who are capable of, perhaps with a little help, building their own electronic hi-fi equipment as well.

Brown goods sales (that includes hi-fi) are also benefiting from a high level of product innovation (obviously our valve amplifiers!) and a growing level of multi-ownership,

says Mintel. This is good news for the hi-fi industry, and should be for the consumer too. The growing level of multi-ownership suggests that products are going to be expected to last longer and hold more of their re-sale value. This places an emphasis upon build quality - perhaps Mission had some inside information before opting for the elaborate casting used in the casework of their new amplifiers.

The Mintel report also shows that spending on the home accounts for the largest proportion of

consumer spending. This is attributed to the recession and the static housing market; people are tending to spend longer in the same house, waiting for the market to improve. It's a situation that has helped hi-fi sales. After all, if you're going to be staying in one place for some time, a good hi-fi is a necessity.

The DIY Supplements show what goes into hi-fi equipment, and they may give you a good idea of how to judge build quality and value when it comes to buying a new piece of hi-fi. This is valuable; if you can recognise quality within hi-fi products, you are less likely to end up with something that is unreliable or poor. And for those DIYers who actually build their own equipment it appears we can't talk enough about such matters.

This is all good for hi-fi. The quality of products should improve as the recession lifts and sales increase. One other nice piece of news from Mintel is that magazines will benefit from increasing sales in the coming years. Luckily we've already seen this at Hi-Fi World!

If you're like me, you've probably wondered how the majority of the public can be so naive about hi-fi separates. It's not down to a lack of demand in general - in the last year over one million hi-fi (midi, mini, micro etc.) systems were sold in the UK. You only need to walk down the local high street on a Saturday afternoon to see half a dozen or so people clutching large boxes of the latest Far Eastern 'box of air', eagerly rushing home.

The cost of hi-fi separates isn't really to blame, either. It's not uncommon for midi and micro systems to cost between £600-£1000 these days. That sort of money will quite easily buy a reasonable separates system which will outperform the midi or micro. Styling and bulk are pretty suspect objections too, as there are many single brand separate systems that offer a smart and unified design, and which are often no more imposing than a midi system. The hi-fi press is, in most cases, firmly behind separate hi-fi components as well.

If you need any more persuading just look at all the other arguments. Separates are generally better built, easier to service, hold their value better, upgradable and not as affected by the whims of fashion as midi/minis are.

As an example of the latter point, consider this. A NAD separates system from twelve, or so, years ago will look little different to one of today's. It should still perform well, and probably last another twelve years, if looked after. In short, it hasn't dated. Yet just take a look at what's happened to the mass market in the past twelve years. We've gone from the silver tower system to the black tower. Then came the midi system, which has since been eclipsed by the mini and micro systems. These too, have not escaped the clutches of the marketer, with the 'organic' look replacing sharp lines, blacks turning to greys, and the advent of A/V with associated swivelling

speakers and the like.

Mass market hi-fi is simply cheap fashion. Every year there's a new style or 'unique feature' (read gimmick), and the public are often conned into believing that whatever the latest fad is they simply must have, such is the 'progress' being made.

Apart from specialist dealers and hi-fi magazines, until now, there's been no real effort by any particular body to really promote and raise the public's perception of 'proper' hi-fi. Yet, perhaps this is about to change with the British



may have a chance of raising the public's perception of hi-fi separates.

Ultimately, it's rather ironic that the very body that BADA seeks to represent, the specialist dealer, may be undermined by the high street stores if the scheme is successful. There are also a lot of unanswered questions. What about the specialist hi-fi stores who aren't BADA members? Will they still be able to sell hi-fi that has recently become a 'Real hi-fi' product? And will a lack of the 'Real hi-fi' status

## Fair Views

- from Dominic Todd, our man in Scarborough

Association of Audio Dealers (BADA), launching a campaign for 'Real hi-fi'.

The association has designed a logo which has been printed onto posters, point of sale material, and badges, and has been sent out to all the hi-fi dealers who are BADA members. Manufacturers are also being approached. The idea is that, for a cost, manufacturers will be able to use the 'Real hi-fi' label on their products. These will first have to be approved by a body in the hi-fi industry, to ascertain whether or not they are 'Real hi-fi', i.e. separates. The approval system is there to prevent the larger manufacturers from simply buying the rights to the label and then using it for low-fi midis, minis or even personal stereos!

If the manufacturers take up the scheme, then the idea is that consumers will then be able to recognise good quality hi-fi through a simple logo on the equipment. BADA flatter themselves somewhat by comparing the 'Real hi-fi' logo to that of the successfully introduced 'Real Wool' mark. Yet they are realistic in realising that they don't have anything

like the capital of the International Wool Secretariat. What they do claim to have, though, is plenty of time. Whether or not this is sufficient is debatable. Should products bearing the 'Real hi-fi' logo only reach the specialist hi-fi dealers then the exercise is somewhat self defeating. However, you may have noticed that more and more hi-fi separates are now being sold through the high street chains. Dixons and Currys, for example, now stock well-respected products such as the Marantz CD-52II and Celestion speakers; even Tandy are turning their attention away from the hobby market, and towards stocking higher quality hi-fi such as Mission 760 speakers.

Whatever you may think of this, and there are plenty of reservations in terms of the major chains' ability to demonstrate the products and serve the customer properly, it can't be denied that it gets hi-fi separates the much needed attention of the mass market. Further more, if products with the 'Real hi-fi' logo begin to start appearing in such stores, then there's a good chance that the scheme

for these stores mean that somehow what they sell isn't a worthy and reputable product?

Manufacturers too, have their concerns about the scheme. Some feel uncomfortable with the 'old boys club' reputation that BADA have, and that they are being forced into the scheme because if they don't sign up then their products may be seen as inferior in the market place.

Although I admire BADA's efforts in finally attempting to tackle the problem of a totally flat hi-fi separates market, with little public awareness of the differences that exist between hi-fi and 'Real hi-fi', I hope that they manage to avoid the pitfalls that are part and parcel of such a scheme. If the scheme flops then no harm has really been done, and it will be seen as a valiant effort. Yet the real danger, from the point of view of specialist retailers, is that if it's too successful, it may play into the hands of the high street stores and undermine the specialists.

Whatever happens, though, you can be assured that it will be, as they say in the movies, a long time in the making ●



you don't have to be a ..

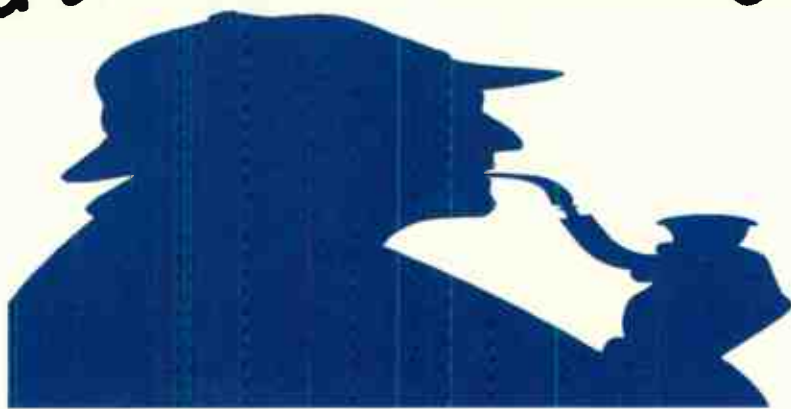

.. to discover the **Best of British** hi-fi in the west country

**mike manning**  
*the hi-fi specialists* **audio**

quad  
roksan  
arcan  
ate  
avi  
ega  
naim

**Together with other fine Hi-Fi from..**

Sugden - Rotel - Pink Triangle - Audio Alchemy - Mission - B&W  
Heybrook - Marantz - Restek - Epos - Shahinian - LYRA - Acoustic  
Energy - JPW - Nakamichi - Denon - AURA - NAD - Pioneer - Philips

NOT ALL MAKES STOCKED AT BOTH BRANCHES PLEASE CHECK FOR AVAILABILITY

*Audition some of the finest Hi-Fi in our purpose built listening lounges where you can, with our expert guidance, choose an ideal system to suit your ears and your pocket.*

*Full Servicing Facilities - 2 Year Guarantees - Mail Order - Instant Credit Facilities - Access - Visa - Switch*

128, POOLE ROAD, WESTBOURNE, BOURNEMOUTH. Phone (0202) 751522

110 MIDDLE STREET, YEOVIL, SOMERSET. Phone (0935) 79361 (Closed Mondays)

0% - INTEREST FREE CREDIT - PLEASE PHONE FOR DETAILS - 0%

# WIN ONE OF BEST CD THE DA CAPO

**H**ere's a fabulous prize - one of the world's most flexible and advanced CD convertors, the Pink Triangle Da Capo. In conjunction with a good transport, this convertor offers the highest possible standard of sound reproduction available anywhere today. Not content with industry standard silicon chip convertors, Pink Triangle

developed their own unique design in-house, effectively challenging the laboratories of industry giants like Philips and Matsushita. The outcome is the Da Capo, widely praised for its stunning sonic qualities.

To ensure Da Capo doesn't get left behind by the relentless forward march of technology, it has plug-in digital filters, so

future upgrades can be bought and plugged in. This also allows various current options to be assessed and selected. Pink Triangle give the lucky winner this option by providing two separate, plug-in digital filters, the Yamaha YM3414 18-bit filter module and Burr-Brown DF1700 20-bit. The YM3414 Dominic Baker thought was "head and shoulders above most other DACs"; even if he personally preferred the 20-bit for its "softer, more relaxed midband". "The Lemon Trees were greeted well, with plenty of atmosphere and space around the performers and the fabulous harmonies on 'Submerge' sounded natural and free from coarseness".

The two filters possess differing sonic properties, the 18-bit sounding more intense and forthright than the 20-bit, Dominic found. But many people like the "analogue" sound of the 18-bit. Our lucky competition winner will be able to judge these matters though, being offered the opportunity to swap over filters at leisure in the comfort of home.

To enter this fabulous competition for the Da Capo digital convertor, just complete the questions opposite.

Please send your entry on a POSTCARD, or the back of a SEALED ENVELOPE, and completed in block capitals, to arrive no later than Friday 8th April 1994 to:

**DA CAPO Competition**  
Hi-Fi World Magazine,  
64 Castellain Road,  
Maida Vale,  
London. W9 1EX.

In the event of more than one entrant submitting all the correct answers, the winner will be picked at random. We will endeavour to publish the results in the JUNE 1994 issue. Purchase of the magazine is not a precondition to entry.

No correspondence about this competition will be entered into and the Editor's decision is final.

No employees of Audio Publishing Ltd. or any of the companies associated with production or distribution of the prizes may enter ●

## COMPETITION ENTRY QUESTIONS

1) Who makes the YM3414 filter?

- |            |               |
|------------|---------------|
| A. Philips | B. Matsushita |
| C. Sony    | D. Yamaha     |

2) Which country does the phrase 'Da Capo' originate from?

- |           |            |
|-----------|------------|
| A. France | B. England |
| C. Italy  | D. Germany |

3) Which digital filter did Dominic prefer?

- |           |           |
|-----------|-----------|
| A. 18-bit | B. 20-bit |
| C. 16-bit | D. 1-bit  |

4) Who makes the Da Capo?

- |                  |           |
|------------------|-----------|
| A. DPA           | B. Linn   |
| C. Pink Triangle | D. Roksan |

## THE TIE BREAKER (OBLIGATORY)

Da Capo can make digital sweet,  
'Cos it's got the technology to compete.  
Switch it on,  
Sit back and wait,  
Whilst the circuits reach a steady state.  
Suddenly, from the speakers you'll find,  
.....

In the event of more than one entrant submitting all the correct answers, the winner will be picked at random. We will endeavour to publish the results in the May 1994 issue. Purchase of the magazine is not a precondition to entry.

No correspondence about this competition will be entered into and the Editor's decision is final.

No employees of Audio Publishing Ltd. or any of the companies associated with production or distribution of the prizes may enter.

# THE WORLD'S CONVERTORS, WORTH OVER £1600

competition



## February Issue Competition - Three NAD 402 Tuners & Three Pairs of Mission 760i SE Loudspeakers

These super-value products are amongst the best in their class. Your competition entries poured in, but this time, with three NAD 402 tuners on offer, as well as three pairs of Mission 760i SE loudspeakers, there are no fewer than SIX lucky winners.

### Winners of the NAD 402 tuner are -

- 1) Vicki Purtock of Chatham, Kent.
- 2) P.H.Pridmore, Plymstock, Plymouth.
- 3) Philip Gard, London E8.

### Winners of the Mission 760i SE loudspeakers are -

- 1) Clive Prothero, Grantham, Lincs.
- 2) David Shepherd, St Michaels, Liverpool.
- 3) Mark Bumford, Aberdovey, Gwynedd

# Back Issues

## HI-FI WORLD BACK ISSUES ORDER FORM

Please tick the box next to the issue(s) you wish to order

- September 1991 ..... £2.00
- October 1991 (incl. CD) ..... £2.00
- December 1991 ..... £2.00
- January 1992 ..... £2.00
- March 1992 ..... £2.00
- June 1992 ..... £2.00
- September 1992 ..... £2.00
- October 1992 ..... £2.00
- December 1992 ..... £2.00
- January 1993 ..... £2.00
- February 1993 ..... £2.00
- March 1993 ..... £2.00
- May 1993 ..... £2.00
- June 1993 ..... £2.00
- July 1993 ..... £2.00
- August 1993 ..... £2.00
- September 1993 ..... £2.00

Total no of issues ordered ..... Total price .....

We are now offering back issues of Hi-Fi World. Unfortunately, all issues prior to September 1991 are completely sold out, but subsequent issues are available for £2.00 including postage and packaging. Issues with Compact Discs (Oct.'91) are now available for £2.00.

(Overseas add £1.00 p+p for every two issues UK p+p free)

I enclose cheque/PO for £ ..... made payable to **Audio Publishing Ltd.**  
I wish to pay by Visa/Access, please debit my account no:

--	--	--	--	--	--	--	--	--	--	--	--	--	--	--	--	--	--	--	--

Expiry date: 

--	--	--	--

Name .....

Address .....

.....

.....

Post Code ..... Tel: .....

Please send completed order form together with your cheque/PO to:  
**HI-FI WORLD, 64 Castellain Road, Maida Vale, London W9 1EX.**

# Subscriptions

## 12 ISSUES FOR ONLY £22 (UK only)

### HI-FI WORLD SUBSCRIPTION FORM

Please send me the next 12 issues of Hi-Fi World, starting with the ..... issue.

I enclose my cheque/postal order for £22 (UK only) made payable to **Audio Publishing Ltd.**

Name .....

Address .....

.....

Daytime Tel No: .....

Please debit my VISA/ACCESS Card No:

--	--	--	--	--	--	--	--	--	--	--	--	--	--	--	--	--	--	--	--

Expiry Date: .....

Tel: 071-266 0461

Send to: **Audio Publishing Ltd.**, 64 Castellain Road, Maida Vale, London W9 1EX.

Overseas subscription rates.

Surface Mail: £29.

Airmail: £42 (Europe & Middle East),

£62 (Australia & Japan).

Airmail

Surface Mail (tick as appropriate)



E&OE

# U.S. & Canadian Subscriptions



## Hi-Fi World

P.O. Box 754, Manhasset, N.Y. 11030 - 0754

Telephone: 516 627 3836 Fax: 516 627 1972

I wish to subscribe right now - and receive monthly copies of Hi-Fi World Air Speeded direct from the Publisher in London U.K. to the N.Y. Office

I enclose my payment to :- FRJ/Hi-Fi as checked below  
1 Year - 12 Issues \$66 (U.S.)

U.S. FUNDS ONLY PLEASE - Add \$10 U.S. for Canada.

OR

Please charge my Credit Card with the amount indicated.

(All major Credit Cards accepted)

No: 

--	--	--	--	--	--	--	--	--	--	--	--	--	--	--	--	--	--	--	--

Expiry Date: 

--	--	--	--

Signature: ..... Name: .....

Address: .....

.....

City: ..... State: ..... Zip: .....

Or Telephone:

**516 627 3836**

Or Fax:

**516 627 1972**

# Specialist Hi-Fi Dealers

**SOUND GALLERY**

**BUCKINGHAMSHIRE'S PREMIER HI-FI DEALER**

Arcam, Denon, Linn Products, Naim Audio, Meridian, Rotel, Yamaha, NAD, Quad, Tripod, Nakamichi, Rega, Creek, Epos, Mordaunt Short, Celestion, Marantz, Mission, Cyrus, etc. ...

65 Castle Street, High Wycombe, Buckinghamshire.  
Open Monday - Saturday  
0494 531682 / 464670

**PRO**

Hi-Fi Specialists

ROKSAN □ NAIM □ REGA □ MICROMEGA □ ARCAM □ CREEK □ ROTEL □ MARANTZ □ DENON □ RUARK □ EPOS □ SYSTEMDEK □ HEYBROOK □ AUDIOLAB □ PINK TRIANGLE □ NEAT □ SHANINIAN □ SOUND ORGANISATION □ SOUND FACTORY □ CHORD COMPANY □ AUDIO TEC □ AUDIO TECHNICA □ MAHA

ACOUSTICS □  
Records also available

PRO MUSICA  
8 Vineyard St., Chesham, Bucks.  
0298 577519

*the powerplant*

**BRIGHTON'S LEADING HI-FI SHOP**

Cyrus, Roksan, Micromega, Audionote, Audiolab, Rega, Arcam, Exposure, Aura, Epos, Thiel, Ruark, Rotel, Marantz and other fine equipment.

66 Upper North Street, Brighton  
Telephone 0273 775978

**CHICHESTER HIGH FIDELITY**

7 ST. PANCRAS, CHICHESTER, WEST SUSSEX

CLOSED ALL DAY MONDAY  
Tel: (0243) 776402

Appointed stockists of: A+R Cambridge, Castle Acoustic, Creek, Dual, Goldring, Linn Products, Monitor Audio, Naim, Nakamichi, Quad, Rega, Rogers, Royd Audio, Sendor

**STATION SOUNDS**

W O R T H I N G

FOR A SELECTION OF VALVE AMPLIFIERS AND OTHER OLDER QUALITY EQUIPMENT

Valve amplifiers (combos and hi-fi) overhauled at sensible rates.  
Audio Note speakers and used Audio Innovations amplifiers stocked.  
Valve and other equipment always wanted.

Mike Pointer 0903 239980 (including Fax)

DOWN PLATFORM WORTHING STATION SUSSEX

**WORTHING AUDIO**

20 Treville Gate, W.Sussex. BN11 1UA  
(0903) 212133

The friendly shop with the best sound system in the South. Friendly advice

- 3yr guarantees • easy parking

Open Mon.-Sat. 10am-6pm Late night Wed. 7.30pm  
Agencies include: Arcam, Exposure, Kinshaw, Naim Audio, Marantz, Ruark, Audio Technica, Target, Tripod, IPW, TDJ, Urelle, and many more.....

Stockists of: ARCAM • CREEK • EPOS  
HEYBROOK • MICROMEGA • NAIM AUDIO  
NEAT • REGA • ROKSAN • ROTEL • ROYD  
TEAC • YAMAHA

**Infidelity**  
indecently good hi-fi

9 High Street, Hampton Wick, Kingston upon Thames, Surrey KT1 4DA. Tel: 081-943 3530  
Open Tues - Sat 10.30am - 7.00pm.

MANN - CASTLE - ALCHEMIST - ALBARRY - AUDIO INNOVATIONS  
NR PETERSFIELD HAMPSHIRE  
FOR OPENING HOURS AND APPOINTMENTS PLEASE RING ANYTIME

**AUDIO GALLERY**

NOW STOCK ALL HIGHEND ABSOLUTE SOUND

HOME DEM ON DEM  
WADIA & MICROMEGA  
CDA, TDL, SME, TEAC,  
VRDS 10, IMPULSE

0730 - 895194

VALVE SPECIALISTS ON A SUPERIOR LEVEL

AMC - PROMAC - JPW - MOTH - PINK TRIANGLE  
KIPSH, AUDIO NOTE, DPA 2008, PRE/PWR

AUDIOALCHEMY - TEAC - NAD - TRIPOD - ALPHASON - PIONEER - DENON

## LONDON & SOUTH EAST

**"One of the 5 best hi-fi shops in the world"**

**GRAHAMS HI-FI**

Canonbury Yard, 190A New North Road  
London N1 7BS, ☎ 071-226 5500  
*Ring for a chat, an appointment and a map!*

**BADA**

For the great sound of sound :

**The Comflake Shop**  
37 Windmill Street London W1P 1HH  
071 631 0472 Fax. 071 436 7165

We stock ATC, Arcam, Meridian, Naim, Rega, Royde, Roksan, AVI, Monitor Audio, DNM; as well as offering a marvellous mail-order worldwide service • Crunch •

**GET THE BEST FROM YOUR HI-FI**

100% OF AERIALS, 100% OF FITTING FOR HI-FI AERIALS, TV, AERIALS & SATELLITE DISHES

**THE AERIAL SHOP**

Quality equipment stocked eg:  
ANTIFERRENT, TRIAX, LAB GEAR ETC.  
188 HALFWAY ST, SIDCUP, KENT, BONDON SE & KEVI AREAS COVERED  
(081) 300 588/8990/7454  
Authorised Agent for Television

**volume one**

Tel: 081 304 4622

Alchemist, Alphason, Arcam, Audioquest, Audio Technica, Beyer, B&W, Cabletalk, Canon, Celestion, Chord Co., Micromega, Michell, Moth, Musical Fidelity, Nakamichi, Neat, Ortofon, Pink Triangle, QED, Rotel, Royd, Ruark, Sennheiser, SME, Sonic Link, Sony

41 UPPER WICKHAM LANE,  
WELLING, KENT

**The Hi-Fi Shop**

GUILFORD'S SPECIALIST SINCE 1950

We are at:  
3 BRIDGE STREET, GUILDFORD  
(By the traffic lights - next door to Alfred Marks.)  
0483 504801 • 0483 304756  
Access • Visa • Switch  
Open Monday-Saturday 9am-6pm (later by appointment)

**World Radio History**

**Seas Hi-Fi Speakers**

Top quality chassis units for DIY and replacement 4" to 10" Bass, Bass-Midrange, soft and Metal Dome Tweeters, Midranges etc.

**HENRY'S**

404, Edgware Road, London W2 1ED  
Tel 071 724 3564 Open 6 Days a week.

**SURREY HIFI**

SPECIALIST HI-FI OUTLET  
DEMONSTRATION ROOM • PARKING

- QUAD • AUDIOLAB • REL • TUBE TECHNOLOGY • TDL • TANNOY • KEF • DENON • NAKAMICHI • THORENS • TARGET • MAGNUM • ROTEL • MARANTZ • MICHELL • SENNHEISER • BEYER HEADPHONES • JPW • SOUND ORGANISATION • SOUNDSTYLE TRIPODS • VAN DEN HUL CABLES •

'HOME CINEMA NOW ON DEMONSTRATION'

Just 2 minutes off Junc. 6 M25, (A25)

**GODSTONE 0883 744755**  
45 High St., Godstone, Surrey RH9 8LS

**Spaldings**

ESTABLISHED IN SOUND

☎ 081-654 1231/2040  
352/4 LOWER ADDISCOMBE RD., CROYDON, SURREY

**KIMBERLEY HI-FI**

A Sound Investment

SEPARATE DEMONSTRATION ROOM • BRANDS STOCKED: • DENON • TECHNICS • KENWOOD • AIWA • NAD • DUAL • CASTLE • GOODMANS • MARANTZ • MONITOR AUDIO • HECO • ROTEL • PIONEER • REFERENCE POINT • SOUTH LONDON'S & NORTH KENT'S ONLY

LARGE RANGE OF ICE INC PIONEER & KENWOOD

193 BROADWAY, BEXLEYHEATH, KENT  
081 - 304 3272

**studio 99**

79/81 Fairfax Road  
Swiss Cottage  
London NW6 4DY  
071 624 8855/6  
Mon-Fri 10-7 Sat 10-6

**AUDIO CONCEPT**

27 BOND STREET, EALING  
LONDON W5 5AS  
TEL. 081 - 567 8703

Acoustic Energy, Aura, Audiolab, Audio Innovations, B&O, B&W, Cannon, Castle, Cyrus, Denon, Daul, Evolution, JBW, Kef, Marantz, Micromega, Mission, Monitor audio, Musical Fidelity, NAD, Nakamichi, Onix, Quad, Rogers, Rotel, Systemdek, Target, Teac, Thorens, Van den Hul.

Two demonstration rooms.  
Free local delivery and installation.  
Repairs and Services

# Specialist Hi-Fi Dealers

**MIDLANDS**

**MUSIC MATTERS**

**THE AUDIO SPECIALISTS**

for the most exciting range of equipment available in the Midlands which includes:

Arcam, Aiwa, Alchemist, Alphason, Apollo, Arcam, Audiolab, Audioquest, Audio Innovations, Audio-Technica, Aura, Beyer, Cambridge Audio, Canon, Celestion, Chord, Cyrus, Deltec, Denon, Dual, Epos, Exposure, Heybrook, Impulse, Infinity, KEF, Luxman, Marantz, Meridian, Michell, Micromega, Mission, B+W, Mordaunt-Short, Michaelson Audio, Monitor Audio, Monster, Musical Fidelity, Nakamichi, NVA, Panasonic, Pink Triangle, Pro-Ac, Revox, Rogers, Roksan, Rotel, Royd, Ruark, Sansui, Sennheiser, Straitwire, Systemdek, Target, Technics, Thorens, Wharfedale, Yamaha etc.

**OPENING TIMES:**  
Tues-Thurs 10.30-6.00  
Friday 10.30-8.00  
Saturday 10.00-5.00  
Demonstration by Appointment

**351 HAGLEY ROAD, EDBASTON,  
BIRMINGHAM B17 8DL**  
Tel: 021-429-2811

**156/7 LOWER HIGH STREET  
STOURBRIDGE, WEST MIDLANDS DY8 1TS**  
Tel: 0384 444 184

**INTEREST FREE**  
(for Ltd Period) APR 0%.  
Written details on request.  
Licensed Credit Broker.  
Switch card accepted



**ELECTRO CENTRE**

TEL 021 554 1878 & 523 2426

FULL RANGE OF H-FI.  
PIONEER, TECHNICS, KENWOOD,  
JVC, SONY, AIWA, AKAI  
Guaranteed the lowest price in the UK.  
24 Hour Mail Order Facility Available

**THE STATE OF THE ART....**

- EXPERT ADVICE  
- CREDIT FACILITIES  
- PART EXCHANGE WELCOME.  
- REPAIRS

Come and hear - NAD• B&W • NAKAMICHI • BOSE • QUAD • BEYER-DYNAMIC • SENNHEISER • AURA - and lots more in our listening room.

Tel. 0743 - 355166

**WON Hi-Fi Limited**  
12 Barker St. Shrewsbury  
Plenty of parking - park and ride buses stop outside!

**HOW TO SAVE £100 ON YOUR HI-FI**

Choosing the right Hi-fi and saving money is a difficult task, make it easy on yourself.  
To get your copy of "Guide to Buying Hi-fi" just telephone

**FREEPHONE 0800 373039**

We will send you one Free of Charge together with our Fact Pack and see how you can save £100 on recommended Hi-fi Systems.

**Active Audio**

12 Osmaston Rd. 29 Market Street, 95 Stafford Street,  
The Spot, Tamworth Hanley.  
Derby Staffs. Stoke-on-Trent.  
Tel: 0332 380385 Tel: (0827) 53355 Tel: 0782 214994

**W.OWEN EST 1901**

**Audio/Video Specialists**  
Pioneer • Reference Point • Kenwood • Sony • Akai • B&W  
Free Installation and Home delivery

58 Market Street, Oakengates 2A Stratford Street,  
Telford, Shropshire. Newport Shropshire.  
Tel: (0952) 613818 Telford. Tel: (0952) 810876

You can come and visit us at:  
**25 HENLEY STREET,  
STRATFORD CV37 6GW**  
Contact Dirk or Jamie on:  
Tel/fax No. **0789 414533**  
We are stockists of the leading Hi-Fi brands including:

ARCAM, SONY, PANASONIC, NAKAMICHI, B+W, PIONEER, TECHNICS, DENON, NAD, KEF, MARANTZ, ROTEL, MUSICAL FIDELITY, MONITOR AUDIO, MISSION, TANNON, QUAD, TDL & SENNHEISER, YAMAHA, CELESTION, ACOUSTIC RESEARCH, AUDIOQUEST, MONSTER, TARGET, BEYER, SYSTEMDEK.

92% Finance is available on selected products and all major credit cards accepted. We also have a Demonstration Room and Service Facilities.  
Monday to Saturday 9.30-5.30. Late night Wednesday  
"WHERE FRIENDLY SERVICE STILL COUNTS!"

**THE MOST EXCLUSIVE  
INDEPENDENT  
HI-FI STUDIO**

The internal atmosphere and easy access make it so much more exciting choosing your hi-fi from the finest audio products available.

Just off the High Street,  
Blywich, nr. Walsall, West Midlands.  
(Ample free parking)  
(OFF M6 JUNCTION 10)

TEL: (0922) 493499 - 473499

Open 6 days a week, Mon - Sat.  
All major Credit Cards accepted  
Part Exchange enquiries welcome

ALBARRY • ACOUSTIC ENERGY • ARCAM • ART AUDIO  
• AUDIOLAB • AUDIO QUEST • B&W • BOSE • CABLE TALK • CHORD • CYRUS • DPA • DYNAUDIO • ENSEMBLE • EPOS • EXPOSURE • JPW • KEF • REFERENCE • MARANTZ • MERIDIAN • MICROMEGA • MISSION • MOTH • MUSICAL FIDELITY • NAKAMICHI • ORTOFON • PROSPECT • PROJECT • QUAD • ROKSAN • ROGERS • ROTEL • SONICLINK • SYSTEM DEK • TDL • THORENS • TRIANGLE • TOWNSEND • TUBE TECHNOLOGY • VAN DEN HULL • YBA •

ARCAM, ROYDE, AUDIOTECH, CELESTION, APOLLO

Surround sound systems available for demonstration

**MUSICAL APPROACH**

STAFFORD ALDRIDGE  
WOODSTOCK ROAD 37 HIGH STREET  
0785 55154 0922 57926

LINN, ROTEL, MARANTZ, HEYBROOK, TARGET

Single speaker demo rooms free expert installation

**CREATIVE AUDIO**

9 DOGPOLE, SHREWSBURY, SHROPSHIRE  
Tel: (0743) 241924  
Closed Mondays

- Comfortable listening rooms
- Home demonstrations available
- Part exchange welcome
- Free home installation
- Interest Free credit

Authorised retailer for:  
A & R ARCAM, AUDIOLAB, CELESTION, CYRUS, DENON, DU AL, MERIDIAN, MISSION, MONITOR AUDIO, QUAD, REVOLVER, ROKSAN, ROTEL, YAMAHA, EPOS, NAIM, KEF, RUARK

**FRANK HARVEY**

**Hi-Fi EXCELLENCE**

163 Spaon Street, Coventry, CV1 3BB Tel : 0203 525200.  
Mon to Sat 9.30 AM 5.30. Closed Thursday

**MUCH MORE THAN HI-FI**  
WE ARE A BADA DEALER MAILORDER • EXPORT • HOME TRIALS

163 Spaon Street, Coventry, CV1 3BB Tel : 0203 525200.  
Mon to Sat 9.30 AM 5.30. Closed Thursday

Audiolab • Audio Alchemy • Arcam • Alphason • Bose • Bang & Olufsen • Celestion • Cyrus • Denon • Dual • Foundation • Kef • Marantz • Monitor Audio • Mission • Musical Fidelity • Nakamichi • NAD • Quad • Rega • Rogers • Rotel • Target • iPod • Tannoy • Thorens • Van Den Hul • Yamaha



**3 Floors, 3 Dem rooms, 3000 sq feet in the pursuit of Hi-Fi Excellence**  
World Radio History

**Peter Ellis Audio**

A wide range of audio products always in stock including:-  
Quad, Denon, Stax, Marantz, Arcam, Creek, Sugden, QED, Castle, Rogers, Celestion, Tannoy, Nakamichi, Yamaha

\* Home Cinema available \*  
\* Demonstration Room \*

29, Kirkgate, Newark,  
Nottinghamshire NG24 1AD  
0636 704571

**MIDLAND STUDIO**

PHONE/FAX OR WRITE FOR OUR LATEST LIST OF EXDEMONSTRATION OR SECOND HAND EQUIPMENT FROM LEADING ESOTERIC MANUFACTURERS

**MIDLANDS HI-FI STUDIO**  
WULFRUNA STREET  
WOLVERHAMPTON WV1 1LX

TELEPHONE 0902 771774 FAX 0902 380083

Advent, Albarray, AKG, Alphason, AMC, AR, Arcam, Audioquest, Audio Technica, Beyer, Bose, Castle, Chord, Denon, Dual, Goldring, Meridian, Michell, Monitor Audio, Nagaoaka, Nakamichi, Ortofon, QED, Quad, Revox, Sennheiser, Sequence Design, Spendor, Target, TDK, TDL, Thorens, Wharfedale, K. Monks Record Cleaning Service.

**Five Ways Hi-Fidelity., (Est.1972)**  
12 Islington Row  
Edgbaston, Birmingham B15 1LD  
021-455 0667 (Closed Mondays)

**EAST**

**The Audio File**

27 HOCKERILL STREET, BISHOP'S STORTFORD, HERTS.  
TEL: 0279 506576  
2 FOUNDRY WALK, MARKET HILL, ST. IVES, CAMBS.  
TEL: 0480 66123



**signals**

- audio innovation • fuller's audio • goldring • heybrook • impulse • ipw • lyro • michell • micromega • qed • soniclink • sumiko • alphason • apollo • audioquest • ixos • projekt • soundstyle • sterling • townshend • trichord • sugden • and many more

Monday to Saturday 10-6

**MARTLESHAM HEATH • IPSWICH**  
(0473) 622 866

**EIRE**

**CLASSIC AUDIO**

**REAL HI-FI**

DOLBY PRO LOGIC AND SURROUND  
A.V. SPECIALIST  
4 Cathal Brugha St., Dublin 1. Tel: 745910

**FRANK HARVEY**



# Specialist Hi-Fi Dealers

## Peter Dand & Company Ltd

Established 1963

Bang & Olufsen, Quad, KEF, Thorens, TEAC, and many more!  
2 Demonstration Rooms  
2 Year Guarantee

111 Clonskeagh Road, Dublin 6  
Tel. 01035 31 269 4433

We Never Compromise On Quality



55 Main St Blackrock Co Dublin  
Tel 2889449/2888477 Fax 2834887  
Open Tue/Sat 10AM-6PM. Thur/Fri 'till 9pm - Closed Monday

## Acoustic Dimension

AVI • ATC • AUDIO INNOVATIONS • ACOUSTIC ENERGY • MICROMEGA • AUDIO NOTE • LFD • REF 3A • IMPULSE • JPW • TDL PROJECT • PRO AC • TRIANGLE • RUARK • ROTEL • MARANTZ • DPA • APOLLO

Now ex demo equipment.  
Credit card accepted.

## WEST & WALES

## ENGLISH audio BADA

### CYRUS CENTRE

PINK TRIANGLE-AUDION-SYSTEMDEK-HEYBROOK-MICHI-KEF REFERENCE MICROMEGA-NAKAMICHI-CHORD-ARCAM-MUSICAL FIDELITY-ROGERS-NAD-ROTEL-DENON-TANNQY-MARANTZ-MISSION-STAX-DUAL-TDL-ALBARRY-JPW-CELESTION-IXOS-SME-RUARK-MOTH-AUDIO TECHNICA-AND OTHERS  
Free installations: Credit Facilities: Service Department.

Mon - Sat 10 - 6  
95 Whitecross Road, Redford, Edinburgh EH4 0JG, 01327 359081

## ACTON GATE AUDIO THE HI-FI CENTRE IN WREXHAM

Aiwa, Albarry, Arcam, B&W, Canon, Celestion, Cyrus, Mastler, Marantz, Michell, Mission, NAD, Nakamichi, Quad, Radford, Rega, Rogers, Rotel, Ruark, Spendor, Teac, Tannoy, Thorens, Wharfedale, Yamaha,  
"Yamaha cinema DSP club authorised dealer"

4 RUABSON ROAD, WREXHAM  
TEL. 0978 3645000

## audio excellence BADA

WHERE THE MUSIC MATTERS

**Bristol** 65 Park Street Bristol BS1 5PB (0272) 264975  
**Cardiff** 134/6 crwys Road Cardiff CF2 4NR (0222) 228565

**Gloucester** 58 Bristol Road Gloucester GL1 5SD (0452) 300046  
**Swansea** 9 High Street Swansea SA11LE (0792) 474608

TUESDAY - SATURDAY 9.00 - 5.30  
CLOSED MONDAY

## NORTH

**ASTON AUDIO HI-FI SPECIALISTS**

ARCA • MERIDIAN • MISSION • CYRUS • AUDIOCAB • B & W • NAKAMICHI • AURA • DENON • QUAD • YAMAHA • KEF • MARANTZ •

ROKSAN • NAD • MF • AIWA • DUAL • CELESTION • ROGERS • AUDIOQUEST • TECHNICS •

WEST STREET • ALDERLEY EDGE • PLUS HOME CINEMA • CHESHIRE • TEL 0625 582704 • INTEREST FREE CREDIT • DISCOUNT CD & TAPE • BADA •



## THE HI-FI STUDIOS

HEYBROOK, MONITOR AUDIO, ART AUDIO VALVES, DUAL, SUGDEN, ALPHASON, TDL, MICHELL, ACOUSTIC ENERGY, TEAC, A&R, AURA, ORIGIN LIVE, SYSTEMDEK, EPSILON, SHURE, AUDIO TECHNICA, GOLDRING, ALBARRY AND OTHERS FROM THE COMPANY THAT CARES FOR CUSTOMERS.

DEMONSTRATION IN OUR LISTENING ROOMS OR AT HOME

SUNNYFIELD, DONCASTER  
Tel: (0302) 781387

## AUDIO COUNSEL HI-FI SPECIALISTS

LINN, NAIM, REGA, ARCAM, ROTEL, ROYD, SHAHINIAN, DYNAVECTOR, EPOS, MARANTZ, NAKAMICHI, MICROMEGA and many more....  
"Time spent with staff may prove to be a particularly wise investment"

Audiophile

12/14 Shaw Road, Oldham OL1 3LQ  
Tel. 061 633 2602

# Swift

## THE hi-fi SPECIALISTS

ST ANN'S PARADE (ON A34) WILMSLOW CHESHIRE

☎ (0625) 526213

● 2 YEAR GUARANTEE ● EASY PARKING  
● DEM ROOM ● PART EXCHANGE

Aiwa • Audio Lab • Aura • B & W • Castle • Denon • Cyrus • Celestion • JPW • Kenwood • Marantz • Mission • NAD • Pioneer • Rotel • Systemdek • Tannoy • Technics

## ACTION ACOUSTICS

Products Include: Acoustic Energy, Albarry, Croft, Denon, Harman Kardon, Michell, Pink Triangle, Revox, Rogers, TDL, Thorens etc.

Demonstration and Credit Facilities available

155-157 High St., Redcar, Cleveland.  
Tel: 0642 480723

## Cheshire Music

Hi-fi systems for music lovers.

ATC Loudspeakers AVI Electronics.  
Clearly the best at any price.

For further details or a demonstration contact  
Roy Parrish on 061-439 0082

Retailers of Fine Audio Equipment  
Congleton

- ▶▶ EPOS
- ▶▶ ONIX
- ▶▶ OENON
- ▶▶ LINN
- ▶▶ AUDIO ALCHEMY
- ▶▶ ARCAM
- ▶▶ B&W
- ▶▶ NAKAMICHI
- ▶▶ ROYD
- ▶▶ TARGET
- ▶▶ TRIPPO
- ▶▶ LOUSY COFFEE

▶▶ SUPERB DEMO FACILITIES  
▶▶ FULL INSTALLATION & HOME DEMO SERVICE

OPEN 6 DAYS A WEEK  
OTHER TIMES BY APPOINTMENT

0260 297544

1/1A Duke St Congleton Cheshire CW12 1AP

World Radio History

**RATA**  
Edge Bank House, Skelmergh, Kendal, Westmorland, LA8 9AS  
Telephone : 0539 823247

If you like the Hi-Fi equipment you have but want a better performance, don't change it.

### UPGRADE IT!

You can build better than you can buy and we offer kits, parts and instructions for anything from simple component upgrades to complete rebuilds, plus kits to build high end equipment from scratch.

### New Upgrading Service.

If you are daunted at the prospect of taking the lid off your prized possession, send it to us and we can do the upgrade for you. We will advise on feasibility and cost before starting work and upgrade to the level of performance you require and can afford. We have a secure, low cost collection and delivery service within the UK.

Upgrades to: Audio Research, Celestion, KEF, Krell, Linn, Marantz, Meridian, Naim, Nlytech, Pioneer, Quad, Leak, Radford, Rotel etc....

Send now for full details and a copy of our 1993 Audiophile Components Catalogue No. 2.  
To cover postage Europe 5 x IMCs, World 9 x IMCs, or quote your credit card number (Visa or Mastercard only). UK - free.

## LOOKING FOR REAL HI-FI or HOME CINEMA IN SWINDON

Audio Technica, Acoustic Energy, Audio Innovations (valve Amp), Beard (Valve Amp), Cerwin Vega, Impulse, Red/Acoustics, and many more....

We also stock quality ex demonstration and secondhand hi-fi Quality car Audio, new, used and secondhand, also available Repair and refurbishment classic equipment

52 Audio Exchange 52

52 Morse St, Swindon Tel. 539888

(Off Commercial Road, Swindon) Open 10am - 6pm, Mon - sat

## BADGER BOARDS Printed Circuit Boards

Prototype-Singles-Multiple runs.

Minimum charge £15.00

Artwork, Plotting from Schematic to final board layout.

Send S.A.E. now for Catalogue of Kits-Boards-Projects available. May magazine boards produced for individual customers.

Dept. HFW 87, Blackberry Lane, Four Oaks, Sutton Coldfield, B74 4JF  
Tel: 021 353 9326

## REVOX SERVICE & REPAIRS "Authorised agent for Revox Products"

- 17 Years experience, ex-Bauch •
- All repairs carried out and guaranteed •
- Fast turnaround •

Tel: 0923 893711

Suite 10, Smugoak Business Centre, Lye Lane, Brickwood, Herts. AL 23UG

**BANDOR**  
MINIATURE LOUSPEAKERS  
DESIGNED AND MANUFACTURE OF MINIATURE LOUSPEAKERS AND SYSTEMS.

Drive Units - 2" module with 1.3gms. mms. + 6" 8" & 15" GLUMINIUM CONED DRIVERS. Flat pack TRANSMISSION LINE KIT and NEW BANDORA-MORA semi: active complete loudspeaker system.  
Free technical sheets etc.  
11 Penfold Cottages, Penfold Lane, Holmer Green, Buck. HP15 6XR  
(0494) 714058

## VINTAGE AND VALVE HI-FI

Haden Boardman buys, sells, modifies & repairs all vintage hi-fi equipment.

Always quality hi-fi available, new and secondhand. Advice is free, phone if just for a chat. Credit cards accepted. New equipment by Croft, E.A.R., Richard Allen + more coming soon!  
Quick worldwide delivery, callers by appointment. Sorry but we are unable to answer queries in writing.

GARRARD 301/401 IN STOCK 7 days a week  
Audio Classics Tel. (0942) 57525 Fax. (0942) 525861  
8 Lowe Mill Lane, Hindley, Lancs WN2 3AF

## mwes electronic services

Repair & services to almost all makes of Hi-Fi. In guarantee repairs to Denon, Kenwood & Pioneer. All repairs tested for electrical safety.

MWES ELECTRONIC SERVICES  
5 KING STREET, DELPH  
OLDHAM OL3 5DL  
TEL/FAX. 0457 820862







Giovanni Dadomo

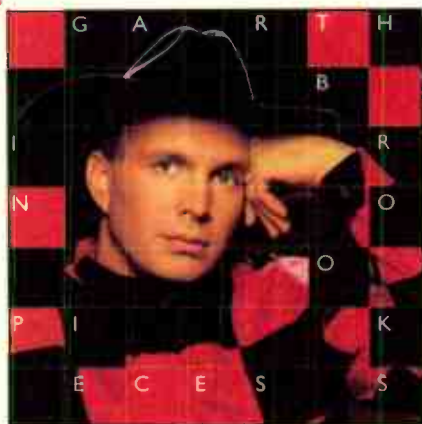

**GARTH BROOKS**  
**In Pieces**  
 LIBERTY CD 0777-7-80857-2-0

INDEX

RECORD REVIEWS

**ROCK & POP** .....73  
 Giovanni Dadomo

**CLASSICAL** .....76  
 Peter Heming

**JAZZ** .....85  
 Simon Hopkins  
 Simon Cooke

● Garth Brooks has probably taken longer to reach British audiences than most of his contemporaries in the New Country boom of a few years ago - I refer to the likes of Lyle Lovett, that geezer who sang about guitars and cadillacs, and so on. See how quickly a fad can turn into a Trivial Pursuit question? Anyway, Garth's the one with the Big Hats, and if he may be little known by we British Bulldogs, he's sold more records in the USA recently than all your Springsteens and Dire Straits put together.

Now a lot of critics have suddenly suggested that this is 'cos Garth appeals to rednecks and good ole boys of the born again Hawk-cum-fundamentalist variety. Mind you, these rag-scribblers have also suggested that the reason he

wears huge Tom Mix-type stetsons all the time is 'cause he has a follicle problem as in Elton John, what in Newspeak we would politically correctly call follically challenged. Well, that's patent bullshit because (how many ways the wonderful world of pop writing can spell or mutate "because", eh readers?) there's a picture of Garth sans stetson on the inside, and grey he may be, but bald eagle he certainly ain't - and that's no lie.

Now to this bambino, and on the evidence of this, Garth's seventh long-player, I believe that Garth's popularity is down to three things, viz: (1) A terrific sense of style - it's surely no coincidence that the first credits on the sleeve of the record are to thank the people who provide him with his shirts, jeans, boots, dusters and any other accoutrements of the well-dressed New Country boy. Didn't Hank Williams and Gram Parsons have similar sensibilities. (2) Garth, who doesn't do a helluva lot of writing himself, has a very good ear for a catchy song. And (3) the man happens to be possessed of a strong, lissome, extremely flexible voice - no bad thing for someone who happens to sing for a living.

Not that Brooks and his writers aren't partial to a little of that comball sentimentality that Country is particularly suited to - there's a song here, 'The Night I Called The Old Man Out', which concerns itself with the inevitable 'East Of Eden' style stand-off between father and son, the one where the kid takes on

**THERAPY?**  
**Troublegum**  
A&M 540 196 2

● Therapy are probably the hardest most dangerous sound ever to come out of the Emerald Isle. Formed five years ago, the trio went the usual Indie/ small label route until signing to A&M a couple of years past. Their debut LP for the label, 'Nurse' marked them as a force to be reckoned with; this follow up can't fail but consolidate their reputation, as trouble boys par excellence. Therapy? are loud, bad and astonishingly powerful for a trio. They combine monstrous guitars jetpropelled rhythms with blood-soaked lyrics and tougher than tough vocal deliveries. But they can also come up with killer hooks and highly persuasive melody lines. To say they're probably the best Irish export since Guinness is hardly an exaggeration. The trio - Andy Cairns (vox. gtrs.), Fyfe Ewing (drums) and Michael McKeegan (bass) - positively revel in the aforementioned Irishness on this LP. At least from a lyrical point of view, with ample references to Jesus ("without the suffering"), his turncoat

pa] Judas, plus oodles of guilt, anxiety, sexual frustration etc. But they can also come up with a song that opens with the ahem, presumably tongue in cheek line "masturbation saved my life".



Which is to say that one of their saving graces is a good sense of humour. I mean, who else but a lapsed Catholic could come up with a phrase like "Heaven kicked you out, you wouldn't

wear a tie"? And you must remember that these are the boyboys who once declared, "I'm bitter, I'm twisted/ James Joyce is f~xxing my sister"! They are - New Puritans beware - also wont to use the f-word a lot on this latest opus. But they're best when you take the lyrics and music as a whole, so try the drum-manic 'Hellbell or the brilliant vocal arrangements that make 'Lunacy Booth' such a special killer. On 'Unbeliever' the lead vocal owes more than a bit to the late Ian Curtis, so it's no surprise to find the band taking on Joy Division's classically psychotic 'Isolation' elsewhere on the disc. On a more melodic note there's the VASTLY impressive coda that graces the Bowie-inspired 'Turn' or the ultra catchy chorus that makes 'Screamager' a treat for the whole wide world.

Therapy? are a wild marriage of metal and pop as if Ministry went and read 'Portrait Of The Artist', got even better hooks, and humour by the bucket. Watch them grow...

his old man, gets the kaka beaten out of him only to realise how much he really does love his "paw". But it's superbly done, dripping in sentiment and just perfect Middle America pap-fodder (fodder dear fodder, or what?). There are tunes covered in fiddles, mandolins everything in fact except a Tex Ritter yodel. There is even a song about the wonderful life that cowboys have, 'The Cowboy Song' - what else?, this one even including a bona fide "Yippee-tie-eye-ay!". And of course, there's Brooks', US version of Ray Davies' 'Village Green Preservation Society', a paen to all things American entitled 'American Honky Tonk Bar Association'. Now it may be a



redneck hymn, but it also happens to be catchy as hell, features amusing lyrics, and is splendidly played, delivered and arranged. So what, I sez armchair cowboys everywhere wan relate to GB, I'll wager. He may not be an auteur like Lyle Lovett, and I love him less but it's easy to see why he's as big as he is. And he wears a mean mean stetson.



**SOUNDGARDEN**  
**Superunknown**  
A&M 540 215 2

● Soundgarden are one of the old guard Seattle bands; in fact, the legend

goes that Kurt Cobain only decided to sign his Nirvana combo to the Sub Pop label because these geezers were there already. This knowledge helps to answer all sorts of tricky questions, because although Nirvana's global success has meant they are now identified with all things Seattle, we on the outside don't really appreciate who came first. See, there are plentiful incidences on this new Soundgarden LP where one could be forgiven for thinking that they'd taken more than the odd leaf from their maturer cousins' book. Whereas the truth may be that Nirvana may owe a great deal more to Soundgarden than anyone's so far chosen to admit.

Mind you this is all petty journalistic-type quibbling because, as we all well know, what really matters is the music to hand - and the music to hand in this case just happens to be fast and furious, strongly metallic rock of the type that never avoids paying its dues to such primary sources of inspiration as early Led Zep or - vocally at least - Free's Paul Rodgers.

Because Soundgarden are the Betes Noirs of the Seattle "grunge" scene their roots lie fairly and squarely buried in the rich loam of late Seventies blues/rock of the sort that Heavy Metal could not have existed without. And to give 'em their

dues, Soundgarden have - despite a pedigree which includes releases on such benchmark indie labels as SubPoP and SST - never really forsaken their metallically Britpop circa 69-71 roots. Hence on this latest disc there are echoes of Led Zep's classic 'Trampled Underfoot' mad shadows of the Sabs variatt and even a subtle hint of Robert Palmer when he was still part of Great Lost Blues-Rock Legends Vinegar Joe.

As previously, this an entertainingly noisy blend of Metal and pop; busily noisome, ripe with Heavy Metal Thunder, and with its tongue firmly in its cheek. Fun being the operative word, this really is a band it's hard not to like a whole lot. Hubba. hubba!



**BLUE AEROPLANES**  
**Life Model**  
**BEGGARS BANQUET**

● Out of Bristol a near decade ago came the Blue Aeroplanes, an intriguing combination of poetry and rock whose nearest relatives are propably Dexy's Midnight Runners at their peak. The BA's share with Dexy's a tendency to lyrical verbosity combined with strong pop sensibilities which means their songs are catchy, laden with hooks and hard to forget or pass by. REM's Michael Stipe has said they're his favourite band, but then he's always saying things like that.

But three well-received LP's later the group are still alive and kicking so it must mean something.

The latest BA line-up features Gerard Langley (vocals), who is their lynch-pin, plus dancer Wojtek Demochowski (try saying that with a mouth full of spaghetti) as well as musos Roger Power on bass, John Wygens on guitar and Graham Russell on drums. Together they make a mixture of poetry and rock that varies from the dubiously pretentious to the highly moving and evocative. Check out 'Vade Mecum Gunslinger' and 'Ghost Nets' and decide which is which for yourself.

I'm not sure this is exactly genius, but no way is it crap either. One for the grubby anoraks - and proud of it.

**KRISTIN HERSH**  
**Hips and Makers**  
**4AD CAD 4002 CD**

● Kristin Hersh is best known for giving her voice and lyrics to indie faves the Throwing Muses. But it doesn't really matter too much if you've never heard the band because this - her first, primarily acoustic, solo album - stands up in its own right. The lead-off single, 'Your Ghost', with backing vocals from REM's Michael Stipe has already made a considerable dent on the indie scene, and the presence of veteran writer/muso Lenny Kaye (Patti Smith Group, Suzanne

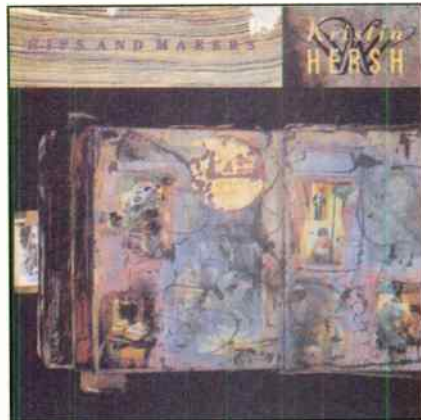

Vega etc. etc.) in the producer's chair is witness to the lady's strong, intelligent sensibilities where music is concerned. And while it's true to a certain degree that the breathy voicings and primarily acoustic backings are often very reminiscent of the aforementioned Ms Vega, Kristin can easily hold her own ground.

There is, for example, an undeniable sense of irony, when such a sweet voice delivers a putdown along the lines of the "You dipshit" declaration featured on the otherwise highly sensitive 'Teeth'. While she can be seductively reminiscent of Lennon at his most acerbic as on 'Beestung'. More predictably, Hersh can be evocatively fragile - witness only 'A Loon', which is a sliver of pure feeling, ditto the achingly delicious 'My Charms'. In fact charm really is the operative word here. This really is a very gentle sound. And one to treasure.

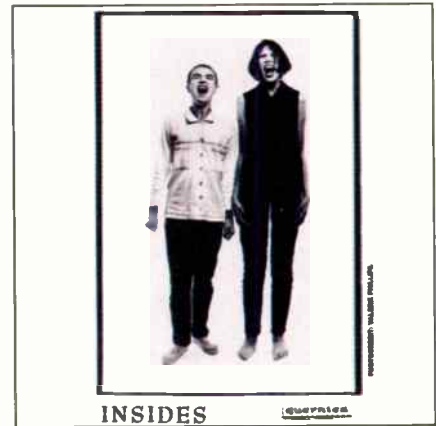

**INSIDES**  
**Clear Skin**  
**GUERNICA**

● The Insides duo are back, but with a difference; whereas they've previously been known for rather straight ahead, dancefloor-orientated techno the latest release from the combined talents of J. Serge Tardo and Kirsty Yates owes a lot more to a longer established tradition of electronic music. The CD-only release 'Clear Skin' is a 38 minute adventure in sound and texture which recalls everything from early Kraftwerk to the more deliberately ambient musings of Brian Eno and the entire 'new music' crew.

It's both engagingly arresting as well as wallpaper-subtle, a subtle blend of tone and texture that can be both arresting or subtly mood-enhancing. This may well be elevator music but it is, at the same time music that elevates you into a world that has yet to be invented. Charming in the extreme, totally engaging, it really will melt those insides of yours.

Rock + Pop

# Classical

Peter Herring

**More years ago than I care to remember, the Hungarian Quartet opened the door for me into Beethoven's string quartets. Will a bargain box of that same ensemble's Schubert recordings do the same for you? More recently, Kenneth Smith and Paul Rhodes on ASV have been opening the door on to some miniature masterpieces of British flute music. And, continuing, the theme of discovery, Radio 3 has revealed to me that I do like Respighi after all!**

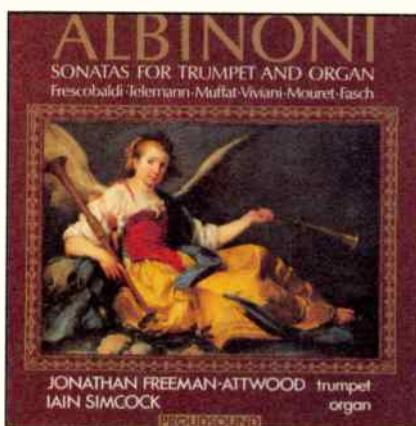

**SONATAS FOR TRUMPET AND ORGAN**  
**Works by Tomaso Albinoni; Girolamo Frescobaldi; Johann Friedrich Fasch; Georg Muffat; Giovanni Buonaventura Viviani; Georg Philipp Telemann; Jean-Joseph Mouret**  
Jonathan Freeman-Attwood, trumpet;  
Iain Simcock, organ  
**PROUDSOUND PROUD CD 135**  
**(DDD/66.59)**

● Another very fine production from Paul Proudman's Proudsound label, a recording made in what proves to be the splendid acoustic of the parish church in Bromley, Kent. The organ is a three-manual and pedal mechanical action instrument by J.W. Walker and Sons of Brandon in Suffolk. The first Proudsound issue to come my way, a selection of German sacred music, was praised in these pages a couple of months back and I have since noticed that the label's CD of Ockeghem and Josquin Desprez was one of the critics' choices for 1993 on Radio 3's Record Review.

There were high expectations, therefore, for this new issue and they were not disappointed. Although the combination of trumpet and organ might seem to epitomise the brilliant sound of the Baroque, it is a comparatively recent partnership. The early valveless trumpet would have been an ill-match for the 'king of instruments' and the notion of

such a duet is largely down to contemporary trumpet virtuosos such as Maurice Andre. As a consequence, the repertoire for trumpet and organ relies heavily on transcriptions but this in no way compromises its 'authenticity', for the art of transcription was practised by virtually every composer of the seventeenth and eighteenth centuries.

Only four pieces here are bonafide trumpet works; the rest have been skilfully transcribed from canzonas, suites, sonatas and concertos by a host of the leading composers of the Baroque period. Particular attention has been paid to the organ accompaniments which have been 'realised' to give an appropriate melodic dialogue to complement the trumpet, or are reductions and reworkings from orchestral scores. The result is an expressive range of a breadth rarely encountered in recitals by this combination of instruments. The recording is also distinguished by its variety of moods: it is by no means all fireworks in the top register which, after the initial impact, quickly becomes wearisome.

There is much fine music to be savoured here, not least the splendid C minor concerto by Telemann who, to judge by the current interest in his work, finally seems to be emerging from the shadow of his contemporary, J.S. Bach. There are two canzonas by that early giant of keyboard music, Girolamo Frescobaldi, three sonatas by Tomaso Albinoni (of 'Adagio' fame, which he unfortunately didn't write!) and a dazzling D Major concerto for the clarino register by Johann Friedrich Fasch. Georg Muffat's suite in E Major, one of the works in his collection *Florilegium II* of 1698 is noteworthy for requiring two pistol shots to be fired during one of its dance movements; here, Jeremy Summerly pulls the trigger in *Les Gendarmes*. After Muffat's exuberance, Giovanni Viviani's *Sonata Prima per tromba sola*, one of two trumpet sonatas in his 'Capricci armonici da chiesa e da camera' is a touch more restrained and Jonathan Freeman-Attwood and Iain Simcock conclude

**Continued On Page 79**

Certain recordings garner a personal affection which transcends subsequent critical dissection. The Hungarian Quartet of the late 'fifties and 'sixties was my introduction to the string quartets of Beethoven, a revelatory and life-enhancing experience. For that, I remain eternally grateful, as I do to the Amadeus Quartet for opening the door to quartets of Mozart, and to the Fine Arts Quartet whose Bartok series on Saga performed the same role. Critical opinion now considers all these recordings surpassed; fair enough, but that does not diminish the impact, or the achievement.

The Hungarian Quartet's Beethoven series came on what we then still knew as the HMV label, a set of LPs whose only concession to graphic design was a change of background colour to each sleeve. The sober black - and - white picture of the players remained unaltered - a marked contrast with the contemporary presentation of classical music.

I continue to enjoy the Hungarians' Beethoven playing, partly I suppose because it is so heart-warmingly familiar. They are honest, unmannered, considered performances unencumbered by mystique or

mythology. The players do not seek to impose an interpretation, rather it unfolds and develops before the listener who is left to derive his own thoughts about Beethoven's intentions. Some say such performances lack 'personality'. Wrong. The personality is there; it is simply the servant of the music, not the music of it.

After so many years treasuring these Beethoven recordings, it was an exciting surprise to discover that EMI France had also recorded the Hungarian Quartet in Schubert and produced a two-CD set of, outwardly, remarkable value and, inwardly, of even greater promise.

## FRANZ SCHUBERT

### String Quartet in A minor D804/String Quartet in D minor D810 'Death and the Maiden'/String Quartet in G Major D887/String Quintet in C Major D956

Hungarian Quartet (Zoltan Szekely, violin; Michael Kuttner, violin (D956, D887); Alexandre Moszkowsky, violin (D804, D810); Denes Koromzay, viola; Gabor Magyar, (cello); Laszlo Varga (second cello) D956

EMI CLASSICS (EMI FRANCE) CZS 7 67422 2 (ADD/156.03) (2 CD SET)

● From the above, lovers of Schubert will know that this set offers not just four of the greatest chamber compositions, but four of the finest pieces of classical music ever written. Here, Franz Schubert not only steps outside the giant shadow of Beethoven, he uses the quartet and quintet medium in a way that even Beethoven only hinted at. Where Beethoven, in his last chamber works, seems to explore certainties, Schubert's music is riven with doubts and fears. It is music's dark night of the soul, disturbing, disquieting, nakedly personal - and utterly compelling.

Perhaps more than any other, the last two quartets expose the inner torment of the composer - and brutally nail any preconception of chamber music as something played by dowdy spinsters in twee drawing rooms. The opening of the G Major quartet, for example, with its sinister tremolo effects is one of the most chilling episodes in all music - and all created from just four string instruments. As in its predecessor, the D minor D810, there is frequently a nightmarish quality to the writing, a fearful urgency. In both works, the slow movements have an aching sadness, even despair, and speak of bitter experience. It is extraordinary music to have been composed by someone in his late 'twenties. How the image of

Schubert, the fun-loving, happy-go-lucky Viennese bohemian masks what must have been his true nature.

For many, the C Major String Quintet represents the apex of Schubert's output of chamber music and, indeed, it is a work of sublime radiance. It is as if Schubert, in his last days, somehow emerged into the light, casting off the terrors that consumed him in the last two quartets. The slow



movement of the Quintet is a benediction comparable to the slow movement of Beethoven's Op.132.

The A minor (D804) and D minor (D810) quartets date from around 1824, four years before Schubert's death. Both quote from the composer's prodigious output of songs, the most conspicuous quotation being from his setting of Matthias Claudius's poem *Der Tod und das Madchen* (Death and the Maiden), the melody of which supplies the starting point for the set of variations which forms the slow movement. In the lyrical and noble A minor quartet two songs are hinted at: *Die Gotter Griechenlands* (The Gods of Greece) and the well-known Goethe setting, *Gretchen am Spinnrade* (Gretchen at the Spinning Wheel). The former, quoted at the beginning of the third movement, is a setting of Schiller in which the poet wonders where the

beautiful world has gone (*Schone Welt, wo bist du?*). We know from Schubert's letter to his friend, the painter Leopold Kupelweiser, just how much that reflected the composer's state of mind: "Imagine a man...whose brightest hopes have come to nothing, to whom the happiness of love and friendship offer nothing but pain...whose enthusiasm for beauty threatens to vanish."

Mercifully for posterity, that enthusiasm did not vanish.

But what of the Hungarian Quartet's performances of this multi-faceted, multi-layered, emotionally complex music? The playing of the A minor quartet is wonderfully refined, but with a keen appreciation of the work's essential poetry; the String Quintet receives a performance full of wisdom, maturity and insight. The Hungarians, augmented by cellist Laszlo Varga, get to the very heart of the work. The G Major blazes with intensity, the strings biting into the rhythms of the quick movements.

Only in the D minor 'Death and the Maiden' was I a little disappointed, the performance lacking some of the coherence and commitment which so characterises the other interpretations in this set. The playing, too, is not quite so assured or polished. This also happens to be the earliest recording here, dating from May 1958. The A minor quartet was taped five months later (both in stereo I hasten to add), while the G Major first appeared in 1968. The most recent of the recording - all of which were made in venues in Paris - is of the String Quintet and that was taped at the Salle Wagram in 1979. Sound quality varies but is never less than acceptable in terms of clarity and balance.

At around £14 for the two well-filled CDs, this set is a true bargain. But, more than that, you could find that the Hungarian Quartet - as it did for me in Beethoven - will supply an introduction to the music of Franz Schubert which will also be recalled with gratitude for many years to come.

# THE NEW PROAC STUDIO 100. PLAYING IN A TOWN NEAR YOU TODAY.

Our new Studio 100 marks a major advance in compact loudspeaker design, giving you the opportunity to extract the very best from the rest of your music system. You can judge this accomplished performer for yourself at any of these discerning dealers.

**THE AUDIO FILE**  
40, Hockerill St.  
Bishops Stortford  
Hertfordshire  
0279 506576

**THE AUDIO SUITE**  
42, St. Andrews St.  
Aberdeen, Grampian  
Scotland  
0224 625635

**AUDIO T**  
442/444 Cranbrook Rd.  
Gants Hill, Ilford  
Essex  
081 518 0915

**DOUG BRADY HI-FI**  
15a, Kingsway North  
Warrington  
Cheshire  
0925 828009

**DOUG BRADY HI-FI**  
Forge Cottage  
19, Crossgate, Otley  
N. Yorkshire  
0943 467689

**BURY AUDIO**  
47, Churchgate St.  
Bury St. Edmunds  
Suffolk  
0284 724337

**THE HI FI STUDIO**  
5, Norman Crescent  
Sunnyfields  
Doncaster  
S. Yorkshire  
0302 781387

**KJ WEST ONE**  
26, New Cavendish St.  
London W1  
071 486 8263

**THE MUSIC MILL**  
Bonnington Mill  
Business Centre  
72, Newhaven Rd.  
Edinburgh, Scotland  
031 555 3963

**PROGRESSIVE AUDIO**  
2, Maryland Court  
Rainham  
Gillingham, Kent  
0634 389004

**RADLETT AUDIO**  
141, Watling St.  
Radlett  
Hertfordshire  
0923 856497

**SHROPSHIRE HI FI**  
St. Michaels St.  
Shrewsbury  
Shropshire  
0743 232065

 **ProAc**

*Perfectly Natural*

130-132 THIRSK ROAD BOREHAMWOOD HERTFORDSHIRE WD6 5BA ENGLAND TELEPHONE 081 207 1150 FAX 081 953 8933

their recital with the unashamedly brilliant and grandiose Symphonies de Fanfares by Jean-Joseph Mouret, the only French composer to feature in the programme.

I confess to normally finding trumpet-and-organ feasts indigestible after a while, but the first rate playing here - and the careful choice of repertoire - won me over and this sixty-six minutes of music went down enjoyably well. The recorded sound, engineered by Paul Produman, complements the playing perfectly.



**OTTORINO RESPIGHI**  
**Aretusa\*/Lauda per la**  
**Nativita del Signore//**  
**Tramonto\*/Trittico**  
**Botticelliano**

Dame Janet Baker, mezzo-soprano\*; Patricia Rosario, soprano; Louise Winter, mezzo-soprano; Lynton Atkinson, tenor; The Richard Hickox Singers; City of London Sinfonia; conductor, Richard Hickox

**COLLINS CLASSICS 13492 (DDD/72.04)**

● Tuning to Radio 3 one day over the Christmas period, I encountered some exquisite choral music. It had colour and charm, and was clothed with sumptuous melodies. Yet I recognised neither the work nor the style, although the language was Italian. It turned out to be Ottorino Respighi's *Lauda per la Nativita del Signore* (Hymn of Praise for the Birth of the Lord). But, wait, I thought - I don't like Respighi, a prejudice wholly based on a dislike of the three 'Roman' tone poems for which he is best known. As a result, Respighi's vocal music was entirely unknown to me until this chance encounter; it has been my loss.

Respighi was an eclectic, although not to the point of submerging his own individuality under the weight of influences. The colourful orchestral palette of one of his teachers, Rimsky Korsakov, made its mark on his style, as did the tone poems of Strauss. Respighi was also one of the prime movers in the revival of interest in 'early music'. He was adept at working devices such as Gregorian plainchant motifs into his own music. It was all unscholarly but his

contribution to the rediscovery of such music has to be applauded.

Respighi's setting of da Todi's nativity text, a joyful act of devotion, also harks back to an earlier age, that of the sixteenth century madrigal; there is even a hint of Monteverdi's early arioso style. But the work has a substance, a beauty and a heart-warming appeal that extends beyond mere parody.

The two other vocal pieces on this recording are settings - in Italian translation - of two poems by Percy Bysshe Shelley and they mark a welcome return to the recording studio for Dame Janet Baker. Her voice proves to have lost none of its richness and suppleness and she colours the vocal line with consummate skill and subtlety. These two works - *Aretusa* and *Il Tramonto* - were early flowerings of Respighi's talent and he responded more to the pictorial elements of Shelley's texts than their dramatic implications. This feeling for the pictorial again manifests itself in the final work on this well-filled disc, the orchestral triptych, *Trittico Botticelliano* (Three Botticelli Pictures). Composed in 1927, Respighi chose to illustrate in music probably the three most famous paintings of his countryman: *La Primavera* (Spring), the *Adoration of the Magi* and the *Birth of Venus*.

While this is no attempt to penetrate the characters and subtexts of the paintings as Mussorgsky so successfully achieved in his homage to his artist friend, Victor Hartmann (*Pictures at an Exhibition*), Respighi's more literal treatment is no less enjoyable for that. His feel for orchestral colour and imagery is at its finest here.

Although Dame Janet Baker's contribution inevitably dominates this excellent Abbey Road recording (a James Mallinson/Mike Steady production), praise must also go to the other vocal soloists, choir and orchestra, and to Richard Hickox for his sympathetic and wholly persuasive treatment of these delightful scores.

**THE REED OF PAN**  
**British works for flute by**  
**Granville Bantock, Howard**  
**Blake, Edwin York Bowen,**  
**Gerald Finzi, Eugene**  
**Goossens, Kenneth Leighton,**  
**William Lloyd Webber, William**  
**Matthias, Cyril Scott**  
Kenneth Smith, flute; Paul Rhodes,  
piano

**ASV CD DCA862 (DDD/77.24)**

● This is the third of Kenneth Smith's and Paul Rhodes's collaborations to appear on the ASV label and, like its predecessors, it merits unqualified praise. (I should add, perhaps, that the previous CDs were 'Summer Music on ASV CD DCA739 and 'Folk and Fantasy' on CD DCA768.) What is especially enticing about these issues, apart from the

playing of Messrs Smith and Rhodes, is the astonishingly high quality of the music which they have uncovered from what - superficially - would appear less-than fertile territory. The reedy, pastoral oboe has always been more beloved of British composers than the Arcadian sound of the flute, which is far more strongly associated with France. Yet here we have, once again, a whole host of impressive compositions, all originating from these shores and all - amazingly - world premiere recordings. Nine composers are represented and there is but one transcription among the works recorded, Kenneth Smith's own arrangement of Gerald Finzi's delightful *Five Bagatelles*, originally written for clarinet and piano.

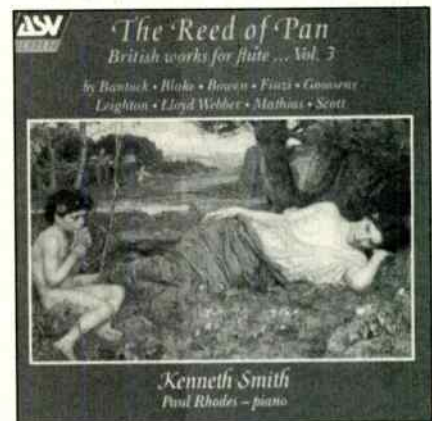

From the pen of the Welsh composer William Matthias comes a sparkling sonatina which gives Kenneth Smith plenty of scope to display his virtuosity in its rhythmic gyrations. Equally imaginative is the three movement *Serenade* by Kenneth Leighton which develops substantial roles for both instruments as it paints an, at times, haunting and wistful musical landscape.

Cyril Scott - whose impressionistic style once earned him the soubriquet of 'the English Debussy' - is represented by *Lotus Land*, an atmospheric piano piece which Paul Rhodes has realised into a duet of considerable beauty. William Lloyd Webber's *Mulberry Cottage* is a miniature suffused with heart-easing contentment and Howard Blake demonstrates there is far more to his talent than the ever-popular *Snowman* theme by contributing an *Elegy* that offers the flute every chance to shine. The programme opens in the most arresting manner imaginable with Granville Bantock's splendid *Pagan Poem* and concludes with York Bowen's finely-crafted *Flute Sonata Op120*. Although ostensibly a showcase for the art of Kenneth Smith and Paul Rhodes, this recital - like its predecessors - also opens a door of discovery on to what is invariably very fine and often very beautiful music. As well as the artistic standard, the technical quality of this hugely enjoyable series is maintained with this latest release.

## transmission line speakers

Transmission line speakers have a reputation for reproducing lower bass frequencies than other loudspeakers of a similar size. TDL now complements its range with a series of 'reflex transmission line' speakers. Incorporating a truncated line to preserve the special bass performance for which TDL is renowned, they are sufficiently sensitive to operate optimally with almost any high fidelity system. They should be judged in performance against speakers beyond their size and price category – affordable TDL!

**TDL**  
ELECTRONICS

P.O. Box 98  
High Wycombe  
Buckinghamshire HP12 3AD  
England  
Tel: (0494) 441191  
Fax: (0494) 461803

# “ASTOUNDING”

### DIGIT THE DAC

QED'S Bitstream Digital to Analogue Converter

"... It really is the most cost effective upgrade ever... For twice its price it would be superb, at what it costs, it's outstanding." (Hi-Fi World May 1992)

Send a 1st Class Stamp for a copy of the full review and our  
NEW 32 PAGE AUDIO CATALOGUE.



QED AUDIO PRODUCTS LTD. RIDGEWAY HOUSE, RIDGEWAY CLOSE,  
LIGHTWATER, SURREY, GU18 5XU, ENGLAND

The thrill of hi-fi is often hearing the most delicate and subtle aspects in a recording. Today's CD technology can present an astonishing amount of information, but getting it all into your system is not quite that easy.



The more you put in

## INPUT

It's here that Audio Technica's micro engineering skills can help, starting with the **AT6078**

**CD Lens Cleaner**. Deep inside your player the lens attracts dust, smoke and other debris, an industry acknowledged problem. A 10 second session with the unique eight brush disc safely returns optimum performance, greatly reducing tracking error for higher fidelity. **AT6078** contains CD control codes for fully automatic operation (in car **AT7121**). As an improvement to all machines but especially those 'budget' models **AT674 CD Stabiliser** is a carbon-fibre disc which helps reduce servo motor movement and aid error correction. Finally there's our magic green damping rings **AT6079** which fit to the edge of individual CD's to absorb stray laser light. The result is a smoother, more integrated sound and added disc edge handling protection.



# &

The better it comes out

## OUTPUT

From the wide A-T headphone range we can offer **ATH308** (and sister model 309), the perfect mid-size headphones. High sensitivity, low weight and extreme comfort make them stand out from the crowd. Our 900 Series offer a 'larger than life' sensation courtesy of large diameter drivers and copper clad aluminium voice coils. Top of this range **ATH911SV** is packed with sound enhancing features including 'High Energy' Neodymium magnets. For ultimate audiophile listening **ATH9000** is a very special headphone/transformer combo which sits in a direct line between your amplifier and loudspeakers. Its electret condenser system is at the leading edge of high fidelity to re-create the very sense of 'being there'.



**audio-technica**

INNOVATION PRECISION INTEGRITY

Technica House, Royal London Industrial Estate  
Old Lane, Leeds LS11 8AG

Tel: 0532 771441 Fax: 0532 704836

SEE THEM AT GOOD HI-FI STORES



# Hi-Fi World Dial-a-Dealer

## AVON

**AUDIO EXCELLENCE** 'Where the music matters', 65 Park Street, Bristol BS1 5PB. Tel: 0272 264975 Fax: 0272 251327. Great Hi-Fi carefully selected and demonstrated by friendly enthusiastic staff. Home installations and check-ups. Two year warranty from our own service department. Open 9.00-5.30 Tuesday - Saturday closed Monday.

**PAUL GREEN HI-FI LTD.** Kensington Showrooms, London Road, Bath, Tel: (0225) 316197. Musical Fidelity, Krell, Creek Rogers, Quad, Cust. car park. Best selection in the West.

**VAUDIO**, 36 Druid Hill, Stoke Bishop, Bristol, BS9 1EJ. Tel: 0272 686005. ATC, Acoustic Energy, Ruark, AVI, Exposure, Pink Triangle, Wadia, Audio Innovations, SME (incl 20A), Chord Amps, Michell, AMC, Analogue Electronics, Cadence Valve, Jamo, LFD, REL, Sansui, Sonic Link, Stax, Townsend, Audio Technica, Goldring, Lira, Ortofon, Sumiko. Demos by appt only. Home trial facilities, free install. service facilities.

## HEREFORDSHIRE

**SOUND DEALS**, 52 Shortmead Street, Biggleswade, Beds, SG18 0AP. Tel: 0767 312249. FAX 0767 315714. Private listening rooms. Audio/Visual demonstration room. Free delivery and installation. Part exchange welcomed. Pre-owned equipment available. Top tape agents. All major credit cards accepted. Credit facilities (including interest free) STS. Agencies include: AR, Alphason, B&W, Castle, Celestion, Denon, Heybrook, KEF, Marantz, Manicover, Nakamichi, NVA, Pioneer, Ortofon, Rotel, Ruark, Sequence, TDL, Teac etc...

**WENTWORTH AUDIO**, 83 High Street North, Dunstable, Beds. NU6 1JJ. Tel: 0582 6633 83. Marantz, Pioneer, Rotel, Audiolab, Mission, Cyrus, Moth, Sony, HK, NAD, Pink Triangle, Yamaha, Systemdek, Albury, etc. Free installation & delivery Home dems. Part exchange. Interest free credit - 6, 9, 12, 18 & 24 month terms. Free car parking at rear of shop. Free refreshments (alcoholic or otherwise!) Open 10-6pm Tues-Sat

## BERKSHIRE

**NEWBURY AUDIO**, 2 Weavers Walk, Northbrook Street, Newbury, Berks, RG13 1A1. Tel: 0635 33929. Linn, Creek, Epos, Denon, Nakamichi, Shahinian, Marantz, Micromega, JPW, Ruark Single speaker dem room. Appt. necessary. Home trial facilities, free install. service dept. late appts. Access/Visa, interest free credit subject to status. 6 days 9.30am - 6.00pm.

**ARC AUDIO**, 9 Dukes Ride, Crowthorne, Berks, RG1 16L2 (0344) 762201. Denon, Harman Kardon, JPW, Marantz, Monitor Audio, Onyx, Rogers, Tannoy, Thorens, Yamaha. Demonstration facilities, no appointments necessary, home trial facilities, free installation. Access, Visa, Diners. Open Mon-Sat 9-6pm (closed Wed at 1pm)

**READING HI-FI CENTRE**, 4 Queen's Walk, Reading RG1 7GF. Tel: 0734 585463. "The best equipment, advice and service from Berkshire's premier Hi-Fi emporium". Products include: Arcam, exposure, Audiolab, Meridian, Rotel, Sony, sennheiser, Top Tape Centre, and many more.

**ASTLEY AUDIO**, Wallingford, 0491 839305. See our entry under OXFORDSHIRE

## BUCKS

**D.L. CHITTENDEN LIMITED**, 59-61 The Broadway, Chesham, Bucks, HP5 1BX. (Opposite Boots). Tel: 0494 784441. Philips, Denon, Kenwood, Canon, Audio, Koss, Wharfedale, Mitsubishi, Target, Grundig, QED, Mordaunt-Short, Toshiba, Dolby Pro-logic Systems, Nicon TV and Video, Surround Sound, AV Systems. Showroom Demonstrations from expert and friendly staff. No appointments necessary. Service Department. Credit facilities available. Open 8.30 to 5.30 Mon-Sat.

**DEJAC HI-FI Consultants**, 21 The Broadway, Old Amersham, Bucks, HP7 0HL. Tel: (0494) 433173. AMC, Arcam, Bose, Meridian, Quad, Denon, NAD, Tannoy, Mission, TDL. 2 dem rooms, Appts necessary, Free installation, Tricity finance, instant credit, open 9.30-5.30 pm, including Saturdays.

## CAMBRIDGE

**CAMBRIDGE HI-FI**, 1-3 Hawthorne Way, Chesterton, Cambs. CB4 1AT. Tel: 0223 67773. Kenwood, Pioneer, Arston, Kef, Technics, Yamaha, Marantz, B&W, AR, Mordaunt-Short, Bose. Single speaker dem room. Tues-Sat 9.30-5.30pm. Closed Monday. Free install, service dept. Vis/Access credit facilities.

**STEVE BOXSHALL AUDIO**, 41 Victoria Road, Cambs. CB4 3BW. Tel: 0223 68305. 10.00-6.00pm 6 days 3

dem rooms. Denon, Rotel, Yamaha, Mission, Nakamichi, Tannoy, Audiolab, Marantz, Krell, Martin Logan, Magneplanar, Wadia. Home trial facilities. Appointments preferred. Free install. and service dept. Access/Visa

## CHESHIRE

**SWIFT HI-FI**, St. Annes Parade, Wilmslow. 0625 526213. Aura, B&W, Denon, Kenwood, Marantz, Nad, Pioneer, Rotel, Systemdek, Tannoy, Revolver, J.P.W. M. Short, Mission, Celestion, Technics, Audiolab, Castle. Open 9.30-6. Dem room. No pressure. BADA member.

**THE HI-FI SHOWROOMS**, 12A West Str, Congleton, Cheshire (0260) 280017. 1 Stanley St, Leek (0533) 383780. Celestion, Creek, Exposure, Marantz, Musical Fidelity, Pink Triangle, Project, Rotel, Ruark, Systemdek, Tannoy, Technics, 5 Dem Rooms, Noappts necc. Home trial. Free install. Service dept. Access, Visa, Lombard Tricity. Open 9-5.30. Closed Wed.

**HALE HI-FI**, 2 Bold St, Hale Road, Altringham, Cheshire WA14 2ER. Tel: 061 929 0834. Open Mon - Sat 10am-6pm & later by appointment. Specialising in equipment by: Naim, Quad, Royd, Nad, Denon plus selected others. Large range of quality accessories. On site service department. Installation & delivery Home demonstrations a pleasure

**ASTON AUDIO**, 4 West Street, Alderley Edge, Cheshire. Tel: 0625 582704. Products include: Celestion, Creek, Yamaha, Monitor Audio, B&W, Alwa, Aura, AKG, Musical Fidelity, Tannoy, Sennheiser, Marantz, Dual, Denon, Quad, Sansui, Technics, Spondor, Mission, SME, Nakamichi, Audiolab, Rogers, Audiocrest, Mordaunt-Short, Meridian, Deltac, Roksan, Arcam, Kef, NAD, Cyrus and others. Discount CD and tape. Extended guarantee, interest free credit and written details on request.

**CHRIS BROOKS AUDIO**, 29 Gaskell Street, Stockton Heath, Warrington, Cheshire, WA4 2UN. Tel: (0925) 261212. Tues-Sat 10.00-6.00. 2 dem-rooms. credit facilities. All credit cards. Established 1978. Total absence of bulls\*\*t.

**CONGLETON HI-FI**, 1/1a Duke St, Congleton, Cheshire, CW12 1AP. (0260) 297544. Acoustic Energy, Arcam, B&W, Denon, Epos, Linn, NAD, Nakamichi, Onix, Royd, Target, etc. Superbly appointed single speaker demo facilities. No appointments necessary, home trial facilities, free installation. 2 year guarantee on all equipment. Access, Visa. Open Mon-Sat, closed Weds.

**DECIBELS**, 12 The Bull Ring, Northwich, Cheshire, CW9 5BU. Tel: (0606) 350 343. Free Home Demonstrations. Free Delivery. Free installations. Single speaker listening room. High quality audio AND Home Cinema equipment. Second hand HiFi catalogue on show. Rotel, NAD, Yamaha, Celestion, JPW, Systemdek, Thorens, Sequence, Target, QED, Goldring plus a variety of cables and accessories. Open Mon-Sat 9-6.

**DOUG BRADY HI-FI**, Kingsway Studios, Kingsway North, Warrington, Cheshire, WA1 3NV. (0925) 828009. "Largest choice of specialist hi-fi in NW. All credit cards 3 dem rooms. Fair demonstrations and home trial facilities. Open 6 days.

## CLEVELAND

**GILSON AUDIO LTD**, 172 Borough Rd., Middlesbrough, (0642) 248793. Linn, Exposure, Arcam, Mission, Cyrus, Denon, Marantz, Rotel, Pioneer, Audiolab, Tannoy. Demonstration facilities in main shop and one demonstration room. Appointments necessary. Home trial facilities. Free installation on request. Service department. Access, Visa, H.P. 10-5-6 days.

**ACTION ACOUSTICS**, 155-157 High Street, Redcar, Cleveland TS10 3AN. 0642 480723. Audio Innovations, Denon, Harman Kardon, JBL, Michell, Musical Fidelity, Pink Triangle, Revox, Rogers, Thorens, etc. Dem room. Appointments nec. Home trial facilities, free installation, service dept. Access, Visa & HP. Open 9.15-5.30.

## CORNWALL

**ART OF MUSIC**, nr. Launceston, Cornwall, Tel: 0566 86649. AC Magnum, Basis, C.A.T., Cogán Hill, Diamond Acoustics, Gramhams, Groove Tubes, Lumley Reference, Moth, Magnum Dynalab, REL Acoustics, Silver Sounds, Translucation. Dem Studio appts necessary, home trial facilities, free install. open 7 days.

**RJF AUDIO VISUAL**, 84 Pendarves Street, Tucking Mill, Camborne, Cornwall, TR14 8NJ. 0209 710777/612660. TDL, Michell, Musical Fidelity, NAD, Nakamichi, B&W, SME, Micromega, Pink Triangle, Pro-ject, Perception, Harman Kardon, Triangle. Integral dem/showroom and special home dems. Appts nec, home trial, free install, service dept. All cards Switch and Transax. Open Mon-Sat 9.30-5.30.

## CUMBRIA

**MISON'S SOUND & VISION**, 11 Warwick Road, Carlisle CA1 1DH Tel (0228) 22620. Bang & Olufson, B & W,

Quad, NAD, Yamaha, Sony Demo Suite. No appts nec. Home trial facilities. Free installation, Service Department 9-5.30 Mon - Fri, Thurs 9-1, Sat 9-5.

## DEVONSHIRE

**THE HI-FI ATTIC**, 58 New George St., Plymouth, Devon PL1 1RR. 0752 669511. We stock most leading brands including Linn, Arcam, Denon, Pioneer, Musical Fidelity amongst others, and have an expert enthusiastic staff. Premises include attractive hi-fi and home cinema demonstration rooms. We offer free installation and credit facilities (written details on request) also a fully equipped service department. We can also provide a mail order service for all your LaserDisc requirements. We accept Visa, Access, Amex.

**CHELSTON HI-FI**, 38 Walnut Road, Chelston, Torquay, Devon TQ2 6HS Tel: (0803) 606863. Denon, Marantz, Rotel, Musical Fidelity, Acoustic Energy, NAD, Castle, Heybrook, Celestion, JPW etc. Two dem rooms. Home trial. Free installation. Access, Visa, Amex, Diners. HiFi Markets Chargecard. Credit facilities 9.30-7.30 Mon-Fri, 9.30-6.00 Sat.

## DERBY

**STRAO TRADITIONAL AUDIO**, 29 Meadowfield, Whaleybridge, nr Buxton, Derbyshire, SK12 7AX. Tel: 0663 733383. We construct custom made reproductions of classic 1950's loudspeaker enclosure designs using authentic blueprints. These have never been bettered for valve amplification. Requests for specific designs considered and researched. Superb new speaker units from Richard Allan and Lowther are used.

**ACTIVE AUDIO**, 12, Osbaston Street, The Spot, Derby. Tel: 0332 380385 Fax: 0332 385185. We have three studios including a dedicated Audio Visual studio for the demonstration of quality equipment from the largest range in the Midlands. Open six days per week. Own service department. Free local delivery, home trial facility. Current special offers and buyers fact pack and quotation on request.

## DORSET

**DAWSONS**, 23 Seamoor Road, Westbourne, Bournemouth, Dorset. 0202 764965. B&O, Castle, Canon, Jamo, JBL, Pioneer, Sony, Target, TDL, Technics. No appts necessary. Free installation. Service dept. Various credit facilities available. Open 9-5.30 6 days a week.

**SUTTONS HI-FI**, 18 Westover Road, Bournemouth, Hants. Tel: 0202555512. Linn, Arcam, Mission, Quad, Audiolab, Rotel, Yamaha, Denon, etc. 2 single speaker listening rooms. Home demonstrations and free installation. Mon-Sat 9.00-5.30. Call for details.

## ESSEX

**BRENTWOOD HI FIDELITY**, 2 Ingrave Road, Brentwood, Essex, CM15 8AT. Tel: 0277 221210. Audio Innovations, Aura, AVI, Castle, Chord Electronics, Denon, DNM, EAR, Impulse, John Shearne, Kenwood, Marantz, Micromega, Mission, NAD, Nakamichi, Pink Triangle, Pioneer, Project, Quad, Rotel, Ruark, SME, Systemdek, Tannoy, TDL, Townshend Audio Yamaha plus many more. Single speaker dem rooms, home trials, dems and installations. Mon-Sat 9.30-5.30. Access, Visa, service facilities. Simply THE place to visit if you're serious about music.

**PRO MUSICA**, 6 Vineyard Street, Colchester, Essex. Naim, Roksan, Rega, Arcam, Audiolab, Creek, Systemdek, Rotel, Marantz, Denon, Shahinian, Micromega, Neat, Aura, Heybrook, EPOS, RUARC, Monitor Audio, Tripod, Sound Organisation, Lots of records, 2 dem rooms, no appts necessary. Service dept, Part exchange, Finance available. 10-6 Mon-Sat.

**TWENTY 20 AUDIO VISUAL LTD.** Unit 205 Lakeside Shopping Centre, West Thurrock, Grays, Essex OM16 1. Tel: 0708 891818 Fax: 0708891300. For your total home entertainment requirements. From a 2" Casio to a 50" Pioneer screen. Dolby surround specialists with three dem rooms dedicated to pro-logic, laser disc software in stock, from Harman Kardon. Pro logic from Yamaha, Marantz, Pioneer, Technics, Kenwood and B&O.

**RAYLEIGH HI-FI**, Chelmsford, 216 Moulsham St. 0245 265245. RAYLEIGH HI-FI, Rayleigh, 44a High Street. 0268 779762. RAYLEIGH HI-FI, Southend, 132/4 London Rd. 0702 435255.

Over 21 years experience of supplying the best. "The best dealer, the best Hi-Fi equipment, the best service" Carefully selected Hi-Fi from: Arcam, Audiolab, Cyrus, Denon, Epos, Linn, Meridian, Mission, Naim, Nakamichi, Quad, Rega, Roksan, etc. etc. 3 years guarantee on Hi-Fi systems. 0% credit facilities.

**AUDIO T**, 442-444 Cranbrook Road, Gants Hill, Ilford, Essex, IG2 6LL. (081) 518 0915. Fax (081) 554 8463. Great Hi-Fi from Arcam, Audiolab, B&O, Bose, Cyrus, Denon, KEF, Marantz, Meridian, Mission, Micromega, Nakamichi, Rotel, Sony, Yamaha & many more. Mon-Sat 10-6. 3 year guarantee on Hi-Fi. Free delivery & installation. 30 day free upgrade scheme. Home

demonstrations. Part exchange. 2 listening rooms. Home Cinema specialists. BADA Bonded.

## GLoucestershire

**AUDIO EXCELLENCE 'WHERE THE MUSIC MATTERS'**, 58 Bristol Road, Gloucester, GL1 5SD. Tel: 0452 300046 Fax: 0452 310680. Great Hi-Fi carefully selected and demonstrated by friendly enthusiastic staff. Home installations and check-ups. Two year warranty from our own service department. Open 9.00-5.30 Tuesday - Saturday closed Monday.

**AUDIO T**, 40-42 Albion Street, Cheltenham, Gloucestershire, GL52 2RQ. (0242) 583960. Fax (0242) 226435. Great Hi-Fi from Arcam, Audiolab, Denon, Epos, Linn, Marantz, Meridian, Mission, Quad, Rogers, Rotel, Yamaha, & many more. Mon-Fri 10-6. Sat 9.30-5.30. 3 year guarantee on Hi-Fi. Free delivery & installation. 30 day free upgrade scheme. Home demonstrations. Part exchange. Single speaker listening room. BADA Bonded.

## HAMPSHIRE

**AUDIO GALLERY**, Near Petersfield, Hampshire, Mana, Castle, Alchemist, Albany, Audio Innovations, Wadia, Deltac, Tube Technology, Denon, Pioneer, Alphason, Tripod, Naim, Teac, Audio Alchemy, Kipsch, AMC, Proac, JPW, Moth, Pink Triangle. Mail order cabinets supplied to order in any size, wood & hand painted finishes, stone-granite-marble shelving. For a demonstration with home comforts call us for an appointment on: 0730 895194.

**HOPKINS HI-FI, 'FOR THE BEST SEAT IN THE HOUSE'** experience home cinema sound with Technics, Denon and Kenwood. Award winning products. Now on demo at HOPKINS HI-FI. 38-40 Fratton Road, Portsmouth, Hants, PO1 5BX. Tel: 0705 822 155. Fax: 0705 830 753

**JEFFREYS HI-FI (Portsmouth)** 29 London Road, Portsmouth PO2 0BH. Tel: (0705) 663604. Individual dem rooms. Full credit facilities, late night Wednesday, Closed Mondays.

**HAMPSHIRE AUDIO LTD.**, 2-12 Hursley Road, Chandlers Ford, Hants SO5 2FU (0703) 252827/265232. 3 hi-fi and 2 home cinema/surround sound dem studio's. Thurs late evening, closed Mondays (except in December). Service dept on site (2 yr guarantee). Large free car park - junctions 4 (M27/M3), 5 (M27), 12 (M3) and 13 (M3) all within 3 miles, est. 1969.

**AUDIO T**, 4 Feathers Lane, Basingstoke, Hampshire, RG21 1AS. (0256) 24311. Fax (0256) 24430. Great Hi-Fi from Arcam, Audiolab, Denon, Linn, Meridian, Mission, Naim, Rotel, Sony, Yamaha & Hi-Fi. Free delivery & installation. 30 day free upgrade scheme. Home demonstrations. Part exchange. Single speaker listening room. BADA Bonded.

## HEREFORDSHIRE

**ENGLISH AUDIO**, 95 Whitecross Road, Hereford, HR4 0DG. (0432) 355081. Musical Fidelity, Arcam, Pink Triangle, Denon, Marantz, Mission-Cyrus, A.I., Rotel, NAD, Nakamichi, TDI and others. Single speaker dem room, home trial facilities, free installation, service dept, Access/Visa, Credit arranged. Open Mon-Sat, 10-6pm.

**GOSPEL MUSIC AUDIO**, 32a High Street, Kington, Herefordshire, HR5 3BJ. (0544) 230254. Alphason, Allison, Revolver, Luxman, Yamaha, QED Audio, Systemine.

**ACOUSTIC ARTS LTD**, 101, St. Albans Rd., Watford, Herts. 0923 245250. Fax 0923 230798. Absolute Sounds, Adcom, Acoustic Energy, Audiolab, Chord, Denon, Marantz, Meridian, Oreile, S.M.E., T.D.L. 3 dem rooms, multi-room & home theatre. Expert installation. Credit facilities available, Tues-Sat 10-6.

## HERTFORDSHIRE

**STUDIO 82**, 82 High Street, Harpenden, Herts AL5 2SP. 0582 764246. Fax 0582 467022. ATC/AVI, Arcam, Aura, Audiolab, B&O, Denon, Epos, Mission, Cyrus, Naim Audio, Nacacmichi, Quad, NAD etc. One single speaker dem room. Appts nec. Home trial, free installation. Service dept. Visa, Access and finance terms. 9-5.30 (Mon-Sat) Closed Weds.

**THE AUDIO FILE**, 27 Hockerill St., Bishop's Stortford Herts. CM23 2DH. Tel: 0279 506576. Fax: 0279 506638. Linn, Naim, Roksan, Quad, Rega, Mission, Arcam, ProAc, Marantz, Sony etc. 4 dem rooms, installation service. Min 3 year warranty, 0%, BADA.

**HERTFORD MUSIC**. We want you to feel good when choosing your system in our 3 demonstration rooms (and bar!). Systems from budget to £15,000. Products include: CR Developments, Micromega, REL Acoustics, Acoustic Energy, Michell, Magnum, Diamond Acoustics, Beard, Lumley, Renaissance, etc. AAccess, Visa Mail Order. Please telephone: 0992 442425.

# Hi-Fi World Dial-a-Dealer

**RADETT AUDIO**, 141 Watling Street, Radlett, Herts, WD7 7NQ Tel 0923 856497 Mark Levinson, Proceed, Proac, Magnepan, Martin Logan, Tube Technology, Teac, Roksan, Audioblab, Stax, Systemdek, Jardi, Copland, ATC, Audio Alchemy, AVI, EAR, Sumiko, Quad, Sonus Faber, Home trial facilities, free installation, Service Dept. Visa/Access 9-5.30 Mon-Fri 10-5.30 Sat

**REVOX Service & Repairs**, Suite 10, Smugook Business Centre, Lye Lane, Brickendonwood, Herts AL2 3UG Tel 0923 893711 Seventeen years experience, ex-Bauch Authorised agents for Revox products, sales and spares. All repairs carried out are guaranteed. Fast turnaround. Any enquiries telephone 0923 893711

**SOUND DEALS**, 1 Drapers Way, Stevenage, Herts, SG1 3DT Tel 0438 369999

Private listening rooms. Audio/Visual demonstration room. Free delivery and installation. Part exchange welcomed. Pre-owned equipment available. Top tape agents. All major credit cards accepted. Credit facilities (including interest free) STS. Agencies include AR, Alphasound, B&W, Castle, Celestion, Denon, Heybrook, KEF, Marantz, Manicore, Nakamichi, NVA, Pioneer, Ortofon, Rotel, Ruark, Sequence, TDL, Teac etc.

## KENT

**ASHFORD, SOUND CRAFT HI-FI**, 40 High Street, Tel 0233 624441. Seeking music lovers, male or female any age, to share common interest in. Multi room. Home Cinema etc. Attractive unusual equipment in unusual setting, your place or ours, we guarantee lasting pleasure. Open Monday - Saturday. Appointment service or just pop in. Bada dealers.

**ELECTRICAL DISCOUNT CENTRE**, EDC, 138 Pelham Road, Gravesend, Kent DA11 0JH Tel 0474569601 Pioneer, Marantz, Technics, Akai, JVC, Jamo

**ELECTRICAL DISCOUNT CENTRE**, EDC, 109 The Broadway, Bexley Heath, Kent DA6 7JH Tel 081 298 7880 Pioneer, Marantz, Technics, Akai, JVC, Jamo

**PROGRESSIVE AUDIO**, 2 Maryland Court, Rainham, Nr Gillingham, Kent ME8 8QY Tel 0634 389004. Agencies include Audio Innovations, Audionote, Audiostatic, Audio Technica, Chord amps, Cogan Hall, Conrad Johnson, Convergent, DALLI, Decca, Eminent Technology, Goldring, Impulse, Koetsu, Levinson, LFD, Lyra, Lumley Reference, Meridian, Mitchell, Micromega, Moth, Origin Live, Pink Triangle, Proac, Proceed, Ruark, SilverSounds, SME, Sugden, Sumiko, Systemdek, Shell, Target, T.D.L. Transfiguration, Townsend Tube Technology, Voyd, V.P.I. etc. Demonstrations by appointment please.

**VOLUME ONE**, 41 Upper Wickham Lane, Welling, Kent DA16 3AD 081 304 4622. Arcam, Dual, Epos, Exposure, JPW, Marantz, Micromega, Nakamichi, Pink Triangle, Rotel, Ruark, Royd, Sony, Systemdek, Alchemist, Celestion, B&W. Large dem room, no appts necessary. Evening dems in shop by appt. Home trial facilities, free delivery and installation. Access/Visa 10.00-6.00pm Mon-Sat

**KIMBERLEY HI-FI**, 193 Broadway, Bexley Heath, Kent. Tel 081 3043272. Pioneer, Technics, Kenwood, Denon, NAD, Awa, Tannoy, Mission, Rotel, Wharfedale, Castle. Separate dem room, no appt necessary, free installation, service dept, instant credit facilities, no early closing.

**V.J. HI-FI**, 29 Guildhall Street, Folkestone, Tel 0303 256860 Mon-Sat 9-6. NAD, Yamaha, Marantz, Sony, Tannoy, Denon, Kenwood, Rogers, Musical Fidelity, Quad, Dem and home trial facil, free install. Credit to £1,000, Amex, Diners, Visa, Access, Service Dept.

**THE WESTGATE HI-FI**, 2 Station Road West, Canterbury, Kent Q227 769329. Suppliers of quality hi-fi equipment including: Arcam, Akai, Aura, B&W, Denon, Jamo, JPW, Mordaunt Short, NAD, Panasonic, ProAc, Quad, Rotel, Ruark, TDL, Technics, Tannoy. Part exchange. Listening room. Service and repairs. Credit facilities. Access/Visa. Open 6 days 9-5.30.

**DOVER HI-FI**, 43 High Street, Dover, Tel: Dover 207562. Suppliers of quality hi-fi equipment including: Arcam, Akai, Aura, B&W, Denon, Jamo, JPW, Mordaunt Short, NAD, Panasonic, ProAc, Quad, Rotel, Ruark, TDL, Technics, Tannoy. Part exchange. Listening room. Service and repairs. Credit facilities. Access/Visa. Open 6 days 9-5.30.

## LANCASHIRE

**AUDIO CLASSICS**, 8 Lowe Mill Lane, Hindley, Wigan, Lancs. WN2 3AF. Sorry but we are unable to answer queries in writing. I buy, sell, modify and repair all vintage and valve hi-fi equipment. Advice is free. New equipment by EAR, Croft, Richard Allen and more soon. Phone if just for a chat. Credit cards accepted. Quick worldwide delivery, callers by appointment. Tel. 0942 57525 or Fax. 0942 525861. 7 days a week.

**NORMAN AUDIO**, 131 Friargate, Preston, Lancashire, PR1 2EE Tel 0772 253057 Fax 0772 562731. Marantz, Pioneer, Yamaha, Audioblab, Arcam, Mission, Cyrus, B&W, Kef. Send for your catalogue. Home cinema dem room plus three sales areas, no appt necessary, free install, service dept, instant credit subject to status. Open 9.30-5.30, late night Wed-8pm.

**ROMERS HI-FI CENTRE**, 94-96 High Street, Rishton, Blackburn, Lancs. Tel 0254 887799. Stockists of: Sony, Esot HiFi, Technics, Marantz, Musical Fidelity, Pioneer, Kenwood, Rotel, Tannoy, Mission, Ruark, B&W and many others. Dem room, service dept, free delivery and installation (local area). Access/Visa and Switch.

## LEICESTER

**LEICESTER HI-FI COMPANY**, 6 Silver Walk, St Martin's Square, Leics LE1 5EW Tel (0533) 539753 Fax (0533) 626097. Acoustic Energy, Arcam, Marantz, Micromega, Mission, Cyrus, Musical Fidelity, Nakamichi, Meridian, Rogers, Roksan and 'oodles more' 2 dem rooms, home trial arranged, free install, service dept, Credit facilities. Access/Visa/Diners/Amex 6 days 9.30-5.30

**LISTEN INN**, 6 Hotel Street, Leicester. Tel 0533 626097. Wide range of records and accessories stocked. Our commitment to standards of service is apparent to our satisfied customers. Two dem rooms and free home install service available.

**STEREO SHACK**, 1-3 Guildhall Lane, Leicester. Tel. 0533 530330. Awa, A.R. Denon, Kenwood, Jamo, Mission, NAD, Philips, Pioneer, Home Cinema specialists. Free installation. Open 9.30-5.30 6 days. Credit available.

## LEMPSTER

**BOSTON HI-FI CENTRE**, 65a Wide Bargate, John Adams Way, Boston, Lincs PE21 6SG. Tel 0205 365477. Quad, Nakamichi, Arcam, Marantz, NAD, Castle, Tannoy, Rogers etc. Separate demonstration studio inc home cinema. Free installation. Access Visa, Tues-Sat 9-5 pm.

**COTTAGE AUDIO**, 17 Bridge Street, Saxilby, Nr Lincoln LN11 2PZ Tel (0522) 702834. Evening (0522) 696708. ATC, AVI, Chord amplifiers, Harbeth, LFD, Michell, Origin Live, QED, Royd, Sansui, Sequence, Something solid, Sonic Link, etc. Demonstration rooms. Home trial facilities. Free installations and above all a personal, friendly service.

## LONDON

**ANALOG AUDIO**, 849 High Road, Finchley, N12. (081) 445 3267. For friendly service and advice. AR, AKG, Allison AT, Carwin, Vega, Denon, Dual, Harmon Kardon, Jamo, Infinity, Marantz, NAD, Pioneer, Rotel, Revolver, Sonab, Teac, Thorens, Tannoy, Wharfedale, Yamaha. Speaker cables and accessories. Free installation. Service.

**AUDIO CONCEPT**, 27 Bond Street, Ealing, W5 5AS. Tel (081) 567 8703. Acoustic Energy, Audioblab, Aura, B&O, B&W, Boston Acoustics, Canon, Castle, Denon, Dual, Evolution, Infinity, JPW, KEF, Marantz, Mission, Monitor Audio, Musical Fidelity, NAD, Nakamichi, Onix, Quad, Revox, Rogers, Rotel, Systemdek, Target, Teac, Thorens, Van den Hul. Two dem rooms. Interest free credit, free local delivery & installation, service department.

'Hi-Fi Specialists without the attitude'

**AUBABER ELECTRONICS**, 158 Uxbridge Road, West Ealing, London, W13 6SB. (081) 579 6315. Akai, Awa, A&R, Celestion, Dual, Goodmans, Harman Kardon, JBL, JVC, Kenwood, Marantz, Panasonic, Sennheiser, Sony, ES range, Tannoy, Technics, Wharfedale, Yamaha.

**THE CARTRIDGE MAN** - Front end problems? It doesn't have to cost an arm and a leg to get the best. Listen to my Koetsu - and - Decca - Eater. Also agents for Croft, Sugden, Thorens, Pentachord Speakers and Notts Analogue. (Plus a cartridge re-tipping service. Tel. 081 688 6655.

**DIVA AUDIO FIDELITY**: For the finest in real HiFi, AV and Multiroom systems. Accuphase, Audio Innovations, Audio Note, Audiostatic, Aura, Chord, Conrad Johnson, Impulse, Kilpschorn, Levinson, Lumley, Lyra, Michell, Micromega, Monitor Audio, Primare, Rel, Rotel, SME, Triangle, Trilogy, XLO. Call us or pop in for a musical experience you'll never forget. Open 10-6, Mon-Sat at Workshop 30, Royal Victoria Pavilion Building, Fitzhugh Grove, Wandsworth Common, London SW18. Tel/Fax (081) 875 9593. Also see our full page advertisement on page 7 of this issue.

**DOUG BRADY HI-FI**, 18 Monmouth Road, London WC2H 9HB. Tel (071) 379 4010 or (071) 479 1346. Fair demonstrations and home trial facilities. Wide range of top specialist hi-fi from Britain, America and Japan. Open 6 days.

**GOLF ELECTRONICS**, 311 Kentish Town Road, NW5 2TJ Tel 071 482 2518. Fax 071 284 3381. Authorised dealers for: Sony, Panasonic, Aiwa, Akai, Mitsubishi,

Philips, Grundig, Bose. We carry an extensive range of hardware from Walkmans to camcorders, including a wide range of TV and video equipment. Free local delivery & installation on selected items. Open 10-6 Mon-Sat. We regularly have special offers on different products. A visit to GOLF ELECTRONICS could save you £££.

**HI-FI & COMPONENTS**, 84 Battersea Rise, London, SW11 1EH (071) 223 1110. Denon, Tannoy, NAD, Rotel, Bose, Dual, QED, Wharfedale, Jamo, Celestion, Kenwood, Ortofon, Infinity, Shure, to name but a few! Established over 29 yrs. Appts necessary. Service dept. 10-6 (closed Weds).

**HI-FI EXPERIENCE**, 227 Tottenham Court Road, London W11 071 580 35535. Arcam, Audioblab, Mission, Cyrus, Quad, Celestion, Kef, Meridian, Rogers, Tannoy, Yamaha, TDL, Thorens, Marantz, Nakamichi, Musical Fidelity and many more. Open 10.00-7.00 Mon-Fri. 9-6 on Sat. Service dept. Credit facilities, delivery and free installation.

**THE HI-FI SURPLUS STORE**, 62 Weymouth Street, W1 Tel 071 486 9981/071 935 7582. Stock a full range of goods including Awa, Akai, B&W, Bose, Dual, JVC, Jamo, Kenwood, Marantz, Mordaunt-Short, Mission, NAD, Pioneer, Rotel, Sony, Technics, Teac, Thorens, Tannoy, Wharfedale. Full range of 'Target' speaker stands always on stock. All goods are brand new in sealed cartons with full 1 yr guarantee. We guarantee you can not buy cheaper elsewhere. Give us your genuine quote and we will beat that price by £10 (goods must be in stock). Access/Visa welcome. Open Mon-Sat 9.30-6pm. Late night till 6.30 Thurs.

**KAMLA ELECTRONICS**, 251 Tottenham Court Road, London W1P 9AD. Telephone 071 323 2747. Fax 071 637 2690. Acoustic Research, Aiwa, Akai, Albarray, Alchemist, Alphasound, Audio Alchemy, Audio Innovations, Audio Technica, Audioquest, Aura, Audiostatic, B&W, Cerwin Vega, Conrad Johnson, Copenhagen, Furukawa, Goldring, Infinity, IXOS, JPW, JVC, KEF, Kenwood, Kuzma, Lynwood, Maxell, Micromega, Mitsubishi, Monster, Mordaunt Short, Moth, Nakamichi, Oracle, Ortofon, Panasonic, Pioneer, Project QED, Rotel, Ruark, Sansui, Slax, TDK, and many more!!!!

**K J WEST ONE**, 26 New Cavendish St., London W1M 7LH. 071 486 8262/63. Fax 071 487 3452. Two hi-fi & dedicated home cinema dem studios. Appts pref. Home trial. Installation by arrangement. Service dept. Major credit cards. Interest free credit on selected items. Major brands stocked. Acoustic Energy, Arcam, Audio Innovations, Audion, Aura, Audioblab, Audio Research, B&W, Chord, DPA, Epos, Impulse, Krell, Martin Logan, Meridian, Michell, Musical Fidelity, Nakamichi, Nitty Gritty, Ortel, Pink, ProAc, Quad, Roksan, Sonus Faber, Stax, Tannoy, Theta. Open 6 days.

**BILLY VEE SOUND SYSTEMS**, 248 Lee High Road, London SE13 (081) 318 5755. Arcam, Linn, Naim, Quad, Creek, Cyrus, Marantz, NAD, Rega, Denon, Yamaha, Tannoy, Mission, Micromega, Heybrook, etc., 2 dem rooms, instant free credit. Access/Visa. Closed Thursdays.

**THE LISTENING ROOMS**, 161 Old Brompton Road, London SW5 0LJ. (071) 244 7750/59. Fax (071) 370 0192. Linn, Quad, Meridian, Nakamichi, Arcam, Audioblab, Acoustic Energy, SME, Audio Research, Krell, Wadia, Theta, Micromega, Apogee, Martin Logan, Revox, Rogers, Pioneer, Tannoy, Systemdek, Slax, Pink Triangle, Michell, Monitor Audio, Yamaha, Marantz, Kef, Bose, Celestion, Epos, Mission, Denon, Neat Petite. Mon-Sat 10-6pm.

**STUDIO 99**, 79-81 Fairfax Road, Swiss Cottage, London, NW6 Tel 071 624 8855 or Fax. 071 624 5315. Linn, Naim, Meridian, Rega, Quad, Nakamichi, Mission/Cyrus, Kef, B&O, Yamaha, Creek, etc. 2 single speaker dem rooms. Appts necessary. Home trials, free installation. Visa/Access. 10-7pm Mon-Fri. 10-6pm Saturday.

**ZEBRA**, 18-24 Brighton Road, South Croydon, CR2 6AA. (081) 688 2093. Rotel, NAD, Technics, Philips, Awa, Kenwood, Tannoy, Wharfedale, MA Infinity and large range of A/V equipment. Single speaker and comparator demo in a more casual environment. Service Dept. Mon-Sat 9.30-6.00. Access/Visa. Instant Credit upto £1,000 subject to status.

**THE CORNFLAKE SHOP**, 37 Windmill Street, London W1 (071) 631 0472 (domestic). (071) 323 4554 (multiroom). Fax (071) 436 7165. Tues-Sat 10-7. Rega, Roksan, Naim, Monitor Audio, Arcam, Nakamichi, Rotel, Epos etc. 3 dem rooms (incl. home cinema). Friendly professional service. Home trial facilities, appts preferred. Full delivery and repair service. Multiroom specialists. Access & Visa.

**MUSICAL IMAGES**, 173 Station Road, Edgeware, Middlesex. Tel (081) 952 5535. See advert under Middlesex for more information.

**MUSICAL IMAGES**, 45 High Street, Hounslow, Middlesex. Tel (081) 569 5802. See advert under Middlesex for more information.

**AUDIO T**, 190 West End Lane, West Hampstead, London NW3 1SQ. (071) 794 7848. Fax (071) 431 3570. Great Hi-Fi from Adcom, Arcam, Audioblab, B&W, Denon, Epos, Marantz, Meridian, Michell, Mission, Philips, Rotel, Proac, Micromega, Nakamichi, Yamaha, & many more. Mon-Sat 10-6. 3 year guarantee on Hi-Fi. Free delivery & installation. 30 day free upgrade scheme. Home demonstrations. Part exchange. 2 listening rooms. BADA Bonded.

**ALPHABEC**, 392 Finchley Rd, London NW2 2HR. Tel: 071 431 9133. Denon, Yamaha, Jamo, Heco, Alphasound, JVC, Nakamichi, B&W, Quad, Soundstyle, Stand Design, Boston Acoustics, Thorens, AMC, Grundig, Musical Fidelity and many more. Home Cinema Products. Free installation & delivery. Open Mon-Sat 10-6pm. Thurs 10-1pm.

## GREATER MANCHESTER

**THE AUDIO COUNSEL**, 12 Shaw Road, Oldham, Manchester. OL1 3LQ. Tel 061 633 2602. Linn, Arcam, Naim, Yamaha, Creek, Nakamichi, Denon, JPW,

TO FIND YOUR AREA  
Use our  
COLOUR REFERENCE



To Advertise in this section, please contact Caroline Knott on:

071 266 0969

# Hi-Fi World Dial-a-Dealer

Marantz, Royd, Lexicon. 3 dem rooms, free install, Visa/Access. Licensed credit brokers up to £1,000 instant credit. Full multi-room & A.V. installation. 10.00-5.30pm Mon, Tues, Wed, Sat. 10.00-7.00pm Thurs & Fri.

**HALE HI-FI**, Tel 061 929 0834. See our main entry under Cheshire.

**BILL HUTCHINSON HI-FI**, 50-52 Deansgate, Manchester M3 2FE. (061) 8321600. For the largest selection of HiFi and audio visual equipment in the North West. Specialist A.V. demonstrations of the highest quality. Best prices guaranteed. Minimum 2 year warranty and an optional 5 yr guarantee available. Instant credit and mail order service on offer throughout the U.K. Pioneer, Denon, Kenwood, Yamaha, Technics, Marantz, Mission, Tannoy plus many more.

## MERSEYSIDE

**ODUG BRADY HI-FI**, 401, Smithdown Road, Liverpool, L13 3JJ. (051) 733 6859. Fair demonstrations and home trial facilities. All credit cards. Largest choice of specialist hi-fi in N.W. Closed Wednesdays and lunch 1-2.15pm.

**P & A AUDIO (BIRKDALE) LTD.** 31 Liverpool Road, Birkdale, Southport (0704) 68373. Arcam, Cambridge, Creek, Denon, Michell, Mission/Cyrus, Mordaunt-Short, NAD, Pink Triangle, QED, Revolver, Rogers, Rotel, Royd, Tannoy. 3 single speaker demo rooms and Naim surround sound dem room. Free delivery, installation (Merseyside) Service dept, Mon-Sat 9.5-3.30 Half day Tues, Access, Visa, Lombard.

## MIDDLESEX

**HARROW AUDIO**, 27, Springfield Rd., Harrow, Middlesex. Tel: (081) 863 0938. Open Mon-Sat 9.30-5.30. Most brands available - see our regular advert for full range including Audioblab, Arcam, Audioquest, Apogee, Aura, B&W, Cyrus, Denon, Epos, Krell, Marantz, Mission, Nacamichi, Tannoy, Target, Yamaha etc. AV Specialist including installation. Interest Free Credit - ask for details. The largest range of accessories for miles around. 2 dem rooms. Plus Carriage Free Mail Order.

**AUDIOCRAFT**, 18 Hillingdon Road, Uxbridge, Middlesex, UB10 0AD. (0895) 253340. Unbelievable but true you can audition these brands here. Audio, Proac, Michell, Erelle, LFO, Lumley, Levison, Lurne, Triangle, Sentic, Mag Audio, Teac, VHD, Silversounds, YBA, Stax, Theta, Monitor Audio, Fuller Audio, Trilogy, Lyra, Sumiko, Ortofon, Decca, Target, Proect, Moth, Kelvin, Townshend, Edison, Audio Alchemy, Keski, Musical Fidelity.

**RIVERSIDE HI-FI**, 422 Richmond Road, East Twickenham, Middlesex, TW1 2EB. Tel: (081) 892 7613. fax: (081) 892 7749. A.R., Arcam, Audio innovations, Audioblab, B&O, B&W, Castle, Dali, Denon, Dual, Kef, Marantz, Meridian, Michell, Micromega, Mission, Monitor Audio, NAD, Nakamichi, Pioneer, Quad, Revox, Rotel, Spondor, Systemdek, Tannoy, TDL, Yamaha. 5 dem rooms. In car demo for car hi-fi systems. Appointments not always necessary. Home trial facilities, free installation, service department. Lombard Tricity, Access/Visa/Amex/Diner/Club.

**MUSICAL IMAGES**, 45 High Street, Hounslow, Middlesex. Tel: (081) 569 5802. Fax: (081) 569 6353.

**MUSICAL IMAGES**, 173 Station Road, Edgware, Middlesex. Tel: (081) 952 5535. Fax: (081) 952 5535. Most brands available - see full page advert. Interest free credit, ask for details. Demo rooms. Repairs & Service. Sunday opening - Open all week. A Home Cinema Specialist. Mail order. Part exchange.

**AUDIO T**, 159a Chase Side, Enfield, Middlesex, EN2 0PW. (081) 367 3132. Fax: (081) 367 1638. Great Hi-Fi from Adcom, Arcam, Audioblab, Celestion, Denon, Marantz, Meridian, Micromega, Mission, Philips, Rotel, Yamaha, & many more. Mon-Fri 10-6. Sat 9.30-5.30. 3 year guarantee on Hi-Fi. Free delivery & installation. 30 day free upgrade scheme. Home demonstrations. Part exchange. 2 listening rooms. Home Cinema specialists. BADA Bonded.

## NORFOLK

**BASICALLY SOUND**, The Old School, School Road, Bracon Ash, Norwich, Norfolk, NR14 8HE. Tel: (0508) 70829. Arcam, Linn, Denon, Naim, Spondor, Sound Organisation, Audio Technica, Creek, Rega, Epos etc. 2 comprehensive dem rooms, home trial facilities, free installations, Visa/Access, HP facilities. Tues-Fri 9.30-1.00pm, 2.00-5.30pm. Saturday 9.30-5.30pm.

**AUDIBLE DIFFERENCE**, The Norfolk/Suffolk High End dealer, near Diss, Norfolk. Audio Research, Audion, Art Audio, ATC, Audio Innovation, Audio Note, AVI, Chord, Concordant, Copland, Croft, Dawn Audio, DPA, EAR, Impulse, Lyra cartridges, LFD Audio, Magnepan, Militek, Orelle, Pink Triangle, Roksan, Sugden, SME, Sonus Faber, Tube Technology. At this level of equipment we

believe that the highest level of service should be offered. We will book only three demonstrations a day to ensure that you have ample time to evaluate the options YOU have chosen. Demonstrations in our listening room or your home. Equipment loan service available. Tuesday to Friday, 12 to 9pm, Saturday 9 to 5pm. Please ring for an appointment on 0379 740227

**PROTECT-A-DISC**, Unit 4, Elvin Way, Sweetbriar Industrial Estate, Norwich, NR3 2BB. Tel: 0603 482193. Producers and suppliers of finest quality card record and CD sleeves with taped edges, poly-lined or unlined, mailers and cruciforms etc. Please send SAE for free current price list. Trade enquiries welcomed. Tel: 0603 482193.

## NORTHAMPTON

**LISTEN INN**, 32 Gold Street, Northants NN1 1RS. Tel: (0604) 37871. Wide range of records and accessories stocked. Our commitment to standards of service is apparent to our satisfied customers. Two dem rooms and free home install service available.

## NOTTINGHAMSHIRE

**ART AUDIO**, 130 Main Street, Calverton, Nottingham NG14 6LU. Tel: 0602 653604. Fax: 0602 637795. Midland dealer for all Art Audio amplifiers & Concordant amplifiers, Mordaunt-Short speakers. Home demonstration & installation service. 9-5 Mon-Fri, 10-6 Sat.

**DEFINITIVE AUDIO**, Tel: (0602) 813562. For a carefully considered approach to building a true high fidelity audio system with components derived from the following manufacturers: Audio innovations, Snell, Wadia, Micromega, Deltac, Voyd, Systemdek, SME, Revox, Impulse, Ortofon, Pioneer. Also the remarkable Living Voice Air Partner loud speaker system. Demos by appt. Please phone for further details, install. Free of charge. Mon-Sat 10.00-7pm. Closed Wed a.m.

**PETER ELLIS AUDIO**, 29 Kirkgate, Newark, Notts NG24 1AD. Tel: 0603 704571. QUAD, Castle, Arcam, QED, Sugden, Tannoy, Threns, Marantz, Denon, Teac. Demo room, free install, Service dept. Access, Visa. Mon-Sat 9.5-3.00. Closed Thursdays.

**CHANTRY AUDIO**, 18-18a Eldon Street, Tuxford, Nr Newark, Notts, NG22 0LH. Tel: 0777 870372. Pink Triangle, DPA, Rotel/Michell, Micromega, NVA, Alchemist, Michell, Monitor Audio, Lumley, SME, Audion, and much more! 1 Three dem rooms, home trial, free installation, service department. Access & Visa, credit facilities, Mail order. Mon-Sat 9.30-6.00. Sun and evenings home dem by appointment.

## OXFORDSHIRE

**AUDIO T**, 19 Old High Street, Headington, Oxford, OX3 9HS (0865) 65961. Fax: (0865) 60415. Great Hi-Fi from Arcam, Audioblab, Cyrus, Denon, Epos, KEF, Marantz, Meridian, Mission, Musical Fidelity, Rotel, Sony, Yamaha & many more. Mon-Fri 10-6. Sat 9.30-5.30. 3 year guarantee on Hi-Fi. Free delivery & installation. 30 day upgrade scheme. Home demonstrations. Part exchange. 2 listening rooms. Home Cinema specialists. BADA Bonded.

**WESTWOOD & MASON**, 46 George Street, Oxford. Tel: 0865 247783. AMC, Creek, Marantz, Naim, Arcam, Rotel, Rega, Epos, Tannoy, JPW, Mission, Nakamichi, Denon, Aiwa, Quad, Aura, Yamaha, Klipsch Speakers. Open 9.30-5.00pm. Dem room. Closed Thursdays.

**ASTLEY AUDIO LTD**, 3 Marketplace, Wallingford (3 miles from Berkshire border), 0491 839305. Aura, B&W, Technics, Panasonic, Pioneer, Kenwood, Sony, Yamaha, Denon, Dual, Marantz, Mission, Tannoy. 1 listening room. Home trial, free installation. Service department. Access, Visa, Amex, Diners. Instant credit. Tues-Fri 9.5-3.0, Sat 9-5. Records & CDs stocked.

## SHROPSHIRE

**AVON HI-FI**, 12 Barker Street, Shrewsbury, Shropshire, SY1 1QJ. Tel: 0743 355166. Aiwa, Beyer-Dynamic, NAD, Quad, B&W, Mordaunt-Short, Kenwood, Bose, Nakamichi, Revolver. Dem room. Home trial. Free install. Service dept. Access/Visa. £1,000 instant credit. Mon, Tues, Wed, Fri, Sat 9-5.30.

**SHROPSHIRE HI-FI**, St Michael Street, Shrewsbury, Shrops. SY1 2ES. Tel: 0743 232065. Stockists of Musical Fidelity, Mordaunt Short, Sony, Kenwood, Pioneer, Rotel, Denon, B&W, Proac, Audio Visual. Products available. Open 9.30 - 5.30pm Mon-Sat.

## SOMERSET

**MIKE MANNING AUDIO**, 110 Middle Street, Yeovil, Somerset, BA20 1NE. Tel: 0935 79361. Fax: 0935 32923. Mobile 0850 325965. Naim, Roksan, Pink Triangle, A&R (Arcam) ION, NAD, Pioneer, Rotel, Denon etc. Dedicated listening lounge, for relaxed and unpressured demos. Apts not necessary but best to telephone first. Home trial facilities on request, free installation and service

dept, Instant credit, Access/Visa etc. 9-5.30, closed Mondays.

## STAFFORDSHIRE

**ACTIVE AUDIO**, 95, Stafford Street, Hanley, Stoke-on-Trent, Staffs. Tel: 0782 214994. Fax: 0782 283346. We have four studios including a dedicated Audio Visual studio for the demonstration of quality equipment from the largest range in the Midlands. Open six days per week. Own service department. Free local delivery, home trial facility. Current special offers and buyers fact pack and quotation service on request.

**GRANGE HI-FI LTD.**, 153 Branston Road, Burton-upon-Trent, Staffordshire, DE14 3DD. Tel: 0283 33655. Arcam, Albary, Audio innovations, Audionote, Castle, Denon, Dual, JPW, Marantz, Moth, Pink Triangle, Quad, Rogers, Rotel, SME, Systemdek, Tannoy, TDL, Yamaha, Stockists of DCC, Access/Visa. 2 dem rooms. Closed Monday & Weds pm and for lunch 12.00-12.30pm. Apts necessary on Saturday 9.00-5.30pm.

**MUSICAL APPROACH**, Unit 7, Woodings Yard, Bailey Street, Stafford, Tel: 0785 55154. Also branch at 37 High Street, Aldridge, nr Walsall. Tel: 0922 57926. Arcam, Audiotech, Apollo, Celestion, Heybrook, Linn, Marantz, Rotel, Royd, Sennheiser, Target, single Speaker Dem rooms, free installation and credit facilities.

**ACTIVE AUDIO**, 29, Market Street, Tamworth, Staffs. Tel: 0827 53355. Fax: 0827 59513. We have two studios including a dedicated Audio Visual studio for the demonstration of quality equipment from the largest range in the Midlands. Open six days per week. Own service department. Free local delivery, home trial facility. Current special offers and buyers fact pack and quotation service on request.

## SURREY

**AUDIO IMAGES**, 7 All Saints Road, Pakefield, South Lowestoft, Suffolk, NR33 6JJ. Tel/fax: 0502 582853. Quad, Triangle, Arcam, Castle, Rotel, Moth, JPW, Finlux, Audio Innovations, plus the amazing ROTHWELL range. Separate dem room, no apts nec. 10-6.30 Tues-Thurs, 7pm Fri. 6pm Sat.

**SIGNALS** Martlesham Heath, Ipswich. Tel: (0473) 622866. Audio innovations, Fuller's Audio, Goldring, Heybrook, Impulse, JPW, Micromega, QED, Sonoclink, Sumiko, Alphonson, Apollo, Audioquest, Ixos, Project, Soundstyle, Storing, Townshend, Tricord, Sugden and more! Monday to Saturday 10 till 6

**BURY AUDIO**, 47 Churchgate Street, Bury St Edmunds, Suffolk, IP33 1RG. Tel: 0284 724337. Arcam, Audio Alchemy, Heybrook, Marantz, Michell, Meridian, Nakamichi, Pink Triangle, Quad, Rotel, Sonus Faber, Stax, Tube Technology, Single speaker dem room. Free install. Credit facilities. Mon-Sat 9.30-6.00, closed Wed. Evening dems by appointment.

**EASTERN AUDIO**, 41 Bramford Road, Ipswich, Tel: 0473 217 217. Fax: 0473. 215705. Quad, Arcam, Audioblab, Meridian, Mission, Systemdek, Marantz, NAD, Sony, Rogers, Nakamichi, Denon, Technics, Celestion, B&W, Tannoy, Morel Thorens and Top Tape. Also stock a wide range of accessories. usual credit facilities. A BADA dealer.

## SURREY

**SPALDINGS HI-FI**, 352-4 Lower Addiscombe Rd., Croydon, Surrey, 081 654 1231/2040. 3 dem rooms and home dem. Free installation/credit. Linn, Naim, Quad, Arcam, Audioblab, Cyrus, Marantz, Denon, Ruark. Mon-Sat 9-6, Tues 9-8. Closed Wed. Service dept.

**PJ HI-FI, THE HI-FI SHOP**, 3 Bridge Street, Guildford, Surrey GU1 4RY. Tel: (0483) 504801. 9-6 Mon-Sat. Linn, Meridian, Rega, Arcam, Quad, Revox, Musical Fidelity, Rotel, NAD, Nakamichi, Marantz, KEF, Reference etc.

**ROGERS HI-FI**, 13 Bridge Street, Guildford, Surrey, (0483)61049. Aiwa, Creek, Denon, Dual, JPW, Marantz, (Onyx) Pioneer, Systemdek, Ruark, Tannoy, Teac. Dem facilities available, no apts necessary, free installation, service dept. Access/Visa. Instant credit upto £1,000 subject to status. Monday-Saturday, 9.30-6pm, later by appt

**SURBITON PARK RADIO**, 48 Surbiton Road, Kingston-upon-Thames, Surrey, (081) 546 5549. QUAD, Castle, Denon, Quad, Kenwood, Mordaunt-Short, JBL, Rotel, Pioneer, QED, B&W and Tannoy. Demo facil. Access, Visa and Switch. 9.30-5pm.

**SURREY HI-FI**, 45 High Street, Godstone, Surrey, RH9 8LS. (0883) 744755. Specialist HiFi outlet, demonstration room and parking available. Quad, Audioblab, TDL, Tube Technology, Rel Acoustics, Nakamichi, Kef, Thorens, Magnum, Rotel, Marantz, Denon, Michell, Furukawa, Tannoy, Target, JPW. Lumley Reference in stock. Single speaker dem rooms. Apts

not necessary. Home trial facilities, free installation service dept, Access/Visa/Mastercard. Open 9-6pm Closed Wednesday.

## SUSSEX (EAST)

**JEFFRIES HI-FI**, 4 Albert Parade, Green Street, Eastbourne, East Sussex. Tel: 0323 131336. 2 dem rooms. Closed Mon. Late night Wednesday. Free parking, Credit facilities.

**JEFFRIES HI-FI**, 69 London Road, Brighton, East Sussex. Tel: 0272 609431. 2 dem rooms, closed Mon, late night Wed. free parking and credit facilities.

**THE POWERPLANT "Brighton's Leading HiFi Shop"**, 66 North Street, Brighton, Tel: 0273 775978. Comfortable listening rooms. Knowledgeable and approachable staff. Roksan, Micromega, Exposure, Audioblab, Epos, Rotel, Marantz, Cyrus, Regal, Arcam, Mission and more.

**WORTHING AUDIO**, 20 Treville Gate, W Sussex, BN11 1VA. Tel: 0903 212133. "The friendly shop with the best sound systems in the South". Friendly advice, 3 yr guarantees, easy parking, open Mon-Sat 9-6pm. Late night Wed. Arcam, Exposure, Naim Audio, Marantz, Ruark, Mordaunt Short, Audio Technica, Target, Tripod, Sennheiser, AR and many more.

## SUSSEX (WEST)

**AUDIO DESIGNS**, 26 High Street, East Grinstead, West Sussex, RH19 3AS. Tel: 0342 314569. Friendly understanding Hi-Fi specialists. Audioblab, Arcam, Cyrus, Epos, Linn, Marantz, Mission, NAIM, NAD, Neat, Quad, Rotel, Sony, Stax, Tannoy, Target, Thorens, Yamaha. Dem rooms, free installation, service dept, credit facilities, mail order, credit cards, 9.30-6.00 6 days a week.

**BOWERS & WILKINS Ltd.** (est. 1945). 1 Becket Buildings, Little Hampton Road, Worthing, Tel: (0903) 2 64141. Top names in HiFi and audio visual including B&W, Nakamichi, Castle, Denon, Philips, Quad, Technics, Aura, Thorens and many more. 3 dem rooms (budget - high end) expert friendly advice, service dept, local installations free. one minute from A24 & A27, free local parking, Access/Visa. Instant Credit up to £1,000 subject to status. Open 6 days.

**CHICHESTER HI-FI**, 7 St Panchras, Chichester, W Sussex. PD19 1SJ. Tel: 0243 776402. Linn, Naim, Rega, Creek Nakamichi, A&R, Denon, Rokska, Epos, JPW, Ruark, Rotel, Quad, Spondor. Evening apts available.

**JAYSOUND AUDIO**, 5 Waterloo Square, Bognor Regis, Tel: 0243 826355. Aiwa, B&W, Beyer, Denon, Dual, Goodmans, Heco, Jamo, JVC, Marantz, Mitsubishi, Pioneer, QED, Samsung, Sennheiser, Sharp, Shure, Teac, Wharfedale. Free local delivery and install. Part exchange welcome, licensed credit broker, Repairs on all makes of HiFi & TV/Video. Open 9am-6pm. Cl. Weds.

## TAYSIDE

**J.D. BROWN**, 28-36 Castle Street, Dundee DD1 9NZ. Tel: (0382) 26591. Rotel, Denon, Pioneer, Technics, Aiwa, Mission, Castle, Mordaunt-Short, Monitor Audio, Bose, Infinity. All equipment ready for demonstration. No appt nec, free installation, service dept. Open 9.30-6pm six days a week, (close 5pm Sat).

## TYNE & WEAR

**BILL HUTCHINSON HI-FI**, 87a, Castle Street, Newcastle-upon-Tyne, (091) 230 3600. For the largest selection of HiFi and audio visual equipment in the North East. Specialist A.V. demonstrations of the highest quality. Best prices guaranteed. Minimum 2 year warranty and an optional 5 yr guarantee available. Instant credit and mail order service on offer throughout the U.K. Pioneer, Denon, Kenwood, Yamaha, Technics, Marantz, Mission, Tannoy plus many more.

## WARWICKSHIRE

**STRATFORD HI-FI**, 25 Henley Street, Stratford-upon-Avon, CV3 0W. Tel: 0789 414533. Pioneer, Technics, Denon, Marantz, NAD, Rotel, Musical Fidelity, Monitor Audio, Mission, Tannoy, Quad, TDL, Sennheiser, 0% finance is available on selected products and all major credit cards accepted. Dem Rooms, Service facilities, open 9.30-5.30pm. Late night Thursday until 8.00pm.

## WEST MIDLANDS

**FRANK HARVEY HI-FI EXCELLENCE**, 163, Spon Street, Coventry, CV1 3BB. Tel: 0203 525200. The Midlands first choice for specialist Hi-Fi. Audioblab, Audio Alchemy, Arcam, Audio Quest, Alphonson, Bose, Bang & Olufsen, Celestion, Cyrus, Denon, Dual, Foundation, Kef, Reference, Marantz, Monitor, Audio Mission, Musical Fidelity, Nakamichi, Nad, Rega, Rogers, Rotel, Quad, Systemdek, Target, Tripod, Tannoy, Thorens, Van den Hul, Yamaha. 3 floors. 3 demonstration rooms. Open 9.30 till 5.30. Closed Thursday. All credit cards incl. Amex & Diners. Instant credit and interest free facilities.

# Hi-Fi World Dial-a-Dealer

Home trials. Free installation, home cinema AV floor. We are a BADA dealer

**MIDLAND VALVE HI-FI**, Specialising in true fidelity systems built around valve amplification: Audion 300B Silver Nights, Audio Innovations, Impulse, Audio Note, KAL, Townsend Audio, Ortofon, Voyd, Micromega, Edison, Stax, Apollo, Dynavector, Seismic Sink, Valves Home Demonstrations and part exchange. Also vintage: Leak, Quad, Croft, Radford, etc. Flexible opening 7 days. phone Gary 021 722 2317.

**MUSIC MATTERS**, 351 Hagley Road, Edgbaston, Birmingham, B17 8DL. Tel 021 429 2811. Roksan, Nakamichi, Arcam, Audiolab, Musical Fidelity, Mission/Cyrus, Meridian, Kef, Monitor Audio, Pink Triangle, Ruark, Epos, Exposure, Pioneer. 2 single speaker dem rooms. Appts necessary. Home trial facilities and free install. Service dept. Access/Visa/instant credit upto £1,000. Interest free credit available also. Tues - Thurs 10.30-6pm, Friday 10.30-8.00pm, Saturday 10.00-5.30pm.

**COVENTRY HI-FI**, 126, Church Lane (off Walsgrave Road), Coventry, CV2 4AJ. Tel 0203 440529. Quad sales & service agent, Pioneer Reference Point, Kenwood, Aiwa, T.D.L. B&W, Tannoy etc. Private listening room. 2 year guarantee on all new hi-fi. Open 9.30-5.30 Mon-Sat Closed Thursday.

**ELECTRO CENTRE**, 244 Soho Road, Handsworth, Birmingham, Tel 021 554 1878. Full range of HI-FI, Pioneer, Technics, Kenwood, JVC, Sony, Aiwa, Akai, "Guaranteed the lowest price in the UK". 24 hour mail order facility available.

**ELMOON AUDIO**, Tel 021 784 8765. Reference Imports Lumley, Alon etc. Esoteric Audio Research 834 integrated on demonstration. Home demonstration can be arranged. Top part exchange prices, lots of used bargains. Quad, Leak, etc. Valves and valve testers, new GEC KT66s available.

**FIVEWAYS HI-FIDELITY LTD.** 12 Islington Row, Edgbaston, Birmingham, B15 1LD. 021 4550667. Advent, Albarry, AKG, Alphason, AMC, AR, Arcam, Audioquest, Auditechnica, Beyer, Bose, Castle, Chord, Denon, Dual, Gold Ring, Meridian, Michell, Monitor Audio, Nagaoka, Nakamichi, Ortofon, QED, Quad, Revox, Sennheiser, Spondor, Target, TDK TDL, Thorens, Wharfedale. K Monks Record Cleaning Service. Closed Mondays.

**MUSICAL APPROACH**, 37 High Street, Aldridge, nr Walsall. Tel 0922 57926. Arcam, Audiotech, Apollo, Celestion, Heybrook, Linn, Marantz, Rotel, Royd, Sennheiser, Target, single Speaker Dem rooms, free installation and credit facilities.

**SOUND ACADEMY**, Just off the high street, Blaxwich, Walsall, W. Midlands. (Ample free parking). Tel. 0922 493499. Albarry, Art Audio, Acoustic Energy, Arcam, Audiolab, Audioquest, B&W, Bose, Chord, Cyrus, Cable Talk, DPA, Ensemble, Epos, JPCW, Kef, Reference, Marantz, Meridian, Mission, Moth, Musical Fidelity, Nakamichi, Ortofon, Project, Quad, Roksan, Tube Technology, Triangle and many more. Open 6 days a week. Mon-Sat. All major credit cards taken. Part exchange, enquiries welcome.

**AMADEUS SOUND & VISION**, 10 Boldmere Road, Sutton Coldfield, West Midlands, Tel. 021 354 2311. Audio Innovations, B&O, Castle, QED, Wharfedale. Single speaker demo, appts preferred, service available. Installations, B&O fmk install, home trials, Access/Visa interest free credit available subject to status. 9.30-6.00pm 6 days.

**GRIFFIN AUDIO**, 94 Bristol St., Birmingham, Tel. 021 622 2230/021 692 1359. Tues-Sat 10 a.m.-6 p.m. Enjoy music at home with a system from Griffin Audio. We demonstrate and install the very best hi-fi, with systems from £500 to £25,000. Ask for Bob, Tim or Alex. Linn, Naim, Shahinian, Quad, Arcam, Rega, Denon, Marantz, Rotel.

## WILTSHIRE

**THE AUDIO EXCHANGE**, 52 Morse Street, Swindon, Wiltshire SN1 5QP. (0793) 539008. Acoustic Energy, Audio Innovations, Beard, Cerwin Vega, C.R. Developments, Impulse, Magnum, Micromega, Michell, REL, Sequence. AV and single speaker demo room. Home trial facilities, free installation, service dept. Mon-Sat 10-6.

**AUDIO T**, 60 Fleet Street, Swindon, Wiltshire, SN1 1RA. (0793) 538222. Fax (0793) 487260. Great Hi-Fi from Arcam, Audiolab, Denon, Linn, Marantz, Meridian, Mission, Rotel, Sony, Yamaha & many more. Mon-Sat 9.30-5.30. 3 year guarantee on JVC. Free delivery & installation. 30 day free upgrade scheme. Home demonstrations. Part exchange. 2 listening rooms. Home Cinema specialists. BADA Bonded.

## WYOMINGSHIRE

**SPAINS HI-FI**, 2 +2a New Rd., Bromsgrove, Worcs. Tel 0527 872460. Aura, B&W, Beyer, Denon, Heco, JVC, Kenwood, Marantz, Mission, Monitor Audio, NAD, Nakamichi, Pioneer, Rotel, Sennheiser, Soundstyle, Sony, Systemdeck, Tannoy, Target, Thorens. Integral demo room/showroom for instant comparisons on Hi-Fi & AV equipment. Free installation. Part exchange welcome. Service department. Access, Visa, 0% finance on selected products. Mon-Sat 9.00-5.30 pm. Closed Thursdays.

## WEST MIDLANDS

**WEST MIDLANDS AUDIO**, 158 Ombersly Road, Worcester WR3 7HA. Tel 0905 58046. Fax. 0905 57585. Naim, Rega, Rotel, Marantz, Nakamichi, NAD, Audiolab, Roksan, Meridian, B&W, Audio Research, Krell, Martin Logan, Arcam. 9-5.30 Mon-Sat. eve's by appt only. Free

## YORKSHIRE (SOUTH)

**HI-FI STUDIO'S**, Sunnyfields, Doncaster, Tel 0302 781387. Heybrook, Monitor Audio, Art Audio, Michell, Sugden, Acoustic Energy, Alphason, Teac, AMC Valves, Ruark, Albary, Proac, Impulse loud speakers, Ref subwoofers, Yamaha surround sound, Project, TDL, Listening room demo's. Home trial, free install, licensed credit broker, 2 yr guarantee on all equipment, service available. Access/Visa. 10-8pm 6 days. phone for further information and free fact pack.

**TRC HI-FI**, 3 Kings Cross Street, Halifax, HX1 (0422) 366832. Agents for Kenwood, Denon, Castle, Rotel. Demonstrations and advice a pleasure. Call at any time to audition some of the best HI-FI and pro-logic systems. Delivering and installation free within 20 miles. "The family firm where the customer matters most."

## YORKSHIRE (NORTH)

**AUDIO CLINIC**, 22 Lord Mayors Walk, Yorks, YO3 7HA. Tel. (0904) 646309. Revox-Qed-Audio Innovation-Allison-Celestion-Yamaha-Teac-Revolver-JPW-Kenwood-Bose-Thorens-Mission-Snell-B&W-Heco-Cannon-NAD-JVC-Musical Fidelity-Wharfedale-Micromega-Ruark-Heybrook. Surround sound and demo rooms, free installation, Service Dept. Credit facilities on request. Access, Visa. Open 10am - 5pm 6 days a week.

**SCARBOROUGH HI-FI**, 14 Northway, Scarborough, North Yorkshire YO11 1JL. Tel. 0723 374547. Albarry, Aura, B&W Matrix, Cyrus, Pioneer, Philips, Marantz, Cabasse, Bose, Tannoy, DCC wide screen and laser vision. Home trial facilities and free installation, service dept, Access/Visa. Credit charge, £1,000 instant credit/Amex/Diners.

**THE SOUND ORGANISATION (YORK)** 2b Gillygate, York, YO3 Tel. (0904)627108. Linn, Meridian, Micromega, Naim, Rega, Arcam, Creek, Nakamichi, Mission, Denon, Epos, Royd, Rotel. 3 single speaker dem rooms, appts. preferred, home trial facilities, free install, service dept. Credit facilities on request. Access/Visa. 10.00am-5.30pm. Tues-Sat. Sony dealer award nominated '86, '87 and '88.

**VICKERS HI-FI**, 24 Gillygate, York. (0904) 629659. Audiolab, Harmon Kardon, Marantz, Musical Fidelity, Pink Triangle, Quad, Systemdek, Tannoy, Technics, and lots more. 3 dem studio's (2 by appointment). Superb showrooms. 2 yr guarantee on all hi-fi products. Appts. as above. Home trial facilities, free install, service dept. Qualified and experienced staff, over 25 yrs experience. 12 mths interest free credit. 10.30-5.30 Mon-Sat.

## YORKSHIRE (WEST)

**AUDIOVISION (BRIGHOUSE) LTD.** 5 Bethel Street, Brighouse, W.Yorks. HD6 1JR. Tel. (0484) 713996. 1 mile from junction 25, M.62.

Yorkshire's experts for the entire range of Technics HI-FI separates & systems. Panasonic Nicaam TV, Satellite Audio, VCR's and Camcorders, Philips Widescreen TV, CD-I and Laserdisc players, Yamaha Cinema DSP separates, Castle, Mordaunt-Short, Bose, TDL, Cerwinvegal and Aiwa HiFi separates. HI-FI, Home cinema and Dolby pro-logic surround systems on continuous demonstration. Free specialist advice and expert installation. In-store service department, Access/Visa/Creditcharge. Mon-Sat 9-5.30.

**BILL HUTCHINSON HI-FI**, 26-28 Woodhouse Lane, Leeds (0532) 427777. For the largest selection of HI-FI and audio visual equipment in the Yorkshire. Specialist A.V. demonstrations of the highest quality. Best prices guaranteed. Minimum 2 year warranty and an optional 5 yr guarantee available. Instant credit and mail order service on offer throughout the U.K. Pioneer, Denon,

Kenwood, Yamaha, Technics, Marantz, Mission, Tannoy plus many more.

**DDUG BRADY HI-FI**, The Forge Cottage, 19 Cross Gate, Otley, West Yorks, LS21 1AA. Tel. (0943) 467689. Naim, Arcam, Rotel, Pink Triangle, Meridian, Epos, Castle. Two dem rooms fair demonstrations and home trial facilities. Access/Visa. Open 10.00-6pm Tues-Sat.

## SCOTLAND

### EDINBURGH

**BILL HUTCHINSON HI-FI**, 43 South Clark Street, Edinburgh. (031) 667 2877. For the largest selection of HI-FI and audio visual equipment in Lothian Specialist A.V. demonstrations of the highest quality. Best prices guaranteed. Minimum 2 year warranty and an optional 5 yr guarantee available. Instant credit and mail order service on offer throughout the U.K. Pioneer, Denon, Kenwood, Yamaha, Technics, Marantz, Mission, Tannoy plus many more.

### ABERDEEN

**HOLBURN HI-FI**, 441 Holburn Street, Aberdeen. Tel: 0224 585713. Arcam, Audiolab, B&W, Celestion, Denon, Dual, Epos, Heybrook, IOM, Kenwood, Creek, Marantz, Meridian, Mission, Cyrus, M.S., NAO, Nakamichi, Pioneer, QED, Quad, Revox, Rotel, Ruark, Tannoy, Technics, Wharfedale, Yamaha. 9.30-5.30 Mon-Sat.

**HI-FI EXCELLENCE**, HI-FI innovators & product designers with 15 years experience. Very much in the business for the music. Musical Fidelity key dealer. Largest Rotel retailer in the area. Particularly keen to make the buying of HI-FI a fun experience. Situated in the West End away from the bustle of the City centre - the perfect environment to enjoy quality HI-FI. Full time service engineer. Open Mon-Tues 10-6, Wed 10-1, Thurs 10-7, Sat 10-5 or later by appointment. HI-FI Excellence, 293 Union Gate, Aberdeen. Tel: 0224 32252

### AYRSHIRE

**LASER AUDIO**, Now at new premises: 1 St Marnock Place, Kilmarnock KA1 10T. Tel: 0563 40292. Audiolab, Awa, Celestion, Cyrus, Denon, Dual, Marantz, Mission, Philips, Pioneer Systemdek and Tannoy. 2 demonstration rooms, AV dem room. Appointments preferred, home trial facilities. Free installation, service facilities. Access. Visa and written credit. Open Tues-Fri 10-5.30 Sat 9.30-5.30.

### GLASGOW

**STEREO STEREO**, 278 St Vincent Street, Glasgow, Scotland. Tel 041 248 4079. Closed Tuesday. Installations throughout Scotland. Credit facilities available.

**BILL HUTCHINSON HI-FI**, 43 Hope Street, Glasgow, (041) 248 2857. For the largest selection of HI-FI and audio visual equipment in South West. Scotland Specialist A.V. demonstrations of the highest quality. Best prices guaranteed. Minimum 2 year warranty and an optional 5 year guarantee available. Instant credit and mail order service on offer throughout the U.K. Pioneer, Denon, Kenwood, Yamaha, Technics, Marantz, Mission, Tannoy plus many more.

### INVERNESS

**THE MUSIC STATION**, 49 Church Street, Inverness, IV 1DR. Tel: 0463 225523. Beyer Dynamic, Celestion, Denon, Jamo, Kef, Kenwood, Mission, Pioneer, Rotel, Sony. Listening room, service department, free local delivery, part exchange, full range of credit facilities.

## IRELAND

### DUBLIN

**ACOUSTIC DIMENSION**, 67 Mountjoy Street, Dublin 7. Tel: 305633, Fax: 305839. (from UK + 0103531). Stockists for speakers: ATC, Acoustic Energy, JPW Triangle, ProAc, Ref 3A, Ruark, Heybrook, Polk Audio, TDL, Impulse, Charjo, Audio Static. Amps by: Albary, AVI, LFD, NVA, Alchemist, Marantz, Audio Innovations, Rotel, CR Developers, EAR, Kinslow, CD Players and DACs by: AVI, Pierre Lurine, Micromega, Kinslow. Turntables by: Project, Tables/Stands: Apollo, Cables: Straightwire, Ixos, VLS, Eagle. Credit cards and mail order.

**CLONEY AUDIO**, 55 Main Street, Blackrock, Co Dublin. Tel. 2889449/2888477 Fax. 2834887. Products include: Arcam, Classe, Philips, Rogers, Epos, B&W, Naim, Audio, Meridian and others. Open Tues/Sat 10am-6pm. Thurs/Fri 11pm-9pm Closed Mondays.

**PETER OAND & CD LTD.** 111 Clonskeagh Road, Dublin 6. Tel. 0103531 2694433. Products include: B&O, Quad, KEF, Thorens, TEAC & many more! 2 demonstration rooms and 2 year guarantee.

**CLASSIC AUDIO HI-FI LTD.** 4 Cathal Brugha St., Dublin 1. Tel 745910. Real hi-fi. Dolby pro logic and surround AV specialist. Awa, Sony, Marantz.

### BELFAST

**LYRIC HI-FI**, 163 Stanmills Road, Belfast (0232) 381296. Linn, Naim, Rega, Arcam, Denon, Rotel and more. Mon-Sat, 10.00-6.00pm. Late night Thurs. ZEUS AUDIO, 6 Hope Street, Belfast, (0232) 332522. Audio Innovations, Pink Triangle, Roksan, Marantz, Celestion, Meridian and more. Mon-Sat 10.00-5.30pm. Late night Thursdays.

### COUNTY DOWN

**ASTON AUDIO**, Unit 8, Kings Road Shopping Centre, Kings Road, Belfast. (0232) 402220. Akai, Technics, JVC, Samsung, Toshiba, Panasonic and many more. Demos. Open Mon-Fri 10-8pm Sat 10-5pm.

### LONDONDERRY

**ZEUS AUDIO**, 23a Kingsgate Street, Colrairie, BT52 4LB. Tel. (0265) 56634. Marantz, Mission Cyrus, Awa, Akai, Alphason, Sony, Pink Triangle, Celestion, Rotel. Mon-Sat 10-5.30pm. Closed Thurs.

## WALES

### GWYD

**ACTON GATE AUDIO**, 4 Ruabon Road, Wrexham, North Wales. Tel. 0978 364 500. Arcam, B&W, Marantz, Mission, NAD, Quad, Rega, Rotel, Tannoy, Yamaha, etc. Dem facilities. A.V. on dem. Mail order. No appts nec, home trial fac. Free install, Service Dept. Access, Visa. 9.30-5.30 closed Weds pm.

### NORTH WALES

**ELECTRO TRADER**, 19 Colwyn Crescent, Rhos on Sea, Colwyn Bay, Clwyd, Wales, LL28 4RN. (0492) 548932. NOW APPOINTED SUGDEN DEALER FOR THE NORTH WEST. Rotel, Yamaha, NAD, Harman, Kardon, Teac, Alphason, Heco, Infinity, KEF, JBL, Sugden, Tannoy, Rotel Michi, Haybrook, Acoustic Research, RUarc and Soundstyle tri-pod racks etc. Dem room appts. preferred. Home trial. Free install. Access, Visa, Open 9.30 - 1.00, 2.00 - 5.30 Mon-Sat.

### GLAMORGAN (SOUTH)

**AUDIO EXCELLENCE 'WHERE THE MUSIC MATTERS'**, 134-6 Grwy Road Cardiff CF2 4NR. Tel. 0222 228565 Fax. 0222398201. Great HI Fi carefully selected and demonstrated by friendly enthusiastic staff. Home installations and check-ups. Two year warranty from our own service department. Open 9.00-5.30 Tuesday - Saturday closed Monday.

### GLAMORGAN (WEST)

**AUDIO EXCELLENCE 'WHERE THE MUSIC MATTERS'**, 9 High Street, Swansea, SA1 1LE. Tel 0792 474608 Fax. 0792 645087. Great HI Fi carefully selected and demonstrated by friendly enthusiastic staff. Home installations and check-ups. Two year warranty from our own service department. Open 9.00-5.30 Tuesday - Saturday closed Monday.

### GWYNEDD

**I&H GRIFFITHS & SONS**, 313 High Street, Bangor LL57 1YA. 0248 370655. Yamaha, Tannoy, Teac, Sony, B&W, Wharfedale, Rotel, JVC. Home trial facilities, free installation, service dept. After hours dems by appointment. Access, Visa, Lombard credit charge. Mon-Sat 9-5.30, Wed 9-1. Audio Visual Specialists.

**TOP TAPE**, 1 Crystal Way, Elm Grove Road, Harrow, Middlesex, HA1 2RJ. Tel: 081 427 1404. The UK's oldest and largest Tape Mail Order Service. TDK, Maxell, Sony, Ampex audio cassettes plus Fuji, JVC, Konica, Memorex, Scotch & TDK video tapes. Send for complete list of latest prices and offers including Video 8, VHS-C, S-VHS, TDI, MiniDisc and Open Reel and tape accessories including Allisoop. Local Dealer Listing available. Telephone orders on 081 427 1404 Mastercard, Visa & Switch accepted.



## Simon Hopkins

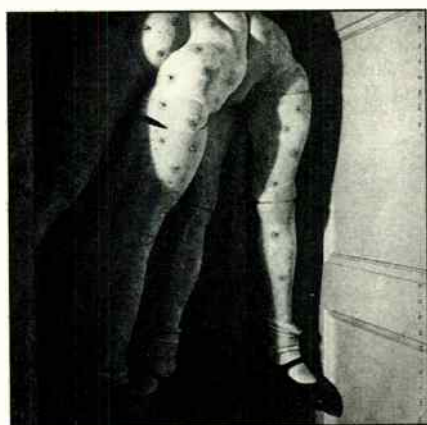

### **NAKED CITY** **Absinthe** **AVANT AVAN 004**

● If there's been one term kicked around more than any other by music critics and fans over the last year, then it's probably 'ambient'. A description apocryphally invented by Brian Eno for music which could be at once background muzak and close-listening stuff, increasingly you can bet that wherever you see the word you're going to hear some kind of rhythmless (or at any rate largely non-rhythm-dominated) post-rave music, some of it excellent, much of it tedious drivel. But whatever ambient denotes, you can generally expect to hear music with not a lot going on, on the surface at any rate.

And then there's John Zorn. I've written enough about Zorn's history here before. If you haven't caught on yet: where have you been? If you are aware of his music, then you'll know that the

phrase 'not a lot going on' isn't exactly one which springs to mind. Zorn is king of maximalism. His music is definitive collage, a music celebrating the culture clash: urban life as art form.

When I first heard that Zorn was starting his own label well over eighteen months ago now, I wasn't at all surprised. Zorn's knowledge of contemporary music is legendary, as is his refusal to recognise a high-brow/low-brow divide, and anyone whose live shows are peppered with reverential name-checking to the degree of his handful of UK gigs with Naked City - of whom more in a moment - was bound to want to do more than stick to simply making his own music. He was going to want to do something with other people's, too.

What did surprise me about the original press release that went out on Avant, was that Naked City were to record an album of ambient music. Remember: ambient = minimalism, Zorn = maximalism. Go figure.

Well, it's been a long time coming, but Absinthe has been well worth the wait. First off, though, Naked City. Zorn formed the group in the late 80s, a compact quintet able to handle the grand ambitions of his genre-melding collages: guitarist Bill Frisell; keyboardist (and grand master of B-movie sleaze 'n' cheese) Wayne Horvitz; bassist Fred Frith; drummer Joey Baron; and Zorn himself on alto. Latterly they've acquired Japanese blabber-mouthing vocalist Yamatsuka Eye - of The Boredoms. But despite his essential presence on the companion piece to this record, Radio, (reviewed elsewhere this month), he's absent from this piece.

So, then, is the classic Naked City line-up renowned for its frenetic energy, chilling out? Er, not exactly, no. Zorn rescued the concept album from the clutches of post-punk scum long ago, and his work has tackled subjects as wide apart as the Holocaust (Kristalnacht), the music of Ennio Morricone (The Big

Gúndown) and Omette Coleman (Spy vs Spy), pulp fiction (Spillane) and on and on. And so, in its way, Absinthe too is a concept album, the narcotic wormwood gin much-abused by fin de siècle French intellectuals, forming the psychological landscape of the pieces that make up this album.

The result is terrifying stuff. Away from their more (in)famous jump-cut escapades, Naked City have ventured into minimal soundscapes before, notably on 'Leng Tche' (a thirty minute tapestry of guitar feedback, subsonic bass and droning synth finally erupting into howling alto sax and tortured vocals) and on the title track of last year's mind-numbingly brilliant Grand Guignol, an eerie, melodramatic evocation of the graphically violent 19th century French theatre.

But nothing so evocative as the ten pieces that make up Absinthe, ten pieces which at once recall the blasted post-industrial soundscapes of Throbbing Gristle and SPK, On Land-period Brian Eno, the fragile, attenuated work of European composers like Scelsi and Ligeti, not to mention that of fellow Americans like Morton Feldman and Ingram Marshall. (The latter a fierce Zorn detractor, but then, you can't win em all.) And, perhaps more than any of these, the sort of anti-rave, minimal ambient music being made by an increasingly large and aesthetically ambitious group of rock musicians, a music being dubbed 'isolationist' in some of the better-attuned critical circles.

The music of Lull (brainchild of erstwhile Napalm Death drummer Micky Harris - not surprisingly name-checked in the Absinthe sleeve notes), of guitar sound sculptors Main, of Final (ambient holiday home for the otherwise far noisier Godflesh guitar god Justin Broadrick), of Techno Animal (similar chill-out, no, freeze-out space for God sax-screamer K Martin and the aforementioned Broadrick) . . . All this music is a parallel world to the ambient sounds of The Orb and co., one which is taken from many of the same sources - American minimalism, Eno, psychedelic rock - but has steered well-clear of the ridiculous cosmic trimmings. The message is clear: the still calm at the centre of the soul is a bleaker place than a generation of former E-heads would have you believe.

Which is why, of course, Zorn takes the effects of absinthe, rather than those of some altogether more enjoyable psychedelic drug, as his springboard into the dark unconscious. What the unofficial Isolationist movement boys know, Zorn knows too, but to it he brings his own particular bag of psychoses and musical fetishes. The results are as far from the genre-rape of Spillane and, say, Naked City, as they are from the beautiful requiem of Kristalnacht, but this is still unmistakably Zorn; the music of the most far-reaching, intelligent, restlessly experimental and endlessly resourceful musical mind of our time.

# The WIZARD



**Hand made Adjustable Shelf Rotary Unit.**

Can hold 1536 CDs or 1440 Cassettes or 384 Videotapes or 575 Penguin Books; or any mixture. Books up to 6 1/4" deep.

Revolves on Ball Bearings in 30-4" turning circle  
21 1/2 x 21 1/2 x 75" high.

Teak, oak, pine mahogany, ash, £1550 inc. VAT & Delivery.

**FOR OUR BROCHURE of CD/Video Drawer Chests CD racks Bookshelves LP, music · Hi-Fi Cabinets & the Budget Line —Specials made to order—**

Please send 3 x 2nd class stamps to:

**Ian Edwards** The Old Chapel  
282 Skipton Road, Harrogate  
HG1 3HB. Tel: 0423 500442

# TABULA RASA LOUDSPEAKERS



"It is a rare experience to play a track that you have known for the better part of, say, twenty years and suddenly, to hear new details and information."

(Hi-Fi World - Dec '93 on CT77 loudspeaker kit)

With the increased popularity of "do it yourself" hi-fi, Tabula Rasa are offering an extensive range of quality loudspeaker kits and car audio kits from top German manufacturer Mainhattan Akustik.

All loudspeakers kits are simple, fun to build, and at prices to suit all pockets. Each kit comprises drivers, filters, connections, terminals, and all the necessary fittings needed to complete your chosen loudspeaker, and every kit is available with or without cabinets. Furthermore, each kit comes with a 10 year warranty as standard and will be delivered within 14 days of confirmation of your order. For a catalogue (including price lists and a brief guide to speaker construction) please send £2.00 (refunded after first kit purchased) and a self addressed A4 envelope to:

Tabula Rasa, 136 Kilnwood, Walters Ash, High Wycombe, Buckinghamshire, Hp14 4UR, Tel 0494 565116

Cheques and postal orders should be made payable to Tabula Rasa.



Trade prices available on request.



## VDH Carbon Cables

### 'THE FIRST'

" These wires will make your system sing. "

*What Hi-Fi? Nov '93*

### Also in the Carbon series

#### THE SECOND

Balanced interconnect

#### REVELATION

Probably the world's finest speaker cable

#### REVOLUTION

Reference speaker cable

#### NEW 'STORM'

Classic interconnect from £24.99pr

#### 'SNOWTRACK'

Superior bi-wire speaker cable £7.99/m

VAN DEN HUL UK  
PO BOX 304, MAIDSTONE, KENT ME16 1HTS. TELEPHONE: (0622) 721636

*van den Hul*

## Affordable Hi-End

### CD Players DAC Amplifiers Loudspeaker

" I also feel that the Orelle CD-10T/DA-180 combination sets a new reference in this price category. "

*Hi-Fi News & RR, Oct '93*

NEW **CD-480** CD Player **£399**

VLS series interconnects

#### IC-1200

Silver plated OFC cable **£34.99pr**

#### D-LINK

Solid silver digital interlink **£49.99**

UNIT 12, I-MEX HOUSE, 6 WADSWORTH RD, PERVALE, MIDDX UB6 7JJ.  
TELEPHONE: 081-810 9388 FAX: 081-810 9365

**Orelle**  
**Hi-Fi**

# Simon Cooke

## ANDY SUMMERS/JOHN ETHERIDGE Invisible Threads INAK 9024CD

● When any ageing rock star suddenly turns to jazz standards, or in this case throws a couple into a set to give credence to a 'jazz inspired album', I get an acute attack of cynicism. The kind of albums I have in mind generally contain rambling and self-indulgent sleeve notes about how deeply meaningful jazz has been to the perpetrators through the long, dark years spent fleeing the paying public with top-ten pop-pap and generally living the life of Riley on the proceeds. Sorry, but I tend to run with Sam Johnson on this one ('No man but a fool ever wrote, except for money').

Having got that out of my system, I'd better explain that the Mr. Summers in

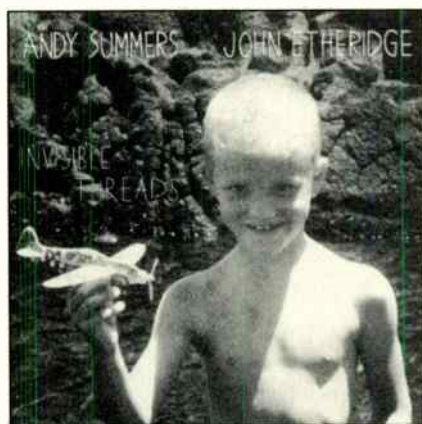

question just happens to have been in The Police, so I wholeheartedly withdraw the 'pop-pap' accusation, but I'll insert a 'copycat' one instead, since Sting has been playing around with jazz since Dream of the Blue Turtles, when some of the best jazz talent suddenly coalesced into a group around him in circumstances that would make the Fortean Times blush. Sting was absolved by the fact that 'Turtles' was probably the best album of the year: arguably of the decade, since many better contemporaneous works seem to have passed into obscurity.

The Summers/Shepherd axis does not carry it off. It follows the common guitar duet path of being instantly forgettable, dismal stuff. It is executed well, excepting the finger-movements which sound loud enough to make Segovia wince, but that doesn't stop it being shopping music. The two standards covered - and they should be - are Django Reinhardt's 'Nuages' and Monk's 'Monk's Mood'. The former is passable, but uninvolved. If the latter had originally been played by Summers, people would have thought that Monk had the emotional repertoire of Postman Pat.

The original tracks in this set are bracketed, in content, between

these two standards: workmanlike, but undynamic. I'd recommend this CD to anybody who wants to dip into jazz guitar, because it's well recorded and inoffensive. Apart from that, Mr. Summers may well have paid his dues in the rock world, but that doesn't necessarily count for anything in jazz.



## TOMMY SMITH/FORWARD MOTION Reminiscence AKD 024

● Another axe I have to grind about jazz today is derivation. Much of the output of younger jazz musicians sounds less like a tribute to jazz giants than a direct rip-off. This disc sounds, in part, like a direct copy of some of Jan Garbarek's work alongside my personal favourite Eberhard Weber. So much so that I was checking various phrases back with my Weber collection and finding very little to choose between them: tone and phrasing are so close as to be almost interchangeable. The differences lie in the quality and clarity of the work, where Garbarek and Weber emerge the clear masters, but they do not have bebop and modern influences in their music which the Smith-penned pieces on Reminiscence use to great dynamic effect as a foil to the delicate strains of bassist Terje Gewelt's writing. This acceptance of extra-Eurasian influences opens the music to an aggression and vibrancy quite foreign, but similar, to the music of truly European 'jazz'. A recommended disc for those who like sax players from Garbarek to Gillespie and Parker, backed by the solid recording quality of Linn.

Jazz



## JOHN ZORN'S NAKED CITY Radio AVANT AVAN003

● A more traditional story from Naked City than Absinthe, but equally far-reaching, intelligent . . . well, you've just read all that.

My first exposure to Zorn was at a Naked City gig: (as a card-carrying guitar junkie I'd actually gone to check out Bill Frisell, whom I admired greatly at the time). In one evening, I genuinely had more of my musical assumptions turned on their heads than before or since. I came out of the concert almost literally reeling, with the single overwhelming memory of a cornucopia of music existing out there that I'd never even imagined. Music that I knew well and loved - Omette Coleman, 50s hard bop - wrestled with music only half knew, and barely appreciated - The Beach Boys, Morricone, Bond soundtracks - and stuff I'd barely even heard of. 'This is something I wrote for Micky Harris, drummer with Napalm Death,' I recall Zorn saying between tracks, 'fucking great band.' It was worth the price of the ticket to discover that band alone.

It's six years on, and alongside mesmerising stuff like Absinthe and Kristalnacht, Zorn's still evangelizing about the music he loves. Radio is one of two sets recorded around the same time as Absinthe - in the spring and summer of 1992 - and is a loving tribute to the sounds which have inspired him. Nineteen short songs, the longest clocking in at a fraction over six minutes, each a collage of music played in the style of a particular musician, group or composer, or perhaps inspired by a writer or film director (the final 'American Psycho' being the ultimate joyride across the radio dial: Liberace/Jan Hammer/Napalm Death/Eddie Blackwell/Charlie Haden/Mick Harris/Carole King/Red Garland/The Boredoms/Jerry Reed/SPK/Roger Williams).

You get the picture. It's a simple idea, and one, as I've said, not exactly novel to NC fans, but the music is executed with such love that you'd have to have stonecladding on your ears - or your heart - not to be won over.

**SOUND ACADEMY**

**marantz®**

"Quality, Clarity, Expertise, Choice... and that's just the service!"

3 Demonstration Rooms  
Home Cinema - In store Demonstration Theatre  
Evening demonstrations by appointment  
Home trials  
Enquiries welcome for interest free credit (APR 0% written details on request)  
Mail Order available  
In-house service department



Sharing the ASDA Carpark with ample free Parking Off High Street, Bloxwich, nr. Walsall, West Midlands off M6 Junctions 10 and 11  
Open 6 Days a week, 9a.m.-6p.m. Fridays late night

Tel: (0922) 493499



Audio equipment from leading and specialist brands on two floors for you to listen and choose from

**PURE HIGH FIDELITY**

Telephone: 0753 680868

ACOUSTIC ENERGY, ARCAM, ALEMA, AUDIO LAB, APOLLO, A.T., AUDIO ALCHEMY, AUDIO QUEST, B.&W., BOSE, BEYER, CABLE TALK, CHORD, CYRUS, CELESTION, DPA, EPOS, EXPOSURE, INFINITY, JPW, KEF REFERENCE, KENWOOD, MARANTZ, MICHELL, MONITOR AUDIO, MONSTER, MORDAUNT, SHORT, MERIDIAN, MICROMEGA, MISSION, MOTH, MUSICAL FIDELITY, NAKAMICHI, ORTOFON, PROJECT, QUAD, ROKSAN, ROGERS, ROTEL, SENNHEISER, SONY, SPENDOR, SUMIKO, SYSTEMDEK, TARGET, TDL, THORENS, TRIANGLE, TUBE, TECHNOLOGY, VAN DEN HUL, VANDERSTEEN, YAMAHA, YBA

Two row video with base plinth and top moulding. Capacity 20 videos.

Three row video with base plinth and top moulding. Capacity 30 videos.



CD/cassette with base plinth and top moulding. Capacity 20 cassettes per shelf. 30 CD's per shelf. CD/cassette without base plinth for wall mounting. CD/cassette units available in 2, 3, 4, 5 shelves

**TEAMPOINT**

**THE PROFESSIONAL SOUND & VISION STORAGE SYSTEM DIRECT FROM THE MANUFACTURER**

Finished in real wood veneer, or as you require. Special units made to order ★ Hi Fi units made to order. Please contact us with your requirements.

Contact Caroline on: 081-390 2101 or send the coupon below to: Teampoint Ltd, 54 Lower Marsh Lane, Kingston, Surrey, KT1 3BJ.

PLEASE SEND ME THE TEAMPOINT SOUND STORAGE SYSTEM BROCHURE

NAME \_\_\_\_\_

ADDRESS \_\_\_\_\_

TEL NO. \_\_\_\_\_

AP1/84

**LORICRAFT AUDIO**

Turntable Repair and Record Cleaning Service.



A new improved version of original design concept. Made of 28mm. ash or oak, with heavily reinforced corner bracing complete with perspex Cover and hinges. Designed for Garrard 301/401, Thorens TD 124 plinth available shortly.

Loricraft is a new low distortion active and isolated power supply, it improves the performance of Garrard 301/401, TD 124. It also enables U.K. specification turntables to be used anywhere in the world. (prototype was shown at Penta 93.) £379 standard £399 with Meter.

Original PSU 1 still in production. All the above is based on original Garrard technical information. £149

Full services, facilities for Garrard 301/401, including Thorens using genuine or re-manufactured parts in dedicated workshop. Damper rings Dramatically reduce ringing of £5.00 per pair. Many new accessories and spares for Garrard available shortly.

**New Catalogue now available**

4 Big Lane  
Goose Green  
Lambourn  
Berks. RG16 &XQ  
Tel. 0488 72267

**WOLLATON AUDIO**

**AUDIOPHILE BARGAINS**

We are having a clear out of ex-dem and second hand stock.

	NOW	LIST
Krell KSA 50 MK 2 (my own amp) s/h	£950	£2450
Audio Synthesis Passion preamp x/d	£295	£500
Audio synthesis D to A (including AT and T and synclock) x/d	£750	£1400
Audioquest AQ7000 cartridge new	£545	£1400
Audioquest AQ7000 cartridge x/d	£400	£1400
Maplenoll Ariadne T/table and arm x/d	£995	£2500
<b>Clements loudspeakers (ex review models) various available.</b>		
Si 300(2 pairs) x/r	£425	£645
Si 600(1 pair) ex review x/r	£795	£1050
Si 400 x/d	£450	£795
Si 800 x/d	£825	£1200

Other items also available, please ring for details. P.S. We have no Ex-dem XLO cables, but even at full price they are the best "sound per pound" : call for details af your local dealer.

**WOLLATON AUDIO - TEL/FAX: 0602 284147**



# WORLD DESIGNS

## by Mail Order

world audio design mail order

### K5881 KIT

£395 ▼



Here's a superb, Class A, 20watt stereo power amplifier that uses the inexpensive Russian 5881 output valve, a military version of the regarded American 6L6, designed for low distortion audio work. It has super-quality output transformers (4/8/16Ω selected internally) to minimise distortion and the input stage uses triode working. A rugged, sixteen-gauge, all-welded steel chassis is provided, together with protective bottom plate for safety; a protective top cover is an optional extra.

Designed for long life, low running costs and excellent sound quality, K5881 is sensitive enough to be used with a simple passive pre-amp. or our own line-drive pre-amp, and it matches modern loudspeakers well. There is a choke-regulated power supply and the channels can be paralleled to turn it into a 40W monoblock if desired.

K5881 costs just £395 as a kit of parts and £595 fully built from our own build service. The U.K./Europe version has a 240/220V transformer but 120/110V can be supplied as an alternative - see Overseas details on Order Form.

### SPECIFICATION

Power	20watts/ch.
Frequency response	16Hz-40kHz
Distortion	0.02%
Separation	60dB
Noise (CCIR)	-103dB
Sensitivity	240mV
Dimensions (mm)	400w,300d,180h
Supply	110/120V or 220/240V, 220W
Weight	16kgs(34lbs)

### VALVE LINE LEVEL PRE-AMPLIFIER £295 ▶

We now have finished the design of a super high quality chassis for the line level pre-amplifier. It is constructed from heavy gauge steel with an aluminium anodised and polished front panel. This new chassis comes with the complete kit of parts necessary to build the valve line level pre-amp.

The components are all high quality and include a special screened toroidal transformer, Military Spec. Russian valves, Alps potentiometer, metal film resistors, polypropylene signal capacitors, silver plated copper wire etc.



### ◀ HIGH DEFINITION LOUDSPEAKER £295

The High Definition loudspeaker is ideal for low power, high quality amplifiers, transistor or valve. It goes very loud with just 1-5watts, having an enormous sensitivity of 94dB - that's 8dB more than most other speakers. It is also a very easy load for valve amps (8ohms) and it gives a terrifically dynamic and fast sound.

As well as being just about unmatched as a partner for esoteric amps, this speaker is also unusually suited to low powered vintage amplifiers, such as Quad IIs, Radfords, Pye Mozarts and such like.

The High Definition DIY loudspeaker is available as a complete kit including flat pack cabinet, drivers modified and tested by us, all crossover components and hardware. The flatpack cabinet is finished in an attractive satin black and requires no further finish, but for those who prefer something a little more traditional a mahogany veneer is an option.

If you would like to build your own cabinets we are also offering a drive unit pack that comprises two tweeters and two woofers, modified and tested.

**KLS2 LOUDSPEAKER**  
Satin Black/Mahogany Veneer  
Drive Unit Pack

£295/£345  
£145

# WORLD DESIGNS

## by Mail Order

### 300B VALVE AMP KIT

£750



### 4W SINGLE-ENDED TRANSFORMERS

£190

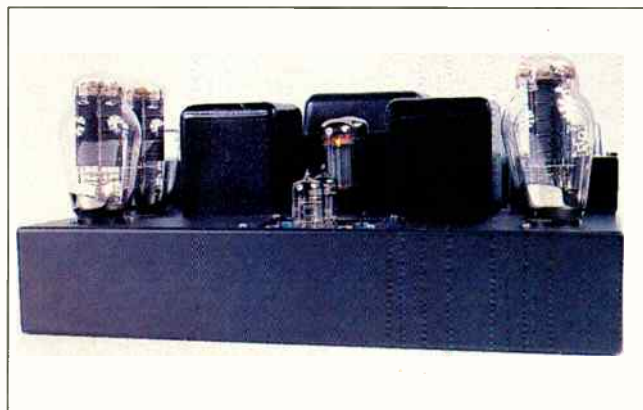

This is a specialised amplifier based on the highly linear 300B triode valve. Tim de Paravicini designed it - including the massive transformers - for minimum distortion without overall feedback. If you want feedback (tertiary or overall), it can be applied without difficulty.

Our 300B runs in Class A, giving one of the most sweet, open and neutral sounds possible today. Matched with good loudspeakers, it is unsurpassed.

The kit comprises a strong 16-gauge mild steel chassis, fully punched, welded and ground smooth. Finish is a durable 'powder coat' black. A protective bottom plate is provided for safety; a protective top cover is an optional extra. Output terminals (one pair) take 4mm plugs axially and radially for bi-wiring, or heavy gauge bare cable. Output options of 4/8/16Ω are selected internally at the transformer. A small circuit board carries most of the components. 240/220V and 110/120V versions available - see Overseas details and prices on Order Form.

All parts are included in the kit, except valves since different 300B makes are available.

A fully built version from an approved build service is also available for £1050 (valves extra). Availability - end of January 1994.

#### SPECIFICATION

Power	28watts
Frequency response	5Hz-36kHz
Distortion	0.2%
Separation	54dB
Noise (hiss/hum)	-100dB/-72dB
Sensitivity	240mV
Dimensions (mm)	405w,295d,175h
Supply	110/120V or 220/240V, 220V
Weight	20kgs(44lbs)

#### DEMONSTRATIONS!!

By the time you read this we hope to have our K588I 20W valve power amplifier and KLP-1 valve pre-amplifier on demonstration at Hi-Fi Confidential, 34 Buckingham Palace Road, Victoria, London. Phone the patient and understanding Luigi on 071-233-0774 to check availability. He's a valve aficionado, knows Tim de Paravicini and is still sane, and stocks plenty of good products - including World Audio Design. So hear us against the others - and don't you dare buy them

A set of transformers (8kgs) for our single-ended amplifier (December '93. Supplement No 6).

- 1) Mains (1 off) Secondary: 0-210V a.c. at 150mA, 6.3V centre tapped. Primary: 220/240V or 110/120V - please state which on order form. Drop through fixing.
- 2) Output (2 off) High quality transformers with grain orientated silicon steel laminations. Secondary tapped 4/8/16Ω. Drop through fixing.
- 3) Choke (1off) Compact 1.2H/150mA choke for under-chassis fixing. Frame mount.

6080 valves - double-triode power valve for the single-ended amplifier - £15.00

### K588I (20W CLASS A ) TRANSFORMERS £220

There are four transformers in all, weighing 12kgs.

- 1) Mains (1 off) Secondary: 0-360, 1 x 6.3V centre tapped. Primary 220/240 or 110/120 - please state which on order form. Drop through fixing.
- 2) Output (2 off) These transformers use high quality materials, laminations of thin and best quality grain orientated silicon steel. Output tapped 4Ω, 8Ω and 16Ω. Drop through fixing.
- 3) Choke For smoothing of the H.T. line to provide best sound quality, a 5H choke that fixes under the chassis. Frame mounting.

### 300B (28W CLASS A) TRANSFORMERS £430

Seven transformers in all, weighing 16kgs (35lbs)

- 1) Mains (1 off) Secondary: 490V-0-490V, 6 x 5V, 1 x 6.3V. Primary 220/240 or 110/120 - please state which on order form. Drop through fixing.
- 2) Output (2 off) Designed for low distortion and broad load compatibility from the 300B. Cores with centre-hole fixing to avoid corner flux concentrations; laminations of grain orientated silicon steel. Output tapped 4/8/16Ω. Drop through fixing.
- 3) Intervolve/phase splitter (2 off) Special Tim de Paravicini design, potted in steel for secrecy. Drop through tags.
- 4) Chokes (2 off) For smoothing of the H.T. lines, two 5H chokes that fix under the chassis. Frame mounting.

### HIGH PERFORMANCE 3-WAY SPEAKER £729

Our high performance 3-way DIY loudspeaker featured in Supplement Nos. 3 & 4 is now available as a kit. The cabinet has been designed to be extremely easy to build (even though there are 36 panels for the pair) requiring only wood glue and stretchy carpet tape to clamp the panel in place. All drive units and hardware are supplied.

When built, the loudspeaker is comparable to those costing more than twice the price, with a transparency and openness in the midrange that is unmatched by most. The price for this entire kit, including VAT and p&p is £729.

See page 91 for order form...



## SPECIAL MAIL ORDER

### HI-FI WORLD SOLID SILVER INTERCONNECTS.

Constructed from strands of solid core silver wire and silver soldered to the excellent Neutrik Profi phono plugs which are probably the best available. These line level interconnects offer the ultimate in transparency, openness and detail. The plugs are bonded to the cable with adhesive heatshrink to ensure that the cable has a long life without fatigue occurring at the plug join. Available exclusively through Hi-Fi World Mail Order

**HI-FI WORLD SOLID SILVER CABLE.....£139.95/1M PAIR.**

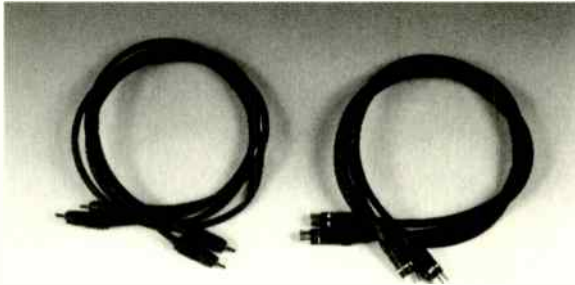

### HI-FI WORLD SILVER PLATED COPPER INTERCONNECTS.

These have a similar construction to our solid silver cables, but use silver plated copper and standard Gold Phono plugs. Because the majority of the audio signal is passed through the skin of a cable these can approach the quality of a silver cable with the cost of a normal high quality copper

cable.  
**HIFI WORLD SILVER PLATED COPPER INTERCONNECTS £69.95/1M PAIR.**

### HIGH QUALITY MAINS CABLES.

Supplied to Hi-Fi World by Campaign Audio Design these mains cables are screened to reduce Radio Frequency and Electromagnetic Noise. They also come with a VDR fitted which protects equipment from mains spikes. The MK plugs have a silver plated fuse and holder for the cleanest supply. Available with IEC or Figure eight (Marantz/Philips CD players) equipment plugs or with a hard wired, soldered 4-way mains block.  
**IM WITH IEC PLUG.....£19.20**  
**IM FIGURE 8 PLUG.....£15.75**  
**IM 4-WAY BLOCK.....£31.95**

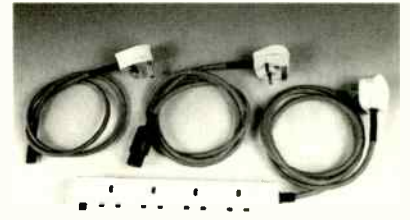

### RECORD STORAGE CUBE

Designed to hold about a hundred LPs, with an internal width of 37cm, height of 32.5cm and depth of 32cm. The cubes can be stacked or placed alongside each other - and are even strong enough to be used as seats! Made from 15mm MDF (Medium Density Fibreboard) with a smart durable black paint finish, the cube is supplied in flat-pack form ready for home

assembly.  
**RECORD STORAGE CUBE .....£42 EACH**

### FREE!

**50 RECORD SLEEVES WITH 4 CUBES**

**6 CUBES FOR THE PRICE OF FIVE .....£210.00**

**8 CUBES FOR THE PRICE OF SEVEN! .....£294.00**

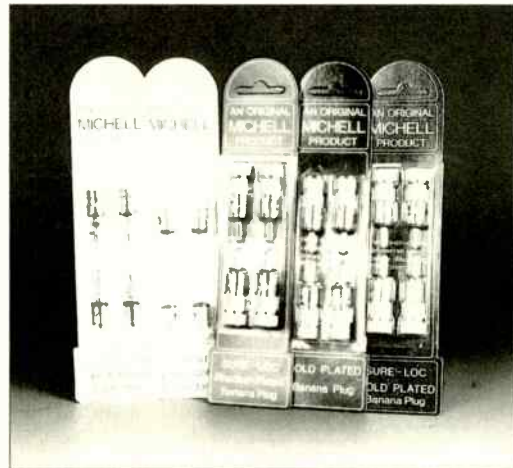

specially made in Japan to Arcam's specification, will accept cable up to 7mm in diameter. The body is nickel-plated, the contacts plated in gold. Supplied in pairs marked with either one ring or

### MICHELL ENGINEERING PLUGS

Craftsmanship marks out Michell Engineering's range of gold and rhodium plated plugs from the competition. Simple but elegant.  
**GOLD-PLATED SIDE ENTRY BANANA PLUGS (4) .....£10.00**  
**GOLD-PLATED SURE-LOC BANANA PLUGS (4) .....£14.95**  
**RHODIUM-PLATED SURE-LOC BANANA PLUGS .....£18.95**  
**GOLD-PLATED SPEAKER CABLE CONNECTORS...£10.00**

### ARCAM RCA PHONO PLUGS

This heavy-duty phono plug,

two to allow directionality to be taken into account.  
**RCA PHONO PLUGS (4).£15.50**

### GOLD PLATED 4MM BANANA PLUGS

We have a new style, heavy-duty, gold-plated banana plug with a unique type of axial solderless connection for loudspeaker cables. The cable is stripped back and pushed into a clamping collar which is then screwed down tight, accepting cable up to 6mm external diameter and 4mm core diameter. Supplied in sets of four.

**BANANA PLUGS (4) .....£8.00**

# Hi-Fi World

# AUDIO ACCESSORIES

## AUDIO-TECHNICA RECORD CLEANING SYSTEM

Removes both dirt and static; a tiny amount of cleaning agent in the handle removes fingerprints, oil and film, while a pad lifts off dust. Pad brush and fluid are supplied.

**AUDIO-TECHNICA RECORD CLEANING SYSTEM £10.50**



## AUDIO-TECHNICA COMPACT DISC LENS CLEANER

A disc the size of a CD, with fine brushes - one of which is dampened with cleaning fluid. As the disc spins in the player, the brushes clean the laser lens. It may not suit all machines.

**CD LENS CLEANER.....£16.25**



## BUG AUDIO

A fascinating little device no larger than a hand-held remote which allows the user to adjust bias on any cassette deck perfectly for any tape. You can check the state of your cables and connections with it, too! Supplied with a cassette test tape and full instructions. (See review, Nov. 1992 issue.)

**BUG AUDIO .....£59.99**



## KONTAK

An effective cleaning solution that removes contaminants from electrical connections. After application, a system regains its original life, sparkle and vigour.

**KONTAK .....£19.00**

## HI-FI WORLD DRY STYLUS CLEANER

Keep your stylus sharp and bright for perfect tracking without using fluid. Cut a strip about the size of a matchbox striker off this sheet of card and draw it gently under the stylus from back to front. One sheet of this card, with its aluminium-oxide micro-abrasive coating, should be enough to clean your stylus at least forty times.

**DRY STYLUS CLEANER...£1.95**

## GOLDRING EXSTATIC MAT

For vinyl users, the Goldring Exstatic is a felt mat made with fine carbon fibre strands. This helps to reduce positively charged static electricity that builds up on the surface of records.

**GOLDRING EXSTATIC MAT £7.50**



## SUPER EXSTATIC CARBON FIBRE DISC CLEANER

Effectively removes dust and grime from record grooves, this cleaner is a combination of one million carbon fibre filaments and a soft velvet cleaning pad.

**EXSTATIC CARBON FIBRE CLEANER £9.75**

## SOUND SWIVEL

A rotating, upright, double-sided, storage cabinet with space for up to 160 Compact Discs, including 8 double jewel-cases. Mounted on an all-steel turntable, it swivels smoothly through 360 degrees giving easy access to the storage compartments either side. Manufactured in durable MDF with a Black Ash effect finish, the Sound Swivel comes packed for self assembly with full instructions.

**SOUND SWIVEL ..... £49.95**

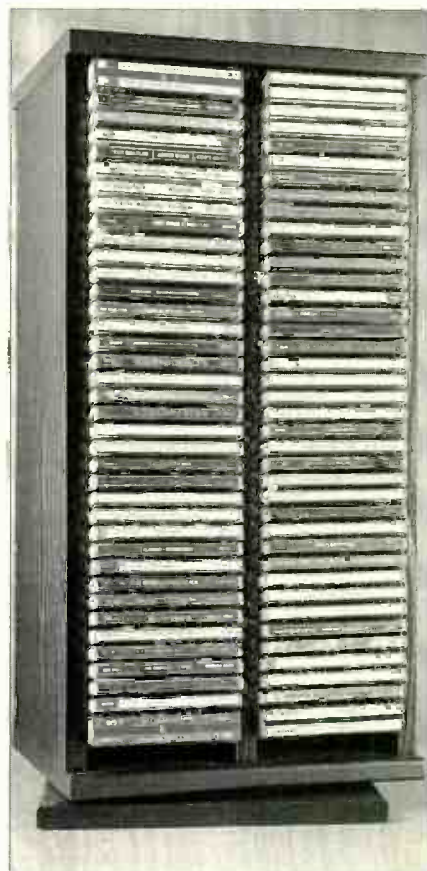

# AUDIO ACCESSORIES

## LASAWAY GREEN PEN

When red laser light hits the reflective surface of a CD, some of it can be scattered off the edges of the disc, causing optical interference. Applying this green coating, formulated by Japanese company Mitsubishi, to the inner and outer edges of the CD reduces this interference, improving sound quality.

**LASAWAY GREEN PEN ....£8.50**



## ANTI-STATIC RECORD SLEEVES

Translucent sleeves, treated to reduce static and dust attraction, supplied in packs of fifty. They will fit inside ordinary printed inners.

**LP SLEEVES (50) PRICE £7.50**

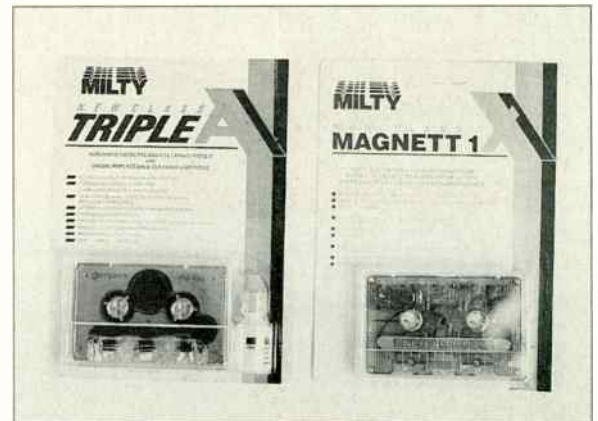

## MILTY TRIPLE A

Suitable for all types of cassette players including auto-reverse, the Milty Triple A wipes clean single/dual capstans and pinch rollers with a non-abrasive cleaning action.

**MILTY TRIPLE A £6.50**

## MILTY MAGNET IX

The Milty Magnet IX comes complete with battery. It requires approx one second to de-magnetise the heads removing magnetic charge build up. Recommended after every 30 hours of playing time.

**MILTY MAGNET IX £10.50**

## HI-FI WORLD SPECIAL AUDIO ACCESSORIES ORDER FORM

Please send me:

- Audio Technica CD Lens cleaner.....£16.25 each
- Audio Technica Green CD Ring Stabilizers.....£6.50 (Pack of 5)
- Audio Technica Record Cleaning System.....£10.50
- Automatic CD Cleaner.....£21.95
- Bug Audio Biasbug.....£59.99
- CD sound swivel.....£49.95
- Gold plated 4mm plugs.....£8.00 (4)
- Goldring Exstatic Mat.....£7.50
- Goldring Super Exstatic Carbon Fibre Disc Cleaner.....£9.95
- HFW Silver Plated Copper Interconnects (1m pair).....£69.95
- Hi-Fi World Dry Stylus Cleaner.....£1.95 per sheet
- Hi-Fi World Solid Silver Interconnects (1m pair).....£139.95
- Kontak cleaning fluid.....£19.00each
- Lasaway Green Pen.....£8.50 each
- Laserguide.....£14.95
- Michell Gold-Plated Side Entry Banana Plugs (4).....£10.00
- Michell Gold-Plated Speaker Cable Connectors.....£10.00
- Michell Gold-Plated Sure-Loc Banana Plugs (4).....£14.95
- Michell Rhodium-Plated Sure-Loc Banana Plugs (4).....£18.95
- Milty Magnet IX.....£10.50
- Milty Triple A.....£6.50
- Nagaoka Anti-static record sleeves.....£7.50 (50)
- ON Stylus Cleaning Kit.....£2.50
- Pixall MkII Record Cleaner.....£10.75 each
- Pixall refill roller.....£2.75each
- Record storage cube.....£42.00 each
- Screened Mains Cable With 4-Way Block (1m).....£31.95
- Screened Mains Cable With Fig 8 Plug (1m).....£15.75
- Screened Mains Cable With IEC Plug (1m).....£19.20
- TDK Head Cleaning Kit CK-A1 (double bottle).....£5.50
- TDK Head Cleaning Kit CK-TB (single bottle).....£4.65

All prices include postage & packing in the UK only, add £1 for overseas p&p.

I enclose cheque/PO for £.....made payable to  
**World Audio Publishing Ltd.**

I wish to pay by Visa/Access, please debit my account no:

--	--	--	--	--	--	--	--	--	--	--	--	--	--	--	--	--	--	--	--

--	--	--	--

Expiry date:

Name.....

Delivery Address.....

N.B. If delivery address is different to the credit card holder's address please supply both.

Tel:.....

Please send completed order form together with your cheque/PO to:  
**HI-FI WORLD,**  
64 Castellain Road,  
Maida Vale,  
London W9 1EX.



Credit Card Orders  
Telephone 071 - 266 0461  
24 hour Mail Order Answerphone

# Hi-Fi World

## AUDIO ACCESSORIES

### SME Garrard Celebration Arm

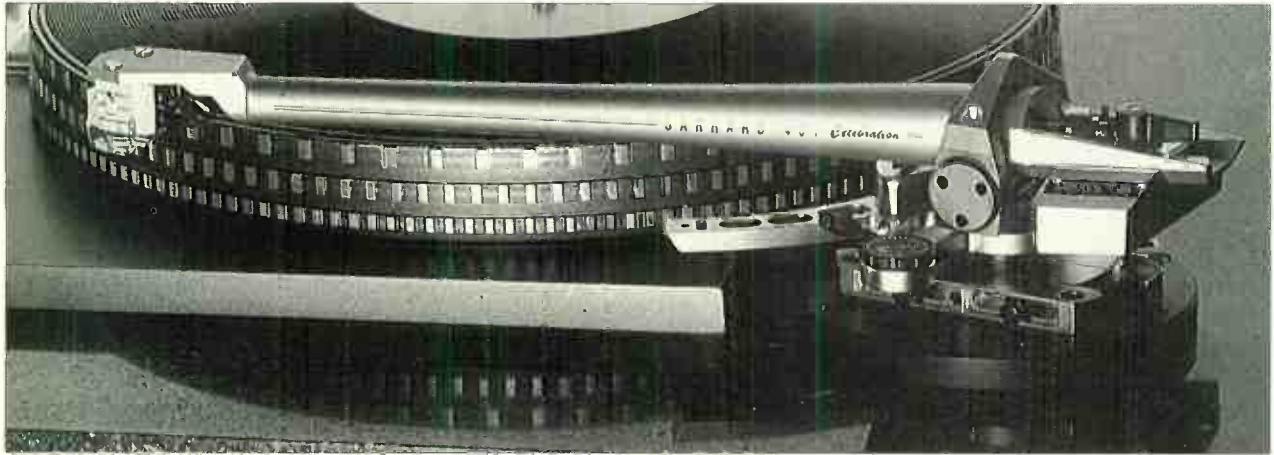

#### GARRARD 401 CELEBRATION SME IV TONEARM

A special version of the SME IV cast magnesium alloy tonearm, dedicated to the Garrard 401. The SME IV is precision engineered to be fully adjustable, making set-up easy and precise. If you want to get the best from your Garrard 401, this is a fantastic tonearm, sympathetically styled to form a perfect combination.

#### EQUIPMENT SUPPORTS

FrameWorks is an innovative range of versatile hi-fi supports whose high standard of strength and rigidity results from their 'triangulate' design. The shelves are supported on struts of thin cross-

section and four sturdy corner columns, to reduce resonances.

Versatility is guaranteed by two or three shelf options, an additional isolation shelf and a stacking unit to expand the system as the hi-fi grows. All you need to do is add components as and when you feel the need.

FrameWorks stands come with attractive 10mm thick toughened smoked glass shelves, supported on rubber-damped spikes to reduce vibration and lessen the tendency for the glass to slide. Metal parts are finished in a hardwearing satin black powder coat.

FrameWorks stands will extract the best out of any equipment.

FrameWorks' excellent hi-fi equipment stands are now available through our Mail Order Department. Please phone for further details: 071 266 0464

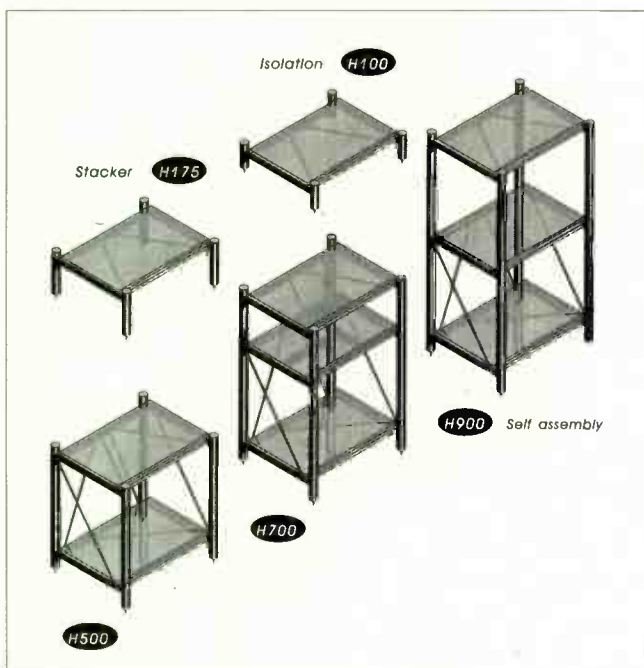

#### H100 ISOLATION TABLE

PRICES FOR FRAMEWORKS EQUIPMENT STANDS ARE AS FOLLOWS;

CODE	HEIGHT	PRICE
H100	100MM	£109
H175	175MM	£119
H500	500MM	£205
H700	700MM	£275
H900	900MM	£305

ALL FRAMEWORKS SHELVES ARE 550MM WIDE BY 450MM DEEP. All prices include VAT & p+p for UK only.



# Music Mill

At the Music Mill, we believe that buying hi-fi should be a pleasurable experience. We offer friendly professional service and advice in comfortable 'no rush' surroundings with the emphasis on your specific requirements. Excellence in hi-fi includes Nakamichi,

## hear

Harman Kardon, DNM, Rehdeko, Audio Innovations, Nottingham Analogue, Pro-Ac, Systemdek, B&W, Cerwin Vega, Dal and Micromega.

The Music Mill - a fresh approach to hi-fi selection.

Access for people with special needs

Specialist hi-fi technical advice and service

## here

The Music Mill (Scotland) Ltd  
Bonnington Mill Business Centre  
72 Newhaven Road  
Edinburgh  
EH6 5QG  
Tel & Fax: 031-555 3963

# SALE

## ONE DAY ONLY

### UP TO 50% OFF

**STRICTLY** for one day only! **Sunday 27th March.**  
The last KJ one day event of the current season. Don't miss this great hi-fi opportunity! You'll be amazed at the array of the best equipment with fantastic discounts on dem' equipment ranging from 20% down to half price on some clearance items. Bring your cheque book, bring your credit cards or we'll even take cash! Above all bring yourself and treat yourself you deserve a break. We open at 10am and close at 4pm. **Sunday parking** around the store is very easy. You can park on meters and single yellow lines.

#### Established brands stocked by KJ

Accuphase \* Acoustic Energy \* Albarry \* Apogee \* Arcam  
Audio Alchemy \* Audio Innovations \* Audion \* Aura \* Audiolab  
Audio Research \* B & W \* Chord \* Croft \* DPA \* Epos \* Gradient  
Impulse \* KEF \* Krell \* Lexicon \* McIntosh \* Marantz  
Martin Logan \* Meridian \* Michell \* Mission \* Musical Fidelity  
Nakamichi \* Nitty Gritty \* Orelle \* Pink Triangle \* Proac \* Quad  
Rogers \* Roksan \* Rotel \* SME \* Sonus Faber \* Stax \* Spendor  
Systemdek \* Tannoy \* Theta \* Thiel \* Wadia



#### KJ WEST ONE

26 New Cavendish Street, London W1M 7LH  
(Close to Marylebone High Street)

Tel: 071 486 8262/8263 • Fax: 071 487 3452

Open: Mon-Sat 10.00 a.m. - 6.00 p.m. Thurs until 7.00 p.m.

## Hi-End Hi-Fi in the heart of East Anglia.

For the best in Hi-End hi-fi Bury Audio is a must. All the names stocked are individually chosen to complement one another to give the best sound in their class. To get the best from CD there are DAC's like **Pink Triangle - Da Capo** or **Ordinal**. Great sounds now can mean good looks too thanks to **Michell - Iso, Argo, Alecto**. Now, Gyrodec sounds better still with the **Tesseract - Tags psu**. Valves from **Tube Technology - Unisis**. For fanatics, **Musical Fidelity - F22** and **F15**. Open natural sounds from **LFD - PAO, LSO, MMO**. Stunning to look at and to listen to the new **Ruark - Equinox**. These are just a selection of the impressive sounds on demonstration now. Why not come in and have a listen to the best sounds in East Anglia.



### Bury Audio

47 Churchgate Street,  
Bury St. Edmunds, Suffolk IP33 1RG  
Tel or Fax : 0284 724337





# CHESTERFIELD SHOW

Saturday 23rd & Sunday 24th April 1994

**Your chance to hear the leading edge in Hi-Fi Technology  
and to meet the Designers**

Over thirty of this country's leading exponents of the Art demonstrating their products plus trade and magazine stands.

Ringwood Hall, a superb setting, has once more been chosen for this year's much enlarged show and offers:

- Real Ale Bars
- Restaurants

*"A great day out for all the family..."*

- Bar lunches
- Free Car Parking

Ringwood Hall  
Brimington  
Chesterfield  
Derbushire

**Further details: (0709) 875408 or (0246) 200096**

On the A619  
4 miles West from J30  
M1 Motorway

## “REAL WOOD HELPS CALLAS HIT ALL THE RIGHT NOTES”

What Hi-Fi? July, 1993



- ★ **Unsurpassed sound at £750 the pair**
- ★ **Phone or write for review reprints and details of the full range of superb Opera loudspeakers**

**CALLAS from UKD**

UK DISTRIBUTION  
23 RICHINGS WAY

IVER, BUCKS SL0 9DA

TEL 0753 652669 FAX 0753 654531

UKD distributes: METAXAS - OPERA - BEARD

## *Real Music Distribution*



*“These speakers produce an extraordinary sensation of strong, clean, firm low bass . . . ‘wow, that’s an amazing sound; they’re so clear!’ . . . it’s the overall precision, tightness, focus and tonal accuracy that my friends and I delighted in . . . they are solid and seriously well made.”*

Eric Braithwaite, Assistant Editor, Hi-Fi World, March 1993.

There are limited quantities to clear, available in most finishes.

Original rrp £1,200.

LIMITED  
QUANTITY **£589**  
plus VAT

DEDICATED  
STANDS **£99**  
plus VAT

For further information, a prospectus or a possible home demonstration, please call:

**Paul Order on 081-651 4149**

Gessmaster

Musical Images Ltd.  
173 Station Road,  
Edgware, Middlesex  
HA8 7JX  
Tel: (081) 952 5535  
FAX: (081) 951 5864



Musical Images Ltd.  
45 High Street,  
Hounslow, Middlesex  
TW3 1RH  
Tel: (081) 569 5802  
Fax: (081) 569 6353

## NEW/BARGAINS & YEAR END SALE

QTY	Item	Type	Condition	Was(£)	Now(£)
50	Sony TCK611S	C/deck	New	330	265
50	Sony STS311	Tuner	New	200	170
10	Sony TCK511	C/deck	New	280	230
50	Nakamichi i- A3	Amp	New	350	200
4	Rotel RTC950	Pre-amp (with remote)	New	420	288
5	NAD 3100	Amp	New	330	200
5	Yamaha AX570	Amp	New	290	250
10	Denon PMA880	Amp	New	300	270
10	Marantz PM32	Amp	New	150	110
3	Rotel RA940	Amp	New	250	175
1	Harbeth HL5	Speakers	Display	1000	750
2	Jamo 707	Speakers	Display	900	700
1	Jamo 507	Speakers	Display	700	550
1	Ruark Talisman	Speakers	Display	700	600
1	Crewin Vega CT1215	Speakers	Display	1300	900
6	Canon S50/ST50	Speakers	New	430	250
2	Kef Centre 100	Centre Spkr	Display	350	300
4	Philips DCC900	DCC	New	550	300
2	NAD 6325	C/deck	Display	170	130
8	Denon TU580	Tuner	New	220	190
2	NAD 4225	Tuner	Display	170	125
2	Michell Syncro	Turntable, no arm	Display	325	275



**081-952 5535**

**N/NW London**



**081-569 5802**

**10 min from Heathrow**

**HOME CINEMA SPECIALISTS**

E&OE

# GOLMUND ACCESSORIES

<b>*Lineal Cable</b>	1.5 meter	£425
digital & analogue reference		
- any other length: £725. - (= 0 meters) plus £50. - per meter		
<b>* Powercord standard</b>	up to 1 meter	£200
(all hifi components)	up to 2 meters	£375
- any other length: £375. - (= 0 meters) plus £35. -per meter.		
<b>* Powercord special</b>	up to 1 meter	£200
(heavy power amp version)	up to 2 meters	£375
- any other length: £375. - (= 0 meters) plus £35. -per meter.		
<b>*Cones</b>	set of 3	£215
applicable under all hifi components		
<b>*Bananas</b>	set of 4	£250
improve speaker connections		
<b>* Miracle Cleaner</b>	1bottle	£20
clean acryl &CD		

YOU'VE TRIED THE REST, NOW BUY GOLDMUND

Documentation can be obtained from the address mentioned below. Prices include p&p.  
Please allow up to 28 days for delivery. Send your cheques or money order to:  
PHOENIX, Grootzeil 7, 3891 KH ZEEWOLDE, The Netherlands.  
In. Tel.: +31 3242 3000. Int. Fax.: 31 3242 3510

## The SPEAKER Company

For all your needs in DIY speaker and crossover construction

We offer a large range of speaker chassis and crossover components for hi-fi, car audio, public address & studio uses. The Speaker Company also offers a range of specialist services.

**Hi-Fi** chassis speakers, crossover's, cabinet kits, cable, cabinet damping materials, spike kits etc

**Car Audio** chassis speakers, crossover's, sub bass cabinets and amplifiers.

**Public Address** chassis speakers, crossover's, mixers, amplifiers, cabinets, microphones and stands.

Plus a comprehensive range of accessories

### Chassis speakers by

Audax, Seas, Morel, Rcf, Kef, Elac, Rcl, Richard Allan, Fane, M<sup>c</sup>Kenzie, Celestion, Eminence, Peerless, Volt, Altai, Soundlab, P.H.L.  
Please phone or post for a copy of our free comprehensive catalogue and price list which includes hints and tips on DIY loudspeaker construction.

Unit 9, Waterside Mill, Waterside  
Macclesfield, Cheshire SK 11 7HG  
Tel: 0625-500507  
Fax: 0625-500508

All goods dispatched within 24 hours subject to availability  
Open 9 am to 6 pm Monday to Friday & 9 am to 5 pm Saturday

## EXPLOIT THE FULL POTENTIAL (and more) OF THE LINN LP12 Turntable

For Only  
**£568.00 inc.**

(Cost much less than a Lingo)

with  
**Avondale Audio's**  
Very Naughty (but Stunning) Conversion

For a chat

**Tel: (0246) 200096**

Please note that we are no longer able to reply to enquiries in writing.

## SLATE AUDIO

HI-FI Design & Cable Services



**THE SPEAKERSTAND** Custom made to suit any loudspeaker. Solid slate, supremely rigid & totally stable. P.O.A.

"Immaculately finished, sublimely rigid, on a par with the best stands I've used."  
Ken Kessler, Hi-Fi News/RR March '89  
"An astonishing degree of instrumental separation, stable and holographic, with great precision and remarkable poise. The ultimate in high fidelity supports."  
David Praker, Hi-Fi Answers Sept. '89  
"Superbly finished, the sound quality was considered to be first rate."  
Martin Colloms, Hi-Fi News/RR May '90  
"The sound quality when using the Slate Audio stands proved to be a revelation, something special."  
Paul Messenger, Hi-Fi Choice, May '91  
"The finish is excellent, the sound quality magnificent and breathtaking."  
Tom Bryant, The Telegraph, June '92

### The Finest Speaker Supports In The World

**GARRARD 401/301 PLINTH SYSTEM** With 20 years of experience, we are the leading experts on the 401/301. Our solid marble plinths transform these decks into world class beaters.

(Free servicing and fitting) £349 + £25 p/p

**THE GLASSMAT** A dedicated platter mat for the Garrard 301/401 that also works with all other turntables. Sensational, unbelievable, brilliant! £49.95 + £2 p/p

**SME 309/3 12/IV/IV** With special graphics "Garrard 401 Celebration"  
£568.39  £660.93  £827.20  £1232.49

**THE TURNTABLESLAB** Solid slate spiked turntable platform, can be placed anywhere with remarkable results. Size 17" x 14" £175.00

**THE TABLESLAB** Solid slate shelf which replaces any other shelf normally fitted to equipment racks, dramatically improving your turntable's performance. Slate size:  £125.00

**THE SPIKEKIT** Specially developed to fit directly to floor standing loudspeakers or any wooden support. Adjustable and very simple to fit. £20.00

**THE STONESET** Spike kit for use with stone, slate or marble only. Fully adjustable. £20.00

ALL PRICES INCLUDE PACKING AND FREIGHT UNLESS OTHERWISE STATED.

(U.K. MAINLAND)

I ENCLOSE A CHEQUE/P.O. for £ \_\_\_\_\_ made payable to SLATE AUDIO

Name: \_\_\_\_\_

Address: \_\_\_\_\_

Tel: \_\_\_\_\_

47 GEMINI CLOSE, LEIGHTON BUZZARD, BEDFORDSHIRE, LU7 8UD. TEL 0525 384174

# HI-WAY HI-FI LTD

071-723 5251

## WE GUARANTEE YOU CAN'T BUY BETTER!

(FROM AUTHORISED DEALER AND IN STOCK)

# MAIL ORDER HOTLINE (071) 723 5251

SAVE ££s  
TRY US  
FIRST!

• AWARD WINNERS • BEST BUYS • RECOMMENDATIONS •

<b>KENWOOD</b> KR-V6050 	<b>MARANTZ</b> CD-52 Mk II SE 	<b>SONY</b> TCK-611S 	<b>TECHNICS</b> SU-A900 	<b>SONY</b> ST-S311 	<b>MARANTZ</b> PM44SE 	<b>TECHNICS</b> SC-CH950 
<b>IN STOCK</b>	<b>IN STOCK</b>	<b>IN STOCK</b>	<b>IN STOCK</b>	<b>IN STOCK</b>	<b>IN STOCK</b>	<b>IN STOCK</b>

### MINI SYSTEMS

<b>AIWA</b>	
LCX-07	£299.00
NSX-220	£249.00
NSX-270 (New)	£279.00
NSX-500	£349.00
NSX-D606	£409.00
NSX-D707	£479.00
NSX-D909	£529.00
<b>AKAI</b>	
MX-570	£329.00
MX-670	£529.00
MX-92	£289.00
<b>DENON</b>	
D65	£569.00
D90	£659.00
D110	£799.00
D250	£929.00
<b>JVC</b>	
Adagio G7	£799.00
Adagio G9	£989.00
Adagio S2	£359.00
Adagio S3	£389.00
Adagio S4	£459.00
Adagio S6	£589.00
MX-55M	£439.00
UX-A3	SPECIAL
UX-A4	£339.00
UX-A5	£349.00
UX-T1	£289.00
<b>KENWOOD</b>	
MS-A7	£379.00
UD-301/351M	£419.00/£469.00
UD-501 551M	£589.00/£639.00
UD-701/751M	£739.00/£789.00
UD-901/951M	£989.00/£1039.00
<b>PIONEER</b>	
N-33/33M	£369.00/£419.00
N-56/53M	£489.00/£539.00
N-57T	£559.00
N-53M/73T	£790.00/£669.00
<b>SONY</b>	
MHC-2800	£539.00
MHC-3800	£739.00
MHC-510CD	£369.00
MHC-710CD	£439.00
MHC-C50CD	£489.00
MHC-C70CD	£589.00
<b>TECHNICS</b>	
SC/CH404	£499.00
SC/CH550	SPECIAL
SC/CH650	SPECIAL
SC/CH655	SPECIAL
SC/CH750	£839.00
SC/CH950	£959.00

### MID SYSTEMS

<b>AIWA</b>	
ZD-3000M	£679.00
Z-720	£379.00
<b>AKAI</b>	
FX-440CD	£489.00
M-48CD	£319.00
M-55CD	£389.00
<b>JVC</b>	
W-37CD	£439.00
W-58CD	£489.00
W-78CD	£729.00
<b>KENWOOD</b>	
M-27	£519.00
M-47/M47G	£589.00/£739.00
M-56AG	£789.00
M-57MG	£839.00
M-76AG	£939.00
M-77MG	£989.00
M-97G/97MG	£1139.00/£1189.00
<b>PIONEER</b>	
J10/10M	£539.00/£579.00
J20/20M	£639.00/£679.00
J30/30M	£739.00/£779.00
J40/40M	£839.00/£879.00
m	£1129.00/£1179.00
<b>SONY</b>	
COMPACT 108CD	£339.00
COMPACT 109CD	£389.00
COMPACT 159CD	£439.00
COMPACT 209CD	£489.00
COMPACT 259CD	£549.00

### AMPLIFIERS

<b>COMPACT 359CD</b>	£589.00
<b>COMPACT 559CD</b>	£749.00
<b>COMPACT 759CD</b>	£1089.00
<b>TECHNICS</b>	
CD-X120	£699.00
CD-X320	£799.00
CD-X520	£899.00
<b>REVOX</b>	
EVOLUTION SYSTEM	£2249.00
<b>DENON</b>	
PMA-250 III 30W	£159.00
PMA-350 II 50W	£219.00
PMA-450 II 60W	£249.00
PMA-480R 50W Remote	£219.00
PMA-880R 75W Remote	£299.00
<b>JVC</b>	
AX-335TN 65W "Special"	£149.00
AX-A442 75W "Special"	£149.00
AX-435TN 85W "Special"	£169.00
AX-R337TN 45W AV Remote	£159.00
<b>KENWOOD</b>	
DA-9010 100W	£579.00
KA-1030 65W	£139.00
KA-3020 45W	£169.00
KA-3050R 45W Remote	£189.00
KA-4050R 70W Remote	£289.00
KA-5020 80W	£219.00
KA-5050R 95W Remote	£339.00
KA-7050R 100W Remote	£479.00
<b>PIONEER</b>	
A-102 30W	£119.00
A-202 40W	£159.00
A-300X 40W Award Winner	£189.00
A-351R 35W Remote	£189.00
A-400X 60W	£299.00
A-602 80W	£339.00
<b>SONY</b>	
TA-F211 30W	£149.00
TA-F242 60W	£189.00
TA-F442 80W	£239.00
TA-F542 90W	£289.00
<b>TECHNICS</b>	
SU-A600 40W	£199.00
SU-A700 45W	£249.00
SU-A800 55W	£329.00
SU-A900 80W "Best Buy"	£399.00
SU-V2220 30W	£129.00
SU-V2320 45W	£169.00
<b>YAMAHA</b>	
AX-470 65W	£239.00
AX-570 100W	£289.00
<b>ROTEL</b>	
RA-940AX 40W	£199.00
RA-920AX 20W	£129.00

### A/V PRO LOGIC AMPS/RECEIVERS

<b>DENON</b>	
AVC-1530	£479.00
AVC-3020	£729.00
AVC-3530	£999.00
AVC-1000	£519.00
<b>JVC</b>	
RX-508V 40W	£349.00
RX-608V 100W	£579.00
<b>KENWOOD</b>	
KR-V850 55W	£689.00
KR-V6050	£349.00
KR-V7050	£399.00
<b>PIONEER</b>	
VSA-701S	£489.00
VSA-D802S	£589.00
VSX-452	£389.00
<b>SONY</b>	
TA-AV570 70W	£389.00
<b>TECHNICS</b>	
SA-GX350 60W	£329.00
SA-GX550 100W	£449.00
<b>YAMAHA</b>	
DSP-A1000 Award	£899.00
DSP-A2070	£1099.00
DSP-A500	£469.00

### CASSETTE DECKS

<b>AIWA</b>	
AD-F410	£119.00
AD-F810	£229.00
AD-WX828	£189.00
AD-WX929	£219.00
<b>DENON</b>	
DRM-540	£159.00
DRM-710	£289.00
DRS-610	£199.00
DRS-810	£299.00
<b>JVC</b>	
TD-X352 "Special"	£109.00
TD-W708	£229.00
<b>KENWOOD</b>	
KX-3050	£159.00
KX-5050	£279.00
KX-5530	£209.00
KX-7030	£319.00
KX-7050	£389.00
KX-7050S	£389.00
KX-W4050	£159.00
KX-W6050	£189.00
KX-W8050	£249.00
<b>PIONEER</b>	
CT-S220	£159.00
CT-S320	£189.00
CT-S420	£239.00
CT-S520	£269.00
CT-620	£319.00
CT-M601	£369.00
CT-W420	£189.00
CT-W620	£239.00
CT-W820	£289.00
<b>SONY</b>	
TC-FX211	£99.00
TC-K311	£139.00
TC-K411	£189.00
TC-K511	£269.00
TC-K611	£319.00
<b>TECHNICS</b>	
RS-BX404 "Best Buy"	£179.00
RS-BX646	£229.00
RS-BX747	£299.00
RS-TR232	£179.00
RS-TR333	£199.00
RS-TR515	£259.00
RS-TR777	£299.00
RS-TR979	£379.00
<b>YAMAHA</b>	
KX-260	£159.00
KX-360	£199.00
KX-650	£199.00
KX-W262	£229.00
KX-W362	£249.00
<b>ROTEL</b>	
RD-945AX	£149.00

### COMPACT DISC

<b>AIWA</b>	
XC-300	£139.00
XC-750	£189.00
<b>DENON</b>	
DCD-1290	£329.00
DCD-595	£179.00
DCD-695	£199.00
DCD-890	£269.00
DCM-340	£349.00
<b>KENWOOD</b>	
DP-2050	£159.00
DP-3050	£189.00
DP-5050	£259.00
DP-7050	£339.00
DP-M6650	£259.00
<b>PIONEER</b>	
PD-102	£149.00
PD-202	£169.00
PD-DM602	£439.00
PD-M602	£259.00
PD-M701	£319.00
PD-M901	£439.00
PD-S502	£219.00
PD-S602	£259.00
PD-S702	£289.00

### CDV PLAYERS

<b>AIWA</b>	
CDP-311	£159.00
CDP-411	£169.00
CDP-711	£239.00
CDP-C325M	£219.00
CDP-C335	£219.00
CDP-M201	£139.00
CDP-M301	£159.00
<b>TECHNICS</b>	
SL-PG340	£149.00
SL-PG440	£169.00
SL-PG520	£179.00
SL-PG620	£199.00
SL-PS740	£249.00
SL-PS840	£419.00
SL-PS900	£349.00
<b>TEAC</b>	
CDZ5000	£329.00
<b>YAMAHA</b>	
CD-C-635	£299.00
CDX-1060	£599.00
CDX-470	£199.00
CDX-570	£239.00
CDX-670	£289.00
CDX-870	£329.00
<b>ROTEL</b>	
RCD-955AX	£229.00
RCD-965BX	£279.00
<b>SONY</b>	
MDP-650	£589.00
MDP-850	£689.00

### TUNERS

<b>AIWA</b>	
XT-003	£109.00
<b>DENON</b>	
TU-260 "Award"	£119.00
TU-580 RDS	£219.00
<b>JVC</b>	
FX-342 "Special"	£99.00
<b>KENWOOD</b>	
KT-1050	£109.00
KT-2050	£139.00
KT-3050	£179.00
KT-6050	£289.00
<b>PIONEER</b>	
F202	£119.00
F301 RDS	£189.00
F401L	£169.00
F502 RDS	£239.00
<b>SONY</b>	
STS-211	£129.00
STS-311 RDS	£199.00

PLUS FULL RANGE OF RECEIVERS IN STOCK.  
RING FOR THE FULL RANGE IN SPEAKERS OR  
CALL IN FOR A DEMO. AR, BOSE, CERWIN  
VEGA, B&W, GOODMANS, JAMO, MORDAUNT-  
SHORT, STUDIO POWER & WHARFEDALE.

MAIL ORDER HOTLINE  
Please supply ▶ 071-723 5251

Send to HI-WAY HI-FI  
318-324 EDGWARE ROAD, LONDON W2

Enclose Cheque/PO for £

or Access/Visa/Credit Card No

Expiry date

**NOW OPEN**

**HI-WAY SUPERSTORE**  
318-324 EDGWARE ROAD  
LONDON W2 1DY  
TEL: 071-723 5251  
FAX: 071-724 6101



**HI-WAY HI-FI (WEST END) LTD**  
242 TOTTENHAM COURT ROAD  
LONDON W1 9AD  
TEL: 071-636 5974  
FAX: 071-323 4159

Name

Address

Post Code

Tel

*You've survived the budget, struggled through Xmas,  
and finally recovered from New Year.*

**Treat yourself, you've earned it.**

For the Best of British...

***DPA Digital, LFD, Michell, Orelle, Pink Triangle***

And the Best of the Rest...

***Classé, Copland, Linaeum, Magnepan,  
Sonus Faber, Van den Hul***

'Phone or fax me anytime, 9am - 10pm, any day on:

**0252 - 377952**

**0385 - 317952**

*Audio Engineering . . . . . creating the illusion of reality.  
Anywhere in the South*

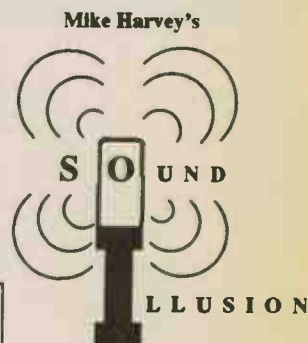

*Major credit cards accepted*

**Hi Fi At** 

**The Independant Specialist For  
Hi Fi & Home Entertainment**

- We Stock Most Leading Makes
- Linn Authorised Retailer
- Excellent Demonstration Facilities
- Home Demonstrations By Arrangement
- Free Installation
- Credit Facilities (Written Details On Request)
- Service Department

**Plymouth: (0752) 669511**  
**58 New George Street, Plymouth**

**The  
Hi-Fi  
Showrooms**

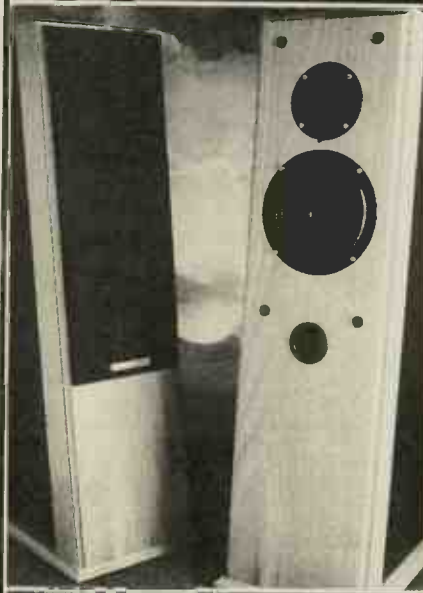

**The Hi-Fi Showrooms**  
**12a West Street, Congleton**  
**Tel (0260) 280017**

**Superlative  
Choice Of  
HI-FI  
Products**  
---  
**5 Superb  
Dem Rooms**  
---  
**Installations  
& Home  
Demo**  
---  
**Credit  
Facilities  
Available**  
---  
**Customer  
Car Park**  
---  
**Repair &  
Servicing**

CANON • SHARP • MITSUBISHI • PANASONIC • SONY • TOSHIBA • JVC • AIWA • NEC

SHARP • TOSHIBA • KENWOOD • MARANTZ • YAMAHA • TECHNICS • BANG & OLUFSEN • CANON • SHARP • MITSUBISHI • PANASONIC • SONY • TOSHIBA • JVC • AIWA • NEC • SANYO • KENWOOD • MARANTZ • YAMAHA • TECHNICS • BANG & OLUFSEN • CANON • SHARP • MITSUBISHI • PANASONIC



HARMAN KARDON

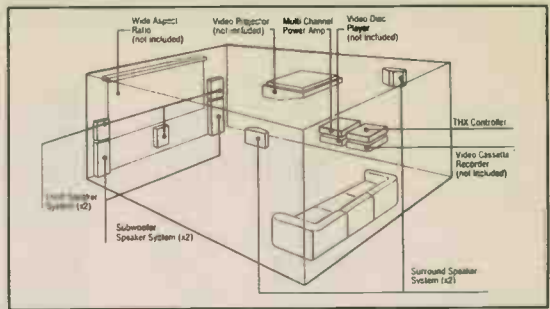

AV ROOM 1 = BANG & OLUFSEN AV9000  
 AV ROOM 2 = YAMAHA DSPA2070  
 AV ROOM 3 = THX, WIDESCREEN & LASERDISCS

**POLK AV PACKAGE**



RM3000 SATELLITES & SUBWOOFER  
 CS100 CENTRE CHANNEL LOUDSPEAKER  
 M3 MULTI APPLICATION MONITORS

**PIONEER CLD2850**

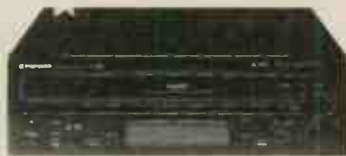

TAKES ALL SIZES CD AUDIO, PAL/NTSC  
 DUAL SIDE PLAY, REMOTE CONTROL WITH  
 SHUTTLE DIAL, NTSC PLAYBACK ON PAL  
 TV's, DIGITAL SOUND LEVEL CONTROL

**YAMAHA DSPA 2070  
 PRO LOGIC AMPLIFIER**



UPMARKET AV CONTROL AMP  
 7 CHANNEL AMPLIFICATION  
 DOLBY PRO LOGIC DECODER  
 DIGITAL SOUNDFIELD PROCESSOR  
 24 DSP SETTINGS

**MAIL ORDER ACCEPTED ON ALL DISCS**

ALL DISCS SUBJECT TO BBFC CERTIFICATION



**STAR  
 WARS**



**ALSO**

**LASER DISCS IN STOCK  
 PAL & NTSC - Over 7,000 Titles available**

TWENTY 20 AUDIO VISUAL LTD

CATALOGUE AVAILABLE

UNIT 205,

LAKESIDE SHOPPING CENTRE,  
 WEST THURROCK, GRAYS RM16 1ZQ

Tel: 0708 891818 • Fax: 0708 891300

**£7.99**

CHEQUES ONLY



SONY • TOSHIBA • JVC • AIWA • NEC • SANYO • KENWOOD • MARANTZ • YAMAHA

**A MANTRA AUDIO** • CARTRIDGES AND STYLI  
 • MAIL ORDER DIRECT 1-10 DAYS  
 • COMPETITIVE PRICE inc P&P  
 • 10% DISCOUNT ON STYLI QTY 2+

TYPE	SWISS QUALITY DIAMOND STYLI	PRICE	MAKE	MODEL	CARTRIDGE	STYLUS
ADC	RK 8, RO 4 OLM 30, RL 3/5	£8.00	Arcam	C 77	£27.00	£15.00
	R20 XE, OLM 32/34/36, XLM III	£12.50		E 77	£45.00	£33.00
Alwa	AN 5/6/7/10/11/13/35/8/745	£8.00		P 77	£56.00	£45.00
	AN 2/5/7/10/11/13/35/8/743	£10.00		P 77Mg	£66.00	£49.00
Akal	APN 2/5, RS 33/35/38/83	£8.00	Audio	AT 95 E	£21.00	£12.50
Audio	ATN 7/21/05/34/51/34/52-E	£8.00	Technica	AT 110 E	£25.00	£16.00
Technica	ATN 7/21/05/34/51/34/52-E	£12.50		AT 412 EP (T4P)	N/A	£13.50
Denon	DSN 24/28/39/44/47/57/66	£8.00		AT402 E	£36.00	£24.00
	DSN 50/54/60/65	£12.50		AT 0C 3	£92.00	£64.00*
Dual	DN 140/236/237/245	£10.00		AT 0C 5	£125.00	£88.00*
	DN 145/155/165 E, DN 149S	£12.50	Denon	DL 110 MC	£65.00	£52.00*
Goldring	G 800/820/850	£8.00		DL 160 MC	£85.00	£68.00*
	G 800 Super E (D110E)	£12.50		DL 304 MC	£180.00	£150.00*
JVC	DT 35/45/55/60, DT Z I S	£8.00	Goldring	ELECTRA	£24.00	£16.00
Kenwood	N32/33/47/48/52/60/61/66/72	£10.00		1006	£44.00	£29.00
(Trio)	N35/36/43/45/56/60/67/69/71	£10.00		1012 GX	£58.00	£38.00
Marantz	TT 333/443/551/553	£10.00		1022 GX	£76.00	£49.00
Nat Pan/Technics	EPS 2/3/4/5/6/30/33/35/51 CS	£8.00		1042	£94.00	£61.00
	EPS 2/70D, EPS 31/34/43 STSD	£8.00		Erocca (LX)/(H)	£90.00	£55.00*
	EPS, 30ES, EPS 202/270 ED	£10.00		Elite	£160.00	£117.00*
Ortofon	FF 15/VMS 10/20 EIL, OMP 10/20	£12.50	Nagaoka	TS 10	N/A	£20.00
Phillips	GP 371/400/780/4001/III	£8.00		TS 11	£63.00	£33.00
	GP 330/401/401 II/412 II	£10.00		TS 12	£72.00	£38.00
Pioneer	PN 110/210/220/K65/250T/295T	£8.00		MP 10	N/A	£10.00
	PN 302/350/135/200/290T	£10.00		MP 11	£25.00	£12.50
Pickering	V15 AT/AC/AA/AT3, XV 15/50	£10.00	Ortofon	OM/P 10	£25.00	£18.00
	XV15 200/400, TL12	£12.50		OM/OMP 20 Super	£54.00	£31.50
Sansul	SN 10/27/28/37/41/50/80	£8.00		OM 30 Super	£72.00	£58.00
Sanyo	STG 8/9/10, ST 28/29 D	£8.00		OM N'CLUB S	£29.00	£18.00
(Fisher)	ST 35/36/37/40/42/55 D	£8.00		OM N'CLUB E	£33.00	£21.00
	ST 26/30/38/44/66 D	£10.00		CONC N'CLUB S	£50.00	£18.71
Sharp	STY 104/111/116/117/118	£8.00		CONC N'CLUB E	£54.00	£21.00
	STY 123/124/127/136/141/160	£8.00		510	£29.00	£19.00
Shure	N 75 6/C N 70/91G	£10.00		520, 520P (T4P)	£49.50	£36.00
	N 75 ED/EJ 72, N 95 ED/EJ	£13.50		530, 530P (T4P)	£78.00	£57.00
	N 97 ED, VN 35 E	£8.00		MC 1 TURBO	£54.00	£45.00*
Sony	ND 133/134/150/155/200/300G	£10.00		MC 3 TURBO	£99.00	£82.00*
	ND 115/135/143/148/153 G/250 G	£12.50		MC 10 Super	£76.00	£65.00*
Stanton	D 5100 E/5107 A/6071A	£10.00		MC 15 Super	£99.00	£82.50
Tenorel	N 2001 D	£12.50		QUARTZ	£126.00	£105.00*
	N 2001 ED	£8.00	Shure	QUATTRO	£190.00	£160.00*
Toshiba	N 62, N 290 D, N 292	£10.00		ME 92 E (T4P)	£22.00	£15.00
	N 377/276/78 D, N 500	£8.00		ME 97 HE	£60.00	£42.50
		£10.00		VN 35 MR	(V 15 III)	£63.00
				VN 45 MR	(V 15 IV)	£90.00
				V 15 V MR		£130.00
MAKE	ACCESSORY		Stanton	500 AL DISCO	£30.00	£18.00
Shure	SFG 2 Stylus Force Gauge	£17.00		680 AL DISCO	£45.00	£32.00
Almal	Cartridge Alignment Protractor	£5.00				

\* Exchange any MC ★★★ Other types available ★★★ Tel (0757) 288652  
 Please state Stylus ident no/colour, Cartridge/ref on all orders/enquires - No credit cards  
 MANTRA AUDIO (HFW), 22 GARTH AVENUE, NORTH DUFFIELD, SELBY, NORTH YORKS YO8 7RP

**HI-FI centre**  
**HUDDERSFIELD**

ARCAM,  
 AUDIOLAB, AUDIO  
 QUEST, B&W,  
 CASTLE,  
 CELESTION,  
 DENON,  
 FOUNDATION,  
 GOLDRING,  
 KENWOOD, MARANTZ, MERIDIAN,  
 MICHELL ENGINEERING, MISSION,  
 MUSICAL FIDELITY, NAKAMICHI,  
 ORTOFON, QUAD, REVOLVER,  
 ROGERS, ROTEL, SENNHEISER,  
 SPENDOR SUGDEN STAX  
 SYSTEMDEK, TANNOY, TARGET, TDL,  
 THORENS.

**VISA** 

2/4 CROSS CHURCH STREET,  
 HUDDERSFIELD  0484 544668

# HALE HI FI



We stock:-  
 ROYD, NAIM, LINN, DENON, CREEK,  
 ARCAM, QUAD, YAMAHA etc....  
 A wide range of accessories always  
 available.  
 Full demonstration facilities - no  
 appointment necessary - full service  
 department.  
 Free delivery and installation

2 Bold Street, Hale Road Altrincham, Cheshire  
 WA14 2ER  
 Telephone: (061) 929 0834



Don't let your  
**LISTENING ROOM**  
 spoil his performance.

With the help of  
**Room Acoustics Services**  
 you can achieve near concert hall realism,  
 in harmony with your home decor.

Full details, reviews etc, of our computerised postal  
 Hi-Fi room acoustics consultancy available from:-  
**ROOM ACOUSTICS SERVICES**  
 3, Queen Elizabeth Way, BARTON-upon-HUMBER,  
 South Humberside, DN18 6AJ. Tel: (0652) 635523



# Billy Vee

## sound systems

Telephone: 081 318 5755 & 852 1321

Hi-fi Specialists

248



THE CHOICE IS YOURS

We demonstrate everything we sell so you can be sure that any of the products you see advertised here are on display and available for audition. Our helpful and experienced staff are on hand every day (except Thursday and Sunday) to help explore the possibilities open to you. We welcome your visit.

- > Two listening rooms
- > Two year minimum guarantee
- > Free 24hr delivery service
- > 0% Finance available
- > Part exchange service available
- > Outstanding product range!

## Welcome to the home of good hi-fi!

248 Lee High Road, Lewisham, London SE13 5PL

Contributors: ARCAM - CYRUS - DENON - HEYBROOK - JPW - MARANTZ - LINN - MISSION - NAD - NAIM - NAKAMICHI II - QUAD - REGA - ROGERS - TANNOY etc

Our services include, two listening rooms, part exchange, systems installation and :-

0% A.P.R. CREDIT - PLEASE CALL FOR DETAILS.

If you would like to join our mailing list and expose yourself to our new 1994 catalogue of Musical evenings, events and Concerts featuring top artists, presented in conjunction with the Blackheath Concert Halls. Please contact Peter or Ian. Come and join in the Lewisham festival of sound - Recorded and Live!

The NORFOLK/SUFFOLK High End Dealer  
**audible difference**  
 near DISS, NORFOLK

Audio Research	<i>Audion (Alema)</i>	ART Audio
ATC	<i>Audio Innovations</i>	Audio Note
AVI	<b>CHORD</b>	<b>Copland</b>
<b>Croft</b>	<b>DAWN AUDIO</b>	<b>dpa</b>
EAR	Impulse	Kinshaw Perception
Lineaum	<i>Lyra</i>	<i>LFD Audio</i>
Magnepan	Micromega	<b>neat</b>
<i>Orelle</i>	Pink Triangle	<b>ROKSAN</b>
Sumiko	<b>SME</b>	Sonus Faber
SUGDEN	Tube Technology	van den Hul

At this level of equipment we believe that the highest level of service should be offered.

We will book only three demonstrations a day to ensure that you have ample time to evaluate the option YOU chosen,

DEMONSTRATIONS IN OUR LISTENING ROOM OR  
 YOUR HOME EQUIPMENT LOAN SERVICE  
 AVAILABLE

Tuesday to Friday, 12 to 9 pm  
 Saturday 9 to 5 pm  
 PLEASE RING FOR AN APPOINTMENT

0850 983233 OR 0379 740227

CLEARAUDIO, AUDIO RESEARCH, KLIPSH

HEATHERDALE AUDIO Ltd.  
 Tel. 0903-261213 or 0860-660001

We are pleased to take your calls 9am  
 to 9pm 7 days a week

CLEARAUDIO  
 IF YOU SEEK THE BEST IN RECORD  
 REPRODUCTION THEN YOU MUST  
 AUDITION THE STUNNING  
 PERFORMANCE OBTAINABLE ONLY  
 WITH CLEARAUDIO CARTRIDGES.

Ex. demonstration and used equipment;	
Jadis Dely 7 amplifier	£3495
Snell A2 loudspeakers Mint/boxed	£2995
Pair Lumley Reference 120's triode/pentode	£2895
Audionote ANJ speakers From	£500
Audionote ANE speakers From	£950
Audio Innovations 800 Stereo amp	£395
Audio Innovations 200 Stereo amp	£295
Audio Innovations 300 Int. amp	£295
Audio Innovations 800 MG transformer	£120
DPA Deltec pdm 1 series 2 DAC	£350
Audionote 10 cartridge (low hours)	£795
Audionote M7 Silver pre-amp (new £12950)	£5995
Graham 1.5T tonearm (Mint/boxed)	£1195
Voyn turntable/SME IV arm. used 25 hrs.	£1995

CLEARAUDIO - AUDIO RESEARCH - MARTIN  
 LOGAN - KRELL - SONUS FABER -  
 MAGNEPLANAR - COPLAND - THETA -  
 AUDIONOTE - LUMLEY REFERENCE - S.M.E. -  
 GRAHAM - VOYD - KLIPSCH - APOGEE

UK distributors for CLEARAUDIO dealer inquiries welcome.  
 DEMONSTRATIONS ARE BY APPOINTMENT.

MANGEPLANAR, COPLAND, THETA, VOYD

AUDIONOTE, LUMLEY REFERENCE, S.M.E, APOGEE

MARTIN LOGAN, KRELL, SONUS FABER, GRAHAM

scarborough hi.fi

14 northway, scarborough, n. yorks yo11 1jl  
 phone: (0723) 374547  
 15 commercial street harrogate, n. yorks hg1 1ub  
 phone: (0423) 504274



**LUMLEY REFERENCE,  
 MUSICAL FIDELITY, ORELLE,  
 CASTLE, RUARK,  
 TANNOY DEFINITION RANGE,  
 ALCHEMIST, ONKYO,  
 PERFECT PITCH, KINSHAW,  
 PERCEPTION, CABASSE,  
 YAMAHA, ALBARRY and  
 PRO-JECT TURNTABLES**

amongst other fine hifi products.

We also offer a re-wiring and sound  
 upgrading service on selected products.

Call us for details.

PIONEER

BEST PRICES GUARANTEED

KENWOOD

TANNOY

LICENSED CREDIT BROKERS ASK FOR DETAILS



LICENSED CREDIT BROKERS ASK FOR DETAILS

MISSION

ALL BILL HUTCHINSON HI-FI SHOPS ARE DEDICATED AUDIO VISUAL CENTRES

ALL BRANCHES ARE MAJOR LASER DISC STOCKISTS

DENON

YAMAHA

PIONEER

REFERENCE UNIT

# Bill Hutchinson

Hi-Fi • CD • Audio Visual Centre

THE PROFESSIONALS

When you purchase from Bill Hutchinson you're buying the best names in Hi-Fi from the best name for Hi-Fi. Our Product Guarantee and Pricing Policy ensure you obtain an excellent deal. My staff and I look forward to being of service to you.

*Bill*

HEAR KENWOOD'S AWARD WINNING AV AMPLIFIER



- MARANTZ CD52 MK115E - CD PLAYER - AWARD WINNER '93 ✓
- MARANTZ PM44SE - AMPLIFIER - AWARD WINNER '93 ✓
- MISSION 751 - SPEAKERS - AWARD WINNER '93 ✓
- SONY TCK-611S - CASSETTE DECK - AWARD WINNER '93 ✓
- SONY STS 311 - TUNER - AWARD WINNER '93 ✓
- AIWA NSX-360 - MINI SYSTEM - AWARD WINNER '93 ✓
- TECHNICS SC-CH950 - PRO-LOGIC SYSTEM - AWARD WINNER '93 ✓

## PRICE PLEDGE

Should you find any local dealer offering a better price for goods currently in stock at Bill Hutchinson and the alternative quoting retailer, we will better that deal.

## THE LARGEST SELECTION OF QUALITY HI-FI AND AUDIO VISUAL SYSTEMS

**LEEDS**

26 28 WOODHOUSE LANE  
**0532-427777**

OPEN MONDAY SATURDAY  
9.30AM - 6.00PM  
THURSDAY LATE OPENING

**MANCHESTER**

50-52 DEANSGATE  
**061-832 1600**

OPEN MONDAY SATURDAY  
9.30AM - 6.00PM  
THURSDAY LATE OPENING

**NEWCASTLE**

87A CLAYTON STREET  
**091-230 3600**

OPEN MONDAY SATURDAY  
9.30AM - 5.30PM  
THURSDAY LATE OPENING

**GLASGOW**

43 HOPE STREET  
**041-248 2857**

OPEN MONDAY - SATURDAY  
9.30AM - 6.00PM  
THURSDAY LATE OPENING

**EDINBURGH**

43 SOUTH CLERK STREET  
**031-667 2877**

MON - SAT 9.30AM - 6.00PM  
SUNDAY 11.00AM - 5.00PM  
THURSDAY LATE OPENING

AKAI

PHILIPS

JVC

SONY

TECHNICS

ROTEL

ALL WITH 2 YEAR GUARANTEE

AIWA

# Our promise.

## You won't buy Hi Fi separates for less.

Up to **£20** PRICE BEAT AT SEVENOAKS SUPERFI

We believe our prices are some of the most competitive around. But if you can find a verifiable offer on an identical product at a lower price, in stock at a local authorised dealer, and if it's brand new in a factory sealed box (no ex-demonstration/display or re-packs). We'll beat that price by up to £20!

SALE VALUES: £110 to £500 = £10. £501 to £1000 = £15. £1001+ = £20.

**CASSETTE DECKS**  
**Nakamichi DR3**  
 Sound quality with ambience and presence  
 was £399.95  
**£339.95**

**CASSETTE DECKS**  
**Sony TCK511S**  
 Dolby S-3 head  
 an absolute steal!  
**Claim £80 CD/  
 Cassette Voucher Free**  
**£279.95**

**CASSETTE DECKS**  
**Alwa ADF410**  
 Great sound from an  
 awards recommendation  
 was £119.95  
**£99.95**

**CASSETTE DECKS**  
**Yamaha KX360**  
 A high performance deck with  
 vibrant sound  
 was £199.95  
**£149.95**

**DCC DECK**  
**Marantz DD82**  
 Punchy, enjoyable sound with  
 top rate recordings from source  
**Claim £50  
 DCC Voucher Free**  
**£399.95**

**CASSETTE DECKS** Free tape offers do not apply on these products

**CD PLAYERS**  
**Arcam Delta 170  
 & Black Box 5**  
 Confident effortless  
 performance  
 ex display  
**£499.95**

**CD PLAYERS**  
**Arcam Delta 70.3**  
 Precise, stable  
 stereo imaging  
 was £699.95  
**£449.95**

**CD PLAYERS**  
**Marantz CD72SE**  
 A fine, cultured player  
**Claim £100  
 CD Voucher Free**  
**£599.95**

**CD PLAYERS**  
**Marantz CD52IISE**  
 The sound simply bubbles  
 with energy and vitality  
**Claim £30  
 CD Voucher Free**  
**£299.95**

**CD PLAYERS**  
**Technics SLPG440AK**  
 High grade MASH,  
 4 DAC  
**Claim £25  
 CD Voucher Free**  
**£169.95**

**CD PLAYERS** Free CD offers do not apply on these products

**CD PLAYERS**  
**Aiwa XC300**  
 Great presence  
 for the price  
 was £149.95  
**£129.95**

**TURNTABLES**  
**NAD 5120 inc cart**  
 Seriously good sound  
 at a super low price  
 was £109.95  
**£89.95**

**TURNTABLES**  
**Technics SL1210MkII**  
 The professional DJs  
 turntable  
 was £399.95  
**£349.95**

**SPEAKERS**  
**TDL RTL2**  
 Warm, good imagery, expansive  
 sound stage - fantastic value  
**Claim £10 speaker cable  
 Voucher Free**  
**£249.95**

**SPEAKERS**  
**TDL NFM**  
 Small but powerful  
 The best sub £100 speaker!  
**Black or Rosewood**  
**£99.95**

**AMPLIFIERS**  
**Audiolab 8000A**  
 Transparency and power,  
 notably neutral.  
**Claim £20  
 CD Voucher Free**  
**£449.95**

**AMPLIFIERS**  
**Marantz PM44SE**  
 Supplies plenty of power to  
 hard hitting rock tracks  
**Claim £20 CD  
 Voucher Free**  
**£199.95**

**AMPLIFIERS**  
**Rotel RA935BX**  
 A well balanced amp  
 with agile bass  
**Claim £30 CD  
 Voucher Free**  
**£224.95**

**SPEAKERS**  
**Tannoy 609II**  
 Hexagonal with 8" concentric  
 gold tweeter  
**Claim £50 Stands Free**  
**£294.95**

**SPEAKERS**  
**Mission 780SE**  
 Latest, improved version of  
 popular 780 - works superbly  
 with budget & serious amps  
**Black or Rosewood**  
**£239.95**

### Sevenoaks Superfi - There's no better place to buy Hi Fi.

SEVENOAKS BRANCHES AT: SEVENOAKS • BRIGHTON • CANTERBURY • CHATHAM • CHELTENHAM • CROYDON • ENFIELD  
 GUILDFORD • LEICESTER • OXFORD • TUNBRIDGE WELLS • WATFORD • WITHAM • WOOLWICH  
 SUPERFI BRANCHES AT: BIRMINGHAM • DERBY • HULL • LEEDS • LINCOLN • LONDON • NOTTINGHAM  
 SHEFFIELD • STOKE ON TRENT

THIS ADVERTISEMENT IS VALID TO 31ST MARCH 1994. ADDED VALUE OFFERS ARE NOT AVAILABLE ON PRICE BEAT SALES.



# World favourites

## COMPACT DISC PLAYERS

NAD 501	£180	A break from the MASH tradition, the Philips powered 501 gives excellent results.	Apr'94
DENON DCD 890	£270	Exciting and forceful sounding player, but slightly characterful	Nov'92
ROTEL RCD965 DIS	£350	A smooth and easy sound make this one of the best value players around.	Jan'94
QUAD 67	£790	A new breed of Quad. Lacking nothing in verve or excitement.	May'93
SUGDEN SDT 1	£850	Airy and spacious with a rare quality of ambience.	Mar'93
NAIM CDI	£1598	Single box, 16 bit player. Close to the two box CDS, has vital 'tingle factor'.	Apr'92

## COMPACT DISC TRANSPORTS

DPA DIGITAL T-1	£795	Superbly detailed sounding transport when sync-locked to DPA's converters.	Jan'93
ORELLE CD10-T	£799	Very involving, unforced and natural when used with Orelle's DA-180 DAC.	Feb'94
M'MEGA DUO CD.2	£1850	Seriously priced, serious CD using Philips' CDM-9 PRO mechanism. Exemplary.	Apr'93

## DIGITAL TO ANALOGUE CONVERTERS

QED DIGIT/OPTO	£139/169	Excellent value, with no rough edges. Now with optical input (Opto).	May'92
DACULA	£376	This little devil from Select Systems really gets its fangs into the music.	Dec'93
DPA DACS	£450-2K	The current masters of DAC-7, their DACs offer superb performance at a range of prices.	
ORELLE DA-180	£599	'Analogue' sounding converter, best with matching transport.	Feb'94
P. T. ORDINAL	£695	Pure sound, smooth and free from hardness. One of the best at any price.	Jul'93
M'MEGA DUO PRO	£1050	Spacious and dynamic presentation, with a detailed and informative manner.	Apr'93
P. T. DA CAPO	£1450+	Pink Tangle's own one bit DAC reaches new standards in digital. One of the very best. Even better with DC supply and new filter options.	Mar'94

## TURNTABLES

PRO-JECT 6	£350	Great involvement and rhythm. Comes with Ortofon MC15 for £399	Dec'93
MICHELL MYCRO	£397	In between the Syncro/Gyrodec, the Mycro has superb midband clarity and poise.	Apr'92
TOWNSHEND ROCK III	£799	The MkIII has a fabulously stable, solid image and terrific bass.	Feb'94
P. T. ANNIVERSARY	£1200	Very neutral turntable. Excellent imagery and detail.	May'92
SME MODEL 20	£2495	The last great turntable, bettered only by the £11,000 Model 30.	Oct'92

## TO NEARMS

REGA RB 300	£139	Simple and superb; dynamic with solid bass.	
SME 309	£568	Based on IV and V: Aluminium armtube and detachable headshell.	Jan'93
SME IV	£850	Looses little to the fabulous V, possibly the best value for money SME.	Dec'93
SME SERIES V	£1232	A masterpiece of precision engineering, with a cohesive sound.	May'92

## CARTRIDGES

GOLDRING 1012 GX	£60	Rounded bass, slightly forward midband, clean transients. A bargain.	Jul'93
GOLDRING 1022GX	£80	Extra degree of dynamic range and speed over the 1012GX	Jul'93
SUMIKO BLUE POINT	£100	The Blue Point casts a romantic charm over all types of music. Robust too.	Oct'92
ORTOFON MC15	£100	Moving coil cartridge at a moving magnet price. Has a tight grip on rhythm.	Jun'92
GOLDRING 1042	£100	A reference to all other MMs regardless of price	May'92
GOLDRING ELITE	£200	British made moving coil. Good value, smooth and detailed.	Apr'92
ORTOFON MC2000	£650	We came across this one by accident; used on a Garrard 401 with an SMEIV it gave one of the best results we've ever heard.	Dec'93

## CASSETTE RECORDERS

SONY TC-K611S	£330	A Dolby S bargain. All the gadgets necessary to produce great recordings.	Feb'94
NAKAMICHI DR2	£500	Worth every penny, pushes recordings to the limit and remains unflustered.	Feb'94
NAKAMICHI DR1	£780	Nakamichi sound quality, and manual head azimuth adjustment.	Jun'93
NAKAMICHI CR-7	£1500	No Dolby 'S', but auto tape tuning and motorised head. The Best!	Aug'92

## TUNERS

NAD 402	£160	Stunning budget tuner, with a warm and open sound. Can compete with the best.	Jan'94
AURA TU-50	£230	Superb FM-only tuner. Produces a delightful, three-dimensional sound. A cracker.	May'92
YAMAHA TX-950	£260	Fine all-rounder, with good AM section.	Jul'92
MISSION CYRUS FM7	£299	Clear and lucid sound. One of the best, regardless of price.	Apr'94

# World favourites

H/K TU9400	£300	Fairly basic facilities, but sound which beats most at the price.	Jul'93
QUAD 66FM	£490	Among the very best in terms of tonal colour and imagery. Remote controllable.	Nov'92
NAIM NAT 03	£500	Warm and easy sound with a good sense of atmosphere. Good value.	Sep'93
NAIM NAT 01	£1377	The best solid state tuner currently available. For better radio, live in the studio!	Mar'92

## INTEGRATED AMPLIFIERS

H/K HK6150	£159	Good sounding starter amplifier. Great dynamic range, excellent bass.	Jun 92
NAD 302	£160	Lots of insight and detail, but could sound a little rough in the wrong system.	Jan 93
PIONEER A-300X	£200	Exceptionally sweet mid and treble, plus the superb dynamic range of the A400.	Dec'92
DENON PMA-350II	£220	Powerful and with deep rhythmic bass drive.	Sep'93
H/K HK6550	£349	Thoroughly refreshing, tonally neutral amplifier with a realistic price tag	Nov'92
AUDIOLAB 8000A	£430	Very neutral and superbly built. Good bass, great imagery, but can be sterile.	Apr'92
J.SHEARNE. Phase2	£495	Gorgeous looks, even better sound. Tight, quick bass and valve-like mid and treble	Dec'93
MISSION CYRUS III	£499	Superb engineering, a solid cast chassis and a clear and spacious sound.	Apr'94
SUGDEN A21a	£639	Class A transistor amp. Sharp, crisp, deep, tight, and it images well too.	Feb'94
AUDIONOTE OTO	£1250	12w Valve amplifier. More in tune with music than hi-fi. Superb dynamic range.	Jun'92
EAR 834	£1295	Valve integrated amplifier with a sweet, open and detailed sound.	Feb'93

## PRE-AMPLIFIERS

EAR.834P	£290	MM/MC phono stage. Uses valves to create a rich sound with tremendous depth.	Jan'94
A. Innovations. L1	£299	Valve line level preamplifier. Outstanding results with vdH carbon interconnect.	Feb'94
A. SYNTH. PASSION	£475	Or £275 for the kit version. Unrivalled transparency from a passive pre-amp.	Aug 93
ROSE RV23-S	£495	Valve/Transistor hybrid. Smooth and clean, rich and spacious.	Nov'93
DPA DSP 200S	£495	Not quite the 50S, but there's still nothing to match it at the price.	Jun'93
MICHELL ISO HR	£850	Impossible not to recommend. What more does your vinyl want?	May'93
NAIM NAC82	£2000	Remote control preamp. The NAC82 thrusts detail forwards in true Naim fashion.	Apr'94

## POWER AMPLIFIERS

ROSE RP-190	£495	Used with the Rose pre-amp it gives 70 watts of smooth relaxing sound.	Nov'93
SUGDEN AU41P	£530	100 Watts of smooth, detailed, full bodied sound. And at a bargain price.	Apr'93
QUAD 606	£675	140W powerhouse. Smooth and civilized, with the legendary Quad back-up.	Aug'93
DPA DPA 200S	£750	Not as cold as the 50S. Better than anything else at the price.	July'93
MICHELL ALECTO (S)	£1300	Valve like transparency, big warm easy going sound.	Sep'93.
MICHELL ALECTOS	£1800	The Alectos have a lucidity and three dimensional realism that is rarely attained.	Dec'92
NAIM NAPI80	£898	Partner to NAC82. Has real drive and grip on loudspeakers.	Apr'94
CHORD SPM 1200	£2995	Massively powerful, dynamic and detailed sound. Among the best of solid state.	Mar'93
E.A.R. YOSHINO	£25,000	Single-ended valve design. Noel is still suffering withdrawal from this product.	Jul'93

## LOUDSPEAKERS

R' ALLAN MINETTEII	£120	Fast and lively sounding, competent bass.	Sep'93
GLL MAXIM	£120	Replacing the Maxim 3; not as tight in the bass but still one of the best at the price.	Aug'93
MISSION 760ISE	£150	One of the best miniatures around, very musically involving.	Jan'94
HARMAN LS 0300	£200	Glass fibre woofer gives a forward and open mid with good bass kick	Nov'93
TDL RTL 2	£250	Bass on a budget. Solid, vibrant and spacious sound.	Dec'93
SYSTEMDEK 93 I	£300	Poor man's LS3/5a? Coherent and involving, these little gems really sing.	Mar'94
HARBETH HL-P3	£400	There probably isn't a more neutral sounding design anywhere near the price.	Feb'93
ROGERS LS8a/2	£449	Big, enjoyable, room filling sound from this 2-way floorstander.	Feb'94
REL STRATA	£499	REL's Strata offers excellent bass depth and power.	Mar'94
H'BROOK QUARTET	£555	Sensitive enough to work with low power valve amps. Fast and detailed sound.	Jul'93
JPW RUBY I	£500	Metal driver 'speaker with an exciting and lively presentation.	Aug'93
TANNOY D100	£650	Believable 3D images produced by this small dual concentric speaker.	Jan'94
PROAC Studio 100	£699	Excellent monitors with detailed, natural sound and plenty of atmosphere	Feb'94
SPENDOR SP2/3	£769	Smooth sounding speaker with a superb mid-range. Very easy to listen to.	Feb'94
PROAC RES I S	£918	Small box design. Can convey the spirit, drive, and passion of music.	Jul'92
TANNOY D700s	£1970	Dynamic and powerful. Needs a good clean power amplifier for best results.	Sep'93
TANNOY GRFM	£3500	Giant loudspeakers. Capable of awesome sound. Need good valve amplification.	Jul'92

OPENING HOURS  
MON.- SAT 10 -6PM



TAX FREE WORLDWIDE  
EXPORT SERVICE

## TO FIND OUT WHAT YOUR RECORDS + CDs COULD SOUND LIKE VISIT US AT HI-FI CONFIDENTIAL FOR A DEMONSTRATION

◆ Demonstration room available ◆ Part exchange welcome ◆ Home trail ◆ Free Professional Advice ◆

Valve equipment from:-  
E.A.R, Audio Innovations, Tube Technology, Conrad Johnson, World Audio Design

Solid state:-  
Aura, Pink Triangle, Orelle, Quad, Shearne Audio, Rotel, Aiwa, Albarry, Alchemist Products, Audio Alchemy, Musical Fidelity

Loudspeakers from :-

Castle, Monitor Audio, Quad, Spendor, Ruark, Proac, Snell, Royd, Opera, Tannoy, KEF, JPW



**HI-FI CONFIDENTIAL LTD**  
34 Buckingham Palace Road,  
London SW1 W0RE  
(near Victoria Station)  
Tel. 071 233 0774



campaign audio design

## LOVE HERTZ

"You pays your money and you takes your choice"  
but our pure silver cables and quality mains interconnects will improve your Hi-Fi system or we will give you your money back.

- ★High Purity Silver interconnects with PTFE
- ★Silver tone arm wires & digital interconnects
- ★Silver speaker cables & mains leads

"We will improve your Hi Fi or give you your money back!"

Campaign Audio Design  
Llandudno Road (HW) Cardiff CF3 8PG  
Tel: 0222 779401

TRADE & INTERNATIONAL ENQUIRIES WELCOME

## NB-2000™

active noise reduction headset

NB-2000 can reduce annoying noise by 50-95%, while leaving desired sounds, such as speech, music and warning signals clearly audible.

Use NB-2000 in conjunction with your portable audio equipment or in-flight entertainment system to reduce environmental noise, and enjoy better audio quality.



Use the comfortable, lightweight NB-2000  
- in the plane, car, bus, truck, boat, train, tube, city, home, office  
- with lawnmowers, vacuum cleaners, home power tools, computers  
- and in many other everyday situations where noise is a nuisance.

### How does "active" noise reduction work ?



Microphones in both headset earcups listen to the offensive noise, feed that information to the NB-2000 electronic controller where it is analysed, and an anti-noise wave is generated.

The anti-noise meets the offensive noise, that noise is reduced.

£139.99 + £5.00 P&P. To order, send a cheque or postal-order made payable to "Don Fordy Ltd." for £144.99 to :

For further information,  
Tel 0792-895435 or  
Fax 0792-891235



Don Fordy Ltd., 7 Orchard Grove,  
Penllergaer, Swansea, SA4 1AD.

### ULTIMATE CD STORAGE UNITS

**CD250:** Holds: Approx. 250 CD's  
Size: 1300 x 300 x 125  
Price: £55 - +P&P

**CD500:** Holds: Approx. 500 CD's  
Size: 1300 x 600 x 125  
Price: £105 + P&P

**CD900:** Holds: Approx. 900 CD's  
Size: 1300 x 1200 x 125  
Price: £175 - + P&P

Finishes: Black & White Lacquered  
Note: Goods made specially to order

For Further Info.:

Tel: 0374 237770 or 0365 251821  
29 Faulkner St., Oxford OX 1 1VA





# IAN HARRISON DISCOUNT HI-FI

BRANDS NEW GOODS WITH FULL UK. GUARANTEES \* NO EX-DEM  
GOODS \* NO GREY IMPORTS \* REVIEWS & DETAILS ON REQUEST (0283) 702875

TECHNICA	AUDIO	SENNHEISER	BEYER
DL304 £170	MC7500	HE 60/V70	DT911 £189
DL103D EPOA	MC5000	HD 1000	IR5790 £139
DL 163 £75	MC3090II	HD380 £155	DT901 £153
DL160 £70	MC2000II	HD560II £109	DT980P £135
DL110 £55	QUASAR	HD250II £99	DT990 £99
	QUATTRO	HD540II £95	DT811 £108
	QUARTZ	HD530II £75	DT801 £105
	MC155II	HD520II £69	DT511 £65
	ATH9800	HD340 £49	DT431 £45
V15VMR £199	MC105	HE60 £415	DT311 £33
VN35MR £55	T3000	HEV70 £415	
TEST DISC 117 £15	T20II		

**GOLDEN AGE** POA. I OPERATE A MOVING CO. EX. ANE. SYSTEM. PLEASE PHONE FOR DETAILS AND PRICES. I'D MOVING CO. I'D. T. WORRY. JUST PHONE. ALL GOODS ARE BRAND NEW WITH FULL UK GUARANTEES. NO EX-DEM EQUIPMENT. PLEASE PHONE OR WRITE FOR DISCOUNT PRICES WHERE CD'S TDK, MAXELL, SONY, AMPEX, BASF DISCOUNT AUDIO & VIDEO TAPE. AUDIOQUEST, SONIC LINK, REVOX, CUA, DISCOUNTS. TILARC, BIS, ATC, SPENDOR. DELIVERY CHARGE IS £5.

IAN HARRISON DISCOUNT HI-FI (MAIL ORDER ONLY), 7 MILL HILL, REPTON, DERBY, DE65 6GQ 9am - 9pm



## FOR STATE OF THE ART HI-FI

### STUDIO ONE

Our dedicated 'Absolute Sounds' Studio. We have on permanent demonstration the following equipment:  
**APOGEE** - from Centaur Minor to Diva  
**AUDIO RESEARCH** - including the LS2b, LS3b & D200  
**CLASSE** - 30, 70, DR4, DR5, DR6, DR10, DR15  
**KRELL** - amplification and digital, now on dem the new KSA50s  
**MAGNEPLANAR** - from SMGa to MG3.3  
**P S AUDIO** - complete range including the Lambda transport  
**SONUS FABER** - Minima Amator, Minuetto, Electa  
**THETA** - Data Basic, Pro basic, Pro prime  
**WILSON AUDIO** speakers

### STUDIO TWO

Our new purpose built audio visual room  
**ADCOM** processors  
**CELESTION** shield speakers  
**CELESTION HT3** package  
**DENON** av amplifiers  
**LEXICON** processors

### STUDIO THREE

**ACOUSTIC ENERGY**  
**ADCOM**  
**AUDIOLAB**  
**CHORD ELECTRONICS**  
**KEF REFERENCE**  
**MICHELL**  
**MICROMEGA**  
**ORELLE**  
**PROFESSIONAL MONITOR COMPANY**  
**ROKSAN**  
**SME**  
**TANNOY**  
**TDL**

Call us or drop in for a chat or to arrange a demonstration. We stock a complete range of speakers from £109 including B&W, CELESTION, HEYBROOK, KEF, SEQUENCE & TANNOY and separate components from £119 from DENON, MARANTZ, SONIC LINK and THORENS all available for audition in **STUDIO FOUR**

A wide range of accessories, headphones and equipment supports available.



Tel: 0923 233011 Tel: 0923 245250 Fax: 0923 230798

### Acoustic Arts Ltd

101 St Albans Rd, Watford WD1 1RD  
 Opening hours: 10am - 6pm Tues to Sat  
 100 yards from Watford Junction Station

## THE AUDIO GALLERY

For a Fine Selection of High Quality Audio Equipment

Tube Technology Audio Innovations Audio Note Wadia  
 Audio Alchemy DPA TEAC Micromega Alchemist  
 Martin Logan ProAc Klipsch Acoustic Energy TDL  
 Heybrook JPW Impulse Pink Triangle SME Denon  
 Moth Audio Synthesis NAD Pioneer Alphason Tripod  
 Replacement Valves by Gold Aero

Demonstrations by Appointment Only.  
 Please call 0730 895194 Hampshire, Nr. Petersfield

## Inaccessible accessories by post.

If you can't get to us, we'll get our accessories to you.

**CARTRIDGES:** Arcam, A.T., Denon, Dynavector, Goldring, Lyra, Ortofon, Sumiko. **CABLES:** Audioquest, Cable Talk, Ixos, Kimber, Ortofon, Sonic Link, Van den Hul. (including the new carbon cables.) **STANDS:** Alphason, Sound Organisation, Stands Unique, Target. **HEADPHONES:** Beyer, Sennheiser, Stax. **ACCESSORIES:** Allsop, BIB, Discwasher, Hunt, Kontak Last, Michell, Milty, Nagoaka, Pixall, QED. **LPs/CD's:** Audioquest, DCC, Fone, Kavier, Naxos, Opus, Proprius, Reference Recordings, Sheffield Labs. **Plus** a full range of quality equipment available.

## Bury Audio

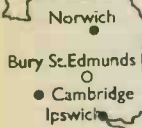

47 Churchgate Street, Bury St. Edmunds, Suffolk IP33 1RG.  
 For a full catalogue or to order telephone or Fax. 0284 724337 or telephone 0850 565693.  
 Access, Visa, Diners Club, American Express.

Play It again, Sam



This time use Gold Aero Tubes.

Available from Tube Technology - tel: 0932 850361 Fax: 0932 850354

making the most  
of the music



PETITE



CRITIQUE

**neat**  
acoustics

62 High Northgate  
Darlington  
Co Durham DL1 1UW  
0325 460812

# DAN DULEY Hi-Fi

**Ultra High Quality Negus System :-** Comprising Passive pre-amp active crossover, 3 matched Stereo amplifiers, Power pack, 3 way active loudspeakers and all interconnects. This system gives unrivalled clarity and realism at the price of £1800 fully installed.

**Video Companion:** Anyone who has connected a V.H.S video to Hi-Fi equipment will know about hiss.

The Dan Duley Video Companion successfully reduces hiss by 12-14 dB using a dynamic filtering system. An essential piece of equipment for video lovers at £90.

**Handbuilt Equipment:-** Constructed on an individual basis. Amplifiers from 50wpc (rms) to 1Kwpc. All equipment is tailor made and installed to the clients requirements.

**Tape Machine Alignment:** Carried out using test tapes and an oscilloscope, rather than "set by ear", for the very best results. Very reasonable rates for all tweaking and tuning work.

For full details of any of the above items either write or telephone Dan Duley Hi Fi at:  
15 St. Georges Square,  
Forest Gate,  
London E7 8HN  
Telephone: 081 470 9795

**QUINTET** 25w Stereo

**CONCERTO** 40w Stereo

**TEMPO** 30w Mono

All Class 'A' Triode

Select Audio  
145 Bath St. Glasgow 041 226 4268

Doncaster Hi-Fi Studios  
Sunnyfields 0302 781387

The Hi-Fi Consultants  
Nottingham 0602 232450

Audible Difference  
Diss - Norfolk 0850 983233

Paul green HI-Fi  
Bath Avon 0225 316197

Hazelmere Audio  
High Wycombe - Bucks 0494 437 892

The Hi-Fi Consultants  
London 071 380 0866  
eves. 071 482 0003

Sound Academy  
Bloxwich, West Midlands  
0922 493499

What do the critics say:

**QUINTET**

The Art Audio gives you music with a sense of rightness that you don't really question but simply get on and enjoy. Sweet, open and lucid, the music is produced with an easy sense of naturalness which makes long term listening fatigue free and especially rewarding.

Roy Gregory, Hi-Fi Choice.

**TEMPO**

I feel that the Art Tempo amplifiers are among the finest valve power amplifiers currently available. The imagery that the Tempos create is vivid, lifelike and full of space and air.

Alan Sircom, Hi-Fi World

**MAESTRO**

... they are just so stunningly gorgeous and open to listen to, I can barely imagine anything more alluring.

Noel Keywood, Hi-Fi World

...the Maestro is part of that rare breed of hi-fi that makes you forget about the equipment and think about the music. In all, unlike the car, the Maestro lives up to its name.

Alan Sircom, Hi-Fi World

**AUDIO CABLES DIRECT FROM MANUFACTURER**

**MAINS CABLES** FOR PRE/POWER AMPLIFIERS P.T.F.E SILVER PLATED MAINS CABLE WITH IEC SOCKET £36/M. + £7/M ADDITIONAL LENGTHS.

**SPEAKER CABLES** 19 x 0.45 mm P.T.F.E INS. 2 CORE SHEATHED SILVER PLATED, FITTED WITH 4MM BANANA PLUG SPEAKER END AND 4MM STACKABLE BANANA PLUG/SOCKET AMPLIFIER END FOR BI-WIRING.

**CD TRANSWIRE** REDUCE THE HARSHNESS IN YOUR CD SYSTEM WITH THIS CABLE THROUGHOUT. FITTED WITH GOLD PLATED PHONO'S £35/METRE - PAIR + £10/METRE ADDITIONAL LENGTHS.

**TRANSWIRE SILVER** SILVER PLATED COPPER SOLID CORE SCREENED RECOMENDED FOR LONG INTERCONNECTS £45/METRE - PAIR WITH GOLD PHONO'S + £12/METRE PAIR FOR ADDITIONAL LENGTH.

**TRANSWIRE GOLD** SOLID CORE SILVER 99.9% OXYGEN FREE TEFLON COATED. £169/METRE - PAIR WITH HIGH QUALITY GOLD PHONO'S + OR - £26 FOR 1/2 METRE ADJUSTMENTS.

ALL PRICES INCLUSIVE OF VAT+ £ 3 POST & PACKING.

**DIGITAL LINK TRANSPORT TO DAC**  
PURE SILVER 99.9% OXYGEN FREE, TEFLON COATED WITH GOLD PLAYED PHONO PLUGS  
£38.25 per 1/3 METRE INC VAT  
£52.75 per 2/3 METRE INC VAT  
£1.50 p&p

**ARTaudio**

ART AUDIO 130 MAIN STREET, CALVERTON, NOTTINGHAM NG14 6LU Tel: 0602 653604



# readers'

## queries

### WARMING UP

At present my system comprises a Rotel RCD-965 BX, Linn Intek MK2, Epos ES1 Is (on Epos stands), AKG K 240, Linn interconnect, Audioquest F-14 and Naim NAC-A5 (single wired).

I am quite pleased with my system but sometimes I think that the upper treble (such as hi-hats etc.) sounds too metal-like and 'un-warm' - this is more evident on some CDs than on others. This bright-sounding reproduction makes it more difficult to follow the vocals and contributes to making the whole system disintegrated. To cure this problem I changed cables to Naim NAC-A5 but to my despair no luck! In your article 'Mini Monitors For The Home' (Jan 1992) I noticed that you also encountered this problem: 'Its flaws . . . such as some tailoring to remove the 'spit' from the metal dome'. So what can I do about this problem?

I also think that my system needs a touch more bass. I'd like to add more weight and scale as well. Unfortunately I can't have too large loudspeakers since my room is very small (five metres by three-and-a-half metres) and since my small apartment (I like to refer to it as my small penthouse) is an old house with springy floorboards, and

**Write in with your problems to Hi-Fi World, 64 Castellain Road, Maida Vale London W9 1EX. Our panel of experts will endeavour to solve them or at least offer some practical advice**

the bass has a tendency to become overblown.

I also want my system to be a bit more involving and exciting as I think it is a bit too sophisticated. I mainly listen to music created by Depeche Mode, Pet Shop Boys, New Order, Simple Minds, U2 etc. and I like a very detailed sound.

I am also on the look-out for a tuner like the Arcam Alpha 3, NAD 402 or the new Denon RDS tuner. What do you recommend? I need a turntable to play my 12" singles as well. I have only about 100 12" singles and I play them only occasionally as I prefer CD as a medium, therefore I want a turntable that is not too expensive. Sound quality is the only thing that is important to me. Will a

Rega Planar 2 suffice or will a Linn Basik significantly improve sound quality? Unfortunately a Systemdek IIX is out of the question since it costs about £500 in Sweden with a RB250 arm. Could you please recommend a tuner and a turntable?

As for my other problem, I have some suggestions that I'd like you to comment on.

Would a change in cables to Linn K400 remove the 'spit' that I don't like and improve the bass? I've placed my speakers one foot from the back wall; do I need to re-position them? I'd really like an article about positioning 'speakers by the way! What is my next logical upgrade? Should I:

Upgrade my front end for an overall sound quality improvement with a Micromega MicroDac for example, or would an Arcam Alpha be a wiser move? Or should I aim higher with a Teac VRDS-10?

Change 'speakers to a floor standing model like the Linn Keilidh for improved bass?

Add a power amplifier to the Intek. Is the Intek good enough? Is it possible (or wise) to connect a Linn LK100 or NAD 2100 instead of the obvious Linn Powertek to the Intek? I am wondering as the Pretek/Powertek really hasn't

got the best reviews.

Thank you very much for the best hi-fi magazine currently available mainly because, in my opinion, you don't change favourites every other week like other magazines do!

**Paul Bjernklo  
Sweden.**

First things first. Find a dealer who'll let you have a careful listen to equipment before you buy it and, better still, allow you to change something after a week or so if it's not right.

As far as the 'metal-like' sound quality is concerned, I suspect it has something to do with the rather analytical nature of the Epos ES1 Is' metal dome tweeter. This can be minimized by using a smooth, high quality, solid core cable. Try using Audioquest Indigo or DNM speaker cable throughout. An interconnect from the same companies will also help out. Using the Indigo will also give you a deeper and more detailed bass.

The lack of involvement is probably down to choice of amplifier and CD player. A NAD 2100 and 1000S combination will certainly show up the Intek in terms of 'the boogy factor'.

Continued on page 117....



.... Continued from page 115

For a decent tuner look no further than the Jan '94 issue review of the NAD 402. This is an excellent tuner, possessing much of the warmth and depth of soundstage of more expensive tuners. The Rega Planar 2 is fine for playing the occasional record, as is the Pro-ject 2, which possibly offers better value now because of the deal you get on an Ortofon Moving Coil cartridge.

The positioning of the speakers sounds fine, although they may benefit from being pulled out into the room a little and the speakers themselves are quite capable of handling a higher quality amp and source.

Arcam's Alpha 5 would be something of a sidestep from the Rotel. A two-box machine such as the Orelle DA-180 and CD-10T, or the integrated Marantz CD-10 would both present suitable upgrades. However an outboard DAC will be the best value upgrade. Try either DPA's Little Bit II or Perfect Pitch's Dacula. **DT**

## POWER PROBLEM

As there is no one in Mauritius I can seek advice from regarding a decision I want to make in respect of a change of power-amplifier, I would be most grateful for your contribution on the matter, together with your views as to whether such a change would really be beneficial. High-end audio equipment is not available in Mauritius for auditioning and my system has been built over the years exclusively from information obtained from test reports, readers advice columns and general comments from audio magazines, including your own publication since March 1991.

I have a large dedicated listening room with good acoustic performance. The

sound quality seems excellent, but since I have no means of comparison, I was wondering whether my thirteen-years-old Yamaha B2 power amp (partnered with the matching C2 pre-amp) might be letting the system down when compared with the latest high-end British equipment. I am seriously considering updating the power amplification side of my system, and I have in mind the following:

Meridian 605 monoblocks,  
Michell's Alecto monoblocks,  
Chord SPM 1200.

My system comprises only a CD player source. I use IMF MK IV Reference transmission line speakers (even older than the B2, but still going strong). I also have a Passion control unit from Audio Synthesis, which, when used in the place of the C2, is no better, or no worse than the latter.

**Alain G Lefebure**  
**Port Louis,**  
**Mauritius.**

Of the three amplifiers you mention the Alecto is possibly the most musically involving, but it doesn't enjoy inefficient or low impedance loudspeakers like the IMFs, so possibly is the least suited of the three to your needs. The Chord SPM 1200 is the complete opposite. It has absolutely masses of power, but is also quite analytical in nature. Having said this, it is very detailed and smooth in its delivery and of the three is the one I'd recommend.

There are a few others that are also worth considering though; Sugden's AU41P has plenty of power and a rich and inviting sound that should suit your system well. Over here it is £500 or so, £2500 less than the Chord, so may be a bargain upgrade, even allowing for the export price. Quad's new 606 also has plenty of power and a gentle, musical sound and should not be ruled out. **DB**

## BASS POWER

Having lived in Germany for 2 1/2 years, I am now returning to the UK, and hope to address the failings of my current hi-fi set-up. My equipment consists of the following:

Linn Axis/Akito  
Ortofon MC 3000  
Audio Note AN-S6 step-up transformer  
Audiolab 8000 C/P  
Audio Concept Type I  
(Snell type K derivatives from Denmark).

The cabling from pre to power amp is Chord, and the speakers are bi-wired with Audioquest type 4 and Linn K20.

The sound is sadly lacking in low end performance, generating an incoherent mush. This is modified depending on which way I bi-wire the speakers.

Using the Audioquest to the tweeters provides a more incisive, tangible (and to me) more exciting sound. However swapping wires over and using the K20 for the high end, and the Audioquest for the woofers gives a more convincing, involving, but fundamentally laid-back sound. Either way something is missing.

How to remedy this? Is the Axis/Akito too poor to resolve the low frequencies accurately or is it mis-matched with the MC3000 and the AN-S6?

I have to listen at low volume (9 o'clock on the dial), but feel that 4 or 5K's worth of kit should do better, even at relatively low volumes.

I used to listen primarily to hard rock, but have now moved to a lighter acoustic, female vocal (RLJ, Michelle Shocked etc.) repertoire as the equipment appears better suited to this genre. It is irritating (good as these artists are) to have my taste in music dictated by the equipment; hi-fi should disappear!

What I have at the moment is incapable of

handling powerful guitars and solid bass lines. It has no punch or conviction. It can however often deliver Martin Stephenson and Paco de Lucia with great clarity.

I am prepared to pay up to £1000 for a new front-end if required. What would you suggest? Or is this the wrong area to address? Could I get some speaker cable to clear up matters instead, and save my money?

**Mark Evans**  
**Bad Solen,**  
**Germany.**

Firstly, from your description, the Audioquest gives best results on the treble, and then when you swap it over to the bass you get a more involving and convincing sound. From this I would draw the conclusion that the Audioquest is better on the bass/mid and the treble than the K20 in this particular system. You should get rid of the K20 altogether and replace it with Audioquest for both runs.

We had a lot of discussion over your problem in the office and decided, from collective experience, that you are facing two major problems. The Snell Type K (we don't know the Audio Concept Type I but assume it is a good Snell copy) is light in the bass and sensitive too, so it does not need the power available from the Audiolab. We suspect that they are the source of your bass problems, since none of the other components are weak in this area. If you like the fine midrange of the Type K but want better bass, then perhaps you should audition an Audionote Type E, which is another Snell derivative, but a bigger one with stronger bass.

Howls of anguish arose at the thought of an Ortofon MC3000 being used with an Axis and Akito, for it demands a much better arm.

Continued on page 119.... ▶▶

# "Absolute Accessories"

DIRECT

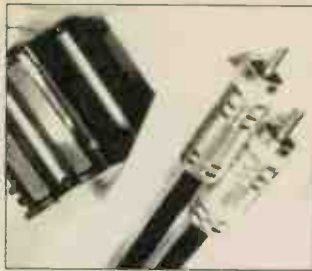

The **SILVER LEAF** collection

*Specialist Silver plated high quality interconnects, -coated silver on high purity copper-, professionally terminated using gold plated "Ring" phono plugs....*

Performance equals and can surpass other interconnects, retailing at 3 to 4 times more

### The **RF LINK** eliminator

*Designed to reduce and overcome harmful Radio Frequency activity on analogue and digital interconnects and mains leads. A true upgrade product which really works, resulting in cleaner audio interfacing hence a purer signal path. Essential for digital interfacing, CD to DAC to AMP etc.*

Silver Leaf Interconnects .....from £36.99 (Stereo pair)  
RF Link Eliminator .....only £12.99 (Per pair)

For more information on the above and other quality products contact us on:

**081-340 2240**

**Keeping your sound alive!**

# V' audio

Hi-Fi Consultants

## Echoes from the past

There are so many new brand names in the hi-fi world these days it's reassuring to find some old favourites re-appearing in the British market. One of these is SUGDEN, who have been doing well in export markets for many years but are now getting back into the U.K. market. These hand built units are superb to look at, particularly the '51' pre-power units, and produce some of the sweetest sounds around. Also worth an audition is their SDT-1 CD player.

Then there is ELECTRO COMPANET amplifiers which many of you may remember from the late 70's when their 25 watt amplifiers won rave reviews and a wide following. Their new range from this Norwegian company include phono stages to 250 watt dual mono balanced power amps plus a 20th anniversary limited edition pre-power combination with rare blue stone facia at £4,972; only 400 available world wide, so don't delay!

Another old favourite of our's was the American Dahlquist loudspeakers, which are now available here in an improved build standard as the ALON range produced by Carl Marchisotto-chief design engineer at Dahlquist for 15 years-of Acarian systems. The range starts at the ALON 1 for £1,300 and are now in stock with the ALON 2 at about £1,900 due shortly. Their top model, the Phalanx, costs a mere £25K, so we haven't got that yet!

So do come and hear some of the most interesting products around; we always have something out of the ordinary.

**36 Druid Hill, Stock Bishop,  
Bristol BS9 1EJ.  
Tel. Bristol 686005**



## The Audio Room



## Pure Sound



### For High End Hi-Fi

Where you can hear the fabulous Audio Note range of high quality systems, together with a wide range of matching components. The modern lower power valve amplifiers give finely detailed sound with excellent dynamics when used with sensitive loudspeakers. Hear for yourself just what they can do. We list below some suggested systems which you can ask to hear and which are based in the Audio Note and other top quality Amps. P.S. We have now in stock the new Micromega stages.

System	Source	DAC	Amp	Speakers	Price
Entry level 1	Micromega Stage 1	Built-in	Triangle TE60	Triangle Titusse:	£1263.99
Level 2	Micromega Stage 2	Built-in	Audio Note P1SE	Audio Note A-N KD	£2108.99
Level 3	Micromega Stage 3	Built-in	Audio Note P1SE	Impulse H7	£2533.99
Level 4	Audiomeca Kreatura	Built-in	Audio Note OTO Line SE	Triangle Alcante	£3347.00
Level 5	Kreatura transport	Audio Note DAC2	Audio Note SORO P2 SE	Audio Note A-NJ/SPx	£4737.00
Level 6	Micromega T-Drive	Micromega T-DAC	Trilogy 948/901	Impulse H2	£6350.00
Level 7	Mephisto CD Transport	Audio Note DAC 3 sig	Lumley M120/Pre	Triangle Octunt eZX	£12999.00
Level 8	Micromega Trio	Included	Audio Note ANKORD	AN-J SE	£16198.00

#### Product Ranges Available

Digital Sources:	Micromega, Audiomeca, YBA
Analogue Sources:	Pro-Ject, Basis, Wilson Benesch, Graham, Townshend, Credo, Transfiguration
Amplifiers:	Audio Note, Triangle, Trilogy, Lumley, YBA, Credo, C.A.T
Speakers:	Triangle, Audio Note, Impulse, Lumley, Townshend, Totem, Ensemble
Tuners:	Magnum Dynalab
Cables and Accessories:	Audio Note, XLO, Silver sounds, Cogan Hall, Lieder, Frameworks, Apollo, Base, Seismic Sink

#### Used/Ex-dem Corner

Item	Sale
Matisse Phantasie Pre amp	1499
Sonus Faber Electas with stands	1100
Apogee Scintillas (4/1 ohm)	1499
Manley 350 Monoblocks	2999
Audio Innovations 2nd Audios	1999
Audio Innovations L2 Preamp	499
Jadis Defey 7	3700
Lumley 120s	2450
Clearaudio Accurate cartridge	999
Chord SMP1000	1499
Mark Levinson 26's	4300
Ensemble pake:- piano black	2350
KEF 105/3	£1399
KEF107/7	1899
ATC.20	999
501	475
Second Audios	1399
YBA CD2	2150
YBA2PKE3 power	1895

**Call 081893 1074, or 0784 458176  
9 to 9 7 days a week**

The minimum would be a Rega RB300, which is a poor man's SME. Ideally though, you should be using an SME Series IV, possibly on a Pink Triangle Export or similar.

Finally, we don't understand why you are using a step-up transformer with an Audiolab 8000C

Not willing to spend the earth on hardware, but wishing to get the most out of the upgrade, I am undecided whether to upgrade my preamp or my amp. Your review of the DPA 200S pre and Michell stereo Alecto come to mind. I listen mainly to classical and jazz and started in the early sixties with a Leak Stereo 30 (wanted the

price, and the option of monoblocking is easily implemented in the future if you wish. The 200S pre/power will bring about a much higher level of detail and a clearer and more sharply focused sound.

If you do upgrade the pre-amplifier you will need a phono head amp to play your record deck, but as a

temporary solution I'd use the Quad 34's phono input to feed the line input of the 200S pre. EAR's 834P is an excellent head amp for only around £300 that can be added at a later date.

I personally have not come across the TechniSat STD 5000 DSR. I presume that the TechniSat

system uses a satellite dish to receive digital radio signals in similar fashion to satellite television - we'll investigate this and may do an article in the future.

As for the armboard, I'd try Technical & General on 0892 654534. They specialise in making spares for Garrard turntables, but should be able to make you up a blank SME armboard for your Technics. **DB**

### VINTAGE VINYL

Until recently I have been listening to my main system, Linn LPI2/Ittok 2/K18/AMC CVT 3030 valve amp/Heybrook HB2Rs on stands via Linn K20 Cables. This setup has been giving my mainly classical collection a reasonable airing until a friend recently gave me a seventeen-year-old (plus) ERA French belt-drive turntable fitted with an SME3009 Improved arm

and Shure M75EJ Type 2 cartridge which had been in his loft for seventeen years. After dusting it down I found it all to be in immaculate condition. I played it to start with through my older Arcam Delta 90 amp and a pair of cheapie single driver speakers and was impressed by the noises it made.

One day, with an hour or two to spare, I set the ERA up in front of my main system; the result was quite astounding: it is the nearest I have heard to a live concert performance and beats the Linn front end (now costing £1700) by a great margin. It lifts a lot more information from the magical black discs and is miles more musical, plus a real solid bass extension always lacking in the Linn. Now the LPI2 has now been relegated to a bedroom system (any offers?). Could anyone out there advise on any suitable modern cartridges (MM) to replace and improve on the Shure.

**D. J. Martin**  
Wellingborough,  
Northants.

I wish I'd placed a bet a few weeks ago when I was idly wondering what old turntable discovery would come next. I thought an ERA might turn up sooner or later. It was one of the classics of its time, but one that sidled off into the shadows. If you want to stick with the SME choices, alas, are very limited. In the ERA's and SME's heyday, cartridge manufacturers vied with each other to see whose would be the first to track at as near as dammit no grams at all. I remember them diminishing rapidly from 2g down to about 0.5g in at least one case. Now, we're on the way up again, and I expect to be faced with one that tracks at 4g, just like the Fifties, any day now. For the SME it has to be another Shure: the VST-V. Its little damping brush and

Continued on page 121....



DPA Digital's 200S, confident amplification.

preamp, since this has a good MC input stage. **NK**

### NEW AMPS FOR OLD

I have been buying your excellent magazine for about a year now and thought it was about time I put the proverbial pen to paper.

I would like to upgrade my old system with your help. It consists of Quad 34 pre and 303 amp, front end being a Meridian 206 CD and Technics SL 110 DD turntable with Ortofon MC10 Super.

My speakers are Spondor SPIs. I added a Digital CD-Radio recently to my system, the quality being superb. I am surprised you haven't reviewed or recommended the TechniSat STD 5000 DSR to your readers. The live concerts transmitted via satellite have caused my current dissatisfaction. Something's missing from the sound.

Quad valve pre and power but couldn't afford them) and Garrard 401 whose rumble drove me nuts so I swapped it for a TD124.

The Technics SL110 armboard I have damped with Sorbothane sheets but it could be improved. SME used to supply an armboard but no longer do. Have you any ideas of who supplies/makes an armboard cut for an SME arm? **K. George**  
Welwyn,  
Herts.

The SPIs are very clean across the midband so you should look for an amplifier that is smooth and neutral for best results. When I reviewed the new SP2/3s recently I got superb results from DPA Digital's 200S pre/power amplifiers, which you suggest and together cost less than the Alecto alone. These are very well built, sound excellent for the

# VINYL & CDs

FROM THE RECORD CONNOISSEUR

**WE CARRY THE FOLLOWING GREAT LABELS:**

ALTARUS.....LP	KING SUPER ANALOGUE.....LP
ALTO.....LP	KAMEI.....CD
ANALOGUE	MAPLESHADE.....CD
PRODUCTIONS.....LP/GOLD CD	MOBILE FIDELITY...LP/GOLD CD
ATHENA.....LP	ORIG. JAZZ CLASSICS.....LP
AUDIOQUEST.....LP/CD	POP/ROCK.....LP/CD
BLUE NOTE (JAPAN).....LP	PROPRIUS.....LP/CD
CHESKY.....LP/CD	REFERENCE.....LP/CD
CBS MASTERSOUND..GOLD CD	RYKO.....LP
CONCORD AUDIOPHILE.....LP	SHEFFIELD LAB.....LP/CD
DCC.....GOLD CD	VITAL.....LP/CD
DECCA (180 GM HQ).....LP	WATER LILLY.....LP/CD
ENJA (180 GM HQ).....LP	WILSON.....LP/GOLD CD
GRP JAZZ.....LP	SUMIKO & LYRA CARTRIDGES
JAPANESE PRESSINGS.....LP	NAGAOKA SLEEVES
JAZZ IMPORTS.....CD/LP	

For a Free 40-page Catalogue send 28p SAE to PO Box 132, Wokingham, Berks, RG11 4NG.

Free to overseas customers

Tel./Fax 0344 780262



## RECORDS WANTED

Paying up to £100 each for Classical LPs on Decca SXL, EMI ASD Columbia Sax, Mercury SR, RCA SB. **Top prices paid** for Mobile Fidelity, Nimbus Supercuts, Nautilus, 1/2 Speed Master, Japanese Pressings, Rock, Pop, Jazz, Folk, Blues & more.

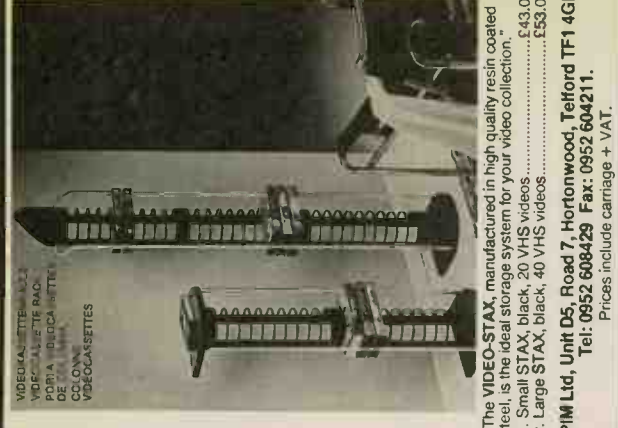

The VIDEO-STAX, manufactured in high quality resin coated steel, is the ideal storage system for your video collection.  
 1. Small STAX, black, 20 VHS videos ..... £43.00  
 2. Large STAX, black, 40 VHS videos ..... £53.00  
 PIM Ltd, Unit D5, Road 7, Hortonwood, Telford TF1 4GP.  
 Tel: 0952 608429 Fax: 0952 604211.  
 Prices include carriage + VAT.

## NEW FROM PIM STEEL-STAX CHEQUES

"The CD-STAX, manufactured in high quality resin coated steel, is the ideal storage system for your CD collection."  
 1. Small STAX, black, 40 CDs + 5 doubles ..... £28.00  
 2. Large STAX, black, 60 CDs + 5 doubles ..... £38.00  
 3. Large STAX, silver, 60 CDs + 5 doubles ..... £53.00  
 4. Table top rack, black, 20 CDs ..... £12.00  
 5. Large STAX "Piano Man", 60 CDs + 5 doubles ..... £38.00

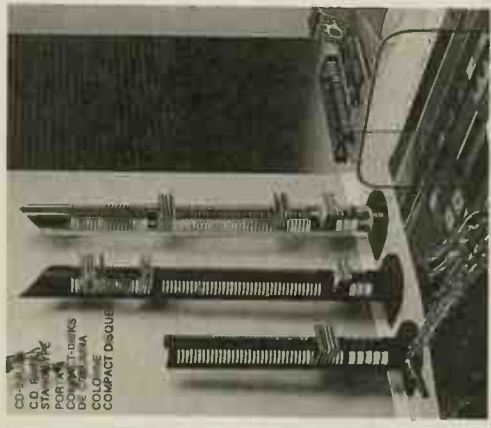

HAD A BETTER QUOTE?  
 THEN PHONE US AND SEE  
 WHAT WE CAN OFFER  
 YOU !!!!!

# R.S.AUDIO MAIL ORDER CENTRE

☎ 071-255 1403/071-255 1503

FREE DELIVERY!!!

TO ALL CUSTOMERS  
 PAYING BY CHEQUE/P.O.

<b>KENWOOD</b> DP7050 £279
<b>MARANTZ</b> CO-52 II ESALE
<b>MARANTZ</b> CO-52 IISE ESALE
<b>KENWOOD</b> KA3020 £135
<b>NAD</b> 302 ESALE
<b>PIONEER</b> A-400X £229
<b>KENWOOD</b> KRV6050 ESALE

CD PLAYERS		
AIWA	XC300	£129
KENWOOD	DP2050	£135
	DP3050	£159
	DP5050	£215
	DP7050	£279
	DPH6650	£215
MARANTZ	CD42II	ESALE
	CD52II	ESALE
	CD52II SE	ESALE
NAD	502	ESALE
	504	ESALE
	505	ESALE
PIONEER	PD102	£122
	PD202	£139
	PDS502	£189
	PDS602	£220
	PDS702	£245
	PDS802	£285
	PDS901	£409
SDNY	CDP311	£140
	CDP411	£175
	CDPC335	£200
	CDP711E	£200
	CDP911E	£260
TECHNICS	SLPG340	£120
	SLPG440	£149
	SLPG520	£157
	SLPS620	£163
	SLPS740	£205
	SLPS900	£285
	SLPS840	£340
	SLPS2000	£810
DAT		
SDNY	DTC750	ESALE
	DTC690	ESALE
TUNER		
NAD	402	ESALE
SONY	STS211	£115
	STS311	ESALE
TECHNICS	ST610	£110
AMPLIFIERS		
KENWOOD	KA1030	£110

KA3020	£135	
KA3050R	£165	
KA4050R	£220	
KA5050R	£280	
KRA4050	£185	
PM44SE	ESALE	
302	ESALE	
304	ESALE	
306	ESALE	
PIONEER	A-102	£105
	A-202	£139
	A-300X	£175
	A-400	£215
	A-400X	£229
	A-502	£285
SDNY	TAFA211B	£130
	TAFA42B	£219
	TAFA42E	£260
TECHNICS	SUV2220K	£110
	SUA600K	£165
	SUA700K	£205
	SUA800K	£270
	SUA900K	ESALE
RECEIVERS/AV AMPS		
KENWOOD	KRV6050	ESALE
	KRV7050	ESALE
	KRV8500	ESALE
MARANTZ	PM700V	ESALE
PIONEER	VSA701S	£379
	VSA802S	£455
SDNY	STRD390	£165
	STRD590	£205
	STRD790	£315
	TAAV570	£349
TECHNICS	SAGX130	£195
	SAGX230	£229
	SAGX550	£365
CASSETTE DECKS		
AIWA	ADF410	£105
	ADF810	£199
	ADWX828	£175
	ADWX929	£199
KENWOOD	KX-3050	£135
	KX-5530	£175
	KX-5050	£185
	KX-7050	£265

PIONEER	KX-90505	£435
	CT-220	£139
	CT-S320	£165
	CT-S420	£205
	CT-S520	£230
	CT-S620	£269
	CT-S920	£515
SDNY	TCFX211B	£87
	TCX311B	£130
	TCX411B	£175
	TCX511S	ESALE
	TCX611S	ESALE
	TCW435B	£150
	TCWR335B	£175
	TCWR635S	£260
TECHNICS	RSBX404	£155
	RSBX646	£187
	RSBX747	£245
	RSTR232	£155
	RSTR333	£169
	RSTR515	£210
	RSTR777	£245
	RSTR979	£309
LOUDSPEAKERS		
BOSE	ACDUSTIMASS 3CSALE	
BOSE	ACDUSTIMASS 5CSALE	
BOSE	ACDUSTIMASS 7CSALE	
	XL1000	ESALE
	XL2000	ESALE
	XL4000	ESALE
JAMD	CENTRE 100	ESALE
	CENTRE 200	ESALE
MISSION	7601	ESALE
	7601SE	ESALE
	7611	ESALE
	7621	ESALE
	780	ESALE
NAD	802	ESALE
MINI SYSTEMS		
AIWA	NSX270	ESALE
	NSX340	ESALE
	NSX500	£310
	NSXD-707	£405
JVC	UX-A3	£250
	UX-A5	£310
	ADAGIO S2	£310
	ADAGIO S3	£335

KENWOOD	ADAGIO S4	£395
	ADAGIO S6	£505
	ADAGIO G7	£670
	ADAGIO G9	£840
	UD301	£355
	UD501	£499
	UD551M	£529
	UD701M	£609
	UD751M	£649
	UD901	£810
	UD951M	£850
PIONEER	N-33	£320
	N33M	£365
	N-53	£425
	N-53M	£465
SDNY	MHC-510CD	£339
	MHC-710CD	£399
	MHC-2000CD	£485
	MHCC-60CD	£440
	MHCC-70CD	£530
TECHNICS	SC-CH404	ESALE
	SC-CH550	ESALE
	SC-CH650	ESALE
	SC-CH665	ESALE
	SC-CH750	ESALE
	SC-CH950	ESALE
MIDISYSTEMS		
AIWA	Z-720	£345
	Z-D3000M	£520
JVC	M-27	ESALE
KENWOOD	M-47	£440
	M-564	£449
	M-76AG	£770
	M-97G	£970
PIONEER	J-10	£459
	J-10M	£499
	J-20	£539
	J-20M	£580
SDNY	COMPACT109CD	ESALE
	COMPACT159CD	ESALE
	COMPACT209CD	ESALE
TECHNICS		ESALE

MISSION	760I	ESALE
MISSION	760I SE	ESALE
BOSE	AMS-II	ESALE
SONY	STS311B	ESALE
NAD	402	ESALE
AIWA	ADF810	ESALE
SONY	TCK611S	ESALE

PRICES SUBJECT TO  
 CHANGE WITHOUT  
 NOTICE  
 BUT ARE CORRECT AT  
 TIME OF GOING TO PRESS

10-12 HANWAY STREET, LONDON W1P 9DD  
 Turn Left from Tottenham Court Road Tube Station



.... Continued from page 119

recommended tracking force of 1-1.25g make it about the only real match for the arm there is left. Fortunately, it's also a very good cartridge. **EB**

The consensus here is that the K18 cartridge is most likely the source of your dissatisfaction. The ERA/SME combination is certainly a good one, but as Eric notes, the 3009 is best suited to super compliant cartridges. These days cartridges commonly track at 1.8gms and put more energy into the arm, under which circumstance you should find the Ittok performs well. The Linn may well need re-adjustment too, plus a service, then it should give excellent results with, say, a Sumiko Blue Point, or better. **NK**

### HOOKED! AND LOOKING TO UPGRADE

Until about two years ago, I was quite happily listening to my Denon music system. It was a fateful day when I took my loudspeakers for repair to a 'proper' hi-fi shop and heard a pair of ESI 1s. I then started down the slippery slope; that is, an interest in hi-fi equipment.

After several improvements I now own a Meridian 200 transport (latest spec), Pink Triangle Ordinal DAC, an Arcam Delta 290 amplifier and Epos ESI 1s. Cables are Sonic Link Green, Audioquest Quartz and Ortofon bi-wire.

I now wish to upgrade to a pre/power combination for around £1500. This, hopefully will improve the positioning and separation of instruments and also improve the bass which I sometimes feel is a little indistinct, as though the notes are blurring into one.

As a future move, how

about an improvement in loudspeakers to the value of around £1000? Is a worthwhile improvement to be had over my Epos, perhaps improving bass, but retaining what I consider to be an excellent mid range and treble?

My music tastes are Sting, Clapton, Fleetwood Mac, Donald Fagen etc. I hope you can give me some advice, perhaps re-allocating the budget or even delving into the second hand market.

**T Cowdill  
Birmingham.**

After looking at the various options available to you,

purchase. The NAPI80 retails for around £900 leaving £600 or so of your initial budget for a pre-amplifier.

As you only appear to use CD as a source, a line level pre-amplifier is all you need, in which case I'd recommend the Audio Synthesis Passion. This is an ultra high quality passive pre-amplifier so it has no gain, but fortunately the Ordinal DAC you are using has a higher than normal output level of 2.75 volts, giving plenty of headroom for driving the power amp. This passive pre-amplifier uses very high quality components

amplifier to match your Epos loudspeakers, the last thing you want to do is change them. As you enjoy the mid and treble of the Epos, I suggest you capitalise on this. Try pulling them a foot or so further out into the room. This will result in an even clearer, better-focused midband at the expense of bass weight. But don't worry because REL make a subwoofer that sounds superb, goes as low as 20Hz with plenty of kick behind it, doesn't cost an arm and a leg and is less intrusive than a large pair of floorstanders (few of which this side of £1000 can reproduce

anything like the quality of bass that the Strata does). The Strata costs £500 and is relatively simple to implement. It does take some time to carefully match the subwoofer to the main loudspeakers, but the effort is definitely worth it. **DB**

The Epos ESI 1 is known to be peculiarly room dependent and although the reviewing community, by and large, love them, and so do most owners it would seem, we do notice a residue of dissatisfaction with their bass quality in particular. It is often described as fat or bloated. As Dominic advises, pull them out into the room, use rigid open stands and make sure they are wired with good multi-strand cable. If this improves matters to your satisfaction, then go for the Naim upgrade.

If the bass remains unacceptable (and perhaps you already have them positioned properly) a Naim amplifier will improve the bass no end, but no amplifier could totally change the speaker's innate characteristics, so just in case the improvement is insufficient I would suggest you try and get a home demo first. **NK**



The much loved Epos ESI 1s.

including re-allocating your budget as you suggest, this is what I would consider to be the best option for you to follow. Naim amplifiers go extremely well with Epos loudspeakers and the new 60watt NAPI80 is superbly revealing with real punch behind it. So this I would recommend as your first

and should provide the cleanest signal path from the DAC to the power amp. The Passion is available built up for £495 or as a kit version for £275, so if you're a dab hand with a soldering iron you could save yourself a few pennies.

Now, after spending the best part of £1500 on a new

# AMADEUS SOUND & VISION

Aura, Audio Innovations,  
Bang & Olufsen,  
Castle Acoustics, Micromega,  
Mordaunt-Short,  
Musical Fidelity, Nacamichi, NAD,  
Pioneer, Quad, Spondor, Technics.

10 BOLDMERE ROAD  
SUTTON COLDFIELD  
WEST MIDLANDS

Tel: 021-354-2311



# CHOOSE

*the powerplant* 

**BRIGHTON'S LEADING HI-FI SHOP**

REGA and ARCAM products now on demonstration

Roksan, Micromega, Audiolab, Rega, Arcam, Aura, Exposure, Rotel, Marantz, Ruark  
Epos, Thiel and other fine equipment

66 Upper North Street Brighton 0273 775978

## Oxford Audio Consultants

### HI-FI SPECIALISTS



Our superb service is the name,  
regardless of price.

### SONUS FABER GUARNERI

The nearest thing to a musical instrument  
you've ever heard!!

### NOW DEMONSTRATING

SME 20 TURNTABLE - top notch analogue built to last.  
TEAC VRDS 7 - a snip at £599  
MICROMEGA T DRIVE AND DAC - tremendous value for money  
MUSICAL FIDELITY F SERIES including the fabulous new CD  
PLAYER  
HEYBROOK SEXTETS AND QUARTETS on dem!  
COPLAND CTS14 - a bargain at £999  
AUDIO VISUAL SYSTEMS including PIONEER, LASERDISC,  
DENON, NAD, ROTEL  
AUDIO ALCHEMY DAC IN THE BOX - unbelievable value for money.  
AUDIO RESEARCH LS5 - earth shattering!  
ROKSAN ATTESSA - VERY VERY GOOD!  
DENON - NEW AGENCY  
KRELL DSP CD PLAYER and STUDIO DAC - give them a go!  
THETA COBALT 307 -stunning sound and value for money!  
THETA BASIC CD TRANSPORT -excellent value  
B&W MATRIX 805  
ORELLE DIGITAL PRODUCTS - JUST IN!  
TEAC P700 2 BOX COMBO -brill!  
MARANTZ CD 10 -The latest MARANTZ heavyweight  
MICHELL GYRODEC -Try the latest power supply  
LYRA LYDIAN CARTRIDGE -simply stunning!  
KRELL KSA 100S & KRC 2 (remote control) - Fabulous  
AUDIO RESEARCH LS2B & LS3 PREAMPS & V70 POWER AMP  
SONUS FABER - THE COMPLETE RANGE; WE LOVE THEM ALL!  
MARTIN LOGAN AERIUS -Stunning looks and sound  
REL STADIUM SUBWOOFERS  
VAN DEN HUL CABLES -including The First, Second and Revelation

### EX DEM & P/EX BARGAINS

MICROMEGA TRIO COMPLETE CD COMBO £2495  
CONRAD JOHNSON PV10AL £675  
ORELLE CD160 £550  
QUAD ELECTROSTATICS £225  
ROKSAN DP1 CD TRANSPORT £795  
WADIA 6 CD PLAYER £2995  
AUDIO RESEARCH V70 ex dem £3495  
AUDIO RESEARCH LS1 PREAMP £795  
AUDIO RESEARCH DAC 1-20 £1995  
SONUS FABER MINIMA AMATOR £1195  
SONUS FABER MINUETTOS £795  
MUSICAL FIDELITY TEMPEST £150  
ACOUSTIC ENERGY AE 1s ex dem £550  
MAGNEPLANAR MG3 REDUCED TO £500  
WADIA WT2000 TRANSPORT £2995  
KRELL MD1 TRANSPORT NOW £1995  
REVOX EVOLUTION SYSTEM £1495  
APOGEE DUETTA SIGNATURES £1995

Please ask for details or our current list

Agencies include: Accuphase, Acoustic Energy, Air Tangent, Apogee, Audio Alchemy,  
Audio Research, Audio Technica Basis, B&W, Castle, Copland, Denon, Denon  
Cartridges, DPA, Dual, Goldring, Harmonix, Heybrook, HPW, Kimber, Koetsu,  
Krell, Lyra, Magneplanar, Magnum, Mandrake, Marantz, Martin Logan, Michell,  
Micromega, Music Fidelity, NAD, Nakamichi, Onix, Orelle, Ortofon, Pioneer, Proceed,  
PS Audio, QED, REL Subwoofer, Revox, Rogers, Roksan, Rotel, Ruark, SD  
Acoustics, Seismic Sink, Sennheiser, Sequence, Sequerra, Slate Audio, SME, Sonus  
Faber, Stax, Target, TDL, Teac,  
Theta, Thorens, Van den Hul, Wadia, Wharfedale

**TAX-FREE EXPORT SERVICE**  
MAIL-ORDER AVAILABLE ON MANY ITEMS  
Open Mon-Sat 10am-6pm

## Oxford Audio Consultants

Oxford Audio Consultants, Cantay House, Park End Street OX1 1JE  
Telephone: Oxford (0865) 790879 Facsimile: Oxford (0865) 791665

Lumley Reference, Nottingham Analogue, Townshend,  
L.F.D., Helms, Silver Sounds, Cogan Hall

Transfiguration, Wilson Benesche,  
Magnum, Dynalab, Graham,

**M.J.S. HI-FI**

We at M.J.S. Hi-Fi are dedicated in the quest for excellence in the reproduction of recorded music. You can be assured that we are not influenced by reviews and all the hype in Hi-Fi magazines. We devote time and patience when auditioning before we recommend and stock the product. We feel very sad about the way in which most Hi-Fi equipment is chosen and sold. We offer a refreshing alternative to the norm:-

- \* EXTENDED AUDITION TIMES
- \* HOME AUDITIONS
- \* HOME VISITS
- \* OPEN DISCUSSIONS
- \* TUNING SUGGESTIONS
- \* EVENING AUDITIONS

AND ABOVE ALL COMMITMENT TO YOU AND YOUR MUSIC.  
For More Details, Please Phone:

**M.J.S. HI-FI**  
80 Stapleton Lane, Barwell, Leicestershire  
LE9 8HE  
Telephone: (0455) 846977  
BY APPOINTMENT ONLY

Ortofon, CAT, Unistar, Sonic Link,  
Pearl, Gamma, Moth

John Shearne, Concordant, S.D. Acoustics,  
Diamond Acoustics, Origin Live, Basis, S.M.F.

**definitive audio nottingham**  
Tel/Fax (0602) 813562 Import/Export

**NOT FLAVOUR OF THE MONTH**

Definitive Audio has for some years now represented a radical departure from convention. Serving both a national and international market Definitive Audio is:

A design forum that draws on the skills and experience of manufacturers and designers from a broad range of disciplines. An advocate that has argued for an alternative method that have subsequently become the norm from both the public and:

A manufacturer, importer and retailer that has allowed the physical realisation of its ideals in systems costing from as little as £1000.

Directly in the late '80's Definitive Audio collaborated with the financially funded Sonomatic Vitavox group. The objective was to develop a full range hi-fi loaded loud speaker system capable of realising the benefits of simple low power valve amplification. The result was the magnificent Living Voice 'Air Partner' [100dB/1m to 35Hz-25kHz] which has established THE absolute benchmark in loudspeaker design.

A similar cooperation with Danish designer Terma Høring has led to a greater understanding of amplifier and power supply technology. [The use of single ended output configuration precludes any such activity in the U.K. by several years.] This progressive approach is reflected in the unusual Agalhan loud speaker system [95dB/1m to 35Hz-25kHz]. Enthusiastically embraced by Hi-Fi Choice as close to perfect it again directly related to valve amplification.

Through such systems Definitive Audio has given new insight into what is possible with domestic audio and provides manifest evidence that progress is achieved through cooperation.  
fax or phone direct 0602 813562.

1000 STYB SUPPLY, WILKIN, MIDLANDS AUDIO INNOVATIONS, S.M.E. XED, TYNCHOFF, EARL BEVOX, NOTTINGHAM (LIVING VOICE, SILVER, DALL). GOLFING, INDEPENDENT SOUND ORIG., JOURNAL STYB, SUPPLY, FROM STOCK P.O.A. (HIGHER SELECTION OF 2ND HAND PRODUCTS ALWAYS AVAILABLE).

SECOND HAND AND EX-DEM EQUIPMENT	RRP	2nd Hand Sale Price
Audio Innovations 15W Triode (2nd Audio Amplifier)	£3000	£1450
Audio Innovations S 800 moving coil transformer	£200	£80
Audio Innovations S 1000 moving coil transformer	£300	£160
Audio Innovations S 3000 Pre-Preamp	£500/350	£300/200
Audio Note 1.0. New	£1580	£1000
Audio Note AN5 (silver oak)	£1000	£650
Revox B2155 (perfect)	£1850	£1110
Linn Intex	£480	£230
Linn Astir ekiva	£680	£300
Leak TL 16		£800
Impulse HS (new osh)	£1850	£1400
Delecta Black Short (new) 1m	£220	£750
Kelvin Labs Integrated		£350
Audio Innovations S 1000 Pre	£1500	£750
Linn Itrek		£220
Norm 135 (Monobloc)	£3000	£1400
Norm 32 Pre Amp		
→ Rola Animesis P S U	£600	
Audiolab 8001 C/8000 P	£1200	£650
Audio Innovations S1000 Illumeo	£1500	£850
Audio Innovations P2 Phono MC	£900	£680
SME V	£850	P.O.A.
KESIKI Black Hi-Fi	£1400	£900
Audio Note AN 2 B (OAK)		
Meridian 603 (New unopened board)	£1700	£1450
<b>VITAVOX COMPONENTS (NEW)</b>		
S2 Pressure Unit (MID)	£720	
S5 Pressure Unit (MID)	£468	
AK 157 1.5" Bass Unit	£555	
RH 330 - 4 Cell Dispersive Horn	£254	
CROSS OVER NETWORKS BUILT AND QUOTED TO ORDER		

**THE MIDLANDS FIRST CHOICE FOR SPECIALIST HI-FI  
FRANK HARVEY HI-FI EXCELLENCE**

THREE FLOORS - THREE DEMONSTRATION ROOMS  
3000 SQ FEET IN THE PURSUIT OF HI-FI



THE FIRST CHOICE FOR THE  
BEST HI-FI SET AMIDST THE  
ELEGANCE OF OUR 14TH  
CENTURY SHOWROOMS

ON OUR FIRST FLOOR WE ARE  
NOW SHOWING THE LATEST  
DOLBY PRO-LOGIC AND SOUND  
PROCESSING PRODUCTS  
AVAILABLE FOR AUDIO-VISUAL  
SYSTEMS

MAKE FRIENDS AT FRANK HARVEY OUR KNOWLEDGABLE AND ENTHUSIASTIC STAFF ARE ALWAYS AVAILABLE TO ADVISE ON YOUR HI-FI REQUIREMENTS. AS MEMBERS OF THE BRITISH AUDIO DEALERS ASSOCIATION WE REALLY DO CARE. WE BELIEVE IN THE PRODUCTS WE STOCK AND THE AFTER SALES SUPPORT WE GIVE. WE BELIEVE THAT YOU OUR CUSTOMER ARE OUR MOST VALUABLE ASSET.

**CAREFULLY SELECTED PRODUCTS**

AUDIOLAB - AUDIO ALCHEMY - AUDIO - TECHNICA - ARCAM CAMBRIDGE - AUDIO QUEST ALPHASON - APOLLO - BEARD - BOSE - BANG AND OLUFSEN - CELESTION - CREEK - CYRUS - DENON - DUAL - FOUNDATION - GOLDRING - HEYBROOK - KEF - MARANTZ - MERIDIAN - MONITOR AUDIO - MISSION - MORDAUNT SHORT - MUSICAL FIDELITY - NAKAMICHI - NAD - PHILIPS - PIONEER - QUAD - REGA - ROGERS - ROTEL - SENNHEISER - SYSTEMDEK - TARGET - TRIPOD - TANNOY - THORENS - VAN DEN HUL - YAMAHA HOME THEATRE ETC

**FROM CAREFULLY SELECTED AGENCIES**

OUR PRICE PROMISE GARANTEES ENSURES THE BEST DEAL AT THE LOWEST POSSIBLE PRICE

FREE CARRIAGE UK MAIL ORDER EXPORT SERVICE AVAILABLE

PART EXCHANGE SERVICE 2 YEAR FULL GUARANTEES FULLY EQUIPPED SERVICE FACILITIES 5 YEAR EXTENDED GUARANTEES AVAILABLE

**FRANK HARVEY  
HI-FI EXCELLENCE**

163 MEDIEVAL SPON STREET TEL 0203 525200  
FAX 0203 631403 COVENTRY CV1 3BB  
ALL MAJOR CREDIT AND BANK CHARGE CARDS ACCEPTED

INTEREST FREE CREDIT ON SELECTED PRODUCTS (WRITTEN DETAILS ON REQUEST)

APR 0%

FREE INSTA-LATION AND DELIVERY SERVICE OPEN MONDAY TO SATURDAY 9.30 TILL 5.30 CLOSED ALL DAY THURSDAY

# THE SPECIALIST'S SPECIALIST

## PETER TYSON



OF  
CARLISLE

WE GIVE YOU

## KNOWLEDGE IN DEPTH



OUR STAFF ARE ALL HI-FI ENTHUSIASTS THEY ALL KNOW THE DIFFERENCE BETWEEN A PUSH PULL ELECTROSTATIC DIAPHRAGM AND A SOFT DOMED TWEETER - AND THEY'RE HERE TO HELP YOU.

WE GIVE YOU.....  
**1 SCORE YEARS  
AND SEVEN**



IN THE HI-FI BUSINESS STEADILY BUILDING A REPUTATION AS A REGIONAL CENTRE OF EXCELLENCE IN PRODUCT KNOWLEDGE, SERVICE AND COMMITMENT TO QUALITY.

THE BIGGEST  
INDEPENDENT  
HI-FI  
SPECIALIST  
IN CUMBRIA  
AND  
THE BORDERS

WE GIVE YOU.....



SPACE

YOU CAN COME AND 'TEST DRIVE' THE VERY LATEST KIT IN OUR DEMO LOUNGE - RELAX IN COMFORT AND ENJOY THE FINEST HI-FI SYSTEMS AND EQUIPMENT WELL AWAY FROM THE SHOP FLOOR AND ALL THE USUAL DISTRACTIONS

WE GIVE YOU



### DISTANT PARTS

OUR MAIL ORDER DEPARTMENT OFFERS A UK WIDE DELIVERY SERVICE ON SPECIALIST COMPONENTS AND ACCESSORIES - YOU CAN PHONE OR FAX YOUR REQUIREMENTS WITH COMPLETE CONFIDENCE BECAUSE YOUR ORDER WILL BE PROCESSED BY EXPERTS.



ABBEY STREET CARLISLE CUMBRIA CA3 8TX TEL. (0228) 46756 FAX. (0228) 49253

“ We stock only  
one hi-fi that  
will suit you. ”



COLIN WELFORD

At Son et Lumière, we hold what we believe is the best audio solution at every price level from £800 to over £25,000.

So, you won't find us trying to confuse you with numerous hi-fi solutions. As far as we're concerned, we've only got one answer to your requirements.

And with our purpose built listening rooms, we make a point of inspiring you with a musical solution that will give unbridled listening pleasure.

Whatever your aspirations.



SON ET LUMIÈRE, 67 TOTTENHAM COURT ROAD, LONDON W1P 9PA. TEL 071 580 9059.

# CLASSIFIED ADS

## PRIVATE

WANTED: Conrad Johnson PV 10A Pre-amplifier. Townshend Seismic Sink, equipment must be in mint condition. Tel: 03552 64586.

TEAC P700 transport, latest model, £695. Apogee Centaur Minors, £695. Jeff Rowland Model One, £1,595 (latest price). Audio Plan LS6 speaker cable, 2 x 6.5 metres, £160 (£320). Various interconnects. Tel: 0442 877853

ROKSAN ARTEMIZ Tone Arm. Good condition. £250. Tel: 0273 884087 (Brighton)

LPI2 (Black, Non Cirkus / Trampoline) ARO, 72 / HICAP / 250 (latest style), KAN I (Black incl. MK II stands) unmarked and boxed with manuals. £2,395 (new price £5,100) will split. Tel: Mike 0625 573117 Ansafone.

NAIM NAC72 (New Style) K + standard MC boards, Hi. Cap (New Style) NAP 250 (Old Style) Linn Saras (Rosewood) stands + cables. £1,700. Tel: 081-874 7404 (evenings).

N.V.A. AMPLIFICATION P50 passive pre-amp with moving coil phono stage and separate p.s.u. plus two 130 watt mono block amps. Clean powerful sound v.g.c. £450 complete. Tel: 0487 840023

THE HEAD MC TRANSFORMER £200. PS Audio MM Phono Stage and high current power supply £100. BLQ speakers £50. Alphason arm lifter unused £8. Arm base (metal) Mission 774, fits direct to subchassis Thorens 160/s £10. Tel: 081 502 3017

NAKAMICHI CR-7E Cassette Deck. Very little use, latest spec. New £1,995.00. Accept £1,000.00. Musical Fidelity A370.2 (updated to latest spec). New £2,700.00. Accept £1,400.00. Tel: 081 428 3815 (EVE)

LEAK TROUGHLINE TUNER £105. Sugden R51 Tuner £85 in excellent condition. Leak Stereo 30 amp £40. Lentek moving coil amplifier £20. Celestion SL6S Speakers and Stands £185. Tel: 0522 792555

NAIM 125 Pre-amp, MC/MM, SNAIC, Sky-cap (beats Hi-cap) £195. Quad 44 pre-amp, silver wired, improved supply, with power amplifier £195, silver interconnect £45. Valve pre-amp (beats SP10 II) Meridian 208. Tel: 0642 559543.

THORENS TDI 60B MK II, SME series III £150. Apollo speaker stands £30.00. Tel: Alan 0675 470556.

CABLES. AUDIOPLAN SUPER AF 1m. £70 1/2 m. £45. Audioquest Optilink X £25 Sonic Link grey 2 x 5m. £40. Rega Planar 3 fitted unused super Bias cartridge. Mint £160. Tel: 081 871 2345

## PRIVATE

ARCAM DELTA 60 amplifier £150. Audio Technica ATH-70 electret headphones and transformer £100. Both as new, boxed, one careful owner. Tel: 0606 871612 Evenings only (Northwich)

MISSION CYRUS 2 amplifier and P.S.X. power supply (1992), grey, good condition, boxed. Will deliver locally, £375 o.n.o. Tel: 0244 378938 (Chester) after 6.00 pm.

LINN LP12 VALHALLA / Basik Plus / K9 (black) £395. Incatech Claymore £150. Allison Sixes (great bass!) £150. Yamaha K300 cassette deck £80. Sound organisation table £20. Original Kan Stands £10. Tel: 0280 702426

AUDIO INNOVATIONS Series 200 MM/MC pre-amp £250. Sugden A48 Series II integrated amplifier £145. Marantz CD40 £95. Heco Interior 120 speakers £90. Tel: 0423 507266 (Harrrogate)

LINN LP12 Valhalla in walnut plus Akito Arm, 2 years old. New Rega Elys cartridge. All still under Linn warranty and in mint condition. £495. Tel: 0723 512379 (Scarborough)

FOR SALE: 1) MAGNEPLANAR "MG1.4" Panels 18 months old. Mint £450 (£1,100 new). 2) MICHELL "Focus - 1" Turntable + SME 3009/II, black piano finish. Bargain £149.00. 3) QUAD 22 pre-amp FM & AM tuners - offers! Tel: 081 340 2240

AUDIO RESEARCH SP14 preamplifier 1.5 years old, mint condition £1,950 (new £3,300). Art Audio Quintet power amplifier low use, mint condition £495 (new £1,050). Tel: 081 993 5634

AUDIO ALCHEMY DDE V1.0 D/A converter. Superb upgrade for budget CD player. Hi-Fi Choice best buy 12/91. Mint condition, boxed, £165. (New £419). Furukawa PCOCC interconnect £25. Tel: 0522 568330

EXPOSURE 17/18 pre/power amplifiers. Mint condition. Boxed. 2 yr guarantee. £995. 2 pairs of Cable Talk reference Analogue interconnects. 1 pair phono £75, 1 pair XLR £75 Tel: 081 360 3799

NAIM NAP 140, brand new, few hours use £435, NAC 42 Ex Cond £150, Linn Intek 2 yrs old £225 Ex Cond. Tel: 0734 866616 (Reading)

LINN LP12/EKOS/ARKIV/LINGO plus Audiotech table LK1/LK280 pre/power amps, black Saras plus stands. Reason for selling - house move £4,500 ovno Tel: Day-081 669 0011 Eve-081 422 4647 (Mark)

## PRIVATE

REVOX G36/736 half track two speed immaculate condition with spare valves £450. Also Revox A77MK IV half track high speed. Recently serviced by Revox agent and under warranty £450. Original manuals. Tel: 0279 724804 Evenings (Hertfordshire)

QUAD 34/405 £275. Quad II power amps (pair) £225. Rogers Panthera T75 FM tuner £50. Tannoy Cheviots (12" HPD units). Offers or exchange smaller speakers. Tel: 0983 297903.

QUAD II AMPS (2) (spare valves + manual). Quad ELS-57. Michell Syncro + Linn K9. Cyrus I amp + manual. Exposure speaker cable (15'). Sell for £1,250 or will split. Tel: 0803 215953

PHILIPS N4450 tape recorder/amp. Needs attention. Not used for 15 yrs. Complete with manual. Offers. Tel: Day-0706 814389; Night-0706 818495

LEAK STEREO 20, valve power amp. Excellent condition, Rata up-graded. (Up-grade cost £245). Fine, transparent sound. £250.00 o.n.o. Croft Micro, valve pre-amp - £125.00 o.n.o. McDonald transmission line loudspeakers. (Hi-Fi News design), in American walnut. 'Deflex' panel modified, very efficient. Astounding bass. (cost £750.00) - £250.00. Luxman PD300, vacuum assisted turntable, with Alphason Xenon arm and Roksan Corus/black cartridge. (Cost over £800.00) - £250.00 o.n.o. Tel: 0803 770006

AVONDALE GENESIS turntable with Avondale arm and new Goldring cartridge. Cost new £1,800 accept £1,000 or exchange for quality recent CD player. Tel: 0803 297691 Evenings after 7.00pm (Devon)

NAKAMICHI 600 TAPE DECK, newly over hauled and re-calibrated by Nakamichi U.K. £260. Sony TC 377 reel/reel deck plus TDK Audua tapes. £100. All in A1 condition & o.n.o. Tel: 0798 873757 eves. (W.Sussex)

FOR SALE Phono head amp. MC or MM. Linsley-Hood (Hart). Professionally built with up-graded components and separate power supply. £75.00. Tel: 091 489 9528

THORENS TDI25 MK II, SME 3009 Series II and Shure VIS III. Mint £150 ono. IMF ALS40 MK II speakers and custom-made steel stands. Mint £170 ono. Armstrong 623 AM/FM tuner £30 o.n.o. Classic Leak FM Troughline 3, needs attention £250 ono. Tel: 0702 201685 (evenings).

MISSION 753 speakers in rosewood. 2 months old, immaculate £550. Tel: 0502 518938

## PRIVATE

WANTED: SME Series IV or V transcription arm in good condition. Also need a line level valve pre-amp. West Oxon. Tel: Terry on 0993 702402. Leave message.

REVOX G36 half track stereo, needs attention (working), ideal for Paravicini rebuild. Many reels of tape up to 10.5inch NAB, offers. Tel: Colin 081 856 4700

CROFT 5 valve power amp, pristine £325. Audio Technica OC7 Stilton bodied cartridge (professionally inspected, excellent) £125. 2x3m Straightwire 'Encore' speaker cables (gold spades) £40 (cost £130). Tel: 0483 271669 (Surrey)

MUSICAL FIDELITY A100 amplifier £240; NAD 4225 tuner £80 (£170); Pioneer PD8700 CD player (stable platter) £180 (£300); All in v.g.c. Tel: 0555 665051 (Lanark)

MUSICAL FIDELITY MC-2 MKII Speakers. Includes Heybrook HBS1 Stands. £150.00. Tel: 081 552 6616 (eves)

NAIM 135S £750 each. Linn Isobariks black with Linn Stands £650. Tel: 0269 591 333 evenings.

SPENDOR SP2/2 speakers walnut boxes £300. Matching heavy stands £40. Notts Analogue Tracer No.1 MM cartridge (£90) £30. Target TT2 wall shelf £25. Marantz ST50L digital tuner (£175) £75. Tel: 0908 644254 Bucks.

ROGERS LS4A speakers. Excellent condition with Foundation stands. I have replaced all electrolytics with polypropylene caps and have split crossover for by-wiring. Very good sound indeed - but have gone up to LS7s! £200. Tel: 0705 781 449.

NAIM NAC72, Hi-Cap and NAP250 £1,650. Epos ES14 inc. stands £350. TOCS and ATOC3 £100 little used. All boxed and mint condition. Tel: 0423 504267 Harrogate.

QUAD Electrostatics Bronze £400. Quad 303 Poweramp £60. Quad FM3 Tuner £40. Quad 303 Pre-amp £40. Rotel RCD-955AX CD Player £150. Thorens TDI25 SME Plinth SME 3009 £60. Thorens TD 160 £15. Revox 77A Reel to Reel £100. Stax Headphones SR3-5 £20. Tel: 0952 510554.

ROKSAN XERXES, Tabriz, PSI VGC £389. QED Digit, Positron + Digiflex as new £119. Tel: Horsham (0403) 250570 evenings or weekends.

QUAD II Valve Amplifiers Groove Tubes fitted £325. Leak Troughline / Hi Fi World Decoder £250. Quad 306 Power Amplifier £230. JR DV2 Super Woofer £60. Tel: 0752 491924 (Plymouth).



**SPECTRA**  
*Dynamics*

**THE PAST &  
THE PRESENT**

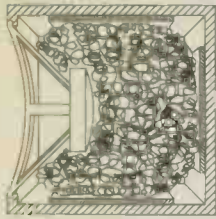

*Inside a Typical Cabinet*

**LISTEN TO  
THE FUTURE**

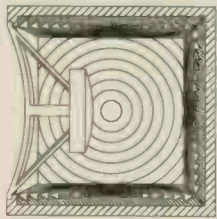

*Deflex Panels Fitted*

**GET THE MUSIC OUT OF YOUR SYSTEM, AND LET  
YOUR SPEAKERS BREATHE!**

Replaces the existing damping material inside your loudspeakers – quick and easy to fit. Available for any loudspeaker.

Deflex acoustic panels have excellent performance characteristics. The polymer is specially formulated to absorb shock and vibration, thus minimising cabinet resonances.

The surface emulation has been carefully designed to eliminate standing waves

The energy inside the enclosure is controlled – **NOT ABSORBED**, as in other cabinets.

Independent tests on MLSSA show energy gains over 50%.

# DEFLEX® A.P.T. ACOUSTIC PANEL TECHNOLOGY

PURPOSELY DESIGNED HI-TECH SPEAKER LININGS  
NOT BY-PRODUCTS FROM ANY OTHER INDUSTRY

**"NEW APPROACH STUNS THE EXPERTS"**

**"BIGGEST BREAK-THROUGH IN 20 YEARS"**

**"RESULTS NEVER ACHIEVED BEFORE"**

**"THE MUSIC IS FASTER, BRIGHTER,  
CLEANER, WITH DEEP, CONTROLLED BASS"**

U.K. DISTRIBUTOR

*The*  
**SPEAKER**  
*Company*

UNIT 9,  
WATERSIDE MILL,  
WATERSIDE,  
MACCLESFIELD, CHESHIRE  
SK11 7HG  
Phone 0625 500507

**CURRENT PRICES**

Standard Panels  
@ £7.95 each

Sub-woofer Panels  
@ £11.95 each

Adhesive from  
£3.50 (200ml)



“ We know how  
to inspire you  
with music. ”



COLIN WELFORD

At Son et Lumière, we make a point of inspiring you with a musical solution that will give unbridled listening pleasure.

In our purpose built listening rooms, we hold what we believe is the best audio solution at every price level from £800 to over £25,000. So, you won't find

us trying to confuse you with numerous hi-fi solutions. As far as we're concerned, we've only got one answer to your requirements.

Whatever your aspirations.



SON ET LUMIÈRE, 67 TOTTENHAM COURT ROAD, LONDON W1P 9PA. TEL 071 580 9059.

# CLASSIFIED ADS

## PRIVATE

HI-FI WORLD Mullard 5-20 Monoblocks, Full built and working, but too large for my room. Exchange for smaller valve power amp(s), (modern design) or sell (offers?). Rotel RCD965BX CD, mint £180. Micromega Microdac, superb £150. Tel Rod 0706 521365.

QUAD 34/306. As new in boxes. Very little use £450.00. (Sevenoaks). Tel 0732 780244 Eve/Weekends.

LINN ITTOK Pick-up Arm £250; Rotel RCD 965 BX CD Player £180. Both boxed as new with manuals. Tel Ramsgate 0843 59206 (Evenings).

NVA PRE-AMP P70 (coil phono input); Power-amp A60, PSU, 10 metres VVA cable. 18 months old, £430. Will split or exchange Linn LK100 Power-amp. Tel 0785 715650 (Staffs).

PINK TRIANGLE LPT/GTI Turntable plus Rega RB300. Mint 18 months old, fully boxed £470. Linn K9 cartridge plus spare stylus £45 or £30 with turntable. Tel Enrico on 0222 499561.

EMINENT TECHNOLOGY Tonearm MEI I-Linear Tracing, air bearing ugs offers over £550. Rata Torlyte Turntable Stand £65. Sound organisation Table £35. Yamaha NS1000 Dedicated Xovers - reletory - from £100. Tel 0602 619991.

ROGERS HE88 MK2 integrated valve amplifier, £160 o.n.o. Garrard 301, Bastin Bearing RB250 Slate Plinth £250. Musical pipelit MA65 class A 65WV Power-amps. 8 months old. £500 (new £950). Tel Paul (0533) 553176.

MICHEL GYRO Power PSU mint condition, £50 o.n.o. Tel Ray 081-854 6738.

ORACLE DELPHI T/Table with up-graded power supply. Well Tempered arm with latest up-grading modifications. Both mint condition. Koetsu Red Cartridge (brand new) £1,495 o.n.o. Tel 0268 402 368 Day 0376 571 682 Eve/W/ends.

FOR SALE. AVI 5200M Mono Blocks 150 watts each £450. Audio Synthesis PAS-02 Passive Pre-amp £150. Tel 081-531 5979.

QUAD FM3,33,303. Excellent condition boxed with instruction books also leads and solid walnut sleeve £260. Tel 0643 - 821137.

NAIM NAIT £199. Cyrus One £199 Onix OA21 £275. Audiolab 8000A £295. New Quad CD67 £730, Arcam, Royd, Roksan, TDL, Heybrook, Marantz, Rotel, P/ Exchange available. Mail Audio, Colchester 0206 861457 (6-11pm).

## PRIVATE

NAIM 32.5 Pre-amp £250 Hi-cap £310 low usage boxed. Sound org table £35. Tel Brighton (0273) 309761 evenings.

PIONEER A400 amp (280) only 6 months old, Marantz CD Player (199), F410 (120) Cassette Deck, Wharfedale 425 Speakers (199) and Alphasan Stands (65). Will separate Bargain! £450. Tel 0228-513477 (eves: Carlise).

ROTEL RCD-965BX £200; Cyrus I (Series 8 Board) £170 o.n.o.; Leak Stereo 20 Valve Amp £250. Tel: 0792 896285 (Swansea).

GARRARD 301 with SME 3009/11 Arm and ADC26 Cartridge in custom made plinth, excellent condition, handbooks etc. £200. Extending mike boom approx. 15ft. made for professional use. Offers. Tel 0203 (Nuneaton) 348375.

ROGERS LS6 Speakers, mint boxed £145. Something solid stands £35. Apollo turntable table £20. Technics digital tuner £45. Tel 0223 292815.

BOSE ACOUSTIMASS 'S' Speakers including wall-mounts and tri-pod stands in mint condition £395.00. MK1 Naim Nait £149.00 also mint will accept £500 the pair. Tel 0708 869 669 Daytime only.

LINN KEILIDH Speakers. Black Ash. Including Linn Ceramic Plinths which greatly improve sound. 11 months old. Immaculate condition. Linn extended 5 year warranty. £475. Tel 0904 631023 for details or leave message.

LINN ISOBARIK Speakers - beautifully figured walnut cabinets - including panelled stands and cables. Mint condition. Boxed. £880. Tel 061 928 8464.

MAGNUM MP 300 Stereo Pre-amplifier Magnum MF 300 Dual-Mono Mosfet Amplifier. RRP £994 wanted £495 for the pair offers/swops invited i.e. S-VHS VCR. Harrogate 0423 528256.

APOGEE CALIPER full-range ribbon speakers. Grey. Boxed, with manual. £890. "Hi Fi News" Class A Headphone Amp (design by T.de Paravicini) little use. £45. Tel: 081-5797451 (West London).

AUDIO RESEARCH LSI Pre-amp. Silver, immaculate, boxed. Only two years old. £720 (original price £1,950). Happy to demonstrate. Tel Colchester 0206 825887.

CROFT SUPER Micro A Valve Pre-amp £350. Croft Series III OTL 30 watt Valve Power-amp £550. Both recently up-dated excellent condition and sound. Tel 0403 891349. Evenings, Weekends. Long ring.

## PRIVATE

ENTHUSIAST'S CLEAROUT! Superb Valve Amps - Leak (several), Quad, E.M.I., Radford, Armstrong, Rogers etc. Mint Garrard 301. Thorens TD124. Quad Electrostatics. Sendor BCIs. Please 'phone for details. Can despatch. Tel 0364 72153.

COLLECTORS CLEAROUT, KEF 101/2 Speakers (boxed - only 22 months old) £285, KEF Chorale Speakers (bookshelf, boxed) £50, Goldring Lenco GL75 Transcription Turntable £65, Leak Stereo 70 Amp £45, Samsui 4000 Amp/Tuner (Glowing Rosewood Case) £60, Armstrong 625 FM Receiver £45, Armstrong 521 Amp £40, Reference 2' Stands £25 Tel 0483 - 233952.

WANTED - Impluse H6 or H5 speakers. Also '70's Lecson power amplifier (API etc) and Tuner (TF1). Good price paid for equipment in good condition. Tel Dave on 0332 676775.

BEARD P35 Valve Power Amplifier, three sets Valves Sovteks, Dragons, Offers. Thorens TD150 Grace G707+MC £95, WANTED Oracle, Xerxes, Koetsu, Transformers, QED Digit, Robertson 4010, Magneplanar MGIB, Target AE4-5. Tel 0642 559543.

EPOS ES14 Speakers Black Ash finish - with stands. Little used, immaculate. £260. Tel: Work 061 - 419 9717 Home 061 - 498 8966.

NAIM 62/90. Last Spec. (Green Facia). MM Board. As new with boxes and manuals. Up-grading. £450. Tel 0204 707653 (Manchester area).

EAR509 PARAVICINI 100 watt Valve Mono Blocks £1,250. Dedicated Stands £80. EAR802 Valve Pre-amp £550. Bargain £1,450 complete set-up! Could better? Leak ST70 £50, Tandberg TCD310 Cassette £50. Pair for £70! Tel 0924 - 870361.

LOUDSPEAKER CABLE Rotel Supra 4mm. 2 x 15 metres complete with gold plated 4mm banana plugs. £80. (Cost £136). Tel 081-302 9063.

WANTED Rotel RB870 BX Power Amp must be good condition. Tel: Richard 0263 733366.

TECHNICS SL110 Turntable / S.M.E. and New Ortofon 520 cartridge. £175 o.n.o. Musical Fidelity P270 II / 3A PRE £850. Mission 753 Speakers £500 (new) (save £200) Meridian 203 D.A.C. £190. Hi-Fi year books offers. Tel: 091-4877796 (Tyneside).

JIM ROGERS JR150 Loudspeakers immaculate condition including foam covering. Hardly used. Or exchange for JR149's or LS3/5A. Tel: 021 427 8810

## PRIVATE

ARISTON RD90 Superior Turntable, D.C. Supply, superbly built, high quality sound, cost £899. Accept £295.00 o.n.o. With RB250, expensive MM cartridge £395.00 o.n.o. Plus other items. Tel Paul for details 0895 446713).

AUDIO NOTE KSP silver wired loudspeakers, black with Huygens K4 stands £650. Magnum Dynalab FT-11 Tuner, Black £325. Everything immaculate condition, (ideal with valve amps). Tel 081 572 2504.

ROKSAN XERXES, white ash finish, Artemiz arm and Shiraz cartridge, very little use. £1,350 o.n.o. Tel: 081 646 2750

MICHELL Argo / Hera - ISO / Hera with Furukawa Interconnects. Cost £1,400 - sell £750. Hardly used. Tel George Watford 0923 230214 .

ALBARRY 408 Mono Block Amplifiers £500. Meridian 206 Delta Sigma CD Player £650. Audio Synthesis PAS-02 Passive Pre-amp £250. Oscilloscope (Telegroup) Offers. Tel 0621 860 630 (Essex).

ACOUSTIC RESEARCH Legend Turntable (Teak) a/R Tonearm excellent condition £85. Wharfedale XPE Glendales (Teak) Offers Tel 0732 850915 Tonbridge evenings.

LINN LP12, Linn Basik LVV, AT31 EMC, Transformer, Turntable Isolating Wall Stand £295. Quad 22 Control Unit, Quad II Power Amplifiers, Quad FM Tuner, Quad Multiplex Decoder £295. Tel 0524 735483.

ARCAM ALPHA CD Player Excellent Condition. Boxed. £175.00 o.n.o. Tel Bill on 0708 222845 evenings & weekends.

GARRARD 401 mint boxed £150. Garrard 301 £125. Leak Troughline Stereo Tuner mint boxed £160. Leak TL12 £165. Leak Stereo 20 Rebuilt £225. Troughline II £65.00 Cadet III £65. Tel: 0533 835821.

PINK TRIANGLE PIP pre-amp £350. Quad 405-II power-amp £250. Celestion SL600 speakers £400. Wife forces sale. Also Aiwa F770 Cassette £150. Phillips CD371 compact disk £50. Tel 0622 814970 (Maidstone).

AUDIOLAB 8000 C/P £775, Meridian 206B CD £450. All boxed, mint condition. Tel: 0602 528518

To advertise here - see order form on page 129

**CAMBRIDGE  
HI-FI LTD**

**NATIONAL HI-FI  
DEALER OF THE  
YEAR - 1987/88**

1 -3 HAWTHORN WAY,  
CAMBRIDGE  
CB4 1AT.  
TEL. 0223 67773  
FAX. 0223 353741

**BOSE, KEF,  
PIONEER,  
MARANTZ,  
KENWOOD,  
B&W, TECHNICS,  
JAMO,  
MORDAUNT  
SHORT, YAMAHA**

*AV Prologic  
Separates &  
Systems  
40" Pioneer  
projection screen  
on AV Demo*

**WIDE RANGE OF  
LASER DISC  
SOFTWARE  
LATEST  
AMERICAN &  
BRITISH TITLES**

**1/2 PRICE LASER  
DISC PROMOTION  
NOW ON**

**CALDWELL  
METALWORK FABRICATION  
CMF**

STRUCTURAL STEELWORK & WELDING

**QUALITY, SOLID TIMBER CD STORAGE.**

AT LAST AN ALTERNATIVE TO CHEAP PLASTIC OR CHIPBOARD STORAGE FURNITURE FOR YOUR CD COLLECTION. SEND NOW FOR OUR FULL COLOUR INFORMATION LEAFLET SHOWING THE RANGE OF CRAFTSMAN BUILT FURNITURE, FEATURING OUR UNIQUE SWIVELLING ACTION SYSTEM.

TELEPHONE 0462 670505 OR 0438 720102 (EVE)  
OR WRITE TO Unit 10 - 11, SHAFTESBURY INDUSTRIAL ESTATE ICKNIELD WAY, LETCHWORTH, HERTS SG6 1HE.

*hi* **Best prices for new, xdem & s/h equipment.***fi*

Lumley Ref 120	mint s/h	£1895	OUU pro	X-dem	£1795
Audio research			EAD 7000 tran/dac	mint s/h	£1895
D115	mint s/h	£1195	Arcam Alpha Plus	mint s/h	£295
Musical fidelity			Micromega Junior	mint s/h	£295
P270/MXL	mint s/h	£995	Arcam 170.2	mint s/h	£295
Musical fidelity P1			The Voyd (no arm)	as new	£995
70/P3A	mint s/h	£495	Michell Gyro/Zeta/		
NVA-50	mint s/h	£295	PSU	mint s/h	£695
Tube Technology			Alphason Sonata/		
prophet	mint s/h	£795	arm	mint s/h	£495
Beard BB100	as new	£795	Lycra Clavis	mint s/h	£695
Albany PP1	mint s/h	£250	Decca Jubilee	as new	£750
Naim Nait 1	mint s/h	£195	Ortofon MC3000		
Musical fidelity			/T3000	as new	£995
P140	mint s/h	£250	Koetsu Red Sig.	mint s/h	£550
KEF 107.2	as new	£1995			
KEF 105.3	as new	£1495			
KEF 103.4	as new	£795			
Monitor Audio					
Studio 10+STDS	mint s/h	£795			
Magne Pan SMG a	mint s/h	£395			
SD Accoustics SD1	mint s/h	£495			
Audio note ESP+STDS	as new	£1595			
Audio note KSP+STDS	as new	£795			
Micromega CD3+					

PLEASE CALL WITH YOUR SPECIFIC REQUIREMENT (081) 568 8808

*hi* **CHOICE** *fi*

Equipment bought or part exchanged  
Full demonstration facility - by appointment  
Major credit cards accepted  
Open 7 days 9.30am - 8.00pm

**LFD Audio**

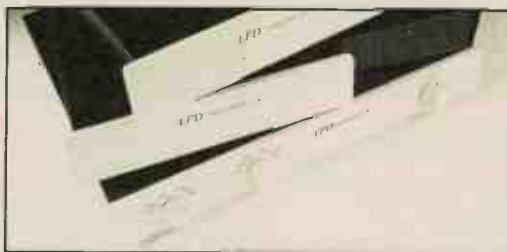

**LFD an affordable high-end alternative  
for audiophiles worldwide.**

"It's a diamond necklace in a world of Plastic- but  
without a Tiffany price tag."

Eric Baithwaite, Hi-Fi World, Sept. 1992

"Clearly then, these LFD components are of  
outstanding quality."

Jimmy Hughes, Audiophile, Jan. 1993

LFD Audio  
110 Oxford Crescent  
Clacton-on-sea  
Essex CO15 3PZ  
Tel. (0255) 422533  
Fax. (0255) 221370

For further information on LFD  
Amplifiers, please fill in your  
details and return to LFD Audio.

Name \_\_\_\_\_

Address \_\_\_\_\_

\_\_\_\_\_

\_\_\_\_\_

**WANTED:**

Responsible individuals  
with a passion for the  
sound of live music -  
AOR, baroque, be-bop,  
blues, chamber, folk,  
jazz, orchestral, rave -  
whatever your choice.

Must have an open  
mind, a healthy  
disrespect for hype, hi-fi  
reviews and 'salesmen'.

The ability to trust what  
your own ears are  
hearing.

**The rewards:**  
Good music, company,  
buffet and the  
opportunity to meet the  
manufacturers at our

**ATC  
Loudspeakers**



**AVI  
Electronics**

**OPEN DAYS**  
on 19th & 20th March  
at COTTAGE AUDIO  
17 BRIDGE ST.,  
SAXILBY,  
LINCOLN  
for further details & an  
invitation call

**0522 702 834**

..... and hear the difference





# Advertisers Index

## MAIN ISSUE

Acoustic Arts	113
Amadeus Sound and Vision	122
Art Audio	114
Audible Difference	106
Audio Freaks	54
Audio Gallery	113
Audiolab	46
Audio Technica	80
Avondale Audio	100
Bill Hutchinson Hi-Fi	107
Billy Vee Hi-Fi	105
Bury Audio	96,113
Cambridge Hi-Fi	128
Campaign Audio Design	112
CD Stax	120
Chesterfield Hi-Fi Show	98
Choice Hi-Fi	128
Cirrus Systems	118
Clear Crystal Systems	56
CMF	128
Connections	44
Cottage Audio	128
Dan Duley Hi-Fi	114
David Ostick Hi-Fi	112
Definitive Audio	123
Diva	54
Don Fordy Hi-Fi	112
Doug Brady Hi-Fi	22
DPA Digital	I.F.C.,3
F&S	116
Frank Harvey Hi-Fi	123
Hale Hi-Fi	104
Heatherdale Audio	106
Hi Way Hi-Fi	101
Hi-Fi Confidential	112
Huddersfield Hi-Fi	104
Ian Edwards Hi-Fi	86
Ian Harrison Hi-Fi	113
Infinity	44
J.E. Sugden	I.B.C.
K.J. Leisure Sound	32,56,96
LFD	128
Listen Inn	22
Loricraft	88
Loughton A/V	54
Market Link UK	42
Mantra Audio	104
Meet Your Maker Directory	97
Merdian	6
Michell Engineering	44
Mike Manning Audio	65
MJS	123
Musical Images	99
NAD	8
Naim Audio	B.C.
Neat Acoustics	114
Orelle	86
Ortofon	20,22
Oxford Audio Consultants	122
Peter Tyson Hi-Fi	124
Pheonix	100
Polar Electronics	44
Premier Marble	20
ProAc	78
QED	80
R.S. Audio	120
Radford	116
Real Music Distribution	98
Record Connoisseur	120
Roksan	12,13
Ron Smith Aerials	26
Room Acoustic Services	104
Scarborough Hi-Fi	106
Sevenoaks Hi-Fi	108,109
Slate Audio	100
Son et Lumiere	124,126
Sound Academy	88
Sound Craft	26
Sound Gallery	30
Sound Illusion	102
Spaldings	116
Steve Boxshall Audio	26
Tabula Rasa	86
TDL	80
Team Point	88
Tesseract	20
The Audio Room	118

The Hi-Fi Attic	102
The Hi-Fi Showroom	102
The Music Mill	96
The Power Plant	122
The Speaker Co	100,126
Try Me & See	10
Tube Technology	56,113
Twenty 20 A/V	103
UKD Callas	98
V'Audio	118
Wollaton	88

## DIY SUPPLEMENT

Audio Components	17
Audio Synthesis	6
Audionote	10,I.F.C.
B.K. Electronics	17
Badger Boards	16
Bandor	8
Billington Export	6
Chelmer Valve Co.	I.F.C.
Falcon Acoustics	6
Halcyon Electronics	4
Hart Electronic Kits	14
Heatherleys	16
IPL Acoustics	8
Kit Suppliers Directory	30
Langrex Suppliers	24
Lockwood Audio	24
Lynwood Electronics	6
P.M. Components	I.B.C.
QED	4
Russ Andrews	B.C.
Serious Kits	20
Sonic Frontiers	17
Sound Investments	16
Sowter Transformers	6
Tabula Rasa	16
The Speaker Company	22
Vintage Valves	4,8
Wilmslow Audio	16
Wollaton	24

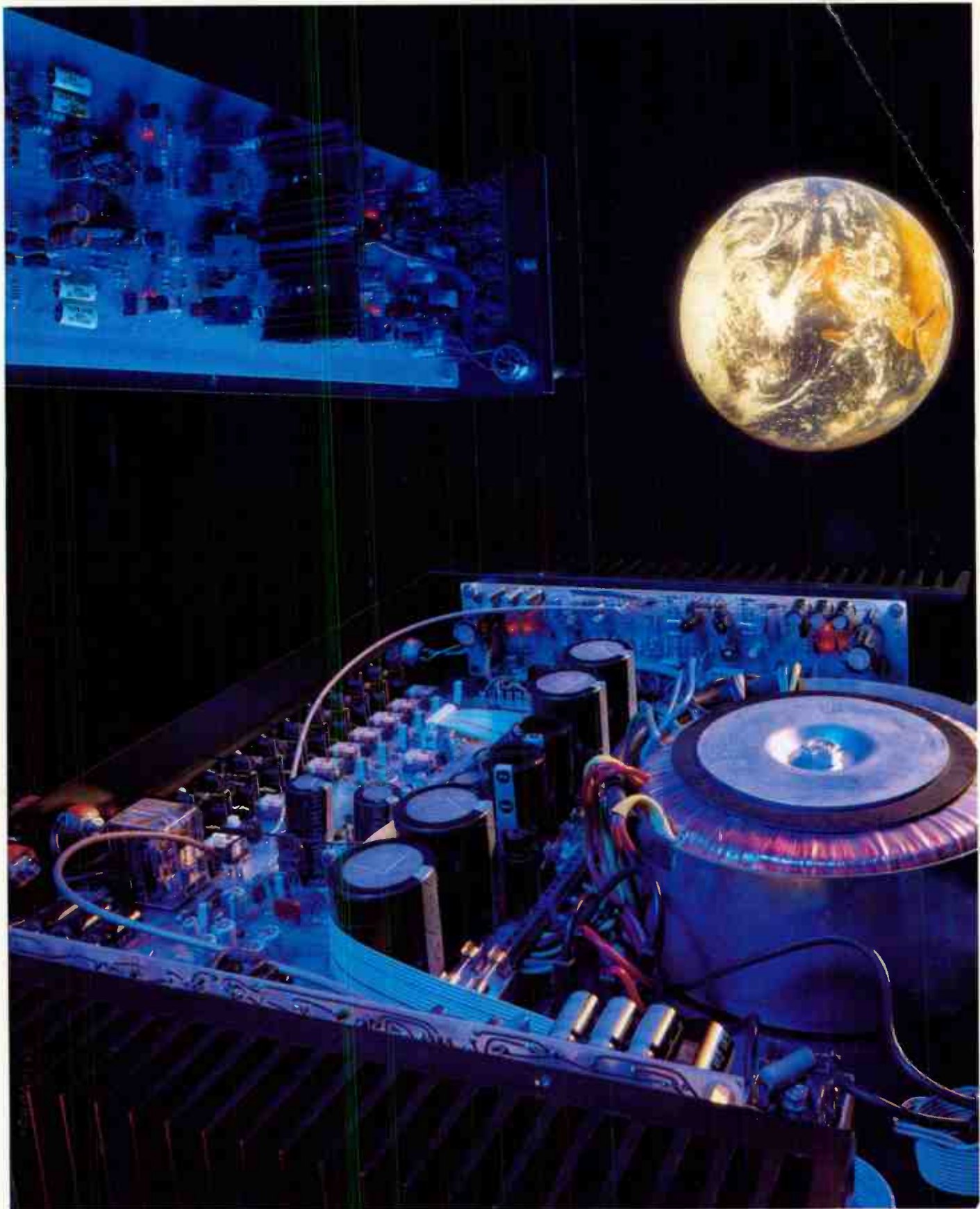

# SUGDEN

HAND CRAFTED ■ FAIT À LA MAIN

DESIGNERS & MANUFACTURERS OF HI-FI & AUDIO EQUIPMENT

J. E. SUGDEN & CO. LTD.

Valley Works,

Station Lane, Heckmondwike,

West Yorkshire WF16 0NF

Tel. Heckmondwike 0924 404088/9

Fax No. 0924 410089

World Radio History

