

# HIFI WORLD

MAY 1993 £2.00

**TOP U.S. TUNERS  
from the  
Sixties**

**NAD 502  
CD Player**

**SCOOP!**

**NEW B&W 803 Series 2  
Floorstanding Monitor**

**KENWOOD KX-9050S  
Dolby S Cassette Deck**

**FIVE SUBWOOFERS  
and SATELLITES**

**NEW QUAD 67  
CD Player**

**ARE CDs  
OVERPRICED?**

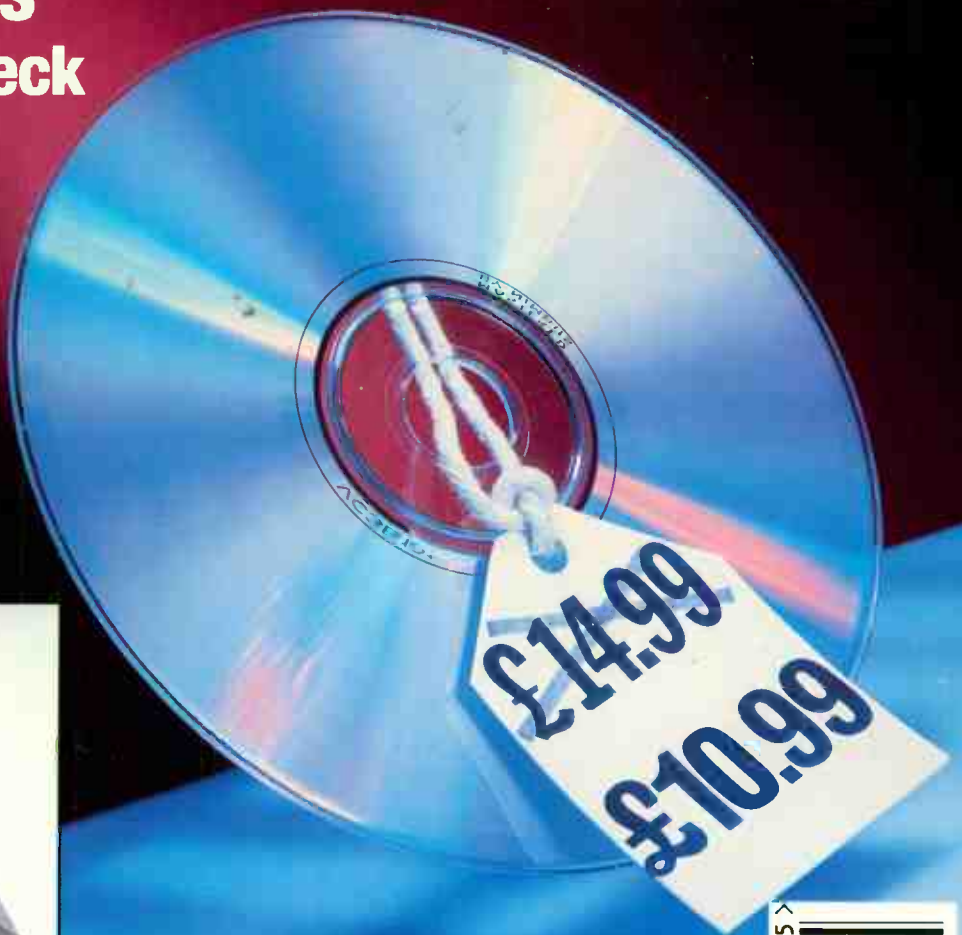

**COMPETITION**

**WIN SILVER NIGHT 300B VALVE  
AMPLIFIERS worth £1995**

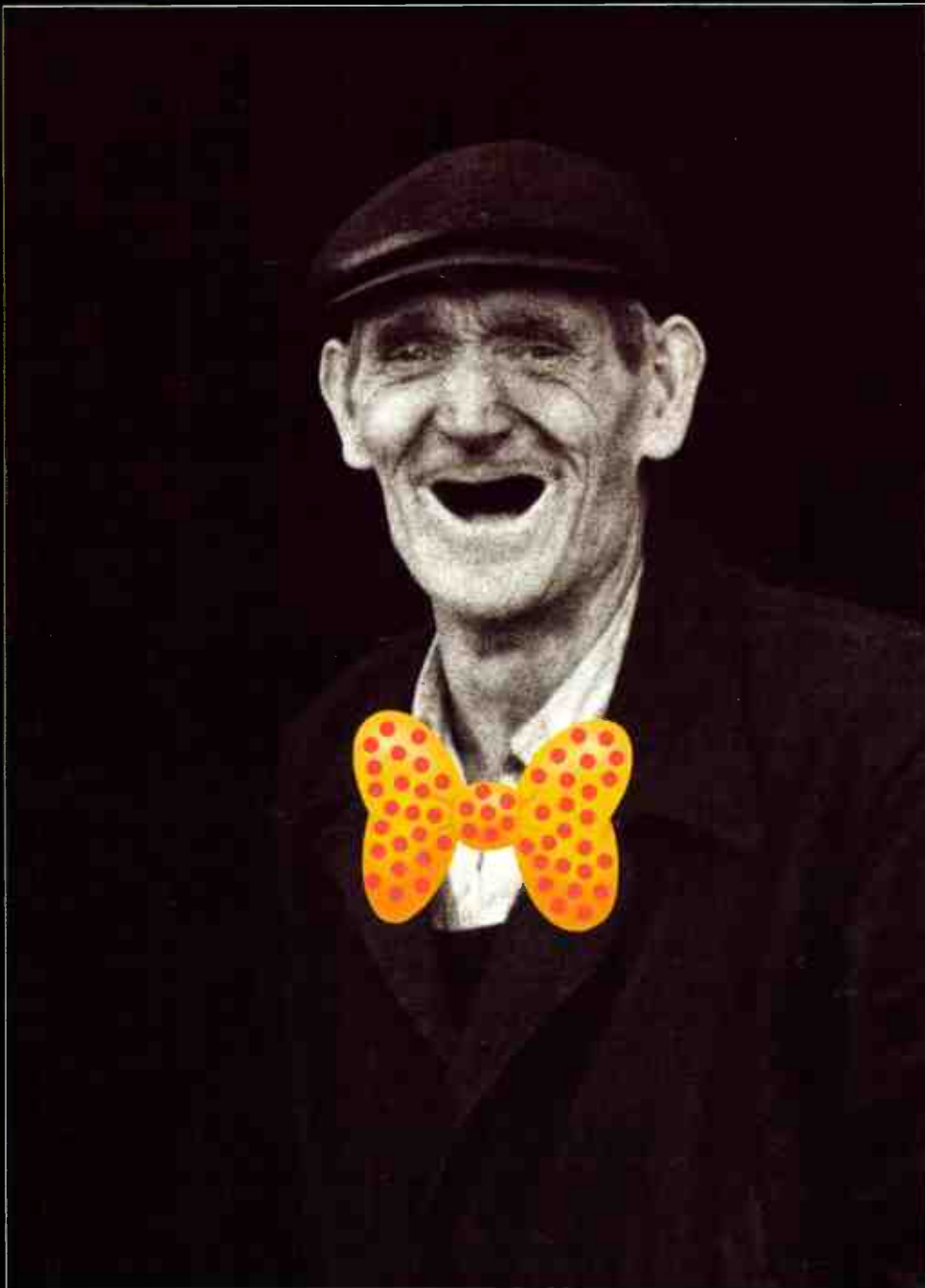

I'M SORRY, I THOUGHT YOU SAID  
UPGRADE YOUR TRAMP...

Upgrade your amp is the message - the New Naim NAP 180 power amplifier could be perfect for your hi-fi system. Dual rectified power supply, 90 watts per channel into 4 ohms, dependable Naim engineering and a sound that will put a smile on your face too!

The only tramp involved is the one along to your nearest Naim retailer.

Now you know what's in a Naim



 naim audio

Naim Audio, Southampton Road, Salisbury SP1 2BN, England, Tel: (0722) 332266

#### LONDON

**Audio Venue**  
24 Church Rd, Crystal Palace, SE1 Tel: 081 771 7787  
**Billy Yee Sound Systems**  
248 Lee High Rd, Lewisham SE13 Tel: 081 318 5755  
**Doug Brady Hi-Fi**  
18 Monmouth St, Covent Gdn WC2 Tel: 071 379 4010  
**The Cornflake Shop**  
37 Windmill St, W1 Tel: 071 631 0472  
**Grahams Hi-Fi**  
Conventry Yard, 190a New North Rd, N1 Tel: 071 226 5500  
**Son et Lumiere**  
67 Tottenham Court Rd, W1 Tel: 071 580 9059  
**The Sound Organisation London**  
4 Pickleworks Wharf, Chiswick, SE1 Tel: 071 403 2255  
**Studio 99**  
79-81 Fairfax Road, NW6 Tel: 071 624 8855  
**Uzbridge Audio**  
108 Chiswick High Rd, W4 Tel: 081 742 3444

#### NEAR LONDON

**Infidelity Hi-Fi**  
9 High St, East Grinstead, W Sussex Tel: 042 314599  
**Radford Hi-Fi**  
43 King Edward Court, Windsor, Berks Tel: 0753 856691  
**The Sound Gallery**  
85 Castle St, High Wycombe, Bucks Tel: 0494 531682  
**Spaldings**  
358-354 Lower Addiscombe Rd, Croydon, Surrey  
Tel: 081 854 1231  
**Studio 99**  
82 High St, Harpenden, Hertfordshire Tel: 0582 784246  
**Unitel Products**  
35 High St, New Malden, Surrey Tel: 081 942 9567  
**Uzbridge Audio**  
278 High St, Uxbridge, Middlesex Tel: 0895 230404

#### SOUTH

**Audio Designs**  
26 High St, East Grinstead, W Sussex Tel: 042 314599  
**Chichester Hi-Fidelity**  
7 St Pancras, Chichester, Sussex Tel: 0243 776402  
**Jeffries Hi-Fi**  
69 London Road, Brighton, E Sussex Tel: 0273 808431  
**Jeffries Hi-Fi**  
4 Albert Parade, Green St, Eastbourne, E Sussex  
Tel: 023 31336  
**Jeffries Hi-Fi**  
29 London Road, Portsmouth, Hampshire Tel: 0705 663804  
**Soundcraft**  
40 High Street, Ashford, Kent Tel: 0233 824441  
**Sound Waves**  
1 Hobury Drive, Princes Risborough, Hampshire  
Tel: 0703 899131  
**Worthing Audio**  
20 Terville Gate, Princes Risborough, W Sussex Tel: 0903 212133

#### EAST

**The Audio File**  
27 Hockland St, Bishops Cleeve, Herts Tel: 0279 506676  
**The Audio File**  
No 2 Foundry Walk, St Ives, Cambridgeshire Tel: 0480 86123  
**Basically Sound**  
The Old School, School Rd, Brackley, N. Northants  
Tel: 0508 70829  
**Carm Audio**  
110 M3 Road, Cambridge Tel: 0513 60442  
**Pro-Musica**  
8 Vireyard St, Colchester, Essex Tel: 0206 57519  
**Rayleigh Hi-Fi**  
218 Moulsham St, Chelmsford, Essex Tel: 0245 265245  
**Rayleigh Hi-Fi**  
122-4 London Rd, Southend-on-Sea, Essex Tel: 0702 435246  
**Rayleigh Hi-Fi**  
44A High St, Rayleigh, Essex Tel: 0266 779762

#### WEST

**Audio Excellence**  
58 Bristol Rd, Gloucester Tel: 0452 300046  
**Audio Excellence**  
65 Park St, Bristol, Avon Tel: 0272 264975  
**Radford Hi-Fi**  
6 Fore St, St Marychurch, Torquay, Devon Tel: 0803 328723  
**Radford Hi-Fi**  
28 Cowick St, St Thomas, Exeter, Devon Tel: 0362 218895  
**Radford Hi-Fi**  
12 James Street West, Bath, Avon Tel: 0225 446245  
**Radford Hi-Fi**  
107 Cornwall St, Plymouth, Devon Tel: 0752 228011  
**Radford Hi-Fi**  
52/54 Gloucester Road, Bristol, Avon Tel: 0752 428248  
**Mike Manning Audio**  
110 Middle Street, Yeovil, Somerset Tel: 0835 79361

#### WALES

**Audio Excellence**  
134 Crwys Rd, Cardiff, South Glamorgan Tel: 0222 228565  
**Audio Excellence**  
9 High St, Swansea, West Glamorgan Tel: 0792 474808

#### MIDLANDS

**Creative Audio**  
9 Dogpole, Shrewsbury, Shropshire Tel: 0743 241924  
**Griffin Audio**  
94 Bristol St, Birmingham 5, West Midlands Tel: 021 882 1359  
**Listen Inn**  
32 Gold St, Northampton Tel: 0604 37871  
**Sound Advice**  
The Sound Factory, Duke St, Loughborough, Leicestershire  
Tel: 0509 218254  
**West Midlands Audio**  
158 Ormsley Road, Worcester, W. Tel: 0905 59046  
**Overture**  
3 Church Lane, Banbury, Oxfordshire Tel: 0295 272158  
**Westwood & Mason (Oxford) Limited**  
46 George Street, Oxford Tel: 0865 247783

#### NORTH

**Audio Projects**  
45 Headingley Lane, Leeds, West Yorkshire Tel: 0532 304585  
**Batten Hi-Fi**  
18 Cook Street, Liverpool 2, Merseyside Tel: 051 227 5007  
**Doug Brady Hi-Fi**  
The Forge Cottage, 19 Crossgate, Cleay, Leeds, West Yorkshire  
Tel: 0943 467689  
**Doug Brady Hi-Fi**  
401 Smithdown Rd, Liverpool 15, Merseyside Tel: 051 733 8859  
**Doug Brady Hi-Fi**  
Kingway Studios, Kingway North, Warrington, Cheshire  
Tel: 0825 828009  
**Lintone Audio**  
8 The Arcade, Metro Centre, Gateshead, Tyne & Wear  
Tel: 091 480 0999  
**Lintone Audio**  
7-11 Park Lane, Gateshead 8, Tyne & Wear Tel: 091 477 4167  
**Lintone Audio**  
20-22 Monument Mall, Newcastle-upon-Tyne, Tyne & Wear  
Tel: 091 232 3994  
**Lintone Audio**  
242 Park View, Whitley Bay, Tyne & Wear Tel: 061 252 4665  
**Moorgate Acoustics**  
184 Fitzwilliam St, Sheffield, S Yorkshire Tel: 0742 756048  
**Moorgate Acoustics**  
8 Westgate Chambers, Westgate, Rotherham, S Yorkshire  
Tel: 0709 370666  
**Murray Hi-Fi**  
396 Wilmshaw Rd, Handforth, Cheshire Tel: 0825 548277  
**Murray Hi-Fi**  
East Angham Buildings, Princess Dock St, Hull, Humberside  
Tel: 0482 227987  
**Sound with Style**  
81 Nether Hall Rd, Doncaster, S Yorkshire  
Tel: 0302 321421  
**Sound with Style**  
284 Glossop Rd, Sheffield, S Yorkshire Tel: 0742 737893  
**The Sound Organisation**  
26 Gillygate, York Tel: 0904 827108

#### SCOTLAND

**Stereo Stereo**  
273 St Vincent Street, Glasgow, Strathclyde Tel: 041 248 4079  
**Robert Ritchie**  
102 Murray St, Montrose, Tayside Tel: 0674 73765

#### NORTHERN IRELAND

**Lyric Hi-Fi**  
153 Stranmillis Road, Belfast Tel: 0232 381296  
**Lyric Hi-Fi**  
84 Bridge St, Portadown, Co. Armagh Tel: 0762 358059





Cover Photograph by Paul Hartley Studios 071-482 3768

# Contents

THIS MONTH'S FEATURES ON PAGE 5



## THIS MONTH'S REVIEWS

### AMPLIFIERS

**A-400GTE** Does Tom Evan's tweaked Pioneer leave the standard model behind? We see if the modifications lift it to genuine Gran Turismo specification. 44

**MICHELL ISO HR** John Michell has remained faithful to the religion of vinyl reproduction. The new 'High Resolution' ISO HR moving coil phono head stage is tested to see if it qualifies for devotion. 24



### COMPACT DISC

**QUAD 67** Quad has opted to use the acclaimed Crystal chip in its new CD player. Does this put the new 67 player up with the front runners? 19



### LOUDSPEAKERS

**B&W 803 Series 2** Standing high and mighty, these new floorstanding B&W's boast multiple drivers and a big sound. Do they offer more magic than the popular 805s? 16

**JBL L1** Battling against the exchange rates are the new American JBL L range. Are the entry level L1s a good rocker? 22

**SUB WOOFERS AND SATELLITES**  
A small alternative to big loudspeakers - but do they have a sound to match? We see how they compare.

**CELESTION 1s/CS-135**  
**BOSTON ACOUSTICS SubSat Six**  
**JBL CONTROL 5/SB5**  
**MONITOR AUDIO MA100 Golds/200/92**  
**ROCK SOLID Solid Monitors/Twinbass** 50

### TURNTABLE

**OASIS TURNTABLE** With High Street supplies of LPs drying up and an increasing move towards CD, an oasis for the vinyl lover is definitely needed. We visit one. 48

### TUNER

**ADCOM GFT-555II** Imported from the States, the Adcom tuner aims to cut down background hiss. 66

### CASSETTE

**KENWOOD KX-9050S** Can the veteran cassette fight off the the new recordable digital formats? Kenwood's cassette deck tries to deflect the first blows in what could be a long fight. 41

**MAXELL Digital** may be the buzzword but analogue cassettes still keep improving a quarter century after their launch. Maxell's new additions to the range come under scrutiny. 58



#### Editor

**Noel Keywood**

Assistant Editor  
**Dominic Baker**

Music Editor  
**Jonathan Jordan**

Production Editor  
**Peter Downes**

Marketing Manager  
**Akila Lingham**

Marketing Assistant  
**Richard Johnson**

#### Contributors

**Eric Braithwaite**  
**Richard Brice**  
**Peter Herring**  
**Simon Hopkins**  
**Paul Miller**  
**Malcolm Steward**

#### Cartoonists

**Freddy Ahmet**  
**David Simonds**

Advertising Director  
**Rob Debenham**

Advertising Executive  
**Caroline Knott**

Advertising Tel: 071-266 0969

Distributed by:  
**COMAG**, Tavistock Road, West Drayton, Middlesex, UB7 7QE  
Tel: 0895 444055

Origination by:  
**Minerva**, 56C Minerva Road, London NW9 0 6HJ  
Tel: 081 961 6468

Printed by:  
**Southernprint**, Poole, Dorset.  
Tel: 0202 622226

**AUDIO PUBLISHING LTD.**,  
64 Castellain Road, Maida Vale, London W9 1EX.  
Tel: 071-289 3533  
Fax: 071-289 3620  
Queries cannot be answered by telephone.  
**MAIL ORDER**  
Tel: 071-266 0461 (24 hours)

**Subscription Rates:**  
UK: £22,  
Overseas Surface: £29, Airmail: £42 (Europe & Middle East).  
American and Canadian Subscriptions - see page 68  
£62 (Australia, Japan & China).

No material may be reproduced from this magazine without the publisher's permission.  
© Audio Publishing Ltd



**AMERICAN**  
and  
**CANADIAN SUBSCRIPTIONS**  
- see page 68

**MORE** SEE PAGE 5



# Here, in our usual, modest manner is the announcement of the decade.

We're the first to admit that we don't exactly set the industry alight with a new product here, and a new one there every few months or so.

For example, our 3020 series amplifier has remained largely unchanged for the last ten years. If we forget our modesty for a moment, it became the largest selling amplifier in audio history and won universal critical acclaim.

We say goodbye to it with a little regret, but then of course, here is the new NAD 302 stereo integrated amplifier.

As it's from NAD, you know it has to be very good because, as you may have gathered, we don't simply make changes for change's sake.

The 302 is a significant advancement in audio design. Using single board construction with minimum length signal paths, you get greater

reliability and more faithful reproduction. Six separate inputs including two tapes and MM phono means it's more flexible, and it's more powerful too.

But most importantly of all, it simply sounds better. After all, it should do. It's taken almost a decade to develop.

Don't take an age to listen to the new NAD 302 amplifier. It's at your local hi-fi dealer now.



## THE NEW 302 AMPLIFIER FROM NAD

**NAD**

BRITISH BY DESIGN

NAD MARKETING LTD. ADASTRA HOUSE, 401-405 NETHER STREET, LONDON N3 1QG. TELEPHONE 081-343 3240

WorldRadioHistory

## BUDGET EQUIPMENT GUIDE

Although purse strings may be tight at the moment you can still enjoy good hi-fi reproduction. Our budget section keeps you on the straight, narrow and inexpensive audiophile path.



**NAD 502:** The CD budget market is a tough street where NAD have always done well. But can the new 502 can pack enough punch to see off rivals?

121

**BUDGET QUERIES:** We strive to solve your problems and preserve your cash flow.

129



Hi-Fi World produces the majority of reviews in-house, using our own lab facilities and listening rooms.

## REGULARS

**NEWS:** Our news hounds give you all the best scents from the hi-fi industry. 7

**LETTERS:** World views from our readers pens. 14

**COLUMNS:** Noel, Richard and Dominic all put their thoughts onto paper. 31, 61, 63

**QUERIES:** Have your hi-fi problems got on top of you? We try our best to be good samaritans and offer free advice. 69

**SPECIAL OFFERS:** Our growing catalogue provides a complete range of accessories and recordings for the hi-fi enthusiast. 74

**NEXT ISSUE:** Feeling sad at having finished this issue? Look forward to what is coming in our bumper June edition - with a DIY supplement! 73

**READERS' CLASSIFIEDS:** Get your audio bargains from this basement. 105

**ADVERTISERS' INDEX** 105

**AERIAL REFERENCE:** Pluck more milli-volts from the sky with a decent aerial: our guide serves as a reference. 125

**WORLD FAVOURITES** 126

## FEATURES



**BRISTOL SHOW:** The first hi-fi show of '93 had people queuing on a Sunday; we sound out what's new and exciting! 26

**COST OF A CD:** Are CDs over priced? Why is record company revenue falling? Hi-Fi World investigates. 12



**U.S. TUNERS:** Vintage Valve Tuners from across the Atlantic: stunning performance, with Sixties style. 33

**EDITORIAL ROCK:** The editorial team get to grips with some of the latest CD chart material! 81

## MUSIC

Rock update from the editorial team 81

**ROCK RECORD OF THE MONTH:** OMAR AND THE HOWLERS Courts Of Lulu



**CLASSICAL RECORD OF THE MONTH:** VENETIAN VESPERS Gabrieli Consort and Players

**ROCK AND POP** 83

**JAZZ** 87

**CLASSICAL** 92

**RECORD OFFERS:** Pages of Rock and Jazz and Blues and Classical - all ready on CD, LP and DAT waiting to be packed off to your door 97

## COMPETITION

Win a pair of **Audion Silver Night 300B valve amplifiers** worth £1995. Bring a glow to your home and their silky sound to your ears, all for the price of a stamp. 64



# BUYING A HI-FI ? OWN A HI-FI ?

To obtain the best from any hi fi, the connections between the components play an important part. We are the only company to specialise purely in these connections. As well as this we make a variety of Audio Visual connections or any requirement you may have. We are also the only company to be purely British made - hand built - to a high standard - fully guaranteed, reliable - using quality components. We are consistently recommended and used by leading British manufacturers and Hi Fi dealers. All these things imply that it is the best product around and the most expensive. Well - that's partly true, it is one of the best products around but as for expensive, well that's just not us. At the Chord Company we like to offer value for money and that means not bumping up the price to cover slinky packs and expensive marketing. We believe in quality and service and by quality we mean something that SOUNDS right, not something that looks expensive. We do not want you to be concerned with technical specifications but to rely on your ears! That's why - we didn't wait for the single European market, we've sold to the single world market for the last seven years exporting worldwide. Send off the coupon below for a full list of suppliers or call us, you will find us helpful and receptive.



**Australia** Wedderspoon PTY 3 Ford Street, Greenacre NSW (642) 2595  
**U.S.A.** Naim Audio North America 1748, North Sedgewick Chicago Ill. 60614 (312 944 0217)  
**Canada** Dimexs, 6818 Saint Denis, Montreal, Que H2S2S2, Canada 273-1675  
**New Zealand** N.A. Distributors, PO Box 40, 461 Upper Hutt (644)569 7332  
**Austria** PMs GmbH Kandlegasse 32/5, 1070 Wien (229) 32183  
**Belgium** Stereotypes64, Rue des Hellenes 1050 Brussels (640) 0463  
**Denmark** Danish Hi Fi Imports Seedorfs Uaenge N0 22, 2000 Copenhagen 187 3633  
**Germany** Phonosophie Klangstudio Laruperhauptstrasse 204 Hamburg 53 083 7077  
**Holland** Phonologic Postbus 21956, 3001 AZ Rotterdam 413 0029  
**Switzerland** Grammophile Rathaus platz 4, 3011, Berne 12 111 71  
**Sweden** Euphonia Misihantaggnigger S Strandgaten 23, 553 20 Jonkoping 36 124 142  
**Italy** Archidee SRI, Via Emilia 95, Pisa 56100 509 85 314  
**Saudi Arabia** M.A.T.E. P.O. Box 1487, Alkhobar 31952

For a full UK dealer list and more information;

Name \_\_\_\_\_  
 Address \_\_\_\_\_  
 Post Code \_\_\_\_\_  
 Tel \_\_\_\_\_

I would like information on:

Phono Cables  Din Cables  Audio Visual   
 Other Accessories  All

**THE CHORD COMPANY, 30A SARUM BUSINESS  
 PARK, PORTWAY, SALISBURY SP4 6EA**

**TEL: 0722 331674**

**FAX: 0722 411388**

trade winds  
trade winds  
**trade winds**



**Hi-Fi World brings you all the latest news from the hi-fi industry**

## DCC SOUND TO BE IMPROVED

Philips representatives recently confirmed that DCC is to be improved by bringing in eighteen-bit coding as an official specification. "This level of resolution is achieved today from the Marantz recorder" they told us, "but as eighteen-bit coding becomes available within studios, it will be allowed to appear on DCC tapes, significantly improving sound quality".

Philips are prepared to accept that CD will have to sink or swim irrespective of this development, since it cannot be altered in its basic specification. "Research is going on into the possibility of twenty-bit coding being incorporated into DCC at a later date but nothing has been finalised" we were told. Eighteen and twenty-bit machines would not make sixteen-bit recordings unusable.

Although eighteen-bit might appear to be a small difference, being only two bits better than sixteen, in fact the resolution increases from  $2^{16}$  up to  $2^{18}$ , or from 65,536 up to a massive 262,144 - a 400% increase! So the improvement in resolution will be enormous and, understandably, it is said to result in significantly better sound quality, free from much of the harshness of sixteen-bit.

## MINIDISC IN JAPAN

A mole, recently returned from Tokyo, commented that only one shop in the whole of the Akihabara (the huge array of electronics and software shops in Tokyo) appeared to be selling MiniDiscs. They are more widely available in London, said our source. The players themselves are in the shops, but sales of the record/playback machines have outstripped those of the playback-only machines, which have not been launched here yet, by ten to one. Concern is developing in some quarters that if MiniDisc is incorporated into portable stereos and mini or mid-systems replacing a CD player and tape deck, as seems likely, the move could seriously affect Compact Disc sales, leaving it a 'high-end' or audiophile medium.



## QUAD RELEASE TWO PIECES OF WIRE WITHOUT GAIN

Quad have developed two types of loudspeaker cables in response to the perpetual debate on this topic. They are based on a round profile carrying 4.0 sq mm conductors and a flat profile of 2.5 sq mm. The cable will be available through Quad dealers and other hi-fi retailers at £5.80 per metre for the round and £3.50 for the flat profile. The round cable is available in several different colours so even if Quad are successful in silencing the debate on cable choice they have at least allowed a little pondering on which colour to choose! And since Quad have always said good amplifiers - like their own - don't have 'a sound', but act as pieces of wire with gain, then these cables will surely be described by them as 'pieces of wire without gain'.

Quad Electroacoustics Ltd, Huntingdon. PE18 7DB.  
Tel: 0480 52561

trade winds  
trade winds  
trade winds  
trade winds



**DRIVERS UP THE WALL**

KEF have produced a custom series loudspeaker that is designed for wall or ceiling mounting: the CR200Q. These employ an 8" polypropylene woofer and a 1" polymer dome tweeter with magnetic fluid cooling. They come equipped with mesh grills that can be painted to suit the decor and retail at £299.

KEF Audio (UK) Ltd, Eccleston Road, Tovil, Maidstone, Kent. ME15 6QP. Tel: 0622 672261



**SPENDOR**

Spendor Audio Systems Ltd have managed to qualify for oriental appreciation: their S100P three-way reflex loudspeaker has picked up an award from 'Stereo Sounds' magazine of Japan. The S100 P is a modified export version of the S100. The modifications include AV shielding and the addition of handles! The UK version of the S100's are available for £1599 per pair.

Spendor Audio Systems Ltd, Station Road Industrial Estate, Halisham, East Sussex. BN27 2ER. Tel: 0323 843474.

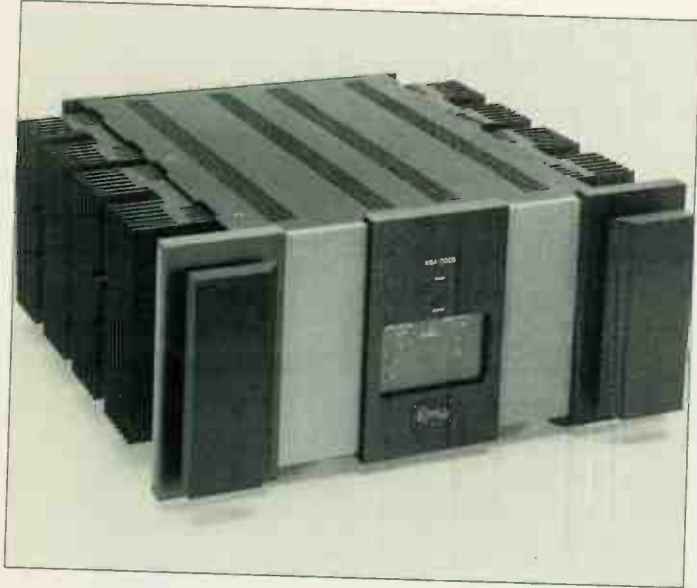

**NEW FROM KRELL**

Krell have just announced their new products for 1993. Pictured here is the KSA-200S pure Class A 200W power amplifier priced at £6,599. Also available is the 100W KSA-100S at £4990, and the KSA-300S at £7990 which offers 300W. For release in April '93, but with no price fixed as we went to press, is the 50W stereo KSA-50S amp. All are stereo amplifiers with balanced inputs. All the new Krell products feature remote switch-on, allowing amplifiers to be slaved together and switched on from one control in multi-amplifier applications. The place of the KSL pre-amplifier has been taken by the line stage KSL-2, also featuring balanced inputs and outputs, for £2799. Owners of the KSL can have their pre-amp upgraded to KSL-2 specification for £200.

Krell's digital products include the Reference-64 24-bit digital-to-analogue convertor with 64x oversampling for the not-insubstantial price of £12,900. Power supply, digital processing and analogue output stages have all been newly engineered. Features include clock synchronisation when partnered with a Krell transport and a Jitter Rejection Module to minimise jitter when used with other transports. Absolute Sounds Ltd., 58 Durham Road, London SW20 0DE. Tel: 081 947 5047; Fax: 081 879-7962.



**B&W ON A BUDGET**

The 2000 series of budget loudspeakers has just been launched by B&W which claim the same technological and engineering quality as their bigger brothers. The four speaker range starts at £119.95 for the two way 2001 with the 2004 topping the range at £249.95 having twin 165mm bass/mid drivers and a 25mm metal domed tweeter. All are said to be easy to drive and sound fast and exciting.

B&W Loudspeakers Ltd, Marlborough Road, Lancing, West Sussex. BN15 8TR. Tel: 0903 750750.

**SIGNATURES FROM WOLLATON AUDIO**

Wollaton Audio is now acting as distributor for the American XLO Signature range of interconnect and loudspeaker cable. The range includes balanced and unbalanced interconnect and a new addition to the range is a specially shielded interconnect to reduce hum. The interconnect does not come cheap: a one metre pair will cost £625 and a six foot terminated pair of loudspeaker cable £1590.

Wollaton Audio, 134 Parkside, Wollaton, Nottingham. NG8 2NP. Tel: 0602 284147.

**GOLDRING STAY DEDICATED TO VINYL**

Goldring have re-affirmed their dedication to analogue music by launching an improved 1000 series range of Cartridges. Included in the range is a brand new cartridge with an elliptical stylus, the 1006 which forms the entry level at £44.95.

Goldring Products Ltd, 8 Greyfriars Road, Bury St Edmunds, Suffolk. IP32 7DX. Tel: 0284 701101



## TARGETING TIDINESS

Target Audio have added a new device to their extensive range of audio products which aims to make short work of even the most messy piles of interconnect and mains leads. Called 'Cable Tidy' it acts as miniature conduit for cables and is supplied in 1m lengths. Sure to be a hit with complaining girlfriends or wives it costs £11.99. We would recommend that anyone intending to apply this system should use a separate 'Cable Tidy' for mains, keeping signal leads well away from the influences of high voltage a.c.

Target now provide 230mm and 330mm spacing bars for their modular systems and have launched a 28" high spiked speaker stand: the TR70 costs £55. They claim to provide an alternative option to mounting book-shelf speakers in places you do not necessarily want a bookcase!

Target Audio Ltd, Suite 6a, Britannia House, Britannia Estate, Leagrave Road, Luton. LU3 1RJ. Tel: 0582 401244.



## ATC STAND OUT

Proudly announcing that business is up by 30%, ATC have revealed plans for a new loudspeaker and two pairs of dedicated stands. The speaker is the bi-wireable SCM20T which is a floorstanding version of the SCM20. Available in September price will be £1,999 for the Black Ash version and £2,499 for a Rosewood finish. Dedicated stands for the SCM10s and SCM20s are now

available. They are constructed from an anodised aluminium central pillar which can be filled with sand and the baseplate has an attractive wooden top. Walnut or Black Ash stands for the SCM10 are £204.95; Rosewood and Yew are £225.09. Stands for the SCM20 are £229.70 and £259.91 respectively.

ATC, Loudspeaker Technology Ltd, Gypsy Lane, Aston Down, Stroud, Gloucestershire GL6 8HR. Tel: 0285 760561; Fax: 0285 760683.



## NAKAMICHI BACK TO THE FUTURE

Readers have already seen two of the latest 'new-look' cassette decks from Nakamichi, which we reviewed in March. The DR-2 and DR-3 are joined by the DR-1 three-head deck at £699.95. The new range of cassette decks, CD players and a new 'audiophile' integrated amplifier have abandoned the previous curved edges and returned to the flat fascias of older Nakamichi designs.

At the same price level as the DR-3 2-head cassette deck, the £299.95 IA-3 amplifier is a line-level only design, built on a 'simple is better' basis with discrete circuitry - no integrated circuits are used - separate left and right channel earth paths and high quality components. Power supply and audio circuits are on separate boards, while the Record out selector is taken out of the main signal path to avoid the degradation induced by a tape monitor circuit. The IA-3 offers 40W output.

Again at £299.95, the new CD-4 Compact Disc player brings down the admission fee for entry-level Nakamichis. Sharing the same styling as the rest of the range, this is a single-disc player using dual 18-bit 8x oversampling converters and is remote-controllable. The three other players in the new range, the MB-3, MB-2 and MB-1, feature Nakamichi's multi-play 'Musicbank' system.

Nakamichi B&W U.K. Ltd., Marlborough Road, Lancing, West Sussex BN15 8TR. Tel: 0903 750750.



## LOGICAL ADDITION

Latest addition to Philips' 900 series range - the one that includes the domestic DCC player - is the FR940 A/V receiver. At £450, the FR940 includes Dolby Pro-Logic and the ability to power two speakers for ordinary stereo, or up to five for full 'surround sound' applications. The inevitable digital signal processing effects to simulate stadiums and so on are included, but so is a tuner which offers thirty memory presets.

Philips Consumer Electronics UK Ltd, City House, 420-430 London Road, Croydon. CR9 3QR. Tel: 081 689 2166

# simply the best

An overused advertising statement? After all, "Simply the best" is such a cliché in today's marketing run world. No, it is something we at DPA believe in and are justly proud of.

Our revolutionary new T1 transport, DAC's, amplifiers and cables are the best for numerous reasons, which start at the design stage. Uniquely DPA designs are heuristic in nature - with each design an incredible number of factors is taken into consideration and carefully balanced to produce the most transparent performance. We believe everything can make a difference to the sound quality and everything is rigorously explored and examined to an unprecedented degree. This approach, of making no assumptions, leads to radically unique designs.

This unrivalled passion and care are not just the province of the design stage; this passion is carried through to the production of the unit. Unique production methods with advanced surface mount technologies are employed again with the ultimate care. Final assembly is carried out unhurriedly by one technician, with fully automated testing of each unit, so that each parameter that can affect performance is tested.

So why should you believe us? After all, we could be accused of bias. Throughout the world, fair but discriminating critics have been universal in their praise for DPA products. Take for example a recent review in Australia's High-End magazine Stereo Buyers Guide where the PDM2, in a group test of 27 DAC's, was quoted ...."you get a sound that can't be matched by any other. Only for those that demand the very best." Hi-Fi Choice Dec '91 also states that ...."(the PDM2) goes on to redefine many areas of CD sound quality."



However, rave reviews are not just the exclusive domain of DPA's PDM2. Hi-Fi World, on the PDM1 S3 said "Any enthusiast who wants the best from CD at a reasonable price should consider (the PDM1)." What Hi-Fi, Nov '91 said ..."the Bigger Bit is set to destroy all its competition." Our amplifiers are equally well respected with Hi-Fi Choice saying of the 50S pre-power ...."unmatched detail resolution, control and transparency."

Why should you believe the Hi-Fi critics? After all, it's your money and your Hi-Fi. Visit one of our dealers and ask for a demonstration of DPA products. If you value music and not distortion we think you will agree with DPA - simply the best.

## dpa digital Ltd

Unit 7, Willowbrook Lab Units, Crickhowell Road, St. Mellons Cardiff CF3 0EI,  
tel: (0222) 795621 fax: (0222) 794267



## HARMAN/KARDON

Harman Kardon have also joined the AV bandwagon launching the AVR30 Receiver. This unit also comes equipped with Dolby Pro-logic and five DSP effects. The AVR30 is able to drive five channels for AV use and is complemented by an audio direct function which allows straight forward stereo reproduction and will retail at £1190.

Harman International Industries Ltd, Mill Street, Slough, Berks. SL2 5DD. Tel 0753 576911.

## JAMO

Jamo's new range of speakers cater for the growing AV market. They have launched six systems ranging from £199.99 to £649.99 that will provide partners for AV amplifiers. They are aimed as part of a complete home theatre system with some packages including rear speaker stands!

Jamo U.K. Ltd, Jamo House, 5 Faraday Close, Drayton Fields, Daventry, Northants, NN11 5RD.

## IN BRIEF

### PRESENCE CHANGES

Latest victims of the pound's devaluation are the Milltek and Kiseki cartridges, imported by Presence Audio. The Milltek Aurora is now £299, the Olympia £399. Of the Kiseki range, the Blue Goldspot is now £499, Purpleheart £749, Purpleheart Sapphire £899, Blackheart £1995 and the Lapis Lazuli only £5000.

A digital telephone exchange has given mostly analogue distributors Presence Audio a new number:

Presence Audio, Woodside, Spronketts Lane, Bolney, Haywards Heath, W. Sussex RH17 5SA. Tel: 0444 461611; Fax: 0444 461510.

### GRAHAM'S GUARANTEE

Is your dealer demised? Grahams Hi-Fi of London have come to your rescue, by offering to undertake guarantee and service work on brands for which they hold the agency. If your dealer left you holding the baby, contact Grahams at:

Canonbury Yard, 190A, New North Road, London N1 7BS. Tel: 071 226 5500; Fax: 071 359 7620.

### SHOWS

The Yorkshire Hi-Fi Show '93 is now scheduled as a two day event and will take place over the weekend of the 16th and 17th October 1993 at the Holiday Inn Royal Victoria Hotel in Sheffield. Admission will be free and the show open 10am to 6pm both days.

All enquiries should be directed to Sound with Style on 0742 737893 or 0302 321421.

## CORRECTIONS TO MULLARD 5-20 ARTICLE

As always, our readers being exceptionally alert, have informed us of a few little errors in the Mullard 5-20 article in the April 93 issue. We apologise for any inconvenience caused but mistakes always creep into a project of this scale.

1. Two of the capacitors have their labels repeated.

C4 appears twice, as an H.T. smoothing capacitor. The right hand of the two, decoupling the line between R9 and R17 should be identified as C5; its value remains 22µF. The left hand of the two, C4, should be symbolised as an electrolytic.

C6 appears twice, and although the values are correct, the capacitor in the feedback loop should be identified as C9.

In the Measured Performance section the reference to C6 concerns the 310pF capacitor in the feedback loop. The reference to C6 in the first paragraph of page 9 concerns the capacitor connected between the cathode of V2 and Ground.

2. In the fourth paragraph (third column) of text beneath the circuit diagram we refer to the cathode volts being 25V of V1, when it should have been 2.5V wherever mentioned. The value printed in the circuit diagram is correct.

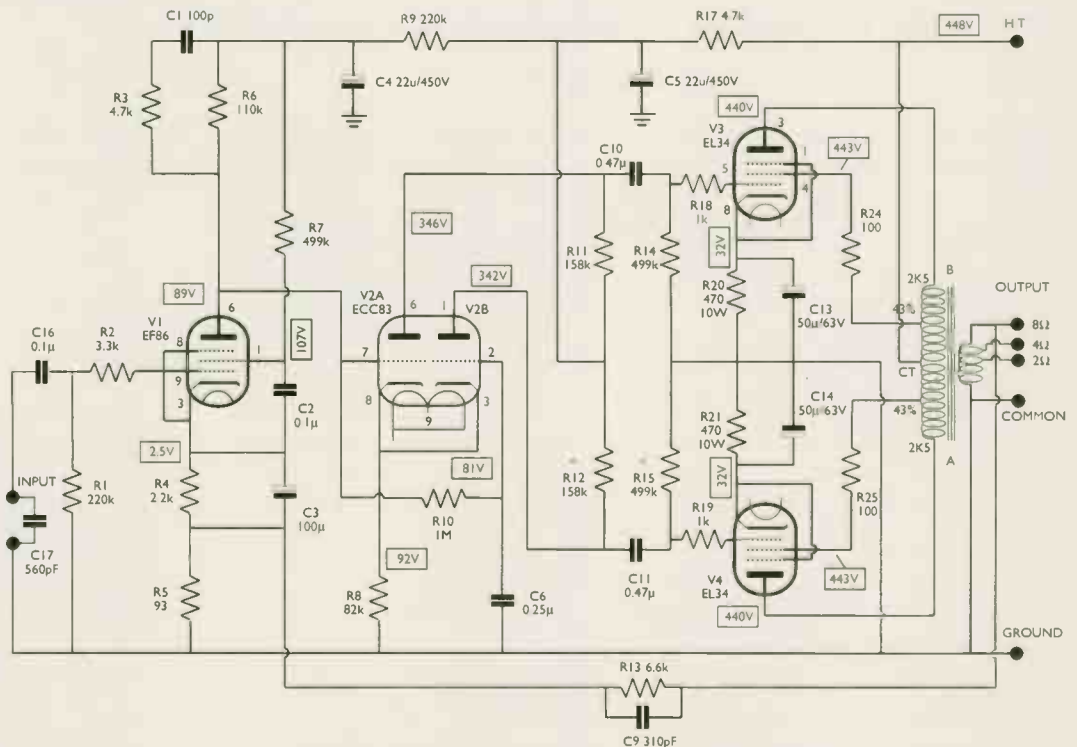

The kit valve amplifiers use components selected for their sound quality and reliability. Each kit is supplied with full instructions and a backup service is offered should anything go horribly wrong. The inclusion of punched and drilled chas-

sis and the features mentioned above, make the kit extremely good value for money and will save endless problems associated with trying to source and build the amplifiers yourself. For this reason the kits are only available in their entirety.

**For details on how to order your pair of kit monoblocks, see page 103.**



# Price Fight

**Are Compact Discs too expensive? Jonathan Jordan questions the industry to discover if we are being charged too much gold for our silver.**

For every seven music retailers alive and well ten years ago, there are now six. Could it be the high price of a Compact Disc - now the leading format - that dealt them a death blow? The growing anger over what many people see as an over-priced rip-off, lining nobody's pockets but those of the record companies, has even spurred the House of Commons National Heritage Select Committee, chaired by Gerald Kaufmann, to investigate CD pricing.

Now Sir Malcolm Field, Managing Director of W. H. Smith, which owns the Our Price chain and a fifty per cent stake in Virgin Megastores, is embarking on a crusade to slash CD prices to under ten pounds. W. H. Smith have twenty-five per cent of the market. That not only makes them influential and likely to be listened to, but gives them access to their own market statistics, which paint a gloomier picture than those from the music industry, as represented by the British Phonographic Industry (B.P.I.). W. H. Smith's recent figures show that CD sales have fallen by ten per cent over the last two years - and the decline has been speeding up over the last six months. "The continuing decline in the recorded music

market adversely affected the performance of Our Price Music" says the latest company report.

Music sales generally, says the B.P.I., declined by 2.4% in 1992, slashing the record companies' annual revenue to £692.4 million. Overall album sales (CD, LP and cassette) have been in decline since 1989, due to a significant drop in LP and cassette sales. However, according to the B.P.I., CD sales have held up well. Differences between their own figures and those of W. H. Smith are probably explained by the fact that the B.P.I. report only trade deliveries and their value. This takes no account of retail price cutting to move unwanted stock.

All the same, in 1992 CD was the best-selling format, notching up trade deliveries of 70.5 million units, which would appear to be good news for the record industry. This is in spite of the fact that recently, the cost of a chart CD has increased 25% to nearly £15 and revenue from CD sales has gone up as a result, seemingly untouched by the recession. However, rises of this size are out of proportion to the increase in the cost of living - currently around 4% - and they appear to be responsible for an alarming

slide in overall sales and revenues. Prices of the old formats, LP and cassette, have been raised to discourage people from buying them. It's proving a narrow strategy; the resultant fall in LP and cassette sales has more than wiped out any gains from CD.

Are CDs simply over-priced? In Spain, the typical retail price of a CD is £15.90; but in France it's £13.32. In the States, even accounting for exchange-rate fluctuations, a chart CD will cost £8 or £9, a cassette between £5 and £6. The B.P.I. likes to point out that CDs are cheaper in the UK than in many other European countries, but to support their case they quote only those countries where it is more expensive.

Germany has an affluent population little larger than Britain's and it offers a more valid and glaring contrast with Britain than America. Deliveries of CDs to the retail trade rocketed past 100 million units in 1991, against 63 million units in the U.K.. Not unsurprisingly, the cost of a CD in Germany is lower than that in Britain - around Dm24.6 on average, we were told by the I.F.P.I., or around £8.20 (at the pre-devaluation exchange rate of 3Dm=£1). This is 2.5% of the average German income of Dm1000 per week. In Britain, where the average weekly wage is £300 per week, a CD priced at £14.99 represents 5% of weekly income, so it appears twice as expensive. Parity with Germany would be achieved at around £8, as the exchange rate comparison suggests.

These figures show that a CD appears considerably cheaper to the average German than to the average Briton. They also indicate that were prices to be lowered, sales volumes would rise considerably in Britain and that the music industry may well benefit as a result.

Polygram, the group that has the largest share of the recorded music business in the UK, declined to comment on these price disparities between countries, referring us to the B.P.I. In answer to the pricing discrepancies between the U.K. and the U.S.A. they said other items were also cheaper besides CDs - Levi 501s and paperback novels for example. They also said incremental costs like the copyright fees, cover designs and promotions are spread over a much larger population in the States. But although the U.S. took 31% of world music sales in 1990, the European Community took 35% of the world CD sales, showing that it is an even larger market. This would suggest that economies of scale are also possible in Europe and that countries like Germany seem able to apply them. The B.P.I.'s argument on behalf of the record industry, that CDs in Britain are fairly priced, still doesn't sound very convincing.

So how much does a CD cost to manufacture? Is its high retail price justified by manufacturing costs? Is it markedly more expensive to manufacture than a cassette? Neither the major record companies nor



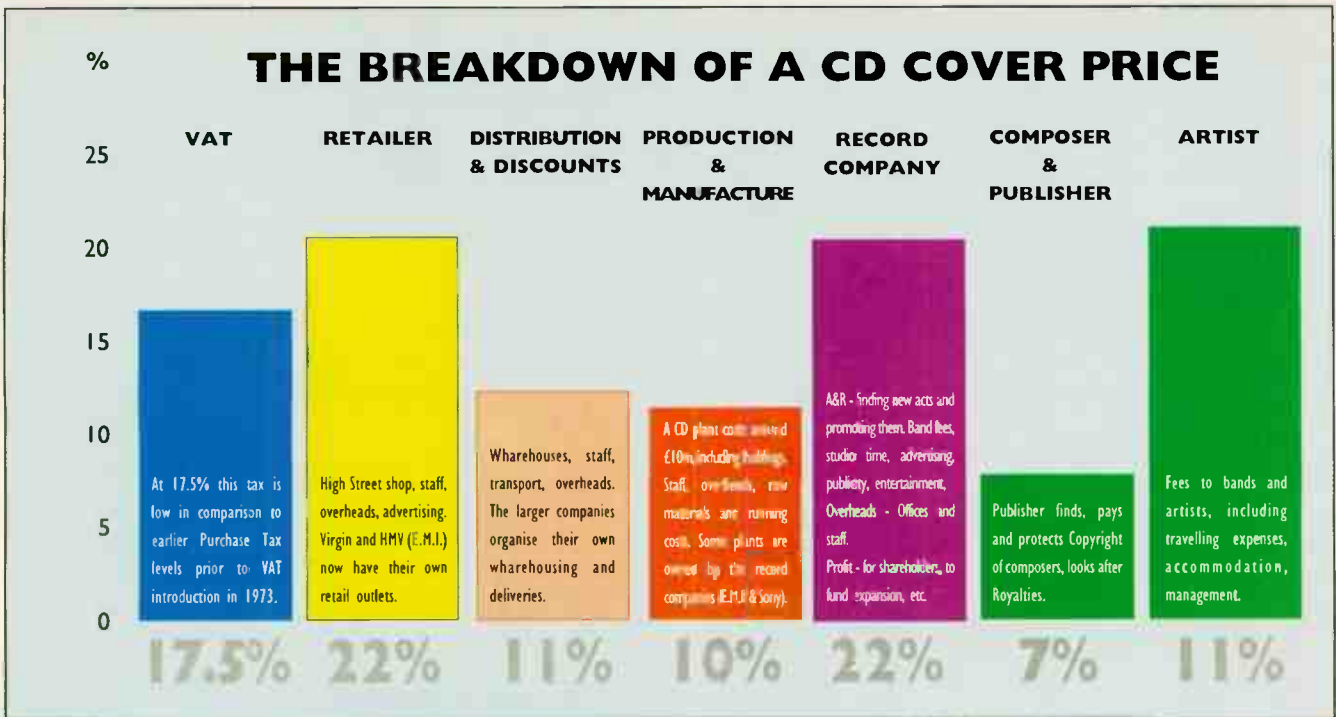

the B.P.I. were prepared to divulge manufacturing costs, so we approached a specialist manufacturer to quote a price on a production run of 5000 CDs, and for comparison, the same number of cassettes.

The results were intriguing: a CD was quoted at around 77p and a cassette about 60p. Add in the cost of mastering



and artwork and the unit cost can be estimated at around 85p for a CD and 65p per cassette. That means a CD costs around 30% more to manufacture. In the shops the disparity opens out to around £13.99 against £8, making CD 87% more expensive than prerecorded cassette. Retailers claim they add a similar mark-up to both, yet CDs cost a lot more in the racks. Someone - either the record company or the retailer - is loading the price of CD it would seem.

The B.P.I. argue that L.P. and prerecorded cassette prices have traditionally been kept down artificially to counter home taping. They also told us that CD has better sound quality and lasts longer. But the difference in quality is reflected in the manufacturing price; the music industry neither developed CD, nor did it fund its development, nor does it in any significant manner make a financial contribution to hardware costs. Higher replay quality has forced studios to re-equip and studio charges have gone up

accordingly, but not enough in percentage terms to explain the price difference between CD and other mediums.

The music companies justify their large slice of the cake by the need to recoup the money they can lose trying to promote new, undiscovered artists and catering for minority interests. To some extent this is true; while there are some wildly exaggerated stories of what it costs to produce a chart album - £1m is often quoted - a more realistic typical figure is in the region of £50,000. This covers the costs of studio time (averaging £2000 a day), paying musicians and engineers. It must also cover the cost of advertising and general promotional activity as well as making a contribution to the music companies significant running costs.

There are other costs, too, though they are hard to quantify. For a chart act, an external Public Relations Company would cost around £1,500 a month. But if the music companies do have massive expenses to recover, is the best way of going about it to load the price of CDs, then load the prices of alternatives to discourage people from buying them, in order to protect CD sales? Recorded music sales in the UK are falling under the pressure of continual price rises - rises that are denying people music and causing

an ever increasing torrent of complaint. Sir Malcolm Field could be right. High CD prices only make matters worse: most people are not willing to risk spending up to £15 on an unknown quantity - or even on a known one. They might be a little more interested if the price was around the £10.50 mark. And if the smaller margins from cassettes generate a viable revenue, why are they not applied to CDs? Why also do the same record companies apply different prices for the same CD depending on what country it is being sold?

For too long the record companies and the B.P.I. have been keeping tight-lipped about the high profitability of CD and in so doing have appeared insensitive to the needs of the consumer. Whilst CD trade deliveries continued to rise (according to B.P.I. figures), albeit at the expense of the less profitable LP and cassette, their pricing policy appeared sustainable. Now it appears the bubble has burst. W.H. Smith say that CD sales are in fact in decline. If this is so, then the future of more than just the music companies is at stake. If they don't do something about this situation, then a solution may well be imposed upon them by the retail trade or a House of Commons Committee, whilst there is still a music business left to save. ●

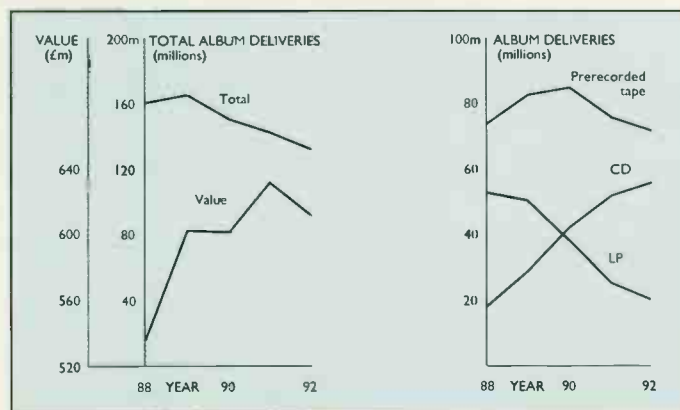

Album deliveries are from B.P.I. figures (excluding singles) for CD, LP and Prerecorded cassette. They represent Trade Deliveries and their estimated value.



# World



## KNOCKED SIDWAYS

I have just finished reading with great delight your Feb'93 issue and frankly I was knocked sideways. Firstly was the Audio Synthesis DAC - which I am seriously considering not only for its rare and accurate silky treatment of solo violin, but also for the sheer build quality employed - I swear these people have a love affair with everything they design.

I am currently waiting with bated breath the release of the Harbeth HL Compact 2 monitor speaker and what should I see but an in-depth article on the most excellent Harbeth HL-P3 monitor! I must say as a guitarist/violinist with a recording background, and as someone who regularly attends classical concerts, that these speakers are probably the closest thing to live sound I have ever experienced. I have heard Harbeths on many occasions and recently next to Quad electrostatics costing a small fortune, yet which by comparison sounded "boxy" or as though they were encumbered by their shipping cartons (of which there was no sign).

I would personally recommend Harbeth to anyone requiring near-total flat electric to kinetic energy conversion. All-in-all it seems that there was not one article that did not have

some relevance to my current quest for knowledge and I would like to thank your magazine's editorial staff for their technical yet unconceited approach to what can be through bad proof, easily baffling - worth every penny.

The Marantz CD52 MkII "Special edition" came under close scrutiny. I own the older CD52 which I agree is edgy. However, I would like to share with you a couple of tweaks. Firstly we are talking about a cheap plastic transport mechanism that will, by definition, be susceptible to read errors. These are only amplified by the poor design incorporated, one of the main culprits being a laser head which is surrounded by shiny metal, possibly nickel plate. Once this is blacked out, the output quality rises dramatically.

For the next modification a Lasaway green pen was utilised to green-out both the inside of the otherwise steel top case and to attend to the bright alloy base upon which the CD rests. I have also re-soldered every digital signal and analogue component on the circuit board with silver solder, again raising the quality.

You may well consider my work as obsessive but I currently cannot afford the Meridian 602 with complementing Audio Synthesis DAC and until I can

this is a fine folly to toil!

Besides, the sound quality I now have is equal to that of the MkII, yet I have not changed a single component. This leaves me wondering what could be achieved with similar modifications to the MkII and more fundamentally what the actual component differences are. Some enlightenment please!!!

**Richard G. Nash  
Petts Wood,  
Kent.**

Folly?

We're always glad to hear the spirit of tweaking is alive and well. As you say, the Audio Synthesis products are of exceptional quality; perhaps we didn't make enough of this.

We've been a bit knocked out by hearing the difference a Philips CDM-9 PRO transport makes to CD. In fact, even the way it's made is surprising, bearing some relationship to

## Letter of

### QUESTIONS AND ANSWERS

I have a few questions to ask you and a few suggestions to make.

First of all, you never told us about the room in which you make your listening tests; is it acoustically treated for best results, or what?

Second, when a listening test is done, how many listeners/opinions do you usually have? One or more?

Third, what kind of records or CD titles do you use?

Fourth, do you have any standard reference equipment in your listening room to which you compare all others; if 'yes', which equipment?

My suggestions are:

To the first question, I'm sure you have an acoustically-treated listening room, otherwise I would suggest you have one. Tell us about it.

To the second question, I suggest you have at least three listeners for your tests and give us three opinions; that would make it closer to real conclusions.

To the third question I would suggest you choose a few records and CDs (Classical, Jazz, Vocals, Rock) very well recorded and others of medium quality and others of bad quality, make your listening tests on all of these and give us the results on how the equipment dealt with each of them. These

recordings should be the same for all your listening tests so that comparison to a reference can be made and we readers may have a chance to know the music and know what you are talking about.

To the fourth question I suggest you have your own standard reference equipment and tell us about it and how it sounds with the recordings mentioned above and compare the ones you test to the reference equipment so we readers can make our own conclusions knowing what you are comparing to, regardless of price, because I can be very happy with my Fiat although compared with a Ferrari! But at least I know how much on this scale my Fiat can do. And I know that I don't have to fear bumps nor a lot of other things!

Well it's only a few ideas that could make decisions easier for us readers.

**Jean-Paul Haggar,  
Alexandria,  
Egypt.**

Our listening room is not acoustically treated in any formal manner, nor are the listening rooms of any British reviewers as far as I am aware. It is, however, sensibly and appropriately furnished for good sound quality. This means sound absorbing settees, a ceiling-to-floor curtain along one wall, carpeted floor, etc. This makes

### WIN FURUKAWA FA-2010 BALANCED ANALOGUE INTERCONNECT CABLES

(1 metre pairs)

The writer of the most interesting or funniest letter will receive a free set of Furukawa FA-2010 "balanced analogue" interconnect cables, worth £120.



Send your letters to: Hi-Fi World Letters Page,



# writes

the sort of anti-vibration, heavyweight, energy-sinking construction applied to record decks. Wait for this to appear in a transport. **NK**

## DIY

I bought the February issue of Hi-Fi World, the first time in perhaps a year. Very good DIY supplement. Do it again and I'll buy another one! More needed **N. Kyriacou, St. Albans.**

## The Month

the room reasonably representative of the average home; it measures 16ft x 12ft.

The problem with 'optimised' rooms is that they are never representative of the norm., so they don't give meaningful results. Listeners commonly report feeling disorientated and confused by the acoustic of such rooms and the few I have experienced didn't leave me especially impressed.

We are the only magazine to commonly give more than one opinion, because we have an in-house listening room, and whilst two opinions are often printed, it isn't uncommon for four of us to have listened. Since there's rarely disagreement about anything, we find two printed opinions give a satisfactorily wide range of expression, without repetition setting in.

Perhaps surprisingly, choice of records is deliberately left unstructured. Why? Because we are human beings, not listening machines. It's impossible to listen to the same records over and over again without becoming bored and even sick of them. To hear anything, you must want to listen - and that means using records that are enjoyable; we play what we like. We do have and use certain 'difficult' and illuminating recordings, but sparingly.

The notion of a Reference system is both difficult and dangerous in hi-fi. Recordings

## LIONS

Recently, myself and a pride of hi-fi enthusiasts have been split by the great Linn debate.

The pride of debating lions included a dealer, an audio engineer and two hi-fi junkies, of which I fall into the latter category.

Whilst it was felt by all concerned that the integrity of Linn's products was not an issue, the way they are priced and marketed are.

The debate began after I had

returned to the shop from where I had bought my Linn Kaber speakers, filled with the intention of buying more K20 to re-wire my speakers. I was told "We haven't got any Sir".

"You what?!" I growled, only to be informed they had no Linn products at all, that they had been taken away by the Linn police, even the records.

A bit daft, I thought, considering I had just been looking at a copy of Hats by Blue Nile in Our Price Music.

I telephoned numerous Linn dealers to let them know of my dilemma and to ask their advice about wiring my Kabers, only to find that they had all been turned into Harry Enfield: i.e. "You want Linn K600 that's what YOU want! Nothing but Linn's is what you want, Linn, Linn, Linn."

Finally I wrote to Sir Ivor of Scotland who replied to me a few weeks later. I appreciated some of his views and understood the new criteria for Linn dealerships, fully explained in the letter, but I disagree with the majority of Ivor's philosophies.

It is a brave man of vision or a fool that implements such reforms whilst gazing into the teeth of a recession.

Which leads me back to the difference of opinion in our little group of hi-fi enthusiasts, as one of these is a Harry Enfield.

The conclusion of my quest came when I bought Cirtofon SPK300 cable instead of Linn cable, not to be bloody minded - it just sounded better.

Although I personally disagree with the present way that Linn products are marketed, I still think that the company make excellent speakers and turntables.

So, as the owner of an LP12, Ittok and a pair of Kabers I am disappointed that these products have not been included in World Favourites, I cannot help thinking that it is because you share some of my views.

Nevertheless, I will continue to read with interest your excellent publication as I have done so since the first issue.

**S Petch,  
Hartlepool,  
Cleveland.**

The whole issue of Linn's revision of their dealerships has caused something of a stir. However, we should make it clear that the reason neither LP12, Ittok or Kabers appear in 'World Favourites' has nothing to do with it. As the number of products we reviewed grew, so did the number we wanted to recommend to our readers in the section. Unfortunately, the amount of space we could dedicate to it didn't. We decided, therefore, to restrict the entries to equipment where we could refer readers to one of our own reviews. We have never printed a review of an LP12 or Ittok. **EB**

## HIGH COMPLIANCE

I recently resurrected, after years of storage, an ADC MCI.5 moving coil. Does anybody remember this beast or the lovely leather bag it came in? More to the point, does anybody remember ADC?. This was a high compliance cartridge with an output of 0.2mv/cm/s - neither low nor high - and a coil resistance of 90ohms. I had previously used this beast under less than optimum conditions and enjoyed its smooth, clear sound.

The acquisition (cheaply) of a Carver Mct transformer with switchable 3, 40 and 110 ohm settings prompted a resurrection of the ADC. Used on the 110 ohm setting the sound is superb - sweet and clear, with deep bass and good dynamics. I am unlikely to return to my Corus Black. However, there is the problem of what to do when the ADC wears out.

Secondly, your advocacy of the ribbon tweeter has my full support. As a long time user of Decca London speakers I have long enjoyed the clarity, dynamics and openness of their ribbon tweeter. Moreover, when distortion appears, it is simply a case of replacing the ribbon.

I have tried to replace these speakers, under pressure, with something a little smaller and more in harmony with the room, but have always been disappointed. Even my wife, the prime mover behind attempted changes, has admitted the superiority of the Deccas.

Finally, I enjoy reading Hi-Fi World and find your selection of albums to review to be compatible with my taste in

64 Castellain Road, Maida Vale, London W9 1EX.

Continued on page 37...

# BRACING BOX

**The latest loudspeaker from B&W to use their ingenious Matrix internal bracing system is the floorstanding 803. Noel Keywood tests this new monitor.**

**B**&W's baby Matrix 805 convinced all of us here that it was a fine loudspeaker, balanced and lucid - and sparky enough to put some bop into Rock. It seems that Abbey Road studio engineers think the same too; the baby 805s are popular near-field monitors. If B&W can wring such a good sound from a small box, what could they do with a bigger one, I wondered to myself when the 805 was around?

The chance to find out arrived recently. Offered the new Matrix 803, a floor standing version of the popular 805, I jumped at the chance of reviewing it. Would adding a bigger box and two extra drive units bring real bass to the superb insight that characterises the 805, turning it into a giant slayer? At £1945, the 803 Series 2 is not cheap. It has been designed to compete in the quality 'monitor' slot, typically against the bigger KEFs, Celestions and such like.

## Boxes & Belief

Lacking space for my own (modified) Quad ESL-63s and subwoofers at the moment, I've been looking for a good box loudspeaker. It was a spur to getting in the 803s. I have reservations about box loudspeakers, but all the same I'm waiting and open to interesting suggestions on this front. Heybrook managed to convince me with their Sextets that enjoyment of music might be possible after electrostatics - but even these speakers acknowledge a property of the electrostatic by using a Tonigen ribbon tweeter; it delivers superbly clear and tuneful treble.

Might B&W's new 803 be comparable or better, I wondered? The Sextet is far from being perfect. Quite the reverse in fact; people often harbour reservations about it. Trouble is, multi-driver, boxed loudspeakers are, in general, easy to have reservations about: you can hear the sound coming from different drivers, a scratchy bit from up there, a boomy bit from down there and a lot of shouting in-between. Then there's the box having a merry time boofing along in - or out - of time with the music. Who couldn't criticise this?

But B&W use a lot of sophisticated research to solve drive unit and





box problems; perhaps the 803 could bring a depth of ability to bass reproduction that the 805 brought to the vital midranges. Perhaps it could resolve high frequency information with the fluency of Tonigen's ribbon tweeter, clearly picking out the unique qualities of a cymbal and a triangle, differentiating between them instead of reducing their sound to a vague clatter, or at worst a sting in the ear. Would research win through? I hoped it would.

The 803 stands 40in high (1020mm) to the top of its tweeter, a bit higher when sitting on its spikes, which improves its stability a little, firming up the bass and adding to general tidiness in the sound. Sitting in a pod on top of the cabinet, the aluminium dome tweeter is higher up than usual. Time alignment with the drive unit below means it sits back a bit, so as to be in the same radiation plane, which in turn means the top of the cabinet obstructs downward radiation. This constrains the ideal listening height; ideally listeners should sit high enough to be on-axis with the mid-range unit at least. I doubt if this is a problem in most homes, but a low position close-up would not be suitable.

### Extended Bass

The cabinet is well finished in black ash, with dedicated plastic mouldings adding to the overall presentation. The grilles have vertical flutes at either side and are removable if desired.

The 803 is, in essence, an 805 with an additional bass cabinet. As a result, it has two ports, one facing rearward, venting the chamber loading the upper 805 drive unit, another facing forwards, venting the chamber loading the two additional bass drivers. The latter are connected in parallel to improve power handling. They also extend bass downwards to a lower limit than that of the 805. B&W quote this as being 32Hz (-6dB), a plausible figure for a cabinet of this size. Bass fundamentals of musical instruments reach down to 40Hz, but our measurements show that there is plenty of information below this on CDs. The heartbeats at the start of *Dark Side of the Moon* are speaker-wrecking full-level pulses at 20Hz, for example and plenty of discs go even lower than this, albeit at a more subdued level. So there is recorded information on CD for big speakers like the 803s to reproduce.

The small print of the owner's manual refers to a bass alignment filter, but this is not available in the UK, since whilst it extends bass downward it also compromises bass quality I was told.

B&W make a number of points about the system they adopt, pointing out for example that having two chambers minimises interaction

between the mid-range unit and the two lower-bass units. The Matrix is an internal bracing structure that minimises cabinet resonances, yet in spite of this I did find there was a certain 'whoomp' from the cabinet in the bass regions, which was probably caused by reflected energy from inside.

All the drive units are B&W's own, made in their Worthing factory. The yellow-coned Kevlar mid-range driver is the one that seems to be able to dig out so much information.

### Exalted Company

Initially the 803s fell in with some exalted company. I connected them up to a pair of Tim de Paravicini's Yoshino amplifiers, their huge 845 valves glowing as bright as light bulbs. Being single-ended, these monsters are the cream of modern valve amplifiers, Tim's answer to Japan's Ongaku. With the volume control set to suit the Sextets, I was taken aback by the sheer level of sound delivered by the 803s in comparison; they're very efficient. Volume was wound down and with a 12in 45rpm single producing a metronomic dance beat from Carol Kenyon's 'Dance with Me', two heads popped around the door in quick succession and said the same thing: "It's like a disco in here;

*"wads of soft, boofy bass that plays and plays"*

those valve amps have got some welly!" They hadn't noticed the change of speakers, but their observations weren't inaccurate.

The 803s have what I would describe as 'generous bass'. In other words, there's oodles of it, wads of soft, boofy bass that plays and plays. The windows were moving in time with the bass, the hallways reverberating like giant organ pipes. 'Dance with Me' changed from being an interestingly clean recording to a heavyweight disco blast, the vocals an embellishment to a massive beat, rather than the other way around. The bass took over, everything else receded.

Worried about the looseness of the bass I disconnected the Yoshinos (valve amps have a poor damping factor, but with crossover inductors in the way it doesn't matter) and connected up a pair of solid-state Audiolab monoblocks, biwired with short (1.5m) Furukawa cables.



The light and fast yellow Kevlar cone lends a clear and open midrange to the 803s. Externally located tweeter was not in the same league.

Surprisingly, there was no appreciable improvement in bass control, but then I recalled a recent conversation with Andrew Jones at KEF during which he explained that mechanical and acoustic damping within a loudspeaker was more significant than electrical damping when it came to bass control.

Whilst the prominent bass of the 803s hit me first, the insight and projection of their mid-band made itself known shortly afterward. In this respect the 803s are all but identical to the 805s. Their woven Kevlar midrange unit, with its distinctive yellow cone is able to dig out enormous amounts of information, finding an acoustic to surround vocals, for example, helping bring them to life. Even as Carol Kenyon came in at the end of a long and pummeling introduction I could tell that the richness and detailing in her voice, the easy way it seemed to hang clearly and naturally between the loudspeakers, were aspects of the 803 that I would appreciate. This feature never weakened; vocals always sounded wonderfully natural and full bodied, without any hint of edginess. I was disappointed that bass quality was not a great step up from that of the 805s though.

### Re-arrangement

The same strengths made themselves known across a range of Steve Earle tracks. His recordings are on the bright side, but since the squalling metal guitars are emphasised by this balance it seems a useful one to strike. But the B&W 803s rearranged matters a little here. Steve Earle became a little more guttural, the hard metallic sound of the strings that the Tonigen ribbon tweeters of the Sextets made jangle around my ears became less challenging, but also less characterful.

The new, smoother and fuller



balance sounded amenable and not incorrect, but the close miking used in these recordings captures a frightening amount of upper treble energy too. It was under this assault that the tweeter started to show up as scratchy, a little hard and limited in its resolution of upper treble character. Having lived with electrostatics and, then, a ribbon tweeter - both drive units known for their resolution of high frequency information - the limitations of modern dome tweeters have become obvious to me. I noticed how the 803s couldn't resolve the full scale and character of the inflexions Earle uses on upper strings to get a delivery that cuts and twists. For the benefit of a second opinion, Jonathan Jordan noticed that it was difficult to tell whether John Bonham was hitting a cymbal, a triangle or a cowbell on Led Zeppelin's second album. The tweeter, we felt, had limitations; I was disappointed to find it could not challenge the Tonigen ribbon of the Sextet. Engineering Correctness All the same, in spite of my critical analysis of the 803, it is still a loudspeaker that has engineering correctness and apparent balance on its side. By this I mean it doesn't leave

anything obvious out and right across the human vocal range at least, it is lucid and revealing. It's also a speaker that doesn't squeeze the life out of music. Quite the reverse in fact, if you like to hear real bass presence and power, plus an ability to reach down low, the 803s won't disappoint. Bass lines rumble along prominently and the ability to reproduce fundamentals gives the sound real weight. For the sake of organ enthusiasts and headbangers everywhere, I applied various well known bass extension tests. The organ at the Basilica of Saint-Semin, Toulouse, gave a convincing enough demonstration of real deep bass power as Peter Hurford worked his way assiduously through the fascinating complexities of Cesar Franck. And would I feel the door slam two minutes into Pumping on Steel, from Billy Idol's Charmed Life CD? This last test is the best one of bass extension and resolution. Celestion SL-6000 subwoofers and the REL subwoofer make the room shake. A real door slams shut: you hear it; you feel it.

Most speakers pass over the event completely. The 803s managed to put out a bass rumble, if not the subsonic earthquake I know exists. So they

have deep bass, but it does have a discernible limit, albeit one that is lower than that of other floor standing loudspeakers of similar dimensions.

### Deeply Revealing

Deeply revealing across a wide part of the audio spectrum, the 803s have merit. They are lucid and clear with vocals in particular. A tendency for the frequency extremes to go their own way detracts from the overall expressiveness of this loudspeaker; there wasn't enough variety and range of character to make me peer into my wallet.

But reviewers do get finicky and pemickety, having their own finely tuned expectations that don't necessarily reflect those of a wider audience. The way B&W have ordered things, the 803s have sufficient ability to impress a broad swathe of listeners who want a loudspeaker that is basically well engineered and of good underlying ability, especially when it comes to providing generous bass at high power levels. The 803 is a floorstander with some significant strengths, one that is likely to find broad appeal; it's worth listening to ●

### MEASURED PERFORMANCE

The 803 produced no less than 89dB from a nominal watt (2.84V) of input. That's very loud by any standard. It even went loud on a valve amp where it was impedance mismatched and, therefore, power transfer mismatched. This suggests the 803 is efficient too.

On transistor amps, which behave differently from valve amps, the low overall impedance of the 803s, which we measured as 6Ω, will draw more current - in fact around double the current - of most British loudspeakers. This alone will make them go loud, the trade-off being they are a demanding load. At 10kHz and below 200Hz there are impedance minima of 3.5Ω (even less below 5Hz). Amplifiers will be obliged to deliver substantial currents into a load value as low as this. The vertiginous slopes around the dual peaks that characterise reflex loading are caused by heavy reactance, making life even more difficult for an amplifier. So the 803 is a difficult load, but high quality modern power amplifiers should be able to cope.

Frequency response was flat enough, in some positions showing a small lower mid-range depression around 300Hz. Our vertically averaged response plot looks better than B&W's own trace (which we requested for other reasons) in this respect. It's a dangerous place to have a depression, since natural reproduction of the human voice depends upon this area being in balance. I suspect that in practice some of the mid-range projection and detailing of this speaker is produced by the small plateau that

stretches from 1.2kHz-2kHz to the right of the dip, and which is given prominence by it.

Upper treble was well maintained, as our ears discovered. The 803 has an unfortunate characteristic in its treble regions: it emphasises high frequency harmonics over fundamentals, which produces a sensation of sharpness, especially from CD. Three of us cringed at the tweeter and measurement shows why. To add 'ting' and remove 'sting', B&W need to tailor the response with more care, such that upper frequencies gently roll off. I've engineered a perfectly flat response to 20kHz many times in speakers (it's not difficult), to find that with a lot of modern digital recordings it results in an unacceptably hard sound. A gentle slope down, one that is barely measurable and easily arranged cures this unpleasantness.

We asked for an anechoic response plot to see how B&W were seeing bass output. In our normal, but not large, 16ft x 12ft room the 803 had excessive bass. Our response plot shows quite clearly a +5dB peak from 63Hz up to 250Hz. Very few loudspeakers we have tested exhibit a peak of this magnitude; KEF's Reference loudspeakers certainly do not. The 803s sounded bass heavy too, but although B&W's response shows signs of lift in this region, it is only 1dB or so, so there is a discrepancy between their results and ours. Irrespective of anechoic performance, however, in real life conditions these speakers do have strong bass and measurement shows why.

I strongly suspect B&W have tailored

the 803 to lean toward 'European' tastes, like the Silver Signature, giving it prominent bass and treble. For the U.K. market I believe they should reconsider this policy. The overall response shape of the 803 is unfortunate. It misrepresents what is, at heart I feel, a well engineered loudspeaker. NK

### Frequency Response



Bass starts to lift from 250Hz, otherwise the 803s have a flat response.

### Impedance

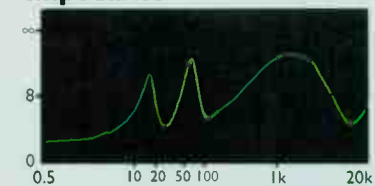

The 803 is a difficult load, but this shouldn't cause a problem for modern transistor amplifiers.



# 67 Classic for the 90s

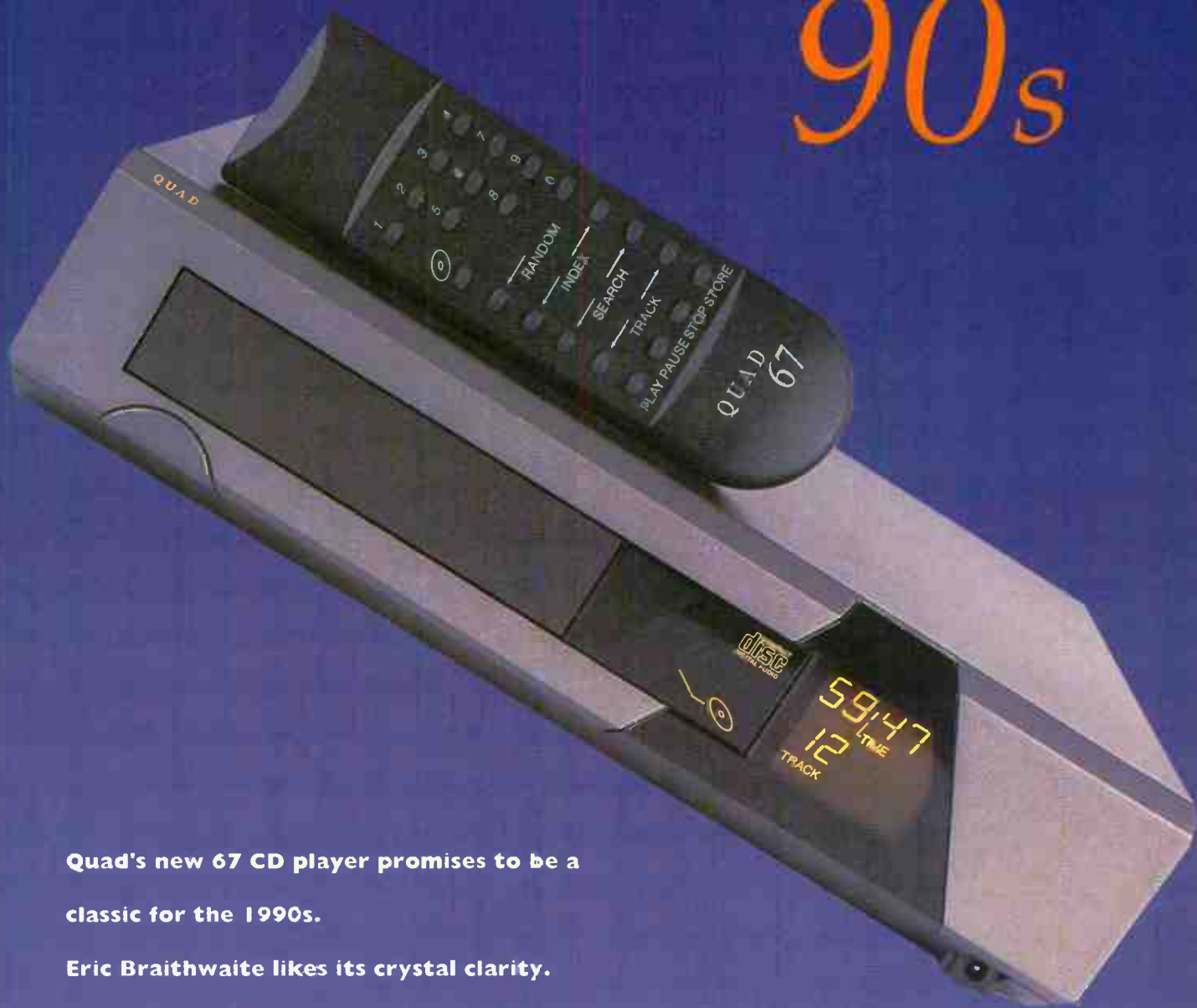

**Quad's new 67 CD player promises to be a classic for the 1990s.**

**Eric Braithwaite likes its crystal clarity.**

As I started the chore of putting away the CDs I'd used during the listening session, the height of the pile transmitted its own message. If I'd denuded my shelves to that extent, there must be something about Quad's new player that was pretty dam' satisfying. Hands up all those who associate this venerable name with a laid-back, 'Classical' sound. O.K., all those with their hands up go and stand in the corner. The 67 is different.

It's different enough to take on Prince, James, Gary Moore, John Lee Hooker, Dr John, REM; oh, you name

them, the list will take too much space. Then, once it's taken them into its crawler, out of the speakers they all come with a quite remarkable clarity, drive and speed. Prince's 'Thunder' was much tighter than I'm used to, all of that amazing mix pinned down in space, every studio trick evident, every component sharp as a new pin, tightly defined between the speakers but effortlessly spreading beyond them and filling the room whenever it was intended. Some of Prince's vocal squeaked a little, but instead of feeling critical I just tried to decide whether it was in agony or in

ecstasy. I couldn't decide; but then, probably neither could he.

That track was exciting and exhausting - as it should be. The word that sprang to mind was 'vivid'. I heard some stickwork in the drum track that I'd never noticed before - and spotted where it had been patched in left and right and parted company with the rest of the drumkit. If there is a signature to the Crystal way of doing things, this is it - I heard it through the EMF DAC as well, but not quite, I believe with this piercing insight. James' 'Sound' was the same. I've never been able to work out

*"All this boils down to a big presence, very stable imaging and the ability to expand and contract musical dynamics instantly to order."*

what he mutters at the beginning, but through the Quad you're sure it's a mumble and not lack of resolution. Just like the Prince track there was dazzlingly clear diction - something which remained a feature whatever the style of music - and a very clean mid-range. I swear I heard two distant 'miaouws' at the end that I've missed before. Like the Crystal DAC from EMF, the Quad's performance in this area is exemplary. Studio engineers watch out! On REM's first track from Automatic For The People, 'Drive', I was peeved to hear some fairly clumsy over-dubbing on the vocals. On the other hand, on this album and others, acoustic guitar has immense credibility.

A good test of acoustic realism and insight is John Lee Hooker's 'Boom Boom'. Through the Quad nothing was hidden, Hooker spotlight for every centimetre's movement behind the microphone. 'Boom Boom' itself was exciting, with the instrumentals starting and stopping dead. The playing simply put a breeze through the listener's hair like riding on the pillion of a BMW at 120 (it may be a while back, but I haven't forgotten). When the Quad seizes a good recording, it doesn't let go. Hooker was standing there, sounding big - and on 'I'm Bad Like Jesse James', so lifelike the final "Ooooh" could have been Jonah disappearing down the gullet of the whale before your eyes. On Lou Reed's 'Magic and Loss', or Mary Black's 'Columbus', even my current favourite - the Sugden SDT-1, which is extremely good at tracing vocal nuances and inflections - didn't quite match the Quad's uncanny eye for tiny detail.

All this boils down to a big presence, very stable imaging and the ability to



**Castings give smooth bevelled edges that contribute to the rugged construction Quad have made their hallmark: Gold plated sockets include a coaxial digital output.**

expand and contract musical dynamics instantly to order. The 67 is very agile, starting and stopping near instantaneously. On pieces like Dr John's 'My Indian Red' there are no two ways about it: this New Orleans Marching Band piece was brassy and bold, with the drumming as taut as an elastic band.

Before we allow it to come in at the finishing-post too many lengths in front of the competition, however, there are one or two obstacles that need closer attention. Dr John's piece should have the effect of the listener wanting to dance a lone conga all around the room. It didn't. Without actually being lackadaisical, and without destroying the feeling of excitement, the timing in the bass didn't quite

keep pace with the fleetness of the midrange. It made the beat difficult to follow in Gary Moore's 'Cold Day 'n Hell', even though in the end it would still be awarded twelve out of ten for sheer guts and realism.

The same sensation could be noticed in Classical music too. The Allegro con spirito of Haydn's Symphony No41 lacked some of the spirit: just a little stolid in the lower registers. Following through to the next movement, a sparkling piece, things lightened up markedly, with splendid tone from the violins, cellos and flute. Rhythmically, it should still have been more danceable than it was - it should have had more fizz, a touch more of Tango in it.

### Dumbarton Oaks

On the other hand, a Decca recording of Dumbarton Oaks, originally analogue, sparkled with vibrancy and life. Internally very detailed, the orchestral sections delineated with precision, the use of a 'Decca Tree' microphone system (left, right and centre fill in) was traceable. There was a slight trace of grain - a 'chromium-plate' sneen - on just some of the violin notes, as there had been on some Rock vocals earlier. Very close inspection suggested that upper woodwind also had a slight trace of 'quacking'. It took time to pin this down, but there is just a trace of hardening in the octave around Middle C, which accounts for a very mild graininess (we're talking of roughly 200-350Hz). Possibly, it also accounted for a soprano recorded in a very reverberant acoustic 'swimming' a little, the ambience of the hall reduced and the depth of the recording being a little foreshortened.

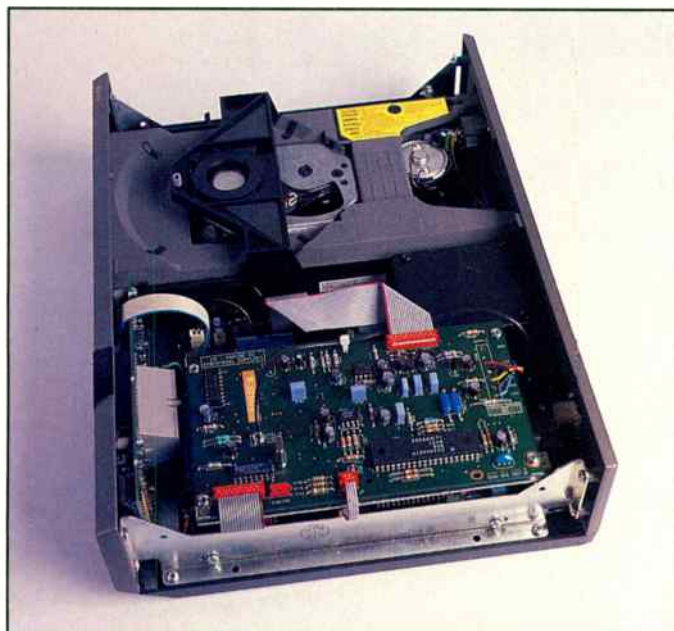

**Quad's internal tidiness serves as a reference to others: the 67 is no exception!**



Having noticed this in the EMF Crystal, perhaps this is inherent in the chipset. But in context these shortcomings are minor. There were two recordings which simply astounded me. One - a Sony 20-bit recording of Bach's G Major Cello Suite - was glorious in its full, round tone and lifelike size; with a score it would be possible to follow every nuance of the phrasing (while we're at it, the cellist in the Brodsky Quartet in Elvis Costello's Juliet Letters sounded awesome too).

**Magic**

The second was Lou Reed's Magic and Loss, which was more three-dimensional in every respect than I'd overheard before. One of the surprises was that the character of the 67 is transmitted directly through a good pre-amp - I used an Argo - into the power amp. Briefly, having a Quad 306 to hand, I wired it up and continued to hear all the strengths of the player.

It looks as though the Crystal chipset and CDM-9 in Quad's new 67 herald a new, different breed of player, whose main virtue is a bulldog-grip, a remarkable solidity and the most detailed and insightful mid-range

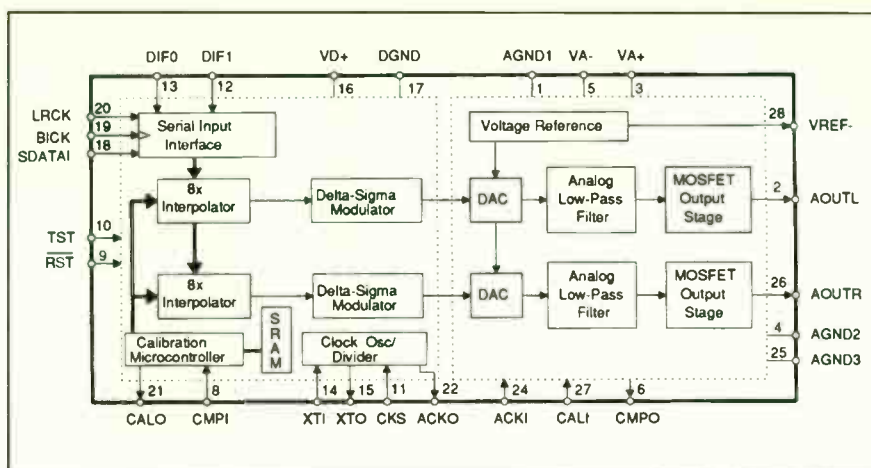

The Crystal CS4328 DAC chip favoured by Quad.

*"A new, different breed of player, whose main virtue is a bulldog-grip, a remarkable solidity and the most detailed and insightful mid-range you could wish for."*

you could wish for. It doesn't lack anything in excitement or verve; it expands with the dynamics of the music with the ease of a top-rank steeplechaser clearing Becher's Brook by a yard. Its styling might not suit everybody, being designed to match Quad's other separates, but that shouldn't put anyone off auditioning it. It's one of the top players available at its price ●

**MEASURED PERFORMANCE**

Quad's first CD player, the 66, used a mechanism and circuit board brought straight in from Philips. It was a standard sixteen-bit design based on the TDA-1541 chip, albeit in selected S1 or 'Crown' form. The 67 is different. It uses a Philips CDM-9 transport and Crystal's 4328 D/A chipset.

I was hoping for a measured performance a trifle different from the norm, to impart some special character or strengths to the 67 and, to some extent, the player offers it.

Frequency response has a peculiar low frequency lift below 500Hz. It's the sort of effect Quad may well claim is inconsequential, since the lift amounts to mere fractions of a dB in amplitude. However, it exists over a wide band and so encompasses more energy than amplitude alone would suggest. From experience I know that with CD, for whatever reason, even small broadband effects are audible, acting to form the sonic character of a player. There's no doubt that the 67 will, subjectively, display strong low frequency output, which may be heard as warmth, full bodiedness or just overblown bass. Only listening tests can pin a description to this measured effect.

The 67 produces less distortion than the 66. Like most well designed low-bit players there's no sign of distortion until -50dB or so is reached. At a typical average music level of -30dB the analysis shows only noise. However, at -60dB this player isn't as clean as some designs, producing 0.7% distortion - little better than that from the 66. In direct consequence, its measured dynamic range was mediocre at 105dB.

At very low levels, around -90dB, the 67 was a little inferior to many designs, although curiously it managed well with a -90dB dithered

signal. With noise stripped away using synchronous time averaging, just 2% second harmonic existed - an innocuous form and level of distortion. Trouble is, not all recordings are properly dithered, so it isn't easy to say what will appertain in practice.

Although a noise peak exists at 80kHz, due to oversampling, it is less pronounced than that of budget Philips and Marantz players. This apart, the 67 produces little in the way of unwanted outputs above 21kHz. It was especially clean with high level, high frequency signals that commonly produce unwanted alias products just above 21kHz, an effect Pioneer exploit in a bizarre manner with their PDS-801 player. Quad, like most manufacturers, seek to remove this uncorrelated information and do so quite successfully within the 67.

Output level was spot on Philips standard of 2V at full output. Bear in mind that within any A/B shop demo, the 67 will sound a little less forceful against most rivals that now deliberately have mildly raised outputs (+1 to +2dB or so) to put them on par or ahead of rivals when it comes to a slug out. **NK**

**TEST RESULTS**

Frequency response	4Hz-21.2kHz	
Distortion (%)	-6dB	0.005
	-30dB	0.005
	-60dB	0.68
	-90	29
	-90dB dithered	2
Separation (dB)	left	right
	1kHz	107
	10kHz	84
Noise		-108dB
	with emphasis	-108dB
Dynamic range	105dB	
Output	2V	

**Frequency Response**

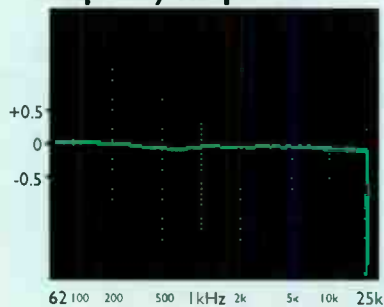

Some bass lift.

**Distortion**

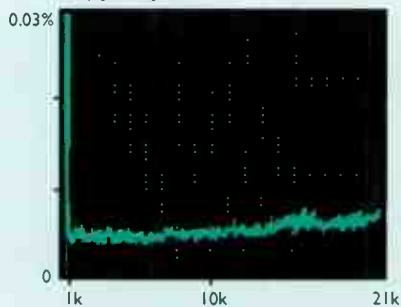

Low distortion at -30dB.



# AMERICAN BEAT

**A loudspeaker with a kick in it: that's JBL's new L1.**

**Noel Keywood listens to James B Lancing's latest.**

**T**he threatening growl made me jump. I'd caught the end of 'I'm bad like Jesse James' from John Lee Hooker's earthy, atmospheric Blues album 'Boom Boom'. The JBLs showed their basic and basic character straight away: Hooker's impersonation of an angry grizzly has real believability. The new L1s add weight to the scuzzy bits; here's a speaker that makes Rock music rock; one that makes even the biggest grizzly sound bigger.

Not that the L1s are particularly big themselves, at 40cm high, 21cm wide and 25cm deep at the base, though the curved grille makes them look a little larger than they really are. Remove it, and a sloping front baffle is revealed. JBL's titan 1µm-dome tweeter, protected by a large circular mesh grid becomes visible, along with a six-inch ribbed doped paper main drive unit. Also revealed is a spider-web plastic framework behind the grille's fabric. Presumably this is simply to

maintain the grille's shape so that the front of the speaker appears to be vertical instead of sloped with the grille in place.

A large reflex port is hidden around the back, above a pair of reasonably chunky loudspeaker terminals. A small problem arises here, for these face downwards from an inset plate; users with extra-large speaker plugs or particularly stiff cables might find them a bit cramped. Our pair were well-finished in standard Black Ash, which is just as well, since the UK price is



quite high at £468.83 including VAT.

The JBLs are tailored for a purpose - and that purpose doesn't encompass subtlety of expression. They're meant to really kick bass, and they do in a certain respect but they also slow the attack blurring bass lines into themselves. They develop bass rather than play it which can become a little uninvolved.

The LI has surprisingly good mid-range clarity and excellent imaging. It sounds remarkably - even dramatically - clear with vocals, even whilst pumping out an enormous bass beat. The metronomic and monotonous dance beat behind Colourbox's 'Say You' made the floorboards quiver and my chest cavity flutter in sympathy; here's a press-you-back-in-the-seat 'bookshelf' speaker, coming from a country where even the bookshelves are obviously larger.

### Clarity and Separation

I was impressed. As Lorita Grahame started her introduction she sounded larger than life between the two speakers, growing slowly stronger and more firmly embodied, yet seemingly separated from the pounding beat. In keeping vocals and bass lines firmly apart the LIs were impressive. Their clear, crisp imaging and quite dramatic hard-etched delineations making easy work of even quite complex pieces. This gave an air of space around instruments that allowed music to flow and evolve in an unhindered manner.

Here's a real sock-you-between-the-eyes Rock speaker, one that'll bring last night's disco experience right back into your bedsit the morning after.

But just a minute. That beat? It's still there behind Make 'em Move. Has Robbie Shakespeare given up the bass that made Grace? I can hear some changing overtones, but they're swamped by the monotonous beat. The LI has strong, resonant deep bass, but it is one-note. Fundamental changes don't alter; there's plenty of power in the bass but it's stuck on one string.

This sort of effect isn't uncommon when a designer is looking for bass at any cost. The way to get it is to design an

under-damped system that tends to resonate strongly at a particular frequency. The term "one-note bass" arose from such systems, since in the past they weren't uncommon when empirical design methods were used. It often - but not always - helps to put a foam wedge in the port to damp down this sort of bass, improving quality.

If there's a track that demands bass expression from the opening instant it's Tina Turner's 'Break every Rule'. This is best heard first on good headphones, like Beyer DT411s, which'll play bass properly, free from room effects, box problems and what have you. I've heard this bass line get fluffed in many ways. The LIs pounded it out from the word go, but again the one-

*"The LIs pounded it out from the word go"*

note fundamental dominated. Changes of chords that rely on the upper harmonics being conveyed in right time and level were largely smudged over. The LIs put their big feet forward a little too eagerly. They come at you with speed and spirit, except in the bass where the pounding monotonicity acts against the music, unless it has a regular beat. The JBLs were too enthusiastic for their own good.

The metal dome tweeter has some obvious brightness that'll sting a little on occasions, even from LP. Generally though, the LI comes across as clear and detailed, yet forceful. I've heard cymbals sound far worse from loudspeakers of greater pretensions. Again, the LIs seem able to pull instruments out of the mix and highlight them, even across their upper ranges. They're as subtle as a Bingo session in a tin shed, but in the UK marketplace, where I suspect the levity of our loudspeakers is a hangover from the sober influence of the BBC, this could well appeal to a broad swathe of Rock'n'Roll headbangers who want a really good 'hi-fi' sound ●



JBLs titanium dome tweeter has a unique folded suspension.

### MEASURED PERFORMANCE

After listening to the LI, the substantial bass peak that appeared in its frequency response under tests, visible at left in the analysis, came as no surprise. Centred at 125Hz, it is high enough up into the audio band to be easily audible. Although at the upper end of the frequency range over which bass fundamentals exist, it is wide enough to bolster output down to 60Hz (-6dB), covering all but the lowest fundamentals. It is this accentuation of fundamental power that gives the LI its strong bass, even when positioned away from a rear wall. Wall mounting on a shelf will provide further reinforcement; it seems inappropriate to me. The LI was weighty enough across its bass ranges when on a stand.

I was gratified to see the speaker's flatness of frequency response further up through the audio band. In use it sounded basically balanced, with nothing left out, if a little bright at high frequencies. The brightness is due to a small amount of plateau lift in output from the tweeter, amounting to +2dB at 12kHz, seen over at right in the response analysis trace.

JBL's LI measures as it sounds: correctly balanced but with accentuated bass and a small amount of emphasis in its upper treble. Bass apart, it achieves a good standard of performance in terms of response flatness.

Sensitivity was on the low side at 85dB sound pressure level for one nominal watt (2.84V) of input. To go loud, an amplifier of some power output is needed, around 60watts minimum I would suggest. Overall impedance measured exactly eight ohms, but it dips down to around four ohms below 200Hz. This will cause the LI to draw bass current, so ideally it should be driven by a sturdy amplifier. Something like a Denon PMA-450 comes to mind.

The accentuated bass of the LI is shown up by measurement, as well as its top end brightness. All the same, across the rest of the audio range frequency response measured flat, accounting for its even-handed rendition of instruments and vocalists. A powerful amplifier with clean treble is best chosen to drive the LI. NK

### Frequency Response



The measured bass lift was clearly audible.

### Impedance

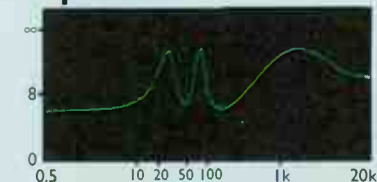

Impedance dips to 4Ω but no lower.

# A New Year Resolution

**Michell's new High Resolution Iso  
cartridge head-amplifier has  
Eric Braithwaite resolving to  
stick with vinyl.**

Rumours spread quickly, and it can't have been much more than a year after the Michell Iso cartridge head-amplifier had established itself on the market, that we all heard of a 'Super' version in the planning stage. Acolytes and disciples of Tom Evans, the designer of Michell Engineering's electronics, were referring to it long before there was much more than a prototype named as the 'Turbo' Iso, perhaps in understandable confusion with Evans' own 'GTE' upgrade to the Pioneer A-400 amplifier. In the end, there are no parallels: this new moving-coil cartridge amplifier from the Michell stable is simply suffixed 'HR'.

If you must know, the initials stand, fairly prosaically, for 'High Resolution' and the Iso HR is the precursor of a new improved Argo pre-amplifier which will bear the same suffix, and is expected on the market within a month or two. Those who thought - like me - that the standard Iso had more than enough resolution for most purposes are due for a shock. Michell's 'High Resolution' means exactly what it says - it's an even clearer window into a recording than the ordinary Iso - and it takes some coming to terms with.

Just going back to basics for a moment, it's becoming increasingly clear to amplifier manufacturers, now that a high proportion of customers will only have CDs, that there is little point in including a stage for a cartridge within an amplifier. On the other hand there is a substantial number of people with a record collection that runs well into the thousands. One friend of mine, a collector who has been accumulating black discs since the dawn of stereo,

recently calculated that to replace his ten thousand LPs with CDs would cost more than his London house. The answer, in these days of amplifiers bereft of phono stages, is to buy one, like the Iso, which is self-contained and is simply wired into an auxiliary line input. It's here where the new breed of cartridge head-amplifiers, like the Iso, differ from the old, including both the RIAA equalisation necessary for LP and active amplification to bring the signal up to line level.

While it's possible to buy a separate phono stage which caters for both moving-magnet and moving-coil cartridges (though admittedly I can think only of one by Sentec of Sweden) Michell has stuck to its guns with both the Iso and Iso HR, making both non-adjustable and dedicated to moving-coil cartridges only. While the Iso was designed for practically any low-output moving-coil, the Iso HR is somewhat different. It is not an upgrade to the Iso, it's a higher-rank alternative. Put in an order, and you will as I did, have to specify the cartridge for which it is to be used so that it can be precisely aligned. Change your cartridge, there may have to be changes to the Iso HR, but that's part of the service. I was warned that while the HR, once set up for a particular cartridge, might well function with others, the result would

*"Those who thought -  
like me - that the  
standard Iso had more  
than enough  
resolution for most  
purposes are due for a  
shock."*

not be satisfactory. I had a convincing demonstration in fact - trying it in another system proved conclusively that another cartridge, that I had thought close in specification to my own, was nowhere near. Extraordinarily open in my system, the HR suddenly closed in and became compressed and undynamic - exactly the opposite performance in all respects - and unnerving it was too.

It was one o'clock in the morning when I came back and said "the hell with the neighbours", plugged it back in where it belonged, and basked in its proper glories. Sorry to be tantalising, but if you want to find the

beef in this particular sandwich, you can always skip the next paragraph or so to discover exactly what the Iso HR's virtues are.

The other differences between the Iso and the Iso HR are revised and improved components, among which is a green LED behind the acrylic case to indicate it's on. I've no intention of

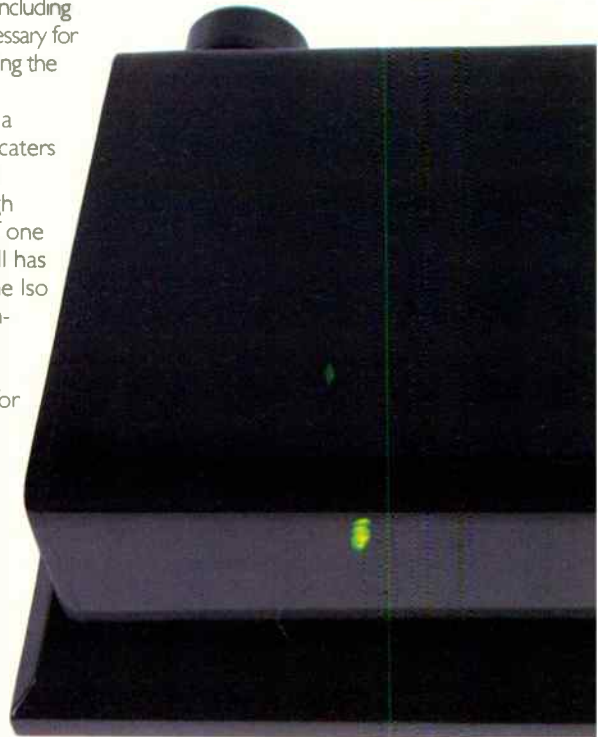

being trapped in another Green Pen controversy, but a green LED is an improvement over a red one, not just a matter of aesthetics. The acrylic case itself now has a chamfered base to make it a little more stable; I have my own doubts about the aesthetics of this change, since it does have the aspect of a jewellery box, but never mind.

More irritating is that the grounding post is still on the small side, especially for those of us who use SME arms with two earth tags. Much less irritating is that the Iso HR comes with a dedicated Hera power supply, an essential upgrade to the standard Iso in itself.

A warning note, the first of two, has to be sounded here. It isn't possible to plug an ordinary Hera into the Iso HR. If you thought you might be able to turn skinflint and save yourself a power supply by using a Hera you already possess, sorry, you can't. The two come together for the all-inclusive price of £850.

Now for the second warning. After a longer spell with the Michell Alecto power amplifiers, I felt that in a way John Michell and Tom Evans had shot themselves in the corporate foot. In some ways, the Alecto was simply too good for the Argo pre-amplifier, superb as it is for the price; in some ways, too good for the Iso which until then had kept me



perfectly happy. Well, one of these problems will be solved by the Argo HR; the Iso HR, however, has created a new one all of its own. It's so good that it will be too good for some people's record collections.

If you have a collection of LPs which consists mostly of first-rate performances or top-quality pressings,

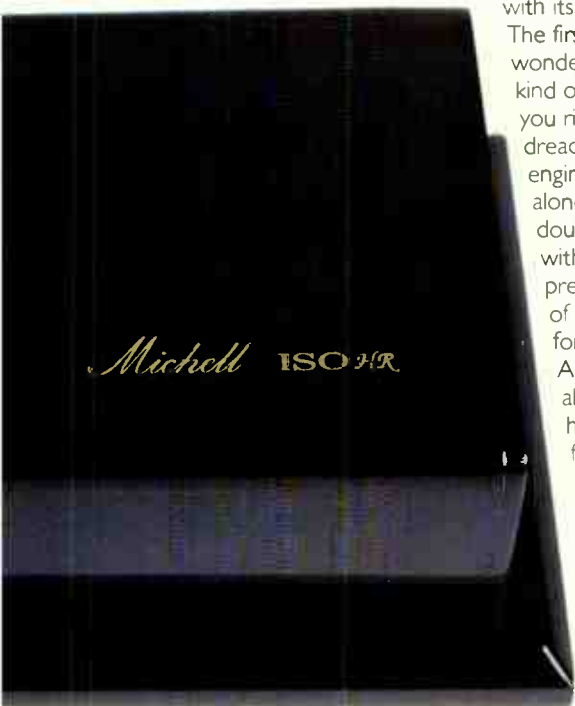

carry on reading. If you are looking for something which will enhance the sound from any black disc, regardless of the quality of the pressing or make Tom Jones sound like Jose Carreras (or vice-versa), the Iso HR is not for you. My own collection includes some prize samples of the great, the good and the more-or-less O.K., but I was taken aback by the ruthlessness with which the HR separated some pretty well-pedigreed sheep from some goats with a reasonable ancestry.

To give an example: Respighi's 'Ancient Airs and Dances' on DG, the Boston Symphony conducted by Seiji Ozawa. A late pressing, this, where I've always forgiven Ozawa's somewhat metronome-driven, mechanical style for the real dance-qualities of the performance. Through the Iso HR, alas, off comes a veil, and the muddy orchestral textures are revealed in all their lack of glory. Call this engineering?

With late pressings, at the end of the LP era, much was made of Direct Metal Mastering, which allowed slightly longer LP sides. The price that was often paid was a somewhat edgy sound, especially towards the inner grooves of the disc, and a consequent apparent reduction in dynamics, which appeared to change across the side. Normally it's not too distracting; but it is with the Iso HR in place. Despite some literal dangers being

more evident - someone in the second violins sideswiping a music stand in a Gershwin piece more realistically than I'd heard it before - the increased amount of musical detail resolved through the Iso HR brought with it such resolution of pressing inequalities, I had to give this one up.

Another case in point is the Mingus album on Impulse, a label with its (awkward) moments too. The first few minutes sounded wonderful - spacious, life-size, the kind of performance that draws you right in. Then - enter the dread hand of the remastering engineer unable to leave well alone. Suddenly that superb double bass becomes soggy and withdrawn; a trumpet solo is precisely placed in an acoustic all of its own and sounds entirely foreign to the rest of the band. A friend who so far has been able to listen to some of these horrors unaffected because - frankly, the performance is superb - almost wept at the ineptitude that was revealed.

If you're not into Classical or Jazz, then the Iso HR possesses the same unblinking glower at less-than-well-produced Rock music too. I have a fondness for the occasional noisy moment and U2's Joshua Tree. Well, I did. Suddenly, with the Iso HR in place the over-eq'd bass and the pan-potting was unmistakable, distracting and menacingly laid bare.

But put on a good pressing and it's like being swept up in a revival meeting. All dedicated collectors know of the Who's own label, Track Record. The first recording of Tommy is startlingly different to the later pressings - even than the CD, with acoustic guitar more obviously acoustic, electric guitars somehow burning with guitar amplifier fuzz, the drumming more present, a real sense of the studio space. Through the Iso HR, the 'Underture' was even clearer, each player locked in space, the drumming spaced over the whole stage with every component and microphone placement located within it as though there was a map reference.

The same was true of Pink Floyd's The Wall - each element of the mix perfectly clear and not in the least distracting from the music, rather enhancing it. Michell's Iso HR was also true to a superb Classical performance from the early days of stereo: Gwydion Brooke's Mozart Bassoon concerto with the RPO under Beecham's baton on the original 'White and Gold' HMV pressing. Every section of the orchestra was precisely in its place, showing not a trace of wavering, like a three

dimensional map of the terrain. The tonal quality was absolutely true to the recording, with the bassoon going deeper and cleaner in the Jazz-like cadenza than any but the soloist - or the original engineer - would have believed.

### Intent

While Michell's new little marvel won't enhance a so-so recording, it has one further little trick up its sleeve. Combine a first-rate performance with a second-rate recording and there's a surprise in store. Under pressure from a friend I played Backhaus's Mozart Piano Concerto No27 on a Decca Ace of Diamonds, a performance I've always found rather wooden at moments and a bit dated in recording quality. Under the guiding hand of the Iso HR, my previous reservations were forgotten. It became more obvious than ever before to discern what all but the very best replay systems hide from view: the intent behind the interpreta-

*"It's so good that it will be too good for some people's record collections."*

tion. Suddenly, it was possible to recognise what we would now call an 'authentic' performance, rather than a modern one, making up a whole context of a fascinating performance. The 'woodenness', the slower transitions, the whole style, could now be mentally transcribed to a piano of the period - and it all made much more sense. Along with all this improved insight comes a sensation of flowing smoothness which also puts it a distinct step ahead of the standard Iso. On a good recording, too, the amount of sheer breadth and spaciousness which the Iso HR displays is extraordinary - like the Alecto power amplifiers, the listening room and loudspeakers cease to have any real existence, the music hanging in space like a sonic hologram.

It's impossible not to recommend the Iso HR as one more wider open window onto vinyl. I shall find it hard to give it up. All the same, it should come with a vinyl health warning: if you already find a large proportion of your black disc collection disappointing on either technical grounds or because the performances are less than first-rate, the Iso HR will turn you into a CD buyer in despair. If you are a true collector, if you enjoy analysing both recordings and musical performances, then give up one of your New Year resolutions and try the High Resolution Iso ●



The MusicSpace Trust about to launch hundreds of competition entries for a portable CD player via balloon power; it raised a total of £1100 for their charity work. The Trust will use this money to help those with physical or learning disabilities and conditions, such as depression, cerebral palsy and autism, by encouraging them to express themselves through music. If you have any further queries, or wish to contact them, you can do so on 0272 638000.

*This year's Bristol Hi-Fi show took place in the new Marriott hotel. It's not a new venue, but the original one refurbished at a cost of £12million. The Holiday Inn, as it was previously known, was looking a bit shabby in its later years and those who remember the sweltering heat of Hi-Fi '90 will testify that the air conditioning was simply not up to the job. The new Marriott was a quite different experience. Marble and glass, brass and wood combined with super-powerful air conditioning and lifts that remained functional throughout the whole event. Together with good food, it helped make the 1993 Bristol Hi-Fi Show an altogether more enjoyable event.*

# BRISTOL SHOW



## ◀ PINK TRIANGLE

Pink Triangle ventured further into digital technology with the Ordinal digital-to-analogue convertor. A Philips DAC-7 device, it inherits some of the da Capo's features, including active re-clocking circuits to reduce jitter, a choice of 18 or 20-bit plug-in filters and Delta Sigma modulators. Price will be under £700, just a little over half that of the da Capo. There were rumours of a 1000W Pink Triangle power amp to drive Pink's Quad ESL-63s. Could the number of zeros really have been right? Into 2ohms, yes; into 8, 200watts. It will be called the Pop (Pink OutPut), by analogy with the Pip (Pink InPut). Pink Triangle said happily that if anyone had a pair of Wilson Watts Puppy 'speakers, they could have a pip, a pop and a pup (all together now - GROAN!)



**MICHELL ENGINEERING ▶**

MicHELL's room saw the launch of three new electronics products, the Iso HR (High Resolution) moving-coil head amplifier which comes individually configured for the owner's MC cartridge, an Argo HR preamplifier in an acrylic case and the first outing of the stereo Alecto power amplifier. Using the same electronics as the Alecto monoblock fitted into a single chassis, the stereo will sell for around £1300.

John MicHELL offered the stalwart vinyl fan a refuge, apparently having the only room entirely bereft of a CD player: the source was a Gyrodec with SME 309 arm. Loudspeakers were the latest Ruark Crusader IIs which sounded extremely promising.



**JPW ▶**

Bristol saw the launch of the first two of four loudspeakers in the new Ruby range, so called because the spun aluminium main driver is a ruby red colour. Very eye-catching, too. The Ruby I will cost £499, the Ruby II £699. Moving up the price ladder, the III and IV will follow later this year.



**HARMAN-KARDON ▶**

Harman were showing two new CD players, both featuring 'Real Time Linear Smoothing' which averages the output from two 18-bit DACs through a single filter. Priced at £449 and £549, both will be available soon.

Joining Marantz, who released some British-made loudspeakers under their own name last year, Harman have come up with three new loudspeakers as well, all designed and made in the U.K. The range starts at £169 and is the first to bear the H-K name.



**AUDIOLAB ▲**

Audiolab exhibited two new additions to their product range at the show. One, a new DAC priced £100 or so above the 8000DAC, is ready-to-go; the other is a mock-up of their projected CD transport. We found this out when we ignored the 'hands-off' instructions and tried to open the drawer. Phil Swift of Audiolab wouldn't be drawn about the transport's innards - or those of the new DAC - but did say that it offered six inputs to keep up with the increase in digital sources, plus a stand-by system which puts the microprocessors to sleep to reduce interference with other sources when not in use.

**MISSION**

Mission were demonstrating the new Cyrus 3 range we announced in Tradewinds last month. On show was their two box CD player, amplifier, tuner, power supply and 'speakers, with a prominent 'New Product - Do Not Touch' sign which didn't deter prying fingers.

**TANNOY ▶**

Tannoy were out in force with their new Definition series loudspeakers. On demonstration were the D700 floorstander and a prototype of the forthcoming D100 stand mounter. Both Definition speakers use Dual Concentric units, the D100 having a single 6.5inch driver and the D700 using a 10inch version, plus a second more conventional 10inch bass cone to add to the lower registers. The 93dB sensitivity D700 in particular sounded as if it could blow your house down, and at £1970 there isn't much else that could compete with its scale of presentation.



**MERIDIAN ▶**

Meridian arrived at the show with their new range of 200 series electronics. The 206ΔΣ is an integrated player that uses the increasingly popular Crystal digital to analogue converter chipset. Also on show was the new £895 200 CD



transport which, as with the 206, will read CDs with no table of contents. This is useful for playing CD-R discs before the TOC is set. The digital output is also double re-clocked and Meridian boast that this provides the lowest jitter yet measured from a transport.

To complement the 200 transport a new DAC, the 263 priced at £495 was launched. Again, it uses the crystal D/A chipset, but with a special circuit to ensure a very low jitter performance. ▶▶

# Great tracking

Ortofon is famed the world over for the tracking capability of its cartridges. Cartridges which will breathe new life into a cherished LP collection, divulging detail as never before.

The cartridge is always the key factor in the reproduction of music from records and Ortofon has dedicated nearly 50 years to the manufacture of the finest pick-ups possible. Enjoying constant critical acclaim along the way. So if you want to bring more out of your records than ever imagined, an Ortofon Cartridge will have you hot on the scent.



**500 Series**  
Moving magnet  
cartridges from £30-£100



**MC Series**  
Moving coil cartridges  
from £80-£110



**Q Series**  
Moving coil cartridges  
from £140-£500



**1000 Series**  
Moving coil cartridges  
from £600-£1500

## ortofon

Ortofon (UK) Limited, Chiltern Hill, Chalfont St Peter, Bucks SL9 9UG.  
Tel: 0753 889949.



# CLEAR AS CRYSTAL



**LISTEN TO THE STATE OF THE ART  
EMF AUDIO CRYSTAL DAC**

For further information, please contact:

**EMF**  
AUDIO

2a BELLVUE ROAD  
FRIERN BARNET  
LONDON N11 3ES  
TEL: 081 361 6734  
FAX: 081 368 3952

"Mike Creek has brought to the market, at an affordable price, a genuinely different high quality converter that is an interesting alternative to the Philips/Burr-Brown options we have been served to date."





**TEAC ▲**

Teac were proudly showing off their latest Philips DAC-7 VRDS-10 CD player, first of a new line of CD players and transports due this year. At the back of the room, looking a little forlorn amidst the newest technology, was a reel-to-reel recorder. "We've got the most old-fashioned source in the show!" said Teac's Dave Hatton, grinning widely. We thought it wasn't true, but as a format reel-to-reel tape did predate the LP... We also snaffled the last pair of Van den Hul carbon interconnects which Teac distribute and left them without any to wave at customers.

**MARANTZ ▶**

While Marantz were displaying their full range of amplifiers, CD players and British-made 'speakers' announced last Autumn, pride of place was taken by the new CD10 CD player.



This is the replacement for the long-lived and highly respected CD94, boasting twin DAC-7 Bitstream conversion. Philips' offshoot hopes it will set the standard for £1100 players. Marantz were making much play with copper-copper shielding in CD players and even a copper stand to hold their 18-bit DCC machine.



**◀ KLIPSCH**

Klipsch has to be the name most associated with horn loudspeaker designs. Making an unexpected comeback on this side of the Atlantic, they made an impressive showing with a pair of classic Klipschorn corner horn loudspeakers in their room. For those who don't have the corners for them, they were also

showing some of the smaller free-standing models as well. The cabinets excited attention for their finish as much as their size, beautiful veneers aglow.

**SANSUI**

After becoming a part of the Polly Peck empire, which ultimately collapsed, Sansui are now associated with U.S. company Singer. They were proving that Sansui isn't just a budget name, with an SME Model 20 turntable source working through their £1500 integrated amplifier driving Apogee Stages - of all things - without stress.



**NAD ▲**

NAD were celebrating their new group of amplifiers and CD players, along with a mock-up of a prospective tuner.

**ORTOFON ▶**

Ortofon were flying a vinyl flag, having taken over distribution of the Austrian budget Project turntables. Very nice they looked, too.



**VALVES**

**AUDIO INNOVATIONS**

The valve renaissance had its place at Bristol, too. Prominent in Audio Innovations' room was the new P2 phono stage, which uses valve rectifiers in the power supply. A no-feedback design, it is provided with a gain control which allows the unit to be directly connected to a power amplifier. Configured for moving-magnet cartridges, its price is £700, or with an additional T2 transformer for moving-coil, £900.



**OCM**

also had a phono stage, the Model 10, at £900 a £1300 Model 55 pre-amp and 100W and 200W power amps at £1700 and £2700 respectively.

**PAPWORTH ▶**

Papworth Audio Technology had on show in their room the TVA50, a fifty watt stereo valve amplifier retailing for £1299, the M100 100w monoblocks at £2499 and the M200 200w monoblocks at £3495. All of their power amplifiers use EL34 output valves in push pull operation paralleled up in varying quantities, depending on the power required.



**MAGNUM DYNALAB**

Other valve items were on show from Magnum Dynalab, who demonstrated the £850 Romulus power amp.

**AUDIO-VISUAL**

Home Theatre, as we now appear to be calling it. Like the Americans, was filling a number of rooms with the cacophonous roars of the Terminator II soundtrack. Rumour had it Bristol Cinemas had their quietest weekend for years.

Yamaha demonstrated their new seven-channel A2070 Surround-Sound amplifier, which at £1100 had enough features to fill an encyclopedia. Sony and Pioneer were also running A-V demonstrations, as were JPVV and AR who had a full set of their 'Holographic Imaging' speakers in the room. Celestion almost went over the top, with a Pininfarina styled TV projector in spangled red that looked as though it might grow up into either a Ferrari or a Gaggia. Backing it up were Celestion SL600Si speakers and SL6000 subwoofers, providing thundering bass ●

# The new Audiolab 8000T Tuner



## The Audiolab product range:

8000A Integrated amplifier

8000C Pre-amplifier

8000P Stereo power amplifier

8000T FM/AM tuner

8000M Monobloc power amplifier

8000DAC digital-analogue convertor

Winner of '92 *What Hi-Fi?* award for "Best CD upgrade"

Winner of '92 *Audiophile* award for excellence

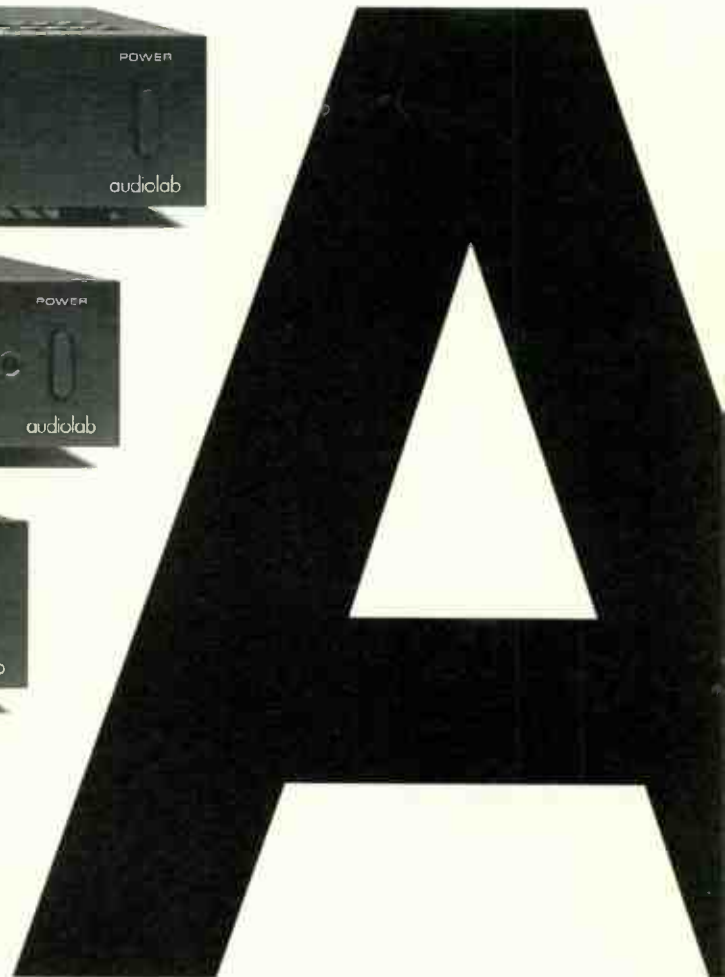

# AUDIOLAB

Cambridge Systems Technology Limited 26 Roman Way Industrial Estate Godmanchester, Huntingdon Cambs PE18 8LN. Tel 0480 52521



Suddenly, the word "hobby" is being used again in hi-fi. It's one of the best trends to have appeared for a long time, coming as a welcome alternative to a current fad - an industry feeding frenzy - centred on AV (audio visual). Whilst AV is purely a "buy more" promise to manufacturers, which in a recession really does take on the importance of manna from heaven to them, DIY is a genuine, firmly based interest and need. AV will slip away quietly when the small market is satisfied, just as "Life Style" did when the late eighties came to an end and recession tightened its grip - and someone fittingly produced a Lifestyle toilet roll. Hah!

Not so DIY. With demand forcing the issue onto a reluctant hi-fi industry, I strongly suspect DIY will flourish again in Britain as it has done in the past. We are noticing a rising flow of letters from readers who have invested surprisingly large amounts of time and effort building or tweaking their hi-fi systems. There seems no doubt that these tweekers and builders derive a lot of satisfaction from being able to alter and improve the performance of products that, superficially, may seem quite complex. We do too, but we were unaware that so many others share our interest and enthusiasm.

### Robbed

The hi-fi industry sees things differently to hi-fi listeners, buyers and enthusiasts: it is baffled by DIY and a little perplexed. Some people wish it would go away, believing it robs them (i.e. manufacturers and retailers) of vital sales. This is a sad misunderstanding, one that has in the past resulted in the experimenter being isolated and ignored, even robbed of the ability to pursue hi-fi as a creative hobby, and an interesting learning experience, as well as a means to deriving enormous pleasure from listening to music.

And it's a simple truth that today's DIY'er is tomorrow's manufacturer (or journalist - looked what happened to me!). Question the managing director of so many of Britain's specialist hi-fi companies and you'll find someone who started designing and building amplifiers or speakers in their teens. What a pity that as powerful commercial pressures

build up on them, when the small company becomes a bigger one, the need to make a profit appears to demand that the company's origins aren't just ignored, but denied. DIY is at best a forgotten word in commercial hi-fi circles, at worst a dirty one!

I remember that for years I used to look at small advertisements for kit loudspeakers placed by a company called Wilmslow and wonder who or what they were. No one around me in the magazines I wrote for knew or cared. Kit speakers? Those are for tweekers and time wasters, seemed to be the view. Let them sell kit speakers - we're not interested.

### Wrestling

Not any more! Now you'll find that wrestling with kits has even fallen within the confined outlook of the most commercial of our hi-fi magazines. Kits are suddenly in (oh, and I ended up buying parts from Wilmslow privately in the end and was incredibly impressed by their component range, their quality, low prices and fast service!).

Outside Britain, the scene is bafflingly different. In continental Europe they have Kit Shows. Germany has Loudspeaker building magazines as does America. They're not amateur either, but surprisingly clued up, possessing the sort of modern digital test equipment most UK manufacturers (and magazines) lack. One of the U.S. publications works right up to the latest standards, adopting a professional and knowledgeable approach to speaker design and theory. Their speakers are imaginative, as well as original, and they plough through obscure design theory, for transmission lines and horns for example, with impressive dedication and fluency.

What a pity that we have no equivalent in Britain. In the background lie numerous drive unit manufacturers, including Celestion, B&W, KEF, Castle, Monitor Audio, Tannoy, Morel, Goodmans, Bando, Wharfedale and others, but few bother to market their drivers in conjunction with box plans and crossovers. Instead, you'll find Audax, SEAS, Scanspeak, Jamo, Dynaudio and such like feeding Britain's constricted hobbyist market and, as their names suggest,



## Reflections from Noel Keywood kaleidoscope

these are all European manufacturers. Remember 1992? That was when European trading barriers came down; they noticed, we didn't.

I was fascinated to hear from a Danish manufacturer that it was impossible to sell budget speakers into Britain, because our indigenous budget products were too good and too cheap; they couldn't match them. That's a compliment for U.K. manufacturers. It also goes some way to explaining why the kit market, for loudspeakers at least, isn't so big here. Why spend hours building something when you can buy a well researched, designed and built product, complete with guarantee, for less? It isn't so easy in Britain to build a speaker clearly better than those you can buy, which must act as a disincentive to some potential builders.

But a substantial part of the DIY market isn't fuelled nowadays by the need to save money. It is a leisure pastime, and I believe our mainstream manufacturers have failed to identify and develop the sort of service so many people want. According to a recent report from the Office of Population Censuses and Surveys, no fewer than 43% of the adult population get involved in DIY at home. They're not all dying to build loudspeakers, that's for

sure, but a glance at the range of increasingly sophisticated machine tools now available to service this broad DIY market shows that it is healthy and wealthy - there's no penny pinching here. Circular saws, routers, groovers, exotic paints, advanced glues, MDF, gorgeous veneers - they're all easily obtained and within financial reach.

So where are the drive units, plans, books and knowledge? Why aren't they available in Britain? The old DIY market, which started in the 1920s with the necessity to build a radio if you wanted one (see the excellent book: Setmakers) and which continued until the late Sixties, was driven by domestic

economics; people could not easily afford manufactured products. Steadily improving industrial efficiency in the electronics sector, notably in Japan, changed that through the Seventies. This is when DIY as a necessity faded away. Hi-fi prices have risen since the Sixties, but the cost of living and average incomes have risen faster.

Now, in affluent markets like Germany and the U.S.A., where people have plenty of leisure time and spending power, DIY is back as a creative and educational hobby, as well as a functionally satisfying one. It is being re-discovered and redefined, a process in which Britain lags about five years behind. Watching television, reading and listening to music are passive entertainments; DIY is involving and active. It is also creative. It can even be sociable! We enjoy designing and building here; our first DIY Supplements have been a fascinating and rewarding experience. Thank heavens DIY is back. I hope we'll be able to support it with increasing vigour in the future.

And here's my heartiest regards to all those determined souls who struggled through the Seventies and Eighties determinedly designing and building no matter what. They kept the memory of DIY alive ●



# CALIFORNIA



The rare H. H. Scott 4310 Broadcast Monitor with its distinctive circular, cranked tuning dial.

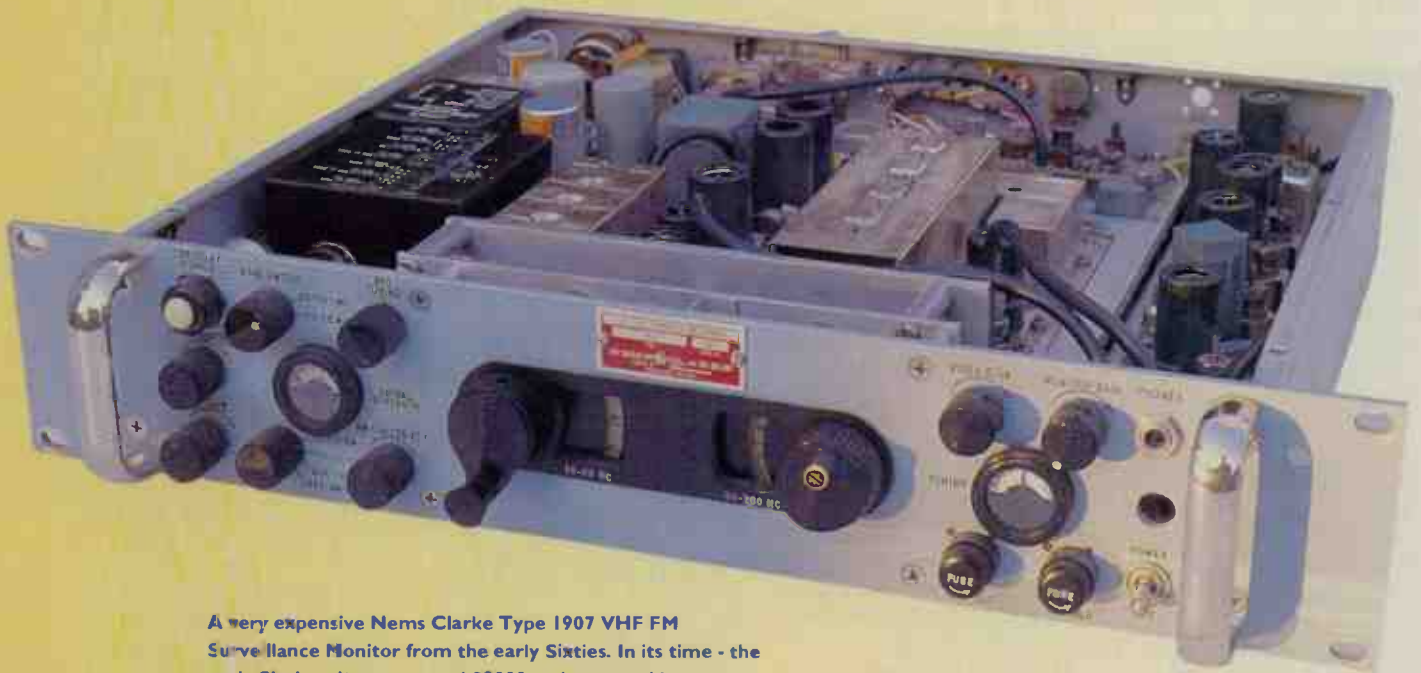

A very expensive Nems Clarke Type 1907 VHF FM Surveillance Monitor from the early Sixties. In its time - the early Sixties - it cost around \$9000 and was used by government agencies. The chassis was silver plated and some of the valves used so specialised that they are virtually unobtainable. We are looking for further details.



# CATHODE FOLLOWER

**Reader Richard Links, one of California's 'Cathode Followers', offers a view of vintage**

**American valve tuners from the Sunshine State.**

I just discovered Hi-Fi World at our local news-stand and wish to commend you. It was refreshing to read of continued interest in the LP as well as a fascination with valved tuners, preamps and amplifiers in Great Britain. Although I missed your discussion of the Marantz 10B tuner in the June issue, the evaluation of the McIntosh MR71 FM tuner in the October, 1992 issue was of particular interest.

Although your consideration of the MR71 was excellent, you overlooked the importance of proper tuner alignment, which is absolutely necessary for optimal performance.

For many years, McIntosh Laboratory did not wish to have their products submitted for review in the press. Despite this anomaly, their reputation for superb engineering and high standards of quality has remained unblemished for more than forty years. McIntosh Laboratories were able to sustain their fine public image by instituting a unique programme of rigorous field maintenance for their products.

Until recently, dealer-sponsored McIntosh 'clinics' were held in most American cities. At these, McIntosh engineers would test any preamp or amplifier, regardless of make or model and would furnish the owner with test results for harmonic distortion versus output. Normally, most McIntosh components would meet or exceed their published specifications. If so, they were 'certified' by means of affixing a factory sticker, signed by the engineer present. If factory personnel found a unit which did not meet specifications, corrective repairs were made so the component would conform to McIntosh performance standards. In the case of older power amplifiers, the service often included free valves, and was done without regard to the vintage of the McIntosh or the status of ownership.

Unfortunately, McIntosh did not provide field maintenance for their tuner. They took a serious interest in maintaining contact with owners of their product. It not only provided a meaningful record of product longevity, but created and maintained unusual loyalty to the manufacturer. As such, the McIntosh 'Amplifier Performance Clinics' were unique. It also helps explain why there is a higher percentage of vintage McIntosh units operating and exceeding published specifications today than those of almost every other American manufacturer.

Among FM tuners I am fortunate to own one MR71 tuner, three Marantz 10Bs, a Fisher FM-200B and a Fisher FM-1000 broadcast monitor. Although most of these are enjoyable to use, some are more reliable than others. Most acquaintances who own MR71 or Marantz 10B tuners usually have their units serviced by professionals. Otherwise, they do their own maintenance with the proper test equipment and know-how.

I have performed several upgrades to my own MR71 by replacing weak tubes (including the original Nuvistor) and substituting fresh electrolytics and many film capacitors. These were one-to-one replacements. The tuner was also re-aligned. These efforts resulted in greater sensitivity, improved selectivity and enhanced quieting. Readers should also be aware that documentation for nearly all McIntosh products is still available directly from the factory

headquarters in Binghamton, New York.

Last year, our local valve enthusiast group, "The Cathode Followers", gathered to conduct an interesting listening evaluation of some of the finest valved FM tuners available. The sampling consisted of several Marantz 10Bs, McIntosh MR71s, a rare H. H. Scott 4310 broadcast monitor, Fisher FM-200B, Fisher FM-1000 broadcast monitor, a Leak tuner and many mono and stereo Scott 310 series tuners. We also auditioned a rare 1930s R.E.L. Precedent mono FM tuner. It was a great privilege to see and hear these interesting and legendary products in a single afternoon. Each tuner was allowed to warm up fully before listening commenced, and signals were supplied by an electronic antenna, which fed each unit in rotation.

Although San Francisco and the Bay Area are noteworthy for cable cars, good restaurants and fabulous vistas, there are also lots of hills and high buildings, making it one

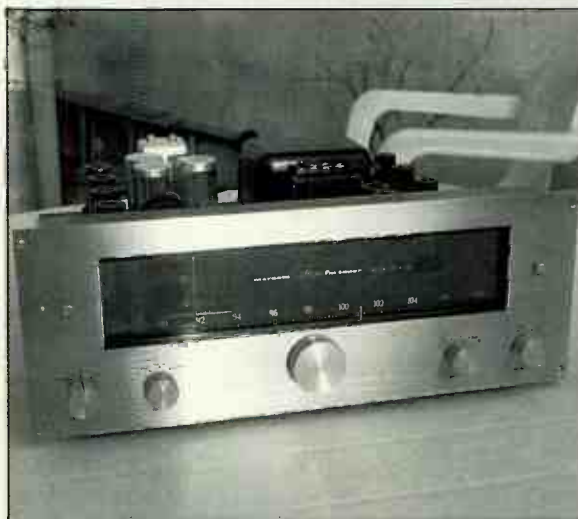

◀ The highly regarded and complex Marantz 10B all-valve tuner.

of the most difficult environments in which to receive clean, multipath-free FM stereo broadcasts. The location for the meeting was nearby Belmont, California. This permitted virtually interference-free reception and also allowed our tuners to capture weaker signals

How did the tuners perform? Reception was remarkably good for nearly all of the tuners we auditioned. Among the most outstanding were the Marantz 10Bs. They were always very lush, sweet and quite musical, and when confronted with multipath-laden signals, seemed to offer tolerable reception. As you can imagine, the 'scope display of the 10B was essential in properly orientating the antenna.

We then provided identical signals (Classical and modern Jazz) to the McIntosh MR71s. Although somewhat less elaborate than the Marantz, they were simple to tune and offered neutral, un-coloured sound and drift-free performance. Both products enabled us to 'log' many stations too weak for clean reception within the urban confines of San Francisco. Stereo tuners were also operated monaurally so as to facilitate comparison with older tuners. Surprisingly, some very ancient tuners



sounded virtually indistinguishable from their more modern counterparts. For the most part, H. H. Scott tuners provided excellent reception, including some monaural units which had been coupled with Scott multiplex decoders. The example of a 1950s Leak Troughline tuner also sounded sweet and clean.

On a cost-effective basis, the tuner which provided the best stereo FM performance seemed to be the Fisher FM-200B, which is still very popular. The FM-200B was originally introduced around 1961-62, when FM stereo broadcasting was in its infancy. Today, some features, such as Stereo-Beacon (automatic stereo-mono switching) seem anachronistic. However, the FM-200B is a well-engineered, solidly constructed tuner capable of outstanding performance and sound, on a par with all but the most sophisticated valved tuners.

The H. H. Scott 310 series tuners were direct competitors to the Fisher FM-200B. Recently, Scott 310s escalated in value because of an enthusiast's recommendation in a past issue of *The Absolute Sound*. They provide good sensitivity, selectivity and clean performance. But for many, their peculiar crank-style tuning mechanism does not compare favourably with the more 'user-friendly' linear flywheel actions or logarithmic dials engineered into tuners by Fisher, McIntosh and Marantz.

As pleased as I am to own many 60s tuners, I find maintenance on the most exotic of them somewhat demanding. For example, many Marantz 10B owners report spontaneous loss of detection while operating their tuners. This has happened to me more than once with each of the three 10Bs that I own. The problem seems to be associated with a weak 6DL4 front-end valve. Needless to say, it also has the potential for ruining otherwise good reception.

Oscilloscope display problems are another annoyance. These are usually attributed to ageing parts and deteriorating LDR (Light-Dependent Resistor) photo-optical switching networks. LDR failure manifests itself in faulty left or right channel displays, defective muting and/or poor mono/stereo switching.

Although the Marantz is probably the most revered of valved tuners, the fact remains that parts are largely unavailable, and technical expertise for repairs is practically non-existent. This relegates the 10B to a collector's piece or one for the dedicated engineer or perpetual tinkerer. To be perfectly honest, I'm rather reluctant to use any of my Marantz 10Bs for 'off-air' recording. For greater reliability, I prefer either the McIntosh MR71 or one of the Fisher tuners. This way, I can leave the listening room and return without fear that the tuner has 'wandered' off frequency or encountered other quirky problems.

Once again, I appreciate your effort to consider component design of the past and wish you continued success with *Hi-Fi World*.

**Richard Links,  
Berkeley,  
California,  
USA.**

We are aware of the importance of good alignment. The misalignment of the review McIntosh was noted in the article and due compensation made for loss of performance. It was offered 'in good condition' and was not ours to realign. Unfortunately, this is a problem with reviewing vintage products; some are not up to original specification. I could not pay full tribute to the McIntosh, so I am grateful that you could provide such an interesting and informative insight.

Graham Tricker specialises in the obscure (for us Brits) subject of US valve tuners and has kindly provided the following notes. We dashed along the A40 from Central London to a village in Buckinghamshire to get some rare shots - captured in a cold winter's sun - of the tuners you talk about. **NK**

## FOLLOW THAT TUBE!

**Graham Tricker, on this side of the Atlantic, explains what to look for in classic tuners from the States.**



Like Richard, I have recently had the opportunity of comparing a Marantz 10B, McIntosh MR71, Scott 4310, Leak Troughline and a special, valve Broad-

cast Monitor tuner called a Nems Clarke, connected to a Scott 335 multiplex adaptor. The Nems Clarke was manufactured in 1962 at a cost of £5000; it is an excellent design. Incidentally the Scott 335 multiplex adaptor is possibly one of the finest outboard decoders ever made. The chassis is made from aluminium and on the inside is a copper sheet bonded to the aluminium to form a ground plain. This helps to reduce the effects of induced RF. The components used are some of the finest I have ever seen. All Scott equipment was particularly good in this area.

Our listening revealed that the Marantz 10B was the clear winner, its flat frequency response and its ability to produce a clear, three-dimensional sound separated it from the rest. Of course, this is totally dependent on the quality of the antenna and the broadcast. After the Marantz came the Nems Clarke tuner coupled to the Scott decoder, closely followed by the Scott 4310. This tuner has a very rich, warm sound akin to the sound of old valve equipment. The MR71 was next, followed by the good old Leak Troughline.

The U.S. tuners sound good not only because of their sophisticated circuitry, but because they have all been manufactured using components almost up to military specification. Even after 20-30 years these tuners perform well and the electronic components test within spec. Equivalent British tuners of the day, namely the Leak, Quad, Radford and Chapman all used components of an inferior quality to the American types and after years of use they go out of tolerance - often by a large amount. However, original components should not be replaced simply by equivalent modern types, as this can have a disastrous effect on performance.

Here are some comments on build quality, circuit details, reliability, and what to look for when buying one of these tuners.

### MARANTZ 10B

The Marantz has a steel chassis with an aluminium fascia, together with a potted mains transformer mounted roughly central in the chassis. It uses 21 valves plus an oscilloscope for tuning. Once properly aligned the 10B is no less reliable than any other tuner. Here are some notable things to watch out for before purchasing one.

Turn the tuner upside down and remove the bottom cover to reveal the electronic components. Look for the optical switches, they are round in shape, about 2" high, 1" diameter with 4 wires coming out of a dome of bitumen. This is how they should look:

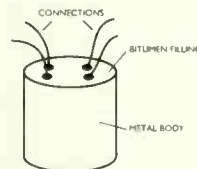



If these fail, the normal solution is to cut open and remove the bitumen top. The problem is normally a faulty voltage neon. A bodged job is resealing the optical switches with insulating tape instead of bitumen. This is totally useless, as any light entering the switch could turn it on. If these switches have been tampered with, give the tuner a wide berth.

Generally, the 10B wears very well; the finish is durable although the aluminium fascia may have taken a few knocks. If the glass tuning scale is cracked or broken, it's not the end of the world, as remanufactured replacements are available.

Finally, check the authenticity of the valves. Original valves often carried the Amperex (Philips) brand name. It is of utmost importance if you are replacing any of them to use North American or West European branded types. Changing any of the valves - even one - will require the alignment to be checked; this is mandatory for any valve tuner.



### McINTOSH MR71

Perhaps the most durable and most reliable in state-of-the-art valve tuners. The MR71 chassis is made from steel with the top plate chrome plated. It too uses a potted mains transformer for silent operation. The fascia of the MR71 is made from aluminium, with glass covering the tuning scale. Most MR71s came with a wooden case which the tuner slides into on runners and locks into place with pan-lock fittings. This also helps to protect the chrome chassis.

Generally the MR71 wears very well. It is often possible to purchase one that looks brand new. McIntosh still carry spare parts for servicing and there are no unusual valves to worry about when getting replacements.

The MR71 tuner has no real vices; but expect a few leaky electrolytics. Apart from routine servicing every 3-4 years, it is a very good buy, if you can find one.

### SCOTT 4310 Broadcast Tuner

Possibly the rarest of all valve tuners and one of the best sounding. The Scott was only made for some 18 months and retailed for \$475 before being replaced by the 4320, a nuvistor/transistor hybrid. The 4310 was primarily used by the broadcast industry in the USA and its ability to pull in a large number of stations was of great use. The 4310's chassis is made from aluminium, with copper bonded to the underside to form a ground plain. There is a potted mains transformer and 20 valves spread evenly around the top of the chassis.

The front fascia is made of anodised silver and gold aluminium. Unfortunately, it's a soft material prone to damage. This tends to age the tuner visually, as it is almost impossible to find one that has not suffered some damage.

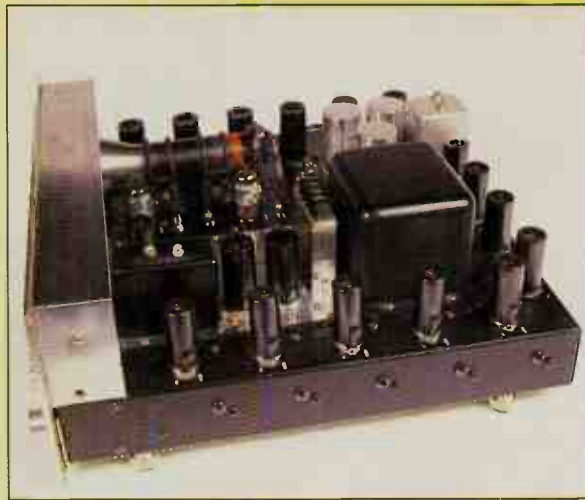

Top: The Marantz 10B had 21 tubes, plus a cathode ray oscilloscope tube.

The controls, which are plentiful, litter the fascia, together with a large rotary back lit tuning dial in typical Scott tradition.

The most unusual technical feature of this tuner is its use of valves in the switching part of the decoder instead of semiconductor diodes. The valve diode elements look like a Venetian blind housed within a normal B9A envelope. This complicates the design, but sonically I think it is what makes the tuner stand out from the rest. It has the most amazingly rich, full-bodied midband and is certainly the best tuner in this department.

Some of the tubes used are very difficult to obtain, particularly the diode valves described above. The USA is probably the only source.

Far left: The McIntosh MR71 tuner with the Marantz 10B above, displayed by Graham Tricker at the Chesterfield Show.



Bottom: A Leak Troughline; much simpler than the American tuners, but little worse for it in sound quality under good reception conditions.

Richard Link is correct regarding the importance of accurate alignment, particularly when a tuner has come from overseas. Another factor is decoder de-emphasis; USA tuners are set for 75µs, whereas in the UK tuners are set for 50µs. If this is not changed, the tuner will sound dull. Also, vintage USA equipment works on 117 volts AC only; in the UK it must be used with a step down or autotransformer.

An important tip when buying any piece of classic Hi-Fi is to try to establish a service history (i.e. parts and servicing receipts) as you would when buying a Classic car. This gives a good indication of the authenticity, condition, and history of the equipment.

**Graham Tricker,  
G.T. Audio,  
5 Upper Road,  
Denham,  
Bucks. UB9 5EJ**

**Tel. 0895 833099**

# Don't trip up on your speaker cable!

When you invest in good quality hi-fi equipment, why skimp on the cable?

Especially now that Ortofon can offer 3 types of top-quality cable for under £10.

Each cable is made up of very fine core copper strands rated at 6-Nines (that's a copper purity of 99.9999% - it doesn't come much better), is flat and flexible for easy installation and features a 'tack-rack' for panel-pin fixing.

Cable Type	Description
SPK 100	Twin-core white cable, each core with 130 copper strands (total 260 strands).
SPK 200	Triple-core grey cable for bi-wiring with twin-core treble (260 strands) and 3-core bass (390 strands).
SPK 300	7-core blue cable having 13 strands per core (each strand laminated). Requires soldering.

You'd better hound us for the name of your nearest stockist.

## ortofon

Ortofon (UK) Limited, Chiltern Hill, Chalfont St Peter, Bucks SL9 9UG. Tel: 0753 889949.

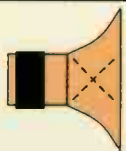

## BANDOR

MINIATURE LOUDSPEAKERS  
THE SOUND OF EXCELLENCE

Design & Development Studio 11 Penfold Cottages Penfold Lane  
Holmer Green Bucks HP15 6XR Tel: (0494) 714058



2" 50MM MODULE	£36
6" 100MM DRIVER	£72
8" 150MM DRIVER	£82
15" 300MM DRIVER	£215

Prices exclude VAT & postage.

PASSIVE & ACTIVE X/OVER  
AVAILABLE

#### SPECIALITY:

1. Exceptionally fast transient response
2. Moving mass under 2 grams (2")
3. Covers 2/3rds of the frequency spectrum 200Hz/20kHz

ANODISED SPUN ALUMINIUM CONE DRIVERS  
DEVELOPED AND DESIGNED BY DOREEN  
JORDAN SINCE OCTOBER 1984

SUPPLIED ONLY DIRECT FROM  
BANDOR MANUFACTURING (UK)

Trade Prices and brochures available on request.  
35 YEARS EXPERIENCE • BUILT FOR RELIABILITY  
WARRANTY

# AMADEUS

## SOUND & VISION

Arcam, Audio Innovations,  
Bang & Olufsen, Carver,  
Castle Acoustics, Hafler,  
Micromega, Mordaunt-Short,  
Musical Fidelity, Pioneer, Quad,  
Spendor, Technics.

10 BOLDMERE ROAD  
SUTTON COLDFIELD  
WEST MIDLANDS

Tel: 021-354-2311



...continued from page 15

music. I look forward to the next free CD - isn't it about time for another? P.S. What happened to Alan Sircom?

**C. D. Topping, Manchester.**

Necessity is the mother of

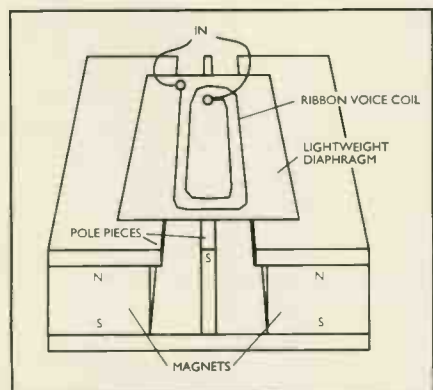

**Tonigen Ribbon Tweeter.**

invention; frustration the father of DIY. We've become so hooked on the Tonigen ribbon tweeter that we got a pair in and are at this very moment experimenting to find complementary midrange and bass units. The general idea is to cook up a loudspeaker with a level of crisp, open clarity across the vital midrange and treble regions that is exceptional. We're fed up with metal dome tweeters; too many are awful. Quacky bass/midrange units are a crime too. But there are precious few good ribbons around (Heybrook Sextet excepted of course) - so DIY it is! And yes, the project will be appearing in one of our DIY Supplements as soon as - and assuming - it reaches successful fruition.

Rumour has it that the Decca Kelly ribbon sounded superb, so your comments come as no surprise. After hearing ribbons or electrostatics working properly it's difficult to regress to paper and plastic cones, I find.

Alan Sircom said he didn't like ribbon tweeters, so we wired him up to a pair of electrostatics instead. He's been silent ever since! **NK**

**BEFORE CYRUS**

Reading about product life of the Mission Cyrus I amplifier in the February issue, I was surprised that no mention was made of the model which was effectively its prototype, namely the Mission/Cambridge 778. I bought one of these in 1983 as part of a complete Mission/Cambridge system. Unfortunately, the amp was destroyed soon afterwards, along with most of my other

equipment, when my flat was struck by lightning (yes, it really does happen, although not - so far - twice in the same place). Although the 778 was returned to the manufacturer for repair, I gave up when quoted a repair price which coincidentally was the same as the list price of the newly-launched Cyrus I.

My tastes and system have moved on since then, but I remember the 778 with particular affection and wonder whether anyone else still remembers or even runs one? The Cyruses which followed shared the same size and shape but the 778 was a beautifully aesthetic design, having an all-metal case, attractive

grey-brown paintwork and less prominent control knobs with a minimum of lettering to interfere with the lines of the front panel. The amplifier was well-received by the hi-fi press on its first appearance, but was, I suspect, too costly to mass-produce.

Incidentally, and in no way connected with the above, has anyone ever suggested using unwanted CDs to level/isolate an unspiked turntable support such as the IKEA 'Lack' table? To begin with, a CD is placed directly under each of the table's four feet, others being added as necessary to compensate for any slope in the floor, the results checked by means of a spirit level. Because CDs are so thin, quite fine adjustments are possible, and the final result lends a playful post-modernist flourish to the appearance of the system, as well as being a visible sign of one's - err - slight disappointment with the CD medium.

**James Taylor, London.**

Ah, so that's what Philips meant by 'Perfect sound for ever' - from LP! **NK**

**LINDLEY & QUAD**

I read with great interest your upbeat article about your experiences at the British Vintage Wireless Society. It sounds like you must have had a great time there!

In your piece you mentioned the name Peter Lindley. I think this is the second time I have seen his name printed in Hi-Fi World. (The first was last month, when you showed some Lindley TL12s, I believe.) Do you know how I could contact Mr Lindley?

As a Quad II and Stereo 20 owner, I have been looking for someone who could modify them appropriately, with well chosen and sympathetically 'period' components, i.e. with composite resistors.

Keep up with the excellent coverage of valve amplification in your magazine.

**Mark Daren, Paris, France.**

Peter Lindley can be contacted at:

91 Spalding Road, Pinchbeck, Spalding, Lincs. PE11 3UE.

Actually, the first time we mentioned Peter Lindley was in one of Alan Sircom's columns just over a year ago. **EB**

**ARISTON IN AMERICA**

Help! I recently purchased the Ariston Q Deck. That's the good part. When I tried to register my turntable in the USA and get some reviews, all the correspondence was returned. The P.O. would not forward letters: they claimed the company left without an address.

When I wrote to the UK, the British P.O. also refused to forward material. They wrote back saying the company would not accept any correspondence.

Where do I go from here? Can you help me with an address?

**Michael Soucer, Hawthorne, New Jersey, USA.**

Ariston ceased trading and went into receivership in June last year with debts of £2,000,000.

Although the Receivers advertised the company for sale, it seems that no-one was interested in buying it and the physical assets were auctioned. The company now simply does not exist, and the Receivers, of course, can only deal with outstanding creditors. The position now is that the guarantees expired along with the company, unless a dealer is willing to take them on. I don't know what address Ariston gave in the USA: the Receivers said they had no knowledge of an American subsidiary. It may have been an importer, a dealer, or a Box Number, but we couldn't trace anyone who would take responsibility in the USA. **EB**

**POLL PLEASE**

Why don't you have a readers' poll like the music magazines? I

would be interested to know what other 'audiophiles' listen to. You could ask for Best Album, Single (yes, I still buy them), Artist, etc. It would be good if you didn't categorise it, i.e. Best Classical LP, Best Rock LP, so we could see the proportion of Classical to Rock.

Here are my Top Five LPs of 1992 to start you off:

1. Sugar: Copper Blue
2. Bettie Serveet: Palomine
3. P.J. Harvey: Dry
4. Disposable Hexes of Hipophrasy: Hypocrisy is the Greatest Luxury
5. REM: Automatic for the People.

**Kevin Holland, Glasgow.**

Obviously a follower of Giovanni's reviews, since our own ex-Punk star reviewed Nos 1 and 5 - favourably, I'm pleased to say. Why not? Join in, everybody. Anybody mind if my own list is all Classical, just to even out the odds, since the Classical lovers seem a bit shy? No, on second thoughts, I'd probably want to put the REM album in too. **EB**

**FENCING**

Why do your record reviewers always sit on the fence? Does Simon Hopkins like Allan Holdsworth's Warendclyffe Tower album or not?

**Ken Pummell, Canvey Island, Essex.**

One other reader at least thought Simon had fallen off the wrong side of the fence in a big way. See below. **EB**

**CRAFTSMAN**

I feel I must write to you concerning Simon Hopkins' ridiculous statements emanating from the review of Allan Holdsworth's new album for your February edition.

To say that his entire 1980s output is unenjoyable is misleading your readership. Admittedly, some of Allan's 1980s output is disappointing, though two albums stand out a mile in terms of guitar playing during this period: the 1982 release IOU is akin to hearing a craftsman at work - few guitarists can live with this playing. Later on, the 1990 release on Legato in unison with Frank Gambale features some of the best guitar playing I've ever heard on 'Truth In Shredding' - and by the way I'm a hi-fi nut with a large collection of guitar albums, so I know good guitar playing when I hear it.

It would be nice to see Hi-Fi World feature some comment from readers on your album reviews once in a while, as I for one don't always find them agreeable. Otherwise, I find your mag. informative, balanced and enjoyable to read.

**S. Hipkiss,  
Birmingham.**

**VINYL VALUE**

I was disappointed with Dominic Baker's comments on vinyl (February 1993), 'dB on the Level'. For a person wishing to build a high quality hi-fi system to say you should discard the turntable was surprising. In the December issue 'For Starters' section, Dominic Baker said, "Vinyl is still highly respected amongst many audiophile enthusiasts, with many rare pressings still unavailable on CD. The massive second-hand record market offers an economical way of acquiring a large and varied music collection."

"The death of vinyl is imminent." How many times are we going to hear this? It's silly to write off an entire format on the basis of not being bothered to shop beyond your local Our Price. Recently at a record fair I purchased a wide selection of music on vinyl without breaking the bank. The material is out there and it's growing all the time. LP still has the potential for more realistic replay than any other format outside of 1/4in high-speed tape.

After reading the bit about discarding the record deck I thought it couldn't get any worse, but it did when Dominic got on to DAT saying, "To date it is the only medium that can record digitally to a high standard."

I couldn't believe it after Tim de Paravicini said on a previous page that: "You cannot get all the information in an analogue signal on to a tape a few millimetres wide" and called DAT "silly", going on to say that back in the Sixties Studer had it right. I've heard some other criticisms in professional circles regarding DAT not being as reliable as stationary head systems because of its complex mechanism and that the cassettes might be susceptible to damage.

For the home user its high price and the apparent lack of software (pre-recorded) could be a problem. Some CDs have a disappointing quality possibly due to mastering off DAT. It would seem that DAT isn't the right answer, but also that it is part of the problem.

It's hard enough trying to get all the albums I want on vinyl and

CD. Whatever format takes over, by the time all the world's music has been transferred to it, another system will be on the market. Maybe it will be analogue again in a new form?

**Matthew Leedell,  
Chelaston,  
Derby.**

Firstly, 'dB on the level' is my own personal opinion. When I discounted LP as a viable source for those who do not already have a large LP collection, or a 'passion for second-hand vinyl', it was for good reason.

I feel that it would be irresponsible of me to advise somebody starting out in hi-fi, something you obviously did many years ago, to invest in a record deck. We are trying to generate interest in hi-fi and music once more, hence the 'enthusiast approach' we have. Advising someone that is new to hi-fi that the only way they can listen to high quality music reproduction is to spend hours scouring back-street record shops would certainly turn them off.

The second article that you comment on was aimed at those people looking to buy a record based system. It was not for those who are trying to decide what format to opt for, but for those who have already made this decision. Hence the reference to 'audiophile enthusiasts' - not the general music buying public.

DAT is the only medium that can record digitally to a high standard on relatively cheap tapes. A Studer is not exactly practical for 99.99% of the population. It cannot record digitally and thus quality will be affected, to a greater or lesser extent, when recording from a digital source.

A direct digital recording onto a DAT tape involves no loss of information, even if some corruption from drop-outs and errors, as well as jitter can occur. All the same, DAT retains quality well.

There will come a time when no further significant advances can be made to sixteen-bit code. Digital has set its own upper quality limit, whereas analogue has not. Perhaps you are correct in predicting that a new analogue medium may be next in line, but the likes of Philips and Sony are going to take a lot of persuading before this comes about. **DB**

**FINYL**

I am amazed that no magazine has yet latched on to the wonders of a treatment known

as Finyl. Having used this product for the last six months on over a hundred CDs I can only marvel at its effect. Even my wife, who is as un-audiophilic as one can get, is amazed at the difference this treatment provides.

This is no green pen! The differences between untreated and treated discs is obvious and extremely beneficial - have you always wanted rid your system of that burping bass, hashy mid-range and 'tch tch' treble of which CD is too often afflicted? Well, Finyl sweetens treble, creates a truly transparent mid-range and extends bass.

Additionally, tonal colours are far better resolved and the music simply becomes more interesting.

If this treatment can have such an effect on my Meridian 200/Deltec PDM-2 player, what sort of effect can it have on cheaper players? At £30 for a pack capable of treating two hundred disks, it is certainly good value and well worth checking out - I can no longer listen to the failings of untreated disks on my system!

**Barry Wakelin  
Winchester,  
Hants.**

Oh heavens! Here we go again. The Green Pen drove some readers - mainly engineers - to apoplexy. Many are convinced that it's a "rip-off", that there's no unequivocal proof (true!), that we are deceiving readers, etc, etc. Doubtless, Finyl will come our way soon - and so will the flack! **NK**

**DRY?**

I have just read with the greatest of interest your review of the Chord 1200 power amplifier. My acquisition of your March issue coincided with my purchase of the SP800 which, I understand, is supposed to be sonically identical to the SPI00 and SPI 200.

My reason for writing is my astonishment at the comments by Noel Keywood about its supposedly "dry and clinical" sound quality; he qualifies that by saying that he was using an Audiolab 8000C pre-amp. It so happens that I am currently using the same pre-amp but, having read his comments, wonder whether he was listening to the same breed of amplifier.

I play mine through Townshend Glastonbury loudspeakers which are, as you know, of extreme frequency range but, also of great neutrality. My Chord replaces one of David Hafler's, the DH 220. It will come as no surprise to you

that as good as the Hafler is, moving into the Chord sound world is a complete revelation.

What baffles me however, is the comment about "dry and clinical" quality, because so far as I am concerned there is not a trace of it. The sound I was listening to was higher, deeper, wider, more three-dimensional and was literally like opening a window.

I am a very regular concert goer and constantly have live reference in mind and can only say that this is the most notable hi-fi purchase that I have ever made. I should add that I have no relationship, professional or family, to Chord.

**Laurence Watt,  
Lincoln's Inn,  
London.**

Oh, all right then - let's try "tightly ordered". Dry and clinical has become vaguely derogatory I suppose, when in fact I was impressed by the Chord, if not in harmony with it. Eric found it very exciting however, almost on par with the Michell Alectos, which he rates above all else.

My own preference these days is for an easy yet enveloping presentation, with fullsome imagery and sound staging, together with deep, deep insight. I'm beginning to find this with ultra-simple, supremely elegant electronics and transducers. Single-ended triode operation, properly executed, delivers almost magic properties; stripped down electrostatics can convey them. Yet Alastair Robertson-Aikman of SME said the other day that he thought there was artifice in the sound of valves. Perhaps; I sometimes suspect the same.

Your system is, however, superb, the Glastonburys being acknowledged as an exceptional loudspeaker. In combination with the Chord, which is a fine amplifier, I can understand your consternation at my comments. But think of them as observational, rather than critical.

It's unwise to become dogmatic about "accuracy" using "references". That sort of stance was taken in the Seventies, when engineers reigned, research was going to take us into a golden land and simple, immutable logics abounded.

I'm thankful they have gone and broader, more accommodating and appreciative views now encourage people to experiment with all sorts of approaches without having scorn heaped upon them for not following 'the one true path' - whichever path that was at the time.



It's the baffling variety in hi-fi and the delights of discovery that can be so intriguing. **NK**

### PORTABLE QUALITY

This missive was prompted by Eric Braithwaite's review of the Technics SL-XP330 CD portable in the December 1992 edition. As I have many hundreds of LPs I have put off buying a CD player as an unnecessary addition to the mass of equipment I have cluttering up the place. However, I have just won said CD player and naturally enough, have tried to listen to it.

What surprised me, especially in the light of Mr Braithwaite's report, was how veiled and enclosed the sound is on most discs. Only two, one a BBC giveaway (of all things that musical joke 'Bolero' in a live performance that almost made sense of the thing) and one a 1961 recording of Mozart violin concertos rehased digitally, gave me any grounds for supposing that it was worth carrying on with the thing.

It seems that the quality of the little silver wotsits is even more variable than my beloved vinyl. So, the big question is "How much better than the portable is a full size player and how much will it cost me to equal the performance of my record player?"

The usual list of equipment is as follows: Quad 34/Leak Stereo 20, Quad FM4 tuner, Garrard 301/Linn LVX/MPII Boron (in back-breakingly solid plinth on 'squidgy' mount). Speakers are tweaked LS3/5a's whilst the Quad ESL's are in store (lack of space at present).

I have to say that in nearly all cases, I prefer the sound of TDK SA via my Pioneer CT333 cassette deck recorded off record and radio to the CD player. The whole sound is much more 'live' and believable. P'raps I'm just cloth-eared. I suspect a time will come when the only music I want is on CD, so should I start saving or remain a Luddite?

**Gordon Steadman,  
Hartest,  
Suffolk.**

### WHY 300Bs?

I read with interest the technical comments on the use of 300B output valves in the Silver Night monoblock amplifiers (March 1993). It rang several bells with me because I built much valve equipment in the 40s and 50s, including a Williamson amp (with massive Partridge output transformer) which, incidentally, I could never get stable at high powers.

My query is - why go back to a directly heated valve with its attendant hum problem? Digging out my old and dusty valve data sheets, I see that several "modern" indirectly heated valves would appear to do at least as well as the 300Bs. For example:

KT 66: 15W at 2% distortion  
KT 88: 27W at 1.3%  
EL 34: 19W at 1.8%

These figures are with the valves wired as triodes and with no NFB. Your measurements on the 300Bs gave 18W with 2% distortion at mid-band and 4% at 10kHz. Assuming that the majority of the amplifier distortion comes from the output valves, then your figure will reasonably represent the 300Bs' distortion.

The only potential disadvantage I can think of with the newer valves is their output impedance. I only have figures for the KT66 and this I have worked out to be 4.7 ohms when matched for an 8 ohm load. This is higher than the 2 ohms you measured for the 300Bs, so it would be interesting to know how the KT88 and EL34 valves compare. On the other hand, if your plea for a 10-12 ohm tap was heeded, this would raise the output impedance of the Silver Nights.

I still have a couple of Quad II amps and have compared them with various solid state amps that I have owned. With reasonable speakers (currently TDL Studio 2s), but unknown quality ears, the only real difference I have noticed is that the solid state amps give a totally silent background. Maybe it's because I always ensure that negligible RF can get into my amps via inputs and outputs.

**Mike Grieve,  
Lorton,  
Cumbria.**

It's widely believed, especially in the thriving hi-fi markets of Hong Kong, Japan, Taiwan, et al, that simple triode valve amplifiers give a better sound than later designs with pentodes and more sophisticated feedback arrangements. The 300B is a linear audio valve of good power output that lends itself to such work. Many people in the industry have been waiting for their re-manufacture to make such amplifiers a viable proposition again, so expect to see more 300B amps appear in the near future. See also the following letter. **NK**

### CATHODE CORRECTION

With regard to the March "Reader's system" article, I hope you'll permit me, as an interested party, a few comments and a correction of an error.

The latter concerns the sentence beginning "For some reason they put insufficiently high voltages on the cathode-followers. . .". What I was talking about in the quoted sentence was a Basic preamp (the £199 one). Jan's trained ears (he used to make his living as an excellent jazz saxophonist) detected a rustling noise through the speakers which turned out to be due to the cathode resistors on the output cathode follower. They were overheating badly and, presumably, injecting thermal agitation noise into the circuit. I corrected this by installing same-value resistors of a higher wattage. This means that the voltages stayed the same.

I also changed the volume pots on the Basic from industrial grade to Sfermice and the associated capacitors to Sidereals. Naturally this made an audible improvement, but it only really allowed the quality of the Croft's circuit to be heard more clearly. One can hardly expect Croft to use state of the art components in a £200 pre-amp. To me the Basic Micro seems as much a public service as a commercial product!

When Jan talks about preferring a Concordant, he is speaking of the Exquisite model, which lives up to its name, but which costs £1800 (including an outboard supply).

Jan next upgraded to a Croft Micro Super-A, which is the one that Eric heard. This was a very definite improvement over the Basic. It has built-in mains filtering, a much bigger power supply, improved voltage regulation, and better quality components (including Holcos and Alps volume pots). It is still markedly less expensive than the Exquisite - and it still benefits from the Sfermice-Sidereal surgery, and from better valves.

Unfortunately, "better valves" means older valves, i.e. "new old stock" ECC 83s and 82s from the 1960s. It's not really on to expect manufacturers to source these at Croft price levels. I suppose what I'm saying is that Croft presents good value for money.

Eric didn't mention that the Leak TL12 Pluses which I supplied to Jan have been completely rebuilt with better valve-holders, WBT input sockets, Kimber cable, Sidereal capacitors and Holco resistors (except for a couple of Vishays in the feedback loop). There has

been no change to the circuit except for a sizeable increase in the amount of power supply filtering capacitance applied in a graduated series, following a formula devised by Andy Nehan (one of the founders of the thriving London Live DIY Hi-Fi Circle of tweekers and scratch builders, to which I belong). This makes the Leaks completely silent and increases their capabilities at frequency extremes. I've recently applied the same treatment to a friend's Leak Stereo 20 and the result, heard through his Sonus Fabers, is equally striking.

I recently rewired the EL34s of a Radford STA-15 as pseudo-triodes (a five-minute job for your German correspondent, unless the Audio Innovations circuit is peculiar) and the improvement in sound quality from my Bastin-modified Garrard 301 is palpable. If pseudo-triodes sound this good, I can't wait for PM Components to release their PX25s (a real, British triode, egad!). It could be the next step on the road to Blue Note Nirvana. **Dave ("the one who knows about hi-fi") Mansell,  
London E5**

We have heard some very interesting sounds from 300Bs, 211s and 845s - all triodes. However, I have at last managed - after being a bit stunned by an Ongaku - to coax a serious (i.e. well designed) single-ended, triode-equipped amp in through the door - Tim de Paravicini's (didn't you know it!) utterly superb Yoshinos. They use single 845s plus a phase-splitter/step-up tranny that has to swing 400volts to drive them. To take the standing direct current the output transformers are, of course, huge. They have a distinctive sound, like the Ongaku, and I strongly suspect there are some definable benefits to single-ended working. More on all this soon; I'll get around to writing the report only when Tim drags them away.

Meanwhile, Dominic has been living with 211s in the form of a KAL211 amplifier and, although at heart a thoroughly modern CD/solid-state man, he swears by this monster. It sounds very different from the Yoshinos though - diametrically opposed in fact.

We find that triodes can deliver superb results, but they can also sound very different from each other. And keep watching for Garrard 301/401 info, 'cos more is on the way. **NK**

## **THE HI-FI LAW OF DIMINISHING RETURNS**

Ask a Hi-Fi dealer to upgrade your system, and he'll sell you ever more expensive bits of hardware, giving you a constantly changing sound, new solutions producing more problems which can only be solved with more expensive equipment. The harder you try, the more it costs and the less satisfying the results. This is the well known Hi-Fi law of diminishing returns.

We have an alternative:

## **THE RATA LAW OF INCREASING RETURNS**

Why buy new equipment when it makes more sense to realise the full potential of your existing equipment. Don't replace it, upgrade it; it's cheaper. Most equipment can be transformed by us for the cost of a dozen CDs. Magic? No - logic! To find out how we do it, ask for our new Catalogue; it provides discussion, analysis and a definitive resource of audiophile components and advice on the art of recreating music in the home.



**1993 Audiophile Catalogue**

**RATA Limited**

Edge Bank House, Skelsmergh  
Kendal, Westmorland LA8 9AS  
Tel: 0539 83247 Fax: 0539 83317

UK: Post Free.

Europe: 3 International Reply Coupons.

Overseas: send US \$3 bill or four IRC.





# Can Cassette Break the Tape?

**Does Kenwood's new high quality KX-9050S cassette deck have enough appeal to beat DCC to the winning tape?**

**Noel Keywood acts as judge.**

I can't help thinking that when manufacturers release decks like the KX-9050S, whilst all around the talk is of DCC and MD, it's not done through blind faith in the cassette. Perhaps Philips' fascinating observation that the cassette is the second most common electrical item in the home, the first being the light bulb, whets commercial appetites. Are Kenwood multiplying homes by cassettes and coming up with an answer that looks large enough to be temptingly profitable?

Whatever it is that seems so attractive, they're not alone in perceiving it. For Kenwood's £549.95 KX-9050S joins other

expensive and sophisticated cassette decks, invariably fitted with Dolby S, that similarly attempt to offer not just hassle free recording, but CD type convenience. It seems to me that the KX-9050S is better seen not in comparison to a Nakamichi, where performance alone is the arbiter, but as a rival to DCC and DAT. If the latter sell to a less committed sort of buyer than the hi-fi buff, who is very likely to lust after a big Nak, then sound quality might not be the only consideration. Ease of use, slickness of operation, low software prices and compatibility with the car stereo and

Walkman might all be deciding factors that would swing a sale toward the humble old cassette, and away from its expensive, complex and slightly alien new rivals.

Being something of a Nakamichi man myself, whose eyes light with wonder when the LEDs hit plus ten on my ZX-9 - almost enough signal level to blow a Walkman apart - I can easily harbour reservations about some of the slacknesses that creep in to affect this new breed. Kenwood's KX-9050S sadly suffered a few, taking the edge off a package that would otherwise have been potent.

The KX-9050S has an automated cassette door, fitted with a cassette shell stabiliser. A small orange back-light shines through the cassette, giving a quick visual check of the amount of tape on each spool. Press the Open/Close button beside it and the door springs open quickly, accompanied by just a few subdued clicks and clonks. Press Play and it springs shut; the deck starts immediately.

Kenwood have fitted a wide variety of 'convenience' facilities, including programme search, preview play (which they call Index Scan), repeat play and timer operation. An automatic tape type sensing system is used, but Dolby selection is manual as always. All the operating buttons for these facilities are grouped at the left side of the cassette compartment, together with the tape counter. They have a short, sharp action and the deck acts quickly and quietly in response to commands, making most noise when fast reeling. Since this was merely a strong mechanical whirl, it doesn't amount to much of a disturbance.

Kenwood have sensibly put operating controls to the left of the cassette compartment and lesser used, basic setting controls to the right. These include Dolby, direct recording from CD, CD peak search to aid the setting of peak record level, a tape/source monitor button and an automatic tape tuning system known as ATCS that gave me some grief.

Tape tuning systems are notoriously erratic and this, I found, included Kenwood's. However, as if they were aware of this, Kenwood have fitted a manual over-ride that in conjunction with a memory, can correct inaccuracies of the automatic system. The approach I adopted was to use automatic tuning first to adjust sensitivity and get a rough frequency response setting. Then, by

comparing direct with recorded sound using the record/monitor facility, I fine-tuned frequency response manually until the recording sounded as close to the original as possible. This setting was then stored in the memory, which memorises the parameters for just one tape in each category - ferric, chrome and metal.

*"There was a smoothness and, when accurately tuned, an openness in the sound of this deck that came from its superb transport"*

The KX-9050S has three heads. Separate record and play heads enable sound quality to be assessed whilst a recording is being made. This arrangement also improves performance, lowering distortion and extending high frequency response. Kenwood pair it with a complex dual-capstan, direct-drive deck that keeps rock-stable speed. It reduces modulation noise and flutter, which helps to improve clarity. Transports like this also impart a sense of great tonal stability to recordings, providing the original programme material comes from a pitch stable source in the first place.

I found the deck easy enough to use. The operational sequence of some functions takes some getting used to, especially the tune system, but difficulties here are only ones of familiarisation. The

record level display is unusually calibrated, maximum record level being set very low, but with Dolby S there is an argument in favour of this.

## SOUND QUALITY

Playing pre-recorded tapes showed that the KX-9050S rounds off high treble, taking the real shine and sparkle out of good recordings. Admittedly, many tapes are sufficiently dull in themselves for this effect not to be apparent, but with better recordings possessing high treble, differences between the Kenwood and a Nakamichi ZX-9 reference became obvious. One cassette I commonly use as a check is Madonna's 'True Blue'. Here the vibrant upper notes of a synthesiser playing a simple melody on 'Open Your Heart' were quite obviously dulled by the Kenwood. Falling in a pure and sweet sounding cascade on the Nakamichi, they sounded dulled and a bit leaden on the Kenwood by comparison.

Without a reference though, most users would probably believe the Kenwood offered a smooth, unchallenging sound, not an overtly dull one. It reproduces treble, but not the extreme treble energy of the best. There was a loss of resolution and dynamic contrast down at low frequencies too. The strong bass line behind Luther Vandross' 'Give me the Reason' was given due weight and authority by the Nakamichi; it took a step back on the Kenwood. Bass lines were slightly weakened and blurred.

Overall, in spite of these blemishes, the KX-9050S played pre-recorded tapes well. Note sustain on piano was perfectly maintained, the transport is so steady in its speed. There was a fine sense of clarity and resolution across the midband; only at spectrum extremes were limitations a little apparent.

In the end, after a lot of tuning and

## MEASURED PERFORMANCE

Head azimuth error makes commercially pre-recorded tapes, or recordings made on other machines, sound dull, even muffled. The Kenwood came to us well adjusted. Measurement revealed some upper treble loss in the replay chain (-5dB at 20kHz where a Nakamichi measures +2dB or so), so I tweaked head azimuth to see if it was out. It wasn't. This showed that replay equalisation at high frequencies was the culprit. As a result, replay frequency response started to roll off above 10kHz. This usually introduces some dulling in practice, especially when Dolby is switched in, since it magnifies such errors. Kenwood could usefully increase high frequency gain a little in the replay-equalisation circuits to help make pre-recorded tapes brighter and clearer.

The record level meter had 0VU set unusually low, -3dB below Dolby flux. I've never found out on what basis the Japanese choose maximum indicated record level, but whilst other manufacturers are commonly raising it to IEC 0dB flux (250nWb/m),

Kenwood have chosen a level no less than -5dB lower - and that's low. I dearly hope this isn't to enable maximum on the record level display (+12) to be hit more easily, in an attempt to convince owners that the '9050 can record higher than its rivals, because it can't.

Perhaps Kenwood have decided that with Dolby S on board to keep hiss down it is best to lower the suggested upper record limit to avoid overload distortion, improving sound quality. Whatever, metal tapes in particular can be taken well over 0VU on this deck. TDK MA-XG goes highest of all, and after auto-tuning, it could be taken up to +10 or so on the display (+6dB MOL315 by the IEC Standard) with musical peaks. Normal inexpensive metals would not go so high, Maxell MX hitting +3dB MOL315 for example, so they could be taken only to +7 on Kenwood's display. Chromes should go no further than 3 and ferrics about 5.

Tests showed that the head is good, but not exceptional in the record levels it can get onto tape and in its frequency response. In

this area the KX-9050S is satisfactorily on par with its rivals, but not ahead of them, the reason being, I suspect, that they are all using the same heads, since these highly specialised items are bought in from outside expert manufacturers, like TDK and Canon.

On a high quality cassette deck, possibly meant to rival modern digital formats, it is important to get frequency response with blank tapes reasonably flat, so that recordings will sound tonally natural and balanced. A good head plus automatic tape tuning is required. The KX-9050S head has a flat response within 2dB limits from 27Hz up to 20kHz with metal tape. It hits 19kHz with chromes and ferrics. Unfortunately, I found the ATCS (Automatic Tape Calibration System) was inconsistent in its results; sometimes it got frequency response very wrong. This had to be corrected manually using the 'manual' up and down buttons, 'up' referring to treble level, not bias level. The presence of manual override button thankfully means that tapes can be tuned-in accurately in spite of its misbehaviour,



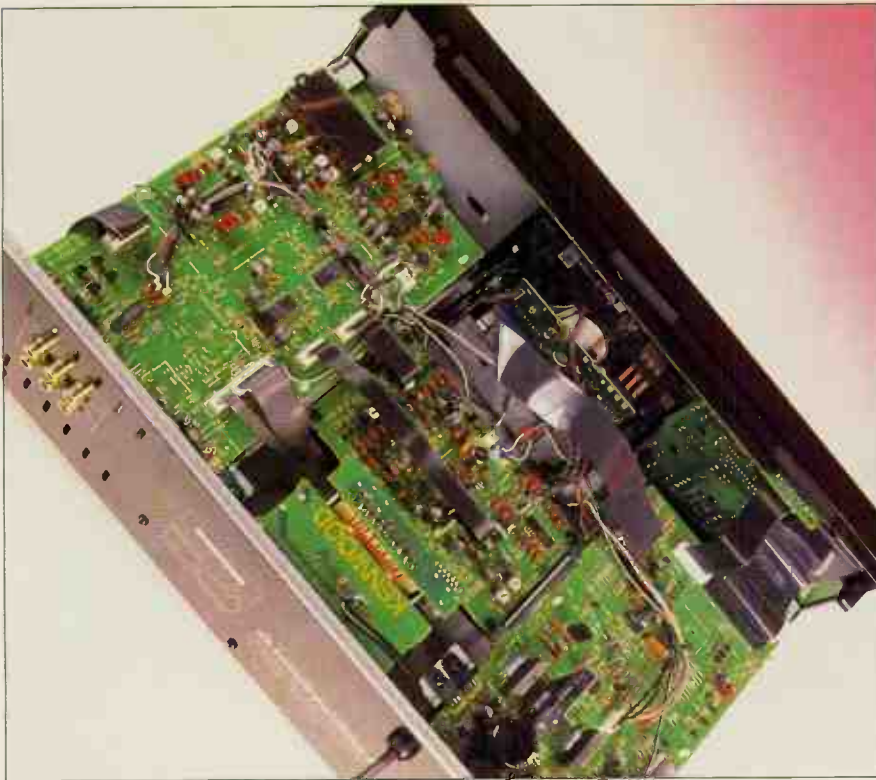

The extra circuitry associated with Dolby S and servo control fills any would-be spaces.

I usually use Dolby B, because it does not affect the openness of a recording much, nor does it round transients if high recording levels are used. But the need to use lower recording levels and the presence of motor drone demanded Dolby S be used on the KX-9050S. This means it will give a smooth sounding, hiss and hum free recording, well balanced tonally when manually fine tuned. But with so many qualifications to make, and the need for expert knowledge to set up this deck, it really doesn't offer hassle free operation if good results are to be achieved.

Chrome tapes and ferrics suffered from dulled, smudged treble due to high frequency saturation (magnetic overload) unless record level was kept right down. Again, it was necessary to use Dolby S and spend some time tuning the deck manually if good recordings were to be achieved. At all times, with all tape types, this deck displayed remarkable speed stability; I just forgot about all the problems associated with cassette due to drift, wow, flutter and modulation noise. There was a smoothness and, when accurately tuned, an openness in the sound of this deck that came from its superb transport.

tape changing, I was impressed by the Kenwood when recording onto metal tapes. However, a lot of care had to be put into getting the deck tuned properly, otherwise it would sound either obviously bright and jangly, or dull. In the end, I resorted to headphones and switched between tape and monitor whilst bias adjusting manually, since the treble level goes up or down in steps, not in a smooth progression.

When tuned, Maxell Vertex metal tape sounded incredibly smooth and natural, mimicking CDs closely. However, Vertex is very expensive. TDK MA-XG sounded

over-warm, but with a tizzy top, because the '9050S couldn't tune it properly. Maxell MX worked well when tuned in, providing recording level was kept down to +5 or so on peaks. At this point I noticed motor drone was coming through as a high pitched hum and that Dolby C or S was needed to suppress it. Dolby S affects transient quality less than C, but whilst it brought deathly silence to MX, hiss and hum disappearing completely, I also found that Dolby S does introduce its own small degradations, adding a slight warmth and an enclosed sound to the stereo stage.

### CONCLUSION

The KX-9050S is a good package in need of further refinement. Motor hum and erratic tape tuning were particular problems. Dolby S and manual fine tuning provide effective cures in practice though, allowing good recording quality to be achieved all the same. Obviously, I have reservations about this deck, yet at the same time I admire what Kenwood have tried to achieve. If only they could develop products like this, instead of changing them completely every year or so, then the high design standards they set originally would probably be achieved. ●

the preferred setting then being stored.

Like the head, the highly specialised transport system of modern, high quality cassette decks is normally obtained from external suppliers. Kenwood have made no concessions here, choosing a direct-drive unit. Good ones have so little basic speed drift that wow virtually disappears, bringing CD-like pitch stability to the sound. This is precisely what I found with the Kenwood. A negligible 0.02% of wow makes it rock-stable. The speed stability analysis shows this clearly: note how sharp the spike of the test tone appears. This is a remarkable performance, showing that both wow and flutter have effectively been eliminated. The KX-9050S has a rock-stable transport of superb quality.

The noise reduction systems, Dolby B, C and S all gave the right amounts of hiss reduction. Kenwood also use Dolby HX PRO, to improve treble overload headroom when recording.

In spite of all the good points, I was a little disappointed with the obvious weaknesses of the KX-9050S. Notably the ATCS and the

replay equalisation. More attention to detail was needed in its design. **NK**

### TEST RESULTS

#### REPLAY (pre-recorded tapes)

Frequency response (-2dB) 30Hz-14kHz  
Speed accuracy +0.4%  
Hiss (70uS, Dolby out) -61dB

#### RECORDING (blank tapes)

Frequency response (IEC Primary Refs.)  
ferric (IECI) 27Hz-19kHz  
chrome (IECII) 27Hz-19kHz  
metal (IECIV) 27Hz-20kHz  
Separation (1kHz) -75dB  
Distortion (315H) 0.6%  
Hiss (70uS, Dolby out) -57dB  
Speed variations (DIN total) 0.03%  
Flutter energy (3-3.13kHz) -44dB  
MOL/SAT (IEC Refs) 315/10k  
IEC I (ferric) +3.6dB/-8dB  
IECII (chrome) +2.6dB/-5dB  
IECIV (metal) +3.6dB/+0.5dB

### Frequency Response

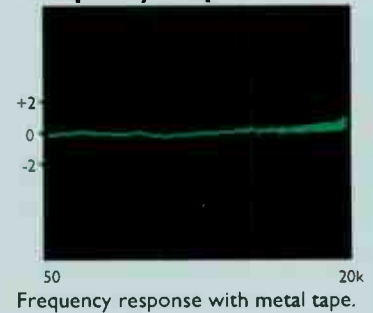

### Speed Stability

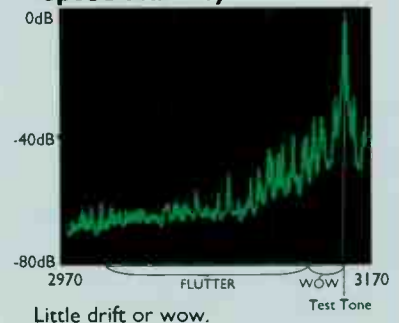



# WELSH WIZARDRY

**In the fastnesses of Wales, Tom Evans tweaks a standard Pioneer A-400 to a GTE model.**

**Malcolm Steward keeps up with the pace.**

In audiophile circles the possession of modified or specially tweaked equipment tends to confer aficionado status upon its owner. But while most garages can and will repair a performance-enhanced car that requires attention, it can be a different story trying to get modified hi-fi serviced. The original maker is likely to refuse to repair your super-charged turntable, CD player, amplifier or whatever when it goes phutt, or if its "improved" performance turns out to be less fulfilling than was at first anticipated. You might approach the outfit which did the tuning to discover that they can't source particular components that might be required for a repair. It's worth considering this before shipping your hi-fi for an upgrade that's not sanctioned by its maker.

The latest product to fall under the sonic surgeon's knife, and the subject of this review, is the widely admired Pioneer A-400 amplifier. You might well ask, considering the glowing praise that's been heaped upon it, why anyone would want

to improve this Goliath-demolishing, transistorised David. Is it not already a paradigm of budget hi-fi excellence? My opinion is that although the original A-400 was a very capable design it wasn't quite the all-conquering hero that some reviews might have led you to believe.

## Heroic Status

There were fabled instances of the amplifier being used to drive large, esoteric loudspeakers that ought to have been beyond its compass, and it was this sort of activity that saw the A-400 elevated to heroic status. Was it, however, the only £200 integrated that could perform the task? I doubt it. It was also true that there were more mundane speakers with which the amplifier was considerably less happy. If you want to hear a standard, heyday-vintage A-400 sounding less than heaven-blessed, try connecting one to a pair of Epos ES1 Is.

I don't, however, wish to denigrate the amplifier: in the right context it could give a performance that was extremely

satisfying. At one point in its history you simply couldn't better the combination of Rotel RCD-965BX, A-400 and Mission 760 without spending significantly more than the £600 this system cost.

It is amplifiers of that vintage for which this particular tuning exercise is intended; amplifiers, please note, whose warranties have now expired. The man responsible for the tweaking is Tom Evans, who designed the Finestra pre-amplifier, the Michell Iso phono stage, and Argo and Alecto pre-amplifier and power amplifiers. He is currently occupied with work on other Michell products but hopes to launch a range of electronics under his own name in the near future, perhaps at this year's Penta hi-fi show.

Evans' modification to the humble A-400 entails fitting an additional circuit board (PCB) beneath the amplifier's main board. The circuit alters the AC coupling of the amplifier's input and feedback stages to improve coherence through the signal path. The customer's amplifier to which I listened had also had its mains



indicator and headphone circuit removed, but these changes aren't part of the Evans' package. When I asked him why his modifications didn't include these or any further alterations, he reminded me that we were discussing the innards of a £200 amplifier and that, being brutally honest, there would be little benefit in making further changes. He had, for instance, experimented with DC coupling the signal path but found that the theoretical gains weren't realised in practice. His common sense philosophy dictated that he stopped opening up the amplifier's sound when the design's inherent limitations started to become audible.

### Dramatic Effect

The effect of Evans' modification on the amplifier's portrayal of music is, nonetheless, dramatic. For the initial listening sessions, where the modified A-400 was compared to a standard amplifier, I used my Naim CDS as the source with a pair of undemanding, well-mannered, musically rewarding compact speakers, the Rega Kytes. The very first disc played suggested strongly that Evans was on to a winner. Elvis Costello's voice on 'Taking My Life In Your Hands' (from the CD *The Juliet Letters*) underwent a transformation of no small consequence when I switched from the standard A-400 to the modified amplifier. It gained significantly in terms of presence, substance and conviction. His singing became far more effective and emotionally involving while also sounding cosmetically more pleasing.

The amplifier's modelling of the Brodsky Quartet was similarly enhanced: their instruments sounded comparatively flat and lifeless on the standard model but demonstrated much greater vibrancy and colour through the tweaked version. What is more important, the Evans A-400 better realised the Quartet's musical dynamic and passion. Their playing assumed more strength and bravura; when the cello plummeted to the bottom of its register it took my emotions with it, while the stock version couldn't muster the same reach-out-and-grasp-you intensity.

### Wealth of Detail

The standard A-400 sounded outwardly detailed and open with an intricately arranged live Frank Zappa recording ('The Best Band You Never Heard In Your Life'). The wealth of information that emerged gave the impression that the amplifier was delving deeply into the recording. The effect was, however, revealed by the modified amplifier's performance to be largely superficial: although you could hear that there was indeed much happening within the performance, the Evans A-400 stripped away another layer of opacity, which allowed detail to present itself with greater musical relevance. It became clearer how and why many minor events and playing nuances worked to bolster the music's overall impact.

I will admit that these might seem to be subtle and highly subjective 'Twilight Zone' considerations, centred purely around the emotional response each amplifier elicited. I've ignored the more clear-cut improvements the modified amplifier wrought thus far. However, it is perhaps the combined influence of these seemingly insignificant artefacts (as they could appear if taken out of context) that make the Tom Evans A-400 so much more persuasive than the standard amplifier. The latter gave nearly the same academic insight into Zappa's music but the modified amplifier conveyed its lyrical and musical sub-texts more succinctly. How many people listen to Zappa solely to appreciate his - admittedly spectacular - musicianship? I would suggest that most of his followers enjoy his irreverence and humour just as much.

### Positive Punch

When you descend below metaphysical levels, the modified amplifier still demonstrates clear advantages over the standard item. For example, the stock A-400's bass isn't all that it could be: the acoustic bass on REM's *Automatic For The People* can sound artificially - albeit pleasantly - enhanced through it, but this causes it to lose a degree of definition and timing precision. Through the Evans-tweaked amplifier it assumes a more taut, ascetic quality. Similarly, the bass guitar line on an early recording of Van Morrison's 'Brown-Eyed Girl' (Bang Masters, Epic/Legacy EK 47041) proved convincing: on the standard amplifier it sounded far less purposeful and precise than it did on the modified one. There was a bloom - an added warmth and softness - that diminished the attack and decay of notes on the standard amplifier; on the Evans A-400 notes showed more positive intonation and punched through more crisply, their distinct initial transients setting the rhythmic measure more decisively.

However, ignoring specifics and looking at its performance from a greater distance, the most significant effect that Evans' modifications have upon this amplifier is to make it sound more coherent with a tightly knit, better integrated character than the production line models display. It allows music to gel and flow more persuasively and this results in a presenta-



There is no external difference between the standard A-400 and the A-400 GTE.

tion that's both easier to live with as well as more musically fluent.

I found these benefits were available for all types of music. The amplifier's insightful nature made much better sense of the organ *Intonazione* from the soon-to-be-released Paul McCreech and Gabrieli Consort's recording of Giovanni Gabrieli's *First Vespers of the Annunciation of the Blessed Virgin* (Technics/Archiv). The standard amplifier, despite its animated projection of the instrument, didn't capture the flumies of notes played over sustained chords with the same grace; the modified version brought out the individual notes within the cascades far more succinctly. It also described tonal colour with more relish and improved the distinctness and dimensionality of the soundstage that is a vital feature of this music (and one that was actively pursued with this particular production).

### Harmonised

Pre-empting a natural question, in view of the praise I've poured upon this amplifier, I still don't think that it's up to the task of driving the Epos ES11s. It turns in a much more acceptable performance with them and the candour of these speakers makes them ideal for graphically demonstrating the better harmonised, more solid character of the Evans amplifier. But I remain unwilling to suggest the pairing as a long-term partnership.

My week spent in the company of this clearly superior A-400 left me satisfied that Evans' modification is worth investigating. The upgrade costs £141 (including VAT and return carriage) and can be arranged by calling Tom Evans Audio Design on 0443 816856 during business hours. Evans assured me that if a customer doesn't approve of the modified amplifier's sound he will refund the cost and return the amplifier to its original state. All of which sounds like a very fair deal for anyone who has an old A-400 whose potential they'd like to exploit ●

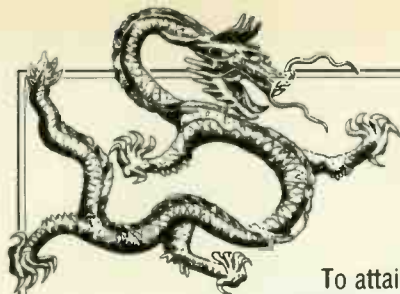

# Golden Dragon

Precision Audio Tubes

To attain a premium tube, sonic quality must be designed in from the start. As with any fine audio component, vacuum tube design is both an art and a science. With the closing of the legendary tube manufacturers it seemed that the magic combination would be forever lost.

Fortunately, a group of British audiophiles and engineers have worked diligently with the Shuguang and Beijing tube factories in China to create tubes of the highest sound quality and reliability. No aspect of design or performance has been neglected. Countless prototypes were auditioned in the creation of custom audio tubes that rival the finest ever made. The results of these efforts are now available as Golden Dragon precision audio tubes.

**Please enquire for any tube types not listed. We have an inventory of over 2,500 different types in stock.**

## RETAIL PRICE LIST

Golden Dragon Pre-amplifier Tubes .....	Singles	Golden Dragon Triodes ...	Singles	Pairs	Quads	Golden Dragon Power Tubes	Pairs	Quads	Octets
* 6AQ8/ECC85 .....	£6.50	2A3 4PIN .....	£22.50	£47.50	£95.00	EL84/6BQ5 .....	£8.50	£17.00	£34.00
12AT7A/E81CC/ECC81 .....	£6.50	2A3 OCTAI .....	£22.50	£47.50	£95.00	E84L/7189A .....	£12.50	£25.00	£50.00
12AU7A/E82CC/ECC82 .....	£6.50	211 .....	£28.50	£59.00	£118.00	KT66 .....	£25.00	£50.00	£100.00
12AX7A/E83CC/ECC83 .....	£6.50	*300B .....	£69.00	£140.00	£280.00	KT88 .....	£49.50	£99.00	£198.00
6DJ8/E88CC/ECC88 .....	£9.50	811A .....	£11.50	£25.00	£50.00	*KT88 SUPER .....	£59.00	£118.00	£236.00
		845 .....	£36.50	£75.00	£150.00	6L6GC .....	£18.50	£37.00	£74.00
						6550A .....	£39.50	£79.00	£158.00
Special Quality Golden Dragon Pre-Amplifier Tubes .....	Singles	Golden Dragon Power Tubes	Pairs	Quads	Octets	*Denotes New Design or New Type			
*E81CC-01 Gold Pins .....	£9.50	EL34/6CA7 .....	£18.50	£37.00	£74.00	Carriage charge: £2.50 on any order. All prices plus VAT @ 17.5%.			
*E82CC-01 Gold Pins .....	£9.50	*EL34S/6CA7S .....	£25.00	£50.00	£100.00	Payment: Cash with order or Visa - Mastercard - American Express.			
*E83CC-01 Gold Pins .....	£9.50					24 Hour Answerphone Service			
*E88CC-01 Gold Pins .....	£12.50								

**Golden Dragon Select Tubes.** A new range of tubes specially sourced from other factories, aged, tested and carefully selected to Golden Dragon standards and available in matched pairs and quads at no extra charge.

ECL86 .....	6.50
EF86 .....	6.50
GZ34 .....	8.50
GZ37 .....	8.50
6CG7/6FQ7 .....	7.50
12BH7A .....	8.50

## Special Gold Plated Ceramic Sockets

300B etc.	3.50
211 etc.	25.00
ECC83 etc.	2.50
EL34 etc.	3.50

## A selection from our stock of over 2,500 different audio quality valves. Please enquire for items not listed

ECC82	RTF	4.50	PL36	MAZDA	3.50	6V6G	RCA	5.50
ECH81	MULLARD	3.50	PL504	MAZDA	2.50	6X4T	EONEX	2.50
ECL82	TEONEX	3.50	PL509	MAZDA	5.50	12AT6	BRIMAR	2.50
ECL86	TEONEX	3.50	PL519	THORN	5.95	12AV6RCA	2.50	
EF86	TEONEX	4.50	PY32	MULLARD	2.50	12BA6	WESTINGHOUSE	3.50
EF804S	TELEFUNKEN	25.00	TT100	GEC	65.00	12J5GT	RCA	3.95
EL32	MULLARD	4.50	U19	GEC	8.50	12E1	RCA	3.95
EL85	MULLARD	4.50	UCC85	MULLARD	3.50	12E1	STC	15.00
EL86	MULLARD	4.50	UU5	MAZDA	5.50	13E1	STC	140.00
EL504	TEONEX	3.50	UU6	MAZDA	6.50	13D3	BRIMAR	6.50
EL509	TEONEX	5.50	2X2A	RCA	5.00	85A2	MULLARD	6.50
EM519	TEONEX	5.50	3A/167M	ITT	10.00	1625	RCA	6.50
EM84	TEONEX	3.50	5Y3WGTA	SYLVANIA	4.50	5687WA	RCA	6.50
GZ32	MULLARD	8.50	5V4G	BRIMAR	3.50	5751	RCA	6.50
KT66	TEONEX	6.00	6AG7	RCA	3.50	5814A	GE	5.50
KT66	GE	16.50	6A7G	RCA	8.50	5881	USSR4.95	
LS9B	COSSOR	6.95	6BH6	BRIMAR	3.50	6146B	TEONEX	8.50
M8136	MULLARD	8.50	6C8G	RCA	3.50	6158	BRIMAR	6.50
M8162	MULLARD	8.50	6DQ6B	PHILIPS	3.50	6189	SYLVANIA	6.50
M8137	MULLARD	15.00	6K7G	RCA	3.50	6201	GE6.50	
MHLD6	MAZDA	5.50	6SL7GT	BRIMAR	4.50	6463	UNITED	7.50
OA2WA	TEONEX	3.50	6SN7GT	BRIMAR	4.50	6870	BRIMAR	11.50
PCC88	SIEMENS	3.50	6SQ7GT	TONEX	4.50			

**P.M. COMPONENTS LTD., Springfield Enterprise Park, Springfield Road, Gravesend, Kent DA11 8HD, England**  
**Tel: 0474 560521. Telex: 966371 TOS-PM-GM, Fax: 0474 333762**



**MEASURED PERFORMANCE**

We weren't told specifically what was different about the modified A-400 - or the A-400GTE as it is known - but a number of improvements have been hinted at. Unfortunately, it turned out that our modified amplifier wasn't performing as expected, which rather complicated the issue.

Power output remains unchanged under all conditions, which isn't surprising since it would be very difficult to increase the power without a major re-design. The modified A-400 turns out 66watts into 8ohms and 110watts into four ohms, just like the original.

The standard A-400 has rather heavy, overblown bass. It isn't due solely to subsonic extension, because other amplifiers - notably Harman Kardons - go down as low and do not sound as weighty, but all the same the low frequency limit of our modified unit was drastically curtailed, to lighten bass subjectively I suspected. Instead of going down to 6Hz or so, via CD and disc, the GTE we tested reached down no further than 40Hz. We spoke to Tom Evans about this and he felt certain there was a mistake. So we checked yet again, pulling blocking capacitors out of the amplifier to measure their values. Everything was, superficially, correct, leaving us with a mystery: why did the review sample reach down only to 40Hz when it was meant to go as low as the original from Pioneer, or even lower (i.e. lower than 6Hz).

Compact Disc can and does produce signals down to 5Hz and amplifiers capable of reaching down this far do not have to sound bass heavy. The Chord SPM-1200 power amplifier I tested recently went down to below 1Hz, yet it had drum-tight bass of superb quality. It's unnecessary to curtail the lower limit of the A-400 to lighten and speed its bass, but this modification appeared to do so - then it was discovered that our sample had been wired incorrectly and was not representative. Tom assured us, from his own listening tests, that our sample was, all the same, representative in terms of its sound quality.

Our modified A-400 had a little less (-3dB) negative feedback - as I suspected it might have - which has increased all sensitivities. The CD input needs just 110mV for full output, whereas 160mV was needed before. Similarly, both disc inputs have increased sensitivity, the moving coil stage needing just 0.16mV (160 millionths of a volt) for the amplifier to be able to deliver full output. That's a very high sensitivity figure, more than enough for the lowest output designs. Since they also tend to offer best sound quality, the GTE is well equipped to work with the highest quality LP sources. Input overload remains high at 12mV for moving coil cartridges.

Surprisingly, reducing feedback hasn't altered measured distortion one little bit. The amplifier in both versions curiously produces some (0.02%) distortion for the

first few minutes of operation, until it warms up. Then it becomes very linear at low levels. Both the original A-400 (re-measured for this report) and the modified unit produced -0.004% at low signal levels, right across the audio band. At high levels, just below full output, distortion hovered at around 0.02%, again on both versions. So the modification does not change the amplifier's distortion characteristics at all.

The high frequency limit on all inputs remains unchanged. It seems as if noise has increased a little, but in fact this is due to the standard noise measuring technique I use being unable to account for increased gain. Noise has not effectively increased.

Channel separation also appears to have worsened, but I'm not sure in this case whether it really has, due to modifications, or whether the untidy wiring of Japanese amplifiers introduces

significant variability between samples.

If I take the example of two different integrated circuits, an 'old' high speed 741 and a new OPA80, our standard steady-state measurements would be hard pushed to discern one from the other. So measurement cannot and does not offer a definitive view on either what has been altered, or what affect that alteration will have. Ears are still better than spectrum analysers.

However, measurement does show what has not changed - power output for example - and that the mods have not had any disastrous effect, such as instability or a large increase in distortion. I was a pity that our sample was not, in measured terms, representative, but we were assured that this didn't not affect the sound unduly. The modified A-400 retains much of the original's measured performance. **NK**

STANDARD		MODIFIED	
Power	66watts	Power	66watts
CD/tuner/aux.		CD/tuner/aux.	
Frequency response	4Hz-70kHz	Frequency response	40Hz-67kHz
Separation	96dB	Separation	83dB
Noise	-94dB	Noise	-92dB
Distortion	0.004%	Distortion	0.004%
Sensitivity	160mV	Sensitivity	110mV
dc offset	25/31mV	dc offset	0/-1mV
Disc (MM)		Disc (MM)	
Frequency response	6Hz-60kHz	Frequency response	47Hz-52kHz
Separation	81dB	Separation	66dB
Noise	-89dB	Noise	-86dB
Distortion	0.005%	Distortion	0.005%
Sensitivity	2.8mV	Sensitivity	2mV
Overload	160mV	Overload	150mV
Disc (MC)		Disc (MC)	
Frequency response	8Hz-58kHz	Frequency response	40Hz-58kHz
Separation	74dB	Separation	66dB
Noise	-71dB	Noise	-69dB
Distortion	0.006%	Distortion	0.006%
Sensitivity	0.26mV	Sensitivity	0.16mV
Overload	14mV	Overload	12mV

**Distortion**

0.1%  
0 8k 10k 60k  
Tilt= Tune

**Distortion**

0.1%  
0 8k 10k 60k  
Tilt= Tune

Once warmed up, both amplifiers measured 0.004% distortion.

It's a curious paradox that just as we have come to believe vinyl was something floor tiles are made from, there appears to have been an upsurge in the turntable market. As I was writing this, it was reported that only forty-two per cent of households in Britain possessed Compact Disc players: nowhere near the kind of market penetration we would have expected after ten years.

Not that the other fifty-eight per cent are necessarily spinning vinyl instead of walking on it, but perhaps there is still room for these mechanical contraptions after all.

Certainly Mark Baker of Origin Live must think so, or he wouldn't have revised the Oasis S turntable,

Part of the scepticism was because outwardly the Oasis looks fairly conventional and it's fitted with a Moth/Rega RB250 arm. What! For nine hundred notes? However, it is not an ordinary Rega, but one modified by Avondale Audio, with some small, secret, but apparently important structural changes and silver-wiring. Although in the past I have modified tonearms for friends, I belong to the school of thought that holds "If it ain't broke don't fix it". All the same, the modified Rega arm proved an excellent partner and worth every penny of its £250 contribution to the turntable.

While the arm was supplied with the original Oasis, the turntable itself

was as quiet as a mouse.

The other major difference between old and new is the platter. It might look like acrylic, but it's actually an expensive polycarbonate construction. Again, there was some criticism of the finish of earlier models, but this one was unmarked by any signs of slovenly machining. Equally, so was the square-section steel tubing of the suspended sub-chassis, when the welding originally looked a trifle messy. Mind you, though the sub-chassis bears some resemblance to that of a Systemdek, and by comparison looks somewhat clumsy, the high-gloss varnished plinth hides it well.

No review is complete without a niggles, however, and I have two - but

# Desert Discs

**Despite the encroaching vinyl desert, some brave souls are still producing turntables.**

**Eric Braithwaite quenches an LP thirst with the Oasis S from Origin Live.**

instead of sticking to the equipment supports, speaker stands and loud-speakers that form the major part of the Origin Live list. While the Oasis has been around a little while, it's not a turntable that has had a high profile; at £899 less power supply it is in a rarified price bracket, competing with more widely available Linns, Roksans, Pink Triangles and Gyrodecs. Without giving too much away too soon, despite some scepticism - "A bit pricey, surely?" - I found it was by no means outclassed.

has been altered since its first appearance. The early Oasis had two motors a la Alphason, which gave them a reputation for transmitting hum when used with moving-coil cartridges. This is not inevitable when one motor is close to the sharp end of the needle, but once there it is difficult to subdue. The new Oasis has only one motor, placed where God intended, out at the back of the plinth, on the left. This has certainly worked; with a Koetsu Black cartridge installed, feeding an Iso headamp, it

only two - and neither is anything to do with the way the turntable sounds. First is the finish of the plinth. It is neatly routed, Linn-style, with a smoothly curved under-edge, and it is made of African mahogany. The trouble is that it has a high-gloss varnish, which one friend commented made it look as though it was plastic at first sight. The second is the smoked acrylic lid, which I felt at this price should have a more substantial feel. Still, when put up, it did stay up. Like most people I've been victimised

by lids that suddenly lose their will to stand upright and come crashing down on one's favourite record.

Setting-up, with the arm already bolted to the thin arm-plate, which in turn is bolted to the sub-chassis by three slim pillars, proved relatively easy. While the normal Rega counter-weight slips on to the rear, the Avondale modification includes a drilled hole for an Allen bolt which allows it to be firmly fixed. A welcome innovation, this, for Rega arms tend to need re-setting after a month or two. Despite Roy Gandy's known

Our Oasis was supplied with a Pink Triangle Pacesetter power supply.

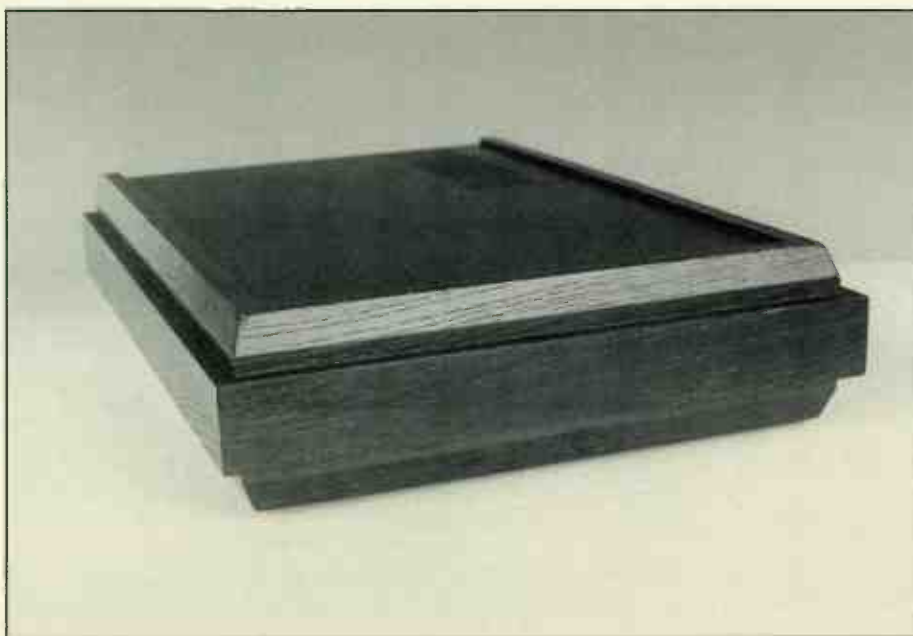





allowed the cartridge to track as though it was married to the groove, undisturbed by heavy footfalls or bashing the top-plate. Presumably, the fact that the polycarbonate platter rests on three spikes facing upwards from the sub-platter also has something to do with it.

All this suggests a considered design; it would be wrong to call it idiosyncratic, because it has a fundamentally neutral approach. Yet, compared to other turntables, it does have a style of its own. While full of fine detail, it lacks the lateral spaciousness of a Gyrodec. Drumkits or a backing group, for example, although clearly separated, were closer together; orchestral sections were also

distaste for the niceties of adjusting vertical tracking angle (I differ, being a confirmed advocate), the Rega now has spacers to adjust arm height. With a little delicate to-ing and fro-ing, the Koetsu was aligned in a matter of minutes.

Curiously, the Koetsu didn't sound quite like the Koetsu I lived with happily for a year or two; less warm, more precise. The Oasis has a distinctive trademark which sets it apart from its competition. It is remarkably clean and taut, especially in the mid-band and the bass - crisp as a frosty night or a packet of salt and vinegar. A trait that is neither generally associated with vinyl or CD, it's unlike either. Vocals, for example, acquired an unusual degree of clarity on glottal stops or the sound of tongue on teeth; the crispness extended downwards, too, where any drumming, no matter how demonic, had a tightness and an ability to start and stop without any sign of overhang - which was startling.

#### Speed and Control

I really couldn't overcome an almost continual surprise that any acoustic instrument recorded with a sharp attack was reproduced with exactly that: speed, control and not the least sign of artificial euphony or uncertainty. The Oasis had a fleetness to it which I've only encountered on our Garrard 401/SME 312 - using the

same cartridge - and one which made my Gyrodec/SMEIV seem lethargic by comparison.

Obviously this is deliberate; something which a conversation with Mark Baker about one of his speakers confirmed. He lays some stress on this carefully damped bass in his loudspeaker designs. In the crystalline

*"crisp as a frosty  
night or a packet  
of salt and  
vinegar"*

cymbals and clear flutes I sniff the effect of silver wire; in the rock-solid grip, I suspect the influence of the carefully-cut base, with its keyhole fretwork similar to Roksan's.

The construction was clearly playing a substantial part, because the Koetsu was much more unforgiving of groove wear than usual. High energy treble, mistracked in a previous incarnation, simply wasn't tolerated and splashed unforgiven. Even though I'm not a great fan of floppy suspensions - though the Oasis is less softly sprung than some - this turntable

less broadly spread. The sound-stage, too, although full of depth, width and subtlety, is also further back than I have become used to. For the life of me, though, I couldn't put my hand on my heart and say it was wrong. Disconcertingly, it had me thinking the Gyrodec was too spacious, too broad a palette, when I turned back to it.

#### Sounds Right

This feeling was confirmed by a friend who pointed out that as the Oasis plays music, it becomes more and more convincing. It simply sounds 'right', from the moment an LP hits the platter until the stylus reaches the run-out groove. It's purely a matter of personal taste, but I would prefer a fuller, less dry bass with more frontal projection, but a spell of continual self-examination while the Oasis was installed failed to persuade me that it should be criticised for not possessing such a presentation. The astonishingly sharp, lucid and fast mid-range remained utterly beguiling.

In these days, where the record shops have created a vinyl desert, the Oasis stands out like a fountain in the Sahara; it sparkles with clarity. The only reservation is that it has its own distinctive attributes which make it a rival to other turntables rather than an alternative. Its relatively high price means an audition is mandatory instead of it being an off-the-shelf purchase ●



Bass needs space. It might be an unwelcome truism for flat dwellers and those who have to share their listening room with children, pets and dining-tables, but real floor-shaking frequencies need a big box - and preferably a big room. You only have to look at a PA stack at a concert with its array of gaping horns to realise the near impossibility of reproducing the same stomach-churning bass guitar in your own home from speakers of a more domestically acceptable size.

If you haven't the space for a big, wide, tall box, there is a way round the difficulty, increasingly being exploited by a variety of manufacturers. It is effectively to keep the upper-bass, mid-range and

## MORE BASS FOR LESS SPACE



treble in a small box suitable for book-shelf mounting and reserve the low end for a single, bigger box which can be parked out of the way elsewhere in the room. In theory, this offers the best of both worlds: the main speakers stay small and relatively unobtrusive; the bigger box which produces the gut-wrenching notes gets hidden.

While this arrangement is convenient and space-saving, most satellite and subwoofer systems remain small to make them domestically attractive. And space - or size - is an inescapable necessity for reproducing very low bass notes. A human chest cavity resonates at about 3Hz; a low organ note higher than that



will literally shake the fabric of a cathedral. But a great deal of air has to be shifted to do it: the lowest organ note is produced by a pipe the height of a five-storey building.

Last year's Notting Hill Carnival in London had a PA stack whose bass really did vibrate the pavements for a hundred yards around - but each half of the stereo pair was forty feet high and fifteen feet wide . . . Try to build that into a subwoofer you can fit into your living-room! It has been done - chimneys converted into horns loading a bass driver, concrete funnels under the floor, but it's not a practical - let alone cheap - prospect for most of us.



**Short of space, but wanting loads-a-bass?**

**Try a satellite and subwoofer loudspeaker combination.**

**Report by Dominic Baker.**



What the hunter after bass needs to remember when eyeing a satellite and subwoofer combination is that it is not going to be a PA stack in miniature. In some cases, and much to the disappointment of the uninformed buyer, they may not even offer more bass than a relatively small stand-mounted loudspeaker. On the other hand, some combinations do make a reasonable stab at producing butterflies in the abdomen, if not a full-fledged churn. We tried out five, ranging in price from Celestion's 248 outfit, which uses the budget Celestion 1 loudspeaker, up to JBL's Control 5 combination at £669.75. We got ready with Reggae and organ recordings.



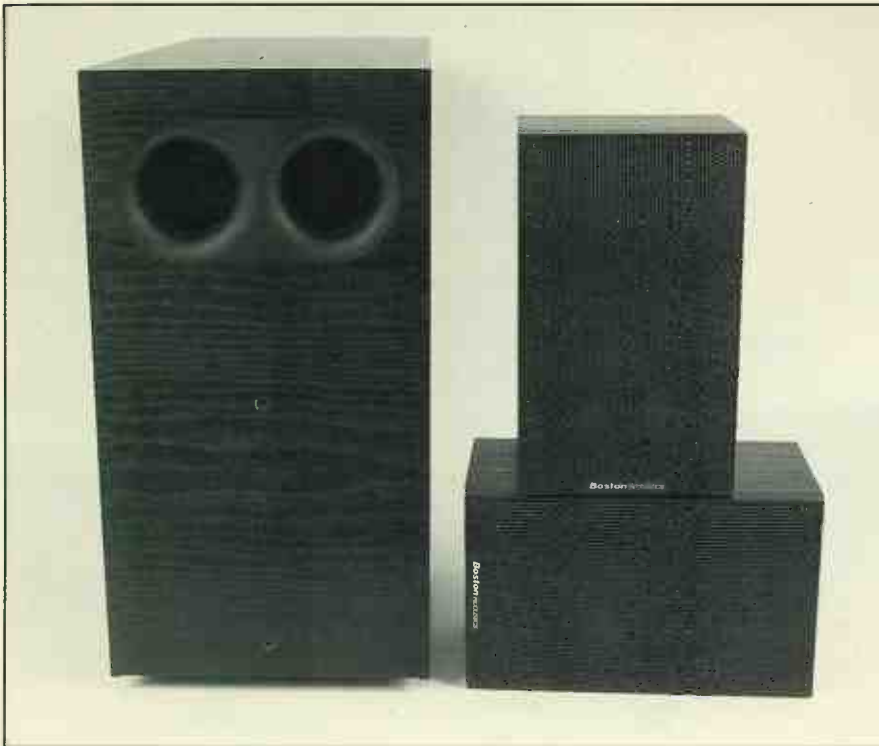

If the purpose of a satellite/subwoofer system is to realise full bass while the units which make it up remain almost invisible, then the Boston Subsat Six was one of only two systems in this group which met that criterion.

The satellites were minute, making it easy to disguise them or fit them in among the books on a shelf. Likewise, the 'Powervent Bass Module', although it uses two small bass drivers reflex-loaded by two ports, was moderately proportioned. Both units are conservatively finished in Black Ash, the satellites furnished with metal grilles to protect the drive units. Small metal wall brackets are available for wall-mounting for an additional £29. For this review, they were placed on stands against a rear wall, or on a shelf. I found, Blue-Tak'd down to a bookshelf with books either side, the satellites produced a surprisingly solid, powerful sound.

The whole system came neatly packaged in a single box, complete with cables and a very informative instruction manual.

**SOUND QUALITY**

Unlike any of the other systems, this one possessed a degree of subtlety which just about saved me from insanity during the course of this test. Enough, in fact, to have me checking wires and crouching down with my ear to the ports of the subwoofer. Once I'd finally convinced myself that the subwoofer was working I decided it would need repositioning for more bass power. Moved from the centre of the room towards a corner, the bass supported the satellites without overshadowing them, sounding surprisingly well-balanced and neutral without being overblown.

Perhaps because of the small size of this

system it seemed faster and had a more delicate touch than the others, producing music, not a fake disco. Given the tiny size of the satellites they were capable of handling more than enough power for any normal listening environment, I found. With the track 'Buddy' from the Lemonheads' new album, the Boston Subsat Six sounded airy and well focused. They imaged very well, their small size, clarity and speed all contributing to a competently focused presentation.

The soundstage was a little squashed in depth, but there was plenty of space above and around the speakers, giving the system an 'out of the box' quality. The treble was light and fast, with plenty of sparkle to it, but it could become a bit sharp with some recordings. Vocals were clearly presented, having a slightly thin and hollow character, but this is certainly more acceptable than being muffled or dull. The sats and the sub integrated extremely well together, so much so that you could be fooled into thinking that all of the sound was coming from the satellites, with no inclination to go hunting for the subwoofer.

**CONCLUSION**

The lack of 'disco' bass could be seen as a disadvantage by those who want the kind that pins you to the far wall. The Boston system was uncritical of placement, with a good balance of bass and treble available at most places in front of the satellites, a property that makes the Subsat Six a flexible and convenient system to use. If you want a discreet speaker system that is capable of conveying some of the more subtle parts of a piece of music, then this is the one for you.

**MEASURED PERFORMANCE**

Being the smallest of the group, the Boston Subsat Six satellites have the most limited bass. At 125Hz it was down by 6dB, leaving a lot of work for the subwoofer. Removing this much low frequency information will make the satellites sound fast and agile, but a little of the stereo information will be fed to the subwoofer.

Between 125Hz and 16kHz their response was reasonably flat, staying within +/-2dB limits, which is as good as many conventional loudspeakers. The treble is slightly rolled off, which should prevent any sharpness but maintain a balanced sound. The subwoofer's response rises smoothly from around 200Hz with a sharp peak centred at 60Hz which may be due to a room effect but is more likely caused by the two reflex ports.

As with all the systems, wiring the satellites and subwoofer in parallel produces a low impedance. This will mean more current drain from the amplifier, making the Boston a heavy load. Additionally the impedance curve was far from flat, indicating that the system presents a reactive load. Couple this with a sensitivity which at 86dB sound pressure level (at one metre for 2.8V/1 watt nominal input), is only average and the Boston Subsat Six is a difficult load to drive.

To be on the safe side and to ensure a lean, powerful and tight bass I would recommend a powerful solid state amplifier of around 100watts with good drive capability into low impedance loads. The Denon PMA-450 would provide good results, for example. **DB**

**Frequency Response**

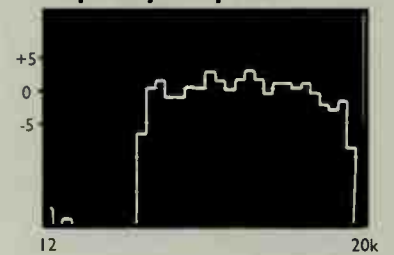

Limited bass extension.

**Subwoofer**

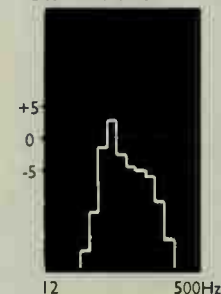

The bass rises smoothly up to a peak at 60Hz, after which it falls off sharply.

**Impedance**

Impedance as low as 3.5Ω.

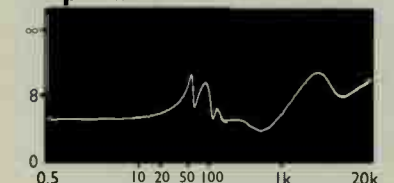





Celestion's satellite and subwoofer system adds a CS135 bass unit to a pair of Celestion Is, which are excellent budget loudspeakers in their own right. As hi-fi speakers go, the Is are quite small, but in the context of the packages reviewed in this test they count among the largest.

The Is use a small doped-paper bass unit and an aluminium dome tweeter in a reflex loaded enclosure. They have rear firing ports which precludes use against a wall, but knowing these speakers well I would recommend free-space placement on stands. If this is not practical, Blue-Taking them to sturdy wall shelves with a foam bung in the ports will achieve similar results.

The subwoofer has an internally-mounted 200mm dual voice-coil bass unit loaded by a single reflex port. This needs to fire into a foot or so of free space, but bearing this in mind, the subwoofer can be stood on end or on its side.

**SOUND QUALITY**

A long-term budget favourite of ours, the Celestion I on its own images well, with a wide, open soundstage, good treble and a clear and well-focused midrange, if a little coloured at the lower end. For a miniature, the I has quite a strong low frequency performance, so the attachment of a subwoofer to fill in the last octave or so could cause some thickening in the bass. Careful matching will be needed if the subwoofer is to be of some benefit to the existing system. The question is - does the addition of a subwoofer to this competent budget loudspeaker represent a worthwhile improvement?

Since minimum bass output from a subwoofer is produced by placing it in the centre of a room, this is where I started. In this position the CS135 added little to the

satellites' strong bass. Moving the subwoofer towards the corner of the room lifted it to a level where the Is were complemented rather than drowned. Things started to look promising, with the lower registers being presented with more weight and authority. There did appear to be some overlap between the Is and the CS-135, but it was only minor.

On 'Your Ages', from the Blue Aeroplanes' album Swagger, the Celestion pairing gave a rich and powerful demonstration of what can be achieved from this kind of system. The bass was full and flowed into the room without slurring or excessive overhang and the satellites did their best through the mid and treble to complete the presentation.

An unfortunate spin-off was reduced pace; an almost sluggish nature affected the sound, removing some of the pleasure of listening to the Is, which are normally fast and precise. As with most reflex loaded speakers - and with subwoofers in particular - a one-note bass quality could be observed in the deeper bass. In fact, one recommendation that I would make as regards this system would be to plug the ports at the back of the Is quite firmly with foam. This serves to reduce the peak in the bass of the Is, which is not needed with the addition of the subwoofer, and consequently enables the two to integrate smoothly.

**CONCLUSION**

The addition of the Celestion CS-135 is certainly worthwhile if a modest improvement in bass extension is required. After plugging the ports of the satellites and carefully positioning the subwoofer the overall result is one that improves upon the strengths of the Is.

**MEASURED PERFORMANCE**

Celestion's CS-135 subwoofer contains a crossover which eases the load on the satellites by removing some of the bass they would normally have to deal with. This means that the Celestion is working more like a three-way system with the main driver of the Is acting as a midrange unit, than a two-way system with an added bass bin. This should improve clarity through the midband and result in higher power handling than would normally be available from just the Is on their own.

The Is have an extended treble response which gives them their sharp but detailed quality. The lower midrange has a raised response which adds some thickening, and the bass is quite pronounced. The bass lift will be removed by the crossover in the CS-135 subwoofer but in each instance we have measured the satellite loudspeakers in their own right to assess their individual abilities. Many people will buy the satellites first and add the subwoofer at a later date so it is important that they can deliver the goods on their own.

The subwoofer's response is tailored to blend with the satellites and add that extra few Hz of bass extension before rolling off. Again, as with most of the other systems in this test, the sensitivity was average at 86dB and the impedance low at 6Ω. However the impedance curve was one of the smoother ones, so the load presented to the amplifier won't be as crippling as most in this test. Amplifiers of 50-80watts should prove adequate, although the Celestion's metal dome tweeter will show up any high treble distortion as harshness. **DB**

**Frequency Response**



**Subwoofer**

Well extended treble.



The subwoofer cones in smoothly to bolster the bass extension of the system.

One of the smoother impedance curves in the group.

**Impedance**

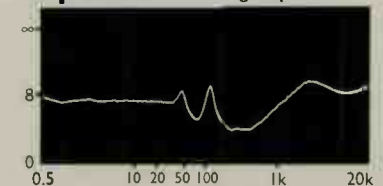

**JBL CONTROL 5 SATELLITE (£368.95) SB-5 SUBWOOFER**

**(£300.80)**



JBL's Control 5 satellite (also available singly at £184.48) and SB-5 subwoofer system was certainly not designed with unobtrusiveness in mind. Each satellite speaker is almost as big as the Boston subwoofer; their paper-coned bass units are complemented by a metal-dome tweeter. Size does have its advantages and the forward-firing port also allows them to be used close to a wall.

The SB-5 subwoofer looks menacing; it uses two large bass units positioned back to back, the front of each cone driving into a chamber containing a moderately sized port. The rear of these two units both fire into a separate chamber where the third and biggest port is located. This suggests that JBL mean business and that output power is not going to be a problem. The subwoofer actually has two output terminals for satellites so a second pair could be added for increased power handling and loudness capability.

**SOUND QUALITY**

As might be expected from JBL's image - and the system's physical size - this outfit provided a full scale disco sound in the front room. Complete with bright treble, piercing vocals and thunderous bass, the JBL caused numerous complaints from neighbours up to four houses away. A more suitably descriptive name would have been Powerhouse 5/Sub-Beast 5.

This is the kind of system that will never fail to impress visiting mates, especially if they have just come from a particularly heavy session in the pub. If you are pursuing these reviews in search of subtlety or finesse, stop reading now. If you want awesome loudness capability and live in a remote area of the Scottish Highlands

where nightclubs are hard to find, read on.

The bass was actually quite well controlled and very punchy. In addition, it went down as deep as the foundations could stand. It had a hard character avoiding the soft, warm overflowing quality that is so often heard from subwoofer systems and in this respect JBL have done remarkably well. It may not reveal the differences between two different makes of bass guitar, but it was tight enough to prevent any blurring or poor timing.

Both halves of this system integrate quite well, with only a little thickening where the subwoofer takes over. As with all of the subwoofers in this test, the Sub-Beast requires some care in its placement. Unfortunately, there was so much bass output that it will be hard for potential owners to place it behind a sofa in the corner. I had to use it in the centre of the room to tame the bass enough to make it bearable.

The satellites have a forceful presentation, but are assertive rather than downright hostile. The treble penetrates your earlobes as if it were directly connected and the midrange shouts vocals at you as if you were in the next town, but in some ways it was good to hear something with guts and vigour as opposed to the namby-pamby blandness of many rivals.

**CONCLUSION**

Imaging wasn't particularly good and neither were other areas that hi-fi critics like to talk about, but that's not what the JBL Control 5/ SB-5 is about. What the JBL does do is reproduce a live event with all the balls and realism of the original - and that's enough to justify its existence as a valid loudspeaker system.

**MEASURED PERFORMANCE**

Like the Monitor Audio MA100s and Celestion 1s, the JBL Control 5s are viable loudspeakers in their own right, which allows anyone to buy a pair of speakers first and add a subwoofer later. They are the largest satellites of the group, which shows in their extended frequency response: the bass goes down lower than any of the others before crossing over to the subwoofer. This means that the subwoofer's job is an easy one and it has a limited frequency range over which it operates.

JBL's Control 5/SB-5 is the most sensitive in the group by a long way. Whereas most of the others average 86dB or so, the JBL's produce 91.7dB at 1 metre for a 2.83volt input. The overall impedance is also a very respectable 7.9Ω which makes the JBLs the easiest to drive by quite a considerable margin. The impedance curve does indicate reactance in the load but it never drops below 4Ω, which is quite satisfactory.

Unlike other combinations in this test, the JBL system is suitable for use with a medium sized integrated amplifier. Even the likes of the NAD 302 with its limited power output of 36watts would be just adequate. Where the sound may suffer is in bass control and dynamics where an over-powerful amplifier has the reserve of current necessary to respond quickly to transients. For this reason an amplifier of around 50watts will provide that extra degree of control and produce more accurate bass. **DB**

**Frequency Response**



Uneven response from Control 5s.

**Subwoofer**

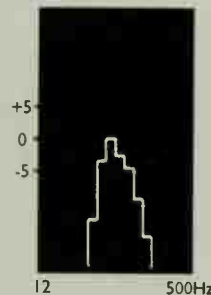

Because of the bass extension from the satellites, the subwoofer has little to do. It comes and it goes.

**Impedance**

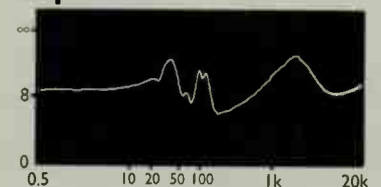

Overall impedance higher than the others.





The pair of MA100 Golds and their associated subwoofer submitted for review were beautifully finished in a deep Rosewood veneer, which adds twenty pounds to the satellites and fifty pounds to the subwoofer over the basic cost for Black Ash. With the black and gold of the drive units this system really did look the business, making others in the group appear cheap by comparison.

The MA100 Golds are the second smallest satellite speakers in the group, containing a miniaturised version of Monitor Audio's gold-anodised metal dome tweeter. The bass unit has a doped paper cone, reflex loaded by a small port firing out above the chunky loudspeaker terminals at the rear. As a reflex design, the MA100s cannot be mounted flat against a rear wall, but a few inches of space should be plenty.

Monitor Audio's subwoofer, fetchingly titled the 200/92, is the only one in this group which is not a reflex design; it employs a single driver in a sealed box. Reflex-loaded loudspeakers can have a 'one-note' quality and suffer lack of control; this unit, with its dual-wound voice coil, should by comparison be tuneful and tight.

Feet are supplied to be screwed into inserts at the corners of the subwoofer to lift the downward-firing bass unit above the floor.

### SOUND QUALITY

Monitor Audio's subwoofer possessed the deepest bass of any in this group. It was also one of the most controlled, staying tight and clean with even the strongest of bass lines. It had the ability to stop and start on command, something the reflex-loaded subs found harder, though if placed

in the corner of a room, the bass could be overwhelming.

A track like The Beloveds' 'Wake Up Soon' pushed the subwoofer to its limits, with the driver cones hitting their end stops. Right up to this point, however, the bass remained tight and clean, playing a tune rather than simply resorting to a garbled onslaught of booms and drones. This made the system one of the more musical of the group.

Though the treble of the MA100s was a little too bright for my liking, sounding not harsh but sometimes sharp, it was detailed and clean. The satellites were very open, clear and coherent, with the midrange being well-projected forward. Overall, the MA100s were articulate and well focused, which along with the tuneful bass from the subwoofer made for enjoyable listening.

As would be expected, imaging from the tiny satellites was very good, placing the various constituents of a band or orchestra with confidence. The best position for the subwoofer to create a deep soundstage was with it between - or just behind - the MA100s. Some experimentation may be necessary if this unacceptable domestically.

### CONCLUSION

Both satellites and subwoofer integrated well together, which is half the battle, the overall package sounding neutral and uncoloured, but lively and entertaining with excellent bass extension. The Monitor Audio combination turned in a very respectable result, a design approach which has fidelity in mind paying off handsomely. Coupled with superb quality of finish, Monitor Audio have a very competitive product.

### MEASURED PERFORMANCE

The MA100s have a small peak in the treble centred at 6.3kHz, close to the ear's most sensitive region, which will emphasise its presence and may even prove uncomfortable for some. However, the treble quality sounded clean, bright and lively, rather than aggressively harsh. The response is otherwise generally even, though rolling off early in the bass at 100Hz. There is a shallow trough between the treble peak and the slight lift in the lower mid, but these speakers sounded fast and clear, which makes up for this deviation.

A smooth roll-off at low frequencies in the subwoofer is characteristic of an infinite baffle (sealed box) loudspeaker and normally results in more tuneful bass than that from reflex-loaded counterparts. The response pattern looks symmetrical, with a smooth crossover from the satellites' lower limit to the subwoofer's upper one, which means the two should blend together well, rather than the bass unit suddenly and obviously taking over at one identifiable frequency.

The sensitivity of the system was average and the impedance low at 6.3Ω so it will not be particularly easy to drive. The impedance curve isn't as severe as some but still indicates a reactive load, making the job of the amplifier no easier. A chunky integrated amplifier such as the Harman Kardon HK6550 should fit the bill nicely, with its lean and neutral presentation and slightly light but tuneful bass. Other amplifiers to consider should be between 60-100watts and have high current capability into low impedance loads. **DB**

### Frequency Response

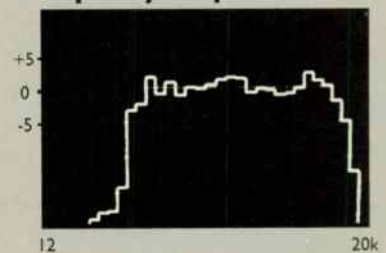

Peaky treble.

### Subwoofer

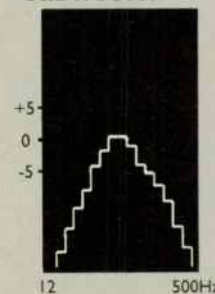

Bass rises in a very well tailored manner. The smooth, even roll off is typical of a sealed enclosure.

### Impedance

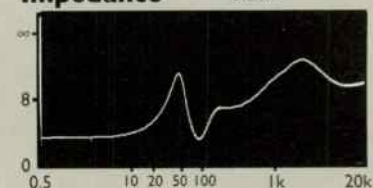

Overall impedance of 6.3Ω.



**ROCK SOLID SOUNDS INC. SOLID MONITORS (£229.95) TWINBASS SUBWOOFER (£199.95)**

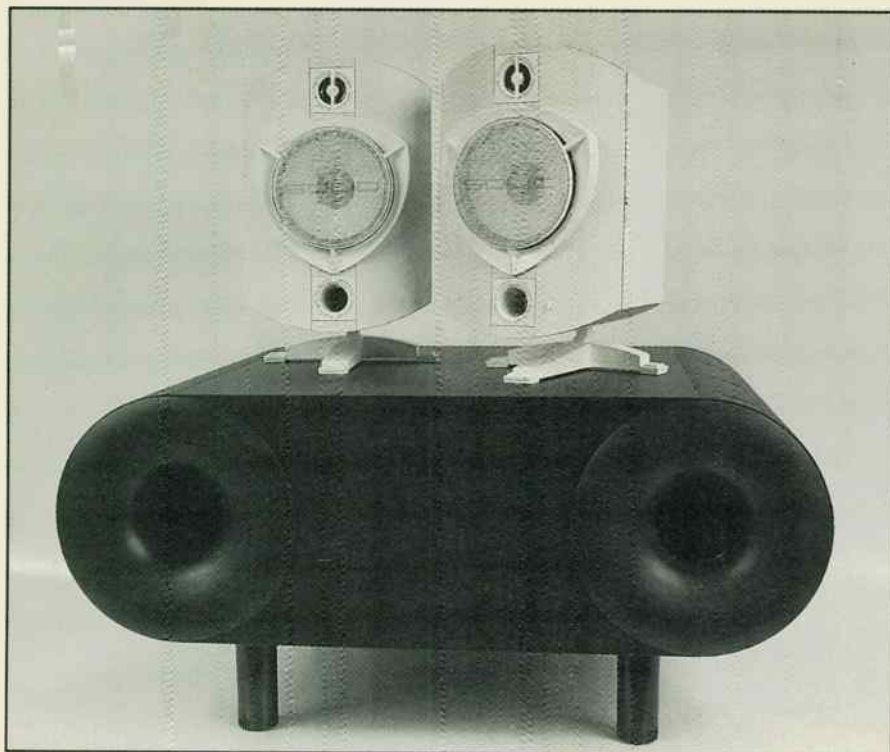

Rock Solid Sounds Inc is a division of the much more staid-sounding B&W. The Solid/TwinBASS system is intended for a mass-market. No doubt the designer would call the Solid satellite speakers, shaped like a knight's shield and plastic-bodied, "stylish". Perhaps they would fit well in a glass-walled Docklands studio flat with pine floors and white leather sofas.

Ours were supplied in white, though they are also available in black with contrasting purple bass units. At the rear is a ball-joint which connects with a crow's foot stand, allowing them to be set at an angle - a useful touch if they must be placed on a higher or lower shelf than would normally be desirable.

Each satellite speaker is a two-unit reflex-loaded design. The subwoofer also uses two reflex ports with flared mouths mounted at one end to load the two downward-firing bass units. Wide and deep, it is also narrow; this means that it can be stood on end with the ports firing upwards, allowing it to be slid behind a chair or settee out of the way. In this respect, though a little odd in appearance, the Solid TwinBASS was one of the most conveniently-shaped subwoofers of the group.

**SOUND QUALITY**

Whereas most of the other satellite and subwoofer combinations integrated reasonably well, the Solids and TwinBASS had me reverting back to my Epos ES1s to check whether my system had developed a fault. Unfortunately for the Solids, it hadn't. The Epos actually had better bass than the TwinBASS subwoofer! Don't get me wrong; the Twin does have plenty of bass, too much in fact, but it is neither fast nor coherent.

There was so much bass output that

even with the subwoofer placed in the centre of the room, as distant from the walls as possible, the sound of the combination was unbalanced. The bass lacked control, and was centred around one frequency, causing some discomfort.

The satellites were possibly the worst I have ever heard, making no attempt to portray the detail of the music fed to them. The treble was dull and splashy, the mid-band closed in and muffled, the two not integrating with each other, let alone with the subwoofer.

Placing the satellites close to a rear wall brought the bass up to a level that aligned with that from the subwoofer a little better, but with the result that the whole system sounded even duller than before.

Using a second power amplifier and a passive attenuator allowed control of the subwoofer's output level. With the output more satisfactorily reduced, I was able to bring the satellites out from the wall to bring the mid/bass more in line with the treble and then set the bass level accordingly. The sound then became much better balanced across the frequency range, which was a great relief.

Set up in this manner, the Solid system could be coaxed into providing almost satisfactory results, but it is hardly practical to purchase a second power amplifier and a loudspeaker volume control - like one made by QED - just to balance the sound. This is a job the designers should have tackled more effectively.

**CONCLUSION**

The Solid system produced a poorly focused image and the soundstage was restricted in all planes. They lacked detail and generally the ability to produce enjoyable music was absent.

**MEASURED PERFORMANCE**

The Solid Monitors had the most even frequency response in the group, with only a small dip in the mid and a slight lift towards the bass end. The treble is 1dB or so below the overall level but this is not particularly serious. The subwoofer rises suddenly but is quite flat when it gets to its operating band. This abrupt rise is possibly the cause of the subjectively disjointed bass performance with bass scales leaping from the satellites to the subwoofer as they go down in pitch. The deep bass roll off is quite steep after the gradual rise towards the lower frequencies.

The overall impedance of the Solid satellite and TwinBASS system was low at 5.6Ω but this doesn't tell the whole story. The impedance curve is the most severe I have seen. The sharp rises and falls indicate a strongly reactive load and the curve actually dips below 2.5Ω at two points. Where the curve drops to a low impedance figure more current will be drawn from the amplifier, possibly to the point of current clipping. Where the impedance is high the speakers will be easier to drive and output will be higher.

This will affect the frequency response of the system unless a powerful solid state amplifier is used which can drive this kind of load without being affected. A separate power amplifier or a very powerful integrated amplifier is mandatory if this system is to work properly. **DB**

**Frequency Response**

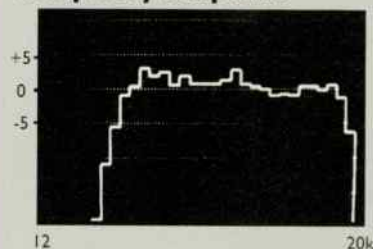

Flat response, but falling treble.

**Subwoofer**

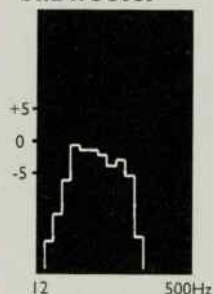

The subwoofer has the most extended bass in the group, but the steep rise as it comes in will cause a disjointed sound.

**Impedance**

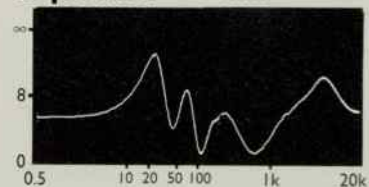

Impedance dips as low as 2.5Ω.



## CONCLUSION

My image of a satellite and subwoofer system is probably the same as many others. It should consist of a pair of small loudspeakers which can easily be hidden among the books on a shelf or wall-mounted on brackets, and a subwoofer that can be hidden behind a sofa. Unobtrusiveness is the aim, without the eyesore of bulky stands. The sound should be clear and open with a balanced and tuneful bass.

In a ranking based on these criteria, the Rock Solid would come last. It fails in every area. Hiding the white shield-like satellites in a domestic environment would be like the Pink Panther trying to hide in the middle of a meadow. At least the subwoofer can be stood on its end, so taking up very little room. Sadly, though, the sound quality wasn't up to much, the bass sounding overpowering and tuneless and the satellites making music distinctly unpleasurable.

### Subtle Boston

Thankfully, Boston Acoustic's Satsub Six is the complete opposite. Sounding open and spacious, it had a degree of subtlety none of the other systems could match. It also had that rarity in sat-sub systems: tuneful bass. In comparison against the others, the bass could be described as positively light, but there was just enough to produce a balanced sound. This was the Boston's strongest point: the bass was in proportion with everything else, as it should be. The satellites were the smallest and least visually offensive in the group and they can be mounted on their own wall brackets or on shelves. This makes them most attractive to those who want something that doesn't take over the whole room. Unfortunately, because of their limited bass extension, they are also the least suited to be used as stand-alone main speakers with the intention of adding a subwoofer later.

Joint second come the systems from Celestion and Monitor Audio. Celestion, with the 1s, had the better satellites; Monitor Audio, with their 200/92, had the better subwoofer. Both set-ups use miniature speakers which are respectable in their own right. This makes both very attractive, because the satellites can initially be used on their own to good effect. Then, at a later date, if you feel the need for more bass, or an excess of cash appears in your bank account, the subwoofer can be added.

Of the two, the Celestion is the best all-rounder. The bass from the



*"the bass was in proportion with everything else, as it should be"*



*"Feed the JBL system with some live music... and they will deliver a real punch in the stomach"*



*"Monitor Audio's 200/92 subwoofer was the best in the group"*

subwoofer is quite crisp and can sound extremely competent if care is taken with positioning, though ultimately it is a little heavy-handed. The Celestion 1s as satellites have a clear, well focused midrange and an open treble. Their ports can be blocked with foam to reduce the bass hump they possess, which results in an altogether more cohesive performance, with the mid becoming faster and more detailed and the upper bass snappier.

Monitor Audio's 200/92 subwoofer was the best in the group. Probably this was because they have chosen to use a dual voice-coil wound bass unit to mono the bass, which also has improved control - and they have mounted it in an innately well damped sealed enclosure. The result is a powerful clean bass that can play a tune as it should, avoiding the one-note drone associated with reflex enclosures, which puts it ahead of all the others. All that lets the Monitor combination down is the slightly peaky treble of the MA100 satellites; they don't quite charm the listener in the same way as the Bostons or the Celestions.

### JBL Powerhouse

JBL's Control 5 combination can only be described as the most impressive of the group, with its huge bass power and high loudness capability. The subwoofer is easily large enough to be placed in the centre of the room with a cloth over it to act as a coffee table.

On its end it would make a useful bar stool or perhaps a bedside table, so its practical uses are not limited to hi-fi. The bass was punchy and deep with plenty of control, but it could sound hard at times.

The Control 5 satellites were the largest in the group and were more than capable of holding their own in terms of filling a room, even without the subwoofer. Again, they were hard sounding; the midrange could tend to shout and the treble had real bite, but at times this is exactly what is needed. Feed the JBL system with some live Rock via a gutsy power amplifier and they will deliver a real punch in the stomach. The sound is all a listener would expect at a Rock performance: hard, fast and immensely powerful.

Many of these subwoofer systems have something that will appeal, but on sound quality alone Boston's Satsub Six was just ahead of the Celestion and Monitor Audio combinations. Its finesse and delicacy made it the most musically enjoyable system ●

# Maximal Maxell

**A new range of cassette tapes from  
Maxell offers maximum value,  
Noel Keyword discovers.**



Maxell recently updated part of their comprehensive tape range. Whilst other manufacturers have either faded away (That's and BASF) or dropped out (Agfa) of the cut-throat cassette tape market altogether, Maxell and TDK have interestingly continued their business as usual.

Maxell's new tapes are not frontier breaking reformulations, so much as upgrades to the standard line. As standard tapes the expectation is that they should give maximum performance

from a compatible formulation. By this, I mean that the tapes should match 'typical' cassette recorders well, in terms of frequency response and sensitivity, whilst giving good results in areas not related to compatibility, such as hiss level.

Getting even more specific, I look for a tape with an IEC-like (International Electrotechnical Commission) frequency response and sensitivity, combined with low hiss and high overload levels. The gap between the noise floor and overload ceiling is the range available for

recording, known as the dynamic range. The bigger this is, the better.

I note from Maxell's literature that they seem to be using the same IEC-based test parameters as myself, but that their figures are different. Should you see these figures and wonder why, it is because they use a higher bias. I test at a bias that is representative of that found on most cassette decks, information derived from cassette deck testing for this magazine.

## Ferric

### MAXELL UR

This is a budget ferric tape, usually priced around the £1 mark for a C90, and competing with TDK D, the brand leader. It isn't especially quiet, tests showed, but as budget ferrics go it is respectable.

Maxell have raised coercivity, in order to give the tape a brighter sound and improve its treble overload margin. Since ferrics overload early with strong treble signals this helps lessen some of the diffuseness and treble muddle that affects budget ferrics so much. Frequency response relative to the IEC I Primary Reference Tape shows rising treble, due also to raised coercivity, and this adds brightness.

Since UR has more treble than TDK D it will sound brighter but, in theory at least, it will also be a little less compatible, giving a less natural tonal balance. How it matches individual recorders though is best left to experiment.

With low modulation noise and good dynamic range UR has no weaknesses, but it is neither especially compatible nor quiet.

### MAXELL SX-I

This tape is a quality ferric, but it costs just 10p more per C90 than UR. That makes SX-I inexpensive, putting it well below the company's premium grade XL-IS ferric.

Just a glance at the frequency response trace shows steeply rising treble, making SX-I a potentially bright sounding tape. But whilst it will sound bright on recorders adjusted for budget standard tapes, recent machines with higher factory bias settings are likely to match better, as will decks with variable bias for tape tuning. However, the +4dB treble lift of SX-I at 10kHz is severe and in most cases it will differ noticeably in its sound from budget ferric rivals.

Whilst high treble sensitivity could be a disadvantage, SX-I has strengths. Low hiss coupled with a high mid-band overload margin gives wide dynamic range. At 60dB, it is no less than +4dB better than UR for 10p extra, which looks like good value to me. Like all Maxell tapes, modulation noise and running properties were well controlled.

SX-I is not very compatible, but it has good basic performance at a low price. Its properties will be best exploited by variable bias decks.

### MAXELL UR

Treble level (10kHz)	+1.2dB
Overload	
mid-band (MOL315Hz)	+2dB
treble (SAT10k)	-2dB
Hiss	-54.5dB
Modulation noise	-42dB
Sensitivity	-0.5dB
Dynamic range	56.5dB

### Frequency Response

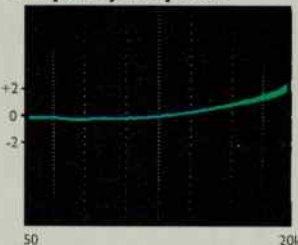

### MAXELL SX-I

Treble level (10kHz)	+2dB
Overload	
mid-band (MOL315Hz)	+4dB
treble (SAT10k)	-0.5dB
Hiss	-56dB
Modulation noise	-41dB
Sensitivity	0dB
Dynamic range	60dB

### Frequency Response





## Chrome

### MAXELL SX-II

Unlike the new ferrics, which ideally should be IEC compatible but are not, Maxell's new budget chrome has a ruler flat frequency response, as the analysis shows. It will suit a large number of recorders as a result, helped also by normal sensitivity which ensures accurate Dolby tracking. In conjunction, these features will give SX-II a smoothly balanced tonal quality, neither sharp nor dull, at least in cases where the recorder is well adjusted for standard tapes.

Like so many chromes though, SX-II suffers early treble overload. In practice this most obviously rounds and blurs the hard transients in Rock music, unless record level is pulled right back. Like so many other chromes, SX-II is best used for Classical works, where its good mid-band overload ceiling of +4dB and very low hiss level of -60.5dB - which add up to a dynamic range of 64.5dB - provide a lot of space for Classical music that doesn't stress the high frequency limits of the tape.

Here's a quiet and compatible chrome that will give a tonally balanced sound. It will round off the transients of close-miked Rock, but otherwise will give good results with undemanding material. At £1.20 for a C90, this tape is also easy on the pocket.

### MAXELL SX-II

Treble level (10kHz)	-0.4dB
Overload	
mid-band (MOL315Hz)	+4dB
treble (SAT10k)	-5dB
Hiss	-60.5dB
Modulation noise	-42dB
Sensitivity	0.2dB
Dynamic range	64.5dB

Frequency Response



## Metal

### MAXELL MX

For really good recordings, with clear, well defined treble, there's little to touch a good modern metal tape. Early formulations sounded a bit coarse and grainy, due much to modulation noise and head distortions. Now, however, coatings are smoother and more consistent and good heads can cope.

New MX doesn't have the very low modulation noise of Maxell's MX-S and, at -41dB, it is even a bit worse than the latest TDK MA, detracting minutely from smoothness of treble. However, it has low hiss, lower than that of its rival TDK MA. It also has lower overload margins right across the audio band, yet dynamic range still improves upon that of MA by an academic 0.5dB. The properties of MX are easier to exploit than those of MA, as lower recording levels are needed, so it has now caught its rival in this area.

The frequency response of MX, relative to the very latest metal IEC IV Primary Reference Tape (MJ507A), is a flat line, as the analysis shows. This makes it generally compatible and already I have found that, in the new Nakamichis for example, MX does in fact offer better matching than TDK MA, the latter possessing rising treble and a brighter sound. Since MX also has a lower treble overload ceiling than MA (-1.2dB down), the latter also maintains treble quality a bit more resolutely. So, generally, whilst TDK MA will sound bright, MX should sound smooth and balanced - that's the difference between them.

Maxell MX is a highly compatible metal tape with low hiss. Needing and being able to accept lower recording levels it is more easily exploited by normal recorders. Unfortunately, even this metal tape is expensive, costing £2.49 for a C90, although that's a lot cheaper than a few years ago and it is going to be considerably less than that of DCC or MD blanks, at least for the time being.

### MAXELL MX

Treble level (10kHz)	0dB
Overload	
mid-band (MOL315Hz)	+4.8dB
treble (SAT10k)	+1.2dB
Hiss	-59dB
Modulation noise	-41dB
Sensitivity	0.2dB
Dynamic range	64dB

Frequency Response



## Metal

## Comparison

For comparison, here are equivalent performance figures for Maxell MX-S and TDK MA metal tapes.

### TDK MA

Treble level (10kHz)	+0.8dB
Overload	
mid-band (MOL315Hz)	+5.2dB
treble (SAT10k)	+2.4dB
Hiss	-58dB
Modulation noise	-42.5dB
Sensitivity	0.5dB
Dynamic range	63dB

### MX-S

Treble level (10kHz)	0.3dB
Overload	
mid-band (MOL315Hz)	+4.8dB
treble (SAT10k)	+1.6dB
Hiss	-59dB
Modulation noise	-44dB
Sensitivity	0.3dB
Dynamic range	64dB

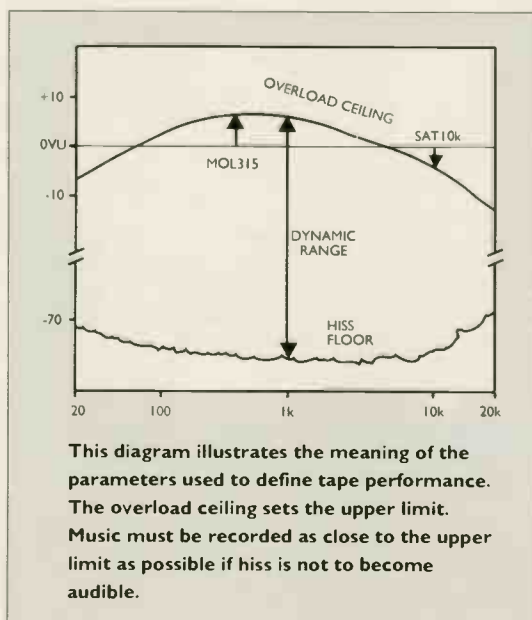

This diagram illustrates the meaning of the parameters used to define tape performance. The overload ceiling sets the upper limit. Music must be recorded as close to the upper limit as possible if hiss is not to become audible.



**NEW CAVENDISH STREET W1**

CITY OF WESTMINSTER

**FREE Express Mail**

Take advantage of our FREE door to door express mail order facility. We guarantee to despatch stock items by return and they are fully insured against loss or damage. In addition you get the benefit of KJ's two year guarantee. (\*cleared payments only).

**INTEGRATED AMPLIFIERS**

ARCAM	Delta 290 (Line Stage)	£449.00
	Alpha 3	£199.00
ALBARRY	PP1 (Line Stage)	£399.00
ALCHEMIST	Kraken	£399.00
AMC	CVT 3030	£529.00
AUDIOLAB	8000A	£429.00
AURA	VA100	£299.00
COPLAND	CTA401	£1699.00
CROFT	Integrated	£499.00
PIONEER	A 300X	£229.00
	A 400	£279.00

**PRE-AMPLIFIERS**

AUDIOLAB	8000 C	£399.00
ALBARRY	AP4	£349.00
ALCHEMIST	Frya	£1020.00
CROFT	Super Micro A	£689.00
MICHELL	Argo (+ Hera P/S £155.00)	£699.00
	ISO MC to Line Level	£399.00
QUAD	34	£389.00

**POWER AMPLIFIERS**

ALCHEMIST	Genesis Mono Blocks	£1525.00
ALBARRY	M408/2 Mono Blocks	£850.00
	M1008/2 Mono Blocks	£1100.00
AUDIOLAB	8000 P	£549.00
AUDIOLAB	8000 M Mono Blocks	£1259.00
CHORD	SPM 1200	£2995.00
CROFT	Series 5	£555.00
MICHELL	Alecco Mono Blocks	£1880.00
MUSICAL FID	P 180	£799.00
	Crps P/Supply	£341.00
QUAD	306	£675.00
	606 Mk2	£675.00

**CD PLAYERS**

ARCAM	Alpha +	£449.00
	CD 52 Mk2	£229.00
MARANTZ	CD 52 SE Mk2	£299.00
MISSION	DAD 5	£299.00
	DAD 5/CDS/Isoplak	£499.00
MERIDIAN	206 B	£995.00
ROTEL	RCD 965 BX	£299.00
	RCD 965 BX Limited Ed	£379.00

**CD TRANSPORTS**

ARCAM	Delta 173 03	£699.00
DPA DIGITAL	T1	£895.00
MERIDIAN	200	£895.00
	602	£1750.00
ROKSAN	DP1	£995.00
THETA	DATA	£2998.00

**D/A CONVERTERS**

ARCAM	Black Box 5	£449.00
AUDIO LAB	8000 D	£699.00
AUDIO ALCHEMY	D/D/E	£419.00
DPA DIGITAL	Little Bit	£423.00
	Bigger Bit	£695.00
	PDM 1 Series 3	£1280.00
	PDM 2	£2350.00
MERIDIAN	203 (DAC 7) Special Offer	£360.00
	263	£495.00
	606	£1350.00
	DA 1	£495.00
ROKSAN	DA 1	£1399.00
THETA	DS Pro Prime	£1399.00

**AUDIO VISUAL - SURROUND SOUND**

CELESTION	HT3 Pro Logic 5/5 Kit	£499.00
DEMON	AVC 3020 P/Logic Amp/Pro	£699.00
INFINITY	See Speakers	
LEXICON	CP2 DSP P/Logic Decoder	£995.00
	CP3 THX P/Logic decoder	£2995.00
PIONEER	CLD 1750 Laserdisc Player	£579.00
YAMAHA	DSP A1000 P/Log Amp/Pro	£899.00
	DSP E 1000	£649.00
	DSP A500	£449.00
	DSP E200	£349.00
	VST SW50 Subwoofer	£199.00

**SPEAKER SYSTEMS**

AC ENERGY	AE 1 (Stands + £300)	£764.00
APOGEE	Centaur Minor	£1345.00
B & W	Matrix 805	£845.00
	Matrix 804	£1395.00
EPOS	ES 11 (Stands + £85)	£350.00
IMPULSE	H2	£2250.00
	H6	£1250.00
INFINITY	Infinitesimal 4	£249.00
	Infinitesimal Subwoofer	£549.00
KEF	103/4	£1095.00
MISSION	760 1	£129.00
	761 1	£179.00
	780	£199.00
	753	£599.00
PRO AC	Studio 1 Mk 2	£613.00
	Supertower Mk 2	£1229.00
QUAD	Response 1	£919.00
	ESL 63	£2384.00
	Subwoofers for ESL 63	£1650.00
ROGERS	LS2a2	£229.00
SONUS FABER	Minuetto	£896.00
TANNOY	605	£160.00
	609	£270.00
	611	£399.00
	CS 1 - 2	£1219.00

**TURNTABLES (Less arm)**

MICHELL	Myro	£399.00
	Gyro	£699.00
PINK TRIANGLE	LPT with GTI	£585.00
	Export	£895.00
	Anniversary	£1495.00
ROKSAN	Radius + Tabrig Arm	£640.00
	Xerxes	£865.00
SYSTEM DEK	11x/900	£229.00
	11x/900+RB250 Arm	£327.00

**TONEARMS (Fitted Free)**

MORCH	DP6	from £665.00
MOTH	Mk 3 (RB300) - Rega fit	£149.00
	Mk 250 - Rega fit	£98.00
ROKSAN	Tabrig	£190.00
SME	Series 4	£827.00
	Series 5	£1232.00

**CARTRIDGES**

AUDIO TECHNICA	ATOC 3	£95.00
	ATOC 5	£129.00
	ATOC 10	£319.00
DENON	DL 304	£199.00
LYRA	Lydan	£549.00
ORTOFON	MC 15	£99.00
ROKSAN	Corus Blue	£75.00
	Corus Black	£130.00
SHURE	VSTV	£175.00
SUMIKO	Blue Point	£99.00
	Blue Point Special	£199.00

How to pay - by cheque, postal orders or by credit card (stating expiry date).

How to order - by post, by telephone or fax. When paying by credit/debit card (Access, Visa and Connect).

All prices include VAT and were correct at time of going to press.

**KJ WEST ONE**  
26 New Cavendish Street, London W1M 7LH  
(Close to Marylebone High Street)  
Tel: 071 486 8262/8263 - Fax: 071 487 3452  
Open: Mon-Sat 10.00 a.m.-6.00 p.m. Thurs until 7.00 p.m.

Please send me .....

I enclose my cheque/Postal Order for £ ..... or please debit my Access/Visa account No: .....

Expiry Date .....

Signature .....

Name .....

Address .....

Daytime Tel No ..... Post Code ..... HFW

**TARGET**

by Mail!

**AUDIO**

**CARRIAGE FREE U.K. MAINLAND (N. IRELAND £10)**

Most dealers cannot physically stock all the range of equipment racks and speaker stands made by Target Audio. It can therefore be quicker and simpler to have what you need sent by mail. It costs no extra, there's no hassle, the carrier brings them to your door. (Please allow 10-14 days for delivery).

**AER EQUIPMENT RACKS**

Tubular welded construction with adjustable spiked feet (with the option of castors if spikes are unacceptable). The upper shelf is supported on 4 adjustable spikes for improved decoupling. Size 505 x 393mm (W x D). Shelves 465 x 355mm (W x D).

	Height (exc. spikes)	Number of shelves	Distance between	Price
AER 2	515mm	2	380mm	£110.00
AER 3	515mm	3	180mm	£128.00
AER 4	660mm	4	165mm	£156.00
AER 5	845mm	5	165mm	£170.00
AER 3TV	515mm	3	190mm	£150.00

(+ depth 395mm)



AER4

**TT WALL MOUNT RACKS**

Wall racks with adjustable isolated upper shelf. Size 505 x 475mm (W x D). Shelves 465 x 355mm (W x D).

	Height (exc. spikes)	Number of shelves	Distance between	Price
TTW1	Wall	1	-	£ 53.00
TTW2	Wall	2	305mm	£ 65.00



TTW2

**HJ SPEAKER STANDS**

A fully welded multi-pillar design which provides maximum control of your speakers. Fine-tuning by use of speaker platform spikes and by filling the pillars (using the filler provided).

	Height (exc. spikes)	Top Plate W x D mm	Base Plate W x D mm	Price
HJ10/3	250mm	280 x 280	305 x 305	£113.00
HJ15/3	380mm	240 x 240	305 x 305	£113.00
HJ17/2	430mm	200 x 200	250 x 305	£100.00
HJ20/2	510mm	165 x 190	250 x 305	£100.00
HJ24/2	610mm	165 x 190	250 x 305	£107.00
HJ20/2T	510mm	152 x 215	250 x 305	£100.00
HJ24/2T	610mm	152 x 215	250 x 305	£107.00



HJ15/3

**BETA "B" SERIES RACKS**

Tubular welded construction with adjustable spiked feet. The upper shelf is supported on 4 adjustable spikes for improved decoupling. Shelf size 465mm x 355mm (W x D). Optional castors kit £9.99 extra. Finished in black ash effect.

	Height (exc. spikes)	Number of shelves	Distance between	Price
B1	65mm	1	-	£ 60.00
B2	480mm	2	380mm	£ 90.00
B3	455mm	3	155mm	£110.00
B4	645mm	4	155mm	£130.00
B5	840mm	5	155mm	£150.00
B5a	840mm	5	200(2)/110(2)	£150.00



B5

**MODULAR "M" SERIES RACKS**

A very versatile system with options allowing modules to be added to suit varying equipment heights. Finished in black ash effect or glass shelves. Select the base module and add shelf modules as required. Supplied with spiked feet (optional castors kit £9.99 extra). Distance between columns 465mm x 395mm depth. Supplied in flat pack for easy self-assembly.

**SHELF UNITS**

Type No.	Distance between	Single Shelf Price	Single Shelf Glass	Type No.	Double Shelf Price	Double Shelf Glass
M1/90	90mm	£38.00	£50.00	M2/90	£70.00	£90.00
M1/125	125mm	£38.00	£50.00	M2/125	£70.00	£90.00
M1/165	165mm	£38.00	£50.00	M2/165	£70.00	£90.00



M1/125

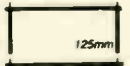

M2/90

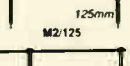

M2/125

**BASE UNITS**

Type No.	Distance between	Wood Shelves	Glass Shelves
MB3/125	125mm	£100.00	£130.00
MB3/165	165mm	£100.00	£130.00
MB3W/165	165mm	£160.00	-



MB3/125



MB3W/165

**HS SPEAKER STANDS**

Medium mass single pillar stands supplied with adjustable spiked feet and top spikes. Can be sand or shot filled. All base plates 250 x 305mm (W x D).

	Height (exc. spikes)	Top Plate W x D mm	Price
HS8	200mm	240 x 240	£ 67.00
HS12	300mm	240 x 240	£ 67.00
HS16	410mm	200 x 200	£ 68.00*
HS20	510mm	165 x 190	£ 68.00*
HS24	610mm	165 x 190	£ 72.00*
HS28	710mm	160 x 160	£ 72.00



HS16

\*Asterisked models can be supplied with Tannoy 600 series mounting top plate for £4 extra - please state speaker model No. when ordering

**KJ WEST ONE (HFW)**  
26 NEW CAVENDISH STREET, LONDON W1M 7LH  
TEL: 071-486 8262/8263 Fax: 071-487 3452  
Open: Mon-Sat 10am-6pm Thurs until 7pm



If ever there was a scape goat in audio electronics, it would be the poor old capacitor. No other component comes in for such a hammering from all and sundry. Ask a hi-fi enthusiast for his opinion on different types of resistor and he (or she) is unlikely to have one. Similarly inductors hardly figure in the audiophile vade-mecum. Even transitions don't attract the same level of blame for everything from "veiled sound" to "diffuse imaging".

True there are some of us that like to swap different makes of valve to compare their relative merits and demerits, but nothing comes close to the capacitor as audio circuitry's supposed Achilles Heel. Each capacitor has to have its credentials checked and re-checked, its role challenged and justified. Every capacitor is guilty until proven innocent.

### Capacitor Construction

Let's look briefly at what a capacitor consists of and at the difference between the types in common use in audio electronics. All capacitors are electronic short-term energy stores. Each capacitor consists of two "plates" separated by a "dielectric". Energy is stored in a capacitor as an electrostatic charge which builds up on the two plates. I mention that they are short-term stores because of the tendency in all capacitors for the charge to "leak away" across the dielectric. The rate at which this happens is a very important measure of a capacitor's worth and is closely related to the type of dielectric used inside the capacitor.

All things being equal, low leakage capacitors are better than high leakage types. Air makes an excellent dielectric and it's quite possible to form a capacitor with air in this role - tuning capacitors in radios are often of this type. But these capacitors are of very low value. An air dielectric capacitor suitable for use as a power-supply reservoir cap' would be bigger than a house.

Other dielectrics need to be used in practical capacitors. These different dielectrics distinguish the different types of capacitor. When you read about polystyrene capacitors, it means polystyrene is used as the dielectric. The same is true of polycarbonate,

polypropylene, polyester and so on.

Each type of capacitor has its own characteristics. The most relevant one in audio terms is leakage, although other characteristics, like power factor, may have some bearing on sound quality. One other characteristic which may be very important in audio terms is accuracy or tolerance. Many capacitors are manufactured to within plus or minus 20% of their marked value. That means that a 100nF coupling capacitor could range



capacitors to pass high-definition television signals without creating any measurable (let alone viewable) distortion!

This viewpoint has met with hostility from my audiophile friends. Many have technical arguments which "prove" I must be mistaken. The rational arguments ranged against my heretical viewpoint all rely on the assumption that there exists charge storage effects within the dielectric. But for charge storage to exist, there must also exist a potential between the two plates of the

# recorded message

Left by Richard Brice

between 80nF and 120nF. Obviously in any application where response, or channel matching, was considered important, a variation of this degree could prove troublesome.

A very widely used form of capacitor - and generally regarded by audiophiles as suitable only for non-critical applications - is the electrolytic. This form of capacitor is formed from two pieces of aluminium or tantalum foil, each forming one plate of the capacitor. The dielectric is supplied by the extremely thin surface oxide which forms on aluminium (or tantalum) in its natural state. Electrolytic capacitors are distinguished from all other types by the necessity that they be polarised. This is due to the action of the electrical charge on the plates of the capacitor which, in one direction, aids the formation of the dielectric oxide and in the other, causes it to break down.

Electrolytic capacitors used in a reverse polarised condition start to get hot and ultimately can explode. Conversely when they are used the right way around, the action of the electricity can actually heal small gaps in the dielectric.

So much for the technical differences between the

different types of capacitor, they clearly exist. No other commonly used circuit element comes in so many different shapes and sizes. But are the audible differences between the different types as great as is supposed? I have my reservations. For instance, I learned the hard way that high leakage capacitors must never be used as inter-valve stage coupling capacitors, but I came to that opinion not on the basis of some subjective evaluation (the circuit sounded fine) but rather because I saw two brand-new EL34's implode before my eyes! Furthermore I've come to doubt the almost universally held belief among hi-fi buffs that electrolytic capacitors should not be used in the signal path. Held, despite the fact that this is nearly universal practice in the professional audio equipment used in recording studios.

### Don't Blame Electrolytics

After many hours of listening and experimentation, I have to report that I have yet to hear any deleterious effects with using, for instance, high quality 10uF/25V electrolytic capacitor in the signal path of low-voltage op-amp type circuitry, providing it is followed by a suitably high impedance load. Indeed, I have used similar

capacitor. And the plain fact is, this should never happen when a capacitor is used in a "coupling" situation where the signal that appears on one plate is supposed to be exactly the same as the signal on the other. A potential difference will never develop in this situation, provided the low frequency breakpoint of the capacitor and following bias resistor is well below the audible range. If it isn't, there will be a loss of bass anyway and, consequently, an audible change. In other words, an electrolytic capacitor will only create distortion in a poorly designed circuit.

There are, of course, occasions when one can blame a capacitor for poor sound quality. An example surfaced in my studio sometime ago. In that case I noticed that one channel of my carefully home designed and built mixer started to exhibit a sea-wash type noise at around 40dB below operating level. The cause turned out to be an electrolytic capacitor fitted the wrong way around and the sea-wash noise was the "sound" of the dielectric breaking down under reverse voltage condition. But who was more to blame, the capacitor for going noisy, or me for fitting it backwards? ●

# Walkin' the dog..

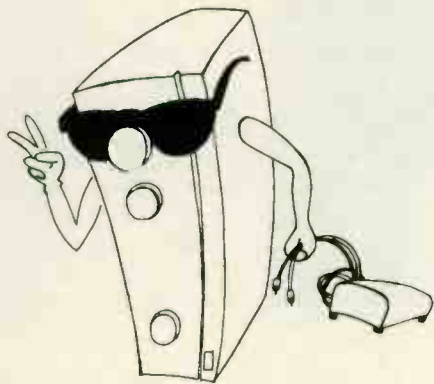

Just when you thought it was safe to go back into the dem room....

## The PIONEER A400 GTE

From the same designer that brought you the Iso, Argo and Alecto, a cost effective conversion that will transform the performance of your A400. You will gain faster transient response, greater resolution, improved imaging, increased tonal accuracy, and far greater bass authority. The sound becomes far smoother at high frequencies without resorting to band width limiting.

See review in this, and other national magazines, against the standard model.

THE COST OF £141.00 INCLUDES RETURN CARRIAGE AND INSURANCE

T.Evans Audio Design

0443 816 856 9.00am to 5.00pm Mon-Fri

# DYNAUDIO®

Dynaudio is considered one of the most distinguished manufacturers in audio. By means of untiring and successful research and exceptional solutions to questions of concept, design and construction. Dynaudio has acquired this excellent reputation, yet success has not altered their independence and single minded concentration on creating products of the highest quality. Dynaudio continues to search for solutions to the basic problems of loudspeaker engineering and then puts these solutions to the test in loudspeakers of their own design. This is especially true for chassis technology. They have set the standards that others must follow.

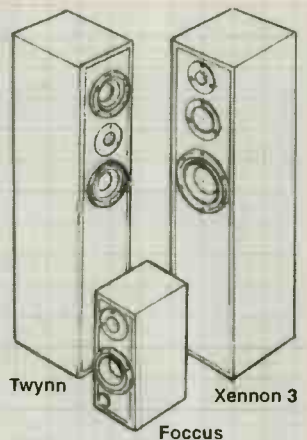

Full demonstration facilities.

4 listening rooms.

We also sell a wide range of quality Hi-Fi equipment.

	Plus Kit	Carr/Ins	Total Kit	Carr/Ins
Gemini	£590.00	£10.00	£645.00	£15.00
Foccus	£360.00	£10.00	£395.00	£15.00
Twynn	£425.00	£10.00	£510.00	£18.00
Xenon 3	£675.00	£10.00	£750.00	£20.00
Finale	£1,200.00	£15.00	£1,600.00	£25.00
Myrage	£1,350.00	£15.00		

## Wilmslow Audio

Dept. HW  
Wellington Close,  
Parkgate Trading Estate  
Knutsford, Cheshire  
WA16 8DX  
Tel: (0565) 650605  
Fax: (0565) 650080

DIY Speaker Catalogue £2.00  
post free (export £3.50)



Telephone credit card  
orders welcome



Open Tuesday to Saturday, 4 demonstration rooms available.

## MAKE BEAUTIFUL MUSIC

Even if you have a modest Hi-Fi system, adding a pair of our 3 way SPHINX loudspeakers will enable you to attain its maximum potential.

Compatible with a wide range of amplification and sources they will take you to the heart of every performance just sit back and let the music flow.

For more information and a demonstration, visit your dealer or contact us direct.

fullers audio, combining innovation with classic design. 20 Tunbridge Rd. Southend on Sea, Essex SS2 6LT. Tel: 0702 612116



Horn loudspeakers were once very popular. Being very efficient, they need little power, which suited low output valve amplifiers. Nowadays, horns are specialised and expensive, being manufactured by companies such as Tannoy, Klipsch and Impulse, forcing them into high-end territory. Very few people will ever hear one of these immense speakers, which adds to the mystery of the horn. What is so good about a horn loudspeaker and why do they cost so much?

With the advent of our D.I.Y. supplement and enthusiasm for horn loudspeakers mounting, I have decided to try and explain some of the basic principles behind their operation. The written material on horn loudspeakers is very limited, so depending upon response we intend to include a comprehensive article in the supplement some time in the future.

Horn loading a drive unit is a highly efficient method of reproducing sound within a room. The horn itself acts as an impedance matching transformer between the room and the drive unit, loading the driver correctly. In a normal loudspeaker with the drive unit mounted on the front baffle, the diaphragm is not impedance matched to the acoustical load of the room. The frequency response characteristic will be affected by the room the loudspeaker is placed in. A horn, however, acts as a buffer, the drive unit seeing a constant load to drive.

at a low velocity. The horn structure transforms this power into low pressure, high velocity energy at its mouth, which better drives the room.

Horn loudspeakers have a low frequency cutoff point that is determined by the size of the horn mouth and may be considered as an acoustic high pass filter. It passes all frequencies above a certain low frequency limit. A horn loudspeaker can be used down to frequencies where the mouth is about 1/4 wavelength wide, depending upon the horn shape. So for reproduction down to 20Hz, where wavelength reaches around 45 feet, the horn mouth would



Dominic Baker

## dB on the level

need to be at least 11 feet wide. In practice, smaller mouths have to be used to provide an acceptable domestic loudspeaker. For deep bass, horns have to be enormous, which is a significant problem - especially when two are needed for stereo.

The curvature of the horn from throat to mouth strongly affects the low frequency roll-off characteristic. Three basic types of curve are common: hyperbolic, exponential and

response above the cut-off point.

In a practical low frequency horn loudspeaker however, a simple conical shape is often used. Although the response will roll-off earlier than either of the other two forms, the actual construction can be far simpler, using only flat panels for example. Electrical equalisation or bass boost can be used to adjust the low frequency extension.

Earlier, I mentioned that the mouth of the horn needed to be about 1/4 of the wavelength of the lowest frequency to be reproduced. This also depends on the shape of the horn and the exponential horn is the only one that actually gets as low as this rule predicts. In practice, with a simple conical horn, the mouth will need to be bigger, 1/2 to 2/3 of the wavelength of the lowest frequency. This raises the size of the mouth from 11 feet to around 25 feet to reproduce a 20Hz note.

Once the mouth size has been determined, the size of drive unit and throat has to be assessed. The drive unit should ideally have its resonant point below the low frequency limit of the horn. The throat should be smaller than the drive unit diameter for most efficient operation. This may be accomplished by mounting the driver in an infinite baffle with a

slot cut in the front through which the sound is fired. This produces the high pressure, low velocity wave at the centre of the horn.

The material that the horn is constructed from also plays an important part in its performance. Wood is most popular in modern low frequency designs, where both rigidity and the ability to shape the material are important.

High frequency horns are often constructed from plastics that offer high rigidity, together with resistance to vibration. Metal can be used to construct a very efficient form of horn having low surface absorption, but care must be taken to

damp panel vibrations. A felt strip around the rim of the mouth of the horn can be used to help control these vibrations.

Horn length is determined by mathematical formula. You have to work out how long the horn will have to be to go from the area of the throat to the area at the mouth of the horn. For an exponential horn to produce 30Hz with a driver of 75 square inches and a mouth of 12 feet, the horn would need to be 18 feet long. It can be seen from this that the smaller the throat of the horn the longer it will need to be. So for practical reasons the throat of the horn is always kept as large as possible.

From this quick look at horn theory I hope you can see where the size, cost and performance of a horn loudspeaker comes from. The theory can get complex and many, many research papers have been produced on horns over the years, yet little of this information has become common currency, because it is too abstruse. Various techniques and fiddles are used to keep the size of the horn reasonable, but all these compromise performance. An ideal horn is efficient and has very low distortion, but in real life few horns are ideal. All the same, they can be very impressive ●

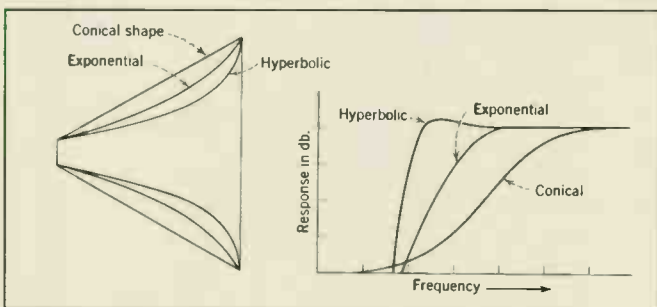

For a horn loudspeaker to work effectively the driver used must have a stiff diaphragm to ensure that it closely exhibits piston-like behaviour. A small cone area helps in this respect, since the diaphragm may be more easily controlled by the voice coil. However, even with a small driver the radiated power from the horn can be made high. The cone in the narrow centre or throat of the horn generates a high pressure

conical. The diagram clearly shows the affect that each shape has on the roll-off characteristic. A hyperbolic form has the lowest roll-off and is suitable for low frequency horns. However, it does produce a peak just before roll-off that may be undesirable. The exponential horn is favoured for high quality audio purposes, having a well extended response, a smooth roll-off and a flat

The prize on offer this month is a contemporary classic based on a vintage valve. The Audion Silver Night monoblock amplifiers use the much acclaimed Western Electric 300B triode valve which was originally designed in 1929! These glowing valve amplifiers are set to enhance your hi-fi system and will deliver 18 watts of undiluted musicality.

The design of the Silver Nights embraces modern technology, producing an amplifier with no feedback working in push-pull is no mean task! Signal is fed to the 300B valve by a 5687 valve acting as a paraphase splitter, which itself is fed by an E88CC double triode which

acts as an input amplifier.

The Silver Nights are designed and manufactured by Alema (UK), a company based just West of Brighton in Hove. The Audion Silver Night is the company's first production power amplifier, a single-ended version called Golden Night, using two 300B triodes in parallel, is due to be released later this year. This will further complement

the company's range of valve pre-amplifiers.

The Silver Night's Swedish designer, Eric Andersson, started working with valves in 1957 but it was not until 1982 that a pre-amplifier became his first commercial venture. Moving between the hi-fi markets of Sweden and England over the last ten years has increased his awareness of good triode valve amplifiers. He joined forces with David Chessel who launched Audion pre-amplifiers. Their expertise has flourished in this partnership, resulting in a full range of valve products and the production of the Silver Night.

When Eric Braithwaite reviewed the Silver Nights he found their strength is in making music gloriously real, to endow recordings with that extra dimension that has no-one doubting the living, breathing performer between the loudspeakers. Noel also found that they measured well and upon listening deduced that triode amplifiers, as rumour would have it, can and do sound superb. The Silver Nights are a wonderful example of the breed.

This monoblock combination would normally set you back £1995 for the pair, but our competition winner will be able to have these burning gems lighting up their music and their home.

Please send your entry form, completed in block capitals, to arrive by 24th May 1993, to:

**AUDION SILVER NIGHT  
COMPETITION,**  
Hi-Fi World Magazine,  
64 Castellain Road,  
London W9 1EX

In the event of more than one entrant submitting all the correct answers, the winner will be decided on the tie-breaker. We will endeavour to publish the results in the July issue. Audio Publishing Ltd. reserve the right to publish such entries or parts of entries as the company sees fit. We regret that photocopies of the entry form cannot be accepted. No correspondence about this competition will be entered into and the Editor's decision is Final. Employees of Alema (UK) and Audio Publishing Ltd. may not enter.

# Win a pair of

## AUDION SILVER NIGHT 300B COMPETITION ENTRY FORM

- The 300B Valve was originally designed in?
 

<input type="checkbox"/> 1987	<input type="checkbox"/> 1929
<input type="checkbox"/> 1948	<input type="checkbox"/> 1957
- Eric Andersson first worked with valves in?
 

<input type="checkbox"/> 1962	<input type="checkbox"/> 1957
<input type="checkbox"/> 1982	<input type="checkbox"/> 1990
- The Silver Night works in which configuration?
 

<input type="checkbox"/> Push-Fall	<input type="checkbox"/> Parastatic
<input type="checkbox"/> Push-Pull	<input type="checkbox"/> Push-Off
- Which component will you NOT find in a Silver Night Amplifier?
 

<input type="checkbox"/> 5687 Valve	<input type="checkbox"/> 300B Valve
<input type="checkbox"/> E88CC Double Triode	<input type="checkbox"/> EL34 Valve
- The amplifier planned for launch by Audion later this year is the?
 

<input type="checkbox"/> Dark Night	<input type="checkbox"/> Golden Night
<input type="checkbox"/> Green Night	<input type="checkbox"/> Hard Days Night

### TIEBREAKER (obligatory):

Complete the following ditty in no more than 10 lines using only the entry form provided.

Reading all these entries takes me a while,  
Tell me something about valves to make me smile,  
Give me something that makes me grin,  
Because if you succeed you may even win!

---



---



---

Name

Address

---



---

Postcode

Daytime Tel.No:



# AUDION SILVER NIGHT 300B

monoblock  
power amplifiers  
worth  
£1995

competition



QUAD SYSTEM AND  
ESL 63'S DELIVERY  
FROM OUR JANUARY  
ISSUE.

The legendary Quad ESL 63 electrostatic speakers with matching Quad 66 remote control system and 306 Power Amplifier were delivered to our January competition winner, James Evans of London. Quad's Sales Manager, Ray Churchouse, presented the prize, saying he was delighted to hand it over to a genuine music lover and true audiophile.

## MONITOR AUDIO COMPETITION WINNER FROM OUR FEBRUARY ISSUE

After several amusing hours reading through the answers to the competition, our winner with the most original answer was judged to be Colin Snook of Hertfordshire. He will be taking delivery of a pair of Monitor Audio Gold loudspeakers. His solution to Mo's commuting difficulties was to ensure that the journey was made more bearable by replacing worn metal with heavy metal! Many thanks for the vast response and all the amusing tie break answers you supplied.



Just as film producers are going through a prolonged stage of naming sequels to films with the basic addition of a II, III or IV, many hi-fi manufacturers have now decided to follow this example when naming their new products. The American-manufactured Adcom GFT-555II tuner follows this logic, claiming to incorporate many improvements over its predecessor.

Even though it costs £399, the Adcom doesn't boast an excess of features: no remote control (although this option can be pursued by connection to other Adcom products) and sadly only eight FM and eight AM presets. The build quality is good and it boasts the use of high quality 'Roederstien' components in all audio circuitry, plus a circuit board that aims to reduce signal degradation.

The Adcom is essentially oriental in appearance. It has a small, vertical, five-bar red LED signal strength meter and a luminous frequency display that is clear and precise, but possibly a little too familiar to have any novelty interest. A filter named Hi-Blend reduces high frequency noise by blending the stereo channels together at high frequencies. It's a reasonably common feature, useful when a stereo signal becomes weak and noisy, providing some stereo effect together with reduced hiss. Eight horizontal buttons are fitted for presets. Other controls in this horizontal array are for selecting stereo or mono and between manual and automatic scan tuning that is common to synthesiser tuners.

### **Straightforward**

Operation was straightforward but as we were using an aerial delivering a strong signal the automatic tuning fell down quite badly. Having a low sensitivity threshold, it responded to unwanted noise signals and distant stations that from a lesser aerial would have been ignored. Like most auto-tuning synthesiser tuners, the GFT-555II has been adjusted to work with a poor aerial. Were it to be set for a good one then auto-tuning would fail to work completely with the piece of wire many people expect to use. Yet the price of this tuner suggests that it's aimed at the real radio enthusiast who is likely to have a decent roof-mounted antenna, so perhaps the 555 should have been given an adjustable scanning threshold.

When on station the Adcom really does capture the signal well, like all synthesised tuners with their crystal locking mechanisms. I was impressed by its relaying of BBC Radio 3 with a very low level of hiss. Not all tuners can reduce the background noise down to this level. It ensured that the



# THE AMERICAN WAY

**Widely known in the U.S.A., Adcom products are now imported into the U.K. Jonathan Jordan listens to an American tuner's way with the ether.**

listening agenda of Mussorgsky and Rachmaninov were not molested or altered by background noise.

A high degree of clarity was the Adcom's strong point. Stereo separation was also good when the tuner had homed in on a strong signal. On weaker signals the use of 'Hi Blend' reduced the level of hiss, but at the cost of reducing the stereo separation as the two channels blended.

### **Firm Bass**

The bass of this tuner was firm, if not expressive. However, I found the bass response was detailed right down to well below the 100Hz mark; it ensured that the low frequency content of the music was not lost.

The Adcom excels in the mid-range where it has a very flat and tight response. The reproduction of voice was intriguing with the breathing, pausing and modulations of the announcers' voices being portrayed with very subtle delicacy; the term "BBC English" definitely took on a new meaning as the announcer's voice became detached from the airwaves; and amplification and joined me in my listening room.

### **Constrained**

With a music programme the atmosphere the tuner generated deteriorated and began slightly to lack in warmth. Although components of depth, width and image were all there, the total image was





constrained. Placing limits on the image created I could map out a box that was positioned between myself and the speakers. All the sound emanated from this central area. It was unfortunate that the box did not extend more than four feet in any one direction.

Within the box, the detail that was conjured up was exact and each individual instrument had its location: I felt I had a miniature orchestra playing away in front of me. Disappointingly, if I closed my eyes I remained an observer from a distance. This tuner could not transport me to the concert hall or studio, nor could it fool me that my room had Tardis type properties!

### Blunted

The high frequency response was not especially sharp. At times the upper ranges of the music were not done the same justice that had been achieved in the midrange. The music almost sounded muddy and bland when the cymbals started crashing; the sharpness of the trumpets and the tremble of the strings were cruelly blunted during Mussorgsky's 'Night on the Bare Mountain'.

Rachmaninov's Piano Concerto No 4 was portrayed with more harmony but the Adcom did not liaise well with high end transient passages. It did do well in the midband and it certainly went down low, but once there it could not quite hum effortlessly and some minor protest rumblings were just noticeable. The strengths of the Adcom tuner

are its midrange clarity and the exile of hiss. This indicates that high quality chips and circuitry have been used inside. The tuner is pleasant, musical and clear but it does not differentiate itself enough from synthesised tuners half its price to win acclaim.

At the £400 mark the Adcom GFT-555II is offering only its hiss free performance as its major forte. It is quite musical and very pleasant to sit with but it does not rejuvenate the electromagnetic waves it plucks from the air and it fails to cause any major excitement or emotion. Perhaps if Adcom started with a clean sheet rather than producing a 'sequel' this tuner may have established a place in the premier league and gained stronger endorsements for performance at its price. The GFT-555II offers a good solid performance, but it does not score the audiophile 'knock-out' that I feel it must do to compensate for the lack of luxuries and ultimately a high price ●

### MEASURED PERFORMANCE

Measurement shows that the Adcom GFT-555II is built around some of the higher performance chip sets available these days to tuner designers. In particular, its low hiss figure of -75dB at full quieting, achieved with 1mV of signal from the aerial, is better than usual by a few dB. I know from experience that, given enough signal, hiss should be inaudible from this tuner, even when listening to low level passages from a Classical piece, or to studio chat where, on occasion a silence long enough to allow hiss to become audible might creep in.

The Adcom is a quiet tuner, quieter than most, and it is also sensitive. Possessing a stereo sensitivity of just 25µV (-50dB noise) it matches its rivals well; few tuners are more sensitive. In light of this it was unfortunate that Adcom should slavishly follow the Japanese (or was this tuner designed in Japan?) in fitting an LED signal strength meter that registers maximum with just 100µV from the aerial. The truth is that for optimum performance this tuner needs ten times as much signal, making the indicator of little value and misleading too. Unfortunately, even Arcam now feel that they cannot compete on the shop shelf with a tuner whose signal strength meter doesn't light up fully, when all the others (from Japan) do, so the pressure to fit a meter as misleading as everybody else's is high.

Audio frequency response possesses a slow and gentle roll-off above 2kHz and above 10kHz rolls away faster, as the analysis shows. This will give the tuner a smooth sound, free from sharpness or hardness, but not to the point where it might sound dull.

An effective 19kHz pilot tone filter suppresses pilot and sub-carrier (38kHz) well, keeping the audio output free from unwanted signals. Channel separation was good at -50dB and distortion very low at 0.1%. Both values are commonly equalled nowadays, but they do show

that the Adcom reaches a standard of performance that exceeds what I would regard as a minimum for high fidelity. **NK**

### TUNER TEST RESULTS

Frequency response	4Hz-12.4kHz
Stereo separation	50dB
Distortion (50% mod.)	0.1%
Hiss (CCIR)	-75dB
Signal for minimum hiss	1mV
Selectivity (at 0.4MHz)	80dB
Sensitivity	
mono	1.6µV
stereo	25µV

### Signal strength meter

LED No.	level (µV)
1	0.3
2	3
3	8
4	20
5	100

### Frequency Response

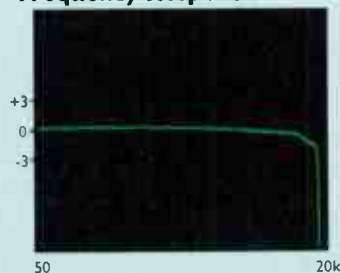

Response rolls off early, -1dB at 12.5kHz.

### Distortion

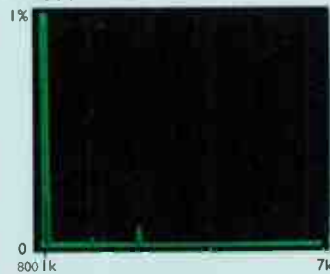

Small amount of distortion.







# readers' queries

## PIONEERING

I recently bought a Pioneer PL12D turntable at a car boot sale for £3 and after I put in a new belt it has always worked nicely. This elderly turntable has aroused my curiosity and since I believe it was sold around the year 1970 (when I was five years old), I wonder if I could draw upon the encyclopedic knowledge of some of your contributors, whom, if I may say so, seem generous of age.

The questions I would like to ask are the following:

1. When I opened up the

**Write in with your problems to Hi-Fi World, 64 Castellain Road, Maida Vale, London W9 1EX.**

**Our panel of experts will endeavour to solve them or at least offer some practical advice.**

deck to stop vibrating before placing the needle. Is there a spring missing as I imagine there is? Or was this turntable always so fragile?

2. Could you recommend a modern moving magnet cartridge to be used on the PL12D (to be used with a NAD 3130 amp and Tannoy Eclipse speakers)?

3. On the question of servicing turntables I once read that on a high end machine such as a Linn LP12 the belt should be replaced once a year. Should all turntables have this done to achieve optimum performance?

If you could answer some of these questions I would be extremely grateful.

This is the first time that I have ever written to Hi-Fi World so I will take this opportunity to say how good I think the magazine is. The very first issue I bought was in June 1991 being immediately hooked by your magazine by an advertiser in your letters page who took issue with the magazine using some of its pages to write about an old classic tuner, the Leak Troughline, instead of being yet another conveyor belt of the latest Hi-Fi products straight from publicity departments.

I can only say that Noel Keyword's dignified response impressed me greatly, while the advertiser's view that hi-fi magazines are only there to serve the interests of dealers and manufacturers I found ludicrous (if this is the case, why not do away with a cover price, lose any journalistic

integrity and become a freebe colour brochure of the latest hi-fi?).

I appreciate that everyone has to try and earn a living, be it manufacturers or retailers, but I would draw the line on them trying to taint the refreshing mixture present in Hi-Fi World. Please continue your articles for buyers, tweakers and hi-fi D.I.Y-ers as well as keeping a strong journalistic style and independence.

**John Moratiel,  
London N11.**

"Generous of age" indeed! I'll have you know that, unlike Noel, I'm in the first flush of my second childhood. Polishing up my Zimmer frame and wiping my rheumy eyes, I will admit to knowing the PL12D. There aren't any springs missing; the PL12D used what is known as three-point suspension as originally dreamt up by Ed Vilchur and used in all classic suspended-chassis turntables for thirty years now.

I suggest that you put a set of three Michell cones ('Tenderfeet') underneath the turntable, points down; then if the turntable is still susceptible to external vibrations, put it on a wall-shelf. The answer to the bounce is to do what I used to do in my first childhood, which is not to bother to switch it off at all during the listening session!

The classic cartridge used in the PL12D's heyday was the Shure M75ED, which is still obtainable, but now overpriced. The Pioneer has a decent arm, by and large, and you could get away with a

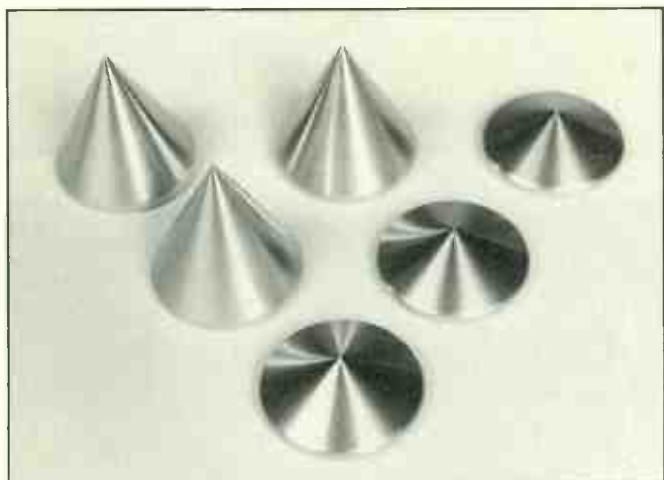

**Placing your turntable on Michell's Tenderfeet may reduce vibration problems.**

Pioneer PL12D I quickly noticed that it was extremely similar to my current turntable, a Dual CS 505-3, having a sprung top section on which is mounted the platter, motor and controls. However, contrary to the Dual which has its springs on each of the four corners, the PL12D has three springs in the middle of three

of the deck's rectangular sides. Why they should be arranged in this way I do not know but one very big drawback is that the deck is very susceptible to slight external vibrations, such as someone walking past it. Even worse, when switching the machine from OFF to ON on the right panel, the user has to wait ten seconds for the top

Goldring 1022, a very good all-round cartridge.**EB**

It is quite easy to judge for yourself when a belt needs replacing. The rubber of a new belt is fresh and supple with plenty of elasticity in it. As it ages the rubber perrishes and becomes sticky to touch. When it is stretched it doesn't completely return to its original length. A useful trick used to extend the life of the belt, by keeping it fresh, is to draw it through a cloth that has had a small amount of Pledge furniture polish sprayed on it. Only use this brand however because some other polish has additives that can cause damage rather than good to your rubber. **DB**

**NO DEEP BASS**

My present system comprises the following components: Marantz CD50SE, Marantz PMA50, KEF Quattro (C15s, C200 sub-woofer), Denon DRM710, Kenwood KT-2020,

suitable equipment supports. My budget for the upgrade is £1000 and your advice would be gratefully appreciated.

**B. Howe, London W11.**

Ariston, alas, are no longer with us, so I fear the CD3 is off the list. In any case, within your £1000 budget it is not going to be possible to replace each component. The prime culprit of the sound you describe I suspect to be the speaker/sub-woofer set-up, which I feel was not a particularly well-integrated system. Few of these in any case deliver the kind of bass that Reggae-lovers are likely to be keen on. One of the difficulties here is achieving a strong bass for this purpose out of any of the speakers listed. I would be tempted to go for a pair of ESI 1s for a good midrange and audition one of REL's subwoofers with an eye to adding on bass later, as it were. Next on the list should be the front-end and

you take the plunge and remember to use open frame stands for the best results.

If they do work it is worth exploiting the results to the full. I would try adding a passive volume control and a power amplifier which will provide the highest quality and cheapest route to this end. An excellent power amplifier, which with the ESI 1s takes you just outside your budget, is the Sugden AU41P which retails for £599. At this price it is excellent value for money.

The Marantz PMA50 and KEF Quattro system could be part exchanged against these purchases, which should pull you back inside your budget and leave enough for a passive volume control. A good quality passive attenuator can be easily built, DIY-style, for very little money and I'm sure that if you speak to either Graham Nalty at Audiokits or Russ Andrews at RATA they will be more than willing to supply all the information that you will need. **DB**

We'll be showing you how to build passive and active preamplifiers in our DIY supplement soon. It's pretty easy, so keep reading. **NK**

**FRONT END FIRST?**

I am currently in the fortunate position of being able to spend £2000 on upgrading my system which consists of the following items:

Arcam I70 transport/BB3 (Linn interconnect), Exposure

I have listed the two pre/power combinations namely Linn's Kaim/LK280 and Naim's 72/Hi-Cap/180 and been very impressed by both, albeit different sounding systems. So what may you ask is the problem? Well, I keep going back to the old adage of front end first. Should I have my transport and Black Box upgraded (five weeks without music - surely not) and invest in Mana supports for my equipment. Your help would be appreciated greatly as this upgrade will have to keep me content for at least two years.

**T. Coombes, Stratford, London.**

I don't support 'front end first' as an all-embracing panacea, but in this case it's a very good start. The original Delta 170, while good, has been overtaken and itself is improved in its 170.3 guise, but the Black Box 3 can definitely be bettered now. What to replace it? The answer is going to depend on which pre/power combination you feel most happy with. As you say, the two you mention are different; without knowing precisely what you liked about each, a recommendation is difficult. A safe bet, given the current set-up, would be Sugden's very musical SDT-1 coming in under £900, or alternatively, of course, Naim's CDI. **EB**

I suspect that Linn/Naim enthusiasts would also like the



**The Denon DRM 710.**

Audioquest Topaz interconnect and QED 79 strand. My musical tastes (in order of priority) are Jazz, Reggae, Rock, Classical and Soul and my room measures 10 feet by 14 feet.

My aim is to upgrade the system to attain the best possible sound with the budget available. I consider the faults to be an unbalanced sound, no true deep, solid bass and a lack of midrange quality.

I have made a list of the options I consider to be possible: Meridian 206B, Ariston Maxim CD3, Marantz CD72, Audiolab 8000A, Rotel RB950BX/RB980BX, Epos ESI 1, KEF 101/2, Monitor Audio I4, Linn K20 and

amplification. At this point, it is going to be essential to audition combinations of CD players and amplifiers with the speakers. **EB**

The ESI 1s are an extremely competent loudspeaker, but beware, they are also very room dependent. I have a room much the same size as yours and get fantastic results from ESI 1s. However it has four concrete walls and thick wooden floorboards. A friend has a similar room and more powerful amplification than mine yet the result is an over-bloated bass which makes them nearly unlistenable. I would strongly recommend a home demonstration before



**Arcam's I70-3 is an improvement over earlier guises.**

XV amp (Sonic Link Violet), Linn Helix 2 on Ku-stone stands fed with Linn LK400 cable. The system is supported by stacking Sound Organisation tables.

forceful sound of the Crystal chip in the EMF Crystal convertor and - surprise, surprise - in the new Quad 67 CD player! **NK**



**UGH! TO CD**

I want my system to sound natural - as close a replica of the real thing as possible, the real thing for me being orchestral and chamber music, but also the odd heavyweight such as Mahler's 8th.

I was quite happy before CD came along. My Systemdek II (the round biscuit tin version) with LVX arm and Denon DL-110 MC being nice and warm, rhythmic and detailed. One day, though, in a fit of insanity, I bought a personal CD player. This was due to a long period away from home and I accumulated a large amount of discs before coming home and plugging it into my system. Ugh! I was left with a suitcase full of CDs.

So I bought a better player

ideas? Does it mean I've bought the wrong speakers? Is Pink's 'Da Capo' DAC worth a try?

**MR. J. Jarvis, Basingstoke, Hants.**

Careful! I've no objection at all to suggesting you blow £1,350 on Pink's Da Capo, but you could be about to pay a lot more money than you need to put right a problem whose solution lies elsewhere.

One thing that catches my eye immediately is that you mention a home-built power amp and a volume pot. Much of the sound of your Systemdek/LVX/DL110 may have been moderated by the disc input stage of whatever pre-amp you were using

What I think you are after is a means of listening to CDs enjoyably rather than making a costly return to vinyl. If this is the case then some fairly major changes to your system are needed. I would completely start again.

To demonstrate what is available from CD I suggest you find a friendly hi-fi dealer that will let you borrow some equipment for home demonstration. Start with an Arcam Alpha 170.3 CD transport and an Audio Synthesis DSM DAC. You can specify the DAC with a sync-locking option that provides a very clear and detailed midrange, removing the coarseness associated with CD. I would suggest that you feed this to a high quality amplifier.

Two approaches could be taken here. You could use a passive attenuator to directly feed a power amplifier or go for an integrated amp. The former is slightly more messy but will offer a cheaper, higher quality alternative. Again from Audio Synthesis, the Passion Reference grade attenuator is simply excellent, being invisible to the ear. This in combination with a Sugden AU41P power amplifier (or two if you wish to bi-amp for ultimate control and quality) will form a strong heart for the system.

All that is need now is a good pair of loudspeakers. I will recommend two just in case one pair doesn't work in your room or blend in with your taste. They are the Epos ES11s and the Spica TC50s. Both have extremely musical qualities the Spica being the softer, warmer of the two.

The total cost of this venture should be similar to that of your existing system, but the results I think you will find to be quite different. Hopefully you will be able to enjoy your music once more, even if it is now on silver discs. **DB**

**LOADSADOSH**

Hey fellas, it's upgrade time and I have three thousand hard grafted smackeroos to spend.

My present system is a Philips CD850, Yamaha K300 tape deck, NAD 3020 amplifier, Technics ST-ST4 tuner (I like the time facility) and a Rega Planar 3 for my occasional forays into a small record collection. All played through a pair of AR18 speakers on Kan 2 stands.

The present sound is very good but lacking in bass and imagery. The listening room is long with chairs facing one of the long walls. I mainly listen to CDs with a musical taste that is verging on the perverse - everything except heavy metal.

I like the CD and turntable and intend to spend the loot on speakers and amp. Am I right, and if so, what do I spend 1993 auditioning.

**Mr. P. Gillia, St Albans, Herts.**

You are right, the amp and speakers need upgrading most, assuming the K300 tape deck is of secondary importance and that you are satisfied with the tuner. All the same, £3000 is a lot of dosh, unless you go mental and get something like a pair of B&W 803s, which have huge bass and a very clear midrange, then drive them with something like a Chord SPM800 or 1200. This will burn up your budget and blow you away. Other speakers worth considering are TDL Studio 4s. They are better integrated than the 803s and might be preferable. **NK**

**THROTTLED**

My current system consists of Roksan Xerxes/Tabriz-zi/AT-



**Epos' ES11s offer a competent, musical performance.**

(Meridian 206B) and some speakers (Linn Kan II) which are bi-amped from a home made class A power amp. There is no pre-amp in the signal path - only a volume knob.

The problem is that CDs sound just slightly scratchy and abrasive (though not sibilant), over-emphasizing stray sounds such as finger movements on a stringed instrument. It's like a tonal over-emphasis in the upper midrange, but it varies between instruments. Strings sound as though they are being scraped with a rough stick. I've found the system rather stressful in the long term. Any

previously. Assuming that you are not hearing a particular trait of your amplifier, I suspect you are hearing more on the upper mid-range and treble than you did before.

Alternatively, the passive pot could be responsible for the emphasis in combination with the amplifier and the Kans. I don't want to depress you, but I think you may have bought the wrong speakers as well: the difficulty in being sure is that you don't mention whether you hear the nasties only from CD or also from other sources. Try a pair of the equivalently-priced ProAc Tablettes, perhaps. **EB**



**The Roksan Xerxes represents one of the best vinyl front-ends.**

OC7, Meridian 206B, Nakamichi Cassette Deck 2, Croft Micro pre-amplifier (and Ortofon T20 MC-transformer) with two Leak TL12+ power amplifiers powering a pair of Acoustic Research AR18BX.

Stands are home made (tubular steel construction) apart from a Target wall shelf for the turntable. Cables, from my student days, are QED Incon and 79 strand speaker cable. The Leak amps have been rebuilt by Glen Croft with modern "ordinary" (rather than high quality) parts and the loudspeakers were modified for bi-wiring. It is all installed in a sparsely furnished 11ft by 11ft room. Musical tastes encompass Rock, Folk and what I term Irish, by which I include anything from Mary Black to the Pogues.

At present I feel it gives a compressed sound, somewhat lacking in dynamics with poor bass definition. With well recorded material I get the impression that the system is being throttled somewhere along the line. I was considering splitting the budget (£2000) between a new power amp and loudspeakers, which is where I think the problems lie.

**Mr. M. Beeston,**  
Norwich,  
Norfolk.

Though I liked the somewhat dry AR18, like many others I was less happy with the BX-suffixed range. More natural partners would be one of the Snell designs - or Audio Note variants. The K or J would take up a third to a half of the budget you've allowed. If you want to bring your power amplifier up-to-date, an Audio Innovations First Audio should be high on your list. **EB**

### A-400 LET DOWN

This is the first time I have written to a magazine so I hope you can help me. My system consists of Pioneer PD75 CD player and a pair of Neat Petite speakers that are bi-amped using two Pioneer A400s.

Well, I think the A400s are letting the system down and would be grateful if you could recommend either valve, or solid state amps. I use QED interconnect and Linn K20 loudspeaker cable. I listen to Rock and Classical and any other tips on how to improve the system would be welcome.

My budget is around £1000.

**Mr. P. Lancaster,**  
RAF Akrotiri,  
Cyprus.

The A-400 has not, I have to admit, found as much favour with me as it did with other reviewers, since I felt its overall tonal performance was unbalanced, favouring hard and fast Rock more than anything else. Soon we shall be reviewing an A-400 tweaked by Tom Evans (Michell Iso, Alecto et. al.), so it may be worth hanging fire until we discover whether the improvement is the markedly better than the standard design as it is rumoured to be. I would also, as an initial measure, try alternative cables: some A-400 users swear by MasterLink, for example. When the Neat Petite was tried by Alan Sircom back in our August '91 issue they were found to be rather sensitive and Alan discovered that the best sound was produced with a 7.5 watt Audio Innovations Series 200 'First Audio' pre-power amp. combination. **EB**

### LOOKING FOR GAIN

I wonder if you could help with a query that centres around the importance of gain in power amplifiers - a term that is not often mentioned.

My current system comprises an Arcam 170 transport, Meridian 203 convertor feeding a Quad 306 power amp via a home grown passive pre-amp. The speakers being used are Castle Warwicks sitting on Linn Sara stands tied to the power amp by Mission solid core. The interconnects are DNM. I have had a chance to buy back a NAD power amp that I used to own and I have been wondering about trying out bi-amping. Since I moved into my new, larger listening room (19' by 12') I have started to notice the lack of deep bass in the 306, so I was thinking of the NAD as a bass amplifier.

The basic question is, can one bi-amp with two different power amps? Is the difference in output impedance and probably the gain of the two amps going to throw the frequency response way off linear? I can imagine that this might be a problem with the passive pre-amp.

I can see that there are two different ways of bi-amping - either feed left and right to separate amps and use the channels on each amp for bass and treble, or feed both amps left and right and use one amp for bass on both channels and the other for treble. Obviously I would have to do the latter. Have you any advice on modifying the Warwick's crossover to enable the bi-amping to take place? I am quite handy with a soldering iron and the speakers are way out of warranty. Is there an advantage in having the crossovers external to the power amps rather than inside the cabinet?

Thanks for the help and the excellent mag.  
**Dr. J. Allday,**  
Canterbury.

In theory you can bi-amp with different amplifiers, but you will have to gain-equalise them by putting an attenuating network in front of the most sensitive one. Output impedances will be low enough not to matter relative to those in the crossover

network. The impact of differing sound characters you will have to assess subjectively, but we'd expect the NAD to give bigger bass, so it should feed the bass/midrange units on either speaker.

Bi-amping splits the high and low pass sections of the crossover, as the diagram shows (this is not the Warwick crossover, by the way). In a two-way, this means splitting the low and high frequency components from each other at the speaker, running them back to the amplifier through separate negative lines, which demands two cables per speaker. Although each amplifier carries the full audio range signal, it only drives operating range of the drive unit it feeds, lessening intermodulations.

You can carry out such a modification yourself or get Castle to do it. We also suggest a bit of experimentation might be in order. Try

using solid core cable to the tweeter and heavier multi-strand for the bass/midrange unit. Replacing the electrolytic capacitors with good polypropylene types will also change treble character in particular. Which way around you configure the amplifiers is best determined by experiment, but devote one to both bass/mid units and one to the tweeter, rather than one to each speaker which would give the left and right speakers different characters. **NK**

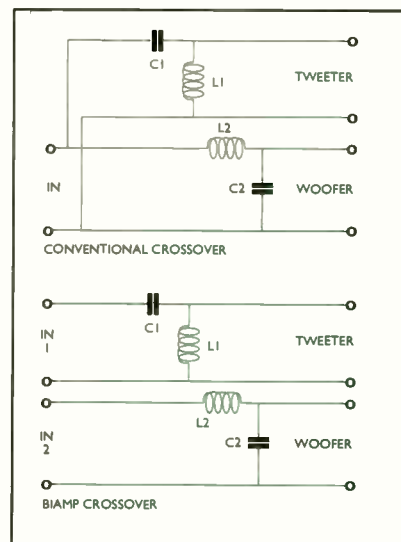

**General method for splitting a crossover for bi-wire operation.**

Castle Acoustics will adapt the crossover for you and fit a dual output terminal panel so you can bi-wire or bi-amp for a fee of £45. Contact them at Park Mill, Shortbank Rd., Skipton, N. Yorkshire BD23 2TT. TEL: 0756-795333. Mr Hill - Technical

### A to D LEVEL

At present I am attempting a project which will go towards the final mark in my A-level Physics course which I am studying at Aylesbury Grammar school. The subject that I have chosen to base my project on is a study of digital sound, its history and also the physics and electronics concerned with this particular project. More specifically A to D and D to A conversion, incorporating quantizing and sampling and a comparison between Compact Disc and DAT tape both of quality and practicality.

Any information that you could



supply me on helpful addresses or the above mentioned subjects would be most grateful.

**J. Orgill,  
Aylesbury,  
Bucks.**

One of our favourite technical bookshops is The Modern Book Co., 19-21 Praed Street, London W2 1NP, Tel: 071-402-9176. Recommended are The Art of Digital Audio by John Watkinson priced £49.50 or Principles of Digital Audio by Ken Pohlmann priced at £17.95, though this last does not have a lot to say on the principles of digital audio tape. Whilst Pohlmann is easiest to understand, Watkinson is a little more comprehensive and he also has a book on DAT. Good luck with the Physics exam.

#### ADDING ADD ONS

My current set up is Micromega Solo CD Pro, Audio Innovations LI/ Series 800 MK3 amplification, Nakamichi CR1E cassette deck, bi-wired Alphason Artemis speakers and a cheap 'n' cheerful Rotel tuner. Interconnect from CD to pre-amp is

Van den Hul MCD102-3 and pre to power is Audio Note AN-S.

My question is, although I find the sound of my system utterly captivating, how do I tweak it even more? I do not want to change any components but just add tweaks such as Vecteur cones, Townshend Seismic Sink, gold plated mains plugs, Sonic Link mains cables or a Lynwood mains Purifier. Would this bring about any gains in sound quality?

Which of the above do you feel justifies its inclusion in a system?

**J. Kavanagh,  
Belfast,  
N. Ireland.**

Primarily, I would suggest experimenting with a Seismic Sink. While somewhat sceptical about these things as a general rule, I have heard it make a noticeable improvement placed under such various items as a couple of Pioneer CD players - at opposite ends of the price range - a couple of amplifiers of different breeds and, as you'd expect, Max Townshend's own Rock turntable. I was even in a

group who thought we saw the picture from a perfectly ordinary VCR improve, but I don't mind if you don't believe me. The point, however (ahem!) is that the Micromegas have their own 'grounding' system and there is no guarantee that the Seismic Sink would work enough of its magic. If you can, try it at home.

Despite many attempts at persuasion, I have never noticed a marked difference using gold-plated mains plugs. Though mine do tarnish quickly, thanks to the London air becoming increasingly mucky, being a reviewer, they are 'wiped' by being unplugged fairly frequently. Their advantage, like gold-plated phono plugs, is that they retain their pristine sheen. If it's your mains that is 'dirty', however, it would be something of a waste of time. I have become a fan of dedicated power supply units, though there are none - as far as I know - for the particular items you have.

If you want to know whether a Lynwood - or Copenhagen - mains conditioner would be beneficial,

then I suggest another experiment. This costs nothing but time, but may be a bit tedious for your family, neighbours and pets. Pick a track or recording you know well and play it at different times of the day and night. If you feel the sound quality varies, then you will find a mains conditioner will make a difference worth the investment. All you have to remember is not to nip out for a pint of Murphy's or Guinness between whiles, or your judgement may become just a little clouded.

Finally, I note you possess a "cheap an' cheerful" tuner. Let me put in a little plug for this under-rated source. Even though you say you don't want to change your sources, add up what the tweaking costs and then go and listen to the Naim 02, the Audiolab 8000T or, at a little less, Quad's FM4. You might find a better sound - and certainly a lot of music - the Rotel hasn't enticed you with yet. **EB**

Yes, and spend some of the budget on an aerial too, since it is vital for good tuner performance. **NK ●**

## Coming in our June issue!

#### MERIDIAN 206ΔΣ

The two Greek letters denote the use of the Crystal chip that has been used to great effect by EMF and Quad. We listen very carefully to Meridian's CD Player.

#### MAGNUM

This new British amplifier boasts a strings of specifications, MOSFET solid state design and sixty six watts to worry the opposition!

#### KAL 211 - FIRST EVER REVIEW!

Dominic Baker hired some removal men to bring the KAL through the door and listens to this mighty integrated amplifier that uses 211 valves and costs a mere £12,500!

#### HOME THEATRE?

Its 'all the rage' or so we're told: Jonathan Jordan gives six Audio Visual amplifiers a comparison test on sound quality, what tricks they play and decides if these multi-channel beasts qualify as genuine hi-fi or just home entertainment!

#### DIY SUPPLEMENT NO 3

Accept no imitations, the original and best supplement is back with more features on tweaking, building and getting much, much more for less.

**UNIQUE** modification to the excellent QED Digit DAC that squeezes even more from this piece of affordable high-end.

#### PRE AMPLIFIER

We offer a high performance valve pre-amplifier to build at home!

#### DRIVERS

We group test mid range units and decide what's best for DIY!

#### KIT LOUDSPEAKER - PART I

The first half of the design for a kit loudspeaker with vivid clarity and imaging, using a unique high performance mid range unit and a Tonigen ribbon tweeter.

#### DENON PMA 250 III

This integrated amplifier aims to eliminate competition and establish itself as one of best entry level audiophile components for under £150!

*ALSO - Some interesting new products that are due for imminent release, but are too early to confirm.*

#### COMPETITION

Ribbon tweeters have made the Heybrook Sextet's gain acclaim for their razor sharp holographic imaging. They can make even a diehard electrostatic fan rethink, especially if room size and practicality are considerations! As our June competition winner you could form your own opinion on these beautifully built speakers!

ALL IN THE JUNE 1993 ISSUE OUT SOON.

# Hi-Fi World SPECIAL MAIL ORDER



## ANTI-STATIC RECORD SLEEVES

Translucent sleeves, treated to reduce static and dust attraction, supplied in packs of fifty. They will fit inside ordinary printed inners.

LP SLEEVES (50) .... PRICE £7.50

## NAGOAKA CD CLEANING KIT

Careful manual cleaning is the most effective way of removing surface contaminants. Nagaoka's kit includes a solvent and chamois leather pad to bring back a pristine shine to Compact Discs.

NAGOAKA CD CLEANING KIT  
£10.50

## AUDIO-TECHNICA GREEN CD RING STABILIZER

Detachable rings which fit around the circumference of a Compact Disc, which add a small but significant amount of mass, improving its stability when it rotates at high speed in the CD player. Improvements can include better focused images and a denser and richer sound.

GREEN RING STABILIZER (5)  
£6.50



## AUDIO-TECHNICA RECORD CLEANING SYSTEM

Removes both dirt and static; a tiny amount of cleaning agent in the handle removes fingerprints, oil and film, while a pad lifts off dust. Pad brush and fluid are supplied.

AUDIO-TECHNICA RECORD CLEANING SYSTEM ..... £10.50

## AUDIO-TECHNICA CD LENS CLEANER

A disc the size of a CD, with fine brushes - one of which is dampened with cleaning fluid. As the disc spins in the player, the brushes clean the laser lens. It may not suit all machines.

CD LENS CLEANER ..... £16.25

## AUDIO-TECHNICA ELECTRONIC STYLUS CLEANER

No need to touch that fragile stylus! Just rest it on the

vibrating pad and the cleaner will vibrate the gunge right off the tip. Powered by an AA battery.

ELECTRONIC STYLUS CLEANER ..... £19.95

## CD JEWEL CASE

To house and protect your CD.  
CD JEWEL CASE ..... £1.00

## LASAWAY GREEN PEN

When red laser light hits the reflective surface of a CD, some of it can be scattered off the edges of the disc, causing optical interference. Applying this green coating, formulated by Japanese company Mitsubishi, to the inner and outer edges of the CD reduces



## AUDIOQUEST LASER GUIDE

Laserguide is a silicone based treatment - not a cleaner - for CD which has a refractive index close to that of a disc's polycarbonate surface. Applied using a cotton cloth, it allows the laser to read the pits below the transparent layer more clearly. Openness and depth of sound are said to be improved, while Laserdiscs benefit with a sharper picture and less noise. one bottle treats approximately 300 CDs.

AUDIOQUEST LASERGUIDE  
£14.95

this interference, improving sound quality.

LASAWAY GREEN PEN ... £8.50

## HI-FI WORLD DRY STYLUS CLEANER

Keep your stylus sharp and bright for perfect tracking without using fluid. Cut a strip about the size of a matchbox striker off this sheet of card and draw it gently under the stylus from back to front.

One sheet of this card, with its aluminium-oxide micro-abrasive coating, should be enough to clean your stylus at least forty times.

DRY STYLUS CLEANER ... £1.95



## PIXALL MK II RECORD CLEANER

Made in the UK, this simple record cleaner uses a replaceable roll of sticky tape which lifts dust out of the groove. After use, the dirty length of tape can be peeled off, reducing the risk of any gritty particles picked up being ground back into the vinyl. When the tape runs out, a new roller is simply clipped in.

PIXALL MARK II ..... £10.75  
REFILL ROLLER ..... £2.75



# Hi-Fi World AUDIO ACCESSORIES

accessory offers



## ON STYLUS CLEANER

A simple but effective cleaning kit, consisting of a stylus brush and cleaning solution. Used carefully, it will keep your stylus sparkling.

**STYLUS CLEANING KIT**  
£2.50

## TDK HEAD CLEANING KIT

TDK's CK-A1 head cleaning kit offers two bottles of cleaning fluid, one for the heads, the other for the rubber pinch wheels, and cotton buds for applying them. The CK-TB kit has a single bottle of dual-purpose fluid.

**TDK HEAD CLEANING KIT CK-A1** ..... £5.50  
**TDK HEAD CLEANING KIT CK-TB** ..... £4.65.

## AUTOMATIC CD CLEANER

About the size of a portable CD player, this battery-operated disc cleaner spins the disc while two replaceable sponges clean it radially. Spray the CD with the cleaning fluid supplied, insert it into the



Record storage cubes

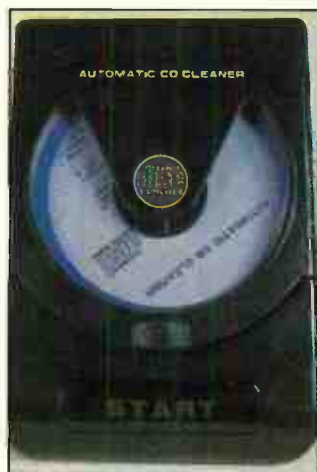

machine, and the cleaning cycle is completed in twenty seconds. Supplied with washable foam cleaning pads and cleaning solution (but not batteries) the cleaner can be powered by any standard transformer like those used for Personal with a 3v dc 350mA output.  
**AUTOMATIC CD CLEANER**  
£21.95

## RECORD STORAGE CUBE

Designed to hold about a hundred LPs, with an internal width of 37cm, height of 32.5cm and depth of 32cm. The cubes can be stacked or placed alongside each other - and are even strong enough to be used as seats! Made from 15mm MDF (Medium Density Fibreboard) with a smart durable black paint finish, the cube is supplied in flat-pack form ready for home assembly.  
**RECORD STORAGE CUBE** .. £42 EACH

## FREE!

**20 RECORD SLEEVES WITH 2 CUBES**  
**50 RECORD SLEEVES WITH 4 CUBES**

**6 CUBES FOR THE PRICE OF FIVE!** ..... £210

**8 CUBES FOR THE PRICE OF SEVEN!** ..... £294



## SORBOTHANE CD FEET

Four round rubber feet, 50mm in diameter and 18mm deep, made from an artificial form of rubber known as Sorbothane. These feet have the ability to soak up vibrations and improve sound quality by providing a platform for CD players or any hi-fi sensitive to vibration.  
**SORBOTHANE CD FEET** £27.95



# Hi-Fi World

## SPECIAL MAIL ORDER



### SWEATSHIRTS AND T SHIRTS

Printed with 'Hi-Fi World' and our slogan 'The Magazine for Enthusiasts' front and back to prove to everybody you read probably the best magazine in the universe.

**SWEATSHIRTS** ..... £12.00  
**HOODED TRACK TOPS** . £15.00  
**T-SHIRTS** ..... £7.99



### SOUND SWIVEL

A rotating, upright, double-sided, storage cabinet with space for up to 160 Compact Discs, including 8 double jewel-cases. Mounted on an all-steel turntable, it swivels smoothly through 360 degrees giving easy access to the storage compartments either side. Manufactured in durable MDF with a Black Ash effect finish, the Sound swivel comes packed for self assembly with full instructions.

**SOUND SWIVEL** ..... £49.95

### MICHELL ENGINEERING PLUGS

Craftsmanship marks out Michell Engineering's range of gold and rhodium plated plugs from the competition. Simple but elegant.

**GOLD-PLATED SIDE ENTRY BANANA PLUGS (4)** £10.00

**GOLD-PLATED SURE-LOC BANANA PLUGS (4)** £14.95

**RHODIUM-PLATED SURE-LOC BANANA PLUGS** £18.95

**GOLD-PLATED SPEAKER CABLE CONNECTORS** £10.00



### ARCAM RCA PHONO PLUGS

This heavy-duty phono plug, specially made in Japan to Arcam's specification, will accept cable up to 7mm in diameter. The body is nickel-plated, the contacts plated in gold. Supplied in pairs marked with either one ring or two to allow directionality to be taken into account.

**RCA PHONO PLUGS (4)** £15.50

### GOLD PLATED 4MM BANANA PLUGS

We have a new style, heavy-duty, gold-plated banana plug with a unique type of axial solderless connection for loud-speaker cables. The cable is stripped back and pushed into a clamping collar which is then screwed down tight, accepting cable up to 6mm external diameter and 4mm core diameter. Supplied in sets of four.

**BANANA PLUGS (4)** £8.00

### GOLD-PLATED SPADE CONNECTOR

A heavy-duty gold-plated spade connector for loudspeaker screw terminals with a unique axial clamp connector which requires no soldering.

**SPADE CONNECTOR (4)** ..... £10

## NEW FROM HI-FI WORLD!

### CD/MC TOWER

Ready built, the CD Tower is of all metal construction with slot-in side panels finished in either mahogany or black ash. Each of the trays slides out for access to the stored cassettes and discs. Total capacity is 160 CDs and 52 cassettes.

**CD/MC TOWER** £199.90



### LIFT JUMBO

This aluminium Compact Disc stacker holds seventy-five CDs, which can be flipped forward by the fingertips to display the insert. Browse through your CD collection without having to squint at the small lettering on the spine.

**LIFT JUMBO** £44.95



# Hi-Fi World AUDIO ACCESSORIES

## MATROW BIASBUG

A fascinating little device no larger than a hand-held remote which allows the user to adjust bias on any cassette deck perfectly for any tape. You can check the state of your cables and connections with it, too! Supplied with a cassette test tape and full instructions. (See review, Nov. 1992 issue.)

**MATROW BIASBUG** ..... £59.99

## AUDIOQUEST OPTICAL LINK Z

A wide-bandwidth, ultra-high performance optical cable for digital links such as that between CD transport and convertor. Available in 1m and 2m lengths with conventional Toslink connectors.

**OPTICAL LINK Z (1M)** ..... £69

**OPTICAL LINK Z (2M)** ..... £99



## AUDIOQUEST QUARTZ INTERCONNECT CABLES

A fully balanced analogue signal cable with heavy duty welded gold-plated phono plugs and advanced ultra-pure copper Quartz Hyper-litz cables using polypropylene insulation.

### AUDIOQUEST QUARTZ CABLE

**1 METRE LENGTHS** .... £79/PAIR  
**2 METRE LENGTHS** .. £120/PAIR

## KONTAK

An effective cleaning solution that removes contaminants from electrical connections. After application, a system regains its original life, sparkle and vigour.

**KONTAK** ..... £21.20

## HI-FI WORLD SPECIAL AUDIO ACCESSORIES ORDER FORM

Please send me:

- |   |                   |   |  |
|---|-------------------|---|--|
| CD sound swivel .....                                 | £49.95            | Michell Gold-Plated Sure-Loc Banana Plugs (4) .....   | £14.95                                       |
| Record storage cube .....                             | £42.00 each       | Michell Rhodium-Plated Sure-Loc Banana Plugs (4) .....  | £18.95                                       |
| Sweatshirt (state size and colour) (XL, L, M) .....   | £12.00 each       | Michell Gold-Plated Speaker Cable Connectors .....  | £10.00                                       |
| Hooded track-top (one-size) .....                     | £15.00 each       | Matrow Biasbug .....  | £59.99                                       |
| T-Shirt (state size and colour) (XL, L, M) .....      | £7.99 each        | CD/MC Tower .....   | £199.90                                      |
| Pixall MkII Record Cleaner .....                      | £10.75 each       | Lift Jumbo .....  | £44.95                                       |
| Pixall refill roller .....                            | £2.75 each        | <i>All prices include postage &amp; packing in the UK only.</i>   |  |
| Hi-Fi World Dry Stylus Cleaner .....                  | £1.95 per sheet   | I enclose cheque/PO for £ .....   | made payable to <b>Audio Publishing Ltd.</b> |
| Kontak cleaning fluid .....                           | £21.20 each       | I wish to pay by Visa/Access, please debit my account no:   |  |
| CD Jewel Case .....                                   | £1.00             | <input type="text"/> <input type="text"/> <input type="text"/> <input type="text"/> <input type="text"/> <input type="text"/> <input type="text"/> <input type="text"/> <input type="text"/> <input type="text"/> <input type="text"/> <input type="text"/> <input type="text"/> <input type="text"/> <input type="text"/> <input type="text"/> <input type="text"/> <input type="text"/> <input type="text"/> <input type="text"/> |  |
| Nagaoka Anti-static record sleeves .....              | £7.50 (50)        | Expiry date: <input type="text"/> <input type="text"/> <input type="text"/> <input type="text"/>  |  |
| Nagaoka CD cleaning kit .....                         | £10.50            | Name .....  |  |
| ON Stylus Cleaning Kit .....                          | £2.50             | Delivery Address .....  |  |
| Lasaway Green Pen .....                               | £8.50 each        | .....   |  |
| Laserguide .....                                      | £14.95            | .....   |  |
| Audio Technica CD Lens cleaner .....                  | £16.25 each       | .....   |  |
| Audio Technica Record Cleaning System .....           | £10.50            | .....   |  |
| Audio Technica Green CD Ring Stabilizers .....        | £6.50 (Pack of 5) | .....   |  |
| Audioquest Sorbothane feet .....                      | £27.95 (4)        | .....   |  |
| Audioquest Optical link Z .....                       | £69 (1m)          | .....   |  |
| Audioquest Optical link Z .....                       | £99 (2m)          | .....   |  |
| Audioquest Quartz cable (pair) .....                  | £79 (1m)          | .....   |  |
| Audioquest Quartz cable (pair) .....                  | £120 (2m)         | .....   |  |
| TDK Head Cleaning Kit CK-A1 (double bottle) .....     | £5.50             | .....   |  |
| TDK Head Cleaning Kit CK-TB (single bottle) .....     | £4.65             | .....   |  |
| Gold plated 4mm plugs .....                           | £8.00 (4)         | .....   |  |
| Gold plated spade connectors .....                    | £10.00 (4)        | .....   |  |
| Arcam RCA phono plug .....                            | £15.50 (4)        | .....   |  |
| Automatic CD Cleaner .....                            | £21.95            | .....   |  |
| Michell Gold-Plated Side Entry Banana Plugs (4) ..... | £10.00            | .....   |  |

N.B. If delivery address is different to the credit card holder's address please supply both.

Tel: .....

Please send completed order form together with your cheque/PO to:

**HI-FI WORLD,**  
64 Castellain Road,  
Maida Vale,  
London W9 1EX.



Credit Card Orders  
Telephone 071-266 0461  
Answerphone during evenings and weekends

# Specialist Hi-Fi Dealers

## REPAIRS & D.I.Y.

If you like the hi-fi equipment you have but want a better performance, don't change it - **UPGRADE IT!**

You can build better than you can buy and we offer kits, parts and instructions for everything from simple component upgrades to complete rebuilds, plus kits to build high end equipment from scratch..

### New upgrading service

If you are daunted at the prospect of taking the lid off your prize possession, send it to us and we can upgrade it for you. We will advise on cost and feasibility before starting work and upgrade to the level of performance you require and can afford. We have a secure, low-cost door to door collection and delivery service covering the UK and Europe plus a collection/delivery point in Manchester.

Upgrades to: Audio Research, Celestion, KEF, Krell, Linn, Meridian, Naim, Nytech, Quad, Leak, Radford ... in fact, EVERYTHING!

SEND NOW FOR FULL DETAILS AND A COPY OF OUR NEW 1992 COMPONENTS CATALOGUE.



**Russ Andrews Limited**  
Edge Bank House, Skelsmergh, Kendal,  
Westmorland, LA8 9AS.  
Telephone: 0539 83247.



## Lynwood Electronics

COLEY LANE FARM, WENTWORTH,  
ROTHERHAM S62 7SQ

Super Analogue Phono Stages	£95.00
Plinth Mounting Head Amp	£95.00
Valve Phono Stages	£295.00
Audio Mains Cleaners	Basic £59.95
	Advanced £149.00
	Mega £295.00
	Source £295.00

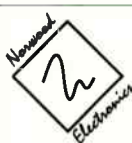

## Audio Components Catalogue

Everything for the DIY audiophile!

D/A Converters, Digital Filters and Interface IC's, Audiophile Op-amps, Capacitors, Resistors, Boxes, Optical devices/leads, Crystals.  
Kits for Power Amplifiers, DAC's etc.

Send today for our free catalogue of components, kits and application advice!

Norwood Electronics, Unit 8, Pinbush Rd, South Lowestoft Industrial Estate, Lowestoft, Suffolk, NR33 7NL.

## READERS!

Do you want to sell your second-hand goods, or are you looking for that special bargain?

Advertise in the cheaper and bigger Readers Classifieds section in Hi-Fi World.

### SPECIAL OFFER!

Now you can advertise in the Classified section for only **£10 (incl. VAT).**

Maximum length is thirty words; each additional word 50p extra.

### NEW!

Display ads -  
2cm box,  
£15 (incl. VAT)

Book your ad. for two consecutive months - we'll give you the second month's insertion free!

(This offer does not apply to Trade Advertisers.)

## Lockwood Audio

Tel: 081-207 4472 Fax: 081-207 5283

WE BUY AND SELL  
NEW, USED AND VINTAGE  
SPEAKERS, DRIVERS, CABINETS, PARTS.

SPEAKER REPAIRS  
THE

Authorised **TANNOY** Specialist

MAJOR CREDIT CARDS WELCOME



IMPERIAL STUDIOS,  
MAXWELL ROAD,



BOREHAMWOOD, HERTS. WD6 1WE

## GT AUDIO

Graham Tricker carries out professional repair & renovation work sympathetically to all types of classic Hi-Fi. Also a limited stock of classic equipment is available including LEAK, QUAD, RADFORD, CHAPMAN, GARRARD TROUGHLINE tuners and many other rare tuners. Original valves can be supplied ie: GZ32, GZ34, EL34, etc.

Tel: 0895 833099

## Audio South

We are probably the only specialist Hi-Fi Dealers who have recorded as well as listened to live music.

**0% INTEREST AVAILABLE ON MOST EQUIPMENT OVER 6 TO 9 MONTHS**

Please ring for further details

Dolby Pro Logic Surround sound through your Hi-Fi will give you cinema sound in your home.

"What impressed me most was Audio South's obvious love of music, the demonstration was both a pleasure and an education; certainly well worth a visit."

Audiophile with Hi-Fi Answers October 1990

**EX-DEM AND SECONDHAND EQUIPMENT AVAILABLE ON SPECIAL OFFER, RING FOR DETAILS**

**24 (The WoolMead) East Street, Farnham, Surrey GU9 7TT. Tel (0252) 714555**  
Open Monday-Saturday 11am-6pm. Closed Tuesday  
Demonstrations, preferably by appointment.

## VINTAGE AND VALVE HI-FI

Haden Boardman buys, sells, modifies & repairs all vintage hi-fi equipment.

Always quality hi-fi available, new and secondhand. Advice is free, phone if just for a chat. Credit cards accepted. Quick worldwide delivery, callers by appointment. Golden Dragons available ex. stock. Sorry but we are unable to answer queries in writing.

GARRARD 301/401 IN STOCK **Audio Classics**  
Tel/Fax: (0942) 57525 7 days a week

## HI-FI WORLD SPECIALIST DEALER DIRECTORY ORDER

BOOK 12 MONTHS FOR A 30% DISCOUNT!! OR 6 MONTHS FOR A 20% DISCOUNT.

I wish to be included in Hi-Fi World's Specialist Dealer Directory starting with the \_\_\_\_\_ issue For a total of \_\_\_\_\_ insertions

Please find enclosed my artwork/copy details. I wish to book \_\_\_\_\_ column centimetres at £12.50 per col. cm.

Name \_\_\_\_\_

Company \_\_\_\_\_

Address \_\_\_\_\_

Postcode \_\_\_\_\_ Telephone No. \_\_\_\_\_

Please return to: **Caroline Knott, Hi-Fi World, 64 Castellain Road LONDON W9 1EX**



# World Rock

A spate of interesting new CDs tempted the Editorial team into music reviewing. Here's what they found.



**PETER HAMMILL**  
**Noise**  
FIE 9104

The Institute of Mental Health, of which Hammill reputedly has intimate knowledge, was my first meeting with the man that Johnny Rotten dubbed the grandfather of Punk. Hammill requires - if not always relaxed - attentive listening. He's a jester who juggles curious, even disturbing visions - on this album backed by fittingly fractured and inventive musical arrangements.

Amazed to see this long termers suddenly appear on the racks again, I bought *Noise* without hesitation. It came as a surprise to learn that Hammill has in fact released thirty albums. *Noise* is a fine successor, strong in the unique style that is his, unrepentantly obscure and in a world of its own. I can only admire and appreciate artists like this; Hammill is an idiosyncratic loner peddling his own peculiar vision of the people and events that surround him.

The material on *Noise* ranges from the impenetrable to the immediately infectious: Like a Shot, the Entertainer is in the latter category. It's punchy from the start, the basic instrumental arrangement relying more upon the abilities of the musicians for its potency than the sort of technological inventiveness and construction wheeled out by Matt Johnson on *Dusk*. Hammill moves slowly up in intensity, bringing in backing singers, breaking the build up by a return back to the strong catchy theme, followed by another push upward, where his lyrical wheelings - free from repetition - demand interpretation. The man from The Institute of Mental Health is as fit as ever; *Noise* is a fine album. **NK**

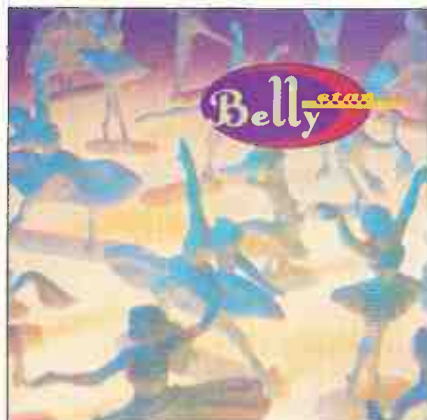

**BELLY**  
**Star**  
4 AD CAD3002CD

Tanya Donnelly is no newcomer to Rock music, initially playing in the shadow of her half sister Kristin, with the Throwing Muses. During her last year with the Muses she sang with Kim Deal of Pixies fame, in the all female band The Breeders. Lately her directional focus has sharpened up: she now writes, sings, plays guitar and manages her own band, Belly. The line up consists of the brothers Chris and Thomas Gorman on drums and guitar respectively, and Gail Greenwood on bass, although this position was filled until recently by Fred Abong, also from Throwing Muses.

Three singles have already been launched from her first album 'Star', including the superb track 'Feed The Tree' which is charged with energy and begs to be played loud. Tanya's voice lies somewhere between the hollow clarity of Sinead O'Connor and the cheeky suggestiveness of Bjork Gudmundottir from the Sugarcubes. It can vary from stomach twisting nervousness to powerfully etched clarity and back to timid innocence from one track to another, which makes the album a roller-coaster of emotion from start to finish.

The opening track, 'Someone To Die For', is devastatingly simple. Along with the first few tracks of the album, it's a slow introduction to her fabulously characterful voice. It conveys so much of her personality, you can actually picture the expression on her face as she sings. By the time you get to 'Every Word', the fourth track on the album, she is starting to warm up, the indie bass lines have appeared and we are into singles territory. 'Slow Dog', 'Low Red Moon' and 'Feed The Tree' form a solid heart to *Star*, affirming

that Tanya is now firmly in the spotlight - and that is where she intends to stay.

After 'Full Moon, Empty Heart' where she holds a high note beautifully, with all the grace of the best, she begins the wind down towards the final track 'Stay'. The phasey distortion on the guitar intro adds to the mystery of what has come before and it is all over too soon. Tanya's invitation to *Stay* is appealing. I wanted to! **DB**

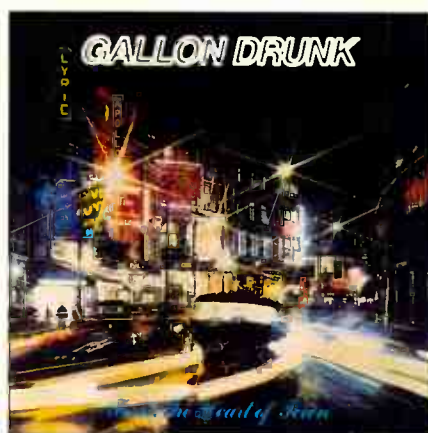

**GALLON DRUNK**  
**From The Heart Of Town**  
CLAWFIST HUNKA CDLS

I don't often impulse buy, 'cos like most people it seems, £14.99 seems a lot to waste on a CD that'll be heard once and be used as a high technology frisbee thereafter. The title 'From the Heart of Town' and a short blurb in *Our Price* Records was however enough to make me take a chance and buy this first album from Gallon Drunk.

It held a few surprises: 'Original' is the first description of its content that springs to mind, but as a smile spread across my face, fun qualifies too. *From the Heart of Town* is an energy charge, a virtual explosion, barely able to hold itself together with a cacophony of songs, sung with wild, croaking abandon by lead singer James Johnston. As the four piece band lurched along crazily and noisily, huge arrangements fleshed it with electric piano, fuzz bass and wailing saxes, all sinuously twisting and turning through a rich collection of sounds and invocations. I realised by the time I reached 'Living Alone', with its Hawaiian flavour, that this lot are delightfully outrageous, happy to collide with any musical style going and re-work it into their own, to produce a fascinating yet interestingly wrought melee guaranteed to entertain anyone, with the

possible exception of Sound of Music fans.

I couldn't easily find comparisons, but at times James Johnston reminded me of a less polished, perhaps more inebriated (is that possible?) reflection of Jim Morrison, on this album as much down on the floor as up above it. Gallon Drunk are like that; they fuse so much into their madcap antics and arrangements, injecting them with oodles of force and energy that this album sears its way out of the speakers. It's a rocker, that's for sure. NK



**SUZANNE VEGA**  
**99.9° F**

A & M 540 012-2

Suzanne Vega's latest album '99.9°F' is shortly to be complemented by a UK tour starting on 1st April at Poole Arts Centre and encompassing major venues nationwide. These are her first dates since 1991's 'Days of Open Hand' tour and judging by the content of this album they are dates that are not to be missed!

To break new ground, yet continue a natural progression from a list of successful albums is not easy, but I found 99.9°F easily fulfilled these criteria and more. The first track instantly shows a progression mainly in terms of the instrumentation. The carefully combined guitar and percussion form an excellently timed beat complementing her sharply focused vocals.

The haunting 'Blood Makes Noise' is enhanced by the hammering percussion and the wonderfully underplayed bass guitar. The theme of the lyrics also serve as an introduction to the messages that run through the album. The pace and nature of the music and lyrical content move from what could be termed as remnants and evolutions of previous styles, 'Blood Sings' for example, to what is totally new, uncharted and varied.

The moods and styles swing between tracks but the impact and the tenacity of the vocals coupled with superb instrumentation keep you alert and intrigued. The album has thirteen tracks, most around three minutes long but each gives a vastly different experience which makes the album such a multiple treat that it never allows boredom or the idea of repetition to creep in. JJ

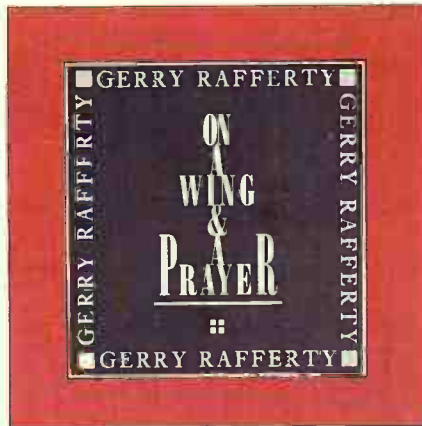

**GERRY RAFFERTY**  
**On A Wing And A Prayer**  
A & M 517 495-2

Gerry Rafferty has settled into a familiar style patterned by recurrent themes and litting but clever arrangements: Baker Street was a fitting classic, one that brought together the intensity and disappointments of the city woven into whimsical lyrics, with a sax break that has become imprinted into musical history. Rafferty doesn't move on, he simply remodels these themes in his own ornate and at times beguiling style; "city" assumes the same symbolic meaning on this album as it has done on predecessors.

For his audience, perhaps he needn't try harder - and here's both the strength and the limit of a man who once broke away from Stealers Wheel to forge his own distinctive folk idiom, one that brings folk into mainstream Rock. I'm appreciative enough to have bought every album, yet after the excellent 'North and South', 'On A Wing and a Prayer', with its over-fussy - even messily complex - arrangements is a mild disappointment. All the same, Rafferty fans won't be disappointed; I'm sure more of the same will be enough. NK

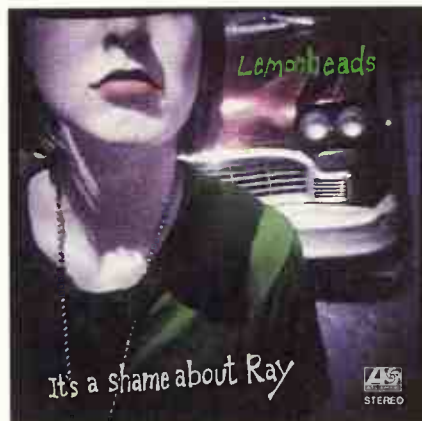

**LEMONHEADS**  
**It's A Shame About Ray**  
ATLANTIC 7567-82460-2

The Lemonheads have been around for six years now, but only recently have they made their climb to fame. It was initiated by a cover of Simon & Garfunkel's 'Mrs Robinson' (similar in many ways to what The Manic Street Preachers did with the Mash theme tune, 'Suicide is Painless')

which they originally recorded to accompany the video release of *The Graduate*. When Vice President of Atlantic Records, Danny Goldberg heard how good it was, the track was launched as a single, gaining success in the charts.

The Lemonheads are a true "sex 'n drugs 'n rock 'n roll" band, Evan Dando being notorious for his wild narcotic induced performances on stage. They are the kind of band that has become known through years of live performances, rather than an hour in a recording studio, which makes them true musicians, not extensions of the Nintendo computer sound culture. Evan expresses a hippy attitude to life, believing that everyone should live in harmony. He has other views that hark back to Sixties drug culture.

The album is very easy to listen to - calming in fact - and comprises a mixture of classic singles tracks such as 'It's a shame about Ray' and 'Buddy'; powerful, commercial rock. 'Ceiling fan in my spoon' and 'Alison's starting to happen'; and country style rock - 'Hannah & Gabi'. The music is quite simple in nature and the band follows a similar make up to REM - with real guitars, drums and excellent backing vocals from Juliana Hatfield. DB



**THE THE**  
**Dusk**  
EPIC 472468 2

Reviews have labelled Dusk as "dark and depressing". Perhaps; but that's Johnson; Dolly Parton is in a different rack. Matt Johnson drives his penetrating visions home with dry, cutting musical structures that sound barren, but have a disturbing starkness that can't be ignored. Johnson is Peter Hammill's modern equivalent, he pulls the same fractured pictures forward in time. Like his earlier albums, Dusk is a welcome disturbance. Following on from the excellent, but sinister album, *Mind Bomb*, Dusk continues the trend towards the acoustic and away from the electronic effects of *Soul Mining*. Johnson's lyrics, as always, require several attempts to completely digest but once this initial barrier has been passed the album opens out to be every bit as powerful as its forerunners. The The have become more cohesive over the years and are now an extremely professional act. NK





Edited by  
Jonathan Jordan

# The Music Pages

Floral Dance'. The Dirty Dozen's second track here, 'The Flintstones Meet The President' is an amazingly funky piece of work; check out the snare drum and tuba rhythm section if you want to be turned wild-eyed by a musical genre that sends most Rock fans into a catatonic trance. (The Rebirth Brass Band - not featured here - is also well worth investigating. Ever wanted to hear a mind-mangling brass arrangement of Michael Jackson's 'Shake Your Body?')

Elsewhere on this album you'll find straight R'n'B (Johnny Adams), Soul (Irma Thomas), Cajun (Beausoleil), Jazz (Alvin Tyler), along with various cocktails of all the aforementioned. Phillip Walker and Walter 'Wolfman' Washington, for example, provide two demonstrations of the skilful and tasteful way that musical styles can be fused in this part of the country without emerging as insipid, emotionally barren hybrids.

Last year I was lucky enough to catch a concert that featured many New Orleans artists and it for me was one of 1992's musical highlights. The music that made up that event, like that which constitutes this album, was an eclectic mix but one common thread linked it all together - a subliminal message that said if you don't want to have a good time give this part of America a wide berth. These are harmonious and agreeable sounds to uplift the spirit; so park your negative vibes on the back porch, take a large slug of Wild Turkey, put on your party hats and prepare to let the good times roll! ▶

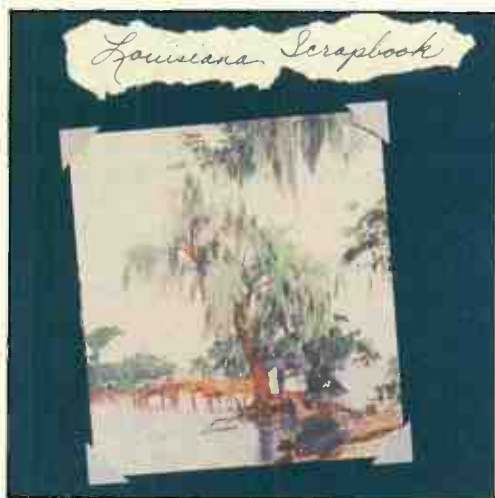

**VARIOUS ARTISTS**  
**Louisiana Scrapbook**  
RYKODISC RCD 20058 (Compact Disc)

● If you share my fascination for the music of America's Southern States - or even if you don't - you're certain to find something to savour in Louisiana Scrapbook. Even if you can muster some unimaginable excuse for not being open to any of the diverse musical compounds that emerge from this hot-bed of talent, you'll have trouble finding a valid reason not to appreciate the musicianship on this eighteen-track album.

The CD-only release opens with Professor Longhair's seminal party anthem 'Mardi Gras In New Orleans'. It's played here by one of only two brass bands that my hi-fi system will ever entertain, the incomparable Dirty Dozen Brass Band. This group is the only enlightenment necessary for those who imagine that brass band music begins and ends with 'The

## INDEX

### RECORD REVIEWS

#### ROCK & POP

Malcolm Steward ..... 83

Giovanni Dadomo ..... 86

#### JAZZ

Simon Hopkins ..... 87

#### CLASSICAL

Peter Herring ..... 90

### RECORD MAIL ORDER

..... 97

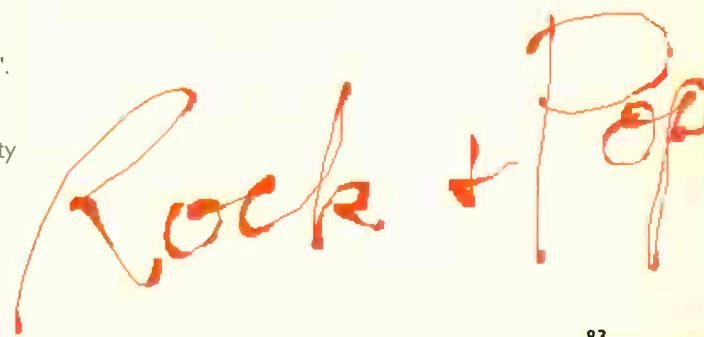
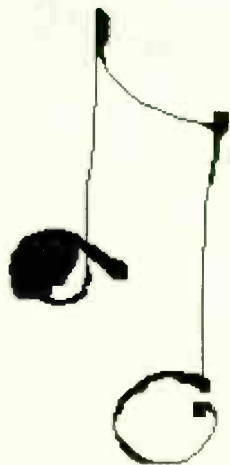

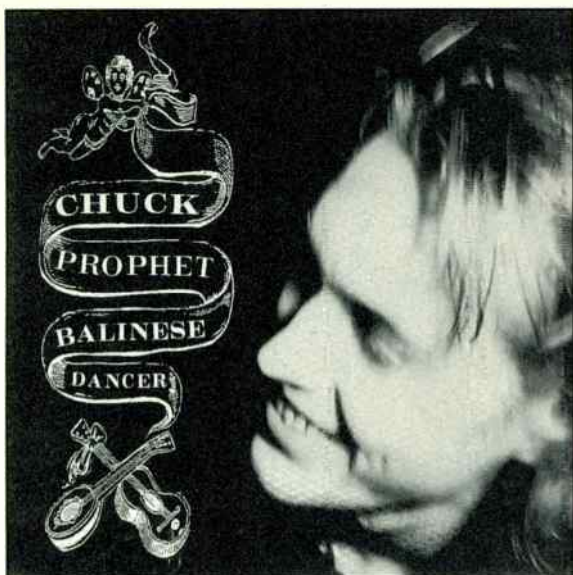

**CHUCK PROPHET**  
**Balinese Dancer**  
 CHINA RECORDS WOLCD 1031

● I was pleased to discover that Chuck Prophet remains a member of Green On Red, a band with whom I somehow managed to lose touch a couple of years back. Judging by the sleeve notes on their 1989 'Live At The Town And Country Club' ten-inch, eight-track LP, it seemed fair to assume that the band was having severe difficulties and might not pull through. They told that "This LP was recorded at the end of a European tour beset with disasters . . . exploding vans, storms in the channel, lawyers, liquidators, independent record companies domestic dramas, riots in Italy, traffic jams in Germany, the police in Greece, the Mafia in Sardinia, stolen equipment, out of tune guitars . . . and then the drummer left." In the final line the band thanked its creditors for being so patient. Things weren't looking good.

Since then, however, the band has continued to record and guitarist Prophet has released two solo albums. *Balinese Dancer* is the second and it shows a different side of his musical persona. Green On Red's appeal for me has always been its laissez-faire approach to songs: I have a particular soft spot for bands that leave the refinement and polishing to middle-aged MOR outfits like Genesis and Dire Straits and adopt the 'let's just get on with it and play' attitude that's always characterised the best Rock 'n' Roll. The album mentioned above epitomises that shambolic, energised charm. (I'll wager that Prophet's GOR cohort, Dan Stuart, has a shrine in his house where he worships Keith Richards.) *Balinese Dancer*, however, is a far less frenetic piece of work. Hell, it's almost laid-back in parts.

At times, Prophet's singing bears an uncanny resemblance to that of

Tom Petty. Musically, the album's more restrained, GOR's threadbare thrash giving way to tenderness and tinkly bits as Prophet swaps East Coast angst for West Coast cool. But while the music's energy is more controlled its gestalt remains far removed from the blissed out, rich, old LA fart onanism (stand up the boy who muttered Travelling Wilburys) that's

indigenous to the region.

Stand out tracks? Try 'Star Crossed Misbegotten Love', which starts out sounding like an anthem for navel contemp ators everywhere but evolves into a totally captivating slow groove made all the more seductive by Stephanie Finch's harmony vocals. And, on the subject of guest players, on the closing track 'Somewhere Down The Road', Chuck wheels Al Kooper out of whatever retreat he's been nibemating in, complete with his Hammond B-2. To make Al feel right at home, Prophet even puts aside his guitar awhile to tinker with a Mellotron. I wonder if he wore flares and a tie-die too?

Seriously, this disc is worth investigating even if you're not familiar with Green On Red-mode Prophet. I still prefer his wilder stuff but that hasn't stopped me from enjoying this album regularly since it arrived.

**JOHN CAMPBELL**  
**Howlin' Mercy**  
 ELEKTRA 7559-61440-2

● How can you ignore an album by someone who plays a National Steel (and Gibsons), and covers songs by Tom Waits and Led Zeppelin on the same disc, even if he does have a maniacally outré haircut? Hold on. Perhaps that last comment was unwise

and should be deleted. We're talking about John Campbell here, a man who claims that he paid his dues playing in places where if you didn't have a gun they gave you one.

Campbell started playing the Blues while convalescing from a teen-age drag racing accident: a telegraph pole brought his car to an abrupt stop but Campbell kept going, face first through the windscreen, sustaining serious injuries. Confined to his home after the plastic surgeons had stitched him back together, he passed the time by playing along to records by Howlin' Wolf, Muddy Waters and John Lee Hooker. It wasn't long before he was obsessed by the music. At the time Campbell admits that he couldn't express himself verbally and was becoming introverted. Playing the Blues proved to be his only release, one that he subsequently turned into a career.

His style is rough-edged, passionate and, unlike many contemporary players, he has a genuine feeling for his music that can't be gained from Play-In-A-Day manuals. Sample his cover of Tom Waits' mesmeric 'Down In The Hole' if you need convincing. Elvin Diablo's percussion - Coyote skull, bones, beads, bags, feathers and snake rattles - adds extra interest and atmosphere to his intriguing performance.

The track that follows, the standard, 'Saddle Up My Pony', with its minimalist National Steel opening bars giving way to an irresistible slow electric Blues groove, will win you over in the unlikely event that the first doesn't succeed.

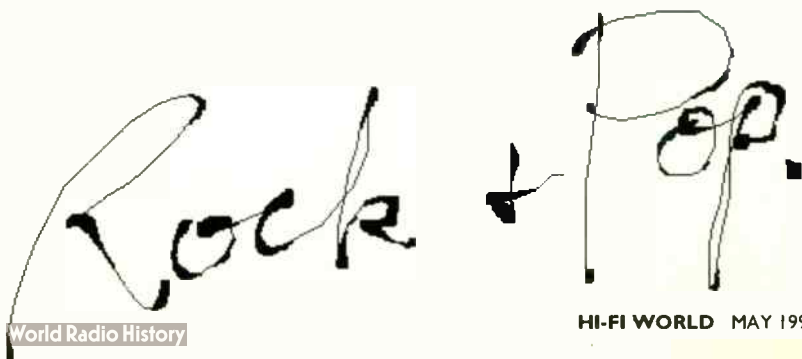
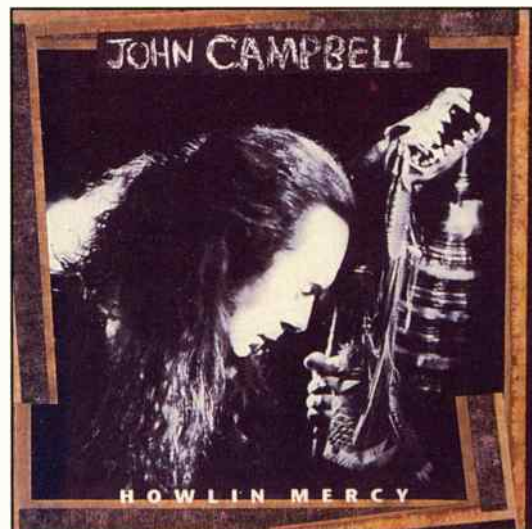



**OMAR AND THE HOWLERS**  
**Courts of Lulu**  
 PROVOGUE PRD 70452

● Omar Dykes and his band The Howlers have featured regularly in these pages. Quality albums like Omar's 1991 solo outing, *Blues Bag*, and last year's live band recording, *Live At The Paradiso*, have demonstrated that the singer-guitarist from Austin, Texas truly is one of the leading lights in contemporary Blues music. His newest album, this time a studio recording, does nothing to diminish his standing.

The album's title refers to a backwater juke-joint in Mississippi. Originally a night-club at the front of a motel court (the kind where rooms were normally rented on an hourly basis), the site was taken over by a woman called Lulu when Omar was in his teens. She planned to turn it into a laundrette. While the local women came to do their washing, their men-folk still came along for Blues and booze. It was in this oddball establishment that the nascent leader of the Howlers played his first gig, jamming with the old black musicians who made up

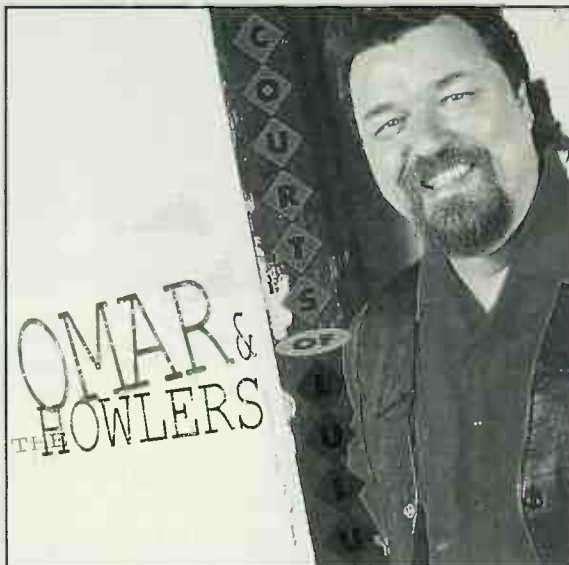

the resident band.

He refers to the Courts as a melting pot, a place where many musical styles - Blues, R'n'B, Rockabilly, Swamp Music and more - collided. To reflect its cosmopolitan atmosphere, which provided many of his early musical influences, he invited other musicians along to augment his usual trio for this album. You'll hear brass, organ, accordion, violin and percussion added to his regular arrangements for guitar, bass and drums. Strangely, though, there are no washboards.

Despite this fleshing-out the music remains typical Howlers' fare

- Southern States' bar-room boogie that's as spiced as Cajun butterfly wings. It's heady stuff with 'Rose Tattoo' thundering along like an Amtrak, 'Do It For Daddy' sounding like Credence Clearwater Revival on amyl, while 'False Faces' conjures images of Jan and Dean taking a wrong turn and surfing right into the bayou.

My favourite track, however, is the fourth, 'Pushin' Fire', where the band drifts deep into steamy Spooksville. This song has the same

tantalising menace as Dr John's 'Walk on Gilded Splinters'. Omar's voice and guitar weave a powerful spell here, his Fender alternating between piquant single string runs and swimming chords while his singing has the usual potent mix of Tequila and asphalt. Frosty Smith's eerie percussion and Danny Levin's haunting violin put the finishing touches to the backdrop of swampland mysticism that invades your living room. Just be sure to keep one eye open while indulging in your reveries in case the hoodoo man decides to come calling late one night!

**ED KUEPPER**  
**Black Ticket Day**  
 HOT 104CD

● Ed Kuepper has been writing and performing music for over fifteen years, quietly producing albums of high quality, maintaining an excellent international reputation, but never really gaining commercial success. And the man is so prolific - six albums in two years. Even though the big-payout hasn't arrived, he's one of the hardest-working musicians around. As a key member of The Saints - one of the most important of the Punk bands - Kuepper wrote the anthem 'I'm Stranded' (released before 'Anarchy in the UK') among other Punk classics. Although very different, his next band the Laughing Clowns were equally influential, blending Jazz-based improvisation with hard Rock innovation. As a solo artist, he became known as one of Australia's finest songwriters.

The opening track of *Black Ticket Day*, 'It's Lunacy' combines all these past elements with a current freshness. It's a great Pop song in The

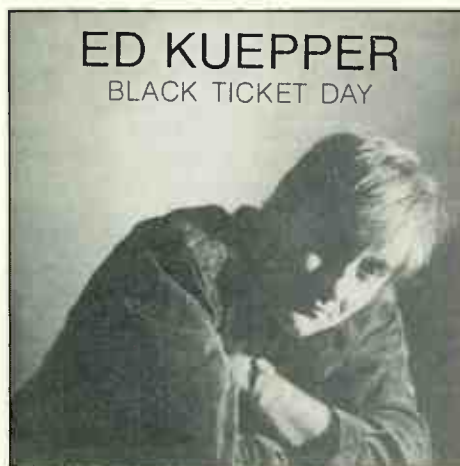

Laughing Clowns mould, with Kuepper demonstrating his uncanny knack for writing instantly memorable and pleasing melodies. Cryptic as the lyrics are - relating through impressions a relationship going sour - this is not frivolous Pop.

'All Of My Ideas Turn To Crime' is a ballad of marriage and murder; beautiful, haunting - and tormented. Like the previous track, Pedro Bull's piano steals the show and the whole

mood is enhanced by Tim Hopkin's saxophone. The real crime will be if this song is ignored by commercial radio, as given the state of things it's bound to be.

The single 'Black Ticket Day' follows. Kuepper's lyrics are abstract and impressionistic, but combining an up-tempo beat with a 'Pop' sound this is the nearest he comes to disposable Pop - but here it's by no means a bad thing.

All the tracks are highlights - there are no duds. Straight Rock, Ambience, Jazz

- and even Folk - all combine with beautiful melodies to produce a stunning album. Versatile as a songwriter and guitarist, Kuepper is one of the best musicians around - a certain West London record dealer calls him 'Mr God'. It can only be hoped the word will spread and he achieves wider recognition; some fame and wealth probably wouldn't go amiss either.

Theresa Bolster

# Rock + Pop.

Giovanni Dadomo



## RADIOHEAD Pablo Honey

PARLOPHONE 077 7 81409 24

● One of last year's best and grooviest singles was Radiohead's 'Creep', a gentle ballad with super lyrics, viz: "You're just like an angel/ your skin makes me cry" - Christ, wish I'd written that! Brave and bold and with a soaring vocal chorus, it marked the Oxford quintet as a band to watch and this debut long-player bears out that promise. 'Creep', which probably would have been a hit were it not for its inclusion of the F-word is, needless to say, a high light as is the subsequent 'Anyone Can Play guitar' which did indeed give the band the first of what will doubtless be a string of Top Forty placings. And love that line about "wanting to be Jim Morrison".

Radiohead, with three guitars, are the ultimate treat for the axe-fiends - check the rolling thunder of 'Ripcord', probably the best-ever re-write of Syd Barrett's immortal 'Interstellar Overdrive', or the mountainous 'Prove Yourself' which shows U2 up for the pretentious crap they are. This is the Stone Roses with muscle - check the gentle/hard contrasts of 'Blow Out' with the requisite Sixties feel suggested by the title (remember the movie?), for the record, the band are: Thom York (lead vocals, guitars, lyrics); Johnny Greenwood and Ed O'Brien (a so guitars); Colin Greenwood on bass and drummer Phil Selway. And guitars really are the operative word here. Produced by Boston meisters Sean Slade and Paul Q. Kolderie of Dinosaur Jr. and throwing Muses fame, this is what we in the trade call a stunning debut. It made me smile and it made me cry: there is no greater accolade. Truly, a band for the Nineties.

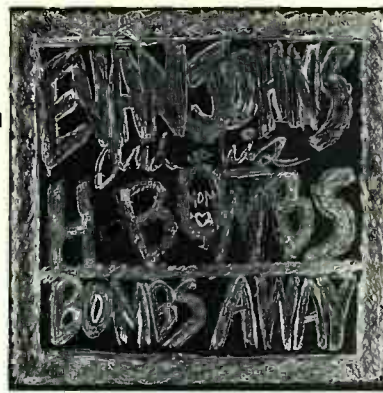

## EVAN JONES & HIS H-BOMBS Bombs Away

SPEEDO DOCS 9117

● The voice is that of a stoked-up Cajun, the sound is that of classic bar-band Rock 'n' Roll: nothing flashy, just tight as the proverbial fly's bottom that's just swallowed a cannonball, and hot and sweaty as a fresh-cooked taco. For this is the sound of Evan Johns and His H-Bombs, who live up to their name in that their music really is explosive and, with a bit of luck they could also be as radio-active as a Z Z Top or Huey Lewis.

Evan and his boys hail from Austin, Texas, which as any fule knows is one of the classic U.S. Rock 'n' Roll habitats, having given us such classic acts as Doug Sahm and Commander Cody, to name but two. They say that in these days of the recession record companies are relying more and more on acts with an established 'fan base', i.e. people who either sell a lot of discs of their own making or who can cut it live, and Evan's band are certainly of the latter category. For this is beer-chuggin' girl-huggin' Rock 'n' Roll in the classic mould. For sheer unpretentious enjoyment, I haven't heard such a pure, unadulterated fun combo in the proverbial age.

Take Evan's Noo Orleans tribute 'Oh New Orleans', a feisty rocker complete with rolling piano and a name check for any figure of note to ever come out of the fabled Crescent City - Fats Domino, Allen Toussaint, Satchmo, Art Neville - you name 'em and so does Evan. 'Boudie Man' is a slide guitar extravaganza with coll call and response vox; 'Pain Of Love' could hold its own with the best of Z Z Top and has a cool Augie Meyers-style keyboard undercurrent, while items like 'Dance, Frannie, Dance' give Chuckleberry a run for his money. There's rockin' Country items ('Poor Boy's Dream') and the hardest of boogies - 'Twister Country', with its walking bass line and bumblebee guitar solo. this is the third of four Evan Johns albums to date and this po' boy can't wait to hear the rest. Can't wait to see 'em live and cookin' too.



## 808 STATE Gorgeous

ZTT 4509-911002

● The tears of British Techno, perhaps, but does that make 808 State a part of a bygone age? (Assuming Techno died already; or was it ever alive?) Personally, I don't think it matters too much because what we have here is classic if ultimately ephemeral Britpop, but then 99% of all Pop is surely ephemeral by definition. This trio employ a vast -say fifty-odd, for details see the inner sleeve - array of electronic machines from primitive Moogs to state-of-the-art mod electricals. And they're a smart bunch of geezers, employing classic hits not so much as bitty samples but as re-making the best of the old with a sharp touch of the new. Hence smart re-cycles of, among others, UB40's 'One In Ten', 'She's Lost Control' from Joy Division, or Paul (Jam) Weller's 'Start'. And no, it isn't a simple rip-off, because this band certainly remake and remodel their source material so as to give it a new lease of life.

One thing I've always faulted in the whole Techno shtick is that it can go on a tad too long and become - if ya know what ah mean - a bit boring. Not so with the stuff here: 808 State are nothing if not masters of the smart coda - take the psychedelic other planet weirdness of the opening 'Plan 9', the (surely) tongue-well-in-cheek schoolteacher tail-off of '10 x 10', or the chiming church bell feel that closes 'Contrique'. At times they remind me of the Pet Shop Boys sans Tennant's vocals (a bad thing or not?) but there are strong echoes too of such gallant and enduring predecessors as Kraftwerk and Heaven 17, the latter at its most resonant on Ian 'Bunny Man' McCulloch's collaboration 'Moses', which borders on the sublime. Very nice indeed, and gorgeous frequently enough to live up to its title.

# Rock





**BUCKETHEAD**  
**Bucketheadland**  
 AVANT AVAN007

● London, late Autumn 1991. It's Company Week, improvising guitarist and godfather of British Free Jazz Derek Bailey's annual gathering of diverse musical spirits for the purposes of collective spontaneous music making. On stage: Bailey himself, electronics manipulator Paul Lovens, New York alto saxist John Zorn and the man in white face-paint and army fatigues with (seemingly) a waste paper basket on his head: Buckethead. Reactions to that first London appearance seem mixed now, two years on, but at the time there was no doubt that all but the most mean-spirited and cantankerous impro-bores at that gig were devastated by this bizarre young man's playing, a hugely distorted, pure HM guitar sound wrapping its paws around the most unlikely vicious and atonal splatterings of notes. A revelation.

A year later, producer-bassist Bill Laswell's Axiom label release the debut album by Praxis, a wild, virtuosic HM-funk-free jazz-prog Rock supergroup comprised of space-funk bassist Bootsy Collins and his fellow Parliamentarian organ grinder Bernie Worrel, Limbomaniacs drummer Brain, the Jungle Brothers' man at the turntables Af Next Man Flip, and at last on record (there'd been only a three or four minute cameo on a Henry Kaiser album eighteen months earlier) Mr Buckethead. I raved enough about that record at the time, and for me it remains one of the albums of last year, a simultaneously menacing and uplifting cut-and-paste tale of urban life and strife.

Six months on, and a half dozen or so releases into the life of John Zorn's own label Avant (Laswell, Zorn - the 1990s: the coming of age of musician-owned labels? Let's hope so), Bucketheadland, a debut album to

shout about. Ground rule 1: Bucketheadland documents this column's favourite kind of music, music-that-gets-called-jazz-because-nobody-knows-what-the-hell-else-to-call-it. Hybrid music. City music. Ground rule 2: Buckethead is either (a) very strange or (b) a very good actor. The front of this - not untypically for Avant - immaculately packaged double CD pictures Mr Bucket standing

in front of a decapitated fifteen-odd foot statue. The rear features a gruesomely decapitated Buckethead playing guitar in a junk yard. The sleeve notes inside kick off: "Bucketheadland is under construction. This recording is a preview of some of the things that will be. The theme to the park is the first thing you will hear: 'Buckethead was raised in a chicken coop'. This is semi autobiographical attraction." And onwards with a fine story of Bootzilla, the Bucketbots, Giant Robot, Virtual Reality and Willy Wonka.

Which should all give a fair picture of what you hear throughout Disc One of this set: a huge, hour-long collage of Buckethead's own personal Furies, with Heavy Metal, Free Jazz's own version of chaos theory, and super-funk (Bootsy Collins, the only other credited musician here providing all the appropriate groovy basslines and psychedelic commentary) all colliding in a purpose-built soundtrack for a visit to the theme park, a place which in turn documents the making of this record.

It's a recursive, self-referential loop to keep us all happy. Like Naked City, like Praxis, it's music for kiddies with big record collections and short attention spans. It's music for kiddies who know better than, or just can't be bothered, to not like monster flicks and Black Sabbath and Disney and The Texas Chainsaw Massacre and P-Funk and Hendrix. In form - idiomatic, episodic - the antithesis of so much Free Jazz; in intensity and imagination (not to mention virtuosity) its natural extension.

And then . . . there's Disc Two, a sixteen minute CD of dance remixes of stuff from Disc One, but about as sure to please the E-head lot as the originals will most regular, good ol' boy metalheads. Not essential, perhaps (and some might question why, at a total length of only 75 minutes, this package needs to be on

**Start here if you like the idea of a jazz guitarist who wears a bucket on his head; move on two pages for Chick Corea and Keith Jarret, who most definitely don't.**

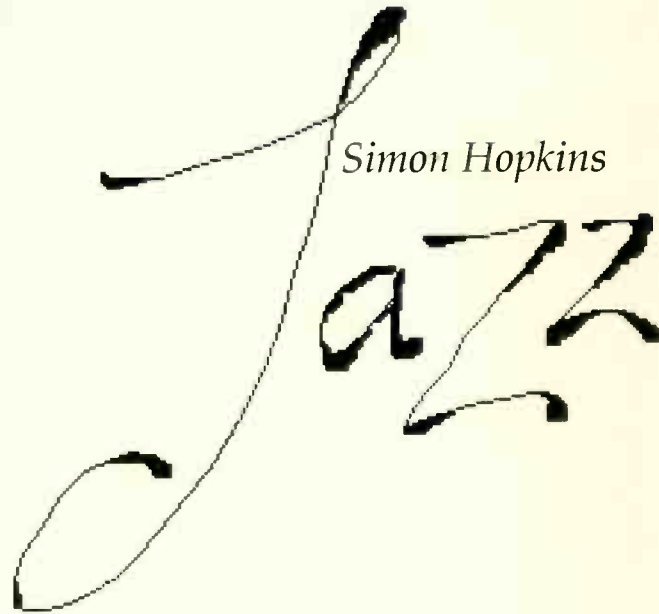

two CDs at all - but I doubt the bouncers at Bucketheadland would let in anyone who looked like the type to raise those sort of objections), but another side to Buckethead, and what with his association with Mr Bootsy, no doubt a side of which we'll see more.

And then . . . there's Buckethead's guitar playing, the equal in hybridity and scope from light-speed runs to lush balladic chording to harmonized white noise freak-out - to his own aspirations, and superior in technique to any gung-ho Heavy Metal speed-freak moron I can think of. One critic recently referred to him as a poor man's Joe Satriani, which only goes to prove the adage about many of my colleagues having padlocks on their ears; the quality of newness, of the unheard, of the revealed in Buckethead (and we're talking about a very young man here) is precisely what the staggeringly vast majority of HM players lack, and what consistently disappoints about them.

"The Irving Family wins a trip to the park before it opens. The next recording will document their trip. Stay around." Oh, we will, we will.

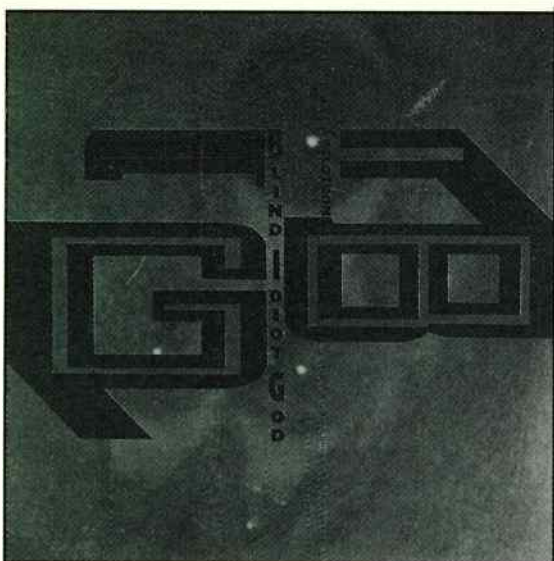

**BLIND IDIOT GOD**  
**Cyclotron**  
 AVANT AVAN010

● Also on Avant, and similarly (naturally enough) Zom-affiliated, not to mention similarly only-tangentially-jazz, second and long-awaited album from Blind Idiot God. BIG - a tidy little trio of Andy Hawkins (guitar), Gabe Katz (bass) and Ted Epstein (drums) - first came to my attention with their debut on Enemy Records, *Undertow*, a fine outing showcasing the kind of mix we go on about at length here. These noisy boys plainly knew their Husker Du and Sonic Youth, but the at-once tight but explorative nature of the instrumentals featured on *Undertow* made it quite plain that they knew a lot else besides, several songs shot through with a healthy dub reggae and Ted Epstein's frenetic drumming in particular hinting at the noisier end of Free Jazz.

And one by one, these suspicions have turned out to be just fied. An EP taken from *Undertow* featured a bonus track, the truly excellent 'Purged Specimen', which lurched from hardcore thrash to dub-funk and back again in the course of just four minutes or so (again, monster music for kiddies with no wish to have an attention span) and had Mr Zomo apparently blowing his brains out all over it. Then there was *Slan*, an all too ephemeral power trio (although us SF kids have all ingested the notion that the brightest star shines half as long) of said Messrs Zom and Epstein plus the radical NYC guitarist and composer Elliott Sharp. And then rumours of another shortlived group in which the BIG boys and Zom were joined by the latter's colleague from the inspirational Omette Coleman tribute *Spy vs Spy*, altoist Tim Berne, on a set of John Coltrane covers. And then a couple of Zom-penned, BIG-performed contributions to a French

double album of cartoon music. And then . . .

*Cyclotron*, a follow-up not just to *Undertow* but to all of this stuff, and a fine summation of all that this band can do, in a pure, stripped-down, collaborator-less form. The industrial onslaught of '747' and 'Broadside', the free-form grunge of 'Slackjaw' and 'Cold Start', the dub reggae of 'Ground Lift', 'Hangtime' and 'Dead Continent

Dub', the Chili Pepper punk-funk of 'Head On' and 'Easing Back', the solo-guitar, wall of (white) noise of 'Cloudcover' (Steve Hillage-meets-Glenn Branca anyone?): it's all in there, and in spades.

What really cuts about this lot though, is just how pure they remain, even at the heart of this maelstrom of eclecticism. Without Zom (directly) at the writing helm, the band have moved on from the jump-cut schizophrenia of, say 'Purged Specimen': now each song presents a fresh sound-picture, with a monomania at times reminiscent of our own grindcore behemoth Godflesh. Whatever, *Cyclotron* is a welcome reminder of just what a fine band Blind Idiot God are; let's hope we don't have to wait so long for their next appearance on wax.

rising Fusion keyboardist Jan Hammer and ex-Miles drummer Jack De Johnette, plugged his guitar into a fuzz box and a wah wah pedal and recorded 'Timeless', as fine a slice of European Jazz Rock as anything recorded by Terje Rypdal or Mahavishnu of The Soft Machine, a record which wholly denies the smug critical hegemony over the naughtiness of fusion. A brooding, intense session, not so much blending Jazz and Rock as pummeling them together with a jack hammer.

Over the years, Abercrombie has recorded in largely different contexts, in hard bop duets with John Scofield, in pastoral, even proto-New Age settings with twelve-string and Classical guitarist Ralph Towner, and, for the last few years, in a regular trio with double bassist Marc Johnson and former Weather Report drummer Peter Erskine. This last group, sometimes augmented by tenor and soprano saxist Mike Brecker, has been a crisp, integrated unit that's turned in some fine post-Bop/Fusion that's enjoyable, if hardly groundbreaking.

But with former Scofield sideman Adam Nussbaum on drums and Dan Wall installed at the mighty Hammond B3, *While We're Young* sees the return, in form and spirit, of the John Abercrombie of *Timeless*. Put simply, this is the finest - no, not the finest, the rawest, most explorative - set that Abercrombie has laid down in a long time. The component parts of the guitarist's own approach haven't changed substantially, the Be-Bop lines - culled from Jim Hall, Wes

Montgomery and the rest are still fed through the sort of post-Miles filter that's served Scofield so well, and his basic guitar sound remains that which he's used throughout most of his Eighties output, distorted, but only just. In fact it's difficult to put your finger on exactly what's changed in Abercrombie's approach, but there's no doubt that while Nussbaum's not one tenth as skilful a drummer as Erskine, he's got a tad more aggression, and Dan Wall makes fine use of

the Hammond, and between them they've got the guitarist into a fiery old state.

Overall, this is a highly accessible set of Jazz Rock, rhythmic, tonal - predominantly modal - and covering entirely known ground, but nonetheless one which bears considerable repeated listening.

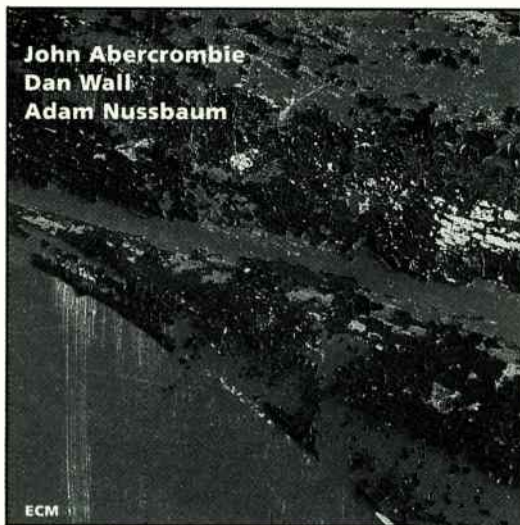

**JOHN ABERCROMBIE**  
**While We're Young**  
 ECM 517 352-2

● A long time before *Naked City* or *Alboth!* or *Praxis* or any of these wonderful people started making a joyous racket, the American guitarist John Abercrombie hooked up with



## CHICK COREA THREE QUARTETS



### CHICK COREA Three Quartets

STRETCH RECORDS/GRP GRS00032

● Finally reissued on CD, albeit with altered artwork. *Three Quartets* is a fine example of that curious thing, 'acoustic fusion'. Through the course of these three pieces Corea on acoustic grand, Eddie Gomez on stand-up bass, session superstar Steve Gadd on drums and Mike Brecker on tenor demonstrate the sort of skills that have made them legends among would-be fusioners. Despite the prospect of slickness overkill, Corea's strident, intense compositions keep everything this side of the fuzak tumpike, and Brecker in particular is on furious form, showing why he's been hailed in some quarters as Coltrane's true heir.

As a bonus, the CD features four extra songs, previously unreleased, of which Charlie Parker's 'Confirmation' is worth the re-issue alone, with Brecker and Gadd locked into a ferocious duet worthy of association with Bird.

### KEITH JARRETT/JACK DE JOHNETTE

Ruta And Daitya  
ECM 513776-2

● Another highly enjoyable re-issue, and certainly indispensable. 1973's *Ruta and Daitya* documents the coming together of two sidemen from Miles' late Sixties band, two of the most influential Jazz musicians of the last twenty years: drummer Jack De Johnette and pianist, multi-instrumentalist and composer Keith Jarrett.

The latter's become world famous for his impressionistic acoustic solo piano recordings in particular, but back in '73 he was still fooling around with the electric piano and even with synthesizers (though they remain uncredited here), and far from the aridity you might expect from a keyboards-drums duet, *Ruta* sparkles

with vitality. Jarrett's Gospel influence has seldom been more evident, and the duo's experimenting with sundry flute and ethnic percussion presages the whole boom in world-music collaborations of a couple of decades later. And with the longest song clocking in at just eleven minutes, Jarrett's grandiose, multi-LP side ambitions are kept in check.

Eclectic, spirited, moving; a timely reminder of just

why Jarrett became one the most popular musicians in Jazz history.

### ALBOTH! Liebefeld

PDCD CDPDP 112

● A brief mention for the second (to my knowledge at any rate) outing from the Swiss pianist Peter Kraut's improvising noise merchants Alboth!. Kraut has already appeared, albeit elliptically, in this column; he guested on 'Love', the Bacchanalian marathon that formed the centrepiece of last year's studio debut from the London-based Jazz-inclined industrialists God. Rumour had it that at the end of that session, Kraut wandered into the mixing room with his knuckles bleeding. Well it'd be nice to think that the Rock and New Music counter-culture go in for outlandish apocrypha as much as the Pop mainstream, but on the evidence of much of the music on *Liebefeld*, it doesn't take too much disbelief-suspension to imagine that Kraut

is unafraid to wear its influences on its sleeve: the wailing saxophonics recalling the American 'New Thing' - particularly Albert Ayler and Pharoah Sanders - as much as any European players; the stop-start, lurching structure an obvious nod in the direction of the New York deconstructivists, although without their idiom-melding tendencies; and - the electric bass aside - the general feel of the band that of a much earlier European Free Jazz acoustic group (Peter Brotzmann's Machine Gun group spring to mind) happily trying to make more noise than ten Rock bands.

In point of fact, there's more than one God connection at work here. The album's been produced by that band's vocalist, saxophonist and general prime mover Kevin Martin, and although Liebefeld is a million



miles from anything that Martin's recorded with one of his own bands, it's nonetheless got his stamp all over it: the painfully close-miked fuzz bass, the saxes mixed high and inescapably in your face, the piano dry and claustrophobic, and proceedings sounding generally as though a lot of material has been fed into a sampler and hacked up a bit. It's an approach that's obviously worked; even at its most frantic, the improvising never gets chance to turn onanistic, and you get the feeling that, within context, every bit of wild thrashing about contributes to the whole picture. A challenging piece of noise, but a good old blueprint that a lot of Europe's younger Free Jazzer's could do worse than using.

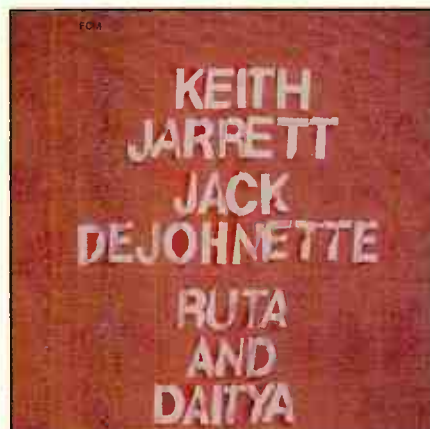

genuinely has left his blood splattered over the keys of a Steinway grand at some point in his career.

A piano-electric bass-drums-sax quartet, Alboth! make a fine old part-written, part-improvised racket, which





# Hi-Fi World Dial-a-Dealer

## AVON

V AUDIO, 36 Druid Hill, Stoke Bishop, Bristol, B59 1EJ. Tel. 0272 686005. ATC, Acoustic Energy, Ruark, AVI, Exposure, Pink Triangle, Wadia, Audio Innovations, SME, Chord Amps, Michell, Demos by appt only. home trial facilities, free install. service facilities.

## BERKSHIRE

NEWBURY AUDIO, 2 Weavers Walk, Northbrook Street, Newbury, Berks, RG13 1A1. Tel. 0635 33929. Linn, Creek, Epos, Denon, Nakamichi, Shahinian, Marantz, Micromega, JPW, Ruark. Single speaker dem room. Appt. necessary, Home trial facilities, free install. service dept, late appts. Access/Visa, interest free credit subject to status. 6 days 9.30am - 6.00pm.

READING HIFI CENTRE, 4 Queen's Walk, Reading RG1 7QF. Tel. 0734 585463. "The best equipment, advice and service from Berkshire's premier Hifi emporium". Products include: Arcam, exposure, Audiolab, Meridian, Rotel, Sony, sennheiser, Top Tape Centre, and many more.

## BUCKS

DEJAC HIFI Consultants, 21 the Broadway, Old Amersham, Bucks, HP7 0HL. Tel. (0494) 433173. AMC, Arcam, Bose, Meridian, Quad, Denon, NAD, Tannoy, Mission, TDL, 2 dem rooms, Appts necessary, Free installation, Tricity finance, Instant credit, open 9.30-5.30 pm. including Saturdays.

## CAMBRIDGE

CAMBRIDGE HIFI, 1-3 Hawthorne Way, Chesterton, Cambs. CB4 1AT. Tel. 0223 67773. Kenwood, Pioneer, Ariston, Kef, Technics, Yamaha, Marantz, B&W, AR, Mordaunt-Short, Bose. Single speaker dem room. Tues-Sat 9.30-5.30pm. Closed Monday. Free install, service dept. Vis/Access credit facilities.

STEVE BOXSHALL AUDIO, 41 Victoria Road, Cambs. CB4 3BW. Tel. 0223 68305. 10.00-6.00pm 6 days. 3 dem rooms. Denon, Rotel, Yamaha, Mission, Nakamichi, Tannoy, Audiolab, Marantz, Krell, Martin Logan, Magneplanar, Wadia. Home trial facilities. Appointments preferred. Free install. and service dept. Access/Visa.

AUDIO FILE, 2 Foundry Walk, Market Hill, St Ives, Cambs. Tel 0480 66123. Linn, Naim, Rega, Quad, Cyrus, Arcam, Musical Fidelity, 9.30am-6pm 6 days. 0% credit.

DEFINITIVE AUDIO, Tel. (0602) 813562. For a carefully considered approach to building a true high fidelity audio system with components derived from the following manufacturers: Audio innovations, Snell, Wadia, Micromega, Deltec, Voyd, Systemdek, SME, Revox, Impulse, Ortofon, Pioneer. Also the remarkable Living Voice Air Partner loud speaker system. Demos by appt. Please phone for further details, install. free of charge. Mon-Sat 10.00-7pm. Closed Wed a.m.

## CHESHIRE

DOUG BRADY HIFI, Kingsway Studios, Kingsway North, Warrington, Cheshire, WA1 3NV. (0925) 828009. "Largest choice of specialist hifi in NW. All credit cards 3 dem rooms. Fair demonstrations and home trial facilities. Open 6 days.

## CORNWALL

ART OF MUSIC, nr. Launceston, Cornwall, Tel. 0566 86649. AC Magnum, Basis, C.A.T., Cogan Hall, Diamond Acoustics, Grahams, Groove Tubes, Lumley Reference, Moth, Magnum Dynalab, REL Acoustics, Silver Sounds, Transfiguration. Dem Studio appts necessary, home trial facilities, free install. open 7 days.

## GLASGOW

STEREO STEREO, 278 St Vincent Street, Glasgow, Scotland. Tel 041 248 4079. Closed Tuesday. Installations throughout Scotland. Credit facilities available.

## HAMPSHIRE

AUDIO SOUTH, 24 (The Woolmead) East Street, Farnham, GU9 7TT. (0252) 714 555. Audio Innovations, Audio note, Deltec, JPW, Marantz, Rotel, Teac, Voyd, Hifi and audio visual dem rooms. Evening appts available. Home trial facilities, free installation. Access/Visa, 10.30-6.30 Mon-Sat, Closed Tuesday.

JEFFRIES HIFI (Portsmouth) 29 London Road, Portsmouth PO2 0BH. Tel. (0705) 663604. Individual dem rooms. Full credit facilities. late night Wednesday, Closed Mondays.

HAMPSHIRE AUDIO LTD., 2-12 Hursley Road, Chandlers Ford, Hants SO5 2FU. (0703) 252827/265232. 3 hifi and 2 home cinema/surround sound dem studio's. Thurs late evening, closed Mondays (except in December). Service dept on site (2 yr guarantee). Large free car park - junctions 4 (M27/M3), 5 (M27), 12 (M3) and 13 (M3) all within 3 miles, est. 1969.

## HEREFORDSHIRE

ENGLISH AUDIO, 95 Whitecross Road, Hereford, HR4 0DG. (0432) 355081. Musical Fidelity, Arcam, Pink Triangle, Denon, Marantz, Mission-Cyrus, A.J., Rotel, NAD, Nakamichi, TDI and others. Single speaker dem room, home trial facilities, free installation, service dept, Access/Visa, Credit arranged. Open Mon-Sat, 10-6pm.

GOSPEL MUSIC AUDIO, 32a High Street, Kington, Herefordshire, HR5 3BJ. (0544) 230254. Aphason, Alison, Revolver, Luxman, Yamaha, QED Audio, Systemline.

## HERTFORDSHIRE

RADLETT AUDIO, 141 Watling Street, Radlett, Herts, WD7 7NQ. Tel. 0923 856492. Mark Levinson, Proceed, Proac, Magnepan, Martin Logan, Tube Technology, Teac, Roksan, Audiolab, Stax, Systemdek, Jardis, Copland, ATC, Audio Alchemy, AVI, EAR, Sumiko, Quad, Sonus Faber, Home trial facilities, free installation, Service Dept. Visa/Access 9-5.30 Mon-Fri 10-5.30 Sat.

STUDIO 99, 79-81 Fairfax Road, Swiss Cottage, London, NW6 Tel 071 624 8855 or Fax. 071 624 5315. Linn, Naim, Meridian, Rega, Quad, Nakamichi, Mission/Cyrus, Kef, B&O, Yamaha, Creek, etc. 2 single speaker dem rooms. Appts necessary. Home trials, free installation, Visa/Access, 10-7pm Mon-Fri, 10-6pm Saturday.

## KENT

ASHFORD, SOUNDCRAFT HIFI, 40 High Street, Tel. 0233 624441. Seeking music lovers, male or female any age, to share common interest ie. Multi room, Home Cinema etc. Attractive unusual equipment in unusual setting, your place or ours, we guarantee lasting pleasure. Open Monday - Saturday. Appointment service or just pop in. Bada dealers.

PANATEC SOUND & VISION CENTRE, 83b High Street, Gillingham, Kent, Tel 0634 573141. B&W, Bose, Dual, Kenwood, Marantz, Pioneer, Philips, Sony, Tannoy, Technics, etc. Dem room facilities 0% credit, service dept, free install, Pioneer reference point dealer.

PANATEC SOUND & VISION, 17 week Street, Maidstone, Tel 0622 661488. (See above for details).

VOLUME ONE, 41 Upper Wickham Lane, Welling, Kent, DA16 3AD. 081 304 4622. Arcam, Dual, Epos, Exposure, JPW, Marantz, Micromega, Nakamichi, Pink Triangle, Rotel, Ruark, Royd, Sony, Systemdek, Alchemst, Celestion, B&W. Large dem room, no appts necessary. Evening dems in shop by appt. Home trial facilities, free delivery and installation. Access/Visa. 10.00-6.00pm Mon-Sat.

KIMBERLEY HIFI, 193 Broadway, Bexleyheath, Kent. Tel 081 3043272. Pioneer, Technics, Kenwood, Denon, NAD, Aiwa, Tannoy, Mission, Rotel, Wharfedale, Castle. Separate dem room, no appt necessary. free installation, service dept, instant credit facilities. no early closing.

## LANCASHIRE

HB AUDIO CLASSICS, I buy, sell, modify and repair all vintage and valve hifi equipment. Advice is free. Phone if just for a chat. Credit cards accepted. Quick worldwide delivery, callers by appointment. Tel/fax. 0942 57525. 7 days a week.

NORMAN AUDIO, 131 Friargate, Preston, Lancashire, PR1 2EE. Tel. 0772 253057. Fax. 0772 562731. Marantz, Pioneer, Yamaha, Audiolab, Arcam, Mission, Cyrus, B&W, Kef. Send for your catalogue. Home cinema dem room plus three sales areas. no appt necessary, free install. service dept, instant credit subject to status. Open 9.30-5.30, late night Wed - 8pm.

## LEICESTER

LISTEN INN, 6 Hotel Street, Leicester, Tel. 0533 626097. Wide range of records and accessories stocked. Our commitment to standards of service is apparent to our satisfied customers. Two dem rooms and free home install service available.

## LONDON

BABBER ELECTRONICS, 158 Uxbridge Road, West Ealing, London, W13 8SB. (081) 579 6315. Akai, Aiwa, A&R, Celestion, Dual, Goodmans, Harman Kardon, JBL, JVC, Kenwood, Marantz, Panasonic, Sennheiser, Sony ES range, Tannoy, Technics, Wharfedale, Yamaha.

DOUG BRADY HIFI, 18 Monmouth Road, London WC2H 9HB. Tel. (071) 379 4010 or (071) 479 1346. Fair demonstrations and home trial facilities. Wide range of top specialist hifi from Britain, America and Japan. Open 6 days.

HIFI & COMPONENTS, 84 Battersea Rise, London, SW11 1EH. (071) 223 1110. Tannoy, NAD, Rotel, Bose, Dual, QED, Wharfedale, Jamo, Micromega, Celestion, Kenwood, Ortofon, Infinity, Shure, to name but a few! Established over 27 yrs. No appts necessary. Home trial facilities. Service dept. 9-5.30 and evening dems.

BILLY VEE SOUND SYSTEMS, 248 Lee High Road, London SE13 (081) 318 5755. Arcam, Linn, Naim, Quad, Creek, Cyrus, Marantz, Nad, Rotel, Rega, Denon, Yamaha, Tannoy, Mission, Micromega, Heybrook, etc., 2 dem rooms, instant free credit, Access/Visa, Closed Thursdays.

THE LISTENING ROOMS, 161 Old Brompton Road, London SW5 0LJ. (071) 244 7750/59. Fax (071) 370 0192. Linn, Quad, Meridian, Nakamichi, Arcam, Audiolab, Acoustic Energy, SME, Audio Research, Krell, Wadia, Theta, Micromega, Apogee, Martin Logan, Revox, Rogers, Pioneer, Tannoy, Systemdek, Stax, Pink Triangle, Michell, Monitor Audio, Yamaha, Marantz, Kef, Bose, Celestion, Epos, Mission, Denon, Neat Petite. Mon-Sat 10-6pm.

ZEBRA, 18-24 Brighton Road, South Croydon, CR2 6AA. (081) 6882093. Rotel, Nad, Technics, Philips, Aiwa, Kenwood, Tannoy, Wharfedale, MA Infinity and large range of A V equipment. Single speaker and comparator demo in a more casual environment. Service Dept. Mon-Sat 9.30-6.00. Access/Visa. Instant Credit upto £1,000 subject to status.

THE CORNFLAKE SHOP, 37 Windmill Street, London W1. (071) 631 0472 (domestic). (071) 323 4554 (multiroom). Fax (071) 436 7165. Tues-Sat 10-7 Rega, Roksan, Naim, Monitor Audio, Arcam, Nakamichi, Rotel, Epos etc. 3 dem rooms (incl. home cinema) Friendly professional service. Home trial facilities, appts preferred. Full delivery and repair service. Multiroom specialists. Access & Visa.

## GREATER MANCHESTER

THE AUDIO COUNSEL, 12 Shaw Road, Oldham, Manchester, OL1 3LQ. Tel. 061 633 2602. Linn, Arcam, Naim, Yamaha, Rotel, Micromega, Creek, Nakamichi, Denon, JPW, Marantz. 3 dem rooms, free install, Visa/Access, Licensed credit brokers up to £1,000 instant credit. 10.00-5.30pm Mon, Tues, Wed, Sat, 10.00-7.00pm Thurs & Fri.

BILL HUTCHINSON HIFI, 50-52 Deansgate, Manchester M3 2FE. (061) 8321600. For the largest selection of HiFi and audio visual equipment in the North West. Specialist A.V. demonstrations of the highest quality. Best prices guaranteed. Minimum 2 year warranty and an optional 5 yr guarantee available. Instant credit and mail order service on offer throughout the U.K. Pioneer, Denon, Kenwood, Yamaha, Technics, Marantz, Mission, Tannoy plus many more.

## MERSEYSIDE

DOUG BRADY HIFI, 401, Smithdown Road, Liverpool, L13 3JJ. (051) 733 6859. fair demonstrations and home trial facilities. All credit cards. Largest choice of specialist hifi in N.W. Closed Wednesdays and lunch 1-2.15pm.

## MIDDLESEX

RIVERSIDE HIFI, 422 Richmond Road, East Twickenham, Middlesex, TW1 2EB. Tel. (081) 892 7613. fax. (081) 892 7749. A.R., Arcam, Audio innovations, Audiolab, B&O, B&W, Castle, Dali, Denon, Dual, Kef, Marantz, Meridian, Michell, Micromega, Mission, Monitor Audio, NAD, Nakamichi, Pioneer, Quad, Revox, Rotel, Spondor, Systemdek, Tannoy, TDL, Yamaha. 5 demo rooms. In car demo for car hifi systems. Appointments not always necessary. Home trial facilities, free installation, service department, Lombard Tricity, Access/Visa Amex/Diner's club. Mon-Sat 10.00-5.30pm, Thurs & Fri 10.00-7.00pm.

## NORFOLK

BASICALLY SOUND, The Old School, School Road, Bracon Ash, Norwich, Norfolk, NR14 8HE. Tel. (0508) 70829. Arcam, Linn, Denon, Naim, Spondor, Sound Organisation, Audio Technica, Creek, Rega, Epos etc. 2 comprehensive dem rooms, home trial facilities, free installations, Visa/Access, HP facilities. Tues-Fri 9.30-1.00pm, 2.00-5.30pm. Saturday 9.30-5.30pm.



# Hi-Fi World Dial-a-Dealer

## NORTHAMPTON

LISTEN INN, 32 Gold Street, Northants NN1 1RS. Tel. (0604) 37871. Wide range of records and accessories stocked. Our commitment to standards of service is apparent to our satisfied customers. Two dem rooms and free home install service available.

## OXFORDSHIRE

WESTWOOD & MASON, 46 George Street, Oxford. Tel. 0865 247783. Naim, Arcam, Rotel, Rega, Epos, Tannoy, JPW, Mission, Nakamichi, Denon, Aiwa, Quad, Aura, Open 9.30-5.00pm. Dem room. Closed Thursdays.

## SHROPSHIRE

AVON HIFI, 12 Barker Street, Shrewsbury, Shropshire, SY1 1QJ. Tel. 0743 355166. Aiwa, Beyer-Dynamic, NAD, Quad, B&W, Mordaunt-Short, Kenwood, Bose, Nakamichi, Revolver. Dem room. Home trial. Free install. Service dept. Access/Visa. £1,000 instant credit. Mon, Tues, Wed, Fri, Sat 9-5.30.

## SOMERSET

MIKE MANNING AUDIO, 110 Middle Street, Yeovil, Somerset, BA20 1NE. Tel 0935 79361. Fax. 0935 32923. Mobile no. 0850 325965. Linn, Naim, Roksan, Pink Triangle, A&R (Arcam) ION, NAD, Pioneer, Rotel, Denon etc. Dedicated listening lounge, for relaxed and unpressured demos. Appts not necessary but best to telephone first. Home trial facilities on request, free installation and service dept, Instant credit, Access/Visa etc. 9-5.30, closed Mondays.

## STAFFORDSHIRE

GRANGE HIFI LTD., 153 Branton Road, Burton-upon-Trent, Staffordshire, DE14 3DQ. Tel. 0283 33655. Arcam, Albarr, Audio innovations, Audionote, Castle, Denon, Dual, JPW, Marantz, Moss, Pink Triangle, Quad, Rogers, Rotel, SME, Systemdek, Tannoy, TDL, Yamaha, Stockists of DCC. Access/Visa. 2 dem rooms. Closed Monday & Weds pm and for lunch 12.00-12.30pm. Appts necessary on Saturday 9.00-5.30pm.

## SUFFOLK

BURY AUDIO, 47 Churchgate Street, Bury St Edmunds, Suffolk, IP33 1RG. Tel. 0284724337. Arcam, Audio Alchemy, Heybrook, Marantz, Michell, Meridian, Nakamichi, Pink Triangle, Quad, Rotel, Sonus Faber, Stax., Tube Technology., Single speaker dem room. Free install. Credit facilities. Mon-Sat 9.30-6.00, closed Wed. Evening dems by appointment.

## SURREY

ROGERS HIFI, 13 Bridge Street, Guildford, Surrey, (0483)61049. Aiwa, Creek, Denon, Dual, JPW, Marantz, Onix, Pioneer, Systemdek, Ruark, Tannoy, Teac. Dem facilities available, no appts necessary, free installation, service dept. Access/Visa. Instant credit upto £1,000 subject to status. Monday-Saturday, 9.30-6pm, later by appt.

AUDIO SOUTH 24 (The Woolmead) East Street, Farnham, Surrey, GU9 7TT. (0252) 714 555. Audio Innovations, Audio note, Deltec, JPW, Marantz, Rotel, Teac, Voyd, Hifi and audio visual dem rooms. Evening appts available. Home trial facilities, free installation. Access/Visa, 10.30-6.30 Mon-Sat, Closed Tuesday.

SURREY HIFI, 45 High Street, Godstone, Surrey, RH9 8LS. (0883) 744755. Specialist Hifi outlet, demonstration room and parking available. Quad, Audiolab, TDL, Tube Technology, Rel Acoustics, Nakamichi, Kef, Thorens, Magnum, Rotel, Marantz, Denon, Michell, Furukawa, Tannoy, Target, JPW. Lumley Reference in stock. Single speaker dem rooms. Appts not necessary. Home trial facilities, free installation service dept, Access/Visa/Mastercard. Open 9-6pm Closed Wednesday.

## SUSSEX (EAST)

BOWERS & WILKINSON (est. 1945). 1 Becket Buildings, Little Hampton Road, Worthing, Tel. (0903) 2 64141. Top names in Hifi and audio visual including B&W, Nakamichi, Castle, Denon, Philips, Quad, Technics, Aura, Thorens and many more. 3 dem rooms (budget - high end.) expert friendly advice, service dept, local installations free. one minute from A24 & A27, free local parking, Access/Visa. Instant Credit up to £1,000 subject to status. Open 6 days.

JEFFRIES HIFI, 4 Albert Parade, Green Street, Eastbourne, East Sussex, Tel. 0323 131336. 2 dem rooms. Closed Mon. Late night Wednesday. Free parking, Credit facilities.

JEFFRIES HIFI, 69 London Road, Brighton, East Sussex, Tel 0272 609431. 2 dem rooms, closed Mon, late night Wed. free parking and credit facilities.

WORTHING AUDIO, 20 Treville Gate, W Sussex, BN11 1VA. Tel 0903 212133. "The friendly shop with the best sound systems in the South". Friendly advice, 3 yr guarantees, easy parking, open Mon-Sat 9-6pm. Late night Wed. Arcam, Exposure, Naim Audio, Marantz, Ruark, Mordaunt Short, Audio Technica, Target, Tripod, Sennheiser, AR and many more.

## TYNE & WEAR

BILL HUTCHINSON HIFI, 87a, Castle Street, Newcastle-upon-Tyne, (091) 230 3600. For the largest selection of HiFi and audio visual equipment in the North East. Specialist A.V. demonstrations of the highest quality. Best prices guaranteed. Minimum 2 year warranty and an optional 5 yr guarantee available. Instant credit and mail order service on offer throughout the U.K. Pioneer, Denon, Kenwood, Yamaha, Technics, Marantz, Mission, Tannoy plus many more.

## WARWICKSHIRE

STRATFORD HIFI, 25 Henley Street, Stratford-upon-Avon, CV3 9QW. Tel. 0789 414533. Pioneer, Technics, Denon, Marantz, NAD, Rotel, Musical Fidelity, Monitor Audio, Mission, Tannoy, Quad, TDL, Sennheiser, 0% finance is available on selected products and all major credit cards accepted. Dem Rooms, Service facilities, open 9.30-5.30pm. Late night Thursday until 8.00pm.

## WEST MIDLANDS

MUSIC MATTERS, 351 Hagley Road, Edgbaston, Birmingham, B17 8DL. Tel 021 429 2811. Roksan, Nakamichi, Arcam, Audiolab, Musical Fidelity, Mission/Cyrus, Meridian, Kef, Monitor Audio, Pink Triangle, Ruark, Epos, Exposure, Pioneer. 2 single speaker dem rooms. Appts necessary. Home trial facilities and free install. Service dept. Access/Visa/instant credit upto £1,000. Interest free credit available also. Tues-Thurs 10.30-6pm, Friday 10.30-8.00pm, Saturday 10.00-5.30pm.

WEST MIDLANDS AUDIO, 158 Ombersly Road, Worcester WR3 7HA. Tel 0905 58046. Fax. 0905 57585. Naim, Rega, Rotel, Marantz, Nakamichi, NAD, Audiolab, Roksan, Meridian, B&W, Audio Research, Krell, Martin Logan, Arcam. 9-5.30 Mon-Sat, eve's by appt only. Free install., service dept and repairs. Finance details on request.

AMADEUS SOUND & VISION, 10 Boldmere Road, Sutton Coldfield, West Midlands, Tel. 021 354 2311. Audio Innovations, B&O, Castle, QED, Wharfedale. Single speaker demo, appts preferred, service available, installations, B&O link install, home trials, Access/Visa, interest free credit available subject to status. 9.30-6.00pm 6 days.

## YORKSHIRE (SOUTH)

HIFI STUDIO'S, Sunnyfields, Doncaster, Tel 0302 781387. Heybrook, Monitor Audio, Art Audio, Michell, Sugden, Acoustic Energy, Alphason, Teac, AMC Valves, Ruark, Albarr, Proac, Impulse loud speakers, Rel sub-woofers, Yamaha surround sound, Project, TDL, Listening room demo's. Home trial, free install, licensed credit broker, 2yr guarantee on all equipment, service available, Access/Visa. 10-8pm 6 days. phone for further information and free fact pack.

## YORKSHIRE (NORTH)

SCARBOROUGH HIFI, 53 Dean Road, Scarborough, N. Yorks, YO12 7SN. Tel 0723 374547. Albarr, Aura, B&W Matrix, Cyrus, Pioneer, Philips, Marantz, Cabasse, Bose, Tannoy, DCC wide screen and lazer vision. Home trial facilities and free installation, service dept, Access/Visa, Credit charge, £1,000 instant credit/ Amex/Diners.

THE SOUND ORGANISATION (YORK) 2b Gillygate, York, YO3 Tel. (0904)627108. Linn, Meridian, Micromega, Naim, Rega, Arcam, Creek, Nakamichi, Mission, Denon, Epos, Royd, Rotel. 3 single speaker dem rooms, appts. preferred, home trial facilities, free install, service dept. Credit facilities on request. Access/Visa. 10.00am-5.30pm. Tues-Sat. Sony dealer award nominated '86, '87 and '88.

## YORKSHIRE (WEST)

BILL HUTCHINSON HIFI, 26-28 Woodhouse Lane, Leeds (0532) 427777. For the largest selection of HiFi and audio visual equipment in the Yorkshire. Specialist A.V. demonstrations of the highest quality. Best prices guaranteed. Minimum 2 year warranty and an optional 5 yr guarantee available. Instant credit and mail order service on offer throughout the U.K. Pioneer, Denon, Kenwood, Yamaha, Technics, Marantz, Mission, Tannoy plus many more.

DOUG BRADY HIFI, The Forge Cottage, 19 Cross Gate, Otley, West Yorks, LS21 1AA. Tel. (0943) 467689. Naim, Arcam, Rotel, Pink Triangle, Meridian, Epos, Castle, Two dem rooms, fair demonstrations and home trial facilities. Access/Visa. Open 10.00-6pm Tues-Sat.

## SCOTLAND

### EDINBURGH

BILL HUTCHINSON HIFI, 43 South Clark Street, Edinburgh. (031) 667 2877. For the largest selection of HiFi and audio visual equipment in Lothian Specialist A.V. demonstrations of the highest quality. Best prices guaranteed. Minimum 2 year warranty and an optional 5 yr guarantee available. Instant credit and mail order service on offer throughout the U.K. Pioneer, Denon, Kenwood, Yamaha, Technics, Marantz, Mission, Tannoy plus many more.

### GLASGOW

BILL HUTCHINSON HIFI, 43 Hope Street, Glasgow, (041) 248 2857. For the largest selection of HiFi and audio visual equipment in South West. Scotland Specialist A.V. demonstrations of the highest quality. Best prices guaranteed. Minimum 2 year warranty and an optional 5 year guarantee available. Instant credit and mail order service on offer throughout the U.K. Pioneer, Denon, Kenwood, Yamaha, Technics, Marantz, Mission, Tannoy plus many more.

## NORTHERN IRELAND

### BELFAST

LYRIC HIFI, 163 Stanmills Road, Belfast (0232) 381296. Linn, Naim, Rega, Arcam, Denon, Rotel and more. Mon-Sat, 10.00-6.00pm. Late night Thurs.

ZEUS AUDIO, 6 Hope Street, Belfast, (0232) 332522, Audio Innovations, Pink Triangle, Roksan, Marantz, Celestion, Meridian and more. Mon-Sat 10.00-5.30pm. Late night Thursday.

### COUNTY DOWN

ASTON AUDIO, Unit 8, Kings Road Shopping Centre, Kings Road, Belfast. (0232) 402220. Akai, Technics, JVC, Samsung, Toshiba, Panasonic and many more. Demos. Open Mon-Fri 10-8pm Sat 10-5pm.

### LONDONDERRY

ZEUS AUDIO, 23a Kingsgate Street, Colrairie, BT52 4LB. Tel. (0265) 56634. Marantz, Mission Cyrus, Aiwa, Akai, Alphason, Sony, Pink Triangle, Celestion, Rotel. Mon-Sat 10-5.30pm. Closed Thurs.

## TO FIND YOUR AREA Use our COLOUR REFERENCE



To Advertise in this section, please  
contact Caroline Knott on:

**071 266 0969**

# Classical

**Common threads connect many of this month's recordings: one is the act of worship; another the Serenissima Repubblica - the city of Venice - and in particular the Basilica of St Marks for which not only did the likes of Monteverdi, Cavalli and the Gabriellis write fine music, but more recently, Igor Stravinsky. Venetian sacred music leads us tenuously to that of Mozart and Bruckner, while Stravinsky supplies a link to other Twentieth Century masters: Bartok, Rachmaninov and Shostakovich.**

*Peter Herring*



**BELA BARTOK**  
**Rhapsody No 1 for violin and piano/Violin Sonata No 2/**  
**Sonata for solo Violin/**  
**Roumanian Folk Dances**  
 Susanne Stanzeleit, violin; Cusztav Fenyő, piano  
 ASV CD DCA 852 (DDD/63.39)

● This is the first of two recordings which will offer Bartok's mature works for violin and piano, music well worthy of greater exposure than it generally receives, such is the dominance of the six string quartets in the composer's output of chamber music. the programme here immediately attracts with its variety, contrasting the challenging solo violin sonatas - written for Menuhin in 1944 and Bartok's last completed composition - with the easy-going Roumanian Folk Dances in the arrangement for violin and piano made (with the composer's approval) by Zoltan Szekely.

Folk music is a fundamental element in Bartok's music: not the kitsch melodies churned out by fake Gypsy violinists in the cafes of Budapest, but the authentic, untainted tunes of village communities in the countryside of Hungary, Romania and elsewhere. Bartok's researches into traditional music took him all over Eastern Europe and beyond, and, as well as employing it in his own compositions, he spent much of his life cataloguing it for posterity.

Bartok was not the first composer to

find inspiration in folk music, but he differed from his predecessors in making no attempt to 'civilise' it. Although the folk melodies, as heard here, are synthesised with formal Classical disciplines, there is no softening of the spiky, percussive rhythms, no dilution of the old, traditional scales that sound so strange to Western ears. the Rhapsody No 1, heard here in its original version for violin and piano, makes striking use of Hungarian and Romanian folk dances.

this work, like so much of Bartok's chamber music for violin, was inspired by the skills of a particular virtuoso, in this case Josef Szigeti. The violin sonatas, of which the wonderful second is recorded here, were written for Jelly d'Aranyi, of whom the pianist in this recording, Cusztav Fenyő, is a descendant. His partner, German-born Susanne Stanzeleit, is no less immersed in the Bartok idiom, as her performance of the demanding Solo Violin Sonata proves. This is a work of immense power as well as virtuosity, owing its inspiration to Bach - in particular to the C Major Sonata BWV 1005. Bartok even adopts the slow-fugue-slow-fast structure of the Bach work.

An important addition to the Bartok discography inasmuch as it offers the chance both to explore relatively unknown territory and to savour some fine playing. A recording of striking presence and fidelity is a bonus.

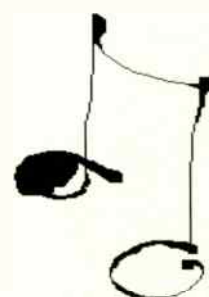



## RECORD OF THE MONTH

"Here one finds as much passion and emotion as in Nineteenth Century music, and as great an intensity of feeling, but the music is more distilled, concentrated in the smallest forms and ultimately, I feel, more powerful in its directness."

Thus Paul McCreesh, founder and director of the Gabrieli Consort, on what draws him to the music of the High Renaissance and Baroque, as a student at Manchester University, he heard a performance of Monteverdi's *Orfeo* - the first opera to truly explore profound human emotions such as desire and grief - and was gripped from the beginning. He was also captivated by the sound of the *cometto*, which awakened a strong interest in early instruments.

The fruits of that experience can already be enjoyed on the Gabrieli Consort's 1989 recording *A Venetian Coronation 1595*. Released by Virgin Classics, it rightly collected a host of awards for its reconstruction of the ceremonial music - largely by Andrea and Giovanni Gabrieli - which may have been heard at the Coronation of Doge Marino Grimani. For his new recording, the first in a series for the Archiv label, Paul McCreesh again recreates one of the grand occasions of the *Serenissima Repubblica*, the *Vespers service* celebrated every March 24, the feast of the Annunciation of the Blessed Virgin. This feast day had a special significance for the Venetians, for, apart from its liturgical importance, it was by tradition also the date that the city of Venice was founded. The *Vespers service*, therefore, was as much an expression of power as well as piety.

Paul McCreesh makes no claim that the pieces assembled here were performed as a whole, but with one exception all the music is by composers associated with the Basilica of St Marks, where the Annunciation service would have taken place. As he explains:

"I always feel that it is important to place the music in an historical context, to recreate a framework in which each piece serves an important function.

"Even if some of these composers are almost unknown, there is no doubt that this fabulous music can stand alongside Monteverdi's famous *Selva morale e spirituale*. In particular, the works of Giovanni Antonio Rigatti, a fellow priest at San Marco, were a marvellous discovery - a real musical personality and some stunningly beautiful music."

As with the Gabrieli Consort's

previous recording, the venue for the Venetian Vespers was Brinkburn Priory in Northumberland. Despite the need to bring in an electricity supply and to come to an agreement with the local airbases, Brinkburn - according to McCreesh - "has a clarity and a wonderful natural ambience which is ideal for recording this music."

And, as with the Virgin Classics issue, essential funding for this project has come from Technics Hi-Fi. It again shows how important Technics' sponsorship has become to music-making in Britain; without it - and without the enthusiasm of the company's Marketing Manager Alan Ainslie - it is unlikely projects such as this would have seen the light of day. The same can be said of the Technics-funded recordings of music by Malcolm Arnold and Andrej Panufnik [And Orphy Robinson among others in *Jazz - Mus. Ed.*] Long may it continue; we are musically the richer for it.

preludes, festive psalm settings and exquisite solo motets is to be presented, with compositions by the greatest of the composers of the Basilica - Cavalli, Grandi and Monteverdi - and by lesser lights such as Rigatti, Banchieri and Marini.

Silence falls. The Sacristy bell is rung and the organist plays a prelude by that distinguished son of St Mark's, Giovanni Gabrieli. Then, from one of the galleries, a male choir intones the opening plainchant, after which a group of instruments plays the delicious introduction to the *Dixit Dominus* of Giovanni Antonio Rigatti, then still a Priest among the Basilica's clergy. The choir then enters with music of thrilling splendour.

This is the effective and spell-binding introduction to Paul McCreesh's reconstruction of the Venetian Vespers, a piece of scholarship every bit as inspired and successful as his Venetian Coronation of three years ago. The music is a rich mixture of the splendid - Rigatti's setting of the Magnificat, for example - the sensuous (Monteverdi's *Lactatus sum*) and the sublime - Marini's *Sonata con tre violini in eco*.

It would be invidious to single out any one or two performers from this magnificent production, for it seems everyone has put their heart into this recording as well as their vocal and instrumental skills. Paul McCreesh directs his forces to great effect, the disposition of voices and instruments being derived from what is known about performing practice in St Mark's and what can be gleaned from contemporary scholarship. The result fully captures the spirit of what must have been a mightily impressive occasion.

Enhancing the brilliance of the top line by adding comet parts to double the sopranos is an exciting effect and evidently justified by a letter dated 1640 issued by the procurators of the Basilica. Paul McCreesh has certainly done his research here.

With production by Ben Turner and engineering by Tim Handley, the technical side of this recording seems impeccable to me, with its atmosphere, perspective and clarity. The tonal quality of both voices and instruments is quite beautiful; but, of course, neither technical excellence nor thoroughness of research nor polished performance would count for anything if there was no emotional commitment to this music. But there is, and it crowns this imaginative exploration of a distant musical heritage.



### VENETIAN VESPERS

Gabrieli Consort and Players;  
director, Paul McCreesh.

ARCHIV 437 552-2 (2CD) (DDD/95.35)

● You are seated within the Byzantine interior of the Basilica of St Mark in Venice. The date is Friday, March 24, 1643 - the feast of the Annunciation of the Blessed Virgin. The church is crowded with the city's great and good, including the Doge himself, and with distinguished foreign visitors. Venice, as a political and economic force, has been in decline for many years, but the elaborate ceremonial rite about to take place is intended to reaffirm the status and importance of the *Serenissima Repubblica*. For that reason, all the musical resources of St Mark's have been marshalled and a programme combining organ



**ANTON BRUCKNER**  
**Mass No2 in E minor/Motets:**  
**Locus iste; Virge Jesse;**  
**Christus factus est pro**  
**nobis; Ave Maria**  
 Kammerchor Stuttgart;  
 Deutschebläserphilharmonie; conductor  
 Frieder Bernius.  
**SONY CLASSICAL SK48037 (DDD/**  
**55.29)**

● Bruckner not only composed some of the greatest symphonies of the nineteenth century - any century, for that matter - but also some of its finest sacred music. Indeed, for much of his composing career, he was lauded more for his Mass settings and motets than for his symphonies. Not least of his admirers were the so-called 'Cecilianists' who saw in Bruckner the salvation of church music. Dismayed by what they saw as the 'secularisation' of sacred music during the eighteenth century, the 'Cecilianists' sought a return to the pure a cappella style of Renaissance composers such as Palestrina. The architecture, counterpoint and word-painting of works such as the E minor Mass recorded here, convinced them that Bruckner was the natural successor to the age of Palestrina. What they overlooked, however, was the essentially symphonic nature of this and other compositions, with the kind of expressive choral writing which relates Bruckner as much to the world of Beethoven's *Missa Solemnis* as Palestrina's *Missa Papae Marcelli*. Just as Bruckner's symphonies are often referred to as 'religious' in temperament, so his three Mass settings are wholly symphonic, the measured, predominantly slow-moving lines destined to be mirrored in the mighty adagios of the later symphonies.

The second of Bruckner's Mass settings, in E minor, was composed in 1866, while he was organist of Linz Cathedral. Its first performance was in 1869, at the dedication of the Cathedral's new votive chapel. The small size of the chapel precluded the music being given within its walls, so the performance took place outside. The Mass is scored for eight-part choir and a wind band consisting of two oboes, two clarinets, two bassoons, four horns, two trumpets and three trombones. Harnessed to Bruckner's majestic choral

counterpoint and idiomatic harmonies, it makes for a sound that soars heavenward out of profound solemnity, and with all the lofty grandeur of the symphonic slow movements. Interestingly, it was one of the very few of his early compositions for which Bruckner received a fee and, like so many of his works, went through several revisions. The final version of 1882 is that heard here, and very well-recorded it is too, with a clarity and definition that allows, for example, the relationship between the instrumental lines and the text to be appreciated. The acoustic of the Klosterkirche in

Alpirsbach strikes me as ideal, as does Bemius's pacing of the Mass. It is beautifully and expressively sung, and the wind playing is first-class.

The style of the Mass is echoed in the accompanying a cappella motets which include arguably the first masterpiece to emerge from Bruckner's pen, the Ave Maria setting of 1861. Of the other motets, the setting of *Locus iste* was also intended for the Linz dedication ceremony of September 1869 but not performed in the chapel until the following month; the remaining two - *Christus factus est* and *Virge Jesse* - are significant for being in Bruckner's favourite D minor tonality. A treasurable addition to the Bruckner discography and earnestly hope these forces go on to record the even finer F minor Mass setting.



**WOLFGANG AMADEUS**  
**MOZART**  
**Requiem K626/Maurerische**  
**Trauermusik (Masonic**  
**Funeral Music) K477/ Ave**  
**verum corpus K618\***  
 Nancy Argenta, soprano; Catherine Robbin, contralto; John Mark Ainsley, tenor; Alastair Miles, bass; Schutz Choir of London; Schutz Consort\*; London Classical Players; conductor, Roger Norrington  
**EMI CLASSICS 7 545252 (DDD/57.53)**

● Mozart left a finished score of just one section of his Requiem - the Introit - before his death. The task of completing the work from the available sketches was given by the composer's widow, Constanze, to one of his pupils, the

competent if uninspired Franz Süssmayr. Despite the inconsistencies of parts of the score, which suggest that in places Süssmayr was working without even a scrap of Mozart's own music to support him, his pupil's version remained unchallenged for a century and more. Now, however, we have alternatives, the latest of which is recorded here. It was commissioned in 1984 by the Yorkshire Bach Choir from the musicologist and violinist (he plays in this performance), Duncan Druce.

Judging that the *Sanctus*, *Benedictus* and *Agnus Dei* contain little - if any - original Mozart, Druce has concentrated his reworkings on these sections. The Süssmayr score is adapted for the opening of the *Sanctus*, but a new fugal movement - using the same subject - has been written for the *Osanna*. The *Benedictus* is also freshly composed from the same melodic idea, Druce basing his argument for this on the many close motivic relationships already threaded throughout the work. The plaintive *Lacrimosa* also benefits from a new ending, leading to a large-scale fugue on what is known to be Mozart's own idea for the *Amen*. Druce has also applied fresh thinking to the *Agnus Dei*, and to the overall instrumentation, with particular emphasis on the winds - as is evident throughout this recording.

Similarly evident is the way original instruments heighten the contrasts and intensify the colouring of this score. The sombre intonation of the basses, trombones and trumpets are matched by the brightness of the trumpets, violins and high voices. Alongside this, recordings with modern orchestras sound almost monochrome. Of course, original instruments - any instruments - are only as good as their players and here the London Classical Players, especially the winds, are on top form. The string playing, too, is crisp and lively and the brass rich and penetrating. The chorus impresses with its clarity and the soloists are uniformly good. Overall, though, it is Norrington's dramatic and finely-paced conducting which seals a recommendation for this performance. There is solemnity, naturally, but without descending into the merely lugubrious and tempos - as in the *Benedictus* - are brisk without being hurried. The momentum is sustained throughout, giving the performance a satisfying unity.

The Requiem is prefaced and followed by two appropriate shorter works, the *Masonic Funeral Music* of 1785 and the simple but sublime choral motet *Ave verum corpus* respectively. Like the Requiem, the motet dates from Mozart's last year, 1791, while the *Masonic Funeral Music* also has a kinship with the larger work in incorporating a Gregorian Plainchant melody.

Given the excellent sound produced by engineer Mike Clements, impressive both in scale and atmosphere and pleasingly translucent, this new version of the Requiem can be unreservedly recommended to all lovers of Mozart - and beyond.





**IGOR STRAVINSKY**  
**Symphony of Psalms/Mass/  
 Canticum Sacrum/Pater  
 Noster/Credo/Ave Maria**

Choir of Westminster Cathedral; John Mark Ainsley, tenor; Stephen Roberts, baritone; Iain Simcock, organ and piano; Martin Baker, piano; City of London Sinfonia; James O'Donnell, conductor  
**HYPERION CDA66437 (DDD/68.10)**

● A most attractive issue, this, combining as it does three of Stravinsky's masterpieces of sacred music in generally reliable and idiomatic performances. The Canticum Sacrum was one of the first works of Stravinsky I discovered, after the obligatory introduction through the three Diaghilev ballets, and I have always relished its astringency and quasi-medieval sonorities. It was composed in 1955 to commemorate the life and work of St Mark, the patron Saint of Venice and its five sections mirror both architecturally and symbolically the five cupolas that surmount the city's St Mark's Basilica. The central section is consequently the most important, the first relates to the fifth and the second to the fourth. It is a glorious composition and most convincingly performed here.

Stravinsky had returned to the Russian Orthodox faith in 1925-6 and is said to have been provoked into writing sacred music by the dreadful quality of what he heard standing in the congregation of the Russian church in Nice. In an effort to recapture earlier standards and traditions, with their emphasis on modal harmonics, he wrote the three Sacred Choruses (settings of the Pater Noster, Credo and Ave Maria). Between completing these, he received a commission from the conductor of the Boston Symphony Orchestra, Serge Koussevitsky, for a work to commemorate the Orchestra's fiftieth anniversary, the result was of extraordinary power and originality, and one of the enduring masterpieces of Twentieth Century music, the Symphony of Psalms. The richly Byzantine flavour is well-captured here by the Westminster choir.

Stravinsky revised the Symphony of Psalms in 1948, the same year that he completed his setting of the Mass. He used a choir of men's and boys' voices which, combined with the wind band accompaniment (two oboes, cor anglais, two bassoons, two trumpets, three trombones) produces a sound of plangent austerity. Though there are

echoes of the church music from the early medieval period, Stravinsky's treatment of his forces is strikingly original - and effective. As, indeed, are these performances, though I found the sound a little recessed and lacking in focus. The disc needs to be played at a high volume if the full impact of Stravinsky's score is to be felt.

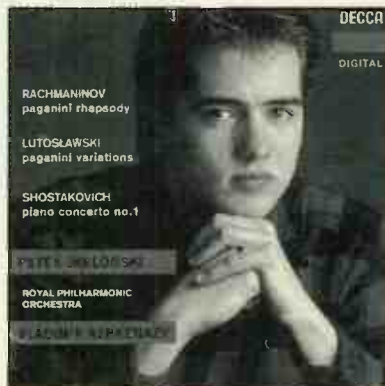

**SERGEI RACHMANINOV**  
**Rhapsody on a theme of Paganini Op43**  
**DMITRI SHOSTAKOVICH**  
**Piano Concerto No 1 in C minor Op35\***  
**WITOLD LUTOSLAWSKI**  
**Paganini Variations for piano and orchestra**

Peter Jablonski, piano; Raymond Simmons, trumpet\*; Royal Philharmonic Orchestra, conductor Vladimir Ashkenazy  
**DECCA 436 239-2 (DDD/54.20)**

● The Swedish-born pianist made his debut for Decca in 1991 with an imaginative coupling of Gershwin, Copland and Barber. There is also a refreshing diversity about the programme on this latest issue. Rather than couple the Paganini Variations with a Rachmaninov concerto, Jablonski instead offers another composer's reworking of the familiar Paganini piece, Witold Lutoslawski's Variations written in the late Seventies. It's a short, colourful and witty treatment of the Caprice and a welcome addition to the repertoire for piano and orchestra and Jablonski's understanding of the character of the Lutoslawski is evident.

Shostakovich gave the first performance of the year following the concerto's completion in 1933, accompanied by the Leningrad Philharmonic and even today its musical maturity is astonishing, as is its tongue-in-cheek humour, chiefly embodied in the solo role given the trumpet. It is a work whose cheerfulness parallels that of Prokofiev's Lieutenant Kije composed the following year and, like the Prokofiev, suggests nothing of the grim circumstances in which it was written.

Peter Jablonski also brings a refreshing lightness and sparkle to even that old warhorse the Paganini Variations. Ashkenazy and the RPO provide a first-class accompaniment and the recording is spacious and vivid, balancing the piano on the forward side and - for some reason - leaving the strings sounding a little under-nourished. However, this seems to be common to a number of modern recordings.

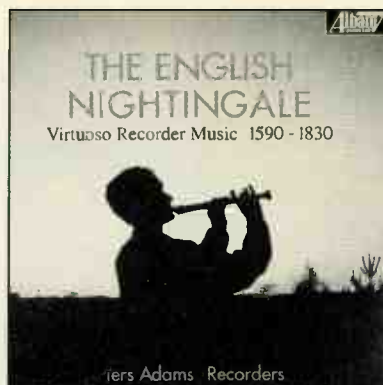

**THE ENGLISH NIGHTINGALE - VIRTUOSO RECORDER MUSIC 1590-1830**

Piers Adams, recorders; Howard Beach, harpsichord, fortepiano, organ; David Watkin, cello  
**ALBANY TROY 088-2 (DDD/63.45)**

● Sadly, the image of the recorder has been tainted for most of us by our experience in the classroom, either being forced to play - worse - listen to others torturing the poor instrument. Moreover, it has always been regarded as the poor relation of wind instruments such as the flute. The first notes of this recording should convince you that the recorder has far more to offer; Piers Adams' recording of Georg Philip Telemann's Fantasia No 12 of 1732 most certainly will.

Adams has a generous programme of recorder music from the Sixteenth to the Nineteenth Centuries and, with its pleasing symmetry, a very attractive one. He begins and ends with pieces by the Sixteenth Century Dutch composer Jacob Van Eyck, including the brilliant little showpiece, The English Nightingale, which gives this recital its title. At the apex of the programme come two sparkling works for recorder and piano by Ernst Krachmer, the Nineteenth Century virtuoso regarded as the Paganini of the recorder. There can be little doubt that, on the evidence of this recital, that title could now be claimed by Piers Adams. This is astonishing, breathtaking playing: a virtuosity built of dexterity, purity of tone and wonderfully-judged phrasing. I found it enchanting listening, not just for the skills of Piers Adams, but for the pleasures contained in the music, too. There are three splendid Baroque sonatas, one by the under-rated composer William Croft, a second by the Italian master Archangelo Corelli, and the third an arrangement of Bach's E minor flute sonata. A variety of recorders was employed to suit the period and style of each piece and it is a pity that Adams' otherwise informative booklet does not elaborate on the instruments used (though I gather one was a copy of Van Eyck's own 'handfluit' recorder).

Piers Adams and his colleagues offer enlightenment on the development of the recorder and its music over some 250 years, and in the most entertaining way imaginable. Adams' playing compels attention in even the lightest of the pieces here and in this is aided by a recording of striking immediacy.

# WOLLATON A • U • D • I • O

For those on a budget with  
a passion for the best.

## Audio Synthesis Passion passive preamplifier £560

See the review by Martin  
Colloms in Hi-Fi News  
April 1993

• • •

Clements Spatial Image 300Si  
loudspeaker £595

*"All of our listeners thought  
we were listening to loud-  
speakers in the \$1200 to  
\$1500 range"*

Inner Ear Report, Summer '92

• • •

## XLO Pro Interconnects and Cables

*Sounds like . . .  
nothing at all.*

Interconnect £85/metre pair  
Speaker Cable £155/9ft pair

*"Its superb quality more than  
justifies the cost"*  
Alan Sircom, Hi-Fi World.  
December 1992.

• • •

## TEAC VRDS 10 £770

*"My first choice for a sub  
£2000 player."*

Alan Sircom, Hi-Fi Choice,  
March 1993.

• • •

## Monarchy 22 D to A convertor £995

*"The Monarchy 22 thoroughly  
trounces the PS Audio  
Ultralink and the Audio  
Research DAC1 which cost  
double and triple the amount  
of the Monarchy"*  
Paul Cervantes, The Audio  
Observatory.

*"Best Buy of the Year"*  
Hi-Fi Review

• • •

We offer a money-back  
guarantee of satisfaction and  
have a number of ex-dem  
special offers at low prices.

Demonstrations by  
appointment.

Wollaton Audio  
Tel/Fax: 0602 284147

## NUMBERS ALWAYS 'IN STOCK'

The best hi-fi Dealers know when they're on to  
a good thing. Get on to a good thing too by  
quoting these award winning numbers on your  
next hi-fi shopping spree.

## AT-110E ← MOVING MAGNET →



## AT-OC5<sub>MC</sub> ← MOVING COIL →



## AT-95E ← MOVING MAGNET →



## ATH-L1a HEADPHONES



Available at Good Hi-Fi Stores **ONLY**



**audio-technica**  
INNOVATION PRECISION INTEGRITY

ATC-003

## WHY BUY A NEW C.D. PLAYER ?

When you can transform the performance of  
your existing C.D. player, with the award  
winning DIGIT the D.A.C. at a truly incredible  
price of only £139.00 + £19.00 for the DIGIFLEX  
interconnect cable.

To quote Audiophile magazine, " its effect is  
remarkable. Add the Digit and the  
performance of the MARANTZ CD 52 SE which  
is already excellent for its price, leaps one  
stage further towards the magically true to life  
transparency of two box players costing  
£1000.00 or more.

In recent What Hi Fi ?, Audiophile and Hi-Fi  
Choice awards, Digit beat products costing 2  
or 3 times the price - so don't be fooled in to  
paying more, it's not necessary.

To obtain DIGIT, with a money back guarantee,  
please telephone (0276) 451166 or complete  
the coupon below.



Please  
send more  
information on  
DIGIT including  
the POSITRON Power  
supply upgrade and  
dealer list.

I enclose a 1st class stamp

NAME \_\_\_\_\_

ADDRESS \_\_\_\_\_

POSTCODE \_\_\_\_\_

# QED

QED Audio Products Ltd, Ridgeway House,  
Ridgeway Close, Lightwater, Surrey GU18 5XU England



★★★ NEW TITLES ★★★

Mastersound Album Classics remastered with Sony's 20-bit 'Super Bit Mapping' process. The reflective coating is pure 24-carat gold.

	<b>AEROSMITH</b> TOYS IN THE ATTIC CK 525857 BOSTON BOSTON CK 52856 DAVE BRUBECK TIME OUT BOB DYLAN BLONDE ON BLONDE CK 53016	<b>BILLY JOEL</b> 52ND STREET CK 5258 MILES DAVIS KIND OF BLUE CK 52861 BRUCE SPRINGSTEEN BORN TO RUN CK 52859 WEST SIDE STORY ORIGINAL CAST CK 53152
---	---	--

Special price: £32.95

# Hi-Fi World record mail order service

A rich and varied selection of recordings, all offered at very competitive prices!



Zakir Hussain: Making Music

**BOBBY KING & TERRY EVANS**  
LIVE & LET LIVE  
RHYTHM, BLUES, SOUL  
**MIGHTY FLYERS**  
UNDERCOVER (LP ONLY)  
**SUGAR RAY & THE BLUETONES**  
KNOCKOUT  
**ROBERT EARL KEEN JNR**  
WEST TEXTURES  
**THE METERS**  
THE METERS JAM  
GOOD OLD FUNKY MUSIC

CDs £10.99

## SPECIAL DELIVERY TOPIC (CD ONLY)

**JUNE TABOR**  
AIRS AND GRACES  
ASHES AND DIAMONDS  
**MARTIN CARTHY**  
RIGHT OF PASSAGE  
**JOHN KILPATRICK**  
FLAIN CAPERS  
**PETER BELLAMY**  
THE TRANSPORTERS  
**RICHARD THOMPSON**  
STRICT TEMPO  
**MARTIN CARTHY & DAVE SWARBRICK**  
SKIN AND BONE  
**TERRY ALLEN**  
LUBBOCK (ON EVERYTHING)  
**WOODY GUTHRIE**  
STRUGGLE  
**NICK JONES**  
PENGUIN EGGS (CD ONLY)  
**DICK GAUGHAN**  
GAUGHAN (CD ONLY)  
**RON KAVANA**  
HOME FIRE  
**PETER HOLSAPPLE & CHRIS STAMEY**  
MAVERICKS  
**PATRICK STREET**  
IRISH TIMES  
**RORY BLOCK**  
TURNING POINT (CD ONLY)  
**GREGSON/COLLISTER**  
MISCHIEF  
A CHANGE IN THE WEATHER  
LOVE IS A STRANGE HOTEL  
THE LAST WORD (£12.99 CD ONLY)  
**CLIVE GREGSON**  
WELCOME TO THE WORKHOUSE  
**JONATHAN RICHMAN**  
JONATHAN GOES COUNTRY  
JONATHAN RICHMAN  
**REBIRTH BRASS BAND**  
REBIRTH KICKIN' IT LIVE  
**VARIOUS ARTISTS**  
HARD CASH  
**MARTIN CARTHY AND DAVE SWARBRICK**  
LIFE AND LIMB  
**BLOWZABELLA**  
VANILLA  
**WEBB WILDER & BEATNECKS**  
IT CAME FROM NASHVILLE (LP)

## DELMARK (CD ONLY)

**ART HODES & BARNEY BIGARD**  
BUCKETS GOT A HOLE IN IT  
**GEORGE LEWIS & DON EWELL**  
REUNION  
**FRANZ JACKSON & JIM BEEBES** CHICAGO JAZZ  
SNAG IT  
**MALACHI THOMPSON**  
THE JAZZ LIFE  
**JODIE CHRISTIAN**  
EXPERIENCE  
**TAB SMITH**  
ACE HIGH  
**SPECKLED RED**  
THE DIRTY DOZENS  
**MAGIC SAM**  
WEST SIDE SOUL  
BLACK MAGIC  
GIVE ME TIME  
**T-BONE WALKER**  
I WANT A LITTLE GIRL  
**DINAH WASHINGTON**  
MELLOW MAMA  
**SUNNYLAND SLIM**  
HOUSE RENT PARTY

Delmark CDs 12.99

## RAVEN

**RASCALS**  
IN INTROSPECT (66-69)  
**MARC BOLAN & T.REX**  
SOLID GOLD RAPID ACTION  
**THE FOUR TOPS**  
SHAKE ME, WAKE ME (HITS FROM 64-73)  
**GRAM PARSONS**  
WARM EVENINGS, PALE MORNINGS 63-73  
**THE MONKEES**  
TALK DOWN UNDER (LP ONLY)  
**ROY ORBISON**  
COMMUNICATION BREAK-DOWN  
**THE ANIMALS** (CD only)  
THE MOST OF (ALL ERAS COMP)  
ROADRUNNERS (CD ONLY)  
**THE BYRDS**  
FULL FLYTE (CD ONLY)

**THE YARDBIRDS** (CD only)  
OVER UNDER SIDWAYS  
DOWN  
**JOE COCKER** (CD only)  
CONNOISSEURS COCKER '69-'78

Raven LPs £7.99, CDs £12.99

## BULLSEYE BLUES

**ANN PEEBLES**  
FULL TIME LOVE  
**SUGAR RAY & THE BLUETONES**  
DON'T STAND IN MY WAY (CD)  
**CHAMPION JACK DUPREE**  
FROM NEW ORLEANS (CD)  
**LITTLE JIMMY KING & THE MEMPHIS SOUL SURVIVORS**  
LITTLE JIMMY KING (CD)  
**OTIS CLAY**  
SOUL MAN (CD)

Bullseye CDs £11.99

## ROUNDER (AVAILABLE ON CD ONLY)

**ALISON KRAUSS**  
I'VE GOT THAT OLD FEELING  
**OTIS CLAY**  
I'LL TREAT YOU RIGHT



Rory Block: Aint I A Woman

**LEADBELLY**  
MIDNIGHT SPECIAL  
**ROD PIAZZA & THE MIGHTY FLERS**  
ALPHABET BLUES  
**TOM RUSSELL**  
HURRICANE SEASON  
**IRIS DEMENT**  
INFAMOUS ANGEL  
**SPANIC BOYS**  
STRANGE WORLD  
**MISSISSIPPI JOHN HURT**  
AVALON BLUES 1963  
WORRIED BLUES 1963  
**AARON NEVILLE**  
MY GREATEST GIFT  
**DUKE ROBILLARD & THE PLEASURE KINGS**  
TOO HOT TO HANDLE  
**DUKE ROBILLARD**  
YOU GOT ME  
SWING  
ROCKIN BLUES  
**RORY BLOCK**  
HOUSE OF HEARTS  
BEST BLUES AND ORIGINALS  
RHINESTONES & STEEL STRINGS  
I'VE GOT A ROCK IN MY SOUL

Munich CDs £10.99

**BLUE HORIZON**  
HIGH HEELED BLUES

**JOHNNY COPELAND**  
WHERE THE RAIN STARTS FALLIN  
AIN'T NOTHING BUT A HOUSE-PARTY 'LIVE'  
BOOM BOOM  
**JOHNNY ADAMS**  
SINGS DOC POMUS - THE REAL ME (WITH DR. JOHN/DUKE ROBILLARD)  
**IRMA THOMAS**  
NEW RULES  
**REBIRTH BRASS BAND**  
FEEL LIKE FUNKIN' IT UP  
**SOLOMON BURKE**  
SOUL ALIVE  
**WALTER 'WOLFMAN' WASHINGTON**  
WOLF AT THE DOOR  
**NATHAN & THE ZYDECO CHA CHAS**  
YOUR MAMA DON'T KNOW  
**CLARENCE 'GATEMOUTH' BROWN**  
TEXAS SWING

Rounder CDs £11.99

## LYRICHORD

**WORLD MUSIC SAMPLER** £7.99  
MUSIC OF THE RAIN  
FORESTS PYGMIES  
JAPANESE KOTO CONSORT  
PERU-MUSIC FROM THE MACCHU PICCHU (HIGH ANDES)  
**INDIAN BAMBOO FLUTE**  
GOUR GOSWAMI & STAVEN GORN  
Lyrichord CDs £12.99

## MUNICH

**RORY BLOCK**  
AIN'T I A WOMAN  
MAMAS BLUES  
**CULTURE IN CULTURE**  
CULTURE  
**IRMA THOMAS**  
LIVE - SIMPLY THE BEST

Munich CDs £10.99

## AMALTHEA

**THE DUKE ROBILLARD BAND**  
TURN IT AROUND  
AFTER HOURS SWING SESSION (Amalthea CD £11.99)

## COOKING VINYL

**THE OYSTER BAND**  
STEP OUTSIDE (CD ONLY £6.99)  
LITTLE ROCK TO LEIPZIG  
DESERTERS  
**FOUR BROTHERS**  
MAKOROKOTO  
**MICHELLE SHOCKED**  
TEXAS CAMPFIRE TAPES  
ARKANSAS TRAVELLER

**EDWAROLKAS**  
SWEET HONEY IN THE ROCK  
BREATHS...THE BEST OF  
**DAVY SPILLANE**  
ATLANTIC BRIDGE  
**COWBOY JUNKIES**  
TRINITY SESSIONS  
**JUNE TABOR**  
ANGEL TIGER  
**JUNE TABOR & THE OYSTER BAND**  
FREEDOM AND RAIN  
**BRUCE COCKBURN**  
LIVE  
**CLANNAD**  
FUAIM  
**BOILED IN LEAD**  
ORB

Cooking Vinyl CDs £10.99

## CROSSCUT

**CHARLIE MUSSELWHITE**  
MEMPHIS, TENNESSEE

Crosscut LP only £7.99

## WORLD CIRCUIT

**BHEKI MSELEKU**  
CELEBRATION  
**JEAN TOUSSAINT**  
WHAT GOES AROUND  
**OLODUM**  
REVOLUTION IN MOTION  
**JOE ARROYO Y LA VERDAD**  
REBELLION  
**BLACK UMFOLOSI**  
UNITY  
**JALI MUSA JAWARA**  
SOUBINDOOR  
**LISANDRO MEZA**  
LISANDRO'S CUMBIA (NOT ON LP)  
**ABDEL GADIR SALIM ALL-STARS**  
THE MERDOUM KINGS PLAY  
SONGS OF LOVE (NOT ON LP)  
**ALI FARKA TOURE**  
ALI FARKA TOURE  
**OUMOU SANGARE**  
MOUSSOLOU  
**ABDEL AZIZ EL MUBARAK**  
STRAIGHT FROM THE HEART

World Circuit LPs £5.95  
CDs £8.99



**HURRY LIMITED STOCKS OF LINN RECORDS AVAILABLE NOW!**

## LINN RECORDS

**OTIS GRAND & THE DANCE KINGS**  
ALWAYS HOT!  
**THE HORSEFLIES**  
HUMAN FLY  
**JOHNNY ADAMS**  
ROOM WITH A VIEW OF THE BLUES  
**UDITEI AMANT**  
17TH CENTURY ITALIAN LOVE SONGS  
**BLUE NILE**  
HATS  
A WALK ACROSS THE ROOFTOP



**CAROL KIDD**  
CAROL KIDD  
ALL MY TOMORROWS  
NICE WORK  
THE NIGHT WE CALLED IT A DAY  
GLAD WE MET  
**DAVID NEWTON**  
VICIM OF CIRCUMSTANCE  
**MARTIN TAYLOR**  
DON'T FRET  
**POLISH CHAMBER ORCH.**  
MOZART/VIVALDI/BACH/  
BARTOK/ELGAR (DBL)  
£11.99 (LP & CD)  
**WILLIAM CONWAY & PETER EVANS**  
CELLO SONATAS  
**ENGLISH CLASSICAL PLAYERS**  
MOZART 40TH & SCHUBERT  
5TH (DBL) £11.99 (LP & CD)  
Linn Records LPs £7.99  
CDs £11.99

## RECUT

**RECORDS**  
**BEETHOVEN**  
5TH SYMPHONY £8.99

## LINN SELEKT

**LPS**  
**ROBERT CRAY**  
FALSE ACCUSATIONS  
**ABC**  
THE LEXICON OF LOVE  
**THE BEATFUL SOUTH**  
WELCOME TO.....  
**STAN GETZ/CHARLIE PARKER**  
JAZZ SAMBA  
**JONI MITCHELL**  
CHALK MARK IN A RAINSTORM  
**ELLA & LOUIS**  
ELLA & LOUIS AGAIN  
**TALKING HEADS**  
STOP MAKING SENSE  
**BILLIE HOLIDAY**  
STORY VOL 11  
**ELTON JOHN**  
ICE ON FIRE  
**KATE BUSH**  
THE DREAMING  
**STEELY DAN**  
AJA

**COUNT BASIE**  
KANSAS CITY SUITE  
**ART BLAKEY & THE JAZZ MESSENGERS**  
LIVE AT BUBBRA'S  
**LISA STANSFIELD**  
AFFECTION  
**JACKIE WILSON**  
GREATEST HITS  
**THE DOORS**  
LA WOMAN  
**VAN MORRISON**  
ASTRAL WEEKS  
**NEIL YOUNG**  
HARVEST  
**THE EAGLES**  
HOTEL CALIFORNIA  
**RY COODER**  
PARIS, TEXAS  
**EDIE BRICKELL**  
SHOOT RUBBERBANDS AT THE STARS  
**STEVE EARLE**  
COPPERHEAD ROAD  
**OSLO PHILHARMONIC**  
TCHAIKOVSKY MANFRED SYMPHONY  
**OSLO PHILHARMONIC**  
TCHAIKOVSKY SYMPHONY NO.6- PATHETIQUE  
**LONDON SYMPHONY**  
BRAHMS SYMPHONY NO.4  
**LENINGRAD PHILHARMONIC**  
PROKOFIEV SYMPHONY NO.5  
**SOLOMON BURKE**  
A CHANGE IS GONNA

COME  
**STEVE PHILIPS**  
STEEL RAIL BLUES  
**MILCHO LEVIEV QUARTET**  
BLUES FOR THE FISHERMAN  
**CRUSELL CLARINET QUARTETS**  
THEA KING/ALLEGRI ST QUARTET  
**DEBUSSY/RAVEL STRING QUARTETS**  
FAIRFIELD QUARTET  
**T-BONE BURNETT**  
PROOF THROUGH THE NIGHT  
**J. B. LENOIR**  
ALABAMA BLUES!  
**MUSICIANS OF SWANNE ALLEY**  
IN THE STREETS & THEATRES OF LONDOC  
**AL GREEN**  
LET'S STAY TOGETHER  
**JUNE TABOR & THE OYSTER BAND**  
FREEDOM & RAIN  
**CAMBRIDGE SINGERS &**



**CITY OF LONDON SINFONIA**  
FAURE REQUIEM  
**THE SIXTEEN**  
HANDEL CHANDOS ANTHEMS NO.1-3  
**HANDEL**  
WATER MUSIC  
**CORELLI**  
CONCERTI GROSSI  
**KAPSBERGER**  
PIECES FOR LUTE  
Linn Select £8.99

## GRAPEVINE

**MARY BLACK**  
COLLECTION  
BABES IN THE WOOD  
NO FRONTIERS  
BY THE TIME IT GETS DARK  
WITHOUT THE FANFARE  
COLLECTED  
MARY BLACK  
LPs £7.99 CD £10.99



## GIMELL RECORDS

An excellent selection of digital recordings from Gimell Records which has won acclaim around the world, and has picked up awards from Gramophone. Featuring The Tallis Scholars directed by Peter Phillips renowned for their clarity and perfect intonation.

**THOMAS TALLIS**  
SPERM IN ALIUM  
LAMENTATIONS OF JEREMIAH (CD ONLY)  
**PALESTRINA MASSES**  
MISSA ASSUMPTA EST MARIA / MISSA SICUT LILIUM  
MISSA BENEDICTA ES  
MISSA BREVIS  
MISSA NIGRA SUM  
**ALLEGRI**  
MISERERE (CD ONLY)  
**HEINRICH ISAAC**  
MISSA DE APOSTOLIS (CD ONLY)  
**JOSQUIN**  
L'HOMME ARME MASSES  
MISSA PANGE LINGUA / MISSA LASOL FA RE MI  
**JOHN SHEPPARD**  
MEDIA VITA  
**WILLIAM BYRD**  
THE THREE MASSES (CD ONLY)  
THE GREAT SERVICE  
**CLEMENS NON PAPA**  
MISSA PASTORES QUIDNAM  
VIDISTIS  
**JOHN TAVENER**  
IKON OF LIGHT (CD ONLY)  
**VICTORIA**  
REQUIEM  
TENEBRAE RESPONSORIES (CD ONLY)

Gimell LPs £8.49 CDs £12.99

## HANNIBAL

**VARIOUS ARTISTS**  
THE YOUNG FLAMENCOS CD ONLY  
**R&L THOMPSON**  
SHOOT OUT THE LIGHTS  
HOKEY POKEY  
**RICHARD THOMPSON**  
HANDS OF KINDNESS  
HENRY THE HUMAN FLY  
**JUNE TABOR**  
SOME OTHER TIME  
**BALKANA**  
MUSIC OF BULGARIA  
All Hannibal LPs £7.99, CDs £11.99

## HANNIBAL BOX SETS

**SANDY DENNY**  
WHO KNOWS WHERE THE TIME GOES (3XCDs: £35.95) (4XLPs: £29.95)  
**NICK DRAKE**  
FRUIT TREE (4XCDs: £38.95) (4XLPs: £29.95)

## DEMON

**DUKE ROBILLARD & THE PLEASURE KINGS**  
DUKE ROBILLARD & THE PLEASURE KINGS  
**CLIVE GREGSON**  
STRANGE PERSUASION  
**GEORGE THOROGOOD & THE DESTROYERS**  
GEORGE THOROGOOD & THE DESTROYERS  
**T BONE BURNETT**  
TRUTH DECAY  
**CHRISTY MOORE**  
ORDINARY MAN  
**RORY GALLAGHER**  
DEFENDER  
IRISH TOUR '74  
**JOHN LEE HOOKER**  
THE DETROIT LION  
**ELVIS COSTELLO & THE ATTRACTIONS**  
THIS YEARS MODEL  
GET HAPPY  
TRUST  
PUNCH THE CLOCK  
**JOHNNY WINTER**  
JOHNNY WINTER  
SECOND WINTER  
**STEVE NIEVE**  
KEYBOARD JUNGLE  
**ELVIS COSTELLO AND THE ATTRACTIONS**  
TEN BLOODY MARYS AND TEN HOWS YOUR FATHERS  
BLOOD AND CHOCOLATE  
**BILL HURLEY (WITH JONNY GUITAR)**  
DOUBLE AGENT  
**IAN DRURY AND THE BLOCKHEADS**  
SEX & DRUGS & ROCK & ROLL  
DO IT YOURSELF  
**EARL KING & ROOMFUL OF BLUES**  
GLAZED  
**JOHNATHAN RICHMAN & THE MODERN LOVERS**  
MODERN LOVERS '88  
**PERCY SLEDGE**  
WANTED AGAIN  
**OTIS RUSH**  
TOPS  
RIGHT PLACE WRONG TIME  
**THE BYRDS**  
SWEETHEART OF THE RODEO  
**SCREAMIN' JAY HAWKINS**  
BLACK MUSIC FOR WHITE PEOPLE  
**TIM BUCKLEY**  
DREAM LETTER (LIVE IN LONDON '68)  
SEFRONIA  
LOOK AT THE FOOL  
**BEN E KING**  
HERE COMES THE NIGHT  
**THE PARAMOUNTS**  
WHITER SHADES OF R'N'B  
**DEL SHANNON**  
I GO TO PIECES  
**THE EVERLY BROTHERS**  
TWO YANKS IN ENGLAND  
PASS THE CHICKEN AND LISTEN  
**BO DIDDLEY**  
THE 20TH ANNIVERSARY OF ROCK 'N' ROLL  
**NILSSON**  
THE POINT  
**CAPTAIN BEEFHEART & HIS MAGIC BAND**  
THE LEGENDARY A&M SESSIONS  
**GERRY RAFFERTY**  
BLOOD AND GLORY (LP ONLY)  
All Demon LPs £7.99, CDs £11.99

## MOBILE FIDELITY

**24 CARAT GOLD PLATED COMPACT DISCS**

A unique opportunity to obtain the ultimate in CDs. For high resolution and immortality Mobile Fidelity plate these discs with 24 carat gold. Almost unobtainable elsewhere, they are not cheap - but what price excellence?

Mobile Fidelity Gold Discs offer better sound quality for many reasons, not least in that they are specially manufactured in Japan using real gold as a coating.

The gold Ultradisc was developed in conjunction with the Ultech Corporation. It has



fewer pinholes, better durability and a more extended life. Accelerated ageing tests have shown that these gold discs outlast normal types by a considerable margin.  
**ERIC CLAPTON**  
SLOW HAND  
**ELTON JOHN**  
TUMBLEWEED CONNECTION  
**BRYAN ADAMS**  
RECKLESS  
**STING**  
NOTHING LIKE THE SUN  
**JOHN COLTRANE**  
BLUE TRAIN  
**B B KING**  
LIVE AT THE REGAL  
**EARL KLUGH**  
FINGER PAINTINGS  
**TOM PETTY**  
DAMN THE TORPEDOES  
**CHARLIE MUSSELEWHITE**  
MEMPHIS, TENNESSEE  
**BELAFONTE**  
RETURNS TO CARNEGIE HALL  
**MAXINE SULLIVAN**  
SINGS THE MUSIC OF BURTON LANE  
**THE WHO**  
QUADROPHENIA (DOUBLE)  
TOMMY (DOUBLE)  
**SUPERTRAMP**  
BREAKFAST IN AMERICA  
CRIME OF THE CENTURY  
**FRANK SINATRA**  
SONGS FOR SWINGING LOVERS  
**ELTON JOHN**  
HONKEY CHATEAU  
MADMAN ACROSS THE WATER  
GOODBYE YELLOW BRICK RD (DBL)  
**BOZ SCAGGS**  
SILK DREGREES  
**ROD STEWART**  
EVERY PICTURE TELLS A STORY  
**JEFF BECK**  
WIRED



**JOE JACKSON**  
NIGHT & DAY  
**BLIND FAITH**  
BLIND FAITH  
**HUEY LEWIS & THE NEWS**  
SPORTS  
**JETHRO TULL**  
THICK AS A BRICK  
STAND UP  
**THE POLICE**  
SYNCHRONICITY  
**MOODY BLUES**  
DAYS OF FUTURE PASSED  
**ALLMAN BROTHERS**  
EAT A PEACH (DBL)  
**STEELY DAN**  
AJA  
GAUCHO  
**CAT STEVENS**  
TEA FOR THE TILLERMAN  
**DEF LEPPARD**  
PYROMANIA  
**BEACH BOYS**  
SURFER GIRL/SURFIN USA (DBL)  
**JOHN KLEMMER**  
TOUCH  
**JEFFERSON AIRPLANE**  
CROWN OF CREATION  
VOLUNTEERS  
**CARPENTERS**  
SONG FOR YOU  
**THE BAND**  
MUSIC FROM THE BIG PINK  
**STING**  
THE DREAM OF THE BLUE TURTLE  
**HALL & OATES**  
VOICES  
**HARRY NILSSON**  
NILSSON SCHMILLSON  
**AFTER THE HURRICANE**  
SONGS FOR MONSERRAT  
**PINK FLOYD**  
THE WALL (£38.99 GOLD CD)  
DARK SIDE OF THE MOON (£23.95  
GOLD CD)  
**All Gold CDs: £22.95**  
(single);  
**£32.95 (dbl)**

## NEW CLASSIC ROCK ON VINYL

**JEAN MICHEL JARRE**  
OXYGENE  
**DAVID LEE ROTH**  
EAT 'EM AND SMILE  
**DAVID GILMORE**  
ABOUT FACE  
**CAN**  
SOON OVER BABALUMA  
**YES**  
TIME AND A WORD  
CLOSE TO THE EDGE  
FRAGILE  
GOING FOR THE ONE  
**NEIL YOUNG**  
AMERICAN STARS N BARS  
TIME FADES AWAY  
FREEDOM  
DECADE (TRIPLE ALBUM)  
**MORRISSEY**  
VIVA HATE  
**GONG**  
LIVE AT SHEFFIELD '74  
**BLUES BROTHERS**  
BRIEFCASE FULL OF BLUES  
**TEARS FOR FEARS**  
THE HURTING  
**TOM PETTY AND THE  
HEARTBREAKERS**  
SAME TITLE  
**THE BYRDS**  
BALLADS OF AN EASY RIDER  
**BOB MARLEY AND THE  
WAILERS**  
CONFRONTATION  
**VAN MORRISON**  
TB SHEETS  
**BLIND LEMON JERRFERSON**  
ONE DIME BLUES  
CAT MAN BLUES  
**AC/DC**  
74 JAILBREAK

**BLACK SABBATH**  
BORN AGAIN  
SACRIFICE  
**BLONDIE**  
PARALLEL LINES  
PLASTIC LETTERS  
BLONDIE  
**ALICE COOPER**  
KILLER  
BILLION DOLLAR BABIES  
**CHRISTOPHER CROSS**  
CHRISTOPHER CROSS  
**DEEP PURPLE**  
LAST CONCERT IN JAPAN  
**FLEETWOOD MAC**  
GREATEST HITS  
**CHRIS ISAAK**  
SILVERTONE  
**LINTON KWESI JOHNSON**  
BASS CULTURE  
**MCS**  
BACK IN THE USA  
HIGH TIME  
KICK OUT THE JAMS  
VINTAGE YEARS  
**VAN MORRISON**  
TB SHEETS  
VAN MORRISON  
**TOM PETTY & THE HEART-  
BREAKERS**  
YOU'RE GONNA GET IT  
**RUSH**  
A FAREWELL TO KINGS  
**SIMON & GARFUNKLE**  
SOUND OF SILENCE  
**THIN LIZZY**  
RENEGADE  
THUNDER & LIGHTNING

**THE BAND**  
ROCK OF AGES DBL  
**APHRODITES CHILD**  
666  
**ROGER WATERS**  
THE PROS & CONS OF HITCH  
HIKING  
**STANLEY ORANGE**  
CLOCKWORK ORANGE  
**THE CHAMELEONS**  
THE FAN AND THE BELLOWES  
**THE SMITHS**  
RANK  
**IRON BUTTERFLY**  
LIVE  
**YES**  
GOING FOR THE ONE  
**VAN HALEN**  
WOMEN & CHILDREN FIRST  
**CROSBY STILL**  
SO FAR  
**GRATEFUL DEAD**  
THE GRATEFUL DEAD  
AMERICAN BEAUTY  
LIVE DEAD  
WORKING MANS DEAD  
**TOM WAITS**  
BLUE VALENTINE  
FOREIGN AFFAIRS  
BOUNCED CHECKS  
**SANTANA**  
LOTUS (TRIPLE)  
**NEIL YOUNG**  
DECADE (TRIPLE)  
NEIL YOUNG  
**VELVET UNDERGROUND**  
VJ  
**RY COODER**  
CROSSROADS(SOUNDTRACK  
FROM THE MOTION PICTURE)  
SHOWTIME  
BORDERLINE  
THE SLIDE AREA  
PARADISE AND LUNCH  
**JACKSON BROWN**  
THE PRETENDER  
**CAPTAIN BEEFHEART AND  
THE MAGIC BAND**  
CLEAR SPOT  
**LED ZEPPELIN**  
CODA  
**JIM MORRISON/MUSIC BY  
THE DOORS**  
AN AMERICAN PRAYER

**GRAM PARSONS**  
GREVIOUS ANGEL  
**CROSBY STILLS & NASH**  
DEJA VU  
4 WAY STREET  
**LOU REED/JOHN CALE**  
SONGS FOR DRELLA  
**RICKIE LEE JONES**  
PIRATES  
RICKIE LEE JONES  
**SLY AND ROBBIE**  
LANGUAGE BARRIER  
**OTIS REDDING**  
DOCK OF THE BAY  
**GRACE JONES**  
SLAVE TO THE RHYTHM

Single LP £8.99  
Double LP £12.99  
Triple LP £14.99

## LIMITED EDITION

**THE ALLMAN BROTHERS**  
LIVE AT FILLMORE EAST  
DBL LP £12.99

## CLASSIC ROCK

**ON VINYL ONLY, FOR A  
LIMITED PERIOD WHILE  
STOCKS LAST!**

**HUSKER DU**  
SONGS & STORIES (DBL)  
CANDY APPLE GREY  
ZEN ARCADE (DBL)  
FLIP YOUR WIG  
**RAMONES**  
LEAVE HOME  
END OF THE CENTURY  
**CAPTAIN BEEFHART**  
TROUT MASK REPLICA (DBL)  
**BLUES OYSTER CULT**  
SPECTRES  
SECRET TREATIES  
**JONI MITCHELL**  
BLUE  
MINGUS  
HEJIRA  
LADY OF THE CANYON  
**JANIS JOPLIN**  
PEARL  
**LOU REED**  
TAKE NO PRISONERS (DBL)  
**STEVIE RAY VAUGHAN**  
TEXAS FLOOD  
**EMERSON, LAKE & PALMER**  
TRILOGY  
TARKUS  
**NEIL YOUNG & CRAZY  
HORSE**  
LIVE RUST (DBL)  
ZUMA  
**IGGY POP (dbl)**  
LIVE AT THE CHANNEL BOSTON  
**BOB SEGER & SILVER BULLET  
BAND**  
LIVE BULLET (DBL)  
**TIM BUCKLEY**  
GOODBYE AND HELLO  
**THE DOORS**  
WEIRD SCENES INSIDE THE  
GOLDMINE (DBL)  
**JONAS HELLBORG**  
ELEGANT PUNK  
BASS  
**CHRIS ISAAK**  
CHRIS ISAAK  
HEART SHAPED WORLD  
LPs £8.99 (single)  
£12.99 (dbl), £14.99 (triple)

**RAMONES**  
LEAVE HOME  
END OF THE CENTURY  
**THE STOOGES**  
FUNHOUSE  
THE STOOGES

LPs £9.99

## AUDIOQUEST

Audioquest recordings are recorded and mastered on valve equipment - not only that, but using microphones, tape decks and amplifiers built or customised by our own favourite valve expert Tim de Paravicini no less. Combined with simple mic techniques, these releases have an unparalleled pristine purity and clarity of sound.

**WORKS OF ART**  
COMPILATION (CD ONLY) £7.99  
**ROBERT LUCAS**  
USIN' MAN BLUES  
LUKE & THE LOCOMOTIVES  
**STRUNZ & FARAHER**  
MISTERIO  
**TUXEDO COWBOY**  
WOMAN OF THE HEART  
Audioquest LPs and CDs  
£14.95

## SHEFFIELD LABS

**DIRECT TO DISC**  
**THELMA HOUSTON  
& PRESSURE COOKER**  
I'VE GOT THE MUSIC IN ME  
**HARRY JAMES & HIS BIG  
BAND**  
THE KING JAMES VERSION  
STILL HARRY AFTER ALL THESE  
YEARS  
**DAVE GRUSIN**  
DISCOVERED AGAIN  
**HARRY JAMES & HIS BIG  
BAND**  
COMIN' FROM A GOOD PLACE  
**THE SHEFFIELD TRACK  
RECORD**  
& THE SHEFFIELD DRUM RECORD  
**JAMES NEWTON HOWARD  
AND FRIENDS**  
ROCK INSTRUMENTALS  
SHEFFIELD LABS CDS £14.49

## CHESKY RECORDS

**JAZZ SERIES COMPACT  
DISCS**  
Oversampled x 128  
Audiophile Quality,  
considered by some to be  
the finest quality jazz  
recordings.  
**JAZZ SAMPLER**  
& AUDIOPHILE TEST CD  
**DAVID CHESKY**  
THE NEW YORK CHORINHOS  
CLUB DE SOL  
**JOHN PIZARELLI**  
MY BLUE HEAVEN  
**HERBIE MANN**  
CAMINHO DE CASA  
**JOHNNY FRIGO  
& JOHN PIZZARELLI**  
LIVE FROM STUD10 A  
**PHIL WOODS**  
HERE'S TO MY LADY  
**LUIS BONFA**  
NON-STOP TO BRAZIL  
**PAQUITO D'RIVERA**  
TICO! TICO!  
**CLARK TERRY**  
PORTRAITS (NOW AVAILABLE ON  
LP)  
LIVE AT THE VILLAGE GATE  
**ANA CARAM**  
RIO AFTER DARK (NOW ON LP)  
AMAZONIA  
**NATASHA**  
NATASHA  
Chesky CDs £13.49

## NEW CHESKY

**CLASSICAL CDS**  
**EARL WILD**  
TRANSSCRIPTIONS OF GERSHWIN  
CHOPIN: 4BALLADES, 4 SCHERZI  
**GARY SCHOCKER (FLUTIST)**  
BACH, HANDEL, TELEMANN  
**RACHMANINOFF**  
PIANO CONCERTO NO.2/ ISLE OF  
THE DEAD  
**SIBELIUS**  
SYMPHONY NO. 2  
**TCHAIKOVSKY/DOHNANYI**  
PIANO CONCERTO NO. 1/VARI-  
ATIONS ON A NURSERY SONG  
**DVORAK/WAGNER**  
SYMPHONY NO. 9/ OVERTURE  
FROM THE FLYING DUTCHMAN  
**BRAHMS**  
SYMPHONY NO. 4  
**MOZART/HAYDN**  
SYMPHONIES 35 & 41/ NO. 104  
**STRAUSS/RAVEL/**  
**TCHAIKOVSKY**  
DER ROSENKAVALIER/BOLERO/  
ROMEO & JULIET OVERTURE  
**BEETHOVEN**  
SYMPHONIES 2 & 5/LEONORE  
OVERTURE NO. 3  
**BRAHMS/STRAUSS**  
PIANO CONCERTO NO. 2/  
SALOME-DANCE OF THE 7 VELS  
**BIZET/TCHAIKOVSKY**  
SYMPHONY IN C/FRANCESCA DA  
RIMINI  
**RESPIGHI**  
PINES OF ROME/ROMAN  
FESTIVALS, FOUNTAINS OF ROME  
**RACHMANINOFF**  
CONCERTO NOS 4 & 1,  
RHAPSODY ON A THEME OF  
PAGANINI  
**TCHAIKOVSKI**  
VIOLIN CONCERTO  
**BRAHMS**  
SYMPHONY NO. 1  
**STRAVINSKY**  
PETROUCHKA, LA SACRE DU  
PRINTEMPS

Chesky CDs £13.49

## ORIGINAL BLUES CLASSICS FROM FANTASY

**SONNY TERRY**  
SONNYS STORY  
**LIGHTIN' HOPKINS**  
BLUES IN MY BOTTLE  
**MEMPHIS SLIM**  
ALL KINDS OF BLUES  
**JIMMY WITHERSPOON**  
EVENIN' BLUES (LP ONLY)  
**TAMPA RED**  
DON'T TAMPA WITH THE BLUES  
(LP ONLY)  
**OTIS SPANN**  
THE BLUES NEVER DIE  
**JOHN LEE HOOKER**  
THATS MY STORY  
THE COUNTRY BLUES OF JOHN  
LEE HOOKER(CD ONLY)  
**MEMPHIS SLIM/TAMPA RED/**  
**LONNIE JOHNSON**  
BAWDY BLUES(CD ONLY)

LPs £7.99 CDs £11.99

## ORIGINAL JAZZ CLASSICS

**DAVE BRUBECK**  
GREATEST HITS  
**GERRY MULLIGAN**  
MULLIGAN PLAYS MULLIGAN  
GERRY MULLIGAN/PAUL  
DESMOND







# PRIMA

## The New Hi-Fi Loudspeaker Kit From HEYBROOK



**Listen to the new heybrook PRIMA  
at the Chesterfield Show  
on demonstration in room 123  
Saturday & Sunday  
The 17-18 April**

*The*  
**speaker**  
*Company*

**At only £105.00 per pair it's got to be  
the best buy of the show**

**Phone 0625-500507  
For further details**

# ameron & Connections

- NEUTRIK - MUSIFLEX OXYGEN  
FREE GUITAR LEADS •
- XLR - JACK - XLP - GOLD PHONO •
- BANTAM PATCH CORDS •
- SAME DAY CALL COLLECT  
SERVICE IN THE LONDON AREA •

**(071) 267 4138**

## SRG DESIGN CL1 LOUDSPEAKER

A new approach to loudspeaker design. A design that brings harmony to both the music and the home. A loudspeaker where attention has been given to the aesthetical design as well as the technical performance.



The CL1 speakers are different. They are a piece of furniture. They can be finished in a colour to suit the decor. They do not look like the normal speaker and are less obtrusive.

As to performance, frequency range 35 hz to 22KHz, power handling 45 watts, efficiency 91db. Physical dimensions: height 41" width 13". from £290 (incl VAT)

For a colour brochure ring 0225-334595 or write to SRG DESIGN  
1 Saville Row, Bath BA1 2QP.



**Home Entertainment  
Specialists**

58, New George Street, Plymouth  
Telephone: 0752 669511

## The Seismic Sink

A revolutionary approach to equipment support



For £169 the *Seismic Sink* provides a more impressive upgrade to the sound of your CD player than adding an outboard D/A converter -- even the Award-winning £700 Audiolab DAC! (WHAT HI-FI?, December 1992)

Spikes are essential for speakers, but - contrary to popular belief - are not the solution to equipment isolation. More vibration is fed into the equipment from so-called 'ground' than is taken away. Reviews to date have shown that the *Seismic Sink* outperforms Sorbothane, cones, MDF, glass and all spiked tables. The acoustic open circuit afforded by the *Seismic Sink* eliminates structure-borne vibration, dramatically improving the performance of your CD player, turntable, amplifier (especially valve kit), Laser Disc, VCR - even an outboard DAC.

Standard size: 43cm x 35cm (W x D), takes up to 7Kg  
Heavy duty version (£189) takes up to 20Kg  
Custom sizes for esoteric audio components available to order.  
The ultimate isolation platform, with built-in spirit level and three adjustable feet for precise levelling.

Can be shipped worldwide. Contact your local dealer or Townshend Audio for further information and specifications.

Townshend Audio, Tims Boatyard, Timsway, Staines, Middx TW18 3JY.  
Tel: (44) 0784 455866. Fax: (44) 0784 455044

# NOTTINGHAM ANALOGUE STUDIO



hand crafted hi-fi

**NAS** If, like us, you believe in the superiority of Analogue reproduction and, in particular, the ability of vinyl to convey the maximum in listening pleasure - you need to visit our studio

Here we can offer you what we consider the ultimate in domestic musical reproduction. No shelves of flashy boxes or flavours-of-the-month, just wealth of the finest hi-fi we can find.

**CROFT • ALBANY • EAR • TUBE TECHNOLOGY  
SPACE DECK • SPACE ARM MENTOR • MENTOR  
REFERENCE • KLIPSCH HORN • BRITISH HORN  
THE DANISH POSSELT speakers • DECCA fitted  
with extended contact area stylus • MAGNEPLANAR  
ANALOGUE TRACER • The single ended ZIKRO  
AUDRO 30 watts using the 845 valve •**

For a musical experience you will remember, please contact us on:

**0773 762947**





# Try me & save

## on ANY current Hi-Fi AV or Home Cinema Unit

### SENSATIONAL PRICES GUARANTEED

- ▶ Budget, Regular and Esoteric Equipment
- ▶ Full Manufacturer's Warranty
- ▶ Fax us your priority order 081-563 0300
- ▶ Free Insured Delivery, anywhere in the U.K.
- ▶ Minimum order £250
- ▶ Credit Cards accepted including Switch and Connect

# Try me & save

## on current Micromega stock

- ▶ MICRODAC ~~£349~~ now £225
- ▶ LOGIC ~~£569~~ now £399
- ▶ LEADER ~~£849~~ now £549
- ▶ SOLO II ~~£1599~~ now £999

\* SOUND AUDIO ~~£1499~~ now £999  
VP3A/HBP60A VALVE PRE/POWER AMPLIFIER

LIMITED OFFER ON CURRENT MODELS  
AVAILABLE WHILE STOCKS LAST

Ex-demo stock sold AS NEW, with full manufacturer's warranty.  
In addition, we promise to collect and return any repairs under warranty.  
WHETHER IT'S MICROMEGA OR REGA, IF YOU'RE SERIOUS  
ABOUT ANY HI-FI, CALL NOW!

*"He has told me how you bent over backwards to fulfil his order."*

*"It is extraordinary nowadays to find someone who is as diligent as you are."*

*"Thank you for your splendid service; it has been outstanding!"*

*(Names supplied on request)*

# 081-563 0003

**Try Me & See Ltd,  
5 Rocks Lane, Barnes,  
London SW13 0DB**





## LORICRAFT AUDIO

**TURNTABLE SERVICE & REPAIR AND PROFESSIONAL RECORD CLEANING SERVICES**

**NEW RANGE** of craftsman made plinths in solid Oak/Mahogany. 18mm MDF substructure, machined in motor, board in various finishes. Resiliently mounted with cover and hinges. Suitable for Garrard 301, 401 and Thorens TD124.

**DEDICATED POWER SUPPLY** for Garrard 301. Improves performance dramatically.



**S.A.E. for catalogue**  
4 Big Lane, Goose Green,  
Lambourn, Berks.  
RG16 7XQ.  
Tel: 0488 72267

**QUINTET** 25w Stereo

**CONCERTO** 40w Stereo

**TEMPO** 30w Mono

All Class A with hard wired P.C.B. and Star earthing (the best of both worlds).

**IN THE NORTH**  
Doncaster Hi-Fi Studios,  
Sunnyfields (0302) 781387

**Hi-Fi Experience**  
Glasgow (041) 226 4268

**IN THE SOUTH**  
Vinyl Tube Audio  
43-45 Fortress Road  
Kentish Town  
London  
071-485-4854

Paul Green Hi-Fi  
Bath, Avon  
(0225) 316197

**ART audio**

130 MAIN STREET, CALVERTON, NOTTINGHAM NG14 6LU Tel: 0602 653604

What do the critics say:

### QUINTET

The Art Audio gives you music with a sense of rightness that you don't really question but simply get on and enjoy. Sweet, open and lucid, the music is produced with an easy sense of naturalness which makes long term listening fatigue free and especially rewarding.  
Roy Gregory, Hi-Fi Choice.

### TEMPO

I feel that the Art Tempo amplifiers are among the finest valve power amplifiers currently available. The imagery that the Tempos create is vivid, lifelike and full of space and air.

Alan Sircam, Hi-Fi World

### MAESTRO

... they are just so stunningly gorgeous and open to listen to, I can barely imagine anything more alluring.  
Noel Keywood, Hi-Fi World  
...the Maestro is part of that rare breed of hi-fi that makes you forget about the equipment and think about the music. In all, unlike the car, the Maestro lives up to its name.  
Alan Sircam, Hi-Fi World

'Were you aware that most  
of the worlds most exciting  
digital electronics come from  
one manufacturer?'



**MICROMEGA**

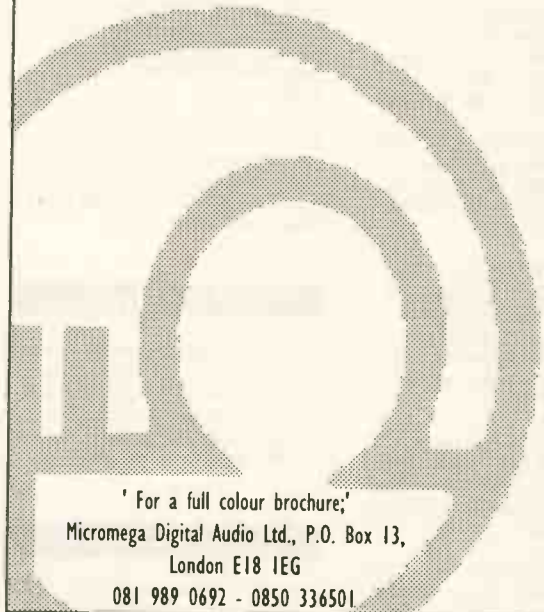

'For a full colour brochure,'

Micromega Digital Audio Ltd., P.O. Box 13,  
London E18 1EG

081 989 0692 - 0850 336501

**A**  
**AUDIOCRAFT**

(0895) 253340 UXBRIDGE, MIDDLESEX

**SA ACOUSTICS**

(0626) 67060 NEWTON ABBOT, DEVON

### THE SYSTEM BUILDERS

A&R LTD - AUDIO TECHNICA - AVI - CHORD -  
IMPULSE - J.A. MICHELL - LEVINSON - LURNA -  
L.F.D. AUDIO - MICROMEGA - ORTOFON - OCM  
TECHNOLOGY - PROAC - SD ACOUSTICS - SUMIKO  
- SEISMIC SINK - SOUND AUDIO - SUGDEN -  
SUPERPHON - SANSUI - TARGET AUDIO - VOYD -  
WILSON AUDIO (RECORDINGS) - YBA - CABLES -  
STERLING - LFD - CANARE - ORTOFON

STOCKIST OF GOLDEN DRAGON TUBES  
PLUS OTHER FINE EQUIPMENT

EX-DEM AND USED EQUIPMENT SOMETIMES AVAILABLE  
PLEASE RING FOR DETAILS

THE MUSIC IS THERE, THE SPEAKER ISN'T,  
THAT IS THE ART OF HIGH FIDELITY

## MANTICORE MAKE MORE MUSIC

Turntable Servicing - all makes please ring for details

### WE ARE APPROVED THORENS SERVICE AGENTS

Arm rewiring - Manticore standard cable	£80.00
Arm rewiring - Van den Hul or Isoda	£160.00
Arm rewiring - Cardas	£160.00
Silver plated mains cable with IEC socket	£50.00
Aerolam equipment support	£54.00
Fibrelam equipment support - superior performance	£130
Mantra replacement belt - supplied in twos	£22.00
Logic DM101 belt - supplied in twos	£25.00
Logic DM101 spring sets	£22.00
Rega armspacers - polished aluminium 1mm increments	£11.00
Impex motor, pulley and PCB	£65.00
Manticore Mantra - no tonearm	£460.00
Manticore Madrigal with Musician	£570.00
Manticore Magister with 12" Magician	£3,800.00
Manticore Musician tonearm	£320.00
Manticore Magician tonearm	£650.00
Manticore 12" Magician tonearm	£720.00

Part-ex available against all other tonearms

MB5 off-board power supply	£250.00
MB6 off-board power supply	£490.00
Motor rebuild	£150.00
RIAA and preamplifier	£490.00

Please telephone or write for more information and a copy of Mumbo Jumbo.



### MANTICORE AUDIO VISUAL

The Courtyard, 56c Shortmead Street,  
Biggleswade, Beds. SG18 0AP  
Tel: 0767 318437



# The SPEAKER Company

**For all your needs in DIY speaker and crossover construction**

We offer a large range of speaker chassis and crossover components for hi fi, car audio, public address & studio uses. The Speaker Company also offers a range of specialist services.

**Hi-Fi** chassis speakers, crossover's, cabinet kits, cable, cabinet damping materials, spike kits etc

**Car Audio** chassis speakers, crossover's, sub bass cabinets and amplifiers.

**Public Address** chassis speakers, crossover's, mixers, amplifiers, cabinets, microphones and stands.

**Plus a comprehensive range of accessories**

## Chassis speakers by

Audax, Seas, Morel, Rcf, Kef, Elac, Rcl, Richard Allan, Fane, McKenzie, Celestion, Eminence, Peerless, Volt, Altai, Soundlab, P.H.L.

Please phone or post for a copy of our free comprehensive catalogue and price list which includes hints and tips on DIY loudspeaker construction.

Unit 9, Waterside Mill, Waterside  
Macclesfield, Cheshire SK 11 7HG  
Tel: 0625-500507  
Fax: 0625-500508

All goods dispatched within 24 hours subject to availability

Open 9 am to 6 pm Monday to Friday & 9 am to 5 pm Saturday



**JORDAN**

We are the world leaders in Metal Cone Loudspeaker Technology and our experience and expertise extends back over 40 years.

Our precision tooled foil cones together with our unique Linear High Compliance Suspensions provide loudspeaker drive units of unrivalled performance.

Our approach permits the use of the most simple crossover and enclosure designs and opens the door to a virtually limitless range of performance options.

The newly developed Jordan JX Series of loudspeaker drive units represent the cutting edge of driver technology. Based on the wide bandwidth, foil cone principle, pioneered by Jordan over forty years ago, these latest drive units offer significant improvements in bandwidth, linearity, efficiency and power.

The Jordan JX Series comprises three drive units:

The Jordan JX51 is a foil cone mid-high frequency unit having a piston diameter of 51mm. It provides an exceptional bandwidth from 100Hz - 30kHz, with good efficiency and power handling. Used singly or in multiples it is intended for use in systems to provide the highest standards of sound quality.

The Jordan JX125 is the complementary bass unit to the Jordan JX51. The low mass foil cone has a piston diameter of 125mm which is suspended by the unique Jordan Linear High Compliance Suspension to achieve a fast and extended bass performance down to 25Hz (depending upon the loading conditions).

The Jordan JX92 is a new addition to the Jordan range. It embraces a 92mm foil cone and is intended for use as a full range driver in compact systems. The bandwidth extends from 45Hz - 17kHz with excellent efficiency and power handling. The unit offers significant advantages for a compact, low cost system, having the special qualities of sound achievable from a crossover-free design.

For further information, please contact:

**E.J. JORDAN DESIGNS**

The dak, Manorbier, South Pembrokeshire. SA70 8QR  
Tel. 0834 871209 Fax. 0834 871770

# HIGH FIDELITY

0582 504560

## This Month's Special Offers

Rotel 965 BXLE	£330
Pink Triangle LPT GTi turntables	£449
Audio Alchemy BDE1	£349
Acoustic Energy AE1 speakers	£595

6 Carolyn Court, Trinity Road, Luton, Beds. LU3 2NF

## SUPERIOR SOUND AUDIO

Bespoke Audio Engineers

Listen to these remarkable amplifiers by AUDION

300B MONOBLOCKS "Probably the best amplifiers in the world"	£1995.00
EDISON STEREO "The original pwr/line integrated"	£399/499
845 POWERBLOCKS "Handbuilt to order, finish to suit"	£35,000.00
CHESELL REFERENCE "m/c input superb '93 spec"	£2495.00

(ALL POWER AMPS, ERIK ANDERSSON DESIGNED)

-tubes-amplifiers-speakers-cartridges-

-REPAIRED-MODIFIED-REBUILT-SERVICED-SALES-

ORIGINAL SNELL LOUDSPEAKER UPGRADES

Full Cartridge testing and rebuilding service

TUBE TESTING STATION

AUDIOPHILE COMPONENTS | CABLES | OUTPUT TRANSFORMERS

GROOVE TUBES EDISON ORIGINAL GOLD DRAGON

(main tubes agents for sussex 1000's in stock)

FOR ALL YOUR REQUIREMENTS

+AUDION+EDISON+ANDERSSON+AUDIONOTE+REFERENCE+JPW+COGAN  
HALL+SILVER SOUNDS+MAGNUM  
DYNALAB+MICHELL+TRANSFIGURATION+WILSON BENESCH+  
TRADE INQUIRIES WELCOME FOR OUR NEWLY EXTENDED RANGE  
TAX FREE EXPORT SPECIALIST'S  
25 MONTEFIORE ROAD, HOVE, SUSSEX. Tel:/Fax 0273 202637

# SLATE AUDIO

HI-FI Design & Cable Services



**THE SPEAKERSTAND** Custom made to suit any loudspeaker. Solid slate, supremely rigid & totally stable. P.O.A.

*"Immaculately finished, sublimely rigid, on a par with the best stands I've used."*

Ken Kessler, Hi-Fi News/RR March '89

*"An astonishing degree of instrumental separation, stable and holographic, with great precision and remarkable poise. The ultimate in high fidelity supports."*

David Prakes, Hi-Fi Answers Sept. '89

*"Superbly finished, the sound quality was considered to be first rate."*

Martin Colloms, Hi-Fi News/RR May '90

*"The sound quality when using the Slate Audio stands proved to be a revelation, something special."*

Paul Messenger, Hi-Fi Choice, May '91

*"The finish is excellent, the sound quality magnificent and breathtaking."*

Tom Bryant, The Telegraph, June '92

## The Finest Speaker Supports In The World

**GARRARD 401/301 PLINTH SYSTEM** With 20 years of experience, we are now the leading experts on the 401/301. In solid marble, this plinth eliminates motor noise, rumble and feedback.

The sound quality from these classic motors have now reached superdeck status. £349 - £25 p/p

**THE TURNTABLESLAB** Solid slate spiked turntable platform, can be placed anywhere

with remarkable results. Size 17" x 14"

£175.00

**THE TABLESLAB** Solid slate shelf which replaces any other shelf normally fitted to equipment

racks, dramatically improving your turntable's performance. State size,  £125.00

**THE SPEAKERCABLE** LC OFC Meets the same high standard set for our loudspeaker

stands. A supremely neutral and clean sound. Please state length required,  £15 per metre

**THE SPIKEKIT** Specially developed to fit directly to floor standing loudspeakers or any

wooden support. Adjustable and very simple to fit.

£20.00

I ENCLOSE A CHEQUE P.O. for £ \_\_\_\_\_ made payable to SLATE AUDIO

Name: \_\_\_\_\_

Address: \_\_\_\_\_

Tel: \_\_\_\_\_

47 GEMINI CLOSE, LEIGHTON BUZZARD, BEDFORDSHIRE, LU7 8UD. TEL 0525 384174

# Connections



Tel: 081 348 5676 (2.00-7.00 pm)

Fax: 081 341 9368

## Esoteric High Fidelity CABLES

Dealers in: Absolute, Audio Note, Audioquest, Deltec, Harmonix, Kimber, Mandrake, MIT, Siltech, Symo, Van den Hul, WBT, and others

... the **RIGHT** cables  
... in **YOUR** system  
... for **YOUR** ears  
... in **YOUR** home

Contact us by phone, fax, or letter and we'll do our best to help you achieve your goal.

(Auditions may be subject to a handling charge)

**CONNECTIONS** 11 Archer St, London W1V 7HG (A division of Connection 90' Travel Ltd.)

MANA - CASTLE - ALCHEMIST - ALBARRY - AUDIO INNOVATIONS  
WADIA DELTEC TUBE TECHNOLOGY

# AUDIO GALLERY

NR PETERSFIELD HAMPSHIRE

MAIL ORDER CABINETS SUPPLIED TO ORDER IN ANY SIZE WOOD & HAND PAINTED FINISHES STONE - GRANITE - MARBLE - SHELVING

HOME DEM ON DEM WADIA 6, MICROMEGA CD3, TDL, SME, TEAC, VRDS 10, IMPULSE

0730 - 895194

VALVE SPECIALISTS ON A SUPERIOR LEVEL

AMIC - PROAC - JPW - MOTH - PINK TRIANGLE

FOR OPENING HOURS AND APPOINTMENTS PLEASE RING ANYTIME

## QUALITY HI-FI IN NORTH WALES

Contact John Hodgkinson for expert advice and friendly service. All equipment may be taken on home demonstration.

Main stockists of:

ROTEL ★ YAMAHA ★ HARMAN KARDON ★ NAD ★  
TEAC ★ MICHl ★ TANNOY ★ KEF ★ HEYBROOK ★  
INFINITY ★ JBL ★ JAMO ★ HECO ★ KEF ★ TDL ★  
INFINITY RENAISSANCE ★ ALPHASON ★ ARISTON ★  
APOLLO ★ TARGET and more!

## ELECTRO TRADER

THE Hi-Fi Centre in North Wales since 1978  
19COLWYN CRESCENT, RHOS-ON-SEA, COLWYN BAY

Tel: (0492) 548932

Mail Order Specialists

Opening Hours: 9.30-1.2.5.30

Demonstrations by appointment preferred



# Alchemist Products

### KRAKEN:

"Every now and then a product comes along that causes a stir in the Hi-Fi industry. I feel the Kraken well built and with a superb sound quality has this potential."

Alan Sircom - Hi-Fi World

### GENESIS:

The genesis amplifiers express dynamic contrasts so dramatically that few British built power amplifiers can match them.

It is refreshing in the realm of the big Krells, heavyweight musical Fidelities and gigantic thresholds, that the Alchemist amplifiers are diminutive by comparison."

Alan Sircom - Hi-Fi World

KRAKEN INTEGRATED ..... £399

KRAKEN/PRE ..... £395

KRAKEN/POWER ..... £380

FREYA PREAMPLIFIER ..... £1020

BRAGI PHONO STAGE ..... £495

ODIN STEREO AMPLIFIER .. £1020

GENESIS MONO AMPS ..... £1525

### OPTIONAL UPGRADES:

KRAKEN MM MODULE ..... £45

KRAKEN MC MODULE ..... £55

UPGRADE P.S.U. .... £45

### UK DEALER LIST

#### LONDON

KAMLA ELECTRONICS W1 (071) 323 2747  
HIFI CONFIDENTIAL SW1W (071) 233 0774  
BRADYS WC2H (071) 379 4010  
CORNFLAKE SHOP W1 (071) 631 0472  
KJ WEST ONE W1M (071) 486 0552

#### KENT

SEVENOAKS (0732) 459 555  
STANDENS (0732) 353 540

#### HAMPSHIRE

AUDIO GALLERY (0730) 895 194

#### WEST MIDLANDS

MUSIC MATTERS (021) 429 2811  
WEST MIDLAND AUDIO (0905) 58046

#### WILTSHIRE

SALISBURY HIFI (0722) 322 169

#### MILTON KEYNES

AUDIO INSIGHT (0908) 561 551

#### NORTHERN IRELAND

ZEUS AUDIO (0230) 332 522



FOR MORE INFORMATION CONTACT

ALCHEMIST PRODUCTS  
Tel: 081 883 3008  
FAX: 081 883 1160



# V'AUDIO

36 Druid Hill, Stoke Bishop, Bristol BS9 1EJ  
**0272 686005**

## SME MODEL 20A

Regular readers will know that we are constantly aiming to provide a different environment for the purchase of good quality equipment, and are always looking out for new items that enthusiasts cannot hear anywhere else in the South-West.

It is equally difficult for manufacturers to find shops that will properly demonstrate their equipment and provide the sort of **friendly service** that is required. We are particularly proud therefore that we are now the only venue with the **SME MODEL 20** turntable on demonstration, this will add to the quality of our front ends so that you can hear our superb speakers, such as the ATC SCM50A and RUARK ACCOLADE at their best.

Other new exciting products include the **CHORD AMPLIFIERS** and the new **PINK TRIANGLE DaCAPO**.

Always changing - please ring Ian Vaudin for the latest situation, or just for a chat.

## LYNWOOD MAINS CONDITIONER

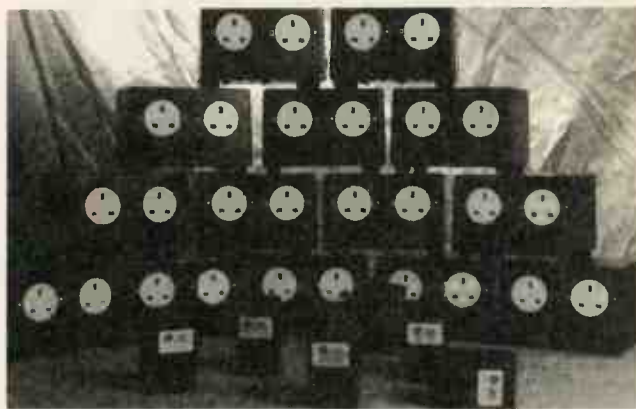

Price:—      **Basic**                      **£49.95**  
                   **Advanced**                **£195.00**  
                   **Mega**                         **£295.00**

**For further information and dealer list send SAE to:**

**LYNWOOD ELECTRONICS**  
 Coley Lane Farm  
 Wentworth  
 Rotherham  
 South Yorkshire

**WE WILL BEAT ANY GENUINE ADVERTISED PRICES!!!**

# R.S.AUDIO

## MAIL ORDER CENTRE

**TEL. 071-255 1403 / 071-255 1503**

1. All Goods Fully Guaranteed
2. All Goods Brand New
3. Delivery charges extra
4. All prices include VAT
5. Prices correct at time of going to press.

AIWA		CD PLAYERS		AMPLIFIERS		CASSETTE DECKS		MINI SYSTEMS	
<b>XC-750</b> £159	AIWA XC300 £125	AIWA XC950 £175	AIWA DP2030 £90	AIWA KA1030 £90	AIWA ADF410 £88	AIWA ADF810 £175	AIWA ADF910 £219	AIWA NSX220 £500M	<b>SONY STS370L</b> £127
	KENWOOD CD4211 £50	MARANTZ CD5211SE £50	MARANTZ CD72SE £50	MARANTZ KRV5040 £569	DENON DR5610 £159	DENON DR5610 £159	DENON DR5610 £159	DENON D-70 £249	<b>MISSION 760i</b> £500
	NAD 502 £50	PHILIPS CD920 £132	PHILIPS CD930 £154	MARANTZ PM32 £119	KENWOOD KX9050X £500	KENWOOD KX9050X £500	KENWOOD KX9050X £500	JVC UX-A3 £249	<b>TECHNICS RSBX404</b> £116
<b>ROTEL RCD965BX</b> £500	PHILIPS CD930 £154	PIONEER P0201 £140	PIONEER PDS501 £182	MARANTZ PM52 £179	NAD 6100 £189	NAD 6100 £189	NAD 6100 £189	KENWOOD UD500M £539	<b>AIWA ADF-410</b> £88
	PIONEER PDS901 £269	PIONEER PDS901 £269	PIONEER PDS901 £269	NAD 302 £50	PIONEER TCK370 £99	PIONEER TCK370 £99	PIONEER TCK370 £99	KENWOOD UD700M £615	<b>TECHNICS SCCH</b> £550
<b>MARANTZ CD52-II</b> £500	PIONEER PDM601 £209	SONY PD75 £669	SONY PD95 £1669	PIONEER A-201 £122	SONY TCK590 £155	SONY TCK590 £155	SONY TCK590 £155	KENWOOD UD700M £615	<b>AIWA ADP-100</b> £127
	SONY CDP397 £189	TECHNICS SLP320 £119	TECHNICS SLP320 £119	ROTEL RA920AX £500	YAMAHA RSX626 £164	YAMAHA RSX626 £164	YAMAHA RSX626 £164	KENWOOD UD900M £819	<b>TECHNICS SCCH550</b> £419
<b>PIONEER PDS-801</b> £249	SONY CDP597 £155	YAMAHA SLP420 £135	YAMAHA SLP420 £135	ROTEL RA940AX £500	YAMAHA RSX727 £199	YAMAHA RSX727 £199	YAMAHA RSX727 £199	KENWOOD UD900M £819	<b>TECHNICS SCCH700</b> £535
	TECHNICS SLP520 £169	YAMAHA SLP520 £169	YAMAHA SLP520 £169	SONY TAF170 £99	YAMAHA RSX828 £245	YAMAHA RSX828 £245	YAMAHA RSX828 £245	KENWOOD UD900M £819	<b>AIWA ADP-410</b> £88
	YAMAHA CDX560 £169	YAMAHA CDX860 £255	YAMAHA CDX860 £255	SONY TAF440 £159	YAMAHA RSX404 £139	YAMAHA RSX404 £139	YAMAHA RSX404 £139	KENWOOD UD900M £819	<b>ROTEL RA-930AX</b> £500
	DAT			SONY TAF540 £199	YAMAHA KX260 £132	YAMAHA KX260 £132	YAMAHA KX260 £132	KENWOOD UD900M £819	<b>TECHNICS SCCH900</b> £535
<b>PIONEER A-300X</b> £500	AIWA HOS100 £500	SONY TCC03 £500	SONY DTC750 £500	TECHNICS SUV2220K £85	YAMAHA KX650 £219	YAMAHA KX650 £219	YAMAHA KX650 £219	KENWOOD UD900M £819	<b>AIWA ADP-410</b> £88
	D.C.C.			TECHNICS SUV2320K £119	LOUDESPEAKERS	BOSE ACoustiMASS £500	BOSE ACoustiMASS £500	KENWOOD M45 £499	<b>ROTEL RA-930AX</b> £500
<b>PIONEER A-400</b> £500	PHILIPS AND MARANTZ SALES PRICES ON REQUEST			TECHNICS SUV500K £139	BOSE ACoustiMASS £500	JVC M45 £499	JVC M45 £499	KENWOOD M45G £499	<b>TECHNICS SCCH550</b> £419
	MINI-DISC			TECHNICS SUV600K £179	JAMO £500	KENWOOD M76G £685	KENWOOD M76G £685	KENWOOD M85E £939	<b>AIWA ADP-410</b> £88
	SONY MZ-1 £500			TECHNICS SUV720K £229	JBL £500	KENWOOD M85E £939	KENWOOD M85E £939	KENWOOD M85E £939	<b>ROTEL RA-930AX</b> £500
	SONY MZ-2P £500			YAMAHA AX550 £219	MISSION 7611 £70	PIONEER CDX120 £429	PIONEER CDX120 £429	PIONEER CDX120 £429	<b>TECHNICS SCCH700</b> £535
				YAMAHA DSPA500 £500	MISSION 7621 £70	SONY CDX320 £495	SONY CDX320 £495	SONY CDX320 £495	<b>AIWA ADP-410</b> £88
				YAMAHA DSPA1000 £500	MISSION 753 £70	SONY CDX520E £695	SONY CDX520E £695	SONY CDX520E £695	<b>TECHNICS SCCH900</b> £535
					MISSION 780 £70	SONY CBX920E £825	SONY CBX920E £825	SONY CBX920E £825	<b>AIWA ADP-410</b> £88
					M. SHORT NAD 800 £80	IN-CAR ENTERTAINMENT	ALPINE BAZODKA £500	ALPINE BAZODKA £500	<b>TECHNICS SCCH900</b> £535
					TANNOY 603 £60	ALPINE BAZODKA £500	DENON JBL £500	DENON JBL £500	<b>AIWA ADP-410</b> £88
					TANNOY 605 £60	DENON JBL £500	PIONEER PHILIPS £500	PIONEER PHILIPS £500	<b>ROTEL RA-930AX</b> £500
					TANNOY 607 £60	PIONEER PHILIPS £500	PYLE £500	PYLE £500	<b>TECHNICS SCCH900</b> £535
					TANNOY 609 £60	PYLE £500	QUART £500	QUART £500	<b>AIWA ADP-410</b> £88
					TV/VIDEO & D.S.P.	QUART £500	SONY - ALL ATSALE PRICES.	SONY - ALL ATSALE PRICES.	<b>TECHNICS SCCH900</b> £535
					WE STOCK AV AMPS, SPEAKERS, NICAM VIDEO'S, T.V.'S AND PROCESSORS - PHONE FOR THE LATEST SALE PRICES.				<b>AIWA ADP-410</b> £88

NOT ALL PRODUCTS LISTED, PHONE FOR OTHER SALES PRICES

PRICES SUBJECT TO CHANGE WITHOUT NOTICE.

**DENON, NAKAMICHI & ROTEL AT AMAZING PRICES PHONE!!!**

10-12 HANWAY ST,  
 LONDON  
 W1P 900

# Northwood



## A U D I O

*Hi-Fi Specialists*

**10% FREE**

**ACCESSORIES WITH ANY PURCHASE OVER £200**

*Can't separate the wood from the trees?*

*Come and audition the very best that Hi-Fi has to offer and let your ears hear music like they've never heard before!*

RUARK, ALBARRY, ROTEL, CELESTION, NAD, TANNOY, MICROMEGA, GYRODEK, HEYBROOK, MARANTZ D.C.C./A.V., PIONEER, EXPOSURE, CREEK, AUDIOLAB, MERIDIAN, AUDIO INNOVATIONS, TDL, MISSION, HECO, THORENS, DENON, KEF, TARGET, plus many more

**BOTH BRANCHES NOW HAVE 2 DEM ROOMS INCLUDING AUDIOVISUAL DISPLAYS**

**FINANCE AVAILABLE.**

**EXPORT AND MAIL ORDER SPECIALISTS**

126 Pinner Rd, Northwood

Middx HA6 1BP.

Tel: (0923) 820877.

**NEW BRANCH NOW OPEN AT:-**

98 Cambridge Street

Aylesbury, Bucks HP20 1BA

Tel: (0296) 28790.

## MAIL ORDERS ACCESSORIES

- Cables - Audioquest, Furukawa, Heybrook, Ixos, Ortofon, QED, Van den Hul
- Stands - Alphason, Goldring, Sound Organisation, Stands Unique, Target
- Cartridges - Arcam, A.T., Denon, Dynavector, Goldring, Lyra, Ortofon, Sumiko
- Headphones - Beyer, Sennhiesser, Stax
- Accessories - Allsop, BIB, Discwasher, Hunt, Kontak Last, Michell, Milty, Nagoaka, Pixall, QED
- LP's/CD's - Audioquest, Klavier, Opus, Reference Recordings, Sheffield Labs.

**TO ORDER OR FOR A FULL CATALOGUE**



**PHONE 0850 565693**



**NOW ON PERMANENT DEMONSTRATION**

**MICHELL - ISO**  
**ARGO**  
**ALECTO**

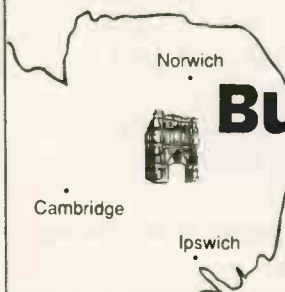

## Bury Audio

47 Churchgate Street  
Bury St. Edmunds  
Suffolk IP33 1RG  
Telephone 0284 724337



Credit Cards Welcome  
24 hrs Delivery Service



**HIFI CONFIDENTIAL**  
FOR YOUR EARS ONLY

Opening Hours:  
Mon-Fri 10-6pm  
Sat 10-3pm

Tel: 071-233 0774 Fax: 071-233 7226

### HOT SOUNDING ITEMS

Teac VRDS 10 CD  
•  
ALCHEMIST KRAKEN PRE AND POWER  
•  
ALCHEMIST FREYA AND ODIN PRE-POWER AMP  
•  
ALBARRY AP4+S60A  
•  
ORELLE DAC 180  
•  
CASTLE WINCHESTER  
•  
AUDIO INNOVATIONS  
SERIES 1000 MONOBLOCKS  
L-2 L-1 PRE-AMPS

**BEST BUY**  
**MUSICAL FIDELITY CDT**  
**£499.00**

**ONIX OA3I**

**ONIX BWDI TUNER**

**PINK TRIANGLE DA  
CAPO DAC**

**"NEW MUSICAL  
FIDELITY"  
PRE-POWER F22+F18  
"EXCELLENT"**

**MOTH PASSIVE AND  
40W MONOS  
ALSO 100VA PHONO  
STAGE**

**JOHN SHEARNE PHASE  
2 INTEGRATED AMP**

**HEYBROOK  
SIGNATURE**

**PRE-POWER AMP**

**CARTRIDGES  
DYNAVECTOR - DENON  
- SHURE - SUMIKO - A.T.  
- ORTOFON**

**PRO-AC  
RESPONSE 3  
AND ROTAL  
MICH**

**HIFI CONFIDENTIAL**  
34 Buckingham Palace Rd  
London SW1W 0RE  
Tel: 071-233-0774  
Fax: 071-233 7226



352-354 Lower Addiscombe Road,  
Croydon, Surrey CRO 7AF  
Telephone: 081 654 1231/2040

Fax: 081 655 3922

High Fidelity/Loudspeaker  
and Video Specialists



## SPALDINGS THE Hi Fi SHOP

THAT PROBABLY HAS  
**THE HIGHEST STANDARDS  
IN THE SOUTH EAST.**

**W**hether you are a complete beginner or have many listening hours under your belt, you need the facilities a really good hi-fi shop offers to ensure you get the best value.

We carefully select equipment in every price range, from good value products at around £200 per item, to more expensive and even more enjoyable systems costing thousands.

In our demonstrations we use listening rooms separate from the main shop and our extensive experience enables us to get the best from every piece of equipment. This makes differences and improvements pleasantly obvious.

We offer free of charge the most vital part of any hi-fi system, the detailed preparation and installation necessary for us to achieve the best sound in your home.

We guarantee that you will be thrilled with your music, not just for the first few months but over many years of listening.

### *Equipment From:*

ARCAM•AUDIOLAB•LINN•NAIM•QUAD  
DENON•ROTEL•MARANTZ•KEF  
RUARK•EPOS•MISSION•CYRUS  
CELESTION•DUAL•MERIDIAN•MICHELL  
AND OTHERS

PLEASE DO NOT HESITATE TO CONTACT  
US TO ARRANGE A DEMONSTRATION OR  
JUST FOR ADVICE ON:

**081 654123 / 6542040**

## Oxford Audio Consultants

### HI-FI SPECIALISTS



**Our superb service is the same,  
regardless of price.**

## SONUS FABER LOUDSPEAKERS

WE LOVE THEM ALL!

### NOW DEMONSTRATING

TEAC VRDS 10 CD PLAYER  
SEQUENCE LOUDSPEAKERS  
AUDIO ALCHEMY DTI - CONNECT BTN CD & D/A CONVERTOR  
FOR A BIG IMPROVEMENT  
VAN DEN HUL THE FIRST CABLE  
THETA DATA 2/DS Pro Prime  
AUDIO RESEARCH LS3 PREAMP  
AUDIO RESEARCH LS2B  
COPLAND CTA 401  
KRELL KSL preamp & KRELL KST 100 power amplifier  
HEYBROOK SIGNATURE AMPLIFIERS & LOUDSPEAKERS  
AUDIO RESEARCH V70 POWER AMPLIFIER  
PROCEED SERIES 3 CD DIGITAL PROCESSOR & CD TRANSPORT  
REVOX EVOLUTION AUDIO SYSTEM  
WADIA - latest range on demonstration  
LYRA LYDIAN CARTRIDGE - simply stunning!  
SONUS FABER MINUETTO/ELECTA/AMATOR/EXTREMA  
MICHELL GYRODECK - Still a Classic!  
MUSICAL FIDELITY PREAMP & TYPHOON  
MAGNUM PREAMP & MONOBLOCK POWER AMPS  
MICHELL ISO/ARGO  
REL STADIUM SUBWOOFERS  
HARMONIX ACCESSORIES

### NOW DEMONSTRATING

#### Ex Dem & P/ex Bargains

CLASSE DR6 PREAMP - MINT £1995.00  
CLASSE DR9 POWER AMPLIFIER - MINT £1995.00  
BEARD BB1 BB100 11 £795.00  
KRELL KSA 50 £895.00  
REVOX H6 TUNER £595.00  
AUDIO RESEARCH CLASSIC 60 new valves £2495.00  
THETA DS PRO PRIME D/A as new £995.00  
MARANTZ PM80 AMPLIFIER £299.00  
PIONEER PD8700 £225  
CHORD 1000 POWER AMPLIFIER £1495.00  
REVOX Hill cassette £595.00  
MUSICAL FIDELITY CD1 £250.00

*Please ask for details or our current list*

Agencies include: Audio Research, Apogee, Air Tangent, Koetsu, Krell, Magneplanar, PS Audio, Sonus Faber, Audio Technica, Goldring, Marantz, Micromega, Ortofon, Rogers, SD Acoustics, Stax, Thorens, Wharfedale, Kimber, Sennheiser, Slate Audio, Target, QED, van den Hul, NAD, Nakamichi, SME, JPW, Revox, Dual, Monitor Audio, Pioneer, Proceed, Onix, Teac, Rotel, T.D.L., Ruark, Acoustic Energy, Audio Alchemy, Deltec, Musical Fidelity, Accuphase, Basis, Wadia, Theta, Sequerra, Castle, Heybrook, Copland, Denon, Cartridges, ART Accessories, Harmonix.

**TAX-FREE EXPORT SERVICE**  
**MAIL-ORDER AVAILABLE ON MANY ITEMS.**  
Open Mon-Sat 10am-6pm.

## Oxford Audio Consultants

Cantay House, Park End Street, Oxford OX1 1JE  
Telephone: Oxford (0865) 790879  
Facsimile: Oxford (0865) 791665



# Bryants

81 HIGH STREET, ALDERSHOT, HANTS. TEL: (0252) 20728, 314448

25 YEARS OF EXCELLENT SERVICE

With 25 years experience in Hi-Fi, we feel our service is second to none. All units are fully guaranteed and backed by our own workshops. We offer three demonstration rooms and knowledgeable staff to help you choose your system. We can also arrange fast mail order, with all normal credit facilities available.

BUYING FROM BRYANTS YOU CAN BUY WITH CONFIDENCE

### AMPS

AMCVT3000	£529.95
CYRUS ONE	249.95
CYRUS THREE	T B A.
DENON PMA250III	149.95
DENON PMA350	189.95
DENON PMA450	249.95
MARANTZ PM32	139.95
MARANTZ PM305E	159.95
MARANTZ PM405E	249.95
NAD 302	159.95
NAD 304	209.95
NAD 306	299.95
PIONEER A119	99.95
PIONEER A201	129.95
PIONEER A300X	199.95
PIONEER A400	249.95
ROTEL RA920 AX	149.95
ROTEL RA930 AX	179.95
ROTEL RA935 BX	199.95
ROTEL RA940 BX	249.95
TECHNICS	STOCKED

### CD

**CLAIM FREE RECORD VOUCHERS WITH EVERY CD marked \***  
(Please ask for details).

AMC CD6	349.95
*AIWA XC300	129.95
*AIWA XC750	179.95
DENON DCD590	169.95
DENON DCD690	199.95
DENON DCD890	269.95
DENON DCD 1290	329.95
*MARANTZ CD42II	199.95
*MARANTZ CD52II	229.95
*MARANTZ CD52SE	299.95
MISSION DAD 5	299.95
MISSION DAD 5	299.95
*NAD 502	199.95
*NAD 505	269.95
*PHILIPS CD920	149.95
*PHILIPS CD930	179.95
*PHILIPS CD950	349.95
*PIONEER PD101	129.95
*PIONEER PD201	149.95
*PIONEER PDS501	189.95
*PIONEER PDS601	219.95
*PIONEER PDS701	249.95
*PIONEER PDS801	299.95
*PIONEER PDS901	349.95
*SONY CDP397	139.95
TECHNICS	
*SLPG320	139.95
*SLPG420	159.95
*SLPG520	199.95
*SLPG620	229.95
*YAMAHA CDX460	179.95

### TUNER/AMPS

NAD 7020I	149.95
NAD 701	249.95
NAD 705	299.95

### TURNTABLES

DUAL CS 503-2	159.95
DUAL CS 505-4	199.95
NAD 5120	99.95
REVOLVER REBEL	139.95
SYSTEMDEK I +	
RB250	229.95
SYSTEMDEK IIX900 +	
RB250	329.95
SYSTEMDEK IIX900 +	
RB300	379.95

### MORSAULT'S

HE STEREO	99.95
HE PRO LOGIC	179.95
SUB	149.95
MS 5-10	129.95
MS 5-20	159.95
MS 5-30	219.95
TANNY 603	124.95
TANNY 605	159.95
TANNY 607	209.95
TANNY 609	269.95
TANNY 611	399.95

### SPECIALS CONT...

PIONEER A119	99.95	79.95
CYRUS ONE	249.95	199.95
TWO (ex dem)	379.95	249.95
PSX (ex dem)	299.95	229.95
SONY TAF170	109.95	89.95

### AV AMPS

PIONEER VSA	449.95
YAMAHA DSPA500	449.95
YAMAHA DSPA1000899.95	

### CABLES

**SPEAKER CABLES**

QED 79	10 Mtr
QED F79	50 Mtr
CABLETALK 3	2.10 Mtr
CABLETALK CONCERT 2	5.95 Mtr

The original and still the best. We supply QED 79 strand as standard on all our systems. **BEWARE OF IMITATIONS**

### INTERCONNECTS

CABLETALK ADVANCED	34.95
STUDIO	59.95
PURE SONIC 6010A	29.95
PURE SONIC 8010A	39.95
QED P1	17.95
QED P1 GOLD	22.50

### SPEAKERS

**CLAIM FREE 16" SPIKED SPEAKER STANDS ON ALL SPEAKERS OVER £110** (Excluding System Building Systems).

CERWIN VEGA AT40	299.95
DALI 104	319.95
HEYBROOK SOLO	169.95
HEYBROOK HB1/3	249.95
JPW MINIM	79.95
JPW SONATA	114.95
JPW SONATA (V)	99.95
MISSION 760 I	129.95
MISSION 761 I	179.95
MISSION 762	249.95
MISSION CYRUS 780	199.95
MISSION CYRUS 781	249.95
MISSION CYRUS 782	349.95
MISSION CYRUS 753	599.95

### SPEAKER/EQUIPMENT STANDS

A COMPREHENSIVE RANGE STOCKED FROM APOLLO, SOUND ORGANISATION TANNY, TARGET and TRIPOD

### TUNERS

PIONEER F737	279.95	169.95
F757	279.95	189.95
CYRUS	299.95	239.95

### DIGITAL SOUND PROCESSORS

YAMAHA DSPE200	349.95
YAMAHA DSPE1000649.95	

### DCC & MINI DISC

**CLAIM FREE TAPE/DISCS WITH THESE MODELS**

PHILIPS DCC 900	549.95
SONY MZ-2P	399.95
SONY MZ-1	499.95

### PLUGS ETC.

ARCAM BANANA	1.25
RADIO SPARES BANANA	0.70
BANANA	0.80
QED BANANA	0.80
MK 13 amp PLUG	2.45

**WE WILL MATCH ANY GENUINE ADVERTISED PRICE**

### SPECIALS TO CLEAR

GREAT REDUCTIONS ON EX DISPLAY & NEW STOCK

AMPS	WAS	NOW
AIWA XA007	179.95	109.95
DENON PMA250II	149.95	99.95
JVC AX435	169.95	99.95
NAD 1300 PRE	189.95	119.95
PHILIPS FA890	229.95	99.95

### CASSETTE DECKS

AIWA ADF 370	129.95	89.95
ADW 800	299.95	199.95
JVC TDW305	169.95	119.95
TDX 341	139.95	89.95
NAD 6340	219.95	149.95
PIONEER CT5609	179.95	139.95
CT565	249.95	199.95
CT737	349.95	149.95

### CD PLAYERS

NAD 5420	169.95	119.95
NAD 5425	199.95	139.95
ONKYO DX130	199.95	99.95
DX230	249.95	129.95
PHILIPS CD634	249.95	119.95
PIONEER PD 4350	199.95	119.95
PDT 303	199.95	149.95
PD 5300	229.95	119.95
PD 8500	399.95	199.95

### TUNERS

CYRUS TUNER	299.95
DENON TU260L	119.95
DENON TU560L	159.95
DENON TU580RDS	199.95
MARANTZ ST40	109.95
MARANTZ ST50	159.95
NAD 402	149.95
PIONEER F201L	109.95
PIONEER F301 RDS	159.95
PIONEER F676	199.95
ROTEL RT 930	159.95
ROTEL RT 950	199.95

### SYSTEM BUILDING

All the systems below include the excellent NAD 5120 turntable as the source component. Alternative turntables or CD players are available at extra cost (please see OPTIONS listed below)

AMPS	JPW Sonata Vinyl Advent Mini	Mission 760I Tannoy 603 M-Short MS5-10	Tannoy 605 M-Short MS5-20	Mississ 761I Heybrook Solo	Tannoy 607 M-Short MS5-30
MARANTZ PM32	£269.95	£299.95	£319.95	£334.95	£364.95
MARANTZ PM305E	£279.95	£309.95	£344.95	£349.95	£384.95
MARANTZ PM405E	£324.95	£354.95	£369.95	£384.95	£415.95
NAD 302	£289.95	£319.95	£339.95	£349.95	£379.95
NAD 304	£329.95	£359.95	£379.95	£389.95	£424.95
PIONEER A300X	£279.95	£309.95	£329.95	£339.95	£359.95
ROTEL RA920AX	£304.95	£334.95	£349.95	£359.95	£389.95
ROTEL RA930 AX	£379.95	£409.95	£435.95	£444.95	£474.95
PIONEER A400					

### CASSETTE

**CLAIM FREE TAPES WITH ALL DECKS marked \***

*AIWA ADF 410	99.95
*AIWA ADWX828	169.95
*AIWA ADWX929	199.95
*AIWA ADF810	199.95
*AIWA ADF910	249.95
DENON DRM510	149.95
DENON DR5610	199.95
DENON DRW650	199.95
*MARANTZSD40	129.95
*MARANTZSD52	159.95
*NAD 6340	149.95
*PIONEER CT-S210	129.95
*PIONEER CT-S310	169.95
*PIONEER CT-S510	219.95
*PIONEER CTW401R	149.95
*PIONEER CTW601R	199.95
*ROTEL RD945	159.95
*ROTEL RD955	199.95
*SONY TCK 390	129.95
*SONY TCK 590	199.95
TECHNICS	STOCKED
*YAMAHA KX260	149.95
*YAMAHA KX360	179.95

**FREE:** 16" SPIKED STANDS with all speakers SOLD OVER £110.00. System Building excluded



### OPTIONS

CD PLAYERS	ADD £
AIWA XC300	29.00
AIWA XC750	69.00
DENON DCD590	69.00
DENON DCD690	89.00
DENON DCD890	159.95

DENON DCD1290	219.95
MARANTZ CD42II	89.95
MARANTZ CD52II	119.95
MARANTZ CD52SE	179.95
NAD 5420	10.00
NAD 502	99.95
NAD 505	159.95
PHILIPS CD920	39.00
PHILIPS CD930	69.00
PIONEER FA5601	109.95
PIONEER PDS701	149.95
PIONEER PDS801	179.95
PIONEER PDS901	229.95
ROTEL RCD955	139.95

**FAST MAIL ORDER OUR SPECIALTY 48 HOURS**

**ALL SYSTEMS SUPPLIED WITH:** All interconnects + 6 metres of QED 79 Strand professionally terminated with Radio Spares banana plugs, recognised by leading manufacturers as the best.

ROTEL RCD965	189.95
ROTEL RCD965LE	259.95
TECHNICS SLPG320	39.00
TECHNICS SLPG420	59.00
TECHNICS SLPG520	89.00
TECHNICS SLPS620	119.00
SONY CDP397	39.00
YAMAHA CDX560	99.00

### TURNTABLE UPGRADES

REVOLVER REBEL	ADD £
SYSTEMDEK I + RB250 + AT95	140.00
SYSTEMDEK IIX900 + RB250 + AT95	240.00
SYSTEMDEK IIX900 + RB300 + G1012	330.00



### Audio Note Audio Component Parts Price List.

We have decided to offer a range of the ultra high quality components used in most of the Audio Note amplifiers to the discerning "do-it-yourself" valve amplifier enthusiast. These components include specially made valve bases, paper-in-oil and silver foil coupling capacitors, Black Gate and Ceratine electrolytics, acid-free silver solder, output transformers and valves. In addition to this we can supply various silver cables and wires for internal wiring.

It should be noted that all prices are exclusive of Value Added Tax and postage/freight. For all EEC citizens it must be noted that we are now required to charge UK Value Added Tax at the standard rate of 17.5% on all sales to individuals living within the EEC, so your payment must include 17.5% added on to the total value of your purchase. Sorry about that, but those are the rules!

### Ceramic Valvebases.

All our valve bases are of the highest quality made from steatite and using metal parts or alloys which retain their spring tension around the valve pin for a very long time indeed. They are recommended both as upgrades for existing amps as well as use in any amplifier construction projects.

Type	£
4 pin UX4 gold plated chassis	8.25
4 pin Jumbo silver plated chassis	157.50
5 pin UY5 gold plated chassis	9.50
7 pin silver plated PCB	6.15
7 pin silver plated chassis	6.75
8 pin silver plated chassis	5.65
8 pin gold plated chassis	8.50
9 pin silver plated PCB	3.70
9 pin gold plated PCB	5.80
9 pin silver plated chassis	4.10
9 pin gold plated chassis	6.50
Topcap with connector	9.50

If the above bases are too expensive, we can supply the following "industrial grade" ceramic valve bases.

8 pin chassis clip mount	1.45
8 pin chassis bracket	1.45
9 pin chassis bracket with shield	1.85

### Cables & Wires.

We can offer the Audio Note range of copper and silver coax and wiring cables, depending on the end-quality of your project. I feel that it deserves at least a piece of silver twin coax on the input, prices as follows,

Cable	£ cost per metre
AN-A copper twin coax filz	15.00
AN-C copper twin coax filz	19.95
AN-S silver twin coax filz	80.00
AN-V silver twin coax filz	145.00

Wiring/Speaker cables.

AN-D copper single strand	6.99
AN-B copper screened speaker cable	12.50
AN-SP Silver speaker cable	125.00
AN-SPx Silver speaker cable	350.00

It should be noted that the cost for the coax cables is per stereo metre and the speaker cables per mono metre. It is recommended to use the internal twin wires of the AN-S and AN-V as internal signal wiring wires, this is what Audio Note do in their best amplifiers.

### Paper-In-Oil Signal Capacitors.

These handmade paper in oil signal capacitors are sonically superior to any of the plastic types we have come across. If you have never experienced the difference that a good paper/oil capacitor makes in a valve amplifier, you really should try. They are easy to put in as a replacement for most plastic capacitors,

improvements will be experienced in Audio Research, Conrad Johnson and other more "modern" valve amplifiers, but most certainly in old Leaks, Radfords, McIntosh and Quad power amplifiers	
0.015mF/400VDC	2.85
0.022mF/400V DC	3.70
0.18mF/400V DC	4.30
0.22mF/400V DC	4.95
1.4mF/400V DC	12.00
0.0015mF/630V DC	2.70
0.082mF/630V DC	3.15
0.22mF/630V DC	5.35
0.33mF/630V DC	7.05
0.39mF/630V DC	7.60
0.22mF/1000V DC	6.50
0.39mF/1000V DC	10.30
1.2mF/1000V DC	14.75
0.22mF/1600V DC	8.05
0.22mF/2000V DC	11.00

Other values available by special order

### Audio Note Silver Foil Capacitors.

Quality speaks for itself! Best signal capacitors available, without question, made by hand at Audio Note's factory in Tokyo, Japan

0.02mF/500v	210.00
0.05mF/500v	345.00
0.1mF/500v	645.00
0.15mF/500v	988.00

Other values available by special order, and at a price

### Paper-in-Oil Reservoir Capacitors.

Can be used in many applications, choked power supplies where low storage capacity of high quality is needed, for example

2mF/400VDC	30x40x55mm	26.00
2mF/630VDC	35x45x72mm	33.50
2mF/1000VDC	45x45x72mm	39.40
2mF/1600VDC	50x70x72mm	42.60
4mF/1000VDC	45x45x120mm	46.90
4mF/2500VDC	70x70x120mm	264.00
10mF/1000VDC	70x70x120mm	92.00
12mF/1000VDC	70x100x100mm	106.00
12mF/1600VDC	100x100x120mm	127.00
12mF/2000VDC	100x100x220mm	151.00

Many of these values are available only in small quantity, and values will be added as we can produce relevant values in competitively priced packages

Other values available by special order.

### Audio Note Acid & Chloride Free Silver Solder.

50 grammes	24.50
------------	-------

### BLACK GATE Electron Transfer, High Performance, Electrolytic Capacitors.

These electrolytics will greatly improve any amplifier or loudspeaker, when used as substitute for any other type of electrolytic.

Type/Value	£
0.47mF/50v	1.05
1mF/50v	1.25
2.2mF/50v	1.55
4.7mF/50v	2.15
22mF/50v	3.35
220mF/100v	423.00
1000mF/50v	92.30
470mF/16v	21.75
100mF/16v	18.50
100mF/50v	15.05
1000mF/50v	24.55
220mF/16v	4.30
470mF/16v	6.35
220mF/63v	36.90
470mF/16v	14.10
47mF + 47mF/500v SK Type	58.56
100 + 100mF/500v SK Type	73.20
220 + 220mF/350v SK Type	67.85

220mF/16v	F Type	6.25
220mF/16v	FK Type	9.95
1080mF/50v	FK Type	43.90
220mF/63v	FK Type	75.75
22mF/350v	VK Type	8.90
1mF/50v	N Series bipolar	4.90
4.7mF/50v	N Series bipolar	5.45
10mF/50v	N Series bipolar	6.80
47mF/50v	N Series bipolar	13.75
100mF/50v	N Series bipolar	17.65
6.8mF/50v	Bipolar	8.90
10mF/50v	Bipolar	9.75
22mF/50v	Bipolar	17.30
47mF/50v	Bipolar	25.95

Many other values available by special order, please enquire about values and prices.

### Valves.

The valves we offer are selected from the best available in terms of sonic performance, microphonics, longevity, consistency and price.

ECC83S/12AX7WA Ultra low microphony	2.70
E88CC/6922/6DJ8W Mill spec. version	3.65
EF86/6267	1.95
6SN7	1.60
6SJ7	1.60
EL84/6BQ5	1.25
EL84M/6BQ5WA Close tolerance Mill type	4.10
6L6GC	2.40
6L6WGC/5881	4.30
VT4C/UV211	36.50
5887	4.50
5887	8.75
5887	6.80
6350	4.30
6072A	6.00
6072A RCA	9.20
6072A GE	7.50
5U4G	3.20
GZ34/SAR4	8.80

### Output Transformers.

We can supply almost any requirement for impedance or power by special order, write for quote. We offer a design service, where we will design almost any output, line or driver transformer for a standard fee of £200.00, prototype cost will be quoted on an individual basis.

Common stock items include,

15 watt for EL84/EL86/6V6PP	9K-60hm	34.00
15 watt for EL84/EL86/6V6PP	9K-4/80hm	42.00
25 watt for 2A3/300BPP	5K-4/80hm	57.00
25 watt for EL34/6L6PP	6K-4/80hm	51.00
50 watt for KT88/650A/PP	6K-4/80hm	69.00
50 watt for EL34/6L6PP	3K-4/80hm	69.00
50 watt for 845PP	11K-4/80hm	119.00
15 watt for EL84/6V6PSE	2K6-4/80hm	81.00
25 watt for 300B/2A3SE	2K5-4/80hm	91.00
25 watt for 2A3PSE	1K2-4/80hm	97.00
25 watt for EL34/650PSE	1K5-4/80hm	97.00
30 watt for 211/845SE	10K-4/80hm	111.00
50 watt for 211/845SE	10K-4/80hm	121.00
50 watt for 300B/2A3SE	1K25-4/80hm	146.00

### Potentiometers & Switches.

We have selected the best available potentiometers and switches covering the affordable and the "state of the art" types.

Noble High Quality Carbon Film Type.

100KOhm frame type	3.20
100KOhm Encapsulated type	8.60

Noble High Quality Balance Controls.

100KOhm frame type	3.70
100KOhm Encapsulated type	9.70

Audio Note High Quality Attenuators.

Handmade silver plated, double brushed attenuators, made with an array of tantalum resistors, probably the ultimate volume control.

50KOhm	172.50
100KOhm	178.00

Other values available by special order.

Standard Type 6-way Switches.

This switch is adjustable 2 - 6 way, has gold plated contacts and a stainless steel ball for best possible contact and corrosion protection.

6 - way Switch	3.30
----------------	------

### Audio Note High Quality Switches.

These switches are commensurate with the quality of the volume controls, silverplated, self-cleaning.

2 channel 6 way	64.50
4 channel 6 way	89.00

We have a range of aluminium knobs to complement your project and add that touch of professionalism that is required

### Resistors.

We can offer 1 watt 1% metal film resistors from

Beyschlag, which are the best commercial metal film resistor available, most values available at 6 pence each

Better quality H2 1% 1 watt resistors from HOLCO are available at 36 pence each, the main advantage of the HOLCO is that they are non-magnetic. It must be noted, however, that HOLCO resistors are quite fragile and can become noisy if their legs are bent too close to the body of the resistor

Very high or very low values of Holco H2s (above 500KOhm and below 100hm) will cost 0.61 pence each

The best sounding resistor type is the Tantalum film. They are also non-magnetic, but of a finer grain than standard metal film resistors

Tantalum film resistors are available in 1/2 watt, 1 watt and 2 watt, most standard values are available, but production is limited and delivery of some values may be restricted.

Prices for tantalum resistors are as follows,

1/2 watt 1%	2.06 each
1 watt 1%	3.70 each
2 watt 1%	7.05 each

Some very low or very high values may cost more

The best way to ascertain whether the improvement of a tantalum resistor is worthwhile is to exchange a loading resistor on the input of any amplifier with a tantalum resistor.

### Electrolytic Capacitors.

We can supply a suitable range of standard electrolytics for valve amplifier builders, apart from the good but expensive Black Gates

Stocks vary, but the following is always available,

220mF/10v	0.25
4700mF/16v	0.70
3300mF/16v	3.10
33mF/350v	1.35
33mF/450v	1.95
220mF/400v	6.10
220mF/450v	6.90

### Potentiometers & Switches.

We have selected the best available potentiometers and switches covering the affordable and the "state of the art" types.

Noble High Quality Carbon Film Type.

100KOhm frame type	3.20
100KOhm Encapsulated type	8.60

Noble High Quality Balance Controls.

100KOhm frame type	3.70
100KOhm Encapsulated type	9.70

Audio Note High Quality Attenuators.

Handmade silver plated, double brushed attenuators, made with an array of tantalum resistors, probably the ultimate volume control.

50KOhm	172.50
100KOhm	178.00

Other values available by special order.

Standard Type 6-way Switches.

This switch is adjustable 2 - 6 way, has gold plated contacts and a stainless steel ball for best possible contact and corrosion protection.

6 - way Switch	3.30
----------------	------

### Audio Note High Quality Switches.

These switches are commensurate with the quality of the volume controls, silverplated, self-cleaning.

2 channel 6 way	64.50
4 channel 6 way	89.00

We have a range of aluminium knobs to complement your project and add that touch of professionalism that is required

### Stand-offs.

If you are building power amplifiers with very high HT rails, like 845, 211, 4212A, 849 or the like, then getting the HT rails "suspended" from the chassis, can be very problematic. We have therefore designed a small range of ceramic stand-offs that are highly suited for this purpose. They are eminently suited for all other hard wiring purposes as well

1 way chassis mounted	1.70
3 way chassis mounted	4.20
5 way chassis mounted	6.70
7 way chassis mounted	9.40

Should you require other parts like, phono sockets, speaker outputs, mains inlets or fuseholders, we can supply these too

### Circuits, Valve Data and Basic Information.

If you would like some suggestions as to which circuits to base your project amplifier around, we shall be happy to provide you with some, please send us a stamped self addressed letter (for A4 size enclosures) plus £4.00 in UK stamps (small denominations, please!), or a US\$10.00 for foreign enquiries

We have many circuits for 300B, 211, 845, 2A3/6B4G and EL34

If you require valve data, add another pound, and I shall copy what I have got

Due to the very large number of enquiries with specific and in some cases very complicated, technical questions, which require considerable time to respond to, I am having to put a small charge on any such enquiries. So accordingly if you have any technical questions regarding your upcoming project or in general, please include £12.00, either by cheque or in small denomination stamps. For foreign enquiries a US\$ 20.00 bill will suffice

There may still be some delay in responding to such enquiries, as I travel a great deal, however, I will guarantee a reply if this small charge is enclosed

A small (to start with at least!) range of suitable mains transformers is under preparation, and by the end of February we should be able to offer chokes and mains transformers suitable for a variety of projects. Likewise, I am hopeful that we should be able to offer one or two complete kits, in a few months time, starting with a single single-ended 300B kit and possibly a 211 kit (poor-mans-ONGAKU sort of thing), keep in touch.

I am constantly being asked about books on the subject of valve amplifier technology, and since nothing exists which gives any basic grounding in the design of Audio Circuitry with valves, Guy Adams and I have written and collected a number of articles and extracts from old books, which together contain a thorough background to the subject, you will not become an instant expert from this, but it will give beginners and the more advanced a good "tool" and basic guideline to the subject.

Again we have to make a small charge for this, a cheque for £6.00 or small denomination UK stamps, or if you live outside the UK and 10.00 US\$ bill. Available March 1993

Just write to,

Peter Qvortrup

Audio Note UK Ltd.  
Unit 1, Block C,  
Hove Business Centre,  
Fonthill Road,  
Hove,  
Sussex, BN3 6HA,  
0273 220511/731498 (fax).

### UPGRADE 1

Get your Audio Innovations Series 500 upgraded to Audio Note specification, this two stage upgrade includes paper-in-oil signal capacitors and Black Gate capacitors in all important parts of the bypasses, new perspex saying Audio Note Series 500, and a complete new set of valves of best quality.

Cost for upgrade 1

£250.00 incl. Vat.

### UPGRADE 2

Upgrade 2, which is only done in conjunction with or after upgrade 1 has been effected, includes new output transformers, new gold plated valve bases, Black Gate power supply capacitors, 100kΩ high quality Noble potentiometer and balance control, goldplated switches, including lowering of the feedback to take full benefit of the better output transformers, this will make the Series 500 a genuine killer amplifier.

Cost of upgrade 2

£300.00 incl. Vat.

We have worthwhile upgrades for Quad II, Leak TL10, TL12, Stereo 20, TL25, TL50, Radford STA15, STA25, Audiomaster, Pamphonic, Dynaco, Croft, Tube Technology, Audio Research, Conrad Johnson, and most other Audio Innovations models.

All Audio Note upgrades are covered by a full 12 months warranty against failure, valves are guaranteed for 3 months. An original Audio Note certificate of conformity is issued with each upgrade.

**AUDIO NOTE**

# G.T. AUDIO HAS ON DEMONSTRATION

The Danish POSSELT Loudspeaker  
*"Probably, the finest Loudspeaker in the world."*

The MATISSE Reference preamplifier and Line stage.

The Mighty ZIKRO AUDRO 845 Monoblocks:  
*"20 watts using the amazing 845 triode."*

ANALOGUE TRACER I,II and III Reference  
 MM cartridges.

GROOVE TUBES:  
*"The only alternative replacement valve."*

G.T. Cables  
*"Loudspeaker and interconnects made to your requirements."*

We have a limited stock of LEAK, QUAD, RADFORD,  
 CHAPMAN, TROUGHLINE TUNERS, GARRARD,  
 301/401 SME etc. for sale.

We also carry some second hand equipment,  
 phone for details.

COME AND LISTEN TO THE GLORIOUS POSSELT  
 LOUDSPEAKER IN THE CHATSWORTH ROOM AT  
 THE CHESTERFIELD HI-FI SHOW

MAIL ORDER AVAILABLE Tel: 0895 833099

# SAVE & ENJOY YOUR RECORD COLLECTION

## Diamond Cantilever MC Cartridge



17-d2 Mk II

£298  
 inc. VAT, P&P

Solid diamond is the hardest possible material and is supreme for cantilever use. All musical information is transferred from the record with great speed and accuracy, with minimum loss of signal.

The 17D2's superb sound is appreciated by not only the domestic user but is installed in many Hi-Fi manufacturer's laboratories.

*"The clarity and precision of sound that the 17D2 MkII can produce are about the best I have ever come across"*

-Richard Black, Hi-Fi Choice

*"This cartridge has all the hoped-for virtues in the best moving coils"*

-John Borwick, Gramophone

Take this copy to your local Hi-Fi dealer or contact us directly. For a full refund, the cartridge should be returned in good condition within 14 days.

14 DAYS HOME TRIAL

0734 699159

DYNAVECTOR SYSTEMS LTD. 32 READING ROAD,  
 WOODLEY, READING, BERKS., RG5 3DB

Please send me further information on Dynavector  
 cartridges, and 14 days home trial

Name \_\_\_\_\_  
 Address \_\_\_\_\_  
 Postcode \_\_\_\_\_

# Soundcraft Hi-Fi

The New Musical Experience



Our single speaker listening room.  
 There are no other loudspeakers  
 interfering with the sound.

No comparators or degrading  
 switches are used. Allowing you  
 to hear all differences clearly.

The result is sound closer to what  
 you'll hear at home.

For your convenience we  
 offer an appointment service,  
 where you can hear the best  
 equipment available today.  
 You are welcome to bring  
 your own records or CDs,  
 and by arrangement, any part  
 of your existing system for  
 comparison.

We guarantee that you will  
 be thrilled with your music, not just for the first few months  
 but over many years of listening.



## Soundcraft Hi-Fi, Music For Life

409 HIGH STREET, ASHFORD,  
 KENT TN24 8TE  
 TEL: 0233 624441 FAX: 0233 640333



# PRECISION CABLES LTD

We really do stand alone for UNBEATABLE SERVICE both in QUALITY and REALISTIC PRICES making our customised cable service simply the best available TODAY AND TOMORROW.

## OLYMPIC RANGE OF HI-FI CABLES

**BRONZE QUALITY**  
 Precision Neutrik XLR. Jack Plugs  
 Musiflex cable is well known throughout  
 the Professional Music Industry for its  
 neutral transparent sound.

DESCRIPTION	LENGTH	PRICE
Phono-Phono pair	0.25m.	£12.75
Phono-Phono pair	0.5m.	£13.50
Phono-Phono pair	1m.	£15.00
Phono-Phono pair	2m. now	£17.00
Phono-Phono quad	0.25m.	£27.00
Phono-Phono quad	0.5m.	£28.50
Phono-Phono quad	1m.	£31.50
Phono-Phono quad	2m. now	£34.50
Jack-Jack patch lead		£8.00
Jack-Jack	0.5m.	£7.50
Jack-Jack	1m.	£8.00
Jack-XLR (mic)	1m.	£8.50
Jack-XLR (mic)	2m.	£9.50
Jack-XLR (mic)	5m.	£12.50
XLR-XLR	1m.	£8.50
Scart-Phono pair	1m.	£10.00
Scart-Phono pair	2m.	£12.00
Scart-phono quad	1m.	£16.00
Scart-Phono quad	2m.	£20.00

**SILVER QUALITY**  
 Neutrik Profi Connectors possibly the  
 best quality Phono connectors available.

DESCRIPTION	LENGTH	PRICE
Phono-Phono pair	0.25m. now	£25.00
Phono-Phono pair	0.5m. now	£25.75
Phono-Phono pair	1m. now	£27.50
Phono-Phono pair	2m. now	£31.00
Phono-Phono quad	0.25m. now	£50.00
Phono-Phono quad	0.5m. now	£51.50
Phono-Phono quad	1m. now	£55.00
Phono-Phono quad	2m. now	£62.00

**Musiflex cable**  
 Please add £1.00 per extra m. single  
 Please add £2.00 per extra m. pair  
 Please add £4.00 per extra m. quad  
 Scart-Phono pair 1m £17.00  
 Scart-Phono pair 2m £19.00  
 Scart-Phono quad 1m £26.00  
 Scart-Phono quad 2m £30.00

## PC OSC CABLE USED

Unterminated per m. £2.00  
 Gold plated 4mm banana plugs std.  
 J. A. Michell available.

## DESCRIPTION LENGTH PRICE

4mm-4mm	2m.	£16.50 ea.
4mm-4mm	4m.	£20.50 ea.
Jack-Jack	2m.	£12.50 ea.
Jack-Jack	4m.	£16.50 ea.
Jack-XLR	2m.	£13.00 ea.
Jack-XLR	4m.	£17.00 ea.
XLR-XLR	2m.	£13.50 ea.
XLR-XLR	4m.	£17.50 ea.

Prices are for single cables (per channel)  
 not pairs.

## PC SCREENED MAINS CABLE

16 amp 1.5mm per m. £4.50  
 20 amp 2.5mm per m. £6.20

To: PRECISION CABLES LTD. 53  
 EFFINGHAM ROAD, LEE GREEN, LONDON  
 SE12 8NT.  
 TEL: 081-297-0255.

Please send me: \_\_\_\_\_

I Enclose Cheque/Postal Order (Made  
 Out To Precision Cables Ltd.)/Cash

For \_\_\_\_\_

£ \_\_\_\_\_

Name: \_\_\_\_\_

Address: \_\_\_\_\_

Post Code: \_\_\_\_\_

tel: \_\_\_\_\_

Please Phone for FREE catalogue

All Prices include V.A.T.

Please add £5.00 for postage.

Personal Callers only by appointment.



•W•

# REFERENCE GRADE AUDIOPHILE COMPONENTS YOU CAN AFFORD

•A•

Wilfred Audio offers a unique approach to the appreciation of top quality audiophile products. Our passion for music is such that we are forever seeking out those components that best convey the true feeling and sound of the music, while at the same time representing the real value. The products described here are such, and we guarantee listening satisfaction.

If you are in the market for reference grade components and you have a passion for music, please call Wilfred Kok on (081) 698 7386 to find out more about these fine products.

## ATC Loudspeakers

ATC design and build demonstrably the finest sounding loudspeaker system in the world. In professional and audiophile circles, ATC are renowned for tremendous clarity, neutrality, dynamic range and imaging capability. That is why you'll find many of the world's most respected professionals, including the BBC, Chandos, and the San Francisco Symphony Orchestra monitoring through ATC systems. In a domestic system, you will be able to simply sit back in comfortable, relaxed surroundings and enjoy the most dynamic, transparent, purest sound you've ever experienced outside of the concert hall.

Prices from £950.  
See reviews Audiophile 9/91  
Recording Musician 9/92  
Gramophone 8/92

## XLO RS Cables

XLO Electric Reference Series audio cables are "The Best in the World." They offer, without exception, the highest level of total system performance achievable today. It is also important that they are easily affordable. XLO Electric RS cables are not system dependent, so most audio systems can use them to sound their best.

In systems of the very highest quality, RS cables deliver unmatched freedom from sonic coloration at component interfaces, and achieve near perfect clarity, timbral accuracy, imaging, focus and retrieval of spatial and ambient field information.

See reviews Stereophile 2/92 & 12/92, The Absolute Sound 4/92.

## AVI S2000MC CD Player

Utilising the Burr-Brown PCM63 20 bit multi-bit converter and 8 times oversampling filters, this AVI CD player also features the latest Philips CDM 9 engine. It is available right now for £999, giving the finest audio quality at an affordable price.

## AVI S2000MP Preamplifier

With a THD and IMD distortion figure of -120dB, this preamplifier betters the majority of its competitors by 40dB. This pre-amplifier will substantially outperform models that are many times its price of £599.

## AVI S2000MM Monoblock

With a distortion figure (THD + IMD of 0.001%), a damping factor of 1000, it competes

against amplifiers costing six times its price.  
Price £899 a pair.

## Audio Synthesis Passion

Price £558.  
See forthcoming issue of HFN/RR 3/92

## Audio Synthesis Digital Sources Module DAC

Price £1234.  
See review HFN/RR 3/92

## Alchemist Kraken

Probably the best value-for-money integrated amplifier. Price £444.

See review Hi-Fi World 9/92.  
Audiophile 2/93. What Hi-Fi 12/92.

## LFD Amplifiers

"An extremely lucid, crystalline performer. Both instrument and vocals were diamond-edged, discs coming through with transparent clarity, every facet firmly in place... Records were extremely lifelike, perfectly proportionally scaled and holographic... Ambience and depth were reproduced near perfectly, with pinpoint imagery and extremely stable positioning."  
- Hi-Fi World 9/92

See also Audiophile 1/93

Priced from £699.

## orelle DA 180

A new reference standard DAC is now available in its improved 1993 edition, with a new toroidal power supply, ALPS switch and higher standard case and fascia finish. The resulting sound is a genuine breakthrough at £549.

See review HFN/RR 11/92

**Wilfred Audio**  
High Quality Audio Equipment

London (081) 698 7386. MON-SAT 9AM-7PM

**MUSICAL IMAGES**  
 173 STATION RD,  
 EDGWARE, MDDX HA8 7JX  
 081 952 5535

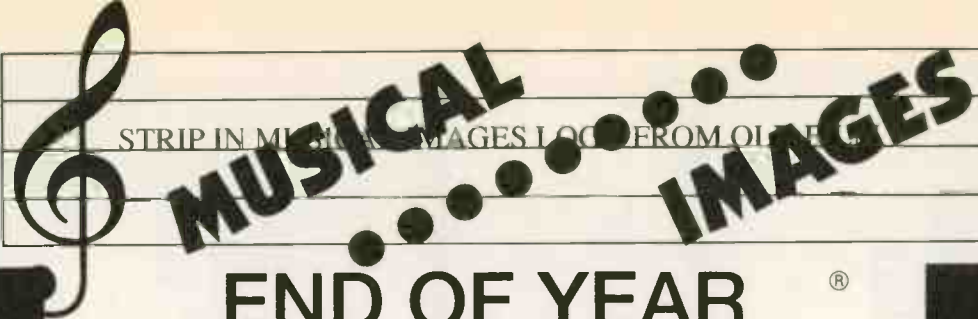

**MUSICAL IMAGES**  
 45 HIGHSTREET,  
 HOUNSLOW, MDDX TW3 1RH  
 081 569 5802

**END OF YEAR**

**SALE**

**PART  
 EXCHANGE**

**081 952 5535  
 N.W. LONDON**

**SUNDAY  
 OPENING**

**081 569 5802  
 081 570 7512**

**MAIN DEALERS FOR:**

- ACOUSTIC ENERGY
- ADCOM
- AIWA
- AKAI
- AKG/AR
- ALPHASON
- APOLLO
- ARCAM
- AUDIO ALCHEMY
- AUDIO INNOVATIONS
- AUDIOQUEST
- AUDIOTECHNICA
- AURA
- B&W
- BANDRIDGE
- BANG & OLUFSEN
- BEYER DYNAMIC
- BOSE
- BOSTON
- CANON
- CASTLE
- CELESTION
- CREEK
- CYRUS
- DENON
- DUAL
- GOLDRING
- HAFLER
- HARMON KARDON
- HECO
- HEYBROOK
- INFINITY
- JAMO
- JPW
- KEF
- KENWOOD
- LUXMAN
- MARANTZ
- MICHELL
- MICROMEGA
- MISSION
- MITSUBISHI

**MAIN DEALERS FOR:**

- MONITOR AUDIO
- MORDAUNT SHORT
- MUSICAL FIDELITY
- MICHAELSON
- NAD
- NAGAOKA
- NAKAMICHI
- ORTOFON
- PANASONIC
- PHILIPS
- PIONEER
- PROJECT
- PROTON
- QED
- QUAD
- REVOLVER
- ROGERS
- ROKSAN
- ROTEL
- ROGERS
- SANSUI
- SENNHEISER
- SHURE
- SOUND ORGANISATION
- SME
- SONY
- SPENDOR
- STAX
- SYSTEMDEK
- TARGET
- TANNOY
- TEAC
- TECHNICS
- TDL
- THORENS
- TOSHIBA
- VAN DEN HULL
- WHARFEDALE
- YAMAHA
- AND MANY MORE

**S  
 A  
 L  
 E**

<b>SPEND</b>			
<b>£100</b>	CLAIM GOODS WORTH	<b>£10</b>	
<b>£300</b>	CLAIM GOODS WORTH	<b>£30</b>	
<b>£500</b>	CLAIM GOODS WORTH	<b>£60</b>	
<b>£750</b>	CLAIM GOODS WORTH	<b>£95</b>	
<b>£1000</b>	CLAIM GOODS WORTH	<b>£140</b>	
<b>£1500</b>	CLAIM GOODS WORTH	<b>£225</b>	
<b>£2000</b>	CLAIM GOODS WORTH	<b>£350</b>	

**F  
 R  
 E  
 E**

**MAIL  
 ORDER**

**AUDIO  
 VISUAL  
 DEMOS**

**INTER-  
 EST  
 FREE  
 CREDIT**  
 ask for  
 details

Promotion valid until 31/5/93 and not with any other offer, nor with interest free credit, nor with special offers, nor with part exchange



# SUGDEN

## HAND CRAFTED AUDIO PRODUCTS

### A WORLD OF MUSIC

#### **SDA-I Digital To Analogue Converter**

U.K. - Sugden's SDA-I bowled us over with a sound populated by masses of high resolution details and complemented by very quiet, dark backgrounds and tremendous dynamics . . .

Canada - At a price well below many DACs of similar sound quality it offers real value for money in addition to its sonic refinement.

Germany - D/A converters from the Sugden stable have established themselves on a solid platform within the hi-fi scene.

#### **SDT-I CD Player**

Canada - The combination of excellent transport and high-quality parts make the Sugden a very relaxed and easy player to listen to, with no digital edge.

U.K. - I have to say Sugden's CD player just has to be near the top of any buyer's list.

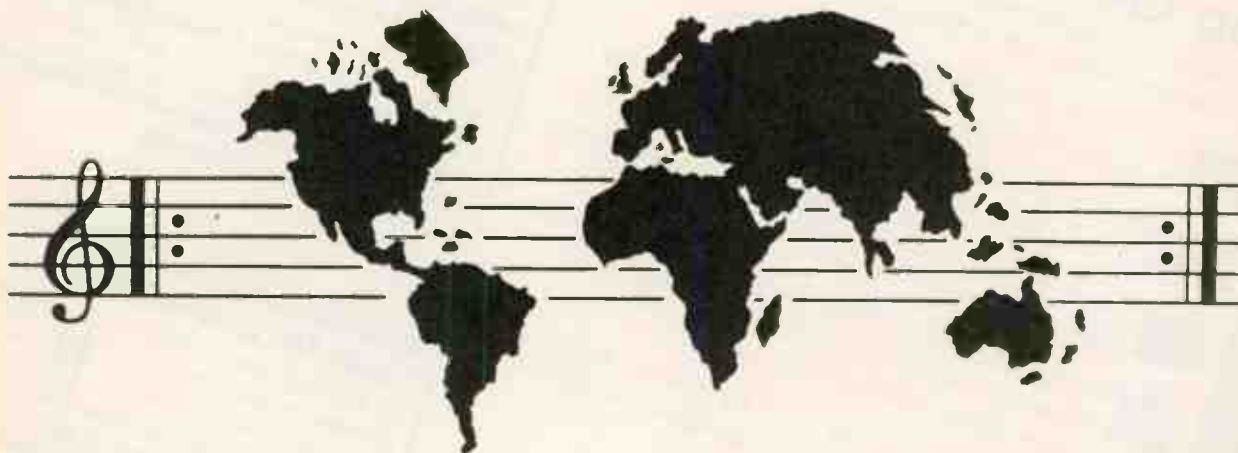

#### **A21a Class 'A' Amplifiers**

U.K. - A true thoroughbred that will undoubtedly attract newcomers to Sugden's dedicated band of followers. It almost begs you to put on more music and then proceeds to play it with aplomb.

Holland - A concert hall in your living room. The reproduction quality of the amplifier is without any stress and gives total involvement in the music.

#### **A25B Integrated Amplifier**

U.K. - Not only does the little A25B look more refined than many of its peers, it also has a sophistication to its sound that is sadly lacking in most of its immediate competitors.

Singapore - The Sugden A25B will not fail to please in the way it presents the music. It is therefore, highly recommended.

Canada - The quality of sound produced by this amplifier is exemplary.

Australia - We are hard pressed to think of an amplifier quite so musical. A delight to the ear.

France - The general transparency of sound and the punch delivered by the amplifier are really astonishing.

#### **A48 Integrated Amplifier**

U.S.A. - In terms of sound quality the A48 is a revelation. More than any other integrated amplifier in my experience. The Sugden imbues music with a warmth and body that is quite addictive.

U.K. - Coherent and musical, the Sugden A48B is on the warm side of neutral, well suited for those who like the valve sound.

#### **Au51c Pre-amplifier**

Canada - You can tell that the Au51c is special. Five minutes convinced everybody present that a pre-amp must sound like this if it is to be of reference quality.

Canada - Cold, out of its packing carton, the Sugden instantly sounded better than great. During the next few hours of operation, the unit literally blossomed and developed the sort of sound closely akin to a live performance.

#### **Au51p Power amplifier**

Canada - We've never tested an amplifier which sounds this big and did its job so well.

FOR FURTHER DETAILS:

**J. E. SUGDEN & Co., LTD. VALLEY WORKS, STATION LANE, HECKMONDWIKE, WEST YORKSHIRE WF16 0NF**  
**0924 404088**

**OVER 25 YEARS SERVICE TO MUSIC LOVERS**







# SEVENOAKS SUPERFI

This advertisement is valid until at least 30th April 1993.

## Too Good to be True!

The moment you step through the door of any one of our branches, you'll be better looked after at Sevenoaks Superfi.

-  An outstanding selection of products from leading manufacturers – all on display.
-  Friendly helpful staff that are there to help you choose the hi-fi that's right for you, without pushing you to buy.
-  Dedicated listening rooms allow you to appreciate the quality before you make your decision.
-  Comprehensive after sales service. We can, where appropriate, deliver and install your equipment and we have our own service department at Sevenoaks.
-  Real value for money. Our prices are highly competitive and our 'Added Value Offers' famous throughout the industry.

## 0% Finance

We offer 0% finance on selected manufacturer's products where there is no cash discount available. These are:-

**Audiolab, Quad, Kef Reference, Exposure, Ruark, Cyrus, Denon, Musical Fidelity, Rogers, Yamaha A/V and Arcam.**

**Option 1:** 10% deposit followed by 6 equal monthly payments. Example. Cost £600. Deposit £60 plus 6 payments of £90.

**Option 2:** 25% deposit followed by 9 equal monthly payments. Example. Cost £600. Deposit £150 plus 9 payments of £50.

**Both options:** minimum balance £400. Subject to status. 0% APR. Personal shoppers only. Written details on request.

## and 3 Year Warranty

Our prices on the above products also include our no quibble 3 Year Warranty. And virtually all warranty work is carried out by fully trained staff in our own service department.

5 Year Extended Warranty is also available on selected purchases at extra cost.

## Avoid the Saturday Crowds

Visit us Monday to Friday to choose your new Hi Fi, TV or Video.

# THE AWARD WINNERS NOW ON SHOW AT SEVENOAKS SUPERFI

## Getting it Together

Once you've chosen your new hi-fi, a small additional expenditure on a quality interconnect, stand or other accessory can enhance its performance. In fact, if you buy a quality interconnect or stand from us and you don't think your sound has improved, just return it in 'as new' condition and we'll refund your money in full.

### Interconnects

We carry a comprehensive range of superb interconnects. Choose from Audioquest, Monster, IXOS and Furukawa. There's one ideally suited to your system. We also stock a complete selection of Speaker Cables.



### Loudspeaker Stands

You need a strong stable platform if your speakers are to sound their best. Our extensive range includes Partington, Target and Apollo.



### Consoles and Racks

Our extensive range includes Alphason universal and expandable variable height units in smoked glass and Nextel coated MDF, Partington and Target rigid steel.



### Headphones

Keep the sound in and the neighbours happy. We have a range of headphones to suit all budgets. Choose from leading names; Sennheiser, Audio Technica and Beyer.



### Too Numerous to Mention

We sell a huge number of essential and useful accessories; audio and video tape – switching boxes – leads – record, tape, CD and stylus cleaners. All too numerous to mention. If you have a particular requirement, ask us, we probably have the solution.

22  
Branches  
Nationwide





# BUY WITH CONFIDENCE

**IN STORE & MAIL ORDER** - You can buy with confidence from Sevenoaks Hi-Fi. We've been in business for 21 years and have lots of experience with personal callers and Mail Order customers. All goods are **BRAND NEW, FULLY GUARANTEED** and maintained by our own service department. For personal attention and demonstration call into any of our branches. If you live too far away, simply post or phone your order through and our efficient Mail Order department at Sevenoaks head office should have your equipment safely delivered within 2 or 3 days, subject to availability. Carriage is only £7 per order and generally FREE if total exceeds £300 (UK mainland only). All goods are insured against loss or damage in transit. Payment may be made by cash, cheque, Access or Visa (Barclaycard). Prices include VAT.

**PLEASE CALL US BEFORE TRAVELLING TO VERIFY PRICE AND AVAILABILITY**

Some branches closed on Wednesdays. Please ring before travelling to avoid disappointment.

## Amplifiers

- Albany PPI £429.95
- Albany S508 £499.95
- Albany AP4 £349.95
- Alchemit Krieger £399.95
- AMC CT 125 (Active) £529.95
- Arcam Alpha 2 £199.95
- Arcam Delta 60 £549.95
- Arcam Delta 120.2 £749.95
- Arcam Delta 110S £449.95
- Arcam Delta 110 £219.95
- Arcam Delta 290 £299.95
- Aura VA50 Black £429.95
- Aura VA100 Black £399.95
- Audiolab 8000D/II £629.95
- Audiolab 8000D/III (tech) £249.95
- Audiolab 8000D/III £299.95
- Audiolab 8000D/III £379.95
- Cyrus One II £149.95
- Cyrus PSX II £189.95
- Cyrus Two II £199.95
- Cyrus PMA250 III £199.95
- Denon PMA350 £249.95
- Denon PMA480R £549.95
- Denon PMA450 £529.95
- Exposure EXP20 £649.95
- Exposure EXP7 £569.95
- Exposure EXP15 MM £249.95
- Exposure EXP85TD £189.95
- Harman Kardon HK6250 £139.95
- Harman Kardon HK6150 £139.95
- Kenwood KA320 £429.95
- Marantz PM32 £229.95
- Marantz PM40SE £299.95
- Marantz PM52 £299.95
- Marantz PM62 £299.95
- Marantz PM72 £199.95
- Musical Fidelity A1 Mk II £299.95
- Musical Fidelity A1 Mk II £874.95
- Musical Fidelity Pre B £199.95
- Musical Fidelity Typhon £159.95
- Musical Fidelity M465 (Pair) £199.95
- Musical Fidelity Tempest £299.95
- Nad 302 £129.95
- Nad 304 £269.95
- Nad 306 £199.95
- Pioneer LA300X £349.95
- Pioneer A400 £341.95
- Philips FA930 £673.95
- Quad 66 inc R1 £179.95
- Quad 34 £199.95
- Quad 306 £249.95
- Quad 606 £299.95
- Quad 606X £399.95
- Rotel RA930AX £199.95
- Rotel RA930BX £399.95
- Rotel RA940BX £199.95
- Rotel RA960BX £394.95
- Rotel RA980BX £299.95
- Rotel RC960BX £299.95
- Rotel RC980BX P.O.A.
- Sony Technics

## Cassette/DCC Decks

- Present this Ad to claim Free Tapes with these models (FT)
- Alwa ADF410 £699.95 (FT)
- Alwa ADF810 £199.95 (FT)
- Alwa ADF910 £249.95 (FT)
- Alwa ADW828 £179.95 (FT)
- Alwa ADW929 £849.95 (FT)
- Arcam Delta 100 £149.95
- Arcam Delta 150 £249.95
- Denon DRW110 £199.95
- Denon DRW510 £299.95
- Denon DRW710 £199.95
- Denon DRW810 £649.95 (FT)
- Denon DRW810 £799.95 (FT)
- Denon DRW650 £129.95 (FT)
- Marantz CD82 £159.95 (FT)
- Marantz CD92 £249.95 (FT)
- Marantz SD04 £189.95 (FT)
- Marantz SD05 £699.95 (FT)
- Marantz SD62 £299.95 (FT)
- Marantz SD415 £549.95 (FT)
- Nakamichi DR1 £199.95 (FT)
- Nakamichi DR2 £199.95 (FT)
- Nakamichi DR3 £199.95 (FT)
- Philips DCC 900 £199.95 (FT)
- Philips FC520 £199.95 (FT)
- Pioneer CT5410 £249.95 (FT)
- Pioneer RD945AX £179.95 (FT)
- Rotel RD955AX £219.95 (FT)
- Rotel RD965BX £159.95 (FT)
- Sony TCK520 £199.95 (FT)
- Sony TCK590 £259.95 (FT)
- Technics RSB404X £159.95 (FT)
- Technics RSB426X £189.95 (FT)
- Technics RSR1515K £149.95 (FT)
- Technics RSTR332K £199.95 (FT)
- Yamaha KX260 £199.95 (FT)
- Yamaha KX360 £199.95 (FT)

## Speakers

- Acoustic Research D.5 £129.95
- Acoustic Research M1 £199.95
- Arcam Delta 2 Black Vinyl £199.95
- B & W DM600 £199.95
- B & W DM610 £199.95
- B & W DM620 £795.95
- B & W 805 £649.95
- B & W 804 £249.95
- Castle Chester £349.95
- Castle Durham II £109.95
- Castle York £129.95
- Celestion 1 £169.95
- Celestion 3 £219.95
- Celestion 5 £299.95
- Cerwin Vega AT20 £99.95
- Cerwin Vega AT40 £249.95
- Dynaudio £119.95
- Goat GS210 £169.95
- Heybrook HBI 1 £699.95 (FT)
- Heybrook HBI 2 £299.95 (FT)
- Heybrook HBI 3 £549.95 (FT)
- Heybrook HBI 4 £179.95 (FT)
- Heybrook HBI 5 £199.95 (FT)
- Heybrook HBI 6 £199.95 (FT)
- Heybrook HBI 7 £199.95 (FT)
- Heybrook HBI 8 £199.95 (FT)
- Heybrook HBI 9 £199.95 (FT)
- Heybrook HBI 10 £199.95 (FT)
- Heybrook Trio £249.95
- Heybrook Quarters £299.95
- JPW AP 3 £249.95
- JPW Sonata £299.95
- JPW Sonata £499.95
- Kel R101 2 £749.95
- Kel R102 2 £1095.95
- Kel R103 4 £1495.95
- Kel R104 2 £2095.95
- Kel R105 3 £3395.95
- Kel R107 2 £169.95
- Kel R107 3 £239.95
- Kel R110 2 £329.95
- Kel R110 3 £399.95
- Kel R110 4 £549.95
- Kel R110 5 £699.95
- Kel R110 6 £899.95
- Kel R110 7 £1199.95
- Kel R110 8 £169.95
- Kel R110 9 £199.95
- Kel R110 10 £199.95
- Mission 753 £169.95
- Mission 760 £129.95
- Mission 761 £349.95
- Mission 762 £649.95
- Mission 763 £599.95
- Mission 764 £199.95
- Mission 765 £349.95
- Mission 766 £449.95
- Mission 767 £1099.95
- Mission 768 £349.95
- Mission 769 £649.95
- Mission 770 £449.95
- Mission 771 £449.95
- Mission 772 £449.95
- Mission 773 £449.95
- Mission 774 £449.95
- Mission 775 £449.95
- Mission 776 £449.95
- Mission 777 £449.95
- Mission 778 £449.95
- Mission 779 £449.95
- Mission 780 £449.95
- Mission 781 £449.95
- Mission 782 £449.95

## Tuner Amps/Receivers

- Denon DRA345R £249.95
- Denon DRA645RD £299.95
- Nad 701 £249.95
- Nad 705 £299.95

## Audio Visual

- Celestion HT1 System £299.95
- Celestion HT3 System £499.95
- Denon AVC 3020 P.O.A.
- JAMO £299.95
- Kenwood KR7040 £399.95
- Kenwood KR8040 £699.95
- Kenwood KR9500 £399.95
- Marantz SP50 £399.95
- Mordaunt Short Stereo or £229.95
- Mordaunt Short Stereo & SW £179.95
- Mordaunt Short Pro Logic £59.95
- Mordaunt Short Dialogue £129.95
- Mordaunt Short Sub Woofer £29.95
- Mordaunt Short Sub Woofer £499.95
- Mordaunt Wall bracket £449.95
- Mordaunt Wall bracket £899.95
- Philips CD205 £1099.95
- Yamaha DSPA500 £349.95
- Yamaha DSPA1000 £649.95
- Yamaha DSPA2070 £449.95
- Yamaha DSPC200 £449.95
- Yamaha DSPE1000 £449.95
- Yamaha RV660 £449.95

## Compact Disc Players

- Alwa XC300 £129.95 (FO)
- Alwa XC750 £179.95 (FO)
- AMC C06 £349.95 (FO)
- Audiolab 8000 DAC £699.95 (FO)
- Aura C050 £399.95 (FO)
- Aura C050 £699.95 (FO)
- Arcam Delta 170 3 £449.95 (FO)
- Arcam Delta 170 3 £449.95 (FO)
- Arcam Alpha Plus £179.95
- Arcam Black Box V £199.95
- Denon DCD050 £269.95
- Denon DCD90 £299.95 (FO)
- Denon DCD1290 £199.95 (FO)
- Denon DCD1290 £229.95 (FO)
- Marantz CD42 II SE £199.95 (FO)
- Marantz CD52 II SE £449.95 (FO)
- Marantz CD62 £499.95 (FO)
- Marantz CD72 £299.95 (FO)
- Marantz CD72SE £549.95 (FO)
- Mission DAC £349.95 (FO)
- Mission DAC £499.95 (FO)
- Mission DAC £699.95 (FO)
- Mission DAC £899.95 (FO)
- Mission DAC £1099.95 (FO)
- Mission DAC £1299.95 (FO)
- Mission DAC £1499.95 (FO)
- Mission DAC £1699.95 (FO)
- Mission DAC £1899.95 (FO)
- Mission DAC £2099.95 (FO)
- Mission DAC £2299.95 (FO)
- Mission DAC £2499.95 (FO)
- Mission DAC £2699.95 (FO)
- Mission DAC £2899.95 (FO)
- Mission DAC £3099.95 (FO)
- Mission DAC £3299.95 (FO)
- Mission DAC £3499.95 (FO)
- Mission DAC £3699.95 (FO)
- Mission DAC £3899.95 (FO)
- Mission DAC £4099.95 (FO)
- Mission DAC £4299.95 (FO)
- Mission DAC £4499.95 (FO)
- Mission DAC £4699.95 (FO)
- Mission DAC £4899.95 (FO)
- Mission DAC £5099.95 (FO)
- Mission DAC £5299.95 (FO)
- Mission DAC £5499.95 (FO)
- Mission DAC £5699.95 (FO)
- Mission DAC £5899.95 (FO)
- Mission DAC £6099.95 (FO)
- Mission DAC £6299.95 (FO)
- Mission DAC £6499.95 (FO)
- Mission DAC £6699.95 (FO)
- Mission DAC £6899.95 (FO)
- Mission DAC £7099.95 (FO)
- Mission DAC £7299.95 (FO)
- Mission DAC £7499.95 (FO)
- Mission DAC £7699.95 (FO)
- Mission DAC £7899.95 (FO)
- Mission DAC £8099.95 (FO)
- Mission DAC £8299.95 (FO)
- Mission DAC £8499.95 (FO)
- Mission DAC £8699.95 (FO)
- Mission DAC £8899.95 (FO)
- Mission DAC £9099.95 (FO)
- Mission DAC £9299.95 (FO)
- Mission DAC £9499.95 (FO)
- Mission DAC £9699.95 (FO)
- Mission DAC £9899.95 (FO)
- Mission DAC £10099.95 (FO)

## Turntables

- Qual CS503 2 £159.95
- Qual CS505 4 £199.95
- Nad S120 £69.95
- Pink Audio Sport LPT £69.95
- Rolsken Radius/Terxes £274.95
- Systemdek III 900 (ex) £429.95
- Systemdek III 900 + Tabro £419.95
- Systemdek III 900 + Tabro £369.95
- Technic SL1200 II £149.95
- Technic SL1210 II £199.95
- Technics TD180 £279.95
- Thorens TD280 Mk IV £159.95
- Thorens TD166R8250 £199.95

## Tuners

- Alwa TU50 £299.95
- Arcam Alpha 3 £199.95
- Arcam Delta 280 £599.95
- Audiolab 8000T £299.95
- Cyrus Tuner £119.95
- Denon TU260 £199.95
- Denon TU560 £269.95
- Denon TU560RD £119.95
- Denon TU660 £119.95
- Harman Kardon TU9400 £269.95
- Marantz STADL £149.95
- Marantz ST50L £149.95
- Musical Fidelity II II £149.95
- Nad 402 £149.95
- Pioneer £159.95
- Philips FT930 £159.95
- Quad 66FM £159.95
- Quad FM4 £159.95
- Rotel RT930AX £159.95
- Rotel RT950BX £159.95
- Sony STS370RDS £149.95
- Technics £149.95

**FINAL REDUCTIONS**  
Up to 30% OFF Selected Products

**22 Branches Nationwide**

- 109-113 London Road SEVENOAKS 0732 459555
- 24 Pittville Street CHELTENHAM 0242 241171
- 162 Powis Street WOOLWICH 081 855 8016
- 67 Smallbrook, Queensway BIRMINGHAM 021 631 2675
- 4 Dock Street HULL 0482 24051
- 55 Preston Street BRIGHTON 0376 733338
- 1 Grove Centre Witham ESSEX 0483 501733
- 73b North Street GUILDFORD 0892 531543
- 34 Mount Ephraim TUN. WELLS 0532 449075
- 7 King Edward Street LEEDS 0522 520265
- 271a High Street LINCOLN 0522 520265

- 20a Lower Bridge Street CANTERBURY 0227 462787
- 369-373 London Road CROYDON 081 665 1203
- 94 Granby Street LEICESTER 0533 557518
- 478 St. Albans Road WATFORD 0923 212736
- 2-4 Camden High Street LONDON 071 388 1300
- 15 Market Street NOTTINGHAM 0602 412137
- 4 Railway Street CHATHAM 0634 846859
- 7 Genotin Road ENFIELD 081 342 1973
- 41 St. Clements OXFORD 0865 241773
- Sevenoaks Branch only MAIL ORDER 0732 458985
- 1 Rockingham Gate, The Hoe SHEFFIELD 0742 723768
- 51 Piccadilly, Hasley STOKE ON TRENT 0709 265010

Most but not all of the offers displayed are also available from our associates Superfi whose addresses appear above. Please always phone first to check price, availability before travelling. State finish required.

MAIL ORDER TO SEVENOAKS HI-FI 109/113 LONDON RD. SEVENOAKS, KENT. TEL: (0732) 458985.

Please send me  I enclose a cheque/cash/card No. + Expiry Date

Name \_\_\_\_\_ Address \_\_\_\_\_ Daytime Tel No: \_\_\_\_\_



**MARANTZ**  
CD 52 MKS  
£179

**MARANTZ CD**  
52 MKII32  
£249

**MARANTZ**  
3P50  
£169



**DENON**  
DRS610  
£170

**DENON**  
TU260L  
£99

**PIONEER**  
A300X  
£165

**PIONEER**  
A400  
£205

**MISSION**  
76i  
£99



# MAGNUM AUDIO - VIDEO



**Tel: 081-544 9266**

**MAIL ORDER CENTRE**

**081-544 9277**

**MARANTZ CD**  
52MKS  
£179

**MARANTZ CD**  
52MKS  
£179

**MARANTZ CD**  
52MKS  
£179

**MARANTZ CD**  
52MKS  
£179

**MARANTZ CD**  
52MKS  
£179

**MARANTZ CD**  
52MKS  
£179

**MARANTZ**  
CD 52MKS  
£179

MIDI SYSTEMS		UD 900 M		£719		PD 5801		£239		KENWOOD		DAT		CTS 510		£175	
<b>AIWA</b>		<b>PIONEER</b>															
ZD93 CD	£440	N 32 T	£310			PD 5901	£315	KA 1030	£80	AIWA		HDS100	£385	CTS 610	£215		
KENWOOD		N 52 T	£345			PD 75	£659	KA 3020	£110	<b>MARANTZ</b>		<b>SONY</b>		<b>SONY</b>		TCK 370	£89
M45	£445	N 72 M	£535			PD95	£1669	PM 32	£109			TCD 3	£445	TCK 520	£135	TCK 590	£160
M76 CD	£625	N 92 T	£589			<b>SONY</b>		PM 52	£175			DTC 780	£420	TCWR 770	£195		
M85 CD	£795	<i>OTHER MODELS AVAILABLE</i>				CDP 397	£179	<b>NAD</b>				<b>MINI DISC</b>		<b>TECHNICS</b>			
<b>PIONEER</b>		<b>SONY</b>				CDP 597	£145	302	£125	<b>SONY</b>		MZ 1	£SALE	RS BX 626	£137	RS BX 727	£167
S137 T	£345	MHC 1700 CD	£389			<b>TECHNICS</b>		304	£165	MZ 2P	£SALE	<b>CASSETTE DECKS</b>		RS BX 828	£235	<b>YAMAHA</b>	
J2 T	£535	MHC 2700 CD	£465			SLP 320	£110	<b>PIONEER</b>		<b>AIWA</b>		ADF 410	£78	KX 260	£122	KX 650	£209
J3 T	£625	MHC 3700 CD	£555			SLP 420	£120	A 201	£112	ADF 810	£105	ADF 910	£209	<b>LOUOSPEAKERS</b>		<b>BOSE</b>	
J4 M	£800	MHC 500	£285			SLP 520	£155	<b>ROTEL</b>		ADWX 828	£140	<b>DENON</b>		AM 3	£299	AM 5	£420
<i>OTHER MODELS AVAILABLE</i>		MHC 700	£349			<b>YAMAHA</b>		RA 930AX	£145	<b>SONY</b>		DRM 510	£125	AM 7	£SALE	<b>CERREN VEGA</b>	£SALE
<b>SONY</b>		<b>TECHNICS</b>				CDX 560	£159	RA 940BX	£220	DRM 610	£160	DRW 650	£180	<b>JAMO</b>	£SALE	<b>JBL</b>	
COMPACT 307 CD	£349	SC CH7	£435			CDX 860	£245	<b>AIWA</b>		ADWX 828	£140	DRM 710	£205	<b>MISSION</b>		761 I	£150
COMPACT 357 CD	£375	SC CH550	£379			<b>TUNERS</b>		XT 005	£99	<b>DENON</b>		DRS 810	£260	762 I	£200	753	£530
COMPACT 507 CD	£470	SC CH700	£529			<b>AIWA</b>		<b>DENON</b>		TU 260	£99	<b>KENWOOD</b>		780	£175	<b>MORDAUNT SHORT</b>	
COMPACT 557 CD	£499	SC CH900	£629			TU 580 RD	£179	TU 9400	£202	HARMAN		KX 3050	£117	<b>BOSE</b>		800	£109
COMPACT 607 CD	£549	<b>YAMAHA</b>	£SALE			<b>CD PLAYERS</b>		<b>KENWOOD</b>		TU 9400	£202	KX 5050	£155	802	£179	<b>TANNOY</b>	
<b>TECHNICS</b>		XC CH7	£435			<b>AIWA</b>		<b>ROTEL</b>		<b>SONY</b>		KX 9050	£395	<b>MISSION</b>		603	£105
CDX 120	£405	SC CH550	£379			XC 300	£110	TAF 170	£83	TAF 440	£149	<b>MARANTZ</b>		605	£129	607	£170
CDX 320	£460	SC CH700	£529			XC 950	£165	TAF 540	£189	TAF 540	£189	SD 40	£105	609	£220	<b>YAMAHA</b>	
CDX 520E	£649	SC CH900	£629			DENON		<b>TECHNICS</b>		<b>YAMAHA</b>		SD 52B	£125	<b>SALE</b>		XC 950	£835
CDX 920E	£775	SC CH900	£629			<b>YAMAHA</b>		SU VZ 220	£75	AX 550	£209	SD 62	£170			D 250	£835
<b>MINI SYSTEMS</b>		DENON				<b>CD PLAYERS</b>		SU VZ 320	£109	<b>PRO LOGIC AMPS</b>		DD 82 DCC	£529				
<b>AIWA</b>		<b>AIWA</b>				<b>AIWA</b>		SU VX 500	£129	<b>DENON</b>		SD 415	£150				
NSX 220	£SALE	XC 300	£110			HARMAN		SU VX 600	£149	AVC 3020	£570	<b>NAKAMICHI</b>					
NSX 330	£255	XC 950	£165			<b>KENWOOD</b>		SU VX 720	£200	KAV 8500	£485	DR 3	£245				
NSX D55	£349	DENON				<b>NAD</b>		SU VX 820	£240	<b>MARANTZ</b>		DR 2	£420				
NSX 990	£299	DCD 590	£140			402	£115	SU VX 920	£395	PM 700	£335	<b>NAD</b>					
<b>DENON</b>		DCD 690	£170			<b>PIONEER</b>		<b>YAMAHA</b>		VSA 701	£339	6325	£145				
D 70	£530 EX. SPEAKERS	DCD 890	£225			F 301 RDS	£132	<b>YAMAHA</b>		<b>SONY</b>		6340	£195				
D 100	£695 EX. SPEAKERS	DCD 1290	£265			<b>ROTEL</b>		TX 550	£SALE	TAA V670 B	£560	6100	£229				
D 250	£835 EX. SPEAKERS	DP 2030	£115			RT 930 BX	£130	<b>AMPLIFIERS</b>		<b>YAMAHA</b>		<b>PIONEER</b>					
<b>JVC</b>		<b>MARANTZ</b>				RT 950 BX	£175	<b>DENON</b>		DSP A 500	£369	CTS 210	£105				
UXA 3	£215	CD 42 11	£160			<b>SONY</b>		XADD 6	£109	DSP A 1000	£749	CTS 410	£160				
UXA 5	£299	CD 52 11 SE	£235			STS 170 L	£80	PMA 250111	£125								
KENWOOD		CD 72 11 SE	£430			<b>TECHNICS</b>	£SALE	PMA 450	£225								
UD 500	£445	<b>NAD</b>				<b>YAMAHA</b>											
UD 500 M	£495	502	£159			TX 550	£SALE										
UD 700	£545	<b>PHILIPS</b>															
UD 700 M	£595	CD 920	£122														

**NOT ALL PRODUCTS LISTED  
PHONE FOR OTHER SPECIAL OFFERS**

26 DENISON RD.  
COLLIERS WOOD

SW19

1. ALL GOODS FULLY GUARANTEED
2. ALL GOODS U.K. PRODUCT
3. ALL PRICES INCLUDE V.A.T.
4. ALL PRICES INCLUDE POSTAGE & PACKING
5. ALL PRICES CORRECT AT TIME OF GOING TO PRESS

**SONY**  
STS3704  
£115

**SONY**  
TCK590  
£165

**YAMAHA**  
AX550  
£205

**YAMAHA**  
CDX 560  
£155

**CYRUS**  
780  
£175

**CYRUS**  
753  
£510

**TANNOY**  
603  
£105

**TANNOY**  
609  
£225





# Jousting for the Crown

**Jonathan Jordan listens to NAD's new 502 CD player  
from a ringside seat**

**A**udiophile acclaim is the prize that Compact Disc players joust for in the £200-£250 arena. NAD have had their fair share of laurels in the past. The British-designed NAD 502, based on the successful 5425 player and retailing at just a shade under £220, is the latest entrant to the battle for the coveted crown.

NAD have always prided themselves on the functional appearance of their equipment, claiming that all unnecessary frills are minimised to promote sound quality. As a result, like its predecessors, the 502 is unlikely to achieve acclaim for its ergonomics. NAD hope it will be a product purchased for its audiophile pretensions.

The new CD player uses low-bit MASH digital-to-analogue processing. The emphasis in the electronics department has been on optimising the design of the power supply, printed circuit board (PCB)

layout, analogue circuits and the quality of the components used.

Dark grey in colour, with grey plastic fascia and feet, the 502's most unobtrusive but possibly most attractive feature is its grey LCD display. The loading drawer, unfortunately, can only be described as flimsy. Its opening and closing did not suggest that motorised bliss and precision other players possess, but after all, NAD has always put sound before servos. Furthering their philosophy of keeping everything simple, there is no headphone socket, or multiple programming features some other manufacturers provide.

However, the 502 is remote-controllable by its own handset; sockets are also provided at the rear of the player so that it can be operated remotely in conjunction with other NAD units in the new series. The 21-key handset duplicates the main Track Search, Skip, Scan and 21-

track programmable memory accessed on the main player, but it also has a direct-access keypad so operation is very straightforward.

The NAD 502 is a forceful and confident CD player that puts plenty of feeling and expression into the music it reproduces. It performed particularly well with P J Harvey's 'Dry', generating good depth and detail, with the music flowing as opposed to being tied down. A touch of brashness could creep in, but made only minor inroads into my listening pleasure. The 502 also gave a good account of itself while I listened to Pearl Jam's album 'Ten', delivering all the punch required without sacrificing either depth or detail. It seemed to be in its element playing music with a heavy beat.

This player is for the Rock or Pop lover who requires firm bass coupled with a flowing mid-range and singing treble but

## CLEAR • CRYSTAL • SYSTEMS

### WANTED: EARLY HI-FI

#### Loudspeakers and Units:

Tannoy Gold and Red units, IILZ, Lancaster, York, GRF etc. Western Electric/Westrex drivers and Cinema speakers. Lowther, Voigt, Axion 80, RCA, Parmeko, Seimans, Vitavox, Lockwood, Altec, Quad, JBL, Dual Concentric units etc.

#### Turntables:

Garrard 301, 401, BBC, EMT 927/930  
Thorens TD124 and TD224

#### Pickup Arms and Heads:

SME 12" Arms, Ortofon Arms and Heads,  
FR-64 and FR-66, Decca FFSS, EMT

#### Valve Amplifiers:

Dynatron, Quad, Radford, McIntosh, Leak,  
BTH, AEI, Western Electric, Pye, RCA etc.

#### Valves:

Audio Valves: DA30, DA60, KT66, KT88, KT77  
ECC83, GZ34, PX4, PX25, PP5/400, WE300 etc.

Interesting early Hi-Fi and Valves Bought and Sold.

John Petrie-Baker,

#### CLEAR CRYSTAL SYSTEMS

Flat 2, 18 Canfield Gardens, London NW6 3JY

Tel: 071-328 9275 - Fax: 071-833 3008

Mobile: 0831-860499.

## IAN HARRISON HI-FI

ORTOFON	AUDIO TECHNICA	DENON	DYNAVECTOR	MARANTZ	MARANTZ
MC5000		DL304	XX-1L	CD72SE EPOA	PM32 £125
MC3000II	AT-ART1	DL103D	XX-1	CD72 £355	PM52 £195
MC2000II	AT-OC30	DL103	17D2MKII	CD62 £230	PM62RC £250
QUASAR	AT-OC10	DL160	23RSMKII	CD52SE £250	PM700AV £350
QUATTRO	AT-OC5	DL110	10X4MKII	CD52MKII	ST40L £105
QUARTZ	ATH9000		50XMKII	£190	ST50L £140
MC15SII	ATH911	<b>GOLDRING</b>		CD42MKII	SR60L £250
MC10S	ATH611	<b>SHURE</b>		£165	SD52 £135
530	AT637	<b>EXCEL GS</b>		<b>PHILIPS</b>	SD415 £160
T3000	CABLES	<b>EXCEL</b>	V15VMR	CD950 £299	SD62 £175
T20 II		<b>ELITE</b>	ML120HE	CD940 £199	EQ515 £169
		<b>ERICA</b>	ME97HE	CD930 £175	SP50 £195
		G1042		CD920 £139	TT42 £110
				CDC935 £199	CP130 £199
				CD920 £139	CP230 £235
				CD682 £125	CP430 £335
				CD680 £115	
				CD PERSONAL EPOA	
<b>SDMY</b>		<b>QUAD</b>		<b>I ALSO SUPPLY:</b>	
DTC77ES	£850	606	£605	APOLLO, SOUND ORGANI-	
DTC1000ES	£850	FULL RANGE	EPOA	SATION, SOUNO FACTORY	
TCD-D3	EPOA			TRIPOD, KOSS, BIB,	
CD PLAYERS	EPOA	<b>SENNHEISER</b>		AUDIOQUEST, WHARFDALE,	
CASSETTE DECKS	EPOA	HD1000	£185	ATC, JBL, QUAD, TDK,	
		HD560II	£109	MAXELL, SONY, THAT'S,	
<b>CASID</b>		HD250II	£105	AMPEX, JVC, PHILIPS,	
TV470T	£85	HD540II	£85	PHOTO CD.	
DAT DECK	EPOA	HD530II	£75		
<b>REVOX</b>		<b>BEYER</b>		<b>AIWA</b>	
B215	EPOA	IRS790	£145	XKS9000	£635
B215S	EPOA	DT911	£170	XKS7000	£499
B260RDS	EPOA				
B250	EPOA	<b>TDK</b>			
B226	EPOA	DAT120	£8.50		
		DAT CLEANER	£8.0		
<b>OED</b>	EPOA				

\*PLEASE PHONE/WRITE FOR DISCOUNT/EXCHANGE PRICES ON THE ABOVE CARTRIDGES.

TRADE IN YOUR OLD MOVING COIL (ANY AGE OR CONDITION) FOR A KNEW ONE AT A SUBSTANTAL DISCOUNT!

### PRECISION TEST CASSETTES

EACH HARRISON AUDIO TEST CASSETTE IS INDIVIDUALLY DIGITALLY MASTERED IN REAL TIME USING HIGH QUALITY EQUIPMENT AND TAPE. THEY ARE USED BY THE HI-FI ENTHUSIAST RECORDING STUDIOS, TV STATIONS AND SERVICE DEPARTMENTS.

MULTI-PURPOSE: TESTS DOLBY LEVEL, AZIMUTH, REPLAY FREQUENCY RESPONSE (30hz-15kHz), DOLBY B & C TRACKING, TAPE SPEED. 120us eq & 70us eq TYPES ARE AVAILABLE. PRICE: £20

DOLBY LEVEL, AZIMUTH & REPLAY FREQUENCY RESPONSE 30hz-15kHz. 120us eq & 70us eq TYPES ARE AVAILABLE. PRICE: £15

DOLBY LEVEL, AZIMUTH & SPEED. PRICE: £12.50

EACH CASSETTE IS SUPPLIED WITH INSTRUCTIONS AND SPECIFICATIONS.

\*PLEASE CONFIRM PRICE & AVAILABILITY PRIOR TO ORDERING. DELIVERY CHARGE £5.00

ORDERS/ENQUIRIES: IAN HARRISON HI-FI, 7 MILL HILL, REPTON, DERBY, DE65 6GQ. TEL: 0283 702875.

# DISCOVER THE ORIGINAL SOUND



The excellent reputation of Origin live products is for good reason. Why not investigate for yourself.

*"Speakers that are worth travelling for"*

What Hi-Fi Feb 93

### ORIGIN LIVE DEALERS

**WORTHING AUDIO**  
20 Teville Gate  
WORTHING  
West Sussex  
0903212133

**MARTON MUSIC**  
5 Ventnor Way  
Downend  
FAREHAM PO16 8RV  
0329 231773

**M.J.S. HI-FI**  
80 Stapleton Lane  
Barwell  
Leics. LE9 8HE  
0455 846977

**COTTAGE AUDIO**  
17 Bridge Street  
Saxilby  
Nr Lincoln  
LN1 2PZ  
0522 702834

**PROGRESSIVE AUDIO**  
2 Maryland Court  
Rainham  
GILLINGHAM  
Kent ME8 8QY  
0634 389004/366216

**THE HI-FI STUDIO**  
5 Norman Crescent  
Sunnyfields  
DONCASTER DN5 8SA  
0302 781387

**HI-FI CONFIDENTIAL**  
34 Buckingham Palace Rd.  
LONDON SW1 W ORE  
071 233 0774

For further information and extended dealer list contact:

Origin Live, 87 Chessel Crescent, Bitterne, Southampton SO2 4BT Tel. (0703) 442183 / 671237



who is not too concerned with intricacies or the finer detail of vocal content. While the 502 reproduces straightforward recordings well, it does not excel in complex orchestral music or when there are bass, vocals and instrumentation which dominates the mid and top range, striving to escape simultaneously from the spinning silver disc. While the 502 generally lets the music flow and build, occasionally it becomes snagged in difficult parts of the repertoire. Sometimes it gives the impression of not quite following the speed of the music. I felt, in Carl Orf's *Carmina Burana*, that the trumpets were struggling to keep pace with the other instruments.

Complexity and change of pace in orchestral music leave the NAD confused,

*"The NAD 502 is a forceful and confident CD player that puts plenty of feeling and expression into the music it reproduces"*

giving the impression of it perpetually trying to catch up with the main stream of the music. The bass arrives well, but can linger a touch longer than is required and can partially eclipse the subtler vocal characteristics of some recordings. Mozart's *Requiem* and *Don Giovanni* reinforced this impression. Low volume choral parts lacked atmosphere and stereo imagery and the overall impression was that the 502 could not generate the fine detail required to handle the mapping of the orchestra, choir or soloists.

The lack of fine detail through the vocal midrange could detract from the character of some artists: going back to Rock music, I felt the NAD failed to do Annie Lennox's voice justice; she sounded almost strained and slightly distorted in the upper octaves.

Provided the choice of music is not too demanding, the NAD offers plenty of character and undeniably conveys its power. It is best placed to suit Rock and contemporary music, where its good overall mid-range performance is optimised and it certainly gains an 'A' for effort.

NAD's new player adds a little sunshine to the music, with overall a sweet, if sometimes airy treble. At its price, it represents good value for the Rock and Pop listener who appreciates punchy and breezy music, enjoys expression and likes to hear a little extra character from their CD collection. The Classical, or more particularly the Opera or Choral fan would find its directness and lack of real subtlety detracting from their listening pleasure. The 502 is certainly a move away from the flat neutrality so many players of its price offer ●

The NAD 502 uses a neat single board assembly with the important Japanese NHK MASH chip soldered to its underside.

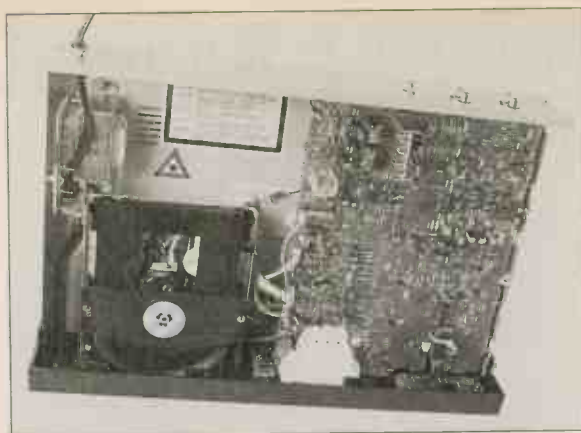

### MEASURED PERFORMANCE

NAD always aim for a smooth sound; it's a property they have built their reputation upon. With its gently rolled off upper treble, the new 502 CD player will fit into the NAD mould very nicely. The right side of our frequency response analysis clearly shows how output starts to diminish, albeit slightly, above 10kHz. The effect is minor, as usual, but it is detectable in use I find, imparting not only a welcome sense of smoothness, pacifying the jitters of CD somewhat, but also a cohesiveness too. Treble seems to integrate better into the rest of the audio spectrum, rather than standing aloof as a bright, shining beacon, divorced from the rest of the music. An overall bandwidth of 4Hz-21kHz, within -1dB limits, was measured, which matches that of other players and the medium in general.

Distortion was minimal at all signal levels; this is a low distortion player. From just 0.006% at full output, level did not rise much until the -50dB mark had been passed. At -30dB - typical average music level - there was barely a trace of distortion, as the analysis shows. At -60dB the usual quantization products started to become significant against the weakening test signal, measuring 0.55% or so. At the bottom end of the range, -90dB, this player was as linear as any other, producing 25% distortion undithered and 10% from a dithered signal. (that's CD for you). The 502 performs well by current standards though, producing negligible distortion at ordinary music levels.

Channel separation was good at 112dB in the mid-band and 91dB at high frequencies; CD is always more than satisfactory in this respect. Good linearity at -60dB, something that is difficult to achieve, gave the NAD a high dynamic range figure of 108dB. It is possible to reach 110dB or so, but rare, so the 502 again performs well.

Various tests showed there was less unwanted output above 21kHz than that produced by many rivals, especially from the latest Philips/Marantz machines which have a large noise peak at 80kHz, caused by oversampling and ineffective filtering. The NAD by contrast offers audio and little else. Noise was also low and output strong at 2.3V, +1.2dB above normal, or enough to give the player a subtle but useful advantage in apparent dynamics if put into an A/B test in a shop.

The new NAD 502 CD player measures well in all areas. Rolled off upper treble and minimal distortion will in conjunction ensure a smooth, easy sound is produced. I'd expect the 502 to sound very 'NAD like', if you'll pardon the obvious tautology. NK

### TEST RESULTS

Frequency response	4Hz-21kHz	
Distortion (%)		
-6dB	0.005	0.006
-30dB	0.005	0.006
-60dB	0.6	0.55
-90	25	25
-90dB dithered	10	10
Separation (dB)	left	right
1kHz	112	110
10kHz	91	92
Noise	-105dB	
with emphasis	-106dB	
Dynamic range	108dB	
Output	2.3V	

### Frequency Response

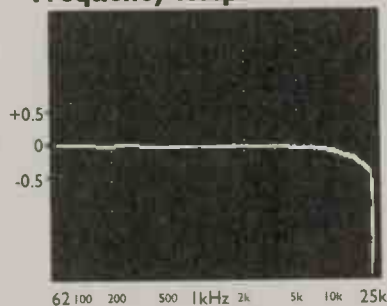

Falling upper treble gives a smooth sound.

### Distortion

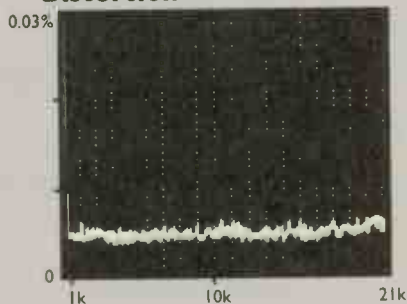

Negligible distortion at ordinary music levels.

# BRIANT & RICE

CAI  
Member  
Confederation of  
Aerial Industries

## Satellite and Aerial Services

PROFESSIONAL SUPPLIERS  
AND INSTALLERS OF SATELLITE  
AND TERRESTRIAL ANTENNAS

AUTHORISED AGENTS / DISTRIBUTERS FOR  TELEVISION

Office/Showroom  
72A Beaconsfield Road  
Brighton BN1 6DD

Tel: (0273) 550125  
Fax: (0273) 550139  
Emergency Service within 24 Hrs.

## GET THE BEST FROM YOUR HI-FI

100's OF AERIALS, 100's OF FITTINGS FOR HI-FI  
AERIALS, TV AERIALS & SATELLITE DISHES  
DIY OR FITTED BY OUR ENGINEERS

## THE AERIAL SHOP

188 HALFWAY ST., SIDCUP, KENT  
(NR. ELTHAM SE9)

(081) 300 5588/8990/7454

## EXPENSIVE TUNER??

### THEN HAVE THE AERIAL IT DESERVES

You spend many hours and quite a lot of money choosing that new tuner, so don't ruin the whole effect by fiddling with bits of wire or old aerials. Have the full benefit of the multipath-free, clean signal which only a well designed and properly installed dunit can achieve. If D.X. is your scene, then go for the ultimate in rotating high gain narrow beam systems like our G.23 with 19dB forward gain, 38dB F. to B. and Acc. Ang. down to 15 Degrees or have a "one off" special built, up to 32 elements.

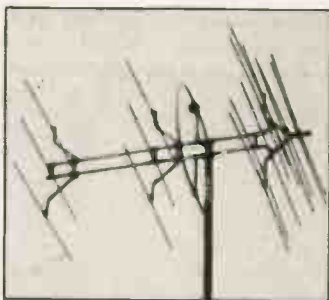

GALAXIE CIRCULAR 17-ELEMENT STEREO  
GAIN 15.9dB F to B 33.7dB L 74°

### WE DESIGN, MANUFACTURE, SUPPLY AND FIT

- ★ FM arrays from 4 to 23 Element. TV from 10 to 92 Element.
- ★ British-built and designed to withstand our weather.
- ★ Interested D.I.Y. advice freely given, backed by our complete range of masts, brackets, rotors, cables and aerials. Systems available for chimney, loft, wall, or through roof mounting.
- ★ Professional installation service available within a nominal 200-mile radius of LUTON. Full details of this service available on receipt of a large S.A.E. which will bring you our complete "Aerial Guide" which is more than just a list of our products and prices, and carries details of all our services, including MAIL ORDER and site surveys.

SEE THE REST, THEN FOR THE BEST, CALL

**RON SMITH  
AERIALS**

98 ASH ROAD, LUTON, BEDS.

Day — Luton 36561 9.0 to 6.0 Eve — Luton 29560 after 7.30 pm

5 Minutes from M1 Motorway. Turnoff No. 11



## Antiference

TV ANTENNAS

THE CHOICE IS YOURS:

**Allrounder** for reception from all points  
of the compass.



**Mushkillers** for the ultimate directional  
performance



Fitted by all good aerial installers.

Antiference Ltd.

TV Division  
Bicester Road  
Aylesbury  
HP19 3BJ



Fax: 0296 84284

## SUBURBAN AERIALS

### THE FM AERIAL SPECIALIST

SALES, SERVICE & INSTALLATION  
BY QUALIFIED ENGINEERS

A NEW AGE IN BROADCASTING HAS BEGUN

RADIO IN CD QUALITY

**IIIIIDSR** 38 CM / 15 DISH  
TECHNISAT 5000 DSR  
RECEIVER

DIGITAL - SATELLITE - RADIO

16 CHANNELS 24 HOURS A DAY  
CLASSICAL, CULTURE, OPERA, ROCK,  
POP, LIVE CONCERTS ETC...

AERIAL HOUSE, EBBERNS ROAD,  
HEMEL HEMPSTEAD, HERTS

**0442 211511**



# WHY A HI-FI TUNER NEEDS A GOOD AERIAL

**For best sound quality, a hi-fi tuner must have a strong signal of around 1mV minimum.**

**The question is: how do you get it?**

## INDOOR AERIALS

Simple pin-up wire types (dipoles) only provide enough signal within a few miles of a transmitter. Otherwise they are noisy and prone to receiving multipath signals that produce distortion.

We've tested powered indoor aerials and expensive hi-tech designs costing up to £50 and find they give no more signal than simple, horizontal dipoles, either of the wire type or of rigid aluminium. Their only benefit is smaller size. It is better to buy a rigid aluminium dipole and mount it high, upstairs on a wardrobe, at the top of a stairwell, or similar.

## LOFT AERIALS

Loft aerials have the advantage of height and, if there are many elements, gain as well, so they provide a stronger signal than a simple dipole indoor aerial. In areas of reasonably high signal strength - which usually means within ten miles or so from a transmitter, a loft aerial may be satisfactory.

Usually with three elements, a director rod (short), reflector rod (long) and dipole element in between, loft aerials are also directional; they must be pointed toward the transmitter. They reject interference and reflected signals better than dipoles, giving a cleaner signal to the tuner.

The best mounting position is high up in the V of the roof, away from metal objects like water tanks. A long downlead will be needed, preferably of good quality to minimise signal loss.

## BALCONY & WALL MOUNTING AERIALS

Balconies in blocks of flats have the advantage of height, giving a much stronger signal. However, the balcony should face the transmitter for good results.

It is often possible, if a little difficult, to wall-mount an aerial on a stub mast outside a window, but you may need consent to do so. Hanging out of a window can be dangerous, so consider using a professional installer. And make sure the wall faces toward the transmitter of course.

## OUTDOOR AERIALS

In most locations, only an outdoor aerial will give a signal strong enough and clean enough (i.e. free from interference and multipath reflections) to provide true hi-fidelity from a good tuner. Benefits are height (the higher the better), crucial for

obtaining a strong signal free of reflections, and number of elements, which determine both gain and directionality.

Multi-element aerials are used in areas of medium to weak signal strength, meaning up to around forty miles from a transmitter. Any further away is judged as a 'fringe' area and will demand even more elements.

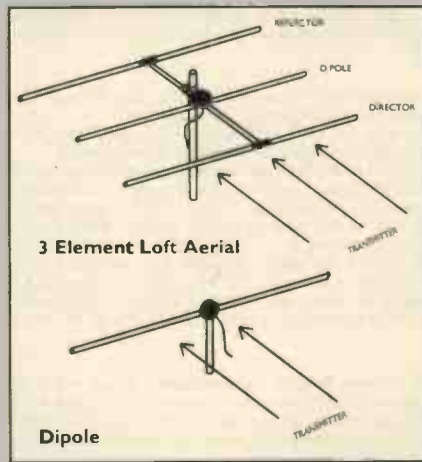

## ALL-ROUND AERIALS AND WHIPS

Whip aerials, vertical dipoles and all-round aerials (curved horizontal dipoles) provide less signal than a simple, indoor dipole (i.e. negative gain). They are suitable only for areas of high signal strength.

Although whips and curved dipoles offer all-round reception, this means they provide little rejection of reflections, interference and distant stations. They are not especially suitable for hi-fi use.

## AERIAL AMPLIFIERS AND ROTATORS

Aerial amplifiers are useful only at the masthead to overcome losses in a very long downlead. They are also used to provide enough signal for distribution around a house.

These roles apart, amplifiers boost noise and rubbish from an aerial by the same amount they boost wanted stations, giving no gain in quality, even though the signal strength meter of a tuner might go up. Not recommended.

Rotators are used to swing a directional aerial around, to receive more stations. A simpler solution is to have two aerials pointing in different directions, with their outputs diplexed together or, for more signal but less convenience, twin

downleads with an aerial switch at the bottom.

## ATTENUATORS

When it's necessary to use a directional aerial to cut down reflections from tower blocks, but the aerial then gives too much signal (i.e. more than 10mV), an in-line attenuator can be used to prevent tuner overload.

## AERIAL INSTALLERS

The best and overriding reason for using an installer is personal safety; roof work is very dangerous. Installers are also very quick and well equipped; DIY may take the large part of a day. Local installers should know about area-specific problems, the location of repeat and fill-in transmitters, and such like - all matters that are likely to be a mystery to most people.

Finally, good installers should have a Field Strength Meter that not only enables them to see whether an aerial is giving the required result, but can prove this to the satisfaction of the customer. Around 1mV is wanted, meaning powerful stations will come in higher (say 3-5mV) but weak ones a bit lower (0.3-1mV). If for no other reason, knowing that the aerial works properly is enough reason for using an installer.

Discuss this matter with them first though. In some areas, it may be impossible to obtain such a strong signal, no matter what aerial is used; get a variety of opinions if necessary.

## CONFEDERATION OF AERIAL INDUSTRIES

The CAI has a countrywide list of aerial installers who are members that abide by the rules below.

To find a local service, contact -

CAI Ltd.,  
Fulton House Business Centre,  
Fulton Road,  
Wembley Park,  
MIDDLESEX HA9 0TF

Tel: 081-902-8998

Fax: 081-903-8719

*CAI members must employ staff competent for the business conducted. They must follow standards of practice, agree to investigation, examination or test at any time. They must guarantee any aerial, equipment and/or installation work for a minimum period of twelve months ●*

# World favourites

Hi-Fi World's revamped, comprehensive, selection of preferred products out of those we have reviewed in the last eighteen months, with the issue in which the test appeared.

## COMPACT DISC PLAYERS

SONY CDP-497	£160	Superb starter CD. Packed with facilities.	Aug 9;
DENON DCD 890	£269.99	Exciting and forceful sounding player, but slightly characterful sound.	Nov 9;
MISSION DAD5	£300	Bitstream based player. Very even handed, with solid bass. Some lack of spaciousness.	May 9;
ROTEL RCD-965BX	£300	Bitstream based player. Calm, open and sophisticated performer.	Oct 9
ARCAM ALPHA +	£420	Offers a warm, full-bodied sound with a big, rich bass.	May 9
CREEK CD60	£500	16-bit player. Excellent rhythmic properties and a superb bass performance.	Apr 9;
CARY CAD-855	£900	16-bit Rotel player, with Cary-designed valve output stage. Packed with ambience and musicality.	Feb 9;
MICROMEGA SOLO	£1350	Distinctive transport; very light and musical, but with a deep, well controlled bass.	May 9;
NAIM CDI	£1598	Single box, 16-bit player. Close to the two box CDS, very disc dependent, has vital tingle factor.	Apr 9;
TEAC X-1	£2300	Superb 20-bit player. Convincing, idiosyncratic and characterful. Has plenty of flair.	Jun 9;
NAIM CDS	£2937	Two box, sixteen bit player. De rigueur for Naim-based systems. Musically informative, has both punch and delicacy.	Sep 9

## COMPACT DISC TRANSPORTS

ARCAM DELTA 170.3	£650	Smooth. Draws the listener into the performance. Improves on all the strengths of the 170.	Jul 9;
TEAC P-500	£650	Can be too restrained for some tastes, but subtle and highly detailed.	Feb 9;
DPA DIGITAL T1	£795	Superbly clean and detailed sounding transport when sync-locked to DPA's convertors.	Jan 9;
MICROMEGA DUO	£1745	CD-ROM based transport. Defines refinement and air, but without sacrificing impact.	Nov 9

## DIGITAL TO ANALOGUE CONVERTERS

QED DIGIT	£125	Based on Philips Bitstream. Excellent value, with no rough edges. Co-axial input for CD only.	May 9;
MICROMEGA MICRODAC	£299	Philips Bitstream-based. Typical Micromega sound, very musical and refined, lacks the cutting edge of detail.	Mar 9;
MISSION DAC 5	£299	DAC7 based. Clean, forward mid-range, capable of portraying real subtleties. Bass lacks firmness.	Jul 9;
ARCAM BLACK BOX 3	£360	Warm sounding DAC. Now looking a bit tired against stiff opposition.	May 9
AUDIO ALCHEMY D.D.E.	£376	Digital Decoding Engine has broad and smooth presentation.	Feb 9;
DPA LITTLE BIT	£395	Sets up a wide, open stage and places a captivating performance within it. High performance/£.	
SUGDEN SDA-1	£650	16-bit Philips based. A wide open window for the transport to flow through. Very neutral.	Jun 9;
DPA BIGGER BIT	£695	The Bigger bit has enormous insight revealing the mixing and production work behind most rock recordings.	Nov 9
AUDIOLAB 8000DAC	£695	Philips Bitstream-based. Well built and flexible. Typical Audiolab sound, very silent and neutral.	Jan 9;
DPA PDM-ONE III	£1280	Less ruthless than, but staggeringly close to the PDM-TWO. The latest version of the PDM-ONE is a two box DAC-7 affair	Mar 9;
PINK TRIANGLE DA CAPO	£1350	Own-design one bit DAC reaches new standards in Digital. One of the best.	Jan 9;
DPA PDM-TWO	£2350	Frighteningly deep and controlled bass. Very forthright; a trifle violent in its truthfulness. Literally - stunning!	Jun 9

## TURNTABLES

SYSTEMDEK IIX-900	£190	Surprisingly natural sound, if not as detailed as some. Suits Rega, Moth and Helius arms.	Aug 9
PROJECT 2	£245	Czech built turntable with much to offer. Very coherent.	May 9;
REGA PLANAR 3	£250	Built to last. Transparent and lucid, although can sound bass light. Sets the standard to beat.	Aug 9
THORENS TD166/VI/UK	£270	Fitted with Rega RB 250 arm. Good basic deck, with tweakability.	Jun 9;
MICHELL MYCRO	£397	(with RB300 arm, £539) Falling between the 5yncro and the Gyrodec, the Mycro has superb mid-band clarity and poise.	Apr 9;
PINK TRIANGLE L.P.T.	£449	Neutral sounding turntable with excellent soundstaging and decent bass. Use Linn, Rega or Roksan arm.	May 9
ROKSAN RADIUS	£550	(with arm) Isn't tripped up by unsettling music, the Radius acts a good mid-price turntable.	Nov 9
THORENS TD-3001BC	£650	Arm-less Thorens, good match for Rega RB-300 or Naim ARO. Easy to use turntable that gets very close to the Linn LP12.	Apr 9
PINK TRIANGLE EXPORT	£676	Terrific soundstaging properties, good bass and a neutral performance that considerably improves upon the LPT.	Jun 9
VOYD VALDI	£699	Similar to the Pink Triangle, the two-motor Valdi is an expressive performer, best suited to Audio Innovations equipment.	Jul 9
ROKSAN XERXES	£785	Highly analytical and exciting turntable. Can be almost CD-like in its presentation.	May 9;
PT ANNIVERSARY	£1200	Very neutral turntable, but with a lot of magic. Excellent imagery and detail. A natural partner to the SME V.	Sep 91/May 9;
SME MODEL 20	£2495	The last great turntable, bettered only by the £11,000 Model 30. The 20 never disgraces itself.	Oct 9;

## TONEARMS

REGA RB 300	£139	For Pink Triangles, Michells, Roksans and Systemdeks. Simple and superb; dynamic with solid bass.	
MØRCH DP-6	£665	'Unipivot plus' tonearm. Plays music with a silken and rich quality. Perfect match for the Da Capo cartridge.	Jul 9;
SME 309	£568	Based on IV & V; uses an aluminium armtube and detachable headshell. High end value for money. Smooth; excellent imaging	Jan 9;
SME SERIES IV	£828	Simplified version of the legendary SME Series V. A precision measuring instrument only bettered by the V.	Mar 9;
SME SERIES V	£1232	A masterpiece of precision engineering, with a cohesive sound.	Sep 91/May 9;

## CARTRIDGES

GOLDRING 1012	£45	Excellent value. Well balanced performer, rich and full without warmth. Very spacious and clear.	Apr 9
GOLDRING 1042	£89.95	A wealth of treble detail and a fine sense of analysis proffered by the Goldring secures its place in this section.	Jan 9;
SUMIKO BLUE POINT	£99.95	The Blue Point casts a romantic charm over all types of music. Robust too.	Oct 9;
ORTOFON MC15	£100	Moving coil cartridge at moving magnet price. Has a tight grip on rhythm.	Jun 9;
ROKSAN CORUS BLACK	£110	Moving magnet cartridge, based on Goldring design. Exciting and detailed, with great speed.	Sep 91/May 9;
SHURE V5T-V	£150	One of the finest moving magnets currently available. Excellent tracker.	Jul 9;
DENON DL-304	£199	Tonally uncoloured the Denon offers a superbly transparent mid-band. It could sound a little thin in some systems.	
GOLDRING ELITE	£200	British made moving coil. Good value, smooth and detailed, but can sound a trifle brittle at times.	Apr 9;
GOLDRING EXCEL	£499	British made high-end m-c. Refined and lyrical presentation, slightly dull at times.	Oct 91
LYRA LYDIAN	£500	Scan-Tech designed moving coil cartridge. Magical sound, even better nude!	Aug 9;
MØRCH DA CAPO	£500	Scan-Tech designed moving coil cartridge. Musical and accurate, without any flaw.	Feb 92/May 9;
AUDIONOTE IO	£1295	Very low output cartridge, with high silver content. Needs step-up transformer. Very musical, can show up how poor most cartridges are.	Nov 91

## CASSETTE RECORDERS

TECHNICS RS-BX404	£130	Terrific value and good sound for the money.	Sep 9
TECHNICS RS-BX606	£170	Three head deck. Superb value, capable of seeing off much more expensive machines.	Nov 9
SONY TC-K677ES	£240	One of the first low-cost three head decks. Can be grainy and slightly bright, but makes for stable recordings and playback.	Sep 9
JVC TD-V541	£280	Three head deck. Good for both recording and playback, especially of prerecorded tapes. Easy to use.	Dec 91
DENON DRS-810	£300	Drawer loading cassette - just like CD. Sweet sounding, but a bit expensive.	Jan 9;
NAKAMICHI			
CASSETTE DECK 2	£350	Makes fine recordings with metal tape. Excellent with pre recorded tapes. One of the finest two head machines about.	Mar 91
CASSETTE DECK 1.5	£500	Scaled down version of the Cassette Deck 1, without rivals at the price.	Jan 9;
CASSETTE DECK 1	£600	In the light of the 1.5, this fails to be such good value, but still a sound three head deck.	Apr 91
PIONEER D-500	£600	Very smooth sounding DAT deck, but still slightly coarser than the original source.	Apr 91
TEAC V8000S	£699	Dolby 'S' deck. Easy to use. Very stable sound, with instrumental textures close to perfect.	Jun 9;
ARCAM DELTA 100	£850	Dolby 'S' deck. Excellent sound quality, close to the original source. The best Dolby 'S' deck around.	Apr 91
NAKAMICHI CR-7	£1500	No Dolby 'S', but auto tape tuning, motorised head and remote control. Astonishing complexity; the best!	Aug 91

## TUNERS

DENON TU-260L	£110	Excellent budget AM/FM tuner. Easy to operate, good all-rounder with a fine sound.	Mar 9;
NAD 4225	£160	Warm sounding, but detailed budget AM/FM tuner. AM poor, looks dated.	Jun 9;
ARCAM ALPHA 3	£199.90	Excellent vocal clarity and decent sharpness; good for Rock.	Dec 91
AURA TU-50	£230	Superb FM-only tuner. Produces a delightful, three-dimensional sound. A cracker	May 91
YAMAHA TX-950	£260	Fine all-rounder, with a good AM section.	Jul 91
KENWOOD KT-7020	£270	Silky smooth sound, but very insensitive and needs a good aerial.	Feb 91
ARCAM DELTA 80	£340	AM/FM analogue tuner. Realistic sound quality, but slightly insensitive.	Jan 91
QUAD 66FM	£490	Among the very best in terms of tonal colour and imagery; remote controllable.	Nov 91
NAIM NAT-02	£853	Little box, big money, dead good. Try and find better unless it's a . . .	May 91
NAIM NAT-01	£1377	The best tuner currently available. All else is mere artifice. If you want better radio reception, go and live in the BBC's studio.	Mar 91

## INTEGRATED AMPLIFIERS

HARMAN-KARDON HK6150	£159	Good sounding starter amplifier. Great dynamic range. Excellent bass.	Jun 91
NAD 302	£159.99	Lots of insight and detail but could sound a little rough in the wrong system.	Jan 91



DENON PMA-350	£170	Packs a lot of punch for the money. Phono stage lags behind the line inputs.	Mar 91
PIONEER A300X	£199	Exceptionally sweet mid and treble plus the superb dynamic range of the A400	Dec 92
SUGDEN A25B	£203	Surprisingly warm and well rounded for the price. Worth seeking out.	Dec 91
ARCAM ALPHA 3	£200	Lean and lively, with an astonishing amount of detail. Excellent line stages.	Oct 91
MISSION CYRUS ONE	£249	The series 8 guise has brought about improvements in balance and power pushing it further forward.	Feb 92
CREEK CAS 4140 S2	£230	Bit soft and rounded, but with a pleasant character. Easy on the ear.	Nov 91
PIONEER A-400	£240	The amplifier that shook up the UK hi-fi industry. Very hi-fi sounding, but can sound good with high-end equipment.	Nov 91
AURA EVOLUTION VA-100	£270	Full of refinement, although not the best measuring amplifier around.	Jul 92
HARMAN/KARDON HK6550	£349	Thoroughly refreshing, tonally neutral amplifier with a realistic price tag.	Nov 92
MISSION CYRUS 2	£380	Best with PSX power supply (£300). More powerful, dynamic and well balanced than almost any of its price rivals.	May 92
AUDIOLAB 8000A	£430	Very neutral and superbly built. Good bass, great imagery, but can be sterile.	Apr 92
SUGDEN A48B	£460	Gentle performer, but never masks the music with warmth. Tonally very even.	Apr 92
AMC CVT-3030	£500	Valve hybrid amplifier. Has valve and transistor virtues in a reasonably priced package.	Aug 92
AUDIO INNOVS. SERIES 500	£990	Sweet sounding valve design. Good looking, but a little system dependent.	May 91
AUDIONOTE OTO	£1250	12w valve amplifier. More in tune with music than hi-fi. Superb dynamic range.	Jun 92
TUBE TECH.UNISYS	£1299	Superbly built chrome valve amplifier. Pacey and musical.	Aug 92
COPLAND CTA-401	£1495	Solidly built Swedish valve amplifier. Very refined and unattinguishing sound.	Feb 92

**PREAMPLIFIERS**

NAD 1000	£180	Wonderful value. Relaxed, smooth and easy on the ear. Best with 2100 power amps.	Jun 91
QUAD 34	£336	Civilised, smooth and unintrusive. Not especially transparent, but relaxing and built to last. Clever tone controls.	Jun 91
AUDIO INNOVS. SERIES 200	£349	Valve preamplifier. Good value, rather Coloured but very dynamic. Best with Innovations equipment.	May 92
AUDIOLAB 8000C	£375	Superbly made solid state pre, without flaw. Clean sounding, if a touch sterile. Excellent all-rounder.	Jun 91
CROFT SUPER MICRO A	£649	Valve preamp. Great mid-band, Good soundstaging properties, a bit warm & euphonic.	Oct 91
MICHELL ARGO+ISO	£687/£393	(+£155 for optional Hera PSU) Pure detail, incisiveness and the beauty of the highest of high end especially with the Hera power supplies. Line-level only, hence an Iso required for vinyl replay.	Oct 91/Jul 92
DPA DSP50S-L-PSU	£745/£250	Line level pre-amplifier + outboard power supply. One of the best pre's available at any price.	Apr 91
DPA DSP50S-D	£325	Disc stage to complement DSP50S-L line level pre. Can be used with DPA power supply to form an excellent disc pre amp which could be used with any line level pre.	Apr 91
CONCORDANT EXCELSIOR	£900	Valve preamplifier with MM phono + 2 line stages. Magical and realistic sound quality, deep soundstage. Superb for recordings.	Dec 91
JOHN SHEARNE PHASE ONE	£1099	Attractive preamplifier with matching power amplifier. valve-like lucidity and sweetness. Suits neutral equipment.	Aug 91
ALCHEMIST FREYA	£1150	Line level preamplifier, with distinctive styling. Detailed and commanding sounding, may sound too bright in some systems.	Oct 91
LINN KAIRN	£1295	Remote control preamplifier. Flexible, but can sound too forward. Best suited to Linn equipment.	Aug 91
E.A.R. G88	£5246	Exceptionally solidly built valve pre, with a 'bolted down' sound to match. Can sound awesome.	Nov 91

**POWER AMPLIFIERS**

NAD 2100	£290	Matches 1000 pre. Powerful (150 watts) but relaxing sound ; big bass.	Jun 91
QUAD 306	£395	Well suited to the ESL-63 loudspeakers. Beautifully built, smooth sound but not transparent; weak bass.	Jun 91
CONCORDANT EXULTANT	£500	Modified Quad II mono amplifiers. Colder sounding than the original. Good value. Good match with Excelsior preamp.	Jan 92
AUDIOLAB 8000P	£545	Powerful solid state stereo power amplifier. Clean, natural sound with a slick styling to match. Very well made.	Jun 91
CROFT SERIES 5	£548	Stereo 25 watt valve amplifier. Can be bridged. Rich, warm sounding. Good with ProAc loudspeakers.	Oct 91
QUAD 606	£570	100 watt stereo solid state amp. Smooth and civilised. Similar to 306, but more power and deeper bass.	Jun 91
DPA DIGITAL DPA50S	£1175	Together with the 50S pre and disc stage this forms Noel's favourite amplifier. Very clean, very clear and very neutral.	Apr 91
JOHN SHEARNE PHASE ONE	£1199	Matching power amplifier to Phase One preamp above. Attractive finish, sweet sound.	Aug 91
AUDIOLAB 8000M	£1190	150 watt solid state monoblocks. Typical Audiolab look, build and sound; crisp and clear but can also be clinical.	Sep 91
ART AUDIO TEMPO	£1398	20 watt triode monoblocks. Attractive looking, vibrant sounding, ambient and subtle.	Dec 91
ALCHEMIST GENESIS	£1400	100 watt valve monoblocks. Powerful sound. Very cable dependent but with plenty of dynamic range.	Oct 91
AUDIO INNOVS. SERIES 1000	£1499	50W valve monoblocks. Powerful sound.	May 92
MICHELL ALECTO	£1800	High end bargain of the year the Alecto's have a lucidity and three dimensional realism that it rarely attained.	Dec 92
ART AUDIO MAESTRO	£1927	Pentode/Triode switchable valve monoblocks. Beautiful looking, sweet and involving.	Jun 91
E.A.R. 549	£4372	Massive 200watt valve monoblocks. Awesome sound, uncanny solidity of images, hard treble.	Nov 91

**LOUDSPEAKERS**

CELESTION I	£99	Low price, compact size, big sound. An exciting all round performer.	Oct 92
GOODMANS MAXIM 3	£99	Excellent budget small box. Forward sound, without undue box coloration.	May 92
MISSION 760i	£119.90	The 760is are detailed, fast and have bags of rhythm. Ear bashing pleasure.	
TANNOY 603	£124.99	The 603's are a rich and smooth blend that offer their best when bi-wired.	Sep 92
MISSION 761i	£169	Not a perfect loudspeaker, but is full of bass and a lot of fun and entertainment for the money.	Feb 92
MISSION 780	£180	Not without flaws, but the accent is on the music. Good small design.	Sep 91
TANNOY 605LE	£189.99	Highly analytical but has limited bass extension and is not particularly smooth. Very revealing.	Jan 93
B&W DM610	£200	Very competent and musical. Loads of life and energy.	Sep 91
ROGERS LS2a2	£209	So far the most correct loudspeaker we have discovered at the price. Sweet and even-natured. A bargain.	May 92
HEYBROOK HB1 Mk III	£249	Powerful, efficient loudspeakers. Loads of welly, loads of bass, but somewhat unrefined.	Apr 91
TANNOY 609	£250	Cheapest Dual Concentric loudspeaker in the range. Fast and fun, but unsuitable.	Jan 92
NAD 8100	£300	Fine floorstanding loudspeaker that goes deep and loud. Terrific sense of fun.	Aug 91
EPOS ES11	£330	Two way reflex loudspeaker with a civilised but giant-killing sound quality. Excellent imagery.	Apr 91/Jan 92
TRIANGLE COMETE	£375	Highly efficient small box loudspeaker with a superb mid-band. Great for valve amplification.	Apr 92
WILMSLOW FOCCUS	£400	Kit loudspeaker, based around DynAudio drivers. Very transparent and detailed for the price.	Feb 92
KEF 101/2	£495	The baby of the KEF Reference range. Very system dependent.	May 91
CELESTION 100	£499	Need powerful amplifier and careful positioning. Have insight and good tonal accuracy.	Dec 91
NEAT PETITE	£525	Baby two-way. Tight, fast, great stereo and good dynamics. Few little boxes come close.	Aug 91
PENTACHORD	£534	(£1059 with subwoofer) Superbly transparent. With the sub-woofer, they go deep too.	May 91
PROAC STUDIO I MK II	£612	Two-way reflex loudspeaker. Easy to listen to and well-balanced, although somewhat Coloured.	Aug 91/Jan 92
KEF Q90	£649	Uni-Q design with ABR. Efficient, dynamic and capable of going very loud indeed.	Jan 92
REL STADIUM SUBWOOFER	£695	Mono, self-powered subwoofer that works! Very flat frequency response.	Jun 92
B&W MATRIX 805	£795	At home both in the recording studio and the listening room. Speedy delivery and excellent imagery; paint a clear picture.	Jan 92
AUDIO NOTE AN-J	£799	Good soundstaging with a very convincing, natural sound. Derivative of Snell design.	Jun 91
MONITOR AUDIO 1200 Gld	£949.99	Excellent resolution of detail maintains a listeners attention; insightful.	Dec 92
HEYBROOK SEXTET	£1079	Revealing, lucid floorstanders. Not smooth, but tight and fast-paced. Need careful partnering.	Oct 91/Feb 92
PROAC RESPONSE ONE 'S'	£918	Excellent small box design. Can convey the spirit, drive and passion in music in a small room.	Jul 92
MAGNEPLANAR MG1.4	£1190	Electro-magnetic planar design. Needs long room. Can create an open, relaxed and easy musical performance. Lacks detail.	May 91
APOGEE CENTAUR MINOR	£1200	Hybrid ribbon design. Great imaging and detail, good value for panel fans.	Jul 92
CELESTION 700SE	£1399	Small box, carved from Aerolam. Excellent imagery, transparency and detail. Needs power and careful positioning.	Mar 92
TDL STUDIO 4	£1499	Need a large room, but can move a lot of air. Best with organ music, the 4's can sound impressive, awesome and frightening.	Jul 91
PENTACOLUMN	£1795	Stunning imagery, excellent detail. Speakers that excel at everything.	Dec 91
QUAD ESL-63	£2072	(Pro version, £2240) Legendary electrostatic loudspeakers. Can lack bass, dynamic range and volume but have detail and imagery impossible to better.	Apr 91
TANNOY GRFM	£3500	Giant loudspeakers. Capable of awesome sound. Need good valve amplification.	Jul 92
NAIM DBL	£6127	Capable of producing immense sound pressure levels. Not for the squeamish.	Mar 91

**MISCELLANEOUS**

AUDIOPLAN DIGITENNA	£55	High-tech coaxial cable, for CD to DAC connection. Highly focussed sound.	Jul 92
AUDIOPLAN MUSICABLE	£VARIOUS	Superb, high quality cables that represent the finest in European cable.	Mar 92/May 92
BEYER DT411	£54	Excellent 'studio' quality headphones. Deep bass, powerful sound, if a bit splashy at times.	Jun 92
CELESTION DLP 600	£349	Digital signal processor for the Celestion 600 series loudspeakers, sounds like a £400 upgrade.	Jun 92
FRANCINSTEIN	£79	CD stereo enhancer, which adds crosstalk to make the sound more 'analogue'.	Jan 92
FURUKAWA FD-11 CABLE	£85	Coaxial cable, for use between CD and amplifier. Good quality, utilitarian cable. Safe choice, easy sounding.	Jan 92
FURUKAWA 7N PC-OCC	£900/£350	per mono metre. Very expensive cables. Highly detailed, sounds like an equipment upgrade.	Jul 92
KONTAK	£22	Space age contact cleaner. Upgrades your system at a single bound.	Mar 91
LASERGUIDE	£15	Coating for a CD surface. Is said to improve clarity, focus and spaciousness.	Dec 91
SONY ICF-SW7600	£150	Superb 'world' radio. Good reception, simple to use, even has a clock!	Aug 91
SONY WALKMAN WM-DD33	£90	Simple to use, high-quality playback only Walkman. Excellent, stable sound quality.	Aug 91
SONY WALKMAN WM-D6	£260	The famous 'Pro' Walkman. One of the finest cassette recorders at any price, but portable. Superb value, if a little 'touchy' at times.	Mar 91
SONY WALKMAN TCD-D3	£500	Better known as the 'DATMAN', this small, sophisticated DAT portable is a technological wonder.	Aug 91
TECHNICS SL-XP330	£129.95	Ignore the price tag for this is one of the best sounding portables around.	Dec 92
TECHNICS SL-XP700	£200	Portable CD player. The thinnest and most stylish of the breed, just happens to sound the best.	Nov 91
TDK NF-C09	£10	Designed to lessen Radio Frequency Interference in cables. Works too!	Feb 92

# SUGDEN

## HAND CRAFTED AUDIO PRODUCTS

### A WORLD OF MUSIC

#### **SDA-1 Digital To Analogue Converter**

U.K. - Sugden's SDA-1 bowled us over with a sound populated by masses of high-resolution details and complemented by very quiet, dark backgrounds and tremendous dynamics . . .

Canada - At a price well below many DACs of similar sound quality it offers real value for money in addition to its sonic refinement.

Germany - D/A converters from the Sugden stable have established themselves on a solid platform within the hi-fi scene.

#### **SDT-1 CD Player**

Canada - The combination of excellent transport and high-quality parts make the Sugden a very relaxed and easy player to listen to, with no digital edge.

U.K. - I have to say Sugden's CD player just has to be near the top of any buyer's list.



#### **A21a Class 'A' Amplifiers**

U.K. - A true thoroughbred that will undoubtedly attract newcomers to Sugden's dedicated band of followers. It almost begs you to put on more music and then proceeds to play it with aplomb.

Holland - A concert hall in your living room. The reproduction quality of the amplifier is without any stress and gives total involvement in the music.

#### **A25B Integrated Amplifier**

U.K. - Not only does the little A25B look more refined than many of its peers, it also has a sophistication to its sound that is sadly lacking in most of its immediate competitors.

Singapore - The Sugden A25B will not fail to please in the way it presents the music. It is therefore, highly recommended.

Canada - The quality of sound produced by this amplifier is exemplary.

Australia - We are hard pressed to think of an amplifier quite so musical. A delight to the ear.

France - The general transparency of sound and the punch delivered by the amplifier are really astonishing.

#### **A48 Integrated Amplifier**

U.S.A. - In terms of sound quality the A48 is a revelation. More than any other integrated amplifier in my experience. The Sugden imbues music with a warmth and body that is quite addictive.

U.K. - Coherent and musical, the Sugden A48B is on the warm side of neutral, well suited for those who like the valve sound.

#### **Au51c Pre-amplifier**

Canada - You can tell that the Au51c is special. Five minutes convinced everybody present that a pre-amp must sound like this if it is to be of reference quality.

Canada - Cold, out of its packing carton, the Sugden instantly sounded better than great. During the next few hours of operation, the unit literally blossomed and developed the sort of sound closely akin to a live performance.

#### **Au51p Power amplifier**

Canada - We've never tested an amplifier which sounds this big and did its job so well.

FOR FURTHER DETAILS:

**J. E. SUGDEN & Co., LTD. VALLEY WORKS, STATION LANE, HECKMONDWIKE, WEST YORKSHIRE WF16 ONF  
0924 404088**

**OVER 25 YEARS SERVICE TO MUSIC LOVERS**



# BUDGET QUERIES

**Write in with your problems to Hi-Fi World, 64 Castellain Road, Maida Vale, London W9 1EX. Our panel of experts will endeavour to solve them or at least offer some practical advice.**

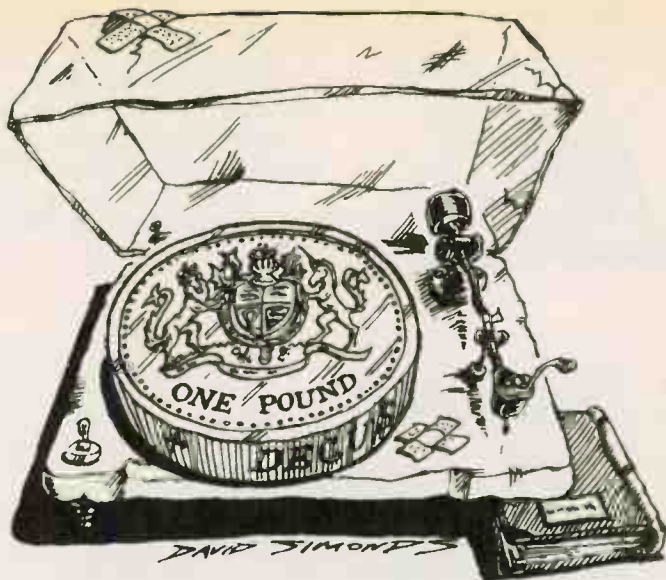

## LACK OF INPUTS

I have recently acquired a Nica Stereo TV and video. On deciding to put the video through my hi-fi system I came upon a problem. My QED A230 integrated amplifier does not have facilities for video, so I decided to take the opportunity to change my amp and speakers.

My equipment comprises the QED, a Sony CDP 497 CD player, a Technics RS-BX606 cassette deck and a pair of Wharfedale Diamond IIs. Could you please advise on a quality make and model of integrated amplifier (£200 or less) that will accommodate my video leads and a pair of small box-type speakers (£200 or less) that will improve and enhance my system. **Stephen McGlue, St. Helens, Merseyside.**

The cheapest solution to your problem would have been to add a QED input expander unit which is plugged into one of the existing sockets and allows switching of additional line level sources. QED make



Pioneer A300X - spare input for video.

two such units adding either one or three extra inputs to your amplifier. The MA20 two way input expander costs £27.50 and the four way MA32 input expander £55.

As you seem to have talked yourself into buying a new amplifier and pair of loudspeakers I will recommend a few that have the relevant inputs. Both the Arcam Alpha 3 and the Pioneer A300X have a spare input that can be used for video, labelled line in the case of the Pioneer. Both retail for

£200 and offer extremely good value for money at this price.

When I auditioned these amplifiers for the budget systems section in the rear of the magazine I found that the Alpha 3 worked well with the Mission 760is and the Pioneer with the Maxim 3s. You do not mention whether you are using loudspeaker stands, so if you are not, then I would strongly recommend that any spare funds left over should be dedicated to this cause. A good stand, like those from

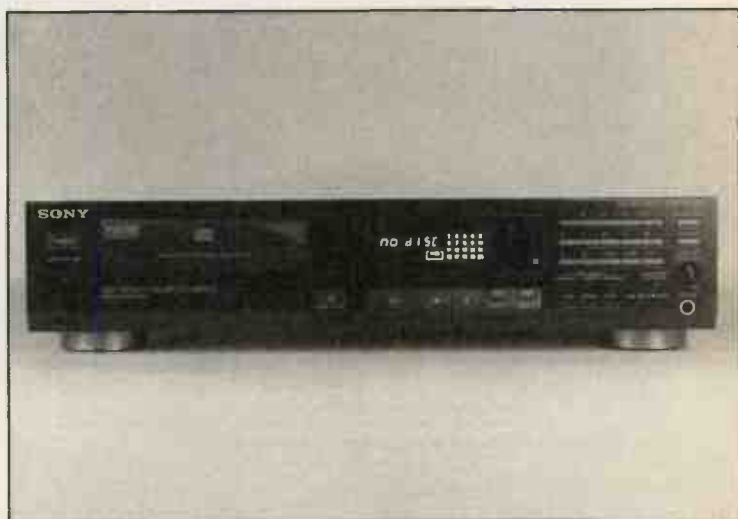

The Sony CDP-497 is a budget bargain.

Target, will enable the loudspeaker to realise its full potential.

If you still have a few pennies after purchasing a new amplifier and speakers, Furukawa's FS-2T07 loudspeaker cable will put the finishing touch to an excellent system. **DB**

## SPEAKER SWITCHING

Can you advise on improving my system? It is a Pioneer A-300 amp, Sony CDP-497 CD player, Ixos 104 interconnect between CD and amp and Leak 2030 speakers, with 49-strand interconnect from speaker to amp.

Can I improve on the CD by buying additions, or should I upgrade to a better model. I know the speakers are a weak point - eighteen years old - and I'm not sure whether to replace or modify by purchase of separate units

from a hi-fi shop. Ultimately, I want to have speaker A/B switching to another pair of speakers in another room. Because of domestic circumstances I have to listen at fairly low volumes, mainly to classical, orchestral and choral.

Can you recommend an A/B switchable amplifier (the Pioneer has only one set of connectors) and a second pair of speakers. As second speakers on my previous system I had a pair of Solavox HPI40s as Bs - these are probably horror boxes to the audiophile. These, with the Leaks, have run on an old Pioneer SX434 receiver.

As a handyman, I could build a pair of spherical speakers - would this be better hi-fi? I've read that this is a better engineering design. **A.L. Williams, Leeds.**

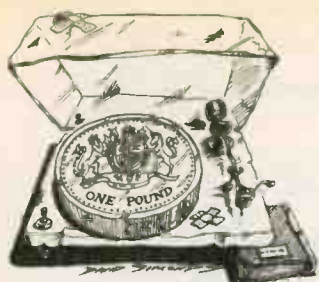

ing unit, the MA17, which retails for £22.50. This is basically a switch that allows operation of either or both loudspeakers from one set of amplifier output terminals.

When you are re-wiring your new pair of loudspeakers into the switching unit it would be a good idea to

If you do fancy building your own loudspeakers, Wilmslow Audio offer over thirty kits that are carefully thought out and come complete with all the information that you will need to ensure that they sound as they should.

They also have several demonstration rooms where

I bought my Rega Planar 3 a few years ago, secondhand for £145 - a bargain. I kept it as my base, then I got cheap Technics speakers for £50, then I was amazed to get a Cyrus 2 for £150, secondhand - so much power for the size. I then got a Philips CD624 for £119, new, but reduced in a sale. I have an old Akai tape deck and an old Tensai tuner which cost £20 each. So there you have it, my bargain system. I know it has flaws, but I love my amp, turntable and CD.

I plan to upgrade my speakers, but don't want to spend hundreds needlessly. What I need to know is what I can get that suits my Rega/Cyrus/Philips line-up and still has detail and power when needed.

I like the look of the Tannoy Sixes range, but where can I hear them near me?

**Steve Rady,  
Dumfries,  
Scotland.**

Unfortunately your closest dealer is not exactly around the corner. However, they are within an hours drive which shouldn't be too much of an inconvenience as long as you have a car. Your best bet is to head for Glasgow where you will find Bill Hutchinson Ltd at 43 Hope St, tel: 041 248 2857 and Hi-Fi Corner, 50 Garden St, tel: 041 248 2840. Both of these dealers stock the Tannoy Sixes range but I would telephone beforehand just to be on the safe side. Slightly closer is Omega Music on the Townfoot Estate in Brampton. Their telephone number is 0697 73067.

Another suggestion for you to try would be the purchase of a second hand pair of loudspeakers, as you have obviously had success with this method of purchase in the past. Models such as Celestion's SL6s, the Epos ES14s and Spica's TC50s all go for very reasonable prices and all will be very suitable in your system.

Also you don't mention what phono cartridge you are using but if it is the standard one supplied with the deck you could do well to replace it with the excellent Goldring 1042. This will add a whole new dimension to your system for the relatively low sum of £99.95.**DB** ●



## TANNOY SIXES

The impressive Tannoy Sixes range of loudspeakers.

The Sony CDP497 and the Pioneer A300 amplifier are both extremely good pieces of equipment so I would suggest that you retain both of these items and look at other solutions to upgrading your system. The first problem to tackle is the loudspeakers. The Leek 2030s were a very good loudspeaker in their day and compared to modern alternatives still rate quite highly. For this reason they will make a very respectable second pair of speakers for use in the other room that you talk about.

A suitable replacement for them in your main system would be the Maxim 3s, or if you want a little more bass at low volume levels the Keswick Arias which are to be reviewed in the June '93 issue may provide a fuller sound.

The next problem to tackle is the lack of A/B switching on your amplifier. This is an easy one to solve thanks to QED who manufacture an external two-way loudspeaker switch-

replace the cable with a slightly thicker variety. QED's flat 79 strand will give a little more bass as well as being able to lie neatly under a carpet.

There are various ways of upgrading your CD player at little cost, such as upgrading the interconnects or using Audioquest Sorbothane CD feet which will isolate it from vibration. The CDP497 is a very good player and should respond very well to such tweaks.

Building your own loudspeakers is not as easy as it seems. The volume of the box used, the combination of drive units and the crossover frequency, and order, are all critical if you want to produce something that will rival what you could buy for similar money. A spherical speaker cabinet has certain advantages, namely a rigid, resonance-free cabinet with no standing waves, but these properties alone are not enough to provide good results.

you can listen to the completed kits before you choose which one to build. This saves you building something that doesn't meet your own personal taste. The satisfaction you get from completing such a project is well worth the effort, even if the design is not your own.**DB**

### BARGAIN HUNTER

I find all the talk of hi-fi 'mix and match' so confusing. Years ago it was so easy: just buy a record player and the speaker was there, built in with the awful mono sound.

Now, where do you start? I have made the change from those awful mono boxes where you could stack six or more LPs on top of each other and ruin them with scratches. Now I have, after much wasted money, bought a system for just over £500.

It has taken a year to get all the parts together and I know what you are thinking! How the hell can you get a decent hi-fi for £500? Read on . . .



# AEGIS

AEGIS SERIES MODEL 1 LOUDSPEAKER BY ACOUSTIC ENERGY



((AE))

ACOUSTIC ENERGY

Manufacturers and distributors of the finest audio products

For full details of these products and our dealers contact:

Acoustic Energy Ltd

3A Alexandria Road London W13 0NP

Tel 081-840 6305 Fax 081-579 1761

World Radio History

# MISSION

because...

