

AUGUST, 1924

25 CENTS

RADIO

(Reg. U. S. Pat. Off.)



Cunningham Radio Tubes

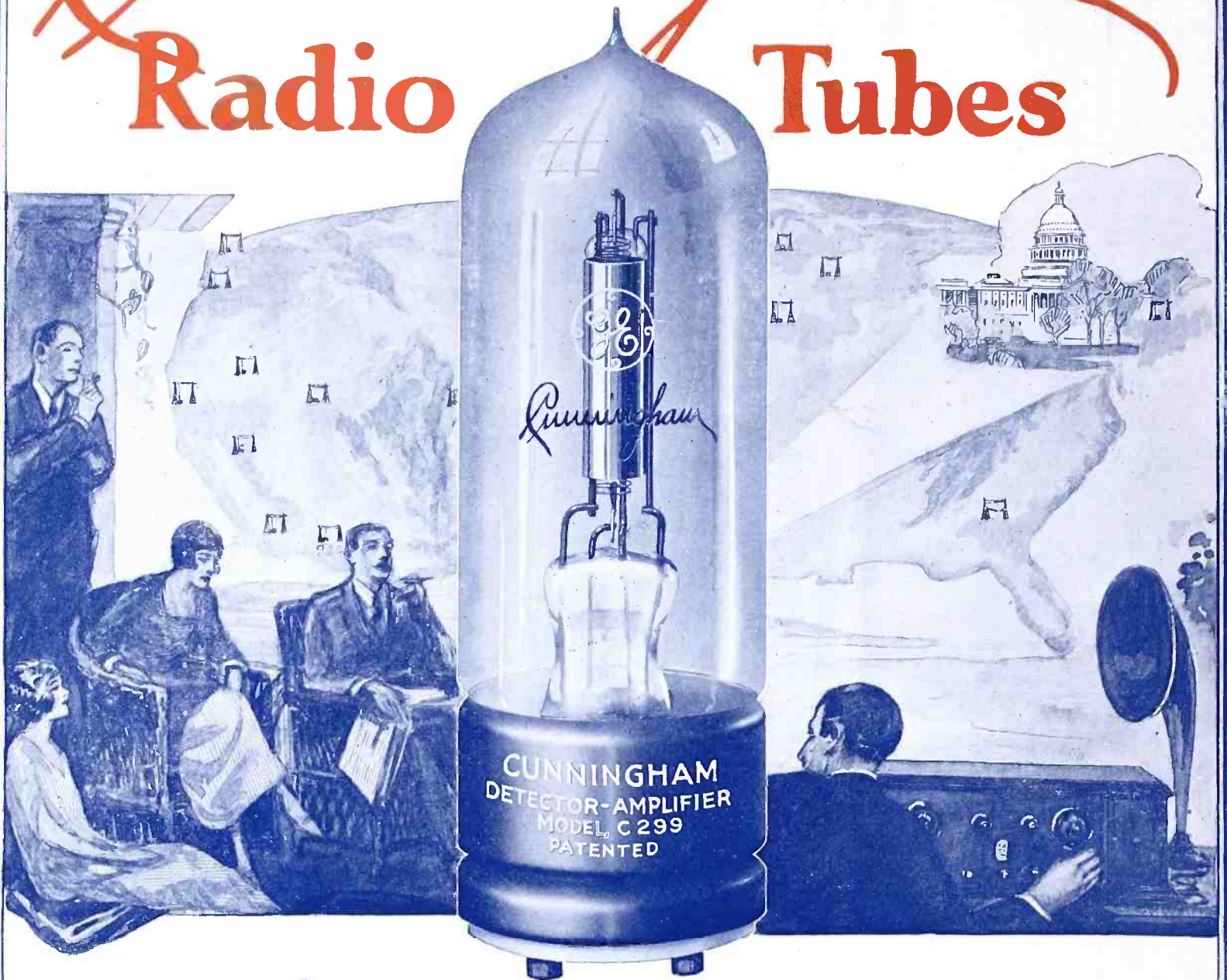

Millions will listen-in on the broadcasting of the Presidential Campaign

This year, for the first time in history, it is possible for millions of United States citizens to hear every word of our statesmen in their oratorical battles for the honor of the presidential nominations and elections.

Radio has created a situation that the founders of the Nation would consider ideal. It has destroyed the sinister isolation that in decades past has caused strife, misunderstanding and even civil war.

Today these entire United States are listening in on the political campaign. Sectional lines are swept away. A united nation will hear, will ponder, will judge, will vote, from a knowledge of real issues and vital questions.

Radio, the Wonder-Worker, has brought the forty-eight States into a radius no larger than a Colonial town-hall. A new political era dawns, thanks to its magic.

PRICES ON CUNNINGHAM RADIO TUBES

Now in Effect

C-301 A—5 Volts 1-4 Ampere filament	\$5.00
C-299—3 Volts .06 amp. Dry Battery Det. and Amp.	5.00
C-300—5 Volts Gas Content Detector	5.00
C-11—1.1 Volts .25 amp. Dry Battery Det. and Amp. Special Base	5.00
C-12—Similar to C-11 with standard base	5.00

The vacuum tube has made possible this broad and far reaching application of radio telephony and plays the most important part in the operation of your receiving set.

It is now your privilege to enjoy this wonderful opportunity of Radio broadcasting. Specify Cunningham Radio Tubes for clear reception.

PATENT NOTICES. Cunningham tubes are covered by patents dated 2-18-08, 2-18-12, 12-30-13, 10-23-17, 10-23-17 and others issued and pending. Licensed for amateur, experimental and entertainment use in radio communication. Any other use will be an infringement.

Cunningham 40-page Data Book fully explaining care and operation of Radio Tubes now available by sending 10c in stamps to San Francisco office.

HOME OFFICE:
182 SECOND ST.,
SAN FRANCISCO

E. J. Cunningham Inc.

Branch, Chicago
Branch, New York



a Mile High

TOWER'S Scientific

Perfect Tone Mates



\$ NOW 2.95

Plus a few cents Postage

**WORLD'S
GREATEST
HEADSET
VALUE**

Production Now Over 1,000,000 A Year

Every set tested and approved by licensed radio operators.
Every set covered with money-back guarantee.

**OUR \$200,000.00 COMPANY
STANDS SQUARELY BACK OF EVERY HEADSET**

Order at once by post card and we will ship immediately by Parcel Post C. O. D.

THE TOWER MFG. Co.

98 Dept. E Brookline Ave., Boston, Mass.

Placed

IN CARTONS, ONE ON TOP OF THE OTHER, 14 DAYS' PRODUCTION WOULD REACH A MILE INTO THE SKY.

TOWER'S SCIENTIFIC HEADSET

Lightest of all in weight, higher resistance, with elimination of distortion. Longer cord (full 5 ft.)

Companies of more limited production could not afford to sell such quality phones at anywhere near this price.

As the **LARGEST EXCLUSIVE MFGRS.** of headsets in **THE COUNTRY**, we are able to produce the **TOWER'S SCIENTIFIC Headset** at the low price of \$2.95.

14 Days Production - 1 Mile High



Tell them that you saw it in RADIO

RADIO

Established 1917

Published Monthly by the Pacific Radio Publishing Co.

ARTHUR H. HALLORAN, *Editor*

LAWRENCE MOTT,
Associate Editor

GERALD M. BEST
Technical Adviser

H. W. DICKOW
Advertising Manager

Branch Offices:

New York City—17 West 42nd St.
Chicago—157 E. Ontario St.
Boston—52 Irving Street.
Kansas City, Mo.—1102 Republic Bldg.

Correct Addresses:

Instructions for change of address should be sent to the publisher two weeks before the date they are to go into effect. Both old and new addresses must always be given.

Rates:

Issued Monthly, 25c a copy. Subscription price \$2.50 per year in the U. S., \$3.00 per year elsewhere.

Advertising:

Advertising Forms Close on the First of the Month Preceding Date of Issue.

Entered as second-class matter at the Post Office at San Francisco, Calif.
Copyright 1924, by the Pacific Radio Publishing Co.

Address all communications to

Pacific Radio Publishing Co.

Pacific Building, San Francisco, California

VOLUME VI

AUGUST, 1924

NUMBER 8

CONTENTS

RADIOTORIAL COMMENT.....	9
A RECEIVER DESIGNED FOR QUALITY.....	10
<i>By Brainard Foote</i>	
THE TELEPHONE RECEIVER.....	12
<i>By Col. J. F. Dillon</i>	
CONSTRUCTION OF POWER AMPLIFYING TRANSFORMERS..	13
<i>By Paul Oard</i>	
RESURRECTING THE ELECTROLYTIC DETECTOR.....	17
<i>By Jacques Avoon</i>	
A SET FOR THE 94-METER BROADCASTS.....	18
<i>By L. W. Hatry</i>	
REASONS FOR TRANSFORMER BREAK-DOWN IN REFLEX CIRCUITS	18
<i>By 9BJB</i>	
RADIO RECORDING	19
<i>By S. G. McMeen</i>	
HANDY HINTS IN RADIO.....	20
<i>By D. B. McGown</i>	
FOR KING AND RADIO.....	21
<i>By Earle Ennis</i>	
WHAT MAKES A GOOD RECEIVER?.....	23
<i>By L. R. Felder</i>	
THE TRUTH ABOUT RECTIFIER AND FILTER SYSTEMS....	25
<i>By Edward T. Jones</i>	
SHOP KINKS	26
<i>By Chas. Andres, Jr.</i>	
A PRACTICAL SPARK COIL I. C. W. TRANSMITTER.....	27
<i>By F. S. Huddy</i>	
NOTES ON RECEIVING STATION OPERATION.....	28
<i>By Kennard McClees</i>	
THE VACUUM TUBE AS AN AMPLIFIER.....	29
<i>By C. M. Jansky, Jr.</i>	
FILAMENT FILTER SYSTEMS	32
<i>By Don C. Wallace</i>	
IMPROVEMENTS IN BEST'S 45,000-CYCLE SUPER-HETERO- DYNE	33
<i>By G. M. Best</i>	
QUERIES AND REPLIES ON C. W. PRACTICE.....	35
<i>By G. M. Best</i>	
PACIFIC RADIO EXPOSITION.....	37
LETTERS TO THE EDITOR.....	38
WITH THE AMATEUR OPERATORS.....	39
FROM THE RADIO MANUFACTURERS.....	42

Forecast of Contributions for September Issue

Volney G. Mathison in "The Brass-pounders of Nippon," explains the little-known Japanese radio telegraph code and throws many interesting side lights on the great odds that have to be overcome by the Japanese operators.

Prof. C. M. Jansky Jr. follows up his remarkable series of articles on radio communication with an account of the use of the vacuum tube as a detector.

The builder of receiving sets will have several good circuits from which to choose. Paul Oard describes the construction of a single control regenerative receiver. E. E. Griffin explains how to add an efficient step of tuned radio-frequency amplification to a single circuit regenerative, and Cessford Kerr describes an excellent adaptation of the Reinartz circuit.

G. M. Best will announce several improvements in his 45,000 cycle super-heterodyne, and L. H. La Montagne will tell how the super-heterodyne should be adjusted.

Paul Oard gives some good "Radio Construction Pointers," including the winding of self-supporting coils, making insulated wire, and home-made insulators.

H. W. Allen gives some ideas for building a receiver that rivals the factory-built article in appearance and operation.

The fiction feature will be an unusual story entitled "A Variable B Battery," by David P. Gibbons.

H. A. Fisher tells of the proper care of storage A batteries, H. Bunch discusses the grid leak, and F. L. Ulrich tells how to make an efficient loud speaker.

The dyed-in-the-wool amateur will be interested in and helped by "250 Watt Tube Secrets" as told by Don C. Wallace, "A Transmitter That Solves the Local QRM Problem" by Franklyn S. Huddy, "A Synchronous Rectifier" by Geo. Becker, Jr., and "A Good Filter" by C. M. Rados.

Kennard McClees gives some excellent suggestions for "Passing the Commercial License Test."

THE GREBE CLARIFIER

Increases Selectivity
 Increases Signal Intensity
 Improves Quality
 Prevents Radiation
 And—
 Is Easily Connected



TRADE MARK
 REG. U. S. PAT. OFF.



\$30

"Do justice to thy neighbor"
 — Confucius

Safeguard him against objectionable sounds by the use of the Grebe Clarifier.

Doctor Wu

THE first practical, workable solution of the problem of radiation from regenerative receivers. Unlike the "wave-trap" it increases signal intensity.

Ask your dealer or write for literature

A. H. GREBE & CO., INC.
 Van Wyck Blvd. - Richmond Hill, N. Y.
 Western Branch: 451 E. 3rd St., Los Angeles, Cal.

Tell them that you saw it in RADIO



New FADA

Neutrodyne Receivers

WE WILL shortly announce new developments in FADA Neutrodyne radio receivers, which, with the far-famed FADA "One Sixty," will complete the most comprehensive line yet developed.

Continuously for eighteen months our experimental and research engineers have been at work developing this new FADA Neutrodyne receiving equipment.

The FADA Neutrodyne line, when rounded out with these new developments, will consist of several styles of receiver cabinets to meet different tastes and purses. Receivers adapted for the musical trades as well as special Neutrodyne receiver panels for adaptation to console phonographs will be included.

As first in the field with a satisfactory Neutrodyne receiver, it has been the successful aim of F. A. D. Andrea, Inc., through continued experimental and research work, to maintain their position as leaders in the radio industry. The new FADA Neutrodyne receivers will fully conserve this end.

The new designs will be nationally advertised throughout the entire year in leading radio and general publications. Arrange your plans for radio sales to take advantage of the complete FADA Neutrodyne line, including the far-famed FADA "One Sixty" and the new models, full descriptions of which will soon be available.

F. A. D. ANDREA, INC., 1581 Jerome Avenue, New York



Tell them that you saw it in RADIO

Your dealer has something
really new and unusual

MAGNAVOX M4

CALL at your dealer's today and
ask him to show you a Magna-
vox M4 Reproducer.

Try out the instrument critically;
satisfy yourself that its clear tone
and natural volume are sustained
throughout the entire musical range;
examine each essential detail of con-
venient size, handsome finish and
sturdy construction; note that its
operation requires no battery.

M4 is a definite contribution to
the radio art—and one particularly
welcome to the moderate income.

There is a Magnavox
for every receiving set

Reproducers

- M4—the latest Magnavox achievement: re-
quires no battery \$25.00
- M1—also constructed on the semi-dynamic
principle, requiring no battery \$30.00
- R3—famous electro-dynamic type: new mod-
el with Volume Control \$35.00
- R2—same as R3 but larger size: new model
with Volume Control. \$50.00

Combination Sets

- A1-R and A2-R—the only instruments com-
bining electro-dynamic Reproducer and
Power Amplifier in one unit
\$59.00, \$85.00

Power Amplifiers

- A1, AC-2-C, AC-3-C—the most
efficient audio-frequency Am-
plifiers: one, two & three stage
\$27.50 to \$60.00

To obtain the fullest enjoyment from
your receiving set, equip it with the
Magnavox—for sale at good
dealers everywhere.

THE MAGNAVOX CO.
OAKLAND, CALIFORNIA

New York Office:
350 WEST 31st STREET

Canadian Distributors:
Perkins Electric Limited, Toronto.
Montreal, Winnipeg

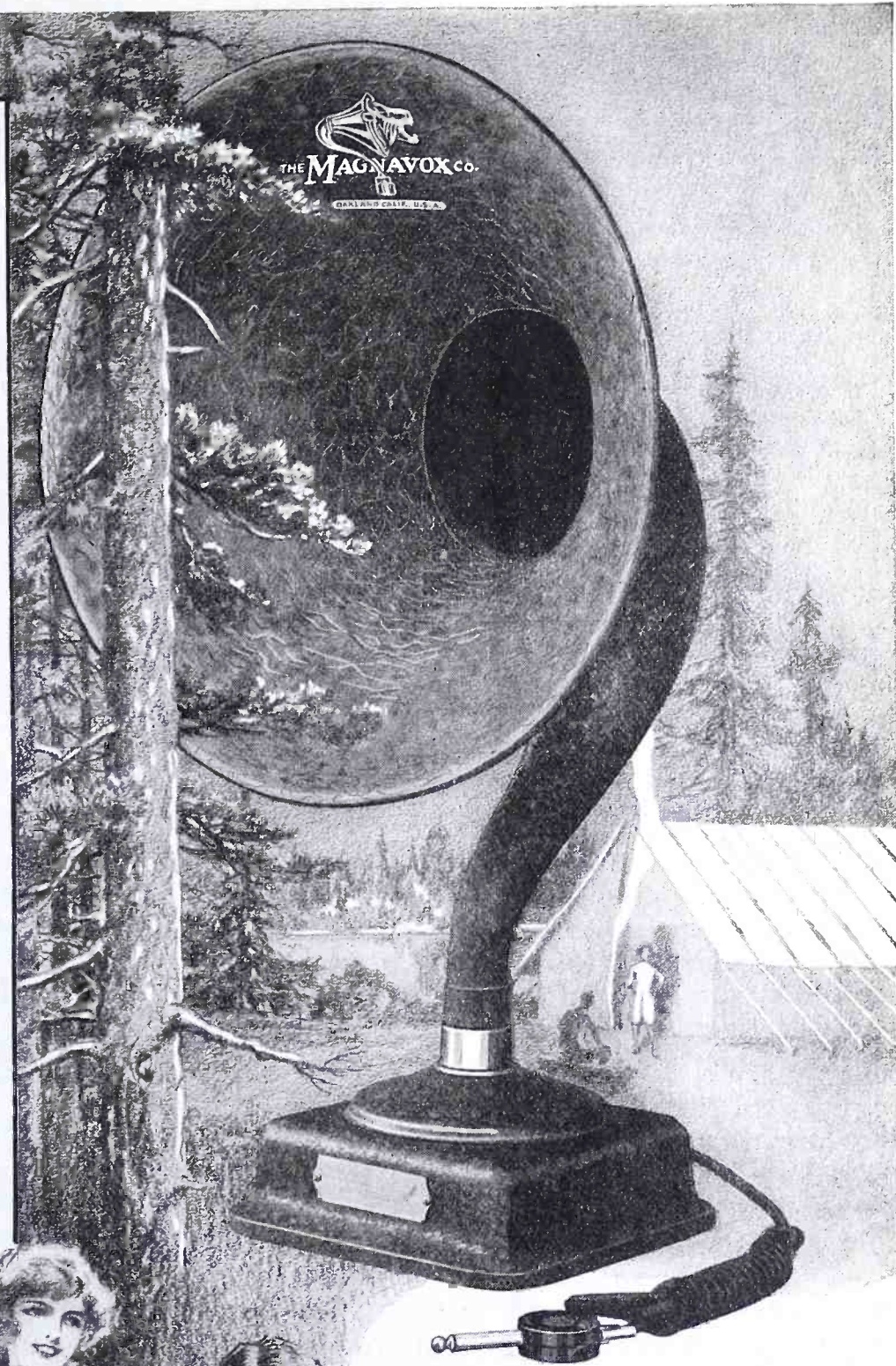

M4
\$25⁰⁰

8R

MAGNAVOX Radio



Tell them that you saw it in RADIO

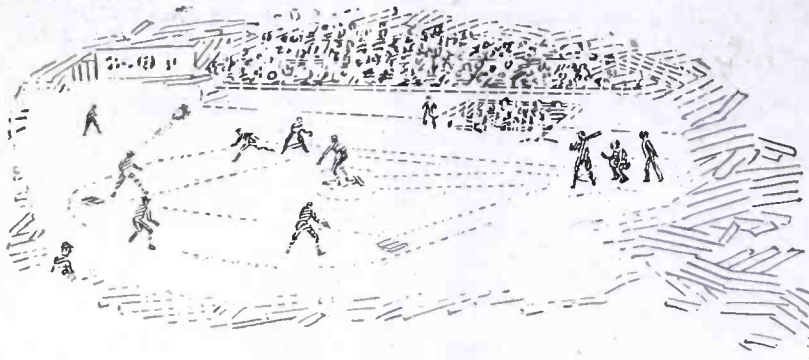

Enjoy Your Radio This Summer

Music Master with its rich, clear tone—unmarred by muffling, blast or distortion—will make radio a pleasure, such as you have never known before.

Summer opens a new world to good radio sets equipped with Music Master. Picnics, camping trips, boating parties, open-air dances—these are only a few of the occasions which Music Master can enliven for you.

No other reproducer is so well fitted for summer conditions. The extremely sensitive precision instrument in the base, the scientifically tapered tone chamber, and the now famous wood horn, the natural and perfect resonator—make up an instrument of balanced proportions and unequalled effectiveness.

Your radio dealer is waiting to demonstrate Music Master for you or to send one for trial with your own set.

Dealers Everywhere

Music Master Corporation

*Makers and Distributors of High-Grade
Radio Apparatus*

10th and Cherry Streets

Chicago PHILADELPHIA Pittsburgh

Music Master

RADIO REPRODUCER



14-inch Model \$30
for the Home

21-inch Model for \$35
Concerts and Dancing

Connect MUSIC MASTER in place
of headphones.

No batteries required. No adjustments.

Tell them that you saw it in RADIO

Listen
in on
W.L.W.

Still Better

New Crosley Radio Receivers

PROVING that Crosley Radio Receivers have made Satisfied Customers, The Crosley Radio Corporation sold more receiving sets last year than any other manufacturer in the world.

The new Crosley line illustrated here is still better, as shown by laboratory tests and by reports, from users, of performance under all weather conditions.

Listen in on a Crosley—Compare it with other receivers—Then you will choose a Crosley!

CROSLY 50, A new one tube Armstrong Regenerative Receiver. We believe this to be the most efficient one tube receiver ever put on the market. Price \$14.50
Crosley 50-A, two tube amplifier may be added at \$18.00

CROSLY 51, Two tube regenerative receiver, the biggest selling radio receiver in the world. Gives loud speaker volume on local and distant stations under average conditions, otherwise use head phones. Price \$18.50
Crosley 51-A, one tube amplifier may be added at \$14.00

CROSLY 52, A new three tube Armstrong Regenerative Receiver. Provides loud speaker volume on distant stations under practically all conditions. Price \$30.00

CROSLY 51-P, This is our new portable set. It is the Crosley Model 51, two tube receiver mounted in a leatherette covered carrying case, provided with "A", "B" and "C" dry cell battery space and all self-contained. Price \$25.00

CROSLY TRIRDYN 3R3, This three tube receiver gives the efficiency and volume of five tubes. We believe it is the most efficient receiver on the market at any price for bringing in long distance stations. Price \$65.00

CROSLY TRIRDYN 3R3 SPECIAL, The same as the Trirdyn 3R3 except cabinet is larger to contain "A" and "B" dry cell batteries and accessories. A beautiful set to match the highest grade of furniture. Price \$75.00

Prices west of the Rockies 10% higher than quoted above.



Crosley 50, \$14.50

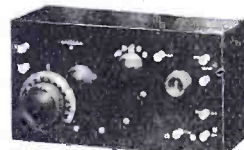

Crosley 51, \$18.50

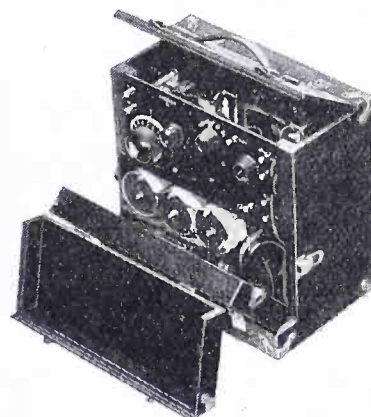

Crosley 51-P, \$25.00

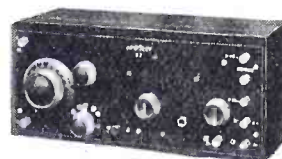

Crosley 52, \$30.00



Crosley Trirdyn 3R3, \$65.00 and below
Trirdyn Special, \$75.00

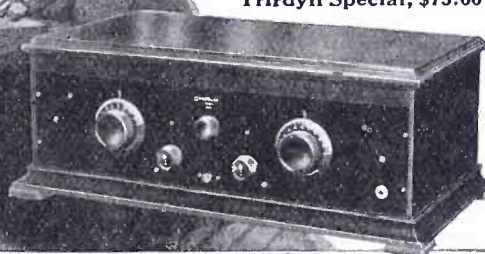

CROSLY

Better-Cost Less
Radio Products

MAIL THIS COUPON TODAY

The Crosley Radio Corporation,
819 Alfred Street, Cincinnati, O.
Gentlemen:—Please mail me free of charge your complete catalog of Crosley instruments and parts together with booklet entitled "The Simplicity of Radio."

Name.....

Address.....

All Crosley Regenerative Receivers licensed under Armstrong U. S. Patent 1,113,149

THE CROSLY RADIO CORPORATION

819 ALFRED STREET

Powel Crosley, Jr., President

CINCINNATI, OHIO

The Crosley Radio Corporation owns and operates broadcasting station WLW

Tell them that you saw it in RADIO

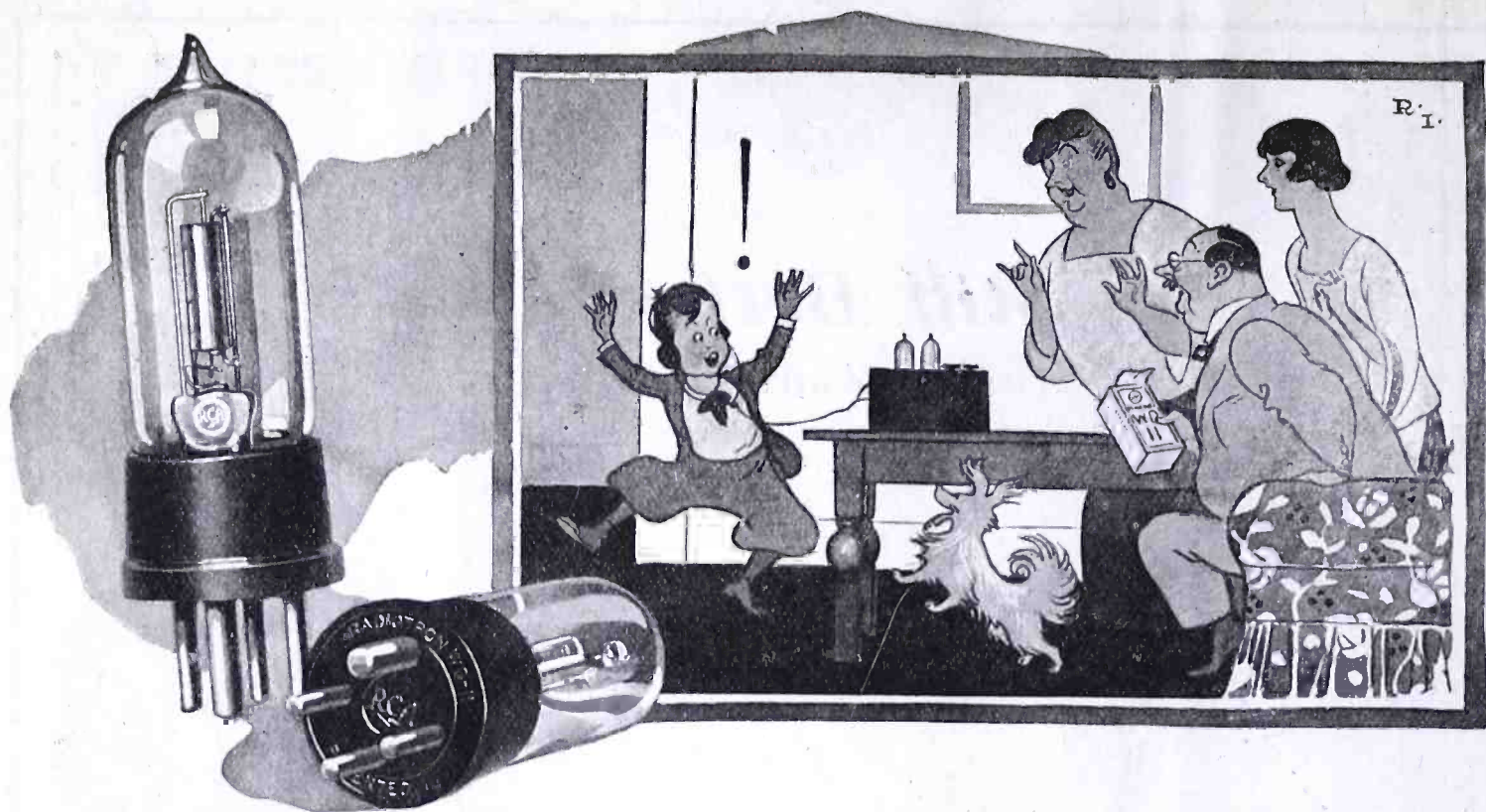

Radiotrons WD-11 and WD-12 *Made History!*

It isn't a genuine WD-11 unless it's a Radiotron.

It isn't a genuine WD-12 unless it's a Radiotron.

It isn't a genuine UV-199 unless it's a Radiotron.

It isn't a genuine UV-200 unless it's a Radiotron.

It isn't a genuine UV-201-a unless it's a Radiotron.

You Can Change Your Set to Dry Battery Operation.

If your radio set is equipped with navy type tube sockets, you can change to dry battery operation by inserting WD-12 Radiotrons. Ask your dealer for information as to how this can be done.

These are dry cell tubes—the tubes that made possible the swift progress of radio in the home everywhere. They meant clear tone—undistorted detection—radio and audio amplification—and volume reproduction—all with dry batteries. They meant radio in the city—on the farm—off in camp—everywhere!

And to-day, there are millions of these popular Radiotrons in use. Today everybody knows them familiarly as “WD-11’s”

and “WD-12’s.” But they are not genuine unless they are RADIOTRONS.

Always be sure to look for that mark on the base, and for the RCA mark on the glass. It's important, whether you are buying a new set with the Radiotrons in it, or buying new Radiotrons to replace old ones. Always look for the Radiotron mark and the RCA mark. Then you have the genuine—sure to live longest—serve best.

Radio Corporation of America

Sales Offices: Dept. 58

233 Broadway, New York

10 So. LaSalle St., Chicago, Ill.

433 California St., San Francisco, Cal.



This symbol of quality is your protection.

Radiotron

REG. U. S. PAT. OFF.

Tell them that you saw it in RADIO

August
1924

RADIO

Established 1917

Trademark Registered U. S. Patent Office

Volume 6
No. 8

Radiotorial Comment

TOO much praise cannot be given to the Southern California Radio Association for its action in banning from the air between 6:45 and 11:00 p.m. all alternating current C. W., I. C. W., spark, 'phone and poorly filtered R. A. C. transmission. This means that the broadcast listener will not be disturbed by amateur signals during the time immediately preceding and following the regular concert periods. It also means that non-interfering transmission from direct current C. W. and 'phones using the Carson method may be employed.

This is only one of many instances where sixth and seventh district amateurs have shown an intelligent spirit of cooperation. They were the first in the country to voluntarily refrain from transmission during the evening broadcast hours. Due recognition of this fact was made when compulsory nation-wide silence was first enforced. At that time the Pacific Plan was allowed to continue until the expiration of the year's agreement with the broadcasters.

It is possible that such commendable action is partly responsible for the exemption from the daylight saving restriction that the Department of Commerce has granted Pacific Coast amateurs. Coincident with the publication in these columns of an objection to this system as applied to districts where daylight saving is not in force, the radio supervisors of the sixth and seventh districts recommended that their districts be exempt. These recommendations were accepted by the Department.

The fine spirit shown by the Southern California amateurs may well be emulated by amateurs throughout the country. Not only is the use of pure C. W. in full accord with progress, but it also wins the good will of the B. C. L. As a whole, the broadcast listeners are fair, and will be more likely to concede the justice of greater privileges to the amateur transmitters if they realize that the amateurs are ready to meet them half way.

NOT least among the several factors upon which is based the thrill of radio, is the opportunity it affords for expression of mechanical ability. Whereas the past generation may have exercised its mechanical genius as a whittler of model ships or in furniture making, this same creative impulse now finds outlet in the construction of radio sets. More than half the sets in use today are home-made.

Their makers justifiably take greater pride in their handicraft and derive greater satisfaction in operation than can come to any user of a factory-made set. The pleasure comes not from money saved—for frequently the home-made receiver costs more—but in the tangible evidence of the owner's knowledge and skill. No matter if the home-made set is not as beautifully finished or as substantially constructed, yet it carries with it the joy of a builder.

Because of this fact the manufacturers of radio parts have

enjoyed a greater volume of sales than the makers of complete sets. Although the demand for the assembled receiver is likely to be ultimately greater than the demand for parts, there is reason to believe that the parts manufacturers will be busy for many years to come.

Discussion of radio construction affords an excellent point of contact between the amateur and the broadcast listeners. Weekly meetings featuring speakers on the merits of various circuits, the advantages of different types of equipment, or the methods of construction procedure will be of benefit to both classes.

Such a plan has been successfully tried out by the radio club at San Diego, California, and a similar scheme has been used for two years by the radio section of the Electric Club of Chicago. Undoubtedly there are many other instances where a common meeting-ground has been found for all kinds of radio fans who are interested in how to "roll their own."

THE easy pleasure of listening to broadcast programs is likely to cause the average listener to overlook the greater pleasure to be derived from understanding and applying radio principles. While radio concerts afford a wonderful means for relaxation in the home, radio study gives an appreciation of many lines of recent scientific advance. The case is similar to that offered by any popular magazine which publishes serious as well as fictional material. The reader who skips the serious part gets as little real value from his reading as the man who is content to receive radio programs without understanding the why and how thereof.

While it is recognized that the great majority will always be interested in radio as a pastime, in what it brings rather than in how it is done, yet there will be a constantly increasing number, spurred on by the desire for knowledge which is the main-spring of all human progress, who will delve into the mysteries of radio transmission and reception. These are the ones who will derive the greatest benefit from this latest application of science to the service of man.

Radio brings us closer to an understanding of the secrets of Nature than any other popular science. The conception of the electron, upon whose motion the action of the vacuum tube is dependent, is the foundation stone of the new physics which finds matter to be but a form of energy. The action of storage batteries and chemical rectifiers form a good introduction to the study of chemistry. And any serious radio student knows more about the elements of electricity and magnetism than the average man on the street.

These studies have not only a practical value in this modern world, but also a cultural value. No person can be considered well-informed unless he understands the facts back of these applications of science to the welfare of mankind. Never before has there been such an opportunity for pleasurable study as is afforded by radio.

A Receiver Designed for Quality

By Brainard Foote

This article describes the construction of a broadcast receiver designed to give the best quality of loud speaker reproduction. It comprises one stage of radio-frequency amplification, crystal detector and two stages of audio. It has a minimum of panel controls and various novel conveniences.

MOST of us suffer at times from the DX fever, but some of us are getting over it. The non-technical members of the family early discovered that the most satisfactory entertainment doesn't come from distances over a hundred miles or so. And they restrained their impatience with difficulty when we tuned away for countless squeals in a ceaseless endeavor to bring them strains of mused-up music from the other half of the country.

Then there's the musical aspect. How comforting to one's pride it would be to have a receiver delivering to the loud speaker such unadulterated musical harmony that our musically-educated friends will sit enraptured for hours and then ask for more! Don't you think this ideal possible of attainment? Yet it is within our grasp and the receiver of such accomplishments is simple of construction, quite economical as receivers go and absurdly easy of operation.

Regeneration and over-reflexing are well known to be causes of poor amplification. Yet experiment shows that the tube detector is even a worse offender in this way. The objector may say, "I've got a one-tube set that's the clearest thing you ever listened to. Try these phones!" True enough, but add a two-step amplifier, audio, and attach a good loud speaker. What then?

Then let us rig up a simple crystal receiver and a double pole switch connected so that we may alternately use the tube detector or the crystal in conjunction with two stages of audio amplification. And if the regeneration in the detector tube be reduced so that the sensitivities of the two detectors are more or less on a par, we'll be surprised to find that our loud speaker is distortionless with the crystal, yet rather disappointing, by comparison, with the tube detector.

"Now," you may say, "I'll admit that the crystal is much more faithful as a detector, but it has no sensitivity." Here's where another tube may be utilized to advantage. Since the tube has proved itself so good and clear as an amplifier, it ought to be efficient as to clarity whether it be a radio or an audio-frequency amplifier. Therefore, let us precede our crystal detector with a single stage of radio-frequency and follow it up with two steps of audio for our musically ideal receiver. Some may ask about reflexing, but this practice, while good on a single tube and phones, isn't clear enough to pass muster for our circuit.

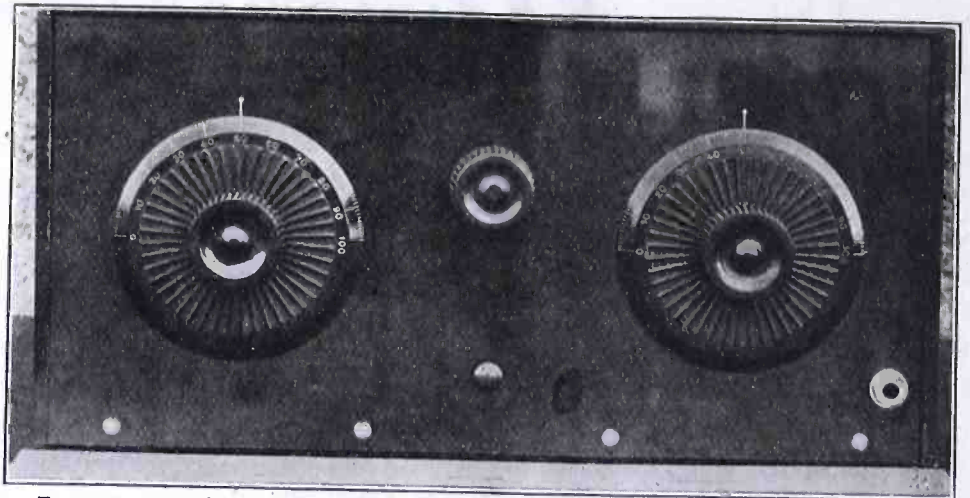

Fig. 1. Front Panel View. The Lower Center Knob Adjusts the Detector, While the Upper Center Knob Controls the Volume

In a reflex the slightly late returning audio-frequency modulates the radio-frequency over again in the reflexed tube, and causes a fringy or fuzzy sound just because there is a certain time interval between the radio and the audio impulses. The reflex is O.K. when it comes to DX signals because the fainter harmonics giving local broadcasting its good quality and richness are lost in transit from the distant points and a slight distortion in the receiver is not noticeable.

Let us now examine the circuit diagram. The antenna is coupled to the set through a small coil placed inside of the honeycomb coil, L_2 . This latter is tuned by a variable condenser and forms the grid circuit of the radio-frequency amplifier. Its plate circuit passes through a reversible sensitivity control coil L_3 and thence to the primary of the radio-frequency transformer. The pri-

mary is placed inside another honeycomb coil similar in size to L_2 and which, with condenser C_2 , tunes the crystal detector circuit. The output from this point passes to the usual two-stage audio-amplifier.

Of course, we don't care for the kind of crystal detector which has got to be adjusted every five minutes, nor one where the sensitive point is too hard to find. Of the ordinary crystals, iron or copper pyrites is the most rugged, and its adjustment is fairly stable. However, the very best detector is a combination of zincite and bornite, several such detectors being on the market. Here the setting is nearly permanent, often lasting for days on end and the "point" is never upset by the relatively strong impulses from the radio-frequency amplifier. A fixed detector is sometimes satisfactory, but these must be used with caution, several being tried to secure the most sensitive.

INASMUCH as the receiver is to be used but seldom for especially long distances, the finer controls may be omitted, such as vernier controls and

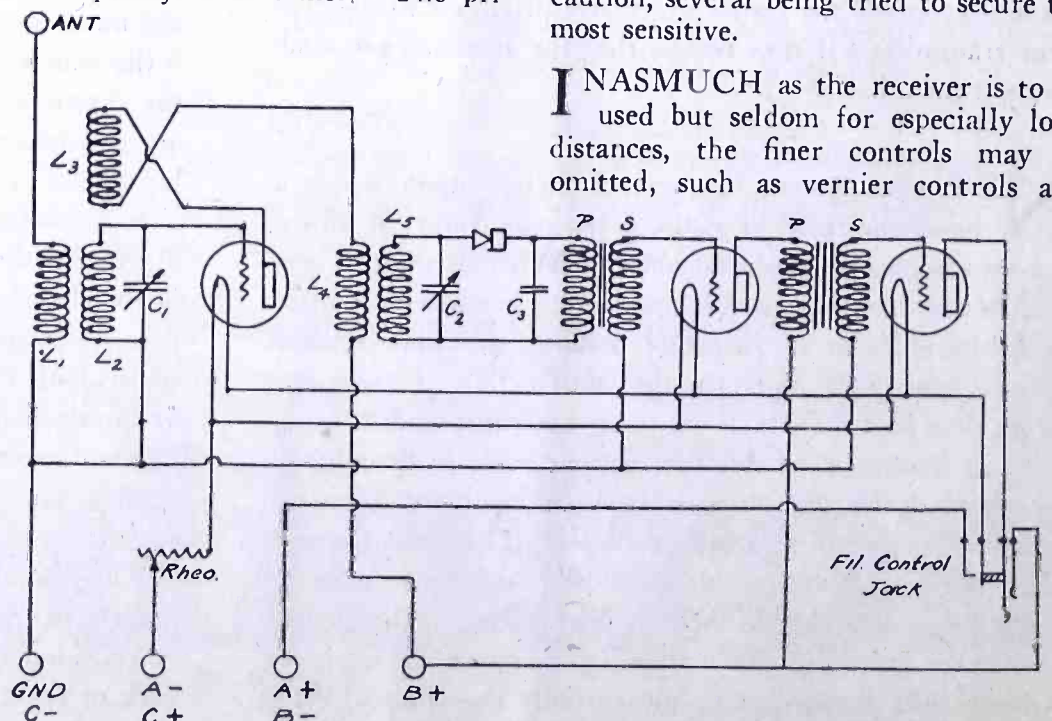

Fig. 2. Circuit Diagram for One Stage R. F., Crystal Detector and Two Stages A. F.

variable filament resistances. Fig. 2 shows how all tubes are connected in parallel as far as the filaments are concerned. A single resistance takes care of the three tubes and they are lighted and turned off automatically as the phone plug is pushed in and drawn out. Since each tube requires a quarter ampere, the three of them take three-quarters together. The UV-201A or C-301A tubes operate well with filament voltages between $4\frac{1}{2}$ and 5. Let us assume that the rheostat must cut the voltage to 5 and that we use the customary 6-volt storage battery. The resistance of the fixed rheostat R shown in the figure must, therefore, be $1\frac{3}{4}$ or 1.33 ohms. This resistance may then be made from slightly over two-tenths of the coil of an old 6-ohm rheostat. Or, if you like, insert a regular rheostat inside the set at this point, reach inside and adjust it once and for all to the correct value. Thus one knob is removed from the panel.

Such a receiver is to be used mainly for the loud speaker and with results so good on the speaker, headphones won't be wanted at all. Hence only one jack is required, and that is made a filament control jack, as well to take care of turning the tubes on and off. No special requirements must be met by the coils chosen, but some care should be exercised in picking out the two audio-transformers. Ratio doesn't mean a great deal at best, so it is safest to fall back on a manufacturer of national reputation. Both ratios may be the same—low, also. You will often find a high class "low ratio" transformer delivering more volume (and better quality) than a cheaper make of higher ratio.

The two tuned circuits are composed of honeycomb coils and variable condensers. Coils L_2 and L_5 may be 50 turn coils, with condensers C_1 and C_2 the .0005 or 23 plate size. Or, if you are a believer in less capacity and more inductance, you may employ .00025 mfd. condensers (11 to 14 plates) and remove a few turns from 75 turn honeycomb coils to get the desired range. Ten turns should be taken off L_2 if you are starting with a 75 turn coil, but only five need be removed from L_5 . This is due to the capacity of the tube, which is in shunt to condenser C_1 .

FIG. 3 shows a close-up of coil L_5 and its primary L_4 . L_4 is made up of 30 turns of No. 20 or 22 magnet wire, double covered. It is first wound neatly on a cylinder slightly less in diameter than the inside of the honeycomb coils. If your sockets are of metal, the cylindrical portion makes a good "form." Release the wire after you have put on about 35 turns, and it will spring apart and form a spiral. Then count off 30 turns, bunch them together into a sort of "doughnut" and bind them with three

small strips of tape. This is forced inside of the coil L_5 and given a coat of shellac to hold it firmly in place.

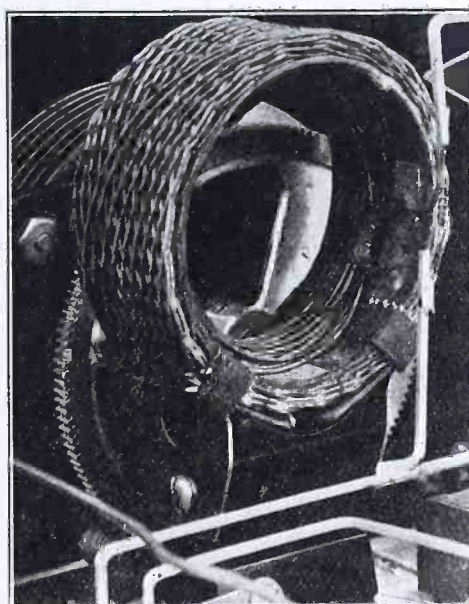

Fig. 3. Coupling Coil

Coil L_1 is made of 20 turns, wound in the same way, and placed inside of L_2 . L_3 is an interesting coupling device, for its normal position is directly at right angles to L_2 . See Fig. 4. Coil L_4 is made large enough so that at about 400 meters the r.f. amplifier tube is very close to the point of oscillation. On waves longer than 400 meters, the volume may be boosted by turning L_3 in such a direction that it acts as a tickler coil and feeds some energy back to L_2 . But on waves shorter than 400 meters, coil L_3 is swung around the other way, a la Superdyne, to oppose regeneration. L_3 is also a honeycomb, of 25 turns, mounted in a manner facilitating this opposing or aiding feedback.

Binding posts are not lavishly used, for there are but five of them—three serving for two connections each. By way of slightly bettering the quality, but mainly to cut the expense for the B battery in half, a C battery is employed in all three grid return leads of the

tubes. These are all brought to the ground post, and the connection of the C battery from this point to the negative A completes the return. 90 volts of B battery are required, the negative being joined to the positive of the filament.

THE front panel view shows how simply the control is made. The 4 in. dials turn the variable condensers, the central large knob controls the sensitivity of the r.f. amplifier, while the little knob below is for the adjustment of the crystal detector. This is mounted on the base-board and its handle allowed to protrude through the panel, in which a large clearance hole is provided so that the panel does not touch the shaft.

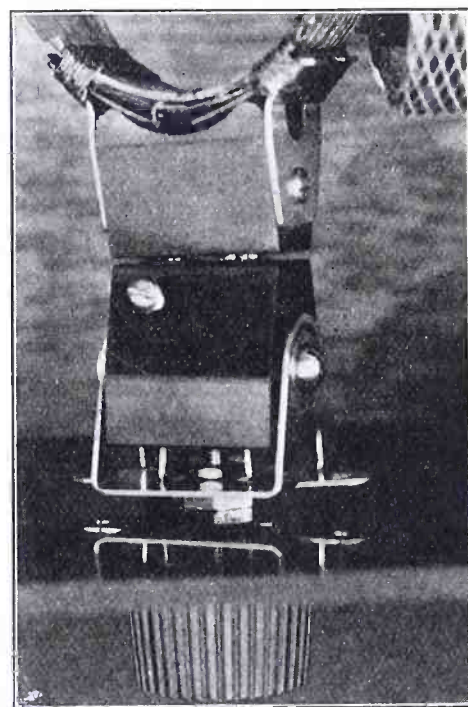

Fig. 5. Mounting of Sensitivity Control Coil

A close-up of the mounting bracket of coil L_3 is given in Fig. 5. This is a standard single honeycomb mounting. A bushing for a $3/16$ in. shaft is placed in the panel at the upper center in such a manner that the coil will line up with the coil L_2 . Through this bushing is

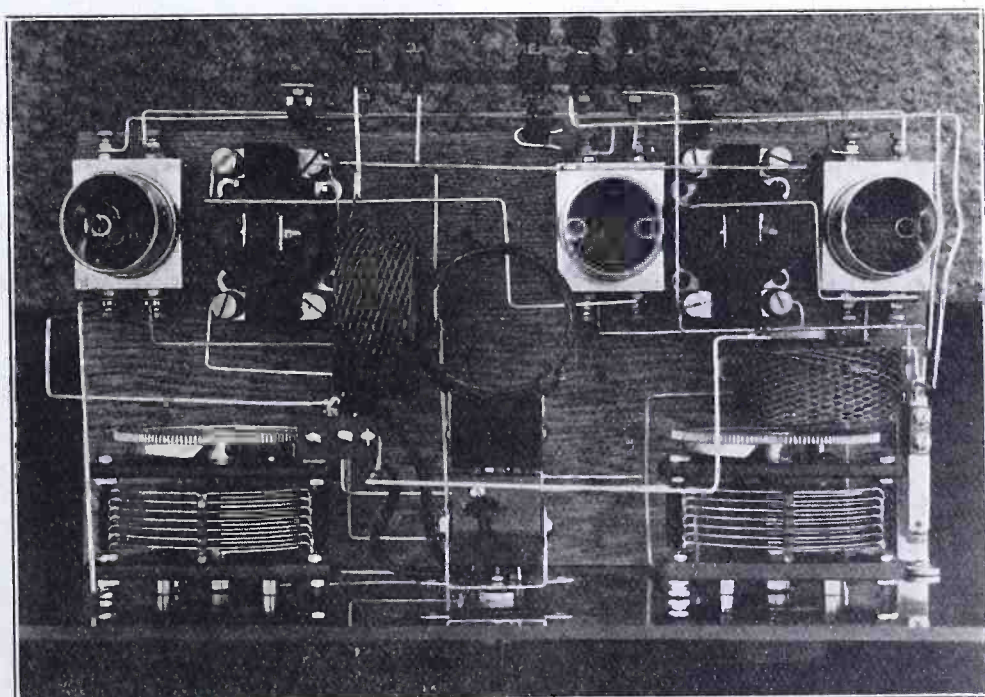

Fig. 4. View from Above, Showing Relative Positions of Parts

passed a regular 3/16 in. switch shaft with a switch knob outside. A hole is made in the exact center of the mounting bracket and the shaft attached to this by means of a thread and nut or a set collar. There is no need for a dial and indicator for this control as it is not used extensively, and its setting may be guided by the volume of the signals.

The binding posts are all carried on a special strip of panel material held up by two brass brackets fastened to the baseboard. A rectangular opening is cut in the rear of the cabinet to allow room for this strip, and the posts all protrude at the rear. It is very easy to make the connections when this plan is followed. The panel measures 7 by 14 in. and the baseboard is 7 in. deep. This is screwed to the lower edge of the panel and slides into the cabinet, carrying all the parts along with it. The lay-out of the parts may be seen in the upper and rear views. Bus bar wiring is indicated. No special precautions need be taken, as the circuit is non-reflex and non-regenerative. It is well to mount the coils L_2 and L_5 at right angles, in order to minimize inductive coupling between them.

In operation, the crystal should be adjusted with the reversible tickler coil set in such a manner as to oppose regeneration. Both dials should tune about the same. Selectivity will be found very good and the control simple, since there are but two critical adjustments. Once the left hand dial has been set, the right hand control will seem rather broad, but when one of them is a bit off wave, the other will be very critical. In this, the tuning resembles that of the neutrodyne, in which the individual setting is not critical but where the tuning as a whole is very selective.

Even a mediocre loud speaker will surprise you with its rich and natural reproduction when you employ a receiver of this type. The musical ear will not be offended and the quality day in and day out is so entirely pleasing that radio entertainment takes on new meaning and enjoyment.

THE TELEPHONE RECEIVER

By COL. J. F. DILLON

Operators of broadcast receiving sets and amateurs using head telephones or loud speakers often ask why permanent magnets are employed in receivers, instead of simple electromagnets. In order to obtain an intelligent conception of the operation of telephone receivers it must be borne in mind that the electric current induced in the aerial wires by the passing space waves is very small, hence, it requires a large number of turns of wire on the magnets of the receivers to create an appreciable field of force. This necessitates the use of very small magnet wire on account of the limited space available, and also minimum air space between the diaphragm and the magnet.

The displacement or movement of the diaphragm which causes the sound waves that affect the auditory nerves through the diaphragm of the ear is directly proportional to the square of the magnetic force acting upon it, and inversely proportional to the distance between them. In order to function efficiently the field of the permanent magnet must be several times greater than the increment induced by the aerial current.

If the magnetic field due to the aerial current is represented by f , and that due to the permanent magnetism by F , the total displacement force during one cycle of the incoming signal is equal to plus or minus the square of the sum of the two forces, $(F + f)^2 \pm (F - f)^2$, which equals $4Ff$. On the other hand, if only the force f acted on the diaphragm, the total force would be plus or minus f^2 , and since the aerial current is very small, the force would not be sufficient to move the diaphragm appreciably, hence, no audible signal would be heard.

Another important factor in the operation of these devices is the saturation curve of magnetization. The magnetization curve of receivers employing electromagnetic fields due to current from storage batteries or other power sources, is found to be similar to the characteristic curve of vacuum tubes,

provided strength of field is substituted for plate current in the direction of the ordinate, which is usually expressed in lines of force per sq. cm. and magnetizing current for grid potential in the abscissa.

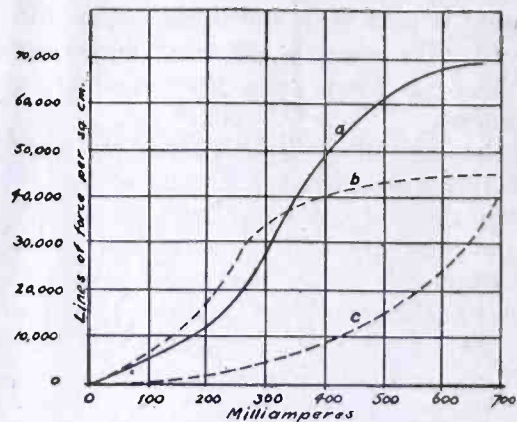

Saturation Curves of Telephone Loud Speaker Magnets

- Proper adjustment for 0.35 ampere field current
- Field too strong or magnets too close to diaphragm
- Field too weak, or too much space between diaphragm and magnets

The lower portion of the curve is seen to be rather flat; hence, the field strength is not materially affected by a slight change in current in the field coils. The middle portion of the curve, however, is very steep and any change in the magnetizing current causes a material change in the field of force about the magnet. The upper portion of the curve becomes flat again and finally becomes a straight line when complete saturation is reached. Therefore, the effect of the feeble impulses of the incoming signal current is practically nullified when complete saturation is reached.

From the above it will be obvious that the point of saturation will vary with the distance of the diaphragm from the magnet. If too close, the curve will begin to flatten at the middle and, hence, less current in the magnetizing coils must be used to obtain maximum efficiency. Conversely, if the space between the magnet and the diaphragm is too great, the lower portion of the curve will continue flat and greater magnetizing current must be used if optimum results are to be obtained.

In some of the receivers on the market provision is made for varying the distance between the diaphragm and the magnet, which accomplishes the same result as adjusting the flow of current in the field coils.

Tinsel cord, such as is used in leads to head-sets and loud speakers is almost impossible to solder, but if the end of the fabric covering is pushed back, and the cord covered with fine copper wire, wound closely together—like the tips of an old fashioned shoelace—this cord can be easily soldered, if a moderately cool iron is used. If the iron is too hot, the fabric inside the tinsel cord will be burned.

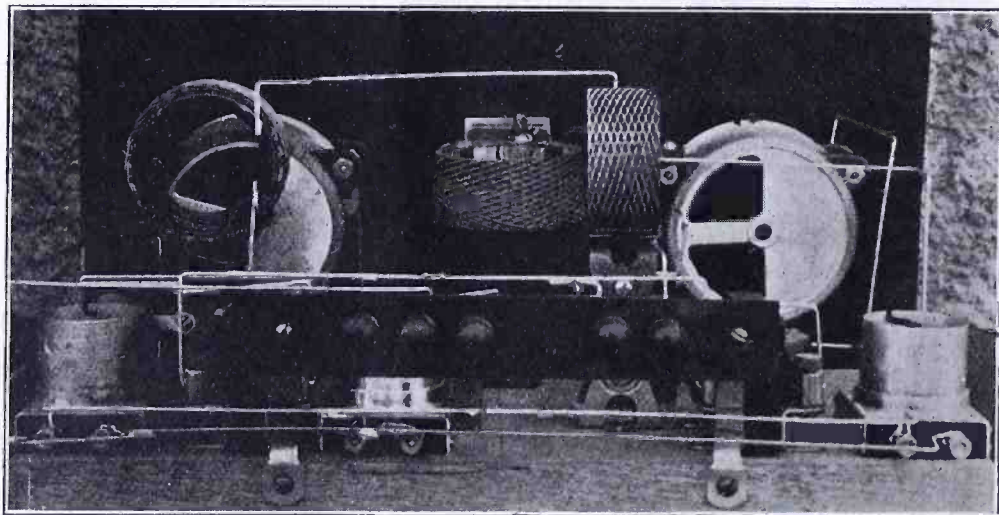

Fig. 6. Rear View of Quality Receiver

Construction of Power Amplifying Transformers

By Paul Oard

Complete details are here given for the construction of a power transformer to be used to obtain three, four or five stages of satisfactory audio-frequency amplification.

AUDIO-FREQUENCY amplification beyond the second stage is handled gingerly by most of those who are interested in radio, whether they rank as broadcast listeners, or as radio technicians. It is generally recognized that amplification at audio-frequency from the third stage up is attended by difficulty in obtaining clear signals, although they may be enormously amplified over the volume obtainable from the second step of amplification.

Various attempts have been made to offset this difficulty—by the use of grid biasing batteries, and of late, through the medium of push-pull transformers. These methods, while undoubtedly helping to a considerable extent, do not take care of the problem in an entirely satisfactory manner—at least not so far as most radio enthusiasts would like.

Keeping out of the technical aspect of the matter, let us see what actually happens when attempts are made to amplify signals from the third stage upward. In a two stage amplifier there is always present a certain amount of "noise" in the nature of a hissing or boiling note, sometimes called "background," but this is as a rule not sufficient to impair the quality of received signals to any great extent, unless the signal at detection is very weak. Most of us know that in such a case it is better to discard the two stages of amplification and drop back to the head set in order to secure a readable signal. When we enter the third or fourth stage of amplification, our hissing noises begin to increase out of all proportion to the received signals, as they were at two stages of amplification. We are not only amplifying signal volume, but also the "boiling note" of regeneration, if the detector be in a re-

generative circuit, or if it be a radio-frequency circuit, the same boiling note obtained in a somewhat different manner; and tube noises on top of this. Then also, we are contending against the well known fact that in practically all audio-frequency transformers there must be a certain amount of inherent distortion apart from the tube, due to eddy losses in the iron core, and to other factors that to most readers are more technical than enlightening.

In spite of the black eye that multi-stage—and by this, I refer to from three to five stages of audio-frequency—amplification has received, and it must be admitted, with much good reason, amplification at audio-frequency without distortion at from three to five stages is not only possible, but is thoroughly practical. Furthermore, properly applied, it will actually increase the working range of a receiver that does not employ radio-frequency to amplify the signal before it reaches the detector. It is possible, by making use of five stages of audio frequency amplification on a well designed regenerative receiver to not only approximate the work done on short inside antennas through multi-stage radio-frequency instruments, but in many cases to surpass, tube for tube, the work of such instruments. I realize that this statement is open to challenge, and that a loud and aggrieved roar will go up from that school which is so thoroughly sold on one form of amplification as to be blind to other forms, but to go back to the old saw—the proof of the pudding is in the eating. It would follow from the above, that if we can add five stages of distortionless audio-frequency amplification to some of the perfected circuits now using multi-

stage radio frequency amplification, that we will have some possibilities in long distance reception on loud speakers that will prove surprising.

The problem in designing an amplifier employing from three to five stages of amplification is to secure a transformer that shall be as free from distortion as possible, and that will handle comparatively heavy plate voltages without danger of puncturing the windings. A great number of the audio-frequency transformers on the market are wound with No. 40 wire, not of sufficient gage to carry the high currents that are generated as we add extra stages. The lowest ratios of such transformers is never less than three to one, while many now in use go to as high as six to one and even nine to one. Let us take the lowest ratio transformer—three to one—and build up a five stage audio-frequency amplifier, with 300 volts on the plates of the tube. On four or five stages we will find, as signals are tuned in, that a steady succession of sparks will jump from the "live" side of the transformer terminal posts, breaking across the fibre insulation that is usually used to insulate the binding posts from the core of the transformer. Also, at the fifth stage, if we are using a plug and jack arrangement, that rather than pass through the loud speaker winding, the high tension current now generated will break across the plug insulation in a steady succession of sparks. If insulation at the transformer terminals and the plug is sufficient to prevent this break down, it will be noted that on strong signals, that the *cores* of the fourth and fifth transformers actually reproduce the signals audibly, but badly distorted. If we make use of

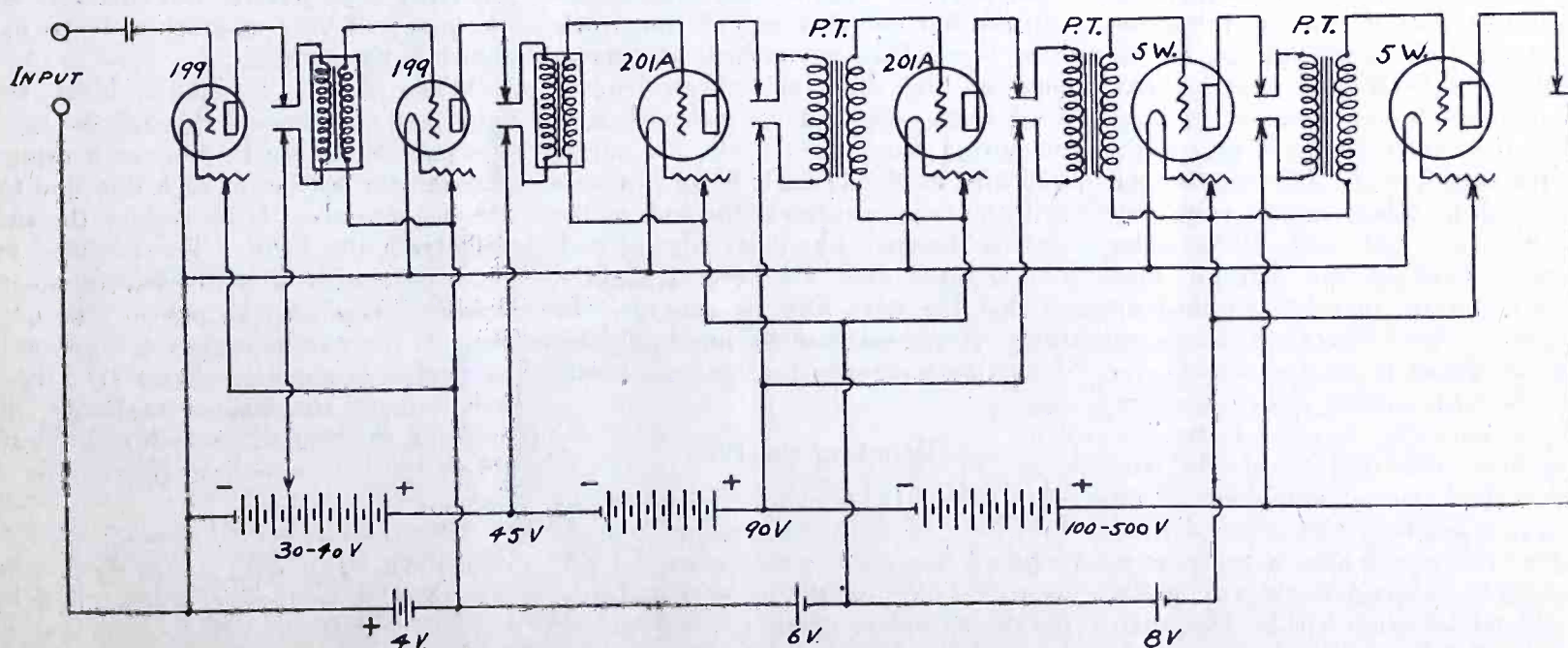

Fig. 1. Receiving Circuit with Power Transformers, in Third, Fourth and Fifth Stages

transformers of still higher ratios than three to one, this performance is aggravated, particularly with high plate voltages.

It follows from this that the ratio of winding is too high, and that with high tension currents being generated, that there is some hazard in the use of fine gage wire. Also, something must be done to eliminate distortion, aside from the lowering of ratios in the winding.

At least one firm has successfully solved the problems connected with audio-frequency in multi-stage amplification, and is marketing amplifying apparatus designed for this purpose. This concern, ranking as pioneers in this particular phase of the radio industry, has more than shown that multi-stage amplification is thoroughly practical. In presenting the construction of suitable power transformers for such purposes, I have drawn from the design that this concern follows, and therefore make no claims to originality except in presenting the form of construction outlined herein.

Anything worth doing is worth doing well, and it is necessary that the constructor follow instructions closely in the assembly of these transformers, in order that the best results be secured.

For a three stage amplifier, two good closed core transformers of any standard make, of three to one ratio, and one special power transformer as described, will be used. For a four stage amplifier, two power transformers, and for a five stage amplifier, three power transformers, in addition to the two standard transformers will be needed.

The power transformers are of *one to one* ratio, the windings are of No. 34 gage enamel wire, wound in pies instead of in layers, and are open core instead of closed core, as are ordinary transformers. The use of a grid or *C* biasing battery is unnecessary, and in fact of no help whatsoever. Plate voltages from 45 to 500 may be used, and either one watt or five watt amplifying tubes, dependent upon the plate voltage, or the UV201A or C301A tubes, may be used. At five stages of amplification, and using 5 watt power tubes on third, fourth, and fifth stages, with 300 volts on the plates of these tubes, signals from stations between 500 and 1000 miles distant, received in the detector tube with fair volume, may be amplified up to a point where they will be heard clearly at distances up to *three miles* from the Magnavox loud speaker, which, incidentally, is one of the few loud speakers that will handle the output of such a type of amplifier. Such volume is of use only where it is desired to throw the sound over a great area. For use in the average home, two stages of power amplification will be more than sufficient, and if an outside antenna is

to be used, one stage of power amplification will be ample.

The Winding Form

THE average amateur's workshop furnishes facilities sufficient for the manufacture of the type of power transformer to be described herein. While a lathe is a great convenience, it may be dispensed with, if one is willing to take pains. The first step in the construction of the transformer is to construct the winding form, to be used in winding the "pies" of wire.

Materials required for the winding form are as follows:

- 2 Disks $\frac{3}{16}$ in. thick by $2\frac{1}{2}$ in. diameter.
- 1 Disk $\frac{1}{8}$ in. thick by 1 in. diameter.
- 1 Shaft of brass or steel, $\frac{1}{4}$ in. diameter by 3 in. long.
- 1 Hexagon machine nut or thumbnut, $\frac{8}{32}$ thread.

Referring to the detail of winding form, Fig. 2, the brass or steel shaft *C* is cut down for $\frac{3}{4}$ in. so that it may be threaded with an $\frac{8}{32}$ die.

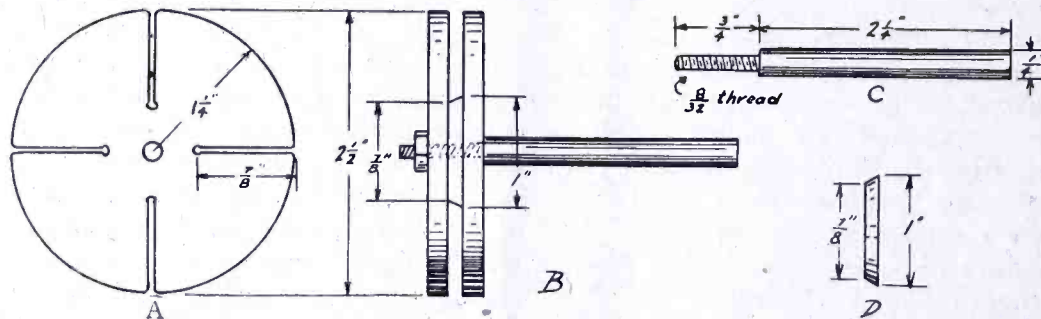

Fig. 2. Detail of Winding Form

A.—Bakelite washer with tying slots. B.—Assembled form showing beveled center washer. C.—Threaded shaft for holding form. D.—Beveled center washer.

The three washers should be of bakelite or formica, although metal or hard wood may be used. They are centered and drilled with an $\frac{8}{32}$ clearance drill. The 1 in. washer is beveled slightly on the edge as shown in *D*. This is to allow the pie of wire to be slipped off easily after it is wound and tied.

Where a lathe is not available, the washers may be cut to rough form by means of a small saw, and finished down with a coarse rasp or file—not a fast process, but one that will do the work. The three disks or washers are assembled on the shaft as indicated in *B*. Four slots, each $\frac{7}{8}$ of an inch in length, measuring from the outside, are cut as indicated in *A*. Using a $\frac{6}{32}$ clearance drill, holes are drilled at the ends of the slots as shown. The inner edge of each of the large disks are beveled slightly, so that the wire may be run into the form at a good rate of speed without danger of going over the edge and breaking.

Winding the Pies

APPROXIMATELY $1\frac{1}{2}$ pounds of No. 34 enameled magnet wire is required for each transformer. Eighteen pies, nine for the primary and nine for the secondary winding, are required. Each pie is made up of 1320 turns. A

slight variation from this number of turns per pie is permissible.

The most convenient way of winding the pies is to mount the winding form in the chuck of a small geared hand or breast drill, and fasten the drill in a vise or some convenient support so that the crank of the drill may be turned freely. Such drills have a ratio of gearing ranging from 4 to 8 on an average. Therefore, if the drill is geared 7 to 1, as is the one the writer used, 188 revolutions of the crank, giving 1316 turns, is necessary to wind one pie. Divide the ratio of your drill gear into 1320, and take the result for the number of revolutions of the crank. The pie should be wound within 10 turns of 1320, and not more.

The spool of wire is mounted a few feet behind the operator so that it will run freely. Fasten the end of the wire in one of the slots, allowing about two inches to project, wrapping this around the end of the shaft to hold the winding in starting. With a handkerchief in the

hand to prevent the rapidly moving wire from burning the hand, grasp the wire with enough tension to insure a firm winding, and wind on the necessary number of turns, counting the revolutions of the crank. The wire should be wound on evenly.

If care is observed and the tension on the wire is uniform, all pies will come out with approximately the same diameter at the outer edge. If wound on unevenly and jerkily, the diameter of the pies will vary as much as $\frac{3}{16}$ in., which is not desirable.

When the pie is wound, break the wire, and slip the end through the same slot used at the start. Slip stout thread through the bottom of each slot, and tie the pie securely. Now remove the end disk from the form. The pie may be removed readily from the beveled inner washer. Wind up 18 pies in this fashion. If the wire is broken in winding a pie and it is not desired to start a new one, remove the enamel insulation by applying the heat of a match to it, clean carefully, and solder with rosin as a flux.

After the pies are all wound, impregnate them thoroughly in paraffine, bees wax or other compound, and set aside to harden. Once that the compound is hardened, they may be handled readily.

Next we take up the assembly of transformer frame, cover, and core, and the cutting of the insulating washers to be used between pies. The balance of material required is:

- 2 Transformer end plates, bakelite, $3\frac{1}{4} \times 3\frac{1}{4} \times \frac{1}{4}$.
- 1 Compression block, bakelite, $2\frac{1}{4} \times 2\frac{1}{4} \times \frac{1}{4}$.
- 1 Fibre core tube, $\frac{3}{4}$ in. outside diameter by 4 in. long.
- 1 Fibre or bakelite tube for cover, 3 in. outside diameter by $3\frac{3}{4}$ in. long.
- 4 Fastening rods, brass, $\frac{1}{4}$ in. diameter by $3\frac{1}{2}$ in. long.
- 4 Compression screws, round head machine $6/32$ thread by $\frac{3}{4}$ in. long.
- 8 Fastening rod screws, round head machine $6/32$ thread by $\frac{1}{2}$ in. long.
- 4 Small binding posts.
- 38 Insulating disks, of oiled linen, or oiled canvas, $2\frac{3}{4}$ in. diameter.
- Soft iron wire sufficient to fill fibre core tube, cut in $3\frac{1}{2}$ in. lengths.

Construction of Parts

IN the transformer detail, Fig. 3, A and B show the end plates. While bakelite or formica is called for, hard wood may be substituted. A groove, indicated by A, A, A, A, in A, is cut in each end plate $\frac{1}{8}$ in. deep and $\frac{1}{8}$ in. wide. To do this, the end plates are either set up in a lathe chuck and cut with the usual tools, or a fly cutter set up in a hand brace or slow speed drill press is used. This groove may be dispensed with if necessary, in which case the length of tubing used as a cover is made just a trifle longer than the four fastening rods, instead of $3\frac{3}{4}$ in. long, and is held in place by pressure of the fastening rods, after they are screwed into place. The groove makes a more workmanlike job.

The four holes B, B, B, B, are drilled with a $6/32$ clearance drill. They are $\frac{1}{4}$ in. from the outer edge of groove A, A, A, A, or $3\frac{1}{4}$ in. from center of the end plate.

The hole C is drilled $\frac{3}{4}$ in. in diameter, and is intended to receive the end of the fibre core tube. It should make a tight fit.

Using this plate as a template or jig, the second end plate shown in B, is drilled in the same manner. Additional holes, shown at A, A, A, A, are drilled and tapped for $6/32$ thread, to receive the compression block screws. Holes B, B, B, B, are drilled $8/32$ clearance, to receive binding post screws.

The dotted lines, indicated at the corners of the end plates in A, are to be used as guides, in case the constructor wishes to finish off the end plates in an octagonal form, as shown in the picture of the completed transformer. Cutting the end plates thus, is optional with the constructor. A more finished job is secured if it is done.

The compression block, C of Fig. 3, is of bakelite or hard wood, and is drilled in the center with a $\frac{3}{4}$ in. drill, as are the end plates. It serves the purpose of compressing the pies closely together in the completed transformer.

The fibre core tube, D of Fig. 3, may be obtained at automobile supply houses, who sell it for use in automobile wiring. Some radio supply houses carry it also. The core tube from certain Ford spark coil units, is of the same size, and may be used, together with the iron wire core inside, by cutting to the required length.

The 3 in. fibre or bakelite tube cover, for covering the completed and assembled winding, not shown, is obtainable at radio supply houses. Metal tubing is not advisable on this type of transformer, for reasons to be explained later. The outer tube covering may be dispensed with, where the transformer is mounted in a sheltered or covered position. If to be used in general experimental work, the covering is advisable.

The fastening rods, four in number, are drilled a half inch at each end, and tapped for $6/32$ thread. For good contrast against the rest of the transformer, they should be nicked.

A piece of oiled linen, empire cloth, or oiled canvas, 12 in. wide by 18 in. long, will provide sufficient insulating disks, with a few over in case of mishaps. This material is obtainable at electrical jobbing and supply houses, and is used to a great extent in insulation of motor and generator windings. Oiled silk is equally good, but more expensive.

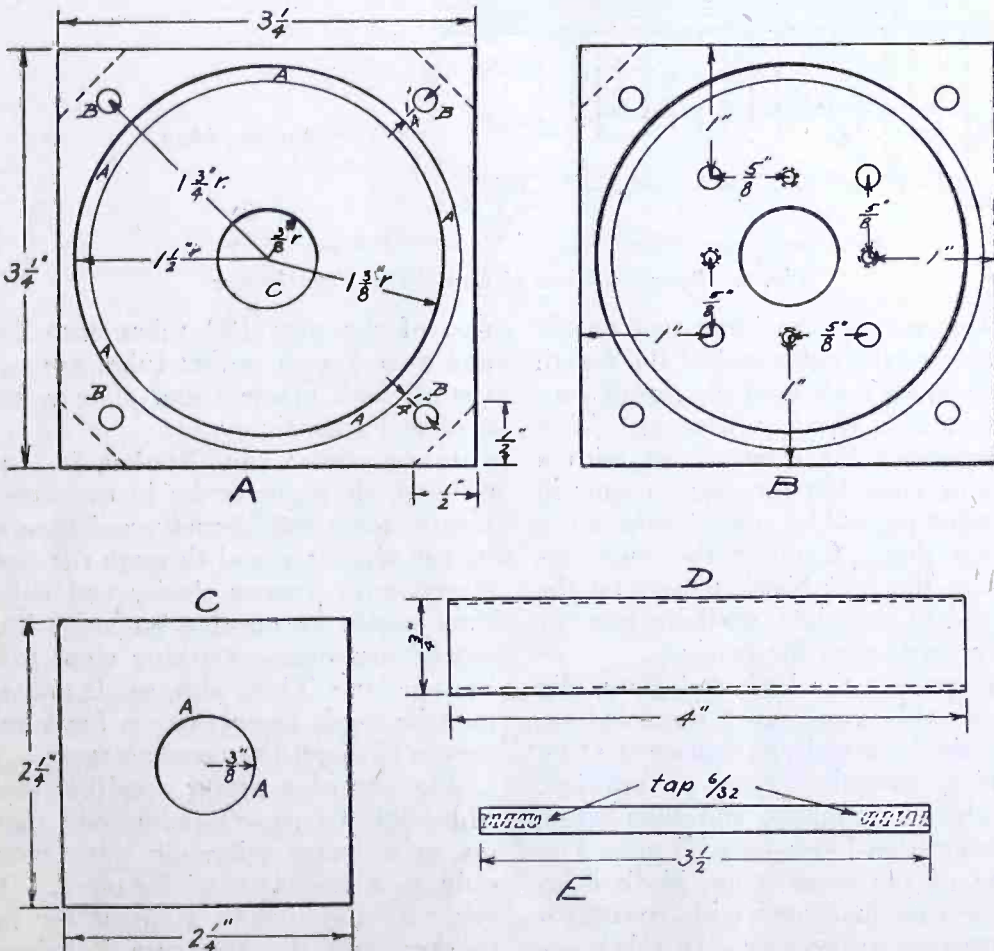

Fig. 3. Transformer Detail

A.—Back end plate. B.—Front end plate. C.—Compression block. D.—Fibre core tube cover. E.—Brass fastening rods.

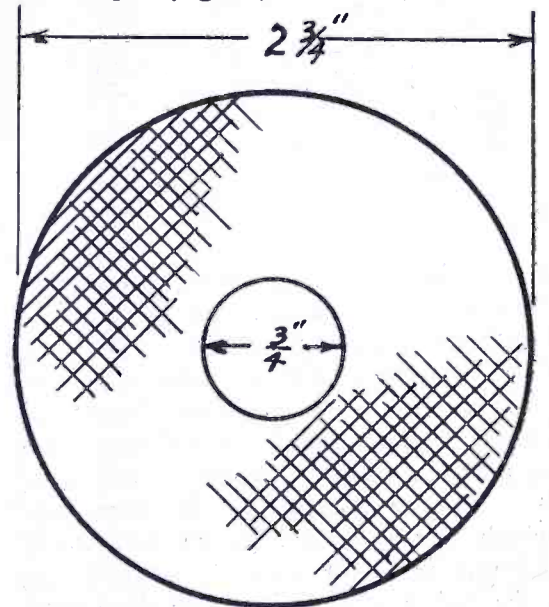

Fig. 4. Insulating Disk, 34 required

A circular disk of cardboard, $2\frac{3}{4}$ in. in diameter, with a small hole in the center is used to mark out the disks on the material, the center of each disk being spotted through the hole, with the pencil used to outline each disk. They are then cut out with a pair of scissors. At any good hardware store secure a steel punch that will cut a hole $\frac{3}{4}$ in. in diameter. A "wad cutter" obtainable at gun and sporting stores, may be used. With this, and with each disk placed on a soft wood block, cut out the center with a sharp blow from a hammer on the punch. If one has the time, the job can be done with scissors, but it is important that this cut-out be just of sufficient diameter to slip over the fibre core cover, and therefore the punch gives a better job.

Assembly of the Transformer

FASTEN the fibre core cover into the back transformer end plate. Set the same up on a level surface at a convenient working height. Place the first pie over the core cover, with the ends of the winding pointing away from you.

Slip one insulating disk down on top of this, bringing the inside end of the pie *over* the disk, instead of under it. Now slip another insulating disk down the core cover. The inside end of the pie will now be brought out *between* these two disks. Next, slip another pie in place, with the two ends pointing *toward* you. Drop an insulating disk down on this, bring the inside end out on top of the disk, as before, and drop another insulating disk on top of this, so that as before the inside end comes out between two disks. Drop another pie in

and so on until nine alternate pies have been connected. As the pies have been put in place with the ends of alternate pies pointing away from each other, there will not be much chance of confusion in this matter. The last end should be an inner one. The two ends now remaining, the first and the last, form the connections of one winding, either secondary or primary, it making no difference which, as the winding is a one to one ratio.

The outer end of the second pie will form one connection of the other wind-

tube, offer appreciable insulation between the bottom of each secondary and primary pie.

YOU now have a power transformer that will handle any plate voltage up to 500. When very low plate voltages are used throughout, as around 45, true power amplification is not secured, but the added clarity and lack of distortion when using several additional audio-stages make the use of power transformers well worth while even on these low voltage values.

In mounting the power transformers, there should be a clearance of at least 2 in. between them, and, if possible, the transformers should be with the windings out of inductive relation to each other, as at right angles. It is well, also, to shield the transformers with metal walls after mounting. A metal cover, in place of the fibre cover, is not practical, as there are undesirable inductive effects between outer windings of primary and secondary pies.

As to tubes to be used: Where no more than 150 volts are to be used on the power stages, 201A or 301A tubes may be used throughout the amplifiers. With higher voltages, it is desirable to use 5-watt power tubes on fourth and fifth power stages. In circuit No. 1,

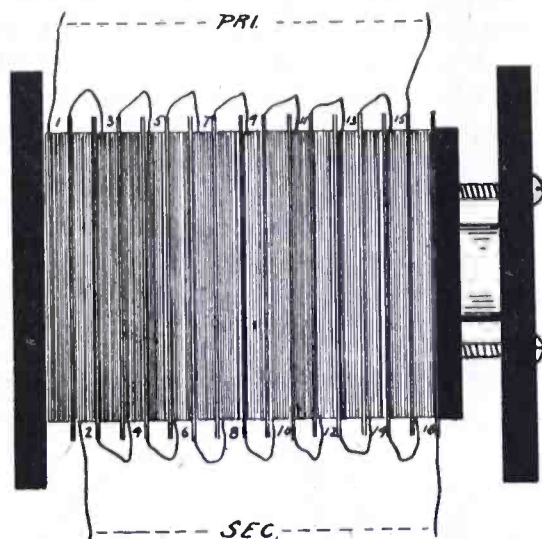
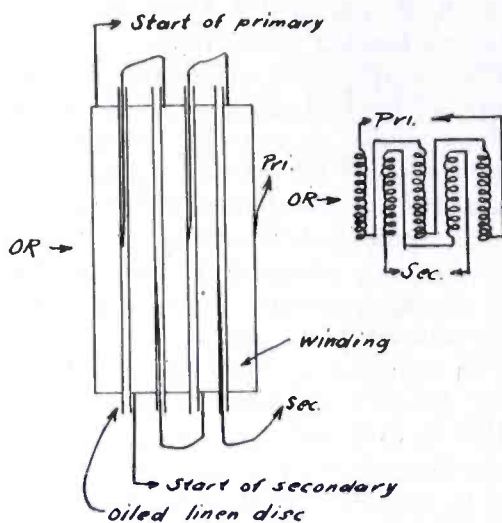

Fig. 5. Method of Connecting Alternate Pies



So as to Form Primary and Secondary

place, with the ends pointing *away*, as in the case of the first pie. Continue stacking the pies, alternating them in position, until all are in place. Center all the pies with respect to their position to the fibre core cover, while assembling them in place, thereby insuring an air space between the bottom of alternate pies, which is important, where high plate voltages are to be used. The insulating disks, being a close fit to the fibre tube, furnish further insulation in this respect.

With the pies in place, slip the compression block over the core cover next, then the front end plate, in which the compression screws have been placed. Now place two fastening rods at opposite corners of the end plates and screw them securely. Next screw down the compression block until the pies are firmly held. The next move is to solder the pies together to form the primary and secondary windings.

The outer end of the first pie will be one connection. Remove the enamel insulation from the ends of each winding by applying the heat of a match to the wire, taking care not to burn the wire in two. This is a better method than scraping the wire, as this tends to harden the wire and is liable to cause breakage when the wires are twisted together.

The inner end of the first pie, which if correctly brought out as above described, will be between the first two insulating disks, should be connected to the outer end of the third pie. The inner end of the third pie should be connected to the outer end of the fifth pie,

ing. Connect up the inner end of the second pie to the outer end of the fourth pie, and so on with even pies, until connected up as is the first winding. Test both windings for open circuits with a battery or lamp test for open circuits in each winding. Use only rosin as a soldering flux. Connect the four terminals to the four binding posts on the front end of the plate, marking two for secondary and two for primary.

Next remove the back end plate, slip the 3 in. tube cover over the winding, replace the back end plate, place the two remaining fastening rods in position, screw them up tightly, and then screw the compression block up well also. The purpose of the compression block is to hold the pies in center with respect to their position to the core. In this manner, with the pies centered, the insulating disks making a tight fit over the core

two of the new 199 tubes, two 201A and two 5-watt power tubes are made use of, with filament and plate voltages arranged accordingly.

Using power amplification, it is possible to cut regeneration in the detector circuit down considerably, and then step up the weaker signal through the power stages, with greater clarity and volume than would be possible on an ordinary amplifying circuit working close to the limit point. Thus, also, small antennas may be used, compensating for weaker signals through the power stages.

The use of a power amplifier makes it possible to record radio code signals on an ordinary telegraph relay wound only to a resistance of 20 ohms. The relay is connected in place of the loud speaker, and the armature is balanced against the initial voltage. It will be

Continued on page 58

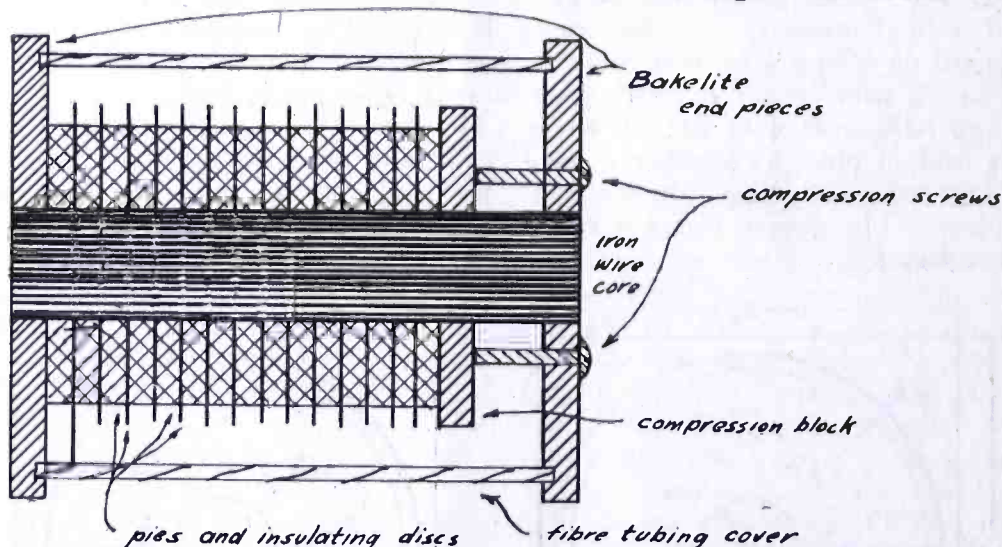

Fig. 6. Phantom View of Completed Transformer

Resurrecting the Electrolytic Detector

By Jacques Avon

The old device here described may be new to some and afford opportunity for an interesting experiment with worth-while results. It also aids to an understanding of the how and why of detector action.

ALL old-timers remember the electrolytic detector. It was the "super-heterodyne" of the days gone by, wresting supremacy from the crystal, only to be conquered later by the three-element vacuum tube.

What has happened to the electrolytic detector? Has it been relegated to the radio scrapheap with the coherer, magnetic detector and single-slide tuning coils? Those who know the possibilities of this old-fashioned device ask the question: "Why?" When used according to best practice and when in the hands of even a novice it could give the best crystal cards and spades, as the saying goes.

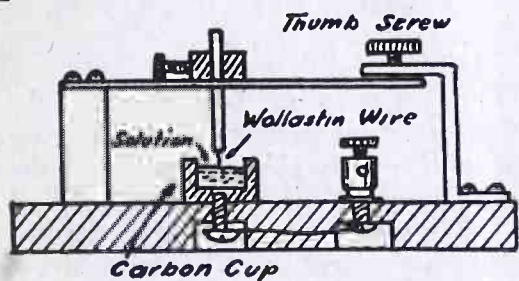

Fig. 1. Electrolytic Detector

demonstrate the similarity. In place of the usual cup which holds the crystal, a glass or carbon cup is used to hold a solution made up of 20% nitric or sulphuric acid and 80% water. Both the acid and the water should be chemically pure. In place of the usual cat-whisker bearing upon the crystal, the electrolytic detector employs what is known as a Wollaston wire, which is a platinum wire .0001 in. in diameter and which may be purchased from any scientific supply house for a few cents an inch. This little wire is attached to an adjustable arm so that its point can be raised or lowered in the electrolyte.

To understand the operation of the electrolytic detector reference must be made to Fig. 2, where a diagram is

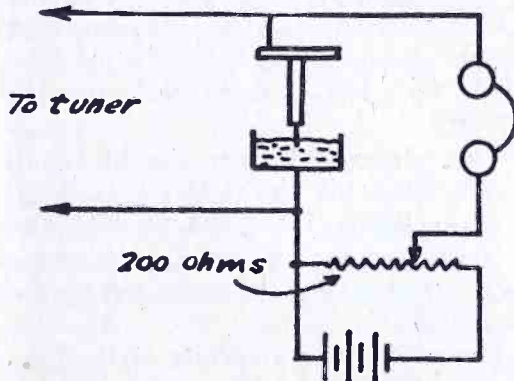

Fig. 2. Hook-up for Electrolytic Detector

given showing the method of connection in a radio receiving circuit. Tuning is accomplished in the usual manner and the electrolytic detector can be used with any receiving circuit that is successful with crystal amplifiers. A potentiometer of 200 ohms is shunted across a single dry cell so that the voltage passing through the detector can be adjusted within rather narrow limits.

To make the detector ready for operation the fresh Wollaston wire must be treated to remove its thin layer of silver by electrolysis in the detector itself before the platinum will be exposed and available for use. The wire is inserted in the detector and brought down so that about .1 in. is submerged in the electrolyte. Current from the local battery through the potentiometer is allowed to pass through the detector, using the Wollaston wire as an anode. Electrolysis removes the silver from the platinum wire and prepares the detector for action.

In actual use it will be found best to make the Wollaston wire positive. The wire is adjusted by the micrometer screw until but the barest fraction of an inch makes contact with the electrolyte. The .1 in. that was used in the original experiment represents too much wire.

When the wire is immersed the potentiometer should be adjusted until there is a sort of hissing noise in the 'phones. This indicates that the detector is now in a position of maximum sensitiveness and the next adjustments to be made will have to do with the tuning apparatus used in conjunction with the detector.

Unlike the crystal detector, the electrolytic will stay in adjustment for some time. Another advantage is that it is not very susceptible to jars and shocks and treatment that will ordinarily put the crystal detector out of the working will leave the electrolytic practically unaffected. If at any time the detector becomes insensitive it might be best to take out the old nitric acid solution with an eye dropper and replace it with a fresh solution which can be prepared and kept in a bottle. It might also be a good idea to clip off a tiny bit of the platinum wire and redissolve more of the silver off the remainder. This will positively restore the sensitivity of the device to its original value, but even this operation does not need to be resorted to often.

What is the principle of this electrolytic detector? It is known that all detectors are essentially rectifiers or devices which permit currents to pass in one direction freely but which effectively cut off their passage in the opposite direction. In the vacuum tube we know that it is the electron which is responsible for this peculiar action. In the crystal detector we are not sure what causes the rectifying action. In the electrolytic detector we know that it is the same action that causes the action in ordinary electrolytic rectifiers that are used for charging storage batteries. Students of chemistry know that hydrogen is always liberated when an electric current is allowed to pass through an acid and electrolyze it. In the case of the electrolytic detector, and all other chemical rectifiers for that matter, tiny amounts of hydrogen gas accumulate around one of the electrodes. Each little portion of gas is surrounded by a bubble of the solution. Electrical measurements show that hydrogen in this condition and under these circumstances offers a very high resistance to the passage of electric current in one direction while permitting it to pass freely in the opposite direction. It is these little hydrogen gas bubbles that accumulate around the platinum point of an electrolytic detector and which account for all the phenomena of rectification associated with that device.

In preparing this article the writer dug down into his junk and salvaged the battered form of what had once been his DX pet. It presented a pathetic sight. One-posted and dilapidated, it stood there on the bench like an humble beggar longing to be placed again on the high pedestal it once held in the art of radio communication.

Determined to give the old thing another thrill, the writer connected it up just to see what it would do. The results were surprising and the material presented herewith is for the benefit of those who operate crystal sets either because they are sticklers for quality or cannot afford the more costly apparatus. The quality afforded by an electrolytic detector is just as good as that made possible by the crystal, which is usually considered the peer of all rectifiers as far as distortionless reproduction is concerned. What is more, the electrolytic is more sensitive than the crystal, bringing in greater distances with ease.

A general description of the constructional features of the electrolytic may not come amiss, since information of this nature has not been published for a number of years and, therefore, may not be available to the broadcast fan without a diligent search in the musty volumes of the radio art stored away in the local library.

In form, the electrolytic detector is not unlike the common crystal detector. A glimpse at the attached sketch will

A Set for the 94-Meter Broadcasts

By L. W. Hatry

The increasing use of short wave lengths for both broadcast and amateur transmission makes desirable a special set designed for most efficient reception of these waves. Such a set is here described for the benefit of the amateur constructor.

THE 94-meter transmitter at KDKA and the 102-meter at WGY, as well as the short wave work of the amateurs, are of great public interest. The minimum of atmospheric disturbances and the greater distances that the signals consistently carry make for enjoyable reception on short wavelengths. Furthermore, several of the bigger stations have harmonics on the shorter waves from 120 meters up, that are often clearer than on their regular wave, due to interference. And if you can read the code there remains the possibility of copying some of the European and American amateurs on the short waves.

To construct a short wave set you need no more material than is in the single-circuit which you, no doubt, have relegated to the shelf. Furthermore, this set is a golden rule receiver: it radiates little energy and so is fair to your neighbors; it is selective and simply tuned and thus is fair to you.

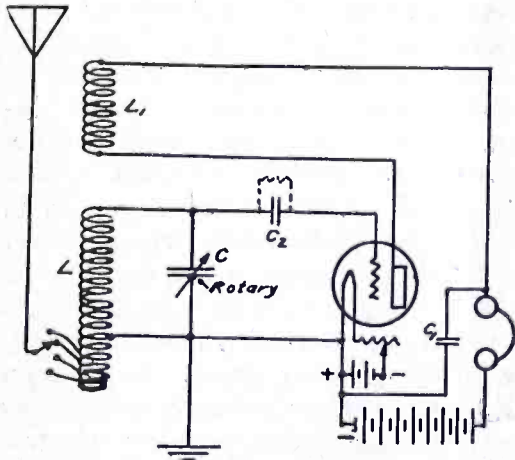

Fig. 1. Hook-up for Short Wave Receiver

Fig. 1 gives the conventional method of presentation. L and L_1 comprise the stator and rotor of an ordinary variocoupler, respectively, and should be wound as follows, the original winding having been removed: L of 19 turns of No. 16 or 18 DCC wire, and L_1 of 18 turns of No. 28, or larger, SCC.

L should not be shellacked or var-

nished, but the beginning and end turns can be fastened as in Fig. 2, which, if carefully done, will result in a tight, trim coil, without the help of adhesives. Taps are taken from L through the antenna switch, from the last four turns, giving four-turn variation of antenna coupling. This leaves 15 turns in the grid circuit and, with an 11-plate variable condenser, .00025 mfd., the wavelength range will be about 75 to 170 meters; with the 23-plate or .0005 condenser, the maximum wave is increased to about 230 meters.

C_1 is the fone condenser and should be a mica-insulated fixed condenser of .002 mfd. capacity. The grid condenser C_2 is of the usual .00025 mfd. type and can be shunted with a 4-megohm leak for the hard tubes, UV-199 or UV-201A, and left without leak for the UV-200.

The filament rheostat should be 30 to 40 ohms for the UV-199 and 10 ohms for either UV-201A or UV-200. In connecting the set, see that the rotary plates of the variable condenser go to the ground.

The addition of a vernier of the friction or mechanical type, to the variable condenser will be of great help. The mechanical type is advised because it reads directly on the dial and thus avoids change of dial readings. A vernier is advised because the short wave signals will be found quite sharp and therefore much easier to tune with the aid of reduction gearing of some sort.

The switch with its four taps is merely the selectivity and, to a certain extent, the volume control. For the use of the real novice, this can be so named and thus avoid misunderstanding.

There is no need to put up a special antenna for the set. It is intended for reception from the regular large size antenna that your usual broadcast set uses. If you install one for it it should be from 100 to 150 ft. long.

For loud speaker operation, you will need the addition of a two-step amplifier of the usual type.

On the Gulf coast, it is possible to receive WGY on the 102-meter wave when his regular long wave does not come through at all. I have, in weather so full of static that it was impossible to understand KDKA on his regular wave, been able to get excellent concerts on 94 meters.

REASONS FOR THE BREAK-DOWN OF AUDIO-TRANSFORMERS IN REFLEX CIRCUITS

By 9BJB

The majority of people using the reflex circuits as a receptor of radio signals will use a poor crystal and the result, due to the high voltage induced in the crystal circuit, is that the so-called "hot spots" are all burned away, or, in other words, the crystal is of no use as a rectifier. Then the operator of such a set will let this crystal remain in it thinking there may be a good point on the crystal, which he will try to find.

Right here is where the trouble starts. In trying to find a new point on the crystal, if there be any, the catwhisker is moved over several points of no value as a rectifier. The action there is a duplicate of the action in the primary circuit of a spark coil. The make and break of the primary circuit will induce a high voltage surging back and forth in the secondary of the audio-transformer. Due to the thin insulation between layers in the secondary, the voltage will leak between these layers or part of them, and break this insulation.

This, then, is a short circuit between one or more layers and will cause distortion in the output of this transformer. Hence, the howling in most reflex sets. It is evident then, that if a new crystal is placed in the set that it would still continue to howl and a new transformer is the instrument that should be replaced to remedy the howling.

The ordinary person hasn't the instruments for detecting a defective transformer and the only sure way to tell whether it is defective, is to replace it with a new one. The windings will show to be O.K. but still the transformer is of no use. Most manufacturers will replace such transformers. The writer has had to replace a great number of transformers that have gone bad in this way.

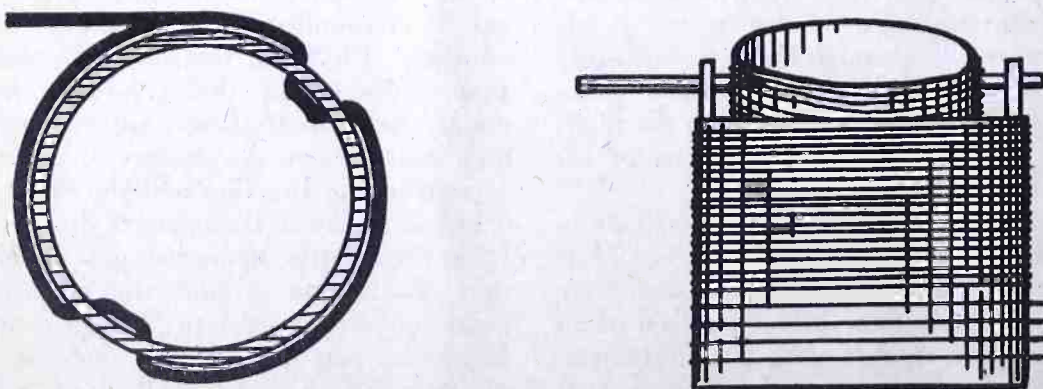

Fig. 2. Details of Fastening and Winding

Radio Recording

By Samuel G. McMeen

These suggestions offer a fertile field for experimentation. With the home-made telegraphone described it is possible to record high speed code and reproduce it slowly or to permanently record music and voice for future reproduction.

RECORDING mechanism for ordinary telephone service seems not to be a public need, as the repeated offering of such devices never has produced more than a ripple of momentary interest. In radio practice, however, the need of a record of telegraphic communication sometimes arises, and it is conceivable that there might hereafter exist the desire to record human speech as broadcast. The pallophotophone has already pointed the way to one such application, and its results are extraordinarily faithful and lifelike when sounds are recorded and reproduced. It is impossible, under good conditions, to detect a difference between the actual voice as broadcast and that voice when first recorded, then reproduced and simultaneously broadcast.

The pallophotophone, as its name indicates, uses light as its recording agency, photographing in lighter and darker shadings an impression on a motion picture film, by one or another of three slightly different methods. In all of the methods the ultimate turning of the varying light back into sound is associated with the use of vacuum tubes for amplifying purposes.

The earliest method of recording sound was by means of the cylinder phonograph, first on tinfoil and later on so-called wax. We say "so-called" because the material of those cylinders, as synthetically prepared by Mr. Edison, is not a true wax, as pieces of it will not return to a lump when crushed together in the hand or otherwise. Recording sound by means of a wax cylinder phonograph is still in wide use wherever the record is to be reproduced at once without recourse to the elaborate and time-consuming process of molding from a matrix. Many amateurs have recorded radio messages in code on such a machine, and there is entertainment in doing so.

During the World War the wax cylinder phonograph, usually spring-driven, was used for making record of enemy radio telegraphy, and on one occasion the method covered itself with glory. For a succession of evenings the observers had been giving the closest attention to certain high-pitched, short, regularly recurrent signals, whose origin was suspected, but in no way definitely known. These signals always came at the same hour of the night. They were duly recorded on a phonograph cylinder, but their reproduction gave merely the same baffling sounds that had been heard on the several occasions.

All through one long night an intelligence officer listened to the sound of the signals as regularly repeated by his phonograph, getting no nearer to a knowledge of their origin, destination or meaning. The little record lasted for a few seconds only, and was of high pitch. But as the officer listened, very tired and very sleepy, he suddenly noted a falling in pitch and a lengthened duration of the sound. Realizing that the phonograph was running down, he rewound it, but, as he did so, he was struck by a thought, suggested by the lengthening of the signal.

He set the machine so as to run as slowly as possible. He associated it with another phonograph adapted to record what the first one should reproduce from the original record, and this second machine he set to run as fast as possible. He started both machines and made the new record. He then reproduced the new record, running the machine this time as slowly as possible. To his immeasurable delight the signal now came out an understandable radio message, in cipher, it is true, but destined to yield promptly to the decoding abilities of the intelligence service. Night by night thereafter the weird signal was recorded and decoded as a regular routine of war work, with valuable results.

Not every amateur mechanic who is interested in radio research has at hand a wax cylinder phonograph, and still might like occasionally, for special purposes, to experiment with such re-

producing speech or other sounds. The action is that the steel wire is permanently magnetized in little ripples of varying magnetism. Then, when the wire is again drawn across the pole-piece of the same receiver, the opposite action takes place, the ripples of magnetism now producing currents, which can in turn be heard in a second telephone receiver connected to the first.

Theoretically the device is perfect in its action, but unfortunately possesses two drawbacks as originally designed and put out for public use. These drawbacks are that the magnetic nodes and internodes produced by the first (recording) receiver are extremely feeble, by their very nature; and that the ability of that receiver to turn these bits of magnetism into an alternating current is limited.

In a word, what the scheme lacks is a means of getting more magnetism into the wire and with as large contrast as possible between the nodes and internodes, and also a method of more robustly utilizing the alternating current when it has been created from this augmented magnetism.

Fortunately for applications of this meritorious instrument in radio practice, the art itself contains the means of accomplishing these two requisite ends. For, by means of vacuum tubes, we can send into the device any desired amount of speech or signal current, and by the same means we can magnify the current produced by the first receiver in repro-

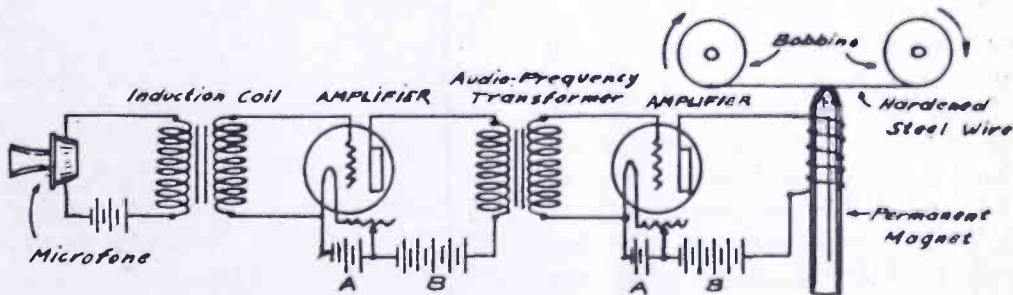

Fig. 1. Amplified Recording on Steel Wire

duction and thus get an augmented sound in the final telephone receiver or loud speaker. For such a person there is a third and most interesting form of recording device that will serve all the needs and at the same time is so simple as to be readily assembled in a modest workshop. It has the further merit of being very faithful in purity of recording, being free from the unwillingness to record sounds of certain characters, as is true of the wax cylinder machine.

The type to which we refer is the telegraphone of Poulsen, in one of the forms of which a hard steel wire is drawn directly across the single pole-piece of a telephone receiver which is at the time

reproducing speech or other sounds. The action is that the steel wire is permanently magnetized in little ripples of varying magnetism. Then, when the wire is again drawn across the pole-piece of the same receiver, the opposite action takes place, the ripples of magnetism now producing currents, which can in turn be heard in a second telephone receiver connected to the first.

As shown in Fig. 1, the speech or signal current is amplified before it reaches the input coil of the recorder. This is done through the action of two amplifiers, the plate circuit of the second containing the input coil. The transformer shown in the figure between the microphone and the first tube is a telephone induction coil, being in fact an audio-frequency transformer, but still carrying its time-honored name. It is best when sent out by the makers as the

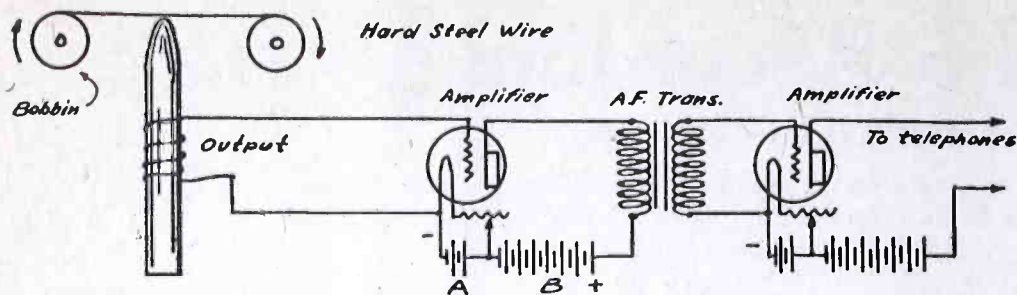

Fig. 2. Amplified Reproduction from Steel Wire

correct one for the microphone it must serve. It is well if it further has many turns in the secondary winding, so as to produce as large a variation of grid potential as possible. The second transformer is a radio unit, with whatever ratio is at hand.

The bobbins carrying the steel wire may be arranged to be rotated by hand for experimental purposes, though in such a case the operator must be prepared to accept some variation of pitch caused by unequal rates of speed. If the experimental work results in an application of the device to more serious recording, the most convenient drive often will be found in a small sewing machine motor, which can be reduced to a very slow rate of rotation by means of the rheostat that accompanies it. We have often worked such devices as low as 800 revolutions per minute, and from such a speed it is simple to reduce still further by means of proper pulleys and small belting of cord. The work to be done in moving the steel wire is nearly negligible, so that the whole moving system can be very simple. If the experimenter, however, has a phonograph of the cylinder type, it can be readily adapted to the needs of the new problem, and can be set to any desired speed by adjusting the governor.

In Fig. 2 are shown the connections when the record on the steel wire is to be reproduced. Here again there are two tubes and an intervening audio-frequency transformer. A switch, not shown in any figure, serves to change over from the recording to the reproducing scheme. The input coil of the telephone element now becomes the output coil, and delivers its magnetic variations first as an influence to modulate the magnetic behavior of the core, there to produce in the coil the alternating current that shall vary the grid's potential.

The steel wire can be had in the market, under the trade name of piano wire. It may well be of a diameter of 17 mils, approximately equivalent to No. 25 B. & S. gauge or No. 27 steel wire gauge. This size will run well on the bobbins. A few gauges smaller will work as well, however.

After a record has served its purpose, it can be erased by passing the steel wire across a strong permanent magnet, which will wipe it clean of ripples.

In an alternative form, the telephone records on the surface of a hard steel disk. In this method it is necessary

that the recording magnet shall be presented to the disk in such a way that it will describe a spiral. For the uses of the laboratory there is but one ordinary machine that will make such a motion. It is the Edison disk phonograph, wherein there is an element that moves the sound box radially, independently of the action of the record itself. In all other types, so far as we recall them at the moment, the sound box "tracks" solely by the moving action of the spiral cut of the record. Therefore, by laying the steel disk on the turntable of the Edison machine, one has only to attach the recording magnet to the tone arm as a support and it will travel in a true spiral over the disk, tracing its magnetic message as it goes. Setting it back to the starting point and moving the change-over switch, one reproduces.

HANDY HINTS IN RADIO

By D. B. McGOWN

When using a tungar, or rectigon charger it will be found, if one side of the filament circuit is opened, taking care not to open the plate circuit, that the emission from the filament, due to the passage of the current through the tube as a rectifier, will keep the filament lighted to a brilliancy that will suffice to allow the current to flow, but by so doing the actual tube life will be increased two or three times.

If the brushes of a motor or generator squeak badly, even though they are fitted properly to the commutator, a little paraffine wax will often act as an ideal lubricant. If the trouble still persists, the brushes may even be dipped into and allowed to absorb some boiling paraffine.

Remember when using the thoriated filament vacuum tubes ("A" tubes) that excessive plate current will often cause these tubes to become inoperative. Burning them at low brilliancy for a considerable time will usually bring them back to sensitiveness.

If you are not using a C or grid bias battery in your amplifier system, don't blame the plate battery, as it will run down rapidly.





"Frothing at the mouth, the leader of the revolutionary party fell forward on the table."

For King and Radio

By Earle Ennis

ANYONE with half an eye could plainly see that the king was having the royal sulks. For one thing, he was as flat as an eel's eyebrow. For another, hi-jackers had broken into the palace wine cellar and stolen the last six bottles of his favorite Chablis—the Chablis with the imported cobwebs. Then, to add to his discomfiture, his five-tube neutrodyne with which he was wont to take the edge off of the carking cares of state had gone on the hickey. Wherefore, in the patois of the Grand Boulevard, his majesty "had a sour on."

It was even so. The dilemma seemed as completely deadlocked as a murder jury. Foot and mouth disease had ruined the crops. The barons and estate owners had been cleaned by the income tax. The queen had taken up mah-jongg and was of no earthly use in official matters of state. And, only the day before, the king's arch-enemy, the duke of Naught, had foreclosed on the Green Mule chewing tobacco concession and cut off his majesty's supply of smokeless plug. It was indeed a desperate outlook.

The king sat in sullen silence and stared across the exotic oriental gardens

of the palace with unseeing eyes. Around, gorgeous butterflies flapped their ailerons and preened their struts. Glorious fountains, fed by a supply more costly than Hetch Hetchy, sparkled in the sunlight. The drone of bees gumming up their hives with official honey, sounded in the air. All was light, color and life, and yet—the king heard and saw none of these things. What he pleased to call his mind was elsewhere.

"Gadzooks!" he muttered into his beard. "There must, forsooth, be a way. A king simply must have spending money. What, with the cost of banquets, breach of promise suits, B batteries and efficiency experts," He broke off abruptly and struck a silver gong at his side. Instantly a Nubian fluttered to his side.

"Yassuh, sire, suh! You-all callin', suh?"

"You're darned tootin'," snapped the king. "Where's the prime?"

"Him and the lawd high chamberlain is masticatin' their edibles, yassuh," said the Nubian, bowing low.

"Humph," growled the king. "Always eating those two. They'd go right on eating—even if I was dead I sup-

pose. Tell prime I want him and to make it snappy."

"Yassuh—Ah shoely will," said the Nubian and clogged.

When he delivered his message, the prime minister and the chamberlain exchanged significant glances.

"Well, anyhow, he can't cut my salary," said the prime minister. "I've been working for three months for nothing now, as it is."

He licked the last drop of casawba juice from his spoon, wiped a bit of egg from his robe of office, and strode majestically from the boudoir du dejeuner. The lord high shook his head.

"There goes a fine hombre," he said. "Would that we had more like him—at the same price!"

The king looked up impatiently as the prime minister bowed before him.

"Squat!" he said succinctly. "I would have speech with thee! Gimme a smoke!"

The prime minister passed over his fancy ormolu cigarette case, the gift of a noted pickpocket whom he had paid to steal it from the king of England on the occasion of his recent trip to see the

prince of Wales in his spectacular horse-falling demonstration.

"Your majesty has much on your mind these days," said the prime minister cautiously. The king smiled.

"Thanks for the compliment," he said. "Now that my mentality is stipulated by both sides, we can proceed with the dirty work. How much money is there around the palace, not counting what the queen has filched during the week to pay her gambling debts?"

"At the noon count, most high, I believe there was, yesterday, the sum of eighteen sturken!"

"Hum—not enough. Not enough by a jugful. Methinks 'tis a tough kitty for a king to be so situate. Prime—we've got to work out some scheme, here and now, for raising revenue, else there will be no sop in which to soak the royal bread. Realizest thou that?"

"You said a mouthful, king," responded the prime minister with enthusiasm. "But how?"

"Aye—but how! For the love of Hercules, do you think I brought you here to bleat 'but how' in my ear? You know my mental limitations. Think up an idea!"

The prime minister shifted uneasily.

"Your majesty . . ." he began, but the king interrupted him with lifted hand on which shone the sign of the Order of the Seamless Garter.

"Aw, can the title stuff," he snapped. "Make it Ed until we get this mess untangled."

"Well, Ed," said Joe, the prime minister, "I have been thinking that we might use this radio thing of yours to make money. It could be done, you know!"

The king sat up suddenly.

"Shoot the piece, Joe," he said. "You interest me—strangely!"

The prime minister collapsed himself confidentially and whispered into the king's ear. As he talked, the face of the monarch of all his people lighted. After a bit he raised the visage that had descended to him from a long line of ancestors and stared at the towers of his private broadcasting station, just visible in the distance over the tops of his garden trees—a mile away.

"By Jove!" he said softly. And then, after a bit—again: "By Jove!" It was the mildest expletive of his repertoire and indicated to those that knew him that he was highly pleased. For the prime minister had given him the germ of an incipient idea. If it was raked, harrowed and cultivated, turned over by the spade, fertilized and sprayed, it might—not certain, of course—but, it might amount to something.

The king was proud of that broadcasting station—almost as proud as he was of his five-tube neutrodyne circuit. The station had been built for his exclusive use by the royal council. The

council had also purchased the neutrodyne so the king could listen-in to his private station. It was all his, exclusively. There was not another receiving set in the entire kingdom, save the king's own in the main lobby of the palace foyer.

In the station, awaiting the king's private signal, sat twelve of the finest symphony orchestras in the country. Fifteen opera companies were ready at a moment's call. Nine musical comedies, seven sextettes, six quartettes, five trios, ten duettists, whole batches of soloists—high, low, medium and jack—while ten entire rooms were given over to trombonists, flutists, harpists, xylophone players, and miscellaneous thumpers, bangers, beaters and whackers of various kinds.

Once a year—at the festival of the Feast of the Grace Note—the entire kingdom lined up and were given a listen over the king's head-set in the palace foyer. They looked forward to it. They counted on it. They dressed in holiday attire, took an annual bath, and brought lunch. The line formed the day before, and messenger boys made a fortune holding places for late comers in the line. On that day, the broadcasting station ran all day, double shifts, with overtime.

It had been the king's idea to erect only one broadcasting station in the country. By so doing, he learned what was going on abroad without his subjects knowing what other countries were doing. He printed the newspapers himself, and by owning the only radio station there was nothing of a disturbing nature to intrude within the borders. His little kingdom was at peace with the whole world. Such tales of wars and disturbances as filtered in were put down by the simple folk as tourist fictions, customary with travelers.

"America is dry!" said one traveler. "They drink no more there!"

"Ha! Ha! Ha!" laughed the king's loyal subjects. "He is a waggish fellow. He would have his joke!"

"There is to be no more war!" said another.

"Haw! Haw! Haw!" chuckled the residents. "How funny he is!"

So it had gone (or went, if better diction is preferred). Now, if the prime minister's suggestion was carried out, all would be changed. It was a radical innovation, a startling departure from what had been. It was as thrilling as a forest fire in a chorus of hula dancers. The king wanted to think it over. Then, if it still looked good, he would pass the buck to the royal council. He always did that. They were hereditary catchers behind the home plate and they had to take his stuff as he pitched it.

"It will rattle their slats," he mused, "but danged if I don't think it will work. I've half a mind to chance it!"

By this, we learn that the king was somewhat of a gambler, casting all on a single throw, but taking the precaution to mark the cards first to avoid disappointment.

(At this point the king got up and walked off and the prime minister went back to his breakfast. The action is shortened here in case this story is filmed by Selznick, who likes to write his own captions.)

SIX weeks later, you wouldn't have known the confounded kingdom. It had changed almost overnight, for, do you know what the king had done—that foxy old coot, using the prime minister's idea? No? Of course you don't. We haven't told you yet. Well, here it is. He took the ban off of radio. Um-hum! Lifted it right off—just like the Democratic party lifted the burden of responsibility for the tariff and heaved it over on the Republicans.

One day—the kingdom had no radio. Then a batch of criers went through the kingdom, riding milk-white palfreys, and blowing coach horns. They paused at street corners and did a little broadcasting for His Majesty, beginning "Oyez! Oyez! Oyez!" Folks clattered up in their wooden shoes and jerkins, and listened. They thought, perhaps, the traction company had declared a dividend or something like that.

"His Majesty the King, by the Grace of God, Ruler Extraordinary, etc.," was the way they began. When they had finished, one of the town reporters wrote it up, translated what the criers said into readable newspaper English, and they learned what it was all about. It wasn't a dividend at all. It was royal permission to buy a radio set and listen-in on the king's broadcasting station—every night in the week.

Of course they might have known there was a joker in the thing somewhere. Every time a crier gets up in front of the public and gives away something for nothing, and says the king told him to do it, the safe motto is "Cheese it! There's an Ethiopian in the wood pile!" But the simple folks never suspected a thing. They threw up their hats, and hung out flags, and put a picture of the king in the window, and named children after him.

"Great is the king!" they shouted. "Viva his royal nibs!"

The king stood at the palace windows and listened to himself being eulogized by the happy populace. Something inside of him warmed. His liver, somehow, seemed a bit less torpid, and life was a thing of sunshine and gleaming hope.

"By my troth," he exclaimed, "I like this popularity thing. It is as monastery wine to my soul!"

The prime minister, who was the

Continued on page 48

What Makes a Good Receiver?

By L. R. Felder

This is a cogent analysis of the electrical factors which influence the selectivity, sensitivity and distortionless reproduction of a radio receiving set. It contains information of interest and value to every owner of a set.

IN the last five issues of RADIO there have appeared a series of articles describing the theory and principles underlying the operation of the five foremost types of receiving circuits, to wit: the regenerative receiver, super-regenerative, neutrodyne, super-heterodyne, and reflex circuit receivers. The circuits in these receivers represent the ultimate in the radio art at present. At this stage it should prove profitable to consider the general requirements of a good receiver such as those listed above. What are the factors which go to make a good receiver? What are the elementary fundamental design principles which must be followed in making a good receiver?

First and foremost a receiver must be *selective*. Whatever other virtues a receiver may have if it is not selective it is not a good receiver. By selectivity we mean the ability of a receiver to discriminate sharply in favor of one signal to the exclusion of all other signals. If, when a receiver is tuned to a particular wavelength, the signal on this wavelength comes in loudly and clearly, but in the background other signals may be heard no matter how faintly, then the receiver is not a selective receiver. The good selective receiver will bring in the desired signal loudly and clearly with *absolutely no trace of any other signal*.

In talking about selectivity there are two ideals to be sought. The first is what might be termed "hair line" or "knife edge" selectivity, which is the goal for receivers designed solely for telegraph reception. In telegraph reception we are concerned practically with the reception of one wavelength and frequency. Hence no matter how sharply selective the receiver is the signal will be properly reproduced when the receiver is tuned to this particular wavelength. A good telegraph receiver is therefore difficult to tune, for it requires the most accurate and careful setting of the tuning dials to just hit the right tuning point. The slightest variation of the dial settings will result in the loss of the signals.

However, the development of radio telephony and broadcasting have necessitated a slightly different ideal for the receiver. The hair line telegraph receiver will not be suitable for the reception of telephone signals for the reason that the reception of telephone signals involves the reception, not of a single wavelength or frequency as in telegraphy, but of a band of wavelengths or frequencies, as will be explained more in detail below. A "hair line" selective

receiver would omit some parts of this band of wavelengths and to that extent would not produce satisfactory results. In spite of the necessity of receiving this band of wavelengths the telephone receiver is capable of being sufficiently selective, if properly designed, to discriminate against and exclude all other undesirable signals. Thus the second ideal is that of the radio telephone receiver which must be able to receive a small band of wavelengths and yet be sufficiently selective to exclude undesirable signals. It might be pointed out that such a telephone receiver will make a satisfactory telegraph receiver also.

There are several factors which determine the selectivity of a receiver, one of the chief being resistance in the receiver. Apart from the fact that resistance introduces losses and makes the receiver inefficient, it also increases the damping and broadens the tuning. This means that when the receiver is tuned to one wavelength at which it gives a maximum response, it also gives great response at wavelengths differing widely from the one to which it is tuned. In consequence, interference results, which is a characteristic of all non-selective receivers.

High resistance may be due to poorly designed coils, imperfect condensers, the accidental presence of an absorbing circuit tuned to the receiver, poor assembly, leakage between the different parts of the circuit due to poor soldering, or poor insulation material causing high dielectric losses. The remedy is obvious. Only the best parts which have a reputation for proved results should be used.

In winding coils avoid the poor practice of bringing out taps. Each tap means a soldered joint introducing that much more chance of high resistance. It

also necessitates bringing the taps to an insulating panel which introduces additional dielectric losses. Examine all the better class receivers and you will scarcely find one single tapped coil. The best practice is leaning away from tapped coils and towards radio-frequency circuits tuned and controlled largely by its associated variable condenser.

Wherever possible use a type of coil which requires a minimum of solid supporting winding form. This will decrease the dielectric losses and resistance. If you wind your coil yourself it is just as easy to wind one of the web types of coils as any other, and the web or weave type of coil has the best kind of insulating medium: *air*.

Do not attempt to cover too large a range of wavelengths with one set of coils, for you are apt to get into trouble by finding that part of your large coil which you will require resonates at some wavelength within your receiver range, and thereby abstracts energy at this wave. The best types of sets on the market cover only a narrow range of wavelengths like the broadcasting range. If a large range is desired a new set of coils or a separate coil system should be used. In the old days of the quenched spark regime it was customary to design receivers to cover a range from 100 meters to 3000 or 5000 meters, and some even went higher. Those days are gone forever. The amateur has a short wave receiver and a long wave receiver. This is one of the reasons why modern receiving sets are so much better. So much then for the effect of resistance, which is added in one way or another, on the selectivity.

Any radio-frequency circuit is apt to be more selective than one not employing radio-frequency amplification in one

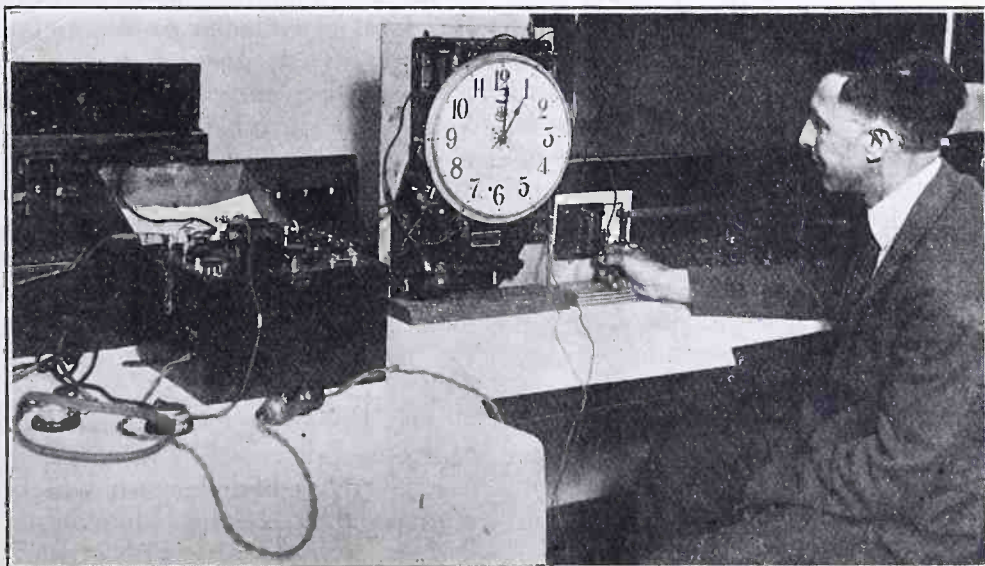

Mechanism Whereby F. W. Dunmore, U. S. Bureau of Standards, Sets Clock by Radio

form or another. This is obvious since each step of radio-frequency amplification is effective in weeding out wavelengths other than the one tuned in. Likewise any multi-circuit receiver must be more selective than others, the selectivity increasing with each tuned circuit. For each tuned circuit is effective in tuning out all wavelengths other than the one to which it is tuned. Of course each additional tuned circuit results in a certain loss of energy due to more coil and condenser used. But the associated tubes more than make up for this. These facts explain the great selectivity of such sets as the neutrodyne, super-heterodyne, and two or three circuit regenerative receivers, for they all employ radio-frequency amplification in one form or another, or have a number of tuned circuits. The radio-frequency type of circuit lends itself readily to reception by means of a loop antenna. As a result of this selectivity is again increased for the directional properties of the loop assist in weeding out the undesired stations.

Finally, selectivity of a circuit depends to a considerable extent on the electrical design of the circuit. This is such a large subject that one cannot go into the necessary details in a short article. The meat of the matter may be brought out, however, by pointing out that a radio-frequency circuit consists essentially of a coil and a condenser adjusted in the proper relation to one another. Any coil and any condenser will not do. Both coil and condenser must be able to tune to the entire range of wavelengths to be received. There is no advantage in having coil and condenser tune above the maximum wavelength. It is a waste of wire and capacity in the first place, secondly it may impair the efficiency of the receiver.

Obviously there are any number of combinations of coils and condensers which will meet the above condition, the extremes being very small condenser and large coil, and very large condenser and small coil. Of the two, the best choice is large inductance and small capacity. This for two reasons. First small inductance and large capacity result in a circuit which may be shown to have a large damping factor, thus resulting in broad tuning which is undesirable from the selectivity point of view. Secondly large inductance and small capacity result in maximum voltage being developed at the terminals of coil and condenser which is desirable from the efficiency point of view.

Of course large inductance means more wire and possibly more resistance, thus increasing the losses. The additional selectivity and the additional voltage resulting, more than make up for this slight added resistance. The development of receiver design and construction are all in this direction. It was

not so long ago that variable condensers of 0.001 microfarad maximum capacity were used in the tuning circuits. Today 0.0005 condensers are very largely used, in fact almost exclusively if modern sets are examined, and in the future the chances are that receivers will be built with 0.00025 maximum capacity condensers.

A GOOD receiver must be *sensitive*, that is it must be able to respond to the very weakest signals impressed on it. For this audio-frequency amplification is *not* the answer. Very weak radio-frequency signals must be attacked by means of radio-frequency amplification. Sensitivity is becoming increasingly important because people are receiving with loop sets more and more, and the amount of energy picked up by the loop is notoriously small. Then again people are becoming long distance fans and distance signals are still more notoriously weak. As a result only the most sensitive types of receivers will do the work necessary to make these very weak signals audible.

Every one of the five receivers previously described in this series is a radio-frequency amplifying set of one description or another. The regenerative receiver is essentially a radio-frequency amplifier as was explained in the article on that subject. The super-regenerative receiver carries the regeneration farther than is possible in the straight regenerative receiver. The neutrodyne is essentially a tuned radio-frequency amplifier of two or more stages. The super-heterodyne converts the low wave signal into a high wave signal in order that radio-frequency amplification may be the more efficiently carried out on this higher wave. Finally the reflex receiver uses radio-frequency amplification in one or more of its reflex stages.

The ultimate receiver must employ radio-frequency amplification in one way or another in order that sensitivity be secured. Of course it is not meant to imply that if a set does not have radio-frequency amplification it is no good. For local reception a good antenna will bring in signals very satisfactorily without radio-frequency amplification. But it is meant to imply that for any kind of very weak signals and for the best selectivity some form of radio-frequency amplification must be used. Practice and experience prove this contention. Where loop reception is concerned it most certainly must be employed. And the coming receivers are undoubtedly loop receivers.

The sensitivity of a receiver will, of course, be influenced by its efficiency. If a receiver has high losses it will be less sensitive than one with low losses. It is therefore necessary to design the parts so that they are most efficient and have a

minimum of losses. This comes back to the matters raised in the previous section on selectivity, namely efficient design of coils and condensers, proper construction and so on.

The fact that a receiver is a regenerative or a neutrodyne or any of the other types does not necessarily make it a good receiver. There are good regenerative receivers and there are bad ones. If a regenerative receiver is equipped with mud moulded sockets, condensers having high dielectric losses, solder flux spread all over the coil, a coil impregnated in high loss varnish, and having 10 taps with poorly soldered joints it is apt to be considerably inferior to a non-regenerative set. We do not mean to imply that just because a receiver is called regenerative it is necessarily a good receiver. Not any more than the fact that a machine is equipped with a gasoline motor, radiator, carburetor and so on, makes it a good automobile. It must be well designed and properly constructed.

A GOOD receiver must reproduce the incoming signals faithfully, it must deliver good quality. We are here referring to the reception of radio telephone or broadcast signals. In telegraphy a single frequency signal is received, generally a 500 cycle or 1000 cycle note, and most any type of modern receiver will reproduce such a single frequency sufficiently well for telegraphic purposes. But in telephony the most faithful and accurate reproduction is essential to the minutest details.

The necessity for this will be apparent when we consider the nature of the signals received via telephony. If speech is distorted not only will the voice be unrecognizable, but the speech may actually not be intelligible. Sounds may be heard but they may not mean anything. In the case of music the received signals if not faithfully reproduced may sound like anything but music, notes may be flat or sharp, tenors may sound like baritones and so on.

The signals received from a radio telephone station differ markedly from those of a telegraph station. A telephone station nominally sends on a single wavelength. Actually, however, it transmits signals on a number of wavelengths. This may be shown mathematically. Here, however, we will merely state the findings of such a mathematical analysis. It is found that if a station, sending on a radio-frequency of F cycles, is modulated by an audio-frequency of f cycles, the station actually transmits the three following frequencies: F , $F+f$, and $F-f$. Thus suppose that the station is assigned the wavelength of 600 meters, its frequency is then 500,000 cycles. Suppose that a 1000 cycle note is modulating the station. Then the station actually transmits the following fre-

Continued on page 60

The Truth About Rectifier and Filter Systems

By Edward T. Jones, I. R. E.

After a brief comparison of the several types of filter and rectifier systems for the plate supply of a transmitting tube, the author describes the construction of an electrolytic rectifier and shows the filter hook-up for both grid and Heising modulation. Special emphasis is placed on the necessity for care in construction and operation.

WHEN one type of filter system does not work satisfactorily with an amateur transmitter supposedly similar to one where it does, and when transmitters and some entirely different type of filter does the work, it usually is not the fault of the filter design, but the fault of the constructor. Too many amateur transmitters are simply thrown together in a hurry to get out that first half-hour CQ. No thought is given to the details which should receive close study. Then, with the transmitter well thrown together, the owner tries out some filter system which another amateur claims to be using in conjunction with the same type of transmitter. The results are not obtained and they begin to wonder why.

Large manufacturers, after considerable research work on the part of their engineers, can design a transmitter for panel mounting with the correct type of filter which will work nearly as well with any number of sets they put into production. In this case, all the parts are manufactured alike and tested in order to insure that their capacities or other values are all alike. The amateur is not only without these facilities but has not constructed similar transmitters in any quantity.

In most cases the amateur is guilty of giving too little attention to rectification—ahead of the filter system. A great number of these installations are actually feeding a.c. into the filter circuit—and that is the main reason why it is sometimes impossible to “filter” out the “hum” no matter what type of filter system be employed.

In all fairness to the amateur, let it be said that it is no easy matter to entirely eliminate all the “ripples.” Even at its best there is the liability of harmonics being radiated from the mast guys or from other metallic objects in the immediate vicinity of the antenna. It is necessary, though, that every amateur give as much attention to his transmitter rectification-filter system as is possible in order that the broadcast lis-

tener will not be disturbed and forced into arms against us.

THERE are two methods available to the amateur for obtaining the high voltage d.c. supply for his transmitter. The first is the motor-generator, while the second is a step-up transformer in conjunction with either of the three types of rectifiers, electrolytic, vacuum tube, or mechanical, as shown in Fig. 1.

Although the motor-generator is considered the best source of high voltage d.c. for the plate voltage supply, very few amateurs have been able to eliminate the commutator “ripple.” The writer has yet to listen to an amateur or experimental transmitter (whose plates are being supplied from a high voltage generator) free from this very disagreeable “interfering noise” which accompanies not only the signals but also the voice when the set is employed as a radiophone. It is not my idea to lead you to believe that it is not possible to eliminate this trouble, but simply to state conditions as they now are and to point out that the motor-generator set is not only expensive in first cost, but generally proves to be a white elephant on the hands of its purchaser. So many complaints have been filed against amateur and experimental radiophone sets operated from motor generators (high voltage supply) that some of them discontinued the use of their transmitters for radiophone or I. C. W. work, while several others closed their stations and sold their apparatus.

The (thermionic) vacuum tube (two-element) rectifier is noiseless and very clean in operation. Its first cost is also high in comparison with the electrolytic system. Contrary to general belief, it is not as efficient as the last-mentioned system and therefore will not be discussed further.

There are several mechanical (synchronous) rectifiers available. Very little experience has been had with these types. Of the few in use in this part

of the country it can be said that they are not what one would expect, and are not consistent in operation.

The most efficient system of rectification for the amateur is undoubtedly the chemical or electrolytic type. It might also be said that at least one hundred amateurs make use of this system for every one using one of the other types.

THE construction of an electrolytic rectifier involves not only the filling of glass jars with a saturated solution of borax or ammonium phosphate, but also a lot of sincere and efficient work on the part of the constructor. There has been enough of these units constructed to arrive at some essential considerations as regards to the size of jars, plates, etc. These should be carefully studied and applied throughout in the construction of filter systems.

The first important point to consider is the voltage to be rectified. That is the main factor in the design. Let us agree that we are going to rectify 1000 volts (full wave—both sides of the cycle). We have available a very efficient transformer whose secondary delivers 2000 volts with a center tap permitting the secondary voltage to be split, each side of the transformer delivering to the rectifier jars 1000 volts.

The writer recommends that not more than 50 volts be allowed for each rectifier cell. This means that there will be ten jars in each leg of the circuit or a total of 20 jars. See Fig. 2. For 5 and 50-watt tubes, one pint jars should be used. These jars should be filled to three-quarters of their capacity with the solution—preferably ammonium phosphate. Lead and aluminum strips 1/16 in. thick and 1 in. wide by 6 in. long (allowing for proper connections) should be inserted in the jars so that it is not possible for a short circuit to occur between the electrodes. Another important feature is to use every precaution to prevent a “jar” from shorting itself out of the circuit by creepage of the solution. One pound of ammonium

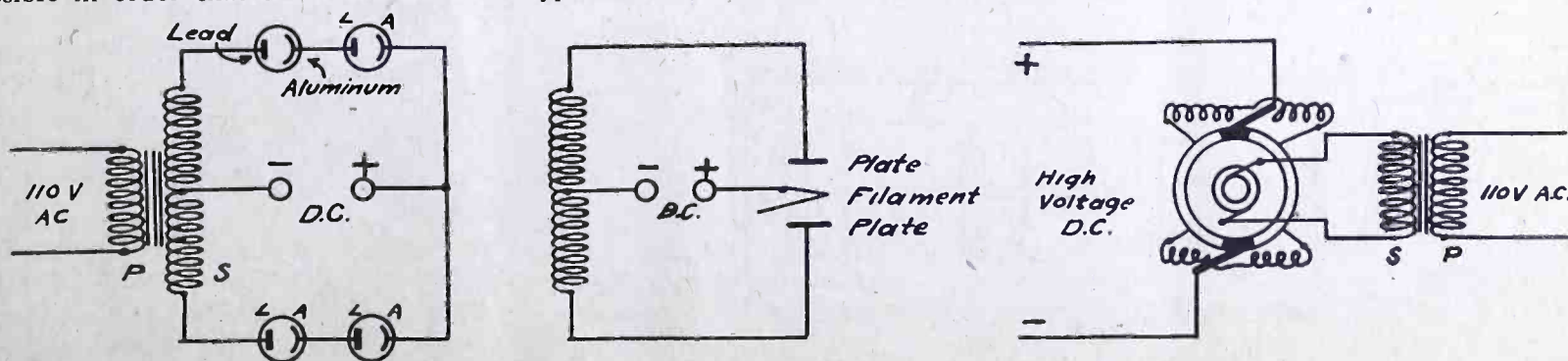

Fig. 1. Hook-ups for Electrolytic, Tube and Mechanical Rectifier

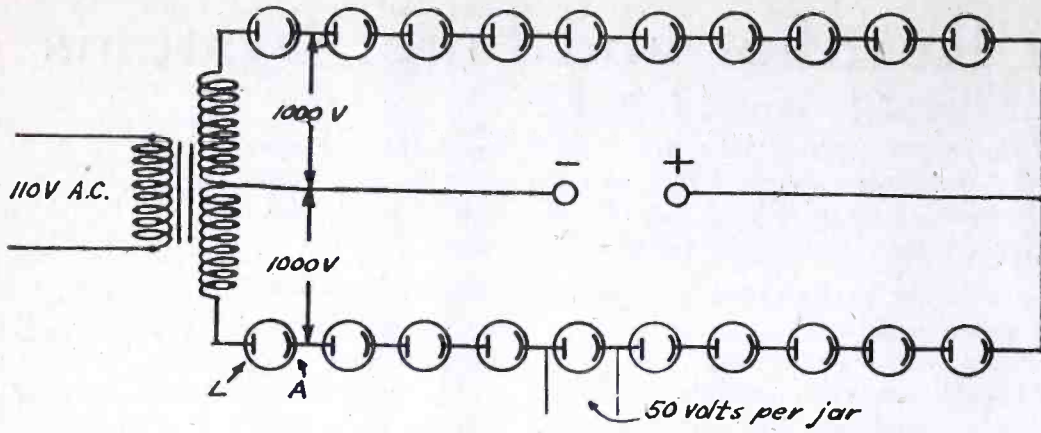

Fig. 2. Hook-up for 20-Jar Electrolytic Rectifier

phosphate will be sufficient for two gallons of solution.

The preparation of the metal strips is important. They should be thoroughly cleaned before they are placed in the jars. The easiest way to accomplish this is to boil all the strips together in a strong solution of lye.

In the forming process, when the aluminum plates are "formed" so that the units may properly rectify the a.c., the entire bank of rectifiers is connected to either a 500-volt supply of a.c. or to the secondary of the transformer itself—see Fig. 2. Be careful to watch the transformer secondary, as it may develop considerable heat. If the windings become too hot, operate at intervals. Two or three hours' operation will suffice to form the plates. A white crystalline formation deposits on the aluminum plate. When the aluminum plates spark over their entire immersed surface it is a sure sign that they are properly formed.

Before going on to the most important portion of this discussion relating to filter systems for the above, let me suggest that the rectifier, as completed above, be properly housed in a cabinet where the dust or dampness cannot settle on the jar tops. The efficiency of the system might be further improved by arranging the jars in racks in a large metal box filled with water—see Fig. 3. Adequate provisions should be made to change the water from time to time. The water in the tank would assist materially in keeping the jars cool.

THE filter reactor is the most important unit. Theoretically, its core should be wound with enough wire to give it a natural frequency of 120 cycles—that of the 110-volt power supply line. This, of course, is impractical. The only real substitution is to shunt a

fairly large inductance unit, in the order of 40 or 50 henries with condensers of known values.

If the amateur is interested in constructing his own filter reactors, he is referred to "Ballantine's Radio Telephony for Amateurs." Very few amateurs, however, have the facilities for making an efficient unit of this type, and much trouble has been caused on the air with inefficient "hit-or-miss" home-made filter reactors. The R.C.A. have available 40 and 50-henry filter reactors, which have proven their merits in many transmitters. It is, of course, necessary that condensers of suitable value be shunted across the filter reactor.

It has been determined by Ballantine that for I. C. W. or phone transmission the circuit shown in Fig. 4 is best.

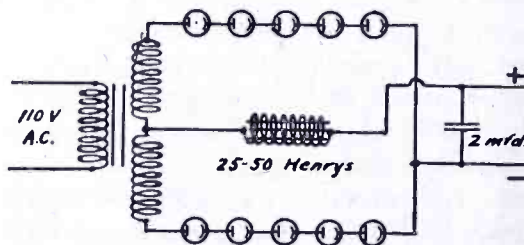

Fig. 4. Hook-up for Grid Modulation

The necessity of providing correct values of condensers and inductances is very important. Unfortunately, however, as has been pointed out earlier in this article, the same good filter system does not seem to hold for any two home-made amateur transmitters. It is suggested that the 40-henry filter be used in 5-watt installations and the 50-henry unit in the 50-watt sets. Furthermore, that various capacities be tried until the most effective combination is found. By adhering to the large filter reactors you have one thing in your favor. The proper capacities for your particular in-

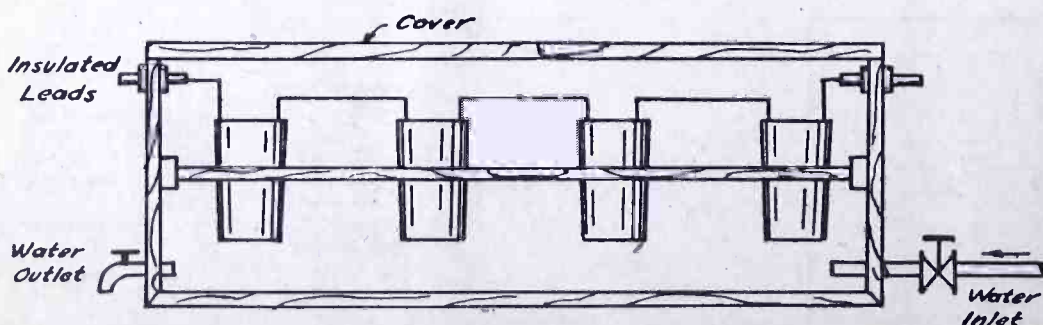

Fig. 3. Arrangement of Jars in Tank

stallations will be found after but a short period of experiment. Listen to your transmitter with your receiving set disconnected from the antenna and find out for yourself whether or not you are radiating 40% a.c. hum.

The main thing is to get as near as possible—perfect rectification. This is in order to relieve the filter circuit of much of its present responsibilities. The filter circuit is no rectifier, but simply "irons" out the fluctuations or ripples that are let through by the rectifier, or result from partial rectification of the full a.c. wave.

SHOP KINKS

By CHAS. ANDRES, JR.

In the absence of bushings and bearings of the proper size it is often possible to find what is needed by taking apart standard apparatus, and this at a saving of cost and time otherwise required in making them specially. Thus the dis-

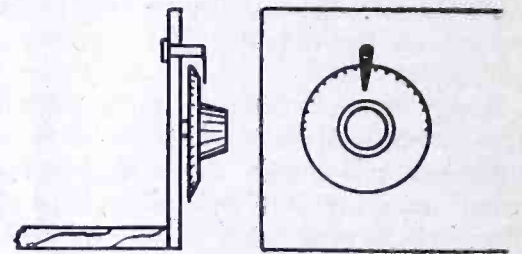

Dial Indicator

assembly of a Klosner rheostat gives two 5/16 to 1/4 in. fiber bushings from the terminal posts, one 1/4 in. bearing and a first class dial indicator. The drawing shows how the latter is accomplished with the aid of a file and some solder.

Turpentine, and lots of it, will be found of great help in drilling glass or in filing and sanding aluminum parts.

HANDY HINTS

Remember, to get the average distance range of a BCL's "wonder" receiver, take the figure he gives you, subtract the square of the BCL's age, and divide by 49.2, or thereabouts, and you will get the average dependable range, under normal conditions.

The filament life of a vacuum tube will be decreased several hundred per cent if the applied voltage is increased by only a few per cent; hence, be careful not to put too high a voltage on them, and never use more than they are rated for.

Don't blame your loud speaker, and amplifier for all the distortion you may have in your receiving set. Remember that if you have a poor horn attached to the device this may give you as much distortion as all the rest of the set put together.

If you are using Edison storage batteries, keep the steel jars well covered with P & B asphaltic paint. If you don't, the jars may rust out, and you may ruin the cells.

A Practical Spark-Coil I. C. W. Transmitter

By F. S. Huddy, 1 II-1 ZS

Here is described the construction and operation of a simple and efficient form of I. C. W. transmitter. The use of a spark coil to produce high voltage pulsating d.c. enables the employment of 32-volt d.c. as a power source.

NOT long ago the author found himself so situated that the only power available was that furnished by a 32-volt farm lighting outfit. The problem then arose of how to make a tube transmitter which would cover good distances consistently, without the use of a motor generator. Recourse was made to the spark coil.

In the spark coil, we have a ready means of producing a high voltage, pulsating d.c. If the vibrator be of good construction, and will give a smooth, steady note, it will do. A coil, the secondary of which is wound with the heaviest possible wire, should be chosen. The secondary of a spark coil delivers a very small amount of current, but a good one will energize a single five-watt tube to perfection.

The set will work on almost any kind of an antenna, if it be well insulated, but the author got the maximum results from a 4-wire cage 3 ft. in diameter, 55 ft. long and 40 ft. high, with a cage lead-in 4 in. in diameter. A well-insulated counterpoise is practically essential to the successful operation of a C.W. set. It should consist of as many wires as possible, stretched beneath the antenna and out to the sides thereof. The idea is to include as much as possible of the antenna's field. The wires should be well insulated and at least 4 ft. off the ground, in order to reduce the effects of any irregularities in the ground surface, and prevent current vortices.

The inductance L_1 consists of 25 turns of heavy, bare wire $5\frac{1}{2}$ in. in diameter and spaced $\frac{1}{4}$ in. The reader may construct one, but the inductance sold by the Radio Corp. of America, UC-1008, is very satisfactory. Have the wire clean and bright so that good contact may be made by the clips.

The author used an old Ford coil. It had an excellent vibrator which gave a high-pitched note. The more modern coils are not so good, but will do. Other coils of almost any make and size will do, but those which give a heavy, fat spark are best.

The grid leak R_1 had best be bought, and is a Radio Corp. 5000,w leak. If one is not available, the secondary of a Ford coil may be used as a substitute.

There are a number of tubes that are satisfactory for use in this set. Any hard-receiving tube will do, except the UV-201A, which seems to be paralyzed if used in connection with such high voltages. If one has a source of 8 volts d.c., the best tube is the UV-202. An-

other good tube is the Western Electric "E" tube. This operates quite well on six volts. The German tubes, now sold in this country, are very hard and seem to work very well.

Two condensers are needed. First a grid condenser C_1 , which may be fixed or variable, and having a capacity not less than .0005 mfd. nor more than .002. A plate condenser C_2 is also needed, and

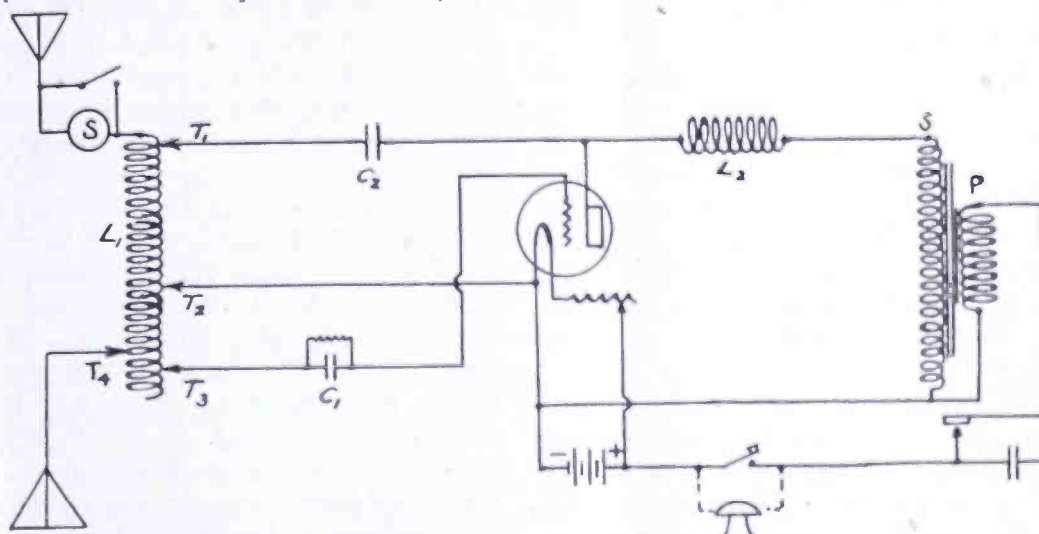

Fig. 1. Transmitter Hook-up

this must be of glass. A section of Murdock moulded condenser will do. If no such condenser can be had, one can be constructed as follows: Coat 8 glass plates 8x10 with tinfoil squares 7x9. Connect every other plate together, and bring out the two sets of leads to binding posts. The condenser may be soaked in paraffine and then clamped together, or may be used without any further treatment. Shellac may be used to cause the tinfoil to adhere to the glass.

The shunt or parallel feed Hartley circuit is used. It is easy to adjust, and a stable oscillator. No trouble was experienced in making the set oscillate as low as 140 meters. The connections are shown in Fig. 1.

The radio-frequency choke L_2 consists of 300 turns of No. 26 DCC magnet wire upon a cardboard tube 4 in. in diameter. Do not put shellac or dope of any kind upon it. The object of the radio-frequency choke is to prevent the high voltage source from shorting that portion of the inductance between the plate and filament taps.

CONNECT up the apparatus according to the diagram. The location of the clips upon the inductance will vary with each station, but a good adjustment to start with is to connect the antenna to top end of coil, the plate tap T_1 to the antenna tap, the filament tap

T_2 , 16 turns down from the antenna tap, the grid tap T_3 , 20 turns from the antenna tap, and the counterpoise tap T_4 , 20 turns from antenna tap. A 3-volt flashlight lamp should be inserted in the antenna lead to indicate maximum radiation.

Light the tube and close the key. If everything is all right, the lamp in the antenna circuit should light up. Next,

reverse the polarity of the leads from the battery to the primary of the spark coil. One way will be very much better than the other. When the best connection is found, move T_2 up towards T_1 . Then move T_3 until maximum radiation is obtained. The radiation may be increased slightly by moving T_1 down from the antenna tap. The wavelength is governed by the position of T_4 . Each new adjustment of T_4 will necessitate the re-adjustment of T_2 and T_3 .

If a microphone be substituted for the key, and the vibrator of the coil screwed up tightly, the set may be used for a short distance radiophone, and is remarkably effective. It is important to remove the lamp from the antenna circuit after all adjustments are made.

The set built by the author radiated 1.4 thermo-couple amperes, and was reported as loud and consistent from Canada to Florida, and from 500 miles east of New York to Missouri. The construction of this little set is easy, its cost small, and its operation simple. It emits a sharp wave, and thus offers a solution to the interference problem.

Strange noises in a receiving set can often be found in poor bearing connections in a variable condenser, where the latter are used to carry current. Fix them and see.

Notes on Receiving Station Operation

By Kennard McClees

Although the various manufacturers of radio sets supply operating information with their instruments, the whys and wherefores thereof are rarely included; and as such knowledge is essential to one desiring of progress in the art of radio the following notes will be of interest to the ready-made purchaser as well as the home-constructor. Practice is so necessary for good tuning that a delicacy of touch is often acquired that in time rivals that needed for the playing of some musical instruments. To an experienced dial-twirler, an added adjustment to reduce the gear ratio is unnecessary, as the sensitive fingering of the dials accomplishes the slight turn with accuracy.

The first operation in "listening in" consists in the proper adjustment of the rheostat controlling the filament current for the detector tube. This will vary with the individual tube, as one of the soft type (which is filled with gas in contradistinction to the vacuumized hard tube), is much more sensitive and also more critical in adjustment than the latter.

The tickler coil, or whatever form your plate inductance may take, should be set at its minimum value, as closely coupled as possible. Then advance the rheostat until a slight hiss is heard in the 'phones, the current should now be retarded to the point just before this is heard and you will have reached the best operating point.

With a hard tube no such care need be exercised as the tube will detect with anywhere from 4 to 6 volts being supplied to the filament. Of course the minimum current necessary will help conserve your batteries, and this is found with a soft tube by a painstaking adjustment of the plate, or *B* battery, voltage.

These batteries have taps on them by which the current can be varied, but a more satisfactory and reliable method is to have in the circuit an *A* battery potentiometer connected between *B* battery negative post and the positive terminal of the *A* battery; the proper plate voltage, which will be somewhere between 18 and 22 volts, can then be determined.

The only precaution to take with amplifying tubes is a negative one; do not overdo the voltage. The plate voltage can be run up almost indefinitely with a view to increasing the amplification, but this is a far from wise practice from any viewpoint. The filament current should also be as low as the signal strength will allow. Ordinary tuning should be done with the detector tube alone and amplifying reserved for the loud speaker; the practice of using 'phones with two stages of amplification

raising hob with their "in'ards" cannot be too heartily condemned.

The next step leads us to the dial-twirling. As the use of single-circuit or regenerative sets is no longer being advised, we will consider the case where a separate primary and secondary circuit is employed. Too tight a coupling must be avoided, as this will hamper the condenser action. It is best to start with a moderate degree of coupling and then, when a signal is picked up, it can be loosened until interference is disposed of.

Turn your condenser dials slowly, relying on them to pick up the beat note, which can later be cleared up by loosening the inductance coupling. This applies particularly to broadcast or radiophone signals, as spark signals, having a broader wave, require a closer coupling.

The reason for this can be simply explained. We all know that if two violin strings of equal value are stretched to the same degree of tautness and one is plucked, the other will vibrate, of its own accord, in sympathy. Radio is simply the same thing happening electrically. If you had an aerial of precisely the same value of any given one that is sending you could receive signals with merely a detector and a pair of 'phones. It is, however, impractical to have as many aerials strung about as there are wavelengths, so we introduce a means of varying capacity and, in turn, wavelength. When you turn your condenser dial, or twirl your variometer, you are really, electrically speaking, winding or unwinding your aerial, to make it of the same length as that of the sending station. It then vibrates in unison and the waves are translated into sounds by your detector and 'phones.

In the case of radiophone signals which have a sharp wave, we can use a looser coupling, as these sharp waves come in only on their own definite wavelength. A spark signal, being broader, hits all around its wavelength and hence requires a closer coupling. You will find, if you have a receiver which is selective enough and has no points at which the weak incoming signals can be waylaid and lost, that when you have a local station on full blast and wish to get a distant one on almost the same wavelength, the tiniest of turns will suffice to do this.

Of course, a poorly-designed set will not function properly even with the help of wave-traps and high plate voltage, but in this case you can always rebuild the set and gain a lot of valuable knowledge in so doing.

Go over your set frequently whether you have trouble or not. This is the only way to get to know it, and only through familiarity can you make and try out improvements. If you hear that someone has doubled his distance by reversing his condenser leads, try it. You can always change them back, and be a wiser man.

Make sure your ground is as perfect as it should be, as oxidation sometimes takes place there and must always be guarded against. The batteries should be kept clean and given a drink of distilled water frequently to take care of the evaporation which goes on continually whether they are in use or not. If you use a home charger, or a bank of lamps, and use your battery continually, you can arrange to give it what is known as a "trickle-charge." This should not exceed $\frac{1}{2}$ ampere and flows into the cells continuously, always keeping the battery at par.



Ralph Slade, New Zealand 4AG, Who Has Been Logging "Yanks" for Two Years, including 1SG, 2ATF, 5KC, 5FT, 6CMR, 6BSG, 6AWT, 6ARB, 6IF, 6CGW, 6CNK, 6PL, 6MG, 7AEL, 7SC, 8YAE, 8ZY, 9CVO, 9AXB, 9CMK, 9BED, 9UU, 9ZT, and Can. 9BX

The Vacuum Tube As An Amplifier

By C. M. Jansky, Jr.

Coincident with a discussion of the method whereby amplification is accomplished the author discusses the cause and cure of distortion in an audio-frequency amplifier circuit. Special attention is called to the influence of proper "B" and "C" battery voltages in reducing distortion.

THE vacuum tube may be used as an amplifying device for either radio or audio-frequency electrical power. Aside from the fact that the capacitance between the elements of the tube is of greater importance, the principle of operation of a radio-frequency amplifier is the same as that for an audio-frequency amplifier. The apparatus used

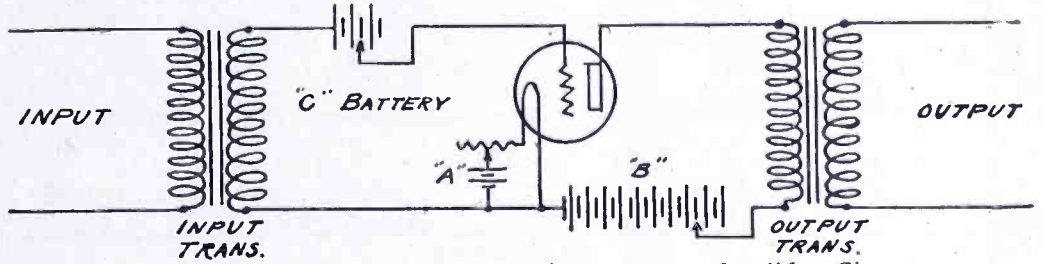

Fig. 1. Transformer Coupled Audio-Frequency Amplifier Circuit

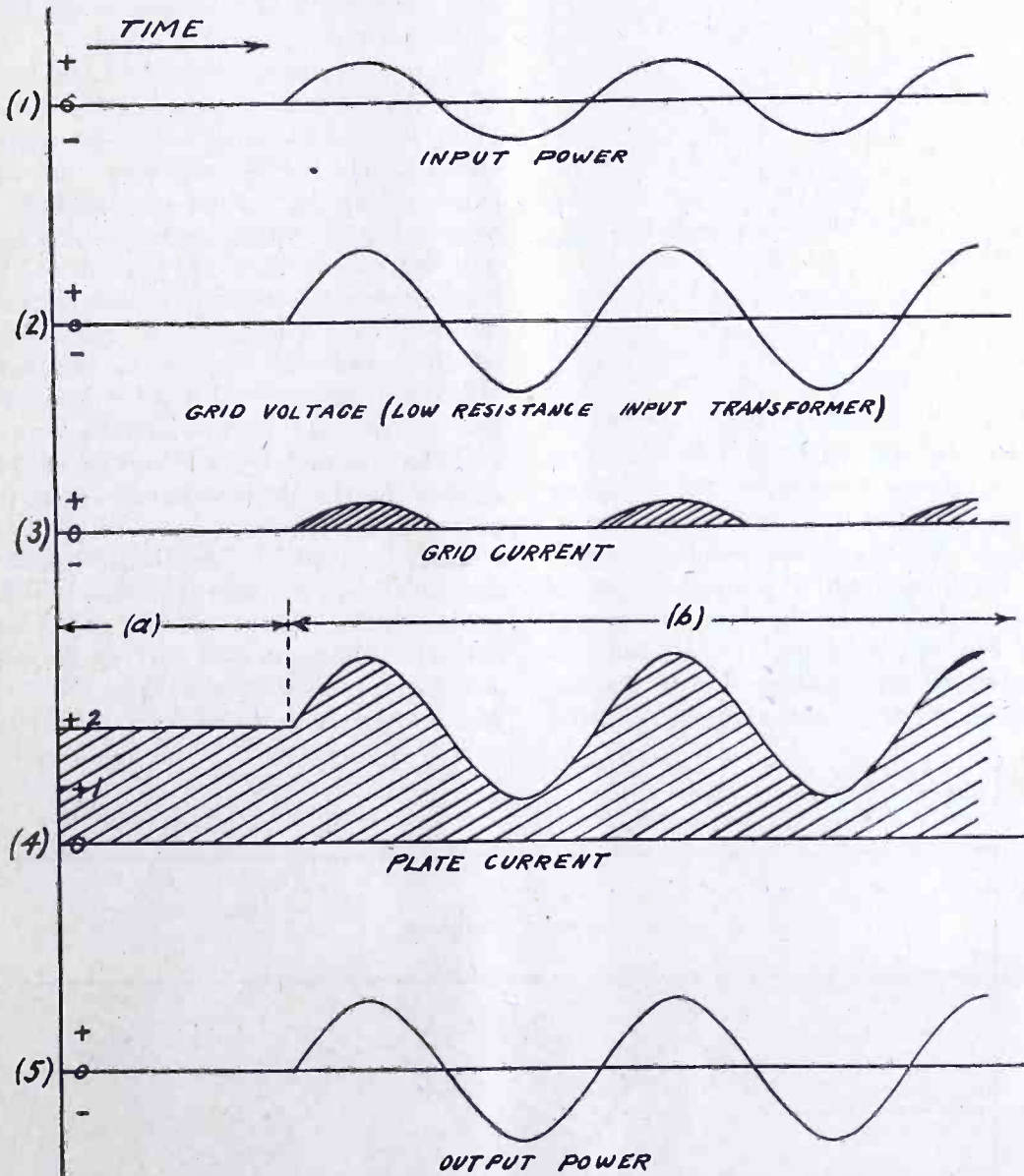

Fig. 3. Output of Transformer Coupled Amplifier Without "C" Battery

with the tube must, of course, be properly designed to take care of the frequency for which the amplifier is to be used.

For the purpose of discussion, let us consider the audio-frequency amplifier circuit given in Fig. 1. Let us assume that the static characteristic curves of this tube are given by Fig. 2. If we assume no C battery, and a B battery voltage of 45 volts, the plate current as a function of time would be represented by a of Curve (4) Fig. 3.

Sine wave alternating power applied to the input side of the input transformer

will give rise to a grid voltage as shown by Curve (2) Fig. 3. (There is, however, no greater power in the secondary circuit of the transformer than there was in the primary. The transformer has merely taken power at relatively low voltage and high current and converted it to power at high voltage and low current. This is accomplished by putting more turns on the secondary than on the primary. As the grid circuit requires but little current, and as the response of the plate current depends upon the grid voltage, it is desirable to deliver power to the grid at relatively high voltage and low current.) This will give rise to variations in the plate current as shown by b of curve (4). The output transformer serves to eliminate the direct current component and delivers power (Curve 5, Fig. 3) either to the next stage or to the power utilizing device such as a loud speaker. The amount of power represented by curve (5) is greater than that represented by the input curve (1). This additional power is obtained from the B battery.

It is evident that without a C battery the grid will be positive with respect to

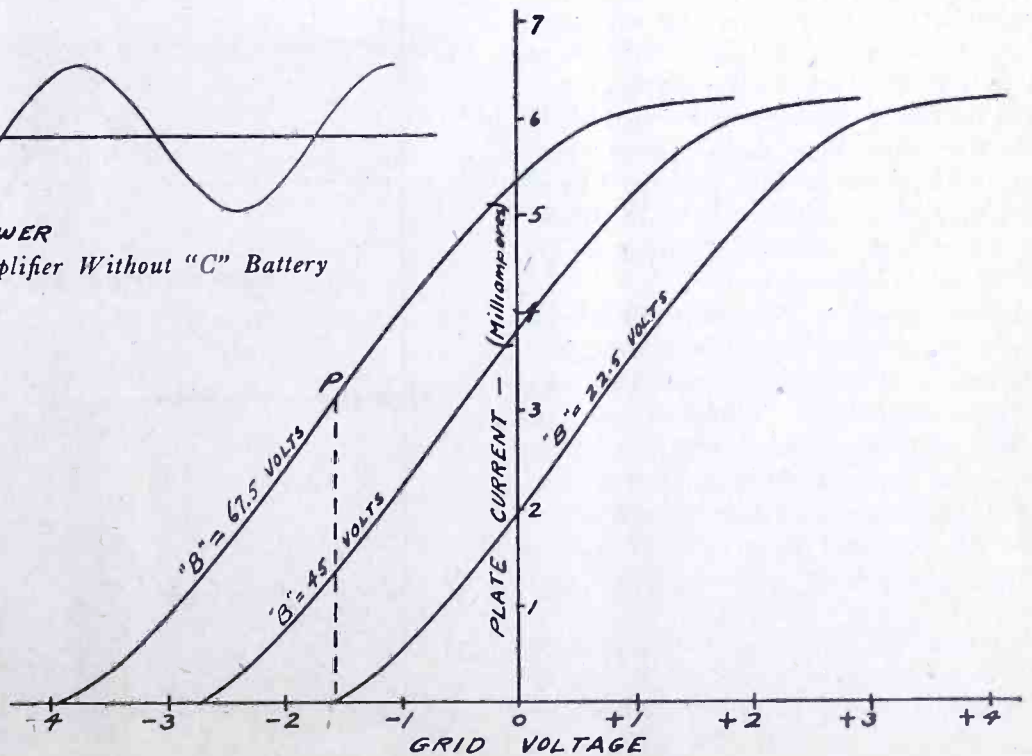

Fig. 2. Characteristic Curves for Tube Shown in Circuit of Fig. 1

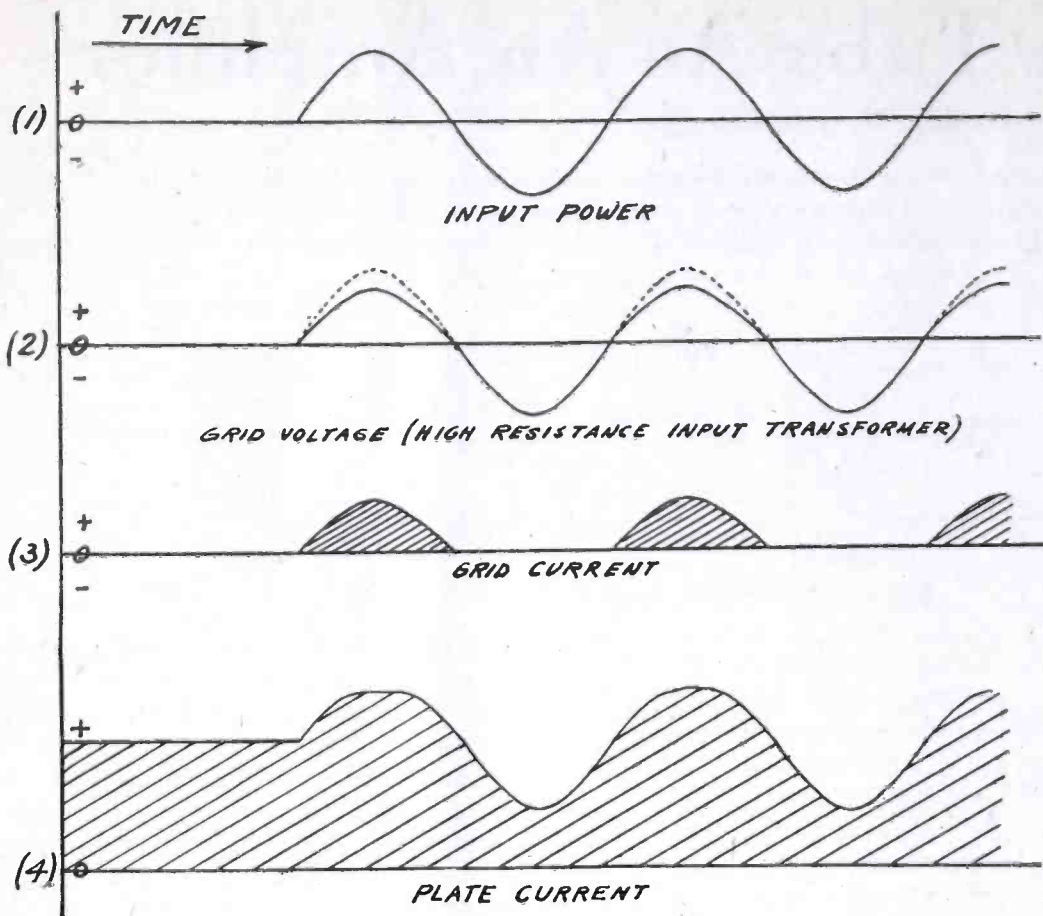

Fig. 4. Distortion Due to Unbalanced Effect of Grid Current

the filament half of the time. During the positive half cycle of voltage some electrons will be attracted to the grid and a grid current will flow as shown by curve (3) Fig. 3. This, however, will do no harm *provided* the resistances of the input transformer are small and the amplitude of the voltage applied to the grid is small.

THERE are a number of possibilities for distortion in audio-frequency amplifiers. Some of these can be avoided by proper adjustment of grid and plate batteries. Others are due to improperly designed transformers. It is not possible in articles as elementary as these to more than mention those sources of distortion inherent in the design of audio-frequency transformers. In general the resistance of the transformer circuits should be as low as possible, consistent with the reactances necessary. Distortion is more likely to occur with high ratio transformers than with those of low ratio. Transformers will act differently with different tubes and different adjustments of the *B* and *C* batteries.

Those sources of distortion due to improper adjustment should be thoroughly understood, as once understood they can be easily eliminated. The writer has in mind a number of manufacturers whose sets would be much more popular if they had provided proper facilities and directions for securing the correct *B* and *C* battery voltages in their amplifier circuits.

Let us assume the same values of plate voltage as previously (45 volts), no *C* battery, but assume that the input power (Fig. 1) is greater than that assumed in Fig. 3, and the resistance of the trans-

former circuits too large to be neglected. The grid voltage will not now be a sine wave due to the fact that the flow of grid current during one-half cycle will produce a voltage drop across the resistance of the secondary of the input transformer. As a result the grid voltage will not reach as high a positive value as would otherwise be the case. In Curve (2) Fig. 4 the dotted line shows the variation of grid voltage due to the unbalanced effect of the voltage resulting

from grid current. The alternating current component of Curve (4) Fig. 4 is not a pure sine wave and consequently the output is not a faithful reproduction of the input.

This type of distortion is often encountered in attempting to operate loud speakers with low plate voltage on the amplifier tubes and without *C* batteries. It can be corrected in two ways. If a resistance of such value is connected across the secondary of the input transformer that the peak value of current taken by the resistance is at least five times as great as that taken by the grid, distortion will be eliminated as positive and negative peaks of the voltage curve will both be of smaller amplitude. The use of the shunt resistance is objectionable, however, in that it reduces the total amplification.

Distortion can be eliminated and more power handled by the amplifier if a high plate voltage is used with the proper value of grid voltage obtained from a *C* battery. If 67.5 volts are applied to plate (Fig. 1) the characteristic curve will be given by (C) Fig. 2. This would normally result in a plate current of about 6 milliamperes in place of 4 which flowed with 45 volts on the plate. With a *C* battery of 1.5 volts, however, the current can be brought back to 4 milliamperes and any alternating voltage applied to the grid will act about the dotted line to *P*.

Fig. 5 shows the resulting currents and voltages. As the grid will not become positive except in case of a very powerful input, no grid current flows at any time. This means that *the only power required to operate the tube is the*

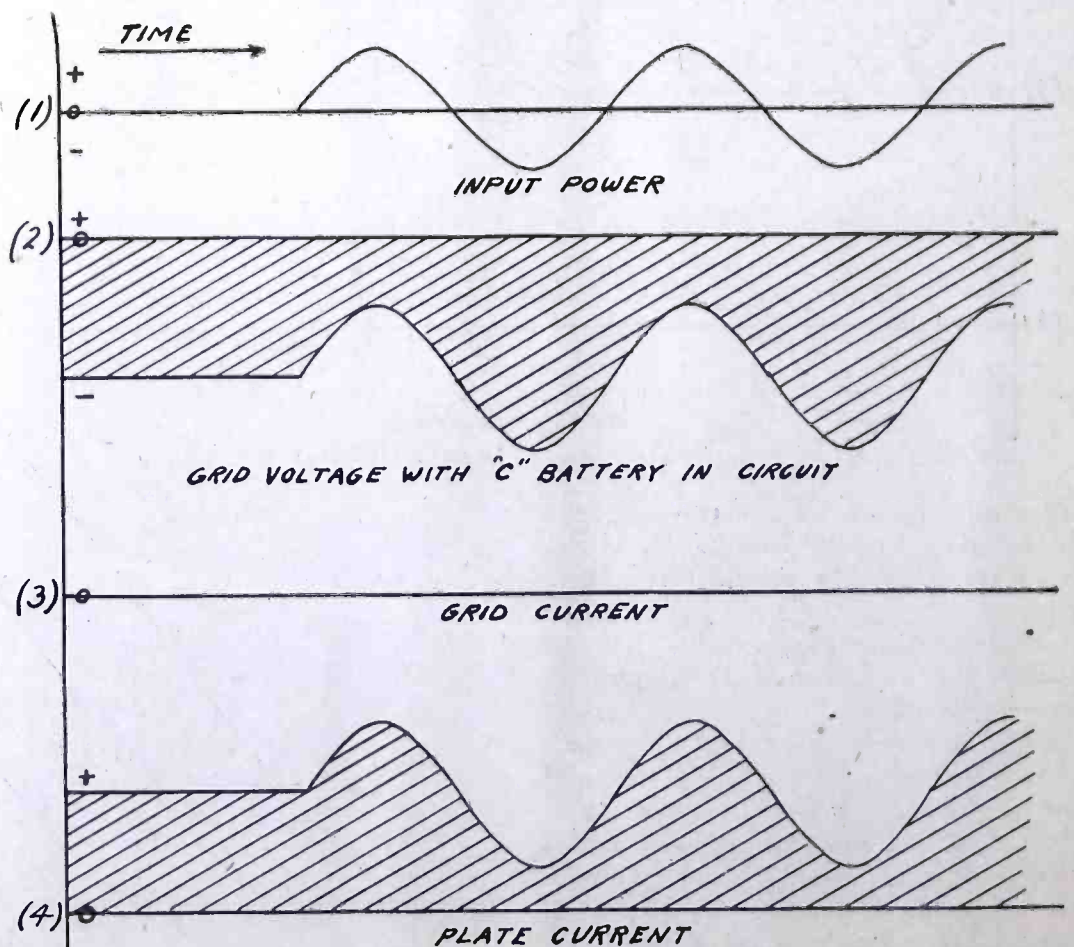

Fig. 5. Characteristics of Amplifier With Correct "B" and "C" Battery Voltage

power necessary to give the grid an electrostatic charge.

The amount of power which can be delivered to a loud speaker or headset is now greater than before because, although the plate current may be the same, the voltage of the *B* battery is greater. If a higher plate voltage is used a still higher grid battery will be required, as the effect of increasing the plate voltage is to shift the characteristic curve to the left.

It is not necessary, however, to use extreme plate voltages. The writer has never found it necessary or desirable to use more than 67.5 volts on a 199 or 299 tube or over 90 volts on a 201A or 301A tube.

The *C* battery should consist of one, two or three flash light cells connected in series. (The voltage of 1 cell is approximately 1.4 volts.) If a *C* battery of 1.4 volts were used with a plate voltage of 22.5 volts or a *C* battery of 4 volts with 66.5 volts on the plate no grid current would flow but distortion would be produced due to the fact that the plate current could not decrease to as far below the normal value as it could rise above the normal value. Fig. 6 shows the resulting plate currents for such an adjustment. Distortion will also result if no *C* battery is used with 66.5 volts on the plate as in this case the plate current cannot rise as far above the normal value as it can decrease below the normal.

Assuming the plate battery of an amplifier is of sufficiently high voltage to require the use of *C* battery, the correct value of voltage to be used in the grid circuit can be determined if a plate milliammeter is available. Insert the milliammeter in the plate circuit and note the reading. Now tune in a strong signal. If loud speech or music causes the plate milliammeter reading to decrease, the voltage of the *C* battery is too low. Distortion in this case may be due to hitting the top of the curve or it may be due to the unbalanced effect of grid current as shown in Fig. 3. If loud signals cause the plate meter reading to increase, the *C* battery voltage is too great and distortion

results due to hitting the bottom of the curve as shown in Fig. 6.

If the voltage of the filament battery is one or two volts greater than the voltage specified for the tube, the drop across the filament rheostat can be used to provide a steady grid voltage in place of a *C* battery. Assume a 6-volt filament battery in use with a tube requiring 5 volts.

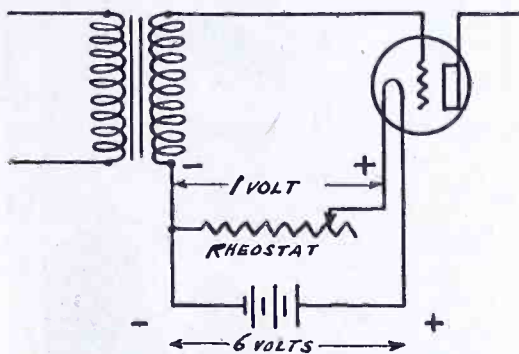

Fig. 7. Connections for Grid Bias From Filament Rheostat

Fig. 7 shows a circuit which will give a steady grid voltage of -1 volt. This method is open to the objection that as resistance in the filament rheostat is decreased to compensate for a drop in voltage of the *A* battery the voltage applied to the grid also decreases.

A variable biasing grid voltage can be obtained by connecting a so-called potentiometer of 200 to 400 ohms across the *A* battery and connecting the grid circuit as shown in Fig. 8. High resistances

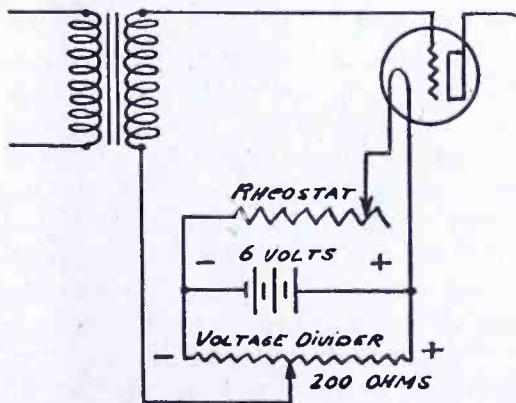

Fig. 8. Connections for Variable Grid Bias with variable connections for this purpose, while called potentiometers, are really voltage dividers. A potentiometer is a much more elaborate instrument used in electrical measurements.

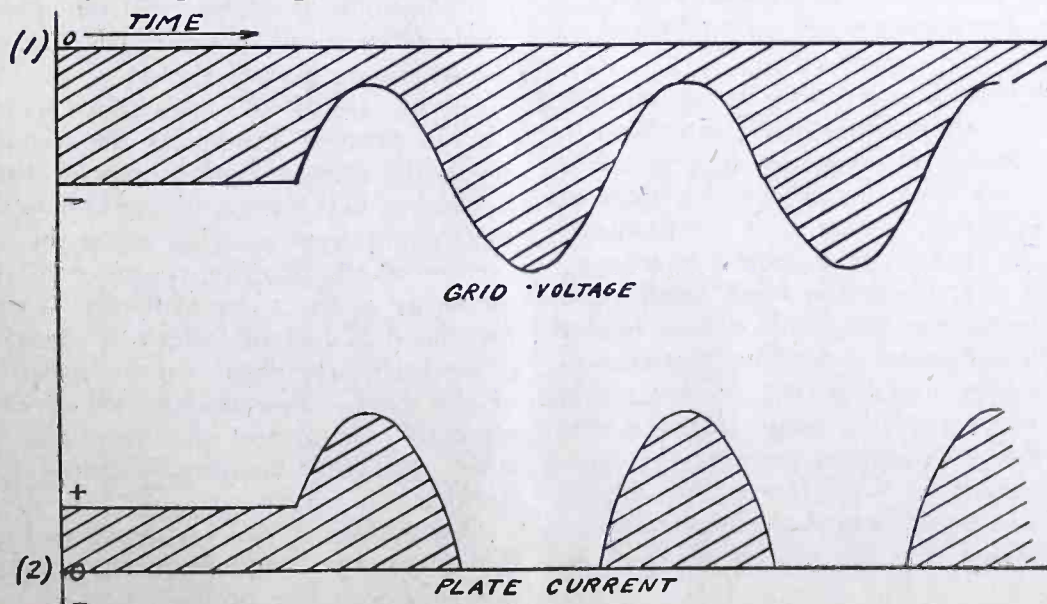

Fig. 6. Distortion Due to Too Much "C" Battery

THREE other typical amplifier circuits should be mentioned, these are resistance coupled, choke coil coupled, and "push-pull" circuits. These circuits are rarely used for radio-frequency amplification. Their particular characteristics will now be discussed.

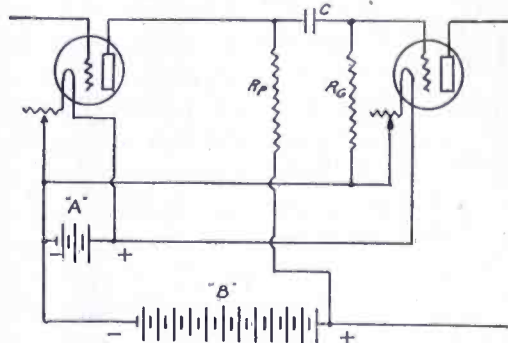

Fig. 9. Resistance Coupled Amplifier

Fig. 9 shows a typical resistance coupled amplifier circuit. In this circuit a large resistance R_p is inserted in the plate circuit and the alternating voltage drop across this applied to the grid of the next tube through the condenser C . R_p should be at least four or five times as large as the internal resistance of the tube (R_o) it is used with. The internal resistance of a tube is the alternating current resistance of the space between the plate and filament. For a tube having an internal resistance of 10,000 ohms R_p should be at least 40,000 ohms. R_g should be from 2 to 5 megohms. C should be 1 mfd. or larger. Its reactance to audio-frequencies should be considerably less than the reactance of R_g . In Fig. 9 the biasing voltage for the grid of the second tube is obtained from the filament rheostat. This type of amplifier, while it will not give as much amplification per stage as a transformer system, produces less distortion than any other type. Because the voltage drop across R_p is four or more times as great as that across the tube it is necessary to use a much higher voltage *B* battery than with transformer circuits. The expression for voltage amplification obtained is:

$$\text{tained is: } \frac{\mu R_p}{R_o + R_p}$$

μ voltage amplification factor of the tube
 R_o internal resistance of the tube in ohms
 R_p value of plate resistance in ohms.

If a large inductance iron core choke (X_p) is inserted in place of R_p (Fig. 9) it is not necessary to use a *B* battery of such high voltage as with pure resistance coupling. Such an amplifier is called a choke coil coupled amplifier. If the resistance of the choke coil is small compared to its reactance the expression for voltage amplification is:

$$\frac{\mu X_p}{\sqrt{R_o^2 + X_p^2}}$$

in which X_p is the reactance in ohms ($2\pi fL$) of the choke coil. The reactance of the choke coil should be four or

Continued on page 60

Filament Filter Systems

By Don C. Wallace, 9ZT-9XAX—(Winner of 1923 Hoover Cup)

These suggestions should be of value in improving the output of both C. W. amateur and broadcast stations. They are based upon experience in a field that is generally overlooked.

THE average C. W. transmitter has no provision to filter the filament supply. This likewise holds true for many broadcasting stations. Extreme care has been taken in designing and installing a good plate supply filter, yet in very few cases has the filament been given any consideration.

This is due mainly to the fact that the plate supply is the more important. But, on the other hand, once the plate supply has been filtered, much still remains to be done. Many broadcasting stations with good modulation, good volume and good range, find their local clientele complaining from a bad generator hum. They have not been able to find it, and wonder what could cause it. In many of these cases the filament needs filtering. The process is simple and quite effective.

All of us are familiar with the saying among amateurs, that the motor generator sets are harder to filter than is rectified alternating current. We are also familiar with the excellent results being obtained at the large broadcasting stations such as KDKA, WGY and many others using rectified a.c. for the plate supply.

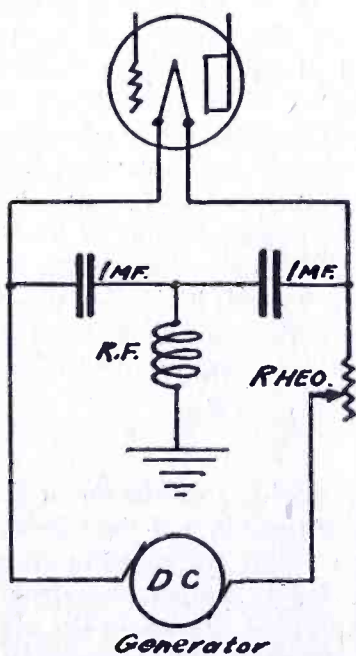

Fig. 1. Filter for Generator Filament Supply

Less of the attendant hum is heard from these stations in proportion to the output secured than in most of the other broadcasting stations of the country. The chief reason is that with alternating current we have a definite number of cycles to filter. All of the harmonics are made up from multiples of the frequency of the a.c. and so the filtering process is comparatively easy. In the case of the direct current generator, the commutator segments do not run so evenly, the harmonics become irregular in nature, and



Don C. Wallace, Winner of 1923 Hoover Cup

so the note on the air is not that of pure direct current.

The above applies to the plate source, and likewise applies to the filament supply. Fig. 1 shows an easy method for filtering the ripple caused by a filament low voltage generator. This has proved effective in eliminating a bad hum from one of the Twin City broadcasting stations. For over a year the hum at this station had been obnoxious to the listeners and this simple plan eliminated practically all of the "hum." In sets where the filament is grounded the radio-frequency choke may be eliminated and the mid tap between the two condensers may be connected directly to earth. More than 1 mfd. may be inserted on each side of this mid-tap and better results may be expected. This is a consideration entirely up to the pocket-book of the station owner.

In these days when we are all striving for the "silent transmitter," anything to help the radio condition as a whole is just that much better for the game in the long run. If we filter our filaments we are being good sports, narrowing down our interfering band locally and incidentally making our signals louder at distant points. Anything tending to make the energy go out on one wave, and one wave only, means just this, that more of the output is reaching these distant points. Very few of us are in radio to work local stations entirely and are really in it for the joy of reaching out.

The insertion of the radio-frequency

choke forestalls the necessity for any re-tuning after having inserted this filament filter. If the radio-frequency choke is not inserted and the nodal point of the transmitter does not happen to be at the filament (in the case of conductively-coupled sets) a part of the effective radiation may be shunted to earth. This would not be indicated on the antenna ammeter necessarily. To preclude any chance of this occurring the radio-frequency choke is inserted and then no further thought need be given to the matter.

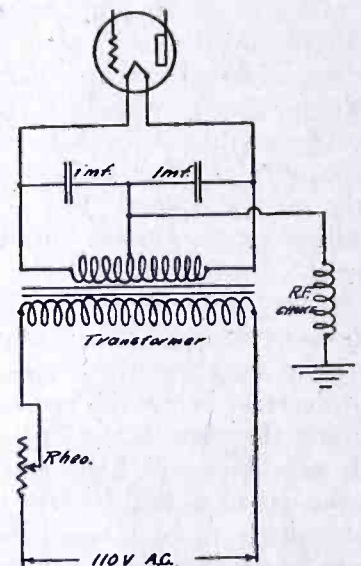

Fig. 2. Filament Current Filter at 9ZT

Fig. 2 shows the method in use at 9ZT. The method is similar to the one shown in Fig. 1, but in this case the mid-tap of the filament transformer is connected to the mid-tap of the condensers. The same is true of the radio-frequency choke in this case—it serves to isolate the set from an actual ground at the filament, and if it is isolated in this manner the tuning of the transmitter may continue, if desired, entirely independent from any possible grounds on the remaining part of the set.

In the case of 9ZT this choke serves another purpose, grounding the secondary of the filament transformer in order to prevent any portion of the high voltage current from jumping across the insulation in the filament transformer. It serves as a direct connection to earth for the d.c. current, which is likewise grounded by the choke (at the negative of the d.c.). Precautions such as this serve to help protect the transformers, tubes and other equipment around the station.

One more suggestion is shown in Fig. 3. Here two radio-frequency chokes are shown in the primary side of the

Continued on page 63

Improvements to the 45,000 Cycle Super-Heterodyne

By G. M. Best

THE best suggestions received this month for improvement to the 45,000-cycle Super-Heterodyne are constructive, and, while in some cases they will add slightly to the expense of the set, the results will be well worth the while of interested experimenters.

The first prize suggestion is a method for eliminating the dry cell C batteries entirely, providing a negative grid potential for each tube by means of the voltage drop across a resistance, and at the same time affording a real protection against burning out the filaments of the tubes through an error in connecting the B battery. The extreme importance of the negative grid bias in this set, particularly on the preliminary detector and the two audio-frequency amplifier stages, and the average constructor's disregard for negative grid bias, inasmuch as it introduces an additional battery which must be added and maintained, makes the suggestion valuable.

Although under normal conditions there is no current drain from C batteries, the life of small flashlight cells used for this purpose is usually from 5 to 6 months, after which it is necessary to replace them. If the owner of the set has no means of measuring the voltage of the C battery or does not know when to replace them, the set is liable to become inoperative because of the failure of this battery.

A potentiometer, shown in Fig. 1, is connected between the negative end of the B battery and the negative end of the filament battery. With this potentiometer in the circuit as shown, the plate battery must flow through this resistance before getting back to the negative side of the B battery. This causes a fall of potential across resistance A of the potentiometer of 1.5 volts and across A and B, or the total resistance of the potentiometer, of 4.5 volts, both poten-

JULY PRIZE WINNERS

In Contest for Improving Best's Super-Heterodyne

1st prize—\$25.00—C. H. Cole, Oakland, Calif.

2nd prize—\$15.00—Charles George Kahant, New York City.

3rd prize—\$10.00—Philo C. Kellogg, Chicago, Ill.

Similar prizes are to be awarded each month for a six-months' period, and additional final prizes of \$60, \$40 and \$20 for the best ideas submitted during the entire period.

tials being negative with respect to the negative end of the filaments.

The grid circuits are connected to the potentiometer as shown in the drawing, in this manner permanent grid bias being obtained without maintaining separate C batteries. It is necessary to bridge 2 mfd. condensers around each resistance in order to by-pass the alternating current output of the combined tubes and which, if omitted, may produce sustained oscillation or howling.

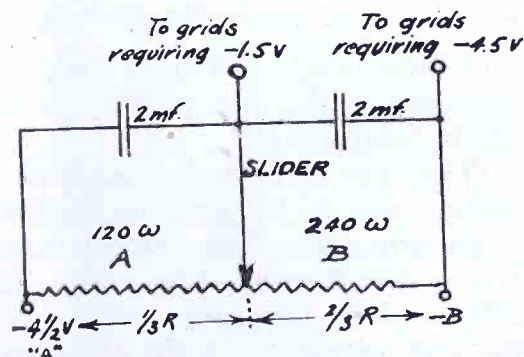

Details of Resistances

A General Radio potentiometer, type 214-A, or any other having an average resistance value of 360 ohms, should be used, as this is the correct value of resistance, and will be an easy

way out for those who have no means of measuring resistance wire. One end of the potentiometer is connected to the negative end of the filament battery and the other end is connected to the negative end of the B battery. The usual connection between the negative B battery and the negative filament battery should, of course, be omitted. The slider of the potentiometer should be set exactly one-third of the distance around the circumference of the potentiometer, so that one-third of the resistance (120 ohms) will be included between the slider and the end connected to the A battery.

All grid circuits requiring 1.5 volts negative grid can be connected to this slider, and circuit requiring 4.5 volts may be connected to the potentiometer terminal next to the negative side of the B battery.

The most convenient 2-mfd. condenser now available is the new Dubilier paper condenser, although any good make of 2-mfd. condenser will do. The potentiometer and condensers can be mounted on the baseboard in the space now occupied by the two C batteries. It will be necessary to mount an extra binding post on the battery terminal board for connection to the negative end of the B battery, since the previous arrangement was to tie the negative A and B batteries together on one binding post.

Should a 360-ohm potentiometer not be available, any good 400-ohm potentiometer will do, care being taken to use one-third of the resistance for the 1.5-volt tap, as accurately as is possible.

An advantage of this system is that when the B battery voltage falls, due to use or age, the potential drop of the grid bias falls in about the same ratio, thus maintaining the proper relation of C voltage to B voltage. There is little likelihood of burning out the filaments

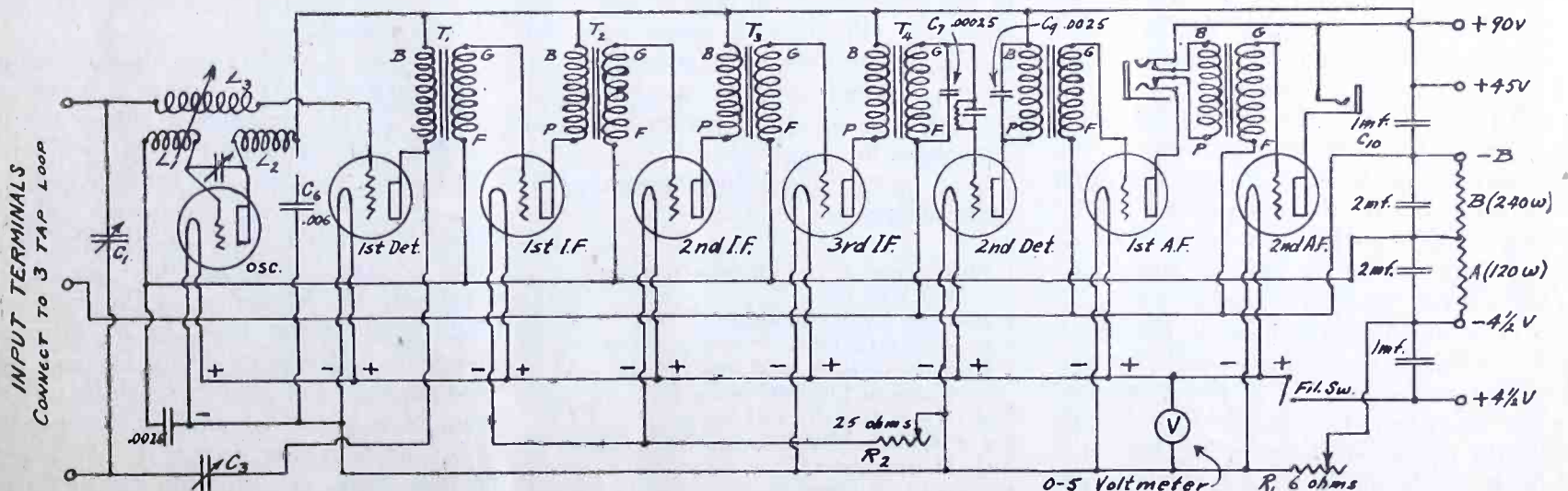

Fig. 1. Suggested Changes in Best's 45,000-Cycle Super-Heterodyne

of the tubes if the *B* battery wiring is accidentally crossed with the filament circuit, inside the set, as the resistance of the potentiometer limits the *B* battery current flow from the 90-volt tap to about .25 ampere, should a dead short circuit occur. Of course, should there be only one or two tubes in the set at the time of the short, the filaments might burn out even with the resistance, but with all eight tubes, requiring .48 ampere, the chances of disaster are remote with the new protection.

THE second best suggestion was for improving the quality of the set by employing a high negative grid bias on the second detector tube, instead of the conventional grid condenser and leak, in a manner similar to that used in the first detector tube. This change is shown in Fig. 1, the same *C* potential as is used on the other tubes being employed. The use of a high negative grid bias type of detector economizes on plate current and greatly reduces the amount of tube noise, as well as giving a good detector action with the average amplifier tube. The sensitivity of the set will be slightly decreased, but, due to the large amount of amplification available in the amplifiers, and the desire to obtain the very best kind of quality in the loud speaker, the suggestion is a good one, and is well worth trying.

The third suggestion is in the nature of a cure for trouble from high-frequency oscillations often noted when using a source of filament potential of high resistance, by the use of a 1 mfd. fixed condenser across the *A* battery terminals. This furnishes a low resistance path for the high or low frequency currents in the filament leads, and prevents coupling due to resistance in the filament battery.

A compact unit will take up a very small amount of room on the baseboard, or back of the cabinet.

SEVERAL questions have been asked in regard to the size of the loop antenna. The smaller the loop, even if the turns are increased and the inductance remains about the same, the shorter the distance over which the loop will receive, with a given radio receiver. The loop can be made considerably smaller with good results, but it is not advisable to make the loop smaller than 15 in. square, if any sort of distance reception is desired. In the case of the 15-in. loop, approximately 18 turns will be required, instead of the 12 turns prescribed for the original loop.

The shield on the back of the panel, and inside of the cabinet, should be connected to the negative of the *A* battery, and this connection should be made by means of an insulated wire, from the point on the shield nearest to the negative *A* battery binding post.

A TWO-TUBE PORTABLE SET FOR SUMMER USE

By R. LEWIS ROCKETT

After experimenting with most of the well known circuits for over a year the set here described has given superior results during the summer weather; bringing in the nearer DX stations and reducing static to a point where the signals could be plainly heard on the phones. This was somewhat difficult with most of the other circuits in which both aerial and ground are used, as usually when a

- 1 Audio transformer ratio 3 to 1 All-American.
- 1 single circuit jack, Frost or Federal.
- 1 two-circuit jack, Frost or Federal.
- 1 aluminum or copper shield 6x14.
- 1 .006 mica fixed condenser Dubilier.
- 1 .00025 mica fixed grid condenser Dubilier.
- 1 6x14 panel.
- Bus wire and spaghetti.

The grid leak is the heart of this set and the one listed proved the most successful after three or four of the prominent makes had been tried. The .006 mfd. condenser is mounted to the left and above the variable condenser, the

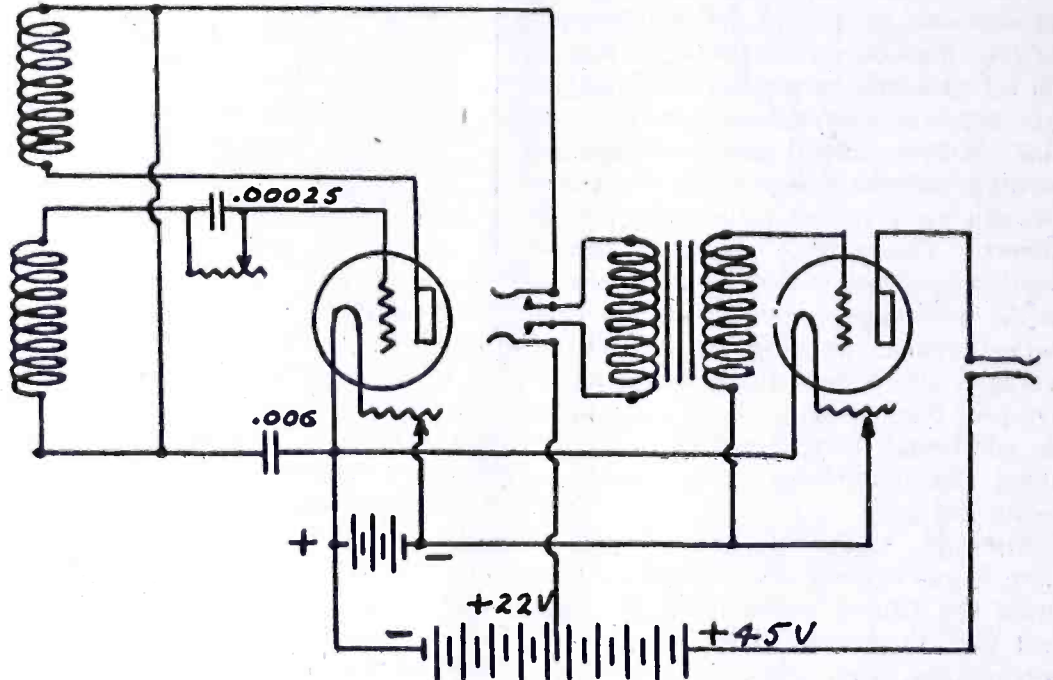

Flewelling Super-Regenerative Hook-up

station was tuned in so much static accompanied it that the program could only be faintly heard.

The success of a circuit depends to a certain extent on the grouping together of the instruments best adapted to it. This is best determined by trying out different makes of parts, which is an expensive method and is the reason for this article being attempted, the writer not claiming any originality as it will be seen that the circuit is the well known Flewelling super-regenerative. Although this receiver does radiate, by the use of dry cell tubes with 16 volts on the plate of the detector and of only an aerial for receiving (the ground being used for shielding) radiation is somewhat reduced. When used on an outing or camping trip one need not bother about disturbing his neighbor.

The parts listed below were used in construction:

- 1 50-turn and 1 75-turn honeycomb coil. Coto Coil Co.
- 1 23-plate vernier condenser.
- 1 two-coil mounting.
- 1 Durham variable grid leak No. 101 100,000 to 5,000,000 ohms.
- 2 WDII or CII dry cell tubes.
- 2 dry cell tube sockets with firm contacts.
- 1 set binding posts.
- 1 22½-volt *B* battery.
- 1 45-volt *B* battery.

coil mount being on a line with it and to the right. All connections for batteries are in the rear, reducing body capacity. Parallel connections should be avoided as far as possible and all connections well soldered.

When the set is ready to operate, with detector rheostat turned on about half way, bringing the tickler and primary coils together should produce a click in the phones; separating them, a sound like the tearing of cloth is evident. The desired position of the grid leak is where the cloth sound is loudest and the click is absent or only faintly heard. It is then possible to approach a point near the oscillating point resulting in much louder signals.

This set is ideal for vacation or camping purposes. When near a river or lake it is only necessary to throw a wire in the water and connect to the aerial post of the set; the coils being placed ½ in. apart for stations 400 meters and below. On the higher wavelengths they may be placed closer together. As a general rule the farther apart the coils the higher, the tubes have to be burned. Separate *B* batteries should be used for the detector and amplifier, which in the long run is not an additional expenditure, as then one battery is not doing double duty, resulting in the batteries lasting at least twice as long.

Radio Compass Calibration

By Wallace Keik

CALIBRATING a radio compass consists in determining the constant error at all points of the compass, this being the difference between the observed and true bearings. The bearing observed by means of the radio compass rarely agrees with the true bearing of the station under test. The resulting difference will be confined to a few degrees only, probably never exceeding ± 10 ; but such being the case, and the discrepancy fortunately remaining constant, it is evident that this is a factor which must be given due consideration.

To calibrate a set properly is quite an art and should be done with extreme care, since this may be considered the final adjustment of the set on which the accuracy of bearings obtained will very largely depend.

testing signals. Simultaneous optical bearings (taken by means of a surveyor's transit) and radio compass bearings are then taken as frequently as possible. The former is, of course, the true and the latter the observed bearing, the difference between the two bearings taken at exactly the same time constitutes the correction factor to be applied in that particular sector. On these stations nothing is left to chance, and where the safety of ships is concerned this is sound policy, and it not infrequently happens that the calibrating vessel will be kept cruising a week or more before the correction factor in all sectors has been accurately and satisfactorily determined.

For the amateur this method is impracticable; at the same time it is fully apparent that, if the best results are to

which will enable one to see at a glance what the corrected bearing reads.

A calibration chart is made up in the following manner. Assuming the area to be covered is to seaward and extends from 200 degrees northwards to 320, each point in this sector must be written down, the correction factor shown against each separate degree and the result when it has been applied.

Observed Bearing	Correction Factor	Corrected Bearing
200	Plus 5	195
201	" 4	197
202	" 4	198
203	" 3	200
204	" 3	201
205	Zero	205
206	Minus 1	207
207	" 1	208
208	" 2	210
209	" 2	211
210	" 3	213

The figures shown are only intended as examples. It will rarely be found that the constant between degrees varies any more than a fraction, as a matter of fact a correcting factor may hold good over several degrees. Therefore, if it is discovered to be impossible to calibrate each point, which is extremely likely, the checks obtained may be applied ten degrees on either side, which means to say that if a plus error of 1 degree was found to exist at 270 and no checks were available at 260 and 280 or in between, this unit could be applied to the whole sector of 20 degrees without being very far wrong. Every effort, however, should be made to ascertain the plus and minus sectors and the zero point at which they change. Provided sufficient checks are obtained, say one to every twenty degrees of the scale, not much difficulty will be experienced in making up a reliable chart.

It may interest readers to know that during the early days of the war, when direction finding was in its infancy, the exigencies of the situation compelled the allies to resort to this method of calibration. Constants held good from 20 to 40 degrees, and were only altered or added to when further checks warranted the course. Those on the inside who had knowledge of the specially valuable services rendered in the cause by this type of station—and the true story has never yet seen the light of day—could not but admit that only by remarkable accuracy could such results be obtained.

Night effect can only be dealt with here briefly. It is due in the main to polarization of electro-magnetic waves and is somewhat akin to freaking. It is most apparent at sunrise and sunset, but is liable to be encountered during all hours of darkness.

Continued on page 66

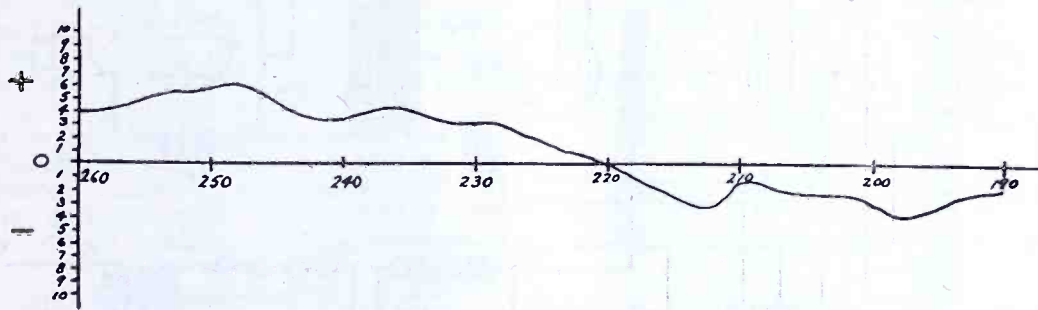

Compass Station Correction Card from 190 to 260 Degrees

No matter with what mathematical accuracy a station has been laid out, constant errors are bound to appear; moreover, they will vary considerably, running from plus to minus and rarely touching zero, which in this case means that the observed bearing exactly tallies with the true without a correcting factor. At the Pachena Pt., B. C., compass station the area of operation extends from 115 degrees west to 300. Here the correction curve shows a minus quantity from 115 degrees to 200 degrees, where for the first and only time it touches zero, from which point the curve runs a consistent but slightly varying plus to the limit of the calibrated sector, 300 degrees. This variation is entirely due to natural causes of a local nature. Screening, masses of conducting material, and mineral matter in the vicinity of the aerial are the causes of distortion and the accompanying variations.

In calibrating a coast compass station installed for the express purpose of assisting the navigation of vessels during bad or foggy weather, it would be a case of the blind leading the blind if it were not carefully carried out, for the few degrees difference between the observed and true bearing might lead to disaster instead of safety. The method of calibrating this class of station is for a vessel to cruise along the coast within visible range of the compass station, at the same time transmitting continuous

be obtained, calibrating of some description must be done. There is no need to despair, however, for there is a way, as the host of fixed stations of all descriptions operating at all hours of the day and night will provide the necessary foundation. To ascertain the exact position of these stations and obtain the true bearing is not a matter of great difficulty; the method to be followed was given in July RADIO. Having obtained the true, the next thing to do is to take radio bearings during transmission. The resulting difference will give the correction factor to be applied in the sector. For example, supposing bearings are being taken on KPH, whose true is 260 degrees, if it is found that radio bearings show consistent readings of 255, it will mean that a constant minus error of 5 degrees has been detected, which, in order to bring it to normal, necessitates the addition of that figure to the radio bearing. If the following little rule is remembered, that a plus error is too high, and must be subtracted from the observed bearing, and minus too low and must be added, there is no danger of applying the correction factor in the wrong direction.

The procedure above outlined should then be followed at all points of the area it is intended to cover. When sufficient checks have been obtained the results should be tabulated and made up into a form of calibration chart,

QUERIES & REPLIES ON C.W. PRACTICE

BY
Gerald M. Best
TECHNICAL ADVISOR



Questions submitted for answer in this department should be typewritten or in ink, written on one side of the paper. All answers of general interest will be published. Readers are invited to use this service without charge, except that 25c per question should be forwarded when personal answer by mail is wanted.

Please publish a diagram for a chemical rectifier, for charging a 4-volt storage battery. Is there any method of determining whether the output is d.c. or a.c.? How many amperes charging rate can I expect from this rectifier? How do you form the plates for the rectifier? Do the Dietzen tubes work as well as WD-11 tubes?—C. W., Wilmington, Calif.

A diagram of a half wave electrolytic rectifier of the well known borax type is shown in Fig. 1. The solution should be made by dissolving as much common borax

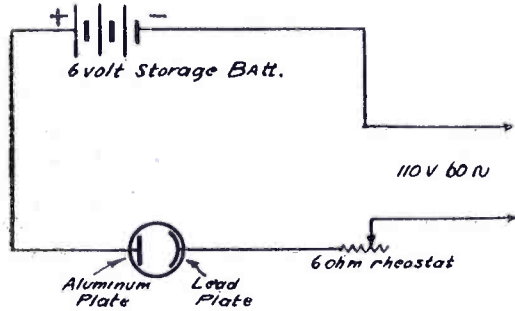

Fig. 1. Chemical Rectifier

as is possible, in distilled water. A quart fruit jar may be used, and the plates should be of pure materials if possible, especially the aluminum. From a 110-volt line you will probably obtain 1½ to 2 amperes charging current. After placing the plates in the concentrated solution, the rectifier may be placed in series with a 100-watt lamp, across the 110-volt line, and left to stand until the plates have been properly covered with a deposit. It is against the policy of RADIO to make direct comparisons between various pieces of radio apparatus intended for the same purpose. Hence I cannot answer your question about the tubes.

Please show how to add a three-stage amplifier to a Neutrodyne receiving set. —H. F., Azabu, Tokyo, Japan.

The complete circuit for a six-tube Neutrodyne receiver having three stages of audio-frequency amplification is shown in Fig 2. It is advisable for you to employ a choke coil of high inductance in the last stage, the primary winding of an ordinary bell-ringing transformer doing very well for the purpose.

Please publish the improved Hartley transmitting circuit, using two 5-watt tubes as oscillators for C. W. and with

potentiometer? My set has a buzzing noise in it, but when I connect a wire from ground to the negative "A" battery the noise stops. What is the reason?—J. R. F., Cleveland, Ohio.

A potentiometer is optional, but not absolutely necessary. The potentiometer should have a resistance of 400 ohms, if used in the circuit. The use of taps will depend upon whether you have a tapped variocoupler,

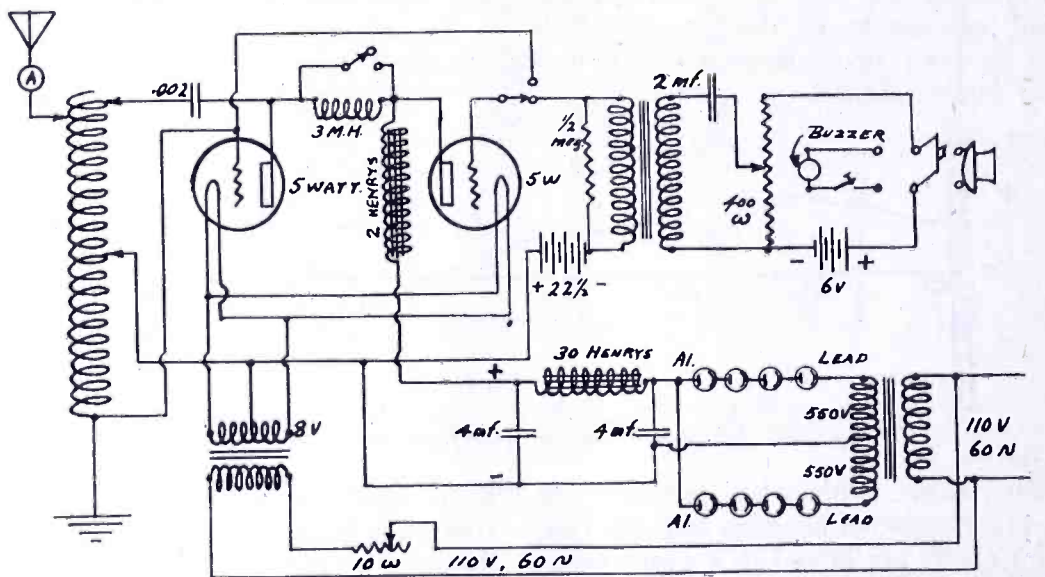

Fig. 3. Hartley Circuit with Heising Modulation

switches for changing one tube to a modulator for I. C. W. and phone.—G. I. S., Columbia, Mo.

The circuit you wish is shown in Fig. 3. In regard to the reflex receiver described by Paul Oard in April RADIO, a potentiometer is shown in the circuit diagram, but not on the panel view. No taps in the antenna coil are indicated on the diagram, but are shown on the panel. What should be the resistance of the po-

but is to be recommended. If you ground the negative of the A battery, you are shorting it through the potentiometer and audio-frequency transformer secondary. Since you are troubled from a.c. hum, it would be preferable to ground one side of the coupler secondary, and omit the connection between the antenna and the secondary coil.

Kindly publish a circuit for a 5-watt telephone transmitter for use on 200 meters.—C. H. A., U.S.S. Prometheus.

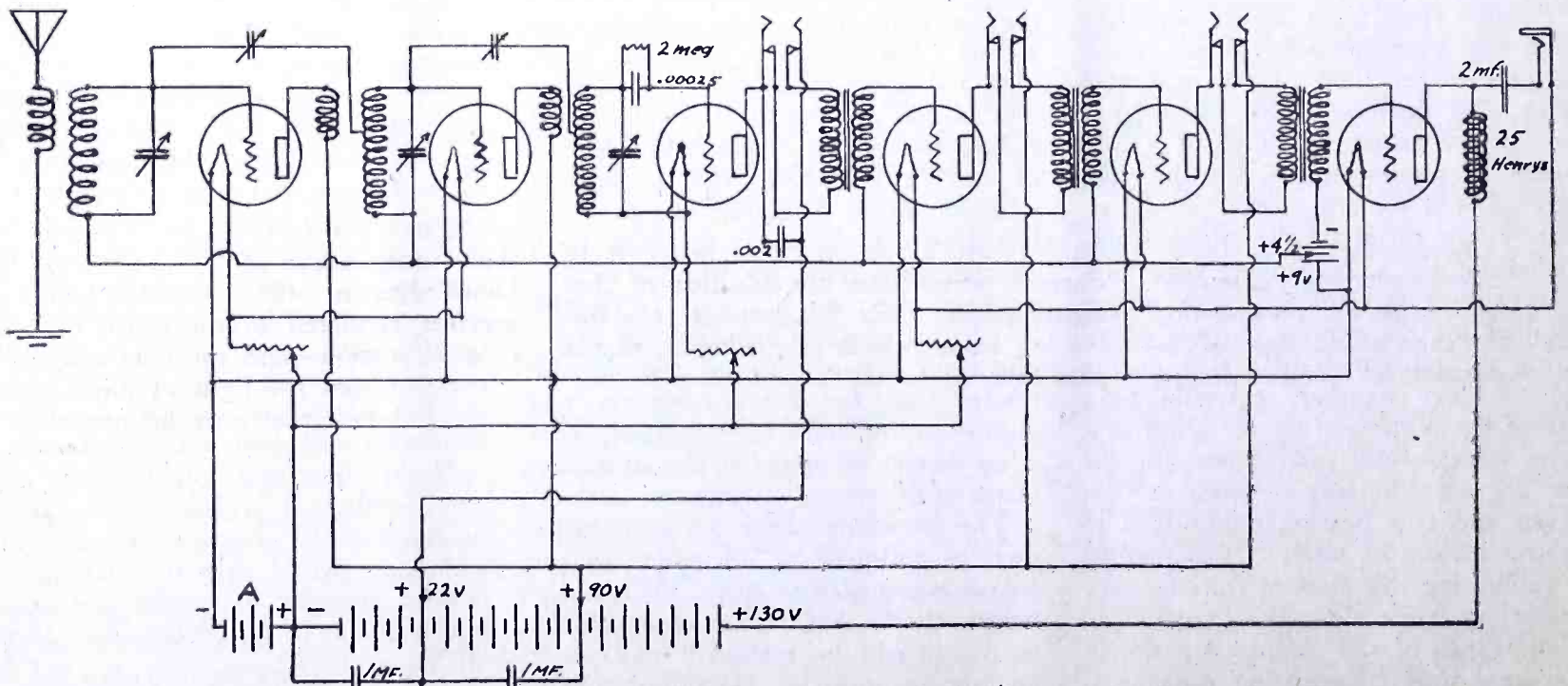

Fig. 2. Six-Tube Neutrodyne Circuit

Fig. 3 shows a 5-watt radiotelephone using a Hartley oscillator and the Heising system of modulation. If you do not care to use it for I. C. W., you may omit the buzzer, key and switch shown in the diagram.

Please publish a diagram using one step of tuned radio-frequency amplification, detector and two steps of audio-frequency amplification. This set must not react on the antenna, as it is expressly forbidden here. This set should be designed for C-299 tubes.—C. R. McD., Inglewood, New Zealand.

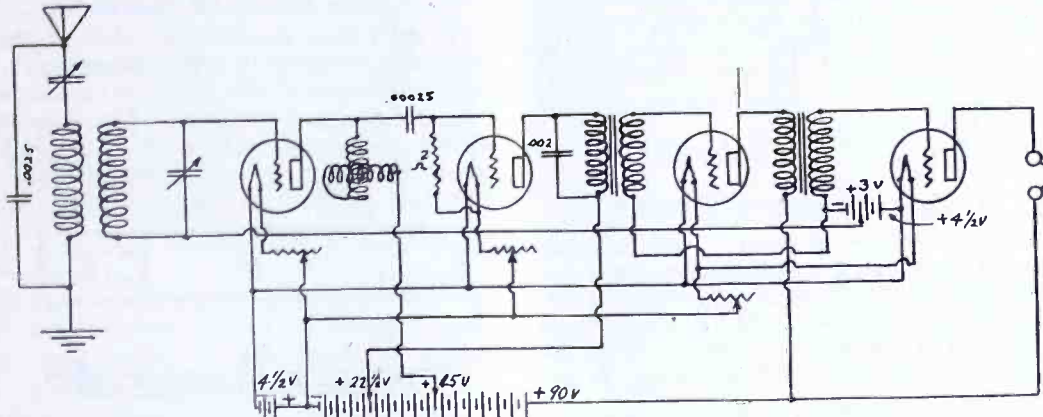

Fig. 4. One Step Tuned R. F. Detector and Two A. F.

A circuit diagram for the set you wish is shown in Fig. 4. A fixed condenser bridged across the antenna and ground binding posts will assist in eliminating the radiation effect, in case the set oscillates.

I would like to modify my present three-circuit set to employ a sodion tube detector instead of the ordinary type of soft detector tube. Will you please publish the necessary circuit changes.—A. J., North Providence, R. I.

A circuit diagram employing a sodion tube as a detector, and using two stages of audio-frequency amplification, with C-299 tubes, is shown in Fig. 5.

I am building a three-tube standard honeycomb coil receiver. Please show a diagram using a C-299 detector and sodion tubes in the amplifier circuit.—R. K. J., Melbourne, Fla.

Sodion tubes are intended for use as detectors only, and not as amplifiers. The circuit given in Fig. 5 shows the use of the Sodion as a detector, with C-299 amplifiers.

Please tell me why a synchronous rotary gap is used only on an a.c. motor, while a non-synchronous gap may be used either with an a.c. or a d.c. motor.—H. M. S., San Diego, Calif.

A synchronous gap is used only with a synchronous a.c. motor, so that the gap is discharged at certain definite periods in each cycle of the a.c. wave, producing a clear, musical note relatively free from disagreeable harmonics. A non-synchronous gap may be used with any kind of a motor at any speed within reason, but the resultant spark discharge will be rough, due to the fact that

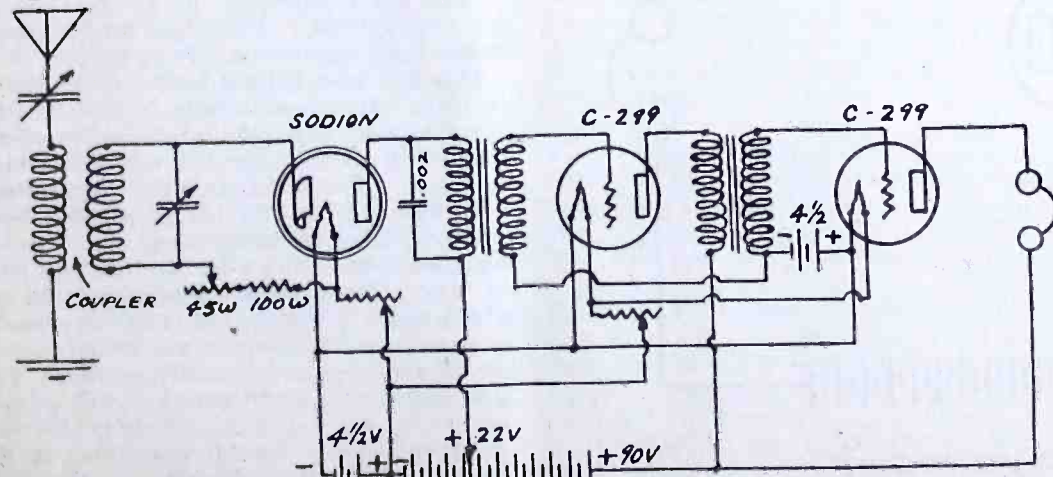

Fig. 5. Sodium Tube Circuit

some of the discharges are not made at the instant that the a.c. wave is at its peak. I would not worry too much about spark gaps in this day and age, for they are hopelessly out of date.

I have a Branston super-heterodyne receiver, built per the manufacturer's instructions. Should the potentiometer be 200 or 400 ohms? Would separate "B" batteries on the detector, oscillator and amplifiers make any improvement? The "C" battery circuit may be opened entirely without affecting the volume or

current down almost to zero, with the result that the set will be totally inoperative. The rotor of the oscillator-coupler, which I presume is the grid coil, should be adjusted on a station a few miles away, so that sufficient volume is obtained with a fairly low setting on the amplification control. With a good loop, this coupling should be about 45 degrees.

Please publish a circuit diagram of a Neutrodyne receiver, consisting of two stages of radio, detector and three stages of audio-frequency amplification.—O. G. P., San Francisco, Calif.

The circuit diagram shown in Fig. 2 will meet your requirements.

I have a variometer, coupler and 23-plate air condenser which I desire to use in conjunction with any necessary additional apparatus, in order to have a three-circuit tuner, with detector and two stages of audio-frequency amplification. Kindly publish a good circuit for the above equipment.

Fig. 6 is the simplest circuit you can use with the above material on hand. You will require an additional air condenser for best results.

What is meant by a "vertical cage" antenna, as compared to a flat-top antenna? For a fundamental wavelength of 170 meters, what should be the length

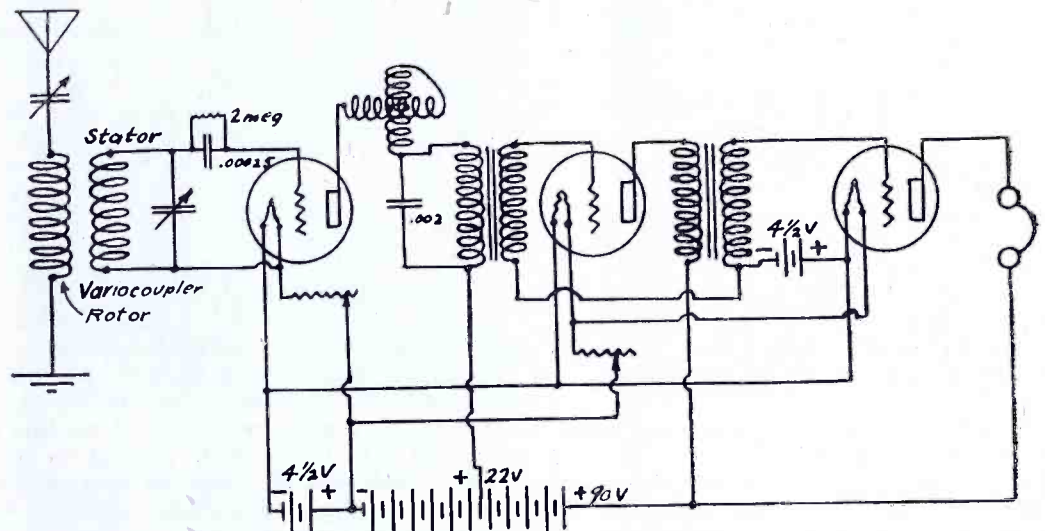

Fig. 6.

quality of reception, although 9 volts negative "C" battery chokes the set entirely. Why is this? Please give method of adjusting the oscillator coupler for best results.—P. E. W., Oakland, Calif.

The potentiometer should be of high enough resistance so that it will not run down the A battery. 400 ohms would probably be the best value. Your set will function very well with a common B battery. If opening the C battery makes no difference in the operation of the set, you must have something radically wrong in the connections. Perhaps the circuit is open already. If you apply 9 volts negative grid to tubes having only 45-90 volts plate, you will bring the plate

of a flat top antenna composed of two 6-wire cages on 20-ft. spreaders, 80 ft. high at each end, used in conjunction with a counterpoise 40 ft. x 90 ft., 6 ft. above the ground. What is the most efficient point with respect to the fundamental wavelength, for general operation of the transmitter?—V. L. H., Exeter, Calif.

Your antenna should not be more than 50 ft. long, for 80 ft. height, and 170 meters fundamental wavelength. It would be preferable to operate your set above the fundamental wavelength, in order that sufficient inductance may be employed in the antenna circuit to allow a proper transfer of energy from the oscillatory circuit, without the use of a series antenna condenser.

W. A. O., La Jolla, Calif., H. V. H., Arden, N. Y., ask questions about the 45,000-cycle super-heterodyne which are answered on the page devoted to improvements to the set, in this issue.

Please give me the winding data for a C. W. transformer, the core of which has the following cross section: 3/4 in. x 7/8 in. Please give data for the secondary as follows: taps at 150, 175, 200, 225, 250 and 300 volts. Filament secondary 3, 6, 9 and 12 volts.—W. L. T., Fresno, Calif.

The primary should be wound with 1250 turns of No. 27 single cotton or black enameled wire. The high voltage secondary will require 3390 turns of No. 32 D.C.C. wire, with taps at the 1695th, 1978th, 2260th, 2542nd, 2825th turns. The low voltage

Continued on page 64

LETTERS TO THE EDITOR

A Mechanical Correction

Fred J. Harbaugh of the U. S. patent office at Washington, D. C., calls attention to the fact that both the driving and the driven element in Fig. 1 of S. G. McMeen's article on "Mechanical High Frequency Generators"

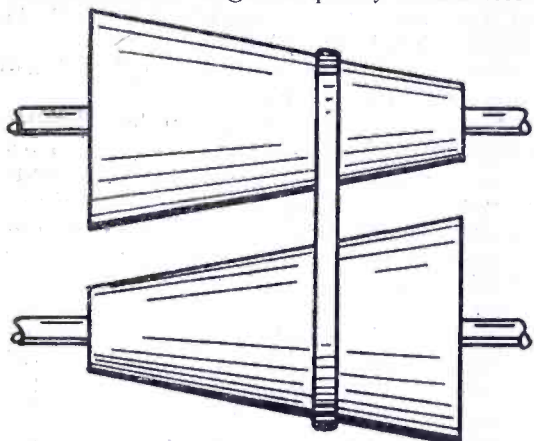

on page 15 of June RADIO should be conical. The correct arrangement with belt is shown herewith. This gives a method of speed variation such that the sum of the diameters, and therefore the length of the belt, is the same in any position of the belt.

Improving The Ultra-Audion

Sir: Herewith is a circuit arrangement built on the ultra-audion foundation, which does away with the objectionable roar or humming—so similar to the "aerial hum" heard when a headset is directly connected across the aerial and ground posts of a receiver. This buzzing, sometimes, may be due to proximity to an a.c. circuit, or a slightly similar hum may be heard without there being any a.c. circuit anywhere near the receiver.

The particular operation necessary to accomplish the result desired consists in winding about ten turns of most any size or insulation of magnet wire—say No. 22 to No. 26, on the outside of a standard 50-turn honeycomb coil—beginning at the outside edge—then, after having measured the width of the ten-turn winding, continue the winding at a distance equal to the width of ten more turns from the opposite edge of the honeycomb coil. In this way a 20-turn aperiodic or untuned primary is formed, and it is of lesser distributed capacity than a

continuous 20-turn coil would be, owing to the two-section winding.

It is important to note that the loudest and clearest signals will be received with a condenser having the smallest number of plates that will cover the range of wavelengths required. In this article a 23-plate condenser has been suggested. However, the writer happens to have *two* 23-plate vernier condensers, very similar in appearance, save that one has aluminum plates while those in the other are of brass. The total measured capacity of the latter is approximately one-half that of the former!

Lincoln, Neb. C. M. DELANO.

To the Amateurs' Rescue

Sir: Allow me to heartily endorse your editorial on the new amateur quiet hours appearing on the first page of June RADIO. I have already expressed the same sentiments to A. R. R. L. headquarters, but yours is the first public statement that has come to my notice.

In the present general attitude of helplessness exhibited by the amateur, it is indeed a welcome relief to find a voice in defense of the amateur against the repeated assaults being made on his very existence—and by those who should be his protectors.

Truly, the slogan of present radio legislation is "The air *must* be made safe for broadcasting" regardless of consequences to any other services. Why not quiet hours for broadcasting after 10:30 P.M. in return—No!!! The broadcaster must be absolutely unhampered in his mission of uplifting the dear public! Yes—with roof garden jazz.

With the prospect of short waves below 100 meters being opened to amateurs, and the coincident demand that we give up 200-220 meters, there arises the suspicion that broadcasting will immediately crowd down into the 20 meters to be vacated, pinning us down again—and with the same old story of interference for lack of a buffer-space of idle wavelengths between.

To cite a contrast, look at the Canadians—with their newly-created 200-225 meter band and *No* quiet hours. Truly, the Canadian amateur can snap his fingers at the American amateur in regard to personal privileges. And this is a state technically ruled by a monarchial form of government. Another thing, in Canada only the best broadcasters seem to exist—we have the idea of letting every Tom, Dick and Harry fill the air with broadcast hash, with the inevitable interference, dissatisfaction, and demand for more available waves, and the stations increase

faster than the waves could be opened to receive them. There must be a limit on *who* shall be licensed to broadcast or chaos is the result.

Kansas City, Mo. L. B. LAIZURE, 9RR

AN ALL-PURPOSE SPRING CLIP

By HARRY W. ALLEN

A contrivance that can be used as a binding post, helix or C. W. inductance clip, battery connector, etc., can be made with little trouble and expense. The only tools needed are a rule, a hacksaw, a small vise, and a pair of pliers. The only material required is a length of 5/8-in. spring brass or

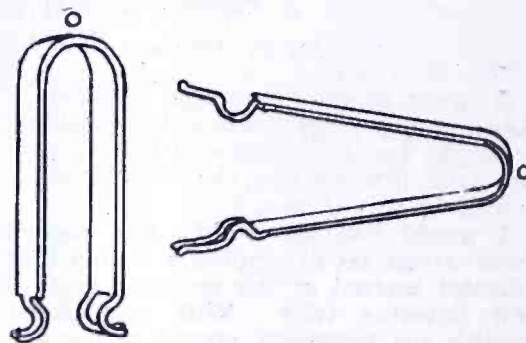
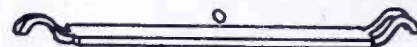

Details for Making Spring Clip

steel. If spring steel is used it would be a good idea to plate the finished clip with copper to reduce the high frequency resistance.

No dimensions are given as the average ham will want to do it in his own way. The drawings need little explanation.

The upper figure represents a length of 5/8 in. spring brass or steel. All spaces marked X are to be sawed out with a hack saw. The projections at either end are bent with a small pair of pliers to form hooks as illustrated in the middle figure. If the clip is intended for use as a binding post, drill a hole in the spaces marked O in the center of the strip.

Now mark off equal spaces on each side of the center of the strip and bend into shape as illustrated in the lower figure. One makes an ideal quick connection for any size wire, battery terminal (dry cell type), or inductance made up of heavy round wire or tubing. The other will take either flat copper strip or round wire or tubing. For all around use it is slightly better.

BOOK REVIEWS

"The Radio Manual," by O. E. Dunlap, 267 pages, 5x7 1/2. Published by Houghton Mifflin Company, Boston. Price \$2.50.

This is a most helpful book for the novice in radio. In simple words it explains the "why" without any technical discussion of the "how." It is at once interesting and informative. The author is radio editor of the *New York Times*. He has prepared a book to answer most of the questions that arise in the mind of one using a ready-made receiving set, why radio waves are transmitted and received, why detectors and amplifiers work, what coils and condensers are used for, and how headphones and batteries operate. The hints on tuning and operation will enable anyone to get better results from his set. In short, it is a popular exposition of the history and practice of radio reception and, as such, is worthy of a place in the library of any broadcast listener.

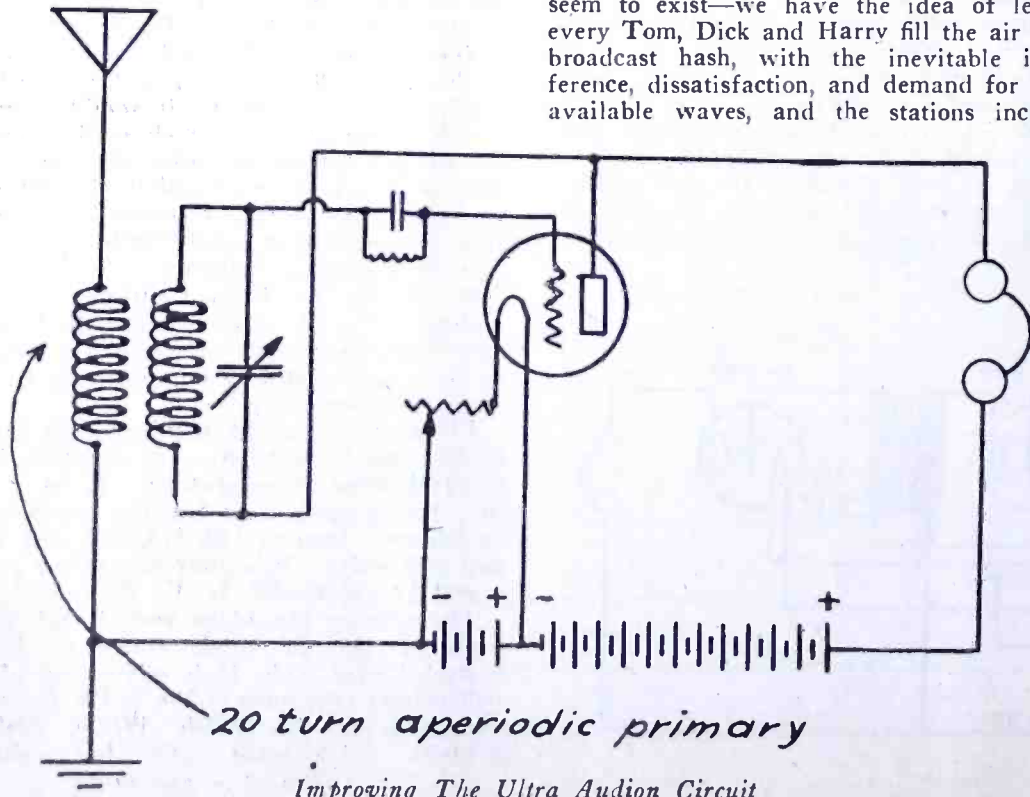

Improving The Ultra Audion Circuit

Pacific Radio Exposition

The Pacific Radio Exposition, which is to open in the Civic Center Exposition Auditorium at San Francisco on August 16th and close on August 21st, has the distinction of having more exhibitors than any radio show yet held. Furthermore, as it is to occupy the entire main auditorium, there will be ample room for the thousands of visitors anticipated.

The visitors will come not only from the San Francisco Bay district but from the entire Pacific Coast, as this will be the first public showing of 1925 models of radio equipment. An exclusive train of Eastern radio men will run from New York to Chicago to the show, three entire coaches already being reserved. Each coach will be equipped with radio receiving sets.

Sixty-seven Eastern manufacturers will be represented either directly or through local agencies. Actual manufacturing processes will be shown by many exhibitors and many spectacular attractions will be in evidence.

KPO, Hale Bros, Inc., will have a studio at the auditorium so that the public can see how broadcasting is done each afternoon and evening. A walking-talking radio mannikin, propelled, operated and controlled by radio, will go from booth to booth, giving an account of each exhibit therein. The various battery companies will show how batteries are made. The Federal Telegraph Co. will have a radio compass in operation and the Western Electric Co. will show a broadcast station.

A model radio home of four rooms, completely furnished in radio style and wired for radio connections in every room, will show how batteries are used, how they are wired into the walls of the home, how the outlets are arranged, etc. The Department of Electricity of the City of San Francisco will have a working exhibit, showing the proper and improper method for erecting aerials and protecting them against damage. Demonstrations will be given by city electricians at regular intervals.

The U. S. Navy will operate a 500-watt tube transmitter, a 100-watt tube transmitter and a complete shore station radio compass installation. This exhibit will be one of the most elaborate in the show.

The "Radio Pioneers" will show relics of the by-gone days of radio. Members of the club have completed all arrangements for a very unusual and highly interesting exhibit. The San Francisco Radio Club will have a good display of a modern amateur installation and will make a membership drive at the show.

The Pacific Radio Trade Association will give away, every day and night, a number of complete radio sets. These sets will be awarded as gate prizes, and for various contests. There will be a radio song contest, a radio fashion parade, a radio costume affair and a prize will be awarded for the best and smallest radio set that can be designed.

The U. S. Department of Commerce will have a booth where the Radio Inspector will hold license examinations.

Some of the large Eastern manufacturing companies are spending \$2,000 or more on their exhibits. These will be of an educational nature and contain novel features never shown before.

The show is co-operative and non-profit. The sales of floor space, amounting to approximately \$18,000.00, will pay the operating expenses. The gate receipts will represent a profit, 50% of which goes back to the exhibitor, while the balance is to be kept in the Association reserve for financing, in part, the 1925 exposition. All of the money, therefore, goes directly back to the exhibitor and not one cent of profit is retained by the Association. This is the first radio show of its kind to be held in America.

The Executive Show Committee of the Pacific Radio Trade Association comprises: A. S. Lindstrom, Chairman; H. W. Dickow, Director of Advertising and Sale of Space; Don. Lippincott, Director of Entertainment and Stunts; C. C. Langevin, Director of Civic Affairs and Interior Decorations; F. J. Cramm, Director of Exhibits.

Space was sold on a lower rate than at

	Booth
Signal Electric Mfg. Co., Menominee.....	27
Electric Research Laboratories.....	29
The Muter Company.....	29
Bell Manufacturing Co.....	15
R. Mitchell & Co.....	15
Philadelphia Storage Battery Co.....	19
Bosserman Radio Labs., San Francisco....	21
Stevens & Co., New York.....	23
The Kodol Co., New York.....	24
Rice-Hitt Co., San Francisco.....	24
U. C. Battery & Electric Co., Berkeley....	30
E. A. Portal Co., San Francisco.....	31
Dodson & Dodson, Oakland, Calif.....	32
Federal Tel. and Tel. Co., Buffalo.....	33
The Bristol Co., Waterbury.....	37
T. White Eastman Co., San Francisco....	38



Auditorium Where Show Is to be Held

any other radio show in the country. All booths will be uniform in size and arrangement and will be built of heavy beaver board, painted in beautiful colors. There will be six center booths, each 400 square feet in size, running up the main aisle. These center booths will contain an 18-ft. "Arlington" radio tower, from which four miniature radio aerials will run to the four pillars on the corners of the booth, each of which will represent a smaller radio tower. The entire booth scheme, therefore, is carried out on radio lines. Inverted loud speakers will contain bunches of evergreen and these loud speakers will adorn all booths.

The following exhibitors will either be represented direct from the factory or through their Pacific Coast Agencies:

	Booth
F. A. D. Andrea, Inc., New York.....	A
Magnavox Co., Oakland, Calif.....	B
Eisemann Magneto Corp., New York.....	C
Atlantic Pacific Agencies Corp., S. F.....	D
Great Western Radio Corp., S. F.....	D
Carter Radio Co., Chicago.....	D
Western Electric Company.....	F
Radio Corporation of America.....	E
Pacific Radio Publishing Co., Inc.....	2 and 4
Baldwin Pacific & Co.....	1
Parkin Mfg. Co., San Rafael.....	3
The San Francisco "Examiner".....	6
The San Francisco "Call-Post"....	Main Stage
Frederic H. Thompson Co.....	7 and 9
The Rola Co., Seattle.....	7
American Radio & Research Corp.....	8
Olin S. Grove Co., Oakland.....	10
Prest-O-Lite Company.....	11
Sadler Mfg. Co., San Francisco.....	12
Quality Radio Co., San Francisco....	13 and 14
Globe Commercial Co., San Francisco....	17
Apco Mfg. Co.....	22

Wholesale Electric Co., San Francisco....	39
R. E. Thompson Mfg. Co., New York....	39
Day Radio Labs., San Francisco.....	41
DeForest Radio Tel. and Tel. Co....	42 and 44
National Carbob Co., Inc.....	43 and 45
Gallagher & Eiferle, Oakland.....	46
Electric Storage Battery Co.....	47
The Spector Co., San Francisco.....	48
Acme Apparatus Co., Cambridge.....	62
Alden Mfg. Co., Springfield.....	62
C. Brandes, Inc., New York.....	48
C. D. Tuska Co., Hartford.....	49 and 51
Colburn Radio Lab., San Leandro.....	53
Kilbourne & Clark Mfg. Co.....	54
Durkee Thomas Products Co.....	55
United Radio Supplies Co.....	56
F. L. Tomlinson Co.....	61
Chelsea Radio Co.....	59
Modern Electric Mfg. Co.....	61
Radio Units, Inc.....	61
Ross Braid Co.....	61
Hartford Instrument Co.....	61
Electric Products Mfg. Co.....	61
Cannon Miller Sales Corp.....	61
E. T. Cunningham, Inc.....	63
Remler Radio Mfg. Co.....	63
Zemansky & Fass, San Francisco.....	64
City of Paris.....	84 and 90
Dept. of Electricity, San Francisco....	110
U. S. Radio Inspector, 6th District....	101
U. S. Navy, 12th Naval District.....	Stage
"RADIO PIONEERS" Assoc.....	103
San Francisco Radio Club, Inc.....	109
L. A. Music Trade Association.....	99
Pacific Radio Trade Association....	Corridor
Herbert H. Frost, Chicago.....	65
Peerless Radio Co.....	69
A. S. Lindstrom.....	70
Dudlo Mfg. Co.....	72
Sleeper Radio Corp.....	74

Continued on page 64

WITH THE AMATEUR OPERATORS

RADIO STATION 6RY

6RY, the new 10-watt C. W. and phone station of Julius Brunton & Sons, at 1380 Bush Street, San Francisco, is noteworthy in being operated entirely with storage battery power. A plate potential of 500 volts is secured from 250 cells of Willard type CBR batteries. An 8-volt A battery and 22-volt C battery complete the power equipment. While many broadcast stations have adopted batteries to eliminate generator ripple and a.c. hum, this practice is novel for an amateur station.

Four 5-watt tubes, two modulators and two oscillators, are used in the transmitter, which employs a grid tickler circuit.

The inverted L aerial is supported by two 50-ft. masts on the roof of the Brunton-Willard Bldg. The aerial is 36 ft. long and consists of two 4-wire cages 3 ft. in diameter with 12 ft. spreaders. The wire is seven-strand No. 18 silicon bronze. The same wire is used in the counterpoise and lead-in.

With antenna current of 1.9 amps, 7JU at Eugene, Oregon, 6ATN at Fallon, Nev., and 6AHP at Pomona, Calif., were worked by phone on May 10th. Cards have been received from 6CEK, 6BQA, 6VD, 7VN and 7AJQ.

The installation of this new station is largely the work of W. M. Riley, who installed broadcasting station KFHJ at Santa Barbara and also several amateur stations. Riley, who will be the operator of Station 6RY, is a former navy and commercial ship operator. He began as an amateur in 1908. From 1914 to 1919 he was with the U. S. Marines as sergeant in charge of the Twenty-Ninth Radio Detachment. From 1920 to 1923 he was a first-class operator in the U. S. Navy, being stationed at various times at Goat Island, Eureka and the Farallones. Subsequently he was operator in charge on the Standard Oil ship *Lubrico*.



Radio Station 6RY, Employing Storage Batteries to Give 500 Volt Plate Potential

NEWS OF THE AMATEUR OPERATORS

Call 2JC has been reassigned to the Bloomfield Radio Club, 82 Broad Street, Bloomfield, N. J., for 100-watt C. W., I. C. W. and phone. The station is in charge of the following operators: 2CRC, 2EY, 2CO, 2CUJ and 2AHY.

The QRA of 3LL is K. B. Foley, 5106 Centre Ave., Baltimore, Md., who will QSL all cards.

Call 5AQW has been assigned to W. Easley, (ex 5ANC), 223 So. Third St., Enid, Okla.

7NO of Aberdeen, Wash., maintains a schedule with 7AEB at Kukack Bay, Kodiak Island, Alaska. Many messages to and from Alaska have been handled. Other Alaskan stations that have been heard in the states this spring are 7MN of Ketchikan and 7AHB of Anchorage. 7CF of Tacoma, Wash., maintains a regular schedule with 7MN.

The following are new stations in the state of Washington: 7MI Yakima, 7HO Sedro, 7ALI Mount Vernon, and 7IX Selah.

9ADS is Abe Benesovitch, 415 McKinley St., N. Hibbing, Minn.

7ACI and 7CO are the most consistent stations in the state of Montana.

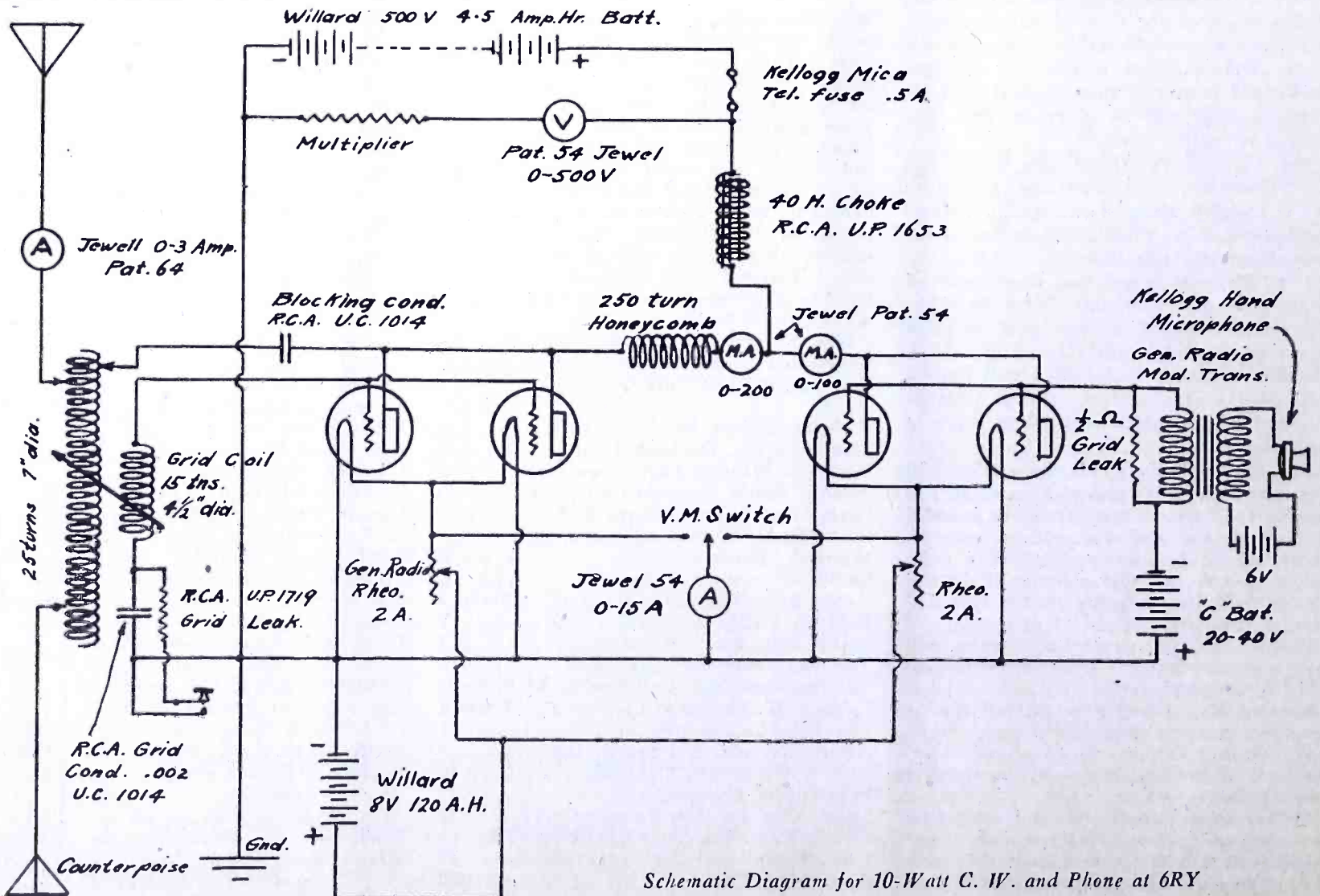

Schematic Diagram for 10-Watt C. W. and Phone at 6RY

7AV is the busiest station in the state of Oregon. 7ABY in the eastern part of the state is also heard regularly.

7IF is the new call issued to The Dept. of Physics of The University of Montana, Missoula, Montana.

The 50-watt station of Ashley C. Dixon Jr. call letters 7IT, Stevensville, Mont., has been heard in Australia recently.

7ZU of Polytechnic, Mont., claims that the superhet receiver is far superior to any regenerative receiver for amateur relay work.

7OF, 7OT and 7IO are about the only stations in Idaho who are on the air these days.

2AHI is Maurice Suffern, 305 New York Ave., Brooklyn, N. Y. All cds. answered.

1AWM has been re-assigned to Gene E. Witham, Nicolin, Maine. Operated by 2CEG and 2CGZ during summer.

5UH, Frank D. Sutton, has moved from Sparta, Tenn., to 1100 Oak St., Chattanooga, Tenn.

6CLZ, portable 6COW, operated by Edward Doell, has changed QRA to 1039 Peralta Ave., Berkeley, Calif.

6NH has been re-assigned to Grahame Hardy, 25 Artuna Ave., Piedmont, Calif. Anyone hearing my 10-watt C. W. fone. Chopper please QSL. All cards answered. O.R.S. A.R.R.L.

MONTHLY REPORT FROM 6XAD-6ZW

Stations worked: 4sy, 5kg, 5vo, 7adp, 7vn, 7wm, 7ali.

Stations reporting: 6xad, 9cky, 9bmd, 9abc, 8axf, F. Keller (Bucyrus, Ohio), C. Teten (Des Moines, Iowa), T. J. Griggs (Brook-

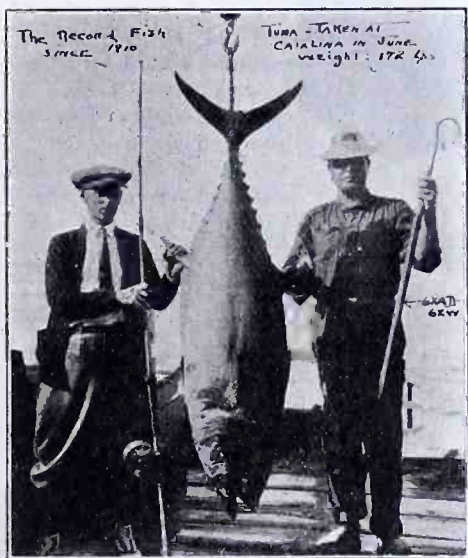

Why 6XAD-6ZW Is Not Heard in Summer

lyn, N. Y.), Can. 2bn, J. S. McDonald (Dunedin, New Zealand), R. J. Orbell (Claudelands, Hamilton, N. Z.), L. S. Speckman (Auckland, N. Z.), 4ag, English 6tm, Eng. 6lj.

NEW RADIO CATALOGS

Small Dry Cell A Batteries for Portable Receiving Sets is the subject of Engineering Circular No. 2 from the Burgess Battery Co. In it are published information and tables of interest and value to every user of portable radio sets.

RADIO 7IT-7ACP-7XAF-KFJR

This station, which is operated by Ashley C. Dixon and his son at Stevensville, Montana, was licensed March 15, 1923. Since then many improvements have been made and, accordingly, much good work has been done.

The main transmitter is a 10-watt C. W. telegraph and 5-watt phone. The straight

50 henries in series with the positive DC line. The 50-"hank" choke serves as filter and as plate circuit reactor for phone. It gives a very good quality to the voice. The generator hum only gets bad on the lower waves, but on 258 meters (our broadcasting wave) it is not noticeable. This according to many hundreds of reports from distances. One BCL 5 miles away says that our modulation is as good as any of the 500-watt class B

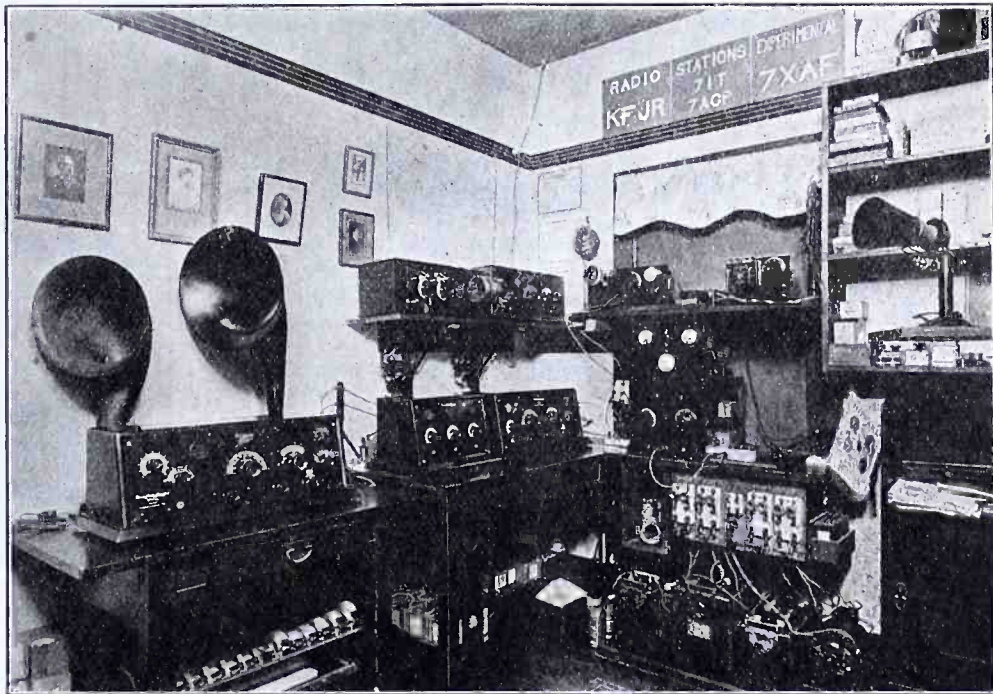

Radio 7IT-7ACP-7XAF-KFJR

Hartley circuit is used with a parallel plate supply. For phone, a switch cuts one tube in as modulator and one in as oscillator with the Heising method. There is nothing unique about the phone hookup except that a 110-volt biasing battery is employed for a grid biasing battery. It certainly gives fine results. The antenna current reaches a maximum of about 1.6 TC on 230 to a minimum of .9 TC on 150 meters for telegraph. The short waves have not been used much; in fact, almost all of this station's best DX has been done in the vicinity of 190 meters. On phone, it is 1.1 on 220.

The power consideration was the big factor in building a good transmitter. There is no commercial "juice" around here. A 500-volt-100-watt "Esco" dynamotor was wound to run on 12 volts d.c. The filaments are run from a 10-volt storage battery. This is a very satisfactory method of obtaining the high potential for the plates. The "Esco" will at times pull 20 amperes on a 60% load, but we charge our own batteries, so that is no drawback.

We have a pretty good filter, but 7IT is not known for its excellent note. The filter consists of 4 mfd. across the generator and

stations. On 150 with telegraph, one fellow recently reported that he had worked us on spark and it was like the old days. Hi. Hi.

A new "1BGF" low loss tuner has been added to the receivers and is not shown in the picture. It works well. In actual practice, however, the Zenith is used, as it has been found to be sharp, brings in very loud signals, and is very fast to tune. On broadcasting, Hawaii and Cuba have been heard, as well as points all over the United States. A long wave receiver is sometimes used for code practice more than anything else.

On phone, music has been heard at a distance of 1500 miles and I have worked over 900 miles, although it is seldom used for amateur work. The reliable range seems to be about 750 miles. (This from some 700 reports received.) The telegraph has been heard QRK in Melbourne, Australia; London, England; and, of course, all over the U. S. The east coast has been worked often and Alaska once. The operators are "SR" and "JR," father and son. We are only on the air a few times a week and will be glad to receive questions or cards reporting signals. Address to either Ashley Dixon Sr. or Jr., Stevensville, Montana.



FROM THE RADIO MANUFACTURERS

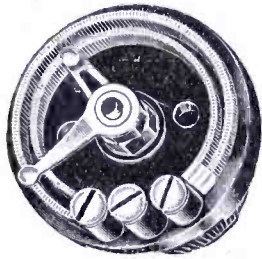
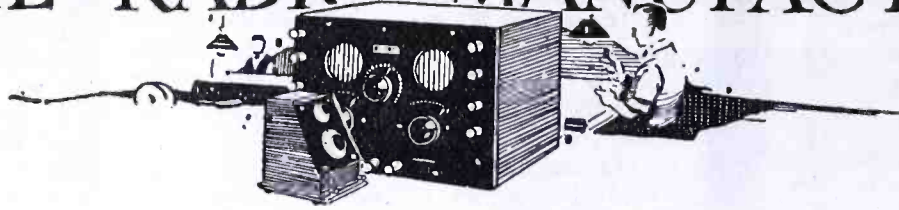

The Amsco Double Rheostat combines two sets of resistances in one part, thus saving space and improving panel appearance. An inner knob controls one and an outer knob, concentric with the inner, controls the other. It is made up as a 6 and 20 ohm combination or as two 20's. The knobs may be engraved to show tube where filament current is thus controlled.

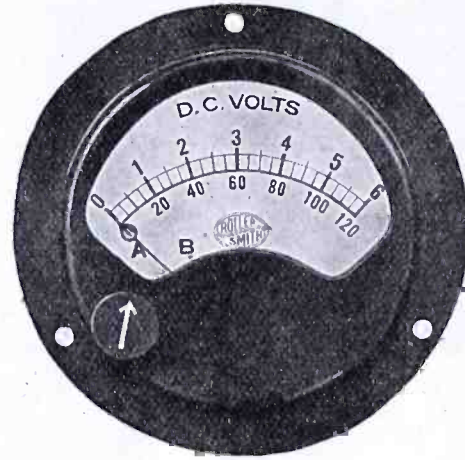

The Roller-Smith direct current radio voltmeter with its 0-6 or 0-120 readings may be used for measuring the voltage of A, B or C batteries. It consumes only 10 milliamperes at full scale and proportionately less at lower values. It is made for either surface or flush mounting on the panel.

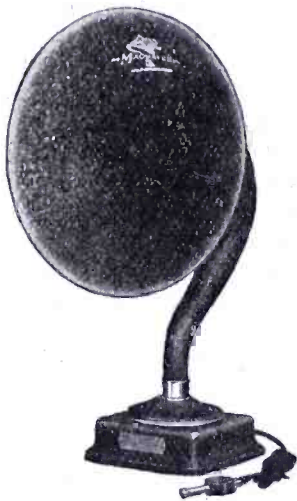

The M4 Magnavox reproducer has a new magnetically balanced armature, an improved type of diaphragm supported by hollow rubber gaskets, and an extremely high resistance winding which make it unusually sensitive. Its sound chamber is acoustically designed to reproduce in true pitch and a large permanent magnet obviates the use of a battery. This latest type of Magnavox involves the same semi-dynamic operating principle employed in the other types.



The Prest-O-Lite B Battery is a new 24 or 48 volt storage battery for radio use especially designed for long life at high efficiency and to harmonize with the finest furniture and radio sets. Every precaution has been taken to prevent breakage or leakage so that even should a cell be spilled the acid solution would be neutralized and absorbed. The cell connectors have been guarded against the possibility of short circuiting and rubber pads on the base prevent marring of furniture.

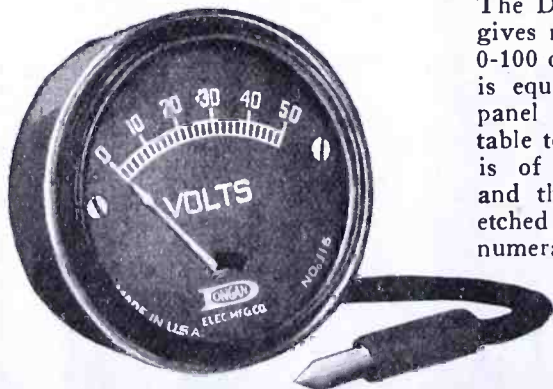

The Dongan voltmeter gives readings of 0-50, 0-100 or 0-150 volts. It is equipped for either panel mounting or table testing. The case is of polished nickel and the dial is black, etched with white numerals.



The General Radio medium frequency transformer has been designed with an efficient working range of from 7000 to 12,500 meters with a peak at 10,000 meters for use in long wave reception and in super-heterodyne sets. It is both electrostatically and electromagnetically shielded, has a thin silicon steel core, and is enclosed in an attractive metal case fitted with convenient terminal posts and mounting holes. The turns ratio is 3.1:1.

No matter what the circuit

*An ACME Audio Transformer
makes it better*

WHETHER you have a neutrodyne, super-heterodyne, regenerative or reflex, the addition of the ACME A-2 Audio Frequency Transformer makes it better.

Send 10 cents for 36-page book, "Amplification without Distortion," which tells how to get it. It also shows you how to get the distant stations loud and clear with "Reflex," the circuit which gives more, tube for tube, than any other.

ACME APPARATUS COMPANY
Transformer and Radio Engineers and Manufacturers
Dept. 81 Cambridge, Mass.

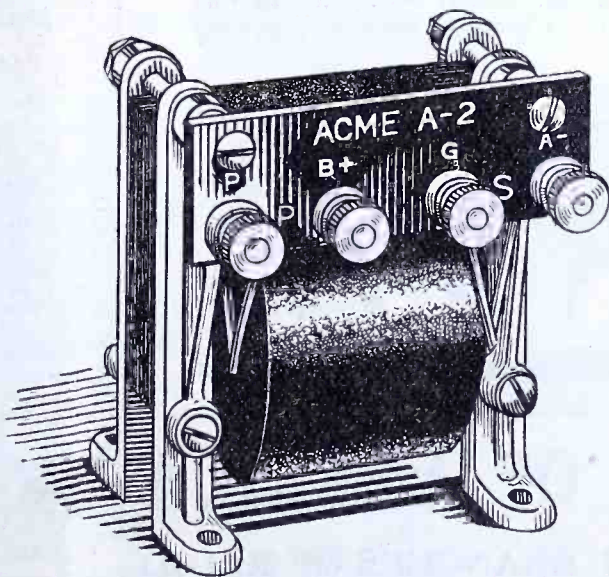

ACME A-2
—for volume

ACME ~for amplification

Don't fail to see
our exhibit at
the RADIO show

**PACIFIC
RADIO
EXPOSITION**

San Francisco
August 16-21
Civic Auditorium

Superior Erla Circuits Are Now Also Easiest to Build

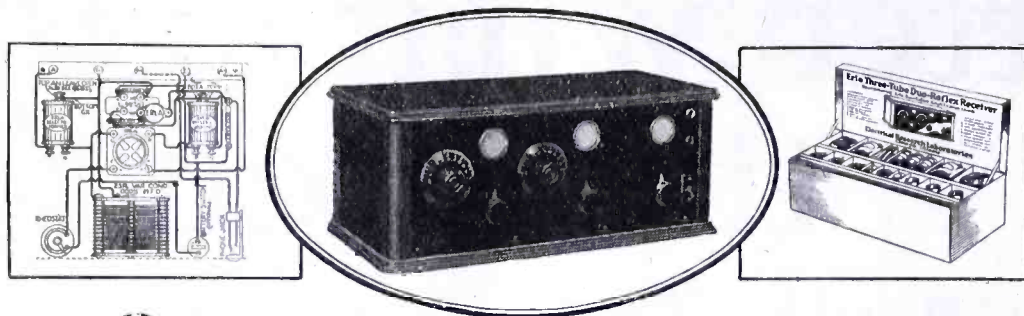

Materially improved range and volume over the whole broadcasting waveband follow the installation of Erla reflex transformers. List, \$5



Providing greatly improved selectivity and simplified control in reflex circuits, Erla Selectoformer records material advancement. \$5ea.



Unrivalled ability to meet the requirements of high resistance loud speakers gives first place to Erla push-pull audios. Pair \$10

Factory Sealed Parts Guarantee Perfect Results

TO the singular efficiency of Erla Duo-Reflex Circuits, tube for tube, the most powerful ever built, now is added maximum ease of construction.

Complete parts for each circuit, down to the last screw, nut and wire, are packed in factory sealed cartons that eliminate all difficulty and doubt in the purchase and assembly of proper materials.

Synchronizing reflex and audio transformers, tested capacity condensers, balanced crystals, every unit designed for the circuit in which it is to function—these positively assure success to the amateur builder.

And, as a final guarantee of accurate, flawless construction, there is also included a drilled and lettered panel, stenciled baseboard, giving the exact location of each piece of apparatus, and full-size blueprints that make child's play of wiring. Even soldering is eliminated, through Erla solderless connectors.

For surest enjoyment of all that radio affords, for purest tone quality, maximum selectivity and ease of control, as well as range and volume, ask your dealer about Erla knock-down receivers, in the factory sealed carton. Or write us direct, giving your dealer's name.

Manufactured by **Electrical Research Laboratories**, Dept. H, 2500 Cottage Grove Ave., Chicago
Coast Representative **Globe Commercial Co.**, 709 Mission Street, San Francisco

ERLA

CALLS HEARD



Readers are invited to send in lists of calls heard from stations distant 250 miles or more from their own station.

By P. Weller, Gardena, Calif.

The following stations were heard between Feb. 1 and June 26, 1924, on a 1-tube set:

- 1ar, 1awe, 1boq, 1bwk, 1cpm, 1id, 1on, (1xah, 1xa, 1xw) (low wave), 2axf, 2ff, 2rk (qra?), 2wz, 2bk, 3bvr, 3jj, 3ma, 3mo, 3oa, 3ss, 4cq, 4er, 4eb, 4fg, 4fr, 4iv, 4io, 4jk, 4me, 4my, 5aaq, 5aar, 5ad, 5ag, 5agn, 5ah, 5aht, 5aiu, 5ajh, 5ajj, 5amo, 5amu, 5be, 5cl, 5cn, 5ct, 5ev, 5dc, 5fn, 5fr, 5go, 5ia, 5in, 5kd, 5lg, 5lr, 5ma, 5mz, 5nr, 5oq, 5rh, 5pi, 5qh, 5ol, 5rg, 5rn, 5ru, 5rw, 5sq, 5tu, 5ux, 5va, 5xp, 6's too many except 6ceu, 6amw, 6bpm, 6ado, 7abh, 7acf, 7aci, 7adg, 7adq, 7aek, 7ael, 7af, 7afa, 7afn, 7afy, 7agg, 7agz, 7ahp, 7ahs, 7aim, 7aiv, 7ajq, 7aju, 7ajv, 7akf, 7akh, 7akk, 7ald, 7ale, 7ali, 7alk, 7am, 7at, 7au, 7av, 7ba, 7cf, 7co, 7cz, 7dm, 7dr, 7ei, 7ej, 7ep, 7er, 7fa, 7fq, 7gq, 7gr, 7gv, 7if, 7ih, 7ik, 7im, 7is, 7iw, 7ix, 7jd, 7jn, 7jp, 7jq, 7ju, 7ko, 7ks, 7lg, 7ls, 7ma, 7mf, 7mi, 7mt, 7mu, 7no, 7ob, 7ot, 7pz, 7qc, 7qt, 7qu, 7rd, 7ru, 7rv, 7sh, 7td, 7to, 7tq, 7tt, 7un, 7ut, 7va, 7vi, 7vn, 7wa, 7wm, 7wp, 7wt, 7zl, 7zu, 8abs, 8abx, 8afa, 8aig, 8as, 8at, 8ate, 8axf, 8axm, 8bba, 8bit, 8bnh, 8bua, 8cei, 8cgj, 8cgv, 8cjd, 8cll, 8csn, 8cvx, 8er, 8es, 8jj, 9aa, 9aaf, 9aaq, 9abc, 9acb, 9ace, 9aci, 9aif, 9aim, 9aiv, 9amb, 9aob, 9apf, 9apu, 9aqd, 9aqr, 9as, 9avs, 9awn, 9awv, 9bal, 9bbt, 9bfp, 9bis, 9bj, 9bjk, 9blw, 9bms, 9bmu, 9bof, 9bpv, 9bpy, 9bqi, 9bri, 9btl, 9btt, 9bun, 9bv, 9bwu, 9bxq, 9by, 9bz, 9ca, 9caa, 9caf, 9cai, 9ces, 9ced, 9cen, 9cjm, 9cju, 9cju, 9cju, 9clz, 9cpu, 9csa, 9cvo, 9cwj, 9daw, 9day, 9dex, 9ddp, 9dfh, 9dlu, 9dno, 9dnw, 9dde, 9dp, 9dpp, 9dra, 9dte, 9dun, 9dvn, 9dvw, 9dwb, 9dwn, 9dxx, 9dxy, 9dyi, 9eae, 9eak, 9eba, 9ec, 9ecy, 9ed, 9edh, 9efo, 9efq, 9efz, 9eht, 9ehv, 9eky, 9elb, 9eld, 9eli, 9es, 9hd, 9hm, 9ic, 9ma, 9rv, 9so, 9sp, 9ss, 9ts, 9zt.

Can.—5gg, 9bp, 9bt. Mex.—bx.

By GATS, Wm. Reeves, 416 Holland Avenue, Los Angeles, Calif.

- 1auf, 1aw, 2awf, 3lc, 4ef, 4io, 4co, 5aaq, 5aar, 5ado, 5adb, 5huj, 5alr, 5alu, 5aiv, 5bz, 5eh, 5dq, 5eo, 5ev, 5cj, 5gm, 5hg, 5ia, 5mi, 5lu, 5lr, 5ot, 5or, 5qr, 5qd, 5to, 5sd, 5sk, 5va, 5xd, 5za, 6's too numerous to mention, 7aek, 7acf, 7adh, 7agz, 7ahc, 7ajt, 7afu, 7akh, 7akk, 7aku, 7ald, 7alk, 7co, 7cd, 7du, 7em, 7fm, 7fq, 7fr, 7is, 7ei, 7go, 7gw, 7iw, 7kz, 7ln, 7lq, 7ls, 7ot, 7qd, 7qu, 7sf, 7sm, 7tq, 7vm, 7zu, 8anl, 8cgj, 8dal, 8did, 8dga, 8ak, 8er, 8vy, 9aa, 9abc, 9aci, 9aco, 9afm, 9ahq, 9ahv, 9aim, 9aim, 9amb, 9any, 9aox, 9ape, 9apf, 9asz, 9avg, 9avn, 9awn, 9abbs, 9bcf, 9bez, 9bfz, 9bhv, 9blt, 9bly, 9bvx, 9bpv, 9bqg, 9bri, 9bun, 9bwu, 9bxq, 9byc, 9caa, 9cac, 9ocw, 9cfx, 9cht, 9cip, 9ojm, 9cju, 9cjt, 9cju, 9ckm, 9eli, 9eld, 9clq, 9cst, 9cvo, 9cwy, 9cxm, 9exo, 9dbf, 9dcj, 9dcr, 9dej, 9dfh, 9dft, 9dix, 9djb, 9djm, 9dlm, 9doe, 9dof, 9dpo, 9dro, 9dte, 9dtg, 9dun, 9dwn, 9dxx, 9dxr, 9dyi, 9dyr, 9eht, 9eku, 9al, 9ar, 9bx, 9ed, 9eq, 9fm, 9fu, 9hn, 9lm, 9ql, 9rm, 9ry, 9sm, 9ss, 9ya, 9zt.

Hawaii—6ceu.

The following were heard on the low wave-lengths: 1xam, 1axn, 2rk, 2xi, 3xar, 8xhm, 4xc, 5xaw, 5xbh, 8pl, 8xhp, 8xbo, 8cp, 9xba, 9xbd, 9xhf, 9xbl, 9xhp, 9xbo, neht, qra?

By Can. 5FU, 8696 Oak St., Vancouver, B. C.

- 1abf, 1bn, 1cmx, 1xah, 1xas, 1xw, 1xam, 2bnc, 2bse, 2cgb, 2rk, 2xab, 2xaq, 2xf, 3bg, 3bq, 3bi, 3mb, 3me, 3gg, 3pz, 3bpb, 3ccu, 3cjm, 3xaq, 4aec, 4xc, 4xu, 5aic, 5ajj, 5aaq, 5ek, 5dw, 5ls, 5rw, 5ov, 5ph, 5xab, 5xab, 5xd, 5xv, 6ceu, 6xaq, 6xbj, 6xn, 6zt, 6xhc, 6zcd, (other 6's and 7's too numerous), 8alm, 8ahc, 8aol, 8bpa, 8bkv, 8cjd, 8xhc, 8xhb, 8xhp, 8xbq, 8yn, 9aac, 9bof, 9bxq, 9bdq, 9bne, 8bdj, 9awv, 9eku, 9cca, 9cmk, 9caa, 9clq, 9bcf, 9cen, 9che, 9cxp, 9day, 9dge, 9doe, 9dpi, 9dbb, 9dev, 9dxq, 9dxr, 9dkb, 9dem, 9edb, 9ebn, 9ekn, 9eea, 9ee, 9eq, 9eli, 9hm, 9rc, 9xax, 9xbd, 9xha, 9xbl, 9xbf, 9xe, 9zg, 9zt, kdef, kdeb.

Can.—2bn, 2cb, 3aec, 3bq, 3ov, 4ad, 4nj, 4cb, 4cr, 4cw, 4dq, 4eo, 4ew, 4gt, 4fn, 4fz, 4io, 4aa, 9al, 9bx. Fone: wgy, kdka, vy qsa. Complete log kept hr. Always gid to qsl crd on above reports.

Continued on page 46

RADIO INSTITUTE OF AMERICA

TRAINING IN ALL COMMERCIAL BRANCHES OF RADIO

If you cannot attend the Radio Institute of America in person the same instruction can come to you through our recently inaugurated "HOME STUDY COURSE"—Investigate.

Detailed information free on request.

Conducted by

THE RADIO CORPORATION OF AMERICA

Phone Douglas 3030

San Francisco, Calif.

Phone Franklin 1144

New York City



331 Call Bldg.
98 Worth St.

Tell them that you saw it in RADIO

The Radio Sensation!

The new American Brand Worm Drive Vernier Condenser, with a *hundred to one* ratio Worm Drive geared vernier adjustment.

This is the highest ratio gear adjustment ever developed on Variable Condensers. With this adjustment the plates may be moved so slowly that the motion is hardly noticed by the eye. A remarkable micrometer adjustment of the entire set of movable plates can be obtained. This wonderful achievement is of special importance to the radio fan seeking distant stations.

Another tremendous exclusive feature—the back panel of American Brand Condensers is adapted for the mounting of any coil desired for use in the set. A. B. Condensers are made from finest heavy brass. The plates are perfectly flat and will never get out of line. Plates and supports are in natural finish, keeping radio-frequency losses at a minimum. Mechanically and electrically, a perfect job.

And the price of this Super Brass Plate A. B. Condenser with Worm Drive Vernier (23 Plates .0005 mfd.) is only \$5.00. 13, 17 and 44 plates with or without Worm Drive Vernier at proportionate prices.

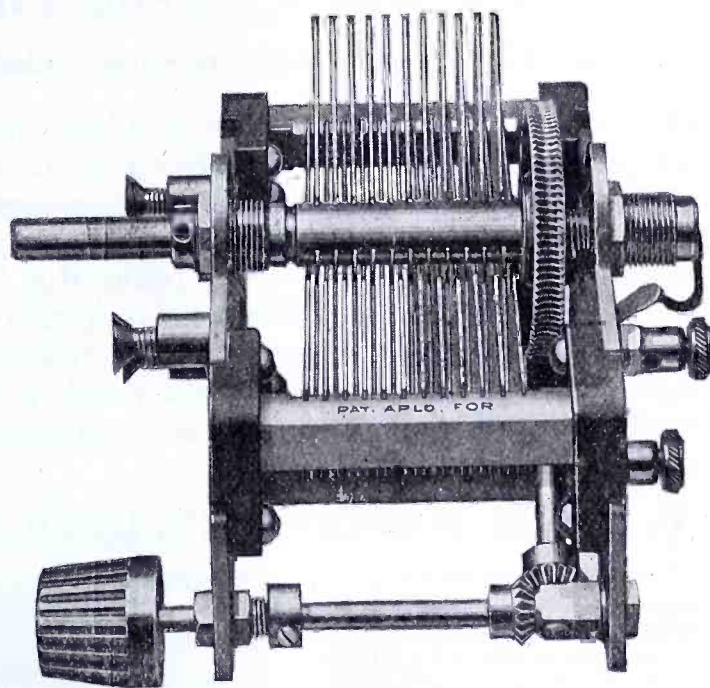

The 100 to 1 Worm Drive

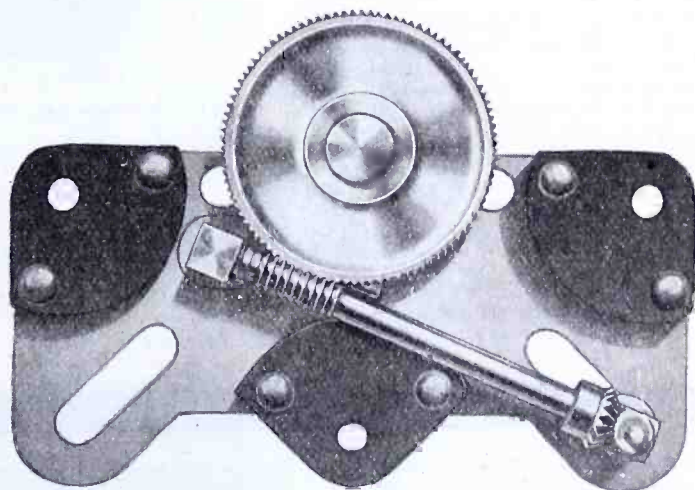

Please ask your dealer to show you this wonderful condenser. If he can't do so, write us for descriptive illustrated folder, and send us your dealer's name.

Note to Dealers—If your Jobber can't supply you with A. B. Condensers write us

AMERICAN BRAND CORPORATION
 8 West Park St., Newark, N. J.
 Factory—Philadelphia

Tell them that you saw it in RADIO

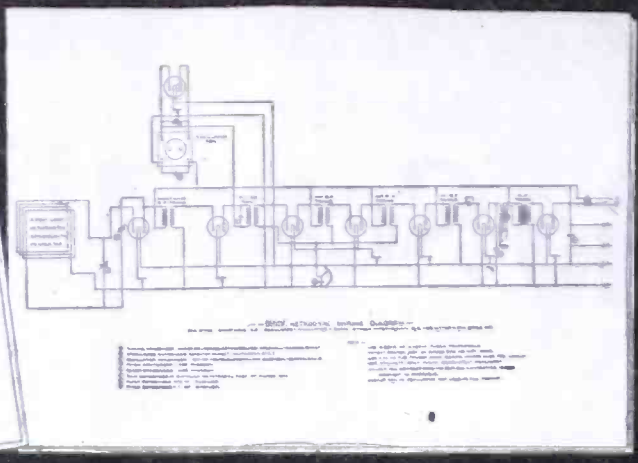
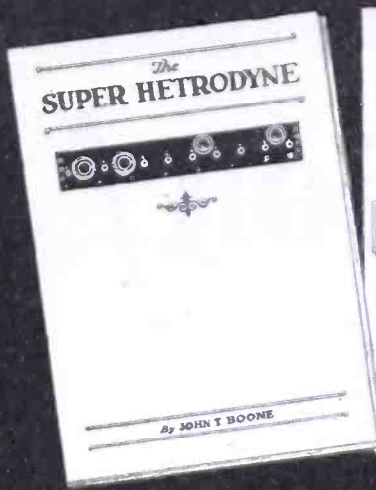

Every Radio Fan Needs This Book

A Complete Text Book on Super-Hetrodynes

Here for the first time is a thoroughly scientific volume treating of what the super-hetrodyne means to radio, together with a wealth of data on its development, advantages and operation. Written by a man who was a pioneer in the development of radio, this book covers the entire field of super-hetrodyne equipment. Profusely illustrated, and liberally supplied with charts and wiring diagrams, this book gives you a fund of information found nowhere else. The price is \$1.00 postpaid. Order today. Use coupon below.

J. T. BOONE CORPORATION, DETROIT, MICH.

Manufacturers of

BOONE SUPER-HETRODYNE TRANSFORMER KIT—This set contains 1 Short Wave R. F. Transformer, 1 Oscillator Coil, 1 Filter Coil or Input Transformer, which is carefully balanced with the 3 Long Wave R. F. Transformers, 1 Audio Frequency Transformer, Wiring Diagrams and Instructions. Price \$50.00.

BOONE SUPER FOLDING LOOP AERIALS—3 ft. size, collapsible to 4"x4"x24". Center tap. Brown mahogany finish. Wound for broadcast range of 200 to 600 meters. Price \$25.00.

BOONE SUPER VARIABLE CONDENSERS—Metal frame type. Brass rotor and stator plates. Low loss, low resistance, small and compact, beautifully finished. Prices—.001 MF \$7.00, .00075 MF \$6.75, .0005 MF \$6.50, .00035 MF \$6.25, .00025 MF \$6.00.

If your dealer cannot supply you order direct from our factory.



J. T. BOONE CORP., 3469 E. Jefferson, Detroit, Mich.
 Enclosed is \$1.00 for your text book "The Super-Hetrodyne."
 Please also send me information on your Super-Hetrodyne Transformer Kits—Folding Loop Aerials—Low Loss Variable Condensers.

Name

Address

C. I.

Do you know of a test to beat this?

Ten irons put on test at 110 volts have burned continuously 24 hours a day for over 1200 hours. Solder and flux used every day and the elements are just as good as ever. Try this new iron. Heat right at the tip.

At all good dealers

Price \$2.50

Hartford Instrument Co. 308 Pearl Street Hartford, Conn.

Coast Representative, F. L. TOMLINSON CO.
 447 Pacific Bldg., San Francisco, Cal.
 1111 Wall St., Los Angeles

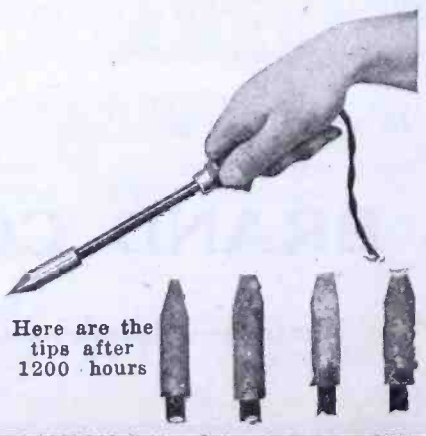

Here are the tips after 1200 hours

Tell them that you saw it in RADIO

Continued from page 44

By 9ZT-9XAX, D. C. Wallace, 54 Penn Ave., Minneapolis, Minn.

Stations Worked using 9XAX on 109 meters (during 1924).

1xw, 1xj, 1ajp, 1bes, 1cmp, 1xah, 1xak, 1xam, 1xaq, 2gk, 2aws, 2bsc, 3ii, 3mb, 3pz, 3vw, 3bdi, 3bwj, 3xao, 4bz, 4fj, 4hs, 4ku, 4xc, 4xe, 5ov, 5ow, 5qw, 5aic, 5ahj, 5xv, 5xab, 6arb, 6ciz, 6xe, 6xbc, 6xbe, 7fq, 7gb, 7ij, 8hn, 8pl, 8ve, 8adk, 8alf, 8awj, 8bbf, 8bnh, 8bwy, 8dcy, 8xbe, 8xbp, 8xbq, kdef, kdeb, nkf, nkf-1 (one).

Can.—1bq, 1ef, 2bg, 2bn, 2cg, 3bp, 3bq, 3ko, 3ly, 3aec, 4cr, 4cw, 9al.

By 6LZ-6COW, 1039 Peralta Ave., Berkeley, Cal.

5alj, 5dw, 5es, 5in, 5lr, 5mi, 5na, 5ql, 5qy, 5rg, 5ux, 5vm, 6aja, 6amw, 6atn, 6awh, 6bbh, 6bnf, 6cbu, 6chj, 6cki, 6cll, 6fm, 6rm, 7abb, 7abh, 7acf, 7adp, 7aft, 7agf, 7agz, 7aha, 7ahn, 7ahs, 7ais, 7aiv, 7ajt, 7akh, 7alk, 7bd, 7bk, 7co, 7dm, 7dz, 7fj, 7fq, 7gd, 7gq, 7if, 7ih, 7io, 7ju, 7lh, 7mf, 7nf, 7no, 7ob, 7ok, 7pz, 7rd, 7ry, 7sf, 7sh, 7td, 7tq, 7vn, 7wp, 7zu, 7zx, 8abm, 8add, 8eci, 8zz, 9aaq, 9aaw, 9aed, 9aen, 9afm, 9ahz, 9aia, 9aii, 9aim, 9amb, 9aqd, 9ato, 9ayi, 9ayj, 9bhv, 9bkk, 9bsp, 9bwt, 9cga, 9cii, 9cjt, 9cju, 9evo, 9czn, 9day, 9dfn, 9ebt, 9edc, 9egu, 9ehn, 9eky, 9elb, 9mc, 9ss, 9zt, kdef.

Hawaiian—6ado. Can.—4ab, 5bw, 5gg.

By 4PV, 148 Avant St., Spartanburg, S. C.

(1aft), 1ajx, (1arf), 1auk, 1bie, 1boq, (1bwx), 1ccz, 1py, (1rr), (2acs), (2aet), 2aey, 2agb, 2al, 2azy, 2bbx, 2bsc, 2buy, (2bxd), 2byk, 2cbg, 2ccd, 2cka, 2epd, 2cwp, (2cj), 2kf, (2kx), (2qf), 2rb, 2sy, 2vh, 2xbf, (3agf), (3ahp), 3ajd, (3apv), (3bay), 3bgt, 3bmn, 3bnu, 3brf, 3buy, 3bva, 3cbl, (3cdu), (3cjn), 3ckl, 3fb, 3hh, (3hs), 3lg, 3mo, (3oe), 3ph, (3qv), 3tf, 3yo, 3zo, 4af, (4ag), 4ai, 4bw, (4dw), 4dy, 4ea, 4eq, (4fs), 4ft, 4gx, 4ia, 4io, 4iz, (4jr), 4kl, 4lo, (4njf), 4og, 4pk, 4rz, 4si, (4tj), (4ua), 4uk, (4un), 4yz, 5aiy, 5alz, (5amh), 5ck, 5es, 5fm, 5gp, 5ka, (5mi), 5zas, (8abq), 8abs, 8abz, 8acm, 8agl, 8aip, 8alx, (8apn), (8atz), 8aws, (8bca), 8bfe, 8bkh, 8bmb, 8bnh, 8boy, (8bqi), 8brc, 8brm, 8bsq, 8byk, 8cci, 8cdc, 8cei, 8oga, 8daa, (8dae), (8daw), 8dc, 8dfn, 8dgo, 8dhs, 8dnp, 8doi, (8ef), 8er, 8fj, 8fm, (8jq), (8tj), 8ue, 8vq, 8vt, 8yd, 8zc, 8zz, 9aul, 9aau, 9ahh, 9aim, (9aio), 9aqd, 9bec, (9be), 9beq, 9bjz, 9bk, (9cjb), 9cjm, 9dlw, 9dmc, 9dsa, 9dwa, 9elb. Wl qsl on request. All repts appreciated es qsl'd.

By 2WZ, 654 East 23rd Street, Brooklyn, N. Y.

1ah, 1eg, 1db, (1dd), (1dq), 1fn, 1gv, 1ij, 1kc 1kr, (1mm), (1pa), (1py), 1uj, (1zt), (1zz), 1aac, 1abf, (1adm), 1aft, (1aid), 1aja, 1ajp, (1al), 1aqb, 1are, (1arf), 1auc, (1aur), (1avj), 1avr, (1axa), 1axz, 1azr, 1bbe, (1bce), (1bdt), (1bdx), (1bhn), 1bie, 1bis, (1bjo), (1bqq), 1bzz, 1cm, 1cmp, (1cmx), 1cpo, (1cqm), (1ctw), 3dk, 3eh, 3hh, 3hj, 3lg, (3me), 3oe, (3oq), 3ph, 3sf, 3tp, 3uu, (3vw), 3aff, 3ajd, 3aoj, 3apv, 3awv, 3bay, 3bce, (3bdi), (3bqp), 3bta, 3buy, (3bvl), 3bwj, (3cdn), (3cdk), 3cgs, 3chl, (3cik), (3cjn), (4ab), 4fa, 4fs, (4su), 4tj, 6awt, 6cgw, (8jq), (8ku), 8qm, 8rj, (8uf), 8xe, 8xx, 8xba, 8zp, (8abm), 8ajn, 8aky, 8avl, 8axf, 8ayw, (8bfe), 8bfh, 8bhe, (8bir), (8bkh), 8brc, 8ccr, (8cdc), 8cei, 8cun, (8cwp), 8daa, 8daw, (8dkm), (8dnf), 8dnn, 8dpo, 8dsc, 9zt, 9ato, 9biu, 9dqu, 9dsa, 1ael, (1bdx), (1bga), (1xak-1aol), (3cdu), (4su).

Can.—1ae, 1dd, 1eb, (1ei), 2be, 2bn, 2cg, 3bd, 3fc, 3ty, 3xi, 3aec. Will qsl to all who ask. Please report if you have heard 2wz.

At 5QP, 410 Reynolds St., Gadsden, Alabama

2mf, 4ai, 4do, 4fg, 4ia, 4io, 4iz, 4qf, 4sh, 4si, 4tj (qra), 5aw, 5acm, 5aek, (5akp), 5amf (fone), 5amh, 5cn, 5ek, 5es, 5gl, 5gp, 5ka, 5nt, 5qh, 5qv, 5rg, 5ve, 5vu, 5xat (qra), 5zas, 8bmb, 8ckm, 8do, 8jq, 8wp, 9aau, 9aaw, 9ash, 9aus, 9ayv, (9baz), 9baq, 9bcb, 9blg, 9bh, 9bk, 9brv, 9cee, 9cer, 9cfk, 9cln, 9cm (vy qsa), 9cmc, 9cmn, 9cta, 9evo, 9czn, 9dew, 9dvw, 9dzu, 9elb, 9eky, 9wu, wgy (on low waves), wyl (on amateur waves clg an "8").

By 5AFZ, Clarence Hoffmann, S. E. Seneca and Bascombe Sts., Mobile, Ala.

1fd, 1blb, 1bjl, 1csw, 2bxp, 2alr, 2kx, 3ov, 3bmz, 3ati, 3si, 3cjn, 3tr, 3lg, 3aky, 3br, 3ek, 3cdk, 3bd. Too many fours and five. 6cc, 6lv, 6bqe, 6cgv, 6bdw, 6bbc, 6bm, 6aao, 6fp, 6akz, 6cng, 6chu, 6atn, 6aj, 6bsg, 6aps, 6bic, 6zu, 6edg, 6vf, 6mg, 6jx, 7agz, 7co, 7adf, 7ov, 7pz, 7zu, 8afd, 8jj, 8ads, 8vq, 8aoq, 8cuh, 8bkn, 8fu, 8bw, 8dbn, 8cei, 8jq, 8cpk, 8bn, 8dhs, 8aig, 8cke, 8cvx, 8dhq, 8ut, 8aib, 8anb, 8dfo, 8dlm, 8cwl, 9cjc, 9err, 9cdp, 9rc, 9cja, 9dbf, 9cfl, 9alx, 9bce, 9dpw, 9ayp, 9bhi, 9cp, 9aii, 9brk, 9big, 9bhy, (9vm), 9dio, 9cuo, 9brs, 9avg, 9blw, 8boz, 9bhm, 9dgv, 9dmo, 9aec, 9ss, 9diy, 9dzk, 9ear, 9azg, 9eae, 9dfh, 9caa. Canada—2fu. Cuba—2by.

Would appreciate reports on my spark coil 10W using a UV201A. All cards answered.

Continued on page 68

BAKELITE

TRADE MARK REG. U. S. PAT. OFF.

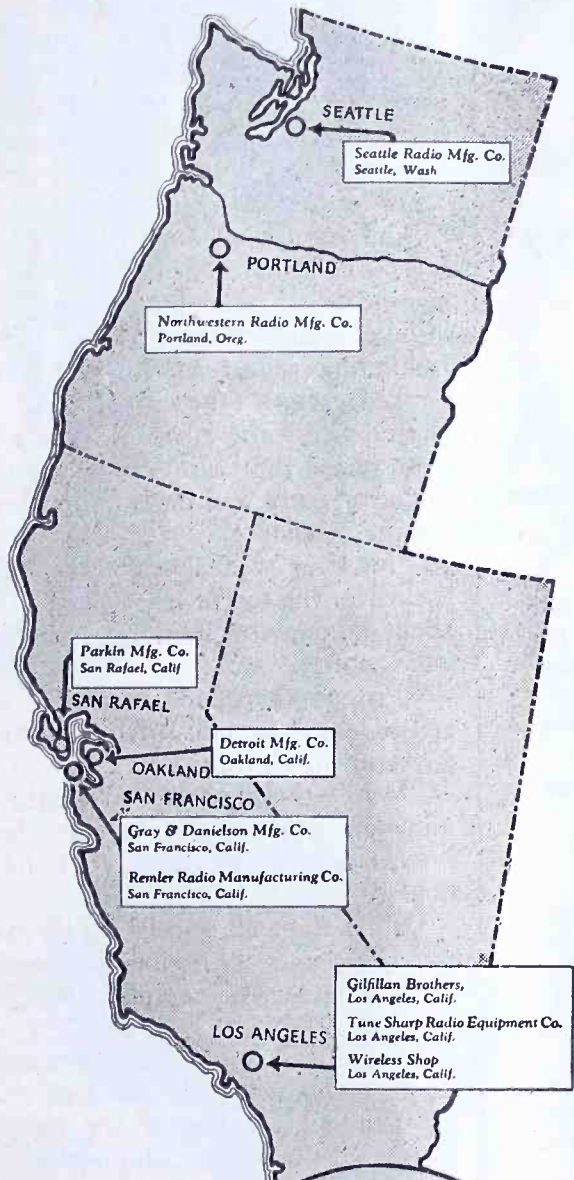

Bakelite—In the West

To meet the ever increasing demand for Bakelite radio parts, adequate sources of supply for the trade have been established all over the country. The accompanying map shows the location of leading radio manufacturers on the Pacific Coast who use Bakelite in their radio equipment.

If you patronize the local manufacturers, jobbers and dealers, you will be assured of prompt delivery and service and your equipment—made from Bakelite, radio's premier insulation—will be of the highest quality.

Dependability is the outstanding characteristic of Bakelite. After years of service it can still be relied upon to maintain the same effective protection as when new

There is no real substitute for Bakelite.

Send for our Radio Map

The Bakelite Radio Map lists the call letters, wave length and location of every broadcasting station in the world. Enclose 10 cents to cover the cost and we will send you this map. Address Map Department.

Send for our Booklet "S"

BAKELITE CORPORATION

247 Park Avenue, New York, N. Y.
Chicago Office: 636 West 22nd Street

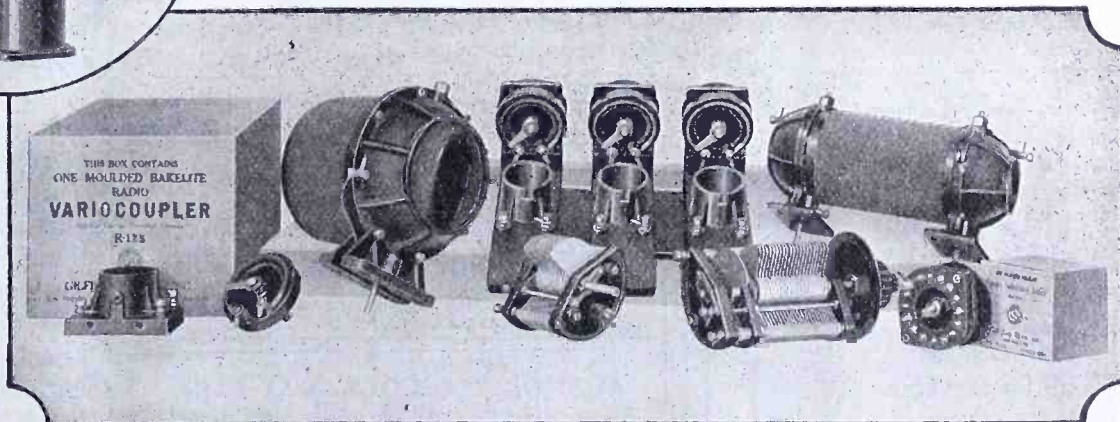
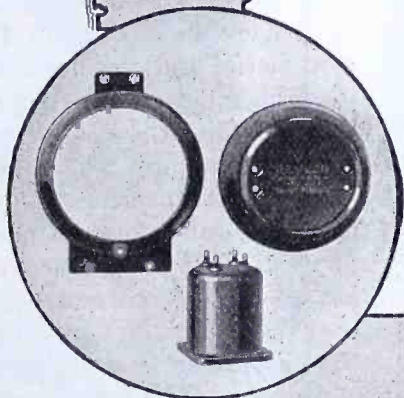

THE MATERIAL OF A THOUSAND USES

Tell them that you saw it in RADIO



"This is station WXYZ—"

When evening comes at your summer camp
tune in on the world with your vacation set

YOU need no longer go on a vacation and leave all the world behind. Carry a radio set with you. Every day it will bring to you the baseball scores and the favorite songs you listened to on your home set.

All you need is a simple single-tube assembly—one that will fit snugly into the old duffle bag.

Use care in selecting your panel

Careful building of your vacation set includes mounting your instruments on a first-class panel. Thus you give your instruments the proper insulation and increase reception.

A Celoron Radio Panel will give your set just the insulation it needs. Besides, it is practically indestructible. It does not chip, crack, or buckle. Celoron may be drilled, tapped, sawed or

bored, and it engraves easily without feathering. You can get it in black, oak, or mahogany finish. It is handsome in appearance and it never loses its lustre or becomes discolored.

Celoron, a bakelite material, is one of the finest insulating materials known. It is approved by the U. S. Navy and the U. S. Signal Corps and it is used by leading radio manufacturers and by thousands of radio fans.

Practically all good dealers sell Celoron Radio Panels.

Send for free booklet

If you will clip out the coupon below and mail it to us, we will send you an interesting booklet entitled, "Getting the Right Hook-up with Celoron." This little book contains many helpful suggestions for building and operating a set. Send for your copy now. It is free.

CELORON A BAKELITE PANEL

Diamond State Fibre Company

Branches in Principal Cities

Bridgeport, Pa.

Toronto, Canada — London, England

If you want to build a beautiful radio cabinet, use Vulcawood—the new cabinet material. If your dealer does not handle Vulcawood, write us. We will send you a pamphlet telling how to make a Vulcawood cabinet and will give you the address of the nearest dealer.

Diamond State Fibre Co., Date
Dept. P., Bridgeport, Pa.

Please send me without charge a copy of the booklet, "Getting the Right Hook-up with Celoron." My radio dealer's name is:

Name
Address

We Repair
RADIO TUBES
WD-11, WD-12, UV-200, UV-201, C-300, C-301, DV-6, DV-1, DV-2, DV-6A, UV-199, C-299, UV-201A, C-301A, Marconi Moorhead.
6v. plain Detector, 6v. plain Amplifier
\$2.50 for any type
Dealers' and Agents' Special Discount
Mail orders solicited and promptly attended to
H. & H. RADIO CO.
P. O. Box 22-M, Clinton Hill Sta., Newark, N. J.

HEATH Radiant Condensers

Permanently FLAT Plates
Micrometer Geared Vernier

Write for Literature

Jobbers and Dealers: Write for Proposition
HEATH RADIO & ELEC. MFG. CO.
208 First St. Newark, N. J.

Canadian Distributor:
Marconi Wireless Telegraph Co., Montreal, Can.

Distance! The Only AUTHORIZED COCKADAY COIL

Gets distant stations easily and clearly. Made in strict accordance with specifications by L. M. Cockaday, inventor of the famous Cockaday Four Circuit Tuner. Greater volume, sharper tuning, maximum selectivity. Guaranteed. At your dealers—otherwise write us direct.

PRECISION COIL COMPANY
209-C Centre Street New York

FOR KING AND RADIO

Continued from page 22

leading wet blanket in the kingdom, shook his head.

"Givest thyself a cheerio while it lasts," he said sourly. "On the morrow they will seek thy head in a basket!"

The king refused to be downhearted by any such prophecy, however. Instead, he ordered truncheons of royal wine rolled into the public square where all who came could make merry. For were not those who cheered to pay the bill by surtax on production costs? Yea verily—even so. All was jake and what cared he for funereal croakers!

The morrow dawned bright and early—as usual. Down in the palace basement all was bustle and activity. Whole regiments of artisans were busy fashioning radio sets for the kingdom. Crystals from the royal lead mines poured in by the carload. On all sides were heard the sounds of screw drivers, soldering irons and hand drills. And all for the people!

The king was about early, his robe tucked in the top of his boots. He went about among the workmen, rubbing his hands softly.

"Fifteen thousand sturken a week—at the least," he said softly, counting the government's profits.

"While they last," growled the prime minister, who refused to take the matter in its proper light. "I have no hopes."

"That's not all you haven't," retorted the king, and the prime departed in a huff, to leave his majesty to gloat in solitude.

It would seem, in truth, as though the king's belief was to be justified. Cheering thousands called at the palace and purchased their new radio outfits. They were instructed in their use, given an aerial and sent home happy, calling down blessings on their royal benefactor. The first day the king personally took in 1002 sturken, of which he turned over half to the government.

"For a going fund," he said to the chief of the treasury.

"Most correctly named, sire," chuckled the chief, pocketing the balance, as the door closed behind the king's august back. His was the creed of co-operation—a Rotarian at heart, a practical man in action.

So passed the week, and then came an element of discord—a shadow that overhung the palace walls like a sable mantle over the undershirt of Death. It was the chief of the secret service that knocked the king's peace into a cocked hat, as with white face and trembling hands, he staggered into the presence of the ruler and got a few remarks off his chest.

"Sire," he gasped. "You've been robbed!"

Continued on page 59

Tell them that you saw it in RADIO

REMLER

PARTS



Remler Type 610
Tuned Stage Trans-
former
Price \$5.00



Remler Type 600
Intermediate
Frequency Trans-
former
Price \$6.00

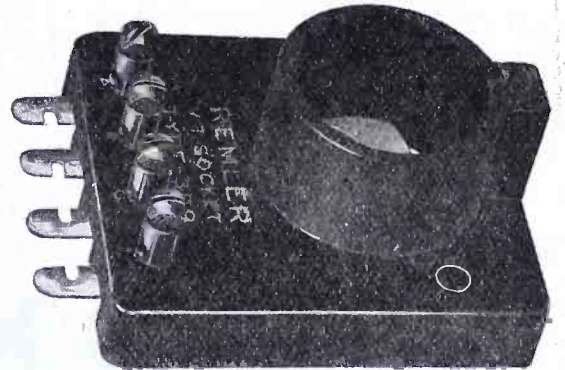

Remler Type 399
Improved Dry
Battery Socket
Price \$.75



Remler Type
620 Coupling
Unit
Price \$3.00

FOR 45,000 CYCLE WORK

Use REMLER Parts Because
They Are Designed And Built By Remler

THE Type 600 Intermediate Frequency Transformer and the Type 610 Tuned Stage Transformer work with maximum efficiency at a frequency of 45,000 cycles. Higher frequencies tend toward instability—lower frequencies may result in distortion and noise.

The Type 620 coupling unit has been designed to work with maximum efficiency when used with Remler Transformers.

The Type 399 Improved Dry Battery Tube Socket—"It cleans the tube contact"—it has a unique terminal arrangement which greatly simplifies the wiring of multi-tube receiving sets, especially those using several stages of amplification.

Remler Parts are designed to give maximum efficiency when used with the C-299 Tube.

Remler Parts require no stabilizer.

Remler Parts permit the use of a "C" Battery in the intermediate amplifier circuit, thus giving maximum output from the tubes.

Remler Parts are designed and constructed to form a complete radio set that is extremely simple in operation, ultra-selective and super-sensitive.

Write for descriptive literature on the assembly and use of these famous Remler Parts.

Remler Radio Manufacturing Co.

Branch
Chicago

Home Office
182 Second Street
San Francisco

Branch
New York

Tell them that you saw it in RADIO

Continued from page 48

RADIO AMATEURS TALK 7,000 MILES FOR 2 HOURS

**Argentinian and New Zealander
Establish What Is Declared a
Record for Non-Professionals.**

BUENOS AIRES, May 24 (Associated Press).—Carlos Braggio of Bernal, near here, and Ivan O'Meara of Gisborne, New Zealand, radio amateurs with 7,000 miles of South American continent and Pacific Ocean between them, conversed for two hours by radio Thursday morning, establishing what is claimed to be a world's amateur radio record.

Braggio, who knows English, had spent most of the night unsuccessfully attempting to get some North American amateur to answer the signals of his station, CBZ8, when at 4 o'clock in the morning he was amazed to receive an answer from the other side of the globe—O'Meara's station, 2AC.

The amateurs opened a conversation which continued until 6 o'clock, when Braggio told O'Meara he had been up all night and wanted to go to bed. The New Zealander answered that he was sorry because it was only 9 o'clock in the evening at Station 2AC. Later on Thursday Braggio received a congratulatory cable from O'Meara, confirming the conversation.

In connection with the radio communication test inaugurated this week with the United States, Argentine amateurs are unable to understand why they are able to get signals from North American amateurs while the latter apparently are unable to get theirs, although some of the Argentine stations are more powerful than some of the American ones which have been heard.

It is believed that many of the powerful broadcasting stations operating in the United States nightly interfere with the Argentine waves. In the future Braggio will try sending on a 120 meter wave-length at 3 A. M., Eastern Standard Time.

Argentinian and Jerseyite Exchange Radio Greetings

Special to The New York Times.

HARTFORD, Conn., June 2.—Two-way radio communication by amateurs between North and South America was attained for the first time last week by Norman R. Welble of Collingwood, N. J., and Carlos Braggio of Bernal, suburb of Buenos Aires. The feat was checked and verified today by the American Radio Relay League of this city, which tonight announced that Welble and Braggio had a twenty-minute connection on short wave lengths just before daybreak last Friday.

Braggio heard the New Jersey amateur calling him, and at 4:15 A. M. sent the following: "GM greetings and congratulations QRZ QRK."

Welble immediately replied in Spanish, "Saludo, Amigo de America del sur QRK."

A letter dated May 21, received today from E. J. Simmonds, an English amateur, stated he had heard the South American station transmitting.

Mr. Braggio Used

"ESCO"

Item 37—Double Commutator
1000 V. 600 W. for Plate
12 V. 300 W. for Filament

He writes:

"If I have the luck to be heard in the U. S. a great part of the success will be due to the good capacity of the "ESCO" set."

This is Item 37, used by CBZ8

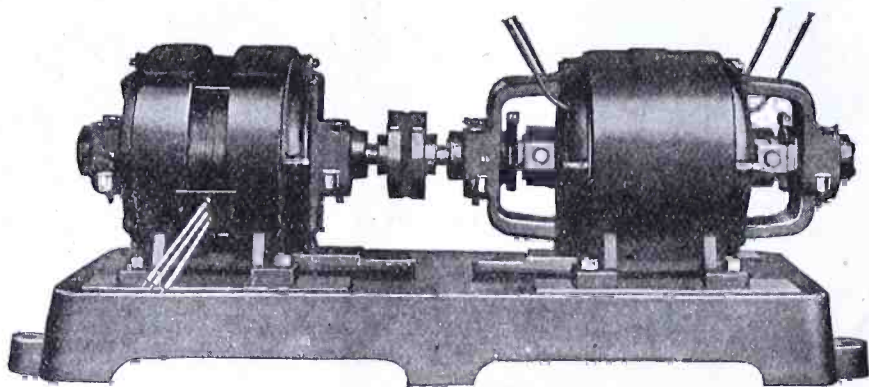

ELECTRIC SPECIALTY COMPANY

TRADE "ESCO" MARK

215 South Street

STAMFORD, CONN., U. S. A.

Pioneers in developing High Voltage Apparatus for Wireless Operation

The Romance of the Sea

Read the Story of the Life of a
Sea-going Radio Operator—

"THE RADIOBUSTER"

SENT POSTPAID ANYWHERE

PACIFIC RADIO PUB. CO.
PACIFIC BLDG., SAN FRANCISCO, CAL.

\$ 1.00
Per
Copy

\$ 1.00
Per
Copy

The king laid down the deck of cards he was marking for his coming poker game with the commander-in-chief of the army.

"What the h" he began, but the other cut him off in the prime of his utterance.

"Yea bo—cleaned like the pocket of a bum in a flop-house" he said. "Your neutrodyne tubes have been swiped!"

"Great Heavens!" The king sprang to his feet in great excitement. "You mean . . . ?"

"Aye!"

"Gosh!"

It was even so. Some bolshevist had snuck into the palace while the guards dawdled below stairs, and grabbed off the lamps that made the king's neutrodyne what it was.

"Who, think you, has dared to do this thing?" the king demanded.

Above the table he looked brave. But below the table his knees quaked aspenly.

"Someone who wishes to hear beyond the range of the legal crystal set," declared the chief of the secret service, sinking into a fauteuil. "It means revolution! I fear the worst!"

The king paled. Quickly in his mind he went over the situation. Then he spoke:

"But—the tubes are useless unless . . ."

"Sure unless the bums have swiped the diagram. But who knows? Maybe they have it already."

It was as he feared. Perhaps! Also, maybe! The thing was quite possible.

"Aux armes!" he ordered, without a moment's hesitation. "That is—if there are enough to go around. Seek out the miscreant and hang him in the public square."

"We seek, already," said the chief detective. "But so far we have only clues. You know what those are worth in court."

The king thought a moment.

"Suspend the writ of habeas corpus, nolle prosequi, and e pluribus assumpsit," he ordered. "Steam up the navy—or have we one—I have forgotten for the moment. Tell the royal grenadiers to change to plain clothes and start sleuthing. We must find this man before he wrecks the empire."

"Aye—it shall be done," said the chief. "But it seemeth to me, that hell is about to pop."

"Let it pop," declared the king, for he was no coward. "Let it pop, and we'll pop right back. Hop to it if you want your pay on Saturday night!"

The chief saluted and went out. An hour later he was back—whiter than before. In fact he looked exactly like a marshmallow, so white was he.

"Sire!" he gasped.

"Yes—yes. . ."

"Sire . . ."

Continued on page 52

Tell them that you saw it in RADIO

! FREE !

RADIO LOG BOOK

For Recording Stations Heard. This Book Free With Only One Subscription to "RADIO" for 6 Months—\$1.00.



Other Free Premiums—

- 5 Plate Variable Condenser
- Copy of "Elements of Radio Communication" by Stone
- Induction Filter
- Radio Map of U. S.
- "The Radiobuster"

Send \$2.50 and get "RADIO" for one full year and your choice of one of these premiums.



"RADIO"
Pacific Building
San Francisco, Cal.

Drills Easier!

If it's
Spaulding BAKELITE-DURESTO

—and furthermore, you can depend upon Spaulding Bakelite-Duresto panels as combining in one material these vital qualities—drills without chipping; cuts clean, leaves no ragged edges; engraves easily; retains its natural mirror gloss finish and color; will not sag or warp under weight of mounted instruments; possesses high dielectric properties.

Write for descriptive circular.
Department 7

SPAULDING FIBRE COMPANY, INC.
Tonawanda, New York

SALES OFFICES—WAREHOUSES
New York City Philadelphia
Chicago Boston

Ask your dealer for Spaulding Bakelite-Duresto. Insist on it and be assured of these qualities—the fundamentals of good construction and best results.

**DO YOU LISTEN TO
KPO--KLX--KGO
KHJ--KFI--KGW?**

If so—you need
"Broadcast Program"
containing complete detailed programs for these stations.

Issued Weekly by the Publishers of "RADIO"
Write for Free Sample Copy.

THE BEST SUPER-HETERODYNE

Is Best "Bar None"

By BEST

Super Fans, wake up! The Jaynxon Radio Research Laboratory has made them all and found the G. M. Best (Technical Editor RADIO) Super-Heterodyne a highly commendable super radio apparatus, by far the best of Super-Heterodynes.

Complete Sets, K'its, Parts—immediate delivery. Send for Super Sheet, free. Explains Parts, Cost, for the Best, Jaynxon, General Radio, and other Supers.

JAYNXON LABORATORY
57 Dey Street New York City

Continued from page 50

"I said yes, yes . . ."

"They have the diagram!"

A cry burst from the king's throat! They had the diagram! Tubes and neutrodyne! Great Hercules! There was nothing to stop them now from building the set. Once done, and the wars, troubles, political machinations and turmoils of the outside world would be theirs for the tuning. Ye godz!

"Call the council! Find every drunken one of them and shoo them into the council chamber! We must save the nation! Make it snappy!"

The king's voice rang out clarion clear, like an auctioneer on his last bid. His father would certainly have been proud of him in that moment.

The chief hurried from the wine-cellar, where the conversation had taken place, and within a few minutes the call bells were ringing in every room of the palace, while the royal pages were calling the various chiefs of departments.

"Call for the grand chancellor—Call for the secretary of the navy. You are wanted on the telephone!"

Fifteen minutes later, a bevy of scared executives were parked in the council chamber. There the king, wearing the uniform of a retiring admiral of the royal navy, addressed them briefly.

"Gents," he said. "Calamity has befallen the empire. Some low-down, wall-eyed piute has glommed the lamps out of our neutrodyne. To make it worse he got away with the wiring diagram also. You know what that means."

"What does it mean?" asked the secretary of the interior, who was not considered bright.

"It means that once the reds build a neutrodyne, my job, your job, everybody's job is worth less than the cube root of zero."

The prime minister cut in with a comment.

"That's darned little," he remarked.

"It is," said the king. "They'll find out, by listening to the Associated Press reports, that I'm about the only king left on the job in Europe. And they'll chase me so far I'll meet myself coming back. You birds will be lined up against a wall, and, without right of clergy, plugged in bunches by a firing squad. That's what it means."

"Good night," exclaimed the chief of the bureau of valuations and increments.

"Exactly," said his majesty. "Now—has anybody a suggestion?"

"You've scared all of mine out of me," said the prime minister without hesitation, turning green.

The secretary of domestic relations and other relatives spoke up.

"Let us meet fire with fire," he said. "Let us give away regenerative sets free to the public!"

Continued on page 54

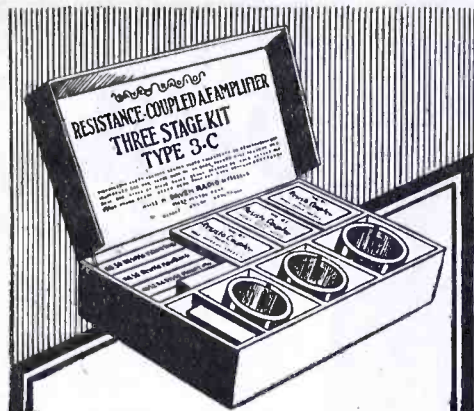

Resistance Coupled Amplification

The tone quality from a Daven Resistance Coupled Amplifier is the most perfect known to the Radio Art.

Our type 3-C KIT, illustrated, contains all the necessary parts to build a three stage resistance coupled amplifier. Cannot disassemble. Price \$13.50.

You will be interested in our booklet, "RESISTORS—THEIR APPLICATION TO RADIO RECEPTION," by Zeh Bouck.

Price 15 cents.

Get a Copy from Your Dealer

DAVEN RADIO CORP.

"Resistor Specialists"

9 1/2 Campbell St. Newark, N. J.

Pacific Coast Representative

W. J. RHYNSBURGER
500 Citizens Nat'l Bank Bldg.
Los Angeles, Cal.

A BUFFALO RADIO FAN GETS LONDON WITH THE HELP OF A **KIC-O**

Mr. E. C. Lewis on March 18th, heard Mr. Marconi's voice on a Model 10 Atwater Kent Machine. He said it would have been impossible without a KIC-O Battery. Improve your set with a KIC-O. Our guarantee protects you.

Volts	Price, Plain	With Panels
22	\$ 5.50
32	7.25	\$11.75
48	9.50	14.00
68	12.50	17.00
100	17.50	22.50
145	23.50	28.50

GUARANTEE

Your money back on any KIC-O Battery if not satisfied within 30 days' trial.

Write for full information on "A" and "B" Batteries.

Unmounted Rectifier. \$1.00
Mounted Rectifier. . . \$2.50

KIMLEY ELECTRIC COMPANY, Inc.
2661 MAIN STREET BUFFALO, N. Y.

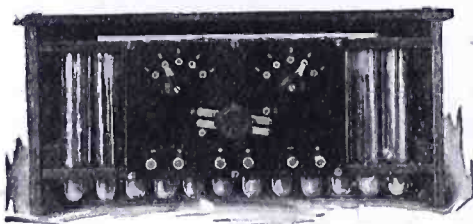

100 VOLT TYPE

Read the RADIOADS on Page 79

Two Condensers in One

Radio fans, who have had trouble connecting and adjusting grid biasing condensers, will appreciate our new condenser, code 610, which the Kellogg Company have just placed on the market. This is a standard 11-plate variable condenser of minimum .000074 and maximum .00035 microfarads, and it has as part of the construction a micrometer vernier condenser with a capacity minimum of one micro-microfarad and a maximum of ten micro-microfarads.

The use of this 610 Kellogg condenser has many advantages.

1. It is designed to provide a vernier of minute capacity that can be used as a bias.
2. To eliminate unnecessary wiring and its attendant difficulties and complications.
3. To limit the number of parts necessary in the set.
4. Providing the greatest degree of efficiency in circuits requiring grid, micrometer, or biasing condenser.

The use of these condensers in any stage improves not only the appearance of the set, because of reducing the amount of wiring and apparatus, but actually aids in more efficient tuning.

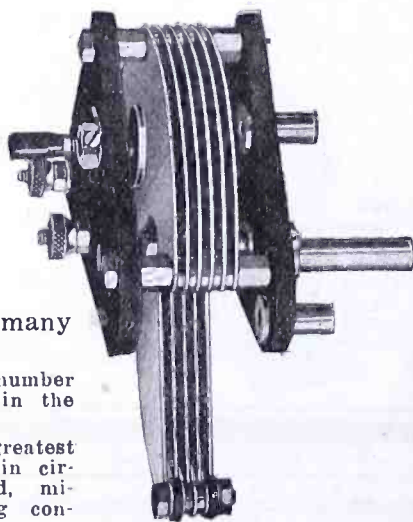

No. 610

KELLOGG SWITCHBOARD & SUPPLY COMPANY

1066 West Adams Street, Chicago, Ill.



THOS. L. KENNON

C. E. THOMPSON

Cable Address "KENNON"

CONSULTING
REPAIRING
REWIRING
ASSEMBLING
SCIENTIFIC
APPARATUS
DEVELOPED

Super-Heterodyne Authorities

All Work Unconditionally Guaranteed

Kennon Radio Laboratories

RADIO RESEARCH ENGINEERS

988 MARKET ST.
804-06 Loew Building
SAN FRANCISCO
CALIF.

Tell them that you saw it in RADIO

A ROYAL TREAT For The RADIO AMATEURS

AT THE Pacific Radio Exposition in San Francisco, August 16 to 21, you will see the latest developments of the radio art. A number of complete amateur equipments will be displayed by the leading radio manufacturers. Engineers from the big Eastern factories are coming to San Francisco to demonstrate their inventions. Almost every well known radio manufacturer will have an elaborate display. No amateur can afford to miss this gigantic show. Meet your brother "hams" in San Francisco—look over the many exhibits at the show and then make your decision as to the type of apparatus to purchase for your "DX" work during the winter.

A Few of the Many Attractions of the Show--

- 1—Complete 10 watt transmitter for C. W. & Voice.
 - 2—Radio Corporation line of sets will be displayed.
 - 3—Many Super-Heterodyne receivers will be shown.
 - 4—"RADIO PIONEERS" will raffle 6 complete sets.
 - 5—U. S. Radio Inspector will have booth at show.
 - 6—U. S. Navy will install 3 complete transmitters.
 - 7—Dept of Electricity will show how to build aerials.
 - 8—S. F. Radio Club, Inc., will have interesting display.
 - 9—Actual manufacturing processes will be shown.
 - 10—Coil winding machines will be in operation.
 - 11—10 Storage Battery manufacturers will have booths.
 - 12—Best's Super-Heterodyne will be on display.
 - 13—Local newspapers will have editorial rooms at show.
 - 14—Latest radio tools and machinery will be demonstrated.
 - 15—Sets will be wired and assembled every evening.
 - 16—Many important lectures will be delivered by exhibitors.
 - 17—Model radio home of 4 rooms will be erected.
 - 18—Broadcasting will be conducted direct from Auditorium.
 - 19—150 original radio stunts will be shown.
 - 20—Prizes will be awarded by many exhibitors.
 - 21—Exclusive dealer hours from 10 A. M. till noon, daily.
- And a hundred and one other attractions!!!!!!

PACIFIC RADIO EXPOSITION

EXECUTIVE OFFICES

Monadnock Bldg., S. F. Telephone Douglas 5887

Doors open at 8:30 P.M. Aug. 16.
Daily thereafter till August 21,
from 2:30 P. M. till 11 P. M.

**WORLD'S GREATEST
RADIO SHOW
AUGUST
16 to 21**

admission
25¢

SAN FRANCISCO
CIVIC AUDITORIUM
150 Exhibits. 150 Radio Stunts.
Every exhibit a show
in itself.

Conducted, Financed and Operated by the Pacific Radio Trade Association

Tell them that you saw it in RADIO

THE CHOICE OF RADIO EXPERTS

Super popularity!

The Master Instrument for the Master Set

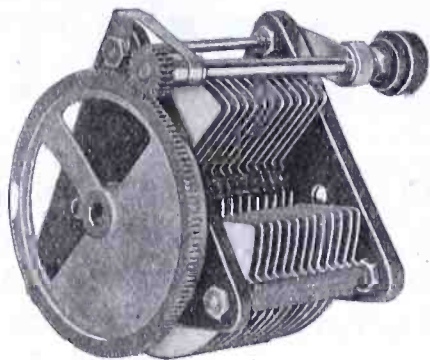

Type 247-H Variable Condenser with Geared Vernier

Capacity 500 MMF. Price \$5.00

For complete description of Quality parts for use in the Super-heterodyne and other popular circuits, write for Bulletins 917 and 918C

GENERAL RADIO Co
Cambridge, Mass.



SIGNAL RADIO CABINETS

Signal radio cabinets have been purchased by the big majority of set builders.

Built by radio engineers, they have all the elements that appeal to the average builder and meet all his requirements.

Ask your dealer.

TYPE "B" CABINET

Sizes and Prices

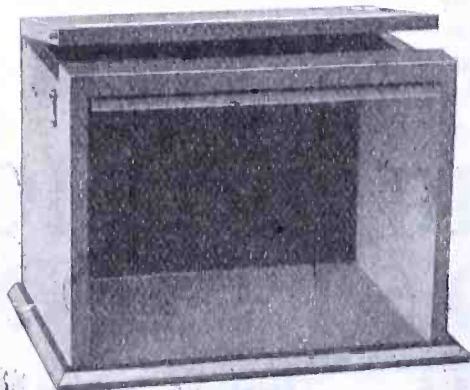

Height	Width	Depth	Regular List Price
7	10½	7	\$3.39
7	12	7	3.57
7	14	7	3.83
7	18	7	4.33
7	21	7	4.71
7	24	7	5.09
7	26	8	5.56
7	30	8	5.94

SIGNAL Electric Mfg. Co.

Factory and General Offices:
1913 Broadway,
Menominee, Mich.

Los Angeles Chicago Minneapolis New York San Francisco
Boston Philadelphia Montreal Pittsburgh St. Louis
Seattle Toronto Winnipeg Havana, Cuba

You'll find our local address in your Telephone Directory.

Continued from page 53

The king stared at him. "What good will that do?" he asked. "Well," said the S. of D.R. and O.R., "you know how women are. Give something for nothing and every housewife in the empire will be there. Once you get the air filled with regenerative sets the neutrodyne babies can't hear a thing!"

There was a moment of stunned silence. Then the king sprang to his feet.

"By my haildom," he exclaimed, "thou hast indeed saved the bacon. Yea bo—that is one hum-dinger of an idea."

He touched a button at his elbow and the boss of production and wholesale marketing stepped through a panel at his left.

"We will start making regenerative one-tube sets at once," the king commanded. "Make them in thousand lots." He ran his eyes around the assembly and, deciding that all could be trusted, went on. "Make them so that every doggoned one will oscillate . . . like the devil!"

The production boss bowed low.

"It shall be as you say, sire," he replied.

The king turned to the S. of D.R. and O.R., and his face was wreathed in smiles.

"Thou hast done the kingdom a royal service," he said. "I will knight thee for thy brain-work. Which night shall it be—Saturday or Sunday?"

"Sunday, sire," said the other modestly, and the king smote him on the head with his sword and that was that.

This was on a Monday. Wednesday the king started giving away the one-tube, single-circuit regenerative sets. More—he offered a prize of 12,000 sturken for the man or woman who first throughout the kingdom was able to tune in Paris and prove it! As a result of this offer the kingdom fairly hummed.

IN a back room, up a narrow stairway, a group of conspirators gathered over the first bootleg neutrodyne set that had been made in the country. It was a gathering of bolshevists of all classes under their great leader—the man at the head of the table. That night had been set for the zero hour—Friday. At 8 o'clock, the supreme test would be made. All was in readiness!

"Slip me the king's tubes!" said the leader.

His assistant opened a safe and from an inner compartment took the precious lamps that were to spell a new order of things. As one handling jewels, he passed the five precious tubes to the head of the anti-royalty movement. One by one they were slipped into their sockets—and then—

A switch snapped and the lamps

Continued on page 56

Loud Speaker is Perfected!

Human Voice and Music Now Actually Reproduced over Radio

The slap-stick assembled loud speaker consisting of a phone unit attached to a horn and absolutely void of any engineering principles has placed radio in contempt. Rather than tolerate its irritating noises mixed with uncanny tones, many still prefer the headsets. A faithful reproduction of the original tones—free from all noises—was necessary before radio could be changed from a braying novelty to a refined medium of entertainment. To reach this goal, it has been conceded by experts that a radical departure in the construction of loud speakers must be made.

The Loud Speaker of Tomorrow Must Positively be Built

*Along acoustical lines, not merely advertised as such.
Only as a reproducer, not as a reproducer and a producer.
Without a resonance that will shade the original reception
into a deep down-in-the-well reproduction.*

Before

*A clear re-creation of the fundamental tones and their overtones—free from all internal noises—is possible.
Such only is the loud-speaker Echo-Tone.*

ECHO-TONE is built upon the principles of catacoustics—the science of reflected sounds or echoes—because it was discovered that the sound waves and air back of the diaphragm needed attention. In other words, the loud speaker needed a nose, and by giving Echo-Tone a nose—the loud speaker was perfected.



Echo-Tone

"The loud speaker with a nose."

Equally adapted to sets using dry or wet A batteries—no extra power needed.

Dia. Horn 16 in.
Height..... 24 in.
Weight..... 5¾ lb.
Color..... Silver Tone
Material..... Aluminum

Durable—Fool-proof.

Price \$30.00

THE NOSE WHICH
ELIMINATES ALL
NASAL, METALLIC,
AND TIN HORN
EFFECTS

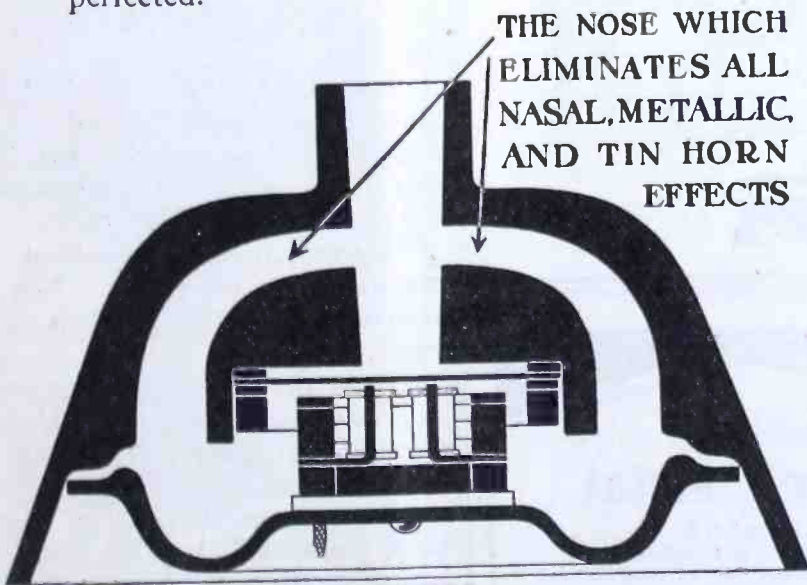

PATENTED

Throw away your headset! Waiting now is wasted time; for that Loud Speaker of Tomorrow is here Today! Order immediately and allow the whole family to enjoy in advance the new improved 1925 model Echo-Tone.

WILLIAMS RADIO COMPANY

1438 Washington Boulevard
DETROIT, MICHIGAN

Western Representatives
GLOBE COMMERCIAL CO. - 709 Mission St., San Francisco

Tell them that you saw it in RADIO

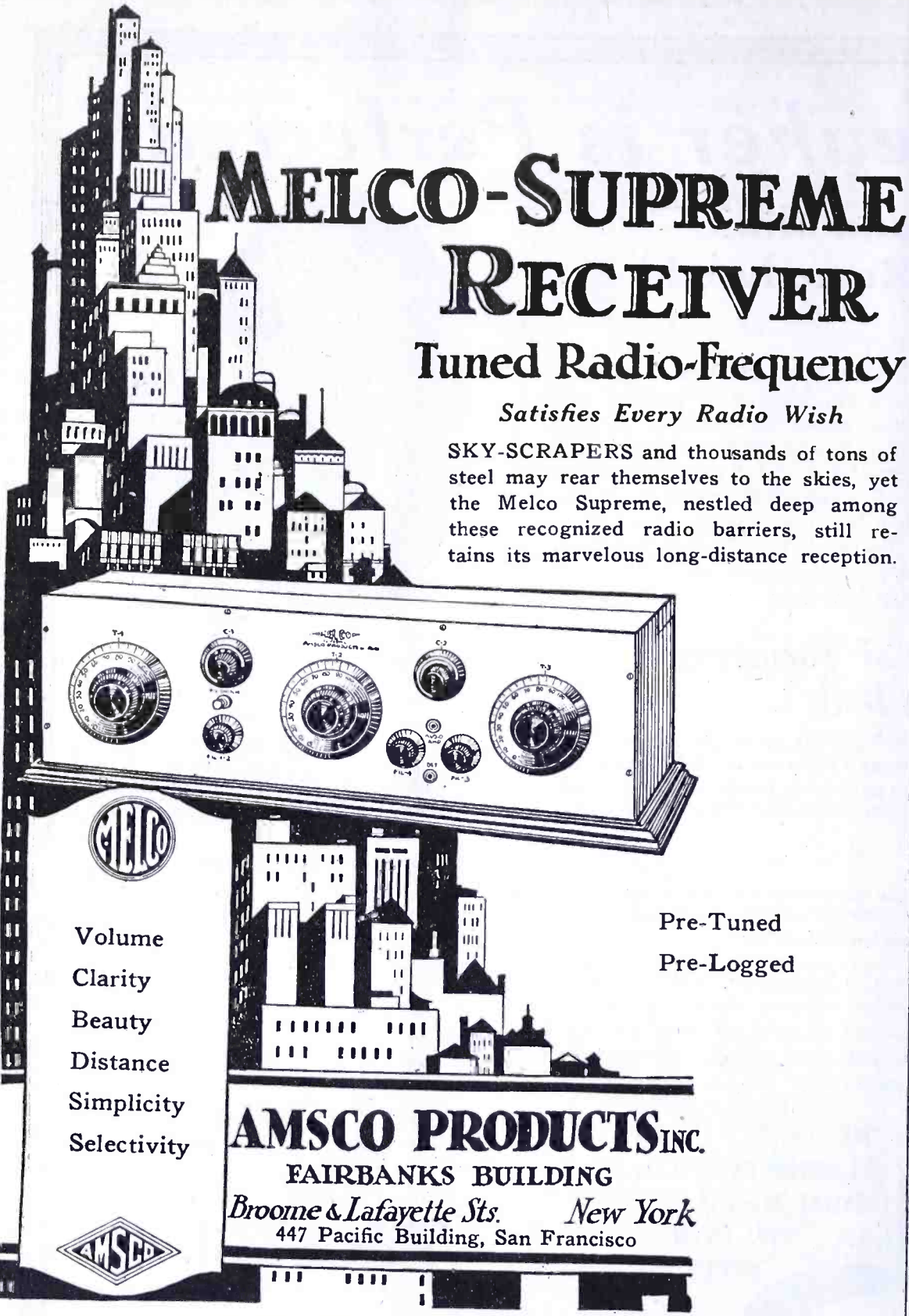

MELCO-SUPREME RECEIVER

Tuned Radio-Frequency

Satisfies Every Radio Wish

SKY-SCRAPERS and thousands of tons of steel may rear themselves to the skies, yet the Melco Supreme, nestled deep among these recognized radio barriers, still retains its marvelous long-distance reception.

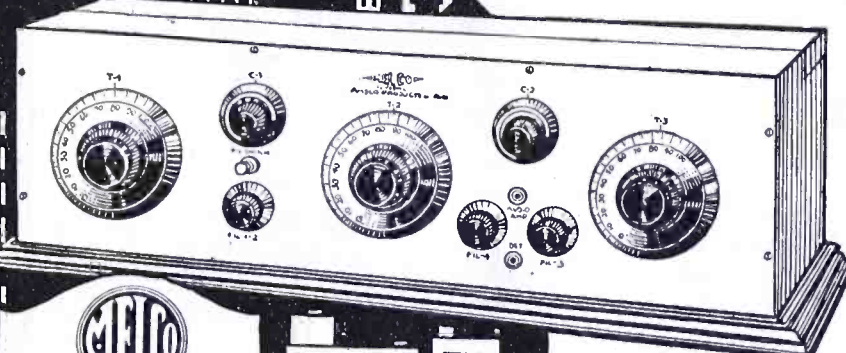

Volume
Clarity
Beauty
Distance
Simplicity
Selectivity

Pre-Tuned
Pre-Logged

AMSCO PRODUCTS INC.
FAIRBANKS BUILDING
Broome & Lafayette Sts. New York
447 Pacific Building, San Francisco

Continued from page 54

glowed with a warm kindness that seemed to fill the room with an augury of future freedoms.

"Kablott!" exclaimed the leader, quoting the famous Jugo-Slovakian statesman Bjorblcm, in his famous speech on liberty.

Outdoors quite another scene was being enacted. In department stores, drug stores, groceries, delicatessens, in hotel lobbies and barber shops, purveyors to the king were handing out the free regenerative sets, given away to the public by official mandate. A free aerial and a card of instructions, accompanied by batteries went with the sets. And the king's faith in psychology was justified.

Housewives by the thousand swarmed the streets, singing national airs and holding receiving sets over their heads. Children carried them home to bed-ridden mothers. Fathers paused in their debates over the income tax to grab a set and bring it home to the folks. In two hours, fifty thousand royal radio sets, each one ready to secretly oscillate, had been distributed and more were on their way. It was a triumph of production and kingly strategy.

At 8 o'clock that night the first great air derby in the kingdom's history, the universal out seeking for Paris, started. At that hour the secret conspirators in the back room attached their neutrodyne set to their aerial and started tuning for the world's hidden storehouse of knowledge. As the stolen tubes warmed into life there came to the ears of the listeners an ungodly crash of noise—wails, catcalls, shrieks, hoots, yowls, yodles and screams, as thousands of regenerative sets, operated by housewives, strove for the prize of 12,000 sturkens offered by the king.

Ten minutes later, the leader of the revolutionary party, the man who had staked his all on a single move, and lost, fell forward on the table frothing at the mouth, a victim of hysteria.

"Ruined, ruined," he sobbed, digging his nails into the table. "Not even a neutrodyne can get through that barrage . . ."

Up in the palace, the king sat beside a private leased wire, taking bulletins furnished to him by the editor of the Royal News.

"The regenerative party wins by a large majority," came the flash at midnight. "All is in chaos. Women are fighting in the backyards, charging each other with mutual interference. Neutrodyne headquarters admit that their efforts have met with defeat. They concede the kingdom lost to their cause."

With trembling hands the king laid down the flimsy and turned to the assembled members of the royal council.

"Boys," he said,—and he spoke as one surcharged with emotion, although the

Continued on page 58

"ROLLS-ROYCE" RADIO TUBES



Like their name, significant of quality. Durable and powerful. Bring in distance with a maximum of volume and clearness.

Type 200 . . . 5 Volts, 1 Ampere Detector Tube.

Type 201A . . . 5 Volts, .25 Ampere Amplifier and Detector.

Type 199 . . . 3-4 Volts, .06 Ampere Amplifier and Detector.

Type 199 . . . 3-4 Volts, .06 Ampere With Standard Base.

Type 12 . . . 1 1/2 Volts, .25 Ampere Platinum Filament Amplifier and Detector

"The Rolls-Royce of Radio Tubes." ALL TYPES . . . **\$2.50**

Type 202 . . . 5 Watt Transmitters, \$3.00

ALL TUBES GUARANTEED to work in Radio Frequency. Especially adapted for Neutrodyne, Reflex and Super-Heterodyne Sets.

Shipped Parcel Post C. O. D. When Ordering Mention Type

ROLLS-ROYCE TUBE CO. 21 Norwood St. (Dept. R) NEWARK, N. J.

50¢

Genuine Miller-B-Metal

Crystal

Reg. U. S. Pat. Office

Once you use Miller-B-Metal Crystal you'll have no other—it certainly makes your set "talk up." Two extra pieces of Miller-B-Metal sent free with every crystal container. Order from your dealer or direct from factory

PACIFIC COAST DISTRIBUTOR

Somewhere in San Francisco or Los Angeles there is a man or organization who can represent us on the coast. If seriously interested write immediately.

THE A. H. MILLER RADIO COMPANY
1218 20th Street Detroit, Mich.
The formula for B-Metal was originated by A. H. Miller

A LIVE-LOUD

Tell them that you saw it in RADIO

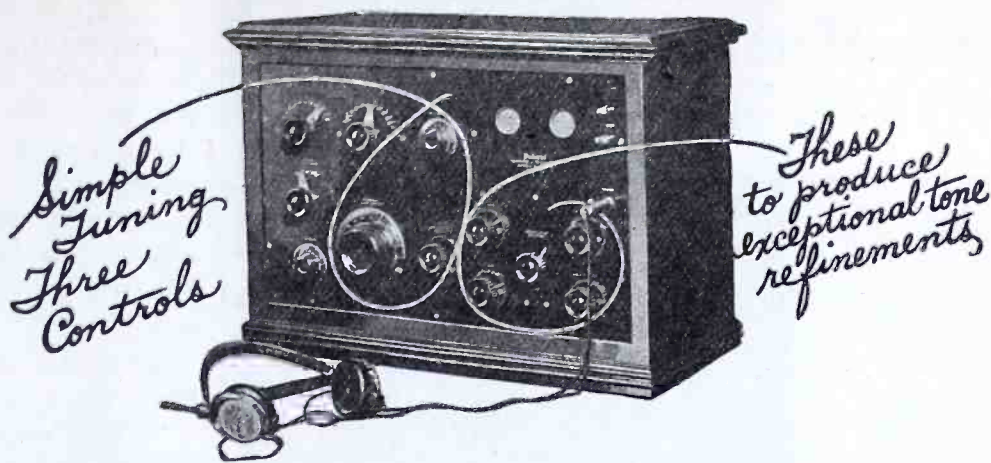

FEDERAL insures to its users only the highest refinement of the art. Each and every manufacturing necessity to produce a harmonious radio set is known to Federal Engineers, and no Federal set is produced without them.

Federal radio sets are built with two thoughts in mind—first: simplicity of operation, but three controls being necessary—second: special controls for refinement for “lovers of good music” interested in reproducing all the beauty of tones that fill the air.

Boston New York
Philadelphia
Chicago Pittsburgh
San Francisco
Bridgeburg, Canada



FEDERAL TELEPHONE & TELEGRAPH CO.
BUFFALO, N. Y.

Federal
Standard **RADIO** Products

Look for this sign



Don't fail to see our exhibit at the **PACIFIC RADIO EXPOSITION** San Francisco August 16-21 Civic Auditorium

The Van-Le Reproducer
ELECTRIC LAMP TYPE



An entirely new and radical departure in the amplification of sound waves. Big improvement over Horn Type of Loud Speaker. All throaty tones eliminated. Sound waves carry equally to every part of room. Made in three types: Electric Lamp (as illustrated), Fruit Bowl and Cabinet.

Ask Your Dealer or Write Us.
Dealers—Write for Special Proposition.

VAN-LE CORPORATION

100 Sip Ave., Jersey City, N. J.

Western Representative:
FREDERIC H. TOMLINSON COMPANY
447 Pacific Bldg., San Francisco
1113 Wall St., Los Angeles
116 13th Ave North, Seattle

Tested and Listed as Standard by Underwriters' Laboratories

The **FANSTEEL**

Balkite

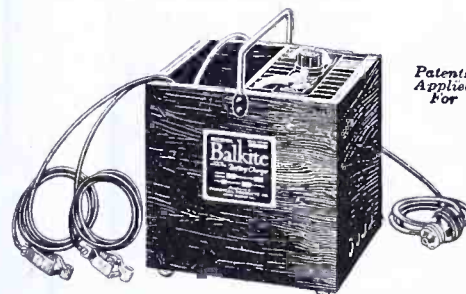

Patents Applied For

battery charger is noiseless
and has no bulbs or moving parts

The Fansteel Balkite Battery Charger for Radio "A" (6 volt) Batteries is an entirely new type of rectifier, based on the use of Fansteel Balkite, a new and rare metal developed for this purpose.

1. It is entirely noiseless.
2. It cannot deteriorate through use or disuse.
3. It has no moving parts.
4. It has nothing to adjust or get out of order.
5. It cannot discharge or short-circuit the battery.
6. It requires no attention other than an occasional filling with distilled water.
7. It will not over-charge.
8. It cannot fail to operate when connected to the battery and line current.
9. It is unaffected by temperature or fluctuations in line current.
10. It is simple, efficient and indestructible except through abuse.
11. Without added attachments the charger may also be used to charge "B" storage batteries.
12. It can be used while the radio set is in operation.

The Fansteel Balkite Battery Charger will charge the ordinary 6 volt radio or automobile storage battery at 3 amperes, from 110-120 AC, 50-60 cycle current.

Price, \$20 \$19.50 East of the Rockies

Manufactured by Fansteel Products Company, Inc., North Chicago, Illinois

Sales Representatives

A. S. LINDSTROM
111 New Montgomery St.
San Francisco

GEORGE H. MAIRE
95 Connecticut St.
Seattle, Wash.

H. A. KILLAM
312 McKay Bldg.
Portland, Ore.

CARL A. STONE & CO.
537 Fernando Building
Los Angeles, Calif.

Tell them that you saw it in RADIO

Como Super-Heterodyne Wins!

A. B. Hoag, Radio Editor "Boston American," says: "In comparative tests we made with Super-Heterodynes, Como Super-Heterodyne proved superior. It is the best and neatest design I have seen."

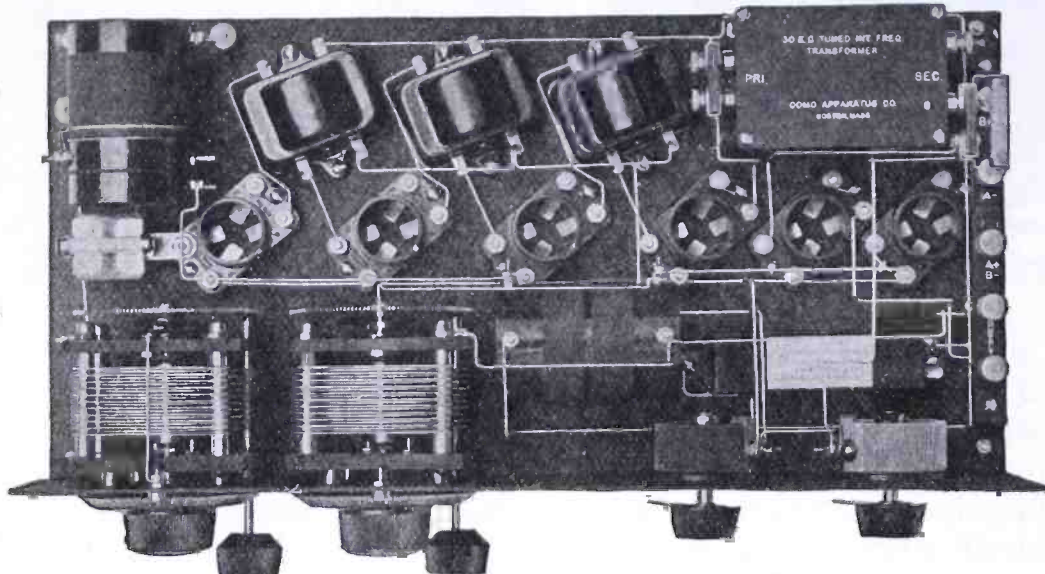

Complete parts as shown above, \$87.50

Constructional data sold separately at \$1.00

Manufactured by
COMO APPARATUS CORPORATION

446 Tremont St., Boston, Mass.

PHILADELPHIA TO LONDON

Quoting from front page of Philadelphia Inquirer: December 26th, 1923: "At about 10:57 o'clock Mr. _____ tuned in 2 L O (London)."

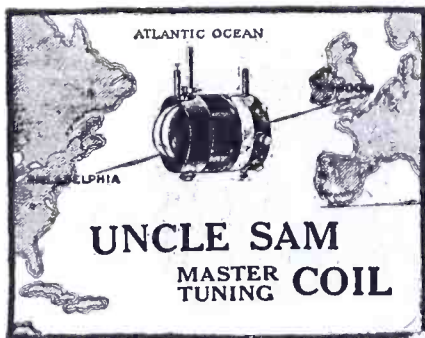

UNCLE SAM MASTER TUNING COIL

Brings In Stations You Never Heard Before

Price \$5.50

Ask your dealer or send self-addressed stamped envelope for wiring diagrams and panel layouts of circuits in which the wonderful Uncle Sam Coil can be used.

UNCLE SAM ELECTRIC CO.
213 East Sixth St. Plainfield, N. J.

MAKE MONEY—SELL RADIO

Radio offers the biggest money-making opportunity today. And the Ozarka Plan opens the door to this big opportunity. This wonderful plan makes it easy and simple for you to manufacture the beautiful, long distance Ozarka Radio Receiving Set. It will be your Radio, made by you and sold by you, with a big cash profit as your reward. No experience necessary. You need not have much cash. All you need is spare time, determination and action. If you're that kind of a chap, the Ozarka Plan will start you on a straight line toward a real money-making business of your own. It can be as big and as profitable as you are ambitious to make it. We want good men in every county. Exclusive territory is going fast. Be sure and give us the name of your county. Write today for the Ozarka Plan. A wonderfully interesting book of facts, particulars and proofs. It is FREE. Act now.

OZARKA, INC.
66 North Peoria St. CHICAGO

FROST-RADIO

Ask Your Neighbor



No. 140 **FONE** Plug 60c
BEST value in a Two-Fone Plug ever offered. Holds fone cord tips under set-screw. Used with two pairs head fones or one pair and loud speaker. Get it at your dealer's.

HERBERT H. FROST, Inc.
New York CHICAGO Kansas City, Mo.

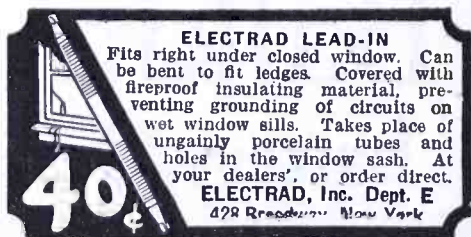

CRESCENT LAVITE RESISTANCES

Absolutely Non-inductive

12,000	Ohms		List \$1.50
48,000			
50,000			
100,000			

Special Sizes to Order
Used in all Circuits. Dealers write for discounts
CRESCENT RADIO SUPPLY CO., 5 Liberty St., Jamaica, N.Y.

To Manufacturers of Radio Receivers

1. We will make horns or concealed loud speakers and sounding boxes to order, using Madera die-cast wood in any size, shape, or quantity.
2. Or, we will supply our regular Madera "Clear-Speakers," in quantities, to be offered by you as standard equipment. This will insure the 100% performance of your sets and protect you from being blamed for the "frightfulness" of metal loud speakers.

AMERICAN ART MACHE COMPANY
357 West Austin Avenue Chicago, Illinois

Continued from page 56

Scotch he had consumed in the last two hours might have had something to do with it. "Boys—this is a great victory. We have won with clean hands. The people will never give up their regenerative sets as long as they can annoy each other. They will never be able to hear what the outside world is doing. Victory is ours!"

The royal council broke into cheers. But the prime minister raised his hand.

"There remains but one more thing to cinch the deal," he said. "We must see to it that they never do give up their radio sets. There is only one way by which that can be accomplished!"

For a moment the king stared at him. Then his face lighted.

"Fine," he said. "We will prohibit them!" In prohibition is our guarantee of permanence!"

And as one man, the royal council bowed with humble respect before the greatness of their king and ruler!

POWER AMPLIFYING TRANSFORMERS

Continued from page 16

found on signals that have a fair degree of strength in the detector circuit that sufficient voltage and amperage will be obtained to operate the relay. Obviously, a tape recorder could be connected in its place, and a definite record obtained of messages. A Weston voltmeter, which uses a galvanometer mechanism, with a scale of 0 to 30, will give a strong deflection of the needle with each dot and dash, easily read by an experienced operator. On strong signals the deflection will be well over an inch. The initial voltage will cause a deflection of between 3 to 15 volts, while no signals are being received, the needle swinging from this point upward.

If one places his hands across the output terminals (use care if the plate voltage is above 150 volts on the amplifiers) incoming code signals may be read in a succession of shocks, sometimes of painful intensity. Likewise, broadcast programs "register" with the inflections of voice or music.

Permanent record of broadcast programs or code signals may be made by use of a dictograph, or an old style Edison cylinder phonograph that is equipped for reproduction purposes. Likewise, a tape recorder may be used on code signals to make a permanent record of received messages. Such a device, making use of power amplification, is practical for use on high-powered stations on the higher wavelengths at distances of several thousand miles from the receiving station.

Tell them that you saw it in RADIO

Sell it in Chicago

*(There are 610,000 Homes
Without Radio Sets)*

There are approximately 90,000 radio receiving sets within Chicago and its forty-mile radius, according to the radio inspector of the ninth district.

But there are 700,000 homes within Chicago and its forty-mile radius.

Here then is a market offering unlimited opportunities for the manufacturer of sets and parts.

In Chicago the "radio newspaper" is the Chicago Evening American—not only because it is Chicago's pioneer radio newspaper but because it has from the beginning kept pace with the growth of the industry.

With a daily average net-paid circulation in June of 473,602, of which

more than 412,000 is concentrated within Chicago and suburbs, the Chicago Evening American gives coverage that no advertiser can afford to overlook.

In 1923 the Chicago Evening American published more radio advertising than any other Chicago newspaper, and during the first six months of 1924 it led the second evening newspaper by 23,872 lines and led the morning newspaper with the highest radio score by 74,333 lines.

Here you have all the facts necessary for judgment, but if additional information is desired an interesting booklet covering the radio situation will be mailed free upon request.

Chicago Evening American

326 WEST MADISON STREET

NEW YORK OFFICE:

2 Columbus Circle

Rodney Boone, Manager

PACIFIC COAST OFFICE:

58 Sutter Street, San Francisco

Arthur Booth, Manager

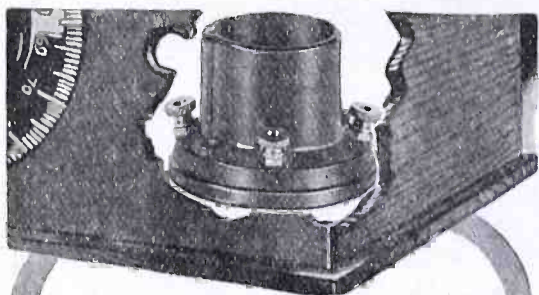

Get Directly at Them

Are the contacts in the sockets of your radio set easily accessible for ordinary and necessary cleaning?

With Na-ald De Luxe Sockets in use you need neither sand-paper or an extra reach to keep contact strips and tube terminals bright and clean.

Just rotate the tube three or four times. Instantly the dual-wipe laminated contacts remove corrosion, making a bright perfect connection. This action is on the side of the tube terminals away from the soldered ends. "It's the contact that counts."

Make your Super-heterodyne set free from socket trouble by using Na-ald De Luxe Sockets.

Sockets and panel mounts for all tubes. Prices 35c to 75c. Send for catalog.

ALDEN MANUFACTURING CO.
Dept. H SPRINGFIELD, MASS.



NA-ALD

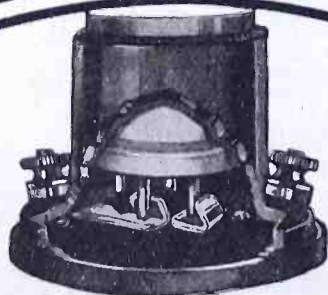

Atlas

TRADE MARK

RADIO REPRODUCTION speaker

floods the room with the best that's in your set

ATLAS is an instrument designed for clear, lifelike reproduction of every type of program, with any good receiving set.

Since its base, of mahogany colored Bakelite, highly polished and permanent, contains no iron, no external magnetic field can influence the sound-producing coils.

Responsible dealers everywhere sell Atlas speakers for \$25.00. Informative booklet on request.

Multiple Electric Products Co., Inc.
36 Spring St., Newark, N. J., Dept. E
New York, Boston, Philadelphia, Baltimore, Pittsburgh, Detroit, Chicago, St. Louis, Denver.
550 Howard Street, San Francisco.



With the Atlas Unit and phonograph attachment coupling at \$13.50 your phonograph may be converted in a twinkling for Atlas Radio Reproduction.



Tell them that you saw it in RADIO

A GOOD RECEIVER

Continued from page 24

frequencies: 500,000, 501,000 and 499,000 cycles. In order that a receiver faithfully reproduce this 1000 cycle musical note it must be able to receive all these frequencies with one setting of the receiver dials. That is, when it is actually tuned to 500,000 cycles it must also be tuned to 501,000 and 499,000 cycles. This is really the telegraph situation, and it will be obvious that an extremely selective receiver will be able to do this, for 1000 cycles in 500,000 cycles is only a difference of 1/5 per cent, which is extremely small.

However the case for speech and music is entirely different. Here we are concerned with audio frequencies as high as 10,000 cycles and as low as 100 cycles. We need only consider the upper limit, 10,000 cycles, for the lower limit cannot cause trouble. If 10,000 cycles is modulating 500,000 cycles the station will transmit 500,000, 510,000 and 490,000 cycles. The receiver now must be able to tune in at one setting the range of frequencies from either 490,000 to 500,000 cycles, or the range of frequencies from 500,000 to 510,000 cycles in order that it reproduce this frequency faithfully.

Suppose the receiver is so sharply tuned that it cannot tune from 500,000 to 510,000 cycles. Then the 10,000 cycle note will not be received on this receiver. In other words, too sharp tuning results in dropping out the very high frequencies of speech and music. Thus speech and music do not sound natural and undistorted on such an extremely selective receiver. If a receiver is so sharply tuned that it can only receive over a range of 5000 cycles then this receiver will drop out all the audible frequencies between 5000 and 10,000 cycles, producing considerable distortion.

This is the reason why hair line selective receivers are not suitable for radio telephone reception. Selectivity is desirable and necessary, but the receiver must not be so selective that it will cut off important sound frequencies. With the modern receivers this is not likely to occur. In the vicinity of 300 to 500 meters, where most of the broadcasting takes place, the frequencies range from 1,000,000 to 600,000 cycles. A difference of 10,000 cycles, which is really the highest audible frequency we are concerned with, is a difference of 1 to 1.6 per cent of the frequency to which the receiver is tuned. The best receiver made for telephony will be able to tune over a band of frequencies varying by only such a small amount. The point is that radio telephony presents an entirely different receiver problem from telegraphy and that receivers require to be more broadly tuned for telephony than for telegraphy.

Distortion of speech and music may be due to a number of other causes. If regeneration is brought to the point where the set begins to oscillate the superposition of the radio-frequency oscillations causes distortion. This is not the fault of the regenerative type of receiver. Such receivers are not meant to be used in the oscillating condition for telephone reception. This point is brought out as it is very often the cause of poor quality, when as a matter of fact the regenerative receiver is capable of giving entirely satisfactory quality. Apart from these two considerations of selectivity and regeneration there is no other way in which distortion may be produced in a radio-frequency amplifier.

Distortion is most apt to occur in the audio-frequency amplifier. This is a subject in itself. One of the most frequent causes is the absence of grid bias voltage. Lack of bias causes the tube to work on the curved part of its characteristic curve, which results in distortion. It also causes grid currents to flow through the secondary of the audio-frequency transformer, resulting in saturation and other effects, thereby again causing distortion. It is a simple matter using a negative voltage on the grids of audio tubes and the practice should be adhered to.

The next cause of distortion is due to the imperfections in present audio-frequency transformer design and construction. All transformers drop out low and high frequencies to some extent. It is difficult to make a good transformer which will not do this, but manufacturers are improving them gradually. The distortion due to the transformer must be tolerated, if one must use transformer coupled amplifiers, until better ones are made.

But where the builder of a set cares to take pains and is willing to get away from the beaten track he can build either a reactance coupled or a resistance coupled amplifier. These amplifiers amplify all frequencies uniformly if rightly designed. The advantage of the transformer coupled amplifier over these is that it gives more amplification per tube. Three stages of resistance amplification are needed to equal two transformer stages. The very best receiver will therefore include an audio-frequency amplifier which gives a faithful reproduction of the incoming audio signals.

There are other qualities, no doubt, which a good receiver should possess. Thus it should use all its parts economically, so that the cost will not be too great. The reflex receiver seems to be the answer in this connection. Appearance is also a matter to consider. The day of the straggling receiver with batteries scattered all over, and wires hanging all around the room is gone. Neatly wired sets, mounted in pretty cabinets are desirable.

Write for a copy today



A new twenty-four page booklet will be sent, gratis, to those interested in building their own receiving sets.

A simplified method of construction is described. Illustrations and diagrams.

On Request

EISEMANN MAGNETO CORPN.

William N. Shaw, President

165 BROADWAY, NEW YORK

Jones Multi-Plug & Cable

Standard equipment on Zenith for over one year. Will be standard equip-

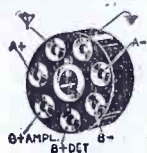

ment on twenty-five of the leading sets this fall — watch for their names.

Ask your dealer and manufacturers to put this trouble and tube saver on your set.

Plugs in all Input Connections.

For Sale by your Jobber

HOWARD B. JONES

612 S. Canal Street CHICAGO, ILL.

RATHBUN
SINGLE-HOLE MOUNTING
SUPERIOR CONDENSERS
LEAD by Efficiency and Superior Values
Plain and Vernier Types
DEALERS and JOBBERS write!
Rathbun Mfg Co Inc.
Jamestown, N.Y.

B-METAL
will be at the San Francisco show in August. Order now and tell us then. Your dealer will respect your wishes.
B-Metal Refining Co.
12th floor 525 Woodward Ave.
Detroit, Mich.

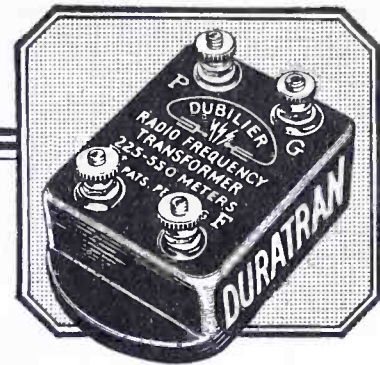

The DURATRAN Gets the best programs

DON'T let the best programs from the best stations go sailing past your set. Install the radio-frequency transformer that will bring them in—the Duratran.

This powerful transformer works on the entire band of standard broadcasting wavelengths — from 225 to 550 meters — and amplifies to the extent of **20 times!**

With the Dubilier Duratran you get the best programs from near and far.

Ask your dealer, or write 45 West Fourth Street, New York, for blueprints of Duratran hook-ups.

Dubilier

CONDENSER AND RADIO CORPORATION

THE ARAGON SILVER NEUTRALIZING CONDENSEE for MARVELOUS RECEPTION. Metal Parts Silver. Neatly mounted. \$1.25
BUY ARAGON SILVER WIRE. Most perfect Conductor known. No Current Loss Easy to Solder. 25-foot Coils. No waste. \$1.25
ARAGON RADIO CO.
6 E. Lake St. Chicago

ULTRA SYNCHRO-DYNE
5-Tube Set, \$67.50
Coast to Coast receiver! A real DeLuxe radio set. A card will tell you why.
THE STANLEY RADIO CO.,
2947 Lorain Ave. Cleveland, Ohio

Tell them that you saw it in RADIO

Everybody is Talking About the Wonderful Performance of this Set

It has a loud speaker range of from two to three thousand miles

It is extremely selective.
It gives enormous volume.

It reduces re-radiation to a minimum.
Its quality is unexcelled.
It is simple to operate.



Licensed under Armstrong U.S. Patent No. 113149. Price \$75.00

It has that essential pleasing appearance.
It is fully guaranteed.

It requires a small antenna, and, with such, will give results equal to or better than the average five, six or eight-tube set now on the market.

Chelsea offers a full line of parts and sets

- SINGLE tube regenerative set.....\$17.00
- Two stage audio amplifier.....\$16.00
- Three tube regenerative set.....\$35.00
- Four tube tuned radio frequency.....\$75.00

CHELSEA RADIO COMPANY

179 Spruce Street

Chelsea, Mass.

Western Agents — FREDERIC L. TOMLINSON CO.

447 Pacific Bldg., San Francisco

1113 Wall St., Los Angeles, Cal.

116 13th Ave. North, Seattle, Wash.

VACUUM TUBE AMPLIFIER

Continued from page 31

five times as great as the internal resistance of the tube. The formulas show that the amplification obtained by use of a choke coil of X_p ohms is greater than if a resistance R_p ohms such that $R_p = X_p$ is used in a resistance coupled amplifier using the same tube. Choke

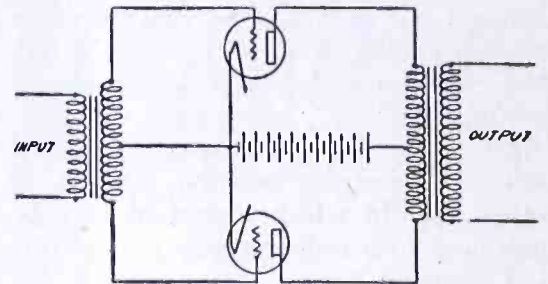

Fig. 10. Push-Pull Amplifier

coil coupled amplifiers are almost as free from distortion as resistance coupled ones providing X_p is large enough. The primary winding of a 110 volt 60 cycle bell ringing transformer makes a good choke coil for this type of amplifier.

The two types of amplifier circuits just discussed are generally used just after the detector. The "push-pull" amplifier circuit permits the use of two tubes in parallel in such a way that any tendency to distortion in one tube due to the curvature of the characteristic curve is offset by the other tube. This circuit is generally used just before the loud speaker. It requires two special transformers, one with a mid-point connection on the secondary the other with a mid-point connection on the primary. Fig. 10 shows a circuit for an amplifier of this type. As the two tubes are in parallel this tube will handle more power than a one tube circuit.

Sometimes 4 or 5 ft. additional height to an antenna will mean more DX records. Many a ham has wished he could get those sky hooks a little bit nearer heaven. So here's an idea which is practical. Secure a stout, light pole about 9 ft. long and measure off 5 ft., attaching firmly your antenna rope with a piece of hay wire. The antenna proper is attached to the short end of the pole and a light rope at the other end and up she goes. Try this out, fellows, and you won't regret it. The longer your extra pole, the stronger your original antenna posts should be, as this means additional strain.

B. S. SHIELDS, 5AJJ.

Remember a good operator is one who gets the best results with the least expenditure necessary. Economy is always a handy thing to be able to practice and the man who impresses into service that which is at hand is far better off than he who runs out to buy each time he is stuck for the moment.

SPECIALIST IN
SUPER HETERODYNE CONSTRUCTION
Complete building and repair service
—any type set—
Herman E. Erickson
(Associate, Institute of Radio Engineers)
One Union Square New York

HEAD SETS LOUD TALKERS
PHONO-ATTACHMENTS
TRIMM
RADIO MFG. CO., Dept. 58
24-30 S. Clinton St. Chicago, Ill.

R A D I O D Y N E
NO LOOPS — NO AERIAL
Ready for operation by grounding to a water pipe or radiator and throwing a few feet of wire on the floor. Uses any standard tubes—dry cell or storage battery. Extremely selective. Simple to operate—*only two controls*. Wavelength from 200 to 700 meters. Write for Folder describing this (antennaless) receiver.
WESTERN COIL & ELECTRICAL CO.
311 Fifth Street Racine, Wis.

Beat These Wet "B" Batteries If You Can
Rabat Junior (12 cells 24 volts) capacity 800 mil-amps, only \$8.96; Rabat Senior (2800 mil-amps), \$9.60. Prices F.O.B. Cleveland, Ohio. If your dealer cannot supply you send direct.
The Radio Rabat Company
814 Bangor Bldg. Cleveland, Ohio

Tell them that you saw it in RADIO

FILAMENT FILTER SYSTEM

Continued from page 32

filament transformer. These serve to further isolate the filament from the ground, allowing the filament to be

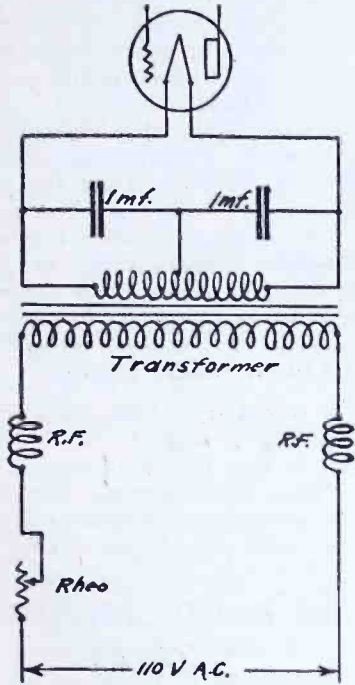
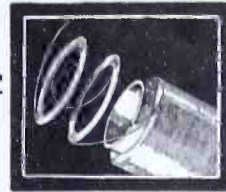

Fig. 3. Filter with Chokes Added

grounded or left ungrounded at will. In this way the parts of the C. W. transmitter which enter into the oscillating portion of the set may be controlled and are not subject to stray grounds which may or may not be desirable.

The RF chokes shown in Fig. 3 may be wound on a large mailing tube two and one-half or three inches in diameter, and should consist of 250 or 300 turns of wire large enough to carry the primary current of the filament transformer. No. 18 or 20 DCC is usually about right. These chokes of course add resistance to the primary circuit and the transformer should be capable of delivering more than the required secondary voltage in order to allow for the drop in primary voltage due to the insertion of this resistance.

The filtering of filament circuits has not received enough attention up to the present time and it is hoped that this brief resume will help the C. W. notes, and the carrier waves, for many of our stations.



THE HELICAL

WOUND COIL

The World's Exclusive Maker of Helical Wound Coils Announce Their New Line of TRANSFORMERS for Fall:

AUDIO

- HW-A2 6-1 Ratio
- HW-A3 3-1 Ratio

PUSH-PULL

- HW-A2-I Input
- HW-A2-T Output

RADIO

- HW-R1 3,000 Meters
- HW-R1 5,000 Meters
- HW-R1 10,000 Meters

SAMSON ELECTRIC CO., CANTON, MASS.

Complete
Line of
All Types
Booth xxx

*Samson
Transformers*

At Pacific
RADIO
Exposition
Booth xxx

MU-RAD RECEIVERS

THE ULTIMATE IN RADIO RECEPTION

Write for complete illustrated FREE Catalog of

PARAGON

Reg. U. S. Pat. Off.

RADIO PRODUCTS

Adams-Morgan Co., 2 Alvin Pl.,
Upper Montclair, N. J.

Pacific Coast Representative—Paul Sutcliffe,
Rm. 400, San Fernando Bldg., Los Angeles



Registered U. S. Patent Office.

MICA INSULATED

By insulating the core laminations with a scientifically prepared mica compound the howling and squealing so prevalent in ordinary audio transformers has been eliminated in the supertran. Write for particulars.

FORD MICA COMPANY, Inc.

33 East 8th St.

New York

AMPERITE

The "SELF-ADJUSTING" Rheostat

PERFECT for every CIRCUIT

Simplifies wiring

Eliminates

hand rheostats

RADIALL COMPANY

320 W. 42nd St., N. Y.



\$1.10

Write Dept.
B-2 for Free
Hookups

From
Your
Dealer

Tell them that you saw it in RADIO

FLERON Radio Specialties

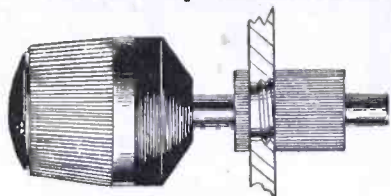

THE VERNIER ADJUSTER

The best adjuster on the market. Spring holds head away from dial when not in use. With slight adjustment spring can be made to hold head against dial if desired. Patented. 65c.



THE PORCELAIN INSULATORS

Lowest power losses in the antenna. Dielectric absorption reduced to minimum because of very low phase difference of Fleron Porcelain. Very tough body. Solid Black Glaze. Seven sizes, 20c. to \$1.00. Each insulator in a separate carton.

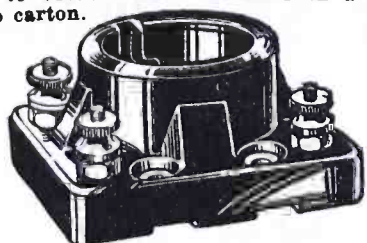

THE PORCELAIN SOCKETS

Very carefully made. Brass parts nickel plated. Black Glaze. Two sizes. Standard Bulbs and U. V. 199. Each socket in a carton. 35c. each.

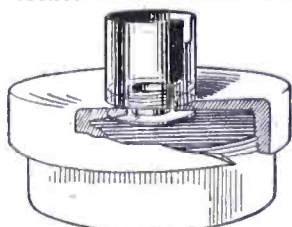

THE PHONO ADAPTER

Fits through the hole of the receiver cap and then slides on the phonograph tone arm. Fits Victor, Columbia, and others. Works perfectly. Only 35c. ea

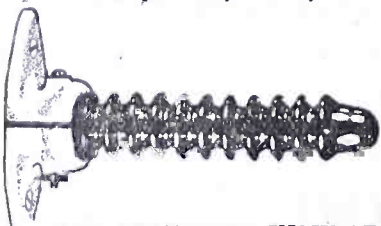

THE STAND-OFF INSULATOR

Fills the much-needed requirement for a good, strong looking and practical stand-off insulator. Meets every requirement of the Board of Fire Underwriters. \$1.25 each.

For Sale by all Good Jobbers and Dealers

M. M. Fleron & Son, Inc.

110 North Broad St., Trenton, N. J., U.S.A.

A Pleasant Surprise Awaits the User of the A.C.H. Sharp Turner Dials

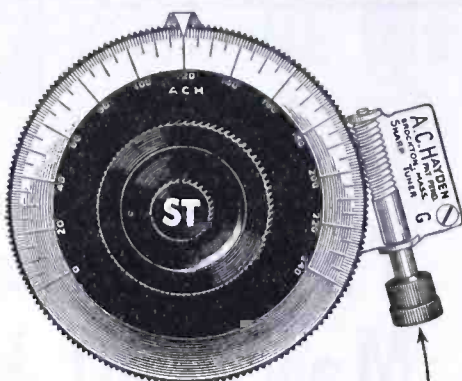

Why the A.C.H. is different

3 in. DIAL → ACH → 156-10-1

4 in. DIAL → ACH → 215-10-1

Will improve any receiving set, making difficult tuning easy

Money Back Guarantee

Price 3-inch size. \$2.50 Price 4-inch size. \$5.00
Regular fitting 1/8 shaft 1/4 and 3/8. . . . 5c each extra

Extra Advantage of the A. C. H.

1. Can be attached or removed from any instrument.
2. Rough tuning same as any dial.
3. Movement so fine that the eye cannot detect but the ear can.
4. Automatically locks instrument so no jar can disturb it.
5. Dial grounded reducing the body capacity to a minimum.
6. Special dial 2 graduations where ordinarily one.

Mail Orders sent Prepaid in U. S. A.
A. C. HAYDEN RADIO & RESEARCH CO.
BROCKTON, MASS., U. S. A.

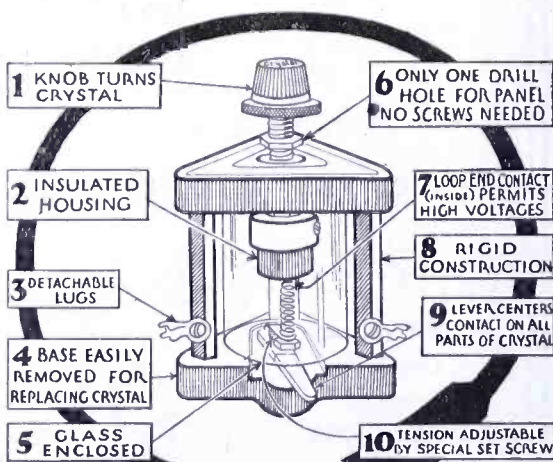

Best Crystal Ever Designed!

FRESHMAN

DOUBLE ADJUSTABLE CRYSTAL DETECTOR, \$1.50

for base or panel

Super-Crystal with Non-Metallic Housing, 50c

At your dealer's or send purchase price and you will be supplied postpaid.

FREE! Write for building plans and hook-ups of Super-Heterodyne, Reflex, and other popular circuits.

Chas. Freshman Co. Inc.
Radio Condenser Products
106 Seventh Ave., New York

6 MONTHS FOR \$1.00
"RADIO" - San Francisco

QUERIES AND REPLIES

Continued from page 37

secondary consists of 135 turns of No. 16 D.C.C. wire, with taps at the 34th, 68th and 102nd turns.

Please publish the circuit of the Secretan system, used in England. In building a Grimes inverse duplex set, what should be the ratio of the radio-frequency and audio-frequency transformers used?—W. C. T., Mesa, Ariz.

I regret very much that I have no data available about the Secretan system. I would suspect, however, from the brief description of the system, that it is a common two-tube reflex circuit under a new name. Radio-frequency transformers are generally not rated as to their turns ratio, but should in any case be less than 2:1. Audio-frequency transformers of 3:1 turns ratio will be the best to use in the Grimes circuit.

ERRATA NOTICE: The circuit diagram shown in Fig. 2, Page 37, July RADIO, is in error, in that the two neutralizing condensers have been omitted. Fig. 2 in this issue shows the correct method of connecting these condensers in the circuit.

PACIFIC RADIO EXPOSITION

Continued from page 39

	Booth
Samson Electric Mfg. Co.	76
Fansteel Products Co., Inc.	70
Precise Mfg. Co., Rochester	71
Kellogg Switchboard Supply Co.	75
The Radio Shop, Sunnyvale	77
Braun Corporation, L. A. and Oakland	78
Freed Eisemann Radio Corp.	78
Warner Bros., San Francisco	79
Jefferson Electric and Mfg. Co.	80
Zenith Radio Corporation	81
Dunham, Carrigan & Hayden Co.	83
Gilfillan Bros., Inc.	85
Amsco Products, Inc., New York	86
Willard Storage Battery Co.	87
Julius Brunton Co., San Francisco	89
Weston Electric Instrument Co.	88
Rudolph Wurlitzer Co.	91
Carl A. Stone Co.	92
Shamrock Mfg. Co.	92
Chelton Electric Co.	92
Dubilier Condenser and Radio Corp.	92
Marshall & Co., Los Angeles	92
H. Earle Wright Co., S. F. and L. A.	94
Radio Art Studio	96
Automotive Service Co., San Francisco	97
Atwater-Kent	97
California Phonograph Co.	98
Keeler White Co.	98
Wm. J. Murdock Co.	98
Kennon Radio Labs., San Francisco	105
Offenbach Electric Co., San Francisco	111
H. F. Haverkamp, San Francisco	112
Conrad Richter, San Francisco	116
Chester N. Weaver Co., S. F.	119 and 121
Lee Electric and Mfg. Co., San Francisco	120
W. A. Vetter, San Francisco	122
Reliable Radio Service, San Francisco	123
Federal Telegraph Co., San Francisco	124
Electric Appliance Co., San Francisco	125
Alexander & Lavenson Electric Supply Co., San Francisco	126
Universal Agencies	127
Work-Rite Mfg. Co.	128-130
Schwabacher Frey Stationery Co., San Francisco	129 and 131
Eagle Radio Co.	131
Garod Corp.	61
Heintz and Kohlmoos, San Francisco	135
B-Metal Refining Co., Detroit	137
Maitland and Spencer Roach, Philadelphia	82
Martin Copeland Co., Providence	138
Experimenter Pub. Co., Inc., N. Y.	140-142
Calif. Electric Supply Co.	139
Kingston Radio Co.	141
Goodyear Rubber Company	144
Marathon Radio Co.	136

BROWNLIE CRYSTAL

"REFLEX SPECIAL" QUICK CONTACT RECTIFIER GUARANTEED \$1.00

The Acme Apparatus Co. says "prevent distortion and howling by using a BROWNLIE CRYSTAL in REFLEX SETS." Order From Your Dealer or Direct ROLAND BROWNLIE & CO. 24 Saunders Street, Medford, Mass.

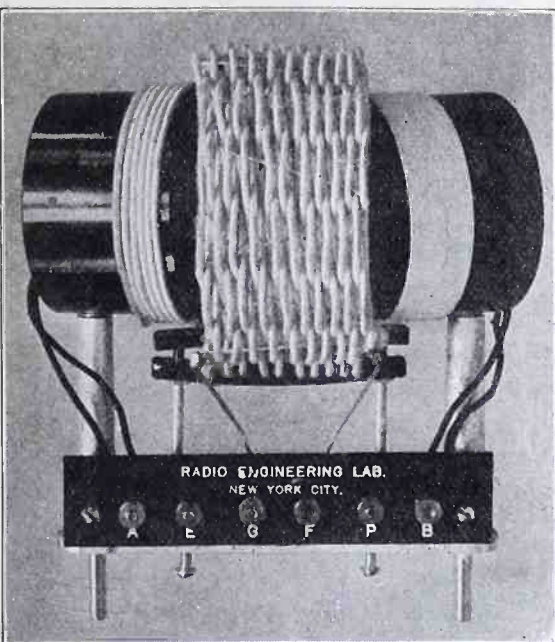

LOW LOSS TUNER UNIT

Most Efficient Tuner Available
Real DX. Reception
Extremely Sharp Tuning

TWO TYPES { AMATEUR—45 to 225 METERS
BROADCAST—250 to 550 METERS

Price \$10 each Write for Information

A. C. LOPEZ & CO.
Sole Distributors
334 FIFTH AVENUE NEW YORK CITY

ELIMINATES INTERFERENCE

INCREASES RANGE and VOLUME

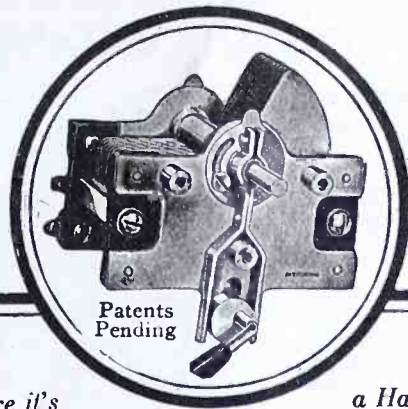

See the HAMMARLUND EXHIBIT at the PACIFIC RADIO EXPOSITION in Space D.

"Just be sure it's

a Hammarlund."

Makes Any Set Better

1. Lowest Losses (Too small to measure)
2. Micrometer Verniers
3. Soldered Brass Plates
4. Rotor grounded to frame
5. Adjustable Cone Bearings
6. Double Wiping Contacts
7. Takes any size dial

HAMMARLUND
New Model "B"
VERNIER VARIABLE CONDENSER

Write for New and Interesting Folder
HAMMARLUND MFG. CO., 144-146 West 18th Street, New York
Pacific Coast Representatives
Atlantic-Pacific Agencies Corp., 204-212 Rialto Building, San Francisco.



At Last!!

A PERFECT RADIO SCREW DRIVER

The COBURN SCREW HOLDING SCREW DRIVER
(Patented)

A new invention. Not magnetic. Holds any screw firmly by its slot. Enters and starts all screws in difficult places where ordinary screw driver is useless.

Useful As A Third Hand.
"The Radio Set Builder finds this tool the greatest time and temper-saver ever invented."

UTILITY MODEL—7 inches long. Handles all screws in Radio sets. All metal. Heavily nickel plated. Knurled grip. Fully guaranteed. \$1.00—at dealers or by mail, all postage prepaid.

AGENTS:—Write for our sales plan. Dept. 1

COBURN TOOL COMPANY
739 Boylston St. BOSTON, MASS.

A Hidden Enemy—

Hidden away—hard to reach and often almost impossible to find—is that hidden enemy of good reception—leakage. In no place can it more easily hide than in a poorly constructed

Jack. That is why the entire staff of Carter engineers gave such minute study to producing a Jack that met this definite requirement.

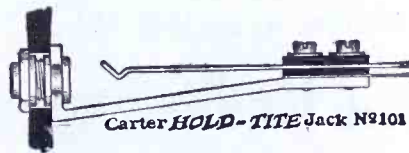

70c each

Made in ten different spring combinations—one to meet every need

The concentration of engineering skill has given the Carter Jack patented features that are exclusive and found only in Carter Jacks. Don't take any chances—buy the best and insist on the genuine, the choice of the big majority.

Compare the Carter Jacks. Note the firm construction; the long heavy phosphor bronze springs; the pure Silver contact points; the wide spaced solder terminals, then you, too, will buy a Carter Jack and deal a death blow to "leakage."

Any Dealer Can Supply



Write for Catalog

Coast Distributors
Atlantic-Pacific Agencies Corp., 204 Rialto Bldg., San Francisco, Calif.

5-PLATE CONDENSERS

Given Free this Month
In return for your subscription to "RADIO" for one year. Full price \$2.50.

"RADIO"
Pacific Building
San Francisco

DO YOU OWN A SET OF



EBY ENGRAVED Binding Posts



They excel in quality. You can't lose the parts.

Demand genuine EBYS from your dealer. The H. H. Eby Mfg. Co., Phila., Pa.

Tell them that you saw it in RADIO

MIRACO GETS 'EM FROM COAST TO COAST

PRICE ONLY \$29.50

At rock bottom prices you get the efficiency of sets costing three times as much. Users tell us that Miraco Radio frequency receivers pick up stations from coast to coast. Operate either on dry cells or storage battery. Solid mahogany cabinets—finest workmanship throughout. Order direct or send for bulletin

Two tube outfit . . . \$29.50
Four tube outfit . . . \$54.50

DEALERS AGENTS—write for proposition quickly—it's a winner.
THE MIDWEST RADIO COMPANY
814 Main Street Cincinnati, Ohio

THE NATIONAL PERFECT VERNIER CONDENSER

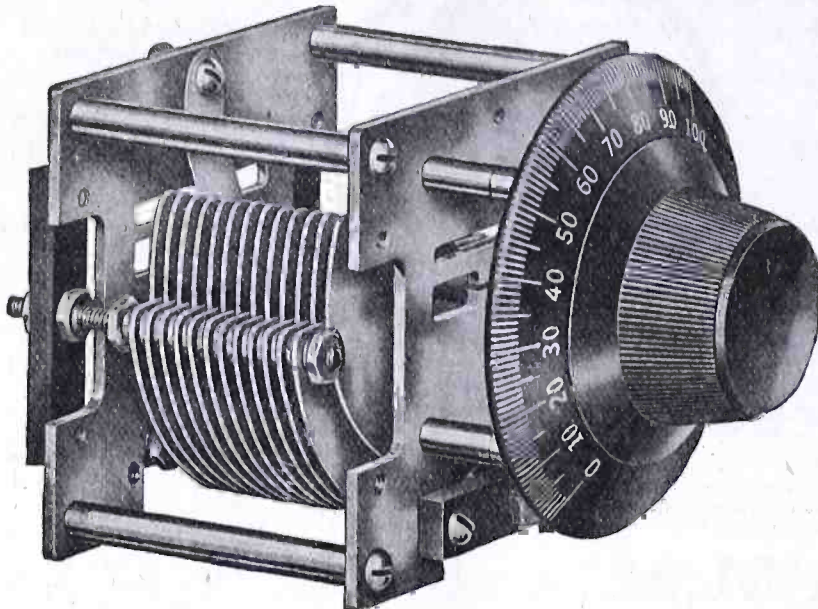

MINIMUM
LOSS

MAXIMUM
SIGNAL
STRENGTH

Size	Price
.001	\$7.00
.0005	\$6.00
.00035	\$5.75
.00025	\$5.50

During the recent Pan-American tests, a short wave tuner fitted with National Condensers and Velvet Vermer Dials operated from Hartford, Conn., successfully copied signals from station C.B.8 Buenos Aires. Extremely low in loss and highly selective, this Condenser is ideal for Radio Frequency, Reflex, Neutrodyne and Super-Heterodyne Circuits.

Write for Bulletin 104 C

Manufactured by

NATIONAL COMPANY, INC., Engineers and Manufacturers
110 Brookline St. Established 1914 Cambridge, Mass.

THERE'S A REASON

why

Ninety per cent of last year's exhibitors
already have reserved space for the

4th Annual Boston Radio Exposition

Mechanics Building

Week of December 1 to 6, 1924, inclusive

*Quadrupled floor space makes possible
additional reservations*

Wire or write for diagram of space

Sheldon Fairbanks, Manager

209 Massachusetts Avenue

Boston, Mass.

"COVER NEW ENGLAND IN ONE
WEEK AT THE BOSTON SHOW"

RADIO COMPASS

Continued from page 34

When this state exists direction finding is impossible. Minimums will be obtained, but will be false and misleading. Great variation in the minimums will also be noticed. As an instance, supposing KPH lays to the southwest of a compass station, when night effect is in existence one test may reveal this station to be on its normal line, yet another taken a minute, or even less, later would seem to indicate that it has left the environs of San Francisco and settled down in the vicinity of the North Pole. The Arctic will then be deserted for presumably more salubrious climes, and, like a disembodied soul searching for what it knows not, these nocturnal ramblings will continue throughout the night. When respectable stations of fixed abode are found to be suffering from wanderlust it can be truly said that night effect exists. The only thing that can be done in this case is to shut up shop and go to bed.

A ONE-CENT MACHINE SCREW VISE

By H. A. HIGHSTONE

As machine screws are practically indispensable in the construction and assembly of radio apparatus it is often found necessary to shorten or file one or more of them, or perhaps do a little re-threading. Being of brass, the threads are easily injured, so holding them in an ordinary vise is nearly always impracticable. Pliers are used with fair success for this purpose, but considerable pressure must be exerted to keep the screw from slipping or wobbling, particularly when it is being sawed or threaded. Also, this method is rather tiresome when any considerable amount of work is to be done.



One cent, the price of a machine screw nut, will make a pair of either "gas" or side-cutting pliers into an excellent vise for holding machine screws; one which holds them with a "bull-dog" grip no matter how fast or furiously we may file or saw. The method is simple and easy. The machine screw to be worked upon is placed in the jaws of the pliers so that the head butts up against one side of them. The nut is next screwed on until it tightens up against the other side. The two are now removed and the nut given half a turn more toward the head of the screw. Replace them in the pliers, and after the jaws have been forced together it will be found that the screw is held almost as firmly as though



RADION

The Supreme Insulation
Panels, Dials, Sockets,
Knobs, Insulators

American Hard Rubber Co. 11 Mercer St. N. Y.

SUPER-HETERODYNE

Reprints from "RADIO"

By G. M. Best

Sent to any address for 25 cents.

Pacific Radio Pub. Co.
Pacific Building, San Francisco, Cal.

Tell them that you saw it in RADIO

it were part of the pliers, with no danger of damage to the threads.

Pliers having narrow jaws will be found to be the most desirable, as they allow the holding of very short screws as well as the longer ones.

*Tune in-
with ease*

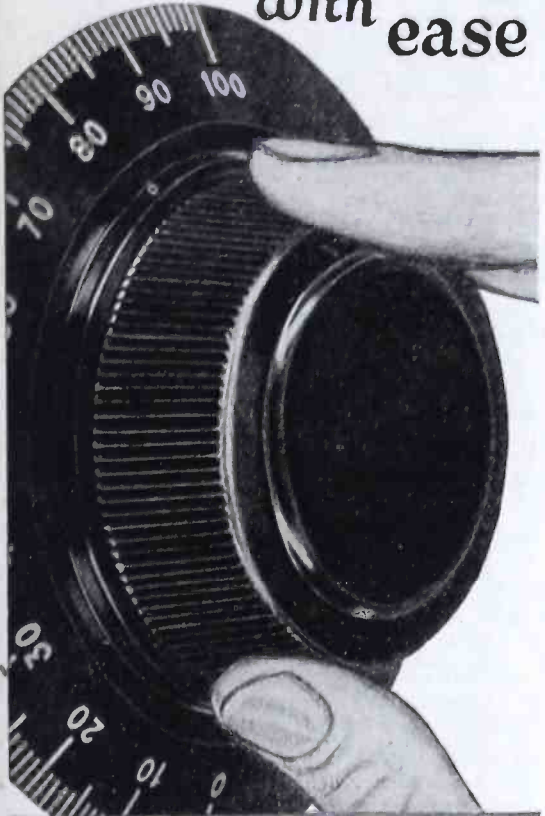

NA-ALD

*Super DeLuxe Dials
Where eye and hand are
in scientific balance*

Test these dials with any other and see how much more quickly you can turn to any degree or fraction of a degree. Shorter intermediate lines; numerals on the bevel and a generous knob are the reasons.

These are truly beautiful creations which give that final touch of dignity and attractiveness to the quality set. On the set you buy look for the minute Na-ald trademark as you would for sterling on silver.

75c. Other prices of Na-ald Dials are: 3 1/2" 50c, 3" 35c and 2" (rheostat) 35c.
ALDEN MFG. CO.
Dept. H. Springfield, Mass.

NA-ALD

2650 MILES

—with ONE TUBE. Broadcasting from Atlantic Coast and Cuba heard in California by users of the CROSS COUNTRY CIRCUIT. This range is due to simplicity of set and operation as only one control is used for tuning. Easily and cheaply built. Dry cell tubes may be used. Complete instructions, with panel layout, assembly views, etc., post-paid for 26c. Or further information for red stamp.
VESCO RADIO CO., Box R117—Oakland, Calif.



A Vertical "B" Battery
*Upright in Shape
—Upright in Use*

WHERE weight, table or cabinet space is a factor in your selection of Burgess Radio "B" Batteries, buy the Burgess vertical "B" No. 5158.

It is right at home in any position in your cabinet. Its sturdy compactness is almost a necessity in portable receiving sets.

Its height, width and weight coincide exactly with the double strength Burgess Radio "A" Battery. You are sure to be pleased with both the convenience and service offered by such an assembly of "A" and "B" Radio Batteries.

"ASK ANY RADIO ENGINEER"

**BURGESS
RADIO BATTERIES**

BURGESS BATTERY COMPANY

Engineers - DRY BATTERIES - Manufacturers
FLASHLIGHT - RADIO - IGNITION - TELEPHONE
General Sales Office: Harris Trust Bldg., Chicago
Laboratories and Works: Madison, Wisconsin
In Canada: General Offices and Works, Niagara Falls, Ont.

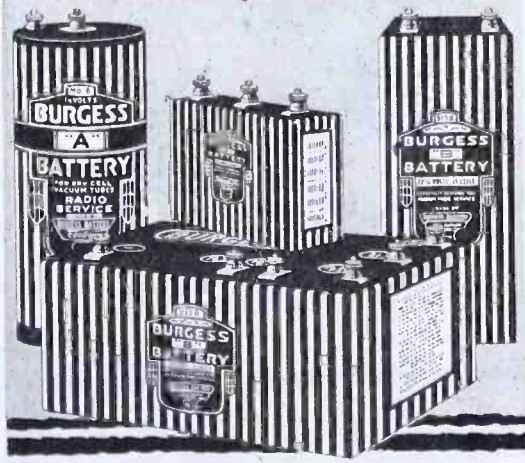

WALNART
"Trouble-Proof" Radio Products include: Tube Sockets, "B" Battery and Inductance Switches, Lettered Binding Posts, Variable Condensers (plain and vernier), Vernier Adjusters, Dials, Variable Grid Resistances, "The Dialog,"

etc. At dealers, or write for booklet.
WALNART ELECTRIC MFG. CO. CHICAGO

*"Built First-
Coto -to Last"*
**INSIST ON THE SILVER
PLATED AIR CONDENSER
FOR YOUR RADIO SET.**

Tell them that you saw it in RADIO

*Why
shouldn't
you be as
particular about
small parts
as WE are?*



YOU USE THEM.

YOU DEPEND on them to help your larger instruments.

YOU EXPECT small parts to preserve the energy that reaches your set.

So why shouldn't YOU be as particular about their quality as WE are?

WE think no accessory too unimportant to build as carefully as we make fine optical instruments. All the craftsmanship we have developed in 44 years of precision work, we put into every MAR-CO small radio part.

Then we put them into the unmistakable MAR-CO packages, so that if you are as particular as we are, you can easily get the "leak-proof" service we build into them.

Simply say "MAR-CO" . . . and insist on seeing the MAR-CO package . . . when you want plugs, jacks, switches, grid-leaks, vernier condensers and other small parts.

MAR-CO
RADIO PRODUCTS

THORIO
-RADIO TUBES- U.S. PAT. NO. 1,518,821
1 1/2-3-6-8-6 V. 1/4 AMP. DETECTOR.
FIT STANDARD SOCKET & WORK
ON ANY CIRCUIT - MAIL YOUR ORDER TO
HAYDEN-SALESCO.
-JERSEY CITY-N.J.-

Learn RADIO At Home
Earn \$70 to \$200 a Week

Become a recognized radio expert. Trained men in urgent demand as broadcasting and ship operators, radio salesmen, engineers, demonstrators, etc. Hundreds of big pay positions now open. No previous training necessary. We train you in theory and practice. Instruments for practical work at home furnished free. First school to teach radio by mail. Thousands of successful graduates. Get facts from Free Book "Rich Rewards in Radio." Write today. State age. National Radio Institute, Dept. 10HA, Washington, D. C.

DISTANCE!

That's what every Radio fan strives for, and the thrill of getting a station thousands of miles away is worth all the time and trouble it takes to build your set properly—

And to get that Distance, choose your panel wisely—it *must* be of the *best*.



RADIO PANELS

(all standard sizes)

insure the minimum in surface-leakage and power loss, and the maximum in volume.

They can be bought at all the better Radio stores

At 25% to 50% Less
than any other standard panel

Drilled correctly—with a *sharp* drill and *slight* pressure—they are unsurpassed, like all the other "Sote" products introduced by THE PANTASOTE COMPANY, Inc.

JOBBER AND DEALERS
Write for our interesting proposition.

M. M. FLERON & SON, Inc.

Exclusive Sales Agents for Electrasote Radio Panels.

TRENTON,

NEW JERSEY

CALLS HEARD

Continued from page 46

By 6HS, 1224 Milvia St., Berkeley, Calif.

1kc, 2cee, 3hs, 3lg, 4bk, 4dm, 4hs, 5aaq, 5aar, 5adb, 5ado, 5ahk, 5ail, 5aiu, 5ajj, 5be, 5cq, 5cy, 5dc, 5gj, 5eh, 5eu, 5kc, 5lr, 5qd, 5tj, 5vo, 5xd, 5zav, 5zb, 6aja, 6akn, 6amw, (6apc), 6aru, (6asy), 6awh, (6bad), 6blh, 6bnf, 6bpm, 6buh, (6bwz), (6cbb), 6cbu, 6cek, (6cez), 6cgk, (6cjl), 6cjl, 6cki, 6cll, (6clr), (6cnf), (6cqd), 6fm, 6fp, (6hi), 6pe, 6rm, 6rs, 6rv, (6sn), (6tn), 7abf, 7abh, 7abu, 7aby, (7acf), 7aci, 7acm, (7adg), (7adi), 7adm, 7ads, 7aek, 7ael, 7aez, 7af, 7afe, 7afk, 7afn, 7afz, 7agf, (7agi), (7agz), 7aha, (7ahs), 7ahv, 7ahw, 7aif, (7aim), 7aiv, (7aix), 7ajd, 7ajt, 7ajv, 7aiv, (7akh), 7akk, 7aks, (7akt), 7akx, 7ald, 7all, (7alk), 7ar, (7av), 7ax, 7bj, (7ca), 7cf, 7cg, 7cm, 7co, 7er, (7cw), (7di), 7dj, (7dm), 7do, 7dr, 7dz, 7ei, 7el, 7em, 7ey, 7fa, 7fc, 7fd, 7in, (7fq), 7ir, (7fs), 7fw, (7fv), 7gb, 7ge, (7gi), 7gj, 7gu, 7gr, 7gu, (7gv), 7gw, (7gy), 7hc, 7hu, 7hw, 7ie, 7if, (7ij), 7ip, 7it, 7iw, 7ix, (7jn), (7ju), 7ke, 7ks, 7ku, 7kz, (7lh), (7lk), 7ln, 7ls, 7ly, (7ma), 7mf, 7mn, 7mp, 7nn, 7no, 7ob, (7pz), (7qc), 7qd, 7qu, 7qx, 7qy, 7rc, (7rd), 7rk, 7rp, (7ry), 7sf, (7sh), 7sy, 7td, (7to), 7tq, (7tt), (7ut), (7vn), 7wa, 7we, 7wm, 7wo, 7wp, 7ws, 7xac, 7zj, 7zu, 7zv, (7zw), 8ame, 8bc, 8bnh, 8bwk, 8dae, 8dbm, 8dhe, 8die, 8er, 8ic, 8ij, 8xe, 8yn, 9aec, 9afm, 9ahv, 9aim, 9amd, 9ami, 9apf, 9awv, 9azg, 9bau, 9bbd, 9bdq, 9beu, 9bfb, 9bjk, 9bkf, (9bly), 9bmu, 9bnu, 9bof, 9bpv, 9bpw, 9btt, 9bun, 9bvn, 9bxq, 9caa, 9cak, 9cga, 9che, 9cjm, 9cjt, (9cju), (9cju), (9cju), 9cvo, 9cvt, 9cuv, 9daw, 9dfn, 9dgv, 9dkk, 9dkq, 9doe, 9dpo, 9dqu, 9dte, 9dum, 9dun, 9dvw, 9dwn, 9dxr, 9dxy, 9ebt, 9edb, 9ee, 9eea, 9efz, 9ekt, 9eky, 9elb, 9lm, 9ry, 9vm, 9zt. Hawaiian—6ceu, (6any). Canadian—3zl, 4bk, 4cb, 4cd, 4dn, 4dq, 4er, 4hh, 5ah, (5as), 5bu, 5cb, 5ef, 5gf, (5gg), (5go), (5hg), 9bp, 9bx. Would appreciate reports on my five watts.

By 4AA, F. D. Bell, Palmerston, South New Zealand. From 5th Feb. to 8th April

American stations—1aac, 1aal, 1bsz, 1cmp, 1cpn, 1yb, 2agb, 2cgb, 2rk, 2bx, 3ccx, 3hs, 3ft, 3wh, 4my, 5aj, 5ajb, 5alr, 5alv, 5be, 5bx, 5ht, 5lr, 5nk, 5nw, 5tj, 5vm, 5zav, 6aao, 6age, 6agk, 6ahp, 6aiv, 6akz, 6aol, 6apc, 6aqf, 6arb, 6arp, 6awq, 6awe, 6avj, 6avr, 6avv, 6bh, 6bm, 6bs, 6bd, 6bic, 6bid, 6bfb, 6bjj, 6blg, 6bnu, 6bql, 6brf, 6bri, 6buy, 6bwp, 6cn, 6cax, 6cay, 6cbd, 6cbg, 6cdg, 6cdn, 6ceb, 6cgw, 6cih, 6cka, 6ckr, 6cmr, 6cms, 6cmu, 6cng, 6eb, 6fh, 6gt, 6ip, 6pl, 6qj, 6nb, 6rn, 6ze, 6zt, 6zbb, 7ael, 7agz, 7bj, 7co, 7fd, 7fq, 7fr, 7cq, 7ih, 7lh, 7ob, 7qd, 7so, 7tq, 7vn, 7zu, 8aa, 8acy, 8apt, 8atl, 8azm, 8bch, 8bgj, 8bnh, 8byn, 8cvx, 8die, 8es, 8jy, 8kg, 8pl, 8rv, 8ry, 8vy, 8xbc, 8xbf, 8yd, 9aao, 9afm, 9aim, 9ash, 9atn, 9awf, 9azg, 9bed, 9bck, 9bck, 9bit, 9bj, 9brk, 9zxa, 9caa, 9cdn, 9cdv, 9cqu, 9cjc, 9cju, 9ckj, 9cly, 9cpo, 9cpz, 9ctv, 9dro, 9dxk, 9eky, 9elb, 9gz, 9mc, 9zy. Canadian stations—3bq, 4xc, 5go, 9bp. Hawaii—6ado.

Continued on page 70

CHARGE YOUR BATTERY FOR A NICKEL
The Gold Seal Homcharger
Charges Radio and Auto Batteries at home overnight for a nickel. Your dealer has it. Write for FREE booklet and list of broadcasting stations.
The Automatic Electrical Devices Co.
117 West Third St., Cincinnati, Ohio



Amplion THE WORLD'S STANDARD LOUD SPEAKER



Use — Price 75¢
DURHAM
Variable Grid Leak
At dealers, or postpaid
Durham & Co., 1936 Market St., Phila.



Ask Your Dealer For a **MONTROSE** VERNIER CONDENSER
The condenser with genuine bakelite end pieces. Has positive contact between the vernier plate and main shaft. Will get the results where others fail, guaranteed to give entire satisfaction.
MONTROSE MFG. CO.
1333 Fulton St. Brooklyn, N. Y.



\$60.00
5-TUBE TUNED RADIO FREQUENCY
FRESHMAN MASTERPIECE
At your dealer—Otherwise send purchase price and you will be supplied without further charge.
Chas. Freshman Co. Inc.
Perfected Radio Products
106 SEVENTH AVE. NEW YORK



Tell them that you saw it in RADIO

We Feature the Following Equipment

It is Nationally Known—Has Reputation

FADA NEUTRODYNE KITS \$25.00. Parts for all circuits.

Kilbourne-Clark WAVE TRAPS \$8.50

COMPLETE SETS

Fada 120.....	\$120
Atwater Kent.....	\$104
Radyne.....	\$130
Grebe, C.R. 12.....	\$175

COMPLETE INSTALLATIONS

We specialize in the installation of complete equipment. Get our prices, they are reasonable. The Warner Guarantee goes with it.

LOUD SPEAKERS

Atlas Loud Speakers.....	\$25
R3, Model D.....	\$35
Magnavox M4.....	\$25
Magnavox R2.....	\$50

Our Line of Parts Includes Every Well Known Make

Remember---Our Mail Order Service is Rapid and Reliable

THREE STORES

WARNER BROS.

THREE STORES

350 Market Street
San Francisco

428 Market Street
San Francisco

Oakland—Twenty-second and Telegraph Avenue

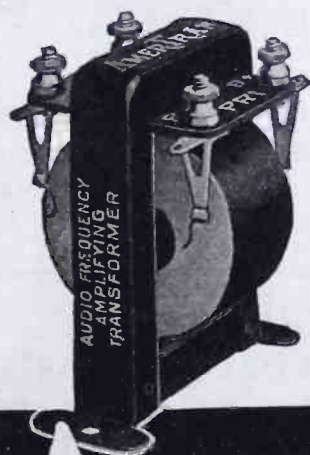

Improve Your Set
with an
AmerTran
and enjoy radio
this summer
as never before

AMERTRAN

TRADE MARK REG. U.S. PAT. OFF.

Type AF-6 (Turn ratio 5), has long been acknowledged the Standard of Excellence for audio amplification.

Type AF-7 is now offered for 2nd or 3rd stage amplification in conjunction with AF-6 for 1st stage. In this use AF-7 decreases the tendency to overload the last amplifying tube on loud signals.

Price, either type, \$7.—at your Dealer's

AMERICAN TRANSFORMER COMPANY

Designers and builders of radio transformers for over 23 years

174 Emmet St., Newark, N. J. Cal. Office, Rialto Bldg., San Francisco

TRI-JACK

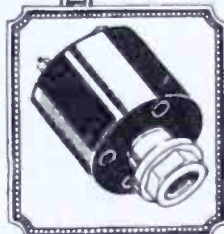

\$1.25

PRACTICALLY zero capacity, dustproof, solderless, supercompact, solid bakelite—those are the outstanding features of the TRI-JACK. The biggest improvement in radio jacks so far!

B. M. S. Products have made a name for themselves in the field of quality. TRI-JACK and TRI-COIL, for instance, are the favorites of radio fans who know.

FREE—Write for the TRI-COIL[®] Reflex Book. It tells how to build this famous one tube reflex.

TRI-COIL Radio-Frequency Transformers are producing wonderful results in one tube reflex circuits and in other sets. Distance and volume without effort!

Pacific Coast Representative:
FREDERIC L. TOMLINSON CO.
1113 Wall St., Los Angeles, Cal.
447 Pacific Bldg., San Francisco
116 13th St., Seattle, Wash.

BROOKLYN METAL STAMPING Corp.
718 Atlantic Ave., Brooklyn N.Y.

TRI-COIL

\$2

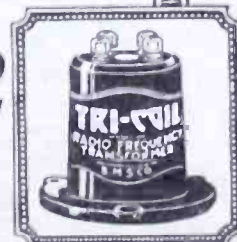

Tell them that you saw it in RADIO

IF YOU WANT A TRANSFORMER

"that makes it clear when you're near"
USE A JEFFERSON

"to bring them in just as clear from afar"
USE A JEFFERSON

"that has just the right characteristics to meet your particular requirement—two radio—six audio frequency"
USE A JEFFERSON

"that is made by a company who have specialized in this field for more than a generation"
USE A JEFFERSON

The Name JEFFERSON is Known Wherever Transformers are used.

You are invited to write our Radio Engineering Department for amplification data. Attractive descriptive literature is also available. This service is gratis.

Jefferson Electric Mfg. Co.
424 S. GREEN ST., CHICAGO

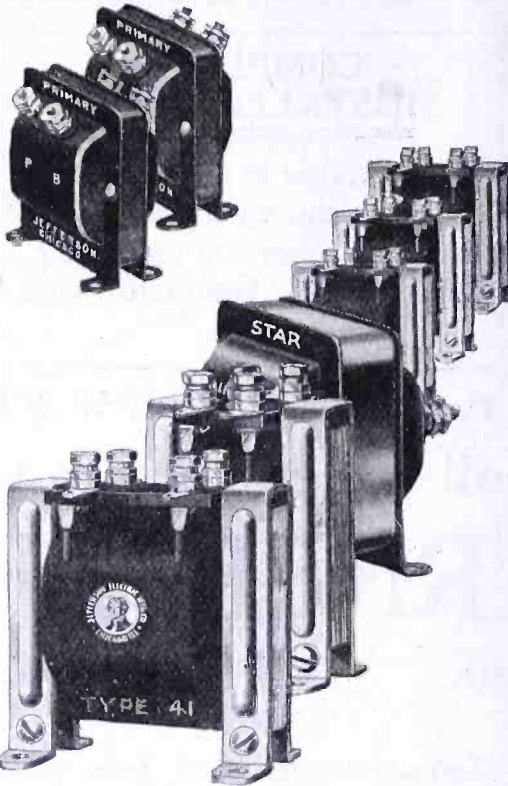

Continued from page 68

By 6GQ, 1819 Virginia St., Berkeley, Calif.
3adq, 4my, 5adb, 5ado, 5ah, 5ahs, (5aiu), 5ajb, 5ajj, 5au, 5ch, 5ef, 5ht, 5ki, 5lg, 5ln, 5ql, 5tj, 5ua, 5xd, 5za, 5zav, 7abb, 7abh, 7abi, 7abu, 7acf, 7aci, 7acx, 7adf, (7acm), 7adg, 7adm, 7adp, 7ads, 7aea, 7aek, 7af, 7afe, 7afn, 7afo, 7afu, 7ah, (7aha), 7ahs, 7ahw, (7aim), (7aiv), 7aiy, 7ajq, 7ajt, 7ajy, 7ak, (7akh), 7akk, (7akz), (7ald), 7alk, (7av), 7ax, 7bj, 7cf, 7cm, 7co, 7cw, 7dc, 7dd, (7dm), 7dn, (7dr), 7dz, 7ea, 7ei, (7em), 7fa, 7fl, 7fq, (7fr), (7fs), 7ft, 7fv, 7fz, 7gi, (7gj), 7gg, (7gr), 7gu, 7gv, (7gy), 7hc, 7hg, 7hm, 7hu, 7if, 7ij, 7io, 7ip, 7it, 7iw, 7jq, 7ju, 7jy, 7ke, 7ks, (7ki), (7lh), 7ln, 7lu, 7ly, (7ma), (7mf), 7mn, 7mp, 7nn, 7no, 7ny, 7ob, 7ok, 7om, 7ot, 7pf, 7pj, 7px, (7pz), (7qc), 7qd, 7qj, 7qt, 7qu, (7qx), 7rk, 7rp, 7ry, 7sc, 7sf, (7sh), 7sj, 7sn, (7sy), 7td, 7to, 7tq, 7tt, 7ut, 7vm, (7vn), 7wa, (7we), 7wp, 7ws, 7ya, 7zo, (7zu), 7zx, 8ahm, 8adm, 8amm, 8bda, 8bjk, 8bnh, 8ckp, 8er, 8nn, 8oa, 9aaq, 9aay, 9abc, (9aec), (9agb), 9ahs, 9aim, 9ajw, 9amb, 9ami, 9aou, 9arq, 9avn, 9avs, 9avu, 9bak, 9beh, 9bdq, 9bhd, 9bji, 9bjk, 9bjm, 9bly, (9bnu), 9bof, 9bri, 9bry, 9bth, 9bto, 9bun, 9bzi, 9caa, 9cbj, 9cht, 9cjm, 9cju, (9clq), 9cvo, 9cyw, 9ddu, 9dkq, 9doe, 9dsw, 9dte, 9dwn, 9dww, 9dxy, 9eam, 9ebh, 9ebt, 9edb, 9eea, 9elb, 9gz, (9hm), 9mc, 9ss, 9xb, 9yy. Hawaii—6ado, (6any), 6cu, Alaska—7mn. Canada—4ab, (4cb), 4cl, 4cn, (4dq), 4fn, (5as), (5bq), 5cn, (5ct), (5ef), (5gf), (5gg), 5go, (6bx).
Allerds answered promptly! Would appreciate check on my so-called 5 watter.

By 6CIX-6ABO, Robert Amsbury, 317 N. Friends Ave., Whittier, Calif.
1bie, 1cib, 2aay, 2cee, 4gc, 5ah, 5agn, 5aiy, 5amo, 7ajq, 7akh, 7af, 7iw, (7ix), 7ry, 8bpa, (8cwp), (8cyi), 9aec, 9agl, (9bgx), 9cdo, 9che, (9dnd), 9eae.
Can.—4fz. Mex.—bx. Beczt qra!!!! Pse note name is wrong in call book. 6CIX wl be practically shut dwn this summer but wl be gld to receive repts on sigs.

By 1AZR, Charles Street, Stamford, Conn.
3bei, 3bgg, 8bng, 3bqq, 3buv, 3brf, 3ckg, 3hs, 3wf, 3xi, 4qf, 4qw, 5mi, 5vv, 5lr, 5zr, 8acy, 8adm, 8agl, 8akk, 8alf, 8aib, 8apw, 8ard, 8bjy, 8bkh, 8blc, 8bnh, 8hoe, 8bqi, 8buf, 8bzt, 8cbg, 8cei, 8cjp, 8clc, 8cmu, 8cqh, 8cud, 8daa, 8dgo, 8dhs, 8do, 8dpo, 8nz, 8ox, 8rj, 8wa, 8xbe, 8xe, 8xm, 9aav, 9abl, 9amj, 9arf, 9aue, 9awf, 9bce, 9bge, 9brq, 9buk, 9efl, 9cii, 9cln, 9cvo, 9day, 9dbj, 9dqu, 9dvp, 9dww, 9es, 9lz. Canadian—1aq, 2az, 3aac, 3gl, 3zl.

RADIO TUBES REPAIRED

Types C-300, C-301-A, C-299, C-11, C-12, UV-200, UV-201-A, UV-199, WD-11, WD-12.

Postpaid, Cash or C. O. D., each **\$2.75**

If you have no burnt-out tubes we will fill your order for genuine repaired tubes postpaid for **\$3.25**

GUARANTEE: We test every tube for vacuum, sensitivity, and durability. We guarantee every repaired tube to be as good as new. Return any unsatisfactory tube after five days' trial with filament intact and we will at once replace it, or if desired, your money will be cheerfully refunded.

NOTICE! WE CANNOT REPAIR "BOOTLEG" TUBES OR COUNTERFEITS OF STANDARD MAKES.

S. P. HANKINS & CO.

1411 Castro Street

Oakland, California



Burnt-out
Cunningham
and Radiotron
tubes made
good as new.

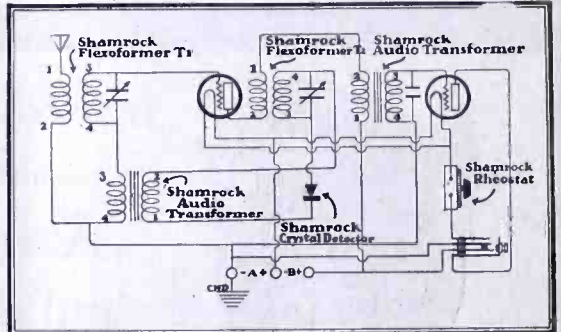

**Saves 60 per cent
in battery costs**

THE Shamrock-Farkness two-tube set that does this is described in "Shamrock Radio Builder's Guide Book." Efo e building your set, send 10 cents for this wonderful booklet. It will save you money.

SHAMROCK MANUFACTURING CO.,
Dept. 73, Market St., Newark, N. J.

SHAMROCK
FOR SELECTIVE TUNING

SHAMROCK MANUFACTURING CO.,
Dept. 73, Market St., Newark, N. J.
I enclose 10 cents (U. S. Stamps or coin) for copy of "Shamrock Radio Builder's Guide Book," containing Log Record. Also diagrams and complete instructions for building 10 sets at prices ranging from \$15 to \$50.

Name.....
Address.....
Dealer's Name.....

THOROPHONE

TRADE MARK REG. U.S. PAT. OFFICE

Makes Distant Stations

LOUDER



High
Power
Type
Model
S-5
\$45.00

"The THOROPHONE'S capacity to amplify makes it possible to bring in on the loud speaker distant stations that would otherwise have to be received on the headset," says W. D. Leet, Chicago, Ill.

The THOROPHONE uses a powerful solenoid, whose intense force is added to that of the signals, giving maximum volume of tone.



Second only to the THOROPHONE is the new THOROLA, just introduced to meet the demand for an instrument which does not require a storage battery, but which is built with the same precision as the THOROPHONE. Here you have the same controlled mica diaphragm which gives the finest possible shadings of tone.

Due to the exclusive method of adjustment found only on the THOROLA, together with the Double Push and Pull Principle of amplification, this instrument will reproduce at highest volumes with the same accurate fidelity as at lowest volumes.

THOROLA Three, 12-in. bell horn, \$20
THOROLA Four, 14½-in. bell horn, \$25

Ask your dealer about THOROPHONE and THOROLA—each the best of its type—or write for booklet.

Winkler-Reichmann Co.
4801 S. MORGAN STREET
CHICAGO, ILL.

This is the sign of Weston Quality

Beware of
that phrase
"Just as good
as Weston"

Weston Electrical Indicating Instruments are standard the world over. In scientific laboratories, power houses, factories, universities and industrial plants, Weston is acknowledged the best. Weston was the pioneer and leader. And, for 35 years, this leadership has been maintained in every branch of the electrical industry.

The name Weston on an instrument means distinguishing merit. It pro-

protects the buyer. Every instrument and plug is guaranteed. Do not be misled by that phrase "Just as good as Weston". Demand Weston and insist on getting it. The Weston Plug is interchangeable in two seconds. Merely press triggers to pull cables out. Shove cables in to connect. No tools. Operators everywhere admit its infinite superiority. Get one today. If your dealer cannot supply you, write direct to the company.

Weston Electrical Instrument Co., 156 Weston Ave., Newark, N. J.

Electrical
Indicating
Instrument
Authorities
Since 1888

WESTON

STANDARD - The World Over

FACTS YOU SHOULD KNOW

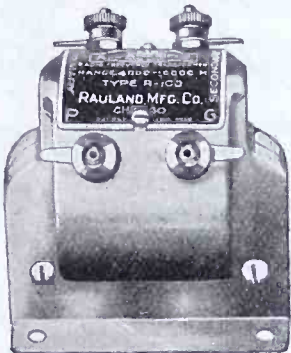

Why this new All-American Long Wave Radio Frequency Transformer, in its handsome nickeled shield at \$6.00, is the finest amplifying instrument to be had at any price for Super-Heterodyne, Ultradyn, and all straight radio-frequency and reflex circuits:

- (1) Highest amplification, without distortion, of any transformer on the market; for wave lengths 4,000 to 20,000 meters.
- (2) Quiet in operation; shielded to prevent inter-stage coupling or reaction.
- (3) Stable; free from any tendency to oscillate.
- (4) Windings specially designed to eliminate capacity; properly treated to exclude humidity.
- (5) Every transformer "circuit-tested" for accuracy and precision—to insure uniformity and highest efficiency.
- (6) The best long wave transformer that can be made. Built and fully guaranteed by the largest exclusive makers of transformers. All the better dealers recommend the All-American.

ONLY 10 CENTS
for new All-American
"Radio Key Book." 48
pages of valuable hook-ups
and up-to-the-minute radio
information. "Worth a
dollar!" Send 10c in coin
or stamps to
RAULAND MFG. CO.
2654 Coyne Street
CHICAGO



ALL-AMERICAN

AMPLIFYING TRANSFORMERS

Largest Selling Transformers in the World

RADIO MAP OF THE U. S. 35c

For Sale by
Pacific Radio Pub. Co., Inc., San Francisco

Tell them that you saw it in RADIO

New!

FIL-KO-STAT
SCIENTIFICALLY CORRECT RADIO RHEOSTAT

with Battery Switch Attached

\$2.00
AT YOUR DEALER



at no extra cost. Still \$2.00. Still the filament control of proven supremacy. The only rheostat and battery switch in one. If you want perfect control of any type tube in any hook-up—if you want DX stations you never heard before—if you want silent tube operation—maximum signal regeneration—longer tube and battery life—then you must use FIL-KO-STAT, the Filament Control of Infinite Adjustment. The Battery switch (patent applied for) attaches to regular mounting screws. No extra holes to drill.

Write for a free copy of our new booklet
"Improved Reception Through Scientific Tube Tuning"

New!

FIL-KO-SWITCH
SCIENTIFICALLY CORRECT
Simple-Sturdy-Sure

50¢
AT YOUR DEALER



A necessity on any radio set. "Current on or off at the touch of your finger." It takes minimum space both on the panel and behind it. The single-hole mounting makes it easy to attach. Fitted with double connections—connect wires to the terminal screws or to the solder lugs. Sturdy interior members give positive contact. Metal parts heavily nicked.

New!

FIL-KO-LIGHTNING ARRESTER
SCIENTIFICALLY CORRECT
Prevents Leakage Losses

\$1.50
AT YOUR DEALER

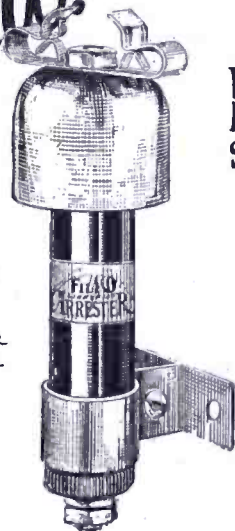

This arrester with its bell-shaped shield will positively keep dry and not gather dust or other conductive matter which causes short-circuits from aerial to ground. This makes certain that all radio impulses reaching the aerial pass through your set, insuring maximum reception. Insulation is of polished Bakelite—the best, most moisture-proof dielectric. It is hermetically sealed—no dirt or moisture can reach the gap. Rugged mounting bracket keeps FIL-KO-Lightning Arrester rigid under all conditions.

MADE AND GUARANTEED BY



HARRISBURG — PENNSYLVANIA
Dept. R 724

Foreign Representatives

RADIO STORES CORP.

New York City

New York Office
220 WEST 34TH STREET
(Address All Mail to the Factory)

"The Best Built Set in America"

A Fact—Not a Slogan

R-212

MATCHED DIAL



Licensed by
Independent Radio Manufacturers, Inc.
NEUTRODYNE
Pat. March 27, 1923 and April 1, 1924.
Hazeltine Pats. Nos. 1,450,080 and 1,489,228
Other Patents Pending.

ARTISTRY—QUALITY—
WORKMANSHIP and
ENGINEERING are exemplified

in the R-212 Matched Dial NEUTRODYNE 5 TUBE MODEL

RADIO SERVICE LABORATORIES

1007-11th Ave.

Asbury Park, N. J.

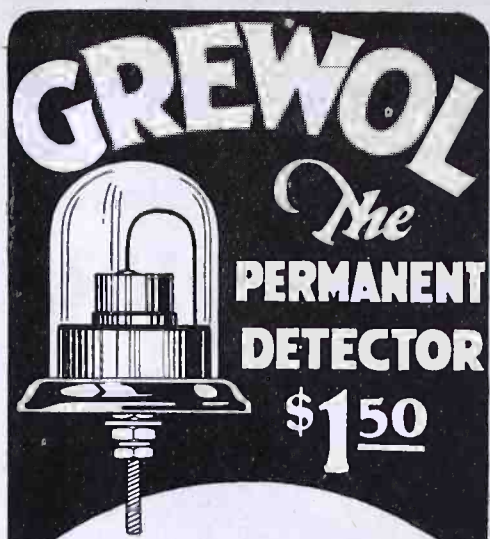

GREWOL
The
PERMANENT DETECTOR
\$1.50

Like a vacuum tube—always set and ready, at the peak of sensitivity. Vibration proof adjustment, all enclosed away from dust and any possible danger. The ONLY standard, nationally advertised REFLEX crystal detector. Best for all circuits.

Sold by Good Dealers Everywhere, or Direct Upon Receipt of Dealer's Name and \$1.50.

Patented May 15, 1923

Serial No. 1454997

Infringement subject to prosecution

GREWOL

2 in One Crystal

Two surfaces instead of only one.
Double life, double value.

50c each



GUARANTEED BY

GREWOL MFG. CO.
NEWARK, N.J.

TELOS RADIO

—that the world may hear the world

Danziger-Jones, Inc. New York

Don't You Get Tired

of only hearing LOCAL stations on your Crystal Set? There's music on your aerial every night from stations far away. If you want to hear it without buying a tube set, WRITE ME TODAY.

LEON LAMBERT
542 South Volusia Wichita, Kansas

Tell them that you saw it in RADIO

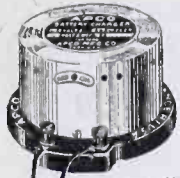

You Can Also Charge "B" Batteries at Home!

The APCO "B" Battery Charger is a worthy ally to the successful APGO Charger for "A" Batteries. Renews any 24 or 48 volt wet "B" battery in ten hours—without disconnecting set. It's noiseless, clean and as easy to hook up as an electric iron. Complete with wires ready to use, \$10. Write for interesting circular and nearest dealer's name.

APCO MFG. CO.
Virginia Ave., Providence, R. I.

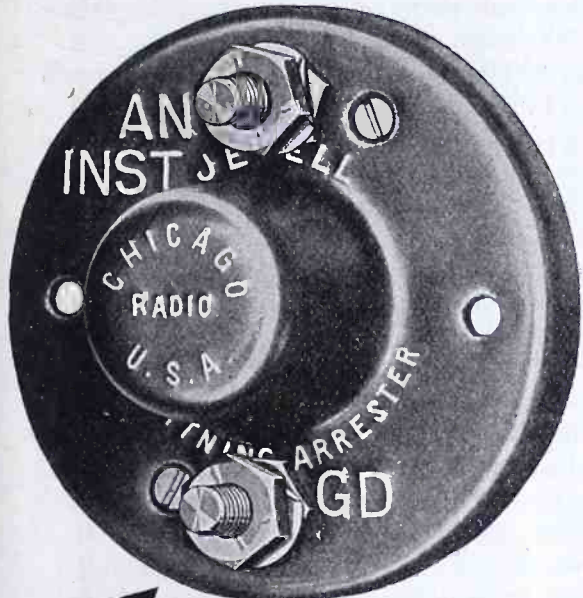

JEWELL LIGHTNING ARRESTER

Approved by Underwriters

The latest regulations of the National Board of Fire Underwriters call for a lightning arrester on every building having an outside aerial. The Jewell Arrester has passed all the Underwriters' tests and carries their approval.

The case is made of porcelain with a brown finish that harmonizes with interior woodwork. The price is right.

PRICE \$1.10

ORDER FROM DEALER

JEWELL ELECTRICAL INSTRUMENT CO.
1650 Walnut St.
Chicago

"A THING OF BEAUTY" THE "RF22"

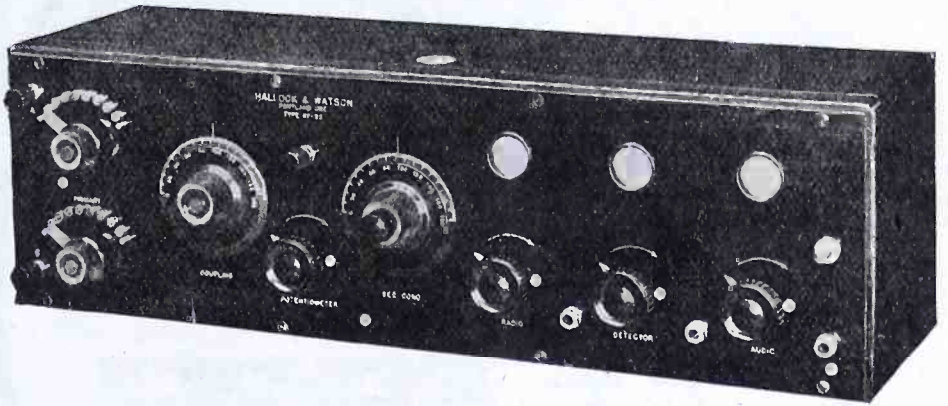

A "Five-Tuber" That Acknowledges No Peer

Write us for Pamphlet and Testimonials

HALLOCK & WATSON RADIO SERVICE

192 Park Street "KGG" Portland, Oregon
WESTERN DEALERS—MAY WE QUOTE YOU?

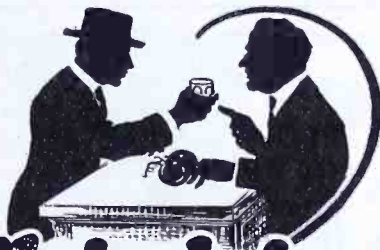

Thinking Radio?



SENT FREE

Then Get Our Free Bulletin No. 92 It shows recent developments and improvements in parts, and the kind you must use if you want the best in Radio. Send for this book today.

PREMIER PARTS

Quality Unsurpassed For Every Known "Hook-Up"—All Good Dealers Sell Them.

Premier Electric Company

3813 Ravenswood Ave. Chicago

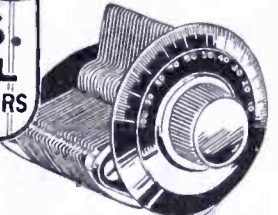

U. S. TOOL CONDENSERS —the Surest Part of Your Set

Designed for most accurate capacity and guaranteed to give 100% satisfaction—the guarantee that is bringing U. S. Tool to the fore with careful set-builders.

BUY CONDENSERS BY CAPACITY—NOT PLATES

100% GUARANTEED
END PLATES OF CELORON

FOR Superheterodyne, Superdyne, Inverse Duplex and Four Circuit Tuner Circuits.

Condensers of recommended capacity for all known circuits are also carried in stock by leading radio retailers.

Write for Booklet.

U. S. TOOL CO., Inc.
114 Mechanic St. Newark, N. J.

Coast Representatives:
THE SPECTOR COMPANY
Rialto Bldg. San Francisco, Calif.

SUPERDYNE

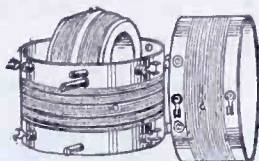

ORIGINAL GLOBE COILS
(Single Mounting)

Wound with silk wire on bakelite to correct specifications. \$6.25
C. O. D. Parcel Post.....

Complete 4-Tube Set, K. D. Panels Drilled, Fitted..... \$35.00

GLOBE RADIO EQUIPMENT
217 W. 125TH ST. NEW YORK CITY

BLACKBURN GROUND CLAMP FOR RADIO CIRCUITS

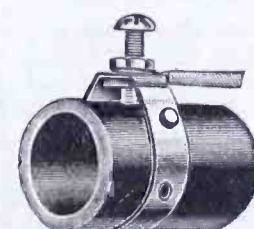

TYPE No. A-1 CLAMP
Adjustable to any size of pipe. Can be attached in one minute. No pipe cleaning necessary. Screw bores through rust and scale. No detachable parts to lose. Assembled with shoe for lead pipe. Not the cheapest but worth more to 10 million users. Heavier types made for lighting circuits.

Samples and prices to dealers.
Blackburn Specialty Co.
1966 EAST 66th ST. CLEVELAND OHIO

Tell them that you saw it in RADIO

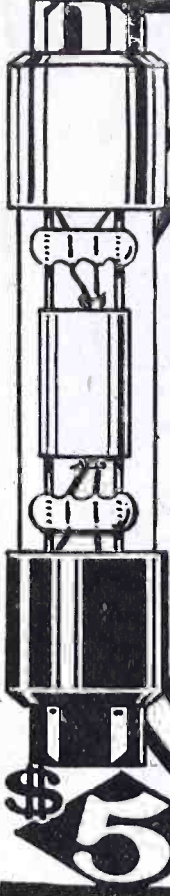

**London
Hawaii - Porto Rico**

A Canadian amateur (T. A. Crowe, Calgary), operating on three Myers Tubes, heard the concert broadcasted by 2 L.O., London, England, and picked up Hawaii and Porto Rico the same evening. (Calgary Herald, April 1st). Are you getting results like this? You can with

Myers Tubes
Practically Unbreakable

They banish the noise that spoils reception and give wonderful volume and clarity to long-distance messages. Myers Tubes function perfectly as Detectors, Amplifiers and Oscillators. You can't break 'em unless you deliberately try. Two types: Dry Battery and Universal for storage batteries. (4 volts)

Demand Myers Tubes at your dealers or send price and be Supplied postpaid. See words 'Made in Canada' on each tube. Others not guaranteed.

Complete with clips ready to mount. No extra equipment required.

E. B. Myers Co. Ltd.
Radio Vacuum Tubes
240 CRAIG STREET, W.
MONTREAL, CANADA

\$5

HOW RADIO CAME TO CAMBRIDGE

Done into part English by
WALTER BLACK

Deer Mistur Ed:

Ay tank bay Gosh ay lak to tal you 'bout one tam ay get stung 'ver' awful bad by little black bug, and don't bane ever get well.

That was year during awful fine Cambridge Fair the weather drop small ocean of wetty raindrops on Fair ground, and them Fair fallers yust go so broke, bay Gosh, as me. One smart faller, he say "Better we put on local play talent and fix 'em all right. Ole, he bane gude faller, he run play talent lak house afire."

Well, ay don't bane here long from Minnysody, but ay spik English purty gude so ay bane take yob to be play manager, bay Gosh. But purty soon ay don't tank it bane play, it bane work lak H—I. Ay bet ay work sax tams harder as ay work in Minnysody, where ay milk nineteen cows for breakfast every morning!

But Mistur Ed, that bane some play! In that play we haf to make believe, bay Gosh, that we bane somewhere in France in big fight wit' Kaiser Bill. We haf shots, and words-to-pass, and blow-ups, and all the excitements of a small size World's war. One faller, he bane telygraffer. Ay never know how war-time telegraffer pack telegraff office along, so ay ax Sharlie. Sharlie, he bane gude friend of mine, but he bane purty gude faller, too, so he say, "Leave that to me. Ay fax him." So ay do that.

Well, Sharlie, he fax oop little yeast cakes box wit' two cute little Never-bane-ready battery cells inside and what he call key and sounder outside, on top. Then when play come off this faller, he take little yeast cakes box in his arms and gallop onto stage and SEND lak saxty for minute, then look oop at Captain and holler: "The enemy is surrounded us; we are lost." Hi!

But one day 'bout that tam Sharlie he say, "Ole, maybe so we put little buzzer on yeast cakes box and you learn code. Ay bane pre-war 8AMN, Columbus, Ohio."

Bay Gosh, ay never know that before, but we yust do some of what he say, and purty soon we have code on paper and yust buzz lak hornet's nest; while small black bug insert his stinger yust little bit in small of may back and hang on.

Then Sharlie, he say we put up small antenny and crystal set and get tam sigs. Ay yust work lak Sam Hill then, but when them tam sigs come they yust go by me lak hand car pass oop tramp. Seem lak they bane in awful hurry for go somewhere. Sharlie say they go fast



\$30.00

COMPLETE
DELIVERED
FREE TO YOU

MARATHON ULTRADYNE

(SUPER HETERODYNE)

The Very Newest Development in Radio at an Unheard of Low Price

Complete set as shown above, including coils and transformers ready for assembly—and with complete assembly chart, \$30.00.

This is the last word in radio. Gives you extreme selectivity, absolute clarity without noise or distortion. No antenna or ground necessary.

Every set of Marathon Ultradyne parts designed and tested by N. E. Borch, internationally known radio engineer.

Send check or money order for \$30.00 and we will pay all transportation charges.

Or, send no money, and we will send set—you to pay postman upon arrival.

These sets are going like hotcakes. Orders filled in rotation.

MARATHON RADIO, 579 Howard Street, San Francisco, Cal.

Tell them that you saw it in RADIO

as light, which go maybe sax hun'erd mile a minute, so ay don't wonder ay never bane ketchum. But small black bug bite now lak iron bulldog, so ay practice code lak one armed man in yaller yacket's nest.

Then Sharlie bane tell me 'bout his friend he got in Roswell, New Mexico. Faller bane got call 5ZA, and he sure bane one gude ham. Sharlie one tam work 'long side him in battery car works at Roswell, and that tam 5ZA yust have big coil what stand oop on end lak stove pipe, but now he bane best ham in United States and Seattle; so Sharlie say we write Looy and tall him purty soon we be on air, better look oop. Then Sharlie send back to Columbus for his old trance former and notary gap, and we burn a midnight Mazda while we build real set.

Purty soon we get snossage tube wit' purty little red and brown and green tails at both ends, and when we get it fastened to our hook-on we hear some Henry sets yust sputter lak forty, and Sharlie say words ay not tell; but ay don't tank he like Henry sets ver' awful much!

Then 8MF move all the way from Buffalo, Noo Yawk on Hardly-Doodleson motor bicycle, and set up at Mesa, yust faften miles outside of us, and get himself a license for use in Idaho called 7CK. Ay tank he have one awful noise for notary gap, for he kill off all other QRM for hun'erd miles around when he open up; but he bane have gude fist, and ay eat him oop for practice.

Sharlie write 5ZA again and tall him 'bout our snossage tube. Sharlie's old private call bane "C W," so he tall Looy if he use that call and send us message some night we hear him-maybe.

And then, one very fine, large, juicy night ay bane listen in, and ay hear it, very slowly and very plain for me to read: "7CK, 7CK, 7CK, de 5ZA, 5ZA, 5ZA. Can U take msg for C W? K."

Mr. Ed, ay bet a yump high as cow's back. Ay feel little shiver skate oop and down may backbone lak one tam when ay tank ay see ghost. 7CK bane pound his ear, ay tank, so that msg never come thru, but little black bug sure make fatal bite on me.

That bane long tam ago. 7CK and his Hardly-Doodleson have left United States and gone to Frisco. Sharlie borrowed call 7ACM from Mr. Redfern, at Seattle, but sent it back and moved to Elko, Nevada, where he chums with high flyers like 6BOE, who runs a mail plane from Salt Lake. But ay go broke as four o'clock, and now ay yust bane poor Swede on homesteading ranch, and got no yuice. But ay tank purty soon ay get on air with spark coil CW, lak Frankis L. J. Bluffy, 9DDY, of Caberry, Ill. Ay try any thing once, and if the little birdie don't bane twitter for



a Scotch- man



Plain types: 3-plate \$1.25, 5-plate \$1.50, 13-plate \$2, 17-plate \$2.50, 23-plate \$2.75, 43-pl. \$3, at dealers'.

Vernier type: 13-plate \$4, 23-plate \$4.50, 43-plate \$5.50, at dealers'.

has nothing on these condensers

If a Walnut Condenser ever let go of more than .00000? it'd probably buckle up with shame. In which event we'd replace it free. Like the Scotch, these condensers are record-holders for "low losses." And, in addition, they STAY TIGHT for life.

WALNART VARIABLE CONDENSERS

are the last place to look for trouble. Plates accurately pressed, aligned and locked to stay in strong slotted studs. Bakelite end plates. Ask your dealer first, please.

"Makers of good goods only"

WALNART ELECTRIC MFG. CO.

Dept. 210

Chicago



See our Booth at the
**PACIFIC RADIO
EXPOSITION**
August 16 to 21

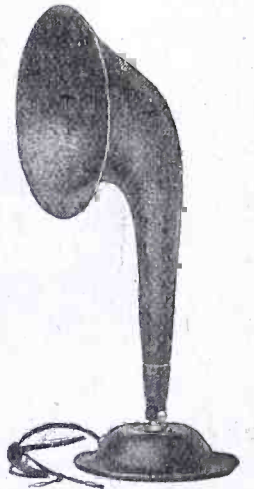

BRISTOL SINGLE STAGE POWER AMPLIFIER-

gives additional VOLUME with any two stage amplifier. No separate batteries required. It provides the additional volume necessary to bring in very distant stations on the loud speaker.

AUDIOPHONE Loud Speaker

Quality of reproduction such as only the original itself can equal. Speech that is so distinct that the voice heard is the actual voice of the speaker. Music that requires no tolerant imagination to be recognized as music of the finest type.

The Audiophone furnished in three models — Baby \$12.50, Junior \$22.50, and Senior \$30.00.

Write for Bulletins Nos. 3014 and 3015-E.

THE BRISTOL COMPANY WATERBURY, CONN.

Pacific Coast Branch Office—Bialto Bldg., San Francisco

"B" BATTERIES AN EVEREADY PRODUCT

43V. Batteries, tapped \$5.00
22½V. Batteries, Navy Type 3.00
22½V. Batteries, Commercial Type 2.00

Latter two types especially adapted to
Cunningham and Radiotron Tubes.
Postage Prepaid Anywhere in U. S.

ETS-HOKIN & GALVIN Wireless Engineers

10 Mission Street San Francisco

SIMPLEX Lightning Arresters

Approved Air Gap type.
Sealed in fine brown glazed
porcelain. Easily
installed.

No fuse or vacuum.
SIMPLEX RADIO CO.
(Mfrs.) Philadelphia

Western
Representatives:
Frederic L. Tomlinson Co.
Seattle San Francisco
Los Angeles



\$1.50

Ask
Your
Dealer

Tell them that you saw it in RADIO

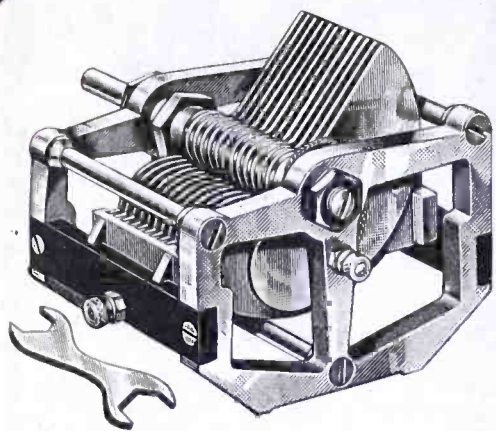

Bremer-Tully "LIFETIME" CONDENSER

The new Bremer-Tully "Lifetime" condenser gives you everything you can and should expect in a condenser.

Adjustable, Lubricated, Two-step, Thrust Bearings with exclusive take up features found only in B-T Condensers. A "Laboratory Type" at a commercial price. For sale at dealers.

Send for "20 Point" circular giving full description.

BREMER-TULLY MFG. CO.

536 S. Canal St., Chicago

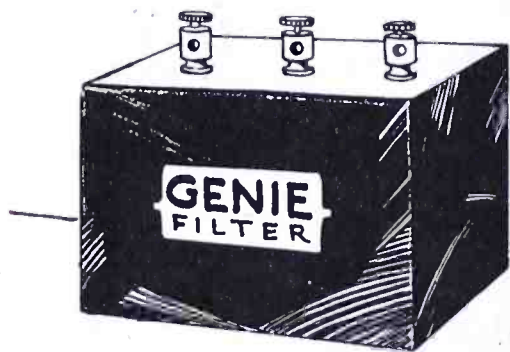

"Noise Killer" INDUCTION FILTERS

Given Free this
Month

FREE—The new Genie Induction Filter for eliminating induction noises from telephone and power lines, etc. Send us your subscription to "RADIO" for one year, \$2.50, and the Filter is yours. Not another cent to pay. This special offer is made again this month by popular demand. Almost 1000 Filters were given free to our subscribers during the last two months. This is your last chance to get one of these practical and useful instruments. Every radio receiving set should be equipped with this device. Don't be bothered with induction noises in your receiving set. Install a filter. This device was designed by Don Lippincott, Radio Engineer. It is manufactured by the Aerovox Corporation of San Francisco. Send your \$2.50 to us right now and you will get a Filter by return mail and receive "RADIO" every month for a full year.

Diagram shows simplicity of connection to your set. No tuning controls to bother with. Can be installed in a few moments.

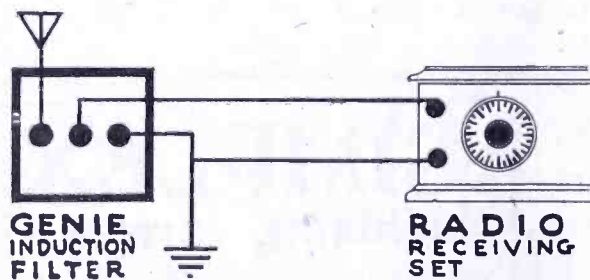

"RADIO," Pacific Building,
San Francisco, Calif.

Herewith is \$2.50. Send me the Genie Induction Filter at once and put me on your subscription list of "RADIO" for one full year.

Name
Address
City
State

RADIO SHOW TICKETS FREE!

Subscribe to "RADIO" for 6 months (\$1.00) and we will send you two admission tickets for the Pacific Radio Exposition.

"RADIO," Pacific Building, San Francisco

me ay tank ay go back to Minnysoty and milk nineteen cows for breakfast every morning till I get rich again; then ay buy mayself one fine large yuicy power plant, and QRM the world!

Disjectedly but hopefully yours,
OLE.

You Can Charge Better With an

F-F BATTERY CHARGER

Be sure to investigate this triple duty battery charger before making a purchase. The type AB F-F charger charges 2, 4 or 6 volt "A" or auto battery and "B" batteries from 20 to 120 volts in series. Charges a battery for about a nickel. No fuss or trouble—operates from the light socket. Price on the coast—Type AB \$21.00; Type 6 for "A" or auto batteries, \$16.50.

Write for literature.

Complete stock in San Francisco.

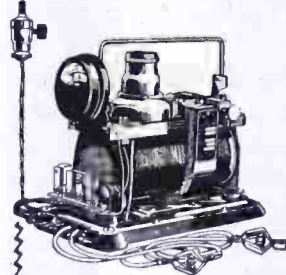

THE
FRANCE
MFG. CO.

10323 BEREA RD.
Cleveland, Ohio
75 FREMONT ST.
San Francisco
53 FOURTH ST.
Portland, Ore.

TELMACO RADIO GUIDE 10

Describes the
Best in Radio



20 Latest Circuits in Blue in New 64 Page Book

These include the Super-Heterodyne, Neutrodyne, Grimes Inverted, Colpitts, Flewelling, Reinartz, Push-Pull Amplifier, Diode Electrad, Super-Regenerative and many others.

Standard Guide for Thousands

The Telmaco catalog has become the standard guide for thousands of radio users in their selection of quality radio. Besides blue prints, it describes and illustrates the best products of America's leading radio manufacturers. Sent postpaid for 10c. Each circuit worth double. Send for your copy today.

Dealers! Dealers' Catalog and Price List FREE to all bonafide dealers making request on their business stationery.

Radio Division
TELEPHONE MAINTENANCE CO.
20 So. Wells St. Dept. A Chicago, Ill.



Quality Radio Exclusively Est. 1918

You Should Be a Subscriber

Why be Satisfied with a Jumble of Interfering Stations?

Install a New York Low Loss Grounded Rotor Variable Condenser in Your Present Set and receive the Full Pleasure of Broadcasting

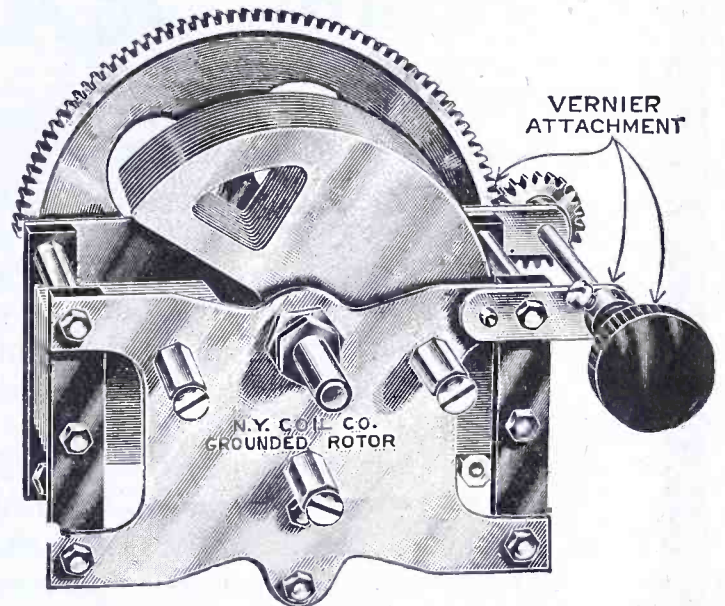
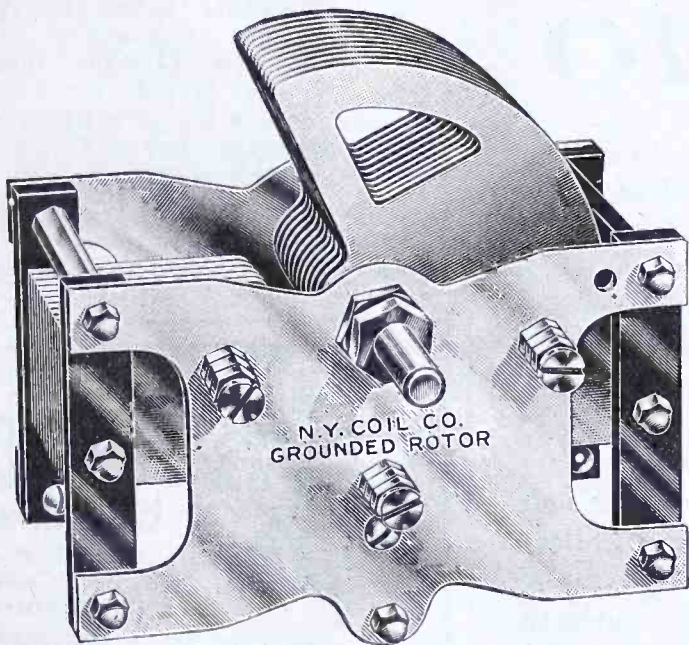

OUR NEW LOW LOSS CONDENSER is in a class by itself — superlatively better — no other condenser manufactured incorporates so many vital improvements.

Adjustable cone type bearings, pig tail connections and stop, straight line capacity, geared vernier action (which may be purchased separately if desired)—only geared vernier that swings a 4-inch dial. Dielectric of genuine hard rubber with wide spacing of plates. In a word a precision instrument possessing the absolute minimum losses, the maximum obtainable efficiency, insuring greatest distance, sharpest possible tuning and wonderfully clear reception.

.0005 (23 plate) **\$4.50**
without Vernier

Geared Vernier attachment, complete, \$1.50

Unequaled for Super-Heterodyne, Neutrodyne and all exacting circuits.

September deliveries

OUR SUPER-HETERODYNE KIT at \$20.00, consisting of oscillator coupler, input, and three matched intermediate air-core transformers, makes up the best set known to date.

Other items of proven superiority: Distortionless Audio Transformers, Tuned Radio Frequency Transformers, By-Pass Condensers, and precision Mica Fixed Condensers.

PRECISION MICA FIXED CONDENSERS

"More Uniform Capacity"

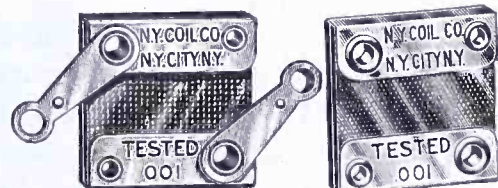

Type B

Type A—No Clips

Adapted by Leading Heterodyne Manufacturers on account of truthful capacity rating. This is the only laboratory precision-built condenser on the market, yet sold at a commercial price. It is standard equipment with some of the largest and most discriminating set manufacturers.

Guaranteed for capacity and against leakage or breakdown.

The following sizes always in stock:

Capacity	Retail Price
.0001 Mfd.	.35
.00015 "	.35
.00025 "	.35
.0005 "	.35
.001 "	.40
.002 "	.40
.005 "	.60
.006 "	.75
.00025, with Grid Leak Mounting attached, 45c list.	Type C

NEW YORK COIL COMPANY

338 Pearl Street, New York City, N. Y.

Pacific Coast—MARSHANK SALES CO., 1240 S. Main St., Los Angeles, Calif.

How You Can Know Latest Facts about RADIO

The very best way to know all Radio facts is to own a Lefax Perpetual Radio Handbook. When you buy it, you become a registered owner. That means complete facts as they are discovered, are mailed to you every month—printed, punched, ready to insert instantly in your Lefax Handbook. Lefax doesn't, cannot grow old. It keeps on giving you information, but you pay only once. There is no charge for twelve monthly mailings.

Here is a different, better book on Radio. It was written by Dr. J. H. Dellinger, Chief of the Radio Laboratory, U. S. Bureau of Standards, and L. E. Whittemore, Department of Commerce, Washington, D. C. Ordinary books on Radio grow old and out-of-date almost as soon as printed. Changes occur rapidly. Lefax gives them all, as they happen. You get all the new ideas, in loose leaf form, pocket size, beautifully, accurately illustrated. And you get a complete list of broadcasting stations, with full information about each one.

The binding is flexible imitation Morocco leather—long, long wearing and very attractive. Pages are most readable and are indexed with linen tabs, plainly marked. There isn't anything else like Lefax, by any name or in any form. Look into it. Ask your Radio dealer, book store or stationer for

LEFAX Perpetual
Radio Handbook

Published by

LEFAX, Incorporated
Philadelphia, Pa.

SUPER-HETERODYNE

25c

Reprints from "RADIO" by G. M. BEST. Sent to any address for 25 cents.

PACIFIC RADIO PUB. CO.
Pacific Building—S. F., Cal.

Only a Few Left

Tell them that you saw it in RADIO

RADIO



PARTS

Formerly
"MASTER" Line

REDESIGNED AND IMPROVED

For ACCURACY, EFFICIENCY and APPEARANCE, insist on "K.B." products from your dealer. Ask to see our new type Variable Condensers with important Special New Features. Jobbers and Dealers write for attractive prices and discounts.

K. B. MANUFACTURING CO.
Dept. C—No. 222 Eighth St.,
San Francisco

BAKELITE Mouldings, Dies, Custom Work



THE
PROUDFOOT
CONDENSER

Losses Cannot
Be Measured!

Think of it—nearly 100% efficiency in condenser service! You have to see the Proudfoot to appreciate its watch-like precision and accuracy. Two-point stator plate mounting (instead of the customary three-point), wiping contacts and fine bronze bearings all contribute to its superior quality and put it in a class by itself in the field of condensers.

One Knob Vernier And Group Plate Control
You can even log your vernier adjustment on the Proudfoot. There are two separate scales on the dial that make this possible and complete tuning is ingeniously done with one knob. No more "will-o'-the-wisp" tuning.

Try One On Your Set
You'll marvel at results. And the Proudfoot costs no more than any reliable condenser. 13 plate (M. F. C. .00025)—\$3.75; 25 plate (M. F. C. .0005)—\$4.50; 43 plate (M. F. C. .001)—\$5.75. Accept no substitute. If your dealer cannot supply you, write us.

CRUVER MANUFACTURING CO.
2456 W. Jackson Blvd. Chicago, Ill.

from the **RB** laboratory

This 52 page Book describes how to make **9 KNOCKOUT Radio Receivers**

50c

B. R. Linton, Hapeville, Ga., using the 1-tube Knock-out set described in this book, hears KFI, Los Angeles and many other distant stations regularly on his loud speaker.

YOU, too, can build a Knock-out distance-getter. This book tells you how! No "trick" circuits; each of the sets has been built and tested in the Radio Broadcast laboratory—where all new circuits are tried out—under the personal direction of Arthur H. Lynch. The 9 Knock-out sets described in this book were chosen because of the exceptional results obtained with them by hundreds of Radio Broadcast readers. You can buy all of the parts from your nearest dealer.

The first edition of Radio Broadcast's Knock-out series was sold in less than 10 days. The second edition—more data, more photographs—is going fast. If your dealer cannot supply you, use the coupon today. If dissatisfied we will refund your money.

RADIO BROADCAST, Doubleday, Page & Co.,
Garden City, N.Y.

I enclose 50 cents in payment for a copy of Radio Broadcast's Knock-Out Series to be sent to

R

A Sea-Going Radio Operator's Adventures Humorously Related in—

"The Radiobuster"

A thrilling book from the skilled, whimsical pen of a wandering adventurer who has faced Arctic blizzards upon the decks of ice-cruled square-riggers and sat at the key in the radio rooms of the greatest ocean liners.

"A good series of yarns."—
New York Herald.

"To one who likes his radio stories crammed full of action and adventure, * * * 'The Radiobuster' should prove an extremely entertaining book."—*New York Telegram.*

\$ 1.00 Per Copy

SENT POSTPAID ANYWHERE

"RADIO", Pacific Bldg., San Francisco, Calif.

Here is \$1.00. Send me a copy of the "Radiobuster."

Name

Address

City

State

RADIO ADS

A CLASSIFIED ADVERTISING SECTION READ BY BETTER BUYERS

The rate per word is five cents net. Remittance must accompany all advertisements. Include name and address when counting words.

ADS FOR THE SEPTEMBER ISSUE MUST REACH US BY AUGUST FIRST

158 GENUINE Foreign Stamps. Mexico War Issues. Venezuela, Salvador and India Service. Guatemala, China, etc., only 10c. Finest approval sheets 50 to 60%. Agents Wanted. Big 72-p. Lists Free. We Buy Stamps. Established 20 years. Hussman Stamp Co., Dept. 150, St. Louis, Mo. (3T)

AMERICAN MADE TOYS—Manufacturers on large scale, and others wanted to manufacture metal toys and novelties. Millions needed of barking dogs, wag tail pups, wild animals, automobiles, Indians, cowboys, baseball players, cannons, toy soldiers, crowing roosters, statues of Liberty, miniature castings of capital, bathing girl souvenirs and others. Unlimited possibilities. Guaranteed casting forms furnished manufacturers at cost price from \$5.00 up, with complete outfit. No experience or tools necessary. Hundreds made complete per hour. We buy goods all year and pay high prices for finished goods. Cash on delivery. Contract orders placed with manufacturers. Catalog and information free. Correspondence invited only if you mean business. Metal Cast Products Co., 1696 Boston Road, New York.

MAKE BIG MONEY OUT OF RADIO

Thousands of People want to buy a good Radio instrument. They have read that vast improvements have been made and they are ready to buy now if you show them the best.

It is one thing to make a good radio instrument for your own amusement, but why not cash in now on your experience? Let us send you full particulars of the Ozarka Plan which shows you how to

"MAKE \$120 WEEKLY"

selling long-distance Radio sets. The season is on right now. Let us tell you how to combine the clear signal of the crystal detector with the distance of the vacuum tube. Write today and don't fail to give the name of your county.

OZARKA INCORPORATED
814 Washington Blvd., Chicago

C. W. and RADIO PHONISTS—Our new converters will satisfy your need for a more efficient and durable direct current plate supply. No armatures to burn out. Output from seven hundred to two thousand volts at 4 amperes. Synchronous Motors, Transformers and other parts sold separate. Write immediately, Kimley Equipment Mfg. Co., 290 Winslow Ave., Buffalo, N. Y. (tc)

ARC & SPARK SYSTEMS
Send for Descriptive Circular QRD.
Interesting and Instructive (tc)
Pacific Radio School 433 Call Bldg., San Francisco

Vacuuro Tube Hospital
We repair and guarantee them.
Agents, Dealers, and Customers Wanted.
Radiotube Co., 903 Broad St., Newark, N. J. tc

TELEGRAPHY—Morse and Wireless—taught at home in half usual time and at trifling cost. Omnigraph Automatic Transmitter will send, on Sounder or Buzzer, unlimited messages, any speed, just as expert operator would. Adopted by U. S. Government and used by leading Universities, Colleges, Technical and Telegraph Schools throughout U. S. Catalog free. Omnigraph Mfg. Co., 16 J. Hudson St., New York City.

BIG Money and Fast Sales—every owner buys gold initials for his auto. You charge \$1.50, make, \$1.44. 10 orders daily easy. Samples and information free. World Monogram Co., Dept. 68, Newark, N. J. (SAS)

RADIO GENERATORS—500V 100 watt \$28.50. Battery Charging Generator \$8.50. High Speed Motors. Motor Generator Sets, all sizes. MOTOR SPECIALTIES CO., Crafton, Penna. (tc)

COMPLETE 3-Tube Radio Set, Magnavox R-3, Storage Battery, B Batteries and Aerial. Only \$125.00. For information, write Albert Roof Ottawa, Ohio.

SPECIAL!!! Inch Display Advertisement 166 Magazines—Thrice \$15, Year \$50. J. Herman Wood's Popular Advertising Service, Atlantic City.

MUST SELL AT ONCE—Magnavox large horn, old style, \$15.00; A.C. 2 C Power amplifier with two power tubes, \$35.00; Crosley 51, \$10.00; Crosley amplifier, \$10.00; Western Electric 521W Horn, \$14.00; New Baldwin phonograph attachment, \$6.50. Many other supplies at comparative prices. Everything guaranteed good as new. Write me or will ship collect. Harry K. McAfee, Center, Colorado.

158 GENUINE Foreign Stamps. Mexico War Issues. Venezuela, Salvador and India Service. Guatemala, China, etc., only 5c. Finest approval sheets 50 to 60%. Agents Wanted. Big 72-p. Lists Free. We Buy Stamps. Established 20 years. Hussman Stamp Co., Dept. 150, St. Louis, Mo.

FOR SALE: Grebe CR 5 and Grebe 2 step with tubes, batteries, phones, and battery charger, \$50. Write Rex Blackwell, Grand Junction, Colo.

1500 AND 750-VOLT D.C. GENERATORS FOR \$45. General Electric Ball bearing dynamotors, absolutely brand new and unused, made for the Naval Air Service. Rated at 25 Volts, 31 Amps., D.C., input, 1500 volts 233 MA output (rated), but will give 500 MA without heating. These machines can also be used as double current generators, giving above output from both ends, fitted with extension shafts for external drive, and will charge batteries, supply nickel-plating current, and do anything a good low voltage shunt wound generator would. The high voltage is supplied from a double commutator armature; if 750 volts is wanted, the two ends of the armature can be connected in parallel, and 750 volts, and plenty of milliamperes (about 1000 MA) to supply 5 watters. At 1500 volts will make a pair of 50 watters hump themselves for all they are worth. Speed 6,000 RPM. Requiring about a 3/4-HP motor to drive them. \$3.00 extra for shafts extended, for external drive. F.O.B. San Francisco, Cal. D. B. McGown, 1247 Forty-seventh Ave., San Francisco, Calif.

GREBE CR-8 AND BALDWIN HEADSET used two months, \$60. Daniel Bergeron, Lathrop, Mich.

THREE KILOWATT 240 cycle motor-generator, 2400 RPM 110-volt D.C. drive, 240 cycles. 3 KW 500 volts A.C. output, such as was used on Marconi 240-cycle ship sets, with extension shaft suitable for external drive, or for synchronous spark gap. Perfect mechanical and electrical condition, although used considerably. Fine for school or college or for 'high frequency ACCW.' DC end will deliver 4 KW at 110 DC as generator, driven externally. Price \$75.00, F.O.B. San Jose, Calif. D. B. McGown, 1247 Forty-seventh Avenue, San Francisco, Calif.

CALLS HEARD CARDS, printed by 6CEC. Write for samples. The Wireless Print Shop, 2434 Leavenworth St., San Francisco, Calif.

250-Watt GE tube for sale \$75.00, including end mountings. Tube almost new—used but two or three hours. D. B. McGown, 1247 47th Ave., San Francisco, Calif.

Something New, Grab Bag—A large quantity of electrical parts valuable to amateurs; one lb. No. 32 enameled wire in each grab; \$1.00 only. Other apparatus price list. 6IC, 715 Bath St., Santa Barbara, Calif.

IS YOUR NEUT RIGHT? To revitalize un-neutralizable Neutrodynes we devised this Kladag Coast To Coast Circuit. Uses same panel, etc., as Neut, except three less parts. Merely re-wire. Success certain. Necessary stabilizer, 22 feet gold sheathed wire, circuit and complete, simple instructions—\$5.00 prepaid. Many have already rebuilt their Neuts—and written wonderful testimonials. Thousands will do it. Be FIRST—have the finest five tube set in your neighborhood, revitalize others' Neuts. Description, etc.—10c. Radio Lists—2c. Stamps accepted. KLADAG LABORATORIES, Kent, Ohio.

MUNZIG REGENERATIVE REFLEX circuit will get DX stations for you. Uses three tubes. Has no body capacity; does not re-radiate; most sensitive 3-tube circuit ever devised. Successful combination of Reflex and Regeneration possible only with the RAYDEE-FORMER, price \$3.75 each, with complete details of panel layout, baseboard layout, list of all necessary parts and circuit diagram. Transformer inclosed in bakelite housing with all terminals marked and numbered. Send stamp for catalog. RAY-DEE-ARTCRAFT INSTRUMENT CO., 1005-17 Tribune St., Redlands, Calif.

Amrad "S" tubes, improved, \$8.00. Myers and Radio Corporation tubes \$3.95. Apex Audiotrons \$3.25, type 202, \$4.00. Prices cheerfully quoted on transmitting and receiving apparatus. George Voigt, 56 Maiden Lane, Dept. R., Maspeth, N. Y.

MAGNAVOX M4. Latest nationally advertised reproducers. Magnetically balanced. Sensitive. Improved rubber cushioned diaphragm. List \$25. Introductory \$21. Radio Central, Dept. P, Abilene, Kansas.

GET YOUR NAME ON OUR MAILING LIST. We want every name. Send today. State whether a dealer. Send dealer's name. Price list now ready, catalogue on press. THE DIXIE RADIO CO., 133 Seventh Ave., New York City.

Tell them that you saw it in RADIO

5 Radio Winners!

Micrometer Control With One Knob Noiseless—Stepless—Selective



Bradleystat

PERFECT FILAMENT CONTROL

Noiseless, stepless filament current control for ALL tubes. Is standard equipment on many sets, including Amrad Console models.

Price . . . \$1.85

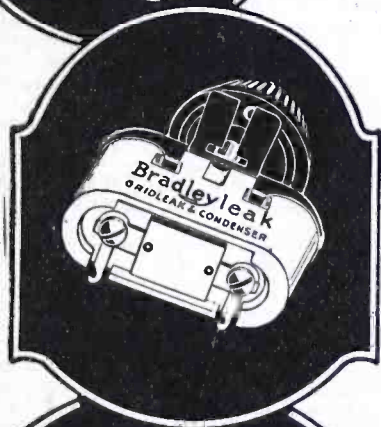

Bradleyleak

THE PERFECT GRID LEAK

Range— $\frac{1}{4}$ to 10 Megohms. A grid condenser of 0.00025 mf. supplied extra. Endorsed by Cockaday, Amrad, Flewelling, Crosley, etc.

Price . . . \$1.85
Condenser35



Bradleyohm

THE PERFECT RESISTOR

An adjustable resistor for radio circuits. Made in three ranges.

10,000 to 100,000 ohms
25,000 to 250,000 ohms
50,000 to 500,000 ohms

Price,
any range, \$2.00



Bradleyometer

THE PERFECT POTENTIOMETER

A stepless, non-inductive potentiometer for all radio circuits. Complete range in half turn of knob. Made in 200 and 400 ohms.

Price,
200-ohm . . . \$2.00
400-ohm . . . 3.00

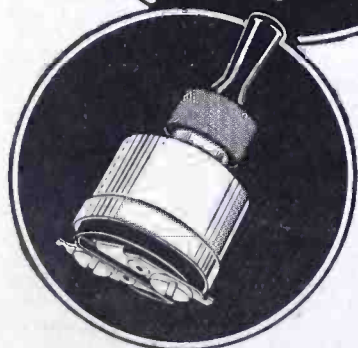

Bradleyswitch

PERFECT BATTERY SWITCH

For A and B battery circuits. Only ONE hole required in panel to mount the switch. Nickel-plated and totally enclosed.

Price 60c

Many new radio circuits have been introduced and numerous modifications of the old ones have been developed, but the need of micrometer control of current and voltage in radio circuits remains unchanged.

The Allen-Bradley line of radio products now includes five super-devices for radio control. The Bradleystat for filament control and the Bradleyleak for grid leak control are known the world over for unrivalled control and marvelous range. The well-known Bradleyometer also marks a distinct advance in potentiometer construction.

Now comes the Bradleyohm in three ranges to meet the demand for an adjustable resistor for resistance coupling and other applications. The demand for the Bradleyohm has grown to enormous proportions. The Bradleyswitch, also, is a marvel of compactness and convenience.

Your radio set will be tremendously improved if you standardize on Allen-Bradley products. Ask your dealer about them or write us for descriptive circulars.

**Mail
the Coupon
Now!**

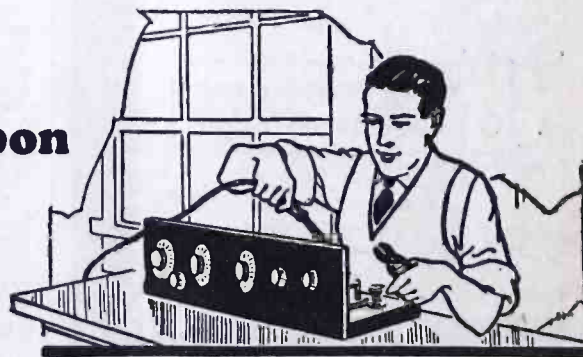

Allen-Bradley Co.
Electric Controlling Apparatus

288 Greenfield
Avenue



Milwaukee
Wisconsin

Manufacturers of graphite disc rheostats and electric controlling apparatus for more than 20 years

ALLEN-BRADLEY CO.
288 Greenfield Ave., Milwaukee, Wis.

We surely want to know more about the Allen-Bradley line of radio products. Please send us your latest bulletins about them.

Name

Address

Use the Allen-Bradley Line

Tell them that you saw it in RADIO

The Greatest Radio Value Ever Offered

"Pacific Quintet" Super-Het Kit

(45,000 Cycle)

\$15.00

Another Leader Product of the Popular "Pacific" Line

AN UNUSUAL VALUE, made possible through huge quantity production. BUILD YOUR OWN SUPER-HETERODYNE. Rebuild or convert your old set to a modern and advanced type Super-Heterodyne. All other parts required are standard. HOOK-UP PRINT with complete and simple instructions packed with each "PACIFIC QUINTET" KIT.

Foresight and Advanced Engineering Efficiency now bring the latest and most popular developments within a price range to suit the average pocket-book.



Satisfaction Guaranteed

Finely finished merchandise built for real work.

"Pacific Quintet" Super-Het Kit

Consisting of 1 Pacific "Ranger" No. 30 Oscillator Coupler, 3 Pacific "Ranger" No. 25 Intermediate Frequency Transformers and 1 Pacific No. 20 "Ranger" Filter Transformer.

SUPER-HETERODYNE

DISTANCE SIMPLICITY VOLUME

The ideal radio receiver. That most sensitive of all circuits devised for extreme long distance reception with small loop antenna and dry cell tubes.

TRULY A REMARKABLE RECEIVER

Build a 45,000 Cycle Super-Heterodyne Receiving Set for \$45.00

MATERIAL REQUIRED FOR ASSEMBLY OF 45,000-CYCLE SUPER-HETERODYNE WITH PACIFIC QUINTET SUPER-HET KIT

1 Pacific Quintet Super-Het Kit, consisting of 1 Pacific "Ranger" No. 30 Oscillator Coupler, 3 Pacific "Ranger" No. 25 Intermediate Frequency Transformers and 1 Pacific "Ranger" No. 20 Filter Transformer.....	\$15.00	
1 Cabinet	5.00	
2 .0005 MF Variable Condensers (Approximately 23 plate)..... @ \$2.00	4.00	
1 .006 MF Mica Condenser.....	.75	
3 .0025 MF Mica Condensers..... @ .40	1.20	
3 .00025 MF Mica Condenser..... @ .35	1.05	
1 .0005 MF Mica Condenser with Grid Leak.....	.45	
1 1 MF Condenser.....	1.00	
2 6 Ohm Rheostats..... @ .75	1.50	
1 4 V. Meter.....	3.00	
1 Chelton Midget Condenser or Equivalent.....	1.50	
2 Audio Frequency Transformers (Any standard 3 to 1 ratio recommended, preferably shielded) @ 2.50	5.00	
1 Open Circuit Jack.....	.30	
1 Filament Control Jack.....	.45	
8 UV 199 or C 299 Sockets..... @ .50	4.00	
7 Binding Posts..... @ .05	.35	
1 Panel 6"x26" to 30"x3/16".....	3.50	
1 Base Board 8"x26" to 30"x7/8".....	.50	
2 4 1/2 Volt "C" Batteries..... @ .40	.80	
1 1 1/2 Volt "C" Battery.....	.20	
30 Feet No. 14 Tinned Copper Wire.....	.45	
	\$45.00	

Note: Aside from the Pacific Quintet Kit, other parts of higher or lower price may be used to suit.

OF IMPORTANCE TO THE RADIO PUBLIC

The Baldwin-Pacific Line is a quality line throughout. Every item built to the highest standard of efficiency from only the best materials. Scientific design, expert workmanship and attractive appearance prevails. Made for those who want the best and the greatest value for their money. The broad guarantee of absolute satisfaction prevails.

JOBBERs and DEALERs—Right policy, attractive prices and guaranteed quality apply to this line. Strong publicity to follow—trade paper, show cards, etc. Order now for prompt delivery.



Baldwin Pacific & Co.

Representatives

Manufacturers - Distributors

Pacific Bldg. San Francisco

Use the Coupon Below

Baldwin-Pacific Quintet Super-Het Kit is designed to give maximum amplification on a frequency band of from 40 to 50 kilocycles (40,000 to 50,000 cycles).

The use of this outfit is attended with many advantages. No potentiometer or other positive grid biasing device is necessary with them to stabilize the circuit. This results in economy in "B" batteries and in tubes, both as regards life and number required for a given degree of amplification.

Type No. 25 Pacific "Ranger" Transformer is of the iron-core variety and is designed for use in the intermediate frequency stages.

Type No. 20 Pacific "Ranger" Transformer is of the tuned, air core or filter class, and used as the final or detector output transformer as shown in circuit accompanying each kit.

SENT TO ANY ADDRESS Upon Receipt of \$15.00, or by Parcel Post or Express C.O.D.

Baldwin Pacific & Co. San Francisco

Gentlemen: Ship the "Pacific Quintet" Super-Het Kit with complete and simple assembly instructions.

If Not entirely satisfied upon receipt I will return immediately and you are to refund

... Check ... Money Order ... Cash sent you herewith.

Name.....

Address.....

My Dealer's Name Is.....

Quality ~

“The
Choice of
Radio
Experts”



Sold by
Good Radio
Dealers
Everywhere

Easily Recognized

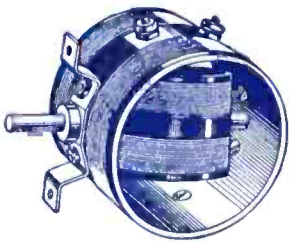

Vario Couplers
Ammeters
Sockets
Wavemeters
Condensers

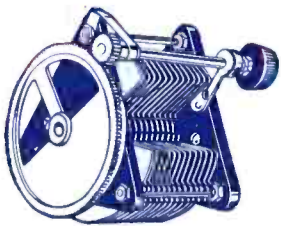

When you buy General Radio apparatus you are buying certainties. You can definitely depend upon its *superior performance* in broadcast reception.

By insisting upon General Radio apparatus at the start you avoid the disappointments which so often follow the purchase of inferior parts.

Look for the red cartons with the General Radio label.

Ask your dealer or write us for our Descriptive Bulletin 917C.



Transformers
Potentiometers
Insulators
Dials, Switches
Rheostats

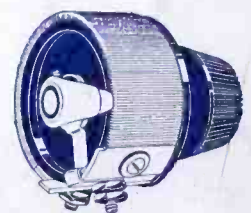

GENERAL RADIO Co

Cambridge, Mass.



Dealers and Jobbers write for Information