

AUGUST 1972  A HARCOURT BRACE JOVANOVIICH PUBLICATION

# ELECTRONIC TECHNICIAN/DEALER

WORLD'S LARGEST TV-RADIO SERVICE & SALES CIRCULATION

FRIM5593349P2AZ 8756723ALL1  
WILLIAM M FRISE  
7176 GALE RD  
ATLAS  
MI 48411  
AS  
XX



## Joint Convention Issue

# Every TV Technician Should Have A **JERROLD** TV First Aid Kit

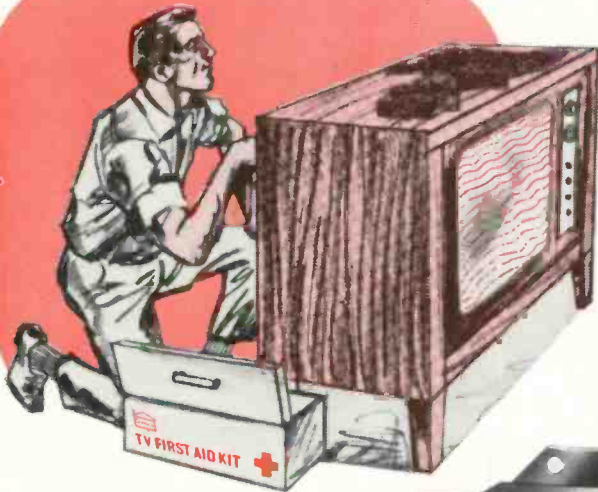

FOR HAM, CB  
OR POLICE BAND  
INTERFERENCE  
(FCO-47)



FOR SNOW  
(POWERMATE)



FOR IGNITION OR  
POWERLINE  
INTERFERENCE  
(COLORAXIAL CABLE)



FOR  
FM INTERFERENCE  
(FMR-300, FMR-75)

FOR LOCAL  
CHANNEL  
INTERFERENCE  
(1435A)



FOR TWO OR MORE SETS  
FROM ONE ANTENNA  
(COLORCASTER)

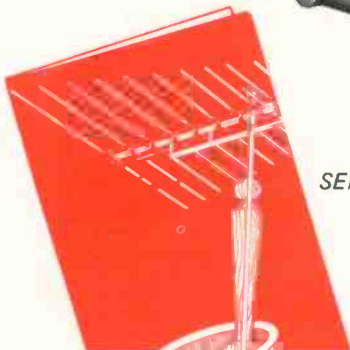

SEND FOR YOUR FREE BOOKLET  
"PRESCRIPTION FOR TV RECEPTION PROBLEMS"

**JERROLD ELECTRONICS CORPORATION**

P.O. Box A, 401 Walnut St., Phila., Pa. 19105/(215) 925-9870



a GENERAL INSTRUMENT company

... for more details circle 119 on Reader Service Card

GROUP  
**240**

MANUFACTURER	MODEL	SCHEMATIC NO.
ADMIRAL	Color-TV Chassis T11K10-1A	1431
GENERAL ELECTRIC	Color-TV Chassis JA	1432
MAGNAVOX	Color-TV Chassis T952	1433
OLYMPIC	TV Chassis 3P70	1430
PHILCO-FORD	TV Chassis 21HT15	1434

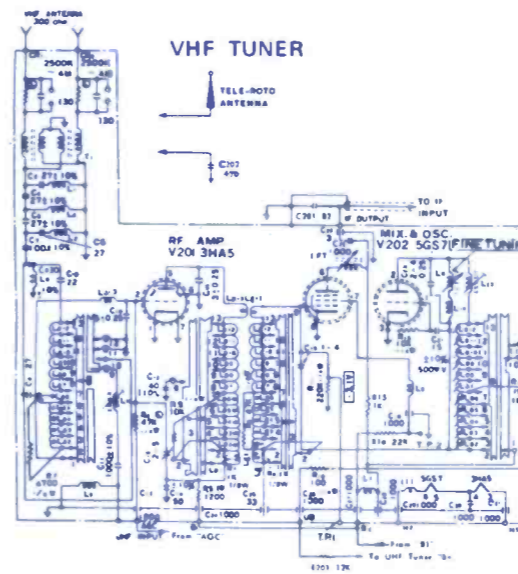

SYMBOL	DESCRIPTION	OLYMPIC PART NO.
C155	1000pf, 2kv	COJ70926
C192A	150µf, 180v	COJ70144
C192B	100µf, 180v	COJ70144
C192C	150µf, 180v	COJ70144
L104	41.25MHz trap coil	CLJ70131
L111	sound IF & trap coil	TRJ70120
L114	sound IF xformer	TRJ70121
L115	quad coil	TRJ70122
L116	horiz stabilizer coil	CLJ70126
L201	deflection yoke	CLJ70916
T101	audio output xformer	TRJ70119
T102	vert output xformer	TRJ70917
T103	horiz output xformer	TRJ70915
R147	1M, vert height	PTJ70140
R149	1M, vert hold	PTJ70140
R154	500K, vert lin	PTJ70921
R202	1M, volume	PTJ70921
SW-1	with off/on switch	PTJ70922
R203	30K, contrast	PTJ70142
R204	100K, brite	REJ70148
D3	horiz AFC diode	REJ70932
TH-1	thermistor tuner, VHF	CLJ70912
	tuner, UHF	CLJ70913

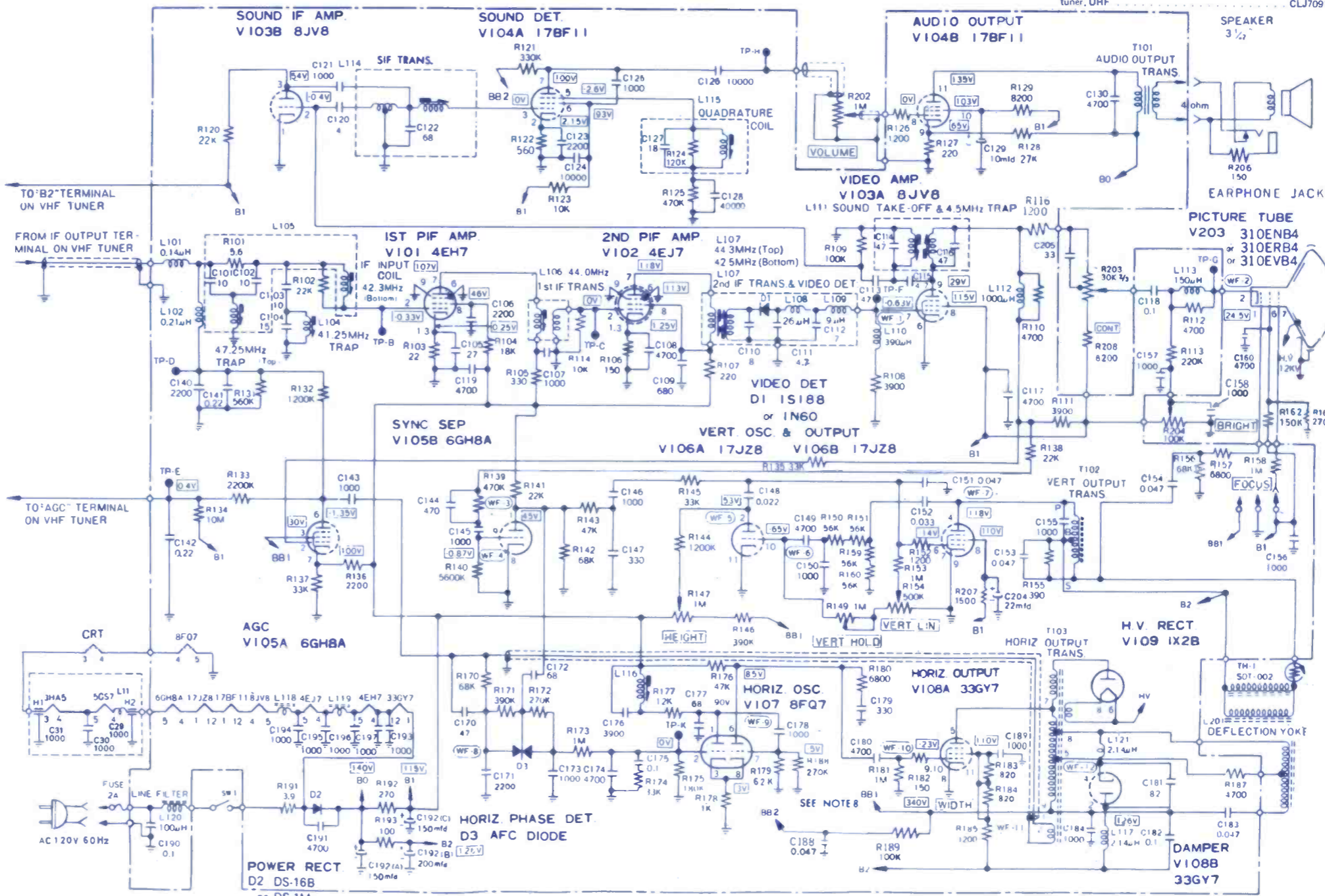
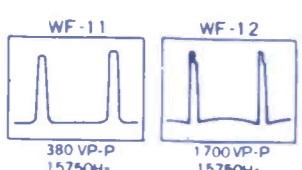
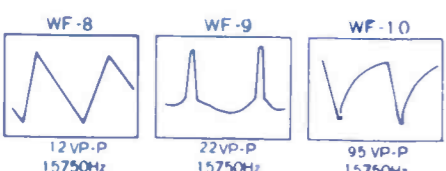
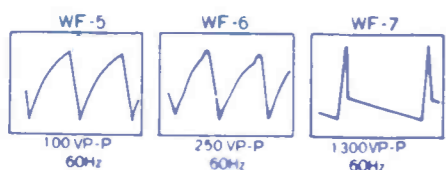
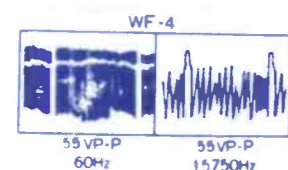
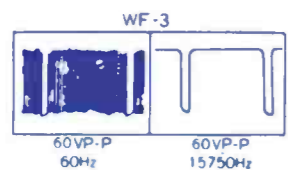
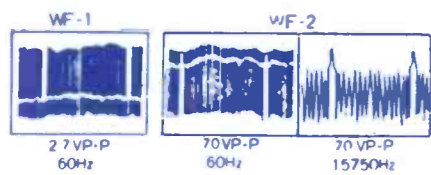

SYMBOL	DESCRIPTION	ADMIRAL PART NO.
RE54	vert lin	
RE55	green drive	75A95-12
RE56	blue drive	
RF37	60K, HV adjust control	75A101-9
RF76	blue screen	
RF77	green screen	75A95-13
RF78	red screen	
RH27	500n, master brite	75A135-11
RH28	2000n, brite control	75A140-1
RH29	350n, contrast control	75A140-3
RH30	100K, vert hold control	75A140-2
RH31	3.4M, vert size control	75A135-6

RH34	500n, slide tint control	75A149-1
RH35	2000n, AGC control	75A135-7
RH36	200n, AGC delay control	75A135-21
RH37	10K, color killer control	75A135-10
RH39	500n, color slide control	75A149-1
RH42	50K, volume slide control	75A149-2
RH56	thermistor	61A27-1
RH69	voltage dependent	61A46-7
RH87	400n, reactance control	75A135-19
ZE23	vert integrator	63A6-29
CH10A	200µf, 350v	electrolytic
CH10B	160µf, 350v	
CH10C	80µf, 350v	
CH10D	10µf, 350v	67A15-403

CH14A	2000µf, 40v	electrolytic	67A15-401
CH14B	2000µf, 40v		
LA49	video detector		72A316-10
LA81	41.25MHz trap		72A316-12
LB2	4.5MHz coil		72A317-1
LC16	chroma input coil		72A329-1
LD52	1µh, 3.58MHz, output coil		73A55-37
LF24	horiz hold control		94A351-1
TA59	4.5MHz trap		72A216-7
TB20	ratio xformer		72A318-1
TC14	burst xformer		72A325-3
TC29	bandpass xformer		72A327-1
TH4	power xformer		80A108-6
TH18	horiz output xformer		79A158-1

VHF TUNER 94C381-6

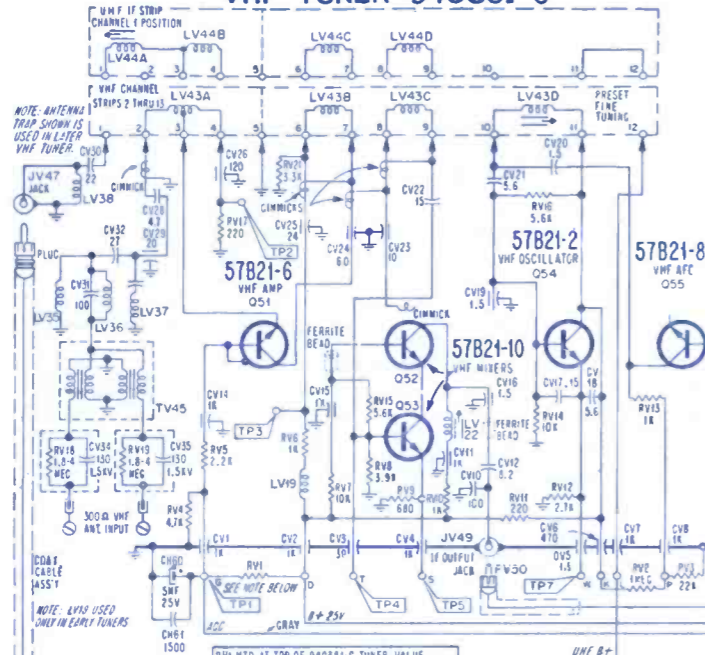

UHF TUNER 94C396-1

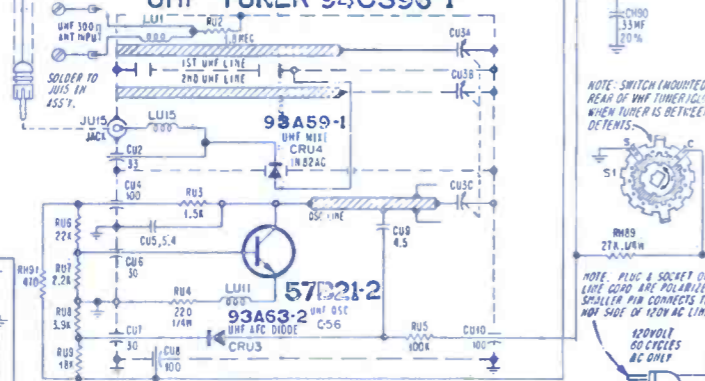

UHF TUNER 94C397-1

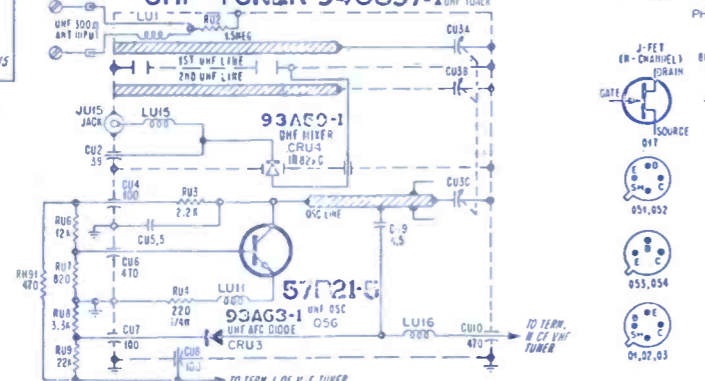

RUN CHANGES

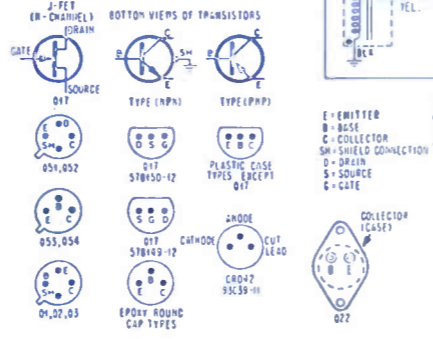
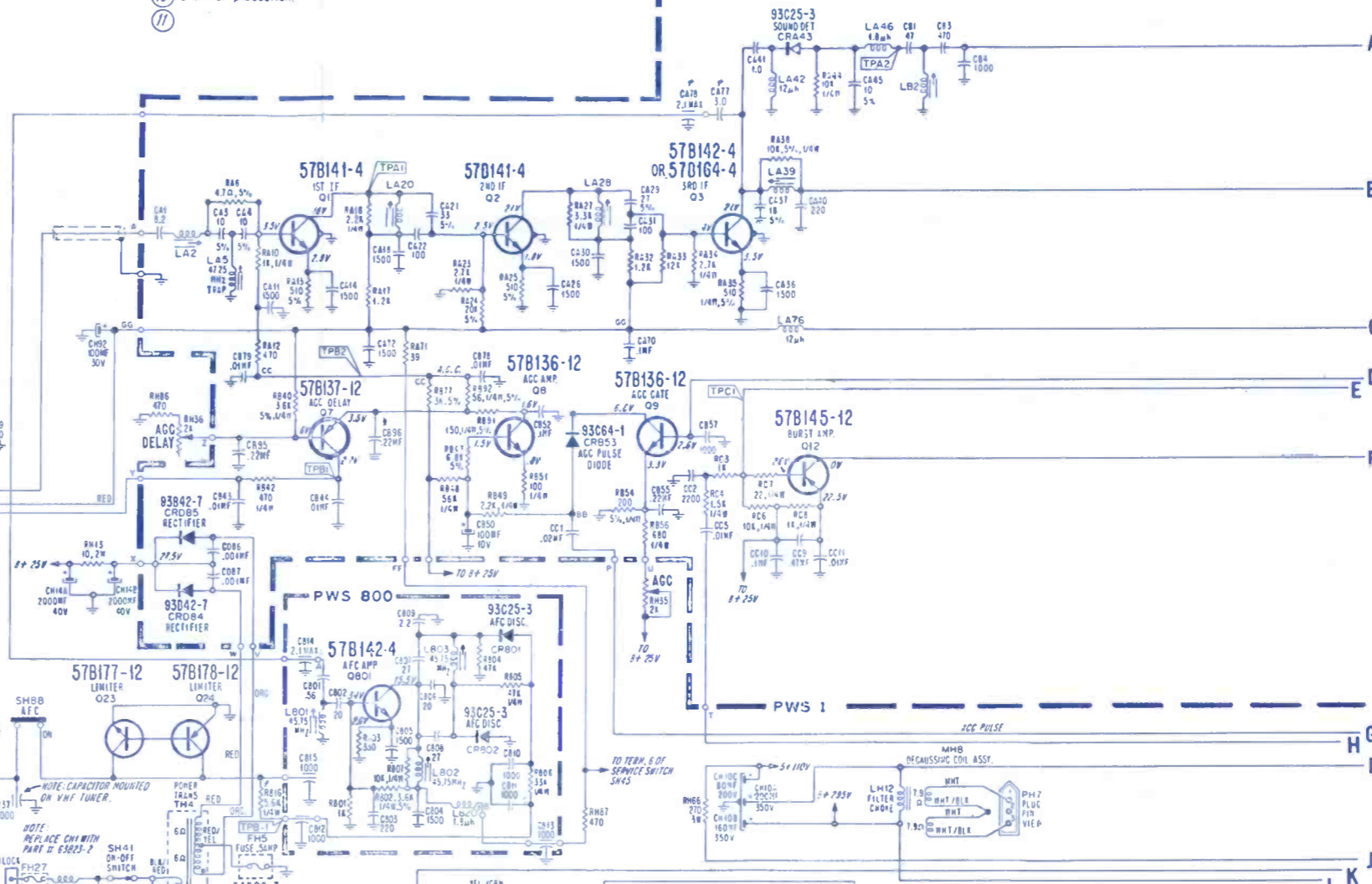

**SCHEMATIC NOTES:** R-RESISTOR VALUE (2WATT, 10% CAPACITOR VALUE IN MICROFARADS UNLESS OTHERWISE INDICATED. S-SPACE VALUES OF COILS LESS THAN 1" ARE NOT SHOWN. HI INDICATES CYCLES PER SECOND VOLTAGE & WAVEFORM NOTES. DC VOLTAGES TAKEN WITH VFW WITH RESPECT TO CHASSIS GROUND. AT 120V AC LINE WAVEFORMS & P-P VOLTAGES MAY VARY DEPENDING ON CALIBRATION OF TEST EQUIPMENT & TEST TECHNIQUES. VOLTAGES SHOWN ON UNUSED UHF CHANNELS WITH VOLUME CONTROL AT MINIMUM POSITION PASS A CLEAREST CONTACTS AT MINIMUM ALL OTHER CONTROLS IN NORMAL OPERATING POSITION. WAVEFORMS SHOWN WITH TRANSMITTED NOISE (SEE SCHEMATIC PRODUCING 5 TO 6 VOLTS AC AT TEST POINT) (B) CONTRAST, BRIGHTNESS CONTROL. SEE FOR GENERAL PICTURE. TRANSMISSION CAUTION: TO AVOID DAMAGE TO TRANSDUCERS DO NOT ARC AND/OR SHORT TO CHASSIS GROUND. DO NOT TURN SET ON WITH TRANSISTERS, TUBE (S) OR LEADS REMOVED OR UNSOLDERED. USE CAUTION TO PREVENT ACCIDENTAL SHORTS BETWEEN TRANSDUCERS TO CHASSIS GROUND. DO NOT USE AN ORDINARY OHMMETER FOR RESISTANCE MEASUREMENT. USE VFW ON A 100 OHM RANGE OR HIGHER. DO NOT APPLY EXCESSIVE HEAT TO TRANSISTORS OR LEADS. AGC CAUTION: DO NOT DISTURB FACTORY SETTING OF AGC CONTROL. IF AGC ADJUSTMENT IS REQUIRED, REFER TO SERVICE NOTES. IF NECESSARY TO DISTURB AGC ADJUSTMENT MARK ROTOR POSITION SO THAT CONTROL CAN BE RETURNED TO ITS FACTORY ORIGINAL SETTING. A COMPONENT NOT MOUNTED ON PRECISION WELDED SYSTEM. WARNING: USE AN ISOLATION TRANSFORMER WHEN SERVICING TO AVOID THE POSSIBILITY OF ELECTRICAL SHOCK & DAMAGE TO TEST EQUIPMENT. AGC AND AUDIO ONLY TO PICTURE TUBE OR DMC GROUNDING SPRING. CHASSIS IS CONNECTED DIRECTLY TO POWER LINE. A PART MOUNTED ON BOTTOM OF PRECISION WELDED SYSTEM.

SCHEMATIC — INDICATES SOCKET TERMINAL SYMBOLS — INDICATES PLUG TERMINAL

TH44—audio output xformer  
 TH73—vert output xformer  
 FH5—5a fuse  
 FH27—2.7a fuse  
 FH74—.35a fuse  
 MH6—circuit breaker  
 SH41—on/off switch  
 tuner, VHF, T11K10-1A  
 T12K 10-1B

79A141-3  
 79A131-2  
 84A28-3  
 84A28-9  
 84A28-8  
 84A17-13  
 77A201-1  
 94A381-6  
 94A344-2

**ADMIRAL**  
 Color-TV Chassis  
 T11K10-1A

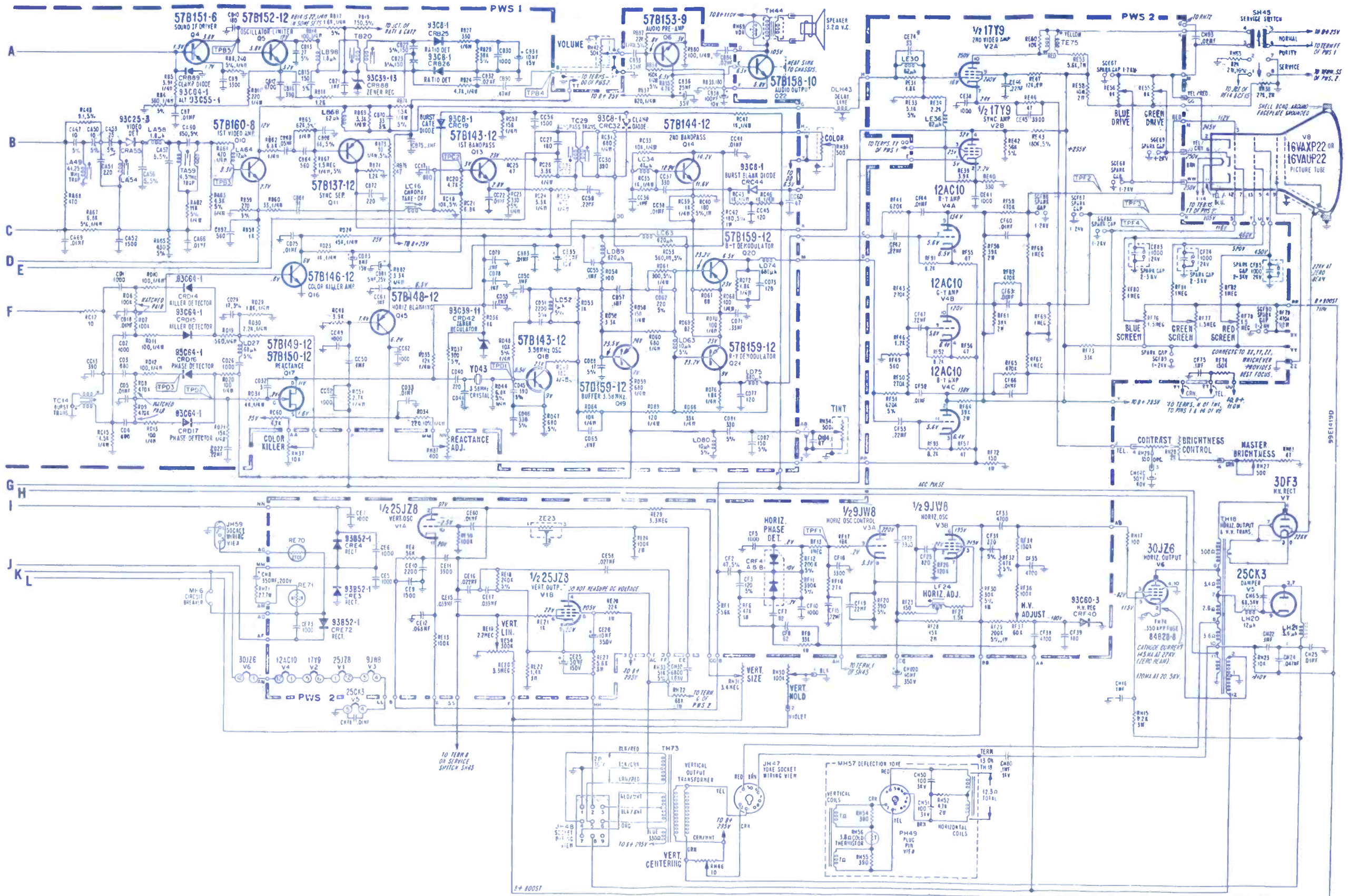

SYMBOL	DESCRIPTION	GENERAL ELECTRIC PART NO.
R248	1K, 10%, 7w, WW	EP14X43
R404	degaussing	EP39X4
R115	RF AGC, 500n, 20% dual control	EP49X02
R122	1F AGC, 2K	EP49X94
R196	blue drive, 40K	
R171	brite centering, 20K	EP49X96

R258	focus, 15M, 20% dual control	EP49X91
R263	vert hold, 500K	EP49X95
R270	vert height, 500K	
R277	vert centering, 2K triple control	EP49X90
R640	green screen, 1M	EP49X93
R642	red screen, 1M	
R644	blue screen, 1M	

C404A	300µf, 175v	EP31X28
C404B	200µf, 175v	
C404C	10µf, 150v	
C404D	100µf, 150v	
L103	coil, 47.25MHz trap	EP36X86
L112	coil, 44MHz trap	EP36X4
	conv yoke assembly	EP62X32
	yoke & plug assembly, 10 in. set	EP76X9
	yoke & plug assembly, 16 in. set	EP76X8

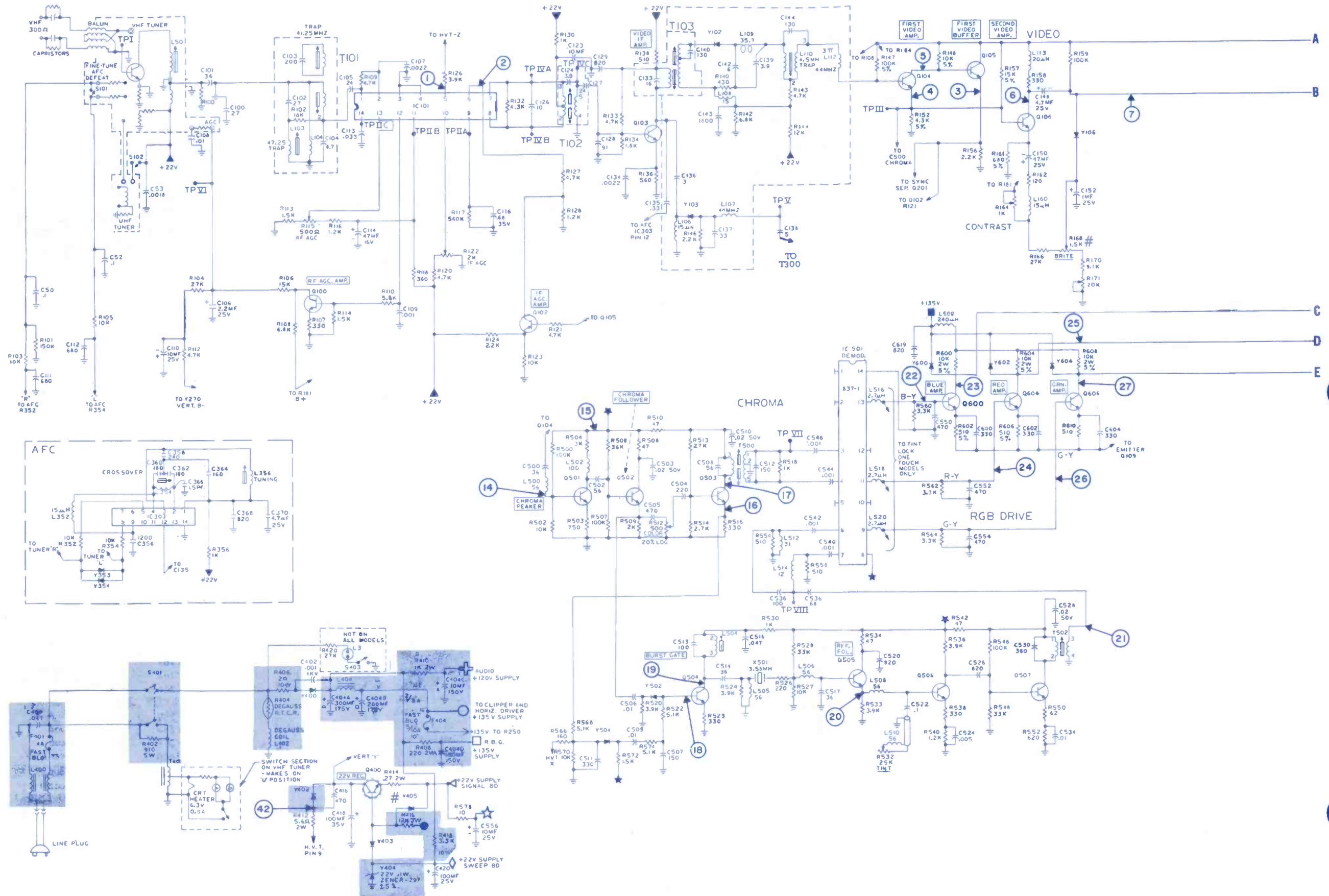

**GENERAL ELECTRIC**  
Color-TV Chassis  
JA

- L202—coil, horiz osc w/core EP36X55
- L301—coil quad w/core EP36X83
- T102—xformer, IF, 44MHz, w/core EP61X11
- T202—xformer, horiz buffer EP64X19
- T204—HV xformer, w/air gap, 10 in. sets EP77X12
- T204—HV xformer, w/air gap, 16 in. sets EP77X12
- T301—xformer, audio output ET64X105
- T401—xformer, filament, 10 in. sets EP64X18
- T401—xformer, filament, 16 in. sets EP64X20
- T500—xformer, chroma bandpass w/core EP61X14
- T502—coil, 3.58MHz output xformer, w/core EP36X84
- 1C101—integ ckt, IF, AGC EP84X1
- 1C301—integ ckt, audio EP84X2
- 1C303—Integ ckt., AFC module EP84X4
- 1C501—integ ckt., demod EP84X3
- Y404—diode, zener, 22v, 5% ES16X29
- fuse, 4a, fast blow, F401 EP10X52
- fuse, 0.5a, fast blow, F404, 10 in. sets EP10X3
- fuse, 0.67a, fast blow, F404, 16 in. sets EP10X15

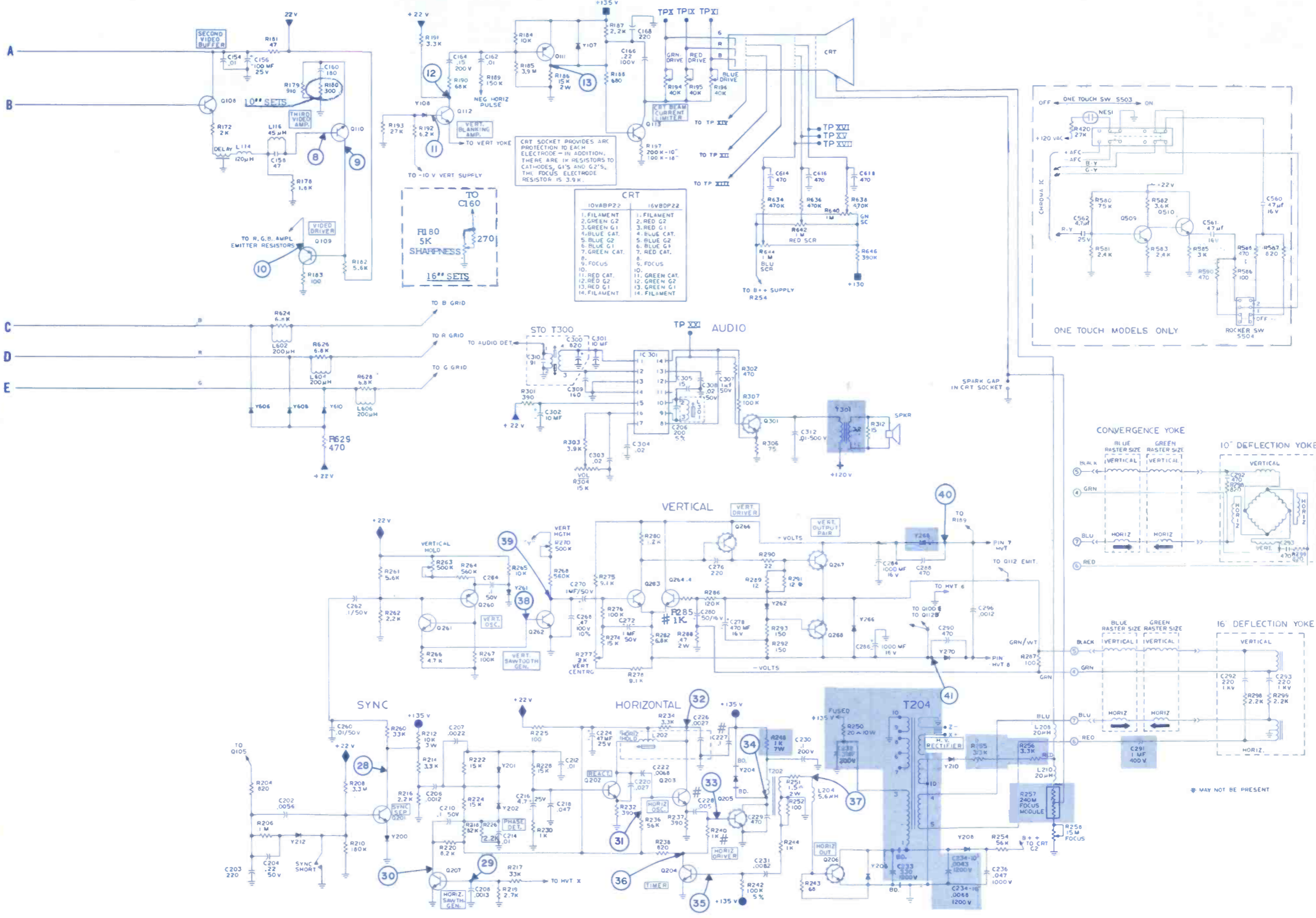

1433

MAGNAVOX

Color-TV Chassis  
T952

ELECTRONIC TECHNICIAN/DEALER **TEKFAK**

AUGUST • 1972

COMPLETE MANUFACTURERS' CIRCUIT DIAGRAMS  
AND TECHNICAL INFORMATION FOR 5 NEW SETS

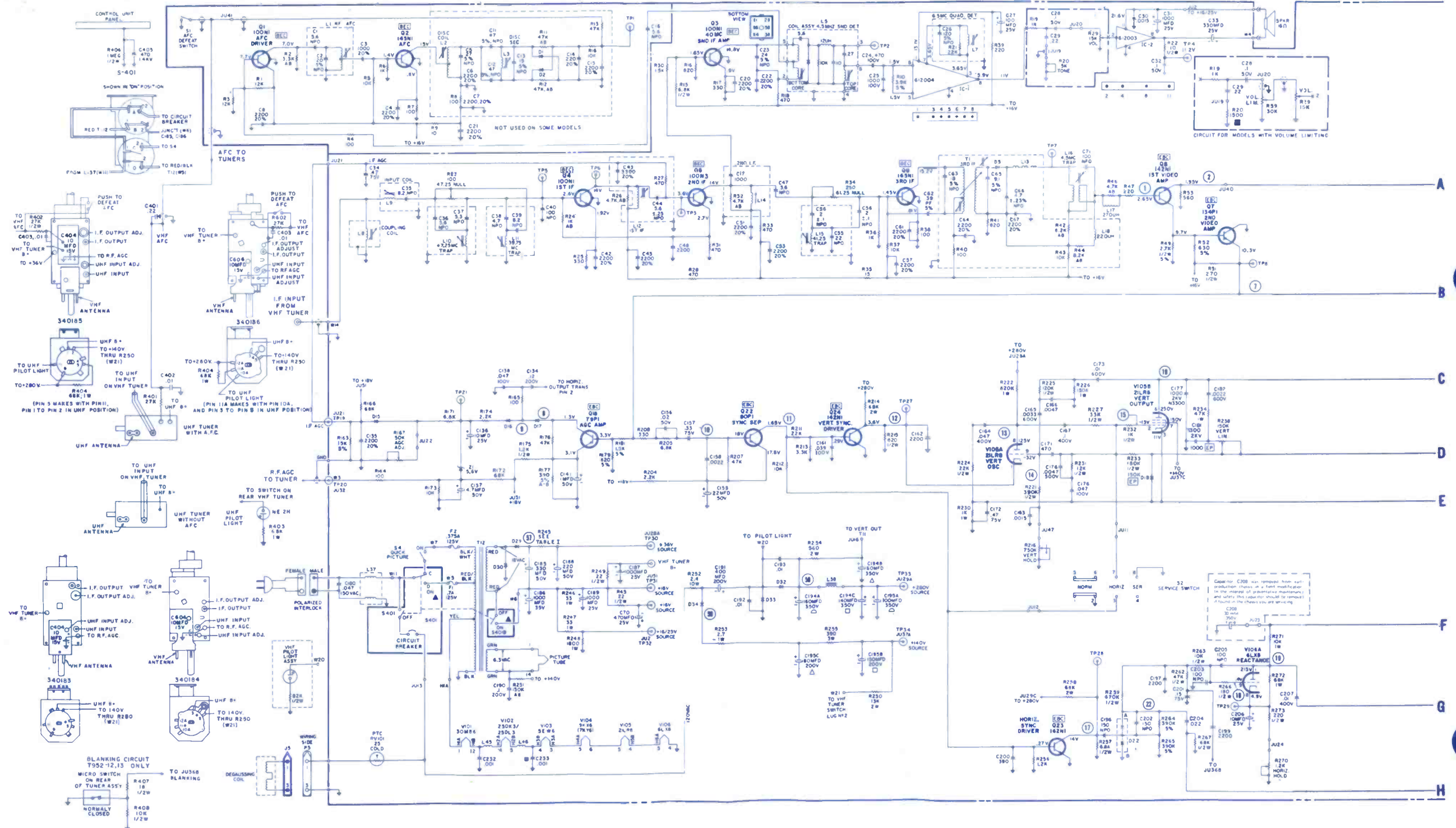
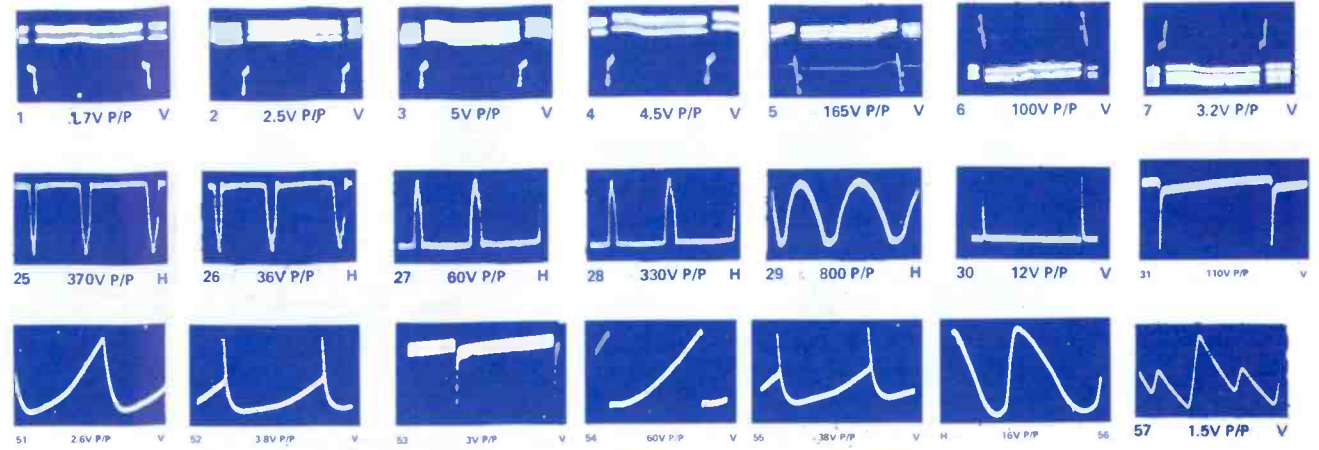



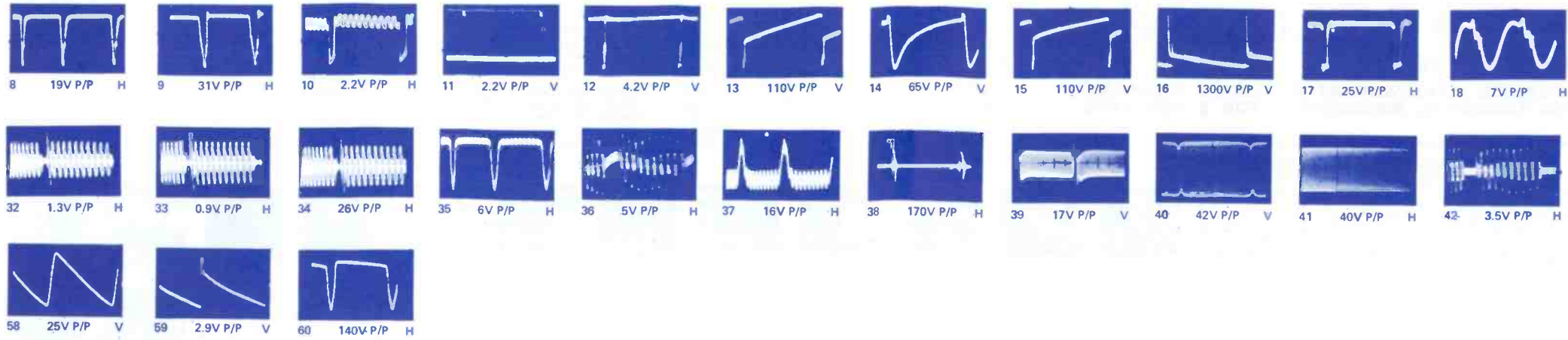

**MAGNAVOX**  
Color-TV Chassis  
T952

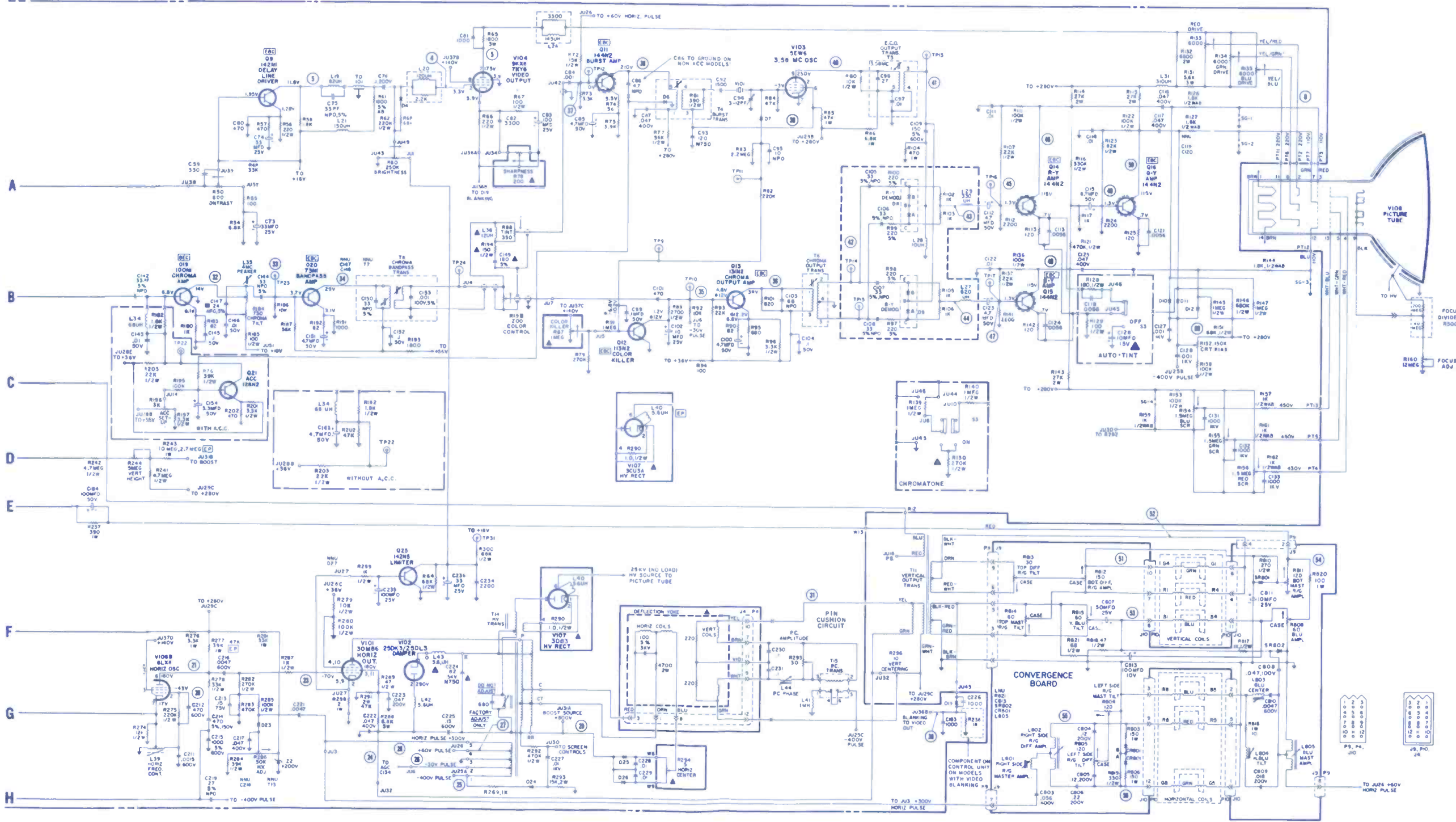

SYMBOL	DESCRIPTION	PHILCO PART NO.
C24A, B	3000µf/25v, 1500µf/20v	30 2585-34
C	350µf/10v, active filter	45 2656-72
F100	1.5a, fast blow, B+	32-4901-1
L3	4.5MHz trap	32-4901-1
L4	sound take-off	32-4906-1
L5	ratio det	32-4938-2
L17	coll, horiz osc	36-1722-1
LS1	speaker, 3M, 12 n	76-14124-3
	tuner, VHF (TT210A)	32-9748-2

S100	ac, on/off (slide)	42-2173-8
T1	audio driver	32-10100-1
T2	horiz drive	32-10104-1
T100	power	32-10159-1
VR2A/B	130K, vert hold, 500 n	33-5627-4
	vert lin	33-5624-16
VR100	25K, volume	33-5624-15
VR101	250K, brite	33-5620-9
VR102	30 n, height	33-5620-9
VR103	30K, contrast	33-5624-14
VR104	500 n, B+ adjust	33-5624-17

ELECTRONIC TECHNICIAN/DEALER is published monthly by HARCOURT BRACE JOVANOVICH PUBLICATIONS, INC., 1 East First St., Duluth, Minn. 55802. Subscription rates: One year \$6, two years \$10, three years \$13, in the United States and Canada. Other countries: One year \$15, two years \$24, three years \$30. Single copies 75¢ in the United States, and \$2 in other countries. Second class postage paid at Danville, New York and at additional mailing offices. Copyright 1972 by HARCOURT BRACE JOVANOVICH PUBLICATIONS, INC.  
POSTMASTER: Send Form 3579 to ELECTRONIC TECHNICIAN/DEALER, HARCOURT BRACE JOVANOVICH PUBLICATIONS, INC., 1 East First St., Duluth, Minn. 55802.

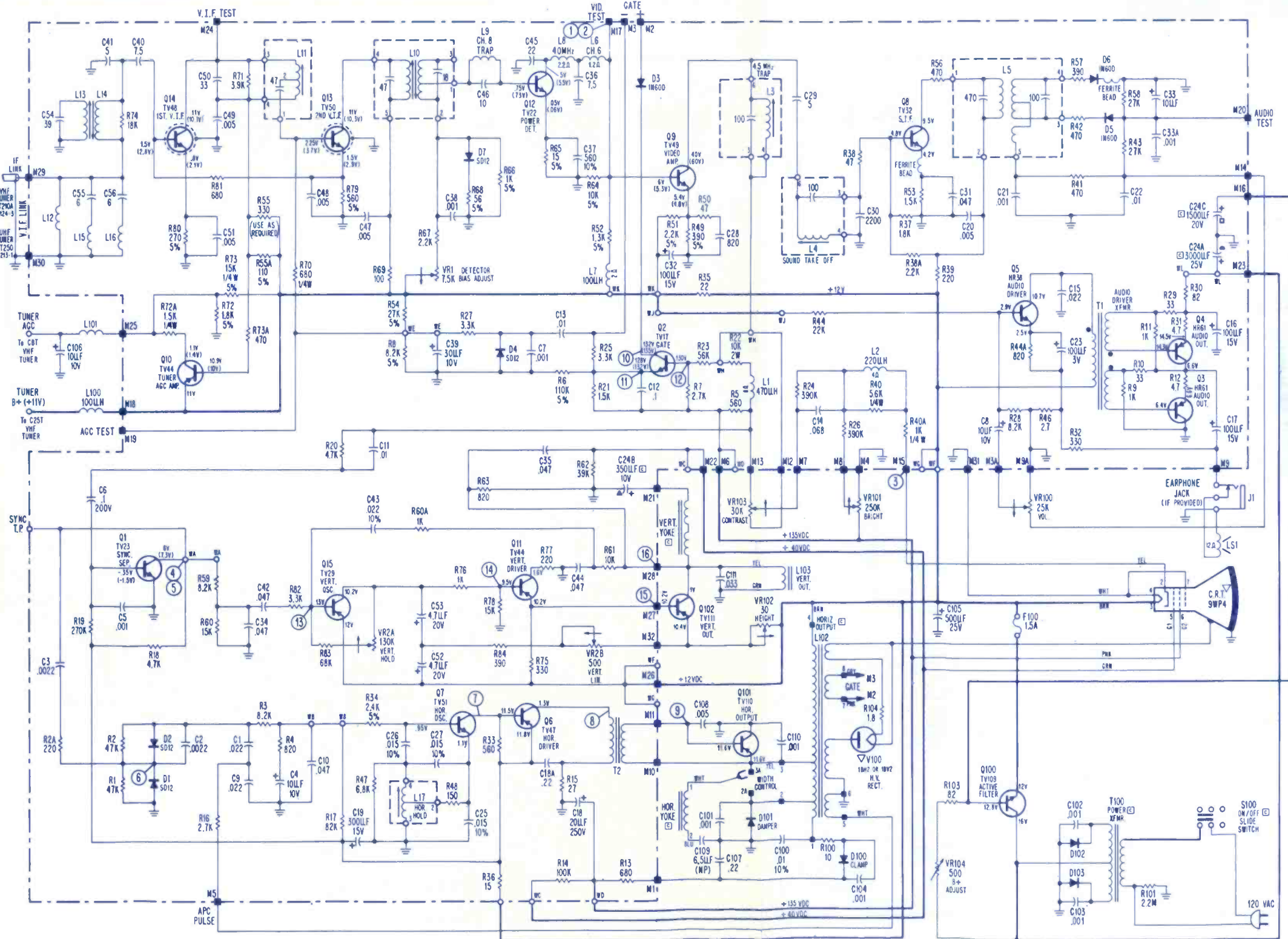
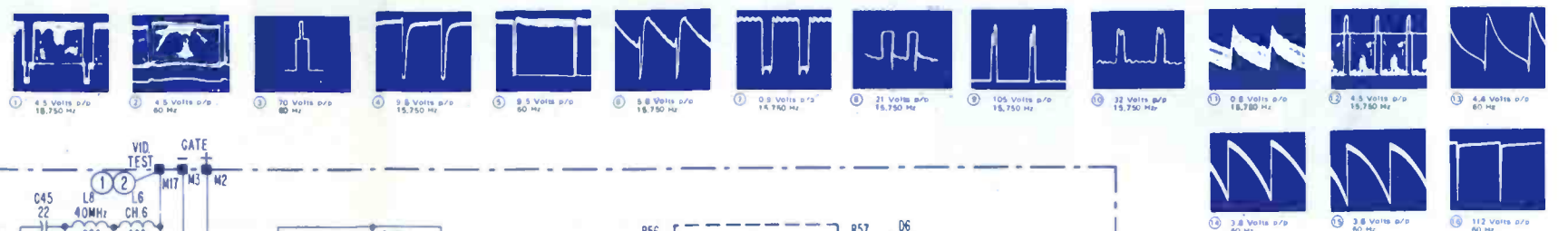

NOTES:

- VOLTAGES TAKEN UNDER NO SIGNAL CONDITIONS; ANTENNA REMOVED AND TUNER OFF CHANNEL. VOLTAGES IN PARENTHESES ARE WITH A MODERATELY STRONG SIGNAL DEVELOPING +14V RF AGC AT TP M23.
- VOLTAGES MEASURED WITH A V.T.M. (B&K MODEL 175) FROM POINT INDICATED TO CHASSIS GROUND.
- BALLOONS (10) ETC. SHOWN ON SCHEMATIC INDICATE WAVEFORM TEST POINTS (WITH RECEIVER ADJUSTED FOR SNOW-FREE PIX).
- CONTROL SETTINGS: VOLUME-MINIMUM, CONTRAST-MAX, BRIGHTNESS-NEAR MAX. ALL OTHER CONTROLS SET FOR NORMAL OPERATION.
- CRITICAL SAFETY (REPLACE WITH EXACT SPECIFIED PART AS INDICATED IN PARTS LIST.)
- CRITICAL SAFETY (REPLACE WITH EXACT SPECIFIED PART AS INDICATED IN PARTS LIST) HIGH VOLTAGE COMPONENT.

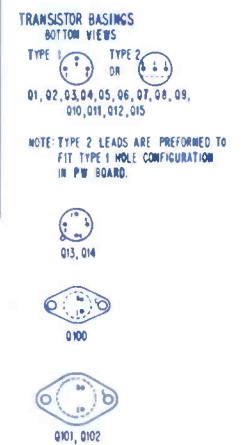

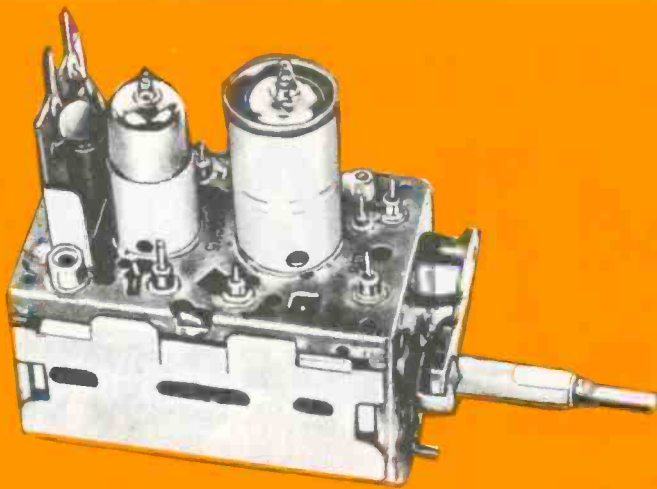

# \$9.75

ALL PARTS  
INCLUDED

ONE YEAR GUARANTEE

## TUNER SERVICE CORPORATION

PROVIDES YOU WITH A  
COMPLETE SERVICE FOR  
ALL YOUR TELEVISION  
TUNER REQUIREMENTS.

### REPLACE

Replacement Tuner \$9.75.

This price buys you a complete new tuner built specifically by SARKES TARZIAN INC. for this purpose.

All shafts have a maximum length of 12" which can be cut to 1½".

Specify heater type parallel and series 450mA or 600mA.

### REPAIR

VHF Or UHF Any Type \$9.75.  
UHF/VHF Combo \$15.00.

In this price all parts are included. Tubes, transistors, diodes, and nuvistors are charged at cost.

Fast efficient service at our 5 conveniently located service centers.

All tuners are cleaned inside and out, repaired, realigned and air tested.

### CUSTOMIZE

Customized tuners are available at a cost of only \$15.95.

Send in your original tuner for comparison purposes to:



## TUNER SERVICE CORPORATION

**FACTORY-SUPERVISED TUNER SERVICE**

Backed by the largest tuner manufacturer in the U.S.—  
Sarkes Tarzian, Inc.

<b>HOME OFFICE</b> . . . . .	817 N. PENNSYLVANIA ST., Indianapolis, Indiana	TEL: 317-632-3493
	(Home office)	
<b>EAST</b> . . . . .	547-49 TONNELE AVE., Jersey City, New Jersey	TEL: 201-792-3730
	(on U.S. Highway 1 & 9)	
	4538 PRINCESS ANNE RD., Norfolk, Virginia	TEL: 703-855-2518
<b>SOUTH</b> . . . . .	938 GORDON ST., S.W., Atlanta, Georgia	TEL: 404-758-2232
<b>SOUTH-EAST</b> . . . . .	1505 CYPRESS ST., Tampa, Florida	TEL: 813-253-0324
<b>WEST</b> . . . . .	SARKES TARZIAN, Inc. TUNER SERVICE DIVISION	
	10654 MAGNOLIA BLVD., North Hollywood, California	TEL: 213-769-2720

... for more details circle 133 on Reader Service Card

# PTC Please The Customer with "around-the-corner" From Mallory.

Here's Mallory's answer to today's replacement parts problem.

Our own broad line of high-quality entertainment replacement semiconductors—transistors, zener diodes, diodes, high-voltage components, color crystals, integrated circuits, field-effective transistors.

You'll find them nearby . . . everywhere Mallory parts are sold now. So you can spend more time working instead of scrambling around to find what you need. And you won't have to keep a lot on hand either because they give you all the functions, ratings and specifications you want.

And they're from Mallory . . . so you can be sure each one has all the quality and reliability you find in all our products.

See your Mallory distributor today. And ask him for our Semiconductor Product Guide . . . the most complete, up-to-date catalog and cross-reference in the industry.



**MALLORY**

**MALLORY DISTRIBUTOR PRODUCTS COMPANY**

a division of P. R. MALLORY & CO. INC.  
Indianapolis, Indiana 46206

# Semiconductors availability.

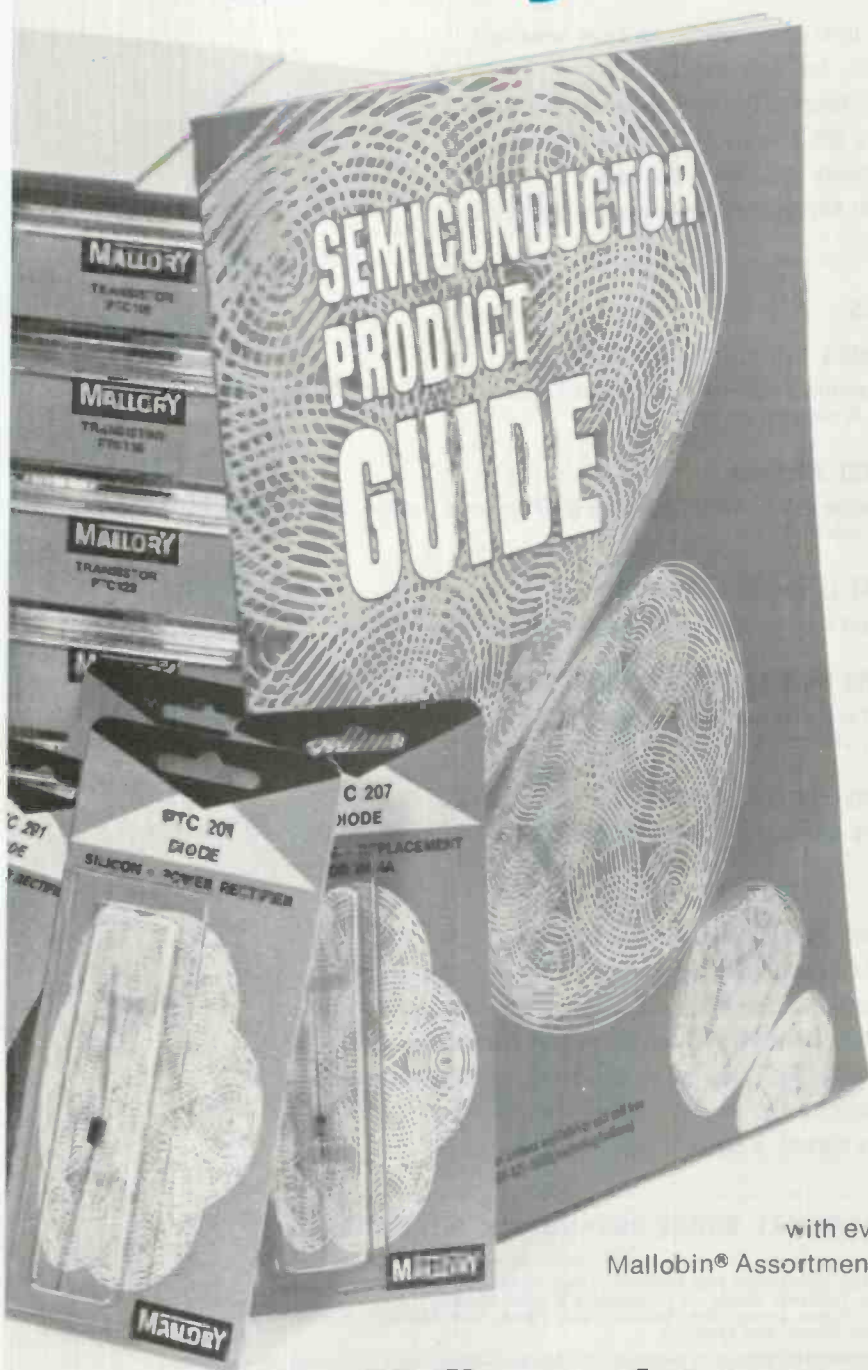

**FREE...**  
the most up-to-date  
**Semiconductor  
Product Guide  
in the industry.**

**SPECIAL  
INTRODUCTORY  
OFFER**



FREE—a Bernzomatic, 10-piece, Socket Set. A \$2.25 value, with every order of a PTC IM Semiconductor Mallobin® Assortment. See your Mallory Distributor, today.

**Mallory...lets you do more with less.**

# ELECTRONIC TECHNICIAN/DEALER

**PHILLIP DAHLEN, C.E.T.**  
Editor

1 East First Street  
Duluth, Minn. 55802  
(218) 727-8511

**ALFRED A. MENEGUS**  
Publisher

757 Third Avenue  
New York, N.Y. 10017  
(212) 572-4839

**TOM GRENEY**  
Publishing Director

**JOSEPH ZAUHAR**  
Managing Editor

**GAYNELLE DAVIDSON**  
Production Manager

**JOHN PASZAK**  
Graphic Design

**LILLIE PEARSON**  
Circulation Fulfillment

**JOHN KESSLER**  
Manager, Reader Services

## MANAGERS

**JIM SMITH, C.E.T.**  
43 East Ohio Street  
Chicago, Ill. 60611  
(312) 467-0670

**CHUCK CUMMINGS**  
Ad Space South/West  
613 North O'Connor  
Irving, Texas 75060  
(214) 253-8678

**KEN JORDAN**  
**DONALD D. HOUSTON**  
1901 West 8th Street  
Los Angeles, Calif. 90057  
(213) 483-8530

**CHARLES S. HARRISON**  
**CY JOBSON**  
57 Post Street  
San Francisco, Calif. 94104  
(415) 392-6794

**ROBERT UPTON**  
Tokyo, Japan  
C.P.O., Box 1717

AUGUST 1972 • VOLUME 94 NUMBER 8

This month's cover photo, supplied through the courtesy of Channel Master, shows their ruggedized Color Crossfire Series, an improved version of their Crossfire line. More information concerning antennas can be found in the article beginning on page 43.

- 
- 3 **TEKFAX:** Up-to-date schematics for easier servicing.
  - 25 **EDITORIAL:** And Those That Don't.
  - 27 **LETTERS:** Pertinent comments concerning past issues.
  - 30 **READER'S AID:** What you need or have for sale.
  - 32 **NEWS:** Events of interest to our industry.
  - 34 **NEW AND NOTEWORTHY:** Merchandise of special interest.
- 

## FEATURES

### 37 SYLVANIA'S D18 COLOR-TV CHASSIS

Our observations concerning their plugability concept, which is used throughout the chassis to simplify servicing.

### 43 THE BEST ANTENNA

The effective selection and installation of TV antennas requires some understanding of their characteristics.

### 50 A GREAT LEARNING EXPERIENCE

How to get the most out of what will be a truly great convention.

### 57 WORKING WITH COMMERCIAL-AUDIO EQUIPMENT

The last in a series of articles telling how you can expand your business to include this very profitable specialty—by Jack Hobbs.

### 58 TEST INSTRUMENT REPORT

Reviewing specifications for LogiMetrics' Model 750 RF Signal Generator.

---

59 **COLORFAX:** Tips for easier color-TV set repair.

60 **TECHNICAL DIGEST:** Hints and shortcuts for more effective servicing.

62 **NEW PRODUCTS:** Instruments and components to make your job easier.

64 **TECHNICAL LITERATURE:** Informative material that you may need.

65 **DEALER SHOWCASE:** These items may increase your sales revenue.

70 **ADVERTISER'S INDEX:** Manufacturers concerned about you.

71 **READER'S SERVICE:** A source of additional information.



A HARCOURT BRACE JOVANOVICH PUBLICATION



HARCOURT BRACE JOVANOVICH PUBLICATIONS: James Milholland, Jr., Chairman; Robert L. Edgell, President; Lars Fladmark, Senior Vice President; Richard Moeller, Treasurer; John G. Reynolds, Vice President; Thomas Greney, Vice President; Ezra Pincus, Vice President; Bruce B. Howat, Vice President; James Gherna, Vice President.

ELECTRONIC TECHNICIAN/DEALER is published monthly by Harcourt Brace Jovanovich Publications. Corporate Offices: 757 Third Avenue, New York, New York 10017. Advertising Offices: 43 East Ohio Street, Chicago, Illinois 60611 and 757 Third Avenue, New York, New York 10017. Editorial, Accounting, Ad Production and Circulation Offices: 1 East First Street, Duluth, Minnesota 55802. Subscription rates: One year \$6, two years \$10, three years \$13, in the United States and Canada. Other countries: one year \$15, two years \$24, three years \$30. Single copies: 75¢ in the U.S. and Canada; all other countries \$2. Second class postage paid at Duluth, Minnesota 55806 and at additional mailing offices. Copyright © 1972 by Harcourt Brace Jovanovich, Inc.

POSTMASTER: Send form 3579 to ELECTRONIC TECHNICIAN/DEALER, P.O. Box 6016, Duluth, Minnesota 55806.

# General Electric introduces a new idea in tv communications.

When we set out to make GE tv the sets you like to service, we recognized the importance of establishing good communications with independent service technicians.

One of the ways we're doing this is with our quarterly newsletter, Television Service News. Right

on the front of each issue of TSN is a list of local telephone numbers of GE people to call for information you need in a hurry. Things like: parts information; placing parts orders; technical help; service manuals; and credit information. Inside of every issue

of TSN, we're putting the kind of advance news you need to more easily service GE b & w and color models. If your tv service company is not receiving GE's Television Service News, send us this coupon and we'll see that you get it.

"Dutch" Meyer

General Electric Company • TRPD

1 College Blvd. • Portsmouth, Va. 23705

Please send me GE's Television Service News.

Name \_\_\_\_\_

Service Company \_\_\_\_\_

Address \_\_\_\_\_

City \_\_\_\_\_ State \_\_\_\_\_ Zip \_\_\_\_\_

We build every television as if we were going to use it ourselves.

GENERAL  ELECTRIC

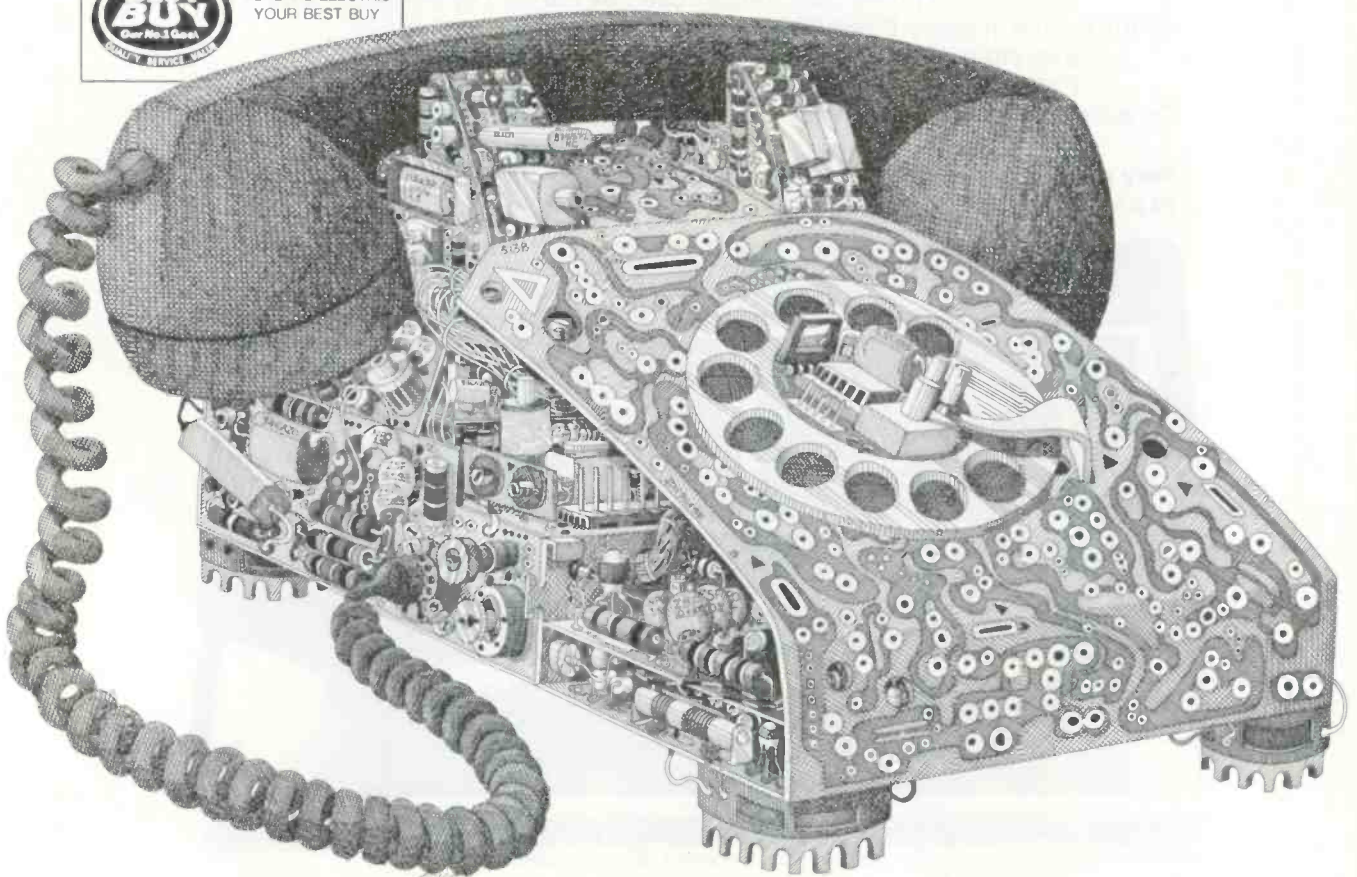

# Introducing the expensive digital multimeter that doesn't cost a lot.

The B&K Precision Model 281. A solid-state, lab-quality portable instrument that measures AC/DC voltage, current and resistance.

The state-of-the-art Model 281 shows readings on a large, clear, 2½-digit numeric display. It also has positive over-range and reverse-polarity indication. There's no need to switch leads. You can reverse polarity at the flick of a switch.

Model 281 readings are faster and more accurate than analog-type meters. Unlike hard-to-see needle indicators, you can read the large, illuminated numerals—including the decimal point—from a distance.

Featured are 26 ranges: five DC voltage, 100mV to 1000V, with 1% accuracy and 10 megohms input impedance; five AC voltage, 100mV to 1000V RMS, five DC current, 100  $\mu$ A to 1A; five AC current, 100  $\mu$ A to 1A; and six resistance, 10 ohms to 10 megohms.

With built-in protection, the 281 can't be harmed by overload. And for safety's sake, it has a three-line AC grounded cord.

Everything about the 281 says expensive—except the price.

Call your B&K distributor.  
Or write Dynascan Corporation.

Very good equipment  
at a very good price. 

# \$169<sup>95</sup>



Product of Dynascan Corporation, 1801 West Belle Plaine Avenue, Chicago, Illinois 60613



**And Those That Don't**



Last month's editorial entitled "Those That Dare," spoke of Morris L. Finneburgh, Sr., E.H.F., as probably one of the best examples of an industrialist who has dared to go all out in support of the electronic technician and service dealer, and their professional associations. Many of the excellent points that he presented in his address to the Electronic

Distributors' Research Institute spelled out in detail why the rest of the industry must give you its whole-hearted support. (Additional background information concerning him and his philosophy can be found in our March 1972 cover story.)

M. L. so beautifully states why you should receive such support that one can easily come to the false conclusion that such support comes naturally and everyone is ready to jump at the chance to help. As an example, I attended a national association board meeting last spring and when the subject of Finco's program for bearing the cost of all new association members came up, I was shocked to hear someone in the back of the room comment to the rest of the group that this program wasn't really so great—any other manufacturer would have jumped at the opportunity of getting such publicity. **Is that so?** I haven't seen any line forming to the right! In fact, ELECTRONIC TECHNICIAN/DEALER's support has been given despite some outside opposition.

One manufacturer told our publisher that too much of our publication was concerned with the support of NEA and NATESA. "You don't want them to turn union and take over the industry do you?" was his comment. Can you imagine the shop owners and management—who make up the entire NATESA membership and the majority in NEA—turning against themselves in collective bargaining? This industrialist failed to realize that these associations exist to make the electronic technician and service dealer a better business man with a better self-image and public image.

After the March Finneburgh article was published, one public relations agent asked how his client might also help the electronic technician and service dealer. I suggested that he follow the advice given in that article, but he was more interested in another book of service tips—fearing that his client would appear to be a Finneburgh follower rather than presenting his own image of industry leadership.

I know of one TV set sales representative who was going to talk to all the service dealers that he saw in his territory and convince them to take the CET Examination—which he had personally taken and passed. However, his district manager forbade him to do so, fearing that this was a "political" subject. I believe that the parent company was unaware of this matter, for as I recall, they are represented at this month's Joint Convention.

We have far too many people with "yellow streaks down their backs." People who would rather stand by the wayside and watch an effort fold without their support—later boasting

"I told you so"—instead of getting in there and fighting—being one of the few that can boast "I helped make it possible!"

In every issue published this year, we have at our own expense designed and printed a different free ad supporting this month's Joint Convention. These ads have been supplemented with many additional news items telling of the convention and promoting it. As an example of how enthusiastically we have promoted this convention: Last month's detailed convention program even promotes the support given by ELECTRONIC SERVICE DEALER, plus the "support" given by our "competing" publications—ELECTRONIC SERVICING and RADIO ELECTRONICS.

In the recent past ELECTRONIC SERVICING has run an ad claiming that they are the only "professional" electronic trade publication, while RADIO ELECTRONICS has sent manufacturers statistics claiming that they represent the greatest number of electronic technicians and service dealers. We find such claims rather strange considering the manner in which these publications have supported our industry.

Last fall, Ed Gorman, editor of TV TECH AID, circulated, through a special mailing, copies of a NEW YORK TIMES article stating that TV repairmen are too often either incompetent or crooks, and that no one came to their defense at a special hearing. He asked for everyone's support in refuting the article. In response, I wrote the editorial "Those Are Fighting Words!" printed in our November 1971 issue, followed in the December issue by a lengthy letter from Frank Moch, executive secretary of NATESA, giving additional background information concerning the incidence in defense of our industry. We failed to observe any reference to this subject in RADIO ELECTRONICS, although page 4 of the December 1971 issue of ELECTRONIC SERVICING did quote the NEW YORK TIMES article—without a single editorial comment questioning that newspaper's detrimental statements. **Now that's some support!**

Have you ever heard of a "good neighbor" that secretly helps those of some minority group, but who wants no publicity for fear that less understanding neighbors will consider him one of those "scum." How is it that as recently as the June issue of ELECTRONIC SERVICING and the July issue of RADIO ELECTRONICS we fail to note any reference to this month's Joint Convention—which they plan to support as indicated in our July issue.

Some critics may consider this public criticism of these two publications "yellow journalism" unbecoming to a professional publication such as ours. However, it is our hope that the shock impact of this editorial will help these two publications become more competitive with us in their support of you and the professional service associations.

*Phillip Dahlen*

**Postscript**

After making plans for the preceding editorial, we received a request that we offer our editorial support to the S.I.S. Program. For those not yet familiar with this program, the initials stand for SUPERIOR INDEPENDENT SERVICE. It is a

*continued on page 61*

# RCA antennas- your answer for the 2 toughest questions you get.

1. "How do I get a better picture?"
2. "What does it cost?"

With RCA in your inventory, you'll never have to turn down a sale because you don't have the right image-improver. RCA has everything for every reception problem—a complete line of outdoor antennas, rotators, reception aids and hardware. Each RCA product is a precision engineered, top quality performer in its class. All carry the RCA name that your customers know they

can depend on. And the complete array of models gives you a full range of prices to bargain from, too. Next time you get a tough question from a customer, make sure you have RCA on hand to answer it for you. See your RCA Parts and Accessories distributor today, or contact RCA Parts and Accessories, Deptford, N.J. **RCA**

... for more details circle 128 on Reader Service Card

## LETTERS

Reader comments concerning past feature articles, Editor's Memos, previous reader responses or other subjects of interest to the industry.

### Requests Reprint of Earlier Editorial

Hanging on the wall of my shop is a shopworn copy of an editor's memo dated August 1956 in *TECHNICIAN & CIRCUIT DIGESTS* (now *ELECTRONIC TECHNICIAN/DEALER*). This copy is pretty well beaten up and I wonder if you could run another copy in a future issue. Some of the new technicians might enjoy reading it, and some of the old timers may want to replace their copies.

THOMAS KING

KING'S RADIO & TELEVISION SERVICE  
P.S. What happened to Al Forman?

*We don't know what has happened to Al Forman. Perhaps someone will drop us a line and let us know. We certainly agree, however, that his excellent editor's memo is just as pertinent now as when it was first written. Ed.*

## Editor's Memo

### WHAT IS A TV TECHNICIAN?

A TV technician is the fellow with the marvelous know-how in his head, a knob and number-filled test instrument in one hand, and a tube caddy in the other. He is found bending over the shop bench, squatting on the customer's living room floor, leaning on the jobber's counter, driving his delivery truck, perched precariously on a rooftop, and puffing his way down stairs with a TV chassis in tow.

His activities include squinting at circuit diagrams, soldering connections, reading meters, pushing probes against now unrecognizedly marked components, plugging tubes in testers, scratching his head when he comes across an intermittent, keeping up with new technical developments and cussing (under his breath) the yoke stuck to the picture tube neck.

His vocabulary is filled with horrible-sounding words like choke, ghost, cheater, trap and bleeder; odd-sounding words like yagi, toggle and grommet; complicated-sounding words like electromagnetic deflection and intermodulation; and delicious-sounding words like spaghetti and cone.

His arsenal in the never-ending battle against receiver failure is varied and expensive. Included among his weapons are soldering gun, oscilloscope, vtvm, vom, generators of several types, tube tester, capacitor test-

er, pliers, screwdrivers and a special little superdooper device of his own design. His ammunition depot is stockpiled with tubes, capacitors, resistors, transformers, solder, screws, wire, speakers, controls, fuses, antennas, switches, batteries, rectifiers, vibrators (to mention just a few), and a drawer full of junk parts he's been saving (which will get thrown away at the next shop clean-up).

He is many things to many people: symptom detective, psychologist (specializing in pestering children), psychologist (specializing in suspicious adults), salesman, engineer, Doctor Fixit and grass roots spokesman for the entire electronic industry.

His playful moments may be punctuated with such practical jokes as handing someone a charged capacitor, or reverting to his youthful cowboy days with a soldering gun. But usually he is dead serious, working long hours, trying to do a good job and make ends meet.

He's been attacked, slandered and slighted. He's been defended, praised and catered to. But most of all, he's been needed. And when he's made a TV set work again, and Momma, Poppa and Junior Video Viewer express their appreciation, the TV technician is the fellow with the satisfied feeling of a job well done.

*Al Forman*

### Plight of the Service Dealer

There have been quite a few letters in *ELECTRONIC TECHNICIAN/DEALER* concerning the plight of the poor underpaid technician. Some of the writers seem to think well of themselves in regard to technical skills.

If they are as good as they say, then the best thing they could do is open their own shops. Then, if they are lucky, they will work twice the hours and get about the same pay as they would working for a big bad boss. They will come to realize that a shop has to take in about \$10.00 in order to keep \$2.00 that can be called profit.

They won't have wages to carry them through the quiet times that all businesses have. There won't be a weekly pay check, even when business grinds to a halt. There will be no body there to pass the buck to when things go wrong.

In addition to bench work, there will be books to keep, endless taxes and insurance to keep track of, complaints, hothead customers, mounds of bills and invoices, floors to sweep and snow to shovel. Ordering needed parts, knowing which parts move well, keeping up with service literature. Keeping up on the new equipment that they sell. Reading the newspaper ads from the discount stores and find-

*continued on next page*

# Pix-Mate™ the crt tester you can afford to take along

only ... \$29.95



- A quality CRT tester with individual test for each gun.
- Compare guns for emission.
  - Test for leakage and shorts.
  - Legible 3 color scale.
  - Compact, portable, rugged.
  - Avoid recalls, check the CRT on every call.

WRITE US!

**TeleMatic**

take along the time savers

- PIX-MATE • CRY-S-MATE • GEN-MATE
- SOUND-MATE • TRACE-MATE

The Caddy-Mate Line.

2245 PITKIN AVE., BROOKLYN, N. Y. 11207

... for more details circle 131 on Reader Service Card

## LETTERS...

continued from page 27

ing that their sale prices are often less than what you paid for the same equipment.

Try to sell a small name-brand TV set for \$100.00 when the discounters run full-page ads on off brands for \$59.95, remembering that the TV set cost you about \$80.00 and you probably spent another two or three bucks for shipping.

You will be expected to be available to your customers from about 6:00 a.m. to 11:00 p.m., all day Sundays

and holidays, during your breakfast, lunch and supper. Also at other times that I won't mention here.

You will also have the joy of watching customers drive by your shop on the way to the discount store, where they will buy a TV set or stereo. Then when it needs service, they will smile and tell you, "I didn't know you sold TV sets," even though the sign out front says, "Joe's TV Sales & Service."

They will raise #### if you can't find parts for their orphan brand equipment. They will always blame you when parts can't be found.

You will find that most people expect their TV sets to work perfectly

for at least five years without any service or parts, while they will buy a new car every two or three years because the "old one" is falling apart. Just let a \$3.00 tube fail in their \$59.95 TV set and they will raise ####. This reaction is for the technician's benefit. They hope you will fix it for 50¢.

So if you fellows who think you are underpaid still want to try, go ahead. Open your own shop and show us how great you are. If you are a good technician, can handle customers without telling them to go to #### and don't mind going hungry for about five years, you might make it.

In case some of you think I am an employer of poor underpaid technicians, guess again—there is only one underpaid technician in my shop, me. I can't afford even underpaid help. In fact, I wonder if I can even afford myself.

If you are doing a good job where you work, ask for a raise. You might get it, if you are producing for your shop.

I may write later about the good points of having your own shop. A post card will do.

DANIEL HILL  
HILL'S TV SALES & SERVICE

# How listening to servicemen made the world's best electronic chemicals even better.

While we're proud of all the R&D we do, some of our best ideas come from the many servicemen who use our products.

Take our newest "first"—**Adjusta-Spray**. Its continuously-variable valve system lets you dial any spray intensity you want. We developed it because different jobs (and different servicemen) require different spray intensities: light for pinpoint cleaning and lubrication without overspray; medium for average jobs; and heavy, to blast away stubborn dirt.

**Adjusta-Spray** has it all. And it's fully compatible with extender tubes, to give you the **exact spray** you want, exactly **where** you want it. **Adjusta-Spray** is available on the world's most popular electronic chemicals: our **TUN-O-BRITE** cleaner/polisher/lubricant and **TUN-O-FOAM** cleaner/lubricant—both at your distributor's now. They're even more of a value, because there's no increase in price. How's that for making a good thing even better?



**CHEMTRONICS**  
INCORPORATED  
1260 RALPH AVE., BROOKLYN, N.Y. 11236  
Our business is improving yours.

## Appreciates Association Support

Thank you very much for the *spare* copy (I am a subscriber) of the February issue of **ELECTRONIC TECHNICIAN/DEALER**. It had already been noted with considerable surprise that you had reprinted the entire Code of Ethics proposal. While I neither anticipated nor expected that, it is possible that the additional exposure will prompt a few more studied responses, either pro or con.

Actually, I've been wanting to write you long before now but have been head over heels in various phases of association activity and projects. (At the present time, VEA is head over heels in the promotion of a licensing and/or registration law for the state and is having to buck some powerful—financial—opposition from Sears.)

Nevertheless, your recent editorials have been nothing short of fantastic. Seldom has anyone other than an association leader ever written with such strength of conviction and persuasiveness. The very fact that these things are being related by someone from outside the associations adds additionally to their credibility. Particularly speaking, your editorial on page 23 of the same February issue was, literally, a literary masterpiece. You provided excellent answers to the most frequently asked questions about al-

... for more details circle 106 on Reader Service Card

leged association cliques, dictatorial policies, price fixing, etc. You very well hammered home the point that these are self-service associations which can be directed toward effective representation only by participating and constructively griping members.

The ads which you have been supplying to promote the joint-association convention in New Orleans are also terrific. Especially pleasing is the emphasis you have been putting upon the fact that this is to be the convention for all people in the electronics service business; technician or dealer, association member or non-member.

Before closing, I must also refer to what I perceive to be a definite realignment of material content—to fall more in line with the changing tastes and needs of the new breed of business-oriented and industry-conscious technician/dealer. You are to be congratulated for your own success in your field and, again, I thank you for your useful, proficient and greatly appreciated support for our association endeavors.

W. S. (BOB) HARRISON  
COASTAL T.V. & ELECTRONICS  
(Bob is an active supporter of  
NATESA)

### Wants More CB Servicing Articles

I have been a subscriber to ELECTRONIC TECHNICIAN/DEALER since November 1965 and the article in the February 1972 issue on CB servicing is the first good article that has been printed on the subject. It could have been even better if it had been given the same treatment that you give color-TV articles. Why do you emphasize color TV with well written articles, then slight other entertainment equipment with meager articles that contain very little if any material equal to your TV articles?

There is another subject that I would like to see explained more fully. The subject of CET tests and mandatory licensing. You keep saying that technicians should take CET tests, then join one of several associations. What will keep a shady shop owner from passing a test, obtaining a license and then continuing to operate as he had been? Also, from the question samples I have seen, the subject of B/W-color TV is covered in the CET tests. What about the technician that does not work with TV, why should he have to take the same test as someone working with TV?

Here's hoping you can continue printing more and better articles for the rest of us.

HOMER J. LONG  
We are now working to expand the

range of service topics included in our publication—while still providing good TV-set servicing articles. You will note that in addition to the CB article, there have been several in-depth audio articles printed lately in our publication—with more to follow. We will also get into other servicing subjects.

Just because you are able to pass a CET examination does not mean that you can automatically become a member of the ISCET. The local chapter of the NEA first screens applicants, and only electronic technicians approved by them can become members of the ISCET. All of the trade associations are able to expel undesirable members.

The ISCET is currently working on a program in which one must first pass a general examination appropriate for all specializations and then a more advanced test directly related to your field of electronic servicing.

### Someone Shot TV Set

Recently you published letters on safety and the electronic technician. Here is a new twist.

Enclosed is a photo of a 1971 Coronado color-TV set hit by a 30-30 caliber soft-nose bullet.

The interesting point is that the

bullet did not completely penetrate the tube. All glass was hand picked in hopes of finding the bullet, but there

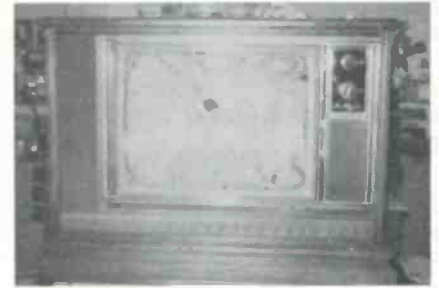

was no sign of it. There were deposits of foil that we believe are remains of the bullet. We believe that there could be a high flash point hot enough to vaporize the bullet at the time of implosion.

A. DELECARIS

### FCC Publication Costs More

Concerning the article, "Servicing CB Transceivers," on page 49 of your February issue: Part 95 of the FCC Rules and Regulations, together with parts 97 and 99, is contained in Volume VI, FCC Rules and Regulations. The current cost is \$2.00 with supplements for an indefinite period—not the \$1.25 mentioned in the article.

CLAXTON SEARLE  
C. B. ASSOCIATES

# all test jigs GO SOLID STATE with a TELEMATIC TRANSVERTER

service:  
Motorola  
Zenith  
Sylvania  
RCA...etc. etc...

- Converts any test jig to service any solid state TV.
- Simple plug-in operation
- Economical — Saves buying a solid state jig.
- Versatile — Dual impedance.

Available from your distributor.



## TeleMatic

2245 PITKIN AVE., BROOKLYN, N. Y. 11207

Write Us! Free subscription for current cross-reference charts

... for more details circle 132 on Reader Service Card

## READERS' AID

Space contributed to help serve the personal needs of you, our readers.

### Schematic and power cord needed

I need a schematic and a power cord for a Mesurmatic CB radio, Model No. MM-2, Serial No. 1104, produced by Mesurmatic, Warner, N.H.

WILLIAM T. JONES

Pilgrim Communications  
2 Regal Drive, Nashua, N.H. 03060

### Schematic Needed

I am in need of a schematic for a Soundarama, Model HC-58E stereo unit. No further information or the name of manufacturer is available. I believe this to be of foreign make. I would appreciate any information where obtainable and will pay any expense incurred.

WM. ZIEGLER

4194 3rd Ave.  
Los Angeles, Calif. 90008

I have recently acquired a Fisher Series 610 Hi-Fi radio-phon. with a series 560 stereo companion. I have

exhausted every available source and haven't been able to come up with a schematic. I would be glad to pay for the cost of reproduction, mailing, etc., if anyone can provide me with a schematic, service notes or anything that would assist in troubleshooting.

JOHN A. BOSHEAR

15546 S. E. 9th St.  
Bellevue, Wash. 98007

### Information Requested

Can anyone supply me with information on a tape recorder made in Germany about 1961? It is a S A J A model MK50 Deluxe. I need a recording head and a schematic. Also I would like a schematic for a Phillips Color-TV set made in Holland (tube type with works in a drawer) Model Monitron 800 No. 21KX106 A.

L. TONELLI

57 Tarrens Ave.  
East York, Ontario

### Meter Needed

I cannot locate a Commander Millivolt meter 720. I would like to buy one—either new or used.

FREEMAN GILMORE

6291 Lake Drive  
Haslett, Mich. 48840

### Equipment for Sale

Because of the death of my husband, who was actively engaged in radio and TV service, I am forced to sell a number of servicing items. They include test instruments, components and radio amateur books. Please write for listing and price.

MAMIE WADSWORTH

8410 Mitchell St.  
Tampa, Fla. 33604

### Business for Sale

Because of age and impending health, I must place my business and home for sale. I will accept terms of so much down and the balance like rent. It would be an excellent venture for two or more younger men to operate. The business has been in this location for the past 23 years. There is approximately 62,500 sq ft of land with a 250-ft front on the highway and a three bedroom, cement block home with large frame shop next door.

BILL REYNOLDS

R.F.D. 3 Box 217  
Valdosta Hwy.  
Waycross, Ga. 31501



It's this easy to install  
Electro-Voice phono cartridges.

Almost 100% original or exact replacements. But half of our competitors' cartridges are substitutes. And you know what problems that means. Like having to adjust the tracking weight and set down position of the tone arm. And changing the terminal clips on the tone arm wires. And installing a new bracket to adjust the cartridge to the arm. And, maybe, when you're finished, an output voltage difference exists.

Of course, when you specify Electro-Voice quality-assured cartridges, you avoid all this time-consuming, costly work. What's more, you don't make unprofitable double repairs. Your customer is happy the first time. And when he needs other services, he'll call you.

You'll find just about every cartridge you'll need in our comprehensive catalog. Use it for fast cross referencing, assistance in identification and detailed specifications. A free copy is available from your E-V/Game distributor. Get yours today, or write E-V/Game, Inc., Box 711, Freeport, N.Y. 11520.



# E-V/GAME, INC.

Division of Electro-Voice, Inc. • A GULTON Company  
In Canada: E-V of Canada, Ltd., Gananoque, Ontario

CARTRIDGES • NEEDLES • WHEELS • BELTS • PULLEYS • STEREO HEADPHONES  
MICROPHONES • HI-FI ACCESSORIES

... for more details circle 110 on Reader Service Card

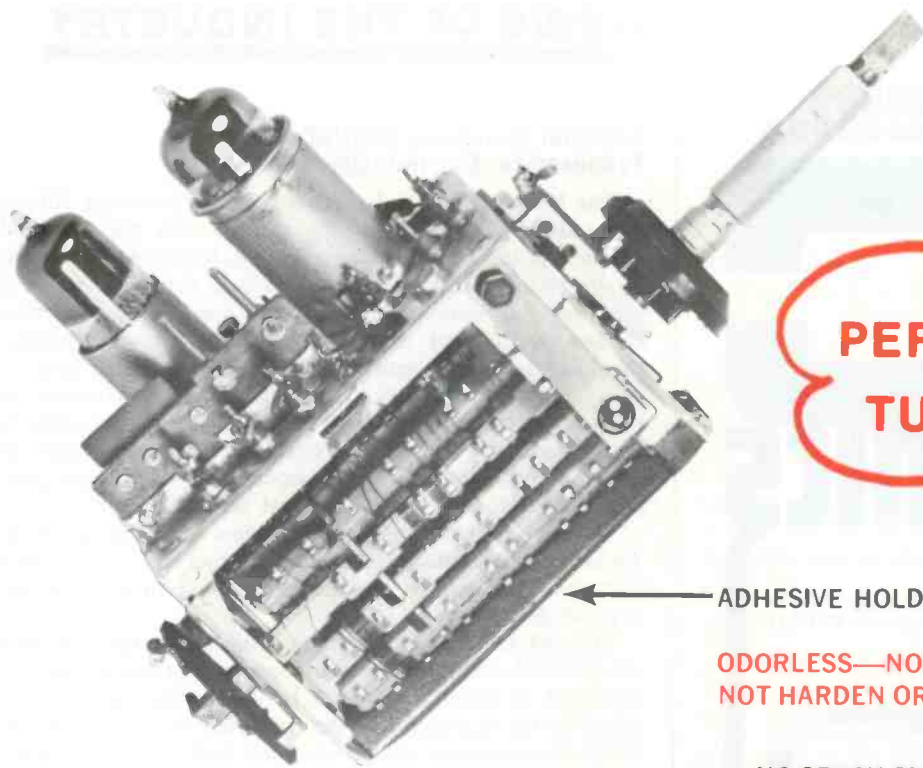

**PERMA-CLEAN®  
TUNER TABS**

PATENT APPLIED FOR

ADHESIVE HOLDS TUNER TABS TO SHIELD COVER

ODORLESS—NON-EVAPORATING LUBRICANT WILL NOT HARDEN OR CAKE

**WHY NOT  
MAKE A PROFIT  
WHEN YOU  
CLEAN TUNERS?**

FOR YEARS, THE SERVICEMAN HAS NOT BEEN MAKING THE PROFIT HE DESERVES. MANY SERVICE SHOPS ARE NOW MAKING AN EXTRA \$50.00 TO \$100.00 AND EVEN MORE IN PROFIT PER MONTH. YOU TOO CAN MAKE THIS EXTRA PROFIT WITH TUNER TABS. MANY OF YOUR CUSTOMERS NEED A TUNER TAB TO CURE OR PREVENT CHRONIC CLEANING PROBLEMS IN STRIP TYPE VHF TUNERS.

TUNER TABS GIVES YOU THAT SATISFIED CUSTOMER THAT YOU ARE LOOKING FOR. THE CELLS OF EACH TUNER TAB CONTAIN THE FINEST CLEANER LUBRICANT AVAILABLE FOR LASTING PERFORMANCE.

TUNER TABS COME TWELVE PER DISPLAY CARD FOR THE BENCH OR DISPLAY IN FRONT OF THE STORE. DISPLAY THEM AND SELL ONE WITH EACH SET BROUGHT INTO THE SHOP. CARRY THEM IN THE TUBE CADDY AND SELL ONE ON EACH HOUSE CALL, AND WATCH YOUR PROFIT GROW. EACH CARD COSTS \$9.95 AND EACH TUNER TAB SELLS FOR \$4.95 INSTALLED IN YOUR CUSTOMER'S SET. INSTALL ONLY TWO TUNER TABS AND THE REMAINING TEN ARE YOUR CLEAR PROFIT.

Ask your Parts Distributor today if he carries PERMA-CLEAN TUNER TABS. If not, contact Universal Tuner Tabs.

- NO SPRAY CLEANERS NECESSARY
- CONTINUOUSLY CLEANS, POLISHES AND LUBRICATES CONTACTS
- WILL NOT DETUNE OR CAUSE FREQUENCY DRIFT
- HARMLESS TO PLASTICS AND TUNER COMPONENTS
- FAST AND SIMPLE TO INSTALL
- DESIGNED FOR B/W AND COLOR STRIP TYPE VHF TUNERS

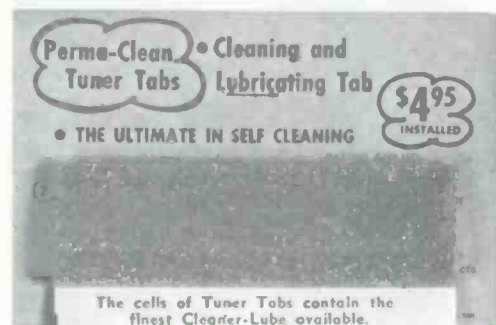

SEND FOR YOUR FREE TUNER TAB SAMPLE TODAY!

UNIVERSAL TUNER TABS MFG.  
12400 MTKA BLVD. HOPKINS, MINN. 55343

Please send me a free sample of your TUNER TABS today. I am enclosing 25 cents in coin to cover the cost of postage and handling.

Name \_\_\_\_\_  
 Address \_\_\_\_\_  
 City \_\_\_\_\_  
 State \_\_\_\_\_ Zip \_\_\_\_\_

**UNIVERSAL TUNER TABS MFG.**  
 12400 Minnetonka Blvd.  
 Hopkins, Minnesota 55343

# NEW! from..

# GC ELECTRONICS

A totally new and complete approach to tape and phono belts and drives replacement.

Now you can determine and select the exact replacement belt in a matter of seconds with the all-new BELT-O-METER from GC WALSCO. CAT. NO. 17-1000 DLR. NET. \$1.95



1. Determines belt size instantly.
2. Specifies exact replacement catalog number.

AVAILABLE FROM YOUR GC WALSCO DISTRIBUTOR

Get your BELT-O-METER FREE in any of these popular drive kits:

## TAPE RECORDER/PLAYER DRIVE KITS



Kit No. 1408-05 includes 21 of the top 15 belts & wheels. DLR. NET. \$19.95.



Kit No. 1408-07 includes 39 belts of the total top 15 nos. DLR. NET. \$34.95.

## PHONO DRIVE KITS



Kit No. 1408-04 includes 12 drives of the top 10 numbers. DLR. NET. \$19.95



Kit No. 1408-06 includes 20 of the 14 most popular. DLR. NET. \$34.95.

Ask your distributor for your FREE GC WALSCO Drive Cross Reference.



## GC ELECTRONICS

Division of Hydrometals, Inc.  
400 South Wyman Street  
Rockford, Illinois 61101 U.S.A.



... for more details circle 114 on Reader Service Card

## NEWS OF THE INDUSTRY

### National Consumer Arbitration Proposed for Our Industry

The National Electronic Associations' Consumer Affairs Committee has been working closely with the National Council of the Better Business Bureau to develop a national system of consumer arbitration that can be used on a local level in conjunction with the local Better Business Bureau, local office of consumer affairs, or an appropriate local law enforcement agency. The resulting plan is being presented to the NEA membership this month at the Joint Convention in New Orleans with the hope that it will receive convention approval and the cooperation of all other national and local associations serving the professional electronic technician and service dealer.

In many parts of the country, when an electronic technician or service dealer is unable to resolve a dispute with a customer, it either remains unresolved or goes to the small-claims court.

The NEA Consumer Affairs Committee believes that many small-claims courts are consumer oriented and not equipped to cover such cases in depth—basing decisions solely on the statements of the consumer and the electronic technician or service dealer—with no understanding of electronics. Such seemingly arbitrary judgements only reinforce any hard feelings that have already developed, and you certainly do not improve customer relations by "dragging a customer into court."

If instead the electronic technician or service dealer merely continues to bill that customer for services that he still considers outstanding—never taking the case to court for final settlement—then the customer will take his future business elsewhere, not wanting to complicate the disputed billing even further with additional purchases or service. Either way, *you* are the one that loses.

Although not directly concerned with the type of problems encountered in electronic sales and servicing, the following Better Business Bureau example helps explain consumer arbitration in action:

A hearing was held on December 29, 1971, involving a home improvement contractor who built an addition to a house, and the owners of the house. The contractor claimed that the owners refused to let him on the premises to finish the job, and the owners, while conceding that they had refused to admit the contractor, claimed poor workmanship and failure to perform within a reasonable time. The arbitration had been requested by the builder, after the homeowner had complained to the Nassau County Consumer Protection Agency. (The agency refused to handle the case because the homeowner refused to allow the contractor to complete the job.) In controversy was \$1100, the final one-third payment upon completion of the job. The homeowners requested three arbitrators instead of one, a request which may be made if the amount in controversy exceeds a certain amount. The Better Business Bureau sent the parties a list of eight persons it considered to be suitable arbitrators, including attorneys, contractors, and persons in the consumer protection and home improvement fields. The parties were asked to strike out those on the list who were not acceptable and to number the remaining persons in order of preference. From the list returned to the Bureau, three persons were selected by the Bureau: the dean of a business school, an engineer, and a local home improvement contractor. Both parties then agreed by contract to submit their dispute to the binding arbitration.

The day before the arbitration, two of the three arbitrators visited the site of the construction. The owners pointed out their complaints, and the builder showed what he had done. The next day the arbitration proceeding took place at the Long Island Better Business Bureau. It was understood that the third arbitrator would visit the house after the arbitration if he or the parties deemed it necessary.

The arbitrators were sworn in under New York State law. (The parties had been advised in advance that they had the right to be represented by an attorney and to have the proceedings recorded, but they had waived these rights.)

The business school dean, chosen by the arbitrators as chairman, asked the homeowners (both husband and wife were present) to state their case. They presented a chronology of events that led to the barring of the contractor from their house and a list of 11 alleged construction defects.

The contractor then gave his position. He felt the defects were minor and could be easily corrected if his workmen were allowed into the house. He pointed out that many of the defects were insignificant in terms of cost and he had no reason not to correct them; second, he had done several things not required by the contract simply for the convenience of the customers and at no charge to them.

The arbitrators then asked questions concerning the cost of the labor and materials involved and the time necessary to complete the job.

The customers, in rebuttal, stated that they had refused to let the contractor into their house because he had failed to complete the job within a reasonable period. The contract was signed in May of 1971, and construction began three to four weeks later as in the contract; however the work had not been complete by August 15th, the date the contractor was barred from the premises. In response, the contractor said that most of the work remaining to be done was in the nature of "finishing touches" or "service calls," the job was essentially completed, and the customers were being unreasonable in their refusal to admit his workmen. In addition, he said that one of the "defects," a bubbling of the roofing paper, was a result of the roof being



walked on and being used as a sundeck, a purpose which was not contemplated in the selection of the roofing material. He stated, "I would be proud to show this building as an example of the quality work we do."

Following the presentation of the evidence, the arbitrators ascertained that the home owners preferred to have a different contractor complete the job if there was an award in their favor, and the contractor preferred at this point, not to be the one to complete the job.

The arbitrators then thanked both parties and told them that they would present a decision within 30 days as required by New York State law.

On the following Monday, January 3, 1972, the manager of the Long Island Better Business Bureau visited the home with an independent contractor who estimated the cost of the job to be completed at \$300.

**DECISION:** Well within the 30-day period New York State allows for a decision, the arbitrators handed down the following award: The customers were allowed \$600 toward the unpaid installment of \$1100 due, and were directed within 10 days to pay \$500 to the contractor in full settlement of all claims submitted in the arbitration, and in full satisfaction of the contractual rights between the parties.

**OBSERVATIONS:** Those observing the proceedings felt that the parties concerned were very happy with the manner in which the dispute was finally being settled. It seemed clear that one session which took part of an afternoon was preferable to a long, delayed court proceeding. The contractor was glad to be able to remove an uncompleted job from his records, and the home owner was happy to have the matter finally settled so that he could make full use of the addition to his house. At the closing of the proceedings both parties thanked the arbitrators and then shook each other's hand with the comment that they were sorry that their relationship had to end in this way.

Upon notification of the arbitrators' awards, all parties felt that they had been treated fairly and that a satisfactory result had been reached.

According to the proposed BBB/NEA plan, any dispute between a customer and electronic technician or service dealer could be brought to the attention of the appropriate local agency by either party. That agency would then draw upon a national list of 8,000 to 10,000 names of arbitrators published by the National Better Business Bureau in cooperation with the national electronic-service associations. Both parties would sign a contract agreeing to the arbitrator's final decision (a form of contract currently recognized in 47 states). In the case of TV sets or similar electronic products, the item in question would then be examined by a qualified electronic technician—one who's identity would remain secret to everyone but the arbitrator. Based upon the informal statements made by you and your customer—plus the report of the anonymous expert—a final judgement would be made. A judgement which—according to experience with arbitration boards that have already begun handling disputes in our professional area—generally meets with the satisfaction of both you and your customer—a customer who will probably continue to do business with you.

## Cartridge Television Inc. Graduates First Students

Cartridge Television Inc. has graduated its first students from the first consumer-oriented video tape recorder service course ever offered in the United States. The seven-day course, offered in support of the maintenance program for the Cartrivision color video tape cartridge system, was the first in a continuing series that will be provided for service management groups and factory technicians of Cartrivision system equipment manufacturing licensees.

Under the program, groups from Admiral, DuMont, Emerson, Teledyne Packard-Bell and Montgomery Ward will attend the course at Cartridge Television Inc.'s Palo Alto facilities. Warwick Electronics, Inc. will operate the same course at its Chicago facilities for Sears service personnel.

The service training course, which is oriented toward the present skills of TV servicemen, is being offered in two versions. A "train the trainer" course is provided to service management personnel of manufacturing licensees so that they can conduct their own schools to train factory-authorized service personnel. In addition, Cartridge Television will be training factory technicians who will require basic maintenance information at the various manufacturing facilities throughout the country.

The VTR service training school curriculum includes an introduction to video tape recording concepts, and covers the Cartrivision system's mechanical transport unit, its electronics, the interface circuits between the video tape recorder and the TV set, service procedure techniques and basic troubleshooting.

# 5 ways to cut your cost of doing more business

## NEW Heathkit Transistor — FET Tester...49.95\*

Tests transistors, diodes, FETs, SCRs, triacs, uni-junction transistors in or out of circuit. 5 current ranges measure leakage as low as 1  $\mu$ A and collector currents as high as 1A. Gain (DC Beta), transconductance (GM), and leakage values read directly on large meter face. Special battery testing circuit gives meter indication of self-contained power supply. Kit IT-121, 6 lbs.



## NEW Heathkit Solid-State FET VOM...79.95\*

This new dual FET portable multimeter has lab-grade accuracy, high (10 megohm) impedance input, and the ranges you really need... at a price you can easily afford. 9 DCV and ACV ranges from 0.1 to 1000 V. at  $\pm$  2% accuracy. 6 DC and AC current ranges from 10 microamps to 1 amp. 7 resistance ranges, x1 (10 ohm center) to x1 Megohm. 9 dB ranges, -40 to +62. 1% precision metal-film dividers. 4 1/2", 100  $\mu$ A ruggedized taut-band meter, diode and fuse protected. Battery check switch provided. Kit IM-104, less batteries, 4 lbs.

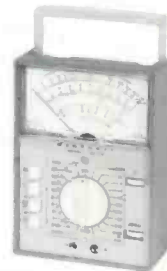

## NEW Heathkit 8-Digit 120 MHz Counter...349.95\*

Measures 1 Hz to over 120 MHz. Over-range, gate, and two range indicators. Preassembled TCXO time base. 1 megohm FET input. Automatic triggering level. Sensitivity 125 mV or less to 120 MHz. ECL logic. Builds in 15 hours. Kit IB-1102, 12 lbs.



## Heathkit 10 MHz Triggered Scope...229.95\*

A 5" triggered sweep scope at a low kit price you can't afford to pass up. AC — 10 MHz response, calibrated attenuator, 50 ns sweep rate with magnification. AC-DC coupling, 50 mV sensitivity. One of the outstanding scope values on the market. Order one for your service bench today. Kit IO-103, 37 lbs.



## Heathkit Digital Multimeter...229.95\*

A digital multimeter that meets lab specs at a low, low kit price! 3 1/2 digits for 100  $\mu$ V resolution on 200 mV range; 1V on 1000V; 5 DC ranges (100  $\mu$ V — 1000V), either polarity; 5 AC ranges (100  $\mu$ V — 500V); 10 current ranges (100 nA — 2A AC or DC); 6 resistance ranges (0.1 ohm — 20 megohms). DC calibrator supplied for 0.2% accuracy without external equipment. Can be lab calibrated to 0.1%. Kit IM-102, 9 lbs.



HEATH COMPANY, Dept. 24-8  
Benton Harbor, Michigan 49022

Enclosed is \$ \_\_\_\_\_, plus shipping.  
Please send model (s) \_\_\_\_\_

Please send FREE Heathkit Catalog.

Name \_\_\_\_\_  
Address \_\_\_\_\_  
City \_\_\_\_\_ State \_\_\_\_\_ Zip \_\_\_\_\_

Prices & specifications subject to change without notice.  
\*Mail order prices; F.O.B. factory.

TE-271

... for more details circle 116 on Reader Service Card

## NEW AND NOTEWORTHY

For additional information on products described in this section, circle the numbers on Reader Service Card. Requests will be handled promptly.

### TV DOLLY 700

*One man can handle heavy TV set*

The Tele-Caster TV Dolly, Model TC-1, is designed to move TV sets and doubles as a handy mover of many hard to handle objects. It is easy to operate by simply placing the jack plate under one end of the object, raise with the automotive type jack to clear the floor, place the nylon strap around object, and the "T" handle belt tightener automatically locks as the belt is tightened. Then "wheel" it as you would a wheel barrow. The object stays in place on the dolly jack plate by its own weight and pressure. The dolly can be "walked" up and down steps, used to tip the TV set upside down to work on the bottom, and can remain attached to the TV set while in the service vehicle. The unit is built to last with a tubular square frame padded with  $\frac{3}{8}$ -in. thick foam tape on contact areas, large 8-in. steel wheels with rubber tires and ball bearings. It comes completely assembled except for wheels. Dealer net price: \$89.50. The Finney Co.

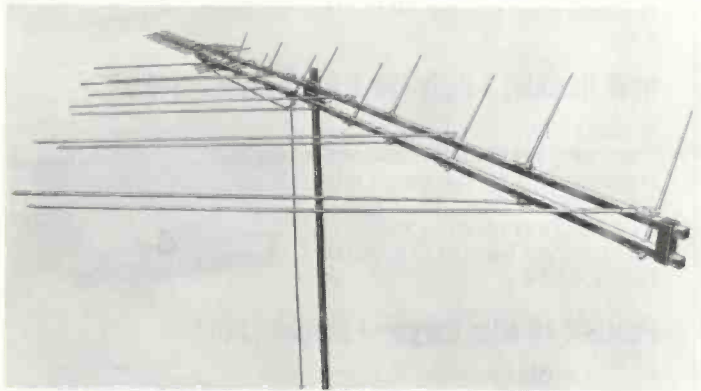

### UHF/VHF/FM ANTENNA 701

*High gain  
and flat response*

The Model 0719, UHF/VHF/FM antenna provides sharp VHF pickup, with high gain and flat response on all channels for top color performance. For ghost and interference free directivity, 21 UHF reception elements are used. This antenna system embodies a non-radiating transmission-line section feeding active dipole elements and operating over a multi-frequency range. A resistive component is used at a critical location across the non-radiating transmission-line section, enabling the reduction of secondary lobes and interference. A unique locking mechanism incorporates a three-region suspension which prevents loosening in the pivot dipole connections. Active dipole elements consist of 10 for VHF, 11 for UHF, plus a 10 element UHF director. Manufacturer's specifications indicate a gain of (relative to dipole) Low VHF: 4.25dB, High VHF: 7.25dB, FM: +3dB, UHF: 8.0dB. Front-to-back ratio: Low VHF: 25dB, High VHF: 24dB, FM: 16dB, UHF: 21dB. Boom length 159-in. Turning radius 95-in. Other features include a gold anodized plating on boom, baked on weather resistant finish on all elements, high gain dual boom log periodic design and exclusive mid-boom inductive tuning on UHF. Blonder-Tongue.

FOR MORE NEW PRODUCTS SEE PAGE 61

### SOUND-LEVEL METER 702

*Has several sensitivity ranges  
to match sound level measured*

The Model 885 sound-level meter is designed to have a sound level range of 40dB to 140dB in 10 dB increments and uses a lead-zirconate-titanate ceramic microphone relatively stable in temperature and humidity environments. The power requirements are two 9v batteries—a Burgess 2U6 or equivalent being furnished with the instrument. The operating temperature is  $-10^{\circ}\text{C}$  to  $+50^{\circ}\text{C}$  with storage temperature (batteries removed) of  $-40^{\circ}\text{C}$  to  $+60^{\circ}\text{C}$ . Temperature coefficient of sensitivity is said to be  $-0.01\text{dB}/^{\circ}\text{C}$  at 6dB below full scale meter indication. The instrument has a molded, high-impact, gray plastic case internally shielded with electronic circuit packaging on a flexible printed circuit board. Weight 1 lb. Measurement: 3.63 in. wide by 5.38 in. high by 2.09 in. deep. Simpson Electric Co.



**BLONDER-TONGUE** LABORATORIES  
INCORPORATED

ONE JAKE BROWN ROAD, OLD BRIDGE, NEW JERSEY 08857 (201) 679-4010

**NEW**  
TEAR-OUT  
PRODUCT  
SELECTOR!

**FROM THE  
COMPANY  
THAT INVENTED**

**MATV... By**

**BLONDER-TONGUE**

A revolutionary concept in broadband amplifier design that eliminates overload problems and provides the extra wide dynamic range you always wanted in solid-state MATV amplifiers . . .

- EVERY AMPLIFIER STAGE IS AN OUTPUT STAGE!
- PATENTED ICEF CIRCUITS
- UNSURPASSED BLONDER-TONGUE QUALITY —“the standard of excellence”
- YOUR BEST dB per DOLLAR BUY
- INDIVIDUAL HB, LB and UHF GAIN CONTROLS ENSURES PRECISE SIGNAL BALANCING



THE RIGHT CHOICE FOR BROADBAND MATV SYSTEMS . . .

HOTELS  
SCHOOLS  
MOTELS  
NURSING HOMES

TV SHOWROOMS  
HOSPITALS  
MOBILE HOME COURTS  
CONDOMINIUMS



CUVB-35 UHF/VHF/FM STOCK No. 4763 LIST PRICE \$163.00



CVB-30A VHF/FM STOCK No. 4733 LIST PRICE \$96.10



## CUVB-35 ENGINEERING SPECIFICATIONS

* Output Capability	LB/FM=52dBmV (0.4v) ea. ch.	Min. Input for TASO	VHF = -5dBmV (560uv)
	HB=52dBmV ea. ch.	Grade 1 Picture	UHF = -4dBmV (600uv)
	UHF=48dBmV (0.25v) ea. ch.		
Gain (Typical)	LB/FM=17dB to 35dB	Noise Figure Increase per	VHF = 0.2dB
	HB=15dB to 33dB	dB of Gain Reduction	UHF = 0.6dB
	UHF= 9dB to 39dB		
Match (Avg. Return Loss)	INPUT = 14.3dB RL	Band Pass Flatness	VHF/LB = ± 0.5dB
	OUTPUT = 12.3dB RL		VHF/HB = ± 0.6dB
			UHF = ± 0.6dB
Noise Figure	VHF = 6.8dB	No. of Semiconductors	12
	UHF = 9.0dB		

### TYPICAL BROADBAND UHF/VHF/FM SYSTEM

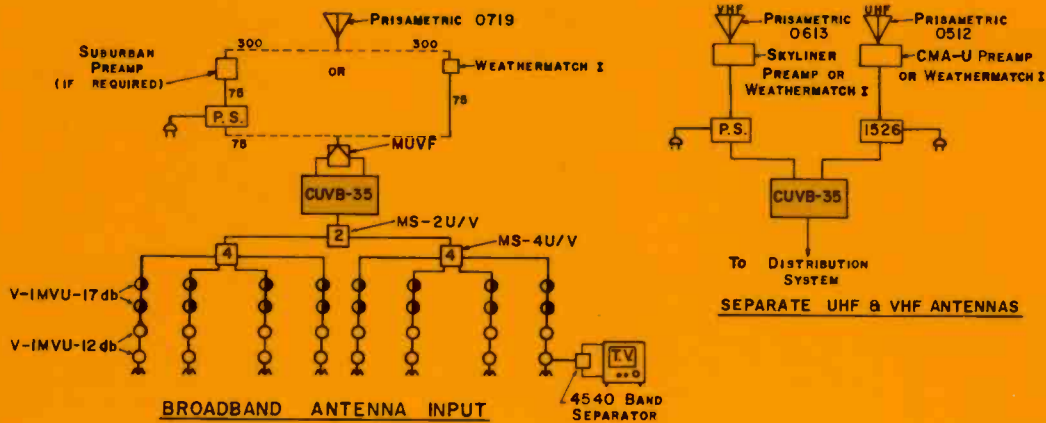

## CVB-30A ENGINEERING SPECIFICATIONS

* Output Capability	LB/FM=52dBmV (0.4v) ea. ch.	Noise Figure	LB/FM = 6.3dB
	HB=52dBmV ea. ch.		HB = 7.2dB
Gain (Typical)	LB/FM=17dB to 35dB	Min. Input for TASO	LB/FM = -7.5dBmV (440uv)
	HB=15dB to 33dB	Grade 1 Picture	HB = -6.5dBmV (480uv)
Match (Avg. Return Loss)	INPUT = 14dB RL	Noise Figure Increase per	LB/FM = 0.2dB
	OUTPUT = 13dB RL	dB of Gain Reduction	HB = 0.2dB
No. of Semiconductors		Band Pass Flatness	LB = ± 0.5dB
			HB = ± 0.6dB

### TYPICAL BROADBAND VHF/FM SYSTEM

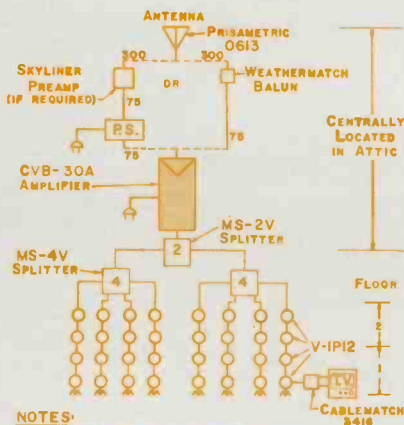

- NOTES:
1. OUTLETS ARE V-IP12 DUPLEX STYLE.
  2. OUTLET BOXES ARE MOUNTED BACK TO BACK IN COMMON WALL TO PROVIDE TWO OUTLETS FOR EACH APARTMENT.
  3. CABLE IS RG-59/U FOAM COAX. TOTAL FOOTAGE TO BE DETERMINED BY INSTALLER.

\*3 Channels in LB } Present simultaneously with  
4 Channels in HB } no perceptible distortion.  
3 Channels in UHF }

**CONTACT  
YOUR LOCAL  
BLONDER-TONGUE  
DISTRIBUTOR FOR  
CUSTOMIZED  
APPLICATION  
ASSISTANCE**

*the standard of excellence*

COPYRIGHT 1972

PRINTED IN U.S.A. REFERENCE NO. 72-31

MADE IN USA

LABORATORIES  
INCORPORATED  
**BLONDER-TONGUE**  
ONE JAKE BROWN ROAD, OLD BRIDGE, NEW JERSEY 08857 (201) 679-4010



**TEKLAB REPORT****Sylvania's D18 Color-TV Chassis**

by Joseph Zauhar

Plugability concept used throughout chassis to simplify servicing

■ Each year with the introduction of new TV sets, we see that more and more of these products are becoming almost entirely solid state in design. Sylvania reportedly at the present time has 95 percent of its total TV-set line in part or wholly solid state. Continuing this trend, they have introduced a new 17-in. (diagonally measured) color-TV set which is more than 85 percent solid state. It also broadens their line, being a new screen size, and includes a remote control reduced in price because of simpler, limited-function mechanisms.

We received in our lab a Sylvania Model CC1157WR portable color-TV set employing the D18 chassis. This TV set has practically every automatic feature available, and yet it is very compact and reasonably light in weight—considering the additional circuits included, such as remote tuning. The cabinet is made of high-impact plastic—featuring slide-throttle type COLOR and TINT controls. To turn the set ON, just press the push type ON/HIGH control button and hold it in until the desired volume is reached. Then to lower the volume level and turn the TV set OFF, press the OFF/LOW control button.

Also included on the front panel is the PERMA-LOCK button, which features a red light when you activate the pre-set controls, plus a special electronic circuit for correcting flesh-tone variations. The CONTRAST and BRIGHTNESS controls are partially hidden on the lower

right edge of the control panel. The pre-set controls are located on the rear top edge of the cabinet. These controls can be adjusted with the back cover in place. This memory system has been preset at the factory, but can be adjusted in the home. No special tools are required to adjust the COLOR, TINT and BRIGHTNESS controls—just push the PERMA-LOCK button in, connecting the pre-set controls, and adjust for an average picture on all channels.

From a servicing standpoint, we were pleased to see the plug-in concept carried throughout this chassis.

All transistors and sound integrated circuits have plug-in sockets on the main chassis. The tuner, COLOR-TINT control, deflection yoke, convergence board, power tuner and degaussing circuit also include plug-in connectors on the wire harness to the main chassis to simplify chassis removal if service is required. When the back cover is removed, the circuit boards are rather well exposed, but the chassis can be pulled out about 3-in. more by removing two screws and then pulling it straight out on the guide rail. When the chassis is pushed back,



Sylvania's Model CC1157WR, 17-in. (diagonally measured) color-TV set, employing a lower-cost simplified remote control, is an ideal portable TV-set for the den, bedroom or commercial uses.

two retaining springs keep the chassis from falling out of the track. To remove the chassis, just lift the retaining springs.

The compact hybrid chassis includes a remote control and the following automatic circuits: Automatic degaussing, automatic frequency control (AFC), automatic tint (Perma-Tint), and factory pre-set controls (Perma-Lock).

The D18 color-TV main chassis consists of two printed circuit boards which are road-mapped on both sides and wired to the chassis

circuitry. This chassis is designed to accommodate the MV17VAEP22, 90° deflection, black-matrix, color-picture tube. The circuits in the D18 color-TV chassis are basically similar to the D16 chassis, with but minor modifications. As we review some of the circuits, they can be followed in this month's Tekfax Schematic No. 1423.

### "X" AND "Z" CW PHASE SWITCH (PERMA-TINT)

The Perma-Tint circuit panel is located on the IF/chroma panel

assembly and is a simple circuit employing two transistors, the "X" CW phase switch transistor Q603 and "Z" CW phase switch transistor Q605. Its purpose is to minimize fleshtone error caused by chroma or burst phase shift. This is accomplished by widening the "X" and "Z" axis so that the normal demodulation angle can be changed from 90° to 130°. Transistors Q603 and Q605 are turned ON by a saturation bias applied through the PERMA-TINT switch, SW600. When this occurs, additional phase shifting components — capacitor C641, resistors R665 and R667, coil L603, capacitor C643 and resistor R675—are switched into their respective "X" and "Z" demodulators.

### SOUND CIRCUITS

The sound section employs a sound detector diode (SC100), a plug-in integrated circuit sound IF/detector/amplifier (IC100) and an audio transistor (Q100). The video IF stages employ an intercarrier (combined sound and video IF) system through the third video IF stage. The output from this stage is applied to a separate sound detector diode for 4.5MHz sound IF detection to prevent interference in the video detector and video amplifiers. The 4.5MHz sound IF is filtered through a low-pass filter to remove all 40MHz video IF frequencies, and it is then impedance coupled to the input of the integrated circuit network. This IC provides amplification of the 4.5MHz IF frequencies, FM limiting and FM detection. The audio signal is amplified within the IC and applied directly to the base of the audio output transistor.

### HIGH-VOLTAGE TRIPLER ASSEMBLY

This chassis employs a new tripler assembly which replaces the high-voltage rectifier tube and eliminates the shunt regulator tube in the horizontal-deflection circuit. Some of the advantages of this system includes the elimination of X-radiation from these tubes and improved horizontal-circuit reliability. This is accomplished by stepping up the voltage on the horizontal-output transformer from 8.3kv to 25kv. The tripler assembly also re-



Pushbutton switches are employed to raise or lower the volume, turn the TV-set ON or OFF, or to engage the AFC. The Perma-Lock circuits are engaged by pushing a button, which lights up when the set is properly tuned. Slide type COLOR and TINT controls are also used.



The small simplified transmitter is powered by a 1.5v battery. It has three control functions: ON/VOLUME UP, OFF/VOLUME DOWN, and CHANNEL SELECTION.



The hand-held remote transmitter consists of a transistorized oscillator with discrete frequency selection buttons for performing the various functions.

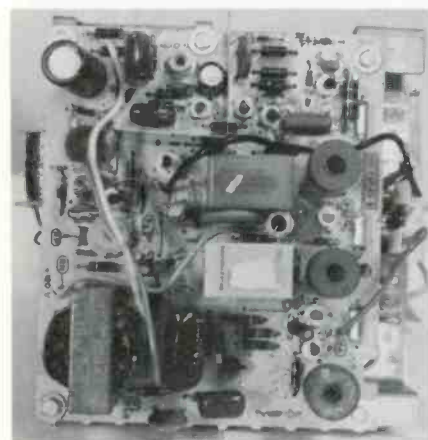

Top view of the simplified remote receiver board.

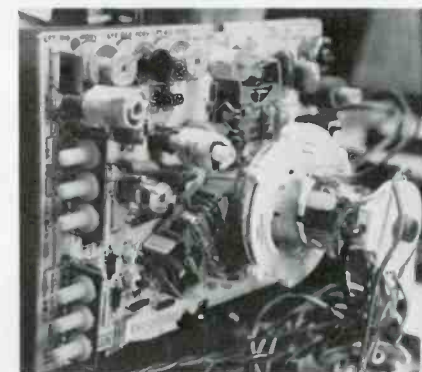

The convergence panel assembly is placed around the picture tube neck and includes the static-convergence magnets.

duces the number of high-voltage windings required in the flyback transformer, and offers lower required heat dissipation and longer life expectancy than tubes or selenium assemblies. The focus rectifier is now an integral part of the high-voltage tripler assembly.

### VERTICAL-OUTPUT CIRCUIT

The D18 chassis eliminates the vertical-output transformer (used in the past) and by doing so vertical linearity is improved. The vertical-output circuit employs five transistors—a push-pull output stage (Q318 and Q322), a Darlington driver (Q316) and a PNP transistor driver (Q320). When the Darlington driver transistor is driven, its high impedance maintains the sweep signal without loading the waveform source. Its emitter voltage provides base signal through resistor R380, diode SC320 and resistor R382 to transistors Q318, Q320 and Q322. When transistor Q318 is turned ON by the sweep drive, it conducts for more than half the sweep cycle, charging capacitor C334 to B+ through sweep coils L302 and L304. Transistor Q318 also provides the collector voltage to transistor Q322 and the emitter voltage to transistor Q320.

When transistor Q320 is turned ON by the negative portion of the sweep drive, it acts as a bias switch to transistor Q318, turning it ON. Capacitor C334 discharges through the yoke coils (L302 and L304) and back through transistor Q318—forming the remaining portion of the sweep-current waveform. Capacitor C334 also prevents dc current from flowing in the vertical-sweep coils and causing possible raster decentering.

Linearity compensation of the drive signal is provided by capacitors C326 and C328, diode SC316, and resistors R366, R372, R370 and R368. This circuit provides the current charging path to boost B+ during the scan time and counteracts the waveform error caused by capacitor slow charge time.

### REMOTE-CONTROL SYSTEM

Even though this remote control system has limited function mechanisms, we were amazed at the quiet, positive action of this system. The

reduced price of the unit should encourage more people to purchase this luxury feature in a portable color-TV set line.

### Transmitter Operation

The small hand-held transmitter contains a very simple circuit consisting of a transistorized oscillator with a selection of frequency buttons enabling the various functions. It is powered by a 1.5v battery. The unit has three control functions: ON / VOLUME UP, OFF / VOLUME DOWN and CHANNEL SELECTION.

### Receiver Operation

The remote receiver must be turned ON by a manual switch on the back of the TV chassis, if it is to be utilized. The receiver is likely to be left in the ON position since it draws very little current.

When a transmitter button is pressed, a given frequency is emitted, and received by a transducer TRD1052, which is coupled to a four-stage amplifier. The output of transistor Q1058, the clipper, is connected to three selective tuning

*continued on next page*

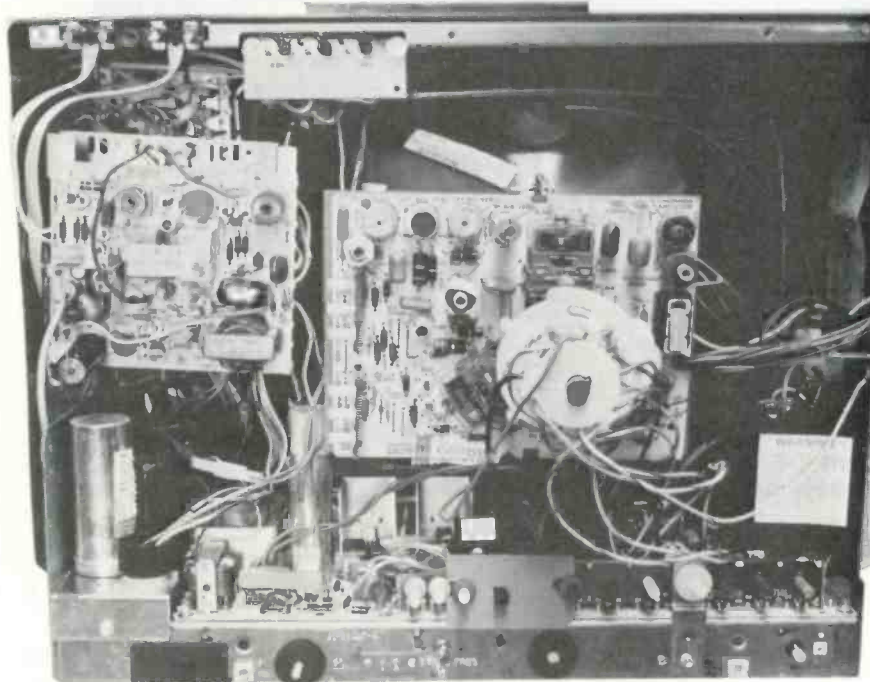

Rear view of the TV-set showing the locations of the convergence and remote control boards along with the service adjustments.

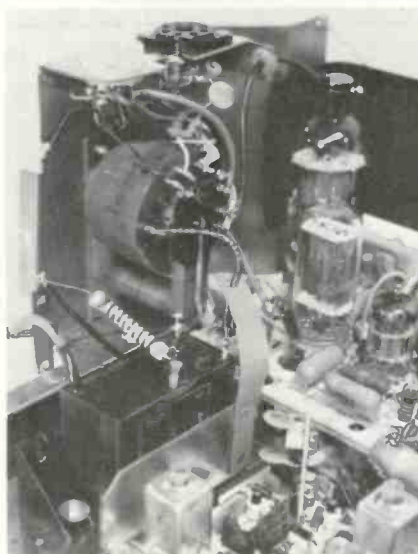

A voltage-tripler assembly is employed, replacing the high-voltage rectifier tube and eliminating the shunt-regulator tube.

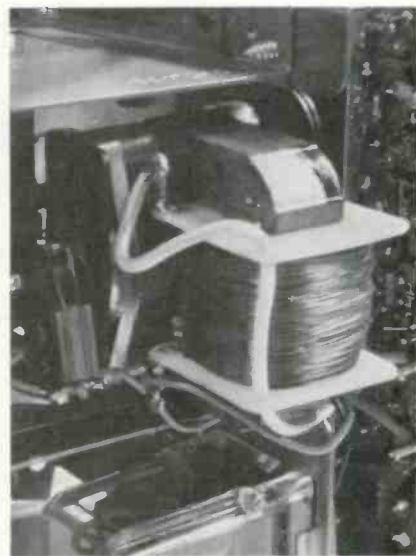

The channel selector motor is the only motor employed for remote functions.

networks by a common buss line. One of the networks will respond to the selected frequency and a signal will be developed across the base of a relay driver transistor biased into conduction. There are two bias controls, R1084 (minimum volume adjust) and R1092 (ON/OFF threshold), which are preset to determine the turn ON point, minimum

VOLUME level setting, and the turn OFF point. The circuit actions for remote-control and manual operation are very similar from this portion of the circuitry on, so the circuit descriptions will be in terms of manual operation.

### ON and VOLUME Control

When the VOLUME-UP button is

pressed, switch SW510 connects the voltage-divider resistors (R1096 and R1097) to ground through resistor R524. The voltage at the junction of R1096 and R1097, which is connected to the base of transistor Q1070, then drops from 24v, turning ON the PNP transistor. Its conduction latches the power switch relay, RY500, turning the TV set ON.

The VOLUME-UP button must be held in until the minimum volume voltage setting is sensed by transistor Q1068. When this point is reached, Q1068 applies its conduction voltage through resistors R1086 and R1087, and resistor R1095 becomes the base leg of the transistor Q1070 bias network—maintaining forward bias after the VOLUME-UP button is released and keeping relay RY500 latched.

As the power relay switch (RY500) closes, switch SW510 also completes the circuit for relay RY1054 latching current by connecting RY1054 through diode SC1056 to resistor R524 and ground.

After the switch contacts on relay RY1054 close, isolating resistor network R1074 and R1078;

*continued on page 64*

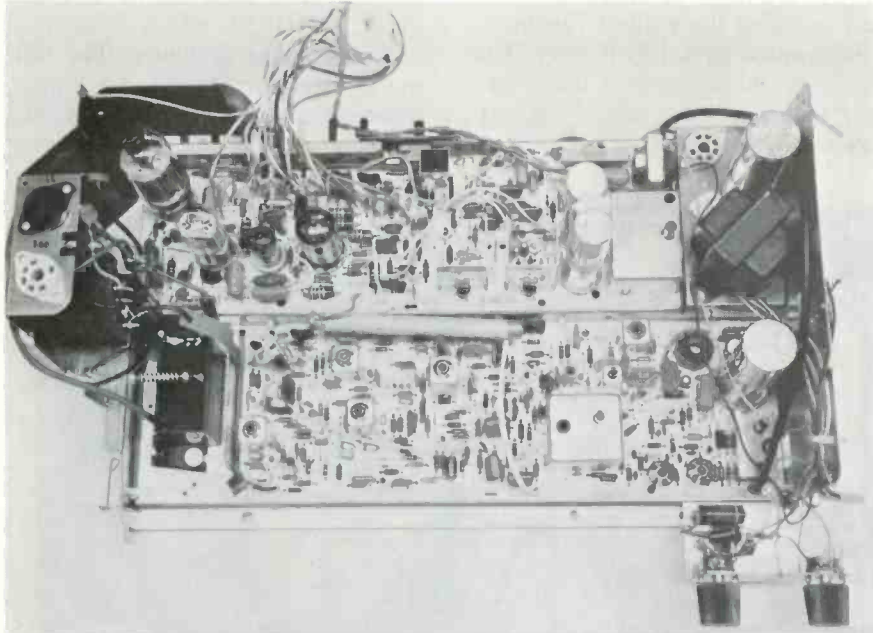

The main D18 color-TV chassis consists of two printed-circuit panel assemblies wired to the chassis circuitry. The panels feature road map printing on both sides and plug-in transistors.

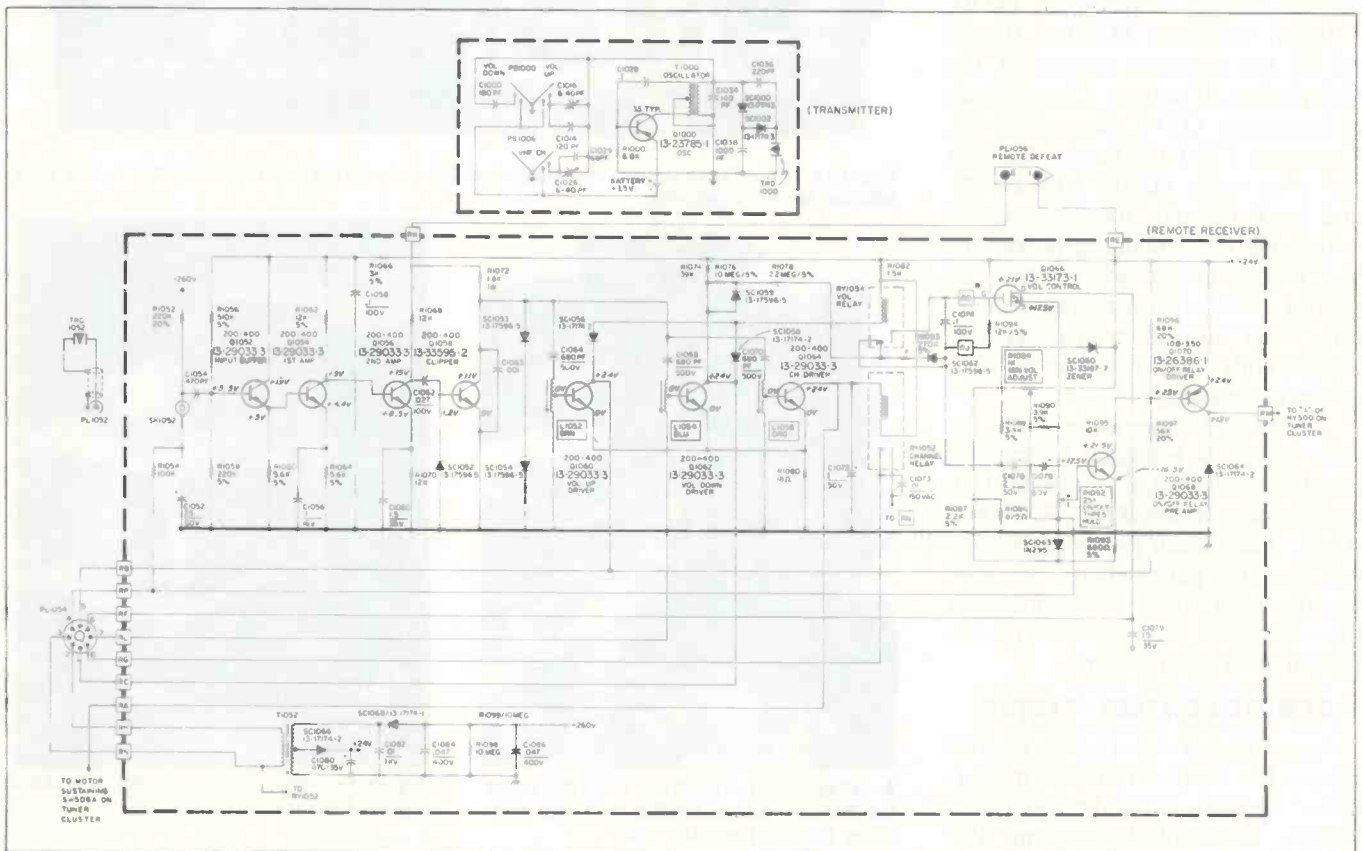

Schematic of the remote receiver and transmitter circuits. Courtesy of Sylvania.





## How to stay in shape without getting your wallet out of shape.

We've shaped up a plan that lets you mix business with pleasure.

The program is simple: You buy Sylvania receiving tubes, you get merchandise award points. When you have enough points, you just pick out what you want from the catalog that Sylvania's distributors will be glad to give you. (Ask him for the "Take Stock with GTE Sylvania" book.)

To keep you in shape, there are things like golf or fishing equipment and shop tools. And if whittling is your sport, there's even a knife for that.

If you'd rather keep your wife in good shape there are pages of kitchen and household equipment that will make her workload a lot lighter.

Or if you are interested in really living the good life, there is everything from clothing to cameras.

And then there are the Sylvania color television sets. They take a lot of points, but they deliver a lot of picture.

Buying Sylvania receiving tubes can keep your business in good shape.

And if you buy enough Sylvania tubes, you can keep the whole family in shape.

But, we have to warn you, your wallet will get a lot fatter.

Sylvania Electronic Components, 100 First Avenue, Waltham, Mass. 02154.



**GTE SYLVANIA**

FROM ANTENNA  
TO T.V. SET

# DELTA-BENCO

## HAS ALL YOUR 82 CHANNEL EQUIPMENT



AMT

### AT THE ANTENNA

- AMT Series — Matching Transformer for single UHF channel, or 2-83.
- MBT Series — Pre Amplifiers for single UHF channel, or 2-83.
- AC Series — VHF-UHF couplers.
- SI Series — Signal Injectors-single UHF channel to all-band down lead.



MBT



TBA

### 82 CHANNEL DISTRIBUTION AMPLIFIERS

**TBA/283/6-4**  
6db Gain  
Four Outputs - 75 ohm  
Max. Input UHF + 27db  
VHF + 20db

**TBA/283/12**  
12db Gain  
Single 75 ohm output.  
Max. Input UHF + 32db  
VHF + 32db

**TBA/283/25**  
25db Gain  
Separate UHF-VHF inputs  
Max. Input UHF + 28db  
VHF + 26db



2x75/283



4x75/283

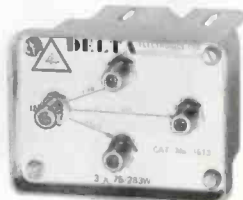

3x75/283W

### 82 CHANNEL SPLITTERS

A complete range of 30 - 890 MHz Splitters; 75 ohm impedance for indoors or out. Available with two, three or four outputs.



TO-2/283

### TO-SERIES



TO-2/283W

### 82 CHANNEL TAP-OFF'S

Available for indoor or outdoor use with 1, 2, or 4 taps. Isolation values of 20, 15, or 10db.

### 82 CHANNEL WALL PLATES

Five models available for 75 or 300 ohms. Taps loss 10, 15, or 20db.

### AT THE T.V. SET

**MM-283**  
UHF-VHF Matching Transformer  
75 ohm input  
2 x 300 ohm output

**LS-U/V**  
UHF-VHF Band Separator  
300 ohm input  
2 x 300 ohm output



## DELTA-BENCO LTD.

70 RONSON DRIVE • REXDALE • ONTARIO  
(416) 247-7431 TELEX 06-965552

### REPRESENTATIVES:

EASTERN USA:  
JERRY CONN & ASSOCIATES INC.  
1070 S. COLD BROOK AVE.  
CHAMBERSBURG, PA. 17201  
(717) 263-8258

WESTERN USA:  
B. E. DUVAL CO.  
29619 S. WESTERN AVE.  
SAN PEDRO, CALIF. 90732  
(213) 833-0951

... for more details circle 108 on Reader Service Card

# The Best Antenna

by Phillip Dahlen

Although you cannot be expected to design and construct your customers' antennas, the use of some basic design principles will aid you in selecting the most appropriate antenna for your signal conditions, adjusting it as necessary

■ Unless working exclusively in an area where all the TV sets receive their signals through CATV systems, you as an electronic technician or service dealer must be concerned with some form of antenna system. (Unfortunately even those that must deal with TV sets on CATV systems must be concerned with the quality of the signal received, though such reception problems more closely relate to problems with wideband distribution equipment—Page 51, April 1972 issue—rather than local antenna systems. We again repeat our position that the best answer to CATV systems is direct satellite reception, and antenna systems for such reception will be covered in detail just as soon as the Canadian TV satellites get on the air.) The TV set that you sell or service simply cannot function properly without the application of proper TV signals—and this your customer *does* consider your responsibility!

We recently learned of a reception problem, which though true, is still hard to believe. An employee of our company called an electronic technician, other than Joe Zauhar, to service his TV set. The problem: no color. After checking the TV set over closely, the technician indicated that the TV set had a bad color picture tube, *plus* some defective color circuitry. An estimate was given indicating that it would cost over \$200.00 to fix the TV set. At that time the employee did not have enough money for such extensive work, so he moved the TV set out of the way—putting it in the other

end of the room. There he has had perfect color reception ever since.

It must be acknowledged that such an experience is definitely the exception, not the rule. However, how many electronic technicians or service dealers have had dissatisfied customers who continually complain of sync problems, poor contrast, fading colors, or "funny patterns" on the picture. The TV set may have been brought in and checked closely, but the problem has persisted in the customers' home—only because the TV set is really in perfect working condition, it is the antenna system that is not working properly. (Project TRIP—frequently mentioned in our news section—is concerned with that specific problem.)

## Dipole Antennas

The basic element in nearly all TV antennas is the dipole. Although the general design of all dipoles is the same (from rabbit ears to large roof antennas), their characteristics differ with their dimensions.

A half-wave dipole is cut so that its total length is equal to half a wavelength of the tuned TV signal. However, since wavelengths in air differ from wavelengths in metal, a correction factor of 0.94 is required for antennas tuned to frequencies above 30MHz. Thus, for a half-wave dipole to be on frequency, its total length must correspond to the following equation:

$$\text{Half-Wave Antenna in Feet} = \frac{462}{\text{TV Channel Frequency}}$$

$$\text{Half-Wave Antenna in Inches} = \frac{5540}{\text{TV Channel Frequency}}$$

The frequency allocations for the VHF Channels are included in Table I.

Measurements can be made to determine the sensitivity of a half-wave dipole antenna at its resonant frequency. Assuming that the antenna was laying on a flat surface, then the resulting measurements would indicate a figure-eight sensitivity pattern (Fig. 1)—the antenna being the most sensitive in a direction perpendicular to its surface, and least sen-

TABLE I—FREQUENCY ALLOCATIONS FOR TV VHF CHANNELS  
VHF LOW BAND

CHANNEL	FREQUENCY MHz	CARRIER		MEAN WAVELENGTH OF CHANNEL IN INCHES	BANDWIDTH, PERCENT OF MEAN FREQUENCY
		VIDEO MHz	AUDIO MHz		
2	54-60	55.25	59.75	207.6	10.5
3	60-66	61.25	65.75	187.5	9.5
4	66-72	67.25	71.75	171.2	8.7
5	76-82	77.25	81.75	149.5	7.6
6	82-88	83.25	87.75	138.0	7.1
FM	88-108				
VHF HIGH BAND					
7	174-180	175.25	179.75	66.73	3.39
8	180-186	181.25	185.75	64.54	3.28
9	186-192	187.25	191.75	62.49	3.18
10	192-198	193.25	197.75	60.58	3.08
11	198-204	199.25	203.75	58.76	2.99
12	204-210	205.25	209.75	57.06	2.90
13	210-216	211.25	215.75	55.45	2.82

sitive in the direction that the metal rods forming the antenna are pointing.

Although in a flat plane this sensitivity curve forms the pattern just described, the actual pattern observed in the air is donut-shaped—the edge of the hole being in contact with the antenna. We are merely looking at a cutaway view of this donut. The antenna is just as sensitive from its sides as it is from above and below. Thus on the roof this antenna may prove too sensitive to cars below or planes above.

When operating at its second harmonic frequency as a full-wave antenna, a somewhat different sensitivity pattern is observed (Fig. 2). In space this pattern would appear the same as if you had two donut-shaped balloons placed side by side, their center portions being pulled together to meet at the center of the antenna. Similar lobe patterns can be observed when the dipole is operated at its third harmonic (Fig.

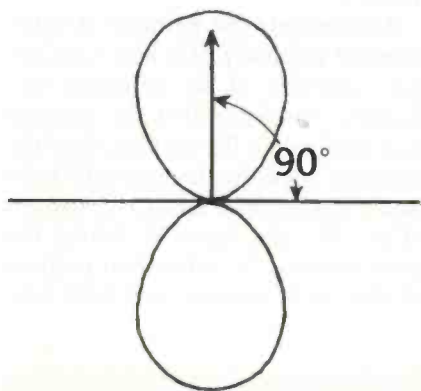

Fig. 1—Single-plane sensitivity curve for half-wave dipole at resonant frequency.

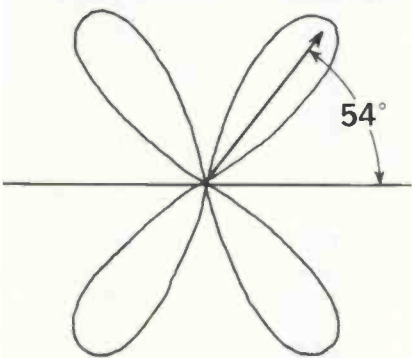

Fig. 2—Single-plane sensitivity curve for half-wave dipole at second harmonic.

3) and at its fourth harmonic (Fig. 4).

From such observations, it becomes apparent that the forward sensitivity of a dipole antenna diminishes rapidly and the side lobes begin to increase when the length of the antenna becomes greater than 1.2 times the wavelength ( $\lambda$ ) of the signal received. However, by bending the dipole (Fig. 5), we can in

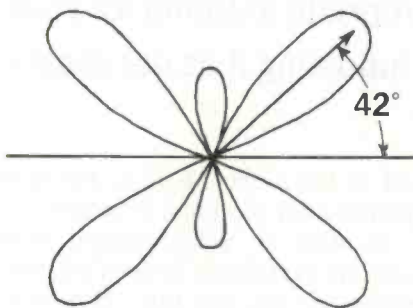

Fig. 3—Single-plane sensitivity curve for half-wave dipole at third harmonic.

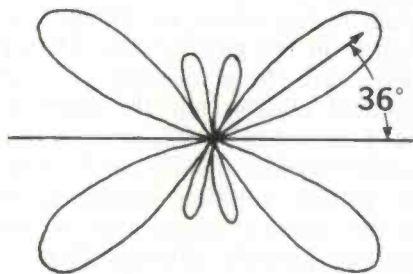

Fig. 4—Single-plane sensitivity curve for half-wave dipole at fourth harmonic.

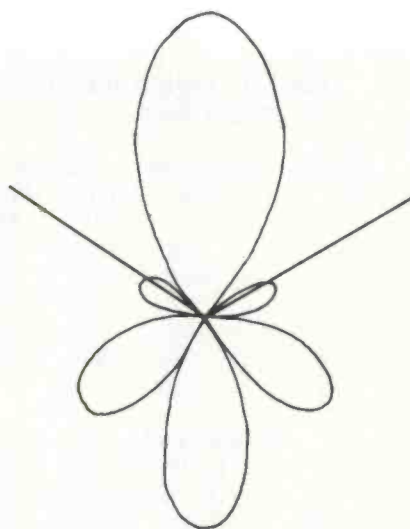

Fig. 5—Bending the dipole  $114.5^\circ$  will combine the third harmonic sensitivity lobes in one direction while spreading them out in the other direction.

effect combine the lobes on one side of the antenna while spreading them out on the other side. It has been found that the optimum angle for bending the dipole to produce this effect is  $114.5^\circ$ . Note, however, that we are referring only to the lobes produced as the antenna functions at third harmonic frequencies. At the primary resonant frequency,  $180^\circ$  still represents the best angle—a straight line.

Upon examining Table I closer, it may become apparent that some of the VHF High-Band Channels are approximately third harmonics of some of the VHF Low-Band Channels. This approximate relationship can be more clearly seen in Table II. Thus a dipole antenna cut for Channel 3 should also be able to receive Channels 8, 9 and 10 with reduced efficiency. However, these third harmonic frequencies on a straight dipole antenna will have sensitivity lobes similar to those shown in Fig. 3, while for Channel 3 the same antenna would have the lobe pattern shown in Fig. 1.

This arrangement (Fig. 6) is fine if the Channel 3 station and VHF High-Band stations are at such locations that the first station falls within one lobe pattern ( $90^\circ$  from the direction the elements are pointing) and the second station falls within the second lobe pattern (one of the lobes  $42^\circ$  from the direction the elements are pointing), but not many antenna sites would have two such

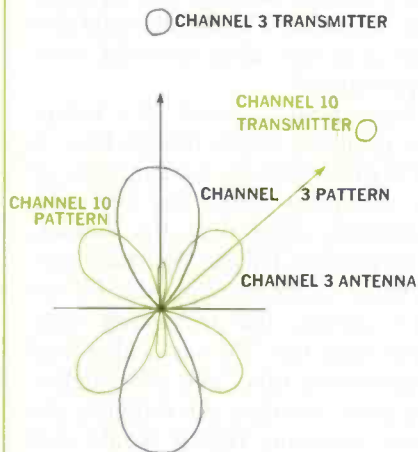

Fig. 6—Relative position of two TV station transmitters where a simple half-wave dipole functions best on both the VHF Low Band and High Band.

stations forming the necessary angles to permit such satisfactory results. Also, the other unused sensitivity lobes would still be present to pick up noise from other directions.

In some reception areas, one satisfactory solution would be to bend the antenna to form the 114.5° angle discussed previously. However, this would slightly reduce its sensitivity to the fundamental frequency (Channel 3), and maybe Channels 3 and 10 are to be received from opposite directions, rather than the same direction.

There are a number of techniques for sectionalizing the dipole so that it has two fundamental frequencies. These techniques involve placing some sort of reactance in series with the antenna arms in order to isolate portions of the antenna at higher frequencies. This can be done with small coils (Fig. 7A), although it is found generally more practical to use open wire loops to form the shape of a modified coaxial cable (Fig. 7B), or the loops can be straightened to form right angles called "vees" (Fig. 7C).

With these antennas, the additional impedance has the effect of loading the antenna down so that at the third-harmonic frequency—say Channel 10—(now shown as wavelength  $\lambda$ ), only the mid portion of the antenna functions as a half-wave dipole; while at the fundamental frequency—which in this case must be Channel 3—(corresponding to a wavelength of  $3\lambda$ ) the entire antenna functions as a half-wave dipole, being virtually unaffected by the additional impedance. Thus the modified dipole antenna has a cloverleaf sensitivity pattern for both the VHF High and Low Bands.

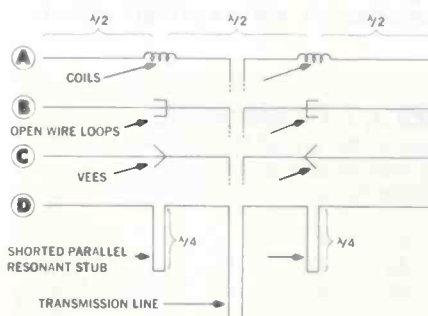

Fig. 7—Sectionalizing a dipole so that the third harmonic sensitivity pattern is the same as that for the fundamental frequency.

Illustrations 7A, B and C have shown coils, loops and vees being used to produce exactly the third harmonic of the antenna's fundamental frequency. However, it would be also possible to adjust them for optimum reception of any one of the VHF High-Band Channels, the greatest efficiency occurring with the channels as grouped in Table II.

Still another variation of the fundamental-frequency dipole antenna is shown in Fig. 7D. There the phase shifting resulting from the use of two shorted quarter-wave stubs permits

TABLE II  
UPPER CHANNEL HARMONICS  
OF LOWER CHANNELS

FUNDAMENTAL RESONANCE CHANNEL	THIRD HARMONIC RESONANCE INCLUDES CHANNEL
2	7
3	8, 9, 10
4	11, 12, 13

the use of all antenna segments for the reception of what was originally considered the third harmonic (now wavelength  $\lambda$ ). The fundamental frequency of this antenna has been increased, with increased sensitivity, while still maintaining the desired figure-eight sensitivity lobes. (This design will also function if the two shorted quarter-wavelength stubs are replaced by two open—non-shortened—half-wave stubs.)

Although a simple half-wave dipole is tuned to but one frequency, it does have a limited frequency range that is not too critical under strong signal conditions. Modifications of the basic dipole, as in Fig. 7, further restricts the frequency range, or bandwidth, at other than the tuned frequencies.

Dipole antennas have a 73 $\Omega$  impedance, which makes them excellent for feeding signals to coaxial-cable transmission wire. However, coaxial cable—unlike twin lead—is not balanced since there is greater skin-effect RF conductance through the outer shield than through the center lead. This imbalance can become rather critical with respect to efficiency at TV and FM frequencies. Although there are a number of

techniques for eliminating this effect, one of the simplest is the use of a detuning sleeve, which is attached to the transmission line. It is of a large enough diameter to permit using air as the capacitive dielectric (a 2-in. sleeve will work well on a 1/2-in. cable) and a quarter-wavelength long (again using a 0.94 correction factor). This sleeve must be kept equally distant from the cable, down to its lower end where it is soldered to the shield of the cable.

If 300 $\Omega$  twin lead is used for bringing the signal from the 73 $\Omega$  dipole antenna to the TV set, a system must be used to match impedances or the resulting standing waves may produce ghost images. Although matching transformers may be used, impedance matching may also be accomplished with a matching section (a 150 $\Omega$  twin-lead wire a quarter-wavelength long—Fig. 8 and Table III) or an open matching stub of varying impedance (Fig. 9). The capacitive or inductive characteristics of these wires (depending upon

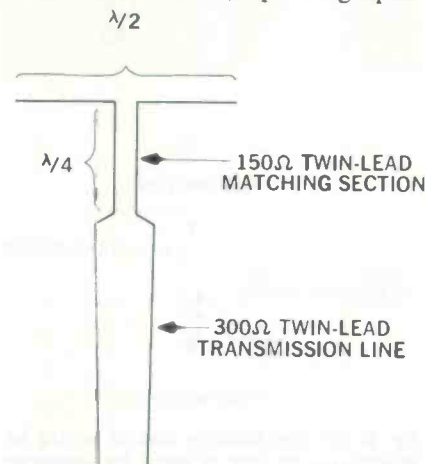

Fig. 8—A quarter wavelength of 150 $\Omega$  twin-lead (the appropriate length is indicated in Table III) can be used to match the impedance of a 300 $\Omega$  twin-lead transmission line with the 73 $\Omega$  impedance of a half-wave dipole.

whether they are tuned to above or below the antenna's resonant frequency) will permit matching impedances. (In a future article we hope to cover the subject of attaching stubs to the TV set end of the transmission line to obtain a "cleaner" signal.)

As had been stated earlier in the article, dipoles represent the basic element in nearly all TV antennas. They are also used as the standard

for measuring the relative gain characteristics of the other more complex antennas. The rated log sensitivity for these other antennas is merely a technique for comparing the signal strength obtained from the other antennas with the signal strength obtained from a simple half-wave dipole antenna.

**TABLE III  
QUARTER-WAVE MATCHING  
SECTIONS WITH STANDARD  
150Ω TWIN LEAD**

CHANNEL	LENGTH OF MATCHING SECTION IN INCHES
2	40
3	36
4	33
5	29
6	27
7	12.7
8	12.5
9	12.1
10	11.7
11	11.4
12	11.1
13	10.8

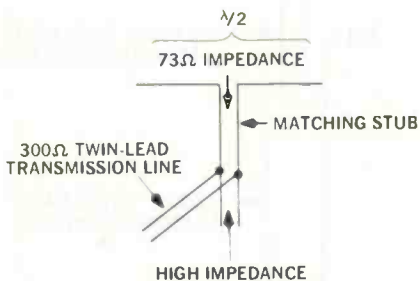

Fig. 9—An open matching stub of varying impedance can be used to match the impedance of a 300Ω twin-lead transmission line with the 73Ω impedance of a half-wave dipole.

### Folded Dipole Antennas

Our reference books differ concerning the dimensions of a half-wavelength folded dipole, and here we might add that the practical design of an antenna is more of an art than a science. Experienced antenna engineers develop a feel for the best design, which is then proven good or bad through extensive testing. Likewise, when peaking an antenna for best reception, the trial and error technique works best—provided you have at least some idea concerning what you are doing.



Fig. 10—A 657Ω folded dipole containing three parallel elements.

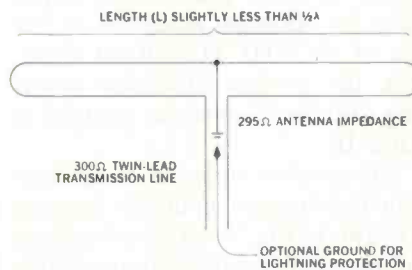

Fig. 11—The basic construction of a simple half-wavelength folded dipole with appropriate lengths indicated in Table IV.

Although there is a 657Ω folded dipole containing three parallel elements (Fig. 10) and other folded dipoles containing variations in tube diameters or printed circuit widths for special impedances (including 73Ω), this article will be concerned entirely with the common 295Ω folded dipole containing a parallel configuration (Fig. 11). Although generally constructed about half a wavelength long, according to the information selected for Table IV, the length of a tuned folded dipole must be reduced more as the signal frequency increases than the corresponding reduction in the signal wavelength.

While the impedance of the two arms of the simple half-wavelength dipole was the primary factor in determining its length for tuning, capacitance becomes another important factor in tuning folded dipoles—the capacitance developing between the parallel segments of the antenna. It has been found that these two factors (the inductance resulting from the length of the antenna and the

capacitance resulting from its parallel segments) tend to complement each other and thus the halfwave folded dipole tends to have a broader frequency response than the simple halfwave dipole described previously.

In general, the direction of the sensitivity lobes for a folded dipole are the same as those for a simple dipole, and this antenna may also be bent 114.5° to combine sensitivity lobes—thus making the folded dipole somewhat directional.

The folded dipole has a better gain than the simple dipole since it has more surface exposed to the transmitter signal. It also has the additional advantage of permitting a direct ground connection at its center (Fig. 11), thus permitting easier lightning protection.

### Short V and Fanned Antennas

Two variations of the simple dipole include the short V antenna (or biconical antenna) and the short fanned antenna (Fig. 12 and 13). Both versions find application in fringe areas since they lend themselves to stacking and the use of parasitic elements (described later in the article) without making the antenna resistance too low. Although their impedance will vary depending upon their use with other elements, alone the short V antenna

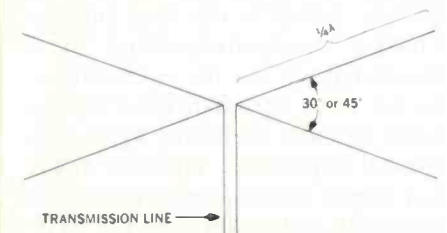

Fig. 12—A basic short V or biconical antenna containing four quarter-wavelength elements.

**TABLE IV—LENGTH OF A TUNED λ/2 FOLDED DIPOLE**

Antenna lengths (L—Fig. 11) for tuning the antenna to the desired frequency when 3/8-in. tubing is used for construction, the tubing being bent to form parallel segments 2 1/4-in. apart and cut to form a 2-in. gap where it terminates for connection to the transmission line

CHANNEL	2	3	4	5	6	FM	
FREQUENCY, MHz	57	63	69	79	85	98	
LENGTH (L) IN INCHES	98.0	88.7	81.0	70.7	65.8	57.0	
CHANNEL	7	8	9	10	11	12	13
FREQUENCY, MHz	177	183	189	195	201	207	213
LENGTH (L) IN INCHES	30.4	29.4	28.5	27.6	26.8	26.0	25.2

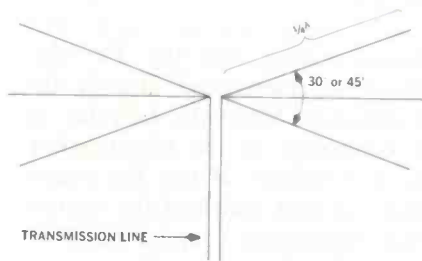

Fig. 13—A basic short fanned antenna containing six quarter-wavelength elements.

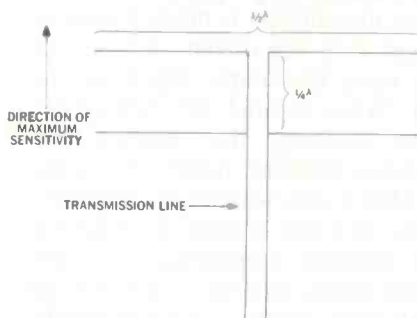

Fig. 14—A pair of simple half-wave dipoles wired and spaced to perform as an end-fired antenna.

has a basic impedance of between  $150\Omega$  and  $200\Omega$ , and the short fanned antenna has a basic impedance approaching  $300\Omega$ .

These two antennas are able to provide a greater cross section for intercepting the transmitted signal, concentrating the signal energy at the apex of the antenna.

### End-Fired Antennas

A simple two element antenna, commonly called an end-fired array, can be constructed by using a pair of any style antenna described thus far in this article, though for reasons of economy a pair of simple dipoles are most frequently used (Fig. 14). Together they will have a gain that is between 2dB and 5dB greater than that obtained with but a single, simple dipole (between around 1.6 and 3.2 times the signal power). This antenna is used primarily in areas requiring greater gain or a reduction of the ghosting effect. The antenna also has a better bandwidth, again due to the interaction of inductive and capacitive characteristics present in parallel elements.

When the two half-wave dipoles are separated by a quarter wavelength and the length of transmission lead between them produces a  $90^\circ$

phase shift, the resulting antenna is very directional, having extremely low sensitivity in the reverse direction. However, under these conditions the antenna gain is only about 3dB (about twice that of a single dipole antenna).

Earlier in the article it was indicated that the wavelength of a signal traveling through a transmission line differs from the wavelength of a signal traveling through the air. As an example, Table III provides a listing of  $150\Omega$  twin-lead transmission wire lengths (for  $\frac{1}{4}\lambda$ ) corresponding to various TV channels, while Table I provides the corresponding wavelengths (for  $\lambda$ ) through the air. A full wavelength is divided into  $360^\circ$ , and thus a phase shift of  $90^\circ$  corresponds to a quarter wavelength phase shift.

If a full wavelength at Channel 3 is 187.5 in. in the air, then the two dipoles must be separated by about 46.9 in. to be a quarter wavelength apart. Since Table III indicates that 36 in. of  $150\Omega$  twin lead is required for a quarter wavelength or  $90^\circ$  phase shift, we see that when correctly cut the  $150\Omega$  twin lead is 10.9 in. too short to reach. We would therefore either have to be satisfied with less than the desired antenna characteristics or substitute another transmission line—approximating the desired phase shift with two uniformly spaced, open-air wires between the two antennas. Otherwise, increasing the length of the  $150\Omega$  transmission wire to  $1\frac{1}{4}$  wavelengths (180 in.) would also have the same effect as a quarter wavelength phase shift, but might tend to prove impractical between two dipoles separated by only 46.9 in.

If we were to increase the length of transmission line between the two dipoles for a  $270^\circ$  phase shift (possibly using 108 in. of  $150\Omega$  transmission line), it would be possible to reverse the direction of antenna sensitivity with no apparent change in gain. This could also be done by connecting separate transmission lines to each dipole and changing relative lengths with a switch near the TV set.

By changing the transmission line so that it produces a  $180^\circ$  phase shift, the gain increases to 3.8dB

(about 2.4 times the signal power obtained from a single dipole antenna). This can be accomplished by draping a 73-in. length of  $150\Omega$  twin lead across the 46.9 in. (Channel 3  $\lambda/2$ ) space between dipoles.

Experimentation indicates that maximum gain can be obtained from a pair of dipole antennas when they are separated by merely  $0.2\lambda$  and there is a  $153.5^\circ$  phase shift through the transmission line between them. This would mean that for Channel 3 the two dipole antennas would be spaced 37.5 in. apart, and that if we used  $150\Omega$  transmission line between them, it would have to be 61.5 in. long in order to produce the desired phase shift. However, as in the case of the  $\frac{1}{4}\lambda$  dipole separation, we can switch the direction of sensitivity with no apparent loss of sensitivity by changing the transmission line phase shift from  $153.5^\circ$  to  $206.5^\circ$  ( $360^\circ - 153.5^\circ = 206.5^\circ$ ). But rather than accomplishing the entire phase shift with the use of a rather long transmission line (82.5 in. for a  $150\Omega$  line at Channel 3), we can reverse the transmission line leads to produce a  $180^\circ$  phase shift and attempt to run about 10.5 in. of  $150\Omega$  transmission line between the two dipole anten-

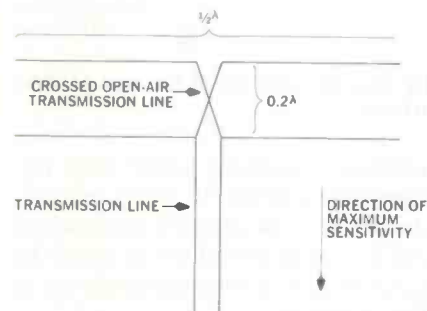

Fig. 15—By changing the wiring between dipoles, the directivity of the antenna can be reversed.

nas for the remaining  $26.5^\circ$  of phase shift. As before, this won't really work since the dipoles are spaced 37.5 in. apart, so we will again have to substitute a pair of parallel bare wires—separated by air and remaining a uniform distance apart even when crossing from left to right. The transmission line connections and direction of sensitivity then resemble that shown in Fig. 15.

Still additional sensitivity and di-

rectivity can be obtained by connecting additional half-wave dipoles in parallel and bending them  $114.5^\circ$  so that the combined third-harmonic lobes point in the same direction as the maximum parallel sensitivity (Fig. 16A for the elements spaced  $\frac{1}{4}\lambda$  apart with a  $90^\circ$  phase shift and Fig. 16B for the elements spaced  $0.2\lambda$  apart with the transmission lines crossed plus a  $26.5^\circ$  phase shift).

When more than two elements are used in an antenna and close spacing exists between elements, the

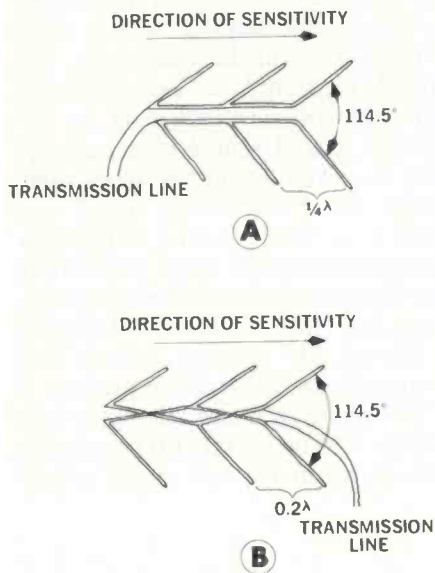

Fig. 16—Two variations of the basic end-fired antenna.

antenna impedance under most circumstances drops 70 to 80 percent. As before, low antenna impedances can be compensated for by using the types of stub arrangements shown in Fig. 8 and 9.

### Log Periodic Antennas

An ideal log periodic antenna is a frequency independent array with the relative lengths and locations of the elements defined with respect to angles rather than merely distances. This implies that all of the elements must be sensitive in a common direction. Although there are quite a variety of antenna elements that may be incorporated into a log periodic antenna, those most commonly used for TV reception contain a series of simple half-wave dipoles coupled together in basically

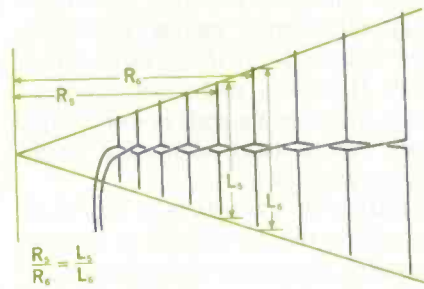

Fig. 17—Basic design of a simple log periodic antenna containing a series of simple dipoles.

the same manner as the end-fired antenna shown in Fig. 15.

The shortest dipole in this antenna (Fig. 17) is cut a half wavelength long for the highest frequency channel to be received, while the longest dipole is cut a half wavelength long for the lowest frequency channel to be received.

This type of antenna is designed more through a system of trial and error than through the application of sophisticated theories, and the number of dipoles between the longest and shortest dipole may vary with each design. However, to be a log periodic antenna, the ratio of dipole lengths and spacings must correspond to the equation:

$$\frac{R_n}{R_{n+1}} = \frac{L_n}{L_{n+1}}$$

### Basic Directors and Reflectors

When a simple dipole or folded dipole is tuned precisely to the desired frequency and ideally matched to the transmission line, it transfers only half of the total power intercepted from the transmitter to the transmission line and final load, the remaining half being reradiated by the antenna. If another antenna element is placed nearby, while not allowed to make electrical contact with the simple antenna (Fig. 18A), it can intercept additional energy; and if the antenna elements are placed close enough together, the reradiated fields of the various elements also affect the eventual signal strength fed to the transmission line—the simple antenna and additional element functioning together as inductively coupled circuits.

When a TV station signal first strikes the dipole antenna, it radiates approximately half the energy

that it intercepts, some of that reradiated energy passing on to the reflector—along with the TV station signal intercepted directly by the reflector. Since the reflector is not connected to the transmission line, it reradiates almost the entire signal received, much of the energy being inductively coupled back to the dipole, increasing the signal voltage applied to the transmission line.

To create the proper phase conditions, the reflector is made 5 percent longer than the driven element (in this case, the simple dipole antenna). When located  $\frac{1}{4}\lambda$  behind the drive element, the antenna impedance remains nearly the same as what it was without the reflector; while at  $0.15\lambda$  behind the antenna, the antenna impedance becomes much lower, but the system has its peak gain (under optimum conditions 5dB or better—over three times the gain of a simple dipole antenna without a reflector).

The reflector obviously also serves to help make the antenna

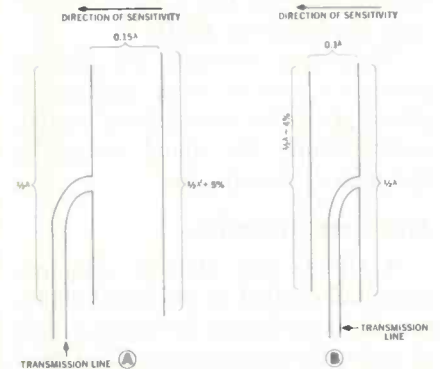

Fig. 18—Directors and reflectors can be used to increase the gain and directivity of simple dipole antenna systems.

more directional, improving front-to-back gain.

If a parasitic element is cut shorter than the half-wavelength drive element (approximately 4 percent shorter for best gain), then at resonant frequencies it behaves as though capacitively coupled, increasing the amount of signal current fed to the transmission line (Fig. 18B). This parasitic element, called a director, also has the effect of partially cancelling out any signals received from the far side of the drive element. It produces the least

*continued on page 67*



# CUT YOUR INVENTORY, BOOST PROFITS

## Just 3 Zenith Chromacolor picture tubes replace 72 others



### C-25BAP22, 23VATP22 replace 39 types

23VAHP22	23VBGP22	25BCP22	25CP22A
23VAJP22	23VBHP22	25BGP22	25GP22
23VALP22	25ABP22	25BJP22	25GP22A
23VANP22	25AFP22	25BMP22	25SP22
23VARP22	25ANP22	25BRP22	25VP22
23VASP22	25AP22	25BVP22	25WP22
23VATP22	25AP22A	25BXP22	25XP22
23VAUP22	25AP22A/25XP22	25BZP22	25XP22/25AP22A
23VAXP22	25AQP22	25CBP22	25ZP22
23VBEP22	25BAP22	25CP22	



### 23VAZP22 replaces 10 types

23VAZP22	25RP22
25AEP22	25YP22
25BP22	25YP22/25BP22A
25BP22A	
25BP22A/25YP22	
25FP22	
25FP22A	



### C-25BKP22, 23VBAP22 replace 23 types

23VACP22	23VBDP22	25AXP22
23VADP22	23VBJP22	25AZP22
23VAMP22	23VBRP22	25BDP22
23VAQP22	25ADP22	25BFP22
23VAWP22	25AGP22	25BHP22
23VAYP22	25AJP22	25BSP22
23VBAP22	25ASP22	25BKP22
23VBCP22	25AWP22	

#### 2-YEAR WARRANTY

Zenith CHROMACOLOR picture tubes sold for renewal use in standard television receivers are warranted against defects in workmanship, material and construction for 24 months after date of purchase by the consumer or user. OR if tube is supplied no charge to fulfill a warranty obligation in a Zenith color television receiver, then the warranty shall be limited to the unexpired portion of said Zenith color television receiver warranty. No other warranty is expressed or implied.

"The obligation of Zenith Radio Corporation under this warranty is limited to replacing, or at its option repairing, such defective color picture tube and does not include the cost of any labor in connection with installation of such replacement tube or repaired tube nor does it include responsibility for any transportation expense."

Available new or re-built. Zenith Cinebeam (C type) picture tubes contain used materials which, prior to reuse, are carefully inspected and selected to meet Zenith's high standards of quality.

**SIMPLE INVENTORY.** Stock Chromacolor and you can immediately replace almost any 23" diagonal tube.

**FASTER SERVICE.** No time lost waiting for replacement tubes to arrive. Less downtime means satisfied customers.

**AMPLE PROFIT MARGIN.** Chromacolor tubes are realistically priced. Zenith's suggested retail price is competitive, yet gives you an attractive profit margin.

**BRILLIANT CHROMACOLOR PICTURE.** Chromacolor... Zenith's patented picture tube that revolutionized color TV. First tube to fully illuminate every color dot on a jet-black background.

**POWERFULLY PRE-SOLD.** Special magazine ads all year long are telling your customers about the bright, sharp picture they'll see with a Chromacolor replacement tube.

**ZENITH** *The quality goes in before the name goes on*  
**CHROMACOLOR**

# a great learning experience

Now that you have decided to attend the First Joint National Convention, the next step is to make plans for getting the most out of it

■ Dissatisfied with the results you brought home from conventions in past years? It is not always a matter of what was offered therein as much as one having taken every possible step to secure the most from the experience. Here are suggestions which, if applied, can assure top satisfaction from this month's convention, held the 9th through the 13th at the Jung Hotel in New Orleans.

Do some planning before you leave home to attend the convention. Decide what you want to secure from it in advance, and obtaining these results will be more assured than if you leave everything to chance.

Before you leave, make a check list of the problems in your own business activities needing solution. If ideas are not forthcoming during the convention, ask people about them. You'll find that just about everyone you meet will feel complimented if asked.

Try to avoid going to the convention alone. Join one or more from your area on the trip. There are chartered flights being arranged by various associations across the country, which will not only reduce your travel expenses but offer fellowship and a team spirit. The exchange of ideas on the way will set the stage for getting more from the convention.

Have some ideas to contribute yourself. Work them out in advance. Check the convention schedule published last month in *ELECTRONIC TECHNICIAN/DEALER* and have these ideas ready for presentation and discussion when the proper occasion arises.

Don't pass up any of the exhibits at the Trade Show. Study them carefully. Some of the instruments and products that at first glance you may think you saw before

could actually turn out to be exciting new modifications.

Make the convention your sole interest while it is in session. Program other things you want to do in the area—such as seeing Jackson Square, the St. Louis Cathedral, Bourbon Street, the world's longest bridge (Lake Pontchartrain Causeway), America's first apartment buildings (Pontalba Apartments), and Preservation Hall—for either before or after the convention.

Mixing activities means a sacrifice of convention values every time.

Leave your personal business problems back home while in New Orleans. The chance of your solving any of them while away is remote. They will be there when you return.

Avoid skipping the fun parts of the convention program—the sight-seeing tours, golf tournament, bowling tournament, night on the town, or the Fais-Do-Do Banquet. They help relieve tensions and provide relaxation—helping to make you more capable of getting value out of the following activities of a serious nature.

Stay away from a tight budget while there. Throwing away caution is equally bad. Either step puts pressures on you which detract from values obtainable.

Be prepared and willing to contribute a little something yourself. When some committee asks for help, by all means provide it the best you can. They will appreciate a fresh approach or another viewpoint.

Make every effort to meet new people in your profession. These contacts always broaden horizons, and can develop into lasting friendships. Staying with the same group tends to limit one's growth.

By all means plan to attend this convention! We are all looking forward to seeing you there! ■

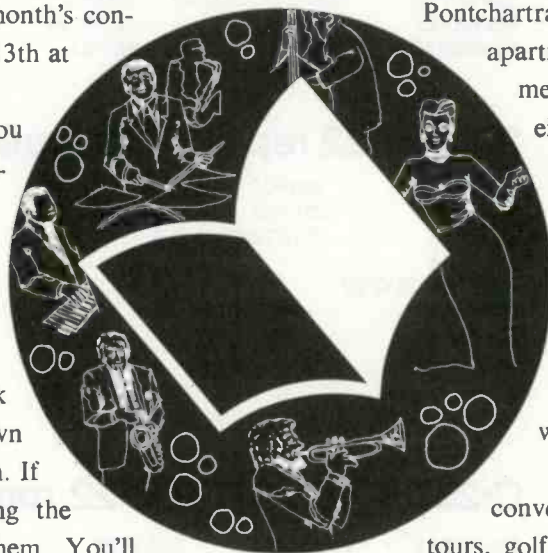

# superstick

Use Eastman 910® adhesive on:  
Wafer Switches,  
Tuners, Drive Belts,  
Cabinets, Ferrite  
Cores, Ferrite  
Antennas, Knobs,  
Panels, Trim.

Use it to bond:  
Metals, Rubber,  
Plastics, Ceramics,  
Glass.

No refrigeration  
necessary. One pack-  
age system. Easy to  
use. No mixing. No  
heat. No clamps. No  
waiting. Virtually no  
shrinkage on setting.



Economical.  
About 1½ cents  
per one-drop  
application,  
which covers one  
square inch.

High Strength.

Reliable.  
Manufactured by  
Eastman—the  
originators and sole  
producers of  
cyanoacrylates in the  
United States.

Available through  
Tech Spray,  
P.C. Box 949,  
Amarillo, Texas  
79105

CHEMICAL TOOLS FOR TECHNICIANS



Eastman Chemical Products, Inc. Industrial Chemicals Division  
... for more details circle 109 on Reader Service Card

# An Extraordinary Offer

to introduce you to the benefits of Membership in

## ELECTRONICS BOOK CLUB

for a limited time only you can obtain

**ANY 3** OF THESE UNIQUE BOOKS ... yours for only **99¢** each ... with Trial Club Membership (Combined List Price \$33.85)

May we send you your choice of any three books on the facing page as part of an unusual offer of a Trial Membership in Electronics Book Club?

Here are quality hardbound volumes, each especially designed to help you increase your know-how, earning power, and enjoyment of electronics.

These handsome, hardbound books are indicative of the many other fine offerings made to Members... important books to read and keep... volumes with your specialized interests in mind.

Whatever your interest in electronics—radio and TV servicing, audio and hi-fi, industrial electronics, communications, engineering—you will find that Electronics Book Club will help you.

With the Club providing you with top quality books, you may broaden your knowledge and skills to build your income and increase your understanding of electronics, too.

### How You Profit From Club Membership

This special offer is just a sample of the help and generous savings the Club offers you. For here is a Club devoted exclusively to seeking out only those titles of direct interest to you. Membership in the Club offers you several advantages.

- 1. Charter Bonus:** Take any three of the books shown (combined values up to \$33.85) for only 99¢ each with your Trial Membership.
- 2. Guaranteed Savings:** The Club guarantees to save you 15% to 75% on all books offered.
- 3. Continuing Bonus:** If you continue after this trial Membership, you will earn a Dividend Certificate for every book you purchase. Three Certificates, plus payment of the nominal sum of \$1.99, will entitle you to a valuable Book Dividend which you may choose from a special list provided members.
- 4. Wide Selection:** Members are annually offered over 50 authoritative books on all phases of electronics.
- 5. Bonus Books:** If you continue in the Club after fulfilling your Trial Membership, you will receive a Bonus Dividend Certificate with each addi-

### SPECIAL FREE BONUS

... if you act now!

Yes, if you fill in and mail the membership application card today, you'll also get this Bonus Book, FREE!

#### TV TROUBLESHOOTER'S HANDBOOK Revised Second Edition

A completely updated quick-reference source for solutions to hundreds of tough-dog troubles.  
Regular List Price \$7.95

tional Club Selection you purchase. For the small charge of only \$1.99, plus three (3) Certificates, you may select a book of your choice from a special list of quality books periodically sent to Members.

**6. Prevents You From Missing New Books:** The Club's FREE monthly News gives you advance notice of important new books... books vital to your continued advancement.

This extraordinary offer is intended to prove to you, through your own experience, that these very real advantages can be yours... that it is possible to keep up with the literature published in your areas of interest... and to save substantially while so doing.

### How the Club Works

Forthcoming selections are described in the FREE monthly Club News. Thus, you are among the first to know about, and to own if you desire, significant new books. You choose only the main or alternate selection you want (or advise if you wish no book at all) by means of a handy form and return envelope enclosed with the News. As part of your Trial Membership, you need purchase as few as four books during the coming 12 months. You would probably buy at least this many anyway... without the substantial savings offered through Club Membership.

### Limited Time Offer!

Here, then, is an interesting opportunity to enroll on a trial basis... to prove to yourself, in a short time, the advantages of belonging to Electronics Book Club. We urge you, if this unique offer is appealing, to act

promptly, for we've reserved only a limited number of books for new Members.

To start your Membership on these attractive terms, simply fill out and mail the postage-paid airmail card today. You will receive the three books of your choice for 10-day inspection. **SEND NO MONEY!** If you are not delighted, return them within 10 days and your Trial Membership will be cancelled without cost or obligation. Electronics Book Club, Blue Ridge Summit, Pa. 17214.

### Typical Savings Offered Club Members on Recent Selections

<b>Commercial FCC License Handbook</b>	List Price \$8.95; Club Price \$5.95
<b>RCA Color TV Service Manual—Vol. 2</b>	List Price \$7.95; Club Price \$4.95
<b>Citizens Band Radio Service Manual</b>	List Price \$7.95; Club Price \$4.95
<b>How to Use Color TV Test Instruments</b>	List Price \$7.95; Club Price \$4.95
<b>FET Applications Handbook</b>	List Price \$14.95; Club Price \$9.95
<b>Fire &amp; Theft Security Systems</b>	List Price \$7.95; Club Price \$3.95
<b>Modern Radio Repair Techniques</b>	List Price \$7.95; Club Price \$4.95
<b>Beginner's Guide to Computer Programming</b>	List Price \$9.95; Club Price \$6.95
<b>199 Electronic Test &amp; Alignment Techniques</b>	List Price \$7.95; Club Price \$4.95
<b>Zenith Color TV Service Manual—Vol. 2</b>	List Price \$7.95; Club Price \$4.95
<b>Transistor Projects for Hobbyists &amp; Students</b>	List Price \$7.95; Club Price \$4.95
<b>Electronic Musical Instruments</b>	List Price \$7.95; Club Price \$4.95
<b>Electronic Designer's Handbook</b>	List Price \$9.95; Club Price \$5.95
<b>Dictionary of Electronics</b>	List Price \$6.95; Club Price \$5.50
<b>Computer Circuits &amp; How They Work</b>	List Price \$7.95; Club Price \$4.95
<b>Japanese Color TV Service Manual</b>	List Price \$7.95; Club Price \$4.95
<b>Solid-State Circuit Design &amp; Operation</b>	List Price \$9.95; Club Price \$7.95
<b>How to Read Electronic Circuit Diagrams</b>	List Price \$7.95; Club Price \$3.95
<b>Electronic Test &amp; Measurement Handbook</b>	List Price \$7.95; Club Price \$4.95
<b>Computer Technician's Handbook</b>	List Price \$10.95; Club Price \$7.95
<b>125 One-Transistor Projects</b>	List Price \$7.95; Club Price \$4.95
<b>Servicing Modern Hi-Fi Stereo Systems</b>	List Price \$7.95; Club Price \$4.95

**SEND NO MONEY!** Simply fill in and mail postage-paid Airmail card today!

## Color TV Trouble Factbook

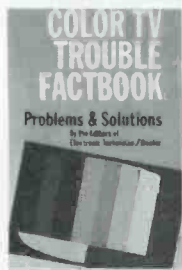

Here's a complete guide to color TV troubles and solutions, arranged by make and model, a low-cost, all-in-one reference handbook every TV service technician should own. The information it contains may easily save you hours of time repairing a "tough-dog" color TV. Included are details concerning repetitive troubles, field-factory

changes, new and unusual circuits and descriptions of how they work, special adjustment procedures and other such pertinent service information. The content is arranged by brand names, covering every major make of color TV receiver produced in the past several years. Models and chassis covered are arranged in alpha-numerical order. 176-pps. Hardbound.

List Price \$6.95

Order No. 519

## Basic Electronics Problems Solved

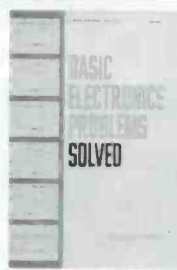

Here are easy step-by-step solutions to basic electronics problems in a convenient one-stop source dealing with both solid-state and tube-type circuits. The content not only presents a detailed explanation of each point, but also provides many actual examples on how to work out problems. Then, to firmly fix the information in your mind,

there are numerous example problems for you to solve; answers to these are included in one Appendix, and worked out solutions in another. Covers DC circuits, AC circuits, powers of ten, semiconductors, power supplies, and receiver circuits. A final chapter shows how to use a slide rule to speed calculations. 192 pps., over 100 illus. Hardbound.

List Price \$7.95

Order No. 530

## 199 TV Tough-Dog Problems Solved

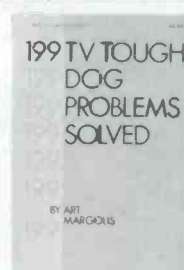

Here is a master collection of actual case-history solutions—answers to the most challenging tough-dog TV problems on both color and B & W sets—covering all popular makes from Admiral to Zenith. This new book is organized so that you can quickly find the solution to particular problems—toughies that required the best efforts of top

technicians to solve. To enable you to find information relative to a particular problem in a specific set, a cross-reference of troubles by brand name and chassis is included. The content is organized into trouble symptom sections. Several different circuits are included; thus, the information provided will apply to similar circuits in other models. 256 pps., 199 illus. Hardbound.

List Price \$7.95

Order No. 559

## Philco Color TV Service Manual



An all-in-one service guide for Philco color sets, with 12 complete schematic diagrams for chassis 15M90/91 to 20QT88. Here in one manual is complete service data for all the color models produced by Philco and Philco Ford (thru 1970), from the all-tube to the latest hybrid solid-state chassis, including the small-screen portable

Model T5062WA. The unique 36-page foldout section contains 12 complete schematic diagrams, representing all the chassis covered. The profusely illustrated text delves into each section (video, chroma, vertical, horizontal, etc.), and points out specific problems based on the author's extensive experience. Included are complete alignment and setup instructions, detailed in step-by-step form. 160 pps., plus 36-page schematic foldout section. Long-life vinyl cover.

List Price \$7.95

Order No. 522

## 101 TV Troubles: From Symptom to Repair

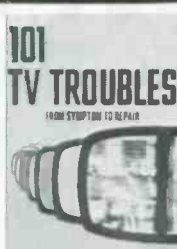

An invaluable "cause and cure" guide to the practical, easy solution for virtually any TV trouble—color or B&W. All you do is analyze what you see and hear, look up the symptoms in the book, and follow the clear and simple steps to a speedy trouble cure. To show how and why certain troubles occur in specific types of circuits, schematics and other illustrations are included for every major manufacturer—Admiral to Zenith. TV troubles are broken down into five basic categories: Brightness, Contrast, Sweep, Color, and Sound. Each category lists specific troubles relating to that symptom. For example, under "Contrast" are 22 causes of actual picture problems. With the categorized trouble list and index, you can quickly and easily find the exact symptom—and the trouble cure—for virtually any TV circuit defect you might encounter. 224 pps. Hardbound.

List Price \$7.95

Order No. 507

## TV, Radio, Hi-Fi Hints & Kinks



If you want to get the best performance out of consumer electronics equipment, you'll find this to be the most informative and useful handbook ever published. Over 150 ideas suggest ways to customize and add accessories to any equipment setup—how to connect single and multiple accessory speakers, how to add remote controls to

TV's, radios, hi-fi systems, how to connect microphones, etc. Also includes many tips on hi-fi equipment, CB and 2-way radio equipment, antenna systems, remote monitoring techniques, intercoms, a wireless baby sitter, telephone amplifier, moisture, fire and other alarm accessories for any existing amplifier. 256 pps., over 150 illustrations. Hardbound.

List Price \$7.95

Order No. 561

## CB Radio Operator's Guide

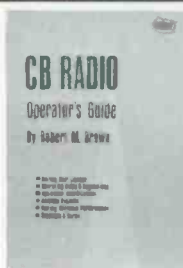

An all-in-one handbook on Citizens Band radio, and how to make the best use of available equipment. Tells you everything you must know to get on the air, with complete details on what you can and can't do right down to the "nitty gritty" rules and regulations! What's more, you receive expert advice on the type of equipment to buy,

and how to get the best performance out of your "system." The information contained in this book will save you time and money in short order! With this one book, you can become an expert on CB Radio, and how to use the service most successfully. You'll learn about antenna systems, including how they are used in CB. 224 pps. Hardbound.

List Price \$7.95

Order No. 499

## How To Fix Transistor Radios & Printed Circuits



Here it is! Just off the press—a completely updated, revised edition of Leonard Lane's best-selling classic on transistor radio repair. In addition to extensive enrichment of the first edition, the author brings FETs, zener diodes, FM radios—in fact, everything related to the current state of the art—into the picture. Here's the perfect

reference and guide for electronic technicians who need to understand and repair semiconductor circuits efficiently. For those interested in transistor physics, fundamentals are emphasized in the first two chapters. The real "meat" begins in Chapter 3 which will thoroughly familiarize you with amplifier fundamentals, basic circuit configurations, biasing, FETs, JFETs, and IGFETs. The next two chapters will acquaint you with RF and IF amplifiers. 256 pps., over 150 illus., 12 Chapters.

List Price \$7.95

Order No. 504

## Electronic Circuit Design Handbook



New Fourth Edition—A brand-new, enlarged edition of the ever popular circuit designer's "cookbook," now containing over 600 proven circuits, for all types of functions, selected from thousands on the basis of originality and practical application. Now you can have, at your fingertips, this carefully-planned reference source of tried and

tested circuits. Selected from thousands submitted by distinguished engineers, these "thought-starters" are a collection of original circuits selected on the basis of their usefulness. This detailed compilation of practical design data is the answer to the need for an organized gathering of proved circuits... both basic and advanced designs that can easily serve as stepping stones to almost any kind of circuit you might want to build. 384 pps., 19 big sections, over 600 illus., 8 1/2" x 11".

List Price \$17.95

Order No. T-101

# AN EXTRAORDINARY OFFER...

... for more details circle 103 on Reader Service Card

# Sliding Door



# Swinging Door



Sales leader  
for 11 straight years.

# Same Price

Only Ford vans have so many better ideas that make vans easier to drive, to service, to use.

Now you have a choice of conventional swinging doors or, at the same



price a new gliding side door for cargo handling in cramped alleys and beside loading docks. Three separate tracks, at top, bottom and center, give bridge-like support for solid, smooth one-hand operation, tight seal.

**Shorter outside, easier to park.** Compared to other makes with similar loadspace, Econolines have significantly less overall length for better maneuverability in city-delivery operations.

**Easy, out-front servicing.** Routine service points are right at hand under convenient outside hood: water, oil, battery, wiper motor, voltage regulator, and many others.

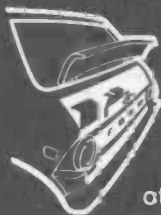

**Strong, Twin-I-Beam Independent Front Suspension**—Ford's exclusive design smooths the going for both cab and driver. Two forged steel I-beam axles provide strength and durability; wide wheel stance means stability in cross winds.



**Wider at top for built-ins.** Body sides are more vertical, wider apart at top than other vans. Built-in units fit better.

**Biggest payload.** E-300 series offers 4,285-lb. payload capacity—biggest of any van.

**Engine clear forward.** In Ford's clear-deck design, engine is forward—all the way out of cargo area. Over 8½ ft. clear floor behind driver's seat...over 10 ft. in the SuperVan.

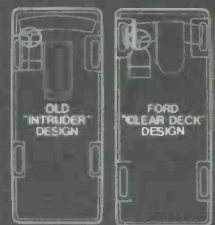

## FORD ECONOLINE VANS



... for more details circle 113 on Reader Service Card

# Working with Commercial-Audio Equipment

by Jack Hobbs

## Part IV—Build your business through top-grade installation and service practices

■ Part III of this series appeared in the May 1972 issue of *ELECTRONIC TECHNICIAN/DEALER*. That article explored the various methods employed in distributing audio intelligence from amplifiers to speakers. This final article reviews basic installation and service practices.

Audio specialists and TV-radio service-dealers already know that their business will prosper or decline in direct proportion to the quality of service rendered to their customers. And service begins with the initial installation. But first, a few purely business considerations.

### Business Approach

You can handle an audio installation in either of two ways: ● sell the equipment outright, with or without a monthly or yearly service contract; or ● lease the equipment on a monthly, annual or longer-term basis, including service charges—prorated to monthly rental payments. The total cost of a leased installation, including labor, interest on your capital investment, taxes, insurance, overhead and profit should be returned within a period of not more than five to seven years. But this time span is flexible and can be varied somewhat—depending on your particular type of business operation. Accordingly, for example, an installation which adds up to a total of \$2100 would “rent” for \$25 to \$35 a month.

Always check building codes regarding cabling regulations. Likewise, in some areas, especially on renovations and new construction sites in progress, you may run into labor problems. Before signing an installation contract, check with local electrical and construction unions regarding their regulations and any existing agreements that may conflict with your work.

On new construction sites, many audio service-dealers are finding it highly desirable to “farm out” the acoustical survey work to audio engineering specialists and cable “pulling” to electrical contractors—confining their operations to specifications, designing, supplying equipment and final “hook-ups,” checking the system out, and subsequent maintenance and repair.

If you lease an installation, protect the financial structure of your business against possible lessee bankruptcy by stating clearly in the lease that the audio equipment is your property and that you can repossess it at any time the lessee fails to live up to any portion of the agreement—particularly when not making a monthly payment when due.

Your business name, address and telephone number should be attached to the amplifier or to the wall close to the equipment.

### Amplifier Installation

The location that you select for the amplifier and input equipment required should be dry, free from dust, well ventilated and away from an atmosphere that may cause

corrosion. Good ventilation is necessary for both electron-tube and solid-state amplifiers when the equipment must operate under continuous duty-cycle conditions. The equipment should be located beyond the reach of unauthorized persons, but at the same time be easily accessible for operation and service.

If you can conveniently place the amplifier and input equipment at a central point half way between the extremes of speaker locations, then do so. It may make the overall installation job easier, other considerations being equal.

Once you have decided on the exact location of the equipment, make sure that electrical outlets are near by for supplying ac power to the amplifier and input equipment used. Avoid using extension cords. If no ac outlets are adjacent to the equipment location and you do not employ a licensed electrician, ask your customer to get the outlets properly installed before you begin work, or inform him of the need and make arrangements for a licensed electrician yourself. Actually, a detail of this kind is usually agreed upon and taken care of during the initial installation survey and when an installation contract is drawn up. If the equipment is supplied with three-wire ac line cords, the wall outlets should be a standard three-wire ground type.

Amplifiers are constructed in various forms for permanent mounting in a number of ways. You can obtain amplifiers for flush wall mounting, surface wall mounting, relay-rack mounting or enclosed cabinet types that can be mounted on floors, tables or appropriate wall shelves.

### Input Cables

Cables from microphones, AM/FM tuners, tape players and turntables should be short and shielded. Keep these cables well away from, and avoid running them parallel to, ac power lines. No low-impedance, low-level input cables, especially microphone cables, should be more than 20 or 25 ft long—preferably not more than 10 ft long. If a very long microphone cable is required, use a high-impedance mike and preamplifier input to match. A balanced line may also be advisable under certain circumstances. Avoid running low-level input cables in the same conduit as speaker wiring. You will discover innumerable other *do's* and *don't's* as you become more experienced. And do not overlook the necessity for proper speaker phasing. Some speaker terminals are marked to facilitate this job. Otherwise, traditional phasing techniques must be employed to sync voice coils.

### Equipment Maintenance

It is assumed here that you or one or more of your technicians are thoroughly trained and experienced in servicing and adjusting amplifiers and all types of input equipment—including tape players and turntables. A

*continued on page 69*

## TEST INSTRUMENT REPORT

# LogiMetrics' Model 750 RF Signal Generator

by Phillip Dahlen

Covers the full range of frequencies  
between 9.5MHz and 520MHz



LogiMetrics' Model 750 RF Signal Generator. For more details circle 900 on the Reader Service Card.

### RF Frequency

Tuning	Continuous mechanical tuning, plus fine electronic tuning to provide ultra-fine control of frequency
Harmonics	At least 30dB below carrier
AM Hum & Noise Sidebands	At least 70dB below the carrier
Residual FM	Less than 0.25 PPM + 50Hz rms
Incidental FM including phase modulation with 30% AM	Less than 1 PPM + 100Hz
Incidental AM with FM	Less than 1%
Spurious Signals	All non-harmonic and non-line-related spurious greater than 60dB below CW

### RF Output

Level	Continuously adjustable from $0.1\mu\text{v}$ (-127 dBm) to 1v rms (+13dBm) into a $50\Omega$ resistive load
Attenuator	120dB with 10dB per step, plus continuously variable 20dB calibrated vernier indicated on the meter

### Amplitude Modulation

Range	0 to 100%
Meter Accuracy	$\pm 5\%$ of full scale (20Hz to 20kHz)
Distortion	Less than 1% for 30% AM, 3% for 70% AM
External Frequency Input	DC to 100kHz

### Frequency Modulation

Deviation	0 to 300kHz peak
Deviation Meter Ranges	0 to 10kHz, 30kHz, 100kHz, 300kHz peak
Accuracy	$\pm 5\%$ of full scale (20Hz to 100kHz)
Distortion	Less than 0.5% at 75kHz deviation
External Frequency Input	DC to 100kHz

### External Pulse Modulation

ON to OFF Ratio	40dB minimum
Pulse Width	0.1 $\mu\text{s}$ minimum
Pulse Rate	50Hz to 50kHz

### General

Power	115/230v $\pm 10\%$ , 50 to 400Hz, 75w
Dimensions	7 in. H by 16 $\frac{3}{4}$ in. W by 18 $\frac{3}{8}$ in. D. Provision for rack mounting
Weight	27 lb
Tentative Price	\$2575.00 F.O.B. Factory

■ This FM/AM VHF/UHF signal generator was one of the more interesting, sophisticated instruments that we observed when attending the IEEE Show last Spring in New York City. It should prove very useful for those engaged in the servicing and alignment of RF preamplifiers and receivers designed to operate in that frequency range.

Not only does this instrument continuously tune over all frequencies from 9.5MHz to 520MHz, it offers direct five-digit frequency readout with variable resolution on its LED display—providing a tuning accuracy equivalent to  $\pm \frac{1}{2}$  the resolution selected (10kHz, 100kHz or 1MHz) plus the reference frequency accuracy, which is typically less than 1 PPM at room temperature.

Versatile modulation capability is provided by incorporating FM, AM and pulse modulation facilities that may be used independently or simultaneously in this instrument. Besides modulating the RF signal with either the 400Hz or 1kHz signals ( $\pm 5\%$ ) produced by an audio oscillator within the instrument, there is also the option of modulating with an external AM, FM or pulse signal.

Additional manufacturer specifications are shown at the left.



# COLORFAX

The material used in this section is selected from information supplied through the cooperation of the respective manufacturers or their agencies.

## ADMIRAL

### Color-TV Chassis K-18—Automatic Degaussing Circuit

The automatic degaussing circuit used in the K18 series chassis, Run 10 through Run 12, is not the same as that used in Run 13. The two circuits are shown in the illustrations.

#### Part List Correction

RV101	VDR, Run 10-12 (Degauss)	61A62-1
	PTC, Run 13 and up (Degauss)	61A52-3
RV102	VDR	61A46-13

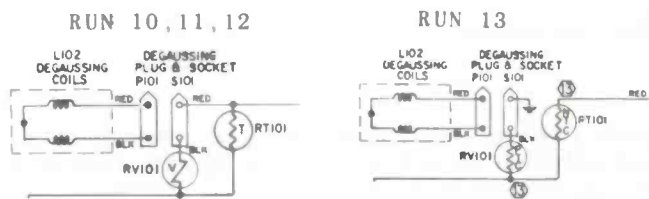

## RCA SALES CORP.

### Color-TV Chassis CTC54 Series—Horizontal Interference

Interference patterns on relatively weak station signals may be the result of switching transients from components in the horizontal sweep circuitry. The general location and configuration of the interference on the screen can give a hint as to which component should be substituted to eliminate the interference.

The interference caused by the Regulator Clamp Diode (CR403) may appear as a straight line (rather than bowed as shown) in some instruments. Stock No. 131475 (Trace Diode) or 131476 (Retrace Diode) can be used as a replacement for CR403 in this chassis.

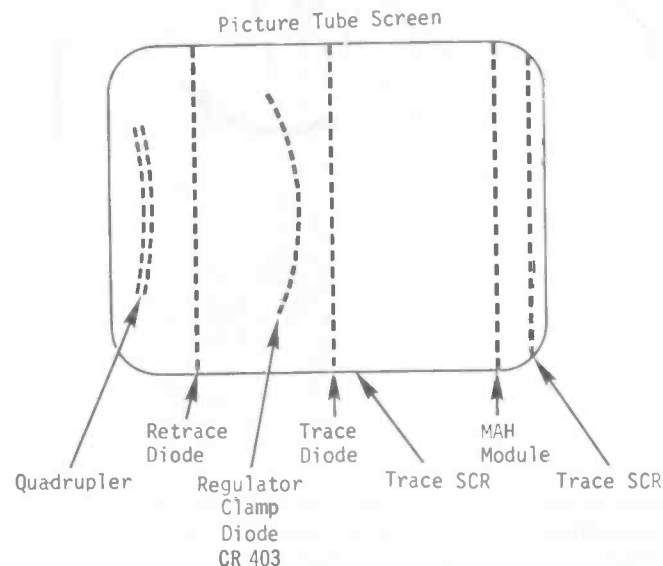

## Color-TV Chassis CTC54 Series—Vertical Sweep/Video Symptoms

There is the possibility of vertical-sweep symptoms (under or over scan) which cannot be resolved with the normal substitution of the MAG module and /or vertical output devices. In some instances, video/AGC symptoms may also be evident.

If these symptoms are encountered, check the +15v source. Excessive voltage may be the result of an open 15v zener diode (CR303 on the partial schematic), while the voltage is low at this point, check for a leaky zener (CR303) or an overload such as a shorted VHF tuner feed-through capacitor on the 15v line.

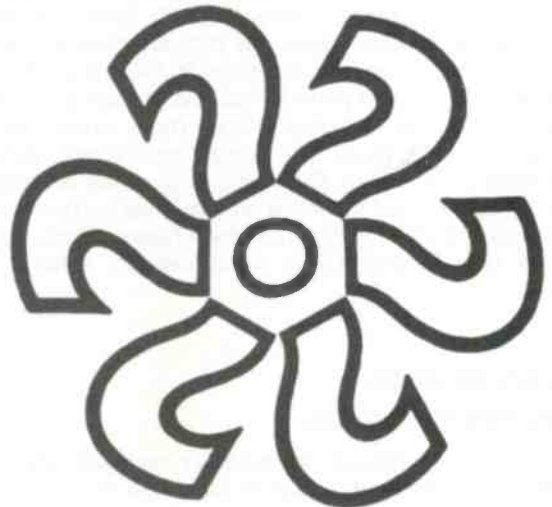
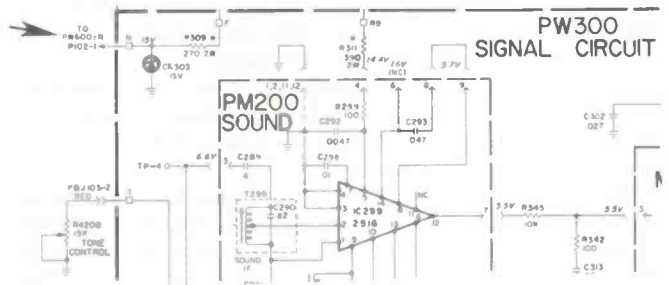

### Did you forget something?

Have you overlooked a chance to improve your efficiency and income as an electronic technician or service dealer? If you are among the few that forgot to make preparations for attending the first joint national convention—NATESA, NEA, ISCET and ETA of Louisiana—you had better get on the phone now (don't even finish the magazine) and ask for your wife to pack your bags as you make your plane and room reservations! Why let the other guy get all the benefits? We'll see you at the Jung Hotel in New Orleans on August 10-13, 1972.

# TECHNICAL DIGEST

The material used in this section is selected from information supplied through the cooperation of the respective manufacturers or their agencies.

## EMERSON

### Ceramic Capacitors

Most service shops obtain standard resistors and capacitors from local part houses. For this reason, Emerson does not ordinarily list such items in their service note parts lists. The ceramic capacitors listed have some special characteristics, and is described so that this characteristic may be duplicated when the capacitor is replaced.

Ceramic capacitors are a large group of capacitors constructed by using a ceramic dielectric which has deposited electrodes on each side to which leads are soldered. The entire unit is then Durez coated.

The characteristic of this type of capacitor depends on the ceramic used. There are many types found in ceramic capacitors. In general, the thicker the capacitor, the higher the breakdown voltage. Small values of capacity from 10pf to 300pf can be made on a high grade of ceramic, which results in very little change of capacitance with temperature. These are called NPO, which stands for zero change of capacity with temperature. Larger capacitors are made on other grades of ceramic. These generally have a negative temperature coefficient; that is, the capacity decreases as the temperature increases. For example: N330 means the capacity will change 330 parts per million of the rated capacity per °C change in temperature. These capacitors are often used to compensate for changes with temperature in other parts of the circuit. Relatively large values of capacity from .001 $\mu$ f to .05 $\mu$ f are made on a high dielectric ceramic wafer, which varies greatly with temperature. These capacitors are used in applications where capacity value is not critical.

## RCA SALES CORP.

### Cleaning Module Edge Connectors

Intermittent symptoms in modular-equipped TV sets, whether associated with signal or deflection circuitry, may be the result of high-resistance module contact surfaces rather than a faulty component. High-resistance connections are particularly prone to development in atmospheres which contain corrosive substances, such as salt and/or various sulphur compounds.



In the event symptoms are encountered which may relate to high-resistance (corroded) contacts, the printed-circuit edge-connector area of the module should be cleaned with a cotton swab dipped in isopropyl alcohol—as shown

in the illustration. Never use any type of spray chemicals to clean either the edge connectors or the module sockets.

Before replacing a module in its socket, inspect the socket for bent or broken contacts.

When replacing modules, always make sure they are completely seated in their sockets and that the spring-clip locks are in place.

### FM/AM Tuner Chassis RC1238D—Stereo Indicator Threshold Adjustment

An FM STEREO INDICATOR THRESHOLD control has been added to the RC1238D FM/AM tuner chassis. The 600 $\Omega$  control (Stock No. 136028) replaces fixed resistor R320 in the FM stereo circuitry. In the event the control re-

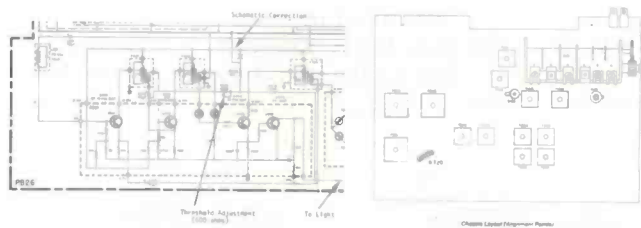

quires resetting, use a stereo FM signal simulator generator and adjust the control so that the light fires between a 5% and 8% 19kHz subcarrier level. If a generator is not available, tune in a known medium-to-weak FM stereo station and adjust the control so that the light just fires.

### TV Chassis KCS172, 179, 183—High Voltage Tube Socket Removal

A new insert screw is utilized for attaching the high-voltage rectifier tube socket to the high-voltage cup in current production of the KCS172, 179, and 183 B/W-TV chassis. To remove the screws, simply turn counterclock-



wise in the normal manner. Use small long-nose pliers, a screwdriver, or a cotter pin to turn the screw. To reinstall, either press in place or turn clockwise.

# EDITORIAL . . .

*continued from page 25*

program designed to improve the image of the independent electronic technician or service dealer who must compete with the service shop owned and managed by some manufacturer or chain store.

We would like to make it very clear that our publication supports every ethical electronic technician and service dealer—whether or not he wishes to affiliate with a professional trade association and whether or not he is affiliated with a national corporation. The primary purpose of this publication is to make your job easier and more profitable, while at the same time helping to improve the public image of our profession.

Really, the independent spirit is so intense in most individuals within our profession—and it is basically so simple for a bright young man with some practical experience and business sense to set up his own shop—that we do not feel that there need ever be a time when electronic servicing will be restricted to the function of a few large corporations. And, being of this free spirit, we are certain that virtually everyone reading this publication (even those not independently employed) has a personal, warm feeling toward Independent Service and will wish to help improve the public image of the independent electronic technician and service dealer—even if their jobs won't permit them to display the S.I.S. Decal.

For those wishing to improve the image of Independent Service (we hope nearly all of you), The Finney Company has printed up 10,000 forms (like the one printed at the right of this memo—which you may use) and distributed them to all the state associations—plus the NEA and NATESA headquarters—asking that contributions to this fund be sent directly to Mr. Finneburgh, a trustee of this fund, at the address shown on the form.

To: MORRIS L. FINNEBURGH, SR., E.H.F.  
 Trustee — SIS Fund  
 c/o The FINNEY Antenna Company, 34 W. Interstate Street, Bedford, Ohio 44146

Dear "M.L." —

I agree! — "If you are NOT a part of the Solution — You are a part of the problem!"

I am proud to do "MY" part in building confidence in and the image of "INDEPENDENT TV SERVICE"! Enclosed is my contribution of \$ \_\_\_\_\_ to the S I S (Superior Independent Service) Fund — Please confirm it.

NAME \_\_\_\_\_ (PLEASE PRINT CLEARLY)  
 FIRM \_\_\_\_\_  
 ADDRESS \_\_\_\_\_ PHONE NO. \_\_\_\_\_  
 CITY \_\_\_\_\_ STATE \_\_\_\_\_ ZIP \_\_\_\_\_



← THIS IS YOUR "NO COST" FUTURE SECURITY !!

Promotional and Creative Idea Compliments of The Finney Company

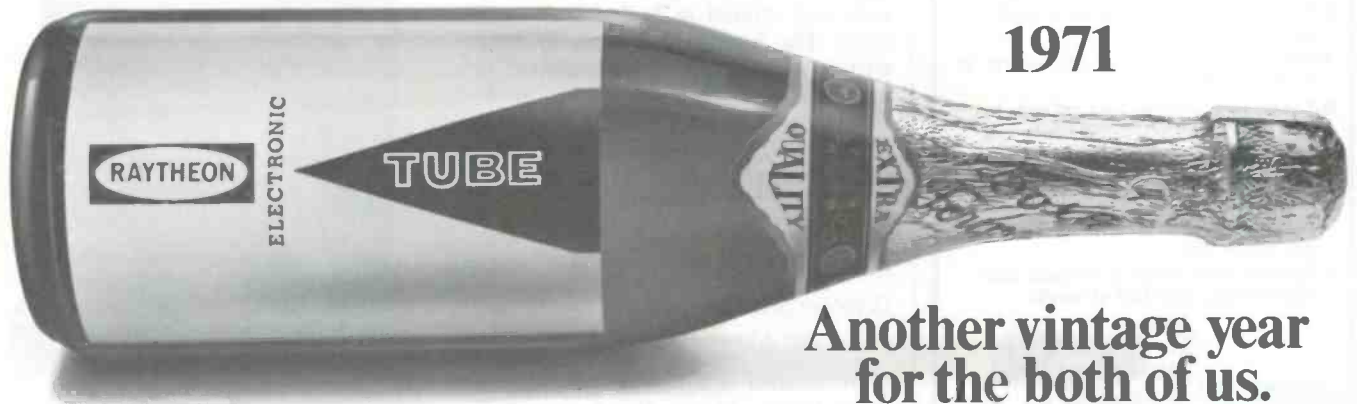

## 1971

### Another vintage year for the both of us.

1971 was a very good year. And 1972 already tastes even better. The truth is every year's a vintage year for you, the independent serviceman, and Raytheon, the largest independent tube supplier in the business. Last year, while a lot of other suppliers were running behind, even dropping out of the race, the two of us had another great year. We've come a long way together. And like a good wine, we keep getting better. That's because Raytheon works so well with you. And never works without you. That's the kind of thing that makes for a very good year for both of us. Year after year.

... for more details circle 127 on Reader Service Card

# FINCO

## tele-caster

LIFTS ANY STYLE TV CABINET—  
APPLIANCES, DESKS & FILES

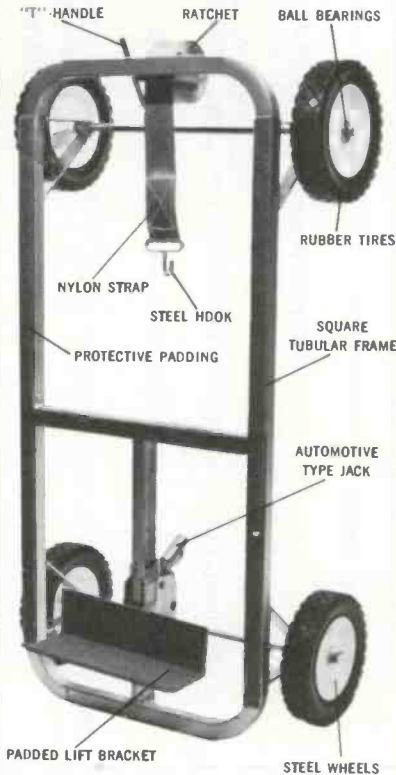

### FEATURES

- Completely Assembled (except for wheels)
- Will clear 3 normal steps in same method used to load Service Truck.
- Can be "walked" up and down steps.
- Can be used to tip set down to work on bottom.
- Can remain attached to set enroute to or from customer.
- Can be used to move long cabinets in shop by putting Tele-Caster under one end and service man lifting other end and wheeling like a wheelbarrow, without strapping unit.
- Jack easily adjusts Tele-Caster for any length legs.
- Operator never needs to lift more than approximately one half of weight.

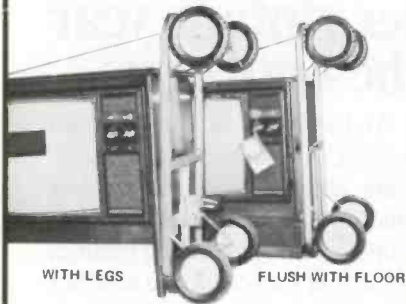

Model TC-1 DEALER NET \$89.50  
WRITE FOR CATALOG 20-621

**The FINNEY Co.**  
34 West Interstate Street  
Bedford, Ohio 44146

## NEW PRODUCTS

For additional information on products described in this section, circle the numbers on Reader Service Card. Requests will be handled promptly.

### CAPACITOR KITS 703

*Radial and axial lead capacitors*

Capacitor kits are available containing low-voltage miniature aluminum electrolytics, high-voltage aluminum electrolytics, non-polarized electrolytics, subminiature polyester film and metalized polyester film capacitors. The aluminum electrolytic and film



capacitors are available in separate high- or low-voltage kits, with non-polarized offered in high voltage versions. The kits are available in compartmentalized plastic containers or metal cabinets to eliminate the problem of having to use what is available or losing time waiting for the correct values. International Components.

### CURVE TRACER 704

*Displays semiconductor characteristics on any scope*

Introduced is a new semiconductor curve tracer, Model 501-A, which is designed to provide electronic current limiting and true current and voltage steps. The instrument measures the gain (beta can be read from the curve at a glance), leakage, breakdown voltage (nondestructive test), output admittance, linearity effects of capacitance and temperature. It tests J-FET's, MOS-FET's, signal and power bipolars, UJT's and diodes; uni-junction transistors, Triacs, SCR's, tunnel diodes, zener diodes and other solid-state components. The instru-

ment can be used for trouble-shooting—both in-and out-of-circuit—for sorting and selecting transistors for substitution, selecting balanced/complementary pairs, and for sorting bulk



stock. There are 11 current ranges and 5 voltage ranges, with 6 steps in continuous display and 120 steps/second. Accessories supplied include cables to scope, the FP-3 probe and a Mylar 10 X 10 graticule. Dynascan Corp.

### COILS 705

*Displayed in package with specifications*

Rack merchandisers for RF coils, chokes and components are designed for your retail customer—the hobbyist experimenter. These items are in new packaging with abbreviated specifications. Complete specifications and diagrams are packed with coils where applicable to assure maximum

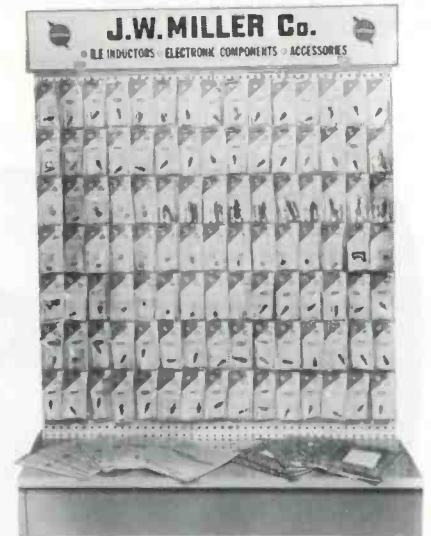

information to users. Initial quantities include three each of individual items with back-up cards to help provide easy inventory control. J.W. Miller.

### MATV DISTRIBUTION AMPLIFIERS 706

*For 30 to more than 450 outlets*

A line of solid-state broad-band MATV distribution amplifiers has been developed for UHF-VHF-FM

... for more details circle 111 on Reader Service Card

reception. Called the "G" Series, the line includes three models, each engineered for 30 to more than 450 TV set outlets. Features reportedly include: two outputs, each at full output for double capability, separate VHF and UHF inputs switchable to a single all-channel input, two separate and adjustable FM traps, and the high gain with separate VHF and UHF Band GAIN controls. Solid-state printed circuit boards are standard in each unit. Other features are said to include



double diode lightning protection and superior FM stereo performance achieved with extremely uniform gain and flat frequency response. Gavin Electronics.

#### CONTACT CLEANER 707

*Cleans and degreases electrical equipment*

Instant Contact Cleaner is recommended for cleaning TV tuners, tapes, tape decks, Hi-Fi equipment and records. Electrical equipment can be safely cleaned and degreased. It is reportedly non-toxic, non-flammable, non-conductive and leaves no residue. LPS Research Laboratories, Inc.



#### SERVICE VAN SHELVEING 708

*Adjustable up and down on mounting tracks*

A highly-flexible steel shelving in kit form is available for late model compact van trucks. Add-A-Shelf solves a wide variety of small parts storage problems because it is doubly adjustable. The shelf units are infinitely adjustable up and down on the mounting tracks by simply loosening four screws per shelf. Each shelf unit also has divider slots on 4-in. centers, allowing up to nine compartments in a 36-in. unit and 12 compartments in a 48-in. unit. Each kit consists of two vertical mounting tracks, two shelf units, two shelf dividers, and all necessary hardware plus instructions. Measuring 12-in. from front to back,

with 8-in. high shelf backs and 4-in. high shelf fronts, up to four units can be stacked on one pair of mounting tracks. Cantilever-type shelves elimi-



nate restrictive braces and corner supports. The shelf units are zinc-phosphate subcoated and finished in green enamel. Total kit-weight is approximately 35 lb. Extra shelf units and dividers are available at extra cost. Parts Systems, Inc.

#### TEST ADAPTER 709

*Use with shielded or unshielded tube sockets*

The Model 1737 Test Adapter is an ideal troubleshooting aid. Current measurement connections are fully insulated, with molded .080 phone tip plugs. The insulated plug will fit either the shielded or unshielded tube socket. Extended test tabs, phosphor bronze contacts, and heavy-duty molded phenolic bases with easy-to-read sockets are featured on the test socket. Pomona Electronics.



"By golly, you're right! There is a clause in your warranty covering shot gun blasts."



# ONE FOR THE MONEY

- Discounted to provide you with a higher profit margin.
- Proven quality for better customer satisfaction.
- A complete range of service types for radio, TV, hi-fi, foreign and industrial electronics.

In every important way, International Servicemaster is number one. For complete details, contact your International representative today, or International Components 10 Daniel Street, Farmingdale, New York 11735, (516) 293-1500.

**International**  
International Components Corp.  
Div. of IESC

... for more details circle 117 on Reader Service Card



# Fastatch II

**THE RIGHT CONTROL.  
THE FIRST TIME.**

Fastatch II is Centralab's precise, complete answer to control replacement in radio, TV, stereo and auto radio. It makes possible more than 9 billion combinations—thus your Centralab Fastatch II Distributor can serve you best—now. The Fastatch II snap-together control exceeds OEM requirements because of these built-in features for constant service.

- Patented, snap together, permanent locking, anti-backlash construction on dual and twin controls.
- No alignment or twisting of controls.
- Shafts can't loosen or pull out.
- No cutting of shafts.
- Universal terminals replace printed circuit, wire wrap and hole type terminals.

**WHEN YOU NEED A CONTROL  
YOUR FASTATCH II DISTRIBUTOR  
IS THE FIRST MAN TO SEE**

*Get the right replacement faster  
with 8 new Centralab service  
kits. See your FASTATCH II  
distributor for complete details*

DISTRIBUTOR PRODUCTS



**CENTRALAB**  
Electronics Division  
GLOBE-UNION INC.

## TECHNICAL LITERATURE

### Communication Antennas

A 96-page general catalog listing over 250 models of professional communications antennas is released. Complete mechanical and electrical specifications and radiation patterns are provided, along with full details of mounting options. The catalog covers full lines for all land-mobile antennas, plus selected base and mobile antennas for the Citizens Radio Service, professional monitoring, marine and avionics. In addition, general information is provided on transmission line characteristics, side-mounting patterns and element cutting charts. Antenna Specialists Co., 12435 Euclid Ave., Cleveland, Ohio 44106.

### Instrument Catalog

The 32-page catalog features the manufacturer's complete line of over 200 electronic kits and factory assembled instruments in the fields of test instrumentation, security electronics, stereo hi-fi, and automotive/marine electronics. New for 1972 are: Fail-safe burglar/fire alarm systems, a four-channel stereo adaptor, solid-state power inverters, creative audio lighting products, FET multimeters, and nine new electronic science project kits. EICO Electronic Instrument Co., Inc., 283 Malta St., Brooklyn, N.Y. 11207.

### Voltage Surge Suppressor Brochure

A descriptive brochure is available detailing advantages and specifications of a new plug-in ac line surge suppressor. It defines how the suppressor prevents destruction of electronic equipment, including TV sets, caused by voltage surges arising from hookup, startup, shut-down, switching, stray pickup and lightning. Transtector Systems, 532 Monterey Pass Road, Monterey Park, Calif. 91754.

### Antennas

A 24-page citizens-band and monitor antenna catalog is available. The text is completely illustrated with new and improved models including the Discone, Power Multiplier Beams, fiberglass assemblies, high efficiency short antennas, Monitor-Match, base matched mobiles and "Double-Talk" antenna systems. New-Tronics Corp., 15800 Commerce Park Dr., Brookpark, Ohio 44142.

## TEKLAB ...

*continued from page 40*

diode SC1059 applies a positive charge to capacitor C1074 connected to the gate of transistor Q1066, causing it to go positive. The impedance of the transistor is lowered by this forward voltage, which is equivalent to lowering the resistance of VOLUME control R118 (on non-remote models), causing the voltage at Pin 6 of integrated circuit IC100 to drop and producing a volume increase. When transistor Q1066 conducts, a voltage drop is produced across resistor R1092. A portion of the voltage across this resistor is tapped by the controls wiper, which is held steady by capacitor C1078 and used as forward bias for transistor Q1068. The conduction of this transistor is now related to the minimum volume setting. When the minimum volume voltage is sensed, transistor Q1070 is forward biased by the conduction of transistor Q1068 and holds the power relay (RY500) in.

### VOLUME Down-OFF Circuit

The impedance of transistor Q1066 is increased by reducing its gate voltage. This is accomplished by closing switch SW512 and connecting the junction of resistors R1074 and R1076 to ground through resistor R524. At the same time relay RY1054 latches and ties the gate of transistor Q1066 to the junction of resistors R1074 and R524, through resistors R1076 and R1078. This action reduces the positive charge on capacitor C1074 and reduces the gate voltage on transistor Q1066. This gate voltage is about 6v, a reduction from the voltage coupled to the transistor gate before the junction of resistors R1074 and R1076 were grounded. The decrease in gate voltage decreases the conduction of Q1066, raising the voltage at Pin 6 of integrated circuit IC100, which lowers the volume.

The voltage drop across resistor R1092 also decreases, removing the forward bias to transistor Q1068. Its collector voltage then rises toward B+ and turns OFF transistor Q1070, unlatching power relay RY500 and turning the ac power OFF.

*continued on page 67*

## DEALER SHOWCASE

For additional information on products described in this section, circle the numbers on Reader Service Card. Requests will be handled promptly.

### HEAD/CAPSTAN CLEANER 710

For all eight-track cartridge recorder/players

Designated Model QM-182, the new cleaner cartridge reportedly features a double-ended design to safely remove oxide and contaminants from the head and to clean the capstan. The head end features a belt of woven soft Dacron and cotton for removing accumulated oxide particles; the capstan cleaner is of Microlon; and the fiber, which is highly effective as a capstan cleaner. Nortronics Co.



### MOBILE ANTENNA 711

No exposed mounting screws

Designated as the Model TKQ, the antenna includes a heavy stainless steel "L" shaped mounting bracket complete with factory installed mounting system, complete quarter-wave antenna, attached coax and PL-259 plug—everything needed for a quick, easy, complete installation. The package includes sheet metal screws,



cutting chart for the frequency desired (any between 140MHz and 500MHz), allen wrench and mounting instructions. The antenna and mount is available with 7 ft or 17 ft of coax, complete with plug. The whip

is made of heavy-duty stainless steel which is heavily silver plated to increase radiation efficiency. Larsen Electronics.

### TOWER ANTI-CLIMB SECTION

Deters personnel from climbing towers

712

The Anti-Climb Section for Model 20G, 25G and 45G towers serves as an attractive tower safety device for private residences, as well as public areas where constant policing is not possible. The section is constructed of a standard 10-ft tower section covered with heavy sheet metal welded to the legs, and then completely hot-dip galvanized after fabrication for a long, maintenance-free life and an attractive appearance. Rohn Manufacturing.



### SPEAKER 713

6½-in cone with heavy-duty magnet

713

The Model 2003 stereo speaker is designed for use as an "add-on-speaker" for stereo units 2001 and 2002, or any stereo using 8Ω impedance.

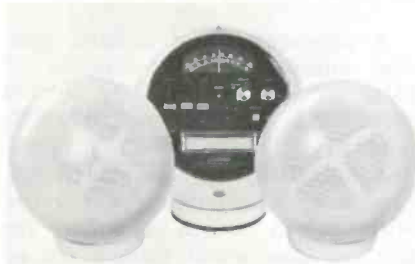

The 20w 6½-in. speaker has a heavy-duty magnet and the dome grille offers new space age appearance. The speaker can be set on a shelf, mounted on the ceiling, wall, or hung from the ceiling. Weltron Co.

*continued on next page*

### MOVING ?

Be sure to let us know your new address. Please enclose a complete address label from one of your recent issues.

## PROJECT PROFITS!



NEW

## ANTENNACRAFT® Color Finder ANTENNAS

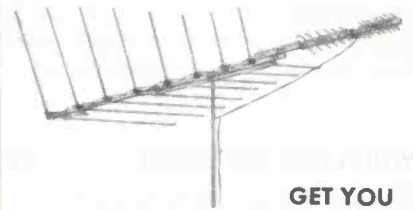

GET YOU  
OUT OF THE  
LOW END BOX

New for '72. Space-age super swept Color Antennas . . . at black and right prices! A full line. At full mark ups with full color packaging and pre-sold brand appeal. Land bigger sales with Antennacraft. Boosted by Gavin selling power we're your new one-source specialists, from antennas to amplifiers!

WRITE FOR SECRET M.A.P.  
PROFIT PLAN

ANTENNACRAFT®  
P.O. BOX 1005 Burlington, Iowa  
AC (319) 754-7515 TWX 910-525-1133  
One-Source Specialists . . .  
Antennas To Amplifiers!

... for more details circle 115 on Reader Service Card

## DEALER SHOWCASE...

continued from page 65

### TV HARDWARE 714

Display designed for self-service

Introduced is a complete, compact, free-standing display of full-color, blister-carded, color-pak TV reception aids. Called "Space Center," the steel and pegboard display measures 54 by 48 in. and is designed for high self-service turnover. Also included are



automatic reorder reminder cards to simplify dealer inventory control. These cards hang behind each product. Each reminder card corresponds to its product by placement and number, with space for dealer pricing. Pegboard hooks are also included. A full line of 29 different TV reception aids can be displayed in the center which holds over 300 items. Gavin Electronics.

### WIRELESS RECEIVER 715

For paging and communications in high-noise areas

A subminiature wireless receiver, Model R-5, is designed for operating on the induction principle. The unit can be used—with any PA system or audio amplifier acting as the transmitter—by installing a wire loop around the area where communication is desired. A 10w amplifier provides a satisfactory signal anywhere within a loop of up to 200 ft in diameter. The receiver is self-contained with power cell, volume control and ear tube housed in the temple piece of contemporary eyeglass frames. Unex Laboratories, Inc.



### BURGLAR ALARM 716

Features dramatic point-of-sale packaging of kit

The Belgard home burglar alarm kit folds open to produce an attractive counter-top display. The burglar alarm sales message is prominently placed in front of the retail customer



and all the components are clearly shown. The package is accompanied by point-of-sale literature, plus complete installation instructions. The package stacks compactly for storage. The intent of this new fold-open display package is to show the retail customer the simplicity of installing his own home automatic burglar alarm system by using household tools. The package contains an all-weather alarm box and bell system, color-coded wiring, a master-control key-switch and enough switches to protect up to six door and window openings. Aqualarm, Inc.

### SCANNING MONITOR RECEIVER 717

Includes visual readout for eight channels

A programmable three-band scanning monitor receiver covering 25 MHz to 50MHz, 140MHz to 174 MHz and 450MHz to 470MHz simultaneously is now available. The unit, designated the SCAN 308, handles up to 16 different channels. With simple switch controls, the unit can give visual readout for up to eight channels at one time. The unit has a wide front-end receiver design to accept a wide frequency range so that one model covers most important frequencies as tuned at the factory, and can be easily retuned for extreme field conditions. Unless specified otherwise, the unit comes tuned to the three most generally used segments—35 to 45MHz, 152 to 164 MHz and 450 to 462MHz. Other features include an integrated circuit, FET-transistor complement to provide versatility of broad-band adjustments while still maintaining good selectivity and sensitivity; rear-panel programming switches that select the desired band and choose the desired combina-

tion from 16 internal crystal sockets (no internal wiring need be changed); front-panel control lights, with lock out controls that indicate which channel is being monitored; and built for both mobile 12v DC operation or 110v AC usage in home or office. The SCAN 308 is provided with ac and dc power cords, a locking mobile mount, non-



slip desk mount, telescoping antenna and built-in speaker. There are, also, provisions for external remote speaker as well as external antenna connections. Pathcom Inc.

### SSB CB TRANSCEIVER 718

Designed for sensitivity and selectivity in SSB and AM modes

The Gladiator SSB reportedly is designed for ultra-sensitivity and selectivity in both SSB and AM receive modes, assuring positive pick-up of

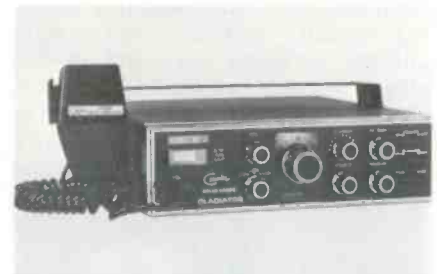

on-channel signals and providing freedom from adjacent channel interference. A lattice crystal filter in the SSB receive mode is said to eliminate interference, while a mechanical ceramic filter in the AM receive mode performs the same function. Other features include FET series gate noise blanker to wipe out impulses present in the receive mode. Convenience features include an on-the-air indicator, illuminated S/R/F power meter and 69 channel illuminated selector. There also is a green light receive indicator. A large dynamic noise cancelling microphone plugs into the front of the unit and is useable on both the PA and CB operating modes. Fanon/Courier Corp.



## TEKLAB...

continued from page 64

### SUMMARY

Most people like the space-age image and some get the idea that a solid-state TV set will never need transistor replacement. Although the transistor is very dependable—we do replace a few. When replacement is necessary, or when troubleshooting by substitution, the plug-ability of this chassis can drastically reduce service time.

The limited-function, lower-cost, remote-control system should encourage more to enjoy this luxury in a small-screen-size portable-TV set. The system operates very effectively and quietly without adding much weight to the TV set.

We were very pleased with the excellent stable color picture produced by this compact portable color-TV set. ■

## BEST ANTENNA...

continued from page 48

change in total antenna impedance when located  $\frac{1}{4}\lambda$  from the drive element, while producing maximum signal gain and lower antenna impedances when  $0.1\lambda$  away.

Both a director and a reflector can be used in conjunction with a driven antenna to sharpen the directional pattern and improve gain

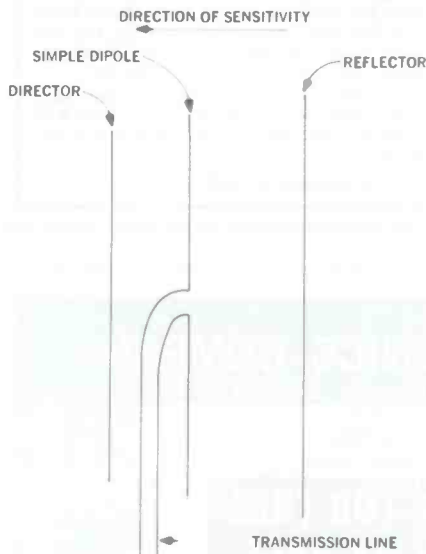

Fig. 19—An antenna system containing both a director and a reflector.

(Fig. 19). The greatest gain, about 8dB or roughly 6.3 times the signal power obtained with a simple dipole antenna) is found to occur

when the reflector is placed  $0.15\lambda$  from one side of the driven antenna and the director is placed  $0.1\lambda$  from the other side (Fig. 19)—the two parasitic elements being cut to the lengths previously recommended in the article.

### Yagi Antennas

Antenna combinations containing a single driven antenna coupled to a reflector and a number of directors (Fig. 20) were first described in Japanese by S. Uda, professor of the Tohoku Imperial University in Japan. Some of his work was translated into English by H. Yagi, and it became customary to refer to this new array as the Yagi antenna—despite the fact that this paper clearly specified the part played by S. Uda.

Experimentation indicates that little is gained by adding more than one reflector to an antenna system, while a considerable increase in gain can result with the addition of more directors. However, each additional director has a progressively smaller effect on the total antenna gain—the practical limit being about 30 directors. Each additional director also helps to make the antenna more directional. The maximum gain that can be obtained with this

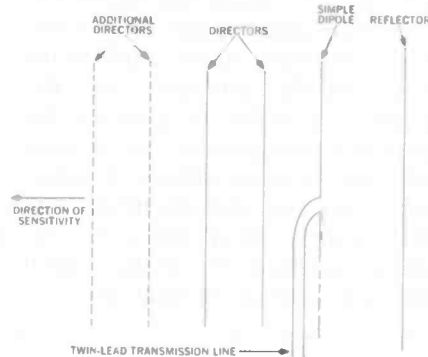

Fig. 20—Yagi antenna systems contain a reflector and two or more directors in conjunction with one or more driven elements (only one driven element—a simple half-wave dipole is used here).

type of an antenna is about 15dB (about 31.6 times the gain of a simple dipole antenna).

Yagis of this design have a rather limited bandwidth, covering at most three adjacent TV channels. Reducing the length of each additional director helps to improve this bandwidth.

continued on next page

## SOLVE YOUR DRIVE BELT PROBLEMS IN MINUTES with ONEIDA'S all new DRIVE BELT KITS

- Eliminates "Down Time" on special and foreign belts.
- No need to stock replacement belts; makes any size in minutes.
- No molds or complicated vulcanizing processes to follow.
- No special skill required, cutting guide, cutting tools and adhesive all included.
- Special Insta-Weld® adhesive makes replacement belts as strong as or stronger than originals for lasting repairs.



ORK-1 Round Rubber Drive Belt Kit ..... \$19.95

ORK-2 Flat and Square Rubber Drive Belt Kit ..... \$19.95

ORK-3 "O" Ring Kit ..... \$19.95

Get up to five times your investment back in belt sales. Each of these kits will make from 80-100 dollars or more in rubber drive belts. Included with the kit is the special cutting guide, razor blade, Special Insta-Weld® adhesive, a large quantity of rubber stock and easy-to-follow directions. Nothing has been left out. Packed in an attractive, handy, plastic box that fits into the tube caddy or on the bench. Now, you can replace over 90% of the belts found on tape recorders, phonographs and cassette recorders, both foreign and domestic, right on the spot. Check with your distributor now. If he doesn't stock them, ask him to order them for you today.

## PERMABOND ADHESIVE POWER WITH ONEIDA'S Insta-Weld®



Makes Space Age Bonds

Great for: Rubber • Plastic • Metal • Ceramics • Glass • Etc.

Insta-Weld® is new, not epoxy, nothing you have heard of before. There is no mixing, just apply and hold parts together. Just seconds are all that is required for a bond stronger than anything you could ever get before. One drop supports 2,000 pounds per square inch.

Now make economical repairs that were never before possible. Extremely economical, up to 132 bonds per tube.

NEW INSTA-WELD®

only \$2.00 per 2-gram tube

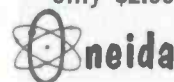

ONEIDA ELECTRONIC MFG., INC.  
MEADVILLE, PENNA. 16335

for more details circle 125 on Reader Service Card

**"STAR-TRACK"™ the most  
Advanced Space-Age  
VHF/UHF/FM Color  
Antennas ever introduced!**

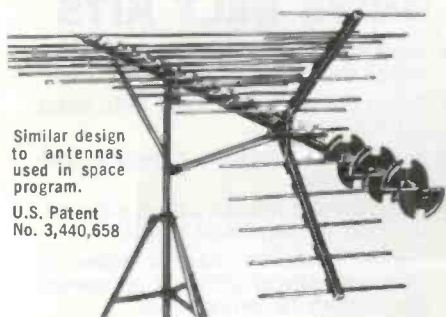

Similar design to antennas used in space program.

U.S. Patent No. 3,440,658

Corner Reflector Driven Disc Director Array for total UHF coverage!  
Multiple Tuned, Cut-to-Channel VHF Elements for total VHF and FM coverage!  
Maximum construction for long installation life!  
Exclusive Reynolds Aluminum COLORWELD durable baked enamel Gold finish!  
Includes RMS SP-332 VHF/UHF Splitter for economical single down-lead installation!

Model	RANGE OF RECEPTION	
	VHF	UHF
SK-716	Up to 50 miles	Up to 50 miles
SK-1117	Up to 125 miles	Up to 75 miles
SK-1519	Up to 150 miles	Up to 100 miles
SK-13	—	Up to 25 miles
SK-15	—	Up to 50 miles
SK-19	—	Up to 100 miles

Write for Catalog Profit Details! — **RMS ELECTRONICS, INC.**  
50 Antin Place, Bronx, N.Y. 10462  
Tel. (212) 892-6700

... for more details circle 129 on Reader Service Card

**BEST ANTENNA...**

*continued from page 67*

**Broadband Yagi Antennas**

A properly designed end-fired array of driver elements (resembling the log periodic antenna in Fig. 17) is found to have a much wider bandwidth than a series of parasitic elements. By combining the two types of antennas and tapering the length of each progressive element (so that the reflector is tuned to the lower-frequency channel and the front director is tuned to the higher-frequency channel), gains of 6dB to 7dB (around four to five times the gain of a simple dipole) are not uncommon over the entire Low Band.

Still a third Yagi system involves interlacing high- and low-band elements—thus eliminating the need to install a low-band and a high-band Yagi with two transmission lines.

**Conclusion**

Space does not permit us to go into more detail concerning the design of antennas. It will be found that antenna gain, bandwidth and directivity may vary from antenna to antenna. In some areas it is enough to slap up the type of antenna considered best for the average reception conditions encountered. In other areas it is important that the electronic technician or service dealer peak up the antenna—through minor adjustments based on the principles just described—in order to provide the greatest signal gain or the greatest reduction in ghost effects or noise. Some antenna manufacturers will gladly supply, on special order, antennas designed for unique signal conditions present in your area.

Other factors that should be considered when making professional antenna installations include the proper stacking of antennas for greater gain or reduced noise and ghost effects, the selection of the most appropriate transmission line for the application, and stubbing the transmission line to increase the signal strength or reduce the ghost effect and interference. All these are important topics that await a future article. ■

**REBUILD  
YOUR OWN  
PICTURE TUBES?**

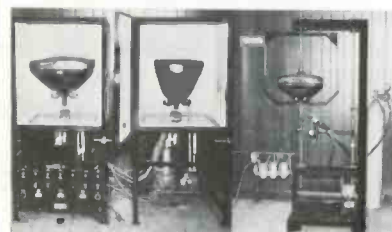

With the Lakeside Industries precision picture tube rebuilding unit, you can rebuild any picture tube, be it black and white or color or 20mm or etc. We offer you the most revolutionized precision equipment of our modern times. This unit is easy to operate and requires only 4 x 8 ft. of space. You can rebuild the finest tube available. The picture will be clear and sharp. Your cost to rebuild a color tube is \$6.60. Your cost to rebuild a black and white tube is \$1.85.

Profit? Imagine building four color tubes per day and if you sold these tubes for \$60.00 each. Total income \$240.00. Total cost \$26.40. Net profit \$213.60. Multiply this figure by five days per week. Your profit \$1,068.00 per week. Cut this figure in half! Build and sell only two color tubes per day. Your profit \$534.00 per week. Facts are facts, figures do not lie.

For further information, please send your name and address to Lakeside Industries, 3520 West Fullerton, Chicago, Ill. 60647. Phone: (312) 342-3399.

P.S. No salesman will call.

... for more details circle 121 on Reader Service Card

**PROVEN  
IMPORTANT DEVELOPMENT  
FOR TV SERVICING**

(OVER 250,000 SOLD)

**SANS-A-FUSE®**

FITS IN SAME  
SOCKET AS CHEMICAL  
OR AMP FUSE

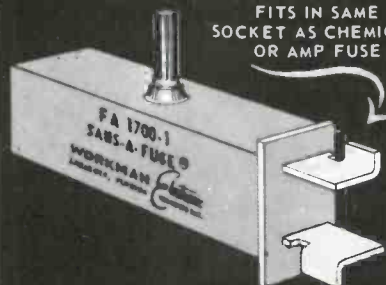

**14 COLOR CODED CIRCUIT  
BREAKER REPLACEMENTS  
FOR CHEMICAL OR  
AMP FUSE**

**SAVES TIME AND FUSES  
WHEN LOCATING SHORTS  
IN TELEVISION CIRCUITS**

DEVELOPED AND  
MANUFACTURED BY

**WORKMAN**  
Subsidiary of IPM TECHNOLOGY, INC.  
BOX 3828 SARASOTA, FLA. 33578

*Electronic*  
PRODUCTS, INC.

... for more details circle 134 on Reader Service Card

**CORNELL ELECTRONICS COMPANY**

4213 N. UNIVERSITY AVE. SAN DIEGO CALIF. 92105

THE ORIGINAL  
HOME OF



Same Low Price  
East or West Coast!

- ★ Bargain Tools
- ★ Transistor Tester
- ★ Technician's Library

**SEND FOR FREE  
NEW 48 PAGE  
COLOR CATALOG**

ONE YEAR  
GUARANTEE

INDIVIDUALLY  
BOXED

5 DAY MONEY  
BACK OFFER

LAB TESTED USED

- ★ Dumont Picture Tubes
- ★ Diodes—Transistors—Kits
- ★ Tube Cartons

**SPECIAL  
OFFER**

ON ALL ORDERS  
OVER \$10.00

**25¢**

PER TUBE  
(NO LIMIT)

FROM THIS LIST

- 6AG5 6CB6
- 6AU6 6J6
- 6AX4 6SN7

**Your Order FREE if Not Shipped in 24 Hours**

... for more details circle 107 on Reader Service Card

## COMMERCIAL AUDIO . . .

*continued from page 57*

supply of manufacturers' service manuals for all models employed is also assumed.

Although differences of opinion still exist regarding preventive maintenance versus spot repairs after breakdown, it has long ago been determined that all types of electronic equipment outages can be reduced by pursuing a carefully planned preventive maintenance program. For electron-tube equipment, the primary consideration is the periodic once-a-year checking of all tubes on a good dynamic mutual-conductance type tube tester. Somewhere around 85 to 90 percent of amplifier breakdowns are caused by tube failures. And tubes should be vibrated by tapping with a pencil (especially on mobile-type equipment) during test and while heated to normal standby temperature to facilitate the discovery of intermittently defective tubes. All defective and marginally defective tubes should be replaced with tubes that are known to be good.

Properly ventilated equipment will usually accumulate considerable dust over a year's time. This dust should be removed from the equipment by a specially designed vacuum cleaner or, if an open-air spot is available, by compressed air.

Many breakdowns of both electron-tube and solid-state amplifiers can be anticipated by making periodic power-supply voltage and hum-level checks with a VTVM and scope. They can also be anticipated by making amplifier-output distortion checks with a sine/square-wave generator and scope. In the first instance, power-supply components, notably filter capacitors, may be marginal and require replacement. In the second instance, an audio-output component, notably a coupling capacitor, may require replacement. In solid-state amplifiers, any one of a half-dozen components can be marginally defective and cause a larger-than-normal amount of distortion. These should also be replaced—and in many amplifiers, this means replacing both units (transistors or resistors) to maintain matched-pair tolerances. Once again, the analysis of a few scope and square-wave checks can reveal substandard or marginal performances symptomatic of future breakdowns. These techniques are applicable to both electron-tube and solid-state types of quality audio-equipment.

After equipment breakdown, troubleshooting and direct servicing are usually done best in the shop. In such case, it is advisable to provide an exact-type spare unit for the customer so that normal service will not be interrupted. Many audio specialists return defective in-warranty equipment back to the manufacturer for repair unless other arrangements have been previously agreed upon.

The actual troubleshooting and repair of most audio amplifiers is simpler than comparable work on regular AM radio receivers. And manufacturers' service literature is bulging with information regarding techniques employed to troubleshoot, adjust and repair this equipment—including FM tuners, tape players, turntables or automatic record players that may be used as auxiliary input equipment. ■

# NEW!

## INSTANT CONTACT CLEANER



**SEND FOR FREE SAMPLE**

**NO RESIDUE • NON-FLAMMABLE  
NON-TOXIC • NON-CONDUCTOR**

**A CHEMICALLY PURE CLEANING AGENT WITH:**

- 1. SELECTIVE CLEANING POWER** — removes greases, oils, dirt and organic soils with no effect on the article being cleaned.
- 2. EXCELLENT PENETRATING AND WETTING ACTION** — Its high density and low surface tension permits maximum penetration of most minute crevices where its superior wetting action then cleans even most difficult materials.
- 3. PURITY** — evaporates completely — leaves **NO** residue.
- 4. SAFETY** — Non-explosive, non-flammable, non-toxic.
- 5. STABILITY** — does not react chemically with other materials.

Available in 7 & 16 oz. aerosols with "Snorkel Tubes"

### LPS RESEARCH LABORATORIES, INC.

2050 COTNER AVENUE, LOS ANGELES, CALIFORNIA 90025  
PHONE: (213) 478-0095

. . . for more details circle 122 on Reader Service Card

## South River's New Improved

# EAVE MOUNTS



**FOR SUPPORTED MAST INSTALLATION**

SLOTTED WASHER HEAD LAG SCREW SIMPLIFIES INSTALLATION



TEARDROP SCREW HOLES FOR MOUNTING EASE



EXCLUSIVE SWIVEL MAST SUPPORT (Back View)



**FOR GROUND-UP TELESCOPING MAST INSTALLATIONS UP TO AND INCLUDING 50 FT. MASTS**

Available in Hot-Dip Galvanized Steel or Aluminum

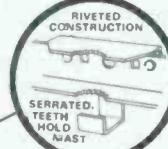

RIVETED CONSTRUCTION

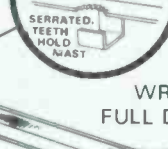

SERRATED TEETH HOLD MAST

WRITE FOR FULL DETAILS

Choice of: 30", 48" or 60" models (size indicates spread of lower bracket).

### SOUTH RIVER METAL PRODUCTS CO., INC.

SOUTH RIVER, NEW JERSEY 08882

. . . for more details circle 130 on Reader Service Card



**WANT TO KEEP THINGS QUIET? AND CLEAN TOO?**

Then use Quietrole . . . the choice of better servicemen everywhere for cleaning and lubricating all T.V. moving parts.

Spray Pack guarantees silent, smooth operation, with absolutely no harmful aftereffects for both color, and black and white sets.

Also available in bottles if you prefer.



Product of **QUIETROLE COMPANY** Spartanburg, South Carolina

... for more details circle 126 on Reader Service Card

**Don't let this familiar face fool you.**



**Messenger 123A is all new inside.**

We've taken our most popular 23-channel CB two-way radio and given it completely new circuitry! New ceramic filter for great selectivity. New acoustically isolated speaker for clearer sound. And more. All for a suggested price of \$149.95.

You're going to hear more from...



**JOHNSON**  
Waseca, Minnesota 56093

... for more details circle 120 on Reader Service Card

**READERS SERVICE INDEX**

**ADVERTISER'S INDEX**

115	Antennacraft	65
101	B & K Div., Dynascan Corp.	24
102	Blonder-Tongue Laboratories, Inc.	35-36
103	Book Club-Tab Books	52-55
104	Centralab Distributor Products	64
105	Channel Master-Div. of Avnet, Inc.	4th Cover
106	Chemtronics, Inc.	28
107	Cornell Electronics Co.	68
108	Delta-Benco Ltd.	42
109	Eastman Chemical Products Inc.	51
110	EV/Game, Inc.	30
111	Finney Company, The	62
112	Fordham Radio Supply Co., Inc.	70
113	Ford Marketing Corp.-Ford Div.	56
114	GC Electronics Company General Electric Co. Television Business Div. GTE Sylvania, Electronic Components	32 41, 3rd Cover
116	Heath Company, The	33
117	International Components Corp.	63
118	Jensen Tools & Alloys	70
119	Jerrold Electronics Corp.	2nd Cover
120	E. F. Johnson Company	70
121	Lakeside Industries	68
122	LPS Research Labs	69
123	Mallory Distributor Products Co.	20-21
124	Mountain West Alarm Supply Co.	70
125	Oneida Electronic Manufacturing Inc.	67
126	Quietrole Company	70
127	Raytheon Company	61
128	RCA Parts & Accessories	26
129	RMS Electronics, Inc.	68
130	South River Metal Products Co.	69
109	Tech Spray	51
131	Telematic Div., UXL Corp.	27
132	Telematic Div., UXL Corp.	29
133	Tuner Service Corporation Universal Tuner Tabs	19 31
134	Workman Electronic Products	68
135	Yeats Appliance Dolly Sales Co. Zenith Radio Corporation	70 49

**NEW PRODUCTS**

700	TV Dolly	34
701	UHF/VHF/FM Antenna	34
702	Sound-Level Meter	34
703	Capacitor Kits	62
704	Curve Tracer	62
705	Coils	62
706	MATV Distribution Amplifiers	62
707	Contact Cleaner	63
708	Service Van Shelving	63
709	Test Adapter	63
710	Head/Capstan Cleaner	65
711	Mobile Antenna	65
712	Tower Anti-Climb Section	65
713	Speaker	65
714	TV Hardware	66
715	Wireless Receiver	66
716	Burglar Alarm	66
717	Scanning Monitor Receiver	66
718	SSB CB Transceiver	66

**TEST INSTRUMENT**

900	LogiMetrics' Model 750 RF Signal Generator	58
-----	--	----

**DISCOUNT PRICES TEST EQUIPMENT**



**SENCORE**

Test Equipment of Other Manufacturers also Available

Catalog & Prices on Request

**FORDHAM** Radio Supply Company, Inc.



265 E. 149 Street, Bronx, N.Y. Tel: (212) 585-0330



**DISTRIBUTORS OF ELECTRONIC SUPPLIES**

... for more details circle 112 on Reader Service Card

**YEATS dollies**

YEATS Model No. 5 566.50

... for more details circle 135 on Reader Service Card

**FREE ALARM CATALOG**

64 PAGES FILLED WITH 350 BURGLAR AND FIRE ALARM PRODUCTS FOR INSTALLERS AND ELECTRONIC TECHNICIANS. INCLUDES RADAR, INFRARED, CONTROLS, HARD-TO-FIND PARTS, AND 6 PAGES OF APPLICATION NOTES.

**mountain west alarm**  
4215 n. 16th st., phoenix, az. 85016

... for more details circle 124 on Reader Service Card

**FREE CATALOG TOOLS**

**HARD-TO-FIND PRECISION TOOLS**

Lists more than 1700 items—pliers, tweezers, wire strippers, vacuum systems, relay tools, optical equipment, tool kits and cases. Also includes four pages of useful "Tool Tips" to aid in tool selection.

**JENSEN TOOLS**  
4117 N. 44th Street, Phoenix, Ariz. 85018

... for more details circle 118 on Reader Service Card

**MOVING ?**

Be sure to let us know your new address. Please enclose a complete address label from one of your recent issues.

Circle the Reader Service numbers of those items of interest to you.

**GET MORE FACTS**

NO POSTAGE NECESSARY

Your own personal copy for only pennies per issue

## READER SERVICE INFORMATION CARD

For more information on products or services mentioned in this issue, simply circle the appropriate numbers below, type or print your name and address and drop in the mail.

### ADVERTISED PRODUCTS

101	110	119	128	137	146
102	111	120	129	138	147
103	112	121	130	139	148
104	113	122	131	140	149
105	114	123	132	141	150
106	115	124	133	142	151
107	116	125	134	143	152
108	117	126	135	144	153
109	118	127	136	145	154

### TEST INSTRUMENTS

900	909
901	910
902	911
903	912
904	913
905	914
906	915
907	916
908	917

### NEW PRODUCTS

700	709	718	727	736	745
701	710	719	728	737	746
702	711	720	729	738	747
703	712	721	730	739	748
704	713	722	731	740	749
705	714	723	732	741	750
706	715	724	733	742	751
707	716	725	734	743	752
708	717	726	735	744	753

This card is usable until November 5, 1972.

8/72

NAME \_\_\_\_\_ POSITION \_\_\_\_\_

COMPANY \_\_\_\_\_ STREET \_\_\_\_\_

CITY \_\_\_\_\_ STATE \_\_\_\_\_ ZIP CODE \_\_\_\_\_

## BUSINESS REPLY MAIL

NO POSTAGE STAMP NECESSARY IF MAILED IN THE UNITED STATES

FIRST CLASS

PERMIT NO. 665

DULUTH, MINNESOTA

POSTAGE WILL BE PAID BY

Reader Service Department

## ELECTRONIC TECHNICIAN/DEALER

POST OFFICE BOX 6016, DULUTH, MINNESOTA 55806

## PERSONAL SUBSCRIPTION CARD

GET A FREE BONUS WITH YOUR PERSONAL SUBSCRIPTION TO ELECTRONIC TECHNICIAN/DEALER!

- 3 Years \$13     2 Years \$10     1 Year \$6\*  
 Payment Enclosed     Bill Me

\*BONUS: With a 2 or 3 year renewal, you receive both TEKFAK 110 and the COLOR TV GUIDEBOOK free! If you are renewing for 1 year, please indicate your choice of either:     TEKFAK 110     COLOR TV GUIDEBOOK



### PLEASE CHECK BELOW:

1. In the TV, Radio and other consumer products fields, is your firm

PRIMARILY a: (please check most descriptive item)

- Retailer with service department     Industrial electronics service firm  
 Service/repair firm with some retail     Manufacturer  
 Service/repair firm with no retail     Other (please describe)

2. Title (please check one)

- Owner, manager, buyer, other executive  
 Service manager  
 Service repairman or other employee

NAME \_\_\_\_\_ STREET \_\_\_\_\_

FIRM \_\_\_\_\_ TITLE \_\_\_\_\_

CITY \_\_\_\_\_ STATE \_\_\_\_\_ ZIP \_\_\_\_\_

If you are renewing your subscription, check here and attach your address label. If you renew your subscription for 2 to 3 years, you are still eligible to receive your free bonus.

## BUSINESS REPLY MAIL

NO POSTAGE STAMP NECESSARY IF MAILED IN THE UNITED STATES

POSTAGE WILL BE PAID BY

Reader Service Department

### ELECTRONIC TECHNICIAN/DEALER

POST OFFICE BOX 6016, DULUTH, MINNESOTA 55806

FIRST CLASS

PERMIT NO. 665

DULUTH, MINNESOTA

# GET MORE FACTS

NO POSTAGE  
NECESSARY

## READER SERVICE INFORMATION CARD

For more information on products or services mentioned in this issue, simply circle the appropriate numbers below, type or print your name and address and drop in the mail.

### ADVERTISED PRODUCTS

101	110	119	128	137	146
102	111	120	129	138	147
103	112	121	130	139	148
104	113	122	131	140	149
105	114	123	132	141	150
106	115	124	133	142	151
107	116	125	134	143	152
108	117	126	135	144	153
109	118	127	136	145	154

### TEST INSTRUMENTS

900	909
901	910
902	911
903	912
904	913
905	914
906	915
907	916
908	917

### NEW PRODUCTS

700	709	718	727	736	745
701	710	719	728	737	746
702	711	720	729	738	747
703	712	721	730	739	748
704	713	722	731	740	749
705	714	723	732	741	750
706	715	724	733	742	751
707	716	725	734	743	752
708	717	726	735	744	753

This card is usable until November 5, 1972.

8/72

NAME \_\_\_\_\_ POSITION \_\_\_\_\_

COMPANY \_\_\_\_\_ STREET \_\_\_\_\_

CITY \_\_\_\_\_ STATE \_\_\_\_\_ ZIP CODE \_\_\_\_\_

Circle  
the  
Reader  
Service  
numbers  
of those  
items of  
interest  
to you.

## BUSINESS REPLY MAIL

NO POSTAGE STAMP NECESSARY IF MAILED IN THE UNITED STATES

POSTAGE WILL BE PAID BY

Circulation Department

### ELECTRONIC TECHNICIAN/DEALER

POST OFFICE BOX 6016, DULUTH, MINNESOTA 55806

FIRST CLASS

PERMIT NO. 665

DULUTH, MINNESOTA

Your own  
personal  
copy  
for  
only  
pennies  
per issue

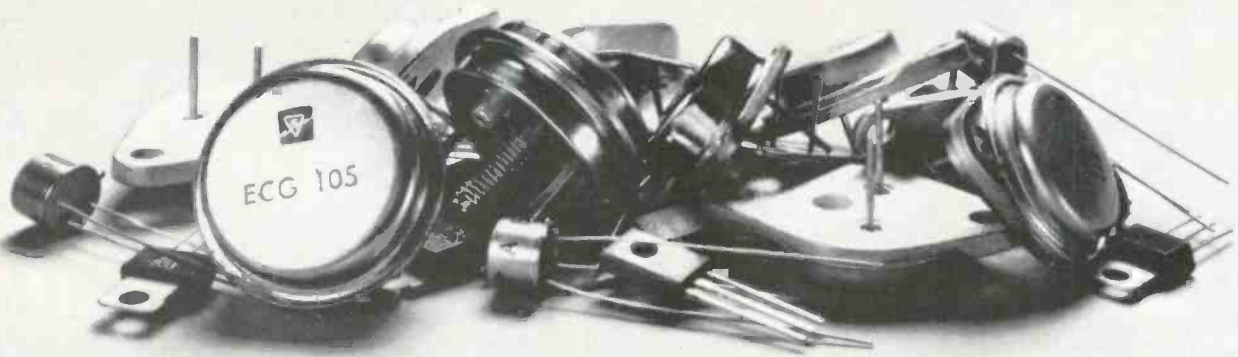

## Our 39 audio power transistors replace...

To Be Replaced	ECG Replacement	To Be Replaced	ECG Replacement
AD138	121	QP 1A	179
AD138/50	121	QP 2	179
AD139	104	QP 3	179
AD140	121	QP 4	179
AD142	179	QP 5	179
AD143	179	QP 6	179
AD143B	179	QP-7	179
AD148	131	QP 8	130
AD149	104	QP 8-1	130
AD149-01	121	QP 8-P	130
AD149-02	121	QP-10	179
AD149B	121	QP-11	130
AD150	121	QP-12	130
AD152	131	QP-13	185
AD155	131	QP-14	184
AD156	131	QP8-6623N	105
AD157	131	QP-13	153
AD159	121	QP-14	152
AD160	175	QOC61209	158
AD161	155	QOC61210	102A

# and thousands more.

There are a lot of identical transistors around hiding under different manufacturers' part numbers.

But we've boiled power transistors down to just 39 types that will handle almost all of your replacement problems.

And we've also put together a cross-reference guide that tells you which one replaces which.

Our cross-reference guide also tells you about the rest of our ECG replacement semiconductor line. Altogether they can substitute for 53,000 others.

Practically everything from diodes to integrated circuits.

And we don't stop there.

The ECG semiconductor line includes a variety of heat sinks, heat-sink compounds, transistor mounting kits, and sockets.

In short, carrying Sylvania's ECG replacement semiconductor line can take a big load off your back.

And you can still give power to the people.

*Sylvania Electronic Components, Waltham, Mass. 02154.*

**GTE SYLVANIA**

# Get less for your money!

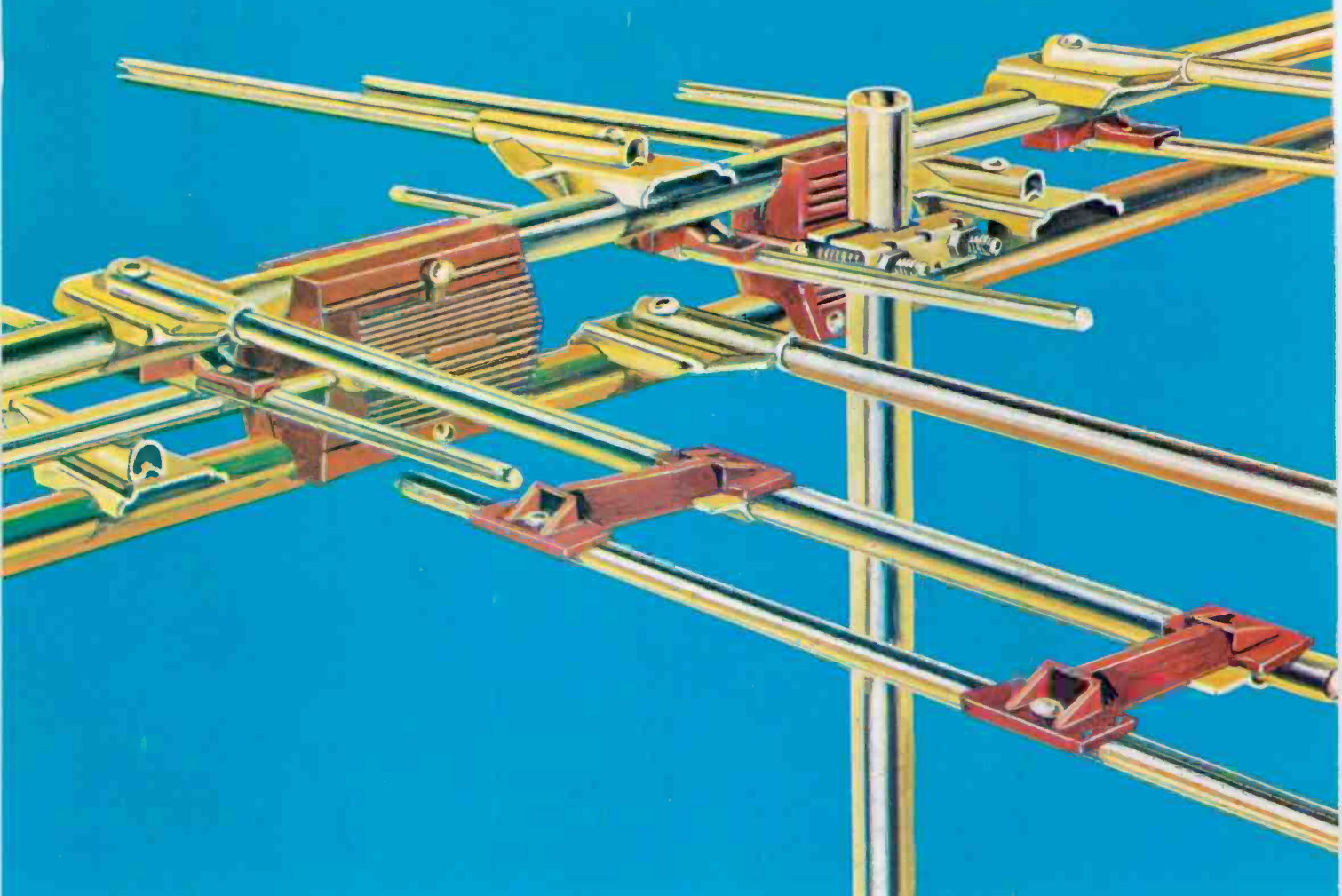

## ...less ghosting ...less herringbone ...less snow

The radical new Channel Master Quantum Antennas give you less of today's major TV reception problem--interference. It's the most highly directive broadband antenna series the industry has ever seen. Front-to-back ratios are up to 50% better than the nearest competitor.

That means a lot less problems with FM, co-channel, adjacent channel, power line...or any other electrical interference.

And that's not all. The Quantum is loaded with features that can't be matched. Like a weather-

proof terminal housing--a tunable UHF section that gives you the highest UHF gain you can get in a UHF/VHF antenna. Plus construction so rugged that it survived hurricane force wind-tunnel testing at the University of Maryland.

So if your customers want better color TV reception--check the new Quantum. It's the antenna that solves the problems ordinary antennas only magnify.

WEATHER PROOF  
TERMINAL HOUSING



... for more details circle 105 on Reader Service Card



## **CHANNEL MASTER** **QUANTUM**

BROADBAND ANTENNAS for  
VHF/FM and UHF/VHF/FM

**CHANNEL MASTER** Division of Avnet Inc.,

Ellenville, N.Y. 12428