

ELECTRONIC TECHNICIAN / DEALER

WORLD'S LARGEST TV-RADIO SERVICE & SALES CIRCULATION

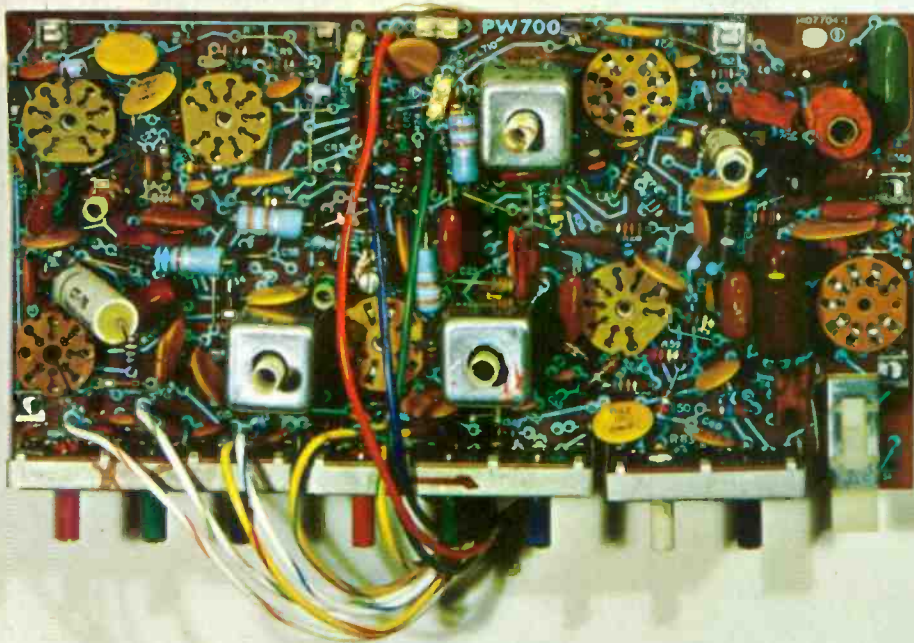

FRISEW33474652M8/2BU3AI 869B
WILLIAM W FRISE
7176 GALE RD
ATLAS MI
XX
48411

TEKLAB REPORT ON CRAIG 6304
CURVE TRACER TROUBLESHOOTING
STEREO SERVICING PART TWO

The first and only solid-state test equipment guaranteed for 5 years.

Now EICO, because of its emphasis on reliability in engineering and manufacture, offers the industry this breakthrough.

EICO's new line of solid-state test equipment comes with an unprecedented 5-year guarantee of performance and workmanship. (Send

for full details of this EICO 5-year GUARANTEE on factory-assembled instruments.)

Additional advanced features include: new functional design, new color-coordinated esthetics, new PC construction, new easier-to-build kit designs.

New EICO Solid-State Test Equipment



EICO 240 Solid-State FET-VOM \$59.95 kit, \$79.95 wired.

One all-purpose DC/AC OHMS Uniprobe®. Reads 0.01V to 1 KV (to 30 KV with optional HVP probe). 7 non-skip ranges, in 10 dB steps. AC or battery operated. RMS & DCV: 0-1, 3, 10, 30, 100, 300, 1000V P-P ACV: 0-2.8, 8.5, 28, 85, 280, 850, 2800V. Input Z: DC, 11 M Ω ; AC, 1 M Ω . Response 25 Hz to 2 MHz (to 250 MHz with optional RF probe). Ohmmeter reads 0.2 to 1 M Ω in 7 ranges. 4 1/2" 200 μ A movement. HWD: 8 1/2", 5 3/4", 5", 6 lbs.

EICO 242 Solid-State FET-TVOM \$69.95 kit, \$94.50 wired.

All the versatility of the EICO 240 plus: AC/DC Milliammeter, 1 ma to 1000 ma in 7 non-skip ranges; single all-purpose DC/AC-Ohms — MA Uniprobe®, and large 6 1/2" 200 μ A meter movement.

EICO 150 Solid-State Signal Tracer \$49.95 kit, \$69.95 wired.

Multi-purpose troubleshooter for TV/FM/AM & Audio Equipment. Independent RF Audio inputs. Speaker and meter output indicators. 400 mW continuous power output. Substitution amplifier, output transformer, speaker. Input for rated output: 1 mV RF, 63 mV audio.

Hum 60 dB below 400 mW, 105-132 VAC, 50/60 Hz, 5VA. HWD: 7 1/2", 8 1/2", 5", 6 lbs.

EICO 330 Solid-State RF Signal Generator. \$59.95 kit, \$84.50 wired.

5 fundamental bands 100 kHz to 54 MHz. Vernier control 0-100%. Output 300,000 μ V into 50-Ohm load. External signal modulation or internal 400 Hz, 0 to 100%. 105-132 VAC, 50/60 Hz, 1.7 VA. HWD: 7 1/2", 8 1/2", 5", 5 lbs.

EICO 379 Solid-State Sine/Square Wave Generator. \$69.95 kit, \$94.50 wired.

5 sine wave and 4 square wave bands. Low distortion Sultzer feedback FET circuit. Sine: 20 Hz to 2 MHz; 0-7.5V rms into hi-Z, 0-6.5V into 600 ohms Max. distortion 0.25%. Square: 20 Hz to 200 kHz; 0-10V p-p into hi-Z, pos. direction, zero ground. Rise time at 20 kHz less than 0.1 μ sec. 105-132 VAC, 50/60 Hz, 10VA. HWD: 7 1/2", 8 1/2", 8 1/2", 9 lbs.

New EICO High Performance Instruments



EICO 385 — Solid-State Portable Color Generator \$79.95 Kit, \$109.95 Wired.
 EICO 465 — Wideband Vectorscope/Oscilloscope \$179.95 Kit, \$249.95 Wired.
 EICO 1025 — Solid-State Power Supply \$34.95 Kit, \$49.95 Wired.
 EICO 443 — Semiconductor Curve Tracer \$79.95 Kit, \$119.95 Wired.
 EICO 633 — CRT Tester & Rejuvenator \$79.95 Kit, \$119.95 Wired.
 EICO 635 — Portable Tube Tester \$44.95 Kit, \$69.95 Wired.

New EICO Probes for the Pros

Hi-Voltage Probe HVP-5, Wired \$19.95.

Convenient built-in voltmeter. Barrier sections isolate HV tip from handle and meter. Measures up to 30 KV. Lightweight, compact.

Solid-State Signal Injector Probe PSI-1, Kit \$5.95, Wired \$9.95.

Pen-size, 1-ounce, self-powered signal generator. Frequency range from 1kHz to 30MHz, with harmonics. Clip it to your pocket — ideal for signal tracing in the field.

Solid-State Signal Tracer Probe PST-2, Kit \$19.95, Wired \$29.95.

Flashlight-size, 2.2oz, self-powered. Hi-gain amplifier, 50Hz to 200MHz with demod tip. Input Z: 3500 Ω , 35K Ω , 350K Ω ; Output: 0.3 p-p volts. Noise —45dB. Distortion <5%. Complete with earphone, all probe tips, AA battery, pocket clip.



SEND FREE 1970 CATALOG

Name _____
 Address _____
 City _____ State _____ Zip _____



EICO Electronic Instrument Co., Inc.
 283 Malta Street, Brooklyn, N.Y. 11207
 EICO Canada Ltd.
 20 Millwick Drive, Weston, Ontario

... for more details circle 112 on Reader Service Card

TEKFAX

COMPLETE MANUFACTURER'S CIRCUIT DIAGRAMS
AND TECHNICAL INFORMATION FOR 6 NEW SETS

GROUP
212

	SCHEMATIC NO.	SCHEMATIC NO.
ADMIRAL.....	1291	EMERSON.....1290
TV Chassis TG2-2		Color TV Chassis 120921,923
AIRLINE.....	1292	EMERSON.....1288
TV Model GEN-11960A		TV Chassis 120969,970
ELECTROHOME.....	1289	PHILCO-FORD.....1293
Color TV Chassis C-8		TV Chassis 20S32/A

SYMBOL	DESCRIPTION	EMERSON PART NO.
R29	— volume/on-off ch 120969	391080
R29	— volume ch 120970	391079
R29	— volume/on-off ch 120959	390814
R30	— contrast ch 120969,970	391048
R30	— contrast ch 120959	391002
R32	— bright ch 120969,970	391046
R32	— bright ch 120959	391001
R37A,B,C	— vert lin vert size AGC	391082
R80	— vert hold ch 120969,970	391047
R80	— vert hold ch 120959	391000
C2	— 22pf NPO	928824X
C12	— 22pf NPO	928824X
C14	— 5.6pf NPO	928817X
C17	— 4.7pf NPO	928816X
C20	— 6.8pf NPO	928818X
C56A,B,C,D	— 250-250-100-50/160v	925714
T1	— sound interstage	720513
T2	— audio output part of speaker	720454
T3	— 1st IF	720455
T4	— 2nd IF	720512
T5	— sound take-off	738210
T6	— horiz output	738193
T7	— vert output	720404
L4	— self sound trap 41.25MHz	720453
S12	— horiz osc	716165
L14	— def yoke	708532A
L16,17	— filament choke	705031
N1	— couplate, sync separator	923059
N2	— couplate, vert integrator	923159
F1	— fuse, 1.2a	808236

NOTE: The partial schematic shown below is to be used with models using 19GJP4 or 19FJP4 CRTs. In addition to differences in CRT circuit, note that the center tap of the vertical deflection coils is grounded.

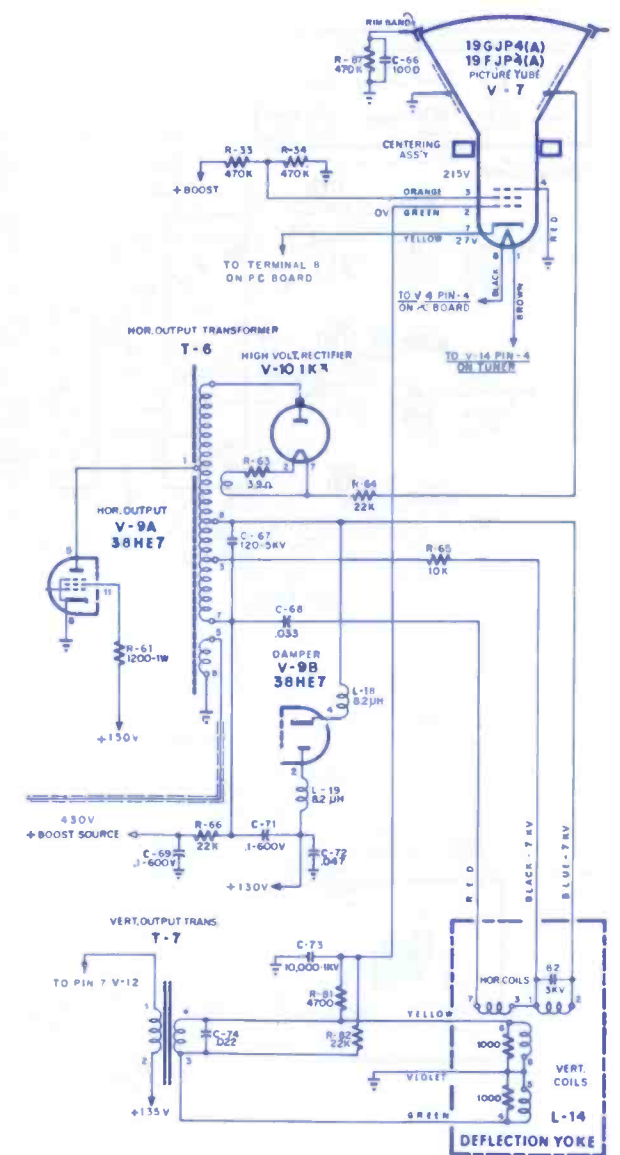
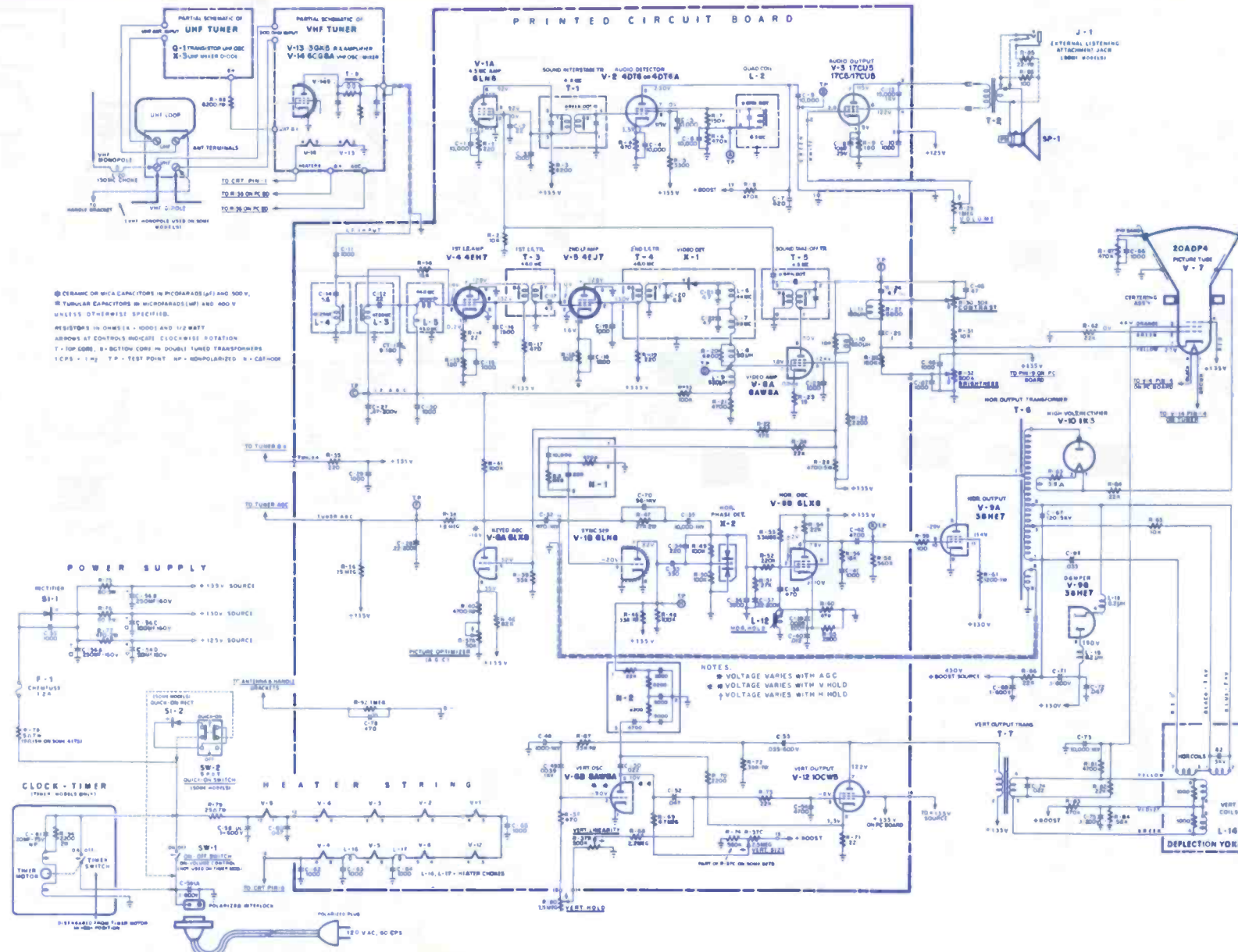

TABLE OF PIN CONNECTIONS

- 0 - 12V
- GROUND
- 0 - 30V
- 0 - 12V
- RELAY
- RELAY LINE
- LOW VHF BANDSWITCH
- HIGH VHF BANDSWITCH
- TUNING VOLTAGE
- AFT LINE
- REGULATOR CONTROL
- TRAP LINE
- COLOR LINE
- VOLUME LINE

PI CONNECTS CONTROL UNIT TO MAIN CHASSIS

BOTTOM VIEW OF SOLID STATE DEVICES

- TI-7A
- BF 173
- MPS5514
- SE5050
- BC169C
- TI591
- S24615
- S1891
- SE5056

VARACTOR P.C. BOARD

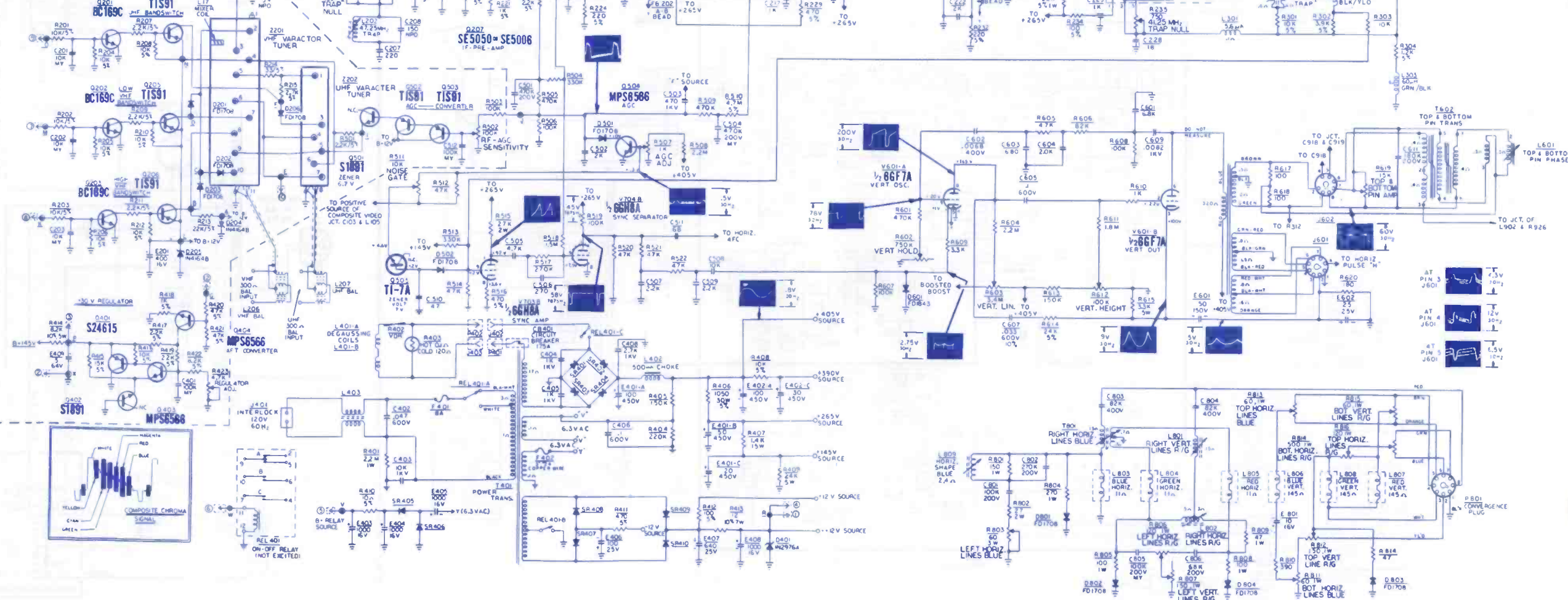

COMPLETE MANUFACTURERS' CIRCUIT DIAGRAMS AND TECHNICAL INFORMATION FOR 6 NEW SETS

SYMBOL	DESCRIPTION	ADMIRAL PART NO.		
R111	10K, 1w	60B14-103	C430	5pf, 10%, 1kv, N750, cer disc
R208	1M, val cont w/sw	75C120-1	C504A	150uf, 165v, elect
R320	30K, contrast cont	75C121-3	C504B	150uf, 150v, elect
R322	100K, bright cont	75C121-2	C504C	200uf, 150v, elect
R402A	vert lin cont, dual	75C95-6	L202	quad coil
R402B	height cont, dual	75C95-6	L401	horiz lock coil
R421	1M, therm	60A64-1	T201	audio output xfmr
R422	1.2M, vert hold cont	75C121-1	T303	sound takeoff xfmr
R502	5.5Ω, fuse type	61C48-1	T401	vert output xfmr
C135	39pf, 5%, NPO, cer disc	65D10-347	T402	def yoke ass'y
C327	6.8pf, 1/4%, 500v, NPO, cer disc	65D10-102	T403	horiz output xfmr
C406	330pf, 10%, 5kv, cer disc	65D10-266	CR401	horiz phase det tuner UHF
				tuner VHF

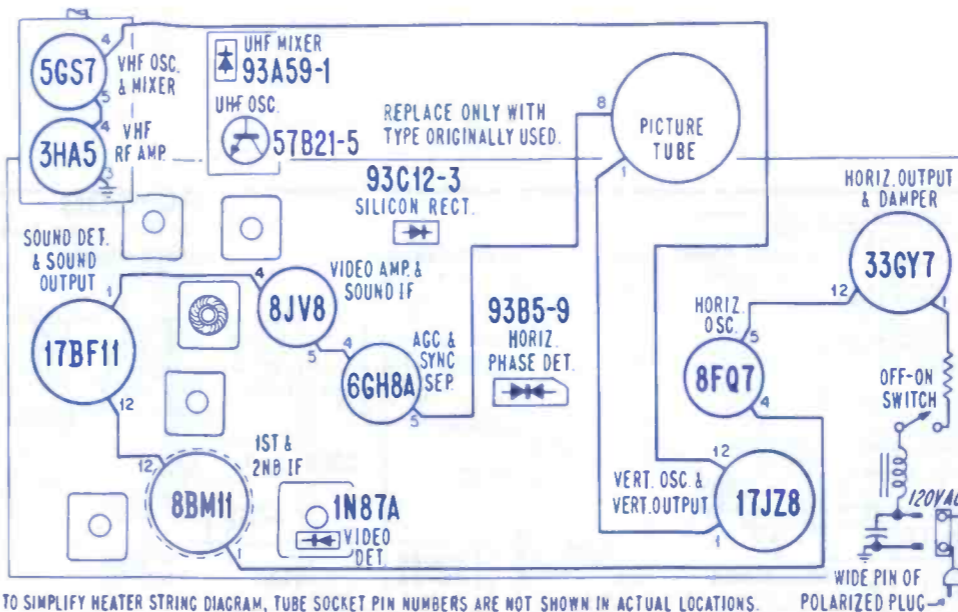

TO SIMPLIFY HEATER STRING DIAGRAM, TUBE SOCKET PIN NUMBERS ARE NOT SHOWN IN ACTUAL LOCATIONS.

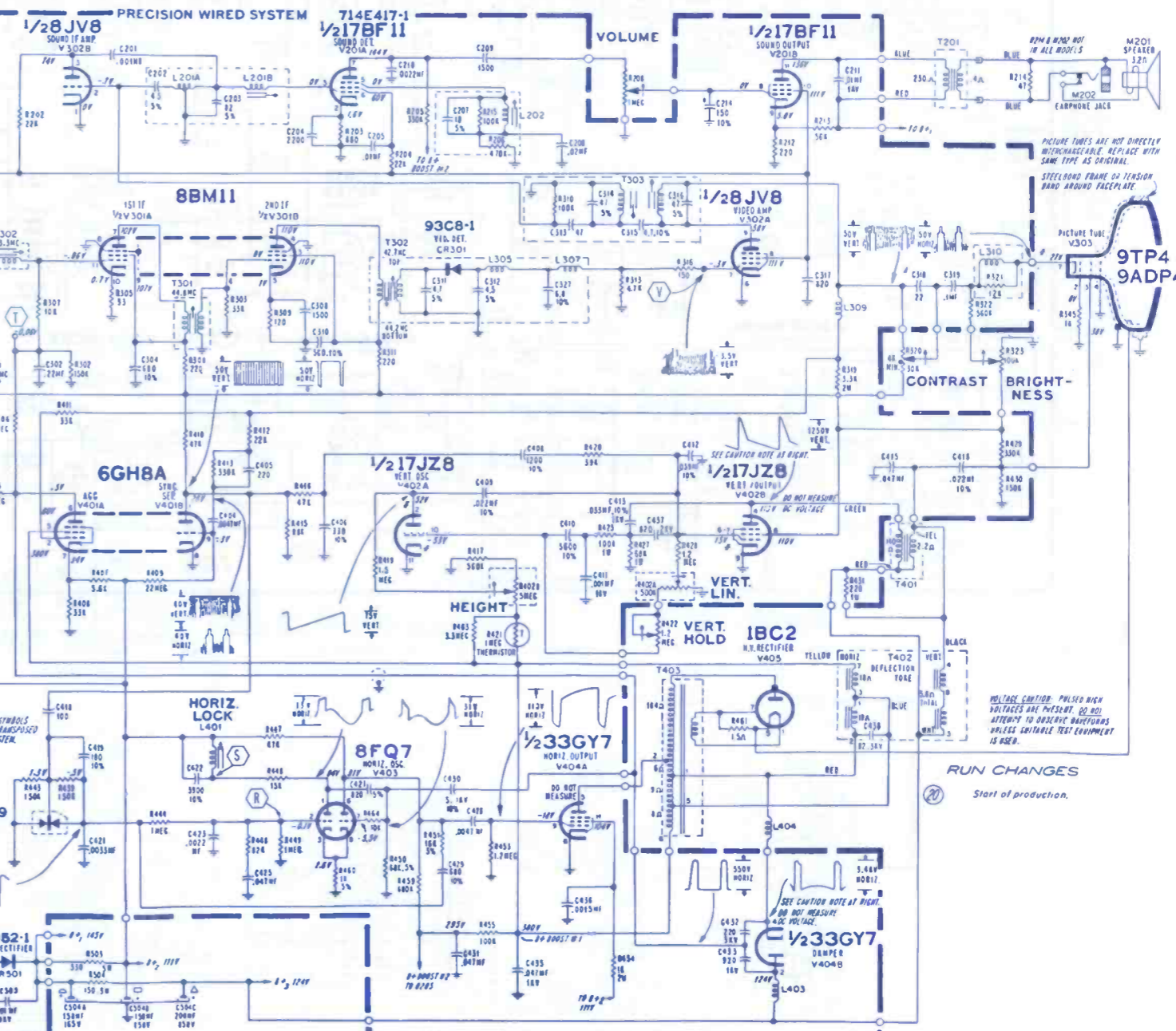
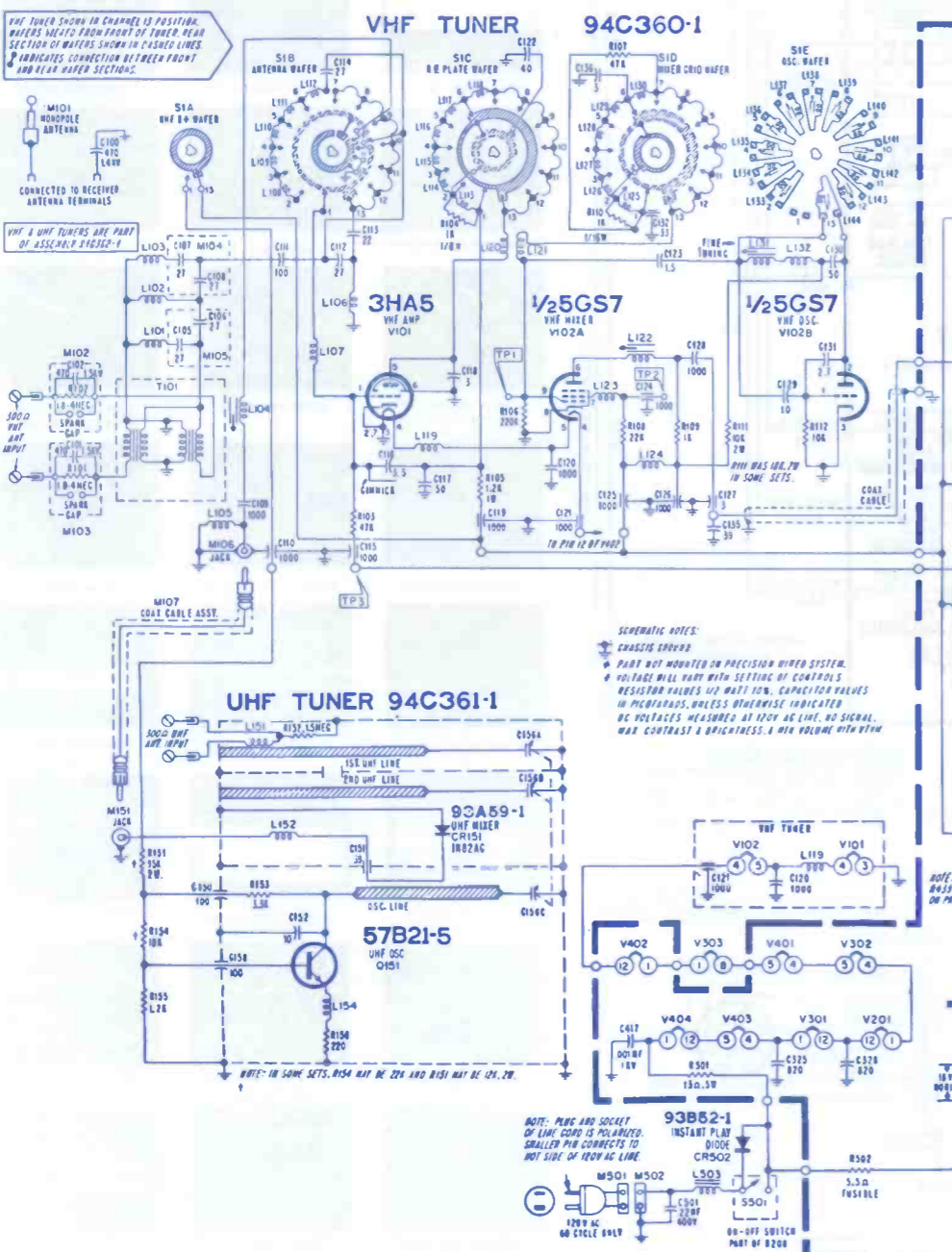

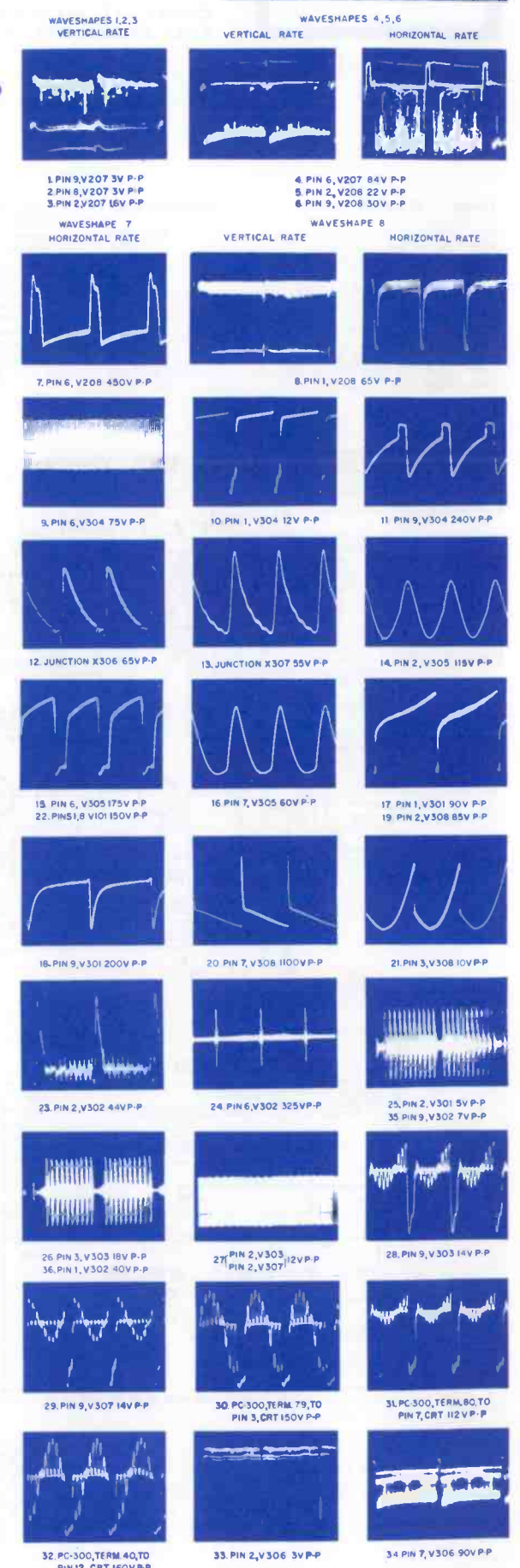
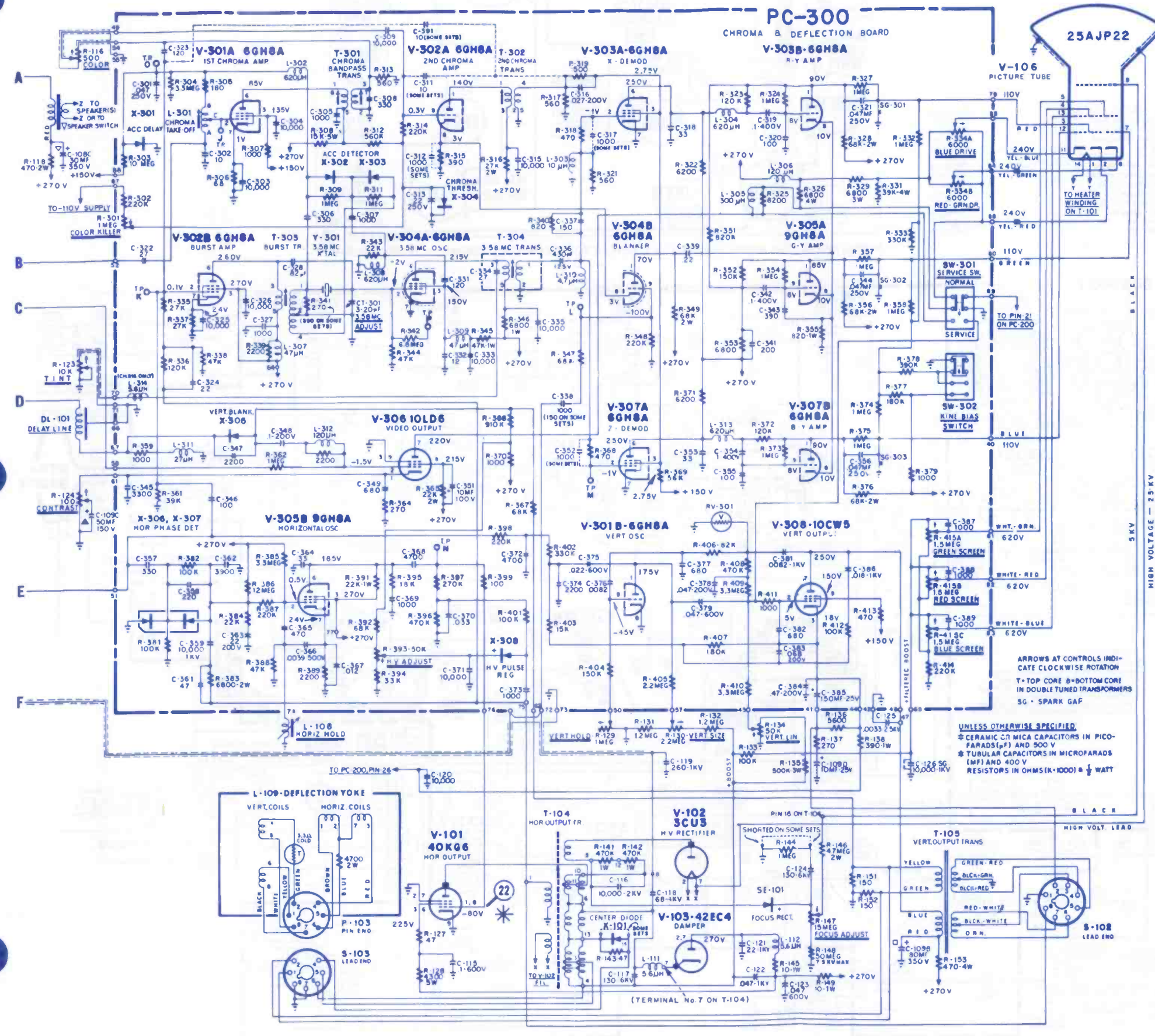

APRIL • 1970

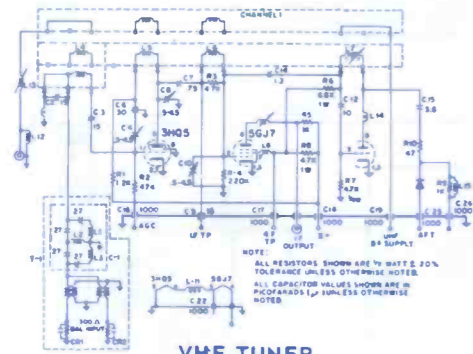

VHF TUNER

SYMBOL	DESCRIPTION	EMERSON PART NO.
R107	resistor WW 3.5K ±10% tol 18w	394302
R109	resistor WW 97K ±10% tol 15w	397215
R116	color control 500 (ch 120920 and 921)	391026
R117	volume control 1M (ch 120920,921)	391028
R121	bright control 250K	391033
R123	line control 10K (ch 120921,923)	391024
R124	contrast cont 100K	391032
R129	vert hold control 1M	391034
R130	vert size control 2.2M	390951
R134	vert line control 50K	390952
R147	focus adjust control 50K	390950
R148	resistor WW 50M ±10% tol 75.kv	397208
R212	adj sound rej control 15K	390954
R224	self sound rej control 750Ω	390883
R247	AGC control 100K	390953
R301	color killer control 1M	390949
R393	high voltage adjust control 50K	Part R301
R415A	green screen control 1.5M	390879
R415B	red screen control 1.5M	390879
R415C	blu screen control 1.5M	390879
RV101	voltage dep resistor	387186
RV102	therm	397187
RV301	varistor	397233
SE101	selenium rectifier focus	817123
X101	diode horiz centering	817120
X302,303	diode ACC det	817177
X304	diode chroma threshold	817172
X306	diode high voltage pulse regulator	817172
Y301	crystal 3.58MHz osc	817175
DL101	delay line	709010
C108A	cap elect 250µf @350v	925707
C108B	cap elect 50µf @350v	925707
C108C	cap elect 30µf @350v	925707
C109A	cap elect 250µf @350v ch 120921,923	925708
C109B	cap elect 80µf @350v ch 120921,923	925708
C109C	cap elect 50µf @50v ch 120921,923	925708
C109D	cap elect 10µf @25v ch 120921,923	925708
C214	cap cer 140µf ±5% tol NPO	929218X
C256	cap cer 47µf ±5% tol NPO	928811X
C302	cap cer 10µf ±10%, tol NPO	928820X
C322	cap cer 27µf ±5% tol 500v NPO	928809X
C324	cap cer 22µf ±10% tol 500v NPO	928824X
C332	cap cer 12µf ±10% tol NPO	928805X
C346	cap cer 100µf ±10% tol NPO	928829X
IC201	int cir AFT chroma board ass'y comp ch 120921,923	815215
T101	x-former filament	730152
T102	x-former audio output	734248
T104	x-former horiz output	738229
T105	x-former vert output	738218
T201	x-former sound take OFF	720558
T202	x-former sound IF	720471
T203	x-former det	720472
T208A	x-former AFT disc primary	720577
T301	x-former chroma band pass	720563
T302	x-former chroma output	720575
T303	x-former burst	720580
T304	x-former 3.58MHz osc	720583
L105	filter choke power supply	737059
L108	def yoke ass'y	708516
L201	choke coil 1.8µh	705049
L203	coil 47.25MHz trap	708427
L207	coil 4.5MHz trap	708432
L210	choke coil 1.8µh	705049
L216	coil AFT take off	720576
L301	chroma take off coil	708438
L304	peaking coil 620µh	708430
L305	peaking coil 300µh	708531
L309	peaking coil 47µh	708521
CB101	cir brkr	808022

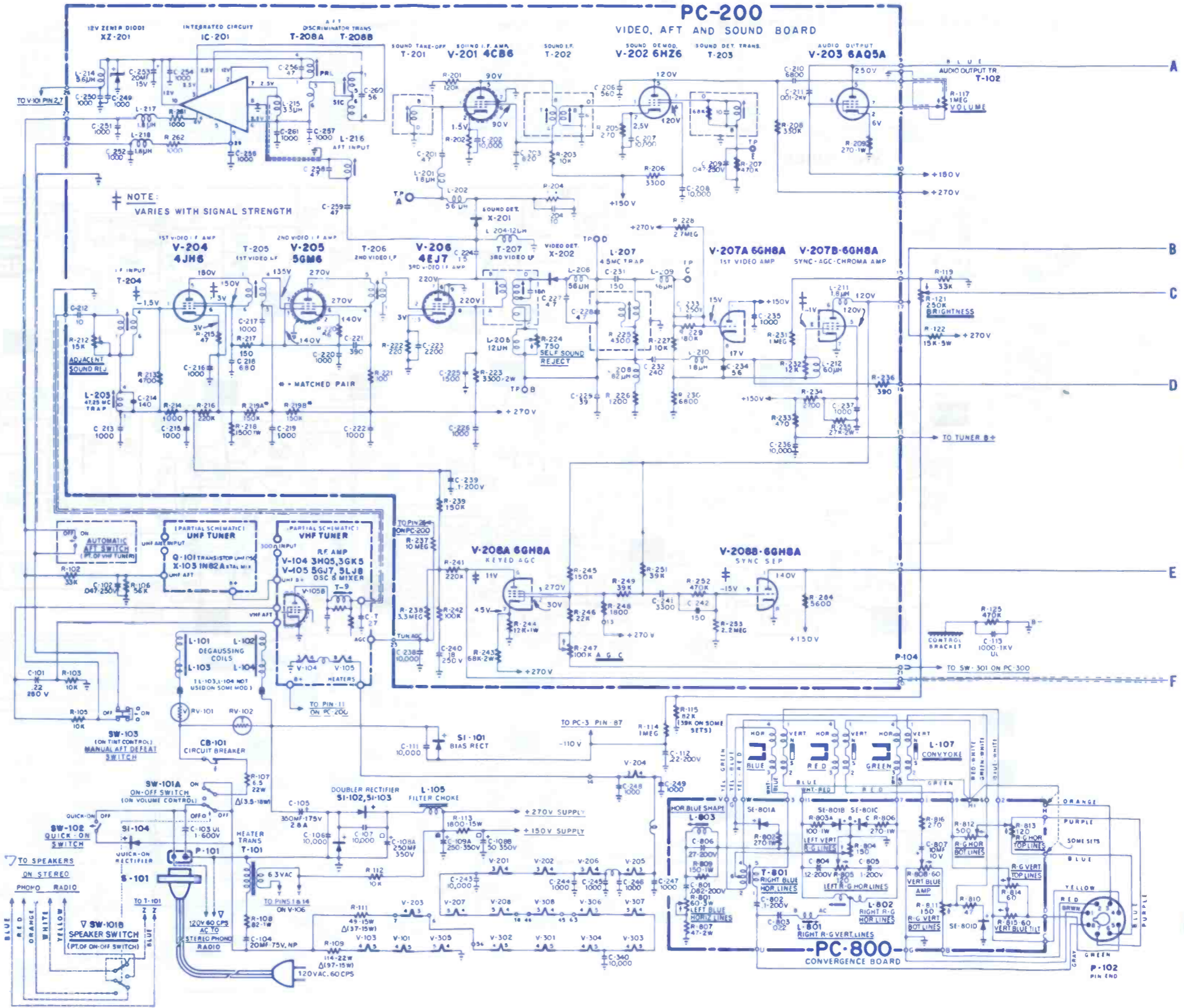

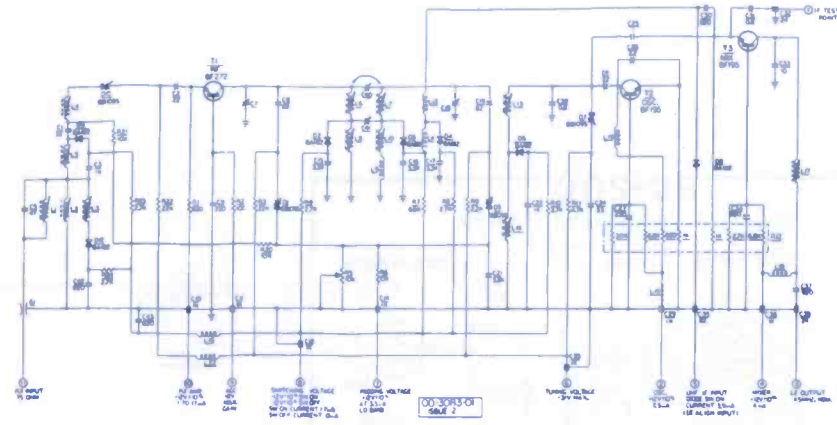

VHF TUNER

SYMBOL	DESCRIPTION	ELECTROHOME PART NO.
T703	coil burst gate	21-1053-02
L901	coil horiz stabilizing	21-334-05
L104	coil sound quad	21-1084-01
L103	coil sound take off	21-347-02
T101	coil sound IF xformer	21-389-01
T202	coil 1st IF interst xformer	21-392-02
L902	coil saturable react (lin)	21-1055-01
DL301	coil delay line (.8µ sec 680K)	21-1054-01
L253	coil discriminator	21-1040-01
T901	horiz output xformer	21-220-01
L910	def yoke	21-113-02

T401	power xformer 60Hz w/stabilizer brkt	24-10140-01
T601	vert output xformer	24-10016-01
T102	audio output xformer	24-80080-02
L402	filter choke 500µH	24-110024-10
CB401	car brkt 1.75a	26-65-09
F401	fuse 8A quick acting (use w/sleeve)	27-14-08
SR901	boost rectifier selected	28-22-22
R813	control WW 1w 60Ω (top horiz lin blu)	41-228-23
R807	cont WW 1w 150Ω (left vert lin R/G)	41-228-25
R216	contr 22K PH (adj sound rej)	41-192-06
R235	contr 750Ω (sound rej)	41-227-09
R913	contr 100K PH (horiz drive)	41-192-08
R329	contr 7M (red screen)	41-227-28
R603	contr 3.4M (vert lin)	41-227-31

R920	contr 2.5M (HV odi)	41-227-37
R909	contr 200K (horiz hold)	41-227-34
R705	contr 2.5M (color killer)	41-227-37
R930	contr 15M (focus)	41-251-01
R406	resistor 30w WW 1050Ω (w/brkt)	42-14-13
R929	focus div resistor 140µΩ ±10% 160M (28M top)	02-100651-01
R914	VDR red dot	42-23-01
E401A	electrol 100µf 450v	44-203-15
E401B	electrol 50µf 450v	44-203-15
E401C	electrol 20µf 450v	44-203-15
E402A	electrol 100µf 450v	44-202-26
E402B	electrol 30µf 450v	44-202-26

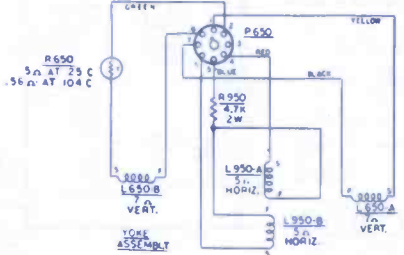
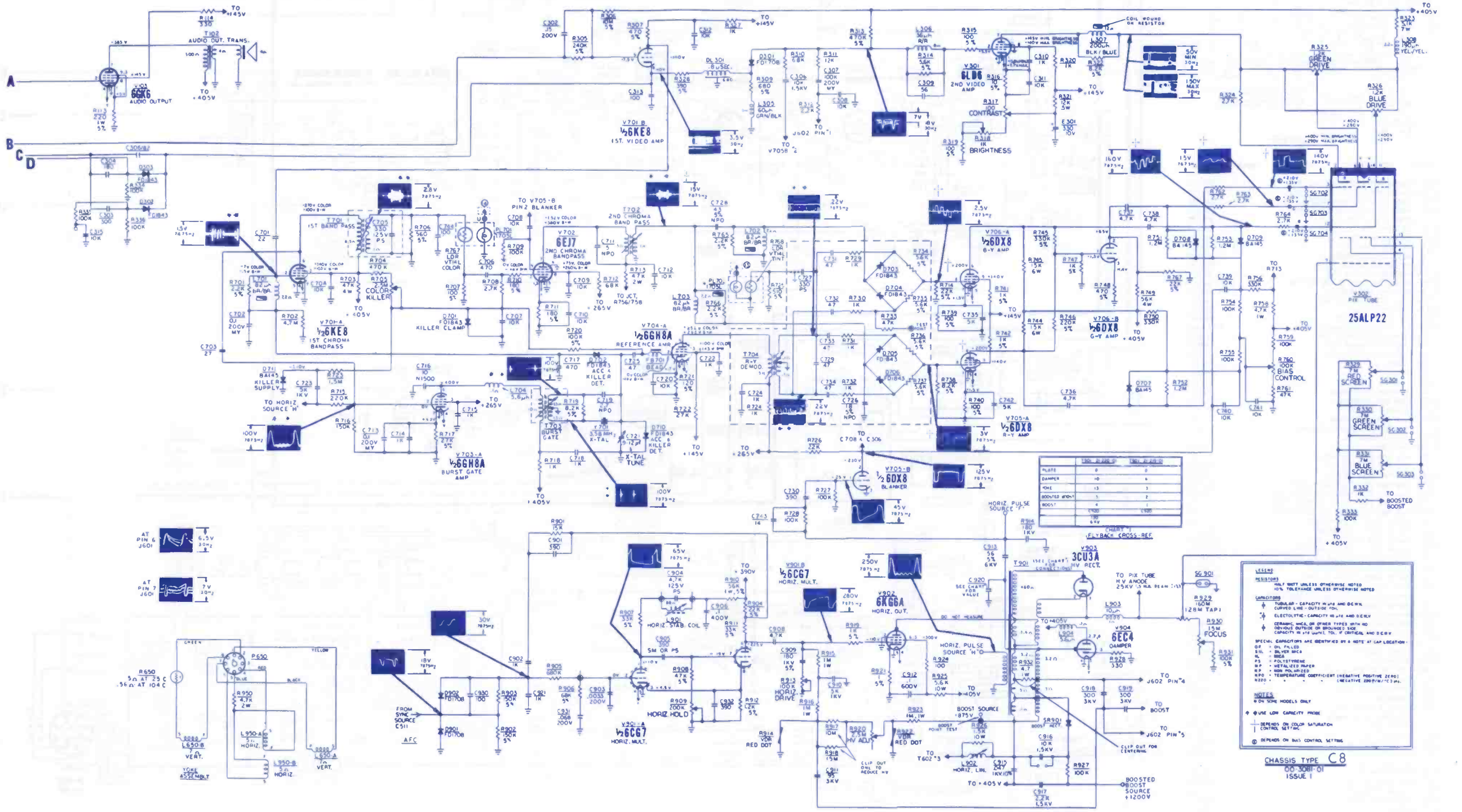

PLATE	0	1	2	3	4	5	6
DAMPER	10	3					
FOLE	13	3					
BOUNDED SH-1	5	2					
BOOST	4	1					
BY	4	1					
BY	4	1					

LEGEND
RESISTORS: ONLY NOT UNLESS OTHERWISE NOTED
% = TOLERANCE UNLESS OTHERWISE NOTED
CAPACITORS:
+ TUBULAR - CAPACITY IN µF AND DC VOLTS
- FILLED - CAPACITY IN µF AND DC VOLTS
ELECTROLYTIC CAPACITY IN µF AND DC VOLTS
CERAMIC, MIC, OR OTHER TYPES WITH NO SPECIFIC OUTLINE OR DIMENSIONS SHOWN CAPACITY IN µF, VOLTS, TOL., IF CRITICAL AND DC VOLTS
SPECIAL CAPACITORS ARE IDENTIFIED BY A NOTE AT CAP LOCATION:
DR - OIL FILLED
SL - SILVER MICRA
M - MICA
P - POLYSTYRENE
PP - METALLIZED PAPER
HP - HIGH POLARIZED
RPO - TEMPERATURE COEFFICIENT (NEGATIVE POSITIVE ZERO) 100PPM
NOTES:
ON SOME MODELS ONLY
USE LOW CAPACITY PROBE
DEPENDS ON COLOR SATURATION CONTROL SETTING
DEPENDS ON BIAS CONTROL SETTING

CHASSIS TYPE **C8**
00 3081-01
ISSUE 1

SYMBOL	DESCRIPTION	PHILCO-FORD PART NO.
C48	240/240/160/5μf @200v B+ filter	30-2601-33
L1	180μh, plate series	32-4762-7
L2	330μh, plate shunt	32-4762-20
L7	quad snd det	32-4876-1
L8	4.5MHz trap & STO	32-4688-13
L12	horiz slab	32-4754-3
N3	vert int	30-6030-12
N4	horiz osc	30-6057-1
N5	phase comp	30-6035-2
N6	isolation, CRT	30-6058-2

R5	15K, contrast	33-1373-6
R14	5.6M AGC delay	33-1381-5
R23	560K, AGC	33-1381-5
R27A	680K, vert bias	32-10113-2
R40	varistor, 560v @10μs	32-10113-2
R63	fusistor	32-10113-2
T1	audio output	32-10113-2
T2	B+ filter choke	32-10113-2
T3	horiz output	32-10113-2
T4	vert output	32-10113-2
VR1A-C	50K vert size, 2M vert lin, 60K horiz aux	33-5595-8

VR3	3K width	33-5620-1
VR4	15K, contrast	33-5623-13
VR5	100K, bright	33-5623-15
VR6	40K horiz hold	33-5623-14
VR7	150K vert hold	33-5623-14
VR8	1M, volume (20S32A)	33-5634-9
PW	panel ass'y w/comp	38-10543
VIF	det panel-less comp	27-10561-4
VIF	panel-less comp	27-10561-9
tuner UHF	TT152	76-13827-1
tuner VHF	TT215 (20S32A)	76-14150-1
yoke & cable ass'y		76-14170-1

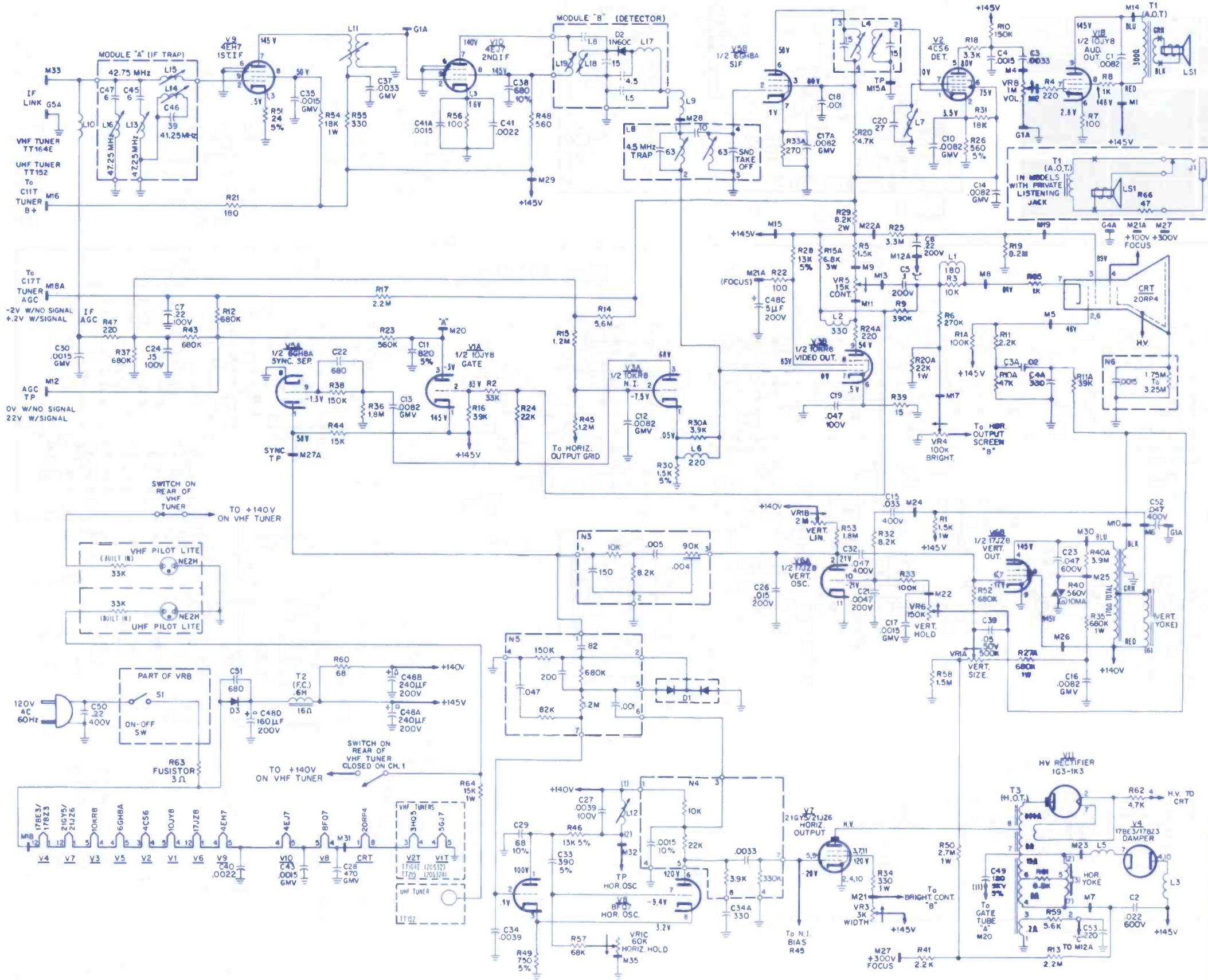

ELECTRONIC TECHNICIAN/DEALER is published monthly by Harbrace Publications, Inc., Harbrace Building, Duluth, Minnesota 55802, a subsidiary of Harcourt, Brace & World, Inc. Subscription rates: One year \$5, two years \$8, three years \$10, in the United States and Canada. Other countries: One year \$9, two years \$14, three years \$18. Single copies 60¢. Second class postage paid at Danville, New York and at additional mailing offices. Copyright 1970 by Harbrace Publications, Inc. POSTMASTER: Send Form 3579 to ELECTRONIC TECHNICIAN/DEALER, Harbrace Building, Duluth, Minnesota 55802.

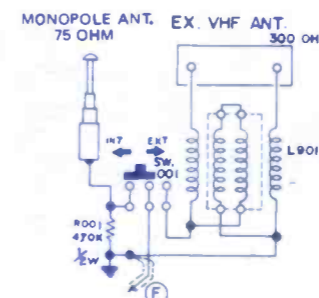
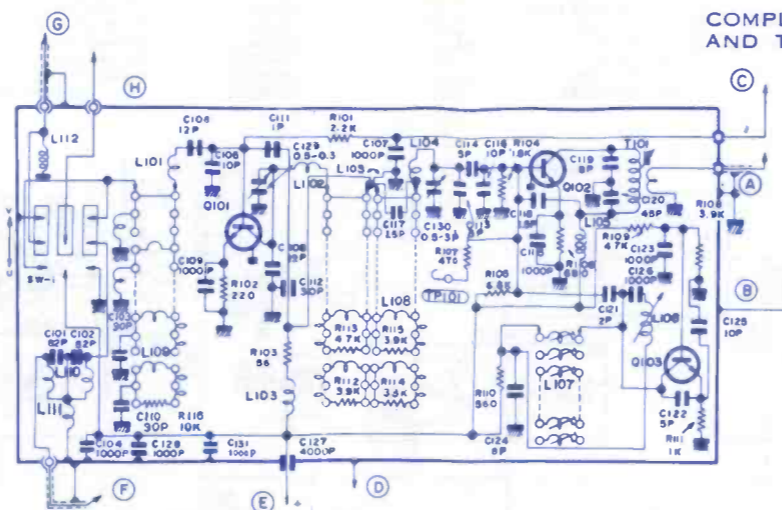
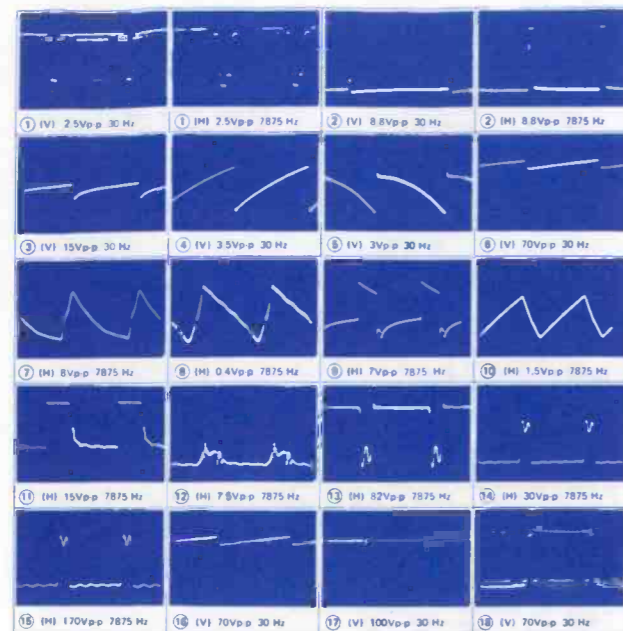

SYMBOL	DESCRIPTION	ADMIRAL PART NO.
R111	10K, 1w	60B14-103
R208	1M, vol cont w/sw	75C120-1
R320	30K, contrast cont	75C121-3
R322	100K, bright cont	75C121-2
R402A	vert lin cont, dual	75C95-6
R402B	height cont, dual	75C95-6
R421	1M, therm	60A64-1
R422	1.2M, vert hold cont	75C121-1
R502	5.5Ω, fuse type	61C48-1
C135	39pf, 5%, NPO, cer disc	65D10-347
C327	6.8pf, 1/4%, 500v, NPO, cer disc	65D10-102
C406	330pf, 10%, 5kv, cer disc	65D10-266
C430	3pf, 10%, 1kv, N750, cer disc	65D10-345
C504A	150μf, 165v, elect	67D15-393
C504B	150μf, 150v, elect	67D15-393
C504C	200μf, 150v, elect	67D15-393
L202	quad coil	72C132-77
L401	horiz lock coil	94D17-17
T201	audio output xformer	79C81-23
T303	sound takeoff xformer	72C185-5
T401	vert output xformer	79D100-17
T402	def yoke ass'y	700D1089-2
T403	horiz output xformer	79D117-1
CR401	horiz phase det	93B5-9
	tuner UHF	94E361-1
	tuner VHF	94E360-1

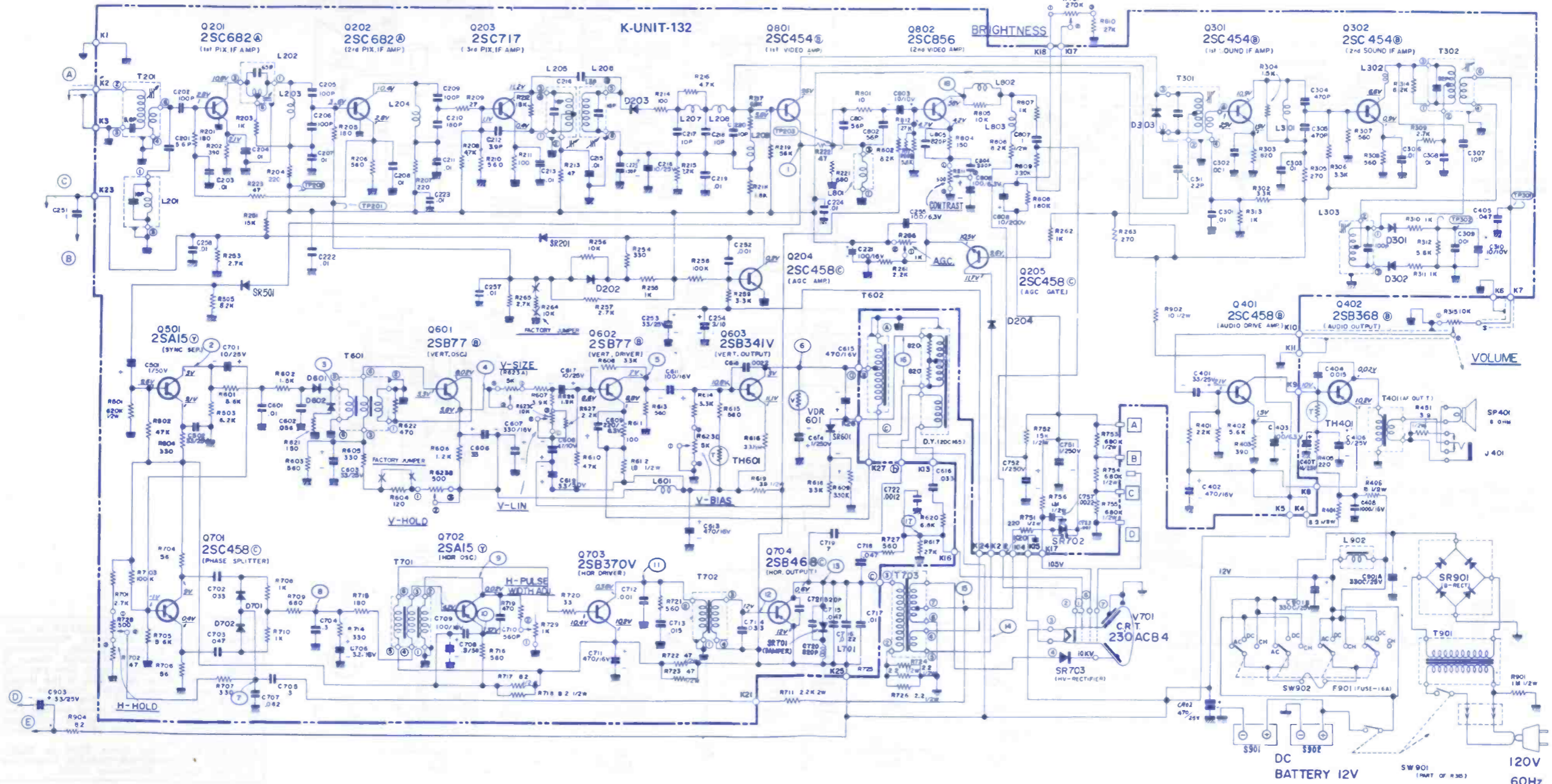

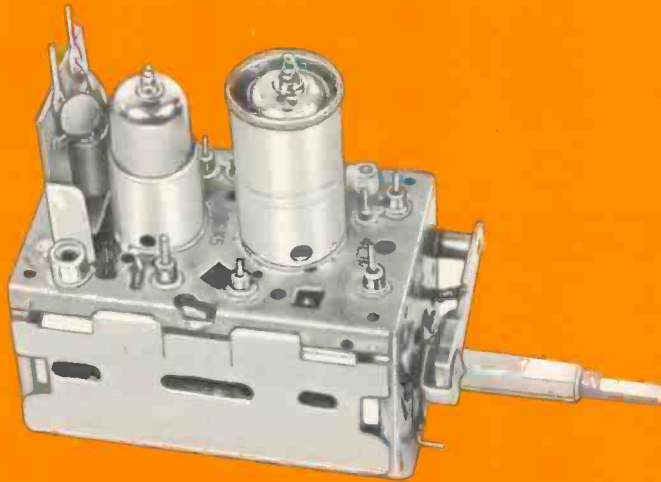

\$975

TUNER SERVICE CORPORATION

PROVIDES YOU WITH A COMPLETE SERVICE FOR ALL YOUR TELEVISION TUNER REQUIREMENTS AT ONE PRICE.

TUNER REPAIR

VHF Or UHF Any Type \$9.75.
UHF/VHF Combo \$15.00.

In this price all parts are included. Tubes, transistors, diodes, and nuvistors are charged at cost.

Fast efficient service at our four conveniently located service centers.

1 year guarantee backed up by the largest tuner manufacturer in the U.S.—SARKES TARZIAN, INC.

All tuners are cleaned inside and out, repaired, realigned and air tested.

TUNER REPLACEMENT

Replacement Tuner \$9.75.

This price buys you a complete new tuner built specifically by SARKES TARZIAN INC. for this purpose.

The price is the same for every type of universal replacement tuner.

Specify heater type

Parallel 6.3V
Series 450 mA
Series 600 mA

All shafts have the same length of 12".

Characteristics are:

Memory Fine Tuning
UHF Plug In
Universal Mounting
Hi-Gain Lo-Noise

If you prefer we'll customize this tuner for you. The price will be \$18.25. Send in original tuner for comparison purposes to our office in INDIANAPOLIS, INDIANA.



TUNER SERVICE CORPORATION

FACTORY-SUPERVISED TUNER SERVICE

MIDWEST	817 N. PENNSYLVANIA ST., Indianapolis, Indiana	TEL: 317-632-3493
EAST	547-49 TONNELE AVE., Jersey City, New Jersey	TEL: 201-792-3730
SOUTH-EAST	938 GORDON ST., S. W., Atlanta, Georgia	TEL: 404-758-2232
WEST	SARKES TARZIAN, Inc. TUNER SERVICE DIVISION 10654 MAGNOLIA BLVD., North Hollywood, California	TEL: 213-769-2720

. . . for more details circle 137 on Reader Service Card

There are now eight new SK devices to broaden replacement coverage in AGC, horizontal deflection, vertical deflection, damper, and audio stages of color TV; and in transmitting stages of CB radio, amateur radio, and communications equipment. Result: RCA *now* offers you a complete system of 47 "Top-of-the-Line" universal semiconductor replacements. Use them with confidence in all entertainment-type electronic equipment.

Every SK device has electrical characteristics comparable with, or superior to, those they replace. And in virtually all cases the recommended SK replacement transistor, rectifier, or integrated circuit can be installed without changes in mechanical mounting arrangements, circuit wiring, or operating conditions.

Get the SK habit. You'll save time, reduce call-backs, and win a reputation for making your customers' sets look and sound like new.

Maybe even better.

For complete information, call your RCA Distributor.

RCA|Electronic Components|Harrison, N.J. 07029

RCA

8 more SK ways to repair and forget

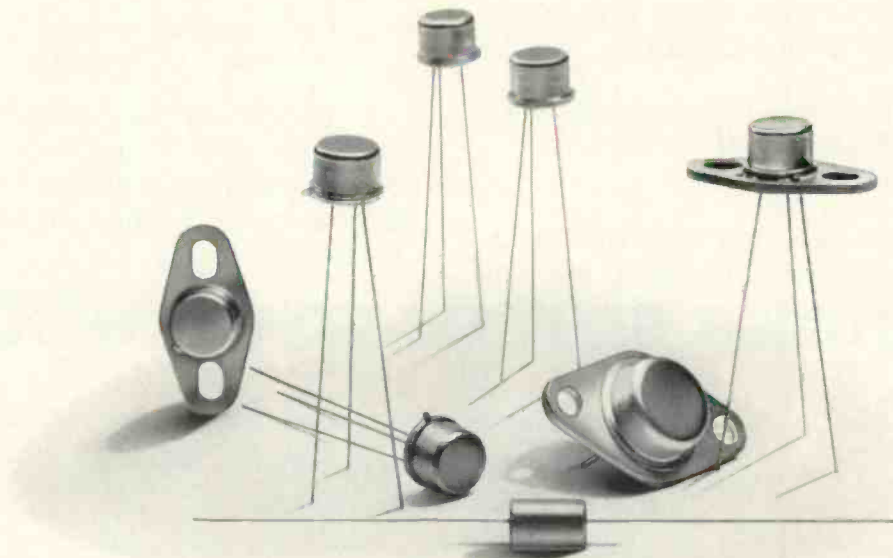

HUGH "SCOTTY" WALLACE
Publisher
Chicago:
(312) 467-0670

PAUL DORWEILER
Editor

JOSEPH ZAUHAR
Technical Editor

KATHIE PONTINEN
Production Editor

BOB ANDRESEN
Graphic Design

LILLIE PEARSON
Circulation Fulfillment

JOHN KESSLER
Manager, Reader Services

BERNICE GEISERT
Advertising Production

OFFICES

757 Third Avenue
New York, N.Y. 10017
Phone: (212) 572-5000
Telex: 01-26286

43 East Ohio St.
Chicago, Ill. 60611
Phone: (312) 467-0670
Telex: 02-53549

1901 West 8th St.
Los Angeles, Calif. 90057
Phone: (213) 483-8530

Harbrace Building
Duluth, Minn. 55802
Phone: (218) 727-8511
Telex: 02-94417

MANAGERS

HUGH "SCOTTY" WALLACE
Chicago: (312) 467-0670

DEAN GREENER
Chicago: (312) 467-0670

ALFRED A. MENEGUS
New York: (212) 572-4829

DONALD D. HOUSTON
Los Angeles: (213) 483-8530

ROBERT UPTON
Tokyo, Japan
I.P.O., Box 5056

**CHARLES S. HARRISON,
CY JOBSON**
San Francisco:
(415) 392-6794

HARBACE PUBLICATIONS, INC.

JOHN B. GELLATLY
President

RICHARD MOELLER
Treasurer

LARS FLADMARK
Senior Vice-President

HARRY RAMALEY
Vice-President

JAMES GHERNA
Art Director

EDWARD CROWELL
Director of Marketing Services

ELECTRONIC TECHNICIAN / DEALER

WORLDS LARGEST ELECTRONIC TRADE CIRCULATION

APRIL 1970 • VOL. 91 NO. 4

37 TEKLAB REPORT

The object of this month's report is the hybrid chassis used in the Craig 115sq.in. (15in. diagonal) color receiver, Model 6304, with a complete circuit analysis and reference diagrams.

41 STEREO SERVICING WITH A SCOPE

By Robert L. Goodman. Part two and the conclusion of this informative feature tells you how to make the most of your service time using scope techniques to troubleshoot and repair solid state stereo amplifiers with many excellent hints geared to increase your proficiency.

45 CURVE TRACER FOR SEMI-CONDUCTOR SUBSTITUTION

By Jud Williams. This timely article explains a procedure using a curve tracer and an oscilloscope to produce the characteristic curves of a semiconductor quickly and easily on the scope face to allow the technician to compare transistors for replacement as well as telling him whether the transistor is operating as it should.

48 FROM SCOPE TO VECTORSCOPE

By Charles W. Janecek. This is a practical featurette describing a method of using an oscilloscope as a vectorscope and some of the advantages associated with this technique.

50 OLD TV SETS REDUCE TAXES

By Leon Rovik. An interesting and timely article which may give you some money-saving tips on ways to get rid of old TV sets that have been gathering dust in your shop.

51 TESTLAB REPORT

Our lab technicians this month dig into the dual trace, triggered D54 Telequipment Oscilloscope and the Eico Model 240 FET-TVM to provide you with some good general information on the characteristics of these units as well as our comments, pro and con, on their operation.

22 EDITOR'S MEMO

26 NEW AND NOTEWORTHY

28 LETTERS TO THE EDITOR

32 TECHNICAL DIGEST

56 COLORFAX

62 DEALER SHOWCASE

70 NEW PRODUCTS

80 NEWS OF THE INDUSTRY

82 CATALOGS AND BULLETINS

84 ADVERTISER'S INDEX

COVER

Our cover photo this month depicts the earlier type circuit boards used in the RCA CTC-31 color TV chassis which is now out-dated by the use of smaller, transistorized circuits in the more modern color chassis now being produced by RCA and other TV manufacturers.

TEKFAX • 16 PAGES OF THE LATEST SCHEMATICS • Group 212

ADMIRAL: TV Chassis TG2-2

AIRLINE: TV Model GEN-11960A

ELECTROHOME: Color TV Chassis C-8

EMERSON: Color TV Chassis 120921,923

EMERSON: TV Chassis 120969,970

PHILCO-FORD: TV Chassis 20S32/A



A HARCOURT, BRACE & WORLD PUBLICATION
Harbrace Publications, Inc.



ELECTRONIC TECHNICIAN/DEALER is published monthly by Electronics Technician, Inc., a subsidiary of Harbrace Publications, Inc. Corporate Offices: 757 Third Avenue, New York, New York 10017. Advertising Offices: 43 East Ohio Street, Chicago, Illinois 60611 and 757 Third Avenue, New York, New York 10017. Editorial, Accounting and Circulation Offices: Harbrace Building, Duluth, Minnesota 55802. Subscription rates: One year \$5, two years \$8, three years \$10, in the United States and Canada. Other countries: one year \$9, two years \$14, three years \$18. Single copies: 75¢ in the U.S. and Canada; all other countries \$2. Second class postage paid at Dansville, New York 14437 and at additional mailing offices. Copyright 1970 by Electronics Technician, Inc.

POSTMASTER: Send form 3579 to ELECTRONIC TECHNICIAN/DEALER, Harbrace Building, Duluth, Minnesota 55802.

All New from GC-Walsco!

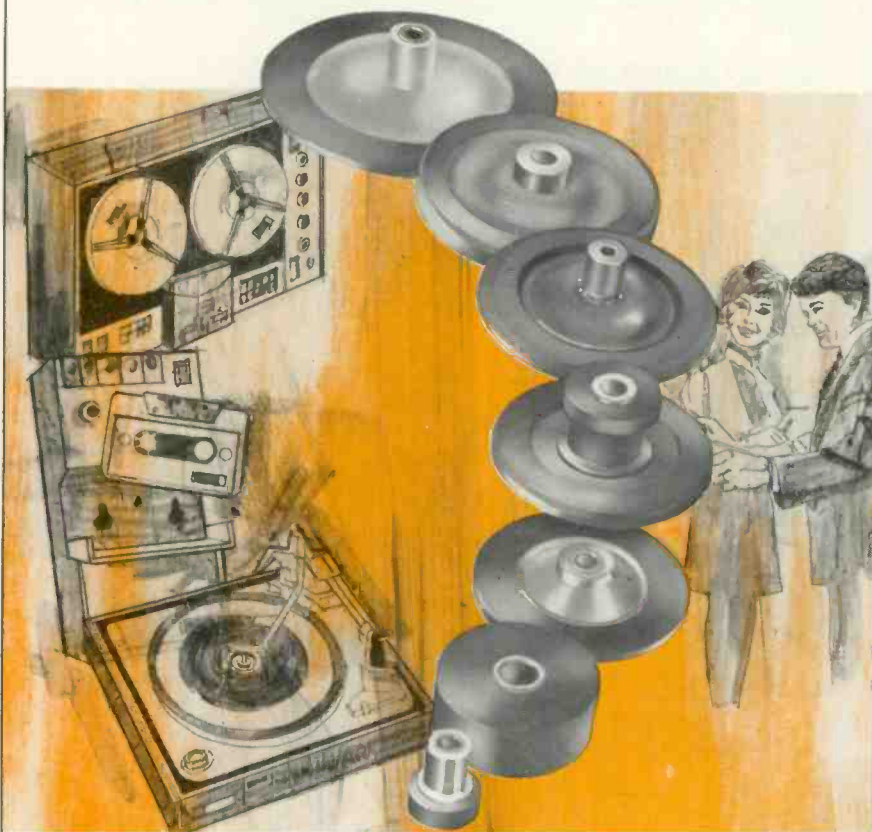

A Complete line of Phono Drives, Belts & Accessories

New — Expanded Listing — includes replacement parts for Cassettes, foreign models, and many new domestic recorders and changers.

All Walsco numbers cross referenced in new, helpful 24-page cross-reference guide. See your distributor today.



GC ELECTRONICS

Division of Hydrometals, Inc.
Los Angeles, Calif. Hicksville, L.I., N.Y.
Main Plant: Rockford, Illinois



ET/D EDITOR'S MEMO

The Industry Watches

The third in a series of annual meetings of the National Service Conference (NSC) was held recently in Peoria and I had the fortune of attending, my first. The NSC meetings are actually gatherings of manufacturers, service associations, trade publications and anyone else interested in the home entertainment industry. The objectives are worthwhile as they are concerned with service problems that the technician has to face, parts availability, training, warranties and many other subjects related to the consumer electronics service field.

Everyone who attended was given a choice of subjects in which he could participate. It was interesting and promising to see competitive manufacturers sit across from each other and hash out ideas with each other and with technicians to help the industry provide a better, more serviceable product. Most of the technicians voiced their opinions quite candidly and were answered in the same vein. As I said, it was a good type of discussion because no one was there just to pat the other fellow on the back. We were there because there are problems that can only be ironed out through communication. I think more meetings like this are necessary in our industry to promote a better image on all sides. This is especially true lately in view of all the publicity given to the relatively few crooked TV technicians, lethal TV fire traps and radiation hazards. Let's face it, not all TV technicians are 100 percent honest and are experts in their jobs. But then, very few of us make that claim to fame although there are a few misguided individuals in all types of work who will take advantage of John Q. Public's ignorance to make a quick buck. We can't play watch-dog for all of them, but as responsible members of our industry we can help make it a better place to live.



Paul A. Rowland

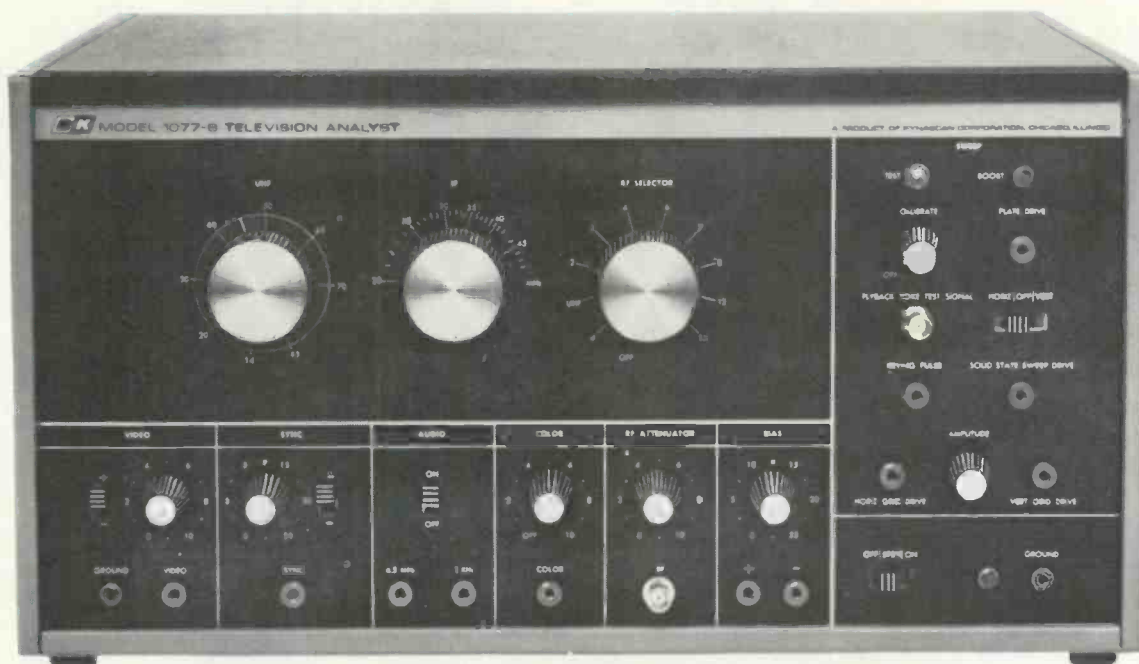

Who said B & K couldn't improve the only complete Television Analyst?

Now there is a new model...the 1077-B, with solid state sweep drive.

The B & K Television Analyst has become standard equipment in repair shops everywhere. And for good reason. It's the quickest, simplest way to test every stage of any TV.

But even classic instruments have to keep up with the times.

That's why we've added a solid state sweep drive in our latest model. It can check any new transistorized color set on the market today.

It's so easy, too. Because the unique B & K signal substitution technique eliminates the need for external scopes or wave-form interpretation.

Whether it's tubes or transistors, VHF or UHF, simply inject the appropriate test pattern or any other known signal. The new Model 1077-B, with its exclusive flying spot scanner, checks everything from the antenna terminals to the input of the picture tube.

Ask your distributor about the new Television Analyst. Only B & K makes it. And now B & K makes it even better.

Model 1077-B \$389.95



Product of DYNASCAN CORPORATION
1801 W. Belle Plaine, Chicago, Illinois 60613

... for more details circle 105 on Reader Service Card

**This is 30,000
solid state replacement parts.**



So is this.

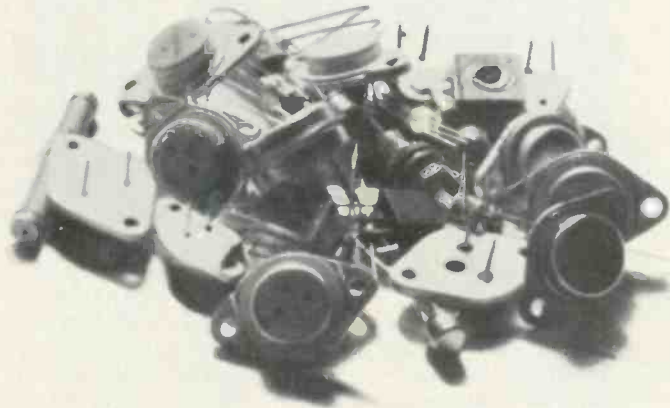

It used to be if you wanted to satisfy everyone, you had to stock over 30,000 different solid state replacement parts.

Well, everyone realized that was ridiculous. So some enterprising people came up with a bunch of universal replacements.

Then you only had to stock about eleven or twelve hundred.

That was a lot better, but we still thought it was a little ridiculous.

So two years ago (when we went into this business), we figured out how to replace all 30,000 with only 60.

Now all you have to do is stock 60 of our diodes, transistors, integrated circuits, etc., and you can replace any of the 30,000 parts now in use. Including

all JEDEC types, manufacturers' part numbers, and foreign designs.

That means you invest less money.

You don't tie up valuable space.

You do away with complicated inventory control.

And you operate more efficiently.

To make life even easier, we've got a new book that gives you all the cross references you need to figure out which part replaces which.

It's available from your Sylvania distributor.

If the whole thing sounds rather incredible, you're right. But why not give your distributor a call and let him narrow the incredibility gap.

SYLVANIA
GENERAL TELEPHONE & ELECTRONICS

700

HI/LO BAND FM/VHF MONITOR*AC or DC operation*

A Hi/Lo Band FM/VHF Monitor is introduced. The listener can monitor fire/police commands, accident reports, emergency broadcasts, official business communications and weather. Designated Model APO-50HL, the monitor has a built-in 117vac power supply or it can also be mounted in an automobile (brackets included) to operate off 12 vdc. It has six high-band frequencies (150 MHz to 175MHz) and six low-band frequencies (25-50MHz). The unit reportedly features crystal control on all channels, assuring "on frequency" monitoring (crystals not included)—Solid-state design incorporating integrated circuits—RF peaking control for receiver sensitivity—Adjustable squelch—Immune to noise—Tone control switch for emphasizing "highs" or "lows." Housed in rugged cabinet the unit measures 8 $\frac{3}{8}$ x 7 $\frac{1}{2}$ x 2 $\frac{5}{8}$ in. Priced at \$139.95. Fanon.



**FOR MORE
NEW PRODUCTS SEE
PAGES 62 & 70.**



701

VHF MARINE RADIOTELEPHONE*New front end receiver design*

The Model 610 VHF marine radiotelephone, featuring a dual front end receiver design giving full sensitivity on both simplex and duplex channels, is introduced. Designed for operation in the VHF portion of the Marine Radio Band, this all solid-state, 25w radiotelephone provides dependable ship-to-ship communications reportedly up to 30 miles, and ship-to-shore communications up to 50 miles. Twelve channels permit full range operation on the newly assigned VHF frequencies for safety and calling, ship-to-ship, ship-to-shore, public correspondence; and reception on ESSA weather bureau frequencies. Complete transistorization plus the use of integrated circuitry assures reliability, minimizes heat, space and battery drain requirements. Special circuitry prevents damage if battery polarity is reversed, or the transmitter is keyed with a shorted antenna, or with no antenna connected. The transceiver is self-contained in an attractively styled, compact, metal cabinet with cast front panel and mounting frame. The unit is designed and built to comply with the requirements of EIA (Electronic Industries Association), the Canadian D.O.T. (Department of Transport) and the F.C.C. (Federal Communications Commission). The radiotelephone includes mounting tray, microphone, crystals for operation on 156.8 and 156.3 MHz., and a fiber glass marine antenna with chrome laydown mounting base with coaxial transmission line. Available optional items are: selective ringer provision, and a 6dB gain antenna. Price \$495. Comco.

CLOCK

702

Runs year on a "C" battery

A multi-purpose portable clock that reportedly runs a year on a single "C" battery is introduced. Employing a fiber-mesh fastening arrangement on its base, the highly-adaptable clock can be positioned on any metal, wood or plastic surface where it will adhere firmly, resisting vibration and jolting. Simply lifting the clock by hand easily detaches it for quick transfer from place to place. Light in weight, it is attractively mounted in a sturdy 3 $\frac{1}{4}$ x 3 $\frac{1}{2}$ x 2 $\frac{1}{2}$ in. gray plastic case. Price \$14.90. Engler.

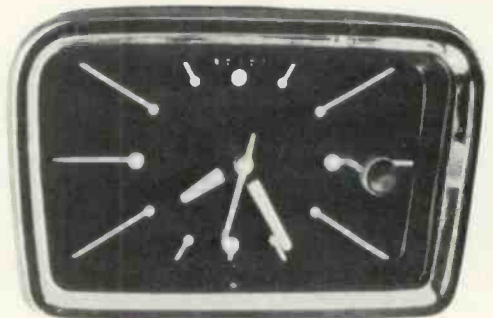
**SOLDERING IRON**

703

Weighs less than 5oz.

Introduced is the Ersu 30 a lightweight balanced soldering iron especially suited for the radio/TV repairman and light industrial applications. Weighing less than 5oz. including line cord, this tool features sturdy construction throughout. An added feature is the long life tip which requires reportedly no filing or shaping during its life. Available in 30 or 40w size. Retail Price \$5.75. Edsyn.



Now the Chromacolor revolution comes to replacement tubes too!

Now you can install Zenith's patented Chromacolor picture tube that outcolors, outbrightens, outcontrasts and outdetails every other 23" diag. color picture tube.

With a full 2-year warranty!

After years of pioneering research and development, Zenith has perfected a color TV picture tube different than any other on the market. So revolutionary that it outcolors, outbrightens, outcontrasts and outdetails every other 23" diag. color tube. And it's a Zenith exclusive—covered by U.S. Patent No. 3,146,368.

Before Chromacolor, every giant-screen color picture was made up of tiny dots on a gray background.

But Zenith made the dots smaller, surrounded them with jet black and, for the first time, *fully* illuminated every dot. Result: the brightest, sharpest picture tube in giant-screen color TV.

The Zenith Chromacolor tube will readily replace the 23" diag. tube in almost any TV, whatever brand. And, unlike most replacement tubes, it's warranted for two full years.



Magnified drawing of ordinary color TV screen before Chromacolor

Magnified drawing of Zenith Chromacolor TV screen

Order the Zenith Chromacolor picture tube from your Zenith distributor for your next installation. And put your customer in a better light.

At Zenith, the quality goes in before the name goes on.®

TWO-YEAR WARRANTY

Zenith Radio Corporation warrants the replacement CHROMACOLOR picture tube to be free from defects in material arising from normal usage for two years from date of original consumer purchase. Warranty covers replacement or repair of picture tube, through any authorized Zenith dealer; transportation, labor and service charges are the obligation of the owner.



Simulated TV picture

ZENITH
CHROMACOLOR™

ONLY ZENITH HAS IT

THREE READERS NOTE ERROR

In the article "Two-Way Radio on the Go," Mr. Sands states: "Then use a clip lead to short the transistor *base to its collector* and watch the meter. If the transistor is operating normally, the meter reading should 'drop' since forward bias has been reduced to zero."

It sure will drop to zero, and prob-

ably stay at zero after the clip is removed. Even a momentary short between *base and collector* can remove any doubt as to the condition of the transistor.

Fig. 1 shows the correct means of removing the forward bias—shorting the base to the emitter, which will cause the collector voltage to *rise* to the supply voltage or the voltage across the emitter resistor to *drop*, because the emitter-collector current will have decreased.

FRANK PAVLIK

In your article on Page 71, January

1970 issue, on transistor testing; Fig. 1 is correct but the written procedure is in error, as is the cutline for Fig. 1. Please read it again and print a correction for us. The way you describe it you may blow a transistor.

GILLS TELEVISION

This is in reference to paragraph four under subtitle: Transistor Testing. Proceeding on in the paragraph it reads: "Then use a clip lead to short the transistor base to its *collector* and watch the meter." It should be corrected to read: "Then use a clip lead to short the transistor base to its *emitter* and watch the meter."

Another correction should be made under Fig. 1 of this article which reads as follows: "Connect a high impedance VOM across the emitter resistor and short the base to the *collector*." It should read: "Connect a high impedance VOM across the emitter resistor and short the base to the *emitter*."

Your schematic diagram in Fig. 1 does show the correct connections.

I have been taught that it is always all right to short the emitter directly to the base of a transistor. All this does is remove the forward bias, turning the transistor off. On the other hand, shorting the collector to the base, even momentarily, may destroy the device instantly.

RONALD B. LORBECKI

READERS' AID

I attempted to convert an EICO 460 scope to triggered sweep, as described in an article in the March 1968 issue of *ELECTRONIC TECHNICIAN*, but have trouble making it work. Would anyone in the western part of Louisiana, that has made this conversion, please contact me.

T. J. VOSS

DRAWER C
KINDER, LA. 70648

Your articles and circuit diagrams have proven to be a valuable asset in my radio lab.

I wonder if any ET/D reader can help me. I need a 7CP4 or a 7DP4 CRT in operating condition for the surplus monitor I am converting.

W. W. CARR

3119 S. DAY ST.
SEATTLE, WASH. 98144

We are in need of a power transformer (possibly two), part No. FT1141955 for a Harmon Kardon TA1040. Harmon Kardon says it is

ACA
ANTENNA CORPORATION of AMERICA

HARRY E. RHEINSCHMIDT
General Manager

BROOKS TOWERS
SUITE 22-D
1020 15TH STREET

DENVER, COLORADO
80202
(AC-303) 892-1481

CLIP and SAVE!

ANNOUNCING...
a new line of patented TV antennas
from a most reliable source

The new ACA Citation line offers a complete selection of VHF, UHF, FM reception in color and black/white. Priced for today's market, with all of the top quality features you expect, including gold-anodized, high tensile aluminum elements, die cut impedance correlators, dual action director/reflector screen and tetrapole collector element.

Also, available from ACA — antenna preamplifiers, booster couplers, matching transformers. Line up today with ACA!

For complete details, write or call:

ACA ANTENNA CORPORATION of AMERICA
Brooks Towers, Suite 22-D • 1020 15th St. • Denver, Colo. 80202 • Tel. 303/892-1481

... for more details circle 103 on Reader Service Card

Krylon® Crystal Clear is standard equipment for all installation and service work. It prevents many of the causes of picture

fading and high voltage losses and keeps lead-in connections tight. It's the repairman's handiest repairman.



Borden Chemical, Division of Borden Inc



radio-tv repairman

Who needs a tuner wash? Save your money and use

QUIETROLE

The product that cleans while it lubricates. Zero effect on capacity and resistance. Harmless to plastics and metals. Keeps color and black and white on the beam. Non-flammable.



manufactured by
QUIETROLE CO.
Spartanburg, South Carolina

... for more details circle 124 on Reader Service Card

ET/D LETTERS TO THE EDITOR

no longer available from stock.

Perhaps one of your readers can help.

JOHN A. SCHWERBEL
Box 215, R.D. 1
CATSKILL, N.Y. 12414

I have a Crosley Model 52, Patented in 1914—an old girl.

I would like information on this unit, when manufactured and schematics. Will trade if of any value.

MARV. POOLEY
805 NORTH DUFF
MITCHELL, S.D.

I need one set of Sam's Photofacts from number 500 to 800. It must be in good condition.

ANTONIO HERNANDEZ L.
C/O LA VILLE DE PARIS
NOGALES, ARIZONA 85621

I wrote you previously about a Model E-200-C Precision Signal Gen-

erator that I have, and you referred me to B & K. I wrote them, and the operating instructions and diagram are not available.

Will you please advertise in ELECTRONIC TECHNICIAN/DEALER for operating instructions and a diagram for the Model E-200-C Precision Signal Generator, Serial No. 19591 (the serial number is important in this case since they had a diagram starting with Serial No. 58865. This will not work since the tubes are different.).

J. M. MELTON
RT 6, Box 382
RINGGOLD, GA. 30736

I am writing about a Belcor Tape Recorder that I purchased approximately five years ago, Model No. B303, for which I need a pressure roller for the fast forward speed.

I find that the company is now out of business and I cannot find any parts distributor that carries this particular item. I would appreciate any information from you or your readers concerning where I might obtain this part.

I have been a happy subscriber of your fine magazine for many years.

MELVIN SHER
66 VIRGINIA AVENUE
LIVINGSTON, N.J. 07039

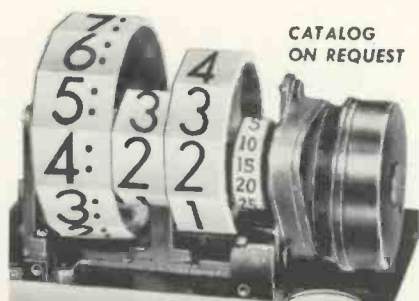

CATALOG ON REQUEST



CLOCK MOVEMENTS

DIGITS RESETTABLE INDIVIDUALLY

Available in 50, 60 cy., all voltages, AC. UL approved motor, cord. One Year Guarantee.

#130... 12-HOUR #131... 24-HOUR

#75
Tymeter
Elapsed
Time
Digital
Computer



Made in U.S.A.

Complete Line: Delay, Interval and Cycle Timers, Digital Computers

PENNWOOD NUMECHRON CO.
TYMETER ELECTRONICS

7249 FRANKSTOWN AVE., PITTSBURGH, PA. 15208

... for more details circle 121 on Reader Service Card

Introducing the world's only \$339 triggered scope.

Before you say you don't need a triggered scope, look what's happening to TV servicing: tubes are out, transistors and IC's are in.

With tubes you could play hit-or-miss, knowing the tube would take the overload. Try the same thing now, and good-bye transistors.

For new-era circuitry, Leader introduces a new-era troubleshooter. A triggered scope, just like the ones the TV designers use.



Now the wave shape is locked in and continuously displayed. Now you can look at a waveform containing high and low frequency components. Now you can determine voltage directly and instantly.

Before you say \$339 is a lot of bread, look what it buys: Leader's LBO-501 5-inch triggered scope, with a bandwidth of DC to 10MHz and a solid state package.

Going like hotcakes at your Leader distributor.

Seeing is believing.

LEADER INSTRUMENTS

37-27 27th Street, Long Island City, N.Y. 11101, (212) 729-7411

... for more details circle 118 on Reader Service Card

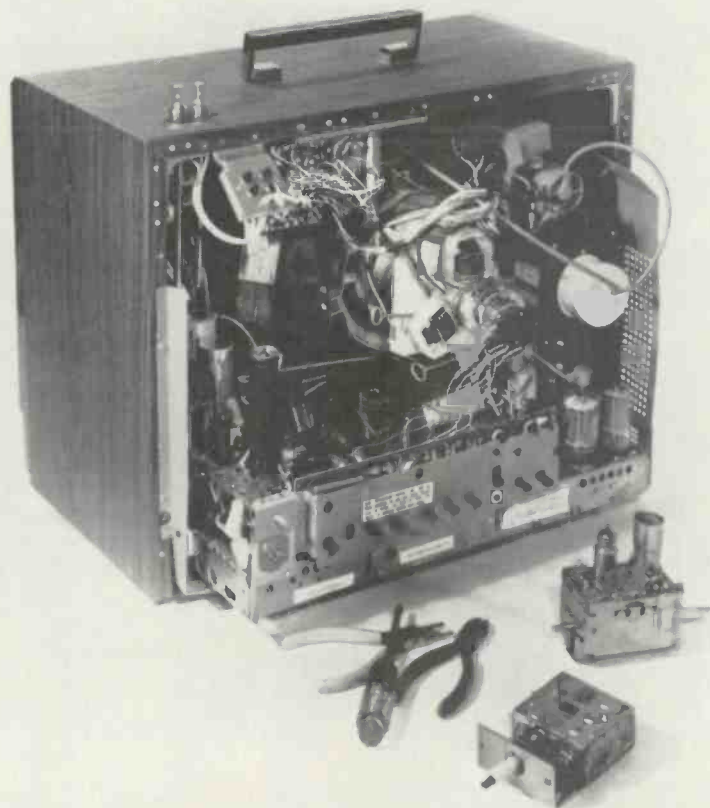

We guarantee the CRT... the rest is your business

Channel Master Opti-Vue Color CRT's with the new three year guarantee not only deliver perfect color pictures, but keep your customers coming back for all their servicing needs.

After all, you've earned their confidence by giving them the finest deal in color tubes...so who else is better qualified to fix the set when something else goes wrong?

Once your customers see the value in Opti-Vue — they're sold! It's a higher profit sale ... and you've got a satisfied customer.

We guarantee Opti-Vue for 3 years so you'll get more CRT profits ... and more servicing business.

OPTI-VUE[®]
The line with the 3 Year Warranty
CHANNEL MASTER

DIVISION OF AVNET, INC., ELLENVILLE, NEW YORK 12428

... for more details circle 109 on Reader Service Card

The material used in this section is selected from information supplied through the cooperation of the respective manufacturers or their agencies.

MAGNAVOX

TV Chassis T908/T915—Horizontal Output Transistor Failure

Capacitor C615 (8200pf, 1kv) forms part of a resonant circuit in the horizontal output circuit. Should this capacitor open, voltage pulses of sufficient amplitude to damage the horizontal output transistor will be developed in the output circuit. Ultimate destruction of the transistor may not occur for a period of weeks after the capacitor has

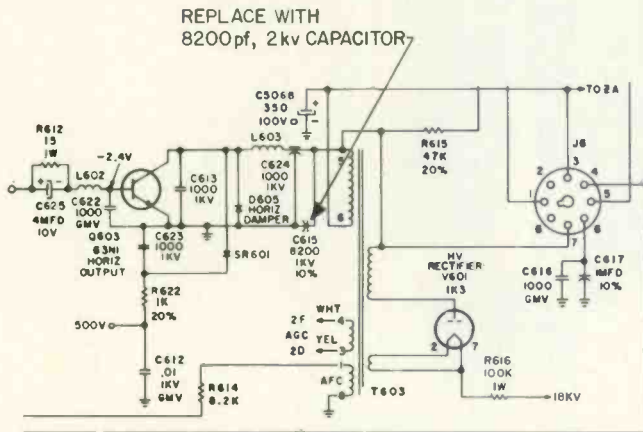

opened and again after a replacement transistor has been installed.

It is suggested that C615 be checked for open prior to installing a replacement horizontal output transistor. In the event a positive check of the condition of the capacitor cannot be made, the capacitor should be replaced. Use Magna-Par Part No. 250290-17, which is a 8200pf capacitor rated at 2kv, for replacement purposes.

Remote Control Model 704054-3—Relay K-106 Slow to Release

There is a small piece of clear tape attached to the armature (movable assembly) of Relay K-106 to provide a gap between armature and core when the relay is closed. The gap is required to prevent the relay from remaining closed because of residual magnetism. The contacts of the relay should open, removing ac to the TV chassis, when the TV Off function has been activated. It is possible, however, for adhesive to be squeezed out around the outer edges of the tape, come in contact with the relay core and hold the contacts in a closed position for as long as five minutes after the TV Off function has been activated. This condition can be corrected by removing the clear tape, cleaning all adhesive from the armature and core and replacing the tape with a similar size piece of masking tape. The armature can be removed from the relay for replacement of the tape by removing the armature return spring and spacer board and lifting the armature free.

RCA VICTOR

Tape Recorder Model YZ5545—Battery Recharge Circuit

The model YZ5545 five-inch reel-to-reel tape recorder features a rechargeable nine volt battery supply. The in-

strument may be operated from either the 120v line or battery supply.

Six special "D" size alkaline cells are series connected, comprising the nine volt supply. These cells, when used under controlled conditions, may be recharged many times.

The transistorized recharging circuit provides these conditions.

Although the alkaline battery pack should provide a number of discharge/charge cycles, the life of the battery is influenced by the way the battery is discharged and charged.

The instruction manual furnished with the recorder advises the user to subject the batteries to an over-night charge after every two to four hours of use. In addition, the instrument includes a battery condition light that serves to alert the user when it is time to recharge.

After this time, the recharge light will glow steadily

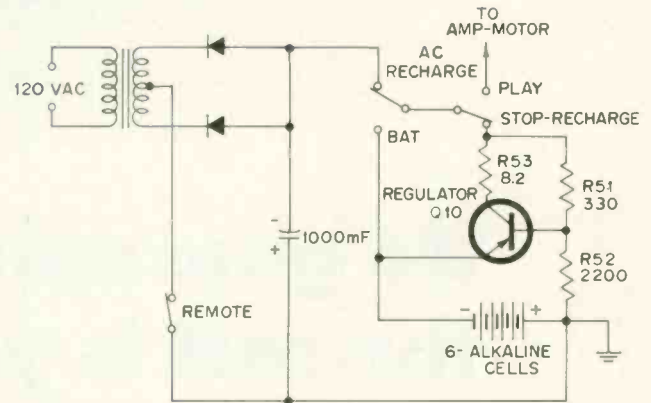

when the instrument is on indicating that further use could damage the battery.

When the battery is to be charged, the rectifier power supply in the instrument furnishes about 9vdc to the charge regulator transistor Q10. The BATTERY/AC-RECHARGE switch selects battery or ac operation while the PLAY/STOP RECHARGE switch allows the rectifier supply to power either the amplifier-motor or the recharge system.

The charge regulator is basically an emitter-follower in

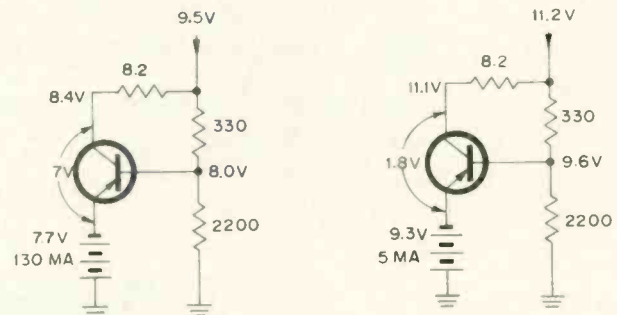

-Battery Discharged

-Battery Charged

which the unity voltage gain characteristic is used to provide a current limiter circuit.

When the battery is discharged as illustrated in the sim-

Untie your money

With "QT." The Quick Turnover Inventory System from RCA.

How much money do you have tied up in old, unsold replacement parts? If you have more than your share of them, then it could be plenty.

RCA can change all that with a new Quick Turnover Inventory System—"QT" for short. It represents years of studying inventory control.

Now you can have an inventory of the fastest moving RCA parts, selected by RCA's computers. You'll have the parts you need when you need them. You'll know when the supply is running low. And, if any parts are dropped from the "top-mover" list, simply return them through your "QT" distributor.

Talk to your RCA Parts Distributor about putting in a "QT" Inventory System. The sooner you untie your money the sooner you'll be counting it.

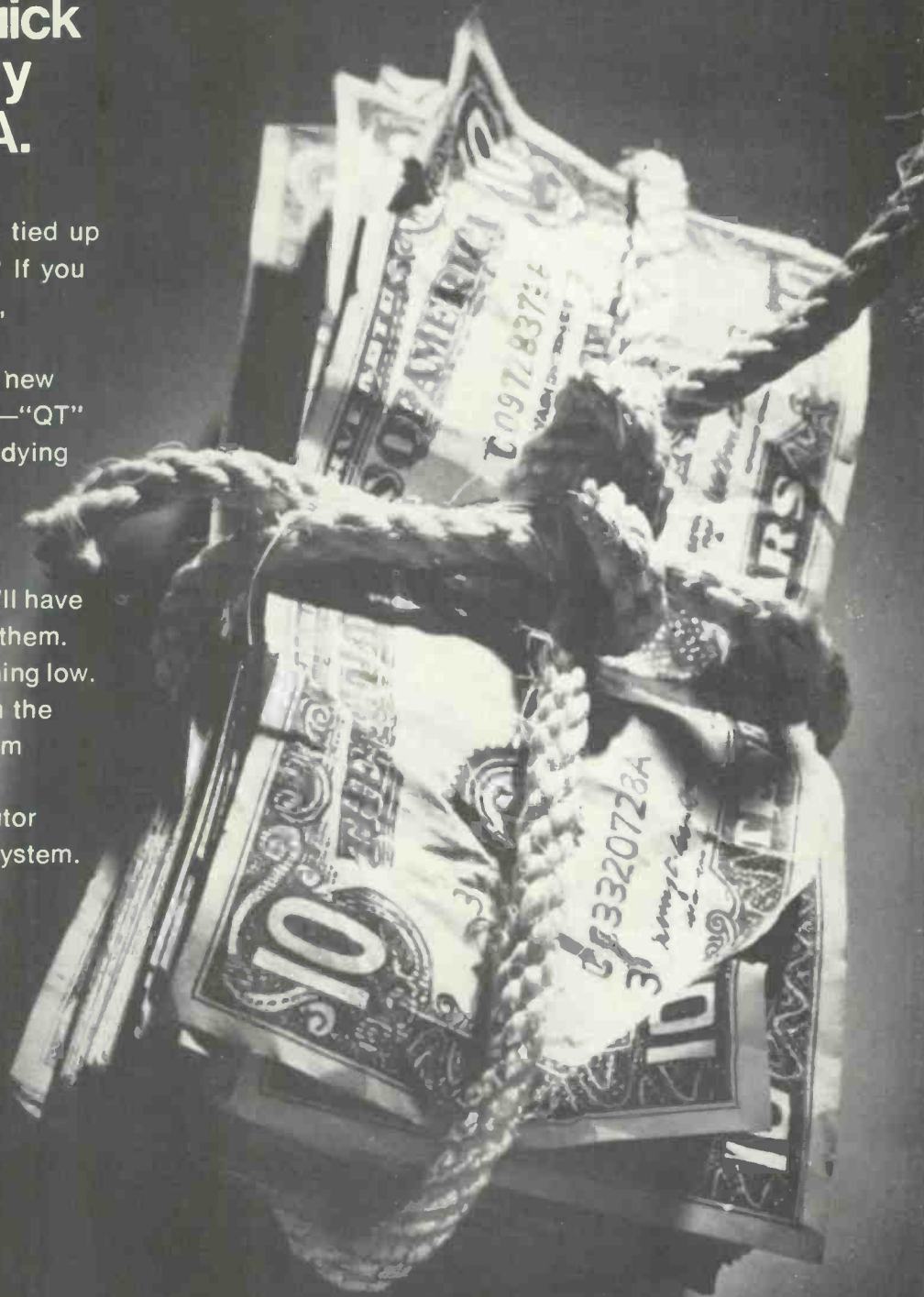

RCA Parts and Accessories

AT LAST solid state triggered sweep, wide-band at a price you can afford!

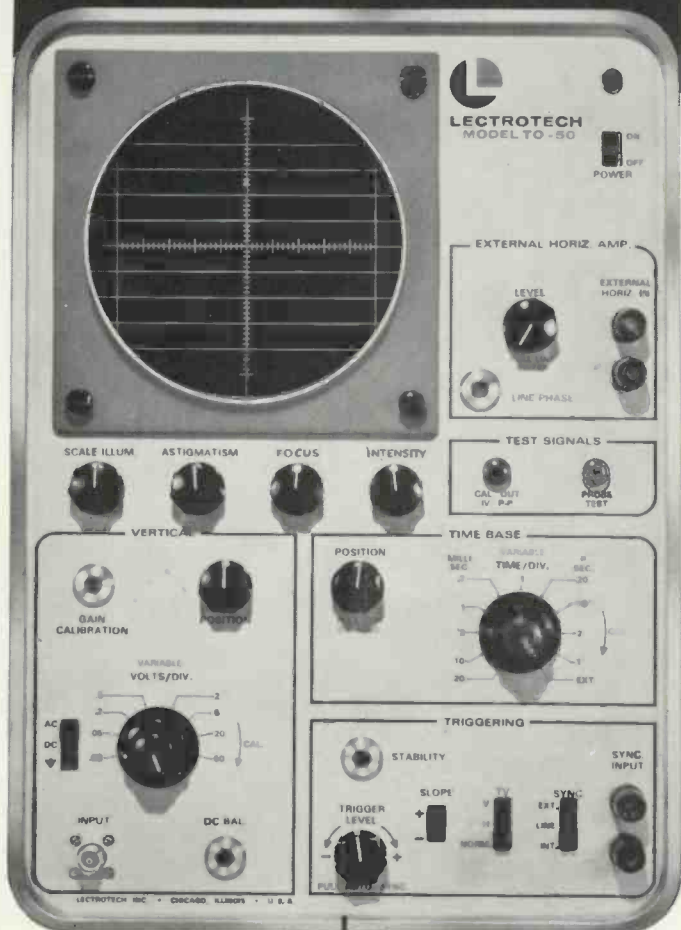

Made in U.S.A.

5" oscilloscope/vectorscope

Triggered Sweep: Easy to use. Positive sync results in absolute stability of patterns.

Solid State: For reliability and performance.

Wide Band: 10 MHz—for increased use in all servicing, industrial and educational applications.

D.C. Amplifiers: Eliminates pattern bounce. Permits viewing A.C. signals and D.C. level simultaneously. Use as a sensitive D.C. voltmeter.

plus . . . Calibrated vertical attenuator. • Calibrated horizontal time base. • Automatic sync mode. • TV sync selector. • Vector-scope input for color TV servicing. • External horizontal amplifier. • 60 cycle horizontal sweep (sine wave) with phasing control. Compatible with all sweep generators. • Edge lit calibrated scale. • All solid state (tube protected input).

ONE YEAR WARRANTY

T0-50—oscilloscope/vectorscope Net 329⁵⁰

See your distributor or write Dept. ET-4



LECTROTECH, INC.

4529 North Kedzie Avenue • Chicago, Illinois 60625

. . . for more details circle 119 on Reader Service Card

ET/D TECHNICAL DIGEST

plified schematic, its open-circuit terminal voltage will be about 7.3v. When the recharge cycle is activated, the regulator circuit must supply a voltage that exceeds the battery voltage. Under these conditions the emitter voltage of Q10 and the battery assumes a voltage of about 7.7v. This causes a base voltage on Q10 of 8.0v (emitter voltage +.3v base-emitter barrier voltage =8.0v). Within the chosen values of R1 and R2, sufficient base current is supplied to drive Q10 into saturation, thus the resistance of the saturated transistor and the 8.2Ω resistor, R3, limit the charging current to a safe value of about 130ma.

As the battery charges, its terminal voltage and the emitter voltage at Q10 increases causing the charging current to decrease until the charged condition illustrated in the schematic is reached. The battery/emitter voltage of 9.3v, results in a base voltage of 9.6v, which is clamped at this point by the voltage divider action of R1-R2. The reduced charging current (now 5ma) allows the input voltage to the regulator to increase to 11.2v; however, the base of Q10 is clamped at 9.3v by R1-R2. Consequently, the base current diminishes and transistor conduction is reduced until the conditions are satisfied. Thus the battery charge current, initially 130ma, has tapered to 5ma as the battery assumes full charge.

GENERAL ELECTRIC

Tape Player Models TA556/TD081—Servicing Hints

(1) These models were built using two (2) different length #4 metric screws for chassis hold down. Screws 16mm in length were used in three of the four locations. A 14mm screw was used under the drive motor-right rear when viewing assembled unit from the front in normal operating position.

Using a 16mm screw under the drive motor can result in its interference with the motor case or even cause a stalled motor.

Be certain to observe screw lengths and install shorter screws underneath the drive motor.

(2) When servicing the preamplifier, it is important that proper grounding be maintained between the chassis and the circuit board ground.

Grounding is normally accomplished by the circuit board retaining screw holding the circuit board ground in contact with the chassis.

When this ground connection is broken, the ground return for the head switching solenoid is through a channel indicator lamp. If the head switching button is depressed to activate the head switching solenoid, the high current of the solenoid will burn the affected indicator lamp.

Be certain to use a jumper lead from circuit board ground to chassis when the circuit board retaining screw is removed.

(3) Many different performance problems can result from oxide accumulations on the playback head and/or the end of tape switch contacts.

Some of the problems are: (A) Dead Channel (B) Low output on one or both channels (C) Loss of high frequencies (D) Hiss or Noise (E) Failure to automatically switch channels.

If one of the previous problems occurs, be certain to clean switch and head. The use of alcohol and a cotton tipped swab is recommended for cleaning.

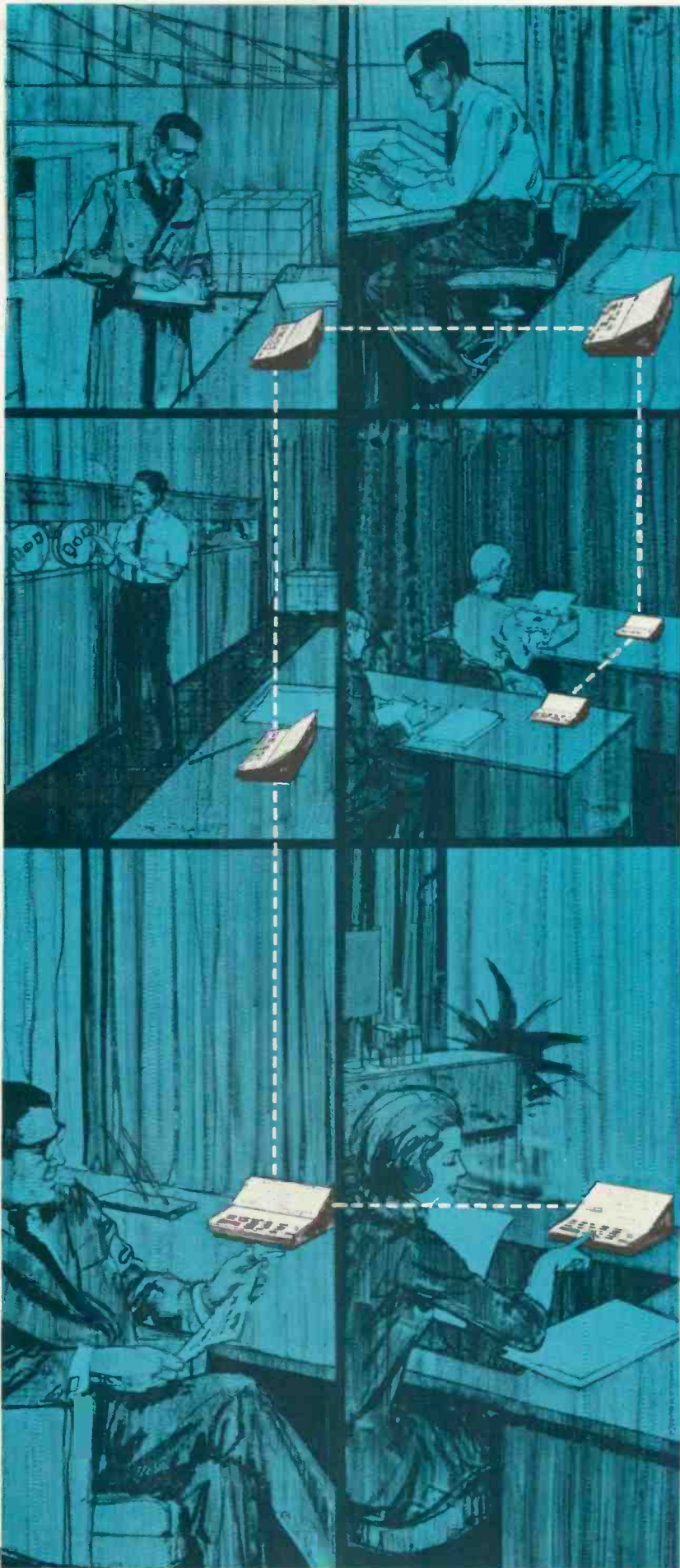

New, easy to install intercom system



Norelco Mastercom™ M 30

From small businesses to large industrial plants, MASTERCOM M 30 systems achieve maximum efficiency in handling internal communications. Instant person-to-person contact with push-button ease . . . and, the telephone system is free to handle important outside calls.

Attractive Desk Top Units • Push-button Operation • True to Life Sound Quality • Hands-free Answering • Expandable System • Handles up to 30 stations • Simple One-cable Installation.

Your Norelco communication specialist will be happy to demonstrate how a MASTERCOM M 30 system can improve communication efficiency . . . saving time and money.

Clip and mail coupon for full information and demonstration.

.....



100 East 42nd Street, New York, N. Y. 10017

ETD-470

Gentlemen:

Please send me full details on the Norelco Mastercom M 30.

Company Name _____

My Name _____

Street Address _____

City _____ State _____ Zip _____

DICTATING EQUIPMENT • MASTERCOM SYSTEMS • ELECTRONIC PRINTING CALCULATORS • OFFICE COMPUTERS

... for more details circle 123 on Reader Service Card

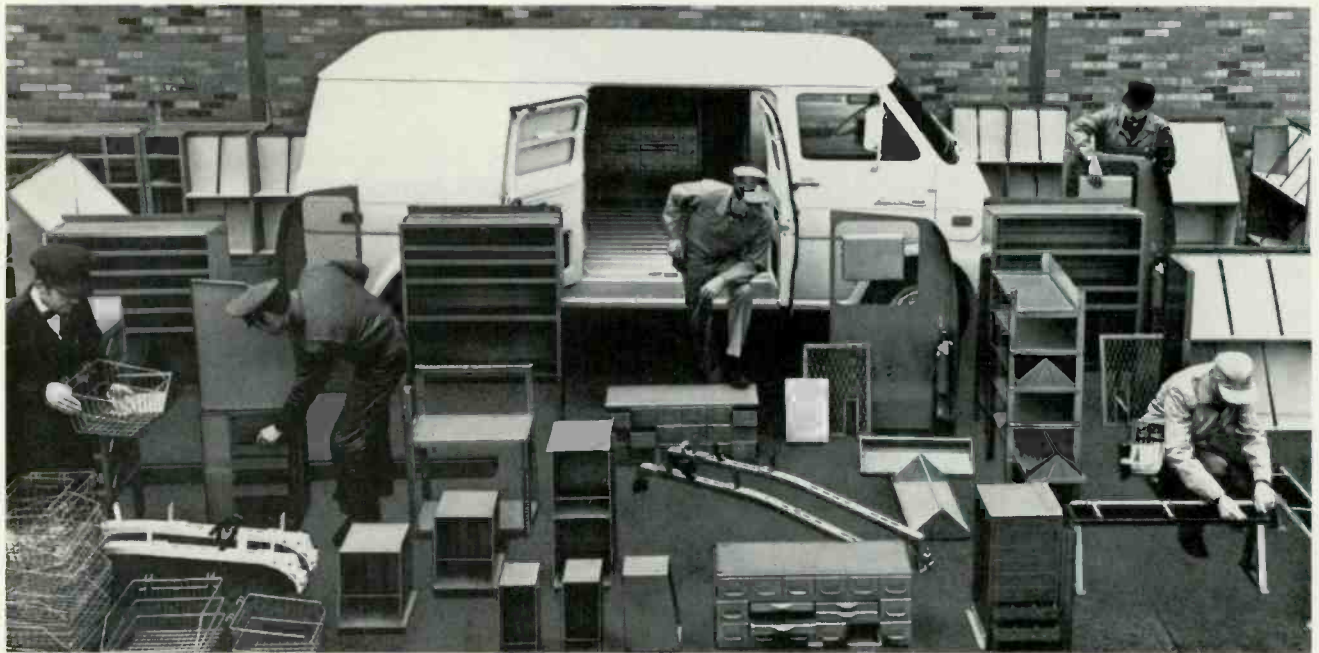

Perfect fit: Econoline Van custom-designed to your job.

CUSTOM-DESIGN YOUR VAN

Your job may call for a one-of-its-kind van. You can get it in an Econoline, and all from one place—from your Ford Dealer.

Sound impossible? Not for the man with better ideas. Your Ford Dealer can custom-design the Econoline's interior into *your* kind of efficient working space, and it comes to you *ready for work*.

WIDE CHOICE OF MODULAR UNITS

Econoline modular units (like those shown above) are the answer. Components include: racks, adjustable shelf units, drawer units, cabinets, bins (both padded and plain), padded trays, tote trays, hanging baskets, book compartments, storage boxes, partitions, padded siderails, padded floor, equipment holders, ladder racks, and many more.

These are not just parts and pieces, but a system of Econoline-engineered units designed to fit and work together. Constructed of heavy gauge steel with gray enamel finish, they bolt to floor and/or body pillars to become permanent yet movable parts of the van. Traveling showcase or workshop—you name it and it's yours with the Ford Econoline.

BETTER IDEAS EASE YOUR WORK

However you design your van, you have all of Econoline's basic better ideas going for you. Convenient outside front service center for quick-checking engine and related parts. Driver "walk-through" for easy access to the load compartment. More clear floorspace by 23% than any other van. Wide 5½-ft. stance for stability, yet a sharp 40-ft. turning diameter for maneuverability. And, of course, exclusive Twin-I-Beam independent front suspension for great durability, easy handling, low maintenance, long tire life.

Because it is the one-of-its-kind van, you see more and more Econolines on all kinds of jobs. See how much more an Econoline Van can do for you—see your Ford Dealer.



Radio, TV, Appliance Repair

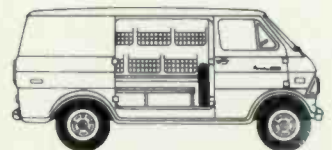

General Utility

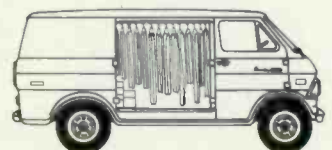

Laundry and Dry Cleaning



Vending Repair

FORD ECONOLINE VANS



... for more details circle 113 on Reader Service Card

ET/D TEKLAB REPORT

Craig Model 6304 Color TV Receiver

Although most of the circuits in this import TV are familiar, the AFT and part of the chroma circuit may be confusing so we have outlined them in this article.

■ According to the statistics of electronic imports to this country, television sets may for the first time be leading the list of consumer import products. Until now radios held the lead with TV receivers bringing up a close second.

Many of these imports came over bearing American manufacturer's brand names. An increase in the number of TV imports means that

if you are not now servicing these sets, you will most likely be called upon for service in the future. A review of these sets will prove to be helpful.

We recently received the Craig Model 6304 color receiver which is manufactured by Sanyo Electric Co., LTD of Japan. Being the first import we evaluated, we found the circuits to be quite standard except for



Craig Model 6304 color TV receiver.

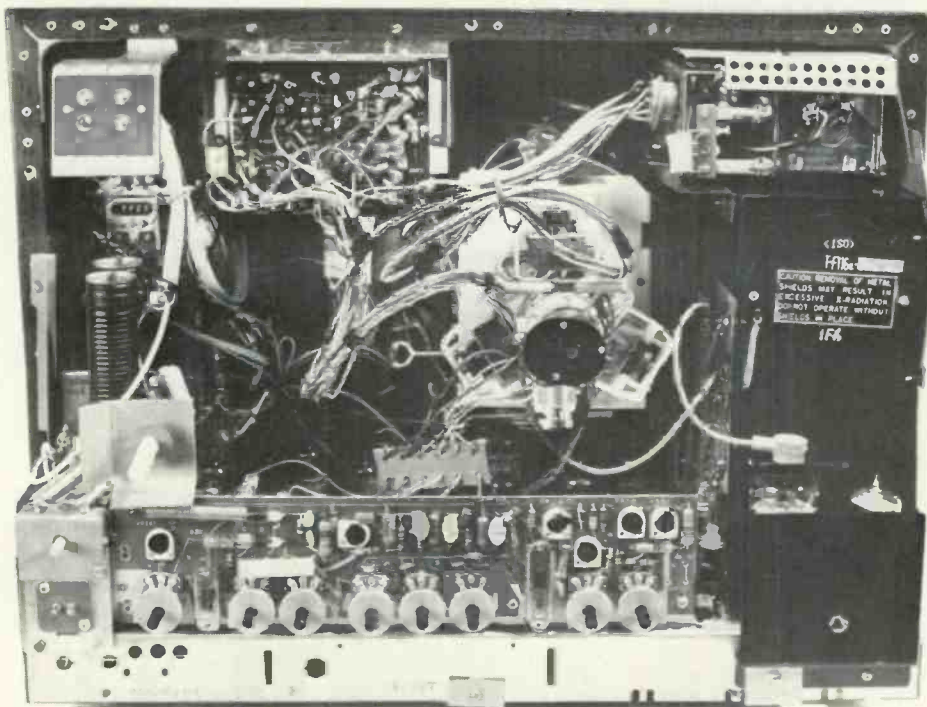

Rear view of the receiver showing service adjustments mounted on a circuit board.

a few minor circuit variations and adjustments which we will review.

The features on this receiver include: AFT, Instant-On, slide type color controls, earphone jack, automatic degaussing and removable contrast screen for viewing under bright lighting conditions.

All of the customers' controls were found on the front panel for easy accessibility. The volume, color and tint are slide type controls with a rocker type on/off switch. The speaker is mounted on the front panel but seems a little muffled, possibly because of the thick material used for the speaker grill.

After removing nine screws on the back cover and four screws on the bottom panel, the complete etched circuit is exposed making component removal easier.

AFT CIRCUIT

The Automatic Fine Tuning (AFT) circuit shown in Fig. 1 uses a different method to prevent the oscillator from locking on the accompanying sound carrier. Negative voltage is derived from the sync separator, compared to the voltage from a B+ source, and applied to the anode side of the AFT diode (varicap) in the tuner (opposite side of the normal AFT correction voltage). If the oscillator is momentarily too high in frequency and the AFT tries to lock in on the accompanying sound carrier, the negative voltage derived from the sync separator will become lower than normal. The resultant voltage applied to the diode becomes slightly positive, therefore, pulling the oscillator back to a lower frequency to lock it on the video carrier as desired. This correction voltage is opposite in polarity to the normal AFT correction voltage as it is applied to the opposite end of the AFT diode. A diode, D26, is used to clamp this resultant voltage to approximately 0v in normal operation as it does not allow the resultant voltage to rise in a negative direction.

LOW VOLTAGE POWER SUPPLY

The rectifiers and dropping resistors are conveniently grouped to the left and the rear of the chassis for easy component replacement. The tube filaments are divided into two

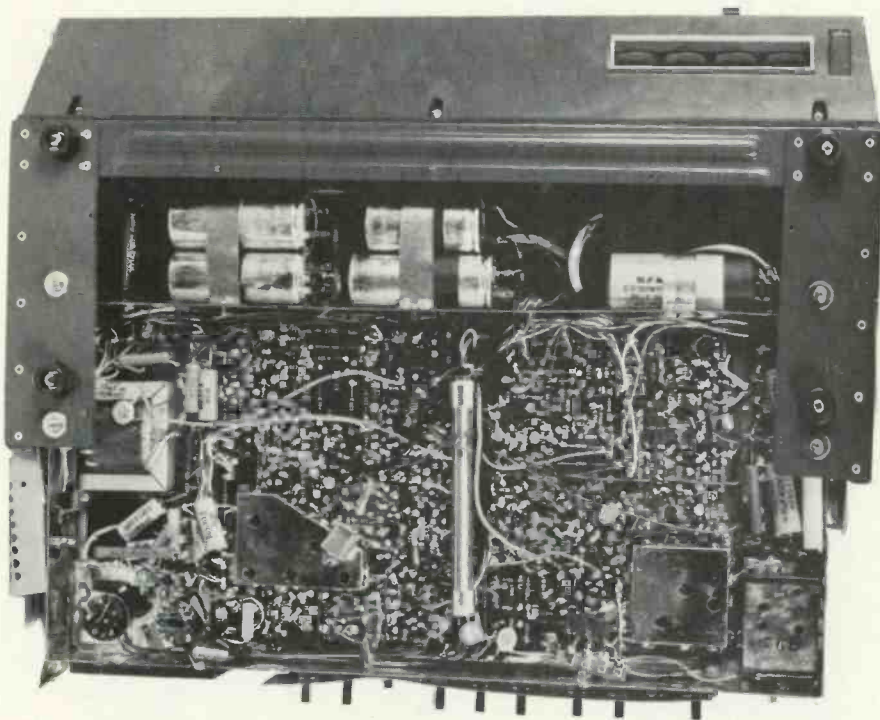

Once the back cover and four bolts on the bottom panel are removed, the road-mapped circuit board is exposed to make component removal easier.

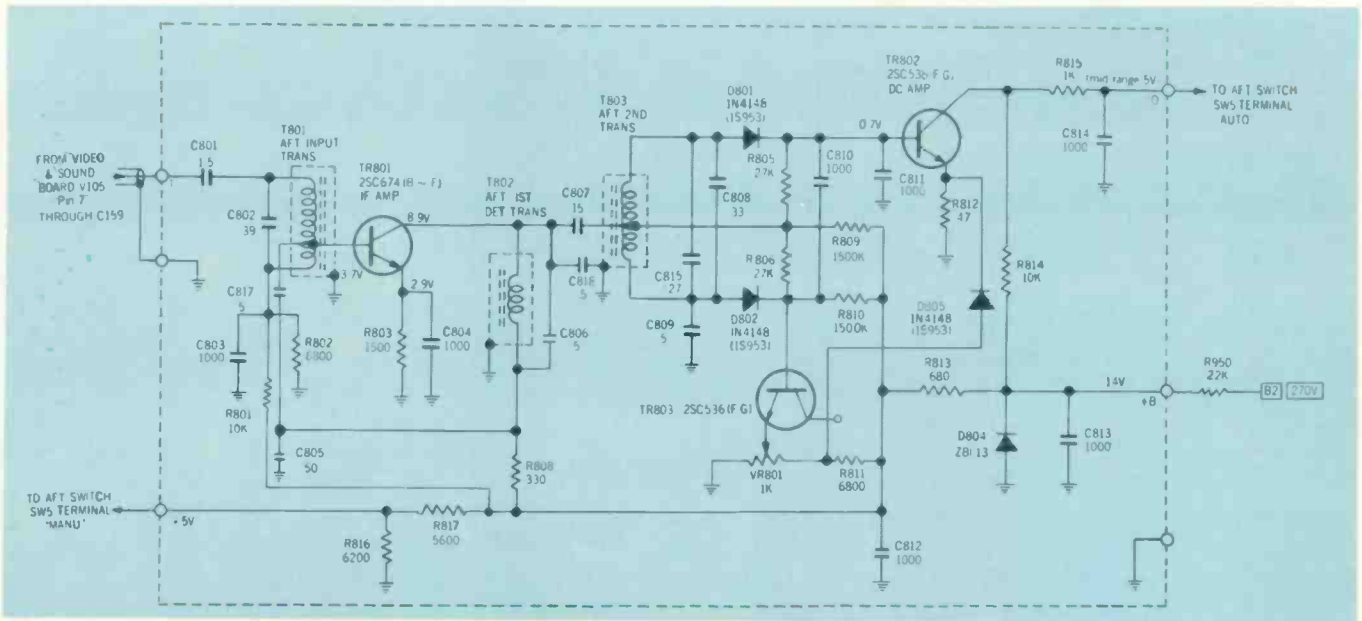

Fig. 1—Schematic diagram of the Automatic Fine Tuning circuit shows a correction voltage opposite in polarity to the normal AFT correction voltage and applied to the opposite end of the AFT diode.

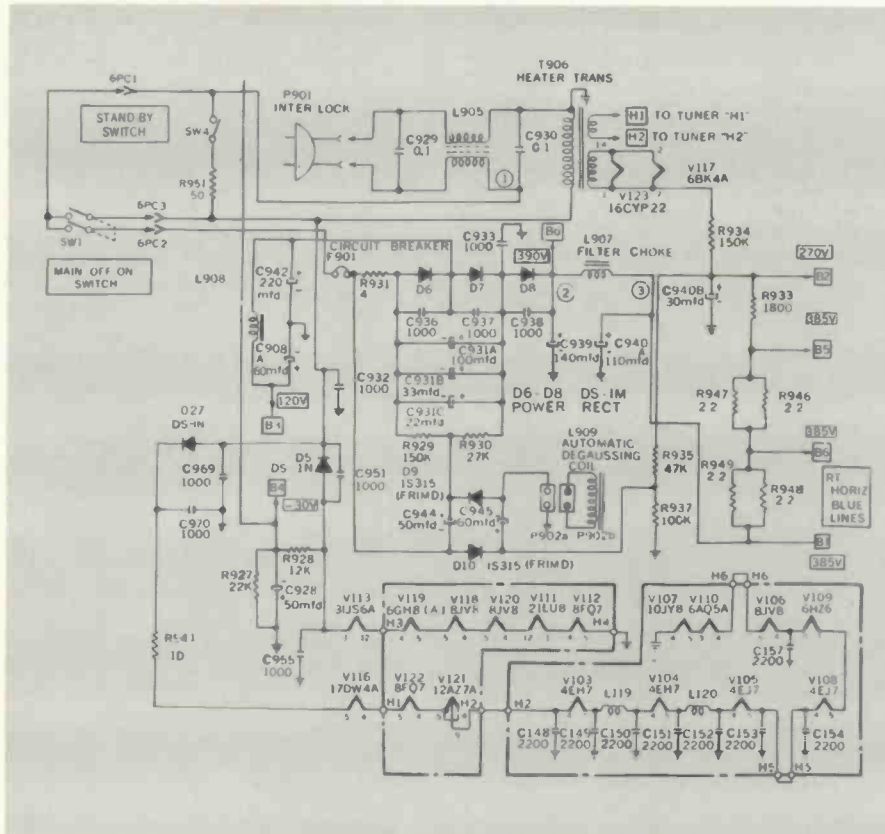

Fig. 2—Schematic diagram of the low voltage power supply shows capacitor connection points for voltage adjustments.

parallel strings, with a series diode in each string to achieve proper voltage to the filaments. The low voltage circuit is protected by a reset type of circuit breaker.

Before attempting to make any adjustments on this chassis, espe-

cially after any one of capacitors, C931, C939 or C942, has been replaced, make sure the voltage at test point "B1" is between 370 and 385v line input voltage. The power supply is shown in Fig. 2.

If the "B1" voltage is too high,

disconnect C931C or disconnect both C931C and C931B. If the "B" voltage is too low, connect C931B or connect both C931B and C931C.

HIGH VOLTAGE SUPPLY

The high voltage regulation circuit employs a 6BK4 shunt regulator tube which is not found on many portable TV receivers. The chassis also features pulse feedback regulation for additional safety (see Fig. 4). Low voltage is applied to the focus electrode connected to the 270v, 385v or 650v taps for best focusing. The focus adjust tip is located on the top of the HV cage. To obtain optimum picture width, reconnect the blue lead to either one of the width adjust terminals on the deflection yoke. The vertical centering adjustment is shown in Fig. 3. Raster position can be adjusted by the vertical centering adjust tip on the center of the chassis.

The horizontal efficiency and HV adjustments are quite standard with the exception of the HV sub-regulation, which is not normally found on a portable.

CHROMA CIRCUITRY

The chroma circuitry contains six tunable adjustments in the band-pass amplifiers for proper amplitude and phase response. It also has individual phase adjustments for each R-Y, B-Y, and B-Y demodulator to

insure accurate phase relationships. Each demodulator has a balanced diode detector with individual adjustment for color noise cancellation.

According to the manufacturer, if this receiver should require service, just phone Western Union and ask for operator 25. On request she will give you the name and location of the nearest Craig warranty service station. There are reportedly more than 400 of these stations throughout the U.S.A. ■

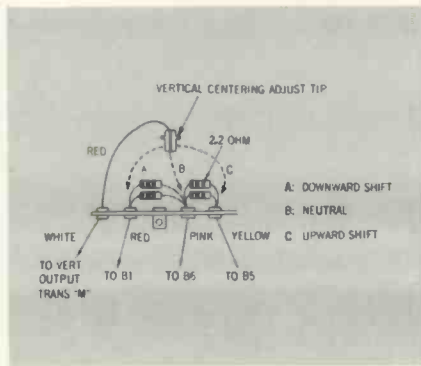

Fig. 3—The vertical centering adjustment.

SPECIFICATIONS

Antenna Input Impedance	_____	300Ω balanced
Convergence	_____	Magnetic
Focus	_____	Electrostatic
Intermediate Frequencies:		
Picture IF Carrier Frequency	_____	45.75 MHz
Sound IF Carrier Frequency	_____	41.25 MHz
Color Sub-carrier Frequency	_____	42.17 MHz
Picture Tube	_____	Approx. 115 sqin.
Power Input	_____	120vac,60Hz
Power Rating	_____	300w total
Sweep Deflection	_____	Magnetic
TV RF Frequency Range:		
All 12 VHF Channels	_____ 54MHz to 88MHz	174MHz to 216MHz
All UHF Channels	_____	470MHz to 890MHz
Transistors	_____	4
Diodes	_____	30
Varistor	_____	1
Thermistor	_____	1
Tubes	_____	22

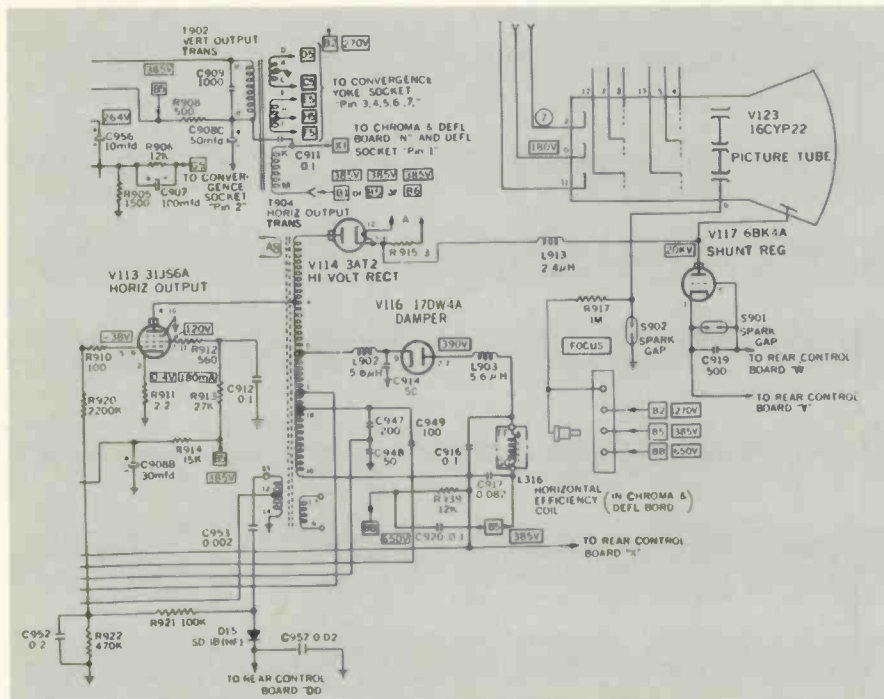

Fig. 4—The HV regulation circuit employs a 6BK4 shunt regulator and feedback regulation.

Part Two

Stereo Servicing With A Scope

by ROBERT L. GOODMAN

Part two and the concluding article in this timely service feature includes dozens of handy troubleshooting hints geared to help you become more effective using the generator-scope technique.

STAGE GAIN CHECKS

Professionally triggered scopes have vertical amplifier gain controls which are calibrated in volts-per-centimeter or per division. The two vertical channels are identical so it's easy to check one test point against another to compare the signal gain of each stage. The comparison method is ideal for checking the gain in each stage throughout the entire amplifier and for checking the overall performance of both channels. This method is, of course, only valid if one of the two channels is operating correctly.

With this technique you can quickly isolate the trouble down to the stage and possibly to the defective component. As a final check of the amplifier, or if the original complaint was insufficient frequency response, the square-wave generator frequency can be tuned throughout the entire audio range for a frequency response check. These checks can be run at 1kHz intervals with the dual-trace scope connected to each channel and both left and right signals observed at the same time. With this method you can quickly observe the amplifier's overall frequency response.

When it comes to finding a case of slight distortion in a high quality component Hi-Fi system for example, the triggered scope can be a great troubleshooting time saver.

Let's put the scope on a Scott stereo amplifier brought into the shop by a critical listener for a frequency response check out. The customer told us the amplifier did not sound as though it was reproducing his stereo

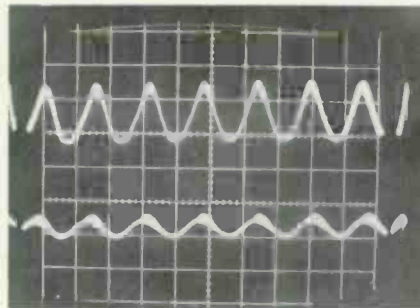

Fig. 1—The top waveforms indicate good amplification at 8kHz while the bottom trace of the split-beam scope shows very little signal amplification.

records like it did when the unit was new. The amplifier was connected and a test record played. To a non-musical ear it sounded fair, but it seemed as though some of the high notes were missing.

The split-beam scope was then connected to each channel's speaker output and a sine-wave signal fed into both amplifier input jacks. The dial of the generator was tuned across the audio spectrum with the left channel indicating normal amplification and frequency response. However, the right channel showed very little amplification at about 6kHz. Note the top wave-forms in Fig. 1 indicate normal amplification at 8kHz while the bottom trace of the split-beam scope shows very little signal amplification. The Scott Model 299F amplifier schematic is shown in Fig. 2.

The scope probes were moved a stage at a time which showed transistor, Q104 to be defective as it would not amplify frequencies at 6 or 8kHz. Other defective components can also cause this problem.

STEREO MULTIPLEX CHECKS

The Motorola AM-FM Stereo IC350 chassis will be used for these checks. Shown in Fig. 3 is the AGC and stereo decoder system schematic. A "flat pack chip" IC-2B is used for stereo decoding while the FM AGC voltage for the FM 2nd RF amplifier is obtained from the AGC amplifier transistor (Q5) collector. The FM 3rd IF signal is sampled through capacitor C11. Diode E2 converts the FM signal to a +dc voltage. The voltage varies with the received signal strength and this dc voltage then biases the NPN AGC amplifier.

A regulated +12v is the IC source voltage at pins 1 and 9. Pin 8 receives a 4.7v bias from the same source through resistor R33. The first check should be for proper voltages at pin 1, 8 and 9. If they are not correct, the IC or some other component may be causing the problem.

While looking at the schematic in Fig. 3, we will follow the signal path around the IC decoder stage. Monaural audio (L + R) enters the IC input at pin 3 and is fed to the right and left audio channels from pins 11 and 12. Stereo information L-R sidebands (23 to 53kHz) at the IC input (pin 3) are decoded into audio: then added to the monaural signal (L+R) to reproduce the left (pin 11) and right (pin 12) stereo audio signals. Each output channel from the IC is then bypassed to permit only audio to pass (30Hz-15kHz) and frequencies above 15kHz are attenuated. Use your oscilloscope when checking for

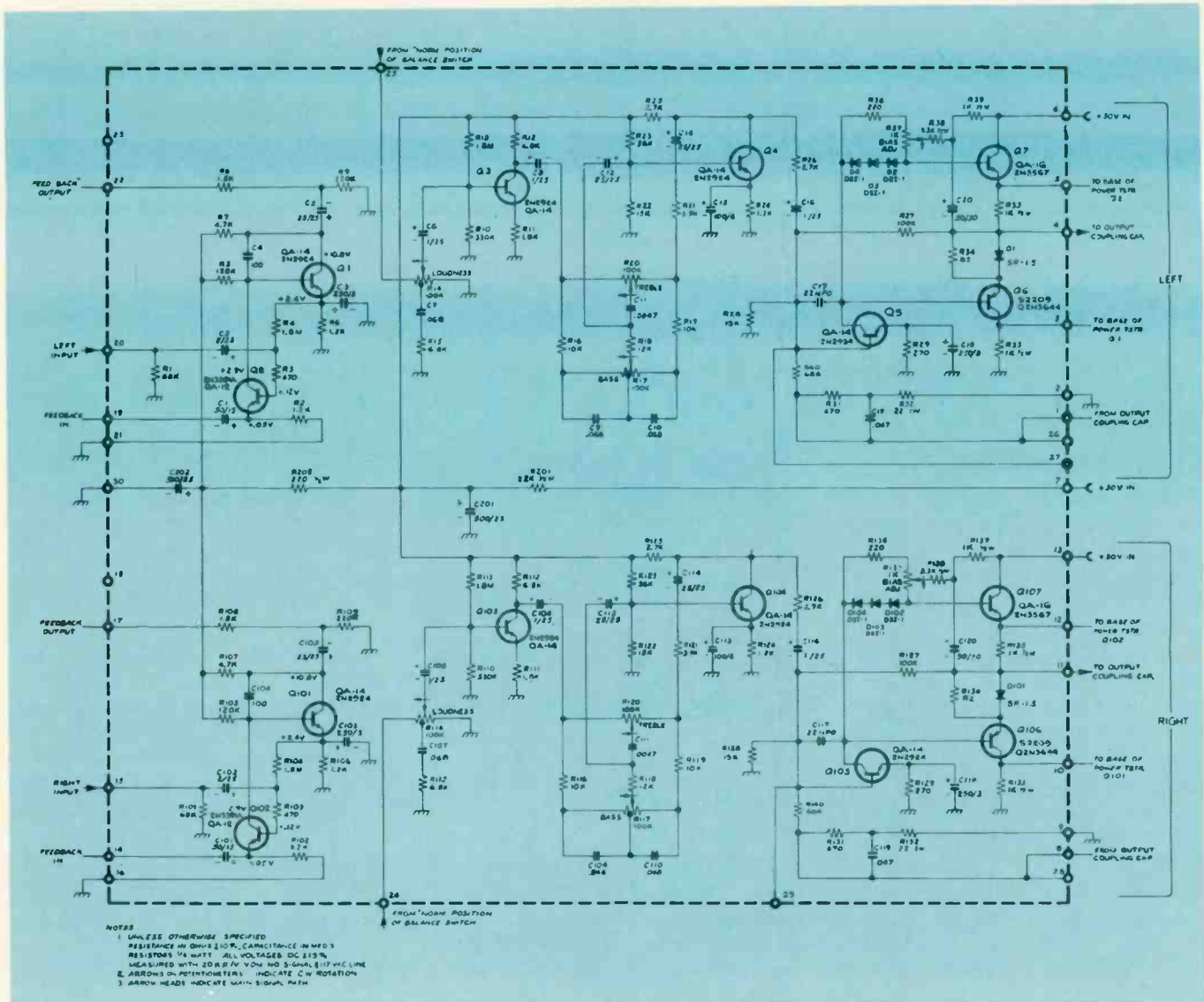

Fig. 2—Schematic of the Scott Model 299F stereo amplifier.

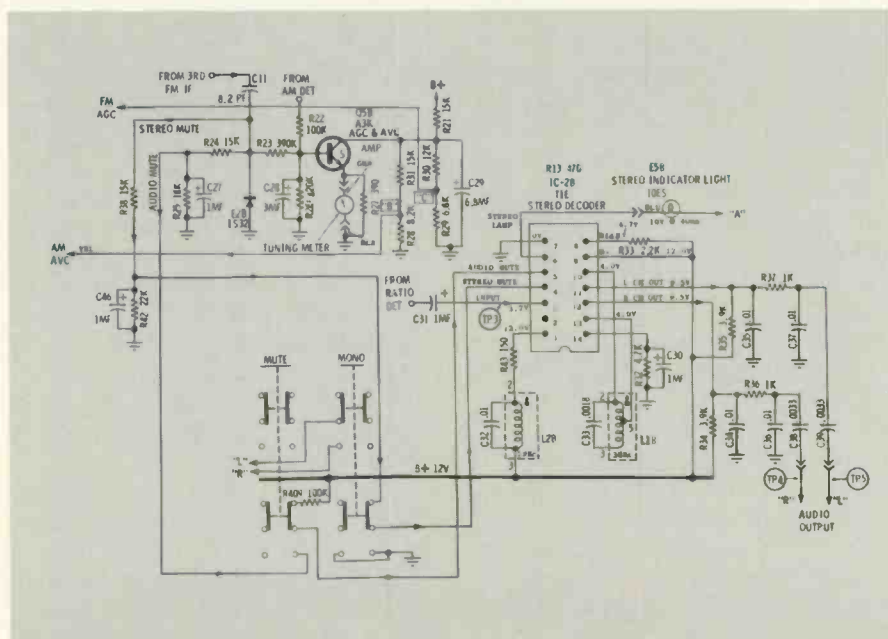

Fig. 3—Schematic of the AGC Amplifier and Stereo Decoder employed in Motorola's AM-FM stereo chassis 1C350.

proper waveforms at pin numbers 3, 11 and 12 of the chip if you are not receiving FM in stereo.

The 19kHz pilot transformer, L2 and the 38kHz stereo-carrier transformer, L1 are external to the IC. These are the only adjustments related to the IC. Connect the scope to check for the proper pilot carrier signals. During a stereo broadcast, pin 6 is grounded through the IC switch action to switch on the stereo indicator light (E5B). The stereo information is blocked if the voltage at pin 4 drops below .9v. Since this voltage comes from the rectified FM signal through resistor R38, this voltage will reduce with signal strength. On weak, noisy stereo stations, the voltage drops below the .9v threshold point and all stereo information with noise is blocked but the monaural signal is not affected.

To eliminate the normal "rushing or hissing" noise between FM stations, the mute switch is depressed. If the mute voltage at pin 5 of the IC drops below a predetermined level (approximately +.9v) all signals are blocked from passing through the IC.

With the mute switch depressed (on), the IC pin 5 is connected to the FM rectified signal (Junction C27, R24, R25). This rectified dc signal varies with signal strength and between stations, the voltage drops below the mute threshold (+.9v) and the IC is cut off with between stations and on undesirable weak stations. This action would be similar to "squench" used in two-way radio receivers.

The mute feature is defeated when the mute switch is released (off) and a fixed voltage (approximately +1.1v) is connected to the IC audio mute input (pin 5) through resistor R409.

More stereo receivers will be using solid-state circuitry in the near future. One new chassis is the RCA Model RC1227 which was developed by the c/COS (computer crafted) concept method. The 1st and 2nd IF amplifier stages are illustrated in Fig. 4 using this concept. Note the substrate Z201 which contains two transistors and many other components. For circuit checks ap-

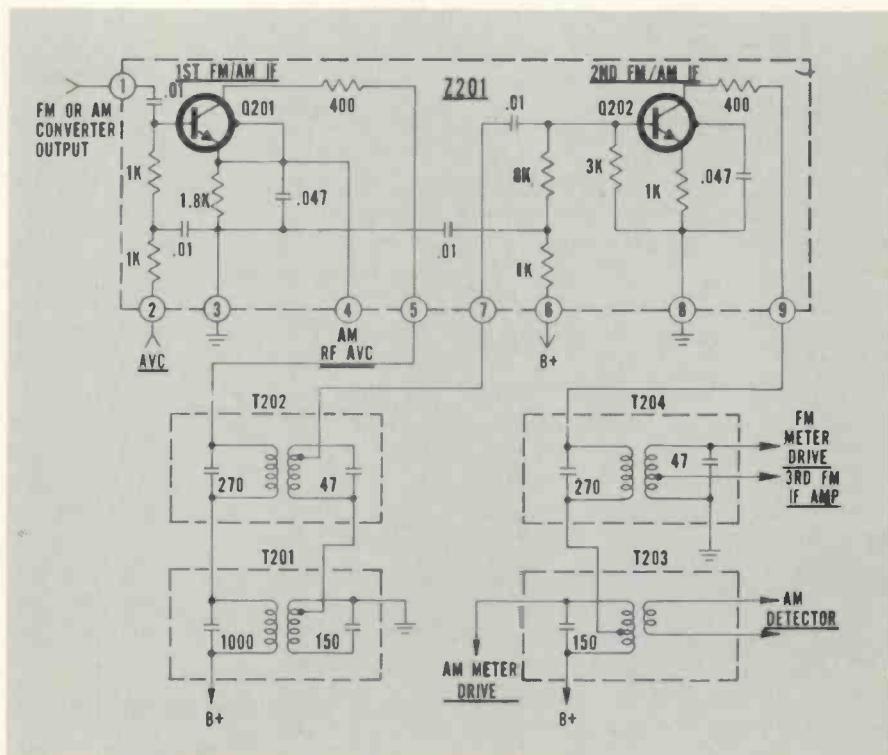

Fig. 4—Schematic of the 1st and 2nd amplifier stages employed in the RCA Model RC1227 amplifier employing the substrate Z201.

ply an RF signal (at the IF frequency) at pin 1 of the substrate and with a detector probe on your scope, check for amplified IF signal at pin number 9. If the pin voltages are found incorrect, you should replace Z201.

COMPLEMENTARY SYMMETRY AMPLIFIERS

This amplifier design produces a uniform frequency response throughout the audible frequency spectrum. Phase shift at low and high frequencies is reduced, while amplifier stability and transient response is improved.

Complementary symmetry amplification is not a new audio engineering approach, but has been a gleam in the audio designer's eyes for many years. New approaches in design for the past few years are matched—paired transistors, dual heat sinks, simplified circuits and application reports.

To enhance the output response and to eliminate a major cause of undesirable frequency discrimination, these amplifiers are designed to take full advantage of transistors without the need for the driver and output transformer or the often

troublesome interstage coupling capacitors. With the complementary design, transformers are eliminated to achieve better performance at lower cost and smaller size.

The name "Complementary-Symmetry Amplifier" is derived from the output transistor circuit configuration. In this circuit, an NPN and a PNP transistor are connected in series to form the output circuit. Both transistors exhibit the same characteristic except for polarities.

In this circuit, a positive going signal increases the conduction of the NPN transistor while a negative going signal increases the conduction of the PNP transistor. Thus, no phase inversion of the drive signal is required. The output transistors compliment each other and produce a symmetrical output signal.

Shown in Fig. 5 is a schematic of a "complementary-symmetry" amplifier. We will review some typical circuits to see how this functions. The 1st audio transistor, Q6, is connected as an emitter follower (common collector). Collector and base bias potentials are supplied from terminal M2 which is also connected to one side of the speakers. The other speaker lead is connected to ter-

minimal M7 and is called the "tap out" point with a potential of 13v. The current required by transistor Q6 must flow through the woofer voice coil and is less than .001 ampere.

Supplying the dc potentials to transistor Q6 in this way eliminates an additional voltage divider and a decoupling network from the 26 volt supply. Capacitor C6 (200 μ fd) provides dc isolation for transistor Q6.

The "bootstrapping" capacitor C16 (30 μ fd) is connected between the emitter of Q6 and R20, the 47K base resistor. This capacitor feeds back a portion of the emitter signal in phase to the low side of resistor R20. This in-phase signal counteracts any current flow through base R20 and effectively raises the input impedance of Q6 to more than 50K.

The signal is amplified by driver transistor Q5 and coupled from the collector of Q5 to the base of the PNP output transistor Q8 and also coupled through resistor R11

and diode D3 to the base of the NPN output transistor Q3.

The use of D3 and C4 in the circuit equalizes the drive requirements of output transistors Q3 and Q8 to permit the output signal in the emitter circuit to be symmetrical. The output signal is taken from terminal M7 and returned through C6, the dc blocking capacitor.

The oscilloscope can be used to trace a square wave signal through all of the amplifier stages. The dual-beam scope can be used for observing the output transistors to see if they are complimenting each other or are possibly being detrimental in producing a symmetrically amplified output signal.

STEREO SERVICE PRECAUTIONS

These tips can be used as an aid to servicing complementary-symmetry or other solid-state amplifier circuitry:

- (1) Change the emitter resistor when the output transistors are replaced even if the original one looks or appears to check normal. (2)

Use a silicone heat sink compound for effective heat conduction when replacing output transistors. (3) Output transistors must be firmly seated against the heat sink. Press down firmly on transistor as solder solidifies. (4) Check all transistors in direct coupled amplifier stages before power is applied to repaired chassis. (5) Slowly adjust the bias potentiometers to prevent sudden bias changes which could cause output transistor damage. (6) Do not ground the speaker leads or the extension speaker jacks. Use extreme caution when connecting test equipment to the chassis to insure that accidental grounding does not occur and could cause transistor damage. (7) When replacing the output transistors make sure replacement transistors are installed in the proper sockets or solder points on the circuit board.

SOLID-STATE SERVICE TIPS

- (1) Monitor the voltage between the complementary-symmetry output transistor bases when troubleshooting the chassis. Reading should be about 1v. (2) If the voltage is less than 1v, the bias diode or bias transistor may be shorted. Audio output will be low and sound will be distorted. (3) Should voltage across output transistor bases measure more than 1.5v, bias diode on base transistor may be open causing forward bias to increase current flow through the output transistors. Tap-out voltage may be normal, but the B+ will be low. (4) Audio output may be normal, however, there may be some hum in the speakers. Excessive current flow through the output transistors will cause increased heating of the output transistor and eventual failure. (5) Monitor the B+ while servicing the amplifier chassis. Low B+, less than 20v for 8w chassis, less than 30v for 20w chassis, indicates excessive current flow in output transistor circuit. (6) High B+, more than 28v for 8w chassis, more than 40v for 20w chassis, indicates an open output transistor or insufficient forward bias on the output transistor. ■

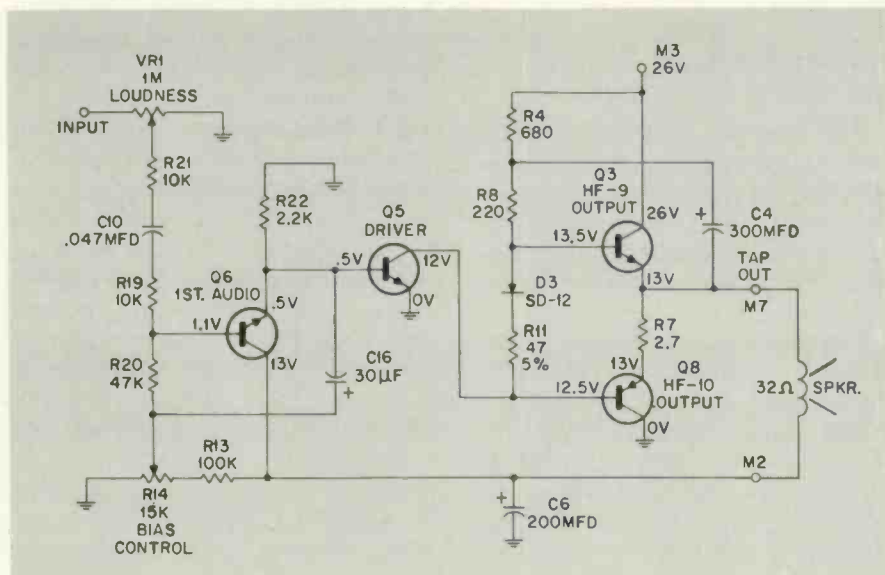

Fig. 5—Schematic of a "complementary-symmetry" amplifier.

Curve Tracer for In-circuit Troubleshooting

by JUD WILLIAMS

The curve tracer and oscilloscope are teamed up in this new technique for fast and easy transistor troubleshooting.

■ Transistor troubleshooting should become a faster, easier task with a technique developed using a transistor curve tracer and a dc oscilloscope. The new method allows a technician to locate a defective transistor in virtually any kind of circuit whether TV, radio, audio or industrial. After the defective unit has been found, the curve tracer and scope can help the technician find the right replacement from the transistors that he normally keeps on hand.

The technique is called "interpretive diagnosis" and uses the dynamic transistor curve tracer, a long overlooked instrument for servicing but used mainly by engineers and quality control people for testing and classifying various types of transistors. A wideband dc oscilloscope is preferred because the display retains a fixed reference.

HOW THE CURVE TRACER WORKS

Basically, the curve tracer does its work by sweeping the collector to emitter of a transistor with a 120Hz pulsating dc voltage. Then a staircase generator in the tracer supplies the transistor base with calibrated steps of current. The result is a characteristic family of curves displayed simultaneously and automatically on the scope as shown in figure 1. This 'family of curves' is that

of an NPN transistor with a Vce of 6 volts and base current of $20\mu\text{a}$ per step. Collector current is calibrated as 10ma per vertical division on the graticule.

The block diagram in figure 2 shows how the voltage across the transistor is applied to the horizontal input of the oscilloscope. The collector current is measured by monitoring the voltage drop across the resistor in series with the emitter and applied to the vertical channel of the oscilloscope.

NEW TECHNIQUE IS TESTED ON IN-CIRCUIT TRANSISTORS

The curve tracer-scope combination has been used for some time now to check and identify transistors out-of-circuit, but because the tracer actually turns a transistor on it was speculated that it might work on a transistor still in the circuit. Several simple audio circuits were tested in the laboratory and the results were surprising. There was

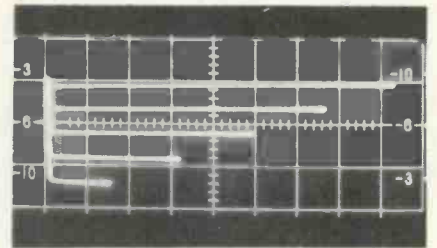

Fig. 1—The 'family of curves' of an out-of-circuit NPN transistor with Vce of 6 volts and base current of $20\mu\text{a}$ per step.

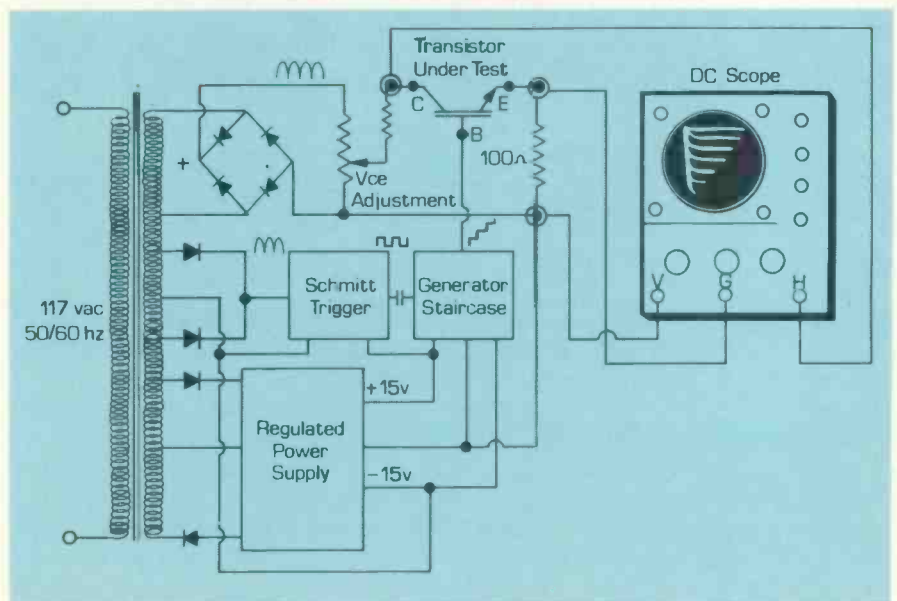
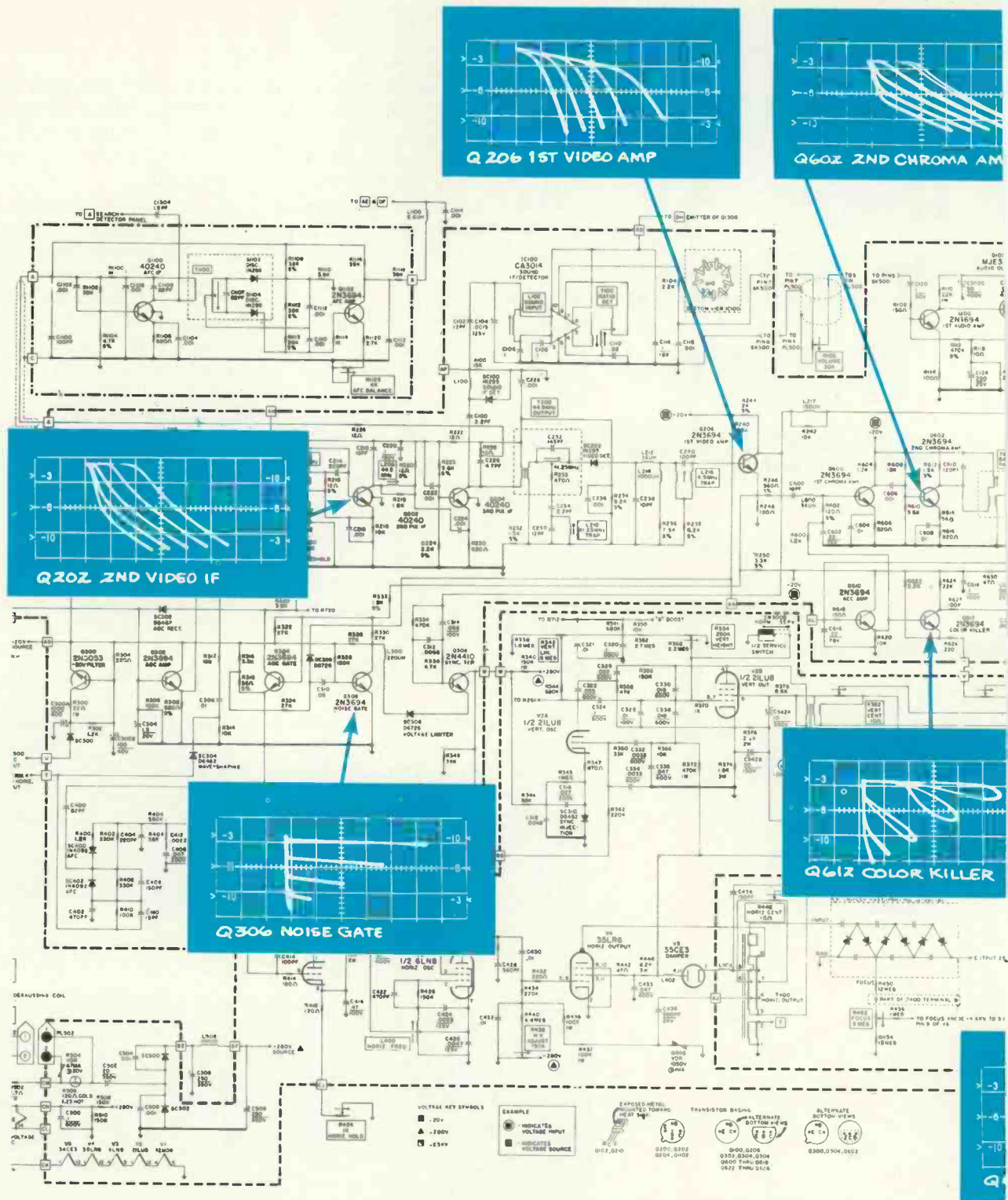

Fig. 2—Block diagram of a dynamic transistor curve tracer showing how voltage across transistor is applied to horizontal input of the oscilloscope.



strong evidence that the curve tracer could be used to determine whether the transistors in-circuit were 'good' or 'bad.'

A digital circuit was tested and the results were again surprising. The big test came when the technique was applied to the Sylvania D14 color TV chassis. Every circuit was tested with both good and bad transistors in place. Audio, RF and video circuits were all checked and even with the loading effects of pe-

ripheral components the curve tracer was able to differentiate between good and bad transistors.

As might be expected, the waveforms of transistors while in a circuit are a far cry from those displayed when the curve tracer is used in the conventional manner. It was found that this doesn't matter because the waveforms derived from this method are very similar in character even though badly distorted. The vast majority of transistor failures are

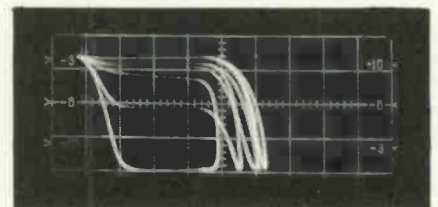
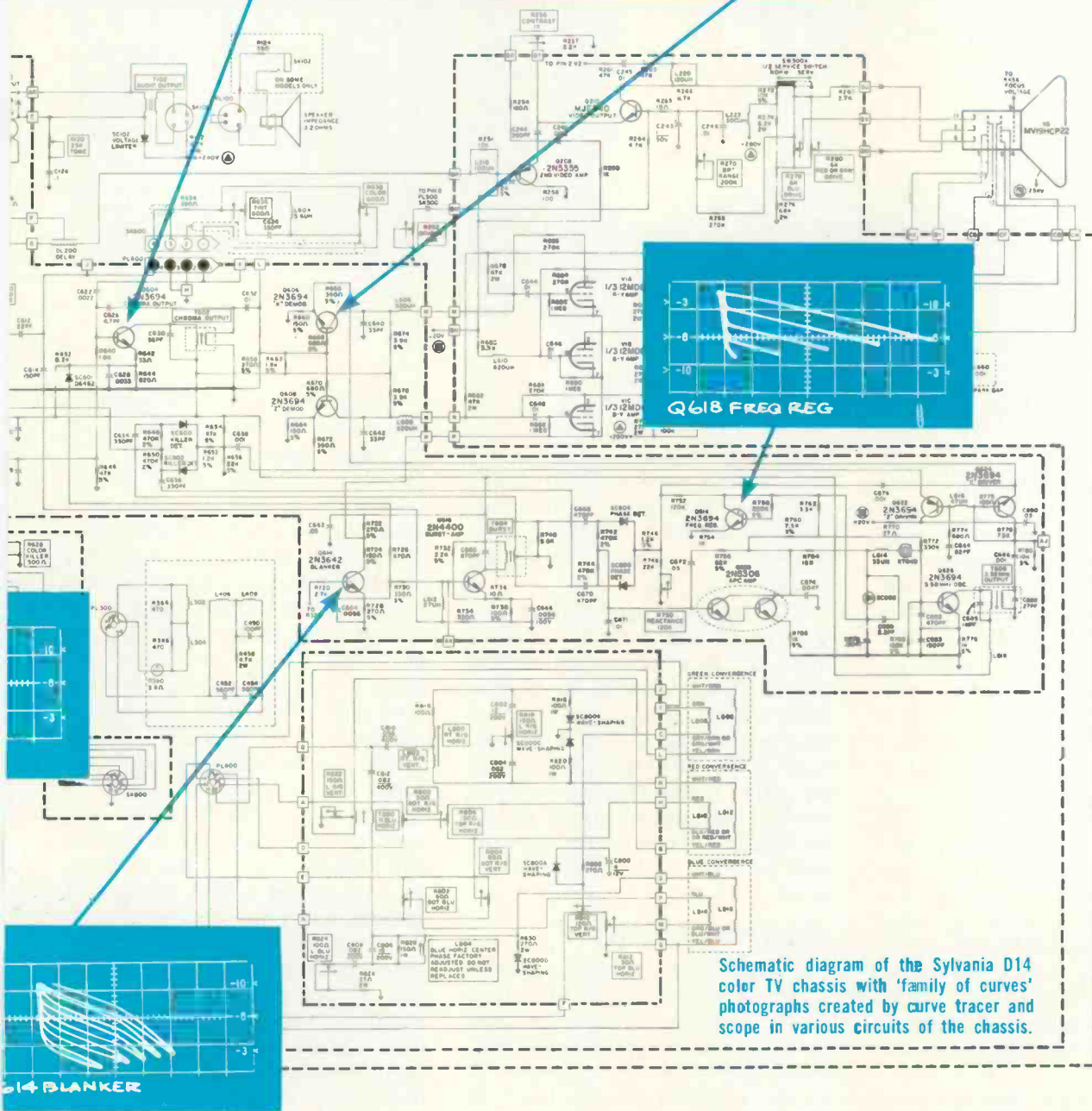
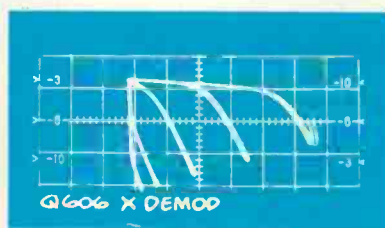
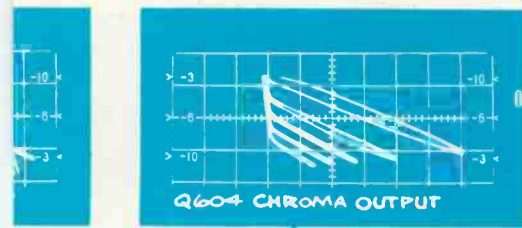

Fig. 3—'Family of curves' created by Q100 in 1st audio amplifier of the Sylvania D14 chassis.

catastrophic and in troubleshooting we are only looking for either 'good' or 'defective' transistors.



Schematic diagram of the Sylvania D14 color TV chassis with 'family of curves' photographs created by curve tracer and scope in various circuits of the chassis.

METHOD SPEEDS TROUBLESHOOTING

Because of the simplicity of this method, it is hardly necessary to use conventional troubleshooting techniques. With the device under test turned off, simply touch the test probe to each suspect transistor and within a few short minutes the culprit is located without laboriously unsoldering each transistor before testing. Once a replacement trans-

istor has been soldered in place, another quick check with the curve tracer will insure that it has been inserted correctly.

In tests with the Sylvania chassis, a three-pronged probe was used. It was a great timesaver as the needle sharp probes make contact with each lead of the transistor simultaneously.

WHAT TO LOOK FOR

Several circuits from the Sylvania

D14 are illustrated here along with photographs of the curves developed by the curve tracer. In the accompanying illustrations, the waveforms indicate properly operating circuits. When a defective transistor is located, the display on the scope will be a straight horizontal line.

In the display of each circuit tested, look for the presence of several curves even if they are completely different in shape to the standard

continued on page 84

From Scope To Vectorscope

by CHARLES W. JANECEK

Convert your scope to display the vector pattern for servicing color circuits without having to view the TV receiver screen.

■ Color television servicing can be simplified by the use of the vectorscope. A great amount of data involving color-circuit operation can be obtained in one easy to read waveform. The waveform obtained on the vectorscope screen is a lissajous pattern since quadrature (90 degree out-of-phase) information is impressed simultaneously on the CRT's horizontal and vertical deflection plates. The pattern is produced by the sine wave outputs of the chroma demodulators when a rainbow generator is connected to the antenna terminals of a receiver.

Color reproduction is basically "Phase" interpretation by the color circuits in a receiver. The principle of operation of the Rainbow generator is the production of a "linear phase sweep" which permits simultaneous viewing on the receiver kinescope of a number of color phases which in turn enables the technician to evaluate the operation of the receiver.

The vectorscope's primary use is for troubleshooting, spotting defective diodes in the new tri-phase demodulators, burst transformer and 3.58MHz color oscillator alignment as well as alignment of the 3.58MHz traps and high level demodulators.

The vectorscope technique can be put to practical use without buying another scope. Servicing color television receivers with automatic frequency control, automatic color control and similar circuits require a good triggered or other quality scope which is a very versatile piece

of test equipment and can also be used as a vectorscope.

All your service scope requires is a horizontal input terminal and a method of connecting an incoming signal to the horizontal amplifier to provide a controlled horizontal sweep.

The procedure outlined uses only your scope and it should perform quite well as a vectorscope without modifications. A special test harness is not required, all you need are two pins to pierce the R-Y and B-Y detector leads (solid red and blue) to the CRT. Connections can also be made at the terminals on the receiver chassis. Insulation piercing type clip leads can be purchased if desired.

SET-UP PROCEDURE

(1) Connect a color bar generator to the antenna input terminals of the TV receiver. (2) Set the color bar generator for a rainbow pattern. The signal from the generator is crystal-controlled at a frequency of 3,563,795Hz, about 15,750Hz less than the 3,579,545Hz subcarrier oscillator in the color TV receiver. The frequency difference produces a signal that will have a phase change of from 0 to 360 degrees in the time of a single horizontal scan of 53 μ s. When 360 degrees is divided by 30 degrees, the result is 12. This is the number of color bars actually generated. One color bar, however, is blanked by the generator and a second serves as the sync reference burst and is emitted during the 10 μ s

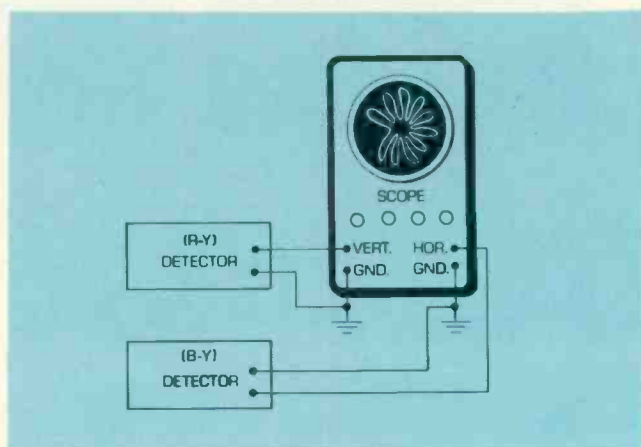

Typical test setup using the oscilloscope to display vector patterns.

blanking time of the TV receiver. Thus, only 10 bars are visible. If the input signal is excessive, or if the color intensity control is advanced too far from a normal signal level, the vectorgram display may become flattened because of chroma circuit overload. (3) Set the vertical input calibrator of the scope at 50 volts per cm. If the signal input to the vertical stage overdrives the scope, it may be necessary to use a 10X probe and adjust the vertical attenuator for a pattern as in Fig. 1. (4) Set the horizontal sweep selector of the scope to the EXT. HORIZ. input. (5) If grid drive is used, connect both the horizontal and vertical inputs of the scope to the grid of the CRT's red gun. If cathode drive is used, connect both the horizontal and vertical inputs of the scope to the cathode of the red gun. In the general low level and Zenith high level demodulation systems (called this because low level must be followed by amplifiers and high level is the final stage after the amplifiers), the vectorscope connections are often made directly to the junctions of the R-Y, B-Y outputs. Whereas in the tri-phase demodulation systems (either cathode or grid connected), vectorscope connections must be made at points where the signal enters the picture tube for the least loading and best isolation from the preceding semiconductors.

In the Motorola TS915 chassis, vectorscope connections would go directly to the kinescope cathodes. (6) Adjust the horizontal gain con-

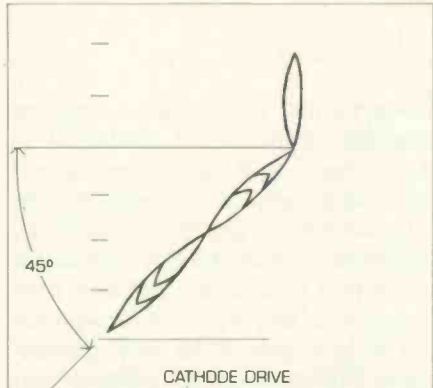
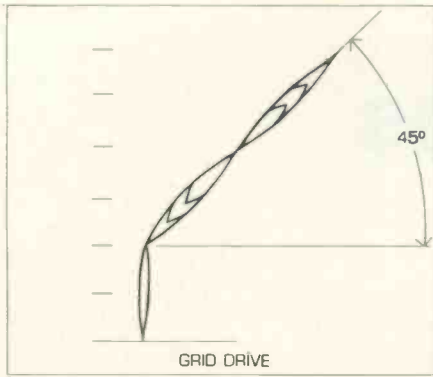

Fig. 1—Patterns produced with grid and cathode drive and the vertical input calibrator of the scope set at 50 volts per cm. The horizontal gain control is adjusted until the pattern appears at a 45 degree angle.

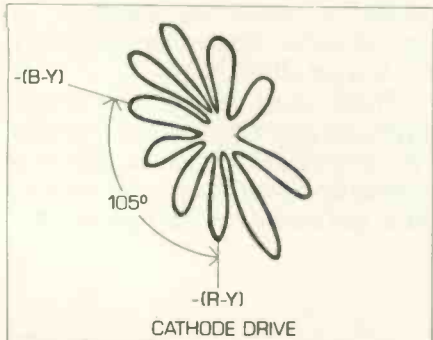
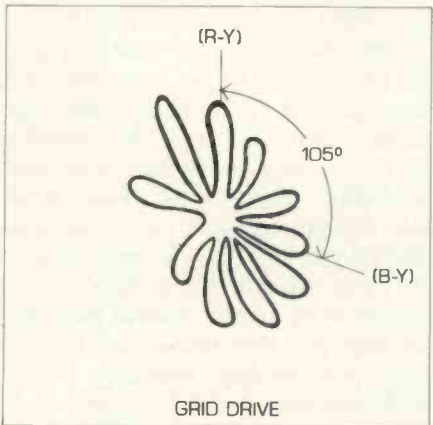

Fig. 2—Patterns produced by sets with 105 degree modulation and horizontal input of the scope connected to the blue gun, grid or cathode depending on the drive.

trol until the pattern appears at a 45 degree (see Fig. 1). Mark the position of the horizontal gain control because it will be in approximately the same position regardless of the TV receiver manufacturer or characteristics. (7) Remove the horizontal input from the red gun

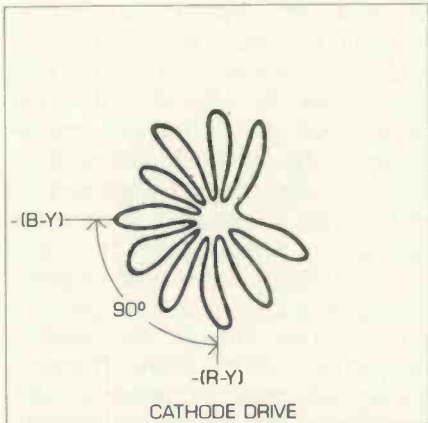
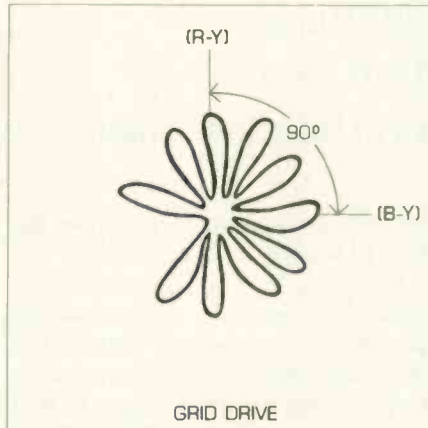
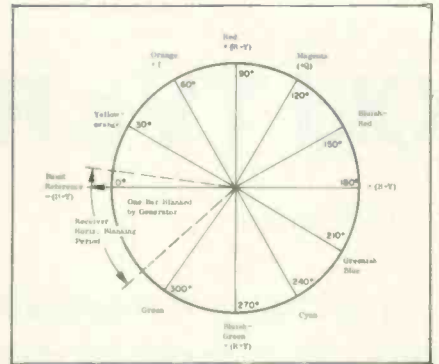

Fig. 3—Patterns produced by 90 degree sets. and connect it to the blue gun, grid or cathode depending on the drive. The pattern in Fig. 2 will be seen for sets with 105 degrees while the pattern in Fig. 3 will be seen for 90 degree sets. Note: 90 degree sets will have a circular pattern while 105 degree sets will have an elliptical pattern.

CONTROL EFFECTS ON PATTERNS

To effectively use the vector display you must be familiar with the effects of the color amplitude and tint controls on the scope display. (1) The color amplitude control will vary the size of the petals but not their angular relationship. (2) The hue and/or tint control changes the angles of the petals but not their am-



Chrominance phase diagram showing sequence of color bars in a 300 degree circle.

plitude. If you are unable to decrease horizontal gain, or if input is overloading the horizontal amplifier, place a 10M resistor in series with the input lead.

The vector patterns may vary slightly between sets and especially between different manufacturers. The specific areas of importance on the vector patterns are the ends of the vectors, which represent angular displacement, and the center of the pattern which must be placed into the center on the face of the CRT.

The vectors of the RCA sets all have approximately the same length, but this is not true on Motorola and Zenith. The R-Y vector on the Motorola is longer than the B-Y vector while Zenith is just the opposite. It is recommended that the vector display for all of the sets be observed on units known to be good to familiarize the technician with various displays.

ADDITIONAL USES AND PROCEDURES

If it is desired, the vectorscope can be used to set the range of the hue control of a color TV receiver. The hue control should first be set to its center range. With a color bar generator connected to the antenna terminals, the display should show the (R-Y) petal in a vertical position. By rotating the hue control back and forth, the third bar should rotate at least as far as the number two position to the left and the number four position to the right. If this is not the case, locate the chroma reference oscillator and adjust it so that the (R-Y) petal is vertical.

continued on page 84

Old TVs Reduce Taxes

by LEON ROVICK

If your shop is cluttered with old TV chassis, here's how you can get rid of them, save money and perform a public service all at the same time.

■ In spite of the many complaints by professional educators that ordinary citizens do not care to get involved in public education and its problems, especially vocational education, many citizens are proving that they do care. Some of these are fraternal organizations who are assisting the radio and television repair classes in vocational schools by collecting old radio and television receivers from private individuals and local dealers. In a period of only two months, one organization in New Jersey was able to supply the Middletown Vocational High School with 15 radios, 19 TV sets, 2 tape recorders and 4 record players. This is only a beginning in what they hope will be a continuing program.

How does this involve the TV dealers? Nearly every radio and TV repair shop has so-called "junk" cluttering up floor and shelf space. Every inch of space in your store costs money. Holding onto this junk cuts into your profits. The question is: how to dispose of this material at no cost. One answer is to get a Fraternal group interested in a project such as the one we just mentioned. There are many such public-service groups around the country, some large and some small, but all interested in serving. Many of the readers of *ELECTRONIC TECHNICIAN* are probably themselves members of such groups. All that is

needed is the interest to ignite the fuse of action.

Not only will you get rid of the stuff cluttering your store, you can yourself also get actively involved in the vocational program in your area. Dealers may not even be aware that there are vocational high schools in their area actively engaged in training television and radio technicians. Of course, you don't necessarily need the help of a fraternal group; you can deliver the sets directly to the school. However, your time and that of your employees as well as the expense of your truck can cost a pretty penny. You can save all this trouble and expense simply by asking a fraternal group in your area to sponsor the project. Moreover, since most fraternal groups are publicity minded, your firm's name will be presented to the public in a favorable light at no expense to yourself. What better advertising can you get?

Further, your tax status may benefit by deducting the equivalent economic value of the contributed merchandise. Although the sets may be junk to you, they do have market value, however small it may seem.

Nearly every radio and TV repair shop in the nation can use more technicians. By getting personally involved in the program along with the fraternal group you can become acquainted with the school officials. By

cooperating with them everyone benefits. Students are motivated to better learning if they know there is an opportunity for immediate employment after graduation. And, by employing these student technicians on a part-time basis, you can have a source of employees who can readily fit into your plans after graduation. You are in effect training your own help. In addition, your local vocational school officials can explain the financial assistance offered to tradespeople in cooperative education. But they can only do this if you make yourself known to them.

One final note—you will feel better emotionally if you know that the material you offer can in some way serve a better purpose than simply as ballast in a city dump. You can probably recall when you were learning principles of radio how you wished you had more material to experiment with that you didn't have to buy. If by error a student destroys an item, that item has served its purpose; the student probably won't make the same mistake again. And isn't it better for the potential technician to make his mistakes in school rather than on a customer's set in your shop?

Think about the obvious advantages this plan offers to you; and you will probably want to get involved, especially when you save money, time and trouble in the bargain. ■

TELEQUIPMENT D54 OSCILLOSCOPE

A properly operated and understood scope is one of a service technician's most valuable tools and to increase this understanding, our discussion this month centers on a dual trace, triggered instrument.

... for more details circle 900 on Reader Service Card

■ Rather than get into a long-winded and very technical description of circuit operation, let's make a tour of this versatile unit by referring to the block diagram in Fig. 1. A brief explanation of the various stages will help you to better understand how a dual trace, triggered scope works. Then we will talk about the use and operation of this unit.

A dual trace scope, somewhat like

a stereo amplifier, has two input channels. The Telequipment Model D54 shown in the block diagram refers to these as Input 1 and Input 2. The photo of the instrument also shows these inputs which use BNC type connectors. Incidentally, these connectors are supplied with the scope, but you have to make up your own test cable.

Since both input channels are identical, reference to one is the same for both. The input signal is fed first to an "attenuator" network. Each attenuator consists of four frequency compensated resistive dividers which are switched singly or in tandem to provide the required division ratios. The input signal is either passed directly to the input amplifier or they are reduced by the resistive dividers to a convenient level.

"Y" INPUT AMPLIFIER

The input amplifiers shown on the block diagram as the "Y" amplifiers consist of transistors TR21-TR27 in one channel and TR21a-TR27a in the other channel. These amplifiers use an FET input circuit for high impedance. Both amplifiers are connected through another circuit shown on the diagram as the Channel-Switching Multivibrator, TR33-TR37. Depending on the condition



Telequipment D54 Oscilloscope.

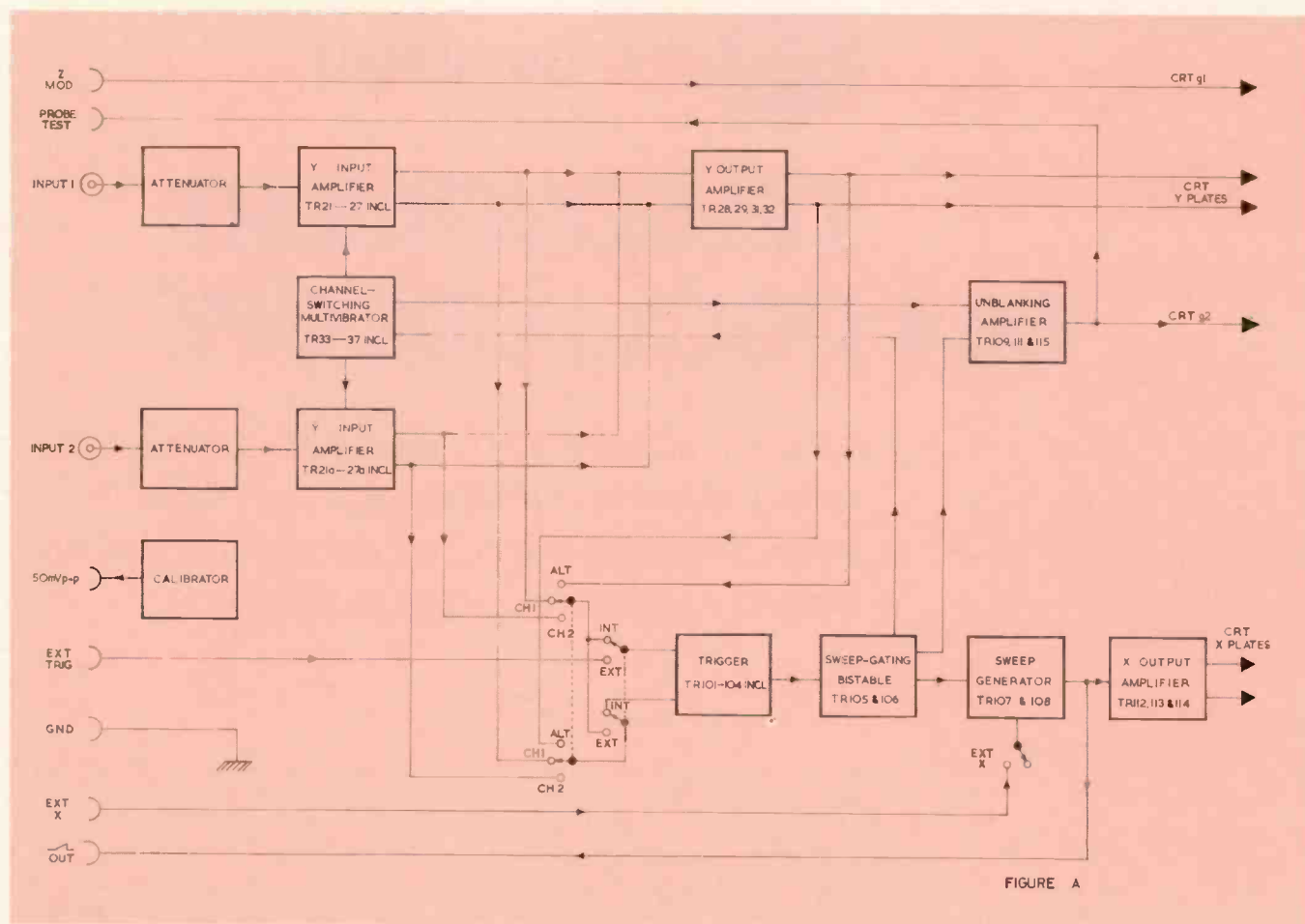

Fig. 1. Block diagram of the Telequipment D54 Dual Trace, Triggered Oscilloscope.

of this multivibrator, the output of either amplifier is fed to the "Y" output amplifier. When the scope is set to internal trigger, a portion of either amplifier's output may be fed to the trigger circuit.

CHANNEL-SWITCHING MULTIVIBRATOR

As we indicated earlier, the channel-switching multivibrator is used to provide switching potentials to determine which of the input amplifiers will drive the output amplifier at any given time. In the alternate mode, a gating pulse from the sweep-gating bistable switches the multivibrator; each amplifier is switched on for every alternate sweep. In the chopped mode of operation, the multivibrator free-runs and switches each amplifier on and off at intervals of about $5\mu\text{s}$. Pulses are provided to blank the CRT beam during switching. This provides automatic transient blanking in the chopped mode.

"Y" OUTPUT AMPLIFIER

This amplifier consists of transistors TR28, 29, 31 and 32. The output signal from either input amplifier is further amplified and fed directly to the CRT "Y" plates. A portion of this output may be fed to the trigger circuit to enable the timebase to be triggered by each channel's output alternately. Looking back at the two input channels, there are five possible channel-switching combinations depending on the two channel push-button switches and the CHOP-ALT slide switch. The combinations are: Channel 1 on, 2 off; Channel 1 off, 2 on; Channels 1 and 2 alternate; Channels 1 and 2 chopped; Channels 1 and 2 off.

The block designated as CALIBRATOR is used to provide a 50mv P-P squarewave at the power line frequency as a means of checking the "Y" amplifier and for timebase calibration.

TRIGGER CIRCUIT

Going down the diagram, we see the block labeled TRIGGER, TR101-TR104. The purpose of this circuit is to provide pulses of suitable amplitude and polarity to trigger the sweep-gating bistable from internally or externally derived waveforms. The bases of the input transistors in this circuit are fed with triggering signals from either the vertical amplifier for internal operation, or from the EXT TRIG terminal for external operation depending on the position of switch S101. This push-button switch is labeled on the front panel as EXT TRIG and INT.

SWEEP-GATING BISTABLE

This circuit consists of transistors TR105-TR106. Its function is to determine the start and finish of each sweep. Suitable voltages are applied to the unblanking amplifier and channel-switching multivibrator

TECHNICAL DATA

VERTICAL AMPLIFIER and ATTENUATOR

Operating modes _____

3dB bandwidth — d.c. coupled _____
 a.c. coupled _____

10 to 90% risetime _____

Calibrated deflection sensitivity $\pm 5\%$ _____
 Variable gain control provides continuous coverage
 between ranges

Maximum input (via 400V capacitor a.c. coupled) _____

Input impedance approx. _____

Channel 1 only
 Channel 2 only
 Alternate — Channel switching during
 flyback
 Chopped — Channel switching at
 100kHz approx. Automatic
 blanking

d.c. - 10MHz
 2Hz - 10MHz
 35ns nominal
 10mV - 50V/cm (12 1-2-5 steps)

400Vp
 1M Ω & 40 pF

HORIZONTAL SYSTEM

Trigger

Internal — Minimum deflection _____
 Source _____

External — a.c. coupled _____
 Input impedance approx. _____

Useful bandwidth approx.
 Automatic _____
 Trigger level _____
 HF _____

2mm
 Channel 1
 Channel 2
 Alternate
 1.5 Vp-p to $\pm 15V$
 100k Ω & 10pF

50Hz - 1MHz
 10Hz - 3MHz
 1MHz - 10MHz or better

Sweep generator

Calibrated sweep speeds $\pm 5\%$ _____
 Variable control provides continuous coverage
 between ranges

Maximum speed range approx. _____

200ns - 2s/cm (22 1-2-5 steps)
 40ns - 5s/cm

Horizontal amplifier

3dB bandwidth _____
 10 to 90% risetime _____
 Deflection sensitivity approx. _____
 Input impedance approx. _____
 Maximum input _____

d.c. - 1MHz
 350ns nominal
 600mV - 3V/cm
 1M Ω & 30 pF
 400Vp

CATHODE RAY TUBE

Display area _____

Overall post-deflection acceleration _____

Available phosphors _____

External intensity modulation

Coupling _____

Signal for cut-off at average brilliance _____

Time constant _____

6 x 10cm
 4kV
 P31 (standard), P7 & P11

a.c. to first grid
 —20Vp approx.
 10ms approx.

FRONT PANEL OUTPUTS

Calibrator — supply frequency _____

Sweep sawtooth

Amplitude _____

Minimum load _____

Probe test _____

50mVp-p $\pm 2\%$

1-35V approx. d.c.-coupled
 30k Ω
 500mV approx.

POWER REQUIREMENTS

Voltage _____

Frequency _____

Consumption _____

100 - 125V in 5V steps
 200 - 250V in 10V steps
 48 - 440Hz
 32VA approx.

PHYSICAL DATA

Approximate overall dimensions and weight:

High	Wide
24.5cm	21cm
9 $\frac{3}{4}$ in	8 $\frac{1}{4}$ in

Deep
44.5cm
17 $\frac{1}{2}$ in

Weight
9.25kg
20 $\frac{1}{2}$ lb

Cooling

Convection

Approximate ambient temperature limits:

Operating	—15 to +40°C	+ 5 to +104°F
Non-operating	—25 to +70°C	—13 to +158°F

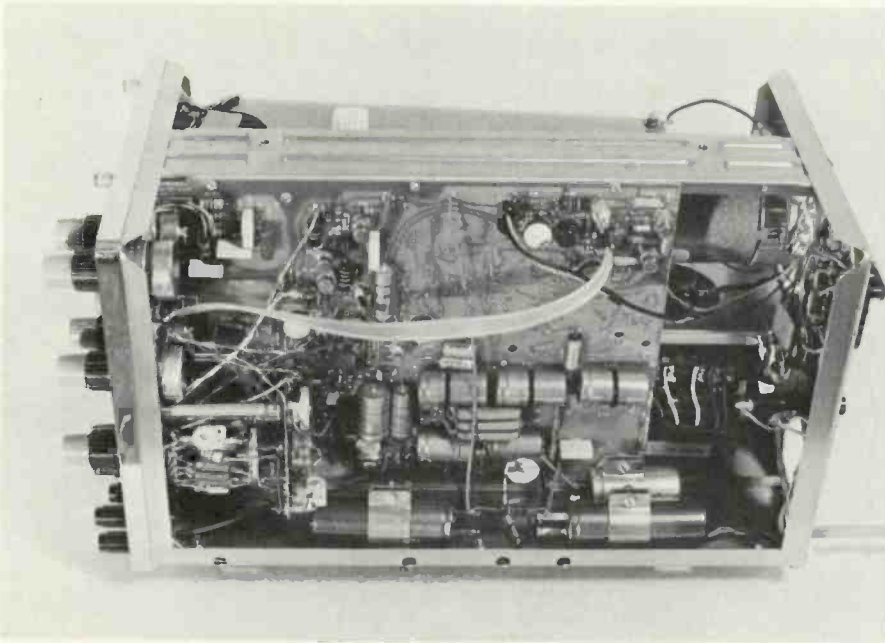

Interior view showing component and circuit board mountings.

to provide beam-unblanking during the sweep and channel-switching at the end of each sweep in the alternate mode.

SWEEP GENERATOR

The sweep generator provides a sawtooth waveform which is passed to the "X" output amplifier and a front panel terminal. In the external X condition, the stage operates as the X input amplifier. The "X" output amplifier, shown on the block diagram as consisting of TR112, 113 and 114, amplifies the sweep sawtooth or the external X signal and feeds it in push-pull to the CRT "X" plates.

UNBLANKING AMPLIFIER

In this circuit, the beam-unblanking pulses from the sweep-gating bistable are amplified and applied to a CRT electrode to deflect the beam on to the tube phosphor for the duration of a sweep and when the TIME/CM switch is set to EXT X. Pulses are then fed from the channel-switching multivibrator to blank the beam when the multivibrator changes state in the chopped mode.

POWER SUPPLY AND CRT CIRCUITS

We mention the power supply because it uses a power transformer which has two primary windings and two secondary windings. The trans-

former primaries are connected in parallel for operation from 100 to 125vac and in series for operation from 200 to 250 vac. So this unit will operate on almost any ac line power available. A plug is provided on the rear panel which is inserted in the correct set of contacts for the line voltage being used. The tapped secondary of the transformer provides other operating voltages except for the CRT filament which is supplied from a separate 6.3 volt winding floated at about -1kV.

The CRT used in this instrument is a 5in. flat-faced rectangular unit operating at 4kV accelerating voltage. The CRT also has provision for external modulation through a Z MOD connector at the rear of the instrument. Intensity modulation is ac-coupled to the first CRT grid.

OPERATION

The operation of a dual trace scope is much like any other good scope except that it has two inputs and provides two traces on the screen. The obvious advantage of such a unit is in its ability to allow the operator to compare two simultaneous waveforms. Since the D54 is also a triggered scope, it has the advantage of being stable—the waveforms will not jump around on the screen and you can accurately determine the value of the waveform being viewed. As we indicated earlier, triggering in a dual trace scope is accomplished by signals from the vertical amplifiers or from an external source. This instrument allows for triggering from either the TV field (frame) or from line pulses. There is also a + and — push-button to provide triggering from the positive or negative slope of the input waveform.

Some of the more common applications of a dual trace, triggered scope in servicing are to troubleshoot stereo amplifiers, FM multiplex circuits, power supplies, color TV and pulse circuits. Naturally a dual trace, triggered scope costs a bit more than a scope which does not have these functions. But if you are thinking of making a scope part of your equipment expansion, a unit of this type might be worth consideration. ■

- 1. 10-inch-longer useable loadspace.
- 2. Independent front suspension and 3½-inch-longer wheelbase for better ride and handling.
- 3. 345 pounds more payload. Up to 3930 pounds on Tradesman 300.
- 4. Hidden cargo step. Cargo doors easier to open. Won't stick or collect ice or snow.
- 5. 6. Power steering, optional. Power brakes, optional.
- 7. 7-inch-larger hood opening. Easier battery, dipstick, and radiator servicing.
- 8. Engine cover is 4 inches lower, 10 inches shorter. Makes it easy for driver to reach cargo area.
- 9. Integral air conditioning, optional.
- 10. Car-style instrument panel. All controls within easy reach

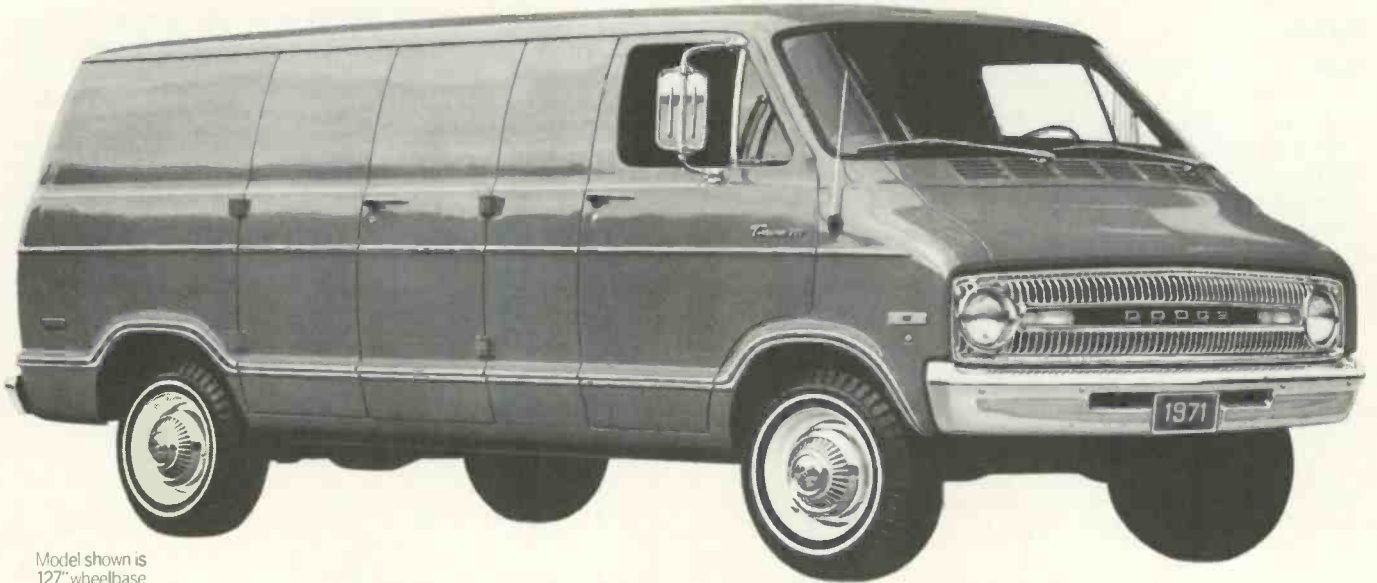

Model shown is 127" wheelbase Tradesman 300.

- 11. Bumper jack can be used with full load on Tradesman 100 and 200.
- 12. 13. Engine can be removed quickly and easily through front of truck. Wider doors and door steps and less wheelhouse intrusion make for easier ins and outs.
- 14. 15. Two-stage door checks stop front doors from accidentally closing on you. Posi-latch doors won't spring open.
- 16. Automatic transmission, optional with all Tradesman models.
- 17. Independent suspension and standard track allow inexpensive front wheel alignment on passenger car equipment.
- 18. Bigger standard engines. 198 Six, 318 V8.

INTRODUCING THE ALL-NEW 1971 DODGE STRONG BOX

The big, new Tradesman Van that outdoes the better idea people 31 ways.

- 19. 26-gallon gas tank.
- 20. 21. Two-inch-wider seats with square corners for better leg support. Full-foam padding means softer ride, more comfort.
- 22. 23. Full-width sun visors. Larger windshield wiper pattern.
- 24. Front seat does not block the cargo door entrance.
- 25. Extra rust protection for underside and rocker panels.
- 26. High-level air intake keeps incoming air cooler and cleaner.
- 27. 28. Wind tunnel body shape and 60" radius windows reduce wind sway effect. Doors adjustable three ways for better sealing.
- 29. 30. 31. Fiber-glass engine cover reduces interior heat and noise. Ashtray on engine cover. Easy to reach. Heater located in engine compartment for more leg- and footroom.



Dodge Trucks



... for more details circle 111 on Reader Service Card



COLORFAX

The material used in this section is selected from information supplied through the cooperation of the respective manufacturers or their agencies.

DUMONT

Color TV Chassis 120957/958—HV Fail-Safe Circuit

More and more significance is being attached to the possible emission of soft X-radiation from color TV receivers. Service notes contain warnings to servicemen with recommendations for safer bench procedures. High voltage settings are being given for various measured line voltages to reduce the possibility of a dangerous rise of high voltage should the setting be made under low line voltage conditions.

To provide even more protection, the models using chassis 120957 and 120958, Triangle Code "A" and up, are wired with a "Fail-Safe" circuit in the high voltage system. The purpose of this circuit is twofold: (1) to prevent the high voltage from rising above safe limits in the event of failure of the shunt regulator tube, and (2) to limit the maximum high voltage obtained by adjustment of the high voltage adjust control.

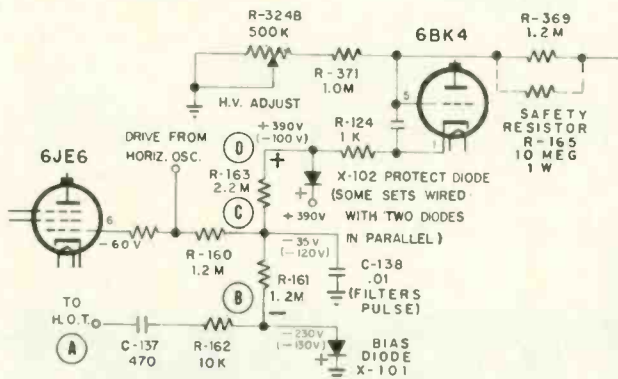

In the event of failure of the shunt regulator tube, this circuit develops a negative voltage which is applied to the grid of the horizontal output tube. This increased bias cuts down the output of the tube, which in turn reduces the high voltage.

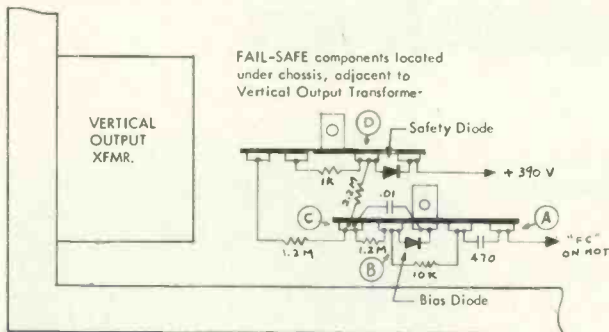

Referring to the schematic, point "A" is connected to "FC" of the horizontal output transformer and couples a positive going pulse to the anode of Bias Diode X-101, which develops a negative voltage at point "B." When the shunt regulator is operating normally, safety Diode

X-102 is a low impedance device in the cathode circuit so that the voltage at point "D" is virtually the same as the supply voltage, 390 volts. Should the shunt regulator fail, X-102 appears as a high impedance, isolating point "D" from the B+ supply.

In normal operation, the resultant voltage at point "C" is determined by the relative values of positive voltage at "D" and the negative voltage at "B." This voltage is applied to the grid of the horizontal output tube through R-160 in addition to the normal grid-leak bias already present. The circuit is designed to maintain normal bias when the shunt voltage at "B" then increases the bias applied to the horizontal output tube.

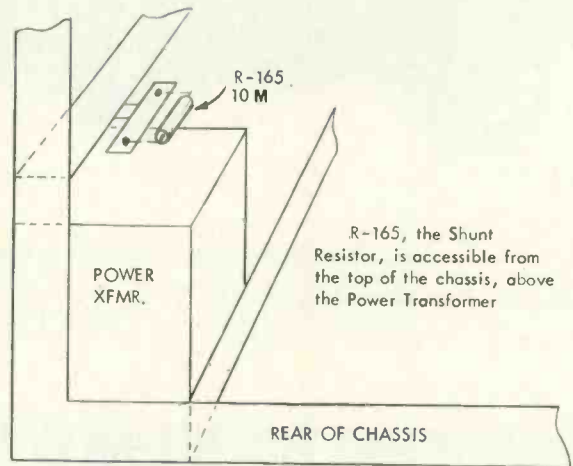

The action of the fail-safe circuit results in visual indications similar to those normally associated with a very weak horizontal output tube. The picture is very dim, focus is poor and width is insufficient. The picture may be too dim to see the sides of the raster and the high voltage reads about 12kv.

Limiting the range of the high voltage adjust control is effected by shunting R-369 with a 10M resistor. The high voltage adjust control and R-369 are part of a voltage divider network which determines the bias on the grid of the shunt regulator tube. As the shunt regulator is biased toward cutoff, the high voltage increases. Reducing the effective value of R-369 reduces the maximum high voltage obtainable by adjustment of the HV adjust control. Should this maximum value be less than 24kv or more than 1kv less than the specified setting, the shunt resistor is simply clipped out of the circuit. This will be done at the factory if necessary and should require attention in the field only when circuit values have changed due to aging or when tubes or components have been replaced.

ADMIRAL

Color TV Models 94D303-59,60,61—Convergence Coil Replacement

The cable from these convergence coil assemblies consists of four color coded wires bonded together as a flat

stack these up against the others . . .

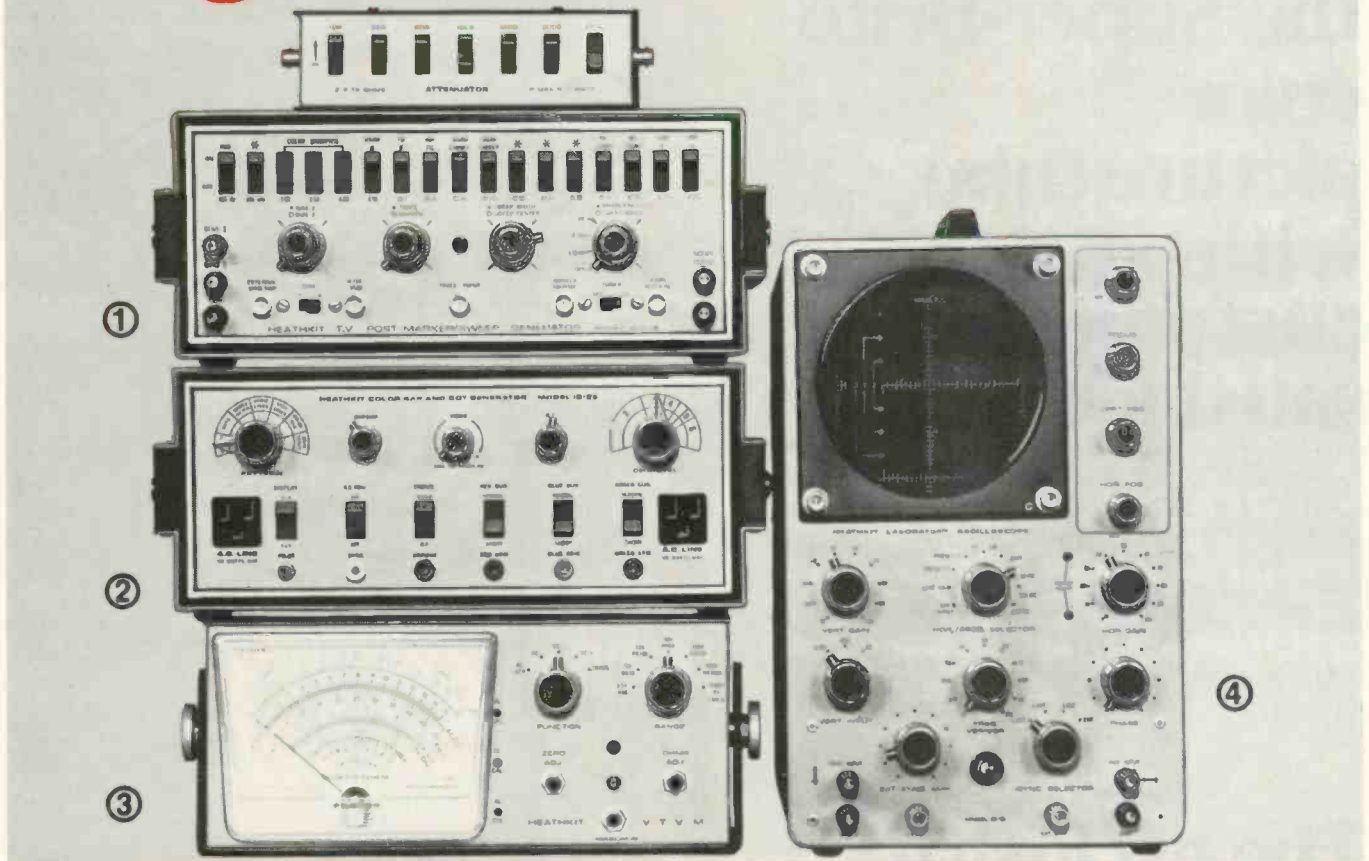

for just the price of other sweep-marker generators,
you can get a bench full of Heathkit® color test gear

Stack These Up Against The Others . . . a high performance Sweep-Marker Generator, an accurate Color Bar-Pattern Generator, a versatile VTVM and a rugged, dependable Scope . . . all for only \$347.40* . . . \$50 less than the cost of other sweep-marker generators alone. At Heath, we still believe that you should be able to get a stack of gear without spending a pile of money.

① **Heathkit IG-57A Solid-State Sweep-Marker Generator . . . \$135.00***. 15 crystal controlled markers for color band-pass, TV sound, IF, picture & sound carriers for channels 4 & 10, FM IF . . . new Video Sweep Modulation allows injection of chroma-sweep directly into IF amplifiers or thru antenna terminals . . . two built-in variable bias supplies . . . 400 Hz modulated or CW output of any individual marker . . . exclusive external attenuator . . . stable, linear sweep signals for the five most used frequency ranges . . . complete scope matching controls . . . quick disconnect BNC connectors . . . complete with all probes, test leads & terminated cables. 14 lbs. Assembled IGW-57A, 11 lbs. . . \$199.00*

② **Heathkit IG-28 Solid-State Color Bar-Pattern Generator . . . \$79.95***. Produces 12 patterns plus clear raster . . . dots, cross-hatch, vertical & horizontal bars, color bars and shading

bars in 9x9 or exclusive 3x3 display . . . all solid-state using computer-type integrated circuitry . . . variable front-panel tuning for channels 2 thru 6 . . . variable front-panel positive and negative video output . . . front panel negative going sync output . . . built-in gun shorting circuit with lead piercing connectors . . . switchable crystal-controlled sound carrier. 8 lbs. Assembled IGW-28, 8 lbs. . . \$114.95*

③ **Heathkit IM-28 "Service Bench" VTVM . . . \$39.95***. Measures RMS DC & AC Volts from 1.5 — 1500 . . . AC P-P from 4 — 4000 V . . . resistance from 0.1 ohm — 1000 megohms . . . easy-to-read 6" meter . . . 10-turn vernier controls for zero & ohms . . . single test probe for all measurements . . . ± 1 dB 25 Hz — 1 MHz response. 7 lbs. Assembled IMW-28, 7 lbs. . . \$59.95*

④ **The Heathkit IO-18 5" Wide-Band Scope . . . \$92.50***. 5 MHz band-width . . . five sweep ranges from 10 Hz — 500 kHz . . . + or — internal, line or external sync . . . two extra, presettable sweep positions . . . front panel 1 V P-P reference . . . Z-axis input . . . retrace blanking . . . 0-135° phasing control . . . frequency-compensated vertical attenuation. 24 lbs. Assembled IOW-18, 23 lbs. . . \$149.95*

Compare Heathkit performance and value . . . you'll see the others just don't stack up.

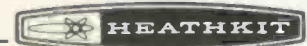

NEW
FREE 1970 CATALOG!

Now with more kits, more color. Fully describes these along with over 300 kits for stereo/hi-fi, color TV, electronic organs, guitar amplifiers, amateur radio, marine, educational, CB, home & hobby. Mail coupon or write Heath Company, Benton Harbor, Michigan 49022.

HEATH COMPANY, Dept. 24-4
Benton Harbor, Michigan 49022

a Schlumberger company

Enclosed is \$ _____, plus shipping.

Please send model (s)

Please send FREE Heathkit Catalog.

Please send Credit Application.

Name _____

Address _____

City _____

State _____

Zip _____

*Mail order prices; F.O.B. factory.

Prices & specifications subject to change without notice.

TE-220

. . . for more details circle 116 on Reader Service Card

Only Admiral
gives you
the Super-Brite
color
picture tube
with built-in
customer
satisfaction.



The exclusive
Admiral
3-year warranty.

Now Admiral offers all new Super-Brite color picture tubes with the exclusive Admiral 3-year warranty. This industry exclusive provides your customers with maximum satisfaction.

Every Admiral Super-Brite color picture tube has Admiral-engineered thermal compensation for unexcelled color purity and the newest phosphors that give your customers clear, bright, sharp color pictures.

Here's another Admiral exclusive: In model 25SP22 (25AP22), our engineers have developed a vacuum deposited thin-metallic film on the inside of the envelope to assure trouble-free operation and longer life.

Admiral Super-Brite service color picture tubes aren't rebuilt. They're 100% brand new. From Admiral, producers of more rectangular color picture tube sizes than anybody in the world—the only one with the 3-year protection you asked for.

Admiral
Mark of Quality

Admiral Corporation warrants this picture tube to be free from defects in material or workmanship for 3 years after date of sale to the consumer.

Admiral's obligation is limited to supplying a suitable replacement picture tube. This warranty is effective if the picture tube is registered with Admiral within 10 days after date of sale to the consumer.

... for more details circle 101 on Reader Service Card

ET/D COLORFAX

conductor cable. The inside wires of the cable are connected to the vertical coils; the outside wires are connected to the horizontal coils.

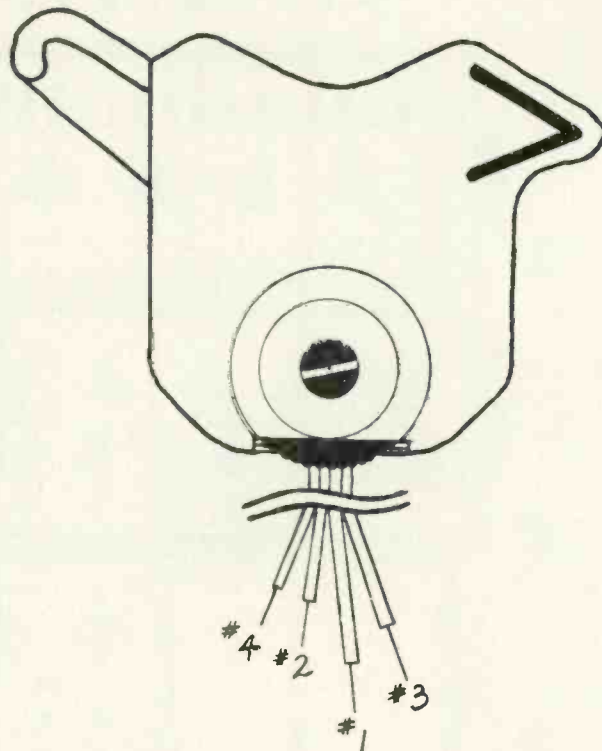

The color coding of the replacement may differ from that of the original either in color or sequence or both. We suggest that you compare the replacement with the original before you remove the original. If they differ in any way, ignore the color coding when wiring the replacement. Connect the wires in the same physical sequence as the original (be sure that you view both original and replacement from the same side).

GENERAL ELECTRIC

Voltage Dependent Resistors (VDR-Varistors) and Temperature Dependent Resistors (TDR-Thermistors)

In modern television design, devices are being used in critical circuits to automatically adjust circuit parameters to maintain constant performance regardless of variables such as line voltage changes, component aging and thermal effects.

Two of these devices which are quite popular today are the VDR and TDR. Both are non-linear resistors. This means that doubling the voltage across them does not double the current through them. These non-linear resistors can be manufactured with either a positive or negative coefficient. A negative coefficient device is one whose resistance will decrease with an increase of the electrical or environmental conditions to which it is sensitive.

Checking a non-linear resistor requires some knowledge of how it functions. A simple ohmmeter check will not provide an accurate test. Most non-linear resistors can be checked in operational circuits using simple voltage measurements and observing circuit performance. The absolute ohmic value is not important—the device's reaction to environmental change is what must be determined.

continued on page 60

How to spend less time selling more batteries

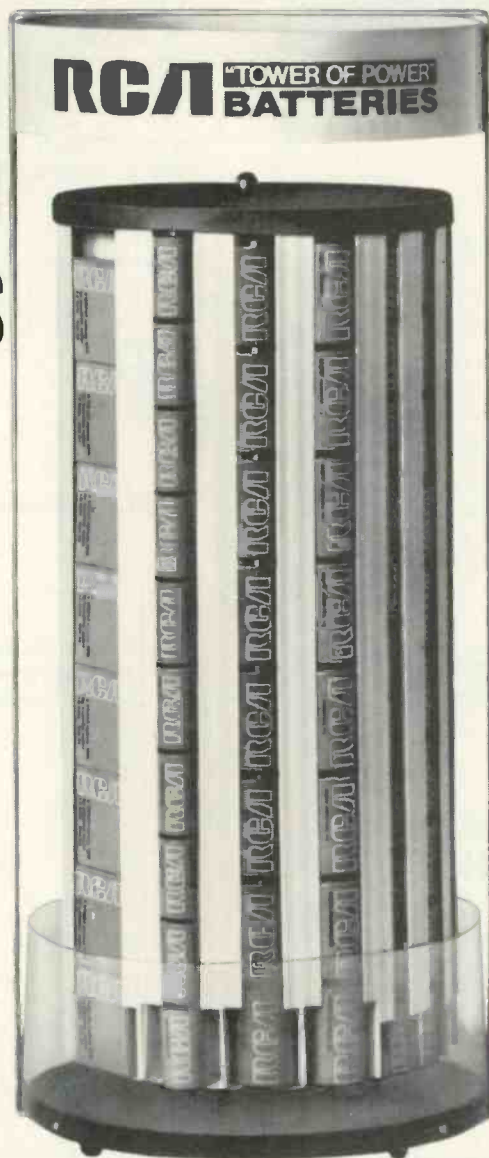

RCA's new "Tower of Power" merchandiser does almost everything for you but make change. It holds over 10 dozen batteries—in just 10 inches of counter space!

Its gravity-feed means automatic stock rotation. It rotates at the touch of a finger (great for impulse sales). It tells your salesmen what they need to know—battery data and prices. And it has individual channels for each of the popular sizes, 9-Volt, "D", "C", and "AA" cells.

Another great feature. If you're concerned about pilferage, the "Tower of Power" can be set up so only

your sales clerks can remove the batteries!

Designed to display any or all of the top 10 types that cover 9-out-of-10 customer needs...Zinc Carbon, Alkaline, or Mercury.

Think round, think today. Get the "Tower of Power" and you'll sell more batteries without even trying. Contact your RCA Battery Distributor for complete details or write RCA Electronic Components, Commercial Engineering, Section D205N, Harrison, N. J. 07029.

RCA

Weller® simplifies soldering



New TEMPMATIC® Temperature Controlled Soldering Tool

Combines all the advantages of a pencil iron, a fast heating soldering gun, and tip temperature control. Exclusive removable Powerhead contains Weller's temperature control system. Protects components even in the most delicate work situations. Tool weighs 7 oz. Use it for light or heavy duty soldering. Model GT-7A has 700°F. $\frac{3}{16}$ " chisel point Powerhead. Model GT-6B has 600°F. $\frac{1}{8}$ " conical point Powerhead.



The original Dual Heat Guns

Fast heating. Long-life tips. Exclusive trigger-controlled dual heat. High soldering efficiency. Spotlight. 3 models from 100/140 watts to 240/325 watts.



Dependable MARKSMAN Irons

They outperform other irons of their size and weight. Long-reach stainless steel barrels. Replaceable tips. 5 models from 25 watts to 175 watts.



Weller 25-watt Iron for intricate work

Industrial rated. Weighs 1 $\frac{3}{4}$ oz. Delivers tip temperatures to 860°F. Cool, impact-resistant handle. Model W-PS with $\frac{1}{16}$ " tip.

Weller®

WELLER ELECTRIC CORP., Easton, Pa.
WORLD LEADER IN SOLDERING TOOLS

... for more details circle 139 on Reader Service Card

ET/D COLORFAX

continued from page 58

Testing the VDR

The VDR is a non-linear resistor whose resistance is a function of voltage. VDR's currently used in General Electric portable TVs have a negative coefficient.

VDR's are used in high voltage regulator and boost voltage circuits and in degaussing circuits.

Most VDR's will read open when checked with a simple ohmmeter. Therefore, the VDR must be tested by applying a voltage to it and measuring the current through it. Such a test may be done with the VDR in the TV circuit or in a special bench test circuit. In either case, a milliammeter is placed in series with the VDR, and the voltage applied to it is varied.

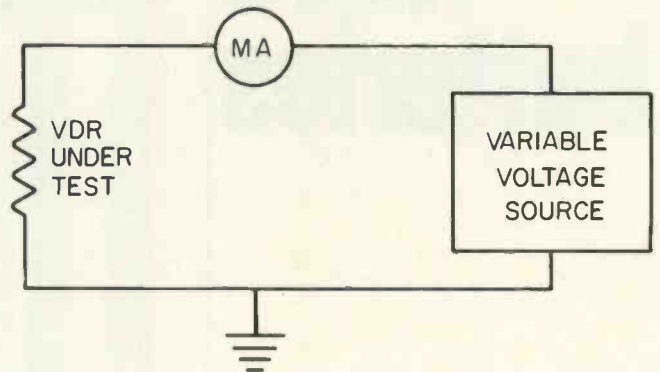

Plotting a graph of voltage vs. current for the VDR shows its performance characteristics. Such a graph might look like the one shown.

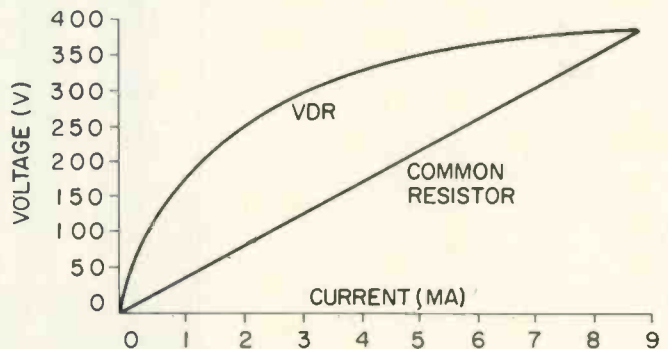

VDR's come with many voltage and current ratings, so don't expect the values in the graph to exactly agree with the numbers on your graph. The important thing is for the non-linearity of current change with voltage variations to be evident.

In most instances, suspected defective units can be verified by checking the current at the voltage specified in the parts list.

Some of the VDR's currently being used include:

EU14X196	65MA@20v ± 20%	(C chassis)
EP13X1	65MA@20v 20%	(G chassis)
EP13X2	1MA@850v ± 15%	(G chassis)
ES14X212	1MA@17v ± 15%	(TC/T-1 chassis)

One precaution must be observed with this test procedure: Don't exceed the power rating of the VDR. Power ratings are similar to carbon resistors; that is, physical sizes are approximately the same. Also, note that VDR's have a negative thermal coefficient, so the readings should be taken quickly.

THE FIRST IN-CIRCUIT TEST TO TELL A GOOD TRANSISTOR FROM A BAD ONE. WITH NO IFS, ANDS OR BUTS.

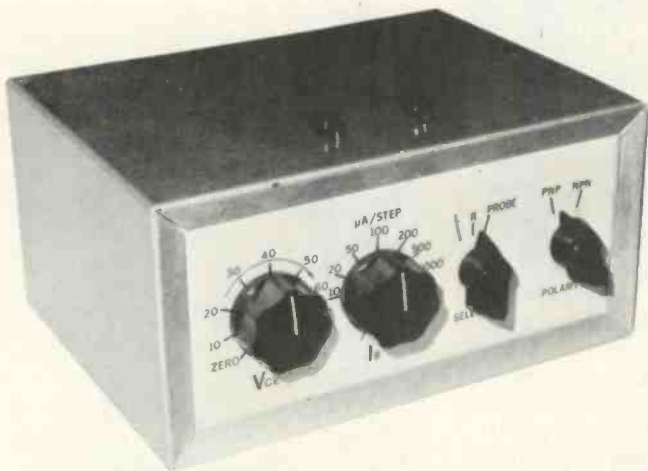

Inside every transistor is a message you want to get at: whether the transistor is good or bad.

We've come up with a way to let the transistor tell you. For dead-certain, without ever taking the transistor out of the circuit. (In fact the circuit isn't even on.)

Our way is the transistor curve tracer you see above. It sweeps a transistor with pulses of DC voltage. And presto, the transistor starts talking.

You get the message on an oscilloscope. If the transistor is good you see a family

of curves; if it's kerflooeey, a single vertical or drooping line appears; and if the transistor is open, the scope will show you a single horizontal line.

Another thing.

Transistor manufacturers make lots of essentially identical transistors. But each manufacturer uses different numbers, so you don't know the transistors are identical.

Our transistor curve tracer can tell you that too. So you don't have to buy all those identical transistors; instead you can build up an inventory of universal replacement types.

It's all so simple, we don't know why somebody didn't think of it before. All we know is, nobody did.

The dynamic transistor curve tracer. \$120 at your local distributor's.

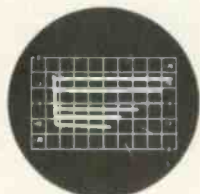

Good transistor.

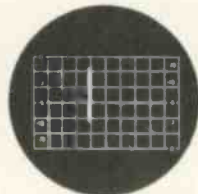

Shorted transistor.

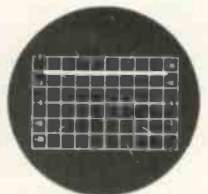

Open transistor.

JUD WILLIAMS

Box 335, Long Valley, N.J. 07853. (201) 876-4376

... for more details circle 140 on Reader Service Card

For additional information on products described in this section circle the numbers on Reader Service Card. Requests will be handled promptly.

COAXIAL RELAY 704

Low-cost and compact size

Announced is the availability of the type 77 coaxial relay fitted with type "F" connectors. This low-cost 75Ω



SPDT relay, which is particularly adapted to CATV service, occupies a space of approximately 2 x 2 x 7/8 in. The relay is available in a number of actuating coil voltages, from 6 to 115v, ac and dc. Dow-Key.

TWO-STATION INTERCOM 705

Personal communication at a low price

A low-cost, battery-operated, two station intercom, blister packed for retail merchandising, is introduced. The



Model BLST-20 "Small-Talk" two-station intercom is a two transistor system. Compact and lightweight, both stations are suitable for wall, table and desk installation. The unit consists of a master with an On/Off volume control and a non-private remote which permits hands free operation at the remote station. A beep-tone signals when someone at the remote wishes to talk. Both stations are equipped with a push-to-talk button.

Both stations are housed in rugged cabinets finished in high impact styrene. The intercom is simple to install and comes complete with a 50ft plug-terminated interconnecting cable. List price less than \$12. Fanon.

706

CASSETTE CLASSROOM SYSTEM

Designed and constructed for educational use

An electronic classroom system that takes advantage of the popular tape cassette is introduced. The new In-



structomatic Cassette System provides full dual-channel operation with a complete line of in-booth and remote student recorders, console and rack mounted lesson sources. All can be custom combined to perform in language lab, stenographic, library, or total audio tutorial applications. A universal record/playback head which accepts all standard monaural and stereo cassettes is used on all decks to guarantee compatibility with recorders outside the system. Each cassette recorder is designed and constructed specifically for educational use. A five-finger push-button control sequence gives the student or instructor one-hand operation of all necessary record/playback modes, including skip-forward and skip-back review. Three-motor drive, all-electronic circuitry, etched aluminum faceplate, and a simple cassette load mechanism are featured. A low cost, lesson media that snaps quickly and positively into the deck with no need for tape threading is available. The cassette is less than half the size of conventional reels or cartridges. It stores easily and can be carried in a student's pocket. The low cost cassette recorders are commercially available to students for homework purposes, and high-speed duplicating machinery is available to schools to allow easy reproduction of

many student cassettes from a single master. Instructomatic.

TELEPHONE AMPLIFIER 707

Powered by four penlight batteries

A battery-powered, solid-state telephone amplifier, which provides "no-hands" phone conversations between individuals or groups, is announced. The telephone amplifier set (Model TA 100) consists of an amplifier and speaker unit. The instrument is powered by four penlight batteries and does not require wiring or installation. Another feature of the amplifier set is that it can be moved from one telephone location to another. Both the speaker and amplifier units are housed in plastic housings, which are contemporary in design and in white and harvest beige color. Operation of the amplifier set is simple. After the batteries have been inserted, the telephone handset is placed in the "well" at the front of the amplifier unit. The user talks toward the mouthpiece of the telephone as it rests in the ampli-



fier unit. His voice is picked up, enabling the listener to hear him or a group of persons as if they were speaking directly into the mouthpiece of the phone. The voice of the party on the other end of the line is amplified through the speaker unit. Volume of the speaker can be increased or decreased by turning the volume control knob on the amplifier unit. After a call is completed, the amplifier shuts off automatically when the phone is lifted off the device and hung up. List price \$17.95. RCA.

continued on page 64

When we introduced the "original wedge" antenna in '67, we told you there'd be plenty more to come.



Well, Color Wedge has not only come. It has arrived!

We've come up with a lot of exciting new products since we introduced the first Winegard antenna. But we've never seen a product capture the imagination of dealers and consumers as completely as Color Wedge has. Or as quickly.

You see, we knew there had never been an antenna as different as our Color Wedge series of Super Colortron antennas.

And not just different. Dramatically different. In design, in performance and in construction. And since the differences can be dramatically shown, Color Wedge has arrived. Big!

Dealers are discovering that a demonstration of Color Wedge is all the selling that's needed. But if they want to talk about Color Wedge, there's plenty to talk about.

- A unique wedge design that provides an increased signal capture area in a much shorter and compact antenna.
- A revolutionary built-in ferrite impedance stabilizer that increases gain 10%, with an automatic match.
- The utilization of booms as both supporting members and phasing lines.
- New truss construction that has given new meaning to the word "rugged." And, of course, they can talk about all the now famous Super Colortron features, including the built-in cartridge housing with its solid state preamplifiers.

The way it looks now, it will be a long time before anybody creates an antenna series that can compare with Color Wedge. And that's something to talk about, too. If you're a Winegard dealer.

© Copyright 1970

Winegard Company • 3019-12 Kirkwood Street • Burlington, Iowa 52601

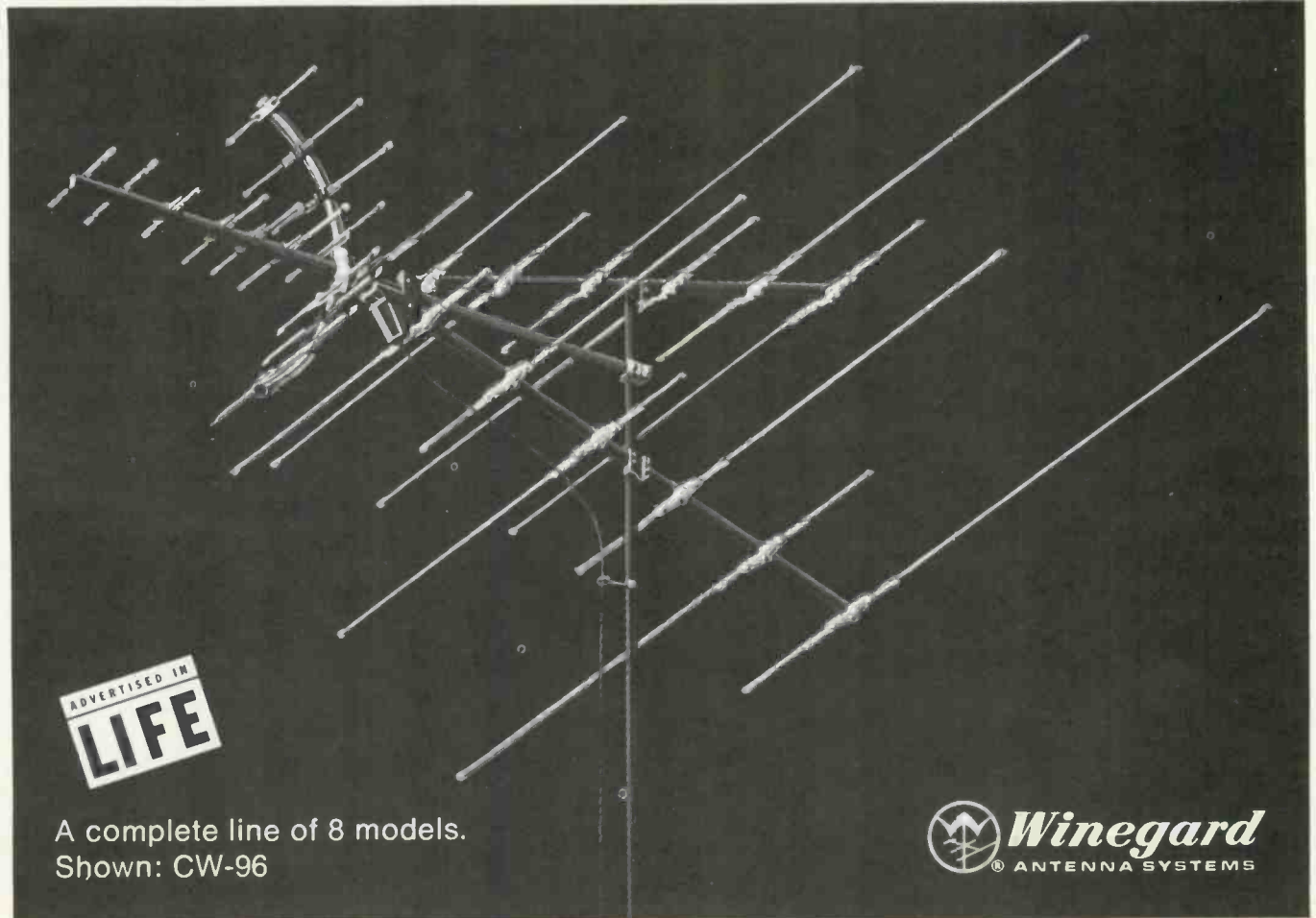

ADVERTISED IN
LIFE

A complete line of 8 models.
Shown: CW-96

 **Winegard**
ANTENNA SYSTEMS

... for more details circle 141 on Reader Service Card

ET/D DEALER SHOWCASE

continued from page 62

SLIDE SYNCHRONIZED CASSETTE RECORDER 708

Built-in slide/filmstrip synchronizer

A heavy-duty, ac-powered cassette recorder with a built-in slide/filmstrip synchronizer is introduced. The basic

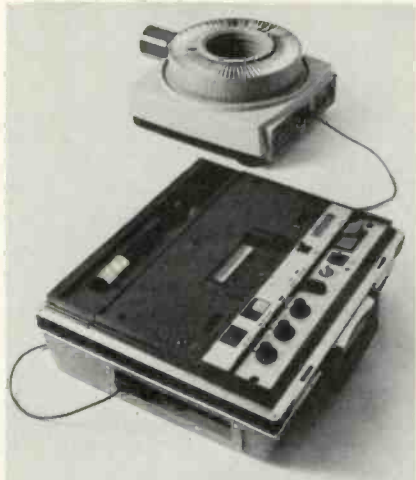

mechanism of the audio-visual recorder consists of a full-sized, heavy fly-wheel, a large-diameter, sturdy cap-

stan and a long-life ac motor. The slide synchronization unit, Model 2550, uses a 60Hz signal to activate the tripping mechanism and minimizes cross-talk between the narration and the sync signal tracks. The narration and sync signal can be recorded either independently or simultaneously. Either can be changed or re-recorded without erasing the other. All operating controls are conveniently located, color-coded for fast, intuitive action and safety interlocked to prevent accidental erasure of tapes. An automatic record level control assures high-quality recordings without need for manual monitoring. The basic performance specifications claimed for the unit are: Frequency response of 50 to 8,000 Hz, wow and flutter of less than 0.25 percent, signal-to-noise ratio of more than 46dB, and a 10w amplifier. They are equipped with permanently attached three-wire grounded power cords. Suggested list price \$299.95. 3M.

HAM BAND RECEIVER 709

Moderately priced 80-10 meter receiver

A moderately priced 80-10 meter Ham band receiver is introduced. The Model A-2516 receiver features a me-

chanical filter to provide highly selective AM, CW and SSB reception on all Ham bands between 3.5 and 29.7



MHz. This includes 80, 40, 20, 15 and 10 meters. It also receives the WWV frequency standard signal on 10MHz. The dual conversion receiver features a crystal-controlled first local oscillator and a solid-state VFO-type second oscillator reportedly having negligible frequency drift. The VFO circuit has output terminals for use as a transmitter VFO. Remote control terminals on the receiver allow easy switching to standby operation. A calibrated S-meter aids tuning and provides an accurate signal strength indication. The mechanical IF filter provides a 1.5kHz bandwidth at 6dB down, 6kHz at 60dB down. Sensitivity is $1.5\mu\text{v}$ for 10dB signal-to-noise ratio at 14MHz. Image ratio and IF rejection are better than 40dB at 14MHz. The circuit employs 7 tubes, 2 transistors and 5 diodes. An anti-backlash double-gear tuning dial provides accurate, direct-reading down to 1kHz. Smooth 28:1 dial speed ratio facilitates precise tuning. Receiver is priced at \$169.95. Allied.

BATTERY DISPLAYS 710

Attractive display in woodgrain design

A series of impulse-buying counter displays covering a variety of batteries for all applications is offered. The compact displays are attractive, wood-



grained designed to catch the customer's eye. Free revolving racks are also available with offer 72-G (general assortment); 7-OR (for transistor radios), and 71-P (for photo equipment). Mallory.



Get in line for your all new solid state instant-on

MIGHTY MITE VI

- Now faster than ever. Instant-on action with all solid state FET circuitry—no waiting for warm-up.
- New push-button operation speeds up every test—saves you valuable time.
- New 13th socket checks still more tubes—now over 3000 including foreign.
- New hi-style case—vinyl-clad and brushed steel. A professional instrument designed for professionals.

At your distributor now, only \$99.50

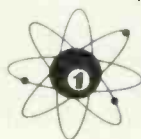

SENCORE
NO. 1 MANUFACTURER OF ELECTRONIC MAINTENANCE EQUIPMENT

426 SOUTH WESTGATE DRIVE, ADDISON, ILLINOIS 60101

... for more details circle 131 on Reader Service Card



With all that free loot, no wonder the chips are starting to fly.

Nearly everybody who uses Sylvania receiving tubes (and that's nearly everybody in the business) is saving those Sylvania chips. And why not? Everybody can come out a winner. You can redeem the chips for blenders, broilers or binoculars; toasters,

tools or TV sets; cameras, clothing, or cutlery. If you haven't seen Sylvania's "In the Chips" catalogue yet, ask for one at your local participating Sylvania distributor. And don't wait for Christmas for the gift you've wanted.

"In the chips" promotion. **SYLVANIA**
GENERAL TELEPHONE & ELECTRONICS

Electronics Reference Databook

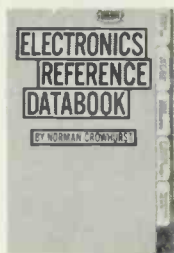

This new book is much more than a simple collection of tables, formulas, graphs, equations, etc. In addition to the abundance of helpful information given, it provides specific guidance in the use of data. Numerous problems associated with every level of interest—from electronics theory (formulas, laws) to measurements, tests, and circuit design work—are covered. In so doing, the author explains how to use the data (from this or other volumes) for purposes other than those listed. Covers Electronics Theory, Use of J Operator, Exponential and Other Tables, Attenuators and Equalizers, Filter Design, Practical Component Design and Application, Tube and Semiconductor Circuit Design and Operation, and Transmission Lines. 224 pps., over 100 illus., plus 45 tables. Hardbound.

List Price \$7.95 ● Order No. 488

RCA Color TV Service Manual



A brand-new full size manual, covering 23 RCA Color chassis. Includes complete schematic diagrams for 12 chassis, from the CTC-12 to the CTC40 all-transistor model. Here in one compact, handy manual is everything you need to quickly and competently repair any RCA color set—from the CTC12 to the 1969 all-transistor CTC40.

Encompasses both general and specific troubleshooting data applicable to all RCA chassis. The text delves into each section (Video, chroma, vertical, horizontal, etc.), and points out specific problems as well as general servicing procedures. Troubleshooting tips on each chassis, including circuit changes and factory modifications, are covered. While this material is related directly to RCA sets, much of it is applicable to other sets patterned after RCA designs. 176 pps., 8½ x 11, plus 36-page schematic foldout section. Over 175 illus.

List Price \$7.95 ● Order No. 496

Electronic Circuit Design Handbook

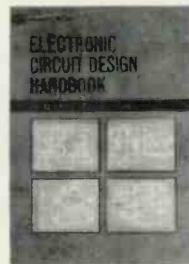

New Third Edition—A brand-new, enlarged edition of the ever popular circuit designer's "cookbook," now containing over 600 proven circuits, for all types of functions, selected from thousands on the basis of originality and practical application. Now you can have, at your fingertips, this carefully-planned reference source of tried and tested circuits. Selected from thousands submitted by distinguished engineers, these "thought-starters" are a collection of original circuits selected on the basis of their usefulness. This detailed compilation of practical design data is the answer to the need for an organized gathering of proved circuits... both basic and advanced designs that can easily serve as stepping stones to almost any kind of circuit you might want to build. 384 pps., 19 big sections, over 600 illus., 8½" x 11".

List Price \$17.95 ● Order No. T-101

Installing & Servicing Home Audio Systems



At last, a long-needed UP-TO-DATE guidebook on home audio systems — your "passport" to the lucrative field of audio equipment servicing, including sales and installation. Included in the comprehensive content are technical descriptions of the latest audio and hi-fi equipment, accompanied in each case by servicing data. The author

describes all the various types of units, illustrates the typical circuits used, then tells how to look for troubles. You'll receive scores of practical "tips," plus troubleshooting shortcuts. After an introduction to audio, and a discussion of test instruments needed, the author gets into AM and FM tuners (including stereo-multiplex), preamps and amplifiers, tape recorders and players, mobile radios and tape players, and automatic record players. 266 pps., over 150 illus., 12 Chapters. Hardbound.

List Price \$7.95 ● Order No. 505

How To Fix Transistor Radios & Printed Circuits



Here it is! Just off the press—a completely updated, revised edition of Leonard Lane's best-selling classic on transistor radio repair. In addition to extensive enrichment of the first edition, the author brings FETs, zener diodes, FM radios—in fact, everything related to the current state of the art—into the picture. Here's the perfect

reference and guide for electronic technicians who need to understand and repair semiconductor circuits efficiently. For those interested in transistor physics, fundamentals are emphasized in the first two chapters. The real "meat" begins in Chapter 3 which will thoroughly familiarize you with amplifier fundamentals, basic circuit configurations, biasing, FETs, JFETs, and IGFETs. The next two chapters will acquaint you with RF and IF amplifiers. 256 pps., over 150 illus., 12 Chapters.

List Price \$7.95 ● Order No. 504

Working with Semiconductors



A BRAND-NEW working guidebook to semiconductor circuit operation of value to technicians and others who work with solid-state equipment. The wonderful aspect of this book is that you can really develop a thorough understanding of semiconductors — and actually enjoy doing it! In striking contrast to the usual textbook

approach, this up-to-the-minute volume avoids dry, theoretical mathematical explanation—it tells you simply how and why things work... backed up by large, clear expository illustrations. More advanced circuits covered are: transistor oscillators, multivibrators, Eccles-Jordan and Schmitt trigger circuits, crystal-controlled generators, counters, power supplies, high-frequency circuits, field-effect transistors, unijunction transistors, tunnel diodes, SCRs, etc. 224 pps., over 185 illus., 15 Chapters.

List Price \$7.95 ● Order No. 501

On The Color TV Service Bench



A handy benchmate for practicing color TV technicians and B & W experts who want to break into color TV servicing. This new practical volume describes causes and cures for both the usual everyday color TV troubles, as well as those tough dogs you run into once in a blue moon. Here are commonsense service bench approach-

es for solving all sorts of color TV troubleshooting problems, many of them adapted from well-established B & W techniques. Definitely not a textbook, the content explains how to tackle specific problems in a logical, professional way. Moreover, the author clearly explains how the operation of each circuit is affected by specific faulty components. 192 pps., 14 Chapters. Hardbound.

List Price \$7.95 ● Order No. 489

Electronic Hobbyist's IC Project Handbook



Here's your chance to become familiar with those fascinating components—integrated circuits—and have fun building some useful devices at the same time. In all, this new book describes 50 different projects, all based on using popular IC's which are inexpensive and available at all parts stores. Some of the devices—such as

the 1-watt phono amp and IC power supply—can be built in an evening. More sophisticated projects—like the electronic organ or the RDIAA equalization preamp—offer a greater challenge. You can build practical devices like the tachometer with bulb alert, or the 50-watt amplifier, or some "just for fun" gadgets like the simple memory tester or the miniature adding machine. 160 pages, 50 projects, 100 illus.

List Price \$6.95 ● Order No. 644

Transistor Circuit Guidebook



Regardless of your niche in the world of electronics, you'll find this collection of transistor and solid-state circuits of value. Section titles read like an electronic circuit "Who's Who": tuners and receivers — amplifiers — test devices — power — controlling — light — controlling — transmitter — audio — special receiver — automotive — computer — TV circuits, and many, many others. Within each section is a wide variety of circuits touching virtually every point of interest. Each circuit is accompanied by a description of how it works, pointing out unusual features and applications. Technicians who acquire a familiarity with these circuits will be far better equipped to cope with present and future equipment troubles. 13 big sections, 104 circuits in all, 224 pps. Hardbound.

List Price \$7.95 ● Order No. 470

AN EXTRAORDINARY OFFER...

An Extraordinary Offer

to introduce you to the benefits of Membership in

ELECTRONICS BOOK CLUB

for a limited time only you can obtain

ANY 3 OF THESE UNIQUE BOOKS ... yours for only **99¢** each
... with Trial Club Membership
(Combined List Price \$33.85)

May we send you your choice of many three books on the facing page as part of an unusual offer of a Trial Membership in Electronics Book Club?

Here are quality hardbound volumes, each especially designed to help you increase your know-how, earning power, and enjoyment of electronics.

These handsome, hardbound books are indicative of the many other fine offerings made to Members... important books to read and keep... volumes with your specialized interests in mind.

Whatever your interest in electronics—radio and TV servicing, audio and hi-fi, industrial electronics, communications, engineering—you will find that Electronics Book Club will help you.

With the Club providing you with top quality books, you may broaden your knowledge and skills to build your income and increase your understanding of electronics, too.

How You Profit From Club Membership

This special offer is just a sample of the help and generous savings the Club offers you. For here is a Club devoted exclusively to seeking out only those titles of direct interest to you. Membership in the Club offers you several advantages.

1. Charter Bonus: Take any three of the books shown (combined values up to \$33.85) for only 99¢ each with your Trial Membership.

2. Guaranteed Savings: The Club guarantees to save you 15% to 75% on all books offered.

3. Continuing Bonus: If you continue after this trial Membership, you will earn a Dividend Certificate for every book you purchase. Three Certificates, plus payment of the nominal sum of \$1.99, will entitle you to a valuable Book Dividend which you may choose from a special list provided members.

4. Wide Selection: Members are annually offered over 50 authoritative books on all phases of electronics.

5. Prevents You From Missing New Books: The Club's FREE monthly *News* gives you advance notice of important new books... books vital to your continued advancement.

This extraordinary offer is intended to prove to you, through your own experience, that these very real advantages can be yours... that it is possible to keep up with the literature published in your areas of interest... and to save substantially while so doing.

How the Club Works

Forthcoming selections are described in the FREE monthly *Club News*. Thus, you are among the first to know about, and to own if you desire, significant new books. You choose only the main or alternate selection you want (or advise if you wish no book at all) by means of a handy form and return envelope enclosed with the *News*. As part of your Trial Membership, you need purchase as few as four books during the coming 12 months. You would probably buy at least this many anyway... without the substantial savings offered through Club Membership.

Limited Time Offer!

Here, then, is an interesting opportunity to enroll on a trial basis... to prove to yourself, in a short time, the advantages of belonging to Electronics Book Club. We urge you, if this unique offer is appealing, to act promptly, for we've reserved only a limited number of books for new Members.

To start your Membership on these attractive terms, simply fill out and mail the postage-paid airmail card today. You will receive the three books of your choice for 10-day inspection. SEND NO MONEY! If you are not delighted, return them within 10 days

and your Trial Membership will be cancelled without cost or obligation. Electronics Book Club, Blue Ridge Summit, Pa. 17214.

Typical Savings Offered Club Members on Recent Selections

Color TV Trouble Factbook	List Price \$6.95; Club Price \$2.95
How to Build a Working Digital Computer	List Price \$7.95; Club Price \$3.95
Small Appliance Repair Guide	List Price \$7.95; Club Price \$4.95
Solid State Circuit Design & Operation	List Price \$9.95; Club Price \$5.95
101 TV Troubles	List Price \$7.95; Club Price \$4.95
Zenith Color TV Service Manual	List Price \$7.95; Club Price \$4.95
Servicing Electronic Organs	List Price \$7.95; Club Price \$4.95
Digital Computer Analysis	List Price \$10.95; Club Price \$7.95
How To Test Almost Everything Electronic	List Price \$5.65; Club Price \$3.95
How to Use Your VOM, VTVM & Scope	List Price \$6.95; Club Price \$4.95
Radio Operator's Q & A Manual	List Price \$8.95; Club Price \$7.50
Motorola Color TV Service Manual	List Price \$7.95; Club Price \$4.95
Tape Recording For Fun & Profit	List Price \$7.95; Club Price \$4.95
Electric Motor Test & Repair	List Price \$6.95; Club Price \$2.95
Elements of Tape Recorder Circuits	List Price \$7.95; Club Price \$3.95
Industrial Electronics Made Easy	List Price \$8.95; Club Price \$5.95
Audio Systems Handbook	List Price \$7.95; Club Price \$4.95
Electronic Test & Measurement Handbook	List Price \$7.95; Club Price \$4.95
Digital Computer Theory	List Price \$7.95; Club Price \$4.95
Installing Hi-Fi Systems	List Price \$7.95; Club Price \$4.95
Pinpoint TV Troubles in 10 Minutes	List Price \$6.95; Club Price \$4.95
Easy Way To Service Radios	List Price \$6.95; Club Price \$3.95
Practical Color TV Servicing Techniques	List Price \$8.95; Club Price \$5.95
Mathematics for Electronics	List Price \$10.95; Club Price \$7.95
Transistor Projects	List Price \$5.95; Club Price \$2.95
Electronic Musical Instruments	List Price \$10.00; Club Price \$7.95

SEND NO MONEY!

Simply fill in and mail postage-paid Airmail card today!



DECISION MAKER

The Sencore CRT Champion. Judge and jury when it comes to color CRT analyzing. Reaches a verdict in seconds — tells you if the tube has adequate emission, and if it will track in the TV set.

Automatic color tracking according to industry standards with exclusive 3 Gun G2 Control.

One-step controlled rejuvenation with automatic RC timer. A Sencore exclusive.

Lots more, too. So try the decision maker — the Sencore CRT Champion — at your distributor today. You'll reach the right verdict. . . . \$119.50



SENCORE

NO. 1 MANUFACTURER OF ELECTRONIC MAINTENANCE EQUIPMENT

426 SOUTH WESTGATE DRIVE, ADDISON, ILLINOIS 60101

... for more details circle 132 on Reader Service Card

ET/D NEW PRODUCTS

For additional information on products described in this section, circle the numbers on Reader Service Card. Requests will be handled promptly.

SOLDERING IRON HOLDER 711

Holds and cleans iron

A combination soldering iron holder and rotary tip wiper is introduced. The Model TWH-444 incorporates the Model TW-555 rotating tip wiper and

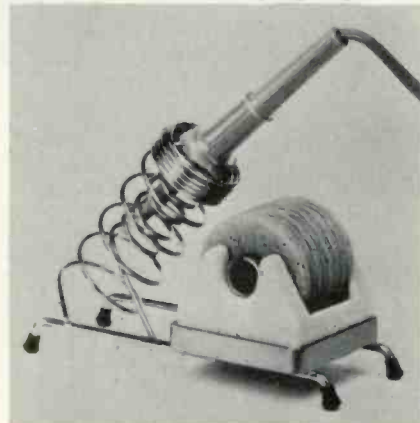

a heavy wire double spiral iron holder mounted on a metal base with non-skid feet. The unit is designed to permit removal of the iron and cleaning of the tip in one continuous motion. The holder and stand are brightly plated for durability and appearance with a metal clamp provided for permanent attachment to the work bench, if desired. The unit accommodates irons to 60w size. The tip wiper features a heavy, non-corrosive porcelain base that eliminates the possibility of tip contamination by contact with the base or sponge contamination caused by rust. The base also provides a large water reservoir to wet sponges as they rotate during tip cleaning. Sponges are acid-free and easily replaceable. Priced at \$5.95 for a complete unit or \$2.75 for the iron holder. Plato.

SUB-MINIATURE FUSE 712 HOLDERS

Available in ratings to 10a

A sub-miniature fuse holder to accommodate either the Microfuse or sub-miniature Picofuse and intended for plug-in printed circuit board applications is introduced. The Microfuse, available in amperage ratings from 1/500 to 5a, offers high interrupting capacity, 10a at 125v, in a small plug-in transistor type concept. The sub-miniature plug-in fuse

we get thru — where others fail

OPERATES ANYWHERE—INDOORS, OUTDOORS... STEEL BLDGS.



SONARCOM VHF-UHF-FM TRANSCEIVERS

Professional performance! Perfectly designed to give the ultimate in dependability for continuous heavy duty use.

- Provides instant voice contact with base stations, mobile units and other portable transceivers
- Compatible with all 2-way systems
- Full frequency range for all public safety, industrial and land transportation services
- 1.6 watt output
- Receiver and transmitter can be operated on independent frequencies
- Sensitive, noise immune squelch
- External connections for antenna, earphone and battery charger

Model 2301 \$375⁰⁰
132-174 MHz
VHF-FM 1 CHANNEL
1 pair of crystals and 1 set of standard batteries.

Model 2301A \$575⁰⁰
132-174 MHz
VHF-FM 2 CHANNELS
1 pair of crystals, 1 set of standard batteries and Tone.

Model 2301A \$475⁰⁰
132-174 MHz
VHF-FM 2 CHANNELS
1 pair of crystals and 1 set of standard batteries.

Model 2302 \$595⁰⁰
450 to 470 MHz
UHF-FM 1 CHANNEL
1 pair of crystals, 1 set of standard batteries and Tone.

SONAR RADIO CORP., 73 Wortman Ave., Bklyn, N.Y. 11207
Please send information on the SONARCOM. Dept. 819

Name _____
Address _____
City _____ State _____ Zip _____

... for more details circle 134 on Reader Service Card

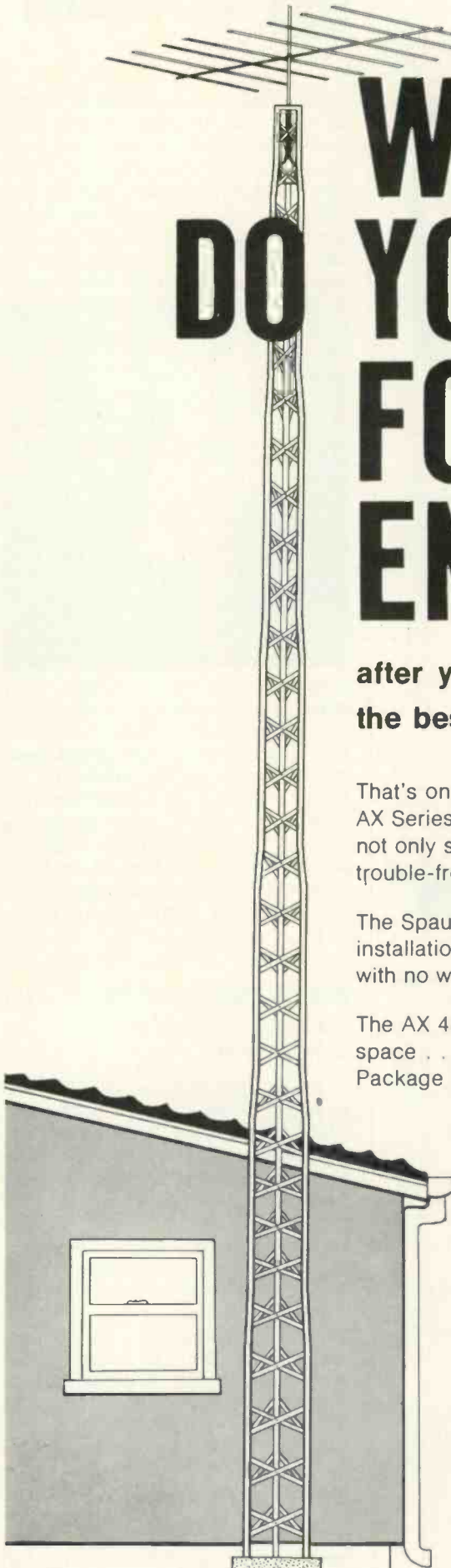

WHAT DO YOU DO FOR AN ENCORE . . . ?

**after you have sold your customers
the best home TV towers.**

That's one of the big advantages when you stock and sell Spaulding AX Series Home TV Towers. You're offering a tower in which they'll not only see the quality, which is apparent, but they'll also see the trouble-free performance they are looking for.

The Spaulding AX Home TV Tower is designed for quick economical installation . . . and is all-steel, galvanized and all riveted construction with no welds to rust.

The AX 48' Home TV Tower package only requires 2 sq. ft. of floor space . . . the AX series packages are available in heights up to 64'. Package includes base stubs, hardware, mast and mast kit.

The Spaulding AX Series Tower is a self-supporting tower and is extremely rigid under most erection situations. The higher the tower goes, the greater the strength at the base. The wind resistance at the top decreases with height. The "tapering" effect adds to the attractiveness of the tower.

Get specifications on this complete tower package, and profit in two ways—bigger sales and greater goodwill from your customers.

ROHN[®]-SPAULDING, INC.

Peoria, Illinois • Birmingham, Alabama • Frankfort, Indiana

. . . for more details circle 130 on Reader Service Card

Check 'em ALL!

TRANSISTORS FET'S IN OR OUT OF CIRCUIT



The TF17 works every time using tried and proven signal injection techniques. New, improved tests on special RF transistors and the latest high power transistors, mean that the TF17 is the only up-to-date transistor tester on the market. A new, exclusive setup book in rear compartment guides you to every test for over 12,000 transistors and FETs. The book is not needed for general service troubleshooting. Regular transistors are checked for beta gain and I_{cbo} leakage. FETs are checked for transconductance and I_{gss} leakage. **Only \$109.50**



SENCORE

NO. 1 MANUFACTURER OF ELECTRONIC MAINTENANCE EQUIPMENT
426 SOUTH WESTGATE DRIVE, ADDISON, ILLINOIS 60101

... for more details circle 133 on Reader Service Card

ET/D NEW PRODUCTS

holders are now available in ratings to 10a, with specially formed leads and insulated body for low voltage and plug-in applications. The fully insulated Microfuse and Picofuse are designed for use where space and weight are at a premium and where mechanical and electrical requirements are high. The plug-in type holder mea-



sures $\frac{1}{4}$ in. diameter by .236 in. high with two .190 in. long x .019 in. phosphor-bronze, silver-plated contacts. The holder is of molded acetal resin and is rated to 10a maximum at 125vac. Nominal pin contact insertion force is 500 grams. Four supporting legs, .032 in. high by .040 in. diameter, are molded into the base of the body to provide further mounting stability on the printed circuit board. Littelfuse.

DIGITAL MULTIMETER 713

Protective circuitry for voltages to 1kv

A $3\frac{1}{2}$ digit table-top, Digital Multimeter, Model 8000, is introduced. The unit is suitable for laboratory, production line, educational testing, general purpose and other applications. Measurements are displayed in the decimal number system by three gas-filled readout tubes. The numeral "1" is displayed for over-range measurements. The readout display is complete with a movable decimal point, automatic over-range indication (O/R) and auto-polarity for DC functions. A readout is possible on the multimeter with as much as a 50 percent over-range (1500 count) indication. The unit has protective circuitry, which prevents damage to the tester when voltages as high as 1000v, ac or dc, are applied as inputs on any of the selectable voltage ranges. The dc voltmeter ranges are: 0-0.1, 1.0, 10, 100 and 1000 vdc. Accuracy is ± 0.1 per-

Play Ball with Perma-Power

an official Rawlings League Baseball is your gift from Perma-Power when you buy three Color Briteners at the lowest price ever!

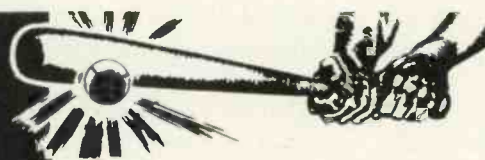

You get these top selling Color Briteners that put back brightness to fading color pictures.

two Perma-Power Color Brite Model C-511 (Parallel wiring 90° small-button diheptal base) (Rectangular Color Tubes) Regular Price **\$5.85**

one Perma-Power Color Brite Model C-501 (Parallel wiring 70° shell neodiheptal base) (Round Color Tubes) Regular Price **\$5.65**

Regular price for all three is \$17.35. With this limited time offer you pay only \$15.50 and the baseball is FREE.

FREE!

"Always rely on Perma-Power Briteners to extend useful picture tube life for months, preserve excellent customer relations for years!"

Perma-Power

Chambon Electronics
845 Larch Avenue, Elmhurst, Illinois 60126

... for more details circle 122 on Reader Service Card



cent of reading ± 1 digit. Temperature coefficient (0° to 40°C) is ± 0.01 percent/ $^{\circ}\text{C}$. Input resistance is 10M on all ranges. AC Voltmeter ranges are:



0-0.1, 1.0, 10, 100 and 1000vac. Accuracy at 50 to 20kHz frequency is ± 0.2 percent of reading ± 1 digit. Current measurement (ac), (dc) ranges are: $10\mu\text{a}$, and 0.1, 1.0, 10, 100 and 1000ma. Accuracy is dc ± 0.2 percent of reading and ac ± 0.4 percent of reading ± 1 digit from 100Hz to 10kHz. Full scale circuit voltage drop is 100mv ac or dc on all ranges. Power source is $115 \pm 10\text{vac}$ or $230 \pm 20\text{vac}$, 50/60 Hz 12w. Its construction consists of all solid-state circuitry, printed-circuit boards and steel sheet material is used for the main chassis and internal module covers. A stored metal leg is provided to elevate the front edge approximately 25 degrees to facilitate table-top use. Cabinet dimensions are: (HWD) $4\frac{1}{8} \times 10\frac{5}{16} \times 8\frac{7}{8}$ in. Suggested user net is \$575. Triplett.

FIELD STRENGTH METER 714

Readings on all UHF/VHF picture and sound carriers

A solid-state portable field strength meter for CATV and MATV systems is introduced. The Model 1720 is said to be ideal for CATV and MATV



field use because it is light, accurate and easy to use. It works from four 9v batteries and provides direct, accurate readings on all UHF and VHF picture and sound carriers. The carriers are clearly marked for each channel. The meter measures inputs

from ten microvolts to two volts. It is reportedly accurate within $\pm 1.5\text{dB}$. To conserve batteries, the unit automatically turns itself off when the cover is closed. The meter includes a special phone-scope jack, providing a detected signal output which can be used to drive a high impedance crystal earphone, a tape recorder or an oscilloscope. JFD.

VOLTOHMYST 715

Operates from batteries or 120vac

A portable all solid-state Volt-Ohmyst, especially designed for service, industrial and laboratory applications is announced. This portable solid-state electronic voltmeter can be operated either from internal batteries

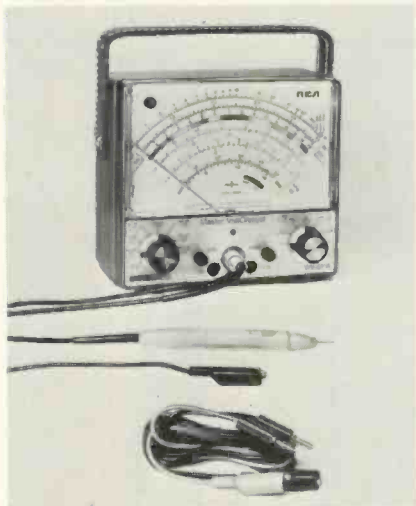

or from 120vac. The voltmeter is ideally suited for use at home, on the service bench or in manufacturing and laboratory test situations. The Model WV-510A measures dc voltage from 0.01 to 1500v, direct current from 0.01mA to 1.5a, ac voltage from 0.2 to 1500 volts, ac peak-to-peak voltage of complex waveforms from 0.5 to 4200 volts, and resistance values from 0.2Ω to 1000M. Seven overlapping ranges are provided for ac, resistance and current measurements, and eight ranges are provided for dc voltage measurement. Accuracy for all voltage and current functions is ± 3 percent of full-scale reading. The solid-state measuring circuit reportedly features "zero" stability and linearity. The current drain of this instrument is low and accuracy is maintained throughout the usable life of the batteries and a convenient battery test function is provided. An input resistance of 21M on all dc ranges permits accurate test results on even critical low-impedance circuits. The instrument has a large, easy-to-read, two-color meter with a mirror scale. Dimensions are as follows: height $6\frac{7}{8}$ in.,

Use Aerovox capacitors available from your local AEROVOX DISTRIBUTOR

He's your best "one-stop" source for virtually every replacement capacitor you require. He carries the complete Aerovox line which includes: ceramics, micas, electrolytics, papers, film and interference filters. So no matter what your replacement requirement, you're sure to find it at an Aerovox Distributor.

service it
FAST
with
components
that
LAST!



AEROVOX
Hi-Q
AEROVOX
CORPORATION

DISTRIBUTOR SALES, New Bedford, Mass. 02741
... for more details circle 102 on Reader Service Card

ARROW AUTOMATIC STAPLE GUNS

CUT WIRE & CABLE INSTALLATION COSTS

... without cutting into insulation!

SAFE! Grooved Guide positions wire for proper staple envelopment! Grooved Driving Blade stops staple at right depth of penetration to prevent cutting into wire or cable insulation!

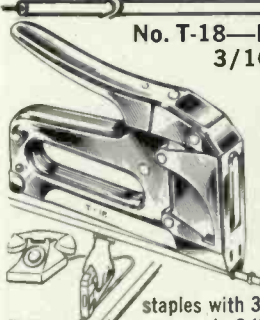

No. T-18—Fits wires up to 3/16" in diameter.

BELL, TELEPHONE, THERMOSTAT, INTERCOM, BURGLAR ALARM and other low voltage wiring.

Uses T-18 staples with 3/16" round crown in 3/8" leg length only.

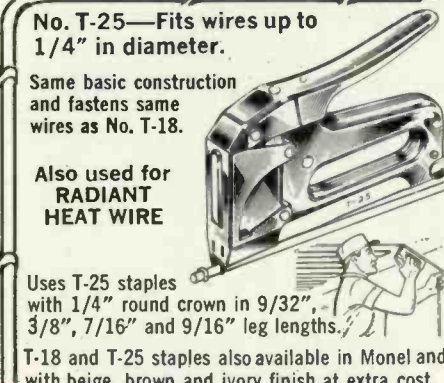

No. T-25—Fits wires up to 1/4" in diameter.

Same basic construction and fastens same wires as No. T-18.

Also used for RADIANT HEAT WIRE

Uses T-25 staples with 1/4" round crown in 9/32", 3/8", 7/16" and 9/16" leg lengths.

T-18 and T-25 staples also available in Monel and with beige, brown and ivory finish at extra cost.

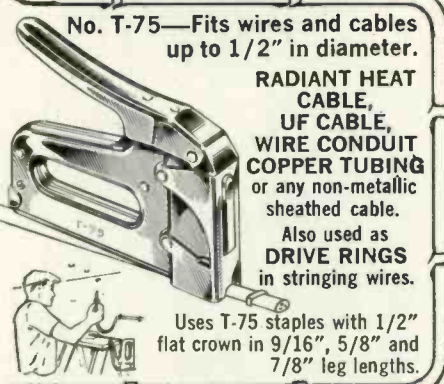

No. T-75—Fits wires and cables up to 1/2" in diameter.

RADIANT HEAT CABLE, UF CABLE, WIRE CONDUIT COPPER TUBING or any non-metallic sheathed cable.

Also used as DRIVE RINGS in stringing wires.

Uses T-75 staples with 1/2" flat crown in 9/16", 5/8" and 7/8" leg lengths.

Arrow Automatic Staple Guns save 70% in time and effort on every type of wire or cable fastening job. Arrow staples are specially designed with divergent-pointed legs for easier driving and rosin-coated for greater holding power! All-steel construction and high-carbon hardened steel working parts are your assurance of maximum long-life service and trouble-free performance.

Ask your Electrical Supply Dealer or write for further details.

ARROW FASTENER COMPANY INC
Saddle Brook, New Jersey 07863
"Pioneers and Pacesetters For Almost A Half Century"

... for more details circle 104 on Reader Service Card

ET/D NEW PRODUCTS

width 5/4 in. and depth 3/8 in. The unit weighs 3 1/2 lb, with batteries in place. The voltohmyst comes complete with a dc/ac-ohms probe with flexible shielded input cable (type WG-401A) with BNC connector, slip-on alligator clip, current test leads, one RCA VSO36 battery and an instruction book. Price \$128. RCA.

VERTICAL SHORT-WAVE 716 ANTENNA

Offers space saving installation

Introduced is the Model SWV-7 vertical SWL antenna for the broadcast bands. This antenna retains the broadband coverage of the Model



SWL-7 predecessor while offering space-saving installation available only in a vertical. Its six weatherproof traps are housed in paper phenolic tubing, a design favorable both to performance and appearance. The antenna includes hardware for simplified mounting either on the ground or roof. Ground mounting requires no guying or concrete footing and when roof mounted a three-foot mast with hinged mounting bracket fastens base assembly to roof

with only one lag screw. Guying is required for roof mounting. The antenna covers bands 11, 13, 19, 25, 31 and 49 meters. Length is 39ft, 10in. and weighs 5lb, 15oz. Price \$33.71. Mosley.

DIGITAL SYSTEM 717

Requires one-minute warm-up

Introduced is a digital system with a fast warm-up, requiring one minute to reach a claimed accuracy of ± 0.1



percent ± 1 digit. Five-minute warm-up brings the instrument to full rated accuracy of $\pm 0.05 \pm 1$ digit. The Model 2700 is a digital dc voltmeter which may be used with nominally priced plug-in adapters for reading dc current and dc resistance. Four full-time digits provide up to five readings per second and automatic polarity indication. The standard dc voltage range module measures from .0001 to 999.9v. Integrated circuits are used throughout this instrument. FET input and 200,000 hour rated readout lights assure reliable, long life. The system weighs eight pounds and measures four inches high by eight and one-fourth inches wide. Kits for rack mounting are also available. Simpson Electric.

718

PREAMPLIFIER AND CONTROL

Modules purchased singly or in combination

Introduced is the Model HL-100 preamplifier and control unit shown as three separate modules which can be purchased singly or in combination. The power supply module drives any two comparable units in the HL-100 series. Modules shown are (left to

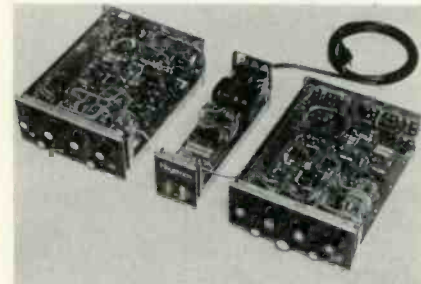

right): Equalizing Stereo Preamplifier (HL-D1), Power Supply Unit (HL-A1), and Switch & Control Panel (HL-D2). Hegeman.

VHF RECEIVER

719

Operates on
30-50 or 148-174MHz bands

Announced is a base or mobile, VHF receiver, which can be operated in either the 30-50 or 148-174 MHz bands. Called Model TMR-1, the vinyl



clad unit measures 2¼ x 5½ x 7½ in. The unit includes ac and dc power cords, mobile mounting bracket, detachable telescope antenna and built in 4in. speaker. External speaker terminals and standard auto antenna jack are available on the back panel of the unit. Located on the chrome trimmed front panel are the on/off/volume and squelch controls plus a power lamp indicator. Circuitry provides for a single plug-in \$4.95 crystal. Five watts audio output is complemented reportedly by ½µv sensitivity and 50dB selectivity at ±15kHz. Price \$99.95. Regency.

DE-SOLDERING TIP

720

Fits standard 3/8in.
screw-type soldering gun

Introduced is the model 4918DIP de-soldering soldering tip which is eas-



ily inserted in a standard 3/8in. screw-type soldering gun of 35w or more. Grooved and channeled for 10, 14 or 16 lead dual inline packages, the tool will reportedly desolder a complete 16 pin CIP in one pass and is combined with a solder pick up. The end tips are shaped for straightening bent connect-

Clip the coupons!

Present one or more to your participating RCA Test Equipment Distributor for big discounts on these four instruments during RCA's big Spring Coupon Carnival. (Only one coupon will be accepted per instrument.) Do it today. Offer good only between February 15th and April 30th, 1970.

\$7.50 Toward Purchase
of RCA WT-501A
Transistor Tester

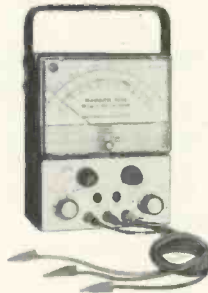

Mr. Distributor, please refer to RCA 1970 Carnival announcement. Void where prohibited, taxed, or restricted. Cash value 1/20¢. Offer expires April 30, 1970.

\$10.00 Toward Purchase
of RCA WT-509A
Picture Tube Tester



Mr. Distributor, please refer to RCA 1970 Carnival announcement. Void where prohibited, taxed, or restricted. Cash value 1/20¢. Offer expires April 30, 1970.

\$7.50 Toward Purchase
of RCA WV-98C
Senior VoltOhmyst



Mr. Distributor, please refer to RCA 1970 Carnival announcement. Void where prohibited, taxed, or restricted. Cash value 1/20¢. Offer expires April 30, 1970.

\$20.00 Toward Purchase
of RCA WR-99A
Crystal Calibrated
Marker Generator



Mr. Distributor, please refer to RCA 1970 Carnival announcement. Void where prohibited, taxed, or restricted. Cash value 1/20¢. Offer expires April 30, 1970.

Look to RCA for instruments to test/measure/view/monitor/generate
RCA Electronic Components, Harrison, N. J. 07029

RCA

... for more details circle 127 on Reader Service Card

ET/D NEW PRODUCTS

or pins. Re-soldering the CIP into position is also possible using the pickup channel to wick the solder to all points. Techni-Tool.

CIRCUIT TESTER 721

Pen-sized
signal source

The "Mosquito," which finds multiple applications in the field of Integrated Circuit testing and provides

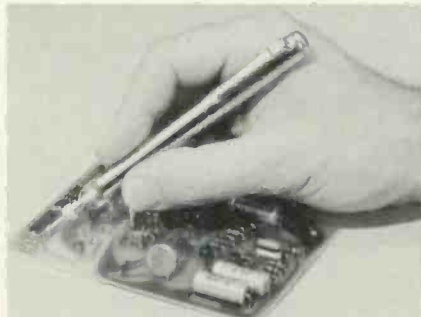

an ideal trigger signal for DTL, RTL, and TTL circuits, is introduced. This simple but effective device is a cord-

less pen-sized signal source. The unit generates and injects pulses covering the audio, IF and RF spectrum. It operates on a single AAA size 1.5v battery and weighs one ounce. The unit can be used for troubleshooting and testing of digital equipment, computers, radios and televisions, instruments, tape recorders, sound motion picture projectors, telephone circuits, hearing aids and audio systems, including amplifiers, reproducers and sound pickup cartridges. Bosco.

MINI-CCTV 722

Weighs less than
two pounds

Announced is the development of a simple, inexpensive CCTV system with built-in two-way sound. Called Mini-CCTV, the system is small and simple enough to be used by any housewife. The unit comprises a (2 x 3½ x 5½ in.) camera, a 5in. monitor, and a 30in. interconnecting cable. Installation consists of plugging the monitor into an ac wall socket and connecting it to the camera by the 30 ft cord supplied. Operation involves aiming the camera and adjusting brightness and contrast controls on the monitor for best picture. The camera can easily be moved from various

locations, since it weighs less than two pounds. Automatic light compensation enables the camera to adjust to almost any light conditions, without adjustment. It can produce good pictures with as little as 20 lux (2 foot candles) of scene illumination. In addition to home uses, the MINI-CCTV is also excellent for business purposes and discouraging shoplifting and theft. The 2-way sound is controlled from the monitor, giving the user the option of listening to sounds from the camera location or turning them off. Price \$350. GBC.

VIDEOTAPE CONSOLES 723

Any low cost TV camera can
be used with the system

Introduced are mobile video tape console units designed to accommodate video recorders made by several manufacturers. The basic console is formed by two cast fiberglass sections enclosing the recorder, audio and video monitors and optional equipment. All components are mounted to a stainless steel frame, which also forms the protective front and rear rub strips and handles. The lower wheeled base section provides storage for videotape and operating supplies. Designed for operational convenience, the console system is permanently connected to the recorder with its own 12in. video monitor and speaker. A



hinged plexiglass top cover over the tape deck keeps dust out and noise in. Any low cost TV camera may be used with the system. No external cables are required, as the pedestal camera mount plugs into the top of the console, automatically connecting power and video to the system. The console fits Ampex VR-5000, VR-6000 and VR-7000 series videotape recorders without modifications to the standard equipment. Additional console units will be available in 1970 for Sony, IVC and other recorders. Any 1in. Ampex machine, with the exception of the VR-7800, mounts directly to the console frame once it is removed from the factory carrying case. The existing

THE GREAT PUT-ON

Put it on dirty, greasy, grimy hands . . . it gets them ready-for-lunch clean. With water . . . without water.

Just rub on, wipe off. It dissolves, loosens, removes dirt. Even fingernails and cuticles look good. No chemical residue to affect electrical components or rubber goods. And no greasy afterfeel either.



We put in lanolin, left out abrasives and harsh solvents. And it's antiseptic . . . that's really important. It prevents infection from those honest-day's-work cuts, scratches, abrasions.

There's a sanitary, just-enough dispenser for the 4½-lb. can. Or get the handy 1-lb. bench-top size. Or 5-oz. tool kit tube.

No petunia smell either.

CRC ANTISEPTIC HAND CLEANER



CRC Chemicals
A Division of C. J. Webb, Inc.
Dresher, Pa. 19025

. . . for more details circle 108 on Reader Service Card

input-output connection panel fits a cutout in the console and the speaker mounts in front under the video monitor. Installation may be done by non-technical personnel in less than one hour using simple hand tools. A 12in. professional video monitor is included already installed, and instructions and hardware are furnished with the "do-it-yourself" kit. Lightweight and sturdy, the console weighs 60lb. (less the recorder). Mark IV Systems.

TV SHOWROOM ANTENNA SYSTEM 724

Packaged system serves 12 sets

A packaged master antenna TV (MATV) system for TV showrooms is introduced. The model SL-9004 in-

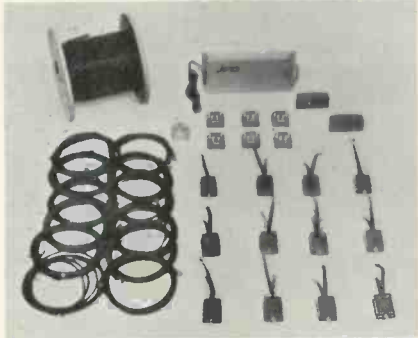

cludes antenna matching transformers, an '82' channel headend amplifier, a two-way splitter, six dual output tap-offs, 12 TV set matching transformers, two line terminators, all necessary cables and connectors. It is reportedly capable of supplying top quality antenna signals (UHF, VHF and FM) to every TV and FM set on the showroom floor. Designed to serve 12 sets, the system can easily and inexpensively be expanded to handle 50 to 100 sets. Installation of the showroom system is easy. It is basically a question of mounting the individual components and then plugging them together with cables. A well-illustrated, step-by-step instruction manual facilitates the installation. List price \$460. JFD.

AMPLITUDE FUNCTION GENERATOR 725

Tone burst and synchronization capabilities

A function generator, Model 743, reportedly providing low distortion sine, square and triangular waves over a dial controllable range from 1MHz to 2MHz, with an output of up to 20v P-P from a 50Ω source impedance is introduced. In the VCG or FM mode the generator may be swept from 1Hz to 4MHz with amplitude variation claimed of less than $\pm 0.05\text{dB}$ ($\pm 1/2$ percent). As features in its

Now it costs less to own the best oscilloscope you need.



The New RCA WO-505A Solid-State Oscilloscope I.Q.*

The best you need is the new 5-inch RCA WO-505A, all solid-state oscilloscope. It makes yesterday's general-purpose 'scopes look old-fashioned.

At just \$298.50† the WO-505A offers an unmatched list of features usually found only in more expensive, laboratory type instruments. For example there's the all solid-state circuitry... an illuminated graph screen calibrated directly in volts, and a deep-lip bezel for exceptional clarity. The regulated power supply minimizes trace bounce and provides excellent stability. And the camera mounting studs offer still more evidence of the functional value built into the new WO-505A.

But you've got to see this new RCA 'scope in operation—see the sharp, clean trace it provides—to appreciate it.

Some statistics:

- High-frequency response, usable to 8 MHz.
- High Sensitivity (.05 V p-p range).
- DC vertical amplifier; DC/AC input.
- Return trace blanking... Trace polarity reversal switch... Phase control.
- High-frequency horizontal sweep; solid lock-in on 5 MHz.
- Preset TV "V" and "H" frequencies for instant lock-in.
- Built-in square-wave signal for calibrating P-P voltage measurements.
- Provision for connection to vertical deflection plates of CRT.

Some statistics! For complete details, contact your RCA Distributor.

RCA | Electronic Components | Harrison, N. J. 07029

... for more details circle 128 on Reader Service Card

RCA

*Inexpensive Quality

†Optional Distributor Resale Price

TeleMatic

FIRST AID KIT for MINI-BASE TV's



BRIGHTEN
MINI-BASE CRT'S WITH THE CR-12, SERIES PARALLEL BRIGHTENER.



TEST
MINI-BASE CRT'S IN PRESENT EQUIPMENT WITH THE CR-165 ADAPTOR.



SERVICE
SETS WITH THE CR-88 SERVICE EXTENSION



REPLACE
MINI-BASE SOCKETS WITH THE CR-84 SOCKET

SAVE . . . BUY THE KIT

Telematic Div. U. X. L. CORP.
BROOKLYN, N.Y. 11207, U.S.A.

for more details circle 136 on Reader Service Card

WARNING BEWARE OF COUNTERFEIT BLUE STUFF

A few electronic parts distributors are marketing a cheap imitation of **BLUE STUFF FOR TUNERS** under names like BLUE FOAM FOR ALL TUNERS and BLUE MAGIC.

These imitations do not carry a manufacturer's name and may deceive the technician into thinking that the material is **BLUE STUFF**, or the same as **BLUE STUFF** packaged under private label.

DON'T BE MISLED

These counterfeit products are NOT **BLUE STUFF** or the same exclusive formula as **BLUE STUFF**.

YOU CAN BE SURE . . . if **BLUE STUFF** is in the can **BLUE STUFF** will be on the label.

**TECH
SPRAY**

P.O. Box 949 Amarillo, Texas
Canada: Wm. Cohen, Montreal
Export: Empire Exporters, N.Y.C.

ET/D NEW PRODUCTS

price range, the generator has both tone burst and synchronization capabilities. Design has reduced the num-

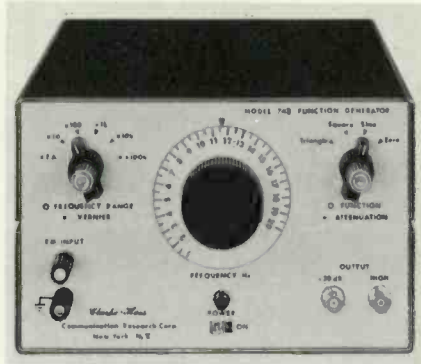

ber of internal adjustments to only six. The unit will handle sweep or FM modulation rates of up to 200kHz and is priced at \$365. Clarke-Hess.

INTRUSION ALARM 726

Converts PA speakers into sensitive microphones

A new intrusion detection and alarm system, called "Intrud-Alarm," is introduced. Used in conjunction with a

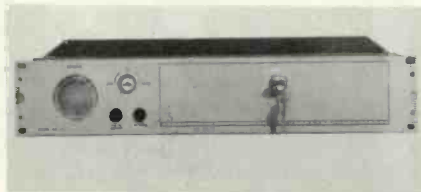

building's sound system, the new equipment uses the public address loudspeakers and wiring to provide detection of extraneous noises. The heart of the system is the Model CA-21 Intrusion Detector which converts all PA speakers into sensitive microphones that can detect sounds in the 1000-5000 Hz range—regardless of softness or loudness. This all-silicon, solid-state electronic unit automatically senses and discriminates between normal building sounds and extraneous noises with extreme accuracy. An internal audible alarm can be triggered to frighten away the intruder or a remote alarm may be transmitted directly over telephone lines to the local police department. The Model CA-22 Audio Monitor is employed in systems wired for the remote alarm. With this method, noises can be first monitored without the intruder being aware that his presence has triggered an alarm system. The CA-22 monitor panel allows up to nine different buildings to be monitored by the same unit. The operation of the detection and alarm

system can automatically be transferred to standby battery supply in the event of any ac power failure. "Intrud-Alarm" provides facilities for the use of magnetic detector switches which can be used as desired on windows and doors. Bogen.

MODULAR INSTRUMENT SYSTEM 727

Duplicates instruments students will be using in industry

A selection of advanced instruments designed expressly for vocational electronics programs is introduced. Known as Modular Instrument System, these devices, i.e., power supplies, metering and test equipment, duplicate the instruments students will be using in industry. Diode protected meters have 100 μ a, hi-torque taut-band suspension movements, reportedly accurate with-



in two percent. DC voltmeter has 10K per volt sensitivity; AC voltmeter has 2K per volt. All have 3½ in. mirror scale and push-button range selection. Some of the power supplies feature metered output, push-button control of max current, and/or output voltage limiting. Fuseless protection of power supplies is provided by either solid-state circuitry or fast-acting thermal magnetic circuit breakers. Both the power supplies and meters are packaged into standard 9 in. high "modules." Various combinations of ac and dc ammeters and voltmeters are available in 6¼ in. wide modules that contain two meters each. Power supply modules are either 6¼ or 12½ in. wide and tunnel sections, into which the modules fit, have 18¾ in. wide openings. Sections are shipped partially assembled so that any tunnel length (in multiples of 18¾ in.) can be achieved in the final assembly. Lab-Volt.

BOOSTER ANTENNA 728

Inductively couples antenna to radio

A booster antenna for any radio is developed. By simply setting the unit near a radio, the antenna will boost weak reception. This unit is 4½ in. long by 1 in. wide by ½ in. thick, and weighs about 5oz. Requiring no bat-

teries, this miniature antenna system inductively couples a short antenna to



the radio, increasing the radio's efficiency and performance. Price \$8.50. Russell Products.

729

PROTO-TYPE BREADBOARD KIT

Equipment designed and built at a minimal cost

A proto-type breadboard kit with slanting front that can be used as an "RF" kit, a conventional R & D laboratory kit and also converted to a piece of laboratory test equipment, is introduced. When the kit is used for critical "RF" circuitry development, a two-sided copper clad deck with gold-plated, teflon-insulated, feed-thru terminals will accomplish this quite satisfactorily as components can be

placed on either side of the copper clad deck. When kit is used as a conventional R & D laboratory kit, a phenolic deck and solder-type, feed-thru terminals will facilitate this requirement. Solderless connectors are also provided. The slanting front, aluminum chassis is available with pre-punched holes or plain. An aluminum pre-punched breadboarding deck similar to the copper clad deck is also



available and when used with the perforated, aluminum cover and the plain, slanting front, aluminum chassis, a permanent piece of laboratory test equipment can be designed and built quickly at a minimal cost. The various brackets and phenolic spacers furnished with this versatile kit allows the mounting of any components used in project development. The kit measures 7 1/4 in. W x 17 in. L x 2 in. H. Hook.

DEPENDABLE ALL-PLASTIC COLOR TUBE BRIGHTENERS



#CTB-70

Restores "New Set" performance to Color TV Sets when Color tubes become dull and lose contrast quality after one year. Increases tube brilliance by increasing the electron emission. All plastic—not paper! Reusable! Simple installation! Just plug in between the color tube and color tube socket. #CTB-70 for 70° button base pic tubes. #CTB-90 for 90° button base pic tubes. Both blister-sealed on attractive, Informative Peg-Hang Cards. For Profit Details—Write:



#CTB-90

RMS ELECTRONICS, INC.

50 AmIn Place, Bronx, N.Y. 10462
• Tel. (212) 892-6700

... for more details circle 129 on Reader Service Card

99.99% reliable

Every now and then, one of our tubes fizzles—and somehow it's the one you install. Even we don't know how you happen to receive that particular tube. But we do know that it doesn't happen more than once in thousands of times. Raytheon receiving tubes—including Raytheon Tubes for Imported Sets—have to be extra reliable. Because, Raytheon is the leading independent supplier of receiving tubes to independent servicemen. We don't have competing service trucks or retail outlets. So, we depend on you just as much as you depend on us.

RAYTHEON

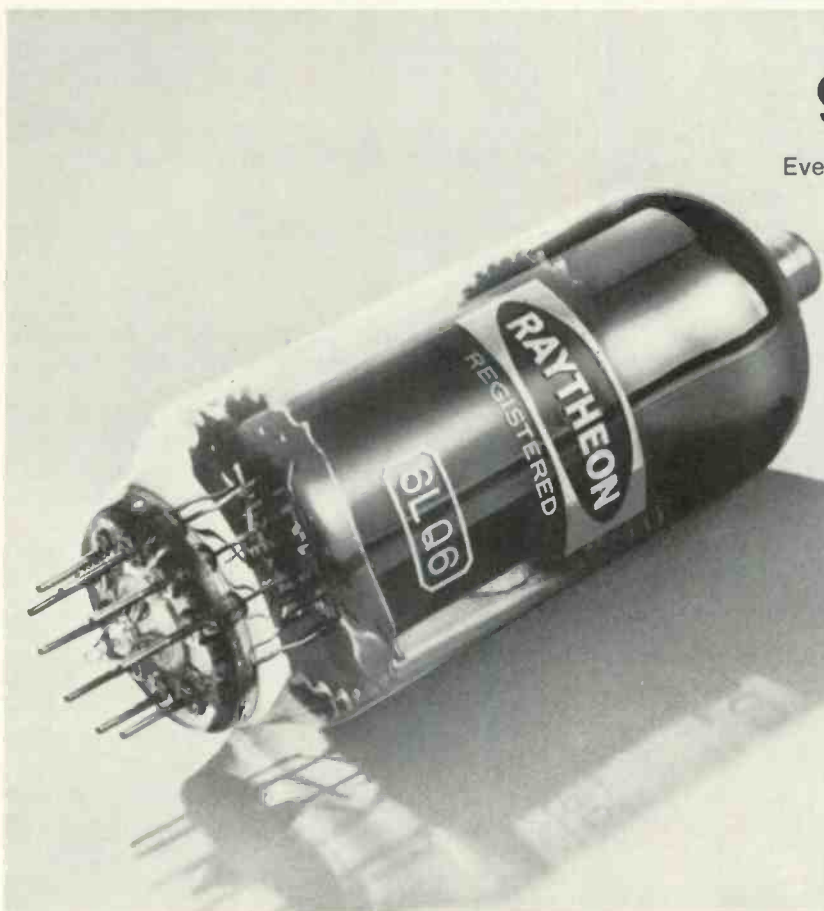

... for more details circle 125 on Reader Service Card

You're making money in electronics now.
RCA Offers 4 Ways to Make More.

Study at home...set your own pace.
**RCA Institutes has an easy approach
 to bring you bigger earnings.**



COLOR TV:

During this course you'll perform over 50 experiments—and receive all parts and instructions to build your own color TV.

The cost of the Color TV Kit is included in the tuition in both the beginner's program and the advanced course in color TV servicing.

Course is based on the latest receiver circuitry and equipment.

SOLID STATE TECHNOLOGY

New courses include the latest findings and techniques in this field. Information you must

have if you are to service the multitude of solid state instruments and devices used in TV, Digital, and Communications equipment.

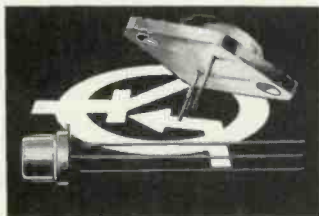

FCC LICENSE TRAINING:

Choose the course for the FCC License you want: third, second or first phone. If you need basic training first, apply for the complete License Training Program. Get your License—or your money back.

CATV TRAINING:

You'll receive two comprehensive lessons, covering the practical phases of CATV systems in either the Television Servicing or Communications courses.

Licensed by New York State Education Department. Approved for Veterans. Accredited Member National Home Study Council.

RCA

MAIL THE COUPON NOW FOR COMPLETE INFORMATION.

RCA INSTITUTES, Inc., Dept. 225-004-0
 320 West 31st Street, N.Y., N.Y. 10001
 Please rush me FREE illustrated catalog. I understand that I am under no obligation.

Name _____ Age _____
 (please print)

Address _____

City _____

State _____ ZIP _____

ET/D

NEWS OF THE INDUSTRY

NAB AUTHORIZES STUDY OF PROBLEMS CAUSING TOWER ICING

The Engineering Advisory Committee of the National Association of Broadcasters has ordered a special study of a problem causing a good deal of concern—ice forming on transmitter towers.

Appointment of a subcommittee was authorized to investigate the availability of ice-resistant towers or of mechanical or chemical means to prevent icing. The group could also recommend a research project for the development of such towers or de-icing devices.

Albert H. Chismark, director of engineering, Meredith Broadcasting Co., Syracuse, N.Y., chairman of the Advisory Committee, will also serve as chairman of the special subcommittee. Others named to the subcommittee were Robert W. Flanders, director of engineering, the WFBM Stations, Indianapolis, Ind.; Royce L. Pointer, director of broadcasting engineering, AGC, New York, and Benjamin Wolfe, vice-president for engineering, Post-Newsweek Stations, Washington, D.C.

The Advisory Committee also approved plans to develop standards for cassette tape recorders, latest in NAB efforts to assure the interchangeability of broadcast equipment. George W. Bartlett, NAB vice-president for engineering, told the committee that broadcasters are now using cassette recorders quite extensively, particularly in gathering news for later presentation on radio.

NAB some years ago adopted standards for disc and tape recordings to assure maximum fidelity in broadcasts and they now are industry standards throughout the United States and in most of the world.

The Association later developed a test record to permit station engineers to evaluate the performance of their audio equipment, including turntables, and since has distributed 6000 copies here and abroad.

Distribution of a cartridge test tape has just begun and a second test tape, reel-to-reel, is about ready for distribution.

CASTLE TUNER SERVICE MOVES

The Eastern Division of Castle TV Tuner Service announces their move from Long Island City, New York, to Richmond Hill, New York.

Their new, larger premises are set up and equipped with sophisticated analysis facilities to provide thorough overhaul service on all makes of TV tuners for the entire Eastern section of the U.S. A large stock of custom and universal replacement tuners will be available.

The new address is: 130-05 89th Road, Jamaica, N.Y. 11418.

The main plant at 5710 N. Western Ave., Chicago, Illinois 60645, continues to provide similar service for the rest of the U.S.

ZENITH ANNOUNCES PAGING RECEIVER

Zenith Radio Corp. announced development of an advanced solid state personal communications system, using a new solid state paging receiver, which opens a significant new field for the company that can lead to further diversification in communications.

Joseph S. Wright, Zenith chairman, said, "This achievement by our research and development engineers combines solid state microcircuits and 'computer language' coding techniques. The result is a digital paging receiver which can increase up to 10 times the number of customers served by a single narrow band FM channel."

Bell Canada, a Canadian company, has developed and patented a paging system covering wide-spread areas, known as System Wide Area Paging, "SWAP" and has entered into a major program to purchase substantial quantities of the new units from Zenith.

Zenith will begin production of the microcircuits and assembly of paging receivers this spring, with first deliveries slated for July.

The solid state paging receiver weighs only 4½ ounces and can be easily slipped into a jacket or shirt pocket, a woman's handbag or clipped to a belt or automobile sun visor.

Telephone companies, such as Bell Canada, operating individual paging systems process messages at a central exchange to serve businessmen, doctors, lawyers, and others who need constant personal communication around-the-clock. The customer has a small paging unit that receives signals over narrow band FM channels (150 to 160MHz). When called, only the unit being paged emits a tone alert signal. The customer then can telephone his caller.

Company engineers said the new paging receiver:

- Expands up to 30,000 the number of individual customers served by a single narrow band FM channel. Extension of the coding concept could further increase the number up to 100,000.

- Permits transmission of signals up to five times per second as a result of the use of new coding techniques, enabling the paging system to provide continuous, efficient service even at peak usage hours.

- Provides lower unit cost, longer life and greatly reduced maintenance costs, because of the use of advanced thick film hybrid microcircuits and the latest monolithic integrated circuits.

- Operates economically on readily available transistor radio batteries.

The unit also has a built-in memory, allowing the customer to interrogate it for calls received in his absence.

The Federal Communications Commission has authorized individual paging systems on narrow band FM frequencies. Large scale test operations have been conducted by companies in the United States and plans are being made for additional installations in many cities throughout the country.

CENSUS BUREAU REPORTS ON ELECTRON TUBES

Manufacturers' shipments of receiving type electron tubes in 1967 were valued at \$256.1 million. This is a decrease of \$31.8 million from 1963, the year of the last previous Census of Manufactures, according to a preliminary report just issued by the U.S. Department of Commerce's Bureau of the Census.

Total number of employees in the industry was 21.2 thousand in 1967, a drop of 4.6 thousand from 1963. Payrolls for 1967 totaled \$119.5 million as against \$136.8 million in 1963.

Value-added-by-manufacture was \$227.7 million in 1967—in 1963 the total was \$250.7 million. Value-added approximates the value of products shipped less the cost of materials used in the manufacture of the products.

The report, "Electron Tubes, Receiving Type," MC67 (P)-36D-5, is for sale by the U.S. Bureau of the Census, Washington, D.C. 20233 and U.S. Department of Commerce field offices (located in principal cities throughout the United States). The price is 10 cents per copy.

GOZINTA®

A NEW TOOL FOR CLEANING
CONTROLS OF TV AND AUTO RADIOS
THRU FRONT PANELS



MODEL NO. WJL
PACKAGED WITH 3 OZ. AEROSOL
LUBRITE. DEALER COST \$2.67

MANUFACTURED BY
WORKMAN Electronic
SARASOTA FLORIDA PRODUCTS INC.

... for more details circle 142 on Reader Service Card

NEW COAX LINE SPLITTER

For UHF/VHF
Color/B&W TV



The Mosley M-22 two set, and M-24 four set 75 ohm coax splitters for color TV/FM Stereo distribution systems. High inter-set isolation, low insertion loss. Models may be combined to provide any number of lines for larger amplified systems.

Solderless. Easy installation.



Write Dept. 159A for FREE detailed brochure.

Mosley Electronics Inc. 4610 N. Lindbergh Blvd.,
Bridgeton Missouri 63042

... for more details circle 120 on Reader Service Card

SERVICE MASTER HANDIEST HANDFUL of service tools

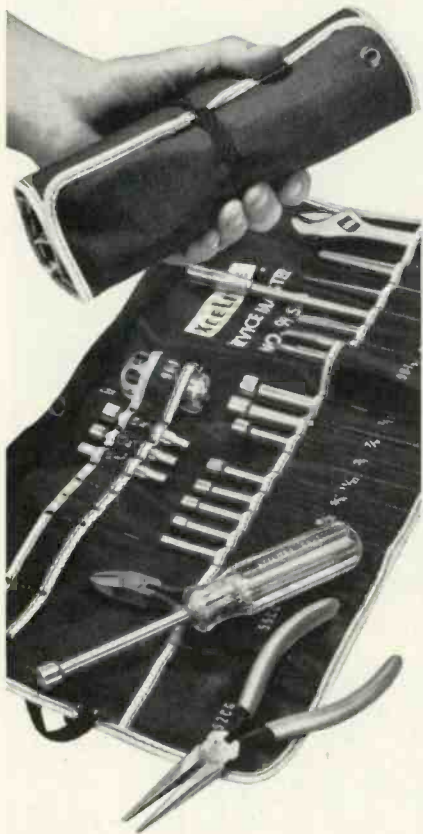

23 essential tools at your fingertips in this light-weight (only 2¾ lbs.), compact, easy-to-carry, roll-up kit. Contains long nose plier, diagonal plier, adjustable wrench, regular and stubby plastic handles with these interchangeable blades: 9 regular and 3 stubby nutdriver, 2 slotted and 1 Phillips screwdriver, 2 reamer, 1 extension. Eyelets in plastic-coated canvas case permit wall hanging. New elastic loop secures roll, eliminates need for tying.

many optional accessories:

Junior and Tee handles... Additional nutdriver, Phillips & slotted screwdriver, and extension blade sizes... Allen hex type, Bristol multiple spline, Frearson, Scrufox, and clutch head blades... Awl/Scriber... Chuck adaptors to use blades in spiral ratchet drivers.

WRITE FOR CATALOG 166



XCELITE, INC. 14 Bank St., Orchard Park, N.Y. 14127
In Canada contact Charles W. Pointon, Ltd.
... for more details circle 143 on Reader Service Card

ET/D

CATALOGS & BULLETINS

400

TV Parts Cross-Reference Guide

Offered is the color and monochrome TV Parts Replacement Guide. The Part-to-Part Cross Reference Guide contains replacement parts for 200 television manufacturers. This year a new section has been added covering the line of flybacks, deflection yokes, vertical outputs, power and output transformers, filter chokes, plus several pages of electrical schematics. Stancor.

RF Voltmeter

401

A specification sheet lists the Model 500 HFE RF Voltmeter, a high-accuracy self-contained instrument for handling the frequency range 20kHz to 500MHz over a potential range from 200mv to 15 volts. The literature illustrates the instrument with emphasis on the low-capacitance bifurcated probe, which increases accuracy and simplifies measurements. High Frequency Engineering.

Ceramic Strip

402

A 4-page catalog containing three families of ceramic strips are explained and illustrated, thread mounting standard types, plug-in miniatures and universal types with snap mounting. A specially created design board kit is available for prototype and instructional use. The terminal strips described are ceramic-base units with fired silver, copper plated and tinned terminals to facilitate high temperature soldering of components and leads. Alcostrip.

Electronic Importers Directory 403

A 1970 Electronic Importers Directory is available. Listing over 150 U.S. based importers of electronic merchandise the directory combines a total of over 5,000 brands and models to choose from. A partial list of items covered include radios, stereos, cassette recorders, amplifiers, speaker systems, musical instruments, cameras, TVs, UHF and VHF equipment plus electronic components. It gives complete information on the importer, including name, address, phone no., items carried and brand names used. Pictorial display on some items. Price \$9.95. Commodore Publications.

Test Instruments

404

A 12-page catalog describing the company's complete line of electronic equipment is available. The catalog,

Form No. 517, features five completely new instruments including the sixth generation of the company's Mighty Mite tube tester, two-color generators, a field effect transistor tester and a seven-in-one bias supply. Other instruments included in the catalog are field effect meters, sweep and marker generator, sweep circuit analyzer, combination oscilloscope/vectorscope, combination transistor/FET testers. CRT tester and special purpose instruments, all complete with performance data and prices. Sencore.

TV Cheater Cords

405

A data sheet on the complete line of television cheater cords is published. The UL-approved cords are all 10a, 125v hanked power supply cords with molded caps and connectors, available in six or nine foot lengths, in brown or white. Caps are standard, polarized with pins. Connectors are standard with ears, snap-in or standard C clip; polarized with ears, C clip, snap-in, or polarized misalignment. Columbia Electronic Cables.

Wire Stripping

406

An 8-page, two-color brochure, No. 6 describing hand and bench mounted wire strippers is available. The brochure offers helpful suggestions on how to select the correct wire stripper for your specific requirements. Various models of mechanical hand strippers, bench mounted strippers and thermal strippers are described in detail with complete specifications, operational drawings and ordering information. Ideal Industries.

Linear IC Tester

407

An 8-page brochure on a linear IC tester describes LIC testing and evaluation of circuit performance in special purpose applications. The tester is a multi-purpose unit designed to simulate various conditions under which LIC's may operate; it can also be used in failure analysis of IC devices. The unit affords the evaluation of IC's such as op amps, comparators, differential amplifiers and it allows the study of transistor characteristics. I. C. Metrics, Inc.

Transistors

408

A 12-page brochure describes the Silect line of low-cost transistors. Details are given on plastic-encapsulated silicon bipolar, unijunction, and field-effect transistors. Featured in the publication is a report on more than 33 million hours of testing transistors, establishing the fact that the devices meet high reliability specifications. An application's guide listing device recommendations and electrical parame-

ters is included. The brochure discusses and illustrates the exclusive transistor package construction. A device cross-reference in the booklet lists transistor type designations, direct replacements, preferred types and nearest equivalents for easy selection by designers. Texas Instruments.

Panel Instruments 409

A 32-page catalog describing over 1,500 stock ranges, sizes and types of panel instruments is published. Included is a quick-reference index on the cover for fast locating of ranges and types in the desired case style. Being introduced are the new Century Series panel instruments, which combine the advantages of a modern clean-cut design with phenolic and glass construction. Available for immediate delivery in four sizes, they can be used to directly replace older glass and phenolic designs. Also introduced are the model 2800 digital panel instruments. Advanced integrated circuit design has non-blinking readouts, changing only when the measured value changes. Accuracy of these readings are reportedly ± 0.1 percent with resolution of 1 part in 1000. Simpson Electric.

Subminiature Indicator Lights 410

Bulletin No. 1470, describing the line of subminiature indicator lights is offered. These indicator lights have been engineered and are manufactured with the idea of achieving the ultimate in simplicity, standardization, reliability and cost reduction. The indicators are front relampable and house any standard T-1 lamp, wire lead type, to meet customer requirements of specific voltage, current and life expectancy. Caps are offered in a variety of transparent and translucent colors for coding purposes. Bloc-Lite.

Communications Range and Cost Calculator 411

Offered is an easy-to-use slide rule wheel calculator which answers the most commonly asked questions about two-way radio communications systems: How far can a given system be expected to communicate? What affect will using gain antennas, increasing tower height, transmitter power, or receiver sensitivity have upon performance and system cost? The calculator enables a person to estimate system costs and ranges in a matter of minutes. The speed of calculation allows one to quickly plan several systems—varying transmitter power, type of antenna, tower height, etc. It also gives the most economical means of achieving the desired system performance. Other factors taken into consideration by the calculator are receiver sensitiv-

ity, frequency of operation, vehicle noise level, type of coaxial cable and environmental factors such as hilly terrain, flat terrain, suburban, urban and industrial locations. Antenna Specialists.

Power Supplies 412

A condensed, 28-page catalog describing power supplies is offered. It features the LVC II/PVC line of laboratory and bench supplies which offer a new concept of regulation through the use of accessible plug-in regulator cards in either the voltage or current output modes. Voltage ranges for the LVC II/PVC line are 0-10v, 20v and 50v, while power loads range from 25w, 50w, and 100w, respectively. Also described in the illustrated catalog are system rack and modular supplies; over 200 voltage and current regulation models; high voltage supplies from 2.5 to 250kv frequency converters, 60Hz to 400Hz and a complete description of custom capabilities. NJE Corporation.

Tape Deck 413

Released is a product bulletin on the Model 407 solid-state stereo tape deck. The bulletin lists features and technical specifications. Also described are the professional facilities and convenience features. Astrocom/Marlux.

Digital Panel Meters and DC Amplifiers 414

A 4-page shortform catalog covering Panel Meters, DC Data Amplifiers, Galvo Drivers, Dual DC Power Supplies, DC Differential Amplifiers, Photomultiplier Amplifiers and Voltage-to-Frequency Converters is offered. Covered in the shortform are over 30 models and 12 options found in the digital panel meters for DC Voltage, AC Voltage, Ratio, DC Current and AC Current in two, three and four digit models. Performance features and mounting options are also covered. Newport Lab's.

Time Dial/Radio Frequency Charts 415

A pocket-size world time dial combined with radio frequency charts lets you convert time differences between local standard times and other cities throughout the world as well as to (GMT) Greenwich Mean Time, is offered. The compact, two-color selector measures four by five inches in size. It is a needed reference for the novice or advanced short-waver that compliments any short-wave radio shack. It is in use with a turn of the big, easy-to-read dial. Frequency charts that are clearly given on the backside of the time dial selector, in-

REBUILD YOUR OWN PICTURE TUBES?

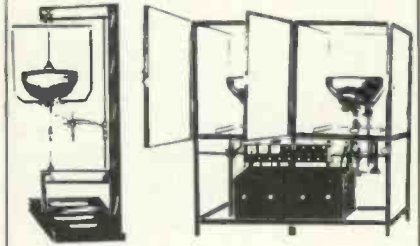

With Lakeside Industries precision equipment, you can rebuild any picture tube!

EASY TO OPERATE!
Requires only 4 x 8 ft. of space.
Your cost to rebuild black and white—\$1.50.
Your cost to rebuild Color—\$5.80.
For complete details, mail coupon.

LAKESIDE INDUSTRIES
5234 N. Clark St.
Chicago, Ill. 60640
Phone: 312-277-3399

Free demonstration appointment
 Send me more information

Name
Address
City State

... for more details circle 117 on Reader Service Card

IF YOU ARE A TV REPAIR MAN YOU NEED TV TECH AID

TV TECH AID is the best trouble shooting guide available today. It takes all the guesswork out of TV repair and is designed to help you solve your problems quickly and economically.

Each month you receive updated information on up to 40 different trouble-shooting cases. This important information is supplied to us by technicians, field reps and all the leading TV manufacturers. You will find every symptom pictured with a clearly marked schematic of the particular faulty stage. The faulty components and corrections will also be listed to aid in repair.

You go right to the source of the trouble without guesswork. In addition you get valuable information on current models as well as older models along with circuit changes and modifications as they occur.

TV TECH AID is the best investment you can make in your own business. The cost to you is only \$7.95 for a full year's subscription.

Send for it now... You'll be glad you did!

TV TECH AID
P.O. BOX 603
KINGS PARK, L. I.
NEW YORK 11754

ENCLOSED IS A CHECK OR M.O. FOR \$7.95. PLEASE SEND 12 ISSUES OF TV TECH AID

TO:

NAME
ADDRESS
CITY
STATE ZIP

... for more details circle 138 on Reader Service Card

clude: International Short-Wave broadcast bands and frequencies, Radio and TV broadcasting bands, Communications and Navigation frequencies (Aircraft, Marine, Citizens Radio, FM two-way, Police, Fire, Business and others) Amateur bands, Standard Time and Frequency Signals. Halli-crafter.

VECTORSCOPE...

continued from page 49

It is also possible to align the adjustable demodulators in a set by using a vector display. To do this, it is necessary to have a set of alignment instructions for the particular receiver so you can locate the proper adjustments. Follow the instructions in the alignment procedure. However, in place of counting the bars, simply adjust for the proper angle between the R-Y and B-Y petals on the vector display.

A NOTE OF CAUTION: Do not attempt any alignment of the chroma bandpass amplifiers. These circuits must be aligned with a sweep generator and cannot be aligned by a vector display.

VECTOR DISPLAY SYMPTOMS

(1) Petals of vector display rotate. TROUBLE: Loss of color sync, color oscillator free running. (2) Vector display pattern elliptical. TROUBLE: The color amplifiers are weak or unbalanced. (3) Petals of vector display are flattened or crushed. TROUBLE: The color amplifiers are overloaded. (4) Angles between R-Y and B-Y petals are not 90 or 105 degrees, depending on manufacturers' specifications. TROUBLE: Color demodulators are out of alignment. (5) The R-Y petal cannot be made to reach the vertical position. TROUBLE: There is a loss of range in the hue control. ■

CURVE TRACER...

continued from page 47

presentation shown in figure 1. An example is the curve of the 1st audio amplifier shown in figure 3. Of-

ten the curves will become loops or they will droop or take on some other odd shape. But as long as the curves are there, the circuit under test has a working transistor in it.

As in the standard family of curves, the lines represent definite parameters. A deflection in the horizontal direction shows that the collector-to-emitter of the transistor will support a voltage drop. A deflection in the vertical direction shows the collector is capable of controlling current as the base current is varied in steps.

TECHNIQUE IMPROVES WITH EXPERIENCE

With increased experience in the use of this technique, it is felt that an operator will learn to identify the quality of the transistors as well as their condition. In fact, as this technique wins acceptance, it is possible that future schematics might show the 'dynamic curves' of each transistor used.

Because the transistor under test with this method is never in danger of destructive voltage or currents, it appears this may also be one of the safest 'in-circuit' techniques available. It seems to work with any circuit, and because it affords a fast, safe means of troubleshooting, its use can be reasonably expected to have universal application.

The primary function of the transistor curve tracer up to now has been for identification and testing of out-of-circuit transistors. Since every TV manufacturer uses specified transistors with their own numbering system, the curve tracer allows a technician to make a satisfactory selection from his stock of transistors thus saving time and eliminating the need for an over-large inventory.

In a future article, we will take a longer look at the use of the curve tracer to identify transistor substitutes plus out-of-circuit checking and how to use the tracer to choose emergency substitutes for diodes and zeners. ■

Get More Facts

NEW PRODUCTS

700	Hi/Lo Band FM/VHF Monitor	26
701	VHF Marine Radio Telephone	26
702	Clock	26
703	Soldering Iron	26
704	Coaxial Relay	26
705	Two-Station Intercom	62
706	Cassette Classroom System	62

707	Telephone Amplifier	62
708	Silide Synchronized Cassette Recorder	64
709	Ham Band Receiver	64
710	Battery Displays	64
711	Soldering Iron Holder	70
712	Sub-Miniature Fuse Holders	70
713	Digital Multimeter	72
714	Field Strength Meter	73
715	Voltohmyst	73
716	Vertical Short-Wave Antenna	74
717	Digital System	74
718	Preamplifier and Control	74
719	VHF Receiver	75
720	De-Soldering Tip	75
721	Circuit Tester	76
722	Mini-CCTV	76
723	Videotape Consoles	76
724	TV Showroom Antenna System	77
725	Amplitude Function Generator	77
726	Intrusion Alarm	78
727	Modular Instrument System	78
728	Booster Antenna	78
729	Proto-Type Breadboard Kit	79

TEST INSTRUMENTS

900	Tequipment D54 Oscilloscope	51
-----	-----------------------------	----

CATALOGS AND BULLETINS

400	TV Parts Cross-Reference Guide	82
401	RF Voltmeter	82
402	Ceramic Strip	82
403	Electronic Importers Directory	82
404	Test Instruments	82
405	TV Cheater Cords	82
406	Wire Stripping	82
407	Linear IC Tester	82
408	Transistors	82
409	Panel Instruments	83
410	Subminiature Indicator Lights	83
411	Communications Range and Cost Calculator	83
412	Power Supplies	83
413	Tape Deck	83
414	Digital Panel Meters and DC Amplifiers	83
415	Time Dial/Radio Frequency Charts	83

ADVERTISER'S INDEX

101	Admiral Corp.	58
102	Aerovox Corp.	73
103	Antenna Corp. of America	28
104	Arrow Fastener Co., Inc.	74
105	B & K Div. Dynascan Corp.	23
106	Book Club—Tab Books	66-69
107	Borden Chemical Co.	29
108	CRC Chemicals	76
109	Channel Master Corp.	31
110	Chemtronics, Inc.	3rd Cover
111	Chrysler Corp., Dodge Div.	55
112	EICO Electronic Instruments Co., Inc.	2nd Cover
113	Ford Motor Company	36
114	GC Electronics Co.	22
115	Grantham School of Engineering	84
116	The Heath Company	57
117	Lakeside Industries	83
118	Leader Instruments Corp.	30
119	Lectrotech, Inc.	34
120	Mosley Electronics, Inc.	81
121	Pennwood Numechron Co.	30
122	Perma-Power Company	72
123	Phillips Business Systems, Inc.	35
124	Quietrol Company	30
125	Raytheon Company	79
	RCA Electronic Components Battery Div.	59
	RCA Electronic Components Entertainment Tubes	4th Cover
126	RCA Institutes, Inc.	80
	RCA Parts & Accessories	33
	RCA Semiconductor Distributor Products	20
127	RCA Test Equipment	75
128	RCA Test Equipment	77
129	RMS Electronics, Inc.	79
130	Rohn Manufacturing Co.	71
131	Sencore, Inc.	64
132	Sencore, Inc.	70
133	Sencore, Inc.	72
134	Sonar Radio Corp.	70
	Sylvania Electric Products	24-25
	Sylvania Electric Products	65
135	Tech Spray	78
136	Telematic Division UXL Corp.	78
137	Tuner Service Corp.	19
138	TV Tech Aid	83
139	Weller Electric Corporation	60
140	Jud Williams	61
141	Winegard Company	63
142	Workman Electronic Products, Inc.	81
143	Xcelite, Inc.	82
	Zenith	27

Technicians, Earn Your Associate

DEGREE

mostly by correspondence

Accredited by the Accred. Comm. of National Home Study Council. G.I. Bill Approved. Free catalog.

Write: Dept. T

Grantham School of Engineering
1505 N. Western, Hollywood, Calif. 90027

... for more details circle 115 on Reader Service Card

ELECTRONIC TECHNICIAN/DEALER

GET MORE FACTS

NO POSTAGE NECESSARY

Circle the Reader Service numbers of those items of interest to you.

OK

FOR MORE INFORMATION fill out and mail today!

Please send more information on items circled.

ADVERTISED PRODUCTS

101	102	103	104	105	106	107	108	109
110	111	112	113	114	115	116	117	118
119	120	121	122	123	124	125	126	127
128	129	130	131	132	133	134	135	136
137	138	139	140	141	142	143	144	145
146	147	148	149	150	151	152	153	154

TEST INSTRUMENTS

900	901	902	903	904	905	906	907	908
-----	-----	-----	-----	-----	-----	-----	-----	-----

NEW PRODUCTS

700	701	702	703	704	705	706	707	708
709	710	711	712	713	714	715	716	717
718	719	720	721	722	723	724	725	726
727	728	729	730	731	732	733	734	735

CATALOGS & BULLETINS

400	401	402	403	404	405	406	407	408
409	410	411	412	413	414	415	416	417

Note: Inquiries serviced until June 22, 1970.

(Please type or print)

4/70

Name

Position

Company

Street

City

State Zip Code

Please describe your type of business.

FOR MORE INFORMATION fill out and mail today!

Please send more information on items circled.

ADVERTISED PRODUCTS

101	102	103	104	105	106	107	108	109
110	111	112	113	114	115	116	117	118
119	120	121	122	123	124	125	126	127
128	129	130	131	132	133	134	135	136
137	138	139	140	141	142	143	144	145
146	147	148	149	150	151	152	153	154

TEST INSTRUMENTS

900	901	902	903	904	905	906	907	908
-----	-----	-----	-----	-----	-----	-----	-----	-----

NEW PRODUCTS

700	701	702	703	704	705	706	707	708
709	710	711	712	713	714	715	716	717
718	719	720	721	722	723	724	725	726
727	728	729	730	731	732	733	734	735

CATALOGS & BULLETINS

400	401	402	403	404	405	406	407	408
409	410	411	412	413	414	415	416	417

Note: Inquiries serviced until June 22, 1970.

(Please type or print)

4/70

Name

Position

Company

Street

City

State Zip Code

Please describe your type of business.

Enter my personal subscription to ELECTRONIC TECHNICIAN/DEALER for the terms checked below:

\$10 FOR 3 FULL YEARS

\$8 FOR 2 YEARS

\$5 FOR 1 YEAR

PAYMENT ENCLOSED

BILL ME LATER

If you are renewing your subscription check here and attach your address label.

NAME

TITLE

FIRM

STREET

CITY STATE ZIP

PLEASE CHECK BELOW:

1. In the TV, Radio and other consumer products fields, is your firm PRIMARILY a: (check most descriptive item)

- Retailer with service department
- Service/repair firm with some retail
- Industrial electronics service firm
- Manufacturer
- Other (please describe)

2. Title: (please check one)

- Owner, manager, buyer, other executive
- Service manager
- Service repairman or other employee

BUSINESS REPLY MAIL

NO POSTAGE STAMP NECESSARY IF MAILED IN THE UNITED STATES

POSTAGE WILL BE PAID BY

Reader Service Department

**ELECTRONIC
TECHNICIAN / DEALER**

HARBRACE BUILDING, DULUTH, MINNESOTA 55802

FIRST CLASS

PERMIT NO. 665

DULUTH, MINNESOTA



**GET
MORE
FACTS**

NO POSTAGE
NECESSARY

BUSINESS REPLY MAIL

NO POSTAGE STAMP NECESSARY IF MAILED IN THE UNITED STATES

POSTAGE WILL BE PAID BY

Reader Service Department

**ELECTRONIC
TECHNICIAN / DEALER**

HARBRACE BUILDING, DULUTH, MINNESOTA 55802

FIRST CLASS

PERMIT NO. 665

DULUTH, MINNESOTA



**GET
MORE
FACTS**

NO POSTAGE
NECESSARY

BUSINESS REPLY MAIL

NO POSTAGE STAMP NECESSARY IF MAILED IN THE UNITED STATES

POSTAGE WILL BE PAID BY

Circulation Department

**ELECTRONIC
TECHNICIAN / DEALER**

HARBRACE BUILDING, DULUTH, MINNESOTA 55802

FIRST CLASS

PERMIT NO. 665

DULUTH, MINNESOTA



**FOR
ONLY
PENNIES
PER
MONTH—
YOUR
OWN
PERSONAL
COPIES**

HERE'S PROOF
TUN-O-FOAM
KEEPS TUNERS
WORKING BETTER
... LONGER!

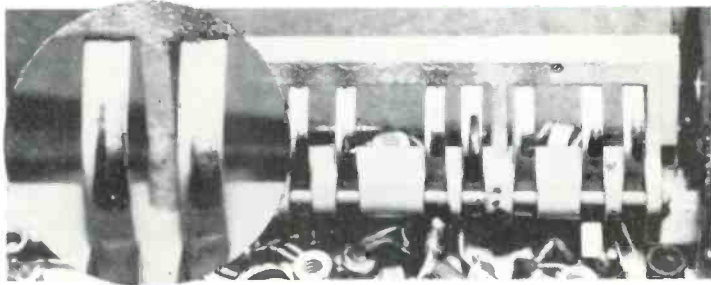
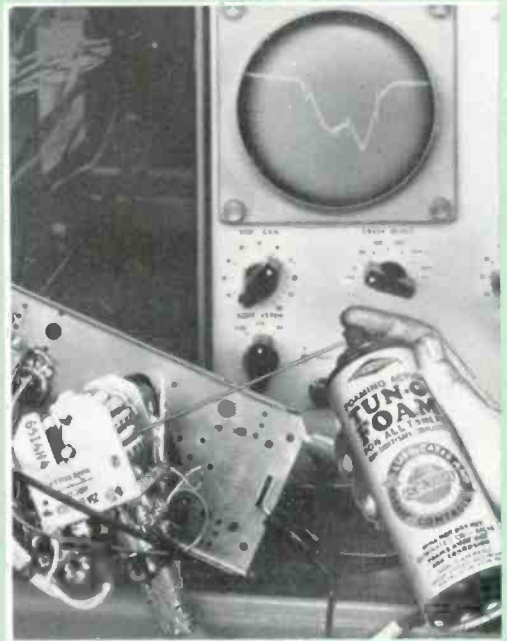

THIS TUNER
WAS USED AS IT CAME FROM
THE MANUFACTURER

*After 36,000 revolutions, the silver has been worn away.
 The tuner does not function on any channel.*

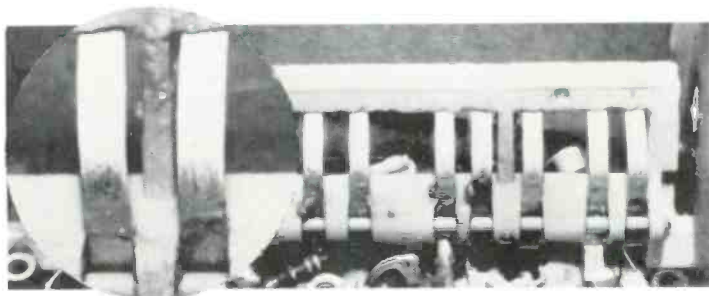

THIS TUNER WAS SPRAYED
WITH TUN-O-FOAM

*After 36,000 revolutions there is no sign of wear.
 The tuner brings in all channels, sharp and clear.*

THE
PROFESSIONAL'S
TV TUNER CLEANER



Foams into the tightest places. Won't cake up, dry out or detune. Keeps cleaning and lubricating contacts each time channel is changed. Guaranteed to be the best tuner lubricant cleaner you've ever used, or money refunded. Full Six month no-callback guarantee.

1260 RALPH AVENUE

CHEMTRONICS

BROOKLYN, N.Y. 11236

For export: ROBURN AGENCIES INC., NEW YORK, N.Y. 10014

In Canada: MAGNASONIC CANADA LTD., MONTREAL 9, CANADA

... for more details circle 110 on Reader Service Card

When you don't have time to
take it back to the bench...

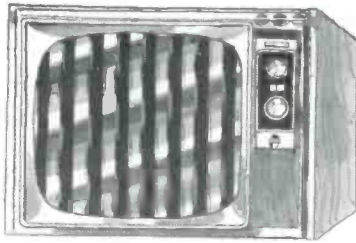

take this book to the home.

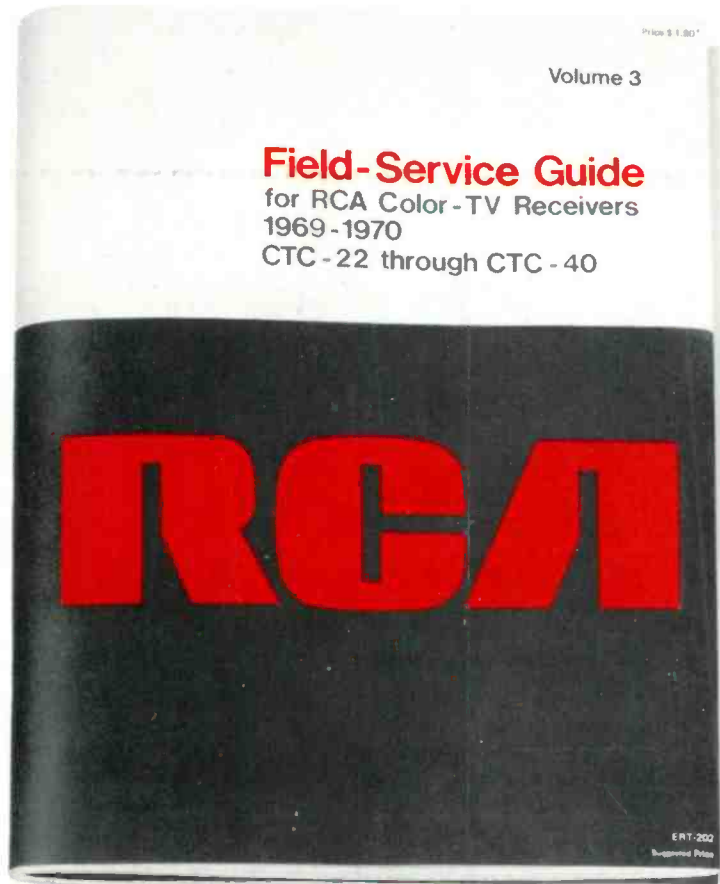

Tells all, shows all, for in-the-home
circuit adjustments on latest RCA color TV's

Here's Volume 3 of the renowned Field Service Guide—the most complete TV service reference of its kind! Add this new edition to Volumes 1 and 2 and you're ready for every RCA color TV dating back to 1955. Seven sections in easy-to-understand form, schematics, plus waveforms and illustrated adjustment procedures:

- 1. General Field Service Adjustments.** Step-by-step procedures and illustrations for adjusting purity, black-and-white setup, static and dynamic convergence, and AFPC.
- 2. RCA Receiving Tubes for Color TV.** Lists all the type numbers used in RCA color receivers.

- 3. Chassis Section.** Specific procedures for adjustment of each chassis series, top-and-rear views, tube removal directions, etc.
- 4. Parts List.** Includes major components and their replacement part numbers.
- 5. Tuner Section.** Schematics, transistor and electrical control parts lists.
- 6. Remote Tuner Section.** Schematics of transmitters and receivers in tuners used in Chassis Series CTC-22 to CTC-40.
- 7. Index.** Cross-references for all receivers by model numbers, set names and chassis numbers.

ONLY \$1.90*

*Optional Price

See your RCA Tube Distributor for details on how you can get this valuable Guide.

RCA Electronic Components Harrison, N. J.

RCA