

OCTOBER 1975 • 75 CENTS



A HARDCOURT BRACE JOVANNOVICH PUBLICATION

# ELECTRONIC TECHNICIAN/DEALER

WORLD'S LARGEST TV-RADIO SERVICE & SALES CIRCULATION



16 C FIELDING  
RD 1 BOX 381  
ASHLAND

9187212492-PP2

-AA

-1773AL

AS  
\*\*

PA 17921

**Systematic Service Labor Pricing**

**RCA Color TV 1976**

**Servicing Signal-Seeking Auto Radios**

# PTS ELECTRONICS

## Precision Tuner Service

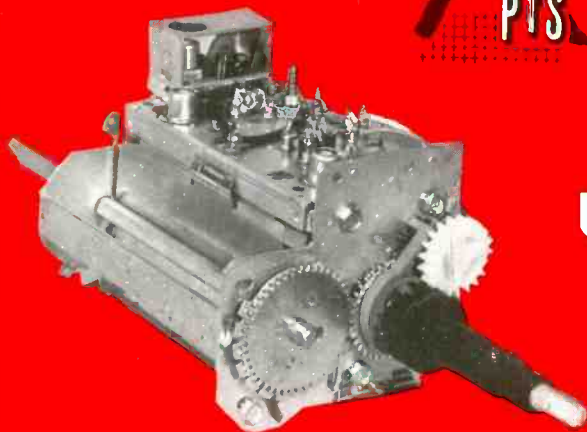

is proud to announce the  
**GRAND OPENING**  
of our new Service Centers in

**LOS ANGELES**  
**COLUMBUS, OHIO**  
**PHOENIX**  
**TAMPA**  
**NORFOLK**  
**INDIANAPOLIS**

**Fast 8 hr. Service!**

### LET US TAKE CARE OF YOUR TUNER PROBLEMS . . .

PTS will repair any tuner—no matter how old or new. Fastest Service—8 hour—in and out the same day. Overnight transit to one of our strategically located plants. Best Quality—you and your customers are satisfied. PTS uses only ORIGINAL PARTS! No homemade or make-do, inferior merchandise (this is why we charge for major parts!). You get your tuner back in ORIGINAL EQUIPMENT condition.

PTS is recommended by more TV Manufacturers than any other tuner company and is overhauling more tuners than all other tuner services combined.

VHF, UHF \$10.95  
UV-COMBO 17.95  
IF-SUBCHASSIS 12.50

Major parts and shipping  
charged at cost.  
(Dealer net!)

## PTS ELECTRONICS, INC.

HOME OFFICE . . . . .	BLOOMINGTON, INDIANA 47401	5233 S. Highway 37	Tel. 812-824-9331
ALABAMA	BIRMINGHAM, ALABAMA 35222	524 32nd St. So.	Tel. 205-323-2657
ARIZONA	PHOENIX, ARIZONA 85061	2412 W. Indian School Rd.	Tel. 602-279-8718
CALIFORNIA	LOS ANGELES, CA. 90023	4184 Pacific Way	Tel. 213-266-3728
Central	SACRAMENTO, CA. 95841	4611 Auburn Blvd.	Tel. 916-482-6220
South	SAN DIEGO, CA. 92105	5111 University Ave.	Tel. 714-280-7070
COLORADO	ARVADA, COLORADO 80001	4958 Allison St.	Tel. 303-423-7080
FLORIDA	JACKSONVILLE, FLA. 32210	1918 Blanding Blvd.	Tel. 904-389-9952
North	MIAMI, FLA. 33168	12934 N.W. 7th Ave.	Tel. 305-685-9811
South	TAMPA, FLA. 33690	2703 S. MacDill	Tel. 813-839-5521
Central	BLOOMINGTON, IND. 47401	5233 S. Highway 37	Tel. 812-824-9331
INDIANA	INDIANAPOLIS, IND. 46202	28 E. 14th St.	Tel. 317-631-1551
South	KANSAS CITY, KANSAS 66106	3116 Merriam Lane	Tel. 913-831-1222
Central	METAIRIE, LA. 70003	2914 Wytchwood Dr.	Tel. 504-885-2349
KANSAS	SILVER SPRING, MO. 20919	8880 Brookville Rd.	Tel. 301-565-0025
LOUISIANA	SOMERVILLE, MASS. 02144	52 Holland St.	Tel. 617-666-4770
MARYLAND	SPRINGFIELD, MASS. 01103	191 Chestnut St.	Tel. 413-734-2737
MASSACHUSETTS	DETROIT, MICH. 48235	13709 W. 8 Mile Rd.	Tel. 313-862-1783
East	MINNEAPOLIS, MINN. 55408	815 W. Lake St.	Tel. 612-824-2333
Central	ST. LOUIS, MO. 63130	8456 Page Blvd.	Tel. 314-428-1239
MICHIGAN	E. PATERSON, NEW JERSEY 07407	158 Market St.	Tel. 201-791-6380
MINNESOTA	BUFFALO, NEW YORK 14212	993 Sycamore St.	Tel. 716-891-4935
MISSOURI	CHARLOTTE, N. CAR. 28205	724 Seigle Ave.	Tel. 704-332-8007
NEW JERSEY	CINCINNATI, OHIO 45215	8180 Vine St.	Tel. 513-821-2298
NEW YORK	COLUMBUS, OHIO 43227	4003 E. Livingston Ave.	Tel. 614-237-3820
NORTH CAROLINA	PARMA, OHIO 44134	5682 State Rd.	Tel. 216-845-4480
OHIO	OKLAHOMA CITY, OK. 73106	3007 N. May	Tel. 405-947-2013
South	PORTLAND, OREGON 97213	5220 N.E. Sandy Blvd.	Tel. 503-282-9636
Central	PITTSBURGH, PA. 15202	257 Riverview Ave. W.	Tel. 412-761-7648
North	UPPER DARBY, PA. 19082	1742-44 State Rd.	Tel. 215-352-6609
OKLAHOMA	MEMPHIS, TENN. 38118	3614 Lamar Ave.	Tel. 901-365-1918
OREGON	HOUSTON, TEXAS 77032	4324-26 Telephone Ave.	Tel. 713-644-6793
PENNSYLVANIA	LONGVIEW, TEXAS 75601	Mopac Rd.	Tel. 214-753-4334
TENNESSEE	NORFOLK, VA. 23504	3118 E. Princess Anne Rd.	Tel. 804-625-2030
TEXAS	SEATTLE, WASH. 98108	432 Yale Ave.	Tel. 206-623-2320
TEXAS			
VIRGINIA			
WASHINGTON			

We offer you finer, faster . . .

**... Precision  
Tuner Service**



ELECTRONICS, INC. . . .

...Number ONE and still trying harder!  
(Not a Franchise Company)

**1 YEAR  
GUARANTEE**

**P  
T  
S  
No  
1**

# WORLD FAMOUS SIMPSON 260

OVER

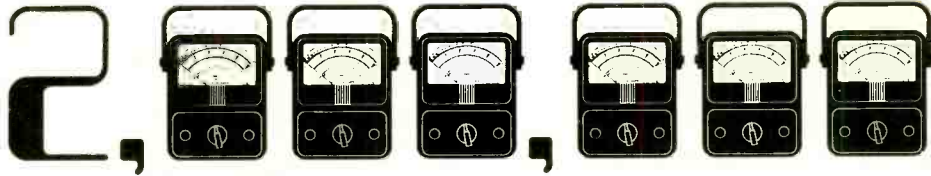

SOLD

*The pace-setting VOM for over 30 years*

## The finest **260**<sup>®</sup> SERIES 6

NOW... with  
special Amp-Clamp dial ranges  
for easy AC current  
measurements up to 250 amps.

New Amp-Clamp, Model 150 Adaptor.  
Measures AC current without breaking  
the circuit being tested. Plugs into the  
260—reads directly on the new Amp-Clamp  
scales. Use with any 250, 260  
(Series 3 thru 6) or 270.  
Ranges: 0-5, 25, 50, 100, 250 amperes.

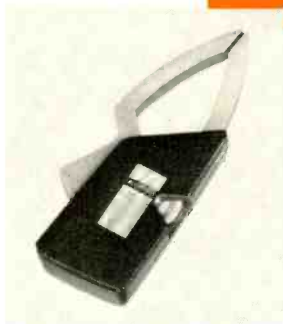

260-6, Complete with batteries, test leads and manual ..... **\$75.50**

260-6P (overload protected), complete with batteries,  
test leads and manual ..... **\$115.00**

**260 CARRYING CASES:**

Vinyl, DeLuxe #00805 ..... **\$20.50**  
Vinyl, standard #01818 ..... **\$16.75**

**AMP-CLAMP, Model 150 Adaptor with test lead, Cata-  
log No. 00532 ..... \$29.50**

*Many other 260 models and accessories to choose from.*

GET "OFF THE SHELF" DELIVERY FROM YOUR LOCAL ELECTRONIC DISTRIBUTOR ... AND WRITE TODAY FOR CATALOG 4400,

KATY INDUSTRIES



**SIMPSON ELECTRIC COMPANY**

853 Dundee Avenue, Elgin, Illinois 60120  
(312) 697-2260 • Cable: SIMELCO • Telex: 72-2416

IN CANADA: Bach-Simpson, Ltd., London, Ontario  
IN ENGLAND: Bach-Simpson (U.K.) Limited, Wadebridge, Cornwall  
IN INDIA: Ruttonsha-Simpson Private, Ltd., Vikhroli, Bombay



...for more details circle 136 on Reader Service Card

OCTOBER 1975, ELECTRONIC TECHNICIAN/DEALER / 1

# ELECTRONIC TECHNICIAN/DEALER

October 1975 • VOLUME 97 NUMBER 10

## J.W. PHIPPS

Editor  
1 East First Street  
Duluth, Minn. 55802  
(218) 727-8511

## ALFRED A. MENEGUS

Publisher  
757 Third Avenue  
New York, N.Y. 10017  
(212) 754-4382

## TOM GRENEY

Publishing Director

## JOSEPH ZAUHAR

Managing Editor

## DEBI HARMER

Production Manager

## BERNICE GEISERT

Production Supervisor

## JOHN PASZAK

Graphic Design

## LILLIE PEARSON

Circulation Fulfillment

## GENE BAILEY

Manager, Reader Services

## LOIS SANDERS

Promotion Director

## ROZ MARKHOUSE

Classified Advertising Manager

## CONTRIBUTING EDITORS

### JOSEPH J. CARR

### DAVID NORMAN

## MANAGERS

### DAVE HAGELIN

43 East Ohio Street  
Chicago, Ill. 60611  
(312) 467-0670

### CHUCK CUMMINGS

Ad Space South/West  
613 North O'Connor  
Irving, Texas 75060  
(214) 253-8678

### KEN JORDAN

DONALD D. HOUSTON  
1901 West 8th Street  
Los Angeles, Calif. 90057  
(213) 483-8530

### CHARLES S. HARRISON

CY JOBSON  
57 Post Street  
San Francisco, Calif. 94104  
(415) 392-6794

### ROBERT UPTON

Tokyo, Japan  
C.P.O., Box 1717

**THE COVER:** The photo on the cover of this issue shows one of the moveable TV bench stations employed by Sperry TV, a Lincoln, Nebraska home entertainment electronic service firm whose owner/operator, John Sperry, is the developer and publisher of a flat-rate pricing system which is described in this issue.

## BUSINESS MANAGEMENT/SHOP OPERATIONS

### 14 Systematic Service Labor Pricing

A review of the format and application of *TV & Radio Tech's Guide To Pricing*, a flat-rate service labor pricing system developed and offered to other servicers by the owner/operator of a Midwestern electronic servicing firm. By J.W. Phipps.

### 22 Profitably Speaking

Introduction to an open forum in which the owner/operators of electronic service businesses and ET/D Editor J. Phipps discuss and exchange ideas and opinions about the various aspects of profitably managing an electronic service business.

## HOME ENTERTAINMENT ELECTRONICS

### 24 RCA TV 1976

New and significantly changed features and circuits in RCA's 1976 TV line. By Joseph N. Zauhar.

### 28 Color TV Module Guide

A comprehensive listing of the modules used in color TV chassis. This month: Zenith.

## VEHICULAR & OUTDOOR ELECTRONICS

### 36 Servicing Signal-Seeking Auto Radios—Part 2

Analysis of the "electronic" portion of the latest version of Delco's *Wonder Bar* signal-seeker car radio (The electromechanical portion was covered last month in Part 1.) By Joseph J. Carr ET/D Vehicular Electronics Editor.

### 38 Carr Talk

ET/D Vehicular Electronics Editor Joe Carr discusses causes and cures of typical problems in signal-seeker car radios.

## COMMUNICATIONS ELECTRONICS

### 39 Selecting and Installing Two-Way Mobile Antennas

Electrical and physical characteristics of mobile two-way communications antennas and hints about installation. By David F. Norman, ET/D Communications Editor.

### 44 Comm Chat

Communications Editor Dave Norman comments about type acceptance and FCC regs and practices.

## DEPARTMENTS

4	NEWS OF THE INDUSTRY	50	NEW PRODUCTS
8	ELECTRONIC ASSOCIATION DIGEST	56	CLASSIFIED ADS
		58	ADVERTISERS INDEX
11	TECHNICAL LITERATURE	61	READER SERVICE
30	TECH DIGEST	63	TEKFAX
45	TEST INSTRUMENT REPORT		



A HARCOURT BRACE JOVANOVIICH PUBLICATION



HARCOURT BRACE JOVANOVIICH PUBLICATIONS. James Milholland, Jr., Chairman, Robert L. Edgell, President, Lars Fladmark, Senior Vice President, Richard Moeller, Treasurer, John G. Reynolds, Vice President, Thomas Greney, Vice President, Ezra Pincus, Vice President, Bruce B. Howat, Vice President, James Gherna, Vice President.

ELECTRONIC TECHNICIAN/DEALER is published monthly by Harcourt Brace Jovanovich Publications. Corporate offices: 757 Third Avenue, New York, New York 10017. Advertising offices: 43 East Ohio Street, Chicago, Illinois 60611 and 757 Third Avenue, New York, New York 10017. Editorial, Accounting, Advertising Production and Circulation offices: 1 East First Street, Duluth, Minnesota 55802. Subscription rate: one year, \$7; two years, \$12; three years, \$16 in the United States and Canada. Other countries: one year, \$15; two years, \$24; three years, \$30. Single copies: 75¢ in the U.S. and Canada; all other countries: \$2. Second Class postage paid at Duluth, Minnesota 55806 and at additional mailing offices. Copyright © 1975 by Harcourt Brace Jovanovich, Inc. All rights reserved. No part of this publication may be reproduced or transmitted in any form or by any means, electronic or mechanical, including photocopy, recording, or any information storage and retrieval system, without permission in writing from the publisher.

POSTMASTER: Send Form 3579 to ELECTRONIC TECHNICIAN/DEALER, P.O. Box 6016, Duluth, Minnesota 55806.

# Tear 'n Share

Save your RCA entertainment receiving tube carton ends\* and color picture tube warranty serial number stickers\* . . . and redeem them for discount certificates or valuable premiums. Just tear and you'll share!



\*Save the receiving tube carton end that is solid red reading RCA Electronic Components and the warranty serial number sticker that appears above the warranty envelope on the upper right hand corner of the RCA color picture tube carton. *One* color picture tube warranty serial number sticker is equal in value to 20 receiving tube carton ends.

Your RCA receiving tube carton ends are valuable! So are your RCA color picture tube warranty serial number stickers. Save them. In various quantities, they will bring you:

- Discount certificates. You can apply these toward purchases of more RCA receiving tubes and color picture tubes from your RCA Distributor.
- Popular merchandise premiums. You can choose from a wide selection for yourself, your family, or your home.

Here's how you do it. See your participating RCA Distributor. Pick up your copy of the RCA "Tear 'n Share" Prize Book and saver envelope. Mail the required number of RCA receiving tube carton ends or RCA color picture tube warranty serial number stickers in the envelope provided, specifying discount certificates or the premium you've selected to:

RCA Tear 'n Share Headquarters,  
P.O. Box 154, Dayton, Ohio 45401.



# RCA

Distributor and Special Products Division, Cherry Hill Offices, Camden, N.J. 08101

# NEWS OF THE INDUSTRY

## Admiral Returns To 12-Month Color TV Parts & Labor Warranty

The Admiral Group of Rockwell International Corporation has announced that, for a limited time, it will provide a nine-month extension of the labor portion of its 1976 color TV warranty, returning both parts and labor coverage to 12 months.

The labor extension, which Admiral says has a \$40 retail value, will be included in the price the purchaser pays for the color TV receiver.

RCA's and Sylvania's service companies reportedly are presently offering dealers optional nine-month color TV warranty service labor extensions but, unlike the strictly imboarded extension offered by Admiral, the cost of RCA's and Sylvania's extensions, at the dealer's option, can be either absorbed by the dealer or charged to the set purchaser.

## W. T. Grant To Drop Consumer Electronic Products

The W. T. Grant Company recently announced that by early next year it will have dropped the retailing of home entertainment electronic products, including its own private-label brand, Bradford. Also to be dropped by Grant are major appliances.

The reasons given by Grant for quitting consumer electronics retailing are increasing costs and price competition and the inherent need to maintain costly delivery and repair networks nationwide.

## RCA Introduces New All-Solid-State Color TV Chassis With Fewer Modules

At a special showing in Chicago on August 26, RCA introduced ten new color TV receivers equipped with a new swing-out color TV chassis in which most of the circuitry is contained on only six modules, exactly half the number employed in this manufacturer's previous XL-100 chassis.

Called *ColorTrak*, the new "high-end" color TV series is designed to "balance out" the line of conventional XL-100 models introduced by RCA last May.

In addition to the new swing-out, six-module chassis design, the *ColorTrak* line features new 19- and 25-inch picture tubes (called *Super Accufilter*) equipped with "filtered phosphors", which reportedly reflect less room light and therefore produce better contrast than conventional black matrix picture tubes.

Other *ColorTrak* features include a "room-light picture control" system which automatically tracks together the color saturation, contrast and tint to maintain the corresponding relative levels pre-selected by the viewer.

Some *ColorTrak* models are available with a new keyboard-type, all-electronic control system, called the *XL-100 Control Center*, which provides remote, continuously variable tuning of color, tint and volume plus selection of any VHF or UHF channel, from 2 to 83. When the color, tint or channel buttons are pressed, a digital readout of the time of day and the channel is displayed for a few seconds at the bottom of the picture tube screen.

Other *ColorTrak* models are equipped with an all-electronic, varactor-controlled, 20-position tuning system which is pre-programmable to all 12 VHF channels and any 8 UHF channels.

(A complete analysis of RCA's new *ColorTrak* color TV chassis will appear in an upcoming issue of ET/D.)

## FCC Proposes First Three Of The Rules It Must Promulgate To Implement Federal Warranty Act

The Federal Trade Commission (FTC) recently proposed three of the various warranty related rules which it must establish and enforce to fulfill the requirements of the Magnuson-Moss Warranty/Federal Trade Commission Improvement Act, which was signed into law by the President on January 4 of this year and which became effective on July 4.

According to a report in *Television Digest*, the proposed rules cover the following three major areas: 1) *Disclosure*—that information which must be included by the warrantor "in a single document, in simple and readily understood language"; 2) *Pre-sale availability requirements*—what retailers and manufacturers must do to make warranty terms available to consumers before they buy; and 3) *Informal dispute-resolution mechanisms*—non-binding arbitration panels which warrantors may set up to handle disputes in an effort to avoid court cases.

Included in the proposed disclosure rule are mandatory statements by the warrantor which explain: 1) which "parts, characteristics, components and properties" are covered and which excluded; 2) what the warrantor will do to remedy defects, including a description of what the warrantor will and will not pay for; 3) the maximum time the



TOP

warrantor will take to fulfill warranty obligation; 4) the precise times the warranty begins and expires; 5) the expenses and duties the consumer must bear to obtain warranty service; and 6) precisely who is authorized to perform warranty service (either a list of authorized servicers or a toll-free phone number from which such information can be obtained).

Included in the proposed pre-sale availability rule are the requirements that 1) retailers maintain, in binders in each department, copies of the warranties of each product offered for sale, and 2) warrantors include on stickers or hangtags attached to the product and its container the statement: "The retailer has a copy of the complete warranty on this product. Ask to see it."

The proposed rule covering informal dispute-resolution mechanisms includes the stipulations that two-thirds of the members of such panels must not be involved in the manufacture, distribution, sale or service of any consumer product and no member can be employed by the warrantor for any purpose other than settling disputes. In addition, the rule states that if a warrantor has a dispute-resolution panel, all cases must be brought before the panel before going to court. However, the decision of the panel is not binding on either the warrantor or the consumer. The rule also stipulates that all cases must be decided within 40 days, and a statistical report of the disposition of resolved cases and the status of pending cases must be supplied annually to the FTC and made available to the public.

### **Magnavox To Open Direct Factory Service Company in Southern California**

Magnavox has announced that in the near future it will open in Torrance, California, a Magnavox Direct Factory Service Company which will install and service only Magnavox consumer electronic products in the metropolitan Los Angeles area.

Although a Magnavox spokesman says that the reason for the factory service company is to provide Magnavox "with information previously unavailable to better monitor product performance, reliability and user satisfaction," a recent report in *Television Digest* states that a "source close to Magnavox" told that publication that the original plan, conceived before the takeover of Magnavox by North American Philips, "also stemmed from a desire to see how closely warranty repair bills submitted by independents matched actual costs."

According to the Magnavox spokesman, servicing dealers and independent service companies already established as Magnavox Authorized Service Centers in the Los Angeles area "will continue to offer warranty service paid for by Magnavox."

### **RCA Raises Prices Of Color TV Replacement Picture Tubes**

RCA has increased by five percent the prices of its replacement color TV picture tubes.

The price increase, which became effective on September 1, affects RCA's *HI-LITE* (all new) and *Colorama* (regunned) color picture tubes, with the exception of *Colorama A* tubes (those which have been refitted with new screens as well as gun assemblies).

The new price structure includes the replacement tube less any glass bulb trade-in allowance on old tubes.

### **Potpourri:**

**Sylvania** introduced in late August the first **Philco brand** color TV receivers it has manufactured since acquiring the Philco TV and stereo business from Ford last year. Models in the Sylvania-produced Philco color TV line are one 19-, two 17- and one 15-inch, all of which are equipped with the solid-state BOSS chassis and inline picture tubes. Sylvania-produced Philco console stereos also were introduced for the first time in August....**The EIA Engineering Department** has developed a new standard (RS-424) which defines the characteristics of and related measurement methods for SSB equipment designed for operation in the Class D Citizens-Radio Service as defined in Part 95 of the FCC Rules & Regs....Forty-seven previously laid-off **Zenith** employees have graduated from a joint government/Zenith-sponsored, 26-week basic electronics and TV repair course and subsequently have been recalled by Zenith....With its Fall model introductions, **General Electric** has completed the transition of its entire monochrome TV line to all-solid-state chassis....**Video Entertainment's Channel Xtra**, Chicago's first broadcast pay-TV channel, is now in service. The new system initially will serve residents of high-rise apartments, condominiums and hotels within a 25-mile radius of Chicago's John Hancock Building, in which the new pay-TV channel's transmitter is located. ■



# DON'T GET STUCK WITH THE TAB.

**Do your Christmas shopping before  
midnight Nov. 30th.**

If you've been saving Sylvania tube tabs, your time has come.

Unless your tabs are received at award headquarters by midnight Nov. 30th, all you'll have is a bunch of tabs.

And that includes those color picture tube labels that are worth 20 receiving-tube tabs.

But before that magic hour you can have anything in the '75 Save-a-Tab catalog.

After midnight your tabs will be as valuable as Cinderella's pumpkin.

Do your Christmas shopping now for everyone (especially yourself) from the catalog available at your Sylvania distributor.

But have your tabs at award headquarters by midnight Nov. 30th.

Nov. 30th, the world.

Dec. 1st, just tabs.

**GTE SYLVANIA**







# ELECTRONIC ASSOCIATION DIGEST

## NESDA Elects New Officers

Leroy Ragsdale, owner/operator of Modern Electronics, Fort Smith, Arkansas, was elected president of the National Electronic Service Dealers Association (NESDA) at the association's annual convention in Winston-Salem, North Carolina, August 13-17. Ragsdale succeeds two-term NESDA president Charles R. Couch, Jr., CET, owner/operator of Couch's, Inc., Gainesville, Florida.

Also elected to NESDA Executive Council positions for fiscal year 1975-76 were: Everett Pershing, Burbank, California, senior vice president; John McPherson, CET, Yorktown, Virginia, secretary; John Kelly, CET, Litchfield Park, Arizona, treasurer; Norman Smith, CET, Hartford, Connecticut, Region 1 vice president; Warren Baker, CET, Albany, New York, Region 2 vice president; W.H. Harrison, Norfolk, Virginia, Region 3 vice president; Hershall Lawhorn, CET, Perry, Georgia, Region 4 vice president; David Garwacki, CET, Toledo, Ohio, Region 5 vice president; Kurt Wertheim, San Antonio, Texas, Region 6 vice president; Jack Hopson, CET, Omaha, Nebraska, Region 7 vice president; Paul Dontje, CET, Wheatridge, Colorado, Region 8 vice president; West Correll, Tustin, California, Region 9 vice president; and Bob Villont, CET, Tacoma, Washington, Region 10 vice president.

## NARDA School Of Service Management Schedule Announced

The National Appliance & Radio-TV Dealers Association, a division of NARDA, has announced the following

schedule and locations for its 1976 Schools of Service Management:

*Eastern School*—February 1-3, Center For Adult Education, The University of Maryland, College Park, Maryland  
*Midwestern School*—February 15-17, Center For Continuing Education, University of Notre Dame, South Bend, Indiana

*Western School*—February 29-March 2, Center For Continuing Education, California State Polytechnic University, Pomona, California.

Each of the ten principal subject areas presented during the School will be introduced by a short sound/slide presentation which illustrates actual applications of related principals. For example, the topic of shop layout will be introduced by a sound/slide examination of the layout of the "satellite" service centers operated by Central Service Company, Chicago.

Other subjects which will be presented during the School, in addition to shop layout, are: service advertising, call taking, routing and dispatching, truck stocking, inventory control, service contracts, financial statement analysis, personnel management, and service rates.

The registration fee for the School, which includes tuition, room and board, and all pass-out materials, is \$135 for NARDA members and \$195 for nonmembers.

Further information about and registration for any one of the three sessions is handled by NARDA, 318 West Randolph St., Chicago, Ill. 60606, phone 312/726-5583.

## RCA Service Company 9-Month Extended Warranty Contract A Major Topic At NATESA Convention

The \$19.95 nine-month warranty extension service contract offered by RCA Service Company to RCA color TV dealers was a major topic of discussion among members

*continued on page 10*



## It puts almost anything to the test.

### RCA's new Industrial Maintenance and Appliance Tester.

It's the one you've been looking for to check out just about everything. From appliances and electrical wiring to heating and cooling systems.

With the special Thermistor Probe, unique LED Probe and Test Leads, the new WV-531A measures: *Temperatures of liquids and gases to 500° F. Continuity: LED Probe for extra visual check. AC and DC Voltage and Current (low DC Voltages with 0.05 V. F. S. range for thermocouples and other low-voltage devices). Resistance to over 1 megohm. AC Leakage (shock hazards).*

To buy the new WV-531A, contact any one of the more than 1,000 RCA Distributors worldwide. Or write RCA Distributor and Special Products Division, Bldg. 206-2, Cherry Hill Offices, Camden, N.J. 08101.

**Only \$89.**

(Suggested price)  
including Carrying  
Case, Probes,  
and Leads.

**RCA** Electronic  
Instruments

... for more details circle 163 on Reader Service Card



# THE NEW ACTION-LOOK AT ASTATIC

Means New Profits For You

OVER 100 ITEMS IN THE NEW  
ASTATIC AUDIO ACCESSORY LINE

- NEW MICROPHONE ACCESSORIES
- STEREO HEADPHONES • AUDIO CABLES, PLUGS AND ADAPTORS
- RECORD ACCESSORIES
- 45 RPM SPINDLE ADAPTORS



## THE ASTATIC CORPORATION

Conneaut, Ohio 44030 U.S.A.

In Canada: Canadian Astatic Ltd., Scarborough, Ontario M1H 2V5

Export Sales: Morhan Exporting Corp.

270 Newtown Road, Plainview, New York 11803, U.S.A.

**THE NATION'S ONLY MANUFACTURER OF ALL 4:  
MICROPHONES, PHONO CARTRIDGES, NEEDLES AND TONE ARMS**

...for more details circle 111 on Reader Service Card

continued from page 8

attending the 25th annual convention of the National Alliance of TV & Electronic Service Associations (NATESA) in St. Charles, Illinois, August 8-10.

Although, as stated by NATESA's executive director, Frank J. Moch, "Reduction of color TV labor warranties to 90 days is the biggest boost for independents we could anticipate," he and many NATESA convention attendees believed that much of the advantage of the warranty labor roll-back might be nullified for independent servicers by manufacturers' low-cost warranty extension service contracts, such as that offered by the RCA Service Company.

In addition to the \$19.95 selling price of RCA's 9-month extension, with which some NATESA members feel they cannot profitably compete, convention attendees also voiced concern about the 50-percent commission which RCA Service Company allegedly is paying dealers for warranty extension prospects and the allegation that RCA's Consumer Electronics Division makes warranty cards available to the RCA Service Company.

Responding to these concerns, Jack K. Sauter, vice president, RCA Consumer Electronics Division, assured convention attendees that his division does not "subsidize" the RCA Service Company nor does it make warranty cards available to the RCA Service Company. Sauter pointed out that the Federal Trade Commission forbids such practices and that if RCA were to attempt them, "The Federal Trade Commission would be all over us like a cheap suit."

### ISCET Elects New Officers and "Names Technician Of The Year" At Annual Convention

The International Society of Certified Electronic Technicians (ISCET), at its annual convention, held in conjunction with the National Electronic Service Dealers Association's (NESDA) convention in Winston-Salem, North

Carolina, August 13-17, elected the following officers. Larry Steckler, CET, New York, chairman; Ron Palluth, CET, Poughkeepsie, New York, vice chairman; Frank Grabier, CET, Phoenix, Arizona, secretary; and George Sopocho, CET, Chicago, treasurer.

The recipient of the first ISCET "Technician Of The Year" award is Atahusian E. Emadi, CET, Camp Hill, Pennsylvania.

Emadi, who came to this country in 1972 from Uganda, was nominated by the Pennsylvania Chapter of ISCET and received 96 out of 100 points in the "Technician Of The Year" grading system established by ISCET. Emadi also received an engraved, gold watch. Emadi is an employee of Morefield Communications Company, Camp Hill.

Clarence Saatkamp, CET, owner/operator of Saatkamps TV, Milwaukee, received the runnerup "Technician Of The Year" award. Saatkamp received a silver watch, furnished by *Radio-Electronics* magazine, the editor of which, Larry Steckler, CET, received NESDA's "Man Of The Year" award.

### Association Conventions

*Indiana Electronic Service Association Annual Fall Meeting*, Atkinson Hotel, Indianapolis, Indiana, October 31-November 2, phone 317/243-8347.

*Arizona State Electronics Association Annual Convention*, October 31-November 2, phone 602/279-4176.

## MOVING?

Be sure to let us know your new address. Please enclose a complete address label from one of our recent issues.

# Need low-cost instruments for frequency counting? Period measurement? Events counting?

## Here they are... the new Heathkit IM-4100



The new Heathkit IM-4100 is the most versatile low-cost counter we've ever offered. It's a full five-digit frequency counter that can also function in a period mode or as a totalizer. Built-in input attenuation and 12-volt operation add even more flexibility. As a frequency counter, it's guaranteed to 30 MHz with 1 Hz resolution. Sensitivity is a low 15 mV.

In the period mode, the IM-4100 measures intervals up to 99.999 seconds. Using the millisecond time base, it will resolve 1 msec!

The totalize mode will add up event pulses up to a count of 99,999.

The attenuator divides input signal amplitude by 1, 10 or 100. A pushbutton resets the display to zero in any mode. Front panel display includes overrange indicator and gate lamp. And the IM-4100 will operate from any 12-volt source through a rear panel connector.

We saved the best part for last. The complete price of the versatile, compact, easy-to-assemble Heathkit IM-4100 is only \$129.95! For more information on this outstanding instrument value, send for your free copy of the latest Heathkit catalog.

Send for your free catalog.

HEATH <b>Schlumberger</b>		HEATH COMPANY Dept. 24-10 Benton Harbor, Michigan 49022	
Please send my free Heathkit Catalog.			
NAME _____		CITY _____ STATE _____ ZIP _____	
ADDRESS _____		*MAIL ORDER PRICES; F.O.B. FACTORY. PRICE & SPECIFICATIONS SUBJECT TO CHANGE WITHOUT NOTICE.	
			TE-330



...for more details circle 122 on Reader Service Card

high  
quality  
without  
high cost



IN A CONTROLLED  
OUTPUT  
SOLDERING IRON

BY **Weller**<sup>®</sup>

Model W-60. Versatile 60-watt, pencil-type tool with automatically controlled temperature and output. Only 7 1/4" long. Weighs but 2 1/2 oz. Quick-change, anti-oxidation-coated 1/4" screwdriver tip. Several other sizes available with choice of temperature outputs. Use with or without optional, mounted or free-standing bench stand PH-60.

Ask your local distributor or write ...

**Weller-Xcelite  
Electronics Division**



The Cooper Group

P. O. BOX 728,  
APEX, NORTH CAROLINA 27502

...for more details circle 142 on Reader Service Card

## TECHNICAL LITERATURE

### ELECTRONIC INSTRUMENTS

A 24-page, 1975-76 catalog which describes various instruments for servicing, industrial maintenance, laboratories, schools and safety tests is now offered. New instruments listed include: Industrial Maintenance Appliance Tester, Tech VOM, Pocket Clamp Tester, Power Line Monitor, Dual-Tracer, Portable Sloped-Stand Meters, 75-ohm Attenuator, Transistor/diode/FET Checker, Battery Tester, plus the new WT-333B picture Tube/Tester/Restorer which replaces WT-333A with an improved Cathode-Emission renewal system. A special section lists the various accessories available with prices. RCA Distributor and Special Products Division, Camden, NJ. 08101.

### CRYSTAL SELECTION GUIDE

A new 72-page Crystal Guide is offered which lists all standard CB, synthesized CB, monitor and 2-meter amateur crystals that are available from CTS distributors and dealers. Included in this complete guide are CB cross reference charts—monitor and 2-meter equipment vs. CTS part number listings—frequency charts for standard and synthesized CB crystals, as well as general information about each crystal type. *CTS Knights, Inc.*, 400 Reimann Avenue, Sandwich, IL. 60548.

### TEST INSTRUMENTS

A 16-page catalog 75CBA, describing its full line of portable and bench test instruments for service, industry and education is now available. Products covered include single and dual trace oscilloscopes, a digital multimeter, a function generator, a curve tracer, FET multimeters, semiconductor testers, color bar generators, tube testers, a CRT tester/rejuvenator, and a sweep and marker alignment generator. Features, operating data, and complete specifications are given for each unit. Instrumentation & Controls Division, *Hickok Electrical Instrument Company*, 10514 Dupont Avenue, Cleveland, OH. 44108.

### TV SERVICE INFORMATION

A new 122-page, 1975 Series, TV Tech Aid manual of technical information is now available. The troubleshooting tips cover all major TV brands (over "500" troubles) and lists the symptoms, possible causes and

## ARROW AUTOMATIC STAPLE GUNS

### CUT WIRE & CABLE INSTALLATION COSTS

... without cutting into insulation!

**SAFE!** Grooved Guide positions wire for proper staple envelopment! Grooved Driving Blade stops staple at right depth of penetration: to prevent cutting into wire or cable insulation!

No. T-18—Fits wires up to 3/16" in diameter.

BELL, TELEPHONE, THERMOSTAT, INTERCOM, BURGLAR ALARM and other low voltage wiring.

Uses T-18 staples with 3/16" round crown in 3/8" and 7/16" leg lengths.

No. T-25—Fits wires up to 1/4" in diameter.

Same basic construction and fastens same wires as No. T-18.

Also used for RADIANT HEAT WIRE

Uses T-25 staples with 1/4" round crown in 9/32", 3/8", 7/16" and 9/16" leg lengths

NEW! Intermediate No. T-37—Fits wires and cables up to 5/16" in diameter.

Same basic construction as Nos. T-18 & T-25.

Also used for CATV and DRIVE RINGS in stringing wires.

Uses T-37 staples with 5/16" round crown in 3/8", 1/2" and 9/16" leg lengths.

No. T-75—Fits wires and cables up to 1/2" in diameter.

RADIANT HEAT CABLE, UF CABLE, WIRE CONDUIT COPPER TUBING or any non-metallic sheathed cable.

Also used as DRIVE RINGS in stringing wires.

Uses T-75 staples with 1/2" flat crown in 9/16", 5/8" and 7/8" leg lengths.

ARROW FASTENER COMPANY, INC.

271 Mayhill Street, Saddle Brook, N. J. 07663

...for more details circle 110 on Reader Service Card

cures. Much of the data included in the manual was received from set manufacturers and their field reps. Price \$7.95 *TV Tech Specials*, P.O. Box 603, Kings Park, NY. 11754.

## FUNCTION/PULSE GENERATORS

A new shortform catalog provides a quick glimpse of the company's signal source family. The full-color catalog shows the function and pulse generators which are available. Also included in the catalog is an applications selector wheel; when you dial up your application needs, it points to the

models and features that suit your application. This is one of the few product catalogs that also offers a background of facts to let the buyer know the company's total business involvement and financial strength. *Interstate Electronics Corp.*, Dept. 7000, Box 3117, 707 E. Vermont Avenue, Anaheim, CA 92803.

## TOOL KITS

A 4-page bulletin illustrates and describes a full line of fitted tool kits used for service and installation, and industrial electronics. A starter tech-

nicians kit is available for student technicians and hobbyists. *Henry Mann Inc.*, Box 496, Mann Rd., Huntingdon Valley, PA. 19006.

## SOLID-STATE REPLACEMENT GUIDE

An updated, 156-page guide to RCA solid-state products for replacement use is now available. RCA Solid State Replacement Guide, SPG-202R, lists more than 103,000 industry types which can be replaced with only 250 RCA SK devices. The 1975 revised replacement guide includes 32 new SK devices currently available from RCA as standard commercial products. Significant ratings and characteristics data are given for each type to aid in the selection of the optimum device for a particular application. It shows dimensional outlines of device packages and terminal diagrams including a revised semiconductor hardware replacement directory. *RCA Solid State Division*, Box 3200, Somerville, NJ. 08876.

## TEST EQUIPMENT

A 24-page Electronics Sales Bulletin lists a wide variety of reconditioned test equipment as well as a dozen different lines of new instruments. *Tucker Electronics Co.*, P.O. Box 1050, Garland, TX 75040.

## AUDIO TEST PROCEDURAL GUIDE

A 20-page "Tektronix Cookbook of Standard Audio Tests" describes the use of a modern low frequency spectrum analyzer and a few associated instruments to make response and distortion measurements on audio amplifiers. It illustrates the 5L4N Spectrum Analyzer tests for power output, frequency response, harmonic distortion, intermodulation distortion, distortion vs output, power bandwidth, damping factor, signal-to-noise ratio, square-wave response, cross-talk, sensitivity, and transient intermodulation distortion. *Tektronix, Inc.*, P.O. Box 500A, Beaverton, OR 97077.

## ELECTRONIC TUBE/SEMICONDUCTOR DIRECTORY

A complete directory of electronic tubes and semi-conductors is now available. The new directory lists some 5,000 currently popular industrial, entertainment and military tube and transistor types in alpha numerical order with quantity discount prices for quick reference. In addition, it lists the manufacturers that make each type and indicate their availability. *C.M. Levit Electronics*, 200 Park Avenue South, NY. 10003. ■

# A hand-y gift from Perma Power...

WHEN YOU BUY THIS MONEY-SAVING FOUR-PACK OF PERMA POWER COLOR-BRITES.

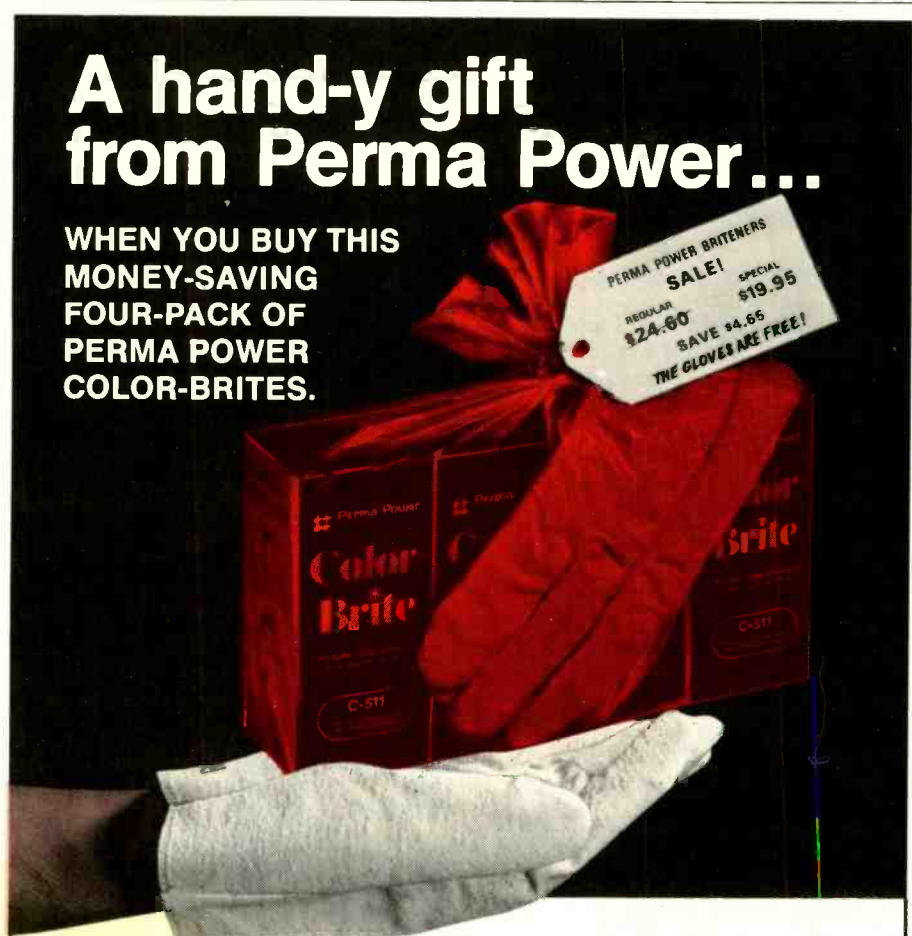

Now you can save \$4.65 on the briteners you use most—Perma Power Model C-511 Color-Brite—and get a pair of Royaltan 600 work gloves absolutely free! You'll find these gloves handy for antenna installations, lifting TV sets, driving, or general work inside and out.

You'll find the C-511 Color-Brite handy, too. No complicated installation, just plug it in; and instantly restore sharpness, contrast and faded color to color television picture tubes. Perma Power Color-Brite extends useful picture tube life up to a full year, makes your customer happy so she'll remember you when it's time for picture tube replacement.

The Perma Power Model C-511 fits all the prevalent rectangular picture tubes with 60 Hz heaters. For a limited time, you can buy well below the usual price of \$6.15 each, with this four-pack for just \$19.95—a \$4.65 total savings. And the gloves are free! Hurry, supplies are limited. See your distributor today.

**Perma Power**

Chamberlain Manufacturing Corporation  
Perma Power Division  
5740 North Tripp Avenue, Chicago, Illinois 60646  
Telephone (312) 539-7171

For more details circle 128 on Reader Service Card

# GENERAL ELECTRIC INTRODUCES THE 4-MINUTE HALF HOUR

## GE's Latest In-Line Deflection and Convergence System hailed by TV technicians.

General Electric's latest in-line system\* makes it possible to converge a color set in three to four minutes, as opposed to the standard time of ten to 30 minutes. It was enthusiastically received at state conventions, where TV technicians and shop owners called it an important advancement in serviceability.



"Saves 30 minutes in convergence, compared to standard Delta convergence."  
Dick Regner, RRR TV, Pearland, Texas

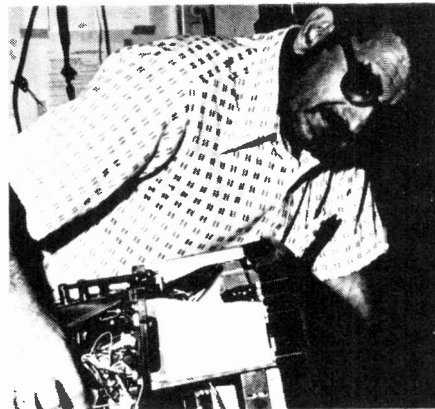

"G.E.'s... convergence system is great. They should have called it the 'time saver'."  
Sidney J. Sabel, Sabel's T.V. Service, Houston, Texas

"Easy to converge, little return to readjust controls."  
Charles Miller, Miller's TV Service, Virginia Beach, Va.

"Time saving. Very flexible. More control."  
G. F. Hill, Bay Area TV & Communication, Seabrook, Texas

"Beats the heck out of other systems!"  
E. B. Swanson, E. B. Swanson Company, Crosby, Texas

Another feature that met with enthusiastic approval was the fact that a technician requires no additional training to converge the set for a sharp, clear picture. A simple control location guide is included inside the set.

"... simple convergence is extremely important. Will make training to technicians very easy."  
Gary Gray, Master TV & Appliance Co., Roanoke, Va.

"It's a serviceman's dream. Easy. Simple. The way to go!"  
Ira Evans, Evans TV, Freeport, Texas

"Fantastic! Great! I wish everyone would go to it."  
David Christian, Whitehill Elec., Kannapolis, N.C.

"Very simple. Easy to do without previous instructions."  
Earl Asher, Asher TV, Denton, Texas



"Greatest improvement in convergence in 15 years."  
Bill Nichols, Radio & TV Service, Inc., Petersburg, Va.

\* This latest in-line deflection and convergence system is in all GE 13" and 17" (diagonal) YA solid state chassis sets.

**We're making it  
our business to make  
your business easier.**

**GENERAL ELECTRIC**

TV Receiver Products Dept., Portsmouth, Va.

...for more details circle 121 on Reader Service Card

# Systematic Service Labor Pricing

By J. W. Phipps

An intro to a service labor pricing system developed and offered to other electronic servicers by the owner/operator of a successful Midwestern service business

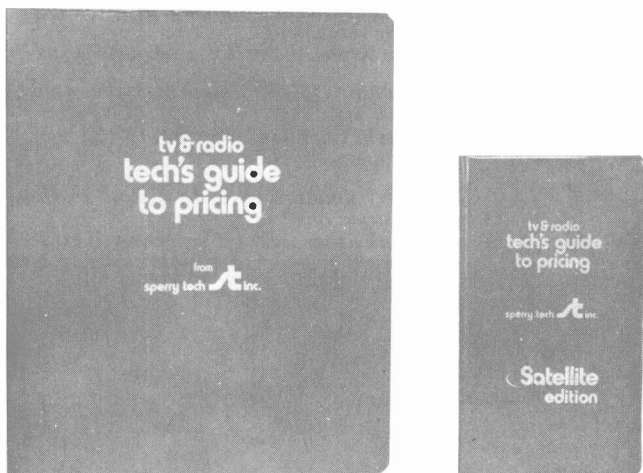

John Sperry is the owner/operator of Sperry TV, a home entertainment electronic service firm in Lincoln, Nebraska, which last year grossed nearly \$800,000 and performed 30,000 service jobs.

Since starting his business in 1949, Sperry has tried and tested almost every conceivable method of service labor pricing, from straight-time pricing to various combinations of straight time and flat rate. Throughout this 26-year period, Sperry has meticulously maintained records of how long it takes his techni-

cians to perform specific servicing functions on specific types of entertainment electronic products and, in addition, has weighed this "field" time-job data against that obtained from more formal time-job studies conducted in his shop and against inputs from other service businesses throughout the country.

About ten years ago, Sperry began to develop and use in his own business a flat-rate service labor pricing system which, after eight years of testing, refinement and updating, has gradually evolved into a sys-

RATES PER HOUR FOR TWO MEN Chart No. 15

TECH'S GUIDE TIME	19.20	19.80	20.40	21.00	21.60	22.20	22.80	23.40	TECH'S GUIDE TIME	ONE-MAN HOURLY RATE
5	1.60	1.65	1.70	1.75	1.80	1.85	1.90	1.95	5	1.40
10	3.20	3.30	3.40	3.50	3.60	3.70	3.80	3.90	10	2.80
15	4.80	4.95	5.10	5.25	5.40	5.55	5.70	5.85	15	4.20
20	6.40	6.60	6.80	7.00	7.20	7.40	7.60	7.80	20	5.60
25	8.00	8.25	8.50	8.75	9.00	9.25	9.50	9.75	25	7.00
30	9.60	9.90	10.20	10.50	10.80	11.10	11.40	11.70	30	8.40
35	11.20	11.55	11.90	12.25	12.60	12.95	13.30	13.65	35	9.80
40	12.80	13.20	13.60	14.00	14.40	14.80	15.20	15.60	40	11.20
45	14.40	14.85	15.30	15.75	16.20	16.65	17.10	17.55	45	12.60
50	16.00	16.50	17.00	17.50	18.00	18.50	19.00	19.50	50	14.00
55	17.60	18.15	18.70	19.25	19.80	20.35	20.90	21.45	55	15.40
60	19.20	19.80	20.40	21.00	21.60	22.20	22.80	23.40	60	16.80
65	20.80	21.45	22.10	22.75	23.40	24.05	24.70	25.35	65	18.20
70	22.40	23.10	23.80	24.50	25.20	25.90	26.60	27.30	70	19.60
75	24.00	24.75	25.50	26.25	27.00	27.75	28.50	29.25	75	21.00
80	25.60	26.40	27.20	28.00	28.80	29.60	30.40	31.20	80	22.40
85	27.20	28.05	28.90	29.75	30.60	31.45	32.30	33.15	85	23.80
90	28.80	29.70	30.60	31.50	32.40	33.30	34.20	35.10	90	25.20
95	30.40	31.35	32.30	33.25	34.20	35.15	36.10	37.05	95	26.60
100	32.00	33.00	34.00	35.00	36.00	37.00	38.00	39.00	100	28.00
105	33.60	34.65	35.70	36.75	37.80	38.85	39.90	40.95	105	29.40
110	35.20	36.30	37.40	38.50	39.60	40.70	41.80	42.90	110	30.80
115	36.80	37.95	39.10	40.25	41.40	42.55	43.70	44.85	115	32.20
120	38.40	39.60	40.80	42.00	43.20	44.40	45.60	46.80	120	33.60
125	40.00	41.25	42.50	43.75	45.00	46.25	47.50	48.75	125	35.00
130	41.60	42.90	44.20	45.50	46.80	48.10	49.40	50.70	130	36.40
135	43.20	44.55	45.90	47.25	48.60	49.95	51.30	52.65	135	37.80
140	44.80	46.20	47.60	49.00	50.40	51.80	53.20	54.60	140	39.20
145	46.40	47.85	49.30	50.75	52.20	53.65	55.10	56.55	145	40.60
150	48.00	49.50	51.00	52.50	54.00	55.50	57.00	58.50	150	42.00
155	49.60	51.15	52.70	54.25	56.00	57.35	58.80	60.25	155	43.40
160	51.20	52.90	54.60	56.00	57.80	59.20	60.60	62.00	160	44.80
165	52.80	54.55	56.30	57.75	59.60	61.05	62.50	64.00	165	46.20
170	54.40	56.10	57.90	59.70	61.60	63.10	64.60	66.10	170	47.60
175	56.00	57.75	59.60	61.65	63.60	64.75	66.50	68.25	175	49.00
180	57.60	59.40	61.20	63.00	64.80	66.60	68.40	70.20	180	50.40
185	59.20	61.05	62.80	64.75	66.60	68.45	70.30	72.15	185	51.80
190	60.80	62.70	64.60	66.60	68.40	70.30	72.20	74.10	190	53.20
195	62.40	64.35	66.30	68.25	70.20	72.15	74.10	76.05	195	54.60
200	64.00	66.00	68.00	70.00	72.00	74.00	76.00	78.00	200	56.00
205	65.60	67.65	69.70	71.75	73.80	75.85	77.90	79.95	205	57.40
210	67.20	69.30	71.40	73.50	75.60	77.70	79.80	81.90	210	58.80
215	68.80	70.95	73.10	75.25	77.40	79.55	81.70	83.85	215	60.20
220	70.40	72.60	74.90	77.00	79.20	81.40	83.60	85.80	220	61.60
225	72.00	74.25	76.50	78.75	81.00	83.25	85.50	87.75	225	63.00
230	73.60	75.90	78.20	80.50	82.80	85.10	87.40	89.70	230	64.40
235	75.20	77.55	79.90	82.25	84.60	86.95	89.30	91.65	235	65.80
240	76.80	79.20	81.60	84.00	86.40	88.80	91.20	93.60	240	67.20
245	78.40	80.85	83.30	85.75	88.20	90.65	93.10	95.55	245	68.60
250	80.00	82.50	85.00	87.50	90.00	92.50	95.00	97.50	250	70.00
255	81.60	84.15	86.70	89.25	91.80	94.35	96.90	99.45	255	71.40
260	83.20	85.80	88.40	91.00	93.60	96.20	98.80	101.40	260	72.80
265	84.80	87.45	90.10	92.75	95.40	98.05	100.70	103.35	265	74.20
270	86.40	89.10	91.90	94.50	97.20	99.90	102.60	105.30	270	75.60
275	88.00	90.75	93.50	96.25	99.00	101.75	104.50	107.25	275	77.00
280	89.60	92.40	95.20	98.00	100.80	103.60	106.40	109.20	280	78.40
285	91.20	94.05	96.90	99.75	102.60	105.45	108.30	111.15	285	79.80
290	92.80	95.70	98.60	101.50	104.40	107.30	110.20	113.10	290	81.20
295	94.40	97.35	100.30	103.25	106.20	109.15	112.10	115.05	295	82.60
300	96.00	99.00	102.00	105.00	108.00	111.00	114.00	117.00	300	84.00
305	97.60	100.65	103.70	106.75	109.80	112.85	115.90	118.95	305	85.40
310	99.20	102.30	105.40	108.50	111.60	114.70	117.80	120.90	310	86.80
315	100.80	103.95	107.10	110.25	113.40	116.55	119.70	122.85	315	88.20
320	102.40	105.60	108.80	112.00	115.20	118.40	121.60	124.80	320	89.60
325	104.00	107.25	110.50	113.75	117.00	120.25	123.50	126.75	325	91.00
330	105.60	108.90	112.20	115.50	118.80	122.10	125.40	128.70	330	92.40
335	107.20	110.55	113.90	117.25	120.60	123.95	127.30	130.65	335	93.80
340	108.80	112.20	115.60	119.00	122.40	125.80	129.20	132.60	340	95.20

Fig. 1—One of the 30 pricing calculator charts provided with TV & Radio Tech's Guide To Pricing.

tem which Sperry believes can be successfully used by any entertainment electronic service business, regardless of size and location. Two years ago, Sperry made this service labor pricing system available to other entertainment electronic servicers.

Called *TV & Radio Tech's Guide To Pricing*, Sperry's system is designed to price both in-home and in-shop service labor for the following 19 generic types and variations of entertainment electronic products:

- b/w TV
- color TV
- compact and compo-

nent audio systems (radio, phono, tape, etc.)

- console and combinations (TV, radio, phonos, tape, etc.)
- intercom systems (home and commercial)
- motel and hotel entertainment electronic products
- antennas and MATV systems
- portable and table radios (AM or FM with and without clock)
- portable and table radios (AM/FM, multiplex, with and without clock)
- portable and table phonos (manual and automatic)
- show and tell (with and



# REPLACEMENT SK Series

## Fix it with SK. The RCA quality replacement.

Count on top quality in SK replacement semi-conductors. Because they carry the name RCA, a top manufacturer of OEM devices. Same strict AQL standards, same strict Director of Quality Assurance. That's how we protect you from callbacks, so you can make more profitable use of your time. RCA's higher-than-ever 410 to 1 replacement ratio will help you save time too. Your key to fast, easy replacement is RCA's new 1975 SK Replacement Guide. Get your copy at the RCA distributor where you buy SK parts.

RCA Solid State, Box 3200, Somerville, N.J. 08876.

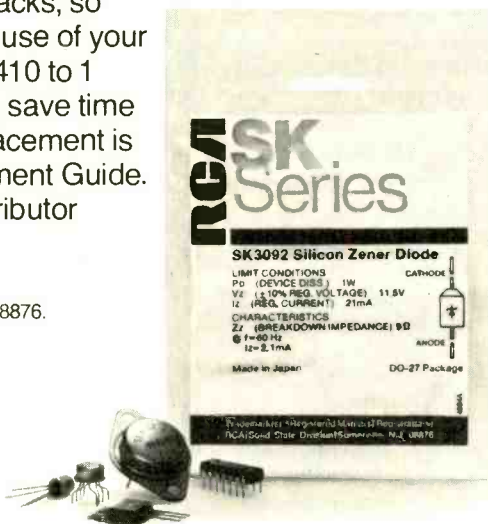

...for more details circle 132 on Reader Service Card

It's OK if it's **sk**

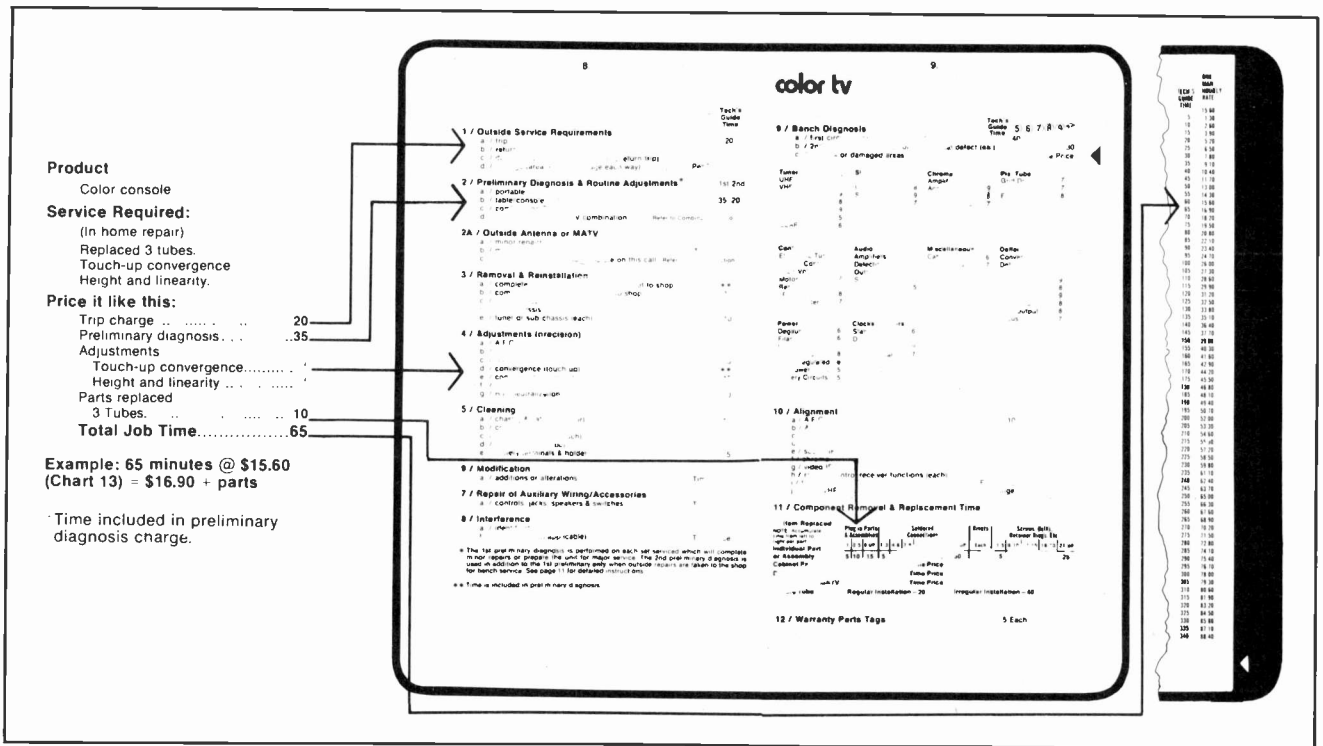

Fig. 2—An example of how the service labor involved in the in-home servicing of a console color TV is priced out with Sperry's system.

without radio/clock)

- monitor and multiband radio (including scanners)
- communication receivers
- car music systems
- portable cassette tape players and recorders (with and without radio)
- deck-type cassette tape players and recorders
- cartridge-type tape players and recorders
- reel-type tape players and recorders (monaural)
- reel-type players and recorders (stereo, including quad)

In addition, a miscellaneous section covers garage door openers, microwave ovens, vibrasonic cleaners and "hobby and novelty" devices.

Pricing of service labor for each of the preceding 19 generic types of products is covered in separate, two-page sections, and, with the exception of the sections covering motel and hotel-installed equipment, antennas and "miscellaneous" equipment, each of the individual product

sections is divided into the following 12 functional pricing categories:

- Outside Service Requirements
- Preliminary Diagnosis & Routine Adjustments
- Outside Antenna Or MATV
- Removal — Reinstallation
- Precision Adjustments
- Cleaning
- Modification
- Repair Of Auxiliary Wiring/Accessories
- Interference
- Bench Diagnosis
- Alignment
- Component Removal & Replacement Time
- Warranty Parts Tags

These 12 functional pricing categories, in turn, are divided into related functions. Beside each related function is listed the average time (in minutes) which Sperry says it takes an average technician to perform that function.

The total service labor time for a particular service job is computed by adding up the times indicated for the functions actually performed during the course of the job.

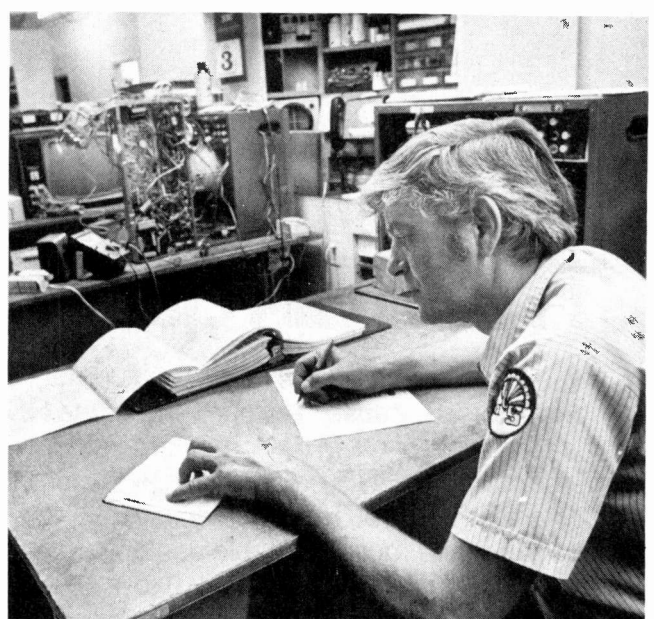

Sperry TV bench technician pricing out the service labor for a color TV with the "Satellite" version of TV & Radio Tech's Guide To Pricing. Also shown is one of the service forms Sperry has developed and markets for use with his pricing system. Sperry also has developed a computerized parts pricing system which should be available on a subscription basis to other servicers by the time you read this.

The total service labor time (in minutes) then is converted to a service charge (in dollars and cents) by referring to one of 30 "pricing calculator charts" supplied with Sperry's pricing system. Each of the 30 charts is for a specific hourly service labor rate (ranging from \$8.40 to \$36.00 per

hour) and, as shown by the sample in Fig. 1, converts time (in 5 minute increments, from 5 to 340 minutes) to dollars and cents charges. The user simply selects the pricing calculator chart which most closely corresponds to his shop's hourly service labor rate; then, for a one-man

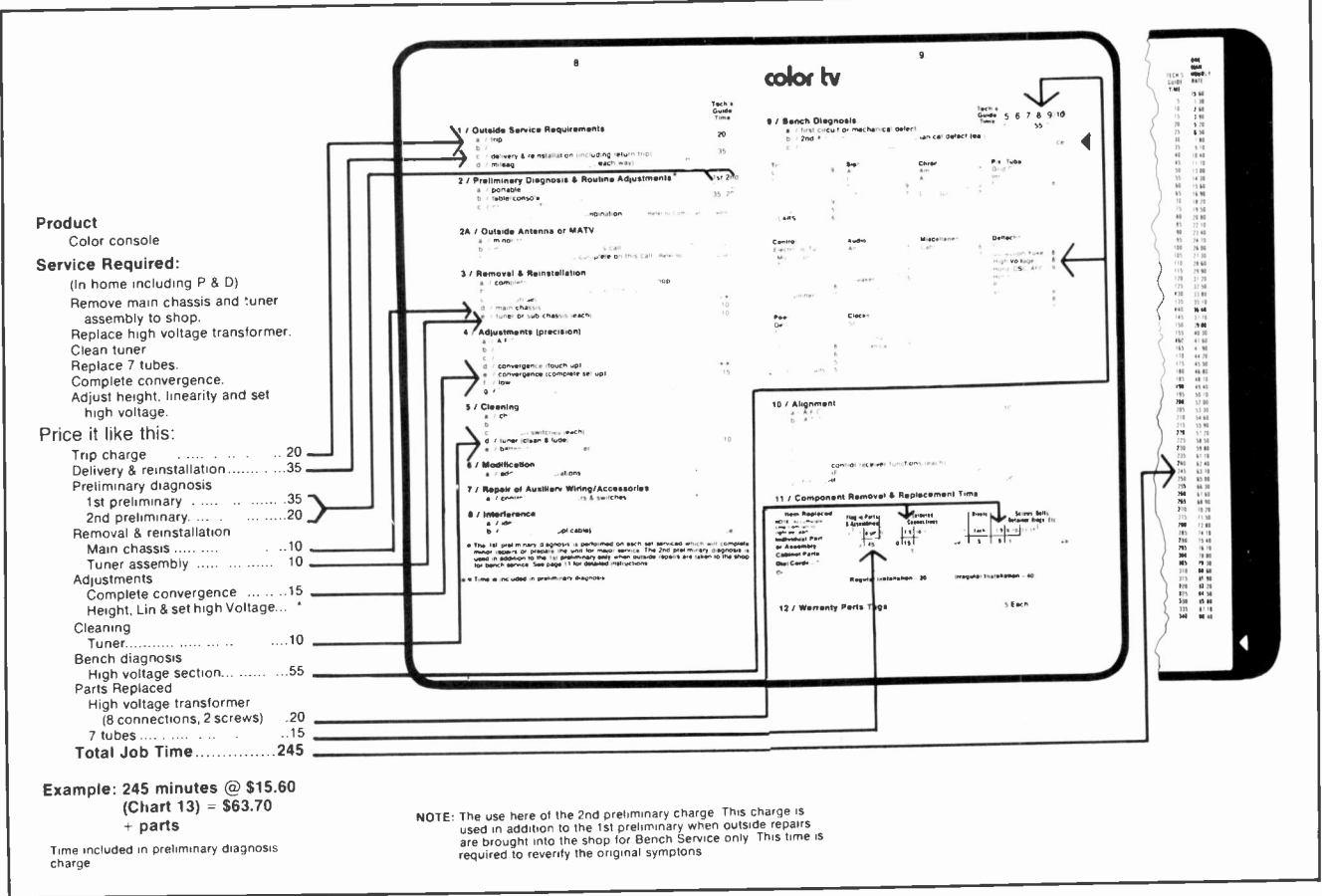

Fig. 3—An example of how the service labor involved in the in-home and in-shop servicing of a console color TV is priced out with Sperry's system.



Front view of Sperry TV, Lincoln, Nebraska, an \$800,000-per-year entertainment electronic service business owned and operated by John Sperry, developer and publisher of TV & Radio Tech's Guide To Pricing.

charge, the user finds the total job time under the vertical column labeled "TECH'S GUIDE TIME" and uses the corresponding service labor charge to the right of that time listing. (The pricing calculator charts also provide time-to-charges conversions for two-man rates.)

Two examples of how TV & Radio Tech's

Guide To Pricing is used to price out color TV servicing are shown in Figs. 2 and 3. (To avoid compromising Sperry's copyrighted system, all items but those essential to the examples have been blotted out.) Both examples involve a color TV console and a \$15.60 hourly service labor rate.

Sperry's TV & Radio Tech's Guide To Pricing

is available in two versions. One version is contained in a durable, 7-3/4 inch by 9-1/2 inch, loose-leaf binder and includes instructions for estimating your hourly service labor rate and complete, step-by-step instructions for use of the Sperry pricing system, plus examples which show how typical servicing jobs are priced with the system. Sperry recommends that this version be employed for training and office use.

Sperry recently introduced what he calls the "Satellite" version of TV & Radio Tech's Guide To Pricing. It is bound in a pocket-sized, 3-5/8 inch by 6-5/8 inch vinyl cover and is exactly the same as the physically larger loose-leaf version except that, for compactness, the instruction section is omitted. Sperry recommends that each technician be supplied with the "Satellite" version.

In both versions of the pricing system, easy indexing to each product section is provided by color-coded tabs on the outside edges of all pages, and because each product section is covered on two facing pages, once the technician has turned to the section which corresponds to the type of product being serviced, in most servicing situations further page turning is not needed until the job is completed and it is time to use the "pricing calculator chart" to convert the total service labor time to a specific charge.

In the loose-leaf version, the pricing calculator chart, which corresponds to the shop's hourly service labor rate is inserted at the back of the folder and is visible without turning any pages. In the "Satellite" version, the appropriate chart is inserted in a

transparent pocket on the inside of the back cover.

In addition, both versions of the pricing manual are equipped with transparent pockets at the inside front of the folder, for insertion of a map of the shop's operating area. Such a map should define the area in which the shop's primary trip charge applies and those remaining portions in which additional time charges are required. A sample map, shown in Fig. 4, plus instructions for preparing and using a map of your own operating area are included with both versions of Sperry's pricing system.

To apply his pricing system to your business, Sperry recommends that after you have calculated the hourly service labor rate you need to recover all expenses and produce the profit you desire, you then should select the pricing calculator chart which most closely corresponds to this hourly rate and compare that chart's one-man charges for 65 and 220 minutes with the rates you presently charge for color TV service calls and color TV bench repairs, respectively.

If the corresponding charges are the same or nearly the same, Sperry says you then should use both your present pricing system and his system to price all jobs during a two- or three-week trial period and compare the results. If at the end of the trial period the total service labor revenue that would have been produced by Sperry's system is equal to or greater than that actually produced by your present system, you should continue to use that pricing calculator chart when you change over to Sperry's system.

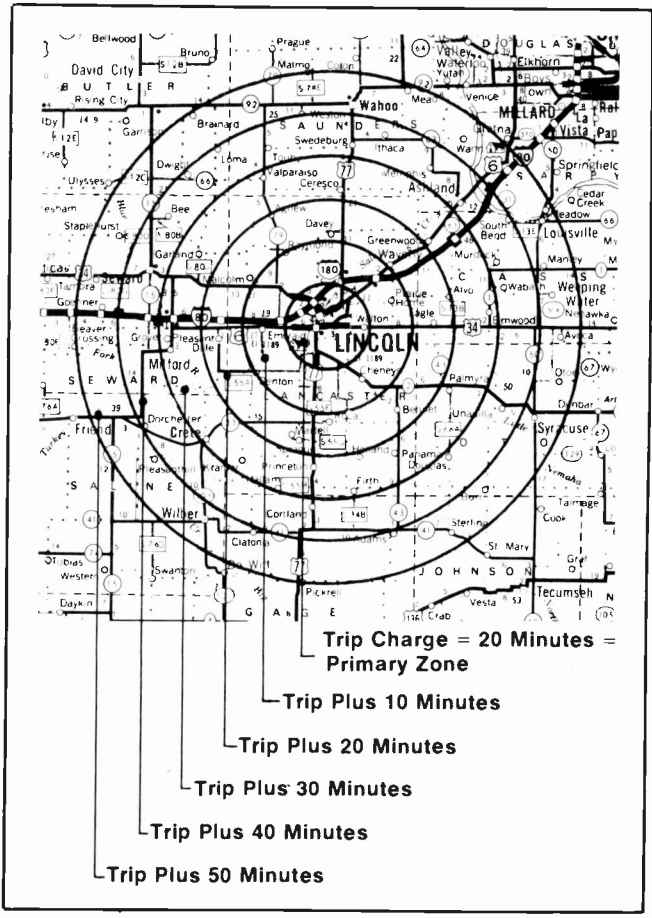

Fig. 4—Shown here is the sample area map provided with TV & Radio Tech's Guide to Pricing.

However, if the charges for 65 and 220 minutes on the pricing calculator chart do not closely correspond to your present respective charges for color TV service and bench repair (including travel, pickup and delivery), or if at the end of the trial period there is a significant difference between the total amount of service labor revenue produced by your's and Sperry's system, Sperry recommends that you select the pricing calculator chart in which the one-man charges for 65 and 220 minutes more closely correspond to your present color TV service call and bench charges, or, if you've already conducted one trial, select a chart which would have produced at least as much service labor revenue as your present system did during the trial period.

**CONCLUSION**

Because my own experience with Sperry's Radio & TV Tech's Guide To Pricing has been limited to a "static" analysis of the system, including the pricing of theoretical service jobs, plus brief discussions with a few of the approximately 2500 shop owners who reportedly already are using it, I do not believe I am qualified to evaluate its universal applicability.

However, based on my own analysis of the system and my limited use of it, plus what I've been told by those who are using it, Sperry's system seems to embody the requisites necessary for convenient, consistent and profitable pricing of entertainment electronic service labor.

The overall generalized format, the limita-

tion of the system to generic instead of brand and model classifications, and the degree to which jobs are broken down into logical functions reflect obvious compromises between preciseness and conciseness, but, in my opinion, such compromises are necessary to make the system conveniently applicable to the relatively broad range of generic product types and the diversity of troubles and combinations of troubles possible in entertainment electronic products. In my opinion, the generalized format and the generic orientation of Sperry's system have made it possible to avoid a system so cumbersome and expensive that its cost and difficulty of use would be prohibitive to most shops and technicians. Besides, the fact that the majority of time involved in entertainment electronic servicing involves diagnostic procedures which do not vary significantly among different brands and models of generic product types makes the need for indexing to specific brands and models very doubtful, if not completely meaningless.

Determining whether or not the job-time increments in Sperry's pricing system are true "averages" for an "average" technician will require long-term use and evaluation. However, Sperry's 26 years of first-hand experience in the entertainment electronic service business, his long-term gathering and evaluation of job-time data, plus the obvious success of his own service business and the testing and successful use of his pricing system in his own business all lead me to believe that

continued on page 49

# while the guy down the street complains about how tough alignments are...I do them!

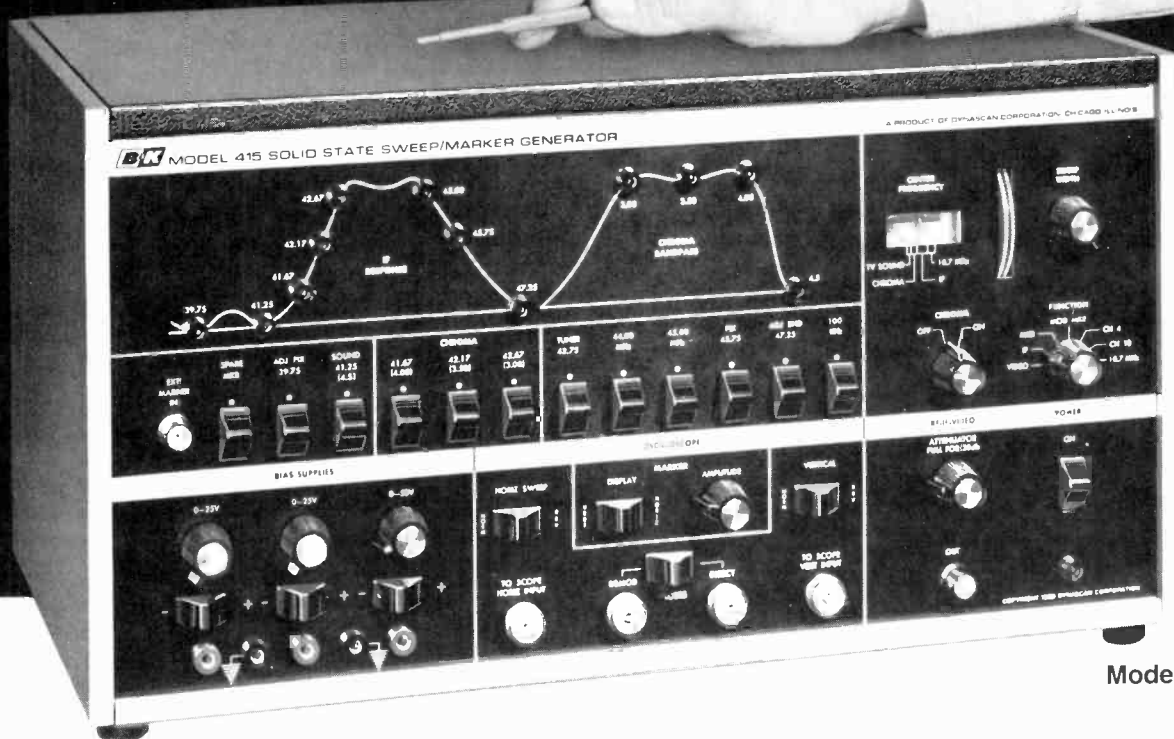

**Model 415**  
**\$459**

I used to hook up a separate sweep generator, marker generator, marker adder and bias supply, hope that everything was properly calibrated and adjusted, and pray that the alignment would hold after I disconnected the cables draped all over the bench.

I didn't do it very often.

Now, in the time it used to take me just to set up, I can almost complete an alignment. And I'm confident the set will perform as well as it possibly can. My customers notice, too. That's the difference B&K's 415 Solid-State Sweep/Marker Generator made.

Setup is no problem. After I connect the 415's outputs to my scope (there's even low-frequency compensation to eliminate pattern errors), I connect its RF outputs (channel 4 or 10) to the antenna terminals or mixer test point, the direct probe to the video detector test point (or anywhere else after the video detector diode) and the demodulator probe to the bandpass amplifier output.

They're all clip-on connections, and the 415 comes with all the accessories I need. Once I've made the initial signal and bias hookups, there's nothing else to connect or reconnect. All intercabling changes and generator functions are controlled from the front panel. There's even a 15,750Hz filter to eliminate disabling

the set's horizontal output section.

Shaping the waveform is easy, because the 415 has 10 crystal-controlled IF markers, each of which lights up on the front-panel waveform diagram as it is used. Markers can be shown either vertically or horizontally on the scope trace. There's a 100kHz modulated marker that makes nulling the traps so easy it's almost automatic. And three low-impedance, reversible-polarity bias supplies—two, 0-25VDC; one, 0-50VDC.

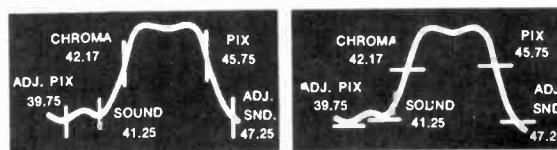

Vertical Markers

Markers Tilted Horizontally

Every step is easy to understand, too, thanks to the comprehensive manual.

Since I have nothing to sell but my time, I have to make the most profitable use of it I can. That's why I have a B&K 415.

In stock now at your local distributor or write Dynascan.

**B&K** PRODUCTS OF  
**DYNASCAN**

1801 W. Belle Plaine Ave. • Chicago, IL 60613 • Phone (312) 327-7270

Complete Line of Analog and Digital Multimeters, Oscilloscopes, Signal Generators, Semiconductor Testers, Power Supplies, Probes, Tube Testers and Substitution Boxes.

...for more details circle 112 on Reader Service Card

# WINEGARD Chromstar THE RUGGEDIZED NEW GENERATION OF TV ANTENNAS!

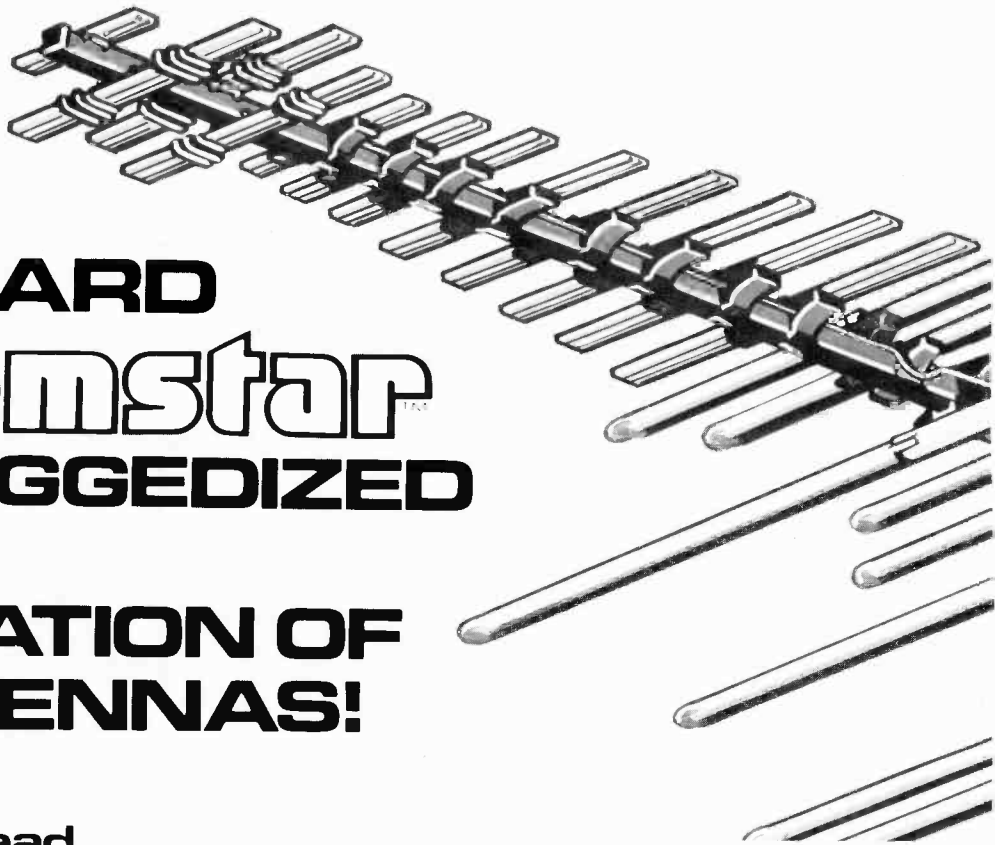

**40 Models  
With Far-Ahead  
Features For  
Finest Color  
Reception Ever!**

**Ask your distributor  
for complete information!**

- New Standard Of Excellence In Construction And Performance.
- Anodized and Ruggedized for Weather Protection and Long Life.
- Models To Solve Every Area Reception Problem.
- Most Powerful UHF and VHF Performance Ever.
- New Tri-Linear UHF Director System Extends UHF Reception Distance Up To 30 Miles Farther From Station in Many Areas.

**PLUS...** New Generation FM Antennas.  
High Performance Ruggedized Yagis.  
New Solid State Preampifiers.



**WINEGARD**  
TELEVISION SYSTEMS

3000 KIRKWOOD  
BURLINGTON, IOWA 52601

## NEW TRI-LINEAR UHF DIRECTOR SYSTEM\*

Increases Gain up to 30%!

Provides broader signal capture area in a more compact configuration.

### ORDINARY UHF Director System.



Uses half-wave directors approximately 5 1/2" long which respond primarily to the high end of the band, with very little gain on the low end.



Boom length required for 12 directors

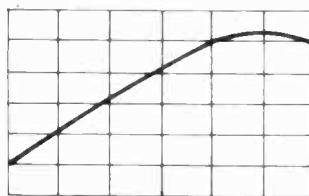

Typical gain curve with ordinary UHF directors. Note low response on low end of band.

### WINEGARD High Gain Tri-Linear® Directors

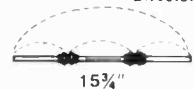

Act as 3 half wave directors on the high end of the band, and re-resonate as a loaded half-wave director on the low end of the band. This results in high linear gain on all UHF channels, giving the antenna sharper directivity and up to 30% more gain over other high gain UHF antennas.

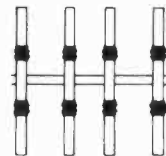

Boom length required for 12 directors

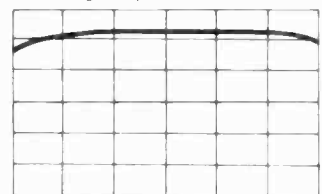

Typical gain curve with Winegard Tri-Linear directors. Note high uniform gain across entire band.

## ANODIZED!

Exclusively Winegard! Elements are silver anodized, the boom blue anodized for the best possible protection for aluminum against corrosion and weather.

## FROM WINEGARD THE FIRST REALLY NEW LINE OF TV ANTENNAS IN YEARS!

**Sells Easier/Goes Up Easier/Performs Better/Stays Up Longer  
Cuts Down Call-backs./Try One On Your Next Installation.**

Chromstar... a new word for a superior new line of antennas—engineered in the Winegard tradition of integrity, quality, craftsmanship.

Rugged construction and advanced electronics move this new line even farther ahead of other antennas. More powerful performance all down the line. New Tri-Linear director system gives sharper directivity and up to 30% more gain over other high gain UHF antennas. New

features. More benefits. Greater advantages. More of everything for you and your customers, to meet today's demand for years of quality performance.

GET ALL THE FACTS FROM YOUR WINEGARD DISTRIBUTOR, PLUS FREE SPEC CHARTS ON ALL MODELS. Try Chromstar on your next installation and see the *big* difference.

**RUGGEDIZED!** Chromstar antennas are designed to defy weather and wear—are engineered for extra strength at all points of stress. You can actually see the difference in the rugged construction.

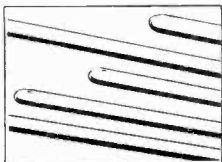

Exclusive 7/16" diameter aluminum tubing for 30% greater strength, better performance, longer life. Winegard is the first and only manufacturer to use this larger diameter.

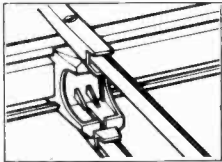

New truss-type phasing bars, top and bottom, with more conductive surface, give maximum transfer of signal. Truss-type bridge construction more than doubles boom strength.

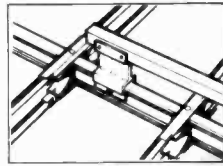

Double boom on longer flat line models for extra strength & rigidity.

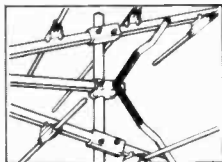

New scissors - type struts between upper and lower booms and center boom on wedge models, for extra support, easier installation.

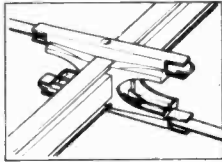

High-impact girder design support insulators are moulded of super-tough Noryl G-E plastic. Four positive locks give maximum support and permanent alignment.

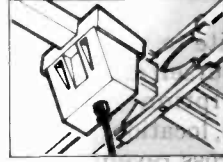

Critical-point weather protection! \*New compact weather-proof cartridge housing for downlead, preamplifiers and filter modules. New printed circuit downlead module with both twin lead and 75 ohm coax connections. No separate matching transformer required.

**TV ANTENNAS MORE PEOPLE LOOK UP TO**

...for more details circle 143 on Reader Service Card

## PROFITABLY SPEAKING



With J. W. Phipps, Editor, ET/D

■ The purpose of this column is to provide an open forum in which you, the owner/operators of electronic service businesses, and I can discuss and exchange ideas and opinions about business management and shop operating techniques, events and developments which affect electronic servicing businesses, and other subjects which are directly related to the successful management and operation of your businesses.

To get into the discussion, simply send your ideas, opinions and comments to me, J. W. Phipps, Editor, ET/D, 1 East First St., Duluth, Minn. 55802. Time will not permit me to provide private responses to your letters, but I will do my best to include in this column all of your ideas, opinions and comments which are relevant to the management and operation of electronic service businesses, regardless of whether or not I agree with them. Conversely, you probably will not always agree with me. However, from our dialogue hopefully will emerge a consensus of opinion about what are and are not sound business management and shop operating procedures and, equally important, hopefully we all will gain a better perspective of the problems, developments and events which directly affect electronic servicing businesses.

When you write to me the first time, identify yourself and include a brief description of your business—name, location, approximate annual gross revenue from servicing, type of products serviced and any other information that you deem relevant.

To start our dialogue—and re-

member, it won't be a *dialogue* unless you send me *your* ideas, opinions and comments—I'd like to suggest the following topics:

- *The effects of modular designs and how to cope with them*—An increasingly larger percentage of the TV receivers being sold and in use are of modular design. About 37 percent of the servicers who responded to a recent ET/D survey said that modularization already has decreased their income or probably will within the next two years. How and to what degree has modularization affected your servicing techniques and your parts income? What, in your opinion, are the most realistic methods of coping with the effects of modularization? (Only 9 percent of the servicers responding to a recent ET/D survey said that they carry a relatively complete stock of modules for most major brands of TV, and 36 percent said that they do *not* stock any modules.)

- *The effects of all-solid-state design and how to cope with them*—About 50 percent of the servicers who responded to a recent ET/D survey said that most all-solid-state products are more difficult to service than comparable tube-type products. Do you agree, and if so, what effect has it had on your business? Are recent all-solid-state products really more reliable than tube and hybrid designs, and if so, how and to what degree is it now affecting service volume and how will it affect volume in the immediate future? (About 28 percent of the servicers who responded to a recent ET/D survey said that their volume of receiving tube sales has decreased by 10 percent or more.) How do you plan

to cope with whatever changes have and will be brought about by all-solid state design?

- *Product diversification and brand specialization*—Some TV servicers say that ongoing changes in the design of TV receivers and/or consumer acceptance of relatively new types of electronic products already have or eventually will force or entice them to diversify into servicing other types of consumer electronic products, such as two-way communications equipment, microwave ovens, air conditioners and home electronic appliances. (For example, of the servicers responding to a recent ET/D survey, about 61 percent indicated a definite interest in two-way communications servicing and about 16 percent already have diversified into this field.) Do you foresee the need for or do you presently have any plans to diversify into servicing electronic products other than those you are now servicing? What are your ideas and opinions about the advantages of or need for specializing in fewer brands, particularly as a means of coping with parts and module inventory requirements?

The foregoing three topics are but a few of the many timely and relevant subjects that *we* can and should deal with in this column. Other vital subject areas include service labor pricing methods, inventory requirements and control procedures, shop layout, shop productivity, manufacturer and shop warranty policies and procedures, and the effects of government regulation on electronic servicing.

Let's start Profitably Speaking. ■



# Your VTVM is obsolete!

This may sound like a harsh claim, but it's true. Thousands of TV technicians are using instruments designed in the 1950's to troubleshoot circuits designed in the 1970's.

And now, most color TV's have solid state circuits. So use of out-of-date test equipment just compounds the problem.

The generation gap has grown too big.

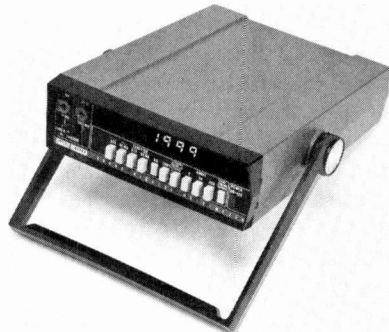

The Fluke 8000A 3 1/2 digit multimeter

## Solid state calls for new performance standards.

Your "old fashioned" test equipment simply doesn't measure up to today's requirements. For example, the typical VTVM gives you 5% accuracy and 2% resolution. In the old days, that was good enough. Not so today.

Now you need an instrument to look at the voltages at each pin of an IC with sufficient accuracy and resolution to determine proper IC operation.

For example, a reading of "around 2.8 volts" is no longer sufficient. You must be able to distinguish between 2.80 and 2.82 volts.

You need a test instrument that gives you 0.1 ohm resolution so you can reliably measure resistance of switch contacts, circuit breakers, and low value resistors.

To do all this and more, you need the superior capabilities of the Fluke 8000A 3 1/2 digit multimeter.

## An instrument designed specifically for testing solid state equipment.

The 8000A gives you up to 50 times the accuracy and 20 times the resolution of a VTVM, so you can measure the various voltage levels in a solid state chassis with absolute confidence.

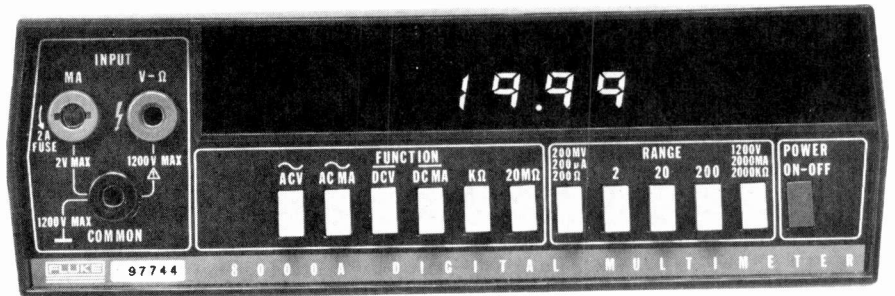

Resolution is 100 microvolts, 100 nanoamps and 100 milliohms

You get the sensitivity you need for low level dc measurements. The 200 millivolt range with 100 microvolt resolution tells you *exactly* what your values are.

The 8000A has an AC frequency response from 45 Hz to 20 KHz and, with accessory probes, to 500 megahertz. Resistance measuring capability ranges from 100 milliohms to 20 megohms. It offers a 15°C to 35°C accuracy temperature span. And a 1-year accuracy time span, meaning it seldom needs calibration.

Unlike other DMM's the 8000A has fast response time—3 readings a second. And the bright, digital readout means that no interpolation is necessary.

## The 8000A measures high voltages, too.

Our 8000A is designed to answer *all* the needs of an electronic service technician.

One very important (and talked about!) safety requirement is that the picture tube anode voltage must not exceed the maximum specified by the manufacturer. Our 8000A has an optional high voltage probe that gives you guaranteed accuracy of 1% at 25,000 volts. The probe also extends the capability of the 8000A to 40,000 volts to measure the high voltage in the new 32,000 volt chassis.

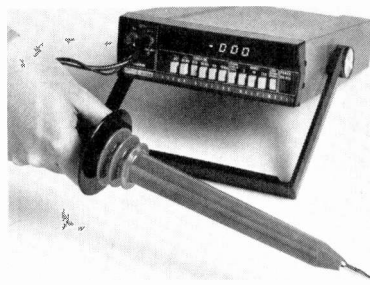

High voltage probe accessory gives you 1% accuracy at 25,000 volts

There's new high voltage protection on all ac/dc voltage ranges. The instrument will take transients up to 6 KV, 10 μseconds wide over a duty cycle of 60 per second.

## Get the most up-to-date instrument available.

Don't be caught in the typical trap. Many electronic service shops don't really update their equipment when they decide to update. Switching to a TVM or a FET voltmeter doesn't really give you the accuracy and resolution you need today, or for that matter, tomorrow.

But with the 8000A on hand, you know you have a *true* solid state testing device.

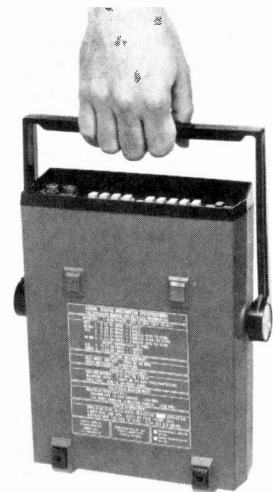

Carry it anywhere. Use it on line or with optional rechargeable battery power (\$50 extra). Note the conveniently mounted specs on the bottom decal.

It costs just \$299 (\$40 more with HV probe). \* And it is far and away the largest selling, most rugged and reliable 3 1/2 digit multimeter in the world.

\* Domestic only.

For data out today, dial our toll-free hotline, 800-426-0361

# FLUKE

John Fluke Mfg. Co., Inc.  
P. O. Box 43210, Mountlake Terrace, WA 98043  
for more information circle 118  
for a demonstration circle 119

# RCA TV 1976

By Joseph N. Zauhar

All RCA Color TV Models for the coming year will feature the familiar XL-100 chassis, which are available in five screen sizes\*

■ RCA's color TV line for 1976 is all solid state which was first offered in 1974, for increased emphasis on power consumption, safety and longer life.

The new "U-Line" includes 28 color TV receivers available in five screen sizes—15-, 17-, 19-, 21-, and 25-inch (measured diagonally). All models feature the familiar XL-100 chassis.

The same 31 kv CTC 68 chassis is employed on all of the 21-, and 25-inch picture size consoles.

This chassis design contains five IC's, which are employed in the TV receiver's AFT, Video IF,

*\*Immediately before press time we learned that RCA has introduced a completely new color TV chassis series called "Color Trak", most of the circuitry of which is contained on only six modules, exactly half the number of modules employed in previous XL-100 chassis. (See News Of The Industry, this issue.) A complete analysis of this new chassis series and related features will be published in the December issue of ET/D.*

sound and color stage. Twelve plug-in Accu Circuit modules provide the functions for the TV set and simplify servicing of the chassis.

Other highlights for the new line include:

There will be less plastic and more multi-ply hardwood and selected hardwood solids in the consoles' units.

A special feature on most models is a lighted "window" indicator with large bright numerals in a jet black crystal for easier reading of the TV channel selected.

The labor warranty is reduced to 90 days of coverage, while replacement parts carry one year warranty and the picture tube is supplied for two years.

## CTC68 Color TV Chassis

The familiar CTC68 chassis will be employed in 29 of the "U-Line" console and table model TV sets. Some of the TV models will feature digital channel indicators, first introduced last year.

Channel indication is accomplished by using seven-segment, gas-discharge lamps. The same lamp-pair-unit (one used for "tens," the other for "units"), indicates both VHF and UHF channels.

A pair of neon lamps, separate from the channel number lamps, are used to indicate VHF or UHF mode of operation.

Electrically, the CTC68 chassis used this year is very similar to the chassis employed in last year's TV models. One change of importance was made in the PW400 deflection board which now uses a single-sided copper pattern which was first produced during 1974.

Another circuit change of interest is the new MAK001C IF module which provides improved performance for optimum picture quality in the XL-100 model TV sets for 1976. The new IF module also will be used in all other XL-100 TV sets. Of importance to the TV service technician is the fact that the *noise* control setting is less critical on the TV sets equipped with the module, than in chassis using previous module versions.

Other than the changes on this module it is physical and electrically interchangeable with the earlier "B" module.

## CTC 71 Color TV Chassis

The CTC 71 chassis, which was introduced in March 1975, is employed in the Model FX465W color TV set. This XL-100 chassis is designed for use in non-remote 19-inch (diagonal) table model TV sets. Resembling the CTC 76 chassis, the CTC 71 chassis employs a transistorized horizontal deflection system which drives the deflection yoke and develops 27 kv for the second anode of the color picture tube.

### Horizontal Output Voltage Regulator

The high voltage output produced by a TV receiver is determined by two factors—the AC line voltage and the beam current. If we did not have high voltage regulation, and with a set load, the high voltage produced will be proportional to the AC line voltage.

The high voltage tripler system employed in the CTC 71 chassis minimizes load-induced voltage

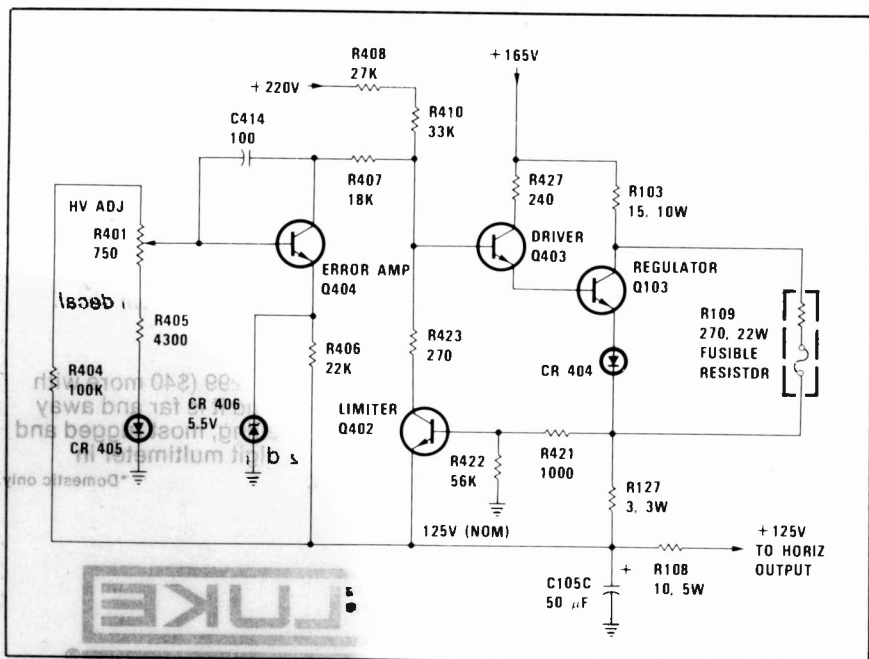

Fig. 1—Horizontal output voltage regulator system employed in the CTC71 color TV chassis.

changes. It is only necessary to provide regulation to counteract line voltage changes. This regulation is provided by the series regulator system shown in Fig. 1.

The operation of the series regulator is quite easy to follow. Regulator transistor Q103 acts as an electronically variable resistor which is unregulated and the load, which in this circuit is the horizontal output stage. The conduction of transistor Q103 is controlled under all operating conditions and the voltage drop across the transistor is equal to the difference between the desired +125 volt horizontal-deflection supply voltage and the unregulated B+ source voltage. To reduce the power dissipated in the regulator transistor the device is paralleled by a 270-ohm, 22-watt fusible resistor, R109.

Transistor Q103 is controlled by two additional stages, which includes transistor Q404, the error amplifier, and transistor Q403, the regulator driver stage. In action, a sample of the +125 volt output is applied to a voltage divider network consisting of resistors R404, R401, R405, and diode CR405. This network cancels the temperature-induced voltage drifts. The emitter of transistor Q404, the error amplifier is clamped at 5.5 volts by zener diode CR406. The collector voltage of Q404 is determined by the setting of *high voltage adjustment* control R401. As shown in the simplified schematic Fig. 1 the base voltage of transistor Q404 must be approximately +6.1 volts before it conducts. Because the emitter voltage is clamped, the gain of transistor Q404 is relatively high, which will cause it to go from cutoff to saturation with a very small amount of voltage change at its base. The emitter-follower driver transistor Q403 receives its base bias from the collector circuit of transistor Q404. The conduction of the driver transistor and the conduction of the regulator transistor Q103 will then increase or decrease by the change in the collector voltage of error amplifier Q404.

During regulation of the horizontal-output stage B+, a slight increase in the +125-volt supply, for example, causes a corresponding increase in the transistor conduction, lowering its col-

lector voltage, which in turn is translated into reduced conduction of the driver and regulator transistors. The tendency for the +125-volt supply to increase in voltage is counteracted by reduced conduction of the regulator transistor.

### Overload Protection

The regulator circuit is protected against overloads by a current-limiter stage employing transistor Q402. As shown in the horizontal output voltage regulator circuit Fig. 1, the base bias for Q402 is obtained by sampling the voltage drop across a 3-ohm resistor, R127. As you may recall that a silicon transistor will not conduct until its base/emitter voltage exceeds .6 volts. The voltage drop afforded by the base-bias network consisting of R421 and R422, the actual threshold of Q402 conduction occurs at about 275 ma, which is approximately the load current at zero beam current. With increased picture tube beam current, (increased brightness), the B+ load current increases from about 275 ma to about 750 ma, increasing the voltage drop at R127. also, the base drive is increased to the limiter transistor Q402, causing its collector current to increase. At the same time, the collector current of Q404 decreases in an equal amount, as it acts to maintain a constant base voltage for driver-transistor Q403.

As the load current approaches

750 ma, the error amplifier cuts off and no longer maintains a constant voltage at the base of Q403. When this action takes place, the increasing collector current of limiter transistor Q402 drives the base voltage of Q403 lower and lower, so that with the increasing load current the voltage drop across R127 finally forces current-limiter transistor Q402 into saturation. As this action occurs, driver transistor Q403 and regulator transistor Q103 are cut off. Then the load current is limited to a maximum of about 550 ma as determined by the series resistance of R103, R109, R127, and R108.

Other features of the Model FX465W TV set include AFT and a 70-position detent UHF tuner with digital channel indication. A KRK 199 VHF tuner and a KRK 207 UHF tuner is employed with this model.

### CTC72 Color TV Chassis

The "U-Line" 15- and 17-inch (diagonal) color TV sets employ the familiar CTC72 chassis. This chassis is designed to be used in conjunction with RCA's "P.I.L." in-line-gun color picture tube.

The CTC72 chassis is a "hot chassis" Fig. 2 using a fullwave bridge rectifier to produce the 160-volts B+ for the horizontal deflection circuit, and all other chassis voltages are obtained from the high voltage transformer through auxiliary windings and rectifier circuits.

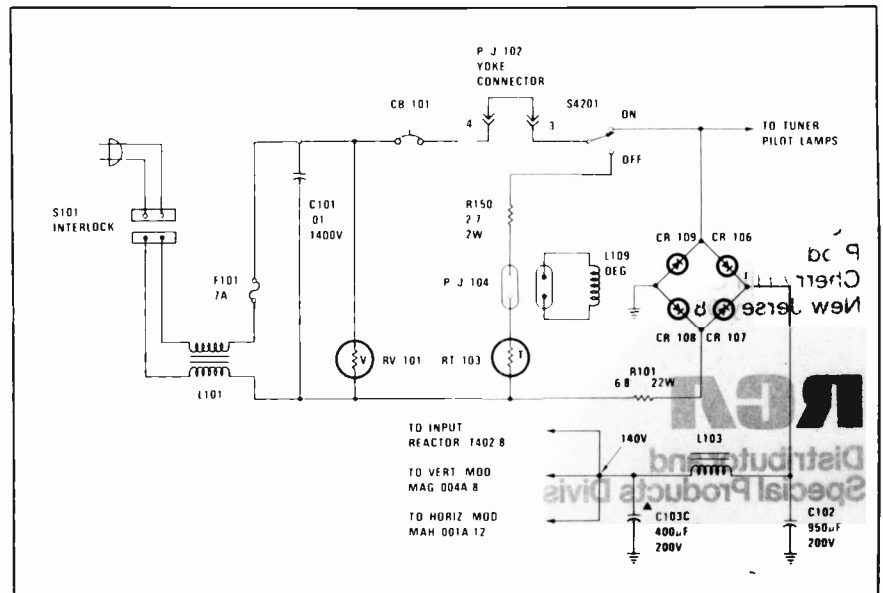

Fig. 2—Power Switching circuit used in the CTC72 chassis. A fullwave bridge rectifier is employed to produce the 160 volts B+ for the horizontal deflection stage.

# Everything we make has you in mind.

When you're looking for profitable electronic lines, look to RCA Distributor and Special Products Division:

## TEST EQUIPMENT & ACCESSORIES

## EXACT REPLACEMENT PARTS

## SK REPLACEMENT SEMICONDUCTORS

## FLAMEPROOF RESISTORS

## COLOR & BLACK-AND-WHITE PICTURE TUBES

## RECEIVING TUBES

## INDOOR & OUTDOOR ANTENNAS

## ANTENNA HARDWARE

## ANTENNA ROTATORS

## CAR RADIOS & TAPE PLAYERS

## STEREO SPEAKER SYSTEMS

## SCANNERS

## BATTERIES

## ... AND MORE

See your RCA distributor. Or, for more information, contact RCA Distributor and Special Products Division, Bldg. 206-2 Cherry Hill Offices, Camden, New Jersey 08101.

**RCA**  
Distributor and  
Special Products Division

A conventional single-pole-double-throw switch is used in the AC input circuit to the power-supply rectifier. When the power switch is *on*, line voltage is applied to the B+ rectifier and when the power is *off* the switch transfers AC power to the degaussing circuit.

It is very important to use an isolation transformer when the chassis is exposed or when being serviced. The chassis will remain "hot" with respect to ground regardless of which way the AC line cord is polarized.

Electrically, the CTC72 chassis is quite similar to the CTC62 chassis which it replaces; the only difference is that the Instant-Pic feature has been eliminated for power conservation.

### CTC76 Color TV Chassis

Seven new models (including one remote) are equipped with the continuing CTC76 chassis which is designed to be used with a 19-inch (diagonal) color picture tube. This chassis, employs a transistorized horizontal deflection system, which evolved from the previous CTC60 and CTC70 chassis.

The remote control model features the familiar CTP 22/CRK 19 remote system to provide remote control of the *channel-change* and *volume/on off* functions. A 20-position detent tuning system is used in conjunction with a familiar detent VHF tuner and a varactor UHF tuner to allow selection of any VHF channel and up to eight preselected UHF channels.

### B/W TV

RCA's b/w television line for 1976 is completely redesigned, all solid state and includes TV sets which can be played on house current, or from a rechargeable, built-in battery.

Eleven models are included in the May introduction of the "U-Line" TV receivers. The line features new styling and a variety of models in four screen sizes—9-, 12-, 16-, and 19-inch (measured diagonally).

The May introduction models employ one of two solid state chassis. They both use three plug-in Accu Circuit modules for ease of servicing. Also included in all of the models is a fast warm-up picture tube providing a picture

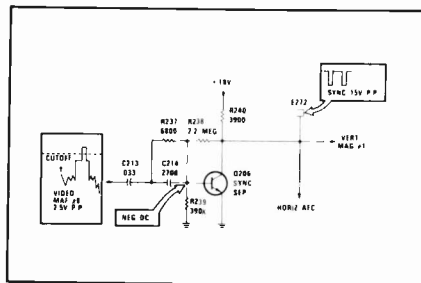

Fig. 3—The sync-separator circuit used in RCA's KCS201 chassis is a "text book" circuit.

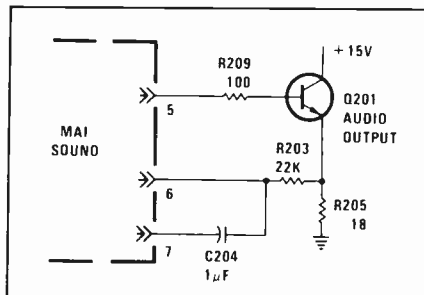

Fig. 4—AC/battery version of the audio output stage of the KCS201 chassis.

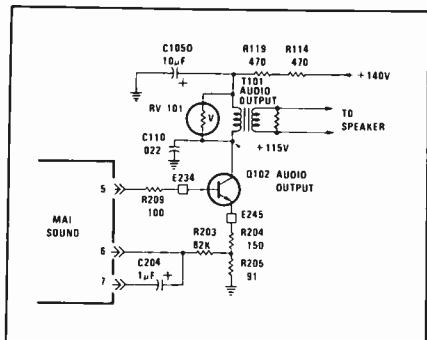

Fig. 5—AC version of the audio output stage of the KCS201 chassis. Illustrations supplied through the courtesy of RCA.

within approximately six seconds after the TV set is turned *on*.

All models are equipped with the "New Vista 100" VHF tuner employing two MOS transistors (RF amplifier and mixer) for improved gain in fringe area operation.

All models feature the familiar 70-detent UHF tuning system and a dual-function VHF/UHF antenna which eliminates the need for a separate UHF ring antenna.

### KCS 201 Chassis

The small screen TV receivers (9-inch and 12-inch diagonal) are equipped with one of four versions of the KCS201 chassis.

Two chassis variations include provisions for a group of 9-inch and 12-inch models that are powered from the AC line, an internal rechargeable battery pack, or an external rechargeable battery

*continued on page 47*

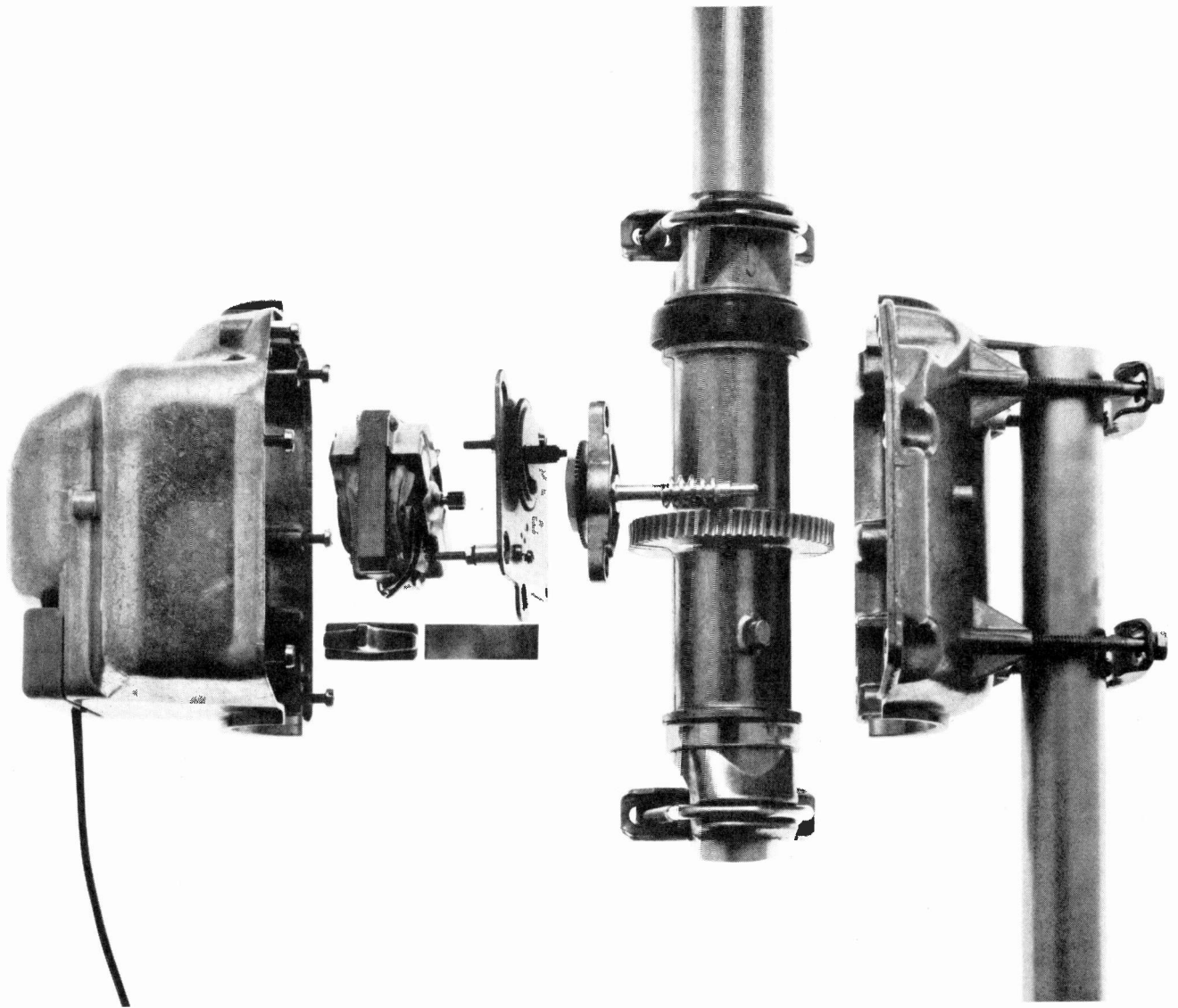

**“RCA warrants this product against defects in materials and workmanship for a period of two years from date of purchase...”**

**RCA's Selecta-Channel Automatic Rotator carries the only 2-year warranty from a major company.**

The Drive Unit for model 10W606 (shown above) features an easily removable high-tensile aluminum alloy housing. Inside, a powerful high efficiency motor. Permanently lubricated oversize stainless steel bearings — no external thrust bearings are required. Quick-connect pressure terminals. A new mast mounting that won't snag lead-in wires. Premounted hardware, and a reinforced shaft.



The Control Unit is an attractive chrome-trimmed beige, with cushioned base. The transparent "direct select" control knob has a moving direction indicator light showing the antenna's exact position. And, it's quiet: no click-clack sound.

For more information on the 10W606 or the deluxe Automatic Rotator 10W707, call your RCA Distributor. Or contact RCA Distributor and Special Products Division, Building 206-2, Cherry Hill Offices, Camden, New Jersey 08101.

**RCA**  
**Rotators**

# COLOR TV MODULE GUIDE

## Zenith G-Line Color Chassis

Ch.	Defl.	H.V.	IF	L.L.	Vid. Out	AGC	Snd.	Chroma	Vert.	Horiz.	Pwr.
13GC10	110	25	150-190	9-88-02	9-121	9-87	9-107-01	9-86-01	9-120	9-90-01	9-122
17GC45	90	26	150-190	9-88-02	9-89	9-87	9-107-01	9-86-01	9-92	9-90	9-123
19GC38	90	26	150-115	9-88-01	9-89	9-87	9-103-01	9-86-01	9-92	9-90	9-123
19GC48	90	26	150-190	9-88-01	9-89	9-87	9-103-01	9-86-01	9-92	9-90	9-123
19GC45	90	30	150-190	9-88-01	9-89	9-87	9-103-01	9-86-01	9-92	9-90	9-123
19GC45Z	90	30	150-401 SWIF	9-88-01	9-89	9-87	9-103-01	9-86-01	9-92	9-90	9-123
19CC50	90	30	150-190	9-88-02	9-89	9-87	9-103-01	9-86-01	9-92	9-90	9-123
19GC50Z	90	30	150-401 SWIF	9-88-02	9-89	9-87	9-103-01	9-86-01	9-92	9-90	9-123
19GC46	90	26	150-190	9-88-01	9-89	9-87	9-103-01	9-86-01	9-92	9-90-02	9-123
23GC45	90	30	150-190	9-88-02	9-89	9-87	9-103-01	9-86-01	9-92	9-90	9-123
25GC45	90	30	150-190	9-88-02	9-89	9-87	9-103-01	9-86-01	9-92	9-90	9-123
25GC50	90	30	150-190	9-88-02	9-89	9-87	9-103-01	9-86-01	9-92	9-90	9-123

# Don't bury your livelihood...

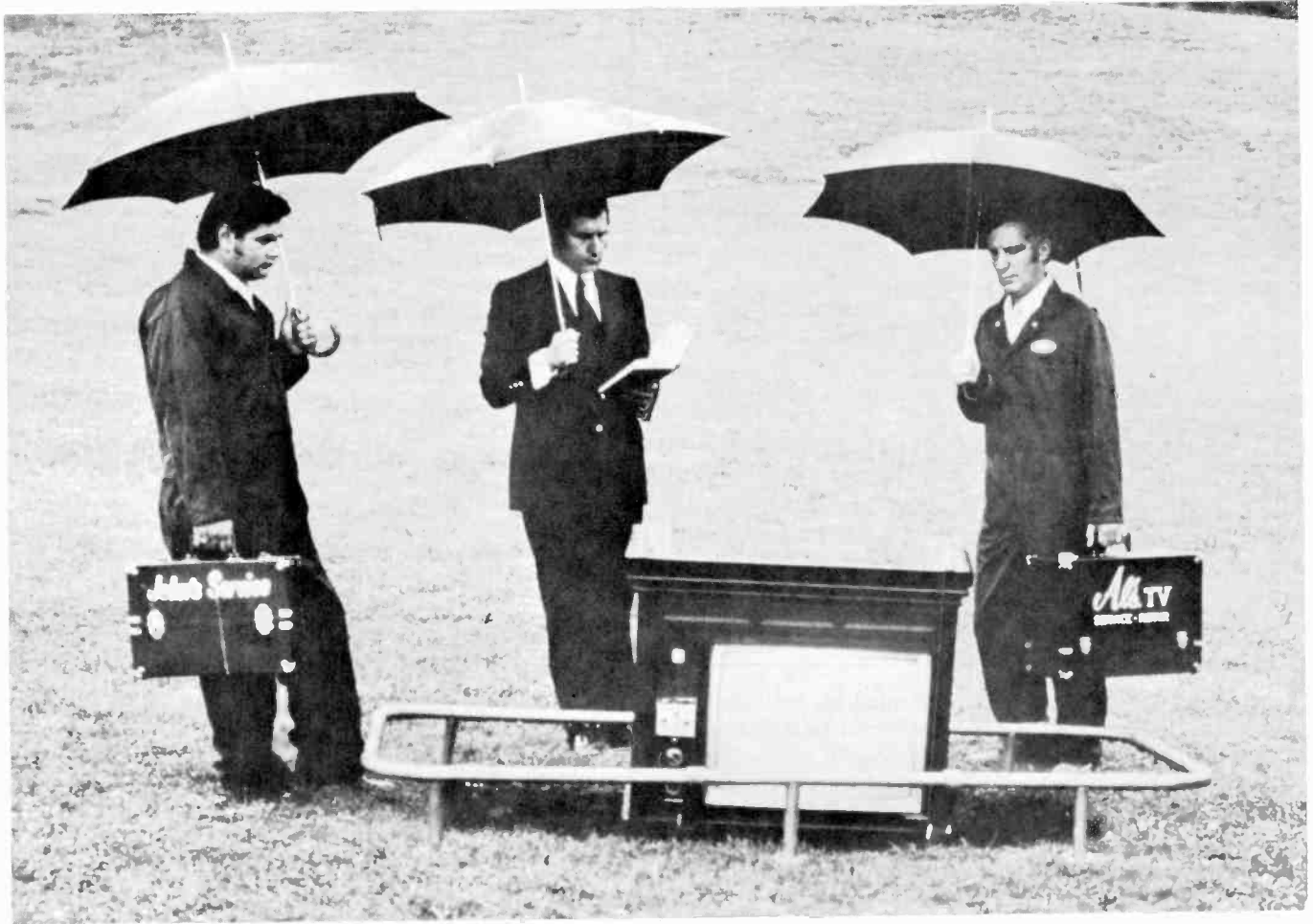

## SAVE THE SET! and save your business with

### *Channel Master* LIFETIME WARRANTY\* **OPTI-VUE PLUS**

You're a serviceman—no one needs to tell you that your business is in danger because of:

- Solid state and modular technology that reduce the amount of servicing needed in any set.
- Consumer willingness to scrap sets, rather than replace dead or dying CRT's.
- Mass merchandisers with service departments, stealing your customers.

It's more important than ever for you to save your service business by saving TV sets.

Give your customers a better reason to keep their sets alive: Channel Master OPTI-VUE PLUS replacement CRT's with \*3 Year Warranty PLUS Guaranteed Replacement Discount for the life of the set.

\*This is a limited warranty; labor not included.

**Channel Master** Division of Avnet, Inc., Ellenville, New York 12428

...for more details circle 115 on Reader Service Card

# TECHNICAL DIGEST

## ADMIRAL

### Color TV Chassis K18—Replacement Focus Module 61A66-2

Two different types of 61A66-2 focus modules were used in the K18 chassis; they are electrically identical but differ in their lead arrangements. The type 2 which Admiral

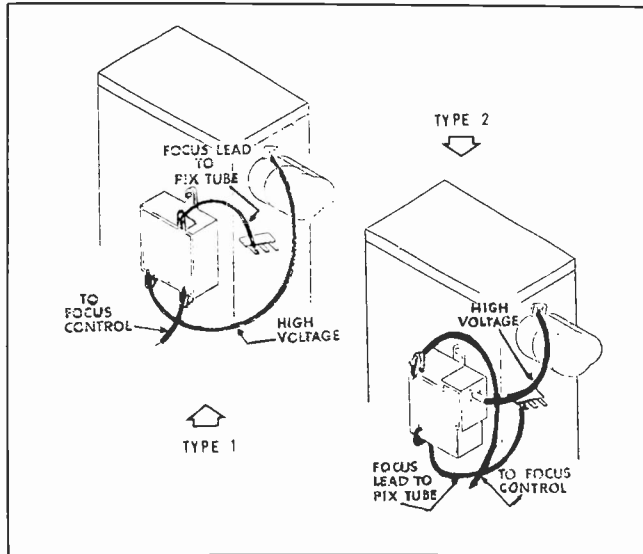

currently supply for replacement must be mounted with the high voltage lead at the upper right as shown in the drawing, to provide adequate lead length.

### Color TV Chassis T15K10/16K10—Loss Of Vertical Or Horizontal Sync

A symptom of no vertical or horizontal sync, or horizontal weave in the picture can be caused by a defective CB66 capacitor (.05 mfd, 50 v).

In some cases, the sync problem may only appear when

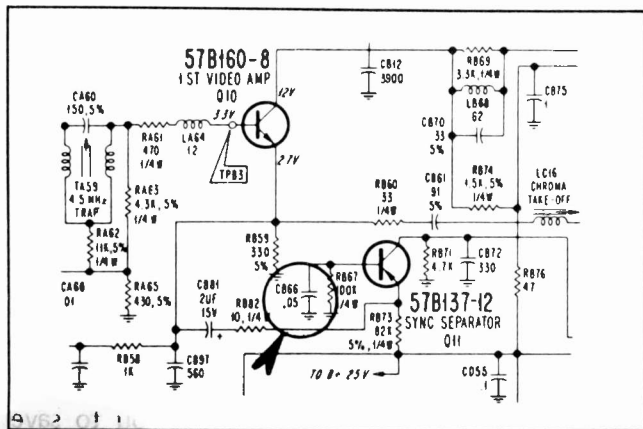

the set is first turned on; as the set warms up, the sync improves.

To correct the problem replace capacitor CB66, .05 mfd ceramic disc, with a .047 polyester film capacitor, part number 64A43-11 as used in later production models.

### Color TV Chassis T40K10 Series—Horizontal Tearing And/Or Poor Sync

A symptom of horizontal tearing and/or poor horizontal sync can be caused by improper second anode lead dress.

The second anode lead can be dressed too near to the components on the high voltage transformer; namely, resistors RH136 and RH138, and capacitor CH137.

The set may lock in satisfactorily on a strong signal but

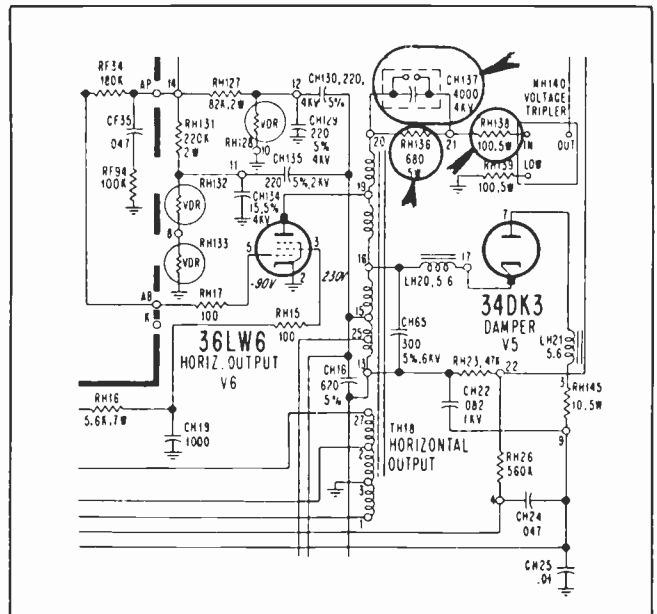

not on a weaker channel—the horizontal oscillator may be off frequency.

To correct the problem redress the second lead away from the mentioned components.

## GENERAL ELECTRIC

### Color TV Chassis CD—Production Changes RGB Screen Control Circuit

TV sets with serial numbers beginning with 5Z1T—and later, contain a new triple pot screen control assembly which has 1 megohm wiper circuit resistances (R559, R562, R564) built into the control. No external 1 megohm

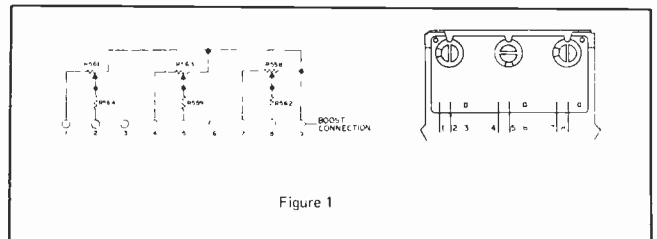

Figure 1

resistors are necessary with this type of control, shown in the illustration Fig. 1.

Each section of this triple pot has only two terminal legs which mount into the circuit board. The third leg of each potentiometer section has been removed. Interconnection between control sections is accomplished internally. The boost B+ line connect directly to a separate solder tab on the control. A piece of buss wire is inserted into the circuit board in place of each of the 1 megohm resistors R559, R562, R564, to provide circuit continuity. The electrical circuitry remains the same as in earlier C chassis receivers as shown in Fig. 2.

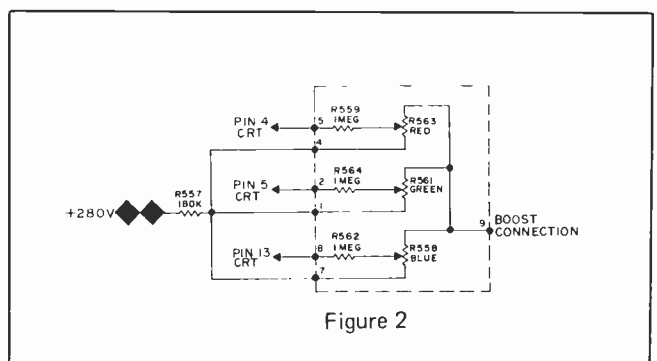

Figure 2

HOME ENTERTAINMENT ELECTRONICS



The catalog number for this new screen control is EP49X247. It should be used in all C chassis sets with serial numbers beginning with 5Z1T-----and later.

#### Model CCD7322 RGB Screen Control

For a short period during production (Serial Code 5S3T----through 5V4T-----), contract model CCD7322WD contained a special screen control assembly. This special assembly was actually a modified EP49X33 control. One terminal leg was removed from each control section, and jumper wires were soldered to the control terminals to provide interconnection between the sections. The boost voltage line was wired directly to the control. Wiper circuit resistors R559, R562, R564 (1M) were attached directly to their respective sections. The opposite end of each resistor was soldered into the circuit board.

Use an EP49X247 control to replace this special assembly and proceed as follows:

1) Remove the old screen control assembly and the three 1 megohm (R559, R562, R564) attached to it, and install the new EP49X247 control.

2) Insert and solder a piece of wire into the circuit board in place of each of these three resistors. This provides circuit continuity to the resistances built into the new control.

#### Color TV Chassis CB—Replacement Parts—EU77X16 High Voltage Transformer Assembly (Includes EU77X4, ET77X93, ET77X91) and EU77X15 High Voltage Transformer Coil and Pulse Windings (Includes EU77X3, ET77X88, EU77X88)

Some pulse windings in the above listed assemblies were wound in reverse. Installed in a set, they will create convergence and/or color sync problems because the pulse will be negative going rather than positive going. The assemblies in General Electric's present stock are wound correctly, but you may have one on the shelf which is wound in reverse. Using the following procedure, you can check the coil before installing it in a receiver. Refer to Fig. 1.

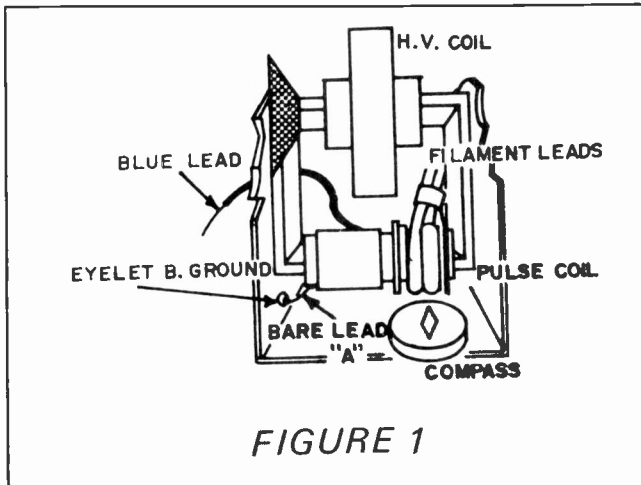

FIGURE 1

- 1) Place a small compass near the filament leads.
- 2) Connect the negative lead of a 1.5 volt battery to the metal frame of the high voltage transformer assembly.
- 3) Touch the blue pulse coil lead to the positive end of the battery.

If the coil is wound correctly, the South end of the needle will point to the filament leads; if it is wound in reverse, the North end of the needle will point to the filament leads.

You can correct a reverse wound coil as follows (refer to Figures 2 and 3):

- 1) Unsolder the bare lead "A" from eyelet "B".
- 2) Cut the blue lead 1/2 inches from the coil. Strip the end of the piece still attached to the coil and solder it to eyelet "B".
- 3) Connect an 8 inch piece of insulated wire to the bare lead "A". Solder the connection and press it close to the coil. Wrap

*continued on page 48*

## Brand new edition of an RCA best seller.

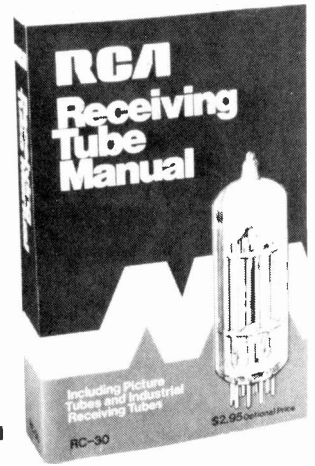

One of the most widely-used manuals in the electronics industry, the RCA Receiving Tube Manual, is now available in a new, updated edition, especially designed for use by technicians, engineers, educators, students and electronic hobbyists.

With 754 pages of tube information, the new manual — RC-30 — includes chapters on basic principles of operation, electrical characteristics, and circuit applications. It also features terminal diagrams, picture tube characteristics chart, and an updated receiving tube replacement guide.

Ask your RCA distributor for a copy of the new RC-30 at only \$2.95 (suggested price). Or send your check or money order for \$2.95 (plus 50¢ for postage and handling per order) to: RCA Distributor and Special Products Division, P.O. Box 85, Runnemede, N.J. 08078.

## RCA Distributor and Special Products Division

...for more details circle 165 on Reader Service Card

## The Money Generator



### A BETTER APPROACH TO TV ANALYZING

The ATC-10 is different from other color bar pattern generators. It's like a portable test lab with the versatility to perform the most commonly used functions of an analyst and a substitute tuner. It's a time saver for both in-home and on-the-bench servicing. That's why we've nicknamed it the MONEY GENERATOR. Since it takes more than a few words to describe the ATC-10's many unique features, we'd like to send you our big 4 page illustrated brochure.

This brochure tells you about the ATC-10's unique patterns which include RED RASTER, 3.58 MONITOR, GRAY QUAD, and HATCHDOTS. It also describes some unusual test capabilities such as: •A full range of crystal controlled RF, IF, and video injection signals •Receiver sensitivity and dynamic range checks using the calibrated RF output control •Fast accurate purity and 3.58 oscillator checks with no need to disable guns or short test point(s) •Extra clear oscilloscope and vector patterns •In-home receiver bandpass checks at 60 Hz, 1.78 MHz, and 3.56 MHz •Complete convergence series using a single composite pattern (all of these and many more for only \$299.95.)

The brochure is free, but, if you'd like still more information on the operation of the ATC-10, you can obtain a copy of the 2 volume (home-shop) owner's manual. Just include \$1.00 for postage and handling. Act now and evaluate for yourself the many ways the ATC-10 can be a real MONEY GENERATOR for you.

Mail Request To: **AMERICAN TECHNOLOGY CORP.**  
Dept. 10B, Canon City, CO 81212

Name \_\_\_\_\_  
Address \_\_\_\_\_  
City \_\_\_\_\_  
State \_\_\_\_\_ Zip \_\_\_\_\_

...for more details circle 109 on Reader Service Card

# An Extraordinary Offer

to introduce you to the benefits of Membership in  
**ELECTRONICS BOOK CLUB**  
for a limited time only you can obtain

**THIS  
GIANT  
448-Page**

**TV Troubleshooter's Handbook**

for  
only

**49¢**  
WITH  
TRIAL  
MEMBER-  
SHIP

May we send you this helpful new book as described on the facing page as part of an unusual offer of a Trial Membership in Electronics Book Club?

This is a quality hardbound volume, especially designed to help you increase your know-how, earning power, and enjoyment of electronics.

This handsome, hardbound book is indicative of the many other fine offerings made to Members . . . important books to read and keep . . . volumes with *your* specialized interests in mind.

Whatever your interest in electronics—radio and TV servicing, audio and hi-fi, industrial electronics, communications, engineering—you will find Electronics Book Club will help you.

With the Club providing you with top quality books, you may broaden your knowledge and skills to build your income and increase your understanding of electronics, too.

### How You Profit from Club Membership

This special offer is just a sample of the help and generous savings the Club offers you. For here is a Club devoted exclusively to seeking out only those titles of direct interest to you. Membership in the Club offers you several advantages.

**1. Charter Bonus:** Take "TV TROUBLESHOOTER'S HANDBOOK" . . . publisher's list price \$8.95 . . . for only 49¢ with your Trial Membership.

**2. Guaranteed Savings:** The Club guarantees to save you 15% to 75% on all books offered. All books are offered at low Member prices (plus a small shipping charge).

**3. Continuing Bonus:** If you continue after this trial Membership, you will earn a Dividend Certificate for every book you purchase. Three Certificates, plus payment of the nominal sum of \$1.99, will entitle you to a valuable Book Dividend which you may choose from a special list provided members.

**4. Wide Selection:** Members are annually offered over 50 authoritative, new books on all phases of electronics.

**5. Bonus Books:** If you continue in the Club after fulfilling your Trial Membership, you will receive a Bonus Dividend Certificate with each additional Club Selection you purchase. For the small charge of only \$1.99, plus three (3) Certificates, you may select a book of your choice from a special list of quality books periodically sent to Members.

**6. Prevents You from Missing New Books:** The Club's FREE *News* gives you advance notice of important new books . . . books vital to your continued advancement.

This extraordinary offer is intended to prove to you, through your own experience, that these very real advantages can be yours . . . that it is possible to keep up with the literature published in your areas of interest . . . and to save substantially while so doing.

### How the Club Works

Forthcoming selections are described in the FREE *Club News*, published thirteen times a year. Thus, you are among the first to know about, and to own if you desire, significant new books. You choose only the main or alternate selection you want (or advise if you wish no book at all) by means of a handy form and return envelope enclosed with the *News*. As part of your Trial Membership, you need purchase as few as four books during the coming 12 months. You would probably buy at least this many anyway . . . without the substantial savings offered through Club Membership.

### Limited Time Offer!

Here, then, is an interesting opportunity to enroll on a trial basis . . . to prove to yourself, in a short time, the advantages of belonging to Electronics Book Club. We urge you, if this unique offer is appealing, to act promptly, for we've reserved only a limited number of books for new Members.

To start your Membership on these attractive terms, simply fill out and

mail the postage-paid airmail card today. You will receive "TV TROUBLESHOOTER'S HANDBOOK" for 10-day inspection.

**SEND NO MONEY!** If you are not delighted, return it within 10 days and your Trial Membership will be cancelled without cost or obligation. Electronics Book Club, Blue Ridge Summit, Pa. 17214.

### Typical Savings Offered Club Members on Recent Selections

<b>Pract. CB Radio Troubleshooting &amp; Repair</b>	List Price \$8.95; Club Price \$5.95
<b>2nd Class FCC Encyclopedia</b>	List Price \$10.95; Club Price \$7.95
<b>Color TV Case Histories Illustrated</b>	List Price \$8.95; Club Price \$5.95
<b>The Complete Auto Electric Handbook</b>	List Price \$8.95; Club Price \$5.95
<b>Computer Programming Handbook</b>	List Price \$12.95; Club Price \$8.95
<b>Transistor Theory for Tech. &amp; Engineers</b>	List Price \$8.95; Club Price \$5.95
<b>Jack Darr's Service Clinic No. 3</b>	List Price \$7.95; Club Price \$4.95
<b>Color TV Studio Design &amp; Operation</b>	List Price \$9.95; Club Price \$6.95
<b>Adv. Applications for Pocket Calculators</b>	List Price \$8.95; Club Price \$5.95
<b>Comp. Handbook of Lawnmower Repair</b>	List Price \$9.95; Club Price \$7.95
<b>Integrated Circuits Guidebook</b>	List Price \$8.95; Club Price \$5.95
<b>Radio Control for Models</b>	List Price \$9.95; Club Price \$6.95
<b>Radio Astronomy for the Amateur</b>	List Price \$8.95; Club Price \$5.95
<b>111 Digital &amp; Linear IC Projects</b>	List Price \$8.95; Club Price \$5.95
<b>Auto Electronics Simplified</b>	List Price \$8.95; Club Price \$5.95
<b>The Complete FM 2-Way Radio Handbook</b>	List Price \$9.95; Club Price \$6.95
<b>RCA Color TV Service Manual—Vol. 3 &amp; 4</b>	List Price \$17.90; Club Price \$8.95
<b>Introduction to Medical Electronics</b>	List Price \$9.95; Club Price \$6.95
<b>Basic Digital Electronics</b>	List Price \$7.95; Club Price \$4.95
<b>Auto Stereo Service &amp; Installation</b>	List Price \$8.95; Club Price \$5.95
<b>Effic. Troubleshooting with EVM &amp; Scope</b>	List Price \$8.95; Club Price \$5.95
<b>Modern Communications Switching Sys.</b>	List Price \$17.95; Club Price \$13.95
<b>Pract. Circuit Design for the Experimenter</b>	List Price \$8.95; Club Price \$4.95
<b>Installing TV &amp; FM Antennas</b>	List Price \$7.95; Club Price \$3.95
<b>Sears Color TV Service Manual</b>	List Price \$8.95; Club Price \$5.95

**SEND NO MONEY!** Simply fill in and mail postage-paid Airmail card today!

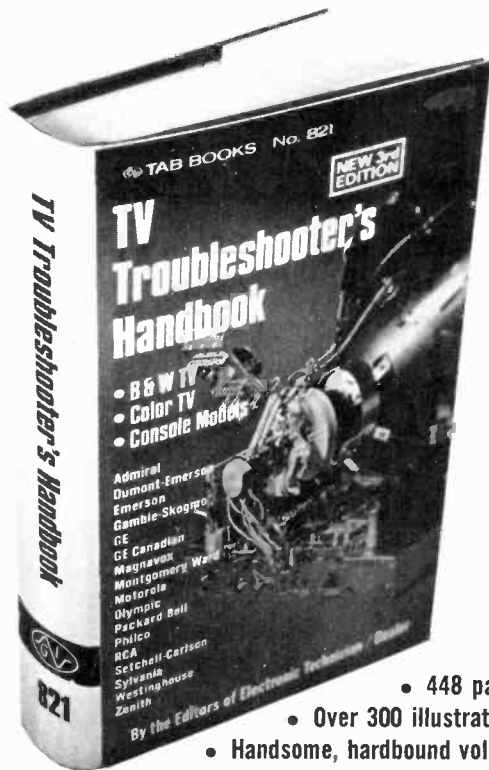

# TV TROUBLE-SHOOTER'S HANDBOOK

## 3rd EDITION

*A GIANT quick-reference, fingertip source-book for hundreds of tried-and-tested solutions to "tough-dog" TV troubles. Thumb-indexed for instant reference!*

- 448 pages
- Over 300 illustrations
- Handsome, hardbound volume

### Partial List of Contents

#### THUMB INDEX

##### ADMIRAL

Black and White; Color; Console Models

##### DUMONT-EMERSON

Black and White

##### EMERSON

Black and White; Color

##### GAMBIE-SKOGMO

Black and White

##### GENERAL ELECTRIC

Black and White; Color; Console Models

##### CANADIAN GENERAL ELECTRIC

Black and White; Color; Console Models

##### MAGNAVOX

Black and White; Color; Console Models

##### MONTGOMERY WARD

Black and White

##### MOTOROLA

Black and White; Color; Console Models

##### OLYMPIC

Black and White; Color; Console Models

##### PACKARD BELL

Color

##### PHILCO

Black and White; Color; Console Models

##### RCA

Black and White; Color; Console Models

##### SETCHELL-CARLSON

Color

##### SYLVANIA

Black and White; Color; Console Models

##### WESTINGHOUSE

Black and White; Color

##### ZENITH

Black and White; Color; Console Models

#### LIST OF MANUFACTURERS INDEX

This completely new and up-to-the-minute third edition of one of the most popular TV handbooks ever published is 55% larger than the prior edition, and now provides coverage of consoles. This detailed compilation of practical help is the answer to the need for a well-organized file of troubles and proven cures, field factory changes, design modifications, circuit improvements, service notes, new and unusual circuits and descriptions of how they work, etc., for all major (and several minor) brands, from Admiral to Zenith. This brand-new edition represents the only known up-to-date digest of specific TV troubles and cures, for both color and monochrome sets, up to and including 1974 models. It also contains service data, schematics, special manufacturers' notes, etc., relating to the peripheral equipment found in TV consoles (such as tape players, phonos, FM and AM radios, combinations, etc.).

Despite its increased size and expanded content, you'll find this volume extremely easy to use: just put your thumb on the edge mark representing the TV brand of interest, and you instantly turn to the book section carrying the data you need. The contents of each Section are arranged according to TV type—there's no need to

plow through entries not applicable to your own individual needs. Black-and-white models in each section are grouped together, as are color chassis, and console equipment. For easy reference, all troubles are categorized by make and model. Included in the color TV section are hints for troubleshooting chroma circuits, making adjustments, etc. Once you have this book in your hands, you'll wonder how you managed to get by without it for so long.

If you've ever spent time chasing down a malfunction only to find that the schematic didn't agree with the circuit, you'll know the value of *TV Troubleshooter's Handbook*. In these times, we all need to take advantage of every timesaver we can—and if you're a practicing TV technician you already know the kind of time you save when you have a little inside info on a set that comes into your shop. This unique volume will be more valuable to you than any of its predecessors because it's more complete, is fully updated, and is easier than ever to use. It's like having a complete file on each major TV brand—all in a huge volume that's still small enough to fit in your tool-and-tube caddy. We absolutely guarantee it! 448 pps., over 300 illustrations. Hardbound. Publisher's list price \$8.95.

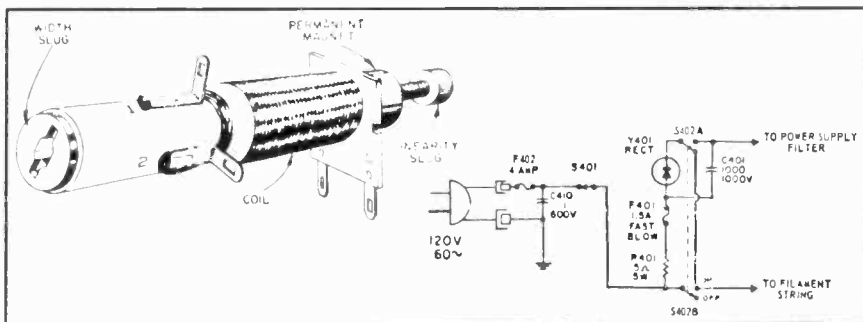

Literally hundreds of complete and partial schematics and illustrations make each of the thousands of entries in "TV Troubleshooter's Handbook" easy to understand.

# AN EXTRAORDINARY OFFER...

...for more details circle 113 on Reader Service Card

# Signal Seeking Tuners—

## Part II By Joseph J. Carr

Last month we analyzed the mechanical operation of the Delco signal-seeking car radio tuners, called "Wonder Bar" by Delco. In this final part of the series we shall discuss the electrical operation of a typical signal seeker radio

■ Shown in Fig. 1 is the DC amplifier used to control the signal seeker. Relay K1 is the same relay used to control the paddle wheel in the governor gear train and S1 is the actuate switch operated by depressing the "Wonder Bar" on the radio front panel. When the customer presses the bar, switch S1 closes and allows current to flow through the coil of relay K1. Three functions occur when the relay is energized. Contacts A1 and A2 are closed, the tang is removed from the paddle of the governor allowing mechanical action to commence, and contacts B1 and B2 are closed. This latter set of contacts turns on a special regulated power supply for the DC control amplifier. When the 8 VDC supply is activated, relay amplifier transistor, Q2, will become forward biased and will conduct current. This current causes a voltage drop across resistor R1 which is great enough to forward bias control amplifier transistor Q3. When Q3 begins to conduct, it will pass enough current to keep the relay energized, even though switch S1 is no longer closed. Normally, the customer's finger will keep the *Wonder Bar* depressed long enough for Q2 and Q3 to turn on (there is a time constant to all such circuits), and take over the relay holding function. Stopping of the signal seeker merely requires transistor Q2 to be cut off.

### AM Stopping Circuit

Trigger amplifier Q1 (Fig. 2) is biased just below the point where it would conduct current by an emitter-base potential of 0.4 volt. Signal samples from the AM IF amplifier are applied to diode D1, and the AM Trigger AGC circuit.

This signal action creates two currents, labeled I1 and I2, the sum of which forms an additional bias sufficient to turn Q1 on. This causes the collector potential of Q1 to drop suddenly to ground. Referring back to Fig. 1, we see the Q1 collector circuitry in detail. Capacitor C1 is charged through collector resistor R2, and pull-up resistor R3. When a signal appears in the AM IF amplifier stage, it causes trigger amplifier Q1 to saturate and this forces C1 to discharge. By dragging the collector end of C1 rapidly to ground, we will generate a large negative-going pulse across resistor R3, turning off relay amplifier Q2 and, in turn, control amplifier Q3.

If only one signal were used in the AM Trigger circuit, we would find the tuner stopping immediately upon encountering the lower sideband signals. The correct point to tune any receiver is dead center in the middle of the signal. To improve stopping accuracy on AM, the signal seeker actually triggers on the summation of two separate signals. As can be seen in Fig. 2, one of these signals is taken from the primary side of the second IF transformer and the other is derived in a similar manner from the secondary of the same transformer. Fig. 3 shows the relationship between these signals. Curve A is the signal across the secondary, while curve B is the primary signal. These signals are summed (Fig. 2) to produce a resultant curve C. This derived signal will produce a DC potential great enough to forward bias the trigger amplifier only when the radio is tuned to a certain critical frequency near the center of the signal. This is point 1 on curve C.

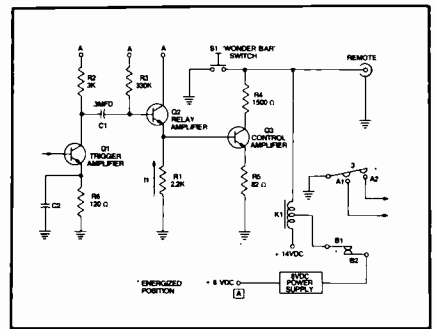

Fig. 1—DC amplifier circuit employed to control the radio signal seeker function.

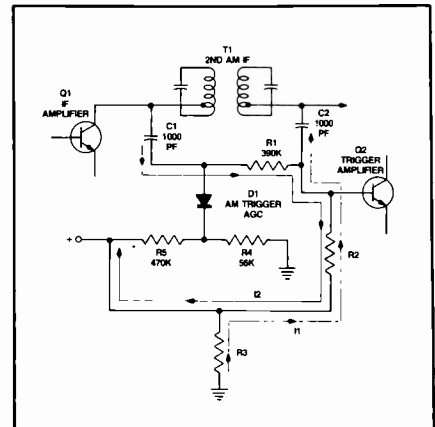

Fig. 2—Simplified schematic of the AM trigger circuit used to stop the signal seeking function.

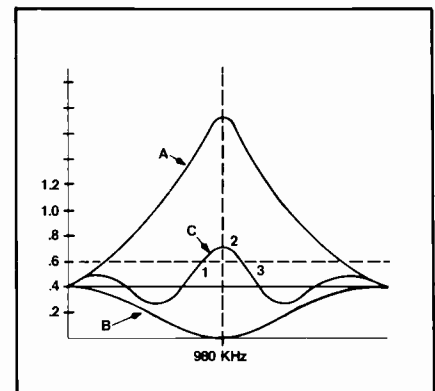

Fig. 3—Relationship of the two signal currents used to trigger the AM AGC trigger circuit.

The distance between this point and point 2, the actual center of the signal, is required to allow the relay to de-energize and drop the tang into the governor paddle wheel.

### FM Stopping Circuit

In previous FM auto radios, Delco employed some relatively sophisticated techniques to assure FM stopping accuracy in *Wonder Bar* equipped radios. Modern Delco receivers use a special Integrated Circuit Quadrature Detector (ICQD) for the FM stopping circuits. Delco numbers for this IC are DM-11 and DM-31, but they are functionally similar to the

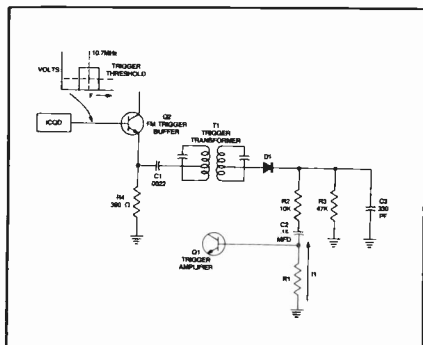

Fig. 4—FM stopping circuit employed in a selected Delco radio employing a signal seeking tuner.

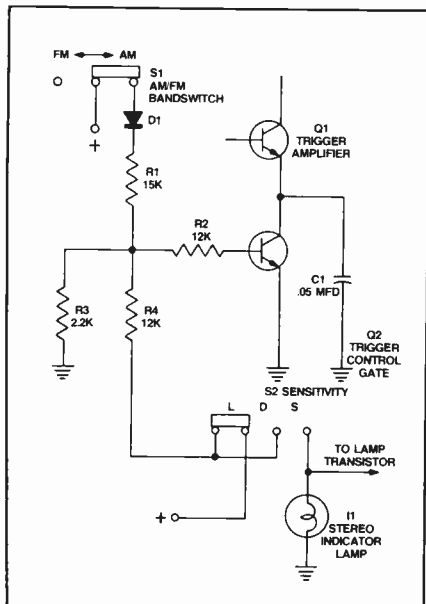

Fig. 5—Simplified schematic of the NAND gate circuit used to allow stopping only on FM stereo station signals.

MC1357P IC offered by Motorola Semiconductor Products Division. Fig. 4 shows the FM stopping circuit of the selected radio. Trigger Amplifier Q1 is the same transistor found in the same circuits shown in Fig.'s 1 and 2. The AM/FM bandswitch at the input of the trigger amplifier has been eliminated to simplify the circuit. Transistor Q1 is normally biased just below its point of conduction. The voltage delivered by the ICQD integrated circuit is nominally zero until an FM station signal is received in the passband circuits. When this occurs, the output voltage rises to a constant level where it remains as long as the station signal is being received. This signal is coupled through capacitor C1 and trigger transformer T1 to Diode D1, where it is rectified and used to charge capacitor C2. The charging action is very sudden and when it produces a current, I1

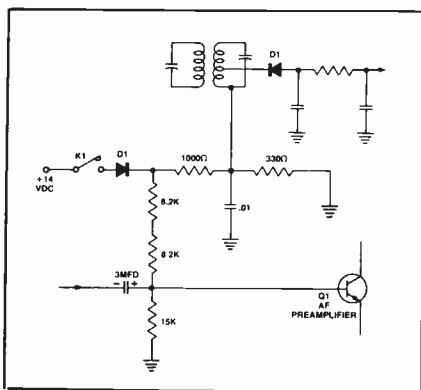

Fig. 6—The audio muting circuitry eliminates the "hash" noise while the signal seeking circuit is operating.

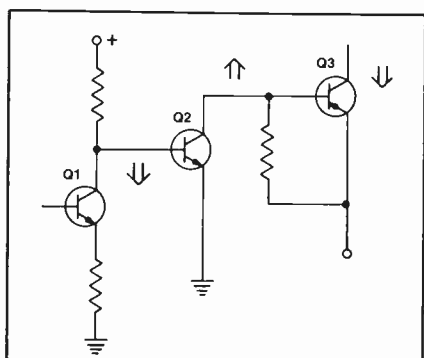

Fig. 7—Simplified schematic of the audio output stage, often referred to as a "See Saw" or "Teeter Totter" circuit.

current will begin to flow in resistor R1. The voltage drop created by this current is sufficient to drive Q1 into conduction and stop the signal seeker action.

### Stereo-Only Stopping Circuit

One position of the seeker *sensitivity* switch (Fig. 5) allows the seeker to stop only on FM stereo signals. This is accomplished by using a trigger control gate transistor Q2 in series with the DC emitter-ground path of Q1, the trigger amplifier covered earlier. This circuit forms a type of NAND gate since the collector of Q1 is grounded *only* when *both* Q1 and Q2 are forward biased. In the AM mode of the bandswitch, permanent forward bias is applied to the base of Q2 through a set of contacts on the switch. In the FM mode, transistor Q2 will be forward biased so long as the seeker *sensitivity* switch is in either *local* (L) or *distant* (D) positions. If the switch is in *stereo* position (S), Q2 will not be forward biased unless the stereo indicator lamp is turned *on*. This, of course, only happens when the receiver is tuned to a

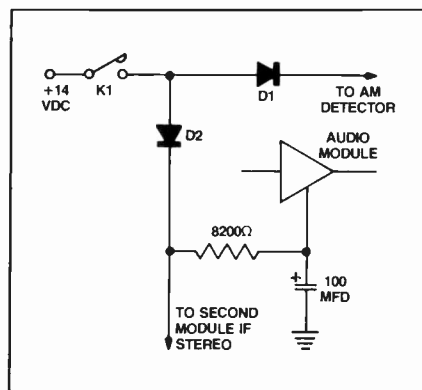

Fig. 8—Plastic, potted, circuit modules are employed in the audio preamplifier and driver stages.

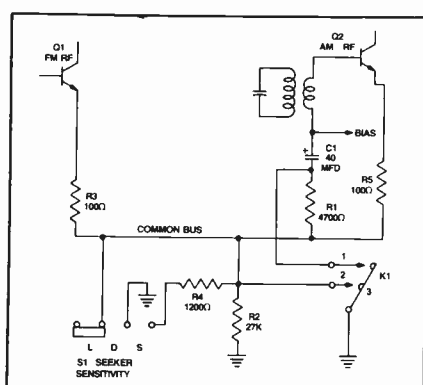

Fig. 9—Sensitivity circuitry employed in a typical signal seeker radio.

stereo station. The stopping accuracy criteria is the same as on FM monaural signal.

### Audio Muting Circuit

If signals were allowed to reach the speaker while the radio is seeking, it would create a messy sound normally expected of radios being tuned rapidly across a band of strong signals! This irritation is eliminated by employing muting circuitry in the seeker stage. An example of an older form of mute circuit is shown in Fig. 6 to give you an idea of how some of the newer, but harder to understand circuits operate. Transistor Q1 is the audio preamplifier transistor. When the seek relay K1 is energized, a set of contacts close and applies +14 volts to the anode of the muting diode D1. This voltage has two effects on the circuit. The first is to reverse bias the AM detector diode so that no signals can pass. The second effect is to saturate the audio preamplifier transistor Q. In the Delco audio circuit (Fig. 7), this causes the output transistor to cut off. This circuit is often called (slang) "seesaw" or "teeter totter" by many in the

continued on page 47

## CARR TALK

with Joseph J. Carr, ET/D Vehicular Electronics Editor

■ Elsewhere in this month's issue of ET/D we completed a two-part series about signal-seeking radios. At the end of the first part we covered two of the most common signal seeker mechanical troubles. To cover the topic more fully, we are going to devote this month's CARR TALK to some other common signal-seeker problems and their cures.

### Failure to Recoek

As the rack and PTM core bar reach the high-end stop of the dial, a switch is tripped which grounds one end of the recock solenoid. When the solenoid plunger snaps into the housing, it recocks the PTM and rack and also turns off the switch energizing the solenoid coil. Failure to recock can be caused by three problems: the switch is not being tripped, the switch is open (defective), or the solenoid is open.

Because the solenoid is wound with relatively heavy gauge wire, it rarely opens. Although the solenoid does open sometimes, shorted solenoids are far more likely, and these cause a different symptom. Troubleshooting this problem requires that you find the point where the solenoid wire connects to the switch. Momentarily ground this point (watch the fingers!) and note whether or not the solenoid fired. If it does, then check the switch adjustment. If the switch adjustment is correct, replace the switch.

### Jams at Mid-dial on Recoek

Two problems can cause this symptom. The most common cause is a mechanical jam in either the PTM assembly or the traveling rack assembly. The other cause is excessive resistance in the DC power supply. I have seen this symptom caused by dirty recock switches, dirty on/off switches and at least one corroded fuse in the customer's automobile.

Generally, the first indication of the problem is a blown fuse and a

shorted solenoid. It can also occur on the bench artificially (no radio fault) if your DC battery eliminator is under rated. In my automobile electronics book (Sams No. 20927) I covered a number of suitable power sources for car radio benches and will again in this column in an upcoming issue.

### Jams at Low-end After Recoek

Two problems also commonly cause this symptom. One is misadjustment of the recock switch. It fails to turn off the solenoid and this forces the PTM and Rack hard against the low end stop. This can burn out the solenoid and the fuse. In one case in which the customer had replaced the fuse with a 30 Ampere type, I found that the "A" choke and the on/off switch were also damaged. (Murphy's Law of Human Behavior calls for customers to do whatever it takes to defeat any circuit protection used!).

Although it presumably is possible for a mechanical jam to occur at the low end, this is not often encountered. Of more frequent occurrence, is the case where the seeker actually stops on a weak and inaudible station at the low end of the dial. Besides receiving the AM broadcast band, we often find marine radiotelegraph stations in the range of the receiver. The marine band adjoins the AM broadcast band and many times we encounter radios with the AM local oscillator off frequency enough to pick up these stations, yet not affect the dial calibration. Since these radios do not have a BFO to detect the C.W. they remain all but inaudible. They can be received especially well in sea-coast areas, but propagation makes it a problem inland a considerable distance. To correct the problem, readjust the local oscillator trimmer capacitor.

### Failure to Seek

One major problem is a bent leaf on the "seek" switch, which fails to ground relay K1 when the Wonder

Bar is depressed. Another problem is jammed a rack or PTM assembly, that can be caused by a number of sources. One is a misadjusted clutch, another is the lack of lubrication on the rail carrying the rack. A fiber washer on this rail which acts as an oil reservoir could be dry. Other possible sources can be a defective seeker relay or a jammed governor gear train.

### Failure to Mute When Seeking

The most probable cause of this symptom is an open muting isolation diode, which prevents the mute voltage from being applied to the AM detector diode and the base of the audio preamplifier transistor.

### Failure to Stop When Seeking

This may well be the most common signal seeker problem and the most likely source of this kind of problem is in the DC amplifier used to control the relay. Another very common problem is the lack of radio sensitivity. You may not notice that the sensitivity is slightly decreased if the audio stages have sufficient gain to overcome the apparent drop in gain. The electronic stages for the seeker, are IF operated and are very affected by the decrease. Most technicians are acquainted with the stations audible in their area and know which of them are audible only if the radio sensitivity is up to specifications. If those stations cannot be received, don't waste your time troubleshooting the circuits in the DC amplifier for an RF amplifier problem.

### INPUT FROM YOU

This column is aimed at the individual technician and his technical problems related to vehicular and outdoor electronic equipment. Write to me at ET/D and let me know what you would like to read about in CARR TALK. Fair game are general electronics questions, specific car radio troubles and circuit operation. ■

# Selecting and Installing Two-Way Mobile Antennas

By David Norman ET/D Communications Editor

## Operational characteristics of various types of mobile communications antennas and helpful hints about proper installation

■ Optimum performance of any two-way radio system depends on several factors. Output power and receiver sensitivity (usable) are certainly important, but perhaps the single most important factor is the antenna system: which type of antenna; how and where it is mounted; and how well it is tuned.

One-hundred watts of output power at the radio is of little benefit if half of it is dissipated in the coaxial cable and the remaining fifty watts are largely wasted in an inefficient, poorly tuned, and poorly mounted antenna. Received signals are similarly affected by poor antenna system design and installation.

This is particularly true when you are dealing with low-power two-way systems such as CB. For maximum performance, when all you have is 4 watts of power output, all losses must be kept to an absolute minimum.

Keeping this thought in mind, let's take a look at what comprises a good CB mobile antenna system. No other land mobile radio service has as many antenna options available, but the basic principles are the same and a good CB system could be adapted to any other service (low band, VHF, UHF) with little more than changing the radiating portion of the system.

### RADIATION PATTERNS

Fig. 1 represents typical radiation patterns with quarter-wave whips installed in various locations on a vehicle. No attempt is made to show all major lobes or nulls, rather the idea is to show where the *best* direction of transmission (and reception) would occur with a specific antenna location.

A quarter-wave (or any other)

whip mounted in the center of the vehicle's roof (Fig. 1-A) provides a more or less omnidirectional signal with slight nulls on either side. Of course, the antenna radiates (theoretically at least) equally at all azimuth angles. The nulls are caused by the antenna's radiation at higher, and thus unuseful, angles in the azimuths without adequate ground plane

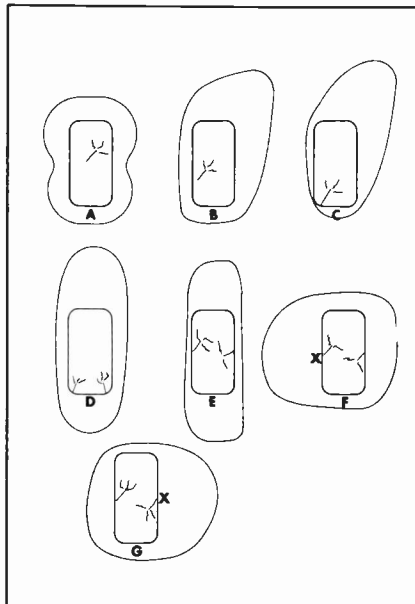

Fig. 1—Radiation Patterns produced with quarter-wave whips installed in various locations on a vehicle. A) Radiation pattern produced with whip mounted in the center of the vehicle's roof, providing an omnidirectional signal with slight nulls on either side. B) Pattern produced with antenna mounted on the left rear quarter-panel. C) The same pattern as 1-B, except that it is slightly more directional, with antenna mounted on the bumper of the vehicle. D) Pattern produced with the installation of "co-phased" or parallel-fed antennas. The drawing illustrates the phenomenon known as a "broadside pattern". Both antennas are mounted on the bumper. E) Pattern produced by mounting two shorter antennas high and clear of the vehicle's roof. F & G) Twin antennas connected out of phase producing an "end-fire pattern." (X) Lagging (-90 degree) antennas. Relative field strength measured at horizon (0 degree radiation L) (Patterns not to scale).

surface, i.e., the sides.

Fig. 1B represents an antenna mounted on the left rear quarter-panel. Again the major lobe is across the largest expanse of body metal (ground plane) and appears at the right front quadrant.

Fig. 1C is basically the same pattern as 1B except that it is slightly more directional, but an antenna mounted on a bumper, as in Fig. 1C, has disadvantages.

Not only does the radiation pattern become highly directional, but some loss of signal is usually caused by the antenna's proximity to a vertical metallic surface such as the foot and a half or so of vehicle body above the mount. In some cases, installations with a sizeable portion of the radiating element below and close to metal can cause severe tuning problems as well as a poor radiation pattern.

Antenna gain begins to enter the picture with installation of co-phased or parallel-fed antennas (Fig. 1D, E, F, G). Fig. 1D illustrates the phenomenon known as a "broadside pattern." There is some gain, or increase in field strength for a given amount of output power, realized by a pair of bumper-mounted antennas (Fig. 1D), but if both antennas are mounted high and clear as in Fig. 1E, the efficiency is much greater. Fig. 1E is typical of many large trucks employing two shorter antennas to approach the performance (seldom equal) of a longer antenna mounted high and clear.

These illustrations use side-by-side antennas for the sake of simplicity, but fore-and-aft or opposing quadrants can be used in an actual installation.

If twin antennas are connected out of phase then an "end-fire pattern" is formed (Fig. 1F, G). In this

# More chances to be right

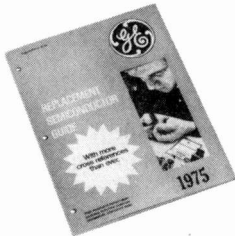

Thousands more cross references

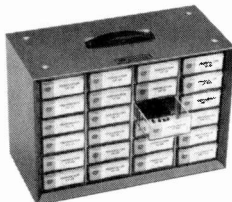

Transistor kit for foreign sets

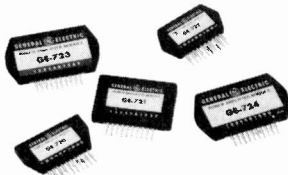

Replacement amplifier modules

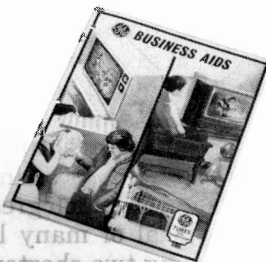

All the help you need at your authorized distributor

Tube Products Department  
General Electric Company  
Owensboro, Kentucky 42301

GENERAL ELECTRIC

case the major lobes are in line with the antennas. The exact pattern depends on many variables such as antenna spacing, difference between feedpoints (phase-wise), and the ground plane surface, if any, affecting each antenna.

Very few customers would spend either the time or money necessary to design and install a switchable system (Fig. 1F, G), but every technician should understand the basics.

## SHORT VS LONG ANTENNAS

With everything being equal (location, resonance, feed-point impedance, etc.), there is no way for a short antenna to out-perform a long antenna. To prove it to yourself, swap a properly matched 102-inch steel whip for a 4-foot fiberglass whip. Not only does reception suffer—an S-9 signal might now read S-7—but so does transmitting range. The longer antenna is simply more efficient.

However, absolute efficiency is not always the most important thing. For example, a 9-foot antenna mounted in the center of a truck cab will have a greater range than a 4-foot antenna. Unfortunately, the longer antenna also reaches traffic light, trees, phone lines, and some overpasses.

Unless the customer is interested in absolute maximum performance regardless of the inconveniences, some compromise is necessary.

Either antenna length, location, or both can be varied to find a happy medium, but can be carried too far, resulting in unacceptable performance. The best general rule to keep in mind is: Use the longest possible antenna, mounted in the highest possible location, taking into consideration the proposed uses of the unit, the type of roads most frequently used, common sense, and last, but not least, the customer's wishes.

If a shortened antenna must be used, try to use one in the 3- to 6-foot range. The little 18-inch CB antennas are cute, but "they ain't much punkin."

## TYPES OF MOUNTS

With some antennas, the mount

is an integral part of the antenna. In other cases, there is a choice of mounts available with a given antenna.

The antenna manufacturers have standardized on the 3/8-inch by 24 T.P.I. for many antennas ranging from 102-inch stainless steel whips to some 2-foot "shorty" antennas. Since any 3/8-inch by 24-thread antenna may be used with any matching mount, you can have in stock 100 possible combinations with only 10 different antennas and 10 different mounts.

All the mounts shown in Fig. 2 are designed to utilize 3/8-inch by 24-thread antennas. Fig. 2-A is a typical bumper mount and will support 102-inch whips with ease.

The trunk-lid mount, (Fig. 2-B) is another way of installing an antenna without drilling holes in the body, as is the gutter mount in Fig. 2C. Normally, only 6-foot or shorter whips are used with the trunk-lid or gutter mounts.

Right here is as good a place as any to make it clear how I feel about temporary or no-hole mounts. With the possible exception of the heavy-duty bumper mounts, clamp-on mounts simply do not have the physical integrity of the ball mount (Fig. 2D). This means that the system is subject to variation in actual electrical ground contact and also subject to removal or damage from vibration and vandalism. From an esthetic point of view, an antenna system which is "hung-on" a vehicle with cables running exposed, is much less pleasing to the eye than is a properly installed permanent mount with all cables concealed from view.

The usual comment made by the customer is to the effect that he feels that drilling a hole in the vehicle's body will somehow make it less valuable. At one time this might have been a valid objection; but the simple fact is that now there are so many vehicles with some sort of two-way radio installed that no one cares. In any event, filling and repainting a hole is a very minor repair job, often under \$20.

Another good argument against temporary mounts is that they



# TAB ALL-IN-ONE SCHEMATIC/SERVICING MANUALS FOR COLOR and B & W TV, RADIOS and HI-FI



Here is complete service data, including full-size schematic diagrams, waveforms, setup and alignment instructions, field modification changes, trouble case histories, etc., for the most popular name-brand TV receivers. Each manual contains everything needed to service all models of the brands covered, including full-size schematic diagrams for every model year. In addition, each manual has something special to offer in the way of unique or improved trouble-finding techniques or in other informative material related to TV servicing in general. Most manuals have parts lists included. All are 8 1/2" x 11", 196 or more pages, including schematic diagram foldout. **EACH MANUAL PRICED AT \$7.95 IN LONG-LIFE LEATHERETTE, \$4.95 IN PAPERBACK, UNLESS OTHERWISE NOTED.**

## COLOR TV MANUALS

**SERVICING THE NEW MODULAR COLOR TV RECEIVERS VOL. 1.** RCA CTC 48, Motorola Quasar CTV7&8, Philco B-Line 3CS and 3CY (90&91). Covers service, alignment, setup, and adjustment for latest models. 176 pps., with 18-page foldout schematic section. **Order No. 662**

**SERVICING THE NEW MODULAR COLOR TV RECEIVERS Vol. 2.** General Electric MA & JA chassis, Magnavox T979, Packard-Bell CTS-34 & 42, Zenith 25DC-57 & 58. Covers service, alignment, setup, adjustment for these solid-state sets, plus special section on troubleshooting IC circuitry. 178 pps., with 6 full-size schematics in big 18-page foldout section. **Order No. 663**

**ADMIRAL Vol. 1.** Covers chassis D11 to 12G13, incl. K10 hybrid. 196 pps., incl. 36-page foldout with 12 schematics. **Order No. 645—\$8.95 Leatherette; \$5.95 Paper**

**ADMIRAL Vol. 2.** Covers modular M20, K16 through K20, and basic 930 chassis. 196 pps., incl. 36-page foldout with 11 schematic diagrams. Cross referenced to Emerson and Montgomery Ward sets. **Order No. 641**

**AIRLINE (for Montgomery Ward/Airline models).** Covers modular chassis, 3M20, 20M20, & M25; hybrids 3K19, 20K19, 21K19, 20K17, 21K17, 22K18, 23K18, 24K18, 27K10, T11K10, T20K10, T21K10, T22K10, T23K10, T24K10, T25K10, GEN-12743, and GEN-12973. Includes service notes and parts lists. 196 pps., incl. 36-page foldout with 12 full-size schematics. **Order No. 741—\$8.95 Leatherette; \$5.95 Paper**

**EMERSON See Admiral Vol. 2.**  
**GENERAL ELECTRIC Vol. 1.** Covers all chassis from CA to KF, incl. 11B and H1 Porta-Color. 196 pps., incl. 36-page foldout with 12 full-size schematic diagrams. **Order No. 536—\$8.95 Leatherette; \$5.95 Paper**

**GENERAL ELECTRIC Vol. 2.** Covers solid-state JA, H-2, H-3, H-4, N-1, N-2, KE-11, C-2, L-2, and L-7 chassis. 212 pps., incl. 36-page foldout with 10 full-size schematic diagrams. **Order No. 609**  
**JAPANESE Vol. 1.** Covers 12 models, SONY KV-1200U; KY-1220U; KY-7010UA; KY-9000U; SHARP CN-32T; CN-62T; CT-51P; CU-501P; CV-61P; C2010, 2030; C6010, 8010, 9310; MIDLAND 15-214, 212 pps., incl. 36-page foldout with 12 full-size schematic diagrams. **Order No. 560**

**JAPANESE Vol. 2.** Covers 17 models, PANASONIC CT-25; CT-65; CT-95; CT-98; CT-99; HITACHI CFA 450, 460; CNC-870, 880, 890; CSU-690; DELMONDO 7020, 7300, 7508, 7428, 7500. Cross-referenced to BRAD-FORD, PENNCREST & SINGER. Incl. parts list. 212 pps., incl. 36-page foldout with 12 schematic diagrams. **Order No. 576**

**JAPANESE Vol. 3.** Covers 16 models, HITACHI SW1-220; CTU-970; CU-100; CWU-220; CQ Chassis; CR-350; CORONA D611, 7000, 7500, 918; 9K18; 10K18; SANYO C1035; 51C-51R; 91C57; 91C57R. Includes parts lists. 228 pps., incl. 36-page foldout. **Order No. 684**

**JAPANESE Vol. 4.** Covers 26 models, SHARP C-922; C-1227; C-1321; C-1517; C-1723; C-1724; C-1725; C-1921; C-1923; C-1925; C-1926; C-2011; C-2031; C-9311; MGA (MITSUBISHI) CS-130; CS-170; CS-195; CS-197; MIDLAND 15-212; 15-213; 15-215; 15-225; 15-228; 15-229; 15-239. Includes parts lists. 212 pps., incl. 36-page foldout. **Order No. 682—\$8.95 Leatherette; \$5.95 Paper**

**JAPANESE Vol. 5.** Covers 9 models, SONY KV-1201; KV-1212; KV-1500; KV-1510; KV-1710; KV-1720; KV-1722; KV-1730R; KV-1700. 196 pps., incl. 36-page foldout. **Order No. 700—\$8.95 Leatherette; \$5.95 Paper**

**MAGNAVOX Vol. 1.** Covers all chassis from Series 310 to T940. 196 pps., incl. 36-page foldout with 15 full-size schematics. **Order No. 526**

**MAGNAVOX Vol. 2.** Covers all chassis from T950 to T962. 196 pps., incl. 36-page foldout with 9 full-size schematics. **Order No. 589**

**MOTOROLA Vol. 1.** Covers all chassis from TS-907 to TS-924 including all transistors. TS-915-919. 178 pps., incl. 15-page foldout with 6 full-size schematic diagrams. **Order No. 509**

**MOTOROLA Vol. 2.** Covers all chassis from TS-929 to TS-938, including remote control systems. Also additional information on TS-915-919. 196 pps., incl. 36-page foldout with 9 schematics. **Order No. 584—\$8.95 Leatherette; \$5.95 Paper**

**PHILCO.** Covers all chassis from 15M90-91 to 20QT87-90. 196 pps., incl. 36-page foldout with 12 schematics. **Order No. 522—\$8.95 Leatherette; \$5.95 Paper**

**RCA Vol. 1.** Covers all chassis from CTC12 to CTC40. 212 pps., incl. 36-page foldout with 12 full-size schematics. **Order No. 496—\$8.95 Leatherette; \$5.95 Paper**

**RCA Vol. 2.** Covers all chassis from CTC39X to CTC55. 212 pps., incl. 36-page foldout with 12 schematic diagrams. Includes parts list. **Order No. 578—\$8.95 Leatherette; \$5.95 Paper**

**RCA Vol. 3.** Covers all chassis from CTC48 to CTC60. 196 pps., incl. 36-page foldout with 12 full-size schematics. Includes parts list. **Order No. 720—\$8.95 Leatherette; \$5.95 Paper**

**RCA Vol. 4.** Covers all chassis from CTC55 to CTC71. 196 pps., incl. 36-page foldout with 12 full-size schematics. Includes parts list. **Order No. 721—\$8.95 Leatherette; \$5.95 Paper**

**SEARS.** Covers Ultra models 4059; 4064; 4072; 4195; 6; 7; 4369; 4374; 5; 6; 7; 8; 9; 43503 & 13. Medalist models 4360, 61, 62, 63, 67, 71, 76, & 77; 4380, 1 & 2; 43801, 11, & 12; 43806, 16 & 26. Hybrid models 4091 & 5; 4111; 4124; 5; 6; 7; 8; 4314; 5; 6; 7; 4320; 1 & 2; 4326; 4329; 4330; 1, 2, 3, 4, 5, & 6; 4350 & 2; 4358 & 9; 41103; 41682; 41881; 43146, 56, 66, & 76; 43266; 43511, 31, 41, 51, & 61. Includes parts lists. 228 pps., incl. 36-page foldout with 12 full-size schematics. **Order No. 740—\$8.95 Leatherette; \$5.95 Paper**

**SYLVANIA Vol. 1.** Covers all chassis from 576 to solid-state E01. 196 pps., incl. 36-page foldout with 12 schematics. **Order No. 539—\$8.95 Leatherette; \$5.95 Paper**

**SYLVANIA Vol. 2.** Covers latest D14, D15 through D19, plus new solid-state E02 and updated E01 chassis. 212 pps., incl. 36-page foldout with 8 full-size schematic diagrams. **Order No. 618**

**TOSHIBA.** Covers 24 models, CT21; OT21BM; C742; C742C; C924; C924BM; C932; C933; C942; C942C; C994; C994C; C335; C335C; C61; C7A; C8A; C501S; C802WR; C811S; C812WD; C912B; C927; C321. Includes parts lists. 160 pps., plus 36-page foldout including 12 full-size schematic diagrams. **Order No. 760—\$8.95 Leatherette; \$5.95 Paper**

**Zenith Vol. 1.** Covers all chassis from 1428C50 to 27K20. 196 pps., incl. 36-page foldout with 12 full-size schematic diagrams. **Order No. 502**  
**Zenith Vol. 2.** Covers all chassis from 12A8C14 through 4B25C19 and 40BC50. 196 pps., incl. 36-page foldout with 12 full-size schematic diagrams. **Order No. 562—\$8.95 Leatherette; \$5.95 Paper**

**Zenith Vol. 3.** Covers over 23 different chassis designations, 14DC14, 15, 15Z, 16, 16Z, 14-CG14 (& up); 18CC27, 29 & 30; 19DC11 & 12; 19DC19Z, & 20; 20CC50 & 50Z; 23DC14; 25CC25, 50 & 55; 25DC56 & 57; the brand new 1974 17-19EC45; 25EC58 series just released. 180 pps., incl. 36-page schematic foldout section. **Order No. 688**

## BLACK & WHITE TV MANUALS

**ADMIRAL.** Covers 58 different chassis designations, from C to K series, including NA1-1A solid state. 160 pps., plus 36-page foldout with 12 complete schematic diagrams. **Order No. 569**

**GENERAL ELECTRIC.** Covers 25 basic chassis designations, from Series AA to V-2. 160 pps., plus 36-page foldout with 16 complete schematic diagrams. **Order No. 558**

**JAPANESE.** Covers 77 models, HITACHI 1A-50 to TWU65; PANASONIC TR-41B to TWU-65; SHARP SQ65P to 58D. 212 pps., incl. 36-page foldout with schematic diagrams. **Order No. 602**

**MAGNAVOX.** Covers all chassis designations from Series 36 to T946—including the latest all-transistor models. 160 pps., plus 36-page foldout with 13 complete schematics. **Order No. 572**

**MOTOROLA.** Covers all chassis designations, from TS-454 through TS-613. 160 pps., plus 36-page foldout with 15 schematic diagrams. **Order No. 594**

**PHILCO.** Covers 42 different chassis designations, from 15G20 to 20V35 ("N" through "T" line). 160 pps., plus 36-page foldout with 24 complete schematic diagrams. **Order No. 564**

**RCA.** Covers 33 different chassis designations, from KC8136 to KC8178. 176 pps., plus 36-page foldout with 18 schematic diagrams. **Order No. 549**

**SYLVANIA.** Covers 22 different chassis designations, from A01 through B14, also 572 through 598 chassis. 160 pps., plus 36-page foldout with 22 full-size schematic diagrams. **Order No. 559**

**ZENITH.** Covers 53 different chassis designations, from 13A12 to 14M23 and 1M30T20 to 1Y22. 160 pps., plus 36-page foldout with 19 complete schematic diagrams. **Order No. 552**

## SPECIAL SCHEMATIC/SERVICING MANUALS

**TV TUNER SCHEMATIC/SERVICING MANUAL.** A one source guide to all the info you need to adjust and repair ANY VHS or Hi-Fi tuner from any of the tube-type tuners to modern varactor tuners. Save time, trouble & money by repairing those tuners in your own shop! Tuner repairs are typically quite simple and straightforward—and capable of being effected in the average shop with ordinary tools and skills—with the aid of this complete guide which alphabetically by brand, describes the principles of representative tuners, their theory of operation, and offers special service tips, helpful diagrams, alignment procedures, trap coil adjustments, "ideal" waveform photos, selected test points, and even complete schematic diagrams for every model. Hundreds of schematic and alignment diagrams. A very comprehensive Appendix contains manufacturer's service hints, special notes, and other helpful data. Brands covered are: Admiral, General Electric, Magnavox, Motorola, Philco, Ford, RCA, Sony, Sylvania, Zenith, 224 pps., hundreds of schematic and alignment diagrams. **Order No. 696—\$9.95 Leatherette; \$6.95 Paper**

**JAPANESE CONSUMER ELECTRONICS SCHEMATIC-SERVICING MANUAL.** A wealth of circuit diagrams for 89 models representing seven manufacturers—JVC, Lloyd's, Midland, Panasonic, Sanyo, Sharp, and Toshiba. This vast selection of schematics covers AM radios, clock radios, AM-FM receivers, FM stereo sets, multi-band receivers, radio & tape player combinations, cassette recorders, phonographs, and TV receivers; a one-stop source of schematics for the models every enterprising technician almost every day. Useful information includes: transistor and IC cross reference, tips on recorder-player servicing, troubleshooting and alignment help for AM-FM and FM stereo receivers, and several troubleshooting charts listing general problems and their causes. 144 pps., including 36-page schematic foldout section. **Order No. 732—\$8.95 Leatherette; \$5.95 Paper**

**JAPANESE RADIO, RECORD & TAPE PLAYER SERVICE MANUAL.** Sourcebook for schematics, alignment data, service tips on a wide range of import models of record players, multiband radio players, cassette tape players, and 8-track cartridge tape players. Covers popular import brands such as Craig, Gambles, Hitachi, JVC, Lafayette, Midland, Montgomery Ward, Panasonic, Sharp, Masterwork, Realistic, and others. 228 pps., including schematic diagram foldout section. **Order No. 682—\$8.95 Leatherette; \$6.95 Paper**

**HOW TO REPAIR SOLID-STATE IMPORTS.** Among this vast collection of nearly 100 hard-to-find schematics you'll find such names as Allied, Lloyd's, Panasonic, Crown, Midland, Penncrest, Toshiba, and Matsushita representing the major foreign-made chassis distributed in the U.S. And to help you find replacement parts, there is a list of importers and distributors of Japanese consumer products. There's also a chapter to help you when a schematic isn't available. 82 pps., incl. 24-page foldout section. **Order No. 532**

**SERVICING ELECTRONIC ORGANS.** Here's your "ticket" to the exciting and rapidly growing field of electronic organ service and repair, covering the most popular instruments in use today: Artisan, Baldwin, Conn, Gulbransen, Hamam, Lowrey, Magnavox, Rodgers, Theodosius, etc. This carefully planned schematic service manual clearly explains how the various electronic circuits work—tone-generating, keying, "voicing," and special effects systems, etc. A special feature of this manual is the 36-page foldout section which contains numerous organ schematic diagrams. 160 pps., plus 36-page foldout section. **Leatherette cover only. Order No. 508**

## These Complete Schematic Servicing Manuals Available on 10-Day Free Trial!

TAB BOOKS, Blue Ridge Summit, Pa. 17214

Please send me the Schematic/Servicing Manuals indicated below. I understand you fully guarantee your Manuals, and that I may return them in 10 days for immediate refund or cancellation of invoice.

I enclose \$..... Please send postpaid.  Please send on 10-DAY FREE TRIAL.

Please send C.O.D. (Please specify paperbound or leatherette.)

Order No.	Order No.	Order No.	Order No.	Order No.	Order No.	Order No.
.....	.....	.....	.....	.....	.....	.....

Name.....

Company..... Phone.....

Address.....

City..... State.....

(Paid orders shipped prepaid. Pa. resident add 6% Sales Tax. Outside USA 10% Extra.)

often cause more body damage than a hole. Exposed coaxial cable acting in conjunction with wind, vibration, and dust can literally chafe all the paint off a large area of the vehicle.

Damage to chrome bumpers is expensive to repair (more than a hole in the body; and a damaged bumper definitely lowers the vehicle's resale value.

Trunk-lid mounts usually remove the paint from a 4- or 5-square inch area and interfere when the trunk door is opened or shut.

The exposed coaxial cable is very likely to be damaged by ice, mud, rocks, and pocket knives.

In spite of all the reasons not to use a temporary mount, such mounts are still indicated in many cases. Your obligation is to select the one least likely to receive or cause damage.

Usually bargain-priced mounts are not bargains. A mount that won't tighten without breaking is useless—its costs money and still won't do the job.

If a spring is necessary to allow bending of the radiation, choose the heaviest spring available which will still allow the antenna to lay over. In some cases you will have to shorten the antenna to compensate for the additional six inches of spring. This is much more likely to occur with short antennas than with longer ones.

For off-the-road vehicles where severe stresses are likely to damage an antenna system, a heavy-duty ball mount and a stainless steel whip may be the only combination that will stay mounted.

My tests have shown that no single antenna will out perform the 108-inch stainless steel-spring combination. The 96-inch or longer fiberglass antennas perform better at highway speeds.

When a flexible antenna such as the stainless steel whip is exposed to wind at high speeds, it tends to bend back and whip around. Not only can this change the polarization of the whip from the desired vertical, the feed-point impedance of the antenna also can change and thus affect tuning.

Shortened (physically) antennas, as mentioned previously, are not as efficient as longer antennas, assuring a given electrical length. However, this does not

mean that they are no good. By and large, the base-, center-, and top-loaded antennas have a slight advantage over the base-loaded antennas because they have a slightly lower angle of radiation. In practice, however, you couldn't live on the difference.

Aerodynamically, the base-loaded antennas have the edge, so it's largely a matter of personal choice.

Mounts available for shortened antennas vary from a 3/8-inch single hole mount to the standard 3/8 by 24-thread ball mount, with a wide choice in between.

My own preference in a single hole mounts is the 3/4-inch mount available from *Antenna Specialists No. M-124*. For quick and easy installations the 3/8-inch "snap-in" mount is adequate but the heavier 3/4-inch mount has more strength.

There are any number of single-hole mounts on the market and some technicians prefer one over another. Again, this is largely a matter of personal opinion.

Avoid the temptation to use one of the combination antennas (CB, AM, FM, etc.), unless concealment is essential.

### SELECTING COAXIAL CABLE

Actually, selecting coaxial cable is quite simple. I prefer using RG-8 Low-loss foam coax whenever possible. This assures that all the output power possible is fed to the antenna.

If the antenna mount will not accept the large coaxial cable, I use RG-58 low-loss foam coax. The only exception to using foam coax would be where physical strength is a factor. (For example, if a cable must be exposed to rocks as in a mount on a fenderwell.) Solid insulation is somewhat tougher than foam and resists damage better.

To sum it up, use the lowest loss coaxial cable possible, taking into consideration the mount and risks of damage.

### TOOLS FOR INSTALLATION OF ANTENNAS

A variable speed drill with a capacity of 3/8 to 1/2 inch is almost indispensable, as is a selection of quality bits from 1/4 to 1/2 inch. A center punch with a sharp point is

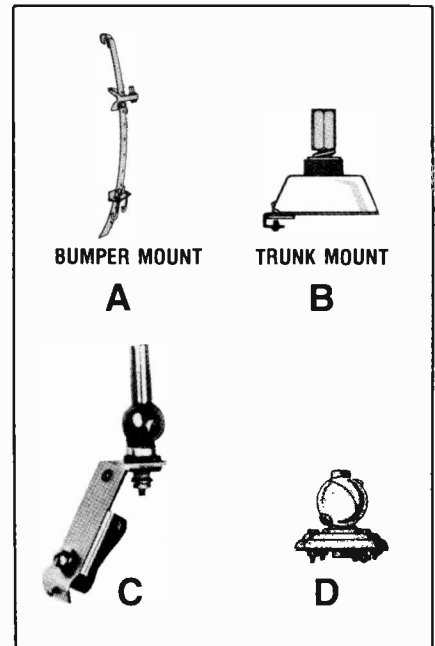

Fig. 2—Typical antenna mounts designed to accept 3/8-inch by 24 T.P.I. antennas. A) Typical bumper mount capable of supporting 102-inch whip antennas. *Courtesy Of Shakespeare.* B) The trunk mount can be installed without drilling holes. *Courtesy Of Shakespeare.* C) The gutter mount clamps on without the need to drill holes. *Courtesy Of Newtronics.* D) Heavy-duty ball mount. *Courtesy Of Shakespeare.*

needed to give the drill a place to start without "walking" all over the painted surface.

Holes larger than 1/2-inch may be made either with a hole saw or chassis punch. I stock 3/4-inch and 1 1/2-inch sizes in both. The chassis punches (Fig. 3-A) make cleaner holes but access cannot always be gained from beneath the surface. Hole saws (Fig. 3-B) do a much better job if wood is to be penetrated as on many motor homes.

An assortment of (12-inch) bits come in very handy if it is necessary to drill through a stud or double lining. It's much easier to drill all the way through the material than to try to meet the hole from either side.

The last special tool is a tapered hand reamer for enlarging holes. Other installation tools required are wrenches, screwdrivers, etc., obtained from your tool box.

### INSTALLATION HINTS

The primary rule to remember is: Look before you drill. It's embarrassing to find a reinforcing member right in the middle of your nice neat hole. If in doubt, make some measurements from the inside and outside.

Carefully check out a proposed

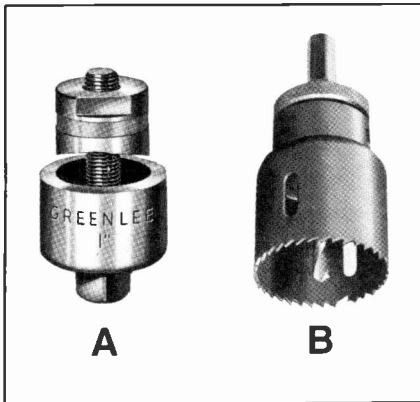

Fig. 3—The chassis punch (A) makes cleaner holes but access cannot always be obtained from beneath the surface. The hole saw (B) is ideal for the penetration of wood as employed on many motor homes. Courtesy Of Greenlee Tool Co., Division of Ex-Cell-O Corp.

rooftop location; there may be a double thickness roof reinforcement member with tarpaper in between.

A cowl location may be what you want, but it also may be impossible to fish the coax cable through the hole, even if the mount *can* be installed from the top. You may have to change your mind (and the customer's) to pick an antenna-mount combination that can be reasonably installed and provide good performance.

Always tighten each part of an antenna mount securely before adding the succeeding pieces. If this is not done, you run the risk of turning a lower piece and twisting the coax.

Coaxial connections at the antenna should always be clean and tight. Depending on the mount, crimping or soldering or both may be necessary.

Many single-hole mounts require the coax to be stripped as indicated in the instructions and the center conductor fed through a hollow pin and secured by a female connection on the base of the antenna loading coil. Often, the action of screwing the loading coil onto the mount, shears part of the center conductor and can cause a direct short.

To avoid a short circuit remove the loading coil and visually check for pieces of wire in the cup. They can be easily blown out and the center-conductor soldered to the hollow pin with a fast heating iron. Don't use a low-power iron because of the danger of heating the insulation and weakening the pin's support.

Coaxial cables should be run

carefully, avoiding situations which might cause pinching or cutting. Prime areas to watch are the edges of seats, the floor-board (run the cable close to the side), and anywhere that the cable could be caught and pulled accidentally. As with any other wires, antenna leads should be dressed out of the way and out of sight.

#### TUNING ANTENNAS

Most commercially built antennas need little or no tuning and usually operate quite well. However, the SWR or Reflected Power—depending on the meter used—should always be checked before the installation is released.

When adjustments are necessary, the manufacturer's directions should be followed closely. Adjustments must be made in small increments if tuning is to be accurate. Make certain that doors, trunk, and hood are closed because they can drastically affect antenna performance.

Components such as matching devices installed at the radio, trimming of coax leads, etc., are, or at least should be, the consideration of an expert technician. The only justification for using these devices is if the *reflected power* is high enough to damage the transmitter. Even then, a better system can usually be designed.

Mounting an antenna close to or below a substantial vertical metal area can cause severe mismatch. If for some reason, the antenna must be mounted in such a location, a matching device may be necessary. If so, try to install it as close to the antenna as possible. Personally, I would never consider the use of a matching device unless the SWR were something like 4:1 (25 percent Reflected Power) and there was no alternative.

#### SUMMARY

The decision of which antenna and mount to use in a particular installation, to make the best compromise of all factors, can be a difficult one to make. Remember the objectives of performance, reliability, and appearance and how they affect one another. Anyway, in the end the decision may be made by the customer's wife who prefers one color of antenna, regardless of its acceptability to yourself. ■

# TROUBLED BY TRIGGERED SCOPES?

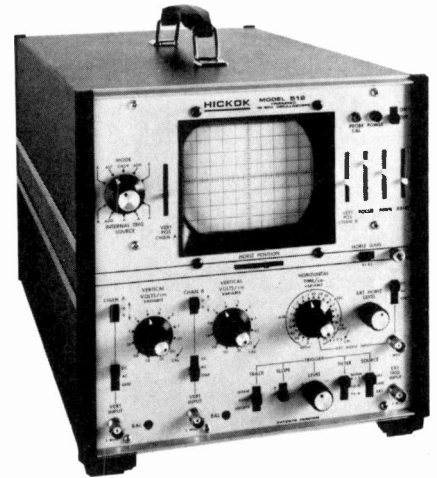

The Hickok Model 512 Dual Trace Oscilloscope eliminates the set-up and precision problems you've had to accept using other triggered scopes.

#### It's easy to set up

- Simplified color-coded front panel controls.
- Beam finder quickly locates off-scale traces.
- Foolproof triggering to 15 MHz.

#### It gives you superior performance

- 10 MHz response flat within 3dB. Excellent pulse response.
- Unique automatic VITS sync separator.

#### Hickok industrial lab quality and construction

Glass epoxy PC boards used throughout. Regulated power supply.

Plus, our exclusive two-year, total warranty.

Ask to see the Hickok Model 512 or single trace Model 511 at your Hickok distributor, or contact us for more information.

**\$675.00**

complete with probes and accessories

# HICKOK

the value innovator

INSTRUMENTATION & CONTROLS DIVISION  
THE HICKOK ELECTRICAL INSTRUMENT CO.  
10514 Dupont Avenue • Cleveland, Ohio 44108  
(216) 541-8060 • TWX: 810-421-8286

...for more details circle 123 on Reader Service Card

## COMM CHAT



With David Norman, ET/D  
Communications Editor

■ It seems that I must spend a fair amount of my time battling bureaucratic red tape. There may be no way around it, but it can get tiresome.

For example, While I was doing the VHF marine article in the September issue, I needed an update on several items. Where would be a better place to get it than from the friendly, local FCC Office? I don't know, but there must be somewhere.

In the field of VHF marine mobiles, there are at least three different sets of requirements. Type acceptance for VHF marine use is one thing. Type acceptance for mandatory Bridge-to-Bridge operation and charter vessels are different from basic requirements and even from each other. Wouldn't it be simple to have one set of specs for all of these services which communicate to each other anyway.

The FCC has even gotten into the area of receiver requirements (band pass, sensitivity, etc.) in the Bridge-to-Bridge requirements. No matter how well a unit is performing, it must be certified by the manufacturer to meet certain paper specs. XWT

All technicians (and technical writers) should be interested in seeing that the highest quality possible is maintained. But doesn't it seem a little silly that a person converting a commercial or private fishing vessel to charter use would most likely have to purchase an entirely new radio—one that was not necessarily better?

Come on, Uncle Charlie, cut us a little slack. Make all requirements uniformly stringent if you wish, but for goodness sake don't make us technicians into "sea lawyers" without a good reason.

It seems to me that a little common sense could be applied in many areas of communications law and about half of the tangle of laws dropped from the books.

A broad spectrum shop now must keep a set of FCC Rules and Regulations over a foot thick. Now, who has time to read all of that! It changes constantly anyway and unless you read everything that comes in, you are still behind. Regardless of the griping, we must keep up with it as well as we can. If your customer gets a citation through your ignorance, however justified, you have a problem.

When I asked about acquiring a Radio Equipment List showing which units are type accepted for what, the FCC gave me a name and telephone number in Washington, D.C.

Guess what? The company listed by the Atlanta FCC Office no longer had the contract. Looks like Charlie has trouble keeping his own store up-to-date. So what else is new?

I was finally referred to the proper company. So if you wish to order your own Type Acceptance Listing for all services, you may do so from: Downtown Copy Center, 1730 K St., N.W., Washington, D.C. 20006. Phone 202/452-1422. The cost is \$22.24, plus postage.

I urge that you do order a copy. The changes in CB Class D alone make such a list necessary. The Downtown Copy Center also has listings of non-Federal Govern-

ment frequency allocations, this information is helpful if you are getting into the scanning monitor business. If you have questions, call Mr. Joseph Walaga at Downtown and he will be glad to assist you.

### COMM TIP OF THE MONTH

Every technician that has used a CANTENNA by HEATH COMPANY has appreciated what a really fine dummy load it is. Not only is it a good 50-ohm match, it will handle up to 1 kilowatt of RF power. The only problem is that if it is knocked over on the bench or in transit, you have an oily mess all over the place. A simple alternative to having to mop up the bench or truck is to fill the CANTENNA with a mixture of one part mineral oil to four parts paraffin. The melting point of the mixture is approximately 135 degrees F. While there is some derating, how many KW transmitters is the average technician going to service?

Reading over my mail, I noticed that Ken Sessions has a new book out from TAB Books, Blue Ridge Summit, Pennsylvania 17214. Ken's new book is "2nd Class FCC Encyclopedia—Complete Study Guide to the Commercial Radio Telephone Exams" (TAB Book No. 652).

Some of you may remember Ken as one of the pioneers of Amateur 2-meter Radio on the west coast. The 602-page volume at \$7.95 in the paperback edition would definitely qualify as a bargain. If you are considering expanding into two-way radio and don't already hold an FCC 2nd Class License (or higher), look for this book at your local bookstore or electronics supply house. You may also order it direct from the above address.

I have taken a lot of tests of all types and believe me, that Element III Exam is a tough one. Since you can only take it at 60-day intervals, it is best to be well prepared. I also found the "ARRL Radio Amateurs Handbook" very helpful in preparing for the theory part of the exam. ■

## TEST INSTRUMENT REPORT

### B & K MODEL 1472 DUAL-TRACE OSCILLOSCOPE

■ There are increasing demands for dual-trace oscilloscopes in industry, engineering, design and service. As the level of technology advances in electronic products, the demands placed on the dual-trace scope also have increased.

B & K's Model 1472 Dual-Trace, 15 MHz oscilloscope meets most of these demands and can be used to inspect most digital waveforms with automatic triggering on waveforms having as little as 1 cm deflection. Although the nominal frequency response extends to 15 MHz, its rolloff characteristics typically permit usable response through 27 MHz, which is ideal for CB service applications.

Possibly two of its most time-

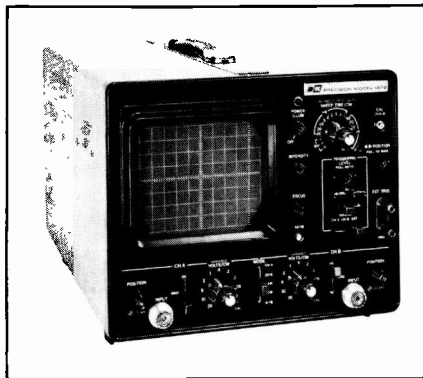

B & K Model 1472 Dual-Trace Oscilloscope. For more information about this instrument, circle 105 on the READER SERVICE CARD.

saving features are its automatic selection of *chopped* or *alternate* mode of display and automatic selection of TV line and frame sync, which also can be used as a low-pass filter for triggering. The trace is automatically chopped at all sweep times of 1 msec/cm and slower to avoid flickering; at all faster speeds, the sweep is alternated.

The front panel control design allows switching from conventional operation to Vectorscope or X-Y operation without changing input connections to the scope. Since the matched vertical amplifiers are used for both vertical (CH A) and horizontal (CH B)

inputs to this mode, the calibration accuracy of both channels is preserved. The horizontal input signal can be measured in volts/cm of horizontal deflection up to specified frequency response.

If the instrument is used to monitor and adjust video processing equipment, where 10 percent is far beyond tolerable limits, the scopes flat in-band response is particularly useful to obtain and maintain consistent picture and color quality.

Other features include: 24 nsec risetime, individual vertical sensitivity and positioning controls, large 8 by 10 cm rectangular viewing area, 5 X magnification for maximum sweep speed of 0.1  $\mu$ sec/cm, 19 calibrated sweep ranges and intensity modulation (Z-axis) input for time or frequency markers.

The oscilloscope has a bright blue P31 phosphor CRT with variable graticule scale illumination and includes tilt stand.

The instrument measures 9.84 inches wide by 14.56 inches deep by 7.84 inches high and weighs 19.6 lb. The price is \$599.

### RCA WT-333B PICTURE TUBE TESTER/RENEWER

New approaches are being made to accurately test picture tubes, simulating the picture-tube gun operation in an actual receiver for



RCA WT-333B Picture Tube Tester/Renewer. For more information about this instrument, circle 106 on the READER SERVICE CARD.

a more meaningful faster test procedure.

Improved cathode-emission renewal systems are being designed to safely restore weak picture tubes while minimizing the possibility of picture tube damage.

RCA's Model WT333B CR111 Picture Tube Tester/Renewer features a new "Simul-Test" three meter system which tests all three color guns simultaneously. This test procedure is faster and more accurate than the single gun tests made with conventional testers. This tester will test for emission quality, emission tracking (under varying voltage conditions), and internal short shorts and leakage.

The picture tube's "tracking" capability—i.e., the emission ratio of the three guns is quickly read on the three separate meters. You can spot an intermittent open or shorted condition quicker, because with conventional testers you may be switching *off* the particular gun, while the problem is occurring.

The gun repair capability of the tester includes an improved, versatile Renewal System. Several emission renewal techniques are provided; high current pulses (cathode reconditioning by electrolysis); steady direct current flow (also electrolysis effect); elevated heater voltage (thermal cathode recondition); or various combinations of renewal techniques. The instrument includes a short removal function, and has provisions for clearing blocked grid apertures, balancing (emission tracking) and cathode welding.

Continuous adjustment of the heater voltage is provided from 1.5 to 15 volts. To assure accuracy, the heater voltage is measured at the tube pins and indicated directly on a special meter scale. Power line voltage is measured on a separate voltage scale.

Meter indications are provided for all leakage measurements. A two-microampere gun cutoff adjustment procedure establishes the proper G2 voltage levels to test

emission under controlled "simulated-picture" conditions.

The test cable has a built-in socket that is used with a large number of color tubes, so that no adapter is required to test them. Four additional socket adapters are included for use with black-and-white tubes and with color where required.

Although the tester incorporates three separate voltage adjustments and metering circuits for the picture-tube guns, engineering techniques have reduced the set-up and testing procedure to a few simple operations. Use of push-button controls has resulted in less operating time than most single meter testers.

Test data is provided for testing over 1,800 b-w and color picture tubes, including the special "one-gun," or "in-line" types, such as the "Precision In-Line," and the "Trinitron."

The functionally designed carrying case is formed of heavy-duty plastic and measures 6¼-inches by 13½-inches by 10¼-inches and weighs 9 lbs. Price is \$249.90.

#### DATA PRECISION MODEL 5740 COUNTER

The Data Precision Model 5740 Multi-Function Counter is a medium-frequency, seven decimal-digit display unit, capable of operating in any of four measurement modes.

The mode performances of the instrument include: 1) Measures frequencies of repetitive signals from 5 Hz to 100 MHz. 2) Measures periods from 0.5 µsec to 0.2 sec. 3) Measures time intervals from 0.01 sec to 99,999.99 sec, and displays five integral decades and two decimals of the total. 4) Totalizes events from one to 9,999,999 and displays seven full decades of that total.

The counter provides four selectable time intervals from 0.01 sec to 10 sec over which to average the measured frequency.

Also it provides four selectable multiples from 1 to 1000 of the number of cycles over which to average the measured period.

The displayed decimal point is

automatically displayed to obtain direct readout of kilohertz (frequency measurement), microseconds (period measurement), hundredths of seconds (time interval measurement), or units (events measurement).

It will measure signal inputs as low as 10 mv RMS (sine wave) or 30 mv peak (pulse), with duty cycles as low as 10 percent of CW or AM modulated signals.

Operation of the counter is simplified by employing clearly marked front panel controls and indicators. The displayed values are read-out in units of kilohertz and microseconds, and the annunciator lamps indicate counter overflow and gate operating status.

Remote display of data, counter

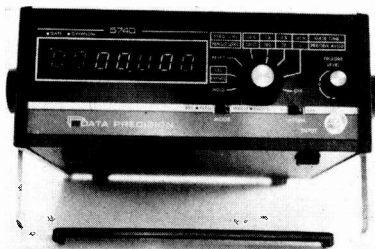

Data Precision Model 5740 Counter. For more information about this instrument, circle 107 on the READER SERVICE CARD.

status, gate status and user control signals are available from the rear panel connector when the BCD option is factory installed.

A trigger level control is located on the front panel to adjust the threshold of axis crossings for low duty-cycle, offset, and AM modulated inputs.

A built-in hysteresis is incorporated so that noisy input signals may be measured accurately.

The counter is self-contained in one portable case which measures 3½ inches high by 8½ inches wide by 7¼ inches deep, with a carrying handle that doubles as a tilt stand. Price is \$295.

#### LEADER MODEL LDM-170 DISTORTION METER

The Leader Model LDM-170 Distortion Meter will measure the distortion, S/N (signal-to-noise ratio), and signal levels in audio

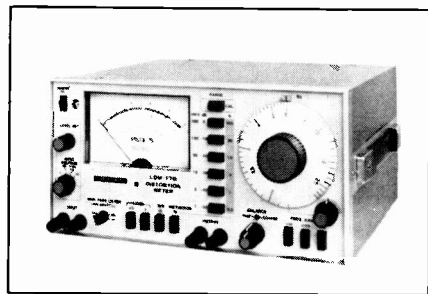

Leader Model LDM-170 Distortion Meter. For more information about this instrument circle 108 on the READER SERVICE CARD.

frequency circuits. A highly selective balancing network is used to eliminate the fundamental frequency in the 20 Hz to 20 KHz band. The distortion products which are being checked are fed to a high-gain wideband amplifier for indication on the meter. This amplifier is effective up to 200 KHz and measurements are possible up to and including the tenth harmonic of 20 KHz. The balancing network is switched out of the circuit when measuring the noise and signal levels whereby the high-gain amplifier is used as sensitive voltmeter. The signal-to-noise ratio can be measured to 70 dB below the reference level. Signal levels in the 100 µv to 300 volt range can be measured for frequencies between 20 Hz and 200 KHz.

The input terminals for the connection from the test circuit output and the output terminals which are used for waveform monitoring with an external scope are located on the front control panel of the instrument.

For faster, simplified operation of the instrument pushbutton switches are used to select the different uses of the instrument, selection of fundamentals when measuring distortion, and selecting the full scale meter ranges for the different functions. A calibrate switch is located on the front panel and is used when setting the input level reference for distortion and S/N measurements.

The power supply has input taps at 100, 115, 215, and 230 volts.

The instrument measures 6½ inches high by 12½ inches wide by 12 inches deep and weighs 11.2 lb. Price is \$412.45. ■

## SIGNAL SEEKING TUNERS

continued from page 37

trade because transistor Q2 will tend to turn off as Q1 is turned on harder. Also, the output transistor turns off as Q1 turns on. We can, therefore, turn off the output transistor by saturating Q1. This is the second function of the voltage applied through the mute diode. Modern Delco receivers, including seekers, use plastic, potted, circuit modules for the audio preamplifier and driver stages. They are numbers DM-8, DM-9, DM-29, and so forth. The muting function in these receivers is accomplished in a similar manner, but may look somewhat different as shown in Fig. 8.

### Seeker Sensitivity Control

The sensitivity requirements of the radio are different in manual tuning and seek modes. Also, the sensitivity of the receiver can be varied in two steps for convenience of the user. In one position, the radio is very sensitive and will usually stop on a large number of stations. In the other position, it is less sensitive and may only stop on the more powerful, local stations.

Shown in Fig. 9 is the sensitivity circuitry of a typical seeker radio. When not in "seek" mode, the contacts of relay K1 (shown as No. 1 and No. 2) are both shorted to ground through contact No. 3. This places the minus end of capacitor C1 and the cold ends of the AM and FM RF amplifier emitter resistors (on the "common bus") at ground potential. When the seek relay is energized, contacts 1 and 2 are no longer grounded. When the *sensitivity*

control is in *local*, the emitter currents for Q1 and Q2 must flow through a high value resistor, R2. In *distant*, the *sensitivity* switch again ground the common bus allowing maximum sensitivity. In some radios, there is a special *stereo* position of the switch (see preceding section) used to allow stopping only on FM stereo stations. The sensitivity in this mode is slightly different from either local or distant. It is not desirable to bias the RF amplifiers to either low or high sensitivity levels so some intermediate value is found. In the stereo position the common bus is returned to ground through a 1200 ohm resistor. ■

### RCA TV 1976

continued from page 26

pack, or an external 12-volt power source such as a car or boat battery. The other chassis versions are used in "AC only" 9- and 12-inch receivers. Electrically and physically all the chassis versions are similar except for certain circuit changes to permit battery operation, or physical differences for the different picture tube sizes.

### Sync Circuit

The sync-separator stage Fig. 3 is a "text book" circuit. Positive-going video from the collector of the second-video transistor is received at the base of the sync-separator transistor (Q206) through capacitors C213 and C214. The positive sync pulse biases Q206 into conduction, producing a negative sync pulse of about 15-volts p-p which is deli-

continued on page 55

# FREE EICO CATALOG

## 346 Ways To Save On Instruments!

EICO's Test Instruments line is the industry's most comprehensive because each instrument serves a specific group of professional needs. You name the requirement—from a resistance box to a VTVM, from a signal tracer to a scope, from a tube tester to a color TV generator, etc., you can depend on EICO to give you the best professional value. Compare our latest solid state instruments at your local EICO Electronics Distributor, he knows your needs best—and serves your requirements with the best values!

**"Build-it-Yourself" and save up to 50% with our famous electronic kits.**

For latest EICO Catalog on Test Instruments, Automotive and Hobby Electronics, Eicocraft Project kits, Burglar-Fire Alarm Systems and name of nearest EICO Distributor, check reader service card or send 50¢ for fast first class mail service.

EICO—283 Malta Street,  
Brooklyn, N.Y. 11207

30 years of service to the Professional Serviceman.



...for more details circle 117 on Reader Service Card

OCTOBER 1975, ELECTRONIC TECHNICIAN/DEALER / 47



## CORNELL ELECTRONICS COMPANY

2423 N. UNIVERSITY AVE. SAN DIEGO CALIF. 92105

THE ORIGINAL HOME OF

# 36¢

PER TUBE  
UNLESS OTHERWISE PRICED  
100 TUBES OR MORE  
33¢ PER TUBE

Same Low Price East or West Coast!

- ★ Bargain Tools
- ★ Transistor Tester
- ★ Technician's Library

**SPECIAL OFFER**

ON ALL ORDERS OVER \$10.00

# 25¢

PER TUBE (NO LIMIT)

FROM THIS LIST

GAG5 6CB6  
GAU6 6J6  
GAX4 6SN7

**SEND FOR FREE NEW 48 PAGE COLOR CATALOG**

ONE YEAR GUARANTEE

INDIVIDUALLY BOXED

5 DAY MONEY BACK OFFER

LAB TESTED USED

- ★ Dumont Picture Tubes
- ★ Diodes—Transistors—Kits
- ★ Tube Cartons

**Your Order FREE if Not Shipped in 24 Hours**

...for more details circle 116 on Reader Service Card



**You  
can study  
FM  
two-way  
radio  
at  
home!**

Thousands have increased their knowledge of FM two-way radio through the MTI home-study courses. Now, newly revised and better than ever!

Cut me in, send free information. (No salesman will call)

Name \_\_\_\_\_

Address \_\_\_\_\_

Code \_\_\_\_\_

I am a Veteran

I am a serviceman on active duty



Formerly

**MOTOROLA TRAINING INSTITUTE**  
College Hill Road, Summerdale, Pennsylvania 17093

...for more details circle 144 on Reader Service Card

**TECHNICAL DIGEST...**

G.E. continued from page 31

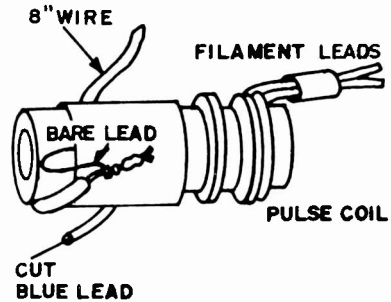

FIGURE 2

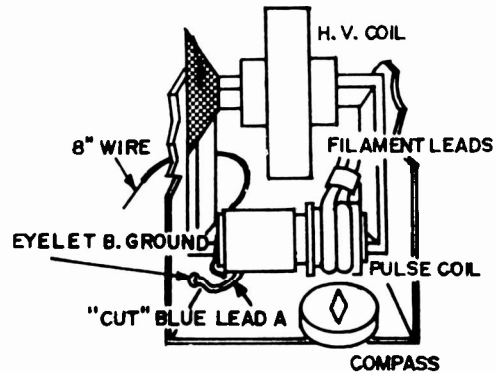

FIGURE 3

several turns of electrical tape around the coil to keep the connection in place. 4) Route the lead under the coil so that it will be captivated by the ground lead. The coil can now be connected into the circuit.

**MAGNAVOX**

Color TV Chassis T995—Servicing the IF and RF Circuits

Some checks can be performed to help isolate the source of a given trouble symptom. For example, a symptom of "raster only, no picture, no sound" could be a bad tuner, or IF module, the AFT module detuning the station, or the AGC/Sync module turning the IF or RF amplifiers off. The module layout is shown in the illustration. The following steps illustrate an approach which could be taken to isolate the source of this problem:

1) Switch the Videomatic and AFT circuit off and adjust the fine tuning.

(A) If the picture can be tuned in manually, check the AFT module by measuring the DC voltage at TP1 and TP2 while the VHF tuner is on an unused channel. The voltages should be between 5.5 volts and 7 volts on each test point, and the difference between the two must be less than 1 volt. (B) If these voltages are not correct, replace the AFT module. If they are correct, perform the AFT alignment.

2) Measure the RF and IF AGC voltages to ensure they are correct for maximum gain.

(A) The RF AGC voltage should be about plus 10 volts and the IF AGC voltage should be about plus 4.5 volts. (B) If the voltages are incorrect, replace the AGC/Sync module.

3) Unplug the IF cable from the IF module and try the IF jack test.

(A) Turn the volume control up and tap on the inside of the IF input jack on the IF module with a small screwdriver. If flashing can be seen on the screen and scratching

**Starting a CB Service Center?**

When Quality AND Price Are Important —

Its TUCKER ELECTRONICS For Electronic Test Instruments

- Reconditioned Test Equipment (8000 Units in Stock)
- Instrument Rentals (excellent Purchase Options)
- Finance Plans (BankAmericard or Mastercharge)
- Trade-Ins Accepted (Make Your Old Instruments Work One More Time)
- Reconditioning Service (If It Worked Right Once. We Can Make It Work Again)

- Instrument Distributors For:
 

RCA	TRI	BALLANTINE
WESTON	EPSCO	AMC ELECTRONICS
LEADER	POLAROID	PACIFIC ELECTRONICS

Call For Our Latest Catalog  
Toll Free Number (800) 527-4642  
(In Texas Call (214) 348-8800)

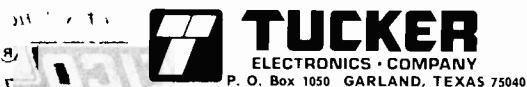



noise heard from the speaker, the IF module is likely not dead. (B) If this test has no effect, replace the IF module.

4. If the first three steps check good, the problem is likely to be the lack of signal to the IF module. Check the tuners.

(A) If located in an area where only UHF stations are available, connect a color bar generator or a UHF-to-VHF converter to the VHF antenna inputs to observe if a picture is produced. Remember, a defective VHF tuner could also

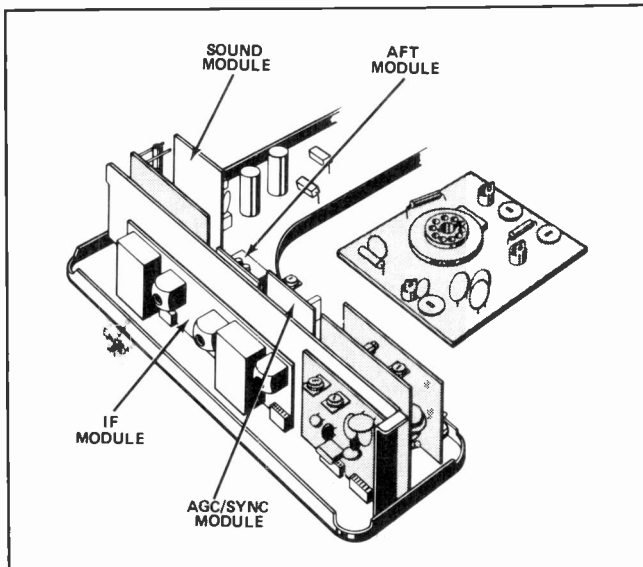

prevent UHF reception because the IF signal from the UHF tuner must pass through the VHF tuner which is likely defective. If both UHF and VHF stations are available, and neither can be received, the VHF tuner is likely defective.

(B) A defective tuner can be confirmed by using a commercially available test tuner.

The RF and IF processing circuitry is designed and packaged in easily accessible tuners and easily replaced circuit modules. With a general understanding of the operation of these parts, the professional service technician can efficiently isolate the source of a problem and repair it with a minimum amount of time and effort. ■

## LABOR PRICING

*continued from page 18*

the odds are overwhelmingly in favor of Sperry's times being "average" to an acceptable degree.

As I stated previously, I do not believe that the universal applicability of Sperry's pricing system can be accurately evaluated at this time. However, the broad range of shop hourly service labor rates covered by the 30 pricing calculator charts provided with Sperry's system seemingly should make his system adaptable to the cost-profit-pricing parameters of any size of shop in any market area of the country.

Acceptance by con-

sumers and various state and federal consumer protection agencies is another important factor in the consideration of a service labor pricing system. Because the basis of Sperry's service labor pricing system is the *average time* for functions *actually performed* during a job and *not* average price, and because the service charges computed with Sperry's system are *directly proportional* to the difficulty and complexity of the service job, consumers and consumer protection agencies should not only accept it but should *welcome* it. ■

# ROHN® TOWERS

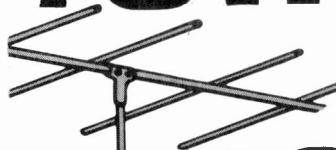

## LAST LONGER

Guaranteed  
against Rust  
because they  
are the *only*  
Tower Hot Dip  
Galvanized  
after fabrica-  
tion and  
*Available*  
*Nationally*

## ROHN® MANUFACTURING

DIVISION OF



P.O. BOX 2000 / PEORIA, ILL. 61601

"Supplying tower needs worldwide  
for over 25 years." JUNE 1974

## NEW PRODUCTS

Descriptions and specifications of the products included in this department are provided by the manufacturers. For additional information, circle the corresponding numbers on the Reader Service Card in this issue.

### COLOR BAR PATTERN GENERATOR 145

The Model ATC-10, Color Bar Pattern Generator introduced by American Technology Corp. has many unique features. The RED RASTER pattern provides purity checks with no need to disable the guns or disturb the screen controls. The 3.58 MONITOR function allows positive verification of the color

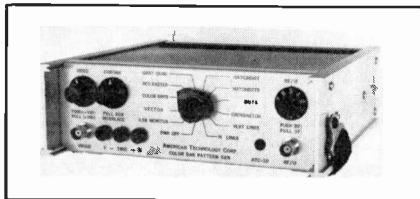

oscillator frequency without access to any test point. Other special patterns include GRAY QUAD for fast gray scale tracking checks; 6 th bar marking for quick, positive identification; composite convergence patterns (HATCHDOT and HATCHDOTS) for completing a full convergence series using a single pattern; bandpass checks in customer's

home at three separate frequencies; and receiver sensitivity and dynamic range test using the calibrated RF output. The generator also provides strong, steady outputs for IF and video injection in addition to vertical and horizontal oscilloscope triggers. All frequencies, line widths, and spacings are crystal controlled with the chroma and sweep frequencies being derived from a common oscillator. Price is \$299.95.

### DISTRIBUTION AMPLIFIER 146

Jerrold Electronics has developed a push-pull internal distribution amplifier for use in MATV systems with up to 35 channel capability. The Model IDA-45 is encased in a die cast aluminum housing. Its radiation shielding exceeds 90 dB. Gain is at least 45 dB over a range of 50 to 300 MHz, enabling the amplifier to handle mid-band and super band channels, as well as VHF band channels. Push-pull output circuitry cancels second harmonic distortion, which makes mid-band operation feasible. It can be used to interface with CATV, the output levels can be as high as +48 dBmV per channel in 35 channel systems or up to 54 dBmV per channel in 12-channel systems. The noise figure is 8 dB and response is flat within  $\pm 0.4$  dB. However, a linear slope control can be used

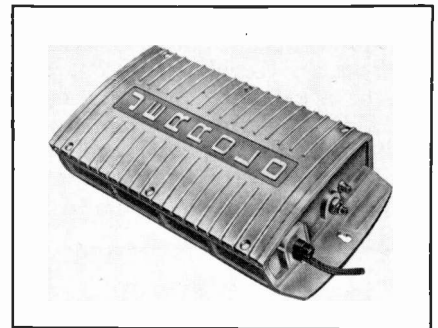

to compensate for 0 to 8 dB of cable slope at 300 MHz. The manual gain control range is 15 dB. Plug-in and accessory modules make the amplifier extremely versatile. The IOC automatic overload control compensates for input signal level fluctuations. IDP sub-channel splitting filters adapt the amplifier for two-way system operation. The 5 to 30 MHz sub-channel band is by-passed with a minimum loss of -3 dB. An IRA sub-channel amplifier module is available, where gain is required, to handle return signals in the 5 to 30 MHz range. Price is \$438.

### FREQUENCY COUNTER 147

Heath/Schlumberger Instruments provides a practical solution to low frequency measurement problems with the introduction of the SM-109A Computing Frequency Counter. It is ideal for applications such as a signal alignment of pushbutton phone systems, alignment of tone access for mobile radio systems, RPM measurements and line frequency monitoring. It measures the elapsed time (T) for a number of periods (N) of the input













waveform, then computes the frequency for the relationship  $F=N/T$ . The range is 0.1 Hz to 20 MHz with sensitivity as low as 20 mV. The display provides six-digit resolution with automatic decimal point placement and range indication. A front panel trigger control allows adjustment of the input amplifier trigger level above the zero-crossing point. This permits the trigger point to be set above most noise or signal distortion to insure an accurate count. The 1 megohm input impedance allows use of a standard scope probe as a 10-to-1 voltage divider. Other features include a switch for display of either hertz or counts

# ISO-TIP QUICK CHARGE

Recharges in 1/3rd the time of any other cordless iron.

Complete line of accessories available:

- |   |   |  |
|---|---|--|
|  No. 7566<br>Micro Soldering Tip |  No. 7577<br>Chisel Tip  |  No. 7556<br>Tuner<br>Extension Tip |
|  No. 7535<br>Regular Tip         |  No. 7574<br>Concave Tip |  |
|  No. 7546<br>Heavy Duty Tip      |  No. 7569<br>"V" Tip     |  |
|  No. 7596<br>Knife Tip           |  No. 7573<br>Tinning Tip |  |
|  No. 7545<br>Fine Tip            |  No. 7572<br>Blunt Tip   |  |

10 **WAHL CLIPPER CORPORATION**  
ORIGINATORS OF PRACTICAL CORDLESS SOLDERING  
Sterling, Illinois 61081 (815) 625-6525  
"Manufacturing Excellence Since 1919"



For more details circle 141 on Reader Service Card

per minute, oscillator input for use of an external frequency standard, reset switch to reset counter to zero. The price is \$640.

## OSCILLOSCOPE

148

Hickok Electrical Instrument Co., announces its new Model 512 Dual Trace Oscilloscope offering industrial accuracy to the service - test technician. It was developed in response to the demand from skilled professional service technicians for bench instruments that combine industrial quality with features especially suited to modern service work. Features such as: wideband triggered - sweep TV VITS display capability, clear high contrast traces, and high sensitivity for solid state work. Other features include: 10 MHz response with 5 mV/cm sensitivity, foolproof triggering to 15



MHz, bright 8 x 10 display, X - Y operation for vectorscope measurement, auto mode triggering, and twelve calibrated vertical ranges and 18 calibrated sweep speeds as well as TV-V, TV-H and TV - VITS sync. Front panel controls are color coded and logically placed utilizing slide pot trace positioning controls for fast errorless set - up. Price is \$675.

## MATV/CATV TAPOFF SYSTEM

149

A new MATV and CATV subscriber tapoff system which can turn "on" and "off" any number of individual TV outlets from a central location has been announced by *Blonder-Tongue Laboratories, Inc.* Called Centap, this system can be used to activate the individual outlets of paid-up subscribers in multiple dwellings. It also can turn off TV service to individual outlets when desired. All of this can be done from one central location without disconnecting or connecting individual TV outlets. In addition to being ideally suited to revenue-producing TV distribution systems, the Centap can be installed for approximately 1/7th the

cost of a standard home-run system. Another advantage is that the tapoffs can be wired in the normal vertical riser manner employed in multiple dwelling buildings. The Centap system consists of a central control unit that makes connection and disconnection for the single location possible. The central control unit is called the

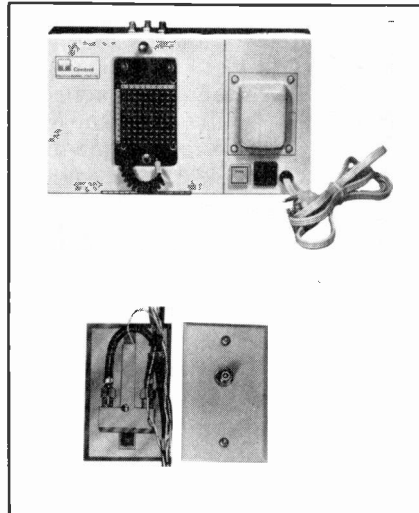

Model 4960 Centrol. Individual subscriber tapoffs are the Model 4959 Centaps. This new system works in the following manner: The subscriber taps are electrically biased in an "off" position via a voltage impressed upon the coaxial cable. The prewire control cable carries the turn-on voltage upon command from the Centrol unit. The tapoffs employ special PIN diode switching which provides more than 65 dB isolation in the turned off mode. The system is completely tamper-proof with the central unit capable of detecting unauthorized misuse of the subscriber outlet.

## CITIZENS BAND RADIO

150

The TRAM XL, a new mini-mobile AM Citizens Band radio is introduced by *TramDiamond Corp.* With the increasing emphasis on "thinking small", this unit will fill an important need for this ever-increasing demand. Its frequency tolerance is—005 per-



cent and has a sensitivity of 0.6  $\mu$ V for 10 dB S+N/N, signal modulation 30 percent @ 1 KHz sine wave. Its selectivity is 6 dB @ 4 KHz, 60 dB @ 20 KHz. The power on, volume, squelch,

# THE VOLKSMETER + NEW!! LM-3.5

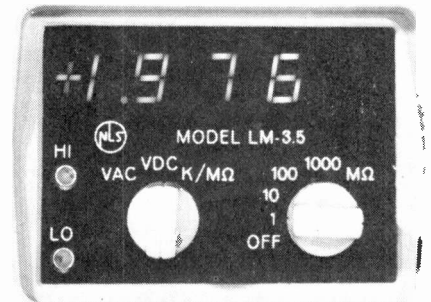

With Rechargeable Batteries & Charger Unit.

**\$147**

Standard Features:

- 3-1/2 digits - the LM-3 plus 100% over-range.
  - 19 ranges: 4 vdc, 4 vac, 3 dc amps, 3 ac amps and 5 ohms. • Automatic polarity with 1% accuracy. • Fully protected input. • Small size: 1.9" H x 2.7" W x 3.9" D.
- Options include. • High voltage probe. • Leather case. • Panel-mount flange. • Tilt stand.

See your local distributor!

Distributor inquiries invited.



**Non-Linear Systems, Inc.**

Originator of the digital voltmeter.

Box N, Del Mar, California 92014

Telephone (714) 755-1134 TWX 910-322-1132

# COUNT ON NLS<sup>®</sup> PC-4

## EVENT COUNTER

All electronic, MOS/LSI construction - lowest cost anywhere! Up to 200,000 counts per second.

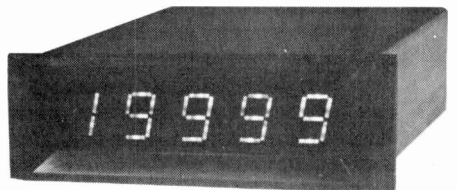

**\$49.50**

Standard Features:

In Unit Quantity

- Count to 19999 events.
- LED display - 0.3" in height.
- Programmable decimal.
- TTL or switch input.
- Electronic reset.
- Display inhibit, dimming and lamp test.
- Leading zero suppression capability.
- Multiplexed BCD output.
- Small size: 1" H x 2.5" W x 3.25" D.
- Operates on +5 vdc, < 0.75 W.

Optional 115 vac operation.

See your local distributor!

Distributor inquiries invited.



**Non-Linear Systems, Inc.**

Originator of the digital voltmeter.

Box N, Del Mar, California 92014

Telephone (714) 755-1134 TWX 910-322-1132

...for more details circle 126 on Reader Service Card

# T & T VALUE SALE

RAYTHEON, I.C.C., RCA, SYLVANIA  
 FAMOUS MAKE, NEW JOBBER-BOXED TUBES  
 NOW WITH NEW 5-YEAR GUARANTEE  
 80% OFF LIST

- |                   |                     |
|-------------------|---------------------|
| 1V2 5 for \$3.00  | 6HA5 5 for \$4.80   |
| 2AV2 5 for \$3.95 | 6HQ5 5 for \$6.85   |
| 3A3 5 for \$5.05  | 6HV5 5 for \$11.80  |
| 3AT2 5 for \$4.90 | 6JC6 5 for \$5.65   |
| 3CK5 5 for \$4.85 | 6JE6 5 for \$11.15  |
| 3HAB 5 for \$4.80 | 6J8 5 for \$9.30    |
| 3HM5 5 for \$4.80 | 6J88 5 for \$5.55   |
| 5GH8 5 for \$5.90 | 6KA8 5 for \$6.15   |
| 6AY3 5 for \$5.05 | 6KE8 5 for \$7.65   |
| 6BK4 5 for \$9.35 | 6KT8 5 for \$6.85   |
| 6CG3 5 for \$4.95 | 6KZ8 5 for \$5.15   |
| 6GG8 5 for \$5.40 | 6LB6 5 for \$10.75  |
| 6CJ3 5 for \$4.70 | 6L08 5 for \$11.15  |
| 6DW4 5 for \$4.70 | 8FO7 5 for \$3.75   |
| 6EA8 5 for \$4.95 | 12BV7 5 for \$4.50  |
| 6EH7 5 for \$4.80 | 12GN7 5 for \$7.00  |
| 6EJ7 5 for \$4.50 | 17JZ8 5 for \$4.50  |
| 6FQ7 5 for \$3.75 | 23Z9 5 for \$6.00   |
| 6GF7 5 for \$6.85 | 33GV7 5 for \$8.05  |
| 6GH8 5 for \$3.95 | 36M08 5 for \$11.40 |
| 6GJ7 5 for \$3.40 | 38HE7 5 for \$9.20  |
| 6GM8 5 for \$5.25 | 38HK7 5 for \$9.00  |
| 6GU7 5 for \$5.25 | 42KN6 5 for \$9.15  |

What is not advertised—write in at 80%  
 Off List!  
 One FREE 6GH8 for every 10 Tubes  
 purchased on orders over \$100.00.  
 6GH8 SPECIAL 100 for \$89.00  
 ALL SYLVANIA TUBES 70 & 10% OFF  
 LIST—SLEEVES ONLY

## TRANSISTORS XACT. REPLACEMENT (BOXED) Up To 85% off LIST

- |             |      |               |
|-------------|------|---------------|
| SK          | ECG  |               |
| 3009        | 102A | 10 for \$5.85 |
| 3018        | 121  | 10 for \$3.38 |
| 3021        | 124  | 10 for \$4.73 |
| 3041        | 152  | 10 for \$6.30 |
| 3052        | 153  | 10 for \$5.85 |
| 3054        | 184  | 10 for \$8.75 |
| 3083        | 183  | 10 for \$8.30 |
| 3084        | 196  | 10 for \$7.20 |
| 3103        | 157  | 10 for \$4.50 |
| 3114        | 169  | 10 for \$3.60 |
| 3115        | 165  | 5 for \$12.40 |
| 3124        | 123A | 10 for \$3.15 |
| 3132        |      | 10 for \$3.90 |
| Zen. 212-48 |      | 5 for \$10.00 |

## LARGE DISCOUNTS ON ALL TEST EQUIPMENT

- B & K Precision Portable Digital Multi-  
 meter Model 280. Reg. Price \$99.95—  
 Our Price \$85.00
- DIODES & RECTIFIERS  
 RCA Damper Diode Equiv. To:  
 RCA 120818 \$1.50 RCA 135932 \$2.95  
 6500 PIV Color Focus Rect. 10 for \$5.00  
 2.5 amp 1000 PIV IR170 100 for \$8.95  
 DD4 10 for \$2.50  
 Zen. Voltage Tripler 212-138 2 for \$8.00

- YOKES - TUNERS - FLYS EQUIV.  
 Y94 Y105 Y107 Y109  
 Y119 Y130 DY107AC  
 95-2779 Syl. 51-29978-E01  
 Philco 76-14328-1 Philco 76-14328-  
 2-1 ea. \$8.95  
 4 Asst. Tuners, New \$15.00  
 4 Asst. Combo Tuners, New \$20.00

## AUDIO - CARTRIDGES - SPEAKERS - NEEDLES REPL.

- 60 Min. Irish Cassette Tape 12 for \$6.00  
 90 Min. Cassette Norelco type box 12 for \$10.00  
 84 Min. Shamrock 8-track Tape 7 for \$6.00  
 40 Min. Shamrock 8-track Tape 8 for \$4.00  
 8-Track Head Cleaner 15 for \$3.50  
 Cassette Head Cleaner 15 for \$4.00  
 Equiv: N77 N75 N91  
 Shure 44 Pickering V15 ea. \$2.95  
 BSR Cart. SXM5 SX1M  
 85M 4 for \$6.00  
 12 Asst. Needles Incl. Diamond \$4.95  
 BSR Adapters (45) 8 for \$2.00  
 5 x 7 Speaker with Grill, pre-wired,  
 3-position Rotary Switch. ea. \$2.95  
 6 x 9 Speaker with Grill, pre-wired,  
 3-position Rotary Switch. ea. \$3.95  
 3 Stereo Headphones \$10.00  
 Universal AC Adapter, 5V, 75V, 9V \$4.95  
 2 of each: 4", 5", 8", 2x4", 4x6",  
 3x5". all 12 for \$13.95

- NEEDLES  
 BSR 1M 3M 5M 12 for \$4.95  
 Tetrad TD9 Universal 12 for \$4.95  
 Electro Voice EV 13M 12 for \$4.95

- ANTENNAS  
 300 ohm 2-Set Coupler 10 for \$7.50  
 300 Ohm 4-Set Coupler 10 for \$10.00  
 72 ohm to 300 ohm Matching  
 Transformer 10 for \$7.50  
 72 ohm Signal Splitter 5 for \$5.00  
 59 UF Connectors 100 for \$10.00  
 8 Antenna Clothespins \$1.19

- GENERAL  
 19 & 25" Color Boosters 3 for \$11.95  
 Color Boosters 25 for \$2.50  
 Belufuses 2250-1 8 for \$1.29  
 HV 30KV Anode Leads 3 for \$1.29  
 SHUNT REG. HOODS (6BK4) 8 for \$1.29  
 Color CRT Harness 8 for \$1.29  
 Minimum Orders \$50—F.O.B. Brooklyn, N.Y.  
 Catalogs \$1—Refundable upon your order  
 C.O.D.'s 50% deposit—CASH ONLY

# T & T SALES CO.

4802 AVENUE K  
 BROOKLYN, N. Y. 11234  
 Phone: (212) 241-5940

channel selector controls are found on the front panel. The illuminated meter indicates the receiving signal strength and relative power output. The unit measures 1.97 inches high by 5.5 inches wide by 6.3 inches deep and weighs 2.5 lb. Price is \$159.95.

## RESISTANCE TEST UNIT 151

A hand-size resistance substitution unit introduced by *Phipps & Bird* provides a low cost tool for repair tasks. Unique in its convenient pocket size, the Model 236-A unit features an over 11-million step range in one-ohm steps. Easily hand-held, it is excellent for instrument repair and trouble-



shooting. Using one-half watt resistors with 1 percent tolerance, the slide-switch unit provides a precision range from 1 to 11,111,110 ohms. Designed with three binding posts (one to ground case), the unit measures 4 inches by 6 inches by 1 3/16 inches housed in an aluminum case and finished in wrinkle blue. The price is \$58.

## ANTENNA AMPLIFIERS 152

*Channel Master* has introduced two new Spartan antenna-mounted TV amplifiers designed to provide improved reception of the UHF trans-

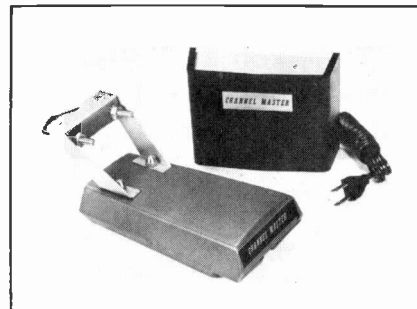

lator band, channels 70 through 83. The transistor-powered amplifiers are Model 0070B, a unit with up to two 300-ohm inputs from the power supply, and Model 0071B, a 75-ohm unit. Several features distinguish these amplifiers from previous Spartan models. The range of amplification has been expanded from channel 70 to out beyond channel 83. Average gain has been increased from 13 dB to 20 dB. The noise figure, previously ranging from 6.0 to 9.5, has been reduced to 4.7 to 7.5. The extremely high input capacity of these amplifiers allows excellent reception of strong, local UHF signals without overload, as well as clear reception of amplified weak signals. The high end of the UHF band, 800 to 900 MHz, has been set aside by the FCC for the conversion and re-broadcast of VHF signals in areas where this is necessary. The amplifiers permit all other signals to pass through freely without amplication, and do not interfere with reception of VHF or FM. List price for Model 0070B is \$56.95; for Model 0071B, \$66.25.

## SOLDERING TIPS 153

Six new soldering tips introduced by the *Wahl Clipper Corp.* for its "Iso-Tip" Cordless Soldering Iron, now brings the total choice of tips to eleven. The new tips are: No. 7569 V Tip to send heat under a circuit board wire; No. 7572 Blunt Tip and No. 7577

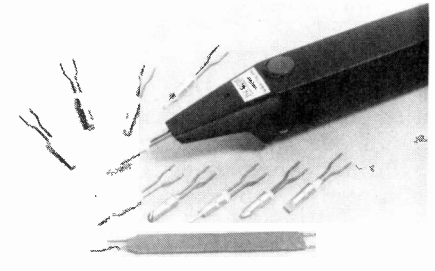

Chisel Tip for general heating applications; No. 7573 Tinning Tip, grooved to coat wire surfaces; No. 7574 Concave Centering Tip for work on the reverse side of the board; and No. 7596 Knife Tip for stripping insulation without marring wire. The Knife Tip is also handy for cutting nylon rope since it seals as it cuts, preventing unraveling.

## DIGITAL MULTIMETER 154

*Simpson Electric Co.*, announces the introduction of its new, low-profile, 3 1/2 digit, Model 464 Digital Multimeter. Housed in an attractive, high-impact, shock-resistant molded case, the instrument features: full push-button operation—ranges and functions; low-profile, modern case design;

unique, tilt-and-view, adjustable handle; 0.43-inch LED readouts; 0.2 percent VDC reading accuracy; bipolar operation and automatic zero; and built-in rechargeable battery circuit in one version. The instrument measures all popular electrical parameters in 28 ranges; six DC and AC current ranges to 10 amperes, six resistance ranges to 20 Megohms and five AC and DC voltage ranges to 1000 volts. The multimeter is offered in two

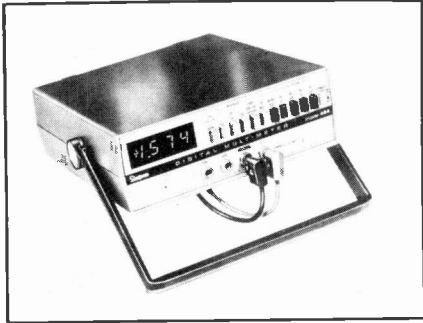

models, 464A and 464D. The A version, priced at \$210.00, operates at line voltages of 120/240 VAC, 50-400 Hz. The 464D, (complete with internal battery-charging circuit), is priced at \$235.

**VHF/UHF PREAMPLIFIER 155**

*Q-bit Corporation* has added a

broadband VHF/UHF preamplifier Model PA-0530 to its CATV and entertainment line. This preamplifier

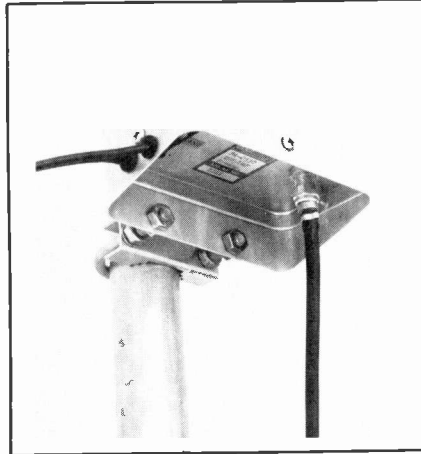

has a flat 15 dB gain from Channel 2 through Channel 83. It utilizes an integrated circuit amplifier stage, yielding a 4 dB noise figure with stable and reliable performance. The input impedance of the unit is 300 ohms and the output 75 ohms. The price is \$42.

**INTEGRATED CIRCUIT TOOL 156**

Insert or extract IC's quickly and easily with the PUL-N-SERTIC integrated circuit tool No. 9481, from *GC Electronics*. The tool provides max-

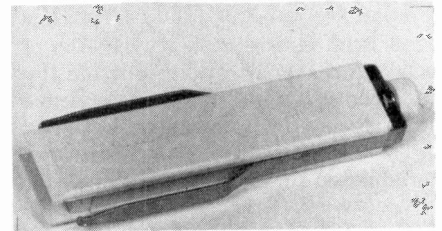

imum protection to IC leads and also acts as a heat sink when desoldering them. Made of high-impact plastic, the tool is ideal in the rework area or field.

**ANTENNA MAST/CONDUIT CARRIER 157**

To augment its existing line of vehicle top carriers, *UPEC Corporation* has begun production of a new carrier. Named the "Condu-Carrier", this transporter is an attachment to the

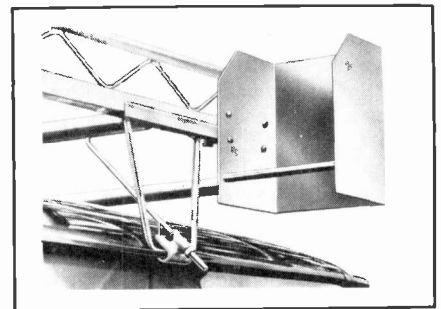

# Add a trace to any scope for only \$108.\*

**RCA's new WM-541A Dual-Tracer . . . the sensible way to update your equipment and servicing technique.**

Think of all the ways you could use a multi-trace scope and you'll see why the RCA Dual-Tracer is so popular. Use it to compare gain, frequency, response, distortion, phase shift, time delay and more. It's great for TV, stereo and digital equipment servicing. Here are some of the reasons why:

The WM-541A features: *Useable DC to 10 MHz. Two 6-step compensated attenuators (1, 2, 5, ratio) 1 Megohm input. Choice of continuously variable "alternate" or "chopped" switching rate. 10 mV to 50 V direct input, 500 V with 10X probe. AC or DC coupling and vertical position controls for each channel. Separate, variable sync-level control with polarity reversing switch.*

To buy the new Dual-Tracer WM-541A, contact any one of the more than 1,000 RCA Distributors worldwide. Or contact, RCA Distributor and Special Products Division, Bldg. 206-2, Cherry Hill Offices, Camden, N.J. 08101 (Phone 609 779-5715).

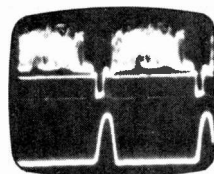

Video waveforms can be checked quickly and precisely with the RCA Dual-Tracer. Top: Composite video waveform. Bottom: Color burst keying pulse. Sweep: TV/H.

**RCA Electronic Instruments**

**plus**  
\*Suggested price

...for more details circle 164 on Reader Service Card

company's Van-Rak. The carrier has been load-testing to carry 100-lbs of antenna masts or conduit outside the van where it's out of the way, never bent, twisted or damaged between the shop and job-site. The carrier can be adjusted to 12 ft. The carrier consists of two holders constructed of hot-dipped galvanized steel and attaches to the rail of the pre-mounted Van-Rak. Set of four nut-bolt assemblies with retaining plate holds the carrier securely but not permanently. The unit can be removed and re-mounted as required.

## OSCILLOSCOPES

158

Tektronix has announced the new T900 line of oscilloscopes. They all feature a large, bright 8 x 10 cm CRT, beam finder, single knob trigger control, delay line, to enable viewing of the waveforms leading edge, automatic selection of TV line or frame display; and functionally color-coded control panels. The instruments weigh 15 to 18 lbs. and measure 7 inches by 10 inches by 19 inches. The Model T921, single-trace oscilloscope has a DC bandwidth to 15 MHz, mono time-base, and 20 ns/cm sweep rate. Priced at \$695. The Model T922 is a dual-trace oscilloscope with similar features and is priced at \$850. The T932/T935 oscilloscopes have a DC

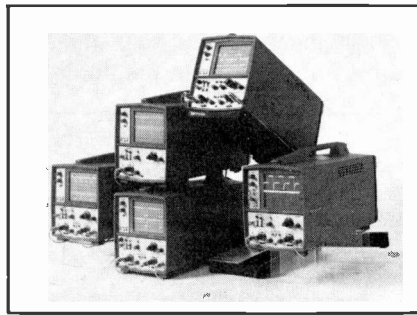

bandwidth to 35 MHz at 2 mV/cm and 10 ns/cm sweep rate. The Model T932 is priced at \$1,050 and the T935 with delayed sweep is priced at \$1,250. The Model 912 Storage Oscilloscope has a DC bandwidth to 10 MHz at 2 mV/cm, 250 cm/ms Stored Writing Speed, 50 ns/cm sweep rate and 8 x 10 cm Bistable Storage CRT. The price is \$1,195.

## COAXIAL WATTMETER

159

Bird Electronic Corp., announces a new Model 4527 RF Directional Wattmeter for the measurement of forward or reflected CW power. The instrument features an RF sampling output for frequency analysis on a scope, spectrum analyzer or frequency counter. The wattmeter is designed for + 5 percent power measurement, from 100 milliwatts to 1000 watts, from 2 to 200 MHz and up to 500 watts, from 200

to 512 MHz, using the same standard plug-in elements in discrete bands and power-levels as cataloged with the Model 43. No plug-in elements are needed for RF analysis: the sample signal is available from a BNC output port at about 53 dB below the main signal level in the built-in section of 50-ohm line (10-512 MHz). Below 10 MHz the coupling decreases gradually to -70 dB. It has a low insertion VSWR of 1.05 maximum. A major feature resulting in this low VSWR value is the use of the patented QC Quick-Change connectors, which permit

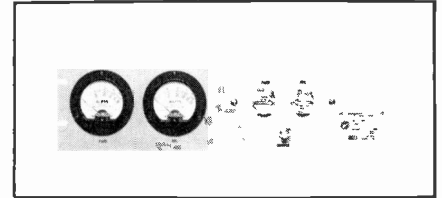

mating with male or female N, BNC, TNC, UHF, C, SC, HN, GR Type 874 and 7/8 inch EIA lines without the need for adapters. The price is \$245.

## RF SIGNAL GENERATOR

160

The Model LSG-16, wide band signal generator that is ideal for service, hobby, education or industrial use, is available from Leader Instruments Corp. The generator features an FET

# Rem's New Superstar Is Loaded With Super Features.



### Still Way Ahead of the Game

Rem's forged ahead again! This time, with the full REM CRT RECOVERY SYSTEM in a small, lightweight (6 lbs.), compact unit.

Five years and a few thousand units ago, Rem originated the "new generation" RECOVERY SYSTEM with the CRU-IA. It startled the industry and caused the "big boys" to take a close, hard look at their suddenly outdated CRT Rejuvenator/Checkers.

Now, take a close, hard look at Rem's brand new CRU-II. Unequaled performance and a pocket-sized price tag puts the CRU-II far in advance of any Tester/Restorer on the market today.

### Fully-Automatic Recovery System

Rem's exclusive feedback control system brings picture tube restoration into the Computer Age. The AUTO-RECOVERY® SYSTEM

in the CRU-II varies the timed recovery cycle according to the exact requirements of the gun being recovered.

Feedback from each gun determines recovery time. This new, unique circuitry allows each gun to receive the optimum current necessary to its recovery.

### Beam Current Checking

Rem originated Beam Current Checking. With this superior checking capability, the CRU-II allows accurate testing of color CRT's. What you see on the meter is what you'll see on the screen. Compare that feature with other checkers!

### Safe and Secure

The REM RECOVERY SYSTEM all but eliminates the danger of cathode damage. The CRU-II makes it practical for the technician to offer CRT restoration as a standard service procedure.

### No Generation Gap

The CRU-II is the forerunner of an even newer generation of CRT Tester/Restorers. Until now, this type of restoration process and innovative beam current checking were available only in units priced from \$262. to \$399.

### Not Just Another Pretty Face

The CRU-II looks like the real pro it is. Great looks and performance to match. Every feature was designed for ease of operation. Switches and buttons were placed where they fall-to-hand, eliminating much of the confusion technicians face when working with other units.

### And For Your Peace of Mind, A Two Year Warranty

Unconditional parts and labor for a full two years. During the second year of warranty, there will be a small handling charge of \$9.95, freight included.

**rem**  
electronic instruments

22708 South Western Avenue/Torrance, California 90501  
AVAILABLE IN CANADA THRU: PACO ELECTRONICS, LTD., MONTREAL

Plus a Super Price Tag!

rem  
\$159.95

...for more details circle 133 on Reader Service Card

oscillator circuitry for high stability performance plus an accurately calibrated frequency dial. The frequency range is 100 KHz to 100 MHz; and up to 300 MHz on harmonics. The internal modulation is 1 KHz at 30 percent



or higher while the external modulation is 50 Hz to 20 KHz at less than 1 V rms. The unit is capable of functioning as a marker-generator when used in conjunction with a sweep generator and will check and align RF and IF circuits in TV, FM and communication-type receivers and transmitters. Use of the product is further extended by provisions to accommodate a 1-15 MHz crystal. It measures 6 inches high by 10 inches wide by 5 inches deep and weighs 5.5 lbs. Price is \$109.95

## SOLDERING IRON

161

The Weller 60-watt industrial soldering iron with automatically controlled temperature and output, offers the capability of operating heat selection with five sizes of interchangeable screwdriver-type tips, producing 600,

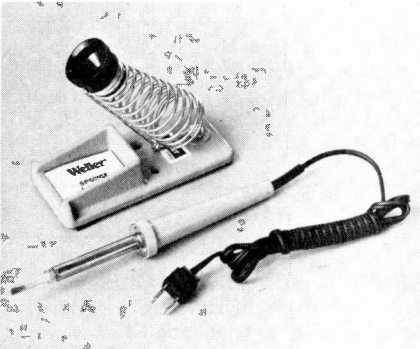

700 and 800-degrees F. The Model W-60, Soldering Iron is 7 1/4 inches long and weighs 2 1/2 ounces and is available with either two- or three-wire cord. It can also be used with an optional stand complete with sponge and receptacle as a bench station.

## TUNER SPRAY

162

A new TV tuner aerosol formulated to meet the critical requirements of color TV has been announced by Chemtronics. The tuner spray cleans tuner contacts thoroughly, then leaves a protective film of silicone lubricant



to assure smooth detent action. Designated Model CLD-4, the new product is safe for plastics, will not detune and is non-flammable. In most cases, the flexible spray aid enclosed with the tuner spray can be inserted into the tuner through the hole used to fine tune the tuner slugs. It is not necessary to remove the back of the TV set; only the channel selector knob must be removed. Price is \$1.35. ■

Please do not send money for items for which there is a fee. The Reader Service Card indicates your interest in an item. The company or organization will bill you directly.

## RCA TV 1976

*continued from page 47*

vered to the vertical module and horizontal AFC network.

## Sound Circuits

The KCS 201 chassis uses the familiar MAI 001 Sound module to detect, amplify, limit and demodulate the 4.5 MHz intercarrier sound signal. The single IC on the module also contains a gain-controlled preamplifier that interfaces with a "DC volume-control" circuit similar to that used in other chassis. Output from module MAI audio at a level sufficient to drive a class-A audio-output stage.

Two versions of audio-output stages are used—one for AC/battery chassis Fig. 4; the other for AC only versions Fig. 5. The differences result from using 140 volt B+ to power the output stage in AC only chassis, and +18 volts as a source in the AC/battery chassis versions.

## KCS201 Chassis

Larger screen (16-inch and 19-inch diagonal) models are equipped with the new KCS202 chassis that bears close similarity to the KCS200 it replaces. Of particular interest is the fullwave bridge power supply which enhances power-supply voltage regulation and filtering. ■

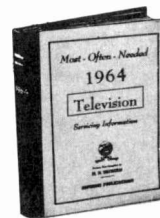

## AMAZING OFFER

### RADIO/TV SERVICE DATA

Your best, complete source for all needed RADIO and TV diagrams and helpful servicing data. Most amazing values. Sold in sets at up to 50% discount. Cover all important makes and models. Use this entire ad as your no-risk order form.

NO-RISK ORDER COUPON

### TELEVISION SERVICE MANUALS

Supreme TV manuals are still best for faster, easier TV repairs. Accurate factory data at bargain prices. Complete circuits, needed alignment facts, printed circuit views, waveforms, voltages, and double-page schematics. Issued in large annual manuals. Sold in sets at up to 50% off, or at \$4 per volume. Send entire ad as your order form.

- 1965 through 1970, in 8 volumes, B-W & color, value \$35, only \$24.95.
- 1957 through 1964, in 7 volumes regular price \$23, now only \$12.95.
- 3 early 50's TV manuals, \$5.95.

### RADIO DIAGRAM MANUALS

These low-priced radio manuals simplify all repairs. Cover everything you may need from recent radios to oldtimers; all type radios, stereos, transistor portables, FM-AM, and auto sets. Large schematics, all needed alignment facts, printed boards, voltage data, dial stringing. Volumes are big, 8 1/2 x 11", about 190 pages each.

- 1960 through 1969, in 8 volumes, all makes, value \$32, only \$17.95.
- 1951 through 1959, in 9 volumes, data you need, value \$34, only \$16.95.
- 1950,  1948,  1946,  1942,  1941, each \$4, or the set of 5 vols., \$15.95.
- 1926-1938 Antique Radios, only \$7.

### SUPREME PUBLICATIONS

1760 Balsam Road, Highland Park, IL 60035

Rush sets of TV and Radio manuals checked in no-risk order form of this ad. I am enclosing full price plus \$2 for postage and handling. Satisfaction guaranteed.

Name: .....

Address: .....

City: ..... Zip: .....

...for more details circle 137 on Reader Service Card

## SILVER PLATED SPLITTERS?

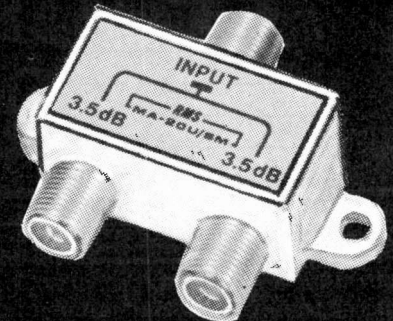

Sure, silver is an expensive metal. But it increases conductivity and resists decay. For superior installations—#MA-20U/SM two-way, #MA-30U/SM three-way, and #MA-40U/SM four-way—from RMS maker of the "Non-Corroables"



RMS ELECTRONICS, INC.  
50 Antin Place, Bronx, N.Y. 10462  
Tel. (212) 892-6700

...for more details circle 134 on Reader Service Card

# CLASSIFIED

RATES: 35¢ per word; 45¢ per word Bold Face Type. Add \$3.00 if you wish Box Number. Minimum \$10.00 charge. Classified Display Rate billed \$40.00 per inch, 1 inch minimum. Remittance must accompany order. Mail ad copy to: Roz Markhouse, ET/D, 757 3rd Ave., N.Y., N.Y. 10017.

## Educational Courses

**REPAIR TV TUNERS**-High Earnings; Complete Course Details, 12 Repair Tricks, Many Plans, Two Lessons, all for \$2. Refundable. Frank Bocek, Box 3236, Ent., Redding, CA 96001.

## Wanted

NEED SCHEMATIC ON SECRETARY TYPE RECORDER, ELECTRO DATA INC. EDI MODEL NT-40 WHICH USES MIRCO CASSETTES. 10/75

UNUSUAL SURPLUS, CLOSEOUTS AND PARTS CATALOG. RUSH \$1 ETCO-4 ELECTRONICS. Box 741, MONTREAL H3C2V2.

WANTED: USED PICTURE TUBE REBUILDING EQUIPMENT. SEND DETAILS TO ROBERT NELSON, 3602 MT. ACLARE, SAN DIEGO, CALIF. 92111 (714) 278-1365 10/75

## Business Opportunities

**ELECTRONICS/AVIONICS EMPLOYMENT OPPORTUNITIES.** Report on jobs now open. Details FREE. Aviation Employment Information Service, Box 240 Y, Northport, New York 11768.

## FIELD SERVICE REPRESENTATIVE COLOR TV

Requires excellent background in Field Service and Field Training in solid state color TV and audio products. You must be able to teach theory and trouble-shooting techniques on the bench and in the classroom. You will locate and set up qualified service agencies. You must present a professional image to dealers and consumers, and be an excellent communicator.

Send detailed resume including salary history and objectives in your first letter to Director of Product Reliability.

**CURTIS MATHES  
MANUFACTURING COMPANY**  
P.O. Box 151 Athens, Texas 75751

## Manuals and Periodicals

NEW CANADIAN MAGAZINE. "ELECTRONICS WORKSHOP". \$5.00 YEARLY. SAMPLE \$1.00. ETCO-C, Box 741 MONTREAL H3C2V2.

DIGITAL IC MANUAL—3rd edition—3000 latest types/pinout diagrams-cross references, \$6.95—IC APPLICATIONS

MANUAL-Numerous circuits-Analog/digital-\$3.95—Electronics/ETD, P.O. Box 127, Hopedale, MA 01747. 1/76

## KNOWLEDGE MEANS PROFIT

Every electronic servicer needs NATESA's Service Contract Cookbook and Practical Operations Manual. Either book \$15.00. \$22.00 brings you both. NATESA, Dept. ETD75, 5908 S. Troy St., Chicago, Illinois 60629. 11/75

## Construction Plans

**SURPRISE! SURPRISE!** Digital Piano Tuning Device tunes ALL musical instruments Accurately! Perfectly! Inexpensively! Construction-Instruction Plans Complete \$12.95 Airmailed Postpaid! Moonlighting quickly repays \$40 electronics investment! **GREEN BANK SCIENTIFIC**, Box 100Y, Green Bank, WVa 24944. 2/76

## Construction Plans

Complete Construction Plans — TELEPHONE: Answering Device, Automatic Dialer, "Black Boxes," Call Diverter, Call Limiter, Conference Bridge, Central Dial Exchange, Melodic Ringing, Recorder-Actuator, Remote Control, Schematics, Speakerphone, Teletink Burglar Alarm, Voice Schrambler, \$3.00 each. ELECTRONIC: Biofeedback Conditioner, Horticulture Stimulator, Multifrequency Encoder Network (Speeds telephone calling 100%!). \$5.00 each. ONE YEAR SUBSCRIPTION to Telephone Electronics Line (TEL) \$6.00. "The Legal Aspects of Interconnection" book, \$29.95. All of the construction plans above plus a one year subscription to TEL \$29.95. TELETRONICS COMPANY OF AMERICA, 22035 Burbank Blvd., Suite 122, Woodland Hills, Calif. 91364.

Convert any transistorized T.V. tuner to a tuner substituter. Plans \$2.00. New accelerated Radio & T.V. course. RADIO TELEVISION TRAINING, Box 279, ET-105, Syracuse, N.Y. 13206. TF

## Catalogs

**FREE** Bargain Catalog. Ultrasonic devices. LEDs, transistors, IC's keyboards. Xtals, unique components. Chaney's, Box 15431, Lakewood, CO 80215. 10/75.

HEAR POLICE/FIRE Dispatchers! Catalog shows exclusive official directories of "Confidential" channels. Send self-addressed stamped envelope. Dealers wanted. Communications, Box 56-ET, Commack, NY 11725

TV & RADIO TUBES .36¢ EA!! Send for free color parts catalog Your order free if not shipped in 24 hours. Cornell Electronics 4215-17 University San Diego California 92105

RADIO & T.V. TUBES — 36 cents each. Send for free Catalog. Cornell, 4215-17 University, San Diego, Calif. 92105.

send a message...  
...write here.

1. Number of insertions: (circle) 1 2 3 6 12
2. Start with (month) ..... issue (Copy must be in by 1st of month preceding)
3. Amount enclosed: \$.....

PAYMENT MUST ACCOMPANY ORDER WE'LL BILL RATED FIRMS NO AGENCY COMMISSION

NAME \_\_\_\_\_ COMPANY \_\_\_\_\_

STREET \_\_\_\_\_

CITY \_\_\_\_\_ STATE \_\_\_\_\_ ZIP \_\_\_\_\_

MAIL COPY FOR AD(S) TO: ROZ MARKHOUSE, Electronic Technician/Dealer, 757 Third Ave., New York, N.Y. 10017

RATES: 35¢ per word; 45¢ per word Bold Face Type. Add \$3.00 if you wish Box Number. Minimum \$10.00 charge. Classified Display Rate billed \$40.00 per inch, 1 inch minimum.

# ELECTRONIC TECHNICIAN/DEALER CLASSIFIED



Computer Accessories, Surplus Electronics Bargains, Electronic Kits, Technical Reports, New Semiconductors and Electronic Parts, Telecommunications, Buyers Guides; CATALOG 752B, 50¢ deposit; E/S Lab, Box 738, College Park, Maryland 20740. 11/75

CANADIANS SAVE BIG MONEY! SURPLUS, CLEAROUTS AND BANKRUPTCY INVENTORIES. HI-FI AND PARTS. CATALOGS \$1.00. ETCO-D, ELECTRONICS. Box 741, MONTREAL H3C 2V2.

### For Sale

**ELECTRONIC TEST EQUIPMENT FOR SALE.** Reconditioned or repairable, from Aerospace Industry and DOD. \$0.50 for catalog. James Walter Test Equipment, 2697 Nickel Street, San Pablo, CA 94806. 8/76

JAPANESE TRANSISTORS—All Transistors Original Factory Made. Free Catalog. West Pacific Electronics, Box 25837, W. Los Angeles, CA 90025. 1/76

### Lease or Sale

Three acres—700 foot frontage on Main St. Will consider franchise. Jasky Bros. M.S. Inc. 169-205 Main St. Prospect Park, N.J. 07508 12/75

**WORKING FOR PEANUTS?** Like television-electronics servicing? Own your own service shop on Florida's east coast. Busy shop with excellent reputation. Nets owner-operator over \$20,000/year. Only \$11,500 for all. Box 904, Titusville, Fla. 32780. 10/75

**DYNACO-A-R-TRANSISTORS, REPAIR BOARDS & UNITS, SPEAKER SERVICE. SEND FOR PRICES AND DETAILS: BEAR ELECTRONICS—177-E-HILL-CREST ROAD, MT. VERNON, N.Y. 10552.**

Game for thinkers: Emphasis on what to think, Challenging: (\$3.00) refundable. Tayo Paul, 980 Greene Ave., Brooklyn, N.Y. 11221. 12/75

**BUSINESS FOR SALE.** T.V. Sales & Service. Zenith Franchise. For more information contact Harold Schumacher, Box 265, Whittemore, Iowa 50590. 11/75

**OSCILLOSCOPE-HEATHKIT WIDE-BAND. GOOD SHAPE. FOR SERVICING COLOR TV.** Jack Mandik, 1333 Ridge Ave. Evanston, Ill. 60201. 10/75

**BURGLAR ALARM DIALING UNIT** automatically calls police. \$29.95. Easy to program and easy to install. Free literature. S&S Systems, Box 12375E, North Kansas City, Mo. 64116. 10/75

TV Sales and Service, "in Sunny Florida", established 14 years, same location, well stocked-excellent price, ill health. Look TV-920 W. Haven Hav., Melbourne, Fla., 32901 11/75

**OWN YOUR OWN PICTURE TUBE REBUILDING BUSINESS**

With Lakeside Industries rebuilding equipment you can rebuild any picture tube!

For complete details send name, address, zip code to  
**LAKESIDE INDUSTRIES**  
 3520 W. Fullerton Ave.  
 Chicago, Ill 60647  
 Phone: 312-342-3399

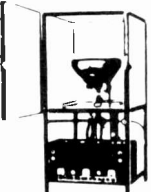

**PICTURE TUBE REBUILDING EQUIPMENT COMPLETE WITH SEALING MACHINE, OVEN AND VACUUMING EQUIPMENT AND ACCESSORIES \$2900.** 609-268-0776 JOSEPH DEILY, LEE DRIVE, VINCETOWN, N.J. 10/75

**COLOR TELEPHONES** with plug and jack, all new American made \$29.90. Ringers Extra. Latest styles available, ten colors. Retired Installers Secrets \$2. Telectra Sales, Box 25117-ET, Richmond VA 23260. 12/75

**REBUILD PICTURE TUBES.** We sell new & used equipment with complete instructions in our plant. We buy used equipment. Factory Outlet, 951 E. Hudson St., Columbus, OH 43211 614-263-0645.

# MEET OUR family

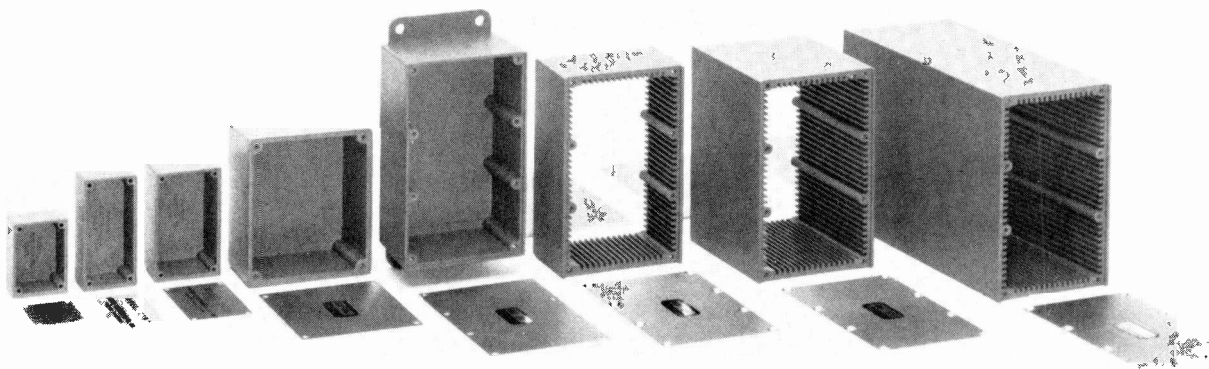

## of shielded "black boxes"

Almost 10 years ago (1966 to be exact) we introduced our first two series of shielded electronic enclosures. They became an overnight success. Since then the demand for different sizes, shapes and applications has increased our family to eight series of models, each with a noise rejection greater than 70db.

Sizes range from 1.50" x 1.13" x 0.88" to 4.13" x 2.68" x 6.0"; in blank versions or with a complete choice of coaxial connectors; painted or unpainted; with or without printed circuit card guides; with mounting flanges or bottom mounting plates. All models supplied with aluminum covers and screws.



SOLD ONLY THROUGH ELECTRONIC DISTRIBUTORS

**POMONA ELECTRONICS ITT**

1500 East Ninth St., Pomona, California 91766 Tel: (714) 623-3463

...for more details circle 129 on Reader Service Card

OCTOBER 1975, ELECTRONIC TECHNICIAN/DEALER / 57

**Some stores  
sell test  
equipment  
at discount  
prices.**

**At Fordham  
we discount  
their discount  
prices.**

B&K, EICO, RCA, SENCORE  
FLUKE, HICKOK and LEADER

Complete line of tubes,  
tools and electronic supplies

**FREE CATALOG**  
**FORDHAM**

RADIO SUPPLY CO., INC.

558 Morris Ave., Bronx, N.Y. 10451  
Tel: (212) 585-0330

...for more details circle 120 on Reader Service Card

**SEND FOR OUR BIG  
FREE WHOLESALE  
CATALOG**  
**FOR DEALERS ONLY!**  
**We do not sell the consumer!**

Save on  
thousands of audio,  
and electronic parts,  
test equipment and accessories.



IEC - MULLARD

**88¢**

MINIMUM 10  
POPULAR 6GH8  
ORDER No. X 114

**SEND CHECK WITH  
ORDER - WE PAY  
SHIPPING CHARGE**

QUALITONE INDUSTRIES, INC.  
17 Columbus Avenue, Tuckahoe, N.Y. 10707  
Please send FREE Catalog to:

Name.....

Company.....

Address.....

City.....State/Zip.....

...for more details circle 131 on Reader Service Card

## READER SERVICE INDEX

### ADVERTISER'S INDEX

109 American Technology Corporation	31
110 Arrow Fastener Co., Inc.	11
111 Astatic Corporation	9
112 B&K Division, Dynascan Corp.	19
114 Charous & Niebergall, Inc.	58
115 Channel Master Cleveland Institute of Electronics	29 59,60
116 Cornell Electronics	47
117 EICO Electronic Instruments Co.	47
113 Electronic Book Club	32-35
118 Fluke Mfg., John-information	23
119 Fluke Mfg., John-demonstration	23
120 Fordham Radio Supply Co., Inc. GTE Sylvania, Consumer Renewal	58 6,7
121 General Electric Co., Television Business Div. General Electric Co., Tube Div.	13 40
122 Heath Company, The	10
123 Hickok Electrical Inst. Co.	43
124 Jensen Tools & Alloys	58
103 Leader Instruments Corp.	Cover 3
144 Motorola Training Institute	48
125 Mountain West Alarm Supply Co.	58
126 Non-Linear Systems	51
127 Oelrich Publications	58
102 PTS Electronics, Inc.	Cover 2
128 Perma-Power Company	12
129 Pomona Electronic	57
130 Projector-Recorder Belt Corp.	58
131 Qualitone Industries, Inc. RCA Distributor and Special Products Accessories Picture Tube Distributor	58 26,27 3
165 Picture Tube Distributor	31
163 Test Equipment	8
164 Test Equipment	53
132 RCA Solid State	15
133 REM Electronic Instruments	54
134 RMS Electronics, Inc.	55
135 Rohn Manufacturing	49
136 Simpson Electric Co.	1
137 Supreme Publicatons	55
138 Tab Books	41
139 T & T Sales Co.	52
104 Triplett Corporation	Cover 4
140 Tucker Electronics Co.	48
141 Wahl Clipper Corporation	50
142 Weller-Xcelite Electronics Div.	11
143 Winegard Company	20,21

# need belts?

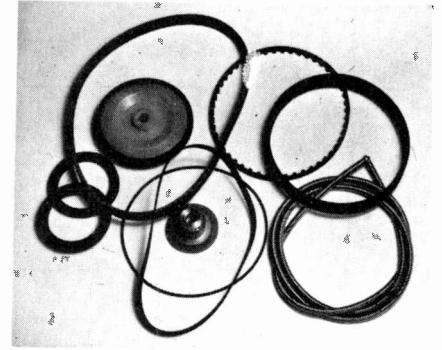

### DEALERS WANTED

**We've thousands in stock**

Ready for immediate shipment!  
Belts for over 1800 makes and  
models of tape recorders, projectors,  
dictating machines, video recorders  
and our simplified cross  
reference system makes it easy for  
you to order. Drive tires, wheels,  
phono idlers also listed. On most  
items we can ship the same day.  
Call or write today for your free  
catalog/cross reference chart.

**PROJECTOR-RECORDER BELT CORP.**

319 Whitewater St., Whitewater,  
Wisconsin 53190 414/473-2151

...for more details circle 130 on Reader Service Card

## FREE ALARM CATALOG

Huge selection of burglar & fire systems, supplies. Motion detectors, infrared beams; controls, door switches, bells, sirens. 500 items, 99 pp. packed with technical details, notes.

(Outside U.S., send \$1.00.)



mountain west alarm

4215 n. 16th st., phoenix, az. 85016

...for more details circle 125 on Reader Service Card

## IT'S NO PUZZLE

TO ORDER



## OELRICH SERVICE FORMS

FOR TV-RADIO & 2 WAY RADIO SERVICE LEGAL FORMS FOR CALIF. FLA. UTAH NOW AT YOUR PARTS JOBBER OR WRITE FOR CATALOG A64

OELRICH PUBLICATIONS  
4040 N. NASHVILLE AVE. CHICAGO, ILLINOIS 60634

...for more details circle 127 on Reader Service Card

## FREE CATALOG

### HARD-TO-FIND PRECISION TOOLS

Lists more than 2500 items—pliers, tweezers, wire strippers, vacuum systems, relay tools, optical equipment, tool kits and cases. Also includes ten pages of useful "Tool Tips" to aid in tool selection.



JENSEN TOOLS  
4117 N. 44th Street, Phoenix, Ariz. 85018

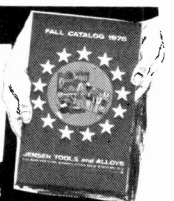

...for more details circle 124 on Reader Service Card

## APPLIANCE REPAIR BOOKS

Written in easy-to-understand language by experts with illustrations & diagrams. Acclaimed by instructors & professionals. How to diagnose & repair air conditioners, refrigerators, vacuum cleaners, ranges, washers, dryers, steam irons, portable kitchen appliances, water heaters; plus how to set up a shop, using test instruments and more. Only \$2.65 to \$4.90 each!

**SEND FOR FREE DESCRIPTIVE PRICE LIST**

C & N, DEPT. ET, 5841 MONTROSE, CHICAGO 60634  
...for more details circle 114 on Reader Service Card

SYMBOL	DESCRIPTION	K MART PART NO.
C502A	—250mf, 165v	67A30-11
C502B	—150mf, 150v electro	67A30-11
C502C	—200mf, 150v	67A30-11
L202	—4.5MHz sound coil	72A317-6
L310	—4.5 MHz trap	72A317-1
L401	—horiz lock coil	94A480-1
T201	—audio output xformer	79A124-7
T401A,B	—deflect yoke	700A1089-15
T403	—horiz output xformer	79A166-1
T501	—filament xformer	80A117-6
R203	—25K volume, on/off	75A1-226
R326	—500 ohm, contrast	75A1-220
R333	—100K brite	75A1-221
R339	—400 ohm, AGC delay	75A101-50
R342	—200 ohm, AGC	75A101-49
R407	—1.2M, vert hold	75A191-1
R410	—1.5M, vert size	75A101-57
F501	—1.5a fuse	84A7-15
VHF	tuner, T1K8-1B	94A526-1
VHF	tuner, T1K8-2B	94A434-1

GROUP  
**278**

K-MART	SCHEMATIC NO.	AIRLINE	SCHEMATIC NO.
TV Chassis T1K8-1B/2B	1608	Color TV Models GAI-17825C/45B	1611
ADMIRAL Color TV Chassis 2M10CA	1609	ZENITH TV Chassis 12FB12X	1612
ADMIRAL Color TV Chassis M10C	1610		

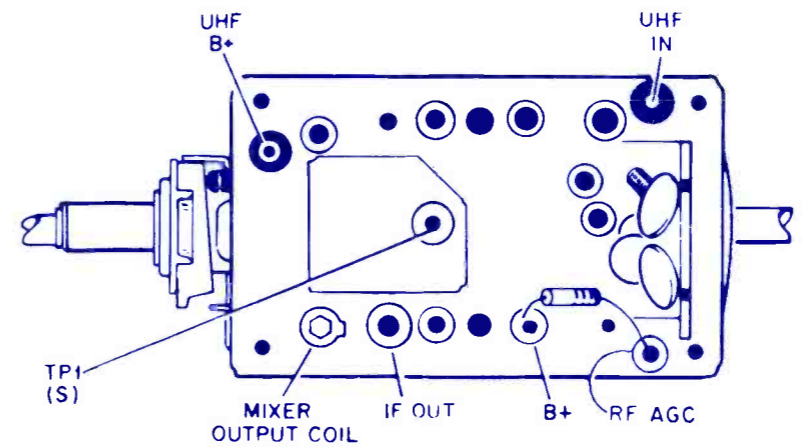

**SAFETY NOTICE**  
THE DESIGN OF THIS RECEIVER CONTAINS MANY CIRCUITS AND COMPONENTS INCLUDED SPECIFICALLY FOR SAFETY PURPOSES. FOR CONTINUED PROTECTION, NO CHANGES SHOULD BE MADE TO THE ORIGINAL DESIGN. REPLACEMENT PARTS MUST BE IDENTICAL TO THOSE USED IN THE ORIGINAL CIRCUIT. SERVICE SHOULD BE PERFORMED BY QUALIFIED PERSONNEL ONLY.

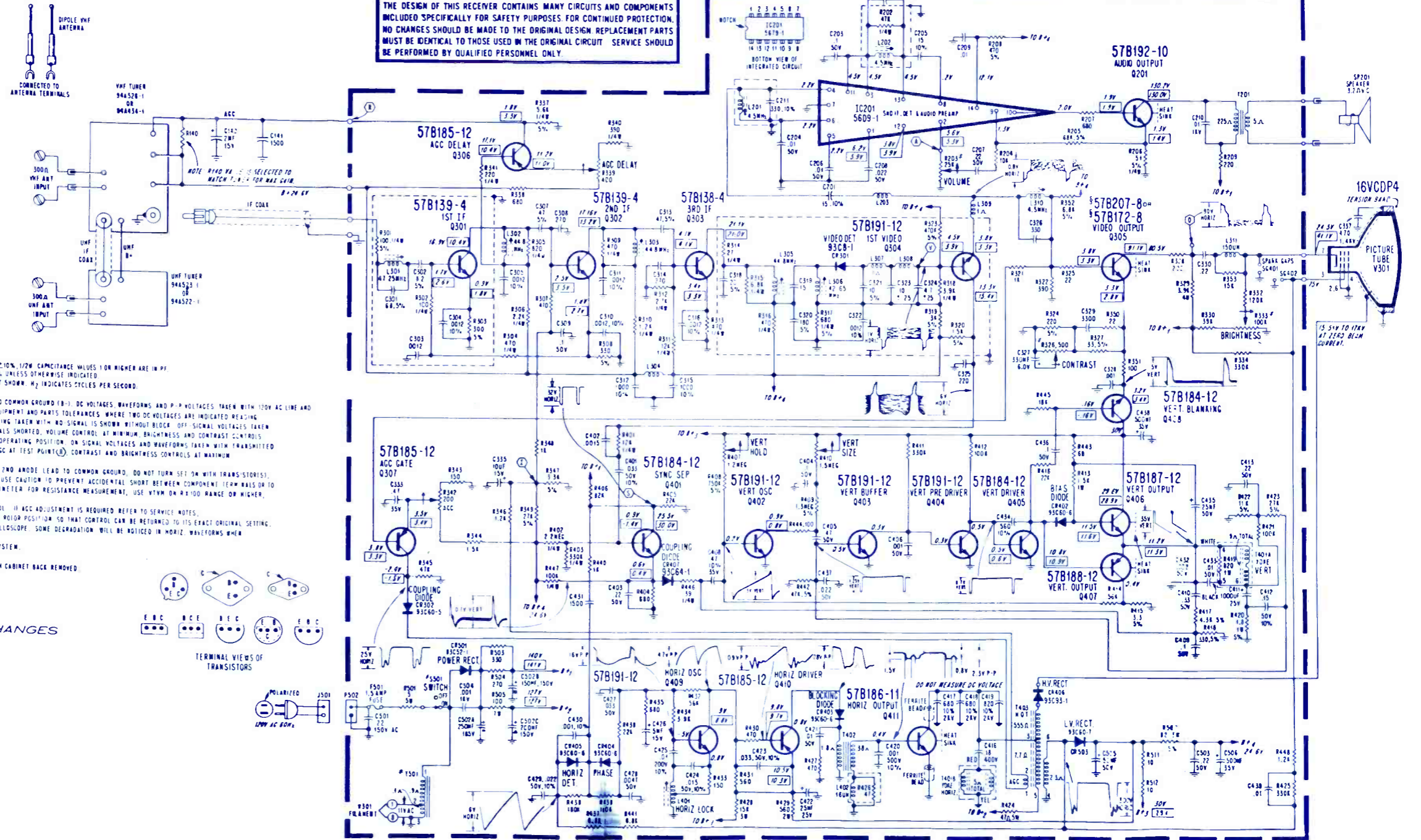

**SCHEMATIC NOTES**  
UNLESS OTHERWISE INDICATED, RESISTOR VALUES  $\pm 10\%$ ,  $1/2W$ ; CAPACITANCE VALUES 10% OR HIGHER ARE IN PF; CAPACITANCE VALUES LESS THAN 100 ARE IN PPF, UNLESS OTHERWISE INDICATED.  
RESISTANCE VALUES OF COILS, LESS THAN 10, IS NOT SHOWN.  $M_2$  INDICATES CYCLES PER SECOND.  
VOLTAGE AND WAVEFORM NOTES:  
DC VOLTAGES TAKEN WITH VTVM, WITH RESPECT TO COMMON GROUND (GND). DC VOLTAGES, WAVEFORMS AND P-P VOLTAGES TAKEN WITH 120V AC LINE AND MAY VARY DEPENDING ON CALIBRATION OF TEST EQUIPMENT AND PARTS TOLERANCES. WHERE TWO DC VOLTAGES ARE INDICATED READING TAKEN WITH TV SIGNAL IS SHOWN IN BLOCK. READING TAKEN WITH NO SIGNAL IS SHOWN WITHOUT BLOCK. OFF-SIGNAL VOLTAGES TAKEN ON UNUSED VHF CHANNEL WITH ANTENNA TERMINALS SHORTED. VOLUME CONTROL AT MINIMUM. BRIGHTNESS AND CONTRAST CONTROLS AT MAXIMUM. ALL OTHER CONTROLS IN NORMAL OPERATING POSITION. ON SIGNAL VOLTAGES AND WAVEFORMS TAKEN WITH TRANSMITTED NOISE FREE SIGNAL, PRODUCING 4 TO 5 VOLTS AGC AT TEST POINT. CONTRAST AND BRIGHTNESS CONTROLS AT MAXIMUM. TRANSISTOR CAUTION:  
TO AVOID DAMAGE TO TRANSISTORS, DO NOT ARC 2ND ANODE LEAD TO COMMON GROUND, DO NOT TURN SET ON WITH TRANSISTORS, TUBES OR LEADS REMOVED OR UNSOLDERED. USE CAUTION TO PREVENT ACCIDENTAL SHORT BETWEEN COMPONENT TERMINALS OR TO COMMON GROUND. DO NOT USE AN ORDINARY OHMMETER FOR RESISTANCE MEASUREMENT, USE VTVM ON R $\times 100$  RANGE OR HIGHER, AGC CAUTION.  
DO NOT DISTURB FACTORY SETTING OF AGC CONTROL. IF AGC ADJUSTMENT IS REQUIRED REFER TO SERVICE NOTES.  
IF NECESSARY TO DISTURB AGC ADJUSTMENT, MARK ROTOR POSITION SO THAT CONTROL CAN BE RETURNED TO ITS EXACT ORIGINAL SETTING.  
ALL WAVEFORMS TAKEN WITH A WIDE BAND OSCILLOSCOPE. SOME DEGRADATION WILL BE NOTICED IN HORIZ. WAVEFORMS WHEN USING NARROW BANDPASS EQUIPMENT.  
COMPONENT NOT MOUNTED ON PRECISION WIRED SYSTEM.  
WARNING:  
USE ISOLATION TRANSFORMER WHEN SERVICING WITH CABINET BACK REMOVED.  
COMMON GROUND (GND).  
REPLACE WITH SAME PART NO. AS ORIGINAL.

**RUN CHANGES**  
⑩ Start of production

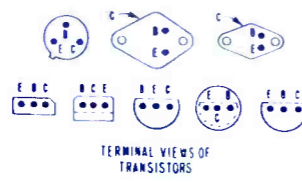

M200, M300, M400, M500 SMALL SIGNAL BOARD

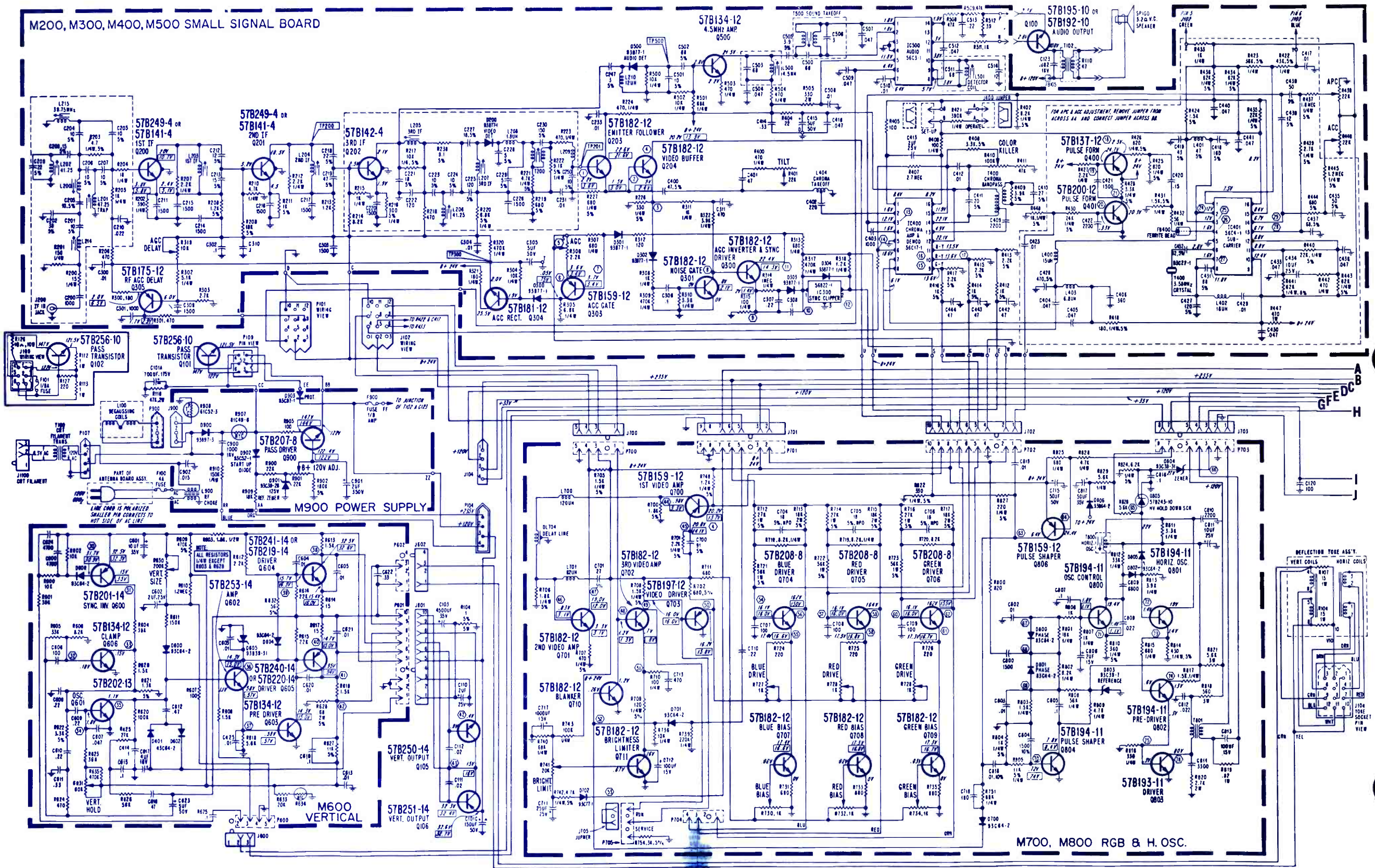

M700, M800 RGB & H. OSC.

**ADMIRAL**  
Color TV  
Chassis 2M10CA

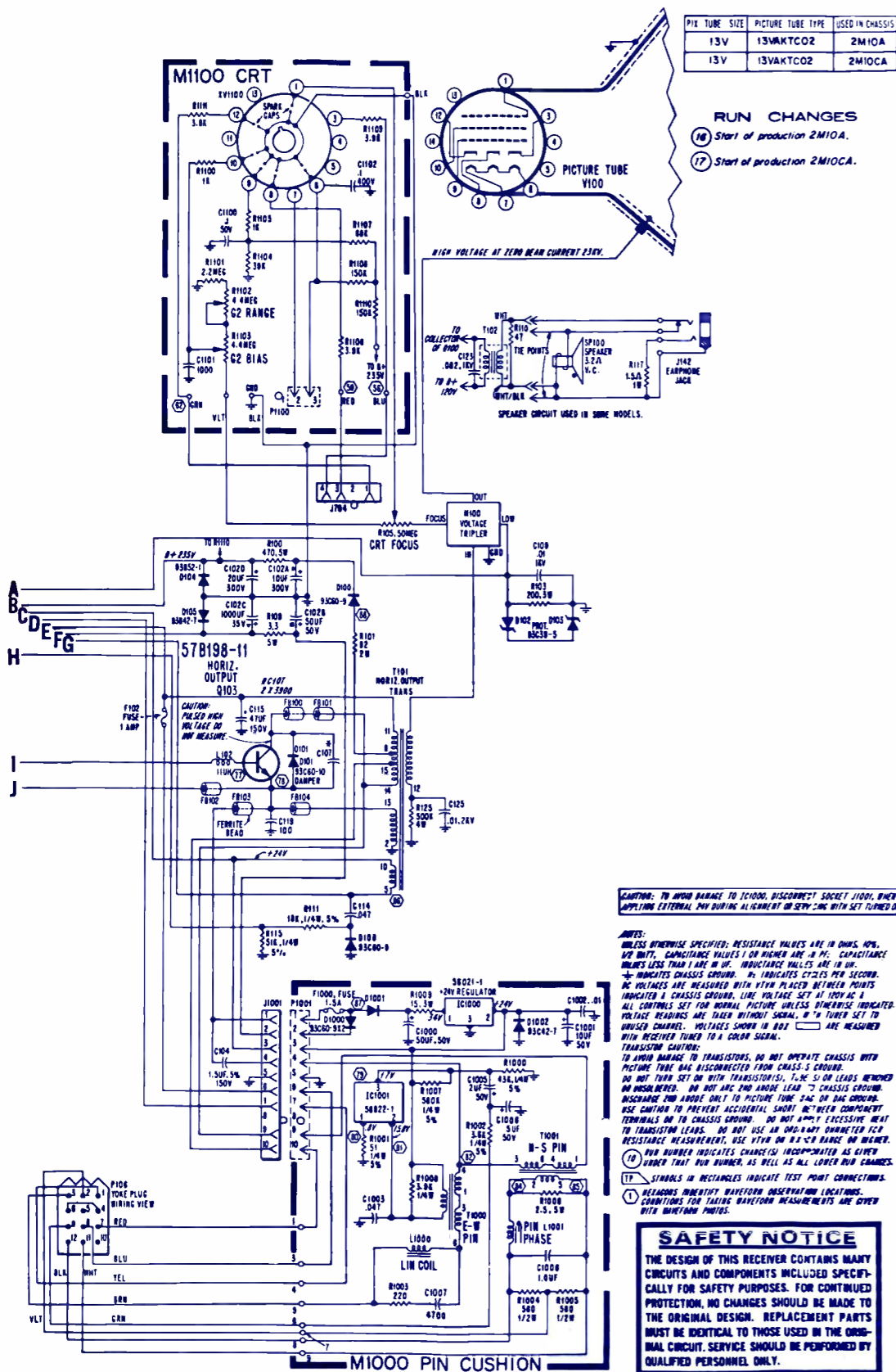

SYMBOL	DESCRIPTION	ADMIRAL PART NO.	
M100	voltage tripler	93A99-3	
C101A, B	700mf/175v, 500mf/125v		
R630	200K, vert size	75A101-2	
R631	60K, vert hold	75A191-2	
R741	20K, brite limit	75A101-47	
Q805	SCR, HV hold down	57A243-10	
R907	thermistor, NTC	61A49-6	
R908	thermistor, PTC	61A52-3	
R901	10K, B+ 120v, adj	75A199-2	
F900	fuse, 1/8a	84A4-1	
T100	x-former, CRT filament	60A119-3	
T101	x-former, CRT filament	79A189-1	
T102	x-former, audio output	79A141-5	
F100	fuse, 4.0a pigtail	84A7-25	
F101	fuse, 1/8a pigtail	84A7-22	
F102	fuse, 1.0a pigtail	84A7-5	

MODEL	FINISH	CRT	TUNER CLUSTER	VHF	UHF	CHASSIS
13C628	Walnut	13VAKTC02	NC2820-1	94A496-2 or 94A497-2 or 94A506-2	94A516-1 or 94A517-1	2M10CA

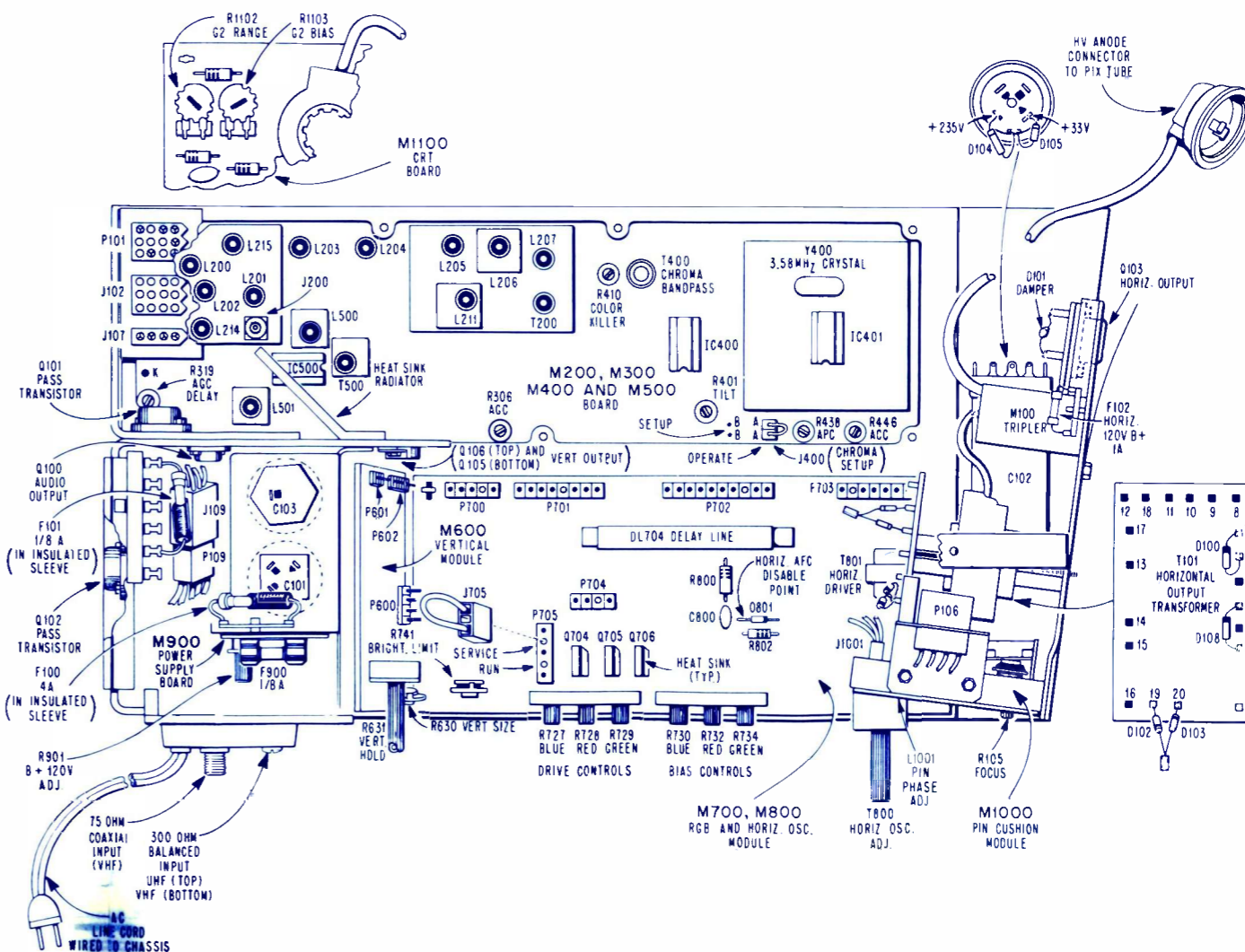

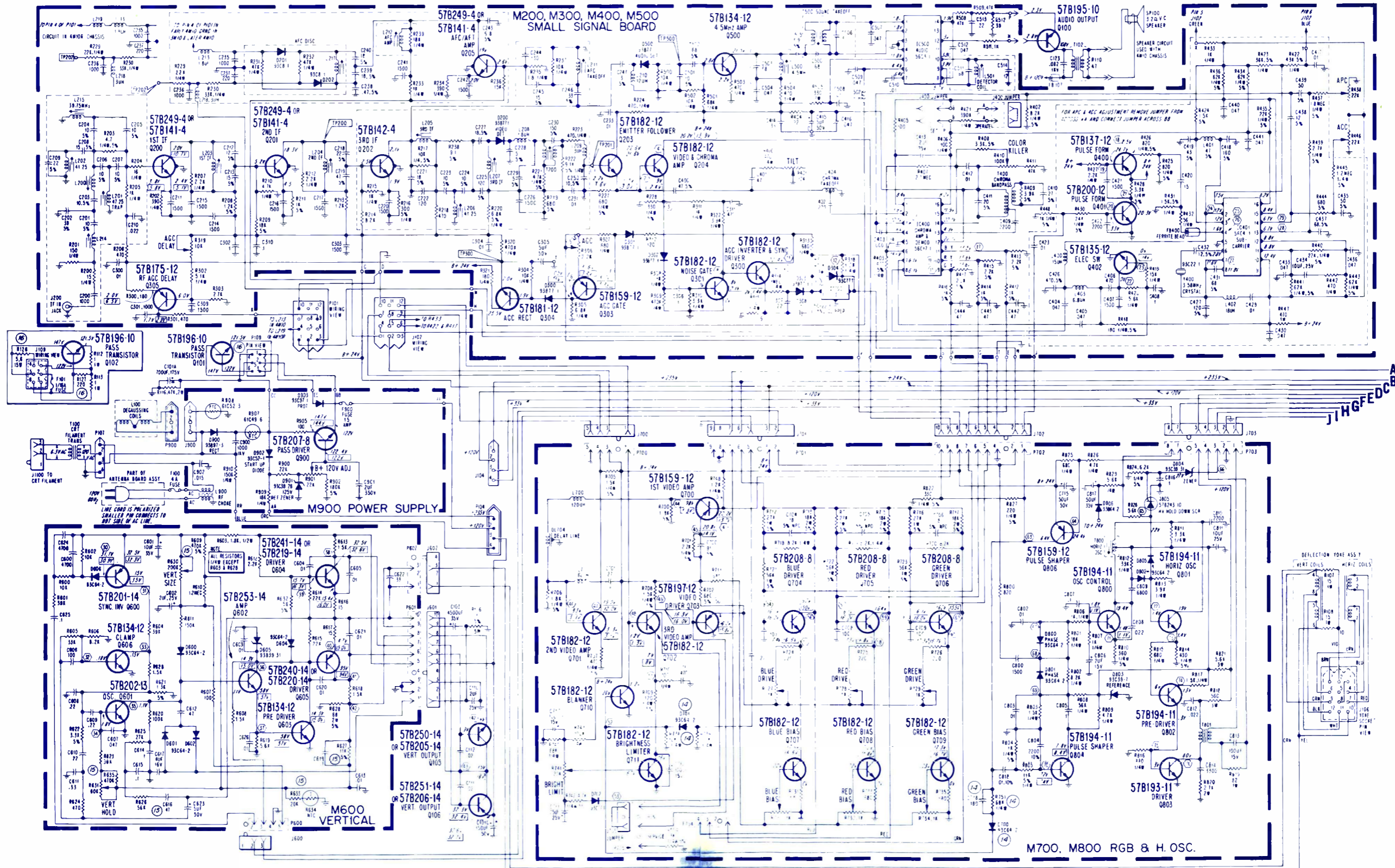

MODEL	FINISH	CRT	TUNER CLUSTER	VHF	UHF	CHASSIS
17C638	Walnut	17VAYTC02	NC2821-2	94A492-2	94A518-2 or 94A519-2	3M10C
19C657	White	19VEJTC02	NC2822-1	94A492-4	94A509-3 or 94A515-3	4M10C
19C658C	Walnut	19VEJTC02	NC2810-1	94A492-4	94A509-2 or 94A515-2	4M10C

**ADMIRAL**  
Color TV  
Chassis M10C

SYMBOL	DESCRIPTION	ADMIRAL PART NO.
F100	fuse, 4.0a pigtail	.84A7-25
F101	fuse, 1/16a pigtail	.84A7-20
R634	thermistor, NTC	.93A96-3
R630	200K, vert size	.75A101-28
R631	60K, vert hold	.75A191-2
R727, 728, 729	1K, blue, red green drive	.75A201-1
R730, 732, 734	1K, blue, red, green bias	.75A201-1
R741	20K, brite, limit	.75A101-47
L704	delay line	.72A418-1
T801	driver xformer, horiz	.79A167-2
R907	thermistor, NTC	.61A49-6
R908	thermistor, PTC	.61A52-3
R901	22K, B+ 120v, adj	.75A199-3
84A4-7	fuse, 1.5a	.84A4-7

**TUNER TOP VIEWS**

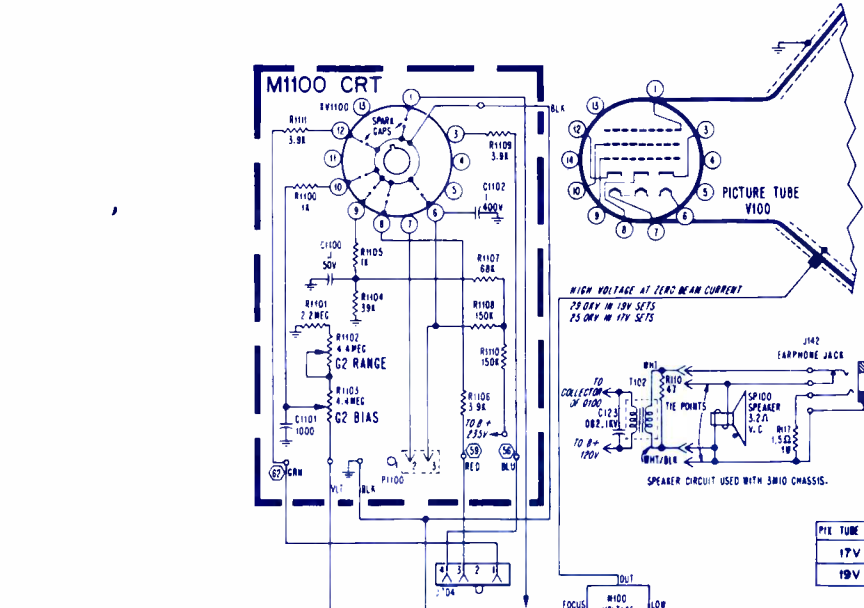
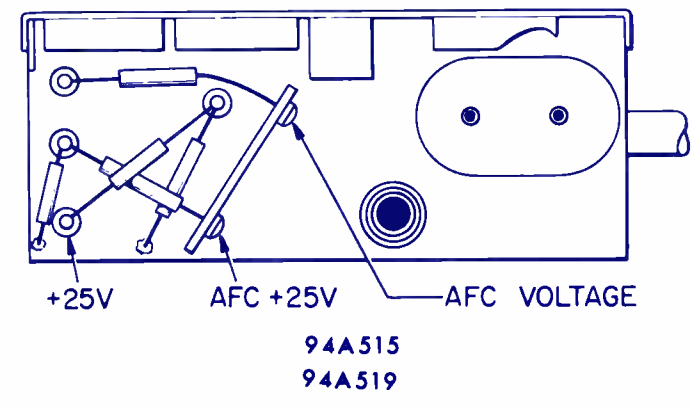
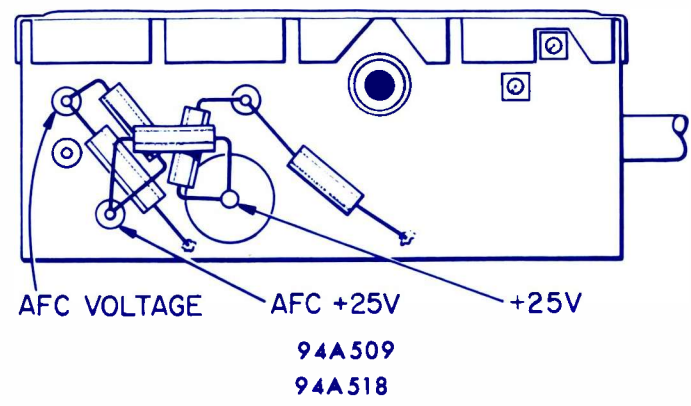
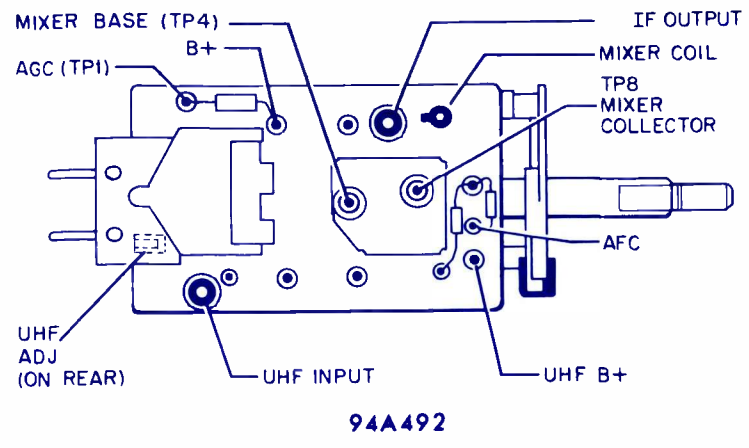

PICT. TUBE SIZE	PICTURE TUBE TYPE	USED IN CHASSIS
17V	17VAYTC02	3M10C
19V	19VEJTC02	4M10C

- RUN CHANGES**
- 10 Start of 4M10 production.
  - 11 Small signal Board changed from AB950-2 to -3. Start of 3M10 production.
  - 12 M700, M800 RGB & H. OSC Board changed from AB951-3 to -5. M900 Power Supply Board changed from AB953-2 to -3.
  - 13 M1000 Pin Cushion Board changed from AB954-2 to -3. Connectors J1000 & P1000 were omitted. Start of 4M10 production.
  - 14 M700, M800 Board changed from AB951-5 to -6.
  - 15 M600 Vert. Board changed from AB952-2 to -4.
  - 16 R126 and R127 added.
  - 17 Start of 3M10C and 4M10C production.

**CAUTION:** TO AVOID DAMAGE TO IC1000, DISCONNECT SOCKET J1001, WHEN APPLYING EXTERNAL HV DURING ALIGNMENT OF SERVICE WITH SET TUNING ON.

**NOTES:** UNLESS OTHERWISE SPECIFIED, RESISTANCE VALUES ARE IN OHMS, KΩ, 10<sup>3</sup> Ω, MΩ, 10<sup>6</sup> Ω. CAPACITANCE VALUES 100 nF OR HIGHER ARE IN pF. CAPACITANCE VALUES LESS THAN 100 nF ARE IN nF. INDUCTANCE VALUES ARE IN μH.  $\infty$  INDICATES CHASSIS GROUND.  $\omega$  INDICATES CYCLES PER SECOND. DC VOLTAGES ARE MEASURED WITH VTM PLACED BETWEEN POINTS INDICATED & CHASSIS GROUND. LINE VOLTAGE SET AT 120V AC. ALL CONTROLS SET FOR NORMAL PICTURE UNLESS OTHERWISE INDICATED. VOLTAGE READINGS ARE TAKEN WITHOUT SIGNAL, WITH TUNER SET TO CHANNEL CHANNEL. VOLTAGES SHOWN IN  $\square$  BETWEEN COMPONENT TERMINALS OR TO CHASSIS GROUND. DO NOT APPLY EXCESSIVE HEAT TO TRANSISTOR LEADS. DO NOT USE AN ORDINARY OHMMETER FOR RESISTANCE MEASUREMENT. USE VTM ON R100 RANGE OR HIGHER UNDER THAT RUM NUMBER, AS WELL AS ALL LOWER RUM CHANGES.

**SAFETY NOTICE**  
THE DESIGN OF THIS RECEIVER CONTAINS MANY CIRCUITS AND COMPONENTS INCLUDED SPECIFICALLY FOR SAFETY PURPOSES. FOR CONTINUED PROTECTION, NO CHANGES SHOULD BE MADE TO THE ORIGINAL DESIGN. REPLACEMENT PARTS MUST BE IDENTICAL TO THOSE USED IN THE ORIGINAL CIRCUIT. SERVICE SHOULD BE PERFORMED BY QUALIFIED PERSONNEL ONLY.

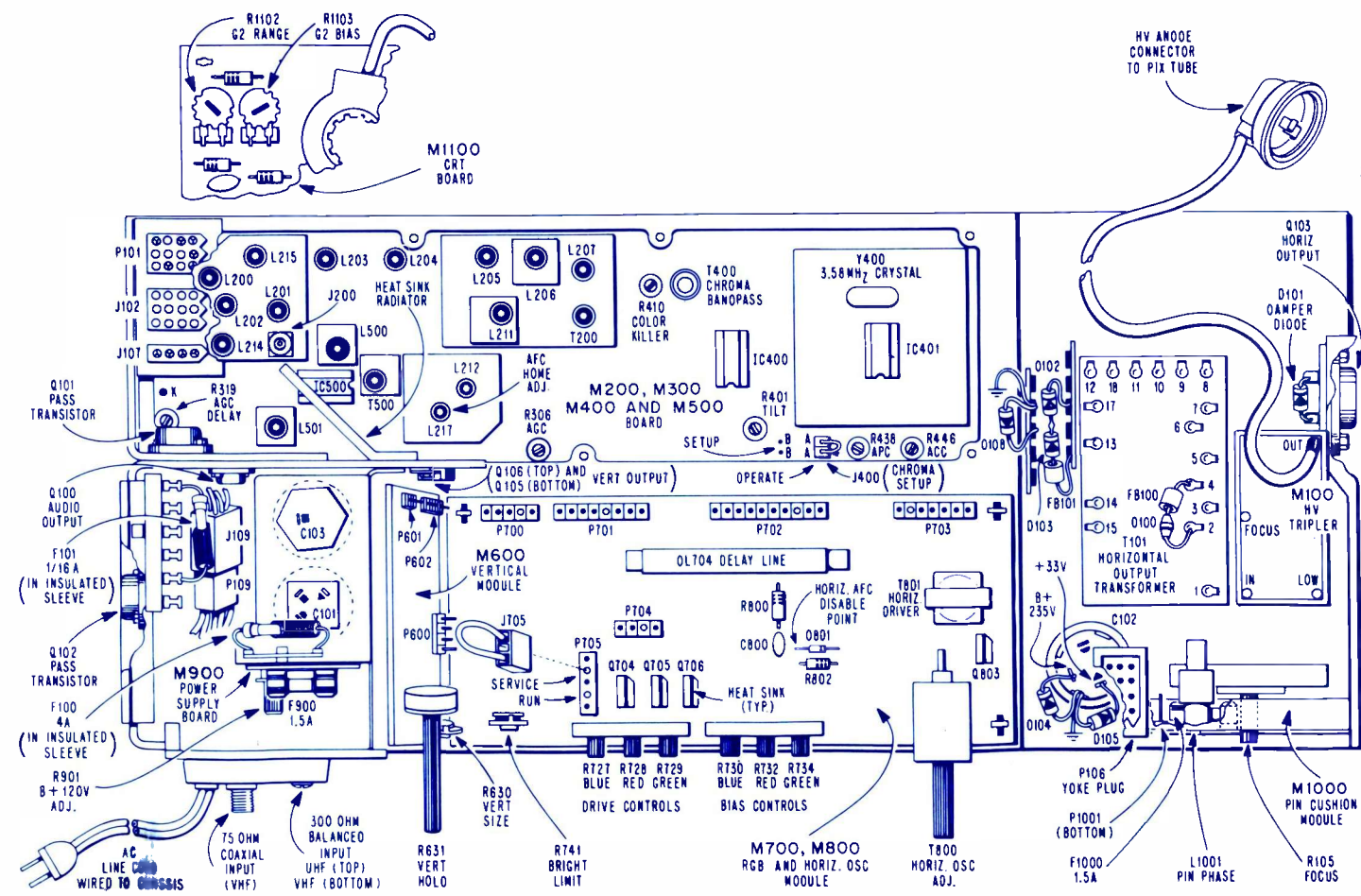
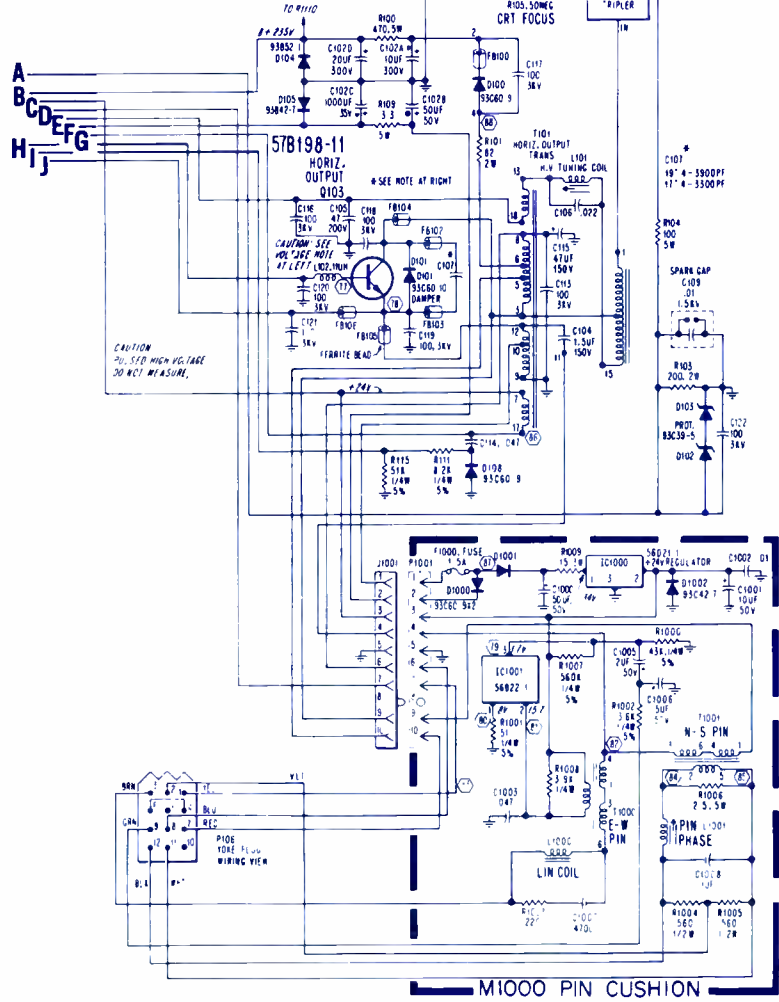

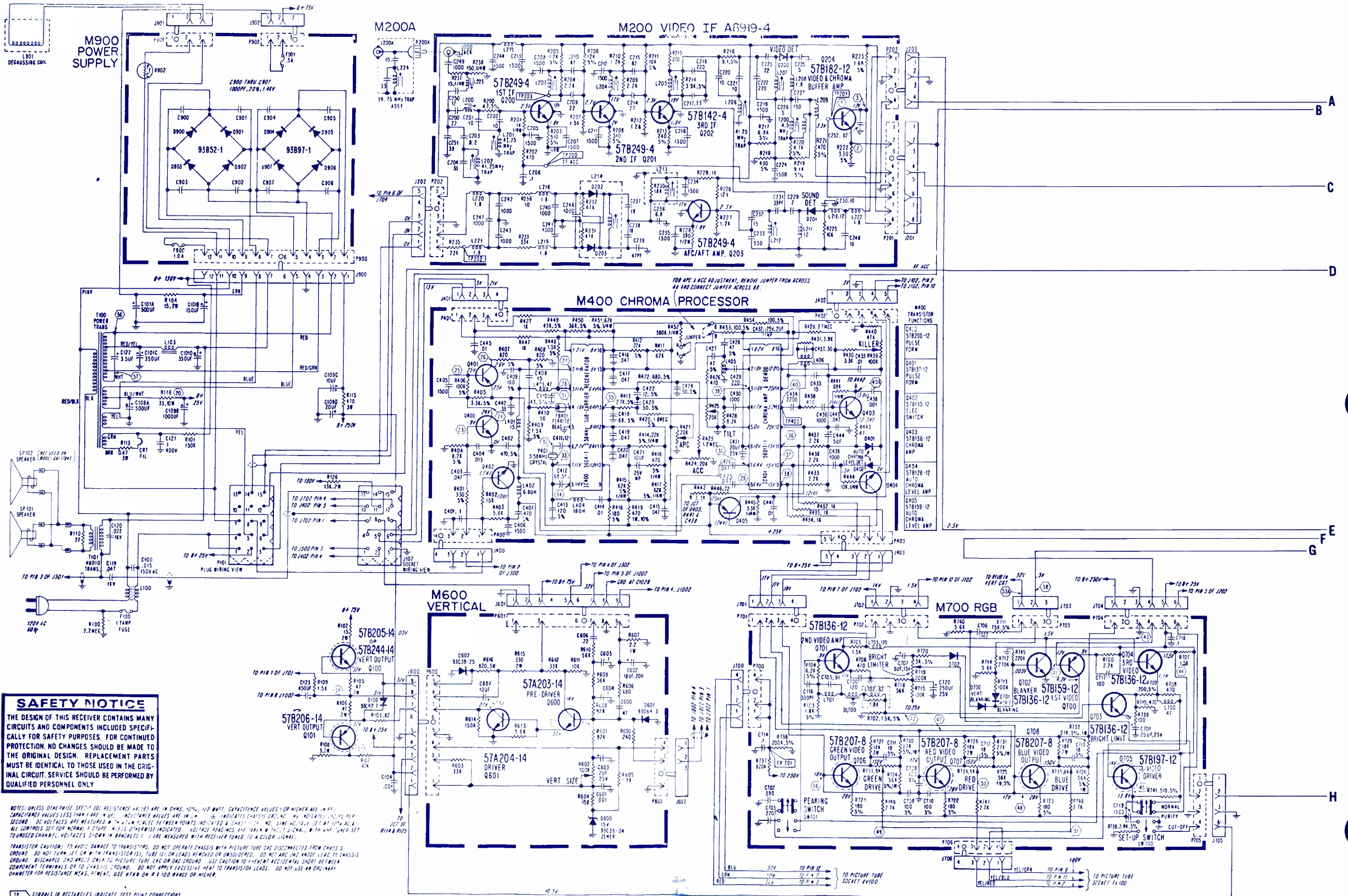

**SAFETY NOTICE**  
 THE DESIGN OF THIS RECEIVER CONTAINS MANY CIRCUITS AND COMPONENTS INCLUDED SPECIFICALLY FOR SAFETY PURPOSES. FOR CONTINUED PROTECTION, NO CHANGES SHOULD BE MADE TO THE ORIGINAL DESIGN. REPLACEMENT PARTS MUST BE IDENTICAL TO THOSE USED IN THE ORIGINAL CIRCUIT. SERVICE SHOULD BE PERFORMED BY QUALIFIED PERSONNEL ONLY.

**NOTES:** UNLESS OTHERWISE SPECIFIED: RESISTOR VALUES ARE IN OHMS, 10%, 1/2 WATT. CAPACITANCE VALUES (FOR MICRONS) ARE IN MICROFARADS UNLESS OTHERWISE SPECIFIED. CAPACITANCE VALUES LESS THAN 100 P.F. INDICATE P.F. VALUES. CAPACITANCE VALUES 100 P.F. AND ABOVE ARE IN MICROFARADS UNLESS OTHERWISE SPECIFIED. DC VOLTAGES ARE MEASURED WITH THE POWER PLUG IN THE POINTS INDICATED BY CIRCLES. AC VOLTAGES ARE MEASURED WITH THE POWER PLUG IN THE POINTS INDICATED BY SQUARES. ALL VOLTAGES ARE MEASURED WITH THE RECEIVER TUNED TO A COLOR SIGNAL. VOLTAGE READINGS ARE GIVEN IN BRACKETS WITH THE POWER SET TO UNTOUCHED CHANNEL. VOLTAGES 5-DIGIT IN BRACKETS ( ) ARE MEASURED WITH RECEIVER TUNED TO A COLOR SIGNAL.

**TRANSISTOR CAUTION:** TO AVOID DAMAGE TO TRANSISTORS, DO NOT OPERATE CHASSIS WITH PICTURE TUBE CAC DISCONNECTED FROM CHASSIS GROUND. DO NOT TURN SET ON WITH TRANSISTORS, TUBE IS OR LEADS REMOVED OR UNSOLDERED. DO NOT ARC AND WELD LEADS TO CHASSIS GROUND. DISCHARGE PICTURE TUBE CAC OR CAC GROUND. USE CAUTION TO AVOID ACCIDENTAL SHORTS BETWEEN COMPONENT TERMINALS OR TO CHASSIS GROUND. DO NOT APPLY EXCESSIVE HEAT TO TRANSISTOR LEADS. DO NOT USE AN ORDINARY DIMMER FOR RESISTANCE MEASUREMENT. USE RTN OR R 100 RANGE OF MICRONS.

STIPPLES IN RECTANGLES INDICATE TEST POINT CONNECTIONS.  
 HEADINGS IDENTIFY WAVEFORM OBSERVATION LOCATIONS. CONDITIONS FOR TAKING WAVEFORM MEASUREMENTS ARE GIVEN WITH WAVEFORM PHOTOS.



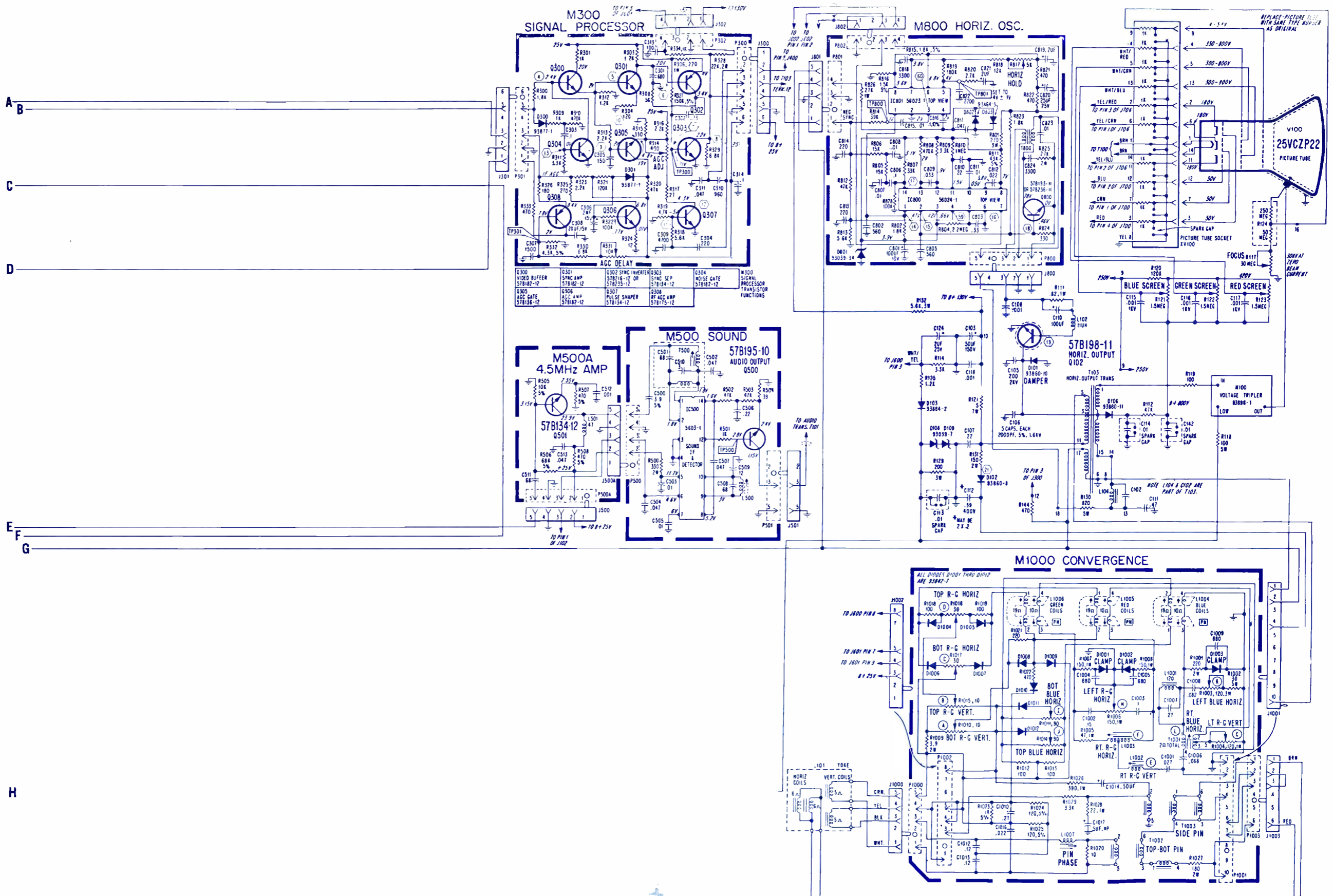

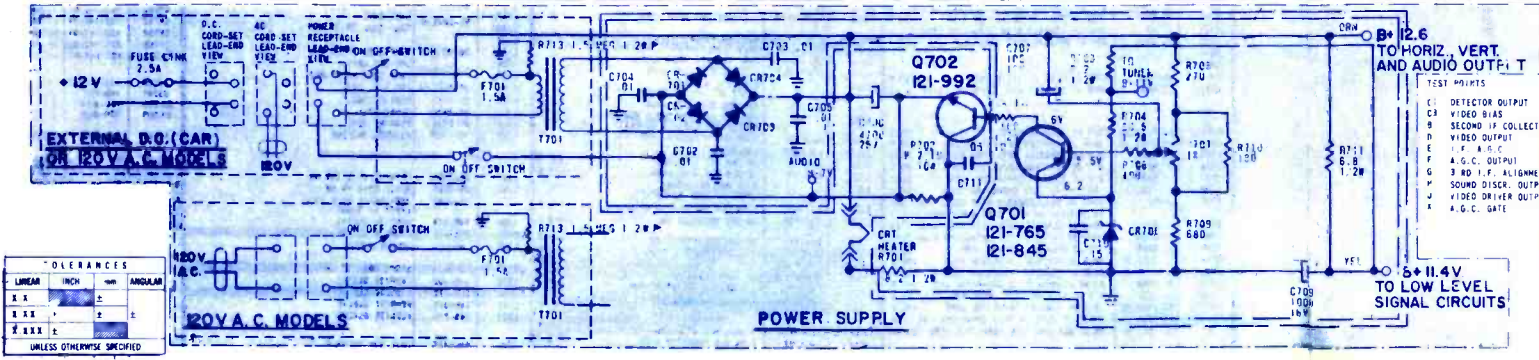
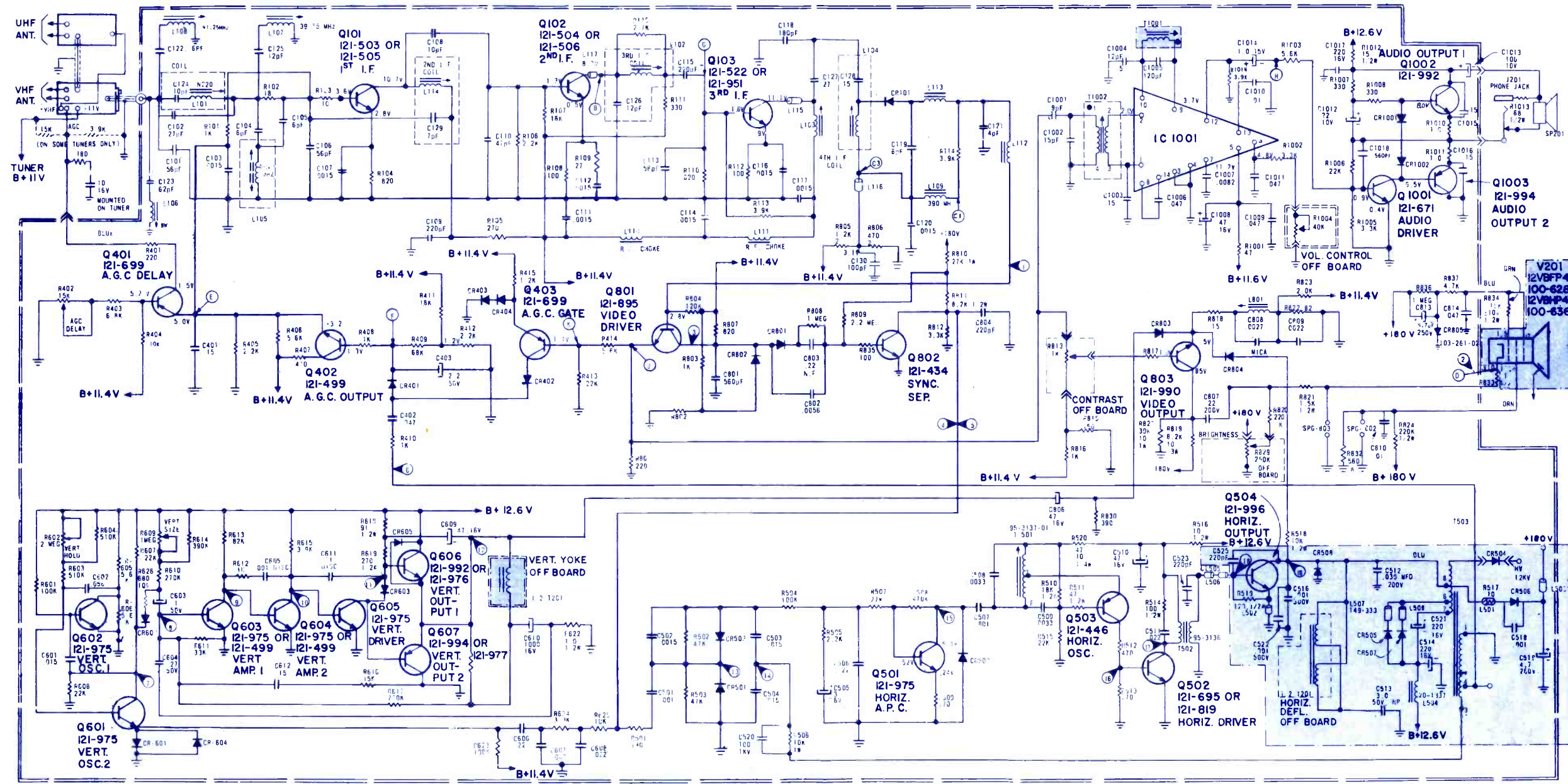

TOLERANCES

RESISTORS	RESISTORS	RESISTORS	RESISTORS
XXXX	XXX	XX	X
UNLESS OTHERWISE SPECIFIED			

**IMPORTANT SAFETY NOTICE**

WHEN SERVICING THIS CHASSIS, UNDER NO CIRCUMSTANCES SHOULD THE ORIGINAL DESIGN BE ALTERED WITHOUT PERMISSION FROM THE ZENITH RADIO CORPORATION. COMPONENTS SHOULD BE REPLACED ONLY WITH TYPES IDENTICAL TO THOSE IN THE ORIGINAL CIRCUIT. IN SOME INSTANCES REDUNDANT CIRCUITRY IS INCORPORATED FOR ADDITIONAL CIRCUIT PROTECTION AND X-RADIATION SAFETY. SPECIAL COMPONENTS ALSO ARE USED TO PREVENT SHOCK AND FIRE HAZARD. THESE CRITICAL COMPONENTS ARE SHADED IN THIS DIAGRAM AND PARTS LIST FOR EASY IDENTIFICATION. IT IS IMPERATIVE THAT THE PROPER TYPE FUSE BE USED SO AS NOT TO CREATE A SAFETY HAZARD IN THE FUTURE DUE TO THE USE OF AN IMPROPER FUSE. PROPER FUSE VALUES AND PART NUMBERS ARE LISTED IN THE SERVICE MANUAL.

# LEADER 5" Quality Scopes Cost Less!

*While the Others Keep Raising Prices,  
Leader Fights Inflation to Save You Money*



**LBO-506**  
**5" Dual Trace/Dual Channel  
Automatic Triggered Scope**

An outstanding value that does your work automatically . . . with auto hzt! sweep, auto vert'l input gain and auto trigger (TV-V and TV-H) to reduce errors. Has sep./simul. sweep mode display; X5 mag; X-Y display; direct RF input; vectorscopic display for color phase adj.; with 10 MHz b'width; 10mV to 20Vp-p/cm vert'l sensitivity in 11 calib. steps. PC board construction assures high reliability. It's beautiful! Complete with 2 probes, 2 adapters, lead, plug & clips.

**A Trend Setter! \$569.95**

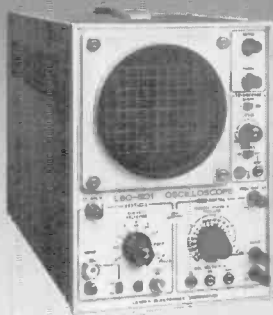

**LBO-501**  
**5" Triggered Scope  
w/Calibrated Input  
& Time Base**

A professional grade solid state instrument recommended by the experts. Vertical input is calibrated (v/cm) for high accuracy. Hzt deflection is time calibrated, with triggered sweep range from 0.2 $\mu$  sec/cm to 0.2sec/cm sweep operable in free running or automatic. Offers 20mV to 10Vp-p/cm vert'l sensitivity; 10MHz b'width; lighted graticule and tilt stand. A quality performer you can depend on. Complete with probe, leads and adapter.

**SAVE \$60.00 NOW \$399.95**



**LBO-502**  
**5" Triggered Scope  
w/Graded Scale**

Solid state dependability lets you put this versatile scope to use for most every electronic purpose. Has automatic and triggered sweep, 17 steps calibrated, from 1 $\mu$  sec/cm to 0.2sec/cm, plus X5 mag at 0.2 $\mu$  sec/cm; 15MHz b'width; 10mV to 20mVp-p/cm vert'l sensitivity w/1-2-5 graded scale readings. Lab grade accuracy and push button ease of use make it a real winner. Complete with probe, leads and adapter.

**SAVE \$80.00 NOW \$449.95**



**LBO-511**  
**5" Solid State  
General Service Scope**

State-of-the-art design for lasting quality and performance. Features recurrent sweep with automatic sync and calibrated vert'l input; 0-140° phase control; TV-V and TV-H inclusive with 4 sweep ranges to 100KHz; 10MHz b'width, FET input stages, DC coupling and push-pull amplifiers account for distortion-free displays and rock-like stability for every use. Complete with probe, leads and adapter.

**SAVE \$50.00 NOW \$299.95**

## LEADER "Put Us To The Test"

Instruments Corp. 151 Dupont St., Plainview, L.I., N.Y. 11803 (516) 822-9300

# A new 310-Type 3. Made to take a fall.

The rugged new "drop-resistant," hand size Triplet Model 310, Type 3 is priced at just \$49.

The latest addition to the rugged Triplet 310, general purpose, multi-range V-O-M family—the Model 310, Type 3—has impressive new features. Its case and clear front are made of high impact-resistant plastic.

The low Ohms range Rx1 has been fused to protect against damaging overloads. These two improvements should eliminate over half of all repair requirements resulting from field use damage.

But that's not all. The case of the new Triplet 310, Type 3 sports an elegant new non-slip "finger-tread" surface finish. The meter movement brackets and pointer feature a new rugged design as well as newly designed lead jacks and Model 10 jack. Added to this, the front range and tester dial markings are changed to read easier when used with Triplet's Model 10 Clamp-on-Ammeter.

#### Outstanding features:

1. Drop-resistant, hand size V-O-M with high impact thermoplastic case.
2. 20,000 Ohms per Volt DC and 5,000 Ohms per Volt AC; diode overload protection with fused Rx1 Ohms range.

3. Single range switch; direct reading AC Amp range to facilitate clamp-on AC Ammeter usage.

The durable new 310, Type 3, self-shielded for checking in strong magnetic fields is an extra-rugged, high-torque, bar-ring instrument with spring back jewels. Interchangeable test prod fits into the top of the tester, making it a common probe and freeing one hand. All this for only \$49.

See for yourself. Try the new Model 310, type 3 V-O-M. Have your Triplet distributor or sales representative give you a free demonstration of this new tester. You'll be glad you did. So, do it today. Triplet Corporation, Bluffton, Ohio 45817.

**TRIPLETT**  
ALL YOU'LL EVER NEED IN V-O-M's.

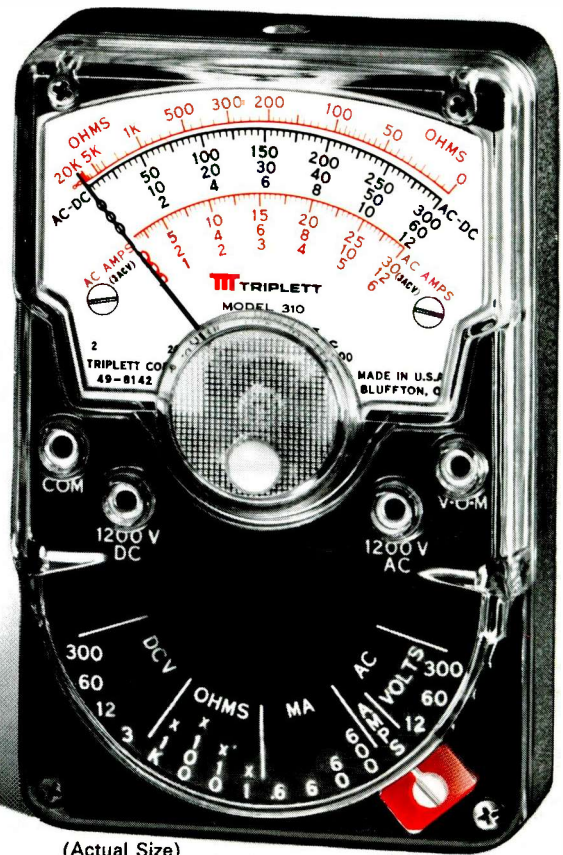

## Triplet. The easy readers.

...for more details circle 104 on Reader Service Card