

RADIO & TELEVISION NEWS

ANC

AUGUST
1950
35¢
In Canada 0¢

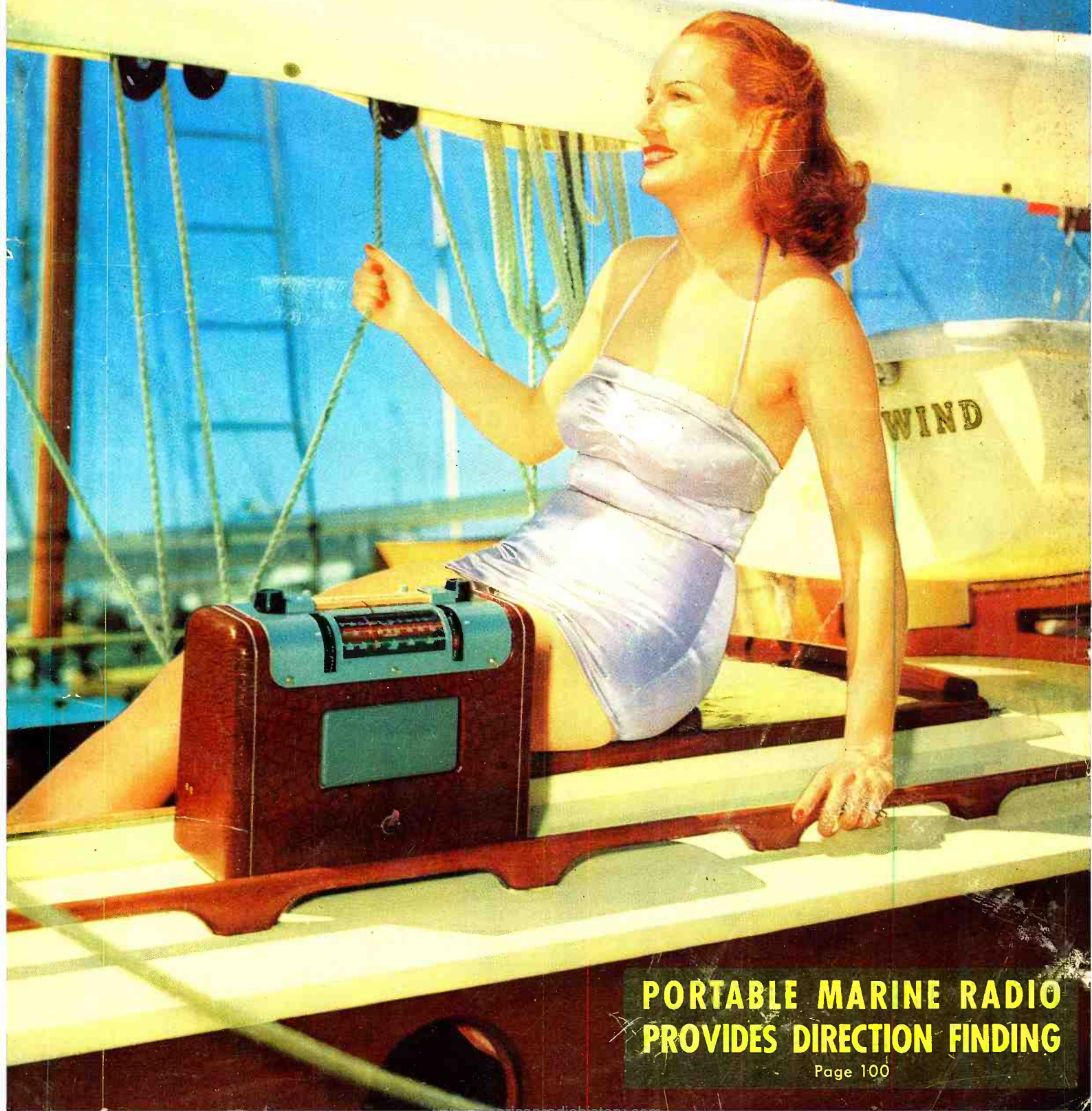

**PORTABLE MARINE RADIO
PROVIDES DIRECTION FINDING**

Page 100

THE QUALITY OF RCA TUBES IS UNQUESTIONED



Seven of the Top Ten are **RCA**

... pioneered for AM, FM, and TV

AMONG THE RECEIVING TUBES used industry-wide during 1949, seven of the top ten volume types were RCA pioneered. Of the remaining three, two were of basic RCA design. Almost one-half of these industry-wide leaders were also among the top ten volume types used in the radio and television service business during 1949.

Only tubes of unquestionable quality—both as to design and manufacture—could merit such acceptance by the industry. Here are leaders designed by the Leader—familiar types, such as the

RCA 6SN7-GT and 6AG5 . . . and more recently the 1B3-GT, 6BA6, 6J6, 6AU6, and 6AL5. Their widespread application has permitted production to be concentrated on fewer types . . . which, in turn, has accounted for lower costs, improved quality, and greater uniformity.

This is but one instance of how RCA's engineering leadership adds value beyond price to the RCA tubes you sell. It is a value shared alike by you and your customers.

Always keep in touch with your RCA Tube Distributor



RADIO CORPORATION of AMERICA
ELECTRON TUBES

HARRISON, N. J.

I'LL TRAIN YOU FOR YOUR FCC LICENSE

A Federal Communications Commission Commercial Operator's License puts you in line for a good job in Radio or Television Broadcasting, Police, Marine, Aviation, Two-way, Mobile or Micro-wave Relay Radio. Mail coupon below for 64-page book FREE. It will give you complete facts about my NEW Communications course.



YOU BUILD THIS TRANSMITTER

with parts I send. With this Transmitter you practice how to put a station "on the air." You perform procedures demanded of Broadcast Station Operators, conduct many experiments, make many practical tests.

NEW

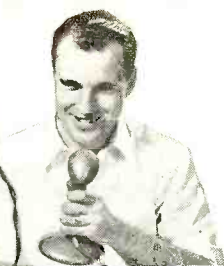
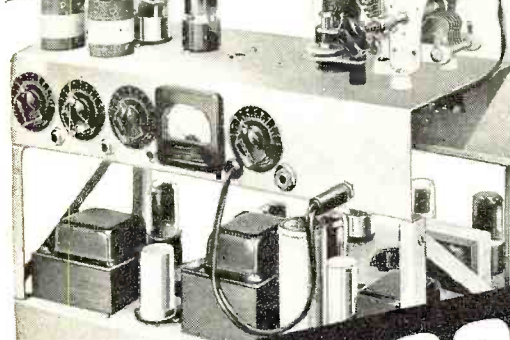

LEARN COMMUNICATIONS by PRACTICING at Home in Spare Time

with MANY KITS of

RADIO EQUIPMENT I SEND

Ever think HOW FAST Radio-Television Communications is changing, developing, growing? Have you considered what this amazing progress can mean to you?

Look at these facts. In 1946 only 6,000 Television sets were sold. In 1949 almost 3,000,000. By 1954, 20,000,000 Television sets will be in use, according to estimates. 100 Television Stations are operating in 35 states. Authorities predict there will be over 1,000 Television Stations. This rapid growth means new jobs, more jobs, good pay for qualified men all over the U. S. and Canada. Then add development of FM, Two-way Radio, Police, Marine, Aviation and Micro-wave Relay Radio! Think what all this means! New jobs, more jobs for beginners! Better jobs, better pay for experienced men!

Are you a beginner who wants steady work in this growing field? My NEW course can help you get an FCC License and prepare for the job you want. Are you a man with some training in Radio or Radar, or a Licensed Operator? My NEW course modernizes, increases the value of your knowledge and experience!

MY COURSE INCLUDES TELEVISION

Course Is New! Different!

Mail coupon now for facts about my NEW, intensely practical course in Radio-Television Communications. Let me send you FREE book. Read outlines of 78 lesson texts written by leaders in Communications and edited for you by my practical staff. See the nine big Kits of Parts I send that "bring to life" theory you learn. Read about the Transmitter you build and operate, about the Electronic Multitester you get. All equipment yours to keep. My NEW course covers Theory thoroughly and you get Practical Experience building units like those shown at the left. It's backed by N. R. I.—the world's oldest and largest home study Radio-Television school.

Mail Coupon For Book FREE

Send today! See what my NEW course is like. Find out how I get you ready for a brighter future, better earnings, more security in Radio-Television. Send coupon now in envelope or paste on a postal. NO OBLIGATION. NO SALESMAN WILL CALL! My book, sent to you FREE, tells the full story. J. E. SMITH, President, Dept. OHR, National Radio Institute, Washington 9, D. C.

YOU BUILD this Transmitter Power Supply used in the basic experiments in RF and AF amplifiers, frequency multipliers, buffers, etc.



YOU PRACTICE setting up code, amplitude and frequency modulation circuits (put voice, music, etc., on "carrier signals" you produce). You learn how to get best performance.

YOU MEASURE current, voltage (AC, DC and RF), resistance and impedance in circuits with Electronic Multitester you build. Shows how basic transmitter circuits behave; needed to maintain station operation.

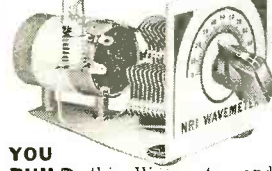

YOU BUILD this Wavemeter and use it to determine frequency of operation, make other tests on transmitter currents.

Servicing Training Also Offered by N. R. I.

If you prefer a good-pay job in Radio-Television Servicing, or your own money-making Radio-Television Sales and Service Shop, I'll train you at home. My famous Servicing Course also includes many Kits of Radio Parts. You use them to get PRACTICAL EXPERIENCE with circuits common to Radio and Television. I also show you how to make \$5, \$10 a week or more EXTRA MONEY fixing neighbors' Radios while training. Full information in my 64-page book. Mail coupon.

VETERANS

HURRY!

To get this valuable training under G. I. Bill, Time is Running out. MAIL COUPON NOW!

I TRAINED THESE MEN



"N.R.I. has been my stepping stone from a few hundred to over \$1,000 a year as a Radio Engineer."—ALTON B. MICHAELS, Trenton, Georgia.



"I am employed by WKBO as transmitter operator. Have more than doubled salary since starting in Radio full time!"—A. HERR, New Cumberland, Penna.



"Am Broadcast Engineer at WLP.M. Your NEW Communications course shows the kind of equipment we use."—J. BANGLE, JR., Suffolk, Virginia.



"4 years ago, I was a book-keeper with hand-to-mouth salary. Am now Radio Engineer with ABC network."—N. H. WARD, Ridgefield Park, N. J.

MAIL NOW-BOOK FREE

MR. J. E. SMITH, President, Dept. OHR National Radio Institute, Washington 9, D. C.

Mail me your 64-page Book about Radio and Television Communications opportunities and training. (No salesman will call. Please write plainly.)

Name..... Age.....
 Address.....
 City..... Zone..... State.....
 Check if Veteran Approved Under G. I. Bill

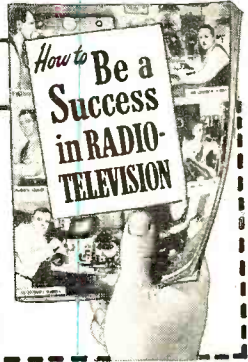

August, 1950

Editor
OLIVER READ, D.Sc., D.Litt., W9ETI

Managing Editor
WM. A. STOCKLIN, B.S.

Technical Editor
H. S. RENNE, M.S.

Associate Editor
RAY FRANK, W9JU

Contributing Editor
R. HERTZBERG, W2DJJ

Television Consultant
MILTON S. KIVER

Short-Wave Editor
KENNETH R. BOORD

Editorial Assistants
I. M. CARROLL

E. V. HITZEL

P. B. HOEFER

Staff Artist
R. S. KUPJACK

Advertising Manager
L. L. OSTEN

Midwest Adv. Manager
JOHN A. RONAN, JR.

Art Director
HERMAN R. BOLLIN

RADIO & TELEVISION NEWS

First in
radio-television-electronics

Average Paid Circulation over 200,000

Radio News Trademark Reg. U.S. Pat. Office No. 378427 • Television News Trademark Reg. U.S. Pat. Office No. 517468
Radio & Television News Trademark Reg. U.S. Pat. Office No. 517025

CONTENTS

AUGUST, 1950

Radio Control of Model Boat.....	William L. North, W4GEB	29
Intercom Applications.....	John B. Ledbetter	34
Home-built Linearity Test Pattern Generator.....	Rufus P. Turner, K6AI	36
An Electronic Musical Novelty.....	Jim Kirk, W6DEG	38
Servicing Speedlights.....	Guy Slaughter	40
Insurance for Service Technicians.....	C. L. Nunneker	43
A 100 kc. Square-Wave Generator.....	Louis E. Garner, Jr.	44
A Simple Noise Limiter.....	R. P. Haviland	46
Voltage Regulation for Higher Fidelity.....	J. Carlisle Hoadley	47
A Compact, Amateur Band Superhet.....	Ray D. Zimmerman, W3KOY	51
The "Tapered Line" TV Tuner.....	Daniel Lerner	55
Oscillations in the Video I.F. Amplifier Circuits.....	Wm. A. Tretter	56
Servicing TV Sync Circuits (Part I).....	Solomon Heller & Peter Orne	57
Complete 30 Watt Ham Station.....	Stan Johnson, WØLBV	61
Mac's Radio Service Shop.....	John T. Frye	63
Home-Built 2" Oscilloscope.....	J. Stephen Anderson, W9UFE	65
Portable Showroom Sells TV Sets.....	Philip Brenton	77
Using the BC-454 and BC-455 for 20 Meter Operation	F. K. Sullivan, W8UYK	91
Cut-Rates Today—Bankruptcy Tomorrow.....	Harold J. Ashe	96
Portable Marine Radio Provides Direction Finding.....		100
A 79-Cent Signal Source.....	Guy Dexter	134



COVER PHOTO: The Lear P10A portable marine receiver provides good listening in addition to its safety function as a direction-finder and marine band set.

(Kodachrome by Robert Tobey)

Chairman of the Board and Publisher
WILLIAM B. ZIFF

President
B. G. DAVIS

Secretary-Treasurer
ARTHUR T. PULLEN

Vice-Presidents
MICHAEL H. FROELICH
Dir. Eastern Div.

H. J. MORGANROTH
Production Director

LYNN PHILLIPS, Jr.
Advertising Director

H. G. STRONG
Circulation Director

BRANCH OFFICES

NEW YORK (17)
366 Madison Ave., Murray Hill 7-8080

LOS ANGELES (14)
815 S. Hill St., TUCKER 9213
Manager, WILLIAM L. PINNEY

DEPARTMENTS

For the Record.....	The Editor	8	Technical Books.....	92
Spot Radio News.....		16	MARS.....	102
Within the Industry.....		24	New TV Products.....	116
Short-Wave.....	K. R. Boord	64	AFCA News.....	135
What's New in Radio.....		82	Manufacturers' Literature.....	143



COPYRIGHT 1950
ZIFF-DAVIS PUBLISHING COMPANY
185 North Wabash Ave., Chicago 1, Ill.
VOLUME 44 • NUMBER 2



Member
Audit Bureau of
Circulations

RADIO & TELEVISION NEWS is published monthly by the Ziff-Davis Publishing Company, 185 N. Wabash Ave., Chicago 1, Ill. Subscription rates: in the United States \$4.00 (12 issues), single copies 35c; in Canada \$4.00 (12 issues), single copies 40c; in Mexico, South and Central America, and U. S. Possessions, \$4.00 (12 issues); in British Empire, \$5.00 (12 issues)—all other foreign countries \$5.00 (12 issues). RADIO-ELECTRONIC ENGINEERING Edition subscription rates: in the U. S. \$6.00 (12 issues), single copies 50c; in Canada \$6.00 (12 issues), single copies 60c; in Mexico, South and Central America, and U. S. Possessions, \$6.00 (12 issues); in British Empire, \$7.00 (12 issues)—all other foreign countries \$7.00 (12 issues). Subscribers should allow at least 2 weeks for change of address. All communications about subscriptions should be addressed to: Director of Circulation, 185 N. Wabash Ave., Chicago 1, Ill. Entered as second class matter July 21, 1948, at the Post Office, Chicago, Illinois, under the Act of March 3, 1879. Entered as second class matter at the Post Office Dept., Ottawa, Canada. Contributors should retain a copy of contributions and include return postage. Contributions will be handled with reasonable care but this magazine assumes no responsibility for their safety. Accepted material is subject to whatever revisions and byline changes that are necessary. Payment made at our current rates, covers all authors', contributors' or contestants' rights, title and interest in and to accepted material, including photographs and drawings.

RADIO & TELEVISION NEWS

Which Do You Want?

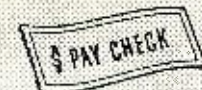

Better Pay



A Nice Home

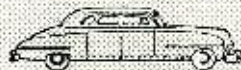

A New Car



Greater Security



Happy Vacations and Travel

Get Your FCC Ticket
Then
Use Our
Amazingly Effective
Job-Finding
Service



Edw. H. Guilford
Vice President

I will send you, free, a copy of the surprising new booklet "Money Making FCC License Information," plus a sample FCC-type Exam, and a copy of "How to Pass FCC License Exams."

How to Pass FCC License Exams

COMMERCIAL
RADIO OPERATOR

Money-Making
FCC
Commercial Radio
Operator
LICENSE
Information

Get this Valuable Booklet **FREE**

TELLS HOW — WE GUARANTEE

TO TRAIN AND COACH YOU AT HOME
IN SPARE TIME UNTIL YOU GET

YOUR FCC LICENSE

If you have had any practical experience — Amateur, Army, Navy, radio repair or experimenting.

TELLS HOW — Employers Make

JOB OFFERS Like These to Our Graduates Every Month!

Telegram, April 7, 1950 from Chief Engineer, Broadcast Station, Pa. "Immediate opening for engineer. Automobile and First Phone a must. If graduate available, please forward name and address."

Letter, April 14, 1950 from Chief Engineer, Broadcast Station, Montana. "Immediate opening for Engineer-Announcer, basic salary \$62.50 . . . real future for right man."

Letter, January 30, 1950 from Chief Engineer, Broadcast Station, Tennessee. "Have openings for operators. If you have men, please have them contact us."

These are just a few examples of the job offers that come to our office periodically. Some licensed radioman filled each of these jobs . . . it might have been you!

HERE'S PROOF FCC LICENSES ARE OFTEN SECURED IN A FEW HOURS OF STUDY with OUR Coaching at Home in Spare Time.

Name and address	License	Hrs. of Training
James A. Grain, 11 West Main St., Cuba, N. Y.	1st class telephone	34
Ernest K. Hodson, Box 1001, Caldwell, Idaho	1st class telephone	71
Howard J. Kischassey, Rt. 2, Box 736, El Capon, Calif.	2nd class telephone	49
Ralph I. Nichols, 510 Elm St., Kerrville, Tex.	2nd class telephone	34
Elbert L. Risinger, P. O. Box 122, Bedin, Tex.	1st class telephone	34
	2nd class telegraph	

CLEVELAND INSTITUTE OF RADIO ELECTRONICS

Desk RN-20, 4900 Euclid Bldg., Cleveland 3, Ohio

Approved for Veteran Training

August, 1950

TELLS HOW —

Our Amazingly Effective JOB-FINDING SERVICE

Helps CIRE Students Get Better Jobs
Here are a few recent examples of Job-Finding results:

GETS JOB WITH CAA
"I have had a half dozen or so offers since I mailed some fifty of the two hundred employment applications your school forwarded me. I accepted a position with the Civil Aeronautics Administration as a Maintenance Technician. Thank you very much for the fine cooperation and help your organization has given me in finding a job in the radio field."

Dale E. Youngs, 122 Robbins St., Owosso, Michigan.

GETS JOB IN PUBLIC UTILITIES
"I have secured the position of Radio Technician with the Toledo Edison Company. I want to thank you once more. The help you gave me was much more than ordinarily to be expected—both in obtaining my license and in finding employment."

Norman W. Stokes, Jr., Rt. 11, Box 612, Toledo 7, Ohio.

GETS JOB AS DEVELOPMENT ENGINEER
"I wish to express my thanks for the Applications-For-Employment you recently prepared for me. I received 3 telephone calls and one letter. As a result I am now employed in a developmental engineering capacity."

K. E. Forsberg, 26 Soley St., Charlestown, Massachusetts.

GETS JOB IN BROADCASTING
"I have accepted a position with KWAD. I secured this position through the help of your Job-Finding Service and I had at least six other offers. I am sincerely under obligation to you."

Fred W. Kincaid, Box 241, Wadena, Minnesota.

Your FCC Ticket is always recognized in all radio fields as proof of your technical ability.

OURS IS THE ONLY HOME STUDY COURSE WHICH SUPPLIES FCC TYPE EXAMINATIONS WITH ALL LESSONS AND FINAL TESTS.



MAIL COUPON NOW!

Cleveland Institute of Radio Electronics

Desk RN-20, 4900 Euclid Bldg., Cleveland 3, Ohio

(address to Desk No. to avoid delay)

Approved for Veteran Training Under G. I. Bill

I want to know how I can get my FCC ticket in a minimum of time. Send me your amazing new FREE booklet "Money Making FCC License Information," as well as a FREE sample FCC-type exam and FREE booklet, "How to Pass FCC License Examinations" (Does not cover exams for amateur license).

NAME

ADDRESS

CITY..... ZONE..... STATE.....

Veterans check for enrollment information under G. I. Bill.



The Redskin of course...

SANGAMO'S NEW MOLDED PAPER TUBULAR CAN HELP SOLVE YOUR CAPACITOR PROBLEMS!

The Sangamo Redskin has the "How" it takes to lick paper tubular troubles. The strong, tough plastic casing stands rough handling and the especially designed, flexible leads are troublefree . . . they resist breakage and they can't pull out. It is used extensively by television manufacturers because it gives dependable *long life* operation at 85° C. The thermo-setting plastic case is molded under low pressure—assuring elements undamaged in fabrication, longer life, greater dependability, and the absence of "hot spots."

A trial of these *better* molded tubulars will convince you. See your Jobber for the Redskin and the other capacitors in the Sangamo Tribe.

NEVER FLINCHES IN THE PINCHES!



WATER TEST

Far surpasses any existing specification requirement.



HEAT TEST

Excellent operation under high temperature conditions.



PULL TEST

Leads resist breaking or pulling out. Takes rough handling.



LIFE TEST

Long life even under most severe operating conditions.



SANGAMO ELECTRIC COMPANY SPRINGFIELD, ILLINOIS

In Canada: Sangamo Electric Company Limited, Leaside, Ont.



BC50-6B

RADIO & TELEVISION NEWS



**YOU DON'T HAVE
TO QUIT YOUR
PRESENT JOB...
To Prepare for an
Exciting,
Profitable
Job in...**



E. B. De Vry,
President
DeForest's Training, Inc.

TELEVISION RADIO and ELECTRONICS!

NO PREVIOUS EXPERIENCE NECESSARY! PREPARE AT HOME OR IN OUR CHICAGO LABORATORY!

Yes—that's exactly what we mean. You don't have to quit your present job in order to prepare for real money, interesting work, and a thrilling future in one of America's most promising opportunity fields.

DeForest's Training, Inc. provides EVERYTHING YOU NEED for real laboratory type training . . . in your spare time, AT HOME. No previous experience needed. You learn-by-seeing, learn-by-reading, learn-by-doing as you prepare for a real job or your own business in thrilling Television-Radio-Electronics. This even includes the opportunity to build and keep a big 16 inch rectangular picture tube TELEVISION RECEIVER—an optional feature available at small added cost after completing training described below.

YOU ALSO USE HOME MOVIES

If you choose to come to Chicago, we shall find comfortable living quarters for you. If you train at home, we shall send you modern, practical equipment. In either of these two methods, you will have the supervision of some of the finest instructors in the country. Fill in coupon below and we shall send you, absolutely FREE, full information about our program of building men for better opportunities in TELEVISION-RADIO-ELECTRONICS. DeForest's Training, Inc. also includes instruction in FM Radio and Industrial Electronics.

If you prefer to remain at home, you receive 16 big kits of radio parts and assemblies from which you can work over 300 fascinating experiments . . . including the building of a Multimeter, Signal Generator and Oscilloscope . . . which you keep. In addition; you receive the use of a 16 mm. motion picture projector and 16 information-packed reels of film which help you learn faster . . . easier. You also get modern lessons.

EMPLOYMENT SERVICE

When you complete your training our effective Employment Service helps you get started toward a real future. Mail coupon today . . . do not delay.

OPTIONAL

When you complete your training you have the optional privilege of building and keeping a 16 inch rectangular tube Television Receiver, available at slight additional cost.

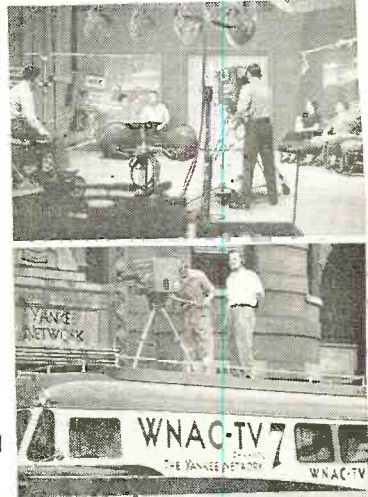
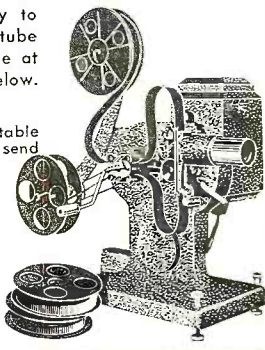

MAIL THIS OPPORTUNITY COUPON NOW!

Mr. E. B. De Vry, President
DeForest's Training, Inc.
2533 N. Ashland Avenue, Dept. RN-G-8
Chicago 14, Illinois

Please show me how I may get started toward a good job or a business of my own in Television-Radio-Electronics.

Name _____ Age _____

Address _____ Apt. _____

City _____ Zone _____ State _____

DeForest's Training, Inc.
CHICAGO 14, ILLINOIS
Associated with the De Vry Corporation
Builders of Movie & Electronic Equipment

POWER- PACKED

FOR HEAVY DUTY



SOLDERLITE

STREAMLINED



5-SECOND
HEATING

RIGID-TIP

LONGER REACH

DUAL HEAT

—single heat
200 watts,
dual heat
200/250 watts;
115 volts,
60 cycles

New WELLER 250-watt Soldering Gun

Heavy jobs and light jobs—the new 250-watt Weller Soldering Gun speeds them all. Chisel-shaped RIGID-TIP provides more soldering area for faster heat transfer. New “over-and-under” terminal design gives bracing action to tip. Your Weller Gun does delicate or heavy soldering with equal efficiency; compact and lightweight, it gets into the tightest spots.

Weller Guns actually pay for themselves in a few months. Fast 5 second heating means no time lost. Trigger-switch control means no current wasted—no need to unplug gun between jobs. Prefocused spotlight and longer length let you see the job and reach the job with ease. No other soldering tool offers so many time-and-money-saving features. Order your new 250-watt Weller Gun from your distributor today, or write for bulletin direct.

SOLDERING GUIDE

Get your copy of “SOLDERING TIPS”—new fully illustrated 20 page booklet of practical soldering suggestions. Price 10c at your distributor's or order direct.



WELLER

MANUFACTURING COMPANY

Packer Street, Easton, Pa.

For the RECORD

BY THE EDITOR

TV-FM OSCILLATOR RADIATION EFFECTS AND HAZARDS

THE most serious threat to successful nationwide TV service today is the excessive radiation of power from TV and FM oscillator circuitry in receiving sets. These spurious signals are playing havoc with nearby television sets and, in some cases, are actually endangering life, limb, and property by causing interference to aviation communications.

Tests conducted by the FCC have shown that many of the most “transmitters”—and we mean just that—are receivers of reputable manufacturers with adequate engineering facilities to reduce oscillator radiation in sets produced in their plants. During an address delivered in Chicago on June 8, 1950, Chairman Coy of the FCC stated “Some manufacturers are already making plans to reduce radiation in their upcoming models. Other manufacturers, however, are making no plans. Meanwhile, receivers continue to cascade off the assembly lines at the rate of 400,000 per month. The need for action is urgent.”

Of all types of interference encountered by the public, including medical diathermy machines, industrial heaters, flashers, motors, heating pads, automobile ignition systems, and amateur radio transmitters, by far the greatest source of “hash,” numerically, is from nearby television receivers.

The amateurs have long been blamed for creating streaks and herring bones on television screens, but few makers of TV sets have come in for their share of blame. The public certainly does not suspect his neighbor's set to be operating in transmitter fashion and even when so informed by a technician, often blames the installation or demands his money back.

It's up to the manufacturer to take the needed steps to reduce oscillator radiation before such receivers leave his plant. If he does not—then we can visualize stringent FCC regulations to force all TV and FM receiver manufacturers to meet requirements of good engineering practice.

Both the Radio-Television Manufacturers Association and the FCC have been studying the problem of limiting receiver radiation with some success. Said Mr. Coy “In Its Notice of Proposed Rule Making on April 13, 1949, relating to the revision of Part 15 of its Rules, the Commission proposed to bring receiver oscillator radiation under its rules. In the discussion of ways of specifying a limitation a value of 15 microvolts per meter at a distance of 100 feet was used by way of

example. No such value has been formally proposed, but tests of different types of receivers and a careful study of receiver requirements indicate that such a value may be achieved by television receivers if adequate consideration is given to the problem in the design stages.”

The suppression of radiation will add to the cost of the TV chassis. Just how much will depend upon the methods employed and the amount of radiation that will be tolerated by the FCC.

Until various committees, working on this problem, can work out methods for reducing oscillator radiation and in designing receivers less susceptible to various types of interference, the existing problem will increase with each day's production.

In the meantime service technicians and dealers, especially in crowded communities, are stuck with the problem of trying to reduce or eliminate the effects of oscillator radiation by using wire mesh, separating antennas, and a dozen other “cut and try” techniques. This can be rather time-consuming and costly to the dealer.

We've encountered the problem in several locations—including our own home. In the latter—partial remedy was to reduce interference by reorienting the two sets and by a wider separation of the individual twin leads from independent dipoles. A line filter is, very often, an additional aid.

We would like to have our readers send in remedies which they have found successful in reducing the effects of oscillator radiation from nearby television sets. Better yet if enough “case histories” are forthcoming we will be glad to select those which we feel best serve the majority of cases and publish the findings in future issues of this publication. As a matter of fact we have always welcomed suggestions, constructive criticism, and other information which we, in turn, can pass along to other radio and television technicians. This serves to make their jobs more profitable and will ultimately add to the prestige of the Industry itself.

We would also like to receive reports from our readers on successful television antenna installations and systems employed in mountainous areas and the results obtained.

We have already received several letters and these are being compiled for a possible future department, devoted to this specific problem. We would like to receive many more. O.R.

RADIO & TELEVISION NEWS



DeLuxe S-72 All-Wave Portable

ONLY
\$9.00
DOWN

The DeLuxe portable! Covers 4 bands: 540-1600 kc, 1500-4400 kc, 4.3-13 mc, and 12-31 mc. Has built-in loop for standard broadcast and 61" whip for short wave. Automatic Noise Limiter; sensitivity control; AVC; BFO: main and fine tuning controls; tone control; phone jack. Brown leatherette-covered cabinet, 14 x 12 1/4 x 7 1/4". For 105-125 volts DC, or 60 cycles AC, or self-contained battery. Complete with tubes, less battery. Shpg. wt., 16 lbs. **\$89.95**

- 97-505. S-72 Portable. *Only*.....
- 97-506. S-72L. Portable. As above, but with 175-400 kc long-wave band in place of 12-31 mc band. **\$99.95**
- 97-507. *Only*.....
- 80-585. Battery Pack. *Only*..... **\$3.85**



ONLY
\$7.00
DOWN

S-53A Communications Receiver

It's a super-value! It's sensitive, powerful, completely dependable! Tunes 5 bands, ranging from 540 kc to 54 1/2 mc—includes 6 Amateur bands, Police, Aircraft and other services, as well as standard broadcast. Features include: slide-rule dial; electrical bandspread; latest series type noise limiter circuit; voltage-stabilized oscillator; iron-core IF'S; tone control; built-in PM dynamic speaker. Handsomely housed in rich satin-black and satin-chrome trim steel cabinet. Complete with 7 tubes and rectifier. **\$69.95**

- 97-573. S-53A Receiver. *Only*.....
- \$7.00 down, \$5.66 monthly for 12 months*

it's ALLIED for hallicrafters!



ONLY **\$17.95** DOWN

SX-71 Communications Receiver

A top-performing communications receiver at amazingly moderate cost! Covers five full bands: 538-1650 kc; 1600-4800 kc; 4.6-13.5 mc; 12.5-35 mc; 46-56 mc. Features double conversion superhet circuit, high image rejection, razor-sharp selectivity, extremely high sensitivity. Includes: full electrical bandspread; tuned RF stage, 3-step crystal filter; built-in NBFM adapter; automatic noise limiter; calibrated "S" meter; BFO pitch; tone control; extra-wide-vision dials; 3-watt communications-peaked audio; temperature compensation; universal antenna input. In satin-black steel cabinet; 18 1/2 x 7 3/8 x 12". Complete with 11 tubes, rectifier and regulator. For 105-125 volts, 50-60 cycles. Shpg. wt., 33 lbs. **\$179.50**

- 97-506. SX-71, less speaker. *Only*.....
- \$17.95 down, \$14.27 monthly for 12 months*
- 97-787. R-46 matching speaker. 19 lbs. **\$16.95**



Popular S-38B Super-Value All-Wave Receiver

The all-star, all-wave value that amazes even the experts. Covers 4 full wave bands, continuous range from 540 kc to 32 mc. Features: full electrical bandspread; Band Selector; Voice-Code switch; Speaker-headphones switch; Standby-receive switch, latest PM speaker. In handsome furniture-steel cabinet, 12 7/8 x 7 3/8 x 7 1/4". Complete with all tubes. For 105-125 volts DC, or 40-60 cycles AC. Shpg. wt., 15 lbs. **\$39.95**

ALLIED RADIO

ALLIED RADIO CORP.,
833 W. Jackson Blvd., Chicago, 7, Ill., Dept. 1-H-O
 Send FREE ALLIED Catalog Supplement
 Enter order for Hallicrafters Model.....
 Enclosed \$..... Full Payment
 Part Payment (Bal. C.O.D.)
 Send Time Payment details and order blank.

Name.....
 Address.....
 City..... Zone..... State.....

NEW ALLIED SUPPLEMENT

Send for ALLIED'S latest Supplement! Packed with new TV releases, recorders, Hi-Fi Music and P. A. Systems, new electronic developments—plus hundreds of big values. Write today for your copy of the FREE ALLIED Catalog Supplement.

Special Savings on Popular Equipment

ALLIED RADIO
Special Supplement No. 121



"We doubled our store space... increased our staff"

REPAIRABLE RADIO SERVICE BY CAREFULLY TRAINED EXPERTS

BETTER RADIO INC.
136 W. Park Avenue
ELMHURST, ILLINOIS
Elmhurst 3228

April 28, 1950

Sylvania Electric Products Inc.
Advertising Department
Emporium, Pa.

Gentlemen:

During January, February and March, I sent 12,000 postal cards to each occupant of three suburban towns, Elmhurst, Villa Park, Lombard and countryside. I had a local letter service handle addressing and mailing at a cost of only 1/3¢ per card.

Business began to pour in soon after the first mailing. In January, it was up 33%, February 35% and March up 45% compared to service business in similar months in 1949. Yes, service business increased an average of 38% the first three months of this year, over last.

Due to the increased business we've had as a result of your campaign mailings, we have doubled our store space, increased our service staff from two to six bench positions, and added an outside staff for antenna installations.

Just thought you would like to know! Thanks for your help in the rapid growth of "Better Radio".

Cordially,
Howard J. Hitzeman
Howard J. Hitzeman
President
BETTER RADIO INC.

Read this remarkable record!

Now let this SYLVANIA DEALER CAMPAIGN boost your business!

The above letter is actual proof of how Sylvania's Service Dealer Campaigns step up sales.

Now the new fall campaign is ready for you. It's tied in with the advertising your customers will be seeing in the Saturday Evening Post, Life, Look, Collier's and Radio and Television Best. It's sure-fire, powerful and complete . . . from colorful window and counter displays to bright, business-pulling postal cards . . . even radio spot announcements and ad mats.

All yours ALL FREE . . . you pay only the postage (1¢ for each card). So don't delay, mail the coupon TODAY!

Call Us for expert radio and TV service at reasonable prices...

We use and recommend SYLVANIA RADIO AND TELEVISION TUBES

DISPLAYS

You'll like our expert radio service and fair prices

WE USE AND RECOMMEND SYLVANIA RADIO AND TELEVISION TUBES

WINDOW STREAMERS

POSTAL CARDS

DEALER'S IMPRINT

RADIO SPOTS

Spot Radio Announcements

DEALER'S IMPRINT

AD MATS

DEALER'S IMPRINT

- RADIO TUBES; TELEVISION PICTURE TUBES; ELECTRONIC PRODUCTS; ELECTRONIC TEST EQUIPMENT; FLUORESCENT LAMPS, FIXTURES, SIGN TUBING, WIRING DEVICES; LIGHT BULBS; PHOTOLAMPS; TELEVISION SETS

SYLVANIA ELECTRIC

Sylvania Electric Products Inc.
Dept. R-1208, Emporium, Pa.

Send full details about Sylvania's Fall Advertising Campaign for Radio-TV Service Dealers.

Name _____

Company _____

Street _____

City _____ Zone _____ State _____

RADIO & TELEVISION NEWS

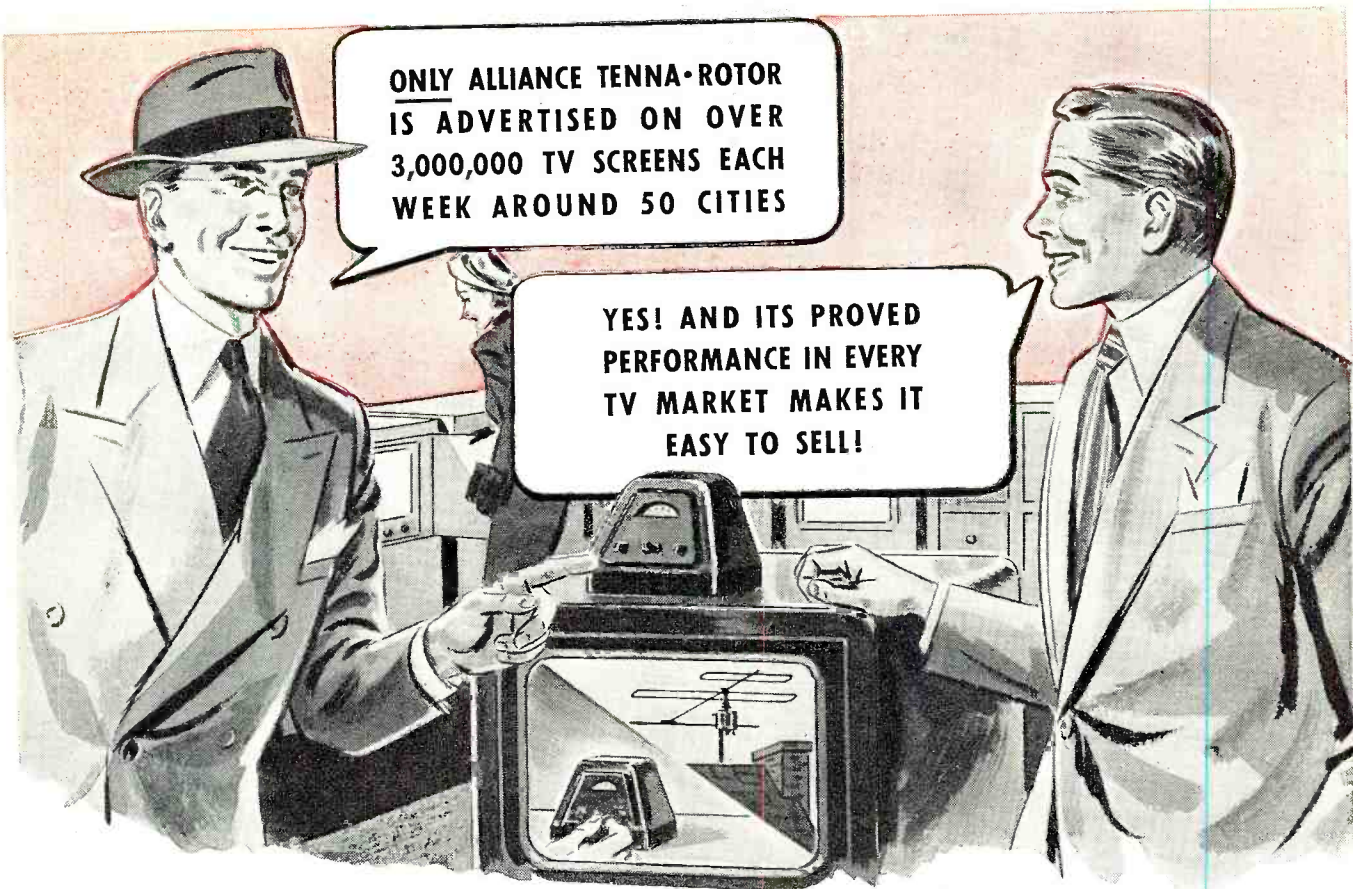

No wonder **ALLIANCE TENNA-ROTOR** is the fastest profit maker in television today!

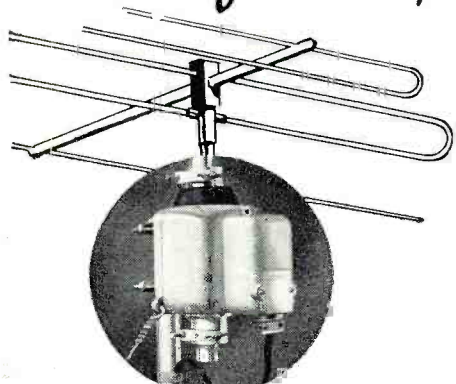

Tenna-Rotor comes complete in one package!
Both standard Model ATR and Deluxe Model DIR available!

New Model DIR as illustrated has indicator control case to show compass direction!



There's Only One TENNA-ROTOR! Here's Why!

- 1** Only Tenna-Rotor blankets the nation with advertising . . . every week your customers see Alliance film demonstrations right in their homes!
- 2** Only Tenna-Rotor can point to over 250,000 satisfied users from coast to coast!
- 3** Only Tenna-Rotor has Underwriters' Laboratories approval and a one year guarantee!
- 4** Only Tenna-Rotor has special 4-conductor cable with "ZIP" feature for faster, easier installations!

E. T. L. Laboratory tests prove operation in sub-zero, rain and icy weather!



Trade Mark Reg. U. S. Pat. Off.

ALLIANCE MANUFACTURING COMPANY • ALLIANCE, OHIO
Makers of Alliance Phonometers and Power-Pak Motors

THE SPOTLIGHTS

Safest for Guaranteed

Centralab®

DIVISION GLOBE-UNION INC., MILWAUKEE, WISCONSIN

the First Name
in Electronic Ceramics



RESULTS prove Centralab Hi-Vo-Kaps Best for TV

Yes, CRL Ceramic High Voltage Capacitors — the kind that high voltage requirements of TV need (10-20-30 KV: 500 mmf capacity) — have become the accepted standard for the TV industry. This is no accident! For these units were specifically designed for the TV job. Behind them stands more years of engineering know-how—more extensive production know-how than offered by any similar units. If you have high voltage capacitor replacement problems, investigate CRL Hi-Vo-Kaps today. Call your CENTRALAB Distributor or write to: Centralab Division of Globe-Union Inc., 910 E. Keefe Ave., Milwaukee, Wis.

*We'll see you at THE NEDA SHOW
Booth 107 • Cleveland • Aug. 29-31*

ON CERAMICS

Radio and TV Servicing

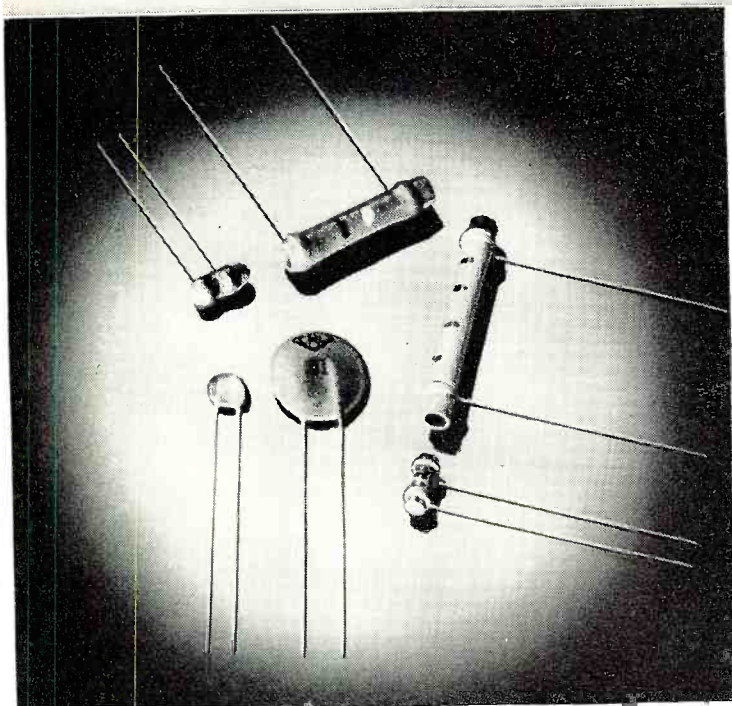

Centralab offers the widest line of ceramic capacitors in the entire industry — By-pass, Coupling, Temperature Compensating — tubulars, discs, plates. Remember — it's ceramics for longest life under high humidity and high temperature conditions.

Ask Your Centralab Distributor for the New CRL Catalog No. 27 Showing These Items.

Printed Electronic Circuits — the pinnacle of their development — Centralab Ampec. . . 3 full audio stages of a speech amplifier — all components complete in one miniature unit — 1 1/4" x 1 1/8" x .340" over tube sockets.

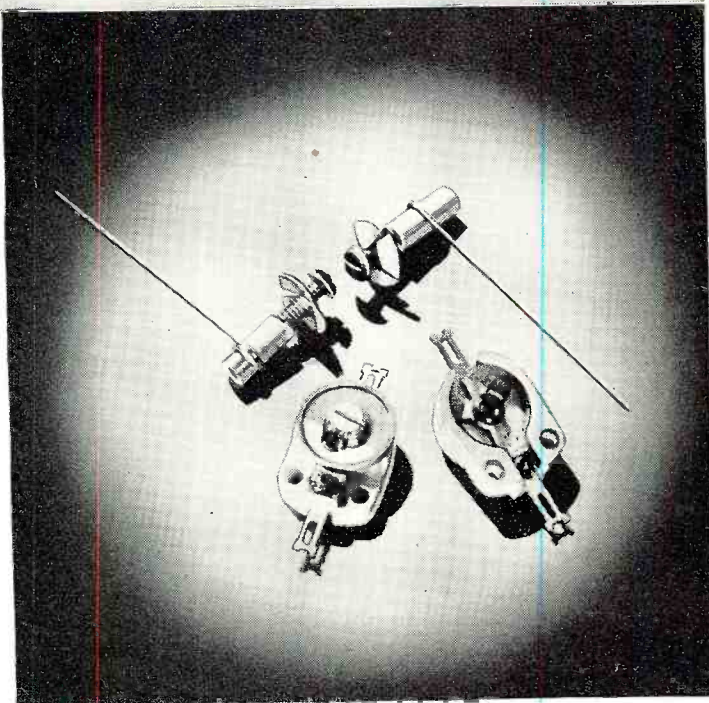

Top — tubular trimmers especially designed for TV tuners. Bottom — ceramic trimmer-capacitors—with unusually stable characteristics. Stability due to *optically ground* uniformly flat surfaces. Rotor and stator plates of metallic silver—fired to ceramic rotor and stator bodies.

Want to speed up service? *At left* — Vertical Integrator — widely used in TV vertical integrator circuits. *At right* — a CRL Pentode Couplate — easily replaces screen, grid and plate resistors; screen by-pass, plate r.f. by-pass and coupling capacitors.

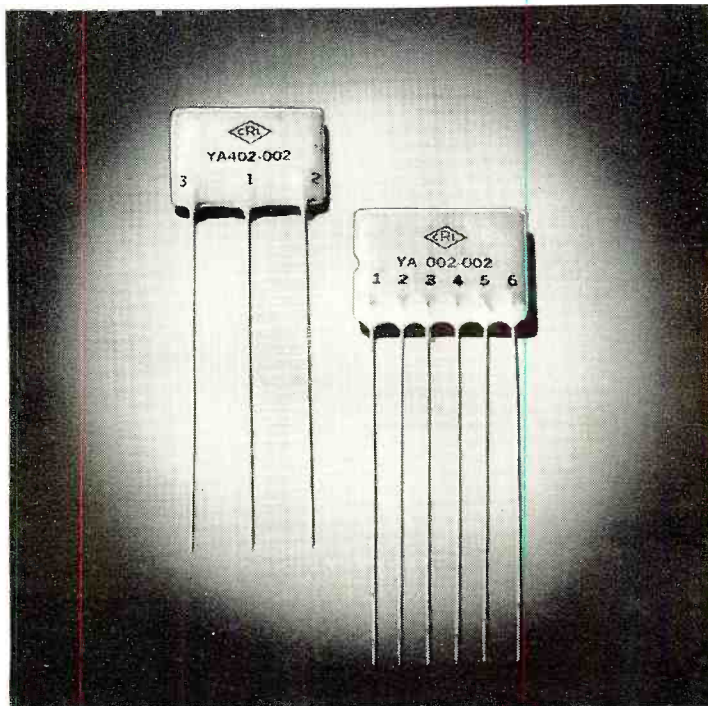
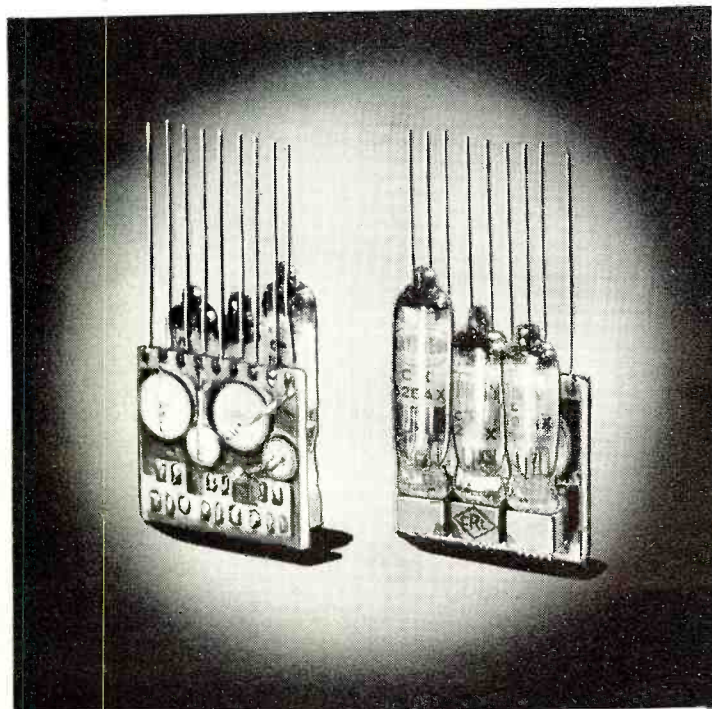

Be Sure of Your Installations – Get the *Aptitude-Tested* RG/U TRANSMISSION LINE CABLES

RG-5/U
APTITUDE RATING No. 8236

Frequency (Mc)	Attenuation per 100 ft
100.	2.65
200.	3.85
300.	4.80
400.	5.60

RG-8/U
APTITUDE RATING No. 8237

Frequency (Mc)	Attenuation per 100 ft
100.	2.10
200.	3.30
300.	4.10
400.	4.50

RG-11/U
APTITUDE RATING No. 8238

Frequency (Mc)	Attenuation per 100 ft
100.	1.90
200.	2.85
300.	3.60
400.	4.35

RG-54A/U
APTITUDE RATING No. 8239

Frequency (Mc)	Attenuation per 100 ft
100.	2.90
200.	4.20
300.	5.50
400.	6.70

RG-59/U
APTITUDE RATING No. 8241

Frequency (Mc)	Attenuation per 100 ft
100.	3.75
200.	5.60
300.	7.10
400.	8.30

For use with television antenna.

RG-58/U
APTITUDE RATING No. 8240

Frequency (Mc)	Attenuation per 100 ft
100.	4.10
200.	6.20
300.	8.00
400.	9.50

For use with radio frequency transmission, video, test equipment, and pulse transmission.

You know what you are doing when you use Belden RG/U Transmission Line Cables—they're aptitude rated. They are designed from the start to provide desirable electrical characteristics, and rigid manufacturing control assures constant, unwavering quality.

You can safely put Belden Wire to work for you, and know for sure how it will perform. You can know, too, that it will have the stamina to stay loyally on the job for years. For trouble-free installations, specify Belden Radio Wires.

Belden Manufacturing Company
4681 W. Van Buren Street
Chicago 44, Illinois

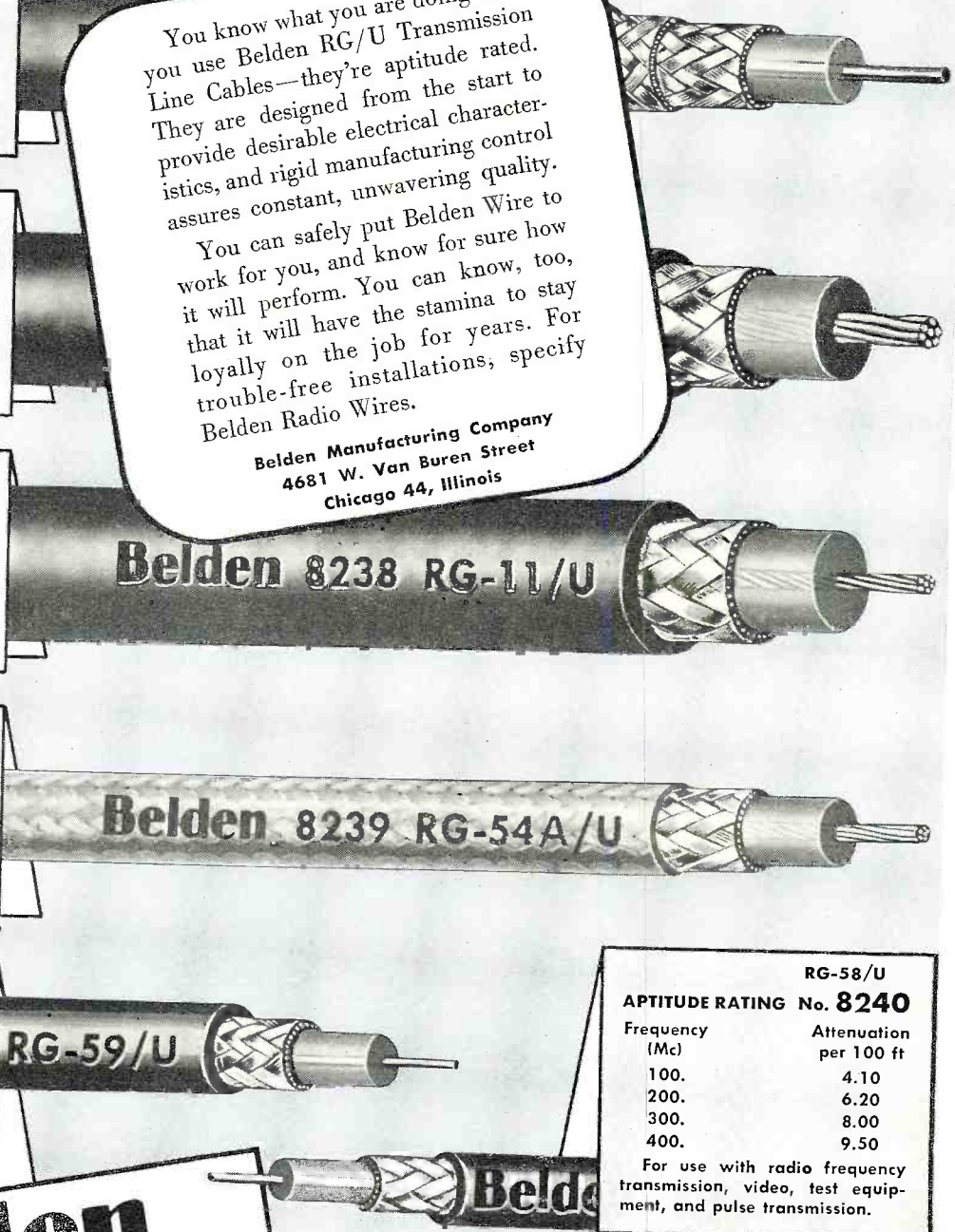

Belden
Radio WIRE The *Aptitude-Tested* **LINE**

★ TO A MAN INTERESTED IN ★ A Better Paying Job in Television

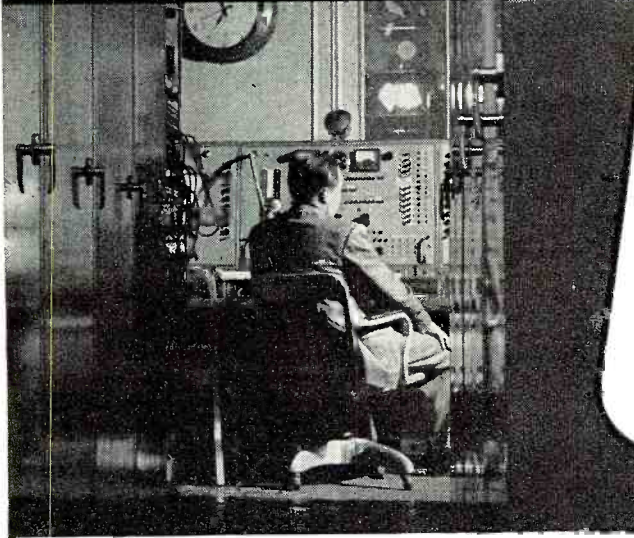

ASK YOURSELF THESE QUESTIONS:

1. Are new men—with less experience than yourself—passing you by?
2. Has it been "too long" since you have received a satisfactory raise?
3. Are you tied down to a routine, production-line job?
4. Does your future seem limited to small stations and small salaries?
5. DO YOU GENERALLY FINISH WHAT YOU START?

If your answer is YES to most of these questions, CREI'S Home Study Course can help you get a BETTER JOB in Television

WHAT YOU DO to keep yourself abreast of new developments is what counts toward advancement in television. Obviously, everyone cannot qualify. *Those who do are well rewarded.* The television industry offers almost unlimited opportunity to trained engineers and technicians. CREI training helps all levels, from novice to experienced engineer, because its specialized individual instruction brings out the best in a man and takes him as far as his own aptitude and effort will let him go.

CREI is an accredited technical institute founded in 1927. Its home study graduates fill important jobs throughout the radio, television and electronics industries. Leading industrial firms—RCA Victor, Pan American Airways, United Air Lines, to name only a few—have CREI group training programs now in opera-

tion. Industry welcomes CREI grads—CREI training is recognized as a respected reference.

Make your own opportunity in television! Add CREI technical training to your present experience — start either at the beginning or at an advanced stage. Get yourself a better TV job—make more money—enjoy increased security. The next two years can be the most important of your lifetime. Write today for complete information. The cost is popular, the terms easy.

FREE SAMPLE LESSON

Send for "The Orthicon and Image Orthicon" which describes the development, theory and operation of the orthicon and image orthicon TV camera tubes.

THE THREE BASIC CREI COURSES:

- ★ **PRACTICAL RADIO ENGINEERING**
Fundamental course in all phases of radio-electronics
- ★ **PRACTICAL TELEVISION ENGINEERING**
Specialized training for professional radiomen
- ★ **TELEVISION AND FM SERVICING**
Streamlined course for men in "top-third" of field

ALSO AVAILABLE AS RESIDENCE SCHOOL COURSES

CAPITOL RADIO ENGINEERING INSTITUTE

An Accredited Technical Institute Founded in 1927
Dept. 118-B, 16th & Park Rd., N. W., Washington 10, D. C.
Branch Office: San Francisco (2) 760 Market St.



MAIL COUPON FOR FREE BOOKLET

CAPITOL RADIO ENGINEERING INSTITUTE
Dept. 118-B, 16th & Park Road, N. W., Washington 10, D. C.

Gentlemen: Send me FREE SAMPLE LESSON and booklet, "Your Future in the New World of Electronics," together with details of your home study training, CREI self-improvement program and outline of course. I am attaching a brief resume of my experience, education and present position.

- Check the Field of Greatest Interest:
- Practical Television Engineering.
 - Practical Radio Engineering.
 - TV, FM & Advanced AM Servicing.

- Aeronautical Radio Engineering.
- Broadcast Radio Engineering (AM, FM, TV).
- Radio-Electronics In Industry

NAME _____ AGE _____
ADDRESS _____
CITY _____ ZONE _____ STATE _____
If Residence School Preferred, Check Here

Terrific FOR TELE-CIRCUITS!

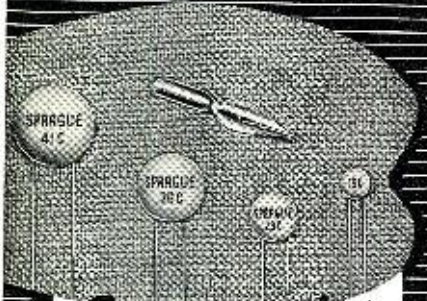

Cera-mite* CAPACITORS

ARE
THE *First* COMPLETE
DISC CERAMIC LINE

DEVELOPED especially for the television industry, Sprague Cera-mite Capacitors fill the bill for the alert service technician!

Temperature-compensating, general-use, and high-K bypass types fit every type of circuit application. The low self-inductance feature of the flat plate with uni-directional lead design gives better high frequency performance than the older tubular ceramics which they replace. And they're ideal as mica capacitor replacements, too!

Tiny and dependable, every Cera-mite is rated at 1000 volts test, 500 wvdc, and for operation at 185°F.

Cera-mites are clearly stamped with capacitance—no confusing color coding.

Stock up at your Sprague distributor without delay!

Write for Cera-mite Bulletin

*Trademark

SPRAGUE

PRODUCTS COMPANY

Distributors: Division of the Sprague Electric Co.
51 Marshall St., North Adams, Mass.

Spot Radio News

* Presenting latest information on the Radio Industry.

By RADIO & TELEVISION NEWS'
WASHINGTON EDITOR

WITH COLOR TV's historic mammoth probe now at a temporary halt, after the longest single session on record, involving nine months of hectic hearings, members of the Commission have begun to pour over the 10,000 pages and 250 exhibits of testimony offered, and attempt to arrive at a series of conclusions which will undoubtedly set a route for the ultimate direction of the video art.

In preparing their verdict, the seven communications jurists will have to weigh carefully the thousands and thousands of opinions on the books, citing the variety of merits of the three systems, over which the wordy battle began. Reviewing the record, they'll find the remarks of those who appeared last, the boys from *CTI*, particularly intriguing. For it was here that the proponents of the system were able, after three disappointing attempts, to demonstrate their idea of a solution to the color problem and then proceed to pepper the Commission with seething remarks about their position in the race to fame. Appearing for *CTI*, as a color expert and as a patent attorney, Colonel Donald K. Lippincott, told the officials from Washington that the Pacific Coast system was better than the *RCA* or *CBS* types because of its synchronizing signal which was most applicable to select the line or field sequentials, which might be employed in color work. It was also his belief that the interlace shift, which *CTI* used, offered the best pattern. In this method, there is a double shift in which each picture line appears in all three primary colors—red, green and blue—in the course of six field scanings. Thus, each color appears in successive frames, as closely as is geometrically possible, halfway between its appearance in the preceding frames. In further testimony, *CTI's* Prexy Arthur S. Matthews, criticized the *RCA* system as . . . "too complicated for the average serviceman to handle or the average viewer to adjust successfully and certainly for television's largest audience, the children, to operate." Reporting on the *CBS* method, the *CTI* Headman claimed that its adoption would render . . . "the transition from black and white to color most impractical from the standpoint of the public." Matthews then added that the use of the setup

. . . "would also prove financially difficult, if not disastrous to all but the largest television manufacturers."

Commenting on the demonstrations, which were held in the St. Francis Hotel, the *CTI* execs said that they were extremely successful. (The colorcasts, originating in the *CTI* laboratories, were microwaved approximately two miles to the transmitter of KPIX and then broadcast over Channel 5. Standard monochrome and *RCA* color receivers, with dichroic mirrors, were used for pickup. The tests were viewed by two members of the Commission, Chairman Wayne Coy and Commissioner Rosel H. Hyde, as well as by E. M. Allen, FCC technical research head and Wilmar K. Roberts of the FCC labs. Also at the viewing was assistant general counsel Harry M. Plotkin.)

As this hearing neared its conclusion, the subject of interference was raised, and *CTI* entered its opinion on the problem. A roar of objections to the admission of the testimony followed and the Commission decided to review the subject. After a detailed probe of the report, Chairman Coy came up with a reply which rocked the room. Overruling the objection and permitting the testimony to be received in evidence, the FCC Chief-tain declared: "I would like to comment . . . that this exhibit brings into sharp focus the difficult problems that the Commission faces. It is apparent that a successful television system cannot be maintained unless a sound allocation is established. A sound allocation is not possible unless the Commission has adequate interference data. It has been the consistent experience of the Commission in this and other proceedings that it is virtually impossible to get the parties to submit adequate interference data. And I address these remarks not only to . . . this exhibit . . . but to all the parties in this proceeding. So far as the parties are concerned, no adequate interference data was offered by any of the parties at the outset. Moreover, when, after extensive prodding by the Commission, the parties did produce some interference data, it is apparent that not nearly as much effort and ingenuity went into the preparation and presentation of such evidence, as compared with other aspects of the parties' cases. It is merely a

RADIO & TELEVISION NEWS

YOUR OPPORTUNITY IS HERE NOW! LEARN

TELEVISION

RIGHT AT HOME!

By the new method of

TRANSPONDENCE

training on film and tape recordings

Now the De Forest-Sanabria Corporation—a division of the world's largest television training school—brings *class-room instruction* to you right in your own home! You actually hear your instructor's recorded voice. At the same time you watch "blackboard" size projected pictures, diagrams and illustrations. It's the quick, easy way to equip yourself for the big earnings in television—today!

LOOK . . . You get the tape recorder and projector right at the start of your course!



HEAR your instructor

It's even better than the classroom, because you can repeat the instructor's lectures until they're thoroughly understood.

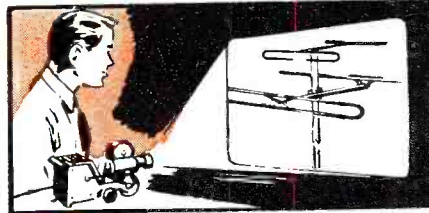

SEE 2000 illustrations

You learn quicker when you see diagrams and illustrations in black-board size.



READ from reference library

You receive complete books, pamphlets and manuals to supplement your instructor's lessons.



ASK your questions on tape

Tell your instructor about anything that puzzles you and get his answers back pronto.



You get the famous "TRANSPONDER" precision built, high fidelity tape recording machine with your very first lesson—and a powerful projector with which you can view diagrams and illustrations enlarged to a size that makes them easy to see and understand.

BE A SUCCESS . . . ACT NOW!

Millions of television set owners are demanding qualified television technicians to service their sets. There is a tremendous shortage of such qualified men today and will be for many years to come. Get in on the ground floor of this booming industry and be prepared to accept a steady, big pay job for life. We can qualify you quickly, easily, surely—and help get you a job when you complete your course. Send for illustrated booklet that gives the complete details.

The De Forest-Sanabria Corp.

An affiliate of American Television, Inc.

5050 North Broadway, Chicago 40, Illinois

MAIL COUPON TODAY!

De Forest-Sanabria Corporation **FREE BOOK**
Dept. RN-8
5050 Broadway, Chicago 40, Ill. **TELLS HOW**

Dear Sirs:

Please send me copy of your free illustrated booklet which describes the new TRANSPONDENCE method of learning television at home under the direction of Dr. Lee de Forest and U. A. Sanabria.

NAME _____ AGE _____

ADDRESS _____

CITY _____ STATE _____

(Mail in envelope or paste on a postcard.)

**TOP SALES PROVE TV
SET OWNERS WANT THE
QUALITY PERFORMANCE
AND QUALITY APPEARANCE
OF**

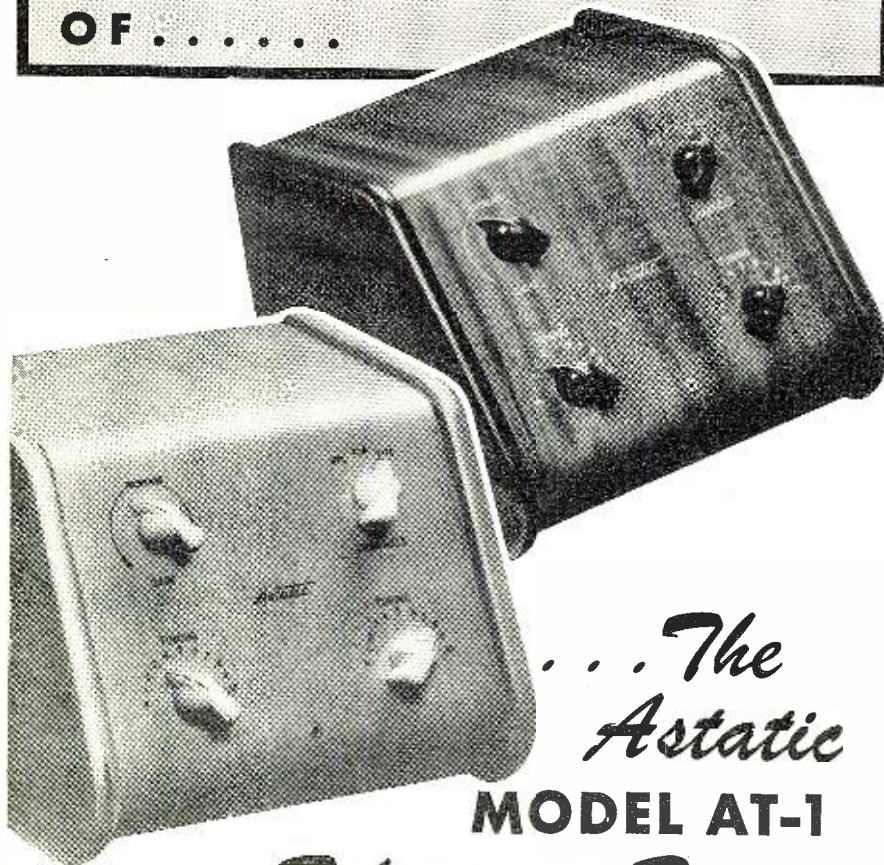

*. . . The
Astatic
MODEL AT-1
Television Booster*

YES, the proof is in! When TV set owners want improved reception, they want the best in boosters — as witness the soaring sales of Astatic's Model AT-1. This is the powerful booster with four tubes, and such exclusive features as dual tuning and variable gain control, the latter permitting pinpoint tuning for exact amount of boost required for best picture and sound. The Astatic AT-1 Booster not only outperforms any other on the market, but it looks the part — in handsome, furniture-finish mahogany or blond cabinet to complement the finest receivers and other costly furnishings. These are typical advantages which have made the Astatic Model AT-1 Television Booster the undisputed leader today. Why not write for complete details, technical data?

Astatic Crystal Devices manufactured under Brush Development Co. patents



repetition of the situation where the industry appears to be perfectly willing to have the Commission allocate on the basis of inadequate interference data in the hope that things will work out well. However, when things do not work out well, strong pleas are made to the Commission, particularly by that portion of the industry which at that time happens to be favored by existing authorizations, to relieve the situation by not licensing any further stations that would aggravate the interference problem. . . . I hope that our experience in this proceeding will teach all of us the importance, not only to the Commission, but to the industry and the public, of securing and offering adequate data on interference, so that sound decisions can be made on an allocation basis, under which the industry can build with reliance . . . on the fact that unforeseen interference conditions will not severely limit the service areas which had been anticipated and thus deprive many rural listeners of service. People who live in rural areas are important people."

There is little doubt that the blast by Coy will ever be forgotten by those engaged in the frequency tangle, on either side of the fence, the furious indictment reemphasizing the extreme caution which the Commission has adopted and will follow before that final allocation edict is offered.

Continuing their review of the encyclopedic volumes of testimony, the FCC will find reference to the complex color-tube developmental situation and the fact that now there are four tubes to consider, instead of one. For during the closing days of the sessions, *Du Mont* had reported that they had received a patent on a tri-color single-gun tube, *Paramount* revealed that their subsidiary, *Chromatic Television Labs*, was engaged in the development of a new tube (which would eventually be produced by *Machlett Labs*), and *Don Lee Broadcasting* announced that they had filed application for patents on a *Color-Vision* type tube, developed in conjunction with a stereoscopic project under the supervision of Harry R. Lubcke, director of research and color at *Don Lee*.

The *Du Mont* tube appeared to have quite an interesting background, for the tube had been conceived shortly after the war ended and a patent applied for at that time. Thus, a span of five years had elapsed before its disclosure, a span of years which indicated that color research had been activated long before the present three-hue talkathon had begun, those sessions many stated were responsible for all the activity in color work.

Describing the tube's construction, Dr. Thomas T. Goldsmith, Jr., said that the tube featured a new form of fluorescent screen. Instead of having a coating of fluorescent material, which produces a black and white picture when struck by an electron stream, this new tube has a screen

(Continued on page 146)



Train at Home in Spare Time for **RADIO** and **TELEVISION**

**I Send You
18 BIG
KITS
OF RADIO-
TELEVISION
EQUIPMENT**



**My Famous Training System Prepares
You in Double-Quick Time for a Good
Job or Your Own Profitable Radio-
Television Business**

Radio-Television is now America's greatest opportunity field! Trained men are needed to fill good jobs and handle profitable Radio-Television Service work. I have trained hundreds of men for success in Radio-Television—and I stand ready to Train you too, even if you have no previous experience. My training is 100% practical—designed to give you the knowledge and experience you need to make money in Radio-Television in the shortest possible time. I Train you with up-to-the-second revised lessons—PLUS many big kits of Radio-Television equipment. You actually do over 300 demonstrations, experiments and construction projects. In addition, you build a powerful 6-tube 2-band radio, a multi-range test meter and a complete Television receiver! All equipment is **YOURS TO KEEP!**

EASY TO MAKE EXTRA MONEY WHILE YOU LEARN

You do all your training with me AT HOME in spare hours. Keep right on with your present job and income while learning—and earn extra cash besides! The day you enroll I begin sending you plans and ideas for doing profitable spare-time Radio-TV work. Many of my Sprayberry students pay for their entire training this way! You get priceless experience and many plans for making extra money. You build all your own Radio-TV Test Equipment from parts I send you—nothing else to buy. Just one more reason why I believe I offer the ambitious man the biggest value in top notch Radio-TV Training available anywhere in America today.

Be Ready for Top-Paying Radio-Television Jobs

Radio-Television is growing with amazing speed. More than 2000 Radio broadcasting stations PLUS an additional 102 Television stations are now on the air. Radio sets and TV receivers are being made and sold in record-breaking numbers. If you enjoy working with your hands . . . if you like to do interesting and varied work . . . if you really want to make good money and work in an industry that has a future . . . **YOU BELONG IN RADIO-TELEVISION.** But you **MUST** have good Training to "cash in" . . . the kind of Training that starts you out with basic fundamentals and carries you right through every circuit and problem of Radio-Television Servicing and Repair. In a word . . . that's Sprayberry Training . . . the course backed by more than 20 years of association with the Radio-Television industry!

FREE 3 BIG RADIO-TELEVISION BOOKS

I want you to have ALL the facts about my complete system of Radio-Television Training! Act now! Rush the coupon for my three big Radio-Television books: "How to Make Money in Radio-Television," PLUS my new illustrated Television Bulletin, PLUS an actual sample Sprayberry Lesson—all FREE with my compliments. No obligation and no salesman will call on you. Send the coupon in an envelope or paste on back of post card. I will rush all three books at once!

Sprayberry Academy of Radio, Dept. 25-M
111 North Canal St., Chicago 6, Ill.

**Mail
Coupon
Today!**

**NO OBLIGATION
No Salesman
Will Call**

**SPRAYBERRY ACADEMY OF RADIO, Dept. 25-M
111 North Canal St., Chicago 6, Ill.**

Please rush to me all information on your Radio-Television Training Plan. I understand this does not obligate me and that no salesman will call upon me.

Name..... Age.....

Address

City..... Zone..... State.....

Please Check Below About Your Experience
 Are You Experienced? No Experience

VETERANS: My Radio Training is Approved for Veterans.

IF YOU ARE EXPERIENCED in Radio I'll qualify you for Television in 4 to 8 weeks. Rush coupon.

**TV DEALERS AND
SERVICEMEN—**



**NOW GENERAL ELECTRIC
OFFERS YOU A SHARE OF A**

**\$30,000,000
REPLACEMENT MARKET**



EM-PM FOCUS COIL—These units combine the effects of Alnico 6 permanent magnet and an electromagnet to provide uniform focus with a minimum of circuit power.



NEW DEFLECTION YOKE—Sweeps 70° with only 20 watts of power from a 260-volt supply. Ferrite core units available for high efficiency applications.



HORIZONTAL SWEEP TRANSFORMER—When used with high efficiency yokes, these ferrite core transformers provide 70° deflection at 13 kv.

You can put your confidence in—

GENERAL  ELECTRIC

ESTIMATES peg the TV market at ten million sets in use by the end of 1950...*that's your opportunity!*

Twenty major TV receiver manufacturers are building General Electric components into their sets. Millions of these parts are in use today, in receivers everywhere...*that's your market!*

G.E.'s complete line of high quality components is now available—for the first time—to distributors, dealers and servicemen...*that's your cue for action!*

Build your business future by establishing a reputation for careful, skilled TV service work. Satisfy your customers by replacing with components that are standard in the best receivers the industry makes, backed by a name you can depend on...General Electric.

HERE'S WHAT YOU NEED!

As television grows, be sure you grow with it. Get your share of a skyrocketing business by selling the dependable components shown here. Send for the new G-E Television Parts Catalog just off the press—just mail the coupon at right and the catalog is yours—free!



August, 1950

WIDTH & LINEARITY CONTROLS—
Provide convenient control of picture and linearity by screwdriver adjustment.

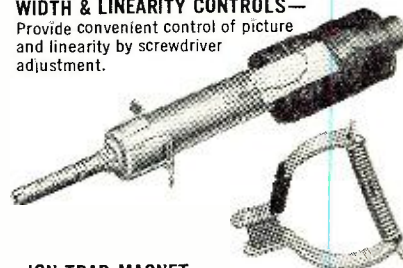

ION TRAP MAGNET—
Available in two sizes, 35 and 42 gauss.

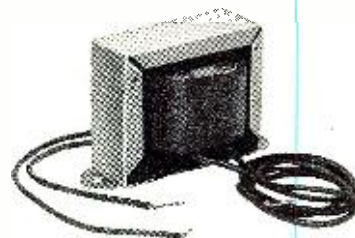

VERTICAL SWEEP TRANSFORMER—For use in magnetic deflection circuits from 50°-70°. Designed to match vertical output tube to deflection yoke.



FM WAVE TRAP—Reduces or eliminates interference caused by FM broadcasting stations operating in 88 to 108 mc channels.



IF WAVE TRAP—Designed to reduce or eliminate interference on TV receivers caused by signals at IF frequencies of 41-47 mc.

**ARE YOU READY?
MAIL THIS COUPON TODAY!**



● General Electric Company, Section 980,
Electronics Park, Syracuse, N. Y.

● I want my share of the new TV replacement market. Send me complete catalog of TV components and facts on service sales.

● NAME _____

● ADDRESS _____

● CITY _____ STATE _____

HERE'S YOUR REPLACEMENT

No Other Control Gives You All These

59 IRC CONTROLS WITH AMAZING ADAPTABILITY MEET ALL YOUR NEEDS WITH LESS STOCK

Compare the amazing adaptability of your IRC Q Control with any other. You'll agree no other control so closely meets all your servicing needs . . . no other gives you so much for your money! Feel its cushioned turn, examine its lustrous finish, study its practical design—ask your Distributor for IRC Q Controls, and you know you're buying the very best.

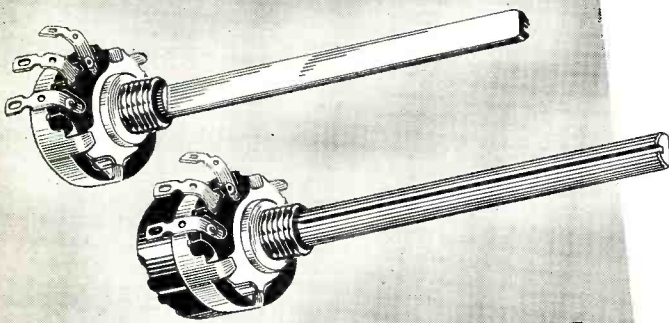

KNOB MASTER FIXED SHAFT

Standard fixed shaft fits most knobs without alteration or inserts. Flatted, knurled and grooved. 3" length meets TV requirements. Ample cross-section prevents bending.

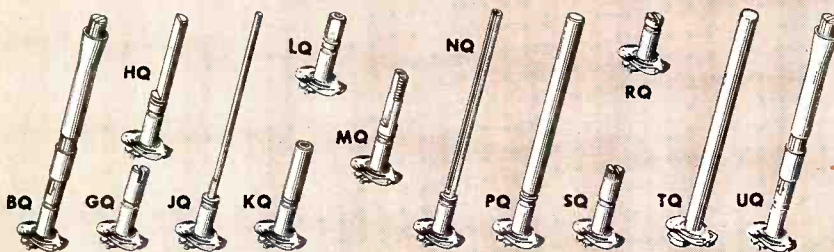

INTERCHANGEABLE FIXED SHAFTS

Easy replacement of standard shaft with any of 13 special fixed shafts is made possible by exclusive IRC Resilient Retainer Ring. This revolutionary feature provides widest replacement control coverage.

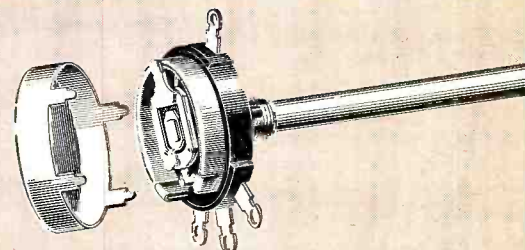

WIRE WOUND CONTROLS

Dependable 2 watt controls available with center tap for TV centering. Specific TV values now available with Knob Master Shaft to accommodate both knurled and flatted knobs.

No. 1 CONTROL

Modern Servicing Features!

- ★ Fits both flatted and knurled knobs
- ★ Separate switches
- ★ Modern small size
- ★ Fixed shaft convenience with complete shaft interchangeability
- ★ 23 tapped types
- ★ Shorter bushing
- ★ Sparkling appearance
- ★ 1/2 watt rating



**INTERNATIONAL
RESISTANCE COMPANY**

401 N. BROAD STREET, PHILADELPHIA 8, PA.

Wherever the Circuit Says ~~~~

In Canada: International Resistance Co., Ltd., Toronto, Licensee

Concentrikit

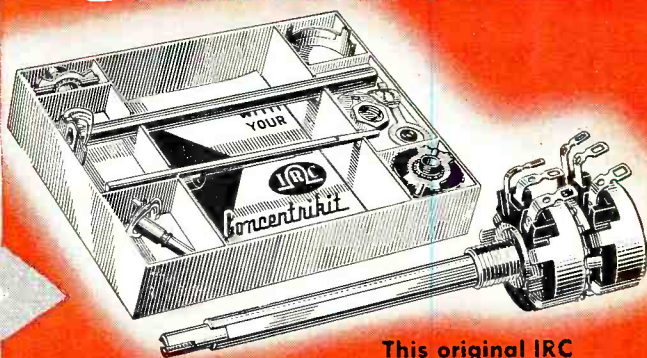

This original IRC feature provides a ready solution to your special control requirements. With this kit of parts you assemble practically any concentric dual control quickly and easily. In a matter of minutes you can prove the advantages of this practical IRC feature.

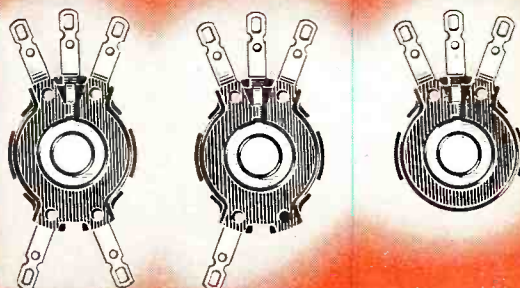

INTERCHANGEABLE BASE-ELEMENTS

Principally intended for use with Concentrikit, this IRC innovation gives you limitless opportunities for adapting controls to specific requirements. Each unit includes molded base, element, terminals and collector ring—no loose parts. Available in 33 resistance values and a variety of taps.

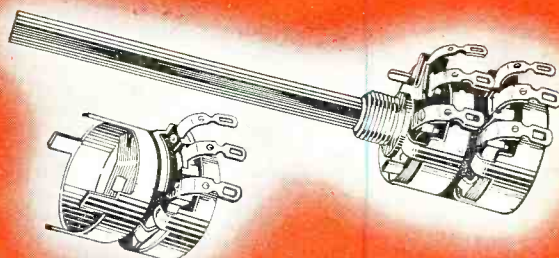

Multisections

For standard duals, IRC Multisections are added to Q Controls like switches. 17 values provide over 11,000,000 variations of dual, triple and quadruple controls; accommodate switches, too!

INTERNATIONAL RESISTANCE COMPANY

415 N. Broad Street, Phila. 8, Pa.

Please send me additional IRC Q Control information checked below:

- Free Catalog Bulletin DC1A
- Enclosed find 25c in stamps or coin for comprehensive Concentric Dual Replacement Manual

Name _____

Company _____

Address _____

the New
PYRAMID
"Humidi-Seal"

(TUBULAR PAPER CAPACITOR)

Repels Moisture!

- Ruggedly built to withstand undue vibration and rough handling
- Outer tube plastic impregnated to prevent moisture-absorption
- Light outer coat of high-temp wax provides double protection
- Each end plastic sealed against moisture
- Leads anchored securely in solid plastic end

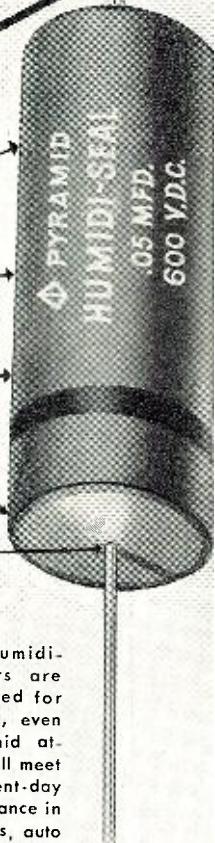

Type 85TOC "Humidi-Seal" capacitors are specially designed for 85° C. operation, even in the most humid atmospheres, and will meet the severe present-day demands of endurance in television receivers, auto radios, etc.

WRITE FOR COMPLETE LITERATURE

Representatives and Distributors throughout the U.S.A. and Canada



PYRAMID

PYRAMID ELECTRIC COMPANY

155 Oxford Street
Paterson, N. J., U.S.A.

TELEGRAMS: WUX Paterson, N. J.
CABLE ADDRESS: Pyramidusa

Within the
INDUSTRY

DR. LLOYD T. DEVORE of the staff of the Electrical Engineering Department of the University of Illinois, has been named manager of the Electronic Laboratory at *General Electric's* Electronics Park in Syracuse.



Dr. DeVore, prior to assuming his duties at *General Electric*, was acting chairman of the Research Committee and Coordinator of Research for the University's Electrical Engineering Department.

He received his B.S., M.S., and Ph.D. degrees in Physics from Pennsylvania State College and held a research fellowship under a grant from the National Research Council from 1930 to 1934. In 1943 he went to Wright Field, Dayton, Ohio, as a radio engineer with the Aircraft Radio Laboratories of the Army Air Force. He also served as chief engineer of the Research Division and as chief engineer of the Special Projects Laboratory. He resigned his War Department appointment in 1946 to join the University of Illinois staff.

* * *

BOND GEDDES, Executive Vice-President of the Radio Manufacturers Association, will retire August 1st after nearly 23 years of service to the Association.

Mr. Geddes was elected Executive Vice-President and General Manager of RMA on November 1, 1927 and his experience spans the industry's history from crystal sets to color television. Mr. Geddes has acted in the industry's development of the automobile, short-wave, and FM radio, as well as television; also in its conversion to war production and subsequent reconversion.

Prior to his RMA service, Mr. Geddes was prominent in Washington journalism for many years, at the White House and Capitol. He was formerly manager of the United Press Bureau in Washington and also served as chief of the Associated Press Capitol staff.

* * *

CHARLES GOLENPAUL, well-known in the industry as "Charley," has just rounded out twenty years' service with *Aerovox Corporation* of New Bedford, Massachusetts.

Mr. Golenpaul joined the firm in 1930 when the company was located in Brooklyn and chose the task of building up proper and profitable distribution of radio parts. From the chaotic "distribution" of radio parts

in the 1930's, Mr. Golenpaul helped to create the radio parts distribution setup of today. Component parts were individually packaged and carried definite parts numbers so that the identical parts could be reordered. Catalogues covering such replacement parts were issued and firm prices and trade discounts were established.

At the present time Mr. Golenpaul is sales manager of *Aerovox's* Distributor Division.

* * *

SHURE BROTHERS, INC., of Chicago recently celebrated its 25th anniversary with a luncheon and afternoon party for all employees.

President S. N. Shure served birthday cake and refreshments at the party while vice-presidents, garbed in white aprons, waited on table during the luncheon. A pioneer in the establishment of various employee service programs, the company is proud of the fact that of its more than 400 employees 50 per-cent have more than five years' service with the organization.

* * *

CLARENCE S. TAY, former general manager of *Admiral Corporation's* four distributing divisions, has been named president and board chairman of these same divisions by the corporation's board of directors.



At the same time, the present branch managers of these divisions, located in Chicago, New York, Milwaukee, and Boston, were elected vice-presidents and directors of their branches. T. C. Carey, of *Appliance Distributors, Inc.*, Chicago; T. J. Hodgens, and E. R. Glauber, *Admiral Corporation, New York Distributing Division, Inc.*; R. O. Habenstreit, *Admiral Corporation, Milwaukee Distributing Division, Inc.*; and E. M. Perkins, *Admiral Corporation, Boston Distributing Division, Inc.* were the men promoted.

Lynn C. Park, *Admiral* treasurer, was elected a director and secretary-treasurer of each branch while George Driscoll, *Admiral* secretary, was named assistant secretary of the three branches and a director of the New York division.

* * *

SYLVANIA ELECTRIC PRODUCTS INC. recently opened a new warehouse and office building at 2936 East 46th Street in Los Angeles. . . **GENERAL ELECTRIC COMPANY** will spend over seven million dollars this year to increase

RADIO & TELEVISION NEWS

FOLLOW THE LEADERS

BUY WISE...

BUY THE ORIGINALS...

BUY **HYTRON** TV FIRSTS

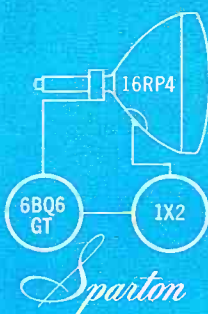
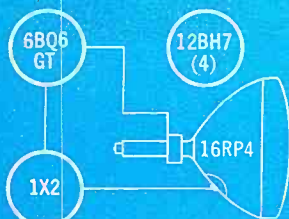
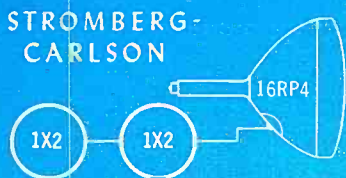
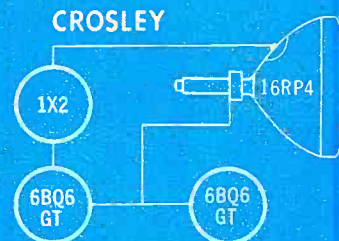
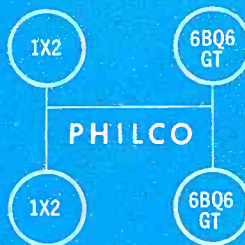
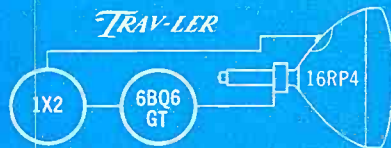
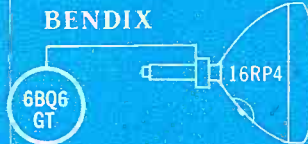
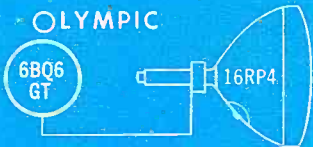
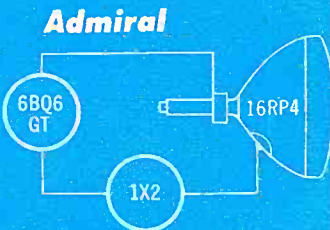
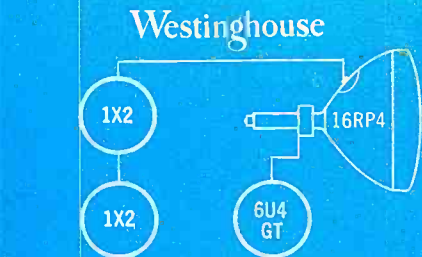

Ask for the original Hytron TV firsts: Hytron 1X2 compact, high-voltage TV rectifier. Hytron 6BQ6GT, 25BQ6GT extra-performance deflection amplifiers. Hytron 6U4GT high-perveance damping diode. Hytron 12BH7 twin-triode sweep amplifier with superior efficiency. Hytron 16RP4 original rectangular TV picture tube.



MAIN OFFICE: SALEM, MASSACHUSETTS

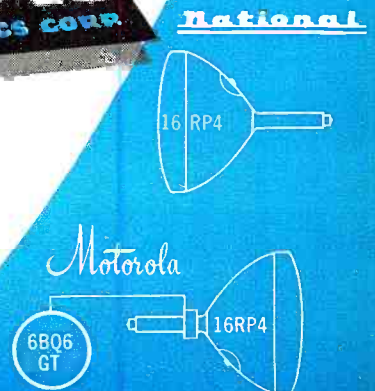

throws
a whole new
light on custom
installation!



the
**CRAFTSMEN RC-100A
TELEVISION**

You'll discover some eye-opening things when you watch this television in action. You will be aware of sensitivity you never believed possible with big-picture operation. Take a look today. See custom television in an entirely new light.

- For use with 16GP4, 19AP4, or 16TP4 (rect. glass) tubes.
- Keyed AGC, and automatic phase control of both vertical and horizontal synchronization which assures perfect interlace.
- Built-in video booster switch for fringe areas.
- Cathode-follower audio output permits remote hook-up with any audio system, preserves high-fidelity.
- 25 tubes, 4 rectifiers. Accommodates UHF channels.

ALL NEW... the RC-10 FM-AM tuner! Especially suitable for high-fidelity and TV custom installations, superbly designed to meet all FM-AM requirements.

Write for information—or send 50¢ for instructions and schematics.

THE RADIO

craftsmen
INCORPORATED

Dept. J, 1617 S. Michigan Ave., Chicago 16, Ill.

production of radio and television receivers, cabinets, and tubes. Some of the funds will be used to expand the company's plants in Syracuse, Utica, Buffalo, Wabash, Tell City, and Owensboro . . . **BENDIX TELEVISION** is building a two-story addition to its radio and television plant on East Joppa Road in Baltimore. The new structure is expected to permit quadrupling of existing TV manufacturing facilities . . . **FREED RADIO CORPORATION** has increased its production facilities by 50 per-cent by leasing additional manufacturing space at 12-16 Vestry Street in New York . . . **ARTHUR E. AKEROYD**, manufacturers' representative, has moved his Boston offices to the 23rd floor of the John Hancock Building . . . **ZENITH RADIO CORPORATION** has recently purchased property at 1500 N. Kostner Avenue in Chicago which will be used for the manufacture of radio and television components . . . **ASTRON CORPORATION**, condenser manufacturer, has recently moved into a new plant at 255 Grant Avenue, East Newark, New Jersey . . . **TEL-O-WIRE SOUND COMPANY** has opened new studios at 24 Newton Place in Holyoke, Mass. . . . **HOFFMAN RADIO CORP.** of Los Angeles recently opened a fifth plant at 6200 South Avalon Boulevard . . . **AEROLITE ELECTRONIC HARDWARE CORP.** has moved to new and larger quarters at 507 26th Street in Union City, New Jersey . . . **PERMA-POWER COMPANY**, a newly organized firm, has taken facilities at 4721 North Damen Avenue in Chicago for the manufacture of selenium rectifier type battery eliminators.

* * *

JAMES CALVIN AFFLECK has been appointed to the newly-created post of sales promotion manager of the receiver sales division of *Allen B. Du Mont Laboratories, Inc.*



Mr. Affleck brings to his new post more than nine years of sales, advertising, sales promotion and merchandising experience. For the past five years he has been advertising and sales promotion manager for *Radiomarine Corporation of America, RCA subsidiary.*

His appointment will enable Henry R. Geyelin, the company's advertising manager to concentrate his full attention to *Du Mont* receiver advertising. He previously held the dual post of advertising and sales promotion manager.

* * *

ROBERT C. SPRAGUE, president of the *Sprague Electric Company*, was elected president and chairman of the board of the Radio Manufacturers Association at the conclusion of that organization's 26th annual convention held recently in Chicago.

At the same meeting, RMA members voted to change the name of the association to Radio-Television Man-

ufacturers Association in recognition of the growing importance of television to the industry. The change in name becomes effective upon the filing of necessary amendments to RMA's Illinois incorporation charter.

James D. Secrest, director of public relations and staff assistant of the RMA Parts Division, was named secretary and general manager of the association to succeed Bond Geddes who retires August 1st.

* * *

MEL BYRON has recently been named chief engineer of *Electronic Instrument Co., Inc.* of Brooklyn, New York.



Actively engaged in electronic engineering, design, and product development for over 12 years, Mr. Byron brings to his new position a comprehensive and diversified background. He has served as an independent research consultant for several manufacturers and as a technical consultant for *D. Van Nostrand Company*. He holds several patents on various electronic devices.

* * *

LOUIS SILVER has been named executive vice-president and general manager of *Majestic Radio & Television, Inc.* while **MILTON R. BENJAMIN** is the new national sales manager for the company . . . **GEORGE E. BURENS**, manufacturing manager of *General Electric's* Affiliated Manufacturing Companies' Department, has been named acting general manager of *Locke Inc.* of Baltimore, a *G.E.* affiliate . . .

ROBERT W. SANDERS has been appointed chief radio and television engineer for *Hoffman Radio Corp.* of Los Angeles . . . **LEO J. DORNBOS** has joined the field engineering staff of the *Sprague Electric Company* of North Adams, Mass. . . .

A recent meeting of the board of directors of *Conrac, Inc.* named **W. J. MORELAND, JR.** president of that Glendora, California TV set company . . . **WILLIAM L. ROBERTS** is the new vice-president of *Shobe Inc.*, Memphis distributor for *Philco* . . . **EDWARD F. WESTON**, chairman of the board of directors of *Weston Electrical Instrument Corporation*, recently marked the 50th anniversary of his association with the company which was founded by his father in 1888 . . .

J. K. BRADLEY has been named assistant central states regional sales manager for the *Allen B. Du Mont Laboratories, Inc.* . . .

J. G. WILSON, executive vice-president of the *Radio Corporation of America* in charge of the *RCA Victor Division*, passed away in his home in Wynnewood, Pa. at the age of 50 . . . **CLIF SIMPSON** has been named managing director of the Electric Association of Chicago succeeding Major Ainsley Gray who is retiring from active leadership after 20 years. He was managing director of the National Appli-

(Continued on page 104)

".. one of many
'firsts' at Rauland" ..

says **Harold T. Cookson,**
manager, Hatry & Young, Lawrence, Mass.

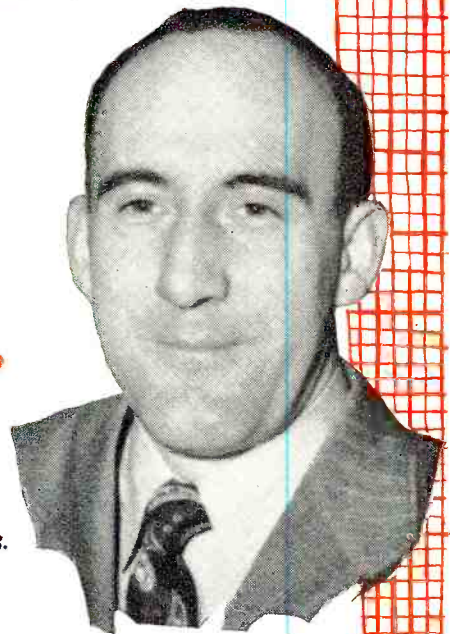

"My experience with Rauland picture tubes has shown that you have an outstanding product. Rauland research has developed feature after feature that result in easier servicing and better viewing. Your new Indicator Gun, for accurate ion trap magnet adjustment without mirrors or guesswork, is one more of the many 'firsts' at Rauland that are contributing to television progress. And the variety of types offered, supplementing our regular tube line, enables us to give the complete picture tube service our customers expect."

From Rauland Research in the past year...

- The **FIRST** Luxide Screen ("Black" Tube)
- The **FIRST** Indicator Gun
- The **FIRST** 12" Metal Tube
- The **FIRST** Reflection-Proof Screen

THE RAULAND CORPORATION



Perfection Through Research

4245 N. KNOX AVENUE • CHICAGO 41, ILLINOIS



THE TOP TOWER OFFERS THE BOTTOM PRICE! NEW TELETOWER PRICES ARE 25% TO 60% LOWER.

MAIL COUPON FOR FREE BULLETIN WITH NEW RETAILER PRICE LIST.

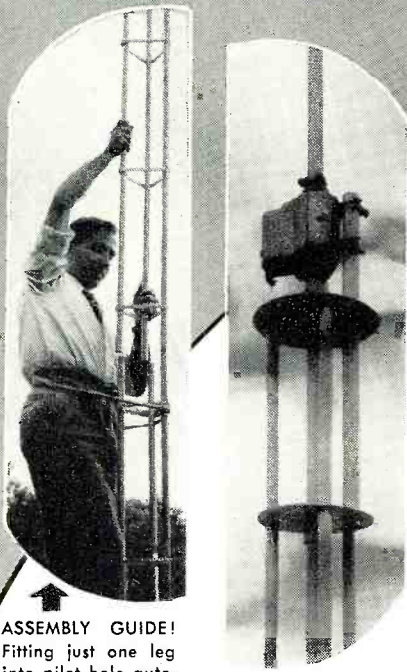

ASSEMBLY GUIDE!
Fitting just one leg into pilot hole automatically aligns both sections.

NO WEIGHT ON MOTOR MOUNT! Mount takes all load . . . permits "free" swiveling in any direction.

FITS ANY SURFACE! Hinged base plate permits safe, easy erection on sloping surfaces.

LIGHTWEIGHT! Eight year old boy lifts 10-foot section which weighs less than two pounds per foot.

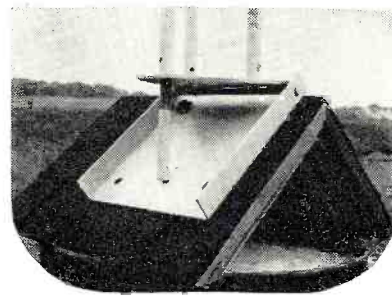

NOW — Penn applies mass production technique to TV tower manufacture! Results? (1) Prices even lower than a former low that set a record. (2) A new, improved tower design. (3) Eight big construction advantages not combined on any other tower at any price.

Penn's low prices — which include prepaid freight east of the Rockies and special shipping cartons that protect finish — are NOT "deals." They are natural results of lower manufacturing costs made possible by the facilities of a factory that was originally established in 1932 and has been growing ever since.

It pays to learn why Teletower sales "tower" above all competition. Paste the coupon to a penny postcard — and mail it today — before you forget!

VISIT BOOTH 305 AT THE NEDA CONVENTION — AUGUST 29-31 — AND SEE 40-FOOT THRIFTOWER ERECTED RIGHT IN THE HALL! WE WON'T SAY DON'T MISS IT — BECAUSE IF YOU VISIT THE SHOW YOU CAN'T MISS IT!

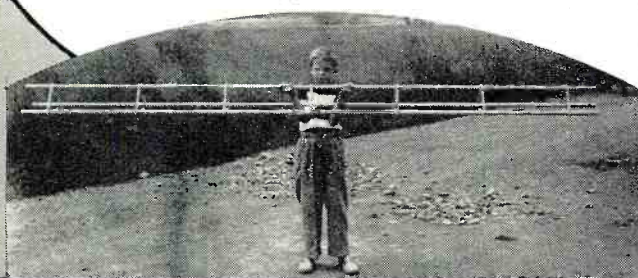

Canadian Representative:
J. R. McVITY & COMPANY
53 Dalewood Road, Toronto, Ontario, Canada

Penn Boiler & Burner Mfg. Corp.
Dept. R1, Lancaster, Pa.

Please send me a copy of your Teletower Bulletin complete with new retailer price list.

Name

Company

Address

PENN TELETOWERS . . . THRIFTOWERS
PENN BOILER & BURNER MFG. CORP. — LANCASTER, PA.

RADIO CONTROL of MODEL BOAT



The author and his son with the radio-controlled model speedboat.

By
WILLIAM L. NORTH, W4GEB

A simplified system which can also be adapted for controlling the operation of model planes.

ONE of the most interesting hobbies is model building. For most, this pastime is enhanced by ultimate operation of the model. While many are satisfied with just the construction of a model, most enthusiasts get their biggest kick out of seeing their completed work perform with all the mannerisms of the full scale subject.

The operational control of a model craft may be accomplished by any of several means, the most fascinating of which is remote control by radio. It is the author's purpose to describe, in terms the layman may understand, the way in which this may be accomplished. Several excellent articles have already been written regarding this subject, but it is believed that the system to be described is the simplest and the most foolproof of those that the writer has encountered.

The primary obstacle immediately confronting the enthusiast who decides in favor of radio control, is that of obtaining the necessary permit. At the moment, such a permit may be obtained in either of two ways. First, the remote control of models is authorized when the operator is the holder of an amateur operator and station license. The details concerning amateur requirements are available from the Federal Communications Commission, Washington 25, D. C. Generally, most model builders will find it easier to go into partnership with some licensed radio amateur, the latter to furnish the technical know-how with respect to the operation of the radio equipment and the former to furnish the brain work and labor with respect to building the model. Secondly, it is possible to obtain a permit to operate in the Citizens Radio Service. In accordance with ap-

propriate rules in this latter service, remote control of models is authorized. To become an amateur requires a knowledge of the Morse Code as well as a limited technical education, while the obtaining of a Citizens Radio license is relatively simple. Unfortunately for the model builder, the control of models is a rather specialized subject and as yet, the author is unaware of any remote control equipment obtainable which could be operated in the Citizens Radio Service band. The system to be described may be applied to the Citizens Radio Service, but due to technical reasons, might prove to be more difficult to design and operate. Therefore this article is written with the thought in mind that the builder may either be an amateur radio operator or will conduct his activities in cooperation with a licensed amateur.

One word of caution! A license from the Federal Communications Commis-

sion is required to operate any type of radio station so don't attempt to radio control anything without first obtaining the proper permit.

Although the system described herein has been applied to the control of a twenty-eight inch model cabin cruiser, it would be equally satisfactory in controlling a model airplane or other object.

The model boat which is mentioned herein was designed and constructed by the author several years ago with radio control in mind and with absolutely no knowledge of marine architecture. It has a beam of 8 inches and a length of 28 inches. The hull is constructed of thin mahogany plywood obtained as "war surplus" material from the *Wanke Panel Company*, 2204 North Clark, Portland, Oregon, at a total cost of about sixty cents. The ribs and lengthwise supports were constructed of $\frac{1}{4}$ inch plywood cut out into the desired shapes with a band saw. The shape and design of the hull were determined by looking at photographs of full size boats and drawing free-hand plan and elevation views

Fig. 1. The radio-controlled model cruiser undergoes initial performance tests.

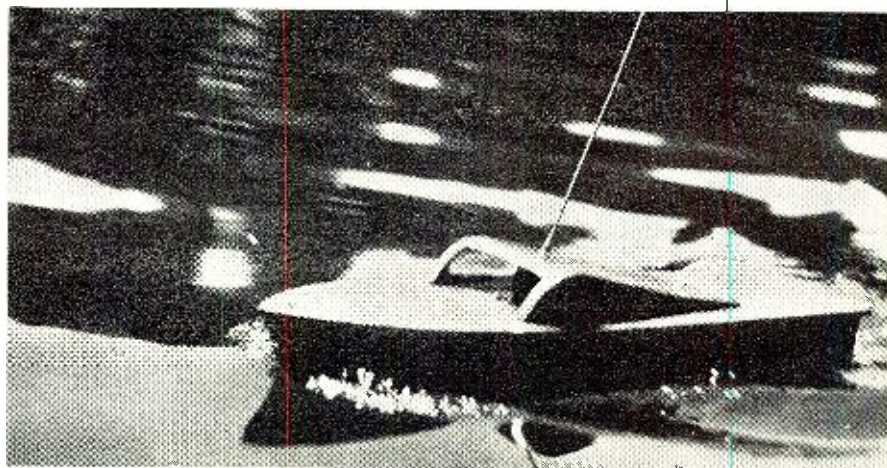

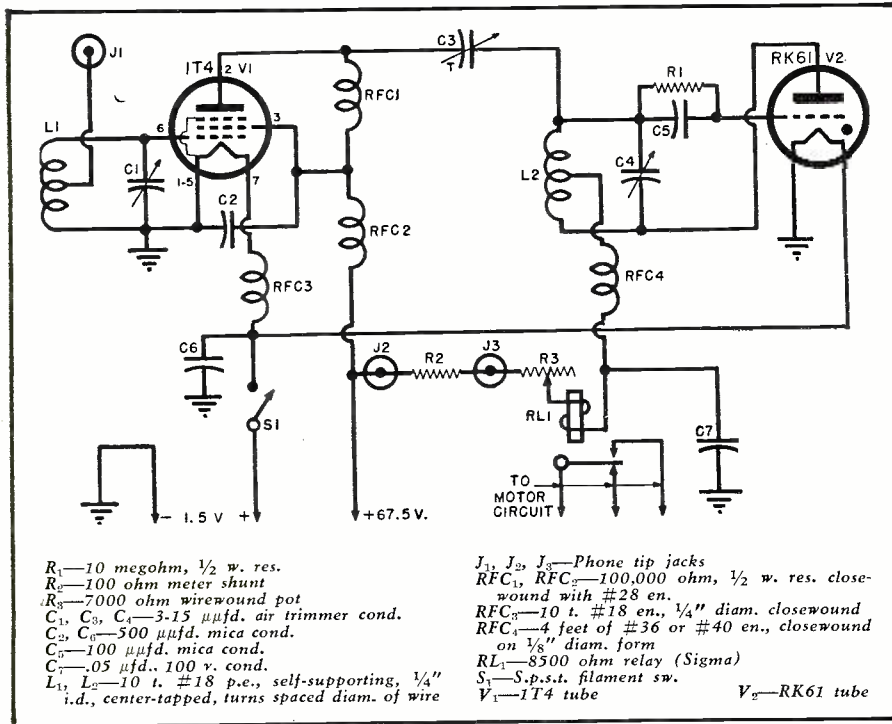

Fig. 2. Circuit diagram and parts list for the receiver section of the control system.

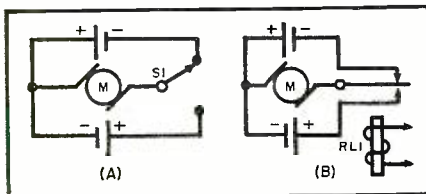

Fig. 3. Principle of operation. The relay (B) is used instead of a s.p.d.t. switch (A) to reverse the rotation of the motor.

from which patterns were made. This tedious process was resorted to due to the previous lack of suitable model boat kits. It was definitely the "hard way," however, and the author recommends the purchase of a balsa wood

or other model boat kits which are now available from model shops for approximately \$6.00. These are beautiful models when finished, are easy to construct, and are available in lengths from 26 to 36 inches. The larger sizes are recommended inasmuch as the smaller sizes will probably ride too low in the water to look natural when loaded with radio gear.

A word about the boat's "power plant" may be in order. The author has successfully used several different kinds and is "sold" on electric power. An electric motor can be started and stopped merely by the turning of a switch. It will not furnish anywhere near the power available from a gaso-

Fig. 4. Rudder motor and gear train assembly shown mounted in hull at right. Note "crank," which turns in the slotted "tiller," protruding from the mounting plate and automatic running motor switch which is mounted directly above the slotted "tiller." The receiver has been dismantled and is now lying on edge in front of the hull. The relay is mounted on its top right outside edge while the variable detector resistor, *R*₃, is shown on its left. The running motor for the boat is visible at the left center.

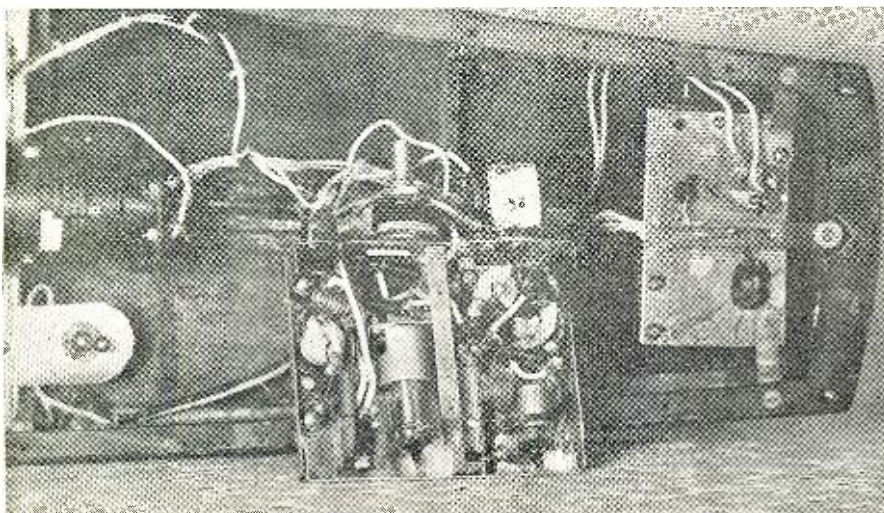

line engine but neither is it ever "cranky" about running. The model described herein has used 6 volt automobile heater fan motors run on No. 6 dry cells, 24 volt motors run on flashlight cells, or several 6 volt lantern cells, and in fact almost anything will do for a start. At a recent demonstration, the author witnessed a 3 foot model battleship being propelled by two flashlight cells and a "Mini-Motor" and was so impressed that consideration has been given to installing one to drive the present radio controlled model.

In all cases it was found undesirable to drive the propeller directly from the motor and all of the motors tried so far were able to drive the boat at a higher speed when the propeller was belt driven with a speed stepdown ratio of about 5 or 10 to 1.

Recently there has appeared on the market a 12 volt "war surplus" motor manufactured by the Oster Co. and described as "Type B-9-2." (Bernstein-Applebee Co., Kansas City, Mo.) One was purchased for \$1.49 and tests by the author indicate it will do a better job of driving the present boat than the one now installed. It is slightly larger, however, and some modification of the equipment arrangement would be required. This motor is mentioned since it would be excellent for the purpose if one was starting from "scratch" with the construction job.

In controlling a model, one must first decide what controls are desired. In the present case, it had to be operated in such a way that the rudder could be made to turn either left or right, in any amount. At the same time it was desired to make the controls for left and right independent of each other. In addition, it was desired to be able to start and stop the boat at will. Since there is no necessity for controlling the rudder of the boat once it has stopped its motion, the "on-off" control need not be independent of the rudder control.

Once the decision was made as to what controls were required, it then became necessary to design the mechanisms for accomplishing the desired operations. Let us first take a look at the rudder control. All that is required is a small motor which may be reversed. An ideal solution is one of the various miniature motors now on the market selling for from \$1.50 to \$2.00. These motors weigh about two ounces and are obtainable from most model supply houses under the trade names of "Mini-Motor" and "Mitymite." They may be reversed by merely reversing the polarity of the applied voltage and have sufficient torque and power to operate small gear or belt driven mechanisms with an application of as little as 1 1/2 volts. By using a single-pole, double-throw switch, and two flashlight cells, we have a simple mechanism for making the motor turn either left or right as shown in Fig. 3A.

Fortunately, now that the kind of rudder control mechanism has been decided, it was found that there is

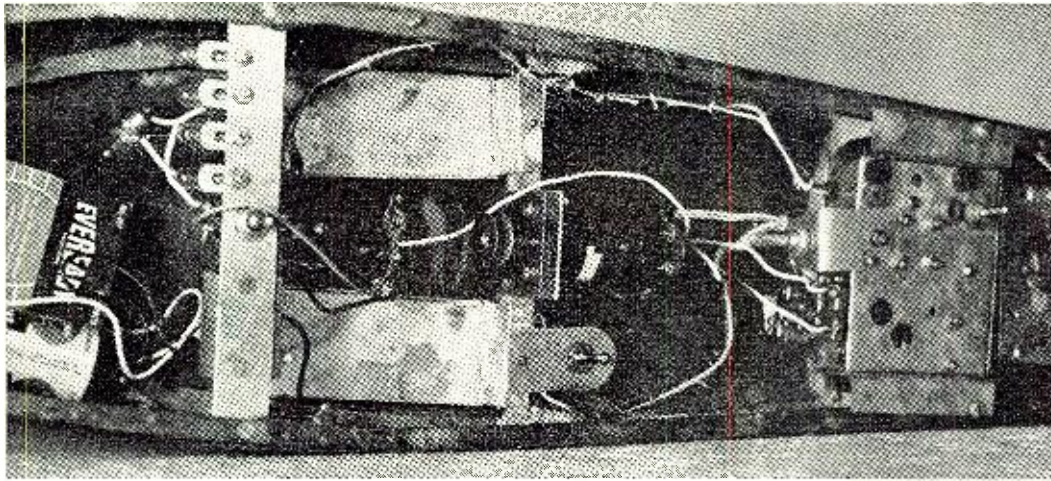
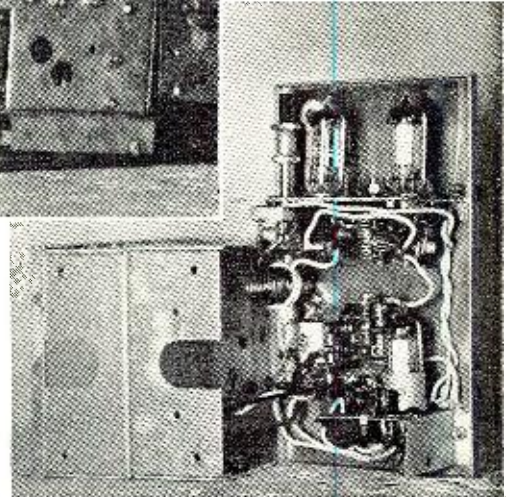

Fig. 5. (Top) The entire radio control system mounted in hull. Rudder control motor and gear train appear at the far right. The receiver is next to the rudder control with the storage battery mounts (aluminum sheets, center, top and bottom), driving motor pulleys (between battery mounts), and driving motor (to right of battery mounts and left of receiver). The master control switch and "rudder starting lamps" are mounted on aluminum crosspiece at center left with the fuses below. Receiver batteries appear at left of photograph. The driving or running motor switch is shown below motor. (Right) Transmitter unit with power amplifier (upper left), oscillator (upper right), keyer tube (lower right) and relay (lower left). The transmitter is shown upright with its case and battery case. The battery case is the left half of unit, transmitter case the right half. All units should be compact and light in weight.



available on the market a midget relay which may be substituted for the switch, Fig. 3B, and this becomes part of the radio receiver. The relay used by the author is a "Sigma," 8500 ohm plate circuit relay. It was purchased for 89 cents as "war surplus." No recent advertisements of this item have been seen but similar relays will do the trick providing they are at least single-pole, double-throw. It is desirable, although not absolutely necessary, to have a relay with adjustable contacts as will be seen in the later paragraphs. Since the relay is the key to the whole system it may pay to shop around and obtain the one recommended. Now all that is necessary is to hold the relay in the down position and the motor turns in one direction and when the relay is released the motor will turn in the reverse direction. The control problem is solved except for the fact that the only way in which the boat may be steered is left or right—zig-zag. How about neutral? By operating the relay so rapidly that the motor doesn't get a chance to start in either direction we have, in effect, a means of maintaining the rudder in any position desired.

If there were some way of operating the relay in the way described, we would have a right control, a left control, and a neutral control. Suddenly the light dawns—we have complete rudder control with just *one* relay. This means that only *one* receiver, *one* transmitter, and *one* frequency is required. There still is no "start" and "stop" control of the model but it is easy to see that if we make one position of the rudder control an auxiliary contact which opens and closes the circuit to the driving motor, we will then have this extra control. In the model shown in the photographs

we chose the position of left rudder to accomplish this control. The contact is shown in Fig. 6 as S_5 and operates only if the rudder is turned to full left position.

Well, everything is figured out except a receiver and a transmitter. We have to have both in order to make that relay operate. There are numerous ways in which a relay may be made to operate when used in conjunction with a receiver and, although the receiver, a diagram of which is shown in Fig. 2, is rather simple, it supersedes several that have been tried over a period of about four years. It makes use of a special type of control tube (RK61) available from radio supply houses. This tube, when operated in an appropriate circuit, exhibits a tremendous change in plate current. This plate current variation is used to operate the relay. If the model builder will bear with us for a few minutes, we will aim a few remarks at our brethren of the radio fraternity who may wish to have the operation of the receiver highlighted for them.

The receiver is made up of an r.f. amplifier followed by a superregenerative detector. The first stage is conventional and except for the rather "ticklish" adjustments required of the detector, the second stage is a conventional one, as shown in the circuit of Fig. 2. The RK61 detector may be used without the r.f. amplifier but the addition of the latter disposes of the ever-present problem of radiation from the detector and of external objects affecting its operation by coupling through the antenna circuit. Since the grid circuit loading of the detector is extremely critical and its adjustment may either "make" or "break" the over-all results at control, the r.f. stage is essential to the receiver.

Constructional features of the receiver are shown in the photograph of Fig. 4 where the unit is pictured with the cover removed. The chassis is formed of light aluminum sheet, one half being the piece upon which the parts are mounted, the other half being the cover. The dimensions are $3 \times 4 \times \frac{1}{4}$ inches. A shield separates the r.f. stage (on the left) from the detector stage (on the right). The placement of parts is not critical but the leads should be kept as short as possible in accordance with regular practice at this order of frequency (53 mc.).

The filament switch S_1 , Fig. 2, and the pin jacks used for meter and antenna connections, as well as the holes giving access to the three variable condensers, are on the top of the chassis, which is upside down in Fig. 4, and thus are not apparent. They do appear in the photograph of Fig. 5 which shows the entire system mounted in the cruiser. The variable resistor R_2 and the relay are mounted on the edge of the chassis where they are readily available for adjustment.

The receiver is adjusted as described in the following paragraphs.

Take the 1T4 out of its socket and disconnect C_3 from L_2 . With R_3 at maximum resistance, the plate current should be on the order of .75 to 1.0 ma. The plate circuit relay should "hiss," that is to say, you should be able to hear a hiss due to the superregeneration present and the relay acting like a headphone diaphragm. A lack of hiss usually indicates either that the RK61 is not in superregeneration or that grid circuit loading is insufficient. Increasing the coupling to the grid circuit should increase the plate current and also should increase the intensity of the "hiss." As an initial test,

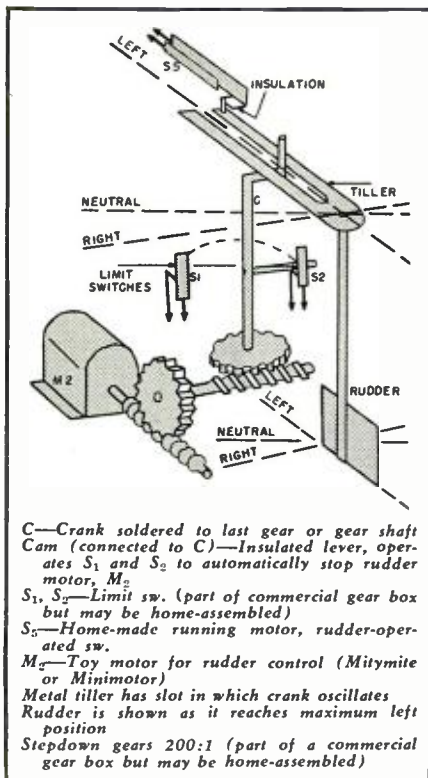

Fig. 6. Mechanical details of rudder control.

a piece of wire approximately a foot long should be connected directly to one end of the oscillator tank circuit through a 3-30 μfd . variable condenser. If the detector is operating properly, increasing the capacity of this temporary condenser should increase the "hiss" and the plate current. If the receiver appears to operate properly, increasing the capacity of this temporary condenser should increase the "hiss" and the plate current. If the receiver appears to operate properly, remove the temporary loading and reconnect C_3 . Plug in the 1T4 and adjust C_3 for a plate current of approximately 1.5 ma. Increasing C_3 should increase the plate current drawn by the RK61 and should also increase the audibility of the relay "hiss." The adjustment of R_3 is not critical providing enough plate voltage is available. The full resistance is used with a new battery and somewhat less is used with one which has had considerable use. Means of providing measurement of detector plate current is essential if best results are to be obtained. Metering jacks J_2 and J_3 are across 100 ohms, permitting the use of a low resistance 0-1 ma. meter.

The receiver is now ready to be set to approximate frequency. This may be done by tuning a wave trap to the signal frequency (in this case 53 mc. is used) and loosely coupling it to the detector tank circuit. When the wave trap is tuned through the detector frequency, an increase in plate current will be exhibited. Appropriate adjustments of C_4 can be made until the receiver is roughly tuned ready to have the signal applied to the antenna. Apply a signal from either a signal generator or from a transmitter operating in the 50 mc. amateur band and tune C_1 and C_4 for minimum detector plate current. If the receiver is operating

properly, the 1.5 ma. maximum will be decreased to approximately .1 to .5 ma. and the "hiss" will become inaudible upon the application of signal to the antenna. At this point it will probably be found that the detector current with no signal applied has been affected by adjustments of C_4 . Adjustments of C_3 and C_4 affect each other and should be adjusted simultaneously for correct loading and frequency. The author's transmitter, with less than one watt input, reduces the detector plate current to .1 ma. when operated anywhere within 100 to 200 feet of the receiver.

A few of the "bugs" and operating conditions encountered in the receiver are set forth here since others may run into similar conditions. Failure to superregenerate may be caused by; low filament or plate battery voltage, too low value of grid leak in the detector, too tight coupling to the RK61 tank circuit, too low capacity of C_7 , or too high L_2/C_1 ratio. Too high a plate current and/or failure of the detector to oscillate generally indicates the coupling to the tank of the RK61 (C_3) is too tight.

The receiver antenna is a piece of rod approximately 24 inches long. A longer antenna might seem desirable but was not found necessary. The antenna used on the transmitter is a quarter-wave type and should be four feet, five inches in length. This will give an adequate signal for control.

Let us go back to the rudder control circuit for a moment. From previous paragraphs we see that if a signal is transmitted, resulting in a decrease in detector plate current, the plate circuit relay will release and make the "upper" contact. If no signal is transmitted, the relay will pull in and make the "lower" contact. Thus, a transmitted signal causes the rudder to turn in one direction while a lack of signal causes it to turn in the opposite direction. Consequently, if we transmit short dashes, spaced by pauses of equal length, the rudder motor will alternately turn left and right. If we make the dashes and pauses short enough, the inertia of the rudder motor and its associated mechanism will not permit movement. However, all that we have to do to make it turn in one direction is to send dashes longer than the spaces. To turn the other way we send spaces longer than the dashes. This is accomplished at the transmitter by the use of a simple keying unit.

The keying circuit is an ordinary multivibrator with a time constant such that the frequency of oscillation is something less than ten cycles per second (Fig. 8). Keying is accomplished by inserting a relay in the plate circuit of one triode section. With the control R_3 set in the middle, dashes are equal to spaces. With the control R_3 set to the left, the dashes are longer than the spaces and with the control set to the right, the spaces are longer than the dashes. Thus we have a control with which we can vary

the nature of the keying from one extreme to another. That is to say, we may send a signal made up of very long dashes and very short pauses or going to the other extreme, we may send a signal made up of very short dashes spaced by very long pauses. Using this system we have, not only a method of causing the rudder to turn right or left, but also if desired, a method of controlling the speed with which it turns. Furthermore, turning our control to the left may be made to turn the rudder to the left and turning the control to the right may be made to turn the rudder to the right, a very simple and effective system.

The circuit of the transmitter, Fig. 8, is entirely conventional and the author had no trouble making it operate properly the first time it was tried. Constructional details are shown in the photograph of Fig. 5.

The wiring diagram for inter-connection of the various boat mechanisms is shown in Fig. 7. The inter-unit wiring is straightforward except that there may be some question as to why the circuits were connected as shown.

The running motor is a surplus, 28 volt tuning motor, several varieties of which are available, modified for 12 volt operation by wiring the two field coils in parallel. It drives the propeller (2½ inch, homemade) from a pulley arrangement giving a stepdown speed ratio about 7 to 1. The belt is a rubber band and gives very little drag and practically no slippage. The propeller can be stopped, however, and the belt merely jumps the pulley.

The gear mechanism which was attached to the running motor in its original form is used as the gear box for attaching the rudder motor to the rudder. It has a stepdown ratio of 200 to 1. Practically any arrangement, including belt-drive will work, but this gear train was available and offered what is considered to be just about optimum speed stepdown.

The rudder motor is attached by a piece of flexible rubber tubing to the gear train and on the last gear, a wire crank is soldered. The turning of this gear causes the crank handle to rotate in a slot cut in the rudder bar, thus transferring the circular motion of the gear to a rotation of the rudder. The gear train is provided with a limit switch at maximum left and maximum right rudder position so that if the controls are held in right rudder for example, the rudder will rotate to the right until it reaches its limit where the right limit switch S_1 , Fig. 7, disconnects the rudder motor. If the control is held in the left rudder position, the rudder will turn to the left until the left limit switch S_2 , Fig. 7, disconnects the rudder motor.

The rudder motor is connected so that it may be reversed merely by the operation of the receiver relay contact. It is powered in one direction by one of the main running batteries and in the opposite direction by the other main running battery. Rudder motor power

is supplied through a dropping resistance consisting of four 250 ma. pilot lamps connected in parallel. This arrangement provides nearly six volts as a starting voltage for the rudder motor. Shortly after it starts rotation, the lamps light to nearly full brilliance and the series resistance increases so that only about 1.5 volts is applied to the motor during rotation.

One toggle switch, S_1 , is connected in series with the running motor so that the control equipment may be adjusted without running the propeller. A double-pole, single-throw switch, S_3 , is in series with the two motors and serves as a master switch for both.

The tuning of the transmitter is accomplished in the conventional fashion and no description is given. However, adjustment of the transmitting relay is as follows. If the multivibrator is operating satisfactorily, the relay will "pulse" at about six or seven cycles per second. To keep it from keying the transmitter it must be blocked closed. Load the transmitting antenna circuit to the power input desired. This adjustment we will represent by reading a plate current value to the final amplifier of I_1 . Now unblock the relay and with the control R_6 (Fig. 8) set at midscale, adjust the contact spacing and the spring tension until the final amplifier plate current drops to $\frac{1}{2} I_1$. Closing S_1 , Fig. 8, now should cause the relay to drop out and closing S_2 , Fig. 8, should cause the relay to close. S_1 and S_2 "off" should cause the transmitter to send evenly spaced dashes interspersed with pauses of the same length as the dashes.

The next step is to adjust the receiver relay. First, the receiver should be tuned to the transmitter as heretofore described. The next step is to set the receiver relay contacts and spring tension. Caution! There is a total of twelve volts appearing across the two fixed contacts on the receiver relay. If these contacts are misadjusted so as to make connection with the armature contact simultaneously, a direct short circuit is caused. This may result in damage to the battery or relay contacts and is the primary reason for use of the fuses shown in Fig. 7. Turn the transmitter on. Adjustment of the spring tension should permit the relay to pulse in accordance with the keyed signal. The proper adjustment of the spring tension and the contact spacing is that which will permit the greatest relay "chatter" with the weakest available signal. Therefore, for best adjustment, the transmitter should be at some distance from the receiver.

We are now ready for a trial run. We have tuned the receiver and the transmitter and have insured that the relays are in proper adjustment. Turn on the receiver, turn on the transmitter and we should now see that the receiver relay is pulsing back and forth between the two contacts, in exact synchronism with the transmitter relay. Now turn on the master switch

S_3 in Fig. 7, thus applying battery voltage to the rudder relay motor through the two receiver relay contacts. A press of the right button S_2 , Fig. 8, should cause the rudder to turn to the right and a press of the left button S_1 , Fig. 8, should cause the rudder to turn to the left. If we hold the left button down, the rudder should turn to the left until it operates the limit switch, stopping the rudder motion. At this point we adjust the running motor "on-off" switch S_5 , Fig. 7, so that with full left rudder the contact opens. If we operate neither switch S_1 , nor S_2 , Fig. 8, we will probably find that the rudder will slowly creep either to the right or to the left. This means that either the receiver relay contacts can stand a little adjustment or that the neutralizing control on the transmitter R_6 , Fig. 8, should be readjusted slightly until with transmitter pulsing, no movement of the rudder is evident. When everything is in the proper operating order, we are ready for launching. Turn off the master switch S_3 , Fig. 7, turn on the running motor switch S_4 , Fig. 7, and place the boat in the water. Now turn on the master switch—but hang on to the boat! She is ready to go. A push on the left rudder switch S_1 , Fig. 8, should cause the rudder to operate for a left turn and a push on S_2 should turn it to the right.

If you are as fortunate as the author, you will now have complete, fool-proof rudder and motor control.

The author wishes to thank W4II,

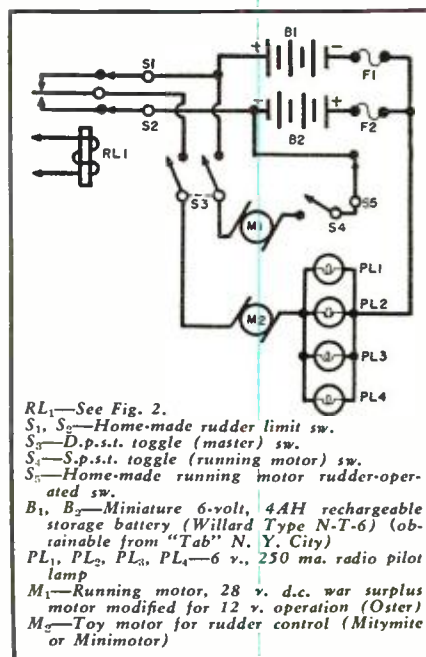
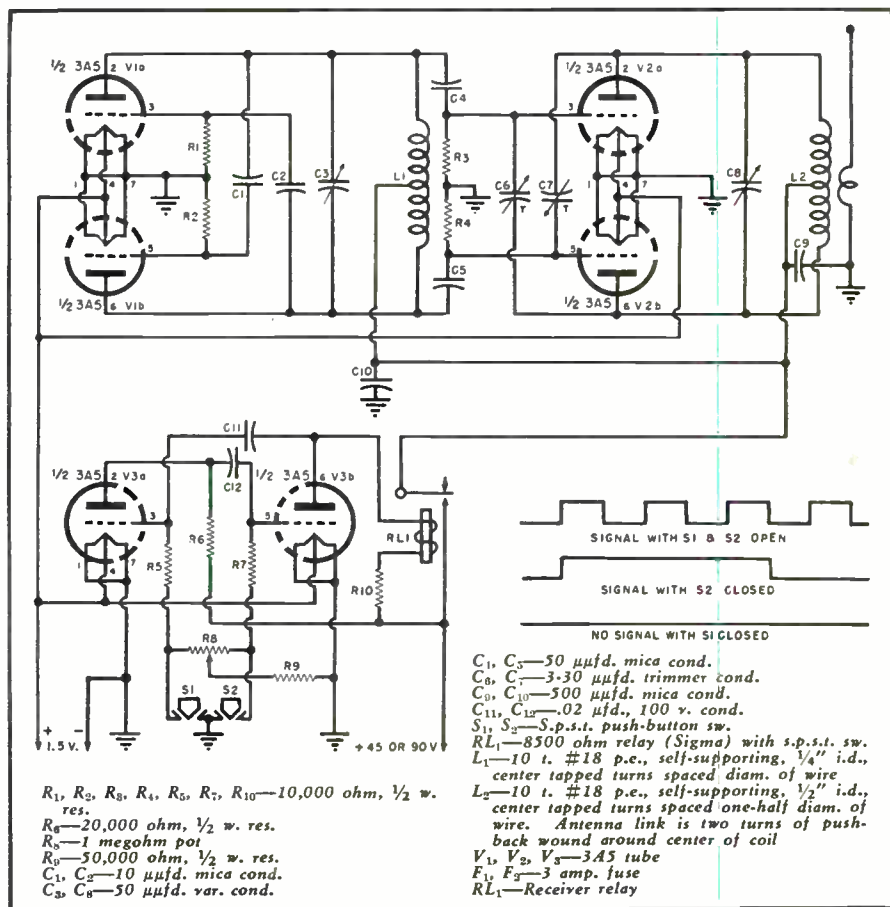

Fig. 7. Wiring diagram showing inter-connection of the various model boat mechanisms.

W4GF, W4JNX for their suggestions and W4WAR for the excellent photography. No small amount of thanks is due W4JKX who pushed buttons, walked miles with the transmitter and waited more than one dinner. Yes, the latter call belongs to the author's ever faithful "XYL." -30-

Fig. 8. Complete schematic and parts list for the transmitter portion of the control.



INTERCOM APPLICATIONS

By
JOHN B. LEDBETTER
Engineer, WKRC-TV

The sales and servicing of intercom systems can become an important new source of shop income.

CAN you think of a hundred uses for an intercom system? This may seem a bit difficult at first thought, but if you have had any experience at all in servicing or installing intercoms you can probably list several hundred uses with no trouble at all.

For the past several years, small intercommunication systems have found increasing popularity both in and out of the radio and electronics field. Doctors, dentists, grocers, and hundreds of small businessmen who formerly could see no advantage in having an intercommunications system, began to realize its possibilities in saving time and steps, expediting orders, and stepping up business efficiency in general. Even the housewife has found that a small intercom or monitor system can save needless steps around the home. In farm homes, particularly, a small system is invaluable in providing contact between the house and outlying buildings. It can be a life-saver, too, when serious accidents occur in the barn or in other remote places. In the city home, an intercom connects the housewife with hubby in the den, basement, or garage, and with delivery boys, meter readers, repairmen, and others without needless steps up and down the basement stairs. A monitor unit installed in the nursery or playroom gives a constant check on small children without requiring occasional work stoppage for a "peep-in." Parents who have seen or used such units are easy prospects for such an installation.

There is no limit to the uses to which an intercom system can be put. In small businesses it may consist of only two units for conversation or reporting; in larger installations it may

consist of several master or originating points with a large number of "slave" or talk-back units.

Typical Applications

If you'd like a rough idea of the possibilities offered by small intercom installations, just do this: make a note of the business establishments listed in the classified section or yellow pages of your telephone directory and visualize the possible applications for an intercom system. Some of these could be listed as follows:

Advertising agencies—manager's office; secretary; display and advertising departments; sales.

Airports—manager's office; restaurant; doctor or emergency station; maintenance department; control tower; business office; cashier; ticket office; baggage, etc.

Ambulance service—manager; dispatcher; drivers' quarters; garage; first aid room.

Amusement parks—manager; ticket boxes; supervisory personnel; first aid; maintenance.

Apartments, apartment hotels—supervisor; janitor; engineer.

Art schools—principal's office; classrooms; janitor; supply room.

Associations, business clubs—connections between various rooms.

Automotive repair shops, garages—manager; repair and paint departments; grease rack, etc.; parts department.

Automobile dealers—manager; showroom; sales department; accounting; service manager; repair department; parts.

Automobile manufacturers—manager; accounting; distribution; sales; publicity; promotion; public relations;

assembly supervisors; inspectors; general call.

Automobile rental agencies—manager; cashier; fuel dispenser; etc.

Bowling alleys—manager; locker rooms; lanes; pin-boys, etc.; concessions.

Breweries—manager; sales; accounting; publicity; delivery; inspectors; various points of distillation.

Bus lines—ticket office; loading lanes; baggage department; rest rooms; shoe-shine concessions.

Cafes, cafeterias—manager; cashier; cooks; bus-boys; waiters, waitresses; locker rooms (in large restaurants).

Department stores—manager; store detective; accounting; salespeople; shipping; credit; janitor; warehouse.

Furniture stores—manager; accounting; sales; credit; painting and re-finishing departments; shipping; warehouse; delivery; collection departments.

Home—kitchen; basement; garage; den; nursery; playroom; barn, etc. (in rural homes).

Night clubs—manager; cashier; floor manager; locker rooms; dressing rooms; gaming rooms; electrician; janitor; hostess; parking lot attendants.

Radio shop—office; service department; delivery.

Radio stations—managing director; secretaries; traffic; continuity; sales; promotion; public relations; program director; music librarian; engineering; announcing; sports director; interconnecting facilities between each studio and transmitter; master control.

Ship, barges—captain; mate; radio room; engine room; hold, etc.; ship-to-shore facilities.

Over-all view of intercom. Any number of similar units can be hooked into system if a rotary selector switch is used as well as the d.p.d.t. momentary push unit.

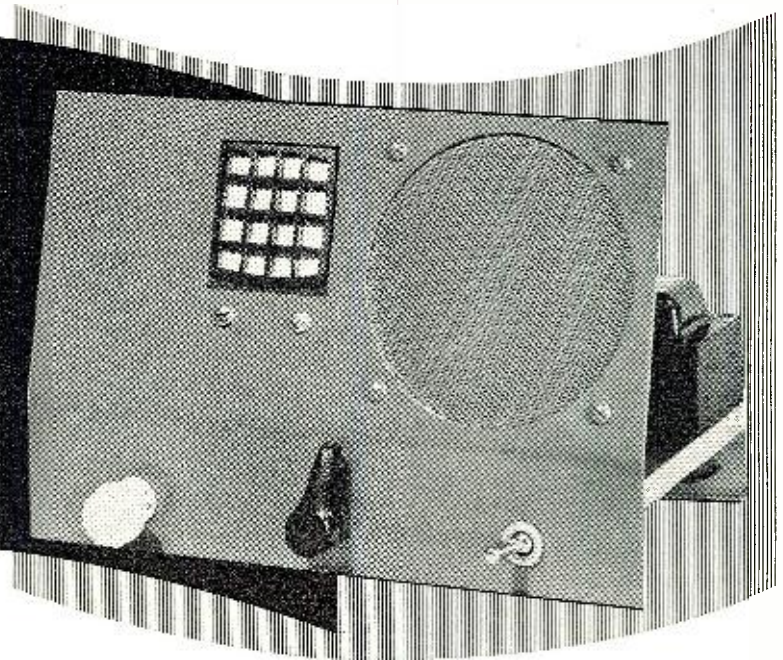

This list could be continued almost endlessly. Small delicatessens, stores, garages, etc., often have living quarters above or in the rear of the store. Intercommunication facilities here are invaluable. A simple monitor from the store to house will prove itself in warning of attempted hold-ups, burglaries, and other emergencies.

Banks, skating rinks, supply houses, beverage manufacturers, beer gardens, schools, etc., are a few more additions to the list of prospective intercom users.

A High-Quality Intercom

The intercom unit described in this article was built specifically for use as a high-quality "cue" system between a broadcast studio and the transmitter located several miles away. A regular telephone line (formerly used as a spare broadcast line) is used as the interconnecting medium. This unit, designed and constructed by George A. Waslo, staff engineer of WKRC, WCTS, and WKRC-TV (Cincinnati) has several interesting details. First, the use of a conventional microphone circuit improves the quality and efficiency of the unit and does away with trick circuitry. Feeding the output of the 6SL7GT preamplifier directly into the line insures two-stage amplification (one stage at the origination, one at receiving) without feeding excessive level over the line. In the case of open or unshielded lines, this feature eliminates the possibility of crosstalk.

The amplifier chassis and panel were constructed of 1/4" steel plate for rigidity and for greater efficiency in reduction of a.c. hum fields, although for all practical purposes aluminum or lighter-gauge steel will work just as well. The front panel is angled slightly (approximately 20 degrees) to allow optimum performance for normal speaking positions. (It also lends a more professional appearance to the amplifier.) This professional note is further achieved by careful spraying of the panel with gray lacquer, by neat parts layout and wiring arrangement, and by installing the intercom in an

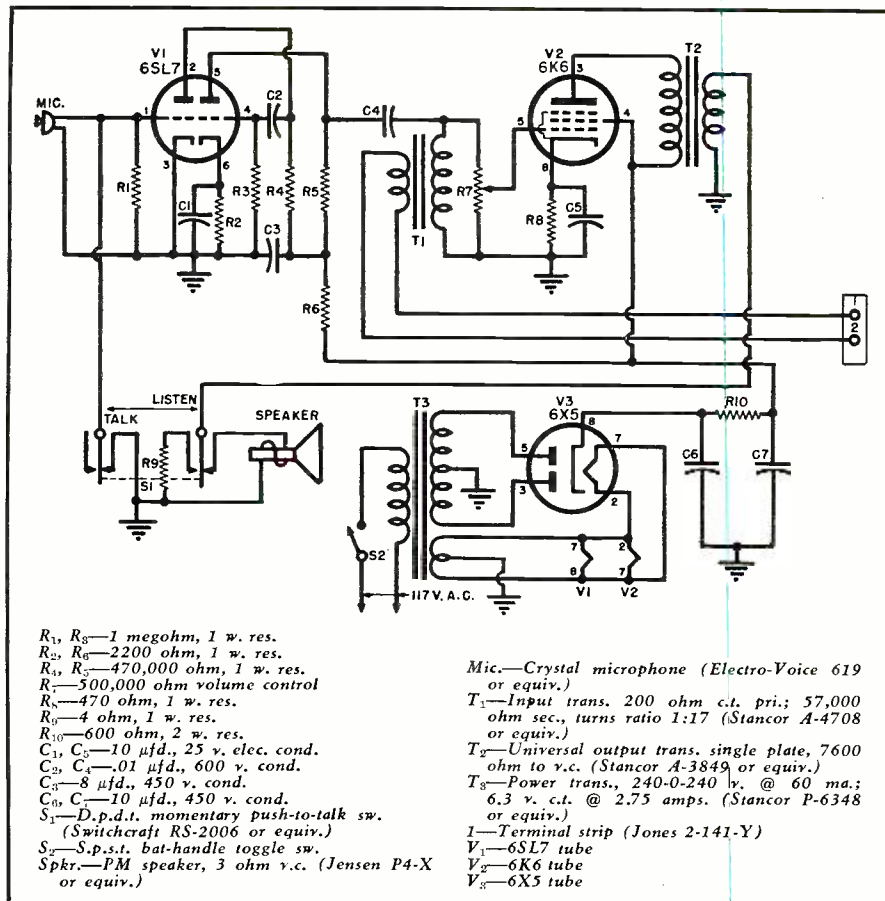

Complete schematic diagram and parts list for an easily-built intercom unit.

attractive hand-rubbed plywood cabinet.

In the unit shown, the selector switch S_1 is a d.p.d.t. momentary push switch. Where more than one receiving station is desired, a rotary-type switch may be added having as many points as necessary for the required number of stations.

Cost of the intercom is very reasonable. If all parts are purchased new, the total cost, including chassis and panel, will run under \$20. Most radio shops will have most of the parts listed on hand or can make satisfactory substitutions. The power transformer, for

example, can be replaced with a transformer having a 5-volt winding and an 80 or 5Y3GT rectifier tube used instead of the 6X5. The 6SL7GT can be replaced by a 6SC7 and the 6K6GT with a 6V6GT, etc., if these items happen to be on hand.

For the particular purpose for which this intercom was designed, the secondary of transformer T_1 is 200 ohms. For other purposes, any impedance can be used as long as it is properly matched with the corresponding transformer in the other intercom units, and with the characteristic impedance of the transmission line.

—30—

Rear chassis view of intercom showing correct parts layout.

Under chassis view showing simplicity of the construction.

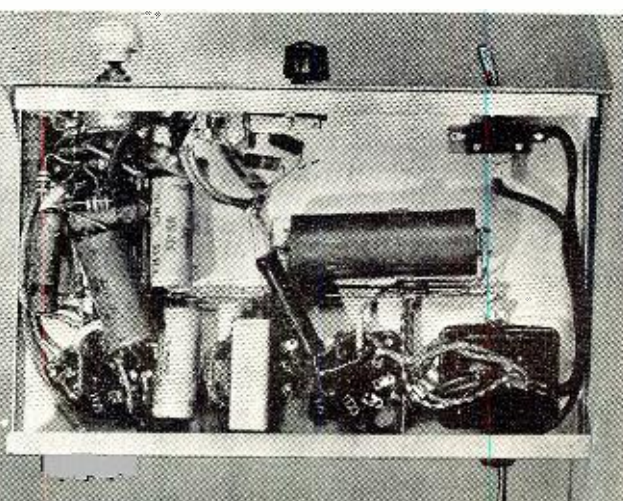
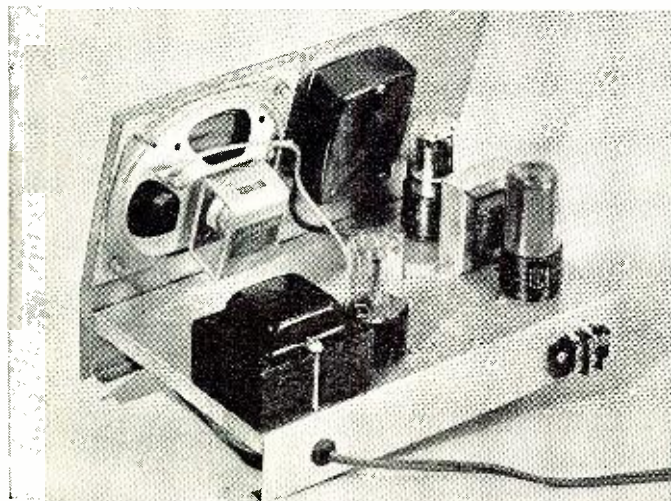

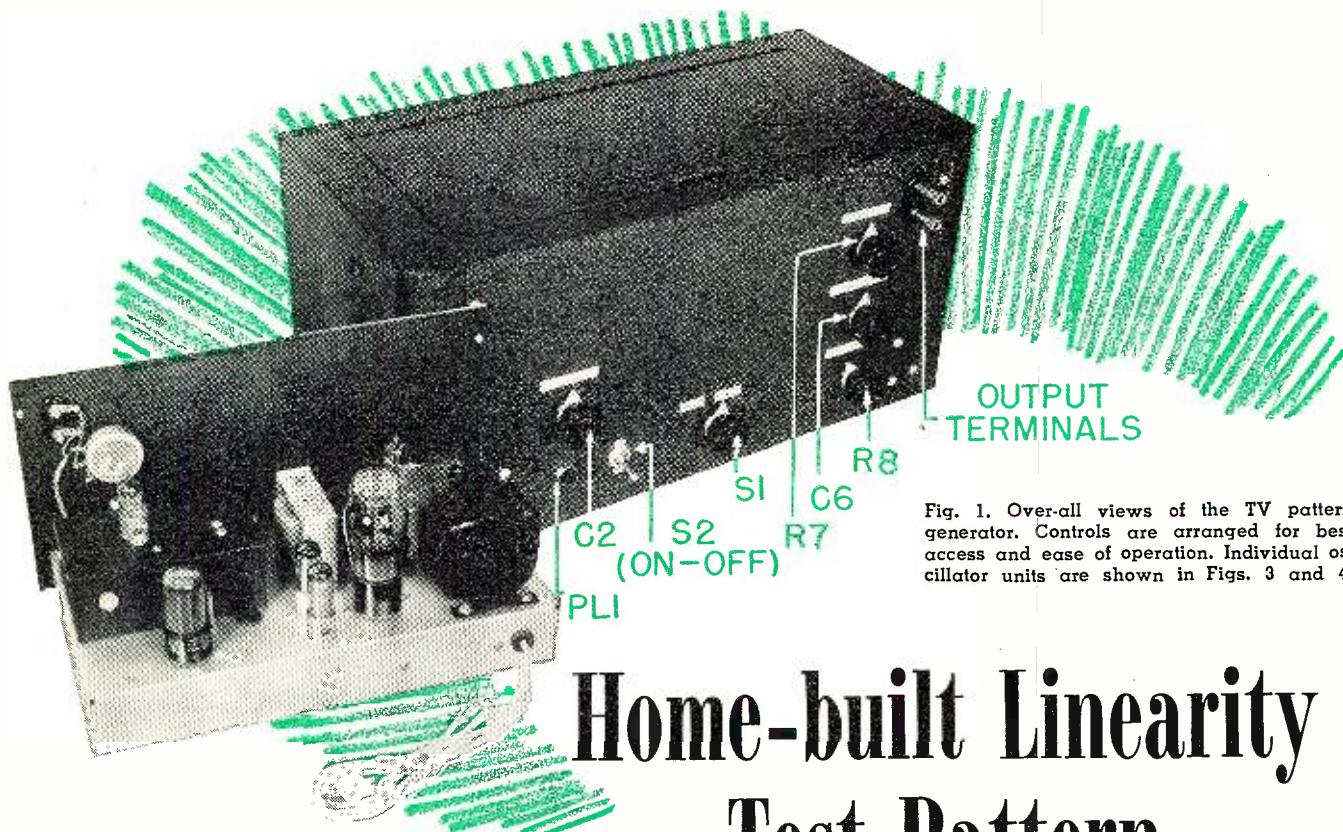

Fig. 1. Over-all views of the TV pattern generator. Controls are arranged for best access and ease of operation. Individual oscillator units are shown in Figs. 3 and 4.

By
RUFUS P. TURNER,
 K6AI

Home-built Linearity Test Pattern GENERATOR

Complete construction details on an easy-to-build television test instrument. By means of a switch either vertical or horizontal bars can be obtained.

A GREAT deal of television receiver testing must be done at times when no test patterns are on the air. Adjusting horizontal and vertical linearity controls is difficult during a program, what with the actors hopping all around on the screen. If you have an instrument which will give a selection of horizontal or vertical lines on the receiver screen, you can make linearity adjustments at any time without having to wait for transmitted test patterns.

It is a simple matter to produce these test lines. All you need is a variable-frequency oscillator covering the TV channel frequencies, and suitable modulators. The low channels will be sufficient, since harmonics will hit all of the high channels adequately. The oscillator is fed into the antenna input terminals of the receiver. Provision must be made to modulate the carrier oscillator at either audio or low radio frequencies. When audio modulation is applied, horizontal bars will appear on the TV screen. Radio-frequency modulation will produce vertical bars. To change the number of bars, simply change the modulating frequency. Increasing the modulating frequency increases the number of bars. With vertical bars on the screen, adjust the horizontal linearity control until the bars are parallel and equally spaced. With horizontal bars on the screen, adjust the vertical linearity control for parallelism and equal spacing of the bars. Simple, isn't it?

The instrument described in this article can be built inexpensively by the service technician. Its carrier output is continuously tunable from 50 to 100 megacycles, thus covering TV Channels 2, 3, 4, 5, and 6 on fundamentals. Harmonics hit Channels 7 to 13. Only one channel really is needed for linearity adjustments. The output terminals of the instrument are connected directly to the antenna terminals of the TV receiver, thus obviating any necessity to tap into the circuit. Tuning the horizontal-line modulating oscillator will give a minimum of 4 and a maximum of 20 horizontal lines or bars on the receiver screen. Tuning the vertical-line modulating oscillator will give a minimum of 8 and a maximum of 20 vertical lines or bars. A 2-position selector switch gives the operator his choice of either horizontal or vertical bars.

Generator Circuit

The complete circuit schematic of the pattern generator is given in Fig. 2. The carrier oscillator utilizes a 6C4

triode in a Hartley circuit. The tank of this oscillator consists of the slug-adjusted *National* AR-5 coil L_2 and the 50 μfd . midget variable C_6 . The coil is manufactured with a center tap, which is connected to the 6C4 cathode. The plate and heater r.f. chokes (RFC_1 , RFC_2 and RFC_3) are homemade.

The horizontal-line oscillator is a variable-frequency audio oscillator of the simple transformer-line-feedback type. The frequency of this unit (and accordingly the number of horizontal lines) is controlled by means of potentiometer R_8 , which is a variable grid resistor. One triode section of the 6SN7 tube is used as the oscillator; the other section as an isolating amplifier.

The 6C4 vertical-line oscillator is a low-frequency r.f. oscillator with a circuit similar to that of the carrier oscillator. The tank consists of the tapped 2½ mhy. r.f. choke L_1 , 100 μfd . fixed condenser C_1 , and 100 μfd . midget variable C_2 . Coil L_1 is a choke having four pi's (*National* R-100). The builder must make a cathode tap between the 1st and 2nd pi's from the

grounded end of the choke. The frequency of this oscillator (and accordingly the number of vertical lines) is controlled by means of the tuning condenser C_2 .

The modulator offered a knotty problem, since it must handle both audio and r.f. modulating signals. No modulation transformer could be relied upon to cover such a wide range efficiently. The solution was use of a crystal diode modulator circuit of the type described in the author's article "New Applications for Crystal Diodes" in the June, 1950 issue of RADIO & TELEVISION NEWS. Switch S_1 connects either the horizontal- or vertical-line oscillator to the modulator circuit, at the same time switching on the plate voltage to the particular modulating oscillator in use. Potentiometer R_7 at the output of the modulator serves as an attenuator for adjusting strength of the output signal.

The power supply is a simple transformer-operated type, using two OA2 tubes in series for voltage regulation. 150 volts d.c. potential is taken from the anode of the lower OA2 to supply the carrier oscillator plate. It is not advisable to use a transformerless type of power supply in this instrument.

Mechanical Construction

The various photographs show mechanical details of the generator. The instrument (See Fig. 1) is built in a 16½" x 8" x 8" standard metal cabinet with matching chassis. The carrier oscillator is built completely in a 5¼" x 3" x 2" metal shield box (see Fig. 3). The vertical-line r.f. oscillator is built in a 3½" x 2" x 1½" metal shield box (See Fig. 4.) Both of these oscillator boxes are mounted on top of the main instrument chassis (See Fig. 1). The 6SN7 horizontal-line oscillator is assembled on the main chassis since it does not require the shielding of the other two oscillators.

Fig. 5 shows the wiring and arrangement of components under the main chassis. In this photograph, note the crystal diode modulator components mounted on the small bakelite sub-panel in the upper left-hand corner, and also the horizontal-line oscillator components in the lower left-hand corner.

Initial Adjustment

After all wiring has been checked, first set the voltage regulator. To do this; disconnect leads A and B (See Fig. 2) from the regulator tubes and insert a 0-50 or 0-100 d.c. milliammeter between resistor R_{12} and terminal 1 of the top OA2 tube. Switch-on the power supply and observe the meter reading. The slider on R_{12} then must be set to give 30 milliamperes through the regulator tubes. For safety, switch-off the power each time before moving the slider. After proper adjustment, tighten the slider set-screw and replace leads A and B.

Next, check the 6SN7 circuit for oscillation. To do this, connect a pair of high-resistance headphones in series

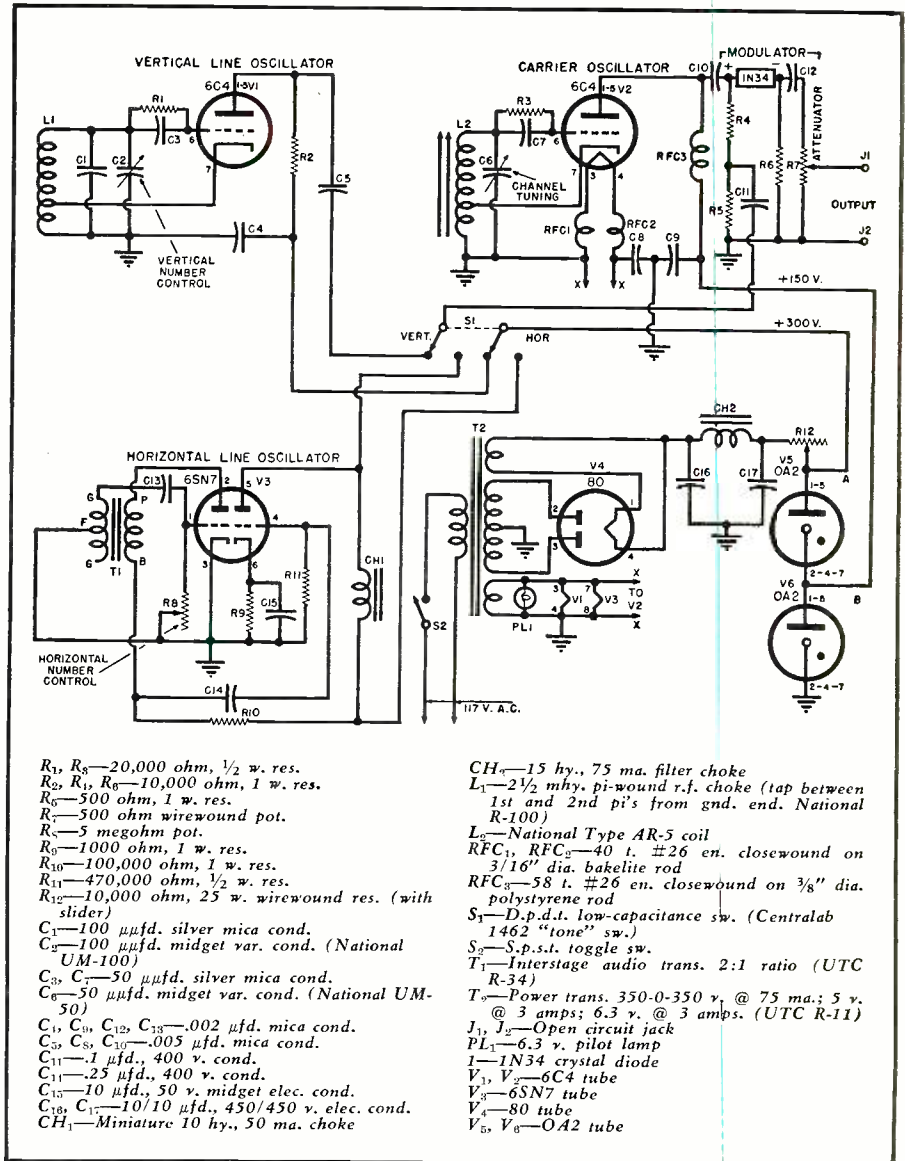

Fig. 2. Complete schematic diagram and parts list for the linearity pattern generator.

with a 0.1 µfd., 400 volt condenser across choke CH_1 , throw switch S_1 to its "Horizontal" position, and switch on the power. After the tube has heated up, an audio tone should be heard. The tone frequency should vary as R_8 is "tuned." If no tone is heard at any setting of R_8 , the circuit is not oscillating and transformer T_1 is probably connected improperly. To correct the

condition, reverse either the primary or secondary connections.

Check the vertical-line oscillator by running a wire lead temporarily from the output end of condenser C_5 to the antenna terminal of a broadcast receiver, tune in any standard broadcast station, throw switch S_1 to its "Vertical" position, and switch on power to
(Continued on page 128)

Fig. 3. (Left) Top view of the shielded carrier oscillator ready for mounting on the chassis. (Right) An under-chassis view of the carrier oscillator section of generator.

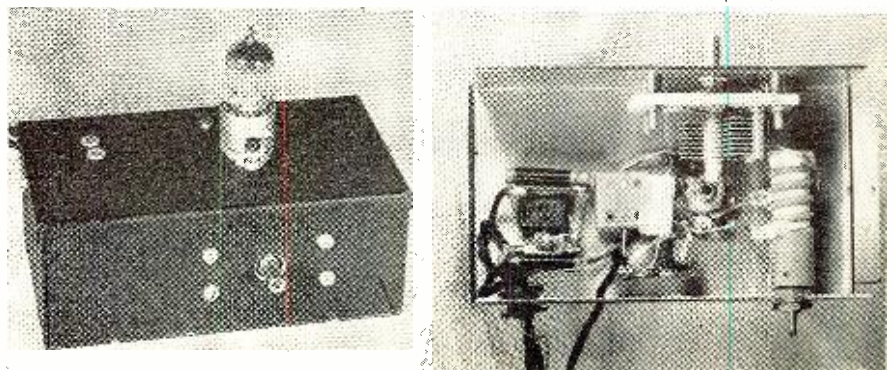

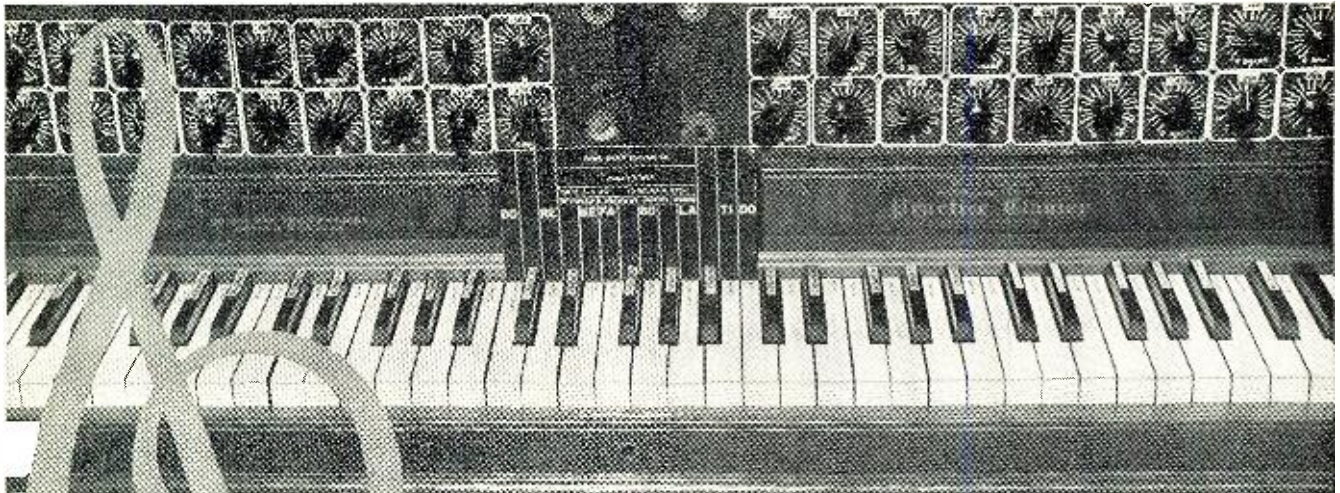

Keyboard—The original 34 notes were built on two chassis mounted above the keyboard with the tuning controls mounted on panels. The two right-hand pots were not used until additional notes were added to extend the tonal range.

An ELECTRONIC MUSICAL NOVELTY

By

JIM KIRK, W6DEG

Individual oscillator for each key permits any number of notes up to a full 66-note keyboard.

“CAN you play the piano?” is the first question I ask any guest. I am amazed how few can. That goes almost 100 percent for hams, who seem to have their musical education in their wives' names. If they can—a piano-organ duet is in the offing. If they cannot—I offer to play the piano and the electronic organ for them. Many have said that some pieces sound better on the organ.

Only it sounds so little like an organ, that I think “Electronic Music Maker” is a better name for this latest brainstorm of mine. I have telephoned many friends and played this “Electronic Whatsis” over the telephone for

them. They all say it sounds beautiful but it does not sound like an organ. Most say it sounds as if I were playing more than one instrument. They say it sounds like an accordion in the lower ranges and, in the higher register, like an electric guitar, a zither, or a violin. One ventured the opinion that I drag in a harp now and then! Perhaps, my style of playing, where I run up and down the keyboard with four finger chords, has something to do with the consensus that I am using more than one instrument.

It seems to hold its tune very well.

The voltage regulation may have something to do with it, because the only times I had to retune it was when trips to the service bench jarred it out of adjustment. When I had it all tuned up the first time, a spot of red paint was placed opposite every pointer, so that if it was badly jarred, that fact was readily apparent. I predict that any ham who builds this rig will not be content to have his wife use it exclusively, but will take piano lessons so he can get the utmost enjoyment out of it himself.

Without an amplifier this model does not have a means for controlling volume: but it is just about right for a living room and I have heard it said that this instrument could be played late at night without annoying the neighbors. Even if they could hear it, the music is soft, beautiful, and conducive to sleep, where a piano or a regular organ would jar a person wide-awake. To meet the objections of musicians, I now control the volume. A non-directional mike is placed in front of the speakers and feeds into an audio amplifier. A paddle on a hinge is placed directly under the keyboard. Pressing this paddle with my knee works a volume control that goes to zero with a spring if pressure is released.

To spread the cost over a period of time, you can build it the way I did it; first build 34 keys and 8 speakers and

Schematic diagram of power supply. With the exception of the filament transformer, T₁, only one such assembly is required. Each of the five separate chassis has its own filament transformer. War surplus parts were used wherever possible to reduce cost.

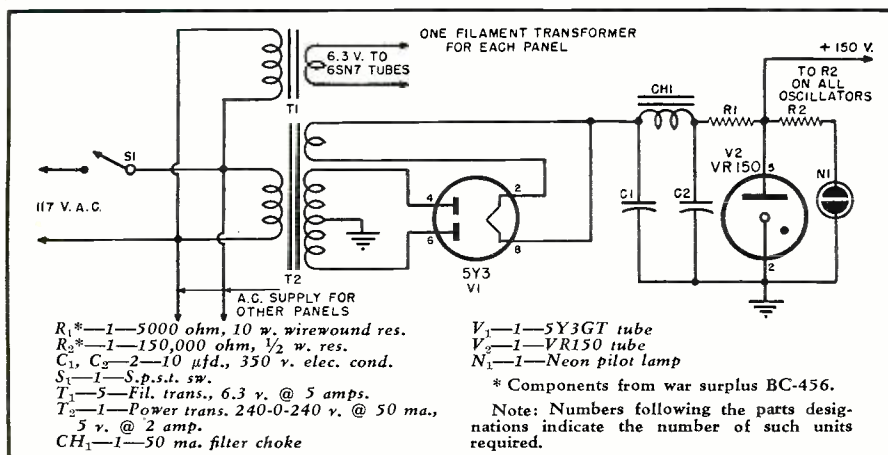

use this while you are accumulating parts for 16 more notes. Adding another 16 notes then gives you a total of 66 notes, which, I have been informed, is about what commercial organs have.

In a previous article ("A Home-Built Electronic Organ," March, 1950) I described how I was fortunate enough to buy a used "Practice Clavier" which was ideal for my purpose. There are no more bargains like this available in San Francisco now, as far as I know, so the reader may not be able to solve the keyboard problem this way. I suggest you watch the want ads for a junk piano or organ. The works can be removed and probably some or all of the panels can be mounted inside. I received a letter from a man who has built the new keyboard himself but he said it took lots of perspiration! He has something he can be proud of, however. Don't wreck the wife's grand piano for the keyboard and then tell her I advised you to do it! I appreciate the temptation but I am afraid you can never talk her into the necessity for carrying out my advice regarding the use of materials at hand.

The BC-456 modulator is a bargain for \$1.50, without tubes, which is the prevailing price in San Francisco. Many of its parts may be used for this project and you do not begin to exhaust the parts. Since each modulator has two audio transformers that may be used, I suggest you buy just half the number of modulators as you have notes on your instrument. In each BC-456, in addition to the usable transformers, there are two octal sockets, two 100,000 ohm resistors, five .05 μ fd. condensers, two ten watt resistors for the power pack, and a couple of mounting panels for resistors and condensers.

Buying modulators is the easy way to do it, because the transformers are high class and uniform and you do not need to experiment with them. I have marked the connection posts. However, I did it the hard way. I had some antique audio transformers on hand, I had some other type surplus, I traded some with ham friends, and I bought a few new *Stancor* units. Quite a few of the maverick audio transformers had to be abandoned. They produced queer sounds or weak oscillations.

Now to explain why I have 16 speakers in the final unit. Cut and try showed that more than 3 notes playing at the same time on the same audio channel produced an unpleasant "overloading" effect even when the notes were in harmony. So I assigned one speaker for each 4 adjacent notes. Four adjacent notes are never played at the same time because that would not be harmony and would sound terrible on any instrument. In order to have 66 notes one speaker has 6 notes on it but the notes are widely separated so that, generally speaking, no speaker has more than two notes playing at a time.

The diagram shows the basic circuit of the organ. Only one power pack

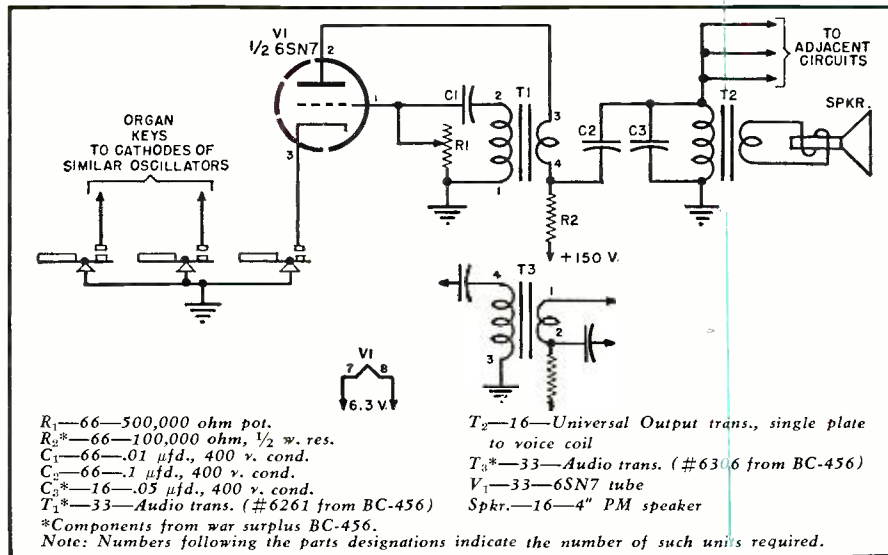

Wiring diagram of oscillator. One such assembly is required for each note. For a full-sized keyboard (66 notes) it will be necessary to use sixty-six oscillators. One speaker is used for four adjacent notes (one exception is a speaker for 6 widely-separated notes). Diagram shows correct terminal identification for audio transformers T_1 and T_3 . Since both of these transformers were available from BC-456 they were used to reduce cost. For more uniform performance, however, and where cost is not a factor, it would be advisable to use the same transformers throughout, preferably the larger (T_3) unit.

need be used because the oscillating tubes use very little current.

That surplus .05 μ fd condenser loading down the primaries of the speaker transformers is the most important part of the whole job and performs three functions. First, it brings the volume way down. The music is soft and beautiful, loud enough to be heard over the telephone, if the telephone is near, but not loud enough for the neighbors to hear. If you want to make a racket, you may omit this condenser, but as for me—new apart-

ments are still impossible to find in San Francisco! The second important function is that of "softening" the tone from a "hard" to a pleasant one. The third effect of this large condenser is to virtually eliminate the key clicks. There are enough left, however, so that the "ping" on the high notes gives the illusion of a stringed instrument.

Tube sockets and tube bases are used for connectors. In order to economize I used aluminum for the chassis because it is easy to work. Panels are
(Continued on page 140)

Front and rear views of rack and panel assembly. For full 66 note keyboard, five separate chassis are required. Two of them, not shown in these photographs, are mounted within the piano. Only one speaker panel is used with the first 34 notes and the potentiometers shown were not used until additional notes were incorporated in the instrument.

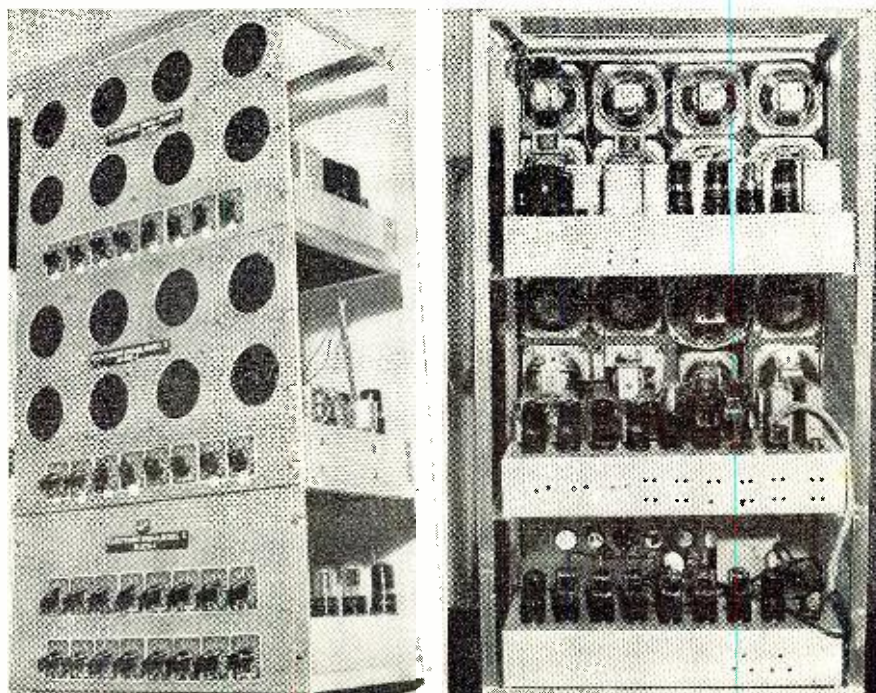

SERVICING SPEEDLIGHTS

By
GUY SLAUGHTER

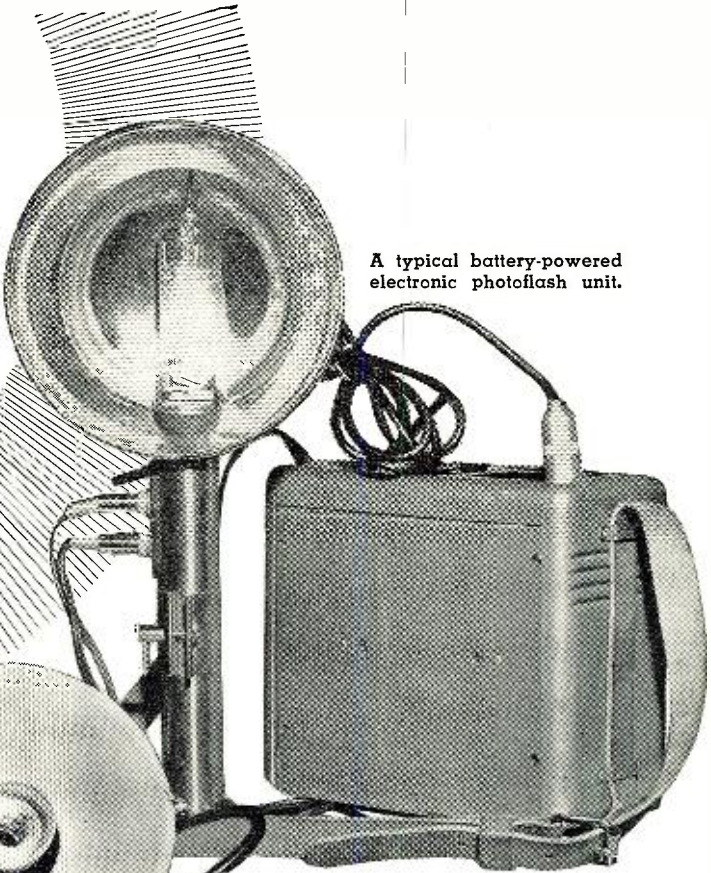

A typical battery-powered electronic photoflash unit.

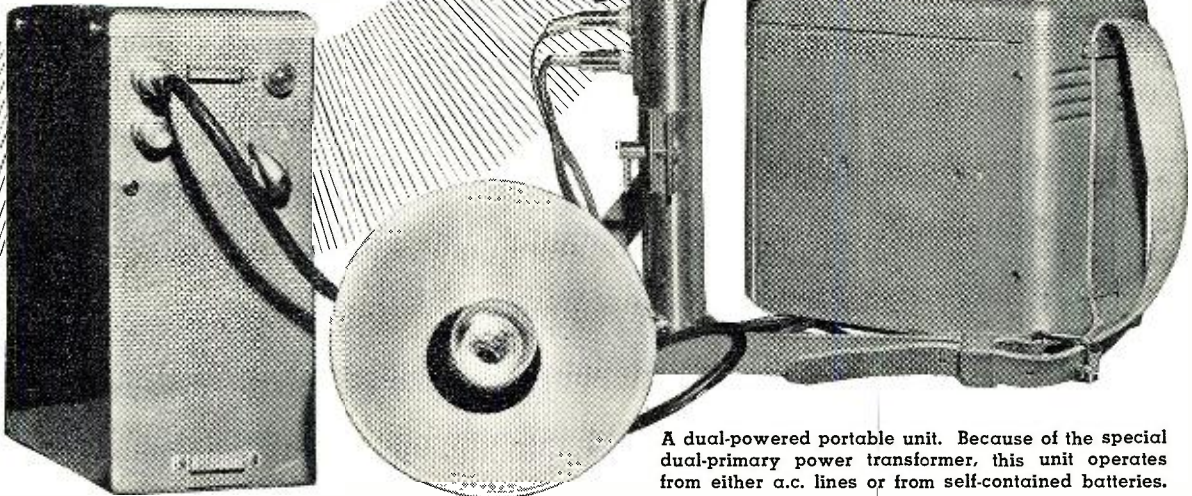

A dual-powered portable unit. Because of the special dual-primary power transformer, this unit operates from either a.c. lines or from self-contained batteries.

Every radio shop has the equipment necessary to service this popular photographic item. The basic circuits of all of the electronic photoflash units, as made by some thirty-odd manufacturers, are alike and only a few special parts and a little extra push in soliciting this business are required.

BECAUSE they have seen "how-to-build-a-speedlight" articles in previous issues of RADIO & TELEVISION NEWS, most radiomen know that this electronic photoflash equipment utilizes conventional radio components and circuits. Likewise, most radiomen could predict that speedlighting equipment would require periodic repairs of the same general nature as do conventional radios. But most radiomen do nothing about soliciting this repair business.

Photographers and camera shop proprietors, to whom a speedlight is a useful tool of the photographic trade, have accepted it as a great innovation. But they do not know what makes it tick, nor do they suspect that local radio service technicians are qualified and equipped to handle the needed repairs. Consequently, when speedlights cease to operate, they are bundled up, marked "fragile," and rushed back to the factory for reconditioning, without a thought being given the possibility of their being serviced locally.

A factory repair job normally re-

quires from three to six weeks, during which time the photographer either does without, or belabors the dealer from whom he bought the unit to loan him another. Either way, somebody is inconvenienced.

The radio service dealer who solicits the speedlight repairs of the local camera shops and photographers, and diverts this factory repair business to his own service bench, can earn himself extra prestige, extra dollars, extra store traffic, and at the same time do a real service to his community.

Speedlighting is not new, but commercial speedlighting equipment, manufactured and distributed on a mass basis, is comparatively new.

All speedlighting units utilize the principle of a condenser discharging its stored energy through a gas-filled tube, and differ among themselves only in the primary source of this energy, the method in which the "storage condenser" is charged, and the means by which the condenser is discharged through the flashtube in synchronization with the camera shutter. Second-

ary design considerations include the voltage to which the condenser is charged, the capacity of the condenser, and the number of flashtubes which can be simultaneously flashed, all of which factors represent a compromise between size, weight, light output, and the cost of the equipment.

Since the light output of any speedlight is proportional to the capacity of the storage condenser and the voltage to which it is charged (determined by the formula W equals $\frac{1}{2}CV^2$, where W equals watt-seconds, C the capacity in microfarads, and V the voltage in kilovolts) most of the portable units, designed to be carried about by the photographer, employ operating voltages on the order of 1200 to 2500 volts, and storage condensers ranging in capacity from 10 to 32 μ fd. On the other hand, those units designed for fixed operation in studios, being less critical as to weight and size, normally use power supplies delivering around 3000 volts, and may utilize storage condensers, usually two or more in parallel, totaling several hundred microfarads of capacity. The portable units are self-contained, and operate from either rechargeable wet cells, or replaceable dry batteries, while the larger studio models are a.c.-line operated. In either case, the storage condenser charging voltage is obtained from a conventional radio-type step-up transformer-rectifier arrangement; usually, although

not always, the portable equipment employs a voltage-doubling circuit, and either cold-cathode rectifier tubes or dry-disc rectifiers, while the studio models use conventional filament-type rectifiers in either half-wave or full-wave circuits.

Difficulties in speedlight power supplies can be traced to the same sources as can those in conventional radio-type supplies, with one difference: *The voltages employed are high, and the energy stored in the tank condenser of any speedlight is sufficient to kill! In working with any speedlight, caution is the most important tool!*

There are two basic types of speedlight flashtubes, each having its own application, and each requiring its own type of firing or triggering device. The open helix or "self-ignition" type will fire whenever any potential exceeding its "critical voltage" (usually a few hundred volts) is applied across its electrodes; this type tube is used in the smaller and cheaper units, and is employed in conjunction with a normally-open relay in series with one of its leads. Whenever the relay is closed, the tube will fire. Since all of the stored energy flows through the relay contacts, these must be heavy, and free of corrosion and pitting.

The so-called "closed helix" tube has a self ignition or "hold-off" voltage considerably in excess of its applied potential, and fires only when an additional "trigger electrode" receives a 15 or 20 kilovolt pulse from the secondary of an ignition coil whose primary is energized by the discharge of a small condenser. This "triggering pulse" ionizes the gas contained in the flashtube, and reduces its internal resistance to a few ohms, allowing the storage condenser to discharge its energy through the now-low-resistance path.

The two generally used methods of synchronizing the trigger pulse with the opening of the camera shutter employ either a relay or a small thyatron tube to complete the circuit between the ignition coil primary and the charged triggering condenser, whenever the shutter contacts close. Sometimes, particularly in "bargain" units or in homemade ones, the shutter contacts mounted inside the camera are used to complete this coil-condenser circuit directly, with no relay or thyatron tube being used; but this is considered poor practice, as the considerable current flowing will ruin the shutter points in a very short time.

Because of the time-delay factor encountered when an inertia-possessing relay is used, the thyatron method of triggering is generally employed in more expensive equipment. However, since the shutter contacts of many cameras are designed to fire foil-filled or gas-type flashbulbs, and are, therefore, built to close from 5 to 30 milliseconds before the shutter leaves are fully open, the relay fired speedlight also has its advantages. It is comparatively easy to introduce a variable time-delay into the relay circuit in the

SYMPTOMS	OPEN-HELIX TUBE	CLOSED-HELIX TUBE (trigger-tube fired)	CLOSED-HELIX TUBE (relay fired)
Dead—will not fire	Faulty flashtube; High voltage too low; Relay contacts pitted	Faulty flashtube; High voltage too low; Faulty trigger tube; Trigger voltage too low	Faulty flashtube; High voltage too low; Relay contacts bad; Trigger voltage too low
Intermittent Operation	Faulty flashtube; High voltage too low; Relay contacts bad	Faulty flashtube; High voltage too low; Bad trigger tube; Bad ignition coil	Faulty flashtube; High voltage too low; Bad relay; Bad ignition coil
Flashes by itself (Self-ignition)	Relay stuck in closed position	Faulty flashtube; Faulty trigger tube; Trigger voltage too high	Faulty flashtube; Relay stuck in closed position
Noisy (Pops or cracks when flashed)	Loose connection in high voltage line; Cold solder joint; Arc-over	Same	Same
Loss of light output	High voltage too low; Flashtube aged (helix blackened)	Same	Same
Poor synchronization	First check camera shutter contacts by substituting another unit		
	Time delay circuit misadjusted; Relay contacts incorrectly spaced	Faulty trigger tube; Resistor or condenser in trigger circuit changed in value	Same as for Column 1, plus; Trigger voltage too low
High voltage too low	Batteries low; Faulty rectifier; Faulty doubler condenser in doubling-type supply	Same	Same
Trigger voltage too low		Resistor in trigger voltage network too low; High voltage too low; Faulty trigger condenser; Batteries low	Same as Column 2, plus; Dirty relay contacts

Some of the most common causes of speedlight failures encountered by technicians.

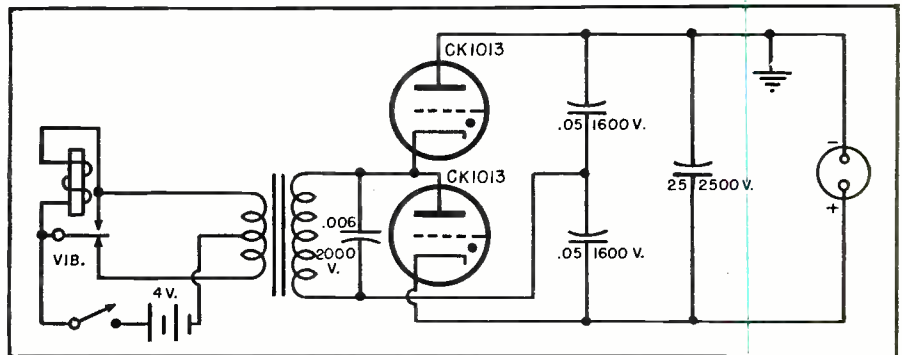

Circuit diagram of a conventional battery-powered portable power supply unit.



Standard flashtubes. The four-prong base tubes are "open helix" or self-ignition types; the five-prong base tubes require the high voltage pulse from an ignition coil in order to ionize them and initiate the necessary discharge.

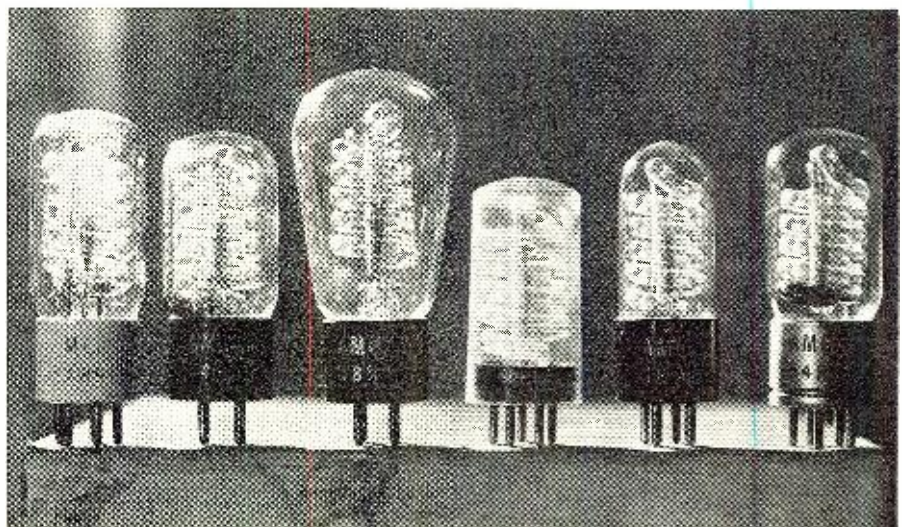

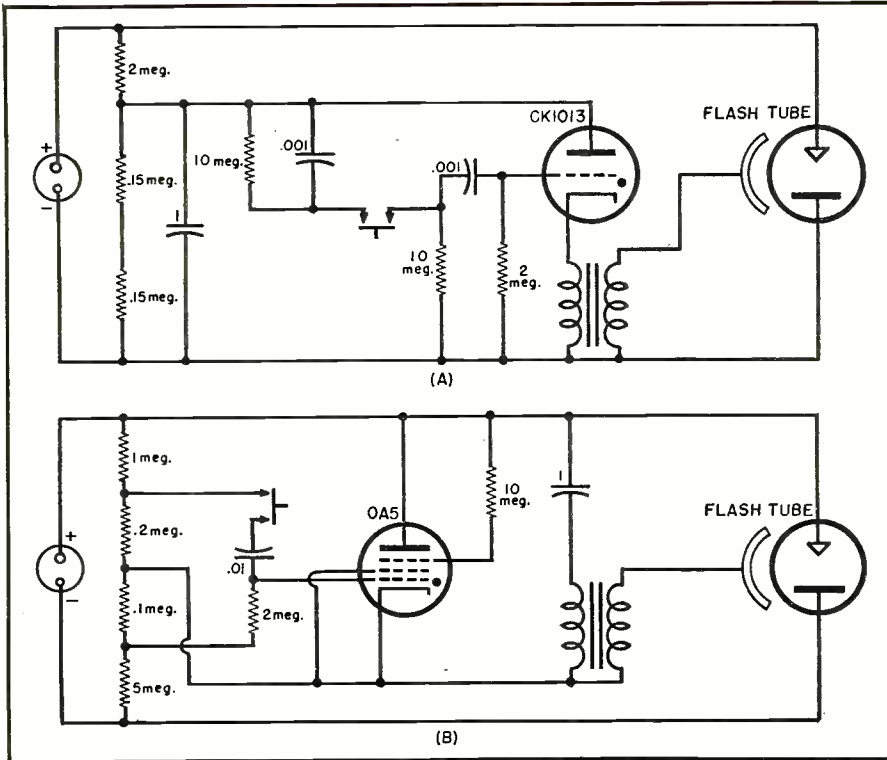

Two of the most commonly used circuits employing trigger-tube firing systems.

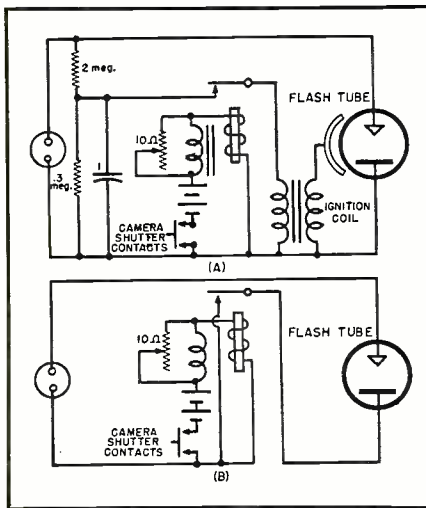

Conventional relay-triggered firing system (A), and typical relay-fired system (B).

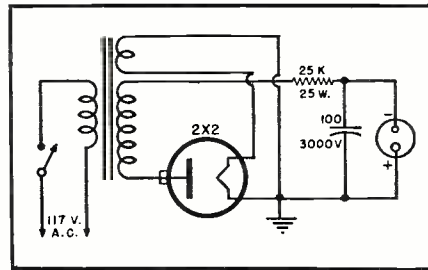

A fixed-location a.c. power supply.

manner outlined by L. M. Dezettel in his article "Build Your Own High-Speed Photo Flash" (December 1946 issue of RADIO NEWS). This type of circuit, which uses a small reactance coil shunted by a variable resistor, is sometimes found in commercial equipment because of the ease with which it can be synchronized to the camera shutter. Besides the usual to-be-expected de-

(Left) Internal view of typical dry-battery powered unit. Shelf contains the power supply and triggering circuits. Bottom compartment holds the storage condenser, in this case a 25 μ fd., 2500 volt oil-filled unit. (Right) Typical a.c.-powered "studio" unit.

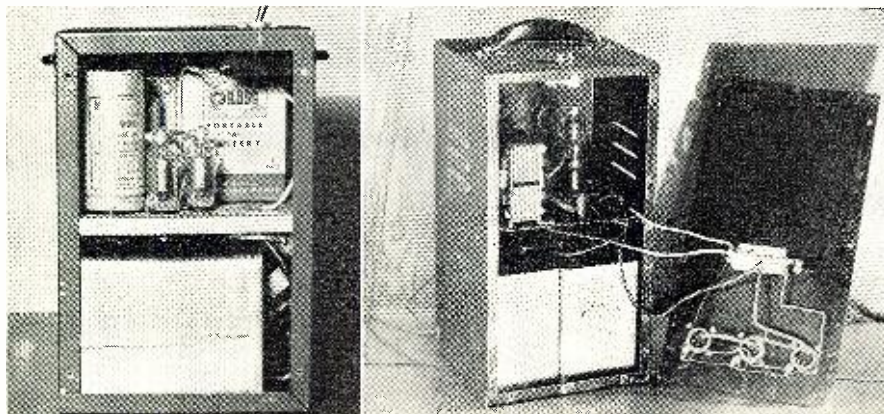

fects found in any equipment utilizing tubes, condensers, and transformers, speedlights are subject to certain additional causes of failure which cannot be anticipated by the radioman. Among these are such things as "low" batteries, and lowered self-ignition point.

Because of the fact that cold-cathode thyratrons are normally used in speedlighting apparatus, the operating voltages are apt to be quite critical. An aged battery, while delivering "almost" its full rated terminal voltage, may be the cause of much grief. For that reason, it is good practice to check the battery voltage, *under load*, whenever working on a unit which fires erratically or not at all. Sometimes a loss of as little as ten per-cent of the primary voltage may mean the difference between perfect operation and non-operation. A quick means of determining whether the batteries (in the case of the widely-used wet-cell type) are at fault, is to plug in the battery charger while the unit is turned on. If the slight increase in primary voltage results in proper operation, it is a good bet that the batteries (assuming they have been charged to their full capacity) are aged and need replacing.

Cold-cathode thyratrons and rectifiers, and flashtubes themselves, possess definite self-ionization points. Whenever the operating voltage exceeds this critical value, the tube becomes ionized, or fires. But, unfortunately, two tubes of the same type may become ionized at slightly different potentials, and individual tubes, after long usage, may gradually change their critical values, usually for a lower one. In these cases, evidenced by continuous periodic firing of the flashtube, it may be necessary to change the flashtube, the trigger tube, or both. Sometimes it may be necessary to install two or three different tubes before one is found which will work satisfactorily at the particular voltages encountered in the electronic photo flash being serviced.

Some of the component parts of a typical piece of speedlighting apparatus are rather expensive to stock, but, fortunately, failure of these parts is very rare. Aside from tubes, flashtubes, batteries, cable and cable connectors, the average radio shop stocks probably all of the components it will ever require. Vibrators (usually of the four-volt variety, remember), storage condensers, transformers, and ignition coils seem to last forever, somehow. But in case of a failure, these parts can be secured either from any large radio-supply house, or from the manufacturer of the equipment being serviced. The maker can also supply schematic diagrams if they are needed. Generally speaking, however, the usual shop is equipped with all the spare parts and technical knowledge that will ever be needed in the profitable sideline of electronic photo flash servicing and repair.

Insurance for SERVICE TECHNICIANS

By
C. L. NUNNEKER
Mgr., Compensation Department
The Shelby Mutual Casualty Co.

If the panel truck in this picture were yours could you stand the loss that might result?

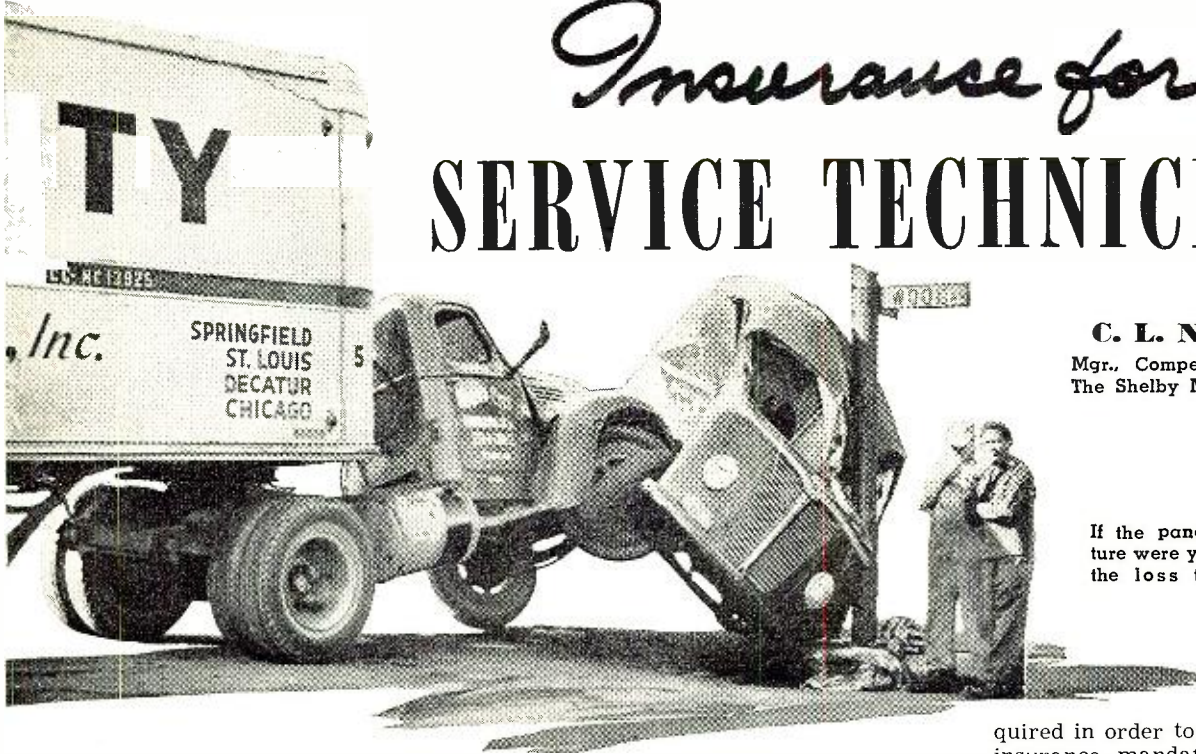

Suits, burglaries, and accidents have put many service shops out of business. How do you stand?

RECENTLY, in a small midwestern city, two small boys were watching the installation of a television antenna. The work was nearing completion when one of the workmen partially lost his balance and dropped a dipole assembly which bounced off the roof and struck one of the two boys. The resulting injuries confined the boy to the hospital for several weeks and in the interim the installation contractor was sued by the boy's parents for \$50,000. A trial court later awarded substantial damages. Fortunately, the contractor had adequate insurance in force to cover the loss.

In Chicago, a paralyzed war veteran was financially ruined by the burglary of sixteen television sets from his store. He and his wife had worked two years building up the business to the point where six men and two trucks were required to carry on the business activities. The \$5000 loss of these television sets put the concern out of business.

For those readers for whom radio and television is a career and a business, the writer believes that knowledge of proper insurance protection is more important than technical knowledge of the devices serviced. The two examples related above, and our daily newspapers prove that this is not an empty statement, as they prove conclusively that the lack of insurance protection can spell ruin, and destroy the results of years of hard work.

The forms of insurance generally needed are:

1. Workmen's Compensation.
2. Bodily Injury liability and Property Damage liability insurance covering premises and operations.
3. Products Bodily Injury liability and Property Damage liability to protect him if defective workmanship by him or his employees causes injury to other persons or damage to their property.
4. Automobile Bodily Injury and Property Damage liability to protect him if an automobile driven by him or on his business causes bodily injury to the public, or damage to their property.
5. Burglary and Robbery insurance as protection against the loss of merchandise, tools, fixtures, and cash.

Workmen's Compensation

Each of the forty-eight states has passed a Workmen's Compensation Law which places the burden of paying for injuries to, and the death of employees squarely upon the employer. This statement assumes that such injuries or death occur "in the course of" and "arising out of the employment" of the individuals. Each state law differs from each other state law to a degree, but in general, these laws are all similar. In some states like New York, Minnesota, and Pennsylvania, one employee other than a purely clerical worker, means that compensation insurance is required by the statute. In Wisconsin and Ohio, compensation insurance is compulsory if the employer has at any time, three or more employees. In those states, where a minimum number of employees is re-

quired in order to make compensation insurance mandatory, the employers of fewer than the minimum number still are liable at common law if the employees are injured through the negligence of the employer.

Examples of what may happen are as follows: It is well known that the high voltages developed in the modern television set can be injurious and even fatal and this exposure of the employee service technician is a substantial hazard to the employer. Simple cuts and burns, usually handled by first aid, if permitted by inattention or lack of care, to develop into serious infections, can be very expensive from the standpoint of medical expense and payment for lost wages. Electric shocks are fairly common in radio work and when incurred may vary in seriousness with the physical condition of the employee at the time of the shock.

The truck driver engaged in delivery work may incur a strain or a hernia which requires hospitalization and an expensive operation. Injury may also arise from an automobile accident while the car is being driven on the employer's business.

Antenna erection for television in fringe areas, where unusually high placement is required, is an extremely hazardous operation. There are exceptional operators on this class of work who insist on taking every precaution to prevent injury to their employees, but by observation, the writer believes that this work, in general, is performed with a minimum of safe equipment and safety devices, and little, if any, attention to safety by the employees. Employees who have fallen while performing this work are sometimes killed but almost always seriously injured. The payment of death benefits to the dependents of the deceased is a burden which even a

(Continued on page 88)

A 100 KC. SQUARE-WAVE GENERATOR



By
LOUIS E. GARNER, JR.

Fig. 1. Over-all view of square-wave generator built by the author at relatively low cost. A small cabinet or metal box can be used instead of open chassis.

A simple multivibrator-type oscillator is used, producing square waves of 10 volts peak-to-peak.

FOR some time, square-wave analysis has been recognized as the fastest and most easily applied method for checking the response of amplifiers, whether audio amplifiers, scope, or video amplifiers. The use of square waves for checking the response of amplifiers up to several hundred kilocycles, using an audio generator and a clipper supplying square waves up to 20 kc. has been covered previously. ("Wide Frequency Range Square-Wave Clipper," March, 1950 RADIO & TELEVISION NEWS). However, low frequency square waves cannot be used for adequately checking the response of video and wide-band scope amplifiers which should be reasonably flat to one or two megacycles or more. In addition to low frequency square waves (for checking low frequency response), a high frequency square wave of 100 kc. or so should be available.

There are few square-wave generators supplying a signal of this frequency available to the average experimenter or service technician, and those that can be obtained are generally high priced.

However, the average home experimenter or laboratory technician may easily construct a suitable 100 kc. square-wave generator, using standard parts and tubes. Such an instrument is shown in Fig. 1, and the schematic diagram is given in Fig. 5.

Circuit Description

The fundamental signal, approaching a square wave in form, is generated by the multivibrator oscillator stage. This signal is fed to a cathode follower preamp stage, and then to

three cascaded RC-coupled amplifier stages. In these stages, the signal is amplified and clipped, until the final signal appears across output plate load resistor R_{15} . The signal here is coupled through C_{11} to the output amplitude control R_{17} . A low resistance control is used here to minimize the effects of distributed capacities and unequal voltage division as the level is changed.

Frequency of oscillation is determined by the sizes of C_2 , C_5 , R_1 , and R_5 . With the parts values indicated, a square wave having a frequency of about 100 kc. is obtained. If for any reason an exact frequency is required, then R_5 as well as R_1 can be made variable, and these resistors adjusted until the desired frequency is reached.

The square wave obtained with this generator has a rise time of less than 0.2 microseconds, and the maximum

amplitude available across R_{17} is about 10 volts peak-to-peak, with "B plus" at 200 volts.

Construction Hints

In the unit built by the author, open chassis type of construction was employed. However, the unit may just as easily be built in a small cabinet or metal box.

The power supply can be separate, as in the unit shown, or may be built-in. The "B" supply should deliver from 180 to 250 volts at 50 ma., and 6.3 volts a.c. at 2 amperes. Any standard power supply circuit may be used, or, if the technician or experimenter happens to have a small power supply already built up, there is no need to construct one.

High frequency signals, up to many megacycles, are present in the 100 kc. square wave, so distributed wiring capacities must be kept to a minimum if a good square wave is to be obtained. This can be done by keeping signal leads short and away from the chassis and other parts, and by using the smallest (physical size) coupling condensers available. The new "metalized" paper condensers are ideal for this application.

The output potentiometer must be carbon or composition if good results are to be obtained. A wirewound control has too much inductance for use at these frequencies.

Fig. 2. Differentiating (A) and integrating (B) networks used to demonstrate the scope patterns shown in Figs. 3A, 3B, and 3D.

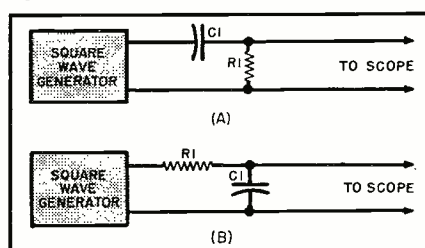

Once the construction has been completed and the wiring checked, a suitable power supply should be connected and the unit allowed to warm up. The output terminals are then connected to the vertical input terminals of a cathode-ray oscilloscope.

At this point, it is important to note that an oscilloscope having extremely good high frequency response (flat to at least 2.5 megacycles), good rise time, and good transient response must be used with this generator. A scope with poor high frequency response will distort the signal too much, and accurate tests cannot be made.

When first connected to the scope, and the sweep adjusted until two or three cycles of the square-wave signal are visible, a wave shape somewhat like that of Fig. 4A will probably be observed. The "Equalizer" or "Symmetry" control R_1 is then adjusted until both "halves" of the square wave are of equal width as shown in Fig. 4B. The frequency as well as the wave shape of the observed signal will change slightly as this control is varied, but with a symmetrical shape, the frequency will still be approximately 100 kc.

Be sure to have the amplitude control R_7 set for maximum output when making this adjustment. Once the adjustment is completed, the square wave generator is ready for use, and the output level may be adjusted to any desired value.

If the sweep of the scope will allow just two or three complete cycles to be observed, then adjust it until the minimum number of cycles can be seen, and expand the horizontal gain until the individual cycles are sufficiently large for good analysis.

Application

This generator is used like any other square-wave generator: The output is connected to the input of the amplifier stage or stages to be checked. An oscilloscope is used to check the wave shape at the input and output of the amplifier, and any changes from a normal square wave noted.

Distortions of a square wave, which may result from high-frequency defects, are shown in Fig. 3. These signals should be compared to the "perfect" square wave of Fig. 4B.

In Fig. 3A a condition of poor high frequency response is indicated. With a 100 kc. square wave, a wave shape approximately as shown in Fig. 3A indicates that the drop in frequency response begins at about 500 or 600 kc. If the condition of poor high frequency response is excessive, so that signals above 100 kc. are lost, then the square wave may be rounded further, finally approaching Fig. 3B in shape. This wave shape will also be given the square wave by an integration circuit.

The type of distortion shown in Fig. 3C is caused by a peak in amplifier response, so that damped oscillations are set up at a high frequency. With a 100 kc. square wave, a signal such as that of Fig. 3C indicates that a circuit

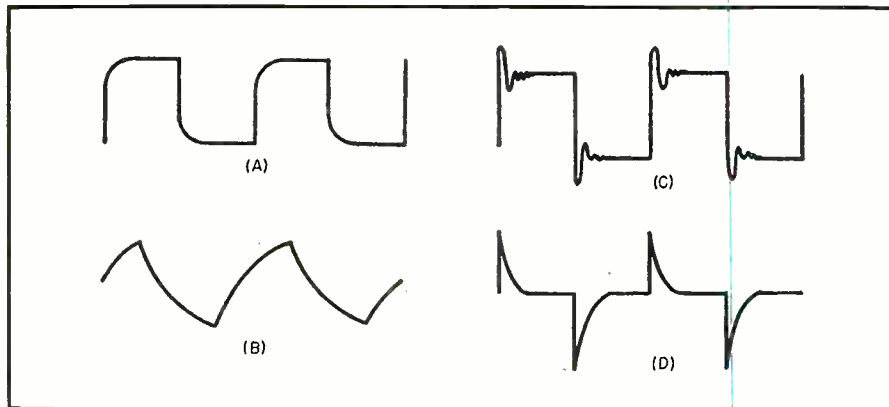

Fig. 3. Possible wave shapes obtainable at the output of amplifier. Any deviation from the original square wave denotes some form of trouble in the amplifier unit.

within the amplifier is resonant at around 4 or 5 megacycles.

Such a resonant condition may be caused by excessive lead inductances, a misadjusted peaking coil, or an open peaking coil damping resistor.

A peaked signal, as shown in Fig. 3D, may be caused by high frequency leakage across a gain control or attenuator, by an open coupling condenser, or similar defect. Such a condition is also produced by a differentiation circuit.

Not only is the 100 kc. square-wave generator useful for checking the response of video and scope amplifiers up to two megacycles or more, but it can also be used to advantage in schools, for demonstrating not only square-wave analysis, but the action of differentiation and integration networks. The home experimenter may also find it interesting to try out something along these lines.

A simple differentiation network is shown in Fig. 2A. With the connections reversed, the integration network of Fig. 2B is obtained.

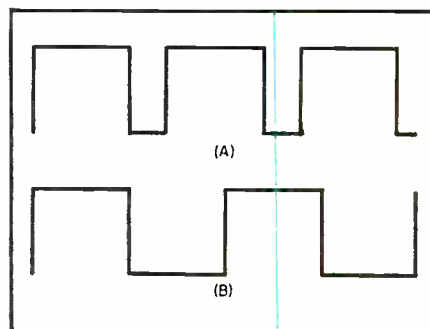
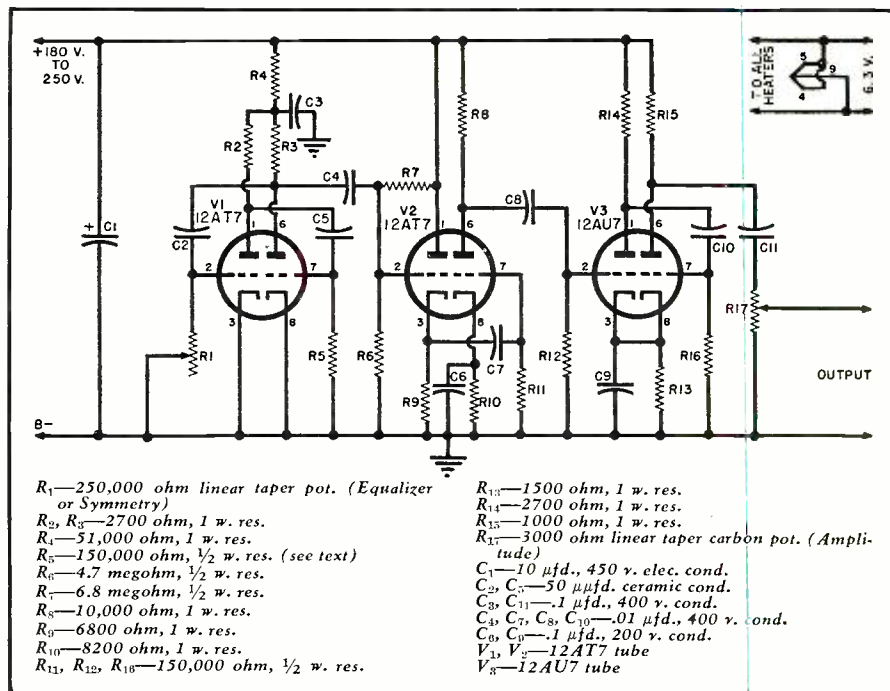

Fig. 4. Adjust R_1 so that both halves of square wave are symmetrical as in (B).

By the use of such networks, the wave shapes shown in Figs. 3A, 3B, and 3D may be easily obtained. Different values of resistors and condensers may be substituted to demonstrate how varying the time constant affects the degree of differentiation or integration. For the 100 kc. square wave, good values to start with are 50 $\mu\text{fd.}$ for C_1 and 18,000 ohms for R_1 .

-30-

Fig. 5. Diagram of 100 kc. square-wave generator. A separate power supply is required.



A SIMPLE NOISE LIMITER

By R. P. HAVILAND

A crystal diode and condenser are only components needed to add this noise limiter to your receiver.

THE basis of operation for all types of audio noise limiters lies in the characteristics of the worst type of noise, that is, that produced by auto ignition systems. This noise is essentially a series of high amplitude pulses of very short duration, with the pulses occurring at relatively infrequent intervals. The average power of the noise is, therefore, low, although the peak power may be, and usually is, many times as large as that of a desired signal.

The injurious effects of this high peak power lie in the overloading of some part or parts of the receiver and of the acoustic reproduction system. It is, therefore, necessary that some operation be performed which will eliminate this overloading.

The first type of limiter developed was a clipping circuit which limited the maximum amplitude of all signals to some preset value. Usually an adjustment was provided to allow for variations in signal strength. Properly adjusted, this type of circuit will give amazing performance—until the signal strength changes. Then, there is either a burst of noise, or a large amount of distortion.

It was not very long before the maximum amplitude adjustment had been tied to the automatic volume control system, either directly or in effect. This removed the major disadvantage of the early type; it is included in the system to be described.

The secondary disadvantages of the earlier noise limiters were a rather large loss in audio signal level, and in distortion at high modulation percentages. Neither of these have been regarded as being of particular importance: they can, however, be eliminated.

Fig. 1 shows a circuit of a limiter which adds only two parts to the receiver, and which provides the features of automatic adjustment, no loss of audio signal voltage, and essentially no introduced distortion for modula-

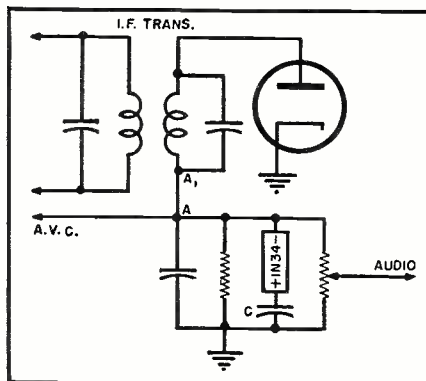
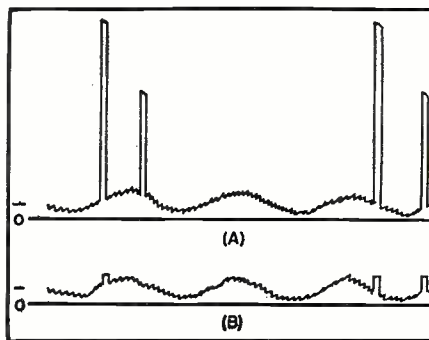

Fig. 1. A conventional second detector circuit which incorporates audio noise limiter.

tion percentages up to 100%. The circuit operates as follows; with an unmodulated signal, the condenser *C* quickly charges up to the level of the d.c. voltage appearing at *A*, since the forward resistance of the 1N34 diode is very low (about 300 ohms). If modulation is present, the voltage across *C* increases to essentially the peak value of the modulation and holds this for

Fig. 2. Tracing on oscilloscope screen of signals received from WWV on 30 mc. at a distance of 30 miles. (A) without limiter, and (B) with limiter. The interference pulses produced by two separate automobile systems are evident. Relative scale: signal 1 volt, interference 40 volts, signal-to-noise ratio 10. Diagonal peak clipping is evident.



an appreciable time, since, to discharge to a lower voltage, the condenser must discharge through the back resistance of the 1N34 diode, which is on the order of several hundred thousand ohms. Some compromise is necessary to preserve adequate low frequency characteristics and still provide sufficiently fast response to follow fading. In practice, if *C* is about 0.5 microfarads, the results are very good.

If both signal and noise are present, the voltage across the condenser remains essentially constant, and the noise pulses are limited to the level of the peak value of the signal. This action is not perfect, in that the voltage across the condenser *C* does increase by the average value of the noise. However, for signals which develop appreciable voltage at the detector the effect of the interference produced by one or two cars is entirely negligible, and some improvement is always secured.

With this circuit, limiting is introduced only for signals which are of increasing negative voltage. Automatic limiting for positive voltage peaks is provided by the detector diode, since it cannot conduct in the reverse direction.

In this circuit, as in all shunt type of noise limiters, the 1N34 diode gives better performance than a thermionic diode, such as the 6H6. This is due to lower forward resistance, about 300 ohms for the 1N34, as compared to approximately 1000 ohms for the 6H6.

Some second detector circuits include a resistor between "A" and "A'" to reduce the negative peak clipping inherent in the diode detector. The presence of this resistor will not affect the operation of the limiter.

Fig. 2 is a drawing of an oscilloscope record of the voltage at *A* without and with the limiter connected, for signals as received from WWV. Aural tests made at the same time showed the 440 cycle tone to be unrecognizable with the limiter out. With the limiter in, the ignition QRM was perceptible against a strong tone, but not objectionable.

It will be found that the limiter gives some improvement when copying very weak signals. This is due to the fact that random or "hiss" noise has appreciable peak power, as compared to its average power. This fact, together with the lack of distortion for strong signals, makes this silencer a "wire-in-and-forget-gadget."

It is to be noted that some improvement in operation may occasionally be secured by adding capacity to the a.v.c. filter network. This is true only for receivers having very fast a.v.c. action and is due to counter-modulation of the signal.

It should be remembered that this circuit is effective only for noise having a low average level. Oscilloscope examination of the voltage at point "A" is recommended to determine if this is satisfied.

The same circuit may be adapted to infinite impedance detectors by reversing the 1N34 diode connections. —30—

VOLTAGE REGULATION for HIGHER FIDELITY

By
J. CARLISLE HOADLEY*

Improve performance of your audio equipment by using a well regulated power supply.

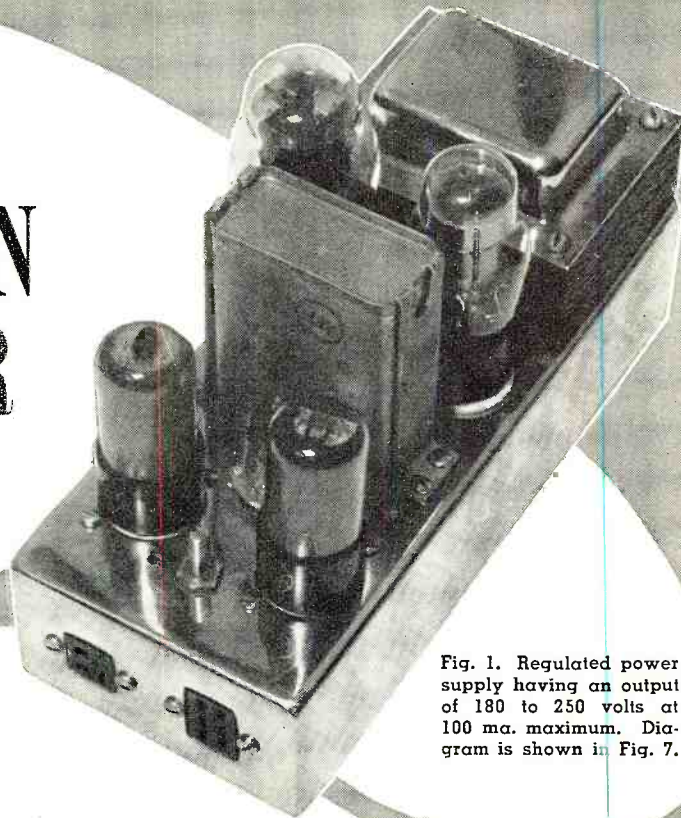

Fig. 1. Regulated power supply having an output of 180 to 250 volts at 100 ma. maximum. Diagram is shown in Fig. 7.

THE plate power source used with a high fidelity amplifier can and does have considerable effect on the noise, hum, and frequency response of that amplifier. In spite of knowledge of this fact, amplifier designers treat the power supply as a necessary evil and, if the supply is capable of delivering sufficient voltage at the required current without overheating, they consider it a success.

It is conventional today to operate power output tubes in Class AB₁, where the average plate current is allowed to swing from some low quiescent value to a much higher value at maximum power output. Since the plate current drawn by the output tubes will vary with signal input, regulation of the power supply is a factor to be considered.

This regulation may be divided into two types. The first is the change in output voltage of the supply due to a change in current drain and is caused by the series of *IR* drops across the rectifier tube, choke, and across the high voltage winding of the power transformer. The changes in average plate current, to be considered at present, will be the relatively slow change involving many audio cycles which is, in general, independent of frequency. The changes will result, for instance, from the increase of volume from the

level of a single violin to full symphony orchestra.

If a given input is introduced to an audio amplifier and the output measured, it is reasonable to expect to get twice the output if the input is doubled. This, although logical, is not always true. Assuming a perfect output stage and perfect output transformer, and assuming constant plate voltage to the tubes, this would be true.

The curves in Fig. 2 compare the regulation curves of various good quality power supplies. Curve A is the regulation curve of a condenser input supply using a transformer rated at 650 volts a.c. center-tapped at 160 ma. Curve B shows the regulation of a supply using a transformer rated at

800 volts a.c. center-tapped at 240 ma.

The choke input supply does have better inherent regulation than the condenser input supply, but requires a power transformer with a higher voltage winding. The ripple in the choke input supply is higher, however, almost invariably requiring a two section filter.

The power supplies being compared are shown schematically in Fig. 3. The chokes are 8 hy. each and the filter condensers are 10 μ fd. each. The choke input supply with a two section filter has slightly lower ripple than the condenser input supply but with a sacrifice in regulation because of the *IR* drop across the second choke.

Curve B of Fig. 2 shows the regulation of the choke input supply with only one choke; for two chokes the curve would lie somewhat below Curve B.

Fortunately, the power output tubes draw appreciable current with no signal, so that the area of voltage regulation in which we are interested is represented by the crosshatched area in Fig. 2. These currents are representative of the drain of an amplifier using two 6B4G tubes operated at 300 volt plate potential with a fixed bias of minus 62 volts. The plate current swing, as given by the tube manual (values for 2 tubes), is from 80 ma. no signal to 147 ma. with full signal.

A glance at Fig. 2 will reveal that the condenser input supply will change from 380 volts with 80 ma. drain to 330 volts with 147 ma. drain, which

Fig. 2. Regulation curves for conventional power supplies using condenser and choke inputs. Curves are based on the use of 10 microfarad condensers and 8 henry chokes.

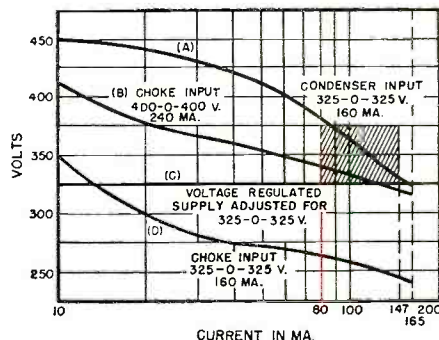

* Audio Sub Section Head, Radio and Communications Section, Electronics Test Division, Naval Air Test Center, Patuxent River, Maryland.

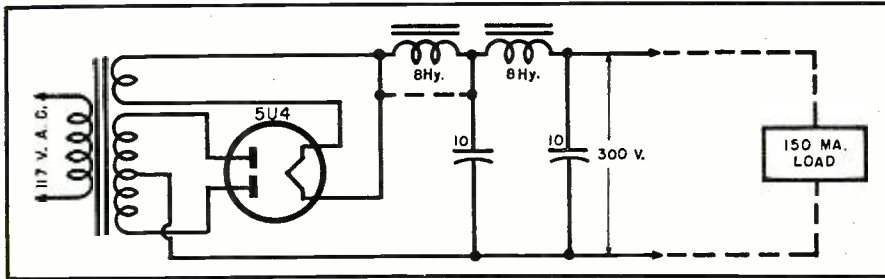

Fig. 3. Standard power supply using choke input. Dotted line shows circuit connections for condenser input. The choke input ripple is 1.5% for one section filter and .07% for two section filter. Ripple is .09% for one section filter, condenser input.

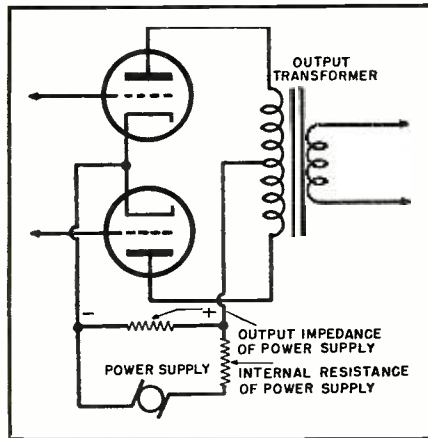
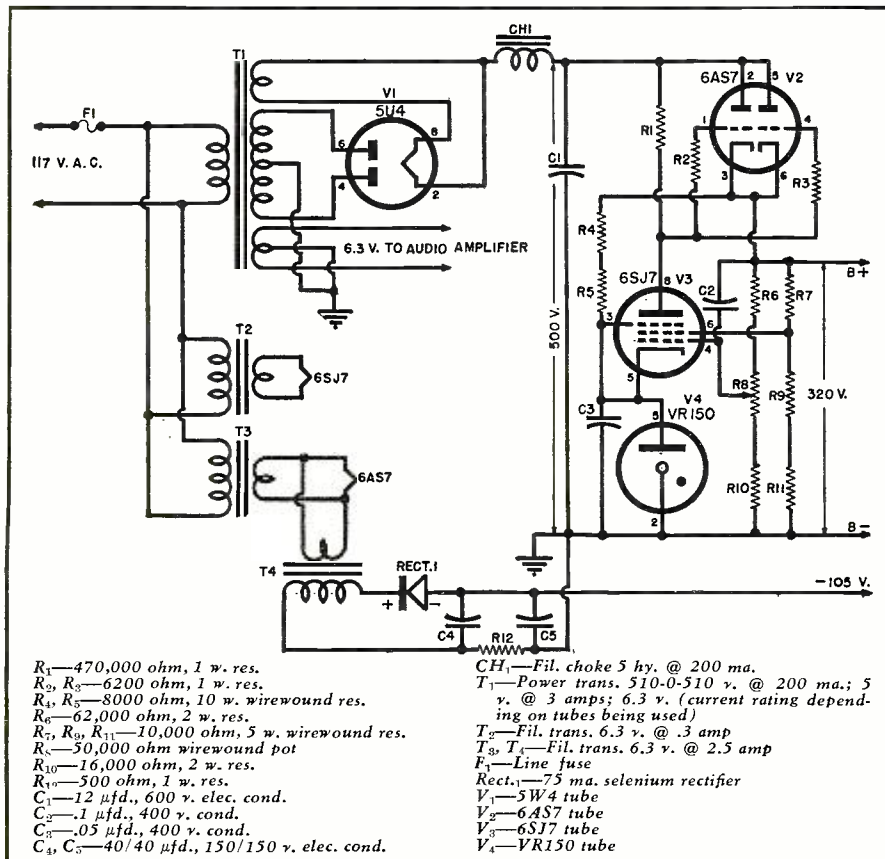

Fig. 4. The output power supply condenser is virtually a short circuit at high audio frequencies. See text for explanation of how this affects performance of amplifier.



Fig. 5. Circuit diagram of a regulated power supply rated at 320 volts d.c., 200 ma.



- R₁—470,000 ohm, 1 w. res.
- R₂, R₃—6200 ohm, 1 w. res.
- R₄, R₅—8000 ohm, 10 w. wirewound res.
- R₆—62,000 ohm, 2 w. res.
- R₇, R₈, R₁₁—10,000 ohm, 5 w. wirewound res.
- R₉—50,000 ohm wirewound pot
- R₁₀—16,000 ohm, 2 w. res.
- R₁₁—500 ohm, 1 w. res.
- C₁—12 μfd., 600 v. elec. cond.
- C₂—1 μfd., 400 v. cond.
- C₃—0.5 μfd., 400 v. cond.
- C₄, C₅—40/40 μfd., 150/150 v. elec. cond.

- CH₁—Fil. choke 5 hy. @ 200 ma.
- T₁—Power trans. 510-0-510 v. @ 200 ma.; 5 v. @ 3 amps; 6.3 v. (current rating depending on tubes being used)
- T₂—Fil. trans. 6.3 v. @ .3 amp
- T₃, T₄—Fil. trans. 6.3 v. @ 2.5 amp
- F₁—Line fuse
- Rect.₁—75 ma. selenium rectifier
- V₁—5U4 tube
- V₂—6AS7 tube
- V₃—6SJ7 tube
- V₄—VR150 tube

to the full 147 ma. required by the 6B4G output stage. The regulated supply, then, will completely eliminate the amplitude distortion caused by poor power supply regulation.

The second type of regulation to be considered is the type where the power supply reacts to fast changes in current such as might occur during one cycle at some audio frequency. Since the power supply is composed almost completely of reactances and impedances it is bound to exhibit different values of internal resistance for various frequencies.

The output impedance is determined mainly by the value of the output condenser. The output impedance is given by the expression Z equals $1/2\pi fC$. At a high audio frequency the impedance of the output condenser will be so low as to constitute a virtual short circuit (see Fig. 4). This has the effect, therefore, of shorting out the internal resistance of the power supply for rapid (inter-cycle) changes in load current.

represents a change of 16 per-cent. The choke input supply (one choke) with the same current swing will change 25 volts or about 8 per-cent.

Since the voltage output of a triode amplifier will change linearly with the change in plate voltage, this output stage will exhibit approximately 16 per-cent amplitude distortion with a condenser input supply and 8 per-cent amplitude distortion with a choke input supply (this figure will increase for a two-section filter). The amplitude distortion will appear as a limiting of the dynamic range of the reproduced music by the above percentages. This is, of course, the extreme case of operating the amplifier at its maximum power output, but remember that the other types of distortion are rated at the same high level.

The Curve C in Fig. 2 will reveal that the voltage regulated supply described here does not change a significant amount from zero current drain

As the signal frequency is lowered, the impedance of the output condenser increases until at some low frequency it is many times the internal resistance of the supply. Then the power supply will exhibit poor "inter-cycle" regulation and a portion of the low frequency signal voltage will be developed across the power supply. This effect will cause no harm in a push-pull Class A audio stage as there is no change in average plate current. In a Class A stage, when one tube draws current the other tube's current is reduced by a similar amount.

In a Class AB stage, due to the greater allowable driving voltage, one tube is driven to cut-off and beyond while the other tube is driven toward zero bias. For example, the 6B4G tubes are each drawing 40 ma. with no signal. As the signal is increased, one tube's current increases while the other decreases. Soon one tube is driven to 0 ma. and the other to 80 ma. As the signal is increased further, one tube is driven to 147 ma. but the other tube is already drawing zero ma. so the total plate current will change by an amount of 147 minus 80, or 67 ma. The phenomenon will be repeated by the other tube on the other half cycle. This will result in a current drain waveform which is comprised of all the positive and negative signal peaks added together.

As the audio signal frequency is lowered, the output impedance of the power supply rises until it is in the same order of magnitude as the load impedance for the output tubes. When the output impedance becomes this high, a significant amount of signal voltage is developed across the power supply instead of across the output transformer, which detracts from the power output on signal peaks. This results in amplitude distortion which increases with a decrease in frequency. Since this amplitude distortion effect is greatest at low frequencies, it would tend to reduce any bass boost by a considerable amount. Failure to main-

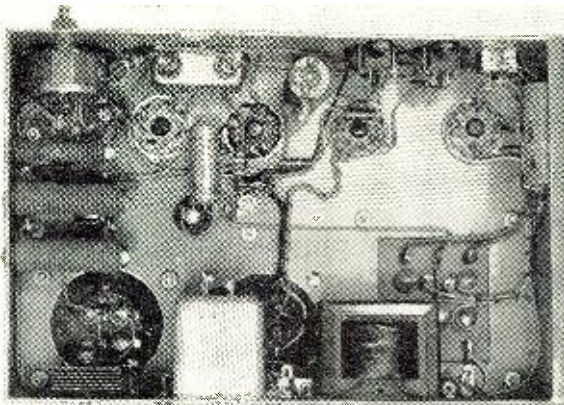

Fig. 6. Top and bottom views of the regulated power supply built by author. Schematic diagram of this unit is shown in Fig. 5.

tain accurate balance of the plate currents of the push-pull output tubes will further aggravate the situation.

In addition to amplitude distortion, the intermodulation distortion in the output stage will increase at low frequencies, due to the increase in power supply impedance. Very serious, also, is the fact that the signal developed across the power supply will be fed into the plate circuit of every stage in the amplifier causing injurious regeneration or degeneration (depending on phase) at low frequencies. The regeneration can be great enough to cause motorboating and/or instability.

We have considered only the case of triode output tubes, so far. The effect on pentode, or beam power, tubes is similar but is caused in a different manner. As long as a pentode is operated on the flat portion of its plate characteristic, small changes in plate voltage are not of much consequence. However, changes in its screen voltage produce the same undesirable results as the change of plate voltage in a triode.

The untoward effect of poor plate voltage regulation can be minimized by the application of generous amounts of negative feedback or by using a voltage regulated power supply. It is a shame to "use up" negative feedback to correct poor power supply regulation when it could be used to greater advantage to provide higher damping factor and wider frequency range, etc.

The two undesirable characteristics of a power supply, then, are high internal resistance and high output impedance. By using a series-triode, tube-type voltage regulated supply, the internal resistance and output impedance can be reduced to the vanishing point. There are, in addition, other worthwhile advantages.

The regulator tubes not only eliminate slow changes in the output voltage but also reduce a large portion of the ripple. In addition, they have the advantage of holding the plate supply voltage constant with changes in input line voltage. They will even remove surges caused by the starting of motors and other noisy line disturbances.

The series tube regulator, which incidentally has been with us for years and is in no way new, will provide

many times as low ripple and almost infinitely better regulation for less money than the conventional "brute force" filter. If honestly rated chokes are used in the choke input filter, the regulated supply will require even less space!

In Fig. 5 we find the circuit for such a regulated supply. It consists of a large power dual triode which is placed in series with the voltage to be regulated. Its grid is connected to and biased by a sharp cut-off pentode d.c. amplifier. The pentode has introduced to its grid the variation in the output voltage of the supply. Since the plate of a tube operates 180 degrees out-of-phase with its grid, the pentode introduces a signal at the power triode's grid which tends to counteract any change in the output voltage by raising or lowering the triode's internal resistance.

Since the gain around the circuit is relatively high, any change in output voltage is quickly corrected. So that the pentode will have a stable target voltage from which to operate, a VR tube is connected to its cathode. This VR tube effectively maintains the pentode's bias constant and renders it insensitive to changes in input voltage.

The current range over which the regulator will operate is a function of the dissipation of the series tube. Several tubes may be placed in parallel if greater current capability is required. Recently, there appeared on the market a tube which was designed specifically for voltage regulator use. This tube, the 6AS7G, has all the desired features, such as low plate resistance, high current carrying capacity, high dissipation, and high heater-

to-cathode insulation. A voltage regulator circuit using such a tube is shown in Fig. 5.

This model was constructed on a 10½" x 7" x 2½" aluminum chassis. The components the author used are relatively large, having been obtained on the surplus market. Since this particular regulated supply was designed for use with a triode-connected 807 amplifier with cathode follower drivers, it also contains a 105 volt negative supply. The layout is straightforward and the wiring is simple. See Fig. 6. All the filament leads are twisted and kept well away from the 6SJ7 tube. A fuse was included as a safety measure. As the power switch was to be located remotely, it was not included on the power supply chassis. By using a standard power transformer and a resistor instead of the choke, the size of the supply could be cut in half. The layout is not critical except for keeping the 6SJ7 grid lead short. The supply could easily be included on the amplifier chassis.

This regulated supply, using the values shown, will deliver from 0 to 150 ma. with no measurable change. There is a change of less than 0.1 volt in 300 at a drain of 200 ma. The output voltage may be varied from 270 to 350 by adjusting R_s . The best regulation is obtained at a value of output voltage between 290 and 335 volts.

Without the regulator, the great change in output voltage is shown in Curve B in Fig. 2. The ripple in the regulated supply at a current drain of 200 ma. is .016 per-cent (.05 v. in 300) which is many times less than that of a double choke filter. The supply will maintain this excellent regulation and

SERIES TUBES		D.C.	Table 1. Tubes which may be used when choosing tube lineup for a regulated power supply. Any sharp cut-off pentode may be used for the d.c. amplifier.
Type	Ma.	AMPLIFIER TUBES	
6AS7G	250	6SJ7	<p style="text-align: center;">TARGET VR TUBES</p> OA2 150 v. (miniature) OA3 (VR75) 75 v. (standard octal) OB2 108 v. (miniature) OC3 (VR105) 105 v. (standard octal) OD3 (VR150) 150 v. (standard octal)
6B4G	75	6I7	
2A3	75	6SH7	
6L6*	70	9001	
6V6*	45	6AC7	
6K6*	35	6AK5	
6F6*	40	7G7	
6Y6*	66	7AG7	
807*	75	6BH6	
		6AG5	

* These tubes must be triode-connected

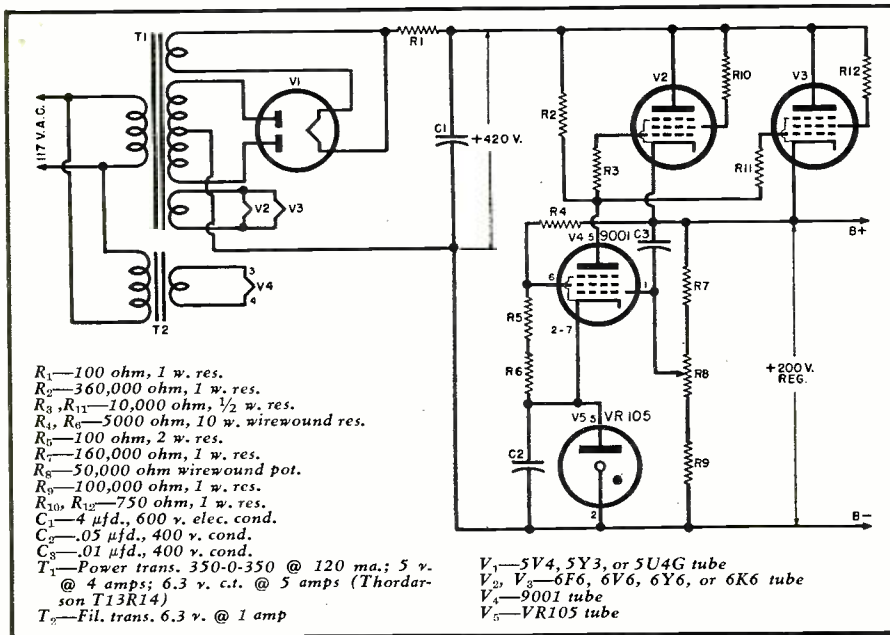

Fig. 7. Circuit diagram of a regulated power supply rated at 200 volts d.c. @ 100 ma. Higher output voltage can be obtained by using a higher voltage power transformer.

low ripple from 95 to 130 volts input to its power transformer.

There are no electrolytic condensers in the regulated supply and it will, therefore, give years of service without the deterioration to which electrolytics are prone. More important, however, the supply exhibits an output impedance of less than 0.1 ohm which is substantially independent of frequency.

Effectively, the power supply is a short circuit to all frequencies in the audio frequency range and well beyond, both above and below. The 0.1 μ f. condenser connected to the grid of the 6SJ7 serves to improve the high frequency response of the regulator tube to beyond several hundred kc.

Although a choke was used in the circuit in Fig. 5, it was not needed from a filtering standpoint but because a choke input system places a more gentle load on the power transformer. It eliminates the high current surges that occur in a condenser input system. A 100 ohm resistor would have done nearly as well in this case.

Since the 6AS7 is relatively expensive (over \$4.00), for those who wish to be economical a number of 6Y6 tubes may be connected in parallel. These tubes make excellent series reg-

ulator tubes when their screens are tied to their plates through a 750 ohm resistor, and they are readily obtainable and are inexpensive. These tubes triode-connected will pass about 75 ma. per tube. Three 6Y6 tubes may be substituted for the 6AS7G in Fig. 5.

Since the 6Y6 does not have the high heater-to-cathode insulation of the 6AS7G, it must be operated from a separate filament winding.

It is essential that the pentode d.c. amplifier tube be operated from its own 6.3 volt winding or serious hum may be developed. The grid leads of this tube should be shielded if they are long so that they do not pick up any hum, or the tube will amplify it and modulate the output voltage.

Fig. 7 shows another regulated supply using different tubes. Miniature tubes can be used to an advantage in this service, and, if very small size is desired, all the tubes may be of the miniature type.

The unit of Fig. 7 will supply from 180 to 250 volts, depending on the position of R_8 , at from 0-100 ma. It has the same inherent low ripple and low impedance that the supply in Fig. 5 has. It uses a standard receiver-type transformer. It will be noted that there

is no choke, only a 100 ohm resistor and a 4 μ f. paper condenser, yet the ripple is low enough for the unit to supply plate power to a reluctance pickup preamp. (See Fig. 1)

One of the few disadvantages of the voltage regulated power supply is that the power transformer must have a voltage rating several hundred volts higher than is usually used. This is due to the drop across the series tube. Most transformer manufacturers list power transformers with the required 500 odd volts each side of the center tap.

There are a number of combinations of tubes which may be used in a specific regulated supply and for all practical purposes will work with equal efficiency. Table 1 may be used in choosing the tube lineup for a regulated supply. Any sharp cut-off pentode may be used for the d.c. amplifier.

It is desirable to select series tubes with some reserve current carrying capacity to allow for extreme variations in line voltage. This reserve will allow the regulator to operate on the flat part of its curve and exhibit almost zero internal resistance. In general, the power transformer should be rated to supply approximately 200 d.c. volts in excess of the desired regulator output voltage.

Fig. 6 shows the regulator whose circuit is diagrammed in Fig. 5.

Tests were conducted using the regulated supply to power a triode-connected 807 amplifier. This amplifier required a current swing from 90 ma. with no signal to 160 ma. for full output. Fig. 8 traces the frequency response curve of this combination at two power levels with a condenser input power supply and with the regulated supply. The improvement in response at low frequencies is quite obvious.

The regulated supply used in conjunction with a high fidelity amplifier then provides lower distortion, less hum, better stability, lower cost (not only for power supply components, but because fewer RC filters are required throughout the amplifier), and will use less space and weigh a lot less. In addition to all this, low frequency response is limited only by the quality of the output transformer.

The regulator's ability to remove external voltage variations is uncanny. To illustrate: A 6.3 volt filament transformer was connected in series with the d.c. regulated output. The output voltage was measured with an a.c. voltmeter and a series condenser of sufficient capacity (10 μ f.). No a.c. voltage could be read on the 0-2.5 volt range on the meter as the regulator was actually regulating out the entire 6.3 volt a.c. impressed on its output.

This test shows how effective the regulator is in smoothing out its output voltage in spite of any normal load condition. It is wise to consider the use of a regulated supply for not only audio amplifiers and receivers, but also for any other quality electronic equipment.

Fig. 8. Output characteristics (from 20 to 40,000 c.p.s.) of a cathode-follower driven triode-connected 807 amplifier with normal and regulated power supply units.

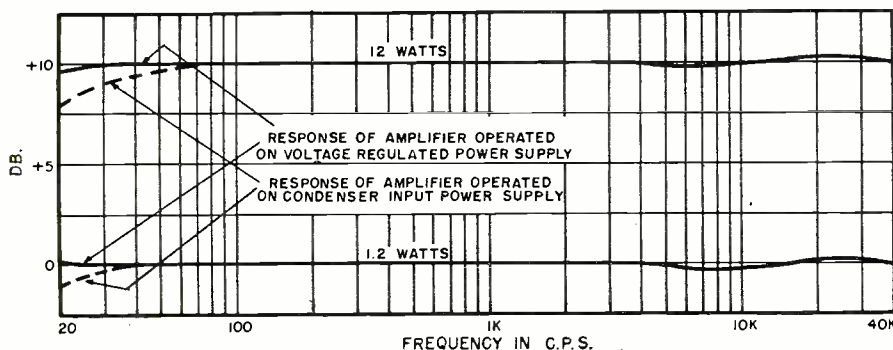

A Compact, Amateur Band SUPERHET

By
RAY D. ZIMMERMAN,
W3KQY

Unit covers all amateur bands from 3.5 to 54 mc. by means of six plug-in type tuning units.

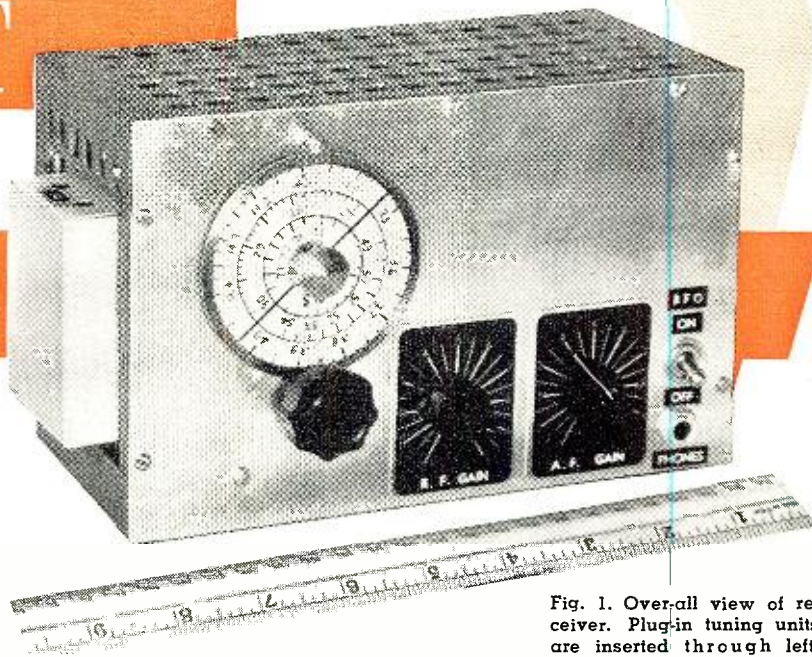

Fig. 1. Overall view of receiver. Plug-in tuning units are inserted through left-hand side of the cabinet.

ALTHOUGH the average communications receiver has numerous refinements and operating conveniences that are desirable in fixed station operation, it usually leaves much to be desired in the way of portability. The need for a receiver that would perform satisfactorily in the home station and still be small enough to fit conveniently into the traveling amateur's suitcase led to the design and construction of the units described in this article.

Despite the small size of the receiver (4" x 5" x 8"), it provides loudspeaker or earphone reception of phone and c.w. signals on all amateur bands from 3.5 to 54 mc. The amateur bands within these frequency limits are covered by six plug-in tuning units, each of which contains the oscillator, mixer, and antenna coils to cover the given band. As an operating convenience, the dial is calibrated in megacycles for each of the tuning units, and each amateur band is spread across a large portion of the dial. The built-in power supply operates on 117 volts 50 to 60 cycles a.c. or d.c.

In common with many communications receivers, the unit was designed to use an external PM speaker. Although there is sufficient space available to mount a very small speaker on the front panel of the receiver, the use of an external speaker is desirable because it eliminates acoustic interaction between the speaker and the plates of the tuning condenser and allows the full output capability of the receiver to be realized. The speaker used by the writer is a 5" PM unit mounted in a homemade, aluminum cabinet. Earphones can be plugged into the phone jack on the front panel of the receiver, if desired.

Although the advantages of an r.f. stage were not overlooked in the de-

sign of the receiver, the r.f. stage was omitted in the interests of simplicity and compactness. This, in turn, made the use of a 1600 kc. i.f. system desirable in order to obtain good image rejection. Two stages of i.f. amplification are required for reasonable sensitivity and selectivity at 1600 kc., while one stage would suffice at 455 kc.; however, the increased image rejection provided by the 1600 kc. i.f. more than justifies the inclusion of the second i.f. stage.

The oscillator, mixer, and antenna coils are built into plug-in tuning units constructed as shown in Fig. 3. A piece of sheet aluminum, formed as shown in the illustration, serves as a mounting plate for the tuning unit components. Running down the center of the mounting plate is a shield which isolates the mixer circuit from the oscillator circuit and, at the same time, serves as a support for the mica trimmer condensers. The two coil forms are supported by an "L" bracket through which the adjusting screw for the slug protrudes. Five banana plugs are mounted on the bottom of the mounting plate. One of these plugs is a common ground connection secured directly to the mounting plate, while the other four are insulated by mounting them on polystyrene strips which are bolted to the underside of the plate. The heads of the mounting screws for the insulated banana plugs protrude through $\frac{1}{2}$ " holes in the mounting plate. Under the heads of these screws are lugs to which the appropriate coil leads are connected. The cover for the tuning unit is made of sheet aluminum, cut and bent as shown in the illustration. Self-tapping

screws hold the cover to the mounting plate.

The slug-tuned coil forms used in the tuning units built by the writer were obtained from two defective push-button tuners of the type used in broadcast receivers. Although the iron slugs in these tuners were not designed for high frequency applications, they were used on all bands covered by the receiver with no apparent ill effects. When these forms are used, however, the 10 and 6 meter coils must be wound near the end of the form so that very little of the slug is within the coil winding. Table 1 shows the number of turns required for the coils when this type of coil form is used. If push-button tuner coils are not readily obtainable, *Cambridge Thermionic Corp.* Type LS3 coil forms can be used. These slug-tuned forms are $\frac{3}{8}$ " in diameter and have a winding length of approximately $\frac{5}{8}$ ". The coil winding data for this type form is also given in Table 1.

One section of a 12AT7 dual triode functions as the high frequency oscillator, operating on the high frequency side of the received signal on all bands, while the other section serves as a triode mixer. The oscillator and mixer grid circuits are tuned by a split-stator variable condenser that originally had a capacitance of 15 $\mu\mu\text{fd.}$ per section. The condenser was modified by removing one rotor plate from the mixer tuning section. This allows a higher LC ratio to be maintained in the mixer grid circuit because it reduces the amount of tracking capacitance required at C.

Two 1600 kc. i.f. amplifier stages follow the converter, and each stage

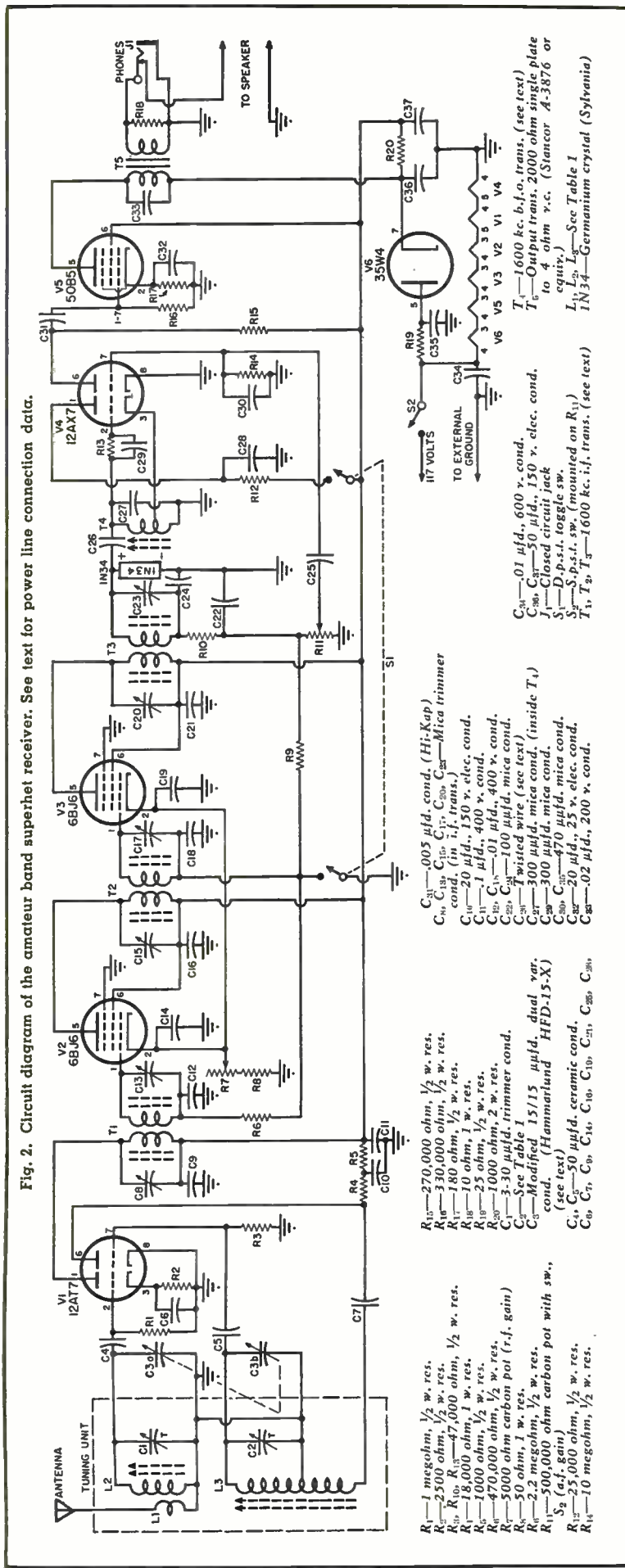

uses a 6BJ6 remote cut-off pentode. The circuit arrangement is such that during reception of phone signals when the b.f.o. is turned off, a.v.c. voltage is applied to the grids of both i.f. tubes; however, when the b.f.o. is turned on to receive c.w. signals, a section of the b.f.o. switch shorts the a.v.c. line to ground, thus disabling the a.v.c. In this manner, the proper conditions for the type of reception desired are automatically obtained by setting the b.f.o. switch to the appropriate position. Manual control of the i.f. gain is provided by the b.f.o. in the cathode circuit of the i.f. tubes. This control is normally turned full on during phone reception and is manually adjusted to prevent blocking when receiving c.w. signals.

The i.f. transformers were originally midget 455 kc. units. They were altered, however, by removing turns from the windings until the transformers resonated at 1600 kc. and then varying the space between the windings until the correct coefficient of coupling was obtained. Since this is a task that requires more equipment than is possessed by the average amateur, it is recommended that ready-made 1600 kc. transformers be used by anyone who builds the receiver. Although ready-made i.f. transformers were not tried in the set built by the writer, Stanwyck Part Nos. SM-129 and SM-130 appear to meet the electrical and mechanical requirements. These units are designed for a 1500 kc. i.f. system which should perform satisfactorily in the set.

A 1N34 germanium crystal serves as the second detector and develops the a.v.c. voltage that is applied to the i.f. stages. In addition to the small size of the 1N34, the fact that it does not require a heater supply makes it ideally suited in this application. Included in the second detector circuit is the audio gain control, R_{11} , to which is ganged the line switch S_2 .

One section of a 12AX7 dual triode is used as a resistance-coupled audio amplifier, while the other section functions as the beat frequency oscillator. The grid of the audio section is bypassed for r.f. by a 470 μ fd. mica condenser, C_{30} , to keep r.f. from the station transmitter out of the audio system of the receiver and thus avoid audio feedback during phone transmissions. The b.f.o. section of the 12AX7 is coupled to the second detector by C_{26} which consists of a few turns of insulated wire wrapped around the lead from the 1N34. By adding or removing turns, the coupling can be adjusted to give the desired b.f.o. injection.

Another home-built component in the receiver is the b.f.o. transformer. This unit was made from a midget 455 kc. slug-tuned i.f. transformer. All the turns were first removed from the coil form which, incidentally, was $\frac{1}{4}$ " in diameter. Then 95 turns, with a tap at 35 turns from the low potential end, of #28 enameled wire were closewound on the form, and a 300 μ fd. condenser was connected across the entire winding. With this combination assembled in the shield can and connected as shown on the schematic diagram, the b.f.o. is tunable from 1450 kc. to 1750 kc. by adjusting the iron slug.

In the output stage of the receiver, a 50B5 beam power amplifier delivers plenty of power for loudspeaker reception. This tube is capable of supplying 1.9 watts into the 2500 ohm load presented by the output transformer. The purpose of the 10 ohm resistor (R_{18}) across the secondary of the output transformer is to keep the impedance reflected into the primary wind-

ing of the transformer down to a reasonable value when earphones are used. Since the voice coil impedance of the speaker is only 3.2 ohms, the 10 ohm resistor has no great effect when the speaker is being used. However, when earphones are inserted into the jack, the 50B5 would be operating into much too high an impedance were it not for the loading effect of the resistor.

The receiver is powered by a half-wave rectifier circuit using a 35W4 tube. Adequate filter is provided by C_{36} and C_{37} in conjunction with R_{30} . Approximately 115 volts are applied to the plate of the 50B5, while the plate and screen supply voltage for the other tubes is about 95 volts. Additional filtering (R_8 and C_{10}) for the oscillator plate drops the voltage applied to this tube slightly below 95 volts. The additional filtering is highly desirable, however, because it eliminates all trace of oscillator ripple and makes possible a nice d.c. signal even on the highest band. The 470 μ fd. condenser, C_{35} , connected from the plate of the 35W4 to ground eliminates a form of hum that appeared on the higher frequency bands, and the .01 μ fd. condenser, C_{31} , connected across the power line serves to bypass line noise. The tube heaters are connected in series across the 117 volt line. It should be noted that the wiring sequence of the heaters with respect to ground is rather important. The heaters in the circuits most sensitive to a.c. hum must be closest to ground potential. If the tubes are wired as shown, no hum troubles will be experienced.

To avoid the shock hazard that usually accompanies a.c.-d.c. power supplies, advantage has been taken of the fact that one side of the outside power line is grounded. One of the wires in the receiver's power cord is not connected in any way. In lieu of the unconnected wire, *the chassis itself must be connected to a good external ground.* Then, when the power plug is correctly oriented in the 117 volt receptacle, the line voltage will be applied to the receiver. If the power plug is incorrectly inserted at first, no voltage will be applied, and it will be necessary to reverse the plug. Since the chassis is connected directly to ground, the unit is as safe to operate as one containing a conventional power supply using a transformer. It should be emphasized, however, that the chassis must be connected to a good external ground, and this ground connection must be made *before* the power plug is inserted into the receptacle.

Sheet aluminum was used liberally in the construction of the receiver. The chassis, which measures 7" long x 3½" wide x 2" deep, and the covers for the tuning units are made of light gauge aluminum, while the front panel and the tuning unit bases are formed from heavier (1/16") aluminum. Also made of heavier gauge stock is the metal support for the tuning unit

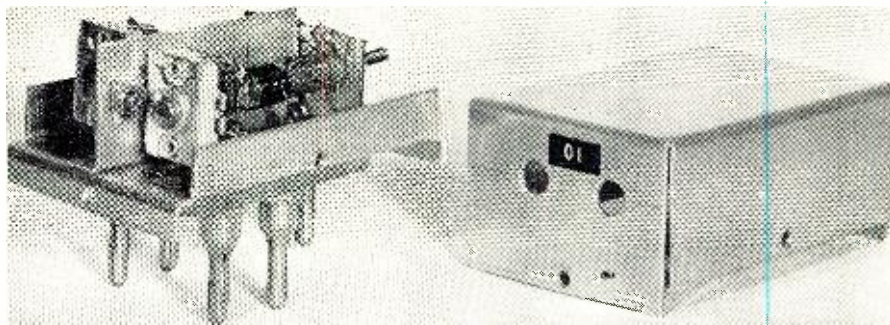

Fig. 3. The 10-meter tuning unit with cover removed. The trimmer and slug-tuned coil on the near side of the shield tune the mixer grid, while a similar trimmer and coil behind the shield tune the oscillator. The holes in the cover allow trimmer adjustments with cover in place. Tuning units for other bands are constructed identically.

socket. This support consists of a 2" x 4" piece of sheet aluminum which is securely bolted to the end of the chassis so that 2" of the support extends above the chassis. To the extended portion is bolted a piece of polystyrene which is drilled to accommodate jacks for the four insulated banana plugs on the tuning unit. One-half inch holes are drilled in the aluminum support at the points where the jack heads protrude. The jack for the grounded banana plug extends through the end of the chassis itself and is, of course, uninsulated. To lend additional rigidity to the socket, an L-shaped strip of aluminum is bolted to the face of the aluminum support in such a manner that it extends from top to bottom, along the center of the support. A similar L-shaped strip is bolted to the end of the chassis at the bottom, inside.

Short leads are obtained in the converter circuits by mounting the 12AT7 tube socket above the chassis on ½" spacers, close to the tuning condenser. The 12AT7 grid connections are all

above the chassis, and the heater, plate and cathode leads run through a large hole directly under the tube socket. All the other tube sockets are mounted flush with the chassis. A tube shield is used on the converter as well as on each of the two i.f. tubes.

The dial is a readily-available, commercial type to which was glued a homemade scale. The scale consists of a circular piece of heavy white paper calibrated in ink as shown in Fig. 1. Each of the six bands covered by the receiver is spread over a 180 degree arc on the dial, and the calibration points were determined by using a signal generator. In order to avoid confusion when placing the calibration marks on the scale, it should be noted that the frequency increases in opposite directions on the two sectors of the scale. A coat of clear lacquer over the finished dial scale prevents smudging and provides a durable finish.

In the alignment of the i.f. system, the first step is to find the frequency between 1500 and 1700 kc. that is most free of interfering signals in your lo-

Fig. 4. Top view of chassis with a tuning unit in place. The tube nearest the front panel is the 35W4. Below the 35W4 are the 12AT7 and the 1st i.f. transformer. To the left of the 1st i.f. transformer, along the back of the chassis, are: 6BJ6 1st i.f., 2nd i.f. transformer, 6BJ6 2nd i.f., and the 3rd i.f. transformer. Directly above the 3rd i.f. transformer is the 12AX7. The b.f.o. transformer is at right of the 12AX7. The output transformer is in the upper left corner while below and to the right of the output transformer is the 50B5.

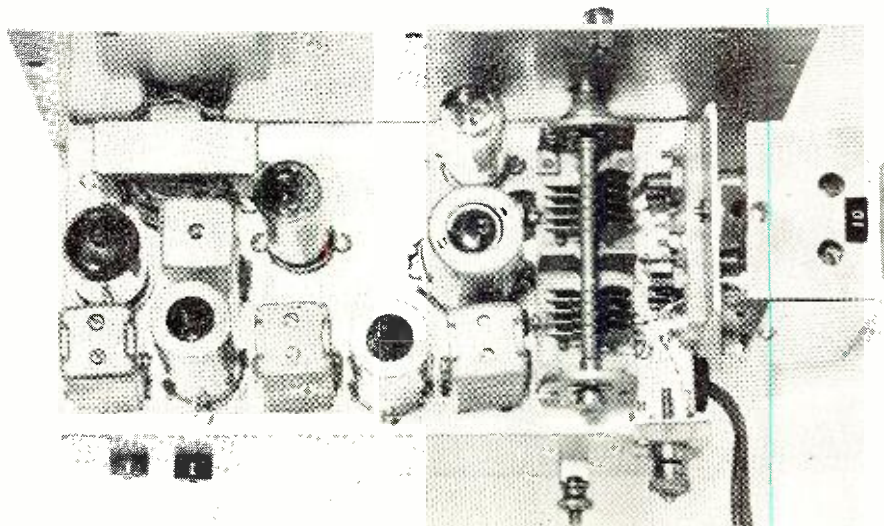

Freq. Range in mc.	L ₁ *	L ₂	L ₃	C ₂
3.5 to 4	7 t.	60 t. closewound 1" long	60 t., closewound tap 15 t. from gnd. end	3-30 μfd. trimmer
6.9 to 7.4	5 t.	30 t. closewound ½" long	30 t., closewound tap 10 t. from gnd. end	3-30 μfd. trimmer in parallel with 50 μfd. fixed cond.
13.95 to 14.45	3 t.	20 t. spaced to ½"	13 t., closewound tap 5 t. from gnd. end	3-30 μfd. trimmer in parallel with 100 μfd. fixed cond.
20.5 to 21.9	3 t.	13 t. spaced to ½"	13 t., spaced to ½", tap 4 t. from gnd. end	3-30 μfd. trimmer in parallel with 50 μfd. fixed cond.
27 to 30	2 t.	10 t. spaced to ⅜"	12 t., spaced to ⅜", tap 4 t. from gnd. end	3-30 μfd. trimmer
48 to 55	1½ t.	5 t. spaced to ⅝"	8 t., spaced to ⅝", tap 2 t. from gnd. end	3-30 μfd. trimmer

*L₁ is interwound with bottom of L₂.

NOTE: The above winding data applies only to slug-tuned coil forms of the type used in broadcast receiver push-button tuners. These forms are ½" in diameter with a winding length of 1½" and contain a powdered iron slug. No. 28 en. wire should be used for these coils.

NOTE: If Cambridge Thermionic Corp. (445 Concord Ave., Cambridge 38, Mass.) Type LS3 coil forms are used in lieu of the push-button type forms, these specifications apply. All of the coils are wound with No. 34 en. wire.

Freq. Range in mc.	L ₁	L ₂	L ₃
3.5 to 4	Same winding specifications as above	85 t. closewound	80 t. closewound, tap 20 t. from gnd. end
6.9 to 7.4		45 t. spaced to ⅝"	35 t. spaced to ⅝", tap 12 t. from gnd. end
13.95 to 14.45		22 t. spaced to ⅝"	16 t. spaced to ⅝", tap 6 t. from gnd. end
20.5 to 21.9		15 t. spaced to ⅝"	15 t. spaced to ⅝", tap 5 t. from gnd. end
27 to 30		11 t. spaced to ⅝"	14 t. spaced to ⅝", tap 5 t. from gnd. end
48 to 55		6 t. spaced to ⅝"	8 t. spaced to ⅝", tap 2 t. from gnd. end

Table 1. Winding data for the various tuning unit components used in the superhet.

cality. This can be accomplished by tuning a receiver over the frequencies in question at different times of the day and night. The least occupied frequency, then, should be your intermediate frequency. In the next step, a modulated signal generator is practically a necessity. Connect the high side of the signal generator to the grid of the second i.f. tube (V₂) through a .01 μfd. condenser, and connect the low side of the generator to the chassis. An output meter, if available, should be connected across the speaker voice coil as an indicator. With the generator set to the desired i.f., the receiver b.f.o. turned off and the r.f. and a.f. gain controls fully on, ad-

just the primary and secondary trimmers of the third i.f. transformer (T₃) for maximum output. During this and the following operations, keep the generator output attenuated sufficiently to avoid a.v.c. action as indicated by an apparent broadness in tuning. Next, move the signal generator connection to the grid of V₂, and repeat the process, this time adjusting T₂ for maximum output. Then, move the generator connection to the mixer grid (pin 2) of V₁, and adjust T₁ for maximum output. At this point, all the i.f. transformers should be repeaked carefully for maximum output. Now, remove the modulation from the signal generator, turn on the receiver b.f.o., and adjust

Fig. 5. Under chassis view. Filter can inside the left end of the chassis contains C₂₂, C₂₆, and C₂₇. The terminals at the lower left of the photo are for the antenna and ground. The pin jacks at the lower right of the chassis are for the speaker.

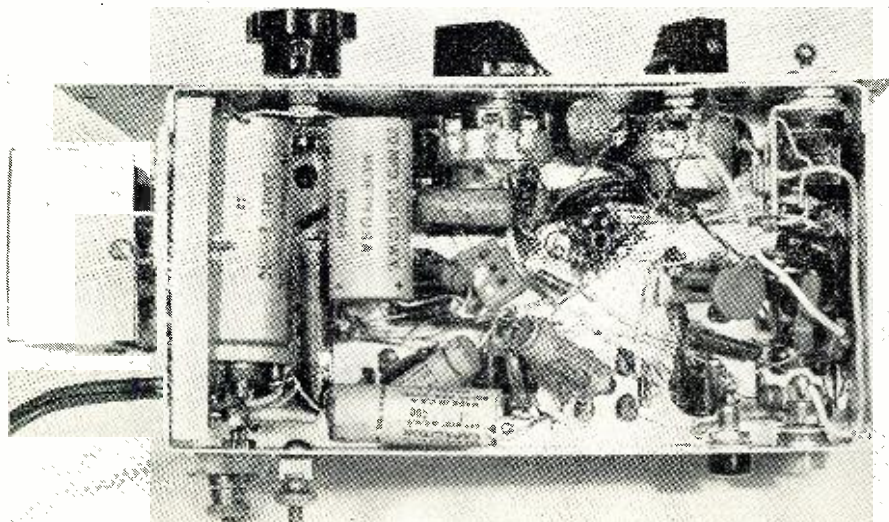

the slug in the b.f.o. transformer (T₁) until a 1000 cycle beat note is heard.

After the i.f. system has been aligned, each of the tuning units should be adjusted in turn. The first step in the alignment of a tuning unit is to make the oscillator cover the required frequency range. This can most easily be accomplished by using a calibrated receiver to locate the signal generated by the oscillator. To determine the oscillator frequency that should be obtained when the tuning condenser is completely meshed, add the intermediate frequency to the lowest frequency covered by the tuning unit in question, and to determine the frequency that should be obtained when the condenser is completely open, add the intermediate frequency to the highest frequency covered by the tuning unit. Set the calibrated receiver to the higher of the two frequencies determined by the method just described, rotate the tuning condenser to its open position, and adjust the slug in L₂ and the oscillator trimmer (C₂) until the signal is heard in the receiver. Then, rotate the tuning condenser to its meshed position, and locate the oscillator frequency on the calibrated receiver. If the frequency is lower than the lower frequency, decrease the inductance of L₂ by turning out the slug. If the frequency is higher than the lower frequency, increase the inductance of L₂ by turning in the slug. Again set the calibrated receiver to the higher of the two frequencies, open the tuning condenser, and this time adjust only C₂ until the signal is heard. Rotate the tuning condenser to its meshed position, and locate the oscillator frequency. This time the oscillator should be closer to the desired frequency. Repeat this process until the desired range is covered by the oscillator.

The final step in the alignment of a tuning unit is to track the mixer grid circuit. Adjust the signal generator to a frequency near the high end of the tuning unit range, and place the output lead from the generator near the antenna terminal of the receiver. Tune in the signal on the receiver, and with the r.f. gain control turned down to prevent blocking, adjust C₁ for maximum output while rocking the tuning condenser back and forth across the signal. Now adjust the signal generator to a frequency near the low end of the band, and again adjust C₁ for maximum output. If it was necessary to increase the capacitance of C₁ to obtain maximum output at the low end of the band, increase the inductance of L₂ by turning in the slug. If the capacitance had to be decreased, decrease the inductance of L₂. Again peak C₁ at the high end of the band, and check the tracking at the low end. Continue adjusting L₂ until the signal peaks with the same setting of C₁ at both ends of the band.

Excellent results may be obtained with a random length of wire, but a resonant type of antenna is recommended where possible.

THE "TAPERED LINE" TV TUNER

By

DANIEL LERNER

TV Field Service Eng., Philco Corporation

Fig. 1. Philco's tapered line TV tuner.

Details on a recently-developed antenna matching system used in Philco model television receivers.

A RECENTLY developed matching system used in conjunction with Philco's wafer-type television tuner does much towards improving the over-all front-end performance. In fringe area work, where good front-end sensitivity is a prerequisite, this tapered line matching system with its inherent voltage step-up has meant the difference between a very snowy picture and a good, clear, well-synchronized one.

Fig. 1 is a photograph of the tuner. The tapered line section is mounted separately on the rear of the unit and consists of two forms upon which are wound two conductors which are closely spaced near the top of the form and more widely spaced near the bottom of the form. These conductors may be considered as open wire transmission lines, the impedance of which will vary directly with the spacing between conductors. The closely spaced ends have a characteristic impedance of 150 ohms. Since the impedance of a particular transmission line depends solely upon such factors as the diameter of the conductors, the length involved does not enter into the impedance calculation. Therefore the tapered line section can be considered essentially as a long non-linear open-wire transmission line.

Fig. 2 is an equivalent circuit of the tapered-line system showing how either a 75 ohm or 300 ohm line can be matched properly. The output side, or widely spaced end of each tapered

line, has an impedance of 300 ohms. The two widely spaced ends are connected in series to give a total output impedance of 600 ohms. This 600 ohm output impedance is maintained at 600 ohms whether a 75 ohm or 300 ohm transmission line is used. The tapered line section is terminated by the tube's impedance and an additional 1200 ohm resistor which is a good optimum value for the input impedance of the r.f. amplifier.

Fig. 3 shows how the input resistance of a 6AG5 varies as the frequency

changes. It should be noted that at the lower TV frequencies, 50 or 60 megacycles, the input impedance is relatively high while at the higher frequencies, 100 to 200 megacycles, it is relatively low. Hence, the necessity for an additional loading resistance of 1200 ohms. The combination of the 1200 ohm loading resistance and the tube's input resistance represents a compromise in securing the best possible transmission line match over the band of frequencies involved. The

(Continued on page 78)

Fig. 2. Equivalent circuit of tapered line. (A) for 75 ohm input, (B) for 300 ohm input.

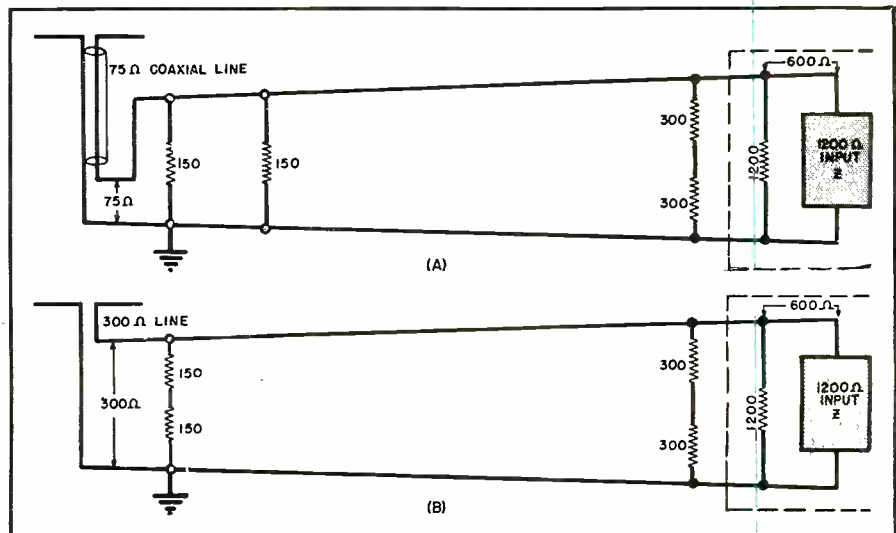

OSCILLATIONS in the VIDEO I.F. AMPLIFIER CIRCUITS

By WM. A. TRETTER

Misalignment or a defective component? Here is a reliable method for isolating this form of trouble.

AT SOME TIME or other, the service technician has or will run into the problem of oscillations in the video i.f. strip. If there is any semblance of a picture on the screen, it is extremely contrasty and covered with long white streaks or has a spotted appearance that is little affected by changes of the contrast control; unless it is a set where most or all of the video i.f. tubes obtain their bias through the contrast control.

Connecting a vacuum tube voltmeter across the detector load resistor gives an excessive voltage reading even when no input signal is present. Normal readings across the detector load resistor average around a volt and less. This is due to space charge in the detector tube itself, plus a small amount of rectified voltage caused by normal disturbances such as noise, etc. When oscillations are present, this voltage will rise to a high value and, in extreme cases, will read as high as thirty volts when the contrast control is adjusted to maximum.

It is very difficult to determine off-hand the cause of oscillations. Connecting up the equipment necessary for an alignment check will be of little help since the meter already indicates the presence of a signal, and in this case, an undesired signal that is being generated in the set itself.

These oscillations can be caused by two things. Either the i.f. strip is misaligned, or one of the components is defective. A leaky coupling condenser or a change in value of one or more of the loading resistors across the i.f. coils can also cause oscillations in the video system. A leaky coupling condenser permits the positive charge on the plate of the tube ahead to leak

over. This charge reduces the normal bias on the tube and results in excessive gain in that stage.

An increase in value of the loading resistors in the grid and plate circuits of the i.f. stages causes the "Q" of the circuit to go above normal. Here again, excessive gain at some particular frequency will permit oscillations to develop.

It may be wise for the service technician, when confronted with this problem, to first acquaint himself with the alignment notes and procedures as outlined by the set manufacturer. The location of the tuning slugs should be marked directly on the chassis, or on a piece of paper with a sketch of the video i.f. strip. Notes should also be made on the different steps taken and their effect on the voltmeter reading or oscilloscope screen.

Before the actual alignment is attempted, it will be necessary to eliminate the oscillations. Since it is comparatively easy to correct a badly aligned i.f. strip, that will be the one to tackle first. Adjusting all the tuning slugs midway in their tuning range is not a reliable method. In some receivers this may result in all the i.f. coils being set to the same frequency, and will most certainly increase the possibility of oscillations. A better method is to locate the i.f. coil that corresponds to the lowest i.f. and turn that slug all the way in. Then locate the coil that corresponds to the highest i.f. and turn that slug all the way out. If one of the coils is normally set to the center frequency of the i.f. bandpass, that slug should be approximately centered. Any other slugs should be set either quarter way in or halfway between the others, de-

pending on their respective frequencies. This will result in an extremely wide i.f. response, but will certainly eliminate any tendency towards oscillations, which previously may have been caused by two or more i.f. coils being set close to the same frequency. The rest of the alignment can now be accomplished by checking over the manufacturer's alignment table and sticking close to that procedure. If the oscillations were merely the result of a badly aligned set, this is about the best procedure to follow.

But suppose that after going through all this the oscillations are still present. This is indicated by an excessive voltage across the detector load resistor which may suddenly develop as one of the i.f. coil slugs is being adjusted close to its normal setting. Then the trouble is due to a defective component and is more difficult to correct than a set that is badly aligned.

Needless to say, a v.t.v.m. should be used when making the checks described in the following text. It does not load down the circuit; has a very high input impedance; and will detect the slightest amount of leakage in a coupling condenser. Measure and record all voltages present at the plates, grids, and cathodes of the picture i.f. tubes. If any of the grids measure less negative than normal, it indicates a leaky condenser or a gassy tube.

Since contrast control circuits vary with different sets, a standard checking procedure should be adopted. Measure the voltage at either end of the grid load resistor. It should be the same with respect to ground. If it is not, then proceed as follows: keep the voltmeter connected to the grid of the tube in question and pull out the tubes on either side of the coupling network. If the voltage on the high side of the grid load resistor is still less negative, the cause is definitely a leaky coupling condenser which should be replaced immediately.

But suppose the voltmeter shows normal reading after the two tubes have been removed. Then check for a gassy tube by replacing the questionable tube with one known to be good. If the question of bias still exists, a resistance check is in order. Turn off the set, let the tubes cool, and then measure the values of all the grid and plate load resistors. Also check the screen and decoupling resistors for change in value.

Another method for locating the stage or stages in which oscillations are being developed is as follows. Here each i.f. grid is shunted to ground with a 1000 μ fd. condenser. This will eliminate any tendency for oscillations to build up. The next step is to remove one condenser at a time, starting from the last stage next to the detector. As each condenser is removed from the circuit, observe the v.t.v.m. for any sudden increase in voltage across the detector load resistor. A large increase in voltage indicates the trouble originates in that stage.

(Continued on page 131)

SERVICING TV SYNC CIRCUITS

By
SOLOMON HELLER*
and
PETER ORNE

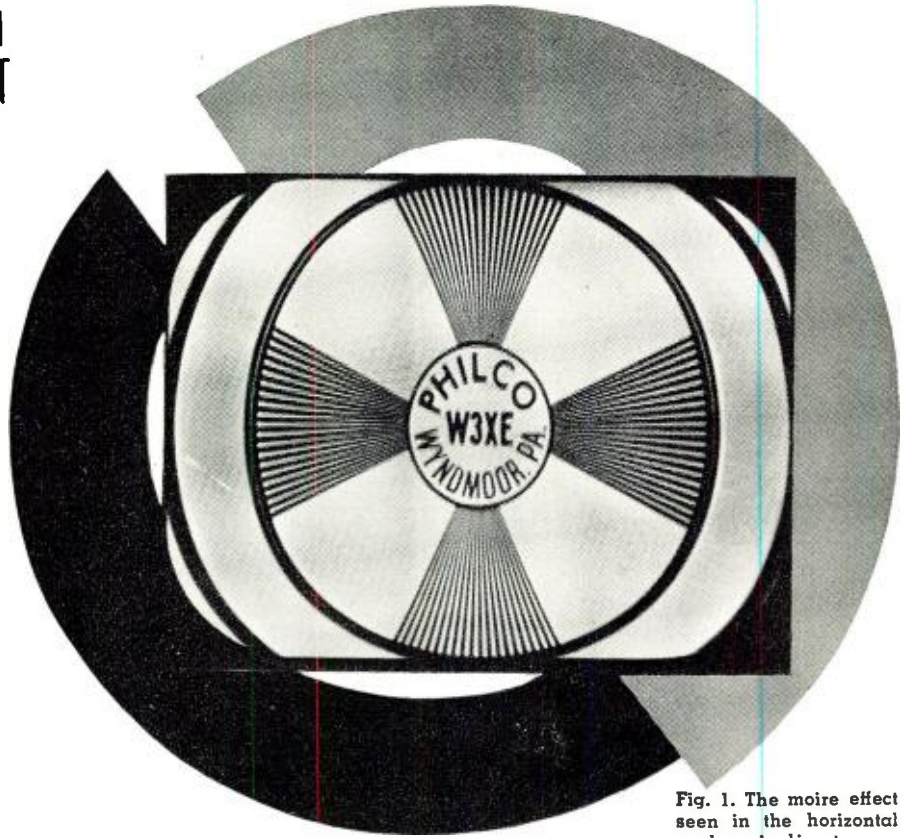

Fig. 1. The moiré effect seen in the horizontal wedges indicates an imperfect interlace.

Part I. A detailed explanation of the operation and servicing of conventional TV sync circuits.

THE sync section of the television receiver probably arouses more feelings of inferiority and self-distrust among service technicians than any other TV section. An explanation of the operation and servicing of typical sync circuits should therefore prove welcome.

The first question that must be faced by the service technician is: When should trouble in the sync section be suspected? If sound and raster are normal, video information is present, but the picture does not hold, a defect in the sync section is indicated. The picture will, in such a case, (a) roll vertically, (b) tear out in horizontal strips, (c) refuse to lock in horizontally, or (d) refuse to lock in horizontally and vertically.

If both vertical and horizontal synchronization are imperfect, trouble should be suspected in the stages through which both horizontal and vertical sync pulses pass, *i.e.*, the sync stages preceding the inter-sync separation circuits. If the picture does not hold in one direction only, trouble in the inter-sync section is indicated. This is the section where the vertical and horizontal pulses are separated, and transferred to the deflection oscillators they respectively control.

Improper synchronization that is accompanied by an impairment of other picture characteristics (such as contrast, resolution, etc.) may be observed. In such cases, trouble in some section of the receiver other than the sync should be considered. For example, improper synchronization that is accompanied by insufficient sound, or an inadequately-sized raster, or both, indicates a fault in the power supply, not in the sync circuits.

Troubles and Troubleshooting

A general description of troubles that may be expected in the sync section will be offered before specific circuits are discussed. Common troubles

* Co-author of book "Television Servicing" published by McGraw-Hill.

may be listed, in the order of their frequency, as follows:

1. Bad tubes (open filament, internal short, low emission).
2. Defective condensers (shorted, leaky, or open).
3. Defective resistors (increased in value, decreased in value, shorting to chassis).

Less common troubles include defects caused by poor servicing procedures, such as: (a) shorts due to solder drippings; (b) cold solder joints; (c) burned insulation; (d) components that make contact against each others' pigtailed; (e) incorrect wiring.

Troubles that are rare, but capable of causing considerable head-scratching among service technicians that don't expect them, are: (a) wax on tube pins; (b) broken lug in a tube socket; (c) leaky terminal post (*i.e.*, one whose insulation is defective).

In the case of a broken lug in a tube socket, nothing may be seen that will indicate the trouble. Circuit resistance checks will also be normal. Continu-

Fig. 2. (A) A video signal in positive picture phase and (B) in the negative phase.

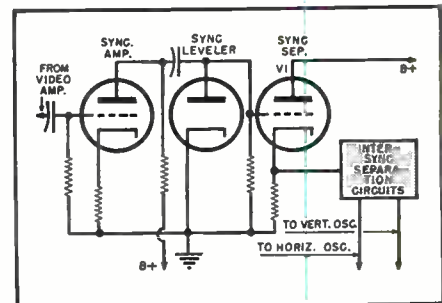
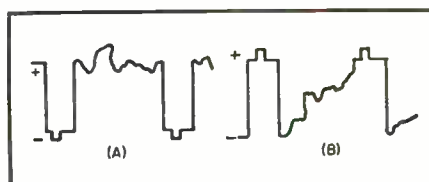

Fig. 3. The basic circuit used in sync section of the television receiver.

ity measurements between contacts *above* the socket, with corresponding contacts *below* it, will, however, reveal the defect.

Leaky terminal posts may draw suspicion by the presence of a carbon deposit on them, at the point where previous arcing took place. Sometimes no carbon deposit may be seen, and the terminal post may still be defective (possibly because of moisture absorption). In either case, a resistance check between the terminal contact and adjacent contacts or chassis will reveal the trouble. The resistance reading should be 1000 megohms or more (measured with a v.t.v.m.). (It is assumed all components have been removed from the terminal post contacts being checked.) If a smaller reading is obtained, the terminal post should be replaced.

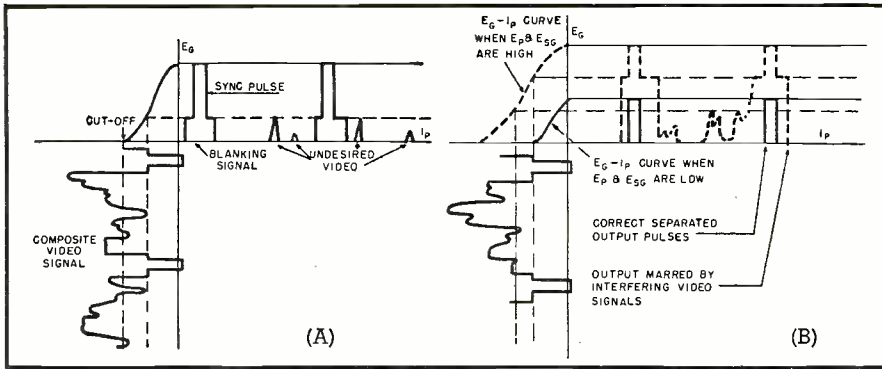

Fig. 4. (A) Interfering video signals may get through the sync separator if the incoming sync pulse is too small, i.e., if the pulse does not extend from 0 volts to cut-off. (B) E_g-I_p curves for low and high plate and screen separator voltages. When plate and screen voltages are low, the E_g-I_p characteristic causes the reproduction of only the desired sync pulses. When plate and screen voltages are high, however, the E_g-I_p characteristic necessitates large sync signal inputs. Smaller sync signal inputs will cause video signals to appear in the separator's output circuit.

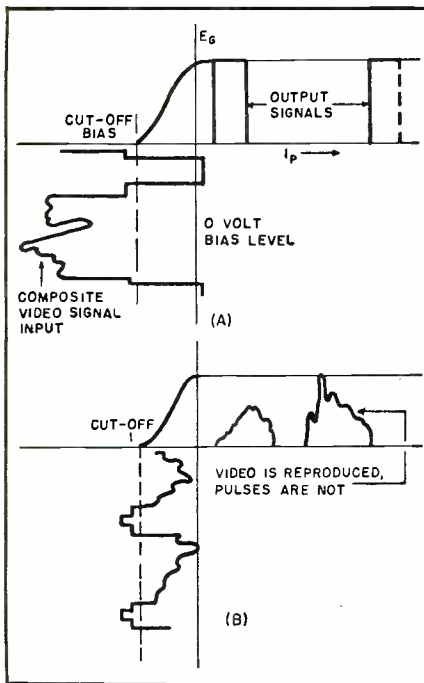
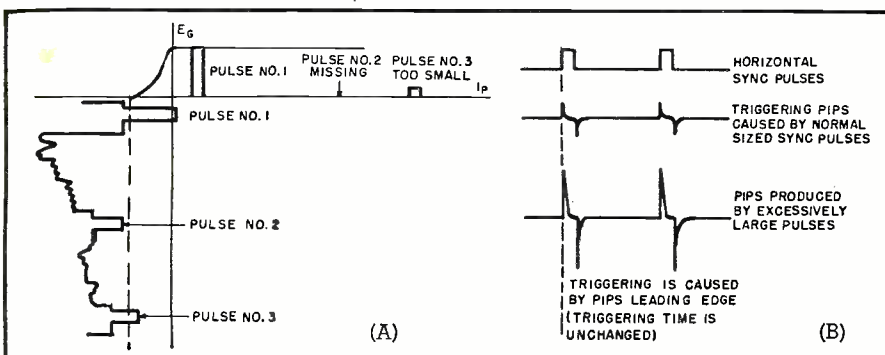

Fig. 5. (A) E_g-I_p characteristic curve of the sync separator. Video signals fall beyond the cut-off point on the curve. Note that the video signal input is in negative picture phase. (B) If the picture phase of the video signal input to the separator were positive, sync pulses would become the most negative portions of the video signal and would, therefore, be cut off.

Fig. 6. (A) A lower than normal sync pulse at the grid of the sync separator may not be reproduced in the plate circuit. (B) Excessively large horizontal sync signals are incapable of triggering the horizontal oscillator prematurely.



ured, since the defective age can be localized more quickly by the former procedure. When no scope is available, however, voltage, resistance, condenser bridging, and possibly condenser substitution tests will have to be made throughout the sync section until the source of trouble has been found.

The oscilloscope is an extremely useful, almost indispensable instrument for troubleshooting the sync circuits. To use it intelligently, a thorough understanding of the function and operation of these circuits is required.

SynC Circuit Functions

Five types of circuits are used in the sync section of the TV receiver:

1. Sync amplifiers.
2. Sync separators.
3. Sync levelers.
4. Phase inverters.
5. Inter-sync separators.

These circuits (a) separate both vertical and horizontal sync pulses from the undesired video information associated with them; (b) make the pulses uniform in amplitude and reduce noise interference; (c) amplify the pulses; (d) put the pulses into the correct polarity, i.e., the polarity required for triggering the deflection oscillators to which the horizontal and vertical pulses are respectively applied; (e) separate the vertical from the horizontal pulses, shape them to the forms required for triggering the deflection oscillators, and apply them to the latter.

This article, and the one to follow, will discuss all the circuits cited except those in the inter-sync separation section. (*Editor's Note: The second article being planned will cover the detection of trouble in sync circuits.*)

Picture Phase

Picture phase will be referred to in the next part of our discussion of sync circuits. Since this is a subject that is generally confusing to service technicians several paragraphs on the subject may prove useful.

A picture in *negative* phase corresponds to a photographic negative, in which all light values are reversed.

A picture in *positive* phase corresponds to a photographic print, in which all light values are correct.

To obtain a positively-phased picture at the grid of the cathode-ray tube, i.e., to get black information to show up as black, and white as white, blacks must be the most negative parts of the signal. Minimum current will then flow in the CRT on black signals, and the screen illumination will be correspondingly very low or absent at these times.

Since the sync pulse is beyond the black region, it must be the most negative part of the incoming composite video signal when the latter's phase is positive (see Fig. 2A). Let us stress this point, since it is an important one: The sync pulse is the most negative part of the composite video signal

when the picture phase is positive.

When the picture phase is *negative* (see Fig. 2B), the exact opposite is true. The sync pulse now becomes the most positive part of the composite video signal.

A signal in either positive or negative phase may be required in various circuits.

The Sync Separator

The heart of the sync section is the sync separator. This is the stage which removes the video information associated with the sync pulses.

The basic sync separator now used in all commercial TV receivers (see Fig. 3) is essentially the same as the limiter employed in FM circuits. V_1 is biased sufficiently so that only the sync pulses are amplified. The video information is beyond the cut-off portion of the E_g-I_p curve (see Fig. 5A), and is consequently removed.

A number of requirements must be satisfied by the sync separator stage:

1. The tube employed must be a sharp cut-off type. (If it weren't, video information would be permitted to get through.)

2. The sync pulses at the grid of the sync separator must be less negative than the associated video information. To meet this second requirement, the composite video signal must be in *negative picture phase* at the grid of the sync separator. If the video signal were in positive picture phase, the sync pulses would be cut off, while the video would get through (see Fig. 5B).

3. The sync pulses should be large enough to go from approximately 0 volts to cut-off on the grid of the sync separator (see Fig. 4A). If the pulses did not extend to cut-off, video information might get through the sync separator, impairing synchronization.

Requirement 3 necessitates either (a) large-amplitude sync pulses at the grid of the sync separator or (b) low separator plate and screen voltages. Fig. 4B illustrates why this is so. Note that even a small incoming sync pulse will readily extend from cut-off to the 0 volt point on the E_g-I_p curve, when low plate and screen voltages are present. If high plate and screen voltages are employed, however, the resultant E_g-I_p curve is such that a large-amplitude sync pulse is needed to go from 0 volt to cut-off.

4. All sync pulses entering the sync separator should be at the same level. (This is the same requirement that must be satisfied at the grid of the CRT, and is met there by a d.c. reinsertion circuit.) If the pulses are *not* at the same level, a lower than normal sync pulse may be cut off (see Fig. 6A). The result might be loss of synchronization for one or more lines, in the case of horizontal sync pulses; or loss of interlace, if the vertical pulses are affected. A diode sync leveler, or grid-leak action in the sync separator, is used to level the pulses.

There should, preferably, be limiting action on the positive grid swing of the input signal, that is, the posi-

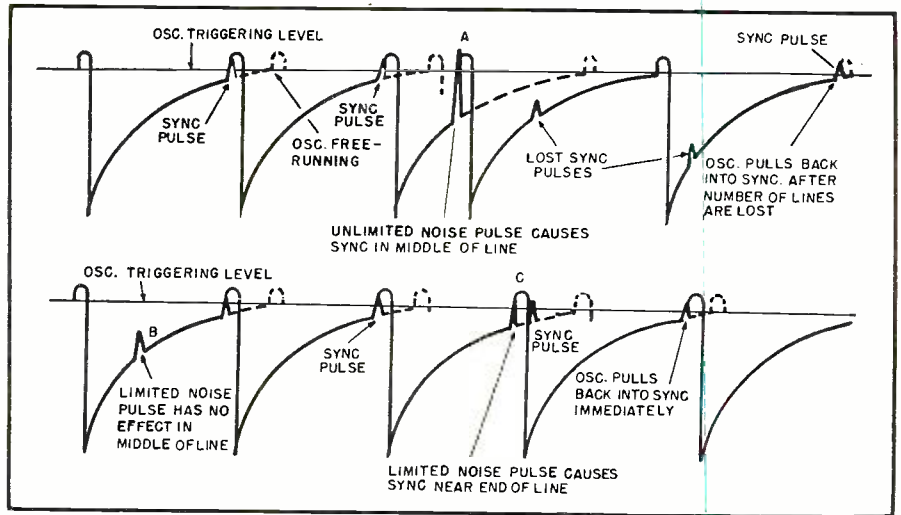

Fig. 7. A large-sized noise pulse occurring in the middle of a horizontal line may prematurely trigger the horizontal oscillator (A). A mid-line noise pulse that has been reduced in size by positive limiting cannot reach the triggering level (B). A limited noise pulse occurring near the end of a horizontal line may cause a slightly premature oscillator triggering (C). In the top diagram the grid waveforms in the sync separator are shown when no positive limiting is present in the sync separator. Lower drawing shows grid waveforms when positive limiting is present.

tive peaks of input signals should be clipped. A circuit that permits the flow of grid current on positive grid swings will produce this limiting action. The reader should note that, while all sync separators limit, *i.e.*, cut off—the negative part of the incoming signal (which is the undesired video component), many but not all separators also limit the positive-going peak sections of the sync pulses.

Limiting on positive grid swings has two desirable effects:

1. Noise pulses are kept from interfering with synchronization.
2. Sync pulses emerging from the

sync separator are kept from becoming too large on strong input signals.

Positive Limiting

Let us discuss these two effects in some detail. Such a discussion may help the service technician decide when to look for improper limiting in the sync separator as a cause of poor synchronization.

Limiting on positive signals prevents noise pulses that occur in the middle of a horizontal line from causing premature horizontal synchronization, with resultant tearing-out. Fig. 7 shows how such a mid-line large un-

Fig. 8. (A) Triggering of the vertical oscillator during each field if no equalizing pulses are present. (B) Triggering of the vertical oscillator when equalizing pulses are present, and sync signals are normal in amplitude. (C) Triggering of the vertical oscillator when equalizing pulses are present, but vertical sync signals are excessive in amplitude. In (A) the last horizontal sync pulse in Field 2 occurs closer to the beginning of the vertical sync pulse than the last horizontal sync pulse in Field 1. These two pulses therefore contribute unequally to the charging of the integrator during each field (with equalizing pulses absent). In (B) equalizing pulses contribute so much more to the integrator charging curve during each field than the single horizontal pulse preceding the vertical sync signal that the unequalizing effect of the horizontal sync pulses is overcome. In (C) excessively large sync pulses increase the unequalizing effect of the last horizontal sync pulse on the integrator charging curve. The equalizing pulses can no longer equalize the two charging curves in this case. At point X note that the charging curves for Fields 1 and 2 are not equalized. Insertion of more pulses might equalize them. Observe that the curves approach equalization more and more closely toward their end.

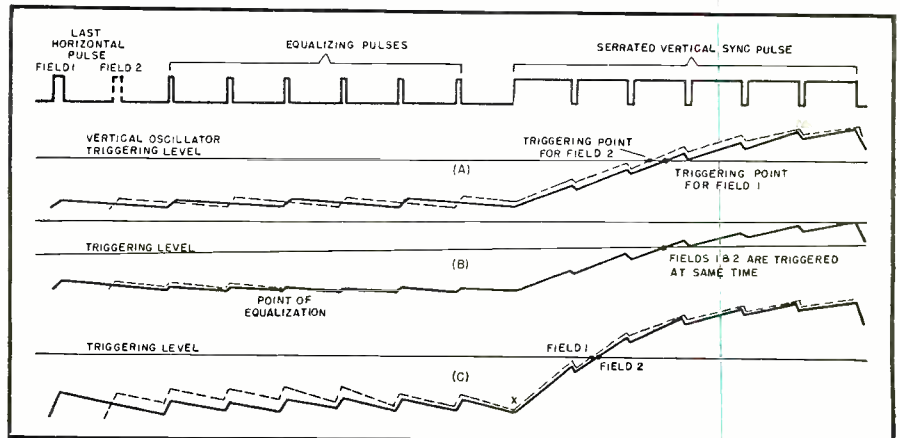

limited noise pulse can cause premature triggering of the horizontal oscillator. Note that when the mid-line pulse has been reduced in size by limiting action, it can no longer reach the triggering level of the oscillator.

It should be noted that a limited noise pulse occurring near the end of a horizontal line may still cause a slightly premature triggering of the horizontal oscillator. The resultant loss in synchronization will, however, affect only a small picture section at the end of a horizontal line—possibly one-eighth of a line—and will scarcely be noticeable.

Noise pulses are far less apt to affect vertical synchronization, since the duration of a random noise pulse is too short to charge up the long time-constant integrator circuit to any appreciable extent. (The integrator, the service technician will remember, is the RC shaping network present at the input of the vertical oscillator.)

Positive limiting, as we pointed out a short while ago, prevents the emergence of a larger than normal sync pulse from the sync separator. If such excessively sized signals were transferred to the vertical oscillator, premature triggering of the latter would result, causing a loss in interlace. The loss in interlace is due to the unequalizing effect of the equalizing pulses.

No contradiction is present here. Equalizing pulses, the reader may remember, are inserted in the transmitted signal to equalize the charging of the integrator network during both picture fields. Triggering of the vertical oscillator at the correct instant during each field results (see Fig. 8). If no equalizing pulses were present, the integrator charging curves for each field would not be exactly the same. Triggering of the vertical oscillator during the second field would, as a result, occur at a slightly differ-

ent part of the cycle than it did during the first field. Proper interlacing of the two fields would, therefore, not occur.

The insertion of six equalizing pulses before and after the vertical sync signal assures that the triggering of the vertical oscillator during each field occurs at the correct time. This assurance, however, only exists when a normal-sized sync signal is present. If the sync pulses are larger than normal, a greater number of equalizing pulses would be needed to assure correct triggering of the vertical oscillator. Since the equalizing pulses transmitted are fixed to six in number, they will not exert their normal equalizing effect in the presence of excessively large sync signals.

Excessively sized sync signals would not, on the other hand, cause improper triggering of the horizontal oscillator. The leading edge of the sync pulse triggers the horizontal oscillator (see Fig. 6B) when it has reached a certain amplitude. No matter how far the pulse extends beyond this amplitude, it exerts no further effect.

Two deductions useful to the service technicians may be made from this discussion:

1. If loss of interlace is observed in the test pattern (see Fig. 1), improper limiting in the sync separator may be responsible. A check for the presence of abnormally large sync signals at the output of the sync separator is in order in such a case. *It is assumed that all other sync circuits have been previously tested and found normal.*

2. The desirability of such a check is also indicated when horizontal tearing out (unaccompanied by other symptoms) is observed in the TV picture. Let us point out once more that more likely sources of the trouble should be eliminated first.

We have just considered why a sync separator is necessary, and how it

functions. Let us now take up the need for, and operation of, other sync stages.

Sync Amplifier

To get an adequately-sized sync pulse, a sync amplifier is often needed. The sync amplifier frequently acts as a limiter on very large signals, easing the sync separator's limiting task. In some cases, the sync amplifier is also used to invert the sync signal to the negative phase needed at the input to the sync separator.

Common Take-off Point

The sync pulses are usually taken off at the video amplifier, rather than at a preceding stage, in order to obtain the high-amplitude signals needed for proper synchronization. A voltage divider network is used (see Fig. 9) to transfer the sync pulses from the video amplifier to the sync section. This divider prevents the sync circuits from affecting the frequency response of the video amplifier.

If no voltage divider was present, and the sync pulses were taken off at point X in Fig. 9A, the sync section would be directly in parallel with the video amplifier (see Fig. 11B). Since the sync section is designed to respond to frequencies up to 150 kc. only, an impairment of the response of the video amplifier (which must respond to frequencies as high as 4 mc.) would result. When the sync section is, however, connected across only a portion of the video amplifier signal output, through a suitable voltage divider, its shunting on the video amplifier is considerably reduced (Fig. 9C).

The Sync Leveler

The need for sync leveling action was previously discussed. It was also pointed out that a diode, inserted in the grid circuit of the sync separator, was often used for this purpose.

To better understand leveling action, let us consider what takes place when no diode leveler is present. Grid current will flow on sync signals, since the grid is driven slightly positive by the peak of each sync pulse. A grid-bias, directly proportional to the height of the incoming sync signal, would be developed as a result.

The peak of the incoming sync pulse will drive the grid slightly positive, causing grid current to flow. The grid current develops a negative voltage across the grid return resistor, charging the grid-leak condenser. The voltage developed at the grid is negative, while the sync pulse voltage is positive; the two voltages consequently buck each other.

Let us suppose a sync pulse following a "normal" sized one tends to become slightly smaller, *i.e.*, tends to drive the grid slightly less positive than its predecessor. A reduction in grid current results which reduces the grid-leak bias in the separator. The sync pulse voltage will, in such a case, no longer be bucked by as large a

(Continued on page 112)

Fig. 9. (A) Circuit commonly used when sync signals are taken off at video amplifier. (B) The high frequency response of video amplifier would be impaired if no voltage divider was used and the sync signals were taken off at point X. (C) Decreased shunting of the video amplifier by the sync section occurs when the latter is placed in parallel with a part of video amplifier plate load. (D) Positive- and negative-going sync pulses.

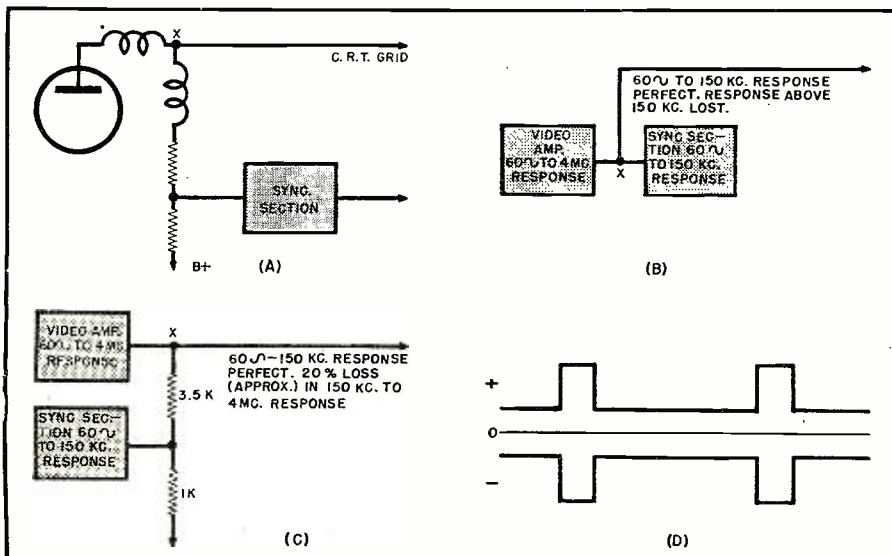

COMPLETE 30 WATT HAM STATION

By
STAN JOHNSON, WØLBV

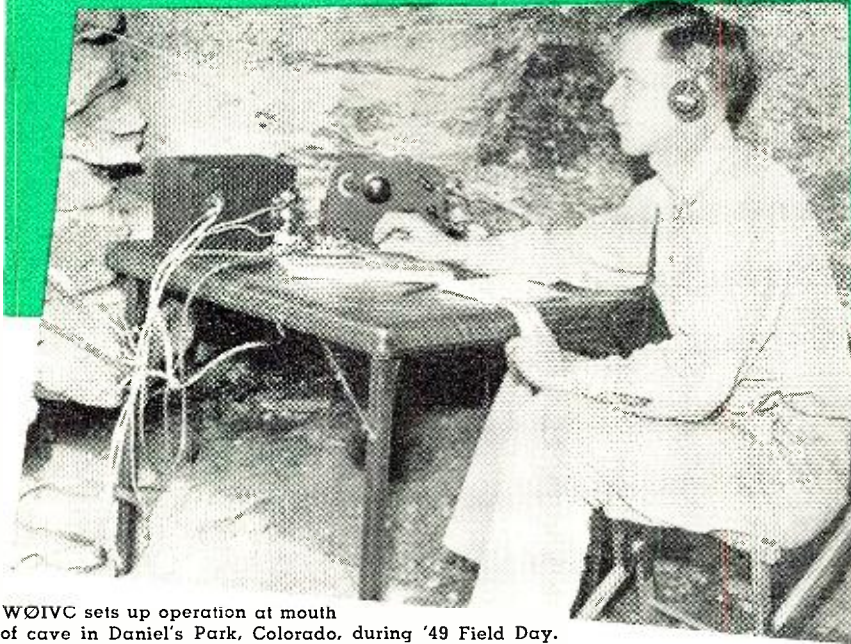

WØIVC sets up operation at mouth of cave in Daniel's Park, Colorado, during '49 Field Day.

A c.w. transmitter and a receiver all on a 7 x 9 inch chassis. It can be built of junkbox parts.

AS MANY a ham has found out the hard way—Field Days can be a lot of fun—providing. Providing going on the “Day” isn’t the equivalent of moving a house full of furniture. Having participated in one such venture, which was more of a feat in trucking than radio, the writer determined that this year things would be different, and that WØLBV’s receiver, transmitter, and antenna tuning set-up would be a single unit, which could be tuned up and put on the air in five minutes. The result was the complete “station” shown in the photographs.

Although the rig occupies a chassis measuring only 7 by 9 inches, the transmitter will take up to 30 watts input—and the receiver is a simple, but surprisingly effective, superhet.

When the writer built the little rig the intention was to tuck it away in moth balls from one year to the next—unless needed for emergency work of some kind. But the unit has proved to be such a useful piece of gear that it has since become a permanent part of the home station, being the one piece of equipment which stayed on the air during the rebuilding of the two regular rigs. It is also enabling the writer to keep his code up without having to shift off his favorite phone bands. Undoubtedly the rig would serve a similar purpose for many, many other hams. And for the newcomer, it offers an easy way to go on the air with a unit which can be tuned up with no more equipment than a flashlight bulb and a loop of wire.

The rig consists of a 6L6 crystal oscillator as a transmitter and a two tube superhet using a 6K8 and a

6SN7GT. Purists who frown on coupling a crystal oscillator to an antenna should try the circuit shown, which was called the “Jones” oscillator years ago and has been called various things since—all complimentary. It hasn’t been too popular as an oscillator in multi-stage rigs because it does not double nearly as well as a tritet. But on its fundamental frequency it has low crystal current, and can be loaded heavily and still key well. If 400 volts or so are available it will take up to 30 watts input, which is the usual maximum for the “power” multiplier for a Field Day. Further, this is a reasonable amount of power to extract from a vibrator power supply operating from a single 6 volt storage battery. The tubes used are all 6 volt, too, so of course the same battery can supply heater voltage.

In the plate circuit of the transmitter is a “pi” network, which makes it possible to load up almost any piece of wire. This means that for portable work you can string out a hunk of wire, as long and as high as possible, and go on the air, without worrying about cutting it to exact length. At home the rig can be coupled to almost anything, for example, a 20 meter beam with the feeders tied together to make a Marconi of sorts.

The transmitter is intended for use on both 40 and 80 meters. Shifting from one band to another is a matter of a few seconds, since it involves nothing more than shifting one coil and crystal. Output is slightly better on 80 than on 40—but only slightly.

The receiver is a very simple superhet which uses a conventional super-

het mixer stage followed by a regenerative detector fixed-tuned to approximately 1600 kilocycles. This receiver is both much more selective and more stable than a standard regenerative set, and gives a surprisingly good account of itself even under the “six deep” conditions characteristic of 40 meters during the most popular evening operating hours.

The oscillator portion of the mixer stage on the receiver has bandspread tuning. The first detector, which is simply “peaked” up for the band being used, requires no tuning within the limits of a ham band, so the set is essentially one dial control without the necessity for tricky ganging operations. The regeneration control can also be left pretty much alone, a feature which is a real luxury compared to the regenerative sets of years gone by.

The transmitter will operate off any “B” supply unit capable of furnishing from 250 to 450 volts at 80 mils or more, plus a 6.3 volt heater supply. The receiver has the same heater requirements and uses a 45 volt “B” battery, which is enough to give adequate headphone volume. The use of a “B” battery eliminates “hash” problems the easy way, and at the same time makes it possible to simplify the receiver circuit. Actually the receiver contains only a few more parts than a “detector—one step,” although there is no comparison in performance.

The original rig was built up on a 7 by 9 inch chassis fitted with an aluminum panel—both retrieved from the junk box. To tone down the “junk box look” both chassis and panel were coated

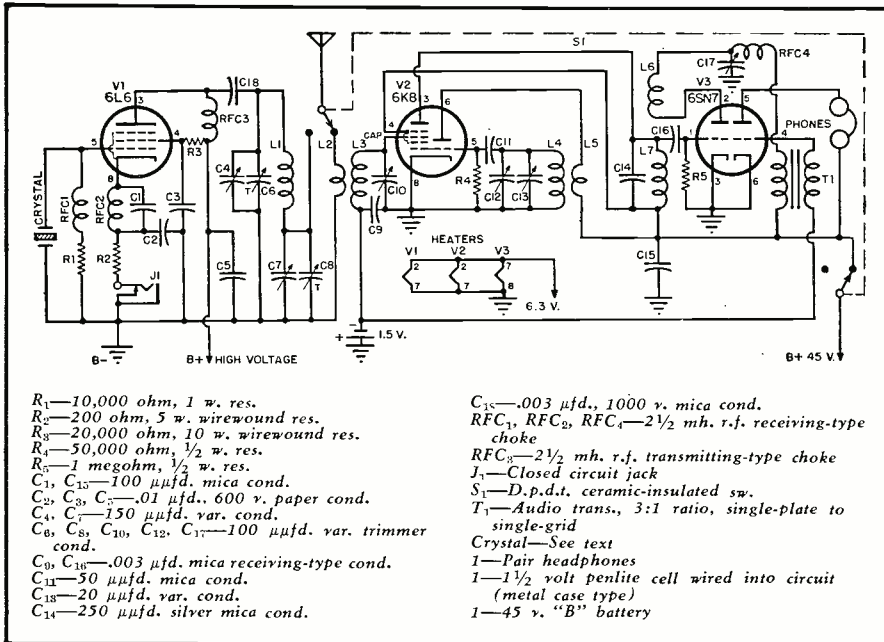

Complete schematic diagram of 30 watt c.w. station. A separate power supply, capable of furnishing 250 to 450 volts at 80 ma., is needed to operate the unit.

Winding data for required coils. Standard plug-in type coil forms are used.

baking job in the oven. If, like the writer, you have been instructed to keep your handiwork in the basement, you can do the drying job by heating up the metal with a 150 watt bulb in a photo reflector—or with a 90¢ heat lamp. The paint dries surprisingly fast when warmed up by a bulb mounted a few inches from the chassis.

As shown in the photograph, the transmitter and receiver just about split the available space between them. Looking at the chassis from the rear, the main tuning condensers for the transmitter are on the front panel, with the tube and coil directly behind. At the rear of the chassis are a pair of sockets, one octal, and the other six

prong, wired in parallel. This makes it possible to accommodate either the old or new type of crystal holders. One of the new octal base types is shown plugged into a socket.

Looking at the receiver portion of the set from the rear the tuning condensers are on the front panel, with the oscillator coil nearest the condensers. Directly behind is the mixer (first detector) coil, and the 6K8 mixer tube. The i.f. coil, which is homemade, is at the rear alongside the 6SN7GT detector and audio stage.

A ceramic insulated switch mounted on the panel shifts the antenna from transmitter to receiver and also breaks the "B plus" on the receiver during transmitting periods.

On the panel are all of the controls, including a jack for plugging in a key. This key can also be used to measure plate current, providing you are that curious.

The set is wired up like any other set, with the usual care to keep the leads short and direct and to make good connections. It will be noticed that the r.f. chokes used in the transmitting portions of the circuit are different in the plate and grid circuit to avoid having parasitics of the tuned-plate, tuned-grid variety. Simply using different brands of chokes will probably help, although to play safe it is well to use a larger choke in the plate circuit.

Also in the transmitter the tuning condensers are both paralleled by small variable "padders." This was done simply to raise the total capacity available to 250 μfd. on each condenser—a capacity which seems to be hard to come by in small variables. If your junk box is better stocked than the writer's you can use a pair of 250 μfd. condensers and omit the padders—thus simplifying the tuning operation somewhat.

In the receiver the only "tricky"

Under chassis view of completed home-built unit. Note the neatness of assembly and relative placement of components.

Top view. Transmitter circuits are to left of the chassis while receiver assembly is confined to section on right.

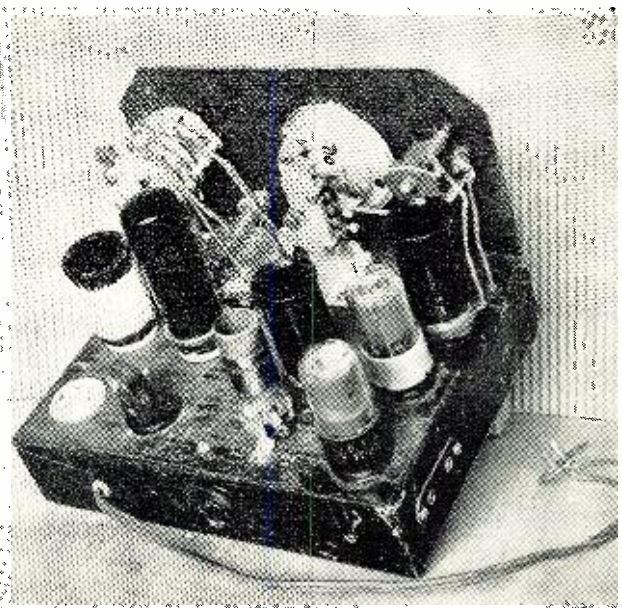
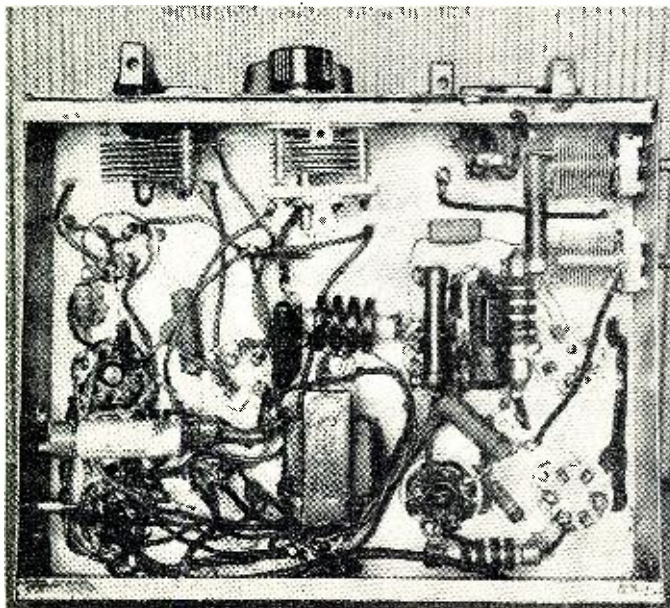

thing encountered was winding the i.f. coil, L_6 , L_7 . This coil, with its fixed condenser, should tune to approximately 1600 kilocycles, although the exact frequency is unimportant. If you have another receiver, with a beat oscillator, you can wind the coil quite easily, of course, by checking the frequency of the set in an oscillating condition. If you are a beginner, however, with no other receiver, the best bet is to wind the coils exactly as specified and then leave the grid (larger) winding alone unless you pick up a local broadcasting station or police radio station on top of the other stations for which you are tuning. In this event, removing a turn or two should shift the offending station off the i.f. frequency.

Getting the receiver going is not at all difficult if everything is wired properly. The first step is to make certain that the second detector and audio stage is working. This is evidenced by your hearing a soft "plop" as the regeneration control (condenser C_{17}) is advanced. If no "plop" is heard in the headphones, recheck the wiring, and if OK, add a few turns to the transformer winding, L_6 , checking at the same time to be certain that the connections to the coil are such that it is "poled" properly.

Once the back end of the receiver is percolating the set should be hooked to an antenna and the mixer stage tuned. If the coils are wound as specified you should be able to find the band with the oscillator tuning condensers, and then peak up the signal with the first detector tuning condenser. For code reception the receiver is operated with the regeneration control turned just past the point where oscillation begins. In the case of very strong signals the control can be advanced to cut down the strength of the incoming signal.

Putting the transmitter on the air is simplicity itself. With the power supply and antenna connected, rotate condenser C_7 to maximum capacity and then rotate C_1 (trimmers C_6 and C_8 are set at one half capacity) until the transmitter oscillates, as evidenced by lighting a flashlight bulb fastened to a single loop of wire. To increase coupling to the antenna open up condenser C_7 in small steps, each time retuning C_1 for resonance. Keep this process up until the plate circuit is pretty well drained of r.f. The idea is to get the most out of the oscillator without interfering with keying. This can be checked by listening with a receiver tuned to a harmonic, or by watching the ever-useful bulb to see if the "dots" are still with you. If they are—the rig is on the air.

No, this compact station won't give California kilowatts any trouble. But if used with a bit of skill it will give even an old timer a lot of fun. And it is a mighty nice thing to have around the shack, just in case a sleet storm puts the power line in the street—or a flood washes the street away!

-30-

Mac's RADIO SERVICE SHOP

By JOHN T. FRYE



STUMPING THE EXPERTS

BARNEY, the apprentice service technician at Mac's Radio Service Shop, liked summer thunderstorms almost as much as Miss Perkins, the "office force" of that establishment, hated them. Miss Perkins disliked the storms because: (a), the blinding flashes of lightning and the earth-jarring claps of thunder scared her half out of her wits; and (b), her fright or the high humidity that accompanied the storms—she was never sure which—made a hollow mockery out of her so-called "permanent" curls.

Barney enjoyed these celestial pyrotechnics partly because they were in tune with his youthful, red-headed, excitement-loving disposition; but mostly because these storms were the one thing that brought service work to a complete halt—just as it had done on this August afternoon.

All of the antennas had been grounded; the main switch to the service instruments was open; no receivers were plugged into the outlet sockets. Mac and Barney sat side by side on the service bench while Miss Perkins occupied the high stool that was her special throne when she visited the service department. At the first threatening rumble of thunder she had thoughtfully scurried across the street and prepared for the ordeal with three frosty Cokes and a huge sack of crisp vanilla wafers, and now the three of them were enjoying these as they waited out the lashing storm.

As usual, Miss Perkins was rattling along nervously, trying to smother with conversation the sounds of the tempest. "I have been wondering," she said, "just how much use you fellows make of that information I get

from each customer about his radio. Does it really help?"

"I should kiss a pig if it does," Barney answered importantly. "Why, in four out of five cases, all we have to do is glance at what you have written down and then we know exactly what is the matter with that particular radio. Right, Chief?"

"Deducting your usual handicap of fifty per-cent for exaggeration, that's about right," Mac agreed lazily; "but why not give the little lady a demonstration? Let her read what she has written down on this bunch of cards, and then you can explain what is most likely wrong with the set. I'll try to be the judge as to whether or not you are guessing on the beam." Saying this, he scooped up a bunch of cards from the end of the bench and tossed them into Miss Perkins' lap.

Barney shot him a sidelong glance that was filled with suspicion, and he muttered something that sounded like, "Me and my big mouth"; but he nodded his head in agreement.

"On your mark!" Miss Perkins warned as she picked up the first card. "This man says his radio changes volume all by itself. It will be playing along all right, and then suddenly the volume will drop to nearly nothing. Flipping the set off and on will usually bring the volume back; so will the cutting in of the refrigerator or turning a light on or off in the house. He insists that the radio always cuts out at precisely the most interesting part of a program."

"That's an easy one," Barney said with a look of relief. "The most likely cause of the trouble is one of the audio coupling condensers. It *could* be a

(Continued on page 124)



International

SHORT-WAVE

Compiled by **KENNETH R. BOORD**

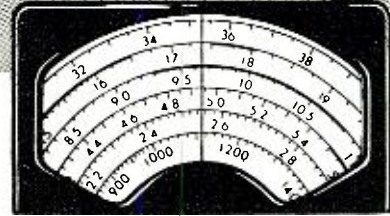

IUR congratulations this month go to *Radio Copenhagen*, Denmark, which has just inaugurated a weekly DX program. "Denmark Calling World Listeners" is aired each Monday around 2225 and lasts approximately 10 minutes; is heard over OZF, 9.520.

Other DX programs are scheduled: *Radio Australia*—"Australian DX-ers Calling" goes on the air each Sunday 0025 over VLC, 15200, to West Coast North America and VLB5, 21,540, to Africa; same day at 0902 over VLC7, 11.81 to North America (beamed on Central and Mountain Time Zones), and VLA4, 11.850, to British Isles, Europe, and Asia.

Radio Sweden—"Sweden Calling DX-ers" is radiated three times on Saturdays—0215 over SBT, 15.155, and SBO, 6.065; 1015, SBT, 15.155, and SDB2, 10.780; 2015, SBT, 15.155, and SDB2 10.780.

Radio National Belge—"OTC Calling DX-ers" from Leopoldville, Belgian Congo, is scheduled on Wednesdays at 2110 (following the 2100 newscast) over OTC2, 9.767 (in the North American beam); at times also may be heard after the 1430-1440 news on Wednesdays beamed to Europe.

This Month's Schedules

Afghanistan—A m. w. transmitter at Kabul is the only broadcasting station in this country thus far, but the Director-General of the Afghanistan Radio, Ata Ullah, was reported in Berlin recently to order two s.w. transmitters. (Radio Sweden)

Argentina—*Radio Splendid*, LRS2, 11.971, noted 1930 battling with *Radio Brazzaville*. (Bellington, N. Y.) Is good level in Calif. around 2130-2200. (Rosenauer)

Australia—Here are revised schedules of *Radio Australia*, which is now being operated by the Australian Broadcasting Commission:

To the Forces In Japan—Mon.-Sat. 1529-1800, Sun. 1559-1815, VLB11, 15.160; also Sun.-Thur. 2145-2315, Friday 2100-0230 (Sat.), and Saturday 2100-2315, VLBS, 21.540; daily 0328-0900, VLB6, 15.200. *To British Isles and Europe*—0155-0315, VLC, 15.200, and 0135-0315 (daily except Sat.), VLB4 11.850; also to Asia and British Isles, Mon.-Fri. 1815-1950 and 2145-0315 Saturday, 1825-0315, and Sunday 1828-0315, VLA10, 17.840; 0900-1115, VLA4, 11.850; 1500-1800 Mon.-Sat., VLC, 15.200, VLA4, 11.850, and Sun.

1500-1815, also VLC and VLA4. *To Southeast Asia and Southwest Asia*—Mon.-Sat. 1800-1950, 2145-2315, and Sun. 1815-2315, VLC, 15.200; 1950-2200 Mon.-Fri., VLG11, 15.210; 0328-0630, VLC4, 15.320, and 0328-1115, VLA4, 11.850. *To Indonesia*—0530-0600, VLC4, 15.320. *To North America*—2330-0045 daily, VLC, 15.200, beamed to West Coast; 0700-1115, VLC7, 11.810 (to East Coast 0700-0900, to Central and Mountain Time Zones, 0900-1000, and to West Coast, 1000-1115). *To Africa*—2330-0045 Sat.-Thur., VLB5, 21.540, and 1000-1115, VLB, 9.540. *To Tahiti and Europe* (in French)—0100-0145 VLG11, 15.210. *To New Caledonia* (in French)—0245-0345, VLG10, 11.760. *To Thailand* (in Thai)—0100-0130 (Wed. only), VLC, 15.200.

Some transmissions have been dropped, including the "evening" beam to Eastern North America, formerly 1643-1815 over VLA6, 15.220.

Austria—Blue Danube Network, Salzburg, for a time was near 9.525 at 0115 with news; later noted close 9.560. (Pearce, England)

Bechuanaland—ZNB, Mafeking, now on 8.230, is scheduled 1200-1430. (*Short Wave News*, London)

Belgian Congo—Leopoldville at times is using 11.72 instead of 11.65 in the transmission heard around 1630-1700 or later. (Bellington, N.Y.)

Brazil—According to the publication *Brazil Calling* the program of

(Note: Unless otherwise indicated, all time is expressed in American EST; add 5 hours for GCT. "News" refers to newscasts in the English language. In order to avoid confusion, the 24 hour clock has been used in designating the times of broadcasts. The hours from midnight until noon are shown as 0000 to 1200 while from 1 p.m. to midnight are shown as 1300 to 2400.) The symbol "V" following a listed frequency indicates "varying." The station may operate either above or below the frequency given.

Wallace Treible, of the State of Washington, uses an SX-42, a DB22A preselector, a BC221 frequency meter, and a FCC 90 frequency standard at his DX listening post.



that name over ZYK3, 9.565, Recife, Pernambuco, is changed from Sunday only at 1530 to daily 1905. (Radio Sweden)

ZYBS, "*Radiodifusora Sao Paulo*," noted back on 11.765 around 1500-2230. (Radio Sweden)

British New Guinea—VLT7, 9.52, Pt. Moresby has good signal in Oregon from around 0200 to 0300 sign-off; usually has native program, introduced and closed with bagpipes; good level for 2 kw. (Neeley)

Cape Verde Islands—CR4AA 5.895, Praia, is again audible when Cape Town leaves 5.880 at 1600. (*Short Wave News*, London) Pearce, England, reports this one heard on approximately 5.910 around 1530 to after 1630; at 1625 has "Radio Journal" (news in Portuguese, introduced and closed with an American march recording).

Ceylon—*Radio Ceylon*, Colombo, was heard recently testing on 17.820 and 15.120 at 1215-1230; asked for comparative reception reports. (Radio Sweden)

China—At the time this was compiled, the Communist-Chinese outlet announcing as "*Radio Peking*" which had been on 15.068 where it suffered bad QRM from London's 15.070 channel, had moved to approximately its announced 15.060 frequency; good signal mornings in East; news still 0830; at times had QRM from AT&T station at Miami Florida.

Cuba—COCH, 9.437, Havana, noted recently 0630 with full announcement in English; continued in Spanish. (Ferguson, N.C.)

Czechoslovakia—At the time this was written, Prague was radiating to North America in English, Czech, and Slovak tongues daily in three transmissions—beginning respectively at 1900, 2100, and 2230; 11.84 was used in all three periods while 15.32 (moved from 15.23, probably to escape QRM from *Radio Moscow*) was in parallel during at least the last two transmissions. Power seems to have been increased although the station so far had mentioned only the use of "improved facilities for North America." Bellington, N.Y., recently noted news in progress at 1720 over the 11.84 outlet.

According to *Radio Sweden*, English programs from Prague (apparently for Europe) are now broadcast 0615-0630 on 11.840; 1415-1445, 1530-1545,

(Continued on page 106)

HOME-BUILT 2" OSCILLOSCOPE

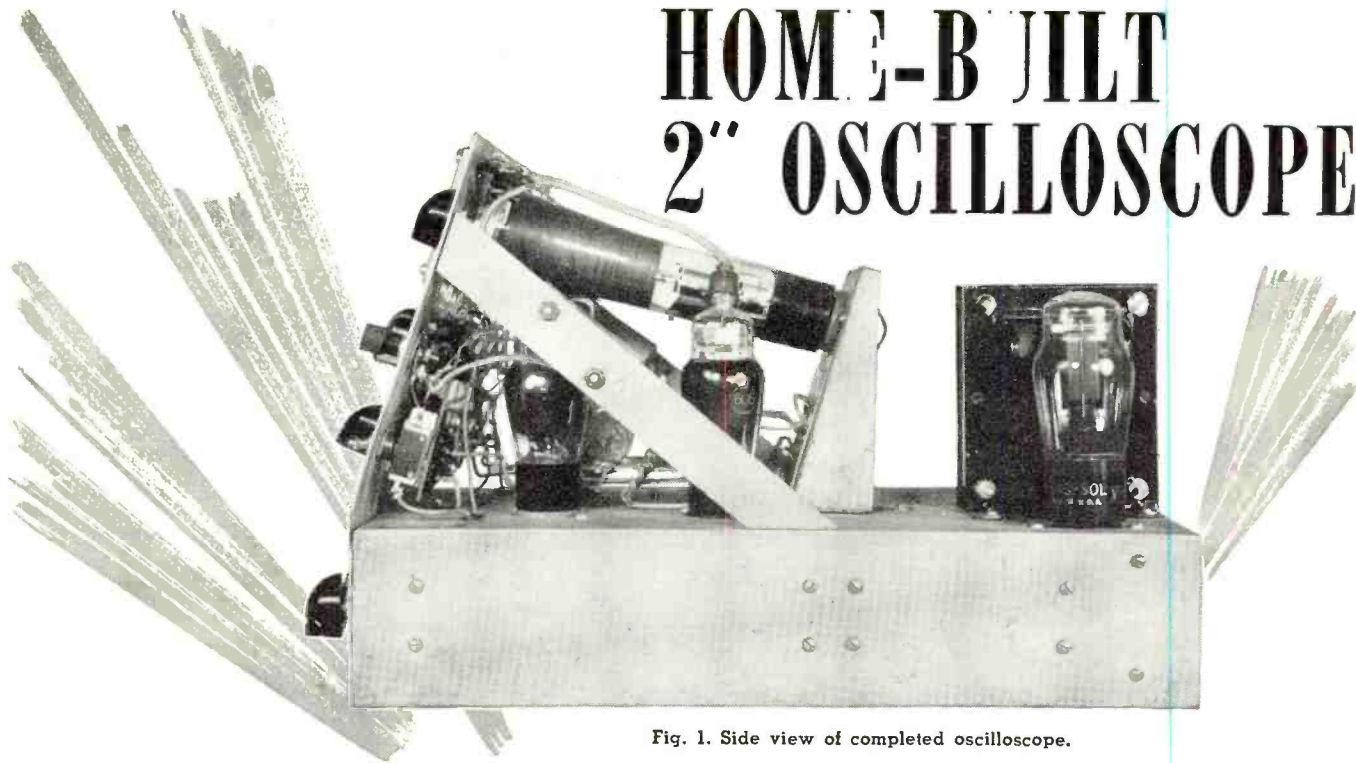

Fig. 1. Side view of completed oscilloscope.

By
J. STEPHEN ANDERSON,
W9UFE

Detailed specifications on an interesting project for the experimenter, student, or technician who really enjoys building his own test equipment.

THE need for a simple cathode-ray oscilloscope suitable for use in the classroom and laboratory is quite generally appreciated. It is almost a necessity in the teaching of advanced courses in radio and electronics, and is valuable in the more elementary courses where the actual waveforms taken from simple bread-board laboratory setups or classroom demonstrations lead to a much better understanding of the circuits than can be obtained by the more common method of plotting theoretical waveshapes. The students will readily ac-

cept what they can see on the screen of an oscilloscope, while they may have mental reservations as to the authenticity of explanations based entirely on unverified "waveshapes" drawn on the blackboard by the instructor.

While the utility of such an oscilloscope is recognized, commercially-built equipment of this type is expensive.

For this reason some thought was given to the problem of building a

number of simple oscilloscopes, using standard radio components wherever possible. Since some commercial oscilloscopes were already available for use in demonstrations in classrooms and for exacting measurements in advanced courses, it was decided to use a small cathode-ray tube which would be comparatively inexpensive and more readily available than the larger sizes. The RCA Type 902 tube was chosen as meeting these requirements. The use of this tube also simplified the problem of a suitable power supply.

The power transformer selected was a conventional receiver type with a center-tapped 700 volt high tension winding. It differed from the usual receiver replacement transformer in that two 6.3 volt windings and two 5.0 volt filament windings were also provided.

Two separate rectifier-filter systems were employed, one using a Type 80 tube as a full-wave rectifier with a single pi-section capacity inductance filter. The output of this rectifier is positive with respect to the chassis ground. The second rectifier produces a negative voltage with respect to ground, and employs a second Type 80 tube connected as a half-wave rectifier. Since the current drawn by the negative power supply is quite low, one half of the high voltage secondary winding is used as the source of al-

Fig. 2. Under-chassis view of the oscilloscope showing correct parts layout.

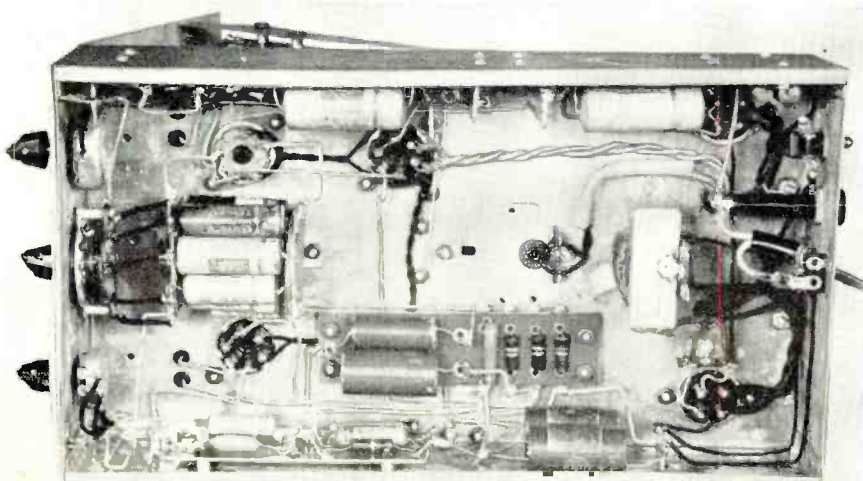
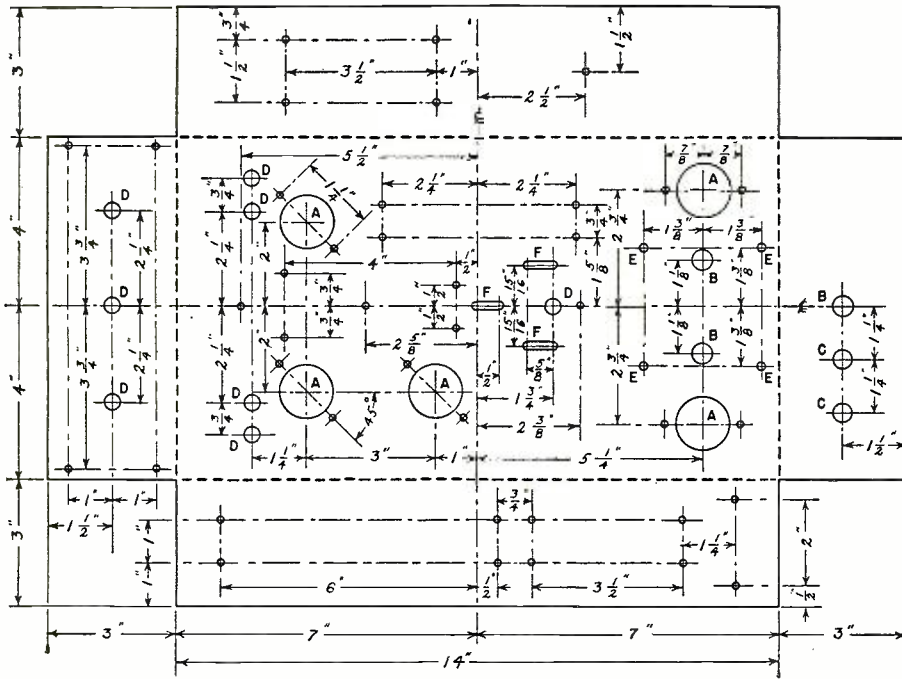

Fig. 3. Developed view of chassis.



- A—5 holes 1 1/4" diam.
- B—3 holes 1/2" diam.
- C—2 holes 7/16" diam.
- D—8 holes 3/8" diam.
- E—4 holes #12 drill
- F—slots .147 x 5/8"
- 40 holes #28 drill (not designated)

Fig. 5. Control panel escutcheon.

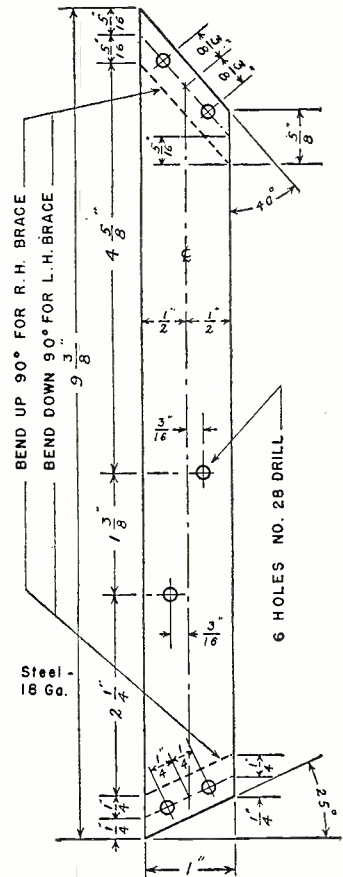
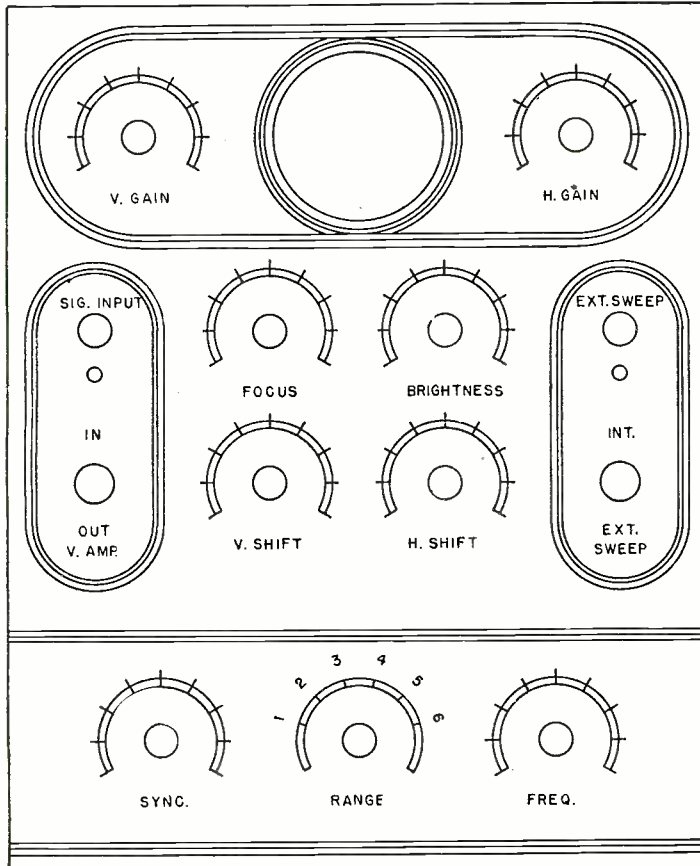
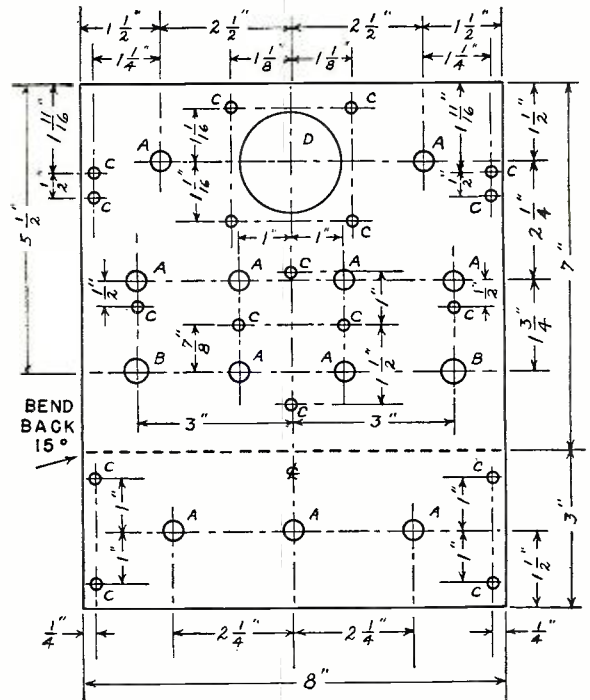

Fig. 4. Panel bracket.

Fig. 6. Front panel.



- A—11 holes 3/8" diam.
- B—2 holes 7/16" diam.
- C—18 holes #28 drill
- D—1 hole 1 1/16" diam.

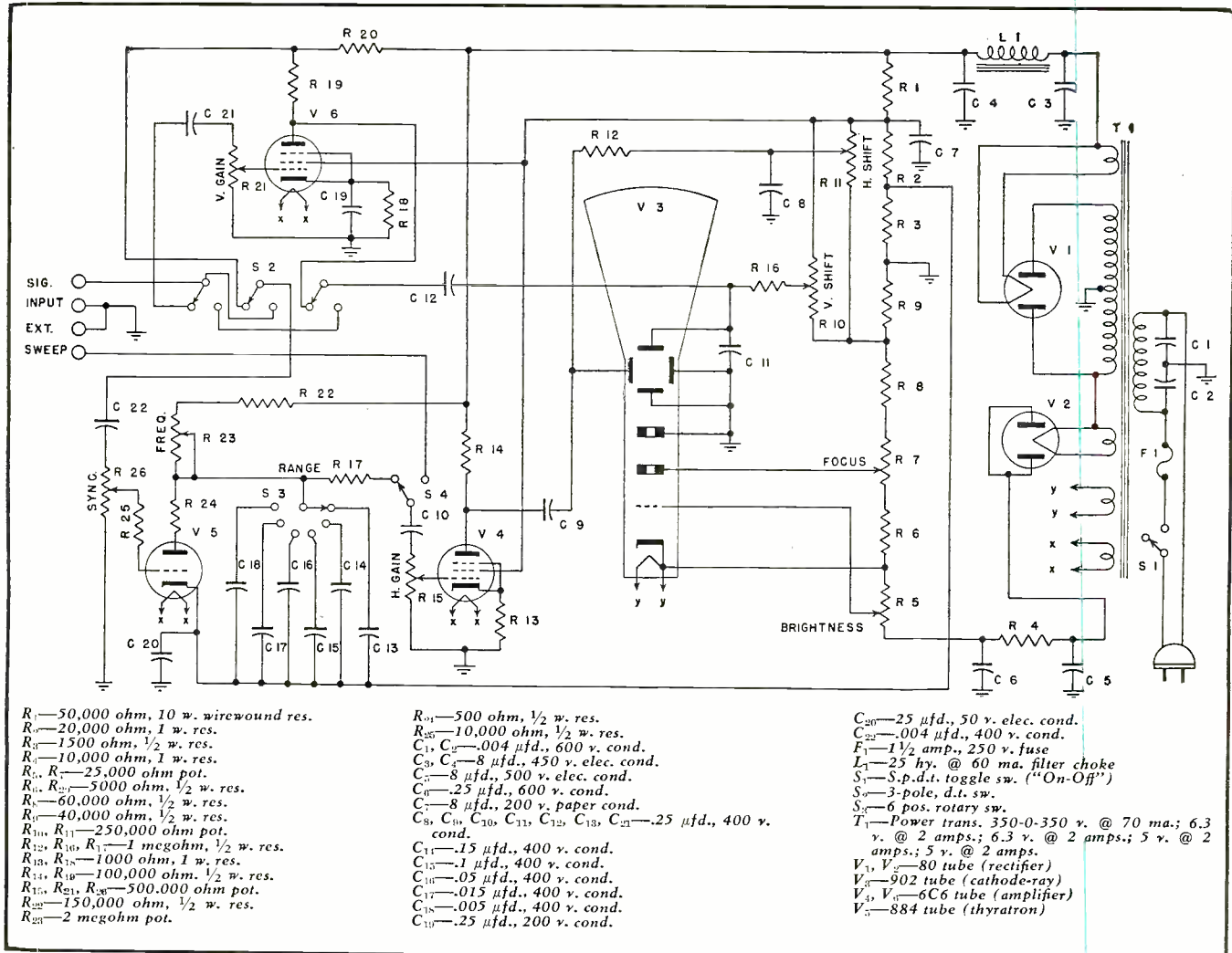

Fig. 2. Complete diagram of oscilloscope. Power transformer is a conventional receiver type unit with four filament windings.

ternating voltage for this rectifier. For the same reason, the filter associated with the negative power supply is a single pi-section resistance capacity filter. The d.c. output of the negative power supply is 435 volts, and that of the positive power supply is 420 volts.

The voltage divider in the positive power supply is arranged so that the full 420 volts is available for the plate supply of the horizontal and vertical amplifier tubes, and for the time-base generator, while 90 volts is provided for the screen grid supply of the amplifier stages and 4.5 volts for the cathode bias of the time-base tube. The negative voltage divider contains potentiometers for the brightness and focus controls of the cathode-ray tube. The horizontal and vertical shift controls are bridged across a portion of both the positive and negative voltage dividers, so that either a positive or a negative bias with respect to ground can be placed on the free deflection plates.

Following the usual practice, the cathode of the Type 902 tube is placed at a high negative potential and the second anode is grounded. In this tube, one horizontal and one vertical deflection plate is connected inter-

nally to the second anode. For this reason only the single-ended type of deflection amplifiers can be used.

The deflection amplifiers used in this instrument are single stage resistance-coupled amplifiers employing pentode tubes. Type 6C6 tubes were used because they were readily available, but other similar types could be employed with equally good results. It was found necessary to leave the cathode resistor of the horizontal deflection amplifier unbypassed, thus introducing negative feedback and improving the frequency response of this amplifier. This allows the saw-tooth time base waves to be passed with very little distortion. The accompanying loss in gain in this stage can be tolerated since there is more than enough amplification available for most purposes. A switch is provided for removing the internal sweep from the circuit so that an external sweep voltage can be used. A switch is also provided for removing the vertical deflection amplifier from the circuit and applying the signal voltage, through a blocking condenser, directly to the vertical deflection plates of the cathode-ray tube.

The time base circuit employs a Type 884 thyatron tube in conjunc-

tion with a condenser-resistor circuit to produce a saw-tooth voltage wave. The condenser is charged through the resistor and discharged through the thyatron. The deflection voltage which appears across the condenser is essentially linear if the charging time is limited to the first ten per-cent of the exponential charging curve. Since the voltage thus obtained is sufficient, when amplified by the horizontal deflection amplifier, to spread the time base across the full face of the cathode-ray tube, no attempt was made to improve the linearity of the sweep by incorporating a constant current device. Condensers of different sizes are switched into the circuit by means of the range switch, giving a rough control of the sweep frequency. The resistance element, a two megohm carbon type control, provides the fine frequency adjustment.

Synchronization of the sweep with the signal is provided by picking off a portion of the signal voltage, either directly or from the output of the vertical deflection amplifier, and applying it to the grid of the thyatron tube. The input to the grid of this tube consists of a condenser in series with a 500,000 ohm carbon type potentiometer which allows the magnitude of

the synchronizing voltage applied to the tube to be varied. Best results are obtained when the smallest voltage which will achieve synchronization is applied to the thyatron. A rather small value of capacity in the series condenser combines with the resistance of the potentiometer to give a rather short time constant to this combination. The signal voltage is differentiated or "peaked" by this circuit producing sharp, narrow synchronizing pulses which are an aid in securing positive firing of the gas tube.

While the circuit of this instrument is quite conventional, being similar to several commercial oscilloscopes, the mechanical arrangement was worked out with the view of making the instrument rugged, easy to construct with limited shop facilities, and free from undesired interaction between the various circuits.

The main chassis is eight inches wide, fourteen inches long, and three inches deep. The control panel is attached to one end of the chassis by means of machine screws. This panel

is eight inches wide and ten inches high. The portion above the chassis is bent back at an angle of fifteen degrees to the vertical so that the face of the cathode-ray tube is easy to see by students standing at a workbench. A hole for the face of the tube is cut in the front panel near its upper edge. The front end of the tube is held in place by a fitted collar made from three-sixteenths inch plywood. The face of the tube is protected by a shield of Plexiglas, on which is inscribed a reference grid. The lines of this grid are spaced one-tenth of an inch, both horizontally and vertically. They were drawn with a sharp pointed scribe, after which the marks were filled in with drawing ink. The rear end of the tube is supported by a bracket which holds the tube socket for the cathode-ray tube as well as a terminal board for the connections to this tube.

The power transformer was located behind the cathode-ray tube at the rear of the chassis, and oriented so that its core laminations are aligned with the axis of the tube. Stray fields

from the transformer have the least effect on the electron beam when the transformer is in this position. A slight change in the position of the power transformer may be necessary to eliminate the last traces of a power frequency signal on one or both axes. No additional shielding of the tube or components was found necessary.

The filter choke was mounted below the chassis, with its core at right angles to that of the power transformer. This minimizes the possibility of inducing a ripple voltage from the transformer into the d.c. supply by way of the filter choke.

The fuse in the power line and the "On-Off" toggle switch were mounted at the rear of the chassis near the power transformer, thus confining all the power wiring to the back part of the set and preventing undesired coupling to the amplifier stages.

All small parts were mounted on fiber strips which were provided with terminal lugs. The mounting strips were made up as sub-assemblies, complete with their circuit components, and with as much of the wiring as

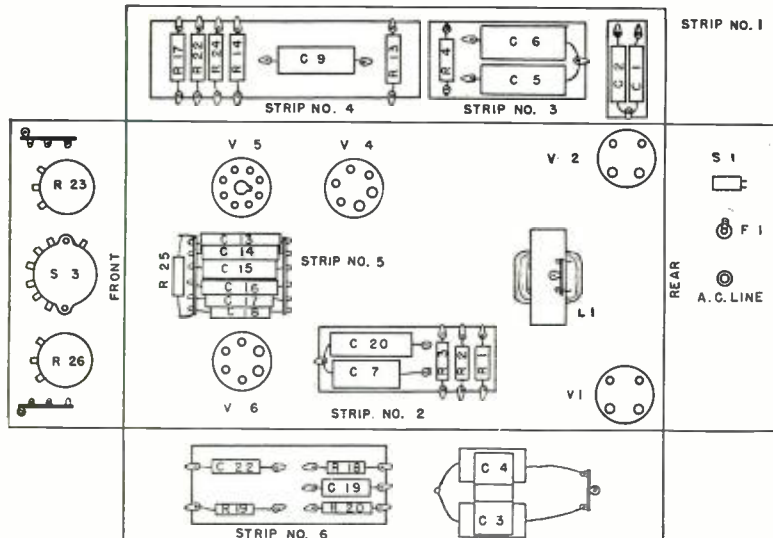

Fig. 8. Bottom view of the chassis showing location of various components.

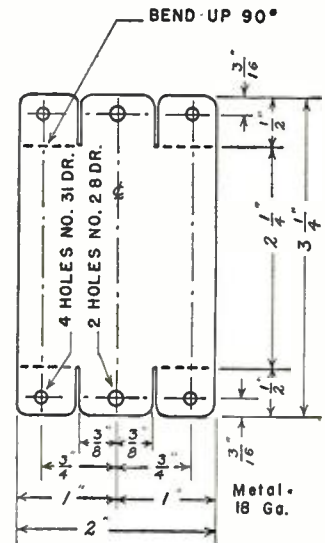

Fig. 9. Turret bracket.

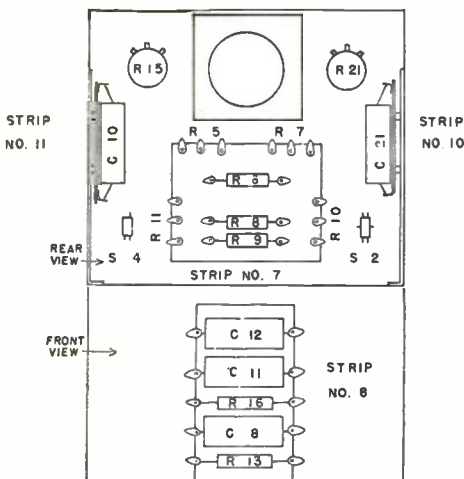

Fig. 10. (Top) Rear view of control panel. (Bottom) Top view of terminal strip mounted horizontally on top of chassis, below the 90 tube.

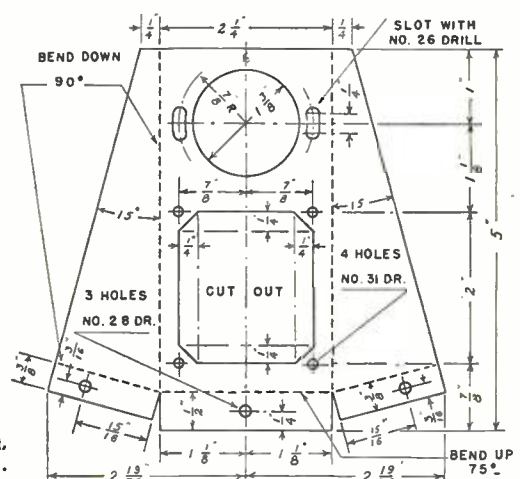

Fig. 11. CR tube bracket. 18 ga. metal used.

"MEET MY ACE SALESMAN!"



"THE G-E monogram on the tubes I stock and install—that's Reason No. 1 why I'm doing more business than ever before!" Plenty of radio-TV servicemen are saying this. It pays to handle a winner; public preference for General Electric puts real money in servicemen's pockets, will profit *you* and accent your reputation for first-class repair-work and quality tubes and parts. . . . Reason No. 2 why you'll do more business, is General Electric tube promotion aids! Help to you from G-E headquarters never stops. Stunning new signs and displays; advertising items that crackle and spark; a host of useful serviceman's aids; a continuous flow of up-to-date TV repair tips in Techni-Talk Magazine—these become dollars-and-cents sales figures. Ask your distributor *today* for the full G-E-tube success story! *Electronics Dept., General Electric Company, Schenectady 5, N.Y.*

ONE SOURCE FOR ALL YOUR TUBE REQUIREMENTS

—metal and glass tubes; miniatures; TV picture tubes in a wide range of sizes and types; also germanium diodes and selenium rectifiers. General Electric's line is complete! G.E.'s list of types includes newest tube designs for new radio-TV receivers! . . . Stock G-E 100-per cent, to simplify ordering—benefit from unit deliveries—profit from General Electric tube quality and popularity!

You can put your confidence in—

GENERAL  **ELECTRIC**

181-JA6

YOUR NEW STANCOR CATALOGS

are ready!

CATALOG OF TRANSFORMERS FOR RADIO, SOUND AND OTHER ELECTRONIC USES.

Here's a "must" for every user of transformers—serviceman, ham, experimenter, engineer. Detailed listings of more than 400 Stancor part numbers. Includes accurate electrical and physical specs, dimensions, prices, illustrations. Complete and up-to-date. Handy charts and easy-to-use indexes help to make this new Stancor catalog the book you'll want to find the part you need.

TELEVISION CATALOG AND REPLACEMENT GUIDE.

The sixth edition of the popular Stancor TV Replacement Guide (50,000 copies printed to date). Now combined in a big, 30-page book with a complete catalog of all Stancor TV components. Original part numbers, with Stancor replacements, are listed for more than 600 TV receiver and chassis models made by 64 manufacturers. Every Stancor component recommended in the guide is listed in the catalog section with complete specs, dimensions and prices. Gives you one convenient source of information. Makes your job quicker and easier.

And remember, when you buy a Stancor transformer, you get a quality product used by the country's biggest set makers as original equipment. Stancor transformers have to be good!

See your Stancor distributor today for your free copies of these books. If he is out of stock, we'll be glad to send you copies. Write Standard Transformer Corporation, 3584 Elston Avenue, Chicago 18, Illinois.



Most Complete Line in the Industry

could be conveniently done at that stage of the construction. The location of these strips can be seen in the photographs and in the drawings. All strips were separated from the chassis by means of spacers, and held in place by machine screws. The connections between the strips and the tube sockets were made with solid wire, dressed well away from the chassis to prevent leakage or arc-overs to the chassis. Rubber grommets were provided as additional insulation where wires passed through the chassis to elements mounted above. All heater leads were twisted to minimize the possibility of inducing sixty-cycle signals into other circuits in the oscilloscope.

The arrangement of the front panel can be seen in Fig. 5. The horizontal and vertical gain controls are located in the upper row on the control panel, permitting the use of comparatively short leads to the grid connections of their respective amplifier tubes. The four controls associated with the cathode-ray tube; "Focus," "Brightness," "V. Shift," and "H. Shift" are grouped immediately below the face of the tube. The controls associated with the internal time base circuit, "Frequency," "Range," and "Sync.," are arranged along the lower edge of the panel, allowing the circuit elements associated with these controls to be mounted below the chassis. The binding posts for signal output and for the external sweep input are located respectively on the left-hand and right-hand sides of the control panel near the amplifiers into which they feed. The toggle switch immediately below the signal input connection is used to switch the vertical deflection amplifier in or out of the circuit, while the switch below the external sweep connection is used to change the sweep from the internal to the external connection.

A number of these oscilloscopes have been built and are in daily use. In addition to their primary use as a laboratory instrument, some of the oscilloscopes were assembled, wired, and tested as a practical exercise in a course in basic electronics. A series of projects has been devised for this course with only one of the circuits of the oscilloscope involved in a single project. After a short treatment of the theory involved, the student completes the wiring of the circuit and tests it for proper operation. A satisfactory sequence for these projects is as follows: First, the positive and negative voltage power supplies. Second, the circuits for providing shift, focus, and deflection of the electron beam. Third, the internal linear time-base circuit. Fourth, the amplifier circuits. The student has the experience and satisfaction of constructing the instrument which he is to use in later experiments, and thereby gains a valuable insight into the possibilities and limitations of the cathode-ray oscilloscope.

TV CHASSIS SPECIAL!

New Improved De Luxe R.C.A. licensed 630 Chassis, complete with 31 tubes. Not a kit, but a factory-engineered, wired, tested and aligned TV Chassis. Just Plug it in and it works.

IMPORTANT FEATURES:

- Newly developed keyed automatic gain control
- Improved A-F-C horizontal hold (Syncrolock)
- Voltage Doubler produces 14 Kv under load
- Wide angle deflection yoke will spread any 16" or 19" picture tube
- Armstrong FM high quality sound
- Moulded plastic condensers

Perfect Chassis for 16" and 19" picture tube **\$139.50** (Less CRT, plus \$1.79 Fed. Tax)
(Includes 12" R.C.A. Speaker)
 16" Glare Proof Tube (1 Yr. Guar.) \$34.50
 19" Glare Proof Tube (1 Yr. Guar.) \$64.50

Terms 25% deposit with order—
 Balance C.O.D.—F.O.B. N. Y.

Beautiful Cabinets for above available, prices on request!

DE SOTO DISTRIBUTORS

1845 Pitkin Ave. (nr. Sackman St.), Brooklyn 12, N. Y.—HYacinth 8-5932
 173 West 26th St. (nr. 7th Ave.), New York 1, N. Y.—CHelsea 3-8440

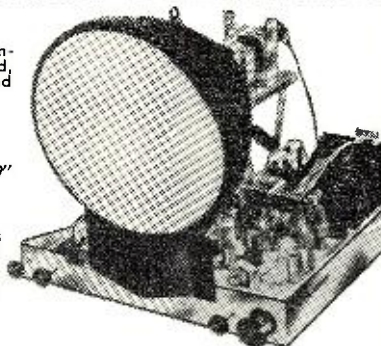

To the Ambitious Young Man Who Wants Technical Training that pays off quickly with a Career in TELEVISION RADIO ELECTRONICS

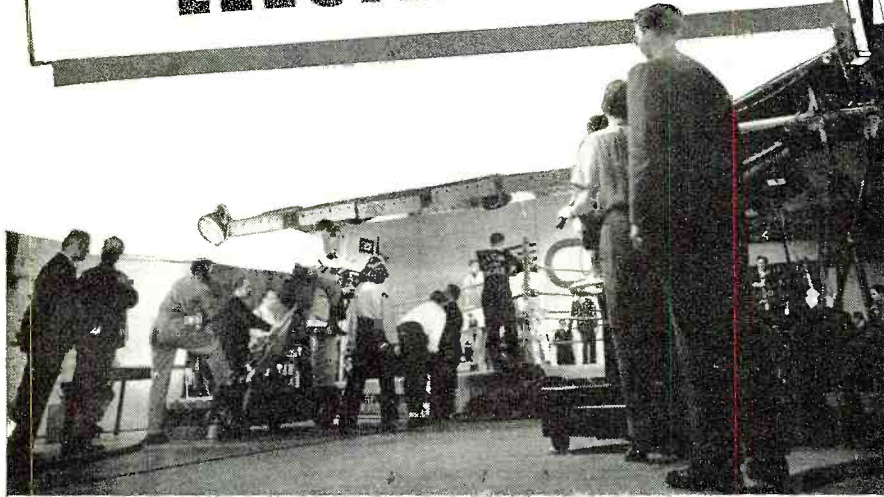

A profitable lifetime career is in the palm of your hand if you accept nothing but the best in technical preparation and make an immediate decision to start training at once!

Jobs—good jobs—await trained engineers and technicians in this Electronics Age. TV's fantastic growth from 10,000 sets at war's end to 8 million by the end of 1950—with set production currently at the rate of 5 million per year—is typical of the speed at which the electronics band-wagon is moving. It is the *new field*, where know-how is rewarded with excellent jobs and life-time careers!



Instrument Landing

VAST FACILITIES. At CREI you work with the latest equipment in our own quarter-million dollar buildings, consisting of over 120,000 square feet of fully equipped class rooms, modern television and radio broadcasting studios, transmitters, control rooms, and experimental laboratories—all under the direct supervision of the same instructional staff responsible for the training of men employed by major

airlines and electronics equipment manufacturers. At CREI you study in beautiful Washington, D. C., center of historical points of interest and countless educational and cultural opportunities. In the Residence School you will be grounded thoroughly in the fundamentals required for development work in television, guided missiles, and all the other important fields of communications and electronics.

UNLIMITED SCOPE. Thus as a CREI graduate, you need not confine your career thinking to a limited field—dozens of career opportunities and good paying jobs are also in your grasp. CREI graduates are today filling important engineering, research and operational posts throughout the world—in every branch of electronics.

CREI TRAINING CHOSEN BY INDUSTRY. What better proof of the genuine high level training and outstanding quality of CREI radio-electronic training than this: CREI has been selected by these major airlines, manufacturers, networks and top merchandisers to train their electronics specialists!

- United Air Lines • Pan American Airways
- Trans-Canada Air-Lines
- Canadian Broadcasting Corp.
- Bendix Aviation Corp. • RCA Victor
- All American Cables & Radio, Inc.
- Sears-Roebuck Co. and Others.

These high-grade organizations demand the best in technical perfection. They are *paying* us to train their men. Certainly this is conclusive evidence that you can make no wiser selection for your own career training than CREI—the only accredited technical institute with this kind of industry approval!



Airport Control

NO DELAY IN CLASSES. New classes start twice a month. Due to the unique, personalized, modern methods of instruction, you establish your own speed of progress, advancing to new work as soon as you have mastered a subject, not retarded by slower students.

To insure *your* training that pays off quickly with a lifetime career, act right now. Send TODAY for free CREI Residence School Catalog!

RESIDENCE SCHOOL APPROVED FOR VETERANS

High level home study training also available for professional radio men.

MAIL THIS COUPON AT ONCE FOR FREE CATALOG

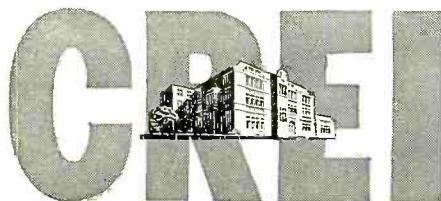

CAPITOL RADIO ENGINEERING INSTITUTE

16th Street and Park Road, N. W.,
Dept. 138B Washington 10, D. C.

Please send free Residence School Catalog.

Name.....

Street.....

City.....Zone.....State.....

Veteran Non-Veteran Age.....

Send details about Home Study Courses.

NEW 1950

Heathkits

have all the Features

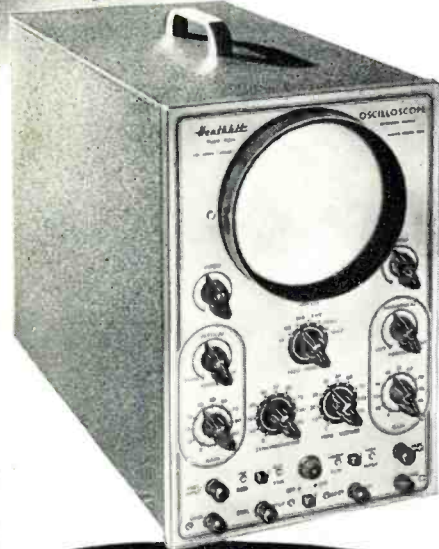

\$39.50

New 1950 Heathkit PUSH-PULL EXTENDED RANGE 5" OSCILLOSCOPE KIT

Features

- The first truly television oscilloscope.
- Tremendous sensitivity .06 Volt RMS per inch deflection.
- Push-pull vertical and horizontal amplifiers.
- Useful frequency range to 2½ Megacycles.
- Extended sweep range 15 cycles to 70,000 cycles.
- New television type multivibrator sweep generator.
- New magnetic alloy shield included.
- Still the amazing price of \$39.50.

The new 1950 Push-Pull 5" Oscilloscope has features that seem impossible in a \$39.50 oscilloscope. Think of it—push-pull vertical and horizontal amplifiers with tremendous sensitivity only six one hundredths of a volt required for full inch of deflection. The weak impulses of television can be boosted to full size on the five inch screen. Traces you couldn't see before. Amazing frequency range clear useful response at 2½ Megacycles made possible by improved push-pull amplifiers. Only Heathkit Oscilloscopes have the frequency range required for television. New type multi-vibrator sweep generator with more than twice the frequency range. 15 cycles to 70,000 cycles will actually synchronize with 250,000 cycle signal. Dual positioning controls will move trace over any section of the screen for observation of any part. New magnetic alloy CR tube shield protects the instrument from outside fields. All the same high quality parts, cased electrostatically shielded power transformer, aluminum cabinet, all tubes and parts. New instruction manual now has complete step by step pictorials for easiest assembly. Shipping Weight 30 lbs. Order now for this winter's use.

CONVERSION FOR OTHER MODEL HEATHKIT OSCILLOSCOPES

A conversion for all 03 and 04 scopes is available changing them to the new push-pull amplifiers (does not change the sweep generator). Complete kit includes new chassis, tubes and all parts. For a small investment, add the latest improvements to your present oscilloscope (Except C.R. Tube Shield). Shipping weight 10 lbs. Order 05 Conversion Kit No. 315. **\$12.50**

THE NEW Heathkit HANDITESTER KIT

MORE Features THAN EVER BEFORE

- Beautiful streamline Bakelite case.
- AC and DC ranges to 5,000 Volts.
- 1% Precision ceramic resistors.
- Convenient thumb type adjust control.
- 400 Microampere meter movement.
- Quality Bradley AC rectifier.
- Multiplying type ohms ranges.
- All the convenient ranges 10-30-300-1,000-5,000 Volts.
- Large quality 3" built-in meter.

The instrument for all—the ranges you need—beauty you'll enjoy for years and you can assemble it in a matter of minutes—an instrument for everyone. The handiest quality volt-ohmmeter of all. Small enough to put in your pocket yet a full 3" meter. Easy pictorial wiring diagrams eliminate all assembly problems. Uses only 1% precision ceramic divider resistors and wire wound shunts. Twelve different ranges. AC and DC ranges of 10-30-300-1,000-5,000 Volts. Ohms ranges of 0-3,000 ohms and 0-300,000 ohms. Milliampere ranges of 10MA and 100MA. Hearing aid type ohms adjust control fits conveniently under thumb for one hand adjustment. Banana type jacks for positive low resistance connections. Quality test leads included. The high quality Bradley instrument rectifier was especially chosen for linear scales on AC. The modern case was styled by Harrah Engineering for this instrument. The 400 microampere meter movement comes already mounted in the case protected from dust during assembly. An ideal classroom assembly instrument useful for a lifetime. Perfect for radio service calls, electricians, garage mechanics, students, amateurs and beginners in radio. The only quality volt-ohmmeter under \$20.00. An hour of assembly saves you one-half the cost and quality parts give you a better instrument. Order today. Shipping weight 2 lbs.

\$13.50



Note
HANDY
OHMS
ADJUST.

EXPORT DEPT.
13 East 40th St.
NEW YORK CITY (16)
CABLE: ARLAB-N.Y.

The HEATH COMPANY

... BENTON HARBOR 15, MICHIGAN

MORE QUALITY in

1950 Heathkits

The NEW V-4 Heathkit

VACUUM TUBE VOLTMETER KIT

Features

- Meter scale 17% longer than average 4½" meter.
- Modern streamline 200 ua meter.
- New modern streamline styling.
- Burn-out proof meter circuit.
- 24 Complete ranges.
- Isolated probe for dynamic testing.
- Most beautiful VTVM in America.
- Accessory probes (extra) extend ranges to 10,000 Volts and 100 Megacycles.
- Uses 1% precision ceramic divider resistors.
- Modern push-pull electronic voltmeter circuit.
- Electronic AC circuit. No current drawing rectifiers.
- Shatterproof plastic meter face.

The new Heathkit Model V-4 Vacuum Tube Voltmeter has dozens of improvements. A new modern streamlined 200 microampere meter has Alnico V magnet for fast, accurate readings. The new electronic AC voltmeter circuit incorporates an entire new balance control which eliminates contact potential and provides greater accuracy. New simplified switches for quicker assembly. New snap-in battery mounting is on the chassis for easy replacement.

The Heathkit VTVM is the only kit giving all the ranges. Check them — DC and AC-full scale linear ranges of 0-3V, 0-10V, 0-30V, 0-100V, 0-300V, 0-1000V and can be extended to 0-3000V and 0-10,000V DC with accessory probe at slight extra cost. Electronic ohmmeter has six ranges measuring resistance accurately from .1 ohm to one billion ohms. Meter pointer can be offset to zero center for FM alignment.

The DC probe is isolated for dynamic measurements. Has db scale for making gain and other audio measurements.

The new instruction manual features pictorial diagrams and step-by-step instructions for easy assembly. The Heathkit VTVM is complete with every part — 110V transformer operated with test leads, tubes, light aluminum cabinet for portability, giant 4½" 200 microamp meter and complete instruction manual.

Order now and enjoy it this entire season. Shipping weight 8 lbs., Model V-4

Accessory: 10,000V high voltage probe, No. 310, \$4.50.
Accessory: RF crystal diode probe kit extends RF range to 100 Mc., No. 309, \$6.50.

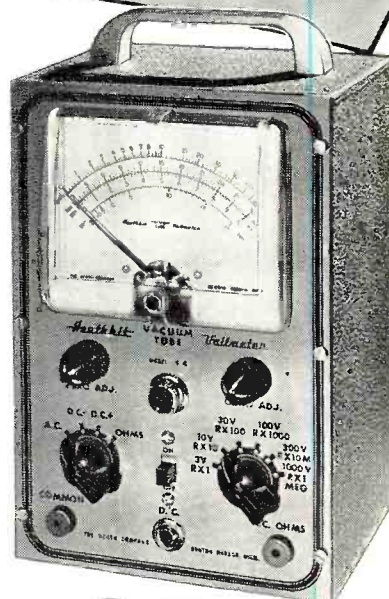

\$24.50

New 1950 VERNIER TUNING R.F. Heathkit

SIGNAL GENERATOR KIT

Features

- New 5 to 1 ratio vernier tuning for ease and accuracy.
- New external modulation switch—use it for fidelity testing.
- New precision coils for greater output.
- Cathode follower output for greatest stability.
- 400 cycle audio available for audio testing.
- Most modern type R.F. oscillator.
- Covers 150Kc. to 34Mc. a fundamentals and calibrated strong harmonics to 102 Mc.

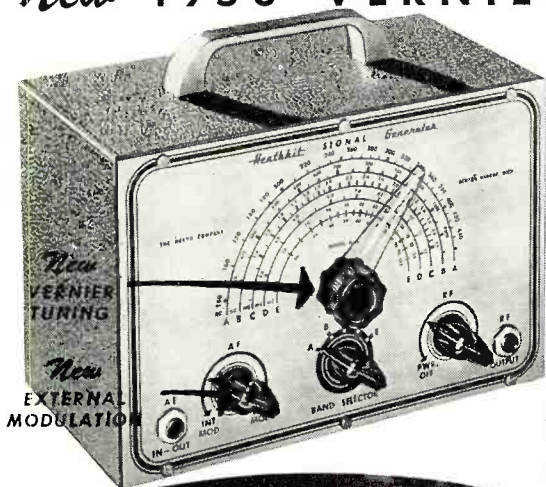

\$19.50

The most popular signal generator kit has been vastly improved—the experience of thousands combined to give you the best. Check the features in this fine generator and consider the low price \$19.50. A best buy for any shop, yet inexpensive enough for hobbyists. Everyone can have an accurate controlled source of R.F. signal voltage.

The new features double the value—think of being able to make fidelity checks on receivers by inserting a variable audio signal. Internal 400 cycle saw-tooth audio oscillator modulates R.F. signal and is available externally for audio testing. The new 5 to 1 ratio vernier drive gives hairline tuning for maximum accuracy in scale settings. The coils are already precision wound and calibrated. Uses turret type coil and switch assembly for ease of construction. The generator is 110 V. 60 cycle transformer operated and comes complete in every detail—cabinet—tubes—coils—beautiful two color calibrated panel and all small parts—new step-by-step pictorial diagrams and complete instruction manual make assembly a cinch even for novices. Why try to get along without a signal generator when you can have the best for less than a twenty dollar bill. Better order it now. Shipping weight 7 lbs. \$19.50

CONVERSION KIT FOR G-1 GENERATORS

Conversion kit for G-1 generators for vernier tuning and external modulation includes new high band coil for greater output. Gives all the features of new G-5 listed above. Order G-5 Conversion Kit No. 316. \$4.50

EXPORT DEPT.
13 East 40th St.
NEW YORK CITY (16)
CABLE: ARLAB-N.Y.

The **HEATH COMPANY**

... BENTON HARBOR 15, MICHIGAN

Beauty · Quality · Economy



Only
\$69.50

Nothing
ELSE TO BUY

New Heathkit

IMPEDANCE BRIDGE KIT

A LABORATORY INSTRUMENT NOW WITHIN
THE PRICE RANGE OF ALL

Measures Inductance from 10 microhenries to 100 henries capacitance from .00001 MFD to 1000 MFD. Resistance from .01 ohms to 10 megohms. Dissipation factor from .001 to 1. "Q" from 1 to 1000.

Ideal for schools, laboratories, service shops, serious experimentors.

An impedance bridge for everyone — the most useful instrument of all, which heretofore has been out of the price range of serious experimentors and service shops. Now at the lowest price possible. All highest quality parts. General Radio main calibrated control. General Radio 1000 cycle hummer. Mallory ceramic switches with 60 degree indexing — 200 micro-amp zero center galvanometer — 1/2 of 1% ceramic non-inductive decade resistors. Professional type binding posts with standard 3/4" centers. Beautiful birch cabinet. Directly calibrated "Q" and dissipation factor scales. Ready calibrated capacity and inductance standards of Silver Mica, accurate to 1/2 of 1% and with dissipation factors of less than 30 parts in one million. Provisions on panel for external generator and detector. Measure all your unknowns the way laboratories do — with a bridge for accuracy and speed.

Internal 6 volt battery for resistance and hummer operation. Circuit utilizes Wheatstone, Hay and Maxwell circuits for different measurements. Supplied complete with every quality part — all calibrations completed and instruction manual for assembly and use. Deliveries are limited. Shipping weight, approximately 15 lbs.

Heathkit CONDENSER CHECKER KIT

\$ **9.50**



Features

- Power factor scale
- Measures resistance
- Measures leakage
- Checks paper-mica-electrolytics
- Bridge type circuit
- Magic eye indicator
- 110V. transformer operated
- All scales on panel

Checks all types of condensers, paper-mica-electrolytic-ceramic over a range of .00001 MFD. to 1000 MFD. All on readable scales that are read direct from the panel. NO CHARTS OR MULTIPLIERS NECESSARY. A condenser checker anyone can read without a college education. A leakage test and polarizing voltage for 20 to 500 volts provided. Measures power factor of electrolytics between 0% and 50%. 110V. 60 cycle transformer operated complete with rectifier and magic eye tubes, cabinet, calibrated panel, test leads and all other parts. Clear detailed instruction for assembly and use. Why guess at the quality and capacity of a condenser when you can know for less than a twenty dollar bill. Shipping weight, 7 lbs. Model C-2.

New Heathkit

TELEVISION ALIGNMENT GENERATOR KIT



\$39.50

Nothing ELSE TO BUY

Everything you want in a television alignment generator. A wide band sweep generator covering all TV frequencies 0-46 54 to 100 — 174 to 220 Megacycles, a marker indicator covering 19 to 42 Megacycles, AM modulation for RF alignment — variable calibrated sweep width 0-30 Mc. — mechanical driven inductive sweep. Husky 110V. 60 cycle power transformer operated — step type output attenuator with 10,000 to 1 range — high output on all ranges — band switching for each range — vernier driven main calibrated dial with over 45 inches of calibration — vernier driven calibrated indicator marker tuning. Large grey crackle cabinet 16 1/8" x 10 3/8" x 7-3/16". Phase control for single trace adjustment. Uses three high frequency triodes plus 5Y3 rectifier — split stator tuning condensers for greater efficiency and accuracy at high frequencies — this Heathkit is complete and adequate for every alignment need and is supplied with every part — cabinet — calibrated panel — all coils and condensers wound, calibrated and adjusted. Tubes, transformer, test leads — every part with instruction manual for assembly and use. Actually three instruments in one — TV sweep generator — TV AM generator and TV marker indicator.

EXPORT DEPT.
13 East 40th St.
NEW YORK CITY (16)
CABLE: ARLAB-N.Y.

The **HEATH COMPANY**

... BENTON HARBOR 15, MICHIGAN

all in HEATHKITS . . .

Heathkit TUBE CHECKER KIT Features

1. Measures each element individually
2. Has gear driven roller chart
3. Has lever switching for speed
4. Complete range of filament voltages
5. Checks every tube element
6. Uses latest type lever switches
7. Uses beautiful shatterproof full view meter
8. Large size 11" x 14" x 4" complete
9. Checks new 9 pin piniaures

Check the features and you will realize that this Heathkit has all the features you want. Speed — simplicity — beauty — protection against obsolescence. The most modern type of tester — measures each element — beautiful Bad-Good scale, high quality meter — the best of parts — rugged oversize 110V. 60 cycle power transformer — finest of Mallory switches — Centralab controls — quality wood cabinet — complete set of sockets for all type tubes including blank spare for future types — fast action gear driven roller chart uses brass gears to quickly locate and set up any type tube. Simplified switching cuts necessary time to minimum and saves valuable service time. Short and open element check. No matter what arrangement of tube elements, the Heathkit flexible switching arrangement easily handles it. Order your Heathkit Tube Checker today. See for yourself that Heath again saves you 2/3 and yet retains all the quality — this tube checker will pay for itself in a few weeks — better build it now.

Complete with detail instructions — all parts — cabinet — roller chart — ready to wire up and operate. Shipping Wt., 15 lbs.



Only
\$29.50

Nothing
ELSE TO BUY

Heathkit SINE AND SQUARE WAVE AUDIO GENERATOR KIT



Nothing
ELSE TO
BUY

\$34.50

Experimenters and servicemen working with a square wave for the first time invariably wonder why it was not introduced before. The characteristics of an amplifier can be determined in seconds compared to several hours of tedious plotting using older methods. Stage by stage, amplifier testing is as easy as signal tracing. The low distortion (less than 1%) and linear output (\pm one db.) make this Heathkit equal or superior to factory built equipment selling for three or four times its price. The circuit is the popular RC tuning circuit using a four gang variable condenser. Three ranges 20-200, 200-2,000, 2,000-20,000 cycles are provided by selector switch. Either sine or square waves instantly available at slide switch. All components are of highest quality, cased 110V. 60 cycle power transformer. Mallory F.P. filter condensers. 5 tubes, calibrated 2 color panel, grey crackle aluminum cabinet. The detailed instructions make assembly an interesting and instructive few hours. Shipping Wt., 13 lbs.

New Heathkit BATTERY ELIMINATOR KIT

Nothing
ELSE
TO BUY



\$22.50

Now a bench 6 Volt power supply kit for all auto radio testing. Supplies 5 - 7 1/2 Volts at 10 Amperes continuous or 15 Amperes intermittent. A well filtered rugged power supply uses heavy duty selenium rectifier, choke input filter with 4,000 MFD of electrolytic filter. 0 - 15 Volt meter indicates output. Output variable in eight steps. Excellent for demonstrating auto radios. Ideal for servicing — can be lowered to find sticky vibrators or stepped up to equivalent of generator overload — easily constructed in less than two hours. Complete in every respect. Shipping Wt., 18 lbs.

NEW Heathkit SIGNAL TRACER AND UNIVERSAL TEST SPEAKER KIT

Nothing
ELSE
TO BUY

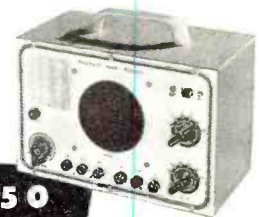

\$19.50

The popular Heathkit signal tracer has now been combined with a universal test speaker at no increase in price. The same high quality tracer follows signal from antenna to speaker — locates intermittents — defective parts quicker — saves valuable service time — gives greater income per service hour. Works equally well on broadcast — FM or TV receivers. The test speaker has assortment of switching ranges to match push pull or single output impedance. Also test microphones, pickups — PA systems — comes complete — cabinet — 110V. 60 cycle power transformer — tubes, test probe, all parts and detailed instructions for assembly and use. Shipping Wt., 8 lbs.

EXPORT DEPT.
13 East 40th St.
NEW YORK CITY (16)
CABLE: ARLAB-N.Y.

The **HEATH COMPANY**

. . . BENTON HARBOR 15, MICHIGAN

PORTABLE SHOWROOM SELLS TV SETS

By PHILIP BRENTON

How one television dealer has increased his sales by taking his showroom to the customers.

A SHOWROOM on wheels that brings a wide selection of television sets right into a prospect's home has proven highly successful for *Magnolia Television*, 11009 Magnolia Blvd., North Hollywood, California.

W. C. Petty, owner of the store, purchased a used house trailer for his experiment, stripped it down completely and remodeled the inside, including carpets on the floor and seats for the customers. The exterior of the trailer is painted white and lettered with red, yellow, and blue signs to attract attention. The total investment, including the rewiring necessary to accommodate a number of sets, ran about \$500.00.

The trailer is taken to a prospect's home upon request, but for the most part it is used with a crew of salesmen working a six-block area. The salesmen canvass the area looking for prospects and then return to the crew manager and trailer when they have an interested prospect. The crew manager then pulls the trailer into the prospect's driveway or in front of the house, an extension cord is run into the house, and the demonstration is on. If the prospect makes a definite selection the salesman stays to close the transaction or otherwise follow it up, and the trailer is moved to another location. The crew manager stays with the trailer all the time and uses his car to pull it around.

Mr. Petty has found that there are a

lot of advantages in using this unusual method of selling. In the first place it is not a substitute for the conventional methods inasmuch as it is used in conjunction with them rather than supplanting them. The firm still has its showroom and it still places demonstration sets in the home for trial.

One of the best features of this trailer selling is that it attracts a lot of attention in itself and gives the firm good free publicity. People see the trailer and talk about it—it was even written up in the local newspaper. In addition, it is much more effective than conventional home demonstrations because the trailer parked in a driveway attracts the neighbors who come over to see what is going on, something they would rarely do if the demonstration were being conducted in the privacy of a home. Then, too, it is obviously much easier to make a demonstration by plugging in an extension cord than it would be to actually install a set in the home, and it permits a number of sets to be demonstrated rather than just one or two. In short, it does everything that a conventional home demonstration will do, and a lot more besides. A car, or often a truck, was needed to make home demonstrations, so there is very little added cost to this method.

So successful has this trailer showroom been that plans are now under way to add other units to the "fleet."

—30—

Magnolia Television's "Portable Television Showroom." The trailer unit is a converted house trailer which has been equipped with rugs, chairs, and a selection of TV sets.



August, 1950



Again Atlas leads

the field with its new line of speakers and projectors.

Again Atlas makes the news in the Sound System field.

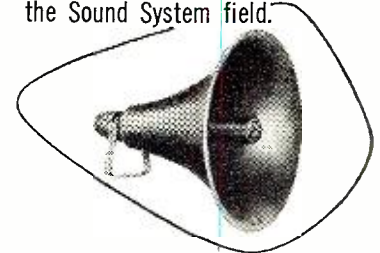

Atlas Reproducer units continue to retain the famous "Atlas V Plus" super-efficient magnetic assembly and in addition many more "Extra Plus" features. A new reversed dome, blast proof diaphragm is now standard in the high power, high fidelity models. Built-in transformers, designed for either constant 70 volt or constant impedance audio circuits are included. Improved appearance—functionally designed for maximum convenience. Double seal weather-proofing. All this and more without any general increase in price.

Atlas projectors have a new micrometrically calculated and controlled rate of expansion. Atlas non-vibrant projectors are rugged and fine in appearance. Sound energy is not dissipated in rattle vibration, distortion or cancellation.

The new improved line of Atlas speakers are really new from the voice coil to the final lock washer. It's really the "modern look" in speakers, a new high in overall performance.

Let Atlas speakers play an important part in your SOUND PROFITS.



Write for our new catalog — the most complete line of speakers, microphone stands and sound accessories.

ATLAS SOUND CORPORATION

1447 39th Street

Brooklyn 18

N. Y.

77

A LONG AND DISTINGUISHED LINE OF CANNON PLUGS

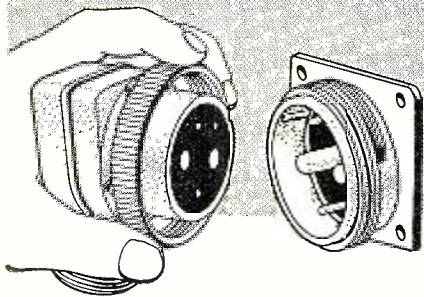

TYPES K AND RK CONNECTORS

for radio, television, instrument and general electrical and electronic circuits

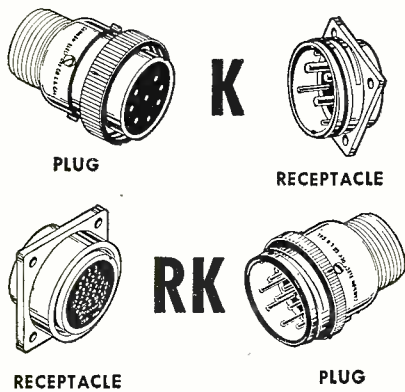

Cannon Electric K and RK plugs and receptacles include 14 shell types in 8 sizes with 199 insert (layout) arrangements. The line includes 6 accessory fittings. Contact capacities include 10, 15, 30, 40, 60, 80, 115 and 200-amperes. Conduit and cable clamp entries accommodate Navy, Air Corps and A-N threads. The special acme thread of the coupling nut assures long service, fewer turns for engagement.

Write to Cannon Electric Development Company, Division of Cannon Manufacturing Corporation, 3209 Humboldt Street, Los Angeles 31, California or contact one of the 28 Cannon representatives located in principal U. S. A. cities. Canadian plant and offices: Toronto, Ontario. Export: Frazer & Hansen, San Francisco, California.



"Tapered Line" Tuner

(Continued from page 55)

"switched channel coil" in Fig. 4 resonates against the input capacity of the tube and other stray capacitances at a particular channel frequency. This eliminates any capacitive reactance effects which would otherwise upset line match. Thus, by matching the r.f. stage's input, we effect maximum power transfer and a minimum standing-wave ratio. Since the tapered line section has a low input impedance and a high output impedance, voltage step-up is accomplished which is proportional to the square root of the impedance ratio. Thus with an input impedance of 300 ohms and an output impedance of 600 ohms a voltage step-up of approximately 40% is accomplished.

Fig. 4 shows the hookup of the tapered line input which is provided with terminals so that either a 75 ohm input or 300 ohm input may be matched

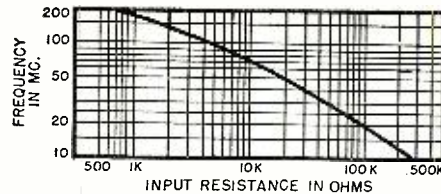
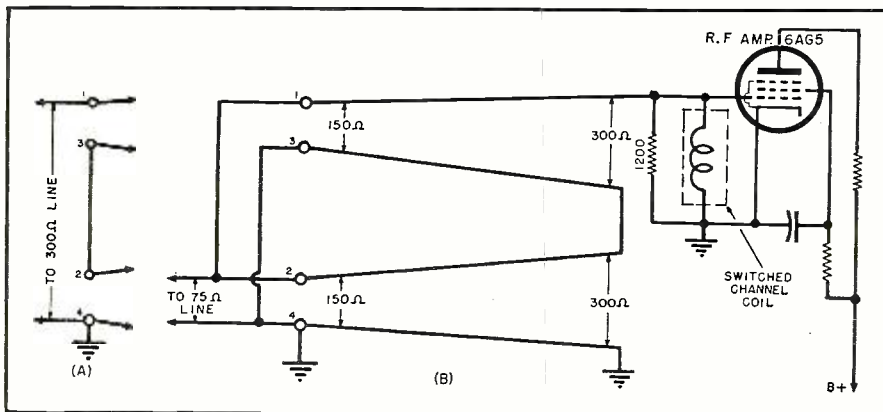

Fig. 3. Curve for the 6AG5 tube showing how the input resistance changes with frequency.

properly. Fig. 4A shows the hookup for a 300 ohm transmission line. In this position terminals #2 and #3 are connected together and the transmission line is connected to terminals #1 and #4. This connects the two 150 ohm tapered line narrow-end input in series to give a correct 300 ohm match.

Fig. 4B shows the hookup for a 75 ohm coaxial line. In this position terminals #3 and #4 are connected together, and the coaxial line is connected to terminals #1 and #4. This connects the two 150 ohm tapered line narrow-end inputs in parallel to give a correct 75 ohm match.

Fig. 4. (A) Tapered line connected for 300-ohm input and (B) for a 75-ohm input.



Doing it the hard way! Aboard this Jeep, 14,431 feet above sea level, is Vir James of Radio Station KVRH, Salida, Colorado, who staged what is believed to be the highest broadcast ever made from land. Colorado's highest peak, Mount Elbert, is the nation's second highest mountain and was conquered only after stakes were driven in the ground four different times so that the Jeep could draw itself over the rougher spots by means of its own mounted winch. The Jeep, piloted by I. R. Jackson of Leadville, was the only one of six starting Jeeps to reach the summit and the broadcast.



RAYTHEON

means business!

Raytheon Television Gives You All This Proof of Dependability!

Look at These Electronic Devices Made by RAYTHEON . . . unexcelled in electronics for 25 years!

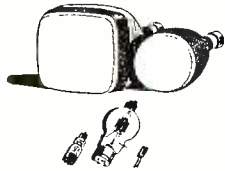

Tubes—Raytheon pioneered in cathode ray, subminiature and other electronic tubes.



Radar—Raytheon revolutionized the making of radar.



2-Way Radiophone—Raytheon is a leading manufacturer of this electronic device.



Radio—Raytheon engineers made possible the first house current radios.

Broadcasting Equipment—Raytheon is a leader in TV and radio equipment.



PLUS

THIS EXTRA PROOF OF DEPENDABILITY



PROOF!
Backed by famous Good Housekeeping Guaranty Seal.



PROOF!
Backed by the most liberal one-year Warranty.



PROOF!
Backed by Underwriters' Laboratories Seal.

with This Exciting NEW 1951 Line That Is

DEPENDABLY Built for DEPENDABLE Performance!

A NEW LINE CONSUMERS WILL LIKE!

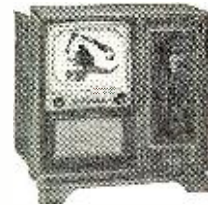
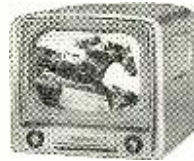

The new 1951 Raytheon television line can mean big profits for you! New models have extra sales appeal that means fast turnover—and they're priced to sell! Line includes table, console and combination models. Raytheon's generous discount on them means *big profits for you*.

Backed by Aggressive Promotion National advertising—plus hard-hitting merchandising—plus local advertising will all make your job of selling Raytheon easier.

Don't Miss Out! Discover the profits in store for you with this new 1951 Raytheon line. For complete information, contact your Raytheon distributor or write us today.

BELMONT RADIO CORPORATION

5921 W. DICKENS AVE., CHICAGO 39, ILLINOIS

Subsidiary of

RAYTHEON MANUFACTURING CO.

IT ALL ADDS UP TO BIGGER PROFITS FOR YOU!



Olson Radio Warehouse, Inc.
73 E. Mill St. • Akron 8, Ohio

IT'S DIFFERENT—IT'S AMAZING—IT'S GREAT
IT'S NEW!

The OLSON LOUDMOUTH



RA-43 Complete with tubes and Electro-Voice Microphone. OLSON'S Special Price, only

\$29⁹⁹
EACH

A complete sound system • Inputs for both microphone and phonograph • Electro-Voice Microphone included • Underwriters Laboratories approved components

An entire sound system capable of delivering 6 watts (8 watts peak) at less than 5% harmonic distortion. Has input jacks for microphone and phono. Two controls, one for volume and one for tone, 8" heavy duty built in PM speaker, safety fused circuit. Hum free operation. Indicating pilot light. Suitable for use by musicians, singers, lecturers, lodges, clubs and any other entertainment application. The dual-channel input permits mixing of singing with the playing of phonograph. Frequency response, ± 2DB 100 to 4,000 cps. Power gain 105DB. Tubes 6SL7zt, 6V6zt and 6X5zt. Hum level 60DB below output level of 6 watts. Power consumption 30 watts at 117 volts, 60 cycles. Dimensions, 11 1/4" x 8 1/2" x 13" high. Genuine leather carrying handle, beautiful tone grey and black carrying case with sloping control panel. Completely assembled ready to operate. Shpg. wt. 15 lbs.

ONLY AT OLSON'S

FREE—SEND FOR OUR LATEST RADIO AND TELEVISION BARGAIN CATALOG



By-Pass Condenser Kit
Assortment of 50 popular values, 200 to 1700 volts, capacities from .0002 to .25 mfd. Quantity limited. Shpg. wt. 2 lbs. **\$1.59**



KIT OF THREE VARIABLE CONDENSERS
A \$3.50 value. Perfect for the experimenter. Brand new stock. Quantity limited. **Olson's \$1.29**



MATCHED PAIR AM-FM CONDENSERS
Get a kit containing 3 assorted variable condensers. Popular values, 2-gang and 3-gang. Some have trimmers, vernier drives, AM and FM styles. **Olson's \$1.29**



Beautifully built! 3-gang. Build a tuner or AM-FM set. AM sections are 365 MMFD; FM is 15 MMFD per section. Can be operated by push-buttons, too. Shaft 3/4" dia. Condenser 3"x 1 1/2"x4". Shpg. wt. 3 lbs. **69¢**

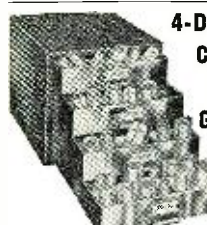

4-DRAWER STEEL CABINET GIVEN WITH OLSON'S GIGANTIC, NEW AKRAD KIT

Olson's Price \$14.95

You get \$45.20 list worth of "Akrad" Condensers plus the 4 drawer steel cabinet FREE, size 3 1/2" x 7 1/2" x 10 1/2". Shpg. wt. 11 lbs.

42 "Akrad" By-Pass Condensers!

Qty.	Cap.	Volts	ea.	Total
2	.001	600	.25	\$5.50
2	.002	600	.25	50
2	.005	600	.25	50
5	.01	600	.30	1.50
5	.02	600	.30	1.50
10	.05	600	.40	4.00
10	.1	600	.45	4.50
2	.005	1600	.55	11.00
2	.008	1600	.55	11.00
2	.01	1600	.60	1.20

Also 27 "Akrad" Electrolytic Condensers

Qty.	Cap.	Volts	ea.	Total
2	10	25	.75	\$1.50
2	25	25	.85	1.70
5	20	150	.95	4.75
5	40	150	1.10	5.50
5	20	150	1.30	5.20
5	8	450	.95	4.75
4	16	450	1.35	5.40

69 Total Value \$45.20



RADIO TUBES

Individually boxed GE, Kenrad, Sylvania, etc. Quantities 1 in. Red. Order early and get your pick. Order by Stock No. as well as Type No.

Stock No.	Type	Olson's Price
Z-6	174	29c
Z-8	3S4	29c
Z-29	5Y3gzt	49c
Z-37	6BE6	29c
Z-33	6SH7	29c
Z-75	12ASgzt	49c
Z-13	12BA6	49c
Z-14	12BE6	69c
Z-15	12SA7	69c
Z-16	12X4	69c
Z-17	12SQ7	69c
Z-23	35W4	49c
Z-25	35Z5gzt	49c
Z-26	30B5	89c
Z-27	50L6	69c



ASTATIC MICROPHONE

Universal high output crystal for public address, home recording and communications. Equipped with handle and desk base. 7 ft. shielded cable. beauty, too, for this price. Shpg. wt. 5 lbs. **\$4.95**

MICA CONDENSER KIT

Contains an assortment of 10 Mica condensers. Priced at less than jobbers' cost. Shpg. wt. 1 lb. **SPECIAL AT OLSON'S 69c**

FP CONDENSER KIT

Assortment of 15 popular FP condensers, double and triple sections. Capacities from 10 mfd to 50 mfd; from 25 to 450 volts. Shpg. wt. 3 lbs. **Olson's Bargain AS-24, each \$2.98**



NEW DESIGN

World's Fastest Automatic Changer for RCA 45 R.P.M. Records

\$7.95 Each

Developed by RCA, built by Crescent, a famous name in the changer field. Plays 8 to 10 records—30 minutes of continuous music. Plays one hour and 40 minutes with one turnover of the discs. New design does away with posts, clamps, which harm records. Discs slide easily down 1 1/2" diameter spindle. Changes records in less than 2 seconds. Crystal cartridge has frequency response from 60-10,000 cycles. Needle pressure is only 6 grams. Has built-in precious tipped 1 mil needle. Size 10 1/4" x 7 1/4" height overall. 6 3/4" requires 3 1/2" above and 3 1/4" below base plate. For 105-125 volts AC. Shpg. wt. 8 lbs. Factory sealed cartons. **SPECIAL AT OLSON'S.**



PLAYER—3 SPEEDS FOR THE PRICE OF 1

Plays 78—45—33 1/3 RPM Discs



Yes, you would expect to pay more for just a single speed player. But Olson made a quick cash deal with a manufacturer and we got 500 of these 3-speed record players. This is not a kit. Complete! Ready to play any size record up to 12" diameter from 78, 45, or 33 1/3. Carrying case is sturdy, attractive leatherette covered with beautiful hardware and carrying handle. 3-speed motor made by Alliance, astatic tone arm has precious tip needle. Amplifier is scientifically designed. PM speaker is Alnico 5. Equipped with volume control and on-off switch. Operates on 115 volts AC. Shpg. wt. 15 lbs. **\$17.97**

RA-34, each \$17.97

TAPE RECORDER

Latest Model, Regular retail price is \$154.50.



A real top quality recorder brought to you at a fraction of the regular list price. All latest features are contained in this tape recorder. Tape speed 7 1/2" per second. Rewind ratio 20 to 1. Frequency response 60 to 8,000 cps. Has dual recording track. Recording time, 1 hour on 1,200 ft. reel or 1/2 hour on 600 ft. reel. Neon level monitor indicator. Input for external mike, phono pick-up or radio tuner. Has jack for external speaker. Equipped with high grade built-in PM speaker. 5 watts output. Beautiful leatherette carrying case with hinged lid. Size 10"x15"x15". Furnished with microphone and reel. Shpg. wt. 29 lbs. **\$79.95**

RA-42

OLSON KNOB KIT with Steel Cabinet



4 drawers with compartments in each drawer. 6 1/4" x 5 3/4" x 8 1/4". Contains a popular assortment of 50 set-screws and push-on type knobs. You'll wonder how we can offer them at such a ridiculously low price. **AS-26 Olson's Price \$2.99**

NEW INTERCOM MASTER STATION

OLSON'S SPECIAL PRICE \$9.99



A real high quality Intercom ideal for home, office, nursery or sickroom. Quickly installed without tools. Remote stations may be placed as far away as 2,000 feet. Beautifully designed plastic cabinets with sloping front. Alnico 5 PM speakers deliver ample volume. Has on-off switch, push-to-talk switch and volume control. Master station uses 125T7, 50L6 and 35Z5 tubes. Size of cabinets 5 1/2" x 8 1/2" x 4". One or more substations may be used with the master station. Master Station with tubes and 50 ft. of 2 conductor cable. **RA-40 Substations, Each \$3.99**

RCA 8" PM SPEAKER

Known as the RCA "Mighty 8." Delivers tremendous volume because of advanced engineering design and super-size Alnico 5 magnet. Ideal for radio and PA use. Voice coil 3.2 ohms. Shpg. wt. 6 lbs. **Stock No. 5-123 \$2.99**

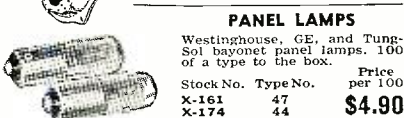

PANEL LAMPS

Westinghouse, GE, and Tung-Sol bayonet panel lamps. 100 of a type to the box. **Stock No. Type No. Price per 100**

X-161	47	\$4.90
X-174	44	

OLSON TELEVISION SCOOP!

Never offered before—TV chassis! Not a kit! Completely assembled!

WITH ALL TUBES EXCEPT KINESCOPE \$99.95

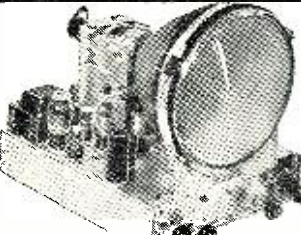

KINESCOPE TUBE 12LP4 \$19.95 Do you know a bargain when you see one? Look at this TV chassis . . . check over its features . . . then RUSH your sample order for just one set. You'll wonder how Olson could bring you such a terrific TV receiver at such a ridiculously low price. Every set is brand new and comes to you in original factory packing. Tube lineup: 3—6AG5; 2—6AU6; 2—6AL5; 1—6BG6G; 3—6SN7; 1—6AC7; 1—6J6; 1—6T8; 1—6V6; 1—6W4; 1—1B3G/8016; 1—5U4G. Set is prealigned and tested. All parts are the finest and the workmanship is really precision. PM speaker is furnished. There is absolutely nothing in the country to compare with this terrific Olson bargain in TV. Pictures are the steadiest, clearest and brightest you ever saw. You get superb performance even in fringe areas. Here's a TV set that defies comparison. Comes to you complete with speaker, knobs, cables, mounting templates and all tubes except the 12LP4 picture tube. Chassis size: 16" wide, 18" deep, 17" high. Operates on 115-v AC. Ship. wt. 70 lbs.

16" Rectangular Tube TV Set 170 Sq. In. Picture Not a Kit • Completely assembled with all tubes • OLSON'S Greatest Bargain, RA-50 \$159.95

Made by a leading TV manufacturer who pioneered in TV development. Received in factory—aligned and tested at the factory. Only Olson's can bring you such a value. Contains 19 tubes in addition to the Kinescope picture tube. Equipped with STANDARD COIL TUNER with 300 ohm input, acknowledged to be one of the finest tuners made. All condensers are latest 85° centigrade, insuring long life. Has built-in antenna which is suitable in all major signal areas. Power supply has fusible primary and uses voltage doubler circuit producing 13,500 volts. Straight AC circuit. NOT AN AC-DC SET. Power supply equipped with safety cover. Deflection yoke is latest model 70° type. All tubes connected in parallel. All picture adjustments made from front of chassis. No fumbling in the rear to set up picture. PM speaker is supplied. Nothing in the country to compare with this great Olson value. Pictures are large, clear, sharp and steady. A fine set even in fringe areas. You can install this set in your own cabinet. Comes to you in factory sealed cartons including 16" rectangular Kinescope tube, all tubes, speaker, knobs, cable and mounting template. Chassis size 16" wide, 18" deep, 17" high. Operates on 115 volts AC. Shpg. wt. 75 lbs.

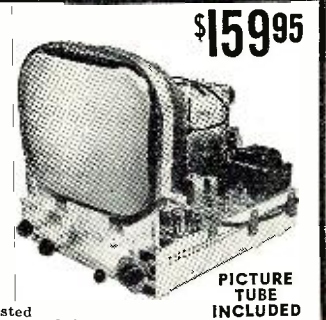

PICTURE TUBE INCLUDED \$159.95

What's New in Radio

LOW-PRICED AMPLIFIERS

Newcomb Audio Products Company of 6824 Lexington Avenue, Hollywood 38, California, has introduced a new low-priced line of amplifiers which has been designated the "E" series.

The new line stresses the essential requirements of utility amplifiers but avoids the frills. The line includes 10,



17, 25, and 50 watt models, phono-tops, mobile and portable assemblies.

The Model E-25 is a 25-30 watt amplifier with inputs for two high impedance microphones and a phonograph. Knock-out holes are provided in the chassis for easy conversion of the mike input to low impedance if needed. The frequency response of the amplifier is ± 2 db. from 40 to 15,000 cycles. Power consumption is 90 watts at 117 volts a.c.

NEW V.T.V.M.

A vacuum tube voltmeter designed to meet the requirements of small laboratories has been introduced by General Radio Company of 275 Massachusetts Avenue, Cambridge 39, Massachusetts, as the Type 1803-A.

The voltage range of the unit is from .1 to 150 volts in five steps with accuracy of $\pm 3\%$. Frequency error is 10% at 120 mc. Correction curves are supplied, by means of which rated accuracy can be obtained up to 200 mc.

The meter is peak indicating and is

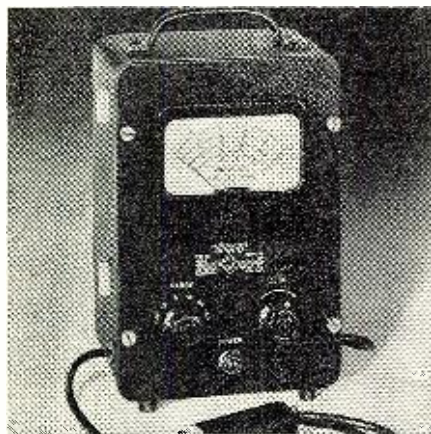

calibrated in r.m.s. values of sinusoidal voltage. The circuit is designed for

For additional information on any of the items described herein, readers are asked to write direct to the manufacturer. By mentioning RADIO & TELEVISION NEWS, the page, and the issue number, delay will be avoided.

high stability, and the mechanical assembly is simple and rugged.

Voltage is measured at the terminals of a probe. Where fixed terminals are desired, the probe is attached to the side of the cabinet and wires can then be connected to it through an adapter plug.

DYNAMIC MICROPHONE

American Microphone Co. of 370 South Fair Oaks Avenue, Pasadena 1, California, is currently marketing a full vision dynamic microphone for TV, AM, and FM applications, the Model D33.

Finished in gold and black, the new unit features a one inch diameter head which provides full vision for the artist and audience. The microphone is easily mounted for stand or suspension use and may be quickly detached for hand use. The unit weighs 7 ounces



and comes equipped with a Cannon "Latch Lock" plug and 25 feet of two-conductor shielded cable. Antihalation finish for TV is available at a slight additional charge.

ELECTRONIC V.T.V.M.

Feiler Engineering Company of 1601 S. Federal Street, Chicago, Illinois, has developed a new vacuum tube voltmeter which is being marketed as the Model TS-9.

The unit features a 0-1 ma. d.c. meter, two separate tubes used in a balanced and compensated bridge circuit with cathode feedback, a zero center scale for FM and TV discriminator alignment, five voltage ranges for a.c. and d.c. volts, decibel measurement from minus 20 to plus 16 db., resistance coverage from .2 ohms to 1000 megohms in five steps, an input impedance of 26 megohms on d.c. and 3 megohms on a.c., and full 2% accuracy on all ranges. The test instrument

also features a d.c. polarity switch which permits polarity reversal by

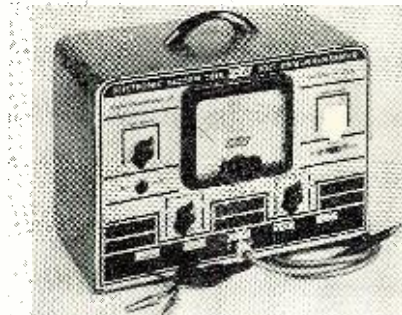

throwing the switch rather than by changing leads.

CUSTOM AMPLIFIERS

Among the units being offered by Precision Electronics, Inc. of 641-643 Milwaukee Avenue, Chicago 22, in its line of custom amplifiers is a moderately priced unit, the Model 50 PG.

This model, like others in the line, features beam power output with exclusive feedback circuits, oversize components and high fidelity output transformers of special design, four input channels with convenient switching from magnetic pickup, crystal pickup, microphone, or radio tuner, and a self-contained magnetic pickup preamplifier that has sufficient gain for regular or microgroove recordings and matches Pickering, G.E., Clarkston, and Audak units.

The Model 50 PG uses six tubes, has an output impedance of 3-4, 8, and 16 ohms, 10 watts of power with less than 2% distortion, 10 db. feedback, and is flat ± 1 db. from 20 to 20,000 cycles at 1 watt. A data sheet covering this and other amplifiers made by the company is available on request.

DETECTOR KIT

Allied Radio Corporation, 833 W. Jackson Blvd., Chicago, Illinois, has put a new, low-priced, portable radioactive ore detector on the market in kit form.

Known as the "Knight Scout," the circuit features a Geiger-Mueller tube, built-in amplifier with CK522-AX subminiature tube, and regulated, vibrator-type high voltage power supply. The kit comes complete with all parts including the two standard flashlight cells which will operate the unit for from 70 to 100 hours. An 8 page instruction manual contains step-by-step pictorial diagrams keyed to the in-

RADIO & TELEVISION NEWS

NOW READY! A Sensational New Line Of 1951 MIDWEST TELEVISION

**CONSOLES and
COMPLETE CHASSIS**

Featuring the NEW MAMMOTH

**19½-Inch
BLACK PICTURE TUBE**
At Low Factory Prices



**DIRECT
FROM
FACTORY
TO YOU**



"VIDEO GRAND"
19½" Television-Radio-Phonograph Console

Never before have you seen such tremendously BIG clear pictures, such luxurious cabinets, such sensationally low Factory Prices as Midwest offers in its 31st Anniversary Line of 19½" and 16½" TV Consoles, TV - Radio - Phono Combinations, and complete TV Chassis.



"CONSTELLATION"
19½" Television Console

Check these features: Mammoth 19½-Inch Picture Tube (225 sq. in. image); Synchronized sound and picture; Simplified One-Knob Tuning; Big 12" Panasonic Speaker; Video-Sonic Tuner; and scores of other features.

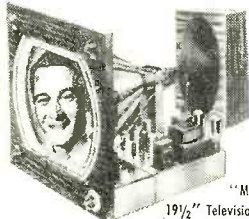

"MIDWEST"
19½" Television Chassis and Speaker

Factory Authorized Service Available in Television Areas

Plus Powerful New 1951 World-Ranging 5-Band
MIDWEST SERIES 16 **RADIOS**
In Beautiful Consoles and Complete Chassis

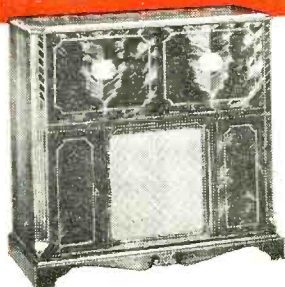

An entirely new line featuring the powerful Series 16 AM-FM Five-Band Radio Chassis and the magnificent Symphony Grand Radio-Phonograph with 3-Speed Automatic Intermix Record Player.

**EASY
TERMS**

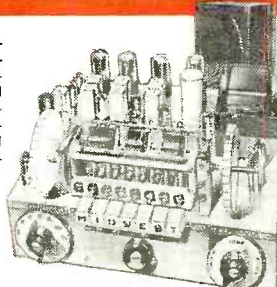

\$44⁹⁵ Will Put This Luxurious
New 1951
MIDWEST "VIDEO GRAND"
19½-Inch TELEVISION
with AM-FM RADIO and 3-Speed
Automatic Intermix Phonograph
In Your Own Home on
30 DAYS TRIAL

You Must Be Satisfied or Your
MONEY BACK

SEND COUPON TODAY
For This NEW 1951 4-Color

FREE MIDWEST
RADIO-
TELEVISION
CATALOG



• WRITE IN NAME AND ADDRESS (PLEASE
PRINT) ON COUPON OR 1c POSTCARD

MIDWEST RADIO & TELEVISION CORP.
Dept. 37-A, 909 BROADWAY • CINCINNATI 2, OHIO

Please send me your new FREE 1951 Catalog.

NAME _____
ADDRESS _____
CITY _____ ZONE _____ STATE _____

MIDWEST RADIO & TELEVISION CORP.
DEPT. 37-A, 909 BROADWAY, CINCINNATI 2, OHIO



EXTRA!

ATR

"A" BATTERY ELIMINATORS

Makes it easy to DEMONSTRATE AND TEST D.C. APPARATUS FROM A.C. LINES



for DEMONSTRATING AND TESTING AUTO RADIOS

New Models . . . Designed for testing D. C. Electrical Apparatus on Regular A. C. Lines. Equipped with Full-Wave Dry Disc Type Rectifier, Assuring Noise-less, Interference-Free Operation and Extreme Long Life and Reliability.

NEW MODELS **NEW DESIGNS**
NEW LITERATURE

"A" Battery Eliminator, DC-AC Inverters
Auto Radio Vibrators

ATR See your jobber or write factory

AMERICAN TELEVISION & RADIO CO.
Quality Products Since 1931
SAINT PAUL 1, MINNESOTA - U. S. A.

structions, plus a schematic diagram. The unit weighs 2¼ pounds and the



aluminum case, which is finished in gray Hammerloid, measures 7¾" x 4¾" x 2¼".

INVERTER LINE

A complete line of super heavy duty inverters has been added to the existing series of such units being manufactured by *American Television & Radio Co.*, 300 East 4th Street, St. Paul, Minnesota.

The new ATR line is designed for operation on d.c. input voltages ranging from 6 volts d.c. to 220 volts d.c. with outputs of 110 volts a.c., 60 cycles at capacities ranging from 175 watts to 1000 watts.

These units are especially suitable for such heavy duty applications as



tape recorders, television sets, portable transmitters, and similar electronic and electrical equipment which operates within the specified ratings.

Literature on the new line is available on request.

SOLDERING TIPS

Ungar Electric Tool Co., Inc. of 615 Ducommun Street, Los Angeles, California, is in production on two new increased wattage soldering tips which have been designed specifically to meet the requirements of radio and television technicians.

The new "Hi-Heat" tips are made of a new and as yet undisclosed material which is pre-tinned to eliminate loss of time in cleaning and dressing. They quickly attain and maintain a constant, uniform flow of heat, according to the company. At present the new tips are available in two different shapes, the No. 1236 pyramid tip and

the No. 1239 chisel tip. Both of these units are interchangeable with the five standard 20 watt copper tips which have been part of the company's line for many years.

ELECTRICAL TAPE

Van Cleej Bros. Inc. of 7800 Woodlawn Avenue, Chicago 19, Illinois, has introduced its "Dutch Brand" Plastix electrical tape in a new ½" width.

The new tape, which comes in 150" rolls, is superthin, has 200 percent stretch, and high dielectric resistance. It is especially suitable for TV and radio taping where space is at a premium and appearance is a factor. The tape resists weather, water, oils, grease, and corrosive chemicals.

NEW PHONO CARTRIDGE

Electro-Voice, Inc. of Buchanan, Michigan has developed a new phono cartridge which has been designated the Model 60 Crystal "Econo-Cartridge."

Designed as a replacement unit for over 20 existing models, the new unit uses the bimorph crystal. By inserting the appropriate 3 mil or 1 mil needle it can be used for 78, 33½, and 45 r.p.m. records. Tracking force is ¾ ounce on 78 r.p.m. and 8 grams on the 33½ and 45 r.p.m. records. Output level depends on the type of needle used. With a compliant needle, the output voltage is 3½ volts while with a straight shank needle the output is from 4½ to 5 volts.

Bulletin No. 157 describes the new cartridge in some detail and is available from the company on request.

"VERSA-TOOL"

Phillips Manufacturing Company, Inc. of 2816 Aldrich Avenue South, Minneapolis, Minnesota, is currently in production on a new instant heating soldering tool, the Model L "Versa-Tool."

Incorporating several new features, the new unit combines a heating element, transformer, light, two-position switch, and a fuse into a single tool. It has four interchangeable tips of rigid construction enabling the operator to unsolder old work by exerting tip pressure with the heating element on.

The two-position, trigger-actuated switch in the first position closes the

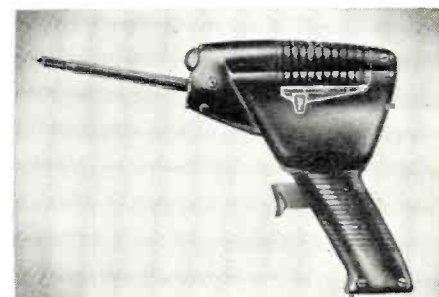

circuit to a highly-concentrated light beam which is set at an angle to eliminate shadows. This position enables the operator to use the tool as a flash-

(Continued on page 142)

THE GREATEST

DEVELOPMENT IN TUBULAR

CAPACITORS IN 25 YEARS



another

C-D first!

now available in "BLUE CUB"*

paper tubular capacitors

Only C-D moulded tubulars have welded leads!

- Sturdy welded joints between wire leads and foil of capacitor section results in permanent connections; no intermittents; no open-circuit defects!
- Permanent bond between lead wire and foil electrodes will withstand soldering temperatures, shock, vibration and rough handling.

That's why "Blue Cubs"* have become the fastest selling moulded tubular on the market today. In addition to "Leadweld"* terminals you get all these plus features:

STYRICAST MOULDED—

The only tubular cast in plastic after Vikane* impregnation. No heat or pressure to pinch, distort or injure unit.

FIXEDRESIN CASE—

Will withstand temperatures up to 300° F. without softening.

VIKANE* IMPREGNATION—

Only C-D tubular capacitors are Vikane* impregnated. This superior impregnant provides high stability of all electrical characteristics during long service life with exceptionally high insulation resistance, low power factor, and great durability under voltage stress.

For fewer servicing headaches, more satisfied customers and greater profits—insist on C-D "Blue Cubs"! Best by Field Test!

CORNELL-DUBILIER ELECTRIC CORPORATION, Dept. RN80 South Plainfield, New Jersey. Other plants in New Bedford, Brookline and Worcester, Mass.; Providence, R. I.; Indianapolis, Ind., and subsidiary, The Radiart Corp., Cleveland, Ohio.

For nearest C-D jobber see your local Classified Telephone Directory.



CONSISTENTLY DEPENDABLE

CORNELL-DUBILIER

CAPACITORS • VIBRATORS • ANTENNAS • CONVERTERS



SARKES-TARZAIN

13-CHANNEL T.V. FRONT END
WITH TUBES
AND DIAGRAM \$795

This popular Sarkes-Tarzain television front end is widely used today. The 13 channel rotary switch type with individually tuned coils. Price includes a schematic diagram and 3 tubes, 6CA osc. 6BH6 RF and 6AG5 mixer. Regular factory cost is twice our price. Each tuner and its own tube sockets are wired, ready to hook up to a video and sound IF strip. May be used with either intercarrier or separate sound IF circuits. Built-in fine frequency control. Ship. weight 3 lbs. Sarkes-Tarzain Type 2 TV tuner with tubes net. \$7.95
Combination deal, Sarkes-Tarzain TV tuner and 205-XX video coil kit both for. \$14.95
Sarkes-Tarzain Type 3—Same as Type 2 only has input IF coil built-on. Tapped for sound IF channel. Net. \$9.95
Sarkes-Tarzain Type 3 tuner and 205-XX coil kit both for. \$16.95

TELEVISION VIDEO COIL KIT—20 MATCHED COILS FOR PICTURE AND SEPARATE SOUND I.F. \$795

Order with a Sarkes-Tarzain Front End For \$14.95

20 matched TV coils; video and sound I.F. McGee Scoop price \$7.95. Television video coil kit, for TV sets up to 16", using separate sound and picture circuits. Consists of 20 coils for use in the nationally famous 20 tube and 22 tube TV circuit. All coils are of the finest construction, furnished to you, just like they go to a TV set maker. Each coil is identified. These are not made by RCA, but by a top quality coil company, especially for McGee. If you are going to use the RCA circuit, you can use this set of coils.
Coil kit has 1-180 uh, 1-250 uh, 2-120 uh, 2-93 uh peaking coils, 4 picture IF coils for 25.75 mc, 2 sound IF's, 21.25 mc, 1 discriminator, 1 converter and 5 filament chokes. Stock No. 205-XX, shipping weight 3 lbs. McGee's price \$7.95.

1950 MODEL PORTABLE TAPE RECORDER \$99.50

Our brand new 1950 model portable tape recorder. Response, 60 to 8,000 CPS. With this you make and play-back top quality tape recordings. Tape speed, 7 1/2 feet per second. New mechanism records 1 hour on 1200 ft. reel of tape. Fast rewind. Record 30 minutes, turn spool over and record second 30 minutes on 1200 ft. reel of tape. Dual purpose former type amplifier with 6" speaker. Inputs for mike and radio. External speaker jack. Price includes 30 minute reel of tape and mike. Hinged lid is removable. Case is attractive leatherette covered. Size 10x13x14". Shipping weight 25 lbs. Stock No. PLT-3. Net price \$99.50.

RADIO AND RECORD PLAYER \$14.95

For your children's room. Buy this superbet radio and record player. Here is what you get: A full 5 tube superbet broadcast chassis all wired and tested, Walnut cabinet, 78 RPM motor and crystal pickup. All you do, when you receive your set is drill mounting holes in cabinet. We are offering you this radio-phonograph at the price of an ordinary record player. Shipping weight 15 lbs. Stock No. JA-70. Net price \$14.95.
Stock No. AUT-JO. Same radio chassis and cabinet as above, but furnished with a 78 RPM automatic record changer. Shipping weight 25 lbs. Net price \$24.95.

SCOOP!

8" Speaker \$2.95
8" Baffle \$1.95
Stock SE-8X 8 inch heavy duty 6.8 ohm Alnico V PM with 1/8" ohm voice coil, (as illustrated) for \$27.50 each 10 for \$27.50.

Stock No. 8-RCM 8 inch tri-color, plastic front wall Baffle with popular wood grain output tap match. Sale price \$1.95 each, 10 for \$17.50.
8 inch 6.8 ohm Alnico V PM speaker made by Jensen for Bell and Howell. A terrific bargain. Stock No. JEN-8. Net \$2.95, 10 for \$27.50.

Model CN-1232 12 INCH 25 WATT P.M. \$5.95
Another McGee Red hot special! 12" 32 oz. Alnico 23 ring magnet PM, 8 ohm voice coil speaker. Made by Bell and Howell. Solidated. A 5 1/2" x 8" x 4" size. Shipping weight 8 lbs. Model CN-1232. Net price \$5.95 each, 4 for \$22.00.

BROADCAST QUALITY TRANSFORMER KIT

Response 18 to 22,000 C.P.S. The Same Quality as Used in the Finest Quality Audio Amplifiers

Why Pay More Sale Price \$12.95

Here is the hottest transformer kit we have ever offered. Originally intended for use in the high priced Lear recorder amplifier. Made of the best possible material to give broadcast station frequency response: 18 to 22,000 CPS. A suggested diagram is furnished to build your own amplifier with input for G.E. variable reluctance radio pickup, crystal phono pickup or radio tuner. Here are the transformer specifications: The output is a compound filled case, 3 x 2 1/2 x 3 1/2" high, weight 2 1/4 lbs., response 18 to 22,000 CPS, matches 2-6V6 in push-pull (15 watts) output tap match, or 8 ohm speaker. The power transformer is a fully shielded upright model, 3 1/2 x 4 1/2 x 4 1/2" tall, weight 8 1/4 lbs. This transformer is utilized in a full wave selenium rectifier bridge, easy to hook up, full details included, which diverts 300 volts at 200 mls, with the best possible voltage regulation. Also has a 6.3 volt 5 amp. filament winding. The selenium rectifiers come with this kit. The choke weighs 2 1/4 lbs. and is the same size as the output. You get full description of the kit, including a suggested schematic. You supply the other parts. We furnish the power transformer, choke, output and rectifiers. Shipping weight 15 lbs. Stock No. TD-1822. Net price. \$12.95

30 WATT MUSICAL INSTRUMENT AMP. KIT \$34.95

Model MM-35. McGee's new 1951 model wide range musical public address amplifier kit. A complete kit of parts to build a top quality dual purpose amplifier. Inputs for two instruments and one mike input. Dual tone control with separate base and treble boost. Leatherette covered case, with plastic speaker grill. Super heavy duty 12" PM speaker. Response 40 to 15,000 CPS, 6 tubes in all, with push-pull 6L6 (30 watts) output tubes. This is a complete kit, including tubes and diagram. It is the most versatile musical amp. that we know of. Shipping weight 26 lbs. Stock No. MM-45. Net \$34.95. MM-45WT, above musical amplifier wired and tested. \$49.95.

TERRIFIC T.V. PICTURE TUBE SALE

16JF4 BLACK FACE \$24.95
16JF4 NEUTRAL FACE \$19.95
12LP4 NEUTRAL FACE \$14.95

★ Every Tube Guaranteed to You for 90 days
★ Limited Quantity ★ Best Value in America

Factory changes in tube specifications make this picture tube sale possible. Quality of these tubes is number one. All are guaranteed by us for 90 days. You must be satisfied. The 16JF4 equivalent is a direct replacement for most 16" all glass picture tubes. Over-all length 20 3/4", greatest bulb diameter, 1 1/2". It is available with new style black face. Specify "Black Face" when ordering. Shipping weight 25 lbs. Net price, \$24.95.
16JF4 equivalent also furnished with a neutral or standard face, at \$19.95. Specify "Neutral Face" when ordering.
12LP4 furnished with neutral face at the scoop price of \$14.95. Shipping weight 10 lbs. All above tubes are not second hand pass RMA standards. Guaranteed for 90 days by us. Name of famous maker has been withheld and not in tubes for various reasons.

WIDE RANGE AMP KITS COST LESS AT MCGEE

34 WATT WIDE RANGE AMP KIT \$29.95

- RESPONSE 20 TO 20,000 C.P.S.
- TWIN ELECTRONIC TONE CONTROLS

It's the newest thing in audio amplifiers. McGee's wide range, 34 watt amplifier kit with inputs for crystal or dynamic mikes and any crystal phono cartridge, as well as the new G.E. variable reluctance cartridge. Output transformer is wax impregnated, weighs 6 lbs. Voice coil tubes 4-8-15-250 and 500 ohms. Push-pull 6L6 output tubes. Separate electronic base and treble boost. Inverse feedback. Input tube filament is DC heated to reduce hum level to nil. Frequency response from 20 to 20,000 cps. Easy to follow diagram and photos for easy assembly of this kit. Ready punched chassis. Stock No. XX-34, net. \$29.95
XX-34 WT (wired and tested) \$12.50 extra. Crystal mike and desk stand \$4.95 extra.

NEW 15 WATT UTILITY AMP KIT

- INPUT FOR VARIABLE REL. PICK UP
- MIKE INPUT
- TONE CONTROL
- FADER CONTROL
- COMPLETE KIT

Kit Model TM-15, push-pull wide-range 15 watt amplifier kit. Ideal for a high quality record player, as a P. A. system or recording amplifier. Matched component parts, ready punched chassis. One control fades from phono to mike. Input compensation for G.E. variable reluctance cartridge. Output matches 8 ohm voice coil, 100 mil power transformer, complete with tubes, photos and diagram. Stock No. XX-34, net. \$12.95
XX-34 WT (wired and tested) \$12.50 extra. Crystal mike and desk stand \$4.95 extra.

6-110 VOLT AMPLIFIER KIT \$39.95

OPERATES FROM 6-VOLTS D.C. AND 110 VOLTS A.C.

McGee offers a new amplifier kit model 6-110 AA. A complete kit of parts including a ready-punched chassis pan, tubes and diagram, nothing else to buy. Inputs for two mikes and phono pickup. Output matches speaker voice coil and line. Push-pull 6L6 output tubes give 25 watts of power. Dual purpose power transformer operates on 110 volts 60 cycle and volts DC. A heavy duty 60 cycle vibrator runs a 6-volt storage battery to run the amp as well as 110 volt ac to run a phono motor or record changer. Has 3 tone controls and tone control. Price includes all parts and kit of 6 tubes. Kit Model 6-110 AA. Shpg. weight \$13.50.
Spare heavy duty 60 cycle vibrators, \$1.95. Astatic JT-30 Crystal Mike and Desk Stand \$9.97 extra.

25 WATT TRUMPET AND DRIVER \$23.95

TRUMPET ONLY \$13.50—DRIVER ONLY \$12.50
BEST VALUE IN AMERICA

Model XX-100, all weather 3 1/2 foot reflex trumpet. Aluminum castings and spinning. The horn is spun on an exponential curve for best low and high frequency response. 19" bell diameter, hammertone finish, adjustable angle mounting bracket. Threaded 1 3/8" x 1 1/8", can be used with any standard make driver unit. This is the best value in America in trumpets. You save money without sacrificing tone quality. Shipping weight 15 lbs. Stock No. XX-100. Net price, \$13.50.
25 watt driver, our Model RM-30. Made for use with the above XX-100 trumpet, threaded 1 3/8" x 1 1/8". An all-weather-proof, 18 ohm driver that will take up to a 100% overload on audio peaks. This driver is second to none and fully guaranteed by McGee. You must be satisfied. Stock No. RM-30, shipping weight 6 lbs. \$11.50.
Combination offer, above XX-100 trumpet and our RM-30 25 watt, 15 ohm driver, both for only \$23.95. This makes the finest outdoor speaker value in America.

BUY YOUR RADIO KITS AT MCGEE FOR LESS

6 TUBE AC SUPERHET KIT BROADCAST AND SHORTWAVE MATCHED PARTS \$11.95

A complete kit of parts, tubes and ready punched chassis to build a fine 6 tube, 2 band AC power transformer type radio chassis. (No cabinet.) We furnish all pieces as well as a printed diagram and 13 photographs. Chassis size 14x7 1/2 x 7". Receives standard broadcast and 6 to 8 MC shortwave. 3 gang tuning condenser used on both bands. 90 mil power transformer and 7C5 output tube. The chassis dial mechanism, gang and coils used in this kit were manufactured for use in a high quality Detrola radio. The heavy plate chassis has etched in numerals. A complete and complete set of parts. The output transformer is furnished but the speaker is not. Use any standard PM speaker. Ship. wt. 14 lbs. Stock No. 6-ACX6. Net price \$11.95.
12" Heavy duty PM speaker, \$2.95 extra.
10" Heavy duty PM speaker, \$3.95 extra.

2-BAND DETROLA—SCOOP COILS, GANG, DIAL, PAN \$3.95

Genuine Detrola Chassis pan with 6 octal sockets. Heavy glass slide rule dial, 3 Gang Tuning condenser. All RF and IF coils and band switch for standard broadcast and foreign short wave. Buy these parts for less than the coil value alone. These parts, all at the chassis price. Only material pictured and listed above is offered with diagram. It is not a complete kit. You supply your own tubes, speaker, resistors, condensers, etc. Stock No. DET-2. Shipping weight 9 lbs. Net \$3.95.

NEW 1950 MODEL 5-TUBE SUPERHET RADIO KIT MODEL NS-5 \$9.95

McGee's new 1950 Model 5 tube AC-DC superheterodyne radio kit. Has loop antenna and 2 gang condenser, with lighted slide rule dial and attractive plastic cabinet. Receives broadcast, 550 to 1650 kc. Full size dynamic speaker, matched 456 J.P.F. automatic volume control. This is a complete radio kit. Everything furnished, including diagram, photos and tubes. Stock No. NS-5. Shipping weight 7 lbs. Stock No. NS-5. Net price, \$9.95.

WRITE FOR MCGEE'S NEW BARGAIN FLYER

JUST OFF THE PRESS!

TERRIFIC VALUES IN
RADIO AND T.V. PARTS
KITS TUBES AMP'S—SPEAKERS
WRITE FOR YOURS NOW

45 R.P.M. RECORD CHANGER \$8.95

Crescent 45 RPM automatic record changer. This small changer (10 1/2 x 7 1/2) is for the 45 RPM R.C.P. etc. records only. It has 50-10,000 CPS crystal cartridge with permanent needle. Changes records in less than 2 seconds. Plays 8 to 10 records. McGee's red hot August price is only \$8.95 each, while our stock lasts. Ship. weight 8 lbs.

WEBSTER 356-1 \$24.95

Brand new in original factory cartons. Only 50 to sell. Webster 3 speed automatic record changers with crystal cartridge and tandem tip permanent needle. Webster-Chicago Model 356-1. Shipping weight 16 lbs. Sale price \$24.95 each while 50 last.

MCGEE RADIO COMPANY

Price F.O.B. K.C. Good 25% Deposit with Order. Balance Sent C.O.D. With Parcel Post Orders. Include Postage

TELEPHONE VICTOR 9045. WRITE FOR FLYER
1422 GRAND AVE., KANSAS CITY, MISSOURI

BRAND NEW—OVER \$80.00 LIST
MOTOROLA 8-TUBE
 MODEL 708-T6
AUTO RADIO \$39.95
 With Speaker and Cables

Universal Under Dash Control \$1.95 Extra
 FITS MOST CARS AND TRUCKS
 Push Pull 6K6 Audio 8-Watts Output
 A FULL SUPERHET WITH RF STAGE

Priced less remote control. For all trucks and cars, order our 2A1 Universal underdash control, or pick custom control from our limited selection listed below. Of course you may buy a custom control from your Motorola jobber. World famous 8 tube Motorola auto set. Merchandised by Tucker but branded Motorola. A real distance getter with high fidelity audio. Tone control and push buttons. Fits most cars and trucks. Compact size, 7 1/2 x 5 1/2 x 5 1/2". Everything furnished, including 6" FM speaker, cables, hardware, etc. You furnish any push-button custom control or buy our 2A1 Universal underdash control at \$1.95 extra. Shipping weight 7 lbs. List price over \$80.00. Motorola \$1.95 extra. (Will supply 7", 6x8", or 8" PM speaker in place of the 6" for \$1.49 extra.)
 Note: Pick a custom control from our limited list below for \$1.49 extra.

REG. \$6.95 DCF-3 FENDER or COWL ANT. \$2.49
 Regular \$6.95. 3 section top cowl or fender mounting antenna. 3 section 50"—only 3 1/2 inches exposed when collapsed. A universal mounting design. May be ordered with your Motorola set or purchased extra for \$2.49. Stock No. DCF-3. Weight 2 lbs. \$2.29 each in lots of 12.

10 Assorted Motorola Remote Control Heads \$9.95
 A RED HOT ITEM FOR THE AUTO RADIO SERVICE DEALER
 10 assorted genuine Motorola remote control heads with knobs, pilot light, etc. 5 of each type, manual and automatic. Automatic heads: 42 Hudson, 46-47 Packard, 40 Hudson, 46-47 Hudson, 42-46 Cadillac, 42 Oldsmobile, 41 Nash, 41 Packard, 40 Pontiac, 40 Lincoln Zephyr, 40 Nash, 42-46 Lincoln Zephyr, 40 Cadillac, 42 Hudson, 46-47 Hudson, 40 Nash, 42 Oldsmobile, 46 Packard, 42-46 Lincoln, 40 LaSalle, 42-46 Cadillac, 40 Hudson, 41 Lincoln Zephyr. \$1.49 each; 10 for \$9.95.

NEW 1951 MODEL 12-INCH "COAXIAL" SPEAKER

- WIDE RANGE RESPONSE—40 to 17,500 CPS.
- ONLY 2 WIRES TO CONNECT TO ANY AMP OR RADIO
- NEW HEAVY DUTY CONSTRUCTION

"WHY PAY MORE?" SALE PRICE **\$12.95**

McGee announces our new 1951 model 12-inch coaxial PM speaker, designed for the critical music listener; for use with high fidelity audio systems and radios. This new model reproduces all music and voice with a natural quality. It is similar to the last model in that the 12" woofer now has a heavy duty 31 oz. Alnico 3 magnet. This reproduces the lower musical register down to 40 cycles. The coaxially suspended tweeter has a specially designed cone for the higher register of music and voice, all response up to 17,500 CPS. The high pass filter is attached and combined impedance will hook up to any 8 ohm output transformer. It will connect in place of any ordinary speaker, only two wires to connect. Why pay \$20 to \$40 for a speaker? McGee has them made to their own specifications. Why pay more than McGee's price? McGee's 12" 20 watt wide range coaxial PM speaker, Model CU-14X. Net price, \$12.95; 2 for \$25.00. Shipping weight 10 lbs.

Model CU-14X
 Critical music listener; for use with high fidelity audio systems and radios. This new model reproduces all music and voice with a natural quality. It is similar to the last model in that the 12" woofer now has a heavy duty 31 oz. Alnico 3 magnet. This reproduces the lower musical register down to 40 cycles. The coaxially suspended tweeter has a specially designed cone for the higher register of music and voice, all response up to 17,500 CPS. The high pass filter is attached and combined impedance will hook up to any 8 ohm output transformer. It will connect in place of any ordinary speaker, only two wires to connect. Why pay \$20 to \$40 for a speaker? McGee has them made to their own specifications. Why pay more than McGee's price? McGee's 12" 20 watt wide range coaxial PM speaker, Model CU-14X. Net price, \$12.95; 2 for \$25.00. Shipping weight 10 lbs.

78 R.P.M. RECORD PLAYER \$11.95
 SELF-CONTAINED AMPLIFIER AND SPEAKER

Here is a real hot value. A complete self-contained 78 rpm record player with its own amplifier built in. It has a 12.5 oz. Alnico 3 pm speaker. Extra heavy duty 78 rpm phono motor, complete built-up player and has extra tone and more power than you would expect for a player of its size. Only 100 to sell. Stock No. EG-78D. Sale price, \$11.95. Three for \$33.00.

McGee's Super High Fidelity
 OUTPUT TRANSFORMER \$6.95 Best Value In U.S.A.
 20-20,000 CPS.

Model A-403 High fidelity output transformer. Why pay \$20 or \$30 for an output when our A-403 is available at \$6.95? Impedance, 600 ohms plate to plate, for 11 1/2 or 6V6, 100% feedback winding, 4-8, 250 and 500 ohm secondary. Housed in a potted case. Net weight 6 lbs. Recommended for all amplifiers up to 34 watts. Size 3 1/2 x 4 1/2 x 3 1/2". Success diagram furnished. Shipping weight 8 lbs. Net Price A-403 \$6.95.

10-WATT WEATHER PROOF PAGING SPEAKER \$11.95
 15 ohm 10 watt spun aluminum magnetic speaker. 7" bell, removable driver, adjustable bracket. Shpg. wt. 4 lbs. McGee's price, \$11.95.

\$19.95 BUYS A NEW St. George Wire Recording Mechanism
 ONLY 200 TO SELL

McGee offers you a terrific buying opportunity. The St. George wire recording mechanism. Brand new and factory cartoned. This unit will record and playback from a standard recording wire, up to 1 hour. The wire take-up reel turns at 78 RPM and will play and record from a 78 RPM phono pickup. The base is punched for phono recording. Space required, 6x11x3 1/2". Shipped with a diagram of how to connect and also how to wire a 3 tube converter to enable the wire recorder to be used in conjunction with any radio or amplifier. St. George wire recording mechanism, Series 1100. Shipping weight 15 lbs. Net price \$19.95 each. Crystal phono pickup arm and cartridge \$1.95 extra. Recording wire, 30 minute spool. Net price \$1.19. 1 hour spool. Net price \$2.79. Crystal mike and desk stand \$4.95 extra.

10 STATION MASTER \$19.95; 50BS. \$13.95 EACH
 Superior heavy duty 10 station interest transformer designed for continuous service. A powerful AC transformer type with 80 rectifier, 6V3 output and 6S4 driver. 5" speaker with 2.5 x 2.5 oz. Alnico V magnet. Housed in a walnut cabinet 14" long, 6 1/2" deep and 7 1/2" high. Designed to install as a 3 wire system. 10 push button station selector on front, with separate all station call switch. Talk-listen switch in silent position. Made to sell for a much higher price. McGee made a fortunate purchase and passes the bargain on to you. Shipping weight 12 lbs. Stock No. 2520. Net price \$19.95 each. Remote station with call switch, for use with the above master, \$3.95 each; 10 for \$35.00.

G.E. RECORD PLAYER ATTACHMENTS SALE PRICE \$6.95

General Elec. 78 RPM Record Player to attach to any radio or amplifier. Heavy duty volume control and off-on switch. Shipping weight 8 lbs. (No pre-amp necessary.) 78 RPM Model, Stock No. GE-78, \$6.95. 33 1/3 RPM Model, Stock No. GE-33 has Webster crystal pick-up with needle. Net, \$6.95. Buy 3 for \$19.50.

Wire Recorder Converter FOR ANY WIRE RECORDER MECHANISM \$12.95
 Wire recorder converter \$12.95. With this 3 tube converter you can adapt the St. George, Air King, or Webster Chicago wire recorder mechanism to any radio or amplifier. Only 3 connections necessary. Must plug in to the phono input of your radio or amplifier and connect to plate of output tube. AC transformer construction, gain for mike. 3 position switch for quickly changing from record to playback. Preceded ready wired and tested with instructions and tubes: 12AT7 preamplifier, 6AQ5 oscillator base and 6X4 rectifier, Model RR-Y, shpg. wt. 6 lbs.

BUY YOUR S-56 HALLICRAFTERS WITH A 15 INCH COAXIAL \$77.95

S-56 HALLICRAFTERS
 11-TUBE FM-AM CUSTOM CHASSIS. A \$110.00 VALUE **\$59.95**
 AT McGEE FOR ONLY
 • WIDE RANGE • AUTOMATIC FREQUENCY CONTROL ON F.M.
 Receives 88 to 108 MC F.M. and Broadcast 550 to 1650 K.C.
 Fine for Custom Installation
 Model S-56 Hallcrafters, 11 tube AM-FM radio receiver chassis for broadcast and FM 88 to 108 mc. Automatic frequency control on FM, holds the receiver in perfect tune. Phone connection on rear of chassis. Full range tone control with bass boost. Push-pull 6X6 tubes in audio system. Frequency response essentially flat, from 50 to 15,000 CPS. Wide vision accurately calibrated slide rule dial, with pre-selection on broadcast band. Output transformer carries any 3 ohm speaker, 4 antenna terminals, two for AM and two for FM. This is the finest type of home radio that we know of today. Better get your order in early. Designed to be used in commercial radio selling in the \$400 to \$600 class. The regular dealers' net on this chassis is \$110.00. However, a lucky purchase enables us to offer these brand new, factory cartoned S-56 Hallcrafters chassis, complete with tubes and operating instructions, at only \$59.95, less speaker. Chassis size 13 1/2 x 10 x 3 1/2". Weight 2 lbs. Brand new factory cartoned. Buy your S-56 with a wide range FM speaker.

Pre-amplifier for S-56 \$3.95
 Dual purpose pre-amplifier for either S-56. Only 4 wires to connect (instructions furnished). Complete with tubes and operating instructions, at only \$3.95, less speaker. Chassis size 13 1/2 x 10 x 3 1/2". Weight 2 lbs. Brand new factory cartoned. Buy your S-56 with a wide range FM speaker.

S-56 chassis with our \$62.50 list 15" coaxial (P15-8) PM speaker, on sale for \$77.95.
 S-56 chassis with our \$32.50 list 12" coaxial (CU-13X) PM speaker, both for \$69.50.
 S-56 chassis with our new 12" curvilinear-cone (1202-X) PM speaker, both for \$67.95.
 VM-950 Tri-O-Matic, 3 speed changer \$28.35.
 VM-950-GE, 3 speed changer with new GE RFX-050 V.R. cartridge \$31.20.

BUY YOUR S-56 WITH A CHANGER AND CABINET

Arm Chair Cab. \$29.95 **VM-950 3-Speed \$28.35** **Furniture Baffle \$29.95** **Radio Changer Compartment \$29.95**

A Armchair radio-phono combination cabinet. Specify when ordering whether you want Will hold a changer up to 14" square. Changer panel 24" high and 16 1/2" wide. construction and finish. Walnut armchair cabinet, cut for S-56 or blank, net price \$29.95. Mahogany armchair cabinet, cut for S-56 or blank, net price \$34.95. Blond armchair cabinet, cut for S-56 or blank, net price \$34.95. Shipping weight 40 lbs.
B speeds now on the market. Protective feature: records are covered, not dropped, no needles. Specify VM-950 Tri-O-Matic automatically plays all records, all sizes and all wobbling down the spindle, no slip or scrape, no possibility of the tiny microgrooves 33 1/3 or 78 RPM, any 10 or 12" records of the same type interlocked. 12 7/8" 33 1/3 RPM and 12 7/8" 45 RPM records. Automatically shuts off on the last record, base size Stock No. VM-950. Shipping weight 12 lbs. Net price \$28.35. New 1950 Model VM-950 with All-in-one General Electric Variable Reluctance Cartridge and Twin
C A fine furniture quality speaker baffle, made of 1/2" brown mahogany. Will hold either a 12 or 15" speaker. (Specify size speaker you intend using when ordering.) You may buy this baffle by itself or for use with our radio and changer compartment. The two pieces are a matched pair. You may extend the speaker leads up to 50 feet on your S-56 or any other radio. This baffle is of high quality, non-rattle construction. Stock No. LS-4. Shipping weight 40 lbs. Net price \$29.95.
D Radio chassis and changer compartment (no space for speaker). Intended for use with the speaker baffle on the left, or may be purchased separately if you have some place to put your speaker. Cabinet is made of 1/2" brown mahogany and is of furniture quality. It is 25" high, 18 1/2 x 17 1/4". Consists of two drawers, one for the record changer 14 1/2 x 14 1/2 x 6 1/4" above the motor board; the other drawer has space for the radio panel cut for the S-56, the 7B-22 utility chassis, or blank. Specify which when ordering. Stock No. UR-2. Shipping weight 38 lbs. Net price \$29.95.

6-TUBE—3 BAND RADIO
 ANOTHER McGEE SCOOP ONLY \$15.95

REG. \$20.58 MASCO T.V. BOOSTER FOR \$13.39

LIGHTED SLIDE RULE DIAL BEAUTIFUL PLASTIC CABINET FULL 2-GANG SUPERHET

Another red hot McGee special. We made a lucky purchase of 250 6 tube 3 band ac dc 3 band radios. Attractive ivory plastic cabinet with lighted slide rule dial. Receives standard broadcast, foreign short wave and police. A full 6 tube 2 gang superhet with AVC. Made by a well known radio factory. Stock No. FR-63. Shpg. weight 10 lbs. Sale price, \$15.95, two for \$30.00.

Masco MTB-13X, 13 channel television booster. A regular \$20.58 dealer's net. Rem. on sale at McGee for only \$13.39. Housed in an attractive complete with 2-6AK3 tubes. These boosters are brand new and factory cartoned. Shipping weight 6 lbs. McGee's sale price, \$13.39 each. Two for \$25.00. The price is good only as long as our supply lasts.
 Atlantic AT-1 "Channel Chief" TV Booster. Equal to two ordinary boosters. Two tuned circuits. Dual controls. Tube picture and sound. Attractive wood cabinet, 8 1/2 x 11 x 5 1/2". Shipping weight 6 lbs. Net price \$29.10.

Build Your Own Phono-Mike Oscillator
 Kit Model DE-6X. \$6.95

Kit Model DE-6X. With this simple kit, you can build a 4 tube phono oscillator that also has a mike input. Will broadcast over any radio, with a crystal mike or crystal phono pickup. Fuller kit. Inputs for crystal mike or crystal phono pickup. Fuller control fades from mike to record. Ideal for a home P.A. system. Kit Model DE-6X. Net price, \$6.95. DE-6XWT, wired and tested. Net price, \$8.95. Crystal mike and desk stand, \$4.95 extra. Concealed microphone unit, only 1 1/2" in diameter and 1/2" thick. Specify hidden mike when ordering. Stock No. T-004. Net, \$3.95 extra.

McGEE RADIO COMPANY Prices F.O.B. K.C. Send 25¢ Deposit with Order, Balance Sent C.O.D. With Parcel Post Orders, Include Postage

TELEPHONE VICTOR 9045. WRITE FOR FLYER 1422 GRAND AVE., KANSAS CITY, MISSOURI

CHELSEA SCORES AGAIN

with the **LOWEST PRICES FOR LATEST 1950 LIC. RCA CHASSIS**

Just off the assembly line . . . completely wired, factory-engineered, aligned, tested and guaranteed

2" \$99.95

6" \$129.95

(plus \$1.80 Fed. Tax)

new low price for our Superior C-4 Chassis

COMPLETE WITH PICTURE TUBE

PHONOGRAPH JACK & SWITCH and FREE 1-YEAR WARRANTY

A superb value! Quality controlled throughout, with keyed AGC, AFC and front end down to 45 microvolts

(THESE ARE SETS)
—not kits

FAMOUS 630 TYPE CHASSIS with Voltage Doubler for 16" or 19" Operation

less CRT **\$134.95**

plus \$2.25 Fed. Tax

A price-shattering offer of our famous 30-tube receiver with AFC, keyed AGC and STANDARD COIL Front End down to 45 microvolts. Nothing finer. May be used for rectangular tubes (please specify when ordering).

16" CRT...\$29.00 19" CRT...\$55.00

Write Dept. U for latest literature and prices—AND COMPARE!

Phone and mail orders filled on receipt of certified check or MO for \$25 as deposit . . . balance COD, FOB, N. Y. Visit our street-level salesroom at 187 Seventh Avenue, at 21st St., N. Y.

The House of Bargains

CHELSEA TELEVISION CENTER, INC.

Office and Showroom: 130 West 42nd Street, near Broadway
New York 18, N. Y. LOngacre 5-2254-5-6

Prices and Models subject to change without notice.

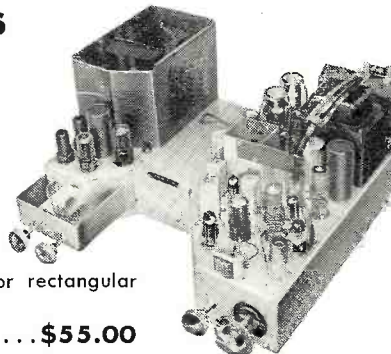
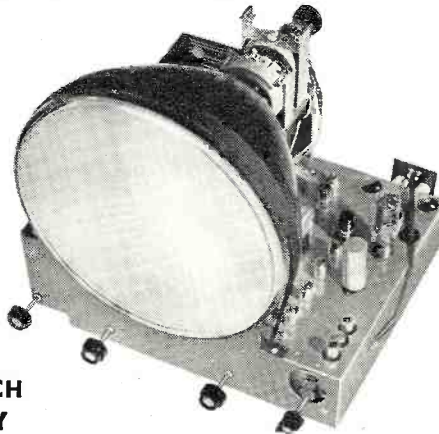

Read RADIO & TELEVISION NEWS Every Month

EASY TO LEARN CODE

It is easy to learn or increase speed with an Instructograph Code Teacher. Affords the quickest and most practical method yet developed. For beginners or advanced students. Available tapes from beginner's alphabet to typical messages on all subjects. Speed range 5 to 40 WPM. Always ready—no QRM.

ENDORSED BY THOUSANDS!

The Instructograph Code Teacher literally takes the place of an operator-instructor and enables anyone to learn and master code without their assistance. Thousands of successful operators have "acquired the code" with the Instructograph System. Write today for convenient rental and purchase plans.

INSTRUCTOGRAPH COMPANY

4711 SHERIDAN ROAD, CHICAGO 40, ILLINOIS



TELEVISION • ELECTRONICS

Learn Radio the Northwestern Way

- BASIC RADIO
- RADIO SERVICE
- COMMUNICATIONS
- INDUSTRIAL ELECTRONICS
- TELEVISION
- RADIO PRODUCTION—CONTROL

Highly Trained Instructors • Modern Equipment • Spacious Building and Grounds
G.I. and Rehab. Approved

NORTHWESTERN VOCATIONAL INST.



745 Grand Ave.

ST. PAUL 5
MINN.

Insurance

(Continued from page 43)

large business cannot absorb, while the medical bills and lost time benefits to injured employees can, in certain states and, under certain conditions, surpass by far, the death benefits payable for a fatal accident.

Bodily Injury Liability

This coverage is important to the owner of the store in the event that a customer or other member of the public is injured on his premises or if the injury arises from some operation away from the store. A customer or other member of the public may fall or trip on some defect in the sidewalk or on the approach to the store. Inside the premises defective floors, misplaced cartons, packing cases, merchandise left on the floor, and awkward patrons, may cause stumbling and falling accidents. Recently, a newspaper published an account of a woman who tripped upon entering a store because the floor was defective. In her attempt to regain her balance, she traveled all the way across the store and crashed into an expensive television set on the opposite side of the store. The store owner lost the value of the television set and may have to pay damages to the injured customer because the entrance to the store had a defective condition in the floor. Falls on icy or otherwise slippery sidewalks also result in large judgments against the owners or occupants of the premises.

When employees are away from the store on service or delivery calls, the employer is vulnerable to claims for damages since he is responsible for the acts of his agents. It is not uncommon for passers-by to be jostled or even knocked down by careless delivery men, or men who are carrying bundles too large to permit a complete view of where they are going. It is also often true that when the deliveries are being completed inside a home, the merchandise being carried causes injury to small children within the home or perhaps wall coverings, floor coverings, and other personal property may be damaged. Inexpensive bric-a-brac becomes an heirloom if broken by a service technician. Rugs, carpets, drapes, and curtains damaged by employees on service calls are annoying and expensive incidents to many service operators.

The service shop owner in addition to the above often performs such tasks as the erection of television antennas. He is responsible for the safe conduct of this erection job. The employees performing the work may fall while making the installation or drop the apparatus, and the ensuing damage to the property of others or the possible bodily injury to by-standers or passers-by or to the employee may be severe. Workers may drop tools which injure pedestrians or they may strike parked or moving automobiles. For all such

RADIO & TELEVISION NEWS

Over 50,000 SERVICEMEN must be right!

NEW... **EICO** Instruments and **KITS** give you Laboratory Precision at Lowest Cost!

VACUUM TUBE VOLTMETER

Versatile top-quality laboratory-precision VTVM for trigger-fast operation and lifetime dependable service.

15 different ranges. Large rugged $4\frac{1}{2}$ " meter, can't-burn-out circuit. New zero center for TV & FM discriminator alignment. Electronic AC & DC ranges: 0-5, 10, 100, 500, 1000 v. (30,000 volts and 200 MC with HVP-1 and P-75 probes). Ohmmeter ranges, .2 ohms to 1000 megs. DB scale. New stable double-triode balanced bridge circuit—extreme accuracy. 26 megs DC input impedance. Attractive 3-color etched rubproof panel; rugged steel case. 115 v., 60 cycle AC. $9\frac{7}{12} \times 6 \times 5\frac{1}{2}$ ".

Model 221-K, KIT, only \$23.95

Model 221, factory wired, \$49.95



New TUBE-TESTER

The brand new professional tube tester and merchandiser EICO Service-Engineered for unbeatable value!

Large $4\frac{1}{2}$ " full-vision meter. Tests conventional and TV tubes including 9-pin miniatures. New lever-action switches—tests every tube element. Illuminated "Speedroll Chart." 2 grid caps. Short and open-element tests. Spare socket for new tubes. Protective overload bulb. Electronic rectifier. Handsome 3-color etched rubproof panel; rugged steel case. 115 v., 60 cycle AC. $12\frac{1}{2} \times 9\frac{1}{2} \times 4\frac{1}{4}$ ".

Model 625-K, KIT, only \$29.95

Model 625, factory wired, \$44.95



5" PUSH-PULL OSCILLOSCOPE

All-new laboratory-precision scope gives you all the extra sensitivity and response for precise servicing of TV, FM & AM receivers.

Push-pull undistorted vertical and horizontal amplifiers. Boosted sensitivity, .05 to .1 rms volts/inch. Useful to 2.5 MC. TV-type multivibrator sweep circuits, 15 cps—75 KC. Z-axis intensity modulation feature. Dual positioning controls move trace anywhere on screen. Complete with 2-6J5, 3-6SN7, 2-5Y3, 5BP1 CRT. Handsome 3-color etched rubproof panel; rugged steel case. 115 v., 60 cycle AC. $8\frac{1}{2} \times 17 \times 13\frac{1}{2}$ ".

Model 425-K, KIT, only \$39.95

Model 425, factory wired, \$69.95



RF PROBE

Sensitive Germanium crystal probe for signal tracing and measurements to over 200 MC. Extends range of VTVMs and scopes.

Model P-75K KIT, for VTVM; P-76K for Scope; ea. \$3.75

Model P-75 or P-76, factory wired, ea. \$7.50



HIGH VOLTAGE PROBE

A new professional EICO-engineered HV-probe carefully designed and insulated for extra safety and versatility. Extends range of VTVMs and voltmeters up to 30,000 volts. Lucite head, large flashguards. Multi-layer processed handle. Complete with interchangeable ceramic Multiplier to match your instrument.

Model HVP-1, only \$6.95



New BATTERY ELIMINATOR & CHARGER

The brand new 6-volt power supply EICO Service-Engineered for extra reserve electrical power for all auto radio testing.

Latest-type full wave bridge circuit, extra-heavy-duty 4 stack manganese copper-oxide rectifiers. Latest Variac-type transformer: 0-15 volts output. Continuous operation: 5-8 v., 10 amps; intermittent: 20 amps. 10,000 mfd filter condenser. Rugged meter measures current and voltage output. Double protection: fused primary; automatic reset overload device for secondary. Handsome rugged hammer-tone steel cabinet. 115 v., 60 cycle AC. $10\frac{1}{2} \times 7\frac{1}{4} \times 8\frac{1}{4}$ ".

Model 1040-K, KIT, only \$22.50

Model 1040, factory wired, \$29.95

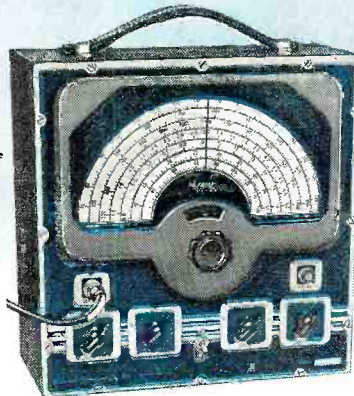
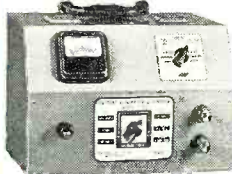

New Deluxe Kit

AM-FM-TV SIGNAL GENERATOR

A laboratory-precision generator EICO Service-Engineered with 1% accuracy.

Extremely stable, frequency 75 KC—150 MC in 7 calibrated ranges. Illuminated hairline vernier tuning. VR stabilized line supply. 400-cycle pure sine wave with less than 5% distortion. Tube complements 6X5, 7F7, 6C4, VR-150. Handsome 3-color etched rubproof panel; rugged steel case. 115 v., 60 cycle AC. $12 \times 13 \times 7\frac{1}{2}$ ".

Model 315-K, KIT, only \$39.95

Model 315, factory wired, \$59.95

Easy-to-follow step-by-step EICO pictorial & schematic instructions—most explicit & comprehensive in electronics!—supplied with each Kit. Anyone can build the EICO Kits!

See these other EICO Instrument KITS:

Model 320-K Sig Gen KIT, \$19.95

Model 360-K Sweep Gen KIT, \$29.95

Model 145-K Sig Tracer KIT, \$18.95

Model 511-K VOM KIT, \$14.95

the exclusive EICO Make-Good GUARANTEE

Each EICO Kit and Instrument is doubly guaranteed, by EICO and your jobber to contain only selected quality components. EICO guarantees to replace any component which might become defective in normal use if returned to the factory within 90 days of purchase. EICO guarantees all Kits assembled according to EICO's simplified instructions will operate as specified therein. EICO guarantees service and calibration of every EICO Kit and Instrument at the nominal charge as stated in the instructions.

Be sure to look at the EICO line before you buy any higher-priced equipment from a local jobber today, and SAVE! Write NOW for free latest Catalog & literature to the complete EICO line.

ELECTRONIC INSTRUMENT COMPANY, INC.

276 Newport St., Brooklyn 12, N. Y.

© 1950, Electronic Instrument Co., Inc., Brooklyn, N. Y.

THE MYTRONIC CO.
119 WEST CENTRAL PARKWAY
CINCINNATI 2, OHIO

Please rush complete tube list and prices.

Name _____
Street _____
City _____ Zone _____ State _____

MAIL COUPON
FOR COMPLETE
TUBE LIST! →

THE Mytronic
COMPANY
Cincinnati, Ohio

WE PAY ALL
POSTAGE
CHARGES!



RMA GUARANTEED

PAY AS YOU SAVE

for ALL
FACTORY
TUBES
WARRANTED

OUR TUBE PRICES ARE LOWER because we sell more . . . and we sell more because we specialize in all types of tubes

accidents, the employer is responsible. The radio service technician bears a substantial responsibility for the manner in which repairs and installations are performed. The antenna, for example, must stay up and perform its function in such a way that no injuries or damages result from defective parts or workmanship. Let the reader observe closely a group of television antennas in any locality and note if all the masts are straight. Some will be bent or out of line. If bent out of line, it is an indication that the mast is probably not sufficiently strong to withstand the maximum of wind pressure in that area. It is possible also that the mast may be insufficiently equipped with guy wires or perhaps may have no guy wires at all. If one of these antennas crashes to the adjoining roof or street, let the installer beware. If the failure of the device can be traced to defective work or parts supplied by the installer, he will have substantial claims to pay. The owner of the concern performing this work has a definite need for completed operations coverage which is a division or form of products liability insurance.

Automobile Bodily Injury and Property Damage Liability

This type of insurance is more familiar than the preceding forms since we are well acquainted with automobiles and automobile accidents, and it is well known that such accidents have been expensive to the owners of the damaged cars. This hazard, like the others mentioned previously, is common to the radio and television worker. The owner of a business, generally speaking, is responsible for the acts of his employees or agents, for the safe driving of automobiles owned by the employer, as well as the driving of personally owned automobiles of the employees on the business duties of the employer.

There is no hard and fast rule to apply which will prove who is at fault in any accident. The question of fact at the time of the accident is all important. If insurance protection is available to cover the accident, the problem is not one which need worry the owner of the car as it is a problem to be solved by the insurance company.

The owner of the business should at all times carry bodily injury and property damage liability on all cars owned by him, and he should insist that insurance protection of the same kind be carried on all automobiles owned by others but which are driven in the owner's business. It is improbable that automobiles will be hired to perform service work. If they are, the employer or person who uses the hired automobile should make absolutely certain that adequate insurance protection is in effect and that it extends to the driver in the event that the hired automobile is involved in an accident for which the driver or his employer may be held responsible.

Summarizing, therefore, the radio

service operator should have automobile bodily injury and property damage liability on:

- A. Automobiles owned by him.
- B. Automobiles hired by him for use in his business.
- C. Automobiles not owned by him but operated in his business.

Burglary and Robbery Insurance

At the beginning of this article, an example was cited of a service and sales agency which suffered a crippling loss from the burglary of television sets from the store. Unfortunately, this actually occurred and will occur again. The hazard of such loss may be covered by the purchase of mercantile open stock burglary coverage or a storekeeper's burglary and robbery policy which is designed to protect the policyholder from the burglary or robbery of his merchandise, tools, fixtures, or cash.

The foregoing is probably not a welcome message to the reader. The writer believes that knowledge of proper insurance protection is extremely important to the operator of a radio sales or service business. He holds no brief for insurance companies. It is the business of insurance companies to sell insurance protection and to pay the resulting proper claims fairly and promptly. The employer, or even the individual running a one man shop, needs insurance to protect himself, his family's welfare, and the permanency of employment to his employees, and he must also insure his moral obligation to reimburse anyone who has suffered injury or loss from his wrongful acts.

It is an earnest recommendation, therefore, that no business operation be without proper protection, and that an insurance agent or qualified insurance advisor be consulted. Your business is to know how to repair radio devices and his business is to know how to design the proper insurance coverage for your needs. If this article encourages anyone to secure proper insurance protection, its purpose will have been accomplished. Remember, very few firms can weather a financial "hurricane"—so don't take chances!

-30-

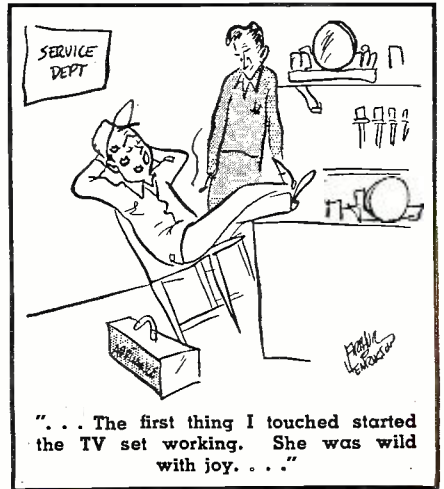

USING the BC-454 and BC-455 for 20 METER OPERATION

By
F. K. SULLIVAN, W8UYK

Method for using h.f. oscillator of a BC-455 as a converter and then feeding a BC-454 receiver.

NO DOUBT many hams, like myself, have the Army surplus command set receivers BC-454 and BC-455 which cover the 80 and 40 meter bands. Many of them, like myself, have undoubtedly considered building converters to receive the 20 meter band. While this can be done, of course, it entails a good deal of work. Here is a suggestion on a method for receiving 20 meters that only takes an hour and a half to hook up and it works!

First of all it is necessary to understand something about the receivers used. The BC-454 covers the frequency range from 3 to 6 mc. and has an i.f. of 1415 kc. The BC-455 covers the range 6 to 9.1 mc. and has an i.f. of 2830 kc. with the high frequency oscillator operating *above* the received signal. Thus, the high frequency oscillator operates in the range from 8.830 to 11.930 mc. Therefore, if a 14 mc. signal could be introduced to the grid of the converter tube of this receiver, a high frequency oscillator *below* the resultant frequency falling well within the range of the BC-454 since in a superhet the resultant, or i.f., is the difference between the high frequency oscillator and the incoming signal regardless of whether the incoming signal is above or below the oscillator.

If this new resultant frequency is fed into the BC-454 we have a double conversion superhet which is capable of receiving the 20 meter band. Once this fact is firmly established, the actual connections required are exceedingly simple to make. The only construction work needed is a 20 meter tank circuit.

A small tank circuit, an antenna coil which tunes the 20 meter band, was mounted on a small panel which was

fastened on top of the BC-455. From the top end of this coil the grid lead was run into the receiver and clipped onto the grid cap of the 12K8 converter tube, after removing the present grid connection, of course. Since this has no effect on the oscillator section of the tube, the incoming signal of 14 mc. will now mix with the high frequency oscillator of perhaps 10.830 mc. (obtained by setting the dial of the BC-455 to 8 mc.), producing an intermediate frequency of 3.170 mc. in the mixer circuit. To get this 3.170 mc. i.f. out, the converter tube was removed and a turn of insulated wire was wound around the plate pin of the tube and then the tube was reinserted. This lead was then condenser-coupled to the antenna of the BC-454. It was only necessary to tune the BC-454 to 3.170 mc. and the 14 mc. signal was received. Actually, this lead could be hooked directly to the antenna post since there

is already a blocking condenser in the antenna circuit but the extra blocking condenser was used for safety since by putting it inside the case of the BC-455 all high voltage is out of sight rather than on an exposed antenna post.

Operation

Tuning over the 20 meter band can be accomplished by tuning either one of the receivers but the author prefers to set the BC-454 on 3.170 mc. and then tune the BC-455 from 8 to 8.4 mc. to cover the range from 14 to 14.4 mc. This is very convenient since 15 mc. occurs at 9 on the dial and WWV on this frequency can be used as a calibration marker. Simply set the dial on 9 mc. and then vary the BC-454 until WWV is tuned in. By doing this any misalignment of either receiver will be compensated at 15 mc. so that the calibration will be very close over the 20 meter band. Ordinarily the antenna tuning condenser can be tuned to the middle of the band and left there, but it should be peaked on the received signal if the signal is weak.

While this completes the actual "conversion" it was found that tuning of the BC-454 was rather broad, especially on a crowded phone band. This condition can be improved considerably by feeding the 1415 kc. i.f. into a standard broadcast receiver. Since the author happens to have a BC-946-B (the standard broadcast version of these same receivers) which is extremely sharp, it is being used as a Q-5'er. The grid of the second i.f. tube of the BC-454 is coupled to the antenna post of the BC-946 in the same manner as described previously except that in this case the grid pin of the tube is coupled so that a blocking condenser is unnecessary. This makes a very sensitive and very sharp receiver for both 80 and 20 meters and by simply removing the new grid connection to the converter tube of the BC-455 and replacing the original connection, 40 meter reception is again possible.

The only addition for 20 meter operation is small externally-mounted tank circuit.

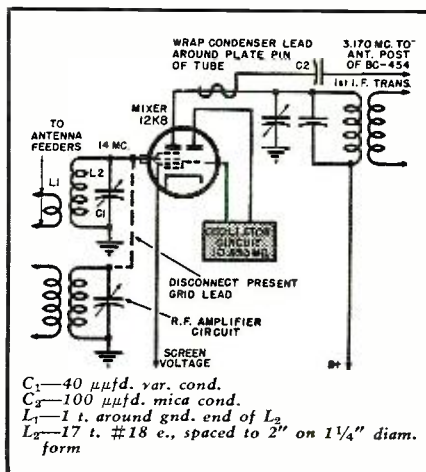

TRANSVISION 19" KIT

\$104⁰⁰

less C.R. Tube*

Finest Quality

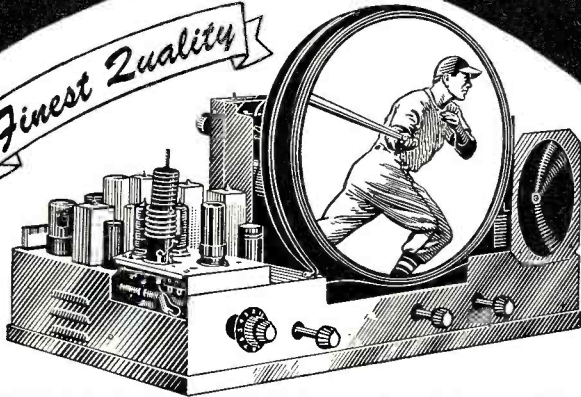

COMPLETE LINE: TV only ("A" line). Also TV-and-FM Radio ("D" line). 12½", 16", 19".
Choice of tuners includes famous DuMont Inputuner.

* PICTURE TUBES—16" AND 19"

Ask for our NEW LOW PRICES!

ANYONE can easily assemble the famous Transvision Kit. No technical knowledge or instruments required. Instruction sheet is simple (each part is packaged and numbered). ALL IFS are wired and pre-tuned. Note: Kit comes complete with all parts except picture tube.

WIRED TV CHASSIS

Completely Wired and Aligned

Transvision "A" Chassis (TV only) comes completely wired, aligned and operating. Especially designed for fringe area reception. 23 tubes, AFC, AGC. Wired-in phono plug. Picture tube and speaker not included.

Transvision "D" Chassis (TV-and-FM Radio) has famous DuMont Inputuner.

PRICES: 16" TV Chassis ("A" line)net \$115.00*
19" TV Chassis ("A" line)net \$122.00*

* Picture tube and speaker are extra.

All prices are F.O.B. New Rochelle, N. Y. . . . Texas and West Coast slightly higher.

TV CABINETS

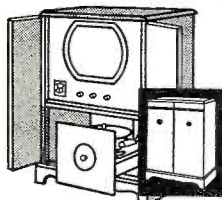

Newly styled complete line of beautiful hand-rubbed cabinets for 19" and 16" TV Chassis or Kits. Also CONVERSION CABINETS to convert any small screen set to a giant 16" or 19" size. WRITE FOR FOLDER.

INSTRUMENTS and PARTS

Transvision FIELD STRENGTH METER

Improves installations; saves ½ the work. Model FSM-1, complete with tubes.
Net \$79.00

Transvision REMOTE CONTROL UNIT—for Any TV Set! "Chairside" control for greater TV enjoyment. Transvision's Remote Control Unit turns set "on," tunes in stations, regulates, turns set "off."
NEW LOW PRICENet \$69.00

TRANSVISION, INC., Dept. RN, NEW ROCHELLE, N. Y.

Branches:—Calif., 8572 Santa Monica Blvd., Los Angeles; 3471 California St., San Francisco Dela., 4 E. 15th St., Wilmington Ill., 4834 S. Ashland Ave., Chicago Md., 1912 N. Charles St., Baltimore Mass., 39 Tremont St., Boston N. J., 601 Broad St., Newark N. Y., 1425 Edw. L. Grant Hwy., Bronx; 167-01 Hillside Ave., Jamaica, L. I.; 622 N. Salina St., Syracuse Ohio, 2001 Euclid Ave., Cleveland; 54 E. Long St., Columbus Penna., 235 N. Broad St., Philadelphia; 620 Grant St., Pittsburgh Texas, 700 Commerce St., Dallas.

ALSO ASK YOUR RADIO PARTS JOBBER! Representatives: Apply now for available territories.

Write for Folders on Complete TRANSVISION Line

STAR SPECIAL!

DELUXE 6-TUBE AUTO RADIO

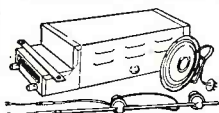

Includes Speaker and Antenna

First time ever offered at our bargain low price. Popular make. Compactly

built 6-tube radio with matching Alnico 5 PM speaker and big 66" side cowl antenna. Radio measures 13" deep, 4½" high, 6" wide. Complete with all six tubes (6SA7, 2-6SK7, 6SQ7, 6K6GT, 6X5GT rectifier). A super-powerful auto radio that will pull in distant stations without fading! Quick, easy installation under dash of any car. Complete outfit at one low price!
Shipping weight 16 lbs. \$27.50

COMPLETE STOCKS
All Standard Brands Just off the press
BIG BARGAIN BULLETIN

STAR ELECTRONIC DISTRIBUTORS, INC.
Dept. RN 2-7736 S. Halsted, Chicago 20, Ill.

PEN-OSCIL-LITE

Extremely convenient test oscillator for all radio servicing; alignment • Small as a pen • Self powered • Range from 700 cycles audio to over 600 megacycles u.h.f. • Output from zero to 125 v. • Low in cost • Used by Signal Corps • Write for information.

GENERAL TEST EQUIPMENT
38 Argyle Buffalo 9, N. Y.

TELEVISION

PREPARE FOR A GOOD JOB!
BROADCAST ENGINEER
COMMERCIAL OPERATOR (CODE)
RADIO SERVICEMAN

Television Servicing

(Approved for Veterans)
SEND FOR FREE LITERATURE
BALTIMORE TECHNICAL INSTITUTE
1425 EUTAW PLACE, BALT. 17, MD.

Technical BOOKS

"TELEVISION SIMPLIFIED" by Milton S. Kiver. Published by D. Van Nostrand Company, Inc., New York. 601 pages. Price \$6.50. Third Edition.

The revised and enlarged Third Edition of this standard text on television contains most of the material included in the author's series "Modern Television Receivers" which appeared in RADIO & TELEVISION NEWS plus additional material to bring the subject up-to-date.

Since most readers of this magazine are thoroughly familiar with Mr. Kiver's lucid and concise explanations of complex subject matter, suffice it to say that this text follows his usual style.

The text is elementary in that the author has not assumed that the reader has any previous knowledge of television circuits. The only prerequisite for an understanding of the material is a working knowledge of AM radio circuits and receiver operation. A chapter has been devoted to a discussion of FM as it applies to the audio portion of the television transmission.

Chapters on the intercarrier sound television system and color video have been added to this edition to bring the reader up-to-date on the latest developments in the field.

A series of check questions covering each chapter has been included to help the student test his grasp of the subject matter. A glossary of television terms is a particularly valuable addition to the book as is the allocation chart, broken down by states.

For the television technician or student looking for an authoritative work on the subject, this text fills the bill.

* * *

"40 USES FOR GERMANIUM DIODES" by Sylvania Technical Staff. Published by Sylvania Electric Products Inc., New York. 47 pages. Price \$1.00.

This is a compact compilation of a group of typical circuits for forty basic germanium diode applications.

The text material has been divided into three main sections covering germanium diode applications in radio and television receivers; transmitters and amplifiers; and a wide range of instruments and supervisory circuit devices.

The first section covering crystal radio receivers and video circuit components carries 10 schematic diagrams along with the correct parts values. The section on transmitters, of particular interest to hams, has six schematics, while the section on instruments and gadgets describes twenty-four devices ranging from a simple sideband generator in which matched diodes are arranged as a ring modulator to a 144 mc. tubeless radio receiver for the remote control of model airplanes and model boats.

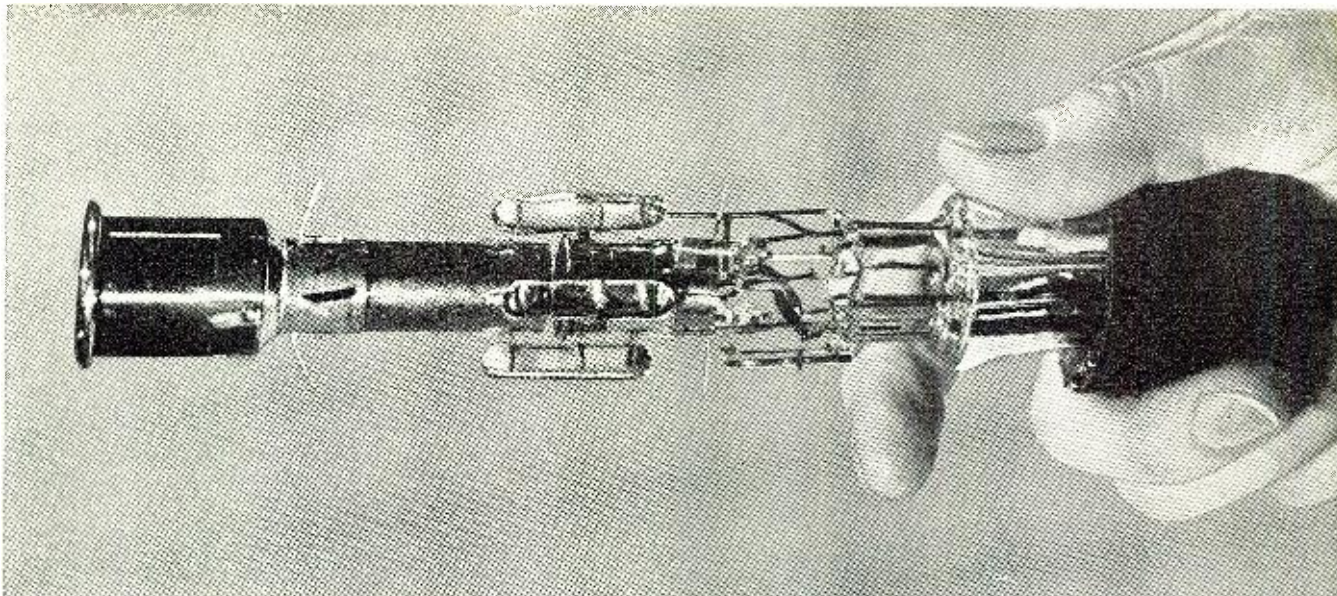

Electron gun which generates the pencil-like beam or "brush," of electrons that paints the television picture on the kinescope's luminescent face.

Wonderful peacetime "gun" shoots electrons

**How a pencil-thin electron stream
"paints" television pictures on TV screens**

**No. 7 in a series outlining high
points in television history**

Photos from the historical collection of RCA

● Though television now is familiar to millions, few know what makes pictures on the screens of home receivers. And little wonder! This, to most laymen, is a highly complex operation.

Many factors are involved, but in home receivers the kinescope tube—developed by Dr. V. K. Zworykin of RCA Laboratories—is undoubtedly most important. The face of this tube is the receiver's "screen." On it, an amazing electron gun paints pictures in motion.

Inserted inside the kinescope—in a vacuum 10 times more perfect than you'll find in any standard radio tube—this electron gun is machined and assembled with watchmaker precision . . . to 1/1000th of an inch. Such care is necessary to assure that the electron stream, emitted by an electrically heated surface, is under perfect control—compressed into a tiny beam, in perfect



After this white-hot block of luminescent material is taken from the furnace, it will be spread on the face of a kinescope to form the screen for television pictures.

synchronization with the electron beam in a distant television camera.

In obedience to a signal originating in the camera controls—then telecast and received in your home—this electron beam moves back and forth across the luminescent screen of the kinescope . . . to paint areas of light and shade. In turn, your eye automatically "combines" these areas, and sees a picture!

One of the miracles of all this is that, although the electron beam moves across the face of the kinescope 525 times in a *thirtieth of a second*—not a single mechanical moving part is involved! Thus there is no chance, in a kinescope, of any mechanical failure.



Radio Corporation of America
WORLD LEADER IN RADIO—FIRST IN TELEVISION

HARVEY brings you two new RCA TEST UNITS

Announcing ...the RCA Senior VOLTOHMYST* WV-97A

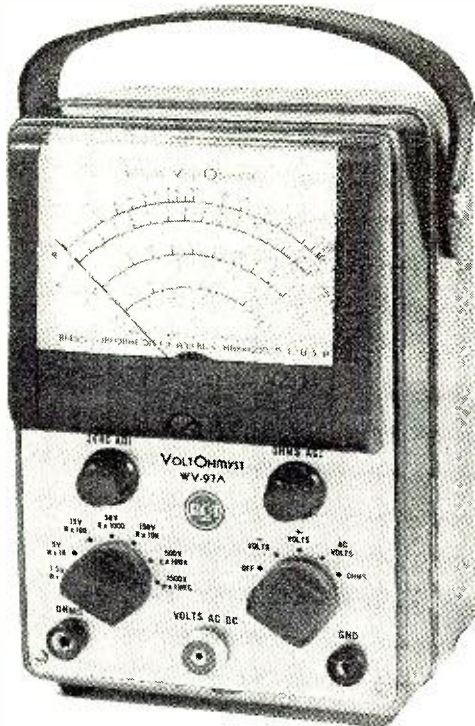

The WV-97A quickly provides information essential for servicing TV receivers with their pulse-type waveforms.

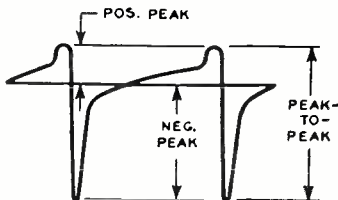

Like all RCA VoltOhmysts, it features high input resistance, electronic protection from meter burn-out, zero-center scale for discriminator alignment, molded-plastic meter case, a 1-megohm isolating resistor in the DC probe, and sturdy metal case for good RF shielding. An outstanding feature is its usefulness as a television signal tracer... made possible by its high input resistance, wide frequency range, and direct reading of peak-to-peak voltages. *Reg. U. S. Pat. Office

SPECIFICATIONS

DC Voltmeter:	
Seven continuous Ranges . . . 0 to 1.5, 5, 15, 50, 150, 500, 1500 volts	Input Resistance (including 1 megohm in DC probe):
All ranges	11 megohms
Sensitivity for the 1.5-volt range	7.3 megohms per volt
Overall Accuracy ± 3% of full scale	
AC Voltmeter:	
Fourteen Continuous Ranges:	
Peak-to-peak values	0 to 4, 14, 42, 140, 420, 1400, 3400 volts
RMS values	0 to 1.5, 5, 15, 50, 150, 500, 1200 volts
Input Resistance and Capacitance with direct cable:	
1.5, 5, 15, 50, 150-volt range	0.83 megohm shunted by 85 uuf
500-volt range	1.3 megohms shunted by 85 uuf
1200-volt range	1.5 megohms shunted by 85 uuf
Frequency Response:	
With WG-218 Direct Probe and Cable	within ± 5% from 30 cps to 3 Mc
Overall Accuracy	± 25% of full scale
Ohmmeter:	
Seven continuous ranges	0.1 ohm to 1000 megohms
Center Scale Values	10, 100, 1000, 10,000 ohms; 0.1, 1, 10 megohms
Dimensions: 7 3/4" high; 5 1/4" wide; 3 3/4" deep	
Available Accessories:	
WG-264 Crystal Probe. Extends range to 175 Mc.	
WG-289 High-Voltage Probe and Resistor WG-206 to extend range to 50,000 volts. \$8.95.	

Includes direct probe and cable, DC probe, ohms lead, and ground lead.

Only **\$62.50**

TEN WAYS BETTER!

1. Reads peak-to-peak voltages directly
2. Has greater over-all accuracy
3. Reads down to 0.1 volt (1.5 volts full scale)
4. Reads up to 1500 DC volts full scale
5. Measures resistance from 0.1 ohm to 1 billion ohms
6. Has 7 non-skip ranges, for both ohms and volts
7. All scales increase in 3-to-1 ratio (approx.)
8. Has wider flat-frequency response
9. Better stability with line voltage fluctuations
10. Provides greater convenience due to small compact size and new slip-on type probes

The WV-97A has a range of usefulness extending beyond that of any other instrument in the field. Its quality, dependability, and accuracy make it a true laboratory instrument; it is exactly what is needed for television in the design laboratory, factory, and service shop.

The new Senior VoltOhmyst measures DC voltages in high-impedance circuits, even with AC present. It reads the rms values of sine waves and the peak-to-peak values of complex waves or recurrent pulses, even in the presence of DC. Its electronic ohmmeter has a range of ten billion to one.

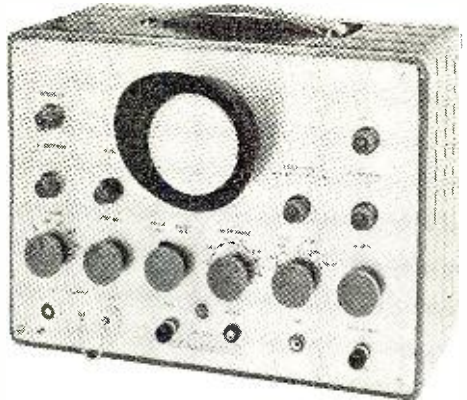

WO-57A FEATURES

- Direct-coupled, 2-stage, P-P vertical amplifier.
- 30 mv RMS per inch deflection.
- Flat within 1.2 db from DC to 500 kc; within ± 3.5 db at 1 Mc; useful beyond 2 Mc.
- Square-wave response — less than 2% tilt and overshoot.
- Only 14 mmf input capacitance with WG-216 probe.

SPECIAL FEATURES

- Preset fixed sweep positions.
- Positive and negative synchronizing for easy "lock-in".
- Sweep reversal switch for L to R or R to L traces.
- Linear sweep range 15 to 30,000 cps.
- Trace expansion twice screen diameter for sweep-alignment applications.
- Standard design — fits regular RCA test rack.
- C-R tube enclosed in nickel-iron alloy shield to minimize hum pickup.

The WO-57A is an oscilloscope of unusual versatility. It has the high sensitivity, superior high and low frequency response, and excellent square-wave response heretofore associated only with laboratory-type oscilloscopes. It is designed to simplify the servicing of TV receivers.

Write today for FREE descriptive literature of this new servicing tool... or place your order now for immediate delivery.

RCA WO-57A \$137.50

WG-214 probe and cable kit \$7.50

All prices Net, F.O.B., N.Y.C. and subject to change without notice.

Telephone: **70RCA** LUXemburg 2-1500

HARVEY
RADIO COMPANY INC.
103 West 43rd St., New York 18, N. Y.



MAY 1950 ISSUE

**63 MANUFACTURERS
575 MODELS
MOST COMPLETE
UP-TO-DATE LISTING**

Get this easy-to-use, time-saving guide to exact replacements for all popular television receivers. Simplifies servicing, cuts repair-bench time. Write us today for your free copy!

**WATCH FOR Merit's
future issues of the
TV "Repl" Guide**



See us at the NEDA National Convention Booth 417.



CUT-RATES Today— BANKRUPTCY Tomorrow

By HAROLD J. ASHE

Many service technicians are discovering that mere volume of business is not nearly enough.

EVEN while we continue to enjoy the greatest and most widely spread prosperity our country has ever known, there is reappearing in this stage of readjustment, a depression-spawned doctrine that the surest way to make profits is to give those profits away.

Already this business folly is finding fertile soil in which to root itself among a small segment of the radio and television service trades. This would be no great cause for concern except that it has a way of spreading.

This writer has had his attention called recently to several service shops whose owners are jumping on what they think is a through train, with independence as its destination. Before climbing on board, wisdom should dictate that these men make a few discreet inquiries. For the overwhelming majority of such service technicians it is going to be a short trip, and a rugged one, with the bankruptcy court at the end of the run. They would be well advised to hit the cinders at the first water tank and hastily retrace their steps.

So far as this writer knows, there is no law in our competitive society which obliges a radio service shop owner to make a profit on his business. Most, however, should concede that the making of a profit at any time is a hard enough trick without lying awake nights trying to think up ways of beating the shop out of any profit which may materialize.

Your author, not long ago, prepared an income tax return for a service shop owner who, for several years, had sought tax counsel. His volume of business and net income, compared with previous returns which were on file, were astounding. Both gross volume and net profit had in one year dropped perceptibly. When questioned, the shop owner told this story:

Early in 1948 business began dropping off for no apparent reason. The shop owner was panic stricken. He had a considerable investment in his shop and service trucks. His charges were fair; his work unexcelled in the community. Yet business was sharply off. What to do?

His solution was painfully simple. He drastically cut his service charges. Within a month or so he was doing as much work as ever. But, while he had built up the physical volume of

his business to where it had previously been, he had not materially bettered himself. He had cut his charges so deeply to get back business that, when the shop was full of work, his gross receipts were not greatly in excess of what they had been when business was down. Actually his net profits fell precipitately because the more work he did the less profit he made. Being volume conscious to the exclusion of net profit consideration, this service technician did not immediately and correctly analyze what was happening to him.

About the time that his volume had returned to a point where he was debating the wisdom of restoring his old charges, an unexpected thing happened. A competitor down the street, feeling the pinch of cut-prices decided that he, too, would solve his problem with deeply cut rates. "After all," reasoned the second shop owner, if my competitor could increase his business by cut-rates, I could do the same thing." He managed within a short time to divide the trade between the two shops. The end result: both shops were again doing a minimum business but with profits non-existent. The two service technicians were quietly going broke.

No great amount of harm would be done if just an occasional service shop would cut prices, and it would stop there. Cut-raters can't do all of the business, even before they go broke. But often, other shop owners are forced to follow the leader. Owners take a long, hard look at their cut-rate competitors and say to themselves, "Well, maybe Joe has something there. Maybe I had better start cutting service charges, too. I'll probably get so much more business that it will offset the reduced net profits on each job."

At this point, the rugged pioneer who started it all in the community discovers his own business is dropping off again. So he complains, "It must be those dopes across the tracks. There ought to be a law so I could sue 'em for breaking in on my scheme to get business. They ought to keep their rates up."

The result: All service shop owners in the district are just barely hanging on, including the wisenheimer who thought he could fill up his shop with cut rates and come out with a fat

EXCLUSIVE VALUES!

for YOU at

CONCORD

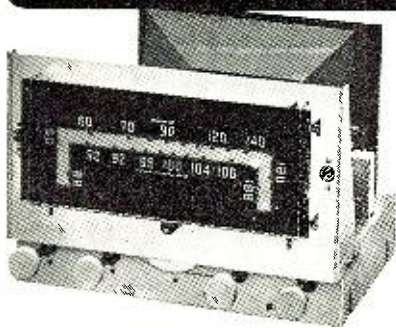

4975 NEW! MEISSNER 9A AM FM CHASSIS

Attractive yet modestly priced unit for custom installations or converting out-dated radios. Features that put the 9A in a class by itself: Complete provisions for phono input with power output plug on back for phono motor - All controls on front panel, and operative on phon-Edge-lighted dial offers ultimate in tuning ease. - 9A is drift proof, has air-wound FM coils, - Two separate FM IF coils and two separate AM IF coils. - Full range tone control - High "Q" die-stamped loop for AM reception - Plus new highly efficient built-in antenna for FM reception - Tube complement, 12AT7, three 6BA6's, 6AL5, 6BE6, 6AT6, 6V6, 5Y3GT - Out-put is a full FOUR watts; more than ample for use in largest home. List \$77.75

30-22447 - Shpg. wt. 12 lbs. **49.75**

Thordason T22558 output transformer for above. 6-2108. 2.44



BIG VALUE! RECORDING AMPLIFIER

Bargain-priced 8 watt Amplifier for use with any crystal or magnetic disc recorder. Gives faithful recording and wide-range, brilliant playback. Electron eye tube shows proper recording level... screw-type control adjusts indicator level to match your cutting. Has connectors for Mike input, Phono, or radio input and speaker output (8 ohms). Has Mike--Phono input switch. 2 vol. controls, for recording and playback. Bass, Treble, & Normal tone control switch, and Record play-back switch. AC outlet for phono motor. Tubes: 6SF7, 6SN7, 6V6, 6E5, and 5Y3. For 105-125 V, 60 cycle AC. Tube included.

99-9588 - Shpg. wt. 12 lbs. **14.95**

Electro-Voice Model 915 Crystal Microphone. Moisture-sealed; high impedance. Frequency response: 60-7, 500 cps. Output - 50 db. Includes desk stand and 7 1/2 ft. cable. List price - 11.50.

99-7054 - Shpg. wt. 2 lbs. **4.95**

6" Alnic V PM Speaker for amp. above - with cord and plug.

99-7042 - Shpg. wt. 2 lbs. **1.95**



SAVE! 10-WATT AMPLIFIER

Bargain-priced 10-watt amplifier originally designed for sound projection applications; can be used for sound or P.A. systems with no conversions necessary. For sound projection use, inputs are provided for photo-electric cell and 6 volt exciter power supply. Frequency range: 40-10,000 cps. Distortion is less than 2%. Has treble control and a bass compensated volume control. Output impedance: 1 or 15 ohms. Operates on 115-125 volts, 50-60 cycle AC only. Power plug has three connectors... 2-conductor plug can be attached if necessary.

When used as a movie projector amplifier, attach photo electric cell to receptacle on chassis... attach exciter lamp to 3.6 volt receptacle on chassis. Size: 12 1/2 x 7 x 5 1/4.

99-9640-Amplifier only. Shpg. wt. 14 lbs. **22.45**

99-9551-Kit of tubes for above. Includes (3) 6V6, 6SN7, 6J5, 6J7, and 5Y3 rectifier. wt. 2 lbs. 6.75

99-140-Photo Electric Cell, type 921. 1.25

99-143-Photo Electric Cell, type CE253. 1.25

99-144-Exciter lamp type T5 6V at 1 amp. 0.39

99-7041-Hi-Fi 10-inch speaker, Alnic V PM; 15 ohm voice coil. Shpg. wt. 6 lbs. 3.95

EXCLUSIVES IN TEST EQUIPMENT

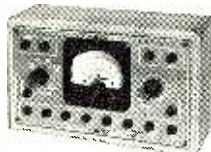

RCP 447BK MULTITESTER KIT

Save money; assemble yourself. Instructions and diagrams included. 1000 ohms/volt. DC volts: 0-5/50/250/500/2500. DC ma: 0-1/10/100/1000. DC amps: 0-1/10. AC volts: 0-10/100/500/1000. Ohms: 0-500/100M/1 Meg. DB -8 to +55 db. Output ranges same as AC volts. Hardwood case, test leads, battery.

32-24382 - Shpg. wt. 4 lbs. **12.75**

RCP 322AK TUBE TESTER KIT

Easy to Build. Practical instructions and diagrams included. Exclusive "Dynoptimum" tube tester kit. Requires only 5 controls for complete tube check. Checks new miniature and sub-miniature types including new 8 prong miniatures. Provisions for checking individual sections of multi-purpose tubes. Neon indicator lamp for quick testing of short and leakage between elements. Jack provided for headphone tests of tube noises. For 100-130 volt, 50-60 cycle AC. 5 1/4 x 12 1/4 x 7.

32-24381 - Shpg. wt. 11 lbs. **25.95**



3-TUBE PHONO AMPLIFIER

Ideal for building your own phonograph or audio system. Uses three tubes; 50L6, 12SQ7 and 35Z5. Built on a steel chassis. Designed to fit into portable record-player case. Has tone and volume controls with 1 inch shafts. Requires output transformer, which may be mounted on chassis. Chassis has mounting holes on front. With 6 ft.

rubber line cord and plug and instructions. For 110 V AC or DC. Chassis less tubes. 99-9649 - Shpg. wt. 2 lbs. **2.25**

99-9646 - Kit of tubes for above (ordered with amplifier). 2.09 (Ordered Separately). 2.32

BARGAINS IN TV TUBES

Featuring Standard Brands
36-24954-Type 12QP4 TV Picture Tube
REGULARLY. \$28.50 - NOW. **22.45**
99-9568-Type 16AP4 TV Picture Tube
REGULARLY \$51.25 - NOW. **29.95**

EXPORT: Address all export orders and inquiries to Concord Radio EXPORT DIVISION, 901 W. Jackson Blvd., Chicago 7, Ill.

ALL CHANNEL

RELIANCE HI-LO ANTENNA

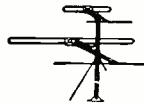

Two band array. Separate matched folded dipole and reflector for high and low bands. Receives all TV channels plus FM band. Range on low frequency array; 44-108MC. on high frequency array, 174-220MC. Average gain above tuned dipole 2.5 db on low band and 1.5 db on high band. Each unit can be rotated separately for maximum signal strength. Includes 5-ft. mast.

28-21983 - Shpg. wt. 8 lbs. **4.75**

Lots of six. Each... \$4.49

6-VOLT BLOWER

Universal 6-volt auto blower and defroster, can be used on AC for power supply blower, darkroom ventilator. Puts out powerful blast of air. Sturdy, rugged unit is made to sell for much more. Complete with mounting hardware and hose.

99-6801 - Shpg. wt. 4 lbs. **3.45**

PERMEABILITY TUNER

Replaces standard broadcast variable condenser, associated coils with a single unit, simultaneously slug tuned. Individually adjusted for tracking. With antenna coil, oscillator padder coil and schematics for 5 tube superhet.

99-3584 - Shpg. wt. 1 lb. **49c**

6-V CHARGER

Has 6 volts DC output at 3 1/2 amps from 115 volt 60 cycle input. Use it as a battery charger or to operate any 6 volt equipment. Use to test or operate mobile equipment or auto radios that draw 3 1/2 amps or less. Steel case, black crackle finish. Size 6 1/4 x 5 1/8 x 5 1/2. With necessary line cords, cables and plugs.

99-9400 - Shpg. wt. 12 lbs. **7.59**

ELECTRIC JIG-SAW

Dozens of uses for this combination Jig Saw-Sander-Filer with built-in 110 volts AC electric motor... all for Concord's low price. Powerful 3,000 RPM electric motor has self-aligning oilite bearings and heavy fly wheel. Saw cuts to center of 16 in. circle. Arm may be removed and saber blades used for larger pieces. Table: 6 x 8" tilts and rotates to cut at any angle. Sanding table tilts through 45°. For filing use 1/4" diameter std. filing machine files. Made of light-weight cast aluminum. Overall size 13 1/2 x 8 1/2 x 8 1/2". List \$14.95.

18-15738 - Shpg. wt. 6 lbs. **11.25**

25 POWER MICROSCOPE

A valuable pocket companion for hobbyists, mechanics, jewelers and technicians. Works under normal light. No focusing or adjusting. Four precision ground lenses give you an image 25 times larger than the original. Overall length is 5 inches. Has handy pocket clip. Take advantage of this bargain price... you'll find dozens of uses for this powerful microscope.

99-4220. **2.79**

CONCORD RADIO CORP. Dept. RH-50
901 W. Jackson Blvd., Chicago 7, Ill.

Enclosed \$..... (include shipping charge).
Any excess will be refunded.) Rush me the following equipment:

Send FREE latest Catalog & Bargain Bulletin.

Name
Address
City Zone State

CONCORD RADIO

Mail Order Center and Showroom
901 W. Jackson Blvd., Chicago 7, Ill.
Branch Showroom: 265 Peachtree St., Atlanta 3, Ga.

Here's Our Investment In Your Future...



THIS IS TO CERTIFY THAT
FRANKS RADIO & TELEVISION SERVICE
has met the requirements of

RAYTHEON
FOR
BONDED ELECTRONIC TECHNICIANS

A Surety Bond Has Been Issued by the AMERICAN MUTUAL LIABILITY INSURANCE COMPANY
Expiring the 31st day of December 1956. Covering This Firm Beginning the 1st day of January 1956.



Now it covers
Television, too!

**THE RAYTHEON BONDED
ELECTRONIC TECHNICIAN PROGRAM**

Raytheon considers the tremendous amount of money invested in the Raytheon Bonded Electronic Technician Program exceedingly well spent because it is an investment in your future. And your success is tightly tied up with ours.

RAYTHEON Bonded Electronic Technicians can offer their customers a cash protected guarantee on all radio and television repair work and parts for 90 days. Think what this guarantee, backed by almost \$100,000,000.00 resources of American Mutual Liability Insurance Company, can do to create customer confidence and good will and to stimulate sales. And yet this big business builder costs you not one cent.

Even before it covered Television, the Raytheon Bond lifted hundreds of Service Dealers head and shoulders above the crowd. Now that it covers Television, too, it's the most coveted key to better business in the industry.

You'll be building a firmer foundation for your business when you ask your Raytheon Tube Distributor to help you become a Raytheon Bonded Electronic Technician.

**RIGHT... For Sound and Sight
RAYTHEON RADIO and TELEVISION TUBES**

RAYTHEON

RAYTHEON MANUFACTURING COMPANY

Excellence in Electronics

Newton, Mass., Chicago, Ill., Atlanta, Ga., Los Angeles, Calif.

RADIO AND TELEVISION RECEIVING TUBES, CATHODE RAY TUBES, SPECIAL PURPOSE TUBES, MINIATURE TUBES, MICROWAVE TUBES

When answering Advertisements please mention

RADIO & TELEVISION NEWS

LEARN DAY and EVENING CLASSES
TELEVISION
ELECTRONICS-RADIO
Modern Laboratory
Instruction in

- SERVICING
- BROADCAST OPERATING
- ELECTRONIC and TV ENGINEERING

G.I. APPROVED

WRITE FOR ILLUSTRATED CATALOG
ELECTRONICS INSTITUTE, Inc.
21 HENRY, DETROIT 1, MICH.

Read Phase Angles Easily
PHASE METER
\$2.95

A special scale which converts an oscilloscope into a direct reading phasemeter. Any frequency. One simple adjustment. High impedance (scope input). Reads phase angle between any two voltages, across transformers, amplifiers, phasing networks, short lengths of transmission lines, etc.

May be used in any circuits where an oscilloscope will give undistorted patterns. No accessory apparatus required. Jobber inquiries invited.

3" size.....\$2.95 4" size.....\$3.95
PREPAID

Technical Products Co.
712 W. 6th St. AUSTIN, TEXAS

profit for his hackneyed scheme. When each shop owner has reached the point where he is ready to take the "cure," a Johnny-come-lately opens up down the line. He doesn't know from nothin' about costs, but reasons if other shops can make a profit with their depression rates he can too. So he further cuts prices when they're ready to call it quits and get back to realistic pricing of their services.

In passing, it might be observed that coincident with cut-pricing is the introduction of shady practices and sharp stunts designed to offset the cut-prices. For a time this may fool the public, but not for long. No lasting business can be built upon the shifting sands of trickery and deception.

We are not here concerned with the ethics of rate cutting, though there are many readers who consider such an unimaginative business-getting device as little short of an instrument of the devil, and not without reason.

Neither do we quarrel with legitimate rate cuts and readjustments which may conceivably come at some time in the future as and when the whole economy of our country levels off. If the purchasing power of the customer drops, this may necessitate rate adjustments. However, such rate adjustments will be made in a period when the service technician's own expenses are scaled downward at the same time. That time is not now.

It does seem that if a service shop owner has any sense of responsibility for the preserving of an orderly competitive society, and one in which fair rules of competition prevail, he might fare better to go on taking his profits as they come. And he should maintain standards comparable to his competitors.

If a service shop owner feels a compulsion to dispose of his profits, let him first take his profits, rather than giving them to his customers. Then let him flush the profits down the drain or, if he is unattached, he might conceivably blow the profits (after they're made) on some flashy blond. At least he stands a sporting chance of having some fun from this last suggested solution for disposing of his profits, and without interfering with the rights of his neighbor shop owners. It might be added that a breach of promise suit is no more expensive than going through a bankruptcy court.

-30-

PHASE METER

"That radio acts like a husband. It makes silly noises, starts smoking—then goes out!"

POWERFUL

PERFORMANCE AT LOW COST



LOW CHANNEL
\$17.35 list
HIGH CHANNEL
12.50 list
For double stack as shown — including phasing rods

JA-*V. S. W. R. = 1.34
*Z = 335 ohms

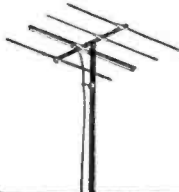

LOW CHANNEL
\$13.20 list
HIGH CHANNEL
6.95 list

JB-*V. S. W. R. = 1.26
*Z = 315 ohms



LOW CHANNEL
\$14.60 list
HIGH CHANNEL
7.95 list

JC-*V. S. W. R. = 1.28
*Z = 317 ohms

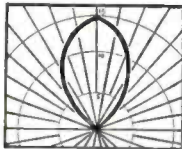
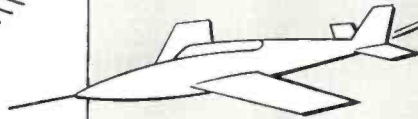

Gain in decibels

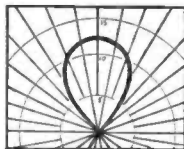

Gain in decibels

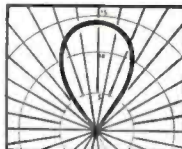

Gain in decibels

PRE-ASSEMBLED FOR FAST, EASY INSTALLATION

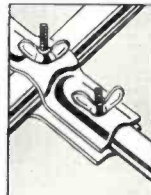
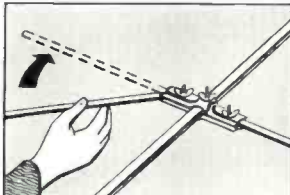
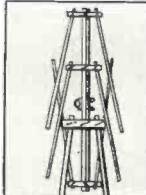

All the parts are in one package ready for assembly. The new clamp type construction makes it easy to swing each element in place and secure it firmly with the wing nut. No bag of hardware to fuss with — no bolts or screws to lose.

Because of the high gain of this antenna, many people have found that they can obtain excellent results with a single bay attic installation.

THESE ANTENNAS STAY UP: Only the highest quality duraluminum alloys are used.

Yield Strength	36,000 lbs. per sq. inch
Ultimate Strength	41,000 lbs. per sq. inch
Shearing Strength	24,000 lbs. per sq. inch
Endurance Limit	20,500 lbs. per sq. inch

*Z = center of impedance

*VSWR = standing wave ratio

Sensational VEE-D-X

J Series YAGI ARRAYS

- Transformer ratio of stepped-up driven element provides perfect match to 300 ohm line.
- Lowest standing wave ratio insures maximum transfer of signal.
- High front to back ratio prevents co-channel interference.
- Sharp horizontal pattern helps reject unwanted interference of all types.
- Extra high forward gain makes this the ideal antenna for single channel fringe reception.
- Not designed to replace the famous heavy-duty RLY and EC series.

LaPOINTE-PLASCOMOLD CORP. 3
UNIONVILLE, CONNECTICUT

Send me information on the entire line of VEE-D-X antennas and accessories.

Name

Company

Street

City

Zone State

LAPOINTE-PLASCOMOLD CORP.

UNIONVILLE, CONNECTICUT

MAKERS OF THE WORLD'S MOST POWERFUL ANTENNAS

READ CAREFULLY AND SAVE

PANEL METER KIT

- Here's what you get:
- 2" Sq. bakelite cased meter, Govt. Surplus
 - Scales for all the following ranges:
 - 0-50 ma., 0-100 ma., 0-200 ma., 0-500 ma.
 - Pre-calculated shunts for all the above ranges.
 - Complete instructions.
- Only \$2.50 each, 3 for \$6.75

PANEL METERS—NEW SURPLUS

3" 75-0-75 micro-amp	\$3.95	3" 0-2 ma	\$3.95
3" 0-5 ma Basic	1.89	3" 0-5 ma	3.95
3" 0-10 ma	1.89	3" 0-20 ma	3.50
3" 0-20 ma Basic	1.89	3" 0-30 ma	3.95
3" 0-25 ma Basic	1.89	3" 0-50 ma	3.95
3" 0-50 ma	1.89	3" 0-80 ma	2.95
3" 0-250 ma AC	2.95	3" 0-100 ma	3.95
3" 0-1 amp RF	1.89	3" 0-150 ma	3.95
3" 0-2 amp RF	1.89	3" 0-200 ma	3.95
3" 0-4 amp RF	1.89	3" 0-300 ma	3.95
3" 0-30 amps DC	1.89	3" 0-1.5 amp DC	3.95
3" 0-20 volts DC	1.89	3" 0-3 amp DC	3.95
3" 0-30 volts DC	1.89	3" 0-75 amps AC	2.95
3" 0-300 volts AC	2.95	3" 0-10 volts AC	3.95
3" 0-1 amp DC	3.95	3" 0-30 volts AC	4.95
3" 0-2 amp DC	3.95	4" 0-200 microamps	8.95
3" 0-1 ma Basic	3.95		

WESTINGHOUSE SELENIUM RECTIFIER

Hermetically sealed, oil immersed, full wave bridge. Input 30 volts AC, Output 24 volts @ 2 amps. Size 3 3/4" x 2 3/4" x 3 1/2". \$3.75 ea.

THORDARSON PLATE TRANSFORMER

Type CHT, #T15P22—Pri. 110/220 V. Sec. 3500-3000-2500-2000 Volts, CT, 625 watts. 65 lbs. net \$22.50 ea.

OIL CONDENSERS

56 mfd 220 vac	\$4.50	10 mfd 2000 vdc	\$5.95
2 mfd 600 vdc	.39	2 mfd 4000 vdc	4.95
4 mfd 600 vdc	.59	1 mfd 5000 vdc	5.50
6 mfd 600 vdc	.79	2 mfd 6 kvdc	8.95
8x8 mfd 600 vdc	1.39	.1/1.1 mfd 7000 vdc	2.25
10 mfd 600 vdc	.89	1 mfd 7000 vdc	5.95
4 mfd 1000 vdc	.95	.01/.01 mfd 12 kv	5.75
2 mfd 1500 vdc	1.25	.65 mfd 12.500 vdc	12.95
6 mfd 1500 vdc	2.95	2 mfd 18 kv dc	59.50
1 mfd 2000 vdc	1.45	1 mfd 15 kv dc	15.95
2 mfd 2000 vdc	2.25		
8 mfd 2000 vdc	3.95		

PLATE AND FILAMENT TRANSFORMER

Pri. 110 V 60 cy., Sec. 510-0-510 Volts @ 400 ma., 6.3 volts 10 amps, 5 volts @ 3 amps. Fully cased. Size: 5" x 3 1/4" x 6 1/4". \$3.95 ea.

GUARDIAN LATCHING RELAY—Type RC100, 110V 60 cy. coil S.P.D.T. Each impulse reverses position of contact. Resets automatically. Contacts rated 100 watts @ 100V 60 cy. Only \$1.95 ea.

FILAMENT TRANSFORMERS

110 V 60 Cy Pri. Fully Cased.	
2.5 Volt 10 Amp	\$3.49
2.5 Volt CT 21 Amp	4.75
5 Volt 4A, 6.3V, 3A	2.45
2.5V CT 20A, 2.5V CT 20A	6.95

CHOKE BARGAINS

6 Henry 80 ma 220 ohms, uncased	2 for \$0.99
8 Henry 150 ma 140 ohms, uncased	.99
1.5 Henry 250 ma 70 ohms, cased	.59
6 Hy 400 ma 97 ohm, cased	3.95
8 Hy 175 ma 120 ohms, cased	1.75
4.5 Hy 445 ma 39 ohms, cased	4.29
10 Hy 350 ma 125 ohms Tapped, cased	2.95
15 Hy 250 ma 290 ohms Tapped, cased	2.20
Swinging Choke 2-11 Hy, 100 ma to 1 amp 150 ohms DC, cased	12.95

POWER TRANSFORMER

550 volts CT, 125 ma, 5 V. @ 2 A, 6.3 V @ 4 A. Pri. 110 V 60 cy. Fully cased. \$1.95 ea.

POWER SUPPLY KIT

Uses transformer described above plus (1) 150 ma choke, (1) dual oil capacitor, (1) socket. All for only \$2.99

POWER TRANSFORMER

Pri. 110 V 60 cy. CT @ 880 V, CT @ 100 ma, 6.3 V @ 4 A, 5V @ 3 A. Fully cased. \$2.49 ea.

FILAMENT TRANSFORMER



6.3V, 12 amps Pri. 110 Volts 60 Cy. Size: 3 3/4" H. x 2 3/4" W. x 2 3/4" D. Wt. 3 1/2 lbs. Fully shielded as illustrated. Worth \$4.50.

Only \$1.69 ea.

LINK TEST SET (Type 1410)

Contains 2 Meters, 3 1/2" Square, consisting of a galvanometer (75-0-75 micro amps). For balancing discriminators, etc., and a MULTI Range 0-1 ma meter. Ranges are as follows: 1 ma, 2.5 ma, 50 ma, 25 volts, 500 volts, 75-0-75 microamps. Built in a hardwood case. 10" x 8" x 4 1/4" with hinged cover. Ideal for lab use. \$14.95

HIGH WATTAGE ANTENNA RELAY

110/220 V 60 cy solenoid DPDT. Heavy duty dual contacts. Rated 15 amps @ 5000 volts. Isolantite insulation. Base 8" x 10 1/2". Made by Monitor Control. \$18.50 ea. Same as above but DPST 4 1/2" x 10 1/2". \$12.95 ea.

MISCELLANEOUS SPECIALS

.004 1000 VDC Pigtail Micas	12 for \$.99
250 mmf Midget Variable, Steatite Ins. 2 for	.98
50,000 ohm 1% WW Prec. Resist.	2 for .95
6 Henry 50 ma Filter Chokes	4 for .95
.07 1000 VDC Xmitting Mica	3 for .99
.02 600 VDC Xmitting Mica	10 for .99
.001 600 VDC Xmitting Mica	10 for .99
3/3 mfd 600 VDC Oil Condenser	.49
6 mfd 1000 VDC Oil Condenser	.59
1 mfd 7500 VDC Oil Condenser	.88
100 ohm 100 Watt Adjustable Resistor	.39
500 ohm 50 Watt Adjustable Resistor	.29
.02 400 Volt Tubulars	20 for .99
.01 mfd 600 VDC Pigtail Micas	10 for .99
Miniature Headphones Type HS30	.59
Transformers for above	.39

PEAK ELECTRONICS CO.

188 Washington St. MR
Phone CO 7-6883 New York 7, N. Y.

Portable Marine Radio Provides Direction Finding



The new Lear Model P10A "Learavian" portable designed to provide marine, aviation, and b.c. band reception.

Operational details on a new radio receiver which is suitable for use on boats or in private planes.

DESIGNED exclusively for the owner of a private plane, the yachtsman, or the sportsman, the new "Learavian" portable radio receiver provides three-band reception; including standard broadcast, marine radio facilities, and accurate direction finding.

One of its many features is its ability to operate on 115 volt a.c., d.c., or self-contained batteries, thus assuring proper functioning whether on land, at sea, or in the air.

A unique battery charging circuit extends the battery life. An attachment cord is plugged into a 105-125 volt, 50-60 cycle a.c. line or into a 105-125 volt d.c. outlet. The normal charging time does not exceed 30 minutes.

The new unit employs six tubes in a highly sensitive superheterodyne circuit which was designed for reception on three bands: Marine band (2-5.5 mc.) for ship-to-shore communications, Coast Guard weather reports, universal radio service for aircraft, U.S. standard time signals, and the 2.5-5 mc. short-wave broadcasts; Standard broadcast band (550-1600 kc.) for entertainment, newscasts, and weather information; Airways band (200-400 kc.) for airport communications, weather reports via range stations, and airways 4-course beacon signals (A/N). A built-in loop antenna provides adequate reception on all of these bands. A panel mounted jack offers a convenient connection for an external antenna which is useful under adverse receiving conditions or where the set is being used as a direction finder.

A second panel mounted jack is provided for plugging in headphones. The color of each dial scale corresponds with the color of the positions on the rim-type bandswitch

knob located at the right-hand edge of the dial. Thus the Marine dial, covering the short-wave band, is blue and covers from 1960-5750 kc. The Broadcast dial is red and covers from 550-1650 kc. while the Range dial is green and covers the long-wave band from 195-415 kc. Changing from one band to another is accomplished simply by rotating the knob up or down so that the desired band is in line with the indicating arrow.

Marine or aircraft installations of this equipment will be governed largely by structural facilities. In all cases, however, the external antenna must be well constructed. The lead-in cannot be shielded.

In most cases, the set performs well in a boat or plane that does not have shielded ignition circuits. However, shielding of sparkplugs, magnetos, and generator, along with all ignition wires, is very desirable. Complete shielding will remove all traces of background ignition noises which tend to reduce the effective receiving range of the radio.

When used in direction finding, the user slides the receiving direction finding switch to the direction finding position and plugs in the external antenna. He then rotates the set until the station fades out, then unplugs the external antenna and slowly rotates the set first in one direction and then the other so that the exact aural-null point is determined. At this point, the speaker of the set is pointing to the station.

Service technicians who operate near yacht basins and airports might investigate the possibility of capturing the installation and repair business as represented by this new Lear Model P10A portable receiver.

Just Out

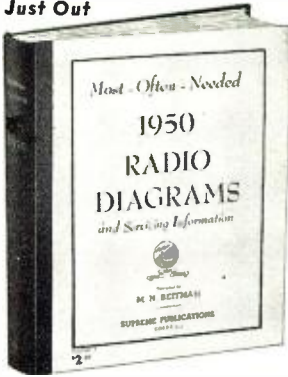

New 1950 Manual

Be prepared to repair quickly all new 1950 radio receivers. In this big single volume you have clearly-printed, large schematics, needed alignment data, replacement parts lists, voltage values and information on stage gain, location of trimmers, and dial stringing, for almost all recently released sets. Makes toughest jobs amazingly easy. Find all faults in a jiffy. Speed-up all repairs. The time saved on your next job will pay the \$2.50 bargain price for the complete manual — after that you use it FREE. A worthy companion to the 9 previous volumes used by over 126,000 shrewd radio men. Giant size. 8½" x 11", 192 pages + index. Manual - style binding. Price, only **\$2.50**

New SUPREME 1950 Radio Manual

GET IT AT YOUR RADIO PARTS JOBBER OR ORDER BY MAIL

Now you can benefit and save money with Supreme amazing scoop of 1950. This one giant volume has all the service data you need on all recent radio sets. A full year of models on all popular makes, home and auto sets, portable radios, combinations, changers, all included. The full price for this mammoth 1950 manual is only \$2.50, nothing else to pay, nothing else to buy for a whole year. Again Supreme Publications

Models Made by:

R.C.A., Zenith, Philco, Sears, Fada, Emerson, Belmont, Sentinel, Crosley, G.E., Westinghouse, Arvin, Garod, Stewart - Warner, Admiral, Delco, Stromberg-Carlson, Wards, Motorola, Bendix, Sonora, Western Auto, and many others.

beats all competition and gives you the greatest bargain in radio service information. Other Supreme radio service volumes for previous years (mostly at \$2) and TV manuals are described below. Available at your radio jobber or by mail on no-risk 10-day trial.

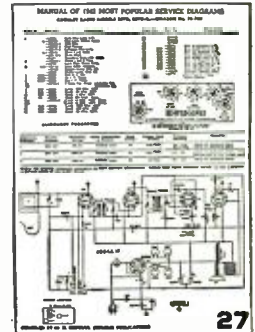

A typical page from any Supreme Publications Radio or TV Manual is extra large in size (8½x11 inches), and is well printed on heavy, 60-pound paper. It contains a complete schematic diagram, easy-to-follow instructions for alignment, voltage comparison charts, parts lists, and other facts needed for fast trouble-shooting and simplified repairs. Supreme Publications give more useful on-the-job information for the lowest cost.

SUPREME TELEVISION MANUALS

MOST AMAZING MONEY-SAVING BARGAIN

The television series manuals are the most remarkable values offered by Supreme Publications in their 17 years of business. These TV manuals at only \$3 and \$2 each are amazing bargains and defy competition. There is nothing else like them. Each manual is a virtual treatise on practical television repairs. By normal standards, each such large manual packed as it is with practical facts, hundreds of illustrations, diagrams, charts, photographs, and expensive extra-large blueprints, should sell for \$10—but as SUPREME special values they are priced at \$3 and \$2 each. Only a publisher who sold over one million TV and radio manuals can offer such bargains based on tremendous volume-sales.

New 1950 T-V Manual, Just Out

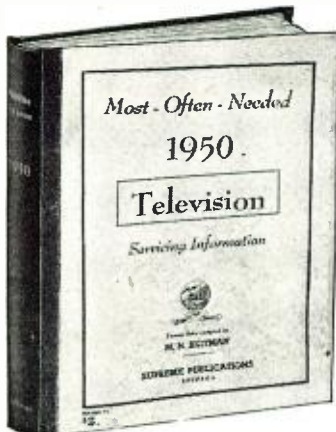

In this new giant volume of 1950 television factory data, you have everything you need to repair and adjust all present day TV sets. There are easy-to-follow circuit explanations, 144 pages of alignment procedure, many test patterns, response curves, waveforms, voltage charts, adjustment hints, and ten mammoth 11x15-inch blueprints.

1950 T-V Manual. Newest volume of the series, covers all popular makes from Admiral to Zenith. Available at your jobber or postpaid, only \$3

1949 T-V Manual. Similar to volume listed above. Has 160 large pages, plus 9 giant blueprints, only . . . \$3

1948 T-V Manual. Earlier volume has material on all popular sets of this period. Remarkable value at only \$3

1947 F.M. and T-V Manual. Covers popular F.M. and TV sets. Data on 192 pages 8½x11". Only . . . \$2

New 1950 TELEVISION manual contains complete service data on all popular present-day television sets of all makes. Gives description of modern circuits, test patterns, response curves, oscilloscope waveforms, alignment tables, service hints, diagrams in the form of double-sized blueprints, test points, voltage charts, etc. Large size: 8½x11 in., manual style binding, flexible covers. \$3 at your jobber or by mail, only \$3

SUPREME RADIO MANUALS for PREVIOUS YEARS



1949 1948 1947 1946 1942 1941 1940 1939 1926-1938
SUPREME Most-Often-Needed RADIO DIAGRAMS
 Each Manual only \$2. (1949 is \$2.50); 192 pages of diagrams, alignment data, voltage values, parts lists, and service hints; large size, 8½"x11". To order, see coupon below. **RADIO Diagrams, 240 Pages Pr., \$2.50**

CUT SERVICE TIME and SIMPLIFY ALL REPAIRS

You can speed-up and simplify all radio repairs with Supreme Publications Manuals. Service all radios faster, better, easier, save time and money, use these most-often-needed diagram manuals to get ahead, earn more per hour. For the remarkable bargain price (only \$2 for most volumes) you are assured of having in your shop and on the job, needed diagrams and other essential repair data on 4 out of 5 sets you will ever service. Every popular radio of all makes from old-timers to new 1950 sets is covered.

Clearly printed circuits, parts lists, alignment data, and helpful service hints are the facts you need to improve your servicing ability. Save hours each day, every day, begin to earn more by making repairs in minutes instead of hours.

BIGGEST VALUES IN SERVICE DATA

Here is your lowest-priced service information. There is no need to spend large sums for bulky, space-wasting manuals, or to buy additional material every few weeks; be wise, use SUPREME radio engineer, Manuals to get the most in diagrams and service data for the smallest cost. Rush coupon today and try these manuals for 10 days at our risk.



Compiled by M. N. Beitman, radio engineer, teacher, author, and serviceman.

NO-RISK TRIAL ORDER COUPON

SUPREME PUBLICATIONS, 3727 W. 13 St., Chicago 23, ILL.

Send for 10-day trial Television manuals checked below and Radio Diagram manual at right. You guarantee complete satisfaction.

- 1950 Television Manual, \$3.— 1949 TV, \$3.
- 1948 TV, \$3.— 1947 TV & F.M. only \$2.
- I am enclosing \$ Send postpaid
- Send C.O.D. I am enclosing \$. . . deposit

Name:
 Address:

- Most-Often-Needed Radio Diagram Manuals**
- New 1950 Manual, \$2.50
 - 1949 Radio Manual, \$2.50
 - 1948
 - 1947
 - 1946
 - 1942
 - 1941
 - 1940
 - 1939
 - 1926-1938 Manual, \$2.50
- PRICED AT ONLY \$2 EACH**

Supreme Publications

Sold by all Leading Radio Jobbers

August, 1950

101

Buy—

TROUBLEPROOF TELEVISION

THE 630 TV WILL WORK WHERE OTHERS FAIL!

Own the Television Set preferred by more Radio and Television Engineers than any other TV set ever made! The Advanced Classic 630 TV Chassis.

With the latest 1950 improvements the 630 TV will out-perform all other makes in every way. The 30 plus tube circuit should not be compared to the cheaply designed 24 tube sets now being sold.

• **Greater Brilliance**

Assured by the new 14-16 KV power supply.

• **Flicker-Free Reception**

Assured by the new Keyed AGC circuit—no fading or tearing of the picture due to airplanes, noise, or other interference.

• **Greater Sensitivity**

Assured by the new Standard Tuner, which has a pentode RF amplifier and acts like a built-in High Gain Television Booster on all channels! The advanced 630 chassis will operate where most other sets fail, giving good performance in fringe areas, and in noisy or weak locations.

• **Larger—Clearer Pictures—for 16" or 19" tubes**

Assured by advanced circuits. Sufficient drive is available to easily accommodate a 19" tube.

• **Trouble-Free Performance**

Assured by use of the finest materials such as molded condensers, overrated resistors, RCA designed coils and transformers, etc.

• **RMA Guarantee**

Free replacement of defective parts or tubes within 90 day period. Picture tube guaranteed fully for an entire year at no extra charge!

PRICE COMPLETE, LESS PICTURE TUBE..... **\$149.50**

EXTRA CLEAR PICTURE TUBES Standard Brands

ONE YEAR GUARANTEE	PRICE
Glass 16" Black Face (round).....	\$39.50
Glass 16" Regular (round).....	39.50
Glass 16" Rectangular (black).....	39.50

YOUR MONEY RETURNED IN FULL

If the New Regency Television Booster fails to improve your television enjoyment! Bring your picture out of the snow and reduce interference.

- Push-Pull Neutralized triode design assures high gain without adding snow.
- No external impedance matching devices required.
- Inductive tuning assures same high-gain wide-band operation on all channels.
- Single knob tuning control.
- Underwriters approved with 90 day RMA guarantee.

LOWEST Price—ONLY **\$17.61!**

HIGH GAIN X TELEVISION ANTENNAS

Covers channels 2 to 13 without separate section. Constant non-varying center impedance. Better than 12 Db front to back ratio. Can be used with 72, 150 or 300 ohm line. Works well in weak areas and gives a sharp conical beam. Price each less mast..... **\$4.95**

Extra for 10 ft. mast \$1.50

FRINGE AREA ANTENNAS

Stacked X Antennas for extra gain in fringe areas including heavy 10 ft. mast. Price..... **\$12.95**

WRITE FOR COMPLETE CATALOG N-8

EDLIE ELECTRONICS INC.

154 Greenwich St. New York 6, New York



Station of the Month

MARS BEAMS WEEKLY BROADCASTS

MARS—Army Headquarters station, WAR, located at the Pentagon Building, Washington, D. C., broadcasts a weekly message each Tuesday at 0100Z and at 0400Z. (This is Monday at 8 p.m. and 11 p.m., Eastern Standard Time; Monday at 7 p.m. and 10 p.m., Central Standard Time; Monday at 6 p.m. and 9 p.m., Mountain Standard Time; and Monday at 5 p.m. and 8 p.m., Pacific Standard Time.)

Simultaneous broadcasts are made on frequencies 3497.5 kc., 6997.5 kc., 14,405 kc., and 20,994 kc. Each message is sent three times, once at 10 words per minute, once at 15 words per minute, and once at a higher rate of speed—usually 20 words per minute.

Designed especially to transmit quasi-official traffic and training information to MARS members, the broadcast offers an excellent opportunity to all amateurs in building up their code proficiency.

THE Fort Knox Amateur Radio Club station A4WBG/K4WBG, formally opened on Armed Forces Day, May 20, 1950, has been named MARS Station of the Month by Captain E. L. Nielsen, Chief of MARS-Army. A theme of public service and military training was observed at the opening by setting up exhibit stations at strategic locations on the post to handle personal messages for post personnel and Armed Forces Day visitors. One of the stations was a mobile unit which cruised the post, setting up wherever a crowd assembled. The official Fort Knox Armed Forces Day program contained a radiogram message blank; on the reverse side was an explanation of the Armed Forces Day amateur radio contest, an invitation to send a personal message via amateur radio, and a personal invitation to visit the K4WBG shack. More than 4000 visitors received these programs.

ARRL numbered messages and special Armed Forces Day numbered

messages were used where applicable. Mimeographed lists of numbered messages were available at each station.

Sergeant Eugene Field, W4QDK, operated portable at Service Club Number Two. A wall display of QSL cards was arranged around the operating position. Assisting Field was Mr. Martin Pierce; the station opened at the start of the QSO contest period (1200 EST). Three hours later they had so many messages on the hook they had to close the doors and buckle down to work to handle them.

Captain L. E. Snapp, W4NFH, operated the mobile unit, assisted by Lieutenant William L. Scott, W4PVR, and Sergeant Joseph T. Olwick, W4RHT. This station was an eye-catcher and rapidly acquired a load of several hundred messages; it was forced to leave the populated section of the post in order to clear messages on hand without becoming swamped with additional traffic. This unit cleared 120 messages during the contest period.

Fort Knox Service Club Number Two where Sgt. Eugene Field, operating W4QDK/4, had his hands full trying to keep up with the Armed Forces Day traffic in GI messages.

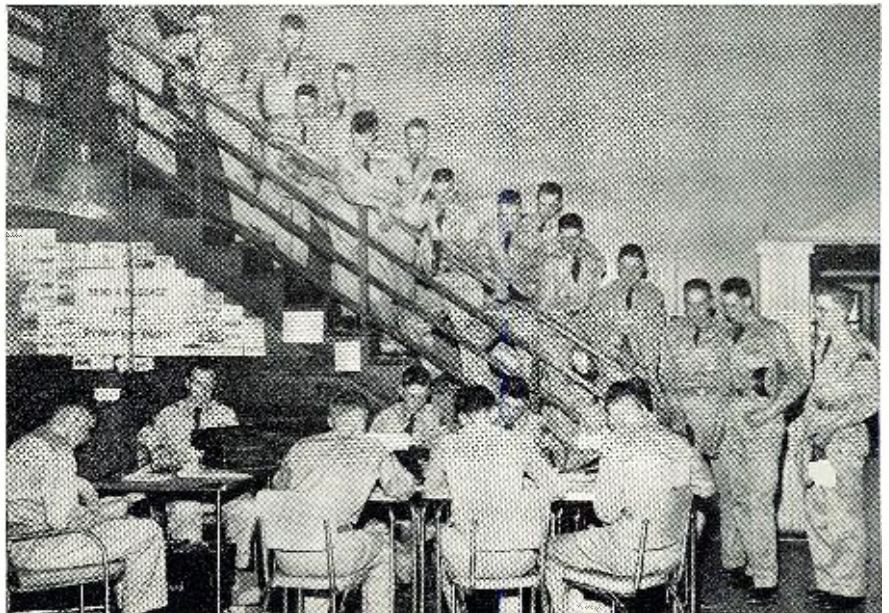

Become an Electrical Engineer



Major in Electronics



B.S. Degree in 36 Months



Prepare Here for Specific Career-Objectives

Your success in the expanding, fascinating field of Electronics will be influenced materially by the type of educational program you choose.

Important advantages are gained at this Technical Institute and College of Electrical Engineering. For example, you achieve the Technician's occupational certificate upon completion of your first level of study toward a B.S. degree. The *comprehensive* nature of the courses gives you other special advantages in securing positions such as are listed below:

Major in Electronics
B. S. Degree
(36 successive months of study which include the 12-month Electronic Technician program)

Typical job objectives:

- Design Engineer
- Electronics Research Engineer
- Radio Engineer
- Sound Engineer
- Application Engineer
- Field Engineer
- Patent Attorney (with additional training in law)
- Salesman of Electronic Equipment
- Manufacturing Supervisor
- Communications Engineer
- Industrial Electronics Engineer
- Television Engineer

Electronic Technician
(12 months of objective study which also completes a third of the program leading to the B.S. degree)

Typical job objectives:

- Laboratory Technician
- Electrical Tester (radio mfg.)
- Maintenance and Repair Technician
- Contractor
- Manufacturing Supervisor
- Salesman of Electronic Equipment

Radio-Television Technician
(18 months of study)

Typical job objectives:

- Radio-Television Serviceman
- Audio, Transmitter or Communication Technician.
- Broadcast Operator (upon passing FCC examinations)

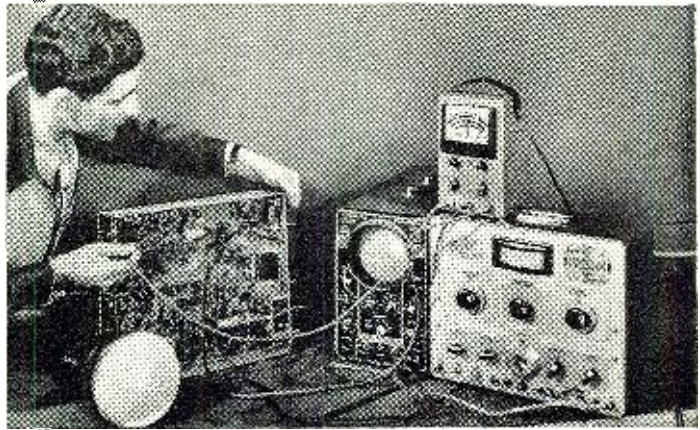

A VALUABLE FEATURE of this educational program is the manner in which LABORATORY experience is woven into *each* successive term to assure a thorough, practical background. You receive electrical practice and technical studies *immediately*. You train with modern equipment such as you will use after graduation.



"HUMAN ENGINEERING" is essential to the full success of tomorrow's technical man. Therefore, courses also include combinations of English, Economics, Engineering Law, Industrial Psychology, Speech and other Humanities.

THIS world-famous course in Electronics presents thorough technical training plus a solid education in the basic sciences, electrical engineering and allied fields. You have an opportunity to save a valuable year by using the option to study the year-round. Thus, you earn your B.S. degree in 36 months.

MILWAUKEE SCHOOL of ENGINEERING

Technical Institute • College of Electrical Engineering

- The 1,555 students enrolled in this 47-year-old school represent 48 states and 23 countries. Over 35,000 alumni. Terms open Oct., Jan., April, July.
- Military, practical or prior academic training will be evaluated for advanced credit. Preparatory and refresher courses are also available.

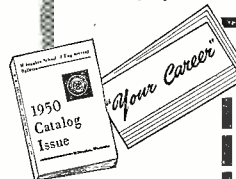

Write or send coupon today for the helpful 44-page pictorial bulletin, "Your Career," and the 110-page catalog.

MILWAUKEE SCHOOL OF ENGINEERING
Dept. RN-850
1020 N. Broadway, Milwaukee, Wis.

Without obligation send the 44-page "Your Career" bulletin and 110-page catalog.

(Check 6 to 36-month courses which interest you)

- Electrical Engineering: Electronics
 Electrical Power
 Radio-Television Heating Refrigeration
 Air Conditioning Electricity Welding

NameAge.....

Address

CityZone.....State.....

Check if World War II Veteran

SAVE \$ \$ \$ \$ \$

3 RED HOT SPECIALS

ANY ITEM 33¢

MIX 'EM UP—SAVE \$ \$ \$

Buy 10-99 Assorted—Deduct 10%

Buy 100 Assorted—Deduct 20%

MIDGET I. F. TRANSFORMERS

Discounts up to 86%



Midget 456 Kc, 1 1/2" sq. 3" tall, HI-Q ceramic coils. Matched pairs.
Input - - - - - 72 B5G
Output - - - - - 72 B6G



VOLUME CONTROLS

Discounts to 85%

CENTRALAB, STACKPOLE, complete with attached switch. Ohms-10M-15M-25M-50M-100M-250M-500M-2000M



CONDENSERS

Discounts to 78%

AEROVOX tubulars, type PRS. 2 FAST MOVERS.
20 MFD-250 VOLT 40 MFD-150 VOLT

INTERCOM & RADIO

AT A PRICE THAT CAN'T BE BEAT



6 tube superhet—3 tube intercom permits communication between radio-master and up to 4 sub-stations.

WHILE THEY LAST

\$29.95

With 1 sub-station and 50 feet of cable

Extra Sub-Stations \$3.95 each

Original cost \$64.50

PUSHBACK WIRE



25% below Mill Cost

1st class, Essex or Lenz. ALL SOLID tinned copper, double cotton serve, waxed finish.

SIZE	COLORS	100 feet	1000 feet	10,000 ft. production reel
22	Black-Brown	.39	\$3.79	\$3.65M
20	White-Blue	.49	4.49	3.95M

ORDER INSTRUCTIONS



Demand This Seal of Quality

Minimum order—\$2.00. 25% deposit with order required for all C.O.D. shipments. Be sure to include sufficient postage—excess will be refunded. Orders received without postage will be shipped express collect. All prices F.O.B. Detroit.

Quantity and Export Orders Solicited

RADIO SUPPLY & ENGINEERING CO., Inc.
89 SELDEN AVE. DETROIT 1, MICH.

Mr. Raymond Cain, W4QBC, operated portable at Service Club Number One, assisted by Private First Class Charles L. Christianson. This station also accepted several hundred messages and had to close as more traffic would have meant a considerable delay in getting the messages out. W4QBC/4 transmitted 22 messages during the contest period.

A portable rig at the Central Mess was operated by Lieutenant Paul W. Jackson, W4NOK, and Captain H. M. Russell, W4PBX. This station received about 50 messages and cleared 17 during the contest period.

K4WBG was the hub of the traffic activity. Chief Operator Jesse D. Newman, W4LEI, assisted by Sergeant Charles F. Jones, W4PUE, cleared 265 messages and received 154, using emergency power throughout the contest period.

Lieutenant Colonel C. F. Fiore, Post MARS Director, was in charge of the activities, assisted by Lieutenant Glenn W. Simpson, W4ORC, club operations officer. Lieutenant Simpson also operated at W4PBX.

-30-

Within the Industry

(Continued from page 26)

ance and Radio Dealers Association for the past four years . . . **RODNEY D. CHIPP**, director of engineering for the *Du Mont* television network, was named chairman of the New York Section of the Institute of Radio Engineers for the 1950-51 season . . . **KURT MULLERHEIM** has joined the patent division of *Stromberg-Carlson Company*. He is a communications engineering graduate from the Institute of Technology in Berlin . . . **AL ISBERG**, *KRON-TV*'s chief engineer, has been elected chairman of the San Francisco Section of the IRE for the 1950-51 term . . . *Federal Telephone and Radio Corporation's* board of di-

rectors recently named **WILLIAM HATTON** and **FRANK B. POWERS** as vice-presidents of the corporation . . . Cornell College of Mount Vernon, Iowa recently conferred an honorary degree of doctor of science on **GLENN H. BROWNING**, president of *Browning Laboratories, Inc.* . . . **ARTHUR W. STEWART** is the new chief engineer for *Clippard Instrument Laboratory, Inc.* of Cincinnati . . . **R. D. BURNET** has been named by the board of directors to head *Starrett Television Corp.* of New York . . . **ARTHUR A. BRANDT** has been appointed to the newly-created post of general sales manager of *General Electric Company's* Receiver Division . . . **LEWIS M. CLEMENT**, technical adviser to the vice-president and general manager of the *Crosley Division* was named "Pioneer Man of the Year in Airborne Electronics" by the Airborne Electronics Conference held recently in Dayton . . . The Association of Electronic Parts & Equipment Manufacturers elected **JOHN H. CASHMAN**, president of *Radio Craftsmen, Inc.*, as a director of the Radio Parts & Electronic Equipment Shows of which the EP & EM is one of the sponsoring trade associations . . . **DR. LEWIS TONKS** has been appointed head of the Physics Division in the Knolls Atomic Power Laboratory . . . **JACK NEWMARK** has been named public relations and sales promotion executive for *Emerson Radio of Florida, Inc.* . . . **F. W. FISCHER** is the newly-appointed manager of field electronic sales for the Electronics and X-Ray Division of *Westinghouse* . . . **PERCY L. SPENCER**, vice-president in charge of the Power Tube Division of *Raytheon Manufacturing Company*, was recently granted an honorary degree of doctor of science by the University of Massachusetts . . . From *Stromberg-Carlson Company* comes word of the appointment of **KENNETH L. HENDERSON** as chief mechanical engineer.

-30-

When the photographer found Former RMA President R. C. Cosgrove, FCC Commissioner George E. Sterling, Dr. W. R. G. Baker, director of the RMA Engineering Department, and Past President Paul V. Galvin sharing a luncheon table at the recently-held Radio Manufacturers Association convention, he snapped this photo to record the event.

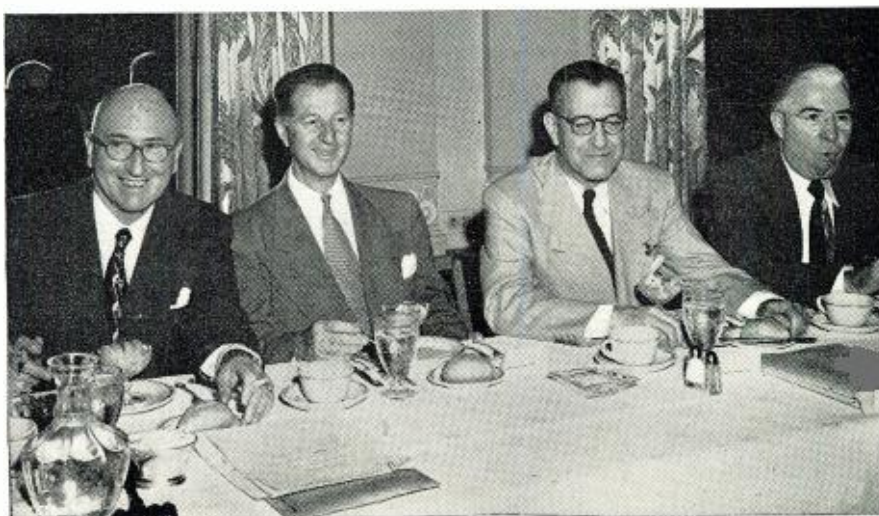

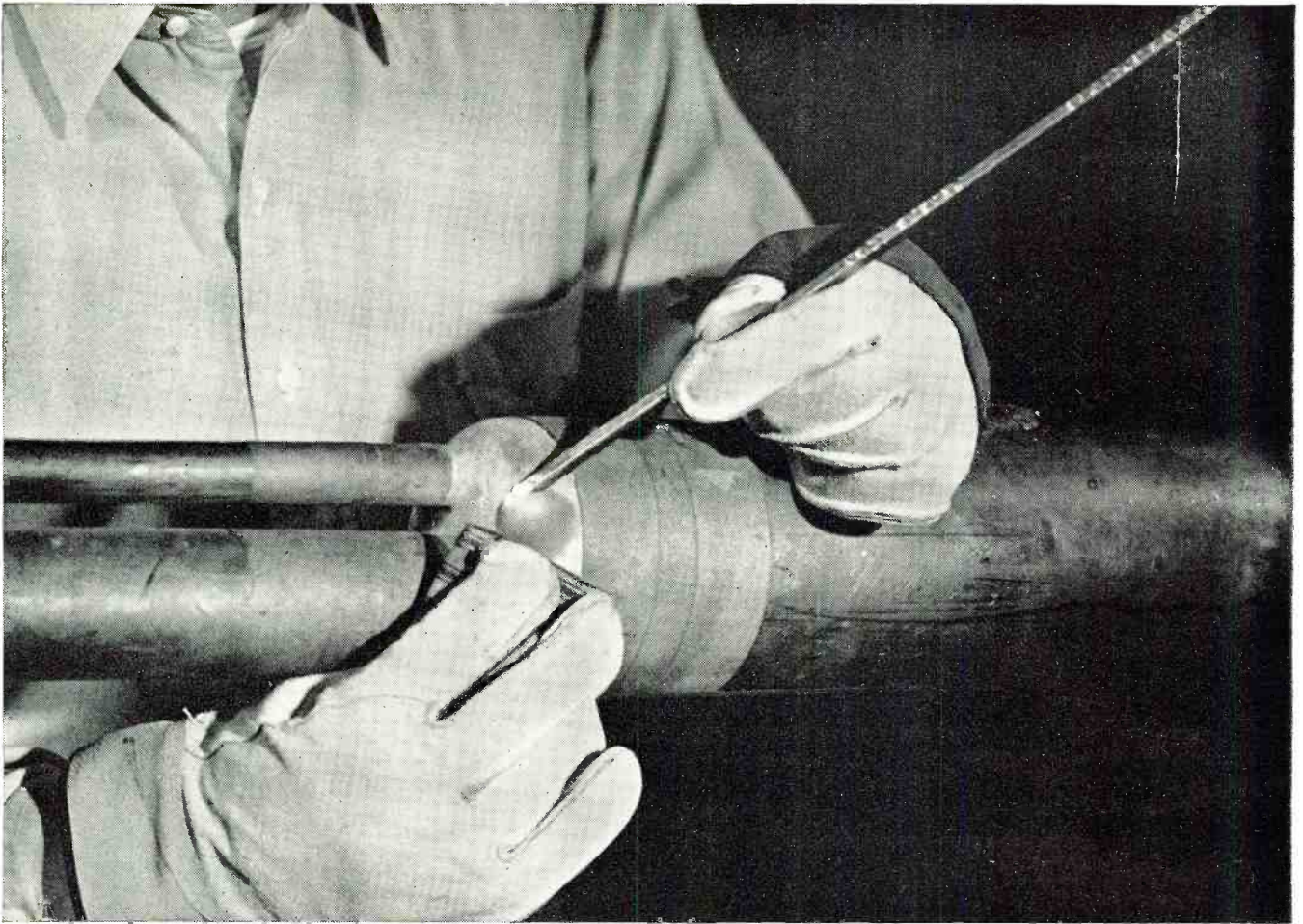

*He seals out
trouble...*

**TO KEEP THE COST
OF YOUR TELEPHONE
SERVICE DOWN**

To make cable joints tight and strong, splicers formerly used lots of solder. Then, Bell Telephone Laboratories developed a new technique for making *better* joints with much less solder. This saves one million pounds of solder a year — helps keep the price of your telephone service low.

Two kinds of solder are now used. One makes the splice strong; the other seals it. First, the splicer builds up a joint with a solder of lead and tin, which flows easily under his wiping cloth. To seal the joint, he applies a light coating of low-melting-point solder, composed of lead, tin and bismuth. On contact with the still hot joint, it flows into and seals every pore.

Cable-sealing solder is only one of 30 low-melting-point alloys which Bell metallurgists have developed for special uses — in fuse wires, for example, and in the solder connecting hair-like wires to piezoelectric crystals for electric wave filters.

Continuing research with a substance seemingly as commonplace as solder demonstrates again how Bell scientists help keep your telephone service the world's best.

BELL TELEPHONE LABORATORIES



• WORKING CONTINUALLY TO KEEP YOUR TELEPHONE
SERVICE BIG IN VALUE AND LOW IN COST

FREE WITH PHOTOFACT!



"Bonus" TV Supplements Preliminary Service Data on Hundreds of Television Models for Your IMMEDIATE USE... AT NO EXTRA COST!

TV set owners are calling for service within days—even hours—after installation. That's why you, the TV Technician, must have your service data *right now!* And *right now*, PHOTOFACT brings you the "rush" preliminary TV service data you need for *immediate use* to keep you going at full speed. FREE with the purchase of PHOTOFACT Folder Sets No. 91 and No. 93, you receive with each a separate 64-page Supplement containing preliminary data (in advance of regular PHOTOFACT coverage) on over 100 popular TV models. Place your standing order for PHOTOFACT today—it's the only way to get *without delay* the TV service data you must have *right now!*

Buy PHOTOFACT Folder Set No. 91 and get **FREE TV SUPPLEMENT NO. 91A:** Covers 114 important Television Receiver models, produced by 11 leading TV manufacturers.

Buy PHOTOFACT Folder Set No. 93 and get **FREE TV SUPPLEMENT NO. 93A:** Covers more than 100 leading Television Receiver models, produced by 17 TV manufacturers.

BUY BOTH! GET THE DATA YOU WANT NOW ON HUNDREDS OF TV MODELS

PHOTOFACT Set Nos. 91 and 93 are going fast—order today to avoid disappointment

HOWARD W. SAMS & CO., INC.

Order from your Parts Jobber today or write direct to HOWARD W. SAMS & CO., INC., 2201 East 46th Street, Indianapolis 5, Ind.

My (check) (money order) for \$..... enclosed. Send me the following:

- Photofact Set No. 91 and Supp. 91A. \$1.50
- Photofact Set No. 93 and Supp. 93A. \$1.50

Name.....

Address.....

City.....Zone.....State.....

International Short-Wave

(Continued from page 64)

9.550; 1715-1730, 9.550, 11.840; with a "night" concert 1800-1845, 9.550.

Prague, 11.84, noted in Calif. signing on 2327 in foreign language (probably Czech); off 0028; fair signal. (Balbi)

Cyprus—ZJM7, 6.79, noted in Australia 1545 with Arabic program of news, then music. (Sanderson)

Dominican Republic—Sign-off of Radio Caribe, 4.980, Santiago de Los Caballeros varies between 1930 and 2040. (Stark, Texas)

Ecuador—HCJB, Quito, is accepting contributions towards a new 100 kw. transmitter. (Neeley, Oregon)

Finland—Current schedule of Helsinki is 2200-2400, 0700-0800, 9.550, 15.190, 17.800; 0800-0810, 1145-1245, 1600-1700, 15.190, 17.800; 2330-0110, 0350-0710, 1000-1600, 6.120. (Radio Sweden)

Formosa—See Taiwan.

France—Paris, 9.560, noted opening in French 0030. (Ferguson, N. C.) The 17.850 channel heard 1200-1230 in French. (Stark, Texas)

French Cameroons—Pearce, England, recently heard Radio Douala, 9.150, on a Sunday signing on 1230; faded badly and was inaudible after 1500; bad CWQRM on channel.

French Indochina—Although Saigon "claims" 11.830, it has been measured by Triebel, Washington State, as 11.8408; noted in English 0930-1005, announced Radio France Asie. Left air 1025 with "La Marseillaise."

French West Africa—The English newscast at 1400 from Radio Dakar

had been suspended at the time this was compiled, but was to be resumed shortly; watch for it at that hour on 11.897 and (possibly) on 15.340. (Radio Sweden)

Germany—Deutschlander Berliner Rundfunk, 6.115 and 7.150, noted with news in German 1600. (Pearce, England)

Hawaii—WWVH verified promptly from Maui Propagation Field Station, National Bureau of Standards, Box 901, Puuene, Maui, T.H.; letter gave power outputs of 400 watts on 5, 15, and 10 mc., and a quarter-wave vertical used on 5 mc.; all transmitters are identical and use high-level plate modulation; also enclosed a 3-page technical report called "Standard Frequency Broadcasts from Hawaii"; was particularly interested in any interference experienced by users of WWV caused by simultaneous reception of WWV and WWVH. (Neeley, Oregon)

Hungary—Budapest, 6.247, and approximately 9.835, now has news 1600. (Bellington, N. Y.)

India—Current schedule, received via airmail from Delhi, lists these English periods—2130 (news), 17.78, 15.26, 15.16, 11.83, 9.68, 9.565, 7.275, 7.225; 2315, 17.78, 15.16; 0230, 17.78, 15.19; 0300 (news), 17.76, 15.29, 11.83; 0530 (Sat., Sun., only), 17.84, 15.16; 0730 (news), 17.76, 15.29, 11.83, 9.68; 0830, 17.84, 15.13; 1030 (news), 15.29, 11.83, 9.68, 9.59, 7.255, 6.010; 1045, 17.80, 15.17; 1400, 15.29, 11.85, 11.76, 9.62; 1930, 15.16, 11.85. In addition to the periods designated as "news," there usually is news in each of the other English periods.

Indonesia—Cushen, N. Z. informs Radio Sweden of these New Indonesian outlets—YDG, 3.332, Surakarta;

RADIO-CONTROLLED DRONES

PRODUCTION is under way at The Glenn L. Martin Company's Baltimore plant on the new KDM-1, a pilotless target drone designed for the U. S. Navy.

The KDM-1's are the result of successful flights made by the Martin designed and built Gorgon IV pilotless aircraft, whose function was to test the possibilities of the ram-jet engine.

In use, the tiny aircraft, which have a wing span of only 10 feet, are taken aloft by a mother airplane, suspended on a special pylon near a wing tip. When proper launching speed and altitude are reached, the ram-jet engine on the KDM-1 is started and the bird released from the pylon. From then on it is controlled from afar entirely by radio while being watched on a radar screen. Controls may be preset before launching, but these may be overridden by radio at the discretion of the distant control officer.

The ram-jet engines used on the KDM-1 are an improved version of the ones tested on the original Gorgon IV. There are no moving parts in the new engines, the fuel pump in the earlier version having been replaced by a pressure fuel system. The engine itself is frequently referred to as the "stovepipe" as it presents an almost unobstructed view through its length. It is suspended beneath the KDM-1.

As the engine tends to build up speed, the bird is provided with drag brakes to maintain desired sub-sonic speeds during firing tests. An instrumented head has been replaced by a control system and provision made for more fuel to give longer flight time. The KDM-1 burns ordinary gasoline. —50—

U.S. Navy's new Martin KDM-1 pilotless target drones are rolling off production lines at The Glenn L. Martin Company in Baltimore. Powered by a ram-jet engine, the KDM-1 target drones are controlled by radio and tracked on a screen by radar.



RADIO & TELEVISION NEWS

GET YOUR NEW Hallicrafters COMMUNICATION RECEIVER HERE and



Save Money With a *"Surprise"*
Trade-In Allowance on Your
Used Test and Communication
Equipment

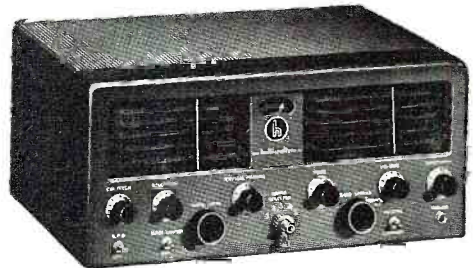

HALLICRAFTERS SX-71
Shpg. wt. 33 lbs.....Only **\$179.50**

But buy it for less by applying our liberal trade-in allowance against the purchase price.

ALL PRICES F.O.B. ST. LOUIS

FREE! New 164-Page
Catalog. The treasure chest of
values! Send for your
copy today.

For super dooper savings on Hallicrafters Receivers get a Walter Ashe "SURPRISE" Trade-In offer on your used (factory-built) Test Instruments or Communication Equipment. Walter will give you an extra-liberal allowance that will put the Hallicrafters model of your choice within easy reach! So don't delay! Get your trade-in deal working today. Wire, write, phone or use the handy coupon below.



HALLICRAFTERS S-53B
Shpg. wt. 19 lbs. Price Only **\$69.95**

Slash the above price by trading in your used test or communication equipment.



Hallicrafters S-38B
Shpg. wt. 14 lbs. Price Only **\$39.95**

Buy it at a substantial saving with a Walter Ashe "Surprise" Trade-In deal. What do you have to trade?

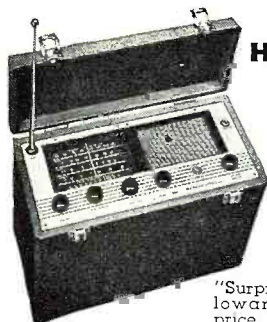

Hallicrafters S-72
Shpg. wt. 16 lbs. Price Only **\$89.50**
(less battery)

For amazing savings apply our "Surprise" Trade-In Allowance against this price.

PHONE: Chestnut 1125

**ATTENTION:
Prospective Novices!**
The Hallicrafters Receivers available at Walter Ashe, represent the best values obtainable at the lowest possible cost consistent with high quality. From the models available you can choose just the one that meets your requirements as the ideal receiver to get you started in the proposed Novice Class of Licensee in Amateur Radio. Write for free Hallicrafters Catalog.



**SEND
FOR YOUR
COPY
TODAY!**

**Walter Ashe
RADIO CO.**
THE HOUSE OF "SURPRISE" TRADE-INS
1125 PINE ST. • ST. LOUIS 1, MO.

Walter Ashe Radio Co.
1125 Pine St., St. Louis 1, Mo. RN-50-8

O. K. Walter, Rush "Surprise" Trade-in offer on my _____
(describe used equipment)

for _____
(show make and model No. of new equipment desired)

Rush Free Copy of your new 164 page Catalog.

NAME _____
ADDRESS _____
CITY _____ Zone _____ STATE _____



SERVICEMEN:

Protect the consumer goodwill and future business you have built in your community. For all servicing requiring picture tube replacement, specify Thomas for a technically perfect, longer-lasting, guaranteed cathode-ray tube.

Ask for the name you know—insist on Thomas television picture tubes. There are no better!

Mail coupon at right for our latest rectangular TV picture tube technical data sheets, at no cost to you.

NAME.....
 STREET.....
 CITY..... STATE.....

THOMAS ELECTRONICS, INC.

118 Ninth Street

Passaic, New Jersey



When Answering Advertisements Please Mention
 RADIO & TELEVISION NEWS

NOW! BUILD 15 RADIOS \$14.75
COMPLETE KIT ONLY...

PROGRESSIVE RADIO "EDU-KIT" teaches amplifier, receiver and transmitter design and construction principles. Excellent background for television. No knowledge of radio necessary. Used by radio schools and the Veterans Administration. Quizzes provided, and corrected at no extra charge. Free Electrical and Radio Tester and tools. Order today or send for free "Kit-Katalog." Postage prepaid on cash orders. C.O.D. orders accepted in U.S.A. Dealerships available.

PROGRESSIVE ELECTRONICS CO.
 497 Union Ave. Dept. RN-8 Brooklyn 11, N. Y.

RADIO Engineering

Complete Radio Engineering course incl. Telev., U.H.F., and F.M. B.S. Degree Courses also in Civil, Elect., Mech., Chem., and Aero Eng.; Bus. Adm., Acct. Visit campus, see well equipped labs. Low cost. Prep courses. Personalized instruction. Grads successful. Founded in 1884. Enter Jan., March, June, Sept. Write for catalog.

DEGREE IN 27 MONTHS

TRI-STATE COLLEGE
 1680 COLLEGE AVENUE ANGOLA, INDIANA

4.160, Madium, Java; 3,510, Kediri, Java; 3,700, Jogjakarta, Java, and 8,910, Kotaradja, Sumatra; YDG's power is 1 kw., others are 300 watts.

Djakarta's YDE, measured 11,772, noted recently 0835 with Hawaiian (recorded) music and announcements in Dutch. (Treibel, Washington)

YDQ3, 11.085, Makassar, Celebes, heard with weak signal 1755; clock chimes 1800, then signs off. (Oskay, N. J.)

Menado, Celebes, more recently was noted on approximately 9.840 at 0600 to after 0730; identified as *Radio National Indonesia*, Studio Menado, followed by chimes. (Stark, Texas)

Iran—At the time this was written, *Radio Teheran* was using EPB, 15.100, at 1330-1530; news 1500 (5 minutes); excellent level in West Virginia; according to Pearce, England, has news in Turkish 1400, and in French 1430; usually has dance music 1505-1530 sign-off.

Italy—When this was compiled, *Radio Italiana*, Rome, was being heard on various channels at different times and days, evidently experimenting. Apparently, it now has at least three transmitters in use. Although for the most part only 11.81 and 9.63 outlets were announced, several other frequencies were being heard. Noted by Saylor, Virginia, on approximately 17.782 with news 1430; heard there by Stark, Texas, at 1300. Heard by Ferguson, N. C., on 15.311V, 1925-2055. Pearce, England, noted it one day on 11.895 at 1430 with news in parallel with 15.120 as well as on announced 9.63 and 11.81.

Japan—Tokyo, 6.015, noted 0215 announcing Far Eastern Network, Tokyo. (Winch, Calif.)

Kenya Colony—Nairobi, 4.855, noted from 1300 when has BBC news; 1315 has local news; 1320 weather report followed by South African news supplied by the Public Relations Officer at Nairobi; off 1400 (runs to 1500 on Wednesday and Saturday). (Pearce, England)

Korea—Treibel, Washington State, and Oskay, N. J., say HLKA is still on (measured) 7.9348 which is contrary to persistent reports had moved to 7.960.

Malaya—*Radio Malaya*, Singapore, sent nice two-colored QSL card which listed frequencies of 133 kc., 4,825, 570 kc., 6,135, 7,200, 1013 kc., 1203 kc., 6,025, 1110 kc., 1280 kc., 1023 kc., and 1073 kc. (Baker, Calif.)

Neeley, Oregon, says *Radio Malaya*, Singapore, has a harmonic of exceptional quality on 14.500 (harmonic of 7.250); news noted 0900; in clear with fine level.

Malta—FBS, Middle East, when opening on 7.27 at 2300 announced frequencies of 4.965, 7.27, and 9.925. (Bellington, N. Y.) The 4.965 outlet noted in England signing off now at 1600 instead of former 1700. (Pearce)

Mauritius—Another verification from Mauritius received by Pearce, England, still lists frequency of 15.075 and schedule to only 1200; however,

Pearce finds the station nearer 15.050 and running to 1230 closedown. Is heard on about 15.060 by Leary, Ind., at 2200-2315; BBC news relay 2200.

Mozambique—CR7BJ, Lourenco Marques, noted 0000-0100, moved from 9.67 to 9.57; fine level in Calif. (Balbi)
New Caledonia—Hutchins, Radio Australia, has measured new channel of Radio Noumea as 6.038; is heard around 0200-0600 now; measured 6.0367 by Oskay, N. J.

Nicaragua—YNDG, 7.660, noted with Spanish programs and frequent announcements in English; stated that has increased power to 1 kw.; schedule is 1800-2230 but sometimes leaves the air as early as 2200. (Leinbach, N. Y.)

Nigeria—Radio Nigeria, Lagos, in verifying for Pearce, England, stated it had been using only 6.035 with 300 watts recently, but hoped to resume transmissions on 9.655 (300 watts) and to also open up on 7.255 using a RCA 4331, 1 kw., transmitter. Said schedule eventually will be 0100-0230, 0600-1700, 7.255, 1 kw.; 0100-0230, 0600-1300, 9.655, 300 watts, and 1300-1700, 4.990, 300 watts; then the 6.035 (present outlet) will no longer be used. Services using 300 watts in the 42-m. band will be opened later in the year at Enugu, Ibaden, and Kaduna. Asked for further reports.

Northern Rhodesia—An airmail report from Hannaford, South Africa, says he has received word from Lusaka's Information Department, Box 209, that power on 7.220 is 2.5 kw., transmitter is Marconi type SWB8; power on 3.914 is 400 watts using a U.S. Army transmitter; is scheduled 0900-1230 daily; regretted does not have QSL cards.

Norway—Oslo has replaced LKQ, 11.735, with LLK, 11.85, noted 2000-2100 to North America. (Balbi, Calif.) Also now using 9.645 and 15.17 in parallel 11.85; latter is best in New York. (Bellington) Weber, Ontario, says Oslo has a special English broadcast on Sunday at 2100-2115 after the regular North American beam.

Pakistan—GDX-aren, Sweden, reports Radio Pakistan, 11.810, Karachi, with announcement of "Huna Karachi" at 1400; the 11.885 channel noted with news 1230.

Peru—OAX1B, 5.706, Piura, heard with weak but clear signal 2230; OAX4Z, 5.895, Lima, is good level around 2215. (Slutter, Pa.)

Philippines—Cushen, N. Z., reports DYB2, 4.980, Bacalod City, now signs off 1000 and that full schedule now is 1500-1000 daily.

DZH5, 9.69, Manila, noted 0530 with music. (Sanderson, Australia)

Portugal—Lisbon, 11.04, noted 1600-1800. (Bellington, N. Y.)

Sao Tome—Radio Clube de Sao Tome e Principe has been heard at good strength in Europe recently on a new channel of approximately 4.800 to closedown 1600. (Radio Sweden) Heard by Pearce, England, from before 1500 to 1600 closedown when signs with "A Portugesa"; man and woman

The NEW Automatic Radio

RECORD SMASHING VALUES!

CUSTOM-BUILT AUTO RADIO

1949 and 1950 FORD AUTO RADIOS



List Price..... \$4995

1949 and 1950 PLYMOUTH-DODGE RADIOS



List Price..... \$4995

1949 and 1950 CHEVROLET RADIOS

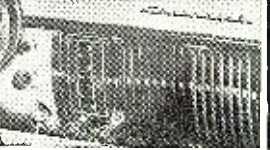

List Price..... \$4995

ATTRACTIVE DISCOUNTS TO DEALERS

Each auto radio is specifically designed to fit all 1949 and 1950 cars shown above and all incorporate the same outstanding features. . . Six-tube superheterodyne. Six-volt storage battery operation. Two dual purpose tubes. Eight-tube performance. Installation in a few minutes. Three-gang tuning condenser and tuned R.F. stage for extreme sensitivity. Permanent magnet dynamic speaker with Powerful Alnico #5 magnet. Low battery drain. Weight 10 lbs.

SPECIALS

- R5/ARN-7 Radio Compass Receiver w/Tubes Used Excel. Cond. . . . \$18.95
- BC-433G Radio Compass Receiver w/Tubes Used Excel. Cond. . . . \$18.95
- Gibson Girl Distress Transmitter complete with bag and parachute. New . . . \$8.95
- Gibson Girl Kit includes 2 balloons w/Hydro. Generators. Kite, Lamp, Wire. New. . . \$8.95

CHECK THESE VALUES

Send in Film Hartron Reorderer Reproducer #A-30 with crystal mike, headset, acces-inst. book. Plays back immediately. No processing of Film Required. Brand New . . . \$170.00

BC-709 Interphone Amplifier Ideal for Aircraft Booster Telephone. New . . . \$4.00

BC-312 Receiver. Used. Good Condition . . . \$75.00

BC-224 Receiver. New. Less Mgr. . . \$100.00

BC-412 5" Radar Oscilloscope. . . \$49.95

BC-1072 Radar Transmitter. . . \$19.95

ROUND PANEL METERS

0-5 RF Amps Westing.	3 1/2	\$4.50
0-300 MA DC Simpson.	2 1/2	3.75
0-300 MA DC Westing.	2 1/2	3.75
5-5 MA DC Weston with 50 MA Shunt.	3 1/2	4.25
0-50 Amps DC Weston.	3 1/2	4.75
0-100 Amps DC Hoyt.	3	3.00
0-3 Volts DC Sun.	2 1/2	1.95
0-15 Volts AC GE.	3 1/2	4.95
0-2500 Volts DC Simpson with Voltmeter.	3 1/2	4.95
0-5 KV DC 0-10 MA DC.	3 1/2	5.50
0-150 Volts DC Hoyt.	3 1/2	3.50
10-0 + 6 DB Weston.	2 1/2	4.50

CAPACITORS UPRIGHT MOUNT

MATCH BOX TYPE	EA.	TEN
2X.25 mfd	400 VDC	\$0.25 \$0.20
1 mfd	400 VDC	.25 .20
500 VDC	.25 .20	
2X.05 mfd	600 VDC	.25 .20
1 mfd	600 VDC	.25 .20
2X.1 mfd	600 VDC	.25 .20
1 mfd	600 VDC	.25 .20
5 mfd	600 VDC	.30 .25
1 mfd	600 VDC	.35 .30

BATHUB

EA.	TEN
40 mfd	\$0.30 \$0.25
4 mfd	.35 .30
50 VDC	.40 .35
4 mfd	100 VDC .40 .35
2X.1 mfd	200 VDC .15 .10
3X.1 mfd	400 VDC .25 .20
2 mfd	400 VDC .45 .40
.05 mfd	600 VDC .20 .15
.25 mfd	600 VDC .25 .20
1 mfd	600 VDC .25 .20
1 mfd	600 VDC .35 .30
2 mfd	600 VDC .45 .40
.05 mfd	1000 VDC .60 .55
2X.1 mfd	1000 VDC .55 .50

OIL-FILLED AND GE PYRANOL

EA.	TEN
.5 mfd	\$0.35 \$0.30
1 mfd	.50 .45
1 mfd	500 VDC .30 .25
1 mfd	500 VDC .35 .30
2 mfd	600 VDC .35 .30
4 mfd	600 VDC .55 .50
5 mfd	600 VDC .60 .55
8 mfd	600 VDC 1.00 .90
1-8 mfd	600 VDC 1.10 1.00
10 mfd	600 VDC 1.10 1.00
4 mfd	700 VDC .65 .60
4 mfd	1000 VDC .45 .40
2 mfd	1000 VDC .45 .40
.5 mfd	2000 VDC 1.10 .90
.25 mfd	3000 VDC 1.95 1.60
1 mfd	3000 VDC 2.00 1.70
1 mfd	7500 VDC 2.60 2.30
1 mfd	7500 VDC 5.25 4.45
.0008 mfd	15,000 VDC 6.50 5.50
.045 mfd	16,000 VDC 4.15 3.25

PAPER TAPERED

Tube Filter	EA.	TEN
3X8 mfd	600 VDC	1.45 1.25
8-8 4 mfd	650 VDC	1.45 1.25
160-160 mfd	150 VDC	1.25 1.00

ELECTROLYTICS

3 VDC	\$0.15	\$0.10
2500 mfd	12 VDC	.50 .45
25 mfd	25 VDC	.20 .15
50 mfd	25 VDC	.25 .20
1000 mfd	25 VDC	.50 .45
150 mfd	50 VDC	.25 .20
2000 mfd	50 VDC	1.00 .90
500 mfd	200 VDC	1.00 .90

TUBES

Price Slashed	
2C34	\$0.20
2X2A	.50
2X2/879	.35
3C24	.30
7C4	.30
7C4/1203A	.30
10Y	.35
13B	1.15
15R	.40
39/44	.25
45 5FEC	.25
HK-54	1.65
713A	.65
7A	.25
801A	.25
803	2.95
804	6.50
826	.35
84B	.30
85B	23.25
872A	1.25
1005	.20
1626	.20
1629	.20
2051	.35
7193	.20
801	2.00
9002	.25
9003	.35
9004	.20

CODE EQUIPMENT

Tape Puller Bohme #11F. . . \$32.95

Tape Bridge Bohme 4-K. . . 3.95

Practice Tape 1 Hour Mounted75

4-2-16M Metal 16MM 400 Ft. Capacity50

Automatic Transmitter XT-150

4-2-16M McElroy-3 to 33 words per minute. . . .29.95

Ink Recorder SR-900 and Amplifier and Leveller SL-950 makes perfect block signals above 200 words per minute. 39.95

LINEAR POTENTIOMETERS WW

OHMS	WATTS	MFR	EACH	TEN
200	2	Chicago Tel.	.25	.20
1000	2	Trefz	.25	.20
3000	2	Chicago Tel.	.25	.20
10000	2	Chicago Tel.	.30	.25
5000	3	Trefz	.25	.20
7500	3	Trefz	.30	.25
10000	3	Trefz	.30	.25
25000	3	Wirtz	.30	.25
50000	4	Trefz	.50	.45
15	25	DeJur	.45	.40
20	25	Ohmite	.45	.40
25	25	DeJur	.50	.45
50	25	DeJur	.50	.45
100	25	IRC	.55	.45
200	25	DeJur	.55	.45
500	25	DeJur	.55	.45
1000	25	DeJur	.55	.45
2000	25	DeJur	.65	.55
5000	25	DeJur	.65	.60
15000	25	DeJur	.70	.65
20000	25	DeJur	.85	.70
150 / Switch	50	IRC	1.10	.90
200 / Switch	50	IRC	1.10	.90
300	50	Ohmite	1.10	.95
10000	50	DeJur	1.50	1.25
15	60	Ohmite	1.50	1.25
15	75	IRC	1.50	1.25
750	150	Ohmite	2.45	2.10

TERMS: Minimum order \$5.00—Mail orders promptly filled—All prices F.O.B. Boston, Mass. Send M.O. or check. Shipping charges sent C.O.D. 25% deposit required with all C.O.D. orders.

SEND FOR OUR CATALOGUE NOW!

Inquiries from Dealers, Schools and Industrial Firms Invited

COMET ELECTRONIC SALES CO.

22 Washington St. Brighton 35, Mass.
BEacon 2-7863

SAVE \$ ON SUN SURPLUS AND STANDARD SPECIALS!

CRYSTALS Low Freq.

FT-241A holder 1/2" pin spacing, for ham and general use, Xtal controlled Signal Generators, marked in army Mc harmonic frequencies—Directions for deriving fundamental frequencies enclosed. Listed below by fundamental frequency, fractions omitted.

412	426	442	475	493	504	516	372	381	390	401
413	427	443	477	494	506	518	374	383	391	402
414	429	444	479	495	507	519	375	384	392	403
415	431	445	481	496	508	522	376	386	393	404
416	433	446	483	497	509		377	387	394	405
418	434	447	484	498	511		379	388	395	408
419	435	448	485	503	515		380		396	409
420	436	452	487				381		397	411
422	437	458	488						400	
423	438	472	490						each	
424	440	473	491						each	
425	441	474	492						each	

450	531.944	Frequency	SPECIAL 200 kc
452.777	533.333	Standard	Xtals without holders
461.111	536.111	98.356 kc	21-32" x 23-32"
464.815	537.500	3-pr. holder	69c each
465.277	538.888		3 for.....\$2.00
526.388			
529.166			
530.555			

HAM CRYSTALS

FT-243 holders 1/2" pin spacing, for ham and experimental use. Fractions omitted.

4190	6140	7773	3735	5850	6425	6806	7573
5030	6173	7806	5305	5873	6440	7306	7640
5485	6205	7840	5677	5875	6450	7340	7673
6006	6233	7873	5700	5900	6473	7373	7706
6040	6240	7906	5706	5905	6475	7406	7806
6073	6273	7973	5740	5925	6506	7440	8173
6075	6290	8240	5750	5940	6540	7473	8340
6100	6293	8273	5750	5973	6573	7506	
6106	6740	8306	5773	5975	6606	7540	
			5775	6273	6840		
			5806	6340	6673		
			5825	6373	6706		
			5840	6406	6740		

5910	6610	7580	2045	2260	2415	3215	3570
6370	7350	7810	2105	2282	2435	3237	3580
6450	7480	7930	2125	2300	2442	3250	3945
6470			2145	2305	2532	3322	3955
6407.9			2155	2320	2545	3510	3995
6522.9			2220	2360	2557	3520	each
6547.9			2258	2390	3202	3550	1.29

Payments must accompany order. Enclose 20c for postage and handling. Minimum order \$2.00 plus postage. Crystals shipped packed in cloth bags inasmuch as they are shock mounted. All shipments guaranteed.

Reduced for Clearance BENDIX 100 WATT TRANSMITTER

One switch used to change 10-20-40-80 meter bands.

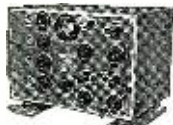

FOUR SEPARATE ELECTRONIC COUPLED OSCILLATORS: these can be easily converted to 20-40-80 meters. Crystal required for 10 meters. Each electronic coupled oscillator dial has 3000 divisions enabling quick precision shifting. This transmitter was constructed of the highest quality of precision parts, with laboratory precision. Four separate output tanks; one 4-position selector channel switch having seven sections which changes the ECO, IPA and output tanks simultaneously. All the controls are mounted on the front panel. The housing is cast aluminum; shields and case are sheet aluminum. Dimensions: 11 x 12 x 15 inches, weighing 35 1/2 lbs. Complete, simple instructions for conversion furnished. Uses three 807, four 12SK7 tubes, one 2-inch 5-amp. R.F. meter.

A complete coverage transmitter, for the new or experienced amateur.

A TRUE HAM VALUE complete with tubes was \$49.95 NOW ONLY \$29.95 LIKE NEW | \$19.95 USED

Famous "Garrard" Record Changers

Single speed, reduced for clearance. MODEL RC 60, automatically mixes 10" and 12" records. High quality crystal pickup. REGULAR PRICE, \$69.50. REDUCED TO \$32.95, brand new. MODEL RC 70, similar to above but slightly smaller and does not intermix. REGULAR PRICE, \$49.50. REDUCED TO \$24.95, brand new.

TERMS: All items F.O.B. Washington; D. C. All orders \$30.00 or less, cash with order. Above \$30.00, 25 per cent with order, balance C.O.D. Foreign orders cash with orders, plus exchange rate.

SUN RADIO
OF WASHINGTON, D. C.
938 F STREET, N. W. WASH. 4. D. C.

announcers. Pearce also recently heard the 17.677 channel 0730-0800 sign-off (was on a Sunday but may have similar schedule weekdays).

Saudi-Arabia—Daily programs are broadcast from Mecca (transmitter at Dheddah) at 0030-0115, 1230-1330 or later on 3.950, 5.957, 9.650, 11.750, 11.950, according to verification received from the station. (Radio Sweden). Pearce, England, says appears to be closer 5.976 than "claimed" 5.980; usually signs off just after 1330 but on one occasion went as late as 1340; no longer hears the 11.95 outlet due to QRM from Moscow.

Southern Rhodesia—Salisbury, 4.885, heard well in England to sign-off 1500; on Saturdays appears to run to 1530. (Pearce)

Spain—Radio SEU, EDV10, sent fine QSL card for reception of January 1949; stated that as yet does not have an English broadcast but will have one soon. (Pearce, England) Alicante, 7.940, noted leaving air 1800; poor but readable signal in New York. (Leinbach)

Surinam—PZC, 15.405, Paramaribo, now signs off daily 2100—a half-hour later than formerly. (Balbi, Calif.)

Syria—Patrick, England, says Damascus may be heard now on 7.260 with news 1630, parallel 6.000. Pearce, England, sends later report listing channel as 7.140.

Tahiti—Radio Tahiti, Papeete, tested some weeks ago in the 33-m. band on approximately 9.050, but soon returned to 12.080. (Bellington, N. Y.) At 2315-2400 has improved signal on 12.080 so may be using 3.2 kw. now (announced the 33-m. test was over a 3.2 kw. outlet). While the 6.982 outlet is seldom audible, it is believed to still be operating in parallel with 12.080.

Taiwan—BED4, 15.235, Taipei, is now heard one hour earlier—2200-2400, first hour in English; bad QRM from Moscow and Tokyo. (Balbi, Calif.) Frequency measured 15.2354. (Treibel, Washington)

Thailand—Bangkok has informed Fox, N. Z., that call of the 15.910 outlet is HS8PD instead of HSJ4 as widely reported earlier; power is 1 kw.; other frequencies used in parallel at 0500-0630 (including English news 0515, 0615) are 6.240 and 11.960. However, an Indian correspondent reports that Bangkok took up 11.905 more recently, having moved from 12.010 (where it was reported earlier by Sanderson, Australia), and that the former 19-m. outlet is now on approximately 14.980. (Radio Australia)

Turkey—TAP, 9.465, Ankara, still has news 1345. (Hannaford, South Africa)

USSR—Moscow, 15.17, noted in English 0000-0015. Soviet, 5.01, seems to have Russian 0730-0800, fair signal in Calif. (Balbi) USSR on 15.39 noted in English 0730-0800. (Leary, Ind.) Moscow noted on 15.360 and 15.440 at 0000 in English. (Sutton, Ohio)

Radio Moscow has inaugurated a "morning" period to North America

0800-0815 or later over (announced) 17.84, 15.16, 11.96, 11.82. (Ferrell, W. Va.) The 25-m. outlets appear the best.

Vatican—HVJ, 11.685, noted recently with news in Spanish 1630-1645; strong signal but bad QRM from London on 11.68. (Bellington, N. Y.)

* * *

Last Minute Tips

Widely reported is a new missionary outlet, 4VEH, 9.886 (measured by Oskay, N. J.), reported as early as 1800 and closing around 2050; however, some nights runs to after 2100; heard in West Virginia on a Sunday closing a transmission at 0805; has mostly religious programs and announcements in French, Spanish, and English; asks for reports to Radio Station 4VEH, P. O. Box 1, Cap-Haitien, Haiti.

At the time this was compiled, I had received widespread reports—particularly from the Eastern U.S.—that Radio Ankara had been heard at various times (including 1500 and around 1800 to after 2300) on (announced) 9.515 with call-sign TAT, in experimental broadcasts; from the strong signal reported, it is assumed this was the projected 100 kw. transmitter on test. Asked for reports to Radio Ankara, Station TAT, Ankara, Turkey. Had woman announcer and played mostly modern dance music.

A new s.w. station list has just been compiled by Arne Skoog, DX Editor, Radio Sweden, Stockholm 7, Sweden; may be had for two International Reply Coupons.

Frequencies announced by Radio Espana Independiente, estacion Piri-naica, clandestine outlet, are 7.373, 8.091, 10.240, 10.440; programs of 20-minute duration are radiated at 1130, 1230, 1330, 1430, 1500, 1530, 1600, 1630, and 1700. (Radio Sweden)

Budapest, Hungary, was noted recently on approximately 11.913 with news 1600. Good signal in Texas. (Stark)

Santiago, 11.998, Chile, noted signing off Sundays 0030. (Stark, Texas)

Pearce, England, has been hearing a new station on 7.625 from around 1230; uses both Western and semi-native recordings, including Greek folk music; signs off 1600 with the Greek National Anthem so is presumed to be a Greek outlet; bad CWQRM.

* * *

Press Time Flashes

At press time I received this interesting data on radio activities in Brazil, direct via airmail from Serrano, ISW monitor in Rio de Janeiro—Tropical band frequencies seem to be 2.335-2.495; 3.240-3.400; 4.750-4.995, and 5.005-5.060. Radio Timbira, listed "construction permit," had just been heard with poor signal; listed 4.985; has m.w. station on 1490 kc., 5 kw., call PRJ9; call of tropical band outlet unknown, power is 2.5 kw.; QRA is Radio Timbira, Edificio da Imprensa Oficial, Sao Luiz, Maranhao, Brazil. ZYB8, Sao Paulo, has returned to

**RT7/APN1
TRANS-
CEIVER
UNIT—**



used as an altimeter, it may be converted for signaling control circuits, citizens band, etc. Complete with 14 tubes and dynamotor they are in good used condition at the amazingly low **\$495** price of.....

Portable VHF Communication Unit

Two-way radio telephone equipment designed for operation between 152 and 162 megacycles. Adaptable for many uses, a complete unit including the rechargeable storage battery weighs but fifteen pounds, and is housed in a sturdy case 11 1/2" x 9" x 4 1/4", provided with shoulder straps. This brand new set of big name manufacture comes complete with battery, battery tray, **\$89.50** and handset but less crystal.....

Battery charger is extra at.....**\$19.95**

Mobile VHF Communication Unit

Adaptable for many mobile uses, this is a compact unit 3 1/2" x 8" x 1 1/2", operating on 152 to 162 megacycles. It is six volt powered direct from storage battery, and is complete with the tone filter and crystal; handset, control box, antenna and installation kit. Brand new, ready to go.....**\$129.50**

Extra 18" stub type antennae are available...**\$2.95**

LM Navy Frequency Meter. A limited supply is available less calibration book, tubes and crystal. Good condition.....**\$12.95** ea.

BC-605 Interphone Amplifier

Easily converted to an ideal intercommunication set for office—home—or factory.

Original—New...**\$4.95**
Like New.....**3.95**
(With Schematic)

See April 1950 Radio News for complete conversion data.

All necessary parts and instructions to convert the above to AC operation with one remote station **\$8.25** additional.



**BC-604 Transmitter FM
20-28 MC**

11 and 15 meters. Can be operated on 10 meters—10 channel push button crystal. With all tubes and meter but less dynamotor. Excellent Condition **\$12.95**

Crystals—**14.95**
Set of 80.....

BC 603

Receiver—Good. Used.....**\$19.95**

BC 620

Receiver-Transmitter—2 crystal channels—20 to 27.8 MC FM—13 tubes. Metered, Plate and Filament.....**\$14.95**
Used **9.95**

PE 97 Power Supply for above 6-12 volt vibrator type. Used—complete.....**\$6.95**
Used less tubes, vib. & cond.....**2.95**

FT 250 Mount for both BC 620 and PE 97 New **\$1.50**

BC 223

Brand new Transmitter with all three tuning units, two tuning unit cases, spare tube carrying case, shock mount and brace; but less tubes **\$19.95** at new low price of.....

Set of 5 tubes.....**\$3.95**
Tuning units are available separately at...**Ea. \$2.50**

PE 125—12-volt Vibrator Pack.....**New \$12.95**
Used **8.95**

Spare parts kit for PE 125 containing 2 tubes; 2 vibrators and 13 fuses in metal container with handle and clasp (BX 41).....**New \$2.95**

**ARROW
has the VALUES!**

Miscellaneous SPECIALS

	Used	New
ID 6/APN 4 Scope, Excellent.....	\$29.50	
R 7/APS 2 Receiver-Indicator.....		\$79.50
R 78/APS-15 Receiver-Indicator.....	34.50	
BC 1287 A Scope.....	75.00	
ASB 7 Indicator Scope.....	12.95	
SCR 522 Transceiver 100 to 150 MC.....	34.95	75.00
BC 1206 Receiver, 200 to 400 KC.....	3.95	5.95
MN 26 C	17.50	24.95
RA 10 DA Receiver.....	17.50	24.95
RT7/APN1 Transceiver.....	4.95	9.95
APN 1 Complete.....		24.50
BD 71 6 Pos. Switchboard.....	9.95	12.95
EE 8 Field Phones.....	7.95	
BC 347 Interphone Amplifier.....		2.95
I-70 Tuning Meter.....		.89
AM 61 Indicator Amplifier.....	9.50	
SCR 625 Mine Detector.....	39.50	
BC 461 Veeder Root Counter.....	.59	
BC 442 Less Condenser.....	1.49	1.95
APS 13 UHF Antenna, Pair.....		.98
FL 8 Filter.....		2.95
I-97 Bias Meter.....	\$4.95	3.95
RM 29 Remote Telephone Control.....	7.95	9.95
BC 602 Control Box.....		.98
BC 906 Frequency Meter.....		12.95

One Tube Interphone Amplifier—Small compact aluminum case fully enclosed. 2 1/4" x 3 3/4" x 5 3/4". Less Tube.....**.79c**
BC 717 Transmitter, New but less Tubes.....**\$24.50**
96Q1 Complete Autotune assembly with motor and frame as used in **ARC-1** Transmitter. New **\$35.00**
BC 709 Battery operated lightweight interphone amplifier. Complete with tube and shock mount, but less battery.....**New \$3.95**
SCR 183 Complete.....**New \$49.50**
Motor—Universal Electric, 24 VDC, will also operate on 24 VAC Diameter 1 7/8"; Length 2 3/4"; Shaft 1/4" x 3/4".....**New \$1.49**
BC 1291—Control box contains motor rheostat control rated 10 ohms at 3.88 amps. Brand new with cord and plug-in ventilated, mounted case. **\$1.95**
MC 385A—Headset Adapter.....**New 49c**

Information and Prices on Request
BC 639 Receiver with **RA 42** Rectifier
RTA 1B Transceiver
TA 2124 Transmitter and **MP 10G** Power Pack
SCR 269 Compass Installation
R 5/ARN 7 Compass Installation
MN 26 Compass Installation
I. L. S. Installation (**R 89-BC733**)
SCR 584 Components
R-132/TPS 10 Radar Receiver
MD-22-URA/T1 Radar Modulator
AN APRI Receiver and Tuning Units
ASB7 Complete Radar Installation
TS-251 Test Set **BC 221** Freq. Meter

SURPRISE PACKAGE

20 lbs. Ass't radio parts. A **\$25.00** value for only **\$1.95**

HEADSETS—MIKES

HS-23 Hi Imp. Headsets.....	New \$2.95
HS-33 Lo Imp. Headsets.....	New 2.95
HS-30 Hi Imp. Headsets.....	New 1.50
	Used .79
T-17D Carbon Mike.....	New 2.75
T-24 Hi Imp. Carbon Mike.....	New 1.19
T-30 Throat Mike.....	New .98
T-45 (or Navy) Lip Mike.....	New .98
CD-307 Extension Cord for Headsets.....	New .59

MONTHLY SPECIAL

BC 188 MODULATOR without tubes but with numerous parts, including an 0-200 MA Simpson meter making it an exceptional buy at... **\$2.95**

Send for free 8-page illustrated **BULLETIN No. 103** listing many exceptional values

ARROW SALES, Inc.

Dept. N
1712-14 S. Michigan Ave., Chicago 16, Ill.
PHONE: HARRISON 7-9374

BC 434 COMPASS CONTROL BOX

contains 0-5 mill meter suitable for "S" meter —pots, knobs, crank, jacks, switches, five grain of wheat bulbs and numerous parts. **\$1.29**



Like new at only

AS-138/ARN—10 inch streamline loop as used with direction finding receivers. Fixed position, it is ideal for planes, boats, auto-mobiles. **\$2.95**

SOLENOID 110V 60 cycle coil complete with trip arms that really snap into place and hold. New **49c**

COMMAND (SCR 274N) EQUIPMENT

	Used	New
BC-453	\$12.95	
BC-454	5.95	\$8.95
BC-455	7.95	9.95
BC-456	1.95	2.95
BC-457	5.95	
BC-458	5.95	8.95
BC-696 (or T19).....	14.95	24.95
BC-450—3 Receiver Remote Control.....	.89	1.95
BC-442		2.95
3 Receiver Rack.....	1.95	
2 Transmitter Rack.....	1.50	

Complete Command set as removed from aircraft—3 receivers—2 transmitters—Relay unit—control boxes—mounting racks—plugs—modulator and dynamotors—crated Set. **\$34.50**

TUBES

Drastically Reduced from 10 to 50% Nationally Advertised Brands

Type	Net Price	Type	Net Price	Type	Net Price
1A4P.....	\$0.24	6SF5GT.....	\$0.34	37.....	\$0.24
1A6.....	.19	6S8GT.....	.39	37.....	.24
1B2/255.....	.24	6S8GT.....	.69	39/44.....	.24
1B26.....	2.29	6S7.....	.69	49.....	.39
1B29.....	.39	6F7.....	.39	50.....	.39
1B32-532A.....	2.29	6S7.....	.69	56.....	.24
1C6.....	.19	6TTG.....	.39	57.....	.24
1C7G.....	.19	6UTG.....	.29	76.....	.24
1D5GP.....	.24	6Z7G.....	.39	77.....	.24
1D7G.....	.19	6ZV5G.....	.29	211/Vt4L.....	.29
1F4.....	.24	7C4/1203A.....	.24	316A.....	.34
1F5G.....	.24	7E5/1201.....	.39	371B.....	.34
1H4G.....	.24	10VVT25A.....	.19	700A.....	7.95
1J6G.....	.24	12A6.....	.34	703A.....	1.49
1K6G.....	.24	12A6GT.....	.34	705A.....	.79
1P5GT.....	.24	12A7.....	.34	714AY.....	6.95
1V.....	.24	12A8GT.....	.19	724B.....	4.95
2A6.....	.39	12F5GT.....	.29	801A.....	.39
2A7.....	.24	12H6.....	.29	829.....	6.95
2C2A.....	.19	12J5GT.....	.24	832.....	4.95
2V3G.....	.49	12J7GT.....	.24	837.....	1.49
2X2/879.....	.39	12Q7GT.....	.24	841.....	.29
3FP7.....	.98	12SF5.....	.24	864.....	.29
4AP10.....	.98	12SF5GT.....	.24	872A.....	.98
5BP4.....	2.95	12SF7.....	.24	954.....	.19
5CP1.....	2.95	12SR7.....	.24	955.....	.34
5D21.....	19.95	12SR7GT.....	.29	957.....	.34
5FP7.....	.96	12SN7GT.....	.89	1625.....	.29
5J23.....	6.95	12Z3.....	.29	1626.....	.24
5T4.....	.49	15R.....	.19	1630.....	.29
6AB7.....	.69	19.....	.59	1642.....	.29
6AJ5.....	.89	2J22.....	1.95	2050.....	.89
6B8.....	.69	2D7.....	.34	2051.....	.49
6C4.....	.39	30SPEC.....	.90	9002.....	.34
6D8G.....	.69	(Vt67).....	.69	9003.....	.39
6F5GT.....	.39	30.....	.24	9006.....	.29
6F6G.....	.69	304TL.....	1.29	GLA21.....	.29
6H6.....	.29	32L7GT.....	.39	Amperite.....	
6J7GT.....	.69	33.....	.24	10T1.....	.29
6K6G.....	.69	33.....	.24	Jan CRP72.....	.98
6LSG.....	.39	34.....	.24	REL36.....	.69
6L7G.....	.39	35/61.....	.24	VR150.....	.49
6R7.....	.34	36.....	.24		

WRITE FOR QUANTITY PRICES

CONDENSERS

2 mfd. 4000 VDC. OIL FILLED.....	Each \$2.95
	4 for 10.00
1 mfd. 6000 VDC. OIL FILLED.....	1.98
.25 mfd. 15000 VDC. OIL FILLED.....	4.95
.00025 mfd. 25000 VDC. OIL FILLED.....	2.95
.4 mfd. 1500 VDC. OIL FILLED.....	.29
	10 for 2.49
2 mfd. 600 VDC. OIL FILLED.....	.39
	3 for 1.00
1 mfd. 600 VDC. OIL FILLED.....	.24
	5 for 1.00
.1x.1x.1—1200 VDC. OIL FILLED.....	.59
	2 for 1.00
50 mmfd—SKV—5 Amp. Vacuum Cond.....	1.19

FLAP PITCH MOTOR

24 VDC. will operate on AC—11000 R.P.M. Complete with gear box **\$2.95** and limit switches.....**ea.**

All shipments FOB warehouse. 20% Deposit required on all orders. Minimum order accepted—\$5.00. Illinois residents, please add regular sales tax to your remittance.

Lowest prices!



SYNCHRON MOTOR
Model 600, 1 RPM, 115 Volts.
60 cycles. Brand New.
Special Price **\$2.45 each**

C-1 AUTOPILOT SERVO UNIT—

Use to rotate beam antenna, actuate boat rudder control, etc. Contains 24 V. motor, clutch, relays, etc. Reversible. Size overall approx. 10½" x 8½" x 6½". Ideal for light hoisting. Make your own garage door opener. Removed from new aircraft.



PRICE \$8.95

C-1 AUTOPILOT VERTICAL GYROS

May be used to conduct many interesting and amusing experiments. Operates from 24 V. DC or may be operated for short periods on 110 V. AC Gyro will run for approx. 15 minutes after actuating. Size—approx. 8"x8½"x8½". Less Amphenol Connector. Removed from new aircraft. Special.....



\$4.95

C-1 AUTOPILOT AMPLIFIERS



Three channel servo amplifier consisting of many valuable electronic parts including 6 relays, 7 tubes, etc. Unit removed from new aircraft.

Super Special \$4.95

12 V. DYNAMOTOR

WinCo Type 41S6 input 13 Volts DC 13 amps. Total output 250 volts at .060 A and 300 volts .225 A. Ideal for boat or mobile use.
NEW at \$3.95 each



BEAM INDICATOR

1-82F Compass Indicator. 0-360°-5 in. dial. 26 v 400 cy. 8-12 v. 60 cy. Ideal position indicator. Brand new.

Price \$2.95 each

SAMPSEL PM MOTOR



Alnico Field
27.5 v. DC. 10,000 rpm. 1/100th hp. Ideal also as tachometer generator.
Price \$3.95 ea.

SERVO AMPLIFIER



Minneapolis-Honeywell Design G-403A
115 v. 400 cy. Use with a-c error signal. Price. \$6.50 ea.
USE WITH M. H. MOTOR G303AY2CA4. Built in gear reduction. 50 in/lb. torque.
Brand New—Special price **\$6.75 ea.**

Edison Time Delay Relay—s.p.s.t. nor. closed. 30 v. 7 sec. to open. Sealed.....59c ea.
Neon Blown Fuse Indicator—110/220 v. AC or DC.....39c ea.
Relay—6/12 v. DC. D.P.S.T.....69c ea.
Relay—6/12 v. DC. Makes one breaks one. (10 Amps.).....89c ea.
Contactor—Cutler Hammer 6041H30B. (50 Amps.).....Special \$2.95 ea.
Tube Specials—7F7, 7N7, 7Y4 at.....49c ea.

TERMS: 20% cash with order—balance C.O.D. Orders accompanied by payment in full must include sufficient postage, otherwise shipment will be made via Railway Express collect. Minimum order \$2.00.

Electro Devices

INCORPORATED
BOX NO. 1941 PATERSON, N.J.

11.765 with irregular schedule; relays m.w. PRG3 of *Radio Tupi*, but also carries "Acquarelas del Brasil" in Spanish 1200-1230 (except Sunday); ZYB9, 15.165, is now inactive.

Serrano continues that *Radio Brasil*, listed "construction permit," is now on the air on 2.46; QRA is Rua Francisco Glicerio 1347, Campinas, Sao Paulo, Brazil. Campinas is a coffee production center of 149,000 inhabitants and is located 40 miles north of Sao Paulo, capital of the state of Sao Paulo. *Radio Brasil Central*, also listed "construction permit," is now on the air, too—transmitting on 4.955 with call ZYY2, and on 1270 kc. m.w. with call ZYW9; operates with 250 watts and 1 kw., respectively, for the present due to electric power shortage; however, has permission for 10 kw. on m.w. and 1 kw. on s.w.; all equipment—including transmitters—is *Phillips*; QRA is *Radio Brasil Central*, Goiania, state of Goias, Brazil; Goiania is a 15-year-old city, built exclusively to be the capital of the state of Goias which has an area of 660,000 km. and a population of approximately 900,000, and which is located in central Brazil. *Radio a Voz do Oeste*, Cuiaba, Mato Grosso capital, is believed to be on the air; tentative frequency is 4.985 with 500 watts. *Radio Guaba*, Porto Alegre, capital of Rio Grande do Sul, has a "construction permit" for a 10 kw. transmitter on s.w. (but not to operate in the tropical band), but is now awaiting permission for another 10 kw. transmitter to operate on m.w. New "construction permits" include *Radio Difusora Brasileira*, Uberlandia, Minas Gerais (4.995, 500 watts), and *Radio Educadora do Ceara*, Fortaleza, Ceara (4.805 and 1420 kc., 10 kw., m.w.); *Radio Religio Federal* will operate on m.w. (not in the tropical band) with transmitter at Niteroi, state of Rio de Janeiro.

Radio Record, Sao Paulo, according to Serrano, is still testing on 9.605; the "official permission act" states that *Radio Record* may operate on s.w. with 150 watts for four months and then with a power output of 10 kw. on these channels—6.055 (0500-1900), 9.605 (0500-1700), and 15.135 (0600-1700, 2100-0100); schedules are based on the June season, Sunspot No. 70; the "official permission act" continues, "All the frequencies may be used with programs for Brazil and the 19-meter band channel (15.135) may also be used in broadcasts for the United States of America"; this likely means that *Radio Record* eventually will have *English* programs beamed to the USA.

A last-minute item from Serrano says that *Radio Nacional*, Rio de Janeiro, plans to purchase a new 50 kw. transmitter but it is not known whether it will operate on s.w. or not.

Stark, Texas, has identified the Spanish-speaking station on approximately 9.497 as La Paz, Bolivia; has bad QRM; sign-off seems to vary 2116-2120; identifies at 2000; leaves the air

(Continued on page 122)

Sync Circuits

(Continued from page 60)

negative bias voltage. The net sync pulse voltage applied to the separator grid will, therefore, be slightly larger, i.e., larger than it would be if the leveling action just described did not occur.

When a sync pulse slightly higher in voltage than the normal one arrives at the separator grid, a larger than normal grid current will flow. The net sync pulse voltage present at the separator grid will now become smaller, due to the increase in the negative bias or bucking voltage. In this way, the differences in sync pulse levels are minimized, and a fairly constant input to the sync separator results.

The sync leveling action described will not occur when insufficient current flows in the cathode-to-grid circuit. The inadequate grid current may be due to a large cathode bias in the sync separator, or to other circuit conditions. A diode is used in such cases to supply a current of adequate value. In other respects, the circuit action is exactly the same as in the case previously discussed.

Service technicians may wonder why the removal of the diode tube from the circuit will sometimes cause no noticeable symptoms. The explanation is that the cathode-to-grid current flow in the sync separator is adequate for sync leveling in such cases.

In other instances, an impairment of synchronization will be observed when the sync leveler tube has lost emission or is removed. Usually this loss in synchronization is slight.

Summing up the matter from the service technician's angle: When a slight tearing is noted at the top of the picture, check the sync leveler tube or circuit.

Phase Inversion

When the sync pulses emerge from the sync separator, they may not have the polarity needed to trigger the deflection oscillators. The pulses are negative in polarity (see Fig. 9D) at the plate of the separator. Now, most sets use blocking oscillators, which require positive-going sync pulses to trigger them. Such a positive-going pulse may be recovered either by taking the output of the separator off at its cathode (where the signal is opposite in polarity to the signal at the plate); or by applying a negative-going signal from the sync separator plate to a sync amplifier, which acts as a polarity or phase inverter.

Response Requirements

The frequency response of the sync section is worth considering. The authors know of a service technician who replaced a resistor in the plate circuit of a sync amplifier with a much larger one, to get higher gain out of the stage. The technician did not realize he was altering the frequency response

SAVE ON RCP INSTRUMENT KITS

NOW you can get in KIT FORM the best professional test equipment, made by the Radio City Products Co. EASY TO BUILD! Each kit contains simple step by step illustrated instructions—clear wiring and assembly diagrams—for easy checking.



AC-DC MULTITESTER

These units are in a class with other makes of testers that sell for considerably more. A 3" square D'Arsonval meter is used, having an accuracy of 2%. Ring type shunt circuits are employed.

MODEL 447 BK
\$1275

SUPER
VACUUM TUBE
VOLTMETER
MODEL 345K
\$2395



TUBE TESTER

A tube tester downright easy to operate. This is one of the lowest priced tube testers anywhere, yet it permits accurate checking of the widest variety of old or new tubes—equipped with the new sub-miniature tube socket. Operates on 100-130 volt, 50/60 cycle A. C. power supply. Open-face in new hammertone grey finish steel cabinet with sloping panel. Size 5 1/4" x 12 3/8" x 8"; weight: 11 lbs.

MODEL 322 AK \$2595

Features long scale 4 1/2" meter in burn out proof meter circuit—electronic balanced bridge type push pull circuit—negligible current drawn due to high input impedance of 25 megohms—Isolation probe—center of ohm scale 10 ohms—5 ohmmeter ranges reading from 2 ohms to 1000 megohms. 20 voltage ranges 0-1000 volts including AC and DC—Complete D. B. Meter. Discriminator alignment scale with zero center. Operates on 105-130 volts, 50-60 cycles. Size 10" x 6" x 5". Weight 8 1/4 lbs. Shipping weight 11 lbs.

ANNOUNCING NEW LOCATIONS FOR GREATER MERCHANDISING FACILITIES TO OUR CUSTOMERS:

Northern New Jersey: 114 Hudson Street at Central Ave., Newark
Eastern Pennsylvania: 701 Northampton Street, Easton
1115 Hamilton Street, Allentown



distributors of RADIO-ELECTRONIC and SOUND EQUIPMENT

66 DEY ST., NEW YORK 7, N.Y., DIGBY 9-3050

BUY of the MONTH TELEVISION SIGNAL BOOSTER



We cannot mention the manufacturer's name of this most successful booster. This booster uses a double tuned push-pull broad band amplifier designed to

increase the signal strength on television channels 2 to 13 by as much as 10 times, without introducing noise or reducing picture quality.

10% YOUR COST \$495 with order

ALMO RADIO CO.
509 ARCH STREET • Philadelphia
6205 MARKET STREET • West Phila.
6th & ORANGE STS. • Wilmington
4401 VENTNOR AVE. • Atlantic City

RADIO and TELEVISION

Over 30 years N.E. Radio Training Center. Train for all types FCC operators' licenses. Also Radio and Television servicing. FM-AM broadcasting transmitters at school. Send for Catalog N.

MASS. RADIO SCHOOL

271 Huntington Avenue Boston 15, Massachusetts
Lic. by Comm. Mass. Dept. Educ.

CODE SENDING RECEPTION SPEED



Free BOOK
HIGH SPEED
WITHOUT NERVOUS TENSION
REVEALING BOOK shows how "crack" operators develop high speed and proficiency. Learn code for Amateur or Commercial Radiotelegraph License, or improve your sending and receiving with the Candler System which develops radiotelegraph experts and code champions.
CANDLER SYSTEM Box 928, Dept. 2-J, Denver, Colorado

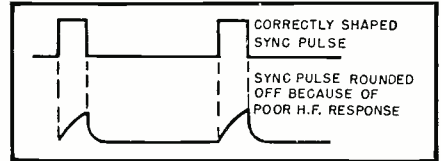

Fig. 10. Rounding off of sync pulses due to the poor high frequency response of the receiver's sync section.

of the sync section in doing so, and impairing receiver synchronization as a result.

The lowest frequency passing through the sync circuits is that of the vertical sync pulse—60 cycles. The highest frequency is about the tenth harmonic of the horizontal sync pulse—15,750 cycles \times 10, or approximately 150 kc. Let us consider very briefly why the 10th harmonic must be passed.

Any type of non-sinusoidal wave can be broken down or analyzed into a number of sine-wave harmonics, or multiples of the original frequency. To get the original wave back, we must have these component harmonics. When harmonics as far as the tenth one are incorporated, a waveform approximately the same as the original is obtained. (To get the exact wave shape as the original, an infinite number of harmonics would be needed.)

The plate resistances used in sync stages must not be so large that an appreciable shunting of frequencies above 150 kc. by the stray capacitance in the circuit occurs. A service technician cannot, therefore, increase the gain of a sync amplifier by increasing the size of its plate resistance, since high frequency losses would result.

Loss of high frequency response in a sync circuit (due, possibly, to a change in the value of some component, or tampering) would impair the sharpness of the horizontal sync pulses. That is, a tendency to round-off of the pulses would occur (see Fig. 10). The sync pulses might not, as a result, initiate the retrace in the deflection oscillator they control at the correct time. Such a delay, *i.e.*, an excessive retrace—would be apt to cause foldover in the picture or test pattern.

Summing up the matter from the service technician's angle: When fold-

Fig. 11. (A) Normal test pattern. (B) Horizontal foldover in test pattern. Strip of picture information at left (or top) of the image is folded over due to double scanning of this strip. Strip is scanned once when beam is retracing, and is scanned once more when beam is tracing.

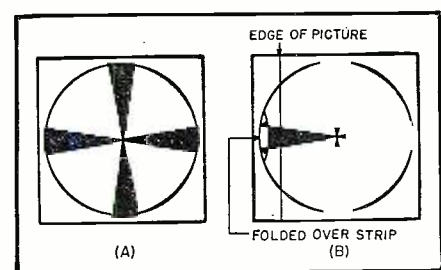

over is observed in the picture or test pattern (see Fig. 11), and a check of the horizontal oscillator shows its retrace to be normal, inspect the wave shapes of the horizontal sync pulses at various circuit points. Note whether excessive rounding off occurs. A certain amount of such rounding-off or distortion is normal when an inexpensive scope is used for this test, due to the latter's inadequate frequency response. Experience, or comparison checks made on another receiver of the same make and model number, will tell the technician whether any rounding-off present is excessive. Component checks of the stage affected will localize the trouble in the latter case.

(To be continued)

GENERATOR WHINE

By DOMENIC R. RIPANI W9JQA

If a high-pitched generator whine is heard over a car radio brought into the shop for repairs, don't start tearing the car generator apart to find the source of trouble.

In most cases this fault can be traced to a leaky oscillator-mixer or i.f. tube. Replacement of the bad tube will eliminate the trouble.

Since this leak can be observed on a tester only by applying a higher-than-normal filament voltage, it is suggested that the defective tube be located by the substitution method.

-30-

LOOSE PICTURE TUBES

By MATTHEW MANDL

WHEN it is necessary to bench service RCA television receivers or other models which do not have the picture tube strapped to the chassis, repairs can be facilitated by the use of an empty drawer as shown in the illustration.

The chassis is first placed on end over the empty drawer and the picture tube inserted into the yoke and focus coil assemblies. The yoke mount will thus act as a support for the tube and the necessity for improvising straps and brackets will have been eliminated. With the chassis in this position all the rear panel controls can be adjusted and both the top and bottom of the chassis are accessible during the servicing procedures. This method also allows full use of the picture tube when checking final performance.

-30-

Method for supporting television chassis when servicing sets with loose CR tubes.

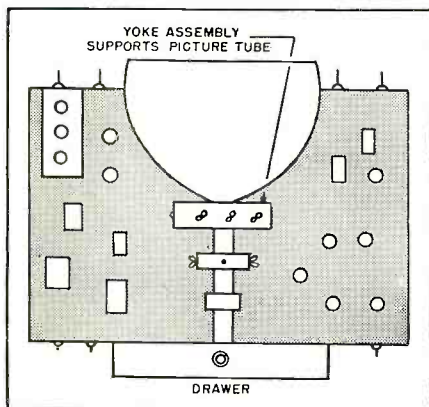

August, 1950

CLEARANCE SALE

TRANSFORMERS-CHOKES:

2.5V, 10A. Heavy-duty, 15kv insulation. Suitable for 866, 836, etc. Only a few. Reg. \$4.95 reduced to \$2.95 ea.

5H, 400ma chokes. Fully shielded, drawn steel case. Made by Chicago Transf. Reg. \$4.95, reduced to \$2.95 ea.

10H, 50 ma choke. Strap mounting. Handy for dozens of applications. Reg. 98c, reduced to 65c. Charger or fil. trans. Pri. 110V, 60 cycle. Secondary, 9-10-11-12-13 volts @ 1.2 A. Fully cased. A buy at \$1.49.

Vibrator transf. 6V inp. Secondary, 345-0-345. Also has bias winding. Fully cased. Bargain at \$1.49 ea.

CAPACITORS:

4 mid., 2500V oil-filled, Industrial Co. only \$3.95 ea.

MICROPHONES:

Aircraft-type, push-to-talk mike. Button on top. NEW. A real buy! Were \$1.15 ea. now reduced to 59c.

RCA Hand Mike. Hi-grade, single button. Bronze colored w/cord and plug. NEW. Were \$1.98 now reduced to 98c ea.

CODE PRACTICE EQUIPMENT:

Code practice sets. (See former ads.) NEW, original boxes. Formerly \$49.50, now \$16.95 ea. McElroy Tape Pullers. Variable speed, 115 V motor. Excellent condition, like new. Now only \$5.95 ea.

TELEPHONE EQUIPMENT:

EE89 Repeaters (see previous ads). Only a few left. NEW! Regularly \$9.95 ea. now \$6.95 ea. EES Field Telephones. Used, good condition. Tested before shipment. Reg. \$18.95 pr. Reduced to \$10.95 pr.

RM-29A Telephones. BRAND NEW. With TS-13 handsets. Formerly \$25.95 pr. Now \$17.50 pr. Used handsets, TS-9 and TS-15. Reg. \$2.95 ea. Now \$1.85 ea.

GF-11 Transmitters and Accessories

GF-11 Transmitters. used \$4.95 ea.
GF-11 Plugs. 1.50 ea.
GF-11 Coil Sets, any range. 1.00 ea.
GF-11 Trans., control box w/plug. 2.50 ea.
Extension control box w/plug. 2.50 ea.
Dynamotor for RU-GF equip. 28V inp., 400V/165 ma. out. 3.00 ea.
GF-11 Dummy Antenna.98 ea.

STORAGE BATTERIES:

2 volt, Willard. Dry packed. Very special at \$1.19 ea.
36 volt storage bat. Consists of 18, 2V units in sturdy case. Here is really a bargain! Only \$17.95.

BATTERY CLIPS:

Heavy-duty battery clips, (2) with cords. A buy at 39c pr.

SHOCK MOUNTS:

LORD, 8 lb. 7c ea. 8 for 45c. \$3.00 per C.
HARRIS, 8 lb. 8c ea. 8 for 45c. \$4.00 per C.
HARRIS, 12 lb. 16c ea. 8 for 1.05. \$9.00 per C.

TWELVE FOOT, HEAVY-DUTY WHIP

Actually 12'8" in length. Composed of four, sturdy sections which plug-in and screw together. Consists of sections MS-50, 51, 52, 55. BRAND NEW! A handsome buy on a highly desirable mobile antenna. Only \$1.50 complete.

AN-75-D WHIP ANTENNA

A great buy for you mobile men. 7'3" collapsible to 14". Has 9 sections—corrosion-proof brass. Sturdy bakelite mount with jiffy wing-nut fastener. These sold formerly at \$2.50 ea. Now, BRAND NEW, only \$1.25 ea.



ALUMINUM CHASSIS

A beautiful little drawn, .025" aluminum chassis, 3 1/2" long, 3 1/8" wide, 1 7/8" deep. Bright-dipped finish. Use for IFT stores, TV filters, amplifiers, etc.

Only 49c ea.; 3 for \$1.35

Power Supply for Any 274-N Receiver



Here it is—at last! Just plug it into the rear of your 274-N RECEIVER—any model! Complete kit, and black metal case, with ALL parts and diagrams. Simple and easy to build in a jiffy. Delivers 24 volts plus B voltage. No wiring changes to be made. Designed especially for the 274-N receiver. All necessary parts for conversion of rest of receiver also included. ONLY \$7.95. TUNING KNOB for 274-N Receiver. 59c ea.

MINIMUM ORDER \$2.00. ALL ITEMS SUBJECT TO PRIOR SALE. ALL PRICES SUBJECT TO CHANGE WITHOUT NOTICE.

FL-8 FILTER

AND
"FILTER FACTS"
BOOKLET

BRAND NEW!

Both for

98c

TUBES . . .

316A, (WE)	\$0.49 ea., 4 for \$1.80
815	1.15 ea., 4 for 3.95
82639 ea., 4 for 1.40
615, (HY)29 ea., 4 for 1.00
114B, (HY)29 ea., 4 for 1.00
388A, (WE)49 ea., 4 for 1.80
708A, (WE)39 ea., 4 for 1.40
801275 ea., 4 for 2.80
53239 ea., 4 for 1.40
211	2 for .90
836	2 for 1.10
5MP1	1.25 ea., 4 for 4.40
20-4 Reg. tube15 ea.
3FP7	1.25 ea., 4 for 4.40
3DP1A	2.50 ea.
2X239 ea.
6KTGT30 ea.
6L6 Metal90 ea., 4 for 3.40
RU-16, 17 Tube sets	\$2.85 set
GF-11 Tube sets	2.85 set

HS-30 Phones. NEW in boxes. Only \$1.29

HS-16 fones. \$1.35 ea.

R89/ARN 5A RECEIVERS. See March Radio-Electronics for converting to FM set. Brand new, orig. boxes. Now only \$10.95 ea.

LOW FREQUENCY CRYSTALS

Precise units in holders. Ideal for oscillators as markers, BFO, etc. Can also be used as resonators for crystal filters. 453.70, 455.5, 457.4, 461.81, 466.66, 468.51, 500, 450. Freq. in KC. These are an excellent buy at only .89c ea.

RESIN-CORE SOLDER

5 pound spools. Excellent quality. A low price at \$4.25 spool.

FONE PATCH!

Now available, the superior new O-R. 6008 phone patch. Provides you with exactly what you need to patch your phone into transmitter or receiver. Featuring a hi-impedance input suitable for xli mike. Both hi and lo impedance outputs to insure proper match to your particular receiver. Unit is complete—"sure-fire" ready to go to work for you. Only \$3.95 ea.



RU-16 RECEIVERS

With conversion sheet. With 3 coils, used \$4.95 good condition. Only \$1.75 ea. Coil Drawers for RU-16, 17 receivers. Any range \$1.75 ea. Receiver control box w/plug \$2.50 ea. Tuning meter for RU-16, 17 \$2.85 ea.



SMALL PRECISION LATHE—110-V. AC

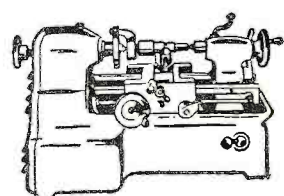

Now with Larger Motor \$44.50

A small lathe for radio shops, jewelers, laboratories, dentists, hobby-crafters, model makers, machine shops, schools, etc. Automatic Feed. Work capacity 3/4" centers. Swing over bed 2". Constructed of steel and cast iron. Accurately machined and finished. Fan-Cooled Motor mounted inside the base. Complete with 1 1/4" face plate, 2 lathe centers, tool post and rocker, one lathe dog, one tool-bit and test rod.

COMPLETE ACCESSORY KIT

including 4-jaw chuck, drill chuck, center counter-sink drill, 2 tool-bits, 2 lathe dogs, 1 face plate with 8 drilled and tapped holes, 4 collets, 1 collet chuck, 1 Allen wrench. \$24.50

* 4-HOUR MAIL-ORDER SERVICE. WE SHIP ANYWHERE. 20% DEPOSIT MUST ACCOMPANY ALL ORDERS, BALANCE C.O.D.

OFFENBACH & REIMUS CO.

372 ELLIS ST. SAN FRANCISCO, CALIF.

PHONE—ORdway 3-8551

NEW TV PRODUCTS on the Market

INSULATED TOOLS

H. K. Porter, Inc. of Somerville, Mass., is now offering a line of insulated tools for use in high voltage work.

The line includes screwdrivers, socket wrenches, wire cutters, and fireman's cutters, and are being marketed under the "Cohardite" label.

NEW TV SPEAKERS

A loudspeaker which has a magnetically enclosed motor structure and is, therefore, suitable for mounting in close proximity to the cathode-ray tube has been announced by the *Rola Company* of Cleveland, Ohio.

The new speaker uses Alnico V in a high efficiency magnetic structure which uses the minimum weight of Alnico V and results in an over-all reduction in the cost of the magnet. Speakers of this new design are available in sizes ranging from 5 to 12 in.

STARRETT TABLE MODEL

One of the most popular items in the current line of television receivers being offered by *Starrett Television Corporation* of 601 West 26th Street, New York 1, New York, is the Model 150.

This 12½ inch table model is housed in a hand-rubbed mahogany cabinet and retails in the moderate price class.

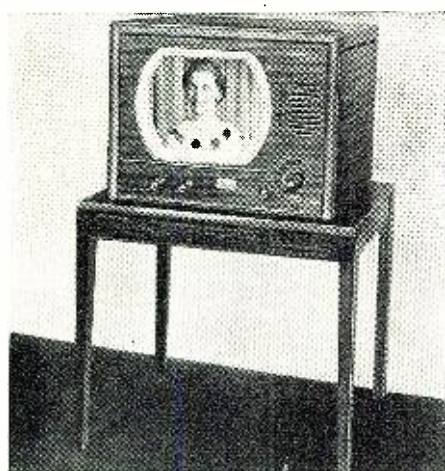

A similar model is also available in luggage finish.

Full details on the entire line are available from the company.

NEUTRAL FILTER

A neutral filter designed for black tube television sets is now being produced by *T. V. Development Corp.* of 2505 Surf Avenue, Brooklyn 24, New York.

By increasing contrast and picture quality, while reducing glare, the new

accessory is designed to provide increased eye comfort and enjoyment for the viewer.

ARVIN TV

Arvin Industries, Inc. of Columbus, Indiana, recently introduced its 1951 line of television receivers to more than 100 of its distributors at a special convention held in Chicago.

Among the receivers in the "custom line" are the Models 4162CB and 4162CM. Both of these sets feature the black picture tube, keyed automatic gain control, and synchrosound tuning. The Model 4162CB is housed

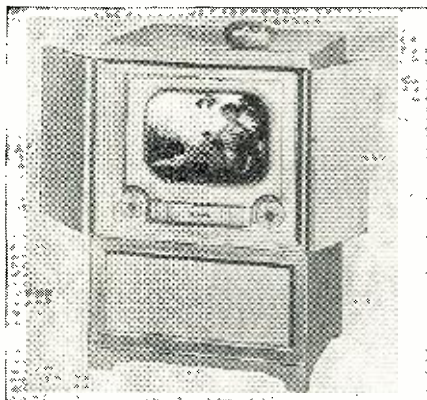

in a high style modern cabinet of limed oak while the second set, which has the same circuit features, is offered in mahogany.

"CLOVER-V-BEAM"

Telrex, Inc. of Asbury Park, New Jersey has just announced distribution of a new low-cost, high-gain, stacked bi-directional array for both TV and FM reception.

Known as the "Clover-V-Beam," the new antenna is a closed loop conical incorporating many innovations in the field. High gain and signal-to-noise ratio are obtained over the entire TV and FM bands, especially at the high frequency channels, due to the flat impedance characteristics and complete absence of "lobe-splitting" over the full frequency range.

The use of transposed transmission line bars which also serve as co-linear elements makes possible a high gain array of compact dimensions. The entire unit, which is preassembled to its own integral mast section, has a lateral displacement of less than five feet and weighs less than 1½ pounds. Universal clamps are supplied for coupling to standard diameter masting.

ADMIRAL COMBINATION

One of the combination television receivers recently introduced by Ad-

miral Corporation of Chicago is a 19" set housed in a mahogany cabinet of period design.

The new receiver features both AM and FM radio reception in addition to a phonograph with an automatic record changer that accommodates all types of records.

This new item is just one of an ex-



tensive line unveiled by the company at the summer furniture market in Chicago.

SERVICE SCOPE

The Triplett Electrical Instrument Co. of Bluffton, Ohio, has announced the development of a new 5" oscilloscope for TV and general servicing use.

Designated the Model 3440, the new unit features an exclusive pattern reversing switch, calibrated meter for peak-to-peak voltage measurements, and high vertical sensitivity (.009 r.m.s. volts per inch). A special feature eliminates double trace in TV alignment by simply flipping a switch. In addition, the circuit incorporates a conventional return trace eliminator, and has a telescoping light shield, linear sweep voltages up to 60 kc., and a wide frequency

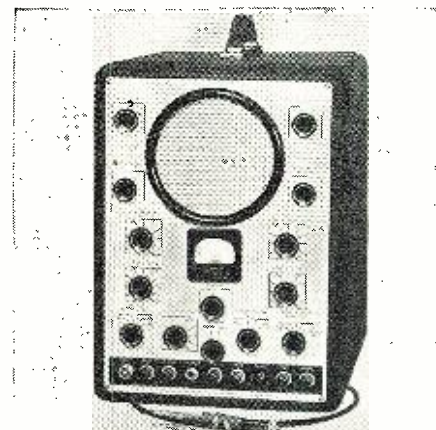

range (20 cycles to over 1 mc.). A demodulator probe is available for signal tracing applications.

ANTENNA MOUNT

Kenwood Engineering Company, Inc. of 265 Colfax Avenue, Kenilworth, New Jersey, is currently offering a new all-position antenna mount for television installations.

The unit adjusts to any position on the roof, parapet, side wall, or corner of the building. According to the

RADIO & TELEVISION NEWS

NEW!

**RECTANGULAR
BLACK TUBE**

16in. TELEKIT

PRICES
BEGIN AT **49.95**
LESS TUBES

**JOBBER: WRITE FOR CONFIDENTIAL
PRICE INFORMATION**

TELEKIT 16BR
\$79.95 Less
Tubes

Now you can build your own rectangular black tube TV set! This exciting new Telekit has a big 160-inch screen from a non-flare rectangular black tube. The entire set is engineered for simplicity, and has new 70% deflection, with video tube mounted directly on chassis. Brightness is assured by a 14KV hi-voltage doubler circuit. The streamlined circuit is easy to assemble. No previous knowledge of TV is required. All you need is pliers, screw driver and soldering iron. The tuning unit and hi-voltage supply are factory wired and assembled for you. A big 54-page illustrated instruction book guides you through easy assembly. Satisfactory performance is guaranteed by our Telekit Factory Service Plan and warranty. Write today for full details.

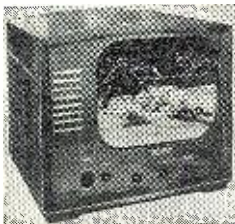

12-B Telekit
\$69.95 Less
Tubes
8-B Telekit
\$49.95 Less
Tubes

Here are new low prices on Telekits. Now you can have a fine 8½- or 12½-inch set at a price far below comparable commercial sets costing much more. Over 30,000 Telekits have been assembled by following the big Telekit instruction book. No previous knowledge of TV is required. Satisfactory results are guaranteed under the Telekit Factory Service Plan. Write for full information.



**TELEKIT
BOOSTER**
\$12.95

This Telekit Booster will bring in TV signals bright and clear. Especially helpful in fringe areas. Will give brilliant performance with any TV set, NOT A K.I.T. Completely assembled. With Tubes.



FREE—Write for catalogue listing Telekits, cabinets, tubes, antennas, boosters, and television accessories.

TELEKIT

ELECTRO-TECHNICAL INDUSTRIES
1432 N. BROAD ST. DEPT. 6 PHILADELPHIA 21 PA.

manufacturer, the mount is quick and easy to install, requires no blocking or shimmiing, eliminates excessive lead-in by permitting the antenna to be installed at the point nearest to the set, and is ruggedly constructed.

The mounting comes in two models, the 105 for masts up to 1½" o.d. and the 101 for masts up to 2" o.d. The offset on the 105 is up to 8" while the larger unit will handle offset up to 12".

MAGNAVOX CONSOLE

The *Magnavox Company* of Fort Wayne, Indiana, is currently in production on the "Plaza," a 14" console receiver.

Housed in a mahogany finished cabinet which measures 18" wide, 35½" high, and 19" deep, the new receiver has a 12" magneto dynamic speaker and retails in the moderate price class.



The set has a synchromatic tuning chassis with 20 tubes, including two rectifiers and the picture tube. The circuit also incorporates the company's instant tuning feature and a built-in antenna.

CONICAL ANTENNA

The *LaPointe-Plascomold Corporation* of Hartford, Conn., has recently introduced a new broadband, high-gain conical antenna in its line of "Vee-D-X" units.

According to the manufacturer, good performance is obtained on all channels through the use of a new material for the element sections. Available in one, two, or four bays, the "Vee-D-X" conical is supplied with universal element brackets to allow a wide variation of reflector and radiator combinations.

Of special interest are the new phenolic vibration straps which are designed to prevent objectionable antenna noise during periods of high wind velocity. The straps firmly support the element arms and, to a large extent, eliminate the wind vibration and noise.

"MICRO-MIKER"

The new dynamic "Micro-Miker" developed by *Kalbfell Laboratories, Inc.* of 1076 Morena Boulevard, San Diego 10, California, is of particular interest to television engineers and those concerned with wideband amplifiers.

The Model 402A measures the small interelectrode and wiring capacities present in video amplifiers under operating conditions, including the Mil-



ler Effect. It also measures the inductance of peaking coils.

Capacities from .1 μfd. up to .005 μfd. are measured in three ranges and the inductance range extends from 1 microhenry to 250 microhenries. The instrument is direct reading and simple to operate.

A descriptive pamphlet covering the Model 402A is available on request.

REMOTE CONTROL TV

The deluxe home entertainment instrument which tops the new *Philco Corporation* line is the Model 2176.

Equipped with a 20" rectangular tube which provides a 215 square inch picture, the set has remote control which permits turning the set on or off, selecting TV stations, and adjusting the picture and sound, all from a remote location.

Other television features include custom-built high gain duplex chassis with extra tubes for added power, full sensitivity and selectivity even in fringe areas, double-action synchronizing to lock-in pictures, amplified automatic gain control, automatic scanning system with *Philco* balanced beam for clearer, sharper pictures over the entire screen.

A new high sensitivity tuner, FM sound system with variable tone con-



trol, tunable built-in antenna system, and an illuminated station selector are also included.

The three-speed automatic record changer plays all sizes of 78, 33½, and 45 r.p.m. records with a single tone arm. The console cabinet is of con-

1000 KC crystal BT cut. \$3.95
 3" scope shield 1.29
 2 speed dial drive for 3/4" shaft ratios 5:1 to 1 :.39
 ATC 100 mmfd air trimmer screwdriver shaft .29
 -10 +5 Weston modulation meter Weston 301. 8.95
 J37 key .69
 500 watt 12.5 ohm power rheostat. 3.49



50 mmfd 5 KV GE vacuum condenser. \$1.49
 2v, 6v, 12v vibrators any type .98
 Rotary switch GE Myleax, 2 deck SP3T. .39
 1 mfd 5000v oil condenser Micamold. 2.98
 2 mfd 3000v oil condenser Aerovox. 3.25
 3 mfd 4000v oil condenser Micamold. 3.95
 24 mfd 1500v DC 3KV flash. Excellent for speed lamp 3.95

TUBES!! BRAND NEW! STANDARD BRANDS! NO SECONDS! COMPARE! TUBES!!

0A3/VR75	3C24/24G \$.35	227A/5C27	813	\$2.45	8014	\$19.95	0A2	\$1.19	3Z4	\$.70	6SN7GT	\$.63	12SL7	\$.55
0B3/VR90 .89	3C31/C1B 3.49	249C 1.75	813H	6.90	8015	99.50	0A3	92	6X4	1.09	6SR7GT	.42	12SN7	.52
0C3/VR105 .74	3CP1 1.39	250R 5.95	814	2.25	8001	.34	0B2	1.49	6BL4A	1.09	6SR7GT	.42	12SR7	.49
0D3/VR150 .45	3CP1 81 2.25	250TL 18.95	815	2.25	9002	.25	0Z4	.57	6A7	.75	6SR7	.72	12Z3	.65
1B22 .295	3DP1 3.10	250TL 18.95	818	.99	9003	.49	1A3	.41	6AR	.65	6SU7GT	1.95	14A4	.79
1B23 .875	3DP1A 3.95	274A 5.50	826	.35	9004	.32	1A4P	.79	6AB7	.75	6SV7	.79	14A7	.52
1B24 4.95	3DP1A 2A 4.75	274B 1.95	828	9.95	9005	1.49	1A5GT	.47	6AC3GT	1.15	6T8	.79	14B6	.67
1B26 2.95	3D21A .98	276A 6.95	829	7.45	9006	.95	1A6	.59	6AD7G	1.09	6T8	.85	14C7	.65
1B27 24.50	3E29 9.95	293A 2.98	829B	9.95	C13A 9.95	7.95	1A7GT	.65	6AE6G	.79	6U5G	.62	14F8	.79
1B28 24.95	3E31 9.97	294A 1.95	830B	4.95	C13A 9.95	7.95	1A8	.59	6A8	.75	6U6GT	.63	14H7	.59
1B29 1.79	3GP1 4.45	300TH 9.95	831	4.95	C6J 3.69	3.69	1B5 8016	1.19	6A9	.65	6U7G	.47	14I7	.49
1B36 24.95	3HP7 2.89	304TH 3.65	832A	7.95	C100D 1.49	1.49	1B5/258	.79	6AC3	.69	6V6	.85	14N7	.85
1B38 32.50	4E1A 1.21	304TH 1.29	833A	33.95	CK302AX 2.95	2.95	1C7GT	.95	6AK5	.83	6V6GT	.57	14Q7	.55
1N21 Xtal .59	4-125A 26.95	307A/RK75 6.95	837	1.35	CK303AX 2.25	2.25	1C8GT	.59	6AL5	.75	6W7G	.77	14R7	.69
1N21A Xtal .89	4-250A 29.95	310A 6.95	838	1.98	CK304AX 2.25	2.25	1C9GT	.69	6AK5	.83	6X4	.49	24A	.55
1N21B Xtal .89	4-500A 32.95	310A 6.95	839	1.98	CK305AX 2.25	2.25	1D7GT	.89	6AL5	.75	6Y7G	.85	2516GT	.51
1N22 Xtal .89	4B22/E15B 9.95	323A/B 24.50	843	.19	CK307AX 2.25	2.25	1D8GT	.89	6AL5	.75	6Y7G	.85	2516GT	.51
1N23 Xtal .67	4B22/E13C 4.75	327A/5C37 2.49	845	3.75	CK312AX 8.45	8.45	1D9GT	.89	6AL5	.75	6Y7G	.85	2516GT	.51
1N23A Xtal .79	4B25/2000 4.95	327A/5C37 2.49	845	3.75	CK312AX 8.45	8.45	1D9GT	.89	6AL5	.75	6Y7G	.85	2516GT	.51
1N23B Xtal .79	4B28 2.95	331A 12.95	851	12.95	CK1005 .63	1.63	1E7GT	1.05	6AR5	.54	7A7	.55	26	.42
1N27 Xtal 1.69	4B32 2.95	331A 12.95	851	12.95	CK1006 .63	1.63	1E7GT	1.05	6AT6	.54	7A7	.55	26	.42
1N34 Xtal .79	4C37 CV32	360A 1.69	860	6.95	EF50 .69	.69	1F3G	.69	6AV6	.45	7A7	.55	26	.42
1P23 2.95	4C35 22.50	371A .39	864	.19	FG23A 7.95	7.95	1G4GT	.65	6AV6	.45	7A7	.55	26	.42
1P24 2.79	4D32 9.95	371B .39	865	1.45	FG23A 7.95	7.95	1G4GT	.65	6AV6	.45	7A7	.55	26	.42
1P26 3.79	4D32 12.95	388A .79	866A	1.05	FG23A 7.95	7.95	1G4GT	.65	6AV6	.45	7A7	.55	26	.42
2AP1 4.95	4E27/2578	393A 3.49	866B	1.05	FG23A 7.95	7.95	1G4GT	.65	6AV6	.45	7A7	.55	26	.42
2AP2 2.45	5AP1 14.95	417A 8.95	872A	1.25	FG23A 7.95	7.95	1G4GT	.65	6AV6	.45	7A7	.55	26	.42
2C21/RK33 .24	5AP1 1.79	434A 2.95	874	.98	FG27A 8.75	8.75	1L4	.48	6B6G	.55	7B4	.53	34	.29
2C22/7193 .24	5BP1 1.79	440TH 1.29	874	.98	FG27A 8.75	8.75	1L4	.48	6B6G	.55	7B4	.53	34	.29
2C24 2.46	5BP1 1.79	440TH 1.29	874	.98	FG27A 8.75	8.75	1L4	.48	6B6G	.55	7B4	.53	34	.29
2C24/RK34 .22	5BP1 1.79	440TH 1.29	874	.98	FG27A 8.75	8.75	1L4	.48	6B6G	.55	7B4	.53	34	.29
2C39 24.50	5CP1 1.39	450TH 1.95	884	1.39	FG37 12.95	12.95	1L4	.48	6B6G	.55	7B4	.53	34	.29
2C43 2.45	5DP1 1.39	450TH 1.95	884	1.39	FG37 12.95	12.95	1L4	.48	6B6G	.55	7B4	.53	34	.29
2C43 8.95	5E22 49.50	507L 9.75	902	2.59	FG172 29.50	29.50	1L5	.59	6C4	.39	7C7	.59	35Y4	.47
2C44 6.79	5E22 49.50	507L 9.75	902	2.59	FG172 29.50	29.50	1L5	.59	6C4	.39	7C7	.59	35Y4	.47
2C51 5.75	5GP1 2.69	52A 9.75	905	2.59	FG172 29.50	29.50	1L5	.59	6C4	.39	7C7	.59	35Y4	.47
2D21 1.99	5HP1 24.45	52A 9.75	905	2.59	FG172 29.50	29.50	1L5	.59	6C4	.39	7C7	.59	35Y4	.47
2E22 1.25	5P2 8.95	52A 9.75	905	2.59	FG172 29.50	29.50	1L5	.59	6C4	.39	7C7	.59	35Y4	.47
2E24 4.69	5P4 24.45	52A 9.75	905	2.59	FG172 29.50	29.50	1L5	.59	6C4	.39	7C7	.59	35Y4	.47
2E26 3.39	5P4 24.45	52A 9.75	905	2.59	FG172 29.50	29.50	1L5	.59	6C4	.39	7C7	.59	35Y4	.47
2E30 2.29	5P4 24.45	52A 9.75	905	2.59	FG172 29.50	29.50	1L5	.59	6C4	.39	7C7	.59	35Y4	.47
2F21A 7.95	5P4 24.45	52A 9.75	905	2.59	FG172 29.50	29.50	1L5	.59	6C4	.39	7C7	.59	35Y4	.47
2F22 7.95	5P4 24.45	52A 9.75	905	2.59	FG172 29.50	29.50	1L5	.59	6C4	.39	7C7	.59	35Y4	.47
2F26 6.50	5P4 24.45	52A 9.75	905	2.59	FG172 29.50	29.50	1L5	.59	6C4	.39	7C7	.59	35Y4	.47
2F31 7.95	5P4 24.45	52A 9.75	905	2.59	FG172 29.50	29.50	1L5	.59	6C4	.39	7C7	.59	35Y4	.47
2F32 39.50	5P4 24.45	52A 9.75	905	2.59	FG172 29.50	29.50	1L5	.59	6C4	.39	7C7	.59	35Y4	.47
2F33 8.49	5P4 24.45	52A 9.75	905	2.59	FG172 29.50	29.50	1L5	.59	6C4	.39	7C7	.59	35Y4	.47
2F34 12.95	5P4 24.45	52A 9.75	905	2.59	FG172 29.50	29.50	1L5	.59	6C4	.39	7C7	.59	35Y4	.47
2F37 12.75	5P4 24.45	52A 9.75	905	2.59	FG172 29.50	29.50	1L5	.59	6C4	.39	7C7	.59	35Y4	.47
2F38 9.95	5P4 24.45	52A 9.75	905	2.59	FG172 29.50	29.50	1L5	.59	6C4	.39	7C7	.59	35Y4	.47
2F39 12.95	5P4 24.45	52A 9.75	905	2.59	FG172 29.50	29.50	1L5	.59	6C4	.39	7C7	.59	35Y4	.47
2F40 24.50	5P4 24.45	52A 9.75	905	2.59	FG172 29.50	29.50	1L5	.59	6C4	.39	7C7	.59	35Y4	.47
2F46 49.50	5P4 24.45	52A 9.75	905	2.59	FG172 29.50	29.50	1L5	.59	6C4	.39	7C7	.59	35Y4	.47
2F48 12.75	5P4 24.45	52A 9.75	905	2.59	FG172 29.50	29.50	1L5	.59	6C4	.39	7C7	.59	35Y4	.47
2F49 39.50	5P4 24.45	52A 9.75	905	2.59	FG172 29.50	29.50	1L5	.59	6C4	.39	7C7	.59	35Y4	.47
2F50 24.50	5P4 24.45	52A 9.75	905	2.59	FG172 29.50	29.50	1L5	.59	6C4	.39	7C7	.59	35Y4	.47
2F51 24.50	5P4 24.45	52A 9.75	905	2.59	FG172 29.50	29.50	1L5	.59	6C4	.39	7C7	.59	35Y4	.47
2F52 24.50	5P4 24.45	52A 9.75	905	2.59	FG172 29.50	29.50	1L5	.59	6C4	.39	7C7	.59	35Y4	.47
2F53 24.50	5P4 24.45	52A 9.75	905	2.59	FG172 29.50	29.50	1L5	.59	6C4	.39	7C7	.59	35Y4	.47
2F54 24.50	5P4 24.45	52A 9.75	905	2.59	FG172 29.50	29.50	1L5	.59	6C4	.39	7C7	.59	35Y4	.47
2F55 24.50	5P4 24.45	52A 9.75	905	2.59	FG172 29.50	29.50	1L5	.59	6C4	.39	7C7	.59	35Y4	.47
2F56 24.50	5P4 24.45	52A 9.75	905	2.59	FG172 29.50	29.50	1L5	.59	6C4	.39	7C7	.59	35Y4	.47
2F57 24.50	5P4 24.45	52A 9.75	905	2.59	FG172 29.50	29.50	1L5	.59	6C4	.39	7C7	.59	35Y4	.47
2F58 24.50	5P4 24.45	52A 9.75	905	2.59	FG172 29.50	29.50	1L5	.59	6C4	.39	7C7	.59	35Y4	.47
2F59 24.50	5P4 24.45	52A 9.75	905	2.59	FG172 29.50	29.50	1L5	.59	6C4	.39	7C7	.59	35Y4	.47
2F60 24.50	5P4 24.45	52A 9.75	905	2.59	FG172 29.50	29.50	1L5	.59	6C4	.39	7C7	.59	35Y4	.47
2F61 24.50	5P4 24.45	52A 9.75	905	2.59	FG172 29.50	29.50	1L5	.59	6C4	.39	7C7	.59	35Y4	.47
2F62 24.50	5P4 24.45	52A 9.75	905	2.59	FG172 29.50	29.50	1L5	.59	6C4	.39	7C7	.59	35Y4	.47
2F63 24.50	5P4 24.45	52A 9.75	905	2.59	FG172 29.50	29.50	1L5	.59	6C4	.39	7C7	.59	35Y4	.47
2F64 24.50	5P4 24.45	52A 9.75	905	2.59	FG172 29.50	29.50	1L5	.59	6C4	.39	7C7	.59	35Y4	.47
2F65 24.50	5P4 24.45	52A 9.75	905	2.59	FG172 29.50	29.50	1L5	.59	6C4	.39	7C7	.59	35Y4	.47
2F66 24.50	5P4 24.45	52A 9												



HENRY HAS THE NEW hallicrafters MODEL SX-71 NOW!



This new type of receiver—the first of its kind on the market—has extra sensitivity, selectivity, and definitely superior image rejection. Continuous AM reception from 538 kc to 35 Mc, and 46 to 56 Mc. One RF, 2 conversion, and 3 IF stages. 105-125 volts AC. 11 tubes plus voltage regulator and rectifier. Only \$179.50. (R-46 matching speaker only \$16.95)

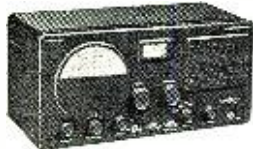

MEDIUM PRICED HALLICRAFTERS MODEL S-40B

540 kc. to 43 Mc. Temperature compensated. One RF, 2 IF, 3-watt output, 4 bands. 115 V. AC. 7 tubes plus rectifier. Internal speaker. Only \$79.95. Other popular Hallicrafters models: S38-B, only \$39.95; S-72, only \$89.95; SX-43, only \$159.50; SX-62, only \$269.50.

I have a complete stock of Hallicrafters receivers and transmitters. I'll make you the best deal on a trade-in for your communications receiver. I give you prompt delivery, and 90-day FREE service. Nobody can beat Bob Henry on a trade-in, and I offer you the world's lowest credit terms. Write, wire, phone, or visit either store today for the best deal.

Bob Henry
WΦARA

HENRY RADIO STORES

Butler 2, Missouri

1120 Olympic Blvd.
LOS ANGELES 75
CALIF.

"WORLD'S LARGEST DISTRIBUTORS OF SHORT WAVE RECEIVERS"

temporary Georgian design in Honduras and striped mahogany veneers, accentuated with a wood serpentine grille. Two large record storage compartments are also provided.

ALIGNMENT TOOL KIT

Service technicians will be interested in the announcement of a new nylon television alignment tool kit being offered by *The JFD Manufacturing Co., Inc.* of 6101 Sixteenth Avenue, Brooklyn 4, New York.

The No. TK60 has been designed to speed television servicing operations while providing the technician with an unbreakable set of alignment tools. Each of the aligning tools included in the kit provides two different tuning tips, one on each end, for a total of 12 separate aligning ends to meet every television or FM servicing adjustment.

The set is packed in a handy permanent plastic case. The tools themselves are molded in contrasting brilliant colors to speed identification for servicing operations.

INDUCTANCE BRIDGE

A new incremental inductance bridge, the Model No. 1110, designed to provide accurate testing of communications and television components under load conditions has been announced by *The Freed Transformer Company, Inc.* of 1718-36 Weirfield Street, Brooklyn (Ridgewood) 27, New York.

The instrument has an impedance range of one millihenry to 100 henries in five ranges. The inductance values



are read directly from a four-dial decade and multiplier switch. The range of the unit may be extended to 10,000 henries through the use of an external resistance.

The inductance accuracy of the bridge is within plus or minus 1 percent through the frequency range from 60 to 1000 cycles.

Full details on this incremental inductance bridge are available from the company.

NEW SCOTT SET

One of the newest additions to the line of television receivers being produced by *Scott Radio Laboratories, Inc.* of Chicago is the "Cressy," a direct-view television and radio-phonograph combination.

The receiver combines a 16" television set with a 14 tube AM-FM radio

RADIO & TELEVISION NEWS

AMPERITE Studio Microphones at P.A. Prices

Ideal for
BROADCASTING
RECORDING
PUBLIC ADDRESS

"The ultimate in microphone quality," says Evan Rushing, sound engineer of the Hotel New Yorker.

- Shout right into the new Amperite Microphone—or stand 2 feet away—reproduction is always perfect.
- Not affected by any climatic conditions.
- Guaranteed to withstand severe "knocking around."



Models
RBLG—200 ohms
RBHG—Hi-imp.
List \$42.00



"Kontak" Mikes
Model SKH, list \$12.00
Model KKH, list \$18.00

Special Offer: Write for Special Introductory Offer, and 4-page illustrated folder.

AMPERITE Company, Inc.

561 BROADWAY • NEW YORK 12, N. Y.

Canada: Atlas Radio Corp., Ltd., 560 King St. W., Toronto

LEARN

Television -Radio OR Electricity IN THE GREAT SHOPS OF COYNE



TRAIN QUICKLY!
OLDEST, BEST EQUIPPED
SCHOOL OF ITS KIND IN U.S.
2 Opportunity Fields

Come to the Great Shops of COYNE in Chicago. Our 51st Year! Get quick, practical training in TELEVISION-RADIO or ELECTRICITY. G. I. Approved. Finance plan for non-veterans. Mail Coupon Today for complete details.

NOT "HOME-STUDY" COURSES!
You learn on real, full-size equipment, not by mail. Finest staff of trained instructors to help you get ready quickly for a better job, a fine future.

FREE BOOKS Clip coupon for big illustrated Coyne book on either TELEVISION-RADIO or ELECTRICITY. Both books sent FREE if you wish. No obligation; no salesman will call. Act NOW!

B. W. COOKE, Pres.
COYNE Electrical & Television-Radio School,
500 S. Paulina St., Chicago 12, Ill. Dept. CO-85H
Send FREE BOOK and full details on:
 TELEVISION-RADIO ELECTRICITY

NAME.....

ADDRESS.....

CITY..... STATE.....

and a three speed automatic phonograph. The set is available in either blonde wood or a dark mahogany cabinet. The 12-channel television chassis has a channel selector and vernier tuner and contrast and brightness dual controls.

The twin-chassis radio unit provides an over-all audio range of from 30 to

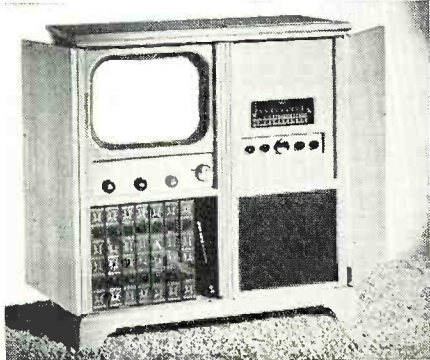

15,000 cycles and is equipped with a 12" coaxial speaker. The "Cressy" will be available either with or without the television chassis, with provision made to install the video unit at some later date.

-50-

Radio technicians at United Air Lines' maintenance base in San Francisco have developed a new technique for testing headphones and microphones. It is based on the use of an artificial "ear" and "voice." The microphone is clamped against the artificial "voice" and fed by an audio oscillator which produces the entire range of conversational tones. The tones, as picked up by the mike, are transformed into a tracer across the CR tube face where they are checked against a predetermined wave shape painted on the face of the CR tube. The opposite procedure is used in testing the earphones.

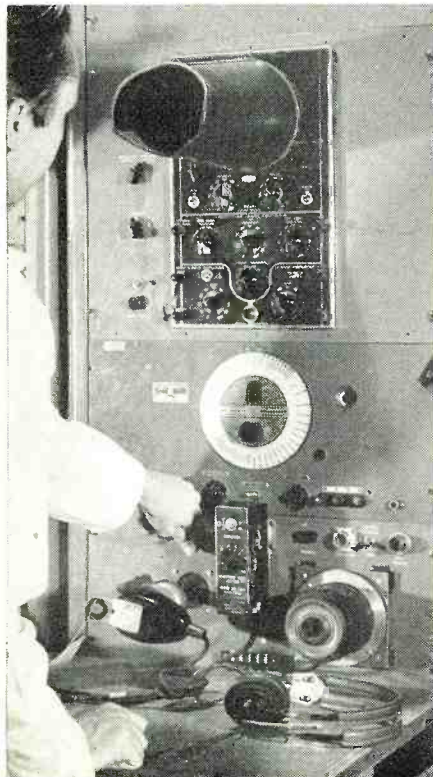

August, 1950

LOWEST PRICES ON TV PARTS

'WHOLESALE RADIO' IS YOUR COMPLETE TELEVISION SUPPLY HOUSE

Convert to Big-Screen TV with Rectangular Tubes!

Now! It's easy to convert to big-screen TV!

Hi-Sweep Voltage Multiplier Kit FOR CONVERTING TO 14"-16" or 19" TUBES

For converting 630 or similar type sets. Supplies 14 KV with full sweep using a 816 or 1B3 rectifier. Kit complete with T771 flyback transformer, special winding coil and all other components necessary to complete your voltage multiplier circuit. Plus wiring instructions. **\$9.45**

Type A for 16" round tubes.
Type B for 14-16-19" rect. tubes.



FOR 14" SCREENS

Shelden Rectangular Tube 14BP4 \$26.50
G.E. Rectangular Tube 14CP4
70 Deflection Yoke M-D-70 4.50
For wide angle tubes. Has built-in damping network 6.60
Focus Coil 202D-2 2.65
Mounting Brackets for 202D-2, Type BR-67 3.45
14" Plastic Mask, Rectangular 9.45
Deluxe High-Sweep Kit B
(See details at left)



FOR 16" SCREENS

G.E. Rectangular Tube 16KP4 \$37.00
70 Deflection Yoke MD-70-F
Greater deflection sensitivity for 16" rectangular tubes 5.40
Focus Coil 202D-2 6.60
16" Plastic Rectangular Mask 4.75
Mounting Brackets for 202D-2, Type BR-67 2.65
Deluxe High-Sweep Kit B 9.45
(See details at left)



We Can't Be Beat on Antenna Quality & Price

UNBEATABLE TV RECEPTION BEST FOR THE FRINGE AREAS

Snyder Lazy XX TV ANTENNA

Complete with three 3 1/2 ft. masts & adj. mounting base

Extremely hi-gain. Superior construction designed to withstand all weather conditions. Easily stacked double conical Lazy XX type. Just unfold, tighten and erect. All TV channels and FM. You also get guy wire rings and connecting stubs. Complete, pre-assembled. Can be used with any type lead-in 72 to 300 ohms. Order model TX-2.

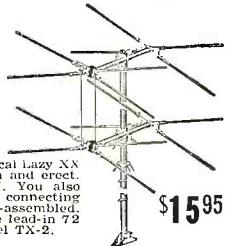

\$15.95

Hi-Gain! Equal to 2 Ordinary Boosters! ASTATIC TV BOOSTER



Four 6AK5 tubes. 2 in high band; 2 in low band. Provides two tuned circuits and two broad band circuits on all channels. Dual tuning controls allow separate tuning for picture and sound. **\$29.70**

Sensational Antenna Buy! SNYDER HI-LO ARRAY



\$5.40

Complete with Mast Sections Model TV 21

We don't believe you'll find a finer antenna anywhere near this low price. Two folded dipoles (High and Low) with reflectors. Complete with two 3 1/2 ft. mast sections, guy ring. Ready for easy, quick installation.

\$5.10 in Lots of 6 or More.

TV HI-BAND & LO-BAND ANTENNA ARRAYS

Folded Dipoles with reflectors



Adjustable mounting brackets. Poles 1 1/2" to 1 3/4". Lo-Band for channels 2-6. Hi-Band for channels 7-13. Less Mast.

Hi-Band HF-3 \$1.49

Lo-Band AR-26 \$2.95

Lowest Price Conical Array! Can Be Stacked for Fringe Areas 8 Interchangeable Elements

Covers complete TV-FM band. Hi-tensil 3/8" aluminum alloy elements. Includes mast clamp for use with poles up to 1 1/4". Can be used with any type lead-in 72 to 300 ohms. Model TX-4. Less Mast. **\$3.75**

\$3.50 in Lots of 6

TV ANTENNA ACCESSORIES

High In Quality! Low In Price!

STEEL EXTENSION POLES. Weather treated. 10 ft. long, 1 1/4" di. \$1.49
5 ft. long, 1 1/4" di. Crimped end.89
3 1/2 ft. long, 1 1/4" di. Crimped end.69
ANTENNA SWIVEL BASE. Aluminum.39
Fits 1 1/2" O.D. mast section.
GUYWIRE. 8 stranded No. 20. Per 50 ft.29
24 reels, 50 ft. each, interconnected. 6.00
72 OHM COAXIAL CABLE RGS9U 1c per ft. Per 100 ft. 3.75
300 OHM TWIN LEAD (\$1.45 per 100 ft.) 1000 ft. 11.50
CHIMNEY MOUNT BRACKETS. Complete with strap 1.39
3" 300 OHM STAND-OFF INSULATORS (3c ea.) 2.50
Wood screw-in type. (3c ea.) Per 100 1.25
SAMS TV ANTENNA MANUAL.06
SNARON TWIN LEAD INSULATORS. Fit 1 1/4" masts. Each.45
MAST COUPLINGS. Galvanized steel. 3" long. Will couple masts of 1 1/2" or 1-3/16" di. 2.25
RFID LIGHTNING ARRESTOR. 1000 ft.65
TIE RODS. For connecting conical arrays. Pr. 1.75
4B STACKING ASSEMBLY. 4 rods and a center tie-point. For stacking two double XX arrays.

Get Rid of TVI For Good! G.E. WAVE TRAPS

IF WAVE TRAP Reduces or eliminates TVI on sets with IF of 41 to 47 mcs. RLW-006. \$2.40
FM WAVE TRAP Reduces TVI caused by strong FM signals in 88 to 108 mc channel. RHL-005. \$2.19

FOR BEST TV RECEPTION ROTATE ANTENNA WITH RADIART TELEROTOR



TR-2 With Direction Indicator \$26.97

Streamlined weather-proof design. Durable, sturdy construction. 12 heavy duty ball-bearings. Heavily reinforced die-cast housing. Precision gears. Positive stop at end of rotation. Heavy duty motor reverses instantly. Mast, tower or platform mounting. Completely weather sealed, factory lubricated for life. Telerotor control with perfect pattern dial gives immediate indication of antenna position. 8 CONDUCTOR LEAD-IN 66 per ft. \$5.50 per 100 ft. TA-3 SUPERSTRUCTURE. Enables use of Telerotor with Ham 10-20 meter Beam Antenna. \$11.97

Address Orders to Dept. RN-8 or Phone Mulberry 2134

WHOLESALE RADIO PARTS CO., Inc.

311 W. Baltimore St.
BALTIMORE 1, MD.

Write for Free Monthly "FYI" Bulletin

Ho Hum! More Summer Specials!

MARINE TRANSMITTERS

(1) G.L. "MARINER." 100 to 125 W. RF to antenna. 100% modulated. 4 chan. xtal cont., 12 or 24 V input (specify voltage & freq. when ordering) w/ Dynamotor, connecting cord, xtal, tubes (813 final, 813 mike; all aligned and ready to operate. Controls are ON-OFF switch, chan. selector, antenna tuner to match any antenna in receiver break-in relay in addition to ant. switching relay. Panel has RF current meter and total current meter. Dimensions: 8 1/4" deep, 17 1/4" wide, 19 1/2" high. Tubes included: 1625 speech amp., 1625 osc., two 211 mod., 814 final. This xmtr built from \$1200 govt. cost surplus. We offer it at the astounding price of..... **\$225.00**

(2) ART-13-ATC. Famous Collins auto-tune xmtr. 100 W. 10 chan., freq. range 2 to 18 mc. Can be licensed for marine use with no conversion. 813 final, modulated by two 811's. Small control box permits full remote control without interfering with control at xmtr. itself. Complete with remote control box. 24 V. dynamotor with relay base, all plugs, all tubes, schematic, and calibration charts. Excellent used condition..... **\$135.00**

(3) BC-223. This is the famous Scout-car set made to take a beating. 15 to 25 W output. 4 chan. xtal control. To modify for FCC approval, just remove a few knobs and put one metal screw into a beautiful conversion selector switch from being turned to MO position. Brand new, with tubes, used 12 V dynamotor PE-53, connecting cable, and 12 V battery. Tubes included: approved mike, and reproduction of tech. manual, inc. schematic. Don't forget to specify xtal frequencies. A LUCKY BUY PERMITS US TO OFFER **\$60.00**

MARINE RECEIVERS

(4) G.L. "MARINER." Long wave, broadcast, marine and short wave reception. A beautiful conversion of finest Navy surplus controls. Vernier tuning. BFO ON-OFF, and AVC-MVC on entirely new front panel. Coaxial type antenna fittings furnished. Tagged wires out of rear to connect to battery, to power the DU-1 loop, and (if specified) to kill B+ with xmtr. break-in relay. 12 or 24 V DC. Compacts: 15 1/2" long, 8" wide, 6 3/8" high. No plugs needed..... **\$49.50**

(5) NAVY TYPE ARA SCR-274N. 1.5-3 MC. Rewired for 12 V with brand new 12 V dynamotor unit on back end. Phone plug built into front, rebuilt for front panel control (ON-OFF, vol., CW-MCW, tuning). With harness and plug for 12 V input and for out V inverter, to power DU-1 loop. NEW, converted..... **\$29.50**

Same as above, but for 24 V..... **\$24.50**

(6) DU-1 Manual Direction Finder. Goes ahead of G.L. "Mariner," ARA, or any other receiver. Converted for Marine bands, still retains half of broadcast band and all the light house and beacon band. 2 tube pre-amplifier. No. 180° ambiguity. **\$32.50**

True bearing immediately. NEW, converted..... **\$27.50**

NEW, not converted for marine..... **\$27.50**

NOTE! COMBINATION SPECIAL

A new, marine frequency modified DU-1 Loop will be included **ABSOLUTELY FREE** with each purchase of the 100 W. G.L. "Mariner," Xmtr and either of the receivers listed here. For a limited time only!

(7) PE-55 DYNAMOTOR. 12 V for BC-223, 500 V @ 400 ma., w/relay, filter, etc. **\$9.95**

EXC. USED

(8) CONNECTING CORD with plugs, 10'..... **\$1.50**

long. PE 55 to BC-223.....

(9) LORAN Special Long Range Navigation! The Coast Guard operates radar beacons stations for you. Use them! Take an accurate bearing in 40 seconds, wherever you are and regardless of weather. No night effects! Complete with instructions and for out V inverter, plugs, shock mounts, receiver and indicator. **EXCELLENT USED.** "A" model. **\$49.50**; "B" model..... **\$59.50**

(10) AT LAST! A Loran Manual! All you need out of the AAF manual: schematics, theory, operation, set-up, etc., plus extra instructions and information..... **\$7.50**

274N AND ARC-5 TRANSMITTERS

274N TYPE. 2-1.3 mc. repacks, like new..... **\$ 9.95**

T-18/ARC-5. 2-1.3 mc. repacks, like new..... **10.95**

T-19/ARC-5. 3-4 mc. repacks, like new..... **10.95**

Excellent used.....

BC-457. 4-5.3 mc. excellent used..... **4.95**

BC-458. 5-3-7 mc. excellent used..... **5.95**

As is, less xtal..... **2.95**

BC-459. 7-9.1 mc. excellent used..... **9.95**

As is, less xtal..... **4.95**

T-22/ARC-5. 7-9.1 mc. repacks, like new..... **9.95**

MD-7/ARC-5 Push-pull Modulator. **EXCELLENT.** **9.95**

BC-456. BC-442. Racks, etc. Send for Catalogue.

274N AND ARC-5 RECEIVERS

BC-946. Broadcast band. Unused. Good..... **\$27.50**

BC-454. 3 to 6 mc. NEW **\$6.95**. Good used **\$4.95**

BC-455. 6 to 9 mc. NEW **\$12.95**. Good used **\$7.95**

R-28/ARC-5. 100 to 150 mc. Excellent used **\$17.50**

Local Control Adaptor parts for 274N or ARC-5 recvr. Exact pot, switch, knobs, etched plate, and instruction data. Ready to mount..... **\$1.29**

Spline tuning knob..... **59c**

BC-375 100 watt xmtr unit, 200 KC to 12.5 MC when used with appropriate tuning units. With schematic showing complete parts description for use with dynamotor PE-73 and also with AC power supply conversion instructions. Xmtr only..... **\$12.95**

Tuning Units for BC-375. Specify freq. coverage desired. Excellent condition. With schematic showing parts description..... **\$1.95**

AN/AP5-13. Tall warning Radar xmtr-recvr. 410-420 MC with 30mc IF strip. 19 tubes: 9-6AB5, 5-6J6, 2-2D21, and VR-105. Int cond. **\$14.95**

complete with all tubes and schematic.....

WANTED! Your Spare Surplus Equipment and Tubes! Dynamotors, Recrs, Smtrs, Test Equipment. Send list, stating condition and your rock bottom Price. See our TV ad elsewhere in this issue.

G. L. ELECTRONICS

Note Our New Address:

905 S. Vermont Ave. Los Angeles 6, Calif.

All prices F.O.B. Los Angeles. Calif. buyers add sales tax

SEND FOR OUR LATEST CATALOGUE

SCHEMATICS—CONVERSIONS FOR SURPLUS GEAR

NEW LIST! MANY ADDITIONS!

Send stamped, self addressed envelope for List B. Add 25c for chart explaining AN nomenclature.

R. E. 345 1/2 N. PALM DRIVE
GOODHEART BEVERLY HILLS, CALIF.

International Short-Wave

(Continued from page 112)

with playing of "Soldiers Chorus" from Faust, followed by "Onward, Christian Soldiers"; slogan seems to be "Radio Vera Cruz del Sur."

Here are late tips from the N.Z. *Radio Times* as airmailed direct to me by Arthur Cushen, N.Z.—a new m.w. station in Manila is operating as DZUC on 1000 kc. and has a s.w. outlet DZU3 on 9.600; schedule is announced as 1700-1005 daily, last 5 minutes being news. Latest official schedules of *Radio Pakistan* are 2100-2300, 11.885, 9.645; 0130-0330, 11.885; 0700-0830, 11.885; 0900-1045, 9.645; 1100-1200, 7.263; 0200-0245, 11.885; 2045-2300, 15.335; 0110-0330, 17.835; 0700-1045, 11.545, and 1100-1330, 11.885.

Radio Noumea, 6.038, New Caledonia, appears to have schedule now of 0200-0540 daily; signs on and off with "La Marsellaise"; has added m.w. outlet of 1550 kc. ZYSS, Manaos, Brazil, now on 4.800, noted signing on 0500. Salisbury, Southern Rhodesia, 5.930 and 9.890, signs off 1500.

A last-minute item from *Radio Sweden*, correcting a previous one, says programs in *English* from ZYK3, 9.565, Recife, Pernambuco, Brazil, are now daily 2015-2030 and Sunday 1620-1700.

The *English* program from Lourenco Marques, Mozambique, 2300-0230, 11.764, 9.755, (and perhaps in the 19-m. band—try 15.191) is called "Lucky Disc." ZFY, approximately 5.984, Georgetown, British Guiana, noted with good signal 1800 in Virginia. (Saylor)

ZL3, 11.78, and ZL4, 15.28, Wellington, New Zealand, have a program called "Radio Magazine," for children, Saturday 0030. *Radio Papeete*, 12.080, Tahiti, has new schedule of 2300-2345 daily, native period now starts around 2335. Forest Side, 15.05, Mauritius, noted on a Sunday playing marches 2215-2230, good level but bad fade. *Radio Belgrade*, 9.505, Yugoslavia, is best now in N.Y. during French news 2345. (Bellington, N.Y.)

Radio Ankara, Turkey, seemed to have concluded tests over TAT, 9.515, and at the time this was compiled had been noted from 1925 over TAV, 17.840; may be experimental broadcasts from new 100 kw. transmitter. (Worris, N.Y.)

Radio Budapest, 11.910, 9.825, Hungary, noted with news 1600 and 1815; on Saturday has Mail Bag program around 1610. (Boice, Conn.) Some days seems to have *English* 1800. (Bellington, N.Y.)

From Roland Peddle, Newfoundland, come these tips—Nova Lisboa, 11.925, Angola, still heard 1415-1545, and CR6RG, 8.242, Dundo, noted 1345-1430; Leopoldville, 11.645, is using OTM apparatus under OTC3 call-sign; LZB, 7.671, Sofia, heard 1430-1700; VED, 8.265, Edmonton, Alberta, Canada, heard 2045-2115; CR4AA, 5.920, Praia,



The listening post of Louis Geis, Wolcott, N. Y. Receiver is a Hallicrafters S-20R. Louis collects both s.w. and amateur QSL cards and has veries from 115 countries.

Cape Verde Islands, heard 1530-1700; EA8AB, 7.514, Tenerife, Canary Islands, noted 1530-1700; FIA6, 9.150, Douala, Fr. Cameroons, heard 1430-1530; ZJM7, 11.720, Limassol, Cyprus, heard 1200-1230; OZU, 7.260, Copenhagen, noted 1530-1730 relaying Home Service; Larissa, 6.745, Greece, noted 1230-1500; OIX5, 17.800, Helsinki, Finland, good with news 0715-0730; Tel Aviv, 9.000, Israel, heard 1530-1730 now; Athlone, Eire (Ireland), still noted on 17.84 with newscast 1230-1245; EQB, 9.660, Teheran, Iran, heard 1400-1600; CR7BG, Lourenco Marques, Mozambique, verified and gave frequency as 15.191.

And from Neeley, Oregon—VLI2, 6.090, Sydney, Australia, noted daily except Sat. signing off 0830 with Interstate Program; Saturday sign-off is 0900; surprisingly good signal but has QRM from the Communist-controlled Chinese outlet on 6.095V, and at times has CWQRM as well. YNZZ, 6.465, Nicaragua, has good signal nightly; announces "Radio Mundiales en la capital de Nicaragua"; uses 4-note chime before station break; no *English* noted; does not give call letters over the air; some nights has CWQRM. *Radio Noumea*, 6.038, New Caledonia, has good signal from 0200 opening; announces "La Voix de la France dans le Pacifique, Noumea"; plays quite a few French, Spanish, and *English* recordings. "The Voice of Vietnam," 7.263, is heard with fair to good signals from French Indo-China; news now 0830; has recordings in *English* to 0930 when announces in *English*, then continues in Vietnamese. Dacca, 7.140, Pakistan, can be heard weakly around 1015 with news, through heavy CWQRM. According to an OTC (Leopoldville, Belgian Congo) DX broadcast, ZNB, 8.23, Mafeking, Bechuanaland, is heard in England 1330-1430, news 1400-1430 sign-off. Leopoldville's 9.767 outlet has a DX program in French each Wednesday 1540; is dedicated to France the first Wednesday of the month, to Switzerland the second, to Belgium and Belgian Congo the third, and to Italy the fourth. BED7, 7.151, Taipei, Taiwan, is excellent level in Oregon mornings; scheduled now around 0400-1100 although sign-off varies; is definitely on Summer Time with news

TINIEST V.O.M. IN THE WORLD
 A Niagara Exclusive
 The "Universal Baby Tester"
 Only 3 3/4" x 2 1/2" x 1 1/2"
 Has 0-2400 microammeter, sensitivity of 2400 ohms/volt. Ranges are 0-15-150-1000 V AC or DC; 0-150 MA DC; 0-100,000 ohms. Has ohms adjustor. Complete switch, test leads. Fully guaranteed. Catalog No. N-258 Special... **\$8.95**

LOW PRICED TUBES AND HIGH PASS FILTERS

BANISH INTERFERENCE with NIAGARA'S FAMOUS HI-PASS FILTER
 Positive protection against interference from radar, amateur transmitters, thermionic, and all other generators of RF interference. Fits any 300 ohm antenna feeder. No loss in brightness or clarity. Complete instructions and test findings included.
KIT (all parts included)..... \$1.95
 Wired and Tested..... **2.95**
 Plus 15c postage and handling in U.S.A.

ALL BRAND NEW—STANDARD BRANDS

1B22	3.45	6AF6G	.88	713A	1.00	2050	.95	VR91	1.49	5Z3	.48	6SK7GT	.54	12X3	.98
1B23	8.45	6AS6	2.89	714AY	4.75	2051	.40	VR105	.75	5Z4	.78	6SL7GT	.64	12X3	.68
1B24	4.49	6C21	24.95	715A/B	6.75	5514	4.95	VR150	.50	6A3	1.28	6SN7GT	.64	14A7/12B7	.88
1B25A	4.95	6F4	4.95	715C	22.50	5515	10.00	VT127A	2.00	6A6	.88	6SQ7	.43	14B6	.68
1B26	4.95	717A	4.95	720Y	5.8	5562	10.00	VU111	.50	6A7	.68	6SQ7GT	.43	14B8	.88
1B27	3.95	7B1P	4.95	720Y	34.95	7193	.18	WL460	14.95	6A8	.78	6SR7	.56	14C5	.88
1B29	.89	7BP7	4.50	721A/B	2.60	8005	4.60	WL468	6.75	6A8GT	.80	6SR7GT	.56	14C7	.88
1B32	1.95	7C23	75.00	723AB	7.95	8011	2.00	WL532A	1.75	6AB5/6N5	.88	6SS7	.58	14E6	.72
1B38	34.50	7C25	90.00	724A/B	2.75	8012A	1.25	WL562	150.00	6AB7/1853	.78	6ST7	.88	14E7	.88
1B60	4.95	7DPA	17.95	725A	6.75	8013A	1.25	WL616	85.00	6AC5GT	1.18	6S7	.88	14F7	.68
1N21	1.8	7E4	250.00	726A/B/C	13.50	8014A	24.95	Z225	1.95	6AC7/1852	.76	6T7G	.97	14F8	.88
1N23	.69	9GP7	15.00	728Y	24.95	8015	1.10	ZB120	6.95	6AD6	.88	6U5/G5	.64	14H7	.64
1P23	1.95	9J1P	6.50	730A	9.75	8020	1.25	ZB3200	150.00	6AD7G	1.28	6U6GT	.72	14J7	1.06
1P25	14.50	9LP7	15.00	730TL	49.50	8025A	7.95	0A2	1.56	6AF6G	.78	6U7G	.54	14N7	.88
1S21	3.95	6NPI	7.95	800	1.75	8026	12.95	0A3/VR75	.94	6AG5	.76	6V6	.96	14O7	.66
2APl	3.59	10Y	.39	801A	.28	BR	2.50	0A4G	.84	6AH6	.97	6V6GT	.62	14R7	.66
2B22	3.95	10SPEC	.69	802	4.25	CH	4.95	0B3	1.74	6AH6	1.28	6W7G	.88	14S7	1.06
2C21	1.18	10B4	22.45	803	3.45	C1A	4.95	0B3/VR90	.64	6AJ5	.78	6X4	.58	14W7	1.06
2C22	.28	10CP4	29.50	804	8.50	C5B	12.95	0C3/VR105	.78	6AK5	.84	6X5GT	.48	14X7	1.06
2C26A	.18	12DP7	12.50	805	3.50	C6A	7.50	0D3/VR150	.54	6AK6	.78	6Y6G	.66	14X4	.88
2C34	.25	12FP7	14.95	807	1.25	C6J	3.75	0Y4	.88	6AL5	.64	6Y7G	.88	19T8	.97
2C40	2.98	12GP7	12.95	808	1.35	CEQ72	1.95	0Z4	.56	6AL7GT	1.06	6Z7G	.68	19T8	1.28
2C43	9.50	12KP4	49.50	809	2.50	CK1005	.68	0Z4G	.36	6A5	.58	6ZV5G	.58	24A	.66
2C46	7.50	12L4	25.50	810	2.00	CK1090	2.75	IA3	.43	6AQ6	.58	7A4/XXL	.58	25A6G	1.06
2C51	6.50	15E	1.25	812	2.50	EF50	.35	IA4	1.08	6AQ7GT	.88	7A5	.72	25A6G	1.06
2D21	1.16	23D4	.49	813	6.75	EL3C	4.95	IA4P	.96	6AR5	.66	7A6	.66	25A6G	1.06
2E22	1.25	24G	.35	814	2.40	FI23A	12.50	IA5GT	.48	6AS7G	4.95	7A7	.56	25A6GT	1.16
2E24	4.95	35E	4.95	815	1.25	FI28A	125.00	IA6	.78	6AT6	.48	7A8	.72	25L6GT	1.16
2E25A	4.25	45SPEC	6.75	816	1.19	FI60A	110.00	IA7GT	.68	6AUB	.58	7A97	1.06	25L6GT	1.16
2E26	3.95	53A	24.95	826	.35	FI60	110.00	IB3GT	1.49	6AV6	.46	7AF7	.72	25Z5	.48
2E28	2.39	75TL	3.50	828	9.95	FG17	2.75	IB4	1.18	6B4G	.88	7AG7	.71	25Z6GT	.48
2J21A	10.75	100TH	11.00	829A/B	7.25	FG27A	8.95	IB5/25S	.88	6B5	1.56	7AH7	.88	26	.56
2J26	6.95	100TS	2.00	830	2.95	FG32	5.95	IB7GT	1.06	6B6	.88	7B4	.56	27	.34
2J27	13.95	101F	4.95	830B	3.25	FG33	8.95	IC5GT	.66	6B7	.88	7B5	.72	29D7	.34
2J30	19.95	114A	6.9	832A	4.95	FG95	1.19	IC6	.88	6B8	.38	7B6	.58	30	.56
2J31	8.95	114B	1.25	833A	31.25	FG104	17.50	IC7G	.96	6B8G	1.28	7B7	.58	31	.88
2J32	11.95	120	5.95	834	5.50	FG105	9.50	ID7G	.88	6BA6	.54	7B8	.72	32	.96
2J33	19.95	121A	2.65	836	1.25	FG166	49.50	ID8GT	.94	6BE6	.56	7C4/1203A	.36	32L7GT	.96
2J34	19.50	203A	16.95	837	1.50	FG172A	13.75	IE5GT	1.38	6BG6G	1.46	7C5	.56	33	.68
2J36	75.00	205B	4.50	838	2.25	FG190	14.95	IE7G	1.56	6BH6	.46	7C6	.72	34	.68
2J37	12.95	205F	4.50	841	.30	FG300	17.50	IF4	.68	6BJ6	.58	7C7	.58	35/51	.56
2J38	21	21	.25	842	4.00	GL146	160.00	IF5G	.74	6C4	.24	7E5/1201	.66	35A5	.66
2I48	24.50	215A	.50	845W	3.00	GL415	9.75	IF6	1.56	6C5	.46	7E6	.58	35B5	.66
2I49	19.50	217C	9.80	849A/H	69.50	GL451	4.95	IF7G	1.56	6C6	.56	7E7	.68	35L6GT	.53
2I50	29.50	218	12.50	851A	25.00	GL473	65.00	IG4GT	.88	6C6G	1.28	7F8	1.06	35W4	.38
2J551	4.95	221A	1.75	860	5.75	GL502A	1.98	IG6GT	.68	6C7	.68	7G7/1232	1.06	35Y4	.56
2J54B	24.95	227A	2.65	861	35.00	GL530	49.50	IG8GT	.68	6C8	.68	7H7	1.06	35Z3	.48
2I61	24.50	231D	1.20	864	3.35	GL530	49.50	IH5GT	.68	6D9	.48	7I7	.63	35Z4GT	.43
2K23	24.95	249C	1.75	865	1.25	GL673	11.50	IH6G	.86	6D9G	.87	7I7	1.06	35Z5GT	.40
2K25	24.95	250R	7.00	866A	1.95	GL697	65.00	IH6GT	.86	6E6	1.06	7L7	1.06	36	.39
2K28	24.95	250TH	19.50	866J	1.19	HF100	3.95	IJ6GT	.88	6E6	.46	7N7	.68	37	.34
3AP1	4.75	252A	4.95	872A	1.30	HF200	17.95	IL4	.54	6F5	.46	7N7	.68	38	.27
3B22	2.50	259A	4.95	874	.38	HF210	17.95	IL4A	.78	6F5GT	.46	7Q7	.58	39/44	.26
3B23	4.95	274B	1.00	876	1.25	HF300	17.50	IL6A	.88	6F6	.64	7R7	.68	41	.51
3B24	1.95	275A	7.95	878	1.75	HF254	19.95	ILB4	.88	6F7	.84	7V7	.79	43	.48
3B24W	4.95	282A/B	9.95	884	1.49	HV18	12.95	ILC5	.78	6F8G	.86	7W7	.88	45	.51
3B25	2.80	283A	10.95	885	.98	HV69	2.75	ILC6	.56	6G6G	.88	7X7/XXFM	.88	45Z3	.56
3B26	1.50	286A	10.95	891	110.00	HV312	2.75	ILD5	.78	6G8	.68	7Y4	.56	45Z5GT	.48
3B27	1.95	287A	9.95	902PI	3.50	HV615	.20	ILE3	.88	6H6	.46	7Z4	.56	46	.68
3B28	5.95	290A	4.95	905	2.75	HV1269	2.75	ILG5	.83	6H6GT	.48	7Z5	.69	47	.88
3BP1	2.50	291A	4.95	922	1.00	KU23H	15.00	ILH4	.64	6I5	.48	7Z5	.56	49	.88
3C23	2.75	294A	1.00	923	.75	KU23	15.00	ILN5	.66	6J5GT	.48	12A6	.18	50	1.56
3C24	.35	301A	6.95	925	1.40	KU610	9.50	ILN5	.66	6J6	.76	12A6GT	.18	50A5	.68
3C30	3.50	304B	5.95	931A	2.60	ML101	75.00	IP5GT	.58	6J7	.66	12A6GT	.18	50B5	.54
3C31	3.50	304TH	3.50	949A	69.50	MX-108U	.49	IQ5GT	.66	6J7GT	.66	12A8GT	.58	50L6GT	.54
3C45	12.80	304TL	1.30	950	.98	R100	3.75	IR5	.88	6J8G	.66	12AH7GT	.84	50V6GT	.56
3CP1	1.40	307A	4.95	954	.30	R200	7.95	IS4	.78	6K6GT	.96	12AL5	.80	53	.86
3DP1A	1.40	308A	7.95	955	.35	R1130	12.95	IS5	.56	6K7	.48	12AT6	.44	56	.43
3D21A	1.10	315A	6.95	956	.35	RL36	.55	IT4	.56	6K7GT	.48	12AT7	1.16	57	.37
3EP1	2.50	316A	.50	957	.19	RK12	2.50	IT5GT	.78	6K8	.78	12AU7	.78	59	.88
3E29	7.95	327A	2.50	958A	1.8	RK19	1.50	IU4	.58	6K8GT	.78	12B6	.56	70L7GT	1.16
3FP7	1.75	331A	14.50	959	.39	RK20A	7.95	IU5	.78	6L5G	1.06	12C8	.48	71A	.52
3GP1	4.95	338A	3.75	966A	.35	RK21	4.95	2A3	.66	6L6G	.86	12F5GT	.57	76	.38
3HP7	3.50	348A	5.95	967A	1.45	RK22	4.75	2A4G	1.06	6L6GA	.86	12H6	.26	77	.42
3JP7	7.95	350A/B	2.75	975A	14.95	RK25	4.95	2A5	.68	6L7	.78	12J6GT	.26	78	.44
4-65A	14.50	354C/D	19.95	991	.23	RK28A	3.95	2A6	.78	6L7G	1.16	12J7A	.80	79	.88
4-125A	27.50	357B	49.50	1603	3.50	RK31	2.50	2A7	.88	6L8	.96	12K7GT	.53	81	1.28
4-250A	37.50	371A/B	.50	1611	1.25	RK32	3.95	2A8	.88	6N7	.78	12K8GT	.58	82	.86
4A1	.98	374A	2.50	1612	1.50	RK33	.25	2V3G	.98	6N7GT	.78	12K8GT	.66	83V	.88
4AP10	4.50	393A	3.50	1613	1.35	RK34	.25	2X2A	.68	6P5GT	.96	12L7GT	.58	84/624	.62
4B25	7.95	394A	3.50	1614	1.35	RK39	1.75	3A4	.36	6Q6G	1.06	12Q7GT	.48	85	.68
4C21	.69	399A	2.50	1616	.15	RK47	3.95	3A5	.98	6Q7	.58	12S7GT	.56	86	.88
4C35	19.45	400A	3.25	1619	.98	RK48A	3.95	3A8GT	1.98	6Q7GT	.78	12SC7	.56	87	.72

INVENTORY SALE

ALL PRICES CUT TO BONE

25c TUBE SALE—#53-247-55-27-85-31-56-57.....6 for \$1.00
TUBES—O24, 79c; 6SC7, 35c; 117P7.....95c
12 BRAND NEW 10" PHONO RECORDS—Ass't. Jazz—Pop—Hillbilly—Folkas.....\$1.79
WOOD MIDGET CABINET, 8 1/2x5 7/8x4 1/4.....69c
3 Ft. 5 Wire Shielded Cable with Amphenol Connection.....8 for \$1.00

U. S. ARMY GAS MASKS

Has O.D. covered case suitable for lunch or tool bag and charcoal container for use in refrigerators to eliminate fish or other odors.
 Brand new—39c each; 3 for \$1.00

TRANSMITTING PLATE TRANSFORMERS

A pair of Signal Corps transformers connected in series to 110-125 Volts, AC, will deliver approximately 750 to 800 Volts, DC, 200 mls. when connected to a rectifier tube and condenser. Cost Uncle Sam \$23.00—per pair, \$2.98. Shipping weight 33 lbs.



JONES 20 TERMINAL BARRIER STRIP.....25c

Signal Corps Phones—2 M. Ohms (8 M. Ohms Imp.).....\$1.00
 2 Ft. Ext. Cord (and Plug).....40c

OIL FILLED FILTER CONDENSERS

1.—MFD—2000 volts.....75c ea.
 1.—MFD—1000 working volts.....16/99c; 12/\$1.75

FAMOUS BRAND RECORD CUTTING HEAD
 Size 1 3/8x2 7/8—ready to fit your cutting arm or bracket. SPECIAL.....\$2.95

TOBE TUBULAR ELECTROLYTICS

20-20 MFD, 150 V.....25c 30-30 MFD, 150 V.....30c
 40-40 MFD, 150 V.....25c

2 1/2 M.H. R.F. CHOKE COIL—27c ea. 5 for \$1.00

3 BAND OVAL DIAL—7 1/2" L x 5 1/2" H.....60c

100 RESISTOR ASST. 1/4-1/2-1 WATT.....95c

Low-Loss Short Wave Lock Type Air Trimmer Variable Condensers



3PI—12-15 Mmfd.12c
 8PI—30-35 Mmfd.16c
 10PI—40 Mmfd..17c
 14PI—36 Mmfd..24c
 20PI—80-100 Mmfd.28c
 27PI—100-110 Mmfd.35c

3 GANG T.R.F. VARIABLE CONDENSERS
 D.E.N.S.E.R.S
 .000265 Con. 65c
 D.P.D.T. SLIDE SWITCH.....15c
 C-D-4 MFP 600V—Oil Upright Bottom Log Elec. Filters 49c

4 PR. WAFER SOCKETS—\$1.49 per C. each.....3c
 PHILCO 4 MF—30 V.—1 3/4" CAN CONDENSER—10c ea.
 5-6 PRONG WAFER SOCKETS.....\$2.50 per C
 100 ASST. SOCKETS—4-5-6-7.....\$3.50 per C
 1,000 OHM WIRE WOUND POTENTIOMETER.....15c
 30 HY-FILTER CHOKE SHIELDED.....3 for \$1.25
 UNSHIELDED.....3 for 1.00
 2,000 ohm Wire Wound Rheostats.....\$1 per doz.
 CARTER WIRE WOUND C.T. VARIABLE 20 OHM RESISTORS.....85c per doz.
 RCA 6 OHM POWER RHEOSTATS.....\$1 per doz.
 GEN. ELEC. WESTINGHOUSE, etc. 60 CYCLE WATT HOUR METERS, slightly used, perfect condition, same as used in your home. 110-125 volts.....\$3.95
 10 Amps.....

PIEZO CRYSTAL HOLDERS with cover.....12 for \$1.00

Grind your own crystals—Pure Brazilian Quartz, all sizes and thicknesses—1/2 lb. package.....\$1.00

RCA Band Switches—3 gang, 3 pos. 3 band.30c 6 gang, 5 pos. 4-5 band.40c

I. C. A. 30 MH RF choke.....25c

Trimmer-Padder Ass't.—all isolantite—singles, dual, triples—100 asst. pieces.....\$2.25

5"—450 ohm AC-DC dynamic speaker.....\$1.25
 Philco rotary tap tone control.....25c

ATTENTION: Prospectors, Explorers for Hidden Treasures! Construct a U.S. Army Type of Metallic Mine Detector Amplifier. Amplifier unit only (less tubes and batteries) with cables, headphone cord, and jack. Army wiring diagram. Type AX/PRS-1.....\$1.95



H&H TOGGLE SWITCH, DOUBLE POLE—DOUBLE THROW.
 29c ea. Lots of 100-25c

DRILLED CHASSIS FOR 5-6 tubes 5"x10"x1 1/2".....25c
 RCA ADJUSTABLE CODE INTERFERENCE WAVE TRAP 436-475 K.C......25c
 PHONE JACKS—OPEN & CLOSED AUTO.....15c
 NATIONAL 20 MFD—450 VOLT CAN FILTER CONDENSER VOL. CONTROL—60 OHMS.....25c
 ERY SPEAKER.....15c
 SALE—PHONO RECORD ALBUMS—SALE
 10"—3 comp.—15c; 4 comp.—20c; 12 comp.—49c
 12"—5 comp.—15c

WESTERN ELEC. TRANSMITTING STEP-DOWN TRANSFORMER AC 110-230, 250 V. W.25 20 AMP. RETARD CHOKE TO MATCH. Wt. 125 lbs. ea. Freight Shipments Only. SPECIAL, \$5.00 ea.

75 MFD., 25 V. Tubular Cond.....15 for \$1.00

CD. 4 MFD. 440 V. Oil Filters.....39c

4 Wire Shielded Cable, 6 Ft. with Plug.....7 for \$1.00

IRC—300 Watt—300.000 OHM Wire Wound Resistor.....95c

6 Prong Amphenol Sockets.....\$4.00 per C

Transmitting Filter Cond. Ass't., W.E. Parvoit, RCA, G.E., Etc. Cap. 1 MFD—3 1/2 MFD..6 for \$1.00

MINIMUM ORDER \$2.00—NO C.O.D. SHIPMENTS—PLEASE INCLUDE POSTAGE

NEWARK
SURPLUS MATERIALS CO.
 Dept. JY
 324 Plane Street NEWARK 1, N. J.

0500 or 0515 (confirmed by Rosenauer, Calif.); Paris, 9.55, noted signing on in French 0030; and testing on approximately 16.9 around 1545.

Latest schedule from Radio Pakistan, 6, Intelligence School, Queen's Road, Karachi, Pakistan, lists newscasts for 2100-2115, 9.645, 15.335; 0100-0120, 17.835; 0210-0220, 11.885, 17.835; 0700-0710, 11.845, 11.570; 1015-1030, 9.645, 11.570. (Rosenauer, Calif.)

The new 4VEH, approximately 9.886, Cap-Haitien, Haiti, missionary station, noted mornings to 0800. (Stark, Texas) OAX1B, 6.197, Peru, heard 2200 with commentary in Spanish; at 2230 played 3-tone chime interval, then continued with popular Spanish music. (Whitman, Ill.)

A Soviet station is now operating on approximately 9.61 with programs in Spanish; beats with ZYC8, Radio Tamoio, Rio de Janeiro, at 1500 and later; Russia seems to have expanded all its programs and stations; many new channels noted on the air. (Serano, Brazil)

CHNX, 6.130, Halifax, Nova Scotia, is scheduled Mon.-Sat. 0600-2315, Sun. 0800-2315; QRA is Broadcasting House, P.O. Box 400, Halifax, Nova Scotia, Canada; an IRC should be sent with report. (ISWC, London)

According to the International Short Wave Club, London, "As a living tribute to Dr. Walter A. Maier, champion of Christ through worldwide radio broadcasts, the new 'Dr. Walter A. Maier Memorial Broadcasting Station' has begun regular broadcasts from Tangier over the 6.200 channel. This station was inspired by the thousands who sent contributions for the continuance of Dr. Maier's outstanding missionary achievement through his weekly radio campaign for Christ, 'Bringing Christ to the Nations'; schedule is Monday, Yugoslav 1500, Russian 1515, Finnish 1530, Albanian 1545; Tuesday, Slovak 1500, Polish 1530, Bulgarian 1545; Wednesday, English 1500, French 1530, Persian 1545; Thursday, German 1500, Roumanian 1530, Greek 1545; Friday, Ukrainian 1500, Lithuanian 1515, Armenian 1530, and Hungarian 1545.

The Forces Broadcasting Service, Middle East, Cyprus, has been heard on a new channel of 11.910 relaying the Malta Middle East sports items originated by Fayid, 7.220, Suez Canal Zone. (Bluman, Israel, via ISWC, London)

Radio Congo Belge, P.O. Box 3, 151 Leo Kalina, Leopoldville, Belgian Congo, is now scheduled over OTM1, 6.295, 0000-0200, 0500-0700, 1100-1500; OTM2, 9.380, 0000-0200, 1100-1500; OTM4, 11.720, 0515-0700. (ISWC, London) If OTM2 is not found on 9.380, try 9.400 where it has been reported operating more recently.

* * *

Acknowledgement

Thanks for the splendid cooperation during the summer; keep reports coming to 948 Stewartstown Road, Morgantown, West Virginia, USA. Good DX-ing, fellows! . . . KRB.

Mae's Service Shop

(Continued from page 63)

bypass condenser or a defective tube or a bad resistor, but the chances are that a light tapping of the coupling condensers will reveal that one of them intermittently 'opens.'

In answer to Miss Perkins' questioning glance, Mac made a circle of approval with his thumb and forefinger. "Case Number Two": she intoned. "The lady says that this radio is weak and not clear when she first turns it on; but the longer it plays the better it sounds. After being on a half hour or so, it is OK; but she is tired of having to turn it on thirty minutes or so ahead of any program she wants to hear."

"That sounds like a weak input filter condenser," Barney offered a little more cautiously. "The electrolytic condenser has some of its capacity restored as the voltage is kept on it, and this increased capacity reduces the hum and builds up the voltage as the radio is left on. Bridging the input condenser with a good unit directly after turning the set on will quickly show whether or not I am right."

"Give that man ten silver dollars!" Mac approved in his best "Dr. I.Q." manner.

"Here's another complaint about volume," Miss Perkins continued. "Maybe it's the same as that first one. The owner of the radio says that he has either too much or too little volume. The control is noisy when he turns it, and the volume keeps hopping back and forth between a whisper and a shout. He can't adjust it to a comfortable value, and when he tries to do so the radio howls and squeals."

"No," Barney said as he judiciously stroked his lean jaw, "that does not sound like coupling condensers. It sounds more like a volume control with a poor connection in a portion of the sliding contact. I'd prescribe a new control."

"And I concur in the diagnosis and prescription of Dr. Jameson," Mac said gravely.

"Say, Red, you are doing all right!" Miss Perkins exclaimed. "Try your pointed little head on this one: during a thunderstorm the owner was awakened by the sound of his radio playing away through the static crashes, although he was certain he had turned the set off before going to bed. When he tried to turn the radio off he could not do so, and he had to pull the plug from the wall socket to quiet it."

"Obviously the switch is bad. Lightning struck the power line and travelled along it until it reached the radio. There it jumped the switch contacts, and this arc welded the contacts together or destroyed the spring that is supposed to click them together or apart."

"A very good deduction," Mac applauded; "however, there is one other possibility: if the radio chassis is

MAIL ORDER ADDRESS
 1060-2 N. ALLEN AVE.
 PASADENA 7, CALIF.
 SYCAMORE 4-7156
 RYAN 1-8271

PHOTOCON SALES

AUGUST SPECIALS

RETAIL SALES STORE
 1240 EAST COLORADO ST.
 PASADENA 1, CALIF.
 SYCAMORE 6-7217

HIGH VOLTAGE OIL CAPACITORS BRAND NEW

1. mfd.—15,000 WVDC General Electric Pyranol	\$14.95
.65 mfd.—12,500 WVDC Cornell Dubilier	12.95
.02 mfd.—20,000 WVDC Cornell Dubilier	4.95
.6 mfd.—25,000 WVDC Industrial Condenser	14.50
.00025 mfd.—25,000 WVDC Western Electric	3.00
1. mfd.—6000 WVDC Westinghouse	5.95

SPECIAL PRICES—AUGUST ONLY

BC-222 Walkie-Talkie—Frequency 28-52 mc., with crystal—less tubes, battery and antenna	NEW \$11.95
BC-684—Transmitter with tubes—Frequency 27—38.9 mc. Excellent mobile—25 watts. EXCELLENT COND.	12.95
MN-26C—Bendix Compass Receiver—150—1600 K.C. with dynamotor, tubes, shock mtg. and new MN-20E Loop	EXCELLENT COND. 17.50
APN-4—Indicator Scope and Receiver Power Supply with tubes, and crystal—GOOD USED	BOTH FOR 29.50
PE-237—Mobile Power Supply—Vibrator, heavy duty, 6, 12, or 24 volt input 5.25 V. @ 95 ma., 105 V. @ 42 ma., 6.5 V. @ 2 amps, 6V. @ 500 ma., 1.3V. @ 450 ma., small supply 100V. @ 17 ma., 1.35V. @ 450 ma. Shock mounted.	NEW 14.50

SOUND POWERED HEAD AND CHEST SETS—T.V. INSTALLATIONS

FIELD TELEPHONES	HOME INSTALLATIONS
LIGHT WEIGHT TYPE	
MANUFACTURED BY U. S. INSTRUMENT CORP.	
New	\$5.95 per set \$11.00 per pair
Excellent used	3.95 per set 7.50 per pair
Pair Used-Tested	2.95 per set 5.00 per pair

SCR-522 EQUIPMENT

SCR-522 TRANSMITTER - RECEIVER UNIT with tubes. EXCELLENT COND.	\$59.00
PLUGS—Set for SCR-522 (6 plugs)	NEW 3.75
PE-94—24 volt Dynamotor power unit for SCR-522	NEW 4.50
BC-602 Control Box	NEW .95
BC-631 Jack Box	NEW .79
AN-104A Antenna	NEW STEEL \$1.95 COPPER 2.95

Crystal and Coil Sets for Handy-Talkies, 2670, 3885, 4280, 4510, 5327, 5437.5, 5500 K.C.—2 crystals and 2 coils per set.....PER SET—NEW \$ 1.95

MINE-DETECTOR SCR-625 for locating metal, underground pipes, etc., with manuals.....NEW 59.50

I. F. Transformers for SCR-522—1st, 2nd and 3rd.....NEW EACH .35

CD-501 Cable for PE-103-BC-654.....NEW 1.95

SPEAKER—6" Compartment P. M. Weather-proof—25 watts.....EXCELLENT 7.75

TRANSFORMER—200-0-200 @ 50 ma. 6.3 V. @ 3 amps. 115 V. Primary	NEW \$ 1.45
TRANSFORMER—700-0-700 @ 75 ma. 6.3 V. @ 1.2 amps. 6 V. @ 3 amps.—115 V. primary 60 cycle	NEW 1.95
TRANSFORMERS—6200 V. @ 325 ma. easily C.T. for 3100-0-3100 @ 650 ma.—Primary 105/110/115 V.—60 cycles. American Transformer Company	NEW 39.50

TEST EQUIPMENT

IE-19A Test Set for SCR-522 Complete with manual, original factory packing	BRAND NEW \$325.00
IE-36 Test Set for SCR-522—EXCELLENT USED \$22.50	BRAND NEW 29.50
TS-181A/AP Test Set for APS-13—GOOD USED \$44.50	BRAND NEW 64.50
I-99 Test Set.....EXCELLENT	9.95
BC-906 Frequency Meter.....EXCELLENT USED	12.95
I-100A Contains BC-713 and BC-714—Test Set for ARN-7 and 269 Compass	LIKE NEW 595.00
TS-16/APN Test Set for APN-1 Altimeter.	69.50
BC-221 AJ and AK Frequency Meters.....NEW	125.00
BC-221 AJ and AK Frequency Meters.....EXCELLENT USED	89.50
BC-221 Frequency Meters...GOOD COND.	69.50
LM Frequency Meters—GOOD USED	\$69.50 NEW 79.50
I-122 Signal Generator by Espy Mfg. Co.—15-27, 95-127 mc.....EXCELLENT	79.50
I-222 Signal Generator.....EXCELLENT	75.00
TS-15A/APM-3 Signal Generator 9200-9600 mc. 110 V. 60-800 cps.....LIKE NEW	125.00

Plug for APN-4 Scope and Receiver—Complete Set.....NEW	\$3.75
Mountings for APN-4 Scope and Receiver.....EACH	2.00

FL-8 Range Filter.....NEW	\$1.95
HS-23 Hi Imp. headset with ear cushions.....NEW	2.45
CD-307 Extension Cord for HS-23—HS-33	.49
MC-385D—Headset adapter.....	.35
ASD Radar Scope with 5FP7. USED	\$2.95 NEW 3.95
HS-30 Headset—Complete with matching transformer, 6' cord and PL55 plug	NEW 1.95
HS-30 Headset.....NEW	.95
Dynamic Headset and Mike—P. O. Mark II.....NEW	1.95

WESTON TACHOMETER GENERATOR—Model 724 Type C.....GOOD USED	\$12.95
WESTON ELECTRICAL TACHOMETER METER Model 545 for use with 724 Generator. Speed 0-2000 R.P.M.—Ratio 2:1.	NEW 14.50

APN-1 Altimeter Indicator, basic movement 0-1 ma.: 5 ma. shunt, 270° dial. An excellent basic movement for constructing your own meters.....BRAND NEW	\$ 1.95
Meter Rectifier—full wave midget selenium—10 volts 30 ma.....NEW	.29

BC-464 TARGET RECEIVER—5 Channel Remote Sensitive Relays, Battery Case, Antenna, 68-73 mc.....BRAND NEW	\$14.95
---	---------

BC-348 Mounting Base.....NEW	\$ 2.25
BC-348 Outlet Plug.....NEW	.69
BC-348 Mounting Base and Outlet Plug.....NEW	2.50

TUBE SPECIALS

5CP1 5" Cathode Ray Tube—New boxed, 4 for \$4.00.....EACH	\$ 1.19
BC-620 MOBILE FM TRANSCEIVER—20 to 27.8 mc. with tubes.....EXCELLENT COND.	\$11.95
RM-29—Part of SCR-284, similar to EE-8. Excellent for wall mounting type telephone.....NEW	\$ 7.95

TERMS: Prices f.o.b. Pasadena. 25% on all C.O.D. orders. Californians add 3% sales tax.

NEW! the MEISSNER 9A

AMERICA'S GREATEST RADIO VALUE!

MEISSNER takes great pride in announcing their new 9A AM-FM chassis complete with Audio. The 9A brings real "Custom" quality reception into the low price field! A complete AM-FM unit — the 9A is a tuner, amplifier and power supply — everything you need for a deluxe custom installation or for converting older radios. Nine tubes, including rectifier, give the 9A ample power while a high degree of stability and selectivity is attained through superior MEISSNER circuit design and the use of high quality components. MEISSNER engineers stress that only a high quality speaker is capable of reproducing the wide range fidelity and tonal richness inherent in the 9A. See this fine instrument at your dealers now. Examine the workmanship — hear the glorious richness of its tone! Compare the MEISSNER 9A with units selling for twice its price. You will agree, it's MEISSNER — For Magnificent Reception!

AM-FM TUNER CHASSIS
 COMPLETE WITH AUDIO

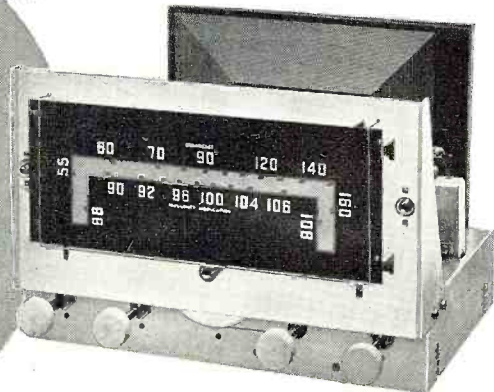

Here's the outstanding 9A — complete with tubes, power supply, built-in antenna, escutcheon, knobs, etc.

features that place the 9A in a class by itself

- High Selectivity and Sensitivity
- Full Audio Fidelity
- Full 4-Watts Output
- FM Circuit Temperature Compensated
- Air Wound FM-Coils
- Separate AM and FM Condenser Sections
- Built-In High "Q" Die Stamped Loop Antenna
- Full Range Tone Control
- Complete Provision For Phono Input
- All Controls On Front Panel
- Power Outlet For Phono Motor

MEISSNER

FOR MAGNIFICENT RECEPTION

MEISSNER MFG. DIVISION, MAGUIRE INDUSTRIES, Inc., MT. CARMEL, ILLINOIS



IMMEDIATE DELIVERY ON ALTEC 21B MIKES

Production Facilities
Stepped Up To Meet
Unprecedented Demand

All Types Now Available...

Since March of '49, Altec has been scrambling to catch up with the deluge of orders that followed the introduction of the 21B miniature microphone. Now, the company is happy to announce that expanded production facilities are in operation, and deliveries will be made upon receipt of order. This is true for all models of the 21B stand, chestplate and lapel.

* A new brochure, giving full details on all models of the 21B, is available on request.



"The mike that became a must" with entertainers and public speakers



1161 N. VINE STREET, HOLLYWOOD 38, CALIF.
161 SIXTH AVENUE, NEW YORK 13, NEW YORK

grounded to a good ground, such as a water pipe, the current may be entering one side of the transformer primary from the 'hot' side of the line, passing through the primary, and then returning to the ground by way of a shorted bypass condenser between one side of the primary winding and the chassis. If so, the set can be turned off as soon as the ground is removed from the chassis."

"Another of this man's radios went out at the same time," Miss Perkins read on. "This one will play, but it has no volume. However, when the man places his hand near one of the tubes, the volume picks up."

"Lightning burned out the antenna coil primary," Barney said with confidence. "Placing a hand near the grid circuit of the mixer allows the signal picked up by the body to be transferred to the input circuit of the set and so brings up the volume."

"Spoken like a maestro," Mac murmured.

"And here we have a radio that sounds like whoever is talking has a mouth full of .mush," Miss Perkins read from another card. "It especially sounds that way at low volume."

"Hm-m-m-m, a case of distortion," Barney said reflectively. "That sounds to me like a leaky coupling condenser that is overcoming the negative bias on the output tube with a positive voltage that is present at the other end of the condenser."

"I'm afraid I can't go along with you on that," Mac demurred. "A leaky coupling condenser *will* produce the kind of distortion described; but when that is the cause, the distortion always grows worse as the volume is increased and the grid is swung even more positive. A more likely guess is that the voice coil is rubbing on the pole piece. At low volume, friction keeps the coil from moving enough to produce normal tone. At high volume, though, it is jerked back and forth so rapidly and violently that it does not get a chance to stick."

"Of course," Barney agreed. "I was a dumb ox not to think of that."

"Don't let it fret you," Mac consoled him. "None of us can know it all in this radio game. Something new turns up every day. The guy who thinks he has nothing to learn is the guy who is on his way out, but—"

He was interrupted by the opening of the front door. They had been so busy talking that they had not noticed that the storm had ceased. The little man who came into the shop carried a small record player under one arm and an album of records under the other. Mac hopped from the bench and went to meet him.

"Mr. McGregor," the little man said, "I wish you would tell me what is the matter with this record player. All the time it is noisy. Just you take a listen."

Without giving Mac a chance to say anything, he plunked the player down on the counter and plugged it into a wall socket. Then he selected a 33 $\frac{1}{3}$

CONVERSION CABINETS

by **River Edge**
INDUSTRIES



Such as that shown will easily convert old 7-, 10-, or 12-inch sets to 16- or 19-inches. The receiver illustrated was originally a 12½-inch standard, name-brand table model. Now it is a 16-inch console of beautiful limed oak. Available with half or full doors.

Special finishes are available to match any furniture setting. Simply furnish us with a sample drawer or the like. River Edge also offers a complete line of contract or custom television cabinets.

RIVER EDGE INDUSTRIES

5 RIVER EDGE ROAD

RIVER EDGE, N.J.

ORADELL 8-2598

r.p.m. record from the album and put it on the turntable. Sure enough, the music could barely be heard above the scratching and rasping sounds that issued from the speaker.

Mac raised the needle from the record, and instantly the noise ceased. Tapping the case of the player with the fingers brought no return of the noise.

"Sounds to me like you are trying to play a worn-out record," Mac told the man.

"No, no, no!" was the emphatic reply. "That is a brand new record. So are these others; but just you listen." Saying this he took another gleaming record from the album and put it on the turntable. It was as noisy as the first.

Mac scratched his head in puzzlement. Then he stepped into the service department and came back with a jeweler's magnifying glass screwed into his eye-socket. First he carefully examined the record on the turntable, and then he scrutinized the point of the pickup needle. Finally he walked over and took one of his own records from the rack and put it on the turntable. The music came forth as clear as a bell, with not a sound of scratch.

"It is your records," was his hardly-necessary pronouncement; "but I can't figure out what is the matter. Is there any way that some kind of abrasive dust, like emery-dust, could get on your records?"

"Oh, no," the little fellow denied, vigorously shaking his head. "No dust causes this trouble. My wife Lena reads that dust in the grooves is what wears out those oh-so-expensive needles; so always before we play a record, even a brand-new one, she carefully goes over it with a fine wire brush like you use on suede shoes and cleans every bit of dust out of those little grooves."

In the room behind him, Mac heard a sound as though some one were strangling; but let it be set down to his everlasting credit that he hardly changed expression as he began gently and patiently to explain that a soft camel-hair brush would be ever so much better for cleaning the records than that fine wire brush!

-30-

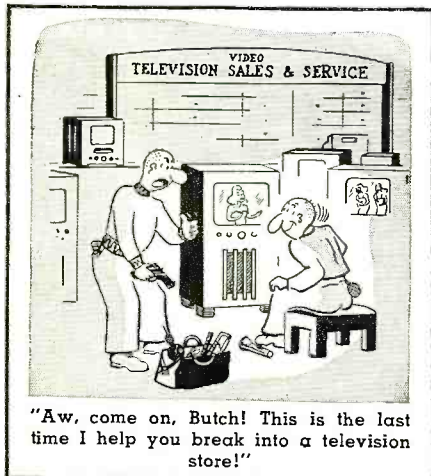

"Aw, come on, Butch! This is the last time I help you break into a television store!"

RECORD SMASHING VALUES! CAN YOU? BEAT 'EM?

3" TRIUMPH OSCILLOGRAPH
Complete Test Scope, with built-in Wobbulator, so as to be used on TV or FM servicing. Operates from 110 V. o. l. t., 60 Cy. A.C. Limited Supply. All these units have been carefully checked and are in excellent condition. A Real Buy. . . . \$39.95 ea.

GYRO MOTOR UNITS
Dual Gyro Unit which was used in conjunction with Auto-Pilot equip. Both Gyro Motors mounted on a single base, wired in parallel for 12 or 24 Volt operation. One used as the Azimuth control and the other as an elevation control. When ordering these Units, specify 12 or 24 Volt.
Our price—Special. . . . \$4.95 ea.

BC 1073 WAVEMETER
Resonant cavity tuning from 120 to 210 MCS. Complete with power supply for 110 Volt, 60 Cy. A.C., and 18 tubes.
Our low price. . . . \$19.95 ea.

T.C.S. POWER SUPPLIES
12 Volt Dual Dynamotor Units
Input—12 Volt D.C.
Output—220 Volt D.C. @ 100 MA . . . \$22.50 set
400 Volt D.C. @ 200 MA
24 Volt D.C. Motor Generator Set complete with Two 24 Volt, 3/16 H.P. Motors driving two Generators, which put out following voltages
225 Volts @ 100 MA
400 Volts @ 200 MA
12 Volt D.C. at 5 Amps. . . . \$35.00 set
Both above units, complete with mounted Filter Bases.

6 INCH WATERPROOF SPEAKERS
Plastic Cone V.C. IMP. 6-8 ohms. Ideal for all outdoor purposes. . . . Limited Supply. . . . Used but in excellent condition. Approx. wt. 15 lbs.
Our price ea. \$4.95

C-1 SERVO UNIT
Part of C-1 Gyro. Contains 24 V. DC. Servo Motor Clutch 4 Relays which control rotation of motor and a set of differential gears which control speed of output shaft in either direction. Can be used by itself to rotate beam antenna or as a tower rudder control. Excellent condition. . . . \$4.95 Ea.

ATTENTION HAMS! GREATEST BUY EVER!
MODEL GO-9 TRANSMITTERS. ALL BRAND NEW. This type of transmitter was used primarily in the U.S. Navy for C. W. and M.C.W. transmission with approximately 100 watts power output. Power supply operates from 115 V., 400 to 800 Cy. but is easily changed for 60 Cy. operation. These units cover the 40 and 80 meter bands directly using an E.C.O. With a simple addition they can also operate on 10 meters. A good modulator for voice transmission can also be put into this equipment. Frequency range is from 300 to 600 K.C. and from 3,000 to 18,000 K.C. These units are furnished with tubes, cables, original schematic diagram and conversion diagrams. Also data for the 10 meter and modulation conversion and all other necessary conversion for operation are supplied. ALL BRAND NEW, COMPLETE. . . . \$74.95 Ea.

MINE DETECTOR, AN/PRS-1
Easy to operate, easy to carry. Can be used for detecting ore deposits, both metallic and non-metallic. Now being used extensively by Miners, Prospectors, Beachcombers, and Explorers. These sets are brand new and come complete with Detector head with antenna; Reflector meter and housing and exploring rod; a bag for carrying equipment while operating and a wooden case for storing or transporting unit when not in use. These units contain Tubes, and instruction books. Shipping weight is 125 lbs. Weight when operating unit is 22 lbs. All New—Complete with Batteries and ready to operate. . . . Set \$29.95

HEINEMANN CIRCUIT BREAKER
15 Amp.—120 Volts AC . . . \$.97 Ea.
7 Amp.—24 Volts DC . . . \$.50 Ea.
ALL NEW (Appr. 1 lb. ea.)

METERS
Westinghouse—G.E. Weston

MILLIAMPERE D.C. 3"-0 to 50. \$3.95 Ea. 3"-0 to 100. 3.95 Ea. 3"-0 to 150. 3.95 Ea. 3"-0 to 200. 3.95 Ea. 3"-0 to 250. 3.95 Ea. 3"-0 to 500. 3.95 Ea. 3"-0 to 750. 3.95 Ea. 3"-0 to 1000. 3.95 Ea. 3"-100-0-100. 1.95 Ea.	KILOVOLT D.C. 3"-0 to 400 DC. \$3.95 Ea. 3"-0 to 500 DC. 3.95 Ea. 3"-0 to 2500 DC. 3.95 Ea. 3"-0 to 1.5. 3.95 Ea. 3"-0 to 4. 3.95 Ea. 3"-0 to 20. 3.95 Ea.
AMPERES D.C. 3"-0 to 2.0. \$3.95 Ea. 3"-0 to 14. 3.95 Ea. 3"-20-0-20. 2.95 Ea. 2"-0 to 150. 2.95 Ea. 2"-0 to 240. 2.95 Ea.	R.F. AMPERES 3"-0 to 1.0. \$3.95 Ea. 3"-0 to 5. 3.95 Ea. 3"-0 to 8. 3.95 Ea. 3"-0 to 10. 2.95 Ea. 3"-0 to 15. 3.95 Ea. 3"-0 to 20. 3.95 Ea.
VOLT METERS 3"-0 to 8 AC. \$2.95 Ea. 3"-0 to 15 AC. 2.95 Ea. 2"-0 to 30 DC. 3.95 Ea. 3"-0 to 150 DC. 3.95 Ea.	2" WESTON SPECIAL 0 to 30 V. DC and 0 to 120 Amps. DC \$3.95 Ea. 0 to 30 V. DC and 0 to 240 Amps. DC 3.95 Ea.
TIME HOUR METERS 99999.9 Hrs. 10-12 Volts, 60 Cycle or 110 Volts, 60 Cycle. 3 Inch. \$6.95 Ea.	

All Mail Orders Promptly Filled. F.O.B. San Francisco. . . . All California Orders—Add 3% Sales Tax. . . . Outside of California—No Sales Tax. Write for our free booklet listing our stock and prices on Radio, Electronics, Tools, Hardware, Motors, Wire, Meters, Batteries, Aluminum Sheets, etc. 20% Dep. on all C.O.D. orders. All items subject to prior sale.

STANDARD SURPLUS 1230 Market St., San Francisco 3, Cal. Telephone HElock 1-3106

BC-605 INTER-PHONE AMPS.
(See conversion of this Unit on Page 140 in April issue—Radio-Telv. News). Ideal for Inter-Com; Office to office; airplane inter-com, etc.; Complete with Tubes, Diagram and Case. Easily converted. Uses D.M. 34 Dynamotor and all brand new.
Our low price, less Dynamotor \$3.95 ea.

MIDGET SELSYNS
AY type operates from 6-12 Volts 60 Cyl. Use as both transmitter and receiver. These compact little units draw almost no current and work fine for remote position indicating applications. OD 2 1/4 x 2 1/4 x 2 1/4".
All New (Appr. wt. 1 lb.) Each 98c

ARMY FIELD TELEPHONES
Type EE-8—Talk as far as 17 miles, wonderful 2-way communication at a very low cost, ideal for homes, farms, factories, etc., up to 6 phones can be used on one line. Each phone complete with Ringer, Magneto, Batteries, etc. Used, but good as new \$16.95 pair
360 Foot Roll Wire for above. . . . \$1.95 roll

DYNAMOTORS
DM-512 Input 12 V. D.C. @ 3.5 Amps. Output—380 V. D.C. @ 100 MA. . . . \$3.95 ea.
DY-82—Input 28 V. D.C. @ 1.1 Amp. Output 250 V. D.C. @ 60 MA. . . . \$1.50 ea.

COMMAND RECEIVERS
190 KC to 550 KC (Appr. wt. 12 lbs.) \$8.95 ea.
3 MC to 6 MC (Appr. wt. 12 lbs.) 6.95 ea.
All used but complete and in good condition.

COMMAND TRANSMITTERS
3 to 4 MCS \$8.95 ea. 5.3 to 7 Meg. . . . \$4.95 ea.
Complete with Tubes and Crystals, excellent condition.

BEACON RECEIVERS
BC 1206C—200 to 400 K.C. (As illustrated). IF Freq. 135 KC. Complete with five Tubes. Ready to operate. Direct from 24 Volt D.C. . . . \$5.95 ea.
BC 1033—70 to 80 Megs. Complete with Tubes, operates off 24 Volt D.C. . . . \$3.95

WILLARD 2 VOLT RADIO BATTERY
NEW. Uncharged (Appr. wt. 4 lbs.) TYPE 20-2. . . . \$1.05 Ea.
Complete set of three with Box and Connections to make a 6 volt, 20 Amp. Hrs. Battery Uncharged (Appr. wt. 15 lbs.) . . . Set \$3.95

CAPACITORS
Pyranol—C.D. Solar—New
1 Mfd. 500 V. DC. . . . \$.20 Ea.
1 Mfd. 2000 V. DC. . . . 1.00 Ea.
2 Mfd. 4000 V. DC. . . . 2.95 Ea.
4 Mfd. 800 V. DC.79 Ea.
10 Mfd. 1000 V. DC. . . . 1.49 Ea.

AN/APN4 INDICATOR SCOPES
ID6B, APN-4 complete with 25 tubes and 100 KC calibrated crystal to time sweeps and marker pips at 2, 20 and 100 KC, 5CP1 tube easily converted to test scope. Greatest value ever—ALL BRAND \$29.95 Ea.
NEW. Our price.
Approx. Weight 45 Lbs.

OVERCURRENT RELAYS
Type MN—0-16 Amp. DC.
Type MN—1-4 Amp. DC.
Type MN—25-5 Amp. DC.
Type MN—5-2 Amp. DC.
Type MN—7.5-3 Amp. DC.
Type SC—1-1 Amp. AC or DC. . . . \$4.95 each

MG-149F INVERTER
Input 24 Volt DC 36 Amps. 110 V. 400 Cy. AC. 500 V.A. Output at 90% P.P. Used, excellent condition \$9.95 Ea.

PROP PITCH MOTORS
For your Beam Antenna: 20 Volt to 32 Volt. A.C. or D.C. 1/2 H.P. Motor; 1 1/4 RPM Gear Reduction, 7000 to 1.
ALL BRAND \$14.95 ea.
NEW.

PLATT'S HOT!

JUST LOOK AT THIS RED HOT SUMMER CLEARANCE

Visit Our Retail Store at 489 Broome St., N. Y. C.

COMMAND SETS

SPECIAL SUMMER BUYS!

Electrically perfect with tubes. Slightly bent covers. LIMITED QUANTITY—Be sure to ORDER NOW!

BC-454—3 to 6 MC	\$3.45
BC-696—3 to 4 MC	9.95
BC-453—190 to 550 KC	9.95

274-N COMMAND EQUIPMENT

Sensational Buys!

	USED	BRAND
	\$ 1.85	\$ 2.75
BC-442		
BC-450, 3 Receiver	.89	1.95
Remote Control	12.95	21.95
BC-453	4.95	6.95
BC-454	1.95	2.95
BC-456	5.95	7.95
BC-457	5.95	7.95
BC-458	14.95	24.95
BC-459	1.95	
BC-696	1.95	
3 Receiver Rack	1.50	
2 Transmitter Rack	1.50	



FOR THIS MONTH ONLY

MARINE SPECIAL!

BC-223 TRANSMITTER



30 Watt Transmitter with crystal or MO control on four pre-selected channels. 2000 to 5250 KC. by use of three plug-in coils. Five Tubes: 2-301 & 3-46. With TU-17-18-25 Tuning Units. Tubes and mount included. Specially Priced.

\$21.95

BRAND NEW. Only.

SPECIAL OFFER! ALL THREE KITS LISTED BELOW FOR **\$3.59** ONLY.

20 POUNDS OF ASSORTED RADIO PARTS

Transformers, Chokes, Wire, Condensers, Knobs, Sockets, Switches, Dynamotor. **\$2.39** ONLY.

100 ASSORTED RESISTORS

Non-insulated, various ohmages and wattages. **SPECIAL 97c**

KIT OF 15 CONDENSERS

Bathubs and Electrolytics. **98c** NOW.

HEADSETS—Excellent Buys!

HS-33 with cord and plug, used, good condition \$0.79
 HS-23—Brand New with ear pads 2.75
 HS-33—Brand New with ear pads, cord and PL54 plug..... 2.75



TH-37A—1200 ohms with dual pluss..... \$2.95

BC-1206 Beacon Receiver	\$ 7.95
BC-348 Receiver—NEW	165.00
BC-221 Receiver—Excellent Condition	135.00
BC-342 Receiver—Excellent Condition	135.00
BC-221 Frequency Meter—Excellent Condition	79.50
SCR-694 and SCR-284. Complete. New Conditioned. Prices Sent Upon Request.	
MX-26C Compass Receiver—NEW	29.50
433C Compass Receiver—Excellent Condition	39.50
ARN7 Compass Receiver—Excellent Condition	49.50
APN 9—Tested and Guaranteed	239.00

SCR 595-695

CONVERSION KITS

A.F. Parts: 22 ft. 52 ohm co-ax cable, 42 ft. #18 aircraft wire, 81 ft. #12 aircraft wire, 1 PL 180 plug, mounting bracket and hardware. **ONLY \$2.75**



DYNAMOTORS

Dynamotor for DV-12 Power Supply for ART-13	Only \$7.95
Type DM-33-A, in. 28 V, out. 540 vdc, 250 MA	BRAND NEW 1.95
	(Excellent—Used 1.25)
Type DM-33-A, 24 V, in. 220 V, 80 MA out.	BRAND NEW 1.95
INVERTER—PE-206, 28 V, in. 80 V at 500 VA, 800 cy. out.	BRAND NEW 7.95
	(Used—Excellent Condition 3.25)

BACK AGAIN AT THIS SPECIAL LOW PRICE!

FIELD TELEPHONES

Army surplus, completely re-conditioned and electrically tested. Guaranteed. **\$8.95** LIKE NEW. Only.



MINIMUM ORDER \$2.00

Immediate Delivery—Send 25% deposit on C.O.D. orders. All shipments F.O.B., N.Y.C. (N.Y.C. residents add sales tax to your remittance.)

PLATT ELECTRONICS CORP.

Dept. A, 489 Broome St., N. Y. 13, N. Y.

PHONES: RE 2-8177 and WO 4-2915

Linearity Generator

(Continued from page 37)

the instrument. As condenser C_2 is tuned through its range, at some point a beat note will occur with the broadcast signal, if the vertical-line oscillator is working. This oscillator operates between approximately 100 and 300 kc., and its harmonics will beat strongly with signals appearing in the broadcast band.

The best way to check operation of the entire instrument is in conjunction with a television receiver which is in good operating condition. (1) Switch on the receiver, remove its regular antenna, set to Channel 2 for a starter, advance brightness and contrast controls about half way. (2) Set attenuator R_7 in instrument for minimum signal. (3) Set switch S_1 to its "Hori-

zontal" position. (4) Connect instrument output terminals to antenna terminals of receiver by means of short length of 300 ohm ribbon or short wire leads. With sets having 300 ohm input impedance, it may be advisable to connect a 150 ohm resistor between each output terminal of the instrument and the connecting line. However, the author's tests do not indicate any difficulty due to the impedance mismatch when working directly out of the instrument into the receiver. (5) Switch on power to the generator. (6) When instrument has warmed up, tune slowly by adjusting variable condenser C_6 . When the video carrier frequency of Channel 2 is reached, stationary black horizontal bars will appear on the receiver screen. Advance potentiometer R_8 , if necessary, for higher signal strength and a stronger pattern. Vary potentiometer R_9 , noting the change in number of bars. Adjust brilliance and contrast controls in receiver for sharp definition of the bars. (7) Throw switch S_1 to its "Vertical" position, noting appearance of vertical bars on screen. If there is difficulty in reaching Channel 2, adjust the tuning slug of the coil L_2 with tuning condenser C_6 set at maximum ca-

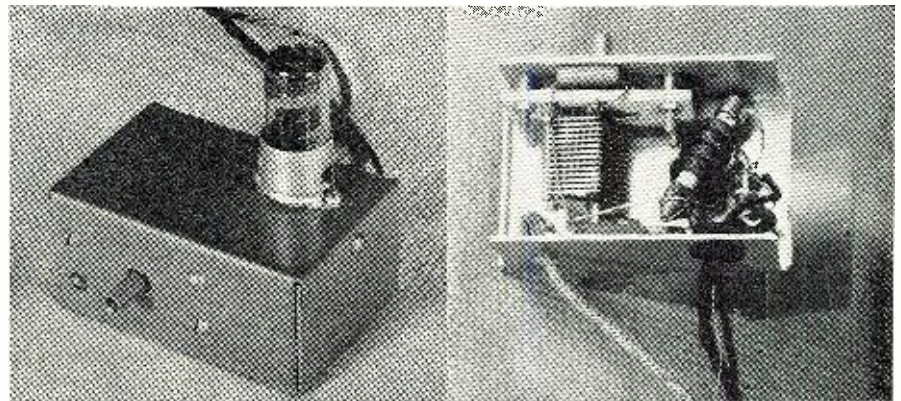
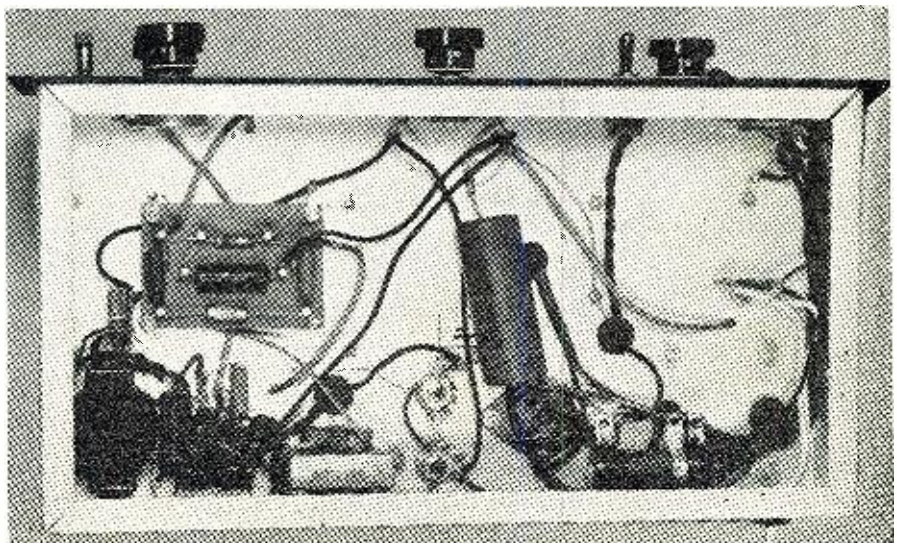

Fig. 4. (Left) The shielded vertical line oscillator mounted in its shield box and ready for mounting on the main chassis. (Right) Inside view of the vertical line oscillator. The bottom of the box has been removed to show internal construction.

pacitance. (8) Tune C_2 , noting the change in number of bars seen. (9) Repeat the entire procedure with the receiver switched successively to each of the other channels.

The dial of C_6 may be marked off to indicate the various TV channels. Similarly, C_2 may be calibrated in number

Fig. 5. Under-chassis view of the complete generator showing wiring and parts layout.



SAVE

THAT GOOD LOOKING OLD CONSOLE
WITH THE OBSOLETE RADIO!

install a modern

ESPEY AM/FM CHASSIS

and your favorite console is "right-up-to-date"

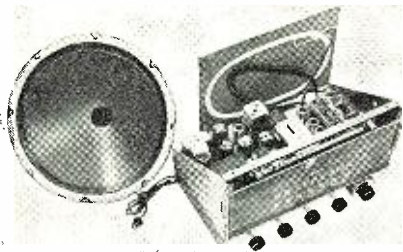

Rated an excellent instrument by America's foremost electronic engineers. Fully licensed under RCA and Hazeltine patents. The photo shows the Espey Model 511, supplied ready to play. Equipped with tubes, antenna, speaker and all necessary hardware for mounting.

ATTENTION SERVICEMEN—Did you know there are over 19 million consoles waiting to have a modern AM/FM chassis installed? Here is a gigantic sales market just waiting for you to develop. In fact there are thousands of out-moded radios in your "backyard" just waiting to be replaced.

Makers of fine radios since 1928.

Write for literature RN for complete specifications on Model 511 and others.

ESPEY TEL. TRafalgar 9-7000
MANUFACTURING COMPANY, INC.
528 EAST 72nd STREET, NEW YORK 21, N. Y.

ANNOUNCING QUAM COAXIAL SPEAKERS



Built to the exacting standards of the Quam Replacement Line, these precision built Coaxial Speakers are designed for FM receivers, television sound, studio monitoring and similar installations where a wide range of frequency response is desired. The Tweeter is mounted coaxially within the large speaker on a built-in bridging network which feeds the proper frequencies to the speaker unit. Alnico V magnets are used throughout.

The new Quam Coaxials are built in two sizes, a 12" speaker with 3" H.F. unit and a 15" speaker with 5" H.F. unit.

For true theatre performance found only in the most expensive units, replace with a Quam Coaxial.



FREE! Write for complete new catalog!

Quam-Nichols Co.
522 E. 33rd Place, Chicago 16, Illinois
Please send me Quam catalog.

Name.....
Address.....
City..... State.....

MANUFACTURERS OF THE QUAM FOCALIZER UNIT

WALSCO ANNOUNCES

AMAZING NEW

NEW

SIGNAL KING ANTENNA

FINALLY, the one antenna that does more to guarantee outstanding reception, trouble-free performance in even the fringe areas. The WALSCO Signal King, with its amazing new patented design, assures longer, dependable service under the most adverse weather conditions.

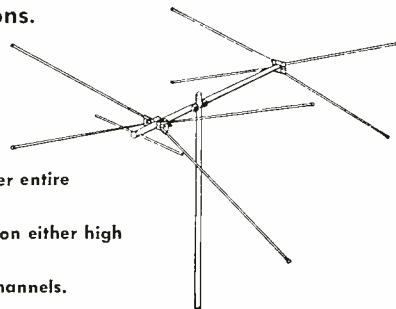

- Broad response over entire TV spectrum.
- No weak channels on either high or low band.
- Extra gain on all channels.
- Marine type high tensile strength aluminum alloy used throughout on elements, cross-arms and masts.
- Elements are reinforced with metal insert and are sealed on outer end.
- Full 1 inch O.D. cross-arm.
- U-bolt assembly fits mast from 3/4" to 1 1/2" O.D. Bracket made of serrated steel that bites into the mast. All cadmium plated.



WRITE FOR FREE ILLUSTRATED CATALOG 50-N

WALSCO

Quality Sells
WALSCO Antennas

WALTER L. SCHOTT CO. Beverly Hills, Calif. • Chicago 6, Ill.

ENGINEERED FOR FRINGE AREA RECEPTION

Custom 19" TV CHASSIS

4 I.F. STAGES!

\$129.50* \$179.50*
19" less CR tube 19" with CR tube

CLEAR, FAULTLESS RECEPTION IN OTHERWISE IMPOSSIBLE LOCATIONS!

- No external makeshift! Weak-signal reception is engineered into the design in two exclusive extras: Four - stage wide - band high - gain I.F. amplifier for super-sensitivity with true 4 MC band width for picture clarity, plus Low-signal current regulation in exclusive electronic Automatic Focus circuit. Result: The best fringe area design! Picture and sound exactly as televised — no distortion whatsoever.
- Limiter control provided for "primary service areas." Perfect reception in close-in areas also!
- Vertical and Horizontal Hold Controls on front panel eliminate rear panel adjustments when line voltage changes and when tubes age.
- Full twenty tube chassis, including many dual purpose tubes, and two crystal diodes
- Standard turret-type tuner for high-est gain and noise rejection.

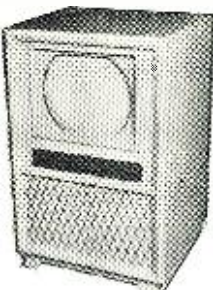

GREATEST TV BARGAINS EVER!

"FAMILY-SIZE" TABLE MODEL Electrically identical to chassis above —including 4 stages of I.F., phono attachments, etc. Beautiful, extremely durable mahogany grain-finish on unbreakable tempered Masonite, appearance like hand-rubbed Philippine Mahogany! Famous Sheldon 12 1/2-inch black tube 4"x6" hi-fidelity speaker. Astounding low price of only \$149.50*



\$124.95*
16-inch CHASSIS AS PICTURED LESS CR TUBE

WITH TUBE \$154.95*



- Complete twelve-channel coverage
- RCA-licensed fully Automatic Gain Control keeps both picture and sound at the same level from one station to another
- Phonograph switch and phonograph input. Beautiful sound reproduction for any make record player
- Complete service manual and schematics furnished with all sets.
- Famous Sheldon "soft-light" CR tube for easy vision viewing. Better than filters!
- 12-inch high quality heavy-duty P.M. speaker, knobs, and mounting hardware included in all prices shown for 16" and 19"

GET THE BEST ENGINEERING AT THE LOWEST PRICES!

- 16-inch console, in beautiful hand-rubbed hardwood cabinet (as pictured, Mahogany) \$199.50*
- 19-inch console, in beautiful hand-rubbed hardwood cabinet. (Mahogany) \$229.50*

*Add \$1.28 excise tax to all prices shown. Blonde cabinets available at \$5.00 additional. California buyers for use, add sales tax. Out of town buyers add \$4.00 packing charges.

G. L. ELECTRONICS
905 SOUTH VERMONT AVENUE
LOS ANGELES 6, CALIFORNIA

NOW! SPEED UP ALL SOLDERING WITH UNGAR FEATHER-LIGHT SOLDERING PENCILS WITH HI-HEAT TIPS



For use with No. 776 Handle & Cord Set

Stop wrestling with big irons. New HI-HEAT TIPS in your Ungar Electric Soldering Pencil produce a really versatile tool that'll perform on a par with the big, bulky 100-150 watt irons. If you can't get immediate delivery, please be patient, for production hasn't yet caught up with demand. Ask your supplier for No. 1236 Pyramid or No. 1239 Chisel. List price, \$1.25 each.

Ungar
ELECTRIC TOOL CO., Inc.
LOS ANGELES 54, CALIFORNIA

OUTSTANDING - TV - VALUES

MODEL #300
Folded dipole complete with reflector and high frequency adapter. Covers 13 channels. All alum. construction. Less mast. Shpg. wt. 7 lbs. PRICE..... \$4.10

MODEL #200-D
Stacked array. Consists of 2 complete conicals and connecting bars. Very rigid construction. Covers all 13 channels. Matches 300 Ohm or 72 Ohm. Center impedance 150 Ohm. Ideal for low signal areas. An outstanding buy. Shpg. wt. 12 lbs. SENSATIONAL OFFER at less mast. \$8.25

MODEL #200-S
Single array. Same construction as above. Shpg. wt. 7 lbs. Price, less mast. \$3.75

MODEL #500
All-band folded dipole antenna. Ideal for rotator use. Maximum gain on any channel. All alum. construction. Less mast. Shpg. wt. 8 lbs. Price..... \$4.25

MODEL #Y-100
5 element Yagi Hi-Gain beam designed specifically for fringe area use. All alum. construction. Cut to specific channels. Shpg. wt. 4 lbs. Channel #7, \$3.75; Channel #9, \$3.50; Channel #11, \$3.35 and Channel #13, \$3.25. The prices are less mast. "V" type antenna. Price, \$3.75

ANTENNA ACCESSORIES

CM-100 Chimney Mount	\$.98
WM-100 3" Wall Bracket50
WM-100 5" Wall Bracket	2.75
5-ft. 1 1/2" OD Steel Mast, Plated75
5-ft. 1 1/8" OD Alum. Mast	1.50
3-ft. 1" OD Alum. Mast	1.25
3 1/2" 300-ohm stand-off insulators (fit coax cable). Per 100, \$2.50; per 500, \$10.50;		
"U" Bolt Assembler—ideal for mast couplings	19.50
..... 100', \$1.05; 500' 5.00		
Best Quality 300-ohm twin lead	9.00
High Quality 72-ohm Coax Cable	
..... 100', \$2.95; 500' 13.75		
Fold Dipole Hi-Frequency Adapters	1.25
Conical Hi-Frequency Adapters	1.50
Straight Dipole Hi-Frequency Adapters	1.25

EAST COAST ELECTRONICS
40 St. Francis Street Newark 5, New Jersey

of vertical lines, and R_s in number of horizontal lines.

This generator, while intended primarily for linearity control setting, is also useful for quick-checking receivers for over-all performance. The line patterns may be used to observe behavior of brightness, contrast, horizontal hold, vertical hold, and width controls. Either the horizontal or vertical lines may be used when straightening a tube in its mountings. Settings of attenuator R_r will show relative sensitivity of receivers.

-30-

SET PRODUCTION

THE most recent figures released on set production by the Radio-Television Manufacturers Association indicate that the output of home radio receivers, including portables, increased in May as television set production dropped slightly below the April record.

May output of home radios by RTMA member-companies totaled 693,592, compared with 648,352 for the preceding month. Television set production amounted to 376,227 compared to 420,026 sets in April.

Production figures for the year, (through May) indicate that 2,024,183 TV sets have been made; 3,066,604 home radio receivers (including portables) have been produced while auto radios have accounted for 1,107,110, for a grand total of 6,197,897 receivers produced by RTMA companies.

-30-

AVOID SHOCKS

By ROBERT HERTZBERG

THE big "safety" campaign being put on by TV manufacturers in the interests of service technicians serves as a reminder that the a.c. power line can be very nasty all by itself, regardless of what type of equipment it is operating. It is very easy, when experimenting with a naked metal chassis, to ground yourself accidentally with one finger on the "hot" side of the circuit. Because of the terrific muscular reaction produced by an electrical shock, you are liable to jerk half of the equipment off the table. I know of one guy who tangled with the a.c. line while working in his basement (watch out for cement floors—they are real "grounds"), and swept a \$150 oscilloscope and a \$125 v.t. voltmeter onto the hard floor when his right arm swung out wildly.

For experimental and service work, it is a very smart stunt to use an isolation transformer (see Fig. 1). This is merely a 1 to 1 ratio power transformer, which gives out the same voltage you put into it; its feature is thorough insulation between the primary and the secondary, which isolates the grounded power line from the equipment being operated. This transformer won't save you if you stick your fingers across the "B" supply, but it will eliminate those sneaky chassis-to-ground loops.

Fig. 1.

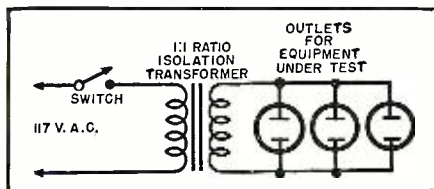

Oscillations

(Continued from page 56)

Carefully check the circuit components to make certain they haven't changed value. Also check for an open screen grid bypass or an open decoupling condenser in the grid or plate circuit. As each of the described checks and adjustments are made, check for changes in the voltmeter reading. A decrease in voltage indicates a move in the right direction. Consequently, an increase in voltage across the detector load means a move in the wrong direction.

Some receivers are very critical as to lead dress. If a part in the i.f. system needs replacement, make sure that all wires and leads are of the same length and in their original location. Grid and plate leads must be kept short and well separated. If an isolating choke is used in one leg of the heater circuits, check it to see if it is bent out of shape. Also check the bypass condensers in the heater circuit. Bridging with the same value will usually show up an open bypass.

An r.f. probe used with the v.t.v.m. will also help locate the source, or rather the stage, in which oscillations are being set up. If one is available, use it to check for the presence of r.f. in all of the i.f. circuits described previously.

Before getting too involved, check over the latest data on that particular model. Perhaps the manufacturer has issued an instruction sheet describing the corrective measures for this type of trouble. Usually when a number of identical complaints are received, the set builder will check into the matter, and using the varied equipment at his disposal, will locate the trouble and devise a means of correcting it. This information is then quickly forwarded to the distributor and is available to service technicians.

When an oscilloscope is used during alignment checks, the oscillations will, of course, show up differently than when a v.t.v.m. is used. With the sweep generator connected as per instructions, and the scope across the detector load resistor, observe the video i.f. response curve. If oscillations are present, a portion of the response curve will show up as a large peak. A closer check may even show the presence of beats on the scope screen. These beats are generated each time the sweep generator frequency approaches the frequency of the oscillations that are being developed in the video i.f. strip.

While observing the pattern on the scope screen, adjust the contrast control from maximum towards minimum until the oscillations cease. If they disappear after only a slight reduction of the contrast control, the trouble is in one of the stages connected to the contrast control circuit. On the other hand, if the oscillations remain over all or most of the contrast control

EVERYTHING IN TELEVISION!

—Now at your fingertips, for quick, easy reference . . .

THE VIDEO HANDBOOK

THE COMPLETE TELEVISION MANUAL

by MORTON G. SCHERAGA, *Television Research Consultant, Allan B. Du Mont Labs.*

and JOSEPH J. ROCHE, *Editor, Radio and Television Maintenance.*

Now in one volume—all the essential know-how of television! All the up-to-the-minute information on television is arranged for quick reference—in easy-to-understand language.

The VIDEO HANDBOOK gives you practical answers to all your questions on television. This best-selling TV encyclopedia tells you . . .

- How Television Works
- How to Plan and Engineer Television
- How to Troubleshoot and Repair Television
- How to Select and Install a Television Antenna
- How to Produce a Television Show. Technical Aspects
- How to Build an Operating Television Receiver
- How to Select a Television Receiver

SEND NO MONEY

You must see this book to appreciate it! 20,000 copies now working for practical Television men! Mail coupon for your copy TODAY.

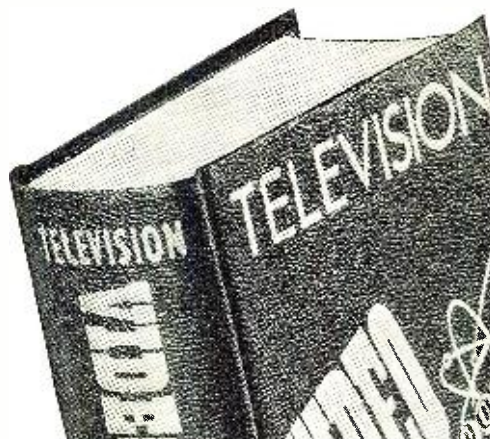

CONTENTS:

Television, Past, Present and Future • Fundamentals of Electronic Television • The Television Station, Pick-up—Control—Transmission • The Television Receiver • Television Antenna Systems • Creating a Television Show, Programming and Production • Description of Modern Television Receivers, Circuit Variations — Design — Mechanical Features • Installing Television Receivers • Servicing Television Receivers • Troubleshooting • Interpreting Test Patterns—Alignment—Repair • Television Test Equipment; How To Use It—How To Buy It • Building a Television Receiver • Data Section • Television Terms • Bibliography.

The VIDEO HANDBOOK contains thousands of vital facts—covering everything you need to know for working in Television. Every important point discussed is visualized in diagrams or photographs (over 860 illustrations).

More than 900 pages . . . handsomely bound in durable Fabrikoid. Only \$5.95.

You must see The VIDEO HANDBOOK to appreciate fully how it can increase your efficiency and assure your future in television. We urge you to accept our 10-Day Free Examination Offer NOW. Just mail the coupon below *without sending us a cent* and we will rush a copy to you.

10-DAY FREE EXAMINATION COUPON

Boyce-Roche Book Co.
Montclair 1, New Jersey

Please send me The VIDEO HANDBOOK for 10-day examination. If I decide to keep it, I will send you \$5.95 plus postage; otherwise I will return the book postpaid. (We pay postage if you send \$5.95 with this coupon; same return privilege.)

Name
Address
City..... Zone..... State.....
Employed by.....

(This offer applies to U. S. only.)

The BROOK All Triode High Quality AUDIO AMPLIFIERS bring into your home



Model 10 C3-30 watts

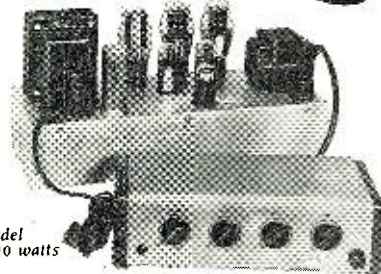

Model 12 A3-10 watts

- The full volume of a symphony in your home with all its brilliance... or reduced to a whisper... still keeping its natural tone.
- Extreme low volume without loss of quality.
- Reduction of listening fatigue.
- Distortion and intermodulation at a new low.
- Separate controls stepped for bass and treble.

Write Today for FREE Booklet,
"BETTER LISTENING",
Technical Bulletin and
detailed Distortion Analysis.

BROOK ELECTRONICS, Inc.

Dept. RH-0 • 34 DeHart Place • Elizabeth, N. J.

CUT ACCURATE HOLES IN RADIO CHASSIS

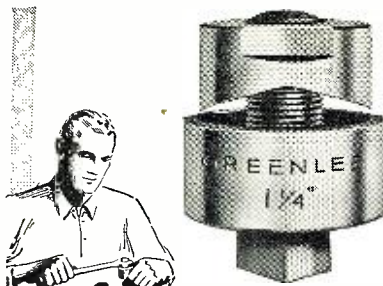

WITH A GREENLEE RADIO CHASSIS PUNCH

• Make smooth, true holes quickly this easy way. Just turn GREENLEE punch with an ordinary wrench and have an accurately-sized opening for plugs, sockets, and other receptacles. No reaming or filing. A GREENLEE Punch for each of these sizes: 1/2", 5/8", 3/4", 7/8", 1", 1 1/16", 1 1/8", 1 1/4", 1 1/2", 1 3/4", 1 7/8", 1 1/2", 2 1/4". Also GREENLEE Knockout Punches and Cutters for conduit and meter holes up to 3 1/2". Get facts now. Write Greenlee Tool Co., 1888 Columbia Avenue, Rockford, Illinois.



An Indispensable EMERGENCY Tool for Every TV and Electronic Technician!

QUIK-SHOT SOLDERING IRON

- 250 Watts • Maintains Soldering Temperature for 6 to 8 Minutes • No Electricity • No Flame • No Blowtorch
- Pull the Trigger and the Iron Heats Itself
In Less Than 10 Seconds!

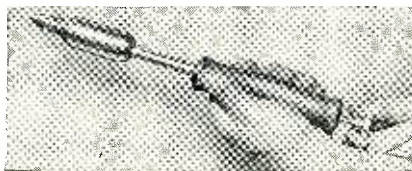

QUIK-SHOT is a "must" for every emergency when line power is not available nor convenient. Heat is generated internally through the QUIK-SHOT cartridge which is inserted into the iron. UNCONDITIONALLY GUARANTEED! Absolutely safe. Accepts 3/8", 5/8" and 1" tips.

Model QS 38 (3/8" Pyramid or Chisel Tip)..... \$7.50
Model QS 58 (5/8" Pyramid or Chisel Tip)..... \$7.50
Model QS 100 (1" Chisel Tip Only)..... \$8.25
All standard models complete with 4 QUIK-SHOT Cartridges and Pyramid Tip.

QUIK-SHOT Cartridges (12 in carton)..... \$1.92
SEPARATE TIPS
3/8" or 5/8" Pyramid or Chisel..... \$2.25
1" Chisel Only..... \$3.00

Ask Your Jobber or Write Direct

JOHN F. RIDER LABORATORIES, Inc.

440 Canal Street • New York 13, N. Y.

range, the trouble is usually in a stage that is not connected to the contrast control circuit. This method is not always reliable, but sometimes helps in reducing the number of possible stages in which the trouble might exist. It's worthwhile making notes of the effects for future reference.

Now a few very important steps will be listed. If they are carefully followed, a lot of trouble will be avoided later on. First make certain that the sweep generator is not overloading any of the i.f. stages. Then reduce the contrast control about one-fourth from maximum. This should cause some reduction in the i.f. oscillations. Now run the marker frequency through the i.f. response curve to the point where the oscillations are observed. Since these two frequencies will now be the same, a reading of the marker dial will indicate the frequency of the undesired oscillations which are being generated in the i.f. stages.

Next locate the tuning slug of the i.f. coil whose frequency setting is normally at or near this frequency. The instruction manual contains this information; or refer to the sketch that was described earlier in the text. Adjust this slug one way and then another, while observing the effect on the scope screen. If this doesn't have much effect on the oscillations, try the same thing on the other tuning slugs. If after adjusting each slug two or three turns in each direction the trouble still persists, it is being caused by reasons other than a misaligned i.f. strip. The same steps should now be taken as described previously when using the vacuum tube voltmeter. If the equipment is available, both the v.t.v.m. and the scope should remain connected across the detector load resistor. In this way there will always be some visual indication, whether using a sweep signal or a fixed frequency, should a changeover be necessary.

In sets employing a.g.c. and in those where the contrast control circuit differs from the standard practice of varying the bias on the i.f. tubes, the manufacturer's alignment and test data must be followed closely. Control settings play an important part in determining final results. The Miller Effect will also cause changes in response curves of the video i.f. system, because the input capacitance of the tube varies as the gain of the tube is varied by changes in grid bias. A response curve that appears normal at one contrast control setting may look altogether different at some other setting.

In some fringe areas the service technician will find it necessary to narrow the video i.f. bandwidth. This does increase the gain although it will result in some loss of detail. While making the adjustments, the set may suddenly go into oscillation or it may start oscillating when the contrast control is turned up after alignment is completed. It may then be necessary to resort to the methods described previously to bring the set out of oscilla-

tion. In fringe areas it may also be necessary to realign the video i.f. channel with the contrast control set higher than that specified by the set manufacturer, in order to maintain some flattop response characteristics in the i.f. system. This will also reduce the tendency to oscillate, should it be necessary to increase the contrast control when tuning in a weak or distant station.

A few hints will be included here that may be of help to the technician who is confronted with this type of trouble for the first time. Do not rush immediately into an alignment check. Rather spend some time on tests that may be helpful later on. Remember that a set doesn't suddenly go out of alignment in the customer's home. Properly aligned i.f. circuits are very stable and are more likely to be knocked out of alignment on the repair bench. Learn the effects and results of oscillations, as indicated by measurements of the voltage across the detector load resistor, and the patterns which appear on the oscilloscope screen. Make certain that no other signal is coupled into the receiver input.

If any trouble is encountered while making the adjustments described, adjust the center frequency i.f. coils first and then gradually work out towards the lowest frequency coils, and then on to the higher frequency coils. The last two adjustments should be made on the lowest and highest i.f. stages. With this procedure, it is impossible to have two i.f. coils set to the same frequency, which, fortunately, is the cause of oscillations in most cases. Detecting the presence of oscillations is sometimes more difficult than finding the cause, once their presence is known.

ANTENNA LEAD-INS

By ED KIRCHHUBER, W2KJY

OPEN antenna lead-in wire in television installations can cause a lot of trouble, especially if one lead is open. With the folded dipole type antenna an ohmmeter will show the open but with the new conical and other open-circuit antennas it is useless.

One solution to the problem is to use a 50,000 ohm resistor installed across the connections when the antenna is erected. With this arrangement it is possible to check the lead-in resistance. The price of the resistor is small compared to its advantages. The effect of this high resistance on antenna efficiency is nil.

Correct placement of 50,000 ohm resistor for checking antenna lead-in resistance.

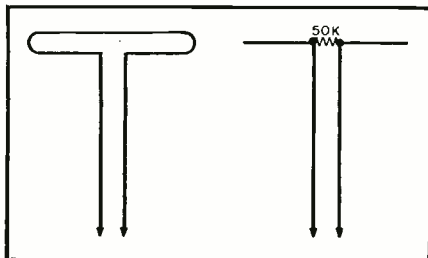

August, 1950

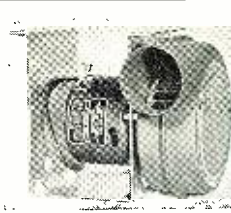

BLOWER

Brand New 115 Volt 60 cycle blowers, as illustrated, approx. 100 Cubic Ft. Dis. 3/4" intake, 2" outlet. Motor size: 3 1/2" x 3". 1525 RPM. Complete with mounting bracket. Gov't. surplus. Individually boxed. Order No. RN-3604 **\$7.95**

TRANSMITTERS and RECEIVERS:

	USED:	NEW:
BC-357 Marker Beacon Rec.	\$2.95	
BC-347 Amplifier, less tubes	1.00	
BC-347C Amplifier, with Tubes		\$2.95
BC-1206 Receiver, 200-400 KC.	\$4.95	6.95
BC-458 Trans. 5.3 to 7 MC.	5.95	8.95
T-20/ARC-5 Trans. 4 to 5.8 MC.		8.95
BC-455 Receiver, 6-21 MC.	6.95	9.95
BC-454 Receiver, 3 to 6 MC.	4.95	6.95
BC-453 Receiver, 190-350 KC.	\$11.95	
RA-10 DA Receiver	17.50	
TA-12 Transmitter	29.95	
BC-375 Transmitter, with One Tuning Unit	14.95	

BC-375-191 ACCESSORIES:

TUNING UNITS: TU-5-6-7-8-9-10-26, or BC-306.	NEW: \$3.95	USED: \$2.95
CABLES: PL-50-61- or 64 each end.		
Price	NEW: \$1.75	Each
FT-151 MOUNTING		\$2.00
A-27 PHANTOM ANTENNAS		1.75

OPERATING MANUALS:

BC-375	\$2.00	SCR-508	\$2.00
BC-223	\$2.00	SCR-522	\$5.00
MARK II B19			\$2.00

BC-223 TRANSMITTER and SPARE PARTS

30 Watt Transmitter with crystal or MO control on four pre-selected channels, 2000 to 5250 KC., by use of three plug-in coils. Five tubes, two 801 and three 46. With TU-17 Tuning Unit 2000 to 3000 KC. and Cable. **USED: \$19.95** less mtg. NEW: \$24.95

OPERATING MANUAL for BC-223.....\$2.00

SPARE TUBE KIT for BC-223—Contains 5 spare tubes in metal box. Price.....\$4.95

TUNING UNITS: TU-17—2 to 3 MC.; TU-18—3 to 4.5 MC.; TU-25—4.5 to 5.2 MC. NEW: \$3.50 Ea. USED: \$2.50 Ea.

PE-125 VIBRATOR POWER SUPPLY for BC-223 Transmitter, 12/24 Volt input; output 500 Volt 150 MA. Price.....NEW: \$9.95

MOUNTING for PE-125.....1.50

SPARE VIBRATOR & TUBE KIT For PE-125—Contains 2 spare tubes, 2 spare vibrators and fuses in metal box. Price.....\$4.95

CABLE only—Transmitter to Power Supply.... 1.75

DYNAMOTORS:

INPUT:	OUTPUT:	STOCK NO.	PRICE
9 V. DC	450 V. 60 MA.	DM-9450	
@ 6 V. DC	275 V. 50 MA.	w/Blower	\$3.95
12 or 24 V. DC	440 V. 200 MA. & 220 V. 100 MA.	D-104	9.95
12 V. DC	600 V. 300 MA.	BD-86	7.95
12 V. DC	330 V. 150 MA.	BD-87	5.95
12 V. DC	375 V. 150 MA.	BD-83	6.95
12 V. DC	1000 V. 300 MA.	BD-77	7.95

PERMANENT MAGNET FIELD DYNAMOTORS:
12 or 24 V. DC 275 V. 110 MA. USA/0516 **\$3.95**
12 or 24 V. DC 500 V. 50 MA. USA/0515 **2.95**
@ 6 V. DC 240 V. 50 MA.

PM FIELD DYNAMOTOR POWER SUPPLY—Completely filtered. Has two PM Dynamotors as listed directly above.....\$5.00
Write—Tell Us Your Dynamotor or Inverter Needs!

MARK II TRANSMITTER & RECEIVER

Ideal for mobile or stationary use. 15 Tube Set transmits and receives 2 to 8 MC. Phone, CW and MCW 25 Watt Master Oscillator Control. Transmits and receives 240 MC. Phone. Also an intercommunicating set. Comes complete with 15 Tubes, Headset, Micro, Antennas, Control Box, 12/24 Volt Power Supply, and instructions—ready to operate. Set size: 27"x10"x13 1/2". Prices: NEW **\$59.50**, USED (TESTED): **\$39.50** Available—All Parts and Accessories for Mark II Sets! Address DEPT. RN • Minimum Order \$2.00 • Prices F.O.B., Lima • 25% Deposit on C.O.D. Orders

FAIR RADIO SALES

132 SOUTH MAIN ST.
LIMA, OHIO

The September issue of **RADIO & TELEVISION NEWS** will be on sale September 1. Be sure to reserve your copy with your Newsdealer.

BLISS Electrical Training

Intensive 32 weeks' residence course in fundamentals of industrial electrical engineering, including radio and electronics. Extensive laboratory, shop work, drafting. Prepares for electrical technician and engineering

aides in communications, power, manufacturing, business machines, sales, service. G. I. approved. 57th year. Enter November 6. Catalog. **7615 TAKOMA AVE. WASHINGTON 12, D. C.**

3/4 RPM ANTENNA ROTATOR MOTOR

High torque, reversible motor—Operates directly from 110 Volt 60 cycle by use of condenser. Light weight, quiet running, ruggedly built, positive stop, easily mounted. Normally operates from 110 Volt 400 cycle. Complete—with in- **\$4.95**
Constructions—NEW.....
10 MFD 400 Volt Cond., \$1.00. SPST Momentary Switch, 35c. DPDT Momentary Switch, 75c. Resistor, 100 ohm 25 Watt, 50c. 4 Wire Cable, 5c per ft. COMPLETE KIT OF PARTS—Motor, Cond., SPST Switch, and Resistor.....\$5.95

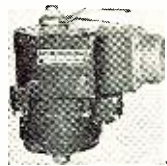

BC-645-A TRANSCEIVER

110 VOLT TRANSFORMER and CHOKE
15 Tube Transceiver, ideal for conversion to 460 MC. Citizens Band. Frequency coverage 435 to 500 MC. With conversion instructions. **\$14.95**
Price: New and Boxed BC-645-A.....
SET of Plugs & Antennas f/BC-645-A.....\$9.95
TRANSFORMER for BC-645-A—110 Volt 60 cycle input; output 400 Volt 150 MA. after filter. 12, 9, and 6 V. A.C. 4 amps and 5 V. 3 amps. No. NH-645.....\$6.95
CHOKE—15 Hy. 150 MA. Order No. NH-646... 2.95
PE-101 DYNAMOTOR—13/28 V. input..... 2.95

METERS:

0-150 Volt AC 3" Round.....	\$3.95
0-150 Volt 400 Cycle 2 1/2" Round.....	2.95
0-5 Amp. AC 3" Rd. 0-100 A. Scale.....	3.95
0-5 Amp. AC 3" Rd. 0-75 A. Scale.....	3.95
0-5 Milliamper AC 2 1/2" Square.....	2.95
0-500 Microamp 2 1/2" Rd. w/0-15 & 0-600 DC Volt Scale.....	3.95

WHIP ANTENNA EQUIPMENT

MAST BASES—INSULATED:

MP-132—(Illustrated) 1" heavy v.v. coil spring, 2" insulator. Overall length: 11 1/2". Weight 2 3/4 lbs. Price.....\$3.95
MP-22—Spring action direction of bracket, 4"x6" mounting. Price.....\$2.95

MAST SECTIONS FOR ABOVE BASES:
Tubular steel, copper coated, painted, 3 foot sections, screw-in type. MS-53 can be used to make any length, with MS-52-51-50-49 for taper.

Price—any section.....Ea. 50c
MS-54 or 55 Larger sections than MS-53.....Ea. 75c
BAG BG-56 for carrying 5 Mast Sections..... 50c

GN-45 HAND GENERATOR

Complete with Leg and Seat Assembly, and cranks! Generator supplies 6 Volts 3 amps, and 500 Volts 150 MA. at 60 RPM. Used w/SCR-28. NEW: **\$9.95**
CD 501 Cord used from GN-45 or PE-103 to BC-654. Price.....\$2.00

NEW TRANSFORMERS And CHOKES

ALL FOLLOWING TRANSFORMERS—CASED 115 V.A.C. 60 CYCLE INPUT:

OUTPUT: 750-0-750 V.A.C. (600 V.D.C. after choke input filter at 250 MA.) Includes 6.3 V.A.C. winding at 5 amps and 5.0 V.A.C. winding at 4 amps. NH-100.....\$8.75
OUTPUT: 600-0-600 V.A.C. at 250 MA. 12 V.A.C. at 3 amps; 12 V.A.C. at 3 amps and 5 V.A.C. at 3 amps. Designed for Army surplus transmitters. NH-108.....\$7.75
OUTPUT: 250-0-250 V.A.C. at 60 MA. 24 V.A.C. at 8 amps; 6.3 V.A.C. at 6 amps. Designed for Army Surplus Receivers. NH-109.....\$3.50
TRANSFORMERS—110 V. 60 CYCLE PRIMARIES:
SEC.:
12 V. 1 amp.....\$1.50 24 V. 2 amps.....\$2.25
24 V. 1 amp..... 1.95 24 V. .5 amp.... 1.50
36 V. 2.5 amps..... 2.95 24 V. 4 1/2 amps... 3.95
Sec. 14-14 or 28 V. 7 1/2 or 15 amps..... 5.50

CHOKES—CASED:

NH-115—8 Henries at 500 MA. filter choke, 5,000 volt insulation.....\$10.95
NH-116—5-20 Henry 500 MA. swinging choke, 5,000 volt insulation.....\$10.95
NH-121—13 Henries at 250 MA. filter choke, 1,500 volt insulation.....\$4.95
NH-412—4-12 Henries 81 ohm. Gov't conservative test voltage 2500 V. 300 MA.....\$4.95



ATTENTION ALL ELECTRONIC- TELEVISION ENGINEERS

For more than 6 years RADIO-ELECTRONIC ENGINEERING, a special edition of RADIO & TELEVISION NEWS, has kept alert engineers dependably and thoroughly informed on all that's really important in electronic engineering.

Selected and exclusive articles and other specialized features of practical and lasting value to electronic engineers are added to the content of the regular edition of RADIO & TELEVISION NEWS.

Subscribers to the regular edition may change to the RADIO-ELECTRONIC ENGINEERING edition by remitting an extra dollar for each 6 months of the unfulfilled portion of their subscriptions.

New subscribers please use the lower half of order card in this issue.

The RADIO-ELECTRONIC ENGINEERING edition is available only by subscription.



edition of
RADIO & TELEVISION NEWS
185 N. Wabash Ave.
Chicago 1, Ill.

A 79-Cent SIGNAL SOURCE

By
GUY DEXTER

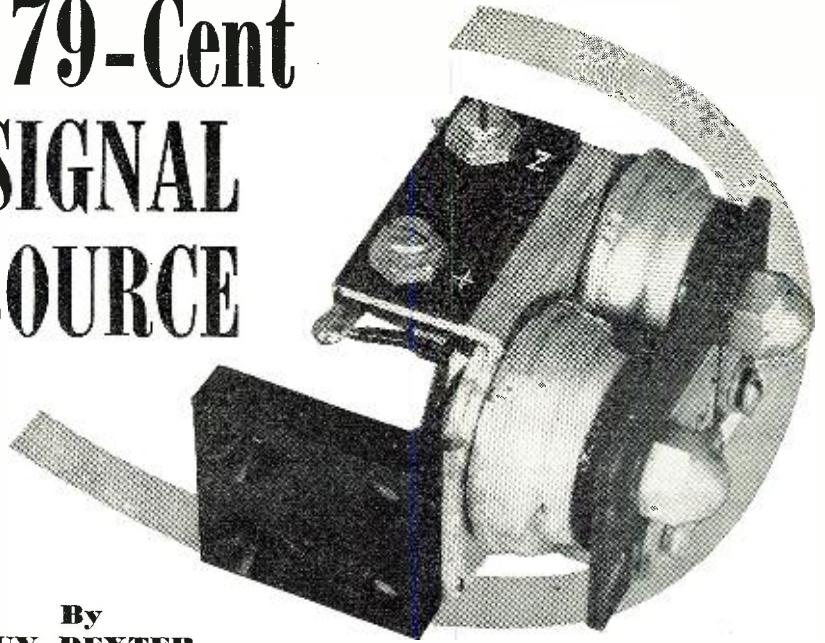

Fig. 1. The BZ-5 interrupter.

A surplus BZ-5 interrupter makes a simple a.f.-r.f. signal injector, code oscillator, modulator, or bridge signal source. Good signal is obtained up to 30 mc.

THE BZ-5 interrupter, now available for less than one dollar in the surplus market, offers attractive possibilities as a simple signal source. This unit must not be confused with an ordinary buzzer. It is a unique arrangement of two vibrating reeds, each operated in conjunction with a cup of carbon granules. Its over-all dimensions are approximately $2\frac{1}{4}'' \times 2\frac{1}{4}'' \times 1\frac{1}{2}''$. Fig. 1 shows the BZ-5.

Best operation of the BZ-5 is obtained with 6 volts d.c. input. Current drain at this voltage is $6\frac{1}{2}$ milliamperes. For intermittent radio use, four penlight cells connected in series give good service. The a.c. output voltage is approximately 3 volts r.m.s.

The fundamental frequency output of the BZ-5 is stated by the supplier to be between 1300 and 1700 cycles. However, most of the large number of units tested by the author checked between 1200 and 1300 cycles. One half-cycle of the output wave is almost pure sine wave, while the peak of the other half-cycle is considerably fuzzed. Reversing the battery polarity reverses the position of the distorted half-cycle.

When the output of the BZ-5 is connected to the antenna and ground terminals of a radio receiver, a frying signal is heard clearly as far as 30 megacycles. Unfortunately, harmonics do not quite reach the lower television channels. The author could produce no picture-screen interference with a sensitive TV set. At lower broadcast and i.f. frequencies, the hiss is tone-

modulated. A surprisingly clean tone is heard when the BZ-5 is connected to an audio amplifier or loudspeaker. This simple unit thus may be used as an untuned troubleshooting signal injector at both audio and radio frequencies. Its output may be applied from point-to-point throughout an entire receiver. Unlike a buzzer, the BZ-5 makes no noise when in use. Fig. 2 shows the circuit for a general purpose signal source and signal injector.

We tried the BZ-5 with good success as a bridge signal source. In spite of its rather high harmonic output, this unit performed satisfactorily in conjunction with a General Radio Type 650-A impedance bridge.

Other uses for the interrupter include code practice oscillator (key the audio output, not the battery voltage), tone modulator for m.c.w. transmitters, signal tone source ("factory whistle") for p.a. systems, etc.

-30-

Fig. 2. Wiring diagram of signal generator.

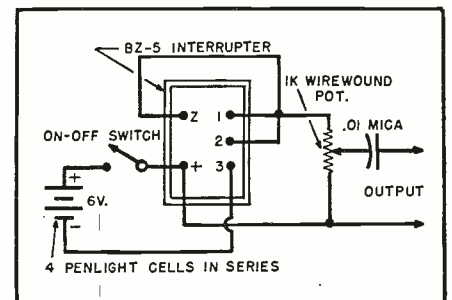

RADIO & TELEVISION NEWS

AFCA



NEWS

This Association is a patriotic non-profit organization, with chapters in most of the larger cities, dedicated to developing and maintaining efficient personnel, commissioned, enlisted, civilian, for the supply (including design and development), installation, maintenance, and operation of communications and electronic equipment for Army, Navy, and Air Force and their supporting civilian activities. It publishes a magazine "SIGNALS" at its national headquarters in Washington. Every American interested in any way in communications is eligible and invited to join. Dues are \$5.00 per year. Application should be submitted to the secretary at 1624 Eye St., N. W., Washington 6, D. C., who will furnish details upon request.

AFCA ANNUAL CONVENTION

The groundwork for a broad program for more specific aids to cooperation between the armed services and the communications-electronics industry, through a revitalized Armed Forces Communications Association, was launched by the officers and directors of the AFCA in the business sessions of the association's annual convention on May 12th in the Commodore Hotel, New York.

In the efforts, endorsed by the AFCA Board of Directors and National Council, to expand the membership and activities of the association, Executive Secretary George P. Dixon will intensify the program to gain more individual and group members through exchange of detailed information on prospective members between the AFCA chapters and the national headquarters. In addition, immediate consideration will be given to panel discussion in which spokesmen for the armed services would lay specific communications-electronics problems before industry representatives to gain the benefit of their technical data and views.

Maj. Gen. William H. Harrison, president of the *International Telephone & Telegraph Corp.* and wartime head of the Procurement and Distribution Service of the Signal Corps, as principal speaker at the annual banquet, paid tribute to the wartime efforts of the communications industry as performing a job under inspired leadership unsurpassed by any industry during World War II. At the same time, General Harrison, emphasizing that manufacturing responsibility for armed services' procurement

should be in the hands of the organizations best qualified to carry on when needed, stressed that there should be greater flexibility in procurement procedures of the services.

Spearheading the discussion of the expanded program of the association were newly-elected AFCA President T. S. Gary, vice-president of *Theodore Gary & Co.*, who has been AFCA first vice-president in charge of chapters; retiring AFCA President Frederick R. Lack, vice-president of the *Western Electric Co.*; and Colonel Dixon. Mr. Lack pointed out that the AFCA would be of definite assistance to national preparedness in such problems as civil defense planning. Another example he cited was the proposal of the Navy's Bureau of Aeronautics that certain types of mass-produced aircraft communications-navigation equipment be designed so that no maintenance would be required, and so that it could be discarded at the end of the useful life of the aircraft in which it is installed.

In addition to Mr. Gary, AFCA officers elected for the ensuing year were: First vice-president—W. W. Watts, vice-president of *RCA Victor Division*; Second vice-president—Rear Admiral Earl E. Stone, until recently Chief of Naval Communications; Third vice-president—J. R. Cunningham, of *United Air Lines*; Fourth vice-president—C. O. Bickelhaupt, vice-president and secretary of the *American Telephone & Telegraph Co.*; and Fifth vice-president—David R. Hull, who was in charge of the Electronics Division of the Navy Bureau of Ships as a Navy captain, and who has recently taken a new post as assistant vice-president of the *Raytheon Manufacturing Co.*

Frank W. Wozencraft, Washington attorney, was reelected as AFCA legal counsel, and Colonel Dixon was reelected executive secretary, a post he has held since the start of this year.

To fill vacancies on the Board of Directors occasioned by the resignation of Hollywood Producer Darryl Zanuck and Brig. Gen. Stephen H. Sherrill, former executive director, and the death of Dr. Frank B. Jewett, former president of the *Bell Telephone Laboratories*, Mr. Gary, Mr. Watts, and Captain Hull were elected to the Board. Four other Directors were elected. They are: FCC Commissioner E. M. Webster, wartime chief of Coast Guard communications; William H. Mansfield, secretary of the *Southern Bell Telephone & Telegraph Co.*; G. F. Metcalf, chief of the Electronics Division of the *General Elec-*

BARGAINS GALORE

PORTABLE VIBRATOR POWER SUPPLY

PE157B Runs off 2V self contained storage battery. Housed in a metal carrying case with leather handle, 6" x 6" x 12". Contains oddies of useful parts including 4" pm speaker, jacks, capacitors, resistors and heavy duty eight wire shielded cable. Incl. 2 Vib. Used but in good condition. . . \$2.95
NEW 2 VOLT storage battery for above. . . 1.95

HANDY 20 RANGE MULTI-TESTER

AC 0-1250V in four ranges, DC 0-1000V in six ranges, DC 0-100 MA in 2 ranges, OHMS 0-1 MEG in 3 ranges, DB -10-37DB in 5 ranges. NOT A KIT. Completely wired, tested and guaranteed. ONLY . . . \$12.50

VIVM ALL PURPOSE TESTER

AC & DC VOLTS 0-1500 in twelve ranges, OHMS 0-100 MEGS in five ranges. Can be used for checking AC circuits from 20 cps to 200 MC with Xtal probe. 15 MEG input impedance, high stability and New circuit design to protect meter from overload damage combine to make this instrument the best in dollar value. Fully guaranteed, not a kit. HIGH VOLTAGE PROBE for above—\$K.V. . . \$23.50

METER SPECIALS

RD 17 1/2" 0-500 ua DC Sp. Scale. . . \$4.95
SQ 2 3/4" 0-9 VDC99
SQ 2 3/4" 0-100 AMP DC with shunt. . .99
SQ 4 1/2" 0-50 ua DC9.95
SQ 4 1/2" 0-200 ua7.95

3" METERS

0-50 ua DC . . . \$14.95
0-200 ua DC WH 10.25
0-500 ua GE . . . 6.95
0-1 MA DC . . . 5.95
0-1 MA DCS Seal. . . 3.95
0-2 MA DC WH. . . 4.95
0-2 MA DC Smp . . 3.95
0-5 MA SP Scale . . 2.95
0-15 MA DC GE . . 3.95
SQ 1 1/2" DC WH . . 3.25
0-30 MA DC GE. . 4.50
0-50 MA DC WH . . 4.50
0-80 MA DC WE . . 2.25
0-100 MA DC . . . 4.50
0-150 MA DC WH . 4.50
0-200 MA DC GE . 4.50
0-300 MA DC . . . 4.50
0-750 MA DC GE . 4.50
0-1 AMP DC WH . 4.95
0-2 AMP DC Smp . 5.95
0-300 VDC Sun. . . 7.95
0-750 VDC . . . 7.95
0-8 VAC WES 476 . 4.50
0-15 VAC GE . . . 4.50
-10-35 DB WES . . 8.95
0-150 VAC WH. . . 5.95
0-30 AMP AC Trip . 5.95
New Weston Model 433, 0-150 VAC . \$37.50
Cy

2" METERS

0-500 ua SP Scale \$3.95
0-1 MA DC 500 . . 3.95
0-1 MA DC GE . . . 3.95
0-1.2 MA 500 . . . 3.95
0-5 MA SP Scale . . 2.49
Test Meter 0-200 MA and 0-2 Amp DC 3.95
0-10 MA WH . . . 2.49
0-20 MA SP Scale 2.49
0-25 MA SP Scale 2.49
0-10 VAC TRP . . . 3.50
0-3 VDC, IMA . . . 3.50
0-20 VDC WEST. . 2.75
0-30 VDC GE . . . 2.95
0-10 AMP DC GE. . 3.50
0-30 AMP DC GE. . 3.50
0-50 VAC GE . . . 3.50
0-300 VAC TRP . . 3.50
0-250 MA AC GE. . 3.95
0-1 AMP RF GE. . . 3.50
0-10 AMP RF GE. . 3.50
0-4 AMP RF GE. . 3.50
0-9 AMP RF WH. . 3.50
New Weston Model 433, 0-150 VAC . \$37.50
Cy

CHOKES

200 HY 6 MA 620 OHM . . . \$0.99
8 HY 50 MA 90 OHM39
10 HY 80 MA 240 OHM45
20 HY 110 MA Sub Sig Herm Seal. . 3.45
10 HY 150 MA 140 OHM1.39
5 HY 200 MA 65 OHM Sub Sig Herm Seal. 3.50
7 HY 200 MA 100 OHM Herm Seal. . . 3.50
4-16 HY 200 MA 140 OHM SWINGING CH. 3.85
4 HY 120 MA 200 OHM1.90
3 HY 250 MA 15 OHM Herm Seal. . . . 1.65
15 HY 250 MA 60 OHM3.25
3-14 HY 300 MA 80 OHM SWINGING CH. 5.60
8 HY 300 MA 80 OHM5.55
12 HY 400 MA 90 OHM Herm Seal. . . 4.95
8 HY 450 MA 88 OHM Herm Seal. . . . 5.95

1T5V FILAMENT TRANSFORMERS 60 CY

2.5 VCT 10, 10KV Insulation . . . \$2.95
5 VCT 3A, 2.5 KV Insulation 2.10
5 V 15 A, 2.5 KV Insulation 3.45
6.3 V 1 A1.85
6.3 V 3 Amps1.95
6.3 V 12 Amps1.75
6.3 V 3 Amps, 6.3V 3 Amps 3.40
6.3 V 3 A, 2.5 V 6 Amp Herm Seal. . 3.49
6.3 V 3A, 2.5 V 6 Amp Herm Seal. . . 3.49
10 VCT 10 A, 2.5 KV Insulation. . . 4.95
6.3 V 4 Amps3.75
6.3 V 12A, 6.3 V 2 A Herm Seal. . . 3.95

1T5V POWER TRANSFORMERS 60 CY

240 VCT 50 MA . . . \$1.95
650 VCT 90 MA, 6.3V 2A, 5V 3A . . . 2.75
700 VCT 90 MA, 6.3V 4A, 5V 3A . . . 2.98
610 VCT 160 MA, 6.3V 3A, 5V 3A . . . 3.95
650 VCT 250 MA, 5V 4A, 6.3V 3A . . . 2.95
800 VCT 200 MA, 6.3V 4A, 5V 3A . . . 2.95
800 VCT 300 MA, 6.3V 10A, 6.3V 9A 5V 3A 8.50
800 VCT 300 MA, 6.3V 10.8A, 5V 6A, 5V 2A 8.50
300 V 100 MA, 22V VCT 100 MA, 6.3V 3.5A, 2.5V 10A2.49
750-800-0-600-750, 225 MA7.95

OIL CAPACITORS

7 MF 330 VAC . . . \$0.95
5 MF 600 VDC45
2 MF 600 VDC59
4 MF 600 VDC79
6 MF 600 VDC89
10 MF 600 VDC95
4 MF 1KV WAX29
2 MF 1000 VDC90
5 MF 1000 VDC 1.79
10 MF 1KV DC 2.75
15 MF 1KV DC 3.39
5 MF 1.5 KV DC. 1.25
2 MF 1.5 KV DC. 1.45
4 MF 1.5 KV DC. \$2.49
6 MF 1.5 KV DC. 2.95
1 MF 2000 VDC. 1.79
25 MF 2000 VDC. 1.95
1 MF 2000 VDC. 2.45
4 MF 2000 VDC. 2.95
8 MF 2000 VDC. 3.95
25 MF 3000 VDC 1.45
4 MF 3000 VDC. 8.95
3 MF 4000 VDC. 2.75
2 MF 5000 VDC. 6.95
1 MF 7500 VDC. .79

TERMS: 25% Deposit with order, balance C.O.D. Rated firms open account

"SEND FOR POLY-GRAM"

POLY-TECH

919 Dawson St., N.Y. 59, N.Y.

Tel. MURray Hill 6-2650



**COLUMBIA'S GEM OF THE MONTH
MD-7/ARC-5 PLATE MODULATOR:**

For ARC-5 VHF and low freq. transmitter. Push-pull 1625 tubes to power stage of xmitr. Excellent cond. The bestest buy what am! \$7.95.

SCRS22 RECEIVER-TRANSMITTER: 100-156 mc. This hot 2-meter rig is complete with all tubes and push-button control box. Excel. cond. \$24.95

ACCESSORIES FOR 522 RECEIVER-

PE-98 12 V. Power Supply. Used.	\$12.95
PE-94 24 V. Power Supply. Low price.	2.95
AN 104 A Antenna. Brand new.	1.95
Set of 7 plugs. New.	3.95
BC-1303 MIKE ADAPTER & TEST UNIT.	5.00

PE104 VIBRATOR POWER SUPPLY: For BC654. Input 6 or 12 V. Output 51 V. neg. bias. 90 V. B plus @ 5-10 mils. 1 1/2 V. filament @ 350 mils. Excel. cond. \$7.50

1D-6A/APN4 LORAN SCOPE & R-9A/APN4 POWER SUPPLY RECEIVER COMBINATION DEAL: Scope is suitable for conversion test scope and other useful indicators. Has a 5CP1 scope tube and 100 kc. xtal. for controlling sweep freq. 27 tubes, raft of useful parts. 400 cycle power supply can be easily converted to conventional 50 cyc. Receiver can be converted to 160 meter band. Both units complete with xtal. and tubes. Excel. cond. Excellent for Marine Use as PPI Radar. \$29.50

TV TUNER

13-channel turret with 6CB6 RF amplifier and 6J6 oscillator mixer. Has silver contacts, 3/4 in. shaft, conical vernier control. 51 tubes, factory connected and aligned. Standard video and audio output. See June/50 RADIO NEWS P. 58. New, late model. \$19.95

DU-1 LOOP ANTENNA

Has RF amplifier and Senses Antenna RF amplifier. Both outputs combined to give figure 8 or cardioid bearing. Can be used with any good receiver covering 200-1600 kc. New. \$24.95

TV TUBES

All new in original cartons, known brands!	
16EP4.	\$37.95
16AP4.	37.95
12LP4.	24.95

CONDENSERS

2 mfd. @ 4000 V. G.E. Paranol.	\$2.50
10 mfd. @ 600 V. oil cond. New in box.	.99

RELAYS

110 V. DPDT. Heavy contacts.	\$1.10
12 V. SPST	.59

ART 13 TRANSMITTER

813 final, 2-811 mod., 250 watts. Excel. cond. \$119.95
FL8 FILTERS: 1020 cycle. Used, ea. .75

RECORD CHANGERS: 78 r.p.m. Standard brands. Near New. \$14.95

HI-FI AUDIO AMPLIFIER: Push-pull 6F6 to low imp. voice coil. Easily modified for use with turntable or PA system. Excel. cond. \$10.95

TU17 & 18 TUNING UNIT: For BC223 Transmitter. TU17 covers 2-3 mc; TU18 covers 3-4.5 mc. Excel. cond. \$14.95
CONICAL TV ANTENNA: New. \$4.95

METERS! BEST BUYS! METERS!

2" G.E. or Westinghouse Rd. 0-1 amp. R.	\$3.49
2" Hickok Rd. 0-1 ma. with 0-10 scale.	3.29
3" Westinghouse Rd.	
0-15 ma. DC movement with 0-300 scale.	2.98
2" Weston Rd. 0-25 ma. DC.	2.49
0-1.5 amp RF.	3.49
20-0-20 amp DC.	2.75
2" Westinghouse Rd. 0-9 amp RF.	2.50
2" Simpson Rd. 0-3 VDC.	2.50

BC 733 & R 89/ARN5 LOCALIZER & GLIDE PATH RECEIVER COMBINATION: Terrific receiver for FM & 2-meter band. Complete with tubes & xtals. Both in good cond. \$39.95
See March/50 RADIO & TELEVISION NEWS for conversion.

APR-1 RECEIVER & TUNING UNITS: 30 mc. IF strip, hi-gain, contains detector & audio stages. Excel. for use with front end converter for UHF Receiver, with plug-in tuning converter. Excel. cond., like new. \$124.50

ARC-5 OR 274-N TRANSMITTERS COMPLETE
2-1-3 mcs. Excel. for ship use. New. \$12.95
3-4 mcs. Used, excel. cond. 9.95
4-5-3 mcs. Used, excel. cond. 3.50
5-3-7 mcs. Used, excel. cond. 3.50
7-9-1 mcs. Used, excel. cond. 9.95

ARC-5 OR 274-N RECEIVERS
1-5-3 mcs. For ship use. Excel. cond. \$14.50
3-6 mcs., excel. cond. 3.95
6-9-1 mcs., good cond. 5.95
190-350 mcs. Excel. cond. 9.95
Command Receiver flex. cable 6'. 95
Command Receiver 28V dynamotor. 79
Command Knobs for Receiver. Ea. .69

BC 375 TUNING UNITS: TU-10, 10 to 12.5 mc.; TU-6, 3 to 4.5 mc.; TU-22, 350 to 650 kc.; TU-26, 200 to 300 kc. Excel. cond. Ea. \$9.95
ORDER 10 FOR ONLY \$50.00

274-N ANTENNA RELAY BOX
Contains RF meter plus 30 mmfd H. V. vacuum cond. and relay. New in carton. \$2.25
SAME but less vacuum cond., used, good cond. .99

EE-8 FIELD TELEPHONE: Uses 2 flashlight batt. Has crank for ringing other phone. Ideal for use in field, mines, camp, house to lab, or garage, etc. Excel. operating condition. Each. \$6.75
ORDER A PAIR FOR ONLY \$12.95

COLUMBIA ELECTRONIC SALES
522 South San Pedro Street
LOS ANGELES 13, CALIFORNIA

tric Co.; and Joseph Wilson, president of the Haloid Co.

Indicative of the heightened interest in AFCA affairs in recent months was the fact that almost every chapter was represented at the Council meeting. The Friday afternoon meeting of chapter presidents, presided over by Mr. Gary, was an innovation reflecting the growing importance of the chapters in the AFCA organization.

Banquet speakers before General Harrison were: Maj. Gen. K. B. Lawton, Deputy Chief Signal Officer; Maj. F. L. Ankenbrandt, director of Air Force Communications; Rear Adm. John R. Redman, chief of Naval Communications; and Capt. D. E. McKay, chief of Coast Guard Communications.

Col. T. H. Mitchell, executive vice-president of *RCA Communications*, who is president of the New York AFCA chapter, acted as toastmaster at the banquet, while Mr. Lack introduced the speakers. Seated at the head table, in addition to the speakers, were Mr. Gary, Mr. Lack, Vice-President Bartlett T. Miller of the *American Telephone & Telegraph Co.*; Western Union *Telegraph Co.*; President Walter P. Marshall; General Telephone Harold V. Bozell; Maj. Gen. H. C. Ingles, president of *RCA Communications* and "father" of the AFCA; Rear Admiral Ellery W. Stone, president of the *International Standard Electric Corp.*; Brig. Gen. A. W. Marriner of *IT&T*; Commissioner Webster; Admiral Earl Stone; Maj. Gen. F. H. Lanahan, commanding general at Fort Monmouth; Colonel Dixon; Maj. Gen. Joseph O. Mauborgne, prewar Chief Signal Officer; and J. Harry LaBrum, Philadelphia attorney. In addition, Col. Mitchell introduced Haraden Pratt, vice-president and chief engineer of the *American Cable & Radio Corp.*, from the floor.

General Lawton, representing Maj. Gen. Spencer B. Akin, Chief Signal Officer, absent on an inspection tour of western Europe, emphasized the current dangers to democracy abroad in the world, and stated that "We do not recommend war, but we believe that a cowardly fear of war and a craven spirit of appeasement will lead to war rather than to peace."

In his talk, General Ankenbrandt stressed the importance of communications in modern warfare, and he commented that "It was quite apparent at the termination of hostilities that there was grave need for an organization to serve as common ground upon which armed forces and industry could meet and exchange views."

Admiral Redman declared "With the mutual interest and enthusiasm of its members as a basis, AFCA's contributions to our nation's defense are sure to be many. There is one direction in which I feel a particular contribution can be made—that is in the field of trained personnel. In the final analysis, people make the wheels

SENSATIONAL VALUE!

RCA Lic.

#630 type
16" CHASSIS

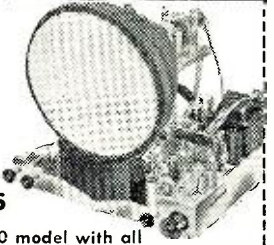

the latest 1950 model with all the newest electronic improvements . . .

- 30 tubes
- synchrolock tuning
- keyed A G C
- 15,000 volts under load
- 12-inch RCA speaker
- phono-jack attachment
- RMA guarantee—Plus our Guarantee

A set—NOT A KIT.

Completely wired, Factory Engineered, aligned and tested.

Complete with 16" first quality tube AND Beautiful hand-rubbed Mahogany Cabinet.

COMPLETE PRICE

\$199.95

With 19" Tube \$234.95

1 YEAR GUARANTEE ON TUBE

A half-hour to mount; ready for operation. Saves up to \$150.

Compare this anywhere for high quality—low price!

Write Dept. F for further information. Phone and mail orders filled on receipt of money order for 25% as deposit . . . the balance C.O.D., f.o.b. N. Y.

NEW ENGLAND TELEVISION CORP.

248 E. 149 ST., BRONX 51, N. Y.

Build Your Career! Become an Electrical Engineer

☆ Major in Electronics or Power

☆ B. S. Degree in 36 Months



World-famous courses in Radio-Television, Electronics and Electrical Power. 6- to 24-month technician courses. 35,000 former students. Write for free pictorial booklet, "Your Career" and 110-page catalog. State if World War II vet. See full-page advertisement in this issue, Page 103.

MILWAUKEE SCHOOL OF ENGINEERING

Dept. RNB-850 N. Broadway, Milwaukee, Wis.

COIN RADIOS

Buy Direct from Manufacturer & Save

- STEEL CABINET
- MODERN DESIGN
- COIN REJECTOR

\$39.50 List F.O.B. Factory

One-third Deposit, Balance C.O.D. Write, Wire, Call for Quantity Discount. Send for Full Story

Coin Radio & Television Co.
190 A Duane St. Dept. R New York City



RADIO and TELEVISION

Thorough Training in All Technical Phases

APPROVED FOR VETERANS WEEKLY RATES DAYS—EVENINGS

FREE PLACEMENT SERVICE FOR GRADUATES

For Free Catalog write Dept. RN-50
RCA INSTITUTES, INC.
A Service of Radio Corporation of America
350 West 4th St., New York 14, N. Y.

RADIO & TELEVISION NEWS

go 'round. No matter how good the machine or equipment, its performance depends on the efficiency of the operator and the maintenance man."

Several hundred AFCA members and guests toured the Signal Corps center at Fort Monmouth, N. J., Saturday, May 13th. The program included the first showing of the Signal Corps' traveling exhibit, which is set up along the lines of the *Bell System's* display of modern telephone advances and techniques, now on tour around the nation.

One of the features of the outdoor showing was a drop by a parachute platoon, with the communications officer "broadcasting" his reactions, during the downward trip, to the assembled AFCA members and guests.

The Signal Corps' displays and exhibits also included a depiction of the first radar contact with the moon, and exhibition of radiac (radioactivity detection, identification, and computation).

AFCA CHAPTER NEWS

Atlanta

Ralph S. Grist, General Coordinator of Military Services, *Southern Bell Telephone & Telegraph Company*, was installed as president of the Atlanta Chapter at the chapter's annual meeting, June 5th.

Maj. General William C. Chase, Chief of Staff, Third Army and formerly Commanding General of the famous First Cavalry Division, was the guest speaker at the dinner meeting held at the Officers' Mess, Fort McPherson. General Chase was introduced by Lt. General Alvan C. Gillem, Jr., Commanding General, Third Army. Both stressed the importance of communications in all phases of war and in peace and paid high tribute to the AFCA as being a means of bringing together the civilian and military "know-how" of all branches of communications and welding them into an organization that should prove of tremendous value in the event of national emergency. General Chase gave a very interesting and informative talk on the Far East.



Other chapter officers were installed as follows: 1st vice-president—H. S. Dumas, Jr., *Dealers Supply Co.*; 2nd vice-president—Lt. Col. Clyde R. Smith, Signal Section, Third Army; 3rd vice-president—John F. Harte, Jr., Georgia Tech; 4th vice-president—Robert J. Smith, *Conley General Depot*; Secretary-treasurer—Capt. Robert L. Oertle, Signal Section, Third Army.

Augusta-Camp Gordon

The Augusta-Camp Gordon Chapter celebrated its distinction as the new AFCA "Chapter of the Year" at a dinner meeting May 17th at the Officers' Club, Camp Gordon.

President Henry J. Hort announced that the chapter had won the 1950 "Chapter of the Year" contest in competition with all other chapters and a framed copy of the award, which had been presented to President Hort and

August, 1950

<p>MICROPHONES</p> <ul style="list-style-type: none"> • Pressure • Velocity • Cardioid • Varacoustic • Hand Sets • Sound Power Telephones • Stands, Plugs, Cables and Connectors 	<p>AMPLIFIERS</p> <ul style="list-style-type: none"> • Pre-Amplifiers • Line Amplifiers • Voltage Amplifiers • Power Amplifiers • Remote Amplifiers 	<p>SPEAKERS</p> <ul style="list-style-type: none"> • Cone Type • Horns and Drivers • High-Fidelity Speakers • Speaker Accessories 	<p>SPEAKER HOUSINGS</p> <ul style="list-style-type: none"> • Baffles, All Types • Console Cabinets 
<p>INTERCOM SYSTEMS</p>  <ul style="list-style-type: none"> • All Master Systems • Master-Remote Systems • Combination Systems 			<p>PORTABLE SOUND SYSTEMS</p> 
<p>CUSTOM-BUILT EQUIPMENT</p>  <ul style="list-style-type: none"> • Consoles • Desks • Turrets • Cabinets 			<p>PROGRAM CONTROL UNITS</p>  <ul style="list-style-type: none"> • Single Channel • Dual Channel • Custom-Built

Why shop around?

It's easy to get the right equipment from RCA's full line of matched sound products

Buy your sound products the easy way. The wide variety of RCA Sound Products simplifies your problem of finding the right equipment for your sound jobs.

Every item in RCA's extensive sound line is electronically engineered with its own special characteristics to give top performance, dependable long-life service with quality appearance. Not only is the

RCA Sound Products line built right, it is also priced right to enable you to build a steady volume of profitable business.

No other manufacturer offers so extensive a line of "matched" sound products from the smallest "ballyhoo" system to the largest systems for industrial, educational, institutional, church, hotel, hospital or commercial users.

See your RCA Sound Products Distributor for catalog and new sound sales manual



SOUND PRODUCTS
RADIO CORPORATION OF AMERICA
 ENGINEERING PRODUCTS DEPARTMENT, CAMDEN, N.J.

In Canada: RCA VICTOR Company Limited, Montreal



new! LOW COST DC SOURCE
ELECTRO "BJ" JUNIOR
 SUPPLIES 1 to 12.5 AMPS. 6 VOLTS CONTINUOUS DUTY
 3 to 9 Volts at Other Ratings

Patent Pending

New Model "BJ" Junior filtered power supply utilizes same exclusive application of selenium rectifiers used in the famous Model "B". This application, using conduction cooling, doubles the rectifier power rating, dissipates over 3 times the heat and provides lower cost per ampere

Operate, Test from AC Lines

Auto Radios • Relays • Telephone Circuits
 Instruments • Other Low Voltage Devices

output over other types. Supplies ample power, with a peak instantaneous current rating of 25 amperes (from standard 50/60 cycle 115 volt source). Heavy duty components withstand high over-loads. AC ripple less than 0.4 volts at 6 volts DC & amperes. Net Price Only \$32.40

Pioneer Manufacturers of Battery Eliminators



ELECTRO PRODUCTS LABORATORIES, INC., 4509-BJ Ravenswood Ave., Chicago 40, Ill



Picture Tube News

Reeves Soundcraft's New 16" and 17" Rectangulars

TRU-LUME'
17" DARK-FACE

REEVES SOUND-CRAFT BUYS REMINGTON-RAND TV PICTURE TUBE DIV.

The Reeves company recently purchased the Remington Rand TV picture tube division, including all manufacturing facilities, and are preparing to expand production immediately in order to make the tubes available to more makers of video receivers.

Lieut. General Leslie R. Groves, vice-president of Remington Rand in charge of disposal of the tube project was necessary because the research phase had been completed and the product was now well along in the commercial marketing stage.

According to Hazard E. Reeves, president of Reeves Soundcraft, production has not been seriously interrupted by the transfer of equipment to the new plant, and orders, already placed by such television receiver makers as Motorola, Magnavox, National and Hallicrafters, are continuing to be filled at a progressively increasing rate of production.

WE could tell you lots about phosphor-deposit water so demineralized and deionized it's downright exhausted, about the Big Bertha electron guns we make ourselves, and about the high vacuum that makes these magic portholes glamorize the ancient flickers, but since all brands, claims notwithstanding, are scarce as elephant feathers, nobody cares. The important thing is that every day WE ARE MAKING AND DELIVERING RECTANGULARS TO FAMOUS-NAME MANUFACTURERS AND DISTRIBUTORS.

In the coming months more and more of these fine rectangulars will become available. An inquiry NOW will enable us to tell you how YOU may sooner become one of our happy kinescopic beneficiaries.

Dictate an inquiry today.

REEVES Soundcraft CORP.

COLORCRAFT PICTURE TUBE DIV.
35-54 36th STREET, LONG ISLAND CITY 6, N. Y.

SUCCESSORS TO REMINGTON-RAND TELEVISION PICTURE TUBE DIV.

PREMAX

First Again! with A New Civil Air Patrol ANTENNA



Designed for 2374 Kc. Is highly efficient! Has a longer range! 8 d.b. gain or 6.3 times the transmitting power. Something every C.A.P. man needs to make his mobile unit efficient. Fits any standard Premax Mobile Mounting.

At your jobber
or write

\$825
Net Less
Mount

PREMAX PRODUCTS
DIVISION CHISHOLM-RYDER CO., INC.

5006 Highland Ave., Niagara Falls, N. Y.

CHICAGO RADIO AND APPLIANCE MULTITESTER

Model
458A

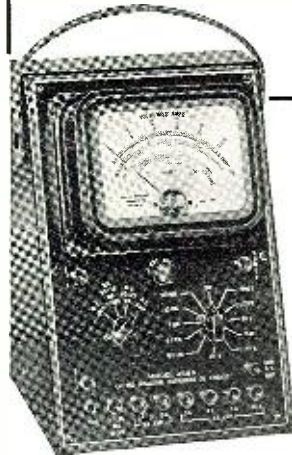

New
Wider
Ranges

NEW
CASE
DESIGN
FOR EASY
READING

AC and DC VOLTS: 0-2.5/10/50/250/1000/5000
AC AMPS: 0-0.5/1/5/10 DC AMPS: 0-1/10
AC and DC MILS: 0-1/10/100
OHMS FULL SCALE: 1000/200,000/2,000,000
OHMS CENTER SCALE: 50/2250/22,500
SIZE OVERALL: 10 1/2"x6 1/2"x8" Meter: 4 1/2" wide.
Handsome brown Hammerloid case with leather strap.
1000 Ohms per volt. Net Price \$26.00

We manufacture a complete line of fine portable multitesters.

Chicago

Write for
circular

INDUSTRIAL INSTRUMENT CO.

536 W. ELM ST. • CHICAGO 10, ILL.

Past President Hugh A. Fleming at the AFCA annual convention on May 12th in New York, was turned over to Lt. Col. Thomas K. Trigg, chapter vice-president, for display with other chapter trophies. Major Norman J. Kinley, former chapter secretary, and Lt. Thomas W. Doepner were cited for outstanding service to the chapter during the contest.

The featured speaker of the evening was Colonel W. D. Harden who, in commemoration of Armed Forces Day, gave a talk on unification. The program concluded with the film "Stilwell's Road."

Baltimore

Dr. Ferdinand Hamburger, chairman of the Electrical Engineering Department of Johns Hopkins University, and Professor of Electrical Engineering, spoke on "Information Systems Research" at the May 24th meeting of the Baltimore Chapter held at Levering Hall, Johns Hopkins University.

The University has a contract with the U. S. Navy to furnish them with pertinent radar equipment studies and information, and a group of electrical engineers and psychologists have been working for the past four and a half years, having turned in over 80 finished studies and 15 partial reports. Dr. Hamburger's talk was most interesting, even to a layman, and the advancement in target location, azimuth, height, and distance, all at one time is amazing to anyone who worked with P.P.I.'s during the recent war. After his talk, Dr. Hamburger conducted the AFCA members and guests through his special laboratory where some of this new equipment was set up and working.

Following the dinner Chapter President E. K. Jett of TV station WMAR, introduced Col. George P. Dixon, AFCA National Executive Secretary, who spoke briefly on the recent annual AFCA convention.

The nominating committee submitted a slate of officers for the next chapter year which was unanimously elected as follows: President—Wilbur L. Webb, director of engineering & research, *Bendix Radio*; 1st vice-president—Col. M. D. Harris, Deputy Commanding Officer, Baltimore Signal Depot; 2nd vice-president—Capt. Richard E. Elliott, Commanding Officer, U. S. Naval Communications Station, Annapolis; 3rd vice-president—Col. Henry W. Williams, Plant Engineer, *Chesapeake & Potomac Telephone Co.*; Secretary—George C. Ruehl, Jr., Veterans Employment Representative in Maryland for Dept. of Labor; Treasurer—Col. Roy T. Bucy, Signal Section 2nd Army, Fort George G. Meade. Member Executive Committee at Large—Commodore E. K. Jett vice-president, *Baltimore Sun Papers* and in charge of TV Station WMAR.

Chicago

The Chicago Chapter held its annual meeting and election of officers

on June 9th at the Officers' Club at the Naval Armory.

The entire 1949-50 slate of officers was re-elected for the 1950-51 term. Named to serve again were: President—Oliver Read, Editor of RADIO & TELEVISION NEWS; Vice-Presidents—Ralph Brengle of *Potter & Brumfield*, Dwight Brown of *Illinois Bell Telephone Company*, John Howland of *Zenith Radio Corporation*, and James Kellogg of *Kellogg Switchboard & Supply Co.*, and Secretary-Treasurer—Col. Raymond K. Fried.

After the adjournment of the business meeting the members enjoyed an informal get-together.

Cleveland

The Cleveland Chapter participated in the Armed Forces Day luncheon meeting sponsored by the Cleveland Advertising Club at the Hotel Carter on May 19th.

San Francisco

Joint meetings with local units of other associations comprised the San Francisco Chapter's activities during the month of May.

On May 22nd AFCA members attended the IRE-sponsored color television symposium in the auditorium of the Mission High School, San Francisco. Mr. R. A. Isberg of Station KRON-TV, chairman of the AFCA Publicity Committee and Program Chairman of the IRE, introduced the speakers.

On May 25th the chapter joined with the AIEE and the IRE in featuring a talk by Dr. Ralph Bown of the *Bell Telephone Laboratories* on "Modern Methods of Electrical Communications." The meeting was held in the *Pacific Tel & Tel* auditorium and was opened by Lt. Col. George J. LeBlanc, AFCA chapter vice-president and *Pacific Tel & Tel* engineer.

-30-

WEST GULF CONVENTION

THE San Antonio Radio Club will be host to the Twentieth Annual West Gulf Division ARRL Convention, August 18, 19, and 20, at the Gunter Hotel in San Antonio.

The \$7.50 pre-registration fee will include the Convention Banquet, the Saturday night dance, lectures, movies, contests, and chances at valuable prizes. The winner of the pre-registration prize will have his choice of a television receiver, a communications receiver, or a complete set of sterling silver.

Activities for the XYL's and YL's include a style show, a tea, prizes, and a visit to the historic Alamo. A special Early Comers party Friday night will be held at La Villita, an old Spanish village in the heart of downtown San Antonio.

The Hill Country Radio Club will sponsor a hidden transmitter hunt on Sunday morning.

Pre-registrations and hotel reservations may be obtained by writing W5EJT, Box 62, San Antonio, Texas. Pre-registration will close on August 10th.

-30-

August, 1950

SELENIUM RECTIFIERS

AND SPECIALIZED ELECTRONIC COMPONENTS

SINGLE PHASE Full Wave Bridge

Input: 0-18 VAC		Output: 0-12 VDC	
Type No.	Current		Price
B1-250	250 Ma.		\$.98
B1-1	1.0 Amp.		2.45
B1-1X5	1.5 Amp.		2.95
B1-3X5	3.5 Amp.		4.50
B1-5	5.0 Amp.		5.95
B1-10	10.0 Amp.		9.95
B1-20	20.0 Amp.		15.95
B1-30	30.0 Amp.		24.95
B1-40	40.0 Amp.		27.95
B1-50	50.0 Amp.		32.95

Input: 0-36 VAC		Output: 0-26 VDC	
Type No.	Current		Price
B2-150	150 Ma.		\$.98
B2-250	250 Ma.		1.25
B2-300	300 Ma.		1.50
B2-2	2.0 Amp.		4.95
B2-3X5	3.5 Amp.		6.95
B2-5	5.0 Amp.		9.95
B2-10	10.0 Amp.		15.95
B2-20	20.0 Amp.		27.95
B2-30	30.0 Amp.		36.95
B2-40	40.0 Amp.		44.95

Input: 0-115 VAC		Output: 0-90 VDC	
Type No.	Current		Price
B6-250	250 Ma.		\$ 2.95
B6-600	600 Ma.		5.95
B6-750	750 Ma.		6.95
B6-1X5	1.5 Amp.		10.95
B6-3X5	3.5 Amp.		18.95
B6-5	5.0 Amp.		24.95
B6-10	10.0 Amp.		36.95
B6-15	15.0 Amp.		44.95

Full Wave Center Tap

Input: 10-0-10 VAC		Output: 0-8 VDC	
Type No.	Current		Price
C1-10	10.0 Amp.		\$ 6.95
C1-20	20.0 Amp.		10.95
C1-30	30.0 Amp.		14.95
C1-40	40.0 Amp.		17.95
C1-50	50.0 Amp.		20.95

THREE PHASE Full Wave Bridge

Input: 0-234 VAC		Output: 0-250 VDC	
Type No.	Current		Price
3B13-1	1.0 Amp.		\$ 22.00
3B13-2	2.0 Amp.		32.00
3B13-4	4.0 Amp.		56.00
3B13-6	6.0 Amp.		81.50
3B13-10	10.0 Amp.		105.00
3B13-15	15.0 Amp.		120.00

RECTIFIER MOUNTING BRACKETS

For Types B1 through B6, and Type C1 \$.35 per set
For Types 3B..... 1.05 per set

CATALOG

Write for our Catalog No. 719, which lists additional Selenium Rectifiers, associated transformers, condensers and filter chokes.

Mini mum order \$3.00. No COD's accepted. Orders shipped via Rwy. Exp. charges Collect unless accompanied by additional 10% for parcel post and handling—15% west of Rockies.

All prices subject to change without notice. Prices and Delivery F.O.B. our NYC Warehouse. All merchandise subject to prior sale.

TELEVISION RECEIVER—\$1.00

Complete instructions for building your own television receiver. 16 pages—11" x 17" of pictures, pictorial diagrams, clarified schematics, 17" x 22" complete schematic diagram and chassis layout. Also booklet of alignment instructions, voltage and resistance tables and trouble-shooting hints—All for \$1.00.

CERTIFIED TELEVISION LABORATORIES
5507-13th Ave., Brooklyn 19, N. Y.

BARGAIN HUNTING? **RADIO SERVICEMEN!**
Write for SENSATIONAL CATALOG
HENSHAW RADIO SUPPLY
3619 TROOST KANSAS CITY, MO.

BATTERY ELIMINATOR

Six Volt Kit

For testing and demonstrating auto radios. Supplies 5-8 volts at 10 amperes continuous duty, 15 amperes intermittent. Step voltage control, ripple less than 3%. Power on instantly—no warm-up period required.

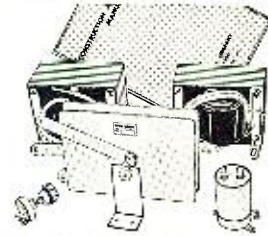

- HERE'S WHAT YOU GET:
- Heavy duty Transformer, Type XFC18-14
 - Rugged Selenium Rectifier, Type C1-10
 - Filter Choke, Type HY10A
 - Filter Condenser, Type CF 2
 - Multi-position Tap Switch

A terrific value at..... **\$19.50**

RECTIFIER CAPACITORS

Type No.	Capacity	Voltage	Price
CF-1	1000 MFD	15 VDC	\$.98
CF-20	2500 MFD	15 VDC	1.95
CF-5	4000 MFD	30 VDC	3.25
CF-18	500 MFD	50 VDC	1.95
CF-15	2000 MFD	50 VDC	3.25
CF-21	1200 MFD	80 VDC	3.25
CF-9	200 MFD	150 VDC	1.60
CF-10	500 MFD	200 VDC	3.25

Mounting clamps for above capacitors..... 15c ea.

RECTIFIER TRANSFORMERS

Type No.	Volts	Amps.	Shpg. wt.	Price
XL15-12	12	1	7 lbs.	\$ 3.95
TXF36-3	36	3	6 lbs.	3.95
TXF36-5	36	5	8 lbs.	4.95
TXF36-10	36	10	12 lbs.	7.95
TXF36-15	36	15	20 lbs.	11.95
TXF36-20	36	20	25 lbs.	12.95
XFC18-14	18 VCT	14	10 lbs.	5.95

All TXF Types are Tapped to Deliver 32, 34, 35 volts. XFC Type is Tapped to Deliver 16, 17, 18 Volts Center-tapped.

RECTIFIER CHOKES

Type No.	Hy.	Amps.	DC Res.	Price
HY5A	.028	5	.20	\$ 4.95
HY10	.02	10	.30	9.95
HY10A	.014	10	.04	7.95
HY20A	.007	20	.02	12.95

D-C PANEL METERS

Attractive, rugged, and reasonably priced. Moving vane solenoid type with accuracy within 3%. Square case, 0-5 Amperes DC } Any range \$2.49 each
0-12 Amperes DC }
0-15 Volts DC }

OPAD-GREEN COMPANY

71-3 Warren St.
New York 7, N. Y.

Phone: Bfekman 3-7385-6

PRINT YOUR OWN POST CARDS

COMPLETE OUTFIT only

\$7.50

Amazing results in sales, inquiries and contacts... saves time and money... very easy to use GEM STENCIL DUPLICATOR is ideal for Advertising, Announcements, Notices, Labels, Forms, Price Lists—hundreds of uses for every type of business and organization. Comes complete with all supplies, instructions and 60-page Book of Ideas.

FREE TRIAL OFFER: Try it before you buy it! Write and a GEM OUTFIT will be sent you postpaid. After 10 days, send only \$7.50 or return the GEM, no questions asked. The GEM must sell itself; you be the judge.

BOND EQUIPMENT CO. • Dept. 111
6633 Enright • St. Louis 5, Mo.

SEND NO MONEY • FREE TRIAL OFFER

RADIO AND T. V. SERVICE MEN!

GET THESE
R. C. P. INSTRUMENT
BARGAINS
Savings Up To 40%!

THROUGH SPECIAL ARRANGEMENT WITH THE MANUFACTURER WE ARE OFFERING THESE FINE INSTRUMENTS AT A SUPER-SPECIAL PRICE TO ADVERTISE THE OPENING OF OUR TWO NEW LOCATIONS AT

114 Hudson St., Newark, N. J.
701 Northampton Street
Easton, Pa.



Model 668

ELECTRONIC MULTITESTER

Special **\$39.50** Regular Price **\$59.50**

AC and DC Vacuum Tube Voltmeter, ranges to 6000 V. Ohmmeter to 1000 Megohms. Capacity meter to 2000 Mfd. Out-performs any other instrument in the field. Operates on 110-13-V. 50-60 Cycle A. C. Size 9 1/2" x 9 1/2" x 5 1/2". Weight 11 lbs.

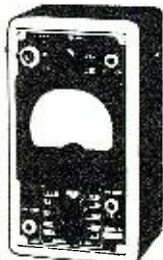

"6 in 1" MULTITESTER

Model 420-S

Special **\$14.95**
Regular Price **\$23.50**

A. C. & D. C. Voltmeter to 5000 V. D. C. Milliammeter to 1000 M. A. Ohmmeter to 1 Megohm Decibel meter-10 to plus 69. Output Voltmeter to 5000 V. Size 6 1/2" x 4 1/2" x 3 1/2". Weight 2 1/2 lbs.

Federated Purchaser
NEW YORK CITY ALLENTOWN, PA.
80 PARK PLACE 1115 HAMILTON ST.
Digby 9-3050 Allentown 3-7441

NOW! NEW LOW PRICE

REMOTE CONTROL TV

CHASSIS OR COMPLETE UNITS

16"-19"-20" TUBE

Custom chassis completely factory wired and aligned. 35 tubes, less C.R.T., including P.P. Amplifier, Variable Impedance Output, Continuous or Turret Tuning, and Synchro-lock.

Write for detailed, illustrated circular EEA Dealer and Jobber Territories Available

ELECTRONIC MANUFACTURING CO.

196 BOWERY - NEW YORK, N. Y.

Musical Novelty

(Continued from page 39)

aluminum because it is easy to work and is convenient for grounding the potentiometers. The two panels in the organ are Masonite because I had it on hand. I would prefer aluminum here because in this application Masonite is not sturdy enough and has to be braced. The rack is made of 3/4 inch aluminum angle, after the style of "Mini-Rack" units described in the March and April issues of RADIO & TELEVISION NEWS, except that I used larger angle and used standard sized panels.

Tuning Up

WWV broadcasts a 440 cycle tone day and night. 440 is A above middle C. The main thing is to get that A tuned right and use it for a reference point. You can do as I did; check your audio oscillator with an oscilloscope and WWV by setting your audio oscillator so it makes a circle on the scope with WWV. Then set your organ A to a circle with your audio oscillator. No audio oscillator or oscilloscope, you say? OK! Bring your short-wave receiver near the electronic organ (I do not know why I keep calling it that) and match it by ear. By the way, WWV also broadcasts a 440 and a 600 cycle note. Either look up the schedule or keep the receiver on long enough to distinguish the difference. You don't have a short-wave receiver? You're not licked! Music stores sell a 440 cycle pitchpipe for 25 cents, so why worry? Probably the next best thing to do is hire a piano tuner. You have already set "A" for him and it should not take him long to do the rest of the job by professional methods.

Then you get a piece of cardboard 7 inches long which will just cover one octave when set back of the keys. When "Do" is "C", name all the white keys with the musical scale. With that little musical scale tune, you can easily and quickly set the rest of the keys in the octave. You move the cardboard and make any key "do" and the little tune always works out right! A drawing is given, showing how I drew up such a cardboard tuner.

An ordinary piece of cardboard marked as shown will simplify the tuning operation.

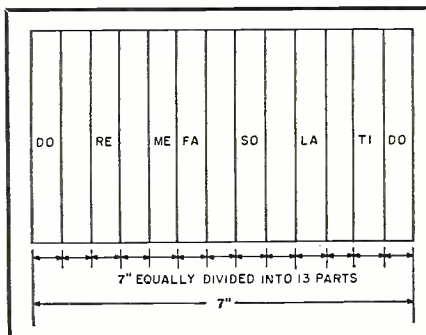

INTERNATIONAL — OFFERS —

"A FEW OF THEIR MANY TERRIFIC VALUES"

- Websters 3 Speed Record Changer (Model 346) \$24.95
- Automatic Changer for RCA 45 RPM Records 8.75
- International's DeLuxe Automatic Single Speed Record Changer 9.95
- VM Model 100A 3 Speed Player Complete with Amplifier 23.50
- "GI" TV Tuner (Less Tubes) 6.25
- RCA (16AP4) Picture Tubes (Factory Sealed Cartons) 38.95

THE RADIO & TELEVISION CENTER OF AMERICA

20% Deposit with Orders
California Buyers Add Sales Tax

SEND FOR OUR MONEY SAVING FLIER

INTERNATIONAL RADIO & TELEVISION PARTS CO.
639 N. Fairfax Ave., Los Angeles 36, Calif.

Deluxe T.V. Receiver Constructors

Complete set of Video IF, Audio IF, Discr. and trap coil forms. Discr.—surplus—see page 24, March R.-E. All others special made with cores, terminals, and single hole mtg's. less wire. Set of 8 coil forms \$3.80
RF. coil forms and trimmer cap. forms as shown on page 41, Feb. R.-E. Complete set of 13 pieces 90c
Station selector switch—special made, see page 39, Feb. R.-E. (less rear mt'g. plate and spring.) Available after July 20. Each \$4.60
Large set of prints and templates (9) to use in conjunction with Jan.-July Radio-Electronics. Postage incl. \$2.50
Include 20c postage with coil sets or 40c with complete order.

16RP4 Conversion will be ready by Fall
Address Checks or Postal Notes to:

CHAS. A. VACCARO

15 Park Ave. Ambler, Penna.

AD-VANTAGE

Take advantage of the world's biggest Classified Ad opportunity—Your ad in RADIO & TELEVISION NEWS Classified Section will get more action—more inquiries—quicker, and at less cost than in any other magazine. Monthly net paid circulation over 200,000.

The complete unit represents the result of considerable experiment, and the appearance could be greatly improved if it were to be rebuilt. However, as it was built when parts and money became available, several chassis were used.

If the constructor so desires, the whole assembly may be built at one time and the entire operation simplified.

An old piano case could be used, with the tuning controls and chassis hidden by the front panel of the piano. This would result in a more compact and neater assembly.

All the wires going to the high 16 note chassis plug in at one time using an 18-contact Jones plug. Do not think I am going extravagant and high class on you. I took that Jones plug from a piece of surplus equipment!

There is not a hum or click, or sound of any kind to let you know this outfit is turned on. It is dead as a door nail, even when you put your ear next to the speakers. You could easily let it run all night if you are absent-minded, so I added a pilot light. I could have used a dial light but that neon pilot was surplus, naturally!

MOBILE ANTENNA

By OTTO L. WOOLLEY, W0SGG

AN efficient and easily-loaded antenna system for mobile operation is the familiar center-fed, half-wave doublet. The practical application of such a system uses the conventional quarter-wave whip as a radiating element and the inner conductor of a coaxial cable as the second quarter-wave. The coaxial portion may be coiled and placed in any convenient location.

The greatest advantage of this system is that it may be fed with 72 ohm twinlead of any length coupled to the transmitter final tank coil, and such an antenna system will take power readily without complicated coupling adjustments. This ease of loading is reflected in the excellent signal reports received.

Difficulties that are often encountered due to non-resonant lengths in the vehicle are eliminated with this system.

Mobile antenna system. The coax may be coiled or placed in any convenient location, outer conductor grounded to car.

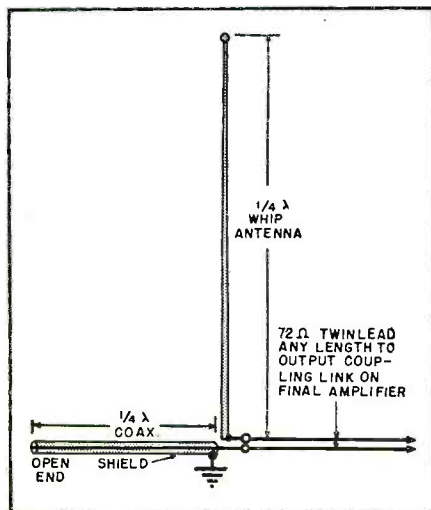

"Premier" Prices on TUBES and PARTS

39c ea.	35W4 31	36 37	57
	35Z5GT 32	37 38	58
1T4	6C4 33	38 39	76
	6X5GT 34	46 47	80
5Y3GT	25Z6GT 35	5T-52 89	
	30 35Z4GT 56	HY-615	

FREE! NEW OFFER

10 high list price tubes over \$25.00 list value FREE with each 100 tubes LIMITED QUANTITY.

49c ea.	6A55	6SA7GT	12K7GT
1C5	6AT6	6SC7GT	12K8GT
1C6	6AU6	6SG7GT	12SF5
1L4	6A8GT	6SH7	12SF7
1R5	6B6	6SJ7GT	12SH7GT
1S5	6BA6	6SK7GT	12SR7GT
1U4	6BD6	6SQ7GT	1629 (eye)
1U5	6BE6	6SR7	24A
2A5	6BH6	6UG7GT	25L6GT
2A7	6B5	6U7	25W4GT
3Q4	6C8G	6V6GT	25X6
3S4	6D6	6W4	26
3V4	6F5GT	6X4	27
5W4GT	6F6GT	6Z4	35B5
5X4G	6G6	12A8GT	35C5
5Y4G	6HG6T	12AT6	35Z6GT
6AB4	6J5GT	12AU6	50B5
6AC4	6J7GT	12AX7	50C5
6AC5GT	6K6GT	12BA6	50Y6
6AG5	6K7GT	12BE6	51
6AL6	6K8GT	12F5GT	77
6AQ5	6L5	12H6	78
6AQ6	6S4	12J5GT	85
6AR5		12J7GT	99

59c ea.	6SF5GT	12A7	69c ea.	12BF6
0Z4	6SF7	12A77	1A3	14A4
1A5GT	6SL7GT	12A77	1A4A	14A5
1A7GT	6SN7GT	12A77	1AB5	14A7
1C5GT	6SS7	12AV6	1H5GT	14AF7
1C7G	6SU7	12BA7	1LA6	14B6
1LA4	6Q7GT	12B6	1LB4	14B8
1LE3	6T7G	12C8	1LC5	14E7
1Q5GT	6W7G	12J5	1LC6	14H7
1T5GT	6Y6G	12Q7GT	1LD5	14J7
1V	6Z7G	12SA7GT	1LH4	14N7
2B7	7A4	12SC7	1LN5	14Q7
5U4G	7A6	12SG7	1N5GT	14W7
5V4	7A7	12SJ7GT	1P5GT	14X7
5Z3	7B5	12SK7GT	1S4	14Y4
5Z4	7B6	12SL7	2V3G	19T8
6A8	7B8	12SN7GT	2X2	25Z5
6AC7	7C4	12SQ7GT	3LF4	35Y4
6AJ5	7C6	12Z3	4AG6	35Z3
6AK6	7E5	20	6B7	45
6AL5	7E6	35/51	6BF6	2050
6AV6	7E7	35L6GT	6J8G	2051
6BA7	7F7	40	6S7G	50C6
6B8	7H7	41	6SU7GT	81
6C6	7J7	42	6T8	83
6CB6	7L7	43	7A8	117Z6GT
6D8G	7M7	50L6GT	7C5	9001
6F8G	7Q7	53	12A6	XXB
6J6	7S7	75		
6K5	7T7	84/6Z4		
6P5GT	7W7	117Z3		
6R7	7Y4	VR150		
6S8GT	7Z4	XXL		

79c each	1B3GT	6G5
	1X2	6L6G
	2A3	6S D7GT
	2A4	6U5
	3Q5	32L7GT
	6A7	50A5
	6AK5	70L7GT
	6BQ6GT	350B
	6E5	807

89c each	6R5	25AC5GT
	6BN6	25BQ6GT
	6N6G	117L7GT
	12BN6	117P7GT

\$1.29 ea. 6RG6G 19BG6G

50L6, 35Z5, 12SK7, 12SQ7, 12SA7	\$2.49	1R5, 1S5, 1T4, 3V4 Battery Tube—Special	\$1.69	10BP4	\$14.95
5 tubes for		4 tubes for		12LP4	19.95
				16AP4	39.50

FILTER CONDENSERS

Very best brands Fresh stock

10 or more assorted 5% discount

450 Working Volts	20-20-20—150 V. ea. 39c
8-450 V. ea. 24c	20-40-150 V. ea. 39c
15-450 V. ea. 29c	30-30-150 V. ea. 39c
20-450 V. ea. 39c	35-35-150 V. ea. 39c
30-450 V. ea. 49c	40-20-150 V. ea. 39c
8-8-450 V. ea. 39c	40-40-150 V. ea. 39c
8-8-8-450 V. ea. 39c	50-20-150 V. ea. 39c
20-20-450 V. ea. 49c	50-50-150 V. ea. 39c
25-10-450 V. ea. 49c	60-60-150 V. ea. 39c
	20-16-16—350 V. ea. 39c
150 Working Volts	
8-150 V. ea. 19c	20-10-15—150 V. ea. 39c
8-8-150 V. ea. 19c	30-5-20-150 V. ea. 39c
10-150 V. ea. 19c	30-20-20-150 V. ea. 39c
10-10-150 V. ea. 24c	20-16-16—150 V. ea. 39c
15-150 V. ea. 21c	150 V. ea. 39c
16-150 V. ea. 23c	Cathode Condensers
20-150 V. ea. 25c	10-25 V. ea. 16c
30-150 V. ea. 29c	20-20-25 V. ea. 16c
40-150 V. ea. 29c	20-20-20-25 V. ea. 16c
15-15-150 V. ea. 23c	20-25 V. ea. 16c
20-10-150 V. ea. 29c	30-50 V. ea. 16c
20-20-150 V. ea. 29c	100-25 V. ea. 24c

Miniature tubes 12AT6, 12BA6, 12BE6, 35W4, 50B5... 5 tubes for \$2.09

3-Way Portable Tube Kit, 117Z3, 1U5, 3V4, 1R5, 1T4... all for \$2.19

SPECIAL on 47 and No. 51 PILOT LIGHTS 100 BULBS...\$3.75 BOX OF 10...49c PILOT LIGHTS—100 BULBS \$4.90

Box of 10 bulbs... 54c
 No. 40 6-8 V. 15 Amp No. 44 6-8 V. 25 Amp
 No. 41 2.5 V. 50 Amp No. 46 6-8 V. 25 Amp

Output Transformers STANDARD REPLACEMENT

For 50L6, 35L6, 50A5, 35A5, 117L7... 39c ea.

For 6V6, 6F6, 3Q5, 3Q4, 35A, 3V4, 41, 42, 6K6, 2A3, 45, 6L6... 45c ea.

UNIVERSAL OUTPUT TRANSFORMER SPECIAL

Up to 12 watts to any speaker (New Supply—Limited Quantity)... ea. 98c

PREMIER RADIO TUBE COMPANY
 551 West Randolph St., Chicago 6, Ill.
 Phone: Andover 3-1590
 'Your Tube Source Since 1926'

Other tubes and parts available. Write for catalog sheet!

20% deposit with order, balance COD. \$1.00 handling charge for orders less than \$5.00. All shipments FOB Chicago. Our parts and tubes are warranted to be 100% replacements for the prototypes in the listings above. Satisfaction Guaranteed. Illinois residents add 2% sales tax.

SPOT SURPLUS SPECIALS

100 Insulated Resistors—RMA Color Coded 1/4, 1/2, 1, 2 watt. Over 50 val. Complete \$1.75

50 Bypass Condensers—Tubular, Bakelite Molded, etc. Pop. val., all purposes. GUARANTEED... \$1.75

FOB Phila. No COD's. Write for complete listings.

THE ELECTRIC SPOT
 132 S. 11th St. Philadelphia 7, Pa.

AUDIO ENGINEERING SCHOOL

Practical engineering training in Audio fundamentals, Disc, Film, Magnetic Recording, and Audio frequency measurements.

Studio training simulates Broadcast, Motion Picture, Television, and Commercial Recordlink work.

Approved for Veterans

HOLLYWOOD SOUND INSTITUTE, Inc.
 1040-N North Kenmore, Hollywood 27, Calif.
 Specify if Veteran or Non-Veteran

RADIO ENGINEERING TELEVISION ELECTRONICS

Thorough training in all phases of radio and electronics, open to high school and junior college graduates. Old established school specializing in Radio training exclusively. Modern laboratories and courses. Enrollments limited. Approved veteran training.

VALPARAISO TECHNICAL INSTITUTE
 Dept. BD Valparaiso, Ind.

TESCO

Has It!
DOUBLE V

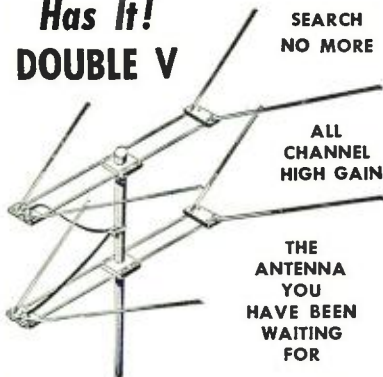

SEARCH
NO MORE

ALL
CHANNEL
HIGH GAIN

THE
ANTENNA
YOU
HAVE BEEN
WAITING
FOR

1236—SINGLE BAY.....\$3.78
1237—DOUBLE BAY..... 7.56

1230—Double Bay Conical.....	\$7.31
1215—Swift-Rig Folded Hi and Lo.....	4.43
1814—Economy Chimney Mount—dozen lots.....	.89
1302-1306—Five El. Yagi any Lo-Channel.....	11.25
1307-1313—Five El. Yagi any Hi-Channel.....	4.95
1219—Swift-Rig Folded Hi Straight Lo.....	4.07
2102—DeLuxe Indoor Antenna.....	1.95
1860—Chimney Mount—dozen lots.....	1.00
1873—3½" Mast Standoff Ins.—lots of 100.....	.06
1870—3½" Wood Screw-Eye Ins.—lots of 250.....	.02
1874—4" Nail-in Insulator—lots of 250.....	.02
1862—10'-1½" Galv. Steel Mast—dozen lots.....	1.20
1229—Single Bay Conical.....	3.90
1231—Four Bay Conical.....	15.89

Send for quantity prices and complete list

TELEVISION SUPPLY CO.
Box 213 Gracie Square Station
New York, N. Y.



What's New in Radio

(Continued from page 84)

light. The second position maintains the completed light circuit and closes the heating element or soldering circuit.

SWITCH CLOCKS

A new line of switch clock movements for radios and household appliances is now being offered by *The Sessions Clock Company* of Forestville, Connecticut.

Incorporating the company's self-starting demountable electric motor, these new switch clock movements are



equipped with 15 ampere switches, are UL approved, and are available with setting controls on the front or back.

Models are available with an "On" switch which permits the turning on of a radio or appliance at any preset time. Other models include a "Sleep Selector" feature in addition to the "On" switch which permits operation of the appliance for any period up to 90 minutes with automatic shut-off at the end of the preset time. Each of these switch clocks is provided with the company's exclusive safety feature which automatically shuts off the appliance or radio in one to two hours if it is forgotten.

Complete details on these switch clock movements are available from the Timer Division, Department 16 of the company.

TIMING MOTORS

Of particular interest to radio amateurs and experimenters is the new stock motor service on a.c. timing motors being offered by the *A. W. Haydon Company* of Waterbury, Conn.

These low cost timing motors are available for immediate shipment in small quantities. Four different speed motors are stocked, 125 volt, 60-cycle units in 1, ¼, ⅓, and 1 r.p.m. Rotation is clockwise with a standard knurled shaft, .080" in diameter, for the attachment of gears, couplings, or shaft extensions.

These stock units deliver a high starting and synchronous torque of 9 in/oz. at 1 r.p.m.

RECTIFIER CARTRIDGE

A new line of high voltage selenium rectifier cartridges has been developed by the *International Rectifier Corporation* of 6809 South Victoria Avenue, Los Angeles 43, California.

One of the units in the line is rated at 440 volts d.c. and 10 ma. d.c. with a peak current rating of 120 ma. and a peak inverse rating of 1500 volts. The 440 volt rectifier is of the half-wave type and is ⅝" o.d. with an over-all length of 1⅝". Its voltage drop at rated load is about 25 volts and it weighs ½ ounce.

These cartridges are also available in either phenolic, glass, or hermetically sealed assemblies from ¼" to 1¼" o.d. or they can be built to individual specifications.

COIL CHECKER

The Clough Brengle Co. of 6014 Broadway, Chicago 40, Illinois, has developed a new coil checker, the Model 301A.

The new instrument, designed for use with the C-B Model 299-A signal generator, measures coil inductance, the distributed capacity of coils, capacitance at r.f. and the "Q" of coils. The basic design of the unit combines into a single instrument a calibrated variable condenser, a v.t.v.m., and a pentode amplifier tube. The calibrated variable condenser is located in the plate circuit of the amplifier tube and binding posts are provided for connecting an inductor in parallel with the condenser. Additional binding posts are also available for connection to an external condenser when required. The v.t.v.m. is so connected that it indicates the voltage developed across the inductor and condenser.

A data sheet on the new Model 301A is available on request.

WIRE RECORDER

A portable wire recorder which incorporates 28 new features has just been introduced by *Webster-Chicago Corporation* of 5610 W. Bloomingdale, Chicago.

The Model 288 replaces the company's Model 180. Its newly designed sound chamber is said to provide "console response." A monitoring position



has been added so that it is possible to listen to the recording as it is being made. Three more spool arbors have been added to the three carried on the older design so that six spools of wire can be carried in place.

The company's "Record-o-Magic" automatic controls and a supersensitive microphone are standard features with this new model.

-30-

TERRIFIC VALUES!



WILLARD 2-VOLT STORAGE BATTERY
20 Ampere-Hours

Exact replacement for GE Model LB-530 portables—brand new.

Each..... **\$1.95**
5" high, 3¾" wide, 3" deep.

24-VOLT STORAGE BATTERY
17 Amp. Hrs. Brand New. \$17.95



GOULD 6-VOLT STORAGE BATTERY

Navy Standard. Black Rubber Case. BRAND NEW. 15 Amp. Hour Rating..... **\$6.95**



WILLARD MIDGET 6-V STORAGE BATTERY

3 amp. hour rating. Transparent plastic case. Brand new. 3¾" x 1½" x 2¾" high. Uses standard electrolyte. Each..... **\$2.65**

7-PRONG 2-VOLT VIBRATOR for portable and farm sets. Replacement for GE-LB530. \$1.65

1-QUART BOTTLE BATTERY ELECTROLYTE

Made by Willard, for above storage batteries, 1 qt. sufficient for 2 two-volt cells. Hermetically sealed. SPECIAL. Per qt. bottle..... **\$1.25**

BUBBLE SEXTANT, for Boat Owners! Complete, sensational value..... **\$12.95**

EES ARMY FIELD PHONES, used, good cond..... **\$12.95**

BC-348 Receiver, New..... **115.00**

BC-348 Receiver, Used, good cond..... **88.50**

BC-221 Freq. Meter, Exc. Cond..... **65.00**

MN-26C Compass Rvvr., New..... **28.50**

BIG BARGAIN BULLETIN!
Just Out! Write Today, for your FREE copy!

25% Deposit with order, Bal. C.O.D.
Min. \$3. FOB our warehouse NYC.

G & G Radio Parts Service
51 Vesey Street • New York 7, N. Y.

Manufacturers' Literature

Readers are asked to write directly to the manufacturer for the literature. By mentioning RADIO & TELEVISION NEWS, the issue and page, and enclosing the proper amount, when indicated, delay will be prevented.

RELAY CATALOGUE

Guardian Electric Manufacturing Co., of 1621 West Walnut Street, Chicago 12, Illinois, has just released its new Catalogue 5-H covering the company's line of hermetically sealed relays.

The catalogue lists relays which are available in four standard mounting arrangements, the lug-header types, Army-Navy connector type, octal plug type, and screw terminal type. A wide variety of contact combinations and operating voltage ranges are listed as standard units.

Technical information concerning the performance of units, which meet the requirements of the ANR-20b and the 10-G vibration tests, is also included.

SPEAKER CATALOGUE

Cleveland Electronics, Inc., of 6610 Euclid Avenue, Cleveland 3, Ohio, has announced the availability of its new Catalogue 127 M which lists the company's line of radio and TV replacement speakers.

Included in the listing are auto, television, radio, and p.a. speakers in permanent magnet types and electrodynamic models. Also featured are the new "Cletron" weatherproof speakers and TV lightning arresters.

Requests for copies of this catalogue should be addressed to the attention of Bill Allen at the company.

INTERCOM CATALOGUE

A new four-page catalogue, entitled "Modern Packaged Inter-Communication Systems," has just been released by *Mark Simpson Manufacturing Company, Inc.* of 32-38 Forty-Ninth Street, Long Island City 3, New York.

The data sheet carries information on the company's Model JMR, JM-5, and IM-5 units as well as details on the newly-available white enamel intercom line.

A copy of the catalogue is available from the company on request.

PICTURE TUBE GUIDE

The Renewal Tube Sales Division of *National Union Radio Corporation* has just issued a "TV Picture Tube Reference Guide" which lists 12 electrostatic deflection and 73 electromagnetic deflection type tubes.

The new guide has been designed to assist design engineers, distributors, dealers, and service technicians. It includes all picture tube types used to date in postwar U. S. television receivers, irrespective of their originating or producing manufacturers.

In addition to giving the usual rating and characteristics data, the new guide provides information necessary to show differences between various tube types which, on the basis of less comprehensive data, might appear to be completely interchangeable.

The new guide is available without charge from any *National Union* radio tube distributor.

ELECTRIC TOOLS

Portable Electric Tools, Inc. of 320 West 83rd Street, Chicago 20, Illinois, is currently offering a copy of its new catalogue, No. 50A, illustrating and describing a complete line of "Hi-Power" and "Zephyr" models of portable electric drills, hand saws, paint sprayers, paint brush cleaners, and drill kits.

The catalogue gives complete specifications on all of the company's portable electric tools and information on the attachments and accessories that can be used with the 1/4" electric drills for sanding, grinding, polishing, buffing, etc.

ACOUSTIC STANDARDS

Of interest to persons who make basic acoustic measurements is the announcement from the American Standards Association that two new and one revised standard for laboratory standard pressure microphones and earphones have been issued.

Developed under the procedure of the ASA with 30 national organizations and others cooperating under the sponsorship of the Acoustical Society of America, the first of the new standards covers the reciprocity technique for pressure calibration of laboratory standard pressure microphones (Z24.4-1949). The second standard (Z24.8-1949) gives specifications for these microphones, while the third (Z24.9-1949) gives a method for coupler calibration of earphones.

Copies of the first standard mentioned are 75 cents each, the second standard are 50 cents, and the third standard are 75 cents each. Copies may be ordered direct from the ASA at 70 East 45th Street, New York 17, N. Y.

CONDUIT STANDARDS

Three new standard specifications for conduit and tubing used in raceways for electric wiring and cables have been announced by the American Standards Association of 70 East 45th Street, New York 17, New York.

The new standards cover zinc coated and enameled rigid steel conduit, and zinc coated electrical metallic tubing.

TUBES

BRAND NEW—STANDARD BRANDS			
1B3GT	\$1.18	6X4	\$0.59
2X2	.49	6X5GT	.59
5V4G	.84	10Y	.19
5Y4G	.46	12A6	.24
5Z3	.65	12AT6	.59
6AC7	.79	12AT7	.99
6AG5	.89	12AU6	.72
6AK5	.82	12AU7	.86
6AL5	.69	12BA6	.64
6AQ5	.72	12BA7	.86
6AT6	.54	12BE6	.64
6AU6	.72	12SA7GT	.59
6BA6	.65	12SK7	.59
6BE6	.65	12SQ7GT	.59
6BG6G	1.72	35L6GT	.59
6BH6	.72	35W4	.45
6BJ6	.72	35Z5GT	.44
6C4	.29	50B5	.69
6J5	.49	50L6GT	.57
6J6	.49	3AP1	.69
6L6GA	.87	3BP1	2.59
6SL7GT	.69	5BP1	2.40
6SN7GT	.79	5CP1	2.87
6V6GT	.59	5CP7	3.76
6W4GT	.65	5HP4	3.35
1P24	\$.29		
2051	.49		
24C	.44		
316A	.66		
446A	.79		
807	1.40		
810	7.95		
813	7.25		
815	1.72		
829	4.91		
832	4.91		
832A	5.50		
837	1.38		
866	2.93		
866A	1.19		
1619	.19		
1624	.69		
1625	.19		
1626	.29		
1629	.29		
9001	.42		
9002	.39		
9003	.39		
9004	.39		
9006	.29		

THRATRONS AND IGNITRONS			
0A4G	\$.95	93	\$5.85
EL-11A	3.35	FG-95	20.60
2AG	1.15	FG-105	9.45
2D21	1.09	FG-172	14.50
3C23	3.20	WE 355A	14.15
3C31/EL		393A	5.77
C1B	3.35	394A	3.77
4C5	21.80	GL-415/-	885
EL-C5B	8.95	5550	22.00
C6J	4.44	KU-610	6.35
FG-17	2.89	KU-628	16.90
FG-33	11.95	KU-634	17.20
FG-67/1904	8.85	WL-652/-	
FG-81A	4.95	5551	38.00
WL-672	\$13.25		
WL-677	24.00		
722A	3.75		
873/973	6.95		
884	1.35		
885	1.29		
885/U	.67		
1904	8.85		
2050	.83		
2051	.49		

SURPLUS EQUIPMENT	
TROUBLE SHOOTING MANUALS (includes schematics)	
BC-348-J, N, Q	SCR-522
BC-779	BC-610
	\$1.00 ea.

SELSYN INDICATOR KIT	
FOR 110V, 60 CYCLE OPERATION	
Includes I-82 5' indicator, Selsyn transmitter, transformer and instructions.	
All items brand new— \$6.15	
I-82 indicator only—NEW	\$3.95

FILTER CHOKES	
10 Henry 400 MA 90VDC res. Hermetically sealed; high voltage insulation	\$3.77
13 Henry 250 MA 120V—Full shield upright	3.22
RCA Sound Power Unit use as mike or receiver	\$2.22 pr.

COAXIAL CONNECTORS			
83-1AC	\$0.42	83-1SPN	\$0.28
83-1AP	.15	83-1T	1.12
83-1F	1.12	83-22AP	1.10
83-1H	1.10	83-22P	.46
83-1J	.80	83-22SP	.60
83-1R	.28	UG-21/U	.67
83-1RTY	.45	UG-23/U	.63
83-1SP	.28	UG-27/U	0.68
		UG-286/U	.90
Full Line of UG Coaxial Connectors in Stock. Prices Sent on Request.			

COAXIAL CABLE	
RG-8/U—7c ft.	\$30.00/500 ft.
RG-58/U—6 1/2 c ft.	25.00/500 ft.
RG-59/U—4 1/2 c ft.	20.00/500 ft.
RG-62/U—6c ft.	20.00/500 ft.
Special—Federal, 72 Ω, 1KW twin-lead—8c ft.	32.50/500 ft.

OTHER TYPES IN STOCK	
200,000 AN CONNECTORS	
75% Discount from List Price	
MICROANMMETERS	
0-500 microamps. Brand New—Orig. Cartons \$3.88 each—10 for \$35.00	

CIRCUIT BREAKERS	
Heinemann, 2-pole, 120 VAC; 15 A	\$2.25
Heinemann, 2-pole, 125 VAC; 15 A	2.25
Cutler-Hammer, 2-pole, 115 VAC; 25 A, with type MO rainproof container	3.65

AIRCRAFT GENERATORS	
Eclipse NEA-3; output, 115 VAC; 10.4 A; 800 to 1,400 Cye. 1φ and 30 VDC; 6 A. Brand New—Original Packing	\$38.50
Eclipse 1235-1A; output, 30 VDC; 15 A; Brand New—Original Packing	\$9.50

SELENIUM RECTIFIER STACKS			
FULL WAVE BRIDGE			
Max. input—18 VAC	Max. output—40 VAC		
Max. output—14.5 VDC	Max. output—34 VDC		
1.2 A	\$ 2.64	1.5 A	\$ 3.00
2.4 A	3.07	1.2 A	3.44
6.4 A	4.09	3.2 A	5.15
13.0 A	7.67	6.0 A	9.32
17.5 A	8.69	9.0 A	10.05
26.0 A	15.33	12.0 A	18.64
39.0 A	23.00	18.0 A	29.12
52.0 A	30.67	24.0 A	35.96
65.0 A	38.33	36.0 A	41.24
Current ratings can be increased up to 2 1/2 times max. values by forced cooling.			

WANTED
Large or small quantities of new or used electronic components, equipment, tubes, etc.—gov't or mfrs. surplus. Cash or trade for standard test equipment or electronic material of your choice.

BLACK LIGHT UNITS
Sylvania 4W black light bulb, ballast for 115 VAC operation and wiring diagram. Excellent for fluorescent minerals, etc. \$2.95

Write for FREE Monthly Bulletin
Include Postage with Orders
LECTRONIC RESEARCH LABS.
1021-R Callowhill St. Phila. 23, Pa.

NOW!
AT *Hy-Grade!* the **SKY-HIGHEST VALUE** in Television Today!

World Famous Quality

630 TV CHASSIS

only **\$139.95** less CRT



Yes, you can believe your eyes! Here's the exact duplicate of the incomparable RCA 630TS Circuit—television's unmatched standard for super-sensitivity and stability—now with all the newest features of trigger-fast Keyed AGC, Voltage Doubler, Standard Tuner, molded condensers, plus the finest quality components, Yoke, Focus Coil, Mounting Brackets, plus 30 tubes. Supplies 13 to 14KV under load for full brilliance and width for all rectangular and round 12½, 16 and 19" tubes.

At only \$139.95 this is the TV super-value you can't afford to miss! Order several NOW! Immediate Delivery! 25% deposit with order, balance COD, f.o.b. Brooklyn, N. Y.

for **SKY-HY VALUES** at rock-bottom costs—it's **HY-GRADE!**

Hy-Grade Electronics, inc. National Distributors of Electronic Parts and Equipment
1509 EAST NEW YORK AVE., BROOKLYN 12, N. Y.

40 FOOT STEEL ANTENNA MAST!



Unassembled in carrying case, complete with the following equipment

- Mast Sections—14
- Mast Base — 1
- Stakes — 11
- Guy Plate — 6
- Guy Assembly (37 ft.)—5
- Guy Assembly (50 ft.)—5
- Guy Assembly (60 ft.)—5
- Axe M-1910—1
- Hammer, Sledge, 8 lb.—1
- Hammer, Engr. 4 lb.—1
- Stake Ring & Snap Assbly.—9
- Strap—4
- Sledge Handle & Wedge—1
- Block & Tackle Assembly—1
- Tube Lubriplate—1

\$39.89

Shipping Weight Approx. 275 lbs.

F. O. B. New York City

Send M. O. or Check

Maspeth Telephone & Radio Corp.
142 ASHLAND PLACE
BROOKLYN, N. Y.

23¢ BUYS 4" WALL MOUNTING BRACKET!



Heavy-gauge steel—4" mast-to-wall clearance. Solid mounting, minimum antenna whip. Holds poles ¾-1¼" in diameter. Complete with plated steel hardware. Immediate delivery from stock—Shipped f.o.b. Brooklyn, N. Y. Order them by the dozen NOW!

Leotone

NEW "JUMBO RADIO PARTS KIT"—17 FULL POUNDS of new & dismounted C.O.D. 1's. Wire Sockets, Pots, Resistors, Cond., etc. **\$2.95**

- "2/5 H.P. REVERSIBLE RPM, ¾" shaft; 4½"x7". 27 VDC. . . . \$3.95
- 4 RPM MOTOR—115V. 2½"x2¼". . . . 2.75
- 60 RPM MOTOR—115 VAC. 1½" shaft; 5x3". 2.49
- PIONEER GEN-E-MOTOR—18 VDC to 450 VDC. WITH DATA FOR SIMPLE CONVERSION TO 115 VAC. . . . 3.49
- 115 VAC INDUCTION MOTOR—1750 RPM, fract. H.P. 2½"x3¼"x1". . . . 1.39
- SELVINS (G.L. #2J1G1). Brand new. ea. 1.49
- MERCURY SWITCH—1A/115 V. . . . 39¢
- ¾" LUMINOUS TAPE—Glow in dark. 100'. . . . 49¢
- JK-48 MIDGET JACK with 7' cord. . . . 1.00
- S' SCOPE VISOR—Ivy, leather & rubber. . . . 59¢
- HS-33 HEADSET—LO-imped. 5' cord & PL-55. 1.69
- DPDT TOGGLES—20A/125 V. Spring return. . . . 39¢
- 50 PANEL METERS—2½"x2" VDC. . . . 1.29
- 0-100 AMPS. DC & SHUNT. . . . 98¢
- 1 MEG.—1% PRECISION RESISTOR (IRC) w.w. .69
- SPST G.E. RELAYS—N.O. 17.5 ohm coil. . . . 39¢
- 5 AG FUSES—1, 3 or 6A. 250 V. 6c; 20/1.00
- #621 PILOT BULBS—3 CP. 28 V. SC bay 15/1.00
- RADIO HARDWARE TREASURE—FULL POUND CAN of Screws, Nuts, Washers, Lugs, etc. .49
- HIGH FIDELITY CRYSTAL MIKE—Hi-imped., rubber shock-mtd. ¾"x1¼". Less housing. .98
- ALUMINUM HOUSING for crystal mike. . . . 1.15
- T-30 V. THROAT MIKES—brand new. 39c; 6/1.98
- CD-508 CORD & SWITCH for T-30. . . . 49c; 6/2.49
- STATION CALLY—24 V. push-buttons. 2340 tabs for every US station. . . . set 39c; 3/1.00
- SELENIUM RECT.—½ wave; 50 VAC. 1A. . . . 69¢
- W-110 FIELD WIRE—rolls of approx. 2800 ft., incl. several ltrhs. Good cond. . . . 5.95
- !!TUBE BARGAINS!!—90 DAY GUARANTEE. Unsealed cartons—#24, 27, 41, 42, 77, 78, 84, 85, 89, GA4, 6D6, 6C5, 6F5, 6G5, 6J5, 6J7, 6K6, 6K7, 6SA7, 6SD7, 6SF7, 6SG7, 6SK7, 7A, 7C5, 7HT, 7VT, 12A6, 12SA7, 12SK7 or 3323. YOUR CHOICE! EA. .39
- GE XMTR SOCKETS for 211's, etc. . . . 49c; 6/2.49
- 18 FT. WHIP ANTENNA—6 steel sects. . . . 1.00
- ½" RED JEWEL ASSEMBLY with bulb. 29c; 4/1.00
- CABINET DRAW SLIDES—Silent, ball-bearing. 13"—\$1.89 pr.; 15"—\$1.98 pr.; 18½"—\$2.19 pr. Hvy. Duty. 1½"x1½". . . . 2.89
- 6 V. BUZZER & KEY (W. E.)—bakelite base. . . . 1.25
- CK503AX SUB-MINIATURE TUBES (Ray). . . . 1.29
- DM-26D DYNAMOTOR—24 V., 220 VDC, 80 ma. RUBBER SHOCK MOUNTS— 4 lb., 1¼" sq.—9c; 15/1.00 5 lb., 1¾" sq.—15c; 8/1.00 17½" x 1¼" PL-259 CO-AX PLUGS—2 on 4' RG-8 cable. . . . \$0.49
- MIDGET OUTPUTS (¾" x ½") matches 50L6. . . . 49¢
- MIDGET AUDIO CHOKES (¾" sq. x ½") 4500 ohms DC. . . . 49¢
- ALNICO MAGNET— 2 gang . . . \$0.59 1½" x 1¼" PL-259 CO-AX PLUGS—2 on 4' RG-8 cable. . . . \$0.49
- SPEAKER CONES—4" to 12" moulded & free-edge. Less voice coils. Kit of 12 asstd. . . . \$1.98
- SPEAKER REPAIR KIT—Liberal assortment of spacers, N.V. forms, Rings, Pk. Leather, Shims, Cement & Instructions. . . . 2.49
- ! SPECIAL ! BOTH "CONE & REPAIR KITS" ONLY . . . 3.95
- SPAGHETTI—plastic & cambric, 40 ft. asstd. . . . 98¢
- MIN. ORDER \$2.00. 20% Deposit on all C.O.D.'s. Full remittance with foreign orders. Please add sufficient postage. Excess refunded

DIONE RADIO CO.
65 Dey Street, New York 7, N. Y.

Specifications are based on provisions required by Underwriters' Laboratories, Inc., the National Bureau of Standards, as well as those contained in existing standards of conduit manufacturers.

Copies of the standard covering zinc coated rigid steel conduit (ASA C80.1-1950) are 50 cents each, that on the enameled rigid steel conduit (ASA C80.2-1950) is also 50 cents, while the standard on zinc coated electrical metallic tubing (ASA C80.3-1950) is 35 cents.

SELECTOR SWITCHES

Several of the company's new oval rotary selector switches are described in the bulletin just issued by *Shall-cross Manufacturing Company* of Colingdale, Pa.

Designated Bulletin L13, the new publication describes and illustrates the six basic plates and three rotor types used to construct switches having from one to three poles per deck or gang and lists the other mechanical and electrical details designed to match the required specifications.

Copies of the new bulletin are available from the company on request.

R.F. COMPONENTS

Selectar Industries, Inc. of 401 East 138th Street, New York 54, New York, has just issued a new brochure, Catalogue 50-T, covering its line of radio frequency components.

Included in the listing are transmission lines, waveguide assemblies, microwave test equipment, coaxial cable connectors, adapters, and cable and cord assemblies. The material is presented in easy-to-use tabular form for ready reference.

G-C CATALOGUE

A 64-page catalogue which covers over 5000 radio and television products and service aids has just been issued by *General Cement Manufacturing Company* of 919 Taylor Avenue, Rockford, Illinois.

In addition to the parts listings the catalogue also covers the company's line of radio chemicals, alignment tools and radio tools, and various types of radio hardware. Service technicians will find this a handy reference for ordering. In requesting copies of this catalogue please specify the new G-C 154.

VIBRATOR REPLACEMENTS

James Vibrapour Company of 3224 West Armitage Avenue, Chicago 47, Illinois, has recently published a completely new communication equipment vibrator replacement guide which is available on request.

The new guide shows the correct types of replacement vibrator units for all nationally-known communications equipment.

STEEL STAMPS

The *M. E. Cunningham Company* of 192 E. Carson St., Pittsburgh 19, Pa., has just issued a new four-page bulletin covering the line of "Mecco" safety

steel stamps for all types of industrial marking applications.

Included in the bulletin are details on dimensions, character sizes, and prices for the various sizes and styles.

Some of the units pictured and described are suitable for stamping receiver and transmitter chassis as well as some of the heavier component parts that go into their manufacture.

SERVICE PLAN

Details of the *Hoffman Radio Corporation's* installation and servicing plan are given in a new booklet just released by this television manufacturer.

Included in the booklet is a facsimile of the company's standard "Owner Policy," a listing of the requirements the company's service technicians must meet, data on the equipment and materials available for servicing work, and other details of interest to the purchaser of the video set.

One point which is heavily stressed and which will receive a hearty endorsement from service technicians is that TV owners should not attempt to make any repairs or adjustments on their sets or antennas, nor entrust the job to an untrained workman.

Copies of this interesting little booklet are available from the company, 3716 S. Hill St., Los Angeles.

GAS TORCH

A newly-printed catalogue sheet which illustrates the various uses of the LP Gas Torch is currently avail-

able from *Otto Bernz Co., Inc.* of Rochester, New York.

The data sheet covers the LP-701 portable torch which has been designed for electricians and maintenance personnel. The torch features a "cartridge refill" unit which is easily replaceable. The torch itself will burn in any position and will reach a calculated temperature of 3660 degrees F without preheating.

Copies of the data sheet are available from the company on request.

TV VIEWING RULES

The American Optometric Association of 707 Jenkins Bldg., Pittsburgh 22, has just issued a 4-page pamphlet entitled "Seven Rules for Viewing Television" which is available on request.

While the points covered in the booklet are probably well known to most viewers there is growing evidence many families are not adhering to these rules for strain-free viewing. A copy of the booklet might prove helpful.

CR EQUIPMENT

The *Allen B. Du Mont Laboratories, Inc.*, 1000 Main Avenue, Clifton, N. J., has available a 16-page booklet which describes its complete line of cathode ray equipment.

Included in the listing are the Types 304-H, 303, 224-A, 241, 294, 250-AH, 250-A, and 256-D cathode-ray oscillographs, a high voltage power supply, polar-coordinate indicator, CR indica-

tor, high voltage power supply of the Type 286-A, oscillograph-record cameras, various oscillographic accessories, and a line of cathode-ray tubes.

Two inexpensive service-type scopes are also described, the 274-A and the 292.

Copies of this booklet may be secured by writing direct to the company and requesting a copy of the booklet on cathode-ray equipment.

OUTPUT TRANSFORMERS

A valuable four-page booklet on the subject of output transformers has been issued by *Acro Products Company* of 5328-30 Baltimore Avenue, Philadelphia 43, Pennsylvania.

Included is a discussion of the various characteristics which an output transformer must possess to provide highest quality performance and an analysis of the various misconceptions that exist regarding certain types of circuitry used in audio applications.

The various features of the company's line of output transformers are outlined, along with a frequency response chart, prices, and model designations.

The fourth page illustrates some of the applications in which the transformers may be used.

INSTRUMENT RENTAL

InstruRental Co. of 411 Albee Building, Washington 5, D. C., has issued a catalogue describing its unique instrument rental service and the instruments available on such a plan.

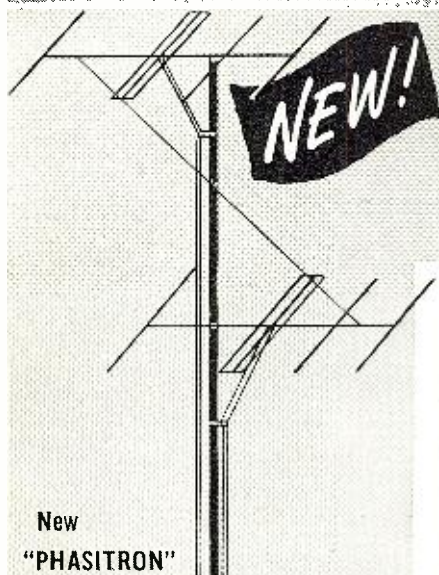

The TRIO "CONTROLLED PATTERN"

PATENT APPLIED FOR

TV ANTENNA SYSTEM MODEL 604

Eliminates Venetian Blind Effect!

USES NEW "PHASITRON" and DOUBLE DIPOLE YAGI

ELIMINATES CO-CHANNEL INTERFERENCE
With 17 db Gain in Forward Direction!

TRIO MFG. COMPANY takes pride in announcing the greatest advance in TV antennas for fringe areas. It's the new TRIO "Controlled Pattern" Antenna System, the culmination of extensive research by G. N. Carmichael, TRIO's Chief Engineer, and one of the nation's foremost antenna authorities.

The new lightweight, yet rugged antenna not only provides terrific gain in the forward direction, but overcomes that ever increasing problem in fringe areas — co-channel interference. This is how the unique system works: high voltage from two double dipole Yagis is phased by the use of the new tuneable "PHASITRON" to provide addition of voltages from the desired direction and cancellation of undesired voltages.

How well the system works is demonstrated by the fact that with voltage ratios up to 25 to 1, i.e., one signal is 25 times as strong as the other, the signal from the weaker will provide a sound carrier free from chatter and a picture free from venetian blind effect. The "PHASITRON" also permits tuning for maximum signal regardless of changing vertical wave angle. Uses two 300 ohm feed lines of random length, two DOUBLE-FOLDED Yagis for exact impedance matching. Separate antenna systems available for each of 12 channels, though considerable gain achieved on adjacent channels.



TRIO MANUFACTURING COMPANY

GRIGGSVILLE, ILLINOIS

©1950 by

Concertone

MAGNETIC TAPE
RECORDER



Model #401

"just like being there"

Monitoring from tape while recording • Less than 0.1% flutter • 50 to 12,500 cycles \pm 2 db • Full 50 db signal to noise ratio • High speed forward and reverse — 2500 feet in 60 secs • Instantaneous choice of 7.5" or 15" tape speeds • Handles 5", 7" and 10 1/2" reels (66 minutes) • All controls interlocked to prevent spilling or tearing tape • Write for Bulletin #102

MODEL #401 — Mechanism and electrical chassis ready for console installation.

\$295.00

Manufactured by

USER'S NET COST



berlant associates

4917 W. Jefferson Boulevard,
Los Angeles 16, California

NEW PRECISION ELECTRONICS SIGNAL TRACERS

MODEL 201 A
\$34.50

MODEL 251 A
\$49.75

Write for literature and name of your nearest Jobber

PRECISION ELECTRONICS, Inc.
641-643 MILWAUKEE AVENUE
CHICAGO 22, ILLINOIS

SIGNAL TRACER SPECIALISTS

Designed for manufacturers and laboratories which have need for certain laboratory-type instruments on infrequent occasions, the line includes such units as the *Esterline-Angus* portable recording a.c. ammeter, utility (a.c.-d.c.) voltmeter, utility (a.c.-d.c.) wattmeter, and universal current transformer.

Full details of the rental plan are also included in the catalogue.

-50-

Spot Radio News

(Continued from page 18)

composed of tiny fluorescent dots which give forth red, blue, and green colors, respectively. The tiny dots are arranged so that each dot of one color is adjacent to adjoining dots of another color. In operation, as the electron beam of the tube passes over the tiny color spots successively, it is turned on and off rapidly in accordance with both the brightness and color of the picture to be reproduced. It was claimed that the tube could be used with any of the three systems proposed; sequential, dot sequential, or line sequential.

The 10,000-page report will also disclose that startling testimony of *CBS* Prexy Frank Stanton, who in the course of a fiery cross-examination by *RCA* General Counsel, John T. Cahill, declared that *CBS* might enter the set manufacturing business, in the event the FCC approved the *CBS* system. Also revealed was the fact that a new company, with a credit of \$50,000,000, might be organized to produce or distribute *CBS* color receivers, if they should become the official means of reception and other manufacturers refuse to make the models.

The fact that other manufacturers would probably make sets to pick up the *CBS* pictures was also placed on record, as *Du Mont* appeared and testified that color-wheel sets could be produced in their plant, if the mechanical system were approved. Estimates of \$500 to \$600 per receiver were offered for models providing a 7 1/2 by 10 picture.

On the record FCC members will also find the comments of others who were quite upset with the prospect of immediate approval of the *CBS* system. The situation, according to the president of the *Air-King Products Co.*, could make the market chaotic for a short period of time, and force many set makers out of business. If the non-compatible system were adopted, he declared, a transitional period should be provided, so that manufacturers could adjust their production schedules. A minimum of nine months would be required before there could be wide-scale production of *CBS* type receivers, according to the *Air-King* Prexy.

FEELING THAT some of the knotty problems which faced the Commission should be reviewed before many in

Approved MODEL A-460 TELEVISION FIELD STRENGTH METER

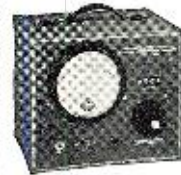

\$79.50 ONLY

Model A-460 is housed in a heavy gauge steel cabinet, battleship grey finish with 6 tubes (standard brands) 1N34 Crystal, operating instructions, circuit diagram and guarantee. Weight 25 lbs. D-8" x H-10" x W-12".

Write for New 16-page catalogue.

Field Strength Meter; television 12 channel tuner; video IF channel; large 6" directly calibrated meter; hammer-tone finished panel; ideal for locating antenna systems; testing transmission lines; testing efficiency of indoor antennas; checking booster efficiency, etc.

APPROVED ELECTRONIC INST., CORP.
142 Liberty St. N.Y.C.

GUARANTEED TUBES

1T4	6BQ6GT	12BE6
3Q4	6C4	19B6
6AG5	6SD7GT	25W4GT
6BH6	6X4	117Z3
6BJ6	12BA7	

In Lots of 100.

May be assorted...

\$32.50

TV PICTURE TUBES UNCONDITIONALLY GUAR.

10BP4 \$15	Prices subject to change without notice
12LP4 20	
16RP4 36	

Other types available, write for quotations
TERMS: 25% with order. Balance C.O.D.
Shipped Railway Express F.O.B., N. Y.

GREENWICH SALES CO.
59 Cortlandt St. New York 7

FLEXIBLE TUNING SHAFTS

For SCR274N & ARCS receivers 6 foot length ea. 75c
11 foot length \$1.25. 18 foot \$1.65.

For ARB, ARN7, BC433, MN26, GF11, BC229 receivers
10 foot \$1.95. 13 foot \$2.20. 15 foot \$2.45.

New, with all fittings. Guaranteed one year.

Add 25c postage and handling.

LONG ISLAND RADIO CO.

164-21 Northern Blvd. Flushing, N. Y.

BUILD YOUR OWN GEIGER COUNTER!

It's EASY to build your own Searchmaster Geiger Counter with this COMPLETE kit. Contains everything you need! Headset, tubes, batteries, metal case. Fully guaranteed! Sensitive to both beta and gamma radiation! Illus. instructions. FREE radioactive specimen.

SCIENCE KITS LTD.

5514-R Hollywood Blvd. • Hollywood 28, Calif.



Write for FREE literature

AUDIO (SOUND) ENGINEERING HOME STUDY TRAINING

Practical, easy-to-understand lessons, written by competent Audio Engineers and Educators, prepare you for a better job and a grand future in the Television, Radio, Motion Picture, and Recording Industries.

Write today for details — Learn while you earn!

HOLLYWOOD TECHNICAL INSTITUTE

4525 Santa Monica Blvd. Hollywood 27, California

different parts of the country, several members of the august body have been touring the land, appearing before industry and professional groups and offering comprehensive analyses of the variety of situations which not only appear in the 10,000-page compilation of color briefs, but which are scheduled to come up during the new sessions soon to be heard in the halls of the capital.

Particularly active in this work has been FCC Chairman Wayne Coy who has appeared in Oregon, Colorado, Chicago, and Columbus, Ohio, within a span of a few weeks. His comments in Colorado, before the Rocky Mountain Radio Council, were extremely topical, revealing just what faces the Commission at present. Stating that there are three main problems before them, involving interference and allocations in the very-high band, allocations in the ultra-highs and engineering standards which would minimize interference conditions, and finally six-megacycle color, Coy indicated that the color problem was quite acute. The FCC must decide, he said, not only which system to approve, but whether the interference problems would be the same for color as for black and white. This latter point, he cited, was of great importance in connection with the allocation program. Referring to the hearings, the FCC Headman called them . . . "the longest, most complex, and most controversial in the history of the FCC." And on it he said . . . "hinges the future course of the fastest growing industry in the United States."

Commenting on the moment when the freeze is lifted, Coy declared: "When we proceed with construction in television, when we give the green light to television's coming expansion, an expansion that will involve billions of dollars, we must make sure that we are right . . . We cannot expect people to make costly investments in television stations unless they are assured that the channel allocation plans are based upon the most complete and most competent engineering testimony available . . . To jump the gun and begin by making piece-meal allocations now would not be calculated to insure the stability of what should be one of America's greatest industries."

In Chicago, before the annual meeting of the Radio Manufacturers Association, Coy said . . . "Television must be an affirmative force in our national life." He then went on to state that it was to the interest of the manufacturer to . . . "project his planning beyond circuits, cabinets, inventories. He must plan beyond vacation shut-downs and next season's models. The broad base of radio itself must be of prime concern to him . . . Why are we in a freeze today which already has halted all new television construction for more than a year and a half? Principally because of a lack of basic information. That information must come in large part from radio man-

SEE LEO FIRST . . . for THE BEST TRADE-IN DEAL



Ask the Fellow Who Deals with Me!

Leo I. Meyerson, WØGFQ

Trade for a new HALLICRAFTER—I'll allow you more for your present equipment. WRL buys more equipment—WRL sells more equipment. Our large volume of sales means faster turnover, greater savings for you! We finance our own paper—no red tape!

LOW DOWN PAYMENTS—NAME YOUR OWN TERMS—LET'S GET ACQUAINTED!

Guaranteed Satisfaction From The World's Largest Distributor Of
Amateur Radio Transmitting Equipment

HALLICRAFTER SX-71 RECEIVER



Double Conversion sharp selectivity, plus built-in NBFM at moderate cost. 11 tubes plus voltage regulator and rectifier.

\$179.50
Low Down Payment

HALLICRAFTER NEW S-40 B RECEIVER



Frequency 540 KC to 43 MC. 8 tubes, rectifier, internal speaker. 3 watt output. One RF, 2 IF.

Only **\$79.95**
Low Down Payment



Deal with the "World's Most Personalized Radio Supply House". Send for your new complete WRL Catalog containing everything new in radio.

GIANT RADIO REFERENCE MAP



Just right for your control room wall. Approximately 28" x 42". Contains time zones, amateur zones, leading shortwave stations, monitoring stations. **25c**

WRITE—WIRE
PHONE 7795

FREE



WORLD RADIO LABORATORIES INCORPORATED
COUNCIL BLUFFS, IOWA

WORLD RADIO LABORATORIES R-8
744 West Broadway
Council Bluffs, Iowa

Please send me: SX-71 Info
 Radio Map S-40B Receiver info
 New Catalog List of Guaranteed Used Equipment

Name

Address

City State

New and Used Surplus Bargain

<p>BC-788 Transceiver—Ideal for Citizens Band Complete with tubes and crystal \$10.00 ea.</p> <p>R-1/ARR-1 Receiver—converts 70 Hi-Freq. Converter 5.50 ea.</p> <p>BC-733D Localizer Receiver 4.50 ea.</p> <p>R-89/ARN-5 Glidepath Receiver 15.00 ea.</p> <p>BC-924 FM Transmitter 27-39 mc. 35 watts output—4 channel..... 17.50 ea.</p> <p>PE-104 Vibrator Power for BC-654 —6 or 12 volt—with spare 6 volt vibrator—New 6.95 ea.</p> <p>ARC-4 VHF Transceiver 9.95 ea.</p> <p>AM-26/AIC Interphone Amplifier ... 3.25 ea.</p>	<p>FL-8 Range Filter75 ea.</p> <p>RL-42 Antenna Reel Motor 1.25 ea.</p> <p>RG-8/U Coaxial Cable—Assorted Lengths 6 to 25 ft.03 per ft.</p> <p>BC-746B Tuning Unit—NE and complete with 2 crystals, antenna coil, R.F. coil, and gang. condenser75 ea.</p> <p>BC-659 Transceiver 27 to 37 mc. FM 11.95 ea.</p> <p>BC-461 Control Box for RL-42 with Veeder-Root Counter35 ea.</p> <p>Minimum Order \$2.50 25% Deposit with C.O.D.'s.</p>
--	--

DAVE RUMPH CO.

P. O. BOX 4178
FORT WORTH 6, TEXAS

CIRCLE X ANTENNA

ENGINEERED TO PROVIDE CLEAR SHARP PICTURES ON ALL CHANNELS

COMPARE CIRCLE-X
TO ANY OTHER TV ANTENNA

No other antenna combines all the mechanical and electrical features engineered into the Circle-X.

The high gain of the Circle-X is equal to stacked arrays. It is made of light weight corrosion resistant aluminum alloys that stand up in all atmospheric conditions.

When you use Circle-X you stock only one type of antenna for all jobs. It has one wire lead-in and weighs only 2 1/2 lbs.

We urge you to compare Circle-X TV Antennas to any other TV antenna on the market.

Use Circle-X on your next tough TV installation. It may save you a lot of "no profit" call backs.

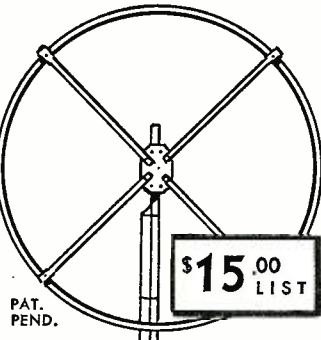

PAT.
PEND.

DEALERS: Air Express or Parcel Post Special Delivery direct from factory to you through your jobber, if he cannot supply you with the Circle-X from his stock.

CIRCLE-X ANTENNA CORP.
507 MARKET ST., PERTH AMBOY, N. J.

CIRCLE X

ANTENNA CORPORATION

TECH-MASTER

Blue Ribbon

TV CONVERSION KITS

HI-SWEEP CONVERSION KITS

- Type (A) and (B) DeLuxe
(A) Type for 16 inch tubes.
(B) Type for 19 inch tubes
(19AP4, 16RP4, 16GP4).

For converting 630 type chassis for use with new large kinescopes.

AGC KIT

Add AGC circuit to any 630 type chassis. Eliminates airplane flutter, appliance interference.

TV BOOSTER KIT

Build this booster and save. Ideal for fringe area use, etc.
Blue Ribbon TV Kit and 630 TV Kit available, all featuring AGC.

At your distributor or write
Dept. RN-8 for literature.

TECH-MASTER PRODUCTS CO.
443-445 Broadway, New York 13, N. Y.

More leading engineers and technicians have built Tech-Master for their own use than any other Television Kit.

TUBES

Guaranteed, Brand New, Individual Cartons! DEDUCT 5c from the price of each tube when ordering any 20!

30c EA. 6K5	27	1Q5	14Q7
1F4	47	2A3	25Z5
1G4	78	2B5	35W4
3B7	80	2Z5	42
6C4	85	6AG6	58c EA.
12A6	117Z3	6AG5	6Y6
39/44	2051	6AV6	6CB6
38c EA. 6SL7	45c EA. 6J6	6B7	12SG7
32Z5	6K8	6C7	3Q5
35Z5	6Q7	6C8	35Y4
2X2	6S7	6C8B	50B5
42c EA. 6V6	6SG7	6D6	50L6
1Q5	6T7	6E6	70L7
1R5	6U4	6F6	VR150
1S5	6Y3	6G7	69c EA.
1U5	6Y4	6H7	6AC7
5U4G	6Z5	6I6	6BG6G
6AL5	6SN7	6J6	6T8
6AR5	6X4	6K6	6T8A
6AT6	6X5	6L6	6X4
6AU6	6X6	6M6	117L7
6BA9	6X7	6N6	M7
6BD6	6X8	6P6	117Z6
6E6	6X9	6Q6	89c EA.
6H6	6X0	6R6	6E5
6J6	6X1	6S6	6L6

SPEAKERS

3 1/2" P.M. .68 oz.	\$.79
4" P.M. .68 oz.	\$.89
4" P.M. 1 oz.	\$.99
4" P.M. 1.47 oz.	1.05
4"x6" P.M. 1 oz.	1.49
5" P.M. .68 oz.	\$.89
5" P.M. 1 oz.	\$.95
5" P.M. 1.47 oz.	1.05
6" P.M. 1 oz.	1.29
6" P.M. 1.47 oz.	1.39
10" P.M. 6.8 oz.	3.69
12" P.M. 4.64 oz.	4.59

ELECTROLYTIC TUBULAR CONDENSERS

Fresh Stock With mounting strap. Standard Brands - CD, Type EDL.
20x20-150 V. 39c
40x40-150 V. 39c
50x30-150 V. ea.
Any Assortment!
10 for \$3.80

AC Line Cords

7 ft. Molded bakelite plug. 12c ea.
10 for \$1.10
6 ft. Reinforced U.L. approved rubber plug. 14c ea.
10 for \$1.25

ROTARY SWITCH, Standard Brand, 2-pole, 5-position, shorting type for meters or hand switches. 34" shaft. ea. 29c

Alnico V Magnets

Lots of
Ea. 5 Ass't.
\$.75
\$.85
\$.95
1.39
1.39
\$.85
\$.89
1.05
1.19
1.29

VOLUME CONTROLS

Standard Brand, B r a n d s w i t c h & l o n g s h a f t o h m s
100,000
250,000
350,000
300,000
1 megohm
34c ea.
49¢

Minimum Order

\$2.50
25¢
posit. bal-
ance C.O.
D. A. I.
p r i c e s
F.O.B. New
York, N.Y.
WRITE TO:
DAY FOR
OUR NEW
FALL CIR-
CULAR!!

SWEDGAL RADIO, INC.

96 Warren St., Dept. N-5
New York 7, N. Y.
Cortlandt 7-6753

OUTPUT TRANSFORMERS

305	34c ea.
6V6	38c ea.
6X4	34c ea.
60L6	49c ea.
60L6 P.P.	1.38c ea.
6V6 P.P. 15 Watts.	
Sec. Taps 4, 8, 15, 250 & 300 ohms.	
Fully Shielded.	89c ea.

PAPER TUBULAR CONDENSERS

Mfd.	Volts	Ea.
.015	@ 200	3c
.015	@ 400	3c
.015	@ 400	4c
.01	@ 400	4c
.005	@ 600	4c
.02	@ 600	5c

DEDUCT 1c ea. in any ass't. of 20!

ANTENNA LOOP, 4 terminal, for AC/DC, Bury, portables & small receivers.

Extra power fut. ea. 12c
FILTER C H O K E, 3/4" stack, 5 henries @ 75 ma. ea. 45c
IF TRANSFORMERS, Precision wound radio coils, med. size, 456 KC. Input or Output. ea. 28c
Midget Iron Core 456 KC. Input or Output. ea. 48c

ufacturers. It should be produced as the result of a consistent year-round program of research. . . . For example, we are now proposing to quintuple the number of television channels by moving into the u.h.f. Here is a problem involving the expenditure of millions of dollars by the public and the radio industry. This part of the spectrum is relatively unexplored for television purposes. And yet, in all America, there were only a half dozen experimental ultra-high TV stations broadcasting programs last year and they were on the air for limited periods. Another half dozen licensees have carried on propagation studies and other limited research. . . . A billion-dollar industry is no place for operation by guess. . . . We cannot afford, and the public will not long permit us to plan our radio system on a crisis basis. By allocating a reasonable amount of your energy and your money to such research programs, you will be helping to assure the stability of your industry and you will be serving the public interest."

Continuing his critical evaluation of research, Coy said: "Your responsibility for instituting research programs to help chart a sound course for radio's future cannot be negated by the claim of the stresses of business competition. In fact, the interest of the radio art, the interest of your industry and the interest of the public would be best served by a healthy competition that would extend not only to products and prices, but to fundamental research that will pave the way for consistent expansion. . . . Armed with this modern weapon of scientific research and operating in the public interest concept, the radio and television manufacturers of America will be prepared to push on to greater heights of achievement in the great days that lie ahead."

FM will soon be used for daily broadcasts by the United Nations in New York City, according to the FCC, with a transmitter to be installed on the fortieth floor of the Secretariat building, now under construction.

The station will operate on Channel 206 or 89.1 megacycles, and will be on the air about twelve hours a day. An effective radiated power of 20 kilowatts has been scheduled for the transmitter, and the antenna will be 500 feet above average terrain.

The original plans for the station were developed by Major General Frank E. Stoner, while he was chief communications engineer for the UN. Gen. Stoner, who is now a consulting engineer in Seattle, disclosed to the FCC that the new UN station would program news of the activities of important meetings held in the Council chambers and in the General Assembly, and special events staged at headquarters.

AN UNUSUALLY informative booklet describing, for the first time, how all the safety and special services

operate, has been prepared by the FCC. Available from the Superintendent of Documents for only fifteen cents, the booklet provides a simplified explanation of the aeronautical radio services, on air and ground; marine radio services used on ship and coastal activities, including a review of radar and loran facilities; public safety radio services, which includes police, fire, forestry-conservation, highway maintenance and special emergency; the land transportation services, where we have the railroads, taxicabs, automobile emergency, intercity buses, highway trucks and urban transit; public radio-communication services, involving domestic public land mobile, rural subscriber and short haul toll; the industrial radio services, which include a host of vital industries, such as power, petroleum, forest products, relay press, motion picture, low-power industrial and special industrial; and the industrial, scientific and medical services; experimental radio services; low-power radio devices; citizens radio services, amateur radio services, and commercial radio operators.

Also featured in this handy guide are chapters detailing what the services are, how they grew, what they do, how they are regulated, and how to secure a license for their operation.

FIRST BRIEFS of that all-important hearing, which will explore the application possibilities of the 470 to 500-megacycle band, which were filed as this column was being prepared, disclosed that there would be quite a tense struggle ahead. With members of the telephone industry making strong pleas for the band and the TV broadcasters plowing in their requirements, the tussle may take on the appearance of another color war. Should TV win, the ultra-highs will begin at 470 mc., but should the mobile interests convince the FCC that this 30-mc. band is essential for their carrier operations, 500 mc. will be the starting point for the u.h.f. band. Another sizzling problem for the boys in Washington to solve. . . . L.W.

It's *rpc*



**for
High Voltage
Television Resistors**

Replace strings of carbon resistors and other types not designed for high voltage. Eliminate costly callbacks by installation of RPC Type T Resistors in voltage doubler and bleeder circuits. Ratings to 20,000 volts, 3 watts, 1 to 10 megohms. Rugged construction—easily mounted—moderately priced.

Available at your jobber. Write for catalog.

ALSO MANUFACTURERS OF HIGH QUALITY PRECISION WIRE WOUND RESISTORS, HIGH FREQUENCY RESISTORS AND HIGH MEGOHM RESISTORS. WRITE TODAY FOR CATALOG.

rpc RESISTANCE PRODUCTS CO.
714 RACE STREET • HARRISBURG 3, PA.

Koenig

Telebeamer ROTATOR

**2 HEAVY DUTY
MOTORS GIVE . . .**

**BETTER PERFORMANCE..
LONGER LIFE!**



PAT. PENDING

Indicator shows exact antenna bearing at every instant; comes in plastic, mahogany or walnut case. Motors work independently; one turns rotor clockwise, the other counter-clockwise.

Write for prices and specifications

Koenig Engineering Co.

735 SOUTHWEST BLVD. KANSAS CITY, 3, KANSAS

**RADAR, COMMUNICATIONS
AND
SONAR TECHNICIANS
W-A-N-T-E-D
For Overseas Assignments**

Technical Qualifications:

1. At least 3 years practical experience in installation and maintenance.
2. Navy veterans ETM 1/c or higher.
3. Army veterans TECH/SGT or higher.

Personal Qualifications:

1. Age, over 22—must pass physical examination.
2. Ability to assume responsibility.
3. Must stand thorough character investigation.
4. Willing to go overseas for 1 year.

Base pay, Bonus, Living Allowance, Vacation add-up to \$7,000.00 per year. Permanent connection with company possible.

Apply by Writing to
**D-4, P.O. Box 3575,
Philadelphia 22, Pa.**

Men qualified in RADAR, COMMUNICATIONS or SONAR give complete history. Interview will be arranged for successful applicants.

WANT \$10,000?
Earn the government bonus by locating Uranium Ore with a

**P.R.I.
GEIGER
COUNTER**



Be prepared to uncover valuable deposits of Uranium ore, while you're hunting, fishing, hiking, or prospecting, etc. With this super-sensitive Geiger Counter, deposits are easily detected. Flasher, meter, earphones indicate presence of radio-active material and estimate quality and quantity of ore right in the field. One control! Simple to operate! World's finest! Guaranteed to outperform any other make, regardless of price. Act now! Win fortune, fame and lifetime security. Find gold, silver, and other valuable ores with a P.R.I. Treasure Locator. World's finest instruments. FREE catalog. Write today. **PRECISION RADIATION INSTRUMENTS, INC.** 5478 Wilshire Blvd. RT, Los Angeles 36, Calif. Dealer Inquiries Invited

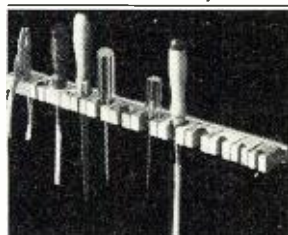

TOOLRAK

puts your
tools at your
fingertips

An ideal arrangement for benches, Toolrak prevents dulling and marring, and keeps tools handy for use. Extruded aluminum backstrip holds hardwood blocks which can be rearranged at will. Non-magnetic.

8" size for 7 tools, \$1.35 postpaid
12" size for 10 tools, \$2.00 postpaid
18" size for 14 tools, \$2.65 postpaid

**ORDER
BY MAIL**

DAVIS Development Dept. 28, Peterson Field
Company Colorado Springs, Colo.

**In Resistors
It's Uniformity
that Counts**



You can install them and forget them. For LECTROHM RESISTORS are built to one standard of quality. Low-loss ceramic cores are wound tightly and evenly with the largest wire size possible for each resistance. Ends are secured by special Lectrohm silver-soldering process. Wire, lugs and core are embedded in durable vitreous enamel, assuring retention of uniform wiring and resistance to moisture or mechanical damage. ±10% tolerances maintained. Rated conservatively on RMA and NEMA standard.

**LECTROHM
RESISTORS**

**5, 10, 25
WATTS**

Consult us on special resistors.
Catalog No. 99 lists all standard types.
Write for it.



5907 Archer Avenue Chicago 38, Illinois
Division of
National Lock Washer Co., Newark, N. J.

Classified

Rate 35c per word. Minimum 10 words

RADIO ENGINEERING

ADVANCED radio-TV-electronics engineering without advanced mathematics. Entirely new, fast systems. Streamlined arithmetic routines. Simplified graphical diagrams. Correspondence training for operating engineers, technicians, servicemen. Reasonable rates. Write Superior Procedures, 2166 Market St., San Francisco, Calif.

PANELS for electronic, nucleonic construction projects. Complete service for designers, custom builders. Circular upon request. Gilpin Instrument Works, P. O. Box No. 8, Mt. Clemens, Mich.

RADIO Engineering Broadcasting, Aviation and Police Radio, Servicing, Marine Operating and Electronics taught thoroughly. Expenses low. Write for catalog. Valparaiso Technical Institute, Dept. N, Valparaiso, Ind.

SALE

RCA Wire Recorders. Famous model MI-12875. Brand new, complete with microphone and cartridge. Original cost, \$195.00. Our price, \$75.00. Electronic, 1310 S. Staples, Corpus Christi, Texas.

833A NEW \$25. Webster 80-A, excellent \$95. Forty QST's '31 '37. W4ATE, 1001 Merritt, Old Hickory, Tenn.

HICKOK Traceometer, new condition. Rider manuals 6 through 14. Make an offer. Eugene Kurseth, 822 6th Ave. S., St. James, Minn.

BARGAINS. New and reconditioned Hallicrafters. National, Collins, Hammarlund, RME, Meissner. other receivers, tuners, television receivers, transmitters, amplifiers, speakers, etc. Lowest wholesale prices. Terms. Shipped on trial. Liberal trade-in allowances. Write Henry Radio, Butler, Mo., and 11240 W. Olympic, Los Angeles, Calif.

HOTTEST surplus list in the country. Electronics-Hydraulics, Aircraft-Gadgets. Dick Rose, Everett, Wash.

RADIO Diagrams 50c; Record Changers, Recorders 60c; Television Diagrams with service data \$1.00 up. State Manufacturer and model number. Kramer's Radio Service, Dept. RX, 36 Columbus Ave., New York 23, N. Y.

WEBSTER Chicago record changer and wire recorder replacement parts. We ship everywhere! Friend's Wholesale Distributors, 106 N. 6th St., Philadelphia 6, Pa.

COLOSSAL bargain in radio parts, over 150 assorted radio parts including resistors, condensers, controls, coils, etc. All new, \$75.00 value, guaranteed satisfaction or money refunded, postpaid in U. S. A., \$2.50. Write for catalog. Buyers Syndicate, 30 N. Taylor St., Springfield 3, Mass.

COMPLETE parts including cabinet and panel to build an Oscilloscope, VTVM, combination only \$39.50. Cosmopolitan Electronics Co., Box 4, North Baldwin, N. Y.

RESISTORS, wire wound, new, assortment of fifteen \$1.00 postpaid. Acme Outlet, 3904 Prospect, Kansas City, Mo.

JEFFERSON Travis Model 52 Radio Telephones 5 watt complete in original packing, \$40.00; Pinco rotary converters 12 volt to 110 ac 60 cyl. 300 watt, \$50.00; B.C. 441 Radio telephone, \$125.00. Superior Marine Radio Co., 62 St. George St., St. Augustine, Fla.

CODE Machines, phototube keying, model RCM-2. Learn the code in shortest possible time. Complete tape selection. Write: Ultradyn Electronics, Oswego, Ore.

COAXIAL Cable: 53 ohms, 100 feet, \$3.00. Sample 10¢; Twin-lead 500 feet, \$4.50. Harry H. Van Dick, Box 236, Little Falls, N. J.

FOR SALE: 150 Loudspeakers, Rola, 12 inch, EM, new. Make your offer. Epiphone Inc., 142 W. 14th St., New York, N. Y.

TWO hour tape record, playback mechanism. Use your amplifier. With instructions, tape oscillator coil, Tri-head. Prepaid with remittance of \$24.50. Wire and tape recording instructions and servicing Kinks, \$1.00. Saftoy, Inc., Electronic Dept., Box 717, Oak Lawn, Ill.

RADIO & TELEVISION NEWS

STEPPING Relays. Made by well known mfr. Brand new. May be used for remote control applications. 6 volt D.C. coil Solenoid, ratchet type, wafer switches removable. 1, SP7T; 1, SP6T; and four others. \$4.00 each postpaid or 3 for \$11.00 postpaid. Will also ship C.O.D. with 20% deposit. Whitegate Co., 6822 Euclid Ave., Chicago 49, Ill.

WANTED

SNIPERSCOPE & Snooperscopes wanted. Any type, any condition. Needed immediately. Box 495, % Radio & Television News, 185 N. Wabash Ave., Chicago 1, Ill.

WANTED: APR-4 receiver and tuning units. State condition and price. W2DB, 274 Boulevard, Scarsdale, N. Y.

HELP WANTED

INSTRUCTORS in Electronics and Radio. Prefer former Navy Radio Technician instructors willing to locate in the Detroit, Mich., area. Write to Box 452, c/o Radio & Television News, 185 N. Wabash Ave., Chicago, Ill.

CORRESPONDENCE COURSE

USED Correspondence Courses and Books sold and rented. Money back guarantee. Catalog free. (Courses bought.) Lee Mountain, Pisgah, Ala.

USED Correspondence Courses and Educational Books bought, sold, rented, catalog free. Educational Exchange, Summerville, Ga.

PATENT ATTORNEYS

HERMAN Lewis Gordon, Registered Patent Attorney. Patent Investigations and Opinions. Warner Building, Washington, D. C.

LANCASTER. Allwine & Rommel. Registered Patent Attorneys. Patent practice before U.S. Patent office. Validity and Infringement investigations and opinions. Booklet and form "Evidence of Conception" forwarded upon request. Suite 414, 815 15th St., N.W. Washington 5, D.C.

MISCELLANEOUS

WATCH dead? Average, reconditioned, \$4.50. Guaranteed. Huntress, 840 W. Cottonwood, Freeport, Ill.

RADIOMEN, Servicemen, Beginners. Make more money, easily, quickly, \$250 weekly possible. We show you how. Information free. Merit Products, 216-32R 132 Ave., Springfield Gardens 13, N. Y.

PHOTO CREDITS

PAGE	CREDIT
43	Acme
55, 57	Philco Corporation
78	Marcia Gregg
100	Lear Incorporated
102	U. S. Army
104	Radio-Television Manufacturers Assn.
106	Glenn L. Martin Company
121	United Air Lines



FLORIAN WINGHAM

"But I don't think it's honest to listen to the program and then turn off the sponsor's word."

August, 1950

Equip for long faithful service



with a

TURNER MODEL 33

Choice of crystal
or dynamic

Over the years, thousands of sound-men have discovered that dependable Turner Microphones give smoother, more accurate performance than any other microphones in their price class. For all-around use, the Turner Model 33 is a long-time favorite. It combines up-to-the-minute styling, high output, wide range response, and utmost reliability under tough operating conditions. Has 90° tilting head for semi- or non-direction use. Complete with 20 ft. quick-change removable cable set.

Model 33X Crystal. List \$24.50

Model 33D Dynamic. List 27.00

For top dollar-for-dollar value in microphones that fit any need Turn to Turner.

THE TURNER COMPANY

900—17th Street N.E., Cedar Rapids, Iowa

• In Canada: Canadian Marconi Co., Ltd., Montreal, P.Q. and Branches.

• Export: Ad. Auriema, Inc., 89 Broad Street, New York 4, N.Y. Crystal licensed under patents of the Brush Development Company



RADIO COURSES

- RADIO OPERATING • CODE
- RADIO SERVICING • ELECTRONICS
- F.M. TELEVISION
- REFRIGERATION SERVICING

Write for Catalog T.S. and Picture Brochure



TRADE & TECH. SCHOOL, 129 W. 66 St., N. Y. 23
ENDCorr 2-8117

POCKET RECORDER

- Conferences
- Reports
- Dictation
- Inventory
- Sales Talks
- 2-Way Phone
- Conversations
- While Riding,
- Walking, Sitting

WALKIE RECORDALL
Up to 4 hrs. of continuous uninterrupted permanent recording at a total cost of only 2 1/2¢ per hr. Concealed candid recorder picks up at a radius of up to 60'. Permanent play-back from same unit at no cost. Fully pat'd.

Size 4 1/2" x 7"
Weight 5 1/2 lbs.

MILES REPRODUCER CO., INC.

812 B'way Dept. RN N.Y.C. SPring 7-7670-1

TELEPHONE WIRE

Sensational purchase means new low prices!

This is genuine W110B Army Field Wire. It comes to you on original steel reels, 2-conductor, twisted pair. Each conductor has 3 copper, 4 steel strands for extra tensile strength. Rubber insulated. Impregnated fabric outer covering.

NEW, unused, excellent condition	
—per Mile (wt. 160 lbs.)	\$13.50
1/2 Mile (wt. 80 lbs.)	\$7.00
NEW, unused, good serviceable condition	
—per Mile	\$10.50
1/2 Mile	\$5.50

Excellent for all-weather, all-purpose communication. Used extensively by telephone companies, industry, engineering projects, ranches, etc., for extended field communication systems.

NEW W130 Lightweight Assault Wire

2 mile reels (10,500 ft.) wt. 85 lbs.	\$37.50
1/2 mile reels (2600 ft.) wt. 16 lbs.	\$9.95
1/4 mile reels, wt. 9 lbs.	\$4.95

All prices FOB Sacramento. No COD. (California residents add 3% for sales tax.)
Send check or money order to **LORIS SALES**
P. O. Box 1896-M8, Sacramento, Calif.

"TAB"

THAT'S A BUY



TRANSFORMERS—115V 60cyc Inpt
 TV Pwr Supply Xfmr for 7" to 20"
 Tubes. HV 5KV to 20KV (w/quad-
 rupler ckt). ALL Tubes, PL & FIL
 w/drgs. dvrng: 300VDC/275Ma Full
 Wave. 6.4V/10.3A, 5.4V/8A, 2.3V/
 3A. Hypersil Core. Oilmpreg. \$6.98
 100Vct/45Ma, 79.5Vct/80Ma & 360
 Vct/55Ma, 88.5V/3A, 6.3Vct/1A, 6.3
 vct/.3A Csd HVins. \$3.98
 900V/35Ma, 2x2.5V/2A. Csd HVins. 2.98
 700Vct/100Ma, 115V/100Ma, 2x3.3V/1A, 5V/2A
 csdHV 2.98
420Vct/120Ma, 6.3V/1.9A w/inpts 6-12-24-115
 vdc & 115/230vac. Each \$1.98; 10 for . . . 16.98

BLOWERS
Cool That Tubel!
 40 CFM 28vacdc. \$3.49
 70CFM 115V/400cy. 4.49
 100CFM 12vacdc. 5.98
 Xfmr 12 or 28
 volts to 115 vac. 1.95
 250CFM 28vacdc. 9.95
 250CFM 42Sto115
 vac Transformer. 11.95
 100CFM 115vacdc. 7.98
 180CFM 115vacdc 10.98

TUBES

"TAB" for TUBES! Tested—Guaranteed— Brand New

455	24G
VR92	2X2
WE215A	3A4
954	6X4
955	6J5GT
956	80
957	6Z5
7193	
9006	
1235	

Unit Price .29c

1L4	6BE6	6SF6T	12SF7GT
1U4	6BH7	6SK7GT	12SJ7
1U5	6BJ6	6SQ7GT	GT
2A4	6C5GT	6V6GT	2SL6GT
354	6F6GT	6V4GT	35B5
5Y3GT	6HG	6X4	35Z5GT
6AQ5	6HE6GT	7A	60B5
6AT6	6K6GT	12A6	50B5
6AU6	6K7GT	12BA6	117Z3
6BA6	6P5E	12BE6	211
	6P6GT	12S7GT	6Y4C

Unit Price .39c

0P3	6AG5	7C4	12SL7
VR150	6AL5	7CS	GT
1NSGT	6AR5	7F7	25Z5
1R5	12BA7	3	751
2V3G	6CB6	12BF6	35L6GT
3V4	6J7GT	12K8	REL36
5U4G	6K5GT	12AT6	5J4
5Z3	6Q7GT	12SK7	50L6GT
6AB4	6SL7GT	GT	2051

Unit Price 59c

1A7GT	1B3GT
1LN5	1Q5GT
6T	6J6
6A8GT	6L6G
12A77	6SL7GT
25W4GT	

Unit Price .69c

OC3	6AC7M
VR105	6AC7
6B4G	6AK5
6B6GT	6B6GG
6C	6L6M
6V6M	6V6M
32L7GT	95C
89C930	866A
	117L7
	98C
	446A

"Williamson" 10-Watt Hi-Fi Kit
 10cyc to 20kc with ease! Internation-
 ally Famous. Simplicity of design. Ex-
 traordinary linearity & lack of distor-
 tion. To 1 Mc for experimenting. RCA
 Chassis. Less Outpt Xformer. \$19.95
 Same with PreAmp-ToneControl Kit. . . \$29.95
 "Williamson" 32 Page Booklet. All rights ar-
 ticles. ONLY 98c
Super Wide-Range Hi-Fi Amp Kit
 20cyc to 20kc. 10W. Max harmonic distortion 134%
 full outpt. 0.5% 15W outpt. PreAmp-ToneCont. RCA
 chassis. Less Outpt Xfmr. \$24.95
 G-E VarRelucCartridge-PermNeedle . . . 1.98
 UTC Hi-Fi Outpt Xfmr 30Watts PP6L6/2A3/6A5G
 PFI400ohmsCT:Sec3taps.2.5to250ohms . . . \$ 5.98
 With 120111 G-E Hi-Fi Speaker 21.35
 "TAB" Hi-Fi Pickup Assemblies: "TAB" Pickup Arm
 & G-E VarRelucCartridge w/Replaceable Stylus:
 Standard RPX040 or "LP" RPX041 (Specify) \$7.29
 Above w/G-E Triple Play Cartridge RPX030 (33,45
 & 75RPM) & Stylus \$9.49

35MM FILM—Guaranteed Surplus
 36Exp. Superpan 35mm Cartridge. 5 for \$1.00
 36Exp. Microfilm 35mm Cartridges. 5 for 1.00
 400ftx35mm SuperPan. Per 40ft roll 3.49
 46mm PAN film GSAFem Ea. (320ft) 4.98

IN34 XTALS, Ea. 67c 100 for. \$ 8.50
 100 for. \$3.00

SCOPE TUBE
 Infra-Red
 500 OPER-
 SCOPE TUBE
 Sees In Dark.
 Ea. \$4.98; 2
 \$9.49
 Circular Slide Rule—
 2 1/2" Rad. Only. 98c
 3" Parallel Rules. 3c

Write for Your FREE "TABOGRAM"
 "TAB" MONEY-BACK GUARANTEE (Cost of Mds
 Only). \$3 Min. Order F.O.B. N.Y.C. Add Shpg.
 Charges & 25% Deposit. Shipments G'd R'Exp
 Only. Prices Subject to Change.

"TAB" Dept. 8RN, 6 Church St.
 Corner Church & Liberty Sts.
 New York 6, N. Y.
 That's a Buy! Phone: WOrth 2-7230

INDEX OF Advertisers

AUGUST 1950

While every precaution is taken to insure accuracy, we cannot guarantee against the possibility of an occasional change or omission in the preparation of this index.

ADVERTISER	PAGE	ADVERTISER	PAGE
Alliance Manufacturing Company	11	Mallory & Co., Inc.	4th Cover
Allied Radio Corp.	9	Massey Telephone & Radio Corp.	134
Alno Radio Co.	114	Mass. Radio School	114
Altec Lansing Corporation	126	Meissner Mfg. Division, Maguire Indus- tries, Inc.	125
American Television & Radio Co.	84	Merit Transformer Corp.	96
Amperite Company, Inc.	120	Midwest Radio & Television Corp.	83
Amplifier Corp. of America	153	Miles Reproducer Co., Inc.	151
Approved Electronics Inst., Corp.	146	Milwaukee School of Engineering	103, 130
Arrow Sales, Inc.	111	Mytronic Co., The	96
Ashe Radio Co., Walter	107	McGee Radio Company	86, 87
Atatic Corporation, The	18		
Atlas Sound Corporation	77		
		National Radio Institute	3
Baltimore Technical Institute	92	National Schools	3rd Cover
Belden Manufacturing Company	14	New England Television Corp.	136
Bell Telephone Laboratories	105	Newark Surplus Materials Co.	124
Belmont Radio Corporation	143	Niagara Radio Supply Corp.	123
Berlant Associates	143	Northwestern Vocational Inst.	88
Biss Electrical School	133		
Bond Equipment Co.	139	Offenbach & Reimus Co.	115
Boyce-Roche Book Co.	131	Olson Radio Warehouse, Inc.	80, 81
Brook Electronics, Inc.	132	Opad-Green Company	139
		Peak Electronics Co.	100
Candler System	114	Penn Boiler & Burner Mfg. Corp.	28
Cannon Electric Development Company	78	Photocon Sales	125
Capitol Radio Engineering Institute	71, 15	Platt Electronics Corp.	128
Centralab, Division of Globe-Union, Inc.	12, 13	Poly-Tech	135
Certified Television Laboratories	139	Precision Electronics, Inc.	146
Chelsea Television Center, Inc.	88	Precision Radiation Instruments, Inc.	150
Chicago Industrial Instrument Co.	138	Radio Supply & Engineering Co., Inc.	141
Circle-X Antenna Corporation	148	Rauland Corporation, The	27
Cleveland Institute of Radio Electronics	5	Raytheon Manufacturing Company	98
Coin Radio & Television Co.	136	Reeves Soundercraft Corporation	138
Columbia Electronics Sales	136	Resistance Products Co.	149
Comet Electronic Sales Co.	109	Rider, John F., Laboratories, Inc.	132
Communications Equipment Co.	113	River Edge Industries	126
Concord Radio	97	Rumph Co., Dave	147
Cornell-Dubilier Electric Corporation	85		
Coyne Electrical & Television-Radio School	120	RCA Institutes, Inc.	136
		Radio Corporation of America	93, 137, 2nd Cover
Davis Development Company	150	Radio Craftsmen Incorporated, The	26
DeForest-Sanabria Corporation	17	Radio Supply & Engineering Co., Inc.	141
DeForest's Training, Inc.	7	Rauland Corporation, The	27
De Soto Distributors	70	Raytheon Manufacturing Company	98
		Reeves Soundercraft Corporation	138
East Coast Electronics	130	Resistance Products Co.	149
Edlie Electronics, Inc.	102	Rider, John F., Laboratories, Inc.	132
Electric Spot, The	141	River Edge Industries	126
Electro Devices Incorporated	112	Rumph Co., Dave	147
Electro Products Laboratories, Inc.	137		
Electro-Technical Industries	79	Sams & Co., Inc., Howard W.	106
Electronic Instrument Co., Inc.	89	Sangamo Electric Company	6
Electronic Manufacturing Co.	140	Schott Co., Walter L.	129
Electronics Institute, Inc.	98	Science Kits, Ltd.	146
Espey Manufacturing Company, Inc.	129	Senco Radio, Inc.	94
		Sprague Products Company	16
Fair Radio Sales	133	Spragberry Academy of Radio	19
Federated Purchaser, Incorporated	114, 140	Standard Transformer Corporation	70
		Star Electronic Distributors, Inc.	127
G. & G. Radio Parts Service	142	Sun Radio of Washington, D. C.	110
G. L. Electronics	122, 130	Supreme Publications	101
General Electric Company	69, 20, 21	Swedgal Radio, Inc.	148
General Electronic Distributing Co.	117	Sylvania Electric	10
General Test Equipment	92		
Goodheart, R. E.	122	TAB	152
Greenlee Tool Co.	132	Tech-Master Products Co.	148
Greenwich Sales Co.	146	Technical Products Co.	98
		Television Supply Co.	142
Harvey Radio Company, Inc.	95	Thomas Electronics, Inc.	108
Heath Company, The	72, 73, 74, 75, 76	Transvision, Inc.	92
Henry Radio Stores	120	Tri-State College	108
Henshaw Radio Supply	139	Trio Manufacturing Co.	145
Hollywood Sound Institute, Inc.	141	Turner Company, The	151
Hollywood Technical Institute	146		
Hy-Grade Electronics, Inc.	144	Ungar Electric Tool, Inc.	130
Hytron Radio & Electronics Corp.	25		
		V & H Radio & Electronics Supply	153
Indiana Technical College	153	Vaccaro, Charles A.	140
Instructograph Company	88	Valparaiso Technical Institute	141
International Radio & Television Parts Co.	140		
International Resistance Company	22, 23	Weller Manufacturing Company	8
		Wells Sales, Inc.	154
Koenig Engineering Co.	149	Wholesale Radio Parts Co., Inc.	121
		World Radio Laboratories Incorporated	147
LaPointe-Plascomold Corp.	99		
Lectromm, Incorporated	150	YMCA Trade & Tech. School	151
Electronic Research Labs.	143		
Leotone Radio Co.	144	Ziff-Davis Publishing Company	134, 140
Long Island Radio Co.	146		
Loris Sales	151		

FOREIGN SET OWNERSHIP

THE number of radios in use in Sweden was 2,500,000 in December, 1949. Of this number 100,000 were in public places. The number of listeners per set was an estimated 3 persons. Approximately 2,328,000 sets were designed to receive short-wave broadcasts.

Radio receivers are not produced in Syria. An estimated 37,000 sets are in use with about 62 per-cent of British manufacture, 10 per-cent Dutch, 7 per-cent French, and 18 per-cent U. S. Imports in 1948 totaled 25,993 sets of which 10,706 were British, 7879 U. S., 2933 Dutch, and 2455 French. Imports during January-June, 1949 totaled 11,151 units. Data on country of origin is not available.

It is reported that the Syrian market is saturated. Radios of U. S. manufacture are not preferred because Syrian consumers consider the postwar models inferior in quality to the prewar product.

An estimated 60,000 radio receivers were in use in Thailand in January, 1950, of which about half were designed to receive short-wave broadcasts. Reflecting the heavy importation of radio receivers during the last 18 months, the number of sets in use in June, 1948 was an estimated 40,000.

Licensed television receivers in the United Kingdom totaled 231,664 on December 31, 1949 of which 74,240 were located in London. On June 30, 1949 the number of licensed receivers was 141,953 of which 47,320 were located in London.

An estimated 12,000,000 radio receivers were in use in the United Kingdom on February 2, 1950. The number of listeners per set was an estimated 2.5 persons. About 9,000,000 of the sets are designed to receive short-wave broadcasts.

United Kingdom exports of radio and electronic equipment continued at a high level during the first ten months of 1949, according to the British Radio Industry Council.

January-October, 1949 exports totaled 9,518,000 pounds, compared with 11,897,000 and 10,272,000 for all of 1948 and 1947 respectively. The figures include radio receivers, transmitters, sound reproducing equipment, electro-medical and industrial apparatus, equipment, navigational aids, tubes, and components.

A steadily increasing production of television receivers, exceeding 36,000 sets in December is also reported. Total 1949 production was 205,500 sets, compared with 90,800 in 1948 and 28,200 in 1947. Increased demand for television receivers is attributed, in part, to the opening of the BBC's second transmitter in December, 1949.

Also from the United Kingdom comes word of the development of two new types of flat, subminiature tubes, the DF66, a voltage amplifier pentode, and the DL66, an output pentode.

The new tubes are said to make possible the construction of a complete hearing aid weighing less than 5 ounces. The filament currents are only 15 ma. The "A" battery thus provides 36-60 hours of useful life before replacement is necessary.

These new tubes are being manufactured by Mullard Electronic Products, Ltd. and are said to be suitable for use in 70 per-cent of the hearing aids currently being produced.

30

August, 1950

SAVE UP TO 95% SENSATIONAL SURPLUS VALUES!



BRAND NEW
APS-13
WARNING
RADAR

17 tubes as follows: 9-6AB5, 5-616, 2-2D21, and VR-105, 410 to 420 Mc. and 30 Mc. IF. Good deal for conversion and citizen band. With instruction book. Originally over \$100. **\$16.16** With antenna.

COMMAND RECEIVERS

Tested Before Shipping

190-550 KC Used. Orig. \$40. Now. \$9.95
3-6 MC Used. Orig. \$30. Now. 4.95
3-6 MC New. Orig. \$35. Now. 6.50
6-9.1 MC Used like new. 7.95
1.5-3 Mex. Brand New. 18.95
ARR-2. Used. 234-258 Mex. 9.95



COMMAND XMITTERS

T-22 ARC. 5 MC. Used. Same as BC-459. \$8.95
T-22 ARC-5.7-9.1 New. Orig. \$50. Now. 12.75
3-4 MC. Used. Orig. \$50. Now. 12.50
5.3-7 MC. Used. Orig. \$30. Now. 12.95
T-21 ARC-5.3-7. New. Orig. \$40. Now. 5.95
4-5.3 MC. Used. Orig. \$30. Now. 3.49
2-1.3 MC. LN. Orig. \$40. Now. 9.95

GO-9 XMITTER Freq. range 3-18 MC and 300-600 KC. 100w output. Brand New! Complete with tubes and spare part kit. Comes in 3 units, high and low freq. xmitter and receiver. Only **\$79.50** a few available.

CITIZENS BAND FREQ. METER LAVOIE VHF FREQ. METER. Type 105SM. Tunes from 375-725 MC. 1%. Brand New! Complete. **\$49.95**

WESTERN ELECTRIC AUDIO AMPLIFIER TYPE D-150300

An excellent mod. driver or PA system with hi-quality components. Input stage consists of 2-617's into 2-617's feeding 2-6CS's. Impedance couple to 616's in PP parallel. Class A 40 W output. 225 ohms output impedance. Power supply 110V 60 cyc. using 2-514's. Has built-in limiter and compression circuits. Maximum gain 110 DB. Fits standard 17" rack. Tube sub-chassis is hinged and folds back for easy servicing in rack as shown. Excell. cond. COMPLETE WITH TUBES. **\$49.95**

ARC-5 VHF SET

R-28 RCVR: Superhet operating on 4 xtal channels 100-156 Mc remote control to actuate turret-tuning mechanism. 12 tubes: 4-717A, 1-12A5, 3-12SH7 and 2-12SL7GT w/dyn. Originally \$55.00.

MD-7 MODULATOR: Contains all necessary circuits and components for plate mod of T-23 Xmitter w/dyn. which supplies plate and screen voltages for mod. Used. Originally \$36.00.

T-23 XMITTER: MCW and phone on 4 channels. 100-156 MC. automatic turret-tuning. tank circuits remote controlled. 4 tubes: 2-1625, 2-832A. Originally \$50.00. COMPLETE SET OF THREE UNITS. Used. **\$42.50**

ARC-4 VHF TRANSCEIVER. 140-144 MC. Xtal cont. Xmitter has 832 Final modulated by 616's, 10w output. 13 tube rcvr. two ind. RF secs. may be operated simultaneously or individually. Comes with Xtal, Dynamotor and tubes. Tubes Top cond., used. **\$17.49** Orig. \$150. Now.

IMPORTANT

NO ORDER LESS THAN \$5.00. Send 30% deposit on cost of item or full amt. to save COD charges. Do not send shipping costs. It will be COD only. Shipments sent via Railway Express unless other instructions given. Nds. subject to prior sale. Prices subject to change at any time.

EXPORT INQUIRIES FROM FOREIGN COUNTRIES INVITED. Immediate answers and prompt service! Many items in stock not listed. Let us quote prices on your requirements!

LUCKY PURCHASE

ONLY A FEW! TCS TRANSMITTER-RECEIVER. For rugged land and sea emergency use. Collins type 5Q-1 and 51-Q-1. 4 Char. xtal. cont. Trucks, ambulances, emergency vehicles; fishing boats, yachts, etc. Withstands shocks and vibration. 1.5-12 MC, 3 bands. 20w voice 40w CW measured at plates of pow output and normal sup. volt. Output easily increased. Write for full particulars.

PE-103 DYNAMOTOR

6-12 velt input, 500 velt @ 160 MA output. Comes equipped with 2 10 foot input leads. Used but like new condition. **\$16.95**

PE-157 VIBRATOR PACK

Part of SCR-511 "Horsie-Talkie." Operates from 2 volt rechargeable battery which can be recharged from 6, or 12 volts DC, or 6.3 volts AC. Contains loudspeaker and mike transformer. Output: Receiver—1.5 filament V @ 355 MA, 67.5 plate V @ 20 MA. Transmitter: 1.5 filament V @ 490 MA, 105-125 plate V @ 50 MA. In excellent used condition. A real buy. **\$9.95**

HORSEY TALKIE XMTR-RCVR. 2-6 MC, xtal cont. in 5" sq. chassis mounted near top of 3' hollow metal staff housing 30" telescoping antenna and serving as support to rest on ground. Complete with PE-157 VIB. Pack checks against unit which supplies all power. Operates from any 2V DC source. Can be used as lightweight unit to substitute for BC-611 to cover greater dist. Used. **\$24.50**

BC-1073 WAVEMETER

PWR. SUPPLY SECTION: 110 V 60 Cy, 330 V DC 85 MA 2 section filter. Also 15 tubes: 10-6NS7's, 1-5Y3, 1-6H6, 1-6S17, 1-6V6, 1-6SA7. Can be purchased separate at **\$9.95**

WAVEMETER SECTION: has high quality resonant cavity tuning from 150-210 MC. oscillator, heterodyne amplifier, electric tuning eye, precision millen gear drive and collapsible antenna. Built-in oscillator checks against cavity for proper frequency setting. Uses 9002, 6SF5 and 6ES tubes. Used **\$14.00**

PWR. SUPPLY AND WAVEMETER IN ONE CASE. BOTH FOR. **\$22.50**

BC-1072 XMITTER

157-187 MC. Input 117VAC 60 cy. Has parallel rod OSC using 2-826 PP. contains power supply, general radio variac 1.5A. 3 1/2" 0-5 kilovoltmeter, 10 tubes and loads of other parts too numerous to mention. With tubes. Less Blower. **\$19.75** Used

BC-611 "HANDIE-TALKIES" FREQ. 3-6 MC ATTENTION CONSTRUCTION MEN, BUILDERS, SURVEYORS! Perfect for short distance communication. Weighs only 5 1/2 lbs. Hand-held. Pre-set to your frequency. Push-button controlled. Transmitter and receiver in same case. 15 3/4" x 3 3/4" x 5 3/4" sturdy aluminum case. Complete with tubes, crystals, 1 set batteries. Extra batteries, accessories available. In good used condition. Models B, C, D, E, F available. PRICE ON REQUEST.

SCR-522 VHF TRANSCEIVER

An all time favorite for all 2 meter ham operators. This unit consists of 2 chassis. BC-625 transmitter and BC-624 receiver, transmitter being xtal controlled and having an am output of approx. 15 watts. Freq. range 100-156 meg. w/diagram. Used. Complete. Good cond. **\$23.50** Xmitter or Revr. Separate **\$14.95**

BC-1306 TRANSMTR-RCVR. Freq. range 3.8-6.5 MC. Xmtr xtal cont., phone or CW. Rcvr. tunable from front panel. Operates on 6, 12 or 24 v in conjunction with Pow. Sup. unit PE-237. Output 10w phone, 25w CW. Used, Good Condition, less front cover. With PE-237. **\$100.00**

PORTABLE FM XMTRS AND RCVR'S! Operate on 6V DC, 34 MC varied either direction depending xtals. Xmtr and Rcvr has aluminum case with antenna relay. Xmtr uses 1073.125 KC xtal in osc. stage followed by 4 doublers and 1 fin. amp., all using HY 65 tubes. Mike amp. and Freq. Mod. use 1076 tubes. Xmtr stages have metering jacks. Rcvr is superhet. Xtal cont. local osc. at 5060 KC. Power Supply on chassis using Carter 6V gen., output 450v, 250ma, 6v vibrator Pow. Sup. for Rcvr. All tubes inst. heating. Included is control box, hand set, 8" spkr. and extra microphone. Used. Complete set only **\$45.00**

SEND 10c FOR NEW 1950 CATALOG

VET RADIO & ELECTRONICS SUPPLY DEPT. R-12, 2033-37 W. VENICE BLVD. LOS ANGELES 6, CALIFORNIA

INVALUABLE!



96 pages crammed with facts. Contains circuit diagrams, parts lists, construction hints, as well as elementary and advanced theory and design. Contains data never before in print!

AMPLIFIER CORP. OF AMERICA
398-2 Broadway, New York, 13, N. Y.

RADIO ENGINEERING DEGREE IN 27 MONTHS

Radio engineering is a big field. There's room for you in it—if you're good. Get first-class training at Indiana Tech. Intensive specialized course, including strong basis in mathematics and electrical engineering, advanced radio theory and design, television. Modern laboratory. Low tuition. Also 27-month courses in Aeronautical, Chemical, Civil, Electrical and Mechanical Engineering. Approved for G.I.'s. Enter September, December, March, June. You can earn part of your expenses right here in Fort Wayne while you are studying.

INDIANA TECHNICAL COLLEGE

980 E. Washington Blvd., Fort Wayne 2, Indiana
Please send me free information on B.S. Engineering Degree in 27 months as checked.

Radio-Television Aeronautical
 Civil Mechanical Electrical

Name.....
Address.....

Latest WELLS Tube Price Lis

Many Types Are Now Scarce At These Low Prices. Check your requirements at once for your own protection. All tubes are standard

brand, new in original cartons, and guaranteed by Wells. Order directly from this ad or through your local Parts Jobber.

TYPE.	PRICE EA.	TYPE.	PRICE EA.	TYPE.	PRICE EA.	TYPE.	PRICE EA.	TYPE.	PRICE EA.	TYPE.	PRICE EA.
OA4G	.95	5AP1	3.75	7B4	.55	RK60/1641	.65	HY615	.35	866A	1.30
EL-C1A	3.95	EL-C5B	4.25	7B8	.60	VT62 BRITISH	1.00	WL632A	8.75	869	19.75
1A3	.60	5BP1	2.45	7C4/1203A	.35	HY65	3.25	700	17.95	869B	27.25
1A5GT	.65	5BP4	3.98	7C5	.60	66B4	.90	700B	17.95	872A	2.45
C1B/3C31	3.75	5CP1	2.45	7C7	.60	VI67/30	.58	700C	17.95	874	.90
1B4P	1.05	5D21	22.50	7E5/1201	.60	70L7	1.05	700D	17.95	876	.40
1B21A/GL471A	2.55	5FP7	1.75	7E6	.55	CEQ72	1.45	701A	3.00	878	1.75
1B22	3.40	5GP1	2.98	7F7	.60	CRP72	.95	702A	2.60	879/2X2	.45
1B23	7.50	5H-4 BALLAST	.45	7H7	.60	CYN72	1.65	703A/368AS	3.60	902	3.75
1B27	7.75	5HP4	4.75	7L7	.65	RKR72	.90	704A	1.05	931A	3.95
1B32/532A	1.85	5J23	13.00	7Y4	.50	RKR73	1.23	705A/8021	1.00	954	.30
1B42	6.75	5J29	13.45	9-3 BALLAST	.45	76	.40	706AY	17.50	955	.45
1B48	9.90	5U4G	.75	10	.50	77	.45	707A	12.95	957	.35
EL-1C	4.85	5W4	.76	10 ACORN	.55	78	.45	707B	14.45	958A	.35
1C5GT	.65	6-4 BALLAST	.35	10/VT25A	.53	VR78	.65	708A	3.45	967/FG17	3.75
1C6	.75	6-7 BALLAST	.35	10E/146	1.00	80	.45	709A	4.75	991/NE16	.24
1C7G	.85	6A3	.80	10T1 BALLAST	.50	FG81A	3.95	710A/8011	1.25	1005	.30
1D8GT	.90	6A6	.65	10Y/VT25	.45	83V	.90	713A	1.45	1007	4.50
1E7GT	.95	6AB7/1853	.95	12A6	.25	89	.42	714AY	3.55	CK1089	3.90
1G6	.65	6AC7/1852	.90	12A6GT	.25	89Y	.40	715B	6.55	CK1090	2.65
1L4	.50	6AF6G	1.10	12AH7GT	1.10	VR90	.95	717A	.60	1148	.35
1LC6	.75	6AG5	1.20	12BD6	.65	VT90 BRITISH	2.55	721A	2.60	1201	.45
1LN5	.80	6AH6	1.00	12C8	.40	VR92	.40	722A/287A	9.50	1203	.45
1P24	1.75	6AK5	1.20	12F5GT	.55	FG95/DG1295	9.95	723AB	14.95	1203A	.65
1Q5GT	.85	6AK6	.80	12H6	.35	VT98/REL5	14.95	724A	3.85	1236	1.75
1R4	.55	6AL5	.85	12J5GT	.35	100R	1.05	724B	3.85	1294/1R4	.55
1S5	.60	6AQ6	.65	12J7GT	.59	101/837	1.65	725A	6.85	DG1295	9.95
1T4	.65	6AU6	.63	12K8	.59	102F	3.55	726A	4.95	1299/3D6	.45
2A7	.70	6AV6	.65	12SA7GT	.62	FG105	9.75	726B	13.50	1299A	.60
2B7	.70	6E4G	.90	12SF7	.50	VU111S	.45	730A	9.95	1613	.55
2B22/GL559	1.75	6B7	.75	12SG7	.55	114B	.80	801	.40	1616	.75
2C22/7193	.35	6B8	.65	12SH7	.40	121A	2.55	801A	.65	1619	.35
2C26	.30	6B8G	.75	12SJ7	.60	122A	2.65	803	3.40	1624	1.25
2C26A	.40	6BA6	.65	12SK7	.55	VT127 BRITISH	.35	804	6.90	1625	.35
2C34	.40	6C4	.40	12SL7GT	.55	VT127A	2.95	805	5.75	1626	.35
2C40	5.25	6C5	.55	12SN7GT	.59	VR150	.48	808	1.65	1629	.35
2C44	1.25	6C6	.65	12SR7	.50	VT158	14.95	809	2.65	1630	2.75
2E22	1.10	6C8G	.70	12X825 2A.TUNG	1.45	PG172	19.25	811	2.35	1638	.65
2J21	10.45	6C21	19.10	13-4 BALLAST	.35	205B	1.35	812	2.95	1641/RK60	.65
2J21A	10.45	6D6	.50	14B6	.75	211/VT4C	.40	813	8.95	1642	.55
2J22	9.65	6F5	.65	14Q7	.55	215A/VT5	.28	814	2.60	1852/6AC7	.90
2J26	8.45	6F6	.60	15E	1.40	221A	1.75	815	2.35	1853/6AB7	.95
2J27	12.95	5F6G	.60	15R	.70	227A	2.90	826	.75	1960	.85
2J31	9.95	5F8G	.85	16X879 2A.TUNG	1.35	231D	1.20	830B	3.95	1961/532A	1.85
2J32	12.85	6G6G	.85	FG17/967	3.25	RX233A	1.95	832	6.50	1984	1.75
2J33	18.95	6H6	.45	19	.85	257A	3.00	832A	7.95	2051	.75
2J34	17.50	5H16 BALLAST	.45	20-4 BALLAST	.45	268A	2.95	834	5.75	UX6653	1.20
2J37	13.85	6J5	.45	REL-21	2.10	274B	2.65	835/38111A	1.00	7193	.35
2J38	9.95	6J5GT	.45	21-2 BALLAST	.45	282B	5.25	836	1.45	8011	2.55
2J48	19.95	6J6	.85	23D4 BALLAST	.45	287A/722A	9.50	837	2.25	8012	2.75
2J61	24.50	5J7	.65	RK24	1.55	304TH	3.70	838	3.10	8013	1.25
2K25/723A/B	14.95	6J8G	.95	24A	.40	304TL	1.95	841	.40	8020	2.10
2X2	.45	6K6GT	.55	VT25A/10	.45	307A/RK75	3.60	842	2.75	8025	6.75
2Y3G	1.20	6K7	.65	25Z5	.65	316A	.45	843	.40	9001	.45
3-16 BALLAST	.45	6K7G	.65	25Z6GT	.52	327A	2.50	851	39.00	9002	.40
3A4	.35	6L6	1.10	26	.55	350B	1.85	852	6.10	9003	.45
3A4/47	.45	6L7	.75	27	.55	354C	14.95	860	7.55	9004	.55
3B7/1291	.40	6N7	.85	28D7	.40	356B	4.95	864	.40	9006	.30
3B22	2.35	6N7GT	.85	30/VT67	.58	368AS/703A	3.75	865	1.85	38111A/835	1.00
3B24	1.75	6Q7	.55	30	.40	371A	.80				
3BP1	3.45	6R7	.75	33	.70	371B	.80				
EL-3C	3.95	6R7G	.75	34	.33	388A	2.95				
3C21	4.85	6R7GT	.55	RK34/2C34	.35	393A	3.60				
3C24/24G	.45	6S7G	.85	35/51	.55	394A	3.60				
3C31/C1B	3.75	6SA7GT	.55	35W4	.45	395A	4.85				
3CP1/S1	1.95	6SC7GT	.65	35Y4	.50	MX408U BALLAST	.30				
3D6/1299	.30	6SF5GT	.65	36	.55	417A	14.25				
3D21A	.95	6SG7	.65	37	.35	434A	2.85				
3DP1	3.75	6SH7	.40	38	.35	446A	1.15				
3FP7	1.85	6SH7GT	.40	39/44	.30	446B	1.75				
3FP7A	2.25	6SK7GT	.50	43	.50	GL451	1.90				
3GP1	4.95	6SL7GT	.60	45SPEC. 7V. FIL.	.28	GL471A	2.75				
3H-1-7 BALLAST	.45	6SQ7	.55	46	.65	SS501	3.00				
3HP7	3.45	6SR7GT	.55	EF50	.45	527	12.85				
3Q5	.65	6U7G	.55	50B5	.65	WL530	2.75				
3Q5GT	.65	6V6GT	.75	50L6GT	.54	WL531	1.75				
3S4	.60	6X5GT	.73	VT52/45SPEC.	.28	WL532	1.65				
GA4	2.00	7-7-11 BALLAST	.35	56	.70	532A/1B32	1.85				
REL-5	14.95	7A4/XXL	.55	57	.45	GL559	2.10				
VT5/215A	.40	7A7	.56	58	.50	KU610	6.90				

JUST OUT - CATALOG H500

Manufacturers, Distributors and Amateurs: Write for the brand new Wells Electronic Catalog H500. It's full of Tremendous values in highest quality components.

WELLS
SALES, INC.

PARTS SHOW VISITORS: Be Sure to See Our Huge Display at Our LaSalle Street Show Rooms

320 N. LA SALLE ST. DEPT. R, CHICAGO 10, ILL.
PRINTED IN U.S.A.

RADIO & TELEVISION NEWS



Get
Into

TELEVISION, RADIO ELECTRONICS

Master ALL Phases

Get Complete Training. You Receive and Keep All Tubes,
Equipment, Parts and Lessons. No Extra Charges.

**GOOD PAY
and Unlimited Opportunities
in JOBS LIKE THESE:**

Business of Your Own. Radio Manufacturing. Sales, Service. Broadcasting. Telecasting. Television Manufacturing. Sales, Service. Laboratories: Installation, Maintenance of Electronic Equipment, Electrolysis, Call Systems. Garages: Auto Radio Sales, Service. Sound Systems and Telephone Companies; Oil Well and Drilling Companies; Engineering Firms. Theatre Sound Systems. Police Radio.

And scores of other good jobs
in many related fields

**YOU CONDUCT MANY
EXPERIMENTS LIKE THESE!**

Checking action of condensers
Experiments with AF and RF amplifiers
Experiments with resonance
Producing beat frequencies
Calibrating oscillators
Experiments with diode, grid-bias, grid-leak and infinite impedance detectors
Practical experience in receiver trouble shooting
Application of visual tester in checking parts and circuits
Experiments with audio oscillators
Advanced trouble-shooting
and many, many others.

**Complete Training by Practical
Resident Trade School, Est. 1905**

The same highly trained faculty, instruction materials and methods used here in our large, modern resident school, are adapted to your training in your own home. Shop Method Home Training has been proved by hundreds of successful graduates.

**Both Resident and Home Study
Courses Offered**

**YOU
LEARN BY
DOING**

You receive special laboratory experiment lessons to show you how to build with your own hands various experimental units such as those shown at left, and how to conduct many tests.

You will find all lessons easy to understand because they are illustrated throughout with clear diagrams and step-by-step examples that you work out yourself. Every piece of the equipment and complete lesson material we send you is yours to keep and enjoy, including the multimeter, experimental equipment, all parts of the Superheterodyne, tube manual, radio dictionary, and complete, modern Television texts. All parts are standard equipment.

**Shop Method Home Training . . .
Earn While You Learn**

With our practical resident Shop Method Home Training, you study in your spare time. You receive Spare Time Work Lessons, which show you how to earn while you learn. Service neighbors' radios and TV receivers, appliances, etc., for extra money and experience. Many National students pay all or part of their training with spare time earnings!

**DON'T DELAY! The Radio-Television
Industry needs trained men NOW!**

**APPROVED
FOR
VETERANS!**
Check coupon below!

For quick action,
mail coupon
today and we'll
rush you full in-
formation.

Free!

**NEW, ILLUSTRATED
OPPORTUNITY
BOOK AND SAMPLE
LESSON SHOW YOU
HOW WE TRAIN
YOU . . . SEND FOR
THEM TODAY! NO
COST. NO
OBLIGATION.**



**YOU RECEIVE THIS
PROFESSIONAL MULTITESTER
YOU BUILD ALL THESE AND
MANY OTHER UNITS WITH
PARTS WE SEND YOU!**



Signal Generator

Audio
Oscillator

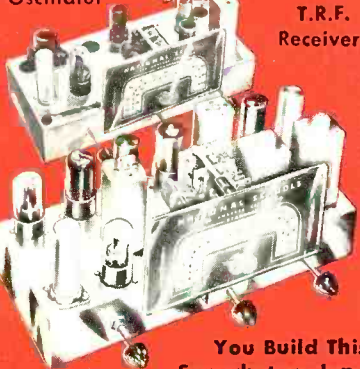

T.R.F.
Receiver

You Build This
Superheterodyne

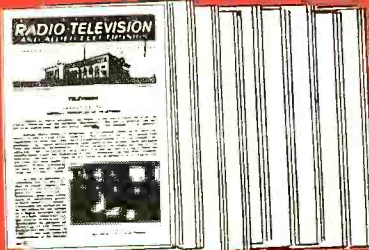

You Receive a Special Series of Modern Lessons in TELEVISION, all a part of your course: you master all phases.

NATIONAL SCHOOLS

LOS ANGELES 37, CALIF. • EST. 1905



FIND OUT NOW . . . MAIL COUPON TODAY

National Schools, Dept. RN-8
4000 South Figueroa Street
Los Angeles 37, California

Mail in envelope
or paste on
penny postal.

Send me your FREE book "Your Future in Radio" and the sample lesson of your course. I understand no salesman will call on me.

NAME..... AGE.....

ADDRESS.....

CITY.....ZONE.....STATE.....

Check here if Veteran of World War II

New



Mallory Plascap*

... Made with Amazing Mallocene*!

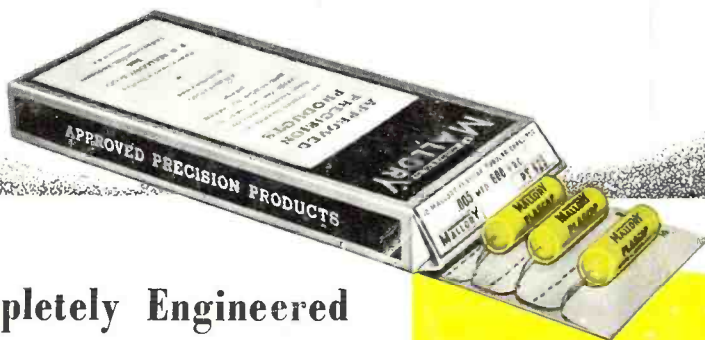

World's First Completely Engineered Plastic Tubular Capacitor

Here's the plastic tubular that's years ahead of its time . . . made possible *now* by Mallocene, amazing Mallory plastic development that gives you *four exclusive* performance firsts, leaves ordinary plastic tubulars far behind!

Gone is the old bugaboo of "call-backs" due to construction weaknesses beyond your control. For the Mallory Plascap is dependable. No oil leakage, no unsoldered leads, no off-center or deformed cartridges, no messy outside wax coating, no insulation problems. The Mallory Plascap makes your service job easier! See your Mallory Distributor.

The Secret of Mallocene . . .

There is only *one* logical way to build a molded type plastic tubular capacitor . . . with a plastic that sticks to the metal leads! But with ordinary construction methods, this has been impossible, for such a plastic would stick to the metal mold!

Here's the secret of the Mallory Plascap. First, an extremely tough plastic shell is molded. The cartridge is carefully centered within this shell. Then, the cartridge is surrounded with Mallocene. When Mallocene hardens, it actually becomes part of the outer plastic shell, and *sticks to the metal leads!* Thus, Mallocene provides a solid plastic tubular capacitor with the *first* moisture-proof construction!



TRISEAL CONSTRUCTION—Sealed *three* ways —with moisture-free Mallotrol* . . . tough outer plastic shell . . . exclusive Mallocene!



DISTORTION-FREE WINDING — No flattened cartridges due to molding pressures . . . no failures due to "shorts"!



FASTITE LEADS—Permanently fastened . . . sealed with Mallocene . . . unaffected by soldering-iron heat!



TRU-CENTER CARTRIDGE—Cartridge centered every time . . . uniform insulation guaranteed at all points!

Plus these Top Features: Operates at 85°C . . . No messy outside wax coating required . . . Great mechanical strength . . . Small in size . . . Light in weight . . . High dielectric strength . . . Lead to outside foil clearly identified . . . Handsome yellow case . . . Legible part-numbers and ratings.

P.R. MALLORY & CO., INC. CAPACITORS . . . CONTROLS . . . VIBRATORS . . .
MALLORY SWITCHES . . . RESISTORS . . . RECTIFIERS . . .
 VIBRAPACK* POWER SUPPLIES . . . FILTERS
*Reg. U.S. Pat. Off.

APPROVED PRECISION PRODUCTS

P. R. MALLORY & CO., Inc., INDIANA POLIS 6, INDIANA

*Trade Mark