

CIRCULATION LARGER THAN THAT OF ANY OTHER RADIO PUBLICATION



RADIO NEWS

REG. U.S. PAT. OFF.

25 Cents

DECEMBER

Over 200
Illustrations

Edited by HUGO GERNSBACK

HOW TO MAKE
THE RADIO DANCER
SEE PAGE 802



IN THIS ISSUE
THE REGENERATIVE INTERFLEX

RADIO'S GREATEST MAGAZINE

SCIENCE and INVENTION

THE EXPERIMENTER
World Radio History

MOTOR CAMPER & TOURIST

TYPES C-301-A C-299

C-300 C-11 C-12

In the
ORANGE and
BLUE CARTON
PRICE
\$2.50
EACH



Quality Detected—Service Amplified

by

Cunningham RADIO TUBES

Since 1915 Standard for All Sets

PEAK SATISFACTION

in detection, amplification and rugged long life are factors that have marked the radio tubes bearing the Cunningham name.

You want real music, true tone clarity and utmost sensitivity from your radio set. Cunningham Radio Tubes—gleaming and glowing in every socket—are the secret in your obtaining the utmost in broadcast reception.

Home Office, 182 Second Street
SAN FRANCISCO

E.T. Cunningham Inc.

World Radio History

CHICAGO
NEW YORK

Tower

A Merry Christmas for all

The Gift Incomparable!

A gift ALL may enjoy—
A gift of unending pleasure—
now, and for years to come.
Tower Speakers and Headsets
possess all the quality of the
most expensive makes. Cor-
rectly designed, their perfect
tonal capabilities are known
from coast to coast.

Wherever there are ears that hear
there's a Tower Product to brighten
your Christmas and bring cheer
and happiness throughout the year.

On Sale by Reliable Dealers Everywhere
TOWER MFG. CORPORATION
98 Brookline Ave. Boston

Meistersinger
Speaker

\$15.00

All Tower Loudspeakers
equipped with adjustable units



Scientific

\$8.50



Midget

\$3.95

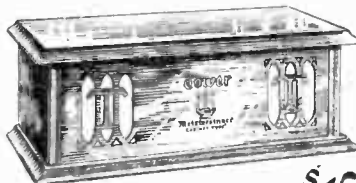

Meistersinger \$15.00
CABINET MODEL

Phonograph Attachment



\$3.95



Little Spitfire \$4.95

WORLD'S GREATEST SPEAKER VALUES

RADIO NEWS

Published by EXPERIMENTER PUBLISHING COMPANY, INC.
 Publishers of "Radio News," "Science and Invention,"
 "The Experimenter" and "Motor Camper & Tourist."
 Editorial and General Offices: 53 Park Pl., New York City
 H. GERNSBACK, President. S. GERNSBACK, Treasurer
 R. W. DEMOTT, Secretary.
 MEMBER: AUDIT BUREAU OF CIRCULATIONS
 RADIO MAGAZINE PUBLISHERS ASSOCIATION

VOLUME 7

CONTENTS
 DECEMBER, 1925

NUMBER 6

In Our Next Issue

New Developments in Short-Wave Transmission.

By A. Hoyt Taylor.

The results of an investigation conducted by the Naval Research Laboratory over the period of a year on transmission on short wave-lengths.

* * *

Further Discussion of Vacuum Tubes.

By C. B. Bazzoni.

Dr. Bazzoni will continue his interesting articles on the various types of vacuum tubes in connection with radio reception and transmission.

* * *

Notes on Coupling.

By Sylvan Harris.

Mr. Harris tells more facts about coupling that are not generally known by the average radio fan, which everyone interested in the game will appreciate. Radio Map and Table of Distances in the United States.

* * *

Aurora Borealis.

By Chester L. Davis, A. M. I. R. E.

The question of just how this most interesting natural phenomenon affects radio transmission and reception is considered in this article, which tells of a very strange characteristic noted in connection with it.

In This Issue

Power By Radio. By Hugo Gernsback	763	Transatlantic Radio Telephony. By G. C. B. Rowe	790
Radio Expositions Reveal What Is New In Radio.	764	The Regenerative Intertlex. By Hugo Gernsback	792
Transmitting Power By Radio. By Joseph Riley	766	The Reactodyne Circuit. By Arthur Reed	796
The Kiro-Vox—Alias Neurophonometer	767	The Isofarad Receiver. By B. P. Minnium	797
Thirty Years In The Dark Room	768	The Radio Beginner. By A. P. Peck	798
Britain's New Superpower Broadcast Station. By A. Dinsdale	770	Is Your Coupling Tight or Loose? By Sylvan Harris	800
The Nature, Cause and Reduction of Fading. By Greenleaf Whittier Pickard	772	How to Make the Radio Dancer. By Hugo Gernsback	802
Radio-Controlled Automobile. By P. B. Hance, Jr.	774	The Baby Transmitter. By W. B. Schulte	803
Is Lightning A.C. or D.C.? By Henry W. Hall	775	Multiple Grid Vacuum Tubes and Their Advantages. By Theo. H. Nakken	804
Radio Aids the Surgeon. By Jay Hollander	776	The Radio Amateur. By A. P. Peck	806
The Radio Lighthouse	778	Five-Meter Transmission. By R. E. Kolo	807
WRNY Plan Now Broadcasts. By Chas. D. Isaacson	780	Electrolytic Condensers. By Theodore A. Smith and James Millen	808
New Radio Developments in Germany. By S. McClatchie	782	A New Impedance Coupled Audio Frequency Amplifier. By Sidney E. Finkelstein	810
Justice Is Deaf—A Story. By Robert Francis Smith	785	Radio Set Directory	811
Cold-Cathode Gas-Filled Discharge Tubes. By C. B. Bazzoni	786	Radio Wrinkles	812
A Dozen Sets on One Antenna. By S. R. Winters	787	Radiotics	814
International Radio	788	Standard Hook-Ups	815
The Straight-Line Craze. By Joseph Riley	789	New Radio Patents	817
Esperanto Broadcast Lesson. By James Denson Sayers	789	Correspondence From Readers	818
		RADIO NEWS LABORATORIES	819
		I Want to Know. By R. D. Washburne	821

RADIO NEWS is published on the 10th of each preceding month. There are 12 numbers per year. Subscription price is \$2.50 a year in U. S. and possessions. Canada and foreign countries, \$3.00 a year. U. S. Coin as well as U. S. Stamps accepted (no foreign coins or stamps). Single copies, 25 cents each. A sample copy will be sent gratis on request. Checks and money orders should be drawn to order of EXPERIMENTER PUBLISHING CO., INC.

All communications and contributions to this journal should be addressed to Editor, RADIO NEWS, 53 Park Place, New York, N. Y. Unaccepted contributions cannot be returned unless full postage has been included. All accepted contributions are paid for on publication. A special rate is paid for novel experiments; good photographs accompanying them are highly desirable.

RADIO NEWS, Monthly. Entered as second class matter, July 12, 1921, at the Post Office at New York, N. Y., under the Act of March 3, 1879. Additional entry at Long Island City, N. Y., and San Francisco, Calif. Title registered U. S. Patent Office. Copyright, 1925, by E. P. Co., Inc., New York. The Experimenter Publishing Co., 53 Park Place, New York. The Contents of this magazine are copyrighted and must not be reproduced without giving full credit to the publication. Copyright in Germany. Reproduction of articles in Germany is reserved for Radio, Berlin 42.

New York City
 General Advertising Dept.
 53 Park Place

Western Advertising Representatives
 Fineman & McClure
 720 Cass St., Chicago, Ill.

New England Advertising Representative
 T. F. Magrane, Park Square Building, Boston, Mass.

RADIO NEWS is for sale at all newsstands in the United States and Canada. European agents, S. J. Wise Et Cie, 40 Place Verte, Antwerp, Belgium.

HOW TO SUBSCRIBE FOR RADIO NEWS. Send your name, address and remittance to Experimenter Publishing Co., 53 Park Place, New York. Mention the name of the magazine you are ordering. We also publish SCIENCE AND INVENTION, the EXPERIMENTER and MOTOR CAMPER & TOURIST. Write clearly.

RATES AND TERMS. The subscription rate for RADIO NEWS is \$2.50 per year. (12 numbers). When remitting do so by check, money order, or registered letter if cash is enclosed. Avoid sending cash through the mail if possible. Subscriptions for less than one year are not accepted. Subscription may be made in combination with SCIENCE AND INVENTION or the EXPERIMENTER.

POSTAGE. We prepay postage in all parts of the United States, Mexico and island possessions. For foreign or Canadian subscriptions we require 50 cents in addition to the subscription price for additional postage charges.

CHANGE OF ADDRESS. Notify us as far in advance as possible. It requires several weeks to make an address change on our records. Always write clearly.

ON EXPIRATION of your subscription we enclose a renewal blank in our last number to you; we stop our delivery to you on expiration.

Pacific Coast Advertising Representatives
 A. J. Norris Hill Co.
 Hearst Bldg., San Francisco, Calif.
 Detwiler Bldg., Los Angeles, Calif.

Kansas City Advertising Representative
 Davies and Dillon
 15 W. Tenth St., Kansas City, Mo.

Detroit Advertising Representative
 Roy Buell, Donovan Bldg., Detroit, Mich.

The New WAVE MASTER-a Radio Set Worthy to Bear the KELLOGG Name



The Wave Master Console Model
 A handsome genuine mahogany design with battery compartments and inbuilt horn. Price, **\$275.00**
 Without battery table, price -- **\$225.00**
 Also made in the beautiful Console model, genuine mahogany, price, **\$235.00**

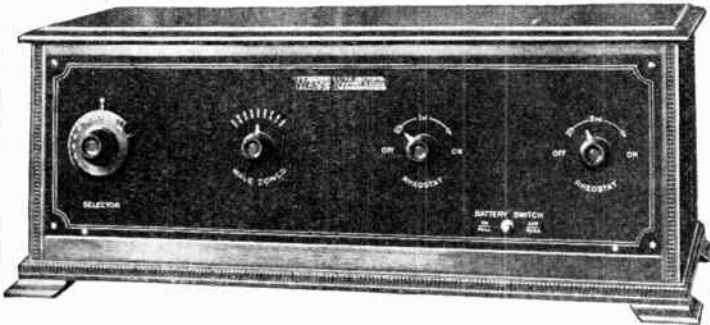

A Year Ahead! The WAVE MASTER, 5-Tube Standard Model
 Cabinet of solid, Genuine Mahogany, beautifully finished, 28 inches long, 11 inches high. Price, **\$125.00**

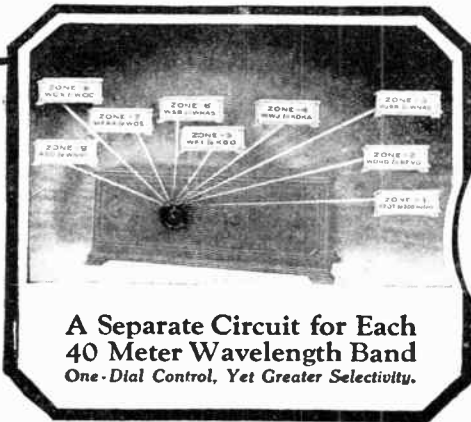

A Separate Circuit for Each 40 Meter Wavelength Band
 One-Dial Control, Yet Greater Selectivity.



Kellogg Symphony Reproducer
\$25.00

"I never dreamed it was such fun"

"I used to be content to enjoy radio merely as a listener, never realizing how much greater pleasure I was missing. I had no idea of the fascinations of radio tuning—the fun of going after any station and getting it."

WHEN you make a telephone call, the operator connects you first with the "exchange" and then with the desired number of that group or division.

To "connect" the WAVE MASTER instantly with any desired broadcasting station, you first set the pointer for the "Exchange" or wave zone group to which the station belongs and then merely turn the Station Selector dial. "Expert" tuning becomes child's play. To separate stations very close together in their wavelengths, is astonishingly easy.

When buying any radio set, protect yourself by learning something about the firm that produced it—their reliability and experience. For 28 years Kellogg has produced the finest of telephone apparatus. Since radio began Kellogg has built the highest quality parts.

If you do not know where you can see, try and hear the WAVE MASTER in your neighborhood, write us. We'll give you the name of your nearest dealer, and, if you wish it, a full technical explanation of the Wave Master Circuit. Ask for Folder No. 1-L.

Radio Dealers and Jobbers

The WAVE MASTER franchise backed by Kellogg resources and our powerful advertising campaign, is most valuable. Open territories are being rapidly taken up. If interested, wire or call on us promptly for our money-making proposition.

Kellogg Switchboard & Supply Company
 1066 West Adams Street, Chicago, Illinois

KELLOGG WAVE MASTER SWITCHBOARD & SUPPLY CO.

INDEX TO ADVERTISERS

INDEX TO ADVERTISERS

	Page
A	
Ace Electrical Lab.	898
Acme Apparatus Co.	887
Aero Products, Inc.	906
Aerovox Wireless Corp.	890
Alden Mfg. Co.	830
All-American Radio Corp.	837
All Radio Co.	931
Allen-Bradley Co., 759, Inside Back Cover	
Ambassador Sales Co., Inc. 852, 898	
American Bosch Magneto Corp.	828-829
American Electric Co.	834
American Foreign Trading Corp.	933
American Hard Rubber Co.	927
American Radio Mfg. Co.	925, 933
Amplion Corp. of America, The.	846
Anisco Products, Inc.	852
Andrews Radio Co.	920
Apex Electric Mfg. Co.	926
Arrow Battery Co.	894
Atwater Kent Mfg. Co.	839
B	
Bakelite Corp.	885
Baker-Smith Co., Inc.	915-923
Barawik Co., The	931
Barkelaw Electric Mfg. Co., The.	886
Bastian Brothers Co.	920
Beacon Radio Mfg. Co., Inc.	901
Belden Mfg. Co.	853
Benjamin Electric Co.	866
Black Bros. Co.	852
Bluebird Tube Co.	850
Boice, W. B. & J. E.	880
Bradley, F. C.	858
Brady, John B.	842
Brant Battery Co.	920
Bremer-Tully Mfg. Co.	929
Bristol Co., The	861
Brownlie, Roland	858
Bruno Radio Corp.	889
Buescher Band Inst. Co.	894
Butts Inc., C. W.	846
C	
C. E. Mfg. Co., Inc.	892
Camfield Radio Mfg. Co.	844
Cannon & Miller Co., Inc.	876
Carborundum Co., The	870
Carter Radio Co.	838
Chelsea Radio Co.	854
Chemical Inst. of N. Y., Inc.	905
Chicago Electrical Devices Co.	860
Chicago Salvage Stock Stores ..	896
Chicago Stock Gear Works ..	884
Clark & Tilson, Inc.	856
Cleveland Engineering Labs. Co., The	929
Como Apparatus Co.	898
Condon, Frank	900
Conneway Elec. Labs.	909
Conrad Co., Inc., The.	922-928-935
Continental Fibre Co., The ..	908
Coyne Electrical Schools	886
Crain Bros. Radio Shoppe ..	892
Crescent Braid Co., Inc.	836
Crescent Radio Supply Co.	856
Crosley Radio Corp.	895
Cruver Mfg. Co.	836
Culver-Stearns Mfg. Co.	878
Cummings Research Labs.	900
Cunningham, Inc., E. T. Inside Front Cover	
Cutler-Hammer Mfg. Co., The.	851

	Page
D	
DX Instrument Co.	890
Daven Radio Corp.	848
Davidson Radio Corp.	890
Dayton Fan & Motor Co., The.	843
DeForest Radio Co.	825
Delta Electric Co.	878
DeWitt LaFrance Co., Inc.	872
Diamond Electric Specialties Corp.	900
Dongan Electric Mfg. Co.	920
Dubilier Condenser & Radio Corp.	842, 925
Duplex Condenser & Radio Corp.	920
E	
E. I. Company	918
Eastern Electric Co.	884
Economy Radio Sales Co.	846
Electrad, Inc.	871
Electrical Engineers Equipment Co.	931
Electrical Products Mfg. Co.	858
Electrical Research Labs.	919
Electric Specialty Co.	880
Electric Storage Battery Co., The	841
Elgin Radio Supply Co.	890
Erie Fixture Supply Co.	904
Esperanto Ass'n of North America	832
Evans & Co., Victor J.	935
Express Body Corp.	912
F	
Fahnestock Electric Co.	848
Fansteel Products Co., Inc.	865
Faraway Radio Co., The	925
Ferbend Electric Co.	921
Fishwick Radio Co.	924
Formica Insulation Co., The ..	863
Ford Radio & Mica Corp.	916
Frost, Inc., Herbert H.	856
Furnell Mfg. Corp., The	874
G	
G. & S. Radio Research Lab.	840
Gale Radio Labs.	904
Gearhart-Schluter Radio Corp.	912
Gem Tube Co.	848
General Electric Co.	913
General Radio Co.	838
Golden-Leutz, Inc.	862
Goodrich Rubber Co., B. F.	877
Gould Storage Battery Co., Inc., The	831
Goyer Co., The	906
Grewol Mfg. Co.	932
H	
Hammarlund Mfg. Co.	864
Hammarlund-Roberts	883
Hatfield & Son, H. D.	916
Heath Radio & Electric Mfg. Co.	858
Heins & Bolet	892
Henninger Corp., A. F.	894
Hommel & Company, Ludwig ..	884
Hughes Electric Co., Benjamin ..	876
Hull & Co.	916
I	
Illinois Radio Co.	896-908
International Correspondence Schools	900, 924
Interstate Electric Co.	904
Ivorylite Radio Panel Co.	930

	Page
J	
Jacobs, J. E.	908
Jewell Electrical Instrument Co.	880
K	
K Electric Co.	898
Karas Electric Co.	881
Kelleradio, Inc.	856
Kellogg Switchboard & Supply Co.	755
Keystone Products Co.	862
Kimley Electric Co., Inc.	908
Kinley Radio Co.	932
Klosner Radio Corp.	884
Kodel Radio Corp., The 760-761-850	
Korach Radio Co.	904
L	
Lancaster & Allwine	884
Lincoln Mfg. Co.	920
Lincoln Radio Corp.	864
Lincoln Typewriter Co., Inc.	894
M	
M & M Company, The	862
MacFadden & Co., Inc.	888
Mack Laboratories	926
Manhattan Knitting Mills	834
Martin Copeland Co.	897
Melodyne Radio Co.	888
Midwest Radio Corp.	936
Montgomery Ward & Co.	872
Multivider Co.	886
Murdock Co., Wm. J.	882
Music Master Corp.	845
Musselman, A. J.	899
Mydar Radio Co.	932
Muter Co., Leslie F.	924
N	
Nagel Electric Co., The W. G.	932
National Carbon Co., Inc.	827
National Radio Institute	757-847
National, State & Local Tubercu- losis Ass'n of the U. S.	930
Niles Mfg. Co.	902
Norden-Hauck, Inc.	888-911
O	
Omnigraph Mfg. Co., The	919
Owen, Richard B.	935
Ozarka, Inc.	762
P	
Pacent Electric Co., Inc.	875
Pacific Radio Mfg. Co.	902
Parcells & Co.	834
Parker, C. L.	935
Pathé Phonograph & Radio Corp.	840
Pfanziehl Radio Co.	873
Phenix Radio Corp.	849-879
Potter Mfg. Co.	864
Precision Coil Co., Inc.	930
Press Co., The	935
R	
Radial Co.	885-874
Radio Association of America ..	844
Radio Buyers Syndicate	898
Radio Cabinet Co.	896

	Page
R	
Radio Corp. of America Back Cover	
Radiogem Corp., The	917-926
Radio Institute of America ..	868-906
Radio Parts Co.	856
Radio Specialty Co.	903
Radio Units, Inc.	902
Randolph & Co.	935
Randolph Radio Co., 836, 858, 876, 890, 911, 916	
Raytheon Mfg. Co.	906
Richardson Radio, Inc.	931
Rix Radio Supply House, Inc.	916
Rola Company, The	893
S	
Saal Co., H. G.	869
Sattler Tool Co., Inc.	927
Saturn Mfg. & Sales Co., Inc., The	932
Shontz & Co., Inc., H. B.	924
Service Battery Co.	913
Shipman-Ward Mfg. Co.	935
Sickles Co., F. W.	920
Silver-Marshall, Inc.	878
Smith, B. R.	894
Songbird, The	907
Southern Toy Co., Inc., The 854-916	
Standard Aerial Base Co.	868
Standard Radio Co.	840-850
Star-King Co.	916
Starrett Mfg. Co.	888
Super-Products Mfg. Co.	836
Sterling Mfg. Co., The	832
T	
Telephone Maintenance Co.	924
Thomas Battery Corp.	884
Thordarson Electric Mfg. Co.	833
Tower Mfg. Corp.	753
Trego Radio Mfg. Co.	866
Trimm Radio Mfg. Co.	876
Tuerk Mfg. Co.	840
U	
U. S. Tool Co., Inc.	860
Utility Cabinet Co.	832
Utt Williams Elec. Prod. Co.	870
V	
Valley Electric Co.	824-867
Van-Ashe Radio Co.	902
Viking Radio Labs.	823
W	
Wade Mfg. Co. Inc.	890
Wakem & McLaughlin, Inc.	878
Werner Radio Mfg. Co.	906
Western Radio Mfg. Co.	860
Westinghouse Elec. & Mfg. Co.	859
Weston Electrical Instrument Corp.	896
Williams Hardware Co.	834
Willard Storage Battery Co.	835
Windsor Furniture Co.	826
Wirt Co.	892
Wizard Wire Winder Co.	930
World Battery Co.	900-908
X Y Z	
X-L Radio Laboratories ..	842-904
Yaxley Mfg. Co.	832
Y. M. C. A. Radio Institute ..	904
Young Typewriter Co.	930
Zenith Radio Corp.	857

Earn \$50 to \$200 a Week in RADIO

You can! Hundreds of ambitious men are already earning thousands of dollars in this wonderful new industry—you, too, can get your share. Mail coupon below for Free Book which describes fully the amazing money-making opportunities in Radio and tells you how YOU can earn from \$5,000 to over \$10,000 a year.

THE astounding growth of Radio has created thousands of big money opportunities. Millions of dollars were spent during the past year on Radio, and thousands of young men are needed right now to meet the ever-increasing demand of work.

Men are needed to build, sell and install Radio sets—to design, test, repair—as Radio engineers and executives—as operators at land stations and on ships traveling the world over—as operators at the hundreds of broadcasting stations. And these are just a few of the wonderful opportunities.

Easy to Learn Radio at Home in Spare Time

No matter if you know nothing about Radio now, you can quickly become a Radio expert, by our marvelous new method of practical instruction—instruction which includes all the material for building the latest up-to-date Receiving Sets.



PAY INCREASES OVER \$100 A MONTH

I am averaging anywhere from \$75 to \$150 a month more than I was making before enrolling with you. I would not consider \$10,000 too much for the course.

(Signed) A. N. LONG,
Greenburg, Pa.

DOUBLES SALARY

I can very easily make double the amount of money now than before I enrolled with you. Your course has benefited me approximately \$3,000 over and above what I would have earned had I not taken it.

T. WINDER,
Grand Junction, Colo.



FROM \$15 TO \$80 A WEEK

Before I enrolled with you I was making \$15 a week on a farm. Now I earn from \$2,080 to \$4,420 a year, and the work is a hundred times easier than before. Since graduating a little over a year ago, I have earned almost \$4,000, and I believe the course will be worth at least \$100,000 to me.

(Signed) GEO. A. ADAMS,
Tamaqua, Pa.



Scores of young men who have taken our course are already earning from \$75 to \$200 a week. Merle Wetzel of Chicago Heights, Ill., advanced from lineman to Radio Engineer, increasing his salary 100% *even while taking our course!* Emmett Welch, right after finishing his training, started earning \$300 a month and expenses. Another graduate is now an operator of a broadcasting station—PWX of Havana, Cuba—and earns \$250 a month. Still another graduate, only 16 years old, is averaging \$70 a week in a Radio store.

Wonderful Opportunities

Hardly a week goes by without our receiving urgent calls for our graduates. "We need the services of a competent Radio Engineer." "We want men with executive ability in addition to Radio knowledge to become our local managers." "We require the services of several resident demonstrators"—these are just a few small indications of the great variety of opportunities open to our graduates.

Take advantage of our practical training and the unusual conditions in Radio to step into a big paying position in this wonderful new field. Radio offers you more money than you probably ever dreamed possible—fascinating, easy work—a chance to travel and see the world if you care to, or to take any one of the many Radio positions all around you at home. And Radio offers you a glorious future!

The National Radio Institute is one of America's Pioneer Radio Schools—established in 1914. Our course is an absolutely complete one which qualifies for a government first-class commercial license. It trains you for *bigger* paying jobs in Radio.

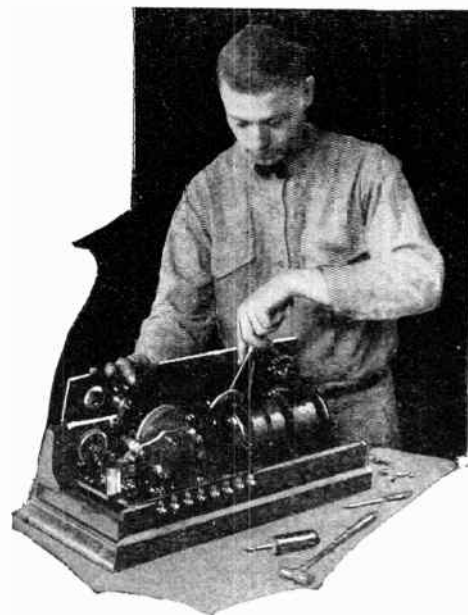

Send for
FREE RADIO BOOK

Learn more about this tremendous new field and its remarkable opportunities. Learn how you can quickly become a radio expert and make big money in Radio.

We have just prepared a new 32-page booklet which gives a thorough outline of the field of Radio—and describes our amazing, practical training in detail. This Free Book, "Rich Rewards in Radio," will be sent to you without the slightest obligation. Mail coupon for it *now!*

For a short time we are offering a reduced rate to those who enroll at once. Act promptly and save money.

National Radio Institute

Dept. 13-OB
Washington,
D. C.

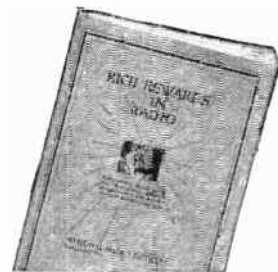

NATIONAL RADIO INSTITUTE,
Dept. 13-OB, Washington, D. C.

Please send me without the slightest obligation your Free Book, "Rich Rewards in Radio," and full details of your special Free Employment Service. Please write plainly.

Name.....

Address.....

City..... State.....

RADIO NEWS READERS' BUREAU

Time and Postage Saver

IN every issue of RADIO NEWS you undoubtedly see numerous articles advertised about which you would like to have further information. To sit down and write an individual letter to each of these respective concerns, regarding the article on which you desire information, would be quite a task.

As a special service to our readers, we will write the letters for you, thus saving your time and money.

Just write the names of the products about which you want information, and to avoid error the addresses of the manufacturers, on the coupon below and mail it to us.

If the advertiser requires any money or stamps to be sent to pay the mailing charges on his catalogue or descriptive literature, please be sure to enclose the correct amount with the coupon.

We will transmit to the various advertisers your request for information on their products.

This service will appear regularly every month on this same page in RADIO NEWS.

If there is any Manufacturer not advertising in this month's issue of RADIO NEWS, from whom you would like to receive literature, write his name, address and the product in the special section of the coupon below.



TEAR ALONG THIS LINE

READERS' SERVICE BUREAU,
Experimenter Publishing Co., Inc., 53 Park Place, New York, N. Y.

RN-12-25

Please advise the firms listed below that I would like to receive detailed information on their product as advertised in the issue of RADIO NEWS.

DO NOT USE THIS COUPON FOR TECHNICAL QUESTIONS

NAME	ADDRESS (Street — City — State)	List here specific article on which you wish literature.	If Catalogue of complete line is wanted, check in this column
.....
.....
.....
.....
.....
.....
.....
.....

Use this space if you desire information from a manufacturer whose advertisement does not appear in this month's issue.

NAME	ADDRESS (Street — City — State)
.....
.....
.....

Your name Dealer's name

Your address His address

If you are dealer check here. City State City State



Bradleystat



Bradleyleak

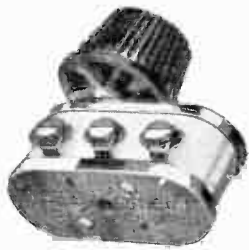

Bradleyometer



Bradley-switch

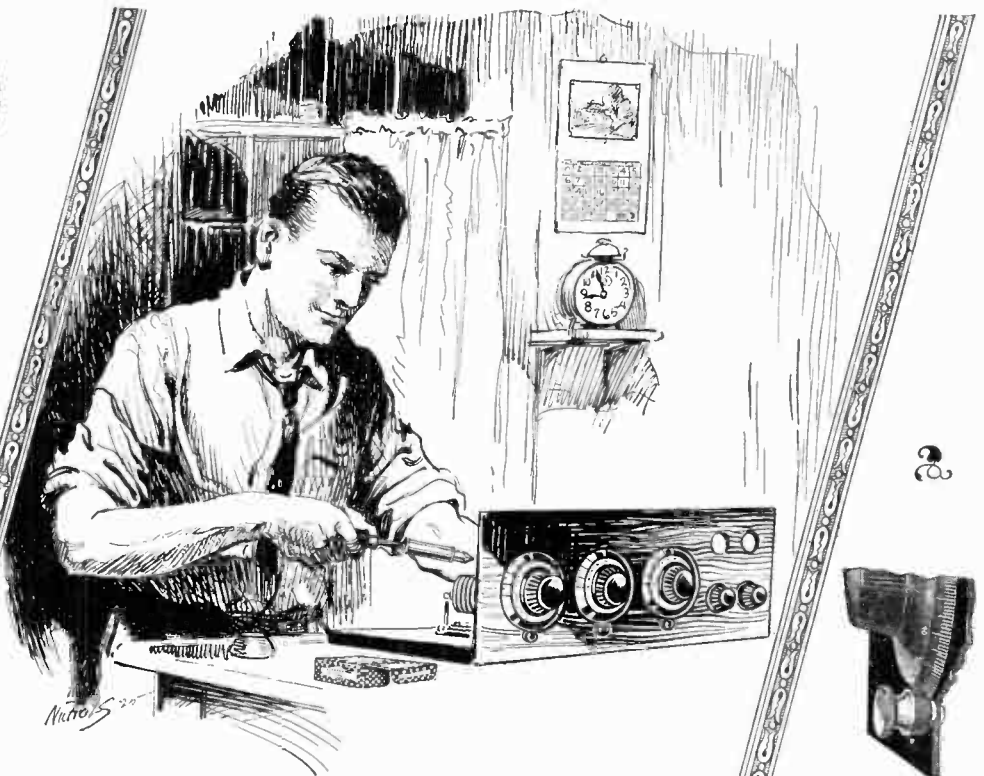

For Genuine Satisfaction Use Allen-Bradley Parts

RADIO SETS, like all electrical devices, are no better than the parts used in their construction. The experienced set builder has discovered the futility of using poorly made, inefficient units in his set.

Allen-Bradley Perfect Radio Devices are so carefully made and so beautifully finished that they assure perfection in performance and appearance. In fact, the noiseless, perfect control of Allen-Bradley radio devices has never been surpassed and many of the finest factory built sets today are equipped with Allen-Bradley parts.

Ask your dealer for Allen-Bradley perfect radio devices when you build your next set. If you are not acquainted with the entire Allen-Bradley line mail the attached coupon today for our latest illustrated literature.



Bradlynier



Bradleyunit



Bradleyohm



Allen-Bradley Co.

Electric Controlling Apparatus

287
Greenfield
Ave.



Mil-
waukee,
Wis.

Manufacturers of Graphite Disc
Rheostats for Over 20 Years

ALLEN-BRADLEY CO.,
287 Greenfield Ave.,
Milwaukee, Wisconsin

Please send me, by return mail, your latest illustrated literature of the complete Allen-Bradley Line.

Name

Address

KODEL RADIO

The Emblem of  Worth in Radio

To Own It, is to Own the Best



LOG·O·DYNE \$90⁰⁰
"BIG FIVE"

Five tubes, self-balanced tuned radio frequency; sloping panel gold engraved; beautiful, massive, Adam brown mahogany cabinet; compartment for batteries; stations already logged for easy tuning.

The LOGODYNE Big Five well deserves to bear the name KODEL RADIO. For no receiver could better express or exemplify, or better prove in actual performance, the high standards of quality to which the KODEL RADIO line is built.

In range and power a master; in tone as true and mellow as an old Stradivarius; in appearance a masterpiece of the cabinet maker's art; the LOGODYNE Big Five matches in every respect the perfection that is required of KODEL RADIO receivers—the best that radio offers.

Free Send for the new edition of our free booklet "The Secret of Distance and Volume in Radio". Gives helpful interesting information on radio operation.

THE KODEL RADIO CORPORATION
501 East Pearl Street Cincinnati, Ohio



LOGODYNE "Big Five" Console Model—the Aristocrat of Radio; built-in loud speaker; compartment for batteries and charger a masterpiece in furniture design. \$275



LOGODYNE "Standard Five" Console Model—beautiful brown mahogany; built-in loud speaker; compartment for A and B batteries and charger. \$165



LOGODYNE "Standard Five"—five tubes self-balanced tuned radio frequency; gold engraved panel and sub-panel; battery compartment; handsome brown mahogany cabinet. \$70



KODEL "Gold Star" Models—Radio's greatest set values;
Three Tube "Gold Star" Model. \$30
Two Tube "Gold Star" Model. \$20
One Tube "Gold Star" Model. \$12
"Gold Star" Crystal Set. \$6

FREE LUNCH

The obsolete, slow 2-ampere battery charger has been put with the other relics of years ago!

Buy nothing' but an up-to-date 5-ampere charger!

The New Improved
5 AMP. A & B
GOLD SEAL
HOMCHARGER
\$19.50



Over 500,000 already in use

Charges in One-Third the Time!

Better Because:—

- New micrometer adjustment, hinged lid, and carrying handle.
- No bulbs to buy or break.
- Can be used anywhere—contains no acids or other harmful liquids to spill.
- Approved by underwriters—trouble-proof, shock-proof and fireproof.
- Beautiful cabinet in maroon and gold.

It takes only one-third as long to fully charge your battery with the New Improved 5-ampere GOLD SEAL HOMCHARGER.

No more of the long, bothersome waits that were necessary when the slow inefficient 2-ampere charger was the best that radio offered. The New Improved GOLD SEAL HOMCHARGER charges 150% faster—fully charges the average battery overnight—and it charges both A and B batteries without additional equipment.

Before you buy any charger be sure it charges at 5-amperes. To be absolutely sure insist on the GOLD SEAL HOMCHARGER.

Free Write for new edition of our instructive booklet on radio operation "The Secret of Distance and Volume in Radio."

The Kodel Radio Corporation
 501 East Pearl Street Cincinnati, Ohio



Ozarka Senior Console—\$197.50 East of Rockies
 Complete with Tubes, Batteries and Speaker



A Good Wife and a Good Radio Assures Lasting Satisfaction

A LITTLE more time, a little more care in making the selection in the first place generally tends to more lasting satisfaction.

Out of every 100 Ozarka's sold in 1922 only eight are not today in the hands of the original owners—this does not include 17 out of each 100 who have purchased later Ozarka models in newer type cabinets. If there is a single Ozarka that is not in active service today, we have never heard of it.

Without the Ozarka Service in charge of direct factory trained representatives, such a record would not be possible. Ozarka service can be had today in almost every country. Purchasers in South Africa, Alaska, Sweden, Newfoundland, New Zealand, and Japan all receive the same practical service as those in Canada, United States, Mexico and Cuba. Whenever you find the sign of the Ozarka long distance goose, you'll find a man who knows Ozarka instruments perfectly.

If such service added more to your cost price it might be a matter to consider, but it doesn't. Quality for quality you'll find Ozarka prices lower—four tube Ozarka's with built-in loud

speakers retail for \$58.00—five tube with built-in speaker \$64.00, up to solid walnut console design, \$160.50.

Our nearest representative will gladly set up an Ozarka in your home, without any obligation whatever. He won't tell you what it will do—he will let you do all the tuning. With the Ozarka you must satisfy yourself, as to distance, tone, volume, ease of tuning and selectivity.

More than this you will be very agreeably surprised at Ozarka prices—selling as we do, thru our own direct factory representatives, our selling expense is very low—we give Ozarka purchasers the benefit of it.

Where is there a value to compare with the one shown above—solid walnut cabinet (no walnut finish or veneer), imported English loud speaker of a marvelous tone, five tube instrument with 75 ampere Exide storage battery, 90 volts of Eveready "B" battery, 5 tubes, aerial equipment all erected and the price is only \$197.50.

A Few More Men are Needed to Sell Ozarka

In a great many counties we have the man we want. He is rapidly building up a permanent and profitable business of his own because he has an instrument that will more than meet all competition. More than this, he is trained to back up his sales with the kind of service that counts.

Many well established Ozarka representatives started by giving us only their spare time—their evenings. If your county is open you can do the same.

The investment in cash is very small. The investment in time necessary for study is considerable. It requires patience, but the results have enabled many men to get out of the salary and time clock class.

Any previous sales experience is helpful but not necessary. We can and will teach you how to sell.

Send for 84 Page Book— "The Ozarka Plan"



This book is entirely too expensive to be sent but on postal card requests. It will be sent FREE to any man who mails the coupon below and who is really anxious to improve his condition. Tell us about yourself—ask for Ozarka Plan No. 100 and don't fail to give the name of your county.

OZARKA

122 Austin Avenue E
Chicago, Illinois



Ask the Man Who
Wears this Button

INCORPORATED

122 Austin Avenue E
Chicago, Illinois

Gentlemen: Without obligation send book "Ozarka Instruments No. 200" and name of Ozarka representative.

Name.....
 Address..... City.....
 County..... State.....

Gentlemen: I am greatly interested in the FREE book "The Ozarka Plan No. 100," whereby I can sell your radio instruments.

Name.....
 Address..... City.....
 County..... State.....



RADIO NEWS

H. GERNSBACK, Editor and Publisher
SYLVAN HARRIS, Associate Editor

EDITORIAL AND GENERAL OFFICES, 53 PARK PLACE, NEW YORK

Vol. 7

DECEMBER, 1925

No. 6

POWER BY RADIO

By HUGO GERNSBACK

WHENEVER the subject of power by radio is mentioned to the average scientist or radio man, you will see him lift his eyebrows and look at you with a sort of pitying expression. The reason is simple. Take an ordinary broadcast station operating on 500 watts, then take the most sensitive measuring apparatus a mile away from the station, and you will find that the energy received at that distance is at the rate of about $1/100,000$ th of a fly-power or thereabouts; in other words, not enough to lift the smallest snowflake. At 100 miles, the power delivered from a broadcast station to a receiving set becomes so incredibly small that it is almost impossible to express it in figures.

Therefore, we should not be surprised, when we talk of power by radio, to find the radio scientist become extremely annoyed. Nevertheless, there are many things in the heavens that are not even dreamt of by our scientists of today, and power by radio is one of these. What seems impossible today is a reality tomorrow. Had you mentioned to any great scientist thirty years ago that it would be possible to speak in New York into an electrical instrument and, without any intervening wires, hear the voice in Europe, the scientist would, of course, have laughed aloud and have chided you for your nonsense. He would have told you that it is not possible to do it even over a transatlantic cable, because if you put only a little power on the cable you burn it out—so why attempt to speak across the ocean without any wires at all, and with no conducting medium to guide the electrical impulses?

Now from speculation to facts: Not so long ago, at the seashore, I had occasion to talk with an eminent radio man on the subject of radio power. He looked at me sharply, as if he doubted my sanity. Then he made several jocular remarks on the subject and refused to treat it seriously. So I finally told him that the thing had already been done, that power by radio was an accomplished fact, and that thousands of horsepower were being transmitted every day for thousands of miles.

This statement caused my friend to laugh uproariously, as he naturally assumed it to be a good joke. We were walking along the beach, and I told him that on the spot on which he was standing, right in front of his very nose, there was being transmitted a power of almost $3/4$ horse power per hour to the square foot. My friend still looking bewildered, I continued:

"The sun, 93 million miles distant from you, is shooting energy down to us by means of electromagnetic waves, which you probably will not deny. All wave motions, whether light, heat, or radio, being the same, and varying only as to their length, I believe that I have a perfect right to call light waves radio waves, because all of them are electromagnetic waves, according to Clerk Maxwell, Heinrich Herz, and many other undisputed authorities. The energy which we receive from our luminary is radiant energy, the same as Marconi's directed radio beam. Both are exactly

the same, except that the wave-length varies, radio waves being rather long, while light waves are short. You will also note that the energy which comes to us from the sun comes through space without any conductor whatsoever."

In Egypt and out west we now have sun power motors, which deliver quite a good deal of energy per square foot.—0.67 horsepower per hour, to be exact. Under these circumstances and in the face of these facts, why not be serious about the problem and look at it from a practical standpoint? Two or three years ago it was demonstrated by the well known American research scientists, Dr. E. F. Nichols and J. D. Tear, that radio waves can be made so short that they lapse into the heat wave band. The wave-length used was astoundingly low—only $1/100$ of an inch. *In other words, radio waves have become heat waves.* What does all of this mean? Simply this—at some future date it will be possible to transform electrical energy into an electromagnetic wave which can then be radiated from an aerial or other tower into space, to be received at the receiving end with hardly any loss of power. As a matter of fact, I believe that sending power through space will be very much more economical than sending it through conductors, because conductors have resistance, whereas free space has none.

Naturally the question will immediately arise: Suppose we do accomplish broadcasting of power by radio by means such as just explained, what safeguard has the future power company? For, if power is broadcast, naturally every one within a certain radius will be able to tap the power by means of the future apparatus which will then be in vogue. The answer, too, is simple. If you have a power line running near your property today it is an easy matter to tap this power line and use the power. However, if you have a conscience and a proper fear for the law, you will do nothing of the sort, because you know that you would get yourself into trouble with the authorities. You cannot steal power any more than you can steal any other commodity. So finally, when power is radiated by radio or by other electromagnetic means, laws will be enacted quickly enough to protect the power interests that radiate the power. Meters will be installed just as meters are installed now, and there will be no more stealing of power than there is today.

My friend, while agreeing with me in the main, then had some doubts as to what would happen to radio broadcasting, should radio power transmission come into vogue. What would happen to the two? Would they not interfere with each other, making one or the other impossible?

"I don't believe that this will be the case," I said, "for the following and very good reasons: I have an idea that the power transmission, for reasons I mentioned a little while ago, will be done on exceedingly short wave-lengths—on the order of a centimeter or less. Broadcasting may come down to perhaps one or two meters, which will still leave a tremendous gap between the two, so that I do not think there will be any possibility of interference, any more than sound waves today interfere with radio waves."

Mr. Hugo Gernsback speaks every Monday night at 9 P. M from Station WRNY on various radio and scientific subjects.

Radio Expositions Reveal

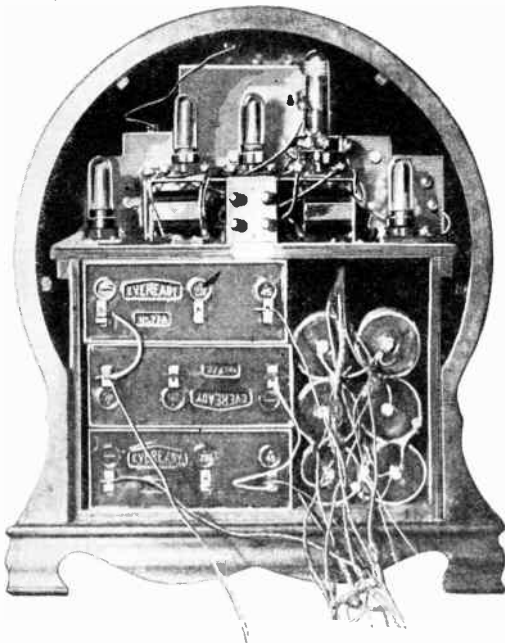

RADIO RECEIVER RESEMBLES A CLOCK. Above is the rear view of the set shown on the opposite page. As can be seen, all the accessories are contained in the cabinet. © P & A Photo.

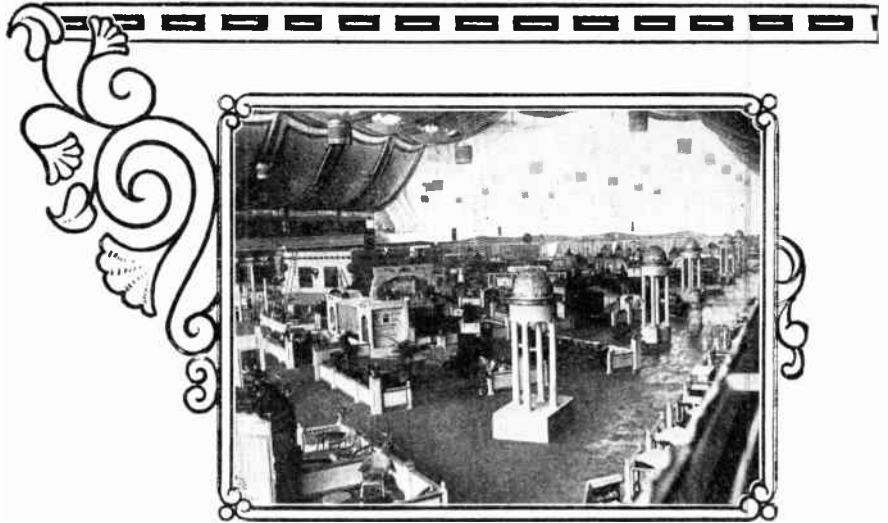

GENERAL VIEW OF RADIO WORLD'S FAIR. This exposition was held at the same time as the National Radio Exposition at the Grand Central Palace, both taking place in New York City. At both these shows many new developments in the radio art were shown for the first time.

SOME idea of the actual greatness of radio may be gained from the fact that during the autumn season just passed, there have been more than a dozen radio shows given in this and foreign countries, which were attended by more than a million people. By comparison with other shows of a strictly class nature or appealing to a definite trade or industry, this is a record at which to marvel.

The opening of the season came in New York with its two shows, one given at the Grand Central Palace and the other at the 157th Regiment Armory. They were run from two different points of view and both received a large number of attendants. The total at the Palace ran to well near 100,000 people for the seven days.

Since the fall is the opening of the radio season, there were several novelties presented in both sets and equipment. As a matter of fact, a new trend was shown which has been predicted by RADIO NEWS for several months past. This trend is, of course, the single-control idea. An editorial in this magazine more than a year ago called attention to the logic of this design. And that the idea has at last been taken up by the chief manufacturers of the industry cannot be denied. A good percentage of the sets shown incorporated this idea and the others showed a visible reduction in the number and intricacy of controls.

Some of the interesting points in connection

THE WORLD'S LARGEST RECEIVER. This monster "super-het" attracted great interest at the show. Some idea of the size can be obtained by comparing the girls with the set. © Kadel & Herbert.

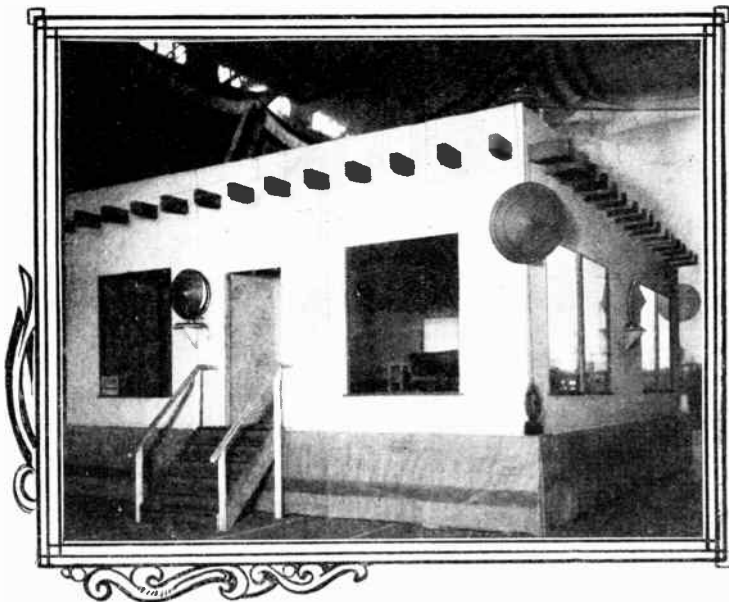
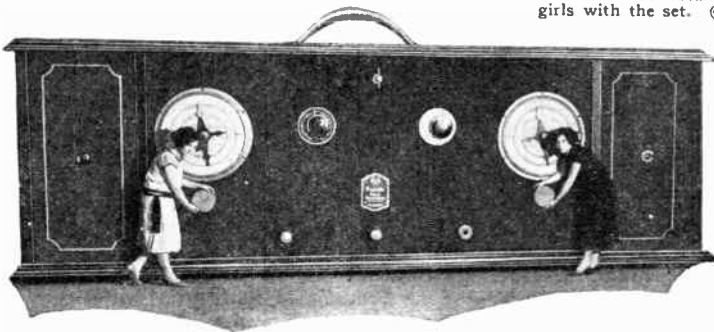

THE CRYSTAL BOOTH AT THE RADIO WORLD'S FAIR. From this booth several interesting programs were put on the air by WRNY. © Fotograms.

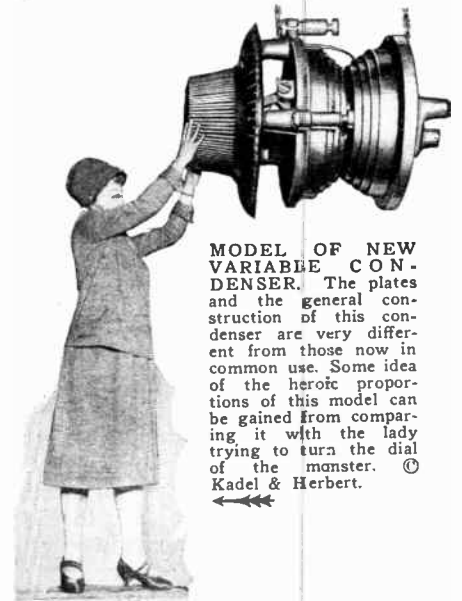

MODEL OF NEW VARIABLE CONDENSER. The plates and the general construction of this condenser are very different from those now in common use. Some idea of the heroic proportions of this model can be gained from comparing it with the lady trying to turn the dial of the monster. © Kadel & Herbert.

What Is New In Radio

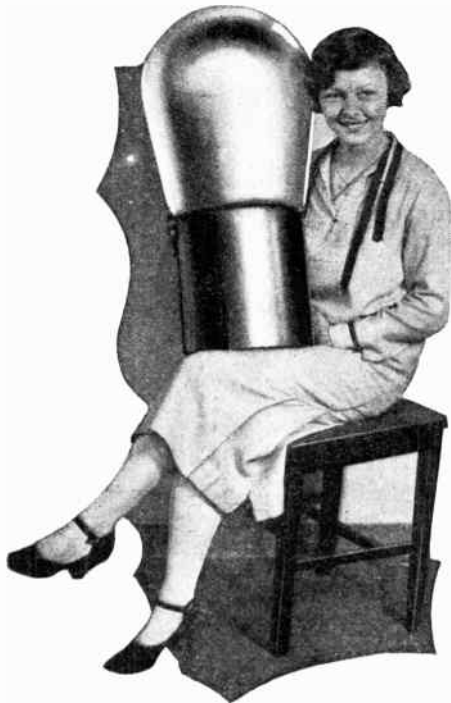

THE WORLD'S LARGEST VACUUM TUBE. Nearly everything at the radio shows in New York City was either "the largest or the smallest in the world" and the above appellation holds for this tube.
© Fotograms.



A UNIQUE RADIO RECEIVER. The cone loud speaker in this set acts also as a dial for tuning as well as performing its usual duty.
© Fotograms.

THE INVENTIONS OF REGINALD A. FESSENDEN

We are sorry to announce to our readers that on account of illness Dr. Fessenden was unable to supply us with this month's installment of "The Inventions of Reginald A. Fessenden," a series which has been running from month to month in RADIO NEWS.

Dr. Fessenden's activities have recently been carried beyond the limit of human endurance with the result that decisive orders from his physician require him to rest for a few weeks. We are pleased to announce, however, that the series will be continued in the next issue of RADIO NEWS. Let us hope that Dr. Fessenden's recovery will be rapid both for his own sake, for the sake of our readers who, we know, follow with keen interest the articles from this world-renowned authority on radio and its allied phases of science.

tion with the various shows are given in these two pages of illustrations.

Following the New York shows which opened the season, there were others which took place in rapid succession in Philadelphia, Washington, D. C., Baltimore, Boston and Chicago. With one exception every show was a huge success and drew an attendance which compared favorably with that of the New York shows.

There were several other innovations besides the single-control idea which made their appearance. Of course, one of the most important was the incorporation of rectifiers and filters so that both the plate current and the filament supply could be



THE RADIO GIRL OF 1925-1926. This young lady is wearing a real radio evening costume. A miniature loop adorns her coiffure, while the familiar dials, coils and condensers are the principal decorations of the "short-wave" dress.
© Kadel & Herbert.

ONE OF THE MOST ELABORATE RECEIVERS AT THE SHOWS. This last word in decorative sets has its loud speaker concealed behind the round grill at the top and the set is tuned by the small knobs in the vicinity of the young lady's hand.
© Fotograms.

taken directly from the house-lighting circuit. There were some three or four of this type of set in evidence and most of them seemed to work very well.

Along the same line, as was to be expected, there were numerous straight "A" and "B" battery eliminators as individual units. Very little that was actually new was incorporated in the design, but undoubted improvement has been made during the past year in constructional and technical details.

One would have thought that these devices would be among the most popular exhibits in the show. They elicited very little more interest, however, than the remainder of the instruments.

Another disappointment was the fact that there were not so many new tubes as might have been expected, following the release of the original tube patent. The chief interest here seemed to be in new rectifiers, there being one or two very interesting new tubes for this purpose.

All of the shows this year found one striking difference to those which have been held in years past. This difference was in the absence of the educational displays. Almost everything this year seemed to be from the "selling" point, made directly to attract the potential buyer, to interest him in some particular type of set.



The general run of exhibits, however, was larger and more interesting. Almost every large company was represented and had placed their wares on display to the best advantage.

SHIPS TO DISCONTINUE USE OF BROADCAST BANDS

CONVINCED that the elimination of ship radio signals within the broadcasting bands will constitute a great boon to radio fans in this country, the Commerce Department has signified its willingness to enter into reciprocal relations with British and Canadian authorities to prohibit vessels from using wave-lengths of 300 to 450 meters when within 250 miles of the United States, Canada and the British Isles.

Ever since the development of radio broadcasting on an important scale, the Commercial Department has been deluged with complaints from owners of radio sets relative to the great interference encountered from ship signals.

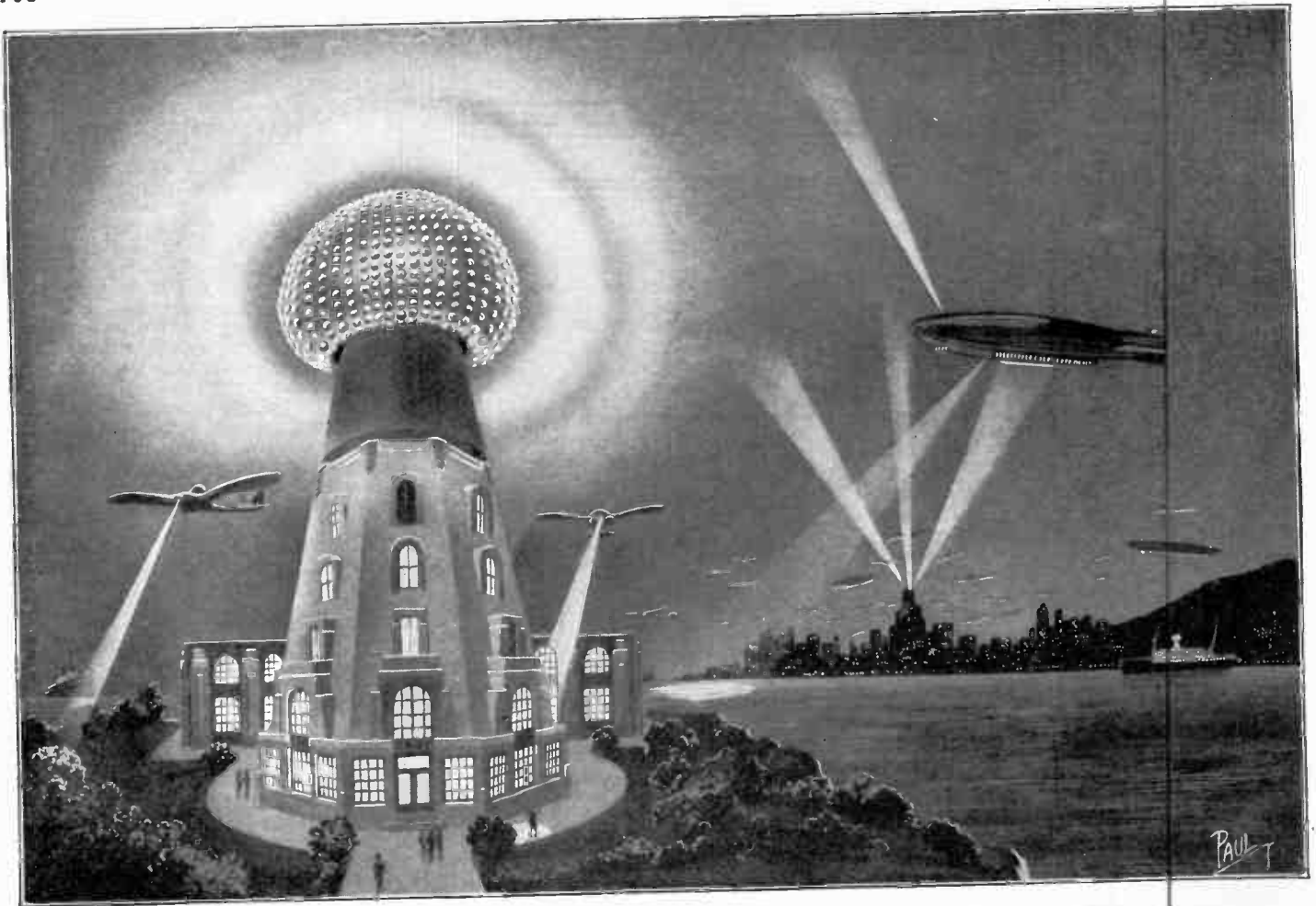

An artist's conception of Nikola Tesla's system for the transmission of power by radio waves, which was proposed several years ago.

Transmitting Power by Radio

By JOSEPH RILEY

An excellent exposition of one of the problems on which investigators have been working ever since the propagation of radio waves has been known.

IT HAS been the fondest dream of inventors for ages past to be able to transmit power in considerable amounts over distances both long and short. They have succeeded admirably, for today there are millions and millions of horsepower being transmitted from the various power plants throughout the world to other parts of the world. But in all cases the transmission is accomplished through the medium of some material substance—in the case of electrical transmission this material substance is the copper of the conducting wires.

But no sooner is the dream of the inventor realized than another inventor has another dream. He is not satisfied with the accomplishments of his predecessor, but he must go him one better. He now wants to do away with the wires themselves. An admirable project, beyond a doubt, but the question which naturally rises is whether or not such a thing is possible.

The writer has no desire to commit himself by making statements that it is impossible to do one thing or another. Time and again the skeptics have been shown the folly of their ways. No sooner does one of these "intelligensia" set himself forth as an unbeliever, just as soon does someone tear down his wall of arguments, and accomplish the very thing the skeptic said was impossible.

For this reason, the writer will not say that it will be impossible to transmit appreciable amounts of power over distances by

means of radio. The writer will say, however, that it is impossible to transmit appreciable amounts of power over distances by means of radio. This paragraph is not an example of tautology, dear reader, for you must note the emphasis placed on the tenses.

The point is, in just a few words, that in the light of the present knowledge, and the existing state of the art, it is not being done today. Let us hope that we will see it done ere our days are o'er.

There is another idea that may be appropriately interpolated here, and that is that, although, as far as I know the patent laws, there is none that prohibits the patenting of ideas dealing with perpetual motion machines, yet it "isn't being done." I do not mean that there should be any antipathy against patenting ideas relative to transmitting power by radio, but what I do mean is that we have a natural and inalienable right to say that we think a thing cannot be done.

Now that the prologue has ended, let us consider some real facts. There are natural barriers that have to be broken down before radio power transmission can become an accomplished fact, and one of these—an exceedingly important one—is the attenuation of the field strength that occurs in transmitting energy from one point to another by radio methods. The reader must understand that when I make the remark "by radio methods" I mean the usual methods. I am not at present referring to radical or revolutionary things like unknown newly discovered "rays," etc.

We can discuss the matter intelligently simply from our everyday experience in trying to get DX. Just think how our friend, the ham, who lives around the corner, comes pounding in, just as if he were doing his brass-pounding right in our own antenna lead-in. And think of how we shorten our mundane existences splitting the hair-lines on our micro-micro-vernier dials, trying to get out of the ether a mere vestige of a sound from "Station KBVD, Wrzxp, China."

If the reader has good eyesight he can see this very plainly in the diagram shown below. The curve is drawn for a station which sends a certain number of amperes up into its antenna. Right at the station, if we had a receiving set there, we would receive a pretty strong signal. Let us call that signal strength 100 per cent.

As we move our receiving station away from the transmitting station, it is obvious that the received signals would diminish in strength, and how much it diminishes is shown by the way in which the curve drops downward. Kindly note that the signal strength is only 2 per cent. at the small distance of 120 miles.

But even this does not nearly tell the whole story. By the expression "signal strength," as used above, we mean the current in the receiving antenna. This, by no means, is the power, for the power is determined by both the current and the voltage, among other things. The voltage in

(Continued on page 848)

The Kiro-Vox—Alias Neurophonometer

SOME months ago, in RADIO NEWS, the public was told of a "wonderful" new radio device which was alleged by the builder to have very valuable properties as a diagnostic instrument. At the time this information was published, the magazine posted a \$1,000 reward to be given the builder, together with all expenses incurred, if he would come to New York, bring his machine and prove before a board of accepted medical and scientific authorities that it had a valid therapeutic value.

Those who remember this article will also recall that a few months later, instead of coming to New York for the demonstration, this claimant filed suit in a court in the State of Texas—his home—asking \$1,000,000 damages, punitive and otherwise, for the harm caused himself and his apparatus as a result of the publication of the story regarding his machine in RADIO NEWS.

So the matter has rested for some time, since "Dr." Rodgers, the inventor and builder

machine could tell us—maybe. From five regularly constituted physicians and surgeons whom we asked concerning the substance of this flow, we received various and sundry answers. One said he supposed it was the blood, another two of them confessed that they had no idea what the reference was to, another just laughed when the reason for the question was explained, and the fifth said it was probably some new discovery made by a sheep doctor. The last-mentioned answer refers to the founder of a certain flourishing school of alleged doctors now advertising very conspicuously.

But, anyway, according to the advertising booklet, the thing does discover the point at which the "life flow," whatever it is, is stopped.

Before going further we must give some description of the machine.

THE CIRCUIT

The accompanying hook-up of the set—

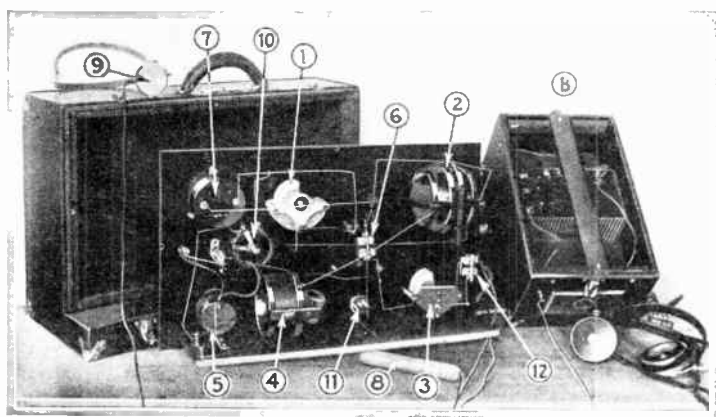

The interior of the Kiro-Vox. 1 and 3 are variable condensers; 2, a variometer; 4, variocoupler; 5, a head-phone; 6 and 12, fixed condensers; 7, voltmeter; 8, search electrode; 9, head electrode; 10, rheostat; 11, battery switch, and B, the battery cabinet.

of the machine, has not pushed the litigation. Lest the matter grow too old, however, and "Dr." Rodgers continue selling these machines at what may be considered a great profit, we give herewith some other facts, not heretofore unearthed, concerning the machine and its operation.

The operating instructions given with the machine are, of course, the main foundation of any investigation as to its real merits. Because of the legal aspects involved in the use of such apparatus in some states, the manufacturer is very particular as to those to whom he sells it. Therefore, it was no easy matter for RADIO NEWS to obtain a bona fide copy of the instructions. At last, however, they have made their appearance, and we reproduce them in full at the end of the present article.

CLAIMS OF KIRO-VOX INVENTOR

For those not well acquainted with the previous stories concerning the Kiro-Vox—or the Neurophonometer, as it was called when first made—we shall hastily re-state the claims and explanations given in the prospectus on which the machine has been constructed.

It purports to help a certain class of physicians locate "impingements and subluxations." (For the sake of those who do not know the meaning of the latter term we give Webster's definition: Subluxation—a partial or incomplete dislocation.)

It states further that the location is made by measuring the resistance of the nerves and so locating the point at which there is a constriction of the "life flow." Just what this latter is, is not clearly stated. We suppose those physicians who know and use the

traced directly from the machine in the RADIO NEWS Laboratories—gives a full account of the circuit used. The reason for the extra grid leak shunted across the second condenser is a mystery. The secret of the machine's operation lies in the use made of

I N our December, 1924, issue, we told our readers about the now famous "Neurophonometer" foisted upon the public by one "Dr." Rodgers. Since that time Rodgers has sued RADIO NEWS for a million dollar damages, the suit pending in his home town in Texas.

At the time the article was written we had never seen the Neurophonometer, but from the claims made it needed no board of radio engineers and no scientists to know that the apparatus was quite a common fake to dupe unsuspecting sufferers.

We have finally located a complete Neurophonometer, name of which has now been changed to "Kiro-Vox" by Rodgers. The staff of RADIO NEWS, as well as the engineering staff of RADIO NEWS LABORATORIES, carefully investigated this Kiro-Vox, which in all respects is the same as the Neurophonometer, and the results are given in this article. There is not one iota of doubt that the Kiro-Vox and Neurophonometer are pure swindles, and any of our readers seeing such instruments in the office of so-called "Doctors" will immediately know what to think. —EDITOR.

an old principle which takes advantage of an audio periodic discharge of the grid. By using a large condenser—in this case, the value is .0025—and the usual grid leak, the tube can be made to "clutch," so to speak, by the discharge. By varying the resistance of the leak, any frequency desired can be obtained. Leaving the other constants at any set value and changing the variable grid leak in the grid lead will change the pitch of the emitted note in the headphones.

(Continued on page 826)

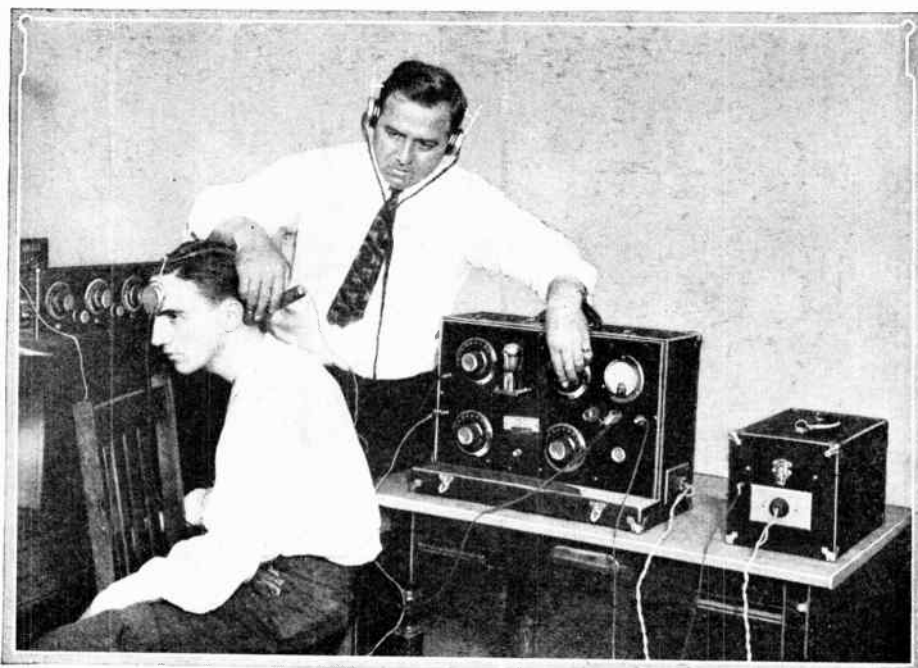

A "doctor" endeavoring to ascertain by use of the Kiro-Vox whether there is a constriction of the "life flow" or whether the patient needs a hair cut.

Thirty Years In the Dark Room

The Experiments of DR. D. MACFARLAN MOORE

This biography, written by W. B. Arvin of RADIO NEWS, gives a history of the early experiments in gaseous conduction and television made by one of the most interesting of present-day scientists.



WHEN the final chapter of radio is ultimately written, the name of D. McFarlan Moore will be one that stands out conspicuously. Mr. Moore, a pioneer in vacuum tubes of all sorts, actually made the first vacuum tube for Dr. DeForest. His researches among various types of vacuum tubes have been most exhaustive. Mr. Moore is perhaps best known through his great contribution of the well-known "Moore Light," and, lately, the Neon Moore Tube Lights, which we see now in all our cities, in all modern electric street advertisements. Mr. Moore has to his credit no less than 30 inventions, on which he has taken out patents.

Mr. Moore's biographical series is starting in this issue, and will run for a number of months.

—EDITOR.

PART I

WRITING the history of the life and work of D. McFarlan Moore is a great deal like writing the history of the development of electricity and radio over the same span of years as those covered by his life.

To those not intimately connected with the development of the two arts, his name may be a bit hazy and call up nothing more than a vague recollection which will send the reader to "Who's Who." But to the man actively cognizant of the history of the year by year advances, he is one of the foremost engineers in the field.

For these reasons, it is probably best that a short sketch of some of his achievements be made at the beginning of this biography.

It is, of course, only necessary for the layman to be told that the famous Moore light is the invention and development of our subject, in order that he may be at once identified. Though this light in itself is a great work, it is not, by a great deal, the sum total of the man's achievements.

When it is explained that the first three-element vacuum tubes used commercially were the work of his hand, made for Dr. DeForest, and when it is also told that he had charge of the first installation of electrical steering gear aboard battleships, a more perfect valuation of the man's true place in the electrical and radio history of the world may be gained.

Whenever an experimenter in cold light, or in the behavior of gases and electricity meets a problem he does not quite know how to handle, his thought is always: "Well, guess I'd better see Moore." And whenever an inventor has built a new vacuum tube for adaptation to radio, his thought is likewise.

When he sets out on his quest, he finds D. McFarlan Moore in East Orange, New Jersey, or at the Harrison Plant of the General Electric Company. And if the questioner sees Mr. Moore he will find him working, for he is working all the time he is not sleeping. He believes in work and lots of it, as the best possible solution for most of the personal problems of man and, thereby, a step toward the solution of the world's difficulties.

SOME OF MR. MOORE'S ACHIEVEMENTS

A sort of resumé of some of his achievements in the radio and electrical field will serve to give the reader a clearer conception of the man's character and greatness.



D. McFarlan Moore, about the time he began experiments with gaseous conductivity.

Of course, most all radio men know that it was his vacuum tubes, manufactured for DeForest, that first were installed in commercial radio stations and definitely decided the future of the radio art, making possible the great advances known today.

In those times, vacuum tubes were used principally as detectors. It was not until years later that they were discovered to have amplifying power and, as today, the detectors contained an amount of gas which made them more sensitive in that position. Mr. Moore made the tubes, placing a gas in them and leaving a small outlet with a cock which could be used to control accurately the vacuum in the little bulb.

His fame rests more firmly upon his investigations in the field of the electrical conductivity of gases, however, and his invention of the "Moore Light" is the nearest approach to cold light we have. The "Moore Light" is not so well known in this country, but in Europe there are literally millions of them in daily use.

This light is well known, even in this country, to those who must have a pure white light. His system of illumination is used almost exclusively in the woolen and silk industry, where artificial light must be used for matching colors. The character of it is so close to that of sunlight that it may be used in this work with perfect ease and safety. An ironic point, in this connection, is that it would probably be the most widely used form of lighting today were it not for the fact that one of the large present-day corporations obtained and began manufacturing tungsten filament incandescent lamps just one year after the first successful demonstration. As the Moore Light was bulky and needed technical knowledge for installation and since it was not backed by a large sales organization, it did not attain general use. At the time of the discovery of the tungsten lamp, however, there were some miles of the tubes being used to light the streets of New York.

THE NEON TUBE

Another of his efforts, more recent in

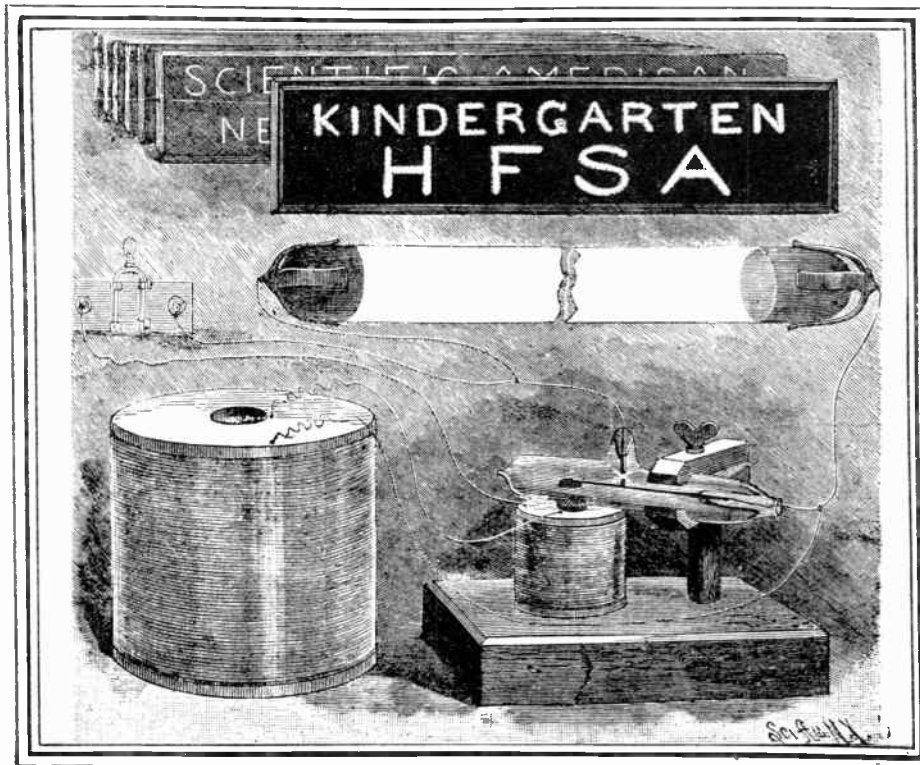

More than twenty years ago D. McFarlan Moore invented the electric sign and took out a patent on the idea. Above is an old drawing from the SCIENTIFIC AMERICAN which appeared at the time.

date, is the famous neon tube. Every experimenter in radio is acquainted with this little device and many automobile owners also use it regularly in the adjustment of ignition troubles. This tube gives off a pink glow and is about four times as efficient as the best gas-filled incandescent filament lights.

Early in the history of wireless telegraphy, Mr. Moore perfected a system of current control and a vibrator in a vacuum which was adapted and used extensively by the Marconi Company in many of their early commercial installations.

Then, more recently, since the development of radio had at last made the space transmission of pictures possible, Mr. Moore has given a great deal of time and work to the solution of several of the problems which are at present hindering the further development of this branch of the radio art. It is well known that one of the most important points in this development is the provision of some means for keeping the transmitter and the receiver in perfect synchronism while they are working. Another is that the lamp used for the projection of the picture at the receiving end must be one which lights and extinguishes with the utmost rapidity. It must so function that there will be not the slight lapse in the time between the arrival of the signal and its change in intensity as controlled by the signal. Shutters have been used in most of the processes, but they are bulky and necessitate heavy and involved apparatus to keep them in step with the transmitter. Mr. Moore has made a small tube, filled with the same neon gas, which will extinguish itself in less than one-thousandth of a second from the time the supply current is withdrawn from its terminals.

NEON LAMP

This light is about the size of a small peanut and consists simply of two cylindrical electrodes spaced about a sixteenth of an inch from each other. When the current is passed through the tube, the internal gas of the tube becomes a conductor of current and the tube glows brightly.

Actual test has shown that the ordinary incandescent filament lamp needs almost a tenth of a second to lose its brilliance. The advantage of the neon light in connection with television, or Telorama, as Mr. Moore calls it, is at once obvious.

A peculiar fact is that as early as 1906 Mr. Moore was thoroughly convinced that television was entirely possible and could be

made practical with the solution of a few technical problems.

As a matter of fact, he prepared and read a paper on the subject, setting out his visions before the National Electric Light Convention in June of that year.

FIRST INTEREST IN TELEVISION

He first became interested in the transmission of pictures when his then new white light made possible the first instantaneous electrical photograph in 1898. This was shortly after the first conception of the gaseous conduction lamp and while it was yet in a crude state. At that time it had to be tinkered with and handled like a small child,

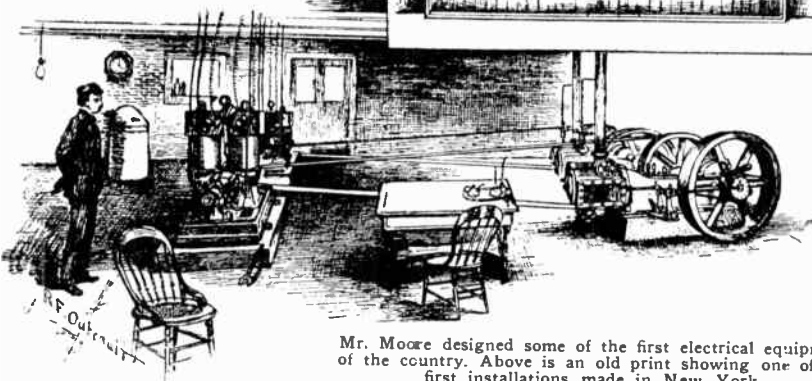

Mr. Moore designed some of the first electrical equipment of the country. Above is an old print showing one of the first installations made in New York.

if it was to work. But it proved excellent for the purpose of photography.

And contemporaneously, he was carrying on a number of other investigations concerning the abilities of his tube in other lines. In the same year, he erected at Madison Square Garden, New York, one of his tubes which sent out pulsations which were picked up a block away, operating a relay device which, in turn, set off a small bomb, blowing up a model of the old *Maine*.

From this beginning, which was at the time the first great interest was being manifested in wireless as a possible means of commercial communication, he continued to take the greatest of interest in it, following it closely throughout its various advances. From the very beginning of radio history, he was in constant touch with the various men who were making history though their inventions and improvements. So it is that Mr. Moore's history, or the history of his

work rather, bristles with the great names of radio and is so enmeshed with its progress that no complete history of the art could be written without many and full references to his work.

But his chronicle does not alone find itself in the radio field. As a matter of fact, one of America's greatest characteristics is due in a large part to him, since a patent was granted to him under the title of "electrical writing" which covers the basic rights to the present-day changeable electric signs that dot the main streets of all our large cities.

But the list could be carried through pages. There are a thousand and one improvements of one sort and another which Mr. Moore has made in electricity and all its practical applications which may never find a place in the popular mind. The thinking man, however, will evaluate all these bits and deduce the real merit of the man.

GREAT NAMES

It is hardly possible that he should have a long history so closely connected with the names of men like DeForest, Tesla, Edison, Fessenden, Westinghouse and a host of others, all idols of the public, and that he should have been given the job of putting into practicable, workable form some of their greatest inventions without having proved himself extremely competent. And all this is aside from the developments and inventions of his own, which thoroughly justify his place among the great.

One of the great differences between him and most of the men whom he has helped from time to time, is his incurable idealism. No matter what the odds or the chances for success, he holds firmly to his own code and to his ideals. He could have been among the immensely wealthy if he had, on one occasion, allowed a Wall Street syndicate to handle the exploitation of his company and its light, if he could have simply shut his eyes and allowed them to carry out their schemes according to their own judgment and principles—but he would not. Instead, he was extremely inquisitive concerning all the methods used and every detail of the financial intrigues. The result was that he withdrew his support and name from the scheme, wherewith it fell to the ground and he automatically cut himself out of several millions. But more of this later.

(Continued on page 917)

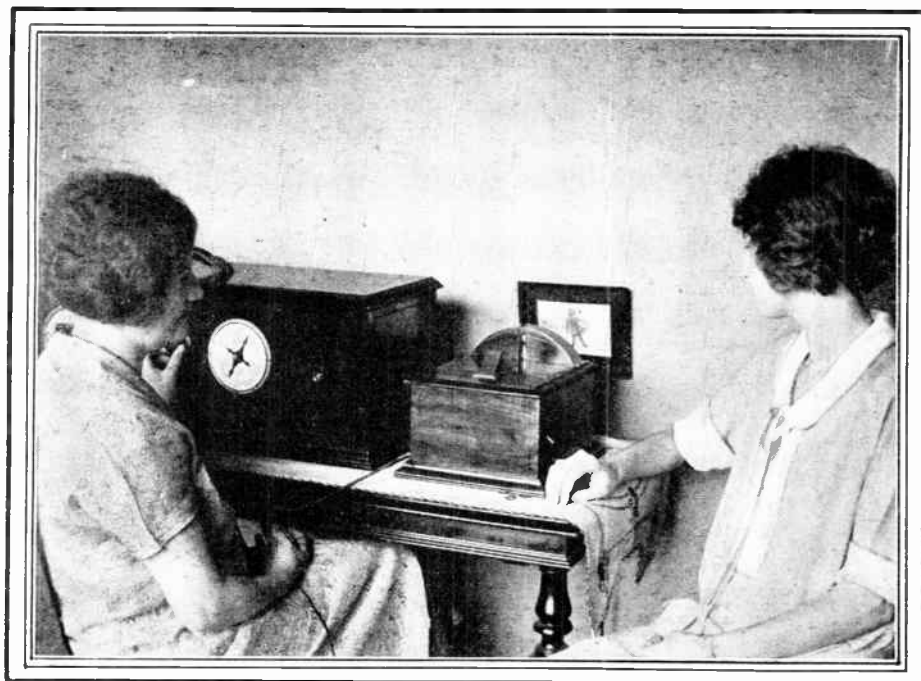

The latest advance in television, made possible through Mr. Moore's gas filament light.

Britain's New Superpower Broadcast Station

By A. DINSDALE

An interesting description of England's largest broadcast station, 5XX, located at Daventry. The present rated power of the station is 25 KW., so American fans should be able to receive English programs this winter.

ON July 27, Sir William Mitchell-Thomson, the British Postmaster-General, opened England's new high-power broadcast station at Daventry. This is probably the world's largest broadcast station. It was built not only to supply the needs of British users of crystal receivers, but also with an eye to the future development of an international broadcast service, whereby programs could be exchanged between England and other European countries and also America.

Daventry is a small town in the Midlands of England, and was chosen as the site for the new station because of its central position. As nearly as possible it is the exact geographical center of the country, and is thus a very suitable location from which to distribute radio broadcasting equally to every member of the nation's vast army of listeners.

The station is built upon a hill, 600 feet above sea level, and between 300 and 400 feet above the surrounding country—an ideal site for the purpose. The building, which houses all the machinery and transmitting apparatus, is of brick and steel girder construction, measuring 116 feet by 64 feet by 16 feet high to the roof eaves.

The interior is divided into two main sections, one section containing the generators, and the other the radio transmitter. The former has a floor space of about 1,500 square feet, and the latter about 3,300 square feet. Smaller subdivisions provide space for a studio, workshop, storeroom, offices, etc.

This information, coupled with a study of the accompanying illustrations, will serve to show that there is no lack of space in the new station.

THE MASTS AND AERIAL SYSTEM

The aerial at Daventry is supported by two stayed triangular-section lattice steel masts, each 500 feet high and placed 800 feet apart.

The interior of the station at Daventry has nearly 5,000 square feet floor space. On the right are shown the modulator panel, the engineer's control panel, the independent drive panel, the magnifier panel, the H. F. choke, the speech choke, two of the rectifier panels, the antenna ammeter and the antenna tuning inductance.



Located on a hill as they are, they form a landmark for miles around, and from the top of them a magnificent view can be obtained of the surrounding countryside, which contains some of the finest scenery in England.

The antenna is of the T type, and consists of a ten-wire cage 600 feet long. The down-lead is a six-wire cage and is brought to an insulator and lead-in trunk mounted on one of the roof ridges.

The ground system comprises a number of copper plates buried in the ground. These are all interconnected and form a ring round the station. A wire from each ground plate runs to an insulator on top of a fifteen-foot mast. Thirty-eight of these masts are disposed in a radius of 100 feet from the antenna trunk.

From these masts the ground leads are continued to the roof of the station building, and connected to a ring secured round the

antenna trunk. From this ring two copper strips run down inside the trunk and are taken to the main ground terminals of the transmitter.

The object of this somewhat elaborate arrangement is to provide an electrostatic screen over the roof with a view to decreasing aerial losses.

The main power supply for the station is

obtained from the public supply system of the nearest large town, Northampton, the home of the British boot and shoe industry. This is a three-phase alternating current supply, having a potential of 11,000 volts, and a frequency of 50 cycles. A sub-station on the site of the broadcast station transforms this supply to 375 volts.

THE POWER PLANT

The power plant is somewhat extensive, as can be gathered from the illustration. It consists of three 70 k.w. motor alternators, each generating current at 1,000 volts, 300 cycles; two 25 k.w. motor alternators, also generating at 1,000 volts, 300 cycles, and three 10 k.w. motor generators delivering direct current at 20-30 volts. In addition to this equipment there are a few smaller machines, such as motor pumps, etc.

Although the present rating of the station is fixed at 25 k.w., by which is meant the power applied to the plates of the transmitting amplifier tubes, provision has been made for any power up to 60 k.w., or slightly more, to be used, and all machinery, cables, coils, chokes, etc., have been designed to have sufficient capacity for dealing comfortably with power of that order, as and when required.

Two of the 70 k.w. machines are used together, the third being held in reserve in the event of break-down of one of the machines in use. One of these generators supplies power for the modulator tubes, and the other supplies the amplifiers, or magnifiers, as they are termed.

One of the 25 k.w. alternators supplies power for the master oscillator, and also for lighting the filaments of all the rectifying tubes, the other machine being spare. Current for the filaments of the master oscillator sub-modulator, modulator and amplifier tubes is obtained from two of the 10 k.w. D.C. machines, thus leaving one of these machines also in reserve. All these machines are fitted with individual self-excitors, as can be seen from the photograph.

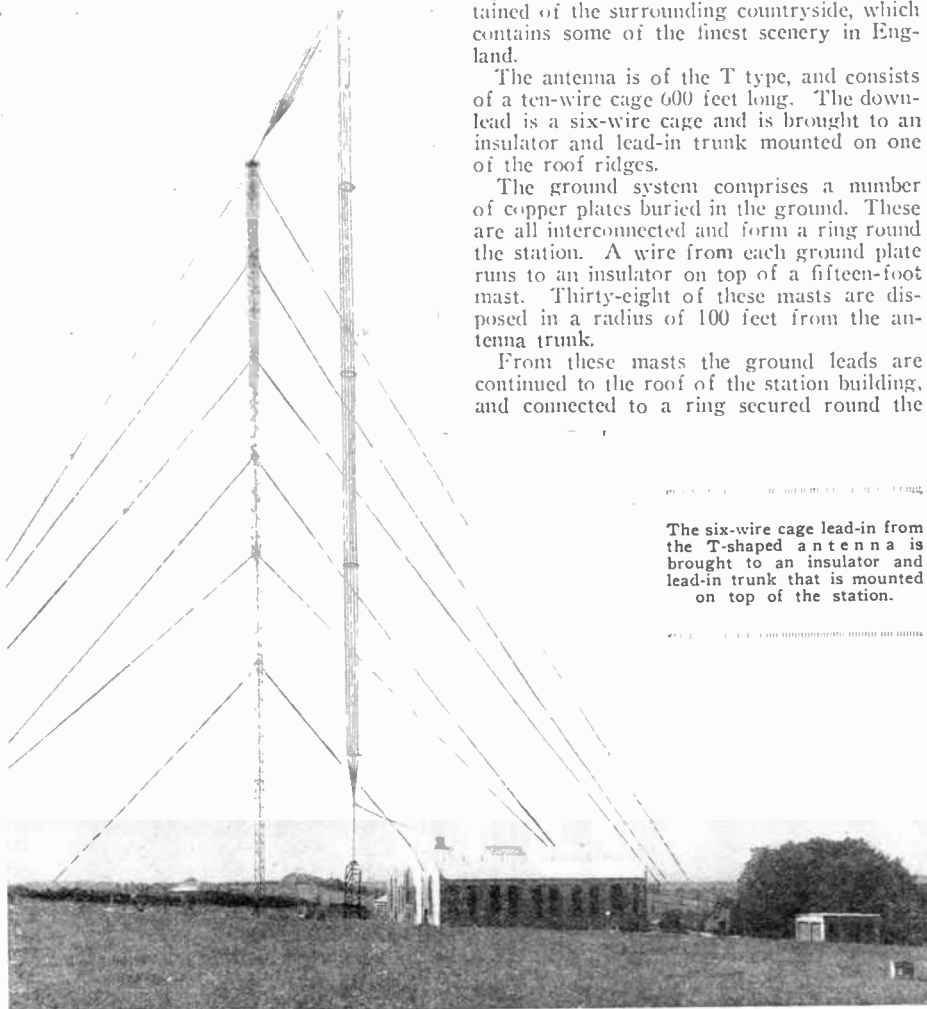

The six-wire cage lead-in from the T-shaped antenna is brought to an insulator and lead-in trunk that is mounted on top of the station.

Since the power supply to the station is at a potential of 11,000 volts, it might at first sight appear to be more convenient to obtain the necessary high-plate voltage by rectifying the incoming three-phase current and then applying it to the plates of the tubes.

In the case of the Daventry station, however, this course was not considered advisable, because any slight out-of-balance load on one of the incoming phases would create difficulties with the smoothing arrangements. As readers probably well know, unless the plate supply is a steady, smooth direct current, all sorts of parasitic noises will be set up in the listener's receiving apparatus.

The high voltage supply, therefore, is obtained by transforming up to 10,000 volts current from the 70 k.w. generators, rectifying it by means of banks of two-electrode tubes, and then smoothing it by means of an elaborate system of chokes and condensers.

All the radio apparatus for this station, which contains several new and interesting

The main modulator tubes are shown on the left and the auxiliary modulator on the right. In the center is the dry battery for supplying the necessary grid bias.

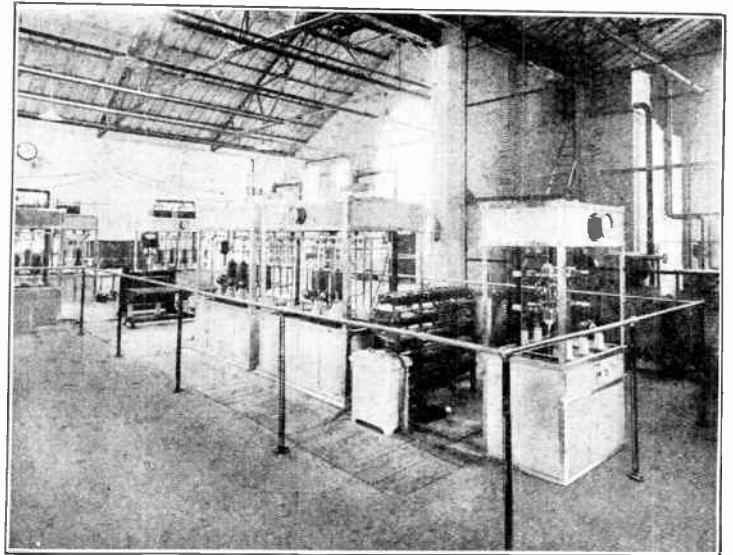

At the left is the independent drive panel, next is the coupling coil to the amplifier. In the foreground is the engineer's control panel.

Like the master-oscillator circuit, the oscillatory circuit of the amplifier is composed of an inductance of stranded cable and a metallicly shielded air-dielectric condenser. As stated above, the grids of the amplifier tubes are excited by the independent oscillator circuit through a loose coupling, the direct grid current necessary being of the order of about 300 milliamperes for the three amplifier tubes.

In the grid circuit is included an anti-regenerative coil which is inductively coupled to the plate circuit in such a manner that the internal tube capacity is neutralized. This makes it impossible for the amplifier tubes to oscillate independently of the master oscillator. If the latter is switched off, oscillations immediately cease.

Such an arrangement does a great deal toward securing stability of working and constancy of wave-length.

The open circuit comprises an aerial tuning inductance wound of the same kind of stranded cable as the amplifier closed circuit inductance, and the two are inductively coupled.

THE MODULATOR AND SUB-MODULATOR

The modulator unit contains four water-cooled rectifier and six water-cooled modulator tubes. These latter tubes are similar

(Continued on page 852)

features, was designed and manufactured by Marconi's Wireless Telegraph Company.

THE MASTER OSCILLATOR

The master oscillator, or independent drive, as it is termed, is constructed as a separate unit, and comprises two air-cooled rectifier tubes with associated smoothing circuits, and one water-cooled oscillator tube and associated oscillatory circuits.

The rectifiers are arranged for full wave rectification, and supply direct current to the plate of the oscillator at a potential of 10,000 volts.

The oscillatory circuit is composed of two copper strip inductances astatically connected to reduce the external field, and an air dielectric condenser shielded by a metallic casing. The input power of the oscillator tube is about 8 k.w., an unusually high ratio of the power supplied to the amplifier, but this allows the necessary amplifier grid excitation to be obtained with a very loose coupling. By making use of such loose coupling, negligible reaction on the oscillator results, with consequent freedom from frequency variations and variations of amplifier input.

In one of the accompanying illustrations the master oscillator unit can be seen quite clearly, while next to it is the coupling coil to the amplifier panels on the right. In the right foreground is the engineer's control panel.

THE AMPLIFIER

The amplifier, which can be seen to the right of the master oscillator, is made up of four water-cooled rectifier tubes, and three water-cooled oscillatory tubes of the same type as that used in the master oscillator. These latter tubes are able to handle

an input power of 30 k.w. The plate current is 2.5 amperes at a potential of 10,000 volts.

The filament input for all the types of water-cooled tubes used at Daventry is 1 k.w. each at 20 volts.

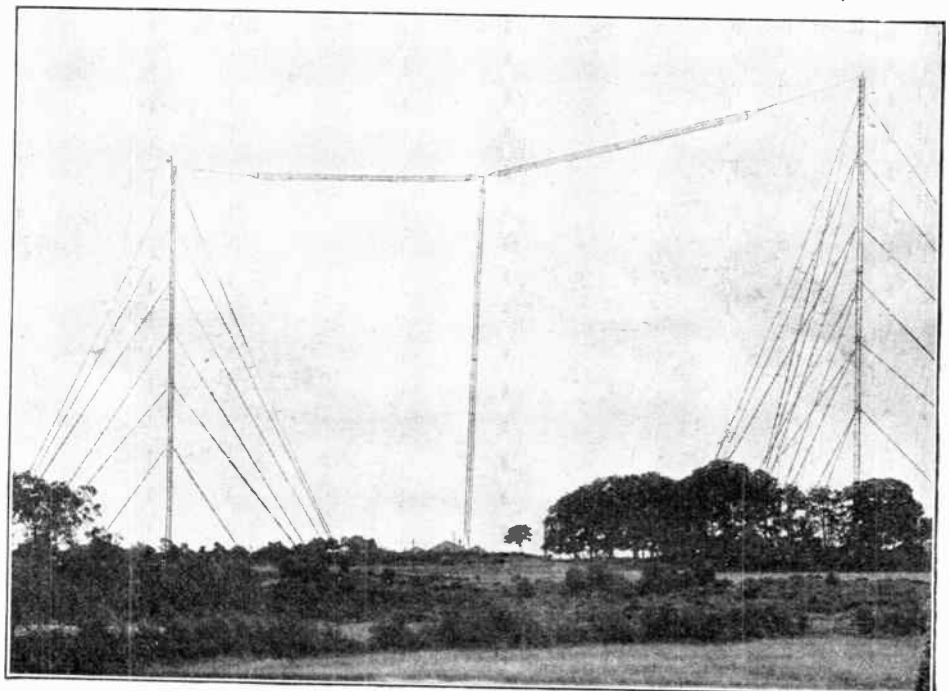

The masts, 500 feet high and 800 feet apart, support 5XX's antenna, which is a 10-wire cage 600 feet long.

The Nature, Cause and Reduction of Fading

By GREENLEAF WHITTIER PICKARD
Inventor of the Crystal Detector

Mr. Pickard is one of the foremost radio engineers in the field today. His work on wave propagation and its relation to external conditions, given here, should be interesting to everyone.

ONE of the most marked differences between wire and radio communication over any considerable distance is the inconstancy of the space circuit. From year to year, season to season, day to night, hour to hour, minute to minute and second to second the ratio of sending to receiving end current fluctuates. So great is the amplitude of some of these variations that they form a real barrier against many desirable uses of radio communication, and without question their reduction is the most important remaining problem in this art.

A STATEMENT OF THE PROBLEM

The best progress toward the solution of any problem is made by first finding out exactly what the problem is; in fact, a clear statement of the difficulty often makes the remedy obvious. When insofar as is possible, the physical agencies involved are determined, and the troublesome phenomena quantitatively measured, the solution is usually close at hand. What then are the physical factors involved in radio communication, and exactly how does it fluctuate or fade?

It has long been known that whenever high frequency currents are set up in a conductor, feebler, though otherwise similar, currents are found in a distant conductor, and for over a quarter century this has been utilized for the communication of intelligence without wires. As the means for producing high frequency currents increased in power, and apparatus for the amplifica-

tion and detection of such currents became more effective, the distance between the sending and the receiving conductors increased until today they may be placed at antipodes and still serve for the transmission of telegraphic and telephonic messages.

From the theoretical reasoning of Maxwell and the classical demonstrations of Hertz, it has also been recognized for a long time that the space around a conductor carrying high frequency current is traversed by a radiation which differs in no respect, save frequency, from visible light. Today there is no gap in the frequency spectrum

ly known attribute of this form of radiation. And because of this it was assumed at the inception of radio communication that the curvature of the earth set a definite limit to the possible signaling distance. Very shortly indeed this limit was passed, and when intelligible signals were transmitted from England to America, over an arc of 45°, the late Lord Rayleigh propounded a question which has stood for over twenty years without an adequate answer; how could the radiation bend around the curvature of the earth?

Many and ingenious have been the hypoth-

A representative graph which shows the minute-to-minute variation in signal strength from WNAC. Such measurements have been made on a great many transmitters.

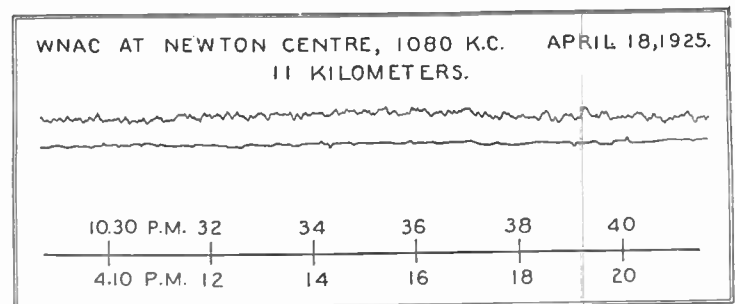

from the radiation at some tens of thousands per second used in long distance radio, to the gamma radiation at over a quintillion periods per second; we can produce and detect radiation anywhere within this enormous frequency range. Radio is therefore merely a special branch of optics; a utilization of the extreme infra-red of the spectrum, and what is true for the ray of visible light must also be true for the radio waves, save insofar as the great difference in frequency enters as a factor.

It follows that all of the laws of optics must apply to radio transmission. Rectilinear propagation in vacuo, reflection, refraction, dispersion, interference, diffraction, polarization, absorption, scattering and the other phenomena of light transmission are necessarily found in radio communication.

The nearly rectilinear propagation of light in the atmosphere is the best popular-

eses advanced in explanation of this bending. Diffraction, that slight bending-in of light around the edge of an opaque obstacle, was entirely inadequate. Another suggestion was that the waves glided along the conducting surface of the earth just as they may be made to glide along a wire, and in this manner conformed to its curvature. Radio transmission from air craft, and the behavior of the high frequency radiation now used by amateurs and others, is difficult to explain by the gliding wave hypothesis. But the most tenaciously held explanation has been that of the Kennelly-Heaviside Layer, an imaginary, intensely ionized stratum at about the auroral level of one hundred kilometers. In the original form of this assumption the layer was supposed to be so good a conductor that it reflected mirrorwise the radio waves, although obviously it could not be so perfect a conductor as to appreciably reflect light waves. Thus the radio waves were supposed to be confined within a relatively thin spherical shell, and by total internal reflection were made to travel over the entire earth.

It may be fairly said that the original Kennelly-Heaviside hypothesis is today considered both improbable and inadequate to explain the now known phenomena of radio transmission. It could only account for the observed transmission over any large arc by assuming practically perfect reflection from the layer above and the earth below, and this, in turn, calls for so high a conductivity as to make its very existence unlikely. Even if such a layer could exist, highly artificial modifications are necessary to explain the seasonal, diurnal and particularly the shorter period fluctuations which we observe in radio reception. My own investigations during the past few years have uncovered such a complex of fading effects that it would be difficult to imagine a reflecting layer of such form and properties as to cause these reception fluctuations. But the most conclusive objection to any form of reflector formed by ionized air is that recently given by Larmor, who points out that such a layer will absorb or damp out

Here is a recording device such as that used by Mr. Pickard in making the graphs showing the fluctuations in field strength during the eclipse period.

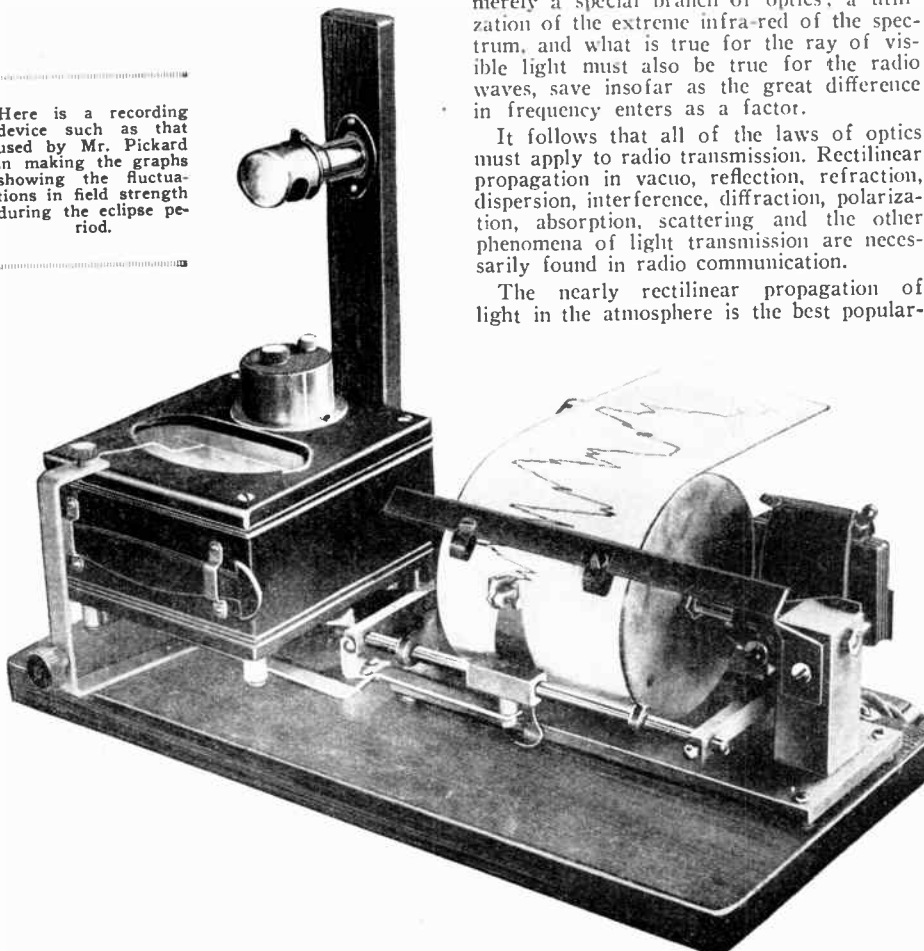

the waves far more than it can possibly reflect them; in other words it would be like a lampblack surface to visible light.

REFRACTION AS A POSSIBLE CAUSE

But it is not necessary to invoke reflection in order to explain the bending of a radio wave. Refraction will accomplish the same result. When light is stopped by an opaque body, reflected by a mirror, refracted by a glass prism or polarized by a tourmaline crystal, it is because the light wave encounters and sets in motion electrical charges which are distributed through the various media which absorb, reflect, refract or polarize the ray. In some media certain of these electrical charges are free to move indefinitely in any direction, and such free electrons are found most abundantly in good conductors such as metals. Other charges appear to be elastically constrained about atomic or molecular centers; the glass prism refracts light because of the presence of these constrained electrons. Substantially all the various phenomena of light transmission are caused by the interaction of the rapidly alternating electric field of the light wave with the free or constrained

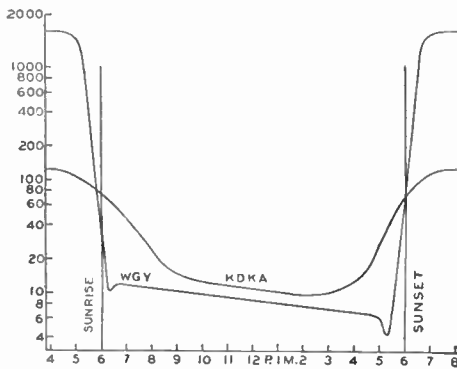

The above audibility chart shows plainly the drop in signal strength with the sunlight and its rise again at sun down.

charges in the medium through which it passes; it is these electrons which make the medium optically active and differentiate it from empty space.

Any mass which is elastically held forms an oscillating system with a definite resonant period or group of periods, so the electrons which are constrained about centers form resonant systems. When a beam of white light passes through a glass prism, it is dispersed into a spectrum, due to the fact that different light frequencies travel with different velocities while in the glass. When the frequency of the light is closely that of some resonant period of the electrons, the medium shows an absorption band for that frequency; the light wave is either reflected back from the surface of the medium, or is absorbed after a few wavelengths of penetration. For frequencies which are not exactly those of the electron systems, but which are quite near to it, the medium shows anomalous dispersion.

It follows therefore that all transparent media, with the single exception of that which we call empty space, are merely transparent for certain frequencies, as they all contain variously tuned electron systems. Glass is transparent for the range of frequencies which affect the eye, but is opaque to the slightly higher frequencies of the ultra-violet. The atmosphere, like glass, is transparent within the visible spectrum, but is quite opaque to both the ultra-violet and to certain frequencies in the infra-red.

So far, I have considered only the optical phenomena resulting from the interaction of light waves and electrons, without taking into account the optical effect of any steady field which may also be present in the medium. It was discovered by Faraday

that when a beam of plane polarized light traversed a block of glass simultaneously with a parallel magnetic field, the plane of polarization was rotated; this is the Faraday effect. In an analogous manner an electrostatic field at right angles to the ray produces double refraction and a change in the plane of polarization of the transmitted light, and this is called, after its discoverer, the Kerr effect.

REFRACTING MEDIUM UNKNOWN

In radio communication the transmission medium is the atmosphere, and perhaps to some extent the empty space outside the atmosphere, although this latter does not seem of immediate importance, as any radiation which strays outside the atmosphere is lost to any radio circuit between earthly points. Radio waves, now that the bugaboo of a reflecting layer is out of their path, are quite free (if properly directed) to pass outside our atmosphere, and writers of technical fiction may once more discuss interplanetary communication. But now, in our examination of the physical factors involved, we come to an *impasse*; we do not know that portion of our atmosphere where the bending and splitting of radio waves presumably takes place. Up to about 35 kilometers we know its pressure, temperature and composition; up to about 10 kilometers the distribution of ionization is known. Above these levels there is yet little real knowledge; today the higher strata are principally fields for speculation. We do know, however, that the atmosphere is traversed by two more or less constant fields, one

magnetic and of an average value of one-half gauss, and the other electrostatic, with an average value of one volt per centimeter at the surface, and decreasing, at least up to 10 kilometers, with altitude.

The electrical charges which are distributed through the atmosphere may be divided into three groups; the unitary, positive and negative charges which in equal quantity make up the atom, the charged atoms or ions, and the free electrons. Within the visible spectrum only the first group, the charges from which the atom is built, have any appreciable optical effect. For the much lower frequencies of the radio spectrum this first group has but little effect, and substantially all the phenomena of radio transmission appear to be caused by the ions and free electrons. In a similar manner, the magnetic and electrostatic fields in the atmosphere have very little optical effect upon visible light waves, but may have a very considerable effect upon certain of the radio frequencies.

We believe today that radio transmission over any but the shortest of distances is made possible solely by a bending of the radio waves by the ions and electrons in the air perhaps aided by the magnetic and electrostatic fields which surround the earth, and it also seems certain, that this highly useful bending does not act uniformly upon the entire radiation from the transmitter, but instead splits it into two or more parts, which pursue different paths through the atmosphere and eventually come together again at the receiver. This split-

(Continued on page 924)

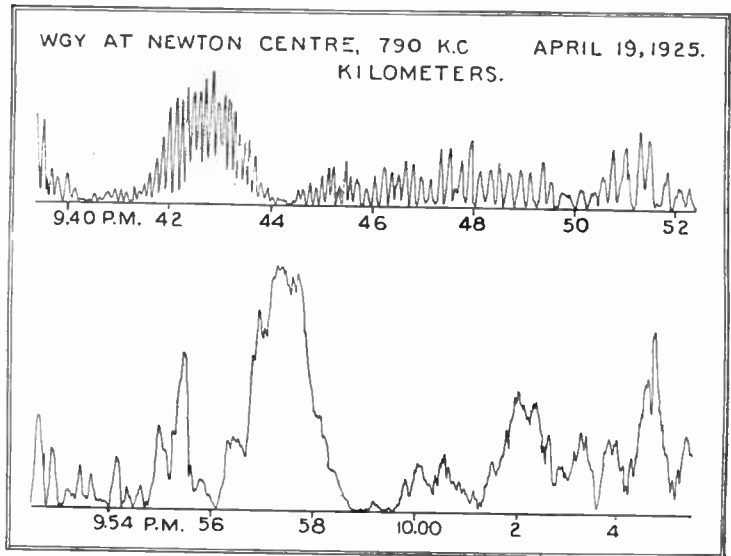

Another of Mr. Pickard's charts, from which he makes the present study of wave characteristics and propagation.

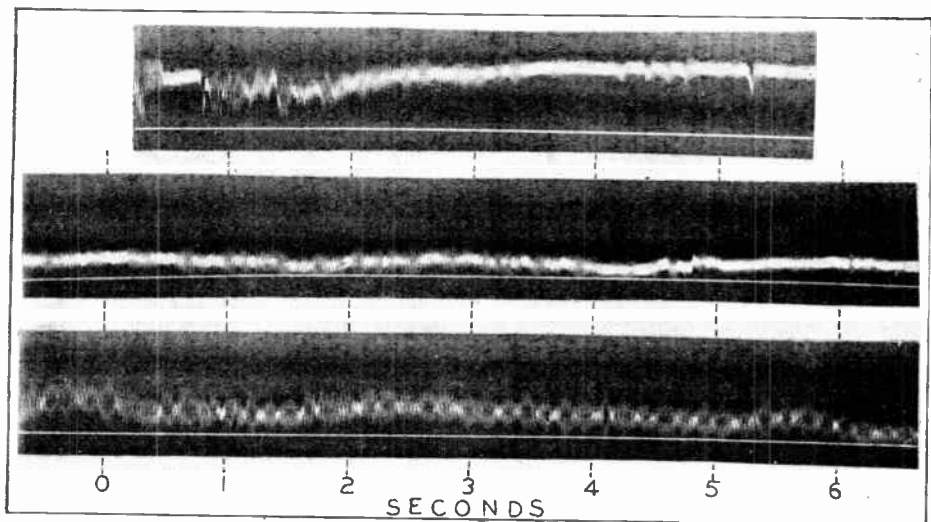

A more advanced method of taking the signal strength measurements is through the use of an oscillograph. A specimen of this type of record is shown above.

Radio-Controlled Automobile

By P. B. HANCE, Jr.

Here is an excellent treatise on automobiles that are controlled entirely by means of radio. The system employed is very compact and almost entirely foolproof.

THE art of controlling vehicles and ships by radio has always held considerable fascination for the experimenter, for it has a strong spectacular appeal and offers unlimited opportunity for the application of ingenuity. The radio control system to be described here will, perhaps, therefore, interest the readers of RADIO NEWS. It was developed by the writer and used to operate an automobile at the time of the last electrical engineering show at the University of Illinois.

THE DEMONSTRATION

The car used was propelled by its starting motor, for the exhibit was in a gymnasium and gasoline could not be used. It ran at a speed of about four or five miles per hour in either direction, and was equipped with the necessary controlling mechanism to start and stop it, blow the horn, light the lights bright or dim, etc. A small transmitter in a balcony at one end of the building was the controlling point, the operator being stationed there. The control circuit was so arranged that any control (there were eleven available) could be selected by sending a certain code letter, such as dot-dash-dot, from the transmitter. Thus the letter R, dot-dash-dot, as assigned to the operation of starting the car in reverse, while A, dot-dash, would start it ahead. To stop anything which might be in progress (for instance, to stop the car), a single dot was transmitted, which would release all controls and shut off the driving motor current.

The car was thus in complete control at all times. The selection of any operation was accomplished within one second or less, and any operation could be stopped almost instantaneously. One of the favorite stunts was to have one of the boys lie down in the path of the driverless car. The operator, after blowing the horn by radio, would then stop the car some six or eight inches away from the intended victim. However, one night, the stop signal did not take effect, for

the driving motor relay contacts were burned and stuck. The young man who was playing victim saw this in time to prevent himself being a real victim, and started rolling away from the car. Soon our audience was guffawing at the embarrassing (to us) spectacle of a driverless car chasing a rolling young man along the floor. Happily, someone ran and pulled the emergency switch on the running board. The audience enjoyed that failure of the car far more than all the successful performances put together.

THE CONTROLLING MECHANISM

The actual controlling mechanism consists of fifteen relays, of the type used in telephone plants, mounted on a small framework. The wiring is all in a cable on the back of the frame and external connections are made by a set of binding posts on the top of the frame. Any radio receiver may be used with this unit, provided it has sufficient variation in the plate current of the last tube to operate and release a sensitive relay. The "output" of the selector consists of eleven control wires, leading to the various pieces of apparatus to be controlled, such as steering magnets, lights, and so on. Each wire corresponds to a code letter. When a letter is received by the radio receiver it "sets up" the relays in such a combination as to connect the corresponding control wire to ground. The operating battery for the control magnets or lights being grounded on one side, this section supplies current over the control wire to the piece of apparatus selected, and it begins to operate.

Then when it is desired to stop the apparatus, a single dot is transmitted. This releases all the relays and returns everything to normal, awaiting the next call. The selector relays remain operative, or rather, "locked," as long as any piece of apparatus is in use. This means that only one circuit may be used at once, so that the car could not be steered, for example, while it was in motion. To overcome this difficulty, a driv-

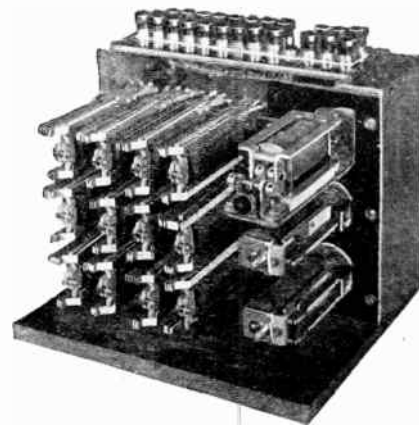

The bank of relays used to control the different parts of the automobile.

ing motor relay was built which could operate in either of two directions, one of them sending the car forward and the other sending it backward. In either position, a little latch would drop and hold the contacts in that position. There was a third operating magnet, which was arranged to lift the latch and allow the relay to return to a normal position, stopping the motor. In that way it was possible to have the selector free for steering, blowing the horn, and so on, while the car was running either way. A code letter for stopping would, when transmitted, ground the lead to the latch-lifting magnet and open the circuit.

Power to operate the relays was supplied from a 22-volt radio "B" battery. Surprising as it may seem, one battery will furnish energy enough to operate the selector over two thousand calls. This is due to the fact that the relays are highly efficient, most of them requiring only a few hundredths of an ampere to operate, and to the fact that the selector is not tied up while the driving motor is running. The time required to select any circuit is small, as stated before, so that the total current required for a call is small.

THE DIAGRAM EXPLAINED

For the details of the relay operations refer to the schematic diagram. A relay is shown as a magnet with pivoted armatures at either end, each armature having one or two contacts associated with it. When current flows through the winding, the magnet is energized and these armatures are drawn toward it, making those contacts which are shown open and breaking those shown closed. The relays designated CI and S are marked "SR" on the core. This means that they are built to operate quickly, but will not release until about one-third of a second after the current in the winding has been cut off. Most of the relays are supplied with "locking circuits." That is, when they are operated, by any means, they close another operating, or locking, circuit through one of their own make contacts, so that they remain operated, or locked, after the original operating force is removed. The battery supply is shown as follows: to every point shown grounded is connected the positive side of the battery, which is grounded, and to every point where a battery and ground are shown, is connected the negative side of the battery. This convention merely simplifies the diagram.

The relays A, B and C really do the selecting. It will be noted that, starting at the right-hand armature of A, it is possible to follow eight different paths to control leads, depending upon the combination of relays operated or released. In order to operate any desired combination of relays, we arrange the code signal so that the three impulses (dots or dashes) correspond to the three relays, A, B and C, in order. If

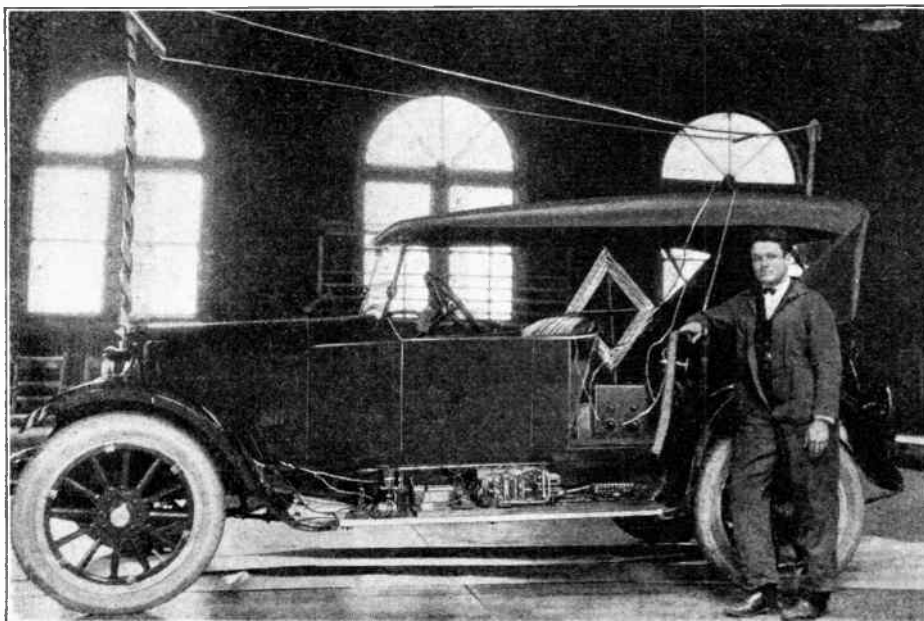

The radio-controlled automobile equipped with the apparatus described above. As the car was operated indoors, there was no attempt made to cover the apparatus, which may be seen on the running board.

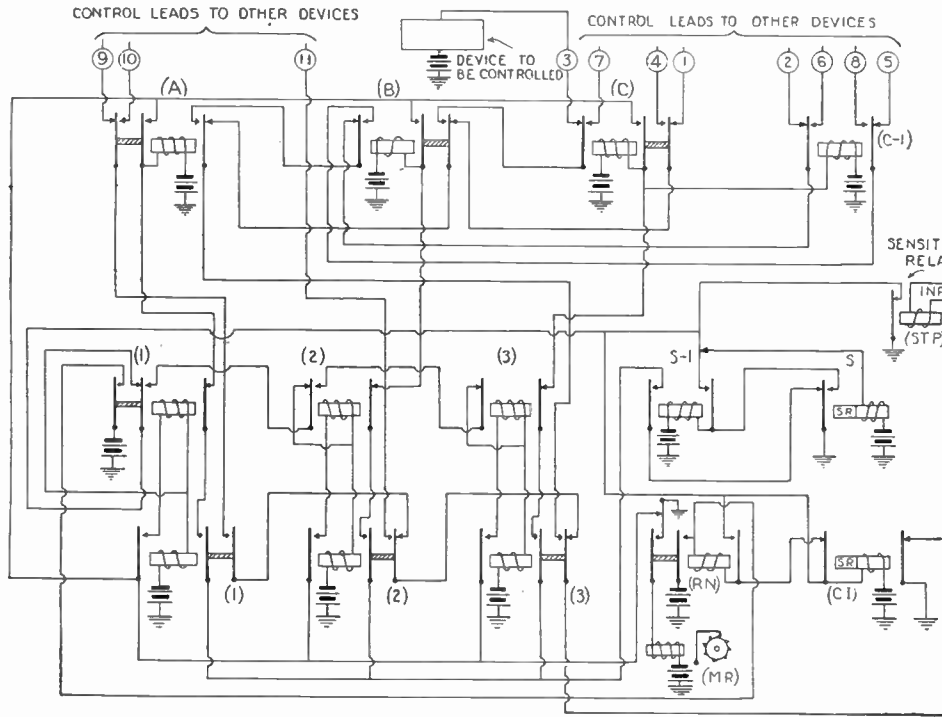

C relay. This and a little study should make clear the process of selection. The CI relay, of the slow release type is energized with each pulse, but does not have time to release between pulses. Its release after the signal is complete closes ground from its right armature and contact to the circuit, which has been selected. The RN

The circuit diagram of the equipment used to operate the automobile. The different relays are operated by the code letters transmitted by radio and are released by a single dot.

or "return-to-normal" relay operates when a pulse is received and the relays have been set up for a call long enough for the CI or "cut-in" relay to release. When RN operates it opens the circuit to ground which has been holding the selecting relays locked. The A, B, C and 1', 2', 3' in a break contact on RN. The STP relay is a sensitive polarized stepping relay, which operates from the radio receiver output. It furnishes ground pulses from its make contact to operate the numbered relays, the CI, and so on.

Although the process of selecting an operation seems to be very complicated, the relays operate quickly and surely, if the dots and dashes are the right length, and almost never fail to select the correct circuit. By adjusting the S and CI relays the circuit may be adapted to any speed of sending. By connecting an electrical counting device, indicated by MR on the diagram, in this circuit, the number of calls handled by the selector is known at all times.

we want A operated, B released and C operated, we send dash-dot-dash.

The relays 1, 2, 3, 1', 2' and 3' operate as follows: the beginning of the first pulse operates 1', the end of the first pulse 1, the beginning of the second pulse 2' and so on. Each relay remains locked after it operates. Note that this action connects

a lead from the right "make" contact of the relay S-1 to the windings of A during the first pulse, B during the second pulse, and C during the third. If a given pulse is a dash, the S-1 relay, with the S will have time to operate so as to place a ground on the lead mentioned above, so as to operate the corresponding A, B or

Is Lightning A.C. or D.C.?

By HENRY W. HALL

WHENEVER a thunderstorm appears in the offing, another cause of disturbance is added to our list of reception destroyers. Lightning adds its crash to the static and induction noises, and that crash is often sufficiently strong to knock out not only DX but even local programs.

1. Lightning striking a telegraph line has often been known to operate the instruments along the line. Were the discharge of an alternating current nature, it would not operate the instruments if of a high frequency, and if of a low frequency would merely cause them to buzz.

2. Direct current electric lighting circuits using overhead distribution wires have, at times, had the polarity of their dynamos reversed as a result of lightning striking the wires. Only a direct current impulse could reverse the field polarity of a dynamo.

3. Oscillographic records of lightning discharge currents indicate that all the energy is on one side of the zero line, thus showing no reversal of the current.

ANALYSIS OF LIGHTNING "CIRCUIT"

In discussing the subject mathematically, Prof. Humphreys analyzes the electrical circuit, composed of the condenser, formed
(Continued on page 846)

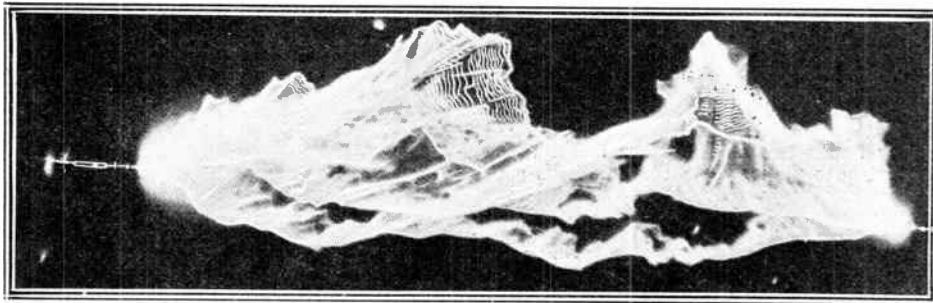

Two examples of lightning. Above is a man-made flash, several hundred thousand volts being necessary to cause the breakdown of the air. On the right is an excellent example of Nature's pyrotechnics.

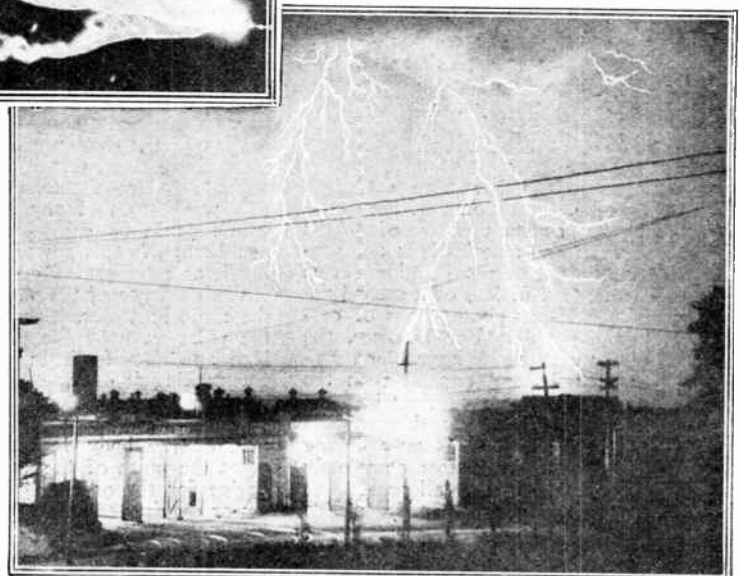

From the fact that lightning can be heard in a radio receiver, it would appear, off-hand, that the discharge must be of an oscillating or alternating current nature, since radio, *a priori*, is an alternating current science. The author was of this belief until recently, when he read Prof. Humphreys' "The Physics of the Air." In this book, in the chapter on lightning, the matter is discussed in considerable detail. Experimental evidence is given of the direct current nature of the lightning discharge, as well as a mathematical analysis showing the impossibility of producing oscillations in the alternating current sense by means of such a discharge.

EVIDENCES OF D.C. IN LIGHTNING

Briefly, the experimental evidences of the existence of direct current only are as follows:

*Prof. W. J. Humphreys, Meteorologist of the United States Weather Bureau.

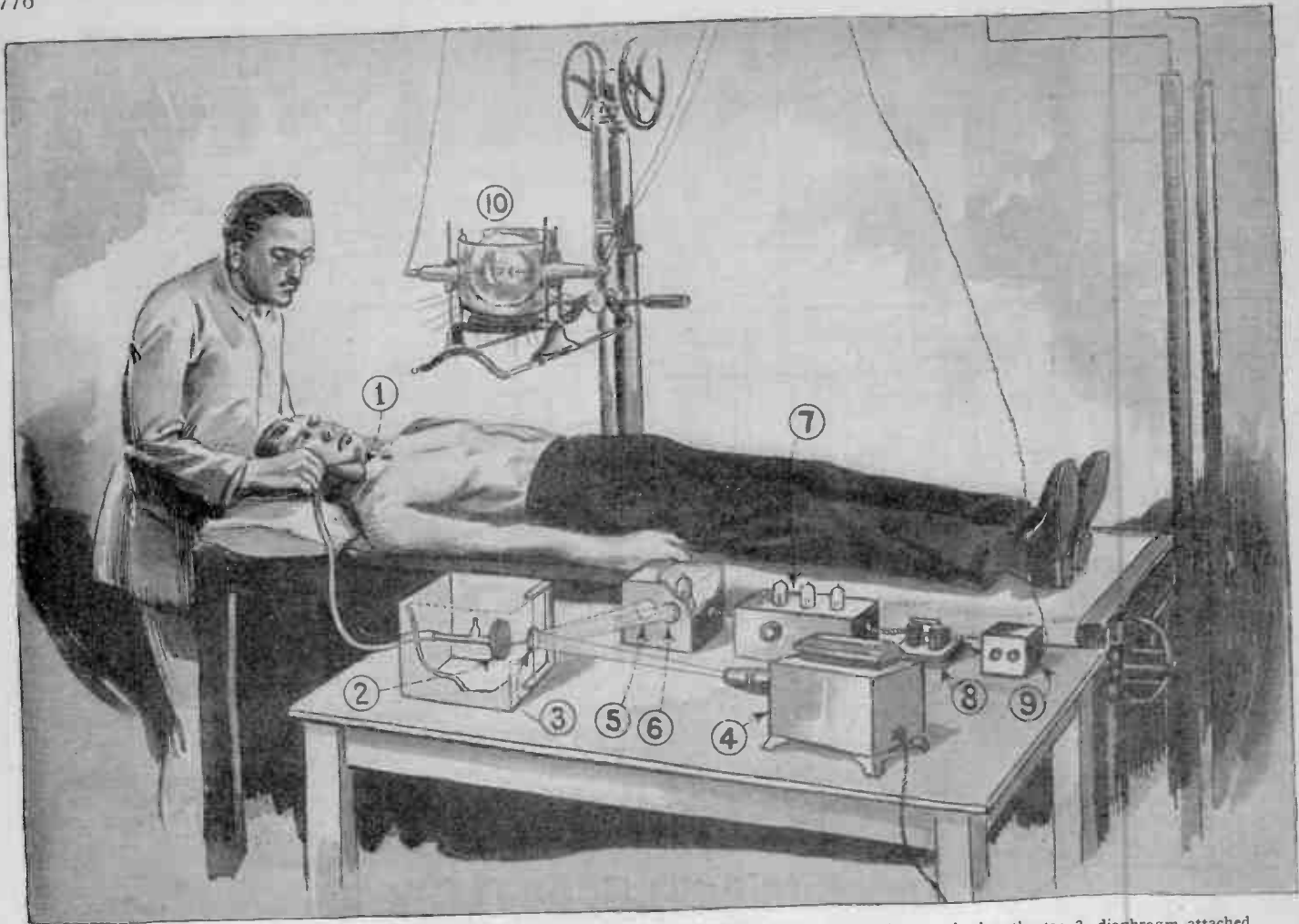

The illustration above shows the latest radio adaptation to aid medicine. 1 is a pressure funnel to pick up the heartbeats; 2, diaphragm attached to mirror; 3, mirror; 4, light source; 5, photo-electric cell; 6, aperture; 7, amplifier; 8, relay; 9, lag device; 10, X-ray machine.

Radio Aids the Surgeon

By JAY HOLLANDER

By the use of an amplifier and a photo-electric cell, medicine, through radio, discovers hitherto unknown facts about the human body.

POSSIBLY no other single science has added so much to the total of human knowledge as radio. Its applications to the solution of other problems since its first discovery and the perfection of its technique are such that it causes wonder. The latest application of radio apparatus to other lines is the use of a photo-electric cell and a standard radio amplifier for the study of the heart and lungs. And the main point of importance in the arrangement is that it enables a real and exact study of these very vital regions of the human body which has never before been possible.

X-RAYING THE LUNGS

The problem which has been solved is briefly as follows: On account of the respiration and the constant flow of blood through the veins and arteries it is not possible, without the aid of some timing device which will work to a fiftieth of a second accurately, to take X-ray photographs of certain parts of the body. For instance, the lungs are partly covered by huge blood vessels. These contract and expand with the flow of blood. The lapse of time between their periods of contraction and expansion are extremely small and it is only during the period when they are most completely drained of blood that it is at all possible to photograph certain parts of the lungs. To add to the complication, the walls and tissues of the veins and arteries are extremely thick and therefore throw a strong shadow,

as compared with the thin, spongy substance of which the lungs are composed.

Too, the location of one of the most important things, from a medical point of view, is that portion of the lung which lies directly under two of the large arteries immediately to the left of the heart. This portion is frequently affected, especially in very young and very old people. This brings up a second point in connection with the problem which made it a particularly difficult one until the advent of radio and its adjuncts. In some cases where examination may be made, the controlling power for operation of the exposure of the photographic plates is so small that it was practically impossible before the adaptation of radio to this work, to find any piece of apparatus which could be depended upon or which could magnify this power sufficiently for using it as any sort of controlling apparatus.

With the use of the photo-electric cell and the radio amplifier, it is possible to convert the pulse-wave of the patient being examined and amplify it to any power desired for making it operate the exposure of the plate to the X-ray. The device which was finally decided upon for the study of this part of the body in minute detail simply takes the pulse of the patient as the timing device for the opening of the camera shutter or making contact of the current to the X-ray tube, thus getting the picture at the exact moment when the blood and the arteries and veins are in the best position for it.

There is needed a time lag relay for adjusting the exposure to the proper instant.

A reference to Fig. 1 will at once make the device clear to the reader. Since the time of the photograph is entirely dependent upon the beat of the heart and the consequent flow of the blood, the design required the finding of some method of making even the faintest heart-beat of the youngest child control an electric current of sufficient proportions as to operate the time lag relay. But the apparatus must also be such that no movement of the patient under examination or the physicians taking the records would affect the relay. It must also be entirely free of affect from such other bodily activities as respiration.

METHOD OF OPERATION

The method employed to make use of the pulse was to take an ordinary small glass funnel, such as that shown in the sketch, and connect it to a very thin rubber diaphragm by means of a rubber tube. The variation in the air column in the tube, due to the pulse beat, when the tunnel is held against the carotid artery of the neck, would cause a corresponding deflection in the diaphragm. But the available force created by the movement of this thin piece of rubber is so small as to make it impossible to apply the power directly to a circuit-making device. The old galvanometer principle was applied and found to work successfully.

(Continued on page 919)

NEW SYSTEM OF RADIO COMMUNICATION. Prof. William Eccles, of the Electrical Engineering Department at the City and Guilds of London Technical College, recently demonstrated the apparatus shown, which was devised to test a method of communication in which the waves transmitted could produce chords at the receiver, the vowel sounds being the most easily recognizable.

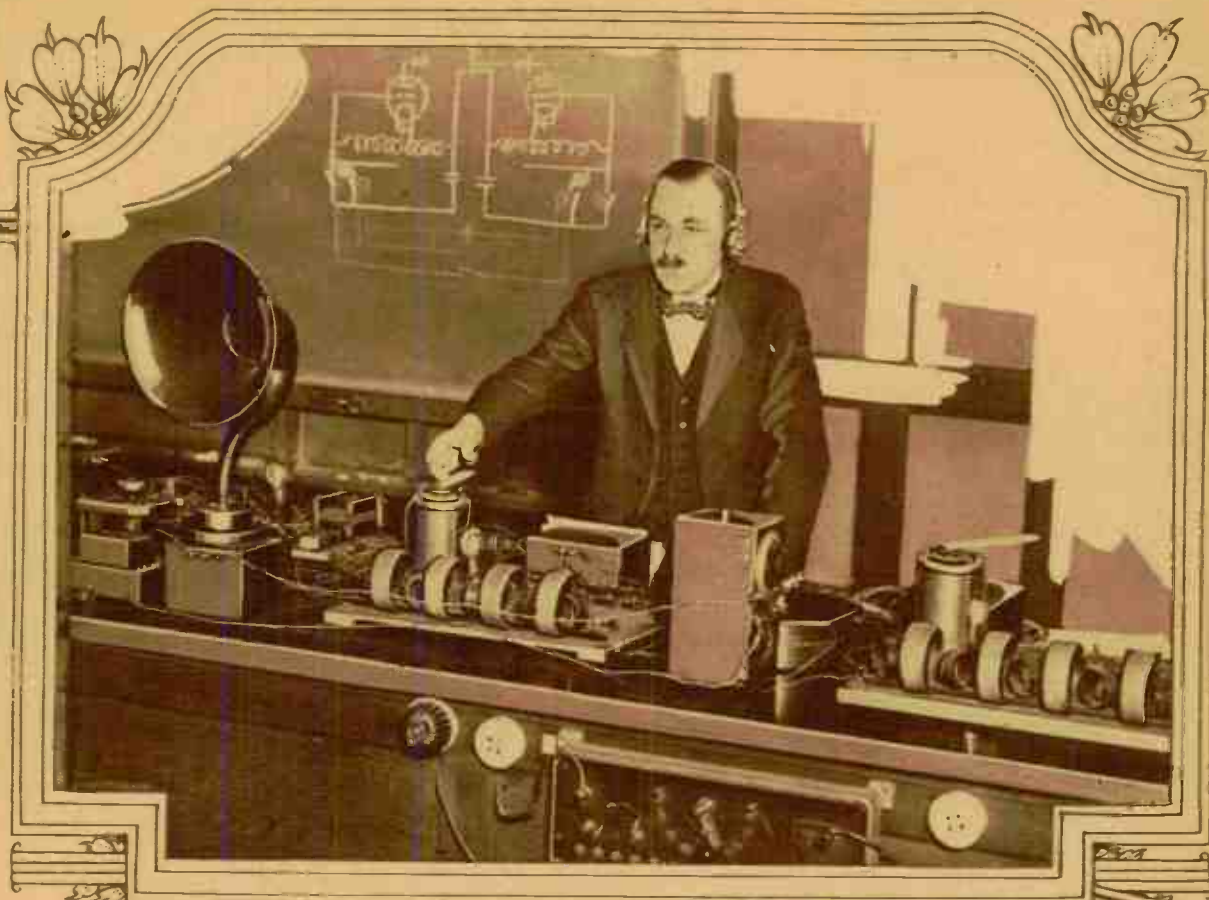

HIS RECORD FIVE EUROPEAN STATIONS IN ONE NIGHT. Thurston McCauley put his six-tube super-het in a van and listened in from the sands at Long Beach, Long Island. He received three English stations, one in Scotland and one in Spain. © Fotograms.



PILOT LIGHTS TELL WHAT IS HAPPENING BEHIND THE PANEL. Harold Herbert, the builder of the set, is pointing to the row of lights that indicate whether everything is functioning correctly within the receiver. © Kadel & Herbert.



"OFT IN THE STILLY NIGHT." This English watchman, in order to while away the tedious hours between rounds, has rigged up the portable receiver shown. He reports "the single-valve works quite all right." © Pictorial Press.



OPENS BIG PLANT TO INVENTIVE BOYS. In Detroit, Mich., the Jewett radio factory has allotted an entire floor to be used as an experimental laboratory for boys who have good ideas for the development of radio apparatus. Two young men are here shown constructing an experimental receiver in this laboratory. © International News.

The Radio

THE use of radio in ships' compass work is a familiar subject to the majority of fans, as the directional qualities of a loop antenna have been demonstrated many times. Useful as the radio compass is, there is always a chance for some improvement on the idea and the photographs on these pages illustrate Senatore Marconi's latest development, which is a radio lighthouse.

This new development eliminates one of the great disadvantages that the loop antenna type of radio compass possessed, which is that, unless the instrument was operated by someone very well acquainted with its eccentricities, large errors were liable to appear in the readings. With the radio lighthouse there is no necessity for an elaborate installation on a vessel in order to utilize the waves sent out from the shore.

Marconi's latest contribution to making shipping safer involves the use of several developments in radio science. The antenna is one that revolves and is built to operate on the beam transmitter principle. This means that waves may be transmitted and spread out no more than about 15 degrees to 100 miles. The wave-length employed is 5 meters, so that there is no interference



FRAMEWORK OF REVOLVING ANTENNA. This antenna is of the beam transmitter type, so that the signals will travel in as narrow a path as possible. An idea of how narrow this path is may be gained from the chart on the opposite page.

TRACK FOR THE REVOLVING ANTENNA. As the antenna must transmit signals to every point of the compass, the circular track, shown in the photograph on the right, is necessary. The details of the construction can be easily seen. Photos by Wide World.

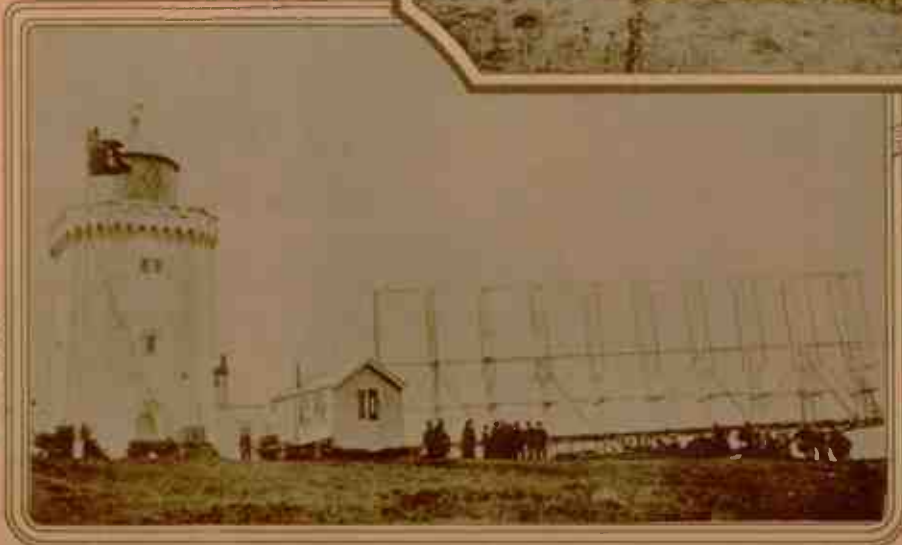
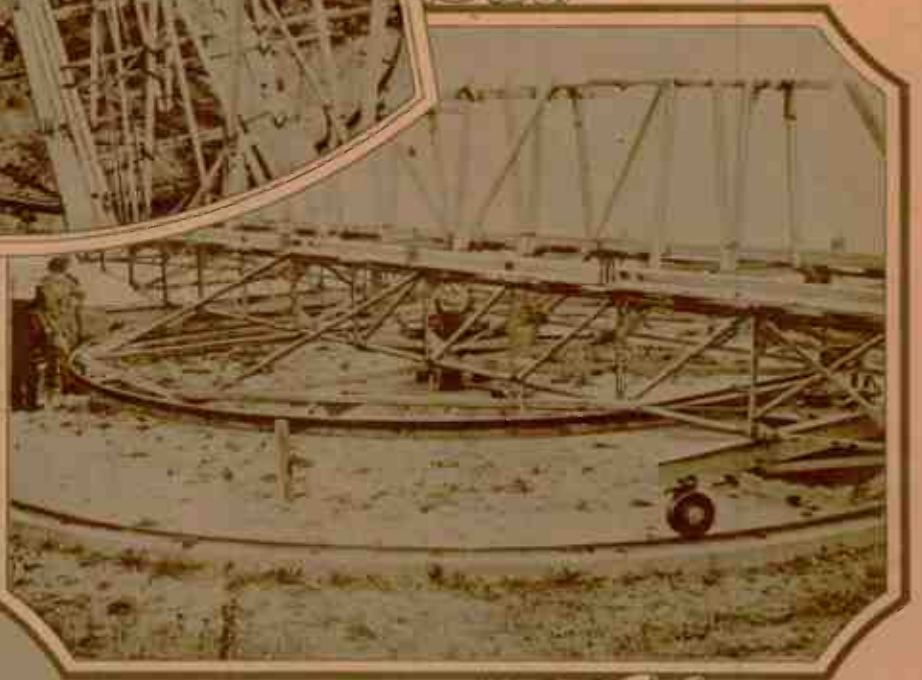

MARCONI'S RADIO LIGHTHOUSE. A general view of the test lighthouse at South Foreland, England, where extensive tests showed the practicability of this type of warning to the maritime traffic. Tests were made in conjunction with Marconi's famous yacht, "Elena." © Wide World Photo.

Lighthouse

with commercial traffic and broadcast programs. The use of such a short wave-length permits the use of an extremely simple receiving set and antenna. As the antenna and reflector revolve through a complete circle, there are automatically transmitted different Morse code letters, as can be seen by the accompanying map. There is a different combination of letters transmitted for every part of the compass, so that it is necessary only to have a map such as mentioned above. Then, by picking up a few of the transmitted letters, a very close approximation of the vessel's position can be obtained.

The power used in this "lighthouse" is approximately 250 watts and it is reported that the signals can be picked up within a radius of 100 miles. It should be mentioned, too, that this system is a vast improvement over the regular lighthouses, as it makes no difference if there is a fog, which was the bête noir of seafarers.

The leads to the antenna from the transmitter are run through a grounded metal conduit. The rotating antenna system comprises a number of energized antennae arranged in a straight line, together with a number of reflecting antenna arranged in a line parallel to that of the first antenna. It is stated that the reflecting antennae are

POLAR CURVE

OF RADIATION IN FIELD STRENGTH FROM SOUTH FORELAND AERIAL SYSTEM



THE FIELD STRENGTH CURVE. This polar curve gives some idea of the narrow path followed by the signals from the radio lighthouse.



CHART OF THE RADIO LIGHTHOUSE. By means of a chart similar to the one above, mariners can determine their position at sea in relation to the transmitter at South Foreland. It will be noticed that every few degrees on the chart has its own letter, which is transmitted within those degrees only.

SPECIAL RECEIVING ANTENNA. As the wave-length is 5 meters, the receiving system employed on the ships is a relatively simple affair. This photograph shows the installation on a ship's bridge of the short-wave antenna.

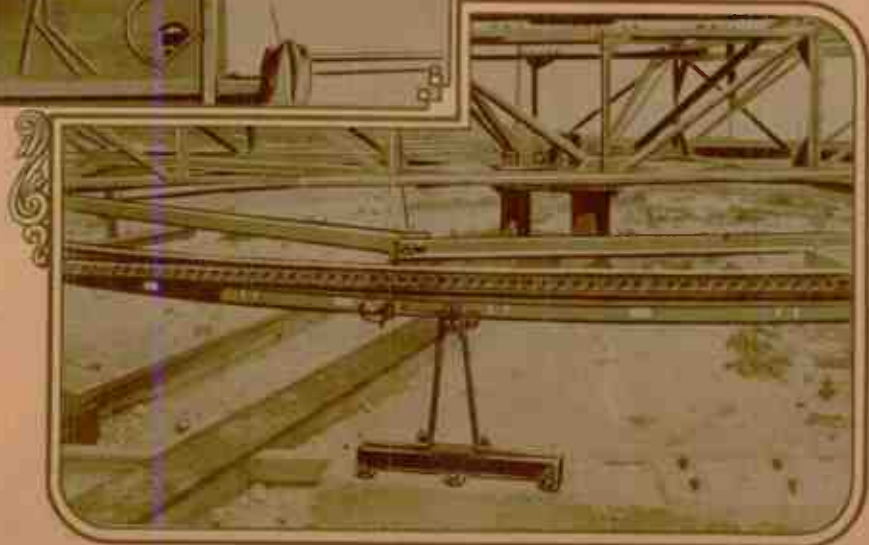
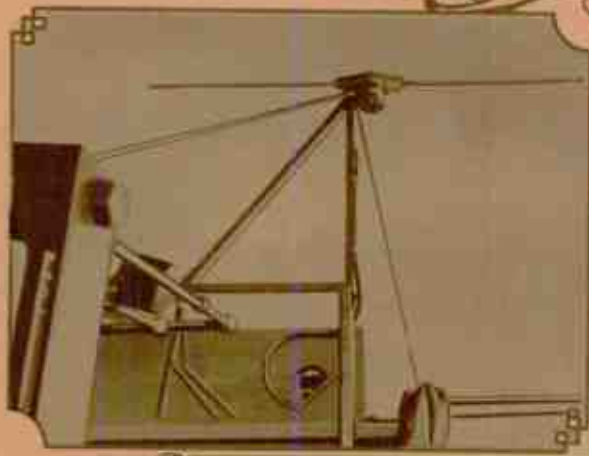

THE "MAKE-AND-BREAK" MECHANISM. The contact plates on the frame of the revolving antenna represent Morse characters and as the frame passes the contact-breaker, signals corresponding with the characters are transmitted from the beam projector. Photos by Kadel & Herbert.

WRNY Plan Now Broadens

By CHAS. D. ISAACSON, Program Director

AS I write this, we are on the eve of our WRNY Artists' Supper. Let me explain what that means. We will meet in the Grand Ballroom of the Hotel Roosevelt, which is our headquarters. It will be the first time that all the artists who give the programs at our

station will be together. It will be, I think, one of the most motley crowds ever assembled. There will be ministers, priests, rabbis, chefs, food experts, dieticians, grand opera singers, light opera singers, actors, actresses, violinists, pianists, dancers, physical culture experts, jazz players, ukelele players, American Indian princesses, cornetists, pipe organists, architects, sculptors, painters, poets, novelists, authors, philosophers, radio authorities, editors, children's fairy tale authors, aviators, automobile manufacturers, finance experts, lawyers, designers, photographers, doctors and labor experts.

This general "get-together" will be as dramatic an explanation of the WRNY plan as anything we can say, and so we are going to take flashlights that night for you to see, and broadcast the merriment for you to hear. We will have a roll call, the like of which has never been presented on stage or screen, for everyone, in response to his name, will have something to say or do by way of entertainment.

We have just finished counting the list of people who belong to the WRNY Company; there are over 700, but only the principals will be present at the dinner. By this, I mean that we shall have the heads of the departments, the soloists and the chief speakers only. Members of the chorus and musicians in the orchestras and bands will not be on hand, but will be represented by their chiefs and directors.

THE RADIO THEATRE PLAYERS

Since last month, much has happened. One of these is the organization of the "Radio Theatre Players," an organization of professional actors and actresses under the direction of Mr. Alfred Rigali. Each member of the cast has been leading lady or leading man in some production or stock company, or touring dramatic company. The cast is as follows: Madaline Hunt, Maisie Cecil Klark, Ruthelma Stevens, Edna Marshall, George V. Dill, Gladys Pabst, Santos Ortega, Herbert MacDonald, Alfred L. Rigali, Harry Mervis. There is also a second dramatic stock company which has organized, and next month we shall tell you more about that.

By the way, practically all big events at WRNY work in duplicate, since it is easier to have two companies to do one performance than for one company to do two performances. Thus, you will find that Clementi de Macchi alternates with the Remo Taverna Opera Company. The cast of the de Macchi Opera Company includes Cornelia Zuccari, Edna Estwald, Sophie Reznick, Dorothy Edward, John Fobert, John Argentino and Mae Gertwin.

The Taverna Opera Company is composed of Hortense Dorvalle, Adelaide Vilma, Teresa Demarchis, Vincent Carelli, Giovanni Lombardo, Luigi Dalle Molle, Louise Vermont. Then we have also other grand opera units: Mr. Louis Aschenfelder, who is concentrating on French music, has the



Harriet A. Seymour, founder of the Seymour School of Musical Re-education and a well-known musical author.



Ilonka, ballet mistress, from whom many interesting talks may be expected.



Bernee Kazou-noff, who will give piano recitals of interest to all music lovers.



Florence Gering-er, jazz piano queen, who will be heard from WRNY every other Monday evening.



Baroness Leja de To-rinoff, writer, lecturer and singer, who will conduct a novel fiction service.



Sascha Fidelman, first violin of the New York Orientale, which renders musicales every Sunday.



Louis Aschenfelder will be one of the features every Friday evening in an "opera duet."



Frederick Hulsmann will talk every Sunday afternoon on the care of your body.



Joseph Pavloff, who will present the "Bellade Minstrel" every other Thursday evening.



J. Van Cleft Cooper, who with his Russian Comacks broadcasts musical travelogues every Monday.



Merryie Stanley Rukeyer, an authority on finance, speaks at WRNY every other Wednesday.



Matthew Woll, vice-president of the American Federation of Labor, talks once each month on "Labor vs. Capital."

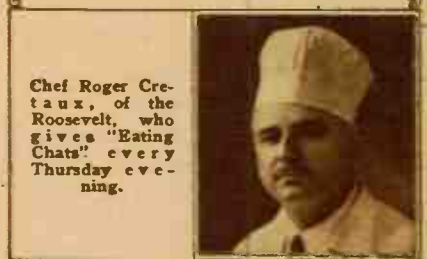

Chef Roger Cre-taux, of the Roosevelt, who gives "Eating Chats" every Thursday evening.

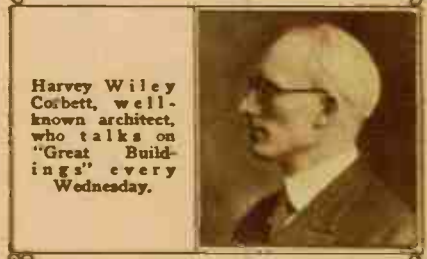

Harvey Wiley Corbett, well-known architect, who talks on "Great Buildings" every Wednesday.

group to aid him which includes Marian Cornwell, Arthur Riehl and Louise Keller. Another excellent grand opera company is that of Leo Braun. He has a splendid cast: Franklin Riter, Waldemar Rieck, Fred Shaer, Siegfried Philip, Palmira Felci Sybil Van Wessel, Frances Golden, Helen Braun and Isabelle Wood.

In light opera, Gordon Hampson and Mme. Andres Parker alternate. The personnel of Gordon Hampson's company includes Charlotte Roze, George Brandt, Rita



Gennaro Maxo Curci, assisted by many other musical artists, entertains every other Wednesday.

Director Taverna, whose operettas will be presented through WRNY every other Friday evening.

Anita Browne is in charge of literature, poetry, fiction and philosophy.

The theatre department is one of the most interesting which we have. *Theatre Magazine* is in charge of the chats which give the gossip of the theatre.

The New York *Telegraph* has charge not only of the theatre news but also of the sports. Their sport flashes, unexcelled in radio, give last-minute news in all branches of sport. The *Telegraph* is presenting "Up and Down Broadway," which has proved extremely popular.

Have you heard anything about the Little Theatre contest and the fact that Mrs. Brock Pemberton, who designed the costumes for "The Green Hat," is doing a series here called "Costumes of the Theatre," and that Resta Crowell is presenting a series called "Theatre Classics"?

THE ARTS

Harvey Wiley Corbett, who designed the Bush Terminal at 42nd Street and the memorial to Washington, discusses architecture.

Alexandre Zeitlin, one of the foremost modern sculptors, discusses the art of sculpture weekly at our station.

Celeonor Dugas, of the painting series, tells of the great painters of the past and present, and Mrs. Rose Berry, who is the head of the Art Department of the Federated Women's Club, appears regularly.

Speaking of Women, WRNY has recently inaugurated a Woman's Hour. Nestor Matson will give exercises for reducing, Dr. Harry Finkel will speak on "Diet," Dr. Siegfried Bloch on "Health," Mrs. Berry on "Arts" and Mrs. Mary F. Roberts, of *Arts and Decorations*, discusses interior decoration and *Pictorial Review*, through its editors, appears regularly once a week.

We are particularly fortunate in being able to announce that some of the editors of *Life*, Charles Dana Gibson, Robert Benchley, Foster Ware, Henry William Hanemann and Robert B. Sherwood, as well as many other illustrators and feature writers, will appear regularly at WRNY. And let us not forget that the greatest food expert in America, Alfred McCann, will give "Food Talks," and that Chef Cretaux discusses the culinary arts each week.

The children are not forgotten, for Gregory Hartswick tells fairy tales, and we have Rita's Kiddy Parties, and Ilonka's Kiddy Dances.

In the educational groups we have Major Dent Atkinson, who takes charge of the geography period.

For finance, we have Mr. M. Ruckuyser, author of "Common Sense of Investment" and editor of the financial column of the *New York American*.

In law, we have Charles A. Vilas, who handled the famous Consolidated Gas suit. We also have speakers from the Constitution League and Women Lawyers Association, and every candidate of political importance is appearing or will appear at this station.

In aviation, we have associated with

WRNY the American Society for the Promotion of Aviation.

The Religious Department is in the hands of Dr. Christian F. Reiser, and the Jewish Circle is directed by Dr. Isaac Landman.

Matthew Woll, Vice-President of the American Federation of Labor, discusses economic problems.

Frederic Hulsmann is in charge of the Physical Culture Department.

Have I left some things out? Perhaps I have, but I will tell you more next month



Anne Russo, whose specialty is old-time songs, is sure to be most interesting every time she appears before the microphone.

Meta Christenson, leader of a quartet which can be heard at WRNY every other Wednesday evening at 9:45 P. M.

MUSIC OF THE MONTH

The Sadrian Trio has been playing old-time music, which has included "Woodland," "Babes in Toyland," "Merry Widow," "Fink Lady," "Floradora," "The Chocolate Soldier," "Mme. Modiste" and "The Fortune Teller." Amongst old operas given have been an outline of "The Mikado," "Pirates of Penzance" and general selections by the Mme. Parker Singers and selections from "The Merry Widow" and others by the DeMacchi Opera Singers, also "Rigoletto," and general programs, and similar numbers in the Taverna group.

Grand opera has brought in the Aschenfelder series, giving selections from "Roméo and Juliette" and "Cavalleria Rusticana."

The Celtic Concert and Theatre Guild gave an interesting program of Irish music and poetry.

Guiseppi Adami, in his violin series, played selections by Monti, Sirori and Boccherini.

Anna Drittell in her first appearance played from Granados, Haydn and Saint-Saens.

The'lma Schiffman gave a general operatic program and sang selections by Amina, Bellini, Del Riego and Fritz Kreisler.

Lorna Lea, in her first appearance, chose Bemberg, Tosti, Dobson, Lohr and Spross.

The Volga Trio has been playing a series of "Around the World" concerts. England and France have been their first choice. They include favorite melodies as well as music of the great composers. For instance, in the English music, they played "Banks of Allen Water," "Cherry Ripe," "Sailors' Horn-Pipe" and "Rule, Britannia." Composers read in the English group were Tate and Sir Edgar Elgar.

One of the interesting novelties was the appearance of Sigmund Spaeth, creator of "The Barber Shop Ballads."

Francine Vyde, our coloratura singer, brought such numbers as "Caro Nome," "La Partida" and "Charment Oiseau." That was her first appearance. Another appearance included Proch's variations and the "Waltz Song" from Gounod. It would be impossible to list all the old-time songs by Anna Russo, as she is selecting from every school.

(Continued on page 882)

Sebastian, Pierre Remington and Eleanor Rogers. Mme. Parker's company consists of Lou Ellen Remmy, Paul Largy, Ann Ermet, Vera Grace Perry, Miss Schwei, Sara Sampson and Chad Parker.

In the interpretation of great song literature, we have some extraordinary combinations—Dr. Sigmund Spaeth's Ampico artists, for instance. These artists have, so far, included John Tasker Howard, Wallace Cox, Frederic Dixon, Stuart Ross and Adam Carroll. Gennaro Mario Curci, best known as the brother-in-law and coach of Amelita Galli-Curci leads, another group. Then we have the Meta Christenson Quartette, directed by Elmer Zoller.

You have probably already heard "The Love Song Girl," Lorna Lea, "The Lullaby Lady," Kathryn Behnke, "The Ballade Minstrel," Joseph Payloff and "The Peasant," Rose Dreeben. But have you heard "Svanhilde," the Swedish singer, or Francine Vyde, our unusual coloratura soprano, or have you, by any chance, yet noticed the work of Louise Vermont, who is presenting "Moods in Song." Many are there who have enjoyed the popular "Old-Time Songs" by Anna Russo, and Englishmen everywhere have listened to James Gordon Beaver.

WRNY'S ORCHESTRA

There is Ben Bernie's Orchestra, Orlando's Roosevelt Concert Orchestra, Jimmy Lent's Stellar Orchestra, and Ferrucci's Orchestra, playing the "Evolution of Jazz."

There is no finer ensemble in America than the New York Quintette, which is composed of Mark Gunzburg, Sascha Fidelman, Bernard Ochs, Samuel Stillman and E. Ligas Shuk. Chamber music is well handled by Rose Becker and the Sadrian, Volga and Bernstein Trios.

In the piano department, we have Bernice Kazanoff and Margaret Hart, who give two-piano recitals, and such soloists as Rita Maginot, Tilly Sper, Iris Brussels, Alex Chigrinsky and Charles Haubiel. J. Van Cleft Cooper carries us "Around the World in Music"; in the violin department, we have Paul Bernard and the Rudolf Larsen Violin Ensemble, and so it goes, through all the instruments.

The Radio Theatre Players, a dramatic stock company whose presentations will interest all, are shown in the photograph below.



New Radio Developments In Germany

By S. McCLATCHIE

Germany is at last coming into its own as a nation of broadcast fans. This article describes her recent radio advances.

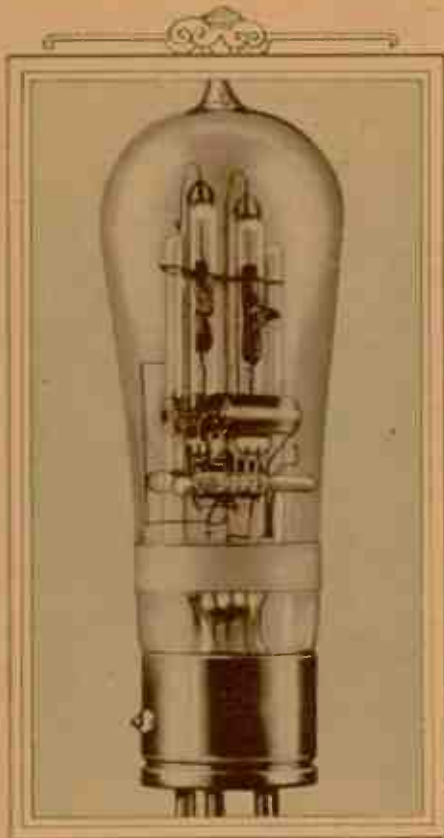

A complete audio amplifier in a vacuum tube! The tube includes the electron elements, the resistances and the condensers.

TWO years ago the first regular broadcast station in Germany was opened and the strict monopoly of the government in all matters concerning telegraphy, telephony and radio was so far relaxed as to permit the private citizen actually to own and operate a receiving set. Under the guidance of Germany's radio Hoover, State Secretary Breslow, a regular broadcast system was gradually built up. The opening up of the wooders of radio to the general public was greeted by a great wave of enthusiasm. This enthusiasm was shared by a considerable number of manufacturers who saw in the new development a means of steadying their fortunes, so badly shaken by Germany's financial difficulties, but who, up to that time, could not have told the difference between a triode and a crystal. The first result of this enthusiasm was, then, a flood of receiving sets, the construction of a great part of which was not exactly calculated to inspire confidence in the future of German radio. However, about a year ago, there began to be very decided signs of improvement. American and English publications made their way into all well-informed radio circles and "low-loss," "straight-line frequency," "Tropatylne," "neutradco," etc., gradually became terms almost as familiar in Germany as in the U. S. A. The last of the obstructive legal restrictions on the building of receiving sets were dropped on September 1, 1925. On all sides intensive development work has been going on during the past fall. A token of the new day in German radio was the great radio exposition held in Berlin last September.

RESISTANCE COUPLING

One of the most interesting pieces of apparatus at the Berlin Radio Exposition was a little mahogany box, the significance of which might have escaped my notice, had not the designer, Dr. Siegmund Loewe, fully explained and demonstrated it to me. Dr. Loewe, by the way, was host to Lee De Forest at the time of the latter's protracted

stay in Germany in 1922. The box contains three tubes of special design, from which the bases have been omitted in order to reduce incidental capacities to a minimum. The look-up, with the values of the various parts, is given in the accompanying diagram. The practiced experimenter will at once recognize the circuit as that of the conventional resistance-coupled amplifier. He will doubtless be astonished, however, at the values given the resistances and the coupling condensers. But herein lies the secret of the performance, and the performance is remarkable enough, for this little set is at the same time a radio and an audio frequency amplifier. In order to get a good signal amplification, it is necessary to reduce incidental capacities to an absolute minimum, and to use a resistance of about 3 megohms in the plate circuit. The very high resistance in the plate circuit brings with it the welcome feature of reducing the drain on the "B" battery to .01 milliamperes, in contrast to the 2 or 3 milliamperes ordinarily consumed. As so little plate current is required, the filament omission and, consequently, the "A" battery current also can be greatly reduced. However, as the last tube is called upon to operate a loud speaker, it is allowed a plate current of 5 milliamperes. This will care for a tremendous volume. As an audio amplifier, the amplification per stage is 30 times. This is as much as is delivered by the best transformer-coupled stages, and is probably more than has ever before been attained with resistance coupling. This is certainly a great triumph for the idea of "voltage amplification." It is to be remembered, moreover, that the amplification is distortionless, which is very far from the case with three transformer stages. For radio frequency, the amplification at 500 meters is said to be about equal to tuned coupling; at 300 meters the amplification is still considerable, and at 200 it is 1:1. However, Dr. Loewe has in his laboratory a device using resistance coupling which gives a high degree of amplification even at 200

meters. The remarkableness of this achievement will be felt by all experimenters who are used to hearing that amplification with resistance coupling ceases below 1,000 meters. Although this new device is still in an experimental stage, it may serve to give a glimpse into future possibilities. Thus, a complete 2-tube amplifier has been built into a single tube scarcely larger than a UV-201A. The arrangement of parts in the bulb may be seen in the accompanying illustration. As in the 3-tube amplifier previously described, special resistances enclosed in tiny vacuum tubes are employed. As the whole amplifying circuit, condenser and all, is included in a single large tube under vacuum, incidental capacities are reduced to an almost unheard-of extent. The amplification attained in this single bulb is equal to that delivered by three normal tubes. Imagine the high-power amplifier of the future reduced to the dimensions of a single tube, and requiring only connection to a small battery to be set in operation!

CALIBRATED RECEIVERS

A very interesting general tendency is toward calibrating receiving sets, large and small, in terms of wave-lengths, instead of putting meaningless numbers on the dials. Already, at the beginning of the year, the firm "Radiofrequenz" brought out a calibrated receiver. It exhibited a 4-tube set calibrated for all wave-lengths from 100 to 4,500. Interchangeable coils are arranged at the ends of the set. An accuracy of 1 per cent. is guaranteed for the readings. A most interesting little set was shown by the Deutsche Telefonwerke. It is hard to imagine a single-circuit regenerator with any sort of calibration whatever, but here is a set of this type, with the dial reading in wave-lengths from 250 to 3,000 meters. Provision is made for adjusting the aerial constants to a certain fixed value. The readings are said to be very accurate when this adjustment has once been made. The whole wave range is covered in four steps. The



The famous German station which employs a mountain for its antenna mast. This station is one of the most powerful broadcasters of the world.

shift from step to step is accomplished by simply turning a switch. The firm "Radio-Amato" showed a receiver in which the name of the station to which the set is tuned is illuminated on a frosted glass window. The window is divided into squares, each square containing the call of a station. As the condenser dial is turned, the names of all the main European stations light up in succession. Naturally, a miniature lamp is required for each name.

LONG WAVE-LENGTHS

Almost all of the receivers shown had some provision for taking in the longer wave-lengths. There are a large number of stations in Europe operating on waves between 1,000 and 3,000 meters. There is a tendency to put the super-power stations up in this region. This minimizes interference, and makes possible long-distance reception in the daytime. The noontime concerts from Paris are received in Germany with almost the same strength as the night programs, due to the fact that they are sent out on a wave-length of 1,780 meters. England has a station of about 30 kw. power working on 1,600 meters. Germany will have a 20-kw. station on 1,300 meters this winter. It is such European stations as these which will be heard best in the United States this winter, so here is a tip for American DX set builders. Right at home, the General Electric Company at Schenectady is making

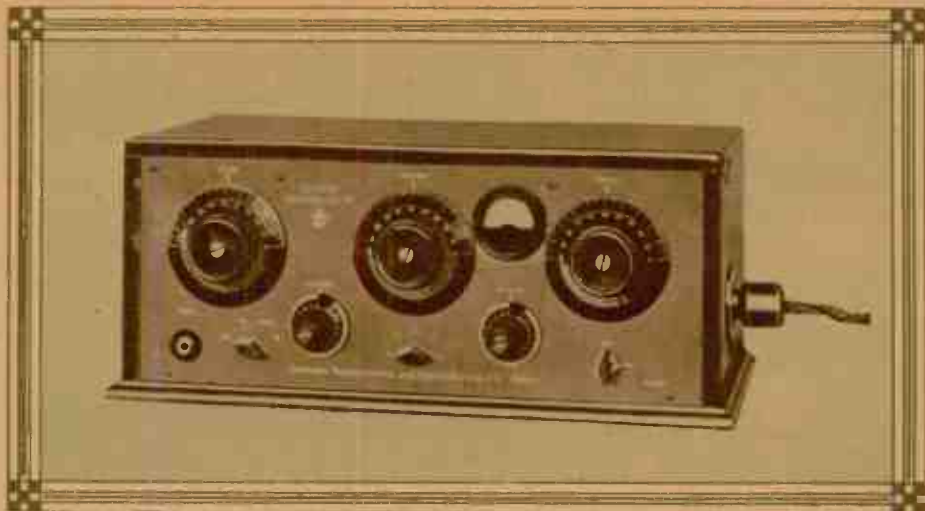

Here we have a standard model radio frequency set such as is popular in this country.

the Telefunken Co., and named in honor of that concern's chief engineer, the famous Count von Arco.

One of the interesting loud speakers shown was a development by the Engineer von Mihaly, of television fame. It is made like a snubowl heater, only, in place of the heating element, there is a reproducer, with its

extremely powerful vibrations may be thus set up in the band. A plate current of about 150 milliamperes is required, at 1500 volts. Current for the enormous field magnet is supplied by a motor generator. The cost of such an installation complete is only about \$5000 so if you want real volume and don't mind the small (?) outlay involved, the outfit is recommended. In spite of the enormous volume of sound delivered, a high quality of reproduction has been attained with this new device.

HIGH-FREQUENCY GENERATOR BROADCASTING

It would be unfair to leave the subject of this article without a description of a most notable German achievement in the line of broadcast transmitting. The vacuum tube as a producer of the high frequency currents required for broadcasting has become so established that one would scarcely imagine anyone's challenging its supremacy. Yet a German engineer, Dr. Karl Schmidt, connected with the Lorenz Company in Berlin, has had the hardihood to do this very thing. He has developed a system for producing oscillations with a rotary high frequency generator, which is capable of entirely supplanting the vacuum tube on all wave-lengths down to 100 meters. The rotor of the generator is made of solid iron, with teeth cut in the periphery, like a gear wheel. The magnetizing winding is stationary, and surrounds the rotor. Current is taken from coils wound about teeth in the stator corresponding exactly with the rotor teeth. A very ingenious speed regulator is provided, which is capable of holding the frequency constant within exceptionally narrow limits. The generator itself produces a frequency of 8000.

(Continued on page 933)

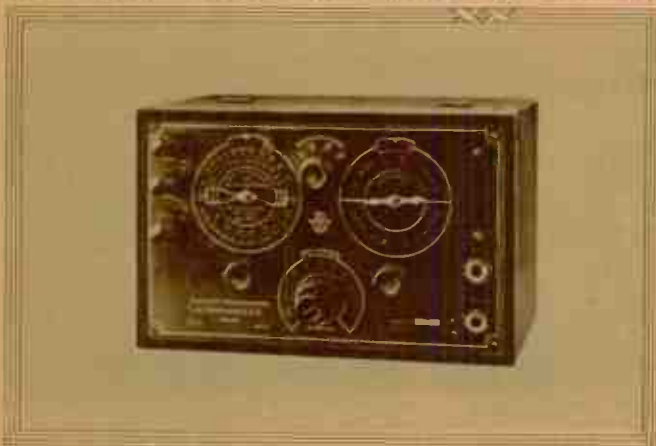

An idea which has never been exploited in the United States is incorporated in the set at the left. It is calibrated in wave-lengths at the factory.

tests of high power broadcasting in the 1,500-meter region, and I understand that other similar plans are on foot. So it is well not to be entirely taken up with the idea that everybody is rushing to the short waves.

"INSTALLMENT PLAN" RECEIVERS

German manufacturers have a tendency to build sets in units, which can be bought one at a time and put together as the pocket-book and inclination dictate. An example of this is the "Arcon" series of units, put out by

diaphragm in the parabolic center. The arrangement is said to give quite exceptional reproduction, owing to the parabolic reflection of the sound waves. Easily the most spectacular feature of the Exhibition was the series of loud speakers set up in and outside the hall by the firm of Siemens-Halske. Two types were used. The most interesting of these employs a very novel principle of operation for loud speakers, namely the electro-dynamic principle. The speech-carrying current traverses a thin aluminum band situated in a strong electromagnetic field. Ex-

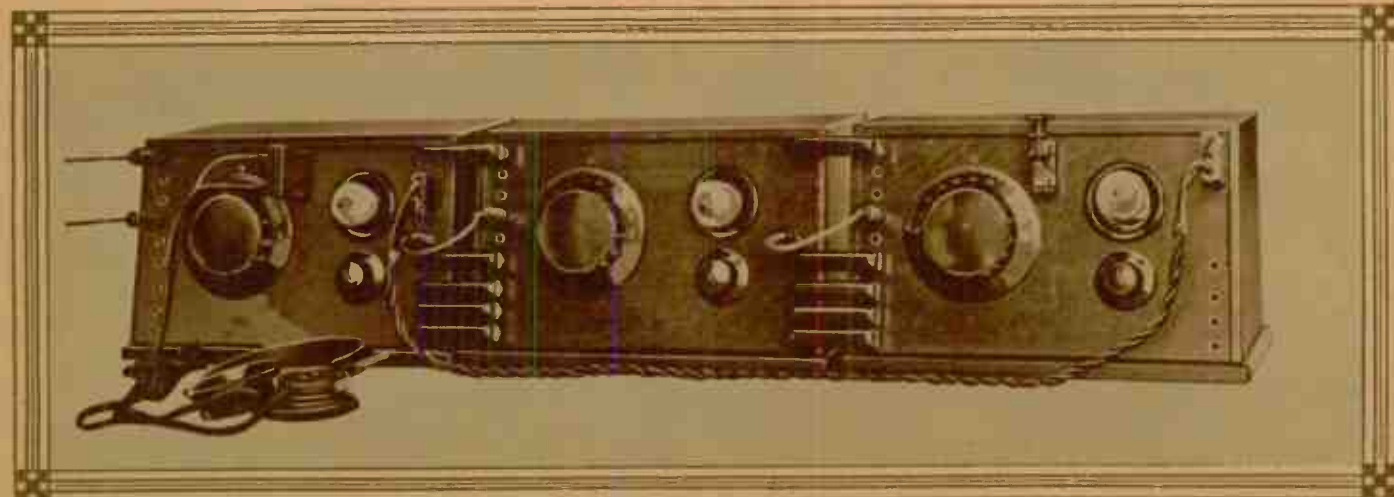

German manufacturers are building sets in units which may be purchased individually. Above is a tuned radio frequency set which is typical.

*Described in full in Radio News for September, 1924.



DEAF AND DUMB SOON TO HAVE RADIO TALKS. According to C. Francis Jenkins, deaf and dumb people will be able to enjoy their radio receivers as well as their more fortunate brethren. The photograph on the left shows how talks can be broadcast by means of the apparatus invented by Mr. Jenkins. © Underwood & Underwood.



CRYSTAL SET OPERATES LOUD SPEAKER. In the Radio Laboratory of the Bureau of Standards in Washington, Morris S. Strick has succeeded in obtaining signals from a loud speaker using a crystal detector alone. He states that a big antenna and a good crystal are necessary. © Harris & Ewing.



RECORDS BROADCAST MUSIC ON MAGNETIZED WIRE. In this four-tube reflex receiver is a magnetized wire on which is recorded broadcast music, which can be reproduced at any time. The recording mechanism can be seen in the bottom of the cabinet. © Kadel & Herbert.



MUSIC BROADCAST FROM AIRPLANE. Maxine Brown sang several songs while the airplane was flying in the vicinity of New York City. These were transmitted from the plane through a government outfit and picked up and retransmitted by station WGBS on their regular wave-length. On the right is shown the equipment being loaded on the plane. © Kadel & Herbert.



Justice Is Deaf

By ROBERT FRANCIS SMITH

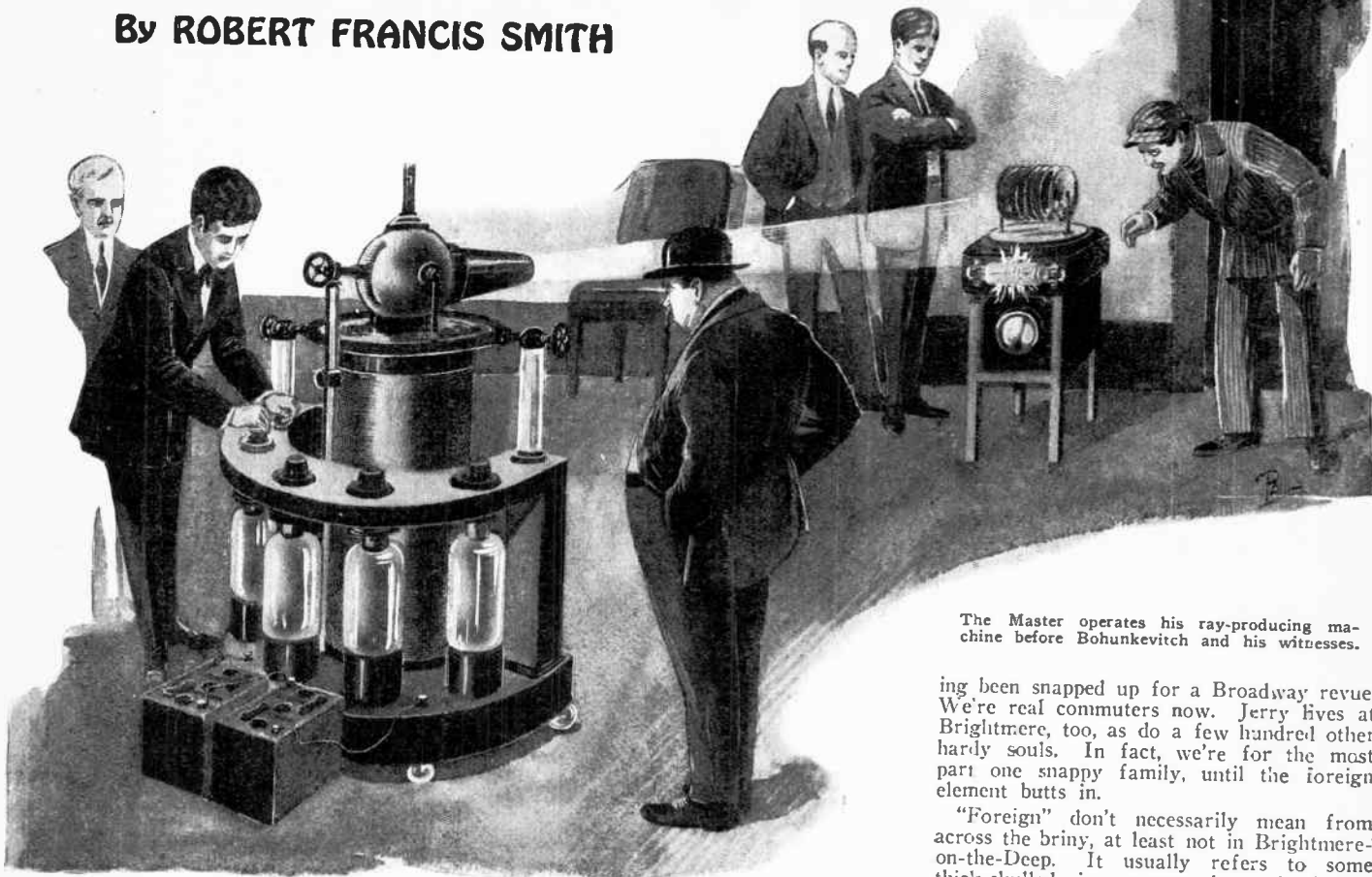

The Master operates his ray-producing machine before Bohunkevitch and his witnesses.

A COUPLA aeons ago some hare-lipped bozo of the carrier-pigeon age opined that it took all kinds of people to make a world. If you listens in onto some of these five-watt backyard amusement palaces that're tuned anywhere within three hundred meters of where they shouldn't be, you'll know where all these kinds of people are.

Oftimes I sorta wonders, in my vague, senseless way, just where all the tyros that infests the air comes from. Of course, we've got talent in the air, but it's shadowed out by the bass voice of a contralto singer in Podunk, Iowa, trying to race a lecture on Grade Crossings and Fast Trains being hullabalooed from some outcast in Where-ami, Kansas.

Maybe radio's freedom from indulgent eggs and cowardly tomatoes prompts some would-be celebrities from disgracing the footlights; only for the fact that we've got just as many uncred hams on the boards today as we ever had loses the motion. But here, I'm way offa my subject. The aforementioned "all kinds of people" ain't confining themselves to the business end of making the ether vibrate; there's some choice specimens of the genus cuckoo inhabiting the region beneath the spreading cans, and I ain't suggesting possibly.

We have with us, more or less, rich radio fiends and poor radio fiends, nice ones and naughty ones, amicable ones and ornery ones, ones with brains and others with vacuums, but there's one pest in the Blue-book of DX Tuners that combines all the vices of the game with such skill that a boarding house cook'd declare his hash grew instead of accumulating.

Doc Maxwell alludes to this form of os-

sified angleworm as a constitutional liberty hound; Jerry Lawson says he's a plain radical. Me, I've always paired him off with the guy that broke his wife's leg with a club and then spanked her because she couldn't do housework. In the field of radio this individual is without question the toughest proposition to deal with since the New Jersey mosquitoes organized under the slogan "Bigger And Better Bites."

Jerry Lawson's the fly in this particular salve. You see Jerry—we privately refers to him as The Master, which he is, being a bachelor—is rich. That's point number one. Next, he's a scientific wizard, specializing in radio in all its probabilities and impossibilities. Point number three combines the first two, which same being about as clear as beauty clay in a London fog, I'll detail a bit.

The Master's laboratory sports about every known form of doodad for altering the shape, form, desires and abilities of that well-known substance which ran down Ben Franklin's kite and didn't kill him. And for the most part all these devices is in use at one time or another.

Now, when you starts to use an adult spark coil, no matter how hard you tries to tune it, there's going to be interference in the atmosphere. A step-up or down transformer ain't to be sneezed at. X-ray machines, in fact nearly any electrical device, especially those of high frequency habits, dispenses that much-profaned quantity now universally termed static.

Me—oh, yes, Joe Hammerstein, of the theatre—and my official can-opener has a summer home down here at Brightmere-on-the-Deep, which same is serving this season as a winter residence by virtue of our hav-

ing been snapped up for a Broadway revue. We're real commuters now. Jerry lives at Brightmere, too, as do a few hundred other hardy souls. In fact, we're for the most part one snappy family, until the foreign element butts in.

"Foreign" don't necessarily mean from across the briny, at least not in Brightmere-on-the-Deep. It usually refers to some thick-skulled piano mover who settles in our little seaside village and dosen't get chummy with the gang, which same revolves eccentrically about The Master.

Jerry ain't conceited. He ain't got the time, nor the sense of humor. But he's the supreme authority on radio, and anybody that don't immediately bow down to the king is sorta mentally ostracized, if the expression means anything.

Practically every home in Brightmere-on-the-Deep has a radio outfit, and they're all either made, supervised or selected by Jerry. Consequently they're all grade A, and The Master's little moments with his Tesla coils don't seriously hurt the programs. But when the new family moves in, peace moves out.

Although close to the Great White Way, our little Main Street is much like any other gopher prairie. We've only one point at variance with the accepted tradition—namely, we're not at all narrow-minded. Only for that, and the fable of Anthracite Albert and the Wild Waves wouldn't have been even an incident.

It's early fall, and me and Doris are having our regular breakfast altercation about where I was last night.

"This thing's gotta end," declares Doris. "Hereafter you come home when I do."

"How can I?" I snaps. "You know it ain't natural to load a dozen neighbors into one sedan. If you'd only let other people travel by themselves instead of being so charitable with our Standard Oil, may be I could get a chance to ride in my own car. I'm sick of glomming the rattlers."

Doris is forced to admit the truth, which hurts, but does her good. "Well, what could I do?" she replies, peeved. "You know perfectly well that the Bohun-

(Continued on page 832)

Cold-Cathode Gas-Filled Discharge Tubes

By C. B. BAZZONI*



A knowledge of the fundamentals of vacuum tube phenomena is necessary for rounding off the students' study of practical radio.



DURING recent months a number of articles have been published in RADIO NEWS dealing with gas-filled, cold-cathode vacuum tubes as applied to radio work. These tubes, which differ from the ordinary thermionic valves in a radical way since they contain no glowing filament, have been applied mainly as rectifiers and, particularly, as rectifiers in "B" battery eliminators. The Schickerling tube described in RADIO NEWS for September on page 293—and the Raytheon tube described in our November issue, page 613—are excellent examples of such devices. Tubes of this character offer such advantages in long life and ease of adjustment that they are certain to come into wider use in the near future,



Fig. 2 shows the arrangement of electrodes in an asymmetrical discharge tube.

wherefore it becomes desirable for the radio fan to give attention to the principles underlying their operation.

GEISSLER TUBES

In the development of vacuum tubes the gas-filled, cold-cathode type preceded the high-vacuum, hot-cathode type by many years. Some of the very earliest electrical observations made, back in the first half of the last century, had to do with the luminous discharges so easily produced in partially evacuated glass tubes when connected to an induction coil or glass plate influence machine. Special tubes were constructed somewhat later to exhibit the brilliant and characteristic colors thus developed in different gases and in containers of different kinds of glass. These tubes, some of which were of very complicated shapes, were called *Geissler tubes* after the German physicist, Geissler, who made some of them at an early date. It is probable that every person at all interested in science has seen Geissler tubes in operation and has admired the weird effects produced by them in a darkened room. All of these tubes contain two electrodes, generally made of pieces of aluminum wire with no provision for heating. Geissler tubes consequently belong in the cold-cathode group.

In order to make a scientific study of luminous discharges through gases it is naturally best to select a containing tube of the simplest possible shape. Consider a straight cylindrical tube $1\frac{1}{2}$ inches in diameter and 12 inches long, such as is pictured in Fig. 1. Let this tube be provided with flat disc electrodes of aluminum placed at either end and let it be connected through a side tube with a suitable air pump for adjusting the gas pressure. Suppose the pump has been operated until the gas pressure in the tube has been reduced to one thousandth of the normal atmospheric pressure of about 15 pounds to the square inch. If now we attach the two electrodes to the terminals of 500-volt storage battery a brilliant glow will instantly spring up inside the tube. This glow at first sight appears to fill the entire tube rather uniformly but closer examination shows it, as a matter of fact, to be built up of a number of distinct regions.

THE FIVE REGIONS OF THE DISCHARGE

Lying directly on the face of the cathode is a velvety purple film called the *cathode glow* (A Fig. 1). In front of this glow is a dark region with a sharply defined edge (B). This region, which is completely dark and generally narrow—a few millimeters across perhaps—is called the *Crookes dark space*, since it was first located and described by Sir William Crookes. Stretching away from the Crookes dark space and gradually fading out in an indefinite termination is a luminous column called the *negative glow* (C). Beyond the negative glow is a second dark region considerably more extended than the Crookes dark space and called the *Faraday dark space* (D) from its discoverer. The length of the tube occupied by the cathode glow, the Crookes dark space and the negative glow depends on the kind of gas in the tube and on its pressure, and is independent of the over-all length of the tube. Beyond the Faraday dark space, stretching out through the entire remaining length of the tube up to and touching the anode, is the highly luminous *positive column* (E). This positive column is usually, at the pressure mentioned, striated or layered in structure consisting of luminous blocks separated by dark sections. Since the positive column fills the greater part of the tube it forms the most striking part of the whole discharge. The luminous effects from Geissler tubes and the light radiated from

a mercury vapor arc lamp arise entirely in the positive column. The different parts of the discharge as just described are shown in the sketch in Fig. 1.

EFFECT OF PRESSURE OF GAS

The appearance of the tube will be exactly as described only when the pressure is roughly one thousandth of an atmosphere—something less, let us say, than the pressure exerted by one millimeter of mercury. When the pressure is much higher than this the Crookes dark space disappears and the discharge seems to consist of two parts only—the negative glow stretching out from the cathode and the positive column stretching out from the anode. At high pressures—half an atmosphere or so—these glows are confined to the immediate neighborhood of the electrodes. At lower pressures they stretch out toward each other and finally split up to display the features described above when the pressure is sufficiently reduced. If the pressure is reduced well below one thousandth of an atmosphere the negative glow and the Crookes dark space spread out while the positive column con-

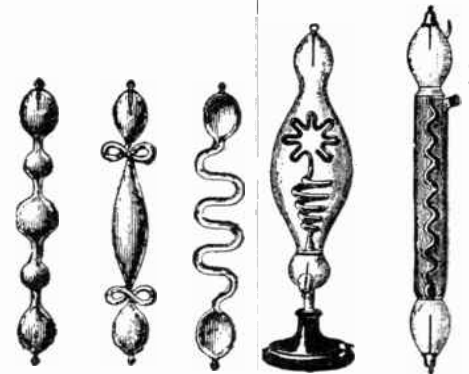

Some interesting styles of geissler tubes.

tracts. This continues with further reduction of pressure until the Crookes dark space has expanded to fill the entire tube and all luminosity disappears from the gas. Under this condition the glass walls of the tube glow brightly or "fluoresce" with a greenish or bluish light. This is the condition in an X-ray bulb.

The spreading out of the Crookes dark space as the pressure is reduced is a very regular and definite effect. The width of this space can, in fact, be used as a measure of the vacuum and some gauges are sold which work on this principle. It is necessary only to hold a scale up against the dark space in order to tell what the pressure is at the instant. The relative lengths of the parts of the discharge and the nature of the colors developed depend on the kind of gas in the tube and on the length and shape of the tube. However, in all cases a careful study of the discharge will disclose a structure substantially like that described in detail above if the pressure is around one thousandth of an atmosphere.

ATOMS, IONS AND IONIZATION

Now that we have before us the characteristic parts of the discharge arranged in the order of their production from the cathode to the anode we are faced with the problem of explaining how and why these parts are produced. It is in the first place evident, from the mere fact that the tube glows,

(Continued on page 930)

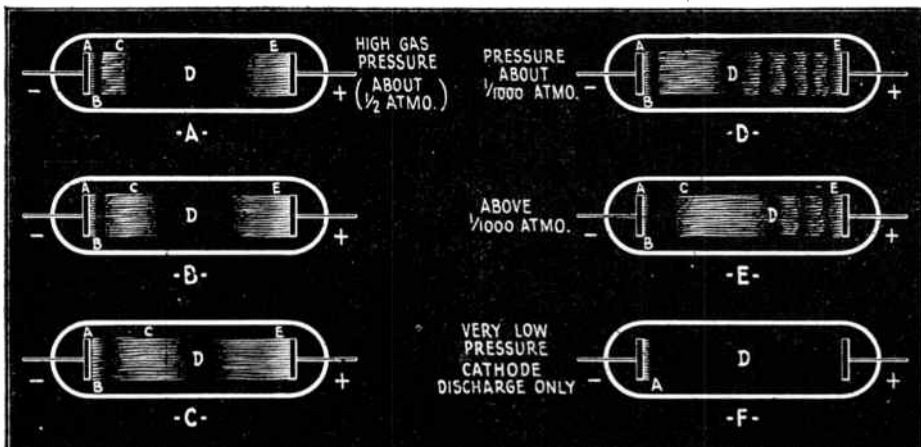

Fig. 1. How the dark spaces and striations in the vacuum tube vary with the gas pressure. Letters inside the tube are explained in the text; Letters outside the tube refer to pressure.

* Professor of Experimental Physics, University of Pennsylvania.

A Dozen Sets on One Antenna

By S. R. WINTERS

Here is given for the first time a technical description of the device, designed for the U. S. Navy by Dr. A. Hoyt Taylor, which allows several receivers to operate on the same antenna.



THE owner of an apartment house may forbid the erection of more than one antenna on the roof, or natural facilities may limit the number of antennae on a certain building! The captain of a ship desires to operate several radio receiving sets at the same time, but facilities for rigging a number of antennae do not permit of this! A radio amateur or broadcast listener is anxious to operate a group of radio receivers on one antenna but finds that the ordinary limit is one collector of energy for each receiving unit!

These hypotheses, until recently, were without basic foundation and such suppositions would have been imaginary, pure and simple. Now, however, by virtue of an invention by Dr. A. Hoyt Taylor, Superintendent of Radio at the Naval Research Laboratory, Bellevue, District of Columbia, the limiting factor which requires one antenna for each radio receiving unit has been removed. In the future, amateurs and radio fans will not be circumscribed in their use of a single radio receiver to each collector of energy, but they may couple, two, four, six, eight, or possibly more receiving units to one antenna. And, what seems remarkable, it is possible to receive radio signals on all of the receiving outfits simultaneously, provided reception is arranged on different frequencies or wave-lengths.

THE "COUPLED TUBE RECEIVER"

This invention, described as the "coupled tube receiver," has advanced beyond a mere plausible theory and a laboratory experiment and has been adapted to practical application on ships of the United States Navy. The truth is the limited facilities for installing several antennae on one vessel with the attendant necessity of operating a group of receivers at the same time first spurred the inventive ingenuity of the Navy Department to devise means of coping with this limiting factor. It was a case of the adage about necessity being the mother of invention reasserting itself. Practical experiments have demonstrated the feasibility of operating five radio receiving sets at the same time on a ship, using only a single antenna. For the sake of illustration, let us designate the arbitrary reception wave-lengths as being 200, 550, 600, 1,000 and 2,000 meters.

Battleships of the future may be equipped with eight radio receiving units, two transmitters and two antennae—one antenna for

transmitting and the other for receiving signals. While one radio operator is sending code to some shore station or to another battleship, in the same room or adjoining room a group of radio operators may be receiving signals from eight different sources at the same time. Or, in case of automatic receivers, one operator may supervise the reception of the entire eight receiving units. Thus, the modern battleship offers a striking contrast to radio-equipped ships of the past when, using spark equipment, it was difficult to send and receive signals at the same time because of the noise emanating

resistance. The plate circuit of this vacuum tube contains the tunable high frequency circuit having inductance L_1 and variable capacity C_1 in parallel relation. I find it preferable to make the ratio of inductance to capacity in this circuit large. There is also included in this circuit a device J , which I term a rejector. It comprises a very low inductance element having very low resistance, usually being one or more turns of very heavy copper strip or wire and a large capacity condenser constructed to have small resistance, the condenser being made variable in order to permit of tuning

Dr. A. Hoyt Taylor's new multiple set device hook-up—through its use any number of receivers may operate from the same antenna.

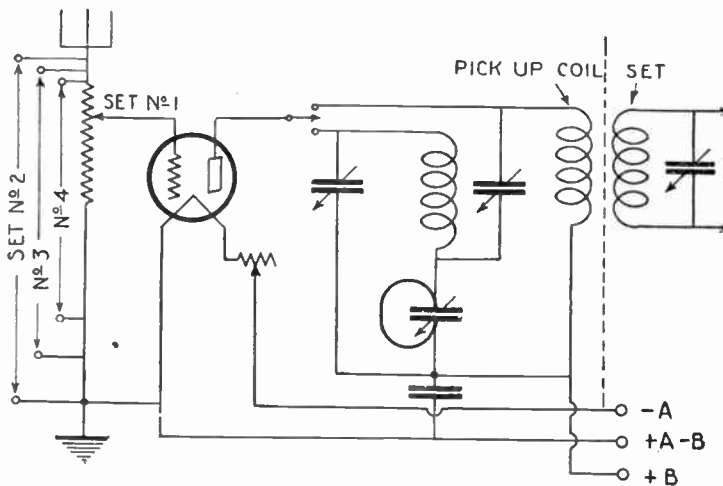

from the transmitting source. Now, not only are vacuum-tube transmitters used, but the sending and receiving rooms are so arranged as to minimize interference.

EXPLANATION OF THE DIAGRAM

But to return to a description of the "coupled tube receiver," which will radically change, if not revolutionize, radio reception on ships. Dr. Taylor describes this "receiver of high frequency electrical signals" by means of a lettered, schematic diagram.

"My invention will be best understood," he states, "by reference to the accompanying drawing, the figure illustrating its use for the reception of radio signals:

"In the figure A is an antenna having a high resistance in series therewith. The thermionic vacuum tube V has its grid circuit connected between two points in this

the rejector element to the desired wave-length. Shunted around the rejector is a tunable circuit containing inductance L_2 and variable capacity C_2 in series. A receiver is associated with this last-named circuit usually through a tunable circuit containing inductance L_3 and variable condenser C_3 with a detecting device or to an amplifier and detector as desired. B_1 is a source of current for heating the filament of vacuum tube V and B_2 is a source of current for the plate circuit of this vacuum tube. These same sources may be used in connection with the amplifier and detector if vacuum tubes are used in connection therewith. The capacity C_1 is preferably large and is introduced mainly for the purpose of preventing a short-circuit of battery B_2 . The antenna may be tuned, but this is not essential, as the high resistance R in series therewith renders it aperiodic.

"Any number of receivers may be connected with the antenna through similar vacuum tubes and circuits as described above through additional leads connected between points in the resistance R, as illustrated.

"I term the vacuum tube V a coupling tube because it couples the collector to the selective circuits and receiver, as illustrated, and at the same time prevents a reaction caused by variations in these circuits on other circuits connected to the collector.

HOW THE SYSTEM WORKS

"The operation of the system is as follows:

"Assuming that a number of signals of different frequencies are being collected on the antenna A, the desired signal is selected by tuning the inductance L_1 and C_1 to this frequency, which admits this particular signal to the circuit containing these elements. However, as other signals cannot

(Continued on page 920)



The panel at the top and to the left is the main "works" of the Taylor device. It complicates tuning somewhat but works efficiently.

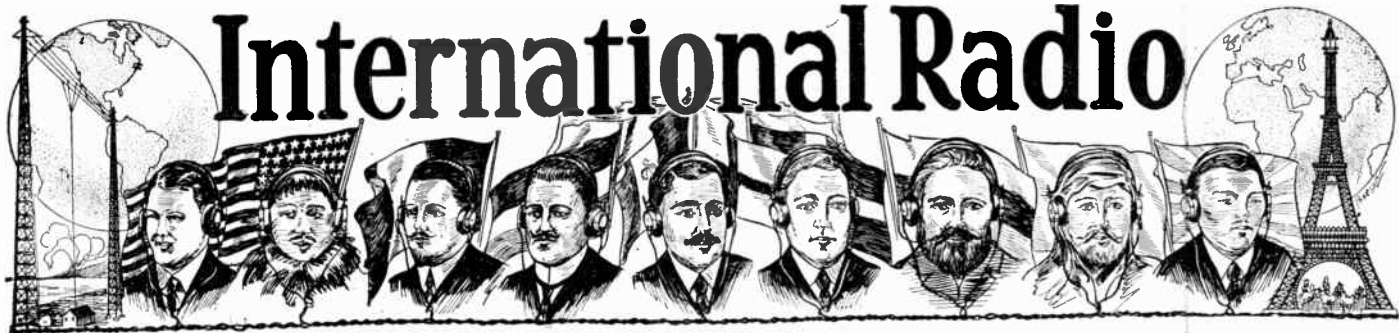

GREAT BRITAIN

The King's Microphone

One of the most interesting exhibits at the radio show in Albert Hall in London was His Majesty's own microphone. Reserved exclusively for the king's use, it is enclosed in a rich filigree silver case, which bears inscriptions showing the exact dates on which the king has spoken through it. In design the microphone is exactly similar to those used in broadcast stations.

The Thousandth Night

Recently the British Broadcasting Co. celebrated its thousandth night of broadcasting and there were mentioned some interesting facts and figures showing the growth of radio in England. There are now twenty-one stations, instead of the original one, and many other amazing developments have been crowded into those thousand days. Not the least spectacular achievement has been that of the listeners, who have joined at the rate of about 1,400 per day.

Dead Men to Tell Tales

The British Broadcasting Co. is engaged in negotiations with the authorities of the British Museum in connection with a projected stunt to be broadcast entitled "Voices from the Illustrious Dead." This will consist of the transmission of



By means of this English series-parallel switch the antenna condenser can be changed from series to parallel and an overlap in wave-length gained without altering the antenna coil. The terminals at the foot are connected to the antenna, condenser, antenna end of the tuning condenser, when the switch is on point 2. In the safety position both the antenna and the ground are shorted; the last position places the condenser in parallel with the inductance and shorts the fixed condenser.

several phonograph records of speeches made by famous men and women whose names are legend to the British public, these records being in the possession of the Museum. Providing certain technical difficulties in connection with the condition of the records can be overcome, they will be broadcast sometime in the near future.—*W. A. Agnew.*

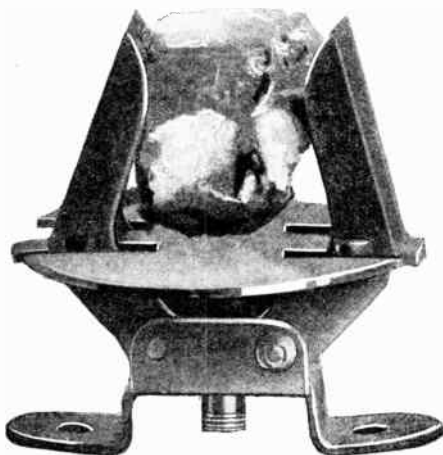

This crystal holder fits in the end of the detector shown at the right.



FRANCE

To Broadcast Government Propaganda

The French Government has made preparations for springing a surprise on the Paris public in connection with the loan propaganda. A powerful receiving

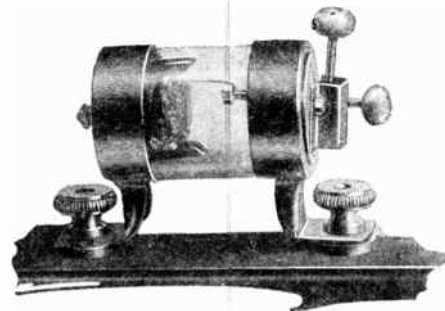

A French inventor has developed a novel idea in a crystal mounting, which he claims will be of great use in improving the crystal set efficiency. Rather than place the detecting crystal in a hollow stand, he sets it in a pair of horizontal grips, which hold it in a glass tube. Thus the crystal can be easily removed and cleaned, or can be set in various positions, getting the most complete use of all sensitive surfaces. Not only is the cat-whisker adjustable, but also the pincer grip is set in a rotating disc, so that all sorts of contact combinations can be made. The crystal, being set in a glass tube, is protected from dust and dirt to a greater degree, and maintains its detecting efficiency longer.—*N. C. McLeod.*

set is being installed with all secrecy on the Opera House in Paris, and ten loud speakers disposed in a fan shape, are to give simultaneous rendering of speeches by Prime Minister Painleve, Finance Minister Caillaux and others, recommending all good and thrifty citizens to invest in the new gold coupon loan. If as is expected, the experiment proves to be a success, it may become a permanent form of government announcements to the people of Paris.

To Our Readers

THE publishers of RADIO NEWS have decided to put the contents of this magazine to a popular vote by its readers. This magazine is published and edited solely for our readers; and we are more than anxious to give them exactly what they desire. For that reason, we thought it best to put the matter to a popular vote, and let the majority decide. You will readily understand that it makes no difference to the editors and publishers what matter is printed as we can have no preferences in the matter. The readers must be satisfied first!

We hope every reader will see it as his duty to fill in the adjoining voting blank, and send it to the editor. One and one-half cents is the total cost, as the blank can be cut out and pasted on the back of a postal card. In case you do not wish to mutilate the magazine, just copy the blank on a postal card and mail.

The editors pledge themselves to abide by the result, which will be published as soon as a sufficient number of votes are in.—EDITOR.

Voting Blank

My vote as to the contents of RADIO NEWS appears in this ballot. I have placed a cross in the blank spaces showing either my preference or dislike of the various subjects enumerated.

NAME

ADDRESS

More <input type="checkbox"/>	Less <input type="checkbox"/>	Biographical Series like Fessenden and DeForest.
More <input type="checkbox"/>	Less <input type="checkbox"/>	General (Non Technical) Articles.
More <input type="checkbox"/>	Less <input type="checkbox"/>	Theoretical Articles.
More <input type="checkbox"/>	Less <input type="checkbox"/>	Constructional Articles describing sets.
More <input type="checkbox"/>	Less <input type="checkbox"/>	Rotogravure Section.
More <input type="checkbox"/>	Less <input type="checkbox"/>	The Radio Beginner.
More <input type="checkbox"/>	Less <input type="checkbox"/>	Standard Hook-Ups.
More <input type="checkbox"/>	Less <input type="checkbox"/>	Radiotics.
More <input type="checkbox"/>	Less <input type="checkbox"/>	Radio Wrinkles.
More <input type="checkbox"/>	Less <input type="checkbox"/>	International Radio.
More <input type="checkbox"/>	Less <input type="checkbox"/>	I Want To Know Department.
More <input type="checkbox"/>	Less <input type="checkbox"/>	Radio Patents.
More <input type="checkbox"/>	Less <input type="checkbox"/>	Amateur Section.
More <input type="checkbox"/>	Less <input type="checkbox"/>	Correspondence from Readers.
More <input type="checkbox"/>	Less <input type="checkbox"/>	Stories.
More <input type="checkbox"/>	Less <input type="checkbox"/>	Editorials.

I would like to see additional departments as follows:

.....

.....

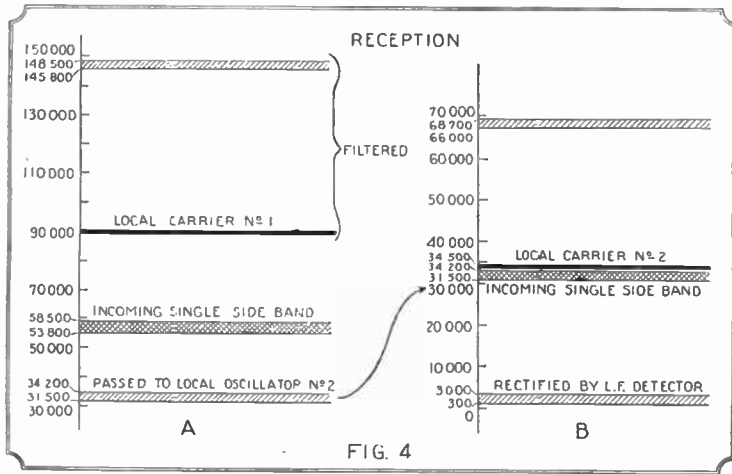

The double shaded side bands are those that are incoming and which set up two other side bands (the lighter shaded portions), as a result of the modulation of the local carrier wave.

it is detected. This stepping-down action is accomplished by combining in the first detector the incoming band of 55,800 to 58,500 cycles with a locally generated current of about 90,000 cycles. In the output circuit of the detector the difference frequency band of 34,200 to 31,500 cycles is selected by a band filter and passed through amplifiers and then to the second detector. This detector is supplied with a carrier of 34,500 cycles which, upon beating with the selected band, gives in the output of the detector the original voice frequency band.

The object of thus stepping down the received frequency is to secure the combination of a high degree of selectivity with flexibility in tuning. The high selectivity is obtained by the use of a band filter. It is further improved by applying the filter after the frequency is stepped down, rather than before. To illustrate this improvement, assume that there is present an interfering signal at 60,000 cycles, 1,500 cycles off from the edge of the received telephone band. This is a frequency difference of about 2½ per cent.; but after each of these frequencies is subtracted from 90,000 cycles, the difference of 1,500 cycles becomes almost five

tenna, this being carried out in three stages. The first stage increases the power to about 750 watts. This amplifier employs in its last stage three vacuum tubes rated at 250 watts each and operating at 1,500 volts.

The output of the 750-watt amplifier is applied to the input of the larger power amplifier system, beginning with the 15 kw. amplifier shown in Fig. 1. This consists of two water-cooled tubes in parallel, operating at approximately 10,000 volts. The input of this amplifier is applied by means of a transformer to the input of the 150-kw. amplifier, which consists of two units of 10 water-cooled tubes each, all operating in parallel at about 10,000 volts.

The high voltage D.C. supply is furnished by a large vacuum tube rectifier unit rated at 200 kw. It employs water-cooled tubes similar to those used in the power amplifiers, except that they have but two electrodes. The rectifier operates from a 60-cycle, three-phase supply and utilizes both sides of the wave. The two sets of rectified waves are combined by means of an interphase reactor, which serves to smooth out the resultant current and, by distributing the load between tubes of adjacent phases, to increase the effective load capacity of the rectifier. The ripple is further reduced by the filtering retardation coil and the condensers, shown in the diagram.

THE RECEIVING SYSTEM

In the method of transmission ordinarily employed in radio telephony by which the carrier and both side bands are sent from the transmitting station and received at the distant end, detection is readily accomplished merely by permitting all of these components to pass through the detector tube. The detecting action, whereby the voice frequency currents are derived, is accomplished by a remodulator of the carrier with each side band.

With the present eliminated carrier method of transmission the side band is unaccompanied by any carrier with which to remodulate in the receiving detector. It is, therefore, necessary to supply the detector with

current of the carrier frequency obtained from a local source. Thus, if a current of the original carrier frequency, 55,500 cycles, is supplied to the detector, it will remodulate, or "beat," with the received side band of

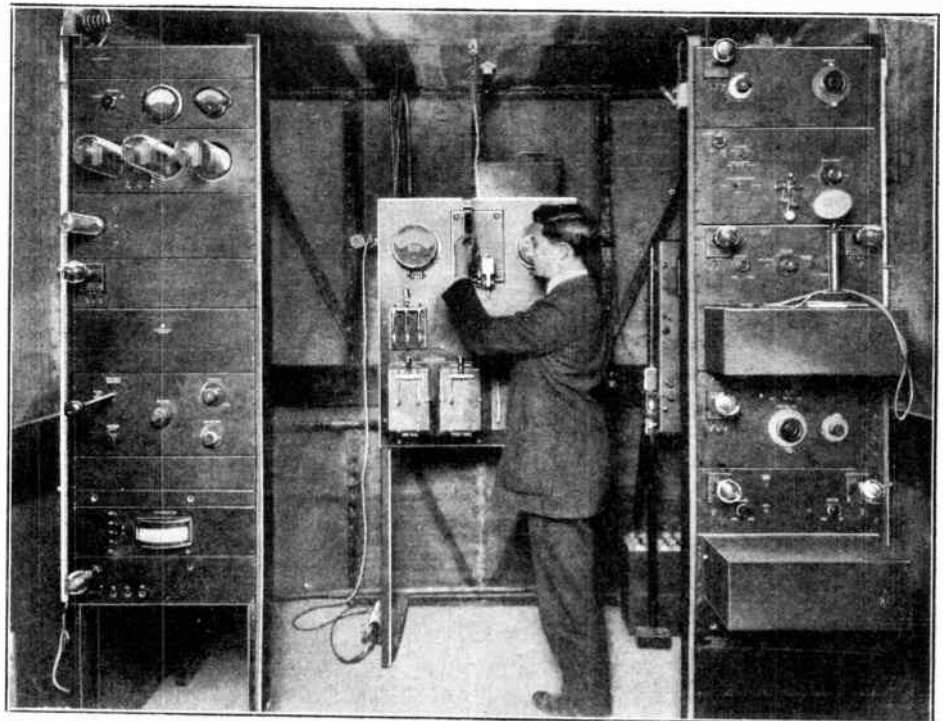

On the left is the 750-watt amplifier unit and below are the smaller amplifying stages. The power supply board is in the center.

55,800 to 58,500 cycles and a difference-frequency band of 300 to 3,000 cycles, i.e., the voice frequency band, will result.

However, the arrangement used, which is not quite so simple as that, is shown schematically in Fig. 2. Reception is carried out in two steps, the received side band being stepped down to a lower frequency before

per cent. Furthermore, the filter is not required to be a variable frequency as would be the case were it employed directly at the received frequency, since by adjusting the frequency of the beating-down oscillator the filter is, in effect, readily applied anywhere in a wide range of received frequencies. The
(Continued on page 866)

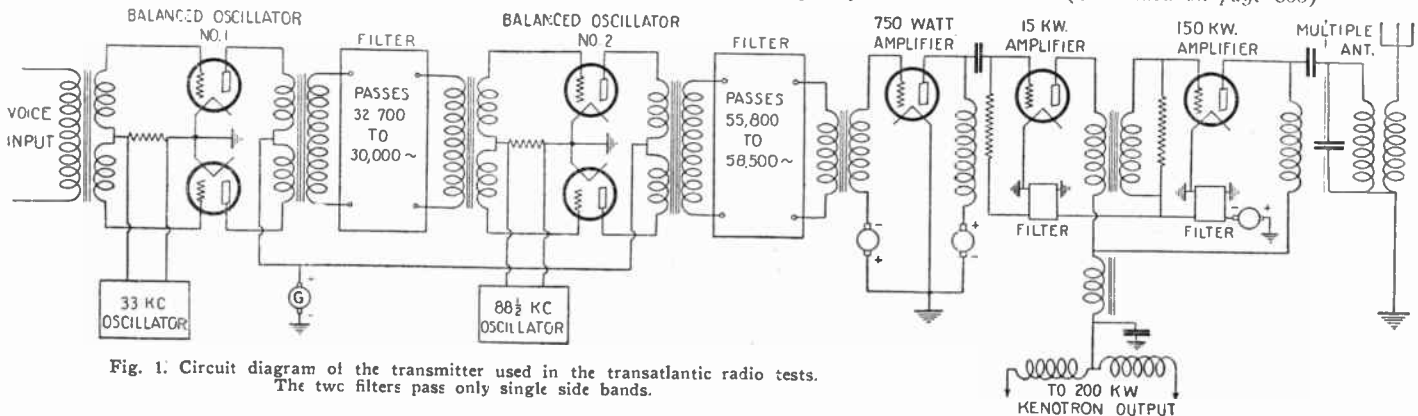

Fig. 1. Circuit diagram of the transmitter used in the transatlantic radio tests. The two filters pass only single side bands.

The Regenerative Interflex

By HUGO GERNSBACK.

Member American Physical Society

In this article the author demonstrates a single control regenerative set in which but one dial—one control—is used. All other controls are fixed, once set. This is a "Golden Rule" set, inasmuch as it does not squeal or howl despite the fact that it is based upon regeneration.

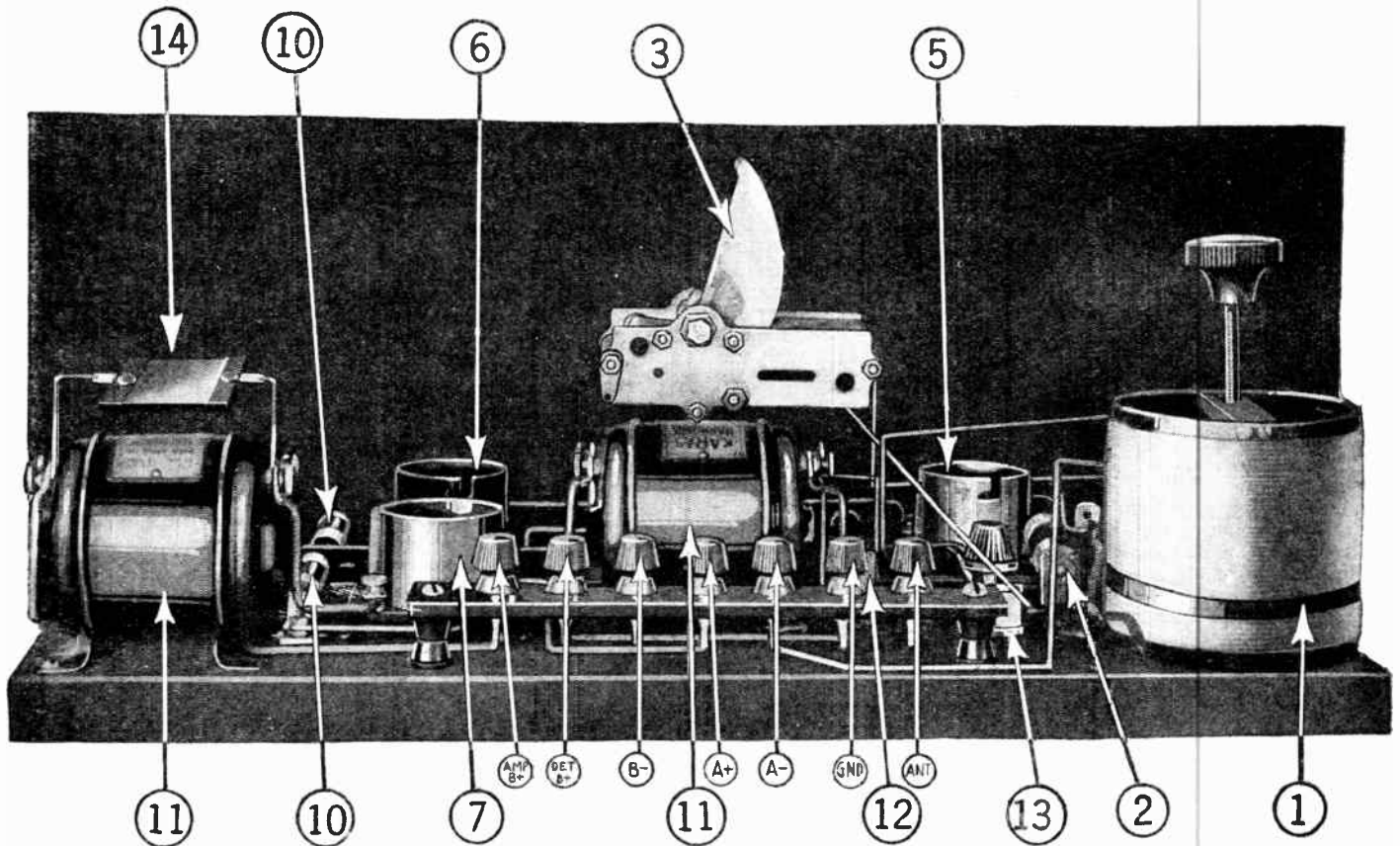

Fig. 2. A complete rear view of the Regenerative Interflex. The numbers shown are identical with those shown in Fig. 4. Note the simplicity of this set.

What This Set Does

ONE single, solitary control—**NO MORE!**
A set your grandmother can operate.

Fair loud speaker volume on a single tube for local stations.

Tremendous volume from three tubes, equaling or bettering most four-tube sets.

No squeals, no howls.

A great distance-getter—1,000 miles under average conditions on the loud speaker.

A set adaptable to ALL local conditions.

Extreme sharpness in tuning, so that you can separate locals from DX stations.

All this and more is accomplished in the REGENERATIVE INTERFLEX, fully described in the accompanying article.

IN THE September issue of RADIO NEWS there was described the Interflex Four—in the October issue, the Balanced Interflex. Both of these sets used the principle of radio frequency amplification, with a fixed crystal inserted directly into the grid circuit. During the past summer I have occupied a great deal of time and study in the design of a regenerative single control receiver. By "single control" I want to make it plain that when I say "single control" I mean exactly that. Right along, this or that article has ap-

peared, featuring a single control, when in reality the set had as many as seven controls. Perhaps it had a single tuning dial, but, stuck away somewhere, there was a potentiometer, a stabilizer, a tone control, several assorted rheostat knobs, and what-not. All these masqueraded under the name of "single control" sets. I wish to emphasize again that even if a number of controls are filament rheostats, these are, nevertheless, controls, because in most of such sets no DX can be effected unless the filament voltage is regulated for each station.

The one-control set should be just what it is called—"one control"—one dial and nothing else. You should, by turning the one tuning dial, be able to get DX stations readily, while the locals are on, providing, of course, that the stations are not right on

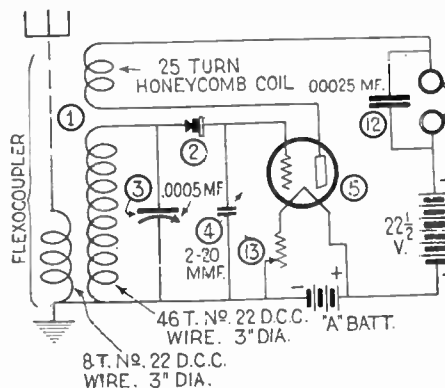

Fig. 1. The fundamental circuit of the Regenerative Interflex, showing the crystal detector, 2, in the grid circuit.

STATIONS LOGGED ON LOUD SPEAKER IN A SINGLE NIGHT

Station	City	Dial Setting	Wave- Length
WNYC	Local	96	526
WCX	Pontiac	95	516.9
WEAF	Local	93	491.5
WOC	Davenport	92	483.6
WEEI	Boston	91	475.9
WJZ	Local	88	454.3
WOR	Local	83	405.2
WHAS	Louisville	79	399.8
WGY	Schenectady	76	379.5
WHN	Local	73	361.2
WMCA	Local	68	340.7
WBZ	Springfield	66	331.1
WGR	Buffalo	62	319
WGBS	Local	61	315.6
KDKA	Pittsburgh	59	309.1
WPG	Atlantic City	57	299.8
WORD	Batavia	53	275
WHAR	Atlantic City	52 1/2	275
WFBH	Local	48	273
WRNY	Local	46	258.5
WGCP	Local	43	252
WREO	Lansing	55	285.5
WODA	Paterson	36	224
WIBO	Chicago	35	226
WOK	Chicago	30	217.3

The Regenerative Interflex takes in the entire broadcast range.

top of each other, when not even the best set in the world can separate them.

In other words, the single dial should take care of everything. It is this ideal for which I have striven, and I believe that in the Balanced Interflex, as well as the present Regenerative Interflex, these aims have been realized to a great extent.

When I first started to experiment with the Regenerative Interflex, it seemed simple enough merely to place a crystal into the grid circuit and use the ordinary tickler for the feed-back. I soon found out, however,

that I was all wrong, and, as a matter of fact, some 400 distinct and separate experiments had to be made before the circuit had been fully realized.

Let us first see what happens in the fundamental circuit shown in Fig. 1. Here we have first a crystal detector inserted into the grid circuit. The crystal, in order to operate correctly, must act as a detector. That means that the tube to which it is connected becomes an amplifier. We now feed back energy from the plate to the grid circuit. It is evident that the crystal (2) is not only a detector but also acts as a resistance, and if this resistance becomes too great, the set will not oscillate (squelch). If the resistance

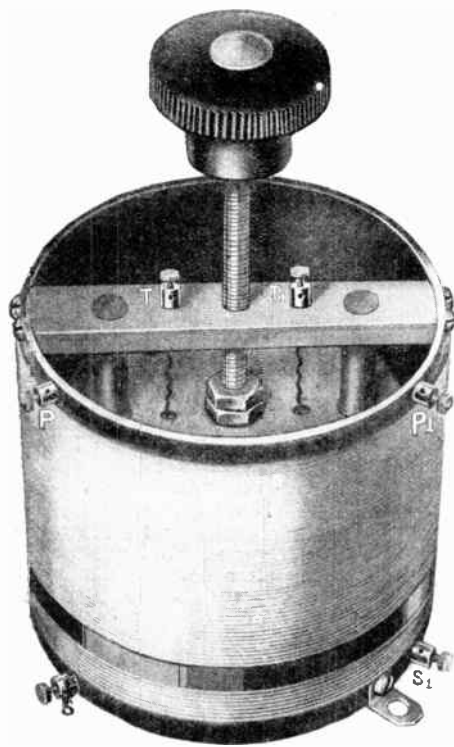
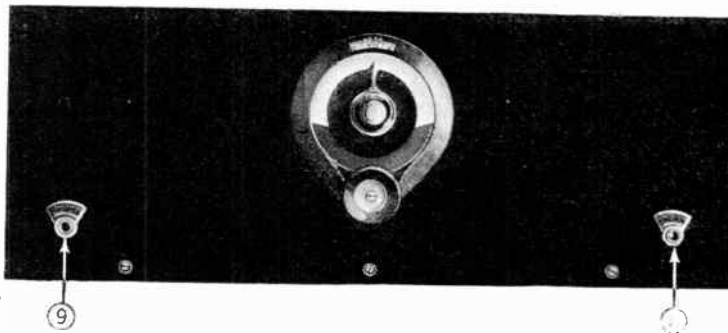

Fig. 3 Full view of the Flexo-Coupler, designed by the author. In this new coupler, the tickler is moved up and down vertically for close adjustment.

Fig. 5 Note particularly the simplicity of tuning this set. One dial—one control. The locals as well as DX stations snap in and out with great volume and excellent quality, merely by turning the one knob. Jack 9 is for one tube use; Jack 8 controls all tubes.



of the crystal is too low, the set will over-oscillate, and then it becomes difficult to stabilize the circuit. Note that the usual grid condenser and grid leak are missing from this circuit.

As is to be expected, no two crystals are alike in characteristics. I have found, as I have stated in my former articles on the Interflex series, that the only satisfactory crystal of any stability is the carborundum type. It is ideal for this circuit and, as a matter of fact, is more stable than a vacuum tube itself. But, just as the vacuum tube, crystal detectors vary in their resistance and other characteristics. So, in order to adapt different crystals to different tubes, it is absolutely necessary to use a filament rheostat (13). This rheostat is adjusted only once. It need never be adjusted again, except whenever the batteries run down. With a normal voltage, the rheostat is never touched.

It is not possible, in this circuit, to use an automatic resistance on the first tube, as the regulation is very critical. So much for the crystal end.

The next important consideration was to devise a coupler which, once set, could remain in the same position for all wavelengths—a feat that usual couplers cannot accomplish. The reason is that with the usual coupler, the rotor cuts both the high and the low potential field of the coil, so I devised a new coupler which I term the "Flexo-Coupler," shown in Figs. 2 and 3. It will be seen here that the tickler is a 25-turn honeycomb coil, which moves up and down vertically. It usually works best in the

position shown in Fig. 2; that is, nearly all the way down. By this means it is possible to place the tickler in such a position that its maximum efficiency is reached not only in regards to the secondary, but also to the primary, which means that, as in the Balanced Interflex, you can adapt this set to your local conditions as to aerial and ground, which you usually cannot do with the ordinary variocoupler. It cannot be accomplished even with a three-honeycomb coupler, as here there is too much angular displacement, which is missing in the "Flexo-Coupler" tickler.

The "Flexo-Coupler" is easy to make and no other instructions need be given, as everything is shown in Fig. 2. The idea is to move the honeycomb coil up and down by means of a screw thread until the best position is found. This position is usually found when listening in to a DX station. They leave it in that position. The "Flexo-Coupler" and the crystal in the grid accomplish two things, namely, a good stabilization of the set and, second, a "broadening of the regenerative effect," if we may term it such, which broadening, however, does not affect the sharpness of the tuning. By this I mean to say that the set can be adjusted in such a way that the tube will be just below the point of oscillation for the highest as well as for the lowest wave-lengths.

I have also found that with practically all crystal detectors it is necessary to have a stabilizing condenser (4), which is a very small one, several types of which are on the market. They are usually provided with a screw at the top, and by screwing this up and down you get a variation of from 2 to

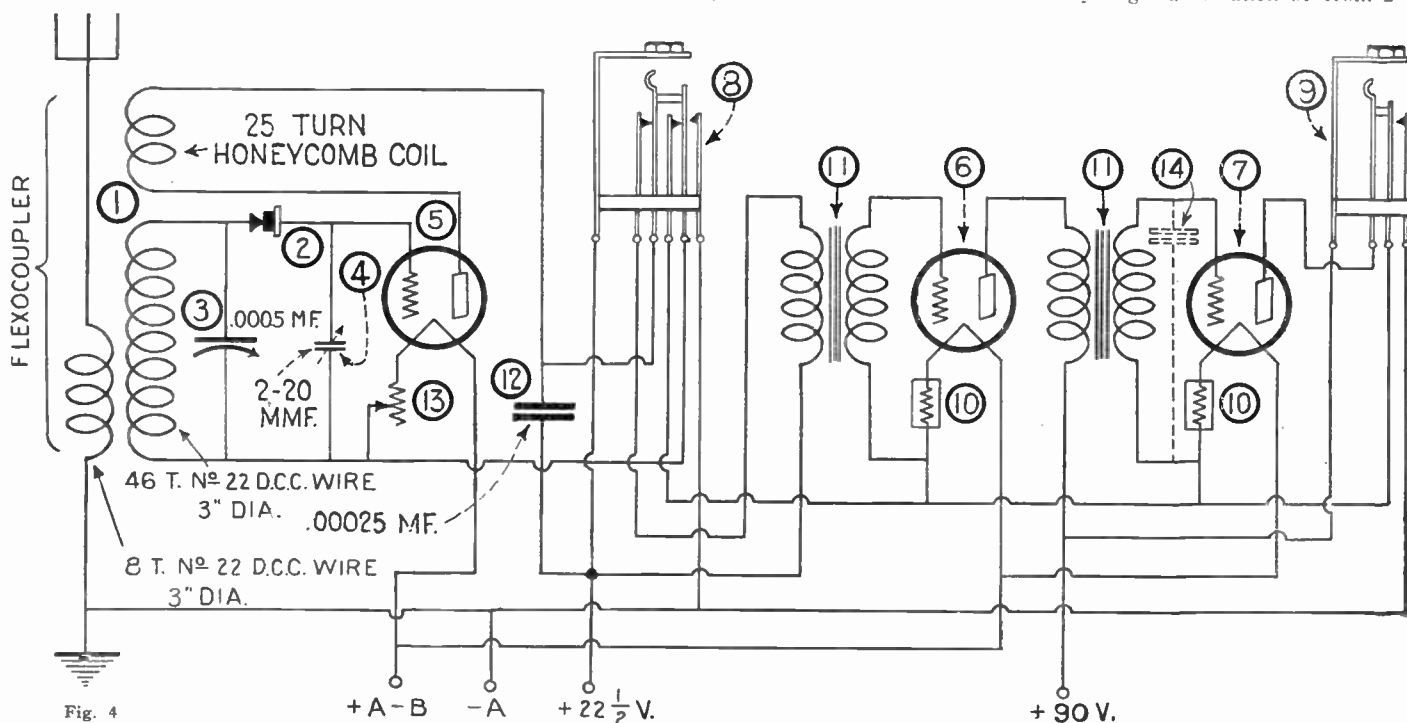

Fig. 4 Complete circuit diagram of 3-tube Regenerative Interflex Circuit. (1) is the Flexo-Coupler, (2) crystal detector, (3) variable condenser, (4) Small balancing condenser. (5) detector-coupled audio amplifier tube. (6) second audio tube, (7) third audio tube, (8) and (9) filament control jacks, (10) Amperites, (11) audio transformers, (12) fixed condenser, (13) carbon type rheostat.

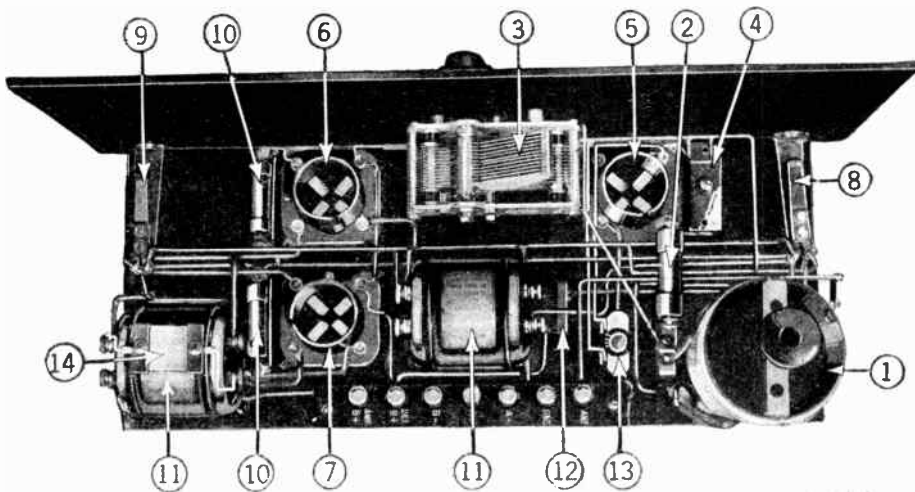

Fig. 6. View from above of the complete 3-tube set. All figures given here are identical with key figures in illustrations 4 and 8. Note simplicity of wiring.

20 micro-microfarads. These are low priced condensers, selling for about fifty cents or a dollar.

If the constructor wishes to build a one-tube set, he should go about it as shown in Fig. 1. Such a one-tube set, by the way, will bring in local stations with a fair volume on the loud speaker, a point that may be of more than passing interest. The one-tube set, as far as distance is concerned, will, of course, do the same thing as the three-tube set, except that for long distance or DX, you will have to use a pair of 'phones, whereas the three-tube set will bring in, not only the local, but distant stations with great volume.

The tuning being identical for one- and three-tube sets, I shall describe the tuning for the single-tube set first. After the "Flexo-Coupler" has been built, and the set wired as shown in the illustration, the tickler is screwed practically all the way down in about the position as shown in Fig. 2. The connections are all shown in Fig. 1, but I should state here that the condenser 12 is most important, as without it the set will not oscillate. You may try also to change the + lead of this condenser to the - lead of the "B" battery. The condenser 3 can be a straight line frequency or any other good variable condenser. The rheostat 13 should not be a wire-wound rheostat, as these usually do not regulate finely enough. A carbon rheostat, such as the Bradleystat or Filkostat, is advisable.

An important point to remember when building this set is that the tickler leads are most important. Do not solder them on at first. The set will work only with the tickler leads connected in one way. After you have found the proper way by reversing the leads you can solder or otherwise connect the leads permanently.

When everything has been mounted, the set should be tuned as follows: Adjust the tickler as mentioned above, and then begin tuning with the single tuning condenser 3. If the set does not oscillate immediately—that is, if it does not squeal—move the tickler up and down until the set squeals loudly. Then work the tickler back a trifle. Now begin tuning for the lowest possible wavelength. You will find in most cases that the set squeals. Do not touch the "Flexo-Coupler" at all, but adjust the balancing condenser 4. It is advisable to use a screwdriver with a wooden handle or a sharpened piece of wood, because of capacity effects. Keep screwing down slowly to increase the capacity of the small condenser until the squeals stop. Now begin to adjust the rheostat 13. Should the set emit a hissing, mushy sound, like steam escaping, the detector has been overloaded. Carefully adjust rheostat 13 until the hissing-steam sound has vanished completely. If you reduce the filament voltage too much you will find that the volume of the set diminishes. This is, of

course, not what you want, and you must strive for a happy balance, using rheostat 13. Note that this control is very critical and must be just so. You will find that 1/8th of a turn makes a vast difference in the results, particularly on DX stations.

You may try now to readjust condenser 4, and the tickler of the Flexo-Coupler, until you finally bring the set to its highest efficiency. While this may all sound complicated, it really is not, because you can balance a set and bring it to its highest efficiency within 20 minutes, providing directions are followed carefully and the proper materials have been used.

Always remember that you cannot get anything for nothing in this world. The usual regenerative set, as you probably know, has at least three controls: condenser, tickler and rheostat. These three controls are all used all of the time. It stands to reason that, in order to eliminate two controls, you have to put in a little more work in the first place, to save work afterward.

The set works normally when the stations snap in with a "quenched hissing" sound, which precedes the actual sounds from the broadcast station. There should be no squeal, no howl, through the entire broadcast range, if the set works normally. If there are squeals or howls, an adjustment

of condenser 4 or rheostat 13 will usually smooth out the trouble.

Another important point to remember right here is that the carborundum detector, as well as any other detector, works best only in one position. If the set does not work right, reversing the detector leads will usually eliminate the trouble.

As to the "B" voltage, it is best to use 22 1/2 volts. More than this should never be found necessary. I need not say here that practically all types of tubes can be used, such as 201A or 301A type, UV-199 or UV-299 type, and others.

BUILDING THE THREE-TUBE REGENERATIVE REFLEX

Figs. 4, 5, 6, 7 and 8 show the complete set. Fig. 4 shows the complete wiring diagram. This is exactly the same as the fundamental circuit shown in Fig. 1, except that there has been added a two-step amplifier, with two automatic filament controls. For the two last amplifier tubes the automatic resistances 10 are excellent, rheostats not being necessary at all.

The same method of tuning should be observed in this set as has just been mentioned for the one-tube set. When the loud speaker plug is inserted into the filament control jack 8 the set should work the loud speaker on a single tube for local stations, or stations located not further than ten miles away. This is a good test for the set, and unless the sound comes in with fair volume for the locals on the loud speaker, with a single tube, it is not working normally and should be adjusted until it does.

It will be found that when using all three tubes the sound received is terrific and as good or better than many four- and five-tube sets. If an audio howl develops, it may be necessary to put in a condenser, 14, as in some crystal detectors complete rectification does not take place and some of the radio frequency current passes through the transformers, thereby causing a howl. This usually can be determined by placing the fingers across the secondary of the last transformer, or sometimes by placing the fingers over one of the primary and one of the secondary connections of that transformer. Place condenser across the correct leads. The capacity of condenser 14 is about .001 m.f.

(Continued on page 878)

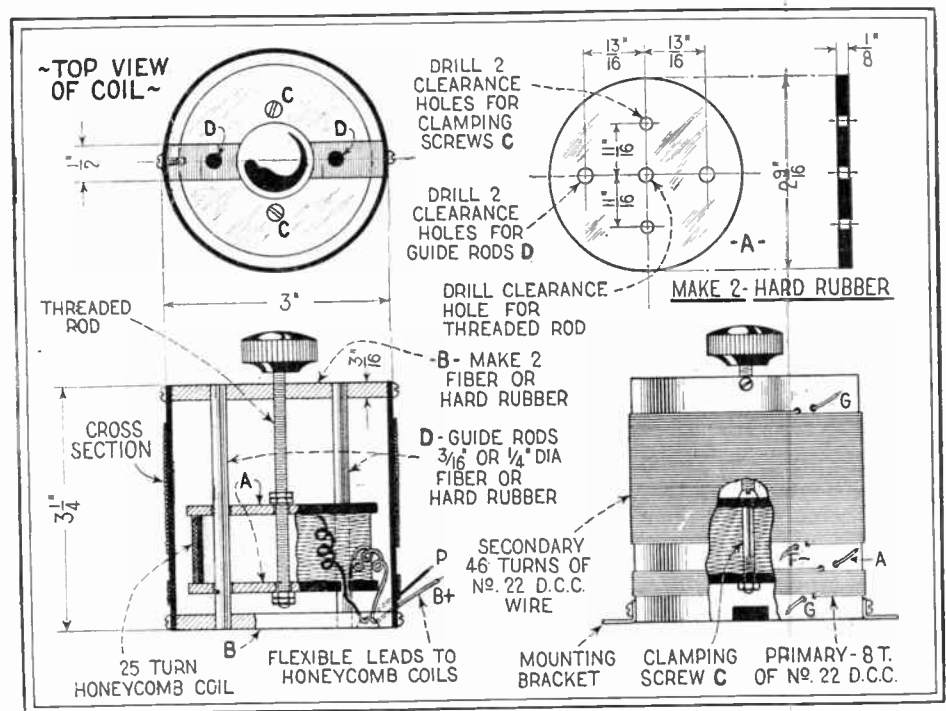
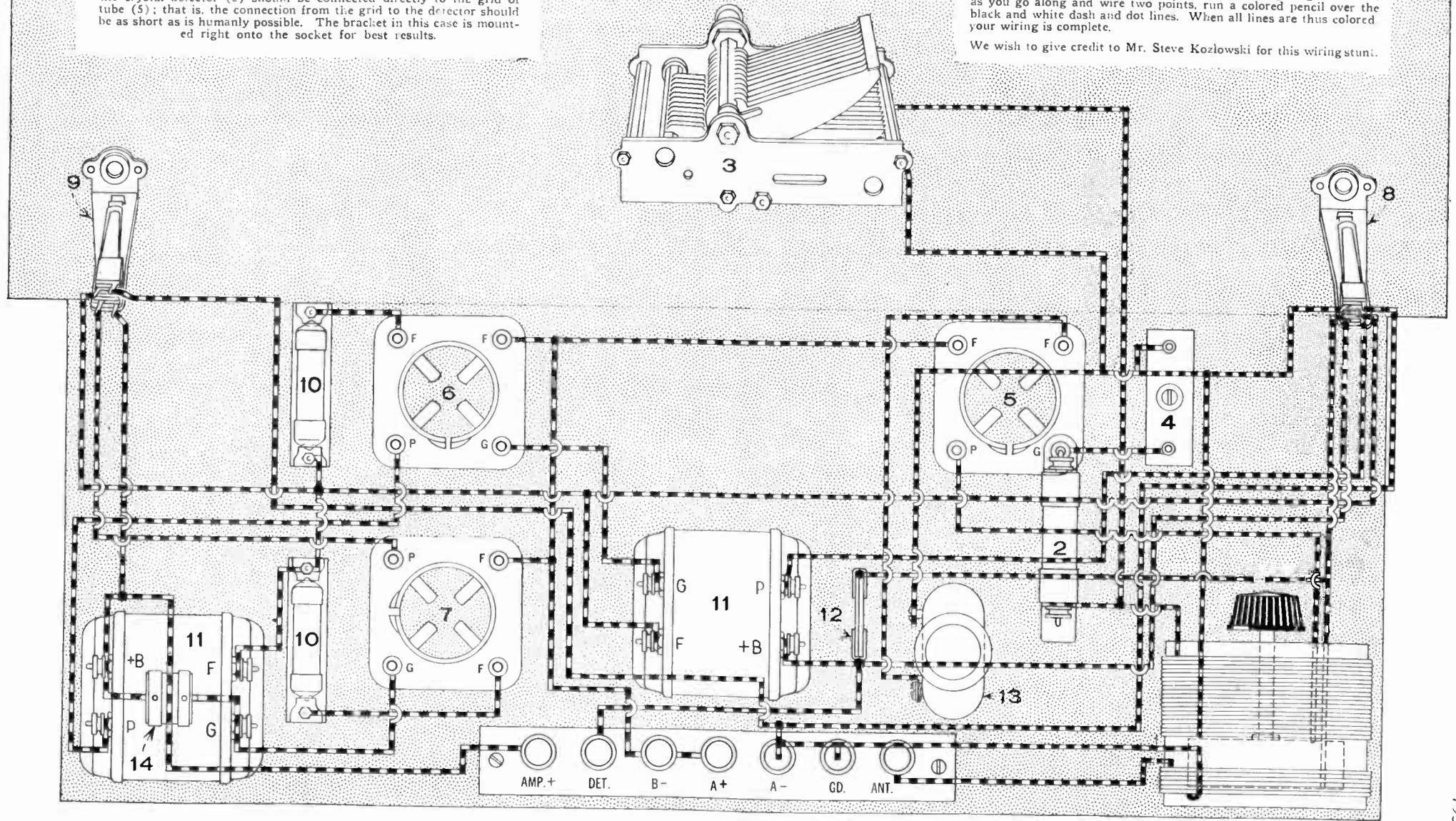

Fig. 2. Complete constructional details on how to make the Flexo-Coupler. Any constructor can make this coupler with simple parts. Note that guide rods (D) must not be of metal, as this will give rise to losses.

ILLUSTRATION 8. Complete wiring diagram of 3-tube Regenerative Interflex. Note the simplicity of the wiring. The parts shown here are the ones actually used by the author. The condenser (3) is a straight line frequency type, although any other type can be used. The author, however, advises the use of straight line frequency, because the set tunes extremely sharply, more sharply than most sets, and unless such a condenser is used, with a good vernier dial, it is almost impossible to separate the stations. The condenser (14) is not always necessary and depends upon what transformers are used. It is used only when an audio frequency howl develops. Note that the crystal detector (2) should be connected directly to the grid of tube (5); that is, the connection from the grid to the detector should be as short as is humanly possible. The bracket in this case is mounted right onto the socket for best results.

One of the critical adjustments of the set is the carbon rheostat (13). Wire-wound rheostats are not advised by the author. This rheostat adapts almost every crystal to its tube. If the set tends to over-oscillate, that is, squeal or howl, slight adjustment of condenser (4) will bring the set to its best operation. Keep all wires away from crystal detector (2) as much as possible, an inch or more. Mount crystal detector as high as possible, as shown in Fig. 6, with wiring underneath at least an inch to an inch and a half away from the crystal detector. Another feature of this wiring diagram is that as you go along and wire two points, run a colored pencil over the black and white dash and dot lines. When all lines are thus colored your wiring is complete.

We wish to give credit to Mr. Steve Kozlowski for this wiring stunt.



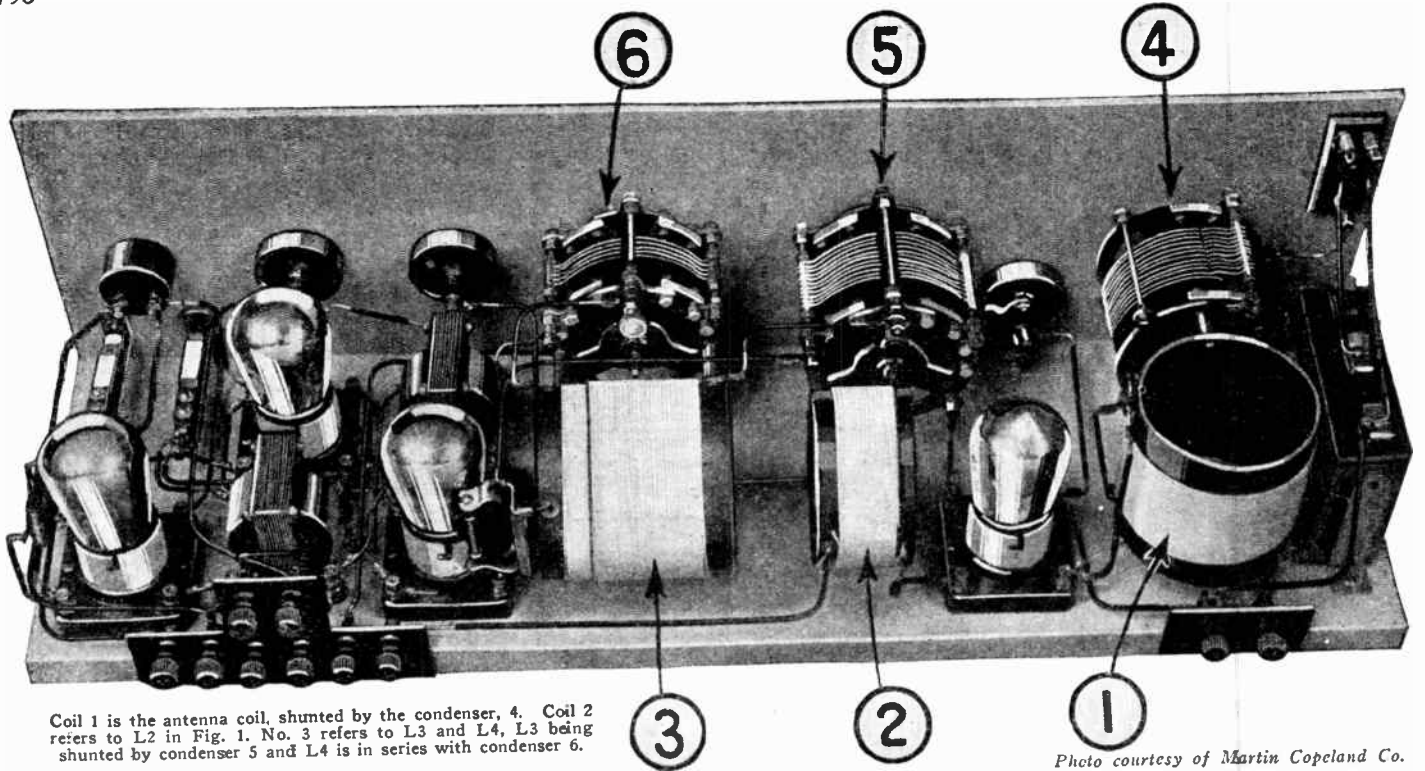

Coil 1 is the antenna coil, shunted by the condenser, 4. Coil 2 refers to L2 in Fig. 1. No. 3 refers to L3 and L4, L3 being shunted by condenser 5 and L4 is in series with condenser 6.

Photo courtesy of Martin Copeland Co.

The Reactodyne Circuit

By ARTHUR REED



An excellent method of eliminating oscillations and controlling regeneration is described in this article.

ONE of the most difficult combinations to effect successfully in radio engineering is that of radio frequency amplification and regeneration. Those experimenters who have endeavored to combine these two types of circuits will fully appreciate the difficulties that have to be overcome before the circuit is free from annoying oscillations.

There have been many solutions offered to this problem. In some circuits a potentiometer across the "A" battery terminals with the movable arm connected to the grid of the radio frequency amplifier tube causes the grid bias to have a positive value. There are many other ways to cut down oscillations,

all too numerous to be mentioned here. In the circuit diagram of Fig. 1 there is another method shown for reducing oscillations to the desired minimum. The coupling inductances, L2 and L3, are very loosely coupled, in fact, there is at least two inches between the ends of the two coils. Regeneration is obtained by the .00025 mf. variable condenser that is in series with the plate inductance, L4, and the plate of the detector tube. This is by no means a new method of regeneration, but it is a good one when the tuned circuit to which it is added is loosely coupled, as is the case in this receiving circuit.

The first tube is used as a radio frequency

amplifier and is tuned by a single-coil-condenser system, shown in Fig. 1, by the inductance L1 and the .0005 mf. condenser that is shunted across it. This inductance coil is wound on a three-inch tube and consists of 45 turns of No. 22 D.C.C. wire. There is connected between the ground and the coil, L1, a "C" battery for the stabilization of the circuit. This battery is unnecessary for some types of vacuum tubes, so a switch is provided for connecting the grid of the tube to the negative side of the filament battery. This "C" battery should be a different one from that which supplies the bias to the grids of the amplifier tubes.

(Continued on page 912)

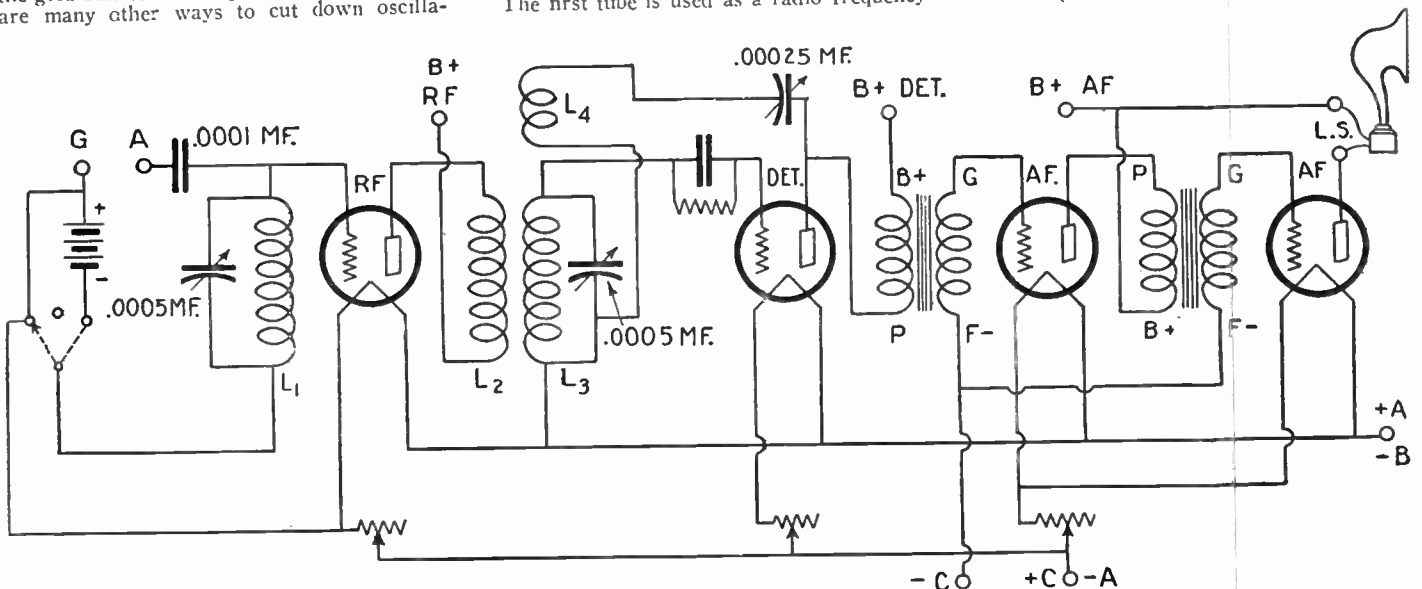

Fig. 1. The main feature of this circuit is the extremely loose coupling between the inductances L2 and L3. Regeneration is controlled by the .00025 mf. variable condenser in the plate circuit of the detector tube.

The Isofarad Receiver

By B. P. MINNIUM*

The circuit described in this article is so constructed that the radio frequency stages are balanced in such a manner that oscillations are eliminated.

THE receiver described below is based upon the Isofarad circuit, an all-capacity bridge circuit, in which an increasing interest is being shown. This circuit effectively balances out the grid-to-plate capacity inherent in vacuum tube receivers and thus eliminates at its source the chief obstacle to efficient radio frequency amplification. The practical result of this is to allow the use of the lowest obtainable value of resistance in the tuned circuits and the proper design of the R. F. transformers for maximum signal strength. Furthermore, it is unnecessary to rely upon the rather uncertain aid of regeneration involving, as it does, instability and howling and the use of an additional control in the operation of the receiver. This is, of course, contrary to the usual custom of preventing self-oscillation by the addition of resistance in the secondary circuits, the use of very few primary turns in the R. F. transformers, or, what is in effect the same, the use of a somewhat greater number of primary turns and a corresponding reduction in coupling between primary and secondary. Such schemes are definitely limited to an approximate approach to the point of oscillation and make very little use of pure repeater action in amplification.

receiver is tuned very little to the longer waves. L is a completely shielded R. F. transformer having resistance at radio frequencies. Its over-all dimensions including shield are 5 inches in diameter and 6 inches

netic interaction between stages, variable with frequency, is avoided.

Fig. 2 shows a front view of the assembled receiver. The panel may be seen just above the three tuning dials. Between the

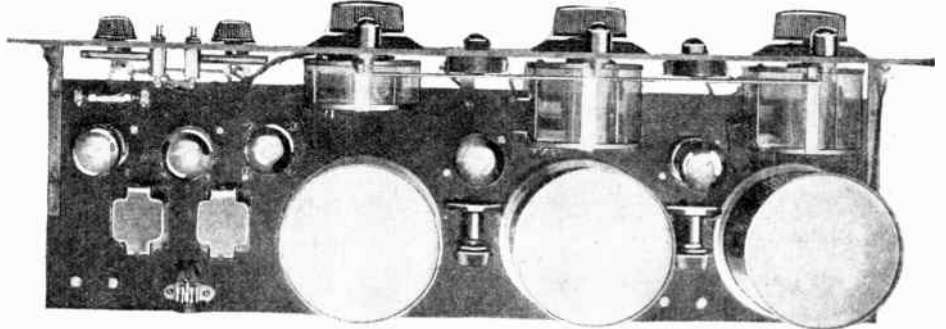

Fig. 3. This photograph shows the arrangement of the apparatus in the Isofarad receiver.

high but since other parts, such as the tuning condensers and A F transformers may be mounted directly against the coil shield, it is obvious that the amount of space occupied in the receiver is actually less than is the case with ordinary unshielded coils, if efficiency is given any consideration.

dials are the two regulating condensers (CR) which, when once set, require no further adjustment. The two mounting screws at either side of these condensers have been eliminated in favor of a single-hole mounting, since the photograph was taken. The two rheostats on the right serve to control volume and quality, as will be explained later. The left-hand switch (of the two mounted between the rheostats) is used to turn the panelites on and off while the right hand switch performs the same function for the tubes. Five bracket screws may be seen—two at each of the extreme ends and one in the lower center of the panel.

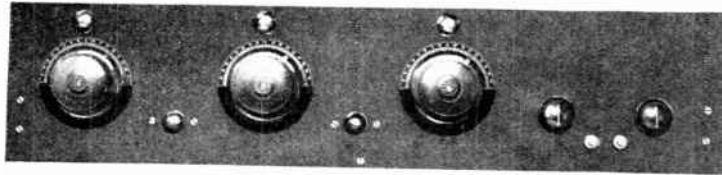

Fig. 2. Panel view of the receiver, showing the two switches for controlling the panel lights and the filaments of the tube.

Fig. 1 is the fundamental circuit of the radio frequency stages, in which C1 and C2 are mounted on the same shaft. They have capacities of about 250 and 500 mmf., respectively. CB and CR are small variable condensers with micrometer adjustment, the former being used to balance the circuit against oscillation, and the latter to regulate automatically the amount of progressive unbalance introduced into the circuit as the

The efficiency of the coils has in no way been impaired by the use of shields, since this feature has been so worked out that shielding reduces the effective inductance, resistance, and distributed capacity of the coil in about the same ratio. Since selectivity is directly dependent upon resistance, the importance of reducing the tuned circuit resistance to the lowest possible value is at once apparent. In addition, the usual mag-

Fig. 3 is a top view of the complete receiver removed from its cabinet. The tuning condensers can be seen directly behind the tuning dials, while the shielded coils are just back of the condensers. The first two tubes (R. F. amplifiers) may be seen between the three coils, while the two balancing condensers, CB, are mounted just back of their corresponding tubes. Since this photograph was taken these condensers have

(Continued on page 915)

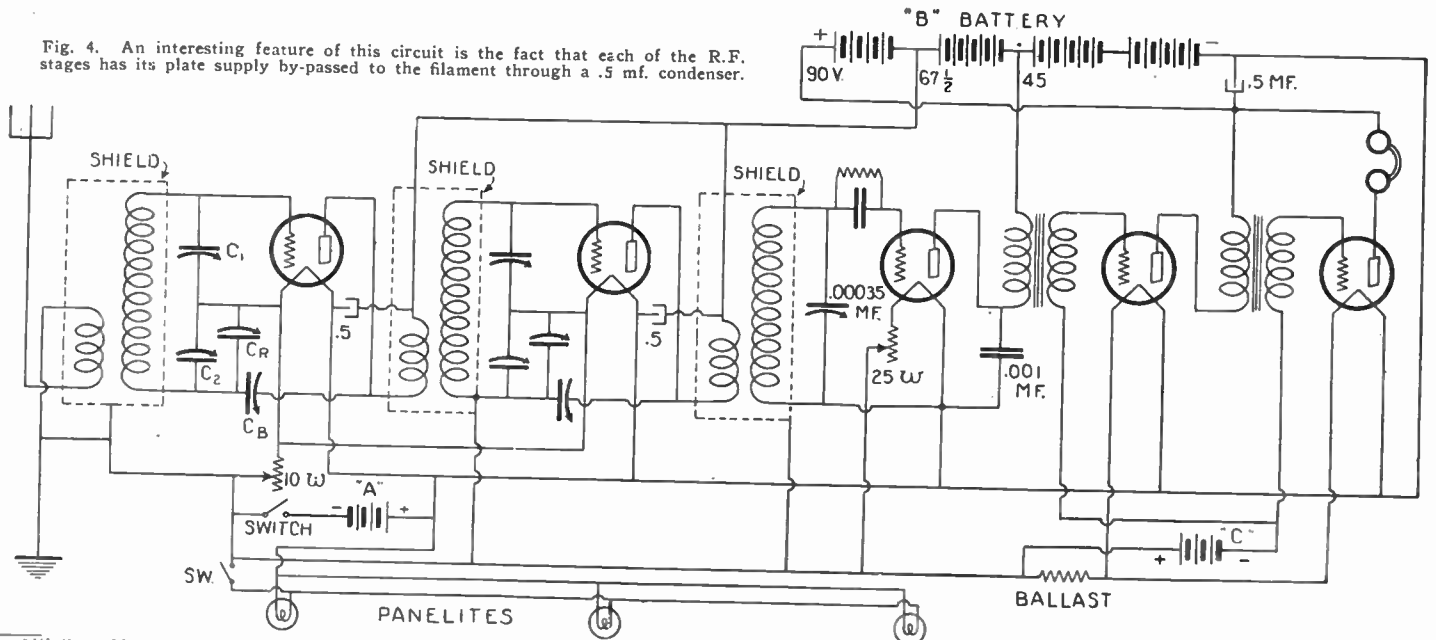

Fig. 4. An interesting feature of this circuit is the fact that each of the R.F. stages has its plate supply by-passed to the filament through a .5 mf. condenser.

*Walbert Manufacturing Co.



What Happens In the Broadcast Station

By A. P. PECK

FROM looking at the pictures of broadcast stations which are published, with their great maze of wires and dials, one might easily be led to believe that it was a very complicated process and needed a course in engineering for the thorough understanding of it. This is not the case, however, not by any manner of means. In the final analysis it is an extremely simple process and one that is very easily understood.

If the reader followed the article by the writer which appeared in this department some two months ago in which was described the working of a vacuum tube, little trouble will be experienced in understanding this article. The previous article was entitled, "How Does Your Set Get Its Power?"

Most of us know the underlying principle of sound, which in reality is the foundation of all broadcasting. Without sound there would be no transmission of audible nature. For the benefit of getting the whole problem clear in our minds we shall briefly go over the facts which we know concerning the nature of voice and sounds and then start the explanation of what happens in the broadcast station, beginning at the microphone where the tones of the singer, speaker or orchestra are started in the marvellous process which brings them from the studio of a broadcast station into your home through a loud speaker.

PRINCIPLE OF SOUND

Whenever any sound is audible to the human ear, in the last analysis it simply means that the air is vibrating at a certain frequency or frequencies—that is, it is simply being shaken a certain number of times per second. No matter whether it is simply the "noise" of a railroad train coming to a stop at a station or the well-regulated series of harmonies made by a famous symphony orchestra, the sound is all the same so far as the scientist is concerned and so far as the microphone is affected. It is simply the vibration of the air. What makes the difference between the two sounds to the human ear is the fact that they are vibrating at

different frequencies, one of them—the orchestra—is giving out a series of controlled and mathematically related frequencies while the railroad train is just "making a noise"—letting forth a lot of frequencies or vibrations in no way related to each other.

A word more concerning this vibration or frequency. When we strike middle "C" on the piano there is an air vibration set up which affects our ear. We say that the vibration has a period or frequency of 256

it arrives there, because it is compressed and heavier than the thin air following it, it presses the eardrum in. The following light space allows the drum to return to its former position and then the following heavy ridge compresses it again. The sound we hear depends entirely upon the number of the ridges of heavy air followed by others of light air that strike the eardrum per second. If there are 256 of them, the note we hear is middle "C." In the case of the or-

The photograph at the right shows the interior of the power and control room of a radio broadcast station. The motor generator at the left supplies the high and low voltages for the tubes.

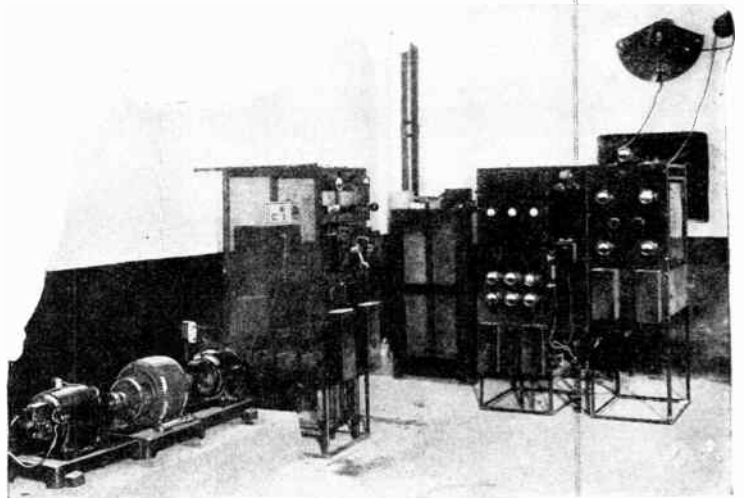

per second, because if we could arrange some way to see the waves in the air we should see 256 places where the air was compressed and following each of these ridges of compression we should find a lighter portion where the air had been thinned out. There would be 256 of these waves in every second. Now each of these heavy, compressed ridges of air reach the ear—they flow out from the piano string to all parts of the room where the instrument is situated, as far, in fact as it can be heard—and when

chestra we may hear a dozen or two of these frequencies at one time.

Let us stress the fact that we cannot hear all frequencies. The lowest note on the pipe organ is about 16 per second. There are many persons who cannot hear this note. It can be felt sometimes more easily than heard.

From this frequency at the lower end up to about 14,000 cycles per second are the vibrations within the range of the human ear. The human voice takes in a range of from about 200 to 3000 cycles. Of course, these are not what might be called pure frequencies, since each letter or each syllable of a word may be composed of a number of frequencies together. However, whether single frequencies or compound, they are sent out in the same way, that is, by waves in the air.

Now it is easily imagined that the performer before the microphone goes into the studio and creates these waves in the air which, if they could strike our ears directly would be intelligible or enjoyable to us. But many things happen in broadcasting between the microphone and the loud speaker, or the receivers, as the case may be. First of all, we must find some way of changing these air waves into an electrical current, or better, some way of making these air waves generated by the voice or orchestra control an electrical current.

In its primary form, the method of solving this problem is pretty generally known. Every time we call a friend over the tel-



A broadcast station's studio is shown at the left. Two different types of microphones are noticeable in this picture, each being adaptable to a certain type of transmission.

phone we employ this process of making an electrical current behave according to our voice. In a word, the voice governs the current or changes it, the changes corresponding with the frequency of the voice.

THE MICROPHONE

At the studio of the broadcast station this same thing occurs. The air waves created by the singer or speaker pass to the microphone through which a small current is flowing. By the alternate compression and thinning out of the air, the resistance of the microphone is changed so that we have coming from it a very small electrical current corresponding exactly to the quality and quantity of the air waves set up in the studio.

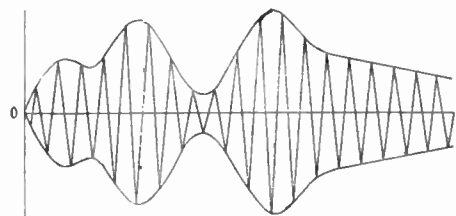

FIG. 3

In Fig. 3 is shown a diagram of a train of radio frequency waves, after having been acted upon by the voice current.

In order to understand fully just how this is done, we must examine the microphone and see how it works. It is nothing more nor less than a rheostat which can be changed by the voice. It is composed of two plates between which there are a number of carbon granules. Carbon has the peculiar quantity of changing its resistance to a very large extent according to the pressure on it—particularly carbon granules. When they are loosely thrown together they have a very great resistance but when they are compressed, they do not offer nearly so much resistance to the current and allow, therefore, much more of it to pass. One of the two plates between which the grains are held is so fixed that it moves easily, while the other is very rigid and will not move. It takes very little pressure to change the pressure between them because of the way they are held together and because of the thinness of the metal from which the one is made. So the thin plate bends inward, putting great pressure on the carbon granules which are held firmly between the thin plate, called the diaphragm, and the rigid plate forming the back.

One of the accompanying illustrations, Fig. 1, shows a microphone in its simplest form. By examining this, and knowing what we know concerning the nature of sound, it is a simple matter to imagine how the al-

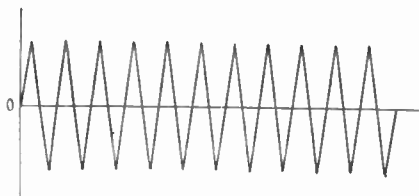

FIG. 2

Fig. 2 is what might be called a picture diagram of an oscillating radio frequency current.

ternate waves of compressed air which are followed by the areas of thinned air, will affect the microphone. The compressed layers will cause the diaphragm of the microphone to bend inward, compressing the carbon granules between the diaphragm and the rigid plate, causing the resistance of the carbon to the current to decrease, therefore letting through more current from the battery, which is in circuit. Of course, it must be remembered that the two metal plates are insulated from each other so that the only current which passes through the instrument has to find its way through the carbon granules.

Now we have an instrument which will change the current of electricity from the battery in direct accordance with the voice or music coming to the microphone. In other words, we have changed the air vibrations into electrical vibrations, but they are very weak and not at all the kind which can be carried through space as radio waves. We now shall have to do a number of things to this very weak and small electrical vibration which will enable it to travel through space from a radio transmitter to the receiving set. In its present form it could very well travel over telephone lines or other metallic conductors. As a matter of fact, what we have actually done is simply to place a telephone transmitter in the studio. For all a telephone transmitter is, in the last analysis, an instrument such as we have described for changing sound vibrations into electrical vibrations.

We all know that we can hear the person at the other end of a telephone line distinctly and clearly, and this is because the current carried by the line is changed to conform with the speaker's voice by means of the microphone or telephone transmitter that we have just described.

THE TRANSMITTING TUBE

Now we come to another part of the operation of a broadcast station, which is a little more complicated to describe. If, however, you will follow the succeeding paragraphs very carefully and refer to the drawings herewith, you should have no trouble, after a little concentration and thought, in comprehending the entire situation.

The heart of our modern broadcast station is the vacuum tube with which we are all more or less familiar, particularly after having studied the last two articles of this

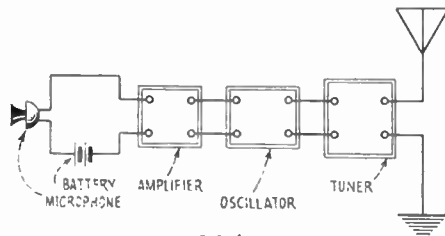

FIG. 4

Fig. 4 gives a schematic layout of the various instruments used in transmitting by radio telephony.

series. Vacuum tubes much larger than the ones that you use in your radio receiving set are used in transmitting stations. The fact that these tubes can be made to generate currents of electricity when properly connected in the circuit and supplied with other currents is the complete foundation of our present-day broadcast system. The same principle is evidenced in regenerative receivers that cause interference with other nearby receivers. It is that technically known

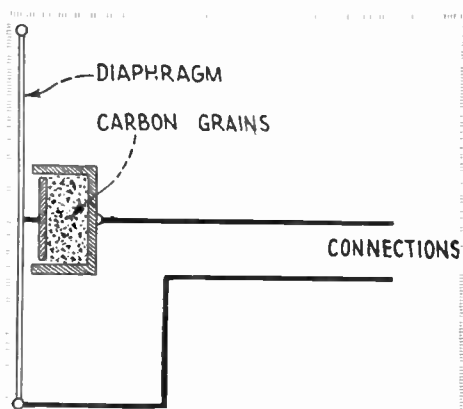

FIG. 1

Fig. 1 shows a very much simplified cross-sectional view of a microphone.

as oscillation. Do not let the term scare you, because we are not going to go deeply into the underlying principle. It is quite sufficient for our purposes at the present time to make the flat statement that when a vacuum tube is connected to a suitable source of direct current and in a correctly designed circuit it makes or generates what are known as sustained oscillations. These are merely the result of currents of electricity flowing with extreme rapidity first in one direction and then in the other. In the work that we have under discussion, the current flows as far in one direction as in the other each time that it reverses its flow. Engineers in practice resort to drawing pictures of these currents and in order to familiarize you more fully with the work, we have reproduced some of these pictures here. For instance, Fig. 2 shows what might be termed a picture of an oscillating current. Note that it starts at zero, rises to full value, falls to zero and then gains full value in the opposite direction. This takes place thousands of times per second, the exact number of times being known as the frequency, as explained above, and is expressed in cycles. When the number of cycles becomes very great, the figures are hard to handle and therefore the result is often divided by 1,000 and expressed in kilocycles, kilo meaning 1,000. The exact frequency at which a current of this nature oscillates is determined entirely by the various instruments connected in the vacuum tube circuit.

"MODULATION" EXPLAINED

Now to sum up a little, we find that we have at our disposal for the purpose of broadcasting two entirely separate and distinct currents. One is the voice current and it is fluctuating in accordance with the voice or other sounds made in the vicinity of the microphone. The other one is the oscillation.

(Continued on page 923)

The transmitter and the power control panel. The operator is also keeping the 600-meter watch on the lookout for SOS signals.



Coupling---Tight or Loose?

By SYLVAN HARRIS

The average radio reader has little knowledge of the actual values existing in his set. Moreover, there is a great tendency among radio writers to avoid the subject of coupling. Mr. Harris here tells a story that should be better known.

THE question has often arisen as to whether the coupling in a tuning unit is loose or close, and most people who dabble in radio have some qualitative idea of what loose and tight coupling mean. But there are very few, even among the "experts," who could answer with any degree of accuracy the question as to what is the value of the coupling coefficient. In fact, there are very few who have the slightest idea as to how tight "tight" coupling is, or as to how loose "loose" coupling is. Generally they think that if there are but few turns

coil, the coefficient of coupling may drop as low as 25 or 30 per cent.

This will be sufficient to show how poor are our qualitative conceptions of coupling. To help clear up the situation, the writer has recently conducted in RADIO NEWS Laboratories a study of this question, part of the results of which are included in this article.

We shall first try to obtain a physical conception of the ideas of coupling and the coefficient of coupling. Suppose we consider a circuit such as is shown in Fig. 1. This diagram shows a source of alternating voltage connected to a transformer, across the secondary of which is connected a resistance. If the equations for the currents in the primary and secondary circuits be worked out it will be found that the current in the primary circuit will be the same as that in a simple circuit whose inductance is

$$L_1 - \frac{4\pi^2 M^2 L_2 f^2}{Z_2}$$

in which M is the mutual inductance between the primary and secondary in henries, L₁ and L₂ are the self-inductances of the primary and secondary coils in henries, and f is the

not thread the secondary at all. The first part is called the mutual flux, and the latter the primary leakage flux.

MUTUAL AND LEAKAGE FLUX

The mutual flux is utilized in inducing electromotive forces in the secondary winding and, in considering the transformer action only, is the only part of the flux that is useful in transferring energy from the primary to the secondary windings. The instantaneous direction of the emf. induced in the secondary is indicated by the arrow on one of the secondary leads.

This secondary voltage causes a current to flow in the secondary winding which, in turn, causes another magnetic field, having a polarity opposed to that of the primary, to be set up. Part of this secondary flux is opposed by the mutual flux coming from the primary, and in this way energy is transferred from the primary to the secondary. Another part of the secondary flux links only the secondary turns, and is known as the secondary leakage flux.

We can now begin to understand the meanings of the terms coefficient of coupling and leakage factor. The total flux which is available for transferring energy from the primary to the secondary windings is that set up by the current in the primary, and is represented by the self-inductance of the primary winding. But not all of this flux is utilized. Part of it goes to waste as leakage flux. The coefficient of coupling, therefore, represents the percentage of the total primary flux that is utilized in the transference of energy. This subtracted from unity (or 1) gives the percentage of the total primary flux which goes to waste, viz., the leakage factor.

Thus far we have considered an untuned circuit, that is, a circuit in which no condensers appear. If the circuits are tuned by condensers, the simple transformer becomes a resonance transformer; similar ideas hold true for the resonance transformer, but the expressions become more complicated. For the sake of mathematical convenience, however, the simple form of the expression for coefficient of coupling is still preserved, viz.,

$$k = \frac{M}{\sqrt{L_1 L_2}} \times 100$$

in which k is the coefficient of coupling in per cent., M is the mutual inductance existing between the two circuits coupled together, L₁ and L₂ are the total self-inductances in the primary and secondary circuits, respectively.

THE COEFFICIENTS OF COUPLING

Now that we have obtained somewhat of

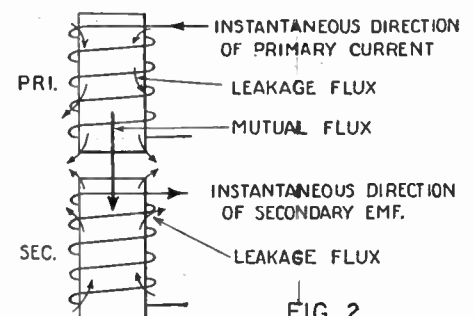

FIG. 2

The magnetic field can be resolved into primary and secondary leakage fluxes and the mutual flux.

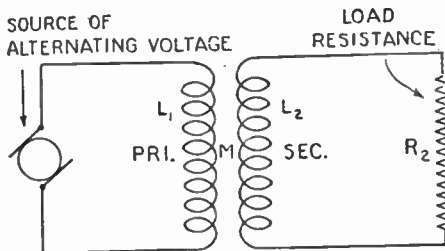

FIG. 1

This is a very simple form of coupled circuit, having a pure resistance load on the secondary.

on the primary of the antenna tuner, considering now the aperiodic or untuned primary, that the coupling is loose; this in total disregard of the other constants of the circuits and of the relative spacing and geometrical configurations of the coupling coils.

A FEW EXAMPLES

To bring the importance of the whole matter clearly to the mind of the reader we may ask him a very simple question: What, does he think, is the coefficient of coupling in a unit having the following dimensions:

- Secondary—55 turns
No. 20 D.C.C. wire
2 3/4 inches in diameter
Self-inductance, 164 microhenries
- Primary—12 turns
No. 20 D.C.C. wire
3 inches in diameter
Self-inductance, 18 microhenries

The primary coil is placed directly at the middle of the secondary coil.

One might be tempted to think that the coupling is very loose. As a matter of fact, if the coefficient of coupling were calculated by means of the formulas given in Circular 74 of the Bureau of Standards, it would be found to be about 66 per cent.

Now suppose we consider a unit with the secondary coil at the middle of the primary of the following dimensions:

- Primary—34 turns
No. 20 D.C.C. wire
2 3/4 inches in diameter
- Secondary—32 turns
No. 20 D.C.C. wire
3 1/2 inches in diameter

One would suppose that because there is a large number of turns on the primary winding the coefficient of coupling would be tighter than for the coils above. On the contrary: the coefficient of coupling of the latter is slightly less—it is about 60 per cent.

To show further how poor our qualitative ideas on coupling happen to be, let us consider again the first described coupling unit. If the primary coil is placed directly at the center of the secondary coil the coupling is 66 per cent., whereas, if the primary coil is moved out to either end of the secondary

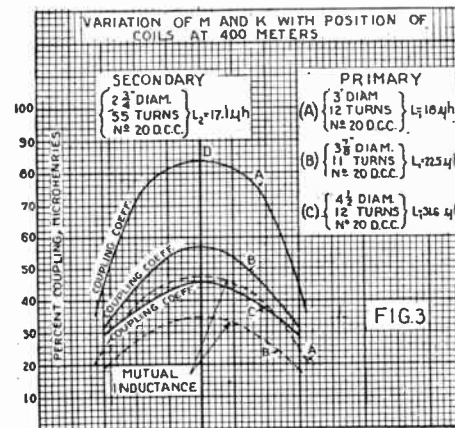

These curves show actual values obtained by measurements made on ordinary antenna coupling coils.

frequency of the impressed voltage in cycles per second and Z₂ is the impedance of the secondary in ohms.

In other words, the effective inductance of the primary has been decreased by the effect of the secondary coil. If the resistance of the secondary R₂ be neglected in the second expression it will reduce to

$$L_1 \left(1 - \frac{M^2}{L_1 L_2} \right) = \sigma L_1$$

The second quantity in the parenthesis is called the coefficient of coupling, and the quantity σ (the Greek letter sigma) is called the leakage factor. (See Calculation of Alternating Current Problems, Louis Cohen; McGraw-Hill, 1913).

Now let us see what these various terms mean. Fig. 2 shows a coupling arrangement consisting of a primary coil and a secondary coil. An alternating voltage is impressed across the terminals of the primary coil. To fix our ideas, let us think of a certain instant when the current in the primary is in the direction shown by the arrow on the wire going into the primary. The current in the primary winding causes a magnetic flux to be set up, part of which threads the secondary winding, and part of which does

a physical conception of these ideas, let us see what values the coefficient of coupling may have in our radio tuning units. An ordinary antenna coupling coil was constructed, as shown in Fig. 7. The mutual inductance between the primary and secondary was measured for various positions of the primary on the secondary. The self-inductances of the two coils were also measured and, by means of the formula given above, the coefficient of coupling was calculated. The chart in Fig. 3 shows plainly the results obtained.

When the primary was directly at the center of the secondary the mutual inductance and the coefficient of coupling were greatest. As the primary was moved away from the center toward the ends of the secondary, these dropped off rapidly, as indicated by the increasing slopes of the curves.

Another set of coils was measured, using the same secondary, but having a larger diameter for the primary coil. The same number of turns was used on the primary. The effect of the increased diameter can also be seen in Fig. 3. The effect of the increased diameter is to lower considerably the mutual inductance and coefficient of coupling.

To investigate further the effect of the primary diameter on the coupling, the curves shown in Fig. 4 were computed. The same secondary coil as used in obtaining Fig. 3 was assumed, having a self-inductance of 164.2 microhenries, and calculations were performed, various primary coils of different diameters but of the same number of turns being assumed.

In these curves (Fig. 4) the primary coil was always at the center of the secondary, that is, their center lines coincided. The calculations were started, with the assumption that the primary coil was to have always 12 turns of number 20 D.C.C. wire on it. The diameter of the primary was taken as small at first and gradually increased. The line AB in Fig. 4 indicates a case where the primary has the same diameter as the secondary. Of course, this is physically impossible, but the point is indicated to show where the maximum value of mutual inductance and coefficient of coupling are obtained.

To the left of the line AB the primary diameter is smaller than that of the secondary, and to the right of AB it is greater. It will be seen that as the diameter is increased the self-inductance increases at a nearly constant rate. At the same time, the mutual inductance and the coefficient of coupling increase steadily, until the maximum values are obtained when the two diameters are equal.

As the diameter of the primary becomes greater than that of the secondary, the mutual inductance and coefficient of coupling drop off almost as rapidly as they increased before, while the self inductance continues to increase steadily.

There is a discrepancy between the curves in Figs. 3 and 4 which I would next like to point out, and which is very important in the design of coupling coils. To illustrate

the point, let us consider the curve marked A in Fig. 3, and the curve marked C in Fig. 4. The first of these curves was found experimentally, and the second was calculated. The secondary coil was the same for each of these curves. The primary coil for curve A, Fig. 3, was 3 inches in diameter, and was placed at the center of the secondary.

The curves in Fig. 4 assumed the primary always at the center of the secondary. Therefore, it will be seen, by following the dotted line vertically in Fig. 4, that for a primary diameter of 3 inches the coefficient of coupling obtained from the curve is 65.5 per cent. This is indicated at the point C in Fig. 4. The measured value of the coupling, obtained from the point D in Fig. 3, is 84 per cent. There is a considerable difference between these two values, which must be due to the capacity of the coils and the capacity between the two coils.

In other words, there is not only the magnetic coupling between the primary and secondary coils, as we have pictured it in Fig. 2, but there is also capacity coupling between them. It can easily be understood that the winding of each coil closely resembles a metallic cylinder, so that we have something which acts like two coaxial cylinders, that is, one cylinder within another.

THE MATHEMATICAL ANALYSIS

The mathematical analysis of the prob-

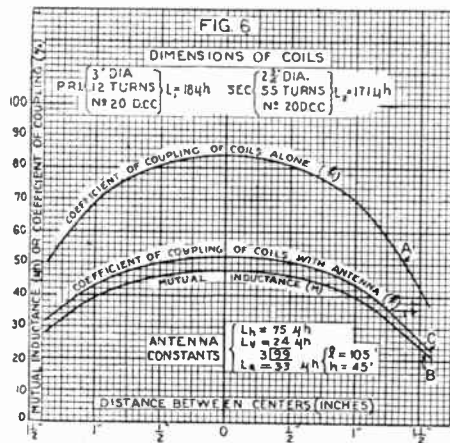

The effect of the antenna on the coefficient of coupling is clearly shown in this diagram.

lem is an exceedingly difficult one, since the capacity is distributed throughout the windings of the coils, and we do not know exactly how it is distributed. The measurement of this capacity is also a troublesome job, at least to obtain any degree of accuracy, since the value obtained will depend a great deal upon how connections are made to the coils. To obtain an approximate idea of the capacity between the coils, however, one coil was regarded as one plate of a condenser, and the other coil as the other plate of the condenser, and the capacity between the two was determined by the ordinary method of substitution described in the November issue of Radio News on page 626. It was found to be about 42 micro-microfarads.

This surprisingly great coil capacity no doubt accounts for the discrepancy existing between the measured and computed values of the coupling coefficient as described above. To investigate the problem further, the mutual inductance was measured at various frequencies, and the curve shown in Fig. 5 was obtained. If the coils had no capacity, the mutual inductance should remain constant in value, and the curve should be flat. That is, there should be no variation of mutual inductance with frequency.

However, the mutual inductance does not remain constant, as Fig. 5 indicates, since the curve turns upward. The "apparent" (or measured) value of the mutual inductance increases steadily as the frequency increases. The measurements were made over

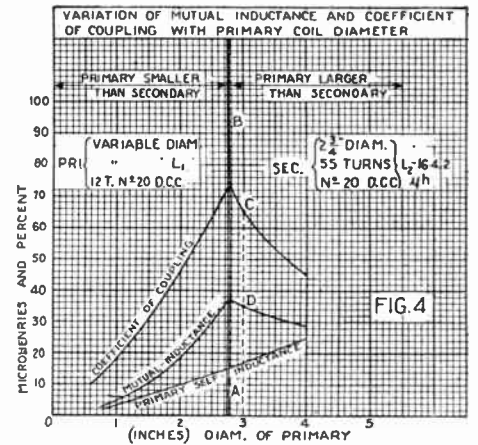

The coupling has its maximum value when the two coils have the same diameter.

a range extending from 200 kilocycles (1,500 meters) to 1,200 kilocycles (200 meters) and extended at the left end until it intersected the vertical axis, which represents zero frequency.

This zero value of frequency corresponds to direct or constant current. The mutual inductance at zero frequency is the true mutual inductance, for at zero frequency the effect of the capacity between the coils is nil. The agreement between the value indicated by the point A in Fig. 5 (the mutual inductance at zero frequency) and the calculated value indicated by the point D of Fig. 4 is very good. In fact, both points show a value of 35.5 microhenries for the mutual inductance. The curves of Fig. 4 were calculated without including the capacity of the coils, which, of course, is not known exactly.

From the values of the coefficient of coupling shown on the various curves, the reader may be led to believe that the coupling in his radio receiver is much tighter than it really is. To tell the truth, the values on the curves apply only to the coils themselves, without considering the circuits to which they may be connected in a receiver. In the formula given above, L_1 and L_2 , it must not be forgotten, are the total inductances in the primary and secondary circuits. Thus, if the primary inductance L_1 is connected in series with the inductance of the antenna the denominator of the fraction above will be $\sqrt{(L_1 + L_a) L_2}$, and the value of the coefficient of coupling k will be much less. This is shown graphically in Fig. 6. The curve A in this figure has been reproduced from Fig. 3, and represents the coefficient of coupling between the primary and secondary coils alone. The curve B represents the corresponding values of the mutual inductance.

Let us assume the primary coil connected to a single-wire antenna 105 feet long and 45 feet high. This antenna has an inductance of approximately 33 microhenries. When the correction explained in the preceding paragraph is made, the curve of co-

(Continued on page 856)

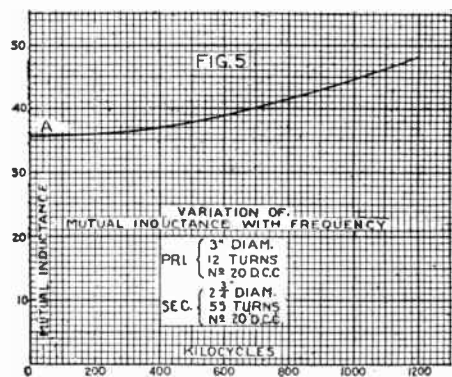

The point A, at zero frequency, agrees with the calculated point D of Fig. 4. Note that M increases with the frequency.

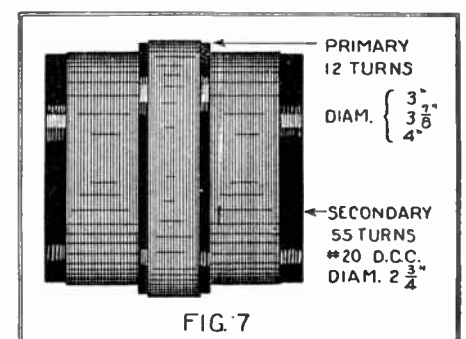

Here is a picture of the coils. There were three primaries, having the diameters indicated, but having the same number of turns on each.

How to Make the Radio Dancer

By HUGO GERNSBACK,

MEMBER AMERICAN PHYSICAL SOCIETY

The author in this article describes a new device that is operated by the output of any standard radio set. The vibration of the large diaphragm loud speaker causes the dolls to dance in a most engaging fashion.

IT has always been a cause of wonder to me why no one has tried to utilize the energy given out by a loud speaker for other purposes than sound. It occurred to me some months ago to make use of these vibrations, and the Radio Dancer, pictured on this month's front cover and in the accompanying illustrations, show the principle.

Years ago, as a child, I remember seeing small dolls, with three steel wires as legs, which were placed upon the top of the piano. As the piano was played, the vibrations set up caused the dolls to glide to and fro slowly, giving a very pretty dancing effect.

The idea association of the radio loud speaker diaphragm and such dolls was, therefore, simple, and I set about constructing such a dancing apparatus and it worked even better than I had anticipated.

Any one can build the Radio Dancer at a low cost. All that is required is a good loud speaker 'phone. When I say a "good" one I mean one that has considerable power. There are on the market now a number

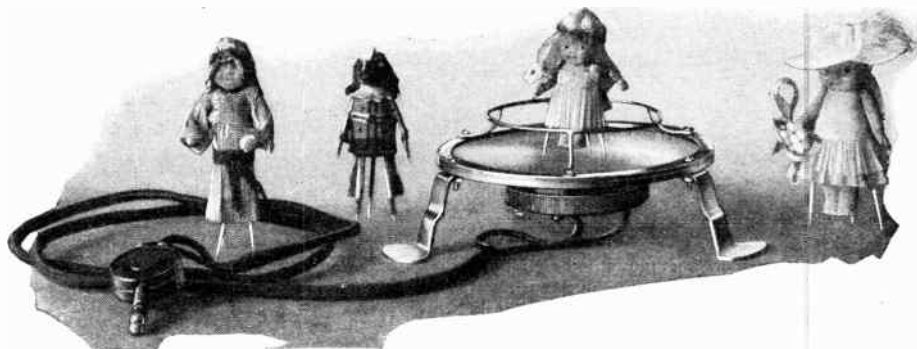

A close-up of the radio dancer, showing four of the dolls, as well as the original instrument with its plug for insertion into the loud speaker.

bus bar wire, soldered as shown. This is the guard rail, and I found it necessary for the following reason: When I first constructed the Radio Dancer I did not use the guard rail but, since the vibrations are naturally

with this. The holes must not be punched but must be drilled—otherwise the diaphragm will warp. The best material to use is Ferrotype plate, which is used in most telephone receivers, and has a brownish-black appearance. It can be bought at practically every photographic supply store, and comes in many different sizes. The main thing is that you must find a piece that is absolutely flat, which has no nicks or bends in it.

The next thing we require is the supporting feet for the entire apparatus, pictured in Fig. 5. These pieces can be made of brass and need not necessarily be shaped as I have shown them in the illustration, but any other bracket or feet will do.

The next part is not shown in the illustration, but is most important. This is a piece of heavy paper, similar to the U. S. postal card. It should be good stiff Bristol and you are to make a piece exactly as shown in Fig. 1; that is, 5 inches in diameter, 4½ inches inside, and with the same holes as shown in Fig. 1. This paper ring is next placed on piece 2. On the paper ring, we next place the piece 1, and then screw the three pieces together. The paper ring is used to give the diaphragm clearance. If we had no paper ring the diaphragm would touch the piece 2 and the diaphragm would not give any sound, nor would there be much vibration.

The guard rail, as well as the feet, are screwed down with screws and nuts, as shown in our assembly illustration, which should be used as a guide.

After everything is ready, all you need to do is to screw the loud speaker unit into the bottom of piece 2, and it goes without saying that your machinist must have provided a suitable thread in piece 2 in order to take

(Continued on page 824)

of phonograph attachment loud speakers, most of which give good power. Practically any one of these may be used. In making this instrument it is necessary to get a loud speaker which has a cap that screws down on it for reasons which will be explained further on.

The cap and diaphragm are removed and the loud speaker 'phone is to be screwed, later, into the piece marked Fig. 2 in the design drawing. This piece, by the way, may be turned out of hard rubber, bakelite, or fibre. The dimensions are given, and any machinist can make the few parts needed for a few dollars. The ring "1" is made of fibre or bakelite or even brass. Either will do, so long as the piece is perfectly flat. The important point is that it should be perfectly flat, and should not warp.

The next piece to be made is shown in Fig. 3. This is nothing but our good old

strongest at the center of the diaphragm, the dolls had a tendency to gravitate to the edge of the diaphragm, where there is no vibration, and then stood still. So the guard rail was designed in order to prevent the dolls from reaching the edge of the diaphragm. It worked out quite satisfactorily. This guard rail is easily made simply by bending a piece of round bus bar wire around a 3 or 3¼ inch tube, and soldering it as shown. Then the three supporting feet can be soldered on.

The next piece to make is the diaphragm, shown in Fig. 4. Here a good deal of caution is needed as the diaphragm is large in diameter—namely, 5 inches. It must be made of metal that is absolutely smooth and straight. Moreover, the metal must, of course, be iron. Ordinary tin will do if it is not more than 10/1000ths of an inch thick, and your tinsmith can perhaps oblige you

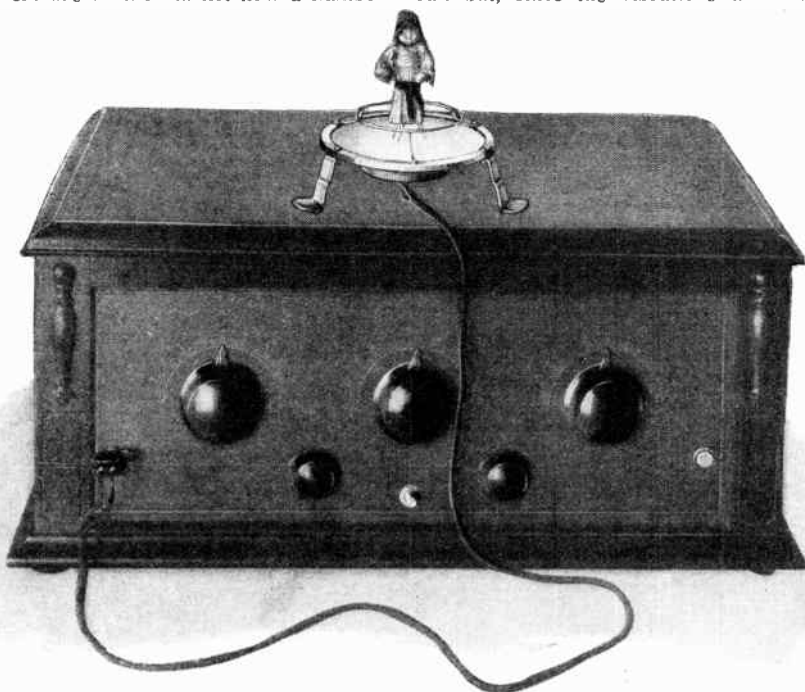

Complete view of the radio dancer and a standard radio outfit. It should be noted that this instrument works well only in connection with a set of at least three tubes. The dancer does not work on one-tube sets or crystal sets, as good loud speaker volume is needed for the operation of the device.

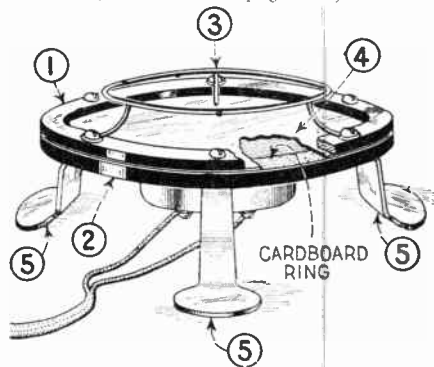

The radio dancer, assembled completely from the parts shown in the detailed constructional diagram on page 824.

The Baby Transmitter

By W. B. SCHULTE

STATION 9EK-9XH is the station of the C. F. Burgess Laboratories at Madison, Wisconsin, and it is being operated with the idea of keeping actual contact with amateurs and other stations and aiding in the development of radio.

One of the interesting problems of this station has been short-wave communication, especially with low power and a study of the possibilities of the use of dry cells for transmission. The Radio Laboratory is in charge of Mr. W. H. Hoffman and the operators are Don Mix and Philip Zurian.

The Baby Transmitter, which is the subject of this article, was built by Mr. Zurian and makes use of circuits which had been developed at this laboratory.

The circuit arrangement shown in Fig. 1 is a modification of the Colpitts oscillator developed at the laboratories, where it has been used for larger power transmitters at frequencies from 1,000 to 150,000 kilocycles

and the transmitter. The power input to the set of 0.41 watts, with which it worked New York, is considerably less than that taken by the two-cell flashlight lamp when it is lighted in a flashlight case.

Every radio fan who operates a radio receiver at any point except perhaps on a farm, is familiar with the interferences caused by other receivers which radiate. The energy from these interfering receivers, gen-

erally called "bloopers," is great enough to carry for many city squares and cause loud whistling and squealing noises in the receivers of others. Ship operators, after leaving port and reaching distances from land as great as 30 miles, have reported that the "bloopers" could still be heard. When a receiver is sending out a signal in this manner it is functioning as a radio transmitter and deriving its power from the "A" and "B" batteries which are connected to it. The circuits and arrangements of a receiver, however, are not usually such as to make an efficient transmitter. For best receiver action the receiving tubes are arranged to generate feeble radio currents only and are coupled to antenna systems very loosely.



Here is operator Phil Zurian, 9EX-9XH, holding the baby transmitter.

If the circuits associated with the small receiver tubes are made highly efficient and properly coupled to an antenna system it is reasonable to expect that the whistling can be heard in receivers at much greater distances and so become useful for communication purposes. This has been shown to be the case in the work accomplished with the Baby Transmitter.

Recent advances among radio experimenters, and especially among the amateurs, have shown that a given power will effect communication over greater distances in the high frequency (low wave) regions.

(Continued on page 921)

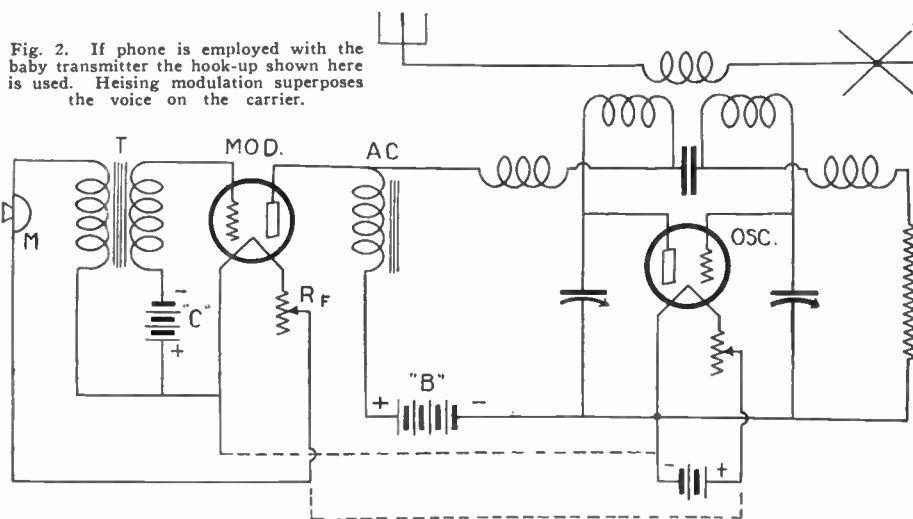

Fig. 2. If phone is employed with the baby transmitter the hook-up shown here is used. Heising modulation superposes the voice on the carrier.

(300 to 2 meters) with high efficiency and splendid stability.

The interest attached to this transmitter is its small power input and the use of the 199 receiving tube. When the transmitter was in operation careful measurements were made of the current and voltages supplied to the filament and plate. These measurements were made on a standard tube testing set so that the wattage input as reported was accurate.

CIRCUIT ARRANGEMENT

The efficiency and stability obtained by use of the circuit in Fig. 1 was due to the fact, in part at least, that the two series inductances and the two series capacities form a radio frequency bridge circuit and the "B" battery circuit, as well as the grid leak circuit, bridges points of little or no differences in radio frequency potential.

The plate and grid coil are each of edge wise wound ribbon and contain 7 turns each. The antenna pick-up coil is of No. 6 copper wire and has six turns. The diameter of the former are six inches while that of the latter is approximately four inches. Both variable tuning condensers are of the usual low loss type and have a capacity of approximately .0002 mfd.

A transmitter operated from dry cells in the high frequencies region has a pure D.C. note which is very difficult to obtain from any source of power other than batteries. This pure note characteristic makes it possible to use a set of this kind for radio tel-

and the transmitter. The power input to the set of 0.41 watts, with which it worked New York, is considerably less than that taken by the two-cell flashlight lamp when it is lighted in a flashlight case.

Every radio fan who operates a radio receiver at any point except perhaps on a farm, is familiar with the interferences caused by other receivers which radiate. The energy from these interfering receivers, gen-

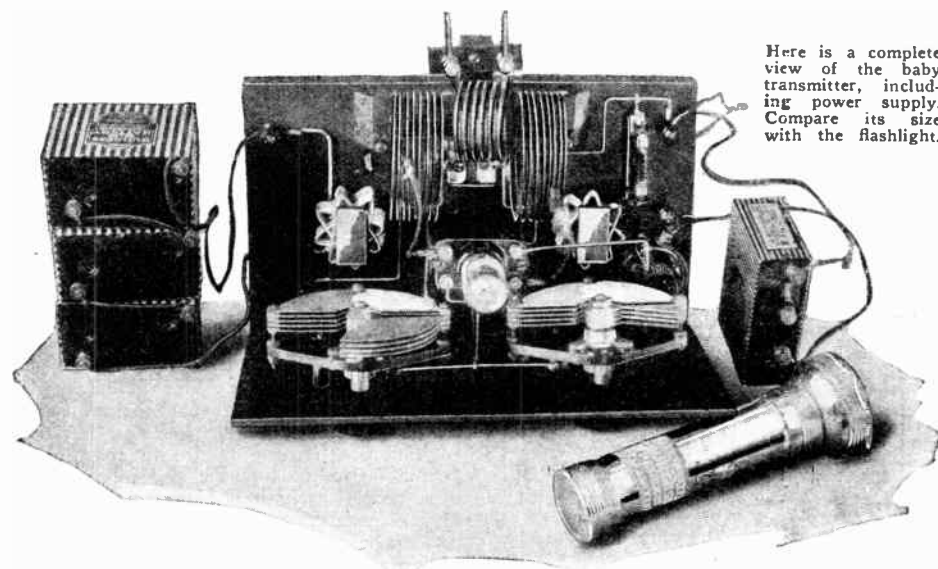

Here is a complete view of the baby transmitter, including power supply. Compare its size with the flashlight.

Multiple Grid Vacuum Tubes and Their Advantages

By THEODORE H. NAKKEN

An interesting article is here presented that every true radio fan should read carefully, as it concerns a development which should soon be widespread.

TO realize fully the advantages of multi-grid vacuum tubes, which are in general use in Europe, it is necessary to understand at least some of the fundamentals of the ordinary vacuum tubes. Above all, the specific functions of its separate elements should be realized, and therefore I will endeavor to outline the matter in the shortest and clearest possible manner.

In the ordinary vacuum tube, as used in practically every radio receiver today, we find three elements enclosed in an evacuated glass tube, *viz.*, filament, grid and plate.

These three elements have been retained ever since the first conception of the amplifying tube, although some may confidently expect that in the near future the filament may be replaced by some other element. The vacuum tubes of today are vastly superior to those of only a very few years ago, but these improvements are due only to better design and manufacturing processes.

THE FUNCTIONS OF TUBE ELEMENTS

In short, we may define the functions of these three elements as follows: The filament serves solely as a source of electrons, as it emits electrons when heated to a sufficiently high temperature, which is dependent upon the material of which the filament is made. The function of the plate is to absorb the electrons emitted from the filament, for which purpose it is given a positive potential, which actually means that it possesses too few electrons and therefore attracts the latter, causing a flow of electric current. The function of the grid is to determine the number of electrons that can flow from the filament to the plate, or in other words, since the number of electrons is measured in terms of current, the grid determines the current flow from the filament to the plate.

If the filament emits a great number of electrons, and the plate is not very positive, not all of the electrons can be absorbed by the plate. So the plate current will increase with increased plate potential, and *vice versa*. But in normal operation the amount of plate current is always determined by the grid.

We know that the plate battery is placed between plate and filament, so that the plate is positive while the filament is negative. We are also familiar with the fact that these two elements are surrounded by a positive and a negative electrostatic field respectively. But at the same time the electrons emitted by the filament represent quantities of negative charges, and therefore the electrons themselves cause the presence of a strong

negative electrostatic field, which is called the space charge. And as negative fields repel other negative fields or bodies, so this space charge tends to repel new electrons emitted by the filament, and if it is strong enough, it drives the new electrons back into the filament. The re-absorption takes place at the most positive part of the filament, which for this reason combined with another one deteriorates more rapidly than any other part.

It is evident then that the fields created by filament and electrons oppose the one created by the plate. These fields determine by their relative strengths how many electrons shall pass from filament to plate and how many shall be re-absorbed by the filament, if we neglect the presence of the grid, as for instance in the original Fleming valve. Of course this does not hold true when saturation condition is attained, that is, when all the electrons emitted by the filament reach the plate. This occurs only when excessively high plate voltages are used.

If now we introduce the third element, the grid, the filament and the plate will retain their respective fields, together with the space charge, but we have now a means of introducing one more field which we can control independently of the others. If now we change this grid field in any one sense, we will cause predomination of either the negative or the positive field, and in this way cause the plate current to change and either decrease or increase it. Thus the grid gives us a convenient means of controlling the plate current at will.

As the grid is ordinarily held at such a potential that no electrons are attracted by it, but are rather repelled, no current will flow in its circuit, and thus it will not absorb any energy; this means that it will operate without any loss of power, and by means of potentials alone. This is meant when it is said that the vacuum tube is a voltage-operated device. As the response of the device is instantaneous, the vacuum tube may safely be called one of the most wonderful inventions of all the ages, and the number of its applications will presumably increase as time goes by.

When now we look back over this simple explanation, we see that there is a considerable waste of energy. What we wanted to accomplish was first of all to obtain emission of electrons from the filament; second, to obtain a flow of these electrons to the plate; third, to control these electrons in their flow by means of the grid potential.

NULLIFYING THE SPACE CHARGE

As was explained, the electrostatic field due to the electrons, *i. e.*, the space charge, tends to prevent the flow of electrons from filament to plate. We must apply energy to overcome this tendency. This energy is furnished in the form of an unduly high plate potential, so that we may say that in a tube serving as an amplifier only part of the plate potential actually takes part in the amplifying process, the other part being used to counteract the space charge.

This then means that if this space charge could be nullified or reduced in some way, not nearly as high a plate potential would be necessary, because in that case there would be a clear path between the plate and filament, the only obstruction being the grid. These considerations induced American

and European physicists to seek means to offset the effect of the space charge. It was reasoned that if this could be done, the plate potential could be lowered by an amount equal to that required to counteract the space charge.

At the same time another advantage would be gained. The action of the grid would be more intense; in other words, the amplification factor of the tube would be increased considerably. How this happens is not easily explained, but the following will give at least a fair idea of the reason.

If the space charge were absent or its effect nullified, the electrons would have a high initial velocity and only the grid charge

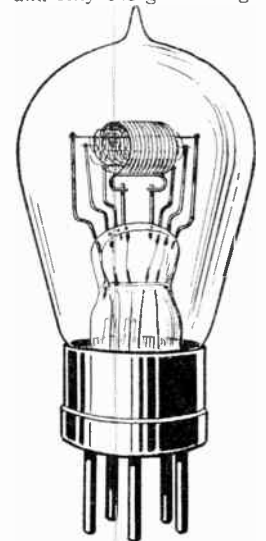

Fig. 4. The two inside spirals are the inner and the outer grid elements; the large spiral of heavier wire is the plate and the filament is the single straight wire stretched between the two outer supporting posts.

would oppose them in traveling to the plate. If the grid is held at a negative potential, it tends to retard the electrons and limit the number which reaches the plate, but the grid would then be the only factor retarding the electrons, instead of being only part of the total of space charge and grid field. Therefore, any variation of grid potential and of the grid field would then be fully effective, while in the ordinary tube the same change in grid field is but a percentage of the total retarding field, of which a large part is the space charge. This absence of space charge would cause the amplification constant of the tube automatically to increase.

Almost simultaneously Dr. Langmuir in the United States and Dr. Schottky in Germany proposed to reduce the effect of the space charge by means of a fourth element in the form of a positive grid.

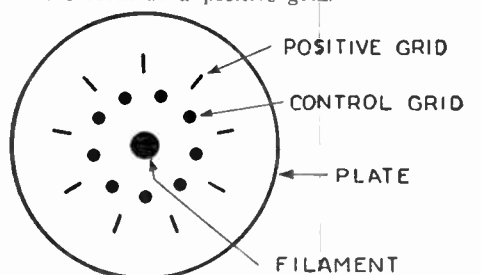

FIG. 2

How the elements of the Siemens-Schottky double-grid tube are arranged.

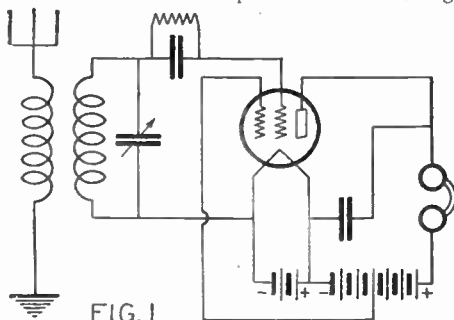

FIG. 1

Fig. 1 shows a circuit employing the double grid tube, the inner grid being connected to the positive tap of the "B" battery for neutralization of the space charge.

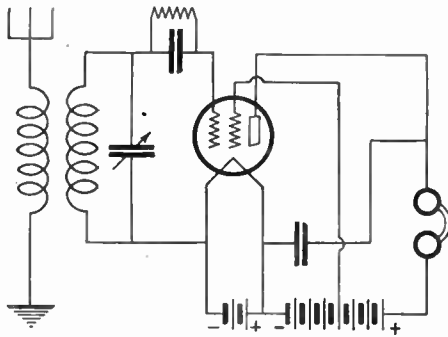

FIG. 3

Fig. 3 gives the circuit diagram for the Siemens-Schottky double-grid vacuum tube.

This grid is placed between the signal grid and the filament, and is made of fairly open mesh, to prevent it from attracting an excessive number of electrons and thus carrying a large current. The majority of the electrons pass right through the mesh.

As this grid is placed at the point where the space charge is formed, a slight positive potential is sufficient to reduce the effects of the latter, and it was found that a well-constructed tube of this nature could almost be operated without the use of a separate plate battery at all, still giving the same results as an ordinary tube using a high plate voltage. The exceptional results obtained with these tubes are due to the fact that the amplification factor of the tubes has been increased from about 6 or 7 in an ordinary three-element tube to about 20 or more, without an increase in the internal output impedance, so that tubes of this kind are also suitable as power tubes. Of course, it is possible to design three-element tubes that have a higher amplification factor, but the internal output impedance of these tubes becomes so high that they are suitable only for resistance or impedance coupled amplifiers, and an ordinary tube must be used as final output tube.

The circuit in which such a tube can be used is shown in Fig. 1, where it is seen that grid A, the inner one, is connected to a variable tap on a small plate battery, while grid B, the outer one, is used as the signal grid in the ordinary manner. This circuit was used extensively in Holland some few years ago (1920-1922), Holland being in those years about the only country where such tubes were available to the public, both of German (the Siemens-Schottky tube) and of Dutch manufacture (the Philips and Van Heusen tubes). Later, in 1923, these tubes came to be used by radio fans in France, England, Belgium.

POSITIVE OUTER GRIDS

Parallel with the experiments on positive grids between filament and signal grid, experiments were carried on with positive outer grids. In fact, the Siemens-Schottky tube was actually built for the use of a positive outer grid. The function of this outer grid is a little more complicated than that of a positive inner grid. Yet it can be easily understood from the following:

If in an ordinary tube the plate voltage is increased, the plate current also increases if the grid be maintained at a constant potential. But an increase in plate current means a decrease in plate potential. Now it should be remembered that a large part of the plate potential is used solely to counteract the space charge, and only a comparatively small part of the plate voltage is actively employed in the production of amplified signals. Therefore, the slightest increase of plate current or decrease of plate potential means an increased effect of the space charge in the first place and less effective voltage in the second place. This latter effect is

partially offset by the capacitative effect between plate and grid, at least at high frequencies. But it is generally known that the greatest enemy of effective radio frequency amplification is this capacitative effect, so that we may easily discount this factor as being, at the least, a great objection.

If now a wide-meshed grid is placed between the signaling grid and the plate, and we give this grid a fairly high positive potential by means of a separate lead, it will assist the plate in its function of overcoming the space charge. If suitably constructed, it will take a negligible current, because the majority of the electrons will pass through the meshes while but a few are absorbed. To minimize this current, the outer grid in the Siemens-Schottky tube consists of but a few radially placed flat spokes assembled as a sort of cage. The spokes present their sharp edges to the direction of electron flow, as will be seen from the diagram of this tube in Fig. 2.

It will be readily appreciated that the potential changes of the controlling grid will have little influence on the current flowing in the outer grid circuit and that therefore this grid will vary little in potential in response to incoming signals. Thus, this outer grid remains almost constant in potential, so that its property of counterbalancing the space charge remains practically constant, and the effect of the latter remains largely eliminated. In other words, the amplification factor of the tube is increased, without loss in conductivity of the tube.

ANOTHER ADVANTAGE

There is, however, a second beneficial effect, which is of tremendous advantage if properly utilized. It has been indicated before that one of the most detrimental effects in vacuum tubes is caused by the capacity between plate and grid. This capacity effect almost completely prevents the construction of efficient radio frequency amplifiers for the broadcast wave-lengths. It may be said that up till the present time a real radio frequency amplifier for these wave-lengths has been sadly lacking, and that not one of the amplifying systems in use gives nearly the theoretically possible amplification, no matter whether the receiver is "neutralized" or not. This is the reason why the regenerative receiver is generally called the "old reliable." No other type of receiver has as yet been designed that gives better results per dollar invested than a well-designed regenerative receiver. The only excuse for the existence of other types of receivers is increased selectivity in some cases, and the elimination of radiation.

If now we turn back to the last tube, with positive outer grid, we shall see that here, as in the ordinary tube, the plate varies in potential on account of changes in plate current. But these variations will be much larger than those of the outer grid, the current of which is much smaller. The variations will take place in the same sense, however, and on account of the capacitative effect between the plate and this grid, the plate will tend to stabilize its potential, because the capacitative effect will cause voltage variations of opposite sign to the variations due to current changes, which are caused by the effect of the inner, the controlling grid. This means that the outer grid is even more stable in potential than would be expected from the fact that it carries only a negligible current.

But not only this: It also will be easily realized that the presence of the outer grid minimizes the influence of the plate on the inner or control grid, due to the fact that the plate grid capacity of the single grid tube has been replaced by two capacities in series, and that each one of these capacities itself is smaller than the plate grid capacity in the ordinary tube. This makes the resultant capacity between plate and control

grid very small, indeed, and also stabilizes the tube when in operation, reducing tendency to oscillate.

POSSIBILITIES FOR POWER WORK

The conclusion which one would naturally make from the foregoing would be that this type of tube is also a better amplifier than the single grid type. Actually, it is easy with a tube of this type to attain an amplification factor of around 30, combined with a low tube impedance which makes this tube also suitable for power work.

It is to be regretted that tubes like these have been designed primarily for low filament and plate battery consumption. It should be possible to develop a tube along these lines for real power amplification, and that this should be possible is proven by following fact:

If one takes a tube of the type of the UV-202 as made by the R. C. A. and puts it into operation with a positive bias on the grid of 10 volts, it delivers, with a plate voltage of only 90, a plate current of fully 10 milliamperes. This means that if a controlling grid were added, we should have ample power available combined with a high amplification factor.

About a year ago this type of tube was rediscovered and quite a few circuits were

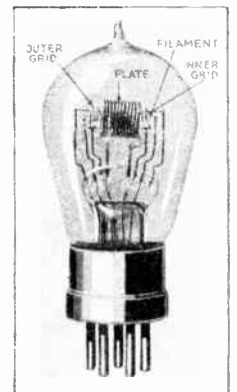

A double-grid vacuum tube that is manufactured in England. It has the same internal construction as that on the opposite page. A special socket is required for these tubes, as they have five connection prongs.

published for its use. These circuits were entirely new in the United States, but were old acquaintances to those who had had the chance of experimenting with these tubes at all. The tube specifically recommended for these circuits was fitted with the two grids

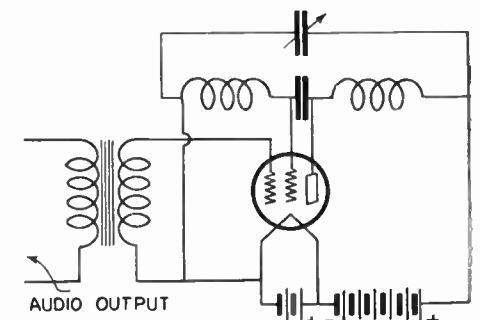

FIG. 5

The double-grid tube used in a circuit, proposed by Langmuir, where it is employed for simultaneous oscillation and modulation.

and the plate in the form of spirals, and it must be confessed that it would be extremely difficult indeed to find another tube that showed greater microphonic properties. It is shown in Fig. 3. The tube was generally used in some kind of reflex circuit, one grid being used for radio frequencies, the other for audio frequencies. Needless to say, this was a principle that had been known long before, but above all it caused one to lose all the good characteristics of these tubes: the tremendously increased amplification fac-

(Continued on page 826)



Traffic or Experiment?

By A. P. PECK

WHICH man is the most valuable to the fraternity, the boy who clears the hook of several msgs. each night, gets a reputation in his district and always has half a dozen schedules to complete, or the fellow who always has something new up his sleeve, waiting for chances to try it, the chap who is always drawing diagrams and wondering what would happen if thus and thus were done to the old bread-board?

Let us tread lightly on this subject lest we have a various assortment of OT's, defunct bottles and burned-out transformers flying directly at our poor head. This same question, we suppose, has been put and started more arguments than the League of Nations, the French War Debt and Prohibition put together. If the rag-chewing caused by this little harmless question were compressed into one night it would require all the commercials, transatlantics and the cable service to make even a dent in it. And yet the thing is not settled—not by some.

Now don't mistake us, we do not intend to do what several thousand nights at the brass has been unable to do. No, we simply want to point out a few salient points in this connection which may change the point of view of those concerned and possibly show that there is no question involved at all, that it is simply two sides of a situation and that the two sides are in beautiful and serene co-operation rather than fighting each other.

In order to get to the crux of the matter, let us consider for the several thousandth

time just what is the foundational *credo* of the American Ham. Just why is he a ham and what compensation does he obtain for the long hours of peaceful sleep he misses and for the gobs of perfectly good jack he soaks in bottles, chokes and conterpoises. It is simply a scientific interest, a knowledge that he is doing something for the world of science and industry.

Now from this, let us examine again this terrible question which has caused so much bloodshed in the ranks. If the work the boys are doing is to improve science and commerce, it is necessary that they find new and better means of communication, is it not so? But suppose we fulfill the first part of the rule, that is, new means of communication, does it necessarily follow that it is a useful means, that it fulfills the second condition of the rule? It does not, you may believe me.

This point must be proven, and I hereby call to witness me in this statement the shades of all the good bottles departed in the service of the array. How, in the name of all that's holy, is it possible to prove the worth of any particular idea without trying it under operating conditions? And how, pray, does one try a set-up under operating conditions without handling the old msgs, and handling them on what the commercial brothers call expedited service?

Here is the whole point, the man who desires to be the real ham, that is, the man who seeks to make his hobby produce something for the good of the game, is the man

who is *both* good to the message hook and to the experimental note-book. Think back through your experience in the field. Which one of the other stations that you work do you respect the most? Do you take hook-ups from the chap who is never ready to take your msg.? And do you ever take any experimental dope from the fellow who never chews the rag in relation to some new kink, and who has no pet theories as to the reason for the skip space of the short waves, hey, do yuh? No, you don't.

The man listened to in the conventions and whose stuff is always read in the prints, is the boy who does both and who does both of them in a workmanlike way. There are scads of fellows who sort of look down on
(Continued on page 888)

THE MONTH'S CROP OF NEW QRA'S

Two Corrections

1ABW—H. O. Fairfield, 63 Elanor St., Chelsea, Mass., and

1AWB—E. L. Deslauriers, 12 Lafayette St., Attleboro, Mass. C.W. on 40 and 80 meters. Crds answd day recd.

4AAH—F. S. Holliday, P. O. Box 1292, Atlanta, Ga. 5 watts C.W. Crds appreciated is answd.

5EH—Reassigned—E. S. Mace, 132 Sunset, Dallas, Tex.

9CKP—Robert L. Willits, 716 Oak Park Ave., Des Moines, Ia. 5 watts on 80. Pse rpt. All crds answd.

9SE—Dwight A. Bancroft, 73 and Lyndale, So., Minneapolis, Minn. 50 watts C.W. on 40. Crd for QSL.

9EBW—Reassigned—Charles A. Luigs, 1229 Chandler Ave., Evansville, Ind. 5 watts C.W. on 40. Crd for crd.

11 ER, SANTANGELI MARIO, MILAN, ITALY

United States: lab, laf, laz, laa, lbs, lbj, lhu, lbv, lbq, lbd, lcu, lei, lej, lek, lec, led, lda, ler, lef, lez, lgs, lgt, lgv, lga, lii, lhn*, lk, lka, lkr, llw, lle, lmy, lnu, lno, lnt, lqn, lqr, lql, low, loj, lpc, lpy, lpm*, lrd, lyb, lyi, lxf, lxj, lxu*, lxm, lxx, lzl, lzv, lzn, lzo, lzm, lza, lzz, lzt, lahl, laud, lawe,* laci, lacu, laer, laxa, laye, laff, lanis, laja, lauf, laur, larc, laww,* lajw, lajp, laua, laac, layp, larh, labt, labs, laf, labi, laar, lapg, lary, laxz, atj, lapl, lagb, lajx, laao, lauc, lall, lawy, axn, lalm, laft, lavf, lapk, lalv, laid, ladp, lars, lah, laep, laos, lhw,* lbzp, lhd, lbyb, lbes, lber, lbyc, lbcc, lbep, lbhm,* lbvs, lbie, lbkq, lbdx, lboa, lbkr, lbqg, lbfi, lbsd, lbph, lbrk, lbef, lbh, lbml, lboq,* lber, lbsn, lbem, lbx, lbuo, lbqi, lbiz, lere, lcbg, lcjv, lepk, leab, lemp, leak, legq, lecx, lepv, lekp, levo, leme, lean, leri, lemx,* lecx, lebb, lebd, lemo, leki, 2aam, 2 act, 2aay, 2ana, 2awj, 2arf, 2 apf, 2awf, 2azy, 2agw, 2axf, 2acb, 2adin, 2aaq, 2agb, 2aan, 2aey, 2auv, 2adk, 2agq, 2afn, 2acp, 2aluk, 2aes, 2 bgi, 2bgi, 2brc, 2byk, 2hdu, 2bnb, 2brb,* 2byw, 2bgg, 2bdo, 2bej, 2bse, 2bec, 2bic, 2bum, 2bnu, 2bqw, 2bqa, 2blm, 2bjx, 2big, 2bee,* 2boa, 2box, 2bur, 2bkr, 2baq, 2bui, 2btg, 2bva, 2cpg, 2cec, 2cla, 2cbr, 2cqi, 2cei, 2cvj, 2cej, scvu, 2shg, 2cyw, 2cxl, 2cxw, 2cvo, 2cix, 2cpd, 2cgo, 2cqs, 2cus, 2clg, 2cpb, 2cnk, 2cpk, 2cns, 2cis, 2cdv, 2ctf, 2ctq,* lcpa, 2cyu,* 2cyx, 2ctb, 2cfj, 2kii, 2xab, 2ag, 2az, 2ad, 2ac, 2af, 2br, 2by, 2bq, 2hg, 2hm, 2bn, 2bw, 2ct, 2cv, 2cc, 2cg, 2dd, 2dx, 2ds, 2em, 2eb, 2ec, 2gx, 2gk, 2kf, 2kx, 2kd, 2kr, 2jw, 2hg, 2ld, 2ll, 2m, 2lu, 2nf,

(Continued on page 890)

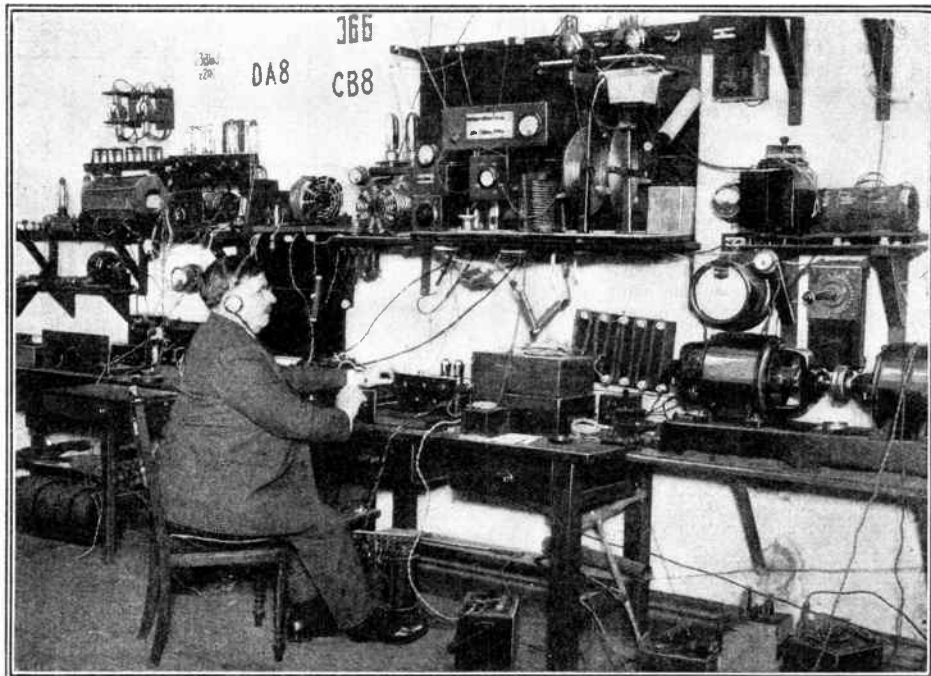

The famous CB-8 of the Argentine. No story of the big international ham doings is complete without a few notes telling of the part played by this station, the first to open trans-Pacific two-way communication.

Five-Meter Transmission

By R. E. KOLO, 8CAU

Here is a new idea in five-meter circuits which presents a novelty in its oscillator and radiator circuits which are combined. It works at 50 watts!



TRANSMISSION and reception at five meters have been greatly limited because of the difficulty of securing the proper circuit relations. The troubles encountered in adjusting very small capacities and inductances are such as to discourage experimentation on this frequency. While possible to use standard circuits on five meters, it is very difficult, in

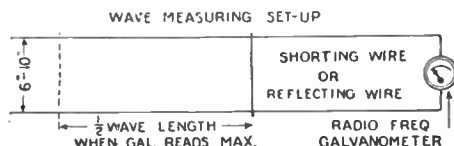

The "Lecher" method of measuring the length of radio waves is used to find accurately the frequency of the transmitter or receiver.

most cases, to maintain steady oscillations. It is useless to go into the numerous difficulties that arise in experimental work along such lines, for the object of this article is to describe and illustrate a circuit and set in which but little trouble was experienced in obtaining the required frequency. Such a set was used with success at the University of Cincinnati.

The circuit was developed at the University of Illinois Experimental Station. It is essentially a series circuit, for all condensers and inductances are in series with the tube capacity. This reduces critical adjustments to a very helpful extent. The wiring of the circuit is the inductance and, in one case, also the loop antenna.

The pictures and diagrams illustrate the circuit far better than a lengthy discussion, so reference will be made according to the lettering of the drawings. The oscillatory circuit ABCD is made in the form of a loop, as shown. The size of this loop will vary according to the use for which the oscillator is intended. For a loop transmitter the inductance, that is, the wiring, should be as large as possible. Where the circuit is coupled to some sort of radiating system it is not so important that the loop be large. On the fifty-watt set illustrated the loop was rectangular in shape and made of one-quarter-inch copper tubing. The sides AXC and BYD were 30 inches long and sides AB and CD 18 inches long. The loop of the five-watt set was 16½x13½ inches. Of course these sizes can be changed to suit any conditions, provided the condenser capacity C_1 is varied accordingly.

THE CONDENSERS

Almost any sort of small variable condenser will do for C_1 so long as the capacity is somewhere near that of the tube A_1 . Two plates widely spaced in an ordinary receive-

ing condenser will serve the purpose very nicely. Or mount two small sheets of brass or copper on insulating supports, such that one plate is movable. The condenser C_1 in the fifty-watt set was made of two copper sheet plates 2 inches in diameter, supported on glass rods. A separation of 2½ to 3½ inches was necessary to cover the range of 4.8 to 6 meters. For the five-watt set an old ordinary condenser was reduced to two plates, separated by ½ inch.

The side AC of the loop is made horizontal or vertical in accordance with the plans as to the method of transmitting. A Hertzian oscillator placed parallel to AC should fundamentally be vertical. However, a horizontal mounting is far easier to support. The better of the two remains to be determined.

The choke coils E are most necessary

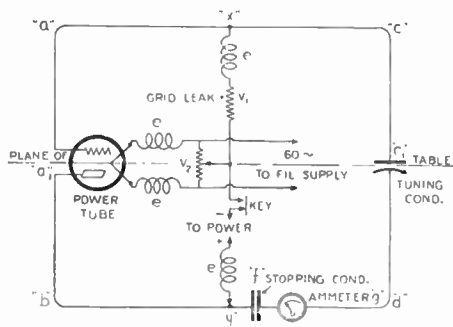

The transmitting circuit uses the connections between the parts as a loop antenna.

and should be placed in the circuit as shown. The portion of the circuit included between the points X and Y is not part of the radio frequency circuit and care should be taken that it be isolated by means of the chokes. The coils were wound with 25 turns of No. 24 D.C.C. basket-weave fashion, on a ¾-inch mean diameter form. This makes a convenient self-supporting coil.

The resistance R_1 is an ordinary grid leak. The usual transmitting leak of 5,000 ohms was used in both sets. The resistance R_2 is for the purpose of getting a center tap to the filament. Twenty ohms tapped in the middle is sufficient. The stopping condenser F is to protect the tube in case of failure of C_1 . A .002-6,000-volt condenser was used for the fifty- and a .002 condenser for the five-watt set. The radio frequency indicating device may be an ammeter or a flashlight bulb. Since the voltage and current waves are stationary the voltage and current will vary in value from point to point throughout the circuit.

This means that the ammeter or bulb must be located near a point of maximum current in order to be of use. The correct position will be near the voltage nodes which can be found as the points X and Y. The meter could be placed near either point, but in order that the side A_1AXCC_1 be continuous it is best placed, as shown, at G. A very sensitive ammeter could be placed anywhere in the circuit except at A_1 and C_1 , but it is obvious that the most convenient place is at the current anti-anode, as shown.

THE RECEIVER

The receiver uses the same circuit with

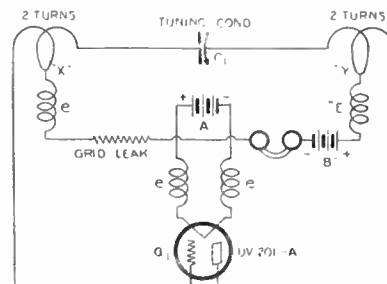

The receiver may be a separate set of instruments, or those of the transmitter can be used for reception with little extra wiring.

but few changes. The stopping condenser F can be removed for the "B" battery voltage is not great enough to flash over in the tube, as in the case of the transmitter should C_1 be shorted. A grid leak of about two megs is substituted in place of R_1 . The sides A_1AXCC_1 and A_1BYDC_1 are made of two turns of heavy wire or tubing. The choke coils are the same as used in the transmitter. It is possible to make one set do for both transmitter and receiver. In fact, the five-watt transmitter was used as a receiver with no changes except the placing of lower voltages, phones and a receiving tube in the circuit. The use of the UV202 and UV201-A tubes, which fit in the same size socket, reduces the change to but the throwing of a battery switch and plugging in of the phones in place of the keying relay. The construction is so very simple that the illustrations give sufficient information for anyone.

The selection of the tubes to be used is largely dependent upon "local" conditions. A hard tube will work best. Slightly soft tubes suitable for 20-meter work will not function at five meters. The five-watt tubes worked very well and no trouble was experienced in any of the five tried. The fifty-watters presented a few difficulties—gaseous tubes, "bum" internal construction, etc., but it was possible to put two of them in parallel and operate them! Fifties with small grid chokes inside the tubes would not oscillate. Where the tubes were finally made to oscillate.

(Continued on page 826)

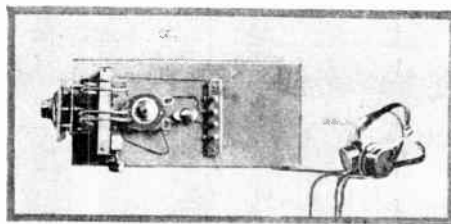
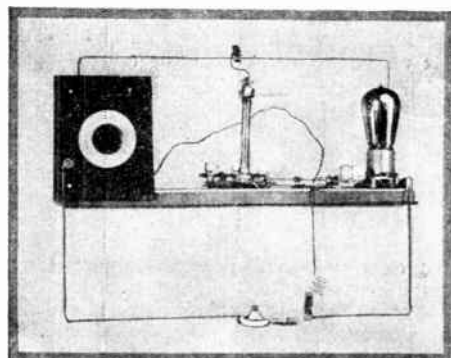

On the left is the transmitter using a 5-watt tube. Above is the top view of the receiving circuit. Copper tubing ¼ inch in diameter was used to form the 2-turn inductances. Note the arrangement of apparatus for shortness of connections. On the right is another transmitter that employs a 50-watt tube. ¼-inch copper tubing is used for the loop, which is also employed as connections for the instruments.

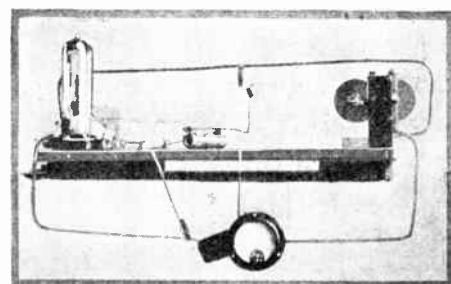

Electrolytic Condensers

By THEODORE A. SMITH and JAMES MILLEN

The electrolytic condenser is a much neglected piece of apparatus—which is surprising as it is easy to build. This article gives an excellent description of these condensers and their construction.

THE condenser is one of the most important elements of any radio set, transmitting or receiving. Together with an inductance, the condenser makes up the tuning element of a set. The phone by-pass condenser serves to separate the direct and alternating currents which flow in the same circuit. Condensers have an important use in filter systems which help to remove the undesirable A.C. hum from rectifiers used in "B" battery eliminators or transmitting sets.

num, the negative to the steel, a current will at first flow through the electrolyte. Soon, however, the aluminum becomes covered with a coating of an oxide or hydroxide layer. Over the solid layer is a thin gaseous layer of oxygen generated by the electrolytic action. This combination of the solid oxide layer and the gaseous oxygen layer makes up the dielectric of the condenser.

On the other hand, a large condenser is expensive, and in combination with a smaller inductance, when properly connected, will raise the voltage of the output. These are distinct advantages which should make the electrolytic condenser more popular than it is at present.

Unlike ordinary condensers, the electrolytic type is polarized. That is, the aluminum must always be connected to the positive terminal. If this is not done the condenser will be ruined. Another peculiarity is the fact that there is a small leakage current which flows all the time. This is due to imperfections in the insulating layers, which allow small currents to flow. As the leakage is not usually comparable with the direct current output, and as it merely wastes a small amount of current which, in the case of a large inductance, would be wasted in resistance losses, the leakage loss is neglected. When a pulsating direct current is impressed across the condenser the leakage

Owing to the fact that these two layers are relatively thin, the capacitance is extremely high. For example, a thirty-microfarad condenser is quite easily constructed, its size being about that of an ordinary tin can. An air condenser of this capacitance, if constructed, would be far too bulky for convenience, and its expense would make it out of the question. A paper or mica condenser of 30 mfd. could be constructed, but its cost would make it impractical. It will be seen that the electrolytic condenser fits into this gap.

The need of such a large capacity occurs in transmission and reception alike. Its purpose is to smooth over the rectified current in combination with a choke coil. Thus, in "B" eliminators such a filter is necessary, and also in any case where the plate supply is derived from alternating current. It might be thought that a large inductance or choke would serve the purpose of a filter without any condenser at all, but this is not the case. In Fig. 1, A represents the alternating current wave before rectification, B represents the output rectified wave and C is the current with a choke coil of large inductance as a filter. It will be seen that such a filter does not produce the straight line of direct current which is desired. D is the current with a large condenser across the line, and with a choke in series. The result is practically perfect D.C.

However, the filter condenser is not only indispensable, but it is economical. For example, practice has shown the best filter to be of the "brute force" type. This is a filter of large size, *i. e.*, a large choke with a smaller condenser, or *vice versa*. It has been usual to employ a very large inductance of thirty to fifty henrys and a condenser of three or four microfarads capacitance. The cost of a large choke is almost prohibitive however, and it has the unfortunate effect of reducing the output voltage by a considerable amount, owing to its resistance.

TABLE 3
RELATION OF CAPACITY TO VOLTAGE OF FORMATION
(Ideal Values)

Formation Voltage (volts)	Capacity (microfarads per sq. cm.)
50	2.00
75	1.20
100	.90
150	.50
200	.37
300	.25
400	.18
600	.10

TABLE 5
CRITICAL VOLTAGES FOR ALUMINUM ANODES WITH VARIOUS ELECTROLYTES

Chemical Formula	Voltage	Name
$(NH_4)_2CrO_4$	122	Ammonium Chromate
$NH_4H_2CO_3$	425	Primary Ammonium Carbonate
$NH_4H_2PO_4$	460	Primary Ammonium Phosphate
$NH_4C_6H_7O_7$	470	Ammonium Citrate
$Na_2B_4O_7$	480	Borax

effect is an advantage. The leakage current is usually taken as being proportional to the cube of the voltage. Thus, at the peak of the applied voltage wave, more current will leak than at the lower voltage values. This tends to reduce the peaks and smooth the wave.

A great advantage of the electrolytic condenser is that it is not harmed by breakdown. Ordinary condensers are ruined when the insulation is punctured. Not so the electrolytic type, for if the oxide layer is punctured, current is momentarily passed and the film is immediately built up again without permanent damage to the apparatus.

The make-up of an elementary condenser is shown in Fig. 2. The electrolyte may be a saturated solution of borax or one of the other salts mentioned later on. Aluminum is usually used for one plate with lead for the other. Theoretically, such a device would stand a potential of 480 volts without undue leakage, but owing to impurities in the electrolyte and electrodes, much lower voltage must be used. If one condenser will not stand the impressed voltage, several may be connected in series. This, of course, reduces the capacitance, and to obtain the

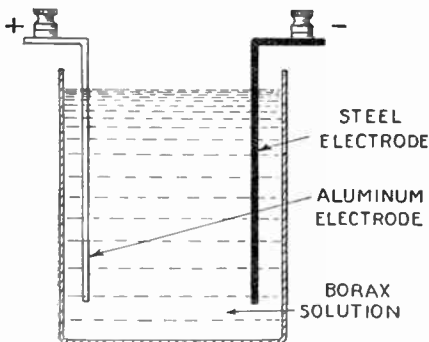

FIG. 2

The construction of an ordinary electrolytic condenser; two unlike metals for electrodes and borax or similar liquid for a solution.

In general, condensers are classified according to the material which separates the electrodes. Thus, there is the gaseous type which exists in nearly every receiver in the form of the variable air tuning condenser. The solid, dielectric type is used for phone condensers and wherever a small fixed capacitance is needed for low voltages. Liquid dielectric condensers are seldom found in ordinary radio sets, but in commercial work they are quite common. Oil is the usual insulating material.

Besides these three fundamental types, there is another kind of condenser which seems to be a combination of all three. It is called the electrolytic condenser, and it consists of a steel plate electrode and an aluminum or tantalum electrode between which is a solution of certain salts, such as borax or ammonium borate. When a direct voltage is impressed across the electrodes, the positive side being connected to the alumi-

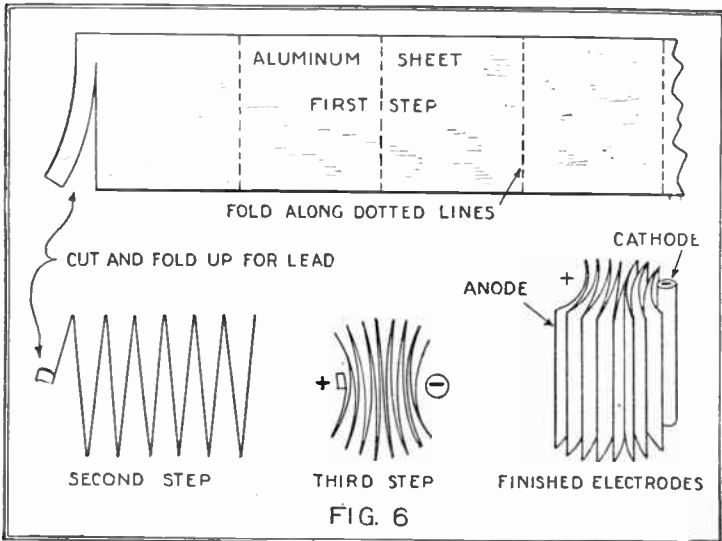

FIG. 6

The method of folding the sheet aluminum for forming the element of the electrolytic condenser.

original value it will be necessary to increase the area of the aluminum plate.

Unlike other condensers, the capacitance depends on the voltage at which the condenser was formed, as this determines the thickness of the oxide layer. Capacitances for various formation voltages are shown in Table 3, above, and the curve of Fig. 4. Once formed, the oxide layer remains nearly constant for ordinary voltage variations. The gas layer will be increased, and the capacity decreased by an increased voltage, and this increased layer will remain for a considerable time, even under a much decreased impressed voltage. It is thus rather difficult to determine the capacity of the electrolytic condenser.

Although perfectly suitable for filter systems, the electrolytic condenser could not be used for a radio tuning device, because of the leakage currents which would become important, and because the solution acts as a high series resistance of as much as a hundred ohms or more.

The theoretical changes in capacitance with various formation voltages are clearly illustrated by Table 3. In practice, however, it will be found that the actual capacities of electrolytic condensers will be about one-fourth of the values shown in the table. The curve of Fig. 4 gives the actual capacitance per square inch of anode surface for different voltages. These values are not necessarily precise, as it is difficult to measure the capacity of "leaky" condensers, because of the effect in them of variations in temperature, time of formation, formation voltage, and elapsed time between formation and measurement. Practically, however, the values given in Fig. 4 are quite satisfactory. The effect of temperature upon capacitance varies considerably with different electrolytes, having little or no effect with

for other electrolytes. In making up the solution, distilled water must be used. Electrolyte containing sodium, potassium, or other active metals will attack the aluminum and badly pit or corrode it. The presence of sodium will also cause the solution to give off a very disagreeable odor after it has been in use for some time. The chemicals should be "chemically pure" and not just "commercially pure," as the presence of even small quantities of chlorides or bromides will interfere with the proper action of the condenser.

THE ELECTRODES

An electrolyte having been decided upon, it next becomes necessary to procure the electrodes. As the sole purpose of the cathode is to make connection with the electrolyte, it may be made of any material which will not be attacked by the solution. A polished steel plate may be used for this purpose, although it is generally more common practice to employ aluminum or nickel. This plate need not be very large as its size in no way affects the electrostatic capacity of the cell.

The anode, however, must be of aluminum and of a high degree of purity. The average commercial sheet aluminum is not satisfactory. As the capacity of the condenser is dependent upon the anode area, it becomes essential to use a large piece of aluminum for this electrode when a high capacity is desired. In order that the complete unit may not be too bulky or cumbersome, the cathode is arranged in the manner illustrated in Fig. 6.

In order to prevent surface arcing, which results in two evils, destruction of the electrode and loss of energy, the anode must be completely covered by the solution. Of course, it is evident that there will still be leakage where the lead to this electrode pierces the surface of the liquid. In order to prevent such an occurrence, or at least to reduce it to a minimum, the lead must be insulated from the solution at the troublesome point.

At first thought, it would seem that the desired insulation might easily be procured by means of paraffin, collodion, asphaltum or some other such substance. Insulation will last but a few hours, if that long. The only practical method is to use rubber tape, held in place by rubber bands, and the whole joint covered with vaseline.

In order to predetermine the size of anode for a given capacity and voltage of formation, refer to the curve of Fig. 4. From it may be obtained the capacitance in mf. per square inch of anode surface for several values of voltage. It is only necessary to divide the required capacity by this number and the result will be the active anode surface area to give the required capacity.

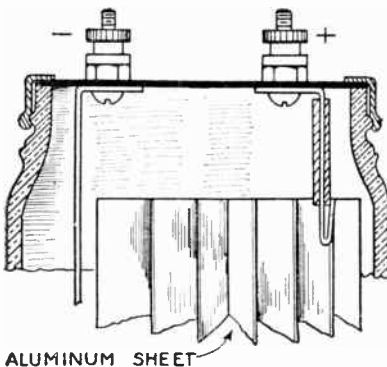

ALUMINUM SHEET
The insulation of rubber tape, shown by the cross-hatched section, on the positive connection, should be covered with vaseline. Care should be taken with this connection.

some, while it may cause either a positive or negative change with others. The effect of a small change is generally but slight.

For the sake of clarity, construction of an electrolytic condenser will be discussed in several parts.

THE SOLUTION

There are many solutions which will give successful results. The main reason for selecting some in preference to others is that the solution determines to a large degree the critical voltage of the condenser. That is, the greatest voltage that it is practical to have across the condenser. The solution has practically no effect upon the capacity. Condensers made with some electrolytes have the undesirable habit of necessitating reformation of plates after a short period of idleness. Ammonium borate possesses many excellent qualities as a condenser electrolyte. It may be prepared by neutralizing ordinary boric (also known as boracic) acid with household ammonia—the clear kind, not containing soap or borax. Another fine solution is ammonium phosphate. Table 5 gives the critical voltages

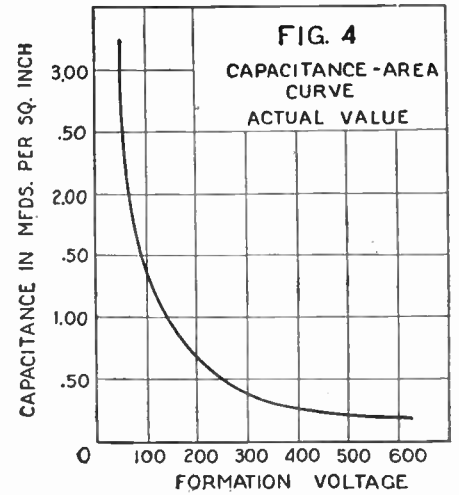

Curve showing actual capacity per unit area for different formation voltages.

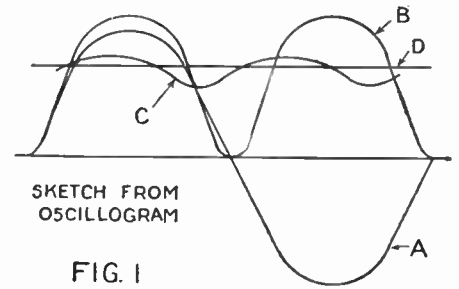

FIG. 1
A, is a pure A.C. wave; B, a rectified wave; C, a filtered rectified wave and D, a wave having a condenser and coil in the circuit.

In order to reduce the evaporation and creeping of the electrolyte, a few drops of high grade acid-free mineral oil should be placed on the surface of the solution. Paraffin oil is well suited to this purpose.

FORMING THE ANODE

The condenser is now ready to be formed. The forming should be done at a voltage considerably higher than the D.C. voltage to which it is to be subjected in service. The forming voltage should not exceed, or in fact even approach, the critical value of the electrolyte. Any high voltage D.C. supply such as a motor generator, 220-volt D.C. house supply or rectified and filtered A.C. may be used for the forming process which will require twenty-four hours. During the first few minutes the D.C. supply apparatus should be carefully watched for signs of overheating as the new "condenser" will act as a very heavy load. The power consumption will soon decrease, and after about fifteen minutes will become quite small. At the end of the twenty-four-hour period, the power consumption is negligible (about .003 amperes for 30 mf.).

When the anode is formed, the condenser is ready for service. Plainly mark the terminals + and - so that they will never be accidentally reversed, as such a connection would instantly destroy the oxide film which took a day to form. For the same reason don't put A.C. across the condenser.

THE INDUCTANCE

The construction of a large inductance to be used in combination with an electrolytic condenser as a filter system offers no particular difficulty to the beginner. The hardest part is the winding of the coils for the choke. However, with the aid of a winder or lathe and a little patience, the job is soon done. The dimensions of a twenty-five henry choke are given in the table below. Two sizes are shown, the first being suitable for a "B" battery eliminator, the second for the plate supply of two five-watt transmitting tubes. The winding consists of half the

(Continued on page 840)

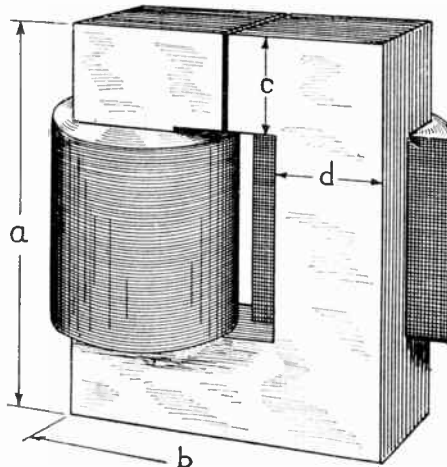

FIG. 7
Dimensions are given in the accompanying table for two different sizes of choke coils; one for receiving and the other for transmitting purposes.

A New Impedance Coupled Audio Frequency Amplifier

By SIDNEY E. FINKELSTEIN, A.M.I.R.E.

For uniform audio frequency amplification over the whole range of frequencies, choke coil coupling is recommended. The reasons are given in the article herewith.

At the present time there are three distinct methods used in coupling tubes for the purpose of audio frequency amplification. First, we have the transformer-coupled type; second, the impedance-coupled method; and third, the resistance-coupled type.

Of these the most commonly used has been the audio frequency amplifier using transformer coupling. Generally no more than two stages of amplification can be used successfully, as distortion is likely to occur with greater amplification. But the resist-

Waterloo test of many transformers, and it is surprising to note how high and low notes are either partly or entirely suppressed.

THE RESISTANCE-COUPLED TYPE

To overcome the difficulties of transformer coupling, the resistance-coupled amplifier has been developed to a stage where it finds favor in the eyes of many. However, the amplification which takes place in a resistance-coupled amplifier is lower, and, therefore, in order to accomplish the work

battery voltage from 90 to 135 or more means that both "A" and "B" battery current will increase and thus increase the expense of upkeep of the receiver. It is admitted, however, that when quality is the main consideration, expense should not deter the experimenter. But why incur more expense than is necessary to attain the same good results? The choke coil or impedance-coupled amplifier may be designed to give as good quality or nearly as good as the resistance-coupled amplifier.

The choke coil coupled amplifier may be called an audio frequency amplifier using auto-transformer coupling. With proper design it is possible to obtain uniform amplification at all frequencies while the intensity per stage is much greater than can be obtained with the resistance-coupled amplifier.

The low tones of the organ at 25 vibrations per second are amplified as much as the medium-pitched tones of 500 vibrations and the high-pitched tones of 5,000 vibrations. Again as much volume with the same tonal purity can be obtained as with four stages of resistance coupling.

Where exceptionally loud signals are required, such as to fill a public hall or for outdoor work, a fourth stage of amplification may readily be added without causing distortion.

THE LAYOUT

If reference is made to the circuit diagram, it will be noted in what manner the three-stage amplifier described here functions. All plate and grid leads are kept as short as possible to prevent the possibility of howling or squealing through undesirable feed-back due to capacity coupling. As regards feed-back from excessive magnetic coupling between successive stages, the condition for self-oscillation is entirely overcome, because the auto-transformers are completely shielded and grounded.

Successful operation of this device is not limited to storage battery tubes, as dry cell tubes also give excellent results. If it is desired to use dry cell tubes, a 25-ohm rheostat should replace the 10-ohm rheostat shown in the circuit diagram. The best operating point will be obtained if approxi-

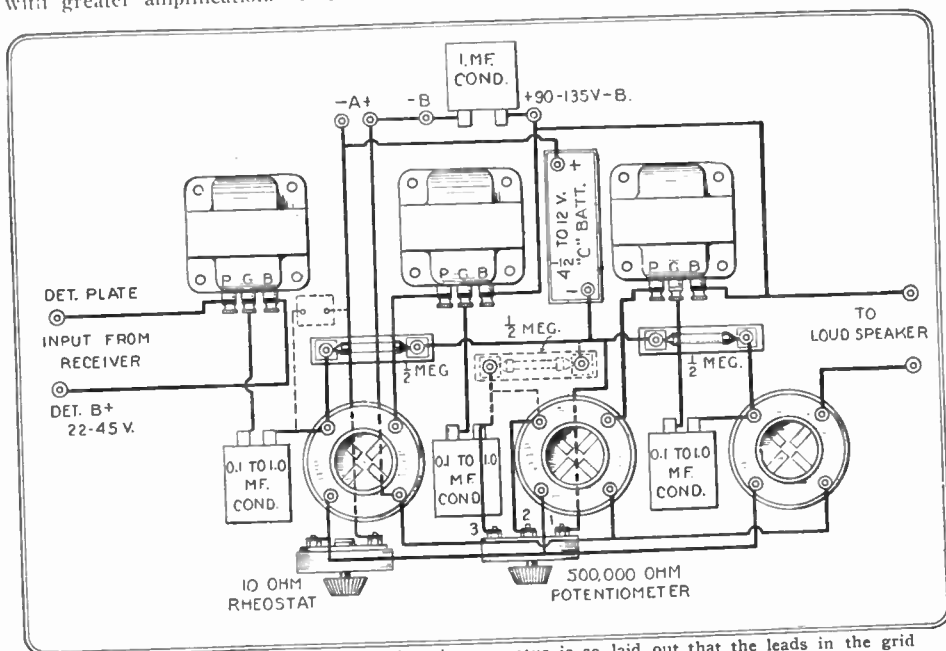

It will be noticed from the diagram that the apparatus is so laid out that the leads in the grid and plate circuits are as short as possible.

ance-coupled amplifier, although it generally employs three stages, can be consummated in as many as half a dozen. Three stages of impedance-coupled amplification have been used successfully, but results were not commensurate with the increase in the cost of installation.

An attempt was made, therefore, to perfect an amplifier which would be commendable from every viewpoint. Let us review the characteristics of the various types of audio frequency amplifiers.

CHARACTERISTICS OF VARIOUS AMPLIFIERS

The principle drawback of transformer coupling is the fact that the transformer often has a decided peak value at a certain frequency. In other words, in the transmission of the voice from the broadcast station and its subsequent detection and amplification in the receiver, the voice, which may range in frequency from 100 to 2,000 cycles, may be subject to serious distortion. True, some transformers have what is known as a flat curve for a small range of frequencies, and it is this type which is classed as the superior transformer. It is obvious, even to the uninitiated, that a transformer has its limitations and will give maximum output only at resonant frequency bands.

The reproduction of band music is the

which a two-stage transformer-coupled amplifier is capable of doing, three or four stages of resistance coupling are necessary. The gain is mainly in improved quality of reproduction. There is one great drawback, however, and this is that the current consumption is increased proportionately. To burn two extra tubes and to boost the "B"

The bottom view of the shelf on which the tube sockets, resistances and condensers are mounted. Notice the short leads.

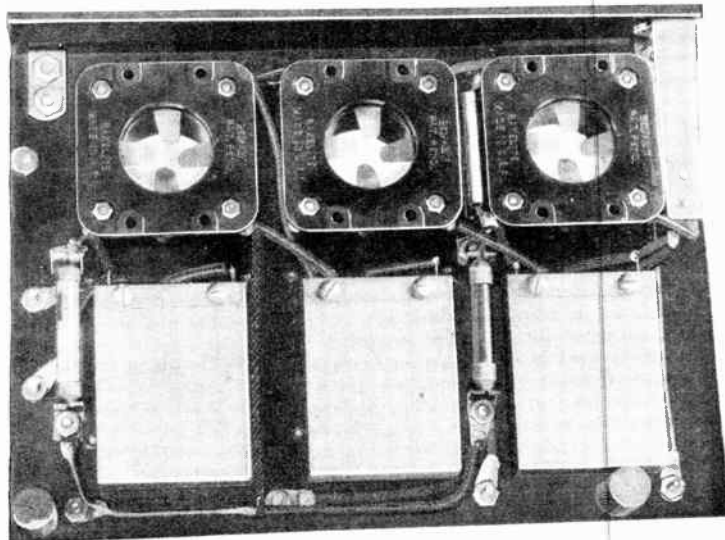

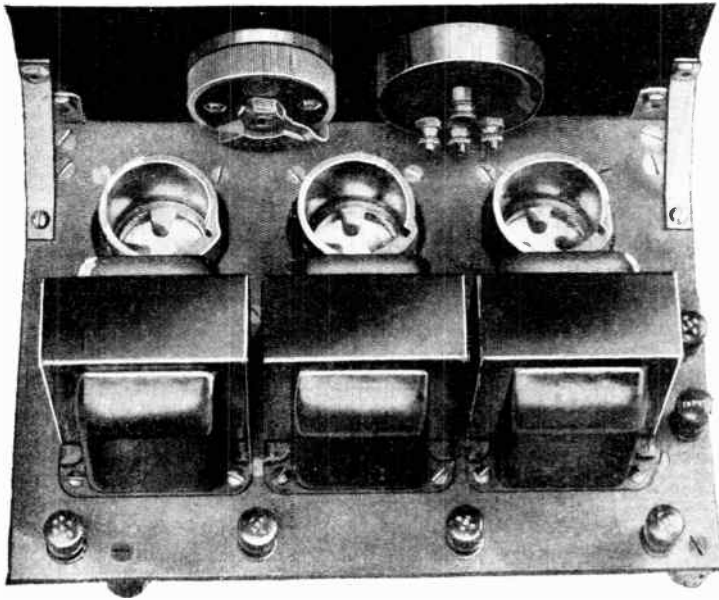

The top view of the amplifier unit shows the rheostat, potentiometer, the three vacuum tube sockets and the three impedances. The condensers and resistances are under the shelf, as shown in the photograph on the opposite page.

mately 110 volts "B" battery and 6 volts "C" battery are used.

The design of the stopping condensers has been such as to allow both the very high and very low notes to be reproduced faithfully. High values of 0.1 to 1.0 mfd. can be used, as their values are not critical. The rate of discharge of the stopping condenser on the third stage determines the maximum volume limits, due to the fact that the charged grid of the tube will block the plate current. The volume attainable with a 10 mfd. condenser on the third stage is usually more than sufficient for home reception. The introduction of a lower resistance leak on the third stage will also increase the volume limit by discharging the condenser more rapidly, but this has the effect of reducing the amplification. If a .002 mfd. condenser is placed between the grid of any one of the amplifier tubes and the negative "A", it will reduce any distortion which may be present. However, this is optional.

Sometimes the amplifier may oscillate at a frequency above audible, and hence give no evidence of oscillation, excepting in the
(Continued on page 842)

RADIO SET DIRECTORY

RADIO has now arrived at the stage where receiving sets have become stabilized to a very high degree. Inasmuch as there is continuous discussion as to various features of sets produced in the United States, Radio News has taken the initiative to present, month by month, a complete picture of the entire set industry.

In presenting the various sets in a directory of this kind, it is naturally only possible to touch the high points, and we have therefore listed all outfits under a simple classification that will, we hope, be of great service to the public, as well as to the trade. We have

attempted in this directory to list every set manufactured in this country, and although we have written a number of letters to all manufacturers, not all have replied. In order to make the directory complete, all sets manufactured by any one manufacturer listed have been included.

The Directory will be kept up to date, month to month. All manufacturers are invited to send monthly corrections as to the various features of the sets which they produce.

BAKER-SMITH CO., Inc.
New Call Building,
San Francisco, Calif.
Trade Name: Syllan
Circuit: Tuned radio frequency
Batteries: Storage
Antenna: Outdoor or indoor
Loud Speaker: Separate
Controls: Three
List Price: \$100.00.
With built-in speaker, \$130.00.

Trade Name: Syllan
Circuit: Armstrong Regenerative
Batteries: Storage
Antenna: Outdoor or indoor
Loud Speaker: Separate
List Price: \$60.00. With speaker, \$90.00.

Trade Name: Syllan
Circuit: Armstrong Regenerative
Batteries: Storage
Antenna: Outdoor or indoor
Loud Speaker: Separate
List Price: \$80.00. With speaker, \$110.00.

Trade Name: Syllan
Circuit: Armstrong Regenerative
Batteries: Storage
Antenna: Outdoor or indoor
Loud Speaker: Separate
List Price: \$90.00. With loud speaker, \$120.00.

DAVID GRIMES, INC.
1571 B'way, N. Y. C.
Trade Name: Monotube
Circuit: Three
Batteries: Storage or dry cell
Antenna: Outdoor
Controls: Two
List Price: \$12.50

Trade Name: Tritube
Circuit: Three
Batteries: Storage or dry cell
Antenna: Outdoor

Loud Speaker: Separate
Controls: Two
List Price: \$35

HARCOURT RADIO COMPANY.
51 Shebourne St.,
Toronto, Ont., Canada
Trade Name: Harco
Crystal Set
Circuit: Crystal
Batteries: None
Antenna: Outdoor or indoor, light socket, etc. Range 25 miles
Control: One
List Price: \$5.00

Trade Name: Harco-dyne Five
Circuit: Tuned radio frequency
Batteries: Dry cell or storage
Antenna: Indoor or outdoor
Loud Speaker: Separate
Controls: Three
List Price: \$65.00

Trade Name: Radioflex
Circuit: Reflex
Batteries: Dry cell or storage
Antenna: Outdoor or indoor
Loud Speaker: Separate
Controls: Two
List Price: \$22.00

H. W. HARMON & SONS CO.
418 Poplar St.,
Grove City, Pa.
Trade Name: Harmonson IV-A
Circuit: One stage tuned and regenerative radio frequency
Batteries: Dry cell or storage
Antenna: Outdoor
Loud Speaker: Separate
Controls: Two
List Price: \$50.00

Trade Name: Harmonson Grand V-C
Circuit: Tuned antenna and one regenerative radio frequency stage
Batteries: Dry cell or storage

Antenna: Outdoor
Loud Speaker: Built-in
Controls: Three
List Price: \$135.00

Trade Name: Unitrol Grand
Circuit: Two stage tuned radio frequency
Batteries: Dry cell or storage
Antenna: Outdoor
Loud Speaker: Built-in
Controls: One
List Price: \$175.00

Trade Name: Unitrol
Circuit: Two stages of tuned radio frequency
Batteries: Dry cell or storage
Antenna: Outdoor
Loud Speaker: Separate
Control: One
List Price: \$150.00

HEARWELL ELECTRIC CO.
53 Devonshire St.,
Boston, Mass.
Trade Name: Forbes Short-Wave Receiver
Batteries: Dry cell
Antenna: 2-foot loop, 3 strands
Loud Speaker: Separate
Control: One
List Price: \$20.00

Trade Name: Forbes One-Tube Portable
Circuit: Single-circuit regenerative
Batteries: Dry cell, WD-12 tube, 18 v. "B" B.
Antenna: Locals, without aerial but with ground
Loud Speaker: Separate
Controls: Two
List Price: \$15.00

Trade Name: Forbes Lyric Crystal Receiver
Circuit: Crystal
Antenna: Outdoor
List Price: \$5.00

HUDSON TERMINAL RADIO & ELEC. CO.
30 Church St.,

New York City
Trade Name: Hudson Sloped
Circuit: Tuned radio frequency
Batteries: Storage
Antenna: Outdoor
Loud Speaker: Separate
Controls: Three
List Price: \$40.00

Trade Name: Hudson Console
Circuit: Tuned radio frequency
Batteries: Dry cell or storage
Antenna: Outdoor
Loud Speaker: Built-in
Controls: Three
List Price: \$125.00

IRVING RADIO CORP.
Columbus, Ohio
Trade Name: Irving Model No. 42
Circuit: Tuned radio frequency
Batteries: Storage
Antenna: Indoor or outdoor
Loud Speaker: Separate
Controls: Three
List Price: \$55.00

Trade Name: Irving Model No. 44
Circuit: Tuned radio frequency
Batteries: Storage
Antenna: Indoor or outdoor
Loud Speaker: Separate
Controls: Three
List Price: \$65.00

Trade Name: Irving Model No. 46
Circuit: Tuned radio frequency
Batteries: Storage
Antenna: Indoor or outdoor
Loud Speaker: Built-in
Controls: Three
List Price: \$95.00

INTERNATIONAL RADIO CORP.
145 Pacific Electric Bldg.,
Los Angeles, Calif.

Trade Name: Rotofo No. 10
Circuit: Tuned radio frequency
Batteries: A and B
Antenna: Outdoor or indoor
Loud Speaker: Separate
Controls: One
List Price: \$110.00

Trade Name: Rotofo No. 20
Circuit: Tuned radio frequency
Batteries: A and B
Antenna: Outdoor or indoor
Loud Speaker: Separate
Controls: One
List Price: \$145.00

Trade Name: Rotofo No. 30
Circuit: Tuned radio frequency
Batteries: A and B
Antenna: Outdoor or indoor
Loud Speaker: Separate
Controls: One
List Price: \$165.00

Trade Name: Rotofo No. 40
Circuit: Tuned radio frequency
Batteries: A and B
Antenna: Outdoor or indoor
Loud Speaker: Separate
Controls: One
List Price: \$260.00

Trade Name: Rotofo No. 50
Circuit: Tuned radio frequency
Batteries: Storage or dry cell
Antenna: Outdoor or indoor
Loud Speaker: Separate
Controls: One
List Price: \$290.00

KELLOGG SWITCHBOARD & SUPPLY CO.
1066 W. Adams St.,
Chicago, Ill.

Trade Name: Wave Master (Table Type)
Circuit: Tuned radio frequency
Batteries: Storage or dry cell
Antenna: Indoor or outdoor
Loud Speaker: Separate
Controls: One
List Price: \$125.00

Trade Name: Wave Master (Console)
Circuit: Tuned radio frequency
Batteries: Storage or dry cell
Antenna: Indoor or outdoor
Loud Speaker: Built-in
Controls: One
List Price: \$225.00

Trade Name: Wave Master (Console)
Circuit: Tuned radio frequency
Batteries: Storage or dry cell
Antenna: Indoor or outdoor
Loud Speaker: Built-in
Controls: One
List Price: \$235.00

Trade Name: Kellogg R.F.L. Receiver
Circuit: Balanced tuned radio frequency
Batteries: Storage or dry cell
Antenna: Indoor or outdoor
Loud Speaker: Separate
Controls: One
List Price: Not established.

KENNETH HARKNESS RADIO CORP.
727 Frelinghuysen Ave.,
Newark, N. J.
Trade Name: (Kenneth Harkness) 2-Tube Reflex
Circuit: Harkness Reflex
Batteries: Storage preferred
Antenna: Outdoor

(Continued on page 858)

Radio Wrinkles

PANCAKE COIL WINDING FORM

Many of the circuits that have been recently published call for coils of the pancake type. To make these coils to have as few losses as possible it is desirable to wind them so there is a minimum of insulation used.

In the accompanying sketch there is shown an easily made form that will be an aid to the constructor who wishes to make coils of this type. Two square pieces of bakelite or hard rubber, having dimensions 4 by 4 by 1/4 inches, are clamped together and through the exact center is drilled a hole large enough to accommodate a 6/32 machine screw. On the diagonals of the squares there are made slots as shown. First there is a hole drilled at each end of the place where the slot is to be made. Then with a fine saw cut away the material between these two holes and smooth with a file. These operations are performed while the two pieces are clamped together.

In one of the pieces there is a hole drilled 3/4 inch from the intersection of the diagonals, about the size of No. 18 wire. This is to hold the wire tight at the start. Three washers are needed to fit the 6/32 machine screw, two of them being large enough to accommodate the head of the screw and the nut. The other should be 3/4-inch in diameter and 1/16 inch thick. This last washer is the spacer between the two bakelite plates and is used as the winding center of the coil.

The wire is first put through the small hole that was drilled just on the edge of the 3/4-inch washer and then the two plates are clamped together, as shown in the sketch. The desired number of turns are then wound on and fastened by winding the wire around the central screw. Through the slots is applied to each side of the coil

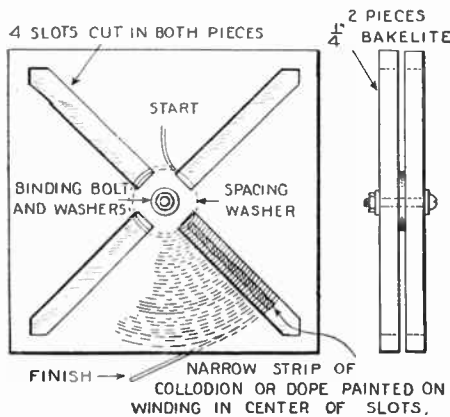

Two pieces of bakelite cut as shown make an excellent winding form for pancake coils.

a thin coating of collodion or other "dope" for holding the turns in place. The result will be a coil that is wound on air and having as great an efficiency as many others that are much more difficult of construction.

Contributed by Wm. E. Anderson.

INSULATOR MADE FROM TELEPHONE RECEIVER CASE

There are doubtless many fans who have in the junk box a discarded telephone receiver from their early days in radio. Maybe they have been tempted to throw it away, but refrained hoping that some day "it might come in handy." Well, here is a way to utilize it and incidentally save the price of a stand-off insulator.

Through the hole in the cap of the re-

ceiver, from which the magnets and coils have been removed, place a wood screw large enough to support the rest of the receiver when it is attached as shown in the sketch. Between the head of the screw and the cap is placed a washer. Care must be taken in screwing the cap to the wall since, if the screw is driven in too tightly, the cap of the receiver will crack. In the other end of the receiver, through the hole that

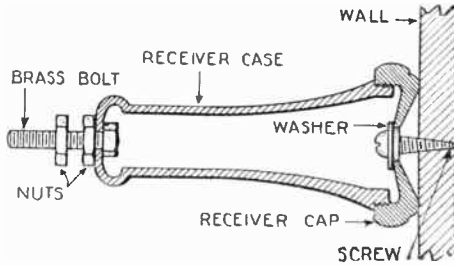

A stand-off insulator is very easily made from a discarded telephone receiver.

is used for the connecting wires, there is placed a bolt that will fit tightly. This bolt is fastened with a nut (again exercising care not to screw the nut on too tightly) and on the end of the bolt is placed another nut for fastening the wire that is to be insulated.

This insulator will be found to be useful and very efficient to the fan who is overhauling the antenna for the coming winter.

Contributed by G. A. Kappel.

ROTOR MOUNTING

One of the most difficult pieces of apparatus to mount so that it will operate smoothly is the rotor in a coupler. The following method should prove satisfactory to constructors, as it provides for an even tension on the bearing, which prevents slipping or binding.

The parts required for this mounting are as follows: a knob and pointer, a shaft which is threaded at both ends, a collar to fit shaft with a set-screw, a strip of insulation about 3/4 of an inch in width, spacers, washers, etc. The ordinary tap-switch will supply most of these parts.

The insulated strip is mounted behind the panel, as shown in the accompanying sketch. The stationary coil is mounted on this strip in any convenient manner and in its proper relation to the rotor coil. The knob, pointer and a threaded washer are fastened to the shaft and the latter thrust through the panel. The collar is placed on the shaft against the inner side of the strip. On the other side a spring or a piece of spring metal bent as shown and drilled to take the shaft, is put in place and a nut

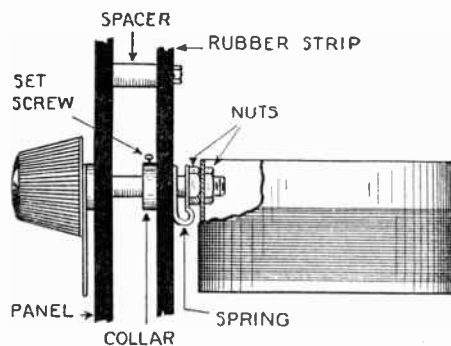

This method of mounting rotor coil keeps it exactly in the desired plane without deviation.

screwed down until the proper tension is obtained. Another nut holds the rotor firmly on the shaft.

Contributed by John P. Arnold.

HOW TO CONSTRUCT "WOUND-ON-AIR" COILS

The "wrinkle" herein described will show you how you can very easily construct a coil which is practically "wound-on-air," but for a few thin supporting strips of a "skeleton" form. It is a simple, cylindrical, single-layer coil and therefore the most efficient in design. The trouble with so many of the "wound-on-air" coils like the basket-wound, spider-web, Lorenz type, the type wound on skeleton forms, similar to the one herein described, all made with wires running in straight or "tangent" lines from rib to rib instead of through the arc of a circle, is that the turns are bent out of the true circular shape, thus cutting down the inductance efficiency, since, all other things being equal, more wire is required to obtain a given inductance value—hence, introducing more resistance. Evidently the reason why the coils wound on skeleton forms have their turns run in straight lines from rib to rib is because it has been a puzzle as to how to get the wire bent through the required arc of a circle over the open spaces and yet get it drawn up tight and in a neat and presentable manner.

Choose for your skeleton form a good, rigid insulation tubing which can be cut readily and neatly with a saw. Obtain or prepare a wooden cylinder which will just fit inside the particular size of tubing you have chosen, and long enough to project an

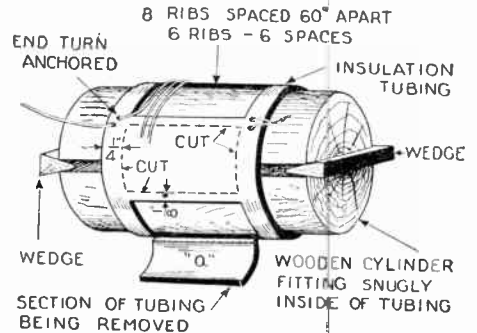

Coils constructed by this method will be perfectly cylindrical and wound on a minimum of insulation.

inch or two at each end. Saw this cylinder in two longitudinally through the center. This cut, besides making it possible to drive a tight fit of the cylinder inside the tubing by means of small wedges, also makes possible the collapsing of the two halves for easy removal when coil is wound. Otherwise the tightness of the winding might make it next to impossible to withdraw the cylinder.

Cut your tubing to a length such that end turns of finished coil can be readily anchored to the end rims as indicated in the figure. Carefully mark off and saw out with a scroll or other small saw the sections marked a, leaving the skeleton form, consisting of the six longitudinal ribs 1/8 inch wide to support the windings and the two end rims 1/4-inch wide. The 1/4-inch ribs lend themselves readily to the attachment of mounting brackets, bearing brackets for tickler coil shafts, for binding posts, etc. A good way to start the saw is to drill a few holes at suitable points along the cutting lines. Be sure to place "matching" marks on each section to be removed

and an adjacent rib or rim, as each one will be wanted back in its right place for winding.

Anchor your wire through the holes provided in one of the rims, leaving a few inches as a lead. Through the holes in the other rim you should loop some good strong string with which to tie down the last turn of wire temporarily, as you cannot anchor this wire through the holes until after the wooden cylinder has been withdrawn. Insert the two cylinder halves inside the skeleton form and tighten up to a snug fit by means of the wedges. Place each of the sawed-out sections back in its place, making it stick to the wooden cylinder inside with a little daub of glue. You are now ready to wind your coil, in effect, on a good, solid cylinder instead of on a shell or on weak, easily broken strips. And you may put all the tension on the wire you want, winding up your coil as neatly and as tightly as you like without danger of crushing the supporting ribs. Tie the last turn securely with the string provided, putting a kink in the wire to prevent its slipping back through the knot. Knock out the wedges, and the two cylinder halves will readily slide out, bringing the cut-out sections of the tubing with them. You now have a coil "wound-on-air" except for the thin supporting ribs, each turn being a true circle.

This system is readily applicable to various requirements. You may put both a primary and a secondary winding on the same form, leaving a small space between the two, or primary, secondary and tickler also, for a Rheintz circuit; or you may wind the primary on a similar form which will either fit inside or outside the secondary, or a tickler coil on a similar or solid form which will rotate inside the secondary in the usual manner, etc.

Contributed by F. C. Ruehl.

HOME-MADE SERIES-PARALLEL SWITCH

Procure a burnt-out tube, also two sockettes. For these latter may be substituted "sockettes" recently described in RADIO NEWS.

The sockets are mounted as usual, in any convenient position on the panel or experimental table; if sockettes are employed, the

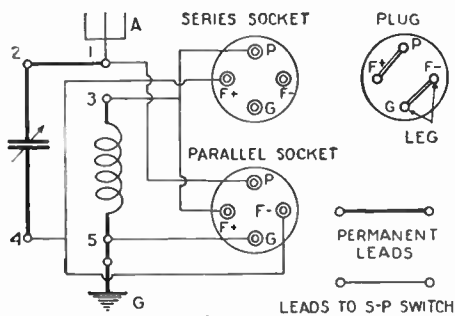

A series-parallel switch that can be constructed from two sockettes and a burnt-out tube.

base itself may be used as a drilling template to obtain the correct spacing.

The tube and its leads are removed from the base (heating them will facilitate the removal by softening the cement), leaving the legs only. A wooden plug is cut to fit the top of the base, or the space may be filled with wax. The connections between the legs, which should be of No. 18 or larger wire, are now soldered in place, as indicated in the diagram marked "Plug." These connections may lie snug against the base where the legs enter it, or they may be made on the interior before plugging the cavity.

The connections to the series socket are

then made. Referring to the diagram, they are: 3 to P, and 5 to F. The insertion of the plug completes the circuit A-1-2-4-3-5-G.

Now the connections to the parallel socket. Again referring to the diagram, they are: 1 to P, 3 to F, 5 to G, 4 to F. The inserting of the plug completes the two circuits, A-1-3-5-G and 1-2-4-5.

It should be noted that the connections A-1, 1-2, 5-G are permanent, being the same in either series or parallel.

This switch will prove acceptable to the fan who wishes to construct for himself as many as possible of the components of his set, as well as solving the problem of an emergency need. Variations of the scheme will no doubt present themselves to the experimenter, as adaptable to many switching combinations.

Contributed by Fernando Steere-Llorens.

ANNULAR COIL CONSTRUCTION SIMPLIFIED

The method for constructing annular coils described here is admirably adapted, for several reasons, to the purposes of the experimenter. The construction is simple and substantial and it has the advantage that changes in windings can be made after completion just as readily as in the case of solenoid coils.

The coil forms are made from cardboard. Cut two pieces as per Fig. 1 and two as per Fig. 2. After cutting out the pieces shown by Fig. 1, crease along lines A and B with the point of a knife to facilitate bending and bend them into the shape shown in Fig. 3. Pieces shown by Fig. 2 should also be creased along the dot-and-dash lines on

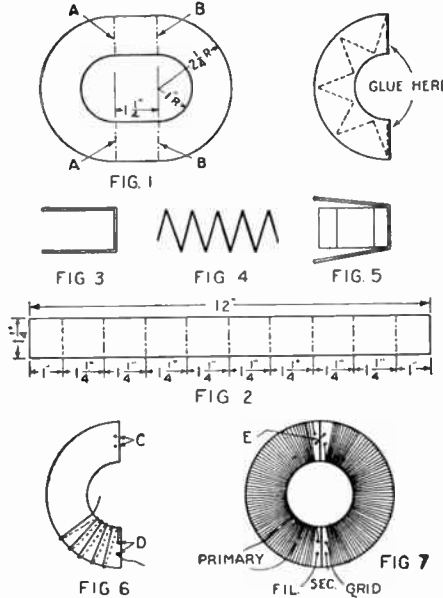

Constructional data for building toroidal coils.

alternate sides and bent into the shape as shown at Fig. 4. Punch two small holes in one side of each end of each form, as shown at C and D, Fig. 5. These holes are used to retain the ends of the windings.

Wind 100 turns of No. 24 S.C.C. wire on each form, starting the winding as shown by Fig. 5. When winding the second form make sure that the direction of winding is the same as in the first one. The primary winding is wound over the secondary and separated from it by winding spirally a narrow piece of empire cloth over the secondary. The ends of the primary are retained by the same method as the secondary. The position and number of turns in the primary is a debatable matter. The writer obtained very satisfactory results by using 25 turns of No. 26 S.C.C. wire placed near the filament end, as shown in Fig. 6.

When both forms are wound, they are placed back to back (see Fig. 6) and held together by several turns of string wound around the outside circumference. The ends of the coils are soldered together at E (Fig. 6) which makes a continuous winding of 200 turns. When used with a .0005 condenser this coil will tune from 212 meters at 5, to 525 meters at 80 on a 100-point dial.

Contributed by Wm. C. Roemer.

HOME-MADE ANTENNA INSULATOR

In this day and age of low loss receivers and high selectivity it is necessary to have an antenna of very few losses, or the resistance of the antenna will be so high as to make it impossible to tune the set sharply.

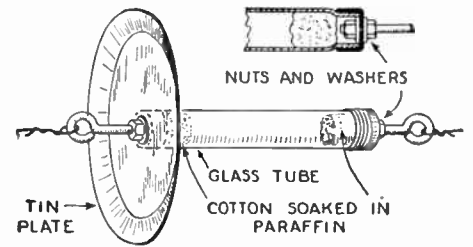

A pie-plate and a glass toothbrush holder are the essential materials for this antenna insulator.

How to do this? The antenna must be constructed of wire that will not corrode readily, enameled wire being the best. However, the most important thing is to have the best insulation possible. The very best insulator for the antenna is air, but of course that is out of the question.

Doubtless, some one will think that because this insulator was designed for a transmitting antenna that it will not be good for the average broadcasting antenna. It is only necessary to remove the aluminum plate at the end of the insulator and you will have one of the very best insulators for a one-wire antenna. The plate is for use only when the insulator is used on a cage antenna with a transmitter.

The material that is necessary is as follows:

Long type toothbrush-holder with screw-cap at each end. This can be bought for about twenty cents.

If the insulator is for transmitting antenna use a small aluminum plate. The other materials are odds and ends and can be found around the work shop.

Begin by removing the caps at the ends of the holder. Stuff small pieces of cotton in each end of the tube. Now it will be possible to pour in melted paraffin. Just enough should be poured in to seal the tube. This will prevent moisture from entering the tube and thus destroying the insulating power of the glass. Instead of paraffin, sealing wax, such as found on the top of dry cells, was used to seal the ends of the insulator used at this station. Now eye-hooks of about the same design as shown in the sketch and threaded on the end, should be constructed. When the eye-hook is attached to the cap it will be found necessary to place a big washer on the inside of the cap and a smaller one on the outside of the cap. This will prevent the ventilation holes on the cap from pulling out. It is a simple matter to place the aluminum plate at the end of the insulator. When the plate is used it should always be put at the end of the insulator which is hooked to the antenna.

When it is constructed, you will have a very fine insulator, which takes very little time to build, has a remarkable pulling strength and is very cheap.

Contributed by C. H. Peck.

~ Radiotics ~

PHEW! PHEW!



In the September, 1925, issue of RADIO NEWS an advertisement appears recommending "a non-spilling, ODOUROUS battery, beautifully polished." Who on earth cares whether the battery has a nice polish if the smell isn't so much like a perfumery counter?

Contributed by E. W. Heister.

WATTA TUBE!

On August 21 the Fresno (Cal.) Bee ran an advertisement as follows: "30x3 1/2 RADIO TUBES—Goodrich Made. \$1.98." The question now before the house is are these tubes 30 inches high and 3 1/2 fat or the other way around? We are very sorry that we cannot give any constants for these tubes at this writing, but we do not recommend them for portable sets.

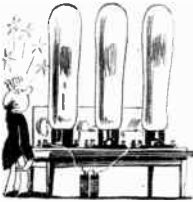

Contributed by O. A. Jones.

MUST BE AT PALM BEACH



This from the Daily News, New York City: "The radio antenna was under BEARDS AND A TAN OF TROPICAL DARKNESS." Radio writers will please no longer refer to the industry as being in its infancy. When anything can raise a beard and play around tropical beaches we can't see this baby stuff at all.

Contributed by Edward Mercer.

DEALERS, WATCH YOUR STEP

In the Springfield (Mass.) Daily News for August 28 there was an advertisement reading that "We repair, install and inspect DEALERS in Thompsonville." We are glad that someone is waking up to the fact that you can't expect million-dollar results from cheap apparatus and that "gyp" concerns should be given the "go-by."



Contributed by Gen. E. Allen.

PLAY BALL!



In the September 4 issue of the Pittsburgh (Pa.) Press was this special "22 1/2-volt large size B BATTER." Some of the bozos that we've seen doing their stuff on some diamonds seem to need a whole gang more volts. They looked to us like dry cells that had lost the well known "pep."

Contributed by R. A. Kausler.

CERTAINLY NOT!

In the issue of September 6 the Decatur Herald, Decatur, Ill., advises a bone-dry public to see that "the LEAK-IN is well insulated from any part of the house." Certainly—you should not subject the people downstairs to the strain of too great a temptation, nor let the fact leak out that you have a permanent connection with the neighborhood hootlegger.



Contributed by J. N. Wilkinson.

WHOA, NAPOLEON



Here's a good one from an article in the September 12 issue of Radio Digest: "Then with a sharp bit and brace, cut the 120 VOLTS. Yes, it is an awful job. I admit it." An awful job? We'll say so. And just suppose it's alternating current. Gosh, it would be as hard to catch as Paddy's flea!

Contributed by Gus A. Dionne.

THERE'S A HITCH SOMEWHERE

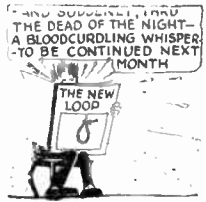

The Oregon Journal, Oregon, Wash., for September 6 has something very novel to offer the radio public—"a new type SERIAL loop, being displayed in Portland." Complete in five parts, we presume, and sold at all newsstands, 25c the copy in U. S. A. and Canada.

Contributed by Robert M. Wisner.

"NOT ALL THE PERFUMES OF ARABY—"

The Chicago Herald and Examiner of August 23 remarks, with what seems to us unnecessary brutality, that "it is a very evident fact that the ultra-audion receiver stands RANK among the very best." Poor little innocent ultra-audion! Not enough to razz it mildly, but they must insinuate that it would properly bear the trade-name "skunk."



Contributed by Ben C. Shilling.

"BLOW, BLOW, BREATHE AND BLOW—"



An advertisement in RADIO NEWS for August announces that "you can get stations 1,000 to 2,000 miles away with the AIR of the Super-Booster." All we got to say is if you can do this with the "air" of the super-booster, it must have one awful strong breath. Does it work on "bootleg" tubes?

Contributed by Porfirio T. Regalado.

IF you happen to see any humorous misprints in the press we shall be glad to have you clip them out and send to us. No RADIOTIC will be accepted unless the printed original giving the name of the newspaper or magazine is submitted. We will pay \$1.00 for each RADIOTIC accepted and printed here. A few humorous lines from each correspondent should accompany each RADIOTIC. The most humorous ones will be printed. Address all RADIOTICS to

Editor RADIOTIC DEPARTMENT, c/o Radio News.

A BOON TO NEWLYWEDS



The New York Herald-Tribune of September 6, quoting from the Crosley Radio Weekly, says: "Concealed WRITING... makes radio receivers, the finest pieces of furniture." Ah, no need now to worry about housefurnishing. Just expose the concealed writing—a few magic passes and presto—the needed article is at hand.

Contributed by Ed Meyer.

HE'S ALL WET!

An ad in the Sun Radio Section for September 12 makes reference to "DRY Fan" Sets. But the disappointed reader of the ad complains to us that the Day-Fan people claim they have no set for a dry fan—in fact, that they have nothing at all to offer any dry fan. Well, Fred, whadyuh expect?



Contributed by Fred Roth.

OH, DOCTOR!



In reply to a question as to which is the better tube for a certain set, we find in Popular Radio for October the helpful information that "as DOCTORS the two are about equal." This sounds to us like "damned by faint praise," although on second thought, we imagine they might make good tube-erectolosis specialists.

Contributed by Leroy D. Bullion.

PIPE THIS ONE!



In the Greensburg Morning Review for September 19 appears an ad of a remarkable radio set "equipped with a FIVE-TUBE loud speaker." In the mad race for volume, this five-tube speaker should run a close second to the well-known pipe organ.

Contributed by L. R. Colbert.

CRIME ON THE INCREASE!

The Security Electric Company of St. Louis, Mo., announces in its catalogue "RAIDED aerial wire." Now we know what became of all those aerials we so trustfully erected on our apartment house roof!

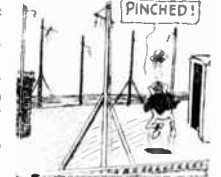

Contributed by James E. Gilfoy.

SOME BABY!

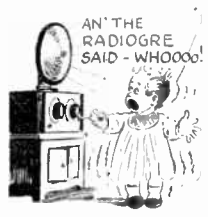

An advertisement in the New York Sun for September 5 offers the radio fan a "TODDLE Switch." We can't quite decide whether this is special size switch for use with the now famous "Babydync" receiver or whether it's only to tune in dance numbers.

Contributed by O. T. Erickson.

BEAUTY HINTS

An advertisement in Popular Mechanics for October announces "long WAVED transformers." We have heard of permanently waved "transformations" for ladies, but never for radio sets. Still, who can say that even a "super" wouldn't look prettier with nice long "coils"?



Contributed by Joseph Y. Jeanes.

TO ELIMINATE FEED-BACK



The St. Paul (Minn.) Daily News carries an article on a new Grimes circuit, part of which reads: "The audio transformers also should be of low RATION." These transformers should be great stuff to use with some of the multi-tubers, so they wouldn't eat up so many "currents."

Contributed by Edward Drewes.

AT LAST—A USEFUL PEST

The Boston Advertiser for Sunday, July 19, advises the radio fan that the best way of locating the coils is by means of four binding posts. "Two of these PESTS," they continue, "will accommodate the grid coil." We have all heard of DX hounds and single-circuit pests, but this seems to be a new species of insect. They must look cute, sitting up on the edge of the panel, holding the coils. And so accommodating, too!



Contributed by Ray L. Gale.

ARE THEY "STRINGING" US?

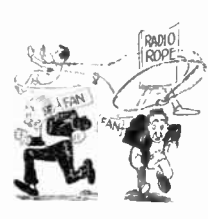

The June 28 issue of the Carrier Wave (Salt Lake City) offers to its readers through its advertising department a complimentary copy of a Western radio magazine which, "is full of the finest kind of radio ROPE." We wonder why the magazine needs all this rope—perhaps it's to help "throw the bull."

Contributed by P. N. James.



STANDARD HOOK-UPS



EVERY month we present here standard hook-ups which the Editors have tried out and which are known to give excellent results. This leaf has perforation marks on the left-hand margin and can be cut from the magazine and kept for further reference. These sheets can also be procured from us at the cost of 5c per sheet to pay for mailing charges. RADIO NEWS has also prepared a handsome heavy cardboard binder into which these sheets may be fastened. This binder will be sent to any address, prepaid on receipt of 20c. In time there will be enough sheets to make a good-sized volume containing all important hook-ups. Every year an alphabetical index will be published enumerating and classifying the various hook-ups.

Handy Reference Data for the Experimenter

THE WHEATSTONE BRIDGE

Circuit No. 130. Although this is not a direct radio circuit, yet to the experimenter who builds his own coils it is one of the most essential circuits known. Too many times the set constructor uses coils in some hook-up that have too high a resistance and finds it difficult where to place the blame when the set refuses to function as it should. The use of a Wheatstone Bridge to ascertain the resistance of coils should be a great aid.

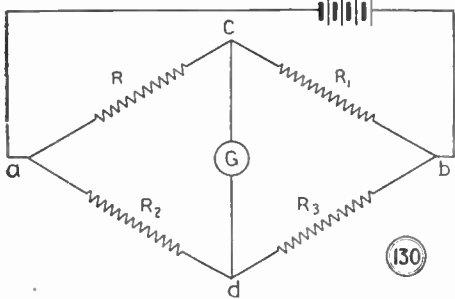

The schematic diagram of a Wheatstone Bridge for the measurement of resistances should be familiar to every radio constructor.

There are very few parts needed for such a bridge and they are comparatively simple to make—several lengths of 1/4-inch brass rod, used for connecting the parts of the bridge, about four feet of No. 18 German silver wire, a meter stick, dry cells

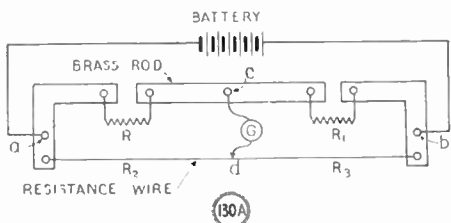

R is the unknown resistance; R1 a known resistance, and R2 and R3 are the ratio arms. Brass rod is used to reduce resistance in the connections.

for supplying the necessary current, and a galvanometer. This last instrument may be made at home by following the instructions given on page 320 of the September issue of RADIO NEWS.

The German silver wire is tightly stretched along the meter stick, after the latter has been fastened to a suitable board on which the apparatus may be mounted. The other connections are made as shown in the diagram. The point, c, should be in the center of the rod connecting R and R1 and a suitable slider should be provided for the silver wire so that the point of contact may be exactly determined.

The theory of the Wheatstone Bridge is relatively simple. The voltage between the points a and b is the same over the path acb as abd. For any point, such as c, on the line acb there is some point, such as d, on the line abd at the same potential. That is, if we have an unknown resistance be-

tween a and c and a known resistance c and b, we can connect a galvanometer at c and with the other terminal explore along the continuous resistance abd until we find a point where the galvanometer, G, shows no deflection. Then R is to R1 as R2 is to R3, or

$$R = \frac{R_1 \times R_2}{R_3}$$

where R is the unknown resistance, R1 the known resistance and R2 and R3 the ratio obtained from the slide wire. The resistance R1 may be a calibrated resistance box, or the experimenter may construct several non-inductive coils of different resistances, say 5, 10, 50, 100, 500 and 1000 ohms. These may be made of so-called resistance wire, the temperature coefficient of which is extremely small.

SUPER-REGENERATIVE CIRCUIT

Circuit No. 131. A very interesting super-regenerative circuit is shown in Fig. 131, in that there is but one tuning control and the set will operate very well on a loop antenna. The inductances L1 and L2 are the two windings of an ordinary variocoupler with the secondary rewound with 100 turns. Coil L3 is a 1250-turn honeycomb and L4 is a 1500-turn coil of the same type. These coils are mounted on a regular double coil variable mounting. The fixed condenser C2 has a capacity of .005 mf. and C3, .004 mf. These condensers are shunted across L3 and L4 respectively. The variable condenser, C1, has a capacity of .0005 mf (23 plates). C4 has a capacity of .005 mf and C5 of .001 mf. The "C" battery in the grid circuit of the second tube may require a greater voltage than is ordinarily used, perhaps as much as 15 or 20 volts. The two "B" batteries should have at least 90 volts for best results. K1 and K2 are 1200-ohm resistances and K3 is an iron-core choke coil of .1 henry. The loop antenna that is best suited to this receiver is one having 12 turns that are tapped and wound on a frame 3 feet square.

Tuning is a little difficult at first but once the set is in a stable condition the only

controls to be moved are the condenser across the loop and the taps of the primary of the coupler. For tuning in a station, couple the coils L3 and L4 as closely as possible, then vary the condenser across the loop and the switch levers until music is heard. Very good results were obtained using but seven turns of the loop. On local stations reception is sometimes strong enough to operate a loud speaker, without the use of any antenna whatsoever.

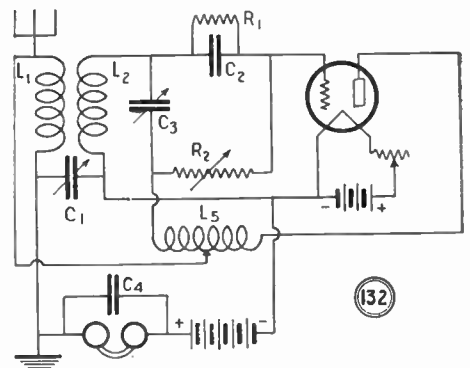

The parts for the Kaufman circuit, with the exception of the "active 20" coil, can be easily obtained and the circuit is an interesting one from an experimental viewpoint.

THE KAUFMAN CIRCUIT

Circuit No. 132. Many interesting features have been embodied in this hook-up, which is one that should appeal to the builder. The parts needed for this circuit, with the exception of the inductance, L5, can be found around the experimenter's workbench. The inductances, L1 and L2, are the primary and secondary of the ordinary variocoupler. R1 is a grid leak of 1 megohm, which may or may not be variable. C1 is an .001 mf. (43-plate) variable condenser. C2 is a fixed condenser having a capacity of .00025 mf. and C3, while it is shown as a variable condenser, may function satisfactorily as a .00005 mf. fixed condenser. R2 is a variable grid leak and is more or less critical. The greater part of

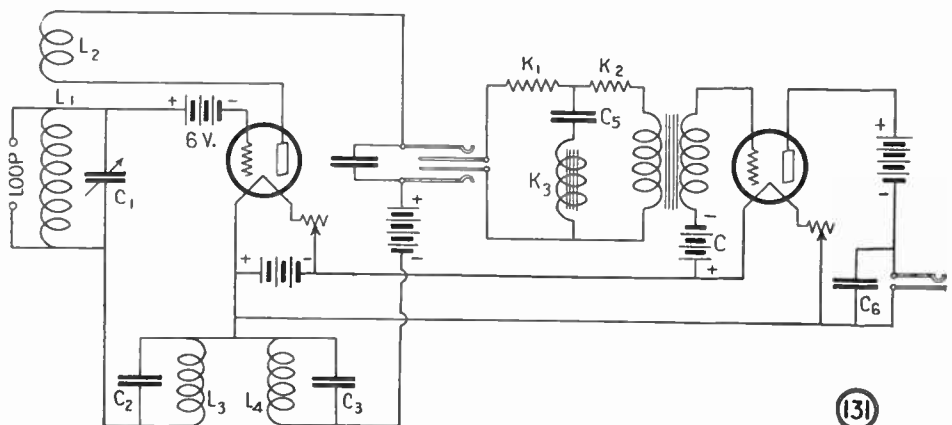

The super-regenerative circuit shown above has but one tuning control. A tapped loop antenna gives excellent results.

the tuning is done with the 43-plate condenser, C1.

The inductance, L5, which the designer of the circuit has named "the active twenty coil," is wound on a tube that is 4 inches in diameter. The coil consists of 80 turns of No. 22 D. C. C. wire, the last twenty turns of which are tapped and led to the usual switch points. As this will require almost the entire space of the circle in the mounting to accommodate the twenty taps, it is suggested that a switch lever of at least 1 1/4 inches in length be used, as this will not crowd the contact points too closely. The taps are taken from the lower end of the coil, the starting end of the coil being connected to the plate of the tube, and the last tap of the switch connected to the .00005 mf. condenser. If these connections are reversed the set will not function at all, so they should be carefully made.

THE DOUBLE COUPLER FEED-BACK CIRCUIT

Circuit No. 133. While a regenerative circuit may be readily obtained by inserting a variometer in the plate circuit, it is not so simple a task to obtain a tickler feed-back with ordinary apparatus on the market unless honeycomb coils are used. There are, of course, couplers with fixed tickler windings. With ordinary apparatus, however, the double coupler feed-back circuit is easily arranged, the objections to single-circuit action are overcome, and there is complete tuning in every circuit and any desired degree of coupling between them.

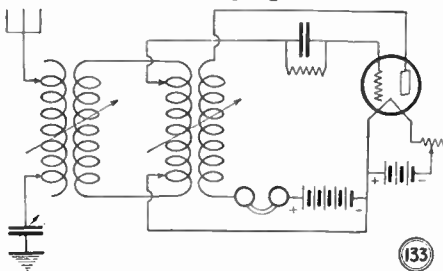

The use of two variocouplers makes this circuit very selective, because of the extremely fine control of the amount of inductance that can be introduced into the circuit.

As commonly employed, the primary switches of one coupler are connected to the antenna and ground as usual. The secondary of this coupler, however, is connected to the ends of the primary winding of the second coupler. The switch points of the second coupler go to grid and filament like the usual secondary connections. The secondary terminals of the second coupler are connected to the plate circuit.

The wave-length of the primary circuit is adjusted by the switch points on the first coupler, aided by the condenser in the ground circuit. This variable condenser should have a capacity of .0005 mf. (23 plates). The coupling between the primary and secondary is adjusted by rotating the rotor of the first variocoupler. The secondary circuit is tuned by the switch points on the second coupler and the coupling between the secondary circuit and the plate circuit tickler is adjusted by the rotor of this coupler. The secondary of the second coupler acts as the plate tickler coil.

This circuit should be very selective and give a little better than the average set's results.

REFLEX CIRCUIT USING HOUSE CURRENT FOR LIGHTING FILAMENTS

Circuit No. 134. One of the greatest drawbacks that experimenters have experienced with receivers using more than two or three vacuum tubes, is the use of a storage battery. However, if the power for lighting the filaments of the tubes is taken from the 110-volt house-lighting circuit,

there is again an objection, *i. e.*, the 60-cycle hum. This hum is for the most part annoying only when the filament of the detector tube is lighted from the house current, in amplifying tubes the hum being more or less unnoticeable.

In the circuit shown in Fig. 134 the filaments of the amplifying tubes are supplied with current from the house-lighting circuit. The step-down transformer, used to reduce the 110-volt current to 6 volts, is the ordinary bell-ringing type. Across the secondary of this transformer is shunted a 600-ohm resistance with a center tap, or a potentiometer of the same resistance may be used with the movable arm going to the "C" battery of 4 1/2 volts. As mentioned above, the filament of the detector tube, if supplied with current from a D.C. source, gives better results than with stepped down A.C., so in this case a dry cell tube of the WD11 type is employed, which has its own "A" and "B" batteries. The radio and audio frequency transformers that are used throughout the receiver may be of any standard make. The inductances that couple the antenna circuit to the rest of the set may be a 50-turn coil wound on a 3-inch tube, over which may be wound the primary of 10 turns, both coils being wound with No. 18 bell wire.

The best tubes to use in the amplifying stages are those of the UV201-A or C301-A type. If it is desired to use a loop antenna with this circuit, this may be done by connecting the terminals of the loop directly across the .0005 mf. variable condenser and omitting the coupler inductances. The 600-ohm potentiometer that is connected across the filament of the last audio frequency amplifier tube gives the grid of that tube the proper bias.

If it is so desired a crystal detector may be used instead of a tube detector and its batteries. The connections for this type of detector are the same as those of any reflex circuit when a storage battery is used to supply the current for the filaments.

The rectifying properties of a crystal detector are excellent, and if employed in the circuit as suggested above, the use of a dry cell battery and extra "B" battery is thus eliminated. However, the experimenter must decide for himself whether the disadvantages of a crystal detector, such as the searching for sensitive points, etc., will overcome the extra trouble of wiring the set for the extra batteries if a vacuum tube detector is employed. Of course, the use of a tube detector will mean reception of a more consistent type.

A NON-RADIATING ONE-TUBE REGENERATOR

Circuit No. 135. Fans who still swear by the old-time one-tube regenerative circuit and who are sworn at by their neighbors because of the squeals that are radiated, will be interested in this circuit, shown in Fig.

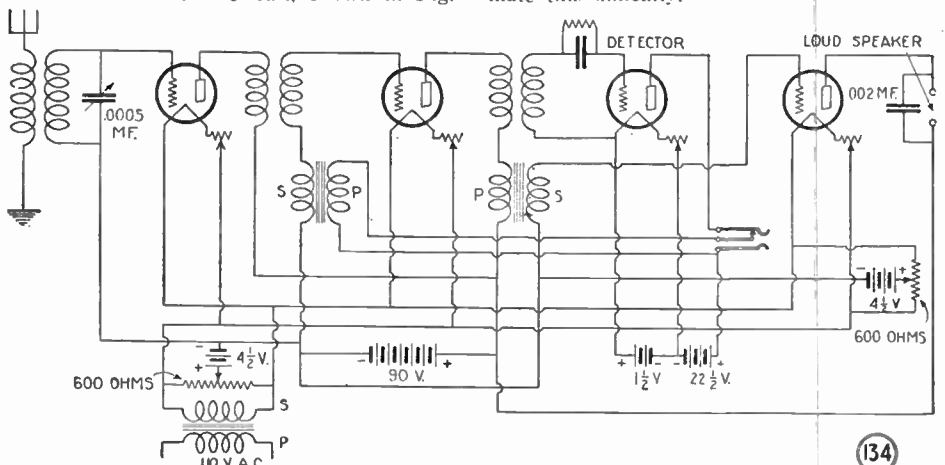

The use of the 110-volt house-lighting current for the current supply of the vacuum tubes is well worked out in this reflex circuit. The detector tube filament is supplied by a separate "A" battery.

135. For volume and distance there are few hook-ups of one tube that can compare with the well-known ultra-audio. The circuit shown in the accompanying figure is one that should prove satisfactory to the most critical fan.

The inductances L1 and L2 are the primary and secondary of an ordinary variocoupler. However, it should be noticed that the secondary is shunted only by a fixed condenser, C2, having a capacity of .001 mf. and is not connected to the rest of the circuit except inductively through the inductance L1. The variable condenser, C1, has a capacity of .0005 mf. (23 plates) and is connected between the ground and the positive side of the "A" battery, with the rotor plates on the ground side. The condenser, C3, has a capacity of .00025 mf. and is shunted by a variable grid leak. The inductance,

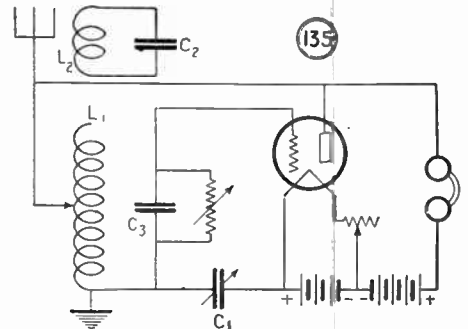

The variation of the ultra-audio circuit shown above will prove to be popular with one's neighbors, as it will not radiate.

L1, should have at least 60 turns, in order that the necessary broadcast wave-length band may be covered.

The best point of operation of a circuit of this sort is just before the circuit spills over into an oscillating condition. Therefore, when the circuit has been connected, tune in a station and then adjust the rotor of the coupler, L2, so that the set is just at the point of oscillation and allow the rotor to remain in that position. This means that it is unnecessary to have a control for the rotor on the outside of the panel, the only controls being the tapped primary and the condenser, C1.

This type of circuit approaches very near to the one control for tuning a receiver, as there is only the variable condenser to adjust and the taps of the primary inductance, L1.

The greatest trouble with the ultra-audio receiving circuit has been the fact that it was extremely difficult to control in respect to oscillating. It has been necessary to have the circuit in this state in order to tune-in a station and therefore the operator, unless he was very careful in controlling the amount of current supplied to the filament, was in most cases considered the neighborhood pest. However, this circuit will eliminate this difficulty.

New Radio Patents

By JOHN B. BRADY*

(1,544,746, J. H. Hammond, Jr. Original filed August 10, 1916; issued July 7, 1925.) Method and apparatus for controlling water craft from aircraft, where the water craft is provided with steering means and a radio receiving apparatus which is arranged to control the steer-

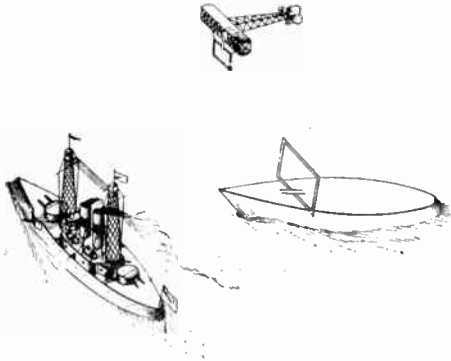

ing means. A directional loop is arranged aboard the water craft so that signals may be received from a radio transmitter aboard an aircraft directly over the loop for controlling the steering mechanism aboard the water craft.

(1,549,737, E. F. W. Alexanderson. Filed September 15, 1919; issued August 18, 1925. Assigned to General Electric Company.)

Signaling system for radio reception where a detector is provided which consists of a resistance device which may be included in the receiving circuit. The current through this device substantially follows Ohm's law and is, therefore, directly proportional to the impressed voltage. The necessary asymmetry of the device for securing the required rectifying effect is secured by periodically

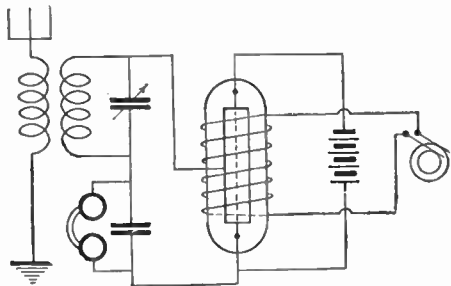

varying the value of this resistance by means of a suitable modifying force which is controllable at the will of the operator at the receiving station. The value of the resistance is controlled or varied in such a way that it is made comparatively small during desired periods and is made exceedingly large during other periods. This permits the flow of an appreciable current in the receiving circuit during desired portions of the impressed signaling wave and causes the practical suppression of the current in the receiving circuit during other portions of the signaling wave.

(1,548,757, J. Scott Taggart. Filed November 30, 1920; issued August 4, 1925. Assigned to Commercial Cable Company.)

Electron discharge device which includes a

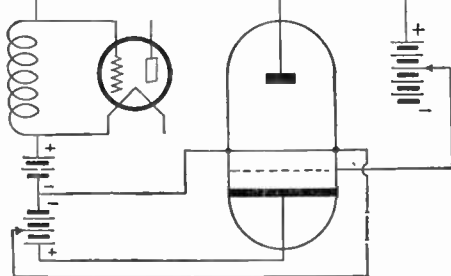

cathode and two anodes. A cathode is provided and the circuits arranged so that electrons flow to both of the anodes. The circuit is such that the potential of one of the anodes may be varied with respect to the cathode and the flow of electrons to the anode may be increasingly diverted to the other anodes as the potential of the first-named anode is increased. The tube may be used as an amplifier and is termed in the specification "a negatron."

(1,547,684, H. C. Rentschler. Filed August 17, 1923; issued July 28, 1925. Assigned to Westinghouse Lamp Company.)

Oscillation generator and joint operation thereof where oscillation generators of the arc type are employed in association with a transmitting antenna system. The arcs are enclosed in vessels

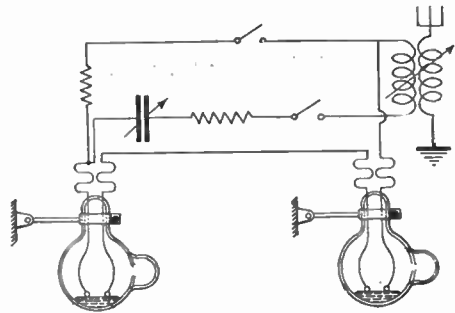

which contain a pool of mercury. The vessels are tilted in order to start the arcs, thereby bridging the distance between the arc electrodes with the mercury, and while in this position the power is impressed across the electrodes and then the vessels tilted in upright position for setting up a sustained arc.

(1,545,639, S. Cohen. Filed July 11, 1922; issued July 14, 1925. Assigned to Grace A. Barron, New York.)

Vacuum tube mounting, in which the electron tube is carried upon a movable structure by which the tube may be normally disposed within a cabinet and withdrawn to permit removal or

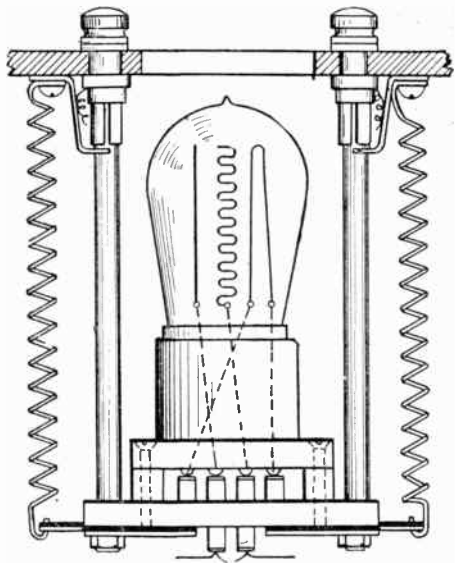

reinsertion of a tube in the socket member. The socket member is guided by rods on opposite sides thereof, enabling it to be readily moved to a point adjacent to the front of the panel or returned to a position behind the panel when the tube is to be inserted or removed from the socket.

(1,550,682, H. M. Dowsett. Filed September 23, 1922; issued August 25, 1925. Assigned to Radio Corporation of America.)

Arc generator of electric oscillations where two arcs are operated in parallel with minimum inter-

arc current circulating between the arcs for affording the maximum output current in the antenna system. The inter-arc circuit is provided with condensers of large capacity as compared

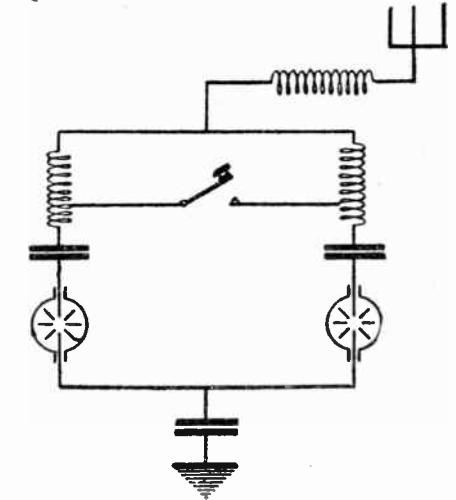

with the output circuit. The output of each arc is fed into the antenna system with substantially no circulating current in the inter-arc circuit.

(1,546,639, C. L. Farrand. Filed May 14, 1919; issued July 21, 1925. Assigned one-third to Cornelius C. Ehret, Philadelphia.)

Method of and apparatus for the reception of radio signals by impressing the received signaling energy upon the anode-cathode circuit of a ther-

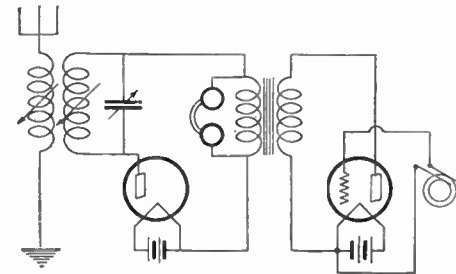

mic impedance. The impedance is independently varied by varying an electrostatic field at predetermined frequency different from the incoming signaling frequency whereby the signaling current may be translated into intelligible sounds.

(1,546,781, C. L. Farrand. Filed October 13, 1919; issued July 21, 1925. Assigned one-third to Cornelius C. Ehret, Philadelphia.)

Method of and apparatus for the reception of radio signals transmitted by undamped waves where the received signaling energy is impressed upon a thermionic detector, the operation of

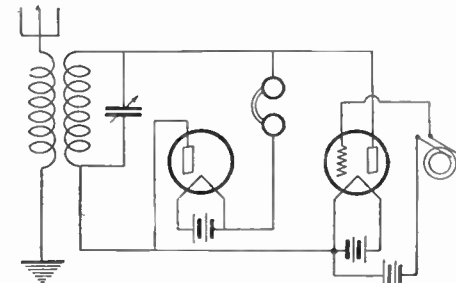

which is periodically varied by means of a thermionic impedance which varies in magnitude periodically at a frequency above audibility. The received signaling current as modified by the impedance variation is translated into intelligible signals.

*Patent Attorney, Ouray Building, Washington, D. C.

Correspondence from Readers

PHANTOM RECEPTION MYSTIFYS

Editor, RADIO NEWS:

In September, I clipped an article out of one of our daily papers, which I think should be of interest to RADIO NEWS' readers.

RAYMOND B. GRONTKOWSKI,
34 N. Broad Street,
West Hazleton, Pa.

COATESVILLE, Pa. (U.P.). — A "phantom" radio set which nightly delivers broadcast programs of London and Paris to the Reading Railroad station agent at Brandymore, near here, for the trouble of raising his telephone receiver from the hook, is puzzling radio and telephone engineers.

The freak receiver consists solely of a five-mile stretch of telephone wire, used as a dispatch line. So far as can be discovered, no equipment beyond the ordinary desk telephone is present. Bell telephone engineers are conducting an investigation, in an effort to discover what radio principles are involved in the novel "DX" hook-up. It has brought in the most distant stations, listeners claim, for two years.

A SUGGESTION FROM JAPAN

Editor, RADIO NEWS:

The regulation of our government regarding radio broadcasting and receiving is as follows:

Both in radio broadcasting and radio receiving, a wave-length of less than 400 meters must be used. Permission is given only for the use of radio receivers that do not cause oscillation and radiation. At present, radio broadcasting is operating at the Tokyo station (JOAK) with a wave-length of 375 meters, at the Nagoya station (JOCK) 360 meters, and at the Osaka station (JOBK) 385 meters.

Under the circumstances, if American manufacturers will send receiving sets with the aforesaid qualifications, we firmly believe that your radio receivers will find much favor with our radio amateurs.

Our house particularly desires catalogs, circulars and other advertising literature from reliable American manufacturers with a view to importing standard radio receivers, accessories and parts.

TAKESHI S. YAMAMOTO, Importer,
548-9 Oka Hirakatacho,
Osaka-fu, Japan.

FROM AN INTERFLEX BUILDER

Editor, RADIO NEWS:

In building the Interflex-4, I have had wonderful results; the volume is very good and also the tone quality. I get better results with a variocoupler instead of a coil, but it makes one more dial.

I can get stations as far as Iowa and Nebraska with Pittsburgh and Cleveland and WGY going full blast.

A few stations that I have had: WCAE, WGY, WEBH, WLW, WHT & WHAS, KDKA, WEAJ, WREO, WOC, KYW, KOAW, WSB, Fort Worth, WCB, WJZ, WQJ, WCX, WOK, WENR, WHBP, KMA, WTAM, WSMB, WOR, WRC, KLDF, WBDM and WJAS.

IRA GRIFFEN,
203 Diamond Street,
Titusville, Pa.

A COMPLIMENT

Editor, RADIO NEWS:

I am writing this letter to you because I believe in giving credit where credit is due.

Speaking pugilistically, your publication has a knockout wallop, and I, as well as many others, rank it the best in the radio publication field today.

One of the reasons of RADIO NEWS' popularity probably lies in the fact that while most of the present-day radio publications have difficulty in keeping pace with the times, yours actually points the way, as it were, containing time and again the most remarkably accurate forecasts of the future trend of radio developments.

This is particularly true of Mr. Hugo Gernsback's lucid editorial and introductory articles.

The "Life and Work of Lee DeForest," and "The Inventions of Reginald A. Fessenden" are real contributions to present-day radio literature, and the remarkably clear, straight to the point, and always instructive articles by Mr. Sylvan Harris would be a credit to any radio publication, bar none. I want to thank you for the "Parlor Magic" articles. It is articles of this nature that most often start the aspiring radio "engineer" on the road of serious investigation. In our age of simplification the certain manipulations that are necessary for the control of certain complex actions are simplified to an extent where there remains nothing to call attention to the really remarkable phenomena that take place. It is the unusual, the unexpected, the mysterious, the apparently *magical* that will usually call the necessary attention and create the proper mood for the intelligent examination of phenomena which we ordinarily take for granted. Such articles increase the entertainment value of radio in the home, show a new way for wholesome recreation and promote radio popularity to the fullest extent.

I want to take this opportunity to express my sincere admiration and appreciation of the splendid and really worth-while radio publication—RADIO NEWS.

BORIS S. NAIMARK, M.A.A.E.,
Radio Editor,
The Novoye Russkoye Slovo,
(New York Russian Daily.)

ANNOUNCERS NOTE

Editor, RADIO NEWS:

Notwithstanding the publicity that has been given to the subject, and the remedies for correction which have been suggested by the contributors to this and various other radio publications, the question of more distinct enunciation on the part of the radio broadcast announcers is still an important, although distasteful, subject to the thousands of radio listeners.

It is bad enough, after listening for ten to twenty minutes to poor and indifferent programs to have "a fade" just as the identity of the station is about to be made known, but to the "DX bug," there can be no more exasperating action on the part of an announcer after waiting patiently for him to give his call than to hear a W or K and then a mumble.

Either the station announcers, who neglect to keep their listeners informed of their identity by frequent and clear repetition of their call letters, do not care to cater to the "on and off" audience or they are merely careless and neglectful. As the primary reason for the expenditure of the money put forth by the station owners is for advertisement, and as the "DX hound" is by far the more important class to give widespread publicity to a station, the latter reason for the announcers' shortcomings is believed to be the reason that they pay so little attention to the subject.

A few nights ago, I picked up a station that was broadcasting what appeared to be an old-fashioned square dance. When I tuned in a figure was being called by the master of ceremonies. Between the figures the announcer addressed his audience through the "mike," but although I listened

for figure after figure with the hope that during the next intermission he would make his identity known, not once did he give the location of his station, and after trying to check his location from the dial readings by means of the out-of-town programs published by the newspapers, and being unable positively to associate the wave-length with any of the printed programs, I gave up in disgust and went hunting for more thoughtful announcers. But it meant thirty-five precious minutes wasted.

A little later, WMBF was picked from the air, and it is a pleasure to listen in to the quality of the service given by the Miami announcer. His enunciation is slow, clear and distinct, and he makes his identity known so frequently and yet so pleasantly that the merest tyro at broadcasting technique cannot fail to know, with but a short delay, where the program is being delivered.

And now for the remedy and method for correction. Impress upon the announcers the importance of giving their call letters frequently and slowly. Not once during their announcement between numbers on their program, but at the beginning, the end and in the middle—the number of times depending on the length of their speech. If this is done it will often enable the listener to recognize the station, even though "a fade" comes when the announcer begins to talk (which in my case, at least, seems invariably to be the case). Let our editor also suggest that each station adopt a slogan, similar to the plan used at Miami, "Wonderful Miami Beach, Florida," or at Atlantic City by WPG, *i. e.*, The World's Playground, etc., or at least, a phrase like "The Voice from the South," used by WSB at Atlanta or "Willie, Tommie, Annie and Sammie," used by the WTAS station at Elgin, Ill.

ALBERT D. COOLEY,
3703 Woodland Ave.,
Philadelphia, Pa.

AN INTERFLEX RECORD

Editor, RADIO NEWS:

The following 18 stations were picked up in one hour, 8.10 to 9.10, September 2, 1925, on the Interflex, using the diagram in RADIO NEWS, 250- to 700-meter transformer, and Vreco 199 tubes:

- 1 KFNF, 261, Shenandoah.
- 2 KAKX
- 3 WFAA, Dallas
- 4 WHB, Kansas City
- 5 KOA, 322.4, Denver
- 6 KFAB, 340.8, Lincoln
- 7 WDAF, 365.6, Kansas City
- 8 KOIL, Cedar Rapids
- 9 Bristow, Okla.
- 10 Hastings, Neb.
- 11 WCCO, 416.4, Minneapolis
- 12 WTAS, Elgin
- 13 WBBN, 226, Chicago
- 14 WWJ, Detroit
- 15 WSMB, 319, New Orleans
- 16 WLS, 344.6, Chicago
- 17 Council Bluffs, Iowa, signing off
- 18 WLW, Cincinnati, Ohio.

Can you beat this with anything as simple as this tuner?

I might add that I have new "A" batteries but "B" is only 75 volts, and has pulled a 3-tube regenerative set for six months. Volume is heavy enough to pull loud speaker. I am more than satisfied. Give us some more dope on a set similar to this one, covering 35 to 260 meters. Could I build one like this with special transformer? Thanks to the editor and RADIO NEWS.

ELLIOTT CARRIGER,
Wakarusa, Kansas,
(12 miles south of Topeka).

P. S. Picked up three Chicago stations more while writing—21 stations in one hour and fifteen minutes.



**APPROVED
RADIO NEWS
LABORATORIES
1922**

RADIO NEWS LABORATORIES



RADIO manufacturers are invited to send to RADIO NEWS LABORATORIES, samples of their products for test. It does not matter whether or not they advertise in RADIO NEWS, the RADIO NEWS LABORATORIES being an independent organization, with the improvement of radio apparatus as its aim. If, after being tested, the instruments submitted prove to be built according to modern radio engineering practice, they will each be awarded a certificate of merit, and a "write-up" such as those given below will appear in this department of RADIO NEWS. If the apparatus does not pass the Laboratory tests, it will be returned to the manufacturers with suggestions for improvements. No "write-ups" sent by manufacturers are published on these pages, and only apparatus which has been tested by the Laboratories and found to be of good mechanical and electrical construction is described. Inasmuch as the service of the RADIO NEWS LABORATORIES is free to all manufacturers whether they are advertisers or not, it is necessary that all goods to be tested be forwarded prepaid, otherwise they cannot be accepted by the Laboratories. Apparatus ready for the market or already on the market will be tested for manufacturers, as heretofore, free of charge. Apparatus in process of development will be tested at a charge of \$2.00 per hour required to do the work. The Laboratories will be glad to furnish readers with technical information available on all material listed here on receipt of a stamped envelope. The Laboratories can furnish resistances of the various instruments, amplification curves of transformers, losses in condensers, etc., and other technical information. Address all communications and all parcels to RADIO NEWS LABORATORIES, 53 Park Place, New York City.

TESTER AND REVIVER

The instrument shown in the illustration was submitted to the RADIO NEWS LABORATORIES for test by Kierulff and Ravenscroft, 163 1/2 South Los Angeles St., Los Angeles, Calif. This tester and reviver is designed



for the purpose of testing and reviving tubes. There are four sockets for reviving the tubes and one socket for testing. It is well assembled in a cabinet in portable form.

AWARDED THE RADIO NEWS LABORATORIES CERTIFICATE OF MERIT NO. 962

VARIABLE RESISTOR

The resistor shown in the illustration was submitted to the RADIO NEWS LABORATORIES for test by the American Apparatus Co., Richmond,



Ind. This resistor has a large variable range and can be used satisfactorily in resistance coupled amplifiers.

AWARDED THE RADIO NEWS LABORATORIES CERTIFICATE OF MERIT NO. 1002.

CROSLY RADIO SET

This radio set was submitted to the RADIO NEWS LABORATORIES for test by the Crosley Radio Corp., Cincinnati, Ohio. It is a two-tube regenerative receiver with variable



tickler and tuning condenser. It operates satisfactorily over the broadcast band of wave-lengths with respect to sensitivity and selectivity.

AWARDED THE RADIO NEWS LABORATORIES CERTIFICATE OF MERIT NO. 980.

U. S. TOOL CONDENSER

The condenser shown in the illustration was submitted to the RADIO NEWS LABORATORIES for test by the U. S. Tool Co., Inc., 117 Mechanic Street, Newark, N. J. This condenser is unique in having but one bearing and in having stator plates punched

out of a single sheet of aluminum. This eliminates the necessity for soldered joints. The rotor plates are cut



away so as to furnish very low minimum capacities.

AWARDED THE RADIO NEWS LABORATORIES CERTIFICATE OF MERIT NO. 1002.

REGENERATIVE RECEIVER

The receiver shown in the illustration was submitted to the RADIO NEWS LABORATORIES for test by the Crosley Radio Corp., Cincinnati, Ohio. This is a one-tube set of the

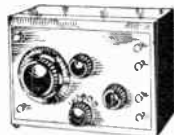

regenerative type with a variable tickler coil. It operates satisfactorily over the broadcast range of wave-lengths.

AWARDED THE RADIO NEWS LABORATORIES CERTIFICATE OF MERIT NO. 951.

TUBE SOCKET

The vacuum tube socket shown in the illustration was submitted to the RADIO NEWS LABORATORIES for test by the Bennington Radio and Electric



Mfg. Co., Inc., Bennington, Vermont. It is well made and possesses all the features desired in a tube socket.

AWARDED THE RADIO NEWS LABORATORIES CERTIFICATE OF MERIT NO. 997.

VERNIER INSTRUMENT CONTROL



This dial, submitted to the RADIO NEWS LABORATORIES for test by the

American Instrument Works, 613 Fulton Bldg., Pittsburgh, Pa., consists of a calibrated disc on the reverse of which rotates a large gear. This is driven by a pinion on the shaft which carries the knob.

AWARDED THE RADIO NEWS LABORATORIES CERTIFICATE OF MERIT NO. 1020.

CIRCULAR CUTTER

The circular cutter shown in the illustration was submitted to the



RADIO NEWS LABORATORIES for test by the Economy Screw Corp., 5215 Ravenswood Ave., Chicago, Ill. This instrument is a very handy accessory for the radio workshop, enabling holes of inconvenient diameter to be cut quickly and accurately by hand.

AWARDED THE RADIO NEWS LABORATORIES CERTIFICATE OF MERIT NO. 996.

TUBE TESTER

The tube tester shown in the illustration was submitted to the RA-



DIO NEWS LABORATORIES for test by R. M. Peffer, 334 Chestnut St., Harrisburg, Pa. This instrument is nicely mounted in a box having an accurate meter and rheostats for varying various voltages.

AWARDED THE RADIO NEWS LABORATORIES CERTIFICATE OF MERIT NO. 949.

VARIABLE CONDENSER

This condenser, manufactured by the Preferred Radio Products Co., 24 E. 93rd Street, New York City, was submitted to the RADIO NEWS



LABORATORIES for test. It has peculiarly shaped plates which enable the short-wave stations to be separated easily in tuning. It is accurately and rigidly constructed.

AWARDED THE RADIO NEWS LABORATORIES CERTIFICATE OF MERIT NO. 1034.

DUBILIER FIXED CONDENSER

The condenser illustrated above was submitted to the RADIO NEWS



LABORATORIES for test by the Dubilier Condenser and Radio Corp., 48 W. 4th St., N. Y. C. It has a capacity very close to the rated value. Provision is made for mounting grid leaks or coupling resistances for resistance-coupled amplifiers.

AWARDED THE RADIO NEWS LABORATORIES CERTIFICATE OF MERIT NO. 1015.

REGENERATIVE RECEIVER

The regenerative receiver illustrated was submitted to the RADIO NEWS LABORATORIES for test by the

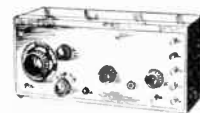

Crosley Radio Corp., Cincinnati, Ohio. This is a three-tube set having a variable tickler and tuning condenser. It operates satisfactorily over the broadcast range of wave-lengths.

AWARDED THE RADIO NEWS LABORATORIES CERTIFICATE OF MERIT NO. 981.

REMOfONE AERIAL

The remofone aerial shown in the illustration was submitted to the RADIO NEWS LABORATORIES for test by the Remo Corp., Meriden, Conn. This is a metallic plate upon which a desk telephone can be set. Operation is



such that the capacity between the plate and the base of the telephone case furnishes a means of coupling the radio receiver to the telephone line. This enables the telephone line to be used as an antenna. It will operate satisfactorily under certain conditions, especially for local reception.

AWARDED THE RADIO NEWS LABORATORIES CERTIFICATE OF MERIT NO. 948.

THREE "E" RHEOSTAT

The rheostat shown in the illustration was submitted to the RADIO NEWS LABORATORIES for test by the Electrical Engineers Equipment Co.,

708 W. Madison St., Chicago, Ill. It has two drums, one drum carries a resistance wire which is unwound and passes over to the other drum as the knob is turned. One of the drums



is made of insulating material and the other of metal. Very accurate adjustments can be secured.

AWARDED THE RADIO NEWS LABORATORIES CERTIFICATE OF MERIT NO. 1065.

HENRY SPECIAL LOUD SPEAKING UNIT

The loud speaking unit manufactured by the Firth Radio Corp., 25 Beaver Street, New York City, was



submitted to the RADIO NEWS LABORATORIES for test. This unit reproduces satisfactorily with regard to both volume and quality.

AWARDED THE RADIO NEWS LABORATORIES CERTIFICATE OF MERIT NO. 998.

VARIABLE CONDENSER

The variable condenser illustrated above was submitted to the RADIO NEWS LABORATORIES for test by the X-L Radio Laboratories, 2424 Lincoln Ave., Chicago, Ill. This con-

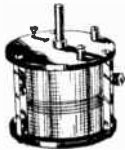

denser consists of a number of concentric cylinders, one set of which slides within another set by means of a worm on the rotating shaft.

AWARDED THE RADIO NEWS LABORATORIES CERTIFICATE OF MERIT NO. 752.

PILOT LIGHT SWITCH

This instrument was submitted to the RADIO NEWS LABORATORIES for test by the Yaxley Mfg. Co., 217 North Desplaines Street, Chicago, Ill. This is a combination switch and pilot light. The pilot light mounted



behind the panel can be made visible through a small hole drilled in the panel. Evidence is thus furnished as to whether the set is in operation.

AWARDED THE RADIO NEWS LABORATORIES CERTIFICATE OF MERIT NO. 1041.

CRYSTAL SET

The crystal set shown in the illustration was submitted to the RADIO NEWS LABORATORIES for test by the



Carter Mfg. Co., 1728 Coit Ave., E. Cleveland, Ohio.

AWARDED THE RADIO NEWS LABORATORIES CERTIFICATE OF MERIT NO. 963.

COIL-WINDING MACHINE

The winding machine shown in the illustration was furnished by the Wizard Wire Winder Co. and submitted to the RADIO NEWS LABORATORIES for test. This machine is a very handy addition to the radio workshop. Tubing of any size can be wound with any size wire. The guide for the wire travels upon a lead screw which is driven through a belt



and pulley by the handle. A wide range of spacing is possible with this machine.

AWARDED THE RADIO NEWS LABORATORIES CERTIFICATE OF MERIT NO. 954.

LECTRON TUBE

This tube was submitted to the RADIO NEWS LABORATORIES for test by the Lectron Radio Co., 1270 Broadway, New York City. This tube is made to operate under a filament voltage of 5 and has a filament rating



of .25 of an ampere. It has an approximate amplification factor of 7.

AWARDED THE RADIO NEWS LABORATORIES CERTIFICATE OF MERIT NO. 993.

CRYSTAL DETECTOR

This crystal detector was submitted



to the RADIO NEWS LABORATORIES for test by the S. A. M. Radio Co., 619 Securities Bldg., Omaha, Nebr. It is provided with a knob for adjusting the crystal contact and is designed for single-hole mounting.

AWARDED THE RADIO NEWS LABORATORIES CERTIFICATE OF MERIT NO. 1037.

CIRCUIT TUNER

The circuit tuner shown in the illustration was submitted to the RADIO NEWS LABORATORIES for test by the Radio Equipment Co., La Verne,



Calif. These coils are constructed as to be replaceable in sockettes and are wound to have various filaments of inductance. This construction affords an easy method of using coils of very low resistance.

AWARDED THE RADIO NEWS LABORATORIES CERTIFICATE OF MERIT NO. 966.

RHEOSTAT

This rheostat, submitted to the RADIO NEWS LABORATORIES for test by the Bretwood, Ltd., 12 London Mews, Maple Street, London, England, is of special design and has a continuous



resistance wire wound around a cylinder which slides or rotates within another protecting cylinder. Contact is made with a resistance wire by means of a spring clip. For rough adjustment the knob is pushed in or out, fine adjustment being obtained by turning the knob.

AWARDED THE RADIO NEWS LABORATORIES CERTIFICATE OF MERIT NO. 1024.

PENETROLA

The Penetrola was furnished by the Walbert Mfg. Co., 925 Wrightwood Ave., Chicago, Ill., and submitted for test to the RADIO NEWS LABORATORIES. This unit is designed to be attached between the antenna and any receiving set. It acts as a self-neutralized stage of radio frequency amplification, the neutralization being

accomplished by the same means as is used in the Isofarad circuit. It operates very satisfactorily and adds both selectivity and volume to the



equipment and also prevents reradiation.

AWARDED THE RADIO NEWS LABORATORIES CERTIFICATE OF MERIT NO. 939.

ELECTRAD CONDENSER

The condenser shown in the illustration was submitted to the RADIO NEWS LABORATORIES for test by the Electrad Co., Inc., 428 Broadway,



New York City. It is designed for all capacities and has a measured value very close to its rated value. This condenser is equipped with a special mounted lug for direct attachment to tube sockets or for holding grid leak resistances.

AWARDED THE RADIO NEWS LABORATORIES CERTIFICATE OF MERIT NO. 1029.

CRYSTAL RECEIVING SET

This crystal receiving set was submitted to the RADIO NEWS LABORA-

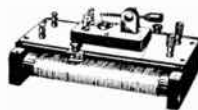

TORIES for test by the Gundlach Manhattan Optical Co., Rochester, N. Y.

AWARDED THE RADIO NEWS LABORATORIES CERTIFICATE OF MERIT NO. 950.

A.F. TRANSFORMER

The transformer submitted by the Kellogg Switchboard & Supply Co.,



1066 W. Adams St., Chicago, Ill., to RADIO NEWS LABORATORIES for test is shown in the illustration. This transformer shows a very flat characteristic and affords faithful reproduction in audio frequency amplifiers. It is totally encased in metal, thereby eliminating interstage coupling, and is very ruggedly built.

AWARDED THE RADIO NEWS LABORATORIES CERTIFICATE OF MERIT NO. 1028.

HILCO FIXED CONDENSERS

The condenser shown in the illustration was submitted to the RADIO



NEWS LABORATORIES for test by the A. E. Hill Mfg. Co., 80 Mangum St., Atlanta, Ga. These condensers are designed for all capacities and have



measured values very close to their rated values. The condensers are equipped with special mounted lugs for direct attachment to tube sockets or for holding grid leak resistances.

AWARDED THE RADIO NEWS LABORATORIES CERTIFICATE OF MERIT NO. 1019.

TERMINAL STRIP

The terminal strip shown in the illustration was submitted by the Stafford Radio Co., Medford Hillside, Mass., to the RADIO NEWS LABORATORIES for test. This strip is furnished with a number of binding posts so that the whole can be mounted as an integral unit in constructing a radio receiver or any other kind of equipment where connections to the outside must be made.



AWARDED THE RADIO NEWS LABORATORIES CERTIFICATE OF MERIT NO. 1043.

AMPLIFIER TUBE

This tube, submitted by the Daven Radio Corp., 158 Summit Street, Newark, N. J., to the RADIO NEWS LABORATORIES for test, is designed for special use in resistance coupled amplifiers but will work satisfactorily in all types of amplifiers. It is also



designed to have a specially high amplification effect and operates under the usual conditions of plate and filament voltage.

AWARDED THE RADIO NEWS LABORATORIES CERTIFICATE OF MERIT NO. 1033.

RADION DIAL

The illustrated dial was submitted to the RADIO NEWS LABORATORIES for test by the American Hard Rubber Co., 11 Mercer Street, N. Y. C. This radion dial presents a pleasing appearance upon the panel of the receiver and, because of the way in which it



is molded, is very convenient to grasp in the hand.

AWARDED THE RADIO NEWS LABORATORIES CERTIFICATE OF MERIT NO. 1018.

MASTERTONE DETECTOR AND AMPLIFIER

The tube shown in the illustration was submitted to the RADIO NEWS LABORATORIES for test by the Acme Products Co., 903 Broad St., Newark,



N. J. It is made to operate under a filament voltage of 5 and has a filament rating of .25 of an ampere. It has an approximate amplification factor of 7.

AWARDED THE RADIO NEWS LABORATORIES CERTIFICATE OF MERIT NO. 1031.

CHUMMY HEAD-BAND



This head-band was submitted to the RADIO NEWS LABORATORIES for test by the Chummy Co., 229-231 W. Illinois St., Chicago, Ill.

AWARDED THE RADIO NEWS LABORATORIES CERTIFICATE OF MERIT NO. 920.

CIRCUIT-BREAKER

The circuit-breaker shown in the illustration was submitted to the RADIO NEWS LABORATORIES for test by



Bruno H. Ahlers, 8524-26 89th St., Woodhaven, L. I. It is designed to operate on fifteen amperes and is to be used in battery-charging outfits.

AWARDED THE RADIO NEWS LABORATORIES CERTIFICATE OF MERIT NO. 965.



I Want to Know

Conducted by R. D. Washburne

THIS Department is conducted for the benefit of our Radio Experimenters. We shall be glad to answer here questions for the benefit of all, but we can publish only such matter as is of sufficient interest to all.

1. This Department cannot answer more than three questions for each correspondent. Please make these questions brief.
2. Only one side of the sheet should be written upon; all matter should be typewritten or else written in ink. No attention paid to penciled matter.
3. Sketches, diagrams, etc., must be on separate sheets. This Department does not answer questions by mail free of charge.
4. Our Editors will be glad to answer any letter, at the rate of 25c for each question. If, however, questions entail considerable research work, intricate calculations, patent research, etc., a special charge will be made. Before we answer such questions, correspondents will be informed as to the price charge.

Mr. Washburne answers Radio questions from WRNY every Thursday at 8:30 P. M.

E.I.S. NAVY MODEL C-10. 50- TO 600-METER SUPER-HET.	38.0	2XI	Schenectady, N. Y.	Call	Location	Wavelength
(2151) Judge Cornelius F. Collins, New York City, asks:	40.0	1XAO	Belfast, Me.	NKF	Bellevue, D. C. 20, 41.6, 54.4, 71.5, 81.5	40, 43, 81
Q. 1. What is the schematic circuit employed in the 50- to 600-meter super-heterodyne of the Experimenters Information Service design? Any constructional details you can furnish will be greatly appreciated.	43.0	WIR	New Brunswick, N. J.	NPM	Honolulu, T. H.	49
A. 1. This extremely efficient circuit is being illustrated and described in these columns. The difficulties that will be encountered in properly constructing this receiver are apparent to the experienced constructor. As is true in building all radio sets, the use of correct parts is half the battle.	47.0	POZ	Nauen, Germany	NPG	San Francisco, Calif.	53
The Navy Model C-10, as it is called, has the highly desirable feature of plug-in coils. Design data given below shows that it is convenient to receive signals from stations operating on as low as 50 meters. This makes it possible to listen in on the short-wave phone and code experiments of this and many other countries. The following corrected list published through the courtesy of QST magazine will be of great interest to RADIO NEWS readers, particularly those contemplating building the E.I.S. Model C-10 set, or even the more standard types of short-wave receivers, such as the one fully described on page 372 of the April, 1925, issue of The Experimenter magazine; page 596 of the July, 1925, issue of The Experimenter, and page 16 of the July, 1925, issue of RADIO NEWS:	50.0	NKF	Anacostia, D. C.	NPU	Tutuila, Samoa	54
	56.0	KFKX	Hastings, Neb.	NBA	Balboa, C. Z.	70
	58.79	KDKA	East Pittsburgh, Pa.	NPO	Caite, P. I.	76
	60.0	1XAO	Belfast, Me.	NAJ	Great Lakes, Ill.	80
	60.0	2YT	Poldhu, England	NEL	Lakehurst, N. J.	77.4
	62.0	KDKA	East Pittsburgh, Pa.	NFY	Quantico, Va.	71.7
	67.0	8XS	East Pittsburgh, Pa.	NPL	San Diego, Calif.	70.5
	70.0	POX	Nauen, Germany	NOQ	San Diego, Calif.	20.0, 30.6
	71.5	NKF	Anacostia, D. C.	NAL	Washington, D. C.	40
	74.0	WIR	New Brunswick, N. J.	NRRL	U.S.S. Seattle	20
	75.0	SFR	Paris, France	NEPQ	U.S.S. Relief	119 to 149
	75.0	WGN	Rocky Point, L. I.	NDF	U.S.S. California	75
	76.0	POX	Nauen, Germany	NIRX	U.S.S. Canopus	70 to 84.5
	83.0	RDW	Moscow, Russia	NERM	U.S.S. Los Angeles	40
	84.0	NKF	Anacostia, D. C.	NOW	U.S.S. Mexico	75
	85.0	SFR	Paris, France	NUQB	U.S.S. Pope	150
	85.0	8GB	Paris, France	NITZ	U.S.S. Sturgeon Bay	119 to 149
	86.0	NQC	San Diego, Calif.	NEDJ	U.S.S. West Virginia	



View of a receiver built from the circuit shown below. The panel is engraved. A well-balanced appearance has been obtained without sacrifice of efficiency.

THE INTERMEDIATES

Amateurs familiar with the telegraph code will not be able to determine the country of origin of telegraph signals heard with this set adjusted to waves below 200 meters, unless the "intermediates" are understood. "Intermediates" are the letters that precede the "call letters" of the transmitting station. The internationally accepted list of "intermediates" follow:

90.0	6XO	Kahulu, T. H.
90.0	1XAO	Belfast, Me.
92.0	2YT	Poldhu, England
94.0	2YT	Poldhu, England
95.0	SFR	Paris, France
96.0	8XS	East Pittsburgh, Pa.
99.0	6XI	Bolinas, Calif.
100.0	POX	Nauen, Germany
100.0	2XI	Schenectady, N. Y.
100.0	NAM	Norfolk, Va.
103.0	WGII	Tuckerton, N. J.
105.0	WIII	S. S. "Big Bill," Schenectady, N. Y.
107.0	2XI	Schenectady, N. Y.
112.0	1XAO	Belfast, Me.
115.0	FL	Paris, France
120.0	1XAO	Belfast, Me.
146.0	6XO	Kahuku, T. H.

In addition to the above list, we are publishing, also through the courtesy of QST magazine, an available record of "N" stations operating on short waves. However, these listings are only approximate and are more variable than the ones shown above:

Wave-length	Call letters	Location
20.0	POX	Nauen, Germany
25.0	2YT	Poldhu, England
25.0	POY	Nauen, Germany
26.0	POX	Nauen, Germany
30.0	2XI	Schenectady, N. Y.
32.0	2YT	Poldhu, England
35.0	2XI	Schenectady, N. Y.
36.0	L'Z	Buenos Aires, Argentina

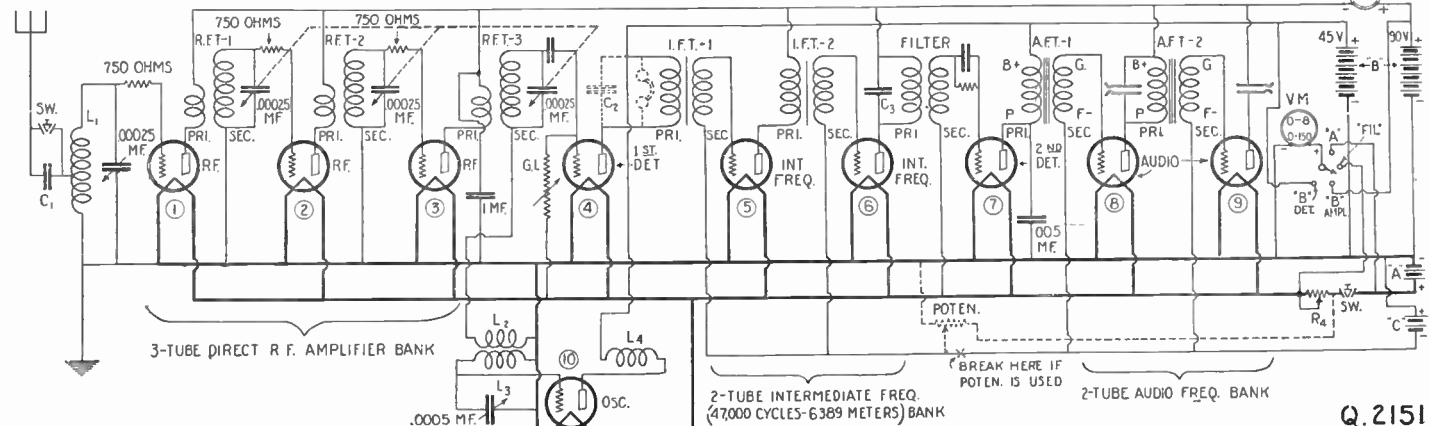

Q. 2151

The Experimenters' Information Service Navy Model C-10 super-heterodyne designed for a wave-length range from 600 meters down to 50 meters, the band being covered through the expedient of interchangeable coils. Blueprints are not available.

U United States
Y Uruguay
Z New Zealand

If the experimenter cares to design coils for the reception of wave-lengths up to about 1,000 meters, the following compendium of long-wave broadcast stations will be of interest.

For wave-lengths above 1,000 meters the experimenter is advised to use a different type of receiver from the super-heterodyne. A circuit designed for long-wave reception is No. "Q. 2100," shown in the "I Want to Know" department of the April, 1925, issue of RADIO NEWS. A circuit that performs unusually well on the longer wave-lengths is No. "Q. 2056," shown in the same department of the December, 1924, issue. Honey-comb coil sizes for all wave-lengths are given in a table appearing on page 1229 (I Want to Know department) of the January, 1925, issue.

Wave-length	Call	Location
550	OKP	Prague, Czechoslovakia
550	YN	Lyons, France
570	PRG	Prague, Czechoslovakia
600	CD	Ocean Falls, B. C.
600	OHW	Vienna, Austria
600	SPE	Rio de Janeiro, Brazil, S. A.
650	—	Hoengg, Switzerland
650	SASD	Zurich, Switzerland
680	—	Sundsva, Sweden
750	—	Berlin, Germany
(1) 775	—	Copenhagen, Denmark
800	2BZ	Calcutta, India
(6) 850	—	Kiev, Russia
(7) 850	HB2	Lausanne, Switzerland
900	FND	Dijon, France
900	—	Abbeville, France
940	—	Leningrad, Russia
950	MT1	Budapest, Hungary
950	HB	Budapest, Hungary
(5) 950	—	Odense, Denmark
1010	—	Moscow (Sokhniki Station), Russia
1050	PX9	Amsterdam, Holland
1050	NSF	Amsterdam, Holland
1050	PCMM	Ymuiden, Holland
1060	HDO	Hilversum, Holland
1070	PCGG	The Hague, Holland
1100	HB1	Geneva, Switzerland
1100	HB2	Lausanne, Switzerland
1100	HBK	Kloten, Switzerland
1100	BAV	Ilaeren, Belgium
1100	2FC	Sydney, Australia
(3) 1150	—	Ryvang, Denmark
(4) 1250	EBX	Cartagena, Spain
1250	—	Hjorring, Denmark
(8) 1250	6WF	Perth, Australia
1300	LP	Berlin, Germany
1370	SASE	Boden, Sweden
1450	RDW	Moscow (Central Station), Russia
(7) 1525	NRD	Toulouse, France
1590	DS	Iroquois, Canada
1590	DT	Twin Falls, Ontario
(2) 1600	5XX	Daventry, England
1600	CD	Ocean Falls, B. C.
1600	—	Issy-sur-Moleneaux, Fr.
1625	FFF	Belgrade, Yugoslavia
1650	EGC	Madrid, Spain
1650	—	Rakovitz, Yugoslavia
1680	GED	Croyden, England
1780	SFR	Clichy (Radio-Paris), Fr.
1780	8AJ	Paris, France
1800	KAV	Norddeich, Germany
1800	OKB	Brunn, Czechoslovakia
1900	DV	Victoriaville, Que., Can.
1900	DW	Gonin Dam, Que., Can.
1900	DX	Quebec, Canada
1900	DY	Thetford Mines, Quebec, Canada
2200	EGC	Madrid, Spain
2400	OXE	Lyngby, Denmark
2500	SASE	Boden, Sweden
2500	YG	Tours, France
2650	FL	Paris (Eiffel Tower), Fr.
3000	DO	Glac Bay, Nova Scotia
3300	DQ	Markham, Ontario
4000	LP	Konigswusterhausen, Germany.

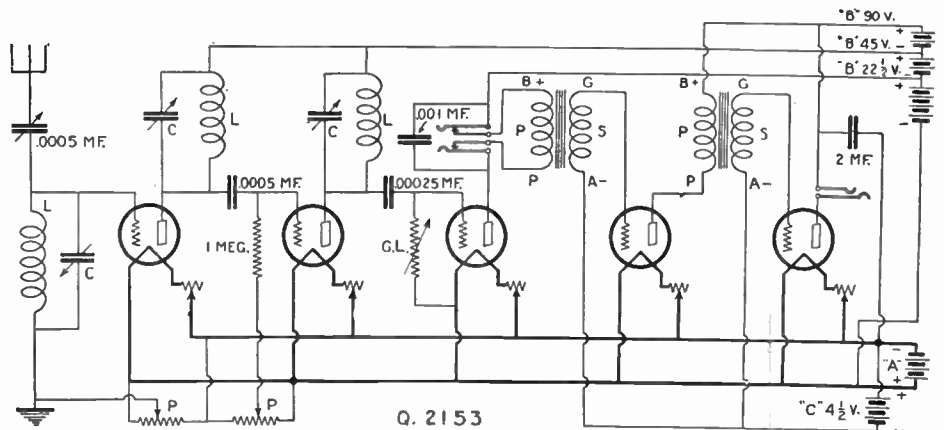

Tuned Impedance. The standard schematic circuit for a receiver using "tuned impedance" coupling. Each tuned unit, when adjusted for a given signal, "rejects" that signal, causing the signal to charge the blocking condenser and, in turn, operate the grid of the amplifier tube. Undesired signals are "accepted" and do not operate the amplifier tubes. The circuit shown is very selective.

The references given are as follows:

- (1) Closed for repairs. See Ryvang.
- (2) Replaces Chelmsford; relays 2LO emissions with 25 k.w.
- (3) Substitute for Copenhagen.
- (4) Ryvang program relay.
- (5) Ryvang program relay.
- (6) All announcements in IDO.
- (7) Aerodrome.
- (8) Konigswusterhausen Station.

It will be noticed from the photograph that the left tuning control is marked "kilocycles." Just why this should be so, we cannot explain, since the shielded variable condensers designed for this set have a straight-line wave-length curvature.

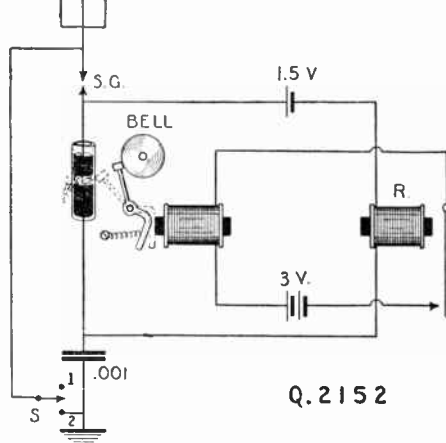

A "storm detector." The coherer operates in a horizontal position. The metal plugs are preferably slanted, rather than straight-faced as shown.

The 750-ohm resistances are non-inductive. One of the most interesting features of this modern super-heterodyne is the single dial control of three variable condensers, each of .00025 mfd. capacity. These condensers must be absolutely precise in their construction, else the individual capacity curves will vary slightly at a given dial setting, resulting in greatly reduced sensitivity and selectivity. Hogan Patent No. 1,014,002 covers this single control of a multiplicity of condensers.

The three individual condensers comprising the

three-condenser unit are shielded from one another and the multiple unit is shielded from the two remaining variable condensers in the set, which two are already shielded in themselves, as is evident from the photograph.

If other variable condenser values are used, entirely different coil construction will be required and we are not prepared to furnish exact coil data for other coils than those herein described. This, because a certain amount of experimental verification would be required and it is not possible at this time to undertake these experiments.

The first three tubes acting as radio frequency amplifiers of the incoming signal at the regular broadcast wave-lengths are called the direct radio frequency amplifier bank.

Straight-line frequency condensers may be used, having the maximum capacities mentioned, if the calibration is desired to indicate frequency. Or, straight-line wave-length condensers may be used, having the maximum capacity mentioned, if indication in terms of wave-length is desired.

A vernier adjustment of the three-gang and oscillator condensers is absolutely required.

Condenser "C-1" will have a value depending upon the constants of the particular aerial system used. Any one of the new, unusually small variable condensers having a maximum capacity of about .0005 or .00025 mfd., and adjusted by means of a screwdriver, may be used, or it may be of either of these two capacities, and non-adjustable, if either of these two values is correct for the aerial system used.

When the set is first tested, it is advisable to try each unit as it is completed. When the direct radio frequency amplifier bank and first detector are fully wired, it is very easy to test it. With a pair of head-phones connected into the circuit in place of the primary of the first intermediate frequency transformer, as shown by the dotted lines, signals should be heard clearly, loudly and undistorted, from stations at considerable distances. It will be necessary to connect a fixed condenser, "C-2," of perhaps .00025 mfd. capacity, across the head-phones, as also indicated by dotted lines. This condenser will probably not be needed with the long-wave transformers, although this is dependent upon the design of the transformers.

If the diagram is studied a bit it will be seen that with the arrangement mentioned above, we have a standard four-tube set consisting of a tube detector preceded by three stages of short-wave amplification with each stage tuned by means of variable condensers. The wave-length at which this four-tube system will operate is dependent upon the inductance and capacity in the tuning circuit, as usual. By arranging the inductances in four sets, and fixing them so that each set can be plugged into receptacles in nearly the same manner as the well-known honeycombs, it becomes possible to tune as low as 50 or 60 meters, or even lower, if the experimenter cares to design coils for the lower wave-lengths, and up as high as 600 meters, or higher, if, once again, the experimenter cares to design coils to go higher than this, although, in this direction, 1,000 meters is about the highest practical wave-length to which designers proportion a super-heterodyne to respond. The design for four sets of plug-in units (of which there are five—four of the direct radio frequency amplifier bank, and one for the oscillator tube circuits) to cover the wave-lengths between 50 and 600 meters will be found elsewhere in these columns.

After this four-tube unit is working properly, the oscillator tube is inserted in its socket and, if everything here is wired correctly, a whistle will be heard as the oscillator tuning dial is adjusted so that the oscillator out-put frequency heterodynes with the incoming signals. If this whistle is not heard, test the oscillator for circuit oscillation. Methods for testing the oscillator and other parts of a super-heterodyne are given in the articles listed below:

- "The L-1 Ultradyne," February, 1924, page 1058.
- "The Tropadyne," August, 1924, page 1970.
- "The L-2 Ultradyne," January, 1925, page 1189.
- "The Pressley," February, 1925, page 1438.

(Continued on page 874)

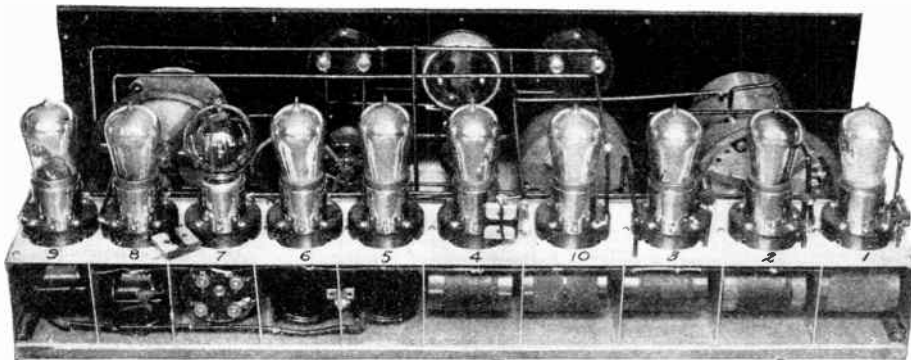

How "the makin's" of the E.I.S. super-heterodyne look when put together. All the sockets are on a metal panel or a strip. General Radio No. 271 I.F. transformers and filter were used. Note vertical shields between each unit.

NOTE—The Viking Receiving Set has been tested and approved by Radio News Testing Laboratory.

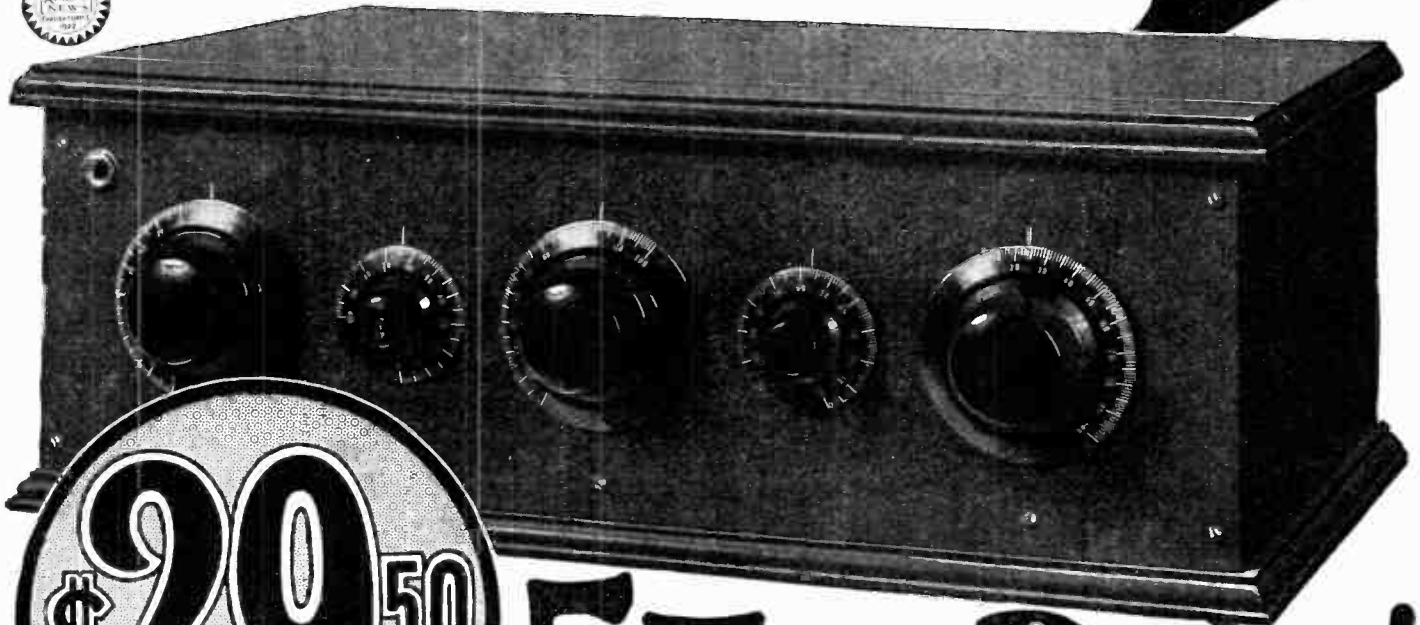

\$29.50

5 Tube Radio!

Tuned radio frequency, 2 stages radio, detector, 2 stages audio. Mahogany finish cabinet. Dull rubbed panel. 3 low loss condensers. 3 low loss coils. 5 bakelite sockets for 201A or 301A tubes. Thordarson transformers.

Send No Money!

We trust you! Just fill out the order blank below and we will send this wonderful VIKING 5 TUBE RADIO RECEIVER to you, express collect. Simply pay the express office the astonishing low price of \$29.50 plus small delivery charge. They will hold your money for 6 days. You keep the set for 6 days—try it—test it under any and all conditions.

Results are what count! By results we mean distance, tone, volume. Prove to your own satisfaction that the VIKING will give the results you want. Don't take our word for it—let the instrument talk for itself! Install it in your home for 6 days at our expense. Test it every way you know how.

Then, if you are not satisfied that it is the most remarkable radio bargain ever offered — if you are not delighted with the

sweet tone, volume and distance it receives— then, just pack it up and return to your express office. They will return your \$29.50 to you without question or quibble.

No two men seem to agree as to just what a radio instrument should do. There is only one way for any man to satisfy himself about the VIKING—try it out! We could tell you many marvelous things about the VIKING — but would it really mean anything to you? We believe you know what to expect from radio. The question in your mind is, will the VIKING give the results I expect? There is only one way to find out.

Send in the coupon! You have absolutely nothing to lose. We take all the risk because we know by comparison this is the most astonishing radio value on the market today. That is why we can afford to make this wonderful FREE trial offer. This receiver is entirely assembled and wired—complete in every respect except for accessories.

Try it for 6 Days FREE

Remember you run absolutely no risk! If you decide any time within 6 days that the VIKING 5 TUBE RECEIVER is not just what you want a radio to be, get your money back from your local express office. You will find it hard to duplicate such a wonderful chance again. All you have to do is fill in the coupon below. Don't send a penny with your order. Your instrument will be immediately shipped to you by express. Act NOW.

VIKING
Radio Laboratories
433 Austin Ave.,
CHICAGO
ILL.

Don't Send a Penny!

Use this Order Blank

VIKING RADIO LABORATORIES,
433 Austin Ave., Chicago, Ill.

Date

Gentlemen:—I want to place my order for a \$29.50 VIKING TUBE RADIO INSTRUMENT (without accessories) as described above which I understand as follows:

- 1 Upon receipt of this order you are to ship one VIKING \$29.50 — FIVE TUBE INSTRUMENT, completely wired, without accessories, express collect, C. O. D. When this instrument arrives at my express office, I have the right to examine it. If I am not thoroughly satisfied, I will instruct the Express Co., to return to you at once. You to pay all charges.
- 2 If I decide to keep this instrument I will pay the express office \$29.50 plus express charges, with the understanding that the Express Agent will

keep my money for 6 days. If at any time within 6 days I am not satisfied with the VIKING for any reason whatsoever, I will return it, packed just as I received it and if it is in good condition the Express Co., is to return my money and return the instrument to you.

3 If I do not return it to Express Co. within 6 days, you can consider I am perfectly satisfied with the VIKING.

4 Please ship as soon as possible and advise me when you have shipped.

Name

Address City and State

Occupation Employed by Age

There's Economy and Satisfaction in these Valley units

You will find both economy and satisfaction in the use of the Valley B-Eliminator and the Valley Battery Charger.

Economy in the B-Eliminator because it stops forever the expense of buying new B batteries. . .

Economy in the charger because it recharges your own storage battery at home overnight at one-tenth the cost of service station charging. . .

And satisfaction in both because, by using them, you need never miss a program on account of low or worn-out batteries.



THE VALLEY B-ELIMINATOR operates from ordinary light socket; provides a steady, noiseless flow of B current at a constant voltage all the time.

With it, there can never be any decrease of signals or frying noises due to low B batteries. Volume is maintained. Reception is uniformly good.

For receiving sets of from one to eight tubes. Costs less at the start than wet B batteries. Costs less in the long run than dry cells. Much more satisfactory than both.

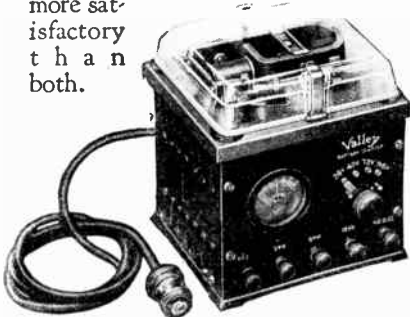

THE VALLEY BATTERY CHARGER is the only charger needed for all radio storage batteries. Its correct 6-ampere charging rate makes overnight charging a possibility.

The Valley Charger also functions on any lamp socket. It takes about a dime's worth of current for an average charge. Quiet in operation. Most radio dealers handle the Valley B-Eliminator and Valley Charger. Any one of them will be glad to show you these units and explain their advantages.

Radio Division
VALLEY ELECTRIC CO. ST. LOUIS, U. S. A.
Branches in Principal Cities

Valley Electric

How to Make the Radio Dancer

(Continued from page 802)

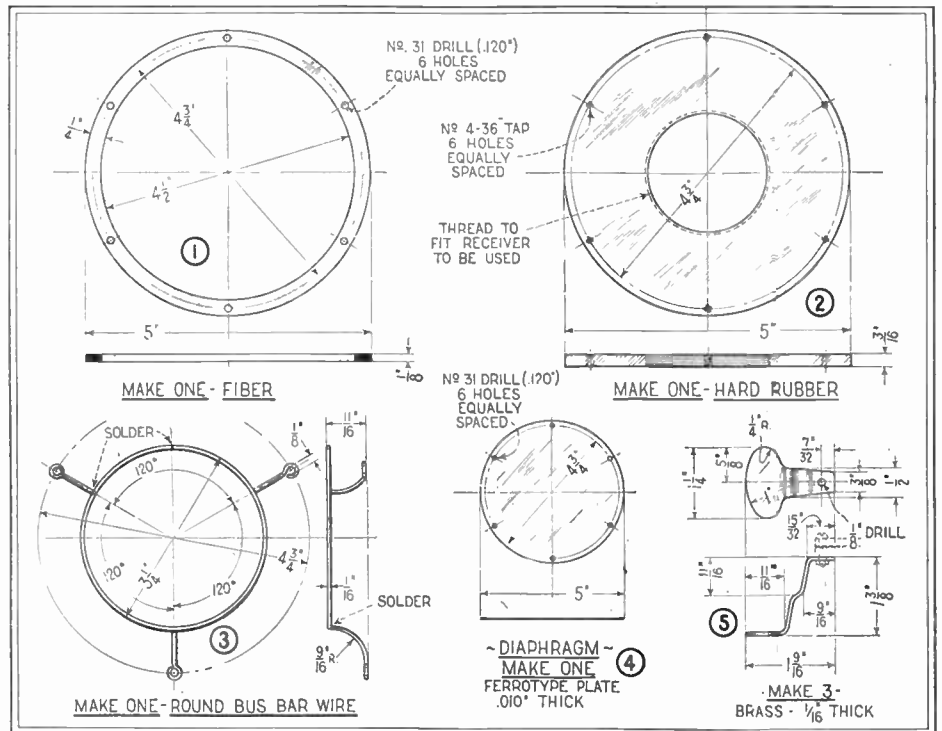

Above is a mechanical layout of the new radio toy—the loud speaker dancer. The legend on the various parts will explain them thoroughly.

the loud speaker unit. This thread, moreover, should be such that the loud speaker unit does not turn too easily. The loud speaker unit should be so made that upon being screwed in, it actually touches the diaphragm. Then it should be unscrewed a quarter of a turn, which will give the device its greatest efficiency, as during operation the diaphragm must not touch the pole pieces of the phone. The next step is to provide the loud speaker with cord and plug and plug the device into your radio set.

It is important to note here that, inasmuch as a good deal of vibration is necessary to operate the dolls, only a radio set with three tubes or more will work the device and it operates really well on local stations only, or such stations as ordinarily come in with good loud speaker volume. The stations that can be heard ordinarily only by means of the head-phones will not operate the Radio Dancer. Please bear this in mind, as if, by any chance, you are so far removed from broadcast stations that your loud speaker ordinarily emits very poor volume, I do not recommend that you build the device. Needless to say, it does not operate on a crystal set.

The next thing to make is the dancing doll. This can be made in a very simple manner by sticking three toothpicks into an ordinary small bottle cork. These can be ordinary toothpicks, but whatever they are, the important point is that the lower part, that is, the part that is going to rest on the diaphragm, must be sharp. I have experimented with a good deal of material and found that wooden toothpicks or ordinary quill toothpicks are the best, the latter being the better of the two. I need not mention that when these toothpicks are stuck into the cork the remaining ends sticking out of the cork must be absolutely level, since if they are not level the doll will topple over. A fancy doll can then be built upon the cork by your mother, your sister or your wife, whatever the case may be, or you can buy small dolls of this kind complete in some novelty shop. If complete dolls are

bought, it is necessary to glue the piece of cork somewhere in the inside of the doll. It should be remembered, when making these dolls, that they must be extremely light—must not, in fact, weigh more than half an ounce. The less they weigh, the better they will dance.

If there are children in the house, a number of these dolls can be made, which will create a good deal of amusement for the little ones. When the radio is turned on, tune in the station in the usual way with your regular loud speaker, and then plug in the Radio Dancer apparatus and immediately music will issue from it. Since the diaphragm is five inches, excellent volume is obtained. The loud speaker may be adjusted by screwing the unit in or out until the best volume is secured. When this is done, one or two dolls may be carefully placed inside the guard rail on top of the diaphragm, and the dolls will now begin to dance in a realistic and charming manner.

If the dolls have a tendency to topple over on very loud music, it is only necessary to give the loud speaker unit a half turn to the left, which will reduce the volume and the vibrations as well. If the dolls still persist in falling over, you have not balanced them correctly; that is, one of the toothpicks is probably sticking out too far, overbalancing the doll. It is also necessary that the entire contrivance be absolutely level, because if it is placed at even a small angle the dolls will invariably gravitate toward one point and remain there. The feet of the apparatus must, therefore, be adjusted by placing paper or cardboard underneath them to make the entire contrivance perfectly level.

This also makes an excellent device for store windows, where it creates no end of amusement, particularly in radio stores. In that case, the dolls can, of course, be made to carry small advertisements of any desired nature.

I shall be glad to hear from those who have constructed this apparatus.

THE PERFECT UNION OF ART AND SCIENCE

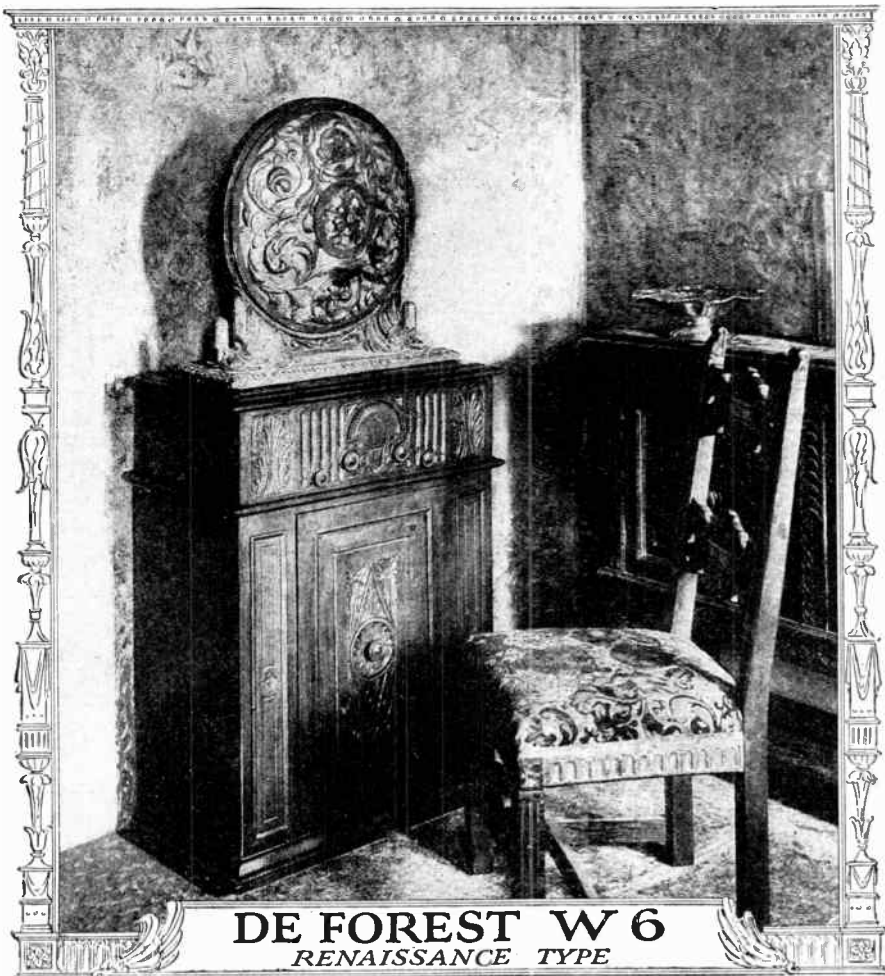

DE FOREST AUDION
is the world standard in tubes. De Forest created the first successful radio tube, and his invention made broadcasting possible. The De Forest policy of a specific type tube for each socket insures finer reception and greater distance. Price, \$3.



DE FOREST F-5 AW
A compact, powerful set in polished walnut that will bring joy to many a household. Gives rich volume, and has the capacity to separate stations positively so that you can pick the broadcast gems without interference. Extremely easy to operate. Price (minus tubes, loud speaker and batteries) \$90.



DE FOREST F-5 M
A superfine 5-tube set in two color mahogany cabinet with built-in loud speaker and concealed compartments for "A" and "B" batteries. A great distance-getter, with uncanny power to tune in and out stations at will, and gifted with splendid tonal qualities. Extremely simple to operate. No howling or hissing in tuning in. An unsurpassed value at \$110.

De Forest Radio Sets can be bought at prices ranging from \$85 to \$450.

De Forest Genius now Humanizes Radio!

MARVELOUS new circuit, just perfected, reproduces flawlessly the mellow, soft modulations of the human voice and captures the hitherto elusive overtones of the musical register . . . tuning simplified . . . a new ease in operation . . . all embodied in the new and beautiful De Forest W5 or W6 Radiophones.

The voice of radio is no longer flinty and metallic, but mellow, human and musical—thanks to the development by Roy A. Weagant, Vice-President and Chief Engineer of the De Forest Radio Company, of a new and marvelous circuit.

This ingenious circuit, and all the joy it means to radio lovers, makes its first public appearance in the De Forest W5 and W6 Radiophones, masterpieces of cabinet art worthy only of a scientific development so outstanding.

So wonderful is the reproduction of tone in the De Forest W5 or W6 that only the presence of the lovely instrument dispels the illusion that the living artist is in the room.

Piano chords come to you with their full rich resonance—true piano tone. High notes

dance, ripple and sparkle . . . clearly, distinctly . . . *musically!* Those brooding low notes, never caught in average reception, are heard distinctly—as though from the next room.

In the reproduction of orchestral music the full importance of the De Forest achievement stands out. For the first time you get the overtones as well as the middle tones . . . the majestic roll of the kettle drums, the crooning of the bass viols, the strident crash of the brasses and the piping heraldry of the cornets and trombones. A symphonic orchestra heard over the De Forest W5 or W6 stirs the soul. No incoherence, no oscillating jumble of noise—every instrument, every octave, in its true value. *A magic achievement!*

To the lover of dance music the De Forest W5 or W6 brings more sprightliness, more beauties of syncopation . . . you should hear Vincent Lopez, Joseph Knecht, The Night Hawks, or any others over either of these instruments!

All the tenderness of song, every shading of the soprano's voice, all the pathos of the folk song—exquisite but elusive elements so much desired but lost in practically all present-day reception, are captured by these De Forest masterpieces.

To everything that is broadcast, the De Forest Radiophone gives animation, life and humanness.

But Tonal Supremacy is Not All—

Elbert McGran Jackson, renowned sculptor, architect and painter, put into this hand-wrought, hand-carved cabinet the spirit of radio, in design, in motif—it is not an adaptation of a phonograph. An image of charming individuality, it harmonizes with the setting of any home.

One unit, everything self-contained—not a wire in sight, nothing to connect . . . and portable; move it any place! Only charm and beauty for the eye.

The artistic conical reproducer is an inseparable part of the cabinet and its tonal mechanism peerlessly attuned to that of the Weagant circuit. There are just two controls for tuning, and these operate on one dial, which makes the normally perplexing task of "tuning in" extremely simple. There are special power tubes in the fifth and sixth sockets which can give you volume to flood an auditorium, if you desire it. And, at your fingers' tips, the means to tune in a far-distant station you want no matter how powerful nearby stations may be.

See the incomparable De Forest W5 and W6 at your De Forest dealer's or write for an interesting booklet describing these masterpieces in detail.

DE FOREST RADIO CO., Jersey City, N. J.

DE FOREST *The Greatest Name in Radio*

DEALERS IN ALL CITIES AND RADIO COMMUNITIES

THE EPOCH-MAKING ACHIEVEMENT WHICH MAKES ORDINARY RADIO RECEPTION A THING OF YESTERDAY

Multiple Grid Vacuum Tubes and Their Advantages

(Continued from page 805)

tor. The author is convinced that the multi-grid tube can be made a huge success in a commercial sense, but it should be used as a straight amplifying tube and be constructed for the handling of ample currents.

One use to which the multigrid tube has been put should be mentioned here: The circuit proposed by Langmuir provided for simultaneous oscillation and modulation. In Fig. 4 is shown such a circuit, one grid serving as the oscillation circuit grid, while the other one is connected in an audio frequency circuit. The first grid causes continuous oscillations to be set up, and these are modulated by the audio frequency grid. It may be said that almost ideal modulation is obtained in this way without great complications in the apparatus involved.

As a result of the fact that both a positive inner and outer grid cause a tremendous increase in the amplifying factor of the tube, attempts have been made to construct tubes with both an inner and outer positive grid, while a control grid was placed between these two. It was then demonstrated that it was possible to construct tubes with an amplification factor well above 900, and yet retain high conductivity or low impedance in such a tube. This sort of tube, however, never seems to have gotten out of the experimental stage. It may be that the tube is not entirely suitable for practical use. No doubt this is due partially to the fact that these experiments were carried out with a view to economical operation instead of true power amplification.

5-Meter Transmission

(Continued from page 807)

late perfectly, steady operation followed. In receiving, the UV201-A tubes were used and no difficulties were encountered.

Oscillation in the receiver is controlled by the grid leak only, but if it is desired a potentiometer could be placed in the circuit. It is advisable to use a vernier dial on the receiving condenser. The receiver needs no critical adjustments, the connections being made as shown in the wiring diagram.

The only adjustments on the transmitter are the locating of the voltage nodes, X and Y. The easiest way is to vary the leads until maximum current is indicated in the ammeter G. Maximum efficiency is obtained when the power leads (the leads included between X and Y) are at zero potential with respect to radio frequency. It should be possible to touch the loop at these nodes without affecting the oscillator. So it is important that these points be properly located. The radio frequency chokes should be given close attention and put in the circuit at the points shown.

The fifty-watt set was coupled to an antenna having a fundamental near 250 meters. With about 1.5 in the oscillator, .3 amp, was pushed into this big antenna. The maximum range during local tests was five miles. In this set the receiver was used without antenna or ground. The transmitter coupled to this antenna was on the air during the recent ARRL tests and as yet the reports have not been published. Tests are now going on to determine the best manner in which to work the set. Three methods are in use, namely, a loop transmitter, coupling to a very large antenna and coupling to a "Hertzian" oscillator.

MEASURING THE VOLTAGE WAVE
The method of calibration is somewhat

different from the usual one employed. The measurement of the voltage wave, as usually done, is inaccurate, especially if the spark testers are used. In this method (recommended by the University of Illinois Laboratory) the current wave is measured. The "Lecher" wires are stretched parallel and a galvanometer or thermocouple placed across one end. A reflecting plate or wire is moved along the system until a maximum deflection is noted in the meter. The distance between two such points represents half a wave-length. The method is extremely accurate and is so sensitive that a movement of two or three centimeters of the shorting or reflecting wire will change the meter deflection more than 50 per cent. of the scale reading. The oscillator is coupled to the "Lecher" wires at the meter end by bringing the side AC near. It is not advisable to couple too closely for the interaction between the wires and the transmitter may change the frequency. If sufficient power is used it is possible to use a flashlight bulb in place of the meter. The receiver, with the tube in, but the filament not lighted, was used as a wavemeter. To find the wave it was necessary only to bring the wavemeter near the transmitter and note the sharp drop in the circuit current of the transmitter.

The illustrations and diagrams will convey the simplicity of five-meter work and perhaps encourage some experimentation in a more determined manner in the near future.

The Kiro-Vox—Alias Neurophonometer

(Continued from page 767)

As the wiring diagram shows, the two terminals which are used in locating the point of trouble in the patients are placed in parallel to a one-megohm resistance and in series with a couple of condensers. In the opinion of engineers of the laboratory, the note in the phones is changed as the resistance of the body is added to the circuit. However, it must be remembered that in case the resistance of the body does make the difference—which is not at all certain—it positively is not the resistance of the nerves that are being measured, but the total resistance of the whole body path between the two electrodes. On the face of it, it is quite preposterous to claim that the machine measures the resistance of the nerve, even if it could measure resistance, as such. How, pray, is it possible to take into consideration only the drop of voltage in the nerve when the two electrodes are on the skin? Why is it not more logical to consider the current in the ordinary manner and say that it takes the easiest path from one electrode to the other?

At school it was always the custom to measure resistance with the aid of a bridge and a known resistance or roughly to compute it from the voltage drop. The voltmeter in the present set is directly across the filament terminals and so it is hardly possible—without the aid of the special dispensation, which remains to be proven—to consider it at all in the investigation.

CAUSE OF CHANGE IN PITCH

However, with the head electrode clamped securely on the victim's forehead and the exploring electrode at some other point on the body, a shift in the latter will result in a change in tone. This is because, mathematically, the Cr of the detector circuit will give a certain note for the \sqrt{LC} factor in the grid circuit. When this is changed, the note will change; a change in the resistance between the electrodes will, of course, change the value of the radical and likewise the pitch of the note.



Patented Nov. 18, 1924

Windsor Loudspeaker Console

For EVERY Radio Set

A stunning piece of furniture that restores order in the room where you have your Radio! No more cluttered table-tops, nor litter of equipment under-foot.

No unsightly horn in evidence, either! This console has its own loudspeaker, in-built. It's out of sight, but with very apparent tonal superiorities. For it has the highest-developed type of unit. With horn built of special non-vibrating, extra-hard, ceramic material. Produces clear non-vibrant tone.



Non-Vibrant Ceramic Horn

The clearest tone producer on the market. Made of special composition which defeats vibration.

There's ample room for everything; space for largest A and B wet batteries—or battery eliminator—required for any home set; and for a big charging outfit, too.

Finished in mahogany, or walnut color. Dainty design of parqueterie on two front panels. Top, 38 in. x 18 in. Substantially built; the product of a 40-year-old furniture maker.

The price, forty dollars, is for the complete console and includes the loudspeaker horn and unit. Thousands of dealers are showing this artistic addition to home radio equipment.

Rear View—Set Hooked Up



Price, \$40
West of Rocky Mts., \$42.50

Windsor Furniture Co.

1426 Carroll Ave.
Chicago, Ill.

EVEREADY HOUR
EVERY TUESDAY AT 9 P. M.
Eastern Standard Time

For real radio enjoyment, tune in the "Eveready Group," broadcast through stations—

- | | | |
|------------------|------------------|-----------|
| WEAF New York | WCAE Pittsburgh | |
| WJAR Providence | WSAI Cincinnati | |
| WEEL Boston | WWJ Detroit | |
| WCTS Worcester | WCCO Minneapolis | |
| WFI Philadelphia | WOC St. Paul | |
| WGR Buffalo | | Davenport |



No. 764
Portable
22½-volt
Vertical
Price \$1.75



Eveready Columbia Ignitor "A" Batteries, the proven dry cell for all radio dry cell tubes 1½ volts

No. 779
22½-volt
Large
Vertical
Price \$2.00



No. 771
4½-volt
"C"
Battery
Price 60 cents



For radio economy

EVEREADY Radio Batteries are noted for their long service and economical operation. They are made in different sizes and types so that every radio user can enjoy the economy and convenience to be had by fitting exactly the right Eveready to his receiver. The five dry cell types of Eveready Radio Batteries are here illustrated and described to make it easy for you to decide just which will give the longest and most economical service on your set. A dealer near you sells Evereadys.

Eveready Heavy-duty "B" Battery for four or more tubes

No. 486. *Extra-large Layerbilt*. 45 volts. Vertical. Eveready's latest contribution to radio. The new Layerbilt construction which gives much greater service. Same size as No. 770. Price \$5.50.

Eveready "B" Battery for one to three tube sets

No. 779. *Large*. 22½ volts. Vertical. Especially adapted for Radiola 25, DeForest D-17 and Operadio receivers. Same capacity as No. 766, and suitable wherever variable taps are not required. Price \$2.00.

Eveready "B" Battery for portable sets

No. 764. *Portable*. 22½ volts. Vertical. For portable sets where medium weight and size are permissible. Price \$1.75.

Eveready "A" Battery

Eveready Columbia Ignitor Dry Cell Radio "A" Battery for all dry-cell tubes. 1½ volts. The dry battery used by vacuum-tube engineers in developing the dry-cell tube.

Eveready "C" Battery

No. 771. 4½ volts. Saves "B" Batteries, improves tone. Price 60 cents.

Manufactured and guaranteed by

NATIONAL CARBON COMPANY, Inc.
New York San Francisco
Canadian National Carbon Co., Limited, Toronto, Ontario

EVEREADY Radio Batteries

- they last longer



No. 486
45-volt
Layerbilt
Extra-large
Vertical
Price \$5.50

BOSCH



RADIO

The Bosch Radio Receiver, unapproached in tonal quality, volume, selectivity, simplicity of operation and beauty of design, is a product of an organization excelling in the manufacture of precision electrical equipment. The Bosch radio receiver and the Ambotone—the Bosch wood conoid reproducer—combine to give a new standard of quality in radio reproduction. The Bosch radio dealer near you will demonstrate the Bosch radio triumph. The Bosch Receiver \$145.00. . . The Ambotone Reproducer \$27.50 . . . The Junior Ambotone \$14.50.

AMERICAN BOSCH
MAGNETO CORPORATION
SPRINGFIELD . . MASSACHUSETTS



for Christmas
A set of NA-ALD
colored Dials
to dress up your radio

Give 'em to your wife and
get the benefit yourself!

WHEN fans first built radio sets, the womenfolk registered silent objection to their ugly appearance but they endured the clutter because radio was such a novelty and because they thought maybe you'd soon get over the craze.

But soon as they saw your craze was a permanent obsession, they began asking for better-looking sets.

The latest, up-to-the-minute advancement in making a set harmonize with its surroundings is represented by the New Alden Colored Dials. They will make your old set most attractive. To the new set they will add the pleasing qualities of color and beauty.

The colors are Garnet, Malachite Green, like mottled green and white marble; Brilliant Tortoise, that blends with every color combination; or in beautiful Grained Mahogany. \$5.00 a set, any color, in hardware, electrical, radio or department stores and in gift shops.

Give a set to someone in your family and then—all of you can enjoy their beauty! Or here's a stunt. Leave this magazine open on the living room table at this page, with a big pencil check mark beside this ad, and see if the family doesn't take the hint, and buy a set for you. If the wife of one of your radio fan friends asks you what to give her husband for Christmas, you might mention Alden Colored Dials.

Mail the coupon below if you'd like some free but worthwhile information on the New Colored Dials.

ALDEN MANUFACTURING Co.
Dept. K14, Springfield, Mass.

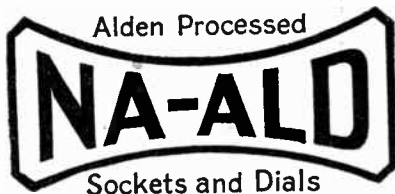

ALDEN MFG. CO., Dept. K14,
Springfield, Mass.

Please send me "What to Build"
information together with information
on Na-Ald Colored Dials.

Name.....
Street.....
City..... State.....

All the directions given are simply formed for showing the buyer how to bring the frequency of the grid discharge into range so that it will give the note. When the practitioner makes his first adjustment for the individual, called "tuning the patient in," he simply sets the constants of the circuit in such a way that the Cr and the \sqrt{LC} are in such a relation as to give a high-pitched note. The funny business about subtracting and adding the dial numbers is all the purest buncombe, just simply bait for the gullible.

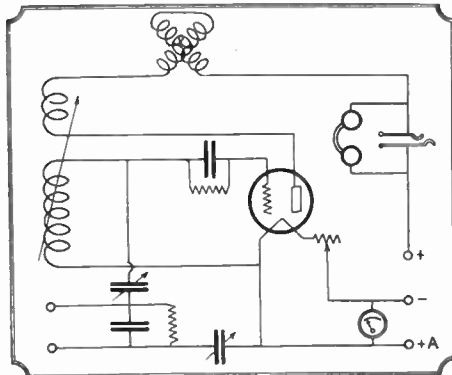

The schematic diagram of the Kiro-vox. With a little juggling it would make a good radio receiver.

Pray, what has the change in capacity or inductance or feed-back to do with the resistance of the patient's nerve. And people who fall for such stuff are patients, indeed.

Just read the directions below, look at the pictures of the dials referred to and examine the hook-up. If the ludicrousness of it all does not strike you, we give up.

The directions follow, verbatim:

DIRECTIONS FOR OPERATING KIRO-VOX

The four large dials represent four variable radio units, mounted behind the panel. The left-hand upper dial (when you are facing the KIRO-VOX) is a vario-coupler. The right-hand upper dial is a variable condenser. The left-hand lower dial is also a variable condenser, and the right-hand lower dial is a vario-coupler.

The radio vacuum tube in the upper central part of the panel is a radio UV-201A vacuum tube. The small knob with a pointer on it is a rheostat. The binding posts at the extreme left-hand side of the panel are for the purpose of connecting the head electrode and the search electrode. The head electrode is attached to the top binding posts, and the search electrode is attached to the bottom binding posts.

The small switch marked "F" is the filament switch, and is operated by pushing in and pulling out. The operating position is "in," and when the switch is pulled out, the entire machine switch is cut off and will not operate.

The phone-jack just above the Baldwin Unit is for the purpose of plugging in the head-phones. The binding post to the right of the panel is the plus side of the "B" battery, and is to be connected by the connecting wire to the binding posts on the battery-box. The battery-box is the small box that comes with the KIRO-VOX.

On one end of the battery-box is an electric plug plate, and a binding post. You will also find a connecting cord, with a plug, that fits into this plate, and also fits into a similar plate in the KIRO-VOX.

OPERATION

First connect your double wire with plugs to the two brass plates, one on the KIRO-VOX, and one on the battery-box. Then connect the binding posts on KIRO-VOX to the binding posts on the battery-box, with a single wire. Then place all dials with the exception of the small vernier dial at "50," the vernier dial at zero. Now push in the switch marked "F," and the machine should oscillate. In the event that it does not, move the lower right-hand dial towards the higher figures, until it does oscillate.

If the oscillation sounds coarse like a fog horn, pull the double wire plug out of the brass plate and reverse it. The oscillation should be a high-pitched tone like a horn, when it is properly connected. Having connected the two electrodes to the binding posts on the left-hand side of the machine, place the head electrode on the forehead of the patient, and the other immediately under the occipital protuberance, then turn the lower left-hand dial toward the higher numbers, until the machine just oscillates. By oscillation, we mean where you first hear the singing sound, then go down over the spine with the search electrode, and where the machine stops oscillating, you will find a restriction to the life-flow over those nerves. (You will not! Editor.)

In case of cord pressure, you will find that the machine stops oscillating at all points below the cord pressure over the right spine. (Absolutely untrue! Editor.) Now, in order to find impingements or subluxations below cord pressure, you place the search electrode at the point of the cord pressure on the spine, and turn the left-hand lower dial toward the higher figures, until the machine again oscillates, always being sure to turn it just to a point of oscillations, but not above the point of oscillations, then continue down the back, as before, and if the machine again stops oscillating, this will indicate an impingement or subluxation below the cord pressure.

MEASURING DEGREES OF RESISTANCE TO THE LIFE FLOW

After tuning the patient in with the electrode on the forehead, and the occipital protuberance, and you find a point at which the machine stops oscillating, you first note the figure on the dial at the point of oscillation, gotten from the forehead, to occipital protuberance, and then subtract that figure from the figure on the dial, when it has been brought to a point of oscillation, where it stops, due to the subluxation, and this method is always good, also, below a point of cord pressure.

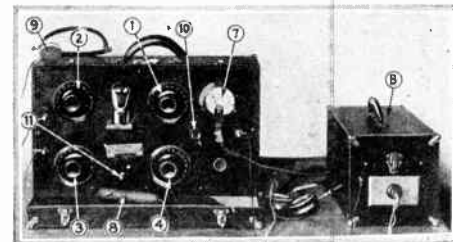

The exterior of the Kiro-vox. The numbers here correspond to those of the photograph on a preceding page.

STARTING MACHINE

After the machine is hooked up according to the above instructions, move the rheostat back towards the left, until the machine does not oscillate when all the dials are set at "50," then move the rheostat to the right slowly until the machine just oscillates, but not beyond this point, then proceed to examine the spine as directed.

If there is anything you do not understand about these instructions, please write us.

INVENT RADIO RECORDS

An innovation in broadcasting has been announced by the Vienna Press. It is the invention by the Austrian scientist and X-ray expert, Moreno Levy, and the engineer, Frank Loeritzo, which they say makes possible the fixing of broadcast sounds as if by a gramophone record and the rendering of them later at will any number of times.

The principal part of the invention consists of disks on which the broadcast sounds are recorded by a spiral consisting, not of deeper or shallower impressions as on a gramophone record, but of a continuous line of points more or less strongly magnetized according to the strength or quantity of the sound.

It is also possible to run down only certain parts of this record, skipping others. The disks are demagnetized by a simple process and may be used again.

The inventors do not declare they have discovered any new principle, but have combined known elements into something decidedly novel.

The invention, it is stated, will have an important bearing on wireless transmission of pictures and on "wireless signals."—*New York Times*.

NOTE: The description of this apparatus sounds very much like the old-time telegraphone used some ten or twelve years ago for the automatic recording of high-speed signals, described in the August installment of *Life and Work of Lee DeForest*. See also Editorial in August issue.—EDITOR.

UNBIASED OPINION

Campus: "Those football players must make good radio men."

Wampus: "Why for, Ulysses?"

Campus: "The coach said they did good grid work."

Contributed by Jack Bront.

Do your BATTERIES fail— when you want them most?

Now—you can be certain of continuous, unfailing "A" power of the highest quality... and always at full voltage.

. . .

A DELIGHTFUL PROGRAM that you've been looking forward to. A circle of friends to share it with you. Your radio is working perfectly. Then the rich, clear tones begin to fade. Embarrassed, you start to tune and tinker.

Your "A" batteries failed—just when you wanted them most!

AN experience that comes to every radio fan! For "A" battery failure is the most frequent cause of poor radio reception.

But to you—this need never happen again. For you can now have continuous, unfailing "A" power that automatically replenishes itself from your house current.

Unipower—a triumph in radio engineering

Unipower is a single compact "A" power unit that fits inside most radio cabinets. It takes the place of dry cells or separate storage battery and charging units.

Unipower comes to you completely wired and assembled—all you have to do is connect two wires to your set and plug in on your house current. Unipower is equipped with an exclusive Balkite charger of special design. Unipower will last you for years, and has no tubes, bulbs, lamps or working parts that require frequent and expensive replacement.

A unique feature of Unipower is the master-control switch that gov-

erns the operation of your entire set. When the switch is ON, Unipower feeds your set rich, quiet power with neither hum nor noise. When the switch is OFF, Unipower automatically replenishes itself from your house lighting current.

Unipower is not a battery eliminator, and should not be confused with any other power device. Unipower is a scientifically designed "A" current supply which automatically converts house lighting current into radio power.

Within the reach of all

The initial cost of Unipower is within the reach of all—and the first cost is the last! Unipower banishes the inconvenience of dry "A" battery renewals, or the bother of charging a storage battery, increases the life of your tubes, and in addition, gives you the finest kind of continuous, unfailing "A" power.

Take time today to see Unipower at your radio dealer's. He will be glad to demonstrate it and explain its features to you. The Gould Storage Battery Company, Inc., 250 Park Avenue, New York.

FREE! Write for interesting booklet, "Unipower—a Triumph in Radio Power", describing Unipower's many advantages and economies.

THE UNIPOWER ILLUSTRATED HERE IS FOR SETS USING UV-199 TUBES OR EQUIVALENT. FITS COMFORTABLY INSIDE MOST CABINETS.



The standard Unipower operates from alternating current, 110-125 V-60 cycle. It is supplied in two types. The 4 volt type is for sets using UV 199 tubes or equivalent and retails for \$35.00. The 6 Volt type is for sets using UV 201-A tubes or equivalent and retails for \$40.00. West of the Rockies, prices are slightly higher. (Special models, 25-50 cycle, are available.)

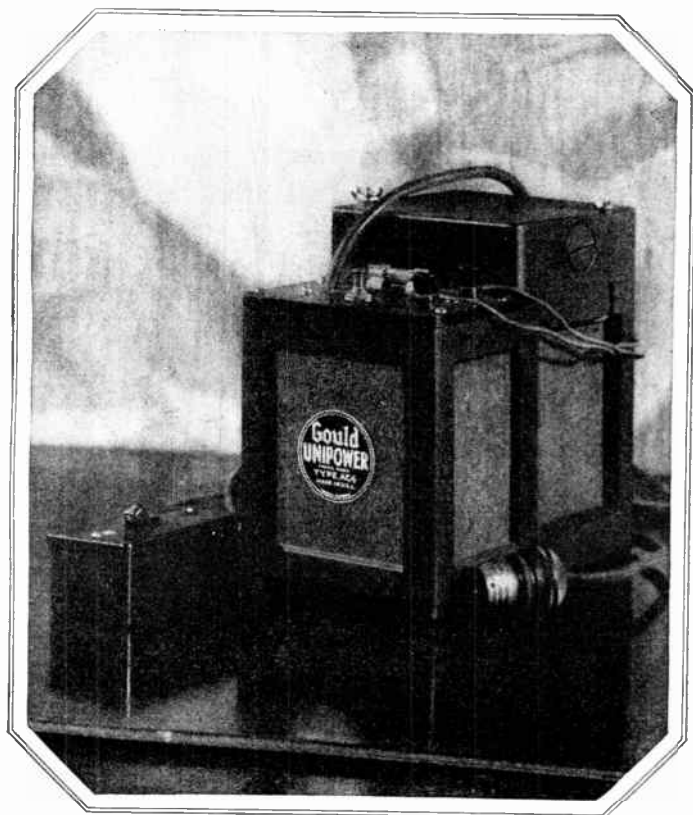

Unipower

Trade Mark

Off when it's on—On when it's off

Say
"Merrie
Christmas"
With A

Sterling Tube Servicing Instrument

and wish them
a year 'round
of tube saving

If you know a radio fan—and certainly there are far more of these species than the almost extinct "non-owners"—give him or her a Sterling Tube Reactivator or Tube Tester. What better gift than one that keeps all tubes bristling with life and saves the set-owner the expense of costly renewals? Or, a compact, handy tube tester always ready for duty to show whether tubes are good, fair or poor amplifiers—certainly an appreciated asset to good radio!

You'll want one yourself, too. A never-to-be-forgotten, practical Christmas with Sterling Radio Equipment that routs most radio troubles all year through!

TUBE REACTIVATOR

Renews worn out filaments in UV-201-A, C-301-A, UV-199 and C-299 types of tubes. Also valuable for matching tubes in the set. The meter tells when reactivation is necessary and shows just how much the tubes have improved after treatment.

List Price \$12.50

"HOME" TUBE TESTER

Tests plate current of large tubes, in the set, showing whether they are good, fair or poor amplifiers. Also a type for small tubes.

List Price \$8.50

"UNIVERSAL" TUBE TESTER

More than a tube tester. Really a complete set servicing instrument for testing tubes, batteries, transformers, sockets, and wiring circuit. For large and small tubes. Equipped with plate and filament emission meter and plate milliammeter.

List Price \$18.00



TUBE REACTIVATOR



"HOME" TUBE TESTER



"UNIVERSAL" TUBE TESTER

THE
STERLING
MFG. COMPANY

Cleveland,
Ohio
Dept. H

for
reliable
results

Sterling
SINCE 1906
PRODUCTS

Justice Is Deaf

(Continued from page 785)

kevitch's couldn't drive their car because they were out of gas."

"Out of a lot of things, too," I grunts. "Say, who are they, anyway?" "They're our new neighbors," informs Doris.

I nods. "I know that. Bohunkevitch's lawnmowing spree woke me up at six this A. M. I recognized the tune. He had our mower."

"I had to lend it to him," defends Doris. "His is in the repair shop."

"Anything else of ours this chromo could use?" I grunts. "Who is he?"

My encyclopedia is pained. "I found out this much about them," she offers. "He used to be a mine worker somewhere in West Virginia until a relative cashed in and left him a wad of jack. Now he's here."

"Evidently," I grumbles. "What'll we do about it?"

Doris shakes her head, dubious. "We've gotta be civil, at least," she decides. "They're a sorta independent lot, all of them."

"All of them?" I repeats. "How many little coal miners are there?"

My first and only lady pauses. "Well, there's four girls that I've seen, ages from three to nineteen, and seven boys, running up to about twenty."

"Holy ether!" I gasped. "Have we gotta be saddled with this wrecking crew all winter?"

Doris shrugs her shoulders. "From now on," she answers, hopeless.

"Well, don't let them borrow anything more," I advises. "First thing you know this slate-sorter'll be wanting to get a loan on my super-het."

"He tried to," says Doris. "I told him it was broken."

I solemnly arises and plants a kiss on my fair one's brow. "Noble, that's what I call it," I declares. "Hereafter, anything we've got is either broke, lost, strayed or quarantined."

But responsibilities ain't so easily dodged. These Bohunkevitch's have the cold cash, all right, and plenty of time. In fact, currency and cupid are the two things these Polacks ain't possessing nothing else besides. But they're sorta averse to spending their own finances when somebody else's will do just as well. There being neither Scotch nor Hebrew in them, I'm puzzled.

One nice day, as I'm puttering around the yard trying to locate a stray peg to tie a guy wire to, who should lean over the boundary line fence but old man Bohunkevitch himself, in person. I says for him he's a bit educated. Anyway, I don't need no interpreter.

"Hello, Mister Hammerstein," he greets, with a voice like a traffic cop. "Have you got—"

"No," I replies.

"—got any idea where a feller can get some aerial wire?"

Which is a sap question to ask, there being a radio store within sight of the house. I sees it's either a stall for a begging proposition or else a wedge for some chatter. Me being unprotected, this son of the underworld unloads his mind.

"Say, Mister Hammerstein," he begins, "there must be something wrong with your radio set."

As it occurs, there is, which ain't unusual. But how did this pick-wielder find out?

"Yeh?" I says, curious.

"Yes. I'm getting a lot of static lately. It must come from your set."

"Oh, does it?"

"Yes," says this nervy Ned. "We'll have to look at your outfit."

World Radio History

YAXLEY

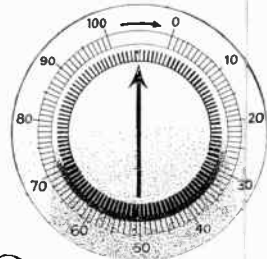

The New
YAXLEY
Panel Light
50¢
Bulb Extra

At your dealer's. If he cannot supply
you send his name with your order to

YAXLEY MFG. CO.
Dept. N, 217 No. Desplaines St., Chicago

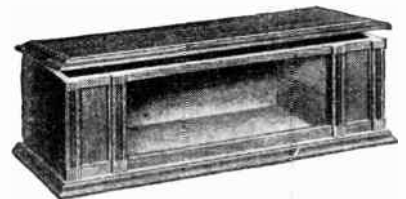

Premier B Battery Cabinet

Our Premier B Battery Cabinet is a beautiful piece of furniture. The B battery compartment will take any type B battery. The space of each B battery compartment is 4½" wide, 8½" high and 10" deep.

No.	For Panel	Deep	Genuine Walnut
718-10	7x14	10"	\$18.50
721-10	7x21	10"	19.00
721-10	7x21	10"	19.50
726-10	7x26	10"	20.00
728-10	7x28	10"	21.00
730-10	7x30	10"	22.00

F. O. B. Waukesha, Wis.

The tops of these cabinets are figured walnut, the ends and B battery panels are select walnut, all 5-ply veneer. The bases are built up of massive molding. Nickel plated piano hinges and lid holders. The material and finish in these cabinets will equal the best furniture obtainable.

We Make 9 Styles of Cabinets for
14 Sizes of Panels.

Send for our 1925-26 line of cabinets at
"Factory to User" prices.

UTILITY CABINET COMPANY
WAUKESHA Phone 721 WISCONSIN

ESPERANTO—Radio Manual

Contains short Esperanto course and exercises, Esperanto-English and English-Esperanto Radio dictionary. List of foreign stations broadcasting in Esperanto. Radio symbols, illustrated. Price 20 cents.

ESPERANTO ASSN. OF NORTH AMERICA
Pierce Bldg. - - Boston, Mass.

Insure your copy reaching you each month.
Subscribe to RADIO NEWS — \$2.50 a year.
Experimenter Publishing Co., 53 Park Place,
N. Y. C.

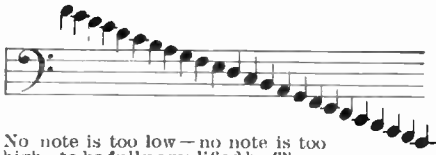

No note is too low—no note is too high—to be fully amplified by Thordarson Autoformers. Autoformers are all frequency amplifiers—they amplify with even magnitude ALL notes within range of the human ear. Developed, perfected and built only by Thordarson.

A Thordarson Autoformer Amplifier built in accordance with instructions and diagrams furnished with each instrument.

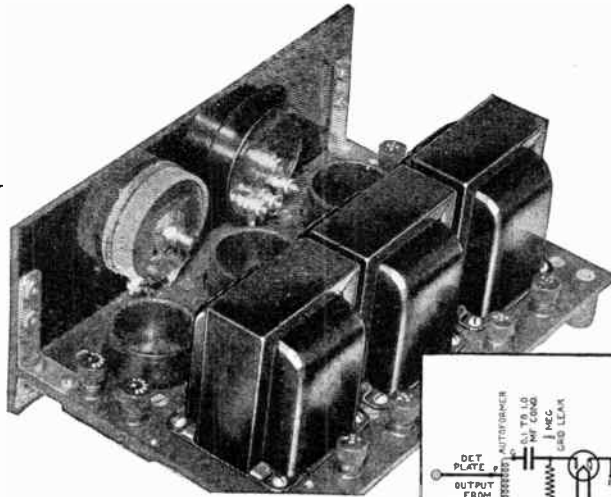

free!

Send for our new interesting bulletins on Autoformer amplification. They contain hook-ups and complete directions.

Autoformer Amplification Amazes Vast Crowds

Used at Radio World's Fair, New York City, to Amplify Programs and Announcements Broadcast by Loud Speakers Throughout the Great Halls

Tens of thousands of radio enthusiasts were completely won to Autoformer amplification during the Radio World's Fair in New York. The Thordarson Booth was besieged by fans, amazed and delighted over this latest Thordarson achievement. It was hailed on all sides as the outstanding development of the year in amplification. "What is it?" "How may I use it with my set?" Such questions were continually repeated.

Our answer was this: As the world's oldest and largest exclusive makers of transformers, we have led for years in broadening their amplifying range. In the Autoformer

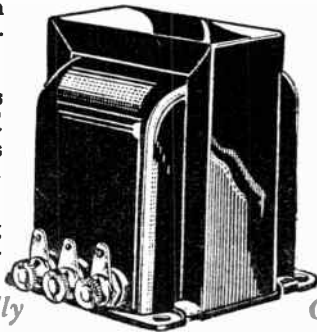

we have finally developed an all-frequency amplifier—a new instrument capable of fully amplifying all notes audible to the human ear. Thus the deepest notes of the grand organ, bass viol, tuba, English horn, etc., at last are brought out as clearly as those in the middle and upper registers of the musical scale. Improved long distance reception and better volume control are further advantages.

Autoformer amplification is expressly for those who seek the finest reproduction of programs to be had. May be used with any set in place of present amplifying transformer hook-up. Autoformers are \$5 each.

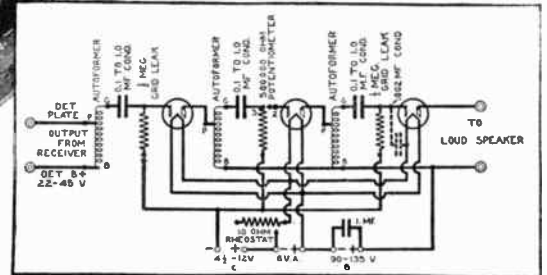

How Autoformer Amplification is praised by its users

Dunkirk, N. Y., August 5, 1925.

This is to congratulate the Thordarson Co. on their achievement in producing such a perfect piece of apparatus as your Autoformer which I embodied in a new hook-up I have just completed—tuned regenerative R. F. 2 stages, soft detector and 3 Autoformers. I wish to advise that it is without parallel, exception or any comparison whatsoever, the most perfect performer I have ever seen, heard, tested or built—and I have built some pretty good ones.

Reproduction is absolutely faultless and perfect throughout the entire register—each and every note from the deepest bass to the highest treble is perfect and uniformly amplified. Sunday night I had Godfrey Ludlow on his 225 year old Stradivarius (from WJZ) absolutely perfect although it was a pretty "rotten" night. It was some treat. To-night (one of the poorest for some time) I pulled in everything east of the Rockies, that was on the air and I pulled in enough music to overcome the static to a great extent. Everything on Speaker.

She's a good D.X. getter and as for volume, has all that the windows will stand—and with all this volume does not distort any. It makes a beautiful outdoor program distributor. You can hear it plainly and perfectly for two or three blocks (at night).

Very truly yours,
John Player.

Unconditionally THORDARSON Autoformer Guaranteed

All Frequency Amplifier

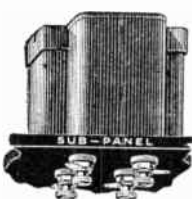

Other Thordarson Transformers

Thordarson Super Audio Frequency Transformers are to be had in either the sub-panel or top mounting type. Sub-panel type permits neater assembly, shorter leads and concealed wiring—as in factory sets. Three ratios: 2-1, \$5; 3½-1, \$4; 6-1, \$4.50.

Thordarson Power Amplifying Transformers, \$13 the pair. Thordarson Interstage Power Amplifying Transformers, \$8. All Thordarson products are unconditionally guaranteed. Shipped direct upon receipt of price, if dealer cannot supply.

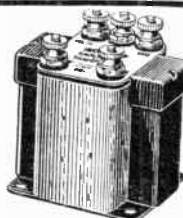

THORDARSON ELECTRIC MANUFACTURING CO.
Transformer specialists since 1895
WORLD'S OLDEST AND LARGEST EXCLUSIVE TRANSFORMER MAKERS
Chicago, U.S.A.

- ZENITH
- KENNEDY
- Radiodyne
- Planstiehl
- Howard
- Thermodyne
- OZARKA
- Deresnadyne
- ADLER-ROYAL
- MURDOCK
- MU-RAD
- Valley
- LEICH
- Silver-Marshall
- GLOBE
- ULTRADYNE
- Newport
- BUCKINGHAM
- NUNN-LONDON
- KUSTOMBILT and many others

Also choice of the MacMillan Arctic Expedition

use Thordarson Super Amplifying Transformers. Leading set builders use more Thordarsons than all competitive transformers combined.

Practicoat



AMERICA'S GREATEST
KNIT JACKET VALUE!

Practicoat

IT'S worth broadcasting—the story of the Practicoat. Tune in on this manly garment and enjoy its comfort, its sturdiness, its good looks.

A chummy, friendly garment that fits snug and wears long. Only \$5, 100—and guaranteed to satisfy you.

If your dealer hasn't it, order direct through us.

Manhattan

KNITTING MILLS
8-14 West 30th Street
New York City

Mens
Sizes
\$5

Boys
Sizes
\$4

The gall of this goof gets me. "Oh, we will, will we?" I inquires, frigid. "And since when have you the nerve to presume it's my set that's causing the trouble?"

"It must be," insists Bohunkevitch. "My set is perfect."

"Oh, is it?" I asks, sour. "Well, we'll just let my set be. What kind of a rigamarole have you got tied to that clothesline of yours?"

Bohunkevitch expands his waist-line. "An eight-tube neutral-dyne," he informs.

"I see," I says. "Did it ever pop into your gray matter that there's other radio sets in this and adjacent municipalities?"

"Sure. But yours is nearest. It must be the one."

"Oh, must it?" I retorts, mad. "Well, you can very politely go somewheres where it's warm." With which I beats it into the house.

The Black Diamond Expert is undecided whether to call the cops—of which we have one, a faithful follower of Morpheus—or to begin hostilities by cutting a coupla my guy wires. However, he thinks the better of it, and goes inside.

But the next day the battle begins in earnest. Bohunkevitch apologizes! Tells me it ain't my set after all!

"What news!" I grunts. "Whose is it?"

"It's a joint up on the hill, run by a guy named Lawson," says Bohunkevitch. "He's got a lot of things up there that's making radio hard to use."

Of my own stuff I ain't so sure, but of Jerry's—well, my Irish is up, ten points, and I rises to the defense.

"What're you beefing about?" I asks. "Jerry's apparatus don't bother nobody else. Why don't you get a real radio?"

"I got a real radio," insists Bohunkevitch. "It's that guy's coils that makes the static."

"You're pretty positive for a little cuss, ain't you?" I remarks. I'm six-feet-one, and this miniature rambles along at about five-feet-eight. "Well, let me tell you; if you starts any rough stuff with The Master you'll have the whole town on you. Lay offa him, get me?"

Bohunkevitch is as stubborn as an army mule in a plaster cast, so I walks off and lets him agree with himself.

Two days passes without anything marring the landscape until I runs into Doc Maxwell. He buttonholes me and asks me if I've heard.

"Heard what?" I inquires. "Did old Bill Hendricks get Scotland on one tube?"

"No, no!" says Doc. "Have you seen the petition?"

I admits the fact, negatively.

"Well, our new fellow-citizen, Bohunkevitch, is circulating a petition to be presented to officials demanding that Jerry discontinue his experiments in radio. Can you beat it?"

I'm not surprised, but I laughs. "Sure," I grins. "Who'll he get to sign it?"

"Nobody, so far, and it's not likely he'll get anybody," states Doc. "Can you imagine the nerve of the man?"

I don't have to do any imagining, and tells Doc. Somehow, he's worried, and I ain't exactly easy.

"Let him circulate until he's absorbed," I laughs. "What'll he do?"

"Oh, nothing, I suppose," replies Doc, musing. We lets the matter drop, but that night I hoofs it over to The Master's.

His laboratory is composed of several rooms on top of his garage. As usual, Jerry's in the middle of an experiment, so I says little until he's through. Then I inquires about the petition.

"Yes, the boulder was here today," says Jerry. "He said it was his constitutional right to make me refrain from using my apparatus. The idea!"

"But what can he do?" I asks. "He can't get a single signer."

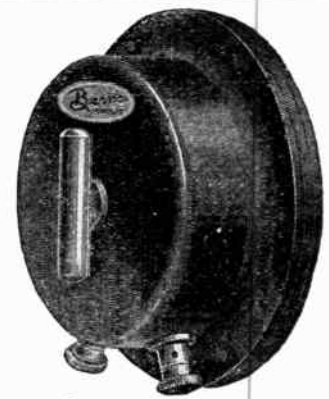

Burns LARGE CONCERT UNIT The Heart of the Speaker

Large size of this unit gives great range with tone of most pleasing quality which, combined with the amplifying properties of the Burns Horn, produces remarkable results.

Horn is of distinctive design with pyralin flare in several handsome finishes. It pleases the eye as well as the ear.

Made by

American Electric Company
CHICAGO, U. S. A.



DEALERS!!

Have Your Orders Shipped

SWIFT—SURE—SAFE

By the Old Established and Reliable

Wholesale Radio Distributors

of All the Leading Genuine Manufacturers

WRITE FOR OUR

CATALOG RD 6

Radio Red Book

The Book That Helps You Sell Radio

PLEASING DISCOUNTS

PROMPT SERVICE

WILLIAMS HARDWARE CO.

RADIO DIVISION

115 S. Vermillion St.

Streator, Ill.

Temple \$21—Cabinet Type \$31
THE ONLY—
ceramic exponential horn—
semi-adjustable protected unit—
way you can get the utmost satisfaction from your set—
Don't Blame the Set—Use a
TEMPLE! Handled by dealers who
make friends of their customers.
Hear a TEMPLE under comparison
before you decide on any speaker.
PARCELS & COMPANY
68 W. Washington St., Chicago, Ill.

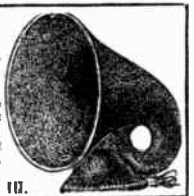

Insure your copy reaching you each month. Subscribe to RADIO NEWS — \$2.50 a year. Experimenter Publishing Co., 53 Park Pl., N.Y.C.

Better Reception

Every sale of Willard "A" and "B" Radio Batteries means a satisfied customer, for the Willard Selling Plan insures strictly fresh, full-powered batteries, which are in the pink of condition when your customer receives them.

As an occasional recharge serves to keep Willards fresh and full-powered the customer obtains better reception. And as Willards last for years he saves money, as well.

WILLARD RADIO BATTERIES

In addition, you are able to offer the convenient service and recharging facilities of the Willard Battery Men to customers whom you do not sell rectifiers.

Willards have the highest endorsement of the radio fraternity. Over 200 leading broadcasting stations have standardized on them because of their steady power and freedom from electrical leakage.

The better job Willards are doing for these stations is identically the same job they are designed to do in receiving sets.

Willard Storage Battery Co.
Cleveland, Ohio

The Right Selling Plan for Radio Dealers

Your local Willard Service Station will act as your jobber on Willard Radio Batteries.

This means a quick source of supply of strictly fresh, well charged batteries which you can turn over to your customers in the pink of condition.

No servicing problems for you. Your local Willard Service Station assumes the responsibility for service.

Willard Radio Batteries will be advertised more extensively than ever this fall. Have your local Willard Service Station show you this advertising and explain the details of this new and practical plan for selling radio storage batteries. The advertisements will be signed:

Sales and Service through
The Willard Battery men
and their
Authorized Radio Dealers

Appropriate signs and window cards will identify you as an Authorized Dealer. Booklets and other valuable selling helps will also be furnished.

*Your Nearest Willard
Service Station is Your
Nearest Willard Jobber*

A New Gift To Make Radio Owners Happy

Anything that makes for betterment in radio reception will receive a royal welcome on Christmas Day. Every owner of a radio receiving set, therefore, will be sure to appreciate such a thoughtful gift as the new

Super-Booster It Improves Radio Sets of EVERY Make

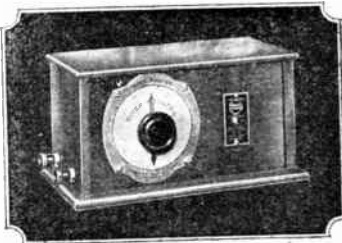

The Super-Booster is the best preventative of interference, static and fading troubles ever devised.

Besides—the increased volume, clear and realistic reproduction, big saving on batteries and tubes are additional Super-Booster advantages.

It is extremely simple to operate and the compact, mahogany case, 9" x 4" x 5" makes a decidedly handsome gift.

Ask your dealer about SUPER-BOOSTER now. Or, send a money order for \$12 and we will send you a Super-Booster at once, charges prepaid.

Super-Products Mfg. Co.
918½ So. Vermont St.
Los Angeles, Calif.

Distributors

Stockhouse & Allen
2729 N. Morgan Street
Chicago, Ill.
Pacific States Electric Co.
575 Mission St.
San Francisco, Calif.
or 236 S. Los Angeles St.
Los Angeles, Calif.
Jackson & Merefild
310 Beckel Street
Dayton, Ohio
Du Pont Carelton Co.
255 California St.
San Francisco Calif.

"But he can have it brought to trial in his own name," informs Jerry. "He'll probably lose, but it'll be a nasty mess. This is the first complaint I've had. Why can't such people stay away?"

"If he'd had a real radio he'd never have been bothered," I declares. "As it is——"

I'm interrupted by the appearance in the doorway of a gent that looks like trouble. He is.

"Mr. Gerard Lawson?" he asks. The Master nods. Then this individual shoves a paper at Jerry and beats it.

It's a summons, all right. An invitation to appear in court and have his family history ironed out. The date is set for next week.

"Next week!" I yelps. "Say, have the great American courts woke up at last?"

The Master smiles, wan. "Oh, this is merely a small civil case, and will have original jurisdiction in Justice Kenway's court here in town. I rather imagined Bohunkevitch would try some trick, so I told the Justice to call the case as soon as possible. He did."

"When is it?"

"Next Thursday. This is Monday. We've three days to prepare."

I'm puzzled. "Prepare what?"

Jerry smiles again. "You'll see, later. Just give me a lift with this death-ray machine."

I don't like secrecy. "What's it all about?"

"The instance cited in the accusation is that the operation of this ray machine one night last week—you were here, I believe—interfered with Bohunkevitch's radio reception."

I've a faint idea now, but I keeps quiet. "You'll be my chief witness, Joe," says The Master.

"What'll I witness to?" I asks. "I don't know a thing."

"Of course you don't," agrees Jerry, which has the fingerprints of a dirty crack, but knowing The Master I takes it straight.

"Then, when they asks me, what'll I say?"

"Tell the truth."

"How?"

The Master sighs. "They'll aim to prove that my machine caused the static. They have no reason to believe this except that I have the device, and it was in operation. We will try to prove that my ray machine did not cause the static. Any clearer?"

"Somewhat," I admits.

"We have the added advantage of having the entire town behind us. This, while excellent from a moral standpoint, will be of little legal value. The fact that the presumed waves from my machine did not interfere with anyone else's reception does not alter the fact that they presumably did hinder Bohunkevitch's pleasure. Between ourselves, I'm afraid they did."

"What'll we do?" I asks.

"Wait, and keep our eyes open," replies Jerry. We does.

Thursday morning we're in justice's court. Most of the townfolk are there, also a delegation of Bohunkevitch's relatives from New York. There's a strong flavor of garlic and dill pickles in the air, and I'm wise. Bohunkevitch may not be able to do anything legal, but if he loses I ain't putting it above his gang to drop a little arsenic in the city water. He's got enough cousins present to do it. You can't beat an East Sider when it comes to having relatives.

In justice's court there usually ain't no jury. So Mr. Kenway asks each one the facts in the situation, and delivers his ultimatum.

"The evidence is lacking," he declares. "The only way to settle matters is to have a test made. Mr. Lawson and Mr. Bohunkevitch will each select two friends as witnesses. Mr. Bohunkevitch, with Mr. Lawson's witnesses, will listen in with Mr.

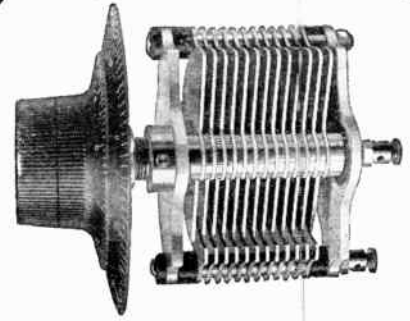

STRAIGHT LINE PROUDFOOT CONDENSERS

You can't pass over or confuse stations with these condensers. Equal divisions on the dial give the same change of wave lengths at all parts of the scale when used with the correct inductance. Equipped with the 360° Proudfoot Universal Train Gear, finest tuning is easily accomplished. Only three insulation points, single hole mounting. Close spacing of plates provides compactness and insures straighter calibration curve. Four sizes—your dealer has them or can get them for you. We will send you circulars and prices. Write today.

MANUFACTURERS

Proudfoot Straight Line Condensers, Train Gears and Matched Coils are used in many standard sets. If you are in the market for quality units, let us send you samples and quotations.

CRUVER MANUFACTURING CO.
2456 W. Jackson Blvd. Chicago, Ill.



Quick As a Wink

Premier 20-ft. Extension Cord (for loud-speakers) now comes with the handiest connecting plug you ever saw. Holds terminal pins securely. Releases instantly. Automatic—with no tiny screws to fuss with or lose.

PREMIER Cord, with Plug \$1.75



At your dealer's or write us.

**CRESCENT
RADIO CO., Inc.**

Makers of Extension
Cords and Battery
Cables for Radios.
Providence, R. I.

**64 Illustrated Pages
of Radio Bargains!
Write for Catalog Today
RANDOLPH RADIO CORP.
159 N. UNION AV. Dept. 2 CHICAGO, ILL.**

Insure your copy reaching you each month. Subscribe to RADIO NEWS—\$2.50 a year. Experimenter Publishing Co., 53 Park Pl., N.Y.C.

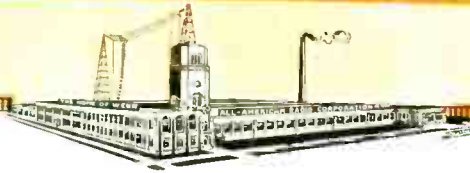

Built and wired complete in the new ALL-AMERICAN factory, the Model R Receiver is offered as an ideal example of the *solid value* which a thoroughly equipped and experienced organization can build into a product.

Compare this receiver with any set you have ever admired or wished to own—disregarding, for the moment, the entire question of price. Compare the *construction*—and check each of the six vital principles of value as briefly outlined below.

Then, apply the final test—*compare the performance* with that of your former ideal of a radio receiver. After that—and not until then—remember the price at which the ALL-AMERICAN Model R is offered and simply ask yourself this question:

What Can You Get by Paying More?



Model R Receiver
Complete Without Tubes \$90

ALL-AMERICAN Challenges Comparison on the basis of the Six Vital Principles of Solid Value in Radio Receivers

- | | |
|---|---|
| <p>1 Quality of Tone The Model R Receiver is equipped with Rauland-Lyric laboratory-grade transformers—designed especially for music lovers, and the choice of music critics.</p> | <p>4 Selectivity Extreme sharpness of tuning has been achieved solely through improved condenser and inductance design, without impairing tone quality.</p> |
| <p>2 Ease in Tuning Two dials (360° type, all markings always visible while tuning) control the ALL-AMERICAN Straight-Line-Frequency TUNING, reaching all broadcast wave channels and eliminating all crowding of low-wave stations.</p> | <p>5 Sensitiveness to Distant Signals The ALL-AMERICAN Tuned-Radio-Frequency system results in a sensitiveness which challenges comparison with any other set made, irrespective of the number of tubes.</p> |
| <p>3 Quietness ALL-AMERICAN Toroids practically eliminate the stray noises which ordinary coils pick up. Rauland-Lyric tone amplification results in a remarkable quietness.</p> | <p>6 Appearance and Serviceability The beautiful two-tone walnut cabinet, with inlaid designs, has ample space within it for all batteries or for a "B" socket-power if preferred.</p> |

Have your dealer demonstrate the Model R for you

The leading wholesaler of radio apparatus in your community has probably been, for years, an ALL-AMERICAN Authorized Distributor. ALL-AMERICAN Guaranteed Radio Products are sold everywhere by responsible and reliable dealers.

ALL-AMERICAN RADIO CORPORATION, E. N. Rauland, *President*, 4207 Belmont Ave., Chicago



OWNING AND OPERATING STATION WENR—266 METERS

ALL-AMERICAN

Pioneers in the Radio Industry

GENERAL RADIO TRANSFORMERS

are
True
Mirrors
of
TONE
QUALITY

(Two Ratios)

1 to 6
for first stage

1 to 2
for second stage



Price
\$ **6** each

The better loudspeakers today are capable of reproducing music with all its truest refinements of tone quality. Consequently a higher standard of transformer design is necessary to deliver to the loudspeaker the desired volume with a purity of tone that makes radio reception delightfully natural.

In designing the General Radio Type 285 transformers particular attention has been given to tone quality—yet volume has been increased to a very marked degree.

In spite of the pronounced superiority over other transformers they sell at a popular price.

Enjoy music in its unmodified form—use type 285 transformers in the set you build or substitute them in the set you already have.

Ask to see them at your local dealer's or write for our pamphlet 285-N which contains amplification curves and wiring diagram.

GENERAL RADIO CO. - CAMBRIDGE, MASS.

“Behind the Panels of Better Built Sets”

New “IMP” Rheostat
(Pat. Pend.)



Half Size
6 ohm or 25 ohm types
\$1

CARTER New “IMP” Potentiometer
(Pat. Pend.)

The smallest made, projects but $\frac{3}{8}$ ” back of panel. $1\frac{3}{4}$ ” in diameter. Single hole mounting. Complete with pointer knob. Exclusive Carter design. See them at your dealers.

In Canada—Carter Radio Co., Limited, Toronto.



Half Size
200 ohm or 400 ohm types
\$1.25

Insure your copy reaching you each month. Subscribe to Radio News—\$2.50 a year
Experimenter Publishing Co., 53 Park Place, N. Y. C.

Bohunkevitch's set. Mr. Lawson, with Mr. Bohunkevitch's witnesses, will operate the ray. You are to be back within two hours, with data; the verdict will then be rendered."

After some deliberation Bohunkevitch picks a cousin from New York and an electrical expert named Williams. Me and Doc are Jerry's witnesses.

We trumps off down the lane and then separates, me going with Doc and Bohunkevitch to the latter's home, while Jerry goes to the laboratory. After all's ready, we listens in for a solid hour, tuning up, down and all over, but we don't get a peep. At the end of the allotted time we're back in court.

The verdict is in our favor, and if you ever saw a peeved bunch of tenement addicts, those bimbos are them. But the case is dismissed, and we goes home. Jerry, Doc and me slips up to his laboratory, sensing that there's something we ain't heard. We 're right.

"I don't get this," I states. "How come that ray didn't affect Bohunkevitch's set this afternoon? What did you do? fake the stunt?"

"Oh, no," assures The Master.

"Well, then, how?"

"You see. I took the mild precaution to move my ray machine from the laboratory into the west room."

"What of that?"

The Master laughs outright. "You see, Joe, that west room is lined with grounded steel! The machine created the rays, all right; Williams took great pains to ascertain that the waves were being given off, and was satisfied. But the waves didn't leave the room. Consequently there was no interference with Bohunkevitch's reception."

We gets a howl outa this. Then I sobers up.

"But say, Jerry, you'll have to move the machine back into another room before you can continue your experiments. Won't it break up his programs again?"

Jerry smiles. "Well, it would, only it won't," he admits. "In the first place, a case once tried cannot be re-opened if a verdict has been given, and in the second place Bohunkevitch won't be here to be interfered with in the first place."

"Huh?"

"You see, we decided to heat him at his own game," smiles Doc. "When he tried to petition, and couldn't get a signer, it stood to reason that we could get them all. And we did. As soon as you sign this sheet we'll have the names of every adult in Brightmere-on-the-Deep affixed to this petition demanding that Bohunkevitch leave the town within forty-eight hours. Since the request is unanimous, he'll have to vacate immediately."

"Hurray!" I yelps. "Gimme that paper!"

And now all's quiet on the ocean—and in the ether—occasionally.

RADIO GATE KEEPER

A radio thief-catcher is used in Berlin, according to reports. It's an electrically wired gateway, which is designed to be placed at the exit of factories and mines. A gate-keeper with a pair of head-phones listens as the workman passes out. The electrical apparatus is so adjusted that whenever an extra amount of metal is carried through the gate, a sharp singing noise is heard in the head-phones. Small metal coins, or a pocket knife, are not noticed, but larger amounts of metal concealed on any workman are immediately detected. This appliance is to be used to stop the theft of precious metals and tools by employees.

ATWATER KENT RADIO

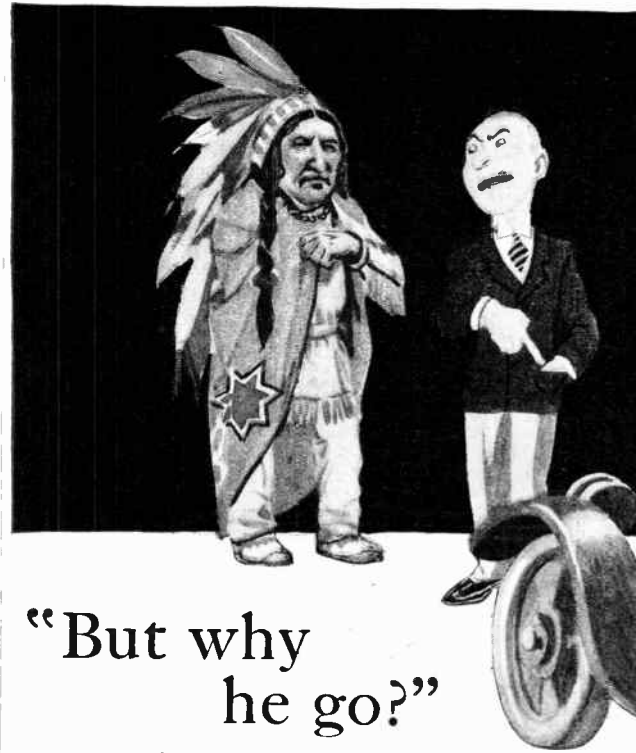

"But why he go?"

WHEN they struck oil on the Indian lands in Oklahoma many of the Indians became suddenly rich. One of them, anxious to begin his life of luxury, went to buy an automobile.

The salesman launched into a description of the car in detail. Technical term followed technical term in a bewildering stream. Finally the salesman thought his work was done. He produced an order blank and paused.

"Now," he asked, "is there anything else I can tell you?" The Indian scratched his head.

"Um," he said. "You tell me: He have no horse. Why he go?"

We could give you a description of the Atwater Kent Radio Receiving Sets and Speakers that would fill hundreds of pages.

But what would be the use? You would still judge an Atwater Kent, as you should, by its performance. We want you to judge it that way, to compare it with any other radio you are considering.

By looking at it and listening to it, you will get some of its technical perfection. When you have owned it and lived with it, you will know how good it is.

Hear the Atwater Kent Radio Hour every Sunday evening at 9.15 o'clock (Eastern Standard Time) through stations:

- | | | |
|-----------------------------|---------------------------------|-----------------------|
| WEAF . . . New York | WEEI . . . Boston | WCAE . . . Pittsburgh |
| WFI . . . Philadelphia | WGR . . . Buffalo | WOC . . . Davenport |
| WJAR . . . Providence | WWJ . . . Detroit | WSAI . . . Cincinnati |
| WCAP . . . Washington D. C. | WCCO . . . Minneapolis-St. Paul | |

Write for illustrated booklet of Atwater Kent Radio

ATWATER KENT MANUFACTURING COMPANY
A. Atwater Kent, President

4713 WISSAHICKON AVENUE PHILADELPHIA, PA.



Model R, \$12



Model H, \$22



Model 12 (without tubes), \$100



Model 19, \$60



Model 20, \$80



Model L, \$17



Model M, \$28



Model 10 (without tubes), \$80



Model 20 Compact, \$80



Model 24, \$100

Prices slightly higher from the Rockies west, and in Canada

Prices slightly higher from the Rockies west, and in Canada

G & S Silk Core DETECTOR

makes possible volume reception with remarkable clarity of tone



G & S Silk Core Detector positively won't burn out, yet will carry load of any number of tubes.

Forty bronzed silk cords cover all points of contact on Argentite and transmit necessary electrical energies without destroying contact points or crystal.

Adjustable spring tension insures constant contact with entire surface of crystal. Made on entirely new and patented principles of manufacture that defy corrosion and burn-out of crystals, which are especially and highly sensitized.

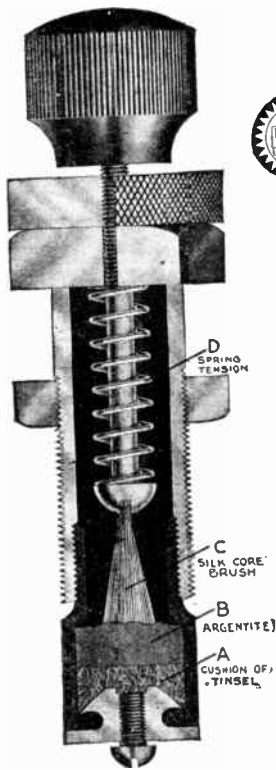

MAKES A DANDY XMAS GIFT!
 Try it! If not satisfied, return it. It's guaranteed
\$1.50 at your dealers or send your name and address to Baker-Smith Co., Inc., and we'll tell you where you can get this wonderful detector. NOT SOLD by mail, except through dealers. Jobbers—Address nearest office.

Manufactured by G. & S. RADIO RESEARCH LABORATORY
 1269 Cochran Avenue, Los Angeles

Marketed Nationally Thru Jobbers by

BAKER-SMITH CO., Inc.

New Call Building, San Francisco

Branch Office Addresses

- New York City, 1270 Broadway
- Chicago, 30 North Dearborn Street
- Salt Lake City, Atlas Building
- Los Angeles, 443 South San Pedro Street
- Denver, McClintock Building
- Portland, Ore., Henry Building
- Seattle, L. C. Smith Building
- Vancouver, B. C., 179 Pender Street W.

Tested and approved by Radio News Laboratories. Test it!

Guaranteed! Money back, without quibble, if not satisfied. Try it!

If you want the best!



Pathé sets operate on house current.



Grecian Model



Exquisite in tone
 Exquisite in design
 Exquisite in workmanship

Cone Loud Speaker

Some territories for both jobbers and dealers still open. Write.

PATHE PHONOGRAPH AND RADIO CORPORATION
 DEPT. 69 20 GRAND AVENUE, BROOKLYN, N. Y.

LATEST WHOLESALE RADIO CATALOG FREE

Simply send name TODAY for big 64-page book explaining liberal proposition paying agents \$60 to \$100 a week, and how to get latest radio goods at wholesale. Live dealers and agents wanted. Standard Radio Co., 1408 Walnut, Kansas City, Mo.

The Radiophon Adapter A "2 in 1" Crystal Detector Improves Reflex and Crystal Sets

Permits the use of two crystals in contact or one crystal with cat-whisker. Nothing like it. Distributors. Jobbers—Dealers—Wanted. Circular free. **\$1.50**
 TUERK MFG. CO.
 581 W. Washington St. Chicago, Ill.



Electrolytic Condensers

(Continued from page 809)

total required amount of wire wound on each long leg of the iron core, as shown in Fig. 7. The air gap is for the purpose of preventing the iron from being operated at too high a flux density, and it is often a good idea to try widening or closing the gap while listening into the receiver for the note, if any A.C. hum is apparent. The coils should be wound on a wooden form the size of the core leg, and slipped over the iron when the choke is ready to be assembled. Paper may be placed between adjacent layers of the first inductance to aid in winding even layers, although it will not be necessary as an insulating material. For higher voltages in the transmitting inductance, insulation between layers will become necessary.

TWENTY-FIVE HENRY INDUCTANCE

Normal current (amperes)05	.10
Wire size (B. & S. gauge)	No. 33	No. 30
Quantity required (lb.)	¼	1
Core size (see Fig. 7)		
a	4 in.	5 in.
b	3 in.	3¼ in.
c	1 in.	1 in.
d	1 in.	1 in.
Length of air gap..	1/32 in.	½ in.
D.C. resistance (ohms)	315	311

There have been many foreign papers on the general subject of electrolytic condensers. These papers are all of a technical nature and mainly of value to the engineer. Some of these technical papers are: "Chemical and Metallurgical Industries," Vol. 7, 1909, page 216; Proceedings of the International Electrical Congress of 1904, paper on the Nodon Valve, by A. Nodon; Proceedings of the Electro-chemical Society, Vol. 1, 1902; "Electrolytic Rectifiers," by Prof. Burgess; "The Electrolytic Rectifier," by N. A. de Bruyne.

STATEMENT

Of the Ownership, Management, Circulation, Etc., Required by the Act of Congress of August 24, 1912, of RADIO NEWS, published monthly at New York N. Y., for October 1, 1925.

State of New York,)
 County of New York,) ss.

Before me, a notary public in and for the State and county aforesaid, personally appeared Hugo Gernsback, who, having been duly sworn according to law, deposes and says that he is the editor of RADIO NEWS, and that the following is, to the best of his knowledge and belief, a true statement of the ownership, management (and if a daily paper, the circulation), etc., of the aforesaid publication for the date shown in the above caption, required by the Act of August 24, 1912, embodied in section 411, Postal Laws and Regulations, printed on the reverse of this form, to wit:

1. That the names and addresses of the publisher, editor, managing editor, and business manager are: Publisher, The Experimenter Publishing Co., Inc., 53 Park Place, New York, N. Y.; Editor, Hugo Gernsback, 53 Park Place, New York, N. Y.; Managing Editor, Sylvan Harris, 53 Park Place, New York, N. Y.; Business Manager, R. W. DeMott, 53 Park Place, New York, N. Y.
2. That the owners are: (if owned by a corporation, its name and address must be stated and also immediately thereunder the names and addresses of stockholders owning or holding one per cent. or more of total amount of stock. If not owned by a corporation, the names and addresses of the individual owners must be given. If owned by a firm, company, or other unincorporated concern, its name and address, as well as those of each individual member, must be given.) The Experimenter Publishing Co., Inc., 53 Park Place, New York, N. Y.; Hugo Gernsback, 53 Park Place, New York, N. Y.; Sidney Gernsback, 53 Park Place, New York, N. Y.; R. W. DeMott, 53 Park Place, New York, N. Y.; H. W. Secor, 53 Park Place, New York, N. Y.; Dr. T. O'Conor Sloane, 53 Park Place, New York, N. Y.; Mrs. Catherine Major, 53 Park Place, New York, N. Y.; M. M. Finucan, 720 Cass Street, Chicago, Ill.
3. That the known bondholders, mortgagees, and other security holders owning or holding 1 per cent. or more of total amount of bonds, mortgages, or

Insure your copy reaching you each month. Subscribe to Radio News—
 \$2.50 a year. Experimenter Publishing Co., 53 Park Place, N. Y. C.



6-VOLT "A" BATTERY
Here is the rugged, good-looking Exide 6-volt "A" Battery. One-piece case.



2-VOLT "A" BATTERY
Compact Exide for low-voltage tubes. Also made in 4-volt size.



24-VOLT "B" BATTERY
In glass cells, 6000 milli-ampere capacity. Also in 48-volt size.



RECTIFIER
Exide Rectifier for economical recharging of "B" Battery from your own house current.

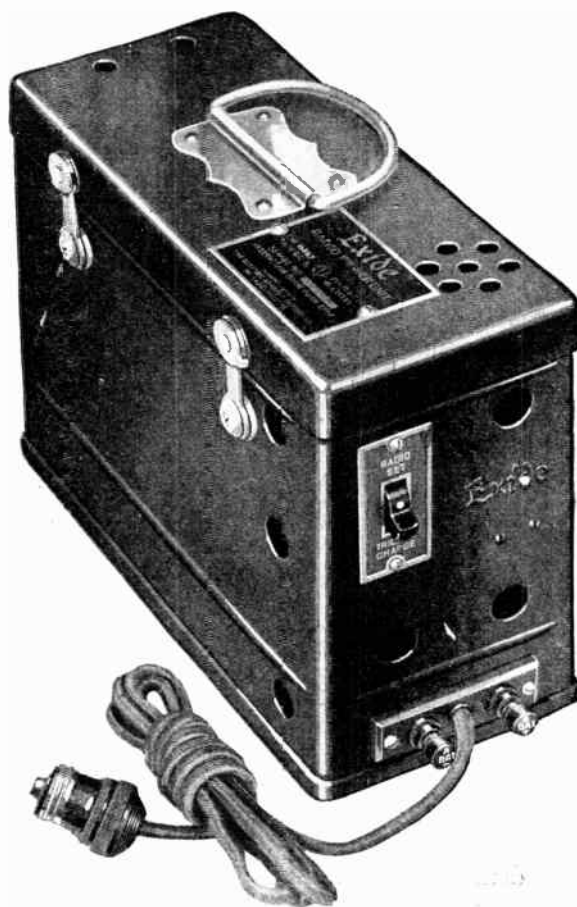

THE EXIDE RADIO POWER UNIT
(Combination "A" battery and charger)

This unit is kept connected to your electric light socket as well as to the radio set. Raise the small switch on the end and the receiving set is ready for use; lower it and the battery is automatically placed on charge. Finished in rich mahogany color, the Exide Radio Power Unit is furnished in two sizes — one, for sets using 4-volt tubes; the other for sets using 6-volt tubes; retailing at \$28 and \$38 respectively — slightly higher west of the Rockies.

Range far and near with your radio set

BRINGING in the distant stations, selecting the choice numbers from local programs—in short, getting the most enjoyment from your radio set—is largely a matter of proper current supply.

All the distance, volume, and clearness that an ample, uniform supply of current gives to radio reception are yours when current is supplied by Exide Radio Batteries. There are Exide "A" and "B" storage batteries for every requirement, and a rectifier for recharging "B" storage batteries.

See the complete line at any Exide Dealer's or at your favorite radio store.

Exide
RADIO
BATTERIES

THE ELECTRIC STORAGE BATTERY COMPANY, Philadelphia
Exide Batteries of Canada, Limited, 153 Dufferin Street, Toronto

FOR BETTER RADIO RECEPTION, USE STORAGE BATTERIES

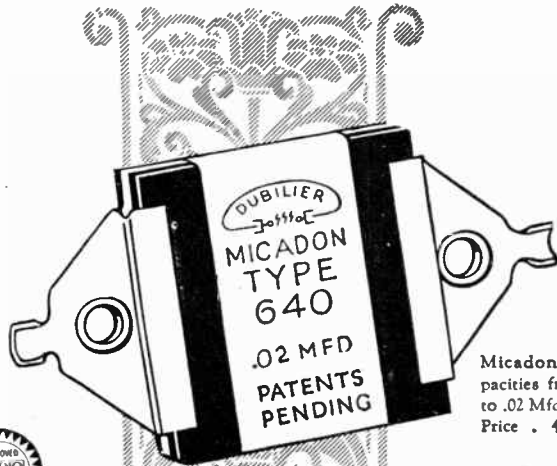

MICADONS

—the standard fixed condensers of radio—are made to meet and solve efficiently every radio condenser problem. They are made in accurate and permanent capacities and are found in 9 out of every 10 radio sets in use.

Guaranteed accurate within 10% of their marked capacity.

Send 10c for 32-page booklet A-1, "Applications of Dubilier Condensers in Radio Circuits".

Address 4377 Bronx Blvd., New York.

Dubilier

CONDENSER AND RADIO CORPORATION



ALMOST TOO GOOD TO BE TRUE
X-L VARIO DENSERS
MAKE POOR SETS GOOD—GOOD SETS BETTER

Endorsed and Used by the Foremost Radio Engineers

MODEL N—Capacity range 1.8 to 20 micro-microfarads, for balance in Roberts two tube, Brownhut-Drake, McMuro Silver's Knockout, Neutrodyne and tuned radio frequency circuits. Price \$1.00

MODEL G—Two capacity ranges, .00016 to .00045 and .0003 to .001 Microfarads, for the Cockaday circuit, filter and intermediate frequency tuning in super-heterodyne and positive grid bias in all sets. Price \$1.50

X-L RADIO LABORATORIES
2426 Lincoln Ave. CHICAGO

Special Library of Information
on
RADIO PATENTS
and
TRADE MARKS

JOHN B. BRADY

Patent Lawyer

Ouray Building Washington, D. C.

Cable address:
RADIOPAT

Telephone:
Main 4806

other securities are: (If there are none, so state.) None.

4. That the two paragraphs next above, giving the names of the owners, stockholders, and security holders, if any, contain not only the list of stockholders and security holders as they appear upon the books of the company but also, in cases where the stockholder or security holder appears upon the books of the company as trustee or in any other fiduciary relation, the name of the person or corporation for whom such trustee is acting, is given; also that the said two paragraphs contain statements embracing affiant's full knowledge and belief as to the circumstances and conditions under which stockholders and security holders who do not appear upon the books of the company as trustees, hold stock and securities in a capacity other than that of a bona fide owner; and this affiant has no reason to believe that any other person, association, or corporation has any interest direct or indirect in the said stock, bonds or other securities than as so stated by him.

5. That the average number of copies of each issue of this publication sold or distributed, through the mails or otherwise, to paid subscribers during the six months preceding the date shown above is (This information is required from daily publications only.)

H. GERNSBACK, Editor.

Sworn to and subscribed before me this 28th day of September, 1925.

(SEAL)

JOSEPH H. KRAUS,

Notary Public, Queens County Register's No. 4523, New York County Register's No. 7364, New York County Clerk's No. 481. (My commission expires March 30, 1927.)

A New Impedance Coupled Audio Frequency Amplifier

(Continued from page 811)

distorted signals. Again, a hissing sound may manifest itself at times. To detect whether oscillations are present, the simple method of detuning the receiver so that no signals are heard and placing a direct current milliammeter with a range of about zero to 10, in series with the loud speaker leads, will suffice. On turning the volume control from minimum to maximum, there should be no variation in the deflection of the milliammeter.

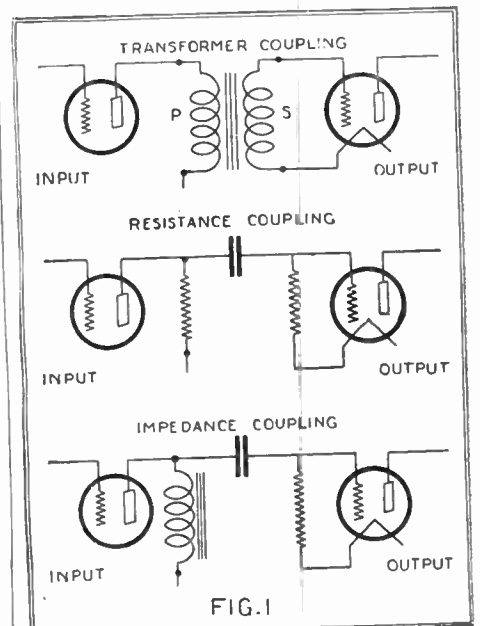

FIG. 1
Three Types of Audio Frequency Amplifiers

A 500,000-ohm volume control potentiometer is incorporated in the circuit, although not essential. In a case where it is not used, one half-megohm leak resistances may be used for all three tubes. If desirable, the familiar plug and jack method of volume control may be used on each stage. Either the head-phones or the loud speaker may be used and any intermediate volume can be readily obtained by turning down the tube rheostat.

Insure your copy reaching you each month. Subscribe to Radio News—\$2.50 a year.
Experimenter Publishing Co., 53 Park Place, N. Y. C.

*The Day-Fan Radio Receiver
is not to be regarded
as a mechanical means for bringing in broadcast
but as a perfected musical instrument
which is actuated by radio waves.*

*What it brings into the home
is the actual sound of the human voice
or of the performing instruments
with all overtones, shading and intonation.*

*It has been developed particularly for musicians
and for those who have waited for such radio enjoyment
as the Day-Fan assures.*

*Additional to this perfection of tone
is the exclusive exactness of operation
which enables the Day-Fan owner
to turn to the performance of any broadcasting station
at the same Day-Fan dial number as is published
for that station in the daily press.*

*Both the price and the performance
of this distinguished instrument
have been made possible only
by thirty-six years of experience in
electrical development work.*

THE DAYTON FAN AND MOTOR COMPANY, DAYTON, OHIO

THERE are ten models of the Day-Fan Radio Receiver, table and console type, from seventy-five dollars to three hundred dollars, four and five tube, single and triple dial control. The name of the nearest merchant who is authorized to sell Day-Fan Radio Receivers will be sent you on request.

3 CAMFIELD aids

to Perfect Radio Reception!

Since the very beginning of radio, the executive and technical heads of the Camfield Radio Manufacturing Company have been actively connected with important developments in this industry.

These three Camfield Products—all aids to perfect radio reception—are the result of these years of experimental and research work. Each one is worthy of the Camfield name—a name synonymous with High Quality and Remarkable Performance in the radio field.

The Camfield Condenser

embodies a new principle of construction, combining every essential, desirable feature in a single unit. Its straight-line action, and 360° dial, absolutely eliminates the necessity of a vernier.

The Camfield Condenser—enclosed in a transparent Dust-Proof Case—prevents accumulation of dust between the plates. It is permanently low-loss. Sold in 3 sizes:

- Type 886—.00025 mfd.\$6.00
- Type 887—.00035 mfd. 6.00
- Type 888—.0005 mfd. 6.50

The Camfield Type 22 Duoformer

is used with the Camfield Type 886 .00025 mfd. Straight-Line Condenser in building the new Duodyne Circuit.

This circuit—using either dry or storage batteries—is designed for the new power tubes, CX230, or UX120, and CX112, or UX112. It gives a combination of Selectivity, Sensitivity, Volume and Tone Quality never before obtained in a five tube set. Wave Length Range 150 to 550 meters. Camfield Duoformers are boxed and sold in kits of three. Price \$10.00 complete.

Send 25c for "The Duodyne Circuit," a descriptive booklet with complete instructions and drawings for building.

The Camfield Bull Dog Grip Socket

is designed to accommodate three different types of tube bases. Tubes having the Navy standard base, the new X Dry Storage Battery base, or the new X Dry Battery base, are all interchangeable in this socket without the use of an adaptor. The heavy phosphor bronze contact springs grip the prongs on all sides, insuring absolutely perfect contact—eliminating one of the greatest troubles encountered in set operations in the past. Price 65c each.

Ask your favorite radio store for CAMFIELD Products, or write to us for name of dealer nearest you.

Dealers: If your jobber can not supply you with a complete line of Camfield parts, send us his name and your order direct.

CAMFIELD RADIO MFG. CO.

807 Harrison Street 1268 West 115th Street
Oakland, Calif Cleveland, Ohio

Factory Representatives:

Baker-Smith Co., Inc., 1270 Broadway, New York City;
30 N. Dearborn St., Chicago

A. S. Lindstrom Co., San Francisco, Los Angeles, Portland, Seattle, Salt Lake City

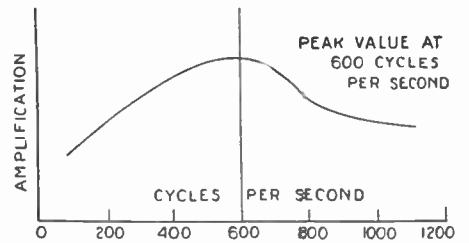
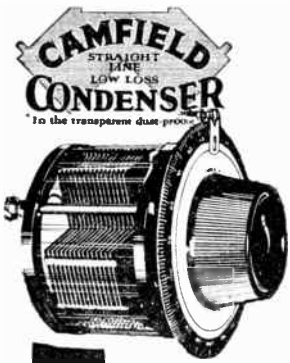

FIG. 2

This is a curve of a typical A.F. transformer, showing the limited efficiency range.

NECESSARY APPARATUS

The complete amplifier measures but 9 x 4 1/4 x 6 1/2 inches. The list of parts necessary is as follows:

- 3 auto-transformers.
- 1 10-ohm rheostat.
- 1 500,000-ohm potentiometer.
- 3 sockets.
- 3 1-mfd. fixed condensers.
- 2 1/2-meg. leaks.
- 1 .002-mfd. by-pass condenser.
- 1 single-circuit jack.
- 6 binding posts.
- 1 panel 9 x 4 1/4 inches.
- 1 sub-panel 9 x 6 1/4 inches.
- 4 small brackets.
- Miscellaneous screws and nuts.

The author is certain that the builder of one of these instruments will feel more than repaid for his efforts by the exceptional results which he will obtain with the out-

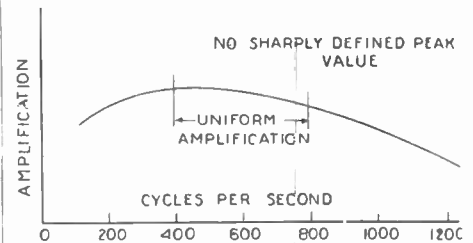

FIG. 3

In the best transformers, the amplification curve is rather uniform between certain frequencies, but not over the entire range.

fit. In conjunction with one of the new cone type loud speakers, music has been reproduced with almost perfect fidelity and many who have listened to the amplifier have expressed themselves as having never before heard such excellent reproduction.

40 Non-Technical Radio Articles

every month for the beginner, the layman and those who like radio from the non-technical side.

SCIENCE & INVENTION, which can be bought at any newsstand, contains the largest and most interesting section of radio articles of any non-radio magazine in existence.

Plenty of "How To Make It" radio articles and plenty of simplified hook-ups for the layman and experimenter. The radio section of SCIENCE & INVENTION is so good that many RADIO NEWS readers buy it solely for this feature.

List of Radio Articles Appearing in the December Issue of "Science and Invention"

- Radio to Guide Air Mail Planes By L. Port
- New Power Speaker Operates on A.C.
- The Radio Constructor—Complete Details on the Construction of a Highly Efficient Short-Wave Amateur Transmitter By A. P. Peck
- Radio Oracle—Radio Questions Answered Radio Wrinkles

LEARN RADIO

Become a big-pay man in the greatest industry of all time. Quickly, easily and right at home, you can fit yourself for highest salary positions, or you can cash in on your spare time. The call is urgent for mechanics, operators, designers, inspectors. Unlimited, fascinating opportunities on land or sea.

I WILL TRAIN YOU AT HOME TO BE A RADIO EXPERT

Under my practical, easy to understand, instruction—you qualify in an amazingly short time. No previous experience is necessary. Every branch of radio becomes an open book to you. You learn how to design, construct, operate, repair, maintain and sell all forms of Radio apparatus. My methods are the latest and most modern in existence.

FREE Wonderful home construction tube receiving set of the latest design. **Write Today "Radio Facts" FREE**

A. G. Mohaupt, Radio Engineer, RADIO ASSOCIATION OF AMERICA, Dept. 1512, 4513 Ravenswood Ave., Chicago

Insure your copy reaching you each month. Subscribe to Radio News—\$2.50 a year. Experimenter Publishing Co., 53 Park Place, N. Y. C.

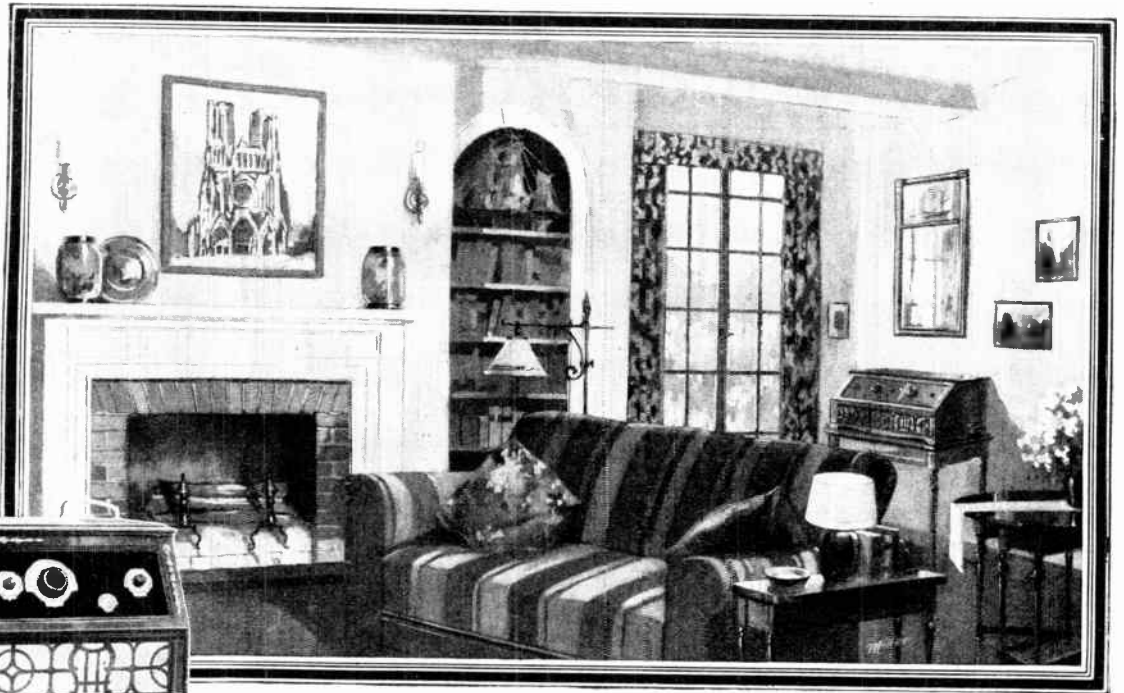

Ten Models
\$50 to \$460
Guaranteed
Unconditionally

Canadian Prices
Slightly Higher



TYPE 215

Remarkable for range, clarity, mellowness. Six tubes, built-in Music Master Reproducer. Beautiful mahogany cabinet and table. Storage battery compartment concealing both batteries and charger. With- \$215 out equipment



TYPE 60

Five tubes. Special Music Master design. Full, round, natural tone. Three selectors for precise tuning. Without equipment \$60



TYPE 100

Five tubes. Resonant reproduction, exceptional range. Massive mahogany console cabinet. "B" battery compartments in cabinet. With- \$100 out equipment

— for every home
a MUSIC MASTER

THERE is a Music Master Receiver for every requirement of taste, every dictate of economy.

Music Master Receivers embody the demonstrated principles of standardized New Era radio. Forming a vital part of the series is the internationally famous Music Master Reproducer, the *Musical Instrument of Radio*, for which there IS no substitute. Thus song, speech and symphony come to you in absolute fidelity to the original through Music Master, Radio's Supreme Musical Instrument.

Ask for a demonstration of Music Master Radio Receiver's distance pick-up, selectivity, clarity, volume, and above all, its supreme Tone Quality developed on the Music Master principle of sound reproduction.

See MUSIC MASTER — hear — compare — before you buy any radio set.

Music Master Corporation

Makers and Distributors of High-Grade Radio Apparatus
128-130 North Tenth St., PHILADELPHIA

CHICAGO

NEW YORK

PITTSBURGH

Canadian Factory: Kitchener, Ontario



The Amplion Pedigree

Thirty-eight years ago—

In 1887 Mr. Alfred Graham invented and demonstrated the first practical loud speaker which the world had ever heard (illustrated above).

In 1893 Graham Loud Speakers placed upon market. Illustration shows the "1893 model."

In 1894 Graham Loud Speakers first used in British Navy. Graham transmitters applied to phonographs for loud speaker reproduction.

In 1896 Graham Loud Speaking Naval Telephones developed and adopted by British Admiralty.

In 1898 Graham Watertight Loud Speakers patented. Placed on many warships and mercantile vessels, throughout world.

In 1902 Complete Graham Loud Speaker installations, on central battery plan, erected on warships as sole means of communication.

In 1906 The most extensive loud speaking naval installation to date was made by Grahams. Included a Graham exchange system fitted to H. M. S. Dreadnought.

Onwards Graham Loud Speakers applied to all sorts and conditions of service at home and abroad, ashore and afloat.

By 1919 No less than 12,000 Graham loud speaking installations in operation on ships alone.

In 1920 (before radio loud speakers were in common use) "AMPLION" Loud Speakers produced for radio by Alfred Graham & Co. "AMPLION" trademark registered.

In 1922 Amplions adopted as standard equipment by leading makers of radio sets abroad.

In 1923 Amplions introduced into United States, Canada and other countries. Quickly attained largest throughout-the-world sale of any loud speakers.

In 1924 To supply demand The Amplion Corporation of America was formed to market and manufacture Amplions here.

In 1925 More Amplion companies formed and agents appointed throughout world to keep pace with international demand. The Amplion Corporation of Canada, Limited, organized.

Created by the actual originators and world's oldest makers of loud speakers, it is only logical that the Amplion should be "the world's finest" radio reproducer. Some of the countries in which Amplions rule as favorites:

- UNITED STATES
- DOMINION OF CANADA
- ENGLAND
- SCOTLAND WALES
- IRELAND
- NORWAY SWEDEN
- DENMARK
- HOLLAND BELGIUM
- FRANCE SPAIN
- SWITZERLAND
- ITALY JAPAN
- SOUTH AFRICA
- NEW ZEALAND
- AUSTRALIA

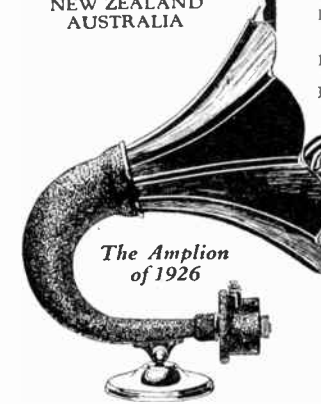

To hear this new Amplion Dragon AK-19 is to appreciate why Amplions, year after year, internationally lead in sales. Six models, including phonograph units, \$12 to \$42.50. Write for interesting literature and dealer's address.

AMPLION

Alfred Graham & Co., London, England Patentees

The World's Standard Loud Speaker

THE AMPLION CORPORATION OF AMERICA

Executive Offices: Suite S, 280 Madison Ave., New York City
Canadian Distributors: Burndept of Canada, Ltd., Toronto

Associated Companies and Agents: Alfred Graham & Co., London, England; The Amplion Corporation of Canada, Limited, Toronto; Compagnie Francaise Amplion, Paris, France; Compagnie Continentale Amplion, Brussels, Belgium; Amalgamated Wireless (Australasia), Ltd., Sydney and Melbourne; British General Electric Company, Ltd., Johannesburg and Branches; Indian States and Eastern Agency, Bombay and Calcutta; C. J. Christie E. Hijo, Buenos Ayres; David Wallace & Co., Valparaiso; Mestre & Blatge, Rio de Janeiro; F. W. Hammond & Company, London and Tokio.

Is Lightning A.C. or D.C.?

(Continued from page 775)

by the under surface of the cloud and the surface of the earth, and the conductor, formed by the ionized path of the discharge.

It can be shown that if the resistance of an electric path relative to the inductance and capacity of the path is above certain critical values, the discharge of electricity along that path is non-oscillatory; that is, it is a unidirectional discharge.

It can also be shown mathematically that the resistance of the ionized path over which the lightning discharge travels is generally higher than this critical value, so that the discharge must be unidirectional. There are other considerations which seem to bear out this contention, which are described below.

Station
WRNY
NEW YORK
258.5 Meters - 1160 kilocycles
is owned and operated by the publishers of this magazine
Our Editors will talk to you several times every week-
See your Newspaper for details
TUNE IN ON WRNY

As to why we hear lightning crashes on the radio set, that is easily explained. Radio listeners living in districts where the house-lighting power is direct current know that if a light is turned on or off in the room with the radio set, a click is heard in the phones or on the loud speaker. In this case, the sudden stopping or starting of the current causes rapid building up or dying down of the lines of force around the lighting circuit wires, and these moving magnetic lines induce currents in some part of the radio receiver. In the case of the lightning discharge, we have, successively, a rapid rise and fall of electric and magnetic fields, since here the current both starts and stops with great suddenness. Thus, although the charge does not reverse in direction, the very rapid motion of the lines of force causes a momentary current to be induced in the radio antenna. Thus we get the crash in the receivers or loud speaker. It is the very suddenness of the disturbance which makes it so loud. The duration of the average single flash is about .0002 of a second, according to Prof. Humphreys.

TRY AND RIDE 'EM

Tad—What are harmonics?

Dad—Harmonics are side-door Pullman emissions from wave trains.

—Contributed by Jack Bront.

A FAIR EXCHANGE

Ned—Jack gave you an inductance for Christmas. Of course, you reciprocated?

Ted—Yes, I gave him a choke coil—a good turn deserves another.

—Contributed by Jack Bront.

EUREKA DIAL POINTER

Radio News Laboratories Certificate No. 829



Beautify your set with this hand-polished heavily nickeled pointer. (Gift if desired). Sent direct upon receipt of stamps if you cannot obtain at your dealers.

DEALERS:—Ask your jobber for this item. Sample card either Eureka or D-X Owl sent upon receipt of \$3.25 if jobber does not handle.

D-X OWL. The mark of a radio fan. Used as a Label button or Dial Pointer, tail being pointed. A popular engraved radio novelty.

Polished Nickel or Gold
Plated 15c each
Manufactured by

C. W. BUTTS, INC. 42 Hadden Place, East Orange, N.J.



Free LOG also RADIO CATALOG



DEMAND

Our 1926 Beautiful Illustrated Catalog of all the latest Radio Merchandise.

JUST OFF THE PRESS!

The largest line of Standard Radio Merchandise in stock. Write for this Wonderful Book today, before you buy anything. Delay means losing exceptional chance to participate in this sale. All those who rush their name and address at once will receive also a

LOG BOOK FREE

ECONOMY RADIO SALES CO.
288 Sixth Ave. Dept. F. New York
DEAL DIRECT AND SAVE REAL MONEY
(No Dealers)

Insure your copy reaching you each month. Subscribe to Radio News—
\$2.50 a year. Experimenter Publishing Co., 53 Park Place, N. Y. C.

Be a RADIO EXPERT



They Earn \$50. to \$250. a week in Radio—most fascinating work on earth

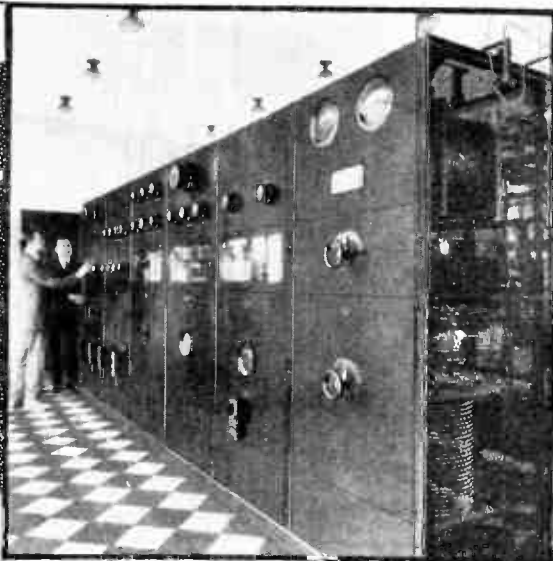

Learn Quickly And Easily At Home This Practical Way ~ ~ ~ ~ ~

Train At Home For A Big-Pay RADIO JOB

Radio today is urgently in need of trained men—Radio Experts. Astonishing opportunities—thousands of them—have been opened up by enormous strides of the Radio Industry. That's why it's easy to make big money in Radio—\$50 to \$250 a week. Here's a field that is teeming with opportunities and room for expansion—a brand-new, wide-awake, and uncrowded industry. If you're earning a penny less than \$50 a week, clip coupon now for Free Book and proof.

Instruments Given With Course

Receiving sets, from simplest kind to thousand mile receiver, included without extra charge in your course. Other apparatus given to help you learn. An UNEQUALLED OFFER. Many other big features for limited time only.

Get This Book

"Rich Rewards in Radio"—most amazing book concerning Radio ever written, will be sent to you promptly when you send the coupon. ACT NOW.



Your Satisfaction Guaranteed

Master Radio Engineers will show you how to qualify, quickly and easily at home, for Radio's fine jobs. We guarantee to train you successfully. You don't risk a penny, for we will gladly return every cent paid in tuition if upon completion of course you aren't absolutely satisfied. Back of this guarantee stands all the resources of National Radio Institute, U. S. Government-recognized and the oldest and largest Radio home-study school in the world.

Famous Course That "Pays For Itself"

Spare time earnings are easiest in Radio receiving sets everywhere nowadays. In every neighborhood there are scores of jobs you can turn your hand to in an hour or so after supper. Right at the start of your course we give you practical money-making lessons which teach you how to do this work, then how to get it—so by our practical plan you can make your course pay its own way while you're studying.

Age or Lack of Experience No Drawback

You don't need experience before taking this course, and common schooling is enough. Our tested, practical methods make learning clear and easy—the most natural thing on earth.

Get All The Facts At Once

Astonishing facts on the marvelous new industry of golden rewards—Radio—the fastest-moving, live-wire line. Free Book puts all the facts before you. No obligation. Send coupon for it now.

NATIONAL RADIO INSTITUTE
Dept. 513-OB, Washington, D. C.

Government Spending Millions on Radio

U. S. Government now spends millions developing wireless Radio. Ex-Postmaster General Hays said: "Probably the biggest part in the future of the postal service will be played by Radio." Photo above sending out the signals at Arlington, great Government Radio station at Washington—Radio is fitting new needs, filling new needs never dreamed of before. Radio Experts are in greater demand than ever.

Send Coupon Now

Get out of the low pay rut. Get into the most fascinating, easiest big-pay profession on earth. Free Book tells you how. ACT AT ONCE—SEND FOR BOOK TODAY.

N.R.I. TRAINED MEN ARE SUCCEEDING BIG



Operates WMAQ

"Accepted a position with Chicago Daily News—Station WMAQ. My income practically doubled, thanks to your fine course." Keith Kinball, Chicago, Ill.

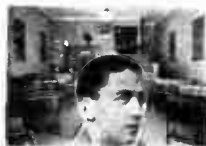

Gets Big Job

"Just been made Sales Manager of this Radio concern—a big raise in pay. Regret I did not take course sooner." R. E. Jones, Bay City, Mich.

"Your course so completely over-Radio it is worth \$100 a week more to anyone in the electrical line. Since graduation have increased \$150 to \$80 a week more." Preston Tower, Gordon, Nebraska.



"The N. R. I. Course has been worth \$2500 a year to me, \$3500 in another year. Thanks a million (this is your training)." Andrew Shurie, Launceston, Pa.

"My charge for consultation now \$2.50 per hour. The course is worth to me at least \$50,000." R. W. Blackhill, Brooklyn, N. Y.



"Your course worth \$2500 a year to me—Radio a gold mine. All my success due to your splendid course." A. R. Herke, Winnipeg, Canada.

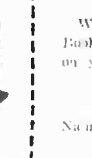

You Can Do What Others Have Done

Why go along at \$15 or \$25 or \$35 a week, when thoroughly-trained Radio Experts earn a hundred or more in the same six days? What this training has done for me is detailed in the book sent you. ACT NOW.

MAIL THIS COUPON

NATIONAL RADIO INSTITUTE,
Dept. 513-OB, Washington, D. C.

Without obligating me in any way, send your Free Book "Rich Rewards in Radio"—also full information on your practical, home-study Radio course.

Name

Address

Town State

LARGEST RADIO SCHOOL IN THE WORLD

ORIGINATORS OF RADIO HOME-STUDY TRAINING

Transmitting Power by Radio

(Continued from page 766)

the transmitting antenna may be way up in the thousands, whereas, in the receiving antenna, it is way down in the micros. Consequently, we may reasonably expect the watts to be also down in the micros.

Now, when we consider that the power used in the transmitter may be a thousand, or even a hundred watts, it becomes apparent that we can expect to receive, at the small distance of 120 miles, less than an amount of power that would have to be reckoned in microwatts or, perhaps, micro-microwatts.

And even with all this we have not considered such problems as fading, etc.

There have been attempts made in the past, some of them by notable scientists, to transmit electrical power over distances by means other than what we call, in this article "ordinary radio." For instance, we show, in the illustration, a plan of Nikola Tesla's, which was started years ago, but was never carried to the point of actual experimentation. This plan was told to the readers of the *Electrical Experimenter* back in March, 1916. The idea was to utilize only the ground waves, the power being generated in a tower, at the top of which was a large dome to be charged to an inordinately high potential, say 4,000,000 volts. Another tower, located at a distance, was to do the receiving, and was similarly built.

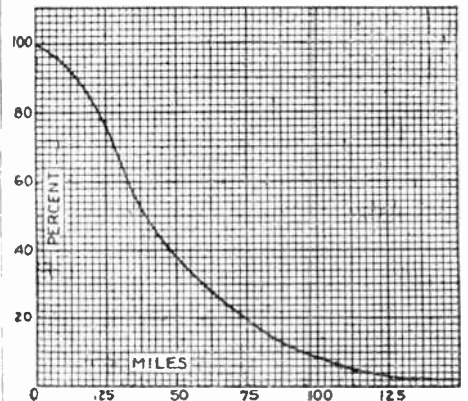

This curve shows how the power sent from the antenna decreases directly as the number of miles traveled.

Although some preliminary experiments employing this principle were carried through to what might be called a successful experimental conclusion, the application never reached what might be classified as a commercially promising result.

Those who have followed the advances in the radio field for the last decade will remember the experiment carried out on the plains of Colorado, in which Tesla successfully heated the filament of an ordinary electric lamp on a small loop of wire from power generated several miles away and transmitted from the generating plant to the light through space without intervening conductors of any kind.

Another plan which was not so long ago given considerable publicity in the press, was that of Grindell-Matthews—the so-called "death ray."

It was claimed by the inventor that he had discovered a new kind of ray which he could control and project at will, and that the interception of this ray with any material body in its path would immediately result in the demolition of the obstacle. The whole thing was taboo in the minds of most of the great scientists of the world, and, as for that, the thing seems to have passed into oblivion, for we do not hear of it any longer.

Ivan T. Nedland
Jeweler
HILLSIDE, N. J.

April 11, 1925

Daven Radio Corp.,
Newark, N. J.

Dear Sir:

I installed one of your super amplifiers and must say that this was the biggest improvement I have ever put in a radio, and there is no question in my mind but that this is the only real way of amplifying as the tone is so far superior that there is no comparison between resistor and the different transformer that I have tried, and I have tried several low ratio of the best makes as well as push-pull.

Awaiting your manual with interest, I am,
Yours truly,
I. T. Nedland

"The Biggest Improvement I Ever Put In A Radio"

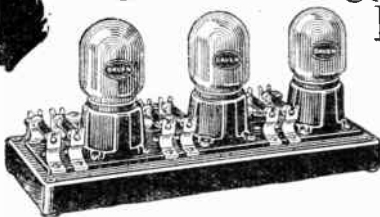

THE Daven Super-Amplifier is the last word in resistance coupled amplification. And resistance coupling is the only answer to the demand for QUALITY that has now become

world-wide and insistent. Amplify the Daven way. Absolutely without distortion. The Daven Super-Amplifier is a revelation to music lovers. Sold by dealers everywhere, complete, for \$15.00. Knock-down Amplifier Kit—\$9.00.

For more volume without distortion we recommend the new Daven High MU Tubes. Know all about Resistance Coupled Amplification. Read the authority, the *Resistor Manual*. At best Radio Dealers, 25c. By mail 30c.

DAVEN PRODUCTS ARE SOLD ONLY BY GOOD DEALERS

"The Sine of Merit"
DAVEN RADIO CORPORATION
Resistor Specialists
NEWARK NEW JERSEY
Reg. U. S. Pat. Off.



Resistor Manual
The Handbook of Resistance Coupled Amplification at best radio dealers 25c. Direct by mail, postpaid 30c.

CLIP THIS COUPON 0-12-25

DAVEN RADIO CORPORATION
158-160 Summit Street, Newark, New Jersey

Please send me the following on Resistance Coupled Amplification:—
 Check One Resistor Manual, 30c. is enclosed.
 Complete Catalogue (free).

Name.....
 Address.....
 For Dealers: Send your letterhead or card, or this coupon and we will have our nearest distributor communicate with you.

THE BIG LITTLE THINGS OF RADIO.

FAHNESTOCK CLIPS



PRESS DOWN HERE

"Popular Wherever Radio Is Used."

FAHNESTOCK Connectors are used by nearly every manufacturer of standard radio sets and manufacturers of high grade "A" and "B" Batteries. FAHNESTOCK makes connectors for every radio purpose.

"THE IDEAL CONNECTOR"
Catalog sent upon request

FAHNESTOCK ELECTRIC COMPANY
Long Island City, New York



GEM TUBE

A Guaranteed Radio Tube Within Reach of All

Every tube guaranteed. A tube for a dollar of \$3 value. A trial order will convince you as it has thousands of others. Send your orders at once.

Orders sent C.O.D. parcel post.
 Type.....401A
 Type.....400
 Type.....499
 Type.....499A

\$1.00
EACH

(with standard base)
Dealers, Write for Discounts

GEM TUBE CO.

Dept. N. 210 B'way, N. Y. City
 220 So. State St., Chicago, Ill.
 Lafayette Bldg., Detroit, Mich.

Insure your copy reaching you each month. Subscribe to Radio News—\$2.50 a year. Experimenter Publishing Co., 53 Park Place, N. Y. C.

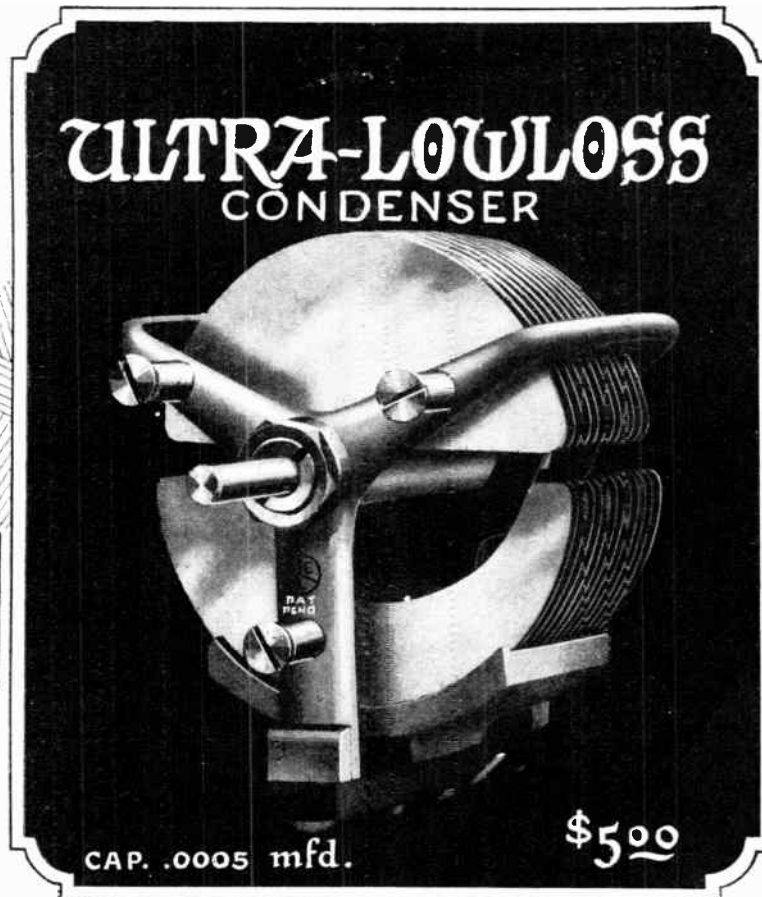

Unusual Features Increase Receiving Efficiency

IN less than six months the Ultra-Lowloss Condenser has proved its right to leadership by greatly simplified design, greater tuning efficiency, and radically different operating results—not only in the eyes of scientific and engineering men, but with the buying public as well.

These are the predominating Ultra-Lowloss features: (1) Single insulation strip reduces leakage losses materially, (2) Monoblock mounting with plates cast into block reduces series resistance and assures positive contact, (3) Minimum of metal of high resistance material in the field and frame reduces eddy current losses, (4) Cutlass Stator Plates produce a straight line wavelength curve—separating stations evenly over the dial. Each degree on a 100 degree scale dial represents approximately $3\frac{1}{2}$ meters over the broadcast wavelength range.

This even separation applies to both high and low wavelengths! Simplifies tuning materially!

The Ultra-Lowloss Condenser is a recent development of R. E. LaCauli, E.E., originator of the famous Ultradyne Receiver.

Design of Lowloss Coils furnished free with each Condenser for amateur and broadcast wavelengths showing which will function most efficiently with the Condenser.

At your Dealer's. Otherwise, send purchase price and you will be supplied postpaid.

ULTRA-LOWLOSS CONDENSER

Write for Descriptive Folder.

PHENIX RADIO CORP., 114 East 25th St., New York

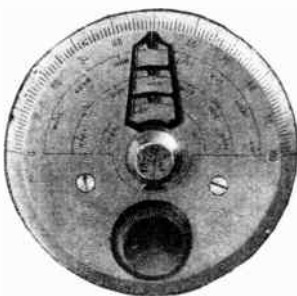
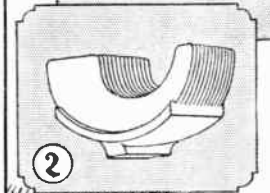
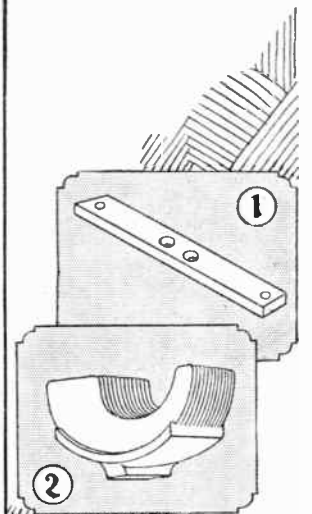
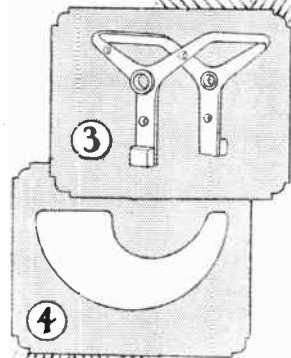

Simplifies radio tuning. Pencil record a station on the dial—thereafter simply turn the fader to your pencil mark to get that instantly. Easy—quick to mount. Eliminates fumbling, guessing. Furnished clockwise or anti-clockwise in gold or silver finish. Gear ratio 20 to 1. Silver \$2.50. In gold finish, \$3.50.

ULTRA-VERDIER
TUNING CONTROL



R. E. LaCauli

To manufacturers who wish to improve their sets

I will gladly consult with any manufacturer regarding the application of this condenser to his circuit for obtaining best possible efficiency.





The Season's Sensation

\$15.00

Design Patented

THE KODEL MICROPHONE LOUD SPEAKER is an exact replica of the transmitting microphone used in broadcasting.

The efficient Kodel reproducing unit, with an ingenious new snail-shell horn, mounted inside the microphone case, produces a remarkably clear, full-toned volume. Non-vibrating tone chamber eliminates distortion.

The \$15 model incorporates the new Kodel, Jr. unit; with the large Kodel unit, \$20.

Radio dealers everywhere have them

THE KODEL RADIO CORP.
501 E. Pearl St., Cincinnati, O.

The KODEL MICROPHONE LOUD SPEAKER



BLUEBIRD RADIO TUBES
— are powerful — sensitive for distance, give clear volume and long service.

GUARANTEED
to work in Radio Frequency, Neutrodyne, Super Heterodyne and Reflex.

WITH BAKELITE BASE

Type 401A	\$2.00	All
Type 400		Standard
Type 499		Types
Type 412		

Also 499A with Standard Base 202-5 Watt Transmitter \$3.00

When ordering mention types Shipped Parcel Post C.O.D.

BLUEBIRD TUBE CO.
200 Broadway Dept. N New York

Radio Offers You \$60 to \$200 a Week

Ambitious men and women can easily make big money in Radio—the world's newest and greatest industry. Thousands cleaning up. Here's your opportunity. No Experience—no capital.



A BUSINESS OF YOUR OWN
I show you how free—tell you all you need to know—put you in this fascinating, profitable business for yourself. Show you how to buy all popular Radio goods at lowest wholesale, sell at handsome profit to friends and neighbors right in your locality and build big, permanent business.

FREE Your choice of exclusive rights to valuable open territory if you act at once. Write now for Free Book and amazing offer.

STANDARD RADIO CO.
1410 Walnut St. Kansas City, Mo.

Insure your copy reaching you each month. Subscribe to Radio News—\$2.50 a year. Experimenter Publishing Co., 53 Park Place, New York City.

Another idea which, I believe, had its inception in France (I have forgotten the inventor's name) employed two extremely powerful beams of ultra-violet rays. These were to be shot up through the air until they came to the Heaviside layer. A powerful transmitter was to be located so as to discharge into one of these beams and the receiver was to be located in the other beam. It was thought, then, that a continuous electrical circuit would be furnished by one of the beams, the Heaviside layer, the other beam and the ground, all in series with the transmitter and the receiver. Oh, Oliver Heaviside! What deeds are committed in thy name!

The Experimenter

has come back! If you are one of the one hundred thousand readers of the old ELECTRICAL EXPERIMENTER, you will no doubt be glad to hear that the EXPERIMENTER has come back BIGGER AND BETTER THAN EVER

Experimental Radio

Nothing but experiments, written by the foremost radio authorities, also a monthly editorial by H. Gernsback. But best of all for you radio readers, is the big radio section of over twelve pages of some fifty radio experimental articles—and mind you, NOTHING BUT EXPERIMENTS.

INTERESTING ARTICLES TO APPEAR IN DECEMBER ISSUE OF THE EXPERIMENTER

- The Story of the Bell Telephone. By T. O'Conor Sloane, Ph.D.
- The Evolution of the Vacuum Tube. By Leon L. Adelman
- Sound and Audio Frequency Amplification. By Theodore H. Nakken
- Home-Made Geissler Tubes. By F. Castro
- A Practical Tesla Coil. By Willis L. Nye
- Chemical Fun With Light Rays. By Raymond B. Wailes

The EXPERIMENTER will be on sale at all newsstands November 20, 1925.

However, to end the effusion, and to tell the whole truth and nothing but the truth, it must be confessed that some power has been transmitted by radio. Further, it must be said that even as much as a few watts of power have been transmitted by means of radio (ordinary radio), but I must not omit to tell that this was done over wires; in other words, it was wired radio.

Far be it from me, however, to disparage the efforts of those altruistic souls who will spend their lives and fortunes in the search. Let us hope for their success, and may that success be not at the same distance as the point to which they wish to transmit power by radio.

RADIO FOG

Radio fog is the latest form of interference, and strangely enough it is said to be more prevalent at night than in the daytime. A report to the Radio Section of the Department of Commerce, from S. L. Steele, of Chicago, states that following observations with a nine-tube Super-heterodyne and a four-tuber, during the past month, he has marveled at the power, clarity and tonal quality of many broadcast stations both distant and local in the afternoon. At night, he advises, the same stations are weaker and the quality changes for the worse. There seems to exist a kind of interference he has never heard mentioned, which cannot be tuned out; musical selections lose their true character, and speech becomes harsh and grating.

Citing a simile, the writer says that we do not see the sun in its true character in a fog and at night, when the too numerous stations are operating, a "radio fog" of side bands and harmonics seems to weaken the signals of certain stations and distort them.



The Mark of quality whether you buy or build!



Manufacturers know by careful testing what fans have learned from experience

A list of some of the prominent radio manufacturers using C-H products

- Acme Apparatus Co.
- American Bosch Magneto Co.
- Astral Radio Corporation
- Boissier Radio Corporation
- Chelsea Radio Co.
- Crosley Radio Corporation
- Dayton Fan & Motor Co.
- Dictagraph Products Co.
- Dubilier Condenser & Radio Corporation
- Electrad, Inc.
- Freed-Eisenmann Radio Corp.
- Garod Corporation
- Gillilan Bros., Inc.
- Allen T. Hamscomb
- Harding Mfg. Co.
- Howard Radio Co.
- The Keyport Laboratories
- King Electric Mfg. Co.
- Kodel Radio Corporation
- LeMor Radio, Inc.
- Magnus Electric & Radio Co.
- Malone-Lemmon Laboratories
- Glenn L. Martin Co.
- Win. J. Murdock
- Newport Radio Co.
- Phanstiehl Mfg. Co.
- Philadelphia Storage Bat. Co.
- Radio Master Corp. of America
- The Radio Compak Co.
- R. B. Radio Co.
- Robbins Radio Co.
- Signal Electric Co.
- Silver-Marshall Co.
- Simplex Radio Co.
- E. E. Thompson Co., Inc.
- J. S. Timmons
- Workrite Mfg. Co.
- Zenith Radio Co.

YOUR new radio set can have C-H quality *whether you buy or build.* Today, reliable dealers everywhere carry C-H radio parts because fans have learned by experience to demand this trademark that insures proper design—highest quality at lowest cost.

But most of these dealers also sell radio sets and accessories that incorporate this same high C-H quality. Radio manufacturers have learned by careful testing what fans already know from experience—the economy of good parts.

Whether you buy or build—the C-H trade-mark on the parts of your radio set is a guarantee of satisfaction.

THE CUTLER-HAMMER MFG. COMPANY

Member Radio Section, Associated Manufacturers of Electrical Supplies

MILWAUKEE, WISCONSIN

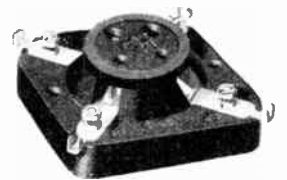

The New C-H UX Socket
for the new UX tubes. Same C-H one piece, silver plated, double grip contacts as in standard socket. Heat proof Thermopax body—terminals cannot loosen under heat of soldering iron.

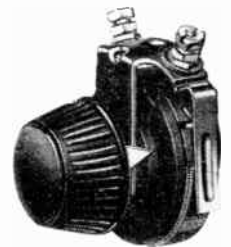

The Perfected C-H Rheostat
Designed to radio engineers' specifications. Revolving drum type with one hole mounting. All spring tensions adjusted at factory and undisturbed by mounting. Instrument cannot turn on panel. Very small size—less than 1/4 inch back of panel and narrower than standard socket. Operation smooth and quiet. 6 ohms, 15 ohms, and 30 ohms—perfect control for all tubes and their combinations.

CUTLER-HAMMER

Radio Parts for Performance



To unscramble the stations

The New AMSCO Allocating Condenser (S.L.F.) spreads the stations evenly around dials. Eliminates the crowding of low wave stations and simplifies tuning. And unlike previous straight line frequency condensers, its "half-a-heart" rotor plates *save space* in the cabinet. Three sizes—single or Siamese.

To get the finest tuning

The New AMSCO Vernier Dial is as easily installed as an ordinary dial—and as easily manipulated. But—each turn of the dial is stepped-down to 1-13th the motion—giving finesse to your fingers. A precision instrument, without momentum or back-lash. There is no vernier like it for distance-getting. Low in price.

Ask your dealer for these and other AMSCO Engineered Radio Products . . . Everything in Condensers, Rheostats, Potentiometers, tube sockets, dials, etc.

AMSCO PRODUCTS INC., Dept. F
Broome and Lafayette Streets, N. Y. City
Makers of the Melco Supreme Radio Receiver



Britain's New Super-Power Broadcast Station

(Continued from page 771)

in size and appearance to the oscillators, but have a more open grid mesh and a consequently lower amplification factor. The same filament and plate voltages and currents are applied to these tubes as to the oscillators, the value of the plate current being dependent, of course, upon the adjustment of the grid negative bias.

During normal working the grid bias is generally set between 1,200 and 1,300 volts negative, thus giving such a very large grid sweep during modulation that there is no danger of running into grid current with its resultant evils of blasting and distortion.

It may surprise many to learn that this grid potential is obtained from a dry cell battery, which can be seen in one of the photographs, mounted in racks alongside the modulator panel. As no current is taken from this battery, it proves to be a satisfactory source from which to obtain the necessary voltage. Twelve months of testing at the old experimental station at Chelmsford showed this.

The sub-modulator panel contains one air-cooled tube, operated from the same high voltage source as the main modulator, and resistance-capacity coupled to the grids of the modulator tubes. The grid of the sub-modulator is in turn coupled by resistance and capacity to the sub-sub-modulator, which consists of a block of four ordinary small power tubes, such as those usually used for loud speaker operation, and supplied by a 400-volt storage battery. The filaments of these four tubes are also supplied from a storage battery.

The usual land line amplifiers are placed in a separate room, situated as far as possible from the high frequency apparatus, and are adaptable for amplifying either the land line audio frequencies or those from a microphone in the local studio.

Speech currents arriving over the land lines are therefore, first of all, amplified by the land line amplifiers, then by the sub-sub-modulator, again by the sub-modulator, and finally applied to the grids of the modulator. When this process is considered in detail, it is indeed remarkable that extensive distortion does not become apparent.

THE SMOOTHING AND WATER-COOLING ARRANGEMENTS

As can well be imagined the smoothing circuits for a transmitter of this size presented quite a problem, for the permissible ripple for high grade broadcasting is very small. Thus the smoothing units are somewhat bulky and expensive.

The necessary capacity for the system is obtained from banks of condensers, composed of zinc plates interleaved with sheets of glass, immersed in oil in porcelain containers. One of these banks can be seen in the background of one of the illustrations. The total capacity used for each half of the circuit (the amplifier and modulator sections) is approximately 3.5 microfarads.

The smoothing inductances are made up of closed iron-core chokes, which are also immersed in oil. They can also be seen in the photograph, behind the condensers. Each choke contains about 560 lbs. of iron in the core, and there are eight of them in all. The total inductance is about 16 henries.

The water-cooling system employed at Daventry is somewhat unique and is deserving of some attention.

The plates of all types of water-cooled tubes being at very high potential, it is necessary to insulate the water jackets from the water supply. This is usually achieved by connecting the jackets to the main supply

ELIMINATE Your STORAGE "A" BATTERY
for Reflex Radios

BLAX A. C. POLARIZER

Uses Electric Light Current—saves you recharging costs and bother. First small cost of Blax is last. Nothing to get out of order. Improves reception. Thousands of satisfied users. Mail coupon today. State representatives wanted.

ONLY \$1.00 Dealers selling BLAX are coining money.

BLACK BROS., INC.,
919 Black Bldg., Los Angeles:
Enclosed find \$1.00 bill. Send Blax at once.

Name.....
Address.....

AMBASSADOR

SEND FOR FREE 4 PAGE FOLDER AND HOOK UPS

TRANSFORMERS BY LABORATORY TEST HAVE NO SUPERIOR

AMBASSADOR SALES CO. 108 GREENWICH ST. N.Y.

Insure your copy reaching you each month. Subscribe to Radio News—\$2.50 a year. Experimenter Publishing Co., 53 Park Place, N. Y. C.

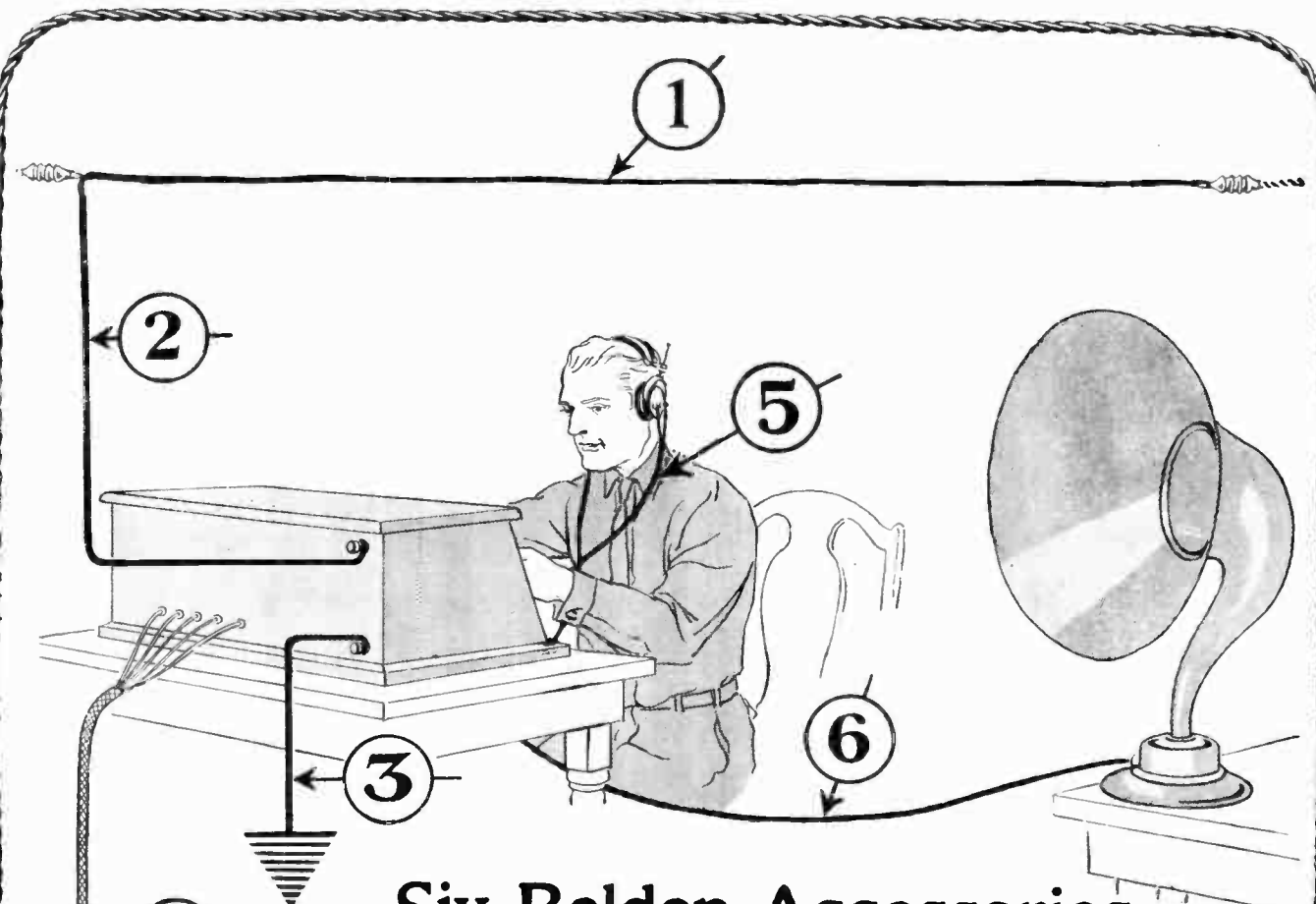

Six Belden Accessories that improve every radio set!

TUBES and batteries are not the only accessories that must be selected with care. Think of the aerial! A poor aerial will cripple your entire set, no matter how fine the set is. That's why you should always specify a Belden Aerial, the aerial that lasts indefinitely.

And a Belden Radio Battery Cord makes a neat installation. It takes the place of a tangle of messy wires that frequently short-circuit and blow out tubes. And for ground wires, extension cords, receiver cords, and many other essential items, be sure to specify Belden. Every Belden product is distributed in a distinctive carton for your protection. An illustrated booklet, "Helpful Hints for Radio Fans" describes each product and its application. Send for it!



- 1 Belden Aerial Wire, made of 7 copper strands, each coated with baked Beldenamel.
- 2 A continuation of No. 1 connecting aerial to set without joint.
- 3 Special Belden Ground Wire—Rubber covered.
- 4 The well-known 6-ft. Belden Battery Cord with five conductors enclosed in a brown braid.
- 5 Belden Headphone Cord
- 6 Belden 20-ft. Radio Extension Cord.

Mail the Coupon for Free Illustrated Booklet

BELDEN MANUFACTURING CO.
 2314G South Western Ave., Chicago

Please send me your booklet entitled "Helpful Hints for Radio Fans."

Name.....

Address.....

Belden



A CHELSEA Christmas

Three Tube Receiver

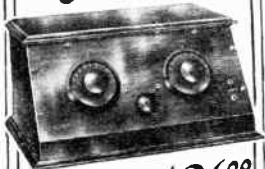

\$26.00

Super Five

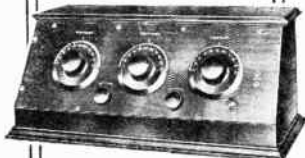

\$50.00

Brightens the Hearth

Snowbound . . . yet all is joy and life within, since Chelsea—the ideal FAMILY radio—is on the Christmas Tree.

The new Chelsea models offer added features, at new low prices. No finer Christmas gift can be conceived!

An Unparalleled Success

The only 3-tube genuine Armstrong circuit Receiver in the world at \$26.00 with a dust-proof, fool-proof panel protecting the delicate working parts. Provided with advanced features found only in the high priced sets, this model has met with widest popular favor. (Licensed under Patent 1,113,149.)

Finer Volume—Great Selectivity

The new Super-Five employs a system of amplification increasing volume—razor-edge selectivity is obtained without expert tuning knowledge. Mahogany finish throughout including panel and dials. Heavy phone cord leads, hand soldered connections, rugged bus wiring and many other refinements.

See these Wonderful Values at your Dealer's before selecting any Set.



Send NOW for These Circulars

CHELSEA RADIO CO. CHELSEA MASS.

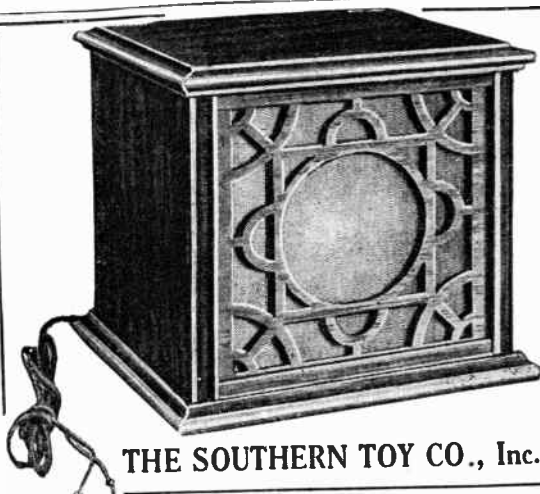

The Ivey Loud Speaker has no equal for clearness

We use a special high-pitched unit just perfected in the laboratory. Your choice mahogany finish or solid walnut. No hoarse, rumbling or throaty signals but a clear, sharp signal that will delight you.

Price \$15.00 F.O.B. Hickory

Free Catalogue

THE SOUTHERN TOY CO., Inc., Dept. N, HICKORY, N. C.

pipes by means of several feet of rubber tubing, arranged conveniently in a coil. However, this method involves a certain amount of loss through the water column, which is to some extent conductive.

The method employed in this case is to run the water both in and out of the jackets through spraying nozzles which atomize the water into isolated drops, thus forming an almost perfect insulator, and eliminating all loss of electrical energy.

The cooling water is stored in a concrete-lined pond holding about 5,000 gallons, and is pumped from there up to a tank on the roof of the station, from whence it falls by gravity through the water jackets back into the pond. The rate of flow is adjusted to allow about one gallon per minute to flow through each jacket, and under these conditions the water leaving the tubes is increased in temperature by only a few degrees.

As it is important to use water entirely free from lime, etc., which might form a deposit on the plates of the tubes, pure rain water is used, this being gathered into the pond by draining the normal rainfall from the roof of the station buildings. With such an arrangement, a rainfall of one inch gives about 1,000 gallons of water to the pond.

THE SWITCHING AND CONTROL SYSTEMS

The necessary control apparatus for the station is located in a central control table, which is placed in such a position that the shift engineer has a clear view of all the various panels and indicating instruments fitted thereon.

On this table are mounted the exciter field rheostats of all the motor alternators and dynamos, so that all machines can be brought up to the correct working voltage from there. Magnetic trip switches enable any particular machine to be cut out instantly and at short notice if necessary, and a master switch is also available which, when opened, stops all the machines from generating except the filament lighting dynamos.

All the high voltage apparatus is enclosed in metal cages or railings, the gates of which have a safety switch to cut off power when opened. Thus it is impossible for an engineer to approach danger points whilst power is on.

On account of the complicated system of relays and wiring employed, it is necessary to start up the station in a certain prescribed order of operations. The high plate voltage cannot be applied to the master oscillator unless the safety gate is closed and the filaments lighted. Neither can power be switched on to the amplifier and modulator tubes unless the gate is closed, all filaments fully lighted and the drive oscillator functioning properly at approximately its correct output.

Also, if, for any reason, the drive oscillator should cease oscillating, the entire transmitter is automatically shut down. A wavemeter with visual indicator on the control table keeps the engineer informed as to the wave-length constancy. This instrument can show a variation of half a meter from the correct value of 1,600 meters.

The whole of the apparatus at the Daventry station is the result of extensive experimenting with high power at the old Chelmsford station. Not only has the technical experience gained been made use of, but also much attention has been given to the appearance of the various units, which have been designed to conform to a general color scheme in which burnished and frosted aluminum predominates, with black matt enamel as a relief. Visible connections between the various units have been reduced to a minimum, all cables and piping being laid in covered trenches where possible.

Daventry is operating on 1,600 meters, using the call 5XX, just as did Chelmsford, and the programs are all supplied by land wire from London, the local studio only being used for special announcements, etc.

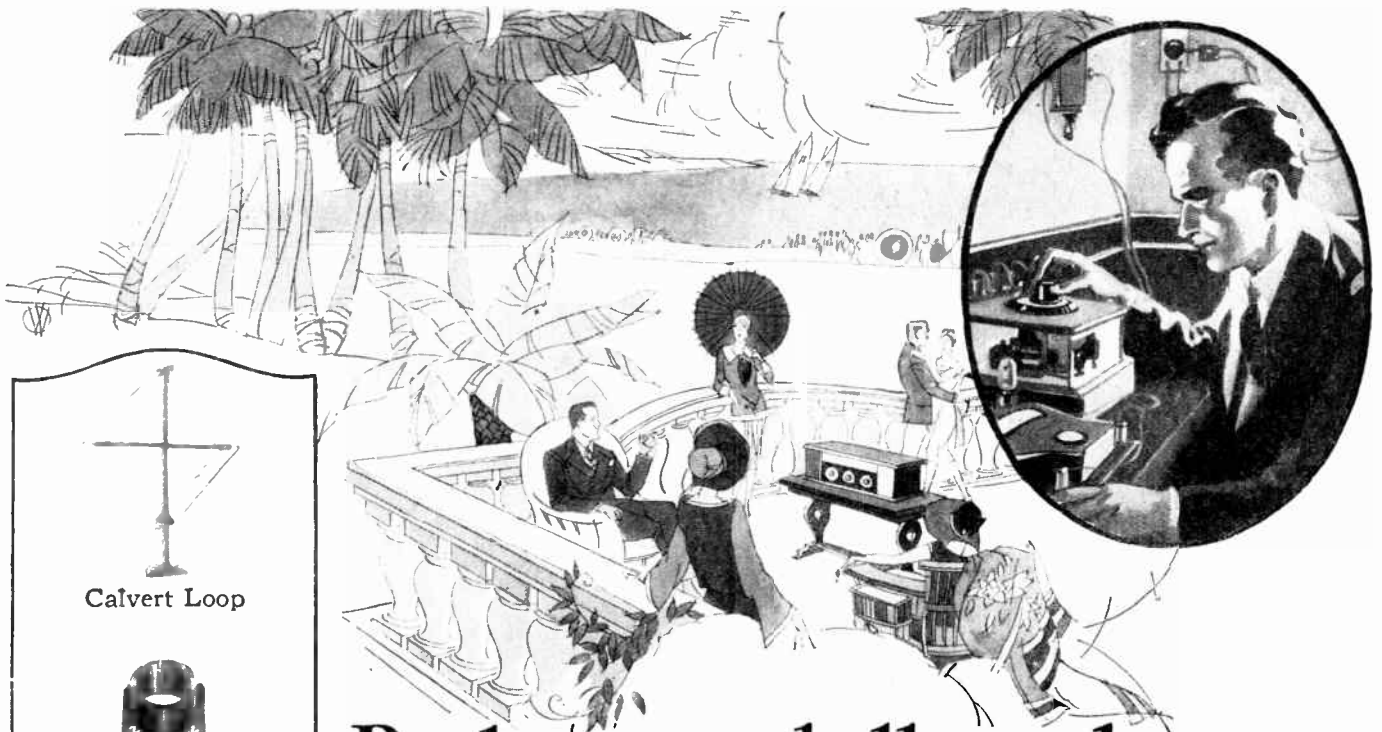

Calvert Loop



Bennington
Tube Socket



Mason Z & T Jr.
Detector



Saal
Soft Speaker



Pacnt Knob



Pathe Dial

Radio tested all insulations- and adopted Bakelite

In the laboratories of radio manufacturers, in actual use in all climates and under adverse conditions, Bakelite has proven its superiority for radio insulation.

The reason for this dominance of Bakelite in radio is easily understood. Its high insulation value, so essential to tonal quality, is unimpaired by time, temperature variations or by service.

Bakelite is generally used for exposed radio parts, dials, knobs, panels and accessories, because its color and high finish are permanent, undimmed by exposure or handling.

The use of Bakelite in the set you buy or build, will insure you against inferior reception through defective insulation. It will pay you to make sure that Bakelite is used in the radio set or parts that you buy.

Write for Booklet 24

BAKELITE CORPORATION

247 Park Avenue, New York, N. Y.

Chicago Office: 636 West 22nd Street

Bakelite is an exclusive trade mark and can be used only on products made from materials manufactured by the Bakelite Corporation. It is the only material which may bear this famous mark of excellence.

BAKELITE

REG. U.S. PAT. OFF.



BAKELITE

is the registered trade mark for the phenol resin product manufactured under patents owned by the Bakelite Corporation.

THE MATERIAL OF A THOUSAND USES

FROST-RADIO

Ask Your Neighborhood Dealer

FROST FONES

THERE is a pair of **FROST-FONES** exactly suited to your own and your sets requirements. We make two types, an aluminum shell lightweight type, in 2000 and in 3000 ohms, and an all-bakelite type in 3200 ohms. As finely made as a high grade watch.



\$3.00
\$3.50
Light Weight Type

OUR new Type No. 174-5 aluminum shell **FROST-FONES** are marvels of lightweight, compactness and sensitiveness. They never tire the head, no matter how long you wear them.
No. 174, 2000 ohm **3.00**
No. 175, 3000 ohm **3.50**
No. 172, 3200 ohm genuine bakelite **6.00**

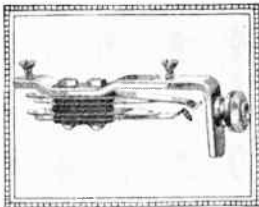

FROST-RADIO FAN-TAB JACKS
All types, 65c to 90c

Parts and Accessories for your Radio Set

These and many other **FROST-RADIO** parts and accessories will aid you in getting better results from your receiving set this season. See them and buy them at your dealers. He has complete stocks.

Pacific Coast prices are slightly higher

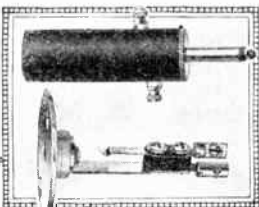

FROST-RADIO LOOP PLUG AND JACK
Complete \$1.50

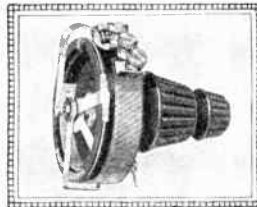

FROST-RADIO TUBE CONTROL UNITS
6, 25 or 35 ohm, \$1.75

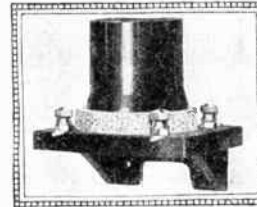

FROST-RADIO BAKELITE CUSHION SOCKETS
Single, \$1.25 3-gang, \$3.75

HERBERT H. FROST, Inc.

314-324 WEST SUPERIOR STREET, CHICAGO
NEW YORK CITY CLEVELAND KANSAS CITY LOS ANGELES
EXPORT OFFICE: 314 WEST SUPERIOR STREET, CHICAGO

The new station is primarily intended for reception on a crystal set anywhere within a range of 100 miles, but, through the International Union of Broadcasters at Geneva, arrangements for the exchange of programs with various countries through the medium of this station have been made.

In the case of the United States, it is proposed at first to exchange programs in conjunction with the Radio Corporation of America, which is prepared to co-operate on this side of the Atlantic. For the purpose of receiving American programs, the B.B.C. built a super-receiving station at Bromley, Kent, which has been fitted with all the latest known devices for ensuring efficient and reliable reception of the American stations at all times.

Thus the B.B.C. is well equipped for filling the rôle of Europe's "Broadcast Central," and it seems likely that Daventry will serve as a model for high-power broadcast stations for some time to come, even in a rapidly developing science like radio broadcasting.

Is Your Coupling Tight or Loose?

(Continued from page 801)

efficient of coupling drops considerably—to the position shown in Fig. 6 by the curve C. Therefore, if the primary coil is assumed to be at the center of the secondary, whereas the value of k for the coils alone is about 83 per cent., it drops to about 47 per cent. when the antenna and ground are connected. Furthermore, as the frequency of the waves received become higher and higher, or the wave-length becomes shorter and shorter, the mutual inductance increases, so that the coefficient of coupling increases slightly. At low frequencies (long wave-lengths) the latter effect is not very great, but increases very rapidly as the ultra-short-wave-lengths are approached.

In this article we have considered only concentric coils. In the next issue of *RADIO NEWS* we shall continue the study of coupling, showing how it varies with the angle through which a rotating tickler coil is turned, and also go into the study of disc or pancake coils.

RADIO USED BY MEXICAN SMUGGLERS

Radio is coming into general use in the Southwest as an important agent in the apprehension of smugglers along the Mexican border, government agents announce. During recent years a band of thieves operating in Dallas and Fort Worth, large cities in northern Texas, have specialized in stealing automobiles which have been smuggled to army officers in Mexico and sold at greatly reduced prices. Department of Justice agents in Dallas, using a Federal code, recently intercepted several thieves by quickly broadcasting a description of the stolen car.

An ultra-modern thief who recently stole an airplane at Love Field near Dallas was caught by another ultra-modernist who broadcast by radio a description of the stolen plane. The airplane was located by a village constable in the extreme northwestern section of the State.

Dope smugglers, long active in the Big Bend district of Texas, also are being combated by means of radio. Suspected dope runners who slip across the river are described by an official code broadcast by radio to cities in the northern section of the State. Government agents declare radio police bulletins broadcast by police and Federal agents at Dallas, El Paso, Houston, San Antonio, Fort Worth, Wichita Falls and Galveston are now the most effective methods of stopping dope runners and bootleggers from operating in the border section.

PLIODYNE-6

One of the most selective receivers on the market—Consistent range of 1500-3000 miles. Two stages radio frequency detector, and three stages of balanced audio amplification. Beautiful Fabri-koid-covered Cabinet.
Price Without Accessories.....\$60.00

RADIO PARTS CO., LABS., 8 S. AUSTIN BLVD., OAK PARK, ILL.

A Laboratory Product



CRESCENT LAVITE RESISTANCES

Used in 50 Big Broadcasting Stations. 12,000, 48,000, 50,000 and 100,000 Ohms. For distortionless amplifications. Order a Crescent today at \$1.50. Special sizes made to order. Discounts to dealers.
CRESCENT RADIO SUPPLY CO., 1-5 Liberty St. Jamaica, L. I.

KELBRACKETS

"Girders for Radios"

Beauty, finish and accessibility for home-built sets.

Write for Kelbracket booklet

KELLERADIO, INC.

821 Market St. - San Francisco, Cal.

DEALERS!

Complete stock of nationally known parts and accessories. Send for illustrated catalog and discount sheet.

Radio Exclusively Since 1921

CLARK & TILSON, Inc.

552 Seventh Ave. :: New York

The Nationally Known House

Insure your copy reaching you each month. Subscribe to *Radio News*—\$2.50 a year
Experimenter Publishing Co., 53 Park Place, N. Y. C.

For some—a “radio” For others—Zenith!

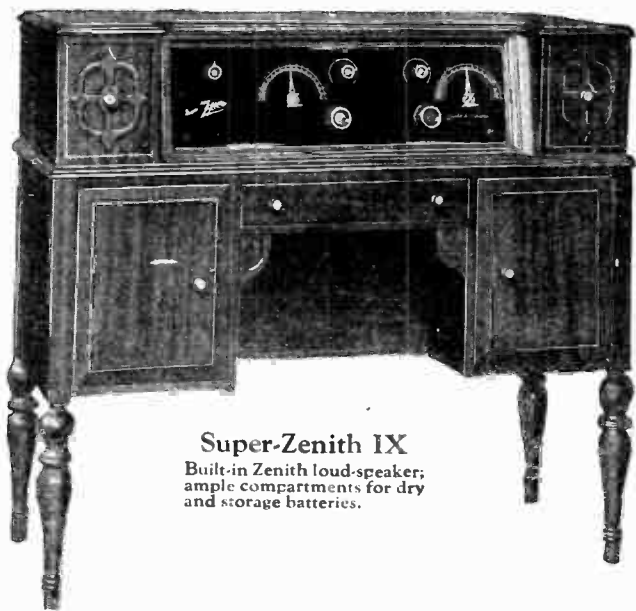

Super-Zenith IX
Built-in Zenith loud-speaker;
ample compartments for dry
and storage batteries.

Super-Zeniths priced from \$240 to \$355.
DeLuxe Art Model Cabinets from \$500 to \$2,000
Other Zenith Sets \$100 and \$175



New Zenith De Luxe Chinese Model
Equipped with two built-in loud speakers, Bates
Rotary Log, illuminated dial, single control
specially constructed Zenith Radio Circuit.

Some prefer the blare of a circus band—or the friendly jangle of a hurdy-gurdy. To them it is the only music.

Those who delight in blare and jangle do not need a Zenith—but they will find that even such music rings truer to their ears brought in by Zenith radio.

Others go breathless at the golden notes of a lyric soprano—or the rapturous harmonies of a great symphony.

Such people—born with a love for music—should never content themselves with any radio instrument less fine than Zenith.

Zenith's appeal to the eye is instant—and enduring. Its clear, sweet tone is a revelation.

To see and hear one of the new Super-Zeniths for the first time is a memorable experience. Yet that experience is yours for the asking—in your own home if you so desire.

Simply telephone your nearest Zenith dealer.

Again Commander Donald B. MacMillan chose Zenith for his Arctic Expedition. When human lives may depend upon the reliability of radio performance, only one reason can explain his choice: Zenith has proved to be the best obtainable at any price.

ZENITH RADIO CORPORATION
Straus Building, Chicago



It Costs More
But It Does More!



Dymac Reception

—like vision on a clear day

AS LOOKING across the water on a cloudless day gives the eye a picture clear-cut to the last detail, so the DYMAC Selecto Five gives the ear clear-cut reproduction, missing none of the shades of detail.

Inside its walnut finish mahogany cabinet is a specially designed circuit. Outside, a dial system, simple but effective. You get remarkable selectivity combined with accurate rendition of tonal values.

This fine musical instrument sells for only \$75.00. Write us for details, or ask your dealer. The DYMAC Type G Headset (\$5) and Loud Speaker (\$8.50) will add to your enjoyment of the DYMAC Selecto Five.

Every DYMAC product is guaranteed for one year

ELECTRICAL PRODUCTS MFG. CO.
Providence, Rhode Island

New York Office: Metropolitan Tower
Export Office: Ad. Auriema, Inc., 116 Broad Street, New York City

Other DYMAC Accessories and Parts:

Type F Headset, \$3
Vernier Dial, \$1.50
Loud Speaker Unit, \$5

Soldering Set (Standard) \$2.50
Crystal Set (Complete) \$7.50
Sub-panel Socket, 75c.



Radio Set Directory

(Continued from page 811)

- Loud Speaker: Separate
Controls: Two
List Price: \$33.50
- Trade Name: (Kenneth Harkness) 3-tube Counterflex
Circuit: Harkness Counterflex
Batteries: Storage preferred.
Antenna: Outdoor
Loud Speaker: Separate
Controls: Two
List Price: \$36.00
- Trade Name: Five-Tube Counterflex
Circuit: Harkness counterflex
Batteries: Storage preferred
Antenna: Outdoor
Loud Speaker: Separate
Controls: Three
List Price: \$47.50
- KOLSTER RADIO,**
Woolworth Bldg.,
New York City
Trade Name: Kolster
Model 8-B
Circuit: Tuned radio frequency
Batteries: Dry Cell A and B
Antenna: Indoor or outdoor
Loud Speaker: Built in
Controls: One
List Price: \$265.00
- Trade Name: Kolster
Model 8-C
Circuit: Tuned radio frequency
Batteries: Dry cell
Antenna: Indoor or outdoor
Loud Speaker: Built in
Controls: One
List Price: \$375.00
- Trade Name: Kolster
Model 6-A
Circuit: Tuned radio frequency
Batteries: Dry cell or storage
Antenna: Indoor or outdoor
Loud Speaker: Separate
Controls: Two
List Price: \$175.00
- Trade Name: Kolster
Model 6-B
Circuit: Tuned radio frequency
Batteries: Dry cell or storage
Antenna: Indoor or outdoor
Loud Speaker: Built-in
Controls: Two
List Price: \$225.00
- LEICH ELECTRIC CO.,** Ill.
Trade Name: Leich
Circuit: Tuned radio frequency, special method of neutralizing.
Batteries: Storage
Antenna: Outdoor
Loud Speaker: Separate
Controls: Three
List Price: \$125.00
- LE MOR RADIO, Inc.,**
P. O. Box: 517,
Asbury Park, N. J.
Trade Name: Le Mor
Uni-Control Receiver
Circuit: "Pretuned" radio frequency
Batteries: Storage A-B, battery space in cabinet
Antenna: Indoor or outdoor
Loud Speaker: Separate
Controls: One
List Price: \$145.00
- MACHINE SPECIALTY CO.,**
Summit and Wildt Sts.
Ann Arbor, Mich.
- Trade Name: Arbor-
phone Cabinet
Circuit: Tuned radio frequency
Batteries: Storage
Antenna: Outdoor
Loud Speaker: Separate
Controls: Three
List Price: \$55.00
- Trade Name: Arbor-
phone Console
Circuit: Tuned radio frequency
Batteries: Storage
Antenna: Outdoor
Loud Speaker: Separate
Controls: Three
List Price: \$165.00
- MagLAREN MFG. CO.,**
26-28 Park Place,
New York City.
Trade Name: Domin-
Air
Circuit: Tuned radio frequency
Batteries: A.C. or D.C.
Antenna: Indoor and outdoor
Loud Speaker: Built-in
Controls: Three
List Price: \$250.00
- MAGNAVOX CO.,**
2725 East 14th St.,
Oakland, Calif.
Trade Name: Magnavox
Model 10
Circuit: Magnavox
tuned radio frequency
Batteries: Storage
Antenna: Outdoor or indoor
Loud Speaker: Separate
Control: One
List Price: \$110.00
without accessories
- Trade Name: Magnavox
Model 25
Circuit: Magnavox
tuned radio frequency
Batteries: Storage
Antenna: Outdoor and indoor
Loud Speaker: Built-in
Control: One
List Price: \$145.00
without accessories
- Trade Name: Magnavox
Model 75
Circuit: Magnavox
tuned radio frequency
Batteries: Storage
Antenna: Outdoor and indoor
Loud Speaker: Built-in
Control: One
List Price: \$200.00
without accessories
- MAGNUS ELECTRIC & RADIO MFG. CO.,**
787-797 East 138th St.,
New York City
Trade Name: Magnatrol
Open Wiring
with Circuit
Circuit: Tuned compensated radio freq.
Batteries: Dry cell or storage
Antenna: Outdoor
Loud Speaker: Built-in
Controls: Three
List Price: \$60.00
- Trade Name: Magnatrol
Sub-Panel Type
Circuit: Tuned compensated radio freq.
Batteries: Dry cell or storage
Antenna: Outdoor
Loud Speaker: Built-in
Controls: Three
List Price: \$60.00
- Trade Name: Magnatrol
De Luxe Type
Circuit: Tuned compensated radio freq.

HEATH CONDENSERS

For Real Radio Reception

Write for Literature

HEATH RADIO & ELECTRIC MFG. CO.,
206 First St., Newark, N. J.

Station after station pops in as you turn one dial. More selective, distance and volume. Daytime service from distant stations. All say "Nothing equals it." Tuner with dial \$10

F. C. BRADLEY, Union, Miss.

YOU CAN GET

Greater reflex or crystal set reception if you use the

BROWNLIE VERNIER DETECTOR

\$2.00 At your dealer or Direct.

ROLAND BROWNLIE & CO.
20 Saunders St. Medford, Mass.

You must see our new 64-page Catalog before you buy anything in Radio. It's FREE. WRITE TODAY!

RANDOLPH RADIO CORP.
159 N. UNION AV. Dept. 2 CHICAGO, ILL.

RADIO 'RITHMETIC

as an example



How *Near* are the *Far* Stations

That's an easy one. They're not far away at all; they're right with you, performing antics on your aerial, trying to make themselves heard.

Give them a real chance by keeping your batteries full of pep. That's another easy one! Just put the job up to a Westinghouse Rectigon.

It's for "A" batteries and "B" batteries;

and your automobile battery will get a full kick out of this handsome little helper.

There's no muss or fuss when you use the Rectigon. No acids or chemicals. No moving parts and no noise! It's a high-quality Westinghouse Product throughout, guaranteed to make your storage-battery radio set satisfying and *complete*.

WESTINGHOUSE ELECTRIC & MANUFACTURING COMPANY

SOUTH BEND, INDIANA

The Westinghouse Rectigon Battery Charger

No storage-battery radio is complete without a Rectigon.



© 1925, W. E. & M. Co.

Westinghouse manufactures, also, a complete line of Micarta radio panels, Micarta tubes and instruments.

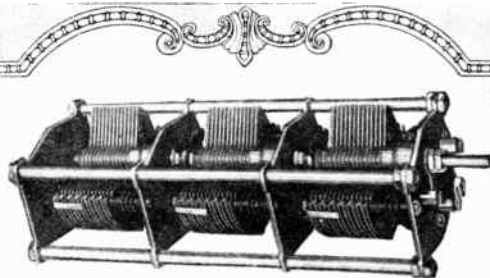

MULTIPLE Condensers

For Single Control Receivers

The latest advancement in radio design is the single control receiver. This latest type set was strongly in evidence at the recent Shows. U. S. Multiple Condensers are scientifically and accurately designed to give maximum results with single dial control. Made under Hogan Patents Jan. 9, 1912—Pat. No. 1,014,002.

Model 8

An efficient condenser made with new and patented one-piece stator, guaranteed to give sharp tuning at the lower broadcasting wave lengths.

Capacity, Max. .00025, Min. .0000076	...\$2.70
Max. .00030, Min. .000008	... 2.85
Max. .00035, Min. .0000085	... 2.95
Max. .00050, Min. .000011	... 3.75

Model 9

Same as Model 8, but with Vernier and Kurz-Kasch Dial.

Capacity, Max. .00025, Min. .0000076	...\$3.75
Max. .00030, Min. .000008	... 3.85
Max. .00035, Min. .0000085	... 4.10
Max. .00050, Min. .000011	... 4.75

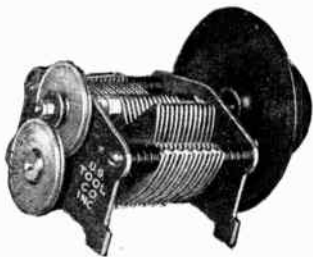

U. S. Tool Products are accepted as the Standard of Quality and Performance.

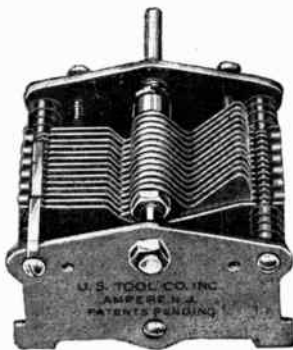

WRITE FOR LITERATURE

See These New Models at Your Dealer's

U.S.TOOL CO. INC. AMPERE, N.J.

RADIO TUBES

Repaired—Exchanged—Sold

\$1.25 Send broken or burned out tubes to us. We repair and return them good as new. \$1.25 each for common types. Or—we exchange one of your present tubes for another type, for your tube and \$1.25. Renewed tubes, guaranteed perfect \$1.75 any popular type. Send no money. We ship C. O. D.

We Operate Our Own Laboratory

You are assured perfect tube performance with our repairs because we operate our own tube laboratory. Don't take chances. Send your tubes to us—one of the oldest high frequency laboratories in the country.

CHICAGO ELECTRIC DEVICES CO.
79 E. 22nd Street, Dept. 30, Chicago, Ill.
Established—1920

RADIO CATALOG

Dealers! Send for new 1925-1926 Catalog. Contains nationally advertised high quality sets, kits and parts. Use your letterhead.

Western Radio Co. MFG
134-136 W. Lake St. Chicago, Ill.

Batteries: Dry cell or storage
Antenna: Outdoor
Loud Speaker: Built-in
Controls: Three
List Price: \$75.00

Trade Name: Magnutrol Sloping De Luxe
Circuit: Tuned compensated radio freq.
Batteries: Dry cell or storage

Antenna: Outdoor
Loud Speaker: Built-in
Controls: Three
List Price: \$75.00

Trade Name: Magnutrol Magnus Phonograph Panel
Circuit: Tuned compensated radio freq.
Batteries: Dry cell or storage

Antenna: Outdoor
Loud Speaker: With phonograph
Controls: Three
List Price: Not established.

Trade Name: Magnutrol Magnus Console
Circuit: Tuned compensated radio freq.
Batteries: Dry cell or storage

Antenna: Outdoor
Loud Speaker: Built-in
Controls: Three
List Price: \$150.00

Trade Name: Magnutrol Magnus Console with A & B Eliminators

Circuit: Tuned compensated radio freq.
Antenna: Outdoor
Loud Speaker: Built-in
Controls: Three
List Price: \$215.00

MEISSNER RADIO CORP.

34 25th St., Brooklyn, N. Y.

Trade Name: Meissner Elektrik

Circuit: Improved tuned radio frequency
Batteries: On A.C. current

Antenna: Indoor and outdoor
Loud Speaker: Built-in
Controls: Four
List Price: \$185.00

Trade Name: Diamond T

Circuit: Tuned radio frequency
Batteries: Storage
Antenna: Outdoor
Loud Speaker: Separate
Controls: Three
List Price: \$49.50

Trade Name: Diamond T

Circuit: Tuned radio frequency
Batteries: Storage
Antenna: Outdoor
Loud Speaker: Separate
Controls: Three
List Price: \$80.00

Trade Name: Diamond T

Circuit: Tuned radio frequency
Batteries: Storage
Antenna: Outdoor
Loud Speaker: Separate
Controls: Three
List Price: \$160.00

Trade Name: Diamond T

Circuit: Tuned radio frequency
Batteries: Storage
Antenna: Outdoor
Loud Speaker: Separate
Controls: Three
List Price: \$160.00

Trade Name: Diamond T

Circuit: Tuned radio frequency
Batteries: Storage
Antenna: Outdoor
Loud Speaker: Separate
Controls: Three
List Price: \$160.00

Trade Name: Diamond T

Circuit: Tuned radio frequency
Batteries: Storage
Antenna: Outdoor
Loud Speaker: Separate
Controls: Three
List Price: \$160.00

Trade Name: Diamond T

Circuit: Tuned radio frequency
Batteries: Storage
Antenna: Outdoor
Loud Speaker: Separate
Controls: Three
List Price: \$160.00

Trade Name: Diamond T

Circuit: Tuned radio frequency
Batteries: Storage
Antenna: Outdoor
Loud Speaker: Separate
Controls: Three
List Price: \$160.00

Trade Name: Diamond T

Circuit: Tuned radio frequency
Batteries: Storage
Antenna: Outdoor or indoor
Loud Speaker: Built-in
Controls: One to three
List Price: \$15.00 to \$35.50

MIDWEST RADIO CO.

410 E. Eighth St., Cincinnati, Ohio.

Trade Name: Miraco
Circuit: Tuned radio frequency

Batteries: Dry cell or storage

Antenna: Outdoor
Loud Speaker: Separate
Controls: Three
List Price: \$59.50

Trade Name: Murdock

Neutrodyne 100
Circuit: Neutrodyne

Batteries: Storage or dry cell
Antenna: Outdoor
Loud Speaker: Built-in
Controls: Three
List Price: \$100.00

Trade Name: Murdock

Neutrodyne 101
Circuit: Neutrodyne

Batteries: Storage or dry cell
Antenna: Outdoor
Loud Speaker: Separate
Controls: Three
List Price: \$92.50

MUSIC MASTER CORP.

128 North 10th St., Philadelphia, Pa.

Trade Name: Music Master Ware Type 50
Circuit: Neutrodyne

Batteries: Dry cell
Antenna: Outdoor
Loud Speaker: Separate
Controls: Two
List Price: \$50.00

Trade Name: Music

Master Type 60
Circuit: Tuned radio frequency

Batteries: Storage
Antenna: Outdoor
Loud Speaker: Separate
Controls: Three
List Price: \$60.00

Trade Name: Music

Master Type 100
Circuit: Tuned radio frequency

Batteries: Storage
Antenna: Outdoor
Loud Speaker: Separate
Controls: Three
List Price: \$100.00

Trade Name: Music

Master Type 140
Circuit: Tuned radio frequency

Batteries: Storage
Antenna: Outdoor
Loud Speaker: Separate
Controls: Two
List Price: \$140.00

Trade Name: Music

Master Type 175
Circuit: Tuned radio frequency

Batteries: Storage
Antenna: Outdoor
Loud Speaker: Built-in
Controls: Two
List Price: \$175.00

Trade Name: Music

Master Type 215
Circuit: Tuned radio frequency

Batteries: Storage
Antenna: Outdoor
Loud Speaker: Built-in
Controls: Two
List Price: \$215.00

Trade Name: Music

Master Ware 250
Circuit: Neutrodyne

Batteries: Storage
Antenna: Loop
Loud Speaker: Separate
Control: One
List Price: \$250.00

Trade Name: Music

Master Type 301
Circuit: Tuned radio frequency

Batteries: Storage
Antenna: Outdoor or indoor
Loud Speaker: Separate
Controls: Two
List Price: \$300.00

Insure your copy reaching you each month. Subscribe to Radio News—

\$2.50 a year. Experimenter Publishing Co., 53 Park Place, N. Y. C.

World Radio History

*A True
Musical
Instrument*

**A
BRISTOL
Loud Speaker
Will Bring
Everlasting
Christmas
Joy
To the
Whole
Family**



Model S—\$25.00

Rubber horn 14 1/2" in diameter. Black mat finish with silvered base decoration.

There are three other Bristol Models, Model "C," (The Cabinet) \$30, and horn types, Model J and Baby Grand at \$20 and \$15.

IT has all the volume you will ever wish, but its fine point—its outstanding claim for distinction—is its tone, a true clear natural reception of voice or instrumental music. This is because it is a true musical instrument, not merely a phone unit in a horn.

Bristol Loud Speakers have highly developed electromagnetic tone mechanisms, non-metallic horns, with long freely vibrating sound chambers.

Models S and C are equipped with the Super-Unit which contains a specially designed diaphragm of broad pitch range. It reproduces not only the low pitched notes, but the high as well.

If not at your dealer's, send for our new booklet "How To Select Your Loud Speaker."

THE BRISTOL COMPANY, Radio Division S, Waterbury, Conn.

Bristol TRADE MARK **AUDIOPHONE** REG. U.S. PAT. OFF. **Loud Speaker**



UNIVERSAL PLIO-6

The Only Set That Tunes All Wave Lengths.

35 TO 3600 METERS

3AR Melbourne 480—WGY 109—2FL Sydney 770—WKAQ San Juan 360—2BL Sydney 350—PCFF Amsterdam 2000—Karachi—Bombay—KOP—WGY 1560—6KW Tuinucu 340—Bankok—NSF Hilversum 1050—WLW—KDKA 64—KYW—5NO New Castle 400

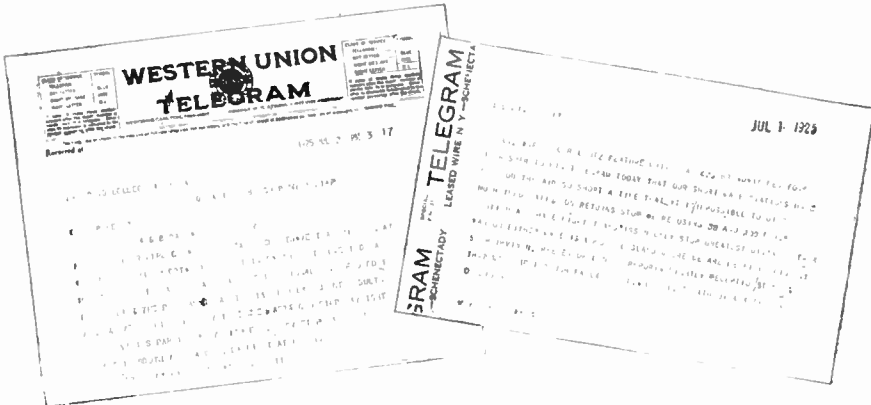

WOC—CYL Mexico City 510—2FC Sydney 1100—KFI—PA5 Amsterdam 1050—Vienna—Colombo—WWJ—WCX Lakehurst 80—ICE Rome 470—5PY Plymouth 330—Voxhaus 430—CNRC Calgary 440—Madras—Stuttgart 437—BAV Brussels 1100—6FL Sheffield 303—WGY 38—PCGG Hague 1050—Otchiski—KGW—CFAC 430—CHXC Ottawa—EBX Cartagena—NAA 2500—PCMM Ymuiden 1050—SBR Brussels 262—KHJ—LOX Palermo 375—OXE Lyngby 2400—KOA—2SB Sydney—OKP Kbely 1150—2BE Belfast 435—KGO—YN Lyons 470—I Nice 360—FL Eiffel Tower 2600—PTT Paris 450—5XX Chelmsford 1600—LZ Monte Grande 425—2LS Leeds 346—5MA Adelaide 850—2LO London 365—PWX Havana 400—RAS Vladivostok—WMBF—CJCM Mont Joli—LOR Buenos Aires 400—LP Berlin 2370—VTR Rangoon—3LO Melbourne 1720—6BM Bournemouth 385—5WA Cardiff 350—PRG Prague 1800—2ZY Manchester 375—HB2 Lausanne 850—JJC Funabashi—JSB Chemulpo—3FL Melbourne 400—6VL Liverpool 318—HBI Geneva 1100—KDKA 64—POZ Berlin 2800—2EH Edinburgh 325—5IT Birmingham 475—Munich 485—Leipzig 452—2BD Aberdeen 495.



THE NEW UNIVERSAL PLIO-6

Six tube, 2 Stages Non-Regenerative Tuned Radio Frequency Amplification. Detector and 3 Stages Distortionless Radio Amplification. Receiving range from 1,000 to 12,000 miles depending upon location, station transmitting, wave-length received and other variable factors.

FULL DETAILS NOW AVAILABLE FROM MANUFACTURERS

GOLDEN-LEUTZ INC.

476 BROADWAY :: NEW YORK CITY

Manufactured under Hogan Patent 1,014,002—Other Patents Pending CABLES "EXPERINFO" NEW YORK

TRY ATOMITE

BEFORE PLACING YOUR SEASON'S ORDER

TOP NOTCH

Reception Guaranteed at Every Point

MOST ATTRACTIVE AND BEST PRESENTED CRYSTAL

Dealers Send Trial Order or by Mail 50c

KEYSTONE PRODUCTS CO
304 Gardenia Ave.,
ROYAL OAK, MICH.



M & M Low Loss INSULATORS

Perfect your entire installation by insulating your antenna-ground system. Your set is not responsible for energy lost thru a poorly insulated aerial. Use M & M Low Loss Lead-In and Wall Insulators.

1" Lead-In Insulators 50
20" Lead-In Insulators 80
3" Wall Insulators \$1.50

Dealers: If your jobber can not supply you write us direct, giving us your jobber's name. Send for our catalog.

The M & M Co.
CLEVELAND, OHIO

Trade Name: Music Master 400
Circuit: Tuned radio frequency
Batteries: "A" & "B" eliminator
Antenna: Outdoor or indoor
Loud Speaker: Built-in
Controls: Two
List Price: \$400.00

Trade Name: Music Master Ware 460
Circuit: Neutrodyne
Batteries: Storage
Antenna: Loop
Loud Speaker: Built-in
Control: One
List Price: \$460.00

MUSICAL PRODUCTIONS DISTRIBUTING CO.
22 West 19th St.,
New York City.
Trade Name: Radio-Art Model No. 210
Circuit: Tuned radio frequency
Batteries: Storage
Antenna: Outdoor
Loud Speaker: Built-in
Controls: Three
List Price: \$95.00

REICHMANN CO.,
1725 West 74th St.,
Chicago, Ill.
Trade Name: No. 55 Thorola Isodyne
Circuit: Straight line frequency
Batteries: Dry cell or storage
Antenna: Loop and outdoor
Loud Speaker: Separate
Controls: Three
List Price: \$115.00

Trade Name: No. 50 Thorola Isodyne
Circuit: Straight line frequency
Batteries: Dry cell or storage
Antenna: Loop and outdoor
Loud Speaker: Separate
Controls: Three
List Price: \$85.00

RICH. GEORGE H.,
S. E. Cor. 18th St. and Dauphin St.,
Philadelphia, Pa.
Trade Name: Rich Reflex Model 3-T-22
Circuit: Special Reflex
Batteries: Dry cell or storage
Antenna: Outdoor
Loud Speaker: Separate
Controls: Three
List Price: \$50.00

Trade Name: Rich Model 5
Circuit: Tuned radio frequency
Batteries: Storage or dry cell
Antenna: Outdoor or indoor
Loud Speaker: Separate
Controls: Three
List Price: \$60.00

Trade Name: Rich Model 4
Circuit: Special
Batteries: Storage or dry cell
Antenna: Outdoor or indoor
Loud Speaker: Separate
Controls: Two
List Price: \$55.00

Trade Name: Rich Model 3
Circuit: Special Reflex
Batteries: Storage or dry cell
Antenna: Outdoor
Loud Speaker: Separate
Controls: Three
List Price: \$60.00

Trade Name: Rich Custom Built 5
Circuit: Special tuned radio frequency
Batteries: Storage or dry cell
Antenna: Outdoor
Loud Speaker: Built-in
Controls: Three
List Price: \$250.00

Trade Name: Rich Custom Built—The Dragon
Circuit: Special
Batteries: Storage or dry cell
Antenna: Outdoor
Loud Speaker: Built-in
Controls: Two
List Price: \$225.00

STEWART-WARNER SPEEDOMETER CORP.,
1825 Diversey Parkway,
Chicago, Ill.
Trade Name: Stewart-Warner Model 300
Circuit: Tuned radio frequency
Batteries: Storage
Antenna: Indoor or outdoor
Loud Speaker: Separate
Controls: Three
List Price: \$65.00

Trade Name: Stewart Warner Model 300-A
Circuit: Tuned radio frequency
Batteries: Dry cell
Antenna: Indoor or outdoor
Loud Speaker: Separate
Controls: Three
List Price: \$65.00

Trade Name: Stewart Warner Model 305
Circuit: Tuned radio frequency
Batteries: Storage
Antenna: Indoor or outdoor
Loud Speaker: Separate
Controls: Three
List Price: \$115.00

Trade Name: Stewart Warner Model 325
Circuit: Tuned radio frequency
Batteries: Storage
Antenna: Indoor or outdoor
Loud Speaker: Separate
Controls: Three
List Price: \$80.00

Trade Name: Stewart Warner Model 310
Circuit: Tuned radio frequency
Batteries: Storage
Antenna: Indoor or outdoor
Loud Speaker: Built-in
Controls: Three
List Price: \$175.00

Trade Name: Stewart Warner Model 315
Circuit: Tuned radio frequency
Batteries: Storage
Antenna: Indoor or outdoor
Loud Speaker: Built-in
Controls: Three
List Price: \$285.00

Trade Name: Stewart Warner Model 320 Console
Circuit: Tuned radio frequency
Batteries: Storage
Antenna: Indoor or outdoor
Loud Speaker: Built-in
Controls: Three
List Price: \$450.00

UNITED METAL STAMPING & RADIO CO.,
410 East Pearl St.,
Cincinnati, Ohio
Trade Name: Para-flex 1
Circuit: Reflex
Batteries: Dry cell and storage
Antenna: Outdoor
Loud Speaker: Separate
Controls: Two
List Price: \$35.00

Trade Name: Para-flex 2
Circuit: Reflex
Batteries: Dry cell and storage
Antenna: Outdoor
Loud Speaker: Separate
Controls: Two
List Price: \$45.00

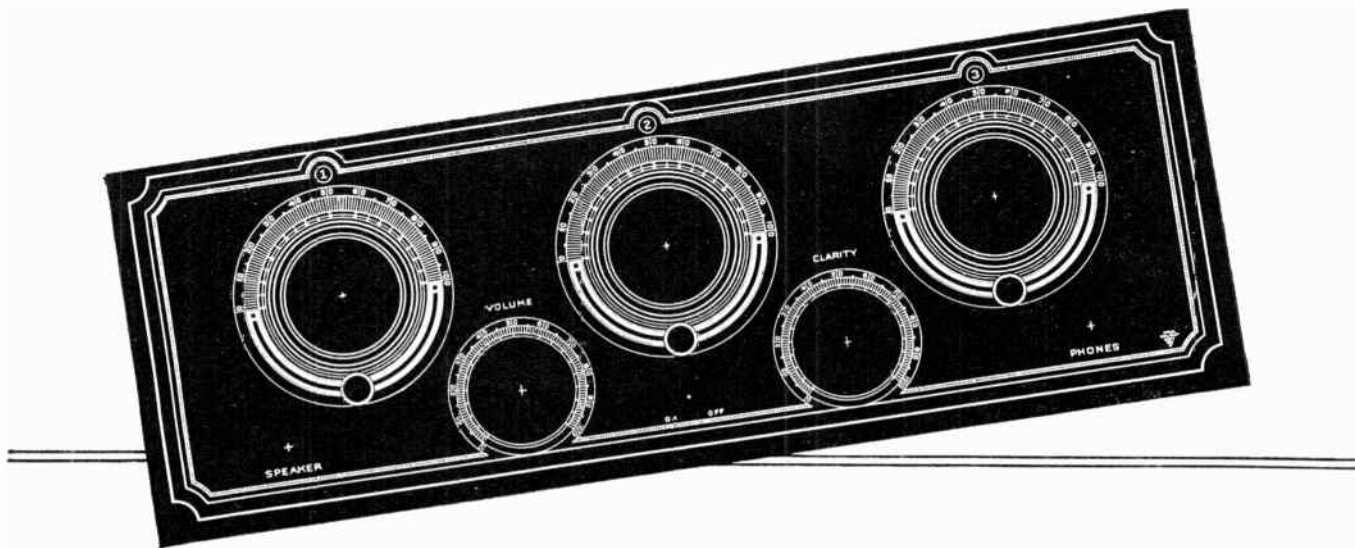

Exceptional Technical Resources Alone Make Formica Possible

THE exceptionally fine finish, remarkable uniformity, and evenly maintained quality of Formica over many years are due to the first rate technical resources which the Formica Insulation Company has concentrated on its work.

The Formica laboratories have been leaders in developing the material, and the largest producing equipment in the country has given first rate service to manufacturing and trade users of radio panels and insulation.

Formica has not only the largest organization in the world devoted to this product, but it is an organization that concentrates all its attention on just one thing.

Formica panels for home set builders, in gloss black, dull black, walnut and mahogany are packed in neat craft paper envelopes and sold by leading dealers everywhere.

Insist on Formica and build your set for permanence.

VERI-CHROME PANELS

By the purchase of a controlling interest in the Veri-Chrome laboratories, the financial and production resources of the Formica Insulation Company have been placed behind this remarkable new process for decorating radio panels. Elaborate decorations can be produced much more rapidly and more economically than by engraving. Decorations designed by the leading American artists are offered. Tuning scales may be marked directly on the panel eliminating the standard dial and substituting pointers instead. The reduction in cost is large. Write for prices on complete panels finished in this way in quantity.

THE FORMICA INSULATION COMPANY
4618 Spring Grove Avenue, Cincinnati, Ohio

- 1 Formica is used by nearly all the leading set makers — and has for years been used by more set makers than any other material.
- 2 Formica is unaffected by weather and time — it lasts forever.
- 3 Formica in appearance is the finest of all panel materials and always remains so.
- 4 Formica's electrical qualities of every kind far exceed any possible requirement.
- 5 Formica has high mechanical strength and will not break in use.
- 6 Formica will not sag from heat or cold flow under pressure. It retains its dimensions. Everything you fasten to it stays tight and precisely where you put it.
- 7 Formica panels are sold in neat craft paper envelopes which assure you that you are getting the genuine.
- 8 Formica is one of the most widely approved materials in radio.

SALES OFFICES

New York	50 Church St.	Pittsburgh.....	422 First Ave.
Chicago	9 S. Clinton St.	San Francisco.....	585 Mission St.
Cleveland	516 Caxton Bldg.	Philadelphia.....	725 Bulletin Bldg.
Rochester.....	327 Cutler Bldg.	Baltimore.....	709 Title Bldg.
Toledo.....	419 Ohio Bldg.	Habana, Cuba.....	55 Calle Obispo
Minneapolis.....	1026 Second Ave. S.	Boston.....	6 Beacon St.
New Orleans.....	Whitney Central Bldg.	Denver.....	1420 16th St.
		St. Louis.....	1362 Syndicate Trust Bldg.

FORMICA

Made from Anhydrous Bakelite Resins

SHEETS TUBES RODS

Hear the Formica Orchestra over WLW every Tuesday evening from 9 to 10 Central Standard Time.

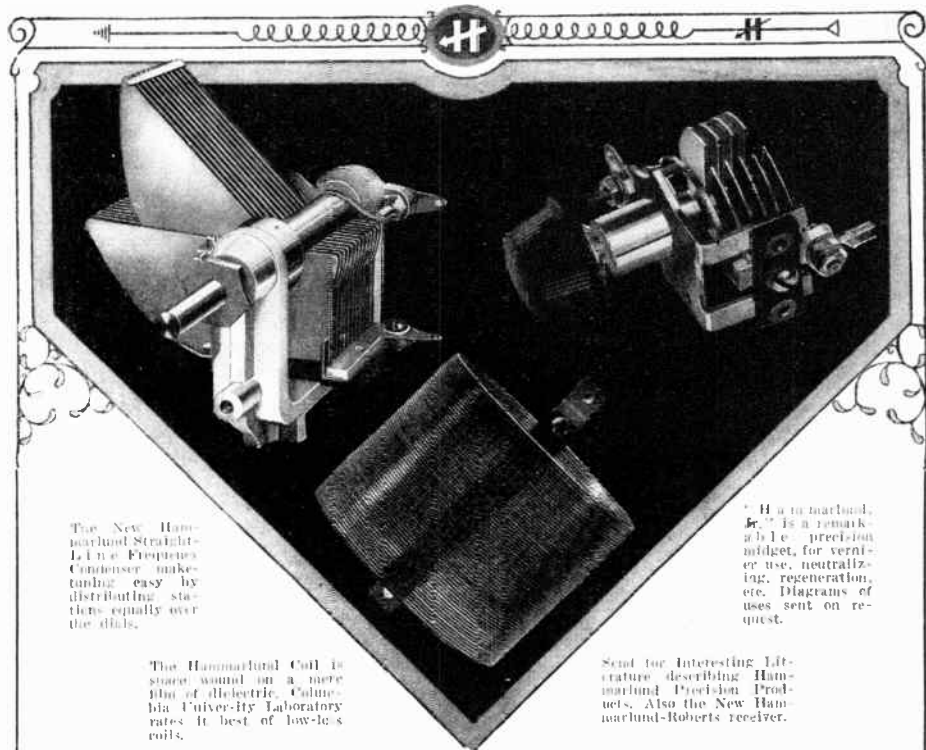

The New Hammarlund Straight-Line Frequency Condenser makes tuning easy by distributing stations equally over the dial.

The Hammarlund Coil is square wound on a new film of dielectric. Columbia University Laboratory rates it best of low-loss coils.

The Hammarlund H.P. is a remarkable little precision midset, for verter use, neutralizing, regeneration, etc. Diagrams of uses sent on request.

Send for interesting literature describing Hammarlund Precision Products. Also the New Hammarlund-Roberts Receiver.

They Will Improve Your Reception

The day of perfection in radio will arrive when set builders discover that quality results can come only from quality parts.

Don't make the mistake of constructing your receiver from poor parts and then complain that radio has not yet been perfected.

These Manufacturers Use Hammarlund Products

- DeForest Radio
- Eagle Radio Co.
- J. B. Ferguson, Inc.
- Madame-Lenson Corp.
- Music Master Corp.
- Press Radio Corp.
- Sleeper Radio Corp.
- Stamwood Electric Co.
- Phenix Radio Corp.
- and many others

Hammarlund Precision instruments for telephone, telegraph and radio use for fifteen years.

Hammarlund Precision Condensers and Coils are acclaimed the world over by engineers and radio amateurs, who have learned the lesson of quality.

HAMMARLUND MANUFACTURING COMPANY

424-438 W. 33rd Street

New York City

For Better Radio Hammarlund PRECISION PRODUCTS

Potter BY-PASS CONDENSERS

- Prevent "B" voltage fluctuation
- Allow undistorted amplification
- Make possible full bass tones
- Improve reception with "B" Supply Units.

Made in $\frac{1}{10}, \frac{1}{5}, \frac{1}{2}, 1, 2, 3$ and 4 Microfarad sizes

At Your Dealer's

POTTER MANUFACTURING COMPANY
North Chicago, Illinois



Popular Prices — Remarkable Results

No better loops at any price. Quantity production keeps prices low. Handsome, convenient and efficient.
LINCOLN 4-POINT TAPPED LOOP . . . \$8.00
 Built for any circuit where it is desired to vary the inductance of the loop. Exceptionally fine for Superhets.
LINCOLN CENTER-TAPPED LOOP . . . \$6.50
 For any set employing radio frequency amplification. For certain Superhets requiring a center tap. If your dealer cannot supply you, order direct, giving your dealer's name. Write for illustrated catalog: RN.
LINCOLN RADIO CORPORATION, 224 N. Wells St., Chicago

Trade Name: Paraflex 3
 Circuit: Reflex
 Batteries: Dry cell and storage
 Antenna: Outdoor
 Loud Speaker: Separate
 Controls: Three
 List Price: \$70.00
 * * *

Trade Name: Flynn Six
 Circuit: Standard tuned radio frequency
 Batteries: Dry cell and storage
 Antenna: Loop
 Loud Speaker: Separate
 Controls: Four
 List Price: \$120.00
 * * *

Trade Name: Flynn Five
 Circuit: Standard tuned radio frequency
 Batteries: Dry cell and storage
 Antenna: Outdoor or indoor
 Loud Speaker: None
 Controls: Three
 List Price: \$90.00
 * * *

U-S-L RADIO, Inc.,
 Niagara Falls, N. Y.
 Trade Name: U S L Broadcast Receiver
 Circuit: Tuned radio frequency with resistance coupled amplification
 Batteries: Storage or dry cell
 Antenna: Outdoor best
 Loud Speaker: Separate
 Controls: Two
 List Price: \$80.00;
 West of the Rockies \$85.00
 * * *

WORK-RITE MFG. CO.,
 1812 East 30th St.,
 Cleveland, Ohio
 Trade Name: Work-Rite Winner Five
 Circuit: Neutrodyne
 Batteries: Dry cell or storage
 Antenna: Outdoor
 Loud Speaker: Separate
 Controls: Three
 List Price: \$80.00
 * * *

Trade Name: Work-Rite Winner Six
 Circuit: Neutrodyne
 Batteries: Dry cell or storage
 Antenna: Outdoor
 Loud Speaker: Separate
 Controls: Three
 List Price: \$90.00
 * * *

Trade Name: Work-Rite Air Master Five
 Circuit: Neutrodyne
 List Price: \$87.75
 (To Be Continued)

Batteries: Dry cell or storage
 Antenna: Outdoor
 Loud Speaker: Separate
 Controls: Three
 List Price: \$120.00
 * * *

Trade Name: Work-Rite Air Master Six
 Circuit: Neutrodyne
 Batteries: Dry cell or storage
 Antenna: Outdoor
 Loud Speaker: Separate
 Controls: Three
 List Price: \$125.00
 * * *

Trade Name: Work-Rite Radio King Six
 Circuit: Neutrodyne
 Batteries: Dry cell or storage
 Antenna: Outdoor
 Loud Speaker: Built-in
 Controls: Three
 List Price: \$170.00
 * * *

Trade Name: Work-Rite Aristocrat Six
 Circuit: Neutrodyne
 Batteries: Storage or dry cell
 Antenna: Outdoor
 Loud Speaker: Built-in
 Controls: Three
 List Price: \$275.00
 * * *

WRIGHT RADIO MFG. CO.,
 1466 Selby Ave.,
 St. Paul, Minn.
 Trade Name: Wright De Coster Model VI C
 Circuit: Radio frequency
 Batteries: Dry cell
 Antenna: Outdoor
 Loud Speaker: Built-in
 Controls: Two
 List Price: \$250.00
 * * *

Trade Name: Wright De Coster Model VI C
 Circuit: Radio frequency
 Batteries: Dry cell
 Antenna: Outdoor
 Loud Speaker: Separate
 Controls: Two
 List Price: \$125.00
 * * *

Trade Name: Wright De Coster Annie Special
 Circuit: Radio frequency
 Batteries: Dry cell
 Antenna: Outdoor
 Loud Speaker: Separate
 Controls: Two
 List Price: \$23.00
 * * *

X-L RADIO CO.,
 1623 S. Vermont Ave.,
 Los Angeles, Calif.
 Trade Name: X-L Three Way Radio
 Circuit: Crystal
 Antenna: Outdoor
 Control: One
 List Price: \$8.75
 * * *

The Radio Lighthouse

(Continued from page 779)

spaced a quarter wave-length from the plane of the energized antennae.

The antenna structure is so arranged that it rotates continuously at a uniform speed and sends out distinctive signals indicating the direction in which the antenna is pointing at that moment. These signals are transmitted automatically by means of contacts that are mounted on the large ring attached to the traveling structure. These contacts operate a mechanism as the structure revolves and in this way the transmitter is automatically keyed.

The reception of these signals is a more or less simple matter. The receiving set can be permanently tuned to the wave-length of the "lighthouse" and as the signals consist of single Morse letters sent at the rate of about ten words per minute, there is need for only a fundamental acquaintance with radio.

Insure your copy reaching you each month. Subscribe to Radio News—
 \$2.50 a year. Experimenter Publishing Co., 53 Park Place, N. Y. C.

Simplify and improve radio reception with Balkite Radio Power Units

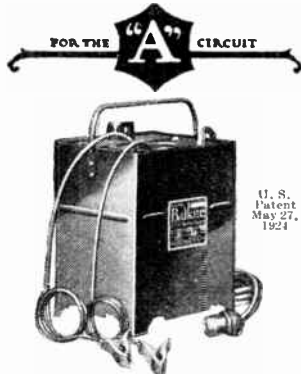

U. S. Patent May 27, 1924

Balkite Battery Charger

This popular battery charger is entirely noiseless and can be used while the radio set is in operation. If your battery should be low you merely turn on the charger and operate the set. Charging rate 2.5 amperes. Operates from 110-120 AC 60 cycle current. Special model for 50 cycles. Also for 25-40 cycles with 1.5 ampere charging rate.

Price \$19.50
West of Rockies, \$20
In Canada, \$27.50



U. S. Patent May 27, 1924

Balkite Trickle Charger

Charges both 4 and 6 volt radio "A" batteries at about .5 amperes. Usable in 3 ways: (1) As a regular charger with a low capacity storage battery for sets now using dry cells. (2) With storage battery sets of few tubes. Furnishes more current than used by 6 dry cell or 2 storage battery tubes, so that if used during operation it need be used at no other time. (3) As a "trickle" or continuous charger for sets of as many as 8 dry cell or storage battery tubes. Size 5 1/4 in. long, 2 3/4 in. wide, 5 in. high. Operates from 110-120 AC 60 cycle current. Special model for 50 cycles.

Low capacity batteries especially adapted for use with this charger with sets now using dry cells are being offered by practically all leading battery manufacturers this fall.

Reputable manufacturers are also offering this fall for use with this charger special switches which turn on Balkite "B" and turn off the charger when you turn on your set. This makes the current supply for both "A" and "B" circuits automatic in operation.

Price \$10
West of Rockies, \$10.50
In Canada, \$15

Balkite Radio Power Units simplify and improve radio reception. They reduce the amount of attention you must give your set. With their use your current supply is always exactly what is required for each circuit.

For the "A" circuit there are the Balkite Chargers. The advantages of the popular Balkite Battery Charger are obvious. Entirely noiseless, it can be used while the set is in operation.

For sets of smaller "A" current requirements—any dry cell set or storage battery sets of few tubes—there is the Balkite Trickle Charger. With a low capacity storage battery it enables owners of sets now using dry cells to make a most economical installation.

For the "B" circuit there is Balkite "B"—the outstanding development in radio. It eliminates "B" batteries entirely and supplies plate current from the light socket. It is especially designed to serve sets of 6 tubes or less. For sets of 6 tubes or more there is Balkite "B" II, the same popular model offered last year.

Noiseless—No bulbs—Permanent

All Balkite Radio Power Units are based on the same principle. All are entirely noiseless in operation. They have no moving parts, no bulbs, and nothing to adjust, break or get out of order. They cannot deteriorate through use or disuse—each is a permanent piece of equipment with nothing to wear out or replace. They require no other attention than the infrequent addition of water. They do not interfere with your set or your neighbor's. Their current consumption is remarkably low. They require no changes or additions to your set.

An "A" battery, a Balkite Charger and a Balkite "B" constitute a complete, trouble-free radio power equipment, one that is economical, unflinching in operation, and eliminates the possibility of run-down batteries.

Manufactured by FANSTEEL PRODUCTS COMPANY, Inc.
North Chicago, Illinois

FANSTEEL Balkite Radio Power Units

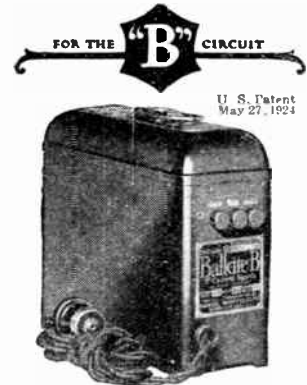

U. S. Patent May 27, 1924

Balkite "B"

Eliminates "B" batteries. Supplies plate current from the light socket. Operates with either storage battery or dry cell tubes. Keeps "B" circuit always operating at maximum efficiency, for with its use the plate current supply is never low. Requires no changes or additions to your set. No bulbs—nothing to replace. Requires no attention other than adding water twice a year.

A new model, designed to serve any set requiring not more than 20 milliamperes at 90 volts—practically all sets of 5 tubes or less and most 6 tube sets. Size 8 1/4 in. long, 8 in. high, 3 1/4 in. wide. Occupies about same space as 45 volt dry "B" battery. Operates from 110-120 AC 60 cycle current. Special model for 50 cycles.

Price \$35
In Canada, \$49.50



U. S. Patent May 27, 1924

Balkite "B" II

The most outstanding development in radio last season. Same as the new Balkite "B" but will fit any set including those of 8 tubes or more. Current capacity 40 milliamperes at 90 volts. Size 9 in. high, 6 1/4 in. wide, 7 1/2 in. deep. Operates from 110-120 AC 60 cycle current. Special model for 50 cycles.

Price \$55
In Canada, \$75

The Unipower, manufactured by the Gould Storage Battery Company, is equipped with a special Balkite Radio Power Unit.

BALKITE BATTERY CHARGER • BALKITE TRICKLE CHARGER • BALKITE "B" • BALKITE "B" II

ALL BALKITE RADIO POWER UNITS ARE TESTED AND LISTED AS STANDARD BY THE UNDERWRITERS' LABORATORIES



You, Too, Can Wave the Magic Wand!

Benjamin Super Radio Parts have taken all uncertainty and chance out of radio reception. With seeming magic they bring amazing volume and tonal perfection, without disturbances, distortions or radio losses, with increase in selectivity and ease in tuning.

Benjamin Electric Mfg. Co.

120-128 S. Sangamon St., Chicago
247 W. 17th St. New York
448 Bryant St. San Francisco

Manufactured in Canada by the Benjamin Electric Mfg. Co. of Canada, Ltd., Toronto, Ontario

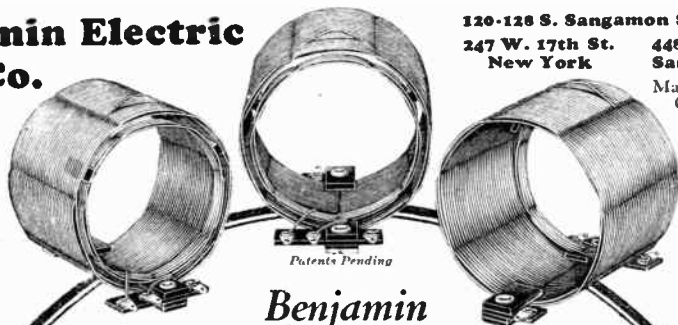

Patents Pending

Benjamin Tuned Radio Frequency Transformers

Even in what has been considered an excellent set, it is astonishing what an improvement in tone, quality, volume and selectivity the introduction of these coils produces. Low Resistance. Low Distributed Capacity. Space wound, air core; double green silk insulation — the nearest approach to an all-air dielectric construction and the highest type of inductance possible.

Benjamin Cle-Ra-Tone Sockets

Benjamin Cle-Ra-Tone Sockets prevent the transmission of outside vibrations into microphonic disturbances. Four delicately adjusted double springs support the socket — "float" it above the base — and absorb all jars and shocks. No rubber parts to deteriorate. Bakelite is used wherever possible to insure sturdiness, long life and high insulation.

Handy lugs make soldering easy. Furnished also in gangs on Bakelite sub-panels for compact set building.



SPRING SUSPENDED SHOCK ABSORBING

Patented

Benjamin Low Loss, Long Range Condensers

First of all a wonderful low loss condenser. The shape of the rotor blades eliminates bunching of stations on the lower side of the dial and makes tuning very easy. Unpolished silver plate finish. Friction disc on rotor shaft adjusts turning tension without loosening or throwing plates out of alignment. Made in three sizes:

13 plate for .00025 Mfd., 17 plate for .00035 Mfd., and 25 plate for .0005 Mfd. Drilling template furnished with each condenser.

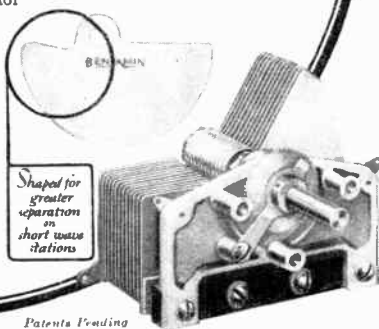

Shaped for greater separation on short wave stations

Patents Pending

Transatlantic Radio Telephony

(Continued from page 791)

receiving method, therefore, enables the filter circuit, and also the intermediate frequency amplifier, to be designed for maximum efficiency at fixed frequency values without sacrificing the frequency flexibility of the receiving set.

Although this system was used for the reception of signals in London, it is quite possible to receive the single-side-band transmission by means of a regular heterodyne receiving set. Even a self-regenerative set will suffice under certain conditions. It is necessary to adjust the frequency of the oscillator very carefully to that of the transmitter, otherwise serious distortion of the received speech will result. Also it is necessary that the tuning be not too sharp if ordinary tuned circuits, and not filter circuits, are employed.

It might be expected that some difficulty would be experienced in maintaining the frequency at the receiving end in sufficiently close agreement with the sending frequency. In the tests no particular difficulty was found, the oscillators at the two ends being so stable that only a slight readjustment of the receiving oscillator was required. With the development of more stable oscillators, doubtless the frequency with which readjustments are required will be further reduced. If serious distortion of the received speech is to be avoided, the two frequencies must be within about 50 cycles, an accuracy of 0.1 per cent. at 50,000 cycles.



One of the high-power water-cooled vacuum tubes is shown at the left. The plate of the tube is the metal cylinder at the bottom, from which the heat is dissipated by the cooling water.

TRANSMISSION ADVANTAGES OF THE SYSTEM

The importance of the system in conserving frequency range will be appreciated, when it is realized that the total frequency range available for transatlantic telephony is limited. Just what the most suitable range is has not yet been determined, but it seems limited to below 60,000 cycles (5,000 meters) because of the large attenuation suffered during the daylight hours by frequencies higher than this. On the lower end of the frequency scale, transatlantic telegraphy at present fairly well preempts frequencies below 30,000 cycles (10,000 meters). Therefore, for the present at least, transatlantic telephony is limited to a range of some 30,000 cycles. Now transmission of speech requires as a minimum for good quality a single side band 3,000 cycles wide. Allowing for variations and clearances between channels it is doubtful if the channels could be made to average closer than one every 4,000 cycles for single side band transmission and one every 7,000 cycles for the ordinary

Millions Want This Set!

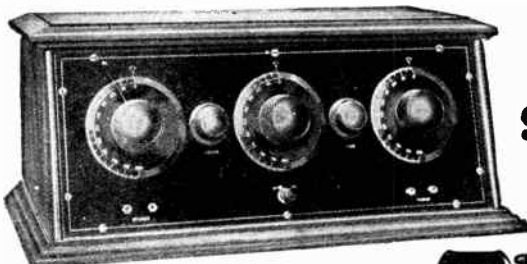

List Price

\$45.00

New 5-Tube TREGO

Coast to Coast Range. Here's the set that sells and satisfies! It's the TREGO 5-Tube Tuned Radio Frequency Set—highest quality at a price within the reach of all. Retail at only \$45.00. Gives you Big Profits. Sell 10 to 1 over high priced sets. Millions want it! Storage or dry-cell operation. Backed by our IRON-

CLAD GUARANTEE. Sold only through dealers. Send for Monthly Catalog and exclusive dealer plan. This TREGO TRF5 is only one of the hundreds of profitable, quick-selling items listed — just off the press. Get your copy now — cash in on the fall and winter radio demand.

TREGO RADIO MANUFACTURING COMPANY

Manufacturers and Wholesale Distributors

1427 Chestnut Street,

KANSAS CITY, MISSOURI

Insure your copy reaching you each month. Subscribe to Radio News \$2.50 a year
Experimenter Publishing Co., 53 Park Place, N. Y. C.



Radio Receiver



This new principle of radio is exclusive in the Valleytone

Appearance

The Valleytone is mounted in a solid walnut cabinet, finished in two tones with inlaid gold stripes. It may also be procured in beautiful console models. Special Valley tables with built-in loud speaker may be obtained for the cabinet model.

Valleytone Console Model

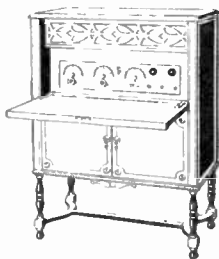

Valley table with built-in loud speaker

Set the dials of a Valleytone for any station you choose. Bring in the signals strong and clear.

Then turn the dials one point beyond or back from the correct tuning. You merely diminish volume. The quality of the signals remains the same. There is no incoherent babble of noises.

Turn the dials two or three points either way from the correct tuning. Your program is gone.

Such tuning is possible only in the Valleytone. It is due to the *potential balance* method of preventing distortion and oscillation. . . a new principle for radio which is exclusive in the Valleytone 5-Tube Radio Receiving Set.

The *potential balance* gives a balanced tone to the Valleytone. The results are an amazing clearness and naturalness of reproduction. If you have never heard the Valleytone, a new experience in radio reception awaits you.

The *Valley Toroidal Coils* make possible a selectivity not previously achieved. Stations four or five meters apart can be brought in clearly and distinctly one after the other whether they are distant or local stations.

Before you buy a radio, hear the Valleytone. Judge it by results. Avoid regrets later by listening to the Valleytone now. Any authorized dealer will be glad to demonstrate the Valleytone for you.

VALLEYELECTRIC COMPANY, Radio Division, ST. LOUIS, U.S.A.

Branches in Principal Cities

Valleytone Receiving Sets

Valley Battery Chargers

Valley B-Eliminators

Valley Electric

On to Success in RADIO!



Mr. R. L. Duncan
Director of the
Radio Institute
of America

RADIO is a profession well worth following. The work is interesting—fascinating. The pay is high. The demand for new men—skilled men—is strong.

You can embark, right now, on a successful career in radio. With a few months study under the expert instruction of the Radio Institute of America you can pass your U.S. Government Commercial or Amateur Radio License Examination and be ready for your first real radio job.

Study in spare time

There's no need to give up your present work. Study at home in spare time. If you really want to make a success in radio, fill in and mail the coupon to the Radio Institute of America for information on the finest theoretical and practical radio courses offered today.

RADIO INSTITUTE OF AMERICA
Formerly Marconi Institute. Established in 1909
324 Broadway New York City

RADIO INSTITUTE OF AMERICA
324 Broadway, New York City
Please send me full information about your Home Study Course of Radio Instruction.
I am interested in the complete course, including code instruction, which qualifies for the U. S. Government Commercial or Amateur Radio License.

Name _____
Address _____

double side band transmission. This means that even if the whole range from 30,000 to 60,000 cycles were devoted to telephony to the exclusion of telegraphy, only about four channels could be obtained by the older methods and some seven by the present one.

The second of the outstanding characteristics of the system lies in the large power economy it permits. Transatlantic telephony requires hundreds of kilowatts of high frequency power. Since it is difficult and expensive to produce this power, it is important that every effort be made to increase its efficiency of effectiveness in transmitting the voice. To illustrate how the present system effects economy in power, consider the case of a carrier wave completely modulated by



A monitor is in charge of the signals as they go from the land line to the radio link in the transatlantic chain.

a single frequency tone. In such a completely modulated wave, only one-third of the total power contains the message, the remaining two-thirds conveying only the carrier frequency which can as well be supplied from an oscillator of small power at the receiving station. It is obvious, therefore, that by eliminating the carrier only one-third as much power need be used as would be required were all the elements of the completely modulated wave transmitted. To realize the maximum advantage of this mode of operation, the system eliminates the carrier at low power and, thereby, the high power apparatus is devoted exclusively to the amplification of the essential part of the signal.

If, after suppressing the carrier, both side bands were transmitted, their reception would require perfect synchronism between the carrier resupplied at the receiving end and that eliminated at the sending end, a condition which is practically impossible to meet without transmitting some form of synchronizing channel, which is, indeed, much the same as transmitting the carrier itself. If the receiving carrier is not synchronized, the two side bands will interfere with each other upon being detected. By eliminating one side band, this interference is prevented and reception may be carried on with a locally supplied frequency which is only approximately equal to that of the suppressed carrier. The two may differ by as much as 50 cycles before the quality of the received speech is greatly impaired. The importance to the carrier suppression method of eliminating one side band will, therefore,

STANDARD ADJUSTABLE AERIAL BASES

Fits any pitch of roof.

Eliminates unsightly aerial.

No wind resistance.

Fitted for 1/2" or 3/4" Standard Water Pipe.

Insist on your aerial being installed with these new Standard Aerial Bases. Get the best and the cheapest at the same time.

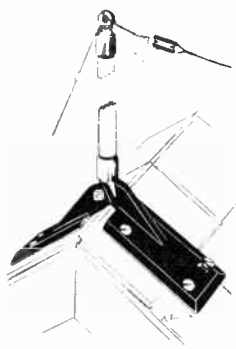

Pat. Pend.

Absolutely protects your building from lightning.

Lasts a life time.

Will not blow down.

Price \$2.00

STANDARD AERIAL BASE CO., 227 W. 2nd St., POMONA, CALIF.



\$25

West of Rockies, \$26.50
In Canada, \$35

The SAAL

Soft SPEAKER

with the Bakelite Bell

SAAL Jr.

The same in every respect as the Saal Soft Speaker except it measures 18½ instead of 21½ inches in height.

\$20 West of Rockies, \$21
In Canada, \$27.50

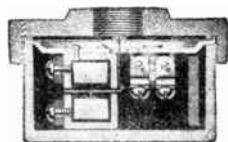

The Saal Soft Speaker Unit has no springs, no rubber gaskets, nothing to deteriorate. The diaphragm is connected to the armature by a pin, which pushes and pulls the diaphragm. The action is extremely precise, reproducing all consonants and overtones, yet the unit can't get out of order. This unit is used as standard in built-in reproducers by many leading radio manufacturers.

THE bell of the Saal Soft Speaker is of genuine Bakelite, the most perfect and resonant of all radio materials. The neck is of aluminum. There is no wood, no tin, no composition. The reproducing unit is of all-metal construction and cannot be harmed or "blasted" by the loudest receiver. It maintains its tone with any volume. There is no adjustment knob to complicate tuning.

When you buy the Saal Soft Speaker you buy once and for all. You buy a radio reproducer built to last a lifetime, one that will render permanent service and stand up under constant usage. It has nothing to deteriorate or wear out.

In buying the Saal you do not choose between volume and tone quality. It combines volume with a velvet tone. It is not a fad. It is not a trumpet. It is a faithful reproducer of radio programs, properly constructed and shaped for the accurate reproduction of sound. It removes the objection to loud speakers. It has no blare, no blast, no metallic ring.

In appearance the Saal, with its black bell, black crackle throat and graceful lines is the aristocrat of horns. Also furnished with a brown bell and gold or silver stippled throat at \$5 extra. It is guaranteed to give you satisfaction. Hear it at your dealer's today.

SAAL *Soft* SPEAKER

VOLUME WITH TONE QUALITY

Manufactured and guaranteed by H. G. SAAL COMPANY, 1800 Montrose Ave., Chicago, Ill.

Why Take It Out in Envy?

Why not *get* the stations your friends say they are getting?

The Key to long range reception is

AERO-LOOP

Used with—or without—outside antennae.

Ask your dealer. If he hasn't stocked it yet, we will ship direct, express prepaid. Specify set with which it is to be used and send dealer's name.

Write for 12-page Descriptive Diagrammatic Aero-Loop Booklet. Your copy free.

SCOTT SALES COMPANY
National Distributors

443 South San Pedro St.
Los Angeles, Calif.

Ut-Williams Electrical Products Co.
Santa Ana, Calif.

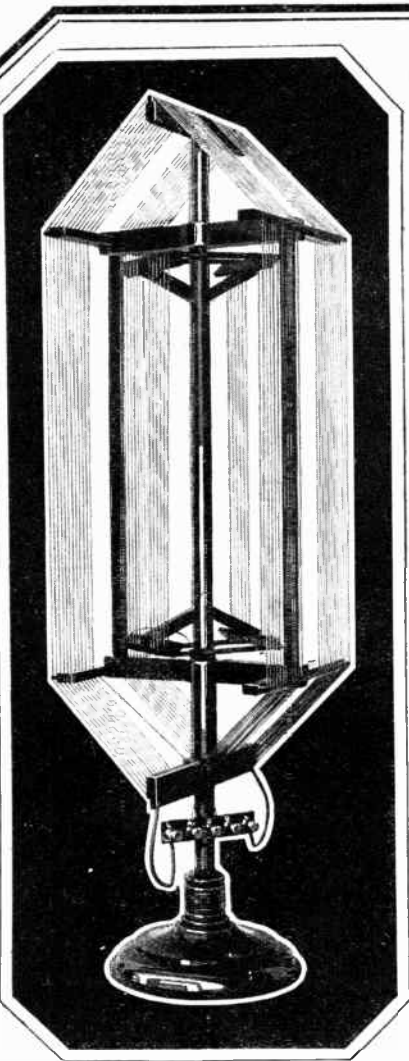

\$12.50

Beautifully finished in mahogany.
Dimensions 50 in. x 8 x 7 in.

Approved, Endorsed, Recommended! THE CARBORUNDUM DETECTOR

Eminent radio engineers, radio authorities and writers have given unstinted praise to the Carborundum Detector for reflex and crystal sets:

The Carborundum Detector has earned their compliments because.

It is the one detector made with a Carborundum specially developed for radio purposes.

This detector is fixed permanent—No cat's whisker nuisance.

It sharpens the tuning, increases volume and selectivity, brings in true, clear tones.

It is highly sensitive yet rugged. It won't burn out.

The Carborundum Detector is guaranteed.

THE CARBORUNDUM COMPANY
NIAGARA FALLS, N. Y.



\$1.50

IN U.S.A.

From Dealers or Direct



be appreciated. The present system eliminates one side band while still in the low power stage. While it would be possible to do this selecting after they have both been raised to the full transmitting power, this would require the use of a filter of high-power carrying capacity, which would make the filter very costly and also render the system inflexible to change of wave-length. The present system overcomes both of these difficulties by filtering out one side band at low power levels and by the use of the double modulation method.

Another very important reason for the transmission of a frequency band as narrow as possible lies in the difficulty of constructing an antenna to transmit more or less uniformly at these long waves a band of frequencies which is an appreciable fraction of the main carrier currents. For example, in the ordinary method of transmission an antenna which was intended to transmit a 30,000-cycle carrier and its two speech side bands would need to be designed to transmit all the frequencies from 27,000 to 33,000 cycles, a band which is equal to 20 per cent. of the carrier frequency. This band is considerably wider than that given by the resonance curve of a highly efficient long-wave

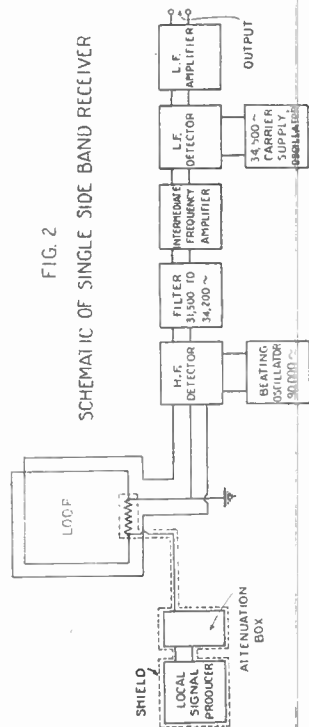

FIG. 2

SCHEMATIC OF SINGLE SIDE BAND RECEIVER

The diagram of the receiving set is easily understood if it is borne in mind that the carrier wave is supplied by local oscillators instead of one broadcast from the transmitting stations.

antenna. To accommodate both side bands would require flattening out the resonance curve either by damping, which means sacrifice in power efficiency, or by special design of the antenna, possibly throwing it into a series of interacting networks and causing it to become a rather elaborate wave filter. The importance, from the antenna standpoint, of narrowing the frequency band required to be transmitted is, therefore, evident.

It is extremely important that the received signal be affected as little as possible by changes in the transmission efficiency of the medium. The voice frequency currents produced at the receiving end, after detection, are proportional to the product of the carrier wave and the side band. If the carrier, as well as the side band, is transmitted through the medium, then a given variation in the transmission efficiency of the medium will affect both components and will change the received speech in proportion to the square of the variation, as compared to the first power, if only the side band is transmitted and the carrier supplied locally. Thus it will be seen that the omission of the carrier from the sending end and the resupplying of it from the constant source at the

Helps to Land Everything You Catch!

THE "Electrad" Lead-In meets that high quality standard set by all "Electrad's" products. There is a difference.

The convenient lead-in. Now you need not scar or mar your walls or sash with unsightly holes or ugly porcelain tubes. This flat, highly insulated and water proofed lead-in fits under locked windows and doors. The windows may be closed tightly—there need be no loss of heat in the room. Pliable, it bends into any shape—meeting your every need. Price 40c.

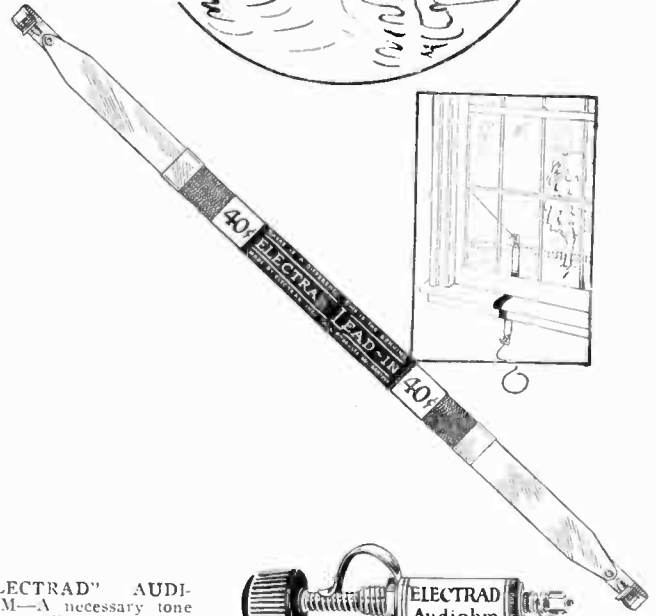

Other Guaranteed Electrad Radio Products

which simplify construction, facilitate installation and improve reception of radio sets—Vari-ohms, Lamp Socket Antenna, Grid Leaks, Resistance Coupled Amplifier Kits and many others. At your dealers; if he can't supply, write us.



"ELECTRAD" LIGHTNING ARRESTER—Price 50c. Indoor type. Listed under re-examination service of the National Board of Underwriters. Should fire occur from lightning, you'll have insurance difficulties unless you have an approved arrester.

"ELECTRAD" AUDIOHM—A necessary tone and quality controlling device. Placed across secondary of first audio transformer it eliminates distortion and transformer noises. Requires no drilling, soldering or tools to attach. Fits any transformer. \$1.50 each.

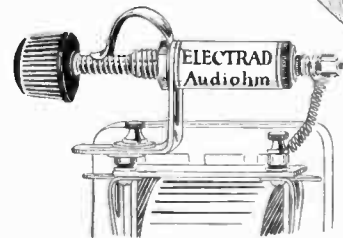

ELECTRAD

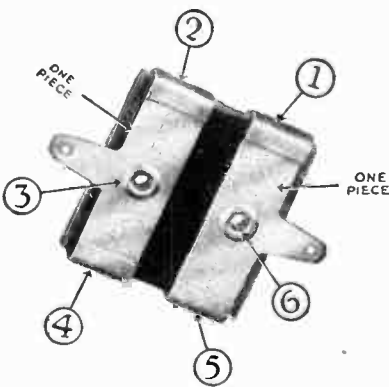

THE "Electrad" Certified Fixed Mica Condenser is a revelation in accuracy and design. Ingenious, rigid binding and firm riveting fastens parts securely at Six different points insuring positive electrical contact. Impervious to temperature and climatic variations. Exerts even pressure upon the largest possible surface—can't work loose. Binding strap and soldering lug in one piece. Accuracy and quietness assured always. Value guaranteed to remain within 10% of calibration. Standard capacities, 3 types. Licensed under Pat. No. 1,181,623, May 2, 1916, and applications pending. Price 30c to 75c in sealed dust and moisture proof packages.

"The Six Point Pressure Condenser"

ELECTRAD, Inc.

428 Broadway

New York City

receiving end, gives greater stability of transmission.

ADVANTAGES OF THE SYSTEM

The advantages of the system may be summarized as follows:

1. It conserves the frequency (wave-length) band required for radio telephony, which is particularly important at long wave-lengths.
2. It conserves power, in that all of the power transmitted is useful signal-producing power. This is practically important also in long distance transmission which requires the use of large powers.
3. The fact that only a single band of frequencies is transmitted simplifies the antenna problem at long wave-lengths, where the resonance band becomes too narrow to transmit both side bands.
4. As compared with a system which eliminates the carrier but transmits both side bands, the single side band system has the important advantage of not requiring an extreme accuracy of carrier, which is supplied at the receiver. Were both side bands transmitted, very perfect synchronization would be required for good quality.
5. It improves the transmission stability of the radio circuit, since variations in the ether attenuation affect only one (the side band) of the two components effective in carrying out the detecting action in the receiver.
6. The receiving part of the over-all system has two advantages: (a) It need accept only half of the frequency band which would be required in double side band transmission, thereby accepting only half of the "static" or interfering energy. (b) By stepping down the frequency of the received currents and filtering and amplifying at the low frequency stage a very sharp cut-off is obtained for frequencies outside of the desired band and a very stable and easily maintained amplifying system is procured.

DESCRIPTION OF SINGLE SIDE BAND SYSTEM

In Fig. 3 is shown a graphic description of the action of the transmission system in which the carrier wave and one of the side bands are eliminated. The heavy line at 33,000 cycles in Fig 3A represents the carrier current on which is impressed the voice input, as shown in Fig. 1. For ease and simplicity of description we shall assume throughout the discussion that the voice input current varies from 300 to 3,000 cycles per second, which is an average value.

The shaded portions above and below the heavy line at 33,000 cycles are the two side bands. When the voice input current is impressed on the carrier frequency, beat notes are set up producing two side bands, one from 33,300 to 36,000 cycles and another from 32,700 down to 30,000 cycles. (These values are derived from adding and subtracting the maximum and minimum values of the input voice frequencies to the carrier frequency.) These two side bands are then impressed on the balanced modulator No. 1, which passes them on to the filter. This filter passes on to the second modulator only the wave band between 32,700 and 30,000 cycles, that is, only the lower shaded portion.

In modulator No. 2 the oscillator generates a carrier current of 88,500 cycles, represented in Fig. 3B by the heavy line. In a similar manner two other side bands are set up, one from 118,500 to 121,000 cycles and the other from 58,500 to 55,800 cycles. The upper side band and the carrier current are again eliminated by the filter and only the lower side band is passed on to the 750-watt amplifier. After this wave band has been passed through the other two amplifiers it is put on the air.

The reception of this single side band is shown graphically in Fig. 4. Refer to Fig. 2 showing the receiving schematic diagram;

The World's Greatest Radio Story



Ward's New Radio Catalogue is Now Ready

Are you interested in seeing what is new in Radio—What is best and what has been approved? And do you wish to know the lowest prices on tested sets, prices made without the usual "Radio profits?"

This Catalogue is a Complete Guide to Radio

Ward's is headquarters for Radio, with probably the largest retail radio department in the whole world.

This new 52 page Radio Catalogue shows everything in parts, batteries, cabinets, contains a list of stations, a radio log for recording stations. It

Write to the house nearest you for your free copy of Ward's new Radio Catalogue. Address Dept. 2-R

ESTABLISHED 1872 Montgomery Ward & Co.

The Oldest Mail Order House is Today the Most Progressive
Baltimore Chicago Kansas City St. Paul Portland, Ore. Oakland, Calif. Ft. Worth

shows the best of the new sets. One tube sets that give amazing results. Five tube sets with a single dial to turn. Think of tuning in one station after another by turning a single dial. Every price quoted means a big saving to you. Everything offered is tested by our own Radio Experts. In fact, the best experts compiled this Catalogue for you. Write for this 52 Page Book. It is yours free.

Our 53 year old Policy

For 53 years we have sold only quality merchandise under a Golden Rule Policy. You can rely absolutely upon the quality of everything shown in this Radio Catalogue.

Superadio Receiver

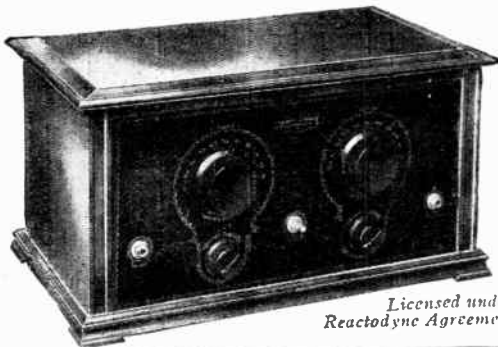

5 - Tubes 2 - Dials

At last—true beauty is combined with scientific design so that results never before expected are now easily achieved. Wonderful tonal quality, marvelous power and only \$56.00.

The Superadio operates on a radically new principle—inductive reaction—yet you get the best on the air with the least effort. Write for literature.

Remember—now you can buy TESTED tubes—where the Superadio Dynometer is on the job. Measures plate impedance, amplification factor and mutual conductance of any tube without calculations or curves:

DE WITT LA FRANCE CO., INC.

54 Washburn Avenue, Cambridge, Mass.

Boston Representative
Martin, Hartley & DeWitt Sales Co., 99 Bedford St.

Chicago Representative
William A. Welty & Co., 36 So. State St.

Everybody Wants Single Dial Control

But few radio makers provide it

Why?

SINGLE dial control is an immense advantage in tuning. It is not only utterly simple; it enables the merest amateur to tune as accurately as an expert. You do not have to grope around adjusting dials. You IMMEDIATELY turn one control to the wave length desired. You can do that by ear, if you like.

What is the handicap?

Why do so few makers offer a single dial? Because most circuits are too complicated to permit of it. You have to drive too many horses. It is evident that you cannot tune with a single dial unless the circuits are *electrically* equal, and they cannot be electrically equal if there is any coupling of stray energy between them. It matters not whether such stray energy is "trapped" by extra condensers or other devices. The inequalities are still there and prevent accurate single dial tuning.

That is why you see single dial sets equipped with verniers and auxiliary adjusters. These are needed to complete or refine the tuning. That operation is as complicated as using three dials.

The secret of success

Pfanstiehl last year laid the foundation for a perfect single dial control by discovering how to prevent stray energy at its source, how to keep the radio stream in its forward path without the use of auxiliary devices. That was the secret also of his OVERTONE reproduction and the matchless tone which results. There is no stray energy to mar the delicate vibrations which make overtones. Voice and music are reproduced exactly as transmitted. And his single dial works with the utmost precision; enables anybody to tune as accurately as an expert. It is *fundamentally* sound.

For further details, address

PFANSTIEHL RADIO COMPANY
11 South La Salle Street, Chicago, Illinois

Prices West of the Rockies Slightly Higher

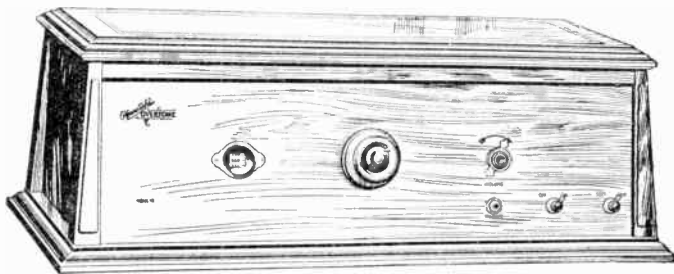

MODEL 10—Overtone Single-dial 5-Tube Receiving Set. Price \$135.00 (less accessories)

Pfanstiehl

"OVERTONE" RECEIVER
Perfectly Reproducing the Overtones

Actual Wave Length **GLOWS**
from Illuminated
Disc—No Scale
Necessary



MODEL 10C—A complete 6-Tube Single-dial Console Overtone Receiver with Overtone Speaker, Control Board, Battery Charger and Compartments for Battery built in. Price \$450.00 (less tubes and batteries).



MODEL 10S—Overtone Single-dial 6-Tube Receiving Set with demountable Console Stand. Overtone Speaker built in. Price \$200.00 (less tubes and batteries).

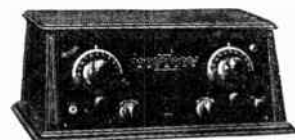

MODEL 8—A low priced 2-Dial 5-Tube Receiving Set, Pfanstiehl quality throughout. Price \$85.00 (less accessories).



MODEL 8C—Two-dial 5-Tube Receiving Set, demountable from console stand, permitting use on floor or table. Overtone Speaker built in. Price \$135.00 (less tubes and batteries).



PATENTS
PENDING

"The Hit of the Show"

One of the most talked-of exhibits at the recent Radio Shows in New York, was that of the new Furnell Taper Coil Condenser.

In the opinion of professionals, the Furnell Condenser offers—in the simplest most practical form possible—the correct solution of the straight-line frequency problem.

The Furnell spaces the stations equally over 360 degrees, a complete rotation of the dial. No more crowding of low-wave stations.

Nothing to get out of alignment. No need for vernier.

And to insure its permanent accuracy and precision, the Furnell Condenser is entirely enclosed in an attractive, strong, transparent Pyralin case—absolute protection against dust, moisture and damage.

No matter what type or model, you build, buy or sell, you can't know its best performance until you use this new and wonderfully improved type of condenser. In three capacities—single and multiple. Write for literature.

A nation-wide organization of exclusive Sales Distributors is now being established. Write or wire for interesting plans and particulars.

THE FURNELL MANUFACTURING CORPORATION
889K Broad Street, Newark, N. J.

FURNELL

360° TAPER COIL
CONDENSERS

Separates Those Crowded Stations

No matter how crowded the low wave stations, they are easy to get, clear, perfect in tone. All accomplished with this beautiful dial. So scientifically thought out that it's really a revelation in tuning. Gives your present set every advantage of the straight line frequency receiver, but without the necessity and expense of rewiring. Gradually changing ratios from 24 to 1 at low wave lengths to 2 2/3 to 1 at high wave lengths does the trick. Instantly attached to any set.

Convert your set to straight line frequency. Send for instructions.

Radiall Company

Dept. T.R.N.-2, 50 Franklin St., New York

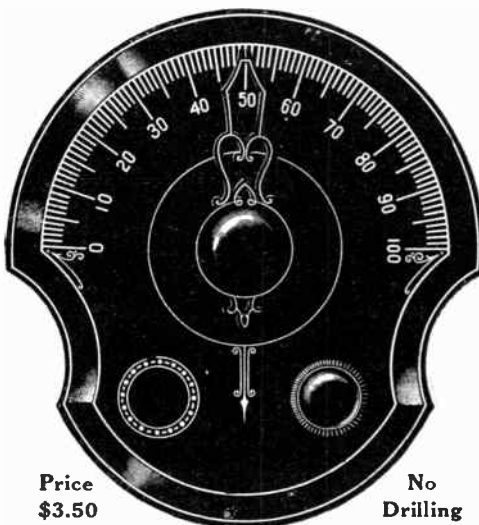

Price
\$3.50

No
Drilling

TUNE-RITE

The Straight Line Frequency Dial

Made by the makers of Amperite, the Self-Adjusting Rheostat

Get a Handy Binder for your RADIO NEWS. Holds and preserves six issues, each of which can be inserted or removed at will. Price 65c. Experimenter Pub. Co., Inc., Book Dept., 53 Park Place, N. Y.

the incoming signal is picked up by the loop antenna and thence passed to the high frequency detector, where there is a local oscillator generating 90,000 cycles per second. (The incoming wave band is shown in Fig. 4A as the heavily shaded portion of the graph.) As above, there are again two side bands set up, one from 145,800 to 148,500 cycles and another from 34,200 to 31,500 cycles. The lower wave band is the only one that is passed through the filter, which, therefore, stops the carrier wave and the upper side band. After being amplified in the intermediate frequency amplifier, the lower wave band is impressed on the next oscillator, which is generating a frequency of 34,500 cycles. Once more there are two side bands set up, but here, as can be seen in Fig. 4B, they are widely separated, and the lower one, from 3,000 down to 300 cycles, can be easily rectified by the low frequency detector and amplified by ordinary audio frequency amplification.

I Want to Know

(Continued from page 822)

- "Second-Harmonic Super-Heterodyne," May, 1925, page 2110.
- "The Super-Unidyne," September, 1925, page 328.
- "Matching Tubes," April, 1925, page 1899.
- "Some Super-Heterodyne Notes," March, 1925, page 1666.
- "L-1 Ultradyne Notes," April, 1924, page 1419.
- "Matching Transformers," July, 1924, page 51.
- "Super-Heterodyne Notes," October, 1924, page 492.
- "Tropadyne Notes," November, 1924, page 691.
- "A New Super-Heterodyne," October, 1925, page 444.

The shielding is of 1/16-inch sheet zinc, polished, and lacquered with a light coating of white shellac. The shielding is grounded to "A" minus, as usual.

The selection of audio frequency transformers is optional. A good combination is a ratio of about 6:1 for the first audio frequency transformer and about 2:1 for the second one. In order to use successfully the high ratio of 6:1 it is essential that only the highest grade transformer be selected; a transformer of poor design may easily have a turns ratio of 6:1 (six times as many turns on the secondary as are in the primary), but made on such skimpy lines as to be a total failure in this circuit, or any other circuit where considerable amounts of current are to be handled.

The writer would recommend that the experimenter use impedance coupling instead of transformer coupling for extreme audio quality, in conjunction with U-X-112 tubes, 6 to 9 volts grid bias and a "B" potential of 140 to 150 volts. A particularly desirable form of impedance coil is the Thordarson "Autoformer," consisting of only one winding. Because it has a tap taken from part of the winding, the instrument becomes an "auto-transformer," having, therefore, a small voltage step-up of 1 1/2:1.

It is suggested that a battery cable be used to connect the batteries to the set. This will modernize the receiver to the extent of eliminating the need for binding posts. The color code may be:

- Black A-B-C+
- Red A+
- Brown C-
- Green B +45V.
- Yellow B +90V.

The separate 45-volt "B" battery should be used to supply the plate potential of the first detector, second detector and oscillator. The experimenter may use the regular 90-volt "B" battery, however, and tap at 45 volts, as a matter of experiment, but reproduction will be better if two separate batteries are used. Batteries must be kept at full charge.

The volt-meter switch makes it possible to indicate at will, the potential of the "B" battery, the "A" battery, and the voltage actually applied to the terminals of the vacuum tubes, after having passed through the rheostat. This "terminal voltage" will be about 5 volts for UV-201A type tubes.

"R-4" is a 34-ohm rheostat. It may be connected in the usual way, or it may be connected in the manner recommended in the circuit. Although separate rheostats could have been used for the various tube banks, there is no question but that construction and operation are simplified in the use of the single rheostat, "R-4." If UV-201A tubes are used, the rheostat must be capable of carrying at least 2 1/2 amperes continuously. It is recommended that the Western Electric 216A tube be used as the second detector (7), if best quality is desired. Since this tube will consume .96 amperes at 5 volts, the potential that will be applied

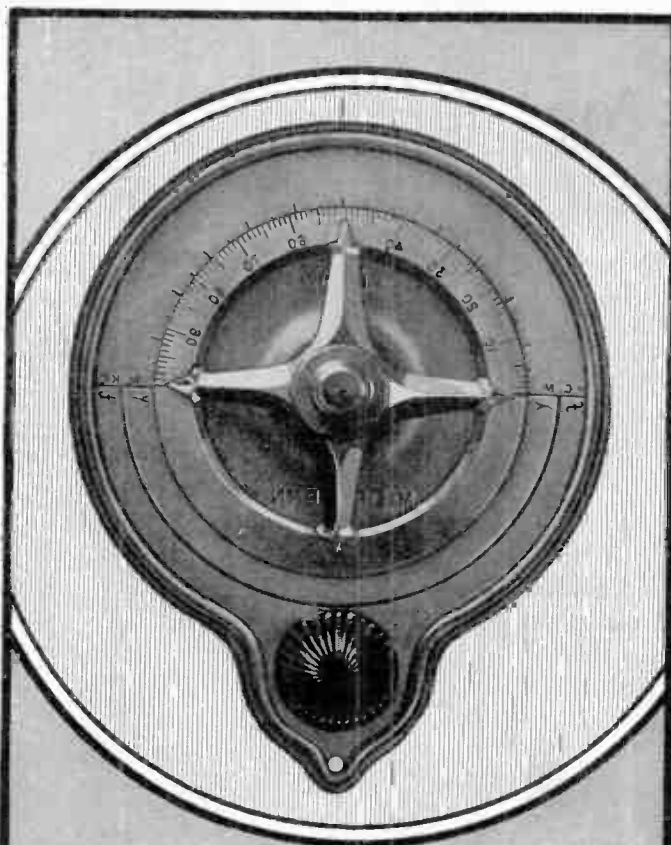

**PACENT MICROVERN—
A SUPER TUNING
DEVICE**



Trade Mark

**PACENT TRUE
STRAIGHT-LINE
FREQUENCY CONDENSER**

PACENT ELECTRIC COMPANY, Inc.
91 Seventh Ave., New York City

Washington	Chicago	Buffalo
Minneapolis	Birmingham	Jacksonville
Boston	Philadelphia	Pittsburgh
San Francisco	St. Louis	Detroit

Canadian Licensees: White Radio Limited, Hamilton, Ont.

**Pacent
RADIO ESSENTIALS**

DONT IMPROVISE - PACENTIZE™

**PACENT
Engineering
Achievements**

**THE LATEST IN VERNIER
DIALS**

HERE'S a dial with the most practical ratio that makes sharp tuning easy. You log stations by name, wave-length and frequency. Delicate adjustments remain put without jump or back-lash. It can be mounted easily on any condenser and provision is made for grounding. There is nothing to wear out. It comes in silver or gold finish to match the other instruments on your panel.

Cat. No. 150S, 150G.....Price \$2.00

**FROM START TO FINISH—
TRUE S. L. F.**

Every single detail in its construction was especially designed to give true S. L. F. It is the last word in condensers. The 3 to 1 ratio covers the whole broadcast band and gives uncrowded equi-spacing of stations. Isolantite, placed where the electrostatic field is lowest, is used for insulation. Sturdy and compact, it will meet the most critical requirements.

Cat. No. 250B .00035 Mfd. Max. Price \$3.50

Cat. No. 250C .0005 Mfd. Max. Price \$4.50

Have you our latest catalog? We will gladly mail it.

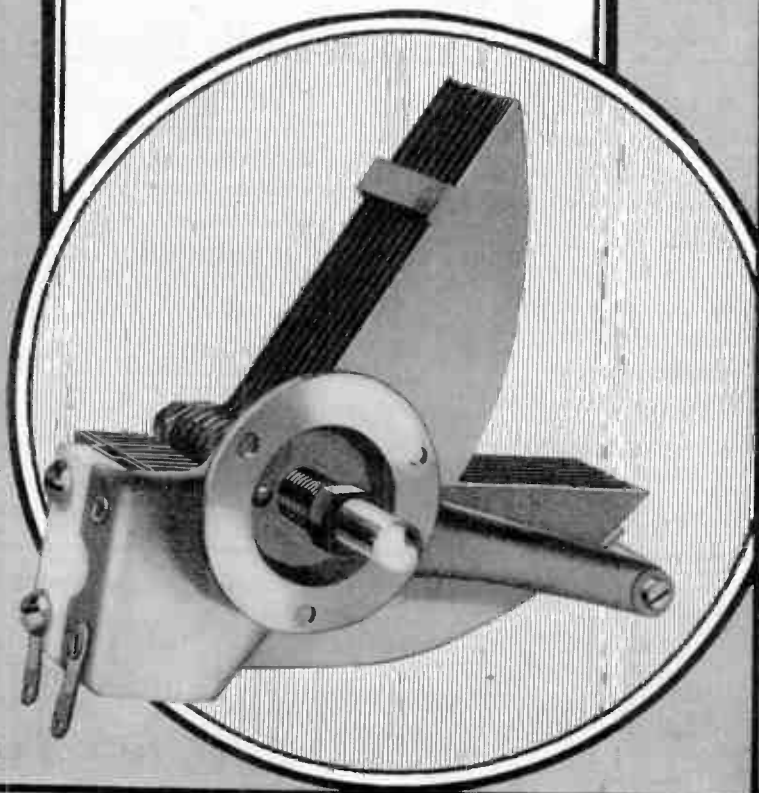



TRIMM
Home Speaker
\$10

The Most for Your Money

Trimm Home Speakers outperform other speakers costing twice as much. Model 25 has large Volconite horn, 18 inches high, with a 12 inch bell which prevents tinny, scratchy noises, and gives a full well-rounded tone.

Factory regulation assures maximum volume without blasting or distortion. Carries the Trimm Lifetime Guarantee of perfect satisfaction. Have your dealer demonstrate it to you.

TRIMM	
Superior Reproducers	
HEADSETS	
Professional - -	\$5.50
Dependable - - -	4.40
PHONODAPTERS	
Giant Unit - -	\$10.00
Little Wonder -	4.50
SPEAKERS	
Home Speaker -	\$10.00
Entertainer - -	17.50
Cabinette - - -	17.50
Concert - - -	25.00
Chello - - -	30.00



to this tube with all the other tubes in operation (the rated consumption of the WE-216A is 1.5 amperes at 6 volts), the rheostat must be able, in this case, to carry about 3 1/2 amperes.

The bias required to prevent oscillation of the intermediate frequency amplifier circuits is entirely a matter of experiment. It is dependent upon the construction of the transformers selected. In the original set the amount of grid bias is determined by experiment, after which there is no variation in this part of the circuit for greater sensitivity by more complete control of grid bias potential of tubes (5) and (6). The writer would prefer to connect a 400-ohm potentiometer in the standard fashion indicated in dotted lines. The value for the filter coils and condenser C-3 are dependent upon the intermediate frequency transformers selected. It will be necessary to use the filter coupler designed for these transformers.

For extreme sensitivity the grid leak of detector tube (4) may be variable. The usual .00025 mfd. fixed condenser and two megohm grid leak are used in the grid circuit of detector tube (7). Tube (4) grid condenser is .00025 mfd.

As previously stated, the wave range of 50 to 600 meters is made possible by arranging the coils in plug-in fashion. The method of doing this is pictured and described in the June, 1925, issue of RADIO NEWS, page 2259, and *The Experimenter* magazine of July, 1925, page 596. The actual constants for the coils are given in the table below:

APPROXIMATE COIL WAVELENGTH

A	Approx.	55 to 110 Meters
B	"	100 to 220 "
C	"	180 to 370 "
D	"	225 to 550 "

UNITS L-1

A	Coil 30 Turns, Tap At 3 Turns
B	Coil 54 Turns, Tap At 10 Turns
C	Coil 70 Turns, Tap At 7 Turns
D	Coil 110 Turns, Tap At 11 Turns

UNITS R.F.T.-1, R.F.T.-2, R.F.T.-3

A	Pri. 3 Turns—Sec. 30 Turns
B	Pri. 4 Turns—Sec. 34 Turns
C	Pri. 5 Turns—Sec. 70 Turns
D	Pri. 6 Turns—Sec. 110 Turns

No. 28 D.C.C. No. 32 D.C.C.

Both coils are wound in the same direction. Secondary is wound on tube 1 3/4 inches in diameter. Primary is wound over the filament end of the secondary. Primary and secondary are separated by Empire cloth or paper.

L-2, L-3, L-4 OSCILLATOR UNIT

A	L-2, 3 Turns L-3, 30 Turns L-4, 15 Turns
B	L-2, 4 Turns L-3, 54 Turns L-4, 27 Turns
C	L-2, 5 Turns L-3, 70 Turns L-4, 35 Turns
D	L-2, 6 Turns L-3, 110 Turns L-4, 50 Turns

No. 28 D.C.C. No. 32 D.C.C. No. 32 D.C.C.

All coils are wound in the same direction. Pick-up coil L-2 is wound over the filament end of grid coil L-3; Empire paper or cloth insulation. L-3 is wound on a 1 3/4-inch tube. One-eighth of an inch from coil L-3 is wound plate coil L-4.

It must be pointed out that the voltmeter switch will short-circuit the "B" battery if the switch-points are not arranged sufficiently far apart to prevent the switch arm's touching two points at once.

Q. 2. I am very anxious to learn the names and publication addresses of some of the highly technical journals to which the advanced engineer in radio subscribes. There must be many publications of interest to the advanced radio man, other than the I. R. E. proceedings.

A. 2. There are many publications of interest only to the experienced radio investigator. An excellent list comprises the following:

- Journal of the Franklin Institute* (Philadelphia, Pa.)
- The* (London, Edinburgh, and Dublin) *Philosophical Magazine and Journal of Science* (London, England).
- The Physical Review* (Corning, N. Y.).
- Journal of the Optical Society of America and Review of Scientific Instruments* (Menasha, Wis.).
- The Journal of Physical Chemistry* (Ithaca, N. Y.).
- Journal of Scientific Instruments* (London, England).
- The Official Patent Gazette* (Washington, D. C.)
- Journal of the A. I. E. E.* (N. Y. C.).
- Proceedings of the Institute of Radio Engineers* (N. Y. C.).
- General Electric Review* (Schenectady, N. Y.).
- Bell System Tech. Journal* (N. Y. C.)
- The Electrician* (London, England).
- Zeitschrift fur Physik* (Berlin, Germany).
- The Electrical Review* (London, England).
- Science Abstracts* (N. Y. C.).
- L'Onde Electrique* (Paris, France).
- Review General de l'Electricite* (Paris, France).
- Jahrbuch der Drahtlose Telephonie* (Berlin, Germany).
- Electrotechnische Zeitschrift* (Berlin, Germany).

STORM DETECTOR

(2152) Mr. Frank Witherspoon, Chelsea, Mass., asks:

Q. 1. How are the "storm detectors" used in electric sub-stations to indicate the approach of storms, made?

A. 1. The circuit is being shown elsewhere. Relay "R" may have a resistance of 400 ohms or higher. The bell is arranged to strike the gong when the spring pulls the hammer back, after the hammer has struck coherer "C." The coherer follows the usual construction. It may be made by



RADIO as you like it



Cannon-Ball Headsets

YOU and the folks at home will enjoy Radio as you like it if you equip your receiving set with enough Headsets.

A Headset is the most reliable means to hear every spoken word or every note of the singer with the same inflections of the voice of the speaker or artist.

You can listen without disturbing

others. Know how thrilling it is to listen to a sermon, a song, music or an opera hundreds of miles away without having to apologize to others for poor reception.

For greater satisfaction, buy a good Headset such as the Cannon-Ball or Cannon-Ball Junior — extremely sensitive, light in weight, comfortable. GUARANTEED by a well established, reliable manufacturer.

Cannon-Ball \$3.50; Cannon-Ball Junior \$2.75; Grand \$4.75;
Cannon-Ball Loud Speaker \$12.50. At your dealer's.

CANNON & MILLER COMPANY, Inc.

SPRINGWATER, N. Y.

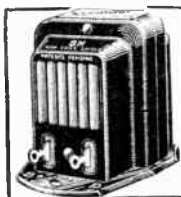

Famous "BH" Transformers
BH VIVAPHONIC (Registered)
A new model of highly scientific design. Wonderfully life-like in amplifying power. Perfectly shielded, with minimum loss in shield wall. A personal invention of Benjamin Hughes of the
BENJAMIN HUGHES ELEC. CO.
298 LaSalle Street, W.
Montreal, Can.
Transformer Builders Since 1910

FREE—Our 64-Page Catalogue. Filled With Radio Bargains. Write Today!
RANDOLPH RADIO CORP.
159 N. UNION AV. Dept. 2 CHICAGO, ILL.

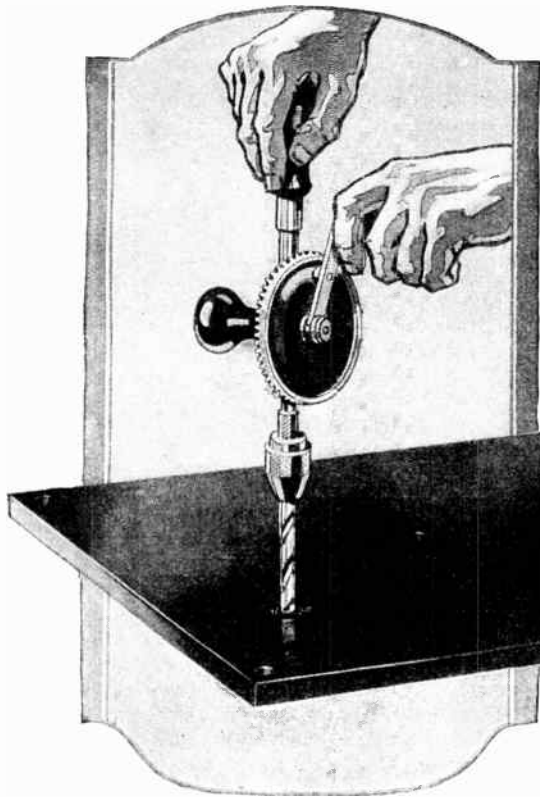

No Cracking

No Chipping



DRILL and machine the Goodrich Silvertown Radio Panel with full confidence—no special tools are required—it won't break at the edge, crack or chip.

It is made with a full degree of Goodrich skill and rubber knowledge, after long study of radio requirements—the product of a company that has always held quality and service as first considerations.

Science says that rubber is the best material for panels. Then by all means buy the *best* rubber panel—and that brings you straight to Goodrich Silvertown.

Fifty-five years of rubber manufacturing experience are a guarantee of greatest efficiency in the following products Goodrich has built for radio—

Goodrich V. T. Sockets Spaghetti Tubing
 Goodrich Variometers Unwound Battery Mats
 Goodrich Radiophone Ear Cushions

The B. F. Goodrich Rubber Company
 Established 1870 Akron, Ohio

- 1 Easier to drill and machine.
- 2 Better color, lasting luster.
- 3 Lower free sulphur — no discoloration.
- 4 Higher softening point — no warping.

Goodrich Silvertown

The Radio Panel Supreme!

SM

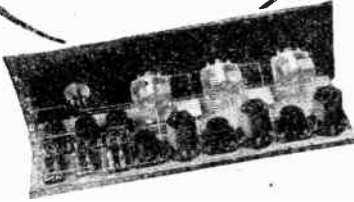
SILVER
SIXEasy to Build
Easy to Control

Results never before dreamed of have been achieved by the Silver "Six." Write today for Mr. Silver's own description of this marvelous receiver. TYPE 600 KIT including all parts necessary to build the "Six" complete \$53.00
TYPE 610 KIT essentials only, including 3 condensers, 3 inductances and 3 inductance sockets. . \$27.75

SEE SM PRODUCTS AT YOUR DEALERS

SILVER-MARSHALL, Inc.
116 S. Wabash Avenue. Chicago

DELTA

"There is no better Headset
at any Price"



No. 50) 2200 OHM \$5.50
No. 501 3200 OHM \$6.00

DELTA ELECTRIC COMPANY, 150 Delta Block, Marion, Indiana, U.S.A.

Standard Makers of Radio Headsets, Electric Lanterns, Auto Spotlights, Auto Ash Receivers, Motorcycle Spotlights, Bicycle Spotlights, Electric Bicycle Lamps, Flashlights and Flashlight Batteries.

Supersensitive, loud and clear. Reproduces clearly and naturally. Electrically and mechanically as perfect as the highest priced headset. Guaranteed equal in performance to any or all other makes. Tested and tone-matched to the utmost precision. DELTAS are BEST sellers because they are best made and best priced.

Write or wire NOW for full particulars and dealer discounts.

Rubber Covered Insulators



Actual Size

Neat and efficient. For antenna, ground and for lead in wires. Small screw starts readily and makes finished job. Great improvement over ordinary large, unsightly insulators. They keep the wires in place and out of the way. Packed 10 in a box, 25c at your dealers or direct from us.

CULVER-STEARN'S MFG. CO.
Worcester, Mass., U. S. A.

for
radio dealers

—our big new catalog; fully illustrates the best in radio. Write on letterhead for copy — ask for P1005.

We Ship Fast!

Wakem & McLaughlin, Inc.
225 E. ILLINOIS STREET CHICAGO, ILL.

arranging two nickel plugs to fit a glass tube of about 1/4-inch bore. Fill a 1/4-inch space with an iron-nickel filings (equal proportions) mixture. Separate spark gap about 1/64 of an inch. Relay coil "R" may be a "ringer" coil. With switch lever on "2," aerial is grounded and the arrangement inoperative. With switch on "1," normal signals and electric disturbances will not affect the instruments. However, as soon as the energy is sufficient to break down the resistance of spark gap "S.G.," the coherer becomes highly conductive, completing circuit through "R," which, in turn, completes circuit through bell, or *de-cohering* apparatus.

TUNED IMPEDANCE COUPLING

(2153) Mr. Gustave Schneider, Minneapolis, Minn., asks:

Q. 1. What is the schematic circuit of a tuned impedance receiver with a tuned aerial circuit?

A. 1. The circuit is shown above.

A variable detector leak is shown. Coils "L" are made by winding 50 turns of bell wire on 3-inch tubes. With these, condensers "C" will have a capacity of .0005 mfd. A smaller capacity will be required if larger coils are used, and *vice versa*. Potentiometer resistance, 400 ohms. A satisfactory relation of the coils is shown on page 644 (I Want to Know Department) of the November, 1925, RADIO NEWS. A.F. transformer ratios and make are optional.

The Regenerative Interflex

(Continued from page 794)

As I mentioned above, stations should snap in with a quenched hissing sound, and on locals the volume should be exceedingly loud. At my residence I can easily tune out the local stations, WGBS and WAHG, both on 316 meters, and bring in KDKA, 309 meters, Pittsburgh, 275 miles distant, with better volume than the local stations. The same is true of WTAS, Elgin, Ill., 302 meters, 700 miles away.

PARTS FOR REGENERATIVE INTERFLEX

- 3 sockets.
- 2 A.F. Transformers.
- 1 S. L. F. Variable Condenser .0005 mfd.
- 1 Carborundum Crystal Detector.
- 1 Carbon Pile Rheostat.
- 2 Amperites.
- 1 Filament Control Jack (double open circuit).
- 1 Filament Control Jack (single open circuit).
- 1 Flexo-Coupler.
- 1 Fixed Condenser .00025 mfd.
- 1 Fixed Condenser .001 mfd.
- 1 Variable Condenser (2-20 mmf.)
- 1 Panel 7 x 18 inches.
- 7 Binding Posts.

The set tunes so sharply that, providing there is a leeway of two or three meters of DX stations, I can get practically any station on the air within a radius of 1,000 miles. This result was obtained in the middle of September, when the weather was still very warm and a good deal of static prevailed. As the nights get cooler, there should not be much trouble in excelling this record at any time.

I call particular attention to the fact that if single control is wanted, the "Flexo-Coupler" becomes necessary. I have not found any variocoupler on the market that would work this set with a single control without readjusting the tickler. In the "Flexo-Coupler," the tickler stays in its best position at all times without further adjustment.

In order to operate this set successfully the builder must remember the following few simple instructions:

1. Place the detector in such a position that a very short wire connects one end of the detector to the grid of the tube. Better yet, mount the crystal detector right on the grid binding post, as shown in illustration 6. The other end of the crystal detector is sensitive to strong currents, by which I

Insure your copy reaching you each month. Subscribe to Radio News—
\$2.50 a year. Experimenter Publishing Co., 53 Park Place, N. Y. C.

No Dials, No Panel, Built-in Loudspeaker



Designed by R. E. Lacault, E.E., Chief Engineer of this Company, and formerly Radio Research Engineer with the French Signal Corps, Radio Research Laboratories.

To protect the public, Mr. Lacault's personal monogram seal (R.E.L.) is placed on the assembly lock bolts of all genuine ULTRADYNE Model L-3 Receivers. All Ultradyne Receivers are guaranteed as long as these seals remain unbroken.

\$135.00

The Quiet Manner and The Eloquent Tone

UNOBSTRUSIVENESS with sufficiency—the rule of good taste—is the distinguishing grace of the ULTRADYNE Model L-3 Radio Receiver. Ushers in a new era of radio reception—a new, easier command of the air's treasures.

A new artistic form of a radio receiver that blends happily with every scheme of interior decoration. Pleases the eye with its charming lines, its beautiful two-tone mahogany cabinet, its fine proportions. Has the appearance of a decorative tablepiece. Utter simplicity with superb receptive and reproductive qualities. Your local radio dealer will gladly give you a demonstration of this new modern receiver.

The Ultradyne Model L-3 is a six-tube receiver employing the fundamental principles of the best circuits greatly refined and marvelously simplified. No dials—no panel; just two inconspicuous levers, which constitute a station-selector. Volume adjustment, the only other control.

Write for descriptive folder

ULTRADYNE
MODEL L-3

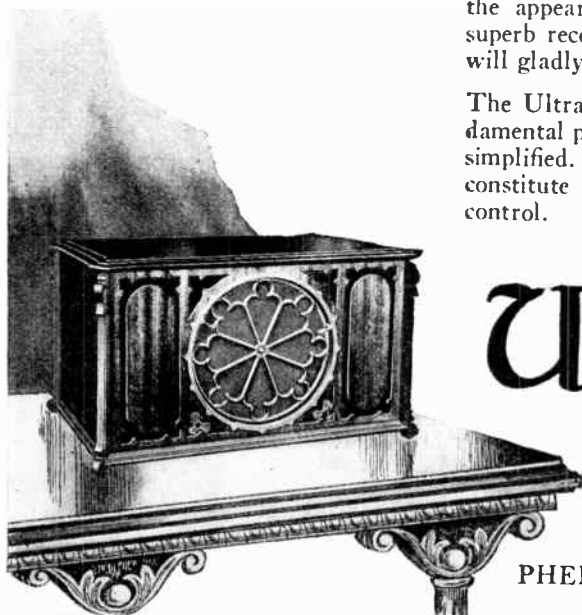

PHENIX RADIO CORPORATION, 114 E. 25th St., N. Y.



New--!

--Just the

instrument that radio set owners have wanted.

A high resistance voltmeter in a 2 inch diameter case.

Save your tubes:—Check your batteries daily. Obtain the best possible reception.

Ask for our No. 15-B Radio Catalog.

Order from Dealer



No. 135
Actual Size

Jewell Electrical Instrument Co.

1650 Walnut St. : Chicago
26 Years Making Good Instruments

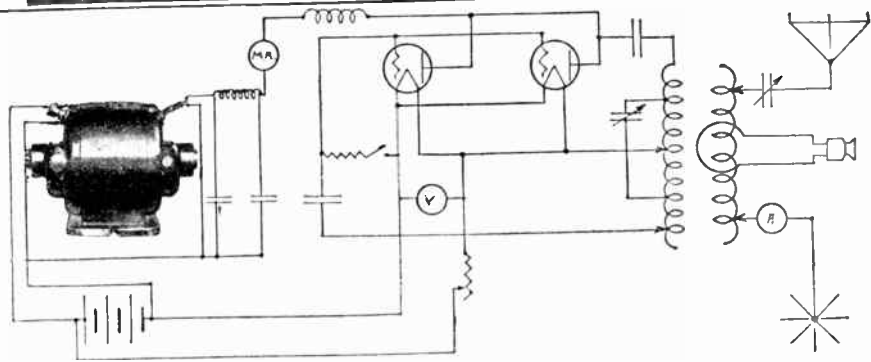

A SMALL PORTABLE SET FOR THE AUTO, BOAT OR HUNTING LODGE.
KEEP IN TOUCH WITH BUSINESS AND THE FOLKS AT HOME.

Item No. 68 6-12 volt primary, 500 volts, 40 watt secondary.

This little ten watt set can easily be constructed for less than \$100.
Requires a minimum of technical knowledge to effectively operate.

This but one of over 200 combinations listed in Bulletin No. 237B.
Write for your copy today.

ELECTRIC SPECIALTY COMPANY

TRADE "ESCO" MARK

211 South Street.

Stamford, Conn.

Get Boice Prices Before You Buy!

Boice offers you greater values in circular saws, hand saws, lathes, and jointers at lower prices with a positive money-back guarantee. Write for literature, prices and the Boice E Z Pay Plan before you buy.

Buy Now Pay Later



14" Band Saw
Table 12" x 14"
tilts 45 deg. Saws
7" stock. Uses
blades 3/16"
to 1/2" wide.
Bronze Bearings.

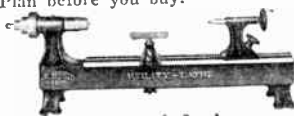

8" Bench Lathe
Does turning, drilling, threading, sawing, grinding and jig sawing in wood or soft metals. Swings 8". Capacity 20" between centers.

Junior Saw
Does ripping, mitring, grooving, sanding, grinding and drilling with ease and accuracy. Table 10"x13". Saws 2 1/2" stock. Dadoes 5/8"x5/8". Makes mortising. Sold with or without motor.

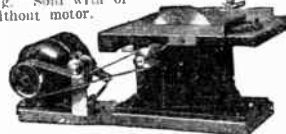

W. B. & J. E. BOICE. Dept. 812-A, Toledo, Ohio

Get a Handy Binder for your RADIO NEWS. Holds and preserves six issues, each of which can be inserted or removed at will.
Price 65c.

Experimenter Pub. Co., Inc., Book Dept., 53 Park Place, New York

mean that no wires should come within two inches of it, except the connecting wire that goes to the secondary. *Keep all wires and everything else away from it.* Even the "Flexo-Coupler" itself should not be too near, as the lines of force extending from the coupler will sometimes create trouble with the detector.

2. Don't forget to reverse the detector. Find out in which position it works best. Be sure that the detector terminals are tight, as loose connections often will defeat the working of the set. If you have several detectors available, these might be tried out. I do not advise an adjustable detector or a galena detector, because it is knocked out very quickly. A good, stable detector can be made by using a brass point on a good piece of silicon, and pouring sealing wax around the point, thus making a permanent detector. It is not, however, quite as sensitive or as stable as the carborundum type.

3. Not all tubes work alike. Some tubes oscillate (squeal) more easily than others, and some of the poorer varieties do not oscillate at all. If the set does not oscillate, switch the tubes around until you find the arrangement that works best.

4. Rheostat 13, I must repeat, is a most important part of the set, and is very critical. If adjusted correctly, the set will reproduce beautifully in the natural tones without any distortion whatsoever. The set then becomes a quality set in all respects.

5. The condenser 12 is also important, because without it the set does not oscillate, as once mentioned. Its capacity also may change for different tubes, different crystals, etc., and before wiring up the set permanently it is best to try out a few condensers to find which one works best. Try also to change the + lead of this condenser to the - lead of "B" battery, as explained before.

6. As the set tunes with razorlike sharpness, it is necessary to use a vernier dial, since it is almost impossible to tune in DX stations with the usual dial.

7. As to the "B" battery, I have mentioned already that the first detector coupled amplifier tube 5 should use 22 1/2 volts, but here again a definite rule cannot be laid down. I have had some detectors that work best on 16 1/2 volts, and others that worked best on 28 1/2. For that reason, I recommend that you use a tapped "B" battery, in order to get the best available voltage.

8. Always remember that if you change batteries, or if you change tubes or detectors, you must rebalance your set, and most of the balance will be found in the rheostat 13. The rest of the fixed controls are not so important, as a rule, and are not touched.

I have used a three-tube set of this kind all summer, and the only time I touched the permanent controls was when I took out a tube or installed a new set of "B" batteries. The set has given a great deal of pleasure and satisfaction, and has required no attention whatsoever, after being once properly balanced. Contrary to general belief, the crystal detector used (carborundum) has been a marvel of stability, despite severe surges of static and other abuse. I dare say it is more stable than most tubes.

Those who used the old type carborundum detector some fifteen years ago will remember that it worked best with a potentiometer and a small voltage impressed upon it. Of course, I tried that combination in the Regenerative Interflex and with interesting results. I may come back to this at a later date.

The policy of RADIO NEWS is such that the magazine does not recommend certain parts that go into the making of any set. The writer will, however, be glad upon receipt of a stamped addressed envelope, to forward a list of the particular parts used in the set described here. He will also be glad to give his attention to correspondence from those readers who have constructed the Regenerative Interflex, or who wish to have further particulars about it.

For Long Distance with Big Volume and Keen Musical Quality



\$7.00
EACH

At Your Dealer's

-Install a pair of **KARAS** Harmonik Transformers in your radio set

KARAS Harmonik Transformers deliver perfect music with loads of volume from stations one to two thousand miles away. Distant reception worth listening to!

With Karas Harmoniks in your set, you can truly enjoy radio broadcast music from near or from far. You can get it in all the volume desired without crowding your receiver to the distorting point. You can sit back in your easy chair and listen with keenest pleasure.

"Fishing" for distant stations becomes a matter of finding programs you want to hear—not straining to catch only the bare announcement, and compiling a list of call letters.

There's power and to spare in Karas Harmoniks. Power that brings the biggest volume without distortion. You hear big, full, round, sonorous tones because you get the *complete* musical tone. All the vital harmonics and rich overtones are there in all their naturalness. Low notes, middle notes and high notes all are amplified to the same degree—a rare achievement for audio frequency transformers.

The true characteristics of all musical tones are recreated in your speaker. Piano music pours forth with the rich beauty of the concert hall. The pure, liquid tones of a violin played a thousand miles away cannot be detected from those of a violin played in the same room. The inflections of the human voice are all retained—the very breathing at the microphone—the soft illusive sounds of S and Z.

If this is the kind of reception you want—whether distant or local, you *must* have Karas Harmoniks in your set. It's the only way you can get it over the radio. Don't wait to build a new set. Take the old transformers out of your present set and install a pair of Karas Harmoniks. The sooner you do, the sooner you will enjoy the highest quality of radio reception.

KARAS ELECTRIC CO., 4038 N. Rockwell St., Chicago
For over 30 years makers of **PRECISION** Electrical Apparatus

*30 Day
money Back
guarantee*

—whenever you buy. If your dealer is out, order direct on this coupon. Send no money. Just pay the postman.

Karas Electric Co.
4038 N. Rockwell St., Chicago, Ill.

Please send me.....pairs of Karas Harmonik Audio Frequency Transformers. I will pay the postman \$7 apiece, plus postage, on delivery. It is understood that I am privileged to return the transformers any time within 30 days if they do not prove entirely satisfactory to me, and my money will be refunded at once.

Name.....

Address.....

If you send cash with order we'll send Transformers postpaid

WRNY Now Broadens Plan

(Continued from page 781)

The Lullaby Lady, Kathryn Behnke, like the old-time song girl, chooses her selections from all types of music.

Sigmund Spaeth has shown most interestingly how the simplest kinds of melodies have developed into great music and has shown how some of our popular music of today, changed in characteristics, could sound almost like great music, also he has shown how great composers would handle some of our simplest themes like "Yankee Doodle."

In the violin series, Samuel Polonsky has done fine work. His selections have included many Kreisler numbers and special arrangements of old themes and Hebrew melodies.

The world of chorus was well represented by the Clara Novello Davies singers in selections from oratorios and by the fine Irving Quartette, with Meta Christensen as its sponsor and leader.

Among the novelties presented at WRNY on Fridays, was the broadcasting from the Woolworth Building at noon, six o'clock and ten in the evening. A seance was held in the studio one evening and on another evening ghost stories were told.

SPECIAL FEATURES

One of the interesting special events was the celebration of the 42nd Street Association, which brought, among others, the motion picture actress, Evelyn Brent, Josephine Duval of "Not So Long Ago," Sidney Machot of "Outside Looking In," Miriam Lax of the Rialto, Anna Dale of "The Fool" and such speakers as Louis Wiley of the Times, Julius Kugelman and the Hon. Travis Whitney.

The English Speaking Union dinner was broadcast. John W. Davis, the Rt. Hon. Sir Robert Horne, Capt. IL Arthur Evans, F. W. Petlick-Lawrence, Esq., and Major-Gen. Sir Robert Hutchinson were among the speakers at this banquet.

The Near East Golden Rule dinner was also broadcast. The principle speakers were Dr. John Finley, Bishop James Cannon, Hamilton Fish, Jr., and Charles Vichrey. Dr. S. Parkes Cadman also made a short address.

Esperanto Broadcast Lessons

(Continued from page 789)

a salary at the rate of ten dollars per day (or daily).

Kaj . . . kaj; nek . . . nek; both . . . and; neither . . . nor; Kaj li kaj lia patro iris kun ni, Both he and his father went with us; La libro nek estas sur la tablo, nek en la librujo, The book is neither on the table nor in the bookcase.

Words are compounded in Esperanto logically, that is, the word expressing the principal idea is last: Stacidomo, stationhouse, depot; fiskaptisto, fisherman; forkuri, to run away; belsona, of beautiful sound; ĉiutage, every day, daily.

Word order in sentences. In English we often depend upon the order of the words in the sentences to understand, but thanks to the accusative "n" and the reflexive pronoun si in Esperanto we are never at a loss to understand clearly, whatever may be the word order. But it is best to follow the simplest, most direct way. As English sentence structure is very much like the Esperanto, you cannot fail to be understood if you form your sentences as in English until you have read enough Esperanto to acquire a natural style. Adjectives precede



The New MURDOCK RECEIVER

*the product of experience—
not experiment*

Murdock has been making radio apparatus since 1904—the year radio was born. You are safe in choosing a Murdock.

Murdock 204

Here's a radio receiver that operates without antenna or ground and yet brings in distant stations with perfect clarity and smoothness. There's a thrill in that! The exquisitely beautiful cabinet will delight your artistic sense. Ask your dealer to arrange for a demonstration.

Murdock 201

Turn the dials and note the smoothness and clearness of reproduction. Note also the ease with which stations are singled out. Choose this receiver and you will know what real radio satisfaction means.

*Send for illustrated circulars giving
detailed description of these sets.*

A WORD TO RADIO DEALERS:
We have a mighty interesting proposition to offer. Write or wire

WM. J. MURDOCK CO.
Dept. 122 Chelsea, Mass.

MURDOCK RADIO
Standard since 1904

*Licensed by the Independent Radio Manufacturers, Inc., under the Hazeltine patents

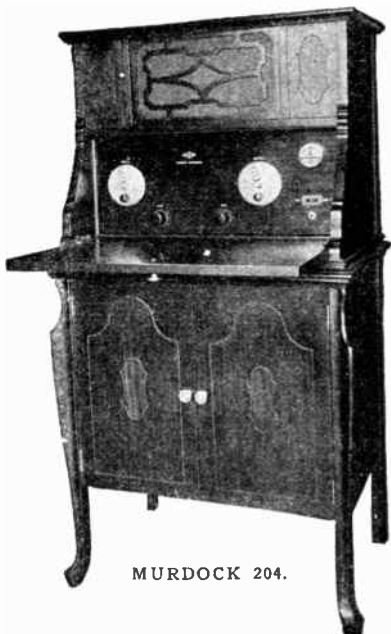

MURDOCK 204.



MURDOCK 201.

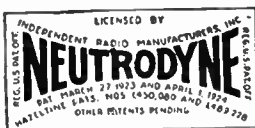

Just the Book You Wanted

"RADIO NEWS" AMATEURS' HANDIBOOK Volume No. 1 (Fourth Printing)

Chock full of radio constructive and instructive articles from cover to cover. Written by foremost radio authorities, in plain everyday language which everyone can understand. Sections include articles on Receiving Sets and Sundry Apparatus, Transmitters and Accessories, Radio Theory, Vacuum Tube Data, and Practical Hints for the Amateur. A book which also serves as a ready reference and should find a place in the library of every amateur. It contains 224 pages and over 375 illustrations, diagrams, and photographs, bound in a multi-colored heavy board. On sale at all leading radio stores. If your dealer cannot supply you, send a dollar bill and the book will be forwarded to you postpaid.

Price \$1.00

EXPERIMENTER PUBLISHING CO., Inc., 53 Park Pl., New York



The United Achievement of Ten Radio Engineers

THE DIFFERENCE in this receiver is no mere superficial difference. It is a distinction that you yourself and thousands of others made in discussing the "ideal Receiver." The Hammarlund-Roberts is a "composite receiver," the individual achievements of ten leading radio engineers.

Every unit in the Hammarlund-Roberts Receiver represents the highest attainment of a leading engineer. The transformers were selected by a transformer engineer familiar with every reliable make, after months of experiment and trial. The condensers were similarly determined on by an engineer whose special study has been condenser characteristics, functions and construction. A man whose whole effort has been on resistance research and perfection selected the resistance units. Even the smallest, usually-neglected units were made the object of scrutinizing study. Never before has so much extraordinary thought been given to every detail of a receiver.

This combination of these harmonizing units in the most desirable circuit is a receiver that is truly the ultimate of five-tube reception, a composite of the higher ideals in radio.

And now—you can obtain this remarkable Hammarlund-Roberts Receiver for LESS than the price of any factory made five-tube receiver on the market of anywhere near equal quality.

Write for descriptive folder

Hammarlund-Roberts, 1182-C Broadway, New York

Hammarlund Roberts

Foundation Unit

The skeleton or foundation for your Hammarlund-Roberts Receiver—bakelite panel, engraved; drilled bakelite sub-panel, brackets and wiring. The other specified parts are standard and can be purchased from any reliable radio dealer. **\$9.40**

Construction Book

Write for this most complete book giving complete details on assembling, wiring and operating the Hammarlund-Roberts Receiver. **25c**

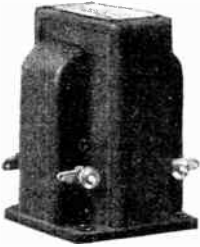

Rauland Lyric
ALL-AMERICAN
TRANSFORMER
Mfd by the All-American Radio Corp.



AMPERITE
Mfd by Radiall Co.



UNION
Mfd by Union Radio Corp.

OTHER ASSOCIATE MANUFACTURERS

Hammarlund Mfg. Co.
Carter Radio Co.
Alden Manufacturing Co.
International Resistance Co.—"Durham Resistors"
Westinghouse Micarta

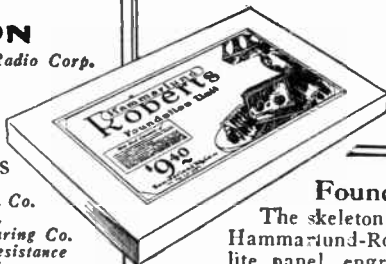



HOMMEL IS AN ACE-HIGH RADIO JOBBER

He works shoulder to shoulder with his dealers at all times—he never competes with them. Large stocks of the best and most desirable radio equipment are carried ready for dealer shipment on a moments notice.

An inspection and repair department is maintained so that apparatus, requiring testing, can be quickly checked before shipment, and repairs made to returned sets without sending the equipment to the factory.

Hommel dealers further benefit from Hommel's national advertising as all user inquiries and orders resulting are forwarded promptly to the local dealers.

Tie up with HOMMEL Now—the Helpful Jobber. Our New Encyclopedia on Radio Apparatus—366-S—will help you,—write for your copy to-day.

WHOLESALE
EXCLUSIVELY

LUDWIG HOMMEL & CO

929 PENN AVENUE PITTSBURGH, PA.

100 AMP. RADIO BATTERY

6 Volt—Rubber Case—Charged and Ready for Use



TWO-YEAR Written Guarantee by THOMAS WITHERBEE

Storage Battery Pioneer for 28 Years
Shipped direct from factory to you. No middlemen's profit—no delays—no grief.

Send No Money

This is an actual 100 amp. Radio Storage Battery honestly built of purest materials by real battery builders. Solid Rubber Compartment cases—not wood (non-leakable)—will outlast the battery itself. Lead coated carrying handle. Wing binding posts.

Will operate the average 5 tube radio set from three to four hours daily for a month to six weeks.

NO DEPOSIT or Advance Payment Required

Simply order—and we will ship by express and you can examine battery at your express office to your heart's content. If you agree with us that it's the biggest offer ever made—pay the express-man \$9.98 plus express charges.

If you prefer to remit with order—deduct 50c. You run no risk as we replace any defective battery during two years.

THOMAS BATTERY CORP.

511 West 50th St., : : : : New York, N. Y.

GEARS

All Kinds—Small



The most accurate made and priced reasonable. We carry a complete line of gears in stock for immediate shipment. Can also quote on special gears of all kinds. Send us your inquiries. Write for Catalogue 40 Chicago Stock Gear Works 105 South Jefferson St., Chicago

PATENTS

DON'T LOSE YOUR RIGHTS

Before disclosing your invention to anyone send for free blank form "EVIDENCE OF CONCEPTION" to be signed and witnessed.

LANCASTER & ALLWINE
Reg. Pat. Attys. in U. S. and Canada
270 Ouray Bldg., Washington, D. C.
Originators of the form "Evidence of Conception"



BUILDING A SET?

You must have rheostats of correct ohmage. Insist on the genuine

KLOSNER RHEOSTATS

Made by pioneer makers of the vernier. FREE.—Send for valuable Rheostat Chart and information on the care and operation of vacuum tubes. Mention dealer's name.

KLOSNER RADIO CORPORATION
1024 East 178th St. Rheostat Specialists, N. Y. C.



RADIO CATALOGUE

and price list of standard nationally known receiving sets and apparatus.

Write for your copy—it's free!

EASTERN ELECTRIC COMPANY
Fair Lawn - - - New Jersey

their nouns as in English, except in cases of emphasis.

De and da; por and pro. De means by, of or from. En la komenco, la mondo estis farata de Dio. In the beginning the world was made by God. Anglo estas ano de angla raso. An Englishman is a member of the English race. Da means of when it is used after words referring to quantity or mass, when the noun which follows has a general signification and does not point out some particular object, as: Dudeko da pomoj, A score of apples, but: La koloro de tiu pomo estas hela. Por means for in the sense of "in the interest of." Mi portis la persikon por mia patrino, I brought the peach for my mother. Pro means "on account of": Pro la pluvo, mi ne povis veni. On account of (because of) the rain I could not come.

ABBREVIATIONS AND USEFUL EXPRESSIONS

A few abbreviations are often used in Esperanto: t. e., tio estas, that is; k. c., kaj cetere, etcetera; k. t. p., kaj, tiel plu, and so forth; ekz., ekzemple, for example. Bonan tagon, sinjoro, Good day, Sir; Kiel vi fartas (or sanas)? How are you? Tre bone, mi dankas, Very well, thank you; Adiaŭ, Adieu, good-bye; Ĝis la revido (much used, and more often just "Ĝis la'"), Till we meet again, lit. "Until the re-seeing"; Mi malsatas, I am hungry; Mi soifas, I am thirsty; Kioma horo estas? What time is it? Bonvolu doni al mi la panon, Please pass (give) me the bread; Kio okazis? What is the matter? (What happened?); Rapidigu! Hurry up!

The following reading exercise in radio terms is taken from the September issue of *The Wireless Magazine*, of London, which, with other leading radio publications of Europe, is actively supporting Esperanto as the world radio language:

UNU-VALVA APARATO

Una-valva aparato ordinare konsistas el la jenaj pecoj; Induktanco iuspeca, krada rezistanco kaj kondensatoro, filamenta reostato, valvingo, kaj taugaj bornoj.

Oni povas aldoni, se necese, pluan bobenon por produkti reakcion, varieblan kondensatoron por akuta agordo, kaj, kiam oni uzas reakcion, trans-kondensatoron.

La cirkvito montrita en la diagramo estas ordinare uzata.

La strio S esta uzata por eligi la reakcian bobenon R. Se oni zorgo uzas la reakcian bobenon, oni ne timu, ke oni interferas per radiado.

Estas vere, ke la forto de la signaloj, kaj la riceva trafpovo estas facile triobligitaj per zorga uzo de reakcio.

A SINGLE-VALVE SET

A single-valve set usually consists of the following items: An inductance in some form, a grid leak and condenser, a filament rheostat, a valve-holder, and suitable terminals.

There may be added, if necessary, a further coil to produce reaction, a variable condenser for sharp tuning, and, when reaction is used, a by-pass condenser.

The circuit shown in the diagram is commonly used.

The strap S is used to cut out the reaction coil R. If the reaction coil is carefully used, there need be no fear of causing interference by radiation.

It is true that the strength of signals and the range of reception are easily trebled by judicious use of reaction.

VORTARO (VOCABULARY)

1. Anteno (aerial).
2. Antena bobeno (induktanco) (aerial tuning coil).
3. Tero (earth).

Insure your copy reaching you each month. Subscribe to Radio News—\$2.50 a year
Experimenter Publishing Co., 53 Park Place, N. Y. C.

AMPERITE

REG. U.S. PAT. OFF.



The "SELF-ADJUSTING" Rheostat

A BASIC Need in Every Circuit

BECAUSE—AMPERITE not only modernizes any set—it keeps it modern.

- 1—Eliminates Hand Rheostats, thereby simplifying control.
- 2—Permits use of the latest types of tubes or any combination of tubes.
- 3—Simplifies and reduces set-wiring, thereby making for greater compactness and avoids losses.
- 4—No moving parts, hence no grinding noises; clear and full tones.
- 5—Prolongs tube-life by keeping filaments at a constant temperature.
- 6—No filament meters needed.
- 7—Brings the most out of each individual tube—automatically—no guessing.
- 8—Makes every set-owner a master operator, no knobs to turn.

Write today for
FREE
Hook-Ups



Sold Everywhere
\$1.10 complete with mounting

AMPERITE is used in every popular present-day construction set. Why? Because of its many outstanding exclusive features, and because it solves the perplexing problem of tube-control—COMPLETELY and AUTOMATICALLY.

For the new tubes:

Amperite No. 112—for the UX-112 and CX-112
Amperite No. 120—for the UX-120 and CX-120

Radiall Company

Dept. R.N.-17 50 Franklin Street New York City

Mf's of "TUNE-RITE" Straight-Line-Frequency Dial

Be sure that the set you buy or build is equipped with AMPERITE.

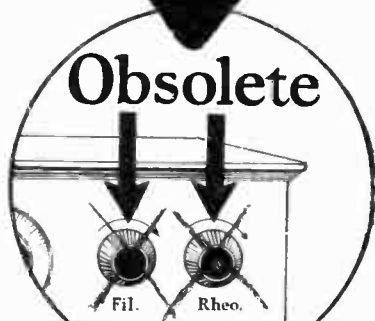

BARKELEW

Attachments for Radiola III and III-A

Antenna Selector Switch

The full range of antenna adjustments can be made by simply turning the two knobs and without loosening a nut. Remove the knurled nuts, slip the switch on the binding posts and replace the nuts. The antenna wire attaches to the one binding post on the rear.

FOUR PHONE POST



No 624
Price .50¢

Four Phone Post

This post will take any number of head sets from one to four and all in series. It is equipped with prongs that push through the phone holes in the face of the panel.

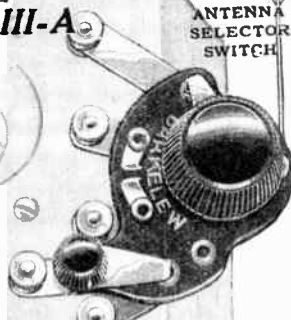

No 605
Price \$1.00

The Barkelew Electric Mfg. Co.
Middletown, Ohio, U. S. A.

NEW YORK, 157 Chambers St.
BOSTON, 31 Bedford St.
WASHINGTON, D. C., Mills Bldg.
ATLANTA, GA., 180 Spring St.
CHICAGO, 15 S. Clinton St.
DENVER, Donham Bldg.

MINNEAPOLIS, 1017 Lumber Ex.
SEATTLE, 1041 Sixth Ave. S.
SAN FRANCISCO, 75 Fremont St.
LOS ANGELES, 443 S. San Pedro St.
TORONTO, No. 7 Crang Ave.
MONTREAL, 296 St. Paul St. W.

Any Radio Map or Log a Month Old Is

Out Of Date

Unless It Has a Monthly Supplemental Service
THE AIR-LINE RADIO MAP AND LOG
With Patented Movable Mile Scale has this Service

Lists stations by dial letters also by wave-lengths. Unique Broadcasting Schedule. Log shows location; difference in time; power, meters and kilocycles; Spaces to list dial settings; time heard, distance, signal strength. Whether you use outdoor aerial or loop, direction of loop; phones or loud speaker.

AN INDIVIDUAL LOG FOR EVERY STATION

If you do not find this the most complete serviceable RADIO MAP and LOG published, we will refund your money.

PRICE 50 CENTS

At your dealers, or sent postpaid. Dealers and Jobbers Write at once

MULTIVIDER CO. St. John & Askew, Kansas City, Mo.

Learn **Electricity**
by practical, personal training in the great shops of **COYNE**

You don't need education or experience. COYNE-trained men earn **\$60 to \$200 a Week**

COMPLETE ELECTRICAL TRAINING in Twelve Happy Weeks

FREE EMPLOYMENT SERVICE while training, after you graduate, and through life. Get my great offer on 2 Big Special Courses without extra cost. Ask for Big, Handsome FREE BOOK containing 151 actual photos of electrical methods and operations in the Shops.

COYNE ELECTRICAL SCHOOL
Dept. 5949 1300 West Harrison Street, CHICAGO, ILLINOIS

RADIO AMATEURS' HANDBOOK

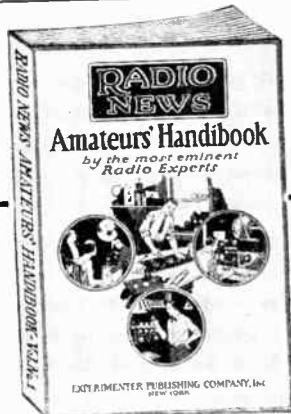

PRICE
\$1.00

224
PAGES

Just the Book You Wanted "RADIO NEWS"

AMATEUR'S HANDBOOK
Volume No. 1 (Fourth Printing)

Check full of radio constructive and instructive articles from cover to cover. Written by foremost radio authorities, in plain everyday language which everyone can understand. Sections include articles on Receiving Sets and Sundry Apparatus, Transmitters and Accessories, Radio Theory, Vacuum Tube Data, and Practical Hints for

the Amateur. A book which also serves as a ready reference and should find a place in the library of every amateur. It contains 224 pages and over 375 illustrations, diagrams, and photographs, bound in a multi-colored heavy board. On sale at all leading radio stores. If your dealer cannot supply you, send a dollar bill and the book will be forwarded to you postpaid.

EXPERIMENTER PUBLISHING CO., INC.
53 Park Place : : : New York, N. Y.

4. Variebla kondensatoro (variable condenser).
5. Krada kondensataro (grid condenser).
6. Krada rezistanco (grid leak).
7. Valvo (valve).
8. Plato (plate).
9. Krado (grid).
10. Filamento (filament).
11. Filamenta reostato (filament rheostat).
12. Filamenta akumulato (filament accumulator).
13. Alta tensia baterio (H.T. battery).
14. Negativo (negative).
15. Pozitivo (positive).
16. Telefoniloj (phones).
17. Fiksa kondensatoro (fixed condenser).
18. Reakcia bobeno (reaction coil).
19. Variebla kuplo (variable coupling).
20. Fadenoj (leads).

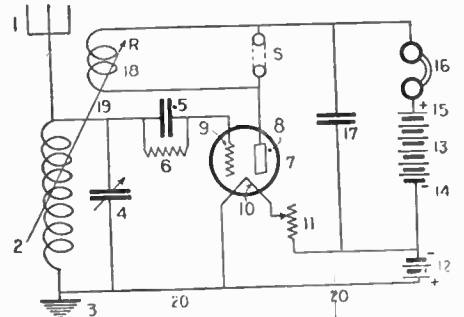

By consulting the text above, the Esperanto equivalents of the names of the apparatus can be ascertained.

In finishing this short broadcast course in Esperanto, I want to add to your vocabulary and appreciation of your world radio language by giving a poem, written originally in Esperanto by L. Zamenhof. In poetry and rarely in prose the definite article la is elided and written l' before words beginning with a vowel. In poetry only the final vowel of words may also be elided.

LA VOJO

Tra densa mallumo briletas la celo,
Al kiu kuraĝe ni iras.
Simile al stelo en nokta ĉielo,
Al ni la direkton ĝi diras.
Kaj nin ne timigas la nokt'aj fantomoj
Nek botoj de l' sorto, nek moko de l' homoj
Ĉar klara kaj rekta kaj tre difinita
Ĝi estas, la voj' elektita.

Nur rekte, kuraĝe, kaj ne flankiĝante
Ni iru la vojon celitan!
Eĉ guto malgranda, konstante frapante,
Traboras la monton granitan.
L' espero, l' obstino, kaj la pacienco—
Jen estas la signoj, per kies potenco
Ni paŝon post paŝo, post longa laboro,
Atingos la celon en gloro.

Ni semas kaj semas, neniam laciĝas.
Pri l' tempoj estontaj pensante.
Cent semoj perdiĝas, mil semoj perdiĝas—
Ni semas kaj semas konstante.
"Ho, ĉesu!" mokante la homoj admonas—
"Ne ĉesu!" en kor' al ni sonas:
"Obstine antaŭen! La nep'j vin benos.
Se vi paciencie eltenos."

Se longa sekco aŭ ventoj ŝubitaĵ
Velkantaĵojn foliojn deŝiras,
Ni dankas la venton, kaj, repurigitaj,
Ni forton pli freŝan akiras.
Ne mortos jam nia bravega anaro.
Ĝin jam ne timigas la vento, nek staro.
Obstine ĝi paŝas, provita, hardita.
Al cel' unu fojon signita!

Nur rekte, kuraĝe kaj ne flankiĝante
Ni iru la vojon celitan!



Round Model Loud-Speaker, price \$25

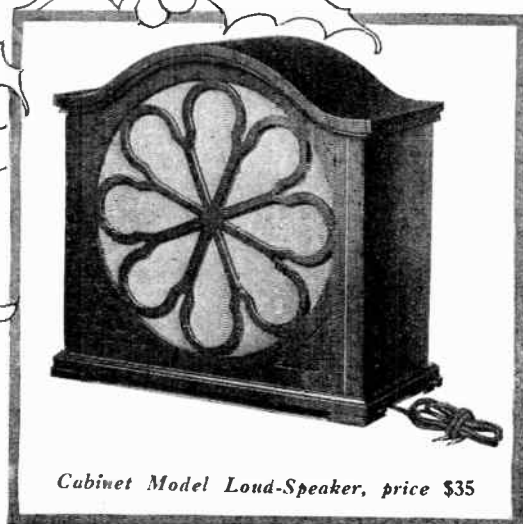

Cabinet Model Loud-Speaker, price \$35

Amplify the pleasures of Christmas with a New Acme Loud-Speaker!

THE difference between an inferior loud-speaker and the New Acme loud-speaker is the same difference which you have observed in people's voices.

From your personal experience of going about among people you know that there is a great difference in voices. Some simply bore you to extinction. While it is sheer pleasure just to hear other people talk, regardless of what they are saying.

Isn't the real difference due to the fact that some voices are monotonous and some are animated? The monotonous voice drones along all on one key. It misses all the interesting inflections, all the pleasing overtones and monotonous. The singer says of such a voice that it has no modulation.

The animated voice, on the other hand, is a voice well-modulated. Proper inflection gives each word increased meaning and interest. All the overtones and monotonous are made use of in a most pleasing way. The singer says that such a voice has "tone color." It is the voice we enjoy listening to.

This is why the New Acme Loud-Speaker is so pleasing to hear. Like an animated voice, well modulated, full of tone color, it reproduces perfectly and beautifully all the interesting inflections, all the pleasing overtones and monotonous that ordinarily are muffled, missed somehow, and the enjoyment of them lost.

Five years and 256 experimental models have

gone into the making of this fine product. Now the Acme double free-edge cone loud-speaker brings in all the beauty of the human voice at its best and all the richness of tone quality of musical instruments as well as of the human voice.

And after all *how well you can* hear is the only thing that counts. Why does the broadcasting station try to obtain the greatest artists? Because their voices and the tones they produce on their musical instruments have all the good qualities we have been discussing. It is sheer waste to have a loud-speaker that cannot reproduce them perfectly.

And if you are pleased with the quality of reproduction, you will be more than pleased with the appearance of this new loud-speaker. It is a cabinet, a piece of furniture. Note how its soft walnut finish and pleasing design play their part in the decorative scheme of the testefully furnished room. They will do the same in a room of your home.

As far as it is humanly possible to judge, this is the perfect loud-speaker. It is now on exhibition at all authorized Acme Dealers and Acme Service Stations. There is no finer Christmas gift.

Send for this book

The whole story of distortion and how this new Acme Loud-Speaker and other famous Acme Apparatus aid in overcoming it is clearly set forth in an interesting 28 page book "Amplification without Distortion." 200,000 of our friends have already found it useful. Perhaps it can help you. At any rate send for it and see.

CLAUDE F. CAIRNS,
President, Acme Apparatus Co.

British Agent

ACME PRODUCTION CO.,
102 Gt. Russell
Bloomsbury, W. C.

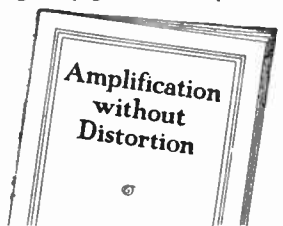

ACME

~for amplification

Acme Apparatus Co.,
Dept. K10, Cambridge, Mass.
Enclosed find 10c (stamps) (coin) for my copy
of "Amplification without Distortion."
Name
Street
City State

Hear Europe with the Universal Plio-6.



35 Meters to 3600 Meters

No Batteries

are required even to operate the powerful receiver pictured above, if you use the new laboratory type

Model A Power Unit

A new broadcast receiver representing the highest type of efficiency obtainable in point of extreme range, tremendous audibility and remarkable selectivity.

Maximum Efficiency—Inexpensive
Parts or Completely Constructed

Write for information today

NORDEN-HAUCK, Inc.
Engineers
1617 Chestnut Street, Philadelphia, Pa.

MacFADDEN B-POWER GENERATORS

Supply your set with an unfailing, uniform supply of B-battery current.

- NO ACIDS
- NO ODORS
- NO NOISE

PRICE \$35.00

This unit has a wide range of usefulness—for sets of five tubes or more use U.X. 216B or U.X. 213—smaller sets, U.V.201A.

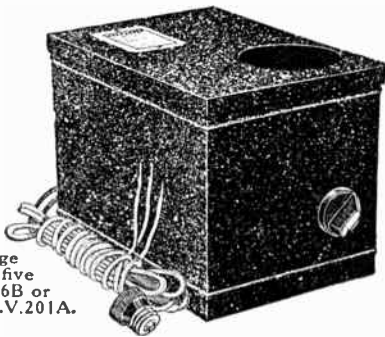

Hook into your light line 110 V. 60 Cycle A.C. house current—no further attention required—just switch on or off.

Sold under a guarantee that really guarantees. Dealers can sell this dependable unit with assurance for continued satisfaction.

It's a Real Job

MacFADDEN & COMPANY, Inc.
2200 ARCH STREET PHILADELPHIA, PA.

GENUINE BAKELITE

Radio Panels

We cut, drill and engrave for you Radio Panels of genuine Bakelite. Send rough sketch for estimate. Plain panels shipped C.O.D. same day order is received. Write for New Catalog on Panels, Tubes and Rods—all of genuine Bakelite.

STARRETT MFG. CO.
520 S. Green St. Chicago

RADIO long-distance COMPLETE sets

THESE are the *Best* long distance sets at the lowest prices in history. Wonderful new circuit that brings amazing results. SATISFACTION GUARANTEED Everything furnished with complete sets. There's a set for every pocket-book.

- 5 TUBE SET—100 Amp. Storage "A" Battery, rubber covered "A" Battery Cable; "B" Battery, 90 V.; 5 Tubes, Loud Speaker, Loud Speaker Plug, Antenna \$89.95
 - 3 TUBE SET—3 Dry Cells; "B" Battery, 90 V.; 3 Tubes, Loud Speaker, Head Phones, Antenna \$46.95
 - 2 TUBE SET—2 Dry Cells; "B" Battery, 45 V.; 2 Tubes, Head Phones, Antenna \$26.95
 - 1 TUBE SET—1 Dry Cell; "B" Battery, 22½ V.; 1 Tube, Head Phones, Antenna \$16.95
- Sets also sold without accessories. Full line radio accessories and partly assembled kits.

THE MELLODYNE RADIO COMPANY
Dept. R-1 Cincinnati, Ohio

Write for free catalog today

Eĉ guto malgranda, konstante frapante, Traboras la monton granitan.
L' espero, l' obstino, kaj la pacienco—
Jen estas la signoj, per kies potenco
Ni paŝon post paŝo, post longa laboro,
Atingos la celon en gloro.

—From *Fundamenta Krestomatio*.

VOCABULARY

Vojo, way, road; densa, dense; brili, to shine; celo, aim, purpose; kuraĝe, courageously; simile, similarly; stelo, star; ĉielo, sky; direkto, direction; timigi, to make afraid; fantomo, phantom; bato, blow, knock; sorto, fate, destiny; moko, mockery; homo, man (generic); elektii, to elect, to choose; flankigi, to turn one's self aside; eĉ, even; guto, drop (of water, etc.); konstante, constantly; frapi, to strike; trabori, to bore through; granita, granite; obstino, obstinacy; pacienco, patience; signo, sign; potenco, power; paŝo, step; post, after; atingi, attain; gloro, glory; semi, to sow; lacigi, to tire; tempo, time; pensi, to think; semo, seed; perdi, to lose; ĉesi, to cease, admoni, to exhort. admonishi, koro, heart; antaŭen, forward; nepo, grandchild; beni, to bless; elteni, hold out; sekeco, dryness, drouth; vento, wind; subita, sudden; velki, to wilt; folio, leaf; deŝiri, to tear from; purigi, to cleanse, make pure; forto, strength; akiri, to acquire; morti, to die; jam, already; brava, brave; anaro, membership (collection of members); staro, stand, halt; provi, to try, test; hardi, to harden; fojo, time (in the sense of occasion).

It will be to the interest of each student who has finished this short course and has desire to go further with the radio language, to send me a card, stating such and giving address. I hope that each will do this at once. Address: J. D. Sayers, Box 223, City Hall Station, New York City.

Traffic or Experiment?

(Continued from page 806)

handling traffic, it is even hard to induce them to take a short msg. for some address in their immediate neighborhood. They must always be adjusting something while you are trying to get through the code. And then, the fault often is that they never have a complete transmitter or receiver in operation when something is wanted of them. They are forever building something but seem to have no end of trouble completing the filament and antenna circuit. Their mind changes more often than that of a sewing circle. They are more fickle than a college widow. The result with the rest of the gang is that these chaps, no matter what they may do, can never impress others with the efficacy or efficiency of any piece of apparatus because, obviously, the others do not know whether it will work or not—never having heard it for more than one evening. No sooner does this type of fellow get a set up complete than he immediately loses interest in it and goes about seeking something else to try his screwdriver and pliers on. As a result his mind is always hazy as to everything he tries. Instead of being a ham, he is more of a plain set assembler. He lacks the true spirit of the ham, the tenacity to stick with an idea until it is put into usable form.

On the other side of the picture is the fellow who is extremely proud of his fist—and often rightly—and who more or less lags behind in the matter of sets and equipment. When the advances of the game force him to change his radiated wave and to install a new transmitter, he does it. But not until the sheer force of necessity makes him. He gets the old set all tuned up, lights the bottles and goes to it. He sits before the brass and does his stuff. He is exceptionally reliable in relays and in testing. He will pay

Uncrowd the Air with a—

"Bruno" MAGIC DIAL

PATENT PENDING

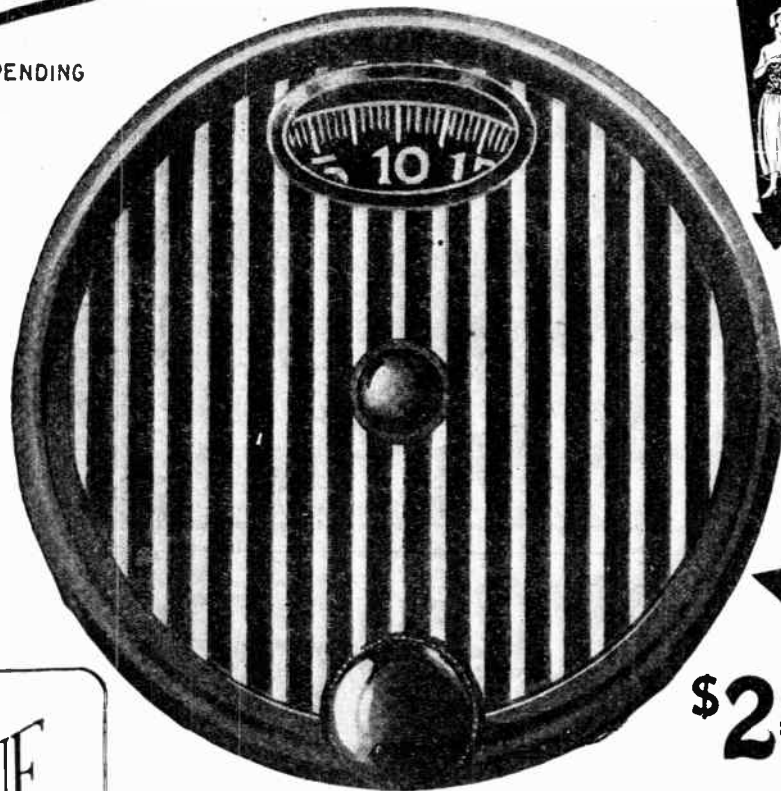

\$2⁵⁰

"Bruno" POWERTONE

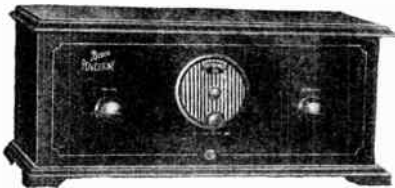

"It Has a Soul for Music"

One dial — Five Tubes —
Charming tone—Excellent volume—Distant reception.

These features put the "Bruno" POWERTONE in the front rank. Judge it by performance, not by price. Set in cabinet, equipped with the "Bruno" MAGIC DIAL and battery cable, with leads identified by markers:

PRICE..... **\$39⁵⁰**

Boxed POWERTONE KIT with full wiring instructions and diagram (no cabinet)
PRICE..... **\$29⁵⁰**

(Set and kit licensed under Hogan Patents.)

The "Bruno" MAGIC DIAL makes any Semi-Circular Plate Condenser Tune like the straight-line frequency type.

Wider dial separation of the crowded low wave-length stations is the demand of the day. The operatic soprano, the patriotic orator and the jazz orchestra must not collide with one another. Why junk semi-circular plate variable condensers to gain this end when all you need to do is to replace your present dials with BRUNO MAGIC DIALS? This can be done in ten minutes on any set.

The existing dial separation of the higher wave-length stations is preserved almost intact, affording superior tuning ease throughout the entire wave-length band.

Rotary tickler coils, also critical on low waves, are cured of their vice by the BRUNO MAGIC DIAL.

Every MAGIC DIAL plainly reveals to the purchaser the brilliant inventive feat that makes these wonders possible.

The BRUNO MAGIC DIAL, a vernier instrument, makes any semi-circular plate condenser tune like the straight-line frequency type. NO GEARS—NO BACKLASH.

BRUNO RADIO CORP.

223 FULTON STREET NEW YORK, N. Y.

Dealer Inquiries Invited

BRUNO RADIO CORPORATION, Dept. N2, 223 Fulton St., New York, N. Y.

Enclosed please find \$..... for which immediately send me.

MAGIC DIAL. POWERTONE SET. BOXED POWERTONE KIT.
(Designate quantity by numeral in proper square)

NAME
STREET
CITY STATE.....

No More Crowding!

HERE is a real straight line frequency condenser at last—a condenser that really eliminates crowding, that really spaces stations evenly over the dials. It is the creation of Rasla, a name made famous by fine parts.

RASLA STRATE-LYNE

The RASLA STRATE-LYNE is built to standards usually adhered to only for laboratory precision instruments. The plates are heavier than on any other condenser, the spacing and alignment is more accurate. Split bushings are provided at both ends. The plates are acid dipped, the endplates nicked and highly polished.

Transparent bakelite insures true low loss.

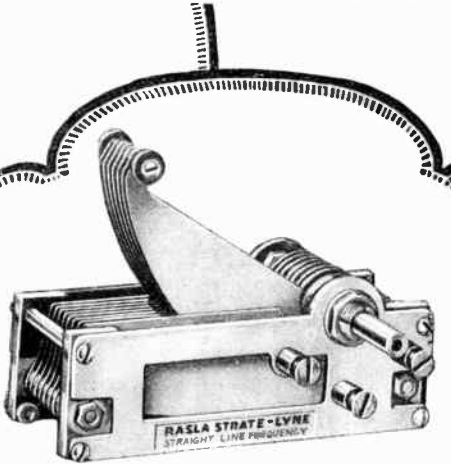

The Rasla Fixed Detector is sensitive—and remains so. Best for reflex or any circuit. At your dealer's \$1.25

FREE—Write for the complete Rasla hook-ups. Davidson Radio Corp., 222 Fulton St., New York

List Prices	
.00025	\$1.00
.0003	4.75
.00035	5.00
.0005	5.25

At your dealer's or direct if he can't supply you.

strict attention, copy perfectly, always give religious preference to schedules and generally make his station one of the best in the net for clearing msgs. But he has little to offer in a scientific discussion of some plan or scheme. He is not primarily a scientist. He is an operator. His pride is founded on his record. The old log bristles with DX records of a sort, he always has things ship-shape and remembers small details. But when it comes to getting over some stiff point, the boy just isn't there. He is not a technician or a real ham. He does not possess that love for going into new fields, taking the lay of the land and then deciding what it is good for.

The difference between these two types of men and the real ham may be illustrated by a comparison. The first chap is like the explorer who just wishes for something to kill time. He travels around, through old countries or new. Usually they must be new, for he is such an inveterate traveler he covers everything possible. He takes no notes, does no investigating, he just simply stands, looks at the surroundings for a few minutes, says "Gee, great stuff," and then passes on to the next new flight. He is simply an intellectual drunkard seeking stimulation. The former chap is like a surveyor passing through a new country for some set purpose, he surveys his line, very carefully, granted, but he does not for an instant get off the straight line. If he were working for a railroad he would certainly lay out a good line, but he would not see a single possibility that the surroundings offered for other work. He would be absolutely valueless, except as an operator of a transit.

And now for the real ham. He is a fellow who goes into some new country exploring. There are strange sights and sounds and new circumstances. He gets the thrill, of course, of seeing something entirely foreign and exotic. But he realizes that the thrill is a part of his work. He enjoys it and his curiosity is aroused. He sees the "how" but he must know the "why," the motivating forces, and the regularity of the things he sees. Consequently, he sets about finding all the data available. Nothing escapes his interest. When he finishes his exploration he is perfectly capable of writing a thrilling travel book telling of his adventures or he is equally able to sit down with hard-headed engineers and tell them just what the possibilities of the country are, so far as exploitation is concerned. In other words, he knows all about the thing.

This is the real importance of the amateur. He is in a position of great versatility so far as equipment is concerned. He may indulge his wildest scientific fancy in order to investigate its possibilities. Then, when he has finished the design, he may turn about and put the idea to the most grilling practical test. Such a complete chance is not available even to the large commercial investigating bodies. Where traffic and good will are involved, it is impossible to give any idea such a thorough trial as is always available to the amateur.

And, incidentally, lest we forget, may we not call attention to the fact again that this very point has enabled the amateurs to play probably the most important part in the growth of radio, when comparison is made between this body of men and any other engaged in the field?

AEROVOX

CONDENSERS

AEROVOX
for Accuracy



AEROVOX
for Quality

Made in all capacities. Write for particulars of our complete line, including Resistofomers, Rheostats and Grid Leaks.

AEROVOX
for Results

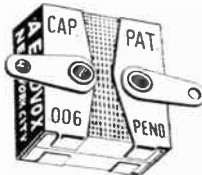
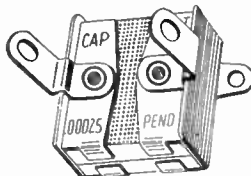

AEROVOX WIRELESS CORP., 493 Broome Street, New York City
Chicago Office: 53 W. Jackson Boulevard

ELGIN SUPER-REINARTZ New 1926 Model

Embodies all the features of the 1915 ELGIN, the set reaching many European stations on 1 tube, with striking improvements in appearance.
FREE working drawings and complete information sent for 2c stamp.
ELGIN RADIO SUPPLY CO.
Dept. C, 207-E Chicago St., Elgin, Ill.

New products by the manufacturers of FIL-KO-PARTS

FIL-KO "A" AND "B" BATTERY ELIMINATOR
KING COLE V RECEIVING SET
Write for descriptive literature, Dept. RN1225
D X INSTRUMENT CO., Harrisburg, Pa.

Calls Heard

(Continued from page 806)

- 2pd, 2qs, 2qh,* 2rk, 2rm, 2tg, 2tp, 2ud, 2uk,
- 2ux, 2yb, 2wr, 2wi, 2wb, 2we, 2xq, 2zh, 2zv,
- 3ab, 3af, 3bl, 3bc, 3bg, 3bp, 3by, 3fs, 3gc, 3hj,
- 3hs, 3hq, 3hg, 3hh, 3kz, 3kd, 3kx, 3kj, 3in, 3io,
- 3jo, 3jw, 3lg, 3lw, 3ll, 3mf, 3mb, 3ot, 3oq, 3pz,
- 3qv, 3sf, 3sd, 3te, 3tf, 3vx, 3vw, 3wo,* 3wb, 3yo,
- 3xt, 3xw, 3zw, 3zo, 3ajd, 3aha, 3adh, 3ade,
- 3adb, 3asf, 3ach, 3apv,* 3bu, 3bjp, 3bwt, 3bof,
- 3bss, 3bco, 3btu, 3bv, 3bta,* 3bdo, 3bng, 3bwj,
- 3bpm, 3blu, 3bnu, 3bms, 3bmz, 3edg, 3elg, 3cjin,
- 3cpa, 3cdv, 3hsc, 3tjn, 4aj, 4au, 4bq, 4bek, 4cs,

WADE SQUARE LAW CONDENSER AND DIAL

All sizes, complete with 4-inch vernier dial, for:
Short wave .000125 mfd. \$7.50
Tuned Radio Frequency, .00025 mfd. 7.75
Super-Heterodynes .0005 mfd. 8.00
At your dealers, otherwise send purchase price and you will be supplied postpaid.
WADE MFG. CO., Inc., 1819-A Broadway, N. Y. City

1926 CATALOG JUST OUT!

SEND FOR YOUR COPY
RANDOLPH RADIO CORP.
159 N. UNION AV. Dept. 2 CHICAGO, ILL.

No, Isofarad Won't Bring In Any Station Whenever Wanted

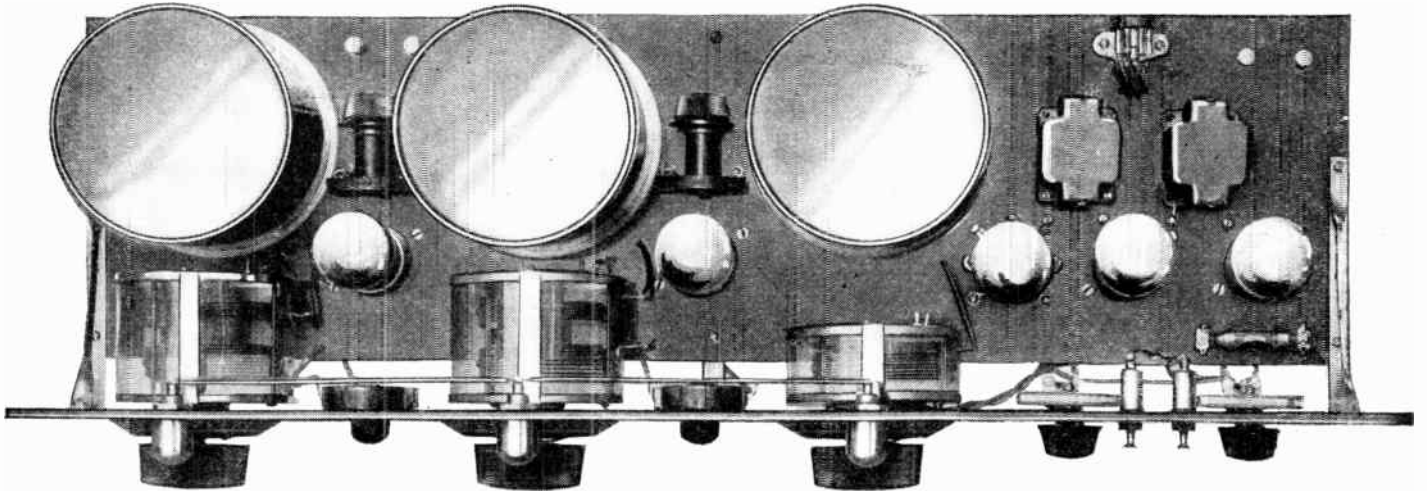

Building your own sets, you have doubtless been astounded and chagrined at the claims that manufacturers dare to make for some of the apparatus you have bought. Please, for a moment, keep Isofarad out of that class, in your mind.

The Isofarad circuit, no more than any other, circles the globe at full volume when you are in the shadow of several high power stations—perhaps on the same wave-lengths as the distant stations you are seeking.

But Isofarad is giving all that the latest sincere radio research really does make possible. Isofarad is the kind of radio the laboratory without a sales department wants to build! The very appearance of Isofarad receivers tells you how far from commercial sets it is now possible for you to go.

For, although Isofarad is not sold as an ordinary "kit", you can have all the gratification of creating this receiver for yourself, with utmost economy. It can really be done in an evening, to highly professional standards, with almost no tools. The specially designed patented apparatus which achieves Isofarad results comes to you;—assembled into the special Isofarad arrangement. Your work, completing the circuit, gives you a de-

lightful insight into astonishing Isofarad principles. The results are really certified. Nothing can reasonably go wrong. Isofarad laboratories cannot obtain better results than yours, because unstable, temperamental factors have been **designed out** of Isofarad.

There is just a hint of Isofarad advancement in the statement that here is the principle which does not **work against itself**—which attains peak results—yet is absolutely incapable of oscillation. Here is the set in which coils are shielded—and fields confined—without penalty. Here is Walbert reputation in a radio receiver. The Univernier—the S.L.F. Vernier Dial—The Panelite—the Enclosed S.L.F. Condenser—the Lock Switch—Walbert made them first.

Isofarad is keeping Walbert first among the experimenters really able to discriminate between genuine brilliant progress and "inventor's" enthusiasm. You have never known anything like Isofarad in circuit or in apparatus. At last reception is **fundamentally** bettered. With Isofarad Walbert gives you a chance to be first in your radio circle. See your dealer. Write us direct if necessary.

ISOFARAD REVEALED

in a clear, instructive book needed by every experimenter who prides himself on knowing the latest radio advancement. 25c sent to the manufacturers of Isofarad brings your copy.

WALBERT



Manufacturing Company, 923 Wrightwood Avenue, Chicago

Hear All Your Aerial Gets

Perfect Insulation Assures Better Reception

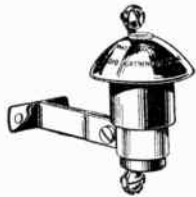

Wirt Radio Lightning Arresters and Wirt Radio Wall Insulators assure better insulation from aerial to your set. Lower loss means greater volume.

Wirt Radio Lightning Arrester. Air Gap Type. Made of Bakelite and Brass. Wide petticoat provides ample insulation even in wet weather. Bracket for rigid fastening. Extra heavy terminals. Lead-in connects without cutting wire. Heavy brass screws for mounting. \$1.00 each.

Wirt Radio Wall Insulators. Made of brown glazed porcelain. Bracket for rigid fastening. Heavy screws furnished for mounting. 35c each. Arresters and Insulators sent post-paid, securely packed, on receipt of price.

Manufactured and Guaranteed by

WIRT COMPANY

PHILADELPHIA PENNSYLVANIA
Makers of Dim-A-Lite

5221 GREENE STREET Dept. C PHILADELPHIA, PENNA.

SALES AGENTS

GEORGE C. KNOTT, 67 Park Place, New York, N. Y.
DOHERTY-HAFNER CO., 730 West Monroe St., Chicago, Ill.
GEORGE A. GRAY CO., 910 Howard St., San Francisco, Cal.
PASS & SEYMOUR, INC., Export Managers, 66 W. Broadway, New York, N. Y.
BENJAMIN ELECTRIC MFG. CO., Toronto, Canada.

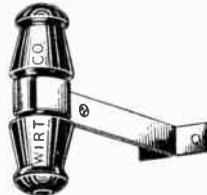

4dm, 4du, 4ek, 4eq, 4fs, 4fg, 4fz, 4fm, 4gw, 4ku, 4kl, 4kt, 4io, 4jc, 4jr, 4jy, 4js, 4ll, 4oa, 4oau, 4pk, 4qi, 4rr, 4sa,* 4sb, 4td, 4tiu, 4tj, 4tv, 4tt, 4ua, 4uk, 4yz, 4xe, 4zd, 4sk, 4ail, 4agl, 4aom, 4bg, (5sk), 5jr, 5je, 5lh, 5ll, 5nj, 5ov, 5ox, 5sr, 5tt, 5uk, 5zas, 8bf, 8ba, 8bt, 8do, 8dx, 8er, 8fm, 8gz, 8jq, 8ks, 8kx, 8ln, 8mz, 8rd, 8nb, 8nx, 8pl, 8ry, 8sf,* 8tt, 8tr, 8to, 8up, 8uf, 8vq, 8yv, 8xc, 8xb, 8xk, 8xd, 8zw, 8zp, 8apw,* 8afm, 8aul, 8add, 8aly, 8adg, 8agw, 8ayd, 8afm, 8adt, 8ame, 8acm, 8ada, 8abs, 8aun, 8bau, 8bh, 8bnh, 8bn, 8bcg, 8buk, 8brc, 8bgn, 8cmi, 8cyi, 8cei, 8dzi, 8eko, 8cnw, 8scr, 8cle, 8caz, 8duk, 8ldo, 8dgy, 8dgl, 8drs, 8jna, 8xav, 8xiv, 8ak, 8ep, 8em, 8ei, 8nv, 8xn, 8xi, 8arp, 8axq, 8bxq, 8htk, 8bcj, 8bey, 8bqu, 8bht, 8cfl, 8cee, 8ecj, 8cus, 8cjs, 8dqn, 8ekt, 8eld.

CANADA: 1ar,* 1af, 1bq, 1cg, 1dj, 1dq, 1ei, 1eb, 1xj, 2am, 2bc, 2bg, 2bn, 2fm, 3bp, 3hq, 8uk, NEW ZEALAND: 1ax,* 2ae,* 2ac,* 2xa,* 4ag, 4ak.

ARGENTINE: cb8,* af2.
BRAZIL: lab,* laf, 2sp.
AUSTRALIA: 2ds, 3bq.
MEXICO: lb, lx.

Additional American States not previously noted: liwe, lmrk, lumf, ludw, lzab, lxah, lxam, lxar, lxav, 2mu.*
(* Worked—Test on 5,80 mts evy Sunday at 12 A. M., E. S. T.)

LIVIO G. MOREIRA, RUA PAULA GOMES 6, CURITYBA, SOUTH BRAZIL

lalw, lanq, lbtr, lecp, lcu, lmy, 2adu, 2agq, 2bc, 2ber, 2bec, 2ety, 2fb, 2go, 2ha, 2mu, 2nl, 2ve, 2xaf, 2xu, 2xz, 3bcj, 3cd, 3cdk, 3hg, 3jv, 3kdk, 3ot, 4cu, 4tv, 5ap, 6das, 8ax, 8nk, 8st, 9bst, 9efi, 9ckl, 9ddj, 9dkr, 9ek, 9es, 9mm, 9qr, 9tae, 9xw, 9xz.

ARGENTINE: a8, afi, af2, apl, db2, de3, cb8.
AUSTRALIAN: 3ae.
BRAZIL: lab, laf, 2sp.
CHILE: 2ld.
URUGUAY: jcp.

MISCELLANEOUS: kdka, wgy, (phone) nkf, fwx, jcw, wir, wiz, wgh.
9CTV, C. PACK, 131 BROAD ST., MENASHO, WISCONSIN

1aep, 1ape, 1art, 1blh, 1bq, 1emp, 1my, 1uw, 1xu, 2aap, 2afn, 2blu, 2cyy, 2ha, 2mu, 3acr, 3aif, 3bn, 3btu, 3fc, 3hg, 3nn, 3vx, 4af, 4as, 4cu, 4gy, 4oa, 4pz, 4uk, 5aa, 5ac, 5atv, 5awl, 5ce, 5oq, 5ph, 5uk, 5vah, 5vl, 5wi, 8aal, 8afm, 8apr, 8apw, 8aub, 8aul, 8ax, 8axd, 8ay, 8ayy, 8bbl, 8bce, 8bf, 8blm, 8bl, 8biq, 8bna, 8bnh, 8boy, 8bpl, 8brc, 8bsr, 8bsu, 8bwk, 8by, 8bvl, 8bz, 8caq, 8cbp, 8eck, 8ecq, 8ecd, 8cdv, 8cbp, 8ck, 8ccq, 8ced, 8cdy, 8cyi, 8dai, 8dem, 8dka, 8doi, 8lok, 8don, 8dor, 8drr, 8eq, 8gz, 8in, 8jq, 8kc, 8nk, 8re, 8ry, 8to, 8tx, 8nk.

OTHERS: nkf, wir, wiz, wap, wqn, wgh.
Anyone hearing my 5 watts pse qsl crd. Any of the above desiring crds pse qsl.

3H P, GEO. E. STEWART, 420 COLLINS AVE., BALTIMORE, MD.

1hoc, 1bq, 2adk, 2amj, 2apd, 4bq, 4cm, 4uq, 4nw, 8bmb, 8boi, 8bwa, 8by, 8dgl, 8vc, 8vs, 9bc, 9hnu, 9dxi, 9dy, 9ea, 9cbq.

CANADIAN: 3aae.
Hyd. on detector. Will qsl all crds.

ROGER F. HATHAWAY, 24 BAY STREET, TAUNTON, MASS., JULY 1925

1aaw, 1abnn, 1adm, 1adr, 1adw, 1ael, 1aes, 1ail, 1ami, 1ash, 1ask, 1awq, 1azr, 1azw, 1bbj, 1bcn, 1beb, 1bft, 1bgu, 1bhp, 1bq, 1bzp, 1ccz, 1coj, 1ow, 1lo, 1qb, 1qz, 1uu, 1vc, 2nd, 2adk, 2ag, 2ahc, 2akg, 2akp, 2amf, 2amj, 2aop, 2apt, 2at, 2bcp, 2cdh, 2cj, 2clg, 2cvc, 2cyy, 2cy, 2dyl, 2ff, 2fj, 2ig, 2jp, 2kc, 2kg, 2kj, 2pp, 2sm, 2adl, 3aea, 3ais, 3aqe, 3arw, 3bcp, 3bng, 3cel, 3co, 3ha, 3lo, 3py, 3qt, 3sn, 3th, 3zm, 4av, 4cp, 4qh, 4tr, 4ts, 4av, 4cp, 4qh, 4tr, 4ts, 5ats, 5om, 6ats, 8adu, 8aov, 8aqv, 8aul, 8ayp, 8bho, 8bjz, 8bsf, 8bsu, 8btm, 8jzu, 8cdv, 8chl, 8cix, 8crl, 8cxl, 8ocj, 8ofc, 8cu, 8fv, 8ta, 8vs, 8wo, 9agb, 9lhi, 9bwn, 9hux, 9hzi, 9ch, 9ckv, 9onc, 9eky, 9ii, 9gx, 9nu, 9ud.

Will take the above stations please qsl?

IAZK, GEO. H. GEIGER, 128 GROVE ST., CHELSEA, MASS.

150 to 200-Meter Band: 1abj, 1awq, 1bed, 1bgu, 1bjk, 2ahc, 2aiz, 2ali, 2ams, 2amw, 2bdo, 2eql, 2ll, 2lz, 2sq, 3afk, 3acu, 3aid, 3aso, 3ctn, 3fu, 3ld, 8ako, 8aqb, 8bdj, 8bdo, 8bga, 8cww, 8cgu, 8civ, 8chx, 8fo, 8hb, 9dmm, 9fg, 9ud.

80-Meter Band: 2adk, 2agq, 2cbk, 2chg, 2cy, 2ff, 2kg, 2lm, 3aa, 3af, 3afu, 3ag, 3sm, 4ai, 8ayb, 8aye, 8bbe, 8bmm, 8bdc, 8dfo, 8dta, 8rt, 9adz, 9av, 9haz, 9hss, 9cja, 9cb, 9cvu, 9cmd, 9ox, 9tm, kio, 3aif, 3apv, 3rd, 5adz, 5gs, 6ajj, 6qk, 6cgv, 6zac, 6xhy, 8aqb, 8ayy, 8jj, 8bna, 8pl, 8ry, 8sg, 9dvi.

AUSTRALIA: 2wa.
GREAT BRITAIN: 5dh.
All cards will be answered immediately.

G. W. ROCKWELL, 42 PHILLIP STREET, HAJIFAX, N. S.

UNITED STATES: 1ann, 1abr, 1aby, 1qo, 1rf, 2bqa, 2bzj, 2cel, 2cpa, 2crr, 2rb, 2xi, 3cbk, 3bhy, 3boj, 3bss, 3cbx, 3cs, 3hj, 3pp, 4aad, 4og, 5zu, 6awt, 6zh, 8xe, 8yv, 9am, 9amb, 9dqs, 9dhi.

CANADA: 1ar, 1ak, 1bq, 1dd, 1df, 1dj, 1dq, 1eb, 1ef, 1ei.

ARGENTINE: cb8.
BRITISH: 2nb, 6nf.
N. Z.: 2ac.
FRENCH: 8qq, 8sm.

PORTO RICO: 4je.

qsl to send a crd to any of the above who qsl me.

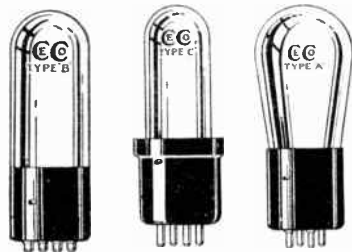

	"A"	"B"	"C"
Filament Volts	5.0	3.0	3.0
Filament Current	0.25	.06	.06
Plate Voltage	20 to 120	20 to 80	20 to 80

Made with Brass and Bakelite Bases

CeCo Tubes

Make a Good Receiver Better!

All tubes look pretty much alike; appearance doesn't tell you a darn thing about performance. There's only one way to be SURE. Buy tubes only when you see the name CeCo on the package and on the tube itself. Then you may be certain of maximum results—clarity of tone, rich volume, long life.

Every CeCo Tube fully guaranteed. Tests of nationally known laboratories confirm the results of our own tests and prove our claim to superiority.

Write for New, Illustrated Catalog with Test Charts.

C. E. MANUFACTURING COMPANY, Inc. 702 Eddy Street, Providence, R. I.

Trade Supplied through Jobbers Only!

Jobbers—Write for details and prices. Set Manufacturers—Ask us about our SPECIAL MATCHED tubes.

Above chart shows why the CeCo Tube is most successful in audio and radio frequency circuits. Write for complete set of graphs.

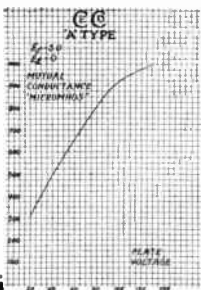

Aeriola X Crystal Set

\$12 Complete with



100 ft. aerial wire, 25 ft. ground and lead-in wire, aerial insulators, porcelain tube, lead-in strip, ground clamp, nail-tite knobs, set head phones. (Without accessories, \$6.60.)

Send for FREE Descriptive Booklet.

CRAIN BROS. RADIO SHOPPE

2304 Telegraph Avenue : : Oakland, Calif.

FREE 100 PAGE RADIO BOOK 5 REFERENCE BOOK

ASK FOR BOOK 5 REFERENCE BOOK

Latest 1926 radio reference book, just off the press. Contains latest parts and those hard to get, everything needed in radio. Liberal discounts on standard quality parts. Get this book and buy right.

HEINS & BOLEY 50 Park Place, New York

Prizes For You

Boys and Young Men—You can earn dandy prizes and liberal commissions by selling and delivering our popular magazines in your spare time. No experience or money is necessary. We furnish all supplies and tell you just how to start. Write to-day.

E. J. FOLEY, Department RN-12
Experimenter Publishing Company, 53 Park Place, New York City

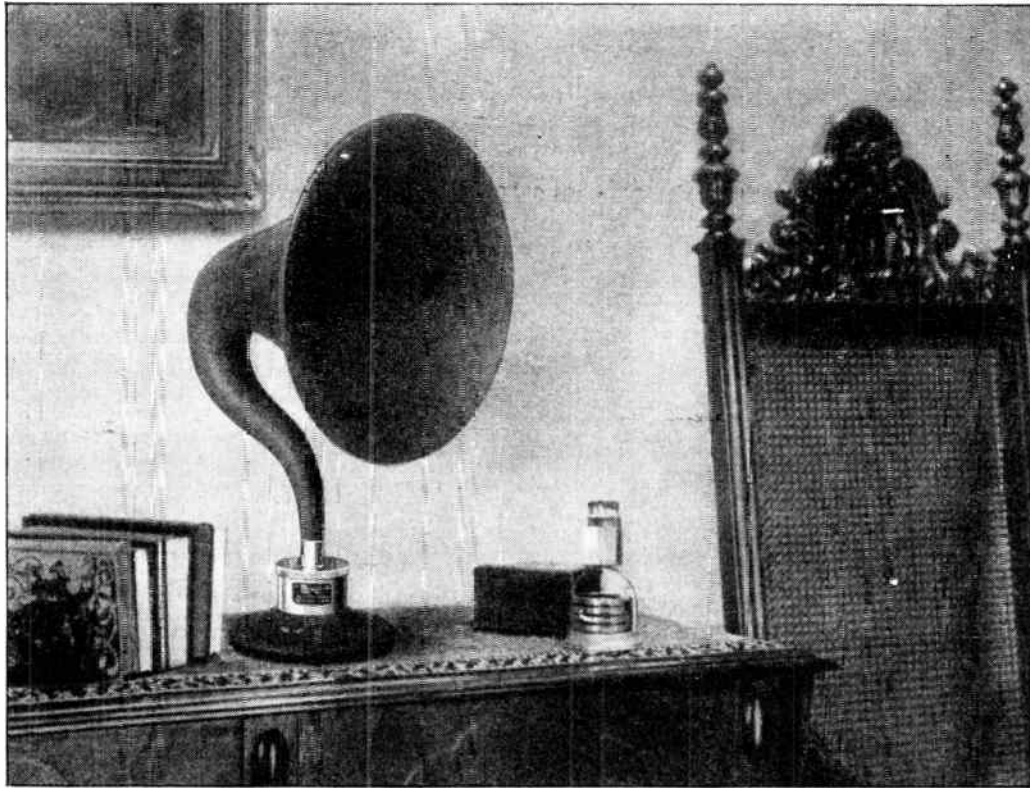

*Unto Re*creation you will come*

SOME time you will hear the *re*creation* of a radio program, and it will so grip you with its realism that almost you will believe your ears, and think yourself in the very presence of the performers. You will thrill to beautifully delicate tones you had been missing all the while, and you will respond to elusive strains of melody that you had, somehow, never caught before. Some time you will hear a Rola Re*creator.

The Rola re*creates the tonal

arts in every original shade and coloring. From the minute you first hear the Rola, your love of fine music finds new joy in radio. And you will be eagerly drawn to Rola, the only Re*creator. The Rola Company, 4250 Hollis Street, Oakland, California. Marketed nationally through—

BAKER-SMITH CO., INC

Head offices, Call Building, San Francisco

Branch offices in the following cities:

New York City 1270 Broadway	Los Angeles 443 S. San Pedro
Chicago, 30 North Dearborn	Portland, Ore., Henry Bldg.
Denver, McClintock Bldg.	Seattle, L. C. Smith Bldg.
Salt Lake City 136 East Broadway	Vancouver, B. C. 179 Pender St. West

Rola
RE ★ CREATOR
\$36

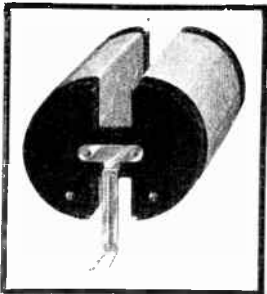

A. F. Henninger's famous Power-Plus Coils — the ultimate in inductances. Coupon below brings you seven Hook-Up Blueprints and booklet in colors FREE.

Super Power—Real Selectivity

Radio constructors demand power—reserve power! POWER-PLUS Coils have earned their name—they are unrivaled. They will give your set a tremendously increased reception range. Easy to install. No external fields. No interference can be picked up. You get genuine selectivity without critical tuning operation.

Your Dial Logging Never Changes

Uniformity of construction of POWER-PLUS Coils means uniformity of dial logging. POWER-PLUS Straight Line Frequency Condensers are recommended for tuning. They will give you wide station spacing on your dial—in addition to uniform logging. The new automatic wear compensator insures a lifetime of service.

Seven Hook-Up Blueprints FREE

New, superior design and unexcelled workmanship in POWER-PLUS Coils and Condensers will bring you RADIO as you want it. Send for descriptive booklet and seven blueprints today—NOW!

A. F. HENNINGER CORP.
4509 Ravenswood Ave., Chicago, Ill.

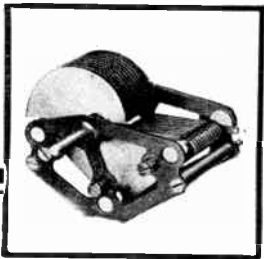

FREE Descriptive Booklet in colors and seven Hook-Up Blueprints with complete instructions mailed to you FREE. Mail this coupon—NOW!

Name
Address

22½ VOLT \$2.95



It's OUT—Complete everlasting ready to run non-acid, non-sulphating 22½-volt rechargeable "B" storage battery. \$2.95. Includes chemical. Does not lose its charge standing idle. Special 2-22½ volts (45 volts) \$5.25; 90 volts \$10.00; 112½ volts \$12.50; 135 volts \$14.75; 157½ volts \$16.80. Nearly 3 years sold on a non-red tape, 30-day trial offer, with complete refund if not thoroughly satisfied. Further guaranteed 2 years. Knockdown kits at still greater savings. Complete ready to run "B" battery charger \$2.75. Sample cell 35c. Order direct—send no money—simply pay expressman its cost on delivery, or write for my free literature, testimonials and guarantee. Same day shipments. My large 32-page radio goods catalogue 10c. B. H. Smith, 32 Washington Ave., Danbury, Conn.

J. G. TINNEY, 74 KAINUI ROAD, HATAITA, NEW ZEALAND. JUNE, 1925
UNITED STATES: 1ax, 1pl, 1te, 1aa, 1anq, 1hcc, 1cki, 1cmp, 1xua, 1alw, 2ha, 2lu, 2ql, 2rm, 2zv, 2bec, 2hrb, 2xaf, 2cty, 3hg, 3ll, 3cck, 3bva, 4dm, 4tv, 5wi, 5mi, 5nj, 5oj, 5ov, 5uk, 5acl, 5ajh, 5apu, 5atv, 6cc, 6eb, 6fa, 6ji, 6jp, 6km, 6nb, 6ns, 6nx, 6ts, 6gx, 6no, 6ahq, 6aji, 6aoi, 6awt, 6bhl, 6bhz, 6bjx, 6bhz, 6bmv, 6buc, 6bur, 6eck, 6ecy, 6cgw, .chs, 6cnc, 6cso, 6ess, 6cto, 6cvm, 6dcl, 6xap, 6zac, 7gh, 7gj, 7mf, 7ya, 7nt, 8do, 8eb, 8gz, 8pl, 8pl, 8ry, 8zf, 8apw, 8hfw, 8ecd, 8chk, 8cht, 9ck, 9og, 9uq, 9wo, 9xw, 9zt, 9aao, 9akf, 9apm, 9baj, 9bht, 9dct, 9ded, 9dfh, 9dfw, 9evr, 9ddf.

ARGENTINE: cb8.
CANADA: 5ba, 5gt.
ENGLAND: 2lz, 2nm, 2od.
FRANCE: 8bv, 8ct, 8qu, 8yor, 8co.
ITALY: 1er, 1rg.
MEXICO: 1aa, 1b, 9a, xda.
SWEDEN: smny.
PORTO RICO: 4sa.
BRAZIL: wjs.
HAWAII: fx1, 3ze, 6asr.
MISCELLANEOUS: 1ab, (bz), 2sp (bz), wiz, nkf, nrrl, npm, lp2.

AUSTRALIA: 2at, 2bb, 2cm, 2hm, 2hs, 2ij, 2me, 2rt, 2js, 2yi, 2zn, 1an, 3bm, 3lp, 3hq, 3ci, 3im, 3jp, 3ze, 4ai, 4wb, 5bd, 5kc, 5wj, 7aa, 7cs, 7gd, 7om, 7pt, 7rb.

All reception done on Detector only for above. I have plenty qst cards.

CALLS HRD AT IAOK, 122 SUMMIT ST., SOUTH MANCHESTER, CONN., JUNE 9-25
(1af), 1bal, 1cot, (1afc), (1clz), 1uz, (1aac), 1afn, 1bjp, 1asu, 1awn, 1alc, (1aim), 1ic, (1lj), (1hl), (1ack), (1ash), (1acd), 1blt 1adg, (1bip), 1lw, (1sl), (1aiu), 1ajk, (1apl), 1aos, (1ns), 1adw, 1ail, 1bvl, (1agq), 1asu, 1cri, 1bu, 1bkp, 1bdv, 1gjm, (1yb), (1arl), (1rf), 1auf, (1bjf), (1ajt), 1bbj, 1ky, 1chv, 1cln, 1se, 1bf, 1azd, (1gc), (1ahc), (1adq), (1akz), 1aki, 1ert, 1qb, 1ch, 1bvp, 1bbo, 1crz, 1awq, (1ckk), 1aug, 1ec, (1bzo), (1aqt), (1ash), 1ben, 1vc, 1hdt, (1hj), 1cx, (1ajm, 1alw, 1ahb, (1tc), 1aal, 1bsj, 1bpf, (1ane), 1kw, 1bsg, 2cxg, 1coe, 2adc, (2akh), 2als, 2bbx, 2 ha, 2cdh, (2cpd), 2adk, (2bzp), (2cyg), 2agb, 2cz, 2cjb, 2hl, (2ang), 2avo, (2kg), 2adr, 2apx, 2cxc, 2auh, 2aav, 2rb, 2hj, 2yv, 2lx, 2xu, 2aej, (2anr), 2ax, 2bqb, 2ans, 2alp, (2bow), 2aky, 2cbw, (2apt), 2lm 2my, 2ha, 2byg, 2ctf, 2amb, 2tr, (2acc), (2aao), (2cpz), 2xs, 2nr, 2clh, 2bay, 2akp, 2ayh, 2cdh, 2ctp, 3cjm, 3zb, (3bo), 3bbx, 3op, 3hd, 3pt, 3mk, 3hmt, 3btq, 3bmk, 3wa, 3zn, (3ot), 3uy, 3ct, 3co, 3as, 3bcl, (3atz), 3cg, 3op, 3cdn, 3cko, 3zo, 3cv, 3ev, 3hqz, (3atw), 3ve, 3rg, 3ao, 3mv, 3oq, 3bve, 3py, 4fm, 4iv, 4ea, 4bk, 4cuk, 4le, 4dfo, 4rs, 4axd, 4hve, 4hto, 4bys, 4rh, 4kx, 4cdv, 4rv, 4vs, 4cdv, 4agw, 4eu, 4ul, 4dgv, 4ek, 4qr, nba, wgh, wj, nerk, nerk-1, wiz, wql.

Qsl crd to ani of above if desired hw?
(Qrk? mi 22 pse qsl eswl re qsl mani tux.
ZASJ, CHARLES ERNEST SPITZ, 2382 ASTORIA, L. I., NEW YORK
U. S. A.: 1di, 1acd, 3aal, 3afu, 3ahh, 3bay, 3hnu, 3cay, 3ek, 3ev, 3oe, 3ok, 3xbx, 4aai, 4aam, 4ab, 4hu, 4it, 4oe, 4og, 4zu, 5li, 6agk, 6cix, 6err, 6daa, 8awk, 8awt, 8ayp, 8ayv, 8bfi, 8dfl, 8cm, 8rh, 9act, 9ara, 9au, 9auc, 9avc, 9bdl, 9hpb, 9cab, 9cyn, 9del, 9deo, 9dvi, 9eb, 9ep, 9ff, 9hp, 9ii, 9ik, 9la, 9rh, 9wa.

ARGENTINE: rah4, raes, reb8.
BERMUDA: ber.
ENGLISH: g6nf, g2au, g2awp, g2kw.
FRENCH: f8bv.
HOLLAND: pl.
JAPAN: jupu, jsda.
LUXEMBURG: lark.
SALVADOR: fmg, fna.
MISCELLANEOUS: kel, ket, aga, gu.
WI qsl ani card, qrk?

2KG HEARD IN EUROPE
This summer, 2kg, using uv-2dias with an input of 24 watts, has been heard in England, Paris, Buenos Aires, and very steady in Los Angeles. Stations g6nf, g2kw, g2au, g2awp, f8bv, rah2 and raes have reported the signals as being very qsa and steady.

RUPERT EATON, 15 CHESTER ROAD, CLAREMONT, WEST AUSTRALIA
u1aa, u2jw, u2cxw, u4xw, u4rr, u4ck, u5aj, u5acl, u5wi, u5qx, u6sm, u6hiz, u6gx, u7ay, u7it, u8ar, u8bau, u8duc, u8gz, u8bg, u9bst, u9cld, u9elx, u9cxc, u9el.
CANADA: 4gt.

RADIO 3HP, GEORGE E. STEWART, 220 COLLINS AVENUE, BALTIMORE, MD.
Heard between July 10, 1925, and August 11, 1925: 1abk, 1akz, 1bqj, 1ci, 1it, 2adk (2), 2aep, 2crj, 2lm, 2ml, 2rl, 2to, 4cm, 5rpi, 5aq, 5awh, 5iq, 7agt, 8bcz, 8bdj, 8bna, 8boi, 8cx, pdgl (2), 9bex, 9bdh, 9bc (2), 9beu, 9bnw, 9ea.
CANADIAN: 2bu, 3ahh, 3dp.
All cards answd day received. Detector only, between 150 and 200 meters and 80 meters.

HRD BY J. BARSBY, 1511½ NORTH COMMONWEALTH, HOLLYWOOD, CALIF.
July and August—40 Meters
1aep, 1are, 1pl, 1xu, 1za, 2bbx, (2ha), 2lu, 2mu, 2wc, 3af, 4al, 4as, 4hg, 4iv, 4ll, 4rm, 4rr, 4sa, Porto Rico, 4si, 5ac, 5adz, (5agn), 5agu), (5akn), 5alj, (5arn), 5atv, 5ew, 5hee, 5ls, 5nw, 5nr, 5ox, 5ph, 5uk, 5uk, 5wa, 5zl, 5zai, 7adq, (7ack), 7ay, 7dd, 7de, 7do, 7kg, 7ku, 7ly, 7nl, 7nt, 8aj, 8ay, (8ajm), 8bce, (8cnl), 8cau, 8cy, 8dem, (8don), 8eb, 8ko, (8pl), 9abo, (9ado), 9aom, 9huf, 9hut, 9crw, 9cwi, 9cld, 9eyu, (9dfl), 9dm, 9dvr, 9efs, 9ek, 9ene, 9gaj, 9eb, 9qb, 9oi, 9uq, (9wo), 9xn, 9zt. Army cxl.

Now Genuine Silent N°8 \$49.50 L.C. SMITH
You SAVE \$55.50
30 DAYS FREE TRIAL

You can save \$55.50 on a Model No. 8 L.C. SMITH—the genuine "Silent Smith." Or you can save \$60.00 on the L. C. SMITH Model No. 5!

Like New in Looks and Service
Both are literally like new! Guaranteed for 5 years. Each has all latest improvements. Standard keyboard; 84 characters. Ball bearing shift, carriage and keys; two-color ribbon, etc. No. 8 "Silent Smith," in addition, is SILENT. It has the newest decimal tabulator, with column selector.

30-day Free Trial; Satisfaction Guaranteed
Try either model 30 days. If it does not please you in every way, send it back at our expense and we will refund every dollar you have paid. Send postcard for full details.

Cut Prices On All Standard Makes
LINCOLN TYPEWRITER COMPANY
INCORPORATED
America's Leading Independent Typewriter House
Dept. 56B 298 Broadway, New York City

ARROW BATTERY
WRITTEN 2-YEAR GUARANTEE
Battery Prices SMASHED!
To Consumers Only
Here is real battery quality, guaranteed to you at prices that will astound the entire battery-buying public. Order Direct From Factory. Put the Dealer's Profit in your own pocket. You actually save much more than half, and so that you can be convinced of true quality and performance, we give a **Written 2-Year Guarantee**. Here is your protection! No need to take a chance. Our battery is right—and the price is lowest ever made. Convince yourself. Read the prices!

Auto Batteries	Radio Batteries
6 Volt, 13 Plate, \$9.50	6 Volt, 100 Amp, \$9.50
6 Volt, 15 Plate, \$11.50	6 Volt, 120 Amp, \$11.50
12 Volt, 7 Plate, \$13.00	6 Volt, 140 Amp, \$13.00

Buy Direct—Send No Money
We ask no deposit. Simply send name and address and style wanted. Battery will be shipped same day we receive your order Express C.O.D. subject to your examination on arrival. Our guarantee accompanies each battery. We allow 6% discount for cash in full with order. You cannot lose! Send your order today—NOW!

ARROW BATTERY CO.
Dept. 6 1215 So. Wabash Ave., Chicago

Easy to Play Easy to Pay
BUESCHER
True-Tone Saxophone
CLYDE DOERR
Of Clyde Doerr and His Orchestra, with his Buescher True-Tone Saxophone.
Easiest of all instruments to play and one of the most beautiful. Three first lessons sent free give you a quick easy start—in a few weeks you can be playing popular tunes. No teacher necessary. You can take your place in a band or orchestra in ninety days, if you so desire. Most popular instrument for dance orchestras, home entertainments, church, lodge and school.
A Saxophone player is always popular socially and has many opportunities to earn money. Six Days' Trial and easy payments arranged.

Free Saxophone Book Shows all Buescher models and gives first lesson chart; also pictures of famous professionals and orchestras. Just send your name for a copy. Mention any other instrument in which you may be interested.

BUESCHER BAND INSTRUMENT CO. (166)
Everything in Band and Orchestra Instruments.
975

The wonderful performance of these CROSLLEY Radios will be duplicated this year—and with these New Prices they should be Radio's best values!

LOW POWER STATIONS HEARD ACROSS THE COUNTRY WITH THE CROSLLEY 3 TUBE 52

"One big asset of Crosley '52' is its ability to pick up low powered broadcast. I have picked up KPON, Long Beach, California, and KFUM, Colorado Springs, Colo., both stations using only 100 watts, and KFEL a 50 watt station in Denver."
PHILLIP S. WILLIAMS,
 Bristol, Pa.

LIVES IN CALIFORNIA—LISTS 35 STATIONS EAST OF ROCKIES HEARD ON LOUD SPEAKER

J. F. McGinley living in Hallster, Calif., sends us a list of stations in the East including Ohio, Pennsylvania and New York, whose broadcasting he enjoys constantly on his loud speaker. He emphasizes the fact that he owns no ear phones.

"COAST TO COAST" RECEPTION WITH A CROSLLEY 3 TUBE 52

"I have a record of reception of practically all the large radio stations in this country and Canada from WBZ, New England to WABP, Miami, from Fort Worth, Texas to CURT, Toronto and from CYL, Mexico City to KGW, Portland, Oregon and KFJ, Los Angeles."

WALTER HAGERTY,
 Burlington, Iowa.

SPRUCE, MICHIGAN, IS WITHIN EARSHOT OF EUROPE WITH A CROSLLEY 3 TUBE 52

"During the International test last year I heard the following stations clearly and distinctly: Paris, Berlin, London, Honolulu and Porto Rico, 6 and 8 tube sets in my neighborhood don't begin to compare with my 'Little Wonder'."

ELLIS C. MARTIN,
 Spruce, Michigan.

CROSLLEY TRIRDYN HAS BROUGHT HIM 178 EKKO STAMPS AND KZKZ MANILA, PHILIPPINE ISLANDS

"In all I have logged 208 stations and received 178 Ekko stamps. The farthest I have received is 7,000 miles, which is Manila, Philippine Island (KZKZ). I have received one Alaska Station and four California stations."

LEO CASSELL,
 Indianapolis, Ind.

EASY TUNING IS A FEATURE OF THE CROSLLEY TRIRDYN

"My little daughter, two and a half years old is a real radio fan. For an honest fact, she can tune in the most powerful stations and get some music."

L. F. INFANGER,
 Rome, New York.

Crosley 2-Tube 51 Regular

This efficient little set uses any make of tubes. Nearby stations on loud speaker, long range on headphones.

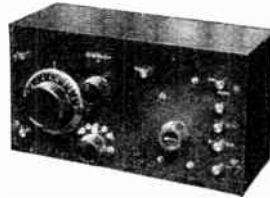

Now \$14.75 was \$18.50

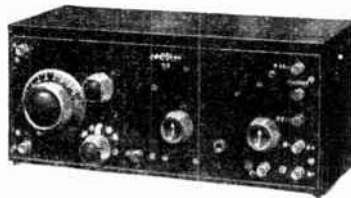

Crosley 3-Tube 52 Regular

For a less expensive 3-tube set the Crosley 52 Regular cannot be surpassed at the new low price.

Now \$25 was \$30

Crosley Super-Trirdyn Regular

In the Super-Trirdyn, 3 tubes do the work of 5. Matchless performance. Beautifully finished solid mahogany cabinet.

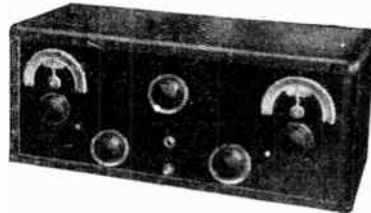

Now \$45 was \$50

These prices do not include accessories. Add 10% to all prices West of the Rockies.

HOT WEATHER DID NOT KEEP THIS CROSLLEY TRIRDYN OWNER HOME

"During hot weather I bring in New York, Schenectady, Detroit, Omaha, Cincinnati, Cleveland, New Orleans, Denver, St. Louis and Atlanta on any night. No matter how many stations are broadcasting in Chicago I can always pick up 10 to 20 outside stations on my set."

ORVILLE G. DAILY,
 Chicago, Illinois.

35 STATES IN THE UNION REPORT TO THIS CROSLLEY TRIRDYN OWNER

"Here is a list of States from which I have received verification stamps—100 one or more stations in each state. I have also heard Scotland during International test."

JOHN H. PUTHOFF,
 Akron, Ohio.

LIVES IN LAWRENCEBURG, IND.—LISTENS TO U. S. WITH A CROSLLEY 2 TUBE 51

"I received program under normal conditions from New England States including Canada, the Western Coast and as far South as Florida and Texas."

EDGAR F. FEIST,
 Lawrenceburg, Ind.

VERMONT MAN APPRECIATES SELECTIVITY OF CROSLLEY 2 TUBE 51

"KOA, Denver, Colorado, as you know is very close to WJLB of New York City. Come in on my dial only one point from each other, yet I get no interference."

ALTON D. FARRINGTON,
 Putney, Vermont.

LIVES IN THE HEART OF CHICAGO—GETS THE COUNTRY'S BEST IN RADIO WITH A CROSLLEY 2 TUBE 51

"E. W. Plank of 5130 Shevland Road, Chicago, sends a list of 46 stations he hears regularly outside of Chicago from New York City to Los Angeles, California, to which he adds 'all praise and credit to Crosley Radio.'"

VANCOUVER TO TORRINGTON, CONNECTICUT IS A SHORT DISTANCE FOR THE CROSLLEY 2 TUBE 51

"Following are only a few of the stations I have received—WJAB—Fort Worth, Texas, 6KW, Cuba, KOA—Denver, Colorado, WTV, Manhattan, Kansas, KPO—San Francisco, Manchester, England and Vancouver, for which I can furnish sworn statement if desired."

HARRIS C. RUSSEFELLOW,
 Torrington, Conn.

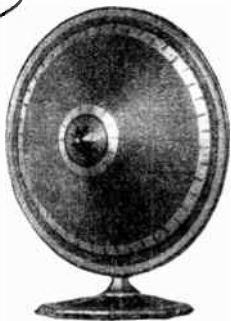

The Famous MUSICONE

This marvelous loudspeaker—well on its way to REPLACE HALF A MILLION HORN TYPE SPEAKERS by January 1st—substantially reduced because of assembly improvements developed by Crosley engineers. Reproduces all tones—without distortion. Crosley patented unit, not cone, secret of its amazing perfection.

Now \$14.75 was \$17.50

CROSLLEY RADIO

BETTER • COSTS LESS

THE CROSLLEY RADIO CORPORATION, DEPT. 22, CINCINNATI, OHIO

Build a set that's designed for 1926 conditions



MAR-CO

R.F. **RADIO PRODUCTS** KIT

No. 2 for the Reactodyne Circuit

special plate coil design to fit different plate types of tubes. Thus, whether you use 199's, 201-A's, UX199 and 120, you will be enabled to get the most out of that particular type of tube.

Put yourself a year ahead

All in all, the Reactodyne principle, built with the essential parts in the MAR-CO kit, points the way to the kind of set design 1926 conditions demand.

The kit, containing the essential MAR-CO parts, is only \$25.00. A majority of the other necessary items, you probably have on hand. Thus, for a comparatively small expenditure of time and money, you may own a set which is easily a year ahead of current practice in set design.

Ask your dealer for additional information about this kit. If he has not yet stocked it, he can get it for you without delay.

Manufactured by
Martin Copeland Co.
Providence, Rhode Island
Branch Offices in
New York, Chicago, Boston and
San Francisco
Jobbers in all important cities

THE trend in radio design, among set builders who know conditions, is along very definite lines.

The ideal set combines extreme selectivity, with plenty of power, plenty of "responsiveness". And these qualities should be obtained, not by the expensive method of using more, and still more, tubes. Rather, they should come thru such efficient arrangements that the number of tubes, and consequently the up-keep cost, is lessened.

To meet these 1926 needs, the Reactodyne circuit was devised. It combines—successfully—tuned radio frequency amplification with regeneration.

Described in this issue

In this issue, there is an article

describing experiments with the Reactodyne circuit, as built with specially designed MAR-CO parts. Be sure to read it thoroly.

In this set, four tubes are made to produce plenty of power, sufficient for local stations without the use of an aerial.

The selectivity is remarkable, and yet, with the use of the new MAR-CO dials, tuning is ridiculously simple.

Excellent tone quality, and precision design are naturally to be expected from the use of MAR-CO parts. But this efficiency is materially increased by

A MAR-CO kit of essential precision instruments for the Reactodyne circuit, makes a Christmas gift, your best radio-inclined friend will enthuse about.

"As Specified"

by Sylvan Harris in his Push Pull Amplifier illustrated and described in RADIO NEWS.

COMO DUPLEX

The World's Standard Push-Pull Transformer



Price \$12.50 per pair

Demand the NEW TYPE COMOS with Binding Posts

For maximum volume without distortion nothing can equal a Push-Pull Amplifier in which COMO DUPLEX Transformers are used. Gives "B" Battery and tube economy, with great volume absolutely undistorted.

COMO DUPLEX Transformers have been endorsed by the leading editors of the country, for use in the Cockaday, Roberts, and other of the most popular circuits. These experts know. Need we say more?

COMO APPARATUS COMPANY

Kelley St., Manchester, N. H.

For sale at all leading dealers

SEND FOR YOUR FREE COPY

TESTED HOOK-UPS SUBMITTED BY USERS OF OUR



WONDERFUL TRANSMITTER

BUTTON FOR LOUD SPEAKERS

PRICE \$1.00

AMPLIFICATION AND EXPERIMENTS

POSTPAID with instructions

K. ELECTRIC CO.

2 RECTOR STREET

NEW YORK

1bcx, 1cae, 1ck, 1ckd, 1ckt, 1cmd, 1cmp, 1cm, 1co, 1cq, 1cql, 1crv, 1rw, 1crz, 1cs, 1csp, 1csx, 1csy, 1cth, 1ctl, 1ctp, 1crd, 1ctw, 1cua, 1cud, 1cuh, 1cum, 1da, 1dc, 1dk, 1dx, 1dy, 1dz, 1gz, 1hc, 1ht, 1hw, 1hx, 1ja, 1jo, 1jy, 1jz, 1mr, 1uw, 1ux, 1vk, 1vq, 1we, 1wn, 1wz, 2aad, 2dbt, 2anr, 2asd, 2bfh, 2bgo, 2bgs, 2bgw, 2bgx, 2bjo, 2bis, 2biw, 2bj, 2bjd, 2bje, 2bjt, 2bjx, 2bkr, 2bkt, 2blf, 2bli, 2bm, 2bmn, 2bmoi, 2bnp, 2bms, 2bnt, 2bpb, 2bpbv, 2bqd, 2bre, 2brd, 2bro, 2bsb, 2bsp, 2bsu, 2bsv, 2bui, 2buj, 2bwk, 2bx, 2bxc, 2bz, 2cau, 2cat, 2chu, 2ckl, 2ckn, 2ckq, 2clt, 2cou, 2cpk, 2cps, 2cpn, 2ctx, 2cu, 2cvh, 2cww, 2ee, 2et, 2fg, 2fh, 2fi, 2kg, 2pg, 2wh, 2ws, 2wz, 3ach, 3ckt, 3dk, 3dx, 3ea, 3eb, 3ec, 3ex, 3ey, 3ez, 3ch, 3hy, 3hz, 3ib, 3ir, 3ks, 3lg, 3ph, 3ps, 3px, 3pz, 3qm, 4aa, 4ab, 4aq, 4bb, 4bl, 4by, 4dx, 4dz, 4ec, 4em, 4en, 4ex, 4fr, 4fs, 4fw, 4ga, 4gb, 4hb, 4ho, 4hp, 4hq, 4jm, 4jn, 6aax, 6aay, 6aaz, 6aba, 6abc, 6abf, 6abk, 6abm, 6abn, 6abs, 6abt, 6aca, 6acb, 6acd, 6acf, 6acg, 6bb, 6bbc, 6bb, 6cd, 6cdr, 6cmn, 6cmx, 6cpp, 6crt, 6crv, 6jn, 6kc, 7abo, 7ajt, 7co, 7hw, 7pj, 7qd, 8tp, 8abu, 8aby, 8acu, 8adk, 8aeg, 8acc, 8ace, 8ahm, 8aje, 8ajf, 8ak, 8akk, 8al, 8aln, 8amin, 8anb, 8anh, 8apn, 8apw, 8aro, 8arz, 8as, 8atz, 8au, 8auc, 8axn, 8azn, 8ayl, 8bcc, 8bit, 8bje, 8bju, 8bjy, 8bz, 8bm, 8bnc, 8bnh, 8bno, 8boe, 8boo, 8bmy, 8boy, 8bpl, 8bq, 8bqi, 8brt, 8bul, 8bz, 8bz, 8cab, 8cap, 8cci, 8ccr, 8cow, 8ced, 8cej, 8cfm, 8cot, 8cgs, 8cu, 8ckp, 8cui, 8cm, 8cni, 8cpz, 8cog, 8csc, 8ese, 8ct, 8cui, 8cv, 8cwl, 8cwr, 8cxi, 8czy, 8cz, 8da, 8daq, 8dat, 8djk, 8dpo, 8opx, 8dq, 8dr, 8drn, 8eb, 8sam, 8ze, 9's too numerous.

CANADIAN: 1ar, 1dq, 1er, 4cr, 4gt, 5gt, 9al. AUSTRALIAN: 2bk, 2ds, 2cm, 2ay, 2ij, 2yi, 3bq.

ENGLISH: 2cc, 2kf, 2wd, 2bac. PORTO RICO: 4sa, 4jc.

NEW ZEALAND: 2ac, 2xa, 2ar, 4aa, 4ag, 4ak, 4ar.

CHILE: 2ld, 2lb, 9tc, ile. SPAIN: smy.

NETHERLAND: onl, oll. BRAZIL: 1ab, 1af, 1ap, 2sp.

MESPOT: gh. ARGENTINA: cb8.

FRENCH: 8bf, 8ct, 8gq, 8yor, 8sm, 8rdi.

BERMUDA: ber, 1ajw, berl. ITALY: 1er, 1mt.

MEXICO: 1b, bx, ly. HAWAIIAN: 6zac.

SOUTH AFRICA: o1yl. NAVAL: nr, nrm, npr, npp.

A card is waiting for every one of the above hams who qsl's, so don't be afraid es thank u one and all. 73's.

CHAS. A. LUGIS, 9EBW

Heard on 40-Meter Band (One Tube)

1aac, 1aci,* 1af, 1ahg, 1ana, 1anq, 1ar, 1arf, 1aw, 1ayt, 1bes, 1bvl,* 1caj, 1ck, 1cmf, 1cmx, 1ka, 1te, 1uc,* 2aft, 2ag, 2agw, 2bbx, 2bee, 2beo, 2box,* 2bqa, 2bur, 2ctf, 2cth, 2cub, 2fi, 2gy, 2ha, 2lu, 3aaa, 3awh, 3btq, 3bva,* 3ekj, 3jw, 3uy, 4aa, 4aae, 4auk, 4cu,* 4km, 4kw, 4se, 4tt, 5aaq, 5ac,* 5ado, 5afb, 5agn, 5ai, 5aj, 5ax, 5ew, 5ji, 5jt, 5kz, 5oq, 5ox, 5ri, 5uk, ux, 6aum, 6cgw, 6wk, 8aa, 8aks, 8aj, 8alf,* 8apo,* 8axk, 8ayy, 8bce, 8ben, 8bgn,* 8bic, 8bn,* 8bnh, 8buy, 8ced, 8cki, 8ckm, 8eug, 8cwi, 8djp,* 8dnf,* 8dno,* 8don, 8er,* 8gi,* 8ig,* 8li, 8lo, 8lv,* 8hp, 8zz. C-4gt; M-9a; Nerk; Nkf; Wiz. Note—*delight reception.

The Bronx Radio Club

By LEON L. ADELMAN, 2AFS

ONE of the most active radio clubs in the country is the Bronx Radio Club, located in the borough of the same name, in upper New York City. Beginning with a mere handful of licensed amateurs, in the fall of 1921—members who at one time or another were part of some defunct radio organization—the club grew rapidly. Today, it boasts of sixty active, licensed radio amateurs, who on account of their spirit of co-operation, have accomplished more than the majority of radio clubs in this country. This statement is not mere talk, but is the summary of what a bunch of live American radio amateurs are capable of doing, once they have recognized the wonderful value of co-operation. And only by learning from past experiences of others, has it been possible for the club to survive for so long a period.

WHAT MAKES A GOOD CLUB?

It is indeed a difficult task to lay down hard and fast rules for a bunch of young fellows to abide by, but it is not difficult to instill the right spirit into a group who are out for the attainment of a common end—a better, clearer and freer ether for the American radio amateur. The hardest part

VOLUME + CLARITY = ACE TUBE



Twice the Power

The clearest and most powerful tube you have ever used.

Same as type 201A but with twice the volume. Makes your receiver give double the volume and helps bring in stations you have never heard before. Guaranteed perfect in workmanship, giving absolute clear, noiseless tone quality.

Price \$5.00 Parcel Post C.O.D.

Ace gives the service of two ordinary tubes. Tubes shipped immediately on receipt of order. Don't buy until you have seen the ACE tube.

An innovation in tube construction; greater volume and power; entirely new and distinctive. Will work in place of ordinary 201A or 301A type tubes; 6 volt detector and amplifier plate voltage 22-175.

Dealers Write for Franchise

ACE ELECTRICAL LABORATORY
41 Commercial Street Newark, N. J.

Shooting for those cat squawks in a set; you find them right in the transformers—but not in AMBASSADOR TRANSFORMERS for their high primary inductance kills sour notes and distortion. Write us for free hook-ups and four page folder entitled "The Truth About Transformers." AMBASSADOR SALES CO., INC. 108-110 GREENWICH ST., NEW YORK CITY

LeCalle Six Tube Receiver



A high grade six-tube set. Long Distance—Easy to tune. Clear as a bell. Cabinet has Load Speaker built in. Two tone Walnut finish. Complete with tubes, batteries, aerial outfit, everything ready to use. List Price \$200. Terms 25% down. Balance C.O.D. Fully guaranteed.

\$98.50 Complete

AGENTS WANTED EVERYWHERE
Write for Splendid Sales Agency Proposition.
Big Profits. Fast Sales.
RADIO BUYERS SYNDICATE
1429 So. Michigan Ave. Dept. RN Chicago

MUSSELMAN MOGUL

A New and Better Power Amplifier

THE Musselman Mogul 5VC Power Amplifier Tube for storage battery operated sets is the latest Musselman Certified Product. This is a marvelous amplifier tube capable of increasing loud speaker volume from 50 to 100%, at the same time improving tone quality and eliminating distortion. This new tube is the logical development from our 3VA Audio Amplifier which was the first three volt amplifier placed on the market by any firm. The Musselman Mogul may be used in any stage of the circuit. However, it is primarily designed to replace the last stage of audio frequency tube. Every set owner using storage battery current should install one or more of these tubes and improve both the volume and tone of his set.



Model 5VC MUSSELMAN MOGUL AUDIO POWER TUBE. 6 volt storage battery, .50 amp., Navy Standard base, fits 201A sockets, each \$5.00

Just one radio tube offers you this certified curve slip

YOU have only one absolutely sure protection in buying radio tubes, and that is to order MUSSELMAN Certified Tubes with characteristic curve slip inclosed. Experts agree that in no other way can you know exactly what you are getting when you buy tubes. There is but one certified Radio Tube —the MUSSELMAN Certified. Our curve slip gives you all of the operating data on the particular tube you buy; this curve slip, filled in at the factory from tests made on delicate electrical instruments, is an absolute guarantee that you are getting a better tube than any other on the market. If MUSSELMAN Tubes do not equal or excel their rating, we refund your money or replace the tubes. List price: Model 5VA, \$3.00 — Model 5VC, \$5.00.



Sales Office
A. J. MUSSELMAN
547 Washington Bld., Chicago

Manufacturer
The VAN HORNE CO.,
Franklin, Ohio

CURVE NO.	6861
MUTUAL CON.	1000
AMP. CON.	9.4
PLATE FLOW	6.4
PLATE RES.	9400

"The Tube with a Pedigree"

Sales Office
A. J. Musselman
547 Washington Bld.,
Chicago
 Manufacturer
The Van Horne Co.,
Franklin, Ohio

I inclose \$..... for which send me.....
 Musselman Certified Tubes. It is my under-
 standing that if they do not prove all you claim
 for them, you will replace them or refund my
 money.

Name
 Address
 City State

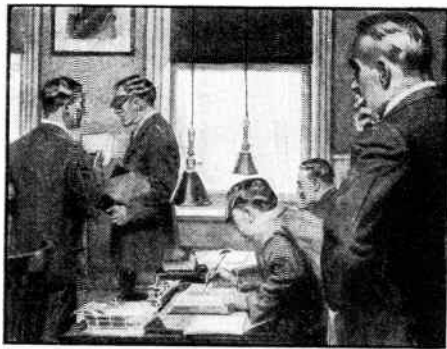

“Which Man Shall I Promote?”

WILL your employer think of you when the next good position is open? Will he say, “There’s a man who is training himself to handle bigger work,” or will he pass you by as just an ordinary routine worker?

Do not try to fool yourself. Your employer is watching you more closely than you may think. He’s constantly checking up on your work, your abilities, your ideals, your aspirations. Stored away in the back of his mind or filed away in black and white, are his impressions of the kind of man you are and the kind of man you want to be.

He’s willing and anxious to pay you more money the minute you prove that you are worth more money. But he can’t take chances. When he promotes a man, he wants to be sure he will make good.

Decide now—today—that you are going to be ready when your chance comes. Choose the position you want in the work you like best—then train for it. You can do it in spare time in your own home through the International Correspondence Schools.

Write today for an interesting descriptive booklet which tells the full story. It won’t cost you a penny, but it may be the means of changing your entire life.

INTERNATIONAL CORRESPONDENCE SCHOOLS

Box 8280-G, Scranton, Penna.
Oldest and largest correspondence schools in the world. Without cost, please tell me how I can qualify for the position or in the subject before which I have marked an X:

- | BUSINESS TRAINING COURSES | |
|---|--|
| <input type="checkbox"/> Business Management | <input type="checkbox"/> Salesmanship |
| <input type="checkbox"/> Industrial Management | <input type="checkbox"/> Advertising |
| <input type="checkbox"/> Personnel Organization | <input type="checkbox"/> Better Letters |
| <input type="checkbox"/> Traffic Management | <input type="checkbox"/> Show Card Lettering |
| <input type="checkbox"/> Business Law | <input type="checkbox"/> Stenography and Typing |
| <input type="checkbox"/> Banking and Banking Law | <input type="checkbox"/> Business English |
| <input type="checkbox"/> Accountancy (including C.P.A.) | <input type="checkbox"/> Civil Service |
| <input type="checkbox"/> Nicholson Cost Accounting | <input type="checkbox"/> Railway Mail Clerk |
| <input type="checkbox"/> Bookkeeping | <input type="checkbox"/> Common School Subjects |
| <input type="checkbox"/> Private Secretary | <input type="checkbox"/> High School Subjects |
| <input type="checkbox"/> Spanish | <input type="checkbox"/> French |
| <input type="checkbox"/> Illustrating | |
| TECHNICAL AND INDUSTRIAL COURSES | |
| <input type="checkbox"/> Electrical Engineering | <input type="checkbox"/> Architect |
| <input type="checkbox"/> Electric Lighting | <input type="checkbox"/> Architects’ Blueprints |
| <input type="checkbox"/> Mechanical Engineer | <input type="checkbox"/> Contractor and Builder |
| <input type="checkbox"/> Mechanical Draftsman | <input type="checkbox"/> Architectural Draftsman |
| <input type="checkbox"/> Machine Shop Practice | <input type="checkbox"/> Concrete Builder |
| <input type="checkbox"/> Railroad Positions | <input type="checkbox"/> Structural Engineer |
| <input type="checkbox"/> Gas Engine Operating | <input type="checkbox"/> Chemistry |
| <input type="checkbox"/> Civil Engineer | <input type="checkbox"/> Pharmacy |
| <input type="checkbox"/> Surveying and Mapping | <input type="checkbox"/> Automobile Work |
| <input type="checkbox"/> Metallurgy | <input type="checkbox"/> Airplane Engines |
| <input type="checkbox"/> Steam Engineering | <input type="checkbox"/> Agriculture and Poultry |
| <input type="checkbox"/> Radio | <input type="checkbox"/> Mathematics |

Name..... 6-26-25
Street.....
Address.....
City..... State.....
Occupation.....
If you reside in Canada, send this coupon to the International Correspondence Schools Canadian Limited, Montreal.

“—more than double the life of other batteries I have used.”
E. E. Avery, Lynn, Mass.

Radio DIAMOND “B” BATTERIES
DIAMOND ELECTRIC SPECIALTIES CORP.
103 South Orange Avenue, Newark, N. J.
Dealers, Jobbers—Write for Proposition

Insure your copy reaching you each month. Subscribe to RADIO NEWS — \$2.50 a year. Experimenter Publishing Co., 53 Park Place, N. Y. C.

of the job lies in getting a responsible leading spirit to guide the club. Usually, he can be gotten from the ranks of the members themselves, and if so, so much the better. In the case of the Bronx Radio Club, the members, instead of forming factions or groups, which would oppose each others’ actions, united into a single club with the sole purpose of harmonious enterprise and worth-while accomplishment. And their record stands as indisputable proof of their earnest efforts. None worked for the glorification of self—here lies the secret of the success of the club.

As each member has a complete receiver and transmitter and is on the air occasionally, it is not a difficult proposition to get the members together for a special meeting, if necessary. The response is usually unanimous; it is seldom, if ever, that a member stays away from a meeting, unless for some really important reason.

Regularly, at 8:30 on each Friday evening during the entire year (holidays excepted), the meetings of the Bronx Radio Club are called to order by the acting chairman. While it must be admitted that perfect silence does not exist—except when visitors are present, as they often are—the club conducts its business and executes its social functions with neatness and dispatch. To say that all the members maintain angelic expressions and abide by the dictates of the chair, would be somewhat difficult for the average mind to believe—especially since we are dealing with the department of a RADIO CLUB! The members do “raise Cain,” but seem to have a keen sense of judgment when it comes to the discussion of matters of real importance. The following case will show clearly how a radio club exists by doing things mostly on the spur of the moment.

About two months before the Transatlantic Amateur Radio Tests, the usual idle prattle and talk that the club enter as a body, came up. True, many were in favor, but on account of the multiplicity of affairs which confront a radio club, and is the bane of its very existence, about all that was accomplished, until a few days before the tests, was exactly nothing.

THE TRANSATLANTIC TESTS

At the last moment, 2ABM volunteered the use of his shack at Rockaway Point. 2CEH assumed the leadership and 2FZ, from past sad experiences, offered to finance the “expedition.” At last, with everything in readiness, a delegation was sent to erect a full wave Beverage antenna.

By the time the party reached the scene it was pitch dark, but with the aid of lanterns, they were able to erect an antenna in spite of the bitter wind that blew up from the ocean, only a few hundred feet away.

Two or three days’ trial convinced the fellows that the thing worked beautifully and everyone was elated at this initial success.

The first batch of fellows to enact the schedule of relief parties on every second day were practically forced to remain at their posts for the first four days of the tests because of some misunderstanding. They remained without sleep the greater part of the time, rather than miss the opportunity of hearing the signals from some far-distant European amateur station. However, after that, a regular stream of fresh members followed in succession and things ran along smoothly.

For an outsider to have visited the place, as it appeared to those who came out to “visit,” it was a habitat of veritable smoke-eaters. Were it not for the long antenna, stretching away in the distance and the spectacle of six of the best receiving sets obtainable, one would have been inclined to think that it was the repose of men seeking solitude away from the turmoil of the city and their “barbarous” inhabitants.

The first thing that a relief member was

You Save 50%

Approved!
Listed as Standard by Leading Authorities including Radio News Laboratories, Popular Science Institute of Standards, Popular Radio Laboratories, Radio Broadcast Laboratories, Radio in the Home, etc., Inc.

Radio “A” and Auto World Batteries are famous for their guaranteed quality and service. Backed by years of successful manufacture and thousands of satisfied users. Equipped with Solid Rubber Cases an insurance against acid and leakage. You save 50 per cent.

Radio Station W S B C
Get your Radio Dials at 210 meters for the new 1000 watt World Storage Battery Sta., W.S.B.C. Chicago, Ill. Watch for announcements.

2-Year Guarantee Bond in Writing
WORLD Battery owners “tell their friends.” That’s our best proof of performance. Send your order in today.
Solid Rubber Case Radio Batteries
6-volt, 100 Amperes . . . \$11.25
6-volt, 120 Amperes . . . 13.25
6-volt, 140 Amperes . . . 14.00
Solid Rubber Case Auto Batteries
6-volt, 11-Plate . . . \$11.25
6-volt, 13-Plate . . . 13.25
12-volt, 7-Plate . . . 16.00

SEND NO MONEY
Just state battery wanted and we will ship day order is received, by Express, C. O. D., subject to your examination on arrival. Extra Offer 5 per cent. off cash in full with order.
Buy now and get a guaranteed battery at 50 per cent saving to you.

WORLD BATTERY COMPANY
1219 So. Wabash Ave., Chicago, Ill.

World

CUMMINGS
Gas Ionic
Photo-Electric Cells

Sold Direct from Laboratory to Experimenter
Price \$25.00

“More Sensitive than the Human Eye”

A tested and proven cell to be used in the practical solution of—
Television Radiovision
Telephotography Radiophotography
Modulation of Wireless Transmission
Talking Motion Pictures
Signaling by Beams of Light
Light Ray Phonograph
Lighthouse and Lightbuoy Operations
Direct Reading Photometers
Stellar Photometry Frequency Meters
Burglar Alarms Color Sorting Machines
Advertising Novelties and Devices
Educational Demonstrations

GUARANTEED to be Stable and Reliable and to function uniformly on light of normal wavelengths, returning from peak to absolute zero instantly, with no dark leakage, giving a straight line curve.
Terms: Cash with order. Cells shipped post-paid and safe delivery guaranteed.
Special cells built to order.

Cummings Research Laboratories
627 W. Lake St. Dept. 59-49 Chicago, Ill.

RADIO SET FREE
STUBE

AND \$100 A WEEK JUST SHOWING IT TO FRIENDS

“The Ambu Institute has perfected the finest 5 tube set ever made. Out of ordinary all others and sells for half store prices. We need men to represent us in every territory and will give demonstrator set free if you will show it and take orders from your friends.”

READ! Your set is certainly a wow! It performs better than any I’ve heard. Took orders for in 2 nights. My profit \$212. Cash 50 more this season easy. I’m out for a big profit.

Coast to Coast Reception. More distance, better selectivity, easier tuning, perfect rich reception of great volume. Big demand in your territory.

All Waves, 40-600 Meters. Sets cannot go below 200. Famous Ambu Five gets all stations, local or over 40 to 600 meters.

FREE Hundreds want the amazing new kind of set. You can make \$100 to \$200 a week just showing free demonstrator. Let you up in Radio business and give you set free. Write quick for information. Postcard will do.

R. MICHIGAN
FRANK CONDON, Dept. 250, 2632 Prairie Ave., Chicago, Ill.

The Chassis that Saves You \$50.00

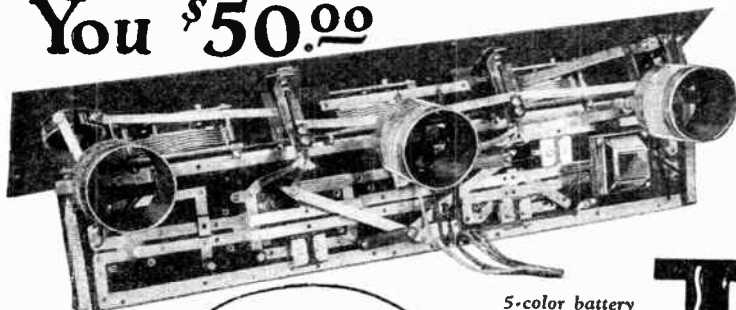

10 U. S. Patents Pending

TRINITY
SIX

5-color battery cable, permanently connected at factory, obviates installation errors.

ADVANTAGES

The Only SIX-tube Broadcast Receiver at \$50.

The Only Production-Engineered Set!

Routed through a scientifically-planned plant. Built by team-work and accurate machine methods—not subject to the inequalities of individual piece-workers.

The Only One-Profit Receiver.

Beacon molds its bakelite, makes its cabinets, panels, condensers, jacks, rheostats, etc., etc., from raw materials, and sells direct through Trinity dealers.

Soldered Connections Reduced To a Minimum

— which makes TRINITY SIX practically trouble-proof.

TRUE Straight-Line Frequency Condensers

Simplify tuning, spread the stations evenly over the dial, making it easy to eliminate interference.

B-Conomizer (Patent Applied For)

An exclusive TRINITY-SIX feature that saves "B" battery current, reducing replacement costs.

Filament Control Jacks

Allowing plug to open and close all circuits automatically, saving rheostat adjustments.

Simultaneous Use of Loud Speaker and Head-Phones

A TRINITY SIX advantage which permits peak tuning.

Damp-Proof Unvarying Resistances—

Bakelite-enclosed Isoleak (for the Grid), Resisto-Grads (patented) for resistance coupling.

Station-Selecting Dialing Chart

Shows how to set dials for different stations.



View Underneath TRINITY SIX Chassis

showing how Beacon eliminates the main cause of set trouble—soldered connections—usually the work of inexperienced hands. At one operation 130 separate holes are punched in TRINITY SIX sub-panel. Nickeled phosphor-bronze "power house" bus strips, 3/8-inch wide, are then riveted fast, forming connections and tube-prong contacts. This exclusive Beacon construction cuts assembling costs in half, and minimizes set troubles.

(See November "Radio News," page 608.)

TRINITY



WEST OF THE ROCKIES #5718

- 1 The "power-house" bus-strip construction eliminating most soldered and bolted joints, reduces resistance and greatly increases efficiency of the circuit.
- 2 Two stages of tuned radio frequency amplification—affording super-DX and selectivity.

- 3 Three stages of audio amplification, including two stages of resistance coupling in addition to one stage of transformer coupling, assuring facsimile reproduction of every type of broadcasting—talking, singing, playing—and affording auditorium volume when desired.

BUILT by a revolutionary method of construction in the set-building division of America's greatest radio parts plant, practically everything in TRINITY SIX is made from raw materials into the finished product under one roof. The TRINITY SIX Broadcast Receiver gives you the most that has yet been offered in Radio—more tubes, more power, more volume, more selective tuning, greater clarity, stronger construction—a bigger and better Radio in a handsome cabinet—at \$50.

The TRINITY SIX dealer franchise is awarded only to selected dealers. If you want a TRINITY SIX, and no dealer has yet been appointed in your town, we will send you a set upon receipt of \$50 and your dealer's name and address.

If you are not convinced that TRINITY SIX is the greatest Radio-value ever offered, return it and get your money back. If you keep it, as we know you will, we will credit the local Trinity dealer with the sale.

Booklet, "The Value Only Beacon Can Build"—sent on request.

BEACON RADIO MFG. CO., INC.

Broadcast Receiver Division

Dept. RN 1225

323 Berry St., Brooklyn, N. Y.

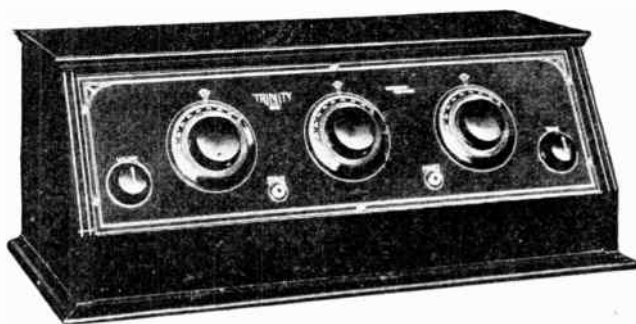

Licensed under 88 U. S. Navy patents.

Mahogany-Finish Cabinet with Anti-Hand Capacity Aluminum Panel

Size: 28" x 11" x 13". Holds 135 volts "B" battery, or 90 volts "B" battery and six dry cell "A" batteries. Genuine Bakelite 4" dials.

The Wilson "B"
Radiopower-Unit



In Walnut Case

This new unit makes it possible to use a light socket for "B" voltage, without any troublesome hum from alternating current. Supplies the constant voltage necessary for perfect reception. No acid to spill. No moving parts. Requires no attention. Semi-automatic in operation. The least expensive type of unit because of low first cost, minimum current consumption and long life. In handsome walnut case. Price \$35.

The Andrews
Paddlewheel-Coil



For best results in home-built sets it is safer to use equipment employed in the best commercial receivers. Here is a superior coil used in such high grade receivers as the Deresnadyne and Buckingham. It can be used in any hook-up requiring a high type inductance. Price \$3.00

Has exceptionally high ratio of inductance to resistance with minimum distributed capacity. Improves tone. Increases range, volume and selectivity. Blue prints of tested hook-ups employing this coil are available. Our Technical Dept. will answer inquiries.

Duo-Spiral
Folding Loop



Price \$8.50

Handsomely finished in silver and mahogany to harmonize with the finest home furnishings.

Easily portable. Has insulated handle and graduated dial. Reduces static and other interference. A special model for every circuit. See these standard units at your dealers or write for complete information.

Radio Units Inc.
1300 First Avenue Maywood, Illinois
Perkins Elect. Ltd., Montreal, Toronto, Winnipeg

expected to do (and which he agreed was fun—one of the gang prodding him with a pitchfork and vowing to feed him pancakes and HIS noodle soup, if he didn't admit it) was to wash all the dishes of the last half of the week, about 413 of them—which is only a fair approximation under the conditions, since the contents of a bottle found lying on the beach had endowed the fellows with an enlarged sense of numbers; after that, he had it "soft." Just as soon as he had chopped enough wood for the stove (it had a ravenous appetite), he naturally worked up a voracious desire to have "lunch." He had it, a "light" one to be sure. Hot soup, as thick as axle grease. Aunt Jemima's pancakes, not as mother makes 'em, but as hams make them (take 'em or leave 'em) and a mug of coffee, with regrets, made up "le diner." An omelette of fourteen eggs was not uncommon and was, in many instances, swallowed at once in order to check any attempts to argue with the cook—which might have proved of disastrous consequence to all concerned.

Such were the trials and tribulations of those who were fortunate enough to play a part in the successful Transatlantic Amateur Tests of 1923-24.

As a result of their excellent work, the Bronx Radio Club was awarded second prize and a large number of pieces of valuable apparatus donated by leading radio manufacturers.

An excerpt from the log: "Truly, the stove and the stovepipe are connected 'inductively' so that the room benefits from the ever-prevalent 'eddy losses.' To augment the scenery, there is an array of smoking oil lamps and the fellows are grease-begrimed and have at least a week's growth to cope with. Most of them are falling off their legs, so sleepy are they, but their spirit does not wane and they crack jokes and are having a fine time."

So you can see that a radio club can persist even in times which would cause many another organization to falter. There was plenty of work for all, and it was always done quickly without a murmur. No one "passed the buck" and things were accomplished in fine style.

WHAT THE HAM DOES

When one asks: "Of what use are the amateurs to the community?" it should be left to the amateur to answer. He alone knows what his fellow beings are doing. Of course, there are those people who take an interest in his work and give him credit for it, but there are ever so many more who know little or nothing at all with which to credit the amateur.

The first and most important service which the amateur gives to the people is a free message service to all parts of the country. This wonderful service is rapidly being enlarged to cover foreign countries as well.

Secondly, the amateurs have formed what are known as Vigilance Committees, which function as bodies to investigate interference difficulties from which broadcast listeners may be suffering. After an investigation, a report is rendered and the condition corrected by authority of the local radio club, and, if necessary, the radio inspector.

In the third place, there will be found many amateurs who are always in readiness to help a radio set-owner to locate trouble in his set and to furnish such assistance as is necessary to erect an antenna, build battery-chargers and do the hundred and one things which are part of the task of owning a radio receiver.

In short, the amateur fills a wide gap and through his services, the people gain, both directly and indirectly.

In many parts of the country, local clubs get together and form larger organizations which are more powerful and are able to effect legislation for the mutual benefit of all. Again, radio shows and conventions are held by the different districts and serve to

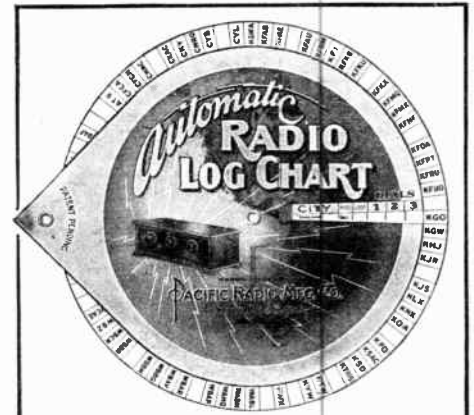

For Xmas

If you give your radio fan friend nothing else for Xmas give him this new and popular accessory. Nothing else like it.

The Automatic Radio Log Chart

is new—something that every radio fan wants, and inexpensive, too. Carries space for logging 180 Eastern, Western, Canadian and local stations. Simple, practical, useful and appreciated. Order one for all your radio friends this Xmas.

Sent Anywhere on Receipt of \$1
Agents wanted

Pacific Radio Mfg. Co.,
8-10 Centralia State Bank Bldg., RN
Centralia, Washington.

Gentlemen—Enclosed is \$..... Send me Automatic Radio Log Charts for Xmas gifts to my friends.

Name

Street

City State

The
Quiet NILES



Battery Charger

Takes Less Time

The only charger that uses both sides of alternating wave in charging. Converts 72 per cent of current into battery charge—at 8 to 10 ampere rate. Quick action. Low upkeep. No acids or fumes. No bulbs to break. Model A for 6-volt batteries, \$19.90; Model AB for 6-volt and 21-volt to 120-volt batteries, \$21.00. West of Rockies, \$1 extra. Ask Any Radio Dealer

NILES MANUFACTURING COMPANY
Dept. 20, Ypsilanti, Mich.

RADIO DEALERS

Have you received your copy of our new catalog? If not, write today. New Circuits. New Apparatus.



Van-Ashe Radio Co.
210 North 10th St. ST. LOUIS, MO.

Send for this Big Catalogue

CONTAINS THE NEW, EASY WAY TO BUILD YOUR RECEIVER

THIS KIT CATALOGUE FREE

Book contains 36 pages 7x10 inches packed full of the most useful and interesting matter ever put into a radio catalogue.

We are Headquarters for **ROBERTS KITS**



Kits Shipped on APPROVAL
Send No Money
Quick Shipment
Transportation Paid
Highest Grade Parts
Lowest Prices

Catalog No. 14

"No-Sod-er"
MAKES SET-BUILDING EASY

Revolutionary Method to "Build Your Own"



SHALL WE SEND YOU ALSO
New 1925 "Rasco" Catalog No. 15
CONTAINS 75 VACUUM TUBE HOOK-UPS, 300 ILLUSTRATIONS, 500 ARTICLES, 100 PAGES

All Armstrong Circuits: These important circuits are explained clearly, all values having been given, leaving out nothing that could puzzle you. Just to name a few of the Vacuum Tube circuits: The V.T. as a detector and one-step amplifier; all Armstrong circuits; one-step radio frequency amplifier and detector; two-stage audio frequency amplifier; short wave regenerative circuits; 4-stage radio frequency amplifier; radio and audio frequency amplifier; inductively coupled amplifier; all Reflex Circuits.

This Free Book Tells

About the Marvels of Radio—How it Helps All and Brightens Every Home—Gives List of Broadcast Stations—Specimen Programs—And How Programs are Made UP—Answers the Questions, "What Set Shall I Buy," and How Much to Pay—Describes "No-Sod-er" Wiring System—Explains How to Get Your Own Radio Outfit Without Money—How to Save \$65.00 in Five Hours—How to Make Money by Going Into Business for Yourself and Building Sets for Others—Tells Where Orders are Awaiting You—Where and How You Can Transact Your Business—CONTAINS DETAILED DESCRIPTIONS AND FINEST ILLUSTRATION OF LARGE NUMBER OF BEST KITS IN EXISTENCE AND QUOTES LOWEST PRICES—Lists Full Line of Radio Parts and Accessories—Explains Our Fair, Easy, Liberal, Golden-Rule Plan of Doing Business. You Need It. Send Coupon or letter NOW.

DON'T EVEN THINK OF BUYING A SET OR KIT BEFORE YOU SEE OUR KIT CATALOG

Book explains what you want to know

About new revolutionary way of assembling your radio set from our many kits—no solder, no bus bar, no poor connections, no waste of time, no skill required, no dissatisfaction, no tools needed except common screwdriver and pliers. Even a boy can quickly assemble a complicated kit.

RADIO SPECIALTY CO., Kit Div. 679Z
245P Greenwich St., New York
You may send me, without charge or obligation, your **KIT CATALOG NO. 14** () **RASCO CATALOG NO. 12** (). I am interested chiefly in (Write on margin if you please)
.....
Name
Street
P. O. State

RADIO SPECIALTY CO.

Kit Div. 679Z, 245P, GREENWICH ST. NEW YORK CITY

**QUIET
FAST
SAFE**

\$22.00
Complete with
2 bulbs. \$14.00
without bulbs
rest of Rockies.

The New TWIN BULB HANDY CHARGER

WHEN YOUR "A" or "B" battery gets low it's a simple matter to recharge it with the new Twin Bulb HANDY CHARGER. Just hook it up at night, and in the morning you have a strong, fully recharged battery. The new Twin Bulb HANDY CHARGER cannot overcharge or discharge your battery. It is perfectly safe. The special ammeter shows the rate of charge. Yet it is fast and economical, too, because it uses *both* halves of the AC wave.

Take the uncertainty, disappointments and trouble out of your battery charging by getting the new Twin Bulb HANDY CHARGER. It is absolutely quiet and is the last word in battery chargers. Ask your dealer or write us for additional information.

INTERSTATE ELECTRIC Co.
4341 DUNCAN AVE.
ST. LOUIS, U. S. A.

"Lighting Fixtures"
READY TO HANG
(Direct from Manufacturer)
Completely wired including glassware
Send for new Catalogue No. 27
(Just reduced prices)
Special Proposition to Dealers
ERIE FIXTURE SUPPLY Co.
STATION R ERIE, PA.

**NO MORE LOOSE CONNECTIONS
X-L PUSH POST**
A binding post that really does excel, looks, action, service, and convenience. Push it down—insert wire—cannot jar loose from vibration. No screwing or danger of shearing off wires. Furnished attractively plated with soldering lug and necessary markings.
Price Each 15 Cents
X-L RADIO LABORATORIES
2426 Lincoln Avenue Chicago

bring together the fellows who have spoken to each other by radio, but who, in many cases, have never seen each other. At these shows and conventions, old acquaintances are renewed, and new ones made. The usual riotous and hilarious good times are enjoyed and when the gang returns home, they bring back with them memories which they will retain for years to come.

Various clubs compete for prizes, both in the matter of the best and most novel booth, and their attainments during the past year.

During the past four years, the Bronx Radio Club has won the first prize at the radio show and convention held in New York, by the radio clubs of the Metropolitan area, of which there are over forty and which are banded together into a large and powerful organization known as the Executive Radio Council of the Second District

CLUB MEETINGS

The meetings of the club are held in the clubroom, which the members constructed themselves and which looks like the dining salon of an ocean-going vessel. Here is a sample of an open meeting, held every Friday evening during the month, except the last.

"The meeting will now come to order," wails the chairman—which seems to be the signal for a general ensuing hub-bub. Here and there about the room, small groups start to hold conversations on anything from astronomy to zoology.

The chairman proceeds: "A little order, gentlemen, a little order!" And indeed, he gets very little. The bewildered chairman, almost despairing of getting order, pounds his gavel with all his might and finally threatens to adjourn the meeting. Realizing what is in store for them if they don't comply with the chairman's request, profound silence falls and things start off.

"The main speaker of the evening," he announces (he dispenses with business in a few words, knowing well that such procedure as business is out of the question) is Mr. Henry Q. McGoofus, who will speak on the "Trials and Tribulations of My Wife and Her New Loud Speaker." Still profound silence, though one imagines he hears the fellow next to him giggling to the bursting point.

We look around the room and note the long-drawn faces of the bewiskered and fossilized old gentlemen, the painful expressions on the dirt-smearred faces of the kids, and finally rest our gaze on the apparition yclept McGoofus.

He begins—yet, never finishes. Time and again, he is interrupted from different parts of the room—some agreeing with him, others violently differing.

You see, since McGoofus is a club member, the silence requirements are not stringent, but, were a visitor to get up to speak, you could hear a pin fall.

Club members, you see, are supposed to have some brains, but visitors are politely given the benefit of the doubt!

CANADIANS GET U. S. BROADCASTERS BEST

The Prince Albert Radio Club, of Saskatchewan, Canada, reports that the United States broadcasters come in better than the Canadian stations to the East of them. The five stations reported as most easily picked up are: WCCO, Minneapolis; KOA, Denver; WEBH, Chicago; WOC, Davenport, and WDA, Kansas City. Montreal, Toronto, and Ottawa stations fail to register clearly, possibly because of the great mineral belt in northern Ontario.

Ham: "Why the horseshoe prints on Roger's trousers?"

Bones: "I suspect he mixed up with a two-way Jack."
World Radio History
Contributed by Jack Bront.

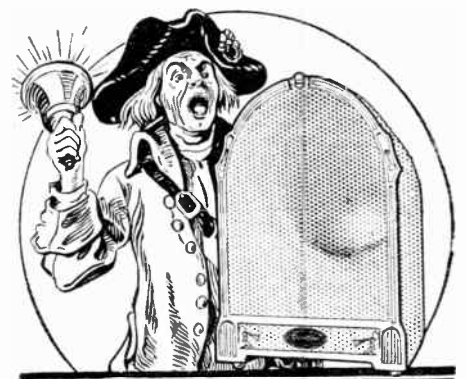

The TOWN CRIER Radio's Most Beautiful Speaker

You will be delighted with the gorgeous colors . . . the handsome, stippled finish, and the novel design of the Town Crier—the Speaker with the voice that thrills. Ask your dealer to show you a Town Crier Speaker. WRITE today for beautifully illustrated circular describing the Golden Polychrome and Green Polychrome models.

List Price \$17.50
West of the Rockies \$18.50

GALE RADIO LABS.

2509 Irving Park Blvd.

CHICAGO

KORACH

Tuned Loop
Multiple Switch
Board Tuner
Directional
Base Compass for
Logging
Collapsible

For Those Who Demand
SUPERIOR RESULTS

Leads the march towards perfect radio reception under all conditions. Not merely a "loop" but an ingenious arrangement of mechanical skill designed for superior results. L. M. Cockaday, using this loop, reached out across the Atlantic to audibly hear many trans-continental stations. **Selectivity Plus Distance** unheard of with common loop aerials. The Korach excels on all sets designed for loop reception. Priced at \$16.50 and for sale by all good dealers. Full particulars sent for 2c stamp and name of local dealer.

KORACH RADIO CO.
20 E. Jackson Blvd., Dept. 7, Chicago, Ill.
Dealers and Jobbers: Write today for attractive proposition.

The Korach Junior
A modification of
the "Senior" but possess-
ing all its important features—\$12.50.

IT PAYS to Know Radio

Radio Operators have well paid, pleasant positions, leading to executive or profitable business opportunities. Turn your hobby into cash through our practical, time-tested courses for operators, mechanics and dealers.

Write NOW for free booklet on
"Opportunities in Radio."

Also Home Study Courses

Y. M. C. A. RADIO INSTITUTE
158 East 86th Street, New York City

Insure your copy reaching you each month. Subscribe to **RADIO NEWS**—\$2.50 a year. Publishing Co. 53 Park Pl. N.Y.C.

Insure your copy reaching you each month. Subscribe to **RADIO NEWS**—\$2.50 a year. Experimenter Publishing Co., 53 Park Pl., N.Y.C.

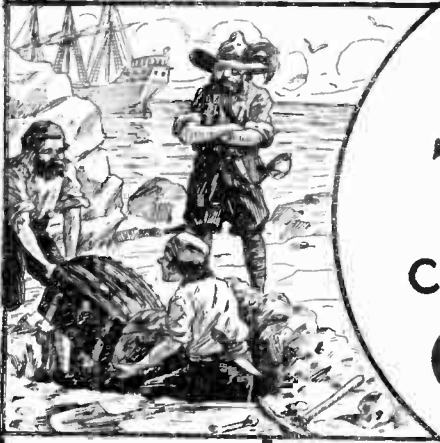

BURIED TREASURE

can still be found in

CHEMISTRY



Good Chemists Command High Salaries

and you can make yourself independent for life by unearthing one of chemistry's yet undiscovered secrets.



T. O'CONNOR SLOANE,
A.B., A.M., LL.D., Ph.D.
Noted Instructor, Lecturer and Author. Formerly Treasurer American Chemical Society and a practical chemist with many well known achievements to his credit. Not only has Dr. Sloane taught chemistry for years but he was for many years, engaged in commercial chemistry work.

Do you remember how the tales of pirate gold used to fire your imagination and make you want to sail the uncharted seas in search of treasure and adventure? And then you would regret that such things were no longer done. But that is a mistake. They *are* done—today and everyday—not on desert islands, but in the chemical laboratories throughout your own country. Quietly, systematically, the chemist works. His work is difficult, but more adventurous than the blood-curdling deeds of the Spanish Main. Instead of meeting an early and violent death on some forgotten shore, he gathers wealth and honor through his invaluable contributions to humanity. Alfred Nobel, the Swedish chemist who invented dynamite, made so many millions that the income alone from his bequests provides five \$40,000 prizes every year for the advancement of science and peace. C. M. Hall, the chemist who discovered how to manufacture aluminum made millions through this discovery. F. G. Cottrell, who devised a valuable process for recovering the waste from flue gases, James Gayley, who showed how to save enormous losses in steel manufacture, L. H. Baekeland, who invented Bakelite—these are only a few of the men to whom fortunes have come through their chemical achievements.

What Some of Our Students Say of This Course:

I have not written since I received the big set. I can still say that it far exceeded my anticipations. Since I have been studying with your school I have been appointed chemist for the Scranton Coal Co. testing all the coal and ash by proximate analysis. The lessons are helping me wonderfully, and the interesting way in which they are written makes me wait patiently for each lesson.—**MORLAIN COUZENS.**

I wish to express my appreciation of your prompt reply to my letter and to the recommendation to the General Electric Co. I intend to start the student engineering course at the works. This is somewhat along, electrical lines, but the fact that I had a recommendation from a reliable school no doubt had considerable influence in helping me to secure the job.—**H. VAN BENTHUYSEN.**

So far I've been more than pleased with your course and am still doing nicely. I hope to be your honor graduate this year.—**J. M. NORKIS, JR.**

I find your course excellent and your instruction, truthfully, the clearest and best assembled I have ever taken, and yours is the fifth one I've studied.—**JAMES J. KELLY.**

From the time I was having Chemistry it has never been thus explained to me as it is now. I am recommending you highly to my friends, and urging them to become members of such an organization.—**CHARLES BENJAMIN.**

I shall always recommend your school to my friends and let them know how simple your lessons are.—**V. ALDRAHL.**

I am more than pleased. You dig right in from the start. I am going to get somewhere with this course. I am so glad that I found you.—**A. A. CAMERON.**

I use your lessons constantly as I find it more thorough than most text books I can secure.—**WM. H. TIBBS.**

Thanking you for your lessons, which I find not only clear and concise, but wonderfully interesting. I am—**ROBT. H. TRAYLOR.**

I received employment in the Consolidated Gas. Co. I appreciate very much the good service of the school when a recommendation was asked for.—**JOS. DECKER.**

Now Is the Time to Study Chemistry



Experimental Equipment Furnished to Every Student

We give to every student without additional charge this chemical equipment, including forty-nine pieces of laboratory apparatus and supplies, and forty different chemicals and reagents. These comprise the apparatus and chemicals used for the experimental work of the course. The fitted heavy wooden box serves not only as a case for the outfit but also as a useful laboratory accessory for performing countless experiments.

Not only are there boundless opportunities for amassing wealth in Chemistry, but the profession affords congenial employment at good salaries to hundreds of thousands who merely follow out its present applications. These applications are innumerable, touching intimately every business and every product in the world. The work of the chemist can hardly be called work at all. It is the keenest and most enjoyable kind of pleasure. The days in a chemical laboratory are filled with thrilling and delightful experimentation, with the alluring prospect of a discovery that may spell fortune always at hand to spur your enthusiasm.

You Can Learn at Home

To qualify for this remarkable calling requires elaborate specialized training. Formerly it was necessary to attend a university for several years to acquire that training, but thanks to our highly perfected and thorough system of instruction, you can now stay at home, keep your position, and let us educate you in Chemistry during your spare time. Even with only common schooling you can take our course and equip yourself for immediate practical work in a chemical laboratory. Dr. Sloane gives every one of his students the same careful, personal supervision that made him celebrated throughout his long career as a college professor. Your instruction from the very beginning is made interesting and practical, and we supply you with apparatus and chemicals for performing the fascinating analyses and experimental work that pays such a large part in our method of teaching, and you are awarded the Institute's official diploma after you have satisfactorily completed the course.

Easy Monthly Payments

You don't have to have even the small price of the course to start. You can pay for it in small monthly amounts—so small that you won't feel them. The cost of our course is very low, and includes everything, even the chemistry outfit—there are no extras to buy with our course. Our plan of monthly payments places a chemical education within the reach of everyone. Write us and let us explain our plan in full—give us the opportunity of showing you how you can qualify for a highly trained technical position without even giving up your present employment.

Special 30 Day Offer

Besides furnishing the student with his Experimental Equipment, we are making an additional special offer for a short while only. You owe it to yourself to find out about it. Write today for full information and free book "Opportunities for Chemists." Send the coupon right now while it is fresh in your mind. Or just write your name and address on a postal and mail it to us. But whatever you do, act today before this offer is withdrawn.

DON'T WAIT—MAIL COUPON NOW!

CHEMICAL INSTITUTE OF NEW YORK
Home Extension Division 12
66-R—West Broadway
New York City

Please send me at once, without any obligation on my part, your free Book "Opportunities for Chemists," and full particulars about the Experimental Equipment given to every student. Also please tell me about your plan of payment and your special 30 day offer.

CHEMICAL INSTITUTE OF NEW YORK, Inc.

HOME EXTENSION DIVISION 12

66-R—WEST BROADWAY NEW YORK CITY

NAME

ADDRESS

CITY

STATE

R.N., DEC. '25



Revolutionizing because of the application of new and fundamentally sound principles to the rectifier. B-eliminators or parts, specially designed for use with RAYTHEON tubes are made by these and other well-known manufacturers, and are now on sale at your dealer's:

- Acme Apparatus Co., Cambridge, Mass.
- All-American Radio Corp., Chicago, Ill.
- Dongan Electric Mfg. Co., Detroit, Mich.
- General Radio Co., Cambridge, Mass.
- Jefferson Electric Mfg. Co., Chicago, Ill.
- Mayolian Radio Mfg. Co., New York, N. Y.
- Thordarson Electric Mfg. Co., Chicago, Ill.
- Tohe Deutschmann Co., Boston, Mass.

RAYTHEON

Long Life **\$6** Economy
No Filament Reserve Power

RAYTHEON MFG. CO.,
CAMBRIDGE, MASS.
Formerly
AMERICAN APPLIANCE CO.

REJUVENATION OF TUBES SUCCESSFUL

RADIO tubes, like some of the older humans, eventually lose their "pep" under the strain of constant work and require a rest, or need to be rejuvenated. This rejuvenating process, as applied to vacuum tubes, is not as serious an operation, however, as the one some humans undergo in the search for youth.

It is known as "reactivation" and is said by the Bureau of Standards radio experts to renew the sensitivity of electron tubes of the thoriated tungsten filament type.

Concerning this method of reactivation, the bureau has issued the following report, so that skilled listeners may "pep up" their tubes themselves:

Electron tubes in radio receiving sets eventually lose their sensitivity. This sometimes progresses to the point where the receiving set operates very poorly or not at all, even though the tube filament is not burned out. The user of the set frequently confuses this condition with that due to an exhausted "B" battery. If the tubes are of the thoriated tungsten (X-L) filament type, they can usually be rejuvenated by a simple process, and made to serve as well as new tubes in the receiving set.

It happens that most of the tubes now used are of the thoriated tungsten type, and it therefore becomes of quite general interest for the public to know how to secure the full life of their electron tubes. The WD-11 and WD-12 type of tubes are the only ones extensively used which cannot be reactivated. In these tubes the source of the electrons is a coating of certain oxides on the surface of the filament, and when this has been used up no process can renew it.

The thoriated tungsten filaments, however, used in most of the various other types of tubes, contain the oxide of thorium throughout the whole mass of the tungsten filament, this oxide having been originally put in incandescent lamps to keep the filaments from being too fragile. The filaments are given a treatment which produces a layer of atoms of thorium on the surface of the tungsten, and this thorium, which is radioactive, emits electrons much more copiously than the tungsten would. After long use, or after burning the filament too brightly, the layer of thorium atoms is evaporated off, and so few electrons are then emitted that the tube does not function properly. Reactivation is a process which boils additional thorium atoms out of the interior of the tungsten filament and forms a new layer of thorium atoms on the surface.

The thoriated filament was developed by the General Electric Company, which has also developed the methods of reactivating tubes of this type. The Bureau of Standards has found that the reactivation process is quite successful, and frequently makes a wonderful difference in the results obtained with a receiving set. The process is essentially the operation of the filament for a very brief interval at a specified high voltage (called "flashing"), followed by a lower voltage for a longer time (called "aging"), all of this with no grid or plate voltage. The flashing reduces some of the thorium oxide in the wire to thorium, and the aging forms the required surface layer. The following schedule of these operations is the result of extensive experience of the Radio Corporation of America, and is published here by courtesy of that company:

FLASHING

Radiotron	Filament Voltage	Time
UX and UV-199.....	10 volts	30 Sec.
UX and UV-201A.....	15 "	1 Min.
UX-120	10 "	1 "

AGING

Radiotron	Filament Voltage	Time
UX and UV-199.....	4.5 Volts	10 Min.
UX and UV-201A.....	7.5 "	10 "
UX-120	4.5 "	10 "

Get the New MATCHED AERO COILS



For SELECTIVITY and DISTANCE

Regardless of how good your set seems to be, you can make it many times more selective and much more powerful by replacing your T. R. F. transformers with Aero Coils. Get Aero Coils now—and tune through strong locals and bring in DX with tremendous loud speaker volume!

95% AIR DIELECTRIC

The secret of Aero Coils' markedly superior performance is its patented construction which makes possible the correct use of 95% air dielectric and dopeless, air-spaced windings with the consequent advantages of lower high frequency resistance and distributed capacity.

AT YOUR DEALERS OR DIRECT

T. R. F. Regenerative Kit.....	\$11.00
3 Circuit Tuner.....	8.00
Wave Trap Coil.....	4.00
Oscillator.....	5.50

Write for the Aero Booklet

AERO PRODUCTS, Inc.
217 N. Desplaines Street, CHICAGO

The "Windham" Wire Former



A Handy Tool for Electricians, Radio Fans and Mechanics

This rugged little tool not only makes accurate loops or eyes for No. 4, 6, 8 and 10 screws but will make either sharp or easy radius right angle bends and the sharp cutter will cut the toughest wire as well.

It is drop forged of the very best steel and carefully tempered in oil.

Retails for \$1.25. Dealers and Jobbers send for full information. Desirable territory still open.

THE GOYER COMPANY
Willimantic, Conn.

SELECTIVE CIRCUIT

This special offer includes genuine full instrument size blue print with illustrations and full instructions, together with large size picture of circuit diagram all for only—

50c
Stamps or coin

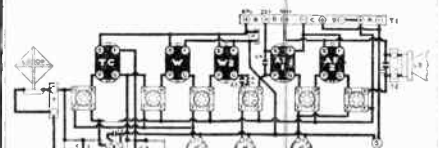

An ideal circuit for selective "DISTANCE GETTER" with fine tone, requires no outside wire, Operates on a loop.

Werner Radio & Audio Frequency Transformers

are used in the above circuit which consists of— 1 stage of tuned radio frequency amplification for selectivity and "Pep"—followed by two powerful untuned stages—a vacuum tube detector and two stages of quality audio frequency amplification.

WERNER RADIO MFG. CO.
204-206 Ninth St., Brooklyn, N. Y.
Send for Free Descriptive Literature

Insure your copy reaching you each month. Subscribe to **RADIO NEWS**—\$2.50 a year. Experimenter Publishing Co., 53 Park Pl., N.Y.C

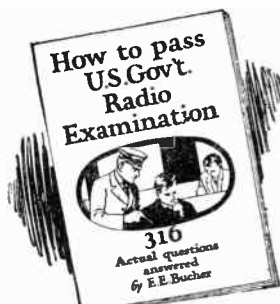

PASS the U. S. Government Commercial or Amateur Radio License examination! This book will help you do it! Send sixty cents in stamps or coin for your copy—postage prepaid to any point in the U. S., Canada or Mexico.

60c For a short time only

RADIO INSTITUTE OF AMERICA
324 Broadway New York City

\$28.90

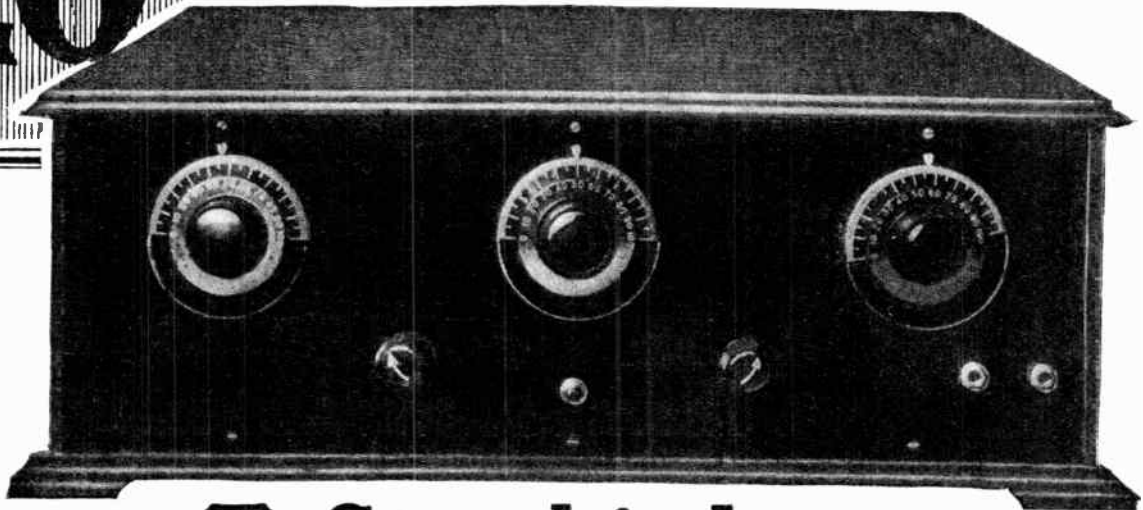

The Songbird TUBE RADIO RECEIVER

5

Here's a low priced radio receiver, made low priced because of extreme manufacturing facilities and careful attention to distribution.

It is a receiver using a standard circuit and a cabinet identical to the finest sets of the same model that are on the market today. Genuine mahogany cabinet, beautifully finished, a handsome receiver externally, and then a sensational standard circuit, built of the latest and best parts, including a special patented set of coils and straight-line frequency condensers that make it far superior in tone and efficiency to many similar circuits of a much higher price.

5 Days Free Trial in Your Home

Not a Day's Extra Waiting—Shipped on Receipt of Order

This is not a bargain offer merely to dispose of sets, it is the result of hard, earnest application on our part to cut down and standardize all manufacturing assembly and distribution operations so that you, and the general listening public, can enjoy the benefit of a fine, high-powered radio receiver at a very small cost.

Every inch of this set reflects fine radio engineering knowledge. It is marvelously simple, is operated easily, can be installed in a few minutes and will last many years.

We want you to try it first—because we want the set to sell itself. You can't lose! Send for it today—Set it up as soon as you get it—tune in the dials—and just lean back and listen! One trial will convince you—and it costs only \$28.90. **ACT NOW!**

THE SONGBIRD

137 Duane Street

New York

→
**This Coupon
entitles You
to 5 Days
Free Trial**

*Just fill out your name
and address*

THE SONGBIRD, 137 Duane Street, New York, N. Y.

Gentlemen:—I want to place my order for a Songbird 5-Tube Receiver (without accessories) as described above, which I understand as follows:

Upon receipt of this order you are to ship one Songbird Receiver—five tubes, completely wired, without accessories, express collect, C. O. D. When this instrument arrives, I have the right to examine it. If I am not thoroughly satisfied, I will instruct the Express Co., to return to you at once. You to pay all charges.

If I decide to keep this instrument I will pay the express office \$28.90 plus express charges. If at any time within 5 days I am not satisfied with the Songbird for any reason whatsoever, I will return it, packed just as I received it and if it is in good condition you are to return my money and I return the instrument to you.

If I do not return it within 5 days, you can consider I am perfectly satisfied with the Songbird 5.

Please ship as soon as possible and advise me when you have shipped.

Name

Address..... City and State.....

LOOK HERE FOR THE RED STRIPE

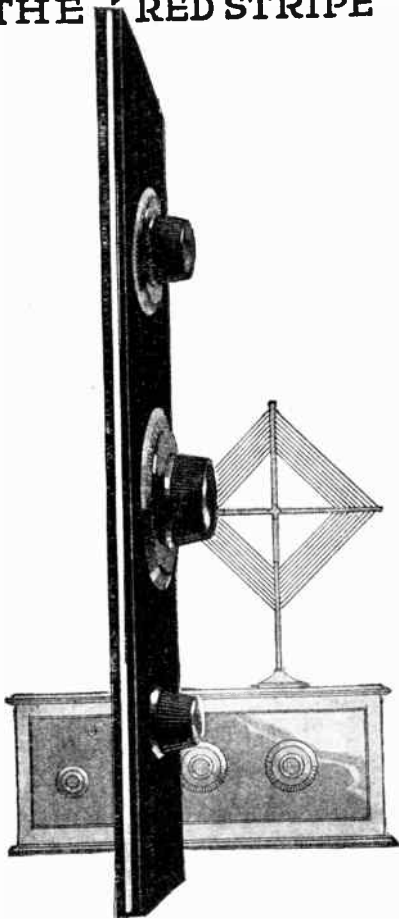

Used by the United States Navy and Signal Corps for over nine years. Dilecto is the strongest, safest radio panel that can be made. Look for the identifying "Red Stripe" that sets apart Dilecto from its imitators.

THE CONTINENTAL FIBRE CO.
FACTORY: NEWARK, DELAWARE

Service on Dilecto, also Contex, Conite, and Vulcanized Fibre, from:

NEW YORK 250 Park Ave. CHICAGO Wrigley Bldg. PITTSBURGH Farmers Bank Bldg.	SAN FRANCISCO 75 Fremont St. SEATTLE 1011 6th Ave., So. LOS ANGELES 307 So. Hill St.
---	---

Offices and Agents Throughout the World

Dilecto
(distinguished by its red stripe)

ILLINOIS CUSHION-RESILIENT SOCKET

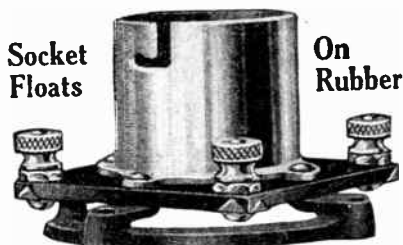

Socket Floats On Rubber

Illinois Cushion Sockets have Live Rubber Base that suspends the socket and absorbs vibrations, thus producing Clear Tones. Practically indestructible and the ORIGINAL and BEST shock absorbing socket for preventing microscopic noises in loud speaker or phones. Price \$1.00 each.

Illinois Radio Co., Manufacturers, Springfield, Illinois
Original Cushion Sockets and Cord Connectors
See Connector ad in Radio News, Nov. and Dec.

Exactly the same procedures apply for C and CX tubes as for the UX tubes of corresponding number; thus, C and CX-299 correspond to U and UX-199; C and CX-301A to U and UX-201A, and CX-220 to UX-120.

In carrying out this schedule it is absolutely essential to have a voltmeter of a good degree of accuracy and to use a watch. No grid or plate voltages are used. Either alternating or direct current may be used for heating the filaments.

It is important that reactivation not be attempted until the tube user has assured himself that the tubes actually need this treatment; that is, he should make certain that his batteries are not run down, and that other parts of the receiving set are in proper order. The schedule above should be followed with great care. The process is useful only for the thoriated tungsten filament type of tubes.

The apparatus necessary for carrying out the process is simple. The filament is connected to the necessary source of voltage, nothing being connected to the grid and plate. A voltmeter is connected across the filament terminals. If alternating current is available the source of voltage can be a small transformer, such as those for operating doorbells or electric toys. The voltage tap nearest the voltage specified should be selected and a rheostat in series with the filament used to adjust to the exact voltage. The voltmeter must be one for alternating current.

If alternating current and a transformer are not available, dry batteries or storage batteries may be used as a source of voltage. A single dry cell, when new, will furnish approximately 1.5 volts. A rheostat should be connected in series to give the exact filament terminal voltage as indicated on a direct-current voltmeter.

There are several manufacturing companies that advertise tube reactivators at varying prices. Radio dealers are beginning to give tube reactivation service.

A LESSON IN ANNOUNCING
By MR. DX LISTENER

LADIES and Gentlemen, Announcers all: May I first say a few words to you, ladies? Without intending to be un-gallant, I must say that I don't like your announcing. It is not that your voices are too light to carry well on the air, but it is the way you say it. Most of the men announcers know better than to assume what, for lack of a better name, I will call an "oratorical" tone of voice. Why can't you read a simple announcement in a simple way? Of course, I know that many of you are retained principally because you are better fitted than the men to read to that large assembly of young 'uns, who are supposed to clamor for the ear-phones about the time father says "bedtime." But why try to imitate the senators at Washington, as you read of Peter Rabbit? Be natural or, at least, read in a natural tone of voice.

Now, men, as well: Whether you know it or not, the reason you draw your salary is not esthetic but business. Your employer may be charmed because you are first, second, or third in a popularity contest, but he is running the station to make money, principally. The way he makes his money is two-fold: renting the right to broadcast another advertiser or using the right to advertise himself.

One form of advertisement and probably the principal one is a good program. You may think you are the principal feature on the program. In some cases, no doubt, you do emulate the usual toastmaster who spends more time and uses more words and tells more would-be jokes than those he announces to propose the toasts. There are some witty people in the world (Chauncy Depew will bow) who have the rare faculty of spontaneous wit. More reputed wits have gained their deserved reputation by carefully pre-

STORAGE 'B' BATTERY

"B" ELIMINATOR SIMPLICITY

PERMANENT ALKALINE STORAGE BATTERY RECEPTION

KIC-O MULTI-POWER UNITS operate from your lighting line and eliminate the replacing of dry cell "B" batteries... usually saving their cost in the first six to twelve months of service on Neutrodyne and Super Heterodyne sets.

Guaranteed Two Years

MULTI-POWER UNITS (Price Complete) 90 volt MX \$28.50

Permanent -- E conical -- P over

Shipped ready to use! No costly bulbs! No acid fumes! Units for 110 volt A.C., D.C., or farm plants. Write for special offer. Distributors! Everybody!

Kimley Electric Company, Inc.
2665 Main Street Buffalo, N. Y.

\$3.25 (COP)

RADIO Storage "B" Battery

Lasts Indefinitely—Pays for Itself

Economy and performance unheard of before. Recharged at a negligible cost. Approved and listed as Standard by leading Radio Authorities, including Pop. Radio Laboratories, Pop. Sci. Inst., Standards, Radio News Lab., Letfax, Inc., and other important institutions. Equipped with Solid Rubber Case, an insurance against acid and leakage. Extra heavy glass jars. Heavy, rugged plates. Order yours today!

SEND NO MONEY Just state number of batteries wanted and we will ship day order is received. Extra Offer: 4 batteries in series (96 volts), \$12.75. Pay expressman after examining batteries. 5 per cent discount for cash with order. Mail your order now!

WORLD BATTERY COMPANY
1219 So. Wabash Ave., Dept. 75 Chicago, Ill.
Makers of the Famous World Radio "B" Storage Battery
Prices: 6-volt, 100 Amp. \$11.25; 120 Amp. \$13.25; 140 Amp. \$14.00.
All equipped with Solid Rubber Case.

World STORAGE BATTERIES

Set your Radio Dial at 210 meters for the new 1000 watt World Storage Battery Station, WSBG, Chicago. Watch for announcements.

KDKA = WEAf = WGN = WJS = KHJ = KGO = KFaf = WJY = KOP

The MOLLIFORMER "B" UNIT REPLACES "B" BATTERIES

BUILD IT YOURSELF

You can assemble this powerful B Unit in an hour, at a great saving, and use the current from the light socket. Excellent for Supers and all TRF Sets--Noiseless--no Tubes or acid--Utilizes full wave rectification. Guarantees greater Clarity, DX and Volume at cost of 1/10th per hour. Completely eliminates "B" Battery, and is sold with a positive GUARANTEE of satisfaction or money refunded.

Write for descriptive circular PRICE

Complete Kit—60 Cycle Unit	\$22.50
Complete Kit—25 Cycle Unit	24.50

Kits include Rectifiers. Parts sold separately if desired. DEALERS—Write for our proposition.

C. E. JACOBS, Sole Manfr.
2806 N. Kedzie Avenue CHICAGO



Vigilance

Constant vigilance is the price of uniformity and constant vigilance is maintained over Magnatrons. That is why Magnatrons are uniform, and uniformly good.

The Magnatron DC-201A, DC-199, and DC-199 (large base) and Rex now list for only \$2.50 each.

Connewey Electric Laboratories
Magnatron Bldg. Hoboken, N. J.

West Coast supplied from complete stocks carried by Pacific Radio Labs., 256 So. Los Angeles St., Los Angeles, Calif.

MAGNATRON REX
the new tube for B battery eliminators

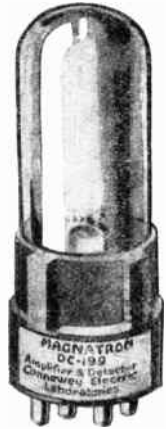

MAGNATRONS

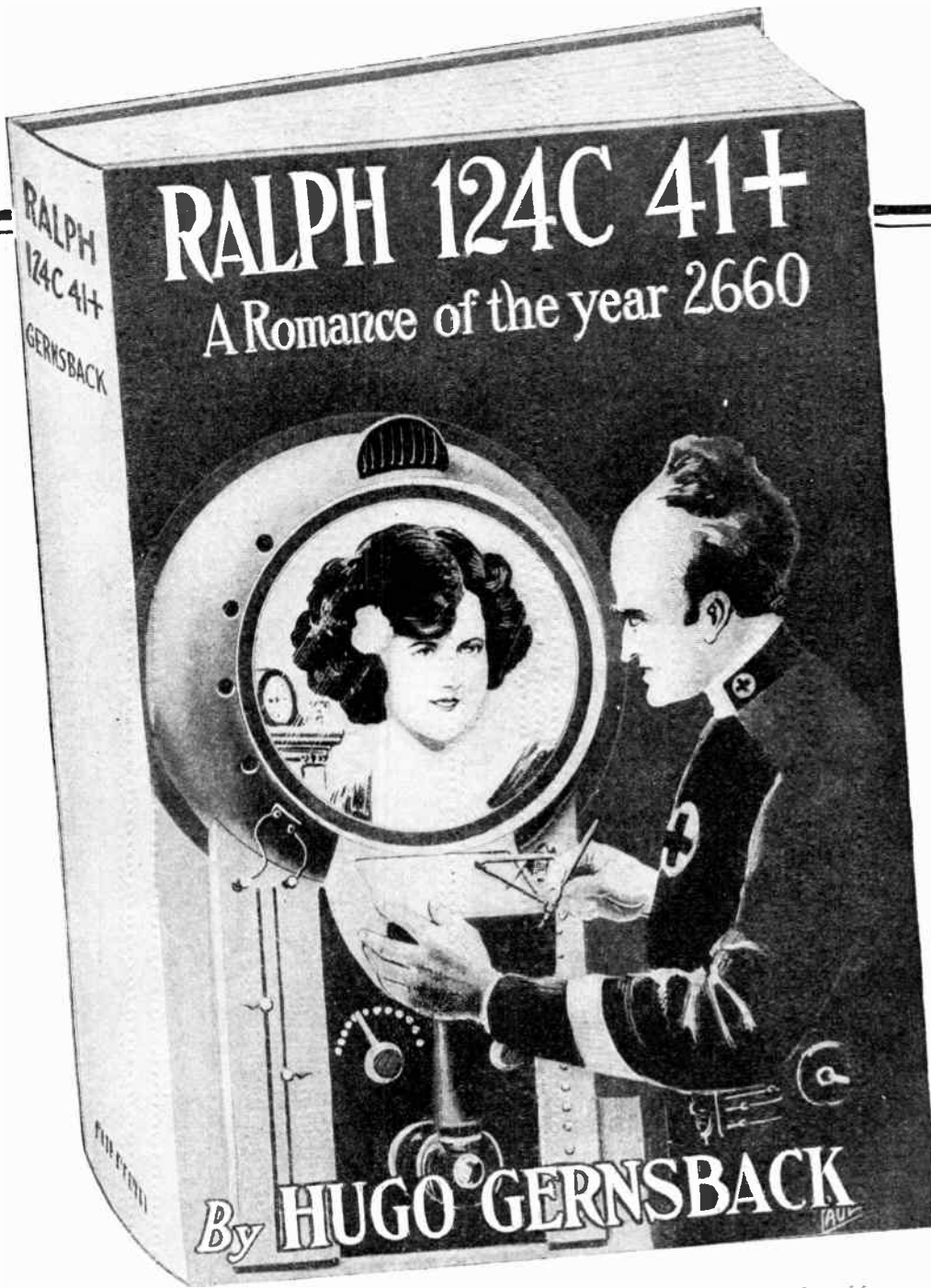

Against an amazing background of mechanical electrical and chemically altered life of mankind there is set a brilliant and colorful romance in the life of the greatest living scientist of that age.

Ralph's love for the beautiful stranger, his conquest of his rival and the worsting of the great saturnine Martian, culminating in a running fight in space with tragedy and terror conquered by almost unbelievable and incredible weapons, make one of the most interesting and gripping stories ever told.

700 YEARS HENCE

IN 1908, Mr. Hugo Gernsback, Editor of RADIO NEWS, published the first radio magazine the world had ever seen—"Modern Electrics." In one of these volumes he ran a story entitled "Ralph 124C 41+ A Romance of the Year 2660." This story, although written many years ago, proved more valuable as the years went by, because many of the prophecies made in this book gradually came true.

This was in the days before broadcasting had even been thought of, and before we had the radio telephone, yet all of this is faithfully chronicled in this story.

Old-time readers of "Modern Electrics" probably remember the story, and now have a chance to get the complete book.

A pioneer in the electrical and radio field, Mr. Gernsback has a profound knowledge of the subjects, coupled with a finely trained and highly imaginative mind.

This unusual combination has enabled him to foreshadow

with almost unbelievable accuracy some of the more recent developments. His earlier predictions, which have appeared from time to time during the past decade in many newspapers and magazines, are now realities. Every prophecy is based on accurate scientific knowledge. His ideas are no more fantastic than the realities and commonplaces of our everyday life would have been to our great grandfathers.

-ORDER BLANK-

EXPERIMENTER PUBLISHING CO.,
53 Park Place, New York City.

Gentlemen:—Enclosed find \$.....for which please send me
.....copies of "RALPH 124C 41+," by Hugo Gernsback.

Name

Address

PRICE \$2.15 POSTPAID RN12

THE STRATFORD COMPANY, Publishers

For Sale by

EXPERIMENTER PUBLISHING CO., Inc., 53 Park Place, New York, N. Y.

paring their witticisms in advance. There are some of you who try to be funny about everything that happens, and all on the spur of the moment. Your occasional successes encourage you to continual failures. Give the performers a chance; they have probably told their jokes beforehand to some visible audience, such as the usual critical wife, and are using only sure-fire specimens.

There is another form of advertisement which chiefly reaches the DX listener. The good program is most valuable in the same county in which the station is situated. With the DX listener, the station call-letters, name of owner, and location are usually the best advertisement. Do you suppose that California listens to New England so as to dance to the music as heard on the loud speaker? If you ask the occasional truthful Californian (or New Englander—if there be truthful listeners in either place) he will tell you that he listens principally for such hashed-up gibberish as he can finally use to identify a station, and uses ear-phones as his only hope, when the stations are several thousand miles away, and the "static level" has risen to the lowest turn on his toroid.

Such being the case, it behooves you to give your employer his money's worth in advertising with the real DX listener. Give that listener a chance. You little announcers in little 50-watt disturbers of the peace can imitate your bigger brothers to advantage. You have to contend with the "blah, blah" of poor modulation, the hum of a second-hand, over-worked motor generator, so it is for you to be extra careful.

Now, ladies and gentlemen, both of you, or all of you:

The cardinal rule of announcing is this: as soon as a number is completed, say: "This is station WXY," or words to that effect. Just saying those few simple words is almost enough to make you popular with the DX listener.

Then you go on and say what has and is



NAVY MODEL C-10 Super-Heterodyne The Highest Class Receiver in the World

Wave length range 50-600 meters with removable Coils.

Panel Dimensions 28 3/16 in. x 8 in. x 1/4 in.

Only two major tuning adjustments.

Total amplification almost 2,000,000 times.

For any Circuit

Prompt shipment can be made on tested, standard apparatus of the following manufacture:

E. I. S., Inc.	
General Radio	
Willard	
Benjamin Electric	
Allen Cardwell	
Dubilier	Formica
Weston	Magnavox
Jewell	Amer Tran
Western Electric	
Radio Corporation	
Music Master	Acme
Cutler Hammer	Frost
Federal	Kellogg

A high powered 10-tube Broadcast Receiver capable of receiving over 3,000 miles under favorable conditions, and having a degree of selectivity far in advance of others.

We believe the Navy Model C-10 represents final superiority over any receiver now being manufactured or even contemplated for broadcast reception.

Attractive illustrated literature gladly mailed upon request. Write direct to

NORDEN-HAUCK, INC.
Engineers

1617 Chestnut Street, Philadelphia, Penna.

Send for this RADIO BOOK FREE



1926 Catalog of Everything New in RADIO at a Big Saving in Price

The World's Largest Exclusive Radio Mail Order House Will Send You This Wonderful Book FREE

A Complete Manual of Radio. You Cannot Afford to Be Without This Book. It's FREE

64 illustrated pages containing thousands of radio sets, semi-finished sets and radio kits of all styles, sizes and approved circuits at attractive prices. Beautiful models of the very latest designs and types. Elaborate console models with loud speakers built right into cabinets of genuine mahogany and walnut. **ALL SETS GUARANTEED.** Coast to coast receiving range. Catalog also contains everything in radio supplies,

You must have our catalog no matter what set or kit you want. Our line is complete and includes all popular sets and all the latest circuits.

Our semi-finished sets come with all parts mounted on the panel and baseboard, ready for wiring.

OUR GUARANTEE
Every article exactly as represented. Every article is tested before shipping. Complete satisfaction or money cheerfully refunded.

No matter what you want in radio—anything from a one tube to an eight tube set, kit, or semi-finished sets—anything in parts or supplies—any radio data—it's in our wonderful catalog.

Our Catalog
Includes complete list of broadcasting stations and general information and facts about our free service division. Our radio engineers will help you solve all your radio problems. Send your name and address on a card or in a letter. We will send catalog FREE.

REMEMBER—WE ARE THE LARGEST EXCLUSIVE RADIO MAIL ORDER DEALERS IN THE WORLD AND CARRY THE BEST OF EVERYTHING IN RADIO. SEND FOR OUR CATALOG TODAY!

RANDOLPH RADIO CORPORATION
The Largest Exclusive Radio Mail Order House in the World
159 N. Union Ave. Dept. 179 Chicago, Illinois



Radio Cabinets



No. 31 Radio or All Purpose Table, \$3.50 15x31x29". Substantial, rigid table that can be used for a thousand purposes.

Our Radio Cabinets are furnished in the natural wood only. Beautiful color card with instructions for finishing sent with each cabinet. Made of beautifully grained Fir Wood.

\$3.50

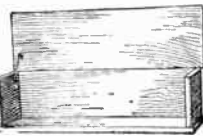
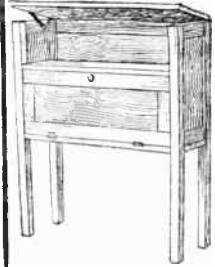

NEAT FIT K. D. CABINETS

Made in a variety of sizes sold knocked down, easily set up. Holes bored for every screw. No other cabinets offer such unusual values.

No. 37 CABINET

7x18" panel, 9" deep, \$10.50. Battery Compartment 10x11x18".

Additional door in front of panel forms arm rest when open. \$3.00 extra.

No. 37—panel sizes 7x21, 7x26 and 7x28"—either size \$11.50.

Set up complete ready for finish, packed one each in carton.

At \$5.00 extra, our Console Cabinets can be furnished with built in loud speakers.

The two chambers of our speakers are made of Pyralin and give forth a full resonant tone. No better made, neat, compact, efficient.

Illustrated circular on request.

Radio Cabinet Dept.

EXPRESS BODY CORPORATION

42 Lake St.

Crystal Lake, Illinois

Panel 7x9" 7" deep	\$1.00
Panel 7x12" 7" deep	2.00
Panel 7x14" 7" deep	2.25
Panel 7x16" 7" deep	2.30
Panel 7x18" 7" deep	2.40
Panel 7x21" 7" deep	2.50
Panel 7x24" 7" deep	2.60
Panel 7x26" 7" deep	2.70
Panel 7x28" 7" deep	2.80

Other sizes carried in stock. Prices on request.

to be, as usual, or do the unusual and leave out the would-be wit.

Then repeat "This is station WXY," after which give the name of the particular tooth paste which will ultimately draw money from people's pockets by reason of having been dinned into their ears, followed by the name of the owner of the station, his phone number (if you hope the DX listener will use it), the city or town, and state. If you are a supreme egotist, announce your station as of "The Atlantic Seaboard," or "of New England," as further identification.

From the standpoint of the DX listener, the principal improvement on the foregoing method of announcing would be to announce the station owner, and location, also at the beginning, as well as at the end of each announcement. Perhaps a confirmed radio golfer would amend this by saying: "One improvement would be to leave out the program—in fact, everything but the announcement." How about it, you radio announcers?

In all seriousness, aside from a good program, a slow, firm announcement of call letters at the end of each number on the program, together with a similar announcement plus the name of owner of station and its location at the beginning of the succeeding number, would be a boon to DX listeners, and if advertising be of value to the owner of a station, such announcements would be of great benefit to your employer.

CERTAINLY!

Ed: Why do you believe buying a radio set is a good way for anyone to spend his money?

Ned: Because it is a sound investment.
Contributed by Wm. G. Mortimer.

MUST BE

Jack: Jim made his set of the best parts money could buy. They're absolutely noiseless in operation.

Black: No doubt that's why he never hears anything.

Contributed by Wm. G. Mortimer.

BOYS!

We'll pay your Christmas Bills



Walter Smith, Jr., of Pennsylvania, one of the many boys earning extra Christmas money and winning dandy prizes by selling our four popular magazines.

And Give You Fine Prizes Besides

HOW much Christmas money would you like to have—money of your own to buy Christmas Presents for mother and dad, for your sisters and brothers and for yourself? You can earn all you need between now and Christmas and start the New Year with a steady income by becoming a member of our Young Men's Sales Association without delay.

It's easy and it doesn't interfere with your school work or your fun. All you do is sell and deliver *Radio News, Science and Invention, The Experimenter, and Motor Camber & Tourist* to folks in your neighborhood—in your spare time. Besides, I'll show you just how to go about it.

In addition to receiving liberal commissions on all copies that you sell, you can also earn a radio set, a watch, a football, a pair of skates, etc. If you would like to own any or all of these prizes, here's your chance to get them.

No experience or money is necessary. Simply send me your name and address on the coupon below and I'll tell you all about our easy way to make money and earn prizes.

-----Mail To-day-----

E. J. FOLEY, Dept. R-12, Experimenter Publishing Co., 53 Park Place, New York City.

Please tell me about your easy way to make money and earn prizes. I would like to join your Young Men's Sales Association.

Name

Street

City..... State.....

The Reactodyne Circuit

(Continued from page 796)

In the plate circuit of the radio frequency amplifier tube there is connected an inductance coil, L2, which couples the radio frequency to that of the detector. This coil consists of 20 turns of No. 22 D.C.C. wire wound on a three-inch tube, and is placed at right angles to the coil, L1, in order to avoid any inductive effects. The inductances, L3 and L4, are wound on the same three-inch tube, which is placed in inductive relationship to L2, but at least two inches distant. The coil, L3, has 45 turns of No. 22 D.C.C. wire and is wound on the same tube; as close as possible to L3 is the fixed tickler coil, L4, which consists of 20 turns of No. 26 D.C.C. wire. A 23-plate variable condenser (capacity .0005 mf.) is shunted across the inductance, L3, and tunes the input circuit to the detector tube. In series with the coil, L4, is a variable condenser, having a capacity of .00025 mf., for controlling regeneration in the plate circuit of the detector tube. This method of controlling the regeneration is made possible only by the extremely loose coupling between the coils, L2 and L3.

The balance of the circuit is an ordinary transformer-coupled audio frequency amplifier. In order to reduce distortion to a minimum and also to reduce the drain on the "B" batteries there is introduced a "C" battery, as shown in Fig. 1, having its positive terminal connected to the negative side of the filament battery. This battery gives the proper negative bias to the audio frequency amplifier tubes.

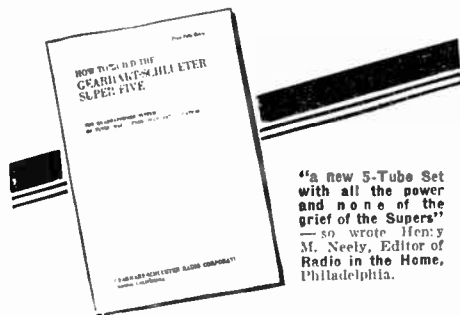

"A new 5-Tube Set with all the power and none of the grief of the Supers!" —so wrote Henry M. Neely, Editor of Radio in the Home, Philadelphia.

How to Build the SUPER-FIVE

Write today for the QUADRAFORMER BOOK. It will bring you a new radio experience. Profusely illustrated with photographs, drawings. It takes you step-by-step through the making of the SUPER-FIVE, an exceptional 5-Tube Receiver developed by engineers of the Gearhart-Schlueter Radio Corporation.

Inclose 25c and you'll have it by return mail.

Gearhart-Schlueter Radio Corporation
711 Voorman St., Fresno, California

To the Radio Dealer

Let us explain how you can make the sale of our publications a worth while, well paying part of your business. Write now and prepare for the Fall and Winter trade.

EXPERIMENTER PUBLISHING CO.
53 Park Place : : New York City

ANTENNA SYSTEM

The Reactodyne circuit will operate rather successfully on any type antenna, the length of which affects the sensitivity of the set at the upper and lower wave-lengths, the selectivity and the calibrations of the dials. The settings of the condenser dial that tunes the grid circuit of the detector tube is little affected by the length of the antenna or its location, but the condenser in the radio frequency stage is greatly affected by any such variations. With an antenna that is from 10 to 20 feet in length the circuit is extremely selective and is very efficient on the lower broadcast wave-lengths. Tuning, however, may be critical and to overcome oscillations in the radio frequency tube it may be necessary to reduce the filament current of that tube and also to reduce the plate voltage. For the higher wave-lengths a longer antenna is recommended, but for all-around broadcast reception an antenna, either indoors or outdoors, about 100 feet in length is about right. This may be modified somewhat in congested districts and an antenna about 50 feet in length will give very good results.

ARE you interested in motoring, touring or camping? If you are, do not fail to read the December issue of

MOTOR CAMPER AND TOURIST

Here is a magazine that tells you things in connection with your car—things that you never even suspected.

Are you just running around the country or are you getting the full benefit of your car? **MOTOR CAMPER & TOURIST** shows you the way. On all newsstands.

ARTICLES IN DECEMBER ISSUE

- Winter Camps In Florida. By C. R. Bradfield.
- From Indiana to Florida via the Mississippi. By Edith D. Lott.
- Camping and Touring Through Florida. By George Newall Moran.
- Routes Down to the Winter Haven. By Wm. G. Irwin.
- Lakes to Florida Highway. By Mrs. C. N. Hagey.
- Trails and Camps Down to Sunniland. By Wm. G. Irwin.
- Florida Roads. By William York.

For local stations there is no need to use any antenna at all. The ground wire is attached to the antenna binding post, the only difference in tuning being that there will be an increased selectivity of the set.

TUNING THE RECEIVER

The tuning of the Reactodyne is fairly simple. The two 23-plate condenser dials are placed at approximately the same setting and if there is no signal heard, they are moved simultaneously until the familiar regenerative whistle is detected. This regenerative whistle is then increased by turning the two dials until it is at a maximum strength and then the variable condenser that is in series with the plate coil of the detector tube is moved until the whistle just disappears. This is the point at which the circuit is functioning at maximum efficiency, as the detector tube is just below the point of oscillation.

The tubes that may be used in this circuit are either the UV-201A type or the dry cell tubes of the UV-199 type. In case the dry cell tubes are used, it is necessary to replace the coil in the plate circuit of the radio frequency amplifier tube, L2, with one having 50 turns of No. 32 D.C.C. wire. It is perhaps unnecessary to note here that the larger type of tubes will give an increased amount of volume.

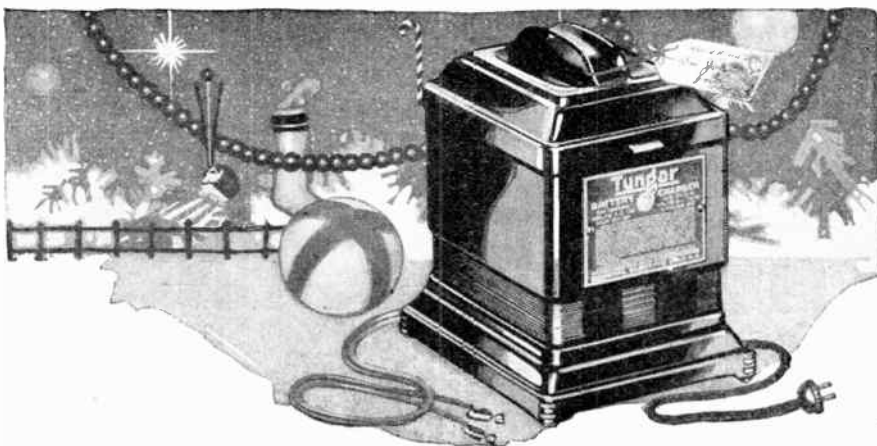

What to give the radio fan

Give him a two-ampere Tungar if he has a storage battery of any kind. It will charge all his radio batteries and his auto battery, too.

Or, for bigger jobs, give him a five-ampere Tungar—built to do the same work but to do it more than twice as fast.

Every man who has a storage battery wants a charger. And every man who wants a charger wants the original General Electric bulb charger—the Tungar.



The Tungar is a G-E product, developed in the Research Laboratories of General Electric.

The new Tungar charges any make and size of storage battery: radio "A" and auto batteries, and "B" batteries as high as 96 volts in series.

Prices

Two ampere size \$18.00
Five ampere size \$28.00
60 cycles . . . 110 volts

Tungar
REG. U.S. PAT. OFF.
BATTERY CHARGER

Tungar—a registered trademark—is found only on the genuine. Look for it on the name plate.

Merchandise Division
General Electric Company, Bridgeport, Conn.

GENERAL ELECTRIC

100 Volt Storage "B" Battery for \$10.00!

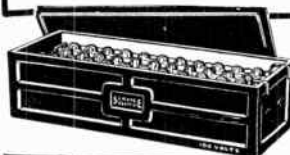

Everybody can now enjoy the benefits of Storage "B" Batteries—more power, quieter reception, greater economy. Rubber case prevents leakage or shorting. Easy to recharge. Will last for years with ordinary care.

SERVICE Rechargeable "B" Batteries
in all-rubber cases
50 VOLT \$5.50
100 VOLTS \$10.00
125 VOLT \$12.50

Prices in Canada
50 VOLT \$7.75
100 VOLT \$14.50
125 VOLT \$17.00

Service "A" Batteries
Indestructible rubber case. Two year guarantee.
6 volt. \$14.00
100 amp. hr. \$16.00
6 volt. \$16.00
120 amp. hr. \$16.00

SERVICE Double-Duty CHARGER

Charges 6-volt "A" or Auto Batteries or up to 125 volts of "B" Battery IN SERIES. Noiseless in operation. Extremely economical. The height of convenience.

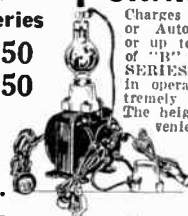

Complete with Bulb \$14.50

SERVICE BATTERY CO. of Canada, 137 Roncesvalles Ave. Toronto, Ontario

SERVICE BATTERY CO.
704 East 102nd Street Cleveland, Ohio

Keeping Pace with the World's Greatest Achievements

in RADIO - SCIENCE CHEMISTRY-ELECTRICITY

Do you want to know what is going on in these great fields from month to month?

RADIO NEWS

Tells you about the whirlwind progress of the mighty new force in the life of the people throughout the world. RADIO NEWS is radio's greatest and largest magazine, containing new hook-ups, up-to-the-minute news and information, illustrations and all the details of the great Radio Industry.

SCIENCE AND INVENTION

Contains page after page of startling, new scientific achievements with plenty of news and pictures from every corner of the world. A never-ending panorama of events in the great world of Science and its co-partner, Invention. Everything in SCIENCE AND INVENTION is illustrated in pictures or drawings and many novel ideas are explained for home builders.

THE EXPERIMENTER

Any man who loves to build things at home and develop and design his original ideas should read THE EXPERIMENTER. It is full of news, hints and suggestions for the experimenter and contains page after page of information on new experiments, large and small. Every word is of benefit. Interesting from cover to cover. THE EXPERIMENTER will afford many hours of pleasure and entertainment.

Published and Distributed by

THE EXPERIMENTER PUBLISHING CO., Inc.
53 Park Place New York, N. Y.

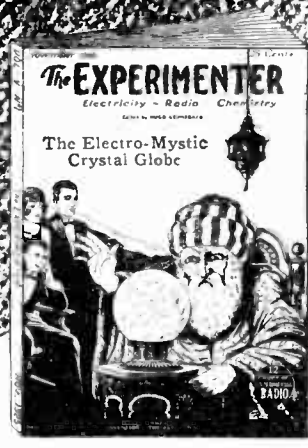

Get These Valuable Premiums

With every subscription to any one of our magazines we are giving free, your choice of a beautiful "Ekko Stamp Album," the new radio craze for keeping stamps of various stations logged, or a copy of the "Radio News Amateurs' Handbook," a compact, illustrated Radio Instruction Book containing over 200 pages of radio data and information.

SUBSCRIPTION OFFERS

One Year's Subscription to:—
RADIO NEWS \$2.50
SCIENCE & INVENTION 2.50
THE EXPERIMENTER 2.50
Combination Subscription
Any two magazines, One year each \$4.25
Or any one magazine for Two years.

EXPERIMENTER PUBLISHING CO., INC.,
53 Park Place, New York, N. Y.

Gentlemen: I am enclosing \$..... for a years subscription to RADIO NEWS, SCIENCE AND INVENTION, THE EXPERIMENTER.

NAME
ADDRESS
CITY STATE
PREMIUM DESIRED

The Isofarad Receiver

(Continued from page 797)

been mounted beneath the panel and the drilling layout has been changed accordingly. The regulating condensers, CK, can be seen mounted on the front panel, just in front of the R. F. tubes. The one on the left controls the temperature of the R. F. tubes and serves as a volume control, while the one on the right controls the detector filament. The two audio tubes are ballasted.

This arrangement of filament control has been found to preserve quality of reception and to reduce "B" battery drain, as compared to the use of ballast resistances for all tubes. The adjustment of filament temperature on the A. F. tubes is not at all critical and for this purpose ballasts are admirably suited. It will be found, however, that the adjustment of detector filament temperature is rather critical, running from 3.25 to 4.0 volts for the 201A tube. In addition to giving better reception, this scheme reduces the "B" battery drain. "B" batteries will be found to last about twice as long as when all filaments are ballast-controlled. The total "B" battery load of this set is from 7 to 10 milliamperes, depending upon the setting of the R. F. rheostat.

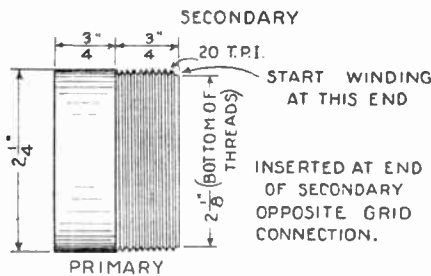
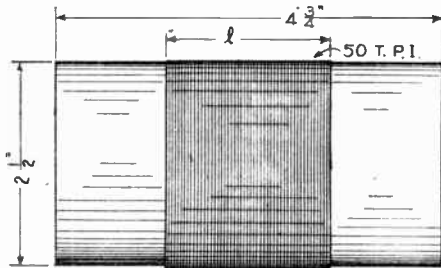

COIL NO.	SEC. TURNS	PRI. TURNS	DIRECTION OF PRI.	DIRECTION OF SEC.	λ
1	102	6	R. H.	R. H.	2 + "
2	102	12	R. H.	R. H.	2 + "
3	52	6	L. H.	R. H.	1 1/2 "

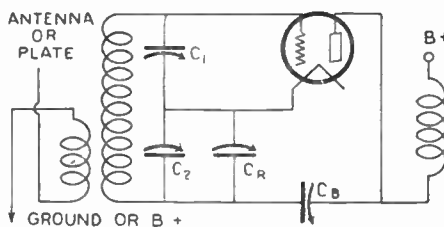

FIG. 1

The fundamental circuit diagram. Above are shown the directions for constructing the R.F. transformers.

The detector tube is held in a socket of the cushion type in order to prevent audio-frequency feed-back to it from the loud speaker through the medium of sound impulses. The two A. F. transformers are immediately behind and between the last three tubes. A cable is used for connecting to the batteries, while the binding posts for antenna-ground and loud speaker are at the rear, left and right, respectively.

Most of the wiring is done beneath the sub-panel, which is supported from the front

NOW you can buy Matched Tubes

and be certain your reception will be clear, smooth, loud and uniform



Sylfan

Blue Specials

cost a trifle more and are worth it. Try them, and you'll never again bother to try to match tubes yourself. 501-A is for storage batteries, and is packed singly and in kits of three and five matched tubes. 499 is for dry cells, with peanut base and is packed singly and in kits of four and six matched tubes.

Price \$2.75 each

Buy them by the box for best reception.



Sylfan

Matched Blue Tubes

(Peanut or Standard Types)

IT is most important to good radio reception that your tubes are matched—and pull in harmony. Equal pull in the tubes means smoothness of reception—sweetness of sound—full throated volume—resonant clarity.

Sylfan BLUE SPECIALS are *matched tubes*. After careful selection by actual test the individual characteristics are plainly indicated and they are packed in kits of three and five *matched tubes*—ready for immediate use. Made for storage batteries only. This process of selection enables us also to discard all inferior tubes and retain only the first grade.

Sylfan BLUE SPECIALS give wonderful results. Try them. Find out for yourself what a big advantage it is to have *matched tubes*. Remember they are *unconditionally guaranteed*.

See the Sylfan line Booth No. 34
Chicago Radio Exposition

Manufactured and Marketed Exclusively Thru Jobbers by

BAKER-SMITH CO., Inc.

New Call Building, San Francisco

Branch Office Addresses

- Portland, Ore., Henry Bldg.
- Salt Lake City, Atlas Bldg.
- Seattle, L. C. Smith Bldg.
- Los Angeles, 443 South San Pedro Street
- Vancouver, B. C., 179 Pender Street, West
- New York City, 1270 Broadway
- Chicago, 30 N. Dearborn St.
- Denver, McClintock Bldg.



SUPERTRAN
AUDIO TRANSFORMER

Equip your set with Supertran Audio Transformers and note the difference in tone. Supertran is the transformer that amplifies without distortion. Ratios, 3/4 to 1 and 5 to 1.

\$6.00

★

FORD "B" ELIMINATOR

for Alternating Current **\$32**



Here is a well balanced, carefully made and thoroughly tested "B" Eliminator, designed by our own engineers and made by us in our own factory. Will supply your set with a steady and uniform flow of current, without any noise or hum.

At All Dealers

FORD RADIO & MICA CORP.
111 Bleecker St., New York

panel by brackets. This is shown in Fig. 4, which is a bottom view. The set has been so laid out as to require a minimum amount of wiring and to give very short grid and plate leads. The two A. F. transformers are of the sub-panel mounting type and are fastened to the sub-panel by means of the terminal bolts extending from the bottom of the transformers. The sub-panel is raised by its brackets so as to give a space of 13/16 inch between it and the bottom of the cabinet.

The grid condenser, with its leak, is mounted beneath the sub-panel, as is also the .001 by-pass condenser from detector, plate to filament.

The complete wiring diagram is shown in Fig. 4. Note that each of the R. F. stages has its plate supply by-passed to its filament through a 0.5 mf. condenser. In addition, the 90-volt "B" battery leads are by-passed, as shown in the diagram.

In putting this receiver together none of the parts interfere with any other part. Everything can be assembled before the wiring is begun. The order of assembly and wiring is immaterial and can be changed to suit the builder. The coil terminals are marked as shown in Fig. 5. B goes to ground in the first coil and to B+ in the case of coils 2 and 3. P is connected to antenna in coil No. 1 and to plate in coils 2 and 3. G goes to grid in all cases. C should go to the stator of the balancing condenser CB in the case of coils 1 and 2; and from coil 3 it should be connected to filament A+.

The filaments and panel sights should be wired with stranded, rubber-covered wire, which should be twisted into a cable.

After the set is wired up and connected to batteries, aerial, ground and loud speaker, one tube should be inserted in its socket. If it lights satisfactorily, put in other tubes.

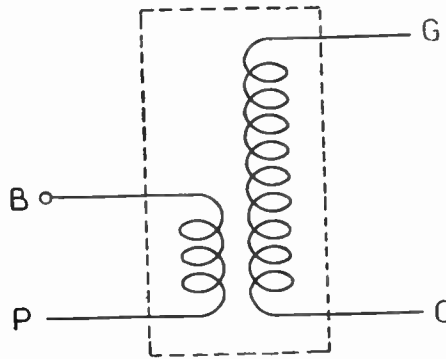

Fig. 5. The coil terminals must be connected as shown for proper operation of the set.

ADJUSTING THE SET

The initial adjustment of the set is as follows: Set condensers CR approximately together at any arbitrary point. Tune in the lowest wave-length station of moderate volume that can be found. Remove the first R.F. tube and cover one of its filament prongs with a piece of paper. Insert the tube in its socket and with this tube in place but its filament cold, adjust the first balancing condenser CB (the one on the left) until the signal disappears. Remove the paper from the prong of tube No. 1, put it back in its socket and repeat this procedure with the second tube. When both stages are balanced, tune the set to the highest wave-length to which it will tune and if it does not oscillate, the adjustment may be considered satisfactory. If, however, oscillations occur, as indicated by squealing or steady ticking in the loud speaker, the capacity of condensers CR should be increased slightly and the balancing process repeated on a low-wave station. In general, the lower the value of CR the greater will be the tendency to oscillation at high wave-lengths after the set has been balanced at a low wave-length adjustment.



Out-performs—Out-lasts—Looks better

As an aid to better radio reception, the James Blue Bullet has no equal in its field. It has proved—through thousands of competitive tests—to be the most satisfactory fixed crystal on the market today.

\$1.00

Distance—volume—fine quality of tone—all are yours with a James Blue Bullet in your crystal or reflex set. You'll agree with thousands of others that it is the highest step forward in crystals that has come to radio.

Its lasting qualities are remarkable—five to ten times longer life than ordinary crystals.

Buy a James Blue Bullet Fixed Crystal from your dealer—today—or send to us direct. Postpaid or C.O.D., \$1.00

STAR-KING COMPANY
200 Davis Street : : San Francisco

\$4.75

POLLO



A loud speaker of surprising musical quality and volume. In the class with high-priced speakers. Artistically designed. Swan neck type. Adjustable unit where volume and tone are at all times under perfect control. Send no money. Just pay the postman.

RIX RADIO
SUPPLY HOUSE, INC.
5505 4th Ave., Dept. 41, Brooklyn, N. Y.

3 Mexican Crystals
"THE CATWHISKERS DELIGHT"

The BEST, bar none. For Crystal sets, "Silver Galena." For Reflex sets, "Placerite." Once tried, always used.

\$1

40c Each, 3 for \$1
Special for DeForest, 50c
70,000 users. You are next.
Dealers, write.
H.D. HATFIELD & SON
1761 Vermont Av.
Hollywood, Calif.

FREE
Diagram for ultra-selective Crystal circuit free with 3 crystals at \$1.

HERCULES
AERIAL MAST

We pay freight
Mail the Coupon

20 Ft. \$10. 40 Ft. \$25. 60 Ft. \$45.
All Steel Construction
Complete with guy-wires etc.

SW HULL CO Dept. B 7048 East 70th St. Cleveland, Ohio
Please send me the full details about the "HERCULES" Aerial Mast.

NAME _____ STREET _____ CITY _____

RADIO CABINETS

Our customers will tell you that we have the best Cabinet for the least money on the market.

Solid Walnut and Hardwood Mahogany finish. Full-length Piano Hinges. Nickered Lid Support. Anti-vibration Feet. Choice of 7 1/2 or 10 in. depth at same price. Free Base-board with each Cabinet.

We also make the IVEY LOUD-SPEAKER which has no equal for clearness.

IT WILL PAY YOU TO SEND FOR FREE CATALOGUES

THE SOUTHERN TOY COMPANY, Inc.
Dept. N. Hickory, N. C.

Write Today For Our 64 Page Catalog of RADIO BARGAINS

RANDOLPH RADIO CORP.
159 N. UNION AV. Dept. 2 CHICAGO, ILL.

The "C" battery is located on top of the sub-panel just behind the first A. F. transformer (it is not shown in the photograph).

In laying out the set the following points were considered in the order named:

1. Correct layout for maximum electrical efficiency.
2. Simplicity in wiring.
3. Ease of assembly and mechanical ruggedness.
4. Appearance.

The finished set will be found to have remarkably fine tone quality with exceptional range and selectivity. It should be operated on an antenna from 50 to 100 feet long, including lead-in, depending upon the amount of interference from nearby stations.

During a one-hour test on the evening of October 6, some twenty distant stations were received with local volume, and without interference while all the Chicago stations were in operation on their usual schedule. Among them were Atlantic City, San Antonio, Minneapolis, Atlanta, Fort Worth, New York City, New Orleans, Denver, Boston and Montreal. This test was conducted within five blocks of the Edgewater Beach Hotel Station WEBH, one block from station WIBO, and one mile from station WQJ.

Thirty Years in the Dark Room

(Continued from page 769)

HOPES FOR THE TELORAMA

Just at present he is working heart and soul for the telorama because he thoroughly believes that it is the chief means available to the world for the elimination of war.

It is his opinion that the most logical way to prohibit wars is to give the populace of each nation a thorough understanding and knowledge of the daily lives of the other nations and peoples about them. This is possible only through radio—broadcasting and television. He reasons that if the Japanese may, at any time, step into a theatre or through the adjustment of apparatus in their homes, see the Americans going about their daily affairs, they will learn both to laugh at us and to appreciate us. Coupled with sight they may have the sounds of our great cities and of our language and music, and knowing and seeing us constantly through the agency of radio, they will learn to think of us as friends rather than strangers, and being so educated, they will be much slower to anger.

It will be the same between all nations and races. Instead of being strangers, as most races are at present, we shall all be friends and as every student of human nature knows, anger is much slower to rise between friends than between strangers.

And it is for this ideal that he holds that he is constantly working with Mr. Jenkins of Washington for the betterment of his television apparatus so that the future which he dreams of may more quickly come to reality.

It was only a few weeks or so ago, that Mr. Moore met Mr. Jenkins while they were working upon a photograph transmission apparatus that Mr. Moore arranged for a demonstration of real television. Within six months, one man—probably a cabinet member—will sit in his office in Washington and talk to another one four or five miles away and see him at the same time. It will be possible entirely through the little neon lamp invented and perfected by Mr. Moore.

This is just another of the advances which he has been instrumental in bringing to pass in his chosen field, and it will also be another incident in which he will keep his own

SAVE TIME AND MONEY

We have radio Tools of every description for every conceivable set building purpose

You will be astonished at the remarkable tools we have for your work and delighted at our low prices

NO. 202

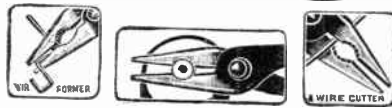

COMBINATION PLIER

Combination Plier, Wire Cutter, Wire Former and Wrench. Drop forged, slender but exceptionally strong. 6 inches long. No. 202—Combination Plier, Wire Cutter, Wire Former and Wrench.....75c

RADIO TOOL SET

This is the handiest set of tools ever made for Radio Work by the makers of the famous "YANKEE" Tools. It contains the following: 1 Ratchet Screw-driver, 6½ in. long holding all attachments; 1 Blade, 5½ x 3-16; 1 Blade, 3½ x ¼; 1 Blade 2½ x ¼; 1 Countersink; 2 Socket Wrenches for all small nuts; 1 Reamer to enlarge holes in panel from ¼ to ½; 1 Wrench, one end 5-16" square or hex. for jack, other ½" hex., etc.

PRICE per set—No. 701.....\$3.00

NO. 701



SIDE CUTTING NIPPER, LAP JOINT

For cutting all kinds of wire. Jaws hardened and oil tempered. Natural steel finish with polished jaws. Length 6 inches.

PRICE—No. 20175c

NO. 201



CIRCLE CUTTER

Especially designed for the Radio Constructor. Made of the finest material and equipped with the highest grade high steel cutting bits. It does three things at once. It drills its own pilot, cuts out plug and puts bead or scroll around the hole in one operation. Cuts holes ¼ to 4 in. in diam.

PRICE—No. 402\$3.00

Nos. 401 & 402



NO. 304

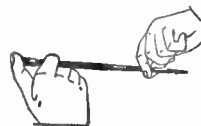

401. Same tool but smaller and not fitted with head or scroll in one operation.

PRICE—No. 401\$2.00

SCREW STARTER and DRIVER

Holds any screw by its slot with a firm grip, makes it easy to place and start screws in difficult places. Just the tool for the Radio Constructor. All parts heavily nicked and polished.

PRICE—No. 304\$1.00

NO. 800



ELECTRIC SOLDERING IRON

A perfect tool for Radio Work. Operates either on 110-volt A.C. or D.C. The heat element is of Nichrome, which prevents overheating and assures the desired even temperature. Size of Iron, 10½ in. long. A 4-ft. cord and plug is furnished.

PRICE No. 800\$2.00

NO. 302

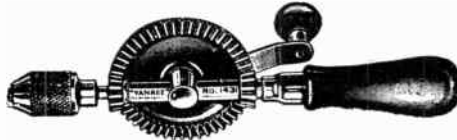

HAND DRILL

Especially designed for Radio Work by the makers of the famous "Yankee" Tools. A beautiful balanced, small, powerful drill with 4 to 1 ratio of gears for speed. Special chuck 9-32" capacity, to take largest drill, mostly furnished with drill or tool sets. Length over all, 9½ in. Weight 1½ lbs.

PRICE—No. 302\$2.75

Order all tools by order number. All goods are shipped free of transportation charges to all parts of the United States and possessions the same day as the order is received.

MONEY REFUND GUARANTEE

If you are not satisfied money will be refunded on return of goods.

THE RADIOGEM CORPORATION

66-R West Broadway

New York, N. Y.

Power Measured in the Millionths!

Radio Books that tell how—when and why

Tips for the Radio Amateur Constructor
Many men fail in building their Radio sets because of some trivial error that could easily have been corrected before it was too late. The E. I. Company has compiled a book that will help you avoid all the common pitfalls while building your Radio sets. **Book No. 1—Price 25c.**

How to Make PRACTICAL Radio Receiving Sets

The man who wants to build only these PRACTICAL Radio Sets that are guaranteed to give good results when properly constructed will need this book. Gives the principal successful hookups of practical Radio Construction. **Book No. 2—Price 25c.**

Radio Questions Answered

Question No. 1—What is Radio? This is the nature of the questions that this book answers. Then it answers questions on all the principal parts of a Radio Receiver. It is a handy book to keep in your Radio File. **Book No. 3—Price 25c.**

Radio Frequency Amplification

Distance lends enchantment—and it's the Radio Frequency Amplification that brings in the distance on your Radio Receiver. If you contemplate adding any Radio Frequency to your set you will want this book at your side. **Book No. 4—Price 25c.**

How to Tune Your Radio Set

Don't struggle in the dark, looking for stations—here is an inexpensive book that gives you detailed instructions on just how to handle your Radio set. You will be surprised at the increased results that can be obtained through proper tuning. **Book No. 6—Price 25c.**

100 Radio Hookups

No better book for your work bench. Gives diagrams, hook-ups and details on 100 Hook-ups galore. One of the most complete hook-up books published. Authentic and up-to-date in every respect. Third edition now ready. **Book No. 7—Price 25c.**

All About Radio Parts

Everyone who constructs a radio set should know the simple fundamentals of the various parts of his set. The E. I. Company has set these forth in a compact little book that is valuable at all times. **Book No. 8—Price 25c.**

History and Operation of the Vacuum Tube

The Vacuum Tube is a marvelous piece of apparatus. A short study of it as given in this book gives you the principle on which every Vacuum Tube Radio Receiver operates. **Book No. 9—Price 25c.**

The Neutrodyne—All About It

Everybody knows the famous Neutrodyne hook-up. One of the finest Radio Receivers in use today. This 51-page E. I. Company book gives an explanation of every detail of the Neutrodyne and how it all works. **Book No. 10—Price 25c.**

How Radio is Received

The simplest and yet most complete Radio Guide Book for any amateur broadcast listener. In print only two weeks, fresh from the press. **Book No. 11—Price 25c.**

How to Locate Troubles in Your Radio Set

Anyone with this handy book as a guide can repair and keep in order his own radio set. Covers every detail of the modern radio sets and tells how to locate and repair any trouble. **Book No. 12—Price 25c.**

Radio Reflex Receivers

Just off the press. Hook-ups galore on the finest and most up-to-date reflex circuits in use today. Diagrams and descriptions on every modern reflex. **Book No. 13—Price 25c.**

E. I. Co. Books

are sold throughout the country by all Radio and News Dealers

If Your Dealer Cannot Supply You, Write Direct

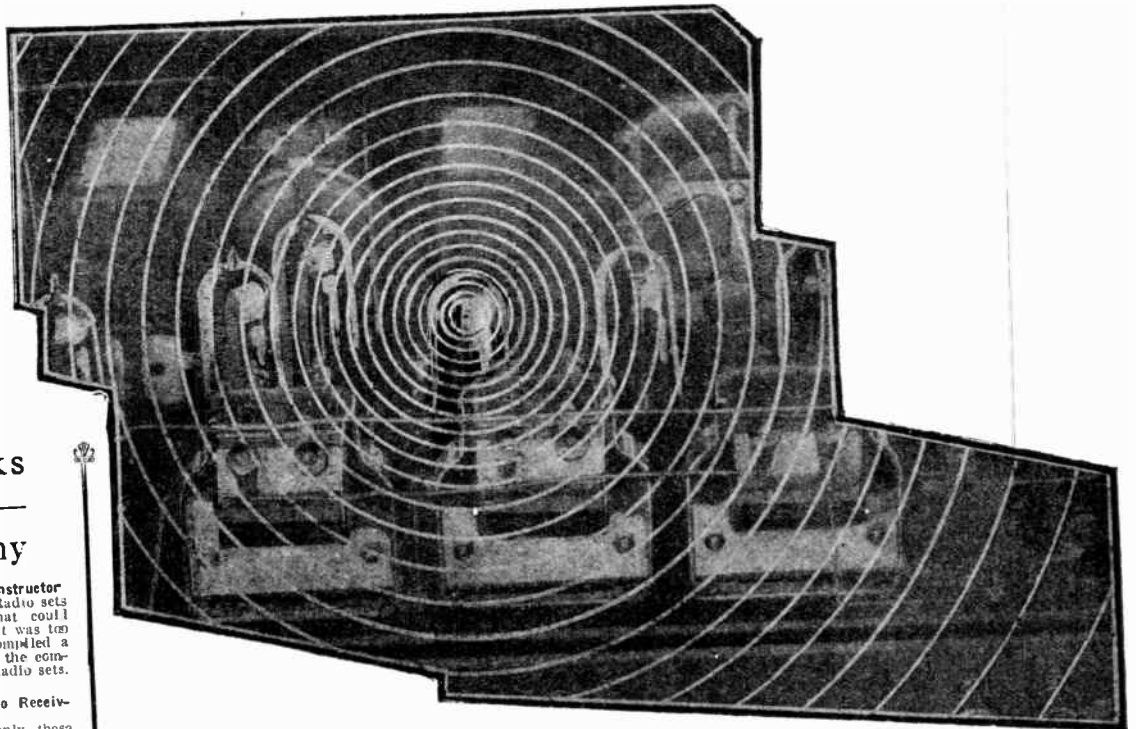

The tiny impulses that reach your radio receiver are measured in Millionths of Watts—Yet they produce the magical wonders of radio

The most remarkable fact in radio is that only the most infinitesimal portions of the power sent by a broadcast station strike your receiver. Instruments of marvelous delicacy must be used to measure the power of an incoming signal.

Yet a radio receiver is a remarkably simple piece of apparatus—thousands build their own receivers with undeniable success.

You can get the most from this weak impulse, and preserve the full value of your set, whether it is home built or bought complete with a little knowledge of what is going on in your receivers and where to look for trouble.

The books described on this page have been written with the needs of the average radio listener in view. They are inexpensive, easy to understand and contain just the information you should have while operating a receiver.

Books are 25c each, within the reach of everyone. They offer the simplest and most inexpensive way to understand Radio.

SELECT THE BOOKS YOU NEED AND ENJOY YOUR RECEIVER TO ITS FULLEST VALUE.

THE E. I. COMPANY, Inc.
233 FULTON STREET NEW YORK, N. Y.

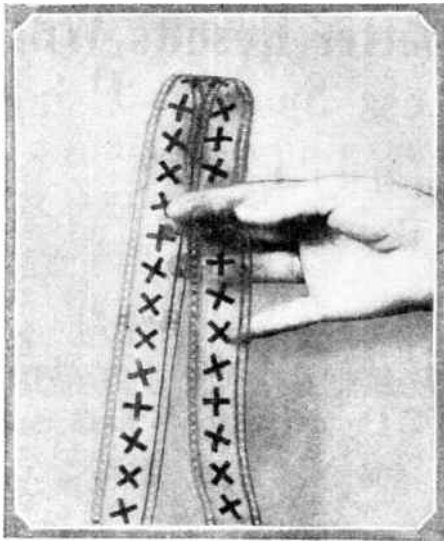

Here is the film which was the first motion picture ever transmitted. It was done with the aid of the Moore lamp.

conceal, be reticent to reporters and so get little, if any credit. But then, he is not anxious for personal credit, for he is an incurable idealist working only for the good of the world and humanity. How these characteristics were formed and his life moulded will be given in detail in this treatise.

(To be continued)

Radio Aids the Surgeon

(Continued from page 776)

Attached to the diaphragm is a small straw which, in turn, connects to a small galvanometer mirror suspended in the usual way. A beam of light from a powerful light is focussed on the mirror through a pair of condensing lenses. The mirror is suspended at an angle of forty-five degrees to the light beam and reflects its beam onto a small box which contains the sensitive photo-electric cell. The output of the cell is connected to the standard radio amplifier which in turn is connected to the time lag relay.

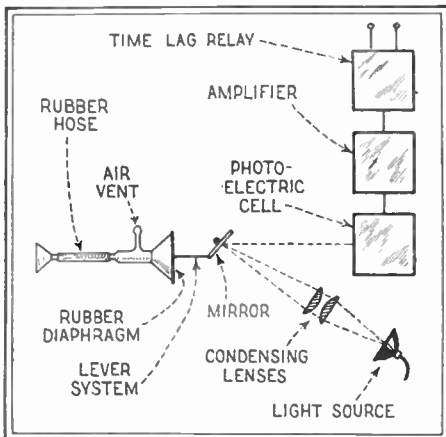

Above is a schematic diagram of the latest radio aid to medicine.

In operation, very small movements of the diaphragm caused by pulse beats move the position of the mirror. But no matter how infinitesimal the movement of the rubber, the leverage given it by the long beam of light which passes the aperture in front of the photo-electric cell will still allow perfect operation of the timing device through the amplifier. This allows the beam of light to sweep over the cell once

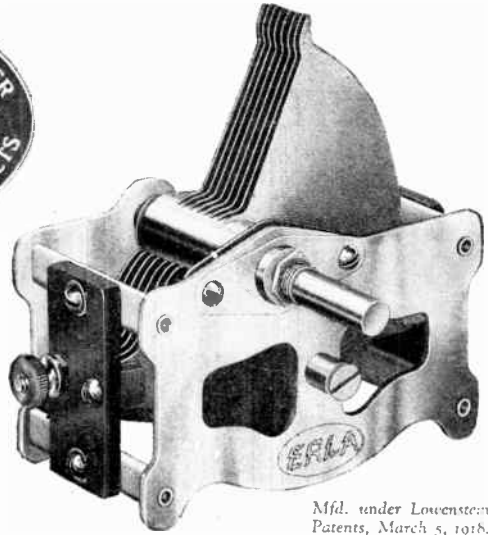

Mfd. under Lowenstein Patents, March 5, 1918.

Equi Space Gives Ideal Tuning at all Wave Lengths

Spreads low wavelength stations without crowding those from 50° to 100°. Lightweight and compact in style.

HERE is a new condenser that surpasses all present-day types. The conventional straight line frequency condenser spreads stations on the low wavelength portions on the dial but it also brings stations between 50 and 100 too close together. On the higher wavelengths are many high-powered stations that are extremely difficult to separate.

The Erla *Equi Space makes allowance for this. It gives maximum spreads between stations over the entire range of the dial. Specially designed plates make this possible.

Now all stations, low frequency as well as high frequency, are spaced on the dial to insure the best results. Tuning is made far sharper. Sensitivity is greatly increased, reducing losses to an unprecedented minimum. Plates of special spring brass are scientifically spaced and give maximum conductivity. Scientific tests show a resistance far lower even than costly laboratory types.

Special Erla Features

- Minimum capacity only 10m.m.f.
- Ratio of maximum to minimum capacity 35 to 1.
- Total resistance of only 3 ohms at 1000 cycles.
- Four riveted cross members supporting stator plates provide rigidity unaapproached.
- Single-hole mounting makes it easy and quick to attach.
- Light weight plates of special spring brass appreciably reduce bulk and weight, and tremendously reduce tendency toward misalignment from rough usage.

Equi Space is small and compact, requiring little space. Very light but having extreme rigidity because of four riveted cross members.

Go to any radio store and see this amazing condenser today. It will make a striking difference in any set.

Send your name and address today and we will mail free, news of the latest radio discoveries and inventions.

*Trade Mark Registered

Electrical Research Laboratories
CHICAGO, U. S. A.

Electrical Research Laboratories, Dept. 17-C
2500 Cottage Grove Ave., Chicago, Ill.
Tell me what's new in radio.

Name

Address

City

County State

LEARN THE CODE AT HOME

WITH THE OMNIGRAPH

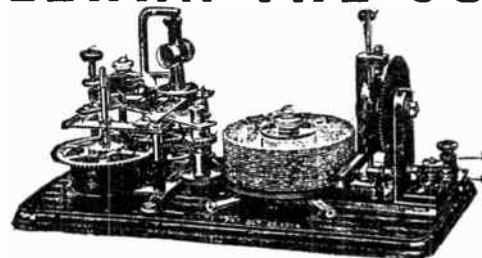

THE OMNIGRAPH Automatic Transmitter will teach you both the Wireless and Morse Codes—right in your own home—quickly, easily and inexpensively. Connected with Buzzer, Buzzer and Phone or to Sounder, it will send you unlimited messages, at any speed, from 5 to 50 words a minute.

THE OMNIGRAPH is not an experiment. For more than 15 years, it has been sold all over the world with a money back guarantee. The OMNIGRAPH is used by several Depts. of the U.S. Govt.—in fact, the Dept. of Commerce uses the OMNIGRAPH to test all applicants applying for a Radio license. The OMNIGRAPH has been successfully adopted by the leading Universities, Colleges and Radio Schools.

Send for FREE Catalog describing three models. DO IT TODAY.

THE OMNIGRAPH MFG. CO., 15 HUDSON STREET, NEW YORK CITY

If you own a Radio Phone set and don't know the code—you are missing most of the fun

Insure your copy reaching you each month. Subscribe to Radio News—\$2.50 a year. Experimenter Publishing Co., 53 Park Place, New York City.

B ELIMINATORS

Assured Success With New Type Tubes and



Transformers and Chokes



Designed especially for operation with the new Filament and Non-Filament Tubes, Dongan Transformers and Chokes are most essential parts of the remarkable new B-Eliminators. These new Eliminators are

thoroughly endorsed by C. O. Kealey and other authorities.

Names famous in the industry are found on these new type tubes. Likewise Dongan—long a leader in the production of quality transformers—shares in this achievement.



Order by Number

Prices and Specifications

- No. 509—Full wave for Raytheon Tubes
 - No. 537—Full wave UX213 for R.C.A. Tubes
 - No. 537—Full wave CX313 for Cunningham Tubes
 - No. 538—Half wave UX2161B for R.C.A. Tubes
 - No. 538—Half wave CX316B for Cunningham Tubes
- List \$7.00**

CHOKES

- No. 514—20 henry
 - No. 506—30 henry
 - No. 539—50 henry
- List \$5.00**

Other Special Transformers and Chokes for both A and B Eliminator Requirements.

Build your B-Eliminator with Dongan Transformers and Chokes. See your dealer or send check or money order Now. Shipments made same day order received.

Dealers

Get your share of this business. Full details upon request.

Manufacturers

We can serve you on any quantity. Prices on request.

DONGAN ELECTRIC MANUFACTURING CO.

2977 Franklin Street, Detroit, Mich.
Transformers of Merit for 15 Years

The "LINCOLN"

Enclosed Fixed Adjustable Detector Kills your Reflex Troubles

New List Price **\$1.50**
Manufactured by LINCOLN MFG. CO., Dept. E. I. Los Angeles, Calif.

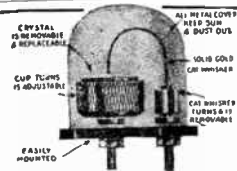

SPECIALY ADAPTED FOR REFLEX WORK

Andrews Deresnadyne

Radio Receiving Set

ANDREWS RADIO CO.

1414 S. Wabash Ave. Chicago

CLASS 25¢ PINS

BUY DIRECT FROM THE MAKER CATALOG FREE

Either pin shown made with any 3 letters and 25 figures. 1 or 2 colors enamel. Silver plate 25 ea. \$2.50 doz. Sterling silver. 40¢ ea. \$4.00 doz.

BASTIAN BROS. CO.

3490 637 Bastian Bldg. Rochester, N. Y. 2534

Insure your copy reaching you each month. Subscribe to RADIO NEWS—\$2.50 a year. Experimenter Publishing Co., 53 Park Place, N. Y. C.

with every heart-beat, regardless of the amplitude of the pulse.

A very small current is set up by the beam of light on the cell. This passes to the amplifier, where it is stepped up to such power as to actuate a relay which operates with a known time of operation. The impulse sent from this relay then passes to the time lag relay, which enables the contact to the X-ray tube to be cut in at any definite interval after the passage of the pulse over the area covered by the funnel. The funnel is usually placed over the cartoid artery in the neck so as to get the maximum of force.

Of course, before the final pictures are taken for examination, several trials have to be made to find the correct setting for the amplifier, the relay and the time lag device.

This piece of apparatus shows once more the really wide field of application that is open to the vacuum tube which was given to the world of science simply through the necessity of radio. There are any number of others which might be enumerated. But it is unnecessary longer to tell of the wonder of this little lamp.

A Dozen Sets on One Antenna

(Continued from page 787)

be entirely excluded from this circuit, the tuning of the rejector J to the frequency of the desired signal permits further selectivity, the desired signals being accepted by the rejector and all other signals being rejected or by-passed by the low inductance element of this device. The desired signals are then passed on to the receiver through the tuned circuit containing inductance L_2 and capacity C_2 , any residual undesired signal being excluded from this circuit through being out of tune with it.

"To aid in picking up signals I provide the switch S, which in its up position eliminates the intermediate selective circuits, connecting the coupling tube directly to the circuit containing inductance L_2 and capacity C_2 . This arrangement, not being very selective, permits of the signals being picked up properly and adjusting the receiver containing inductance L_3 and capacity C_3 to the desired frequency. When the desired signal has been found and the receiving circuits adjusted, the switch S is thrown to the down position connecting in the intermediate selective circuits and these are then tuned until the desired signal is brought in and the undesired signals excluded.

"Having described my invention, I claim:
"1. In a system for the reception of high frequency electrical signals the combination of a collector circuit having a high resistance in series therewith, a coupling thermionic vacuum tube having its input circuit connected between two points in said resistance and an output circuit having in series therewith a tunable circuit containing variable constants in parallel relation, a tunable rejector circuit in series relation within said tunable circuit, a tunable circuit in parallel relation to said rejector, and a receiver associated with said last tunable circuit.

"2. In a system for the reception of high frequency electrical signals the combination of a collector circuit having a high resistance in series therewith, and a plurality of receivers connected thereto, each through the following elements: a coupling thermionic vacuum tube having its input circuit connected between two points in said resistance and an output circuit having in series therewith a tunable circuit containing variable constants in parallel relation, a tunable rejector circuit in series relation within said tunable circuit, and a tunable circuit in parallel relation to said rejector."

Better Results With Less Space—Using

DUPLEX



CONDENSERS

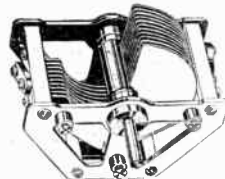

DUPLEX STANDARD

Their carefully-planned design retains all low-loss advantages and keeps DU- PLEX S.L.F. Condensers as small as the previous models.



DUPLEX JUNIOR

Their specially shaped-out stators afford separation on all wave-lengths, increasing selectivity and eliminating interference.

Learn the secret of DU- PLEX superior construction. Sample plate and literature sent on request.

Duplex Condenser & Radio Corp.
52 Flatbush Avenue Extension,
Brooklyn, N. Y.

Is Your "B" a Worker or a Drone?

Your Set Deserves

The Brant B Battery

\$26.00



100 Volts
In One
Compact
Unit

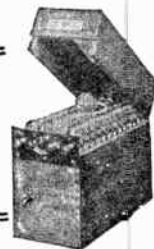

Guaranteed
TWO
YEARS

As Good as It Looks

A good storage battery with the cleanliness and compactness of dry batteries.

Ask Your Dealer

BRANT BATTERY CO.

1622 W. 16th St., Los Angeles, Cal.

DIAMOND-WEAVE

(Trade-Mark Reg. Aug. 4, 1925)

SICKLES COILS

for Roberts, Browning-Drake, Craig, Hoyt and other leading circuits.

The F. W. Sickles Company

136 Union Street, Springfield, Mass.

Insure your copy reaching you each month. Subscribe to Radio News—\$2.50 a year. Experimenter Publishing Co., 53 Park Place, N. Y. C.

The Baby Transmitter

(Continued from page 803)

THE BABY TRANSMITTER DEVELOPED

With this advantage in view, the Baby Transmitter was built for operation in the 40-meter wave band allotted to the amateurs by the Government, on which there is communication carried on each day and night by scores of boys and many laboratories and experimental workers.

In all instances the set was coupled to a large antenna and tuned to the fifth harmonic, the wave-length of the transmitter being set at 37.5 meters and the free period of the antenna circuit adjusted to five times this value.

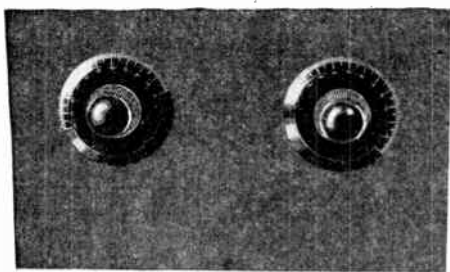

The front panel view of the baby transmitter. Note that only two controls show.

Of interest in connection with the working of this set is the question of how long the small size of batteries will last. Under average conditions, that is, in the lowest wattage, a plate drain would be from 4 to 6 milliamperes and working about two hours a day the "B" batteries would last from 200 to 400 hours. The "A" batteries were used at a higher current than 0.06 amperes on the tube. Their life would be from 50 to 75 hours; if six-inch dry cells were used instead of the small "C" battery type, the hours of service would be lengthened out into more than 500 hours.

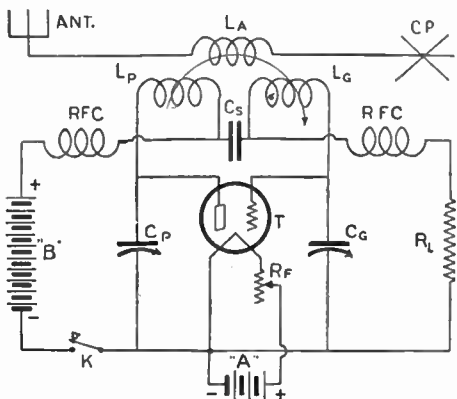

Above is the complete wiring diagram of the baby transmitter as it is used for C.W. work. Keying is in the plate supply.

The attached table shows some stations worked and the reported signal strengths as well as the total watt input. This watt input is the sum of the filament and plate wattage. By measuring the distances from Madison to these various points, it is seen that communication has been carried on from 1000 to 2000 miles per watt.

Further experiments on transmission and design are being carried out and an even more compact and lighter transmitter is now under construction.

Real Estate Salesman: This is the best radio location in the city.

Prospective Buyer: That's enough! I'll take it.

Contributed by Wm. G. Mortimer.

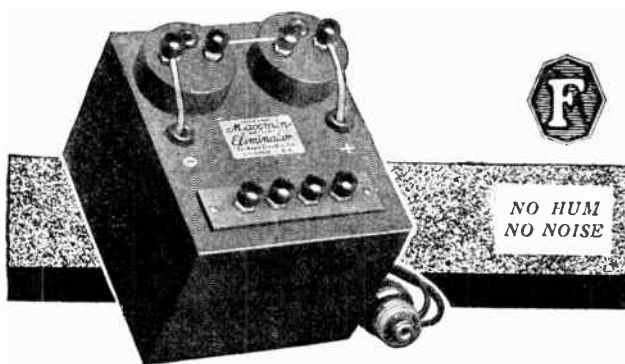

Now-Plate Voltage for any Set — and You can afford it!

First Cost Economy now makes it possible for EVERYONE to obtain efficient "B" current supply right from their electric light socket. Now one of the biggest improvements in modern-day radio reception is placed within the reach of all. Think of it! A perfect, always efficient source of plate voltage for any set for \$9.75! It marks a revolutionary step forward and will be welcomed by millions of radio enthusiasts.

Ferbend "B" Eliminator

The price of this remarkable new unit is spectacular in more than one way. Besides saving you from \$15 to \$50 it is amazingly low considering the quality and superiority. You may ask "how could it be possible to build such a unit for the ridiculously low price of \$9.75?" True mechanical genius and resourcefulness alone are responsible. But the logical way to answer this question is to equip your set at once with this marvelous unit and be convinced.

ASK YOUR DEALER—OR SEND DIRECT

FERBEND Wave Trap

This company also manufactures the famous Ferbend WAVE TRAP—the instrument which has been widely imitated but never equaled. It is the only original and genuine.

Until nation-wide distribution is completed it is possible that your dealer hasn't stocked the MAXMIN "B" Battery Eliminator as yet. So you will not have to wait, we will make prepaid shipment direct to you upon receipt of \$9.75, or C. O. D., plus postage. Remember, superior results are guaranteed or your money back. Be one of the first to own and use the Ferbend MAXMIN "B" Battery Eliminator.

Use the COUPON NOW!

Ferbend Electric Company

425 West Superior Street
Chicago, Ill.

Ferbend Maxmin "B" Eliminator

FERBEND ELECTRIC CO.
425 West Superior St., Chicago

- Send Postpaid. I am enclosing \$9.75.
- Send C. O. D., Plus few cents postage.
- Send Literature.

Name.....

Address.....

City.....

State.....



Lambros Callimahos of New Jersey wrote us recently: "I have been a agent for 17 leading magazines but have found that none of them sell as well as your publications."

BOYS! Here's Money For You!

DO YOU want a steady income every week—extra money for football games, for the movies, and for Christmas Presents? You can easily earn it in your spare time and get dandy prizes besides by selling

RADIO NEWS and our other popular magazines.

Start a business of your own by sending along your name and address on the coupon below—TODAY!

Clip Here

E. J. FOLEY, Dept. RA-12,
Experimenter Publishing Co.,
53 Park Place, New York City.

My Name Is.....

Address.....

City..... State.....

RADIO LISTENERS' GUIDE and CALL BOOK

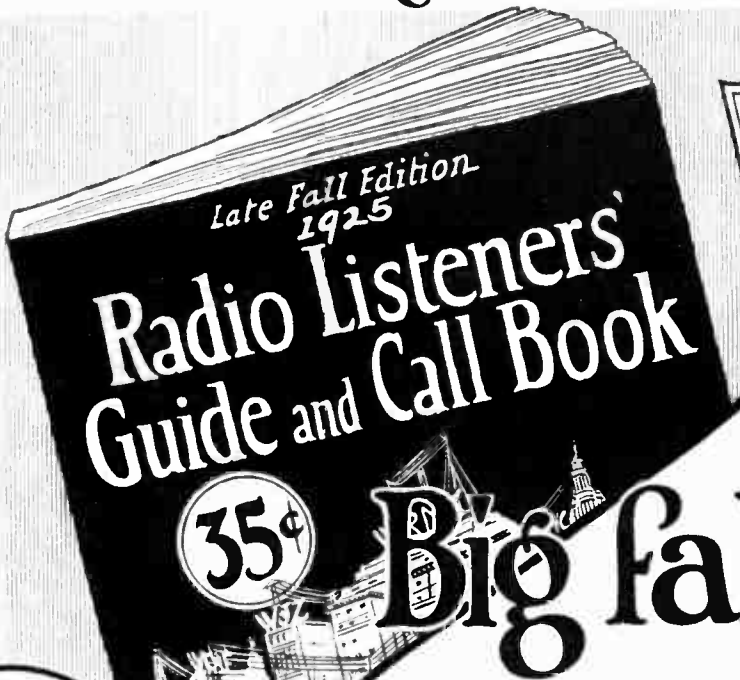

The
Radio Set Owners'
Book
 of
Information

Big fall Issue

116
PAGES
 OF
RADIO

World's Greatest Book of Information with the Latest Complete List of Radio Stations and Call Letters

Here is the latest and greatest radio book of its kind published for the Broadcast Listener. It is a National Radio Guide Book of the United States in that it gives you, completely and comprehensively, the location of radio stations on the air. It lists all stations of the United States, both Broadcast and Amateur, giving size and location of each station, its wave-length, etc., with ample space for tabling and logging those you receive.

Then just as an Automobile Guide Book tells you how to care for your car, this book explains the complete care of your radio set by explaining the fundamental operation of all principal parts.

And also it gives foreign radio stations, time signals and a multitude of similar, valuable listings.

116 pages filled to the brim with valuable data

PARTIAL LIST OF CONTENTS

- | | |
|---|---|
| Selecting a Radio Receiving Set. | Radio Broadcast Stations of the U. S., by States. |
| Reaching the Shorter Wavelengths. | Radio Broadcast Stations of Canada. |
| How Broadcast Stations Operate. | Special Land and Experimental Radio Stations of the U. S. |
| Locating and Eliminating Trouble in Radio Sets. | Foreign Radio Broadcast Stations, by Countries. |
| All About Radiologs. | American Radio Relay League and Directory. |
| The Function and Care of Vacuum Tubes. | Amateur Radio Stations of the U. S., by Districts. |
| Loud Speakers—How to Select Them. | Foreign Amateur Radio Stations. |
| Fundamental Principles of Radio. | Table for Making Time Transitions. |
| The Care and Operation of Storage Batteries. | Radio Broadcast Maps of the United States and Canada. |
| Basic and Modern Radio Circuits. | Time in All Parts of the World. |
| Aerials, Loops, Ground and Lightning Arresters. | |
| How to Understand Radio Circuits. | |
| Radio Broadcast Stations of the U. S., by Call Letters. | |

35c the copy—Sold at all Newsdealers and Radio Stores

If Your Dealer Cannot Supply You, Order Direct. Using This Coupon.

THE CONSRAD CO.,
 233 Fulton St., New York City.

Herewith find 35c for which send me Fall Edition of Radio Listeners' Guide & Call Book.

Name

Address

City

State

SOLD AND DISTRIBUTED BY

The Consrad Company, 233 Fulton St., New York

Consrad

What Happens in the Broadcast Station

(Continued from page 799)

tory current. If now, we were to combine these or, as it is termed, superimpose the voice current upon the other one that is rapidly running in first one direction and then the other, we should have what is known as a modulated oscillating current. This is just exactly what is done in transmitting sounds by radio. The result is a curve such as shown in Fig. 3. Here we find that the oscillating current has imposed upon it the voice currents and the result is that, instead of running exactly the same distance in one direction and then the same distance in the other direction, the amount that the current rises or falls from zero is variable. The exact variations are in accordance with the voice or other sound and the current is thus said to be modulated by that sound. As a result, we have a rapidly changing current that corresponds in intensity to the spoken word or sounds.

The character of oscillations set up by the oscillator tubes in a transmitting station is such that if the current is fed into an antenna or wire suspended in the air it will set up radio waves in the ether. These waves will go out in all directions and can affect radio receiving sets in such a way that the sounds made at the broadcast station will be reproduced in the receiving set phones or loud speaker. However, we are not going into details here regarding reception, as most of this has been covered in past articles in this department. It is quite sufficient to say here that the current, such as the one shown graphically in Fig. 3, goes into the antenna and here disturbs the ether. The latter term, ether, is one that must not be misunderstood. The ether is conceded to be an all-pervading substance that is found everywhere. It permeates wood, stone and steel just as well as air and the gases. This ether must not be confused with the well-known anesthetic. Since we cannot go into deep technicalities here we shall merely state that the current, such as shown in Fig. 3, flowing in an aerial wire will cause the ether all around it to shake. These vibrations are transmitted from one part of the ether to another by contact, just as waves in water are transmitted. The ether is shaken or vibrated in exact accordance with the sounds at the broadcast station microphone because of the fact that the current that shakes it is modulated by the voice currents.

In Fig. 4 we have shown an extremely simplified diagram of the various essential parts of a radio telephone transmitting station. First, we have the microphone with its local battery. The voice currents from this instrument are fed into a voice amplifier for the purpose of making them stronger. This is quite necessary because if the currents are too weak, they cannot be properly super-imposed or placed on the oscillating currents. From the voice amplifier, the strengthened current goes into the oscillator and here changes the current, a chart of which is given in Fig. 2, to a form such as that given in Fig. 3. This modulated radio frequency current then goes through a tuning arrangement so that the station can be tuned to a definite wave-length and then goes out into the antenna and shakes the ether. We have discussed tuning before in this department and will not go into the details here.

THE STATION ITSELF

Now that we have seen what principles underly broadcasting, let us take a trip through such a place. Aside from the various offices and reception rooms there are two other rooms in the average station. One is the studio where the artists perform and the other is a room, known as the control

FOUR THINGS to look for in any **RADIO REPRODUCER**



faithful reproduction
price
volume
appearance

You have all four, to a superlative degree, in

Sylfan "B"
Eliminators

Sylfan
REPRODUCERS

take the place of "B" Batteries, and *increase your range—clarify your reception—give positive, perfect, satisfying results not obtainable from "B" Batteries.* Operate from 110-120 Volt A. C. only.

Nothing to put together.
Nothing to spill.
No acids or water to add.
Nothing to test.
Nothing to charge.
No tubes to burn out, nor will it injure, in any way, vacuum tubes in your set.

No vibration.
No fire hazard.
Needs no attention.
Costs 1 cent to operate 16 hours on 10 cent power rate.

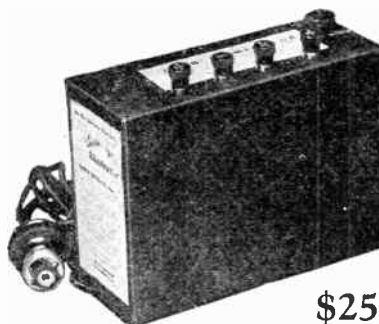

\$25

Every inch of Sylfan Reproducers is constructed by scientific formula, designed to pick up and amplify the fine shading of vocal and instrumental artists to a degree long sought but seldom realized. No need to coddle it for fear of having to apologize.

Even at much higher price it would be difficult to obtain a loud-speaker as nearly attuned to perfect reception.

\$25 at your dealers

See the Sylfan line Booth No. 34
Chicago Radio Exposition

Manufactured and Marketed Exclusively
Thru Jobbers by

BAKER-SMITH CO., Inc.

New Call Building, San Francisco

Branch Office Addresses

Portland, Ore., Henry Bldg. New York City, 1270 Broadway
Salt Lake City, Atlas Bldg. Chicago, 30 N. Dearborn St.
Seattle, L. C. Smith Bldg. Denver, McClintock Bldg.
Los Angeles, 443 South San Pedro Street
Vancouver, B. C., 179 Pender Street, West

Insure your copy reaching you each month. Subscribe to Radio News—
\$2.50 a year. Experimenter Publishing Co., 53 Park Place, N. Y. C.



The Shontz Radio TROUBLE SHOOTER tells you **What's Wrong with your Set & how to fix it**

25c

A boon to the fan living far away from the Radio Service Station THE SHONTZ RADIO TROUBLE SHOOTER tells you in easy readable English how to locate every radio trouble and how to correct it. If your dealer does not stock it yet, send 25c to

H. B. SHONTZ & CO., Inc.
161 West 64th Street New York, N. Y.

Shontz RADIO TOOL KIT



\$10

YOU CAN MAKE MONEY REPAIRING RADIO SETS

Become the RADIO DOCTOR of your neighborhood.

Besides containing every radio tool necessary to correct any radio trouble, the SHONTZ RADIO TOOL KIT contains the famous SHONTZ RADIO TROUBLE SHOOTER which tells you what's wrong with any radio set and how to fix it.

IF YOU LIVE IN THE COUNTRY YOU NEED THIS TOOL KIT.

In the event your dealer does not stock it, send your order direct to

H. B. SHONTZ & CO., Inc.
161 West 64th St. New York, N. Y.

Every Radio Fan should have this book

JUST OUT—514 PAGES



I. C. S. RADIO HANDBOOK

\$1

Compiled by **HARRY F. DART, E.E.** Formerly with the Western Electric Co., and U. S. Army Instructor of Radio. Technically edited by **F. H. Doane**

NO MORE need you turn from book to book, hoping to find what you want. It is all here, in 514 pages crammed full of every possible radio detail. Written in plain language, by engineers for laymen. 100,000 sold.

IT EXPLAINS: Electrical terms and circuits, antennas, batteries, generators and motors, electron (vacuum) tubes, many receiving book-ups, radio and audio frequency amplification, broadcast and commercial transmitters and receivers, super-regeneration, codes, etc.

Send \$1 today and get this 514-page I. C. S. Radio Handbook—the biggest value in radio today.

International Correspondence Schools
Box 8284-F, Scranton, Penna.

I enclose One Dollar. Please send me—post-paid—the 514-page I. C. S. Radio Handbook. It is understood that if I am not entirely satisfied I may return this book within five days and you will refund my money.

Name.....

Address.....

Check here and enclose \$1.50 if you wish the edition bound in leatheroid.

room, where the apparatus is kept. In the studio the microphone or microphones are placed, as well as other essential musical instruments and a signal system so that the announcer can keep in constant communication with the control room. This is necessary because the studio is made absolutely sound-proof so that no extraneous noises can affect the transmission.

In the control room we find a multiplicity of panels and various instruments. There is the voice amplifier, such as indicated in Fig. 4, and also a control for it. An operator is on constant duty in front of this control at all times that the station is in actual operation. If a speaker starts to talk too loudly or if some musical instrument threatens to overload the radio apparatus by vibrating the diaphragm of the microphone too violently, the operator cuts down on the control and does not allow as much current to pass through the voice amplifier and into the oscillator. If the operator at this point is not alive to his job at all times, the result is severe blasting of loud notes and consequent poor reception. He really controls the quality of the outgoing sounds at all times.

In back of another large panel in the control room are usually two or more huge vacuum tubes. Standing about two feet high, they are actuated by a high voltage source of electricity and generate very powerful oscillations that, in turn, go through the tuner and into the aerial, as described above. Aside from these essential parts there are other instruments in the room that lend refinements to the work. Specially designed circuit-breakers and protective devices guard against damage to the expensive vacuum tubes. Furthermore, over in one corner of the operating room there is a receiving set that is always tuned to the commercial transmitting wave-lengths. It is by means of this set that one of the operators on duty listens in for possible SOS distress signals. At such a time, of course, the broadcast station has to be taken off the air until the commercial stations signify that the trouble has been cleared up or that the ship in distress has been located and aided. In this way broadcast stations will not be on the air during times of trouble and cannot interfere with the quick and easy dispatch of messages of mercy.

The Nature, Cause, and Reduction of Fading

(Continued from page 773)

ting of the wave, and the reunion of the separated parts at the receiver is far from being a useful effect; it is the cause of fading, and probably also of the dead zones which are so unpleasantly prominent in high frequency working. For at least one of these paths is inconstant, and the waves which travel along it are irregularly and rapidly varied in phase, and perhaps also in polarization, so that when they arrive at the receiver they alternately add and subtract from the strength of the other waves.

DATA ON FADING

Coming now to the nature of fading, I have shown in Fig. 1 the variation in field strength at Washington of the waves from station POZ, at Nauen, Germany. The data from which this curve was drawn was by Dr. Austin, and is unique in that it represents the longest series of measurements of a single transmitter which has yet been made. The ordinates of this curve are in microvolts per meter, and the points for the full-line curve are monthly averages. In dotted line is a curve of yearly averages, and this shows a five-year period, with maxima in 1916-1917 and 1922, and a minimum in 1919. This is the longest "fading" period we yet know; probably some centuries hence we may be acquainted with still longer period fluctuations, and will have then

"Twice the Range and more volume on this indoor aerial!"

—says a Youngstown, O. fan



Equip your set with a new EFFARSEE and watch your old distance records go! Thousands of unsightly inefficient outside wires have been replaced with this marvelous new scientifically designed antenna.

Increases Selectivity! Cuts Down Static!

You never have trouble separating stations with an EFFARSEE, and it eliminates local interference — reception with EFFARSEE is reception at its best.

Type IXL contains 1000 feet of copper wire; type BXL slightly smaller; both models equipped with special fixed condensers. Write for testimonials of enthusiastic users.

Type IXL (large) . . \$4.00
Type BXL (small) . . 2.50

At any radio dealer —or write direct.

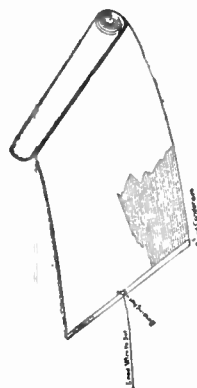

FISHWICK RADIO CO.
131 CENTRAL PARKWAY, CINCINNATI, OHIO



The Famous Truly Portable TELMACO P-1 Receiver
Four Tubes Do the Work of Seven

The peer of portables in size, weight, ease of tuning, selectivity, distance, volume, workmanship and price. Aerial, loud speaker and batteries self contained. Complete with tubes and batteries, \$125.00 \$141.50. Receiver only . . .

P-1 Kit Saves You Money!

Our offer of the Telmaco P-1 Receiver in kit form has met with enthusiastic reception. This contains all parts, as built by us, including case, drilled and engraved panel, and illustrated instructions. \$80.00 Complete kit. Ask your dealer or write us. Descriptive folder free.

Radio Division:

Telephone Maintenance Co.
20 So. Wells St. Dept. B Chicago, Ill.



Quality Radio Exclusively Established 1918

MUTER

Dependable Audio Transformers \$2.25 at all dealers

Insure your copy reaching you each month. Subscribe to RADIO NEWS—\$2.50 a year. Experimenter Publishing Co., 53 Park Place, N. Y. C.

EFFICIENCY

That Meets the Requirements of Eminent Radio Engineers

Apex Vernier Dials are more than mere "knobs." In reality they are instruments endowed with an ultra degree of efficiency. Their rich elegance of finish lends a touch of striking attractiveness to any set. Precision of production and of operation makes a good set a better set—providing greater range of selectivity—positiveness of control—and utmost simplicity of tuning in most difficult stations. Ratio 12 to 1. Clockwise and counter clockwise. No backlash. Royal Brass finish 4-inch \$2.00. 3 1/4-inch \$1.65. Satin Silver finish 4-inch \$2.50—3 1/4-inch \$1.90. DeLuxe Gold (24K) Finish 4-inch \$3.50—3 1/4-inch \$2.50. Your dealer has them. If not, order direct.

APEX Rheostat Dials

are as essential to successful operation and pleasing appearance as are Apex Vernier Dials. Royal Brass Finish—75c. Satin Silver Finish—85c. DeLuxe Gold (24K)—\$1.00.

APEX ELECTRIC MFG. CO.

Dept. 1206

CHICAGO

1410 W. 59th Street



THE SIMPLEST PRACTICAL RADIO SET MADE

\$1⁰⁰

The **RADIOGEM**

The simplest radio outfit made—yet as practical as the most expensive. A crystal receiving set that you can operate and enjoy even though you know absolutely nothing about radio. You receive the RADIOGEM unassembled, together with a clearly written instruction book, which shows you how to quickly and easily construct the set, using only your hands and a pair of scissors. The outfit comprises all the necessary wire, contact points, detector mineral, tube on which to wind the coil, etc., etc. The instruction book explains simply and completely the principles of radio and its graphic illustrations make the assembling of the RADIOGEM real fun.

THE RADIOGEM CORP.

66-R W. Broadway New York City

an index, which is also connected mechanically to a recording pen traveling across a slowly moving strip of paper. This recorder is shown in Fig. 4.

Fig. 5 is a record which shows fading at its inception, made from a broadcast station only eleven kilometers distant. The upper line of this record was made during the evening, while the lower was made in the afternoon of the same day. The slight wavering of the day record line is probably principally due to small changes in the antenna current at the transmitter, caused by either slight fluctuations in the line voltage supplied to the motor-generator, or by occasional overmodulation. The greater and more rapid fluctuations of the night record are true fading, although their amplitude is so small as to escape the ear entirely. This record represents an average evening for this reception; some evenings show an even smaller amplitude than this, while others show much larger fluctuations.

As the distance between transmitter and receiver increases, the difference between night and day reception also increases. At first the character of the record does not materially change, although the amplitude of the swings steadily increases with distance, but when a zone of between 100 and 300 kilometers is reached—the exact distance depends largely upon intervening geographical features, such as hills, wooded land and bodies of water—the fading is found to be most violent. This distance is also about the limit of reliable day-time transmission, and the change from day to night is large.

Fig. 6 is a record made at Newton Centre from WGY at Scenectady, distant 225 kilometers. The upper record was taken in the day-time, and the fluctuations are relatively slight. The lower records were made on the evening of the same day, and show some striking changes, including a number of complete fadeouts. Portions of this record show very periodic changes in signal intensity, with a gradual change from an interval of about 6 seconds, as at 9.42, to a period of over 2 minutes at about 10.00 P. M.

The records shown in Figs. 5 and 6 were taken with a moving coil galvanometer having a period of several seconds, so that fluctuations of less than a few seconds in duration are not effectively recorded. By using a string galvanometer, with a fast moving photographic film, it is an easy matter to record all fluctuations, even those of audio frequency. In Fig. 7 is shown a string galvanometer record of evening reception from WGY, in which the time scale, as compared with the previous records, has been opened out about one hundred-fold. This record was taken at a time when the broadcast station was not modulating, so that the changes shown are due to true fading. It will be seen that some of the fading periods recorded here are at frequencies of from 50 to 100 per second; that is, the fading is at an audio frequency, and is itself a cause of sound in the receiving phones, which usually takes the form of a low-pitched, rumbling note. Such high frequency fading is a frequent cause of distortion in radiophone reception. At frequencies higher than those of the present broadcast band, this audio frequency fading is particularly prominent, and forms a real barrier against the use of these high frequency channels for broadcasting.

TRACING THE CAUSE OF FADING

These are the more important facts of fading; what is their exact cause? Clearly it is somewhere in the atmosphere, for neither the intervening geographical conditions nor the moisture in the surface soil are capable of such rapid changes as are indicated by these records. We are still on firm ground when we further say that it is not possible to account for the fading by



\$2⁹⁵

OLD TUBES MADE GOOD AS NEW

This latest Laboratory product will recondition any old, run-down, even worthless tubes, as long as the filament still lights. Makes them good as new in few minutes time. Costs but few cents more than new tubes! Simple, efficient, practical. Big money-saver. Operates on either A.C. or D.C.—110-120 Volts. Model No. 24 for UV201A (201A, etc.) and all similar types. Model No. 10 for UV199 (2299, etc.) and all similar types. Bound to do the work on our **MONEY-BACK GUARANTEE**. You cannot lose! Act quick on this special short-time introductory price. Sent Postpaid with full directions on receipt of \$2.95. Be sure to state Model Number wanted. Our guarantee refund price protects you. *Send now.*

724 Cass St. **MACK LABORATORIES** Chicago, Ill.

MACK RECONDITIONER
"THE CURE FOR RUN-DOWN TUBES"



In Twenty Minutes

of your spare time, you can easily earn this handsome watch and stand outfit. The watch is an accurate time keeper, light in weight, and has an unbreakable crystal. It may be instantly removed from the stand for ordinary pocket use.

This is only one of the many desirable premiums you can get for a little of your spare time. Full particulars mailed immediately on request. No obligation. WRITE TODAY.

E. J. FOLEY
Experimenter Publishing
Company

53 Park Place : : New York City

either changes in the composition of the atmosphere, or by varying amount or distribution of its moisture content, which leaves us with the only known remaining variable, ionization.

As only the electrical charges in the atmosphere can account for the bending and splitting of radio waves, so these ions and electrons are the sole cause of fading. There are two possible ways in which ions can act to vary signal strength. If they are set in motion by passing waves, and as the result of this motion collide with other ions and gas atoms, energy drawn from the wave is dissipated, and a weaker signal is obtained at the receiver. The ionization absorption of the whole atmosphere may possibly vary enough from year to year, season to season and even from day to night to account for the longer periods shown in the first three figures, but it seems altogether unlikely that the ionization of any considerable portion of the atmosphere could change so abruptly as to account for the shorter periods shown in the other records. But as we have seen from purely optical reasoning, the electrical charges in the air are competent to alter the velocity of the waves, and so, without absorption, change the normal rectilinear path to one that is curved. It is possible, therefore, to have two or more distinct paths from the transmitter to the receiver, and if the waves passing along one route arrive at the receiver in either different phase or plane of polarization, they will interfere with the other set or sets of waves. If we further assume that one of the paths varies slightly in actual length, or if the phase along this path is advanced or retarded, or if the twist given by this path to the plane of polarization changes from moment to moment, the resultant at the receiver may pass through large changes in amplitude. This effect, which we call fading, is obviously at a maximum when the amplitude of the waves arriving at the receiver is the same for both paths; if then the phase difference is 180° the two sets of waves will add to zero, and a complete fadeout results.

We are in complete ignorance today of the mechanism by which the path length, phase, or plane of polarization is so rapidly altered as to produce such short period fluctuations as we find and record for broadcast transmission over moderate distances. We assume that this action takes place in the upper levels of the atmosphere, primarily because we know very little about the state of the air at great heights and so anything in or out of reason *might* happen there, and secondarily because in these higher strata the air is so attenuated that electrons and ions have much greater freedom—that is, much longer free paths—than they can have near the surface.

AN OPTICAL ANALOGY

But whatever the exact mechanism by which it is brought about, it seems altogether likely that fading is purely an interference effect between two or more sets of waves. Therefore, and entirely regardless of the exact manner in which the radiation from the transmitter is split into separate rays, we may treat the problem of fading as elimination just as if it were an optical problem. Let us imagine that a sealed box were handed to us, with a hole in each end, and we found that whenever a point source of light was placed in front of one aperture, and a screen behind the other, that a set of interference fringes would appear on the screen. As we watched these fringes we further found that they were in irregular, rapid motion, shifting back and forth across the screen, so that if we confined our attention to a single point on the screen it would be found alternately illuminated and dark. Without opening the box, we could merely conclude that it contained some sort of optical system like an interferometer, and



Radion Panels in black and Mahogany come cut in standard sizes for whatever set you wish to build.

To be sure of lowest losses—

you must have insulation made to order for radio

THERE is an undisputable scientific reason why Radion Panels are most effective in reducing surface leakage and leakage noises:

The insulating material of which they are moulded—Radion—was *made to order for radio purposes exclusively*. Tests after tests have proved that this special insulation insures lowest losses and highest efficiency.

Radion Sockets, Dials, Insulators and Tubing play a part of equal importance with Radion Panels in keeping down losses to the minimum. They have the same high-resistant characteristics and they embody the latest developments in radio. Ask your dealer to show you the complete line of Radion low-loss parts.

Send for booklet, "Building Your Own Set." Gives wiring diagrams, front and rear views, lists of parts and directions for building popular circuits. Mailed for 10 cents.

AMERICAN HARD RUBBER COMPANY
 Dept. A12, 11 Mercer St., New York City
 Chicago Office: Conway Building
 Pacific Coast Agent: Goodyear Rubber Co.,
 San Francisco—Portland

RADION

The Supreme Insulation

made to order for radio purposes exclusively



No. 2 Radion Socket for new UX tubes with collar adapter for old type tubes.



No. 4 Radion Socket for new UX tubes.



New No. 10 4-inch Radion Dial, built to conform to the fingers, helping you to get close tuning. May be used for single mounting condensers. Nine other styles of Radion Dials in several sizes to meet all requirements.

American Hard Rubber Company,
 Dept. A12, 11 Mercer St.,
 New York City.

Please send me your booklet for which I enclose 10 cents in stamps.

Name

Address

The Handy Radio and Electric Tool

A set of tools all in one wrench

"GRIP-IT"

SOCKET WRENCH

Fits all radio nuts and screws—holds wires for soldering. Reaches in and grips where neither screw-driver nor pliers can go.

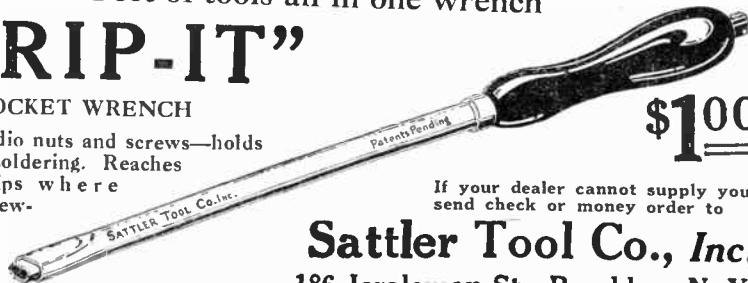

\$1.00

If your dealer cannot supply you, send check or money order to

Sattler Tool Co., Inc.
 186 Joralemon St., Brooklyn, N. Y.

Just Seven Simple Tools



—and you can build the finest Radio Receivers Quickly and Easily

It takes but one or two evenings, using only the simplest tools to construct, at home, any one of the big, popular receivers shown on this page.

All you need is the well known CONSRAD Pattern that covers this particular receiver. CONSRAD Patterns are marvelously simple. You don't have to measure the spacing on the panel board or the placing of the parts. It is all drawn for you on the Blueprints the same as indications are given on a lady's dress pattern.

And you don't have to use 100 different tools to complete the job—just six or seven ordinary tools found in every household. A screwdriver, a pen-knife, a pair of pliers, etc., and you are ready to go ahead.

Visit your nearest Radio Dealer, ask him to let you look at some CONSRAD Patterns, select the one you want. Pay the Dealer 50c and you have complete instructions and blueprints for the construction of the Receiver.

IF YOUR DEALER CANNOT SUPPLY YOU, WRITE DIRECT, MENTIONING THE RECEIVER YOU WISH TO BUILD AND ENCLOSING FULL PRICE.

REMEMBER: CONSRAD Patterns—only 50c—give complete full sized blueprints and instruction booklet. Everything ready to build.

The CONSRAD COMPANY, 233 Fulton St., New York

Consrad

EVERYTHING IN RADIO BOOKS, PATTERNS AND DIAGRAMS

SUPER-HETERODYNE



THE TROPADYNE



THE NEUTRODYNE

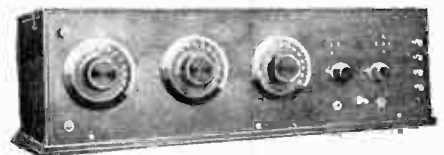

5-TUBE COCKADAY



THE REFLEX

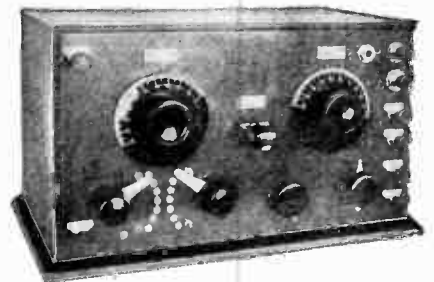

THE PORTABLE

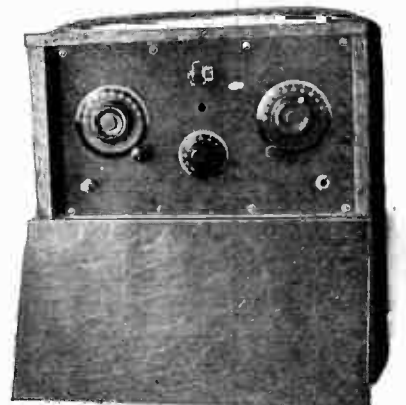

that, possibly driven by clockwork, one of the mirrors was incessantly moved through a slight angle or distance.

If now it was required that with light transmitted through the box, and without further knowledge of its contents, a single point on the screen should be steadily illuminated, we could proceed with some assurance to do this, still in ignorance of the exact optical system concealed in the box. One method would be the substitution of a multipoint light source which would give an overlapping series of interference fringes and so a nearly uniform illumination on the screen. Another method would be to retain the single point source, but by a multipoint pick-up, such as a condensing lens, to focus the light from a considerable area on a single point, which would be uniformly illuminated, regardless of the interference fringes and their movement across the field. We could combine both methods, if we wished a further refinement.

Now we can make a precisely similar change at either the transmitter or the receiver, or both by substituting for single radiant and collecting points a special system of multipoint aeri-als. Such an arrangement is not new, and was in fact invented by me some twenty years ago. In my U. S. Patent 956,165, filed in 1907, is disclosed a multipoint aerial system, which may be used either as a receiver or as a transmitter, and in Fig. 8 the drawing of this patent is reproduced. It is important to note that the separate aeri-als which comprise this system must, as the patent points out, be separated by distances greater than a half wavelength; if they are closer than this, the system acts substantially as a single antenna, and there is no advantage in its use, other than certain important directional effects, with which we are not here concerned.

At a broadcast transmitter using my system, three or more aeri-als would be erected, separated by distances of one or more wavelengths. If sufficient land is available, separations as great as ten or more wavelengths would be even better. Each aerial would be fed by a power amplifier at its base, and these power amplifiers would, in turn, be connected by high frequency transmission lines to a central point, where current from a low power master oscillator, modulated in the usual manner, would be supplied to the network. At the receiving end a single point receiver of the ordinary type would experience very little fading, owing to the large number of different paths from the transmitter, and a still further reduction could be obtained by a similar multipoint receiver, consisting of a number of well-separated aeri-als joined to a common point through transmission lines. It would be better at the receiver to effect a frequency conversion at each antenna, as by the use of a super-heterodyne, so that the transmission lines would carry current to the common or central point at a materially lower and more manageable frequency.

A portion of my complete system has already been tried out by the repeater station at Hastings, Nebraska, where two widely separated aeri-als were employed to receive the high frequency transmission from Pittsburgh, and a very material reduction in fading was obtained. But better results are to be obtained by using the complete system, or, to help the broadcast listener who can hardly afford to erect a multipoint receiver, the use of a multipoint transmitter.

In conclusion, it is interesting to note that several other proposed solutions of the fading problem, such as upwardly directed radiation, obtained by harmonic excitation of the transmitting antenna, horizontal polarization at the transmitter, increased power and directional transmission and reception, have been tested during the past year and found ineffective.

The Year's Best Improvement

The B-T Terostyle Transformer

A Product with a Purpose—For a Circuit with a Pedigree

B-T Engineers have solved the "toroid" problem. They have designed a coil combining the "toroid" advantages of non-pick-up and non-intercoupling with the most efficient method of oscillation control known to radio—the patented B-T "Counterphase" circuit.

The B-T Terostyle is more than just a primary and secondary—it is an inductance for a circuit that is in turn designed for the coil—the combination is unbeatable for 4, 5, or 6 tube sets.

The "Counterphase" is equally efficient on all wave lengths.

B-T Terostyles are sold in 5- or 6-tube "Counterphase" Kits or singly.

Three types, TA, Antenna Coupler; TC, R. F. Stages; T4, 4 tube circuit.

Price \$4.00
The Counterphase-Six complete, shielded receiver \$165.00

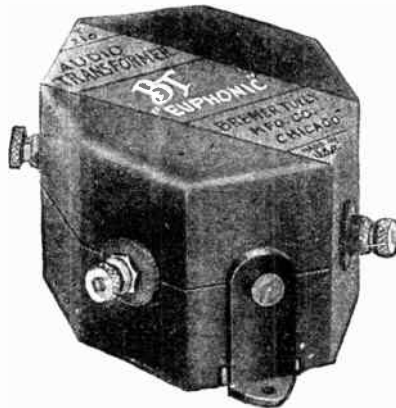
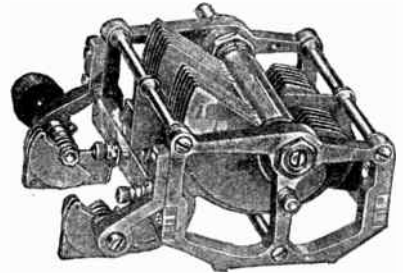

"The BEST Transformer We Ever Tested"

says a leading laboratory. B-T engineers, to do full justice to B-T circuits and apparatus, designed the B-T "Euphonic." It is a superior transformer with an added mechanical feature that eliminates howling and distortion due to leads being too close together.

Case and movable brackets so designed to permit any type mounting—base board, sub-panel or side with terminal always in correct position for wiring.

For better tone, and convenience in building, buy B-T "Euphonic."

— The Biggest Dime's Worth in Radio! —

"Better Tuning," an 80 page booklet of hook-ups and helps to set builders and owners. Send 10 cents for your copy.

Literature describing B-T parts free.

Bremer-Tully Mfg. Co.

532 S. Canal St.

::

Chicago, Ill.

STORAD

Automatic Power Unit

Controls both "A" and "B" Power Circuits.

The Storad Automatic Power Unit simplifies your power problem. Put one on your set, connect it with the house lighting circuit and forget about both "A" and "B" circuits. Your set switch is all you operate.

The Storad contains an "A" Power Unit which assures ample current at all times automatically.

The Storad controls the "B" circuit automatically. If you use Storage "B" batteries,

they are kept fully charged at all times. If you prefer a "B" eliminator, the Storad Power Unit controls its operation without individual attention. Dry "B" batteries can also be used with the Storad Power Unit control if desired.

The Storad Automatic Power Unit is the most complete power unit on the market today.

Use a Storad. It thinks for you.

Write for complete information and prices.

THE CLEVELAND ENGINEERING LABORATORIES CO.
2142 Superior Viaduct, N. W.,

Cleveland, Ohio

Now only \$7.50
formally \$9.50



Sent Prepaid Anywhere in the U.S.

Here's good news for Radio builders. Now you can get the famous WIZARD WIRE WINDER prepaid, for only \$7.50. Due to greatly increased manufacturing facilities and a tremendous growth in sales, you get a higher quality winder and save over \$2.00 as well. The

WIZARD WINDER

eliminates the most trying and difficult job in building sets. Saves hours in time and waste! Winds automatically and uniformly any thickness of silk, cotton and enameled wire into practically any style coil from 1/8 in. to 4 1/2 in. diam and up to 10 1/2 in. long. SPACES PERFECTLY. Ready for instant use. Nickel plated throughout, strongly built.

Send No Money

We'll send your WIZARD C.O.D. or enclose \$7.50 with your order—either way we pay the postage, and ship under our positive money-back guarantee. Wizard Wire Winder Co. 3812A Central Ave. Los Angeles, Calif. Dealers! Investigate!

Sold on an Absolute Money Back Guarantee

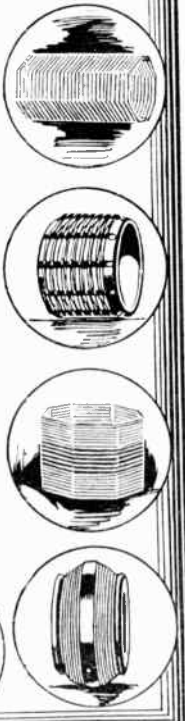

Cold-Cathode Gas-Filled Tubes

(Continued from page 786)

that ionization of the gas atoms must play an important part in the discharge. This can be said to be evident because we now know that the giving out of light from a gas always results from the recombination of positive gas ions with electrons and positive gas ions occur in a gas only as the result of ionization. Almost everyone now knows that an ordinary, electrically neutral gas atom consists of a number of protons—elements of positive electricity—grouped with an equal number of electrons—the elements of negative electricity. If we in any way dislodge an electron from a neutral atom we must leave the residue with a positive charge and this operation is called ionization. As a result of ionization the neutral atom is converted into two ions—one positive ion consisting of the positively charged residue and one negative ion consisting of the dislodged negative electron. It is evident that all negative ions of this simple kind are alike, no matter from what atom they may be dislodged. On the other hand, positive ions differ from each other according to the atom from which they are formed—positive oxygen ions are different in properties from positive hydrogen ions.

Atoms can be ionized by a number of different agencies as, for example, by X-rays or by gamma rays from radium but the ionization in a gas discharge tube is produced by the impact of free electrons against the neutral atoms. These impacts break off electrons from the atoms just as a rifle bullet knocks off grapes from a bunch of grapes although with much less damage to the parts knocked off. An electron, being a negative charge, falls down through an electric field toward the positive electrode just as a brick falls from a high building to the ground, picking up energy as it drops, and this energy enables the electron to knock apart any atoms which it may strike on its path. Since a certain definite amount of energy is required to break up any given atom it is plain that an electron must fall through a certain distance before it can pick up enough energy to damage an atom. This explains why no important ionization is produced in a tube like that of Fig. 1 at full atmospheric pressure. Under these conditions the gas atoms are so numerous and so close together that it is impossible for any electrons which may be present to fall freely far enough to pick up the energy necessary for ionization. As the pressure is reduced, that is, as more and more gas atoms are drawn out by the pumps, the distance of free fall of the electrons through the electric field increases until finally some of them pick up enough energy to break up the atoms they strike and ionization starts. Immediately also recombination begins and glows appear in the tube. An electron which hits an atom and ionizes it, of course loses its energy and stops temporarily but it begins at once to fall again and may then repeat the ionizing operation further along the tube—how far along depending on the strength of the electric field and on the pressure.

Let us now fix our attention on the tube of Fig. 1 and on a definite pressure of one thousandth of an atmosphere. At this pressure there will be about 10,000 million million atoms in each cubic centimeter of the space (one cu. cm. equals about 1/16 cu. in.). The average distance through which a free electron can move in this space without hitting an atom will be, if, for purposes of definiteness, we assume the gas to be helium, about 1/10 of an inch or, say, three millimeters. Now although helium, like practically all gases, is, when in the normal



Stamp out Tuberculosis with these Christmas Seals



The National, State, and Local Tuberculosis Associations of the United States

YOU CAN GET

THIS TUNEFUL BANJO-UKE

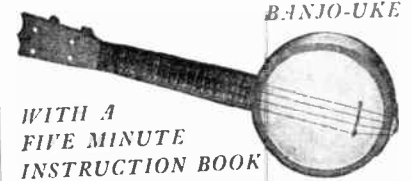

HERE'S a Banjo-Uke that you will be proud to own. Fine workmanship and high grade material have given it rich tone, a neat looking appearance and it will stand plenty of rough usage.

A complete Instruction Book is packed with every Uke. In five minutes the simple lessons in this book can teach you how to play many of the latest song and dance hits. A few weeks later and you may be known as an expert, welcome at parties, dances, church, lodge and school socials, etc.

We will award hundreds of these Banjo-Ukes. You can easily earn one in your spare time. Full particulars mailed immediately on request. No obligation. Write today.

E. J. FOLEY,

Experimenter Publishing Co., 53 Park Pl., New York

1/2 SAVED on All Standard Typewriters

World's best Typewriters now at positively lowest prices and easiest terms offered

10 DAYS FREE TRIAL

A Year to Pay 5 YEARS GUARANTEE Standard Machines so perfectly Remanufactured by the exclusive Young Process they look and write like brand new

FREE Illustrated BOOK. See our amazing typewriter bargains. Read what users say and the unusual service we give you. Write today.



YOUNG TYPEWRITER CO. 654 W. RANDOLPH, Dept. 177C, Chicago, Ill.

IVORY RADIO PANEL



Grained white IVORYLITE makes most beautiful set of all. Any size 3 1/2 sq. inch. 3/16 in. thick. Beautiful IVORYLITE dials inlaid gold numerals \$1.35 ea. Knobs, 55c ea. Shipped anywhere prepaid or C.O.D. Write for FREE sample.

IVORYLITE RADIO PANEL CO.

3222 Avenue F, Dept. N Fort Worth, Texas

Authorized Cockaday Coil \$5.50
Precision Autodyne Coupler \$3.50

PRECISION COIL CO., Inc.
209 CENTRE ST. NEW YORK CITY

Specialists in the manufacture of all types of radio coils

state, an *excellent* insulator, it is not a *perfect* insulator—it always contains a few free electrons which are thought by many scientists to have been developed by gamma rays or similar but more penetrating radiations coming up from radioactive materials in the earth. These few electrons give the gas a very small conductivity and they also play a most important part in starting the glow discharge in our discharge tube, when we apply a potential of a few hundred volts to the electrodes. The neutral gas atoms in the tube are unaffected by the electrical forces since they are neither attracted nor repelled by the electrodes. The free electrons, however, fall toward the anode, the positive electrode, and act like so many destructive projectiles amongst the gas atoms converting them to ions which at once begin also to fall toward the electrodes in two oppositely moving streams. Since, however, the electrons which reach the positive electrode remain there, it is plain that the discharge cannot continue indefinitely unless fresh electrons are supplied to it from some source. The general opinion at the present time is that these extra electrons are knocked out of the cathode, the negative electrode, by the impact of positive gas ions on it. These gas ions crowd up around the cathode and fall sharply into it, knocking out electrons which move away with considerable velocity. The electrons are very small and light and they consequently shoot off with much greater velocity than the heavy positive ions themselves have. This leaves the space immediately in front of the cathode occupied at any instant almost exclusively by inward moving positive ions. In this space, consequently, very few recombinations can take place and no light is given out. The space is, in fact, the *Crookes dark space* referred to above. The process going on in this space is unquestionably essential to the maintenance of the glow. If the anode be made movable and be slowly slid up the tube of the positive column, the Faraday space and the negative glow are in turn absorbed without destroying the discharge but as soon as the Crookes dark space is penetrated the discharge is extinguished.

THE CROOKES DARK SPACE

Another important point about the Crookes dark space is that, once the discharge is in operation, practically all of the potential drop in the tube takes place in this region. For example, if the potential between the electrodes as measured with a voltmeter is 400 volts, the drop from the cathode to the far edge of the Crookes space will be high above 350 volts. The drops in the other parts of the discharge are insignificant compared with that in the Crookes space. Further, if the density of current flow through the tube be not too great, this fall of potential in the neighborhood of the cathode is found to depend only on the nature of the gas and of the electrode and to be independent of the total potential applied to the tube. If the electrodes are *platinum* and the gas is *air* the cathode fall of potential is about 340 volts; if the gas is *argon* the fall is 167 volts. If the platinum cathode be coated with *potassium*, a metal which emits electrons very readily, the potential fall into *argon* is found to be only 68 volts. These figures show that the applied potential necessary to start a discharge in a tube can, to some extent, be adjusted by selecting proper electrode materials and proper gases. The gases which give the lowest values are the so-called "noble gases"—helium, argon, neon, krypton and xenon. It is mainly for this reason that the modern rectifier tubes using the gas discharge are invariably filled with helium or neon or argon or with a mixture of these gases. In practice, little is gained by selecting unusual metals like potassium for electrode surfaces since these metals are ex-

THREE "E" STRAIGHT LINE RHEOSTAT

Oscillation is another term for annoyance. After getting an elusive station, can you keep it? Many rheostats are affected by temperature and consequently throw the tube into oscillation. Perhaps you, too, have noticed it.

Perfect Reception depends on a fine, smooth, dependable variation of filament temperature in the detector tube. For there is only one temperature at which efficient reception is obtained and this point is very critical.

The THREE 'E' STRAIGHT LINE RHEOSTAT finds this critical point as no other can, and once found, it cannot vary. Here you get STRAIGHT LINE STEPLESS variation, smooth running, no noise—all in all—perfect control of filament temperature under all conditions. You need this precision instrument on your set for best results. Ask your Dealer or order direct, giving us his name. Price \$2.50—Postpaid.

ELECTRICAL ENGINEERS EQUIPMENT CO., Radio Division
708 W. Madison St. Dept. 6 Chicago, Ill.

Circulars on Request

And now another 3-E product—
"SOLDER-CLEAN"

Cleans white you solder and stays clean.
The perfect soldering fluid. 2 oz. cans,
35c. From your Dealer, or direct.

RICHARDSON
RECEIVERS ACHIEVE RESULTS
Factory and Executive Offices:
Foster Avenue & Hulst Street, Long Island City

EVERYTHING IN RADIO
AT ATTRACTIVE PRICES
SETS OR PARTS
Mail order only
ALL RADIO COMPANY, 417 North Clark St., Chicago

Insure your copy reaching you each month. Subscribe to Radio News—\$2.50 a year
Experimenter Publishing Co., 53 Park Place, N. Y. C.

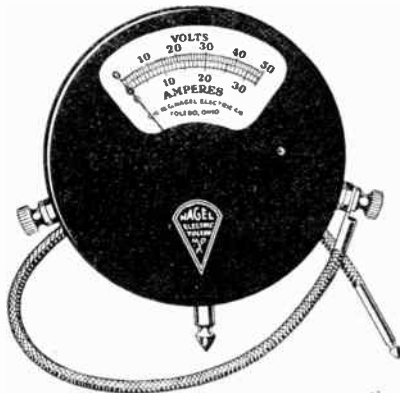

If you own a "Super-Het" or are operating your set with dry cells, you need this Nagel Voltmeter, a combination instrument for testing both A and B batteries.

60 Ohms per volt!

High resistance means longer life for batteries

60 Ohms per volt is high resistance. Nagel Voltmeters and Voltammeters are built to this standard, enabling the user to test his batteries by intermittent touch or continuous contact without danger of shortening their life by draining them. Nagel instruments are accurate under any condition and are used by experimenters because of their dependability. If your dealer cannot supply you, write The W. G. Nagel Electric Company, 512 Hamilton Street, Toledo, Ohio.

NAGEL

Manufacturers of
**DRY CELL TESTERS · AMMETERS
 HIGH-RESISTANCE VOLTMETERS
 VOLTAMMETERS · BAKELITE
 HOT MOULDED INSULATIONS**



The Permanent Detector

A rigid contact made on the best point of the crystal at the factory and a glass protector against dust, dampness and vibration, guarantee perfect reception to the user of Grewol Detector.

Sold by good dealers everywhere, or Direct Upon Receipt of Dealer's Name.

**Guaranteed by
 GREWOL MFG. CO.
 Newark, N. J.**

\$1.50

pensive and not durable in service. Alloys containing *magnesium* have, however an application in this direction.

Returning to the consideration of the discharge, we note that the electrons liberated by the positive ion bombardment at the surface of the cathode shoot out through the Crookes dark space, picking up energy as they go. Now, we have pointed out already that when the electrons have collected sufficient energy in falling through the field they will be capable of ionizing any atoms which they may strike and that this ionization will be evidenced by the glow resulting from recombination. The part of the discharge which we referred to above as the *negative glow* is the region in which these electrons coming from the cathode are producing ionization. Since they have picked up their energy by falling through the Crookes space they must have fallen through without hitting any atoms and the thickness of the dark space ought, therefore, to be about the same as the length of the average free travel of an electron. This is, in fact, found to be the case. It is for this reason that the width of the Crookes space can be used as an indicator of the pressure in the tube.

Since there is in the Crookes space a strong excess positive charge, due to the accumulation of positive ions there, the electrons traveling into the negative glow will be subjected to a backward pull which will gradually reduce their energy until they are no longer capable of ionizing the gas. This accounts for the *Faraday dark space*. The electrons tend to accumulate in this space and this accumulation increases the electric forces between the dark space and the positive electrode. At a certain distance down the tube the force will thus be built up to a value sufficient to give the electrons there the energy necessary for ionization and we have at that point the beginning of the *positive column*. Ionization continues throughout the entire length of this column right up to the anode, so that a more or less uniform column of light is produced.

ASYMMETRICAL DISCHARGE TUBE

The simple considerations outlined above serve to explain how the characteristic features of the gas discharge are produced in a long cylindrical tube when the electrodes are similar in area and symmetrically placed. In such a tube the drop in electrical potential is fairly regular and uniform down the length of the tube before the discharge starts. That is to say, the number of volts drop per inch is the same for each and every inch of the tube length. If the two electrodes are not alike in area this condition does not hold. Suppose, for instance, the one electrode is a cylinder (A) and the other electrode a fine wire along the axis of the cylinder (B) (Fig. 2). In this case the electric field is found to be very intense near the wire and very small near the cylinder. In other words most of the voltage drop is close to the wire. The theory which we have outlined above enables us to predict how this device ought to act when filled with gas at low pressure. In the first place, we would expect the discharge to pass at a lower applied voltage when the central electrode is cathode than when it is anode. This because the field necessary to produce the positive ion bombardment on the cathode, which is essential to maintain the discharge, will be sooner reached at the central electrode due to the asymmetrical nature of the field distribution. This is found to be the case. In an actual tube of this kind filled with neon the discharge started under an applied potential of 140 volts with the wire as cathode, whereas 180 volts were needed when the wire was anode. Next, we might expect a much larger current to flow through the discharge when the cylindrical plate is cathode than when it is anode. This because of the enormous area of the plate compared to that of the wire.

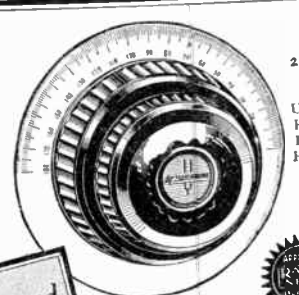

Pat. April 21, 1925
 Other U.S. and Foreign Patents Pending

Geared 80 to 1

Ideal

THE ACCURATUNE
 This is ideal for coarse or extremely fine tuning, segregating even those stations now so closely grouped on the lower wave lengths; it brings them in with absolute precision. Volume and clarity are matters of course to the Accuratune. Quickly substituted without alteration of your set.

MYDAR RADIO CO.
 7 CAMPBELL ST., NEWARK, N. J.

ACCURATUNE

REGISTERED TRADE MARK U.S. PAT. OFF.

Why Use a Multitude of Dials

Pat. Applied For

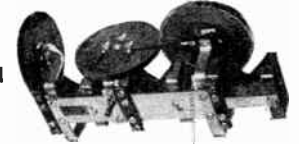

PRICE \$16

The KINLEY Tuned Radio Frequency Unit

GIVES SUPERIOR RESULTS WITH ONE DIAL

The trend of radio today is towards greater simplicity in operation and more faithful reproduction of music and speech. The Kinley Tuned Radio Frequency Unit meets these requirements. Accurate tuning with one dial over the broadcast range of wave-lengths is now possible through the use of a new, yet simple condenser construction.

Complete instructions for building a five-tube set are furnished with each unit.

Order direct if your dealer cannot supply you.
 Send for descriptive circular.
KINLEY RADIO COMPANY
 45 Elmhurst Ave. : : : Detroit, Mich.

The SATURN
 Perfect Jack and Automatic Plug.
 Your order filled by mail promptly.
 Every article absolutely guaranteed.
The SATURN Mfg. & Sales Co., Inc.
 48 Beckman St.
 New York, N. Y.
 Dept. R.N.
 Write for Literature



Insure your copy reaching you each month. Subscribe to **RADIO NEWS** — \$2.50 a year. **EXPERIMENTER PUB. Co., 53 Park Pl, N. Y. City**

It is evident that once the critical cathode drop has been reached at the surface of the cathode the number of electrons liberated will be more or less proportioned to the area of the cathode. The current passed through the tube depends, in turn, on the number of these electrons liberated. In the neon-filled tube mentioned a moment ago a current of about one milliampere passed through the discharge when the cylinder was anode, while a current of over 200 milliamperes passed under the same applied voltage when the cylinder was cathode. These facts explain the efficiency of such devices as rectifiers.

RECTIFYING DISCHARGES

All cold-cathode, gas-filled rectifier tubes applied up to this date in the radio art make use of this principle of unequal electrode areas to secure rectification of the alternating potential. Readers interested in this phase of the work are referred to the two articles, recently published in RADIO NEWS, which are mentioned in the opening paragraph of this article in which some useful figures taken from actual tube tests are quoted.

The general principles outlined here will enable the radio amateur to understand how cold-cathode tubes work. It must not be thought, however, that all of the problems connected with gas discharges between cold electrodes have been solved by the physicists. This is a field in which a great deal remains to be learned and in which we may look for useful progress in the near future.

New Radio Developments in Germany

(Continued from page 783)

Now, by means of special connections and transformers, the development of which is the particular achievement of Dr. Schmidt, this basic frequency is so multiplied by the production of harmonics that the normal broadcast frequencies in the region of 1,000,000 are reached. An interesting feature of the transformers is that the core laminations are only .00025 of an inch thick, and that the iron costs nearly a thousand dollars a pound, or twice as much as gold! Fortunately, only a pound or so of iron is required for even the largest transformers. A 10-kw station employing Dr. Schmidt's system is now in regular operation in Munich.

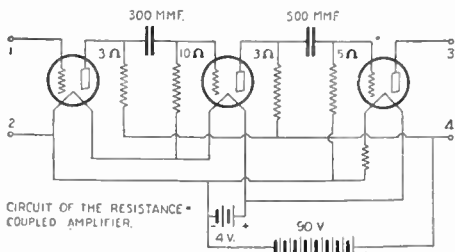

A very interesting resistance amplifier of German make. Note the constants of the circuit.

The purity of tone and the constancy of the signals are remarkable. Evidence that the system is already a great success is offered by the fact that three further senders for other German cities have been ordered. Moreover, what is to be the world's greatest broadcast station is being fitted with this equipment. Up in the snows of the Bavarian Highlands is being erected the station known as Herzogstand. The aerial is stretched between mountain peaks. 500 kw will be put into it. This tremendous energy is to be modulated by the human voice, and he who speaks into the microphone will be heard around the world. The entire installation is to be ready very soon.

50% Discount to Dealers

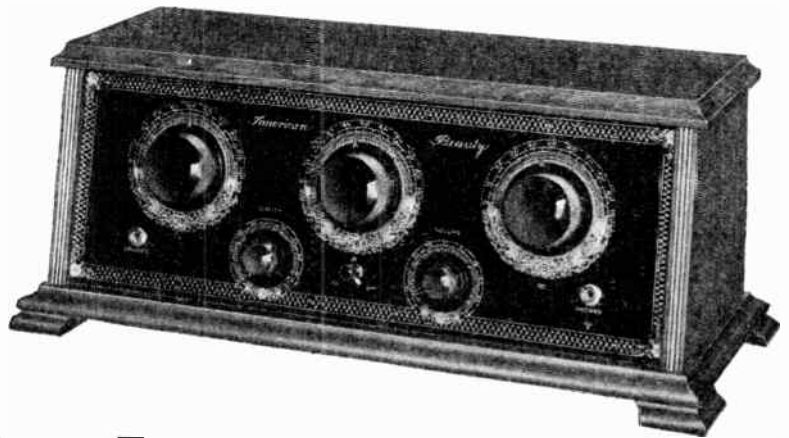

Direct Factory to Dealer Plan Allows You Jobber's Profits—

We manufacture and sell to dealers at lowest wholesale prices. American Beauty set above just one of dozens of attractive new radio numbers proved satisfactory by tests in thousands of homes. American products build confidence, regular customers, big repeat. Outsell and outdemonstrate all competition.



Wholesalers of Over 225 Nationally Advertised Lines
Authorized distributors for over 225 nationally advertised lines. Big stock always on hand. You are assured shipment when you want it. Three hour service. Everything in Radio for less. Dealers write today for 112-page catalog just off the press. Get your name on our list for valuable monthly mailing. Keep in touch with the latest and best. Get prices that make you profit. Amazing offers will delight you.

PIN TO YOUR Letterhead and Mail

AMERICAN RADIO MFG. CO.,
1402 McGee St.,
Kansas City, Mo.

Gentlemen: Mail me your new 112-page catalog. Also put me on list for regular monthly mailings.

Name.....
Address.....
City..... State.....

AMERICAN RADIO MFG. COMPANY
1402 McGee St., Kansas City, Mo.

Assemble Your Own Radio Cabinet and SAVE \$20.00



By installing your radio set in this handsome console cabinet you increase its value \$50 to \$100. Similar cabinets ready-made cost \$40 or more in stores. Buy direct—assemble it yourself—and save 50%.

Easy To Assemble

... No bolts, nails, or glue. Just 10 minutes easy work and you have a beautifully finished Rembrandt Radio Console, 36 in. high x 34 in. long x 13½ in. deep. Rigid patented construction: front of cabinet adjustable to any standard panel size. Roomy compartments for loud speaker, charger and batteries. Makes your set just like expensive ones seen in best radio shops.

Free 30-Day Trial Satisfaction Guaranteed

... Just mail coupon and we'll ship cabinet in corrugated carton, by express prepaid, to any point in United States. Just deposit \$19.95 with expressman—assemble and use cabinet 30 days—then if you're not convinced it's a wonderful bargain, return cabinet and we guarantee to refund your money at once, less shipping costs only.

American Foreign Trading Corporation,
1300 I. W. Hellman Building,
Los Angeles, California.

SEND NO MONEY Just Mail Coupon Now!

Send me, express prepaid, a Rembrandt Radio Console 11 Mahogany 11 American Walnut. My radio panel measures... inches from top to bottom. I will pay \$19.95 on delivery but if I am dissatisfied after 30 days trial you are to refund my money, less express charges, on return of cabinet. Send Agent's Outfit also.

Name.....
Address.....
City..... State.....

Earn Your Own Cabinet

... Be Our Agent ...

... Because this console is such a sensational value at \$19.95 you can easily take orders from friends and visitors. We supply No-Money-Down order blanks and give you 20% Commission. Five orders pay for your Console.

OPPORTUNITY AD-LETS

Follow these advertisements every month. Reliable advertisers from all over the country offer their most attractive specials in these columns.

Classified advertising rate twenty-two cents a word for each insertion. Ten per cent discount for 6 issues, 20 per cent discount for 12 issues. Name and address must be included at the above rate. Cash should accompany all classified advertisements unless placed by an accredited advertising agency. No advertisement for less than 10 words accepted.

Objectionable or misleading advertisements not accepted. Advertisements for the February issue must reach us not later than Dec. 1st.

CIRCULATION LARGER THAN THAT OF ANY OTHER RADIO PUBLICATION

EXPERIMENTER PUBLISHING CO., INC., 53 Park Place, New York, N. Y.

Agents Wanted

Big Money and fast sales. Every owner buys gold initials for his auto. You charge \$1.50; make \$1.35. Ten orders daily easy. Write for particulars and free samples. American Monogram Co., Dept. 133, East Orange, N. J.

Guaranteed Genuine Gold Leaf Letters anyone can put on store windows. Large profits, enormous demand. Free samples. Metallic Letter Co., 422 N. Clark, Chicago.

Big Money—fast sales; everyone buys gold initials for their auto; sell \$1.50, profit \$1.14. Ten orders daily easy. Samples, information free. World Monogram, Dept. 27, Newark, N. J.

Agents. \$100 a week paid to men who will help me in spare time in local assembly of amazing new kind of 5-tube radio set. I show you how. Demonstrator set given free. No capital needed. Write quick for details of work. Frank Condon, Dept. 12-Q, 2632 Prairie Ave., Chicago.

Bankrupt and Rummage Sales. Make \$50.00 daily. We start you, furnishing everything. Distributors, Dept. 213, 609 Division, Chicago.

Agents: \$300-\$500 monthly easy taking orders for Morey Rim Tool. Autolists and trade buy on sight. L. Morey Rim Tool Company, Blissfield, Mich.

Agents—\$100 weekly for your spare time. Radio is calling you. The biggest season in history is about to open. Let us show you how to make \$80 to \$125 per week working all or part time selling our marvelous five-tube radio set on 30 days' free trial (direct from factory to user at a saving to your customer of about half, at the same time making a good profit for yourself. We want exclusive agents everywhere. No experience necessary. Write for proposition today. Metro Electric Co., 1213 S. Wabash Ave., Desk 577, Chicago, Ill.

Wanted—District agents to sell Tri Trol Super Five. Apply F. H. Hall, Erie Proving Grounds, La. Carre, Ohio.

Agents—Quick sales, big profits—outfit free. Cash or credit. Sales in every home for our high-class line of Pure Food Products, Soaps, Perfumes, Toilet Articles, etc. Write today for money-making plans. American Products Co., 4204 American Bldg., Cincinnati, Ohio.

Business Opportunities

Free Book. Start little Mail Order Business. Pier, 996 Cortland Street, N. Y.

Responsible manufacturer wants competent men to manage office and salesmen. \$300 to \$1,500 necessary; will allow expenses in Trenton if you qualify. Address Manager, 556 Forst Richey Bldg., Trenton, N. J.

Make Money! 150 Plans FREE! Wolverine Bureau. (D-1) Muskegon, Michigan.

\$100 weekly up. We want experienced Radio men to operate branch assembling plants. Part or whole time. Barfield Radio Co., 13 Tillery Street, Dept. N. R., Brooklyn, New York.

\$50 a week. Mail Order business. Booklet tells how. Sample and plan free. Outfit furnished you free. Bradford Co., Dept. E, Shawnee, Okla.

Chemistry

Learn Chemistry at Home. Dr. T. O'Connor Sloane, noted educator and scientific authority, will teach you. Our home study correspondence course fits you to take a position as chemist. See our full page ad on page 905 of this issue. Chemical Institute of New York, 66 W. Broadway, New York City.

Chemistry supplies. List free. Radio catalog 10c. Chemical Apparatus Co., 4402 West End Avenue, Chicago.

Exchange

Radios for Cameras. Liberal allowances made for Kodaks, Cameras, Binoculars, Office Equipment, and Electrical Household Appliances in trade on Radio Sets. Ar-Te-Co Radio Exchange, Ottawa, Ill.

200-20,000 meter Receiver Radiotron \$25.00. Smith, 4416 Market, Philadelphia.

Farms and Orchards

Pecan-Orange-Fig Groves "On the Gulf." Guaranteed care. Monthly payments. Big quick returns. Suburban Orchards, Dept. R, Biloxi, Miss.

For Advertisers

24 Words—355 Rural Weeklies \$14.20. Admeyer, 4112-R Hartford, St. Louis.

For Sale

Atwater-Kent, Model 10. Demonstrator, like new, \$50.00. Bristol Amplifier \$15.00. The Tate Dental Drug Co., Somerset, Ky.

Help Wanted

All men-women, 18-65, wanting to qualify for Government Positions, \$140-\$300 monthly, write Mr. Ozment, 251, St. Louis, Mo., immediately.

Detectives Needed Everywhere. Travel. Experience unnecessary. Write, George Wagner, former Government Detective, 1968 Broadway, N. Y.

Firemen, Brakemen, Baggage-men. Sleeping car, train porters (colored), \$140-\$200. Experience unnecessary, 237 Railway Bureau, East St. Louis, Ill.

Instruction

Learn Chemistry at Home. Dr. T. O'Connor Sloane, noted educator and scientific authority, will teach you. Our home study correspondence course fits you to take a position as chemist. See our full page ad on page 905 of this issue. Chemical Institute of New York, 66 W. Broadway, New York City.

Miscellaneous

Gummed Labels, Name and Address, 500, 2 lines 30c, 3 lines 50c. Catalogue. Eastern Label Co., X Clintonville, Conn.

Imported Pups and Green Doks. Veri-Best Police Dog Kennels, Portland, Ind.

Tattocid removes tattoo marks painlessly, leaves no scar; full treatment on trial. Vestfold Company, 952—42nd St., Brooklyn, N. Y.

Boys! Money for Christmas or that Radio Set. Sell the Draw-O-Graph. Drawing and enlarging board with real Pantograph, paper, crayons, paints. Make your own Christmas money. Write for particulars. Draw-O-Graph, 506 E. 19th St., New York City.

Lightning Electrolyte. Charges storage batteries instantly. Make it yourself. Guaranteed formula \$5.00. Write for free circulars. Murphy, Chemist, Tujunga, Calif., Box D.

Skinderviken Transmitter Button. Free tested hook-ups. Loud speaker. Experiments. K Electric Co., 2 Hector Street, New York City.

Motion Pictures

Films for Toy Machines. Hart—Mix—Chaplin. Complete stories 1000 feet \$2.50. Special 200 foot lengths \$1.50 postpaid. Big Boys list free. Monarch Films, Department 3, Memphis, Tenn.

Motorcycles, Bicycles

Don't Buy a Bicycle Motor Attachment until you get our catalog and prices. Shaw Mfg. Co., Dept. 6, Galesburg, Kansas.

Musical

Play Piano by Ear. A Sound System. Postal brings full particulars and Free Booklet. No obligation. Boucher's Harmony Studio, 127 Metcalfe St., Ottawa, Can.

Old Money Wanted

\$2 to \$500 each paid for hundreds of Old or Odd Coins. Keep all old money. It may be very valuable. Send for our New Illustrated Coin Value Book, 45c. Guaranteed prices. Get posted. We pay Cash. Clarke Coin Company, 14 Street, LeRoy, N. Y.

Patents

Inventions Commercialized. Patented or unpatented. Write Adam Fisher Mfg. Co., 278 Enright, St. Louis, Mo.

Patent Attorneys

Inventors—Should write for our Free Guide Books and "Record of Invention Blank" before disclosing invention. Send model or sketch of your invention for our Free Inspection and Instructions. Radio, Electrical, Chemical, Mechanical and Trademark experts. Terms reasonable. Victor J. Evans & Co., 922 Ninth, Washington, D. C.

Patents. Send drawing or model for examination and report as to patentability. Advice and booklet free. Highest references. Best results. Promptness assured. Watson E. Coleman, Patent Lawyer, 644 G Street, N. W., Washington, D. C.

Patents—My fee in installments. Free personal advice. Frank T. Fuller, Washington, D. C.

Patents—Send for form "Evidence of Conception" to be signed and witnessed. Form, fee schedule, information free. Lancaster and Allwine, Registered Patent Attorneys in United States and Canada, 269 Ouray Bldg., Washington, D. C.

Patent Attorneys—Continued

Patent-Sense—As one of the oldest patent firms in America we give inventors, at lowest consistent charge, a service noted for results, evidenced by many well-known Patents of extraordinary value. Book, Patent-Sense, free. Lacey & Lacey, 631 F St., Washington, D. C. Estab. 1869.

Personal

Lonesome—Join our club—make acquaintances everywhere. Big illustrated book with descriptions and photos, sent in plain wrapper for ten cents. Bonafide Co., Dept. 58, Kansas City, Mo.

Printing Outfits and Supplies

Print your own cards, stationery, circulars, paper, etc. Complete outfits \$8.85; Job Presses \$12, \$35; Rotary \$150. Print for others, big profit. All easy, rules sent. Write for catalog presses, type, paper, etc. Press Company, A-13, Meriden, Conn.

Radio

Boys! Don't Overlook This. The "Rasco" Baby Detector. Greatest detector ever brought out with molded base. Fully adjustable. See former advertisements in this publication, or our catalog. Detector with Galena Crystal, complete 50c, the same detector with Radiocore Crystal, 75c prepaid. Send for yours today. Radio Specialty Company, 96-98 Park Place, New York City.

Attention!—50 Vacuum tube hook-ups. The greatest collection of vacuum tube circuits ever brought under two covers at such insignificant cost. These diagrams will be found in the great "Rasco" catalog, which contains raw materials and parts in a greater profusion than any other catalog. 15c in stamps, or coin, will bring the catalog to you. Radio Specialty Co., 96-98 Park Place, New York City.

Make Your "B" with Edison Elements. They last a lifetime. Pair 5 cents; welded, 7½ cents postpaid. Henry Chapelle, Woodburn, Ore.

Supersensitive Galena Crystals, pound \$1.00, prepaid. Alkemie, All-sensitive Crystals, 50c. Huskett, Joplin, Mo.

Magnet wire. Silicon Transformer Steel No. 12 D.C.C. wire 58c lb. add 4c for each size up to No. 20. No. 24 Enamel 1.25. Silicon Transformer Steel, 011 25c lb. cut in desired strips, 4 cubic inches pr. lb 100 ft. No. 12 Enamelled Aerial wire 85c Postage extra. Morton Elec. Co., 4852 Rice St., Chicago, Ill.

Write Parker for his big Radio bargain list and save money. Every article in original carton and guaranteed. E. Parker, Putnam St., Peabody, Mass.

Assemble your own Edison "B" Battery. All necessary parts promptly sent C.O.D., postpaid. Sample cell and "dope sheet," 10 cents. Chas. Snively, Woodburn, Ore.

FREE: A beautiful 5 tube tuned radio frequency receiver to the first man in each community who answers this ad within 10 days. Write now for particulars. E. W. Parker, Putnam St., Peabody, Mass.

Used Murad (MA) 15—\$80 (six tube) write for prices on new RCA Reetron Model—Guard Neutrodyne. 10% must accompany order on Murad—MA15. Amateur Radio Supply, 325 Park Ave., Kent, Ohio.

Amateurs, get call list of European amateurs with names and addresses. Sent for fifty cents unmet stamps. F. L. Bjerregaard, 1 East, Denmark.

New Pal Radio Headsets (\$2.19 Postpaid). Send for free bargain list. Robert E. Bedford, Johnson, New York.

Virginia Man Receives KGO Oakland, California, every night for a period of six weeks using homebuilt Transcon Receiver. Free Booklet. James M. Chapple, 1809 West 54th Street, Los Angeles, California.

Have you received a copy of our new 32-page "Ham" Bulletin? Hundreds of rare bargains in transmitting and receiving apparatus. Write for copy FREE today. Chicago Salvage Stock Stores, 509 So. State St., Dept. R.N.6, Chicago.

Radio Sets, Parts, Electric Supplies—Special Holiday prices. Stamp for circulars. Lincoln Electric Co., Box 253, Springfield, Ill.

Write for our wonderful money saving radio catalogue. Malone Radio Company, 8 West Ontario Street, Chicago.

Universal Pile-6 tunes 35 to 3600 meters. \$125. Ultra-dyne 1-3, \$135. Original tests 45,000 cycle Superheterodyne Kit \$81.50. Harkness, Erla, All-American Kits, Willard Batteries, Literature Free. Ray Radio Supply, Sandusky, Ohio.

Radio Fans wanted to sell standard radio apparatus. H. A. Roberts & Co., 180A Broadway, New York City.

Transmitting Sets—DX Records—5 Watts \$25; 10 Watts \$40. Complete—Key, Tube, Microphone connections. STVO S. Strobel, 3925 N. 6th St., Philadelphia, Pa.



PRICE \$1.97

A Radio Education

IN 5 VOLUMES

Theory, Design, Construction,
Operation and Maintenance

Learn at Home

These five component parts of a complete Radio Instruction Course are outlined in five volumes that contain not merely the essentials as so many books do, but more, they contain all that any modern up-to-the-minute textbook on any subject would cover. They are in themselves a COMPLETE radio education, teaching every possible portion of Radio science.

Size of each book 6 by 9 inches, handsomely bound and illustrated with charts, diagrams, descriptions of equipment, etc.

SEND NO MONEY for these books. Just forward your name and address. We send you the books at once. On receipt of same you pay the postman \$1.97 plus a few cents postage and then they are yours.

Distributed by

The Conrad Co.

233 Fulton St. New York, N. Y.

Salesmen Wanted

Radio Salesmen for territory not now covered by our representatives; exclusive lines; protected territory. Full or part time. Wellston Radio Corporation, St. Louis, Mo.

Manufacturers of new and improved station-finder and vernier tuning-dial want live salesmen to call on radio trade. Excellent side line; good commissions; exclusive territories. Westerland Corp., Dobbs Ferry, N. Y.

A Salesman wanted in every town or city within 25 miles of a broadcasting station to sell Radlogem, the complete radio receiving set that retails for \$2.50. With Radlogem there is nothing else to buy—the outfit includes the Radlogem receiving apparatus, 1,000 ohm phone, and aerial outfit. The cheapest radio outfit on the market—yet as practical as the most expensive. Big money to the right men. Send \$2.00 for sample outfit. The Radlogem Corp., 66-R West Broadway, New York City.

Make \$100 Weekly in spare time. Sell what the public wants—long distance radio receiving sets. Two sales weekly pays \$100 profit. No big investment, no canvassing. Sharpe of Colorado made \$955 in one month. Representatives wanted at once. This plan is sweeping the country—write today before your county is gone. Ozarka, Inc., 130-II, Austin Ave., Chicago.

Scenery to Rent

Settings for Opera, Plays, Minstrels, Plush Drops. Address Amelia Grain, Philadelphia.

Song Writers

Songwriters: Let me furnish the music for your songs, guaranteeing you absolute satisfaction. Copyrights secured. Submit your scripts for estimate and free advice. Walter W. Newcomer, 1674 Broadway, New York.

Stamps and Coins

French Colonies Free—Jungles, Tigers, Native Chief. 2c Postage. Empire Stamp Company, Station E1, Toronto, Canada.

Telegraphy

Telegraphy—Both Morse and Wireless taught thoroughly. Big salaries. Wonderful opportunities. Expenses low; chance to earn part. School established fifty years. Catalog free. Dodge's Institute, Cour St., Valparaiso, Ind.

Wanted to Buy

Full Value Paid for Old Gold, Jewelry, Watches, Diamonds, crowns, bridges, dental gold, silver, platinum, gold or silver ore; magneto points, old false teeth. Packages returned if our offer is not satisfactory. United States Smelting Works (The Old Reliable) 39 So. State St., Dept. 16, Chicago, Ill.

To the Live Radio Dealer

Are you tying up with the manufacturer of the sets and parts that you handle by selling to your customers The GREATEST RADIO Magazine that contains his advertisement?

Sell Radio News

**WRITE Today
Now**

NEWSSTAND DEPT. 12

**Experimenter Publishing
Co., Inc.**

53 Park Place, New York, N. Y.

PATENTS

To the Man with an Idea

I offer a comprehensive, experienced, efficient service for his prompt, legal protection and the development of his proposition. Send sketch, or model and description, for advice as to cost, search through prior United States patents, etc. Preliminary advice gladly furnished without charge. My experience and familiarity with various arts frequently enable me to accurately advise clients as to probable patentability before they go to any expense. Booklet of valuable information and form for properly disclosing your idea free on request. Write today.

RICHARD B. OWEN
PATENT LAWYER

2 Owen Building, Washington, D. C.
414 Park Row, New York City

OWN A TYPEWRITER



© 1925

\$3 and it's yours
if you clip this now

The ace of writing machines—at a bargain price! A free trial, and easiest monthly payments if you buy! This Underwood No. 5—rebuilt from top to bottom—five-year-guaranteed—removes the last reason for not owning your own machine. Get our proposition with new and valuable Typewriting Manual, free.

FREE! Typewriting Manual, large catalog, and full particulars of free course in touch writing, if you mail this to SHIPMAN-WARD MFG. Co., 1939 Shipman Bldg., Chicago.

Name _____
Address _____

PATENTS

If you have an invention and desire to secure a patent, send for our Evidence of Invention Blank and free guide book, "HOW TO GET YOUR PATENT." Tells our Terms, Methods, etc. Send model or sketch and description of your invention for INSPECTION and INSTRUCTIONS.

No Charge for the Above Information

RANDOLPH & CO., Dept. 459 Washington, D. C.

PATENTS WRITE for our Four Guide Books and "RECORD OF INVENTION

BLANK" before disclosing inventions. Send model or sketch and description of your invention for our INSPECTION and INSTRUCTIONS FREE. TERMS REASONABLE. Electrical and Radio Cases a specialty.

VICTOR J. EVANS & CO.
919 NINTH ST., WASHINGTON, D. C.

PATENTS C. L. PARKER
Formerly Member
Examining Corps,
U. S. Patent Office.
PATENT - LAWYER
McGill Bldg., Wash., D. C.

Patents, Trade Marks, Copyrights, Patent Litigation
Handbook for Inventors, "Protecting, Exploiting and Selling Inventions," sent upon request.

Print Your Own
Cards, Stationery, Circulars, Paper, etc Save money. Print for others, big profit. Complete outfit \$8.95. Job press \$12.95. Rotary \$150. All easy, rules sent. Write for catalog press type etc. THE PRESS CO., Y-72, Meriden, Conn.

for
Set Builders

for
Set Owners

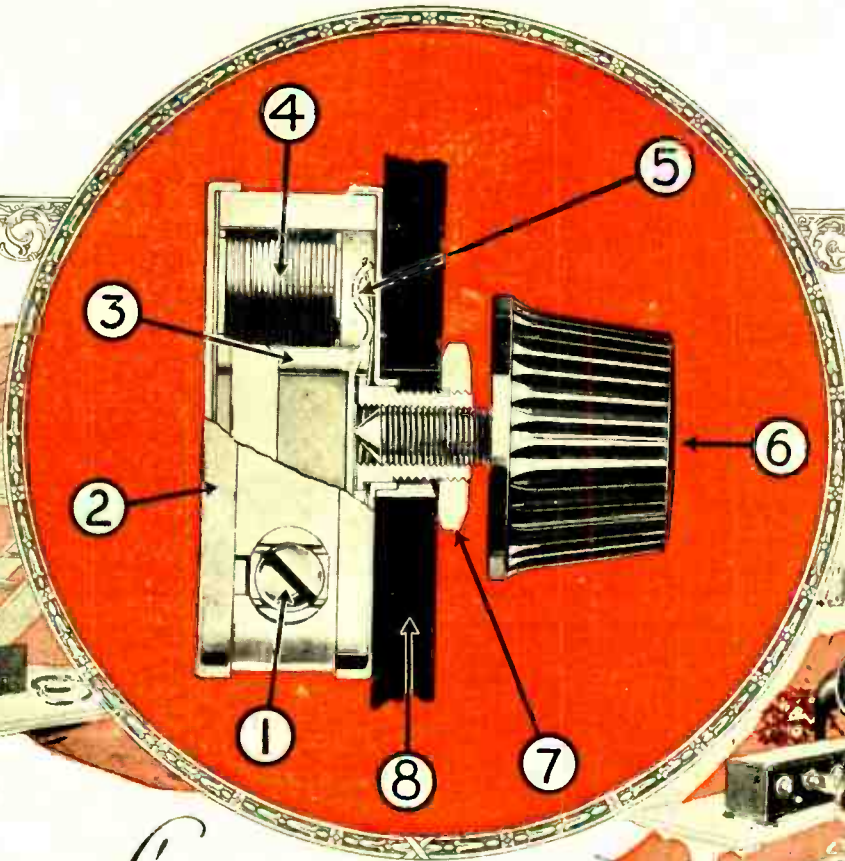

Superfine — in finish and performance



WHETHER you build your own radio receiver or buy a factory-built set, you will improve your set by installing Allen-Bradley Perfect Radio Devices. Not only are Allen-Bradley Radio Devices strikingly beautiful in finish and design, but their marvelously silent, selective control never fails to amaze and delight you. The eight salient, unrivaled Allen-Bradley features are:

- | | |
|--|---|
| <p>1 Terminals are readily accessible. Designed for bus wire or terminal lugs.</p> <p>2 Metal parts are heavily nickle-plated and buffed to a high polish.</p> <p>3 Container is made of glazed porcelain that excludes moisture.</p> <p>4 Specially-treated graphite discs give amazingly wide and noiseless control.</p> | <p>5 Internal switch opens battery circuit, if desired, by turning knob to the left.</p> <p>6 Highly polished bakelite knob is removable if you prefer to match other dials.</p> <p>7 One-hole mounting makes installation simple and easy on all sets.</p> <p>8 Can be used with any panel thickness. Back panel extension is extremely small.</p> |
|--|---|

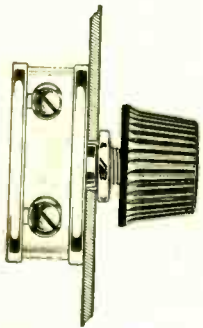

Bradleystat — Perfect Filament Control for All Tubes

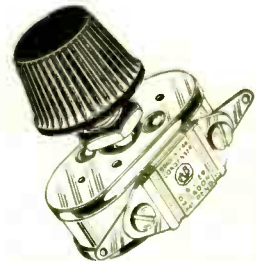

Bradleyleak — Perfect Grid Leak $\frac{1}{4}$ to 10 Megohms



Bradleyohm — Perfect Adjustable Resistor

Mail the Coupon for Latest Booklet

Allen-Bradley Co.

Electric Controlling Apparatus

287
Greenfield
Ave.



Milwaukee,
Wisconsin

Mfrs. of Graphite Disc Rheostats
for Over 20 Years

ALLEN-BRADLEY CO.
287 Greenfield Ave., Milwaukee, Wis.

Please send me your latest literature on
the complete Allen-Bradley line of Per-
fect Radio Devices.

Name

Address

#600

who tests your tubes?

WHO makes the vacuum tubes you use? is one important question. Who tests them? is another

The same great research laboratories that developed the MAZDA lamp have developed the Radiotron. The five great factories that manufacture the MAZDA lamp, manufacture the Radiotron. And the same genius and the same scrupulous accuracy are behind the test methods developed for the RCA test laboratories.

You would not think of putting into your lighting socket today, anything but a MAZDA lamp. Why put into your radio socket, anything but an RCA Radiotron—backed by the same skill, the same engineering and manufacturing resources?

A Radiotron is far more difficult to make than an electric lamp. It demands accuracy to the hundredth of an inch. It demands ten million times rarer exhaustion of the air from the tube. And to guard against error in the turning out of hundreds of thousands of Radiotrons—to insure the high standards of uniform perfection that have made famous the names of RCA, General Electric and Westinghouse, the RCA laboratories have developed tests delicately exact. When you buy a vacuum tube—know who made and tested it. Look for the RCA mark and the name Radiotron on the base.

RADIO CORPORATION OF AMERICA
CHICAGO NEW YORK SAN FRANCISCO



RCA-Radiotron

MADE BY THE MAKERS OF RAD OLAS

