

CIRCULATION OF THIS ISSUE OVER 228,000 COPIES

RADIO NEWS

REG. U.S. PAT. OFF.

25 Cents
May
1923

Over 200 Illustrations

Edited by H. GERNSBACK

A RADIO ROMEO

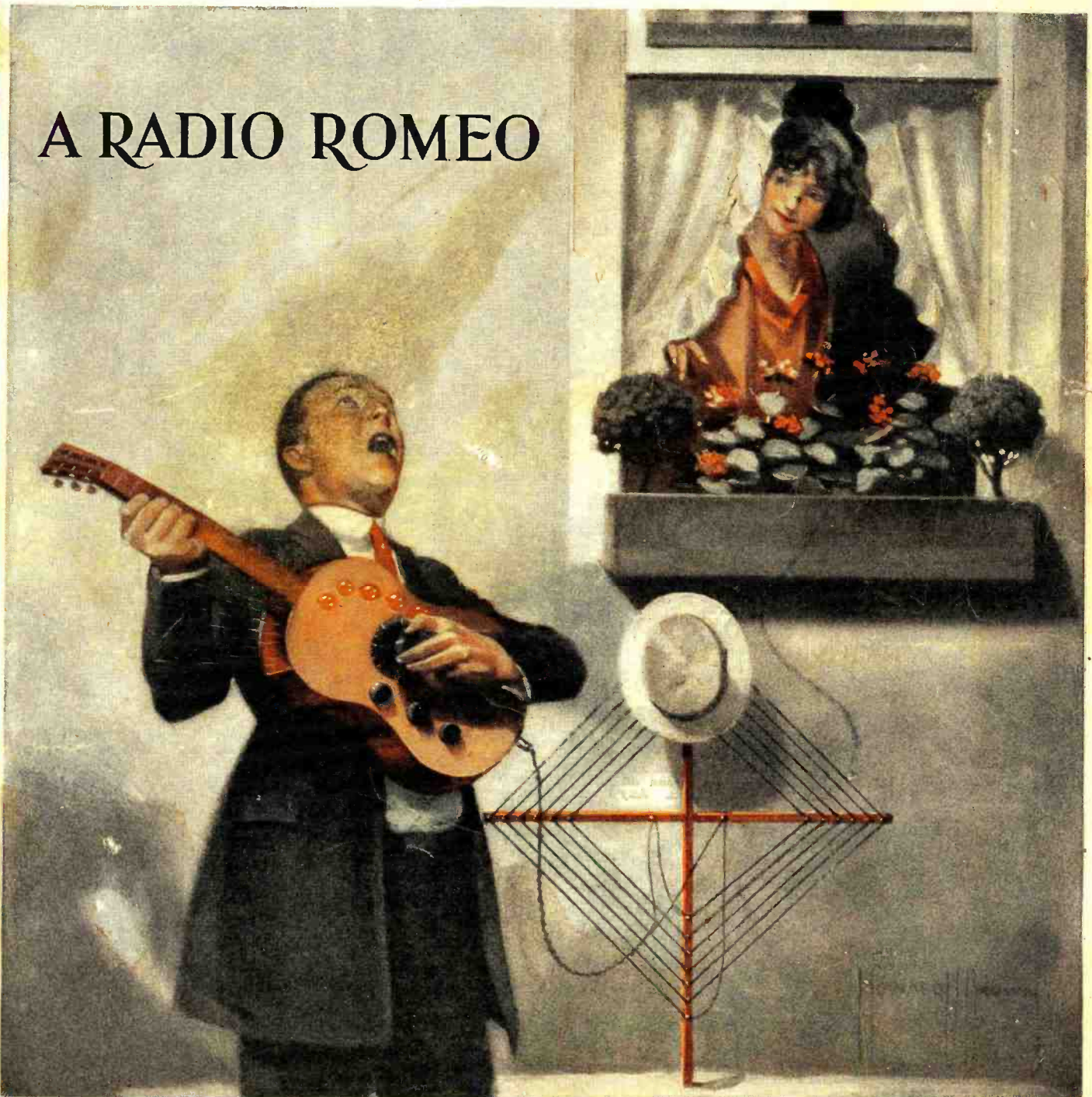

THE 100% WIRELESS MAGAZINE



Cunningham

Tubes for Every Requirement

Vacuum tubes are used for two distinct individual purposes in a receiving set—as DETECTORS and as AMPLIFIERS. The qualifications of a tube for these two uses are so different that for maximum efficiency tubes of entirely different design must be used.

This point was one of the chief considerations of the research engineers who designed Cunningham tubes in the great laboratories of the General Electric Company. After years of research and experimental work, the Cunningham C-300, a SUPER-SENSITIVE DETECTOR, the Cunningham C-301, a DISTORTIONLESS AMPLIFIER, and the Cunningham C-301A, a LOW FILAMENT CURRENT AMPLIFIER, were developed. These three tubes, now nationally recognized as standards for all types of receiving sets, are responsible for the highly perfected results obtainable in radio phone reception.



The trade mark GE is the guarantee of these quality tubes. Each tube is built to most rigid specifications.

TYPE C-300
Super-Sensitive
DETECTOR
\$500

TYPE C-301A
 $\frac{1}{4}$ Amp. Fil-Current
Amplifier and Detector
\$650

Patent Notice—Cunningham tubes are covered by patents dated 11-7-05, 1-15-07, 2-18-08 and others issued and pending. Licensed for amateur, experimental and entertainment use in radio communication. Any other use will be an infringement.

Home Office:
248 First Street
San Francisco, Calif.

Eastern Representative:
154 West Lake St.
Chicago, Illinois

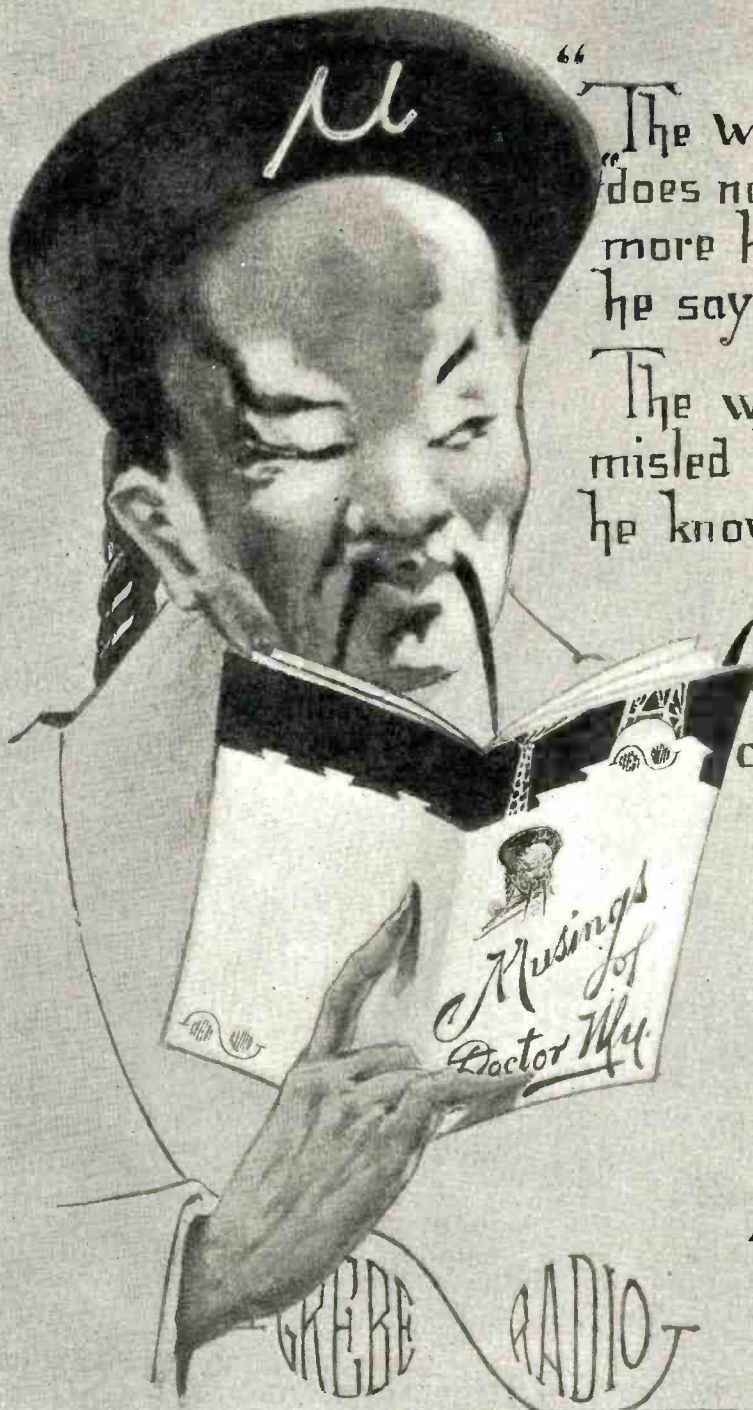

“The wise man,” said Confucius, “does not esteem a person more highly, because of what he says. —”

The wise radioist is not misled by extravagant claims, he knows that only a

Grebe Receiver
can come up to his expectations.

Doctor Mu.

A. H. GREBE & CO., Inc.
Richmond Hill, N. Y.

Western Branch
451 East 3rd Street, Los Angeles, Cal.



Write for
“Musings of
Dr. Mu.”

Licensed under Armstrong
U. S. Pat. No. 1113149

Index to Advertisers

A	Page
A. J. M. Company, The.....	1980
Acme Apparatus Co., The....	2007
Airway Electric Appliance Corp.....	1998
Aitken Radio Company.....	1998
Ala Mfg. Company.....	2018
Alden Mfg. Company.....	2040
Allen-Bradley Company.....	2005
American Bell Radio Corp. ..	1986
American Electrical Heater Co.	2033
American Governor Company.	2048
American Hard Rubber Co. .	1997
American Radio Mfg. Company	2044
American Time Clock Rep. & Sup. Co.	2050
American Transformer Co. ..	2000
Andrae & Sons Company, Julius	1988
Andrea, F. A. D.	1980
Angiers, U. S. A.	2022
Atlantic-Pacific Radio Supplies Co.	1932
Atwater Kent Mfg. Co. 1928-1929	2040-2042
Automatic Electrical Devices Co., The	2040-2042
B	
Barawik Company, The. .1994-1995	2015
Barkelew Electric Mfg. Co., The	2015
Bel Canto Corp.	2026
Bergen Radio Supply Company	2061
Black Cross Metal Works Co.	2061
Bogue, B. N.	2050
Brach Mfg. Co., L. S.	2008
Brandes, Inc., C.	2041
Broadway Electrical Novelty House	2056
Bunnell & Co., J. H.	2033
Burlington Watch Co.	2048
Butler Mfg. Co.	2040
C	
C. & K. Radio Manufacturers	2041
Cady & Lundberg.....	2043
Carter Radio Company	2039
Central Radio Laboratories. .	2028
Chaslyn Company	2042
Chelsea Radio Company.....	2024
Chemical Institute of New York, Inc.	1925-2050
Chicago Radio Apparatus Co. Inc.	2046
Chicago Salvage Stock Store	1999
Clapp-Eastham Company	1981
Clarke Coin Company.....	2050
Cleartone Radio Co., The....	2036
Connecticut Tel. & Electric Company	2057
Consolidated Radio Call Book Company	1996-2030
Continental Fibre Co., The..	2044
Conway Electrical Company.	2052
Copper & Brass Research Association	2044
Coto-Coil Company	2010
Coyne Trade & Engineering Schools	2050
Cram Company, Geo. F.	2034
Crosley Mfg. Company	1926
Cunningham, E. T.	2048
Inside Front Cover	
Cut Rate Radio Company....	1998
D	
D-X Radio Company	2048
Delfelco Battery Corp.	1998
Delta Electric Company	2014
Demaree, C. S.	2054
Diamond State Fibre Co.	2003
Dictograph Products Corp. ..	2006
Dobbins, Ray	2048

D	Page
Dodge, C. K.	2055
Dodge's Institute	2040
Donnell Mfg. Co., L. H.	2037
Douglas Shoe Company, W. L.	2056
Drake, The	2028
Dreyfuss Company, Inc., P. M.	1988-2044
Dubilier Condenser & Radio Corp.	1988
Duck Company, The Wm. B. .	2057
E	
E. I. Company, The	2032
Eiseman Magneto Corp.	1984
Ekko Company, The	1988
Elco Radio Company	2010
Electric Specialty Co.	2016
Electric Storage Battery Co., The	2009
Electrical Research Laboratories	2043
Electro Thermal Company....	2049
Elwood Electric Company, Inc.	1990
Engravers & Printers Machinery Co.	1992
Ernest Electric Company	2014
Evans & Co., Victor J.	2054
Experimenter's Information Service	2025
F	
Fedders Mfg. Co., Inc.	2021
Federal Radio Electric Co. .	2020
Federal Tel. & Tel. Co.	2019
Ferbend Electric Company	1986
Foot Mineral Company, Inc. .	2056
Formica Insulation Co., The. .	2029
Four Way Co., The	2044
France Mfg. Co., The	2034
French Battery & Carbon Co.	1987
Freshman Co., Inc., Chas. .	2010
Frost, Inc., Herbert H.	1930, 1931, 2024
G	
Galena Crystal Mfg. Co.	2045
Geiger, J.	1989
General Electric Company	2035
General Radio Company	2051
General Radio Corp.	2006
Gibbons-Dustin Radio Mfg. Co.	2016
Goodell-Pratt Company	1982
Gould Storage Battery Co. .	1986
Great Eastern Radio Corp. .	2026
Great Lakes Radio Company	1985
Grebe & Co., Inc., A. H.	1923
H	
Hammarlund Mfg. Co.	2045
Harvard Radio Laboratories. .	2059
Hayden Radio & Research Co., A. C.	1990
Hayes & Newton	2016
Home Supply Company	2026
Hommel & Company, Ludwig	2036
Hutchinson & Company	1984
Hygrade Electrical Novelty Co.	1992
I	
Izenstark, Radio, P.	2040
J	
Jacobi and Jacobi	1980
Jefferson Electric Mfg. Co. .	1984
Jones Radio Co.	2017
K	
K Electric Company.....	2027
Kennedy Co., The Colin B. .	2045

K	Page
Killoch Company, David.....	2047
Kimley Electric Co.	2000
Klosner Improved Apparatus Co.	2006
L	
Lacey & Lacey	1980
Lancaster & Allwine	2054
Leich Electric Company	2026
Lewis & DeRoy Radio Corp. .	2014
M	
M. P. M. Sales Company ..	1990
Magnavox Company, The	1921
Magno Storage Battery Corp.	1992
Manhattan Electrical Supply Co.	2034
Marko Storage Battery Co. .	2014
Massachusetts Radio & Telegraph Schools, Inc.	1998
Mead Cycle Co.	2018
Metric Metal Works	2058
Metro Elctrical Co., Inc.	2008
Michigan Radio Corp.	2047
Midwest Radio Company, The	2022
Mitchell & Company, R.	2056
Montgomery Ward & Company	2004
Montrose Mfg. Co.	2024
Mu-Rad Laboratories, Inc.	1979
Murdock Company, Wm. J. .	1992
N	
Nassau Radio Company, Inc. .	2044
National Airphene Corp.	2031
National Radio Institute	2001
National Vulcanized Fibre Co.	1982
Newman Stern Company	1980
New York Coil Company, Inc.	2051
North American Radio & Sup. Corp., The	1984
Novo Mfg. Company.....	1986
O	
O'Brien, Clarence A.	2058
Omnigraph Mfg. Co., The ..	2002
Owen, Richard B.	1980
P	
Pacent Electric Company, Inc.	2037-2059
Parker, C. L.	2058
Philadelphia Storage Battery Co.	1983
Pignolet Instrument Co.	2043
Pioneer Radio Corp.	2021
Pitts Company, F. D.	2023
Pittsburgh Radio & Appliance Co., Inc.	2052
Precision Equipment Co., The	1927
R	
Radiall Company	1982
Radio Corporation of America	Back Cover
Radio Cut Price Company....	1990
Radio Directory & Publishing Company	1982
Radio Distributing Company, The	2040
Radio Equipment Company ..	2055
Radio Experimenters League.	2000
Radiogem Corp., The.....	2060
Radio Guild, Inc., The, 2038, 2052,	2058
Radio Industries Corp.	1993
Radio Instrument Company. .	2019
Radio Kraft Shop	1988
Radio Parts Mfg. Co.	2047
Radio Print	2018
Radio Research Guild	2046
Radio Service & Mfg. Co.	2022

R	Page
Radio Specialty Co.	2064
Radio Stores Corp.	2013
Radio Testing Station	2000
Randolph & Company	2054
Rasla Sales Corp.....	2028
Rauland Mfg. Company	2023
Remler Radio Mfg Co.	2039
Reynolds Radio Company, Inc.	2024
Rhamstine, J. Thos.	1992
Rose Radio Supply	2053
Rusonite Products Corp.	2035
S	
Sadler Mfg. Co.	2025
Saturu Mfg. & Sales Co., Inc., The	2000
Scholes Radio & Mfg. Corp., The	2006
Service Exchange	2059
Shaw-Walker Co., The.....	2050
Shinn Mfg. Co., W. C.	2046
Signal Electric Mfg. Co.	2004
Simon & Skidmore Mfg. Co. .	2012
Simplex Radio Co.	1988
Sinclair, Mr.	2048
Smith-McKinney Hardware Co.	1990
Steinmetz Wireless Mfg. Co. .	2034
Stover Mfg. & Engine Co.	2047
Stromberg-Carlson Telephone Mfg. Co.,	2000
T	
Telephone Maintenance Co. .	2002
Teleradio Engineering Corp. .	2036
Trade Circular Addressing Co.	2012
Trimm Radio Mfg. Co.	2020
True Tone Radio Mfg. Co. .	2053
Tuska Company, The C. D., .	2012
Twentieth Century Radio Co.	2012
Twitchell, S. A.	1986
U	
Union Construction Corp. .	2036
United Mfg. & Distributing Co.	2022
Universal Radio & Research Co.	2008
Universal Sales Company	2050
V	
V-De-Co Radio Mfg. Co.	2046
Valley Electric Company....	1998
Vesco Radio Shop	2008
Vesta Battery Corp.	2008
Inside Back Cover	
W	
W. E. Supply & Service Corp.,	2011
Walbert Mfg. Co.	1992
Walwart Electric Mfg. Co. .	2038
Ware Radio Corp.	2061
Waveland Radio Co., Inc.	2048
Webster Electric Co.	2053
Westinghouse Union Battery Co.	2027
Weston Electrical Instrument Co.	2018
Wicks Electrical Institute. .	2050
Willard Storage Battery Co. .	2020
Wilmington Fibre Specialty Co.	1986
Winston Co., The John C.	2033
Wireless Mfg. Co., The.	2020
Wireless Shop, The	2042
Workrite Mfg. Co., The	1991
World Battery Co.	2050
Y	
Y. M. C. A. Radio School. .	2040

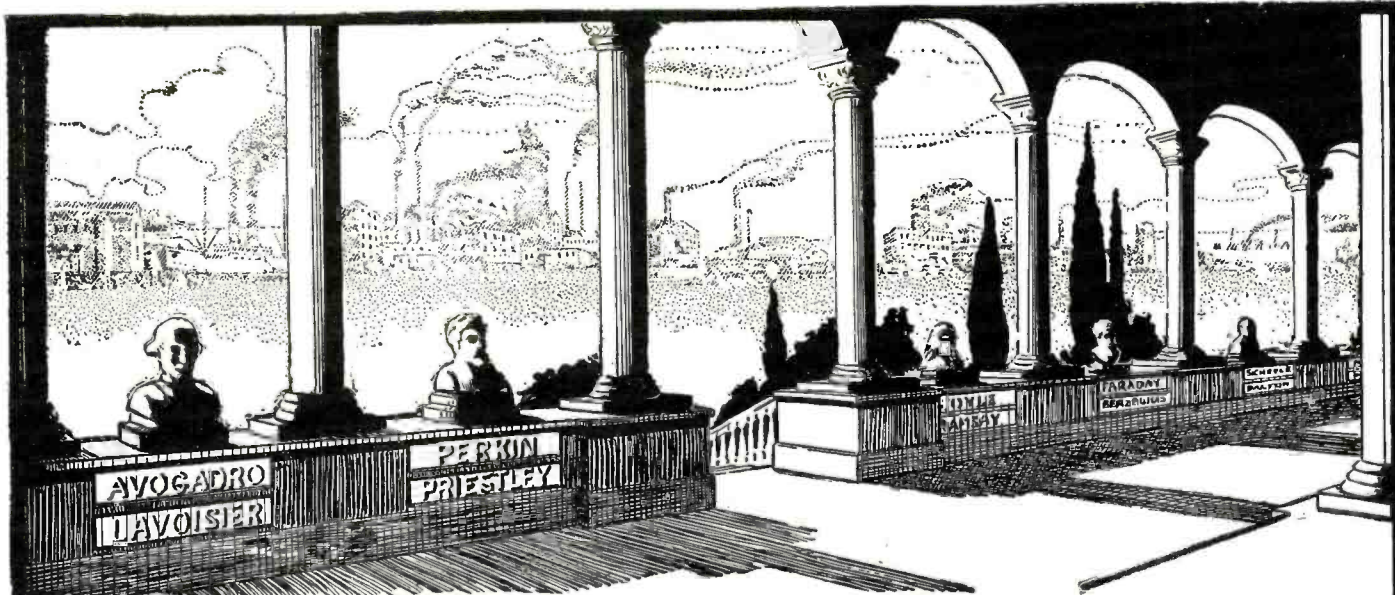

THE HALL OF FAME

Will There Be A Niche For You?

NO man knows what is in store for him. Men now famous in business and scientific worlds were obscure only yesterday. Men today unknown may leave their names in the HALL OF FAME. Great discoveries have been born over night—marvelous scientific deeds sometimes were the results of decades of labor, other times the outcome of a scant week's research. Truly, no man can tell what the future holds for him. But it is within the power of each and everyone of us to control our own destinies, by self-training and diligent study to fit ourselves to render a lasting service to the world—a service that will bring reward, perhaps in fame, perhaps in riches. You control your own future.

Great Growth of Chemistry

What It Means to YOU

It is the growth of chemistry that has made the past century the most wonderful period in man's history. In a few years the chemist has changed the industrial customs of the world. In a little more than one century he has advanced civilization by ten centuries. Do you know you can learn chemistry at home in your leisure hours? You can—hundreds of others are learning now!



Experimental Equipment Furnished to Every Student

We give to every student without additional charge this chemical equipment, including forty-two pieces of laboratory apparatus and supplies, and seventeen different chemicals and reagents. These comprise the apparatus and chemicals used for the experimental work of the course. The fitted heavy wooden box serves not only as a case for the outfit but also as a useful laboratory accessory for performing countless experiments. Full particulars about this special feature of our course are contained in our free book, "Opportunities for Chemists."

Dr. T. O'Connor Sloane Will Teach You Chemistry in Your Own Home

The Chemical Institute of New York, of which Dr. T. O'Connor Sloane is Educational Director, was founded to fill the need of ambitious, far-sighted men who realize and recognize the splendid future chemistry offers them, but who cannot spare the time nor the money to attend college. Dr. Sloane, a foremost authority on chemistry, will teach you and will give you any individual help you may require. He will personally go over your papers, correct them, point out your faults, and place you on the path which bears foot-prints of many who have trod it on to the HALL OF FAME.

Easy Monthly Payments

You don't have to have even the small price of the course to start. You can pay for it in small monthly payments—so small that you won't feel them. The cost of our course is very low, and includes everything, even the Experimental Equipment—there are no extras to buy with our course. Our plan of monthly payments places a chemical education within the reach of everyone.

Chemical Institute of New York, Inc.

Home Extension Division 5

140-R Liberty Street, New York City

Industries Need Chemists— Pay Them Good Salaries

Industrial plants of all kinds have awakened to the need of skilled, trained chemists. Good salaries are paid them. There is no reason why you, too, cannot join this small army of trained men who are reaping material benefits from their knowledge that guards and advances civilization!

—and Special 30-Day Offer!

Besides furnishing the student with his Experimental Equipment, we are making an additional special offer for a short while only. You owe it to yourself to find out about it. Write today for full information and free book, "Opportunities for Chemists." Send the coupon right now while it is fresh in your mind. Or just write your name and address on a postal and mail it to us. But whatever you do, act today. Signing the coupon may prove the most important event in your life—mail it at once and let our book give you the facts.

Act Now!

CHEMICAL INSTITUTE OF NEW YORK
Home Extension Division 5
140-R Liberty St., New York City

Please send me at once without any obligation on my part, your free Book, "Opportunities for Chemists," and full particulars about the Experimental Equipment given to every student. Also tell me about your plan of payment and special 30-day offer.

NAME.....

ADDRESS.....

CITY.....

STATE..... B.N. 5-21

CROSLEY *Model X*

\$55

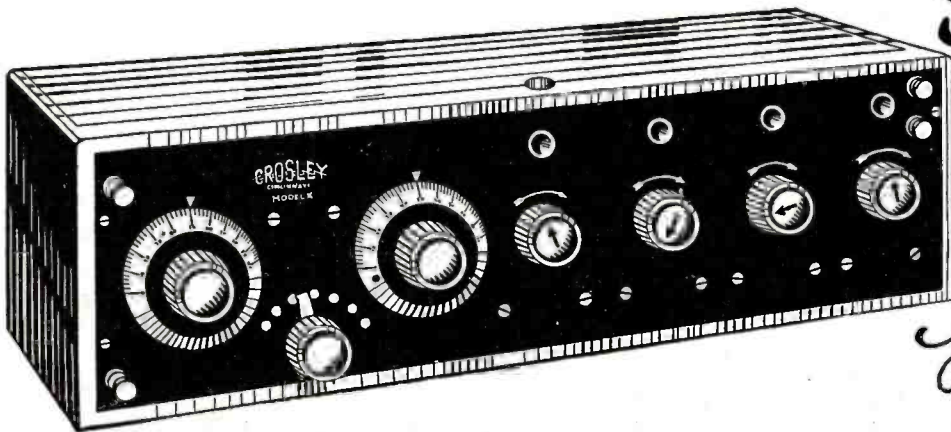

*A 4 tube
Radio
Frequency Set*

**TWO VERY
EFFICIENT
RECEIVERS**

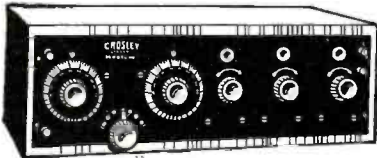

Crosley Model VIII

A recent Crosley achievement. A three tube set that stands in a class by itself. Price, without tubes, batteries or phones...\$48.00

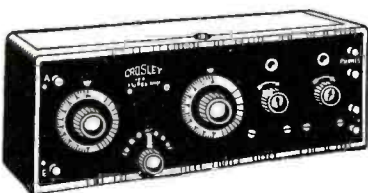

Crosley Model VI

An instrument that has taken the country by storm. Its efficiency, in comparison to its cost, cannot be equaled. Price, without tubes, batteries or phones.....\$28.00

CROSLEY PARTS

We also manufacture a complete line of parts each one of which is guaranteed to perform perfectly. Among these are: Crosley Variable Condensers, Radio Frequency Amplifying Tuner, Sheltran Transformer, Cabinets, Vacuum Tube Socket, Rheostat, Vacuum Tube Adapter, Knob and Dial, Vario Coupler, Crystal Detector Stand, etc.

Write for Complete Catalog.

The hit of the radio world. Not until you have listened in on a Crosley Model X can you appreciate the wonders of radio. Every day letters are received from satisfied customers telling of far distant stations clearly and distinctly heard.

The Crosley Model X offers you by far the greatest value on the radio market today. It is a four tube set, consisting of one stage of tuned radio frequency, detector and two stages of audio frequency amplification. It is very easy to tune and eliminates static and local interference to a remarkable degree. Because of its simplicity anyone may quickly tune in the desired broadcasting station to maximum volume.

Listen in on a Crosley Model X and you will have no other.

We invite correspondence from high grade dealers concerning their handling these self-selling instruments.

For Sale By Good Dealers Everywhere.

CROSLEY MANUFACTURING COMPANY

Better - Cost Less Radio

522 ALFRED STREET

CINCINNATI, OHIO

CROSLEY *Model Vc*

\$20 *Regenerative Receiver Set*

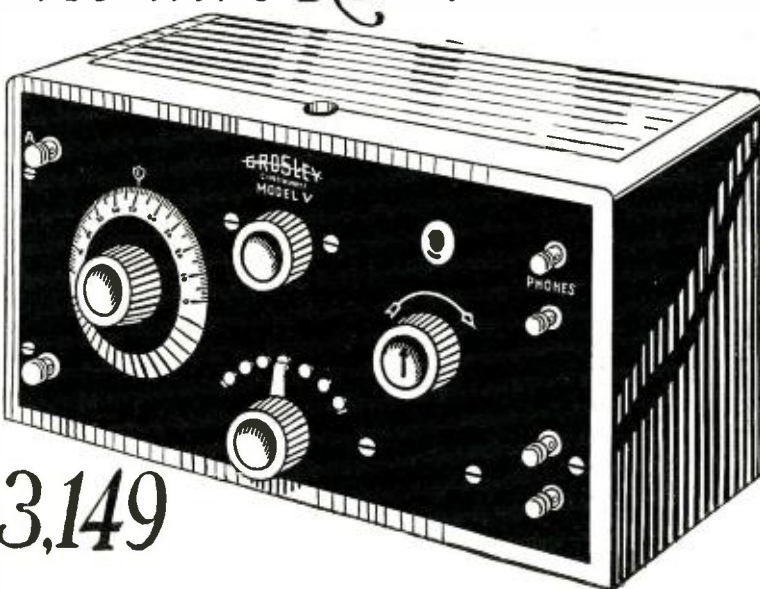

*Licensed
under Armstrong
U.S. Patent No. 1,113,149*

There is no other one-tube set being manufactured today that will give better results than produced by the Crosley Model Vc Regenerative Radio Receiver. The proud owner of one of these instruments can bring in any powerful station in the United States. Stations more than 1000 miles away are being copied regularly on this set. Equal in every respect to the guaranteed performance of this instrument are its finish and appearance.

It is made in two models as follows:

	Tuner Detector	2 Stage Amplifier
Model Vd With overhanging lid, panel engraved, without tubes, batteries or phones	Price \$19	\$17
Model Vc With regular new style Adam Brown Mahogany cabinet, panel engraved.	Price \$20	\$18

Compare these prices with any set on the market.

The cabinets of both models are arranged so that the now popular 1½ volt tubes may be used if desired. The trade name "Crosley" is used by permission of the Crosley Manufacturing Company.

For Sale By Good Dealers Everywhere

The Model Vc, pictured above, is only one of many regenerative receivers made by The Precision Equipment Co., which have proven so tremendously popular.

We also offer a complete line of parts.

Wide-awake dealers will find it to their advantage to get in touch with us concerning the handling of this popular line.

THE PRECISION EQUIPMENT CO.

Powel Crosley Jr. President

522 GILBERT AVENUE

CINCINNATI, OHIO

ATWATER KENT

Radio Receiving Sets and Parts

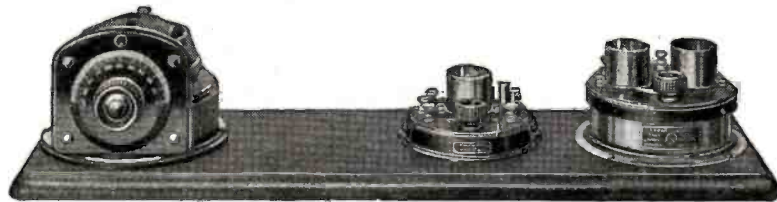

Complete Set consisting of Coupled Circuit Tuner, Detector Unit and 2-stage Amplifier. Other sets shown in circular.



Mounted Variometer

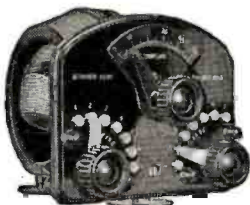

Mounted Variocoupler



Type 11 Tuner

ATWATER KENT Receiving Sets and Parts are built with the most particular care. From the moulding of the condensite forms and winding of the various coils, through the assembling and finishing of the units to the final mounting and wiring, every step is subjected to the most rigid inspection. It must be "just so." This is the reason why ATWATER KENT radio equipment has that "different" look that makes it instantly noticeable in any surrounding.

Atwater Kent products sell on appearance.



Standard Tube Detector Unit



1/2-Volt Tube Detector Unit



1-stage Amplifier



Detector 1-stage Amplifier
A similar unit is furnished in a 2-stage Amplifier

ATWATER KENT MANUFACTURING COMPANY, PHILADELPHIA, U. S. A.
Radio Department 4943 STENTON AVE. Correspondence Solicited

ATWATER KENT

Radio Receiving Sets and Parts

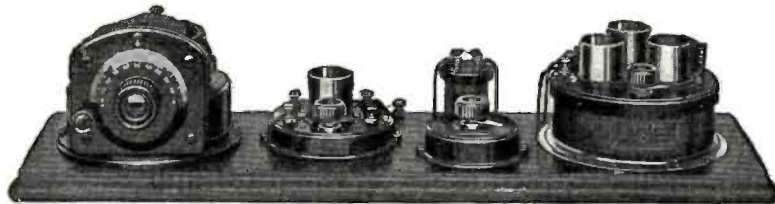

Complete Set consisting of Type 11 Tuner, one stage of Radio Frequency Amplification, and Detector 2-stage Audio Frequency Amplifier.

BUT appearance is not the only feature that is watched. Even though the factory is pushed to its utmost capacity by the extraordinary demand for ATWATER KENT sets and parts, every unit is carefully tested to make certain that its performance is right. By this means, the radio fan is sure of getting a part or set that is not only strikingly handsome in appearance, but works perfectly, and gives the utmost satisfaction.

They stay sold on quality of performance.



R. F. Transformer



2 to 1 A.F. Transformer Type L



Standard Vac. Tube Unit



Detector 2-stage Amplifier



Table Potentiometer



Panel Potentiometer



1 1/2-Volt Tube Socket

ATWATER KENT MANUFACTURING COMPANY, PHILADELPHIA, U. S. A.
Radio Department 4943 STENTON AVE. Correspondence Solicited

FROST

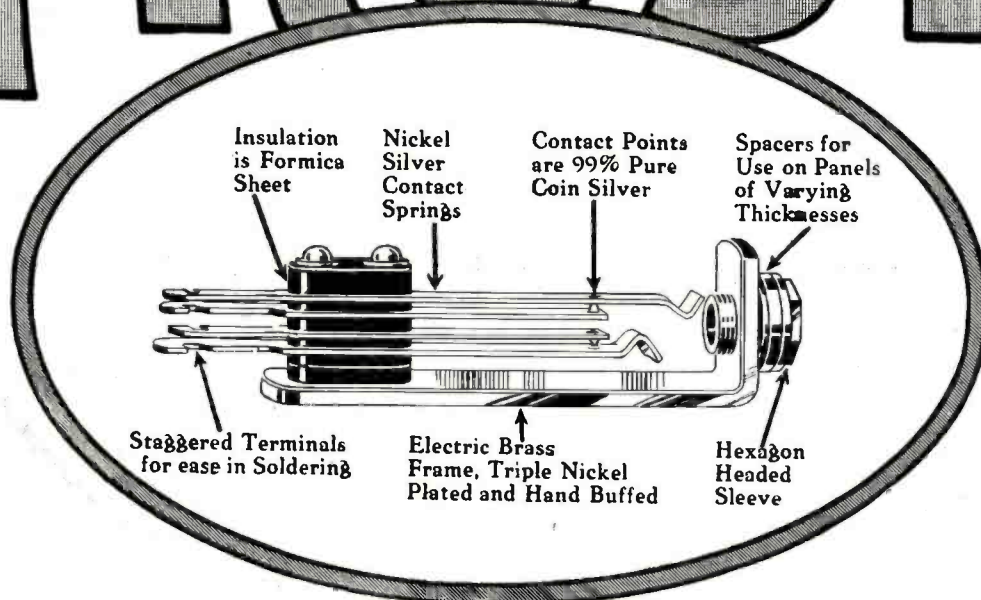

Over one million Frost Jacks in use

THERE can be but one reason for the almost universal adoption of Frost-Radio Jacks by the discriminating builders of receiving sets all over the United States.

That reason is Highest Quality.

Last year more than one million Frost Jacks were purchased for use by manufacturers and amateurs.

Study the illustration in the oval. It makes clear the seven big features of Frost Jacks.

Your dealer will tell you that Frost Jacks are the most compact jacks made, as well as the highest in quality. See him today about Frost Jacks for your set.



HERBERT H. FROST, Inc.

154 WEST LAKE STREET, CHICAGO, ILLINOIS.

RADIO

FROST

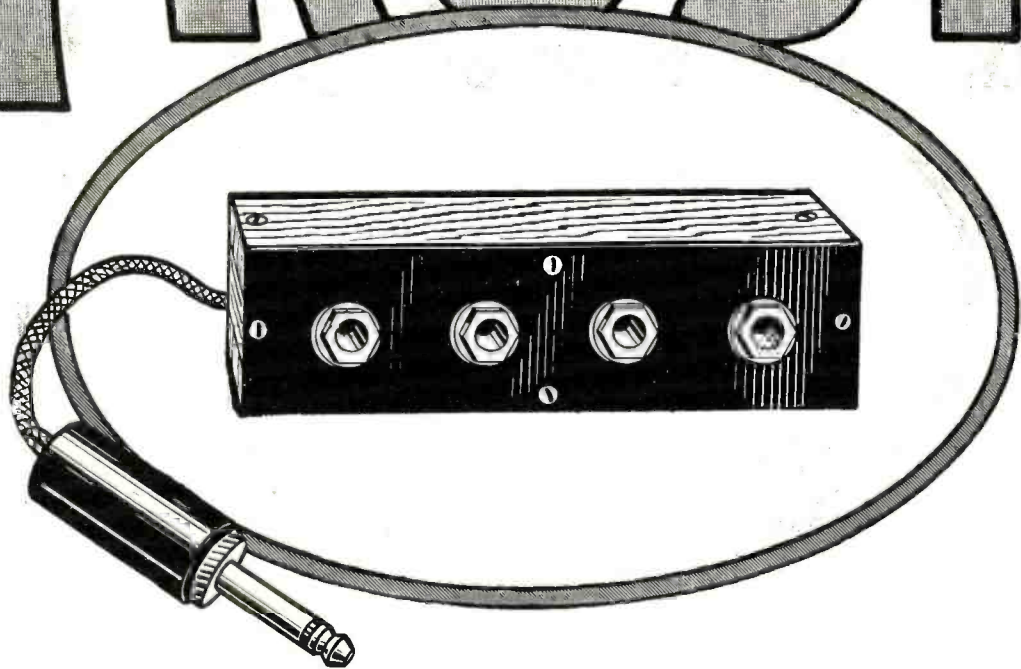

A new Frost Radio Jac-Box will complete your present receiving set

Every owner of a radio receiving set will see at a glance the tremendous advantage of the NEW Frost Jac-Box. It quadruples the jack capacity of any receiving set. Enables four pairs of fones to be used at one time, or three pairs and a loud speaker. Loud speaker may be tuned in without disconnecting fones.

Thousands of these handy Jac-Boxes have been sold since we introduced it a month ago. Handsomely made of polished oak, with formica panels and hand buffed nickel plated metal parts. Sold separately, or with cord, or complete with cord and plug. Price: \$2.25 to \$3.00. Order a Frost Jac-Box from your dealer today.



HERBERT H. FROST, Inc.
154 WEST LAKE STREET, CHICAGO, ILLINOIS.

RADIO

Long distance

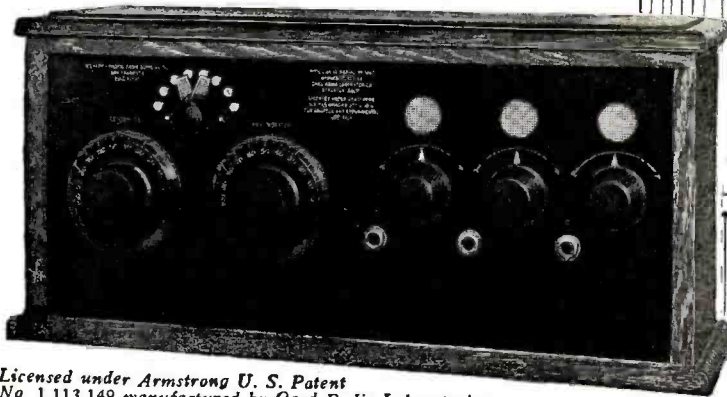

Licensed under Armstrong U. S. Patent No. 1,113,149 manufactured by Oard Radio Laboratories, Stockton, California, Atlantic-Pacific Radio Supplies Co., Sole Agents.

You are losing a vast amount of radio enjoyment every day you are without Type AR-10 Long Distance Regenerative Receiver and Two-stage Amplifier. It brings in distant programs, too. The reception of music and speech a thousand miles and beyond is considered not at all extraordinary by owners of this marvelous set.

It is simple, beautiful, sturdy, and efficient—a complete set of the most practical type with the latest accepted improvements. And so compact—with WD11 ("Peanut") tubes there is room for both A and B batteries inside the cabinet, and only two external outlets are required, one for ground, and one for antenna. But standard tubes can be used if preferred. Individual rheostats provided for each tube. Polished Bakelite panels and dials. Genuine quarter-sawed oak cabinet. Wave length range 175 to 650 meters.

The low price only possible because of quantity production and organized facilities of manufacturer, who is one of the oldest in radio.

Don't delay. For several months the demand for AR-10's will probably exceed the number that can be produced. Mail the coupon NOW!

regenerative receiver with two-stage amplifier-
for \$75

Construction and performance FULLY GUARANTEED

Atlantic-Pacific Radio Supplies Company
648 Mission St., San Francisco, Cal.

MANUFACTURERS' REPRESENTATIVES

- Cutler-Hammer Mfg. Co. Rheostats & Potentiometers
- Alden-Napier Co. Sockets & Dials
- Carter Radio Co. Telephone Plugs & Jacks
- Dayton Fan & Motor Co. Variometers & Variocouplers
- A-P Quality Line. Transformers, Condensers, etc.
- Oard Radio Laboratories. Oard Phantom Receptor

JOBBERS and DEALERS invited to stock these lines.



MAIL THIS COUPON

Atlantic-Pacific Radio Supplies Co.
648 Mission Street, San Francisco, Cal.

Gentlemen:—Without cost or obligation, please mail me folder giving full information on your Type AR-10 Regenerative Receiver and Two-stage Amplifier.

NAME

ADDRESS

CITY..... STATE.....

My favorite radio dealer is

NAME

ADDRESS

CITY..... STATE.....



RADIO NEWS

H. GERNSBACK—Editor and Publisher
ROBERT E. LACAULT—Associate Editor

EDITORIAL AND GENERAL OFFICES, 53 PARK PLACE, NEW YORK

Vol. 4

MAY, 1923

No. 11

The Radio Experimenter

THERE are two classes of radio amateurs, generally speaking; the amateur who has his sending and receiving outfit, which he uses for routine work, such as transmitting messages, etc., and the amateur who is continually in search for better Radio. The Radio Experimenter may not be an amateur at all, and may not even as yet have reached the "dyed-in-the-wool" stage. He usually starts in with a crystal set, and after he has mastered its intricacies, he begins soaring to the higher radio levels. A surprising number of the new crop of radio experimenters seem to stick, right now, to their crystal outfits, and some remarkable results are reported. Many amateurs who have constructed high-grade crystal sets, and who have done away with the usual dead-end losses, having substituted basket weave or spider web coils for tuning coils, report remarkable results from such sets. Ranges of from 100 to 500 miles, as a regular performance, are not unusual. This is surprising because the average crystal set probably does not have a range greater than about 25 miles when receiving broadcast programs. The modern radio experimenter, however, seems to be able to do much better, for by doing away with the usual losses he is able to concentrate all the incoming energy in such a manner as to conserve it and bring in the sounds where in other sets they would be lost.

When we stop to consider that the crystal is one of the best rectifiers that we have today, and that there is no distortion whatsoever in the received sounds, there is no wonder that the crystal still holds a great fascination for the radio experimenter. Indeed, as time goes on, crystal reception seems to be becoming more popular than ever.

That the crystal is coming back may best be proven by the fact that one of our largest radio manufacturers is now equipping his Reflex Circuit sets with a crystal detector, because he has found that the addition of the latter makes for quality that cannot be had with the vacuum tube alone.

While we are talking about the Reflex Circuit, it might be well to point out that a tremendous amount of work remains to be done by radio experimenters along these lines. One thing is certain; a single vacuum tube and a crystal detector form an ideal team, as far as good reception is concerned. We urge all experimenters to work along these lines, particularly now that we have the dry-cell tube. The Reflex Circuit will rapidly come to the front, because by its means we shall have an ideal portable set. With a single tube and one crystal detector it is possible, even on a 2-foot loop, to bring in local stations on a loud speaker, a thing that was not possible a few months ago. The price of the parts for the Reflex is quite low, and unless something better comes along, the Reflex may yet prove to be to the Radio industry what the Ford car is to the auto trade.

While, of course, we have the Armstrong Regenerative Circuits, radio experimenters have found them difficult to operate as yet, and even today it takes an expert to operate such sets. This is not the case with the Reflex Circuits, which may be attempted by anyone with a fair knowledge of Radio.

Then, we have the Reinartz Circuit, which is also very popular at the present time, and which, too, has the great advantage of not having too many fussy adjustments. The Reinartz Circuit uses a special form of spider web coil, which has been found to be most efficient.

As a matter of fact, the popularity of the various spider web coils is not due to the fact that their price is low and that they do not take up much room, but because of their very high efficiency.

We make the prediction that such spider web or basket-weave coils will be used by radio experimenters almost exclusively before many months have passed.

But when it comes to long-distance reception, we must turn to radio frequency amplification. There still seems to be much confusion as to what radio frequency really is, and what it means. If the radio amateur and experimenter will think of *radio frequency as distance*, and *audio frequency as sound volume*, he will no longer be puzzled. Two and three stages of radio frequency amplification are coming more and more to the front, when long distance reception is desired.

As a rule, radio frequency reception is preferred to regeneration, because the adjustments are not so difficult and there is not so much distortion, although, perhaps, it costs more to build a radio frequency amplifier than a regenerative set.

Much original research work has yet to be done with radio frequency systems employing a crystal somewhere in the hook-up. Very little has been accomplished along these lines, although the possibilities seem alluring.

Finally, the radio experimenter should bend all his energy towards perfecting his set in such a manner that an aerial is no longer required. Except for sending purposes, and particularly in cities, the days of the aerial have been numbered. There is no doubt that within the next five years the unsightly aerial will have disappeared entirely. With modern radio it is no longer necessary, and the sooner all receiving aerials come down, the better. Even for sending purposes the loop is sure to come into use more and more, and it will be found shortly that if you have a large indoor loop, and providing you are not located within a steel building, the amateur will be in a position to transmit better than he can with his outdoor aerial now.

H. GERNSBACK.

The Ears of the Fleet

By CHARLES F. CARTY

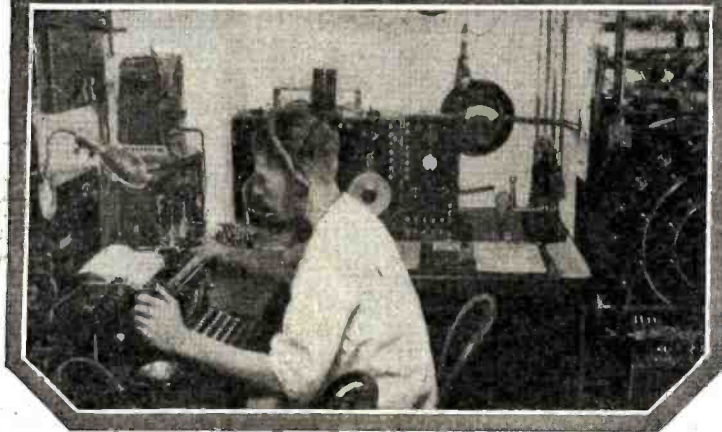
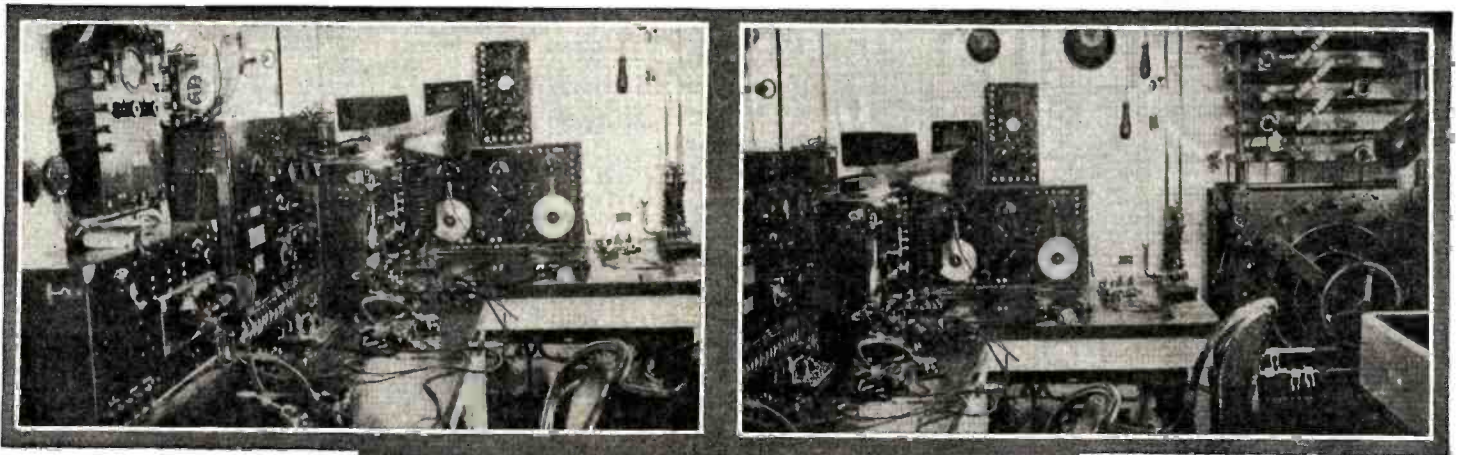

On the Left Fig. 1 Shows the Radio Room Aboard a Destroyer. Here are Seen the Various Receiving Sets, a Radiophone Transmitter and in Fig. 2 the Upper Right Hand Photograph, the Five K.W. Spark Transmitter Which is Used for Handling the Bulk of the Traffic. Fig. 3 Below Shows How Messages are Received Directly on the "Mill."

THIS is a phrase often used to indicate the work of the torpedo-boat destroyer. The destroyer is to the fleet of battleships as the Cavalry is to the main body of troops of the army. The commander-in-chief of a battle fleet must rely to a great extent for his information upon the trim little steel destroyer, and for this reason the destroyer is outfitted with all that science can suggest to make her an efficient scout. Sensitive radio apparatus, the gyro-compass, powerful searchlights, high-powered steam turbines that drive the slim, stream-line craft through the water at the speed of an express train, and many other inventions of science have earned for the American destroyer the title "Greyhound of the Ocean." As a very important part of the work of the destroyer depends to a great extent upon reliable communication, the radio apparatus is of the kind which insures the highest efficiency.

The main transmitter is the Navy Standard, 5-k.w., a transmitter that can easily vie in power with the average shore station, and often carries on reliable communication for distances in excess of 2,000 miles. Two audion receivers are supplied, one with a range of 50,000 to 60,000 meters, the other covering anything up to 25,000 meters, but working best on the longer waves. A two-stage audio-frequency amplifier may be used with either receiver by throwing a switch. Filament current is supplied by either of two Edison batteries. While one battery is in use, the other may be charged and in this way uninterrupted watch may be kept. A wireless telephone for use over short distances up to 25 miles is an important adjunct. This radiophone is a complete unit containing its own receiver and a power amplifier generally connected to a loud speaker on the bridge. By the use of this loud speaker or an auxiliary pair of head phones connected to a remote control station on the bridge, the commander of the destroyer may carry on a conversation with another destroyer which he can see rising and falling on the waves several miles away. The auxiliary radio room is located in the after part of the ship. This room contains a radio compass, upon which very accu-

rate bearings may be obtained within a radius of several hundred miles. There is also an additional receiver with two-stage audio frequency amplifier attached in this room. In addition to this there is a ½-k.w. emergency transmitter with a storage battery source of power. The destroyer carries four antennae, one each for the radiophone, radio compass, emergency transmitter, and main sending and receiving sets.

Fig. 1 is a view of the radio room aboard a destroyer. Prominent in this picture is the radiophone set. In the upper left-hand corner is the power panel, and directly beneath it is the power amplifier upon the front of which is mounted a rack which holds the transmitter mouthpiece. When talking, this mouthpiece is held by its handle close to the mouth like an ordinary telephone, the only difference being that one must hold a small button on the side of the handle depressed while talking and released when listening. The next piece of apparatus on the right is the main panel of the radiophone. In the corner are the two main receivers, upon one of which are mounted an ultra-audion control panel for use in conjunction with the long-wave receiver, and a two-step amplifier. Fig. 2 is a fuller view showing a portion of the Navy 5-k.w. transmitter. At the extreme right of the picture is the antenna transfer switch, and to the left of it are two sending keys; one main key for handling the juice direct, and the other an ordinary Morse key for controlling either of two heavy

relay keys which are used in working on high power. Fig. 3 shows the radio room of another destroyer in which the apparatus is arranged somewhat differently. The "mill" is set conveniently in the desk beneath the desk lamp. The operator is in the act of adjusting the short-wave receiver, which is of the type often referred to as "SE 1420"—a very efficient little receiver, and very highly thought of by Navy and commercial men alike. The knob of the Morse relay control key appears protruding above the operator's right arm, which position was found to be a very convenient one for it. Behind the handle of the antenna transfer switch may be seen a low resistance

"pilot lamp," which is in series with the motor field. The pilot lamp is necessary due to the fact that the motor is remotely controlled. When the motor is running this pilot lamp is lit up, and this eliminates the possibility of letting the motor run through error. Sunk level with the surface of the desk may be seen a piece of plate glass beneath which are data signals, etc., for ready reference. It will be seen that there is nearly everything aboard one of these vessels that the heart of a radioman could desire, and thus there is every incentive to give an efficient radio service.

Although the work of the destroyer in time of war is directly connected with the fleet, in time of peace a variety of work is cut out for her. Due to their efficient radio apparatus, the destroyers are often stationed in European waters, particularly in the Near East, for the purpose of facilitating communications of the various diplomatic representatives, the Near East Relief, etc., and also for the purpose of handling commercial traffic for American commercial interests such as the Standard Oil Company, American Foreign Trade Corporation, Shipping Board, American Tobacco Companies in Turkey, etc., etc. It will thus be seen that a radio operator aboard a destroyer often has unusual opportunities for travel. The author in this manner visited many places of interest, including Constantinople, Athens, Jerusalem, Cairo, Sebastopol, Russia, Arabia, India, China, Honolulu, etc.

(Continued on page 2024)

Radio Proves A Boon To Farmers

By J. FARRELL

IF there is anyone in this world who still scoffs at radio, saying that it has no practical value and that it is useful only as a plaything for boys, here is the evidence with which you can squelch him for all time.

A few weeks ago the United States Department of Agriculture set out to learn in a concrete way how widely the market reports broadcast by radio were being received and put to practical use. The Department knew, in a general way, that farmers and other agricultural interests were getting the reports daily but it had no specific information on the subject.

The 90 or more radio stations that now broadcast agricultural news over the country were asked to send out the following paragraph:

"If you are interested in these market reports Uncle Sam wants to know about it. Write direct to the Radio News Service, Bureau of Agricultural Economics, United States Department of Agriculture, Washington, D. C., and tell them the use you make of the reports. Also make suggestions regarding the market news service if you have any—write today. The future of market reports by radio depends upon your interest in them."

At first only meager response was made to the inquiry, and J. C. Gilbert, in charge of the Department's radio work, felt somewhat discouraged. Then letters from novices all over the country began

to pour in. As this is written, more than 400 replies have been received and the flow of mail continues heavy.

The replies abundantly prove the hold that radio has taken on the rural population of the country. Nearly one-third the number of letters received are from farmers, one fourth from flour mills and grain elevators, and the remainder from banks, miscellaneous firms and individuals, co-operative marketing organizations, newspapers, rural telephone companies, and farm bureau organizations. The chief note struck in this correspondence is one of alarm at the prospect of discontinuance of the service. The correspondents are one in acclaiming the practical value of the work, stating that it is one of the most progressive steps yet made in the promotion of American agriculture.

Farmers removed from local centers, without telephone service, and who usually receive mail two to four days late, were particularly loud in their praise. One agriculturist wrote:

"We 'hill billies' out in the 'sticks' look upon radio as a blessing direct from God. I am on a farm 100 miles northwest of St. Louis, and 15 miles from the nearest railroad station. We have dirt roads, and six months out of the year a trip to the railroad station is a sixteen-hour job. We have

been using a home-made crystal set for receiving the radio news and we feel that we could hardly get along any more without these reports. We have not had service at our church since August, 1921, and we listen in to a good sermon or two on Sundays. We farmers are all going broke anyway, but we would like to have our radio to 'sorter ease the pain'."

At the risk of making this article read like a patent medicine advertisement, the following excerpts from some of the letters are given.

"The market reports come 24 hours ahead of the daily newspapers, and give the farmer a chance to know the value of his products, thus permitting him to be equally informed with traders and shippers who have obtained their reports by telegraph, and enabling him to take advantage of any sudden turn in the market."

"Farmers in this territory are equipped

to this service principally because it educates the farmer, but in the long run it is to everyone's advantage. The same thing was said when rural mail delivery was inaugurated. Radio means that the seller will get a fair price for his commodities."

"In the busy season when grain is moving, the radio reports save me from \$10 to \$20 in half a day. There are some 20 or 25 receiving sets in this immediate vicinity."

And so on, *ad infinitum*.

In later day agriculture it is the generally accepted view that one of the reasons why farmers get low prices for their crops is their lack of market information. Newspapers reporting the markets arrive on the farm several days late, and the farmers cannot afford the expense of special telegraph reports. On the other hand, the men who buy the crops are informed up to the minute on prices and have the upper hand in market trades. The result is low prices to the producer and relatively high prices to the consumer.

The economic work of the United States Department of Agriculture was recently reorganized to bring the business facts of agriculture closer to the farmer, and the extension of its radio news service has been cited as one of the leading accomplishments of the Department during the past year. Congress has endorsed this view in recent appropriation bills providing for extension of the Department's market news



This is a Picture of Typical Farm Life. The Whole Family Has Gathered to Listen to the Radio, Which Means More to These People Than Can Be Imagined by Sophisticated City Folk. Radio Probably Plays Its Greatest Part in Farm Life.

with up-to-date radio apparatus and know before they crank up the old Lizzie to take their stuff to market just how much they will receive for their butter and eggs."

"For the sake of Mike don't stop it. Paid \$200 for set."

"We now get the markets 24 to 36 hours sooner than by newspapers."

"Radio is a great thing for the farmer, as he can learn as much about the market as the speculator."

"By receiving prices each day we know better just when to ship to meet a good market."

"Our stock buyers used to get the market report from their commission houses in the morning, and then come around later in the day and trade us out of our stuff. That day is past, if you stay with us."

"The service is almost as beneficial as having a member of our company on the floor of the grain exchange every day. Before radio, it was necessary to use long distance telephone or telegraph to get daily market news. This was expensive and frequently unsatisfactory. The radio service is a boon to thousands of small mills, elevators, grain dealers and shippers."

"Nearly 500 farmers make direct use of our radio service."

"There may be firms that are antagonistic

service all over the country. This will enable broadcasting stations everywhere throughout the land to keep in close touch with the Department's branch offices, and receive quickly for broadcasting purposes the market facts developed in the leading produce and live-stock markets.

More than 90 stations, both telegraph and telephone, now broadcast market news by radio and with the contemplated additions to the service, farmers will be able to get radio reports wherever they may be located.

In the early days of radio telephony farmers were slow to take up the radio idea and depended largely upon town organizations such as banks and merchants to receive and relay the market news by wired telephone. But in more than half the letters received by the Department the writers state that many farmers in their immediate territory now have their own radio sets, and that many other farmers are planning to make installations. Indubitably, farmers and other rural folks are sold on radio.

One-third the total population of the United States lives on farms; combined with the number of people in villages and small towns, the rural population is estimated at more than half the total population. Here is a fruitful field for radio expansion.

Further Peculiarities of Wave Transmission

By SIR OLIVER LODGE

WAVES are transmitted by a combination of momentum and elastic recoil; and, in order to convey them, the medium must have the two corresponding properties, viz., something corresponding to inertia or massiveness and something corresponding to elasticity. There is a displacement from the mean position, with a tendency to spring back, this displacement being either material or electric, according to circumstances; and there is a rushing past the mean position with a momentum which overshoots the mark, and carries the particles into a region of recoil, propelling them against the electric force, which in due course drives them back again. It is the elastic force which generates the momentum; and it is the momentum which piles up an opposite elastic force. It is by the interaction of these two properties that oscillations are maintained and it is by possession of these two properties that the medium is able to pick up the oscillations and transmit waves.

In the case of mechanical waves the momentum is straightforward mechanical momentum, due to the inertia of matter; in electric waves the momentum is magnetic momentum, and is due to the inertia of ether, just as the elastic recoil is due to the electrical rigidity or elasticity of ether—the term “rigidity” being a technical or quantitative one, not at all implying infinite rigidity.

The reaction of the two properties is easy enough to follow in the oscillator, or source of the waves, where the two are in different phases. It is rather less easy to follow in the wave itself, where they are both in the same phase. But it may help if we consider the simplest case, viz., that of sound. As the wave advances, the particles are simultaneously thrown forward and nearer together, so as to make a condensation. If at the maximum condensation they came to rest, they would rebound, and the wave would go backwards. That is exactly what happens when sound encounters a wall or other obstacle and is reflected, giving rise to what are called “stationary waves,” with nodes and loops in definite places. But in a progressive wave the particles are thrown forward into the condensation, and the condensation moves on by reason of the momentum of the particles, and so continually advances into new regions, spreading the disturbance at a steady advancing pace. The particles ultimately come to rest, and go back again; but when they do that the rarefaction is beginning. And so this rarefaction, or pull on the medium, travels forward likewise; though it requires a little more effort to follow the details of the advancing rarefaction, as compared with the more easily grasped details of an advancing condensation; since in a rarefaction the particles of the medium are moving in a direction opposite to that of the advancing wave—which at first seems a little confusing.

To follow out the details in the electromagnetic case is less easy, because we are less familiar with the intimate nature of electricity and magnetism. We know that magnetism is the result of an electric current (or rather that the two are different names for the same thing), and that it simulates mechanical inertia and momentum. We also know that electric

displacement is another name for electric charge, and that it simulates an elastic spring-back, which is demonstrated by an electric discharge. The term “charge” is only applied to a conductor. The more general term is electric displacement, because that applies to an insulator, too. But, as the process is not a mechanical one, the only way we can safely and completely follow it is by the use of the vitally important equations of Clerk Maxwell, which contain the whole theory imbedded in their intricate and illuminated recesses.

Diffusion Waves

But now, to understand the phenomenon of wave transmission more thoroughly, we ought to ask whether there is any kind of wave which does not obey those laws—which has not both momentum and elastic recoil, which does not require those properties in the medium, and which does not advance at a definite pace.

WE are pleased to present to our readers this month, another article by Sir Oliver Lodge, the well known English authority on radio. In this further article on the Propagation of Waves, the author clearly explains how electromagnetic impulses traveling through space are propagated, and affect all receiving aerials. This should be of great assistance to the amateur, and layman as well, in grasping this point which is generally not well understood by the majority of radio students. The analogy used to explain the wave propagations is particularly well adapted for comparison, and we feel sure that our readers will be interested in this authoritative article from the pen of the well known scientist.

The answer is that there are such waves—if they can be called waves—waves of diffusion, transmitted from an alternating source. It may be a source of alternating temperature, for instance, like the summer and winter temperatures applied to the crust of the earth. The result is that periodic waves of temperature sink into the crust, and succeed one another at regular intervals; so that by penetrating a sufficient depth you will find a trace of last summer's heat, and by penetrating deeper you will find a trace of the preceding winter's cold, and so on, though it is true that these traces tend to smooth themselves out rapidly, and become before long difficult to recognize. But if we ask at what rate these waves travel we can give no answer, at least no clear and simple answer, as we can in the case of true waves with momentum. For the peculiarity of these heat waves is that they have no momentum. They travel according to a different law; and the time taken for any given portion of heat to reach a certain depth will depend upon how sensitive the detecting instrument can be.

We may illustrate the matter by taking a long rod of metal, packed in cotton wool or some insulating material to prevent loss of heat from the surface, and then put a thermometer at one end (which might be a sensitive thermopile), and to the other end apply heat and cold alternately; for instance, first a flame and then a douche of liquid air. The thermometer at the far end will exhibit alterations of temperature. There will be a lag, perhaps a very considerable lag, before it feels the first heat wave. The cold wave may be well on its way, and another heat wave too, before it re-

sponds; but in due time it will go up and down in response to the succession of impulses imparted to the other end. But if we ask how soon it will feel those impulses, after they started, we must realize that it is merely a question of how sensitive it is. If it will only respond to a Fahrenheit degree or two, it will be very sluggish; but if it could feel the millionth of a degree, it will be fairly quick.

This is the actual problem which had to be solved in connection with the first Atlantic cable, and Lord Kelvin solved it completely. He perceived that the electric capacity of the cable would make the laws of electric propagation correspond exactly with the laws of the flow of heat—which had been worked out by Fourier. So he gave the theory of the cable, treating it as a long conductor to one end of which positive and negative electrification was alternately supplied, a detecting instrument being at the other end. And he realized that if signalling was to be at all rapid this detecting instrument must be of surpassing sensitiveness. He knew that there was no true velocity of propagation in a cable possessing only resistance and capacity; he knew that the waves were waves of diffusion, having no definite speed, and that the rapidity of their detection must depend on the sensitiveness of the receiving instrument. Hence his mirror-galvanometer, and then his syphon recorder. He knew further that violent applications of electricity to a cable were unnecessary and troublesome, as well as dangerous; that they put into the conductor disturbances which would have to leak out; and that within limits the feebler the signals were, the better. Sharp momentary curbed signals ought to be sent, and though at the far end they arrive washed out by diffusion, yet a sufficiently sensitive instrument can detect them without more than a fraction of a second delay, and with a reasonable amount of sharpness.

But this theory after all was not complete, was not quite complete. It left out of account self-induction; that is to say, it treated the electric waves as if they were really like heat waves, without momentum. As a matter of fact, the heat wave theory is only an approximation or an analogy. Electric waves must have momentum, since every electric current has a magnetic field round it. The magnetic-inertia effect was omitted in Kelvin's theory. If thought of at all, it was thought to be insignificant, wiped out as it were by the capacity and the resistance; just as sound waves trying to pass through a haystack would have their momentum wiped out by friction, and would be stopped. Or, a better analogy, as light waves are stopped when they encounter a conducting material. The propagation of heat waves through a good conductor, the propagation of light waves through a bad conductor, and the propagation of electric oscillations through a long submarine cable, all follow the same law—the law of diffusion—the law according to which a colored solution like sulphate of copper is conveyed along a tube of water; or a law on which a particle of salt dropped into a bucket of water is ultimately found to permeate every part,

(Continued on page 2024)

Electrons, Electric Waves, and Wireless Telephony

By Dr. J. A. FLEMING, M. A., D. Sc., F. R. S.

Part IV

ELECTROMAGNETIC RADIATION AND THE QUANTUM THEORY

BEFORE we can proceed to explain the manner in which the vibrations of electrons, atomic nuclei and atoms or molecules give rise to a vast gamut of electromagnetic waves stretching from the shortest X-rays up to the longest known dark heat rays, and beyond these the Hertzian and the wireless waves, we shall have to attempt the task of elucidating the nature of the so-called Quantum Theory or hypothesis introduced into physics by Professor Max Planck about the year 1901, which has opened a new chapter in the development of physical ideas.

It will be necessary to preface explanations by some definitions of terms and words used in the science of mechanics.

An important physical conception is that of *Energy*. Energy is defined as the ability to do *Work*, and this last is a technical term meaning the displacement of a material substance against some force which resists that displacement. Thus, if we lift up a weight against the force of gravity, we do work in this sense of the word. The work is measured by the product of the displacement and the force, each reckoned in certain consistent units. Thus if we lift up a mass weighing 10 lbs. to a height of 10 feet, we do work against gravity to the extent of 10×10 foot-pounds. The time taken in doing the work does not affect its numerical value. Thus in the above example the work done is 100 foot-lbs., whether the mass is lifted very slowly or very quickly. When the substance has been so lifted up against the force of gravity it is said to have potential energy or energy of position to the extent of 100 foot-lbs.

There are many ways in which such potential energy can be accumulated. For instance, by bending or stretching a spring, by pumping up water to an elevated cistern, or electrically, by charging with electricity a condenser or Leyden Jar. In all cases the work or energy is measured by the product of two factors, viz., a displacement and a force, a quantity of water and a height through which it is lifted, or a quantity of electricity and the mean potential to which it is raised.

The rate at which work is done is called *Power*. Thus, if we lift up a mass of 550 pounds weight a height of one foot in one second, we do work of 550 foot-pounds at a rate called *One Horse Power*, which, however, has nothing to do with a horse.

Energy also can exist in the form of a mass in motion or some equivalent. In this case it is called *Kinetic or Motional Energy*. It is then measured by half the product of the mass and the square of its velocity.

The reason for this is as follows:

Force is defined as any agency which changes the momentum of a body. The momentum is defined as the product of the mass and the velocity. The force is measured by the rate at which it changes momentum or by the momentum added per second.

Thus if a body of mass m grams has a velocity denoted by v_1 centimeters per second and after a short time t seconds, during which it is acted upon by a force f , acquires a velocity v_2 , then the force f is measured by the difference $(mv_2 - mv_1)/t$, because this is the time rate of change of its momentum. During this time its velocity has changed from v_1 to v_2 and if this has taken place uniformly, the distance or space moved over by the body is $\frac{1}{2}(v_1 + v_2) \times t$.

The work done is then the product of force and displacement or is $W = \frac{(mv_2 - mv_1)}{t} \times \frac{(v_1 + v_2)}{2} \times t = \frac{1}{2}mv_2^2 - \frac{1}{2}mv_1^2$

This shows that the work done on a mass m in increasing its velocity from v_1 to v_2 is the change in the quantity $\frac{1}{2}mv^2 = T$, called the kinetic energy.

The above statement may be regarded as valid in accordance with Newton's Laws of Motion and his doctrine of absolute space and time. The searching analysis to which the ideas of space, time, and motion have been submitted by Einstein and his followers have, however, shown the necessity for modification in our fundamental conceptions. This basis on which these new views have arisen was the inference made from the experiments of Michelson and Morley, and from other observations, which demonstrated clearly that the velocity of a ray of light is independent of the motion of the source of light or of the observer, and in fact is the same for every frame of reference. The velocity of light is therefore a fundamental constant of nature. It is always and everywhere 300,000 kilometers

a velocity v should be given by the expression $mc^2 \frac{1}{\sqrt{1 - v^2/c^2}} - \frac{1}{2} mc^2$ where c is the constant velocity of light. If v is small compared with c , the energy is equal to $mc^2 + \frac{1}{2}mv^2$. Hence we see that even if a mass is at rest with reference to a certain frame of reference it is not therefore destitute of kinetic energy.

Furthermore, it can be shown that if an amount of energy E in the form, say, of heat is given to a body of mass m without altering its velocity of translational motion v , its energy is increased by an amount

$$\frac{E}{\left(1 - \frac{v^2}{c^2}\right)^{3/2}} - \frac{1}{2} mc^2$$

and therefore its total energy is expressible as— $\left(m + \frac{E}{c^2}\right) \frac{c^2}{\sqrt{1 - v^2/c^2}}$

This implies that the apparent mass m is increased by an amount E/c^2 by the addition of the energy E . This seems to suggest that what we call the mass of a body is only a manifestation of energy of a certain kind, possibly some form of spinning or rotational energy, and that the indestructibility of Energy and of Matter are only two different aspects of the same fact.

As long as the velocity of translation of a mass is small compared with that of light the increase in its kinetic energy, which results from giving it a velocity v , is expressed by $\frac{1}{2}mv^2 = T$, and this, in ordinary classical theory, is taken to be its kinetic energy, although the theory of Relativity shows that it is not the whole of it. There is in addition, in connection with a mass m a concealed or latent kinetic energy measured by mc^2 , even when that body is at rest with respect to the framework of reference considered.

Suppose then that a massive body like a planet is moving along a certain path with a certain kinetic energy at each point. Let us suppose the path divided up into little elements ds , and let each element of length be described in a short time, denoted by dt . Then the velocity of the body in each little stage is measured by the quotient ds/dt and

the kinetic energy by $\frac{1}{2}m \left(\frac{ds}{dt}\right)^2$ if we

call the mass m . If we multiply the mean kinetic energy during each element of motion by the time dt taken to describe it, we obtain the product

$$\frac{1}{2}m \left(\frac{ds}{dt}\right)^2 dt \text{ or } \frac{1}{2}m ds \text{ or } \frac{1}{2}m v ds.$$

What may be called the value of the energy for physical purposes or the opportunity of using or transforming a certain amount of this energy is not merely measured by its numerical amount, but by the product of its amount and the time it is available.

In a large class of physical phenomena the spontaneous operations always take place in nature in such a manner that the Action expended is the least possible.

This principle of Least Action is of very wide application in dynamics. Thus, a planet moves in its orbit round the sun along a path such that the Action in going from one point to another is the least possible. There is a corresponding principle of Least Time in optics. A ray of light moves through a medium with a velocity

THIS article is the fourth of a series by Dr. J. A. Fleming, F.R.S., which appears under the above title. It is a reproduction, with some additions, of the lectures on electric waves and wireless telephony he gave at the Royal Institution, London, in December and January, 1921-1922, for which RADIO NEWS has been able to secure the exclusive serial rights of publication in the United States. The articles are therefore copyrighted, and rights of translation and reproduction are strictly reserved.

It is hardly necessary to remind the readers of RADIO NEWS that Dr. Fleming has been closely and practically connected with the developments of wireless telegraphy and telephony from the very beginning, and was last year awarded, by the Royal Society of Arts, the Gold Albert Medal.

per second or very close thereto. We denote this velocity by the letter c .

Experience also shows us that our statements about the facts of nature have in general identical form whether we refer them to one frame of reference or to another in uniform relative motion with respect to it. Thus, if a scientific man had a laboratory on board a ship and made measurements of the time of vibration of a certain pendulum or the space fallen through in one second by a released ball, he would find exactly the same numerical results whether the ship was at rest in harbor or moving smoothly and uniformly over the sea at any speed. This is called by Einstein the *restricted principle of relativity*.

In accordance with this theory, which, however, is by no means universally accepted, it can be shown that the kinetic energy of a mass m moving uniformly with

which is inversely as the index of refraction (denoted by μ), of that medium. Hence the time of traveling over an element of path ds is the product μds . The path of a ray of light through a series of transparent media is always such as to make the sum of the elementary products μds a minimum.

The important innovation introduced by Planck in 1901, in connection with radiation phenomena, was the idea that Action is discrete in nature and that there exists what may be called an *atom of action*, or least possible indivisible amount of it.

We cannot explain why this should be the case. We have seen that electricity is also atomic in structure and that there exists an atom of electricity called the electron, equal to 4.77×10^{-20} of an electrostatic unit or to 16×10^{-20} of a coulomb or ampere-second, which is indivisible. All charges of electricity must be in integer multiples of this electron unit. We can have them in millions or billions, but we cannot have a fraction of a unit or of an electron.

In the same way Planck has shown that radiation of energy can only take place in integer multiples of a very small unit of Action which is equal to 6.547×10^{-27} erg-seconds. This means $\frac{1}{10^{20}}$ of an erg of

energy lasting for one second or one erg lasting for the same fraction of a second. The reader may be reminded that one erg is the work done when a force of one dyne acts through a distance of one centimeter.

The *weight* of a mass of one gram is nearly 981 dynes. The above unit of action is an extremely small one and we need take no account of the atomicity of action in large scale dynamics, but only when we are dealing with atoms singly.

Planck has particularly applied this view of the atomicity of action of electromagnetic waves by electrons and atoms. When a solid body, say, a mass of carbon or metal, is raised to a high temperature, its atoms and electrons are thrown into a state of rapid vibration. Planck calls these vibrators oscillators.

If we consider a single electron moving to and fro along a straight line with a vibratory motion, we see that its velocity is changing at every instant, and therefore in accordance with explanations already given, the electron is sending out vibrations along its electrolines or lines of electric force; in other words it is radiating energy. It is very easy to prove that in the case of an electron oscillating in one line like the bob of a long pendulum, the Action in one period is the product of the mean energy of motion and the periodic time. Also that the energy radiated per period is a definite fraction of the oscillating energy. If T is the time of one complete vibration, and if in that time an amount of energy denoted by E is radiated, then the Action is the product of E and T reckoned in ergs and seconds.

Planck then says that the product of E and T , or $E \times T$, must be an exact integer multiple of the unit of action which is denoted by h ($= 6.55 \times 10^{-27}$ erg-seconds). Therefore we have the equation $ET = mh$ where m is some integer. But if the frequency of the oscillations or number per second is n , then $n = 1/T$ and $E = mn h$. Accordingly, radiation of energy appears to take place in integer multiples of a unit of energy equal to the product nh . This unit is called a *Quantum* and is denoted by the Greek letter ϵ .

Planck's fundamental equation is then

$$\epsilon = nh.$$

The reader should carefully notice that the magnitude of this quantum of energy (ϵ) is not constant but is proportional to the frequency n . It is the atom or element of Action denoted by h which is invariable in magnitude.

The upshot of all the above is as follows: If there are a number of little oscillators or vibrating electrons which vibrate with different frequencies, like pendulums of different lengths, some moving fast and some slow, or with high frequency and low frequency, then each of these electric oscillators is radiating energy but they can only radiate this energy in whole quanta and the size of the quantum radiated in each case is proportional to the frequency.

In an incandescent body the electrons and atoms which constitute the oscillators, do not all possess the same energy of vibration, any more than the molecules of a gas have the same velocity. The speeds of the gas molecules and also the energies of the oscillators are distributed according to Maxwell's law, as already explained, and according to a similar law the energy is distributed between oscillators having the same frequency.

Let us consider then the condition of things in a mass of incandescent metal or carbon. We have atoms and electrons which can vibrate in very various periods depending on their mass and the elastic constraint to which they are subjected by the attractions and repulsions of neighboring electrons. Moreover they are vibrating with different amplitudes, or in other words have different amounts of energy associated with them. We may, in imagination, divide these oscillators into groups arranged progressively according to the frequency of their oscillations, and each group of similar frequency

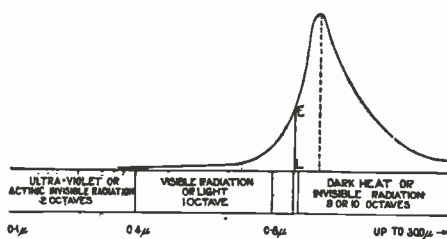

Fig. 46. Radiation Energy Curve for the Spectrum of Visible and Invisible Radiation. The Height of the Ordinate of the Curve at Any Point is a Measure of the Energy of the Radiation at That Point.

may be considered as divided into sub-groups, which have similar amounts of oscillatory energy, but the sub-groups arranged in order of increasing energy content. Each of these oscillators is sending out electromagnetic waves of identical frequency and of various amplitudes. This electric radiation constitutes the light, heat and actinic radiation of the incandescent body. If then we send a thin beam of this radiation through a prism or diffraction grating, these rays of different frequencies are differently refracted and spread out into a spectrum when received on a screen.

As regards those waves, the wave-lengths of which lie between 0.395μ and 0.76μ , or say, 3,950 Angström units to 7,600 A.U., these have the power of stimulating the retina of our eyes and exciting the sensation of light, the short waves creating a sensation of violet light and the larger red light. It is, however, well known that there is a range of ultra-violet light or invisible rays of wave-lengths lying between about 250 A.U. and 4,000 A.U., which can impress a photographic sensitive plate, but not our eyes. Again, there is a range of longer ultra-red or so-called dark heat rays, extending in wave-length from 0.8μ to about 300μ , all the waves in which cannot affect our eyes but can heat a sensitive thermometer.

Suppose then that we form a spectrum, that is, expand the complex many-frequency radiation from an incandescent body, such as the light and heat from an electric arc lamp or from the sun, into a spectrum or band of radiation, every strip of which is formed by waves of one particular wave-

length. Let us place across this band a blackened platinum wire. This wire will absorb all the energy at that point and be heated thereby. We can determine the temperature of the wire by the increase in electric resistance that then takes place. So used this wire is called a bolometer wire and it enables us to measure the energy associated with the waves of each particular radiation from the least unto the greatest wave-length (see Fig. 46).

When this measurement is made we find that the waves of very large wave-lengths or very small frequency have little or no energy and that as the frequency increases the energy of radiation increases also, but not indefinitely. It increases up to a certain wave-length of maximum energy and then begins to fall off again, so that the waves of very high frequency have also small energy associated with them.

We can thus plot a radiation energy density curve in terms of wave-length or frequency, as in Fig. 46.

When we attempt to account for this form of this curve, and especially for the fact that it has a maximum ordinate for a certain wave-length, difficulties are found. As long as we assume that energy can be radiated continuously, that is in any amount per second from each oscillator, theory shows that the radiation energy should increase rapidly with the frequency so that oscillators of high frequency should radiate very much more energy than those of low frequencies, whereas in the normal spectrum it is found that the waves of very high frequency have small energy as well as the waves of very low frequency.

Planck's theory of energy quanta was devised therefore originally to meet this difficulty and to enable a formula to be found which will express or predetermine the curve of radiation energy along the spectrum. This it has done very successfully.

He assumes, as we have seen, that energy is not radiated continuously by the oscillators, but comes out, so to speak, in gushes or quanta, the size of the quantum being in the case of every oscillator proportional to its frequency of oscillation or number of vibrations per second. Hence for the high frequency oscillators the quantum will be large and the probability that any particular oscillator or many such oscillators will have this amount of energy at disposal is small. Hence the total energy contribution of the high frequency oscillators is small. On the other hand, the quantum for the low frequency oscillators is small and therefore nearly every one is capable of giving it, but then, owing to the smallness of the unit, the total energy contribution is again small. But for oscillators of medium frequency the total contribution may be, and is, much larger. Hence we get for a certain wave-length, a maximum energy radiation.

We might give an illustration as follows:

Suppose that a collection was being made in a church or in a number of churches for some charitable object, say, hospitals. Imagine that in one church the clergyman announced that no person must give a donation of more or less than £5. The chance of there being many persons present who had that amount in their pockets and were willing to give it in one lump sum might be small and hence the total offertory would be small also, comprising perhaps only one or two such donations.

On the other hand, imagine that in another church the minister announced that no person must put more or less than one penny in the plate. Nearly everyone would be able to give this coin, but the unit being small, the total offertory would again be small. If, however, an intermediate sum, say, one shilling or one half-crown, was announced as the sum which was to be the

donation unit, a large number of the congregation would be able to give this amount and hence the total offertory would be much larger than in the extreme cases in which the unit of donation was either one penny or five pounds. By this ingenious idea Planck was able to find a formula which when represented graphically, exactly agrees with the experimentally determined curve of radiation energy distribution in the spectrum, and no one had previously been able to achieve this result.

Nevertheless, Planck's theory seems to necessitate certain assumptions which are rather forced. We have no proof that in an incandescent body there are oscillators of every possible frequency, in short, oscillators of an infinite number of frequencies. Also it is difficult to form any clear idea why Action should be atomic in structure unless Space and Time are also in discrete indivisible units.

In the spectrum there are, however, an infinite number of rays of different frequency and wave-length, extending from the longest dark heat rays yet observed of wave-length about 200 to 300 μ , to the shortest ultra-violet rays of about 0.1 μ in wave-length. Moreover, the spectrum may be said to extend to infinity in both directions, for beyond the longest dark heat waves we have the Hertzian and wireless waves to be considered in our next chapter, and beyond and below the shortest ultra-violet waves we have the X-ray waves.

A way out of this difficulty has, however, been suggested as follows. The process of radiation in an incandescent body probably consists in the creation of sudden groups of complex vibrations of finite duration, caused by the impact of electrons against atoms, and these last in turn are set in vibration as a whole and in their component electrons. These complex vibrations may by Fourier's theorem, already explained, be regarded as made up of a large group of simple harmonic vibrations each of different frequencies.

Since the complex groups of vibrations which can thus be analyzed are not produced simultaneously and in step or phase or absolute agreement with each other, we have in fact sent out from the incandescent body an infinite number of trains of complex vibrations which are built up of an infinite number of component harmonic vibrations and the prism or diffraction grating separates these out from one another and spaces them in order of wave-length or frequency in the observed spectrum of the radiation.

ATOMIC ENERGY AND ITS RELEASE

The previous explanations will have made it clear that the nucleus of the atom in which its gravitative mass chiefly resides is a structure which is probably built up of helium and hydrogen nuclei and of unnamed nuclei of mass three times that of the hydrogen nucleus, which are powerfully held together by negative electrons into a very compact mass. The helium nucleus in particular seems to be a very strong structure.

It appears that a very large amount of energy has to be put into the ultimate ingredients, viz., the positive and negative electrons, to bind them together in this extremely firm manner, so as to make a very small but exceedingly dense mass of matter about 10^{-13} or 10^{-14} of a centimeter in diameter. We might regard the nucleus as a sort of clock-spring which has been coiled up very tightly by the exertion of energy and then bound in some manner not easily released. If, however, certain kinds of atomic nuclei such as those of nitrogen are bombarded by α -particles, the nucleus is disrupted and its approximate constituents, viz., helium and hydrogen nuclei, are flung out with great velocity.

This, and the phenomena of radio-activity, has suggested that we have in the nuclei of atoms an enormous store of energy which in some way we may be able to release.

At the present time, if we set on one side the not very large stores of water power which are often in very sparsely inhabited places, the chief sources of potential energies lie in the stores of coal and oil in the earth's crust. But the oil represents but a fraction of the energy stored up in the coal or to be obtained by burning the coal. Hence we may say that the chief source of power in the world is the potential energy of its stores of coal.

Nevertheless, the increasing cost of raising and transporting it, owing to the increase in the cost of labor, creates the hope, that in some way the human race may be able to tap this almost illimitable store of atomic energy. The prospects, however, at present are not very bright. Such small achievements in direction which have been accomplished have required the expenditure of the expensive element radium.

Having regard to the fact that the atom is probably a wholly electrical structure, it may perhaps be possible to break it up by

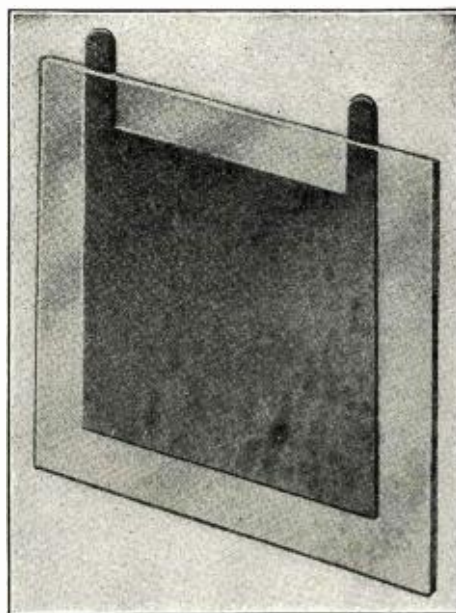

Fig. 47. A Leyden Jar or Electrical Condenser Consisting of a Sheet of Glass or Other Dielectric Partly Covered on Both Sides With Tinfoil or Sheet Metal.

means of suitable high frequency electric oscillations to the study of which we shall next direct attention.

ELECTRIC OSCILLATIONS

As already stated, we have reasons for believing that in metals, carbons, or other substances which are conductors of electricity, there are free electrons which are moving irregularly with very high speeds in the interstices of the atoms of matter, or jumping from atom to atom.

Conductive materials such as metals are built up of atoms which easily lose one or more electrons from their outer shells or orbits. These detachable electrons are called the *valency* electrons, and it is probably one or more of these that become free to roam about in the inter-atomic spaces.

From certain facts we can infer that in a metal there are about as many free electrons as there are atoms in any given volume. In those substances we call non-conductors but which Faraday appropriately named *dielectrics*, such as glass, ebonite, paraffin wax, mica or shellac, the number of free electrons is very small, but under the action of electric force certain of the electrons in the atomic orbits or structure can be displaced or strained elastically, so that when the electric force is removed they spring back to their old positions in the atoms.

We can thus cause in metals and conductors generally, by means of electric force,

a drift of the free electrons which is called an electric current, but in dielectrics we can only produce an electron displacement or strain. The drift motion of the electrons in the case of the electric current creates, as we have seen, a magnetic force which is distributed round the conductor in closed lines embracing it. In the case of a straight wire conveying an electric current with return wire at a considerable distance, the lines of embracing magnetic force due to the drifting electrons are circles whose centers are in the wire and whose planes are perpendicular to it.

In considering this effect called electric displacement in dielectrics, Clerk Maxwell, whose scientific thought on this subject was epoch-making in its importance, saw that it would be logical to conclude that an electric displacement *whilst it was being made or removed* was equivalent to an electric current and should therefore produce a magnetic field in the same way as does a conduction current in conductors. We have then to distinguish between conduction currents and displacement currents in one sense, but in another they are quite identical and both involve the production of a magnetic force or field embracing the current.

Let us next consider a compound circuit comprising a sheet or layer of dielectric, say, glass contained between two sheets of metal made in fact like a sandwich, the meat being the glass and the two slices of bread the metal sheets. Such an arrangement is called a condenser or Leyden pane (see Fig. 47).

Suppose we give to one sheet of metal a charge of negative electricity. This implies that we force into it an excessive number of free electrons over and above those naturally present in it.

Owing to their mutual repulsion the result is that the displaceable or mobile electrons in the sheet of glass are all strained or displaced as far as possible away from this electron super-charged metal plate. Also the free electrons in the other metal plate move as far away as possible from the super-charged plate. If this extra electron charge has been given by an electrical machine or by a battery, it implies that at the opposite pole of this battery or electrical machine there is a deficit of electrons. Hence if we connect this last named pole with that plate of the condenser which has not been charged with extra electrons, a number of electrons equal to the excess in the other plate will return to the battery or electrical machine, whilst the plate itself is left with a deficiency of free electrons.

As regards the condenser the state then is, that in one metal plate there is an excess of free electrons, in the other plate a deficit and in the intermediate dielectric plate of glass the mobile electrons are strained or displaced from their normal positions in their atoms and this elastic displacement represents a store of potential energy, just as does a stretched or bent steel spring. The condenser is then said to be charged or have energy stored up in it. The energy of that charge is measured by half the product of the charge, reckoned in extra electrons, of one plate and the potential difference or voltage between the two plates.

The reader should note that in electrical phenomena the potential difference of two points is the exact analogue of the temperature difference in thermal or heat phenomena, and of difference of level or pressure in the case of hydraulic effects or flow of water.

In the next place let us suppose that the two metal plates of the condenser are connected by a metal wire. The result is that electrons begin to drift through this wire from the plate which has an excess of them to the plate which has a deficiency of them, and at the same time the electrons in the dielectric or glass plate which are strained or displaced, begin to return to their normal

positions. The return of electrons is, however, not merely by a uni-directional motion.

Suppose that instead of connecting by a wire two conductors having respectively an excess and a deficit of electrons in them, we were connecting by a wide pipe, in which was a tap suddenly opened, two vessels, in one of which there was an excess of air under pressure and in the other a partial vacuum or deficit of air. On opening the tap the air in the full vessel would rush over into the empty one, but owing to the mass or inertia of the air it would at first over-rush and then rush back again and equilibrium of pressure would only be established after a series of to and fro rushes of air each less than the last. These are called aerial oscillations.

In exactly the same manner, if we connect suddenly the two plates of a charged condenser, the electron equilibrium or equality is only established after a series of rapid movements of electrons to and fro in the wire which gradually die away. These are called *electric oscillations* and are in fact brief currents of electricity alternately in one direction and then in the opposite, which decrease at each reversal. This is termed a damped train of electric oscillations. It can be represented by the ordinates or heights of a periodic but decrescent curve, as in Fig 48, in which horizontal distances represent time and vertical distances the current in the connecting wire.

There are then two terms which must be defined as regards the condenser and the connecting wire and these are *capacity* and *inductance*.

If we wished to measure in a certain way the capacity of an airtight vessel we might state it as the weight or quantity of air that the vessel would hold when pumped full up to one atmosphere of pressure or, say, 14½ lbs. per square inch. In the same manner we define the electrical capacity of a condenser as the quantity of electricity it holds when the potential difference of its plates is one volt or one unit.

The exact relation between the quantity of electricity Q or number of excess electrons in the negative plate, the potential or pressure difference V of the plates and the capacity C is expressed by the equation.

$$C = \frac{Q}{V}$$

or numerically, capacity is measured by quantity divided by voltage. The consistent units in which these things are measured are, voltage in volts, quantity in coulombs, and capacity in farads. As, however, the capacity of a condenser of one farad is extremely large, its millionth part, called a *microfarad*, is usually taken as the unit of capacity. We have seen that the quantity called a coulomb is equal to six million billion electrons; so that a condenser has a capacity of one microfarad when, if six billion excess electrons are put on one plate the potential difference of the plates becomes one volt or about 2/3rds of that of the poles of a single dry Leclanché battery cell.

In the next place as regards the wire with which we connect the plates of the condenser. It has two special qualities which can be measured in appropriate units. These are, first, resistance, and secondly, inductance. The electric resistance of a conductor is that quality of it in virtue of which the electric current energy is converted into heat in the wire.

Now this heat consists in part in the energy of irregular motion of the free electrons in the wire, and the electric current is the regular or uni-directional drift or movement of the free electrons in the wire, which is super-imposed on the irregular motion.

As the electrons are struggling along in one direction in the wire under the guidance and pressure of the electromotive force urging them, they are continually bumping up

against the atoms of the metal and against one another and having their own course changed and some of the energy of their drift or regular motion converted into energy of irregular motion or heat.

The greater this irregular motion, that is, the higher the temperature of the wire, the less in general is the effect of the electromotive force in producing a uni-directional drift. This means to say that for a given electromotive force the current is less; in other words, the electrical resistance is greater.

On the other hand, the lower the temperature of the wire the less is the irregular motion of the free electrons and the greater is the uni-directional drift under a given electromotive force. Hence the electric resistance of pure metals is found to decrease with fall of temperature.

The matter is, however, a little more complicated than the above statements imply. We may regard these free electrons in the metal as the molecules of a kind of gas, and as in the case of gas molecules, their irregular velocities are different, some moving fast and some slow. The velocity is distributed in accordance with Maxwell's law for gas molecules and the electrons have a certain mean free path between collisions with each other and with the atoms. It is only during the time of this mean free path that the impressed electromotive force is

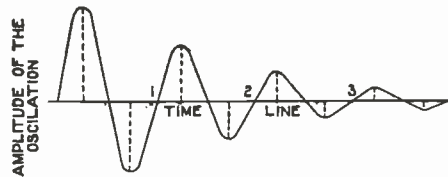

Fig. 48. A Graph or Delineation of a Damped Electric Oscillation.

able to act upon them and impose the drift motion in one direction, which constitutes the electric current.

If we call N the number of electrons per cubic centimeter and u the drift velocity of each parallel to the axis of the wire and X the electric force acting on the electron, then the electric current I per square centimeter is measured by the product NXu . If t is the time between two collisions and m the mass of each electron, then the drift velocity acquired in the free time between two collisions is $\frac{1}{2} X \frac{e}{m} t = u$. Again, if l is the

mean free path and v is the average irregular velocity of the electron, we may take l to be equal to the product vt , and if the drift velocity u is small compared with v , then the current I is given by the equation

$$I = \frac{1}{2} \frac{NXe^2lv}{2mv^2}$$

But mv^2 is twice the kinetic energy of the electron due to the irregular motion.

If we regard these free electrons as forming a kind of gas, then from the kinetic theory of gases we know that the average energy of a gas molecule is proportional to the absolute temperature T , that is, to the temperature measured from the absolute zero, which is 273° below zero centigrade.

Hence, to convert temperatures measured on the centigrade scale into absolute temperatures, we add 273° to them if the centigrade temperature is above zero centigrade viz., the melting point of ice, and if the centigrade temperature is below zero centigrade we subtract it numerically from 273° to obtain the absolute temperature.

Thus +15°C = 288° abs.,
but -180°C = 93° abs.

If then we consider the same holds good for the free electrons, we see from the previous equation that the ratio of electric force

X to current I , which is a measure of the electric resistance of the cubic centimeter of the metal, is proportional to the absolute temperature, and therefore falls with it.

Experiments made in 1893 by the author, in conjunction with Sir James Dewar, showed that in the case of pure metals when cooled in liquid air to about 80° absolute, there was a fall in electric resistance approximately proportional to the decrease in absolute temperature, but other experiments made subsequently by Sir James Dewar with liquid Hydrogen, giving low temperatures, and later on at still lower temperatures by Prof. H. Kamerlingh Onnes of Leyden, in Holland, with liquid Helium at a temperature of about 4° absolute, showed that the resistance of pure metals at very low temperatures does not decrease continually according to the same law. For many metals the electrical resistance tends to a minimum constant value at temperatures near the absolute zero. On the other hand, in the case of certain metals in a state of great purity such as mercury, tin, thallium and lead, the electric resistance at temperatures near 5° absolute suddenly falls from a finite value to a nearly zero value. Thus, in the case of lead at about 7° absolute the resistance very suddenly decreases, and at a temperature of 2.45° absolute its electrical resistance is only 50-millionths of that which it has at 273° absolute, or at 0° centigrade, the melting point of ice. In this condition the metal becomes, as Onnes calls it, a *super-conductor*. In this state very large currents may be passed through the intensely cooled metallic wire without creating in it any heat, because it has little or no resistance.

Moreover, if a powerful magnetic field is made to traverse a ring of lead in the state of super-conductivity and then is withdrawn, an electric current, called an induced current, is generated in the ring which lasts for several hours, whereas at normal temperatures it would not last more than a fraction of a second.

A wire, which is a conductor of electricity, possesses, however, another quality called *inductance*, also due to the properties of these little free electrons which swarm in it. We know that a heavy object such as a motor car or railway train, when once set in motion cannot be instantly stopped. In consequence of its mass (m) and velocity (v) it possesses, as already experienced, kinetic energy measured by $\frac{1}{2}mv^2$. This energy has to be used up in overcoming friction or some resistance, or in doing some form of work before the velocity can be reduced to zero. We have seen also that an electron in motion possesses electric mass, and hence when in motion has a store of kinetic energy.

Accordingly an electric current in a conductor, which is a procession of electrons moving together in one direction, acts as if it were a massive body, and cannot be instantly started or arrested. If i is the current in a conductor at any instant, then the energy stored up by it in the form of an electromagnetic field is measured by the quantity $\frac{1}{2}Li^2$ where L is called the inductance or electric inertia of the circuit.

The current energy depends upon two factors, viz., the current i and the inductance L , just as the kinetic energy of a moving mass depends upon the mass m and the velocity v .

By analogy we can see that if the electric current energy $\frac{1}{2}Li^2$ corresponds to motional energy $\frac{1}{2}mv^2$, then the product Li corresponds to mv or to the momentum of the moving body. The product of inductance L and current i is called the *electric momentum*. Again we have shown that when a mass is set in motion by a force, the latter is measured by the rate at which it produces or destroys momentum. Hence again by analogy, when an electric current is changing, the electromotive force cor-

(Continued on page 2045)

The Saturation Point

By ARMSTRONG PERRY

JUST because the public is not fighting for radio sets and parts as it was a year ago, certain pessimists are beginning to suggest that the saturation point is near. These prophets of the imminent end of things base their predictions perhaps upon the big cities where radio, because of narrow-visioned exploitation, has as yet been little more than a plaything, for the rank and file. They evidently overlook the smaller cities and country districts where the need of radio as a practical utility is beginning to be seen and appreciated.

Even the big cities are no more saturated than a concrete pavement after the passage of a street sprinkler and the country beyond their last street lamps is not even damp. It is time to saturate some territory to the limit and, because less damage has been done in the country than in the city, it might be well to begin with the rural districts.

City folks, because they have movies, theatres, operas, shop windows, passing throngs, and excitement of every kind to take their attention and their time, can throw radio onto the junk pile as soon as they learn that it requires a little more gray matter to get the results they demand than they anticipated. Country folks on the other hand have a continual thirst for contact with the outside world that forbids their casting aside anything that offers even a promise of opportunities such as city dwellers have.

RURAL DISTRICTS READY FOR RADIO

There are difficulties in the way of reaching country people, it is true. The farmer, and the townspeople with whom he trades, do not jump at new things as city people do. The reasons are obvious. A large part of their income is received in products of the soil and not in cash. Because they have less money to spend, they hold onto it a little longer and make sure they really need the things that attract them. Many of them have been imposed upon more or less often by crooks of one type or another. Their gullibility has made them the butt of many a joke, but the joke is really on the rest of us. It is rugged honesty, and unwillingness to think evil of a stranger, that lays them open to fraud and dishonesty. Country life breeds honesty as city congestion breeds crookedness. There is no fun or profit in being a crook if everybody knows it, and where people are few they know each other thoroughly. In country districts houses and barns are often open day and night. The rural mind is in the same condition, normally. But every smooth "city feller" who sells a country customer by misrepresentation or over-persuasion makes it that much harder for anyone to sell him on an honest basis unless the salesman is personally and favorably known to the prospective customer.

The practical mind of the farmer and small town man is another element in the situation. It is shown by what he reads. There are magazines for city folks, selling hundreds of thousands of copies to the issue, that are doped out by dreamers, but look at any rural paper and you find that almost every article is said to be based on the actual experience of somebody. The rural

reader wants to know who tried the stunt and just how it worked. He has no desire for rainbow chasing. He goes at radio in the same practical way he goes at his other activities.

The manufacturer and dealer who expect to accumulate fortunes by quick and easy methods are sometimes satisfied to let the country trade take care of itself. They are the men who jump in when a business is booming as radio was last year and who are found in the list of bankrupts when the boom turns to a dull thud. Business builders know that country trade, though it may be relatively hard to build up, stays up much longer than the air castles of the man who erects his electric sign first and tries to build from that down to the foundations.

COUNTRY TRADE BECOMES CITY TRADE

One reason for building country trade is that a lot of it soon becomes city trade. The flow of population from country to city is rapid and the saturation point of the metropolis is not in sight. Because of their well developed qualities, country bred persons often exert a stronger influence in the city than those who are city

trademarks in radio becoming firmly entrenched in the country mind. "Did you ever use X—'s goods?" a farmer asks. Everything is "goods" in the country, even "bad goods." If I say I have used them, it establishes an immediate bond of fellowship. If not, he wants to show them to me. He could not be persuaded to buy any other kind. But so far, radio sets in the country are few and far between.

ONLY FOUR RADIO OUTFITS IN TOWN OF 3,000

In Florida, I landed in the town of Kissimmee the first of February. Kissimmee is a rural town of but 3,000 population, but in comparison with its surroundings it is as large and certainly as influential as a northern town of 30,000. Its people stay there; only a small percentage of them are tourists or winter colonists. The average Kissimmian has a comfortable home, a car, an orange grove, a garden, and a very good idea of what is going on in the world.

While making some purchases in a dry goods store the first day, I inquired for a radio shop.

"There is none here," the proprietor answered. "I have sold and installed all the radio sets used in our town."

"How many are there?" I asked.

"Four," he replied.

Figured on the usual basis of five persons per family, this is only one radio set to 150 families. I asked why there was not more interest in radio. The answer was that the people did not know how much profit and enjoyment they could get out of it. What was needed was to get them to give it a trial, but he, with the largest department store in town to look after, could not give radio the necessary time and attention.

A FARMER'S SUCCESS WITH RADIO

His argument was sustained by the experience of a poultry farmer with whom I spent an evening a little

later. He had read about radio when it first became a craze and had kept on reading until the fall of 1922, by which time he had a table piled high with radio magazines. By that time he had developed a plan that fitted his conditions. Avoiding fads and untried innovations, he purchased a tube, socket, rheostat, batteries, grid leak and condenser, variocoupler, variable condenser and two pairs of phones, all with good trade-marks. He went out into the woods and cut two 60-foot poles, fitted them, and erected them a hundred feet apart with an antenna well insulated and at right angles to the nearest wires. He built a neat cabinet, and a shelf for the "A" battery. In the cabinet he installed his apparatus, following directions found in a magazine.

The demonstration he gave me was better than most that I have heard in the cities, but he apologized for it. The battery was low, the tube seemed to have hardened, and the results were not as good as usual, he said. He brought in Atlanta, Fort Worth and Havana clearly. He showed me his log as evidence that he had heard western stations as far out as Denver, eastern stations as far as Rhode Island, and a total of more than sixty stations.

He had not been blighted by that type of
(Continued on page 2006)

MR. PERRY in this article takes the radio industry to task for its inability to sell more goods than it does at the present time.

There are 20,000,000 automobiles in the United States, while it is estimated that there are 2,000,000 radio outfits. This is a pretty high estimate. Now the average price of an automobile is anywhere from 10 to 15 times higher than that of a radio outfit, so, instead of having 2,000,000 radio outfits in the United States, there should be, in reality, at least 30,000,000 to 40,000,000.

In other words, we have not scratched the surface. The greatest market, as we have pointed out editorially before, is the rural market, and this has not been touched!

Also, as Mr. Perry explains, no effort is being made to sell the radio idea to the women. Why is it that, out of 1,000 homes where radio outfits are installed, not more than two outfits can be operated by the female members of the household! On the other hand, many women drive automobiles, a mechanical device infinitely more complicated than a radio outfit.

Where is the genius who will remedy these conditions? Read Mr. Perry's article, and think it over.—Editor.

born. They come to fill a large proportion of the positions of responsibility and become nuclei of circles of substantial friends.

A trade name and reputation, once firmly established in the country districts, is as good an asset as the finest plant that can be erected to manufacture the product that bears the name.

A few weeks ago an aged woman, country bred, asked me to get her a bottle of a remedy she had used for forty years for curing colds. I visited thirty New York drug stores, called up two of the largest wholesale houses in the city and wrote to two manufacturers. None of them had it. Knowing the fendish efficiency of the modern chemical laboratory in stealing formulas I felt justified in saying to the lady that I could get her something exactly the same. The imitations may have had everything else, but they certainly lacked the patient's confidence. I went to Washington and searched the drug stores there. Two clerks who knew the article said that the manufacturers had gone out of business. There was not a bottle of it in sight. Eventually I located three bottles in a country drug store several hundred miles from New York and the cold was cured.

This is not an extreme case and it illustrates the radio situation as well as the medicine business. Already I find certain good

The Radio Doctor—A New Profession

Services of a man who knows his business and can carry on work in a professional manner greatly in demand

By JAMES ASHTON GREIG, B.S.E.E.*

WHILE great progress has been made in the design of radio receiving sets during the past year or two, no well informed radio engineer would attempt to dispute the fact that the apparatus, as a whole, is still a complicated piece of delicate machinery which, in the hands of a novice, is subject to frequent and serious failure.

Indeed, if the writer's experience can be taken as a reflection of general conditions, such troubles are by no means limited to the field of the novice, but may be found almost anywhere.

One of the safest things for the novice to do, when he is in trouble, is to call in the nearest licensed amateur, for he will usually find that the amateur can quickly locate and correct the matter. While paying my respects to the average amateur's knowledge of radio, however, I cannot say very much for his professional manner, and this in the case of the "radio doctor" is a prime requisite.

The average amateur is generally a likable "kid," but when he enters the house of a novice in trouble and starts twirling the knobs of his receiving apparatus, at the same time talking about "oscillations" and "wave decrement," and using a lot of other technical terms, he is bound to leave the wrong kind of impression behind him.

Your novice usually appreciates talking to a man who comports himself with dignity and takes his business seriously. For the services of such a man there is a distinct and increasing demand.

During the past three or four months hardly a night has passed when I have not been called out in a professional capacity to the homes of two or three novices who are having trouble with their sets and it may be interesting to others to know how I built up this demand for my services.

My first call came from a doctor who lives about two blocks away. He stated that his signals were so faint he could hardly hear them; he had tried every remedy he knew, but without success and would like me to come over to find out what was wrong. When I asked him how he had learned about me he stated that it was through a local newspaper contest in which my name had been mentioned as taking the prize for long distance reception.

Not knowing just what his trouble might be, I had the forethought to take along a battery and a lamp so that I might test for short circuits. When I arrived at his house, I found the parlor quite crowded with guests whom he had invited over to witness his reception of long distant stations. One can easily imagine his chagrin, under these circumstances, on finding that his set was out of order.

His receiving apparatus was quite the most beautiful I had ever laid eyes on. He said that he had paid over \$500 for the complete equipment, and I could readily believe him when I looked it over.

Instead of starting to work on the controls, I first asked him the history of the trouble and from the impression this created

I have continued the practice ever since. He was just itching to tell me his "symptoms," like the fellow who is sick wants to do with his doctor; I let him go as far as he liked. After he was through I asked him a few definite questions. What was he using as an aerial? How was his ground connection made? Had he gone over the connections on his set? To this last question he replied in the negative, so I quickly took out my short circuit tester and started to work.

It was not more than five minutes before I located a broken connection on his variocoupler and quickly repaired it. Mind you, during this time I had not laid a finger on any of his dials nor attempted to operate the set. When I had repaired the broken connection I simply said, "Try it now, doctor." He went to the controls and soon found his set working to perfection. As I left he asked me what my charges would be. When I replied that I was very glad to be of some service and that there would be no charges he was visibly disturbed, and right there I learned that most persons prefer not to be under obligations of this character and that

up a list of the troubles I have encountered, as follows:

Broken or bad connections.....	25	per cent
"B" battery defects and troubles	21	"
Incorrect wiring	18	"
Tube defects	4	"
Faulty parts	12	"
Wrong assembly	6	"
Antenna and ground defects....	14	"

The troubles in broken and bad connections, including short circuits, are always the first things to look for. The fact that the circuit is "open" at some point can be very easily and quickly established by a lamp or buzzer test and with a little experiment can be localized to some particular part of the set. Fortunately, troubles of this sort are usually found at some accessible point in the circuit. Rarely, if ever, do they occur in the windings of transformers or inductance coils. If definitely located in one of these latter, I think the best practice is to recommend the purchase of a new piece rather than try to repair the old except perhaps in some temporary fashion.

One of the most peculiar cases of this kind of trouble that I ever came in contact with was on a set where the set screw on the variable condenser dial made contact with a metal projection on the operator's table and rendered the set completely out of order when the contact occurred. Frequently I have discovered short circuits due to the collection of dust on filament rheostats which, when carefully cleaned, were again as good as new.

Sometimes bad contact is easily confused with "B" battery troubles as for instance when the spring contact of the plate circuit in the detector tube socket is of insufficient tension.

On account of the high frequency character of the currents passing these points, a certain amount of current will "leak over" from the spring contact to the tube even when there is an actual air separation between. The noise of this leak closely resembles a run down "B" battery.

Undoubtedly the most baffling of all troubles are those which we ascribe to our "B" batteries, which are blamed for everything from static to transformer hums, and in my experience they very rarely have proved to be the real culprits.

An excellent practice is to disconnect and separately test the condition of each "B" battery before subjecting them to unwarranted condemnation. The "crackling," "scraping" and "whistling" which are so often attributed to faulty "B" batteries may be due to a number of different causes. It may, as stated previously, be due to static, though this is quickly recognized by an experienced operator. It may be due to reversed "A" battery leads. It sometimes occurs when tubes are operated above their rated capacity from the disintegration of the filaments.

A discharged "A" battery, an incorrectly wired plate connection, parallel connected binding post leads, a dusty condenser, a loose connection, and a good many other things may be the real causes we are looking for.

Incorrect wiring is most frequently found in a set which the novice has attempted to build at home. If only one or two connections are wrong I usually make it a practice

(Continued on page 2050)

IN this article, Mr. Grieg points out facts which have great possibilities for us amateurs. At last, the time has come when we can make our radio knowledge pay for itself. We suggest that all the amateurs who know the game, read this article as we feel sure they will be able to help some broadcast listeners who are having trouble with their outfits and thereby make enough money to buy that new tube with which to make more DX. Not only will this bring profit but also recognition of the amateurs as a special body of trained radio men. This should be of great importance to us from the standpoint which has been explained thoroughly in our recent prize contest "Who Will Save the Amateur?" We shall be glad to hear from amateurs who have been able to improve their stations by doctoring sick sets.

a charge for services rendered will make more friends for you than the other method.

My charge is \$2.00 per call, regardless of the character of the work. Of course, very few cases are as simple as the one just described, but after a little experience a fellow soon gets so that he can tackle most any trouble with confidence and if he is careful and conscientious his reputation spreads very quickly. Classified, the cases that I have worked upon stack up about as follows:
Sets completely out of order, 34 per cent
Sets in bad working order...42 "
Sets unsatisfactory as to design, 16 "
Recommendations as to sets and appliances 8 "

The first classification is self explanatory. In the second classification I put all such troubles as bad wiring, battery fault, tube faults, broken connections and a host of other difficulties which annoy but do not prevent operation of the set. In the third classification I place all troubles due to incorrect design, such as interference, dying signals, humming and other noises due to improper placement of the parts. The fourth classification is sufficiently described above.

A peculiar thing about the work is that one hardly ever has exactly the same kind of trouble to deal with. They may be grouped together under broad classifications, but in each case there will be some different conditions to contend with, however slight. For the purposes of analysis I have made

*Formerly radio engineer with the Marconi Wireless Telegraph Co. of America.

Awards of the \$500.00 Prize Contest

Who Will Save the Radio Amateur?

By ERNEST G. UNDERWOOD

First Honorable Mention

THE answer to this question seems to be at the present time, causing no little amount of anxiety to many radio amateurs.

Some see in the near future complete oblivion for the amateur; others, more optimistic, see the danger ahead, but without undue alarm, counsel caution about flaunting the inherent rights and privileged character of the Government Licensed Amateur transmitting stations before the eyes of a public that is bent primarily upon receiving radio broadcast concerts, and receiving these concerts without the interference of amateur transmitters.

The Great War brought the American amateur into the public eye—temporarily—as nothing else ever had. However, all such waves of publicity gradually die out, and the service that the radio amateur rendered the Army and Navy during the war is being forgotten, especially when the same amateur by chance interferes with the reception of a concert.

We amateurs cannot expect the general public to enter into the reception of broadcast concerts with the enthusiasm with which we entered into the amateur game. Consequently, we must not expect the average man who wishes to listen to the broadcast programs, to put a couple of hundred dollars into equipment, when he can secure apparatus that will meet his requirement for \$65 or \$70.

There is no question in the mind of anyone at all familiar with the receiving apparatus that the average receiver used by the general public is of such construction as to permit the reception of signals from zero to infinity without any appreciable difference at any point on the receiver.

With this kind of equipment being in use in ninety per cent of the broadcast receiving stations, it is not surprising to hear rumors of the drastic action that is to be taken to eradicate the amateur nuisance.

When on top of this comes the prediction of a well known radio authority that there will be 2,000,000 broadcast listeners by 1925, and 20,000,000 by the end of 1927, it is plainly evident that the amateur who wishes to retain his right to transmit must watch his step!

Now, personally, I can see only one solution to this problem, and I am sure that I am not the only one who looks at the situation in this manner: the amateur of today is not the free lance of the air that he was in 1915. The amateur of today MUST sacrifice in order to maintain his present status. In the large cities where the regular broadcast stations furnish everything in the nature of news and reports, from stock and market quotations to setting up exercises, it is plainly evident that the only thing for the amateur to do is to KEEP STILL, and REFRAIN FROM USING HIS TRANSMITTER UNTIL

SUCH TIME AS THE LOCAL BROADCAST SCHEDULES ARE COMPLETED, THEN, AND THEN ONLY, SHOULD HE USE HIS TRANSMITTER.

In the outlying communities where broadcast stations are located at a great distance, the amateurs in the vicinity should cooperate with the editor of the town paper and arrange to furnish him with the market and stock reports, weather forecasts, and other interesting information. This information is usually too expensive for the average town paper to secure by leased wire service, and when obtained from the local amateur stations, would not only be appreciated by the editor of the paper, but would be an obligation that the editor would be more than willing to discharge by means of the publicity offered through the columns of his paper. It can be readily seen that the publicity gained by rendering a service to the town paper would immediately place the amateur in the position as an asset to the community rather than a nuisance.

Therefore, the answer to the question asked at the beginning of this article would seem to be: The amateur and the amateur only can work out his own destiny; cooperation where cooperation is needed; service where service is wanted; and a generous attitude towards those who wish to enjoy themselves at the expense of a part of the time previously used for "chewing the rag."

Saving the Radio Fan

By AN OLD TIMER

Second Honorable Mention

WITH mingled feelings, I read Mr. Armstrong Perry's exposé of the American Amateur. In turn, my amateur blood, and then my radio fan feelings surged forth, and I was finding myself fighting with myself.

Yes, I am a radio amateur. I believe I can lay claim to the title without impunity, and without fear of inviting from other members of the radio fraternity perpetual doom and curses. I have a good receiving and transmitting station, and have been continuously licensed for the past eight years, and even joined two radio clubs.

On top of that, I am a radio fan. I confess that, occasionally, I slip up on 360 and 400 meters, where all broadcasting lets loose, and I listen quite frequently to really good musical selections. I find that this is a little bit of well-earned recreation after a few hours at the key.

Now that those things have been said, I think that I can have a few words with Mr. Perry himself, about his article, on which the whole fight started. You see, there are several things which he has said, which even a radio fan like myself couldn't pass up without comment.

For instance, I do not like his definition of an "amateur," as given in his first paragraph, and I know that many others do not either. A man doesn't have to belong to "a national non-commercial organization" to be a radio amateur. Someone will have to come out with a better definition than that before I shall subscribe to it.

On the other hand, I admire Mr. Perry's views in the next paragraphs. The one in which he states that Government officials

chuckled when wave-lengths were passed around to the first amateurs, is actually funny.

It shows that some officials have a sense of humor, anyhow. And the eulogy to the 4,000-odd radio amateur operators who formed the backbone of the U. S. Army and Navy radio communication systems during the war is very well done. Too much cannot be said about it, and I can personally appreciate it: I served nearly two years on one of Uncle Sam's battle-wagons. Mr. Perry is right in what he says, but he does take an awful lot for granted in that short paragraph. Wonder if he tried some war-time radio?

However, that is neither here nor there.

The big point comes in Mr. Perry's next paragraph, in which the keynote of his whole 2,500 words are summed up. He says: "And now arises a situation which *apparently* means death to amateur radio as it has been!" (The italics and the exclamation point are mine.)

Now this statement would be extremely interesting had not Mr. Perry advisedly used that word "apparently" in that prophetic (?) sentence. I'll bet my new syncrackers gap against his three-phase rotary condenser that he knew that that would come about!

And what he says about listening in to a distant station, and getting an earful of phonograph records, health talks, music, speeches, and other bunk positively arouses my radio fan feelings. Radio fans do know how to tune their sets, and discriminate between stations. I wonder if Mr. Perry has a receiving set?

Again, my amateur feelings are flattered at the news in the next paragraph. As an amateur, my vanity is pleased when I learn that I am placed in the "fighting" class. Yes, I *can* fight, and so can nearly 500,000 others like myself. And what he says about the "League" is true, every word of it. The "League" *can* fight, and is organized, as many of us have learned. But be it understood, I am not a "League" member. I can't say that I endorse all of their policies, but they've been mighty decent to radio fans, and I'm a radio fan.

His allusions to the powers (assumed "political") down at Washington, where they will want to put the lid on the amateur is rather far-fetched. They may have apparent powers, but what will these amount to, if they can't produce any better results than those obtained in having the Prohibition Law reversed? Eh, I ask you that?

Now, it was very kind and nice of Mr. Perry to credit the radio amateur with starting this radio industry, and giving the manufacturers a living. Yes, Murdock, Clapp-Eastham, General Radio, Grebe, Duck and many others were here long before the radio fan, and amateurs liked them pretty well, too. But the radio fan in me wants to know why you don't give him some credit, too? Many shirt and pants, and button-hole makers spoiled a perfectly good radio market by making fortunes on us poor fans, who didn't know a grid that leaked from a cracked insulator.

Now, Mr. Perry, it is the radio amateur, the man who knows, who is setting us

(Continued on page 1982)

Controlling Models By Radio

By MAJOR RAYMOND PHILLIPS, I. O. M.

Part IV

SERIES-WOUND MOTOR

AS many wireless enthusiasts have on various occasions asked me to describe a scheme for controlling a series-wound model electric motor, a skeleton plan, Fig. 4 shows a method of connecting such a motor to the selector already described, and comprises a battery A, series-wound model electric motor B, drum C, with contacts D, D1, D2, and E, E1, E2.

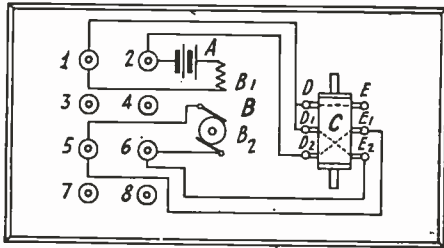

Fig. 4

Layout of Circuit Showing the Method of Connecting a Series Wound Motor to the Selector Already Described

In operation it will be observed that electric current from the battery A would traverse the field magnet winding B1, thence to terminal No. 1, and contacts D1, E2, and terminal No. 6 through the windings of armature with commutator B2 to terminal No. 5, thence to contacts E1, D2, and finally to battery A, thus causing the armature with commutator B2 to revolve in the usual manner.

REVERSING THE CURRENT

It will be noted that electric current can be caused to flow in a reverse direction in the windings of armature B2, by revolving the drum C until contact D1 is connected with E1, and contact D2 connected with contact E2.

The polarity of the current traversing the field magnet winding B1 would, however, remain unaltered, so that the armature with commutator B2 would revolve in a reverse direction to that previously described.

The skeleton plan Fig. 4 shows a scheme for controlling a series-wound motor. Model electric locomotives are invariably fitted with either a series-wound motor or a permanent field magnet type.

Many wireless enthusiasts have asked me to describe a method of controlling a shunt-wound electric motor.

I furnished a diagram showing a scheme for controlling four such motors. I should, however, advise beginners to confine their energies to constructing apparatus for the wireless control of one electric motor before attempting complicated feats.

SHUNT-WOUND MOTORS

I had, perhaps, better explain that the term shunt-wound (as applied to electric motors) simply means that the field magnet winding is connected in parallel with the armature windings, but the resistance of the field magnet winding of such a motor is so high that only a small amount of electric current passes through same.

A skeleton plan, Fig. 5, shows a method of connecting a model shunt-wound electric motor to the selector (described in my previous articles), and consists of a battery A, shunt-wound electric motor B (with field magnet winding B1, and armature with commutator B2), drum C, contacts D, D1, D2 and E, E1, E2.

In operation it will be observed that electric current from the battery A would pass through contacts D, D1, E, and E2,

thence to terminals Nos. 6 and 8, through armature windings and commutator B2, also field magnet winding B1 to terminals Nos. 2 and 5 respectively. From terminal No. 5 the electric current would flow through contacts E1 and D2, thence to battery A, and being connected with terminal No. 2 forms a common return from the field magnet winding B1.

The armature with commutator B2 would thus revolve in the usual manner, but it will be apparent that by revolving the drum C until contact D1 is connected with contact E1, and contact D2 connected with contact E2, electric current would be caused to flow in a reverse direction in the windings of armature B2.

The polarity of the current traversing the field magnet winding B1 would remain unaltered, so that the armature with commutator B2 would revolve in a reverse direction to that already described.

Fig. 6 shows a model shunt-wound electric motor which clearly shows the field magnet and armature windings connected in parallel.

THE COHERER

A coherer is generally classified as an imperfect contact detector, and was used for detecting wireless telegraph signals in the early days of radio-telegraphy. Although now obsolete for that purpose, it still has many advantages for controlling mechanism at short distances.

A coherer consists of a non-conducting tube (suitably mounted) containing contacts upon which rest metallic filings. The latter offer a high resistance to the passage of an electric current, but the arrival of an incident wireless wave causes such filings to

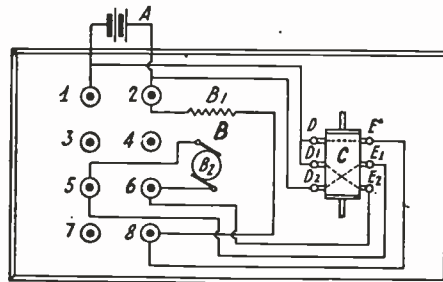

Fig. 5

Showing How a Shunt-Wound Motor Would Be Connected to the Selector.

short-circuit the contacts, and so close a local circuit connected with same.

The operation of shaking the filings (called de-cohering) restores their resistance, and so opens the local circuit previously referred to.

Many years ago experiments were conducted with various types of "self-restoring" imperfect contact detectors, but the latter appeared to need such extremely fine adjustment that at the time a coherer with "tapping" device (the latter for shaking up the filings in a coherer) was generally used.

For controlling models by wireless the simplest, but at the same time most efficient, form of coherer should be installed in the "receiving" apparatus.

A simple form of coherer can be constructed as shown in Fig. 7. It consists of a glass tube, A (1½" long by ⅜" inside diameter), with two brass plugs B, C and rods B1, C1 attached. The latter may be passed through small holes cut in corks D and D1.

The corks may also form plugs for seal-

ing the ends of the glass tube A. A space of ⅛" should be left between the brass plugs B, C, and should be half filled with nickel filings. The latter can be made by filing a piece of nickel and collecting such filings on a sheet of clean paper.

COMPARISON BY RESULTS

The efficient working of a coherer will be seriously impaired if the filings contained therein are touched by an operator's

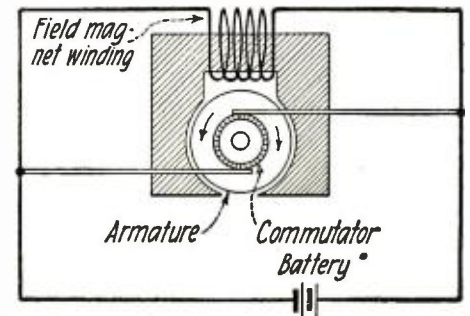

Fig. 6

A Shunt-Wound Motor. The Diagram Clearly Shows the Field Magnet and Armature Windings Connected in Parallel

hands, as the latter (due to perspiration and other natural causes) would coat the filings in question with a film of grease, thus producing obvious deleterious effects.

The coherer as shown in Fig. 7 can be mounted in a "horizontal" position, in any suitable manner upon an insulated base, and it functions satisfactorily if properly adjusted, but its large contact surfaces might sometimes tend to make it sluggish in "de-cohering."

VERTICAL TYPES

Such a defect would be a source of annoyance if a coherer controlled a circuit connected with a relay, on account of its tendency to cause the latter to intermittently operate other apparatus which might be connected with same. For instance, the resultant effect upon a model electric train (as described in previous articles) would be to cause the electric locomotive to function in an erratic manner.

If such a defect had become apparent in the receiving apparatus attached to my well-known wireless-controlled airship, it can be better imagined than described what the effect would have been when the craft in question floated over the heads of ladies and gentlemen seated in the auditorium of a theatre, more especially in such large halls as the London Coliseum or London Hippodrome.

It is, of course, possible to construct a more elaborate "horizontal" type of coherer to that shown in Fig. 7, but, after conducting various and numerous experiments, I formed the opinion that a "vertical" type

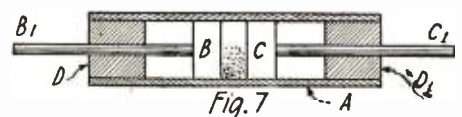

A Horizontal Type of Coherer.

of coherer proved more reliable for controlling my apparatus. Fig. 8 shows a simple "vertical" type of coherer which was used with great success in connection with my early experiments, and has proved quite satisfactory for controlling models by wireless.

A VERTICAL COHERER

It consists of a wooden base A, brass support B with clamping screw C, coherer D with glass tube D1, cork plug D2, brass cap D3, vulcanized fibre bush D4, and supporting rod E, contact spring F, terminal screws G and H.

The wooden base A can be made of white pine (shellac varnished or French polished) 8" long by 4" wide by 1/2" or 5/8" thick.

The brass support B can be circular in form; the flange at the base being 1" diam-

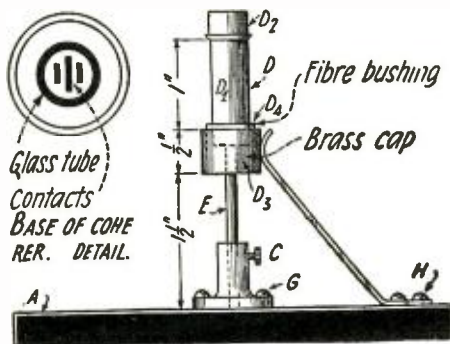

Fig. 8

The Vertical Type of Coherer Which Has Proved Superior to the Horizontal Type

eter by 1/8" thick. The "shank" can be 1/8" diameter, while the total height of the support can be 3/4". The brass "cheese head" clamping screw C can be 3/8" long by 1/8" diameter.

The coherer supporting rod E should be made of No. 14 gauge hard drawn brass wire 1 1/2" long, and one end of the rod should be screw-threaded to engage with a similar screw-threaded hole in the vulcanized fibre bush D4.

The glass tube D1 should be approximately 1 1/4" long by 1/8" outside diameter, and inserted in the vulcanized fibre bush D4, as shown previously. The glass tube may be secured to the fibre bush with "secotone," or other suitable cement. If desired the glass tube D1 may be dispensed with, and the fibre bush D4 made 1 1/4" long, and bored out, so that the cork plug D2 can be used for sealing the end of the bored-out portion of the bush. The glass tube D1 is handy for the purpose of inspecting the filings contained therein, but the coherer will function equally well without it if made in the manner described.

The brass cap D3 should be made of brass tube 1/2" outside diameter, and should fit tightly over the vulcanized fibre bush D4 as shown.

The contact spring F should be made of No. 24 gauge spring brass 1/2" wide and bent as shown.

THE FILINGS

The contacts in the base of the coherer should be made of No. 25 gauge hard drawn brass wire, and passed through holes drilled in the vulcanized fibre bush as shown in Fig. 8. The sum of the total length of the two outer contacts should equal the length of the center contact. The latter should (by soldering) be connected to the brass supporting rod E, while the former should be connected to the brass cap D3.

When the coherer is completed as described sufficient nickel filings (made as previously referred to in this article) should be placed in the glass tube D1, so that the contacts in the base of the coherer are completely covered.

DE-COHERING

I will furnish a complete wiring diagram of the whole "receiving" apparatus, when it will be observed that an incident wireless wave would have the effect of "short circuiting" the contacts of the coherer in question, thus closing a circuit connected with a relay.

I explained that the operation of shaking the filings in a coherer causes same to "de-cohere," or, in other words, restores their initial resistance to the passage of an electric current.

An ordinary electric bell movement (minus the bell, or gong) makes a suitable piece of apparatus for effecting the "tapping" of a coherer, and thus "shaking up" the filings contained therein, as and when required.

THE NEW COHERER

An ordinary electric bell (fitted with a 2 1/2" bell) can be purchased at a small cost, and the movement consisting of an electromagnet with armature, also hammer, should be removed from the bell-base board, and suitably mounted upon the wooden base A (Fig. 8) in such a manner that when the electric bell movement in question is caused to function its hammer should strike the brass cap D3 fitted to the coherer D at a point opposite the contact spring F.

I am not furnishing constructional details of my latest and very reliable type of coherer, as readers will understand that its present efficiency has only been attained after a considerable amount of experimental work in connection with metal contents and mixtures of filings.

The baseboard in question can be made of which pine 15" long by 12" wide by 5/8" thick, and should be shellac varnished or French polished.

A lath 12" long by 3" wide by 5/8" thick should be secured at each end of the baseboard to prevent the latter warping, and at the same time improve its appearance.

A small box or receptacle should also be provided to accommodate a 3 1/2-volt pocket-lamp battery. The latter will furnish current for the coherer circuit.

The coherer, with de-cohering device, relay, and selector, can be mounted upon the baseboard as shown in Fig. 9. Six large terminals—A, B, C, D, E, and F—should also be fitted as shown.

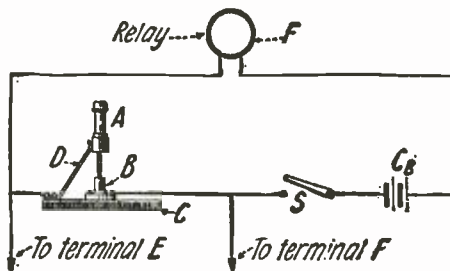

Fig. 10

Diagram of the Connections Between the Coherer Relay and Antenna System.

THE AERIAL TUBES

It will be observed that terminals E and F are for supporting metallic tubes G, G1 (brass, copper, or aluminum), each 2' 6" long by 1/8" outside diameter. The latter represent an aerial for receiving transmitted wireless waves.

It is advisable for the metallic tubes G and G1 to be at least 6" from the baseboard. This can be effected by connecting the terminals E and F to a length of screw-threaded brass rod 1/8" diameter, and passing the latter through a length of ebonite or vulcanized fibre tube 1/2" outside diameter. The screwed brass rod can be secured by means of nuts and washers under the baseboard in such a manner that the lengths of ebonite or vulcanized fibre tube will rest on washers H and H1 (made of similar material), thus producing a neat appearance.

A miniature flanged lamp holder (which can be purchased for 6d. from practically any dealer in electrical material), also coherer circuit switch can be mounted upon the baseboard as shown at K and L respectively (Fig. 9).

The whole of the apparatus comprising the receiver is now ready for connecting up.

When the receiver is completed it will be found that on connecting terminals A and B (Fig. 9) with the terminals of a 4-volt storage battery, and terminals C and D with the "conductor" and "outer" rails respectively of a model electric railway, it will be possible to control at will a model electric train (the locomotive being fitted with a permanent magnet type of electric motor) by means of wireless waves radiated from the transmitter.

Fig. 10 shows a wiring diagram of connections between the coherer, relay, and antenna of the wireless receiver in question.

It will be observed that on the coherer A

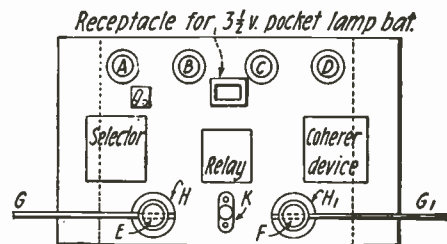

Fig. 9

Showing the General Layout of Apparatus on the Baseboard.

detecting a wireless wave, and the switch S being closed, current will flow from the coherer battery CB (an ordinary 3 1/2-volt pocket-lamp battery) through coherer A, contact spring D and the winding of relay F thence returning to battery CB.

It will be further observed that the contact spring D and coherer base B are respectively connected to contacts E and F (Fig. 9), thus providing (through the coherer A) a circuit or path for an oscillatory current such as would be received from a wireless transmitter as previously described.

The circuits as shown in Fig. 10 are extremely simple, and it will be apparent that in connection with the wireless control of models, detecting a wireless wave and the consequent functioning of a relay only involves one step in what might be (according to requirements) a complicated series of operations.

I explained before that an incident wireless wave would have the effect of short-circuiting the contacts and filings contained in a coherer, but that if such filings were shaken up the resistance of the coherer contacts would be restored to normal, thus "opening" a circuit connected with same.

On referring to Fig. 10 it will be apparent that the function of a coherer is somewhat similar to that of an ordinary press button, in that it opens or closes a circuit as desired.

FINAL CONNECTIONS

Having regard to the function of a coherer, it will be obvious that a "tapping" device should be so arranged that the filings contained in a coherer will not be shaken up until such time as a selector has completed its cycle of operations.

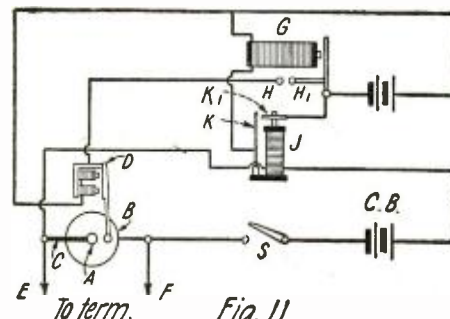

Fig. 11

This Designates the Connections Between the Antenna, Coherer, De-cohering Device, Relay and Selector.

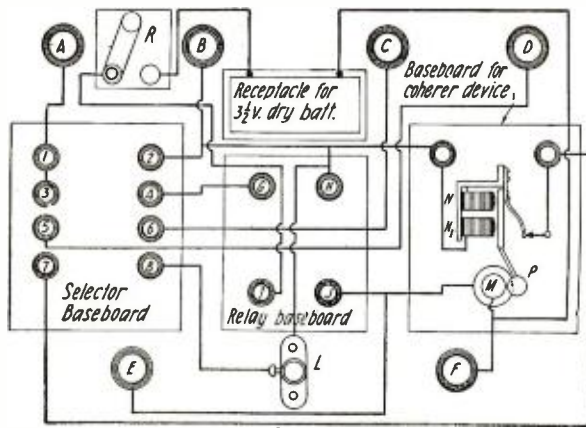
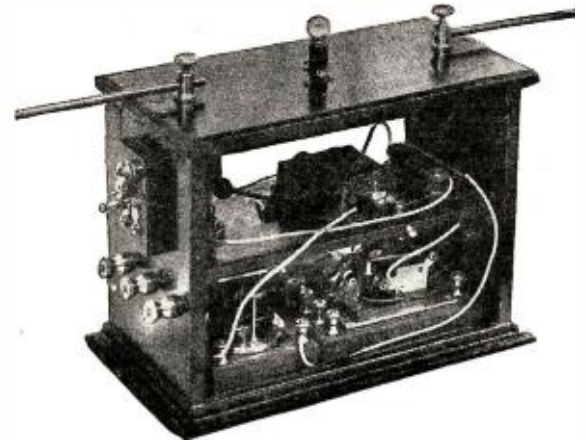

Fig. 12



Left: Showing the Connections of the Instruments Mounted on the Baseboard. Above: The Relay. Right: Photo of the Complete Receiver.



For that reason the contacts J and J1 are arranged in such a manner that the armature D (of the selector) practically completes its stroke before the contacts in question admit current to a de-cohering device, or tapper.

Fig. 11 shows a wiring diagram of connections between the antenna, coherer, de-cohering device or tapper, relay, and selector. The circuit shown in Fig. 10 is included in this diagram.

It will be observed that on the coherer A detecting a wireless wave, and the switch S being closed, current from the coherer circuit battery C B will flow through the windings of relay J, causing the latter to attract its armature K, thus closing contact K1, and admitting current from the relay battery R B to the windings of the selector electro-magnet G, causing the latter to attract its armature L, and close contacts H and H1, thus admitting current from the relay battery R B to the de-cohering device or tapper D.

The latter will strike the coherer A (somewhat similar to the action of an electric bell) and shake up the filings contained therein, thus opening the circuit connected with the relay J, causing the latter to release its armature and cut off electric current from the selector electro-magnet G, and releasing armature L, which will cause the selector drum to move a step forward.

The relay battery R B is a 4-volt storage battery connected to terminals A and B (Fig. 9), as previously referred to. In the complete wiring diagram to be furnished, the simplicity of all the circuits described will be apparent, more particularly to those who have carefully studied all the diagrams previously furnished.

Quite apart from controlling model electric trains by wireless, it will be found that the wireless receiver in question can be used for numerous other experiments.

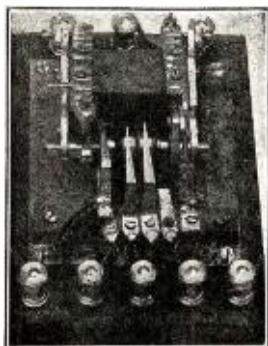

The Selector Relay Used in Conjunction with the Rotary Selector Drum.

When the coherer, with de-cohering device, relay, selector, etc., are mounted upon a baseboard as shown in Fig. 9, the various instruments can be connected up, as shown in Fig. 12.

The connections can be made with No. 18 gauge double-cotton-covered copper instrument wire.

It will be apparent that where junctions of wires are shown, these may be effected by twisting such wires together, and securing them by the terminal involved. On referring to Fig. 12, it will be observed that terminals A and B are for connecting to the terminals of a 4-volt storage battery.

Terminals C and D are for connecting to the conductor, and outer rails of a model electric railway.

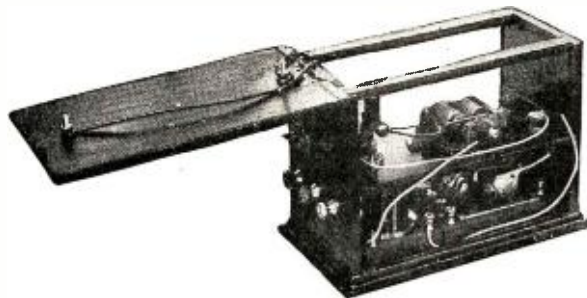

A Better View of the Complete Receiver is Obtained from the Picture Above. The Rotary Selector Drum in its Completed Form is Also Shown.

Terminals E and F are supports for metallic tubes (the antenna), as shown in Fig. 9.

Terminals G and H shown in Fig. 12 are connected with the contacts of the relay while terminals I and J are connected with the windings of the electro-magnet of such relay as previously described.

The selector terminals are marked 1 to 8 respectively. The coherer M (with base), shown in Fig. 12, is mounted in such a manner that when the de-cohering device N and N1 functions, the hammer P strikes the coherer, thus shaking up the nickel filings contained therein.

It will be observed that the de-cohering device is somewhat similar to the movement of an ordinary trembling type of electric bell. In Fig. 11 I showed the device connected up similar to a single stroke type of electric bell.

I have shown the two types in case any amateurs may wish to try experiments. I am of opinion that the trembling type of de-cohering device will be found more re-

liable for apparatus controlling models by wireless. The coherer circuit switch R as shown in Fig. 12 is an inexpensive one-way type such as is used in connection with electric bell circuits.

FINAL ADJUSTMENTS

The 3½-volt dry battery is simply one of a type used for pocket lamps. It will be advisable to fit small terminals to the brass strips attached respectively to the positive and negative poles of the battery in question, so that the terminal wires of the coherer circuit can be connected to, or disconnected from the battery terminals as desired.

A miniature 4-volt electric lamp should be fitted to the miniature lamp-holder L shown in Fig. 12.

Assuming the complete wireless receiver has been connected up as shown in Fig. 12, it will now be ready for testing.

The terminals A and B can be connected by means of a short length of insulator copper wire (No. 16 or 18 gauge double-cotton-covered copper wire will do) to the terminals of a 4-volt (40 ampere-hour capacity) storage battery, and the terminals C and D connected respectively to the conductor and outer rails of a model electric railway as previously described.

On closing the coherer circuit switch R the selector will probably function. There is nothing to be alarmed at if such a thing happens; but, if the functioning continues; it indicates that the coherer M is too sensitive. To reduce its sensitiveness, it will only be necessary to remove some of the nickel filings contained therein.

It may also be necessary to increase the tension of the balance spring H of the relay.

TESTING

When the complete receiver is properly adjusted, it will be found that by functioning the transmitter the selector and other component parts of the "receiver" will also



The De-cohering Device in Its Finished Appearance

function, and the miniature electric lamp fitted to the lamp-holder as shown in Fig. 12 will light up each time the contact-pins fitted in the selector drum make contact with the spring brass contacts.

(Continued on page 2052)

R. F. Measurements With the C. W. Oscillator

By L. R. FELDER

Part III

THUS far we have taken up the measurement of inductance, capacity and resistance by means of the C. W. oscillator described in the January issue of RADIO NEWS. There remain to be considered a group of miscellaneous measurements such as mutual inductance coupling coefficients, distributed capacity; and the discussion of certain other important uses of the C.W. oscillator, such as calibration of receivers, transmitters, determining the wave-length of received signals or of a distant transmitting station, studying the characteristics of coupled circuit sets, and finally its use as external heterodyne in the reception of C. W. signals. These miscellaneous uses will be taken up in this article.

I. Measurement of Mutual Inductances. When two coils whose inductions are L_1 and L_2 are connected to each other in

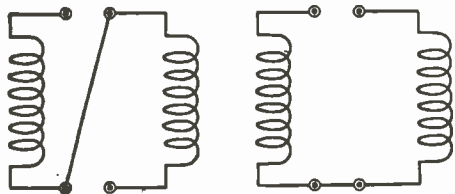

Fig. 1

Left: Coils Connected so That Fields Assist, Turns Going in Same Direction.
Right: Coils Connected so That the Fields Oppose, Turns Going in Opposite Direction.

series (see Fig. 1) the resultant total inductance is not given by the sum of these individual inductances, but depends upon the manner in which they are connected together. If they are so connected that their magnetic fields reinforce one another then the resultant total inductance is found by mathematical analysis to be given by the equation

$$L_A = L_1 + L_2 + 2M \dots \text{eq. (1)}$$

If the two coils are so connected together that their magnetic fields oppose each other then the resultant total inductance of both coils in series is found upon analysis to be given by the equation

$$L_B = L_1 + L_2 - 2M \dots \text{eq. (2)}$$

The additional inductance factor M is the mutual inductance between the two coils which is contributed by the coupling of the coils to each other, and depends upon the individual coils and the degree of coupling between them. This mutual inductance exists regardless of whether the two coils are connected in series or not, as in the case of the well known variocoupler. This factor is important to know as a knowledge of the degree of coupling depends upon it.

The mutual inductance M may be measured without knowing the individual values of inductance L_1 and L_2 , in the following manner: Connect the two coils together so that their magnetic fields assist each other, i. e., so that when connected together the turns all run in the same direction. Since the coupling may be measured with the two coils at different distances from each other and at different angles to each other, place the coils in the position in which it is desired to measure the mutual inductance. Measure the total inductance of the two coils thus connected in series by any one of the inductance methods described in the February issue of RADIO NEWS. Call the value of the total inductance thus obtained L_A . Now reverse the connections

In this article, the third of a series on radio frequency measurements, the author gives some valuable information which we believe the real radio experimenters will welcome. These articles have been written in simple language and with a minimum of formulae and technical terms, which brings them within the understanding of the average amateur.

We urge all amateurs worthy of this name to build a C. W. oscillator as described in the first part of this article and to experiment along the lines suggested by the author. They will derive from it a real benefit and will be able to design and build better and more efficient apparatus themselves.

of the two coils to each other (see Fig. 1) without altering the relative position of the coils, in which case the same coupling will be maintained and the coils will be connected so that their magnetic fields oppose each other. Again measure the total inductance of the two coils in series as above and call this value L_B . Now L_A and L_B are given by the equations (1) and (2) above, respectively. If we subtract equation (2) from equation (1) we will get

$$L_A - L_B = 4M \dots \text{eq. (3)}$$

$$\text{Hence } M = \frac{L_A - L_B}{4} \dots \text{eq. (4)}$$

Thus having obtained L_A and L_B by measurements we can calculate the mutual inductance M for any given setting of the coils from equation (4), without knowing the individual inductances of the coils. In this way the mutual inductance between the coils may be obtained for different separations and settings of the coils.

II. Determination of Coupling Coefficient. Method (a). The mutual inductance thus measured is in fact a measure of the reactance which is common or mutual to the circuits coupled to each other. The coupling coefficient is a measure of the closeness with which the two circuits are coupled to each other and is a very important factor in receiver design, and is defined by the ratio of equation (5)

$$K = \sqrt{\frac{M}{L_1 L_2}} \dots \text{eq. (5)}$$

where M is the mutual inductance between the two coils, L_1 and L_2 are the individual inductances of the coupled

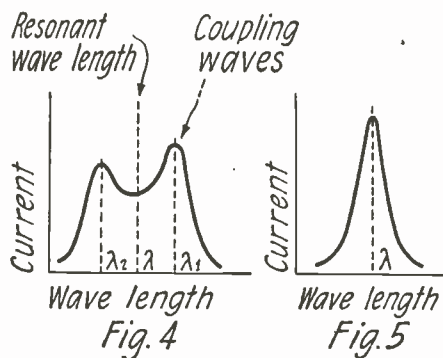
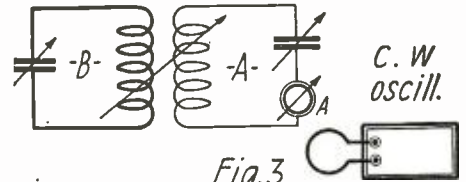

Fig. 4. Effect of Tight Coupling. Fig. 5. Effect of Loose Coupling.

coils, and k is the coefficient of coupling. To obtain this factor then it is essential to measure the individual inductances of each coil by any of the inductance methods given in the February issue of RADIO NEWS, and to measure the mutual inductance by the method given above. The coupling coefficient K can then be calculated by equation (5). In this way K



Method of Measuring the Coupling Coefficient of Two Circuits.

may be determined for any pair of coils for various settings and positions of the coils.

Method (b). The second method of measuring the coupling coefficient is a very important one, as by this method the characteristics of a circuit may be simultaneously obtained with the coupling coefficient. Consider two circuits coupled to each other as in Fig. 2, each being tuned to the same wave-length λ . It is an established principle, derived mathematically and verified experimentally, that due to the reaction of each circuit on the other two peak waves are produced, one larger than the resonant wave-length λ , the other smaller than the resonant wave-length λ . These peak waves are called "coupling waves," and their values are given by the following equations

$$\lambda_1 = \lambda \sqrt{1 + K} \dots \text{eq. (6)}$$

$$\lambda_2 = \lambda \sqrt{1 - K} \dots \text{eq. (7)}$$

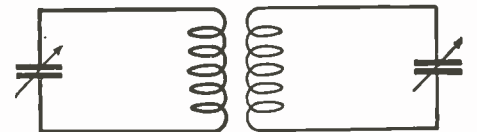

Fig. 2

Coupled Circuits Produce Coupling Waves.

in which λ_1 is the larger coupling wave, λ_2 is the smaller coupling wave, λ is the resonant wave-length to which both circuits are tuned, and k is the coupling coefficient. From these two equations there is derived the very closely approximate equation

$$K = \frac{\lambda_1 - \lambda_2}{\lambda} \dots \text{eq. (8)}$$

The problem of measuring the coupling coefficient is therefore that of measuring the coupling waves λ_1 and λ_2 , when the circuits are tuned to the resonant wave-length λ . The method for determining these coupling waves is then as follows: Set the C. W. oscillator at the wave-length to which the circuits are to be tuned, this is the operating wave-length λ . Tune each of the two coupled circuits individually to this wave-length by means of the C. W. oscillator. The two circuits are then tuned to the same wave-length, hence to each other, and they are coupled to each other in the position desired, as in Fig. 3. A radio frequency milli-ammeter is inserted in one of these circuits, say circuit A. Without

(Continued on page 2040)

A Remarkable Loud Speaker



One of the Loudspeakers Embodying a New Principle of Construction. The Mechanism is in the Cylinder, Upon Which is Mounted the Horn, and May Be Adapted to Any Type of Sound Box

ON November 27th of last year, General Ferrie presented to the French Academy of Sciences a paper on some new developments in loudspeakers.

One of the instruments described was installed in one of the corners of the large auditorium and a demonstration was given after the lecture which convinced everybody of the great superiority of the new apparatus which had just been described. The instrument shown at the meeting was only of medium size and was designed to amplify efficiently so as to permit about 6,000 people to hear a speaker. Another type of these loudspeakers has been designed and installed on the top of the factory of the Gaumont Company in Paris for the purpose of demonstrating the extraordinary carrying power of the new instrument and to give orders which may be heard all over the plant and in the streets surrounding it within almost one-half a mile.

During the demonstration given to newspaper men, it was possible to hear some music transmitted with a phonograph and the voice of the announcer on a large boulevard where a great number of automobiles and street cars are running constantly. In spite of the noise, it was possible to hear every syllable and even the weakest notes

played by means of phonograph records. The clearness of the voice was remarkable and the "s" and "ch" were heard plainly without the whistling noise which generally accompanies these letters when heard through a loudspeaker. This is due to the special construction of the diaphragm which is made of a cone-shaped piece of varnished silk having an opening of 90° around which is wound in one or more layers, a very fine wire of aluminum. This cone and coil combination is placed in a very strong magnetic field produced by an extra coil wound around the closed core as in a well-known type of telemegaphone.

On account of the construction of the main pole-piece, the magnetic gap is extremely small and all the diaphragm and coil combination is submitted to the field, insuring a maximum response even when very weak currents pass through the movable coil. A great advantage of this diaphragm is that it has no natural period of its own which insures the perfect production of every vibration whatever their frequency. For the passage of sound, the inside of the pole-piece is provided with small holes as shown in the diaphragm. These holes open directly inside of the horn, which is mounted with a tight fit to the loudspeaker mechanism.

The manufacturers of this new loudspeaker have succeeded in making the new type of diaphragms in very small sizes which weigh less than two grams including the wire. Since the diaphragm and the coil have the same surface exposed in the field, they are both influenced over the entire surface, producing a greater amount of the diaphragm than in the systems where they are attracted and repulsed only in the center. With one of these loudspeakers having a small diaphragm where no less than two grams are used, as illustrated in Fig. 2, it is easy to speak to an audience of over 6,000 persons in a great auditorium so that every syllable is understood by everyone. This gives an idea of the carrying power of this instrument.

Of course, this apparatus is used in conjunction with vacuum tube amplifiers by means of which the voice or music may be amplified up to any desired value. This instrument is the result of more than 20 years of research by the Gaumont Company which tried to design a perfect loudspeaker to be used in conjunction with their talking moving pictures. Every possible system has been given a tryout in the laboratories by the engineers of this company who built a system using the properties of flames, compressed air and several other systems which were not found satisfactory. The volume obtained was sufficient, but the clearness of the speech and music never satisfied these never-tiring workers, Messieurs Gueritot and Aschel, who developed the new loudspeaker. It is claimed that this instrument with its very light diaphragm is the perfect loudspeaker.

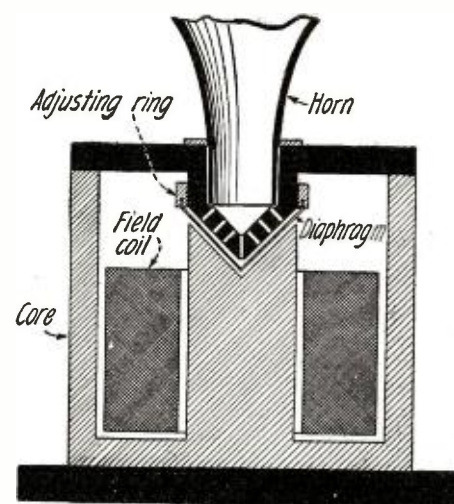

Sectional View of the New Type of Loudspeaker. Note the Small Gap in the Magnetic Circuit with the Cone-Shaped Diaphragm Upon Which is Stuck the Fine Wire Composing the Armature.

Fair Dealing Pays

WE are glad to give the fullest publicity to the entire correspondence as published below, with the hope that the radio industry will take note of it. There has been much sharp dealing in radio circles heretofore, so when we come across a transaction such as the one outlined below we do not hesitate to broadcast it. It should serve as an object lesson for every radio manufacturer and every radio dealer throughout the country.

Editor, RADIO NEWS:
New York City.

I am enclosing herewith correspondence I had with one of your advertisers, who, I think deserves much credit.

The way they have handled the situation in general is commendable and merits for them the highest respect and confidence of the radio public in their concern and their product.

I trust you will find your way clear in some way to show these people how much their policy means to the radio game today. From a knocker they have turned me into one of their most ardent supporters and boosters.

This will demonstrate that your readers should have no hesitancy about ordering any

articles as advertised in your magazine, even though situated miles away from the manufacturer.

Thank you for whatever attention you may find your way clear to give this.

L. W. Houlroyd,
Bayonne, N. J.

Acme Apparatus Co.,
New York City.

Gentlemen:

A month ago I had a 2-stage regenerative set with which I was getting excellent results. With the idea of extending my range, I started reading up on radio frequency, after which I picked your transformer as having the best construction, etc., of any on the market. Having used your audio transformers and knowing the status of your concern, I was confident that I was making no mistake.

Well, I purchased an R-2 and this called for a complete remodeling of my set. After purchasing a new cabinet, panel and additional instruments I mounted everything in its place in accordance with your hook-up, and when everything was finished I turned on the lighting juice and not a peep came from the machine.

I carefully checked over the wiring, which was O. K. In succession I tried every known radio frequency hook-up (which necessitated in some cases buying many additional instruments) with the same results.

I figure I worked about an average of four hours a night besides all Sundays and holidays for the past month. Never realized until now how much broadcasting meant to the family and myself.

I tested out every instrument in my set individually, besides aerial, phones, jacks, etc. Finally, I came to the transformer which I had every confidence was O. K., and upon lifting off cover found the "B" battery wire from the coil to binding post was snapped off close to the coil and was touching filament wire. (This explained the blowing out of four tubes, which cost me twenty dollars to replace.)

Would like to return this transformer to you, and as I am thoroughly disgusted with radio frequency, could I request you to give me an audio frequency transformer in exchange? Shall be very glad to send the difference and transformer to you upon receipt of instructions.

This was a very costly experience in radio,

(Continued on page 2026)

The Neutrodyne Receiver

This Tuned Radio Frequency Amplifier Gives Tremendous Amplification Without Regeneration as the Internal Capacity of the Tubes is Neutralized, Preventing Feed Back Action. It is the Latest Invention of

Prof. L. A. HAZELTINE. M.E.*

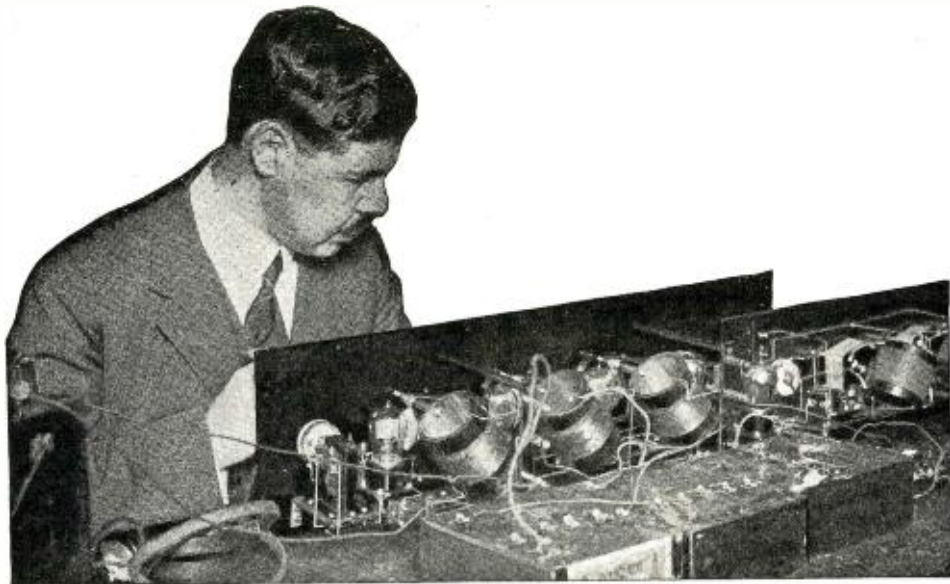

Professor L. A. Hazeltine Tuning a Neutrodyne Receiver. On the Right May Be Seen Another Neutrodyne Set of the Reflex Type Using Four Tubes Which Provides Two Stages of Radio Frequency, Detector and Two Stages of Audio Frequency Amplification.

increases the amplification although it has been found that the regenerative effect is more beneficial for short wave-lengths than for the broadcasting wave-lengths. This is of tremendous importance to us amateurs who are more interested in 200 meters than in 360. We can expect now to bring in DX stations with a two-stage Neutrodyne receiver with regenerative detector, as this has been done by two amateurs who, for Professor Hazeltine, tried his amplifier on a short wave-length. Both of them have been able to get every district during the same night. The Neutrodyne receiver has also proved very efficient for broadcast receiving, as with a short antenna, an amateur in New York City was able to copy 17 distant stations in the same evening including Calgary, Canada. This type of receiver provides extremely sharp tuning, although not extremely critical to adjust. Professor Hazeltine himself was able, in his laboratories in Hoboken, New Jersey, about one mile from station WEAJ, to listen to Fort Worth, Texas, while WEAJ was sending on almost the same wave-length, the difference being approximately 15 meters. With a 60' antenna and a three-tube non-regenerative receiver consisting of two stages of radio frequency amplification and a detector, Fort Worth, Kansas City, St. Louis and Minneapolis are heard regularly with head phones. With a four-tube Reflex set embodying two stages of radio frequency, detector and two stages of audio frequency, WSB, Atlanta,

At the last meeting of the Radio Club of America, Professor L. A. Hazeltine of Stevens Institute of Technology, read a very interesting paper on his latest discovery which is an epoch-making one. In the paper entitled "Tuned Radio Frequency with Neutralization of Capacity Coupling," Professor Hazeltine related how he first used neutralization of capacity coupling when he designed the well known SE-1420 Navy radio receiver. In this apparatus, all capacity effects were removed between the windings of the coupler by means of an extra coil wound over the secondary and grounded so as to prevent transmission of energy from the primary to the secondary through the capacity between windings.

It is well known that in tuned radio frequency amplifiers it is very difficult to eliminate undesired oscillations which take place due to the internal capacity of the vacuum tubes when the various circuits are tuned to resonance for high amplification. This limits the usefulness of such radio frequency amplifiers, as one is soon limited in the number of stages on account of these oscillations which are very difficult to control. It occurred to Professor Hazeltine that the neutralization principle, which he devised for the Navy receiver, might be applied to tuned radio frequency amplifiers, and, after experimenting, designed the Neutrodyne receiver in which the internal capacity of the tubes is neutralized suppressing, therefore, any feed-back action from one stage to the other, preventing the production of oscillations while keeping the tuning very sharp.

Until the present discovery, tuned radio frequency amplifiers did not go into general use on account of the difficulties in tuning, but thanks to Professor Hazeltine, amplifiers of tremendous sensitiveness can now

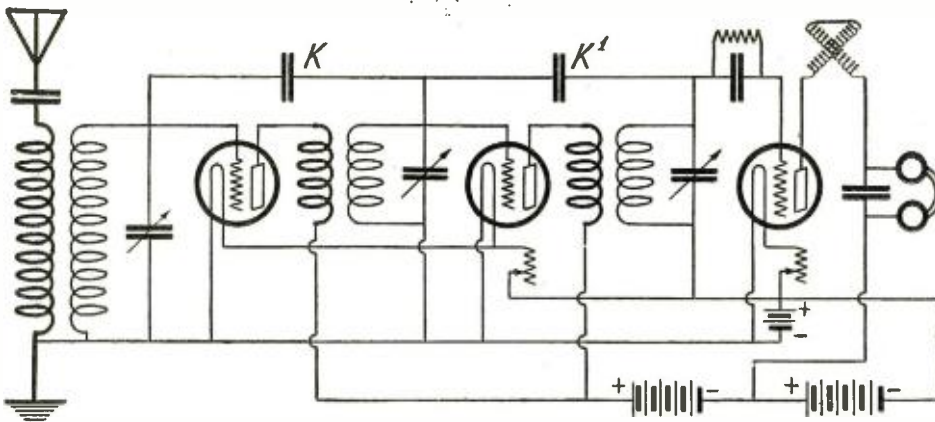

Hook-up of a Three-Tube Neutrodyne Receiver Composed of Two Stages of Tuned Radio Frequency Amplification and Detector, in the Plate Circuit of Which Is Connected a Variometer for Regeneration and Reception of Continuous Waves by the Autodyne Method. The Two Condensers K and K¹ Are Small Capacities Equal To About One-Quarter the Internal Capacity of the Tubes.

be made giving a power amplification at the telephone receiver as high as one hundred million for two stages of tuned radio frequency. This is for an amplifier in which only the relay action of the tube is used, as the detector circuit may be caused to regenerate in the usual way by introducing a tuning element, either a tuned coil or variometer in the plate circuit. This, of course,

Georgia, is heard on a loud speaker when no antenna is used. With the antenna, broadcasting stations in Los Angeles, California, were heard in Newark, New Jersey with the same Reflex outfit. The diagram shows the connection of a two-stage radio frequency Neutrodyne receiver with detector.

As may be seen, the diagram is similar to that of a standard tuned radio frequency amplifier with the addition of two extremely small capacities between the grids of the various tubes. These capacities which equal about one-quarter the internal capacity of the tube, consist of two pieces of wire covered with insulation over which slides a small piece of brass tubing. These give a very small capacity constituted, in reality, of two condensers in series. The adjustment of these condensers depends upon the type of tube used in the Neutrodyne receiver; usually, they are adjusted while listening to strong signals received in the antenna circuit. After the set is tuned by means of

(Continued on page 2052)

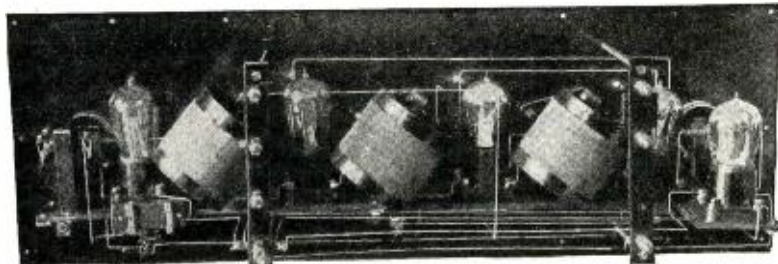

Back View of a Five-Tube Neutrodyne Receiver Embodying Two Stages of Radio Frequency, Detector and Two Stages of Audio Frequency. Note the Arrangement of the Coils To Prevent Magnetic Coupling Between the Circuits.

*Professor of Electrical Engineering, Stevens Institute of Technology.

Awards of the Super-Regenerative Contest

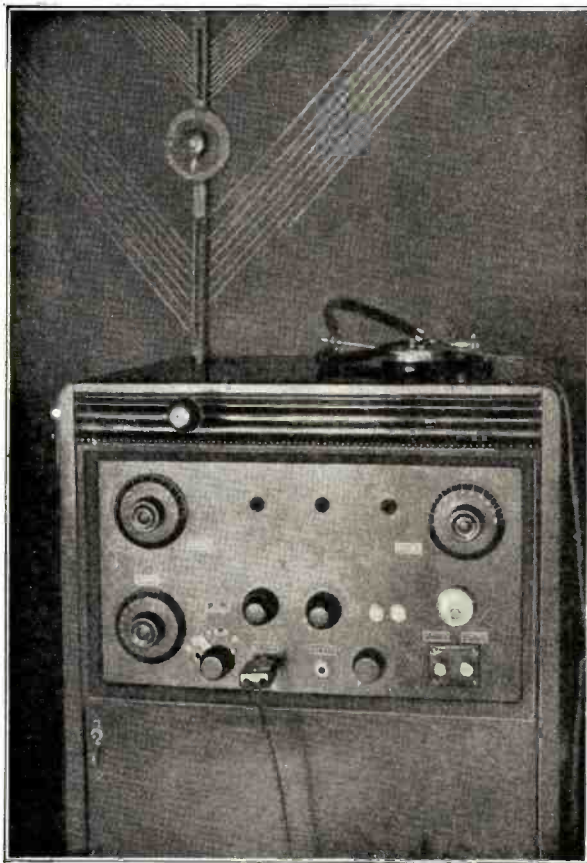

Front and Interior Views of Mr. Hanscom's Super-Regenerative Receiver. Special Attention is Called to the Separate Loop Which is Clearly Shown in the Photographs. The Use of This is Explained in the Article. Three Myers Tubes are Employed in This Set.

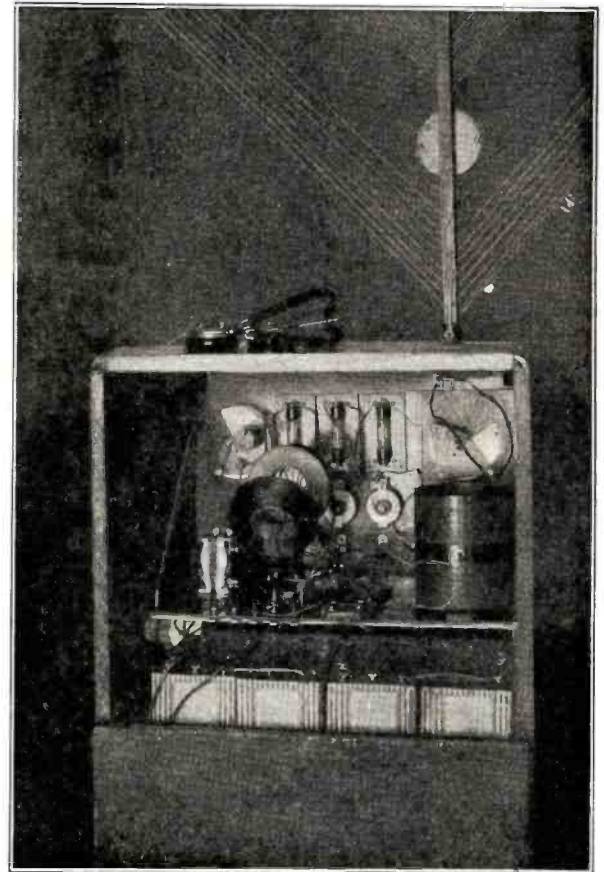

Second Prize—Class I A Super-Regenerative Set

By ALLAN T. HANSCOM

FOLLOWING is a description of a super-regenerative set which has been used successfully for two months. With this set, we have heard all of the large Eastern broadcasting stations, the wave-lengths of which range from 200 to 650 meters. From the West, we have heard the St. Louis Post-Dispatch, Davenport, Iowa, Detroit News, Chicago, the Drake Hotel and several others also Atlanta, Georgia, Charlotte, N. C., and Havana, Cuba.

Referring to the photographs, the loop is mounted by means of a round telephone plug inserted in a jack and turned by a knob above the panel which is attached to a fibre speedometer gear. There are really two loops, one inside of the other. The outer loop consists of eight turns of No. 22 bare copper wire and the inner loop has eleven turns of No. 32 with a .0004 mfd. Variadon condenser across its terminals. It functions as a wave trap and permits sharp tuning, thereby eliminating interference. For ordinary work, the Variadon condenser may be placed at zero. The coupler is a 6" formica tube. This was put on a lathe and 36 threads to the inch were cut on its surface. The tube was then wound with No. 22 bare copper wire. An additional inductance is placed in the grid circuit of the oscillator tube and is wound on the same form. The feed-back for the plate of the regenerator consists of the rotor of the coupler in series with the lower windings on the outside of the coupler. The number of turns are indicated in the wiring diagram. Two tubes only are used for ordinary work. For loudspeaker operation, the third tube is provided as an audio-frequency amplifier. The only controls are the tuning condenser and the tickler which are on the left of the panel

looking from the front. The 31-plate condenser on the right is used in parallel with a .1 henry choke coil as a filter. The lower part of the cabinet contains a Westinghouse vibrating rectifier Ever-ready storage battery and two sets of Burgess "B" batteries. The materials used are as follows: Giblin-Remler honeycomb coils, Myers tubes, Cutler-Hammer rheostats, Micadon condensers and Acme transformer.

In closing we wish to emphasize the advantages gained by using the extra inductance of 40 turns in the grid circuit of the oscillator tube and the separate loop which allows for sharper tuning.

Second Prize—Class II A Single Tube Super-Regenerative Set

By RUAL C. JONES

Herewith is a description of my single tube super-regenerative receiving set which has proved to advantage in the reception of

amateur and broadcasting stations. This set tunes a great deal easier than a single circuit regenerative receiver and the signals come in as loud and clear as an ordinary receiver using an aerial and ground and two stages of amplification.

The loop employed with this set is 2½' square with approximately 13 turns of wire on its frame. Referring to the diagram, A, is an inductance on a card-board tube 3½" in diameter wound with 45 turns of No. 22 D.C.C. wire tapped every five turns. This inductance is necessary if the loop has the proper length of wire wound on it. L¹ and L² are honeycomb coils of 1,500 and 1,250 turns respectively. After the set is wired, the terminals of the coils may have to be reversed before the set will work properly. these coils are mounted stationary with a coupling of about ½" between them.

B—.001 mfd Variable Condenser (Brilliantone Radio Products Co., N. Y.)

C—Variometer (Brilliantone Radio Products Co., N. Y.)

D—U. V. 201 Amplifying tube and socket.
E—45-volt "B" battery (Eveready.)

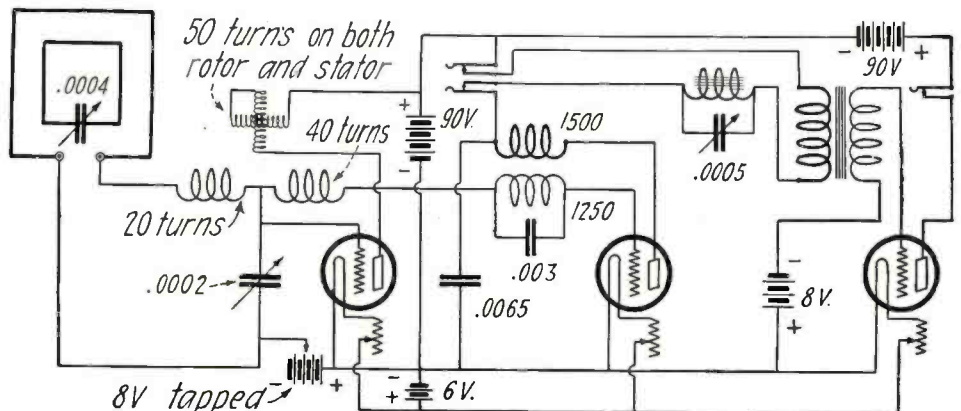

The Wiring Diagram of Mr. Hanscom's Set. As Seen, a Variometer is Connected in the Plate Circuit of the First Tube, This Being in Inductive Relation to the 20 Turn Coil in the Grid Circuit.

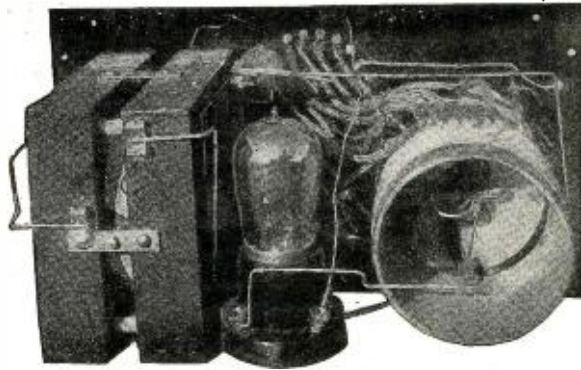

Two Views of Mr. Jones' Super-Regenerator. This Set Employs a Plate Variometer and a Tapped Inductance in Series with a Loop Aerial. The Circuit is Shown on the Right.

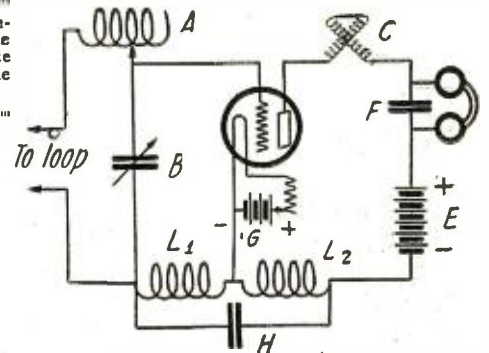

F—.001 mfd fixed phone condenser (Radisco.)

G—6-volt storage battery.

H—.004 mfd fixed phone condenser (Radisco.)

To tune this set, turn on the rheostat until the filament burns brightly. Place the rotor windings of the variometer at right angles to the stator windings and turn the condenser, B, until the plates are nearly out, or to a point where a hissing sound is heard. After a station is heard, it can be cleared up with the variometer and by slightly moving the condenser, B. If the loop is set in the right direction, the station usually bursts in clearly and loudly by only varying the condenser, B.

The photographs show clearly the construction of the set and the arrangement of the apparatus. The panel is of hard rubber measuring 6" x 12". From my home in Car-

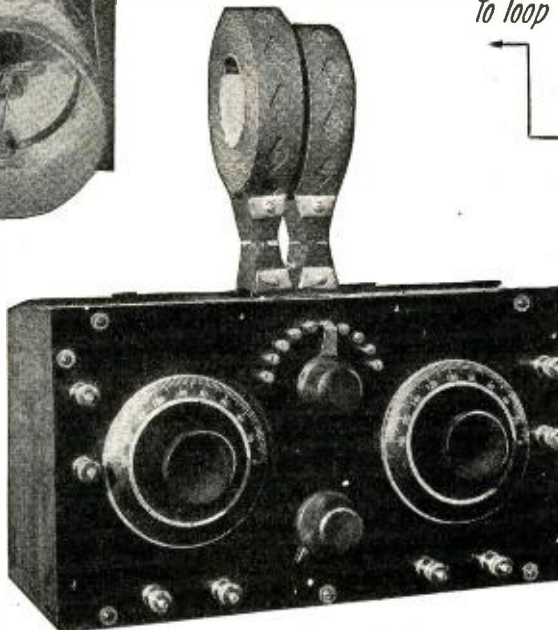

ter, Oklahoma, I receive radiophone programs from all stations such as Detroit, Chicago, St. Louis, Atlanta, Ga., Los Angeles Calif., and San Antonio, Texas, employing

the 2½' loop aerial as described. The simplicity of control makes this set ideal for the reception of amateur C.W. stations on 200 meters.

Having tried out this type of super-regenerative receiver, we can vouch for the statement concerning its efficient reception of C. W. stations on 200 meters. Its characteristics are the same as a regenerative receiver using a similar circuit. Employing this circuit but with inductance A, replaced by a variometer and the variable condenser eliminated, such stations as 4EA and 4DC have been received in New York with sufficient volume to be heard throughout the operating room. In this instance, nothing but a ground connection was employed.—EDITOR.

Two Simple Arrangements for Reducing Interference and Static With Single Circuit Tuners

By P. H. RUSSELL

WITH the coming of silent nights, the home radio man will be trying his luck at fishing for minnows and whales of the ether, that swim distantly. If he is like most of us who are beginners he has a single circuit tuner hooked up regenerative with a tickler for a plate feed back or may have a variometer in the plate circuit. In either case the scheme hereafter shown will be of service.

His single tuned combined grid and antenna circuit has been letting in interfering howls and whistles of stations near and far and he has, as did the writer, wished that he had constructed or acquired a coupled tuner.

Let the single circuit man then wind up another antenna coil having an appropriate number of turns, say 30 to 40 on a 4" tube tapped every 10 turns if he wishes. Then make another coil which will rotate inside the other and in some convenient manner mount it, bringing out leads through the shaft or with flex-

ible wire. This coil should have not more than 20 to 30 turns at most or it may be found that the main tuner will not tune down because usually as much inductance as possible is put on for the sake of efficiency. If the main tuner has taps, this is less important. Then try results. Hook the leads from the rotating coupling coil to the antenna and ground connections on the tuner and hook the ends of the tuning coil with a

variable condenser if used, in series or parallel as may be found best, to the antenna and ground leads. Then tune in and the results may prove surprising. The typical single circuit hook-up is shown in Fig. A, with the coupler above suggested hooked on. It will be seen that the result is practically a coupled circuit with a tuned grid having a variable condenser in series with a grid leading coil. For reasonable comfort in tuning, a vernier condenser on the main tuner is necessary, as tuning is very sharp on the grid, especially with loose coupling. The antenna circuit tunes very broadly. Body capacity will be found to be very slight if (as in the writer's instrument) spider web coils are used. For the coupler described he uses an 18-turn spider web coil on a 5" frame for a coupler with a 60-turn spider web on a 5" frame in the antenna circuit. The main tuner is a 60-turn spider web with a 60-turn tickler wound on thin celluloid frames; all are 5" in diameter. If a thicker medium is used for the tickler frame more turns than 60 will be needed for proper regeneration, as the thin medium seems to give closer coupling and greater inductance.

A word as to results may not be amiss. The writer lives in Central Alberta, Canada. The nearest stations have respectively 2,000 watts and 1,500 watts input. They are distant about 75 miles and can be heard over about 30 degrees on a .001 condenser in the single circuit tuner loud enough to interfere badly with the faint distant stations. They have been heard all over the United States and in Hawaii. They come in at about 400 meters. Now using the above coupler, Los Angeles, KHJ; KGW at Portland, KYW at Chi-

(Continued on page 2027)

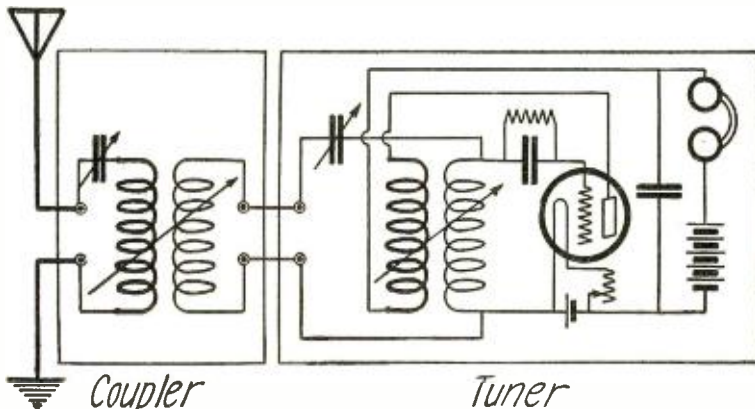

Two Circuits That Are Effective in Reducing Interference. There Is Nothing Complicated About These Arrangements, Either in Their Make-up or Control.

The Resonance Principle: Its Radio Applications

By LOUIS FRANK

IN the preceding articles of this series the phenomena of coupling and damping which continually make their appearance in radio were considered. In this article a third phenomenon will be discussed which is of paramount importance, and which, in fact, is the basis of all radio design and operation of transmitting and receiving circuits. This phenomenon is **RESONANCE**.

The idea of resonance can best be obtained and grasped from the following mechanical illustrations: If we take a pendulum and strike it with a given definite force at certain intervals the pendulum will swing through a certain amplitude. As we vary

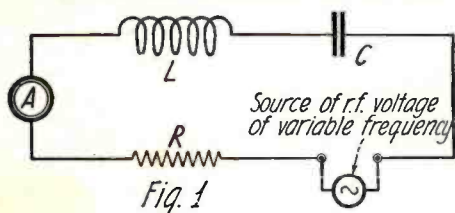

Representation of a Receiving Circuit Including Inductance, Capacity and Resistance.

the frequency at which we strike the pendulum, all the while keeping the force the same, the amplitude through which the pendulum swings also varies, and at a certain particular frequency the amplitude is a maximum. This occurs when the frequency of striking the pendulum is the same as the natural frequency of vibration of the pendulum. This condition of equality of frequencies is known as the "Resonant" condition or simply "Resonance." The effects produced in the resonant condition are much greater than otherwise, or, in other words, *Resonance in a system magnifies the natural effects in that system.* It is for this reason that at resonance the pendulum swings through a much larger amplitude than it does otherwise.

The reader will perhaps recall having read of occasions when the passing of troops over wooden bridges has resulted in damage to the bridge. The reason for this is explained by the "Resonance Principle" and will help clarify the idea of resonance. Every bridge has a certain natural period of vibration and if forces are applied to the bridge it will vibrate, although the swing of it may not be perceptible. Now, when a troop of soldiers marches over a bridge the impact of the feet on the bridge is great and the bridge does vibrate. When the soldiers march in step the impact is greater than otherwise, since they strike in unison, and the bridge vibrates more strongly. Ordinarily no harm can come of this, but it sometimes happens that the natural vibration period of the bridge is equal to, or almost equal to, the frequency at which the soldiers are marching time. Thus a state of resonance is obtained between the bridge frequency and the marching time of the soldiers. As a result, in accordance with the resonance principle explained in the previous paragraph, the bridge swings through a much greater amplitude than ordinarily, which is not safe for it, and damage, therefore, occurs. In order to avoid this, when soldiers march over bridges they fall out of step, thus preventing the occurrence of resonance and danger.

From the above illustrations the reader will be able to understand the idea underlying the resonance principle: *That it is a condition of harmony between two systems*

such that natural effects produced by one system on the other are magnified many times.

In studying the phenomenon of resonance in a radio circuit the effect produced, and to be considered, is most commonly the current flow in the circuit. Suppose we have in Fig. 1 a circuit consisting of an inductance, L, capacity, C, and an ammeter, A, and electro-motive force being introduced in the circuit. Keeping everything constant except the frequency of the applied voltage, it will be found that as the voltage frequency is varied the current registered by the ammeter also varies. At one particular frequency of the voltage it will be found that the current in the circuit is a maximum. This frequency is the "resonant" frequency; i. e., the natural frequency of the circuit and the very large current at this frequency is due to the magnified effects produced by the resonance condition.

Exactly what happens in a radio circuit like Fig. 1, when it is in the resonant condition? We know that in a radio circuit the current is limited by the total impedance of the circuit, which includes ohmic resistance, R, inductive reactance, L, and capacity reactance, C. As resonance is accompanied by a maximum of current, it follows that the total impedance at the resonant frequency must be a minimum. This is exactly what takes place. What happens is that at the resonant frequency the reactance of L exactly neutralizes the reactance of C (since their effects are opposite), thus leaving only the ohmic resistance, R, to limit the current. At other frequencies there is an effective reactance which adds on to the resistance thus resulting in lower currents. In other words, resonance in a radio circuit implies

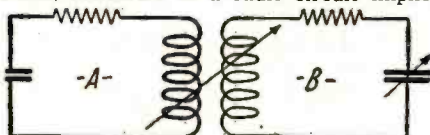

Circuit B may be tuned to resonance with circuit A.

If the Circuits A and B Are Tuned So That Their Frequencies Are the Same, They Will Be In Resonance With Each Other.

that there are no inductance or capacity limitations to current flow, and that only ohmic resistance is present to limit the current.

The effects produced by such resonance are very great. To cite one particular case in which an important practical application is made of this principle, we have the "resonance transformer." In quenched spark gap transmitters, which are at present largely used on board ships and in some land stations, a special type of power transformer is designed and used to develop the high voltage required for breaking down the spark gap resistance. Ordinarily a transformer steps up the primary voltage in proportion to its transformation ratio. Thus, if the secondary has 50 times as many turns as the primary, the secondary voltage will be 50 times as great as the primary voltage. In the resonance transformer, however, if the secondary has 50 times as many turns as the primary, the secondary voltage may be much greater than 50 times the primary voltage, it may, in fact, be 70 to 90 times as great as the primary voltage. The resonance transformer is designed so that its circuit is in resonance with the alternator frequency, and hence due to magnified effects obtained at resonance, the secondary

voltage builds up to much higher values than the simple transformation ratio of the transformer warrants. Other important applications of this resonance principle will be given in the course of this article.

Not only can a radio circuit be in resonance with a generator source of voltage, but it may also be in resonance with other circuits. Thus, Fig. 2 represents two circuits coupled to each other, and if these two circuits are tuned so that their frequencies are the same, they will be in resonance with each other. The primary condition for resonance between any two systems is, therefore, equality of frequencies. As in the above case, when the two systems are in resonance there is a maximum current flow and a maximum effect produced by the one circuit on the other. It will be immediately evident why in both transmitting and receiving circuits, the primary is always tuned to the secondary. When you read about sets containing two or three circuits and are told to tune each circuit to the same incoming frequency, the principle underlying this design and operation is the resonance principle. Tuning to the same frequency brings all the circuits of a set into resonance, hence produces maximum effects and currents, and in this way maximum radiation from a transmitting antenna, or maximum signal in the telephones will result. It should be borne in mind that nothing is done in the design and operation of good sets without some real substantial basic reasons. Resonance will be found to be one of the main cornerstones of the radio art.

In order to visualize what this resonance is and means, we can plot graphically a so-called "resonance" curve. If in the circuit of Fig. 1 we measure the currents corresponding to different frequencies of the voltage, while the value of the voltage remains constant, and then plot current against frequency, a curve such as Fig. 3 will be obtained. This curve is very instructive. It will be seen that at one frequency, namely f_0 , the current is a maximum. This frequency is the resonant frequency and is the natural frequency of circuit Fig. 1. The point on the curve showing this resonant condition is called the resonance point. As soon as the frequency is altered so that it is somewhat removed from the natural frequency of the circuit, the current in the circuit is immediately reduced to much lower values. This will at once make clear how in practice tuning out is accomplished. Suppose it is desired to receive 200-meter amateur transmission, and to eliminate interferences from special stations transmitting near this wave. The receiver is tuned to resonance with the 200-meter wave and hence is operating on the

(Continued on page 2053)

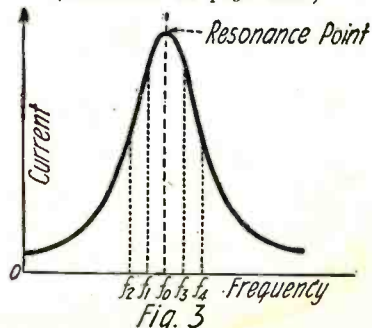

A Curve Illustrating the Current That Would Flow In the Circuit of Fig. 1 At Different Frequencies.

The Commercial Wireless Operator

By "ONE OF THEM"

THIS article is written especially for the amateur and the student operator who is preparing himself for a life on the "briney deep." To these two this article will give an idea of the commercial operator's life on shipboard.

I graduated from a radio school in Boston and passed my commercial first grade examination on June 9, 1921. At that time old-timers, experienced operators, were on the "beach," so I found it impossible to obtain a ship. On May 28, 1922, I happened to be in the office of one of the radio companies, when an operator came in and quit his job. After considerable pleading, I got the job, a coastwise coal ship.

I rushed home and packed up, said good-bye to the folks, as if I was bound for a trip around the world, instead of a 500-mile coast trip, and went aboard the ship feeling like a king. Having inquired my way to the radio room, I found it to be away aft on the boat deck. It was locked, so I hunted up the first officer and obtained the key from him. I returned to the "shack" and opened the door, feeling as though Marconi, Tesla and the rest had nothing on me in radio.

Entering the room, I dropped my suitcase on the floor and looked around. My eyes rested first on the receiver, an IP500 type. That was easy. My eyes roamed around the room and rested on the transmitter. My knees weakened and the perspiration came out on my brow. For a second I thought that I must have entered the switch room of the lighting plant for the City of Boston. I never realized that a radio transmitter could need so many switches. At the time there seemed a great many more than there really were. My estimation of what I knew about radio took a decided drop.

The transmitter was a 2-K.W. Navy Standard. On the panel were at least 25 switches of all sizes and types, and I had never even seen this kind of transmitter before, let alone start it. I went over to the panel and gazed at it, and

the more I gazed, the more I realized that I had lots to learn about radio. I pushed in one switch and then another expecting any minute that the thing would blow up, but nothing happened. I found an instruction book and followed its directions, throwing in all the switches called for, but with no results; I just could not get a kick out of it. I was stuck. I had heard of operators being assigned to ships and of their being unable to start the set. I had laughed at them, but now, the shoe was on the other foot, so to speak. I did not dare go back to the radio company for help, for fear of losing the job. Suddenly I hit upon the happy idea of finding another ship equipped with the same type of transmitter, and obtain as much information as possible from the operator.

I proceeded to carry out this plan of action, and so, after boarding a couple of ships, I found one that I was looking for, and the operator was on board. At first I had intended to bluff along and gradually get the information I wanted. After a few minutes conversation with this operator, I found him to be a pretty good sort of a chap, so told him of the predicament that I was in, my first ship, etc. He sympathized with me and told me to lead the way to my ship and he would fix me up. I lead the way and in a few minutes we were standing in front of the



I Proceeded to Open the Door, Feeling as Though Marconi, Tesla and the Rest Had Nothing on Me in Radio. My Chest Was More Than Its Normal Size, But—

panel of my transmitter. It was easy after I knew how.

The next morning we steamed out of Boston for Sydney, Cape Breton Island. The ship's officers I found to be a fine crowd, although later I had trouble with the second mate. The captain was a fine fellow, but his one bad fault was his constant desire for radio bearings. He not only wanted them when it was foggy, and in bad weather, but also when land could be plainly seen. His reason for the latter was to find out just how accurate the bearings furnished were. And, in practically every instance where bearings were furnished from stations from Bar Harbor to Cape Lookout, they were all as near perfect as could be expected, except in possibly one or two cases.

We steamed out of Boston Harbor bound for Sydney. We were about 30 miles out when the door of my room opened, and in stepped the "old man." He told me that he would like a bearing from Chatham. My stomach quivered as I sat down at the key, and to make matters worse, the captain sat down to wait until I had the bearing for him. I nervously started up the set, and threw the "T" switch to the transmitting position. I was so nervous that I did not look Chatham's call letters up, and sent out a call for "NAD"—"QTE?"

"N A D" thundered back "QSY 800." I looked up at my wave-length changing lever, and sure enough, I was on 600 meters. I threw the lever to the 800-meter position and called "NAD" again. He answered, and told me to test. I tested for two minutes, and then stopping my meter-generator, I threw the "T" switch to the receiving position. Not a sound could I hear. For some reason or other, I touched the crystal detector, and I heard "NAD" just starting on my bearing. Luckily, I had accidentally moved the crystal onto a sensitive spot just in time, so that I did not lose any of the bearing.

I copied the bearing, repeated it back, (Continued on page 2014)



Upon Entering, My Size Rapidly Diminished. For a Second I Thought I Must have Entered the Lighting Plant for the City of Boston. I Never Realized That a Radio Transmitter Could Need So Many Switches.

panel of my transmitter. He pushed in a few switches and pressed the key, "dit, dit, dit, daa," sang the spark gaps; it sure sounded good. The motor-generator was below in the engine-room, so that it could not be heard from the radio room. I found that only a few of the many switches were used to control the operation of the transmitter, most of them being used for auxiliary lighting, storage battery charge and discharge switches, etc. So that out of the whole bunch of them, only about four controlled the transmitter, viz., D. C. main line switch, generator field switch, A. C. line switch, and the local or remote con-

Radio Pictorial

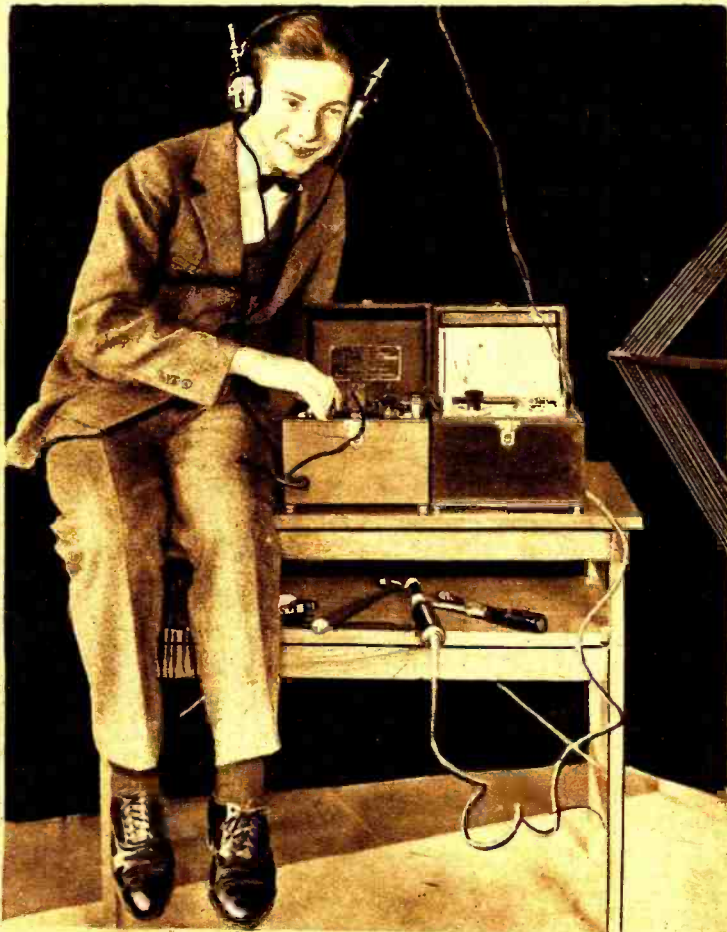

Here is Our Friend, Wesley Barry, Listening in on His Westinghouse Tuner and Two Stage Amplifier. He Has Been Interested in Radio for Some Time and He is an Adept in the Art of Tuning.

(c) Radio Corporation of America

Below is the Pallophotophone, the Latest Type of Transmitter Used in Broadcasting Stations. It is Far Superior to the Type of Microphone Usually Employed. The Voice Vibrations Vary the Intensity of a Light Ray Which is Focused Upon a Photo-Electric Cell Which Faithfully Reproduces the Modulations of the Voice in Varying Electric Currents. This Instrument Has Been in Use at Broadcasting Station WGY, Schenectady, New York, for Some Time.

(c) General Electric Co.

One of the Smallest Vacuum Tube Sets That Has Yet Been Constructed. It is Very Efficient in the Reception of Broadcast Programs and Takes But Little Space, as Seen from the Photograph in the Left Hand Corner

(c) Photonews

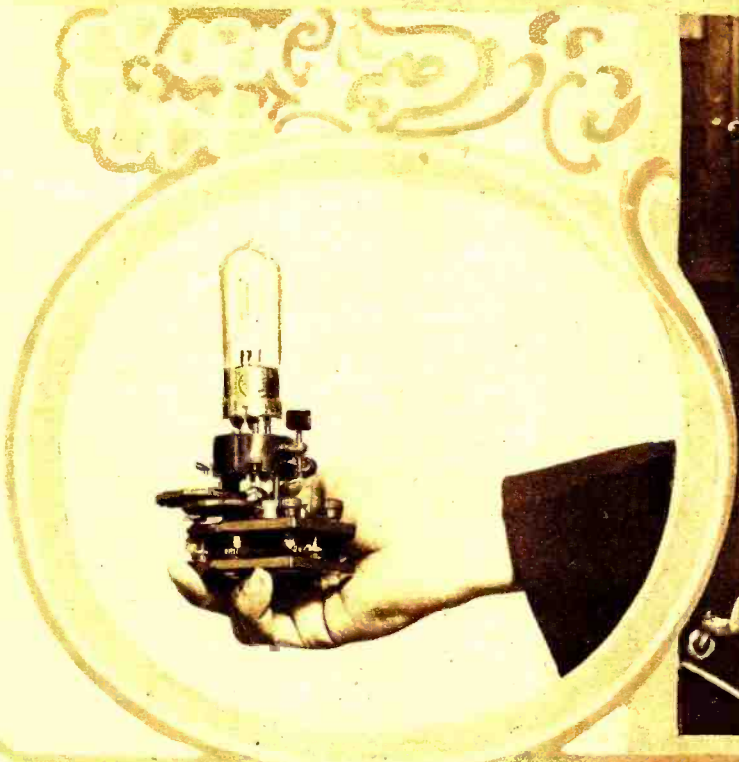

With the Broadcasters

The Liverpool Express, a Fast Train Running Between London and Liverpool Has Installed a Radio Compartment on the Train for the Comfort and Entertainment of its Passengers. This Photograph Shows the Interior of the Radio Salon on Board the Train. This Outfit Employs a Multi-stage Amplifier, Thereby Allowing the Use of the Loudspeaker Shown on the Left. A Loop Aerial is Used Which is Conveniently Located Under the Table and is Oriented by Means of a Large Knob Extending Out on the Side of the Table. This is a Good Idea and People in Crowded Apartments Might Take Advantage of This Arrangement. (c) Kadel & Herbert

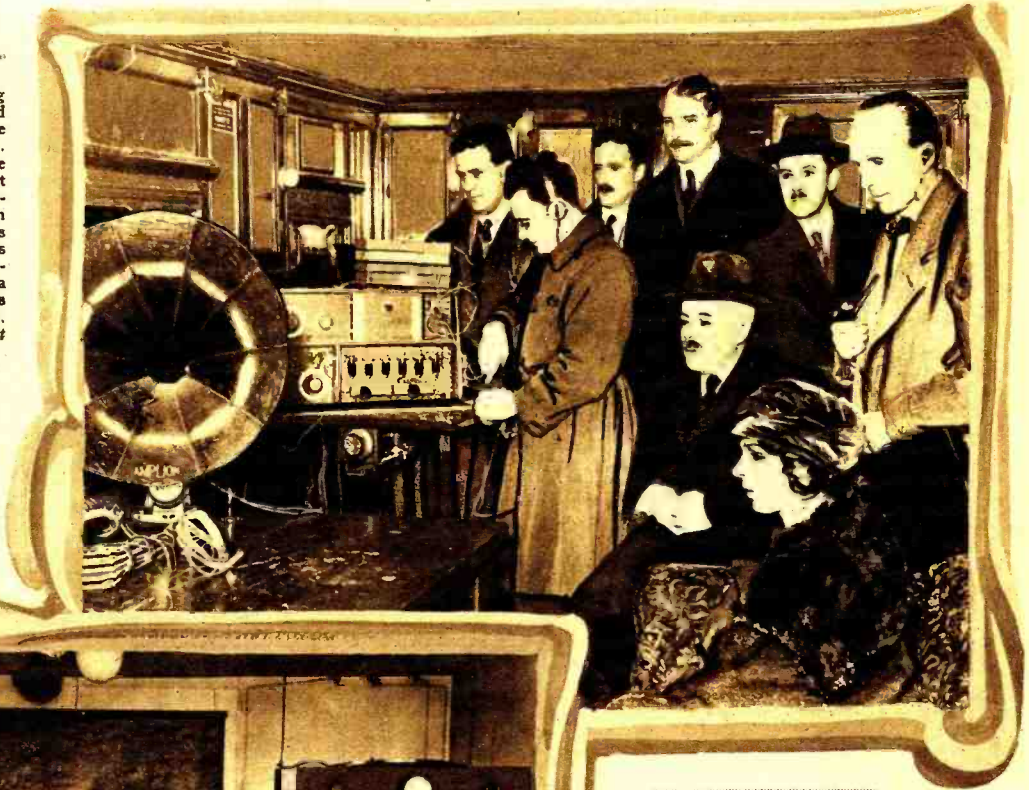

Here is a View of the Operating Room of one of Our Most Powerful Broadcasting Stations, that of WJZ, Whose Signals Are Heard Regularly in the British Isles. This Station is Located on the Roof of the Westinghouse Electric & Manufacturing Company's Plant at Newark, New Jersey. The Rectifying Outfit on the Left Consisting of Six Special Tubes Transforms 3,300 Volts Alternating Current to 200 Volts Direct Current. This Outfit Replacing the 5 H.P. Motor-Generator Previously Used. The Five Modulator Tubes and Four Oscillator Tubes Are Shown on the Right. (c) Kadel & Herbert

Here is a Little Receiver That Picks Up Concerts from the Lighting Lines. This is a System of Wired Wireless Developed by General G. O. Squier. It Has Proved Very Successful and it is Possible to Send a Number of Programs Over the Same Wire. It is, Therefore, Possible for a Person to Pick Up One of a Number of Programs Without the Usual Interference That is Encountered in Regular Receiving Sets. These Little Sets Are Being Rented for a Small Sum by the North American Company to Their Subscribers. The Programs Furnished Originate in the Numerous Power Houses of the Company. The System of Wired Wireless is Being Practiced in a Number of our Big Cities. Being Very Practical, it Will Probably Extend to Other Localities. (c) Kadel & Herbert



Mr. Bink's Radio

By ELLIS PARKER BUTLER

Author of "PIGS IS PIGS"

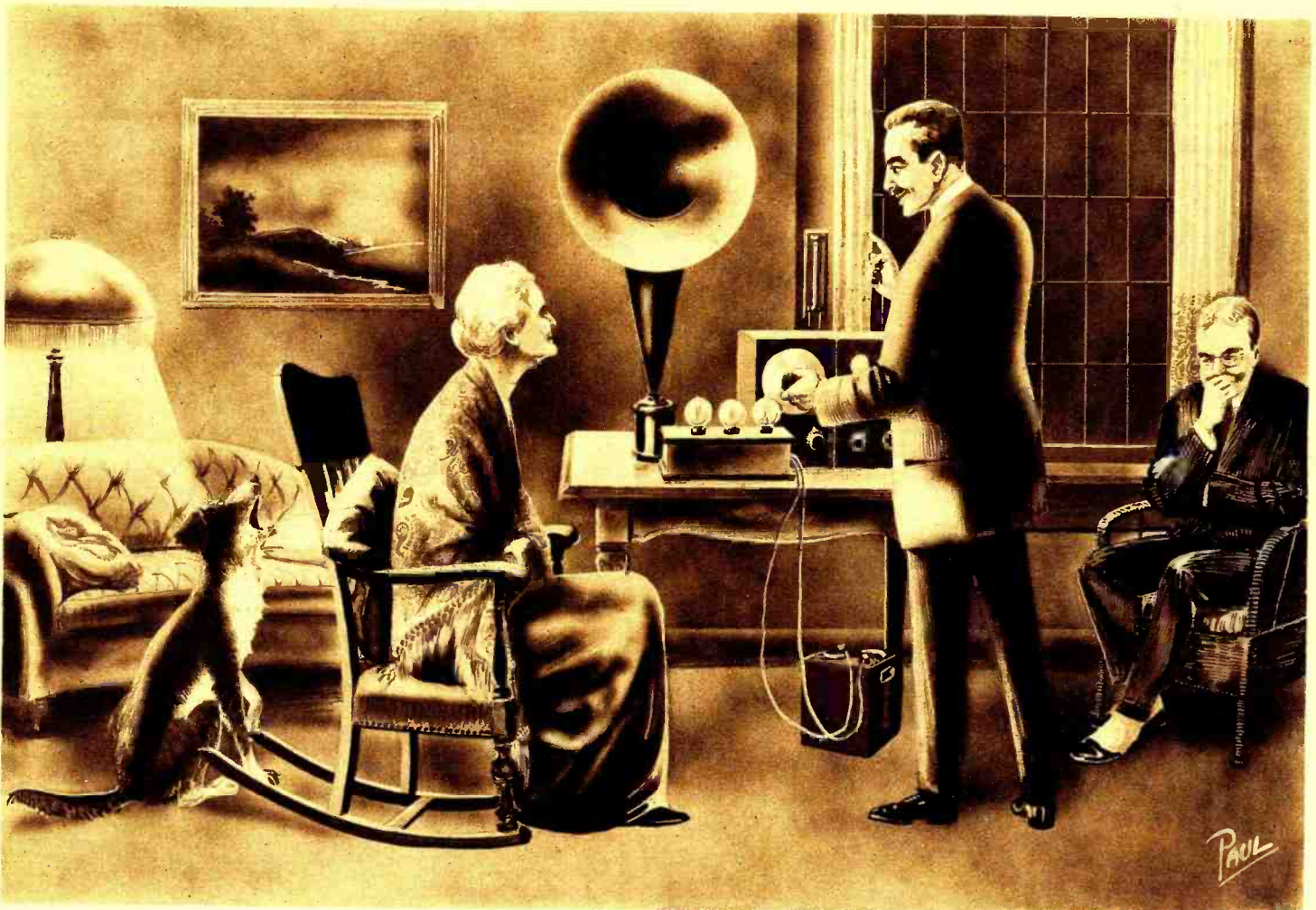

And in an instant, two big tear drops welled into Grandma's eyes and trickled down her dear old cheeks and she gave a great sigh of satisfaction and said, "My, My! I hear her perfectly; ain't she got a lovely sweet, sad voice?"

IT was, unquestionably, a wonderful thing when radio became no longer a mere knit-sweater affair but could be bought in a box and brought home like a dozen fried oysters or a pint of ice cream. By "knit-sweater affair" I mean that sort of radio that comes through the air with a message that is about as interesting to the average man as is the page in the women's magazine telling how to knit a sweater. You know how that goes—"Knit four, purl three, skip one, knit two, purl three, skip two—" and so on for line after line.

The old style radio used to come—and still comes—that way. "Dah-de-de-dah—dah-de-dah." "Code" is what the technical fellows call it, and it still spits in your ear now and then when you are trying to hear Patagonia or Peru or Peoria. The "spitter" we have most of here near New York is the one Mr. Binks calls "Navy Yard." Whether it is the Navy Yard or not I don't know, and—as far as that goes—neither does Mr. Binks, but that is what he calls it.

The Navy Yard—if it is the Navy Yard and if you have Mr. Binks' sort of "take-home-a-radio-in-a-box"—lurks at the far side of the dial. The concerts are mostly at the near side of the dial. Now and then "Navy Yard" gets lonely at the far side and comes sneaking over to the concert-and-lecture side, but it knows it does not belong

there and it says "dah-de-de-dah" in a faint little voice and goes away again. Then, sometimes, Mr. Binks says—to show off, perhaps—"That's Navy Yard," and just to show you, he swings his dial hand to the far end of the dial and "Navy Yard" is right at home there.

"ZANG—ZANG—A—ZANGY—ZANG" "Navy Yard" shrieks then, spitting sharp pointed gravel into your ear as if shooting it out of a machine gun at three yards distance, and Mr. Binks grins and says:

"That's Navy Yard, sending Code. May be talking to a battleship in the Indian Ocean or the China Sea. Strong, ain't it?"

Then Mr. Binks shifts back to the near end of the dial, and you get:—"tull Annie Laurie, I wuh-hu-hud la-hay-me-he dow-houn-un-hund dee" or, faint and far, that beloved refrain: "The-e At-lan-tah Journall. Dong-dong-dong!" or, from Ridgewood, the cheery announcement: "The next number on our program, played by the Hit-Em-in-The-Eye Jazzbo Six, of Brooklyn, New York, is the 'Don't-Bite-Your-Garter-If-You-Have-False-Teeth' Fox Trot."

For the radio has become all things to all men. You can tune in at one white line on your dial and be asked to support the movement for supplying second hand curling irons to the suffering natives of Zanzibar, or move on to the next white line and hear "And little Tootsie took the hand of the great big bear and went into the wood-chuck's house," or

move to the next white line and hear "This is WVJ signing off. One minute, please. Good night!" You can hear anything from a symphony orchestra of three hundred pieces to a scared amateur playing "Doo-dah, doo-dah" on one of these jewsharps that bites the tongue that caresses it. It's wonderful.

And Mr. Binks thought so, Mr. Binks was an enthusiast. It is one of the amazing things about radio-in-a-box that everyone who possesses one is an enthusiast. A man can buy a phonograph or a grand piano or an elephant and be quite calm and normal about it. He can say "Yes, this is my elephant. He's fair to middling. He isn't a Jumbo by any means, but I'm rather fond of him in some ways," and let it go at that; but for some reason a man can't own a radio-in-a-box without getting all keyed up and excited and telling his neighbors and—in a general way—behaving as if he had discovered the moon and had to call everybody to come and see it, and brag about it, and feel fussed if anyone seems to think it isn't a perfectly wonderful moon and the greatest thing ever discovered. That's the kind of enthusiast Mr. Binks was.

And that is all right too. It is a wonderful thing to sit down and turn a couple of knobs in your own home in Westcote, Long Island, and hear a tiny squeaky little voice, somewhat like a feeble mouse gnaw-

(Continued on page 1998)

Domestic Radio



Here is an Idea for the Ambitious. Feed Music to Your Neighbors Through the Vacuum Cleaner Hose, or Borrow a Hose from the Nearest Fire Department. If the Evening's Program is Especially Good, There is Always the Chance of Some Liquid Refreshments Coming Down via This Arrangement.

(c) Kadel & Herbert

This Kitty is no Novice but a "Dyed-in-the-Wool" Ham. She Can Operate This Set to Perfection. She is Shown in the Act of Tickling the Set Into Regeneration with Her Catwhisker and Incidentally, Listening in at the Same Time.

This Picture Shows Another "Radio Cat" Who Really Enjoys the Music and News from the Radio Set and Listens in When His Master Fixes the Receivers Over His Ears. This Cat Has Passed the Crystal Stage and Would Not Lower Himself to Listen in on Anything Less Than a Vacuum Tube Set. The Truth is That He Got Tired of Having His Master Use His Whiskers for the Crystal Detector.

(c) Kadel & Herbert

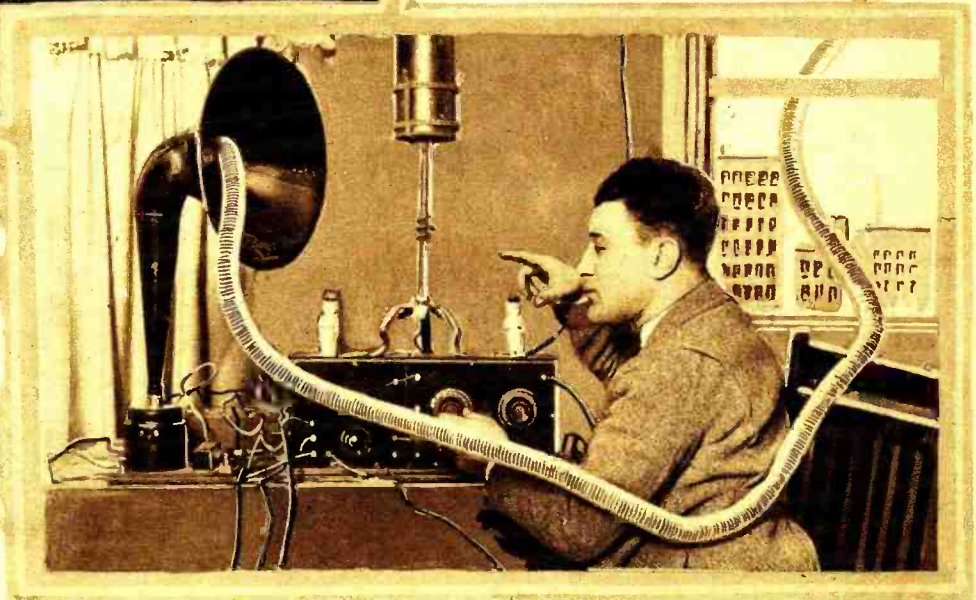
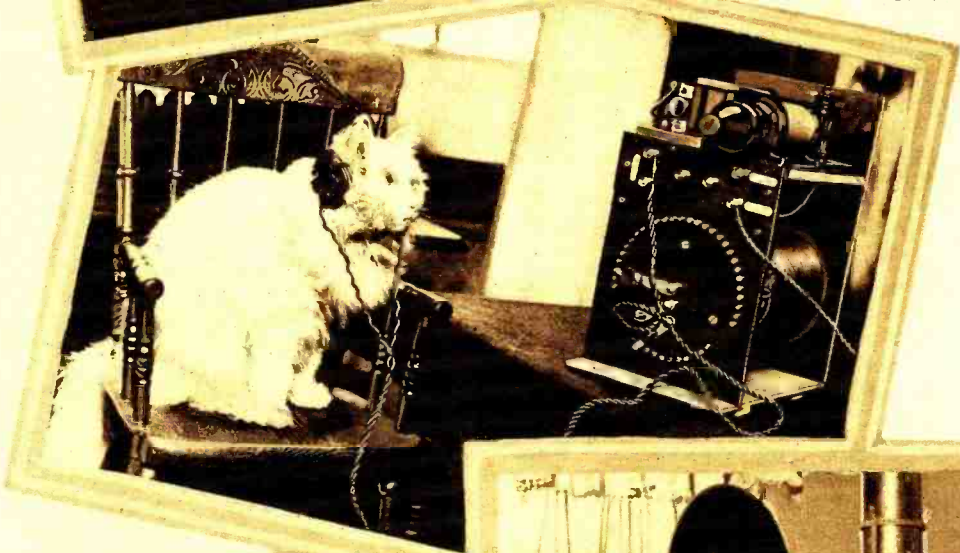

Radio Review

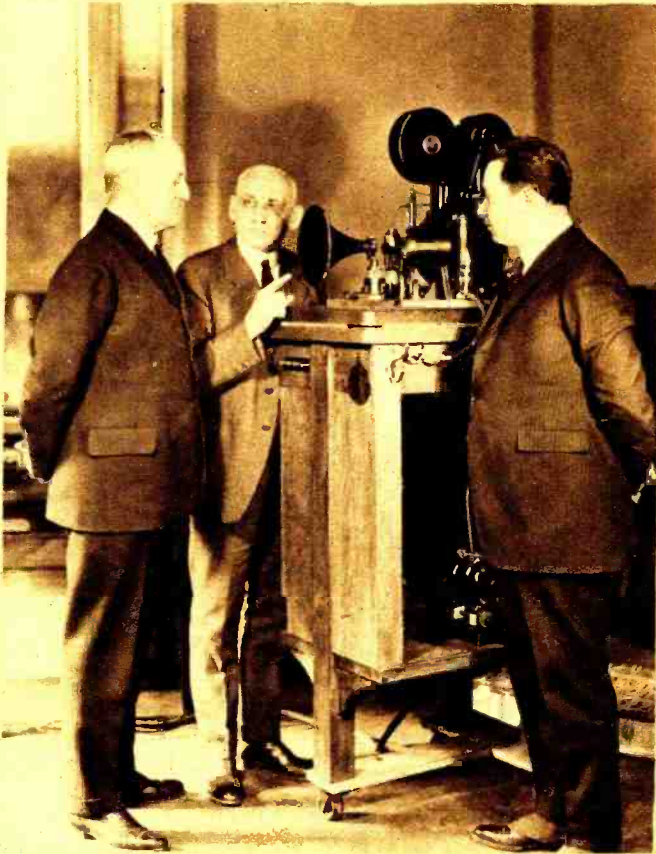

Above—Radio Is Again Used For a New Purpose. A Lecture That Was Broadcast Concerning Various Guns Used in the Navy Was Explained in Person By An Expert At the Receiving End. He Pointed Out Various Parts of the Guns As the Talk Progressed. The Photograph Shows Chief Petty Officer A. L. Whalen, U. S. N., Who Explained the Guns During the Lecture.

(c) Kadel & Herbert

Left—This Picture Shows, From Left To Right, General Harbord, President of the R. C. A.; Mr. A. Hoxie, Inventor of the Pallophotophone; and Mr. David Sarnoff, Vice-President of the R. C. A. Mr. Hoxie Is in the Act of Explaining the Mysteries of the Pallophotophone.

(c) R. C. A.

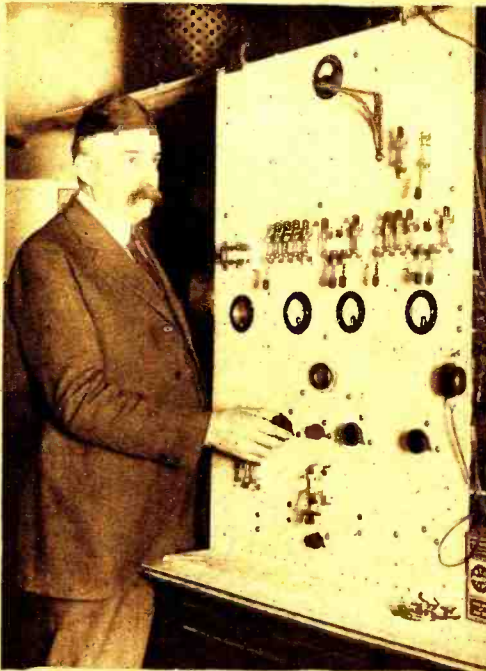

Above—The Radio Room of Station WQAO; Calvary Baptist Church, New York. Photograph Shows George F. Koster, Sexton of This Church, Who Installed the Set. Right—Miss Florence Kiersted of Brooklyn Is Shown Demonstrating a Radio Tea Wagon Receiving Set to R. U. Decker, an Amateur Operator.

(c) Kadel & Herbert

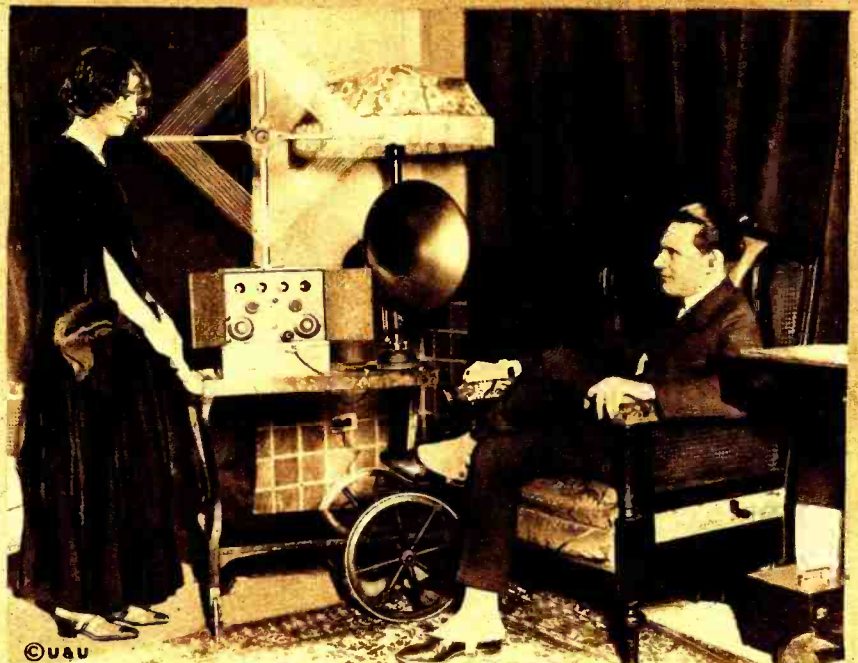

©U&U

New Radio Applications



If you cannot guess what this is, see page 2026

Above—(Left)—How Would You Like To Have This Fair Damsel Seated On the Top of Your Radio Set? Not Only Is the Appearance of the Receiver Improved, But There Is An Added Body Capacity Effect That Allows For Sharp Tuning. With a Collection of Women, a Wide Band of Wave-Lengths May Be Covered By Rapid Substitution.

(c) U. & U.

Above—Who Would Have Thought That Radio Would Fall In Line With Fashion? Miss Ethel Fleming Has Decided That a Loop Aerial Is a Desirable Piece of Headgear. It Doesn't Look So Bad At That.

(c) Kadel & Herbert

Above—As Said Before, Radio Is Fast Becoming Popular With the Women, Being Demonstrated By the Use of Many Important Parts of Radio Being Used For Decorations On Their Hats. Miss Marie Fleming Has Used Knobs and Dials For Decorations. She Is Ethel's Sister, So You See the Radio Craze Runs In the Family.

(c) Kadel & Herbert

Right—William A. Brune of the American Society of Electrical Engineers Has Completed a Radio Receiving Set Which He Claims Is the Smallest of Its Type. The Welfare Department of a Large Corporation Has Installed a Number of These Sets In Their Stenographic Department For Their Stenographers' Use. This Picture Shows Miss Rose Smith Listening In While Eating Her Lunch.

(c) Kadel & Herbert





THIS Department is open to all readers. It matters not whether subscribers or not. All photos are judged for best arrangement and efficiency of the apparatus, neatness of connections and general appearance. In order to increase the interest in this department, we prefer to publish photographs of stations accompanied by a picture of the owner. We prefer dark photos to light ones. The prize winning pictures must be on prints not smaller than 5 x 7". We cannot reproduce pictures smaller than 3½ x 3¼". All pictures must bear name and address written in ink on the back. A letter of not less than 100 words giving full description of the station, aerial equipment, etc., must accompany the pictures. **PRIZES:** One first monthly prize of \$5.00. All other pictures will be paid for at the rate of \$2.00 each.

Robert M. Stephens' Station 9AUC Hastings, Nebraska. This Month's Prize Winner

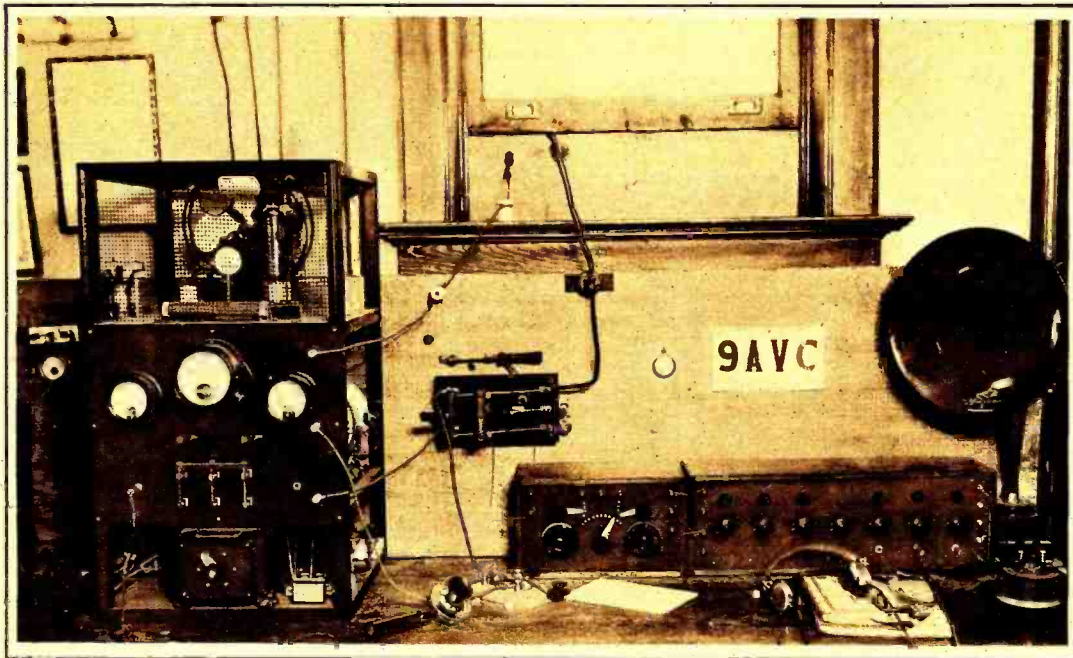

MY station, as shown in the accompanying picture, is located at the Y. M. C. A. of Hastings, Nebraska. The antenna is supported by one 60' wood mast, in a vacant space behind another building and the other mast is a 25' pole on the roof of the "Y." The antenna is

We Published a Picture of Mr. Stephen's Spark Set in October, 1921 and Stated That We Hoped to See His Tube Set When it Was Built. Well—Here it is. Judge its Qualities.

a six-wire cage, inverted L type. The lead-in is a six-wire cage 9" in diameter. The counterpoise is a six-wire flat top on 20' spreaders, directly under antenna and only 30' below the antenna. The transmitting wave length is exactly 196 meters.

(Continued on page 2049)

Station 8YD Cleveland, Ohio

C. J. CARTER, operator of Station 8YD of the Shaw High School, at East Cleveland, Ohio, has been notified by the American Radio Relay League that his station has been heard by stations in England and France, during the recent transatlantic tests. The message did not state at what point 8YD was heard, but stated that the station was heard three times. Mr. Carter and his station equipment are shown in the accompanying photograph.

This station is one of the most efficient amateur stations in the country. The antenna is of the T type, using four wires, and is erected on towers surmounting the high school building. The wires are supported on 16 foot spreaders and the flat top of the antenna is about 105 feet above the ground. A counterpoise of five wires is used in place of a ground. The station uses three 50-watt Westinghouse power tubes for transmitting.

The station is highly directional in its transmitting qualities and Mr. Carter has 145 letters from Pacific Coast points, ranging from Vancouver to the Canal Zone, acknowledging receipt of signals. The greatest distance that has been reported to Mr. Carter is 5,600 miles, when operator Morrison, of the S.S. China picked up the station

(Continued on page 2028)

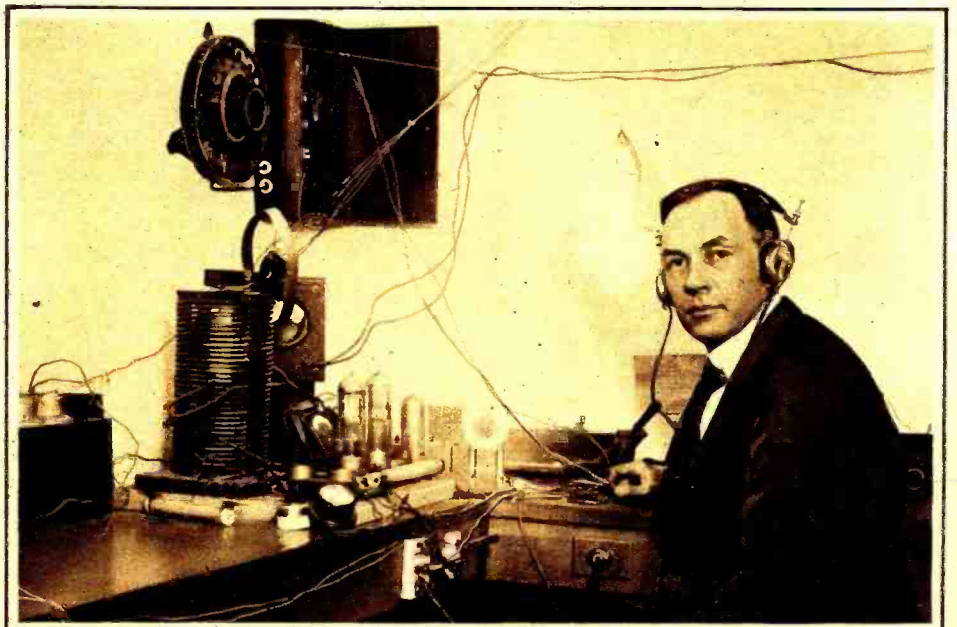

Mr. C. J. Carter, Station Operator of 8YD.

How I Received the American Amateurs' Signals in France

By MARIUS THOUVAIS*

WELL! O.M.! It is not so difficult a matter to hear the American signals here in France! My receiver is not a specially designed one; it is not an elaborate multi-stage amplifier, nor even a good standard two-variometer short-wave receiver. . . . It is a very usual home-made set. A description and photograph of this station appeared in the October, 1922 issue of Radio News. In a later article, which was published in the January, 1923 issue, I told of this receiver's extremely selective and rather unusually efficient reception of all long-wave trans-oceanic stations, when both heterodyne and auto-dyne are suitably combined together. I will now endeavor to show what results may be expected from this receiver, when it is carefully handled.

As this set uses no radio frequency at all on the short-wave lengths, I shall not claim it is as efficient as a nine-tube super heterodyne, or a multi-stage radio frequency amplifier, but yet, in spite of its low amplification, it works, and it has proved that U. S. A. is not beyond its range! Before the coming of the tests, it had not established noticeable records on short waves, and I must say, it did not work as well on 200 meters as on 360, and as I believed that it required a tremendous amplification to get such DX signals, I did not listen in during the first four days of the event. After having read so much about the super-sensitive amplifier used by the winners of last year's trans-Atlantic tests, I confidently believed my much simpler receiver was quite unable to pick up the easiest "test". . . . However, on the fifth day,—or rather night, I decided to spend a few hours to try it out. On 200 meters I could hear nothing but a few weak signs among heavy static, but on the other hand on 328 and 360 meter waves I was able to enjoy some fine concerts sent out by

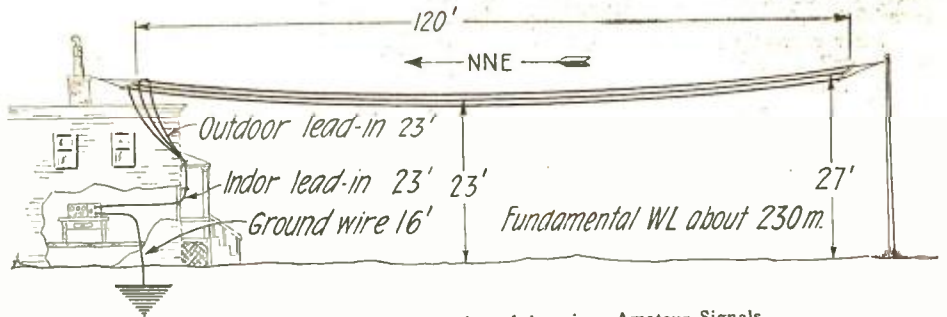

The Aerial Used for the Reception of American Amateur Signals.

180-250 was very materially increased. During the four following nights, the last four of the event, I picked up the following calls: 1AZP, 1AWP, 1BDT, 1BES, 1BET, 1FB, 1II, 1OR, 1XM, 1ZE, 2AWF, 2CBX, 2CKR, 2CGZ, 2GI, 2GK, 2LO, 2FP, 2FW, 2GY, 2XAP, 2ZY, 3BG, 3AGR, 3BLF, 3BGT, 3HG, 3ZP, 8ADG, 8AGO, 8AWP, 8AGZ, 8BRK, 8CGH, 8CYH, 8IB, 8BSS, 8YD, 8AM, 8SP,—several of them were logged several times: 1BDT, 1FB, 1II, 3HG, 8AGO; the last has been received not less than five times and I think it was one of the strongest and steadiest and was certainly among the easiest to pick up. I also received several amateur telephones on 200 and 275 meters, but I could identify 2XAP's only, which was particularly strong.

On hearing of these results obtained with a two-tube receiver some might believe I am using some unusual aerial, but I am not. My antenna has already been described in this magazine, the October issue, but Fig. 1, will give a better idea of its shape. As the wires were stretched three years ago, they are now slack and form a graceful curve, and are hardly 23' above the ground in the middle. Fig. 2 gives the complete hook-

ing and reaction, one is not puzzled by the multi-controls of elaborate amplifiers and therefore the operator is enabled to concentrate all his attention on the weakest of the signals, thus getting the best out of his set. The inductances that I am using for very short waves are of my own design; they are something like the well-known spiderweb coils, but are an improvement over same. With a .001 MFD. variable condenser in series in aerial circuit, the W.-L. range covered is from 180 to 300 meters for a 30-turn coil and about 250-500 meters for a 50-turn inductance. Either a 30- or a 50-turn coil is found quite suitable for reaction over the 150-500 range.

The vernier condenser, which is used together with the main tuning capacity, has two movable plates and three fixed ones. Both condensers need to be controlled with long ebonite handles to avoid capacity effects, as the set is not shielded. The bulbs I am using are always the hard vacuum French audions, the filament of which is fed through a four-volt storage battery. The grid leak and condenser are home-made and are nothing unusual, the leak being of the pencil mark type. The audio frequency transformer, which was bought from a French manufacturer, is the usual iron core type, the primary of which is shunted by a .002 MFD. fixed condenser. A small negative potential taken from some dry cells is applied to the grid of the second audion in order to have its grid slightly more negative than the filament so as to get a greater and distortionless amplification. The headset which I used has a single phone and is of French make. This has been in service since 1917, and though a good one, is doubtless not so efficient as several first class phones made in this country. It may be interesting also to learn that the tubes have been used continuously for nearly three years.

In conclusion, I want to state that the reception of American amateurs here on but two audions is not a freak feature; several other French people have picked up a lot of calls on somewhat similar sets, and a friend of ours, Mr. Leon Deloy, French 8AB, whose transmission got across, was also successful enough to receive some American calls with only a detector tube.

It may be fair to state, however, that this set was a variometer tuned plate receiver providing a more critical adjustment of regeneration than my tickler coil set. But I wish to say that static was so bad that the second tube, the audio frequency stage, magnified atmospheric and jammed so that audio frequency was very often useless and in some cases rather a bother than a help. Most of the calls I logged were strong enough and could have been read with the detector alone. Do you call this F.B.? . . . And can French amateurs be recognized as "hard boiled hams" now?

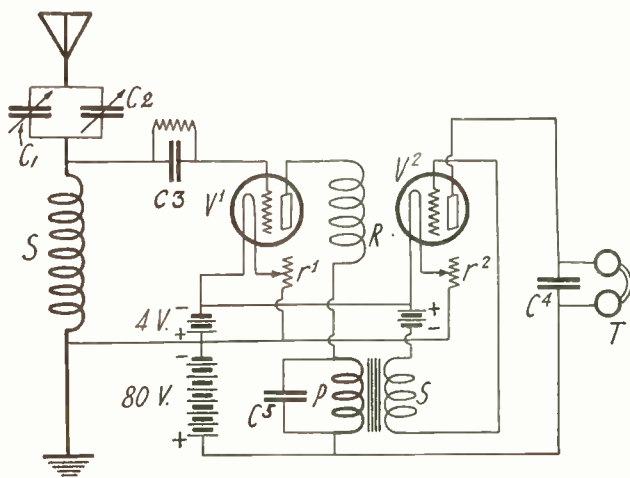

The Hook-up Employed by Mr. Thouvais During the Tests. It is of the Single Circuit Type and Has an Exceedingly High Factor of Selectivity in Comparison with Other Single Circuit Receivers. Having But Two Controls, it is Ideal for Amateur Work. The Instruments marked are: V¹ Detector Tube, V² Amplifier Tube, P and S Audio Frequency Transformer, R¹ and R² Filament Rheostats, C¹ .001 M.F. Variable Condenser, C² Vernier Variable Condenser, C³ .00025 M.F. Fixed Grid Condenser, C⁴ .002 M.F. Fixed Condenser, S Aerial Tuning Inductance (30 Turns for 200 Meters, 50 Turns for 360 Meters) R 30 to 50 Turn Tickler Coil Coupled to Aerial Tuning Inductance.

WJZ and several other broadcasting stations. The next day I decided to improve my set for the shorter W.L. I increased the voltage of my "B" battery up to nearly 80 volts; I removed the antenna lead-in a little further from the wall and replaced the defective and inefficient paper insulated variable condenser by a new and better one—of the air dielectric type; and in view of lowering the radio frequency resistance of the whole I tripled the single ground wire. Immediately I found that the set oscillated much more freely on as short a wave as 150 meters and that the efficiency over the band

up of the short-wave set. It is a single circuit tuner which I find sufficiently selective, and very easy to control. It is certainly much easier to handle than several stages of tuned radio frequency, as all the tuning is done with the aerial condenser and its necessary vernier, of course. Regeneration is controlled by a simple tickler coil, but the coupling of this reaction coil should be adjusted carefully in order to get the higher efficiency if faint signals are to be heard.

I think the extreme simplicity of my receiver is not the least element of its efficiency; as there are two controls only, tun-

*President of the Radio Club de Sologne.

Amateur News

ANOTHER LOW POWER RECORD BY AUSTRALIAN 2 CM. 200 Miles Daylight on 1/7 Watt

During low power transmission tests recently conducted by Mr. C. D. Maclurcan, Strathfield, signals were received and the test letter correctly noted by Mr. Channon, of Inverell (350 miles), and also by Mr. L. V. G. Todd, of Tamworth (200 miles). The input plate voltage was 60 and the current 6 milliamperes; total power, .36 watts.

In a letter to Mr. Maclurcan, Mr. Channon said:

"Your set seems to be in good going order tonight. The music, etc., came in better than I have ever heard it before. I am still using the single Expanse A Valve. The letters you sent were F, V, and W. There was considerable static, but I'm sure I could get your C.W. stuff with less power than the last you used tonight."

Mr. Channon little knew at the time that less than two-fifths of a watt was the lowest power used—and he wants less! These country radio men can show us a lot in the receiving line, but they are certainly hard to please.

Following on this another test was arranged with Mr. Todd in daylight, with the astonishing result that signals sent with a power of 1/7 watt were clearly received. Mr. Maclurcan's log shows the following particulars of the powers used:

5:45 p.m.	7:15 p.m.	Volts	M. Amps	Watts.
J	L	500	35	16.5
L	P	320	21	6.4
O	X	120	11	1.21
K	C	90	8	.72
X	K	65	6	.39
M	M	50	5	.25
W	W	40	5	.2
O	O	35	4	.14

CRYSTAL RECEIVING RECORD

Mr. Maclurcan has received the following letter from Mr. H. Hinks, Mount View, Mulgoa:

"Dear Sir: I am writing to tell you that I heard your concert last night on a home-made crystal set, using a pair of Brown's phones, the lady's voice coming in very clear and also the steel guitar, of which I never missed a note.

"I have an aerial 600 feet long and about 80 feet at the highest point, single wire only 7/20g.

"I do not think it a bad performance for a crystal set, as the distance is about 40 miles.

"I would be very much obliged if you would let me know what power you were using last night, 26/11/22. I may add that my call number is 21S."

Mr. Maclurcan informs us that this is, as far as he is aware, the furthest distance at which his concerts have been received on a crystal, and that he considers Mr. Hink's performance a very excellent one. Even at five miles, very skilful tuning is necessary with a crystal set, for there is no "carrierwave" to help the adjustment.

—"Sea, Land and Air."

"I received the first issue of the *Southern Minnesotan* a short time ago and find it is "the berries." "Great Stuff, OM." I certainly wish I were back in Fairmont pounding brass and I would do my best to help raise the list to 40000 msg's. It wouldn't be a five watter either—but what's the use—I am going to school now and so ND on the DX although I migrate over to 9AUA once in a while and boil owls and pound brass. I am using a crystal set here for local broadcasting stations, of course. Can you imagine it? I started over eight years ago (9QF knows) and here I am again down to the crystal stage. . . . A fellow was trying to tell me here that a crystal oscillates but he had considerable trouble in putting it across. In fact he didn't succeed for some reason or other. Hi!"

"A good way to make a crystal oscillate is to hang it on a string and swing it like a pendulum."

73's 9QE.

NOTICE

Mr. J. V. Newson of 139 Ormside Street, London S. E. 15, would like to get in touch with an American amateur owning a 1 K.W. transmitter with a view to carrying out some experiments on trans-atlantic work.

8CBP

The QRA of 8CBP is Jack J. Donner, 214 Paddock St., Watertown, N. Y. Any one hearing my 5-watt C.W. pse QSL.

5AIX

The call 5AIX has been issued to Albert L. Presley, Box 66, Vaughan, Miss. Word from those hearing his signals will be appreciated by him.

THE SOUTHERN MINNESOTAN

We recently received a copy of the *Southern Minnesotan*, the official organ of the Southern Minnesotan Radio Organization, published by the Luverne High School Radio Club at Luverne, Minnesota. It was but recently born and is still a bit wobbly on its legs, but judging from the material within its pages, there is no doubt that it will grow to be a husky.

Minnesota amateurs should find a happy home in this little paper. We are reprinting below a letter received by them from one of their subscribers.

Calls Heard

F. J. BUESO (4DA) RIO PIEDRAS, P. R.
(One Tube)

1BDI, 2ZL, 2FP, 3ZW, 4FT, 5EK, 7FG, 7BSY, 8XAE, 9ZN, 9BP, 3FC (Can.)
Broadcast. KDKA, WGY, WJZ.

HEARD BY HARRY W. MONEY 3BGB
ABOARD KDQW FROM LOS ANGELES
TO BALBOA, C. Z.

All C.W. Jan. 13th—1320 miles S. E. Los Angeles—5PO, 5TC, 5UJ, 5VY, 5ZAK, 6BBC, 6XXA, 6ZB, 6ZH, 9CNS. Jan. 15th—1649 S. E. Los Angeles—5SK, 5XV, 6BUN, 9CKP. Jan. 19th, 2250 S. E. Los Angeles—3ARO, 5QY, 8BXX, 8ER, 8YV, 8ZW, 9BBF, 9B1K, 9KP, 9YI. Jan. 20th, 2500 S. E. Los Angeles—3PZ, 4EB, 4EN, 5AAR, 5MB, 5ZB, 5ZAK, 8ALT, 9DWK.

3RB, PHILADELPHIA, PA.

All C.W. 1AW, 1EE, 1FB, 1GV, 1HK, 1II, 1LL, 1LO, 1ON, 1OR, 1PM, 1PR, 1QP, 1RD, 1SN, 1UN, 1XM, 1XP, 1XU, 1ABY, 1ADD, 1AGH, 1AJP, 1AJU, 1AKL (1ALZ), 1ANR, 1AOK, 1ASF, 1ATJ, 1AUN, 1AXE, 1BES, 1BGW, 1BJN, 1BKA, 1BKQ, 1BLN, 1BOA, 1BOE, 1BOP, 1BRQ, 1BSD, 1BWJ, 1CDO, 1CDR, 1CIK, 1CIT, 1CJA, 1CMK, 1CPN. Following two's and three's daylight, rest too numerous to mention. 2NZ, 2AWL, 2AYV (3BJ), (3ZO), (3ACC), 4BX, 4CG, 4EA, 4EN, 4FT, 4GX, 4KM, 4NT, 4YA, 5DA, 5EK, 5FV, 5MB, 5MT, 5PX, 5QM, 5XK, 5AAM, 5ZAV, 6ZZ, (8KG), (8AQO da-lite), and 210 other eight's heard. 9BP, 9PE, 9EP, 9GK, 9HK, 9II, 9IO, 9KM, 9KP, 9LC, 9LQ, 9LZ, 9OX, 9PF, 9RC, 9UC, 9UU, 9XI, 9XM, 9YM, 9ZN, 9AD, 9AP, 9AEN, 9AQO, 9AFK, 9AIP, 9AII, 9AMH, 9AOT, 9AOU, 9APS, 9AQA, 9ARD, 9ASD, 9ATN, 9AUL, 9AWM, 9BBI, 9BSG, 9BCT, 9BED, 9BEY, 9BRK, 9BRX, 9BSG, 9BZI, 9CBA, 9CCV, 9CHF, 9CJA, 9CJC, 9CPI, 9CUI, 9CVI, 9CYW, 9DFB, 9DGE, 9DGO, 9DJO, 9DNH, 9DOU, 9DVL, 9DVN, 9DWQ, 9DXM, 9DYN, 9DUY, 9XAC, 9YAJ. Canadians. 2AF, 3AD, 3BO, 3BV, 3CO, 3DE, 3DH, 3GE, 3IL, 3JL, 3JT, 3KO, 3PL, 3SX, 3XN, 3ZL, 9AJ, 9AL, 9AW, 9BJ.

7RI, MONTESANO, WASH. (One Tube)
C.W. Can.—4BV, (4DQ), (5UN), (5CT), 9RC, 9AX, 9BD. U. S.—4HH, 5ACF, 5ADE, 5AVR,

5DI, 5EK, 5PX, 5TJ, 5ZA, 5XAD, 5ZAK, (6AK), 6AR, 6AW, 6AAT (6ABX), 6AJH, 6ALH, 6ALV, 6AMW, 6AMZ, 6AOI, 6ARB, (6ARF), 6ARK, 6ASN, 6ATC, 6AUU, 6AVD, 6AVV, (6AWT), 6BRK, 6BC, 6BCI, 6BCL, 6BCR, 6BIC, (6BIN), 6BIZ, 6BJK, 6BJO, 6BKJ, 6BMD, 6BNH, 6RNU, 6BQB, 6ROF, 6BUI, 6BUN, 6BVZ, (6CC), 6CP, 6DD, 6EC, (6ESM), 6FF, 6FT, 6GB, (6GY), 6HM, 6ID, 6KA, (6KU), 6LF, 6LO, 6NX, 6PI, (6OM), 6RD, 6VM, 6SU, 6SZ, 6TC, 6TI, 6UW, 6VF, 6VM, 6W, 6XAC, 6XAD, 6XAV, 6XWL, 6ZZB, 6YF, 6ZH, 6ZL, 6ZZ, 7AAD, 7ABC, (7ABB), 7ABH, 7ABY, (7ADG), (ADM), (7ADP), (7AEA), (7AEM), 7AFF, (7AFH), (7AFS), (7AHW), (7AII), (7BB), (7BJ), (7BK), (7BZ), (CZ), (7DP), 7EB, (7EO), 7FR, 7HM, 7HS, 7IF, (7KE), (7LR), 7LU, (7MC), (7MF), 7NA, 7NC, (7NG), (7OT), 7OM, (7PB), 7PF, (7QF), 7IG, (7JW), (7QT), (7RN), 7RW, (7SY), 7SZ, 7TH, (7TO), (7TT), (7UD), 7VF, 7WF, 7WG, (7WM), (7WQ), 7XB, 7XG, 7YG, 7ZK, 7ZO, 8AB, 8CUR, 8IB, 9AHK, 9ANO, 9ARZ, 9ASF, 9BED, 9BII, 9BM, 9CMK, 9BZZ, 9DMT, 9GK, 9LF, 9PI, 9PN, 9ZAF, 9XAC, 9ZN, 9AWM, 9BBF.

Voice—(7AEA), (7AFS), (7AHW), (7MF), (7QF), (7RN), (7SY), 7XI, 7XL, 7ZU, (6KU), 6XAC, 6XB. Can.—9AC.

9BDR, FORT DODGE, IOWA (1 STEP)

1ADK, 1BSZ, 2AWT, 2DD, 3APR, 3BLF, 3JJ, 3OT, 3PZ, 3SM, 4MK, 4NV, 4YA, 5ADO, 5AEC, 5CI, 5EK, 5GR, 5HZ, 5IX, (5NN), 5OV, 5VY, 5ZAE, 6ZH, 6ZZ, 8AA, 8ADT, (8ADZ), 8AOK, 8ATC, 8ATN, 8ATZ, 8AUE, 8BEF, 8BFO, (8BJC), 8BOZ, 8BRW, 8BWK, 8BYO, 8BZC, 8CF, 8CIA, 8CIH, 8CIM, 8CLK, (8CUR), 8DAA, 8DAT, 8FU, 8JJ, 8KG, 8OK, 8SB, 8SS, 8VL, 8WA, (8YN), 8ZY, 8ZAE; 9's too numerous. Canadian—1AJ, 9BJ.

9EFD AND 9CON, HOPKINSVILLE,
KENTUCKY (ONE TUBE)

C.W.—1CY, 1BK, 1CKP, 2FP, 2XAO, 3CO, 3MB, 2AQR, 3BEC, 3BNU, 3CAN, 4BY, 4KL, 5BI, 5EK, 5IK, 5IX, 5KP, 5MY, 5ND, 5NK, 5SK, 5XA, 5ZB, 8AX, 8BY, 8FG, 8FT, 8IO, 8KO, 8LS, 8OI, 8OW, 8QK, 8SP, 8VQ, 8XU, 8YD, 8AEA, 8AME, 8ANB, 8APW, 8AQQ, 8ATU, 8AXE, 8AZQ, 8BDB, 8BNK, 8BOG,

8BTV, 8BXH, 8BYT, 8CAO, 8CGO, 8CID, 8CJH, 8COZ, 8CPD, 9KPF, 9PC, 9PS, 9RC, 9UR, 9VK, 9AAD, 9AIII, 9AJH, 9AJS, 9AOU, 9AUT, 9AWS, 9AZG, 9BEY, 9BGE, 9BII, 9BKW, 9BTT, 9BZI, 9CAO, 9CBA, 9CEB, 9CFI, 9COM, 9OX, 9DAH, 9DGE, 9DHH, 9DPL, 9DQM, 9DXV, 9DYG.
Spark—5XU, 8XA, 9CP, 9VQ, 9ZN, 9AAW, 9AZE, 9BOF, 9BSZ, 9COZ, 9DAY, 9DKY, 9DQQ.

8APK, CHARLESTOWN, W. VA.

(ONE TUBE)

1AHZ, 1AJP, 1AOL, 1ASF, 1AWB, 1AY, 1BCE, 1BE, 1BEP, 1BFE, 1BK, 1BKA, 1BSD, 1BWJ, 1CAC, 1CDR, 1CKP, 1CNF, 1EE, 1FB, 1LL, 1MY, 1NG, 1XK, 1XZ, 1YS, 2ANM, 2BEA, 2BON, 2BRC, 2CGT, 2CJN, 2CKL, 2CKR, 2CPA, 2EL, 2FC, 2FP, 2GI, 2GK, 2MO, 2VD, 2XA, 2XAO, 3AFR, 3AQB, 3AUU, 3AZ, 3BEC, 3BER, 3BMK, 3BO, 3BRW, 3BUV, 3BU, 3BZ, 3FR, 3HK, 3IW, 3KE, 3LK, 3OJ, 3PZ, 3TI, 4BY, 4EA, 5EB, 4EU, 4HK, 4HW, 4LJ, 5AEC, 5EK, 5IK, 5MO, 8ADZ, 8AEG, 8AGD, 8AII, 8AIM, 8AIW, 8APW, 8AQQ, 8ASF, 8AZL, 8BCH, 8BE, 8BEF, 8BOG, 8BOZ, 8BWA, 8BXY, 8BYO, 8BYT, 8CAB, 8CAR, 8CAZ, 8CGU, 8CIH, 8CJJ, 8CKO, 8CLC, 8COA, 8CP, 8CPB, 8CRB, 8CTN, 8CVE, 8CW, 8DAA, 8FU, 8AJ, 8JY, 8KG, 8LT, 8ML, 8MZ, 9ADZ, 9AFK, 9AIU, 8AME, 9AON, 9AP, 9AQA, 9AWF, 9AWH, 9AZA, 9BED, 9BIJ, 9BM, 9BS, 9BUX, 9DLR, 9DPJ, 9DPV, 9DVI, 9DXN, 9EJ, 9EL, 9GX, 9HK, 9PO.

GEORGE KRIVITZKY, SCOTTVILLE, MICH.

Spark—3CCB, 4DWK, 8CZY, 8BDK, 8EB, 9DAE, 9AOJ, 9AHQ, 9BSE, 9DRA, 9AZT, 9CTW, 9AGG, 9CLV, 9AAW, 9JX, 9UK, 9OF, 9DAR, 9CUD, 9BGO, 9DNC.

C.W.—1TU, 1BKA, 1BOP, 1AJP, 1BFE, 2AYV, 2SG, 2OM, 2XAO, 3JJ, 3BZ, 3GK, 3TBE, 3TJ, 3CA, 4EA, 5EK, 5XA, 5IX, 5ND, 5ZI, 5DQ, 5PV, 5MO, 8CAZ, 8BBS, 8CLD, 8ZAE, 8CYE, 8CDD, 8AEA, 8BCH, 8BIN, 8UE, 8HI, 8DAA, 8DQU, 8CNE, 8AZA, 8BAA, 8IH, 8BXX, 8EO, 8CEI, 8IUF, 8II, 8CED, 8ANB, 8MZ, 8BOG, 8AAF, 8AIM, 9AOD, 9DIF, 9DJR, 9BVT, 9DVE, 9AIU, 9EGE, 9BAK, 9BCF,

(Continued on page 2061)

Practical Hints for Amateur Constructors

A NOVEL VERNIER CONDENSER

A two-plate vernier condenser which is novel in every respect and which continues its originality right up to the point where it is mounted on the panel, describes the home-made device for which instructions are given in this article. The instrument described in the following paragraphs not only fills every need of the amateur for close tuning, but it is also so easy to make that there are no work-bench difficulties to discourage even the most unskilled of enthusiasts. When finished, the vernier condenser may be mounted in a vertical position on the base of the receiver and controlled by thumb from the face of the panel.

The rotor of this novel vernier condenser is made up in a jiffy from three familiar parts of other apparatus. These three are a dial, a spare condenser plate (or one cut from brass, copper or aluminum if no spare movable plates are available) and a $\frac{1}{4}$ " brass rod with a shoulder. Put together in the order named, we have a rotor

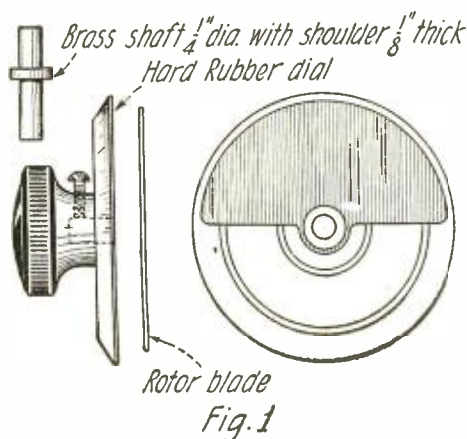

Showing the Method of Mounting the Rotary Plate on the Dial. This is Accomplished by a Brass Shaft with a Shoulder.

element for our condenser which is held together by the set screw in the knob of the dial. The single plate is pressed closely against the under side of the dial by the shoulder on the brass rod, as indicated on the assembly Fig. 1.

The brass rod need not be very long, in fact there is a limit to how much of it may be above the shoulder, that limit being set by the depth of the hole in the dial. The shoulder, as may be seen, plays the dual role of check nut and space washer, since it

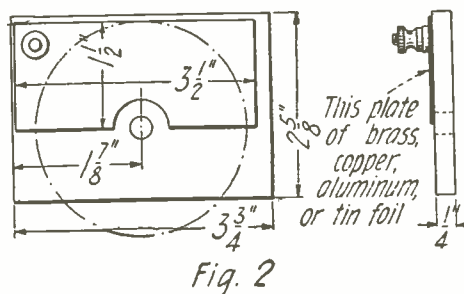

Fig. 2

Dimensions and Details of the Stationary Plate and Its Mounting.

not only holds the spare rotary plate in place but also determines the thickness of the air dielectric between that plate and the stator.

The stator, in this home-made instrument, is made by fastening a piece of sheet brass, copper or aluminum over the greater half of a piece of wood or bakelite, which has been

About Our Radio Wrinkle Prize Contest

Due to the short month of February, haste was necessary in the publishing of our May issue of RADIO NEWS. In order to insure the forthcoming issues appearing on time, the May number is earlier than usual. For this reason we have been unable to include the results of the Radio Wrinkle Prize Contest. We shall, however, publish them in the June issue of RADIO NEWS. They will be found of unusual interest.

drilled to take the brass rod now acting as the shaft of the rotary plate. Fig. 2 gives the dimensions for this half of the instrument. Using a three-inch dial and the usual size of condenser plate, the stator plate should be $1\frac{1}{4}$ " by $3\frac{1}{2}$ ". The bakelite should be about the size indicated in the sketch. In some cases where the writer has equipped a receiver with these vernier attachments, it has been advisable to omit the bakelite block altogether, mounting the fixed plate directly on the base of the receiver.

Whichever the case, the $\frac{1}{4}$ " hole which is to take the rotor shaft should be drilled not more than 1" from the panel edge of the base. To illustrate the reason for this, a broken line circle showing the position of the 3" dial is drawn on Fig. 2. The rim of the 3" dial overlaps the edge of the base $\frac{1}{2}$ ". This overlap protrudes through a narrow slot in the panel, cut so that it is directly below the main condenser of which the smaller and home-made device is an auxiliary. With just enough of the dial showing to permit of thumb pressure, the capacity of the two plate vernier may be controlled

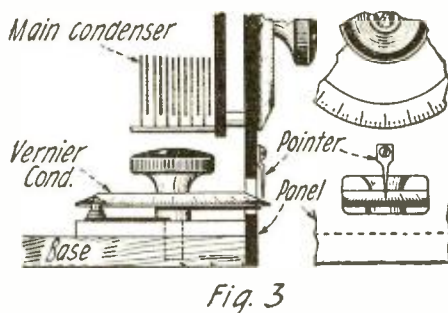

Method of Mounting the Novel Vernier Condenser. It is Adjusted from the Front of the Panel by the Thumb or Fore Finger.

from the outside of the panel. This method of control is illustrated in Fig. 3 which also shows the manner of mounting the home-made condenser after it is made.

If a bakelite base is used, it is put close against the panel, and the hole continued down into the base of the receiver, deep enough to provide a firm bearing for the movable plate. Mark out the slot in the panel, drill it and then complete the job with a hack-saw blade or a file. A pointer is added—and presto, the work is done!

For the stator connection, put in a binding post as shown in the sketches: for the rotor, solder the wire on the head of the set screw which holds the rotor element of the instrument together. And if there is another word of caution one radio

amateur ought to tell another when suggesting this vernier, it is this: drill that hole straight!

Contributed by Arthur S. Gordon.

A MAKESHIFT LOUD SPEAKER

The following kink may be of use to some of us who for various reasons, do not care to place a horn on the radio set.

I have found that if a single receiver is lowered gradually into an ordinary fish bowl, there is a point found where the music simply roars out. This point will vary with the size of the bowl but is usually only a short distance from the bottom. The action is the same as with a Hertz resonator.

If one does not care to use the fish globe he can secure still better results by utilizing another article to be found in every household; the food chopping bowl. A thin board is placed over half of the bowl and the phone placed as shown in the sketch. The music will roll out in an astonishing volume.

Contributed by Wesley McArdell.

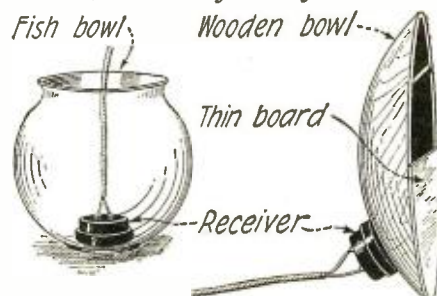

A Fish Bowl and a Wooden Meat Chopping Bowl Both Make Good Loudspeakers. This Illustrates How it is Done.

A CORRECTION

The article entitled "A Lightning Switch Indicator," appearing on page 1656 of the March issue of RADIO NEWS, contained an error in its drawing, which is on page 1729. As it is shown, the switch blade will ground the aerial through the resistance of the lamps when thrown to the left. In its original form, this arrangement uses a DPDT with two sets of contact jaws, one of which was used for the lamp circuit. The two outside wires from each lamp were connected to these extra jaws instead of to the main switch jaws as shown.

SAVING SWITCH POINTS

In a set I made, I got along without switch points, by making my taps long

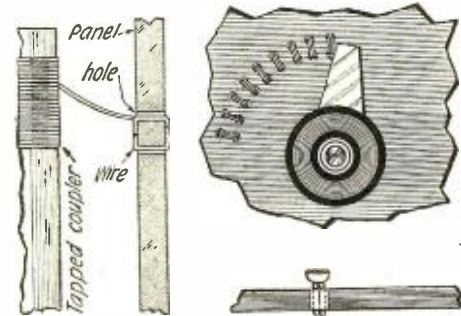

This Scheme Does Away with the Use of Switch Points. Loops of Wire Are Used Instead.

enough to run through a small hole in the panel and then back through the panel again, without cutting. When the wires are in place, the holes can be plugged, but the loops are not cut off in back; in this way there is no joint in the circuit at all. The wires can be countersunk so that the switch will slide over perfectly smoothly.

Contributed by F. C. Galbreath.



The Radio Constructor

An Efficient Reinartz Tuner

By HOWARD S. PYLE, I. R. E.

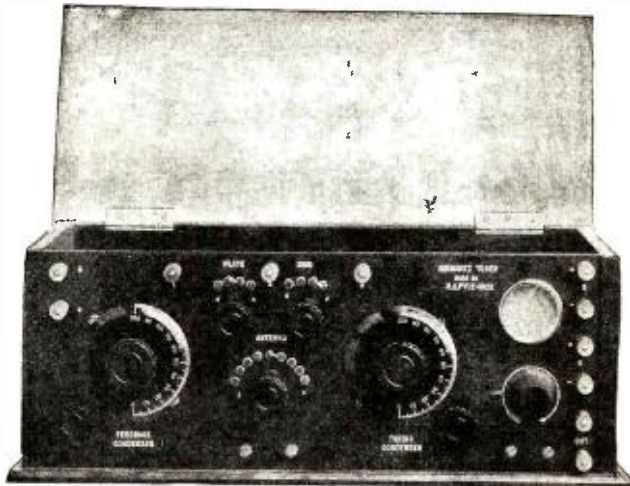

Two Views of the Reinartz Receiver Described in This Article. Instead of the Usual Spider-Web Coil, a Single Layer Inductance is Employed.

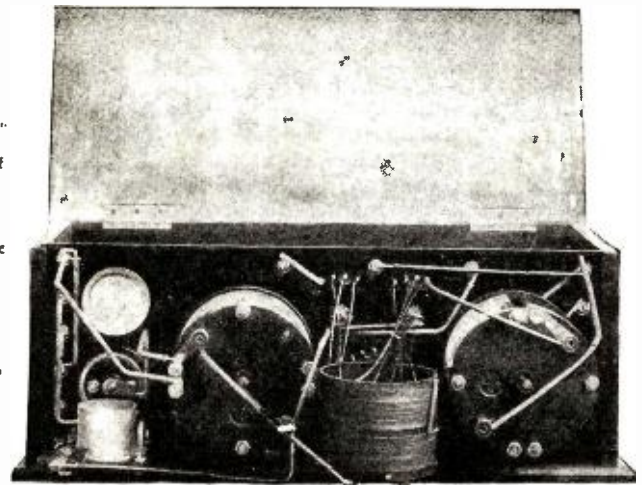

MUCH has been written of late, relative to the new development in tuning arrangements known as the Reinartz tuner, named for its originator, Mr. John L. Reinartz of South Manchester, Conn. This appears to be the long looked for tuner for relay stations and traffic work, involving but a single tuning control and a number of other desirable features.

We will not enter into a discussion of its theory herewith, this having been very thoroughly treated of late in the various publications. It is the author's purpose, however, to describe briefly the construction and specifications of an efficient Reinartz tuner which will give very satisfactory results. The drawing of the panel face, being made to scale, the various dimensions may be had by using the dividers. A panel having a length of $15\frac{3}{8}$ " and a height of $5\frac{3}{4}$ " was chosen, this being a stock size, and a well finished walnut cabinet being available to accommodate that size panel. Obviously, any size panel may be used, but this size was found to be admirably adapted to the purpose.

A departure from the usual Reinartz design is incorporated herewith, in the use of a single layer coil in preference to the spider-web type. The single layer is considerably easier to wind and to mount and was found to give equal results to the spider-web. This one coil constitutes the only inductance in the circuit and contains two separate windings; one an antenna inductance and the other serving as the plate inductance. Part of the main antenna coil is used as the grid coil also.

A formica tube, 3" in diameter and $2\frac{1}{2}$ " long serves as the winding form. For best efficiency, a winding of stranded wire, or "Litz" is recommended. A very excellent wire for this purpose is the type known by the code name HABITUAL, manufactured by the Belden people or Radio Specialty Co.'s No. 323 Litz Wire. Starting at the bottom of the tube, a $\frac{1}{4}$ " space is left and the end of the wire is passed through a small hole

and secured. Forty-five turns are then wound, a tap being taken at the 15th and 30th. This leaves two ends and two taps when completed. The finishing end is secured in the same fashion as the starting end, and another small hole is made through the tube, $\frac{1}{4}$ " above the END of the first winding. The antenna inductance is then wound on, consisting of 40 turns with taps taken at the 2nd, 4th, 5th, 6th, 7th, 8th, 9th, 10th, 26th, 33rd, and 40th turns. With the exception of the 10th tap, these are all soldered progressively to the switch marked "ANTENNA" in the illustrations, and which controls the antenna inductance in circuit, and to the grid switch as shown. The 10th tap is carried to the ground post of the set. It will be noted that the last switch point on the various switches is connected to one of the three binding posts marked "1, 2, 3" at the top of the panel. This is a recent refinement of Mr. Reinartz and permits of an external coil being used if a greater wave range is desirable.

Oscillations, and regeneration to a certain extent, are controlled in this tuner through the variable capacity marked, "FEED-BACK CONDENSER." This adjustment is not critical. All tuning is accomplished with the capacity labelled "TUNING CONDENSER" and which will be found to be very sharp. Likewise the grid and plate switches will be found to be important in-

itial adjustments. However, once the three switches are set at the point giving maximum response to the desired signals, it will seldom be necessary to change their position when tuning, it being necessary only to move the tuning condenser throughout its arc. Of course any great wave change requires a suitable re-adjustment of the inductance switches.

While a vernier attachment on the feedback condenser is not really necessary, it is almost imperative that the tuning condenser be provided with a suitable vernier for proper operation. The writer uses the reducing-gear type of vernier adjustment with entirely satisfactory results.

The vacuum tube is incorporated in the tuner unit, as it has always been considered desirable from the standpoint of efficiency to combine the two. It also allows of greater portability and presents a neater appearance.

In connecting the various elements, No. 12 or No. 14 bus wire should be used, and covered with suitable varnished cambric tubing, known to the trade as "spaghetti." The leads should be run as directly as possible, and all terminals well soldered.

The nomenclature should be engraved on the panel face, as shown in the illustration, and this work may be arranged for at a reasonable charge, with any radio manufacturing company equipped with an engraving machine.

For those who wish to follow the writer's design and produce a duplicate instrument, the following specifications are given:

- Panel—Hard Rubber, $16\frac{3}{8}$ "x $5\frac{3}{4}$ ".
- Cabinet—Walnut, hinged cover.
- Condensers—Vernier type .00052 Mfd.
- Switches—Self Cleaning—one inch radius.
- Switch points—Optional.
- Binding posts—Optional.
- Dials—Optional.
- Rheostat—SHRAMCO.
- Socket—With built-in grid leak.
- Bezel—E.R.L.A.
- Grid Condenser—Dubilier Micadon, .0005 Mfd.

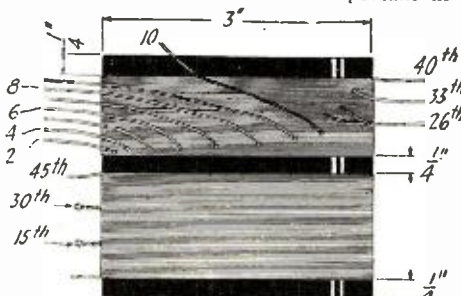

Details for Winding the Inductance Used in the Set. This is Easier to Wind Than the Spider-Web Type.

Stopping condenser—Dubilier Micadon. .001 Mfd.

Nothing exceptional can be claimed for this tuner in the reception of radiophone signals nor those from spark stations, although the writer's experiments would tend to indicate that the results were at least equal to those obtainable with other types of apparatus. It is in the reception of C.W. signals that a Reinartz tuner stands prominently at the head of all other known types. The ease with which the elusive whistles are picked up and HELD, and the lack of body capacity when tuning, are remarkable, and in addition to these good points, the signal strength is a marked improvement over the more familiar regenerative circuits.

In conclusion, the writer will be pleased to hear from any reader making an instrument such as described above, and will be glad to lend any assistance within his power. Communications to him may be addressed in care of the Editor.

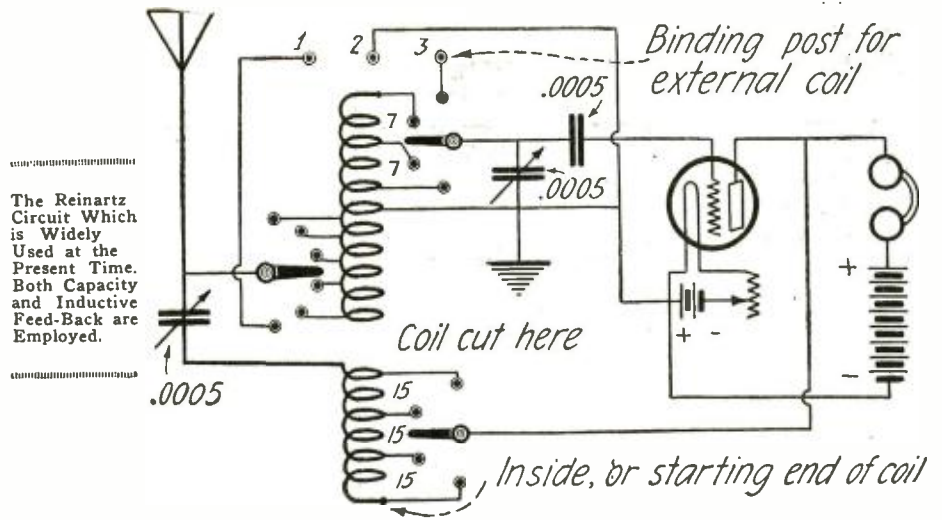

How to Transform a Regenerative Tuner Into a Tuned R. F. Amplifier

By CHAS. G. KAHANT, I. R. E.

TUNERS more sensitive than the standard single tube regenerative sets are needed for two general purposes; one, to increase the range for long distance reception and, second, to enable the use of small outside aerials, inside aerials or indoor loops for strong reception of local broadcasting stations. It is the purpose of this article to describe a simple way of attaining this sensitivity by adding but one tube to the set.

There are, of course, several ways of increasing sensitivity and for most people the selection becomes a question of which gives the most amplification per tube consistent with ease of control and freedom from foreign noises. The super-regenerative circuit gives tremendous amplification per tube, but for the layman at least is difficult to adjust and is accompanied by quite a variety of high pitched notes which are difficult to eliminate. Radio frequency amplification using one of the several makes of radio frequency transformers on the market is easier to handle and is effective if one knows what makes of such transformers have the proper electrical characteristics

wave-length being received. This tuned plate circuit is then coupled loosely with the tuned grid circuit of the next amplifier tube or with that of the detector tube as the case may be. Standard variometers alone or inductances shunted with variable condensers are used in place of the commercial R. F. transformers.

This last named method is so sensitive that but one stage of it is needed for all

A very good feature of this R. F. amplifier is that there is no distortion or howling when adjusted for maximum signal strength. In adjusting the controls, signal strength increases up to the point where sustained oscillations start as evidenced by a single sharp click in the telephones, unaccompanied by any other audible noises or whistles whatsoever.

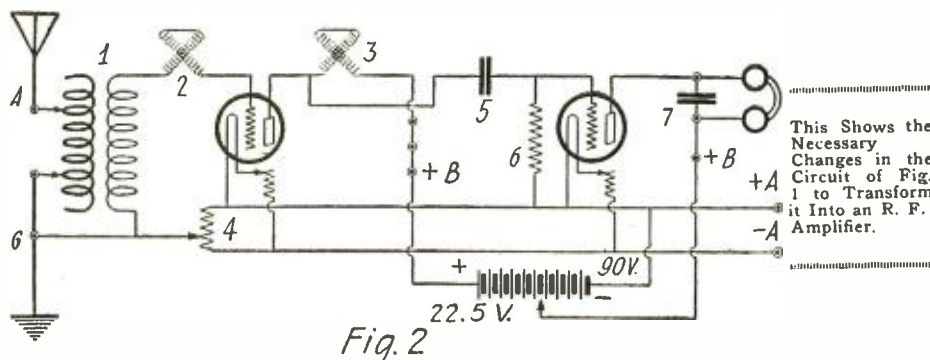
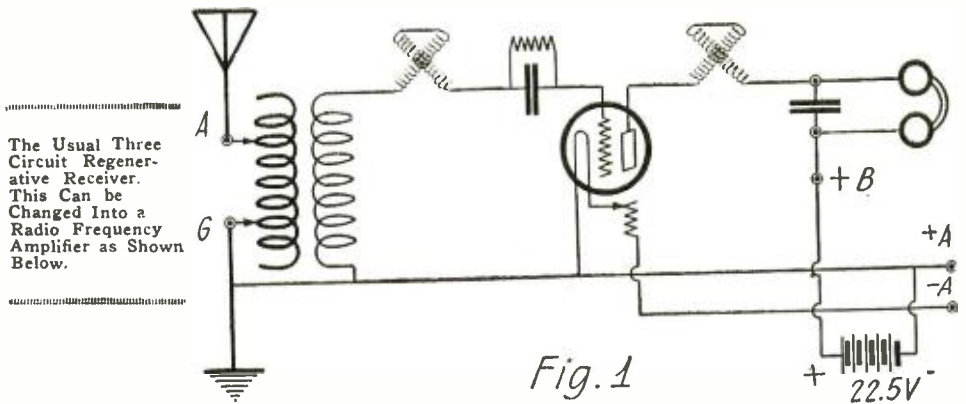

for best reception on broadcasting wave-lengths. Usually, however, two stages of it are necessary to show an improvement in sensitivity over a good regenerative tuner.

A very efficient method of R.F. amplification which has been utilized lately by several manufacturers of prominence is the so-called tuned plate circuit, in which the plate circuit of the amplifier tube is adjusted to resonance to the particular

ordinary purposes. On a recent test in daytime it was found that this one stage brought in quite loudly a distant station that was only faintly audible with a regenerative tuner carefully adjusted. At night-time this one stage used with a short outside aerial enable the reception on a loud speaker of stations over a thousand miles distant. One stage of audio frequency was employed between the detector and the loud speaker.

One stage of tuned R. F. amplification can be added very readily to most regenerative tuners, particularly those of the double tuned circuit type. Referring to Fig. 1, we have the conventional wiring diagram for one incorporating a variocoupler and two variometers. Fig. 2 shows the same circuit with one stage of tuned impedance R. F. amplification added. The grid condenser in Fig. 1 is short-circuited or removed and the socket in Fig. 1 becomes the amplifier tube socket in Fig. 2, where a second socket and rheostat are added for the detector tube. The by-pass condenser in Fig. 1 should be disconnected or removed. If removed it can be used in the plate circuit of the detector in Fig. 2. A potentiometer is installed as shown to control the voltage on the grid of the amplifier tube. Three new binding-posts will be required, two for the new "output" and one for the positive "B" battery connection to the detector. The two original output posts are shorted and the two original "B" battery posts connected to the amplifier plate battery which should

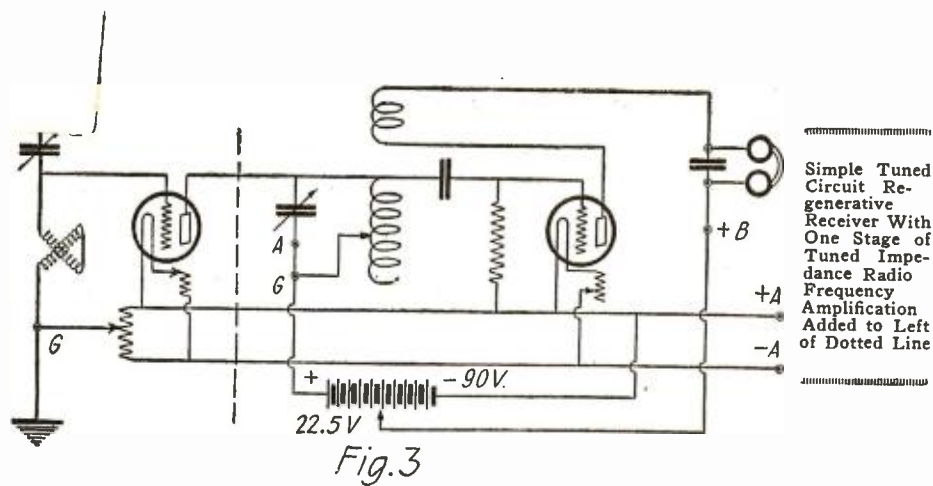

Fig. 3

be about 90 volts for best results. A UV-201 tube serves very well in the amplifier and any good detector tube can be used in the second socket.

The coupling between the amplifier and the detector circuits is accomplished by one manufacturer by using two separate inductances inductively coupled, each with a variable condenser. A much simpler scheme which is just as effective is that shown in Fig. 2, where but one inductance is used. The grid condenser in the detector circuit is very small and should be preferably between .00005 and .0001 mf. The value of the grid leak is on the order of one megohm and the leak should be connected as per Fig. 2.

It was found feasible in the case of a Grebe type CR-8 tuner to install the extra parts in the cabinet with the new rheostat, potentiometer and binding-posts mounted at the right-hand end of the panel.

Where a single tuned circuit* tuner is involved it will probably be necessary to mount separately the apparatus to the left of the dotted line in Fig. 3. Note carefully that the "ground" post of the tuner is to be connected to the positive side of the amplifier "B" battery so that the connections in the tuner between the "ground" post and the rest of the interior wiring must be broken except for the lead running to the inductance. The "aerial" and "ground" posts are then connected together so as to put the variable condenser in parallel with the inductance. The grid lead is changed so that one end is connected to one of the "A" battery wires. The inductance in the amplifier is a standard variometer and the variable condenser in the aerial circuit is about .0003 mf. total capacity with vernier.

If the aerial is connected to the set through a variable condenser as shown in Figs. 3 and 4, it is recommended that the aerial be a single straight wire not over 75 feet total length. It can be either indoors or outdoors, but naturally the latter would usually be better.

When a loop is used it can be connected to advantage in series with the grid variometer as shown by the dotted lines in Fig. 4. The aerial condenser is then not needed, tuning being accomplished by the grid variometer. Using a loop consisting of five turns of No. 18 bell wire tacked to the inside of a closet door it was found that a broadcasting station fifteen miles away could be heard quite loudly when the door was pointed in the proper direction. The loop was about two feet wide by six high.

While a variometer can be put, if desired, in the plate circuit of the detector tube, the writer can find no advantage in doing so as the same increase in signal strength can be obtained by adjusting the potentiometer.

A very pleasing characteristic of this circuit which will be noted as soon as it is tried is the absence of distortion, even

with the potentiometer set for strongest signals. If any of the controls are set beyond that point, there is a sharp click heard after which nothing is heard at all until the control involved is brought back to its proper position. This action is quite different from that of a regenerative receiver where considerable distortion is produced when the regenerative effect is used beyond a certain point to say nothing of the many varied squeals with which we are all so familiar.

In tuning this R. F. amplifier it is best to work up on the grid variometer, but from a high point down on the plate variometer or the plate variable condenser as the case may be. It is also suggested the potentiometer arm be set initially near the positive post and then gradually turned towards the negative until the point of best reception is found, keeping in mind that each new setting of the potentiometer will usually necessitate slight readjustments of the variometers.

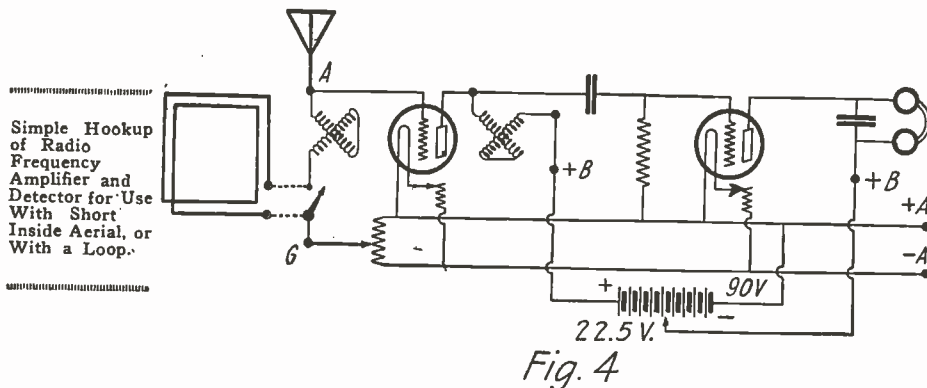

Fig. 4

It is interesting to note that the addition of a by-pass condenser across the amplifier "B" battery seems to decrease strength of signals instead of increasing it as might be expected. Similarly a by-pass between the potentiometer arm and one of the "A" battery wires gave poor results.

For broadcasting reception the writer believes that this system of R. F. amplification is the best so far developed because for one stage it requires no more tuning controls than a regenerative tuner while the sensitivity is increased many times. Frequently when used with an outside aerial the signals from broadcasting stations within a radius of ten to fifteen miles are loud enough to work a loud speaker direct from the detector.

Supplementing the above, WD-11 tubes do not perform well as radio frequency amplifiers in this circuit. The new UV-201-A tubes are better, but not quite as good, apparently, as the regular storage battery tubes for this purpose.

As to using honeycomb coil inductances instead of variometers for 360 and 400 meters, it was found by the writer that a 75-turn coil with about ten turns

removed was satisfactory in the plate circuit when shunted by a seven or thirteen plate condenser. The inductance used in the grid circuit was a 75-turn coil with four taps brought out, but standard coils without taps could probably be used instead. In using honeycomb coils or the equivalent, it is interesting to note that if these are plugged into a two coil mounting, the potentiometer may be omitted if desired and control of amplification is then secured by varying the position of the coils relative to each other. In this case the lead which ordinarily connects to the potentiometer lever is attach to the positive "A" battery lead.

The coupling between the aerial and the R. F. amplifier circuits and between the latter and the detector circuit must be rather loose for best results. The coupling between the R. F. amplifier and the detector is controlled by the capacity of the grid condenser, hence the desirability of keeping the condenser to a low value. If a seven plate variable condenser is substituted the best value can readily be ascertained. The coupling between the aerial and the R. F. amplifier is most easily controlled where inductive coupling is employed as in Fig. 2. The best coupling value in this case will usually be found where the coils are almost at right angles to each other, particularly if the aerial is of fair size. The single tuned arrangement shown in Fig. 3 is not adapted so well for obtaining loose coupling and that is the reason why this scheme cannot be used successfully except with small aerials. With the latter, however, suitable variation of coupling is brought about by increasing the value of the inductance with consequent decrease of the series condenser setting for a given wave-length, until the best combination is found.

NEW RULES FOR FRENCH RADIO AMATEURS

Paul Laffont, Minister of Posts and Telegraphs, has just drawn up a set of ten commandments covering the installation of wireless apparatus in France. To become the possessor of a receiving outfit, it is not only necessary to know these commandments, but one must prove it by filling out a long questionnaire correctly.

The first of these commandments says: "Make out a double application on especially prepared forms, one of which must be stamped and sent to the chief of the telegraph service.

"Second—Send also documents to show your identity, your residence and nationality.

"Third—If you are not French, special authorization from the Ministry is necessary which will be accorded you after an understanding with the Foreign Office.

"Fourth—Your post must not interfere with that of your neighbor.

"Fifth—The upkeep of your machine is your own business.

"Sixth—The Government is not responsible for your operations.

"Seventh—Respect communications you
(Continued on page 2033)

Radio Condensers

By JESSE MARSTEN

A CONDENSER consists essentially of two or more conducting plates, of one shape or another, with an insulating medium between the plates, which is called the "dielectric." By virtue of its construction this apparatus has the ability to store in the dielectric between its plates a certain amount of energy. The measure of its ability to so store electric energy is called the "capacity" of the condenser, and this capacity is directly proportional to the energy it can store. The capacity of a condenser is also dependent upon other factors: in general it is directly proportional to the area of the plates, to the number of plates, and to a constant K called the "dielectric constant" which depends upon the material of the dielectric. For air this factor is unity, but for all other dielectrics this factor varies generally between 1 and 10. The capacity is also inversely proportional to the spacing between the condenser plates, the closer the spacing the greater the capacity. A condenser so built by design to have a capacity is called "lumped" or "concentrated" capacity, in contradistinction to "stray" or "distributed" capacity which arises accidentally between metallic parts of a circuit which are at different potentials.

Condensers may be classified in a number of ways, but for our purposes they may be divided as follows:

- I. Transmitting condensers
- II. Receiving condensers.

Each of these classes may be further subdivided into the following groups:

- (a) Fixed condensers
- (b) Variable condensers.

Generally it will be found that transmitting condensers are seldom, if ever, variable, while receiving condensers may be either fixed or variable, depending upon the purpose for which they are intended.

The ideal condenser would have absolutely no losses due to any cause and its capacity would remain constant over a wide range of temperature and voltage conditions. Ideal condensers do not, of course, exist, but the nearest approach to it is the air condenser whose losses are very small. It is for this reason that air condensers are generally used as capacity standards.

The causes for the departure of practically built condensers from the ideal lie mostly in the imperfections of the dielectric. There exist losses, of course, also in the plates and plate leads of the condenser due to their resistance, but these losses are very small. The chief imperfections may be enumerated as follows:

(a) *Leakage.* The currents flowing through a condenser should be a true capacity current flowing by virtue of the capacity effect and not by virtue of any conductance. However, due to the imperfection of the dielectric, the condenser may have some conductivity and hence there will be some flow of current which is a conduction current through the resistance of the dielectric. This current is leakage and results in a total loss of energy. Not only may there be leakage of current through the dielectric, but there may also be leakage of current across the surface of the dielectric between the plates.

(b) *Dielectric Absorption.* This is really the chief and most important source of condenser losses. When a voltage is applied to an ideal condenser it is charged instantaneously, and when

it is discharged it is also discharged instantaneously. In the case of imperfect dielectrics something else happens. When the voltage is applied to the condenser an instantaneous charge flows into it, but immediately thereafter there is a small continuously decreasing current in addition which flows into the condenser and which seems to be absorbed by it. This represents an energy loss which appears as heat.

(c) *Brush and Corona Losses.* These occur only in the case of transmitting condensers which are operated at high voltages. At high voltages ionization of the air occurs and leakage of current takes place at points favorable to it, namely, where there are sharp edges, at corners, points, etc. This leakage is made evident by a thin bluish discharge and when this brushing is really powerful the ionization is accompanied by the generation of ozone which can be detected by its peculiar odor.

The above imperfections exist in both transmitting and receiving condensers, but the last is, of course, solely a trans-

THIS article is of interest to the amateur and the novice as well, as it explains the how and why of radio condensers which play an important role in radio receivers and transmitters. The author gives many tips which are of value to the real "ham" and points out what to look for when buying a condenser, a thing that most of the novices do not know. In addition, a lot of information is given which will help everyone interested in the construction of radio apparatus to get more efficiency out of it.

mitting condenser phenomenon, since high voltages are not present in receivers. They all result in increasing the effective resistance of the condenser, hence in increasing the losses. The extent to which they increase the losses depends upon the frequency of the current, and may generally be represented as increasing with the wave-length. The importance of minimizing these losses is at once apparent when we consider that a poor transmitting condenser may increase the resistance of its circuit by several ohms and thus cut radiation, and in the case of reception, where incoming energy is extremely small as it is, it will reduce the audibility factor.

The problem of reducing the losses in condensers is then one of reducing the losses in the dielectric. The resistance due to plates and plate leads may of course be reduced by using good conducting material for these and making the leads as short as possible. If air could be used efficiently and economically in transmitting condensers this would be the best type of dielectric to use. But air has a low dielectric constant, hence would require great bulk to give high capacities. Furthermore, its dielectric strength, ability to withstand high voltages, is not great. Compressed air has a larger dielectric strength, but these condensers are bulky. Glass used to be very popular, as in the case of the well known Leyden jar, but they have high brush losses, and are easily breakable

thus requiring frequent renewals. The best and most suitable dielectric for transmitting condensers is mica. This dielectric has been found to have very low dielectric losses, less than any other dielectric, excepting air, and it approaches air very closely. Also it has a high dielectric strength which enables building of condensers to withstand high voltages. Its high dielectric constant also permits the construction of high capacity condensers in very small space, which makes these condensers very convenient since they may be built in small units. In the case of variable transmitting condensers, liquid oil is usually used as the dielectric in an ordinary air condenser. A good grade of mineral oil has fair dielectric properties, and it has one added advantage which makes it a favorable type, namely, its self-healing properties, when a breakdown occurs. When the voltage between condenser plates becomes too great a breakdown occurs, and an arc takes place between the plates. If the dielectric is a solid one the dielectric is pierced by the arc-over and is spoiled. It will never be able to withstand the high voltage any more since it will spark over at the injured part. In the case of the oil dielectric this does not happen. When the arc-over occurs new liquid oil flows into the space at which the arc occurs and the dielectric is immediately healed.

An interesting point in connection with transmitting condensers is the breakdown voltage. This voltage depends upon the dielectric, of course, but is subject to different conditions from breakdown at constant voltage. A condenser will withstand a high voltage at direct currents indefinitely. But it may not withstand such high voltage at radio frequencies indefinitely. After a while it breaks down, and this breakdown is due to a cumulative effect in time. As time goes on the losses heat the dielectric, and this heating deteriorates the insulating properties so that it heats up still more and the cycle repeats itself, until a point is reached where the insulating properties have deteriorated to such an extent that it can no longer withstand the voltage. Amateurs do not generally understand this and think that breakdown is always due to poor dielectric or excessive voltage. This cumulative effect will explain many breakdowns.

The above details apply particularly to transmitting condensers. In purchasing transmitting condensers the only sensible thing to do is buy one of the standard reliable makes employing mica as dielectric for fixed condensers. Inquire about the voltage it will withstand, if it is not marked on the condenser; reliable manufacturers have no hesitation in giving the maximum voltage and current carrying capacity. If the amateur builds his own condenser made of mica he should observe the following: If high voltage is to be applied build the condenser so that there are a large number of sections in series, in this way the voltage will be distributed over a larger number of condensers in series, thus reducing the possibility of breakdowns. If high current-carrying capacity is the chief requirement, the condenser should be built of a large number of sections in parallel, distributing the current so that the heating effect is a minimum. If both requirements of high voltage and current-carrying capacity have to be met, then the condenser

(Continued on page 2057)

Reflexing With One Tube

By BERT. T. BONAVENTURE

DID you ever become curious about a certain thing that was talked about from morn till eve and then went ahead on your own hook to see what was really in it? Then you must have laid out on Armstrong circuit long ago and "suped" with that to the exclusion of everything else in heaven and on earth, just as we have done. Ah, me, yes—while listening to squawks and squeals, and other foreign disturbances in our pet "super" we had overlooked another circuit which we shouldn't have neglected. Wherewith the "super" was put on the shelf for a couple of weeks and its dearly beloved, and by this time familiar symptoms were replaced by less deafening murmurs. We took up the Reflex circuit and promptly neglected heaven and earth again.

There were as many as 57 varieties of reflex circuits when the present investigation started, some titled "circuit originated by the author," others not quite so pretentious. It was obviously inadvisable to try each and every circuit, so that it was necessary to eliminate blind leads by a weeding-out process. Weeds aplenty were found figuratively speaking. How some manufacturers can put out the diagrams that they do is beyond reason. Some drawings were labyrinths of wiring, which, when deciphered, gave circuits that must have caused the very electrons to weep in shame. The circuits were evidently intended for puzzle pictures for the kiddies, as no thought of proper functioning seemed to be evident.

In view of these sad facts, we thanked whatever stars there be, for having been in the game a little before the boom started. No wonder the novices get sick of radio when confronted by the mess such as some of the circuits were in that we came across.

We decided, therefore, to stick to standard practice and concocted a circuit out of the many at hand, only to find practically the same circuit published the following Saturday in the radio magazine section of one of the daily newspapers. As shown in Fig. 1, the circuit is a standard reflex as far as reflexes go.

An ordinary variocoupler was used as the tuning element with a .001 mfd. variable condenser in series with the primary and a .0005 mfd. variable across the secondary. The rest of the apparatus consisted of a mass of fixed and variable condensers, transformers, both audio and radio frequency and a flock of tubes and "B" batteries. As to the crystal detector, it was decided that poking around with a catwhisker involved too much labor, besides collecting dust and forever losing its adjustment, so one of the "Gold Grain" detectors was purchased. The apparatus was laid out on a board with Fahnestock clips wherever instruments were to be compared against others. For instance, the radio and audio frequency transformers were connected to four Fahnestocks for each transformer so that any one of them could be replaced by another type for comparative tests. The potentiometer was one of 200 ohms, or so the manufacturer claimed.

After wiring the various pieces of apparatus, it was decided that a loop could be used just as advantageously as the tuning unit with an outdoor aerial, being located in

New York City with several high powered local stations available for reception. In the preliminary tests a 22" loop with 14 turns wound solenoid fashion, was used, which reduced the number of controls by two. No sooner was the filament of the U.V.201 tube lighted than signals came in—a pleasant diversion from our first trial of the "super."

After all the experiments were concluded the following facts remained to be logged in the dope book:

When the circuit was "reflexing" properly, the removal of the crystal detector from the retaining clips either greatly diminished the signal strength or else cut it out entirely. If the circuit was not functioning normally the crystal detector could be removed or replaced without seeming to affect the signal strength at all, the tube then functioning merely as a detector by virtue of the negative bias on the grid through the potentiometer.

in the operation of the circuit. Once the tuner was set for any particular signal, if the filament current was changed, the circuit would no longer respond to that wavelength and the controls had to be shifted to regain the signal. The only exception in this case was the U.V.201-A tube, which was more or less free of this phenomenon. All the other tubes tried behaved as mentioned above.

These tubes included the Western Electric J. E. D and 216-A; a U.V.201, U.V.201-A and a W.D.-11 tube. For sensitivity, the D tube with a μ of 30 was the best. When larger powers were required to operate a loud speaker, the E or the 216-A tubes were used with higher plate voltages than 45. These two tubes, when the antenna was used, delivered sufficient energy to the loud speaker, so that the signal could be heard 30 or 40 feet away, with the door shut. In the long distance reception tests the U.V.201 was used exclusively.

A peculiarity of the crystal detector soon manifested itself. With each different position of the crystal and the contact element a slight readjustment of the circuit seemed to be necessary, although if the shell was rotated enough a condition approximating the original could be obtained. The signal strength also seemed to depend upon the direction of current flow through the crystal, for louder signals were obtained with the rotating shell of the detector in a certain position. Reversing the position of the shell in the clips would change the volume delivered from the loud speaker, even when the detector was adjusted for maximum sensitivity.

The amount of grid voltage, with respect to the filament, affects the operation of the circuit considerably. It is possible to obtain a condition where the tube begins to oscillate, thus permitting the reception of C.W. signals. By changing the position of the potentiometer arm, the grid is relieved of its potential and the reception of spark and phone signals is permitted. The oscillating condition is helpful in receiving distant stations because of the heterodyne note locating the station. Then the problem of avoiding the zero-beat method of reception enters, and can be solved by careful tuning if one does not have a shield on each instrument at the tuning end. The system of zero-beat reception is more sensitive, however, but also more annoying if shielding is not resorted to.

A word as to the transformers: In the audio frequency, a ratio higher than three to one or four to one is not recommended. Ratios as high as ten to one were tried, but the lower ratios were found to give better results. A half dozen different makes of transformers were tried with good results. Any good audio frequency transformer seems to do the work. On the other hand, much more discrimination must be exercised in the selection of the radio frequency transformer. Quite a number were rejected because they did not operate as satisfactorily as was desired. A certain well known firm manufactures three different transformers, to be used between various stages of a multi-stage radio frequency amplifier. Of

(Continued on page 2050)

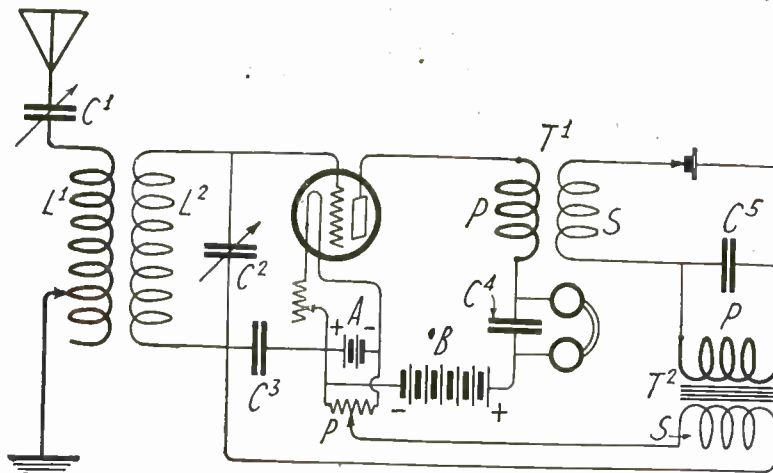

Fig. 1

The One Tube Reflex Circuit Employing a Crystal as a Detector. The Tube Acts as Both a Radio and Audio Frequency Amplifier. The Circuit Values Are: C^1 .001 M.F., C^2 .0005 M.F., C^3 .001 or .0005 M.F. Fixed, C^4 and C^5 .001 M.F. Fixed. Potentiometer 200 to 400 ohms, L^1 65 turns on 3" Tube. L^2 40 Turns on 2½-in. Tube.

The fixed condensers in the circuit are merely by-pass condensers for the high-frequency currents present. Varying C_4 and C_5 from .00025 to .005 mfd. gave practically the same results. A final value of .001 mfd. was decided upon as a suitable value, since both audio and radio frequency currents were present in their respective circuits. If the condenser was too large, some of the audio frequency component of the current would pass in addition to the radio frequency; if too small, the impedance to the high frequency was much greater than need be. The .001 mfd. value was the mean between these extremes.

Condenser C_3 proved a retractive conveyance for electrons. At first small values were tried, the assumption being that this condenser also was merely a by-pass around the secondary of the audio frequency transformer and the potentiometer. This hypothesis had to be abandoned later in view of the fact that different values of C_3 would make the circuit behave differently. With no condenser at all, the circuit was unstable, functioning at times and laying down on the job at others. Higher values of C_3 seemed to choke the signals somewhat. Finally, there were only two possibilities left, one a .001 mfd. and the other a .0005 mfd. condenser. The former gave somewhat the better results, although it is believed that this value may vary slightly with different tubes. The .0005 mfd. condenser worked very well, however.

Filament temperature is a variable factor

Notes On the WD-11 Tube

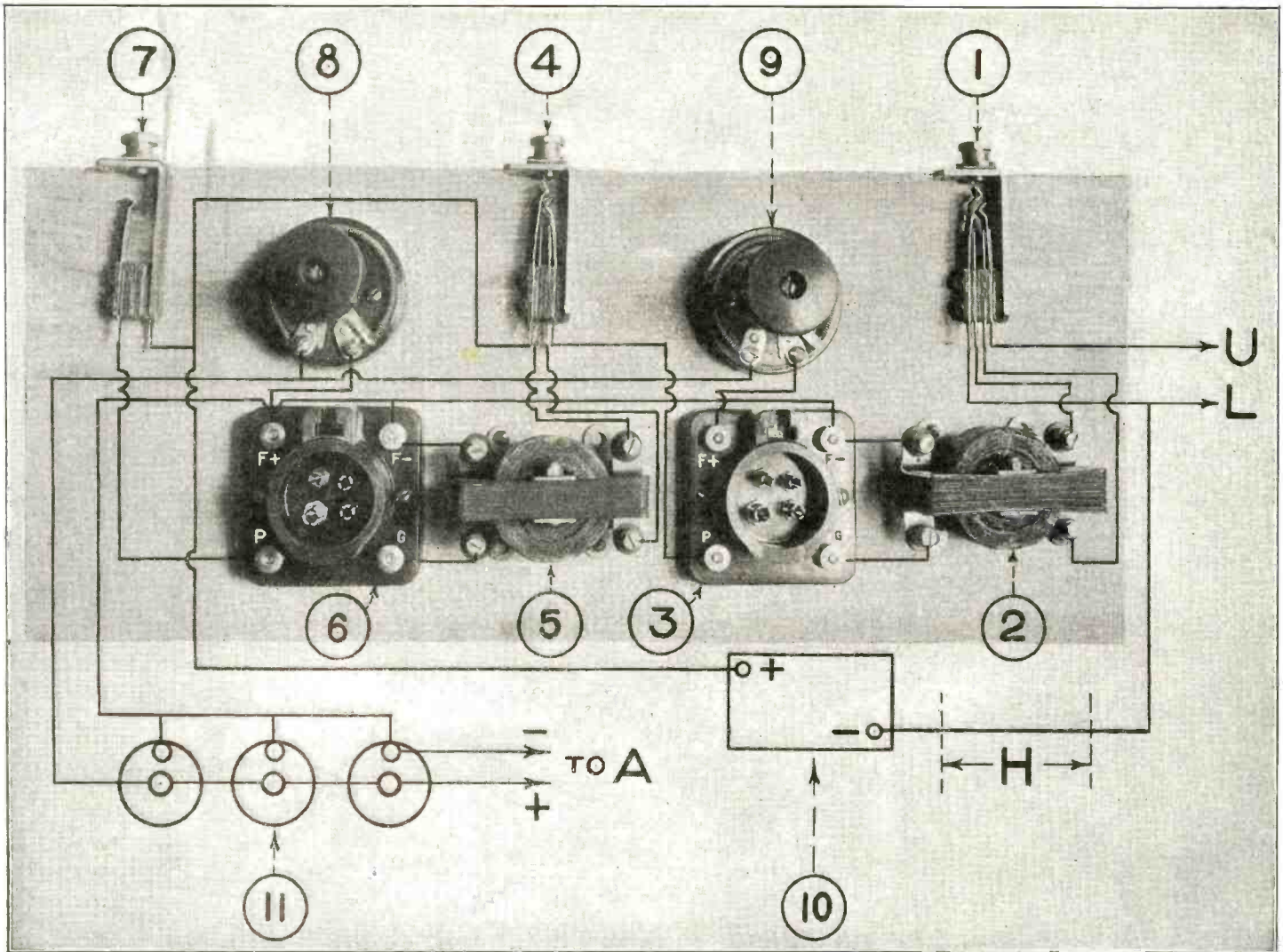

Layout of a Two Stage Amplifier That Can Be Used with 6-Volt Amplifying Tubes as Well as the WD-11. The Only Necessary Change for the 6-Volt Tubes Would be the Replacement of the WD-11 Sockets Shown, with Standard Sockets, and the Addition of a Six-Volt Storage Battery. This Amplifier Can be Connected to Any Receiving Set at Will.

IN our last issue, we described the most popular type of regenerative receiver, namely, a set employing two variometers and a variocoupler for tuning. The detector was incorporated in the layout of the apparatus. This is advantageous and if possible should be carried out in the design and construction of all tuning units since it allows for the very shortest leads from the detector to the various tuning instruments.

Before covering other types of receiving units, we shall take up the more important points on the design of a two stage audio frequency amplifier, since the average person desires sooner or later to add one to their outfit. The amplifier described below is

unit in itself and can be connected to any receiving set at will, without the necessity of changing any of the wiring, aside from disconnecting the phones. The parts required for the building of this amplifier are: One phone plug, two double circuit jacks, one open circuit jack, two audio frequency amplifying transformers, two WD-11 tubes, two tube sockets, one 22½-volt "B" battery and two 1½-volt dry cells. One of the main considerations of this case is the layout. Howling and squealing amplifiers are usually the products of careless design, where no thought has been given to the position of the apparatus nor to the spacing and length of the wires. The proper ar-

angement of the apparatus is clearly shown in the accompanying photograph where each instrument has its own place in respect to another. Fig. 1 is the circuit diagram of the two-step amplifier, this corresponding to the apparatus and wiring shown in the photographs. The parts are numbered as follows: 1, double circuit jack; 2, audio frequency transformer; 3, WD-11 tube; 4, double circuit jack; 5, audio frequency transformer; 6, WD-11 tube; 7, open circuit jack; 8, 9, filament rheostat; 10, "B" battery; 11, "A" battery.

In connecting up the set, it is suggested that the wires to the primary terminals of the amplifying transformers (P and P-1) be left unsoldered until the proper connections can be determined. Try them both ways. When connected to the right terminals, the signals will be loudest. In attaching this amplifier to the receiving set described in the last issue, proceed as follows:

Take out the phones and connect the wire, "U," to the upper phone post and the wire "L" to the lower phone post. The wires marked A- and A+ should then be connected to the negative and positive terminals respectively, of the dry cells used for lighting the detector tube filament. The entire set is now ready for operation. By plugging the phones in the jack marked 1, only the detector is used; in jack 4, detector and one step; in jack 7, detector and two steps. As will be noticed, each tube is controlled by an individual rheostat, which
(Continued on page 2051)

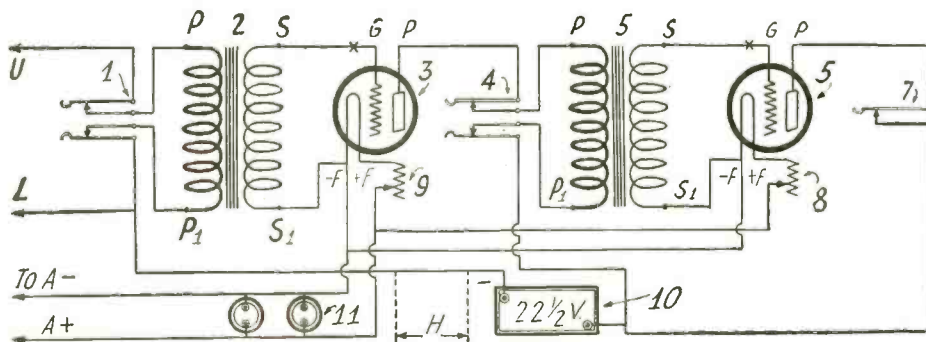

Fig. 1

This Wiring Diagram Corresponds to the Connections Shown in the Photograph and Provides a Good Means for Checking Up. The Tube on the Right Should Be Numbered 6 Instead of 5 as Shown.

Instructions in International Code Signalling For Use in Self Studies and Exercises

By S. L. TOPLITZ

WHEN giving instructions on any new subject, the vital point of importance is to properly estimate the volume which can readily be absorbed and to permit it to thoroughly enter into the mind.

By such accurate gauge a definite foundation is laid, upon which a sub-conscious mind can continually draw for adjustment when in doubt.

It is preferable to teach a little less than to teach too much, for the latter creates a condition best explained by the phrase "Mental Indigestion."

These tabloid lessons, six in number, could be absorbed within three or four lessons by the more competent, yet as a general method such curtailment of the divisions would affect the majority of students and would fail to afford a subconscious foundation.

While still learning, it is most important to send the message or vocabulary slowly so as to correctly ascertain the distinction in sound, and accuracy should take precedence over speed as the latter will be readily acquired when the code has been well absorbed, at which time reading will then become almost automatic.

An exaggerated pause between each letter sufficient to permit the readers mind to function is the best plan and when two or more students are together they can try to verify the correctness of their lessons.

LESSON NO. 1

In the first lesson is taken up the primary elements of the code only; the simple Dot or Dash which are seven in number, viz.:

Letter	
One Dot.....	E .
Two Dots.....	I ..
Three Dots.....	S ...
Four Dots.....	H
One Dash.....	T —
Two Dashes.....	M — —
Three Dashes.....	O — — —

Four consonants and three vowels.

From these seven letters numerous words and phrases can be constructed and should be thoroughly and diligently practiced.

Studying can be done by drumming with a finger for the Dot and two fingers simultaneously struck for the Dash.

VOCABULARY EXERCISES

Is, It, To, Me, He, Oh, Toc, Met, Hoc, Tom, Moss, His, Sit, Tie, Hit, Tot, Hem, The, Hot, This, Toss, Hoot, Hiss, Meet, Them, Site, Mist, Stem, See, Him, Miss, Shoe, Home, Shots, Moth, Host, Tote, Mesh, Most, Some, Time, Item, Test, These, Hoist, Teeth, Motto, Sheet, Smith, Emmet,

Moose, Tithe, Omits, Moist, Esteem, Smooth, Shoot, Tooth, Those, She, Set, Hostess, Misses, Setto.

SENTENCE EXERCISES

See the moss. It seems moist. It is Tom. Tom tosses the sheet to Emmet. Time tests the teeth. The moose's tooth is smooth. The hot shoe seethes. It emits hisses. Hit it hot is the smith's motto. Tie those shoes to some sheets. Hoist me those shoes. The theme is "Shoot to hit home." She smites the moths to stem them. Most mists seem moist. The misses meet the moist mists. Sometimes she sits home to soothe the tots. He sees Tim hit Tom. Essie is the hostess this time. She hems the settee sliects. He

Note that letter "C" is equal to two N's in succession.

Letter	
Dot, Dash.....	A . —
Dash, Dot.....	N — .
Dot, Dash, Dot.....	R . — .
Dot, Dot, Dash.....	U . . —
Dash, Dot, Dash, Dot..	C — — .
Dash, Dash, Dash, Dash.	Ch — — — —

Three consonants, two vowels. One combination consonant.

VOCABULARY EXERCISES

Au, Ran, Can, Run, Arc, Nun, Car, Urn, Us, Aaron, Ranch, Church, Reach, Acorn, Nature, Carman, Crunch, Arnica, Romance, Near, Counteract, Raccoon, Carnation, Nuisance, Announce, Rustic, Certain, Rescue, Accurate, Anchor, Nourish, Usher, Ruin, Harness, Ancient, Occur, Human, Retain, Contrast, Amount, Utmost, Enumerate, Nectar, Curator, Rain, Tournament, Traction, Trance, Trounce, Truant, Turncoat, Tuscan, Auction, Macaroni, Manure, Intricate, Instruct, Insecure, Increase, Ocean, Saunter, Saucer, Stonecutter, Unanimous, Sustenance, Surname, Smartness, Merchant, Oration, Taciturn, Strenuous, Occasion, Orchestra, Ounce, Monarch, Much.

SENTENCE EXERCISES

The circus circuit actress runs to romance in the arena. At the rustic ranch see the raccoon run. The church summons scouts to hear sermons. Accurate announcements counteract certain nuisances. Arnica assists nature in its cures. A Scotch archer shot mother's Irish terrier. Cats catch rats. The rats rather eat cheese. Chariot races astonish the recruits at the tournament. Narcissus nectar is much nicer than noisome nicotine. Strenuous scenic schemes secure staunch stamina starters. Monarch or merchant must react as occasions occur. Intense interest insures instant intuitions. Resources reassure restitutions remittances. Oration utterances accentuate senators assertions. Intricate traction transactions increase tourist torments. Sincere seniors search science's serious sources.

LESSON NO. 3

In the third lesson the subject of opposite signals should be carefully memorized. This will act as a check-up when in doubt.

OPPOSITES

Letter K is opposite of letter R.
Letter G is opposite of letter U.
Letter L is opposite of letter Y.
Note that Y consists of Dash, Dot, Dash, Dash, which can easily be memorized as follows: Dash, an up stroke; Dot, a

(Continued on page 2055)

IN OUR NEXT ISSUE DON'T FAIL TO READ

The Vast Range of Ether Vibrations

By Sir Oliver Lodge

Electrons, Electric Waves, and Wireless Telephony—Part V

By Dr. J. A. Fleming, F. R. S.

Principles of the Antenna System

By Louis Frank.

Plenty of practical data is given in this article and every amateur who is after efficiency should not fail to read it.

How to Make D-Shaped Variometers.

By D. R. Clemons and many other interesting articles.

omits to test the shots. The mists met them so he misses the moose.

Although four dashes, — — — — is the "ch" signal it is best to learn this at the second lesson when learning the simple "c".

LESSON NO. 2

In the second lesson is taken up compound signals and the balance of the vowels, A and U. It is advisable to note that all vowels with but one exception start with the Dot. The exception is the letter O, which is entirely Dashes.

Letter C is also taken up in this lesson as it is of primary importance in the English language, as is also the Ch postponed from the previous lesson.

Note that letter "N" is the opposite of letter "A".

How To Hook Up A Set and Make It Work

By ARTHUR W. LAMBERT, Jr.

SEVERAL months ago an article on "How To Construct a Novel Short-Wave Regenerative Set" appeared in RADIO NEWS. This article was written by the writer, who magnanimously offered, at the end thereof, to answer questions provided the self-addressed and stamped envelope was enclosed. An unexpected deluge of letters from all parts of the country and Canada has kept him busy at the typewriter "shooting" trouble. Lately, however, the letters proclaim excellent results, and request information of real interest that any hard-boiled ham is only too anxious to discuss. But nine-tenths of the early mail was from novices who had never made a set before or from fellows who

wished "picture drawings." One fellow wrote, "Please draw the connections on the enclosed drawing and return, as I cannot read diagrams."

Say, fellows, for Heaven's sake, if you are going to play with the most wonderful hobby that has yet been invented, stop right here and learn to read a diagram. And learn to know what each part is for. Nearly every night the telephone rings and this is the stuff that comes over the wire: "Say, old man, doing anything tonight? I just made a radio set and can't get the thing to work." Nine times out of ten the set was hooked-up from a picture, and it is generally a complicated regenerative hook-up with one or more stages of amplification,

made by a beginner who never before even made a crystal set. It seems that the ambitious novice buys a hushel or two of parts, a pictured hook-up and a soldering iron. Then he gets to work in the kitchen, hooks her up and takes a chance. Once in a while the thing works right off the bat, but more likely nothing happens and another distress call goes out over the telephone.

In days gone by the writer would often spend two or three days soldering connections, only to obtain a similar result. And sometimes two or three weeks of searching and reconnecting were necessary to make the thing work. And usually it was some fool connection that was made wrong or a

(Continued on page 1980)

Radio Digest

BUREAU OF STANDARDS TRANSMITS STANDARD RADIO WAVE SIGNALS

HERE has just been concluded at the Bureau of Standards at Washington, D. C., a preliminary series of tests on transmitting of standard wave signals. These tests were preliminary to regular transmissions of signals of constant and known wave frequency or wave-length. The transmission of such signals will make it possible for any person having suitable receiving equipment to so calibrate his receiving set that he may know where to tune for a station transmitting on a given wave-length. Such signals may also be used by laboratories and transmitting stations for calibrating wavemeters. The preliminary tests included the measurement of the wave-length of the signals transmitted from the Radio Laboratory at the Bureau of Standards on January 29 and 30 by 30 observers located within 1,000 miles of Washington.

These tests were conducted primarily for the purpose of ascertaining what would be feasible and desirable in the way of standard wave signals, that is, the range of wave-lengths and the schedule for transmission. Another purpose was to obtain information as to the accuracy of wavemeters used by the various observers. From the information obtained it appears that it is desirable to transmit standard wave signals after 11:00 o'clock p. m. (Eastern Standard Time) when broadcasting stations are through with their programs.

The wavemeters of the observers were in general in fair agreement, but some differences were as much as 7 per cent. When the pending radio bill becomes a law it will be necessary for the Secretary of Commerce to assign carefully selected wave-lengths to each radio telephone broadcasting station, and an error as much as 7 per cent would cause serious interference. In view of this it is desired that the wavemeters used be in closer accord than shown in the tests. To correct these errors is the purpose of the standard wave signals.

The first transmission of standard wave signals will be made on March 6 from 11:00 p.m. to 1:15 a.m., Eastern Standard Time, and will include wave-lengths from 550 to 1,500 meters. The schedule of this transmission is given below:

TIME		(Frequency) Kilocycles per sec.	Wave-length Meters
11:00 to 11:05 p. m.	General call	550	550
11:05 to 11:10 p. m.	Standard wave		
11:10 to 11:15 p. m.	Announcements		
11:20 to 11:25 p. m.	General call	500	600
11:25 to 11:30 p. m.	Standard wave		
11:30 to 11:35 p. m.	Announcements		
11:40 to 11:45 p. m.	General call	440	680
11:45 to 11:50 p. m.	Standard wave		
11:50 to 11:55 p. m.	Announcements		
12:00 to 12:05 a. m.	General call	380	790
12:05 to 12:10 a. m.	Standard wave		
12:10 to 12:15 a. m.	Announcements		
12:20 to 12:25 a. m.	General call	320	940
12:25 to 12:30 a. m.	Standard wave		
12:30 to 12:35 a. m.	Announcements		
12:40 to 12:45 a. m.	General call	260	1,150
12:45 to 12:50 a. m.	Standard wave		
12:50 to 12:55 a. m.	Announcements		
1:00 to 1:05 a. m.	General call	200	1,500
1:05 to 1:10 a. m.	Standard wave		
1:10 to 1:15 a. m.	Announcements		

The general call will be "QST de WWV Standard Wave Signals" repeated and will be on the same frequency as the test signal. The standard wave signal will be the letters WWV repeated. In the announcements the wave-length of the test signal will be stated. The general call and announcements will be made by both radio telephony and radio telegraphy.

These standard wave signals may be used by anyone having suitable receiving equipment for calibrating a wavemeter or receiving set. Suggestions on suitable apparatus for this will be published in the Radio Service Bulletin.

About April 1 standard wave signals will be transmitted covering the wave frequency range between 1,000 and 500 kilocycles per second, (wave-lengths from 300 to 600 meters) and about May 1 between 2,400 and 1,000 kilocycles per second (125 and 300 meters). The exact dates and schedules of transmission will be announced later.

RADIO FUND GIVEN TO YALE BY DR. DE FOREST

In recognition of the great assistance given him by his Alma Mater while he was studying at New Haven, Dr. Lee de Forest has established two funds at Yale University with a view to extending the benefits of radio research and instruction to those students interested in the science of radio communication.

One fund is for the purpose of a labora-

\$50.00 IN PRIZES!

PRACTICAL ELECTRICS gives monthly prizes in the various departments as follows:

- ELECTRICAL WRINKLES, \$50.00
- "SHORT CIRCUITS," 3.00
- "ELEC-TRICKS," 3.00

—o—

Interesting Articles in the May Issue of PRACTICAL ELECTRICS:

- "The Loud-Talking Heart," by Clyde J. Fitch
- "Chicago-New York Engineer's Symposium";
- "Electric Drying Oven";
- "Influenza and the Telephone," by Dr. Albert Neuburger, Berlin Correspondent of PRACTICAL ELECTRICS;
- "Electricity and Crime";
- "Electric Prevention of Fires."

tory devoted to radio, while the other fund is to provide an annual course of lectures to be given for the benefit of advanced students and members of the engineering staff. With the aid of this fund the University will be enabled annually to invite a number of leading experts to supplement the instruction afforded by the regular courses in radio.

The lectures for 1923 will be given by the following: George A. Campbell, American Telephone & Telegraph Company; Lloyd Espenscheid, American Telephone & Telegraph Company; Commander S. C. Hooper, United States Navy; Dr. Albert W. Hull, Yale '05, General Electric Company; Prof. John Morecroft, Columbia University; L. E. Whittemore, Bureau of Standards.

Dr. de Forest himself was a graduate of Sheffield Scientific School at Yale in the class of 1906, after which he remained at the University for the purpose of securing his degree of Doctor of Philosophy, which he secured three years later, his subject being the reflection of Hertzian waves along parallel wires.

ENGLISHMAN GETS WGY ON TWO-FOOT LOOP

The extraordinary reception of music from the General Electric Company station, WGY, on a two-foot loop in London, England, is commented upon as follows by E. Blake, A. M. I. E. E., in the London (England) Daily Mail of January 1:

"The challenge palm for the reception of long-distance broadcasting undoubtedly belongs for the time being to Captain H. J. Round, of the Marconi Company, for his performance on Christmas Eve. Using a six-valve Marconi-phone plus two 'Note Magnifiers' (i. e. low frequency amplifiers), he received music and speech from several United States stations. A pianoforte solo broadcast from WGY (Schenectady, United States) was received at Captain Round's house at Muswell Hill, N., fairly uniform in strength and of about the same audibility as the Manchester Broadcasting Station, also received at the same place.

"Two facts in particular render this result remarkable. First, the aerial employed was a frame 2' square; that is quite a moderate size for a frame aerial, even for amateur use, and I wish Captain Round would measure the electromotive force it acquires from the Schenectady generator, for it must be easier to measure than to imagine. Also I should like to know whether he elected to sit up to the small hours with that pathetic little frame out of pure optimism or because he had what Schenectady would term a 'hunch.'

"Much trouble was experienced as the result of jamming by harmonics from Leafeld, Oxfordshire and Northolt, Middlesex, which stations are evidently competing keenly with each other in the 'jam' trade. Hence amateurs will do well to give further study to the possibilities of frame aeri-als, for these will enable them to escape a certain amount of interference.

"The other interesting fact about Captain Round's Christmas Eve-Christmas Morning vigil is that there was no mere 'pig's whisper,' but a loud speaker in full blast. Now, one needs quite a respectable volume of sound to make a loud speaker shout about the house, so, although eight valves were at work, the result is really surprising, and should give a fine fillip to amateur endeavor. I may mention, for the benefit of those who wish to repeat the experiment, that the wave-length on which WGY was sending was about midway between those of the Manchester (385 meters) and Birmingham (425 meters) Broadcasting Stations, and that the signals were heard before 2 a. m. (Greenwich)."

RADIO AN OBJECTIONABLE ADVERTISING MEDIUM

It is a matter of general advertising interest to record that the American Telephone and Telegraph Co. is trying to establish a new advertising medium. Through its station WEA-F, New York, it is permitting advertisers to broadcast messages. So far, the company's venture is only in the experimental stage. As a tryout, it has placed a nominal charge of \$100 on a 10-minute talk. During this time about 750 words can be delivered.

The fact that several advertisers have already availed themselves of this service would seem to indicate that there is a demand for it. Just the same, it is our advice to the American Telephone and Telegraph Co. to "stop, look and listen" before extending this new branch of its business. The plan is loaded with insidious dangers. The company, itself, evidently recognizes this, as it is proceeding cautiously in this advertising broadcasting experiment. For one thing, it is restricting the number of times a product may be mentioned during the course of a talk. It feels that the radio audience may regard the advertising message as an unwarranted imposition on its time. For this reason, it is insisted that the advertiser make his announcement subtle. No bald statements are permitted.

(Continued on page 2033)

Correspondence From Readers

ABOUT FAULTY TUBES

Editor, RADIO NEWS:

Referring to query No. 564, Mr. G. N. Hughes, Marysville, Tennessee, "I want to Know" column. The trouble he mentions with respect to his vacuum tubes failing may be due to the same cause that I have experienced, i.e.: the flux used by the manufacturer in soldering the leads from the elements of the tubes into the prongs of the base has corroded the wires to such an extent that with a small fraction of current the circuit in either grid or plate, opens up. I have had this experience with A-P tubes and discovered the cause. When I removed the base of a tube and found each wire encrusted heavily with verdigris and the plate lead entirely eaten through. The leads and metal parts of the base were carefully cleaned and a new wire soldered to the broken one using rosin for flux and the base replaced using melted shellac for cement, the tube thereafter functioned perfectly.

WILLIAM R. SNYDER,
San Francisco, Calif.

8ANX BREAKS IN

Editor, RADIO NEWS:

I usually keep the peace pretty well, but once in a great while I have to break out. The cause of the present spasm is the letter from Mr. Walter S. H. Atkinson, in the January issue of your paper.

Mr. Atkinson states that he has a tuner which tunes to a trifle over 800 meters, and that some of the amateurs are going strong beyond that wave-length. He also states that he cannot read code very fast, and so is unable to send in a report of the calls. That, to my mind, explains the difficulty. If he were able to copy at a fair rate of speed, he would soon learn that the supposed "amateurs" were such busy little boys as WCY, WNY, NAH, WLC, etc., who have nothing to do but handle the traffic for practically all of the vessels in the North Atlantic. As Mr. Atkinson is located in the state of Ohio, it is quite likely that our old friend NAJ occasionally flutters into his pulsating diaphragms with a word or two.

He also states that a good method to smooth out the difficulties would be for the Radio Inspectors to get busy and earn their salaries by weeding out the offenders. He cannot be very closely in touch with affairs in the radio world (which he does not claim to be) or he would know that most of the Radio Inspectors have to eke out Uncle Sam's allowance by acting as instructors in radio schools. The Government does not allow enough appropriation for the proper carrying on of the radio work, as far as inspecting is concerned.

Now, I have been interested in radio, or "wireless," as we called it then, since old *Modern Electrics* was the only technical publication on the market which covered the radio world as it then existed. I have also owned and operated a set for the last ten years, having had a licensed amateur station since about 1915, with the exception of the time when we were all shut down "for the duration," and never in all that time have I heard an amateur transmitting on a wave of 800 meters. In the old days, I remember one or two husky sparks who used to pound in on about three or four hundred, but that was the highest.

I can go to my instruments at any time, and tune in successively amateurs on 175 to 200 with specials on 275 and experimentals on 375, broadcasts on 360 and 400, and commercials from 450 to 600, with Direction Finder stations on 800. While they are not all sharp on the wave allotted, I never heard an amateur which I could not

tune out within ten degrees on the shunt condenser scale, with a single circuit tuner, which, as you know, is not very selective. However, I have heard commercials who were extremely audible over a band of about three hundred meters, and sometimes more, using a three circuit tuner with loose coupling.

I did not start out to "razz" Mr. Atkinson, as he is one of the old timers at radio, and, to judge from his letter, has the "makings" of a first class radio man, but there were certain things he said which gave amateur radio a "black eye." I therefore felt compelled to speak up in defense of the dyed-in-the-wool "brass-pounder."

BLAKELY E. CROSS,
Gloversville, N. Y.

WE AGREE

Editor, RADIO NEWS:

Seems to one who started a year ago with a cereal box coil, and who has made sets until he has a honeycomb regenerative, and

Over 600 Broadcasting Stations In This Country

A complete list, corrected from month to month, appears in every issue of **SCIENCE AND INVENTION**.

If you are a novice in Radio, **SCIENCE AND INVENTION**, through its Radio Oracle, will give you a huge amount of useful information.

RADIO ARTICLES APPEARING IN THE APRIL ISSUE OF SCIENCE AND INVENTION

The Belin Radio-Television Scheme
By Robert E. Lacault

A Simple DX Broadcast Receiver and Amplifier

Ultra-Selective Short Wave Tuner
By A. P. Peck

Cheap Versus Standard Apparatus
By Bert T. Ferencz

Wave Traps and Interference Preventers
By A. P. Peck

Radio for the Beginner—No. 14—Batteries
By Armstrong Perry

who is located in a hot-bed of 360 and 400 meter radiophones and 200 meter amateurs, that this constant bickering between "amateurs," "novices," and the others, over 200 meter QRM is both silly and a revelation of the many poor sets used to listen in on phone stuff.

Using my home-made set as an index, I am willing to assert that no properly built and designed set, crystal or bulb, ought to have 200 meter QRM while listening to 360 or 400 meter broadcasts. I am only six miles from WJZ and WOR, both using 1,000 watts, with amateurs galore in every block, so I feel I have opportunity for experiment and experience.

By changing honeycombs, I can get an airtel of 200 meter stuff (which I cannot yet read), but then I can't get up to 300 meters. Using coils for 360 and 400 meters, I cannot get down to where I can hear any 200 meter stations spark, C.W., phone, or anything else.

Of some 20 crystal sets, vario-coupler, loose coupler, variometer, and one and two tapped coils, I never have had one with which there was 200 meter QRM while listening at 360 meters.

Whence cometh the awful interference all these people are writing to the magazines about?

I might say here, that I have never had a set, crystal or bulb, which would keep out WNY, on 600 meters. With honeycombs at 400 meters, he is dim and distant at the phone intermissions. On most crystal sets he is a bother unless condensers are used to a degree which cuts signal strength somewhat. Wonder if he is the cause of a lot of QRM laid to amateurs in this district? Perhaps other high-power commercial stations in other sections are responsible for a lot of this "200-meter interference," which causes so many letters to editors.

While I am not and have no hope of every being a 200 meter sender (too old for one thing), I believe in a square deal. Talk that the phones will put the telegraphers out of business is twaddle. As well say that because a careless autoist gets hit by a trolley that the trolleys must get off the streets for the benefit of the autos.

The amateurs are with us. They'll stay. They have a well defined wave length band and 99 out of 100 stay in it. The sparks are going out gradually and C.W. bothers no one, frequently not even the one called, if what I hear is correct.

The future of radiophone broadcasting is limitless, I should say. Its devotees are many, more than the amateurs can hope to muster. Its wave bands are limited and its stations are kept to pretty sharp waves, especially the 400 meter stations.

Any clash between the two classes can be laid to one of three causes in, I venture to assert, every case. Poor sets, sets poorly handled, and ignorance of the difference between commercial stations on 600 meters or thereabouts, and amateurs on 200 meters.

Let the phone man get a selective set (he can build it for \$15 or less if crystal, or \$25 if bulb), let him learn how to operate it and, if he doesn't blame some 600 meter commercial station on the amateurs, he'll have no 200 meter QRM.

GUY M. CHASE, Elizabeth, N. J.

FROM BRITISH GUIANA

Editor, RADIO NEWS:

It might be of interest to some of your readers to hear that I regularly receive WOO broadcasting every night from 9:50 to 11:50 P. M. (local time). This on an indoor aerial 20' long, a single tube set. I can distinctly hear the announcer's voice. On the 13th of November at 11:50 he announced that "This is WOO, Wanamaker's at Philadelphia. This station is officially recognized for broadcasting." Also at 10:20 P. M. I heard him relaying time signals. Then followed a very fine grand organ recital. I also heard WSO, Trinidad, CPL, NSS, WJZ (weak), WFF (?), 2BO, C. W., 2AN. I am giving a description of my apparatus herewith:

My receiving gear consists of a coupler for 150-800 meters, honeycombs 500-2500 meters. The detector panel is made of dried greenheart wood, ebonite or bakelite being unobtainable. The coils are wound with wire taken off old ignition coils and starter field-coils. The tube in use at present is small Marconi-Bram, using 3½ volts at ¼ amp. filament current, and 15-250 volt plate potential. I have a U. V. (201), but getting the filament current is such an expensive business that I had to give it up in favor of the above.

The variable condensers are of the well-known Siebt German variety (shielded). The coupler is made as follows: Primary 80 turns 24 S. W. G. I respaced with wool yarn, 5 taps, 4" diameter. Tickler 100 turns of 28 S. W. G., 2" diameter, made in vario-coupler fashion. The thing that astounds me most of all is the grid leak. I tried

(Continued on page 2059)



Apparatus Awarded Certificates

BELL ROUND SOCKET

This socket, made by the Bell Manufacturing Company, 11 Elkins Street, South Boston, Massachusetts, employs a simpler spring contact system than their Round Socket described in last month's issue of *RADIO NEWS*.

The shell and base are of molded condenseite finished in a maroon color. Phosphor bronze springs are used to make contact to the prongs of the tube. Four binding



posts, approximately marked, are provided for external connections. The slot is reinforced to reduce the liability of breakage at that point. There are two holes in the base for mounting purposes. Overall dimensions are 2½" in diameter, 1¾" high.

Received in good packing.

AWARDED THE RADIO NEWS LABORATORIES CERTIFICATE OF MERIT NO. 142.

STAR CRYSTAL RECEIVER

As far as crystal sets go, this receiver made by the Star Manufacturing Company, Turtle Creek, Pennsylvania, is one of the best inexpensive sets we have seen. The wave-length range with a standard amateur antenna of 250 micro-microfarads capacity was from 150 to 750 meters. Selectivity was fair and the tuning sharp for a two slide tuner. The tuning coil is wound on a treated cardboard tube 2½" in diameter for a length of 4½", heavy gauge enamel wire being used. The end supporting pieces are of vulcanized fibre. A ball and socket joint

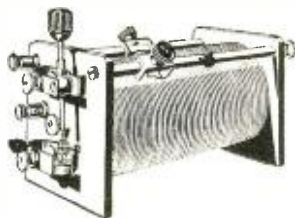

is used for the catwhisker wire and once the sensitive spot on the crystal has been found, the catwhisker may be locked in position. No set screws are used in clamping the crystal but the mounting is such that the crystal may be easily removed and replaced by another. The system of contacts at the sliders is good and is smooth in operation. Metal parts are finished in polished nickel, with binding posts for the various connections.

Arrived in good packing with no instruction sheets enclosed.

AWARDED THE RADIO NEWS LABORATORIES CERTIFICATE OF MERIT NO. 144.

ACMESTAT (PLAIN)

In this filament current control device made by the Acme Electrical Manufacturing Co., 503 East Water Street, Milwaukee, Wisconsin, the carbon pile method of varying the resistance is used. The carbon pellets are contained in a porcelain case with suitable means provided for mounting purposes. A 1¼" diameter knob controls the pressure on these pellets, thereby increasing or decreasing the resistance in the filament circuit.

Tested for eight hours at 2½ amperes, representing a power consumption of 15 watts, which was a 50 per cent overload on the manufacturer's rating. Maximum current is reached in three complete turns of the knob.

Arrived in good packing with instructions and template printed on the container.

AWARDED THE RADIO NEWS LABORATORIES CERTIFICATE OF MERIT NO. 146.

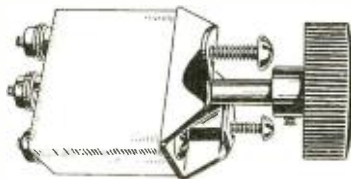

ACMESTAT MODEL B

Essentially similar in design to the plain Acme stat, this model is provided with a means for switching the filament current on and off. This is done by means of an extra knob alongside the major control. Overall dimensions are 3½" by 2½" by 1¾". Tested for eight hours at 2½ amperes, representing a power consumption of 15 watts. This was a 50 per cent overload on the manufacturer's rating. Three complete turns of the knob are necessary to bring the current to its maximum value.

Arrived in good packing with instructions and template printed on the container.

Manufactured by the Acme Electrical Manufacturing Company, 503 East Water Street, Milwaukee, Wisconsin.

AWARDED THE RADIO NEWS LABORATORIES CERTIFICATE OF MERIT NO. 145.

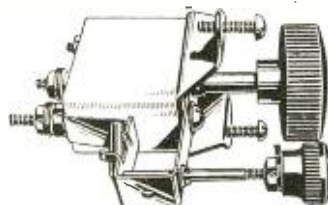

ROGERS RECEIVING RADIOMETER

Departing from conventional variometer design, the Rogers Radio Company, 5133 Woodworth Street, Pittsburgh, Pennsylvania, offers its receiving Radiometer, which consists essentially of two figure 8 wound coils. The inductance is wound part spiderweb fashion and part figure 8 fashion around the molded bakelite forms. Enamelled wire

is used for the winding. The front support is provided with two mounting projections and is fastened to the back of the panel while the rear support rotates directly behind it. A projection on the moulds serves as a stopping device. The diameter of the



forms is 4" and the separation between the windings is ⅜". With a 32-turn secondary of a variocoupler in series with the instrument, the wave-length range obtainable was from 175 to 350 meters. The Radiometer may be used in any circuit which employs the usual type of variometer.

Arrived in good packing with instruction sheets enclosed.

AWARDED THE RADIO NEWS LABORATORIES CERTIFICATE OF MERIT NO. 148.

CUTLER-HAMMER POTENTIOMETER

Following mechanical design similar to that embodied in its plain and vernier type rheostats, the Cutler-Hammer Company, Milwaukee, Wis., now offers its potentiometer.

The resistance wire of 320 ohms is wound on an insulated form, clamped between two metal discs which are fastened to the shaft. The ends of the wire are soldered to each of these metal discs, one of which is grounded to the frame of the instrument and the other has a spring contact sliding over it. The center arm of the potentiometer consists of



another spring contact bearing over the surface of the resistance wire. Contrary to ordinary design, it is the resistance element which rotates and the contact arms remain stationary. Two holes for mounting purposes are provided on the "U" shaped bar which supports the entire instrument. The knob has a sufficient diameter to practically conceal the mounting screws.

Arrived in good packing with instructions printed on the container.

AWARDED THE RADIO NEWS LABORATORIES CERTIFICATE OF MERIT NO. 149.



THE NEW HAVEN RADIO ASSOCIATION

There has been in existence in New Haven for the past year an organization known as the New Haven Radio Association, which at the present time is making rapid progress in all phases of the radio art. A new form of code practice by which a local C. W. station transmits code on a fixed schedule was recently instituted and has proved of great value to all taking advantage of the opportunity of learning the code. A large convention has been planned for April 16, at which time many prominent men will be secured as speakers. A cordial invitation is extended to all clubs and to any individuals interested, to attend. The convention will, in all probability, be held in the local Commercial High School and there will be ample room for all.

The present officers, elected for the year 1923, are the following: Warren Doolittle, president; W. H. Wygant, vice-president; P. E. Boyce, secretary; and F. M. Heberger, treasurer. Communication will be appreciated from other clubs and all such communication should be addressed to the secretary, care of the New Haven Radio Association.

THE RADIO CLUB OF AMERICA

At the last meeting of the Radio Club of America held at Columbia University, New York City, Professor L. H. Hazeltine of Steven's Institute, presented a very interesting paper on "Tuned Radio Frequency Amplification With Neutralization of Capacity Coupling."

In this paper, Professor Hazeltine presented a new means of neutralizing the capacity of the vacuum tubes, which in radio frequency amplification causes regeneration between the different stages when resonance is reached. By means of an extra very small condenser of about one micro-microfarad connected between the stages, each grid circuit may be tuned to exact resonance without oscillations taking place due to reaction through the inter-electrode capacity. This system, which he called Neutrodyne, will not only be of great use in radio frequency circuits, but will find several applications in other circuits where oscillations are not wanted. Several types of receivers having two stages of radio frequency amplification combined with one or two stages of audio frequency were presented and tested on a very short indoor antenna. Results were highly satisfactory showing great simplicity of adjustment and ease of tuning.

All communications to the club should be addressed to the Corresponding Secretary, Mr. Renville H. McMann, 380 Riverside Drive, New York City.

THE MILWAUKEE AMATEURS' RADIO CLUB

The design and operation of station 9AAP, Milwaukee's only station to have its signals span the Atlantic, was the subject of a paper presented by Marian Szukalski, Jr., at the Milwaukee Amateurs' Radio Club's first meeting in February. E. G. Nickel and E. A. Carey, both of station 9ATO and members of the Club's publications committee, have given digests of current radio literature in the reports. The topic of one of the most interesting of these was station 6KA, its design and records.

Dist. Supt. C. N. Crapo announced in his monthly report that Milwaukee County, the smallest of the districts, with 415 messages handled, ranked second in the race among A.R.R.L. traffic districts of the state. A silver cup, known as the Wisconsin Cup, is offered by B. A. Ott, 92Y, manager in charge of the state, to the stations which monthly handle the greatest amount of traffic. Members of the Milwaukee club are now out for this honor. City Manager I. H. Strassman, 9AHO, advised the members of the presence of several local unlicensed stations in the air, and that he and his staff were taking steps to clear the situation up.

Incorporation of the Club under the laws of the State of Wisconsin was the second case assigned to Attorney L. J. Topolinski, the society's general counsel. Business Manager L. S. Baird has opened negotiations with both the South Side and West Allis radio clubs with the objective of bringing about consolidation with the Milwaukee club at the time of incorporation and forming one large county radio association.

HUDSON RADIO CLUB

The annual banquet of the Hudson Radio Club was held on the evening of January 26, and it was a decided success. Forty-two of the Club's mem-

bers were present, which is slightly more than eighty per cent of the total membership.

The dinner actually got under way at 7:15 P. M., and after a few minutes occupied in taking a photograph of the assembled crowd, a merry hour was spent in consuming enormous quantities of food.

The vice-president of the Club, Mr. Kilbourne, 2BRO, acted as toastmaster, and introduced the speakers. The first on the program, was Mr. Droste, the vice-president of the Executive Radio Council of the Second District, who gave a very interesting address on the services of the amateur to the army during the World War. Mr. Droste gave a very comprehensive description of the work performed by the amateur operators, and of the difficulties overcome by them, during their service.

The second speaker of the evening, was Mr. F. B. Ostman, traffic manager of the 2nd District Executive Council. Mr. Ostman spoke on the traffic system now in use in the Atlantic Division of the A. R. R. L., and also urged everyone to be more conscientious in their delivery of messages.

The last speaker was Mr. W. F. Crosby, Editor of the Modulator. He spoke first, of the importance of efficient organization among the amateurs, and secondly of the support which they should give the Council's organ, "The Modulator."

At the conclusion, the President, Mr. Danziger, announced the new committees which have been appointed for the coming year, and expressed his thanks to those retiring from office. He also stated, that in view of the very enjoyable evening had by all, he sincerely hoped that another such dinner would be possible in the not far distant future.

THE COLLEGE OF THE CITY OF NEW YORK RADIO CLUB STATION 2NXA

As most of the readers of this periodical have never had a chance to visit 2NNA, the following write-up has been printed here to make the readers familiar with this active radio club. The station is open to visitors between 1 and 2 o'clock every week day and hams are invited to drop in. Now to get down to business.

The "radio cabin" of the C. C. N. Y. Radio Club is located at the top of the Bell Tower in the main building of the College. This room was used during the war by the U. S. Navy as a Radio Compass Station and a depot for the detection of the enemy wireless stations. Through the kindness of Professors Fox, Turner and Hubert, and the Club's Faculty Adviser, Prof. A. N. Goldsmith, the historic room was turned over to the Radio Club for their exclusive use, day and night.

From the top of the tower a fine view of the city may be had. The loop aerial originally used by the Navy is located here. A regulation 200-meter aerial is stretched between the two towers of the Main Building (one of which is the Bell Tower); and a two wire receiving aerial, about 150' long is stretched from the Main Towers, which can be seen from all over the Southern and Western Bronx, Northern Manhattan, and a part of the Jersey Palisades across the Hudson River. Lately a counterpoise has been added to the aerial system.

Upon entering the "Radio cabin" one may perceive on one side, the Code Table equipped with buzzers, keys, and an automatic tape transmitter. Here also may be found the latest issues of the leading radio magazines, and the "log" which every member signs as he enters and leaves the room. On the other side of the room, the sending and receiving outfits are located. The transmitter may be used for wireless telephony, continuous wave telegraphy, or buzzer modulated telegraphy. Four 5-watt power tubes are used. The receiving set consists of a short wave regenerative receiver, a two-step amplifier, and one step of power amplification, and a Magnavox. All the instruments are enclosed in cabinets with panel fronts.

On the top shelf of the book-case stands the clock which is set by the radio time signals. The Club's library is rapidly increasing under the librarian, who keeps a sharp lookout for the latest radio books. Books are circulated and also kept for reference in the "radio cabin," and copies of radio magazines are kept on file.

During 1921, the Club conducted experiments in broadcasting music and songs as well as reporting the scores of the College games. Phonograph selections and College songs sung by the members were broadcast without any difficulty. Mandolin and banjo-mandolin music was also transmitted and favorable reports were received

from those who heard it. The banjo-mandolin music furnished by Operator Fusco was especially appreciated. Last fall, during the exciting C.C.N.Y.—N.Y.U. football game which took place in the College Stadium, Radio Club members were on the side lines with a field telephone connected to the station in the Bell Tower. There, an operator repeated the plays as they were reported into the radiophone transmitter.

1922 was ushered in with broadcasting experiment. On January 1, 1922 at 4 p. m. 2NNA broadcast the first Radiophone Organ Recital. While the noted organist, Professor Samuel A. Baldwin was playing the organ before a large audience in the Great Hall of the College, the recital was being broadcast from the Club's Station in the Bell Tower on a wave-length of 280 meters. Microphones attached to large megaphones were installed in the two organ lofts and connected in series so that the sounds from each organ loft were combined to form the complete melody. On January 22nd, the second Radiophone Organ Recital was broadcast, following which letters were received from several stations which heard the concert and appreciated it enough to notify the Club. Unfortunately, we had to disappoint these and the other amateurs who may have been hearing us, as a result of a communication from the Department of Commerce to Prof. Goldsmith requesting that the Commercial Companies be given the sole monopoly of broadcasting. This request has been complied with. However, we feel that the experiment was worth while for WEAJ has taken our place, and with their expensive apparatus obtain results we aimed at. It was Prof. Goldsmith who made the Radiophone Organ Recital a reality for us with his material aid and professional advice.

For many years the College Bell was seldom struck and many students went to the College without knowing that the College had one, but now the Radio Club has taken charge and every day that the College holds regular sessions the College Bell strikes on the second of noon. The club members take turns according to a regular schedule, at the Radio Time-Watch. Just before the dash, which signals exact noon, is sent from Arlington, the operator on duty presses a button in the "radio cabin" which sets in motion the striking mechanism of the College Bell and on the second of noon the hammer strikes.

Some of the club activities that can be briefly enumerated are daily code practise, a weekly lecture by one of the advanced members or by some outside expert. Our next lecture, to start off the new term was given by Mr. D. Freed of the Freed Eisman Corporation, on a "New Type Radio Receiver." Mr. Freed is an alumni of the College.

We are working on an even more ambitious program for the year of 1923. Adopting as our motto, "Service to Alma Mater," we are going to show how useful a Radio Club can be in a College.

Plans have been formulated for the building of a 250 watt set.

With this new transmitting set in operation, we hope to complete another pet idea of ours, the Intercollegiate Radio League. Favorable responses have already been received from all the large Eastern College radio clubs. This service will take care of radio chess games, scores of college games, and free transmission of messages between students of the respective colleges.

A few items of interest might be added here. 2NNA is a member of the American Radio Relay League, and also a part of the 2nd District Radio Council. The officers of the club are:

President—R. Carlisle 2VY
Vice Pres.—M. B. Gillespie 2CVN
Chief-Operator—Ben Orange 2CEC
Sec.—Treasurer—D. Weinbloom

We would appreciate it very much if distant stations hearing our call, especially after the 250-watt set is put in, would drop us a card. Address all communications to—

C. C. N. Y. Radio Club,
c/o Prof. Goldsmith,
College of the City of New York,
139th St. and Convent Ave.

TRAFFIC REGULATION OF THE ST. LOUIS RADIO ASSOCIATION

We recently received a neatly printed calendar from the St. Louis Radio Association, listing their traffic regulations which took effect Jan. 8, 1923. This seems to be a very good scheme and might be followed by associations in other districts. The small slip attached to the top of the calendar reads:

(Continued on page 2052)

THE RADIO GAZETTE

CARL DREHER, Editor

PUBLISHED:
WHEN WE HAVE TIME

EDITORIAL OFFICE
47° 22' Long. E.
17° 33' Lat. N.

Price, Free
Subscription, given away for
nothing and for one year

Editorial

THE LUNATIC FRINGE

WHEN Colonel Roosevelt originated the phrase "lunatic fringe," he surely did not have radio in mind. Fringe? Radio in its present state consists rather of a small sane clearing surrounded by extensive steppes and jungles of pure delirium. The sane oasis is populated principally by the Editor of RADIO GAZETTE, and a few of his friends, particularly the ones to whom he owes money. Outside of it, what do we find? Radio half-wits with three foot loops and crystal sets in New York City, complaining because they cannot hear Detroit on a loud speaker. Spiritualists who proclaim that static is caused by the spooks spitting out fishbones at the celestial dinner tables. Journalists printing pictures of dogs, cats, newborn infants, chorus girls, and other fauna listening raptly to imaginary concerts, the phone terminals having been hooked onto the "A" battery posts of the set. Novice listeners in Borough Park, Brooklyn, who write hot letters to their congressman demanding the suppression of amateur transmitters, while actually they are being jammed by WNY, eight blocks away, calling his flock of ships with a kilowatt or two in the aerial. Loving couples being spliced by radio. Women falling in love with announcers of broadcasting stations and writing them mash notes asking for interviews.

We could continue enumerating symptoms of lunacy, but there is no necessity. A touch of insanity was characteristic of radio men in the old days; it was the only thing that gave them strength to bear up against coherers, fading periods, spark coil vibrators, patent lawyers, summer static, harbor testers, and the other manifold curses of the art. But the early style radio men were crazy within reasonable limits, while the rising generation has gone the whole hog. Much as we dislike the rôle of a prophet of evil, mere self-protection impels

us to issue a lone protest and exhortation. Let all radio men and women—particularly women; and let us mention in passing that we are very fond of red-haired girls weighing around 120 pounds—let all such who have remained partially sane rally around the *Radio Gazette*! All the departments of the *Gazette*, as this first issue shows, will be conducted along sober and conservative lines. Furthermore, *Radio Gazette* intends to pursue a virile and militant policy. We make no threats—but let the batty radio experts take warning while there is yet time. The next feature writer who lets loose the power-transmission-by-radio-is-at-hand yarn will discover what we mean. As we said before, we make no threats, but that feature writer will be measured for a wooden cabinet, and it will not have a bakelite panel, either. We have stood all we can stand, and, like the worm on the binding post, we are about to turn.

Who is Which in Radio

PROF. VASSILY BULLCHUCKOFF



Everyone has heard of Professor Bullchuckoff, the famous Russian authority on radio, inventor of the Bullchuckoff combustible vacuum tube. When the filament current is increased beyond the safety limit, the entire tube bursts into flame, thus warning the experimenter that he has gone too far.

At great expense we have secured a short communication from Professor Bullchuckoff to the radio men, women and children of the United States. "My combustible vacuum tube," says the Professor, "will revolutionize radio. It will make radio safe for the home. Up to now burned-out vacuum tubes have been the most prolific source of divorces and broken-up homes. 'You did it,' says Mother. 'now there's another six berries gone to H-ll.' 'Didn't I warn you last Tuesday not to burn her so high?' demands the head of the family. 'Who do you think I am—Coal-Oil Johnny?' So dissension creeps into a once harmonious household. My invention precludes this catastrophe. The tube is incinerated, and there is nothing left to fight about."

The Breakdown

Question and Answers

Question: The catwhisker of my detector has broken. What shall I do? Clarence, Simp Falls, Mo.

Answer: Kill another cat.

Question: The lady upstairs threatens to break my neck if I don't stop picking up the concerts on my loud speaker till 2 A. M. and waking her up via the airshaft. How would you handle a situation like this?

Answer: Add another step of amplification.

Question: I made a set. Why don't I hear anything? I think the radio is a fake. Pianomover, Sauerkraut Junction, Pa.

Answer: Certainly, certainly. We have always thought so ourselves. We never argue with a pianomover.

Question: My husband is a wireless operator on board a ship. Do you think he makes love to other women when he is away from me? Worried Bride, Soup Lake, N. Y.

Answer: Not if he ships on an oil tanker.

Question: My antenna runs directly under a 33,000 volt transmission line. What must I do to safeguard myself and my wife and 14 children? Father, Gruntville, Illinois.

Answer: Get in touch with one of the manufacturers of synthetic insulation. If you have the whole family thoroughly bakelized there is little danger. The dull brown finish is best.

Answer: Get in touch with one of the manufacturers of synthetic insulation. If you have the whole family thoroughly bakelized there is little danger. The dull brown finish is best.

Radio Gazette's Why is Series

UNDER this heading we shall publish each month an informative article on some topic of interest to everyone who has become unbalanced through radio. The first article of the series appears below.

1. WHY IS STATIC?

WHY is the air full of static? This is a question which must have occurred to many of our readers, who, being incautious enough to demonstrate their sets to their best girls on a summer night when a lightning storm interfered with the usual park-bench petting parties, heard crashes and growls instead of the sweet notes of their favourite broadcasting station. The following history will enlighten them. It may also be read to the children as a bedtime story. After hearing it, they will hawl all night.

Rollo Senseless was a handsome Lad who, instead of becoming a Movie Actor, got a Job as a Research Assistant in a Radio Laboratory. In this Laboratory there glowed a Pilotron Bulb, which the Engineer for whom Rollo worked valued more than his first-born Child. One day Rollo, while carrying the Pilotron about the Laboratory to the Place where its Oscillations were

(Continued on page 2056)

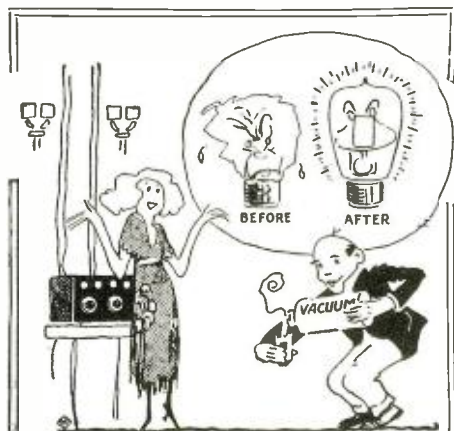

REPAIR YOUR OWN VACUUM TUBES

For the small sum of 14c we will send you, by freight collect, one bottle of the highest grade "hard" vacuum. This, when poured into your "exhausted" vacuum tubes, will immediately rejuvenate them. Satisfaction Guaranteed. Send \$25 for illustrated pamphlet. Money refunded if satisfied!

VACUUM FIZZ CO., OSKALOOSA, MICH.

WANTED

I want a silent partner to finance a terribly lucrative business. Am now engaged in manufacturing bottling tubes, which meet with ready sale, but I have recently made improvements whereby, instead of the vacuum, I use a good grade of Scotch Whiskey. This makes it a double-barreled bottling tube, which is very popular with the trade.

Guarantee results.

For particulars, address E. Z. COINE, Box No. 11968, c/o this publication.



Chopper Operation in Arc Transmission

By JACK BRONT*

THE older types of arc transmitters, such as those produced by the old Continental Syndicate and the Berliner Company in Europe, are fairly efficient and stable radiators, destruction. Some surprising results have been obtained from them even in radio-telephone transmission by the addition of stabilizing accoutrements. The American type of arc adapted from the original Poulsen design, and perfected by the Federal Telegraph Company, is the essence of excellence, yet notwithstanding the radical departure in chamber design and the improved auxiliaries to aid good operation, the average Marine operator absolutely fails to accomplish the best results which are obtainable on the 600-meter wave using the chopper.

Generally, the operator is fain to proceed with transmission using the bluntest and most ragged of carbons, which, although functioning fairly well on straight C. W. emission on long waves, nevertheless is a nemesis to the emission of a clear chopper modulated note. In the first place the arc must be operated at the most critical point where the clearest and most uniform C. W. is obtained. Unless the C. W. note is clear and sharp and the oscillations are uniform in sequence, there is no possibility of obtaining a good chopper note. One might as well try to heterodyne the emissions of a spark coil by means of the emission from another. In other words, the C.W. on the chopper wave-lengths must be a nearly perfect sine wave emission, if the best results are to be obtained in the modulation of antenna current by the functioning of the chopper loop.

The chamber must be rigidly airtight and the hydrocarbon supply watched with extreme care. A slight quantity of water in the chamber or a small air leak, hardly noticed when long waves are employed, will show up detriments at short wave-lengths which are appalling.

Clean-cut, squared carbons are a secret in obtaining clear chopper notes, although if the carbon burns evenly all around its perimenter, a good note can generally be obtained. If the chamber of the transmitter is "warmed up," there is a better possibility of getting best results. When the chamber is warmed up, it means that there is a sufficient amount of free hydrogen within from the disintegration of the hydrocarbon base and that the arc can be operated on the steepest part of its curve, other things being equal. The hydrogen is most important in the production of clear C. W., aiding in the rapid conduction of heat from the anode and cathode and the cooling of the carbon, which also plays an important part in the conductive quality of the

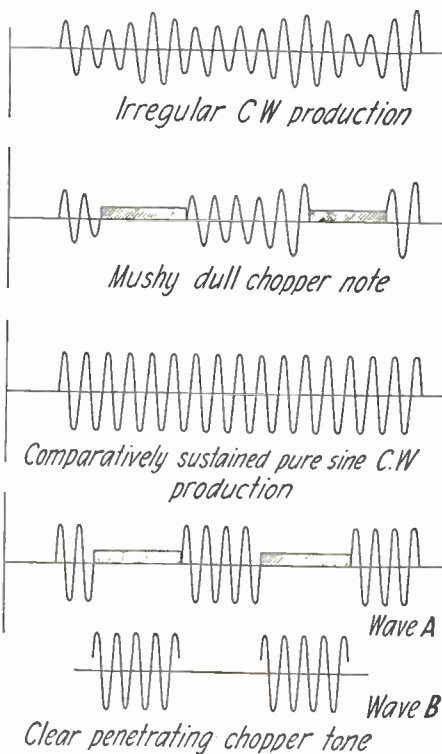

Comparative Waves Produced by the Chopper Under Various Conditions

space filled with ionized particles in the arc gap.

Some men claim that in one type of the present Federal arc transmitters there is no possible chance of carrying the speed of the chopper motor. This is not manifestly important, although many blame their inability to obtain a good chopper note upon this condition. The chopper disc between certain limits will produce a good note regardless of the speed. What most operators fail to grasp is the fact that there must absolutely be a clear C.W. before it may be modulated, and thus render a clear chopper note. If the C. W. is not clear, there is about as much chance of obtaining a good note as the proverbial snowball. Reference to the figure will

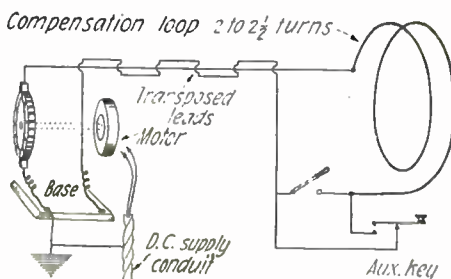

Connections of the Chopper When Employed with a Compensation Loop.

show the reason for this. An article in the February, 1922, issue of RADIO NEWS explains the process at greater length. The comparison between the chopper emission with a clear C. W. production, and that obtained without it, is easily grasped.

The theory of the operation of the arc should be well gone into with profit by the average operator, but there is not sufficient space for it here. The chopper, however, is an excellent piece of apparatus and much research has been expended upon it.

Under ordinary conditions the chopper can cover 400 miles by daylight and should function over 1,500 miles at night, as has been demonstrated by actual work not of a freak or extraordinary character. In communication with the Federal station at San Francisco, where loops are employed for reception and in work with many different ships one of which was KDPR (West Coast), the 400-mile range was maintained with chopper without difficulty and it is possible with any arc of the usual 2-K. W. type if care and intelligence are used in the adjustment of the apparatus. There is one specific point about the arc type of transmitter; that is, it will not adjust itself and differs radically from the rock crushing type of spark apparatus, which, although not correctly adjusted, will emit some kind of clatter. However, if the arc is adjusted, as it should be, and only moderate care exercised in connection with it, the best of results will be obtained.

When the chopper is functioning properly, the 1,750 revolutions-per-minute motor will turn over the disc at a rate which gives approximately an 800-cycle note of pure and penetrating characteristics. This refers to the ordinary type of Federal chopper with 24 segments connected to the inner ring and interspersed with the non-conducting segments which are greater in number, presenting the disc with a rigid and smooth working surface.

An interestingly simple chopper circuit is given here, which, although but slightly different from the originally planned circuit, is most proficient in the emission of clear and well modulated antenna current. Instead of one turn in the loop as is usual, two to two and one-half turns are coupled to the low tension end of the antenna loading helix and the leads from the loop, through the small switch on the one leg, and direct from the first turn in the other leg, are heavily insulated and tightly wrapped together with the conductors transposed as often as is possible in a given space. One leg leads to the top chopper brush and the other connects to the cast iron of the chopper motor base. The latter is well grounded, as is the sheathing of the leads of the D. C. supply to the

(Continued on page 2038)

*Marine Dept., Independent Wireless Telegraph Company.



THIS Department is conducted for the benefit of our Radio Experimenters. We shall be glad to answer here questions for the benefit of all, but we can publish only such matter as is of sufficient interest to all.

1. This Department cannot answer more than three questions for each correspondent.
2. Only one side of the sheet should be written upon; all matter should be typewritten or else written in ink. No attention paid to penciled matter.
3. Sketches, diagrams, etc., must be on separate sheets. This Department does not answer questions by mail free of charge.
4. Our Editors will be glad to answer any letter, at the rate of 25c for each question. If, however, questions entail considerable research work, intricate calculations, patent research, etc., a special charge will be made. Before we answer such questions, correspondents will be informed as to the price charge. You will do the Editor a personal favor if you will make your letter as brief as possible.

A. F. TRANSFORMER RATIO

(657) Mr. T. G. Miller, McDonald, Pa., requests:

Q. 1. Give the transformer ratio for the 1st, 2nd and 3rd stages of audio frequency amplification.

A. 1. As a rule a transformer with a ratio of more than five to one will not give good results in any stage, although a nine to one ratio can sometimes be used in the first stage. The best results will be obtained with a five to one transformer for the first stage and a three to one ratio for the second and third stages. This holds good for all standard tubes on the market.

Q. 2. Please give directions for adjusting Baldwin Type C. phones.

A. 2. These phones are adjusted correctly at the factory and should not be touched. If the

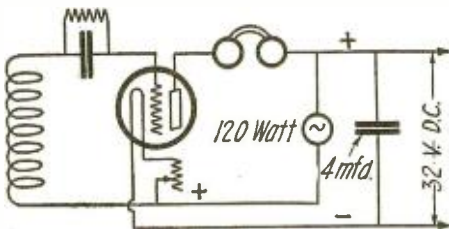

Q658

A 32 Volt Lighting Circuit Can be Used to Light the Filament of a Tube. The Plate Voltage is Also Supplied From the Same Source.

phone does not give good results it should be sent back to the maker for repairs.

32 VOLTS FOR PLATE AND FILAMENT

(658) Mr. C. S. Smith, Slayton, Tenn., wants to know:

Q. 1. Can the electric current from a 32-volt farm lighting plant be used to light the filament of a tube?

A. 1. A diagram will be found on these pages showing how this is done. One 120-watt lamp is placed in series with the line to cut down the voltage and supply the amperage for the tube. We assume that a tube drawing one ampere, such as a radiotron is to be used.

Q. 2. Could same source of current be utilized for plate voltage?

A. 2. This has also been shown on the diagram.

COMBINATION RECEIVER AND TRANSMITTER

(659) Mr. George Brown, St. Louis, Mo., wants:

Q. 1. Please publish a receiving hook-up that can also be used as a C.W. and phone transmitter.

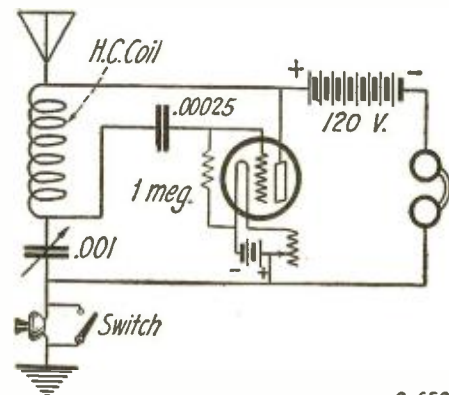

Q-659

The Colpitts Circuit is an Excellent Oscillator, and Will Give Good Results as a Receiver or a Transmitter.

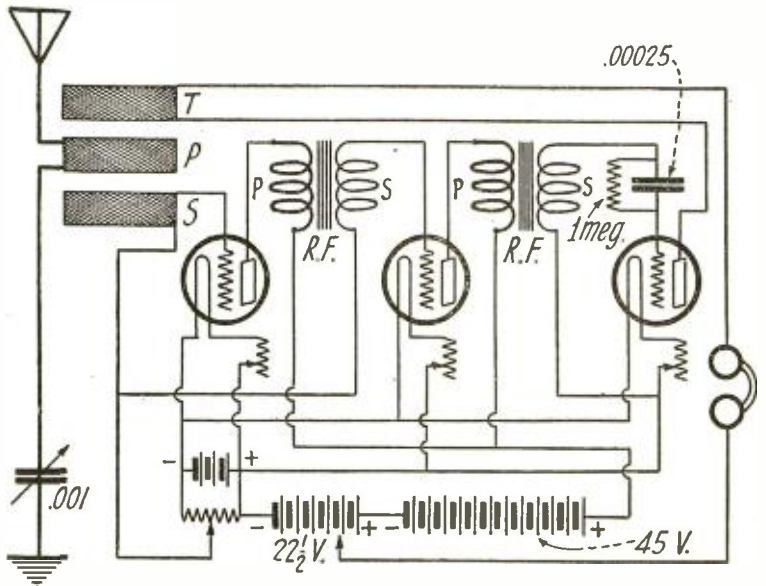

Q-662

A Standard Three Circuit Honeycomb Receiver May be Used With Radio Frequency as Shown Here. The Tickler is Placed in the Plate Circuit of Detector Tube.

A. 1. This hook-up will be found in these columns. A honeycomb coil may be used as the tuning inductance and a microphone or key may be inserted in the ground circuit for transmitting. A hard tube should be used so that a high "B" battery voltage can be used on the plate

LIFE OF A VACUUM TUBE

(660) Mr. Frank Crites, Amanda, Ohio, writes: Q. 1. Is the life of a vacuum tube good as long as the filament lasts?

A. 1. A vacuum tube should continue to function until the filament burns out. Sometimes the connection to the plate or grid becomes loose or corrodes in the base and the tube will cease to work.

Q. 2. I have two Baldwin Type "C" phones. One is much better than the other. Can the poor one be repaired?

A. 2. Get in touch with the manufacturer, Nathaniel Baldwin, Salt Lake City, Utah.

Q. 3. How may I eliminate some of the noises from three stages of audio frequency?

A. 3. The third stage should be entirely shielded on all sides, if possible, and grounded. If the cores of all the A. F. transformers are grounded, it will help to a great extent. It is possible that the "B" battery is the cause of a good deal of trouble. Fluctuating voltage from the "B" battery, although not noticeable in the detector, will be very much in evidence on three stages. A radio frequency choke coil, consisting of 75 turns of wire on a 2" tube, placed in the grid circuit of all the amplifying tubes will be beneficial. In such an amplifier the turns ratio of transformers should not exceed 3 to 1.

CAPACITY OF COIL WINDINGS

(661) Mr. E. W. Green, Jr., Cincinnati, Ohio, wants to know:

Q. 1. Does wax on the windings of variocouplers and variometers effect them?

A. 1. As wax has a higher dielectric constant than the cotton or silk covering of the wire, it will slightly increase the distributed capacity of the coil. The effect, however, should not be noticeable on the signals.

RADIO FREQUENCY WITH REGENERATION

(662) Mr. Joseph Howarth, Jr., Passaic, N. J., writes:

Q. 1. Can radio frequency amplification be used with a three-circuit regenerative receiver of the honeycomb coil type?

A. 1. Radio frequency amplification can be used with a honeycomb coil regenerative receiver. If more than two stages of R. F. are used, difficulty might be experienced with regeneration. In this case the coil can be shorted out of the circuit.

Q. 2. Please show a hook-up of this circuit with two stages of R. F. amplification.

A. 2. This hook-up will be found in these columns.

REFLEX WITH LOOP

(663) Mr. Lee Alloway, Lexington, Ky., writes:

Q. 1. Is the reflex circuit as published in answer to question 611 in the February issue practical with a loop and a variable condenser as tuner?

A. 1. Yes. A loop may be used with success with this circuit. It should be connected in place of the secondary coil.

Q. 2. Can W.D. 11 tubes be used?

A. 2. Yes. These tubes can be used in this circuit.

Q. 3. Would this set operate a loud speaker at distances up to 300 miles, under favorable conditions?

A. 3. If a good loudspeaker is used, excellent results should be obtained.

CAGE ANTENNA LENGTH

(664) Mr. Steuart Eaton, Troy, N. Y., wants to know:

Q. 1. What should be the length of a cage-aerial, using four strands of wire to receive the 360 and 400 meter stations?

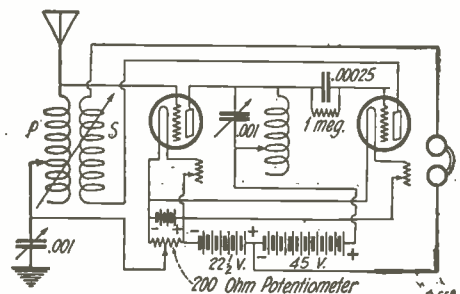

Q-664

Very Good Results Will be Had by Using One Stage of Tuned Radio Frequency. The Inductance May be the Primary of a Variocoupler.

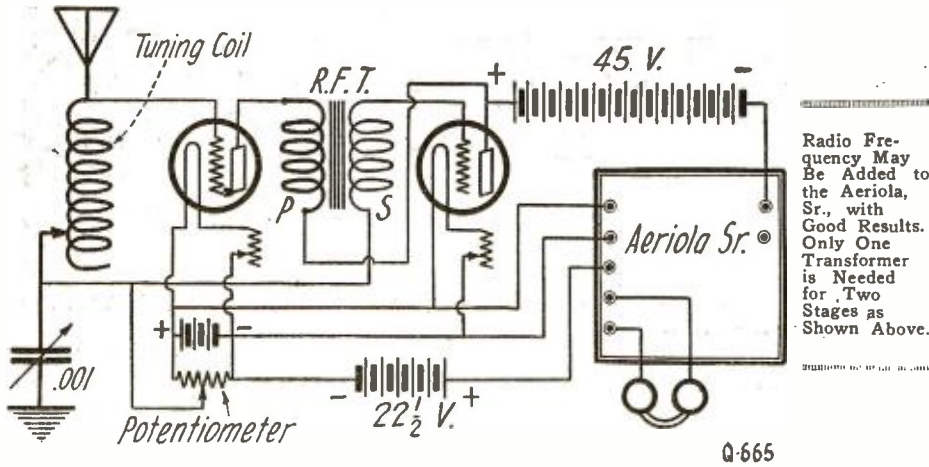

Radio Frequency May Be Added to the Aeriola, Sr., with Good Results. Only One Transformer is Needed for Two Stages as Shown Above.

Q-665

A. 1. An antenna of this type should be about 80' long. No better results, however, will be obtained with this antenna than with a single wire of the same length.

Q. 2. Where can I get plans for constructing a good 180-degree variocoupler?

A. 2. A very good variocoupler of this type was described in the "Wrinkle Contest" in the February issue of RADIO NEWS.

Q. 3. What would be the correct capacity phone condenser for a receiving set using the above instrument for 360 and 400 meter stations?

A. 3. A phone condenser has no effect on the wave-length of a receiving set. This condenser is used to allow the radio frequency currents to pass around the high resistance phones. A condenser of .002 mfd. will be about right for this purpose.

R.F. AMPLIFICATION WITH AERIOLA, SR.

(665) Mr. F. O. Jones, Boston, Mass., requests:

Q. 1. Can radio frequency amplification be added to the Aeriola Sr. receiver? If so, please show a diagram using two stages.

A. 1. This hook-up appears on these pages. The radio frequency in this case is put before the tuner, and a separate tuning coil is used for tuning. Two separate "B" batteries must also be used.

TRANSFORMER FOR POWER AMPLIFIER

(666) Mr. L. G. Hess, San Angelo, Texas, asks:

Q. 1. Where may I obtain the transformer required in the construction of a power amplifier as described in the "I-want-to-know" column of the December, 1922, issue?

A. 1. There were two power amplifiers described in that issue. If you mean the one in answer to question 553, any good audio frequency transformer with a low ratio would do. The transformers used in the amplifier shown in answer to question 557 cannot be bought separately from the complete unit which is manufactured by the Western Electric Company.

Q. 2. What kind of battery is the one shown between the secondary of the first transformer and the ground?

A. 2. This is an ordinary "C" battery and will vary from five to nine volts.

HETERODYNING INTERFERENCE

(667) Mr. R. W. Lowrie, Hudson, Ohio, writes:

Q. 1. I have had great trouble trying to stop a squealing sound when receiving broadcasting. How can I prevent this?

A. 1. This is, no doubt, due to the carrier wave of two or more broadcasting stations heterodyning each other. This carrier wave would not be heard if only one station was transmitting, but when two are on, the two carrier waves overlap each other and produce an audible beat note in the receivers. This could also be caused by a receiving set in the vicinity, tuned to the same wave-length as the transmitting station and receiving with the detector tube in a state of oscillation.

ONE STAGE TUNED R.F.

(668) Mr. J. F. Roddy, Rock Hill, S. C., writes:

Q. 1. Will you please publish a circuit for a detector and one stage of radio frequency?

A. 1. This hook-up appears herewith. Tuned radio frequency is used and exceptional results should be obtained with this system. The R. F. inductance may consist of a tapped coil of 50

turns on a 3" tube. A variometer may be used in place of this inductance and condenser if desired. If W.D.11 tubes are used, two dry cells, connected in parallel, should be substituted for the storage battery.

R. F. AMPLIFICATION FOR ALL WAVES
(669) Mr. F. F. Casterline, Arkansas Pass,

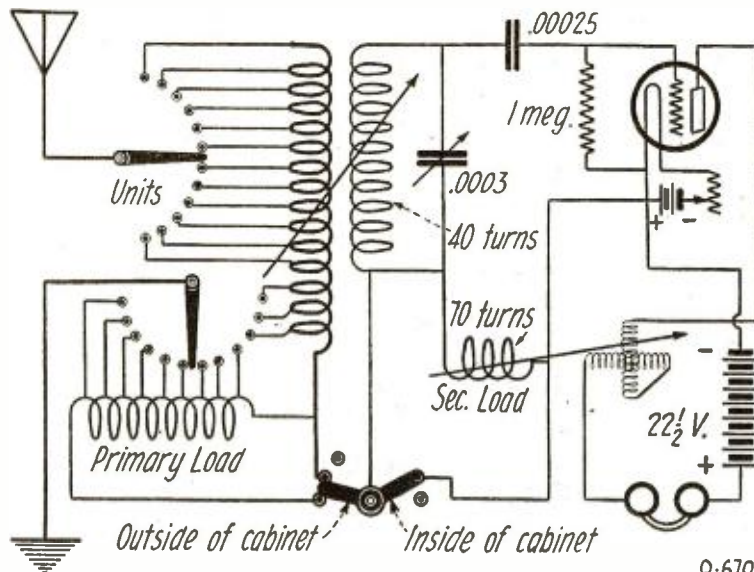

The Circuit of the Well-Known Paragon R. A. 10. Special Attention is Called to the Switching Arrangement.

Q-670

Texas, requests:

Q. 1. Kindly publish information how to make a radio frequency amplifier to cover a range of from 200 to 5,000 meters.

A. 1. A radio frequency transformer cannot be made to cover this band of wave-lengths. A transformer of this kind would receive efficiently on wave-lengths around 2,000 meters, and all above or below this wave the results would be very poor. To receive efficiently on all waves it

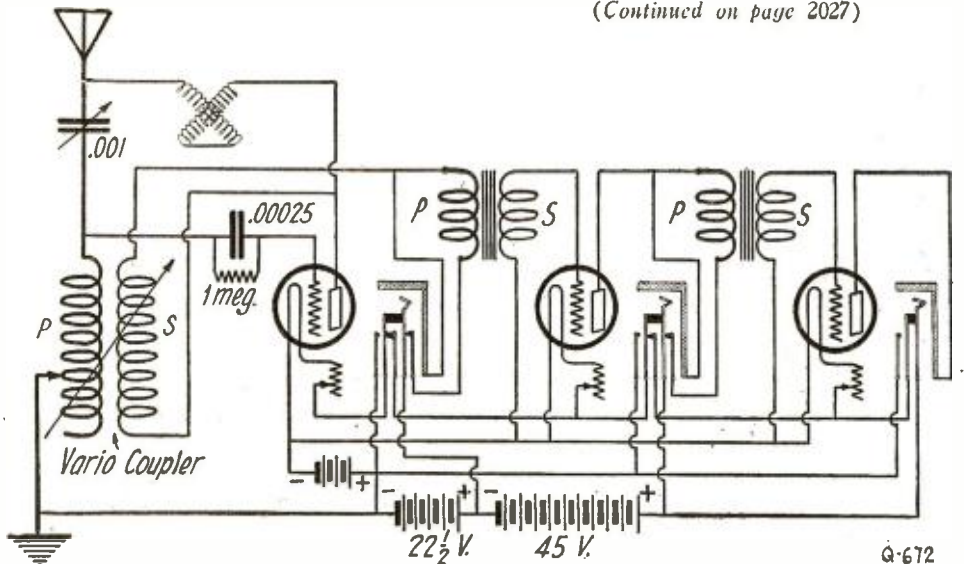

A Very Efficient Single Circuit Receiver is Shown Here. Great Selectivity is Obtained by Means of the Variometer When Connected in the Position Shown.

Q-672

would be necessary to use transformers that could be plugged in and out of the circuit for different wave-lengths.

Q. 2. Can the same kind of transformers be used in each stage of amplification?

A. 2. Yes, the same kind of transformers are used in each stage.

PARAGON R. A. 10

(670) Mr. T. S. Wood, Newark, N. J., writes: Q. 1. Please publish a hook-up of the Paragon R.A. 10 receiver with full description of the inductances and capacities.

A. 1. This hook-up is shown herewith. Special attention is called to the switching arrangement for the long waves. Two blades are mounted on the same shaft, one on the outside of the panel and the other on the inside, and insulated from each other. When thrown to the left, both of the long wave coils are shorted out of the circuit.

SPIDER WEB COIL QUERIES

(671) Mr. H. H. Chapsman, Syracuse, N. Y., wants to know:

Q. 1. What size spider web coils are most efficient on wave-lengths of 200 to 600 meters?

A. 1. A spider web coil should contain about 45 turns of wire for these wave-lengths. A variable condenser of .001 mfd. capacity should be used in shunt with the coil.

Q. 2. Can spider web coils be built to tune up to 2,500 meters?

A. 2. Such a coil could be made which would work efficiently, but it would be very large, having an approximate diameter of 2 1/2 ft., 1,200 turns of No. 26 S. C. C. wire would be needed for this coil.

THE NEW U. V. 201-A.

(672) Mr. Sheldon Hine, Waterloo, Ind., writes:

Q. 1. Is the new U. V. 201 A tube as good for detecting or amplifying as the W. D. 11 or U. V. 200?

A. 1. This tube is a hard or amplifying tube and when used for this purpose, gives results second to none. It is not meant for a detector, but will give very good results in this capacity with the right grid condenser and leak.

Q. 2. Please publish the special hook-up the advertisements say this tube requires.

A. 2. No special hook-up is needed for this tube.

REFLEX AND REGENERATIVE

(673) Mr. Herbert Lehman, Oakville, Ont., wants to know:

Q. 1. Would the reflex hook-up shown in answer to the question 611 in the February issue give as loud results on nearby stations as a regenerative receiver with two stages of audio frequency amplification only?

A. 1. This receiver will give just as loud results on nearby stations as a two-stage regenerative receiver. On long distance work it will prove far superior.

Q. 2. Are the fixed condensers shown across the audio frequency transformers necessary?

A. 1. These are by pass condensers and are used to allow the radio frequency currents to pass around the high resistance coils of the transformers. These condensers are absolutely essential in this circuit.

(Continued on page 2027)

MU-RAD RECEIVERS SUPREME



EVERYDAY RECEPTION over distances that far outstrip the commonly accepted records — this (not baseless claims) is the evidence of MU-RAD superiority. The only set that can achieve such astonishing sensitivity, using a small loop aerial. Delightfully fine selectivity. With all this efficiency and completeness, utterly simple to operate. Each set guaranteed for 1000 miles reception.

4300 MILES
on an indoor loop aerial

Four thousand, two hundred and seventy-eight miles away in Honolulu, the Royal Hawaiian Orchestra plays for delighted listeners in St. Louis, U. S. A., through their MU-RAD Receiving Set. An example of MU-RAD supremacy.

Write For Literature.

*The New
Star in
the Radio
World*

MU-RAD LABORATORIES, INC.

801 FIFTH AVE. ASBURY PARK, NEW JERSEY





Double As Good

The scientifically correct design of the *Fada Vario-coupler* enables a very gradual variation of coupling over a full 180 degrees.

Ordinary couplers give only a 90 degree variation and hence the *Fada* 180 degree type has double the efficiency.

Its simplicity and high efficiency in signal selections by vernier control of coupling has given the *Fada* 180 degree coupler universal demand.

Vernier Rheostats

The nationally famous *Fada* Rheostat with a new vernier attachment.

No. 150-A *Fada* Vernier Rheostat\$1.25

Potentiometers

Mechanically perfect spacing and winding of the resistance wire resulting in smoother adjustment.

No. 152-A Potentiometer (200 ohm)....\$1.00
No. 154-A Potentiometer (400 ohm).... 1.00

Fada ingenuity—manufacturing economy—value—guarantee—and low prices, are responsible for the popularity of *Fada* radio parts.

The Fada Handbook gives facts about the use of each radio part, and will be of aid to you in your radio construction work. Send 10c for your copy.

F. A. D. ANDREA

1581-A Jerome Ave., New York City



How To Hook Up a Set and Make It Work

(Continued from page 1970)

drop of solder in the wrong place that caused all the trouble.

But, as Goldberg, the famous philosopher, would say. "Them days is gone forever." No longer do we "just hook 'er up and take a chance."

The experienced amateur knows that a few minutes or even a few hours spent in planning a hook-up will often save days of exasperation and profanity. About two years ago the writer reformed. He adopted a common-sense method of procedure that gives great results, saves a lot of time and reserves the profanity for more deserving subjects.

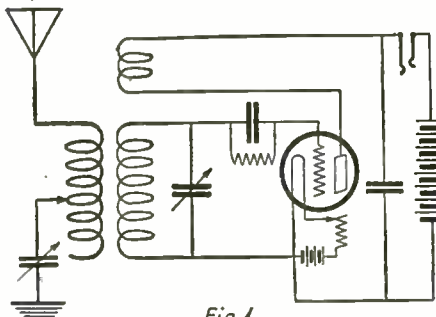

Fig. 1
The Circuit of an Embryonic Receiver Drawn in the Usual Manner.

First of all, study out your circuit. The best of publications often show a diagram that contains a misconnection. Therefore, go over the hook-up and see that it is right. Fig. 1 shows an embryonic receiver in the usual way. To the average beginner, this circuit is as clear as mud. Fig. 2 shows the same diagram. The hook-up is the same as before, only the filament lighting circuit is made heavy and the plate circuit is shown in broken lines. This breaks up the drawing into its component parts, and each part can be studied without confusing it with the rest.

A box of assorted crayons is the most valuable "set of tools" in the writer's possession when it comes to studying a com-

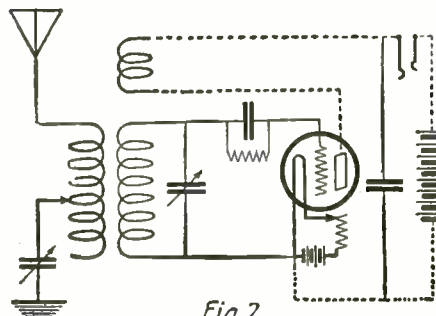

Fig. 2
This is Identical to That of Fig. 1 Only the Filament Lighting Circuit is Made Heavy and the Plate Circuit Shown in Broken Lines

plicated hook-up. The usual procedure is to first color the "A" battery, or filament current circuits RED. This makes the low voltage circuit stand out boldly from the rest. The grid circuits are then colored GREEN and the plate circuits YELLOW. Other parts of the diagram are colored in other shades to suit the fancy. This makes the drawing resemble an Easter decoration, but it certainly clarifies the design and makes it easy to study and understand. Then each circuit is traced to its end. Each branch is then followed, and here a special caution is exercised to see that the "A" and "B" battery connectors do not cross and

RADIO-LOG

RECORD YOUR RADIO DATA
RADIO LOG AND DATA BOOK

Actual size—5 x 7 1/2"

PRICE
\$1.00

Postpaid on approval

Substantially bound

Do you remember how you tuned in for that distant station? The Radio-Log, most recent useful Radio Book permits record of each minute control adjustment, station heard and worked. Contains 75 recording pages, in addition to Maps, Station Lists, Wave Lengths, Data, Codes, Etc., Complete; just what you need.

Write for FREE Club Offer.

THE A. J. M. COMPANY
Dept. R. P.O. Box 247, TROY, N. Y.

PATENTS

To the Man with an Idea

I offer a comprehensive, experienced, efficient service for his prompt, legal protection and the development of his proposition. Send sketch, or model and description, for advice as to cost, search through prior United States patents, etc. Preliminary advice gladly furnished without charge. My experience and familiarity with various arts frequently enable me to accurately advise clients as to probable patentability before they go to any expense.

Booklet of valuable information and form for properly disclosing your idea free on request.

Write today.

RICHARD B. OWEN
PATENT LAWYER
2 Owen Building, Washington, D. C.
2276A Woolworth Bldg., New York City

GIVE YOUR EARS A TREAT!—USE

RED-HEADS

3000 Ohms Now \$6.50

With Military Head-Band and Cord

At your dealers or direct on receipt of price.

A Triumph in Radio, Receiver Design

The Newman-Stern & Stern Building
Cleveland, O.

PATENTS Secured

Prompt service. Avoid dangerous delays. Send for our "Record of Invention" form and Free Book telling How to Obtain a Patent. Send sketch or model for examination. Preliminary advice without charge. Highest References. Write TODAY. Jacobi & Jacobi, 414 Ourray Bldg., Washington, D. C.

INVENTORS

who derive largest profits know and heed certain simple but vital facts before applying for Patents. Our book *Patent-Sense* gives those facts; free. Write Lacey & Lacey, 631 F St., Washington, D. C. ESTABLISHED 1889.



MODEL R23 and MODEL A23 RADAK

Only radio set combining Radio-Frequency Amplification with Regeneration. Model R23 contains all the tuning elements, ingeniously isolated. Model A23 embodies the detecting and amplifying elements—regenerative receiver with one stage each Radio-Frequency and Audio-Frequency amplification. It is impossible to describe the remarkable results this combination gives. Or

the surprising simplicity with which the sets are controlled—three simple tuning dials of the new Radak vernier type and two filament rheostats. Receives wave lengths 175 to 550 meters. Each cabinet 9 in. wide, 10¾ high, 7 deep. Handsome mahogany cabinet work. Retail together \$100; R23 alone \$40. A23 \$60. (Licensed under Armstrong U. S. Pat. 1,113,141).

Regeneration—Plus Audio-Frequency— Plus Radio-Frequency

The two new Radak models pictured here—R23 and A23—comprise an absolutely unique radio set. Selectivity—the most desirable feature a radio set can have—is brought to surprising development along with increased distance, loudness and clearness of signals, freedom from interference.

Radio-Frequency amplification, backed by regeneration has produced these results, which are further enhanced by audio-frequency reflex amplification.

Do not fail to hear these new radio sets. If your radio or electrical dealer is not yet showing them, notify us promptly and we will see that you have the opportunity.

Just Off the Press

is a *new booklet* which goes into the subject of radio from a new and quite different angle. It also gives full information about the various new Radak models. Copy free for your name and address on a post card. Do not fail to send for this book.

Radak

Reliable Radio Sets

**CLAPP-EASTHAM
COMPANY**

America's Oldest Largest Exclusive
Radio Equipment Manufacturers

107 Main St., Cambridge, Mass.

*New York Sales Office, 295 Broadway; Pitts-
burgh, 332 Third Ave.; Chicago, 33 S. Clinton
St.; San Francisco, 709 Mission St.*

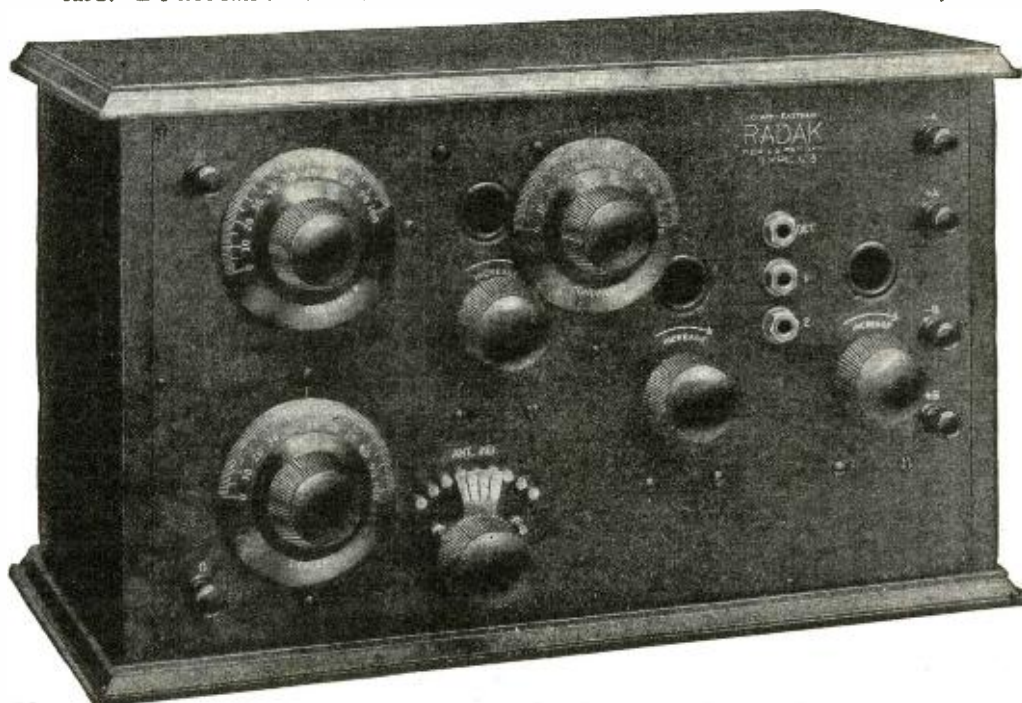

Another Interesting New Radak Set—Model C3

A very simply controlled regenerative receiver with two stages of audio-frequency amplification. May be used with loud speaker if desired. Receives wave lengths 175 to 3000 meters. Uses sensitive new Radak vernier dials. Cabinet of beautiful figured walnut. Size 16½ in. wide, 10 high, 8¾ deep. A very popular home set costing only \$100. (Licensed under Armstrong U. S. Pat. 1,113,149.)

Just Out

4th Edition \$1.00

AMATEUR RADIO CALL BOOK

Over 20,000 Call Letters and Map-size 2x3ft

Indispensable to every radio owner. Contains up-to-date list of over 20,000 Amateur, Commercial, Army, Navy, Transoceanic High Powered, and Broadcasting Stations in the United States and Canada; International Morse Code and Convention Signals; the construction and operation of the Reinartz Tuner, Detector, and one-stage Amplifier; also an abundance of other useful information.

Included with the book is a splendid two-color map of the United States and Canada, 2 x 3 ft, showing radio district boundaries, standard time lines, geographical location of broadcasting stations, etc.

The greatest dollar value on the radio market. At your dealers or direct by mail. Use check or money order. Do not send stamps.

Dealers: Write for proposition.

Radio Directory and Publishing Co.,
45-C Vesey Street, New York City

Send me a copy of the Amateur Radio Call Book and Map. Fourth Edition, for which I enclose \$1.00.

Name

Street Address

Town and State.....

**AMATEUR
RADIO CALL BOOK**

that no short circuits exist in the battery circuits. When satisfied that the hook-up is all right, it is then re-drawn or traced *very lightly* in pencil. This is the working diagram from which the set is actually wired.

Now here is the advice that is worth the price of this number of the magazine alone: When you decide to hook up a set according to some diagram of connections, don't just begin somewhere, make a connection, puzzle the thing out, make another, work from one point to the next as best you can, then hook on the batteries and expect the worst, but hope for the best. No! Make a light pencil tracing of your diagram; then begin ANYWHERE, preferably on connections close to the panel or in out-of-the-way places. Study each connection and connect up one point on the diagram with the next one. Then mark that particular connection as complete by going over the relative connection shown on the diagram in heavy pencil. Then forget it and make another. When the entire diagram is HEAVY, the hook-up is complete and it's a ten-to-one shot that if the diagram was correct the set would work right at once.

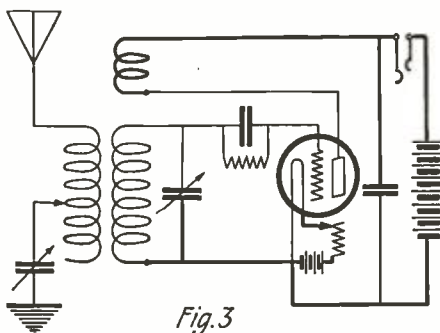

Fig. 3

As Each Part is Hooked Up the Corresponding Line on the Diagram is Made Heavy.

Fig. 3 shows the same diagram as Fig. 1, partially hooked up. You can see at a glance just what has been done and what remains to be done.

The writer never hooks up an outfit, or makes a change in a hook-up, no matter how simple it is, without following this procedure. And it is rarely, if ever, that failure to work as hoped for results from a misconnection.

Saving the Radio Fan

(Continued from page 1943)

straight on this matter of buying apparatus. We radio fans rebel against the advantage which was taken of our ignorance by unscrupulous dealers and manufacturers. We have a bunch of cheap junk on our tables, and we have to call in the radio amateur to get it going again. Nine times out of ten, he will counsel us to throw the trash out, and get some real apparatus. He will tell us where to go, and we will take his advice. He is usually right, and his experience is worth something to us. So, it is, after all, the amateur who is still providing the bona fide and reliable manufacturer with good orders, be it directly or indirectly.

But I've been QRM'ing long enough. What are you going to do about all this, you ask?

I shall suggest a rather unusual solution. First, educate the public regarding the activities and accomplishments of the radio amateur. Provide him with a good advertising manager, and some live wire press agent, and "let 'er go!" The reason for this is obvious: before you want to launch a

The Seal of Volt-Cot Fibre Service



This is the seal of a service—a service with threefold facilities for producing Vul-Cot fibre and Vul-Cot fibre parts and products. It represents the combined equipment of three great factories for speedy manufacture and delivery of this famous material.

As hard as horn

is Vul-Cot fibre. This toughness—ability to wear and wear under the hardest service is one of the reasons why Vul-Cot fibre is replacing mica, porcelain, wood, rubber and leather in thousands of modern products.

As durable as steel

Vul-Cot fibre gears are noiseless and current proof. Meshed with metal they prolong the life of the whole gear train. And as insulation you will find Vul-Cot everywhere.

As adaptable as rubber

Vul-Cot Fibre can be threaded, Stamped, Turned, Drilled—all with the same tools that have been used for metal work.

Less costly than any

In spite of its wonderful qualities Vul-Cot is far less expensive than any of the many materials that it replaces. It comes in sheets, rods, tubes or the finished parts made to your own specifications. Write us, naming your requirements, and we will gladly send samples.

National Vulcanized Fibre Company

Wilmington Delaware

Write for free catalog illustrating and describing our complete line of 1500 Good Tools

GODELL-PRATT COMPANY
Toolsmiths
Greenfield, Mass., U. S. A.

WANTED — Back numbers of Radio News, Sept., Oct. and Dec., 1921, Jan. and Feb., 1922. Experimenter Publishing Co., 53 Park Place, New York City.

PHILCO

DRYDYNAMIC RADIO BATTERIES

THE convenience of a dry-cell battery—plus the uniform voltage and all-round superiority of a famous long-life, high-powered Philco STORAGE Battery.

That's what you get by equipping your radio with the wonderful new Philco Drydynamic (Dry-charged) Radio Batteries—the latest and highest development in battery engineering.

Charged DRY at the factory, the life of a Philco Radio Battery doesn't start until you pour in the Philco Electrolyte. There's no waiting for initial charging—no paying for life lost on the dealer's shelf.

What's even more important—Philco Batteries deliver a constant, uniform flow of current, an absolute essential for noiseless, uninterrupted radio reception.

And they last longer, demand less care, give longer service per charge and cost less per month of service than any other radio batteries built.

You'll want to know more about these remarkable radio storage batteries. See your radio dealer—the nearest Philadelphia Diamond-Grid Battery Service Station—or fill out the attached coupon and mail to us at once.

Philadelphia Storage Battery Company, Philadelphia

Makers of the famous Philco Slotted-Retainer Batteries for automobiles, electric passenger cars and trucks, mine locomotives and other high-power, heavy-duty battery services.

RADIO DEALERS—Philco Drydynamic Radio Batteries let you into the storage battery business on a package goods basis. No acid sloppage. No charging equipment. No batteries going bad in stock. Wire or write for details.

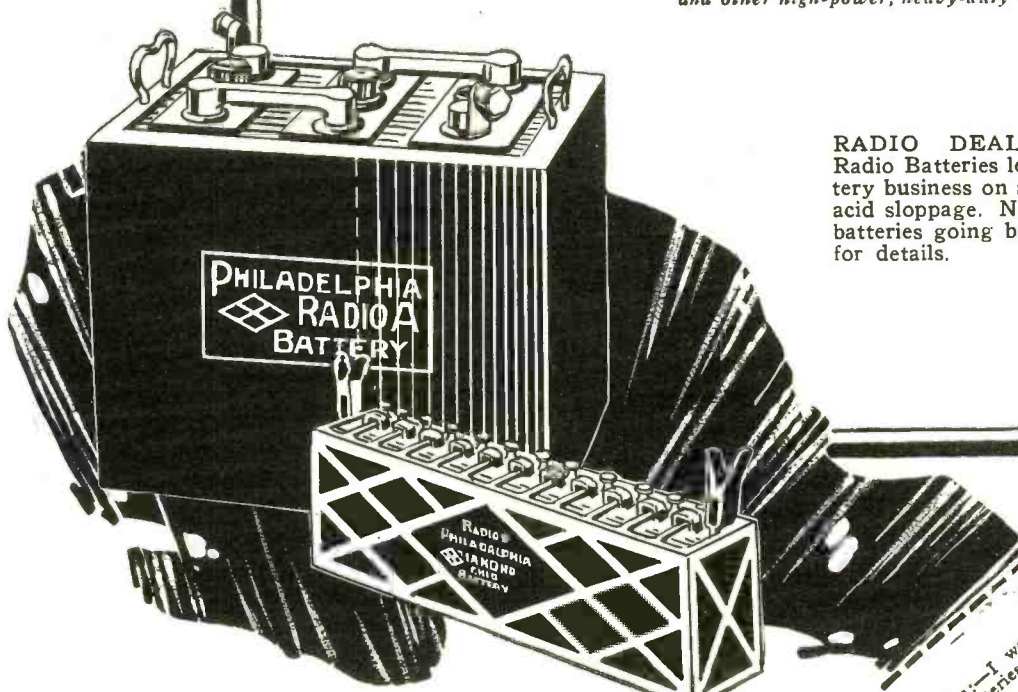

Mail This Coupon Today

Sirs:—I want to know more about the new Philco Drydynamic Radio Batteries.

Name _____
 Street _____
 City _____
 State _____
 Business _____

The 1001st!

—but dealers will find it the first

CORRECT! The radio industry has been flooded with books and catalogs galore. Especially has the radio dealer been bombarded with his share. But now comes the thousand and first radio book, *that is, the first* which is both catalog and mentor to the dealer and public alike.

This book doesn't sell for five dollars, or fifty cents or one red cent. But to get it, friend reader, you must do one thing, and do it clearly and distinctly. If you will carefully extract your trusty Waterman from your inside vest pocket, give it a tentative shake, and print your name so our mailing department won't need to use a magnifying glass or a Sherlock Holmes to detect its significance, we will be glad to send to you without one penny (red, blue or otherwise) your own individual and autographed copy of a catalog that is more than a catalog—a book that will prove your adviser and friend.

Within you will find illustrated and priced the most deservedly popular finished sets, construction sets and parts of such well known companies as Western Electric, DeForest, Acme, Sleeper, Murdock, Stromberg-Carlson, Marshall-Gerken, Atwater-Kent, Klosner, Dubilier, Briggs & Stratton, Thordarson and others.

Sign on the dotted line and Uncle Sam will do the rest.

THE NORTH AMERICAN RADIO & SUPPLY CORPORATION

"Wholesale Only and Only The Best"

5 Columbus Circle, New York City

Please send me that catalog you say so much about.

Name

Street

City

product on the market, you begin an advertising campaign, do you not? Here you are trying to sell your selves, which I shall outline later, to a public which has yet to be convinced of your utility. This is the right way to begin.

This campaign will apprise the public of the fact that the amateur is a real being, not merely the author on untold QRM during broadcasting hours, but also a citizen of the community. The first point of contact which will lead up to amicable relations has been established.

If the thing is well done—and I am confident that it could be put across in the regular manner—the public will be interested, and even curious to know more about you. (Remember the interest shown in Marconi's first experiments?)

And when everything is all set, at the psychological moment, do another unheard of thing: invite the radio fans to visit the radio amateur. When you want to get some real good advice on a law case, do you have the lawyer, the expert in matters of law, visit you at your home, or do you consult him in his sanctum? You always go to seek advice; advice is rarely brought to your front door step. The amateur is the expert you wish to consult. The radio amateur, for some unknown reason, is a very bashful individual, terribly wrapped up in ethical and professional etiquette. But he is a mighty fine fellow, and he's human.

Radio fans, then, should try to seek the friendship and advice of the amateurs. They themselves know better than anyone else where the trouble might be, but do not possess the methods or the knowledge to correct it. The amateur's fee will be nothing, but the relations between the fan and the amateur will be considerably better.

You radio fans hunt up a few amateurs in your town. Make it a point to go up and visit him, and "talk it over." You will both profit by it, and both of you will learn something of each other's points of view. In one hour, you yourself may learn more about radio than you did by wading through the entire 20 volumes of the "Home Radio Course." And it goes without saying that the amateur will be mighty glad to meet you.

You will gradually see his point of view, and will want to join his Radio Club, meet some of the other members of that queer tribe, for these amateurs are a fine bunch of fellows—even if I do say so myself!

Now, mind you, we don't want to convert a lot of good citizens, who care naught for radio beyond listening to concerts, into a lot of operating amateurs. Goodness, no! As Mr. Perry himself says, every new man who transmits brings the ether that much nearer the saturation point, and a saturated solution of ether will do no good to anybody.

What would be effected between the two would be a personal contact, which would result in a better understanding of what the one and the other is doing, or wants to do. And that is the keynote to the whole situation.

Then there will be absolutely no doubt in the mind of the radio fan that the radio amateur is a necessity, and that he is doing good work for the community. In fact, he himself may suggest other ways in which he may be of further use, ways of particular interest to him, and to thousands of other fans:

1. Tune the amateur transmitters sharply, and arrange for a transmitting schedule agreeable to all.
2. Get off that broadcasting wave with those transmitters.
3. Show the fans how to use their sets; how to use their present single circuit receivers to best advantage.
4. Relay citizen messages, reports and comments to broadcasting stations.

ANNOUNCING THE NEW "STAR" Amplifying Transformer

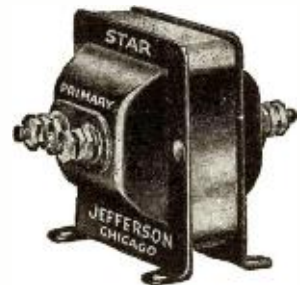

The Radio Fan's Lucky Star insures greater range, and increased volume without distortion.

A GENUINE JEFFERSON QUALITY audio frequency amplifier, of the same high grade construction as our well known No. 41 and 45 Transformers.

THE STAR TRANSFORMER IS DESIGNED to insure clear, sharp amplification without annoying tube noises or distortion.

THE WINDINGS HAVE BEEN CAREFULLY calculated and the characteristics of this transformer are ideal for use in connection with Vacuum Tubes now on the market.

RATIO—3½ to 1

PRICE—\$3.25

"Send for Radio Bulletin"

JEFFERSON ELECTRIC MFG. CO.
424 S. Green Street CHICAGO

\$1.00 Buys One Hundred SUPER-SENSITIVE GALENAS

Each guaranteed to receive. Mountable size. Direct from the most sensitive galena mine in the Southwest. Formula furnished for cold mounting if desired.

HUTCHINSON & CO.
DALLAS, TEXAS
500 for \$4.00 1000 at \$7.50

EISEMANN

RADIO UNITS

Made to the highest electrical and mechanical standards.

EISEMANN MAGNETO CORP'N

Chicago BROOKLYN, N. Y. Detroit

SEE OUR GUARANTEE

REDUCED PRICES ON STANDARD QUALITY PARTS

WRITE FOR FREE CATALOG

WE PAY TRANSPORTATION CHARGES IN THE UNITED STATES AND U. S. POSSESSIONS

PHONES

Genuine Frost, Baldwin and Brandes head sets complete with cords.

Frost E162—Double head sets, 2000 ohm \$4.25

Frost E163—double head sets, 3000 ohm 4.90

E168—Genuine Type C Baldwin phones 10.50

Type C unit... 4.75

Brandes Superior E166—Double head sets 2000 ohm 7.20

MAGNAVOX

The genuine R-3 Radio Magnavox with the 14 inch horn is the ideal loud speaker for use in homes, offices, amateur stations, etc. It operates from your 3 volt storage "A" battery and amplifies as it reproduces. "B" battery voltage should be 90 to 200 for best results. "Radio brings it," Magnavox tells it.

E170—Radio Magnavox \$32.50

JACKS AND PLUGS

Jacks are polished nickel, nickel-silver springs, pure silver contacts. Nickel washers for mounting on any panel 1-8 to 3-8 inch thick. Spread terminals make soldering easy.

E133—One spring (open circuit). Each \$0.46

E134—Two spring closed circuit). Each52

E131—Four spring (two closed circuits) Each63

E135—Three spring (two open circuits, commonly called "single circuit filament control"). Each70

E136—Five spring two open and two closed circuits, commonly called "two circuit filament control"). Each88

E137—Plug (as shown), cord tips fit into plug 1.05

E139—Plug with threaded barrel instead of set screw. Takes cord tips55

ANTENNA WIRE

The following are 100-ft. coils of 7 strand cable of No. 22 wire, which makes the best Aerial. Use phosphor bronze, where the span is 100 feet or more. It is stronger.

E350—Stranded Phosphor Bronze, 100 ft. \$1.47

E355—Stranded Copper, 100 ft. 1.77

E356—Single No. 14 bare solid Copper Wire, 100 ft.42

GRID AND PHONE CONDENSERS

Mounting holes spaced to fit screws of above Grid Leak. Alfa insulation, wrapped with varnished cambric tape. Capacity, .00025 Mfd.

E55—Grid Condensers 12c

E59—Phone Condenser, .001 Mfd. 20c

LOOSE COUPLER

This loose coupler is preferred by many because of its wide range—200 to 3500 meters. Mahogany finish. All metal parts are brass, nickel and highly buffed. Secondary has 12 point switch mounted on Bakelite coil head. Windings are green silk-covered wire.

E800—Size, 5 1/2 x 6 x 18 inch \$6.50

CRYSTAL DETECTOR

A very high grade glass enclosed crystal detector including the crystal. All metal parts nickel plated. Adjustable to any point on the crystal.

E20—Enclosed crystal detector \$1.30

A lower priced but nicely constructed detector Crystal included.

E30—Detector88

TESTED CRYSTALS

Selected and tested galena or silicon. Each box contains enough for four to six ordinary crystals.

E12—Galena, per pkg. \$0.12

E13—Silicon, per pkg.12

LIGHTNING ARRESTER OR PROTECTOR

Mounts indoors. Porcelain base, nickle-plated cover. Listed by the Underwriters' Laboratories under April, 1922, regulations.

E300—Protector \$1.40

OUR GUARANTEE YOUR PROTECTION

Your satisfaction guaranteed. If for any reason you do not feel satisfied with your purchase, you may return it and we will refund your money. We will pay return transportation charges.

180° VARIOCOUPLER

The primary and secondary windings of this coupler are properly proportioned and spaced. The center of the secondary is always in the center of the primary field. Unlike most couplers, it aids in tuning. Black fibre base, brown formica tube and nickle-plated metal parts. Panel or table mounting.

E1100—Coupler \$2.75

180° MOULDED ROTOR TYPE COUPLER

This 180 degree variocoupler has heavy black tube and moulded rotor ball. Wound with green silk wire and has 10 taps on the primary. Metal parts are brass nickel plated. Furnished without base, but can be mounted on panel or table.

E1120—Variocoupler \$3.75

DAYFAN MOULDED VARIOCOUPLER

This is one of the highest grade moulded couplers made.

E1122—Variocoupler \$7.20

VARIABLE CONDENSERS

Condensers are made of heavy aluminum plates, evenly spaced with high grade bakelite ends.

E1443—13 plates .001 Mfd. without dial \$2.25

E1423—23 plates .0005 Mfd. without dial \$1.75

E1411—11 plates .00025 Mfd. without dial 1.35

E1403—3 plates .00005 Mfd. without dial 1.15

VERNIER VARIABLE CONDENSERS

For fine tuning, neat appearance, this condenser is just the thing. Made of heavy aluminum plates and high grade bakelite ends. These condensers are furnished with neat appearing knob and dial.

E1441—41 plates vernier .001 Mfd. with dial \$4.95

E1442—21 plates vernier .0005 Mfd. with dial 4.25

INDUCTANCE COIL MOUNTINGS

For base or panel mounting. Connecting leads furnished, coil settings are adjustable by means of knobs. Made entirely of bakelite with nickle-plated brass metal parts. Coil position can be locked by knurled set screws.

E1603—Three coil mounting \$3.90

E1602—Two coil mounting 2.75

E1601—Single coil mounting50

INDUCTANCE COILS

Rigidly wound, nicely finished, low distributed capacity. All coils are equipped with standard mounting. We can supply any of these coils without mounting plugs, for 5% less than the prices shown. The wave lengths shown are range limits, based on a variable condenser of .001 Mfd. capacity.

Number of Turns	Wave Lengths	Price, Mtd.
E1725	25 125-250	\$0.88
E1726	35 175-450	0.95
E1727	50 240-720	1.03
E1728	75 390-910	1.07
E1729	100 540-1350	1.12
E1730	150 600-2000	1.16
E1731	200 900-2500	1.25
E1732	250 1200-3500	1.34
E1733	300 1500-4500	1.35
E1734	400 2000-6000	1.56
E1735	500 2800-8100	1.77
E1736	600 3000-10000	1.77
E1737	750 5000-12000	1.92
E1738	1000 7000-15000	2.27
E1739	1250 9750-19500	2.48
E1740	1500 14500-26500	2.64

VARIABLE GRID LEAK

Pencil mark type. Removable black enameled cap.

E50—Grid Leak 18c

INSULATORS

These are very strong strain type insulators. Each Doz.

E360—Moulded insulator shown above \$1.10 \$1.10

E365—Porcelain insulators09 .95

HOW TO ORDER

Order from this page. Please give number description and price of the articles you order to help us avoid mistakes. Total the amount of your order and send Post Office money order, certified check or draft with your order. Be sure to give your name and street address on both letter and envelope. Do not include money for transportation. We pay it except on storage "A" batteries. See ads of previous months for other items.

VARIOMETERS

For efficiency, perfect inductive ratio, low capacity effect and neatness of design these variometers are unequalled. All metal parts nickel brass. Stator and ball mahogany finish. Furnished completely assembled and tested.

E1200—Variometer, No. 20 wire \$2.65

E1300—Variometer, No. 18 wire 2.65

The following knocked-down variometers have the stator windings wound and cemented ready to put in place. Two sizes of wire as listed. Complete with wire and metal parts.

E1205—Knocked-down variometer with No. 20 wire \$1.85

MOULDED TYPE VARIOMETER

This variometer is made of high grade black moulded composition. Wound with green silk wire. Metal parts are nickel plated.

E1220—Moulded variometer \$4.95

DAYFAN MOULDED VARIOMETER

This is a bank wound variometer.

E1222—Variometer \$6.95

AUDIO FREQUENCY AMPLIFYING TRANSFORMERS

Correctly designed for minimum distributed capacity and low core loss. Shielded, beautifully finished in nickel and black enamel. Ratio 3 1/2 to 1.

E1506—Shielded Transformer \$3.75

The unshielded types listed below have terminals mounted on Bakelite panel. Two ratios.

E1510—Transformer, 10 to 1 ratio \$3.55

E1503—Transformer, 3 to 1 ratio 3.50

THORDARSON AUDIO FREQUENCY AMPLIFYING TRANSFORMER

There is probably no better known transformer. Made by a company that specializes in transformers. Entirely of aluminum cased in sheet aluminum cased in heavy connecting straps to binding posts.

E1504—Thordarson Transformers, 3 1/2 to 1. \$3.55

E1505—Thordarson Transformer, 6 to 1. \$4.10

"B" BATTERIES

Standard high grade radio "B" batteries. Never over five days old.

E290—22 1/2 volt Signal Corps type. Size 3 1/2 x 2 1/2 inch. \$1.08

E235—22 1/2 volt U. S. Navy variable—5 positive taps. Size, 5x3x2 1/2. Price \$1.80

E240—22 1/2 volt large variable—5 positive taps. Size, 6 1/2 x 4 1/2. Price 2.25

E245—45 volt large size. Leads only. Size, 13x4x3. Price 4.00

INDUCTANCE SWITCH

For neat appearance and time saving, we suggest this inductance switch, as it needs but one hole in the panel to be mounted. Switch Points are mounted on this switch. 15 switch points, in all.

E1095—Inductance Switch \$1.76

STORAGE "A" BATTERY CHARGER

Charge your "A" Battery at home, at a cost of a few cents. Screws into a 110 volt socket to be used with 60 cycle current. Remember our GUARANTEE is your protection.

E82—Storage "A" Battery Charger \$13.65

MAGNET WIRE

High grade, double cotton insulated magnet wire. 8 oz spools. Price per Spool Each

E18	\$0.48
E20	0.58
E22	0.73
E24	0.83
E26	0.93
E28	1.12
E30	1.63

BINDING POSTS

Complete with screw and washer. All brass finished in polished nickel or with black composition top as listed. Order by number.

E110—Large size, all nickel plated 10c
E122—Medium size, nickel-plated with hole for phone tip or wire 4c
E142—Medium size, black composition top 5c
E120—Large size, composition top 8c

SPAGHETTI AND WIRE

Yellow finish spaghetti.

E33—Per 4-ft. length 27c

E32—Tinned Copper No. 16 Wire Ft. 2c

E33—Wire with insulation similar to spaghetti on it. Wire is tinned for soldering. Price 10 feet 37c

VACUUM TUBES

Genuine Cunningham or Radio-tion made by the General Electric Co. Every tube guaranteed new and in original package. We do not sell "bootleg" tubes.

E-C200—Detector \$4.40

E-C201—Amplifier 5.90

E-201A 6.00

METAL AND BAKELITE SOCKETS

Bakelite brown finished socket for panel or table mounting. Double spring contacts held rigidly in place.

E1076—Bakelite socket \$0.65

E1075—Nickle-plated metal socket .45

WD11 WESTINGHOUSE TUBES

This tube eliminates storage batteries and is operated by a 1 1/2 volt dry battery. It can be used in any tube having the proper socket or adapter.

E11—Tubes \$5.90

WD11 BAKELITE SOCKET

This socket is to be used with the above tube.

E1077—Bakelite socket. \$0.49

WD11 ADAPTER

The purpose of the adapter is to make your regular socket usable for a WD11 tube.

E1078—Adapter \$0.48

VACUUM TUBE RHEOSTATS

This is a reasonably priced, smooth acting rheostat that will mount directly on back of panel. Bakelite arrow knob.

E1050—Rheostat 45c

Genuine Cutler-Hammer rheostats, we believe, are the best rheostats on the market today.

HOWARD POTENTIOMETER

E1066—200 ohm Potentiometer \$1.40

DIALS

Genuine Bakelite Dial as pictured. Sharply engraved divisions and figures filled with a brilliant white. Set screws Composition included.

E502—Dial, 2 inch, 3-16 in. Shaft \$0.39
E500—Dial, 3 inch, 3-16 in. Shaft 0.48
E500—Dial, 3 inch, 1/4 in. Shaft 0.48
E501—Dial, 4 inch, 1/4 in. Shaft 0.73
Moulded composition dial as pictured. Has a huster that cannot be told from Bakelite. Set screws included.
E553—Dial, 2 inch, 3-16 in. Shaft \$0.18
E550—Dial, 3-16 in. Shaft 28c
E555—Dial, 1/4 in. Shaft 28c
E555—Dial, 3/8 inch, 1/2 in. Shaft \$0.40

CABINETS

Mahogany finished cabinets with hinged top, sturdily built. These make a wonderful appearance. These cabinets are made to fit panels listed below. Panels not included. See table for panel sizes.

E217—6x7 \$2.40
E218—7x9 2.70
E219—8x12 3.40
E220—7x18 3.80
E224—9x14 3.80
E221—7x21 3.60

PANELS

Genuine Formica Panels, to fit our cabinets.

E267—6x7x 1/4 \$0.65
E269—7x9x 1/480
E263—7x12x 1/4 1.10
E259—7x18x3-16 2.30
E264—8x12x3-16 2.50
E261—7x21x3-16 2.65

SWITCH LEVERS

A high grade, polished nickel-plated lever with solid moulded black composition knob. Complete with panel bushing.

E151—1 -in. Radius 18c
E155—1 1/2 -in. Radius 18c

SWITCH POINTS & STOPS

Brass, polished nickel finish. Screw size, 6/32x 3/8 ins. long, two nuts with each contact point and one with stops.

E130—Switch Point	Each	Doz.	Handled
.....	3c	20c	\$1.40
E150—Switch Stops	3c	20c	1.40

Gould

Radio "B" Battery



The compact Gould Radio "B" Battery, (patent applied for) is designed to prevent grounds between cells, thus doing away with noise in headset. 24 volts in variable 2-volt steps. Non-stopping hard rubber case. Will not detract from the appearance of the finest set. \$2.50 f. o. b. factory.

Essential for Clear Reception

Noiseless operation is the goal of every radio enthusiast. Much of the noise attributed to static is actually developed in the "B" batteries. Especially is this true after the batteries have been in use for a period of time. The reason is due to the internal construction of the dry battery and other types of storage batteries not being properly designed to prevent external grounds between cells. Freedom from noise of the Gould "B" battery is due to its internal construction and the external design of the case which makes grounding between cells practically impossible. (Patent applied for). By the use of the Gould "B" battery not only is noise eliminated, but its constant non-fluctuating voltage throughout the greater part of its discharge results in clearer reception and increased range. Costing but a few cents for recharging, the Gould Radio "B" battery is more economical and will give most satisfactory results.

On sale by Radio Dealers and over 3000 Gould Service Stations.

GOULD STORAGE BATTERY CO.
30 East 42nd St. New York

Plant: Depew, N. Y.

Gould

Radio "A" Battery



Gould Radio "A" Batteries are used by the various Radio Branches of the U. S. Government. Built for continuous service. Made in sizes from 60 A.H. to 160 A.H. \$18.00 to \$33.00, f. o. b. factory.

TWO SUPERSENSITIVE CIRCUITS

(Both Copyrighted)

My Highly Improved Reinartz brings in all important stations on both coasts and Mexican border, loud, clear and without distortion. We dance to music from Atlanta received on one loud Baldwin unit. Build one of these wonderful sets from my blueprints and specifications, price 50c, or with a perfect and complete double wound spiderweb coil, \$3.00 by mail. No other windings used. Photo of my set on a glass panel with every order.

My W. D. II Circuit is especially designed for use with the "Pickle" tube and brings out the full value of that little tube as no other circuit can. Stations 1000 miles away come in clearly on one tube. This set is small, complete, portable. For the man who wishes the highest efficiency this is the set to build. Price of blueprint and specifications 50c, or with complete and perfect windings \$3.00. Photo of set with every order.

Either set is cheap and easy to build, easy to operate. Everything clearly shown.

S. A. Twitshell, 1927 Western Ave., Minneapolis, Minn.

VULCANIZED FIBRE Be sure and specify "WILMINGTON FIBRE"

Sheets, Rods, Tubes, Washers, Etc., Specialties

Wilmington Fibre Specialty Co., Wilmington, Del.
Branch Offices "Everywhere"

5. Furnish the fans and public with all news which is now only sent in code. Such would include weather and other types of reports, and news items.

6. Make the Radio Clubs popular Radio Clubs. Make the clubs so that fans won't come in to sit down once, wondering what it is all about. Then radio fans will join.

7. Issue bulletins, on the style of the Circular Letters of the Bureau of Standards, telling how to make good sets, and what to do to improve present receivers.

8. Replace your spark sets with C. W. sets equipped with radiophone apparatus. This way the public will listen in on your conversations, and actually hear you carrying on important communication.

If the amateur does that much for himself, he will be saved. If the radio fan does his share, he also will be saved. The amateur is not a bad fellow, and he certainly will not fail to cooperate with the novice and radio fan, if they will tender him a friendly hand.

Get a Blue Sky Through Co-operation

By SUMNER B. YOUNG, 1 A E

A.M.I.R.E.*

THIRD HONORABLE MENTION

The radiophone will not annihilate the amateur transmitter, because both have a legitimate place in the sun, and the present diplomatic misunderstandings can be settled without bloodshed. Moreover, a pitched battle would put neither party permanently out of action, because each has moral and practical resources that are practically impregnable.

The amateurs are well organized and have had years of experience in handling radio legislation. They have shown not only the disposition to uphold the regulations of the Department of Commerce, but considerable success in handling their own affairs. Furthermore, amateur radio has produced a few scientists, and a large body of trained men who proved immensely valuable in time of war. As a result, they command respect in government and scientific circles, because they know what they are talking about and their fighting spirit is a matter of record. Their struggle to preserve the rights of the average citizen when people thought air was simply fit to breathe should heap coals of fire upon the heads of newcomers who thoughtlessly clamor for their destruction.

An appraisal of radiophone assets shows that the listening stations are in the majority about fifty to one. However, the broadcast fans are not organized. They do not talk to each other over the air, and even their names and addresses are not listed. They are no more likely to fraternize than an audience in a theater.

Naturally, anybody who interferes with a good show and deliberately tries to be obnoxious will be slung out on the sidewalk, but that is not what is happening in the air at the present time.

The moral claim of the individual listener is the right to enjoy life to the best of one's ability, but it is the broadcasting station and not the audience that performs a real service to the community, and incidentally does everything possible to keep alive the wholesale demand for sets. It is the leader of the radiophone public, but it should remember that a theater crowd will not tolerate what bores them, and that it soon becomes sophisticated. The attraction of the radiophone will be lasting only if it broadcasts worth-while entertainment, and healthy man-

*Former Chairman, Boston Executive Radio Council

TRADE MARK

Wave Trap

PATENT APPLIED FOR

The Missing Link in RADIO

Stops Interference!

Radio's latest wonder is ready for you. The Wave Trap will get you that elusive DX station through heavy interference. An attainment impossible heretofore. This remarkable little instrument will also greatly increase your range. We guarantee its satisfaction to you.

It is installed in a minute by changing only one connection, and is indispensable on any receiving set with any type of antenna. It is mounted on a formica panel in a handsome mahogany finished cabinet 6x5x6 and is a high grade instrument throughout. Write us for our circular.

850 Ferbend Electric Co.
CHANGES PREPARED
25 E. SOUTH WATER ST.
CHICAGO

GUARANTEED

SUPREME TO ANY OF ITS TYPE



With You As A Judge

If not satisfied that it is Better than the Best, you can return within 10 days from purchase and receive full amount of purchase cost back.

A wonderful instrument of mechanical perfection. Endorsed by radio engineers, journals and fans. "Certified" American Bell from all over the U.S. A trial will mean a most marvelous surprise to you in radio satisfaction.

Don't delay trial—send at once You are absolutely guaranteed.

- 43 Plate Variable Condenser complete with Dust Proof Transparent Case
- 23 Plate Variable Condenser complete with Dust Proof Transparent Case

\$5.00

State if for Panel or Desk Set.

AMERICAN BELL RADIO CORPORATION
316 75th Street, Brooklyn, N. Y.

NOVO "B" BATTERIES

NOISELESS DEPENDABLE

NOTE THE INSULATED BINDING POSTS AND TIN WIRE CONNECTOR

NOVO MFG CO.
24 W. 33rd ST. NEW YORK 51 80 DEARBORN ST. CHICAGO



New Ray-O-Vac Dry Battery

Puts Radio within Reach of Everyone

Dry Battery Tubes, a History-Making Development, Marks Great Forward Step

The dry battery tube and the compact dry battery to replace cumbersome and costly storage batteries, is hailed by authorities as the greatest development in Radio since the vacuum tube.

It makes radio an established reality for thousands who were restrained from installing sets because of high cost, lack of space, danger from acids and impracticability of home charging.

Hundreds of thousands of rural homes can now enjoy the full benefits of radio because recharging is eliminated. By simplifying the maintenance and operation of sets, the new Ray-O-Vac Dry Battery gives radio to thousands who have heretofore been deprived of it.

Ray-O-Vac Assures Success with Dry Battery Tubes

By using dry battery tubes, the new Ray-O-Vac Dry Cell "A" Battery can be adapted to any tube set. Thousands of confirmed radio enthusiasts are rapidly changing to the dry battery tube, not only because it is more handy and economical, but because of the improved reception.

Ray-O-Vac "A" Batteries are made in units of 1, 2, 4 and 6 cells to operate sets of 1 to 4 tubes. Send for complete facts about this epoch-making battery. Include the name of your radio dealer if you wish a copy of our booklet "How to Get the Most Out of Radio and Radio Trouble Finder."

French Battery & Carbon Company
Madison, Wisconsin

Atlanta, Chicago, New York, Minneapolis, Kansas City, Dallas

Two cell 1.5 volt Ray-O-Vac "A" Battery. Designed especially for operating W. D. 11 and W. D. 12 tubes. One battery per tube gives 200 hours service.



Use Ray-o-Vac "B" Batteries for longer service and elimination of noise.

RAY-O-VAC

The Battery that Completes Radio

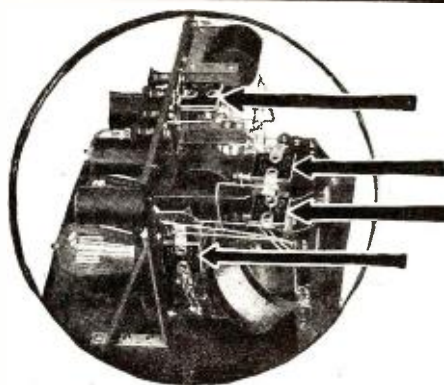

In this DeForest radio receiving set three Dubilier Micadon are used as a shunt across the transformers and one Dubilier Micadon as a grid-condenser. Dubilier Micadons are similarly used in other standard receiving sets.

Why Dubilier Micadons are used in De Forest Sets

PERFORMANCE (and therefore the reputation of a radio manufacturer) is so dependent on good condensers that in De Forest radio receiving sets and in others equally well known, Dubilier Micadons are the standard equipment.

Unless a radio receiver is fitted with Dubilier Micadons the broadcasting station is not heard at its best.

The list price of Dubilier Micadons varies from 35 cents to \$1.50 each, depending on the capacity.

Send for descriptive circular.

DUBILIER CONDENSER AND RADIO CORPORATION
48-50 West Fourth St., New York

BRANCH OFFICES

- San Francisco, Cal., 709 Mission St.
- Washington, D. C., Munsey Building
- St. Louis, Mo., Syndicate Trust Bldg.
- Chicago, Ill., 32 So. Clinton St.
- Atlanta, Ga., Forsyth Building
- Seattle, Wash., 1926 L. C. Smith Bldg.
- Pittsburgh, Pa., 704 Granite Bldg.
- Los Angeles, Cal., 329 Union League Bldg.
- Huntington, W. Va., 1028 Fourth Avenue

Distributed in Canada by Canadian General Electric Company, Ltd., Toronto

FREE Radio Catalog



Our big stock of standard makes of radio sets, parts and supplies, fully illustrated. Play safe—buy standard equipment from a reliable house. We ship from stock. Send \$6.50 for genuine Westinghouse WD-11 "Dea-nut" tube—no storage battery needed. 60 cents extra for signal socket. \$1.00 for Bradley Adapter. Wonderful results.

JULIUS ANDRAE & SONS CO.
In business since 1880
117 Michigan Street, Milwaukee, Wis.

PHONE SPECIALS

- | | | | |
|------------------------|--------|--------------------------|------|
| 2800—Simplex | \$3.45 | 3000—True-Tone | 3.85 |
| 2200—Federal | 5.95 | 2000—Kellogg | 6.05 |
| 3000—Dictograph | 6.00 | 2200—Western Elect. | 9.15 |
| Brandes Superior | 5.85 | Nathaniel Baldwin | 9.10 |
- Simplex Radio Co., 1808 Lafayette St., St. Louis, Mo.
- GRID LEAK, instantly adjustable, 1/2 to 5 meg., \$1
B Battery GLASS TUBES, 7"x1" (strong glass walls)7c
Lead Elements (impregnated); 6"x1/2"6c
RADIO KRAFT SHOP, New Canaan, Conn.

ufacturing prosperity will come only when the public gets efficient apparatus at a fair price. These two things are not being done as generally as they might be at the present time.

There will always be more people interested in broadcasts than in amateur activities. The public can buy receiving sets over the counter, and pass the buck to the manufacturer when it comes to producing entertainment. It pays the cost indirectly, and does not have to furnish individual initiative or imagination. Furthermore, the technical problems are pretty well solved, at least on the transmitting end.

The engineering difficulties precipitated by a rapid increase in the number of amateur transmitters are enormous, and if the appeal of amateur radio were simply scientific, or if it catered solely to personal diversion, radiophone receiving stations would always outnumber amateur plants a hundred to one. Such a conclusion is short-sighted, however, for the roots of the matter go very deep.

This is a country where free speech is rightly regarded as a guarantee of personal and political freedom. A certain portion of the American public has learned to talk by wireless, and the appeal is so vital and intense that it cannot be denied. It should be remembered that the desire to exchange ideas is so basic in human psychology that it was the origin of language itself. The amateurs will travel hundreds and even thousands of miles to one of their conventions, not only to talk wireless, but to see what the other fellow looks like, and find out how the world is treating him.

Despite the difficulty of finding elbow-room in the sky, the number of amateurs will increase with every improvement in short-wave apparatus, just as in the past. When "radio bugs" had to design and build their own apparatus, and a range of twenty-five miles was remarkable, only those having experimental instinct were interested. The regenerative receiver brought the first relay lines into operation, and multiplied the number of stations by at least ten. When the constructional details of the C. W. transmitters had been worked out by the leading experimenters of the fraternity, and the radio magazines and a few newspapers had spread the good news, remarkable distances began to be covered with a set that operated noiselessly, and could be fed from an electric light socket. The family could sleep, and the waves were sharp; and the result was an increase in amateur activities that passed all expectations and prepared the way for the utterly astounding broadcast boom. Now comes the super-regenerative receiver, opening the way to practical reception on a loop, and to transmission on very low wave-lengths. It means more amateurs and more effective relay lines as sure as fate.

What will happen when an efficient, inexpensive radiophone transmitter is manufactured and directional transmission begins, it is hard to say, and in the light of what has already happened, it is not foolish to expect this within a decade.

As to the present situation, it is small wonder that citizen radio has growing pains. Three hundred and sixty meters is supersaturated, and the congestion on 200 meters is plugging the amateur's relay routes. Some of his stations, mostly the sparks, are giving the new boy in the neighborhood some QRM. Something must be done to relieve the situation because the radiophone listener is inexperienced and the manufacturers have sold him non-selective apparatus, either to add to their profits, or to give the public something simple. Everybody must clean up his own back yard, and in order to find time for such work there must first be a mutually satisfactory distribution of rights and privileges. I believe that a conference

ekko
Makes a loud speaker of your phonograph



listen to radio through your phonograph

Ekko connects your head phones with the tone arm of your phonograph and transmits Concerts and Programs through the tone chamber.

EKKO now \$2.75

The best Loud Speaker you can use—utilizes the scientific design of the phonograph tone chamber, produces a mellow pure tone. Not adapted to crystal sets without amplification. If your dealer does not yet carry Ekko, use the coupon—send \$2.75 and we will mail one immediately, postpaid. Money back if not satisfied. Mention the make of your phonograph and name of your local dealer.

THE EKKO COMPANY

911 Harris Trust Bldg., Chicago.
Enclosed \$2.75. Send me one Ekko Radio phonograph adapter. Money back if not satisfactory
My phonograph is a
Name
Address
Dealer's name

GET THIS! Dreyfuss Headsets Heavily Reduced

The popularity of these standard headsets has enabled us to manufacture in such quantities as to cut the regular price nearly in half. No distortion—ample volume—compare favorably with any phone made.

2000 ohm (reg. \$8.00) Concert type
now \$4.50 pr.

1000 ohm (reg. \$4.75) with head
band \$3.50 ea.

1000 ohm for loud speakers—with-
out head band \$3.00 ea.

Every pair guaranteed. If not entirely satisfactory in every way, return to us and we will cheerfully refund money.

At Your Dealers or Direct From

P. M. Dreyfuss Co. Inc.

179 GREENWICH ST., N. Y. CITY

Branch
29 Cedar St.
Newark, N. J.

Branch
150 Chambers St.
New York City

REDUCED PRICES

	REGULAR PRICE	OUR PRICE		REGULAR PRICE	OUR PRICE
Radiotrons UV 200	\$ 5.00	\$ 4.00	Ammeter Jewell 0-5 Thermo	\$ 12.00	\$ 8.40
Radiotrons UV 201	6.50	5.20	Ammeter Jewell 0-7-1/2 Thermo	12.00	8.40
Radiotrons UV 201A	9.00	7.65	Ammeter Jewell 0-10 Thermo	12.00	8.40
Radiotrons WD-11	6.50	5.90	Voltmeter Jewell 0-15 A.C.	7.50	5.25
Radiotrons UV 202	8.00	7.20	Voltmeter Jewell 0-10 D.C.	7.50	5.25
Radiotrons UV 203	30.00	27.00	Thompson Levering Variometer	6.00	4.20
Audio Amplifying Transformers			Sleeper Variometer Moulded	7.50	4.75
UV 712	7.00	5.30	Atwater-Kent Variometer	8.00	6.40
Radio Amplifying Transformers			Atwater-Kent Variocoupler	8.50	6.80
UV 1714	6.50	4.80	3" Dial & Knob Moulded	.90	.44
Baldwin Phones	16.00	12.67	4" Dial & Knob Moulded	1.50	.91
Western Electric Phones	12.00	9.60	Variable Condenser Unmounted		
Brandes Superior Phones	8.00	6.25	.001 MF	4.00	2.80
Western Electric Loud Speaker	55.00	45.00	Black Formica Panels 19x6 1/2 x 3/16"	3.80	2.60
Western Electric Loud Speaker	161.00	129.00	African Mahogany Cabinets		
Western Electric 216A Tubes	12.00	9.60	19x6 1/2 x 6 3/4"	11.00	6.10
Eveready 22 1/2 Volt B Battery 766	3.00	1.80	Black Formica Panels 19x8x 1/4"	4.62	3.31
Eveready 45 Volt B Battery 767	5.50	3.30	African Mahogany Cabinets 19x8x6 3/4"	10.50	7.10
Bradleystats	1.85	1.65	Porcelain Antenna Insulator 2 1/2 "Diam.	.25	.08
Magnavox R-3	45.00	37.50	No. 14 Bare Copper Wire	.01 ft.	.1/2 ft.
Storage Battery 6 Volt 110 Amp. Hour	20.00	16.00	No. 12 Tinned Copper Wire	.02 ft.	.01 ft.
Homecharger	18.00	16.00	R. C. Rheostats PR 535	3.00	2.40
Tungar Charger 2 Amp.	18.00	16.90	R. C. Potentiometers PR 536	2.00	1.65
Tungar Charger 5 Amp.	28.00	25.90	Open Jacks	.70	.45
Ammeter Jewell 0-100 Milliamp. D.C.	7.50	5.25	Two Circuit Jacks	1.00	.70
Ammeter Jewell 0-250 Milliamp. D.C.	7.50	5.25	Plug, two pairs phones	1.50	1.00
Ammeter Jewell 0-500 Milliamp. D.C.	7.50	5.25	Antenna Protector UQ1310	2.00	1.60
Ammeter Jewell 0-1 Amp. D.C.	7.50	5.25			

	REGULAR PRICE	OUR PRICE
Westinghouse Radiola Grand	\$350.00	\$280.00
Westinghouse Radiola IV	275.00	220.00
Westinghouse Radiola V	132.50	106.00
Westinghouse Radiola VL	162.00	130.00
Westinghouse Radiola RC	132.50	106.00
Westinghouse Radiola Combination	263.00	211.00
Westinghouse Radiola AR-1375	40.00	32.00
Westinghouse Radiola I	25.00	19.00
Westinghouse Radiola Jr.	25.00	19.00
Westinghouse Radiola Sr.	65.00	49.00
Westinghouse Radiola Sr. AC Amplifier	68.00	44.00
Gen. Elec. Radio Receiver AR-1300	50.00	39.00
Gen. Elec. Detector-Amplifier AA-1400	75.00	59.00
R. C. Loop HG 1380	25.00	19.20

ALL NEW MATERIAL. IMMEDIATE SHIPMENTS

No C. O. D.'s. Add Parcel Post

Offered Subject to Prior Sale

J. GEIGER Suite 612, Candler Building
TIMES SQUARE, NEW YORK CITY

1000 MILES with a Crystal Set

A Needles California, radio fan writes:

"Using your M. P. M. Radio crystal, I picked up Los Angeles, San Francisco, Salt Lake, Denver and St. Louis. It is far superior to any crystal I have ever used."



The discovery of M. P. M. has revolutionized the possibilities of ordinary crystal sets. M. P. M. is super-sensitive — reproducing from every point on its surface. It increases audibility as well as radius, and makes the purchase of an expensive tube set unnecessary.

Send 25c and name of your Radio Dealer for a sample M. P. M. crystal—concert tested and guaranteed.

DEALERS: Write today for our attractive sales proposition.

M. P. M. Sales Co.
Dept. N.
247 S. Central Ave., Los Angeles, Calif.

ASSORTMENT

Of Machine Screws with hex nuts for Panel Mounting and building Radio Apparatus. Flat, Round, and Oval Heads. Brass and Nickel-plated. Generous variety of lengths and sizes. 50 cents postpaid. No stamps. Special Proposition to Dealers.

Smith-McKinney Hdwe. Co.
Clifton Forge, Virginia

ELWOOD ELECTRIC CO. INC.

Bridgeport, Conn, U. S. A.

Manufacturers of

Radio & Telephone Equipment

between the American Radio Relay League and the leading manufacturers controlling broadcast stations would do just that. Exclusive periods for broadcasting and amateur work may be the solution for the time being, but problems of interference should be solved by refinements in apparatus and intelligent wave-length allocation to be of permanent and practical value.

The immediate problem of the broadcasters is to prepare for the pinch of competition already developing. Resentment against those who sold inferior apparatus will put many concerns out of business, and the novelty of listening to a radiophone concert is wearing off, especially in the cities where other forms of amusement are close at hand. When the inflation is over and the crash comes, only a few well directed companies and the government will have resources to maintain a high-powered radio telephone and pay for the artists and the information which the public will demand.

The amateurs must give the broadcast fans the right hand of fellowship, and help them solve their operating problems in a tactful and neighborly manner. They must recruit new members while they're at it, and then turn their attention to developing decent relay routes. The existing lines are unreliable, and are therefore of no practical value to the general public. A sure remedy is the development of transmission on waves between 25 and 200 meters, and the establishment of club stations at important points. Such stations could afford better apparatus, and could be manned by a number of high-class operators.

What I want to hammer home is this: the leaders on both sides know what should be done, and are doing the best they can to put their ideas into practice, but, as usual, the rank and file are several jumps behind. The greatest factor for good or for evil in the present situation is the press, which can fan the flames of misunderstanding, or help kill off the "die-hards" and bring about co-operation. The radio magazines should act accordingly, and the frantic cries for vengeance, justice and the police would cease.

Of What Use Are We "Hams?"

By A. W. PARKES
FOURTH HONORABLE MENTION

Evidently the clash is upon us "Hams." What are we to do? Are we going to sit tight and let the great mass of the radio public crush out our very existence? Or are we going to think it over in a calm and collected manner? Or are we going to raise up in arms and fight the "radio public?" Which?

As should be the case in any controversy, we should get together and see if there isn't some plan whereby we can all enjoy life together. RADIO NEWS has taken the lead and volunteered to captain us in the controversy and not only that but to pay us for doing so by offering handsome prizes of cash.

Just what are we clashing over? Simple — John Doe wants the air so that he and his family can receive a concert or a lecture or the agricultural report or the stock market report according to what John Doe is particularly interested in. John Jones at the same time, however, wants to test his new C.W. or spark set with a buddy across the city. Without thinking about it particularly he opens up to test and all the John Does of the city are unable to hear a decent concert. Each one feels that he has a lease on the air—that this is a free country and that he has as much lease on the air as anyone else. But if that idea were literally true, there would be no need for courts, because everyone could do just as

USE ACH SHARP TUNER DIALS



Your Choice of

Rough tuning with dial or one thousandth of an inch in either direction with the Sharp Tuner Knob. Both controlled by center Knob ST.

Eliminates a vernier condenser. Locks instrument automatically. Dial grounded, reducing body capacity.

Guarantee

If purchased direct and you find the ACH Dial does not warrant your own personal award of merit, return it and we will refund your money, what better guarantee can we give.

Regular fitting 5/16" hole. 1/4" and 3/16" Bushings, 5c. each extra. 10c. for all.

Price of ACH 3" Dial Complete..... \$2.50
With ACH Condenser 4.00
ACH Condenser without Dial 2.50

Free Plan with mail orders on request.

**A. C. HAYDEN
RADIO & RESEARCH CO.**
BROCKTON, MASS., U. S. A.
Mail Orders sent prepaid in U. S. A.

CUT PRICES

To Consumers

	Regular List	Our List
UV 200 Tubes	\$ 5.00	\$4.20
UV 201 Tubes	6.50	5.50
WD-11 Tubes	6.50	5.50
Baldwin type C Phones	16.00	13.00
Magnavoxes	45.00	37.00
Murdock Phones, 2000 Ohm	5.00	4.20
Murdock Phones, 3000 Ohm	6.00	4.90
Acme Transformers ...	5.00	4.20
Plugs	1.50	.59
Rheostats	1.00	.50
Moulded Sockets75	.45
B Batteries, 22½-volt ..	1.25	.80
Crystal Detectors	1.00	.60
Contact Points, per doz	.35 per doz.	.15
Switches, tapered knob	.35	.20
Honeycomb Coils, all sizes 25% discount.		
Paragon Ra 10	110.00	68.00
Variometers	3.50	2.50
Variocouplers	1.50	1.10
Dreyfuss Phones	8.00	7.00
3-inch Dials75	.30
Rheostat Dials50	.23
No. 14 Hard-drawn Aerial Wire, C ft.60 C ft.	.38

We give a discount of 10% on all standard merchandise not listed.

MAIL ORDERS ONLY No STORE TRADE

Mail check or money order.
No stamps or currency.

RADIO CUT PRICE CO.
320 Broadway, New York City

“WorkRite” SUPER VARIOMETER



USE THE WORKRITE TUNER TEAM

When you want to get a certain station and tune out all others you will find the WorkRite Tuner Team consisting of Two WorkRite Super Variometers and One WorkRite 180° Super Variocoupler is just the apparatus you need.

The WorkRite Super Variometer is Exceptionally well made from polished mahogany. Has just the right number of turns and air space to tune extremely sharp.

The WorkRite 180° Super Variocoupler has a range from 180 to 800 meters. Both secondary and primary are made from moulded Bakelite and are wound with green silk wire. It has 12 taps.

The prices on these instruments have been reduced from \$6.00 since last spring.

Workrite Super Variometer each \$3.50
“ 180° Super Variocoupler “

WorkRite 180° Super
Variocoupler

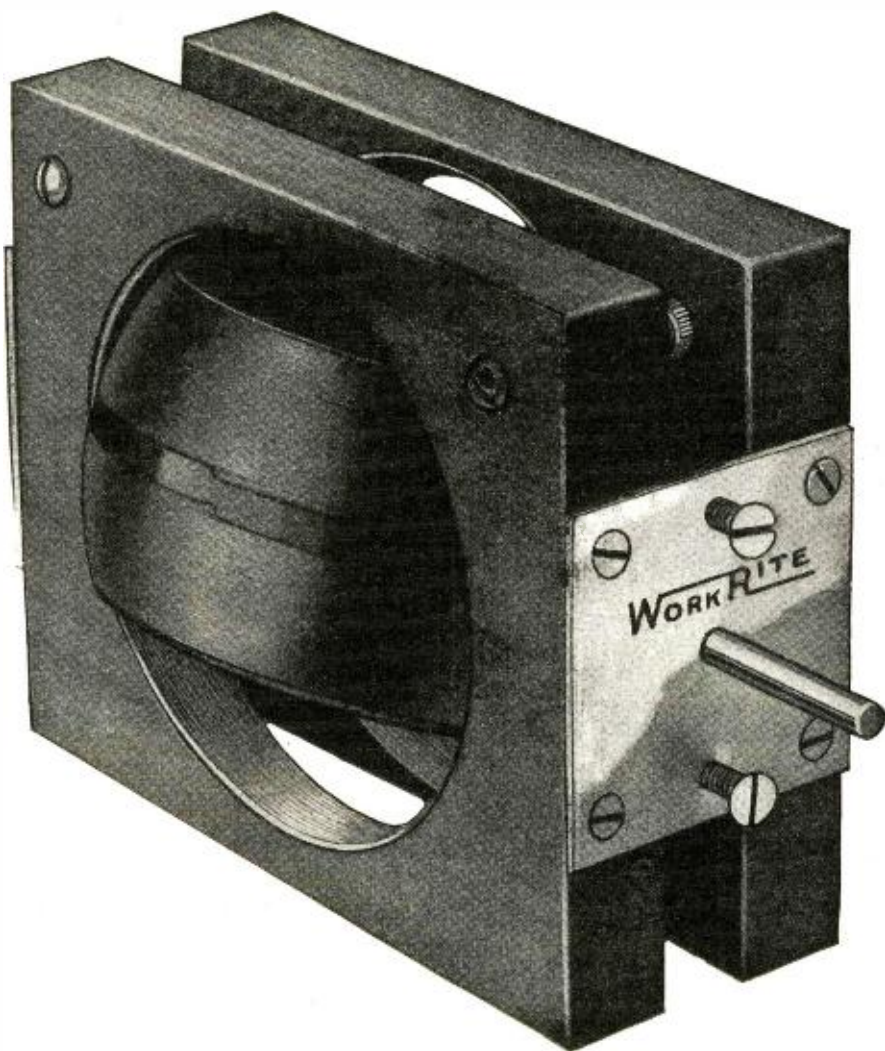

“Workrite Radio Parts Workrite”

The name WorkRite is a guarantee of quality and reliability. Insist on WorkRite Radio Parts from your dealer or if he does not have them send your order to us, and you will receive them by mail prepaid. Here is a partial list of WorkRite Products:

WorkRite Concertolas, Workrite Super Vernier Rheostat, WorkRite E-Z-Tune Dial, WorkRite Concert Headset, WorkRite Hydrometers.

THE WORK-RITE MANUFACTURING CO.

5508 Euclid Ave., Cleveland, Ohio
Branch Office, 2204 Michigan Ave., Chicago

The BEST BATTERY

for
**Dry Cell
Tubes**

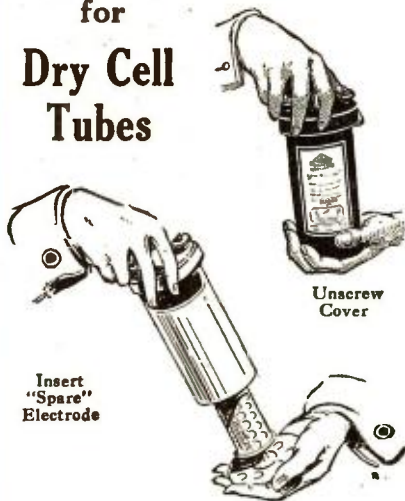

Insert "Spare" Electrode

Unscrew Cover

Instantly Recharged

"Spare" electrodes exchangeable at your dealer's or direct from us at 40c each. One 40c MAGNO electrode will operate one to four dry cell tubes. Furthermore one MAGNO charge lasts several times longer than dry cells. Voltage always sufficient, assuring long distance reception minus bothersome battery noises. "Spare" electrodes maintain full charge indefinitely on dealer's shelf or in the home. Think of the money this battery will save you, giving at the same time ideal service. Our 6 volt unit is designed for operating the 6 volt, 1/4 amp. tubes such as U. V. 201-A. Write today for descriptive folder R-5.

STORAGE BATTERY MAGNO



Price only
\$4.00

Exchange
Electrode
40c.

Magno
Storage Battery
Corp.
Aeolian Building
New York

HYGRADE SPECIALS

- 200 ft. 7 strand No. 22 Copper aerial wire... \$1.25
 - Morse Eureka Test Clips, Per dozen..... .50
 - Skinderviken Transmitter Buttons..... .95
 - No. 763 Eveready 22 1/2 V. Variable B. Bat. 1.25
 - No. 766 Eveready 22 1/2 V. Variable B. Bat. 2.25
 - No. 767 Eveready 45 V. Variable B. Battery 4.25
 - 2000 Ohm Murdock No. 56 Head Sets..... 4.49
 - 3000 Ohm Murdock No. 56 Head Sets..... 4.98
 - Federal or Brandes 2200 Ohm Head Sets..... 6.50
 - Dietograph 3000 Ohm Head Sets..... 6.98
 - Fade or Framingham Rheostats (new type)..... 6.25
 - Acme Amplifying Transformers (new type)..... 4.25
 - Acme R. F. Transformers, Types R2-R3-R4 4.25
 - 6 Volt Marko Storage Batteries..... 8.95
- All orders must include Parcel Post charges

Hygrade Electrical Novelty Co.,
41 West 125th Street New York, N. Y.

ENGRAVING MACHINES

For
RADIO PANELS
And Other Radio Engraving

ENGRAVERS & PRINTERS MACHINERY CO.
Sag Harbor, New York

he pleased. Where is the limit? The limit comes at the point when one interferes with the rights commonly agreed upon by all to be for the benefit of all. Since the great majority at present interested in this controversy are the broadcast listeners, it is no more than right that we should concede to them the only reasonable hours of the evening for listening in to broadcasts. These hours are, of course, up to ten o'clock. It is very seldom that one wants to listen to concerts of that kind after ten o'clock. So let us say that we give those hours up exclusively to the broadcast listener. Then surely the hours after ten o'clock will not be envied by that large majority. Let the "Hams" pound away and have their enjoyment in their way—we don't all like sauerkraut.

How are we to stop the "Ham" who will not close his transmitting set until ten o'clock? Enact State or Federal laws. Is there any other thing to enforce the rule of the majority? I would then suggest that as move No. 1, all radio clubs throughout the country make rules barring men from transmitting until after ten o'clock at night, and that the A. R. L. start a movement toward enacting a law to this effect.

It must not be overlooked that at present a great many of the operators seldom open up before ten, and possibly they do not know that they are interfering with anyone if they are on a very sharply tuned low wave. Most radio men whom I have met were very good scouts and I am sure that if requests were made by neighbors to shut down and let them listen, they would only be too willing to do so.

Mr. Gernsback's blow that hits us the hardest is the one that says, "There is today no real purpose for the radio amateur. He simply regards radio as a sort of sport, and in many cases does not realize the great and wonderful utility of the art." Yes, perhaps, but pray tell us who of the broadcast class does not regard it as a sort of sport and after tuning in one broadcast station as well as possible, tune around and try their luck on another and more distant station. Every one of us does it, we've got to admit, and furthermore how many of us have ever listened through three consecutive broadcast schedules without tuning around and experimenting with our set to see if we couldn't get it "just a little better than last time?" Why, really that's the joy of radio and it's the same thing exactly, but on a bigger scale, that the radio amateur is continually trying.

Well, if 50,000 radio amateurs find great enjoyment in experimenting and it can be arranged so that they will not interfere with the 500,000 or more broadcast listeners, who in the world wants to stop them, even if they never did a thing for the community in radio? Isn't that a fair request? Do you care what a man does with his spare time, as long as he is not interfering with anyone or harming himself? Certainly not. Under these conditions why then should the amateur be doomed?

But let us not stop here—let's assume that we can find something that the radio amateur can do to benefit the public and thereby put himself on a solid and respected footing in the community.

What are some of these things, and how can they be accomplished? They must be done by organized effort under staunch and untiring leadership by the radio clubs in the towns and cities. Let us not set up a barrier of class distinction, which is part of the present trouble, the unwillingness of each to co-operate with the other. This can be traced to the periodicals of the two factions partly, but mainly to the insipid feeling of superiority of one class to another. Let's cut that out.

A thing that amateur stations might do
(Continued on page 1997)

SOMETHING \$ 1.00 NEW

SELECTIVITY AT LAST!
The UNIVERNIER provides ultra fine vernier adjustment for ordinary Variable Condensers, Variometers, Vario-Couplers, Potentiometers and Rheostats.
EASY TO INSTALL
The UNIVERNIER takes the place of the ordinary knob, and is applied in a few minutes without disturbing the set.
DISTINCTIVE
The UNIVERNIER will add to the attractiveness of any radio set. It is an instrument of precision, and has that appearance. It consists of a well designed knob inside of which is a simple gear mechanism, so arranged that the knob rotates nearly 12 times to one revolution of the shaft. By pressing lightly towards the panel, it functions as an ordinary knob, thus combining vernier and coarse adjustment in a single unit. D. K. results are surprising!
Made in two sizes:
No. 251 for 1/4 inch shaft.
No. 188 for 3/16 inch shaft.

At your Dealer's or direct **\$1.00** postpaid
Special 360° finely graduated silver-plated DIAL for use with the UNIVERNIER 25 cents extra.
Dealers and Jobbers write for Discounts.
WALBERT MANUFACTURING CO.
933 Wrightwood Ave. Chicago, Ill.

UNIVERNIER

RHAMSTINE* "Gold Seal" Amplifying Transformer

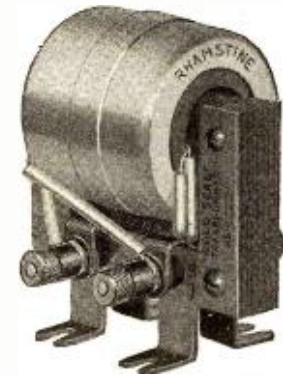

Model
C
Price
\$4.50

You will be especially satisfied with the new "Gold Seal", Model C. It stands for the accurate knowledge of transformer design and construction—it assures you the best both in material and workmanship and its handsome gold-finished frame and coil shield will immediately appeal to you.

Dealers: Write for attractive discounts.
J. THOS. RHAMSTINE*
2152 E. Larned St., Detroit, Mich.
*Maker of Radio Products

MURDOCK RADIO

STANDARD APPARATUS SINCE 1904



"Rico" TUNED Loud Speaker



ADJUSTABLE DIAPHRAGM

Radio receiver experts have realized for a long time that a loud-speaker receiver, if equipped with an adjustable diaphragm becomes a perfect acoustic instrument.

Our engineers have perfected our loud-speaker 'phone, and it is now being offered to the public with the added feature of an adjustable and tunable diaphragm (patents pending).

As will be seen from our illustration, the new development comprises a specially-formed pure Para rubber gasket, accurately made, upon which the diaphragm rests. By tightening or loosening the cap, the diaphragm approaches or recedes a desired distance toward or away from the pole pieces.

So remarkable is this adjustment, and so wonderfully exact does it work, that any sound volume or quality can be readily obtained.

For instance, a given adjustment will bring in certain qualities of sound heretofore unobtainable. It is now in your power to TUNE your loud-speaker in such a manner that, if you wish quality with a moderate amount of sound, you can readily obtain it—or if you wish volume, as, for instance, band concerts, the adjustment can be made instantaneously.

By means of this new adjusting feature, the diaphragm can be moved to or from the pole pieces from .006 to .025 of an inch.

To make the adjustment simply screw cap slightly backward or forward. No screws, no nuts, no fussing, no extra price!

Here is the loud-speaker 'phone for which you have been waiting! For the first time you are now able to buy a single 2,000-ohm loud-speaker 'phone that has been planned by radio and acoustic engineers for one purpose and one purpose only—namely, to reproduce sounds clear and loud through a horn.

Used in any standard horn, it will amplify the weakest of sounds so that the whole family can hear your radio all over the house. Furnished complete with a five-foot (5 ft.) cord. The RICO LOUD-SPEAKER 'PHONE will prove a revelation to you, if you have used regulation head receivers for loud talkers.

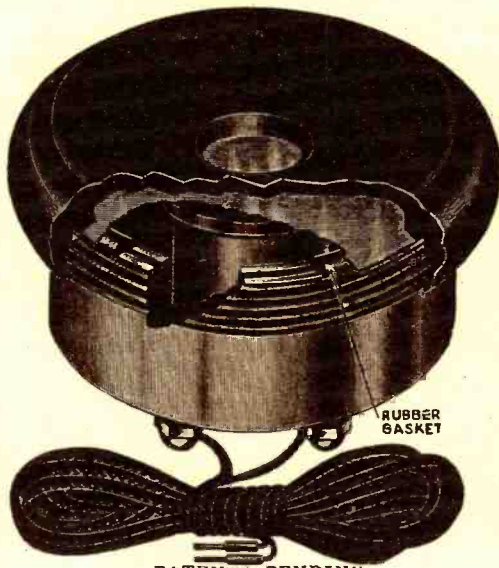

PATENTS PENDING

Phone Price List

Parcel Post—Paid Anywhere in North America

No. 25 Tuned Loud-Speaker Phone with cord	\$4.50
No. 20 2000 ohms Double Head Set	5.00
No. 30 3000 ohms Double Head Set	5.50
No. 40 4000 ohms Double Head Set	9.50
No. 10 1000 ohms Single Head Set	3.50
No. 15 1500 ohms Single Head Set	3.25
No. 2 1000 ohms Receiver only	2.00
No. 3 1500 ohms Receiver only	2.25
No. 05 5 ohms Receiver only	2.00
No. 075 75 ohms Receiver only for Telephone work, not for radio	1.00

SPECIAL OFFER

We are so convinced that you will be enthusiastic about this phone that we make this

Try this LOUD-SPEAKER 'PHONE for five days, and simply consider the money you are sending in to us as a deposit. If, at the end of five days, you are not convinced that it is the best loud-talker 'phone you have ever seen or heard, return it to us and your money will be promptly refunded.

\$4.50

SEND NO MONEY

RICO Phones achieve remarkable results, due to the three poles. The only ones that have return circuit through the diaphragms, with the magnetic pole in the mathematical center of the diaphragm.

USE COUPON BELOW

Note: The RICO Tuned Loud-Speaker No. 25 'Phone must be used in connection with a 1- or 2-stage amplifier or more.

Just write us and tell us that you wish one or more (choose any type) of these phones, and we shall rush the order to you at once. Pay your postman the price of the phone and then test it out at our expense.

75c



YOUR PHONOGRAPH A LOUD TALKER

This adapter fits Columbia, Victor, and Sonora phonographs. Is made entirely of pure rubber, with brass tube insert.

Fits any telephone receiver, as well as our LOUD-SPEAKER Phone.

No. 131 "RICO" Phonodapter, each, prepaid **75c**



\$5.00

Rubber Head Band

Rico No. 20, 2000 ohm Double Head Set with pure rubber covering. Now **\$5.00**

Rico No. 30, 3000 ohm Double Head Set with pure rubber covering. Now **\$5.50**

"RICO" TUNED "Super-Sensitive" Phones

This 'Phone comprises two of our Loud-Speaker 'Phones, described above, with our stock headband and cord.

The resistance is 4,000 ohms, and is made especially for use with vacuum tubes. Not suitable for crystal outfits.

Note particularly that this set of receivers has the two receivers connected in parallel, not in series, as is usual with other receivers. The parallel connection gives double the intensity; this phone will surprise you with its extremely powerful volume of sound. No. 40, Super-Sensitive Double Headset, each **\$9.50**

RADIO INDUSTRIES CORPORATION

131 Duane Street NEW YORK CITY

California, Washington and Oregon Distributors: Western Agencies, Inc. 711 Mission St. San Francisco, Cal.

Mail your order at once, if your dealer can not supply you. Insist upon RICO Tri-pole. There is a very good reason why you should use RICO 'phones, and that is they are different—not merely Phones, but

Phones built for Radio purposes.

SEND NO MONEY

COUPON

R.N. 5

Radio Industries Corporation, 131 Duane Street, New York

Gentlemen:

Please send me prepaid for which I will pay the postman the amount advertised in these pages. (NOTE: "Phonodapters," due to the very low price, cannot be sent C.O.D.) If within five days I do not find the phones all you claim for them, or if for any reason I am not satisfied, I may return same to you in good condition and you will refund the full purchase price.

NAME

STREET AND NO.

CITY

STATE

BUILD YOUR SET WITH BARAWIK STANDARD

PLATE CIRCUIT "B" BATTERIES



You can make real savings on these batteries. Don't pay more. We guarantee them to equal any on the market regardless of price. Absolutely uniform. Extra long life.

- T180 Signal Corps type, small size, 15 cells, 22 1/2 volts. Each... 95c
- T184 Variable Large Navy size, 6 1/2 x 4 3/8 inches, 5 taps, giving range from 16 1/2 to 22 1/2 volts in 1 1/2 volt steps. Each... \$1.80
- T188 Combination Tapped 45 volts 30 cell, 13 1/2 x 4 3/8 battery. Tapped to give 45, 22 1/2, 21, 19 1/2, 18 and 16 1/2 volts. Handles both detector and amplifier tubes. Each... \$3.55

HOMECARGER BATTERY CHARGING RECTIFIER



Charge your battery at home over night for a few cents. Simply connect to any 110 volt 60 cycle light socket, turn on current and rectifier does the rest automatically. Will work for years without attention. Simple connections. Gives a tapering charge which batteries should have. You can make it pay a profit charging your friends' auto batteries. Long connecting cords with pair of battery clips.

- T201 For 6 volt battery... \$13.95
- T203 For 12 volt battery... 13.95

STORAGE "A" BATTERY

A very high grade battery for radio service. Guaranteed for three years. Properly cared for will give many more years of service for filament lighting. Made of best new materials. Full capacity. The best battery on the market. Try one of these batteries on your set for 10 days. If at the end of that time you are not fully satisfied with the battery return it and we will refund the purchase price.



- T194 6 volt, 40 ampere size. Each... \$10.00
- T196 6 volt, 80 ampere size. Each... 12.50

BATTERY CLIPS

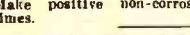

T198 Two for... 28c

Clip onto storage battery terminals, lead coated. Make positive non-corrosive contact at all times.

WIRE CONNECTING CLIPS

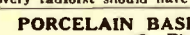

T199 Per dozen... 30c

Small connecting clips for quick fastening leads onto binding posts, etc. Handy and useful. Every radioist should have at least a dozen.

PORCELAIN BASE SWITCHES

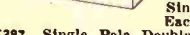

T387 Single Pole Double Throw. Each... 20c

T384 Double Pole Double Throw. Each... 50c

FILAMENT CONTROL RHEOSTATS



T132 Each... 45c

Heat grade. High heat resisting base. Diam. 2 1/2 in. cap 1 1/2 amp. Resist. 6 ohms. 1 1/2 in. knob with pointer. 75c value.

POTENTIOMETER

T133 Each... 89c

VERNIER RHEOSTAT

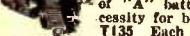

T135 Each... 89c

QUICK ACTING VERNIER RHEOSTAT

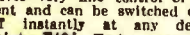

T136 Each... 78c

Porcelain Base Rheostat for table mounting. Resist. 10 ohms.

MURDOCK LOUD SPEAKER

T610 Each, complete... \$4.78

MAGNAVOX LOUD SPEAKER

T612 Each... \$32.50

WORKRITE JR. LOUD SPEAKER

T614 Each... \$10.80

WE PAY TRANSPORTATION CHARGES EAST OF THE ROCKIES

THE PRICES QUOTED DELIVER THE GOODS TO YOUR DOOR

FAST SERVICE—TRY US AND BE CONVINCED

THIS GUARANTEE PROTECTS YOU—Examine the goods we ship you. They must suit you in every respect. If you are not satisfied with your purchase return the goods at once and we will refund the price you paid.

AGENT-DEALERS WANTED

We want Agent-Dealers in every locality to handle our line of goods.

Our Proposition Means Money to You

Our prices save you money. The quality of our goods insures satisfied customers. Our service will help you do a large business on a small investment.

SEND FOR OUR CATALOG

For the Person Who Makes His Own Set

We have selected a line of goods—both completed sets and parts to assemble sets—that will enable you to supply every demand and make money. You can make a good income on our proposition with a very small investment.

Our catalog shows the merchandise you should handle, gives much radio information and will help you establish a successful business. Enclose 10c for the catalog. Tell us what you can and want to do, and how much you can invest. We'll do the rest.

Our catalog is interesting and valuable. Even if you are not interested in radio as a business you will find many interesting things in this catalog and you will save money buying your supplies from us.

Standard Brands—Cunningham Radiotron. Every one guaranteed new and perfect. We will ship brand in stock unless you specify otherwise.

- T105 Detector, UV200 C300 Ea. \$4.38
- T110 Amplifier, UV201 C301 Ea. 5.95
- T118 5 Watt Transmitter. 7.20
- T107 WD11 1 1/2 v. Fil. Each... 4.35
- T108 WD11 Socket. Each... 49c
- T109 WD11 Adapter. Each... 48c

VACUUM TUBE SOCKETS

Our Special Socket. A wonderful value. Moulded entirely of brown bakelite. Four binding post connections. Eight angled contact springs.

- T144 Cresley for either panel or table mounting... 36c
- T146 Each... 45c

TWO AND THREE GANG SOCKETS

These sockets make it easy to build detector and amplifier units and make a neat, compact workmanlike job. Perfectly made of high grade materials. Quickly mounted on panel or base.

- T147 Two-gang socket... \$1.05
- T149 Three-gang socket... 1.45

FIXED CONDENSERS

Moulded cases, nickel plated binding posts.

- T804 Each... 48c

CARBON PRESSURE VERNIER RHEOSTAT

Current regulation is obtained by changing of pressure on carbon. This permits of infinitely fine variation of current. Very durable. Resistance 15 ohms. Capacity 2 1/2 ampers.

- T131 Each... \$1.65

RADIO TUBES

Tubes for winding coils. Strong solid material, with smooth clean surface.

- T950 Diameter 3 inches, per foot... 20c
- T951 Diameter 3 1/2 inches, per foot... 25c
- T952 Diameter 4 inches, per foot... 30c

VARIABLE GRID LEAK

Pencil mark type. Resistance may be varied exactly as needed. T160 Each... 19c

GRID CONDENSER

T162 Mounting holes spaced to fit plugs of above leak. Cap. .0025 MF. 14c

T163 Same as 162 but higher grade. Enclosed in metal case. 39c

PHONE AND GRID CONDENSERS

A compact style of condenser that is very satisfactory. Conducting sheets and dielectric are wound on fiber strip with eyelets for mounting and connections. Each 12c

- T170 Phone Condenser .001 Mfd.
- T172 Phone Bridging Condenser .0005 Mfd.
- T174 Grid Condenser .0025 Mfd.
- T176 Grid Condenser .0025 with Pencil mark leak. Each... 24c

TUBULAR GRID LEAKS AND CONDENSERS—MOUNTED STYLE

Very convenient. Permits quick change of leaks or condensers of varying capacities.

- T850... 5 Meg. T855... 2. Meg.
- T851... 1 Meg. T857... 3. Meg.
- T853... 1.5 Meg. T859... 5. Meg.

GRID AND PLATE CONDENSERS

Price, each... 55c

- T830 .00025 Mfd. Correct for Myers Tubes.
- T832 .0001 Mfd. For special circuits.
- T834 .00025 Mfd. For U.V.201 and Cun. 301
- T836 .0005 Mfd. For U.V.200 and Cun. 300

MOUNTINGS

Bakelite base. Spring clip contact.

- T840 Single mounting. Each... 32c
- T842 Double mounting. Each... 57c
- T844 Triple mounting. Each... 76c

"HONEYCOMB" COILS

Carefully made—fine looking coils. Highest efficiency. Low distributed capacity effect, low resistance—high self inductance. Very firm impregnation. Range given in meters when varied with .001 variable condenser. Mounted coils have standard plug mountings.

- Turns Range Art No. Mtd. No. Mtd. Price
- 25 120-250 T301 \$0.39 T320 \$0.89
- 35 175-450 T302 .42 T322 .96
- 50 230-720 T303 .49 T323 1.04
- 75 300-910 T304 .54 T324 1.08
- 100 500-1450 T305 .58 T325 1.17
- 150 600-2000 T306 .63 T326 1.17
- 200 900-2500 T307 .72 T327 1.26
- 250 1200-3500 T308 .78 T328 1.35
- 300 1500-4500 T309 .82 T329 1.36
- 400 2000-5000 T310 .97 T330 1.57
- 500 2800-6100 T311 1.12 T331 1.83
- 600 4000-10000 T312 1.27 T332 1.78
- 750 5000-12000 T313 1.43 T333 1.93
- 1000 7900-15000 T314 1.70 T334 2.28
- 1250 9750-19500 T315 1.92 T335 2.49
- 1500 14500-26500 T316 2.18 T336 2.65

COIL MOUNTINGS

High grade fine looking mountings. Polished by a silk composition. Center receptacle stationary, two outer ones adjusted by knobs. Takes any standard mounted coil.

- T340 Three-coil mounting... \$3.95
- T341 Two-coil mounting... \$2.95

COIL PLUGS

Made of moulded bakelite. Fits any standard plug. Mounts any standard honeycomb coil.

- T344 Each... 50c

PANEL MOUNTING COIL PLUGS

Take any standard mounted coils. Made of moulded bakelite, mounted on brackets.

- T345 Stationary. Each... 89c
- T346 Movable with anti-capacity handle. Each... \$1.10

RADIO FREQUENCY AMPLIFYING TRANSFORMER

T995 Very special... \$3.25

This transformer will get the long distance stations loud and clear. Permits of easy sharp tuning. Helps cut out static and interference. Makes your set sensitive enough to use a loop aerial. Enclosed in metal case offering perfect shielding. Suitable for panel or base mounting. Because of its special design can be mounted in any V. T. socket. Works with any style of tuner. Wave ranges 150 to 550 meters. Wiring diagrams included.

OUR SPECIAL AUDIO FREQUENCY AMPLIFYING TRANSFORMERS

As high as three stages can be used without howling due to proper impedance ratio, minimum distributed capacity, low core losses and proper insulation. Mounted style has bakelite panel with binding post connections. Unmounted has core and coils assembled with two holes in core for fastening to apparatus.

- T234 10 to 1 Mounted. Each... \$3.48
- T235 10 to 1 Unmounted. Each... 2.95
- T236 3 to 1 Mounted. Each... 3.40
- T237 3 to 1 Unmounted. Each... 2.85

THORDARSON AUDIO FREQUENCY AMPLIFYING TRANSFORMER

An especially high grade audio transformer with correct characteristics for Cunningham, Radiotron or A. P. Tubes. Wonderful results without distortion on one, two or three steps. Low distributed capacity. Fully mounted bakelite panel.

- T232 8 to 1 Ratio. Ea. \$3.60
- T233 6 to 1 Ratio. Ea. \$4.10

RADIO CORPORATION TRANSFORMERS

Audio Frequency Amplifying Transformer. Especially designed for Radiotron tubes. 9 to 1 winding ratio.

- T712 Each... \$6.40

RADIO FREQUENCY AMPLIFYING TRANSFORMERS

Range 200 to 5000 meters. For long distance reception.

- T714 Each... \$5.95

OUR COMPETITOR AUDIO FREQUENCY AMPLIFYING TRANSFORMERS

While these are very low priced transformers, nevertheless they will give excellent results. They are carefully designed and carefully made. Quantity production and small profits make the low price possible. They will equal in results many transformers selling at much higher prices.

- T238 Unmounted, with wire leads... \$2.00
- T239 Mounted, with binding post connections, completely shielded... \$2.75

BARAWIK SPECIAL PANEL MOUNTING VARIABLE CONDENSERS

T812 43 plate .001 Mfd. \$2.29

T813 21 plate .0005 Mfd. 1.80

T814 11 plate .00025 Mfd. 1.32

T815 3 plate Vernier... 1.05

These are especially high grade condensers and we guarantee them to be mechanically and electrically perfect. Fine polished end plates of heavy bakelite. Shafts 1/4 inch diameter. Sturdy, heavy aluminum alloy plates perfectly spaced to insure smooth, even reliable capacity. Our low prices save you money. These condensers are of the very best make and are not to be compared with inferior cheap condensers offered. We guarantee them to please you or your money back.

COMBINATION VERNIER VARIABLE CONDENSERS

T824 23 plate .0005 Mfd. with dial and knob. Price... \$3.25

T826 43 plate .001 Mfd. with dial and knob. Price... \$3.95

The latest improvement in condensers consists of regular variable condenser controlled by large knob and dial mounted with three plate vernier condenser, which is controlled by separate knob mounted above is controlled by separate vernier knob on dial. This arrangement permits of very fine tuning. Compact convenient mounting on panel. High grade design and construction. Finely finished.

ENCLOSED VARIABLE CONDENSERS

One of the best made condensers. Rigid, accurately spaced aluminum plates. Formica ends. Engraved scale. Knob and pointer. Clear transparent case.

- T806 43 plate .001 Mfd. \$3.95
- T808 21 plate .0005 Mfd. \$3.25

KNOCKED DOWN VARIABLE CONDENSERS

You can save money by assembling your own condensers. Formica top and base. Complete with all parts not assembled. Go together easily and perfectly. Panel moulding type.

- T820 41 Plate .001 Mfd. \$1.95
- T821 21 Plate .0005 Mfd. 1.60

RADIO GOODS---DEPENDABLE QUALITY---LOWEST PRICES

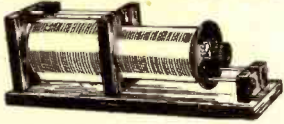

ARLINGTON RECEIVING TRANSFORMER

Will tune in all stations up to 3,500 meters. Very efficient on short waves and for radio-telephone reception. Used with our Detector Two Step Amplifier it produces very excellent results. Also does good work with crystal detector. Silk covered windings on formica tubes. Very fine mahogany finish wood work. Base size 6x18 inches. Slider controls, primary, 12 point switch on secondary. Can be tuned very close. Brass metal parts nickel finish. A wonderful value at its price.

T720 Price \$6.39

TUNING COIL

Range up to 950 meters. Wound with bare copper wire, machine spaced. Ends of mahogany finished hard wood. Two easy sliding contacts on polished brass rods, four binding posts. Substantial, efficient, attractive. Length, 8 1/2 in.

T722 Price \$2.45

VARIOMETER

T410—Completely assembled, price \$2.69
Perfect in design and construction. Accurate for all forms of genuine wild mahogany. Correct inductive ratios. Solid bakelized windings. Positive contacts. Highest efficiency. A real bargain.
T411—Not assembled nor wound but all parts complete, except winding form, \$1.48

VARIO-COUPLER

T415 Price, completely assembled \$2.40
With this loose coupler and two variometers, together with the necessary other parts, a highly efficient tuning set can be made. Easily mounted on panel. No base included. Primary winding on formica tube. Inductively coupled for 180 to 600 meters. Multiple taps permit fine tuning.

T416 Not assembled nor wound but all parts complete except wire. Price \$1.18
T417 Rotor ball only. Each 29c
T408 Bakelite stator tube only. Each 35c

MOULDED VARIOMETER

Polished black moulded rotor and stator forms. Maximum inductance with greatest efficiency and minimum distributed capacity. A high grade durable instrument that will make up into a set you will be proud of and will get the best results. Wave length 180 to 600 meters. 4 1/4 in. square, 1 1/2 in. thick.

T412 Price including mounting brackets \$3.48

MOULDED VARIO-COUPLER

This coupler is designed to work with the above variometer. The stator and rotor forms are of polished black moulded composition. Primary has seven taps to enable finest tuning. Wave length range 180 to 650 meters. Fitted with panel mounting bracket.

T419 Price \$3.48

IMPROVED 180° VARIO-COUPLER

T418 Price \$2.89
Our price shows you a big saving. An instrument of highest quality. The most efficient type of coupler. Insures sharper tuning and louder signals. Primary and secondary wound on genuine bakelite tubes. Secondary connections through soldered flexible cables eliminates contact noise. Primary has 7 taps. Can be panel or table mounted. Range 180 to 650 meters.

Supplied only in 8 inch lengths.

BRASS ROD
T861 Threaded 6-32, per 8 inch length 8c
T863 Threaded 8-32, per 8 inch length 10c
T865 Solid 3-16 inch, per 8 inch length 10c
T867 Solid 1/4 inch, per 8 inch length 12c

TINNED COPPER WIRE
Size 14 tinned copper wire. For wiring sets. Beat size for neat job and proper results.
T969 Ten feet for 12c

CHOKE COILS AND RESISTANCES

For Super Regenerative Circuit
T355 100 Millihenrie Iron core choke coil. Each \$1.20
T354 10 Millihenrie Open core choke coil. Each 92c
T357 12,000 ohm Non-Inductive wire wound resistance. Each \$1.58
T356 12,000 ohm Moulded resistance. Ea. 45c
T358 5 Millihenrie Open core choke coil. Each 92c
T359 1 Henrie Iron core, choke coil. Ea. \$1.20

PRESERVE THESE PAGES—ORDER FROM THEM AND SAVE MONEY FAST SERVICE—TRY US AND BE CONVINCED

THE PRICES QUOTED DELIVER THE GOODS TO YOUR DOOR
OUR GUARANTEE PROTECTS YOU—We handle only the best goods, carefully tested and checked by expert radio engineers. You are assured of getting guaranteed apparatus that will give superior results. And while our goods are best, our prices are lowest. Our goods equal or surpass the claims we make for them. We do not attempt to deceive or mislead. Our reputation for fair dealing is our most valued asset.

HOW TO ORDER—Write your Order plainly, state Article Number, Description and Price of items wanted. Send Postoffice or Express Money Order. Certified Check or Bank Draft for Total of Order. Prompt Shipment is assured when these directions are followed.



BARAWIK QUALITY HEADSETS

These headsets have proven on rigid tests to be one of the very best on the market. The tone quality is excellent with an unusual volume. Skilled workmen make them from only the best selected materials. The receiver cases are fine polished finish with polished black ear pieces. Fabric covered head band comfortably and quickly fitted to the head. Supplied with 5-foot cord. These sets were designed to sell for much higher prices than we ask, and at our price are a wonderful bargain. We guarantee that you will be pleased with them and agree that they are the best value by far yet offered. If they don't suit you we will cheerfully return your money.

T.70—2000 ohm \$3.75

OTHER STANDARD BRAND HEADSETS

T751 Murdoch 56, 2000 ohm \$4.20
T752 Murdoch 56, 3000 ohm 4.95
T754 Frost, 2000 ohm 4.20
T756 Frost, 3000 ohm 4.85
T758 Western Electric, 2200 ohm 9.50
T754 Baldwin Type C with universal jack \$12.00
T755 Baldwin Type C unit with cord 5.50
T756 Red-Head, 3000 ohm 5.78
T768 Brandes, 2000 ohm 6.90

TWO-WAY ROUND PLUG

T397 Each 98c
Takes two pairs of head set terminals. Quick easy connections. Polished round barrel. Fits any standard jack.

ENCLOSED DETECTOR

One of the finest crystal detectors on the market. Supersensitive galena crystal enclosed in heavy glass shield. Quick, positive adjustment. Brass parts polished nickel finish.
T730 Each \$1.18

GALENA DETECTOR

Easy fine adjustment. Crystal mounted in cup. Moulded base and knob. Brass parts polished nickel finish. An unequalled value.
T732 Each 59c

DETECTOR CRYSTALS CAREFULLY TESTED

T736 Galena, Arlington tested, per piece. 19c
T738 Silicon, Arlington tested, per piece. 19c
T735 Tested, Galena, per piece. 9c
T737 Tested, Silicon, per piece. 9c

DETECTOR PARTS

T725 Price set 32c
All metal parts for crystal detector. No base included. Easily assembled. Polished nickel finish.

BAKELITE DIAL AND KNOB

Moulded of genuine bakelite, polished black finish. Fluted knob. Fine engraved scale with sharp clear gradations and figures in contrasting white enamel. This is the finest quality dial and knob in a very attractive pattern. Two inch cannot be supplied for 1/4 inch shaft.

T915 2 in. Diam. for 3-16 in. shaft. Ea. 36c
T902 3 in. Diam. for 3-16 in. shaft. Ea. 36c
T903 3 in. Diam. for 1/4 in. shaft. Ea. 36c
T916 4 in. Diam. for 1/4 in. shaft. Ea. 45c

ONE-PIECE DIAL AND KNOB

Moulded in one piece of polished black composition with clean plain engraved scale and numerals in contrasting white enamel. Fluted knob to fit the hand. An attractive neat pattern.

T900 2 1/2 in. Diam. for 3-16 in. shaft. Ea. 19c
T901 2 1/2 in. Diam. for 1/4 in. shaft. Ea. 19c
T902 3 in. Diam. for 3-16 in. shaft. Ea. 25c
T903 3 in. Diam. for 1/4 in. shaft. Ea. 25c
T906 4 in. Diam. for 3-16 in. shaft. Ea. 35c
T907 4 in. Diam. for 1/4 in. shaft. Ea. 35c

ROSIN CORE SOLDER

T958 Per coil 22c
Self fluxing. Especially designed for soldering electrical connections. Fine for use with above electric iron. Coil will last a long time.

TINOL

T959 Per tube 19c
With this preparation you can solder your connection with the heat of a match. Works fast. Makes a perfect electrical and mechanical joint. Self fluxing.

LONG NOSE PLIERS

T970 Price \$1.10
The handiest pliers for radio work. Made of fine hardened steel. Length 5 inches.

DIAGONAL JAW NIPPERS

T972 Price \$1.05
For fine electrical work. Made of hardened steel. Length 5 inches.

RADIO JACKS AND PLUGS

Finest grade jacks. Improved design. Best materials. Phosphor bronze springs. Silver contact points. Nickel finish. Mount on panels 1/4 to 3/4 in. thick.

T390 Open circuit. Each 43c
T391 Closed circuit. Each 49c
T392 Two circuit. Each 60c
T393 Single circuit filament cont. 60c
T394 Two circuit filament cont. 85c
T395 Plug. Large space with set screws for attaching cord. Each 49c

COMPETITOR JACK AND PLUG

Well made, durable, smooth working. Interchangeable with any standard Jacks and Plugs Solder connections. Nickel finished metal parts.

T387 Open circuit jack. Each 27c
T388 Two circuit jack. Each 35c
T389 Standard plug. Each 35c

BINDING POSTS

Brass, polished nickel finish. Washer and 6-32 in. screw extending 1/2 in.
T370 Large size—barrel and knob 3/4 in. long, dozen 85c
T372 Small size—barrel and knob 9-16 in. long, dozen 70c
T374 Large size with composition knob, dozen 50c
T376 Large size with hole for phone tip or wire, dozen 80c
T378 Small size with hole for phone tip or wire, dozen 35c

SWITCH CONTACT POINTS

Brass polished nickel finish. All have 1/4 in. long size 6-32 screws and two nuts. All prices the same.
Dozen 18c Hundred \$1.05
— Order by Article Number.
T360 Head, 1/4 in.; Diam. 1/4 in. High
T362 Head, 3-16 in.; Diam. 1/4 in. High
T363 Head, 3-16 in.; Diam. 1-16 in. High
Solder Lugs to Fit Contact Points
Also for connecting wires to binding posts, etc.
T365 Dozen 12c Hundred 60c

SWITCH LEVERS

Moulded composition knob. Exposed metal parts polished nickel finish. Fitted with panel bushing, spring and two set nuts. A high grade switch.
T382 1 1/2 in. Radius 19c Ea.
T381 1 1/2 in. Radius Doz. \$1.95
T380 1 in. Radius Doz. \$1.95

SWITCH LEVER STOP

Brass, polished nickel finish.
T386—Dozen 18c. Hundred \$1.05

INDUCTANCE SWITCH, WITH KNOB AND DIAL

Mounts switch point and contact lever behind panel. Enables you to build neat attractive set. Only one hole needed to mount on panel. 15 switch points, any number of which may be used. Dial indicates position of lever. Smooth wiping contacts. Attractive tapered knob.
T285 Price including knob and dial \$1.80

OUTDOOR LIGHTNING ARRESTER

T980 Price \$1.68
Protect your instruments with this lightning arrester. You cannot afford not to. Weatherproof porcelain case. Air gap type. Permanent. Durable. The most practical quality arrester obtainable. Underwriters approved.

CABINETS

Fine looking cabinets solidly built. Made of genuine solid mahogany in elegant hand rubbed finish. You will be proud of your set mounted in one of these cabinets. Hinged tops. Front rabbeted to take panels. Panels not included. Prices are transportation paid.



Panel Size	Inside Dimensions			Art. No.	Price Each
	High	Wide	Deep		
6x7"	5 1/2"	6 1/2"	7"	T420	\$2.48
6x10 1/2"	5 1/2"	10"	7"	T422	2.75
6x14"	5 1/2"	13 1/2"	7"	T424	3.30
7x14"	6 1/2"	13 1/2"	7"	T423	3.60
7x18"	6 1/2"	17 1/2"	7"	T426	3.90
7x21"	6 1/2"	20 1/2"	7"	T425	4.20
8x14"	8 1/2"	13 1/2"	10"	T428	3.70
12x14"	8 1/2"	13 1/2"	10"	T430	4.40
12x21"	11 1/2"	20 1/2"	10"	T432	5.25

RADIO "BAKELITE" PANELS

Notice our very low prices on this fine quality material. We supply genuine Bakelite, Condensite Celoron or Formica, all of which are materials with practically identical mechanical, chemical and electrical properties. Machines well without chipping. Won't warp. Waterproof. Highest mechanical and dielectric strength. Attractive natural polished black finish which can be sanded and oiled for extra fine work.

Panel Size	1/4" thick	3-16" thick	1/2" thick	Art. No.		Price	
				Art. No.	Price	Art. No.	Price
6x7"	T450	\$0.50	T460	\$0.75	T470	\$0.98	
6x10 1/2"	T451	.75	T461	1.11	T471	1.47	
6x14"	T452	1.05	T462	1.55	T472	2.05	
7x14"	T458	1.20	T468	1.80	T478	2.40	
7x18"	T453	1.55	T463	2.30	T473	3.10	
7x21"	T457	1.78	T467	2.65	T477	3.60	
8x14"	T454	1.60	T464	2.30	T474	3.10	
12x14"	T455	2.10	T465	3.10	T475	4.15	
12x21"	T456	3.15	T466	4.65	T476	6.20	

ETCHED METAL NAME PLATES

Plate of brass. Silver plated clear and border on black background. All plates are 1 inch long and 3/4 inch wide, except "INCREASE CURRENT" which are quarter circle 1 1/4 inch over all, and "ON" "OFF" which are 3/4 inch long. Attaching holes pierced.

Plate	Dozen	Price
Plate Variometer	Secondary	Aerial Ground
Grid Variometer	Primary	Phones
Vacuum	Tieker	Coil Input
Primary Condenser	Load & Coil	Output
Secondary Condenser	Coupling	On
Increase Current	Parlet	On
Increase Current (to right)	Seris	On
Increase Current (to left)	Detector	1st Step
	A Battery	2nd Step
	B Battery	3rd Step

ELECTRIC SOLDERING IRON

T567 Price \$5.75
Especially adapted to radio work. Will enable you to do neat clean work quickly. Simply attach to any light socket 110-120 volts. Complete with six foot cord and attaching plug. Renewable solder point. Will last a lifetime for ordinary home or light shop work. A wonderful value at the price.

MAGNET WIRE
Insulated copper wire. Best quality even drawn wire, one piece to a spool. Prices quoted are for 8 oz. spools.

Number	990	Enamelled Insulation	Green Silk Covered	Number	991	Price
Gauge	Price	Gauge	Price	Gauge	Price	
18	50c	20	45c	20	50c	\$0.78
20	60c	22	55c	22	60c	.90
22	75c	24	61c	24	75c	1.05
24	85c	26	65c	26	85c	1.18
26	95c	30	70c	30	95c	1.70
28	1.15	32	75c	32	1.15	2.05
30	1.65	36	98c	36	1.65	2.75

STRANDED ANTENNA WIRE

Cabled of fine copper strands. Very flexible. High tensile strength. Best for aerials.
T248—100 ft. coil 72c T249—500 ft. coil \$3.20

SPAGHETTI
For covering connecting wires in sets. For size 12 and 14 wires.
T955—Finest quality braided and saturated with best baked lustrous transparent insulating varnish, 3 feet for 20c
T956—Best quality braid and covered with black insulating compound 3 feet for 15c

ANTENNA INSULATORS

T260 Size 1x3 1/2 17c
T267 size 2 1/2x3 1/2 50c
T264 Size 1 1/2x1 80c
T266 Size 1 1/2x1 1/2 \$1.35
T260 T262 T264-6

SOLID BARE COPPER WIRE

Solid Bare Copper Wire, size 14
T240—100 ft. coil 45c T242—500 ft. coil \$2.15
Solid Bare Copper Wire, size 12
T244—100 ft. coil 61c T245—500 ft. coil \$2.75

50c EACH THE BIGGEST SUCCESS IN RADIO: CONSOLIDATED RADIO CALL BOOK CO.'S. **EACH 50c**
PATTERNS and DIAGRAMS

**Complete Patterns, Diagrams and Instructions
 How to Make Your Own
 SHORT WAVE REGENERATIVE
 RADIOPHONE SET**

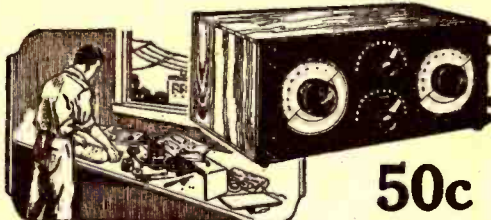

50c

One of the foremost Radio engineers constructed this set for us; it's simple to follow our patterns and assemble the parts comprising this set with which spark, C. W. signals and Radiotelephony may be received. We don't only give you pictures of how the apparatus looks, but each pattern is full size and printed on heavy blue print paper. Only standard parts are used.

PATTERN No. 1

Consisting of a Five-Page Illustrated Direction Pamphlet, size 8½x11½ inches, One Blue-Print pattern, size 16x22 inches and One Blue-Print pattern, size 17½x22 inches, all contained in a heavy Two-Color printed Envelope, 9x11 inches.

SENT POST-PAID

**DETECTOR and AMPLIFIER
 RADIO UNITS**



50c

You can build this detector and the amplifier units anywhere in your house; no machine shop is needed. When built they may be used with any type of Regenerative Receiver or short wave set, with which spark, C. W. Signals and Radiotelephony may be received. We've tested these patterns by actually building the outfit—they're perfect! Only standard parts are used in making the outfit.

PATTERN No. 2

Consisting of a Four-Page Illustrated Direction Pamphlet, size 8½x11½ inches, One Blue-Print pattern, size 16x18 inches, and One Blue-Print pattern, size 13½x15 inches, all contained in heavy, Two-Color Printed Envelope, size 9x12 inches.

SENT POST-PAID

RADIOPHONE CRYSTAL SET

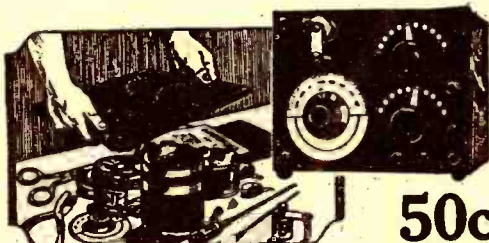

50c

We designed these patterns especially for those who are without technical knowledge but who are sufficiently abreast of the times to desire a radio receiving set in their homes. An instruction pamphlet comes along with the blue prints and all you have to do is follow the simple instructions. This radio set can be tuned in from stations within 30 miles. Standard materials only are used.

PATTERN No. 3

Consisting of 4-page illustrated Direction pamphlet, size 8½x11½ inches, one Blue-Print pattern size 16x22 inches. All contained in two-color printed envelope, 9x12 inches.

SENT POST-PAID

**14 RADIO FORMULAE
 AND DIAGRAMS**

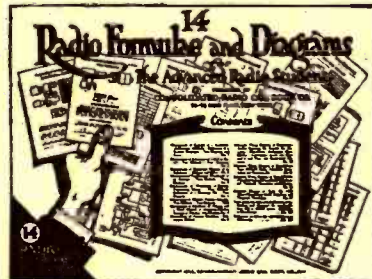

Usefulness!

Economy!

Pleasure!

50c

With this packet of radio knowledge you need never worry about schematic wiring diagrams, measurements and radio tables. All formulas and diagrams are printed on heavy paper in black and blue; and contained in two-color printed envelope, 9x12 inches.

SENT POST-PAID

ALL ABOUT AERIALS

12 Diagrams How to Construct and Erect
 All Types of Aerials



RECEPTION

and

TRANSMISSION

ALL FOR

50c

THESE ARE DIAGRAMS THAT EVERYONE with a radio set wants and needs. These blue prints were made after practical erection of each aerial, and point out to you how simple it is to erect not only the proper aerial for your particular need, but how to erect this aerial in the most practical manner and at the least expense.

Consists of 12 blue prints 8½x11 inches and one four-page instruction pamphlet 8½x11 inches. All contained in a heavy two-color printed envelope 9x12 inches.

SENT POST-PAID

**20 Radiophone Diagrams and
 Hook-Ups of**

Crystal and Audion Receiving Circuits, Amplifier Circuits,
 Regenerative Circuits, Sending Circuits

with

Key Chart of Symbols and Pamphlet
 "How to Read Diagrams"



50c

These diagrams show how to get the best possible efficiency from the instruments you make or purchase. They cover hook-ups from the simplest to the most complicated, in a way that any amateur can understand and follow without difficulty. Get this set, and hook up right.

All 20 diagrams are printed on heavy paper, each sheet size 8½x11½ inches, and together with KEY CHART OF SYMBOLS and pamphlet "HOW TO READ DIAGRAMS" are contained in a heavy two-color printed envelope, size 9x12 inches.

SENT POST-PAID

ORDER FROM YOUR DEALER—or direct from us
CONSOLIDATED RADIO CALL BOOK CO., Inc.
 98 Park Place PUBLISHERS NEW YORK CITY

(Continued from page 1992)

is to transmit news of the doings of their clubs; co-operate with the Y. M. C. A. in inter-Y. M. C. A. news bulletins, or the local Boy Scout Organizations. They could act as instructors in the wig wag to the Boy Scouts as well as in their heliograph and radio work, all of which is a very useful occupation which would take a lot of time and for which no other man in the city or town is equipped. It must not be forgotten either that in time of war the amateur will be the largest possible class of men from whom Uncle Sam can call for volunteers to fill the place at the key in the dugout, behind the lines, in the air, on the ship and at the big shore stations. It takes long practice to fill these places and how much longer would it take if the men were to be recruited from those not knowing what a key looked like? Is that not a service? Can that be overlooked? And in peace time it is almost always the ex-"Ham" who fills the operator's chair aboard our great merchant marine and naval vessels flying the Stars and Stripes, of which we are all proud. How then can we say that the amateur is doomed because he is useless?

Who Will Save the Radio Amateur

By J. H. TOLLEY
FIFTH HONORABLE MENTION

The echo answers "Who." Nobody is going to save the amateur, he must save himself, and the way in which he is going about it spells certain defeat, if persisted in. Regardless of the merits of his complaints, there are certain irrefutable facts to be faced, and no amount of snarling, ridiculing, and whining will serve to surmount the obstacles which these facts impose. Had the amateur radio fraternity acted as they are now acting when pressure was being brought to bear in Washington in past years to eliminate them, they would most certainly have been extinguished. It was only their willingness to co-operate, their apparent eagerness to progress in the art through the most earnest experimentation, and their ready admission that others than they had rights to be respected, which stayed the legislative hand and secured to them the right to continue their spluttering existence.

That the number of radiophone users is enormous and constantly growing is an undisputed fact, and that very fact is all the argument needed as reason that they must be given the greatest consideration in any regulations that may be put in effect. The amateur telegrapher must come to realize that he is now an almost inconsequential minority of home station owners, and must use the "soft pedal" in making his demands, for we in the U. S. A. have a way of catering to the majority and sympathizing with the minority, which in the vernacular "does not buy anything." I do not mean to imply that the amateur should be ignored, far from it, for he alone is responsible for keeping alive the popular interest in radio and starting us on the road to where we are today, and he must be given all consideration possible. *He is in the position of a man who has loosened a flood of water he cannot control; he was the only original radio bug, and he has done his work so well that he is swamped and inundated by the radio tempest he has created.*

It is not the first time, however, that they who labored and struggled to bring forth an idea have been carried away by the backwash, while new-comers frantically gathered in the spoils. Until the radio amateur can assimilate these facts and take them into account, he will be playing a lone and a losing game. Any allotment of special schedules for transmitting that are made must be arranged in conjunction with, and not in spite of, the great majority of radio users.

Furthermore, if the radio amateur is to ex-

RADION

Panels and Parts

RADION is a superior grade of hard rubber developed exclusively for Radio use.

RADION is mechanically better than ordinary panel insulations, because it will not warp under normal conditions; it is easily worked with simple tools, cuts and drills clean without chipping, is easily engraved.

RADION has a beautiful satin-like polish comparable to the finest finish ever put on hard woods.

RADION excels all other insulations in the four most important characteristics required for Radio use, viz.: (1) low phase angle difference, (2) low dielectric constant, (3) high resistivity and (4) non-absorbent qualities.

RADION costs no more, in most cases LESS, than other insulation materials usually offered for panels.

RADION is made in two colors, black and mahogany. The latter resembles fine old mahogany in appearance.

RADION is made in 18 stock sizes of panels, hence it can be used with minimum waste. Each panel packed in envelope to protect beautiful finish. Stock sizes follow:

6x 7 inches	7x21 inches
6x10½ "	7x28 "
6x14 "	7x48 "
6x21 "	9x14 "
7x 9 "	10x12 "
7x10 "	12x14 "
7x12 "	12x21 "
7x14 "	14x18 "
7x18 "	20x24 "

RADION is economically moulded to any specifications at our factory.

RADION is more fully described in our new folder. Send for a copy today.

**Panels, Dials, Knobs, Sockets,
Condenser Ends, Phone Parts,
Bases, Antennae Insulators**

American Hard Rubber Co.
11 MERCER STREET NEW YORK

Manufacturers and Moulders of

"The Supreme Insulation"

Compare These Prices

WHY PAY MORE WHEN YOU CAN GET ROCK BOTTOM PRICES FROM US

Just glance over our list and send us your Money Order. Twenty-four hours after receiving your order it is on its way to you.

LIST PRICE	OUR PRICE
\$ 5.00 Radiotrons UV-200	\$ 4.25
6.50 Radiotrons UV-201	5.75
16.00 Baldwin Phones, type C	12.00
7.75 Baldwin Units Loud Speakers	6.00
8.00 Federal 2200 Ohm Phones	6.00
8.00 Brandes Superior Phones	7.00
5.00 Acme Transformers	4.25
1.00 Double Jacks	.60
.70 Single Jacks	.50
2.50 Bull-Dog Plugs	1.25
Contact Points, per doz.	.15
Switch Levers, 1 1/2" radius	.25
45.00 Magnavox	38.00
1.50 100 ft. Stranded Aerial Wire	.60
.50 Aerial Insulators	.20
1.00 100 ft. Solid Aerial Wire	.40
75.00 Paragon RA-10 Set	68.00
25.00 90 ampere guaranteed Storage Battery	18.00
1.00 Rheostats	.75
1.00 Fada Rheostats	.75
1.00 Vacuum Tube Sockets	.65
18.50 Homchargers	15.50
3.50 B. Batteries volt meters 0-50 V.	2.75
55.00 Western Electric New Style Loud Speakers	42.75
.75 Rheostats	.60
3.00 B. Batteries	2.25
2.50 B. Batteries	2.00
1.75 B. Batteries	1.10
1.50 Dials	.75
1.00 Dials	.40
2.75 De Forest Detectors	1.95
.75 Sockets	.60
4.50 Thordarson Transformers	3.75
2.00 Potentiometers	1.25
1/2 Megohm Grid Leaks	.60
1 1/2 Megohm Grid Leaks	.65
1.00 Grid Leak Holders	.65
1.00 Double Phone Cords	.60
.50 Single Phone Cords	.35
Duplex Phone Adapters, fits Edison, Victor or Columbia	1.75
Genuine Bakelite Panels, per sq. in.	.02
Spaghetti, per ft.	.09
12.00 Genuine Western Electric Signal Corps V.T.-2 Tubes	9.00
112.00 De Forest type Honeycomb Set, special Mahogany Cabinet	65.00
3.00 Racyon Electric Light Aerial	2.00
35.00 Audmiax Loud Speakers	18.50
6.50 Turney 3,000 Ohm Phones	4.25
4.50 Diamond 2,000 Ohm Phones	3.75
5.00 Fischer Variometers	3.75
6.00 Fischer Variometers	4.75
5.00 Fischer VarioCouplers	3.75
6.00 Fischer VarioCouplers	4.75
8.00 Atwater-Kent Variometers	7.00
8.00 Atwater-Kent VarioCouplers	7.00
5.00 Pathe Variometers	3.75
14.00 Atwater-Kent Mounted Vario-Couplers	11.75
16.00 Atwater-Kent 2-step amplifier	13.75
8.50 Everet Head Phones, 3,000 Ohms	4.95
1.50 Thordarson Rheostats	1.15
Bus Wire for wiring sets, per ft.	.02

Honeycomb coils, all sizes, 20% discount. Space being limited, we are obliged to omit many items.

Write for our Quotations

Cut Rate Radio Co.

Dept. A

P. O. Box 472

Newark, N. J.

RADIO SCHOOL

All our graduates are placed. Shortage still exists.

Send for Catalog

MASSACHUSETTS RADIO & TELEGRAPH SCHOOLS Inc.

18 Boylston St. Boston, Mass.
G. R. ENTWISTLE, Radio Director

FREE

Complete price list of radio parts. Write Aitken Radio Co., 504 Superior St., Toledo, Ohio.

pect concessions, and concessions is the proper word in view of the numbers involved on both sides, he must do something besides growl at those from whom he wants help. It seems to me that the first thing to be done is to replace this attitude of antagonism with one of good fellowship and helpfulness. If the radio clubs in every locality would give their experience and services free to help newcomers to install receiving outfits, if they would go around and locate trouble, correct mistakes, and give advice as to the best way to spend what money is available for radio gear, if they would instruct in the tuning and handling of apparatus, and do all this in the name of the amateur radio association, they would at once create a friendly atmosphere. They would then be of use to the community, and would be in demand by the community; they would be friends not enemies, and in the very nature of things, there would be created a desire to help them in return, and in such a state of mind it should not be impossible to arrange a division of hours.

This much is certain; if it cannot be arranged in some such diplomatic way, it will not be effected at all. To attempt to legislate a solution is to hasten the post mortem obsequies, for the amateur will be outnumbered a thousand to one both in numbers and in political influence at the legislative halls.

A very desirable thing, too, would be an association of broadcasting stations; the amateur could help to bring such a thing about and it would be vastly more satisfactory for the radio amateurs as an organization to deal with the broadcasters as an organization, and it is more than probable that a division of hours could be arranged to mutual advantage. The most important thing of all is to keep on the right side of Uncle Sam—now, in the time of stress, is the time to see to it that Government regulations are strictly lived up to by amateur station owners. There is no doubt that eventually the Government will be forced to make some kind of regulations in order that all may have some share of the sport, and it will be vastly more comforting to be "sitting pretty" with Uncle when the time does arrive. One more thing will eventually come to us without fail, and that is undamped transmitters only. Weep and wail, figure your losses up and howl to Heaven in despair, argue and expostulate in vain, if you will, but prepare to install bulb transmitters or go out of business.

The high resistance rainbow wave producers are obsolete and doomed. Do not think that because you were a prominent amateur seven years ago that the same obtains today, such is not always the case, we are moving ahead very fast and those who cannot stand the pace must drop out. Kismet, it is fate.

Mr. Bink's Radio

(Continued from page 1956)

ing a cake of very hard ice, say "This is Kansas City." But I ask you, as man to man, is a man who happens into a shop and buys a radio outfit as he would buy a pound of cheese entitled to swell up and strut around as if he had invented radio and patented it and given it alone and unaided to a waiting world? The answer seems to be "Yes." The ayes have it, so to speak. That is just what a man does seem entitled to do and feel. That's how I did and felt about the box of radio I brought home. Until Binks bought his and swelled and bragged and jawed until I was ashamed of him.

Yes, nearly all the men I know are that way about radio—except one. Dodson Bates is different. Dodson Bates is a stout, red-faced man and he has one of these small



Recharge Your Battery at Home

Charges Both A and B Radio Batteries

Don't be without the use of your Radio Receiving Set while your battery is being charged. Get a Valley Charger and charge your battery right at home.

Attach the Charger to your home lamp socket—attach the clips to the battery terminals and you will get a quick, tapering charge which just exactly charges your battery, but cannot over-charge or harm it in any way.

Will charge the A 6 volt battery at a 5 ampere rate, and the B 2 1/2 volt battery at the required 1/2 ampere rate. 45 volt B batteries may be connected in parallel so that they can also be charged.

SATISFACTION GUARANTEED. If your local distributor cannot supply you, write direct to

VALLEY ELECTRIC COMPANY,

Department R. ST. LOUIS, MO.

----- Mail the Coupon -----

Valley Electric Co., Dept. R., St. Louis, Mo.

Gentlemen: I am enclosing money order (or check) for \$18.00 for which send me a Valley Battery Charger with five-panel glass display case and indicator. If not satisfactory, I will return it and get my money.

Name

Address

\$18.00
F.O.B. St. Louis



DEL FELCO

Radio B BATTERIES



The Battery with a Reputation Built In!

Larger cells of extra-heavy construction guarantees absolute dependability and longer life. They are built to "stand up!"

Small size, 22 1/2 volts	\$2.00
Large size, 22 1/2 volts	3.00
Small size, 45 volts	4.00
Large size, 45 volts	5.50

Postage Prepaid.

DEL FELCO

BATTERY CORPORATION

General Office.....12 Meeting St.
Factory.....28 Bayley St.
Pawtucket, R. I., U. S. A.

GREEN SEAL
AIR-WAY RADIO Equipment appeals to the discriminating user for its genuine quality at fair prices. Write for Free Air-Way Bulletin of Complete Sets and Standard Parts. Attractive dealer proposition.
Air-Way Electric Appliance Corporation, Toledo, Ohio.

Largest
Radio
Store
in
America

RADIO BARGAINS

Largest
Radio
Store
in
America

Buying Direct—in Quantities—for Cash, and operating on a "Small Profit—Big Sale—Quick Turn" basis Makes Possible These Values
Radio Supplies Purchased Here are Sold Under a Positive Guarantee of Satisfaction. We Carry the Largest New Stock of First Quality New Merchandise.

Complete Parts for Reinartz Circuit

Includes 1 7x18 Formica Panel, 1 Bakelite Socket, 1 Howard Vernier Rheostat, 23 Plate Condenser, 11 Plate Condenser, 3 Switch Levers, 2 Dozen Switch Points, 1 Reinartz Wound Coil, 1 Freshman Variable Grid Leak, 8 Binding Posts, 25 Feet Tinned Wire, 1 Base for Coil, 1 Mounting Base Board, and Diagram to Construct This Set. Complete..... **\$11.45**

COMPLETE KNOCKDOWN RECEIVING SET

This includes 2 Variometers, 1 Coupler, 3 Dials, 1 Rheostat, 1 Cunningham Detector Tube, 1 Bakelite Socket, 1 Mahogany Cabinet, 7x18 Formica Panel 6 Binding Posts, 1 Switch Lever, 12 Switch Points, 2 Stops and 1 Diagram to construct this set. Set is capable of receiving 1,000 miles if installed with outdoor aerial..... **\$17.95**

VARIABLE CONDENSERS

\$4.30 Value, 43 PLATE, now	\$1.75	\$3.10 Value, 5 PLATE, now	\$1.25
\$3.70 Value, 23 PLATE, now	\$1.45	\$2.70 Value, 3 PLATE, now	\$1.15
	\$3.30 Value, 11 PLATE, now		\$1.35

U. S. A. Signal Corps Aviation Type 194-W Western Electric Phones, \$7.95

Each Phone Cap is covered with large soft rubber ear cushions, and an aviation leather helmet goes with each set! These are the only phones to pass the Government specifications for sensitiveness and loudness, the requirements called for in aircraft reception.

COMPLETE PARTS FOR FLEWELLING CIRCUIT

Includes 6x14 Formica Panel, 23 Plate Condenser, 3 Micon .006 Condensers, 1 Freshman Variable Grid Leak 1 Remler Leak, 2 Coil Mount, 2 Honeycomb Coils, 2 Coil Plugs, 1 Socket, 1 Howard Vernier Rheostat, 8 Binding Posts and 1 Diagram to Wire and Construct this Set. Complete..... **\$12.45**

MAGNAVOX, Loud Speaker,
Type R3 **\$27.45**

VARIOMETERS Genuine Mahogany
\$5 Value, NOW **\$1.95**

VARIOCOUPERS NOW \$4.50 Value **\$1.75**

MICROMETER VARIOCOUPLER,
A Super Efficient Coupler with 180° Rotor Movement (For sharper tuning) and having 20 Antenna Taps **\$2.95**

FORMICA PANEL, 1/8 in. thick,
Square Inch, Black or Brown..... **1 1/2c**

HONEYCOMB COILS

1,500 Turns Coto Coil.....	\$1.50	150 Turns	60c
1,250 Turns Coto Coil.....	1.50	100 Turns	50c
1,000 Turns	1.25	75 Turns	40c
750 Turns	1.00	50 Turns	40c
250 Turns Coto Coil.....	75c	35 and 25 Turns	40c

Signal Corps Super Sensitive Microphone Transmitters . . \$2.45

Solid Copper Aerial Wire, 100 ft. **35c**
Spaghetti Tubing, yard **10c**
Corp Tip **60c**
Plugs **95c**
Brach Lightning Arresters

2-Slide Tuning Coils, at **\$1.95**
3-Coil Honeycomb Mountings, with Knobs..... **\$3.45**
Phone Caps, for mostly all phones **25c**
Signal Corps Hot Wire Ammeters, at **\$5.45**

Anti-Capacity Switches

Lightning Switches

Hydrometers, now at

Freshman Variable Grid Leaks

\$8.50 Guaranteed 3,000 Ohm
HEADPHONES **\$3.65**

FRAMINGHAM RHEOSTATS **45c**

Sponge Rubber EAR CAPS, Aviation Type
Pair **50c**

DIALS, 2, 3 and 3 1/2 in. **25c**

Thordarson Amplifying TRANSFORMERS
\$4.50 Value, Now **\$2.95**

500 OHM POTENTIOMETERS **\$1.45**

SWITCH LEVERS **20c**

BINDING POSTS, per doz. **50c**

GREWOL DETECTORS **\$1.45**

Original Type C Nathaniel Baldwin Mica Diaphragm Loud Speaker Units \$4.95

We Guarantee All Merchandise Purchased of Us

Mail Orders Receive Immediate Attention

CHICAGO SALVAGE STOCK STORE

509 SOUTH STATE ST.

Dep't RN.

CHICAGO, ILL.

Prices Reduced

ON

Saturn  Products

HAVING had more than the anticipated success in the sale of our goods, we are pleased to inform the trade that the correspondingly larger output caused lower production cost, and consequently we are now in a position to lower our list prices.

THIS reduction is for the United States only and will be effective after February 28th.

The New Prices Are:



The Saturn Automatic Radio Plug

The Plug with the RED SEAL

\$1.25

The Saturn "PERFECT Jack"



- No. 1. Single Circuit, Open\$0.50
- No. 2. Single Circuit, Closed 0.55
- No. 3. Double Circuit, Closed 0.70
- No. 4. Single Filament Control 0.75
- No. 5. Double Filament Control 0.80

Now the best at the price of common goods

The Saturn Mfg. & Sales Co., Inc.

Dept. R.N.
48 Beekman Street
New York, N. Y.



Equipment Cord Tip Jack

This R.T.S. Cord Tip Jack leads the way in quality, service and price. Constructed of spring phosphor bronze, highly nickeled. Wiping spring contact insures clean, positive contact at all times. Where others sell from \$1.00 to \$2.50, this R.T.S. Cord Tip Jack Retail atpre paid 50c



RADIO TESTING STATION
Dept. R-5, 25 Sturgis St. Binghamton, New York



This official 14K. gold plated lapel button is now being given free to all new members of the Radio Experimenters' League. See special notice under Wireless heading in Classified Section this issue. Old members who have not yet received their lapel buttons send at once for one FREE. Tell your friends to join. New dope sheets covers complete constructional details of set, using new W. T. 501 Peanut Tube.

RADIO EXPERIMENTERS' LEAGUE
68 Glen Ridge Ave. Glen Ridge, N. J.

wiry wives that I call pin-prickers. Always pricking and prodding otherwise comfortable husbands to do this and do that. And for twenty-three years, every Sunday morning, just when Dodson Bates had settled down with the Sunday newspapers his wife would begin prodding and pricking him to get ready to go to church. For twenty-three years, every Sunday morning, Dodson Bates did go to church, too, and sat in the pew fighting to keep his eyes open during the long sermon, and suffering as only a man does who has played eighteen holes of golf Saturday afternoon and then read until one or two A.M. and who has to sit and listen to a sermon in a hot church. About the middle of the twenty-fourth year Dodson Bates' wife passed on to a better climate and it was when she had been an angel for about six months that I managed to coax Dodson Bates to come to my house and listen to my radio. I had to coax him for two months, and then he came reluctantly, and all we got that night was static and squeals. Dodson Bates came five times and all we got was static and squeals, and he got plumb disgusted and said he wouldn't have one of those radio machines in his house for a million dollars. He said he could not be hired to have one, and nobody could get him to listen in again for any amount of money.

That's how things were when we were coming out from town one afternoon on the 5:15 train, and four of us were playing 500—Binks and Dodson Bates and Joe Minch and I—and Joe Minch happened to mention that he had just bought a radio outfit. He said it was one of the sort that is built like a phonograph cabinet, like a Victrola.

"And its wonderful," he said. "Why last Sunday I sat there in my own living room and heard a whole church service, right direct from the church."

Dodson Bates looked up instantly. "With the sermon?" he asked. "Could you hear the sermon, too?"

"Absolutely!" Joe Minch said. "Clear as anything. Every word."

"And your radio is built like a Victrola? About four feet high, say?" asked Dodson Bates getting more and more excited.

"That's right," Joe Minch told him. Dodson Bates threw down his cards and got out into the aisle.

"What's the matter?" I asked.

"Matter?" Dodson Bates exclaimed.

"Matter? I'm going to get off this train at the next station, and I'm going back to town and I'm going to buy one of those radio machines like Joe Minch's. Yes, sir! I'm going to have it sent out to my house, and I'm going to rig it up, and next Sunday morning I'm going to turn on the sermon and pull my biggest and easiest easy-chair up to that machine, and I'm going to put the ear things on my ears and sit down in that chair and put my feet on top of that radio cabinet and go to sleep! And every Sunday morning for the next twenty-four years I'm going to turn on that sermon and sleep right spang through it from start to finish!"

And I shouldn't wonder if he did. He has always been very bitter about sermons.

But what I wanted to say was that some of these people do annoy a radio enthusiast dreadfully. I remember what Dodson Bates told Joe Minch about me. Time and again, as I have told you, I invited Dodson Bates to my house to hear my radio, and he said to Joe Minch:

"This is how it works. Ellis comes to me and he begins bragging about getting concerts and talks from Honolulu and the moon and further—from San Francisco and Podunk and Chicago and forty eleven other places. And every night, too. He just goes home about 10:30 P.M. and turns the knobs and hears the King of Siam and Galli Curci and Napoleon Bonaparte and Skagway and Havana and Patagonia—all as



The announcer's voice is distinct, the music as clear as a bell, because her radio outfit is equipped with the

Stromberg-Carlson Radio Headset

Comfortable, quickly adjustable to any size head—forked cord permits use by two observers.

Backed by 8 years' experience in the manufacture of radio apparatus and 28 years in the manufacture of high grade telephone equipment.

Order Stromberg-Carlson apparatus through your electrical dealer or write us for free bulletin No. 1029-R describing exclusive Stromberg-Carlson features.

Stromberg-Carlson Telephone Mfg. Co.
Rochester, N. Y.

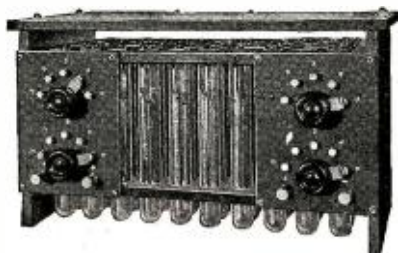

KICO Radio Storage "B" Batteries for EFFICIENT Receiving

THINK over the following FACTS before buying again.

1. KICO "B" batteries allow single cell variations by means of switches on mounted panels. (The first in the market with this feature.)
2. Alkaline type.
3. One charge lasts from three to six months in the detector plate circuit.
4. Rechargeable from your 110-volt A. C. line in connection with the rectifier supplied.
5. Neat, efficient and compact.
6. Unlimited life.
7. Your money back if unsatisfied within a 90-day trial.

		(Plain)	(With Panels)
16 cell	22 volt	\$6.50	
24 cell	32 volt	8.00	\$12.00
36 cell	48 volt	10.00	14.00
50 cell	68 volt	12.00	17.00
78 cell	100 volt	18.00	21.00
108 cell	145 volt	21.00	28.00

Literature gladly furnished

KIMLEY ELECTRIC CO.
1355 Fillmore Ave. Buffalo, N. Y.

The AMERTRAN

super audio frequency amplifying transformer
—Audibility amplification, 38.6—
without distortion

Perfect tone Price \$7. Maximum volume
American Transformer Co., Newark, N. J.

Your Radio-Knowledge Worth Big Money

MANY amateurs are so absorbed in the fascinating fun of radio that they do not realize the big opportunities awaiting them in the commercial field. Thousands of men operating amateur stations have never considered that they can earn amazingly big salaries doing the same easy, interesting work.

Radio Amateur, don't waste your knowledge of Radio. Don't use it only as a fad or a hobby. Radio is more than that. It is a gigantic, six-billion-dollar industry—and growing bigger every day! Hundreds of commercial stations are in operation today; thousands more are being erected. Nearly every vessel on the seas is a floating radio station. Hundreds of manufacturers, thousands of stores, millions of people are interested in this great, new, marvelous industry

Trained Men Needed Now

Do you realize what this worldwide expansion means to you? Many land radio interests employ a force of a thousand or more Radio men. Every vessel needs from one to three operators. Schools, stores, factories, newspapers and cities need operators, demonstrators, salesmen, instructors, technicians, designers, inventors, engineers. Everywhere you turn you see the tremendous demand for more trained certified Radio-tricians.

Here is your greatest opportunity for fortune and success. Take advantage of it. Radio needs YOU NOW! Get into this fascinating profession. The field is uncrowded. Jobs are literally going begging for competent trained men. The pay is big, and the work fascinatingly easy.

"Cash In" On Your Knowledge

Don't be a stay-behind. Don't let the other fellow beat you to the wonderful positions now awaiting for you in Radio. Make Radio a profession—not a play-thing. Don't let your Radio-knowledge go to waste. "Cash in" on it—*Big!*

Thousands of men with no knowledge or experience now, are preparing for wonderful careers in this great profession. Will you allow these beginners to get ahead of you? Will you let them get all the big jobs while you sit idly by? Will you always be satisfied with being just an extra-good amateur when it is so easy to earn big money as a professional Radio-trician?

"Radio Headquarters" Will Help You

The knowledge you have now of Radio operation and maintenance makes it easy for you to train yourself and obtain a wonderful position. You can work up to positions paying as

high as \$10,000 a year. If you are attracted by the adventure and excitement of travel, Radio offers you a glorious opportunity to see the four corners of the earth, with all expenses paid and a fine salary besides, or you can stay at home and take one of the fine positions all around you.

Use your present Radio experience to help you achieve a wonderful success in this great field. America's "Radio Headquarters," the National Radio Institute, has devised an amazing new plan that will complete your Radio education in spare time at home, and enable you to qualify for a Government Commercial operator's license so you can take your place in the Radio profession in the shortest possible time.

One of the features of this remarkable course which is approved by the Government, is that you are furnished free with four wonderful instruments for practical work at home. Among them is the wonderful Natrometer which quickly helps you acquire expert speed and accuracy in sending and receiving code.

In addition to this splendid, simplified short-cut course and the four patented instruments, nationally known Radio experts are your instructors. They correct your papers, give you the advice you seek, help you in every way with their wide experience to become a successful Certified Radio-trician.

Special Opportunity Now Open

The urgent need for radio experts and the calls which come to us for our students prompt us to make a special offer open to new students for a limited time. Through this special offer your enrollment will be accepted at a special rate, and you will receive, without extra cost, our new course in Wireless Telephony.

Get This New, Free Book

The National Radio Institute is ready to give you the same practical help that has put hundreds of its graduates on the highway of Radio success. Read the letters in the panel from just a few of our 8000 students and graduates. You have the basic knowledge now. Just a part of your spare-time spent in learning the professional side of Radio will qualify you for your career in this field of unparalleled opportunities. Radio is paying enormous earnings to men all over the country today—it is making hundreds of men wealthy. Find out at once about your opportunity in Radio. Send for the interesting big Book which tells all about the future waiting for you in this great field, and gives complete details of the plan by which the National Radio Institute prepares you quickly in your spare time to become an expert Radio-trician and helps you through its Free Employment Service to a good Radio position. Mail the coupon, or write a letter NOW!

National Radio Institute

Radio Headquarters
Dept. 13-E
1345 Pennsylvania Ave., N. W.
Washington, D. C.

WARNING!

Ours is the one complete Course that prepares you for a first class government license. It is complete in every detail. Necessary practice instruments are supplied free. Don't be confused by cheaper or free courses. They cannot secure for you a government license which is necessary to obtain a good position in Radio.

NATIONAL RADIO INSTITUTE
Radio Headquarters
Dept. 13-E
1345 Pennsylvania Ave., N. W.
Washington, D. C.

Please send me your free book, "How to Learn Radio at Home," with full particulars about the opportunities in Radio, and how you will quickly train me in my spare time at home to become a certified Radio-trician. Also, tell me how your free employment service will help me to a position and particulars of your special short-time offer.

The National Radio Institute Can Help You As It Helped These Men

N. R. I. Graduate a Radio Engineer
I believe your course in Radio Telegraphy and Telephony operation to be the best and most complete on the market today. I feel more than confident that any student taking your course and applying himself should have no trouble in passing the government examination. I, myself, am a graduate of your school.
R. J. DAUGHERTY,
Radio engineer, Hamilton, Ohio

No Course More Complete
No course could be more complete, more clear to the beginner. Besides giving a comprehensive study in Radio, the N. R. I. course practically covers every branch of electrical phenomena. An N. R. I. graduate has a wide and useful knowledge that cannot but be of use to him in any line of electrical work.
NELSON V. LLOYD, Ralston, Washington.

Easy to Get Good Job
Only a short letter to let you know that I am still on board and waiting for the ship to sail. Tell your students for me that a man with a license has no trouble obtaining a good position. Believe me a job like this is worth a good deal of studying.
L. M. WARING, JR.,
S.S. "Lake Farnay," Norfolk, Va.

Course Superior to Others
I will say that the training I received from you and the careful instructions have enabled me to thoroughly understand Radio. The Natrometer is a great help to one who wishes to receive the code fast. The course is superior by far, to any other I know of.

PHILIP PAUDIER,
Lawrence, Mass.

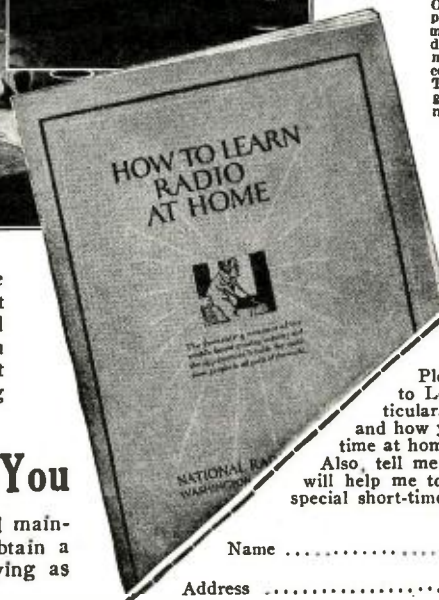

Name Age
Address
City State

The Receiver

which has met with
Universal Favor

Telmaco

Type B-R Receiver



Manufactured exclusively for us by the Tri-City Radio Electric Supply Co., licensed under Armstrong U. S. Patent No. 1113149, Oct. 6th, 1914, for use in amateur stations and for radio experimental work.

A careful analysis of the past two revolutionary years in Radio shows unquestionably that the receiver of the future must have the following qualifications:

EFFICIENCY OF OPERATION: Securing distance, volume, selectivity. **EASE OF OPERATION** enabling the novice to secure satisfactory results. **HIGHEST QUALITY OF WORKMANSHIP AND MATERIALS.** The time when inferior radio products can be successfully merchandised is past. **PRICE** within the reach of everybody. All these qualifications are combined in the TELMACO Type B-R Receiver.

Specifications:

Panel—Formica, grained and machine engraved. Varico-Coupler—TELMACO special silk wound with loading inductance in series with primary. Condenser—Special 13-plate with Bakelite ends. Rheostat—Single knob control. Sockets—Highly nicked shell, Bakelite base. Dials—are polished, presenting pleasing contrast with dull panel. Workmanship—manufactured according to TELMACO'S rigid specifications. This guarantees your satisfaction. Either 6 volt or 1½ volt tube may be used.

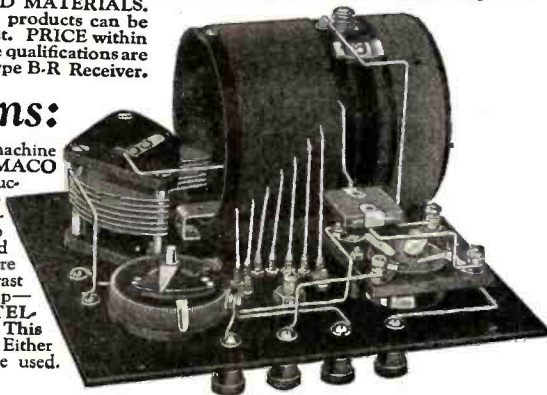

Telmaco Type B-A Two Stage A. F. Amplifier

Matches the above in size and construction. The greatest Amplifier value on the market. Price \$20.00.

Price \$25

The ultimate in value.



Quality Radio Exclusively
Bona Fide Jobbers—If our salesmen have not reached you with our proposition, write or wire for it today.

RADIO DIVISION
TELEPHONE MAINTENANCE CO.

20 S. Wells Street
Dept. B :: Chicago, Illinois

clear as a bell and just as if they were in the next room. So I let him coax me to go and hear it. So I go. He sits me down on a sofa and says "Now! Now we'll see what we get!" And he turns sixteen knobs and all I hear out of the thing are grunts from some pig yard and then a couple of cats screeching on a back fence and then one of the pigs gets caught under a gate and squeals bloody murder. That keeps up from 10:30 till half past one A.M., and then he says 'I'll just use the ear-phones until I get tuned in right.' So he puts the ear-phones to his ears and twists the knobs, and all at once his face lights with a glow of utter bliss and he turns his eyes to the ceiling and whispers with awe 'Chicago! Chicago!' And he hands the ear-things to me and I put them on and what I hear is 'Psst! psst! Ugh! Ugh! Yeow!' Same old cats and dogs and razor back hogs. Ain't it awful?"

Some of your friends are like that, always, but I know only two other individuals quite as unsatisfactory as Dodson Bates. One is my grandmother and the other is Mr. Binks' dog. Grandmother is a dear old soul but she has never been able to get any satisfaction out of my radio whatever. I'll put her in a chair in front of my horn and shout—we have to shout at grandmother at the tops of our voices, she is so deaf.

"Now grandmother, this is the great tenor, Rosario Bossi."

Grandmother will listen. She will keen herself up and strain her ears and fold her hands across her stomach and close her eyes and just concentrate for all she is worth, and in a minute she will say:

"It ain't no use, Ellis; it ain't no use—it don't sound to me like nothin' but a dog yowling."

Then I'll try her with the celebrated Boomeray Marine Band of one hundred and eight pieces and she'll say:

"It ain't no use, Ellis; it ain't no use—it don't sound to me like nothin' but a dog yowling."

Then I'll try grandmother with Galli Curci or Maria Forlorna or Ethel Bethel Butts or whatever great soprano happens to be singing that night, and all grandmother says is:

"It ain't no use, Ellis; it ain't no use—it don't sound to me like nothin' but a dog yowling."

That is mighty discouraging to a man who loves his radio and is eager and tremulous to have all his family and friends enjoy it but, after all, a grandmother is a grandmother and you have to treat her kindly. As I said to Binks.

"Even if a grandmother does make mean remarks about a man's best radio efforts he can't take her out and shoot her for it, as if she was a dog. But," I said, "if I had a dog like yours I certainly would take it out and shoot it."

Binks' dog—it is the other individual that does not appreciate radio—is what I would call an anti-radio hound, if I did not call it something worse. I don't know what is the matter with that dog unless it has invented a new disease that might be called radiophobia. The dog—his name is Caesar—is a large yellowish dog with sad eyes and burrs in his tail, and I think the trouble with him is that his liver over-amplifies and gives forth too much of the static he seems to be full of. As soon as Binks or any of Binks' family goes to the radio machine, Caesar gets as close as possible in front of it, or behind it, or under it, if he happens to be in the cellar, and raises his head and rolls his eyes and opens his mouth and utters a loud long tremulous wail that is like the wail a soul in torture would utter if it was an especially loud utterer and in especially painful torture.

Caesar's wail begins with a sad but gentle wail, increasing and becoming sadder and

LEARN THE CODE AT HOME

"Just Listen—The Omnigraph will do the teaching"

with the

OMNIGRAPH

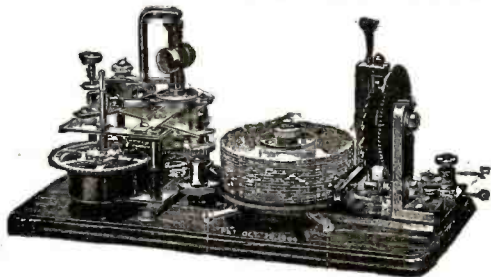

THE OMNIGRAPH Automatic Transmitter will teach you both the Wireless and Morse Codes—right in your own home—quickly, easily and inexpensively. Connected with Buzzer, Buzzer and Phone or to Sounder, it will send you unlimited messages, at any speed, from 5 to 50 words a minute.

THE OMNIGRAPH is not an experiment. For more than 15 years, it has been sold all over the world with a money back guarantee. The OMNIGRAPH is used by several Depts. of the U.S. Govt.

—in fact, the Dept. of Commerce uses the OMNIGRAPH to test all applicants applying for a Radio license. The OMNIGRAPH has been successfully adopted by the leading Universities, Colleges and Radio Schools.

Send for FREE Catalog describing three models, \$14 to \$30. DO IT TODAY.

The Omnigraph Mfg. Co., 20 Hudson St., New York City

If you own a Radio Phone set and don't know the code—you are missing most of the fun



One of these panels fits your set

YESTERDAY you would have had to wait while the size was cut from sheet stock.

Today you can get the panel you need immediately. Celoron Radio Panels come in standard sizes, one of which will be right for any set you may build.

The days of waiting for your panel to be cut are gone. Each Celoron panel is already cut and wrapped ready for you to take home and begin working at once. Full instructions for working and finishing are on the glassine paper around every panel.

The sizes have been selected only after careful study of present day needs of set-builders. Your dealer should be able to supply you with any of the following sizes:

- | | |
|---------------------------|----------------------------|
| 1.—6 x 7 x $\frac{1}{8}$ | 4.—7 x 18 x $\frac{3}{8}$ |
| 2.—7 x 9 x $\frac{1}{8}$ | 5.—9 x 14 x $\frac{3}{8}$ |
| 3.—7 x 12 x $\frac{1}{8}$ | 6.—7 x 21 x $\frac{3}{8}$ |
| | 7.—12 x 14 x $\frac{3}{8}$ |

Also comes in sheets and can be cut in special sizes when desired.

Condensite Celoron, the material used for these panels, has high insulating qualities, high dielectric strength, and low dielectric losses. It is a laminated phenolic condensation product used by many of the leading manufacturers of radio equipment. It is easily machined and can be sawed, drilled, turned, or milled.

Send for free booklet

We have prepared an attractive booklet, "Tuning in on a New World," which tells more about Celoron and gives lists of leading broadcasting stations in the United States and Canada, symbols used in reading radio diagrams, and several highly efficient radio hook-ups. This booklet will be of use to every radio fan and will be sent to you free of charge upon your request. Write today.

Diamond State Fibre Company

BRIDGEPORT (near Philadelphia) PENNSYLVANIA

BRANCH FACTORIES AND WAREHOUSES
BOSTON CHICAGO SAN FRANCISCO

Offices in Principal Cities

In Canada: Diamond State Fibre Company of Canada, Limited, 245 Carlaw Avenue, Toronto

To radio dealers: Celoron Radio Panels cut in standard sizes offer an exceptional opportunity for quick sales and substantial profit. Write for special dealer price list showing standard assortments.

CONDENSITE CELORON STANDARD RADIO PANEL

sadder until it shakes the house and makes the dishes rattle in the house next door. Then Caesar pauses for breath and begins again and tries to beat all records for sadness and blood-curdlingness and loudness—and does it. Then he pauses for breath again and does it again, louder than before. People who hear Caesar wail to the radio a couple of times want to rush out and commit suicide before they have to hear him wail again.

And it does not seem to make any difference what comes out of the radio horn; one thing is as good as another to Caesar. A high class soprano solo and a wad of static and a lecture on baked beans are all the same to Caesar. A link of fat code that sounds like sausages frying and a few remarks by a Boy Scout person are both equally disagreeable to Caesar. A broadcasted fox trot from Denver that yields nothing but the "thum-thum-thum" of the drum, and a thousand-dollar-a night baritone from Newark give him equal pains in his howler. No matter what is turned on, the etheric waves seem to penetrate to Caesar's secret inwards and make him let loose all the agony of soul that has been accumulated by all his ancestors since the time of Adam and Eve. I told Binks quite frankly that if I had a dog like that I would shoot him. But Binks is fond of the dog.

On this particular night, Binks came over to my house and dear old grandma was sitting in front of my loudspeaker saying: "It ain't no use, Ellis; it ain't no use—it don't sound to me like nothin' but a dog yowling."

I saw a look of fiendish triumph come over Binks' face; the look of a man who thinks he has a better radio set than yours.

"I don't wonder," he said. "That set of yours never did sound like anything but a dog yowling. Miserable loud-speaker you've got. Now mine—"

He turned to grandma and shouted at the top of his voice.

"Grandma," he shouted, "you ought to come over and hear my radio. I've got a good radio. Not like this. I say NOT LIKE THIS. I say, come over and hear mine."

"I'd be pleased to," grandma said, "this one never sounds to me like anything but a dog yowling."

So there she went, after all the trouble I had taken for weeks and weeks to make her enjoy my radio, trotting over to Binks' house.

He took her in the living room and set a chair for her and eased her into it, and she folded her hands across her stomach and closed her eyes and leaned back in the chair. Binks picked up a newspaper and looked at the broadcast programs, and that dog of his—that miserable anti-radio hound, Caesar—got up and walked over to the loud-speaker and put his tail between his legs and raised his nose and got ready to pour forth his agony in sound. Then Binks went over to grandma and shouted to her.

"I'm going to get WKX first, grandma," he shouted. "WKX. I say I'm going to get WKX first. Singing! I say it will be singing! It's Ethel Bethel Butts singing, grandma. It's Ethel Bethel Butts, the great soprano, singing. From WKX."

"Yes, yes! I hear you," grandma said. "Ethel Bethel Butts, the soprano singing."

So Binks walked to his radio and turned the knobs. It was a bad night—a static night—and nothing came out but spits and fizzes. But that was enough for Caesar. He sat down on his haunches and elevated his nose and yowled ten times louder than a steam siren and forty times as sadly. And in an instant two big tear drops welled into grandma's eyes and trickled down her dear old cheeks and she gave a great sigh of satisfaction and said:

"My, my! I hear her perfectly; ain't she got a lovely 'sweet sad voice?'"

(2204C)

Audiola adopts the Bradleystat

Another Radio Manufacturer discards the wire rheostat!

Why? Read this letter—

January 2, 1923.

Allen-Bradley Co., Milwaukee, Wis.

Gentlemen:

Regarding the Bradleystat in the Audiola Receiving Set, we wish to advise that while your rheostat is more expensive than the wire-wound type, we would not go back to the wire rheostat and have standardized on the Bradleystat.

The Bradleystat is noiseless, permits more accurate tuning and increases the loudness of signals and the range of our set. Since incorporating the Bradleystat, we have received many letters from dealers and users stating that they are receiving stations 700 to 1,100 miles distant with our single tube detector set.

Yours very truly,

AUDIOLA RADIO COMPANY.

A. E. Anderson
Sales Manager.

For bulletins, write to
Allen-Bradley Co.
Electric Controlling Apparatus
287 Greenfield Avenue
Milwaukee, Wis.



Retail Price
\$1.85
Parcel Post 10c Extra



Bradleystat

REGISTERED U. S. PAT. OFF.
PERFECT FILAMENT CONTROL

The Most Wonderful Radio Loud Speaker in the World

A New Principle—A New Adjustable Unit
That Revolutionizes Radio Reception
DICTOGRAND



\$28⁵⁰

Overcomes the defects common to all other radio loud speakers—the harsh jarring sounds, the noises and overtones. It creates the illusion that the artists are in the very room with the listeners. The new wonderfully effective mechanical arrangement for adjusting the air gap of the DICTOGRAND LOUD SPEAKER regulates the magnetic flux as simply as the flow of water is controlled through a faucet.

This new Adjustable Air Gap consists of a measured dial mounted in front of the cabinet, by means of which the distance between the magnetic poles and the diaphragm may be increased or decreased, thus varying the pull of the magnet on the diaphragm and permitting tuning up in complete harmony under all varying conditions of reception.

For use on any vacuum tube receiving set, giving maximum results when two stages of amplification are used. Requires no extra batteries. You simply plug in—and listen.

The DICTOGRAND RADIO LOUD SPEAKER, like all Dictograph products, is guaranteed for a period of one year against all electrical or mechanical defects.

Ask your dealer to demonstrate it.
(The unusual demand upon our facilities has not enabled us to complete our distribution. If your dealer has not yet received his stock of DICTOGRAND Radio Loud Speakers, send to us direct.)

DICTOGRAPH PRODUCTS CORPORATION

220 WEST 42ND STREET, NEW YORK CITY
Branches in All Principal Cities

The Saturation Point

(Continued from page 1941)

amateur ambition that makes a man neglect his business. He had plans for the future that included a two-stage amplifier and a loud speaker. In short, he was typical of a class of men ten times more numerous than all the radio sets manufactured in the world to date, a class in which the saturation point will not be reached until every one of them has a radio outfit. I have found similar men in Vermont, New Hampshire, Massachusetts, Rhode Island, Connecticut, New York, Pennsylvania, New Jersey, Delaware, Maryland, District of Columbia, Virginia, West Virginia, Ohio, Kentucky, Illinois, Iowa, Nebraska, Colorado. Also in Scotland, England, Belgium, France, Switzerland, Germany and Holland, but the average European is even more cautious about spending money than the most conservative American, and governmental restrictions affect the European market.

SOME NEGLECTED OPPORTUNITIES

When anyone mentions the saturation point of radio I think of a New England trust company president, some Long Island millionaires, a score or more of well-to-do families in my old home town in Pennsylvania, an insurance man and his family who were present with me at the Kissimmee demonstration, a mine manager and a hundred other well paid officials in West Virginia, the owner of the \$300,000 Luray Caverns, and a hundred other men who are able to buy what they want. They are all interested in radio, all above the average in mentality and education, all influential among wide circles of friends and acquaintances, yet none of them has a radio outfit. One of the Luray guides built himself a set, but his interests are strongly in the direction of electrical work, whereas the proprietor is of the managerial type.

To illustrate some possibilities of one neglected opportunity: Luray Caverns are visited by as many as 8,000 persons in a day. Endless Caverns, Shenandoah Caverns, Weyer's Cave, all in the same valley, attract thousands also. On busy days some excursionists have to wait quite a while for their chance to go through the caves. Expectantly looking for new thrills, they are ripe for radio. What an opportunity to tie up some profitable customers, give radio continuous and novel publicity, and connect up the fascinating new science with these natural wonders that, having once, in all probability, been the homes of prehistoric men, women and children, will always interest other human beings.

"Welcome, strangers. I am the King of the Troglodytes. I will tell you the story of the caves of the Shenandoah Valley."

Can you imagine the weird, never-to-be-gotten sensation that could be produced in an audience in the silence of a cavern, surrounded by the mysterious beauties of the hanging stalactites, the flowing, stony draperies and the unlifted stalagmites, by a voice from the air? The last awed whispers silenced by a reverberating chime from a stalactite organ, a concealed radio loud speaker could tell the story of the caves to underground groups from Staunton to New Market. One transmitter with a fifty-mile radius could serve them all. Daytime interference in The Valley is negligible.

There are a thousand equally good opportunities to introduce radio that must be grasped before the saturation point on that one line of effort comes as near as Mars.

IF OTHER THINGS WERE ADVERTISED LIKE RADIO

If by saturation point the foreseer of the radio limit means the point at which the

PERFECT ELECTRIC CONTROL RESIST-O-METER

TRADE MARK

Go to your Radio Dealer today and buy this super-rheostat. It is being acclaimed a wonder by all users. The Instrument shown here is Type A-Filament, price \$1.80.

If your dealer is sold out write to us direct.

Write to Mr. H. L. De Muth

The Scholes Radio & Mfg. Corporation

32-36 W. 18th St., N. Y. C.



With adjustable brackets for mounting

(Actual Size)

Parts and Accessories for makers of radio apparatus

GERACO

Details and Prices on request
GENERAL RADIO CORPORATION
Sole U.S. Distributors of
First Quality Radio Equipment
including **MUSIC MASTER RADIO AMPLIFIER**
624-628 Market St. Philadelphia

KLOSNER RADIO PRODUCTS

Send for free literature.

KLOSNER IMPROVED APPARATUS CO.
2024 BOSTON ROAD NEW YORK CITY

3 Letters! and they will be interesting to every radio user.

HUDSON MOTOR CAR COMPANY OF N.Y.
INCORPORATED
DISTRIBUTORS OF
HUDSON AND ESSEX MOTOR CARS
 1402 BEDFORD AVE.
 BROOKLYN

November 23rd, 1922.

Acme Apparatus Company,
 Cambridge, Mass.

Dear Sir:-

It will possibly be of interest to you to know that with the aid of your Radio Frequency Transformers B2, B3 and B4, I have built an ideal set. This set brings in WFL, Havana, as clear as a bell any time that I care to hear him. I have also reached other stations that I never knew existed. Last night I hooked up 3 Transformers in place of yours, and with the stations that I received there was enough howls and yells to make one think that all Hell was let loose at once, so put the old Acme's back and the loud speaker started to give out some real music. This set has given such satisfaction that I simply couldn't refrain from writing you to let you know that you have satisfied at least one Radio Bug. However, I might add that I am using a loop antenna and my tuner consists of only 2 Variable condensers, one 43 plate and one 3 plate hooked right across the loop outside.

Please do not think that this is the first set I have ever seen and that my enthusiasm is running away with me, I have owned 2 step cut 2 and have also built numerous other sets, but this Acme Radio Frequency Transformer sure has the world licked.

Very truly yours,
 Hudson Motor Car Company of N. Y., Inc.

John M. Craig
 Service Manager

ACME APPARATUS COMPANY
TRANSFORMER AND RADIO ENGINEERS AND MANUFACTURERS
 186 MASSACHUSETTS AVENUE
 CAMBRIDGE 39, MASS., U.S.A.

December 7th, 1922.

Mr. John M. Craig,
 610 St. Marks Avenue,
 Brooklyn, N. Y.

Dear Sir:-

We wish to thank you for your letter of November 23rd and would like to know if you would be willing to allow us to use this as a testimonial either with or without putting a radio frequency amplifying transformer on the market and it is exceedingly gratifying to receive such letters as yours as a reward for this endeavor.

We worked for practically nine months before putting a radio frequency amplifying transformer on the market and it is exceedingly gratifying to receive such letters as yours as a reward for this endeavor.

Yours very truly,
 ACME APPARATUS COMPANY

John M. Bertram
 For Chief Engineer.

HUDSON MOTOR CAR COMPANY OF N.Y.
INCORPORATED
DISTRIBUTORS OF
HUDSON AND ESSEX MOTOR CARS
 1402 BEDFORD AVE.
 BROOKLYN

December 6th, 1922.

Mr. G. E. M. Bertram,
 186 Massachusetts Ave.,
 Cambridge, Mass.

Dear Sir:-

Your letter of the 7th instant came to hand this morning and in reply would say that you are at liberty to use my letter of November 23rd, in any way you desire, with or without my name. I might add that I know of four sets copied from mine that are giving results equal to mine.

On Wednesday evening I had a transmission engineer from the New York Telephone Company out to my home and believe me having ever seen my set, in twenty minutes he tuned in WFL, WJAP, WJZ and several near stations. What pleased him especially was that he could tune in the 200 meter stations as well as the 400 meter boys.

Very truly yours,
 Hudson Motor Car Company of N. Y., Inc.

J.M.C.
 610 St. Marks Avenue,
 Brooklyn, N. Y.

John M. Craig
 Service Manager.

You can purchase Acme Radio and Audio Frequency Amplifying Transformers at practically all radio, electrical and hardware stores. If, for some reason your nearest dealer does not carry them, we shall be glad to see that you are taken care of promptly. Bulletins and leaflets describing hook-ups for various Acme Transformers will gladly be sent on request.

THE ACME APPARATUS COMPANY
 (Pioneer transformer and radio engineers and manufacturers.)
 CAMBRIDGE, MASS., U. S. A.

New York, 1270 Broadway
 Chicago, 184 W. Washington Street

ACME ~ for amplification

WHY METRO HEADPHONES ARE SUPERIOR



MAGNETS

Permanently Sensitive

METRO Headphones will always respond as distinctly to the slightest impulses as they did the day you purchased them. The magnets upon which their sensitivity depends, are made of highest quality tungsten steel, put through a special heat treatment, magnetized and then carefully "aged" to a uniform magnetic strength. These magnets will not weaken or lose their magnetism. If you want lasting sensitivity, you should insist on Metro Headphones.

Price \$6.00

Little Giant Set
A surprisingly compact set. Cabinet, highly polished American Walnut finish. Simplest, easiest tuning device. Complete with Metro Headphones... **\$14.00**

Metro Wave Selector
Makes any set highly selective. Completely separates 360 from 400 meters. Adds only one control without changing set. Cabinet, highly polished American Walnut finish... **\$7.50**

Metro Electrical Co., Inc.
Manufacturers of
Metropolitan Radio Products
70 Goble St., Newark, N. J.

public will stop buying \$300 outfits in order to hear: "The next number on the program of Wow Wum Wuzzle will be—" it may be time right now to get out the mop. Most persons who have brains enough to earn the price of a good radio set have too many to waste their time on logging call letters. But why hover around a bubble fountain with a clogged drain and let a Niagara of business go undeveloped? The people who would use radio are the big market, not the people who play with it.

The dealer who advertises a radio set as he would a Pigs-in-Clover puzzle (and some are doing that) is merely setting the skids for a quick slide to oblivion. If other manufacturers and merchandisers should follow the lead of some who advertise radio we would read ads like this:

"Miss Neatcalf puts on and takes off 27 pairs of Holeproof silk hose in fifteen minutes!"

"Wear Sorosis Shoes—they have fifty-nine stitches to hold the sole to the welt."

"Nehemiah Nearsight read all the way through to the back page of RADIO NEWS, last issue."

"Make yourself a suit of Stein-Block clothes—we furnish the cloth."

"Buy a seat in the last row for the opera and let us know if you hear the performance."

Such ads might appeal to certain classes of buyers, as similar radio ads do, but the saturation points on such lines come as quickly as those that follow a fall into a puddle.

20,000,000 AUTOS—HOW MANY RADIO OUTFITS

The economic experts have been busy lately prospecting for the saturation point in the automobile industry. With 10,000,000 cars registered in the United States, several big men in the business began to get cold feet. Among them, according to reports, was Edsel Ford, whose concern makes about 49 per cent of the yearly total of gas buggies. They believed not only that the absorption of cars was reaching the limit but that the expense of operation was going to squeeze out of the hands of the present owners many autos that had already been sold.

The problem was put up to a number of college professors who, if the appeals for funds to raise their salaries are well founded, are not able to own cars, but who know more about the public's ability to buy than the purchasers do themselves. They figured, from accurate data, that an American with an income of \$1600 a year can own and operate a flivver. In fact 1,364,000 such persons do. Extravagance? None at all. Among the less wealthy car owners, and particularly among the rural car owners, the cars are not merely a means of amusement. On the contrary they are paying for themselves, paying for their upkeep, and paying a profit, because of the practical uses to which they are applied.

The trend of prices seems to indicate that before long, persons with annual incomes of \$1500 will be able to own cars. Any considerable lowering of prices opens markets broader than have been reached before. The consensus of opinion among the experts is that even if the growth of our population should stop where it is, the saturation point for automobiles would not be reached until the number in use was doubled, making a total of 20,000,000. By the time that number of cars are in use, the population will have increased and the market broadened. The saturation point, say the experts, is not a point at all, but only a ratio. The auto maker should worry, let Einstein figure it.

The lesson is obvious: the saturation point of radio depends only upon the uses to which we adapt it. Most regular listeners

BRACH

VACUUM RADIO PROTECTOR

Ask Your Insurance Agent



Approved
by National Board
Fire Underwriters

The Choice of the Foremost Engineers for over 17 years.

SOLDERALL



The Only Convenient Metal Solder
Every Electrical Joint or Connection
Needs SOLDERALL for Perfect Reception

L. S. BRACH MFG. CO.
NEWARK, - - NEW JERSEY

AT JOBBERS AND DEALERS OR BY MAIL 25¢ A TUBE

PHANTOM - CIRCUIT

Build Your Own. This marvel of mystery, using no loop, no aerial and no ground brings in music instead of interference. We have heard stations 950 miles distant on one tube. By using WD-11 tube set can be entirely self contained. Very easy to build from our instructions, use your own spare parts, nothing complicated like radio frequency or super regenerative. Only one tuning control. Complete instructions, with hookup and photo of circuit mailed to you for 60 cents. Stamps accepted. Vesco Radio Shop Box RN-704 Vacaville, Calif.

UNIVERSAL

RADIO

199 So. Fair Oaks Ave.
PASADENA CALIFORNIA



How much do you expect your battery to do?

TURNING the dials with a battery that is a constant offender is not much fun. You cannot thoroughly enjoy radio broadcastings unless your battery is up to the job.

Exide Radio Batteries are conservatively rated and give full ampere-hour capacity. They maintain steady voltage and deliver uniform filament current to the tubes. From plates to connector terminals each detail is the result of experience gained in every field of battery service by the oldest and largest makers of storage batteries in the world.



Exide Batteries play a leading role in the industrial world. They propel trucks, mine locomotives, and submerged submarines; they operate the fire alarm system and send your voice over the telephone. Most of the government and commercial wireless stations are equipped with Exide Batteries.

Your radio dealer will show you an Exide Radio Battery, or you can get one at any Exide Service Station.

Exide

BATTERIES

THE ELECTRIC STORAGE BATTERY CO.
Philadelphia, Pa.

Service Stations Everywhere
Branches in Seventeen Cities

FRESHMAN PRODUCTS—ACCURATE AND DEPENDABLE



“MICON”

Tested Mica CONDENSERS

Assure absolute noiselessness—clarity of tone—accuracy—constant fixed capacity.



Antenella

No antenna or aerial needed. Eliminates all the inconveniences in radio; operates from any light socket. Price only..... **\$2.00**

Variable Resistance Leak

With .00025 mfd. Micon Condenser **\$1.00** Without Condenser **75c**

Unbroken range—Zero to 5 Megohms. Clarifies signals, lowers filament current, increases battery life, eliminates hissing.



Size	Price	Size	Price
.00025	\$.035	.0025	\$.050
.0005	.35	.005	.75
.001	.40	.006	1.00
.002	.40	.01	1.50

.006 MICONS and Variable Resistance Leaks especially adapted for New Flewelling Super Circuit.

At your dealers—otherwise send purchase price and you will be supplied without further charge.

Chas. Freshman Company, Inc.
106 Seventh Avenue, New York

Pacific Coast Branch,
329 Union League Bldg.,
Los Angeles.



The Superlative Inductance

Four years of careful attention to the details of manufacture of this type of inductance unit has yielded a product of unquestioned superiority. And with increased efficiency in manufacturing methods, moderate prices prevail for all sizes

Ask Your Dealer

Cotoco

"Built First to Last"

COTO-COIL CO. PROVIDENCE

LETTER THAT RADIO SET!

Engrave your Radio Set with ELCO TRANSFERS. Make the most amateurish set look like a professional job. Come in card of 35 different words and characters; everything necessary for the most complete receiving set. Letter panel in Five Minutes. Elco transfers come in gold with black letter; enhance appearance of your set 100%. Are indestructible.

Price per Card, with Directions (in coin) **35c**

If your Dealer cannot supply you, send us 35c with his name and address. DEALERS AND MANUFACTURERS Write for samples and discounts.

ELCO RADIO CO. 937 LIBERTY AVENUE
PITTSBURGH, PA.



quickly reach their saturation point for phonograph records and player piano rolls, though there are ways of putting these across that the bored announcers have not yet thought of. Still trying to get his money's worth, the jaded listener-in tries radio golf or some other means of prostituting a noble scientific achievement. Unless he has a Pigs-in-Clover brain he gets over that in about the length of time required for a run of measles. What then? In many cases the answer has been: Nothing. The saturation point of the radio promoter's brain was reached, in reference to these cases, when he developed a device potentially as useful as language, and then classified it with the hobby horse, the playing card, and the swagger stick. Why not begin now to promote radio as a household necessity, like running water or electric lights?

It is a common thing to find homes in which there are first class radio outfits that have not been used for weeks. So firmly has the idea that radio is an amusement been established, that the owners let their high-priced outfits stand like novels that have been read and relegated to the bookcase to gather dust. In the same homes are bespectacled men, women and children wearing their eyes out by too constant application to the printed page. The oculist does not dare to suggest that they use their ears and rest their eyes any more than the physician dares to tell his patient that proper food, sufficient drinking water, exercise, rest, baths and fresh air are all that are needed to restore most folks to health who have not hopelessly abused their bodies. But the spread of proper information about radio, plus the development of broadcasting programs so that they will give even better stuff than newspapers and magazines do, may in time change the popular attitude.

"Why don't you rest your eyes and get it by radio?" can be made as common a remark as "Why don't you take aspirin?" and it will certainly be more helpful.

ONLY 1 AMERICAN FAMILY IN 11 HAS TRIED RADIO

The highest estimate of the number of radio sets in use in America that has been commonly quoted is 2,000,000. That is one set to every fifty-five persons, or one to every eleven families. The estimate is certainly too high or else three-quarters of the sets are cleverly concealed. Not in any city block, county seat, rural village or farming district have I discovered any such proportion of the population supplied with radio outfits. But even if the estimate is correct, it shows only one-fifth as many radio sets as automobiles in use. The saturation point, assuming that the lower prices of radio outfits will enable persons with incomes of \$1500 a year to own them, will not be reached until there are ten times more in use than there are today.

There are several reasons why the saturation point for radio should be much higher than a similar point in the motor vehicle business. Children do not own and operate cars, if they are blessed with sane parents, but a child of six enjoys a simple radio receiver. The whole family generally rides in one car, for the expense is too great to permit each person in the average household to have an individual car, but the desire of each to enjoy himself in his own way is still there and in the case of radio it can often be gratified without prohibitive expenditure. Line radio opens the possibility of giving each member of the family simultaneously a program suited to his tastes, via the light or telephone wires. Listening all at the same time, to their separate programs, they will be as independent, while as sociably grouped around the hearthstone,

RADIO SUPPLIES—LOWEST PRICES

WE SELL STANDARD RADIO AND ELECTRICAL MERCHANDISE AT ROCK-BOTTOM PRICES. OUR CATALOG GIVES A FULL LINE OF RADIO PARTS, COMPLETE RECEIVING SETS—ELECTRICAL GOODS AT GREATLY REDUCED PRICES.

OUR GUARANTEE: All merchandise offered is standard and guaranteed perfect in material and workmanship. If any goods are found defective they will be exchanged or money promptly refunded.

**Our Prices
Speak Louder
Than Words**

Order Direct From This List

- Magnet Wire 20 per cent. off list.
- RHEOSTATS:
 - \$1.00 Rheostat \$.32
 - Homecharger De Luxe 13.25
 - Johns-Manville Blk. Com. Tubes, 3-in.25
- DETECTORS:
 - \$.75 Crystal Detector35
 - \$.40 K. D. Crystal Detector16
 - \$1.50 Multi Jack15
 - \$1.50 Twin Adapter15
 - \$1.25 Universal Plug75
- BATTERY CHARGERS:
 - \$18.00 Westinghouse Battery Chargers \$4.40
 - \$19.50 Westinghouse Battery Chargers for A. & B. Batteries 15.60
 - 70c Open Circuit Jack30
 - 85c Double Circuit35
 - 75c Battery Hydrometer35
- KNIFE SWITCHES:
 - Knife Switch S. P. S. T.14
 - Knife Switch S. P. D. T.22
 - Knife Switch D. P. D. T.35
 - Wooden Horn50
 - Contact Points08
 - \$5.00 Standard Metal Horn 4.00
 - \$7.50 Standard Metal Horn 6.50
 - \$20.00 WESSCO Battery Charger, highest quality guaranteed. Large size. 1.45
 - \$1.75 B Battery, 22½ V. Variable, highest quality guaranteed. Small size.75
 - \$7.00 Westinghouse Storage B Battery 5.30
 - \$1.00 W. D. 11 A Battery50
- CONDENSERS:
 - \$5.00 WESSCO 23-pl. Variable Condenser 1.85
 - \$5.50 WESSCO 43-pl. Variable Condenser 2.10
 - 8-plate Vernier Variable Condenser70
 - 50c Mica Condensers25
 - Thordarson Grid Condenser10
 - Bronze Bus Bar, tinned, ft.02
- PANELS:
 - Guaranteed Genuine Bakelite Panels—7x10, \$1.25; 7x18, \$1.85; 9x10, \$1.00; 5x5, 47c; 5x9, 95c; 6x12, \$1.25; 7x12, \$1.50; 7x9, \$1.15; 12x14, \$3.00; 7x24 3.00
 - \$1.50 Microstats85
 - Spaghetti, per length07½
- SPECIAL ELECTRIC SOLDERING IRON, TWO HEAT. 4.95
- 20c Bezel15
- PHONES:
 - \$10.00 WESSCO Phones 4.95
 - \$5.00 Murdock Phones 3.55
 - \$1.00 Freshman Variable Grid Leak65
- WIRE:
 - 100 ft. coil No. 14, 7-strand pure copper Aerial Wire55
- SOCKETS:
 - \$1.00 Genuine Bakelite Socket45
 - \$1.00 Sockets35
- DIALS:
 - \$1.00 Genuine Bakelite Dials—3-in. 45c; 4-in.55
- VARIOCOUPLES:
 - \$7.00 Guaranteed Genuine Bakelite Pioneer Variocoupler, silk wound 4.75
 - \$4.25 Variocoupler, guaranteed high quality 2.25
 - \$8.00 Moulded Variocoupler, highest quality 4.50
 - \$5.00 Shamrock Variocoupler 2.59
- TRANSFORMERS:
 - \$5.00 Acme Transformer 3.40
 - \$3.00 Radio Frequency Transformers 1.50
 - \$6.50 Wessco Audio Transformers, highest quality guaranteed. 3.25
 - Thordarson Transformer 2.75
- VARIOMETERS:
 - \$6.50 Pioneer Variometer, genuine Bakelite, silk wound 4.50
 - \$6.50 Wessco Variometer, highest quality guaranteed 3.25
 - \$4.50 Variometer, guaranteed high quality 2.40
 - \$6.50 Moulded Variometer, highest quality 3.50
- BATTERIES:
 - \$24.00 A Battery, 100 amp., 6 V. 16.75
 - \$19.00 A Battery, 80 amp., 6 V. 11.45
 - \$14.50 A Battery, 60 amp., 6 V. 8.75





\$5 Wessco 23 Plate Variable Condenser.
Special \$1.85



\$5.50 Wessco 43 Plate Variable Condenser.
Special \$2.10



\$20
Wessco Battery Charger
De Luxe
\$12.95
Special Introductory Price



\$10 Wessco Phones.
Special \$4.95
Guaranteed to be superior to any phones on the market at \$10.



\$6.50 Wessco Audio Amplifying Transformer. High Ratio.
Special \$3.25

Better Than The Best
AERIAL-A
The Radio Tube Set  Made Good in a Night
W.E. Supply & Service Corp. 18 Murray St. N.Y. U.S.A.

Price Complete

Ready To Use

\$35

Complete including Batteries, Tube, Phones, Aerial, etc.

This is the most outstanding value ever offered in a highly efficient Vacuum Tube Receiving Set.

We guarantee the Aerial A to be perfect in all details. Can be set up in less than an hour. This set is guaranteed to receive 250 miles in summer and 500 miles in winter. The price \$35.00 includes: Receiving Set; "A" Battery; "B" Battery; Vacuum Tube; Phones; Aerial; Insulators, etc. No extras to buy. Write for our descriptive bulletin.

The Wessco Policy

Every WESSCO product is guaranteed and is backed by the principles of Highest Quality; volume production and small profit which combine to give you greatest value and complete satisfaction.

Terms: Orders must include postage. Money order, bank draft or check acceptable. All merchandise offered is standard and guaranteed on a money back basis against defective workmanship.

Manufacturers, Jobbers and Importers of Radio Supplies and Household Electrical Goods.

W.E. Supply & Service Corp

18 Murray St., Dept. RN New York

Ask for new Illustrated Catalog

The New Tool You Are Looking For

**The Simore Lightning-Change
Magazine Screw Driver**

3 Blades—Change them in 2 seconds

RADIO FANS

Ever wish for a different size screw driver while working with your installations or adjustments without having to stop and hunt for it? Here it is. Three blades in the handle—gravity produces the blade you want—just the easiest, quickest thing you ever saw. Tip the handle—the selected blade slides out—turn the knurled cap at the base of the blade one quarter way and the blade is locked for use. Turn the cap again and that blade springs back into the magazine and you instantly get the other blades you may need.

You need this in your Radio equipment.

You'll say it's the handiest thing you ever saw. For the man or woman around the house it's just right. Mechanics, carpenters and cabinet makers won't be without it, once they see it. It is a brand new tool, the strongest of its size and kind. Send for one today. Each tool guaranteed.



\$ 1 80

Prepaid
Parcel Post

Dealers and others are invited to write for our proposition.



1 2 3

There are three steel blades, each carefully ground to fit the screw slots.



Simon & Skidmore Mfg. Co.

110 E. 6th St., Santa Ana, Calif.

Makers of the Simore Automatic Universal Square

as though they were reading. Many difficulties that are inevitable when ordinary types of antennae are used may be eliminated.

TELEGRAPHERS A GOOD MARKET

The low saturation point of the air, which, so far as the 200-, 360-, and 400-meter wavelengths are concerned, has been reached already, keeps down the saturation point in the sale of receiving apparatus. On the other hand, there is no reason why sales of medium- and long-wave receivers should not be multiplied. There are enough telegraph operators and ex-operators in the United States, interested in learning to handle radio traffic but not yet brought to the point of action, to keep several factories working overtime. I met three in Kissimmee and if the ratio is the same throughout the country, there are at least 100,000 in the United States. The high-power, long-wave stations are the ones they would want to tune in for first.

SCHOOLS SHOULD BE INTERESTED

The promotion of code classes in public schools would open the way to thousands of sales that today are not even thought of. Youngsters are so interested in codes that they invent all sorts of weird systems of secret writing. A teacher would not need to know Morse code herself. By the mere suggestion of a Morse class she could arouse interest, and the pupils who received permission to organize a class and study by themselves would feel highly favored. Sending and receiving the spelling, geography, history and language lessons with buzzer outfits would fix them more firmly in the mind than ordinary classroom methods. Morse plus a typewriter would start many a pupil on the way to earn his own living. When the class had built its own long-wave receiver to pick up the traffic that moves at easy speed from many high-power stations it would have accomplished something more practical than much of the instruction ordinarily given in the average school, and the foundation would have been laid for future radio sales on a better basis than most of them have today. Perhaps some radio business-builder has gone into the matter of promoting radio in schools, but there are thousands of schools where radio still has no part.

**CITY, TOWN AND COUNTY PLANTS
NEEDED**

The saturation point for municipal radio plants, and plants to serve townships and counties, is about as far away as when Noah installed the wireless system on his ark, consisting of two doves. Such local systems which, in rural districts, could spread essential information much more quickly and satisfactorily than it is distributed today, have been crowded out of the running by the promotion of long-distance broadcasting and reception, but some day they may come into vogue and open the way for the sales of receivers by hundreds of thousands. The time of day, the lateness of trains, the arrival of the cattle car, the time of departure of the refrigerator car, the sudden news of the pausing of a celebrity en route, these matters the rural population want to know. Even where they are well supplied with telephones there is seldom a system for sending all the news over the lines.

WOMEN THE BIGGEST MARKET OF ALL

Of all the means that could be suggested for raising the saturation point of radio, the most potent is undoubtedly the adaptation of apparatus and systems to the requirements of women. There are a few women who can and will learn to operate the types of receivers now in use, but ninety-nine per cent of women cannot and will not. It takes a generation to get the rank and file of women to use a mechanical device if it requires more application than the manipulation of a powder puff. There are women who drive cars. Many of them can be lo-



Thrills !!!

THRILLS never end when you have a Tuska Popular—the regenerative receiving set that experts recommend. Signals clear and sharp come in night after night from far-away stations. And for nearby programs, plenty of volume without distortion. Every part Tuska-made; known for 12 years as fine radio instruments.

THE C. D. TUSKA CO., Hartford, Conn.

Tuska Popular No. 225
Regenerative Receiving Set, Tuska receiver, detector and 2-stage amplifier, licensed under Armstrong U. S. Patent No. 1,113,149. Catalog No. 11-A, showing Popular and other sets, on request.



TUSKA RADIO

RADIO DEALERS

In addition to carrying the usual Radio Corporation products, we are now distributors for New York State of the well-known Paragon Radio products, famous throughout the world. Write for latest bulletin and price discounts.

20th Century Radio Corporation
565 Fifth Avenue, New York City

RADIO MAILING LISTS

12,400 Radio Dealers, covering U.S. by States	per M. \$7.50
1,614 Radio Manufacturers, covering U.S. by States	per list 15.00
1,757 Radio Supply Jobbers, covering U.S. by States	per list 15.00
260 Radio Stations	per list 4.00
257 Mfrs., who make and assemble complete Radio Sets	per list 4.00
25,000 Radio Amateurs and Managers of Radio Stations	per M. 7.50

Ask for Price list covering Canada and England. Above ready to send on receipt of remittance.

Trade Circular Addressing Co., 166 W. Adams St., Chicago

Proof!

Graphic proof of FIL-KO-STAT superiority as shown here can be had in any laboratory equipped with Bureau of Standards Instruments.

Practical proof of FIL-KO-STAT superiority is evident the moment you put FIL-KO-STATS in place of the devices you now use to regulate filament action.

Here's the Comparison of Fine Adjustment Control Range of FIL-KO-STAT with Rheostats and Other Filament Controls Clearly Indicating How FIL-KO-STAT Excels and Showing Wherein it Permits Perfect and Gradual Current Increase With Infinite Adjustments

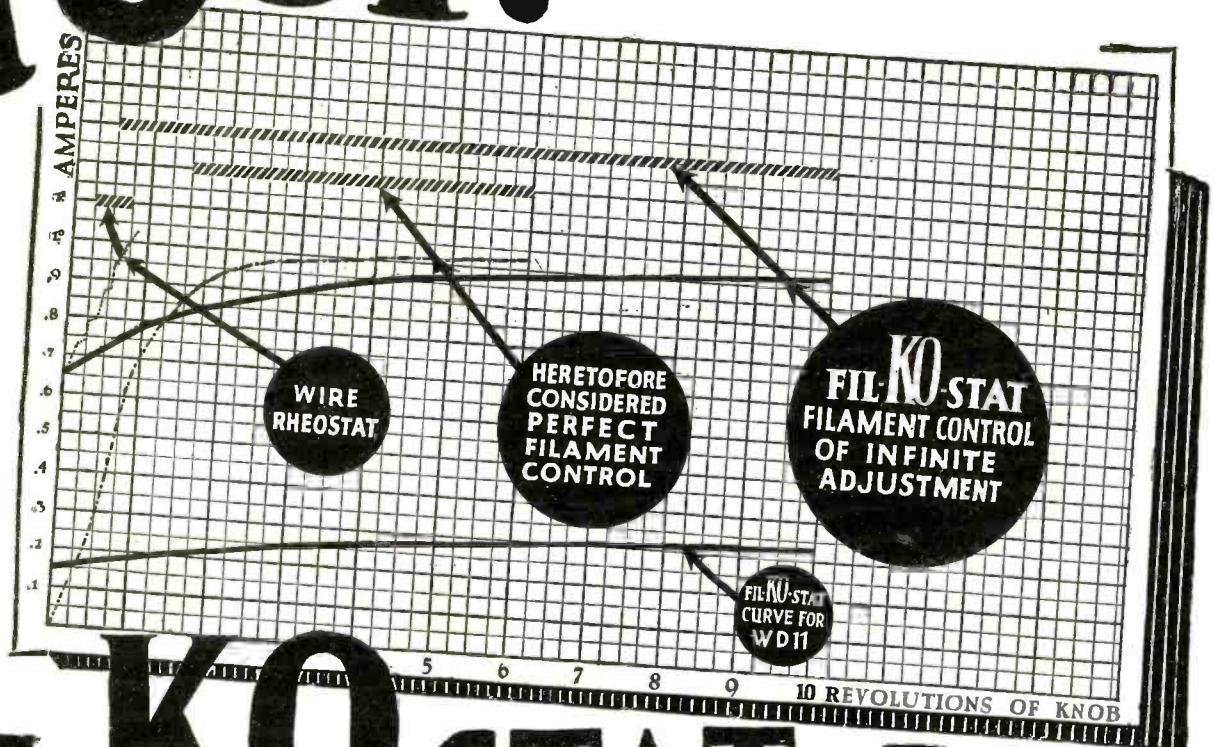

FIL-KO-STAT Best Filament Control

FIL-KO-STAT
CURRENT INCREASE PERFECT AND GRADUAL
LIKE THE RISING SUN
Trade Mark Registered

Infinitesimal Control of Electronic Flow
Definite Off indicating complete "A" Battery disconnection.
Fine Adjustment starts where tube begins to function.
At Full On Resistance practically zero.
Absolutely Silent Non-microphonic, free of all noises.
No Current Variations Resistance constant at any setting.
No Disks to Break or Chip Resistance element so finely divided further division impossible.

GUARANTEED
 The FIL-KO-STAT is to all purposes "fool proof". Each instrument is packed with the maker's guarantee that it will be replaced if broken within one year.

Manufactured by
DX INSTRUMENT CO.
 HARRISBURG, PA.

You have been eagerly waiting for just this instrument Mr. Set Builder, amateur or manufacturer. It marks a step forward in Radio. It is not an adaptation of some old method of current control. It is not a rheostat. **IT IS A FILAMENT CONTROL**, distinctly designed to utilize the great tuning possibilities of the vacuum tube itself.

Its superiority is proven by every test. It regulates the **FILAMENT HEAT**. It gives absolute control of the **ELECTRONIC FLOW** and consequently permits **THE FINEST TUNING POSSIBLE**.

Perfect and gradual increase of filament heat assures longer life to the tube. Fine adjustment of fractional currents makes it ideal for use with Dry Cell tubes.

And infinitesimal control of electronic flow gives a corresponding control of fine detection so absolutely essential in DX tuning.

The time to replace all other filament control devices with FIL-KO-STATS is now. Say "FIL-KO-STAT" to your dealer today. If he has none in stock send his name and your remittance direct to

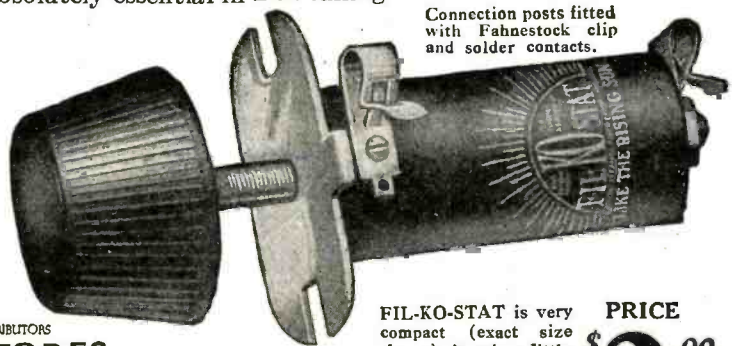

Connection posts fitted with Fahnestock clip and solder contacts.

SOLE INTERNATIONAL DISTRIBUTORS
RADIO STORES CORPORATION
 218-222 West 34th St.
 NEW YORK
 Dept. RN

FIL-KO-STAT is very compact (exact size shown) it takes little space on the panel. So mountable it can replace any other control without redrilling.

PRICE \$2.00

WIRE ORDERS FILLED TO JOBBERS AND DEALERS

DELTA

GOLD STRIPE RADIO HEADSET

Pronounced the **BEST** by all users — both in Quality and in Price.

Delta Distributors say: "It is Mechanically perfect."



Every Delta Headset is guaranteed satisfactory.

Order Today.

DELTA ELECTRIC COMPANY

470 DELTA BLOCK, **MARION INDIANA** KNOWN BY HER PRODUCTS MARION, INDIANA

Standard Makers of Radio Apparatus, Bicycle Lamps, Auto Spotlights, Lanterns, Flashlights and Flashlight Batteries

NEW YORK SAN FRANCISCO WINNIPEG

cated in a stream of traffic by listening for the loud curses of the drivers waiting for a chance to pass them. Salesmen say that the color of the paint, the little artistic touches that give a car an air of distinction, make more sales among women than all the work that goes into the essential mechanism. These are the things that women say about women and they are not a reflection upon the sex that ordinarily sticks to the activities for which it is adapted.

Women at present are but little interested in radio, as compared with men. If the man of the house installs and operates a set successfully it is a nice feature for an evening party, but after listening a few moments the party goes back to hats, clothes, weddings and gossip as usual. Broadcasting programs, if they are to sell receiving sets to the most numerous class of buyers, must get closer to the women's needs and interests. Phones must be adapted to the fashion of women's hairdressing, unless the loud speaker can do better than it has done. Direct advertising must find a place in the scheme, for women are far more anxious to know the prices of dry goods than they are to know the state of affairs in Europe.

If women can be aroused to a real interest in radio the saturation point for receiving outfits in the United States will go as high as that of beer in Germany.

The Commercial Wireless Operator

(Continued from page 1953)

received his O. K., and signed off. I turned around to the captain and handed him the bearing, bearings from Deer Island, Fourth Cliff and Gloucester. He looked at me and looked at the bearings. "I don't see anything here from Chatham," he said. I felt like hunting for a hole and crawling into it. Why had I ever come to sea? I mumbled something to him about "Sorry, my mistake," and turned around to my key to call "NXA." He told me to never mind, the bearings from "NAD" would do. He walked out, leaving me in a pretty badly downhearted condition. But having called my first coast station, and finding that it wasn't so hard, after all, my confidence returned, and I called the Radio Corporation station at Siasconset, Mass., asking him if he had anything for me (QTC?). He replied "NIL." It was easy after I knew how.

At 9:55 P. M., I hunted around on my receiver for Arlington, Va., to get the "tick" and weather. I finally picked him up, but he was so weak I was unable to copy him. This was due to the fact that my receiver was equipped with only a crystal detector, which is not much good for receiving signals from any great distance. The next morning at breakfast the officers asked for press. I told them that I was unable to get it. Nothing much was said, then, but later, when we became better acquainted, I didn't hear the end of the yell for press, until my argument with the second mate. During the entire time that I was north of Boston, I was unable to get either press or weather from Arlington. I obtained several bearings for the captain along Nova Scotia coast without difficulty.

We arrived at Sydney about three days after leaving Boston, and docked at 5 A. M. As soon as his ship docks, the operator is free to do as he pleases until the ship is ready to leave. I took advantage of this and looked the town over. There was not much to see, so returned to the ship at noon. We were

"CONQUEROR"



The Rolls-Royce of Radio Receiving Sets

Custom built, absolutely one knob control, capable of an unprecedented degree of super-sharp tuning, rendering undistorted tone, clear and voluminous. Simple to operate, built of the finest units known to the science. Most beautiful set ever seen, housed in solid mahogany piano finished cabinet. There is an unconditional bonafide one year guarantee with every "Conqueror" Set we sell. Dealers and Jobbers write right now for specifications, price, and discounts.

LEWIS & DERoy RADIO CORP.

560 SEVENTH AVE.

Designers & Builders of



NEW YORK CITY

Conqueror Radio Sets

RADIO CATALOG

Free to every one, although we would appreciate 10c in stamps to pay printing and mailing. Send us your name and address today.

ERNEST ELECTRIC CO.

4847 Easton Ave., ST. LOUIS, MO.

A QUALITY BATTERY

Always Dependable

Marko Storage Battery Company.

1402 Atlantic Ave. Brooklyn, N. Y.



BARKELEW

RADIO ACCESSORIES

Antenna Equipment

Four Phone Plugs and Posts

LIGHTNING ARRESTER
Required on the antenna of every Receiving Station.
Cat. No. 606 Price \$2.00

FOUR PHONE POST
For Vacuum Tube Sets
Connects four or less head-sets in Series.
Cat. No. 618 Price \$0.75

FOUR PHONE POST
For Crystal Sets
Connects four or less head-sets in Multiple.
Cat. No. 615 Price \$0.75

LIGHTNING ARRESTER SWITCH
For Receiving Stations
Demanded by those who want the best.
Cat. No. 602 Price \$3.50

FOUR PHONE PLUG
Connects four or less head-sets in Series to any Radio Set using telephone jacks.
Cat. No. 616 Price \$1.50

In this grouping of Radio Accessories, we present to the radio trade a variety of parts which are in keeping with the reputation of BARKELEW Products.

The Four Phone Plugs and Posts shown at the right are of unique design, compact and practical. On old sets they are easily applied by anyone. Manufacturers are installing them on new sets to meet the public demand.

FOUR PHONE PLUG
Connects four or less head-sets in Multiple to any Radio Set using telephone jacks.
Cat. No. 614 Price \$1.50

Accessories of Merit and Quality

Our Lightning Arrester Switch No. 602 is recognized by Radio Engineers as the most effective device yet developed for that purpose. All of our switches and Lightning Arresters are approved by the Underwriters' Laboratories.

Insulators and Pedestals meet the best Radio Engineering practice as well as the latest requirements of the National Electric Code.

All radio material is packed in paper boxes and labeled, making excellent shelf stock.

GROUND SWITCH
Required on all Transmitting Stations. Built of 100 Ampere copper.
Cat. No. 601 Price \$3.15

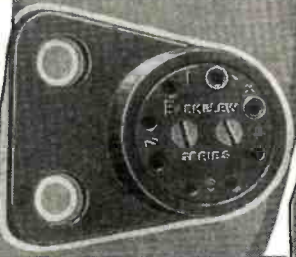

FOUR PHONE POST
Adapted for Aeriola Senior
For four or less head-sets in Series. Remove nuts and slip over phone posts.
Cat. No. 617 Price \$1.00

GROUND SWITCH
Required on all Transmitting Stations. Built of 60 Ampere copper.
Cat. No. 600 Price \$2.50

PORCELAIN PEDESTAL
Brown Glass
For spacing Switches No. 600, No. 601 and No. 602. 5" out from the wall.
Cat. No. 611 Price \$0.50 pr.

"LEAD IN" INSULATOR
For Receiving Stations
Spaces the "Lead In" Wire 5" out from the wall.
Cat. No. 612 Price \$0.50

"LEAD IN" INSULATOR
For Transmitting Stations
A large petticoat insulator on a treated wood pin.
Cat. No. 613 Price \$1.00

To Radio Distributors and Dealers

Trade discounts to Radio Distributors and Dealers who have established standing or can prove their status.

Local distribution is through Dealers where available.

To Consumers

Try your Dealer first; if he cannot furnish write our Middletown Office for name of one who will.

THE BARKELEW ELECTRIC MFG. CO.

MIDDLETOWN, OHIO

15 S. Clinton St., CHICAGO
75 Fremont St., SAN FRANCISCO
411 Main St., LOS ANGELES

603 Century Bldg., PITTSBURGH
1487 Broadway, NEW YORK CITY
Denham Bldg., DENVER

Export Department, 29 Broadway, NEW YORK CITY

"ESCO" Battery Chargers

To meet an insistent demand for
RUGGED—
RELIABLE
NEVER FAILING
MOTOR-GENERATORS.
 For charging Batteries in Wireless Operation. We have developed a complete line of **MANY SIZES.** With or without panel boards. ESCO quality thruout. You know what that means.

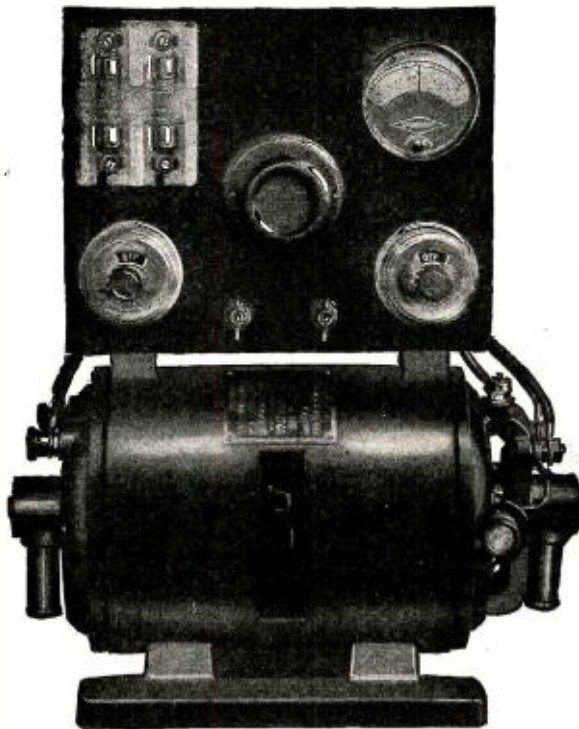

Ask for Bulletin 242

ELECTRIC SPECIALTY CO.

211 South Street

STAMFORD, CONN., U. S. A.

Pioneers in Developing Quality Wireless Apparatus

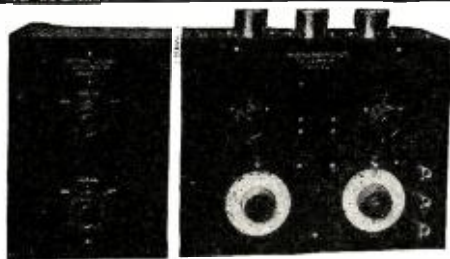

Did You Ever "Stop"
 To Think
 That Here Is Your
 Opportunity

to obtain a Radio Receiving Set that affords you a simple, flexible, compact and exceptionally efficient assembly of standard radio instruments.

Several of the important features are:

1. Tuning is accomplished by **VARIABLE CONDENSERS** mounted in the detector amplifier cabinet on the right.
2. Distortion of Signals is reduced to an absolute minimum by a permanent negative amplifier grid potential.
3. Amplification is greater than 2000 times the audibility of signals received over a crystal set.

Before you make your final decision as to a Radio Receiving Outfit we invite you to write for our descriptive bulletin G. describing the Universal Radio Receiver and Coil Unit.

HAYES & NEWTON

Machinists and Manufacturers of
 Scientific Instruments and Testing Machines

115 North Market Street,

URBANA, ILLINOIS

Hit it anywhere!

MAGNETITE
RADIO-CRYSTAL

The most sensitive Crystal Detector on the world market. Unaffected by handling or moisture and will render efficient service indefinitely. Price 50 cents at ALL DEALERS—or mailed direct. GUARANTEED by

GIBBONS-DUSTIN RADIO MFG. CO.

OWNERS AND NATIONAL DISTRIBUTORS

518 WEST 9TH STREET

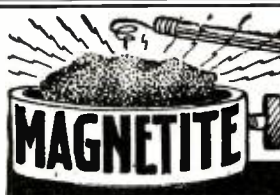

LOS ANGELES, CALIF., U. S. A.

loaded at 2:30 P. M. and steamed out of Sydney at 3 P. M. Coastwise ships do not stay long in port. The same applies to oil tankers, I have learned.

On the way back to Boston I took gravity readings of my storage batteries. I found most of them to be below 1.150, so put them on charge. I gave them 10 hours' charge, and then took new readings. A few had risen slightly, but most of them had not moved at all. I gave them more charge. In school I had been given 25 or more rules regarding care of storage batteries. Some of those rules, such as "keep cells clean and dry," "keep all naked flames away from cells," etc., may be all right, but the rules for charging did not seem to quite fit, especially the one about "take frequent voltage and gravity readings during the last few hours of charge." There did not seem to be any "last few hours of charge." So I disregarded the rules and charged, and charged, and charged, until they gassed, and gassed, and gassed some more.

After giving them about 25 hours of charging, I took readings again. One or two of the cells were up to 1.220. The rest of them ranged from 1.200 down to no reading at all. This was the best that I could do with them, so decided that the rules for charging were all "bunk." The rules do hold good for new cells, but for older cells there is no fixed rule; just charge to your own discretion. While on that ship I had no trouble with batteries, as I kept a leak charge going into them practically all of the time, and kept them up as high as possible, never letting them run down.

The old operator had left the set with five quenched gaps in circuit. Believing that that was the proper number to use, I did not change the number. I began having trouble with the insulating gaskets puncturing, and the spark jumping from one gap through the hole in the gasket to the next gap. I thought of cutting more gaps into circuit, but, although my radiation was low, my tone was fine, and I was afraid that if I cut more gaps into circuit I would blow my condensers.

The trip from Sydney back to Boston was a bad one, as far as fog was concerned. The captain kept me on the jump getting bearings. My gaps continued to blow, and when one would blow I would take that gap out and replace it with a spare, or one in the rack that I was not using. I finally used up all the spare gaps, and then had to take the used ones apart and put in spare gaskets. I used nearly all my spare gaskets, and still they continued to puncture. Fortunately, we arrived in Boston just before I used the last one. I reported at the radio company and casually mentioned that I was having trouble with my gap gaskets puncturing. They told me that I was probably not using enough gaps. When I went back to the ship I cut eight into circuit, and had no more trouble with gaps.

My next trip was to Norfolk, Va. The first night out I was still unable to copy Arlington. The following night I got him fine. Copied the weather and took it to the bridge and stuck it up on the wall where there was a nail for that purpose. Made two copies of press, one of which I gave to the captain, putting the other on the officers' mess table. I ate with the officers, and while I was there I don't believe more than two gave the press even a glance. I decided then and there that it wasn't the press that they kicked about, but because it is tradition that the wireless operator must be "kidded" about press and static and everything else in general that could be thought of. Press and static have been bug-bears for the wireless operator on

The Receiver of Tomorrow



The Symphony

Tomorrow in Radio means a wider and more useful as well as more entertaining broadcasting. Therefore, to the purchasers of receiving sets, the design, the material, the workmanship, the circuit and the assembly, all play an important part in the quality of reception, and distance heard.

The placing of a Symphony in your home is a permanent investment that will win your instant approval, and occupy a prominent place among your most cherished possessions.

The clear reception and unusual volume are the results of the high grade units, the fine workmanship, the most

efficient circuit, and the correct assembly. The improved circuit used in the Symphony combined with the accuracy of its construction, has increased the selectivity to a marked degree.

The range of the Symphony Receiver is unlimited. Recently, in Chicago, Havana, Cuba, was tuned in not only on a head set but heard plainly on a loud speaker.

The Symphony Receivers are made in two types — Three and Two stages of audio frequency amplification.

If your dealer cannot furnish information on the Symphony, write for illustrated catalog, giving us his name.

JONES RADIO COMPANY

Lytton Building, Chicago

The Symphony is manufactured under the U. S. Patent No. 1113149, Armstrong Regenerative Circuit

All parts used in the Symphony are built and guaranteed by the Kellogg Switchboard & Supply Company for twenty-five years manufacturers of complete telephone equipment

"The Watch Dog of the TUBE"

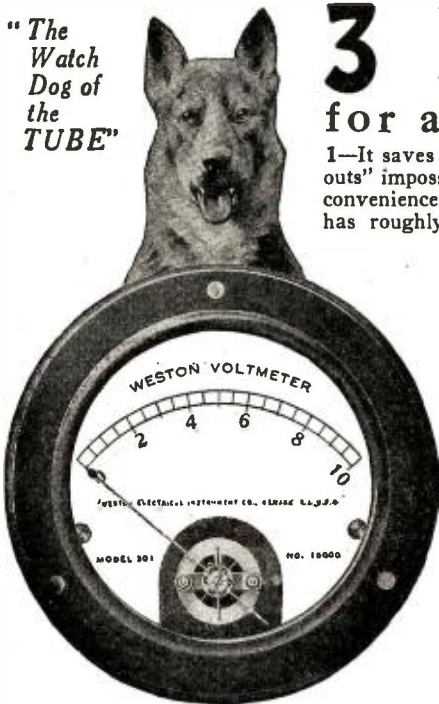

Weston Filament Voltmeter

3 Reasons for a Weston Voltmeter

- 1—It saves tubes. Properly used, it makes premature "burn-outs" impossible. A voltmeter has always been a tremendous convenience even with larger tubes where the filament light has roughly indicated the voltage. Today—with many of the smaller tubes showing none or little light—a voltmeter is absolutely imperative.
- 2—It saves current, prolonging the life of your dry cells and making it unnecessary to recharge storage batteries so often.
- 3—It improves your reception by greatly simplifying tuning and makes it possible to quickly duplicate results.

Tubes cost money—current costs money—better reception increases your pleasure. You can't afford to be without this handy, money-saving instrument another day.

Booklet J. gives you full information on Weston Voltmeters, Ammeters, Milliammeters, Thermo-Ammeters and Thermo-Galvanometers for amateur, advanced experimenter or commercial station. FREE. YOU SHOULD HAVE IT. Send for it.

Weston Electrical Instrument Co.

173 Weston Avenue Newark, N. J.

Electrical Indicating Instrument Authorities since 1888



KEEP YOUR "A" BATTERY FULLY CHARGED

This is the READ-EASY

Your Storage battery needs constant attention. Do not neglect testing the charge every day. It will save you money to keep it in best condition.

Read-Easy Hydrometer

is a professional instrument made for the amateur. It is simple to read and always works.

For Your Battery's Sake Do Not Accept Cheap Substitutes

The Read-Easy sells for \$1.25 at all good supply stores. If you can't get it, send your order direct to us. We will mail post paid and insured.

ALA MFG. CO., 401-417 S. Sangamon St., Chicago

Read-Easy Hydrometer

tells at a glance the exact condition of every cell in your battery. No guess work—absolutely accurate. No dripping—no slopping—no sticking with a Read-Easy



shipboard ever since the first set was put on a ship, and I guess it will always be the same.

Occasionally I would have a little trouble with my set, and needing tools that I did not have myself, I would go to the chief engineer for them. He wouldn't pay any attention to me. My steam heater needed new connections. I told him about it, with no results. The officers continually "rode" me about press. The second mate, especially, went out of his way to "ride" me. This second mate was a young fellow with a master's license, and I guess had acquired a big head with his imagined importance.

One day, about two months after my first trip, we were laying at anchor in the harbor at Sydney. The captain asked the second mate and myself if we would row him ashore in one of the ship's boats. We did so. Two hours later we started to row back. The water was choppy. I sat in front of the mate. It was my first experience at rowing a boat. Occasionally, on the way back to the ship, my oar would skim over the top of the water and give the mate a shower bath. He cursed me in a half-serious, half good-natured way. After we had climbed back to the deck of the ship he continued to curse me. I began to get a little "peevish," so walked away from him and climbed up to my "shack."

The next noon, at the mess-table, the second engineer started on me about press, and how useless a wireless operator was on board a ship. I took it good-naturedly, for I had reached the point where I realized this nagging at me was done with the same feeling as a mother has when she kisses her baby. Then the second mate started. I began to see red. The others, feeling the tenseness in the air, kept quiet. The second mate kept it up, until I could stand it no more, and jumping up, I told him where he could go, and a few other things that the law will not allow me to put on paper. He jumped up and we started for the deck to "have it out." The others stopped us before we could get out on deck. We subsided, and that was the end of it. From that day until the day I left that ship we never went near each other, or spoke a word to each other.

After the argument that day, the others who were at the table at the time, came up to my "shack" during the afternoon and each one told me that they were glad that I had finally shown some spirit. From that day on, nothing was said about press, static, or any part of my work, so my life aboard the ship became much more pleasant. The chief engineer would come up occasionally, sit down and talk with me, swap magazines, etc., and my heater was fixed. The stern chief I found to be a regular good fellow.

But try as hard as I could, it was impossible to tune Arlington in loud enough to copy him with my crystal detector. Finally I never bothered with Arlington until I had got down as far at least as

EXPERIMENTAL ELECTRICITY COURSE IN 20 LESSONS

By S. GERNSBACK and H. W. SECOR, E.E.

Every phase of experimental electricity is treated comprehensively in plain English. New Experiments are described and explained and nearly every application of Electricity in modern life is given in simple language. A masterpiece. Explains every electrical device from a push button and bell to the biggest generator made. Worth its weight in gold for the man who wishes to know about electricity, and to the experimenter it is still more valuable because of its many facts, tables, etc.

The Best Electrical Text-Book on the Market. Size of Book is 6x9". The book contains 128 pages, and more than 400 illustrations. Cloth bound, stiff covers, hand-sewed, green and black stamped, each \$1.25. EXPERIMENTER PUB. CO., Inc. 53 Park Place, New York City



KEEP A RECORD

A great interest will be added if you record important matters received.

RADIO LOG

A well designed Record Book. Indexed and arranged to record all details.

No Advertising. 50c post paid.

RADIO PRINT Tiffin, Ohio 216 Circular St.

Delivered to you Free

for 30 days trial on approval. Your choice of 44 Styles, colors and sizes of the famous Ranger Bicycles. Express prepaid. Low Factory-to-Rider Prices.

12 Months to Pay if desired. Many boys and girls easily save the small monthly payments.

Tires, wheels, lamps, and equipment at half retail prices. Write for remarkable factory prices and marvelous offers.

Mead Cycle Company Dept. D116 Chicago





Federal Standard Radio Head Sets

FOR durable efficiency, clearness and wide distance-range Federal Standard Head Sets have no superiors.

Made of specially treated steel with permanent magnets, scientific wiring and adjustment, and precision machining of metal parts, these Head Sets have achieved a well deserved universal recognition and endorsement by Radio experts.

To secure professional efficiency from your receiver insist on having Federal Standard Head Sets; Federal Standard is the product of over twenty years' experience in the manufacture of communication apparatus.

Federal Standard Head Sets are made with 2200 Ohms and 3200 Ohms resistance.

Federal makes a complete line of Standard Radio apparatus—all reasonably priced. Write for latest catalog.

Ask your dealer for Federal Standard Head Sets. If out of stock he can get them from our nearest office. Accept no substitute.

Federal Telephone and Telegraph Company

BUFFALO, N. Y.

DX DX DX DX DX DX DX DX DX DX

“VirBren”

(New trade name for our Products)

“AFTER MAKING TESTS of the various makes of RF transformers I find that the DX Transformer is superior to any so far tested; I would gladly recommend the DX to anyone desiring to get BEST RESULTS IN RADIO FREQUENCY.” Writes well known Consulting Engineer.

ONE STAGE of Radio Frequency Amplification and detector, using DX Transformer with non-regenerative tuner is equal, and often far superior, to a good regenerative detector set. Thus, BY USING ONE TO THREE STAGES OF DX TRANSFORMERS you simplify tuning, reduce expense, increase your receiving range, with perfect tone volume.

DX TRANSFORMERS are especially effective with W.D.11 tubes; in fact, you will get the very best service this tube is capable of giving by using the DX transformer for radio frequency amplification.

Write for circuit showing method of using one or more stages of Radio Frequency in connection with your present set. Also ask us about a REAL DX RADIO RECEIVING SET.

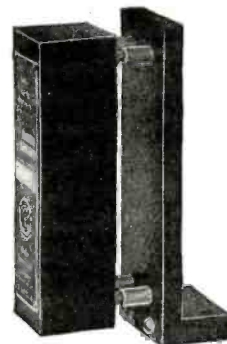

Patented
Attractive proposition to distributors.

WRITE FOR LITERATURE

	Wave-length Range	
DX-1	170—450	\$6.40
DX-S	400—1200	6.60
DX-2	900—3000	6.60
Standard Mounting		.90

**RADIO
INSTRUMENT COMPANY
WASHINGTON, D. C.**

IT PAYS TO HAVE THE BEST

Become expert in Radio Frequency. Read the new Kenneth Harkness book on Radio Frequency Amplification. Order early. Price \$1.00.

DX DX DX DX DX DX DX DX DX DX

Here's a Pair of Winners



The Wimco Condenser

Made to meet a demand for quality—highest efficiency, 3 plate, 23 plate and 43 plate sizes.



The Carco Coupler

Just the thing for the popular receiving set. Bakelite tube, and rotor, silk covered wire, perfect contacts.

We invite Dealer and Jobber inquiries.

Send for literature and prices on Wimco Socket for WD11 tube.

THE WIRELESS MFG. CO., CANTON, OHIO
 MANUFACTURERS DISTRIBUTORS

NOW READY! ACT QUICKLY!

The first and only complete line of high-grade receiving instruments made by one manufacturer. For many years we have specialized in Radio instruments for voice and musical reproduction. We now offer a perfectly developed and GUARANTEED line of apparatus with a price range to meet every demand. Send for circular.

The Wonderful, New ACOUSTICOLA with Loud Speaker Unit
 Made in four models: especially designed as a loud speaker. Has a large highly sensitive diaphragm with ADJUSTABLE device. Will not "blast" on the strongest amplified signals and gives remarkable volume and clarity on weak signals. Gives Truest reproduction of voice and music.

Trimm "Concert Grand" Model
ACOUSTICOLA

A finely finished large walnut cabinet enclosing a Cast Aluminum horn with Loud Speaker Unit of exceptional tone quality and volume. A handsome ornament for the finest home.

Trimm "Studio" Model
ACOUSTICOLA

Has same Loud Speaker Unit as "Concert Grand" model but a composition horn of somewhat smaller size. Walnut cabinet. Reasonably priced.

Trimm "Simplex" Model
ACOUSTICOLA

Designed to give all the advantages of the more expensive "Concert Grand" and "Studio" models but less expensive because not enclosed in a cabinet. Has the same Loud Speaker Unit mounted on wood base with composition horn uncovered. A wonderful value.

**T
R
I
M
M**

Trimm "Professional"
3000 Ohm Head Set

The finest instrument of its kind. Moulded Bakelite cases and ear caps, single bar Tungsten steel magnets; light weight. Exceptional tone and volume. A \$12.00 quality to retail at \$7.65.

Trimm "Dependable"
2400 Ohm Head Set

Standard bi-polar construction. Aluminum case. Splendid appearance, volume and tone, to retail for only \$5.00. Greatest value ever offered.

Trimm Acousticola
Phonograph Attachment

The wonderful Trimm Loud Speaker Unit mounted in a small cabinet to be placed in any phonograph, with bushings for attachment to the tone arm. A convenient and handsomely finished instrument.

ORDER ANY TRIMM PRODUCT ON APPROVAL.
YOUR MONEY BACK IF NOT SATISFIED.

Write us today for full description and prices. Mention your dealer's name.

TRIMM RADIO MFG. CO. Dept. 40 24-30 S. Clinton St., Chicago, Ill.

CUT RATE RADIO

Standard apparatus only.
 Write for 54 Page Catalog of Bargains.
 Baldwin Type "C" Phones\$10.25
 Brandes Superior Phones 6.45
 Radiotron U V 200 Detector Tubes 4.25
 Acme Audio Transformers 4.45
 Everything for Radio at less. Immediate Delivery.
Federal Radio Electric Co., Dept. A
 1233 GRAND AVE. KANSAS CITY, MO.

— FREE —

A book on how to get "Better Results from Radio"—Write to Willard Storage Battery Company, 281 East 131st St., Cleveland, Ohio

Willard

Chatham or Siasconset. I hooked up a single vacuum tube to my receiver, in place of the crystal. It did not work much better with Arlington, but I obtained better results when working nearby stations. The most disagreeable feature of the crystal detector in commercial work is not so much the limited distance of receiving as the fact that after finding a nice sensitive spot on the crystal, the high frequency kick-back of the transmitter knocks the point off of the sensitive spot. So, when switching back to receiving, the point must be readjusted. If the station you are communicating with comes back quickly, by the time the crystal has been readjusted, you may have lost half of his communication and be forced to call for a "QTA" (please repeat). Unless you are real close to the other station, this will happen every time, and it is a matter of how quickly you can readjust the crystal, as to whether or not you are going to miss anything. Most of the ships today are equipped with a vacuum tube detector and one stage of amplification, which makes the receiving a great deal more agreeable.

Many times while using crystal I have been tempted to rip the receiver off the table and jump on it. It would get on my nerves so badly at times that tears would come in my eyes and I'd feel like crying like a baby. After hooking up a tube as a detector, my receiving became more "sunshiny." An operator is not supposed to use tubes on a commercial set unless the set is licensed for them, as the tubes are patented and to be used for amateur and experimental use only. I was within the law, because I was using them in an experimental way, viz., finding out which was the best way to receive, with tubes or with crystal. As a result of my experiments I found that receiving is better when using a tube.

Last September, October and November I was in the Gulf of Mexico trade on an oil tanker. You "hams" who are reading this undoubtedly have been bothered, more or less, with static. But you don't realize just how bad static is until you have had a touch of Tropical static. "Bad" is no name for it. It is worse than that. It doesn't come in crashes, it comes in a steady roar, so loud that it is next to impossible to hear a station close by. This is at its worst at night, and only during the months previously mentioned. Often it is impossible to hear a weather report through it. In that case you have to wait until the next morning and obtain it from some other station which is near a shore station. During these three months it is absolutely necessary to get the weather as often as possible. For these three months are the months of the hurricane season, and if the weather is known ahead of time much bad weather can be avoided.

An operator's life on shipboard is an easy one, too easy, in fact. Some operators have the idea that the ship couldn't get along without them, but an attitude of that kind will cause an operator's life to be anything but pleasant. The operator should consider himself a happy medium between the deck and the bridge, not mixing too much with the sailors, and not making himself a nuisance on the bridge. The captain is the only one to whom the operator is responsible or from whom the operator takes orders. But, if any of the other officers, carpenter, boatswain, etc., should ask you to do them a favor, it is advisable to do it, as the occasion often arises when you have to ask favors yourself. Be a good fellow. The operator eats with the officers, so he has the best food on the ship. He is

“Having time of my life getting most splendid results from the ‘Socostat’” says one radio fan.

“SOCOSTAT”
(Socket and Rheostat)



Single-unit socket and Rheostat for Table or Panel Mounting.

The “Socostat” is a combination of socket and rheostat that eliminates the wiring of two separate parts. Saves time, material and money.

No exposed wires. The internal rheostat permits very sensitive filament adjustment. Tube noises reduced to a minimum. Bakelite base and cover. Nickle plated receptacle takes any standard detector and amplifier tube. Rings and screws all nickle plated.



View showing panel mounting of “Socostat.”

The “Socostat” simplifies your construction and improves the appearance and operation of your set. Guarantees a smooth and positive contact.

Another radio expert writes: “The “Socostat” practically eliminates the usual tube noises and gives better results than the socket and rheostat in every way. Have shown it to several of the boys and all agree that it is O. K. It should go big with the Radio Bugs.”

We guarantee that you will be satisfied. Price \$2.50 at your dealer or write



View showing cover and ring removed.

FEDDERS MANUFACTURING CO., INC., 55 Tonawanda Street, BUFFALO, N. Y.

“Pioneer” Innovation in Variocoupler Design

Here again we are “Pioneers,” giving to the world a wholly-new and vastly-better type of Variocoupler.



“Pioneer” Variocoupler
Price, each, postpaid \$7.00

“PIONEER” VARIOCOUPLER

Coupler has 16 taps on the primary circuit, 8 of which are tapped every wire, for selective or close tuning, and fine modulation. The other 8 are tapped every 6 turns, for coarse tuning.

“PIONEER” VARIOMETER

A companion-piece to the coupler. Can be used on either grid or plate-circuit up to 960 meters.

MAXIMUM AMPLIFICATION AND SELECTIVITY

without distortion, are assured by the close-coupling; the fixed and positive balance, and perfect alignment secured by our close-coupled design and method of winding. Both instruments are perfectly balanced on 240 to 960 meters, and are especially designed for clear reception of long-range signals.

The most beautiful instruments made, both in outward appearance, and in the work they do. They have been awarded Certificate of Merit No. 37 and 68 by the Radio News Laboratories. Send for circular. Better still, order the instruments, and put them to every test on your own set. In no other way can you be sure of permanently selective tuning or satisfactory reception.

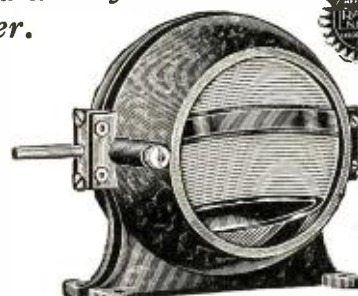

“Pioneer” Variometer
Price, each, postpaid \$6.50

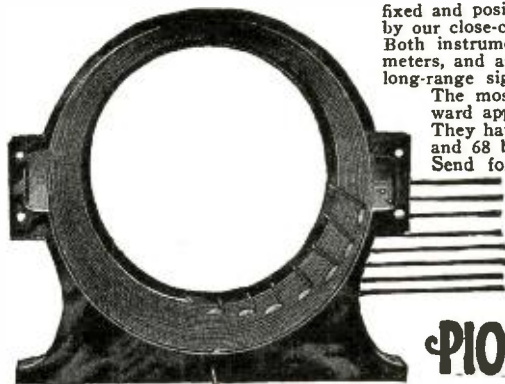

Stator Shell of “Pioneer” Variocoupler



GALESBURG, ILL., U. S. A.



“Pioneer” Rotor

Miraco Gets 'em 1500 Miles Away



Users of the MIRACO Radio Frequency Broadcast Receiver report wonderful results. St. Louis hears Schenectady—Davenport hears Newark—Cincinnati hears San Francisco. Reception is clear and distinct, tuning is very sharp, and there's practically no interference. MIRACO sets may be used with either WD 11 tubes and 1½ volt dry cell or 6 volt tubes and 6 volt storage battery.

Order your MIRACO set TODAY and be sure to specify tubes to be used.

Retail Price — \$54.50

DEALERS—When you get our proposition in detail—you'll WANT TO PUSH THE MIRACO LINE.

AGENTS wanted everywhere.

THE MIDWEST RADIO CO.

804 Main Street

Cincinnati, Ohio

New "United" Vernier A MIRACLE-WORKER IN FINE, SELECTIVE TUNING. OPERATES ON A NEW PRINCIPLE.

Will bring in the elusive stations that have thus far defied you, by giving at least *twice* as fine a tuning as has ever been possible with the best condensers thus far developed.

Can be attached to any plate condenser, by drilling one hole in top plate.

Price, each, postpaid \$2.50.

"UNITED" VARIABLE CONDENSERS WITH NEW VERNIER

- 43-Plate each \$6.50
- 23-Plate 6.00
- 11-Plate 5.50

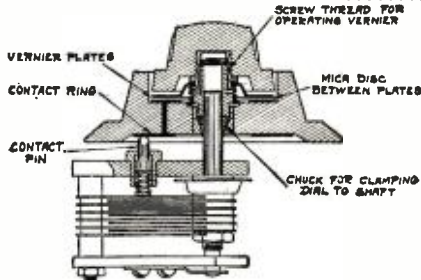

"UNITED" TRANSFORMER

Audio Frequency. Amplifies detected signals so they come in clear and strong, for either headphone or loudspeaker reception.

Each \$4.50

Send for catalog of United Products

United Mfg. & Distributing Co.
536 Lake Shore Drive Chicago, Ill.



a licensed man and rated as an officer. The operator's room is kept clean and the bunk made up by a mess-man. He is at liberty to go ashore as soon as the boat docks, and is free until she leaves. The wireless operator has a chance to see the world. If he gets tired of one ship he can quit and wait in line for another, although at the present time, with ships so scarce, that isn't a very profitable thing to do. There is always the chance of exchanging ships with some other operator, with the controlling radio corporation's permission.

The radio operator's salary varies; in the coastwise trade it averages about \$75 per month. On "off shore" ships his salary averages \$90 per month. The duties on the ship are very easy. In my own case, I turn out at 8 A. M., have breakfast, "listen in" from 9 A. M. until I get the "tick" at noon, when I eat; send the ship's position to the nearest coast station, and "listen in" for an hour or so, possibly until 3 or 3:30, lay down for afternoon nap, until supper-time. "Listen in" again from 6:30 or 7 until 9 P. M. Rest for an hour and then tackle Arlington weather and press, until he signs off at, usually, about midnight. Then turn in. Copy the press over the next morning while "listening in." Make three copies of press, one for the captain, one for the officers' mess, and the other for the crew.

At one time I had a habit of sleeping until about 11 A. M., but felt doxy all day, so gave that up. Obtaining weather at least once a day and sending the noon position is practically compulsory, but outside of that the operator has nothing else to do, except "listen in." If unable to get weather, press, or part of a message, never make something up in your own imagination and put it down. If a message, ask for a repeat; if weather or press, and unable to get a repeat, let it go as it is. Do the best you can. That is all that is expected of you.

In operating your set, looking for troubles, etc., it is a good idea to carry your theory into practice; and then, there are times when you should forget your theory and tackle the job practically. As long as an operator uses his head, he should have no trouble. Commercial sets are fool-proof, in a way; protective devices take care of any mistake, so if any trouble occurs, you will find it in some simple place. For example, one morning on my first ship the captain asked me to get a bearing. I threw in the main-line switch, A. C. switch, generator field switch, remote control switch, and at the time, thinking of the compass station's call letters more than I was thinking of what I was doing, I pressed the key. Not a sound from the spark gaps. I stopped the motor-generator and spent half an hour looking for the trouble. Sat down at the key again, started the set the same as usual, and this time the gaps responded. I couldn't figure it out until I did the same thing a couple days later, and caught myself at it. With my mind on something else, I had left my antenna switch in the receiving position, thus leaving the primary power circuit open. These things all happen to a new operator.

No matter how many switches a set has, or no matter how big or complicated it looks, always remember that there are only four circuits, viz., input power, transformer, closed, and open oscillating circuits. There cannot be any more, if it is a spark set.

A ROYAL BUG

H. R. H. the Prince of Wales has taken up radio. His Radio Highness.

BRASS Rods in round and square. Machine screws, any size. Tubing and sheet. Nuts. Small drills and taps. Knobs and dials.
ANGIERS, U. S. A.
STREATOR, ILL. BRUCE ST. PLANT

- Variable Grid Leaks \$.45 each
- Tubular Grid Leaks (all resistance)30 each
- Tubular Grid Leaks mounting35 each
- Single V. T. Sockets Type S-1090 each
- Triple V. T. Sockets Type S-4 2.70 each
- Bakelite WD-11 Sockets50 each

RADIO SERVICE & MFG. CO.

(Established 1918)
Factory—Lynbrook, L. I.
We carry a Complete Line of Radio Apparatus

**WDAP
CHICAGO**



3,700 MILES

CHERBOURG



'ALL AMERICAN'

Sets World Record for Long Distance Radiophone Receiving

When WDAP Chicago Talked to S. S. Berengaria
The Signals were Amplified Aboard-Ship Thru
"ALL-AMERICAN" AMPLIFYING TRANSFORMERS

WDAP, The Drake Hotel, Chicago, made history in radio, by talking, day-by-day, with the S. S. Berengaria, enroute, New York to France. Miss Florence McDonald, a passenger, installed standard Zenith Receiving Set in the steamship cabin and, every evening during the voyage, WDAP talked to her and other passengers from Chicago, their voices coming clear and strong with the personality easily recognizable. The Set used by Miss McDonald is one of the regular Zenith Sets, manufactured by the Chicago Radio Laboratory, Chicago, Illinois. It contains, as standard equipment.

"ALL-AMERICAN" AMPLIFYING TRANSFORMERS

R-10—Radio Frequency (150-500 meters) \$4.50	R-13—Audio Frequency (Ratio 10 to 1) \$4.75
R-12—Audio Frequency (Ratio 3 to 1) 4.50	R-21—Audio Frequency (Ratio 5 to 1) 4.75

Send for our circular—"Cascading of Amplification." Also Free Book of Radio Hookups.





RAULAND MFG. CO.



200 N. Jefferson St., Chicago, Ill.

RADIO MERCHANDISE

F. D. PITTS COMPANY

(Incorporated.)
 219 COLUMBUS AVE., BOSTON, MASS., U. S. A.
Wholesale Only

Distributors for

- A. H. Grebe and Co.
- Acme Apparatus Co.
- American Eveready Works
- American Radio and Research Corp.
- Atwater Kent Mfg. Co.
- Baldwin, Nathaniel Co.
- Burgess Battery Co.
- Chelsea Radio Co.
- Clapp-Eastham Co.
- De Forest Tel. and Tel. Co.
- Dubilier Condenser Co.
- Electrose Mfg. Co.
- Fada.
- Fahnestock Elec. Co.
- Federal Tel. and Tel. Co.
- France Mfg. Co.
- Frost, Herbert H. and Co.
- General Radio Co.
- Jewell Elec. Inst. Co.
- Magnavox Co.
- Mitchell, R. and Co.
- Murad Laboratories
- Murdock, Wm. J. Co.
- Pacent Elec. Co.
- Radio Corp. of America
- Remler Radio Mfg. Co.
- Signal Elec. Mfg. Co.
- Western Elec. Co.
- Weston Elec. Inst. Co.
- Wireless Press



"GREBE RADIO"

Grebe CR-3 Receiver, 150-1000 meters.....	\$65.00
Grebe CR-5 Receiver and Vacuum-tube Unit, 150-3000 meters.....	\$80.00
Grebe CR-8 Receiver and Vacuum-tube Unit, 150-1000 meters.....	\$80.00
Grebe CR-9 Receiver, Detector and Two-stage Amplifier, 150-3000 meters.....	\$130.00
Grebe CR-10 Radiotone Concert Receiver, Detector and Three-stage Amplifier, Victrola type.....	\$315.00
Grebe RORK Two-stage Amplifier.....	\$55.00
Grebe RORD Detector and Two-stage Amplifier.....	\$75.00
Grebe RORN Tuned Radio Frequency Amplifier.....	\$60.00

"Without going out of doors," said Lao-Tzu, "one may know the whole world." "Let a GREBE RECEIVER bring the whole world to your evening fireside."

DEALERS—Attractive discounts and immediate deliveries from stock! Send for Our Latest Price List, No. 3.

"F. D. PITTS CO. NEW ENGLAND DISTRIBUTORS OF GREBE RADIO"

FROST

No. 162
2000 Ohm Set
\$5⁰⁰



FONES

No. 163
3000 Ohm Set
\$6⁰⁰

If watches were made by hand—

you would pay several hundred dollars for a high grade timepiece, just as did the people of olden times. Similarly, if Frost-Fones were made in small quantities they would cost you several times their present price, yet would be no better. Jealously guarded quality has made quantity production a synonym for perfection in Frost-Fone manufacture. Your dealer sells Frost-Fones because he knows they bring in the broad casting clear and sweet and because he knows they are correctly engineered down to the most minute detail.



FROST RADIO TUNING COIL

A high grade double-slide tuner with 1000 meter range. Green silk-covered wire on a seamless impregnated tube. Mahogany-finished hardwood ends. All metal parts of brass nickel-plated, polished and buffed. The nation's biggest tuning coil value. No. 410 Frost-Radio Tuning Coil **\$3⁰⁰**





HERBERT H. FROST, Inc.

154 WEST LAKE STREET, CHICAGO, ILLINOIS.

The Ears of the Fleet

(Continued from page 1934)

Incidents of stirring interest often occur, and SOS calls are not infrequent. The following is a specimen distress call, although they are generally more serious. While on watch one night aboard a destroyer that was threshing her way through the waters of the Sea of Marmora, the author was surprised to suddenly hear an SOS almost immediately followed by this message, sent in the most shaky and indecipherable Morse imaginable:

SOS DE OCJ . . . SS ERNEMORE
... OFF SERAGLIO POINT ...
STRUCK WRECK . . . MAKING
WATER SOS . . . IS ANYONE
COMING TO OUR HELP?

We answered the ship and after about a half hour she started sending again. Now, however, the operator's Morse had lost its shaky characteristics, and his letters followed one another clearly:

CQ DE OCJ THANKS FOR
PROMPT ATTENTION TO OUR
SOS WE ARE NOW INSIDE
CONSTANTINOPLE AND WILL
NOT REQUIRE YOUR ASSIST-
ANCE

The author also had the unusual experience of hearing a signal from the opposite side of the earth. Early one morning as the ship was passing through the Strait of Bab-El-Mandeb signals were clearly heard from the Naval Station at El Cayey, Porto Rico (NZR), although approximately 12,000 miles away at the time. These signals were heard on the receiver showing behind the operator's head in Fig. 3.

Further Peculiarities of Wave Transmission

(Continued from page 1936)

even if the water is not stirred but continues stagnant.

But whereas in the chemical case and the heat case the absence of momentum is complete, in the electromagnetic cases it is only approximate. And when electromagnetic momentum is taken into account, the law is somewhat modified; an element of true wave makes its appearance, and there is a true velocity of propagation, though it may be only for an insignificant part of the wave. The head of the wave, however, does advance with the velocity of light, though it may be a head so small as to be undetectable.

But it may be strengthened, and the way to strengthen it is to increase the magnetic momentum, that is to say, to increase the self-induction, as might be done by coiling the wire upon itself. In that way the diffusion effect can be minimized and the wave effect strengthened, with immense gain in rapidity and clearness of signalling. The complete Theory of the Cable exhibits all this, and enables quantitative calculations to be made. And that complete theory the world owes to Mr. Oliver Heaviside, whose brilliant investigations were not recognized at the time by those in high telegraphic authority. He seemed to be merely complicating matters, and not introducing anything practical. So no practical improvements resulted, until ultimately Lord Kelvin himself perceived the merit of Heaviside's extended theory:



\$40.00

CHELSEA REGENERATIVE RECEIVER

A real Broadcast Receiver

Range 150 to 800 meters

- † Perfection in design
- † Pleasing appearance
- † Simple and accurate tuning

A Chelsea product, embodying Chelsea equipment throughout.
Licensed under Armstrong U. S. Pat. No. 1113149. For amateur use only.

Write for our new No. 7 catalogue

CHELSEA RADIO COMPANY

179 Spruce Street

Chelsea, Mass.

DENVER

COLORADO

9ZAF

REYNOLDS RADIO CO.

1534 Glenarm St.

KLZ

LARGE RADIO DISTRIBUTORS



VARIABLE CONDENSERS

3-Plate Vernier \$0.75

28-Plate .0005 Mfd. 1.75

43-Plate .001 Mfd. 2.25

24-Plate Balanced Cond. 3.75

44-Plate Balanced Cond. 4.75

Aluminum Plates, accurate spacing. Please send 10c additional for postage.

Money back if you are not satisfied.

MONTROSE MFG. CO.

1200 Bedford Ave., Brooklyn, N. Y.

and Silvanus Thompson in England, and Dr. Pupin in America, advocated the introduction of special self-inductance coils into a cable, especially one that was to be used for telephonic purposes.

Undoubtedly the construction of such electrically improved cables was a real difficulty; and the men who had to lay them naturally shied at additional complications to a problem which in its early form was difficult enough. Moreover, the Kelvin instruments had enabled so much speed and certainty to be obtained in ordinary Morse signalling through a cable, that there was no great stimulus to a revolutionary improvement.

But when it came to telephony, the case was different. Telephonic speech was impossible if all the consonants and vowels were diffused and run together in a vague indistinguishable mass, with no genuine velocity of propagation; so that as it were the stronger waves arrived first, and the feebler ones never arrived at all, and the peculiarities and harmonics of a tone on which speech depends were blotted out in transit. Speech through a submarine cable a hundred miles long is impossible, unless extra self-induction is introduced. Even forty miles long is difficult, and the difficulty increases with the square of the length. But if sufficient self-induction is introduced, so as once more to gain magnetic momentum, true wave propagation is restored; the signals travel with a definite speed, independent of intensity and of pitch, and arrive with their features fairly intact, weakened no doubt, but not disfigured. The deleterious effect of capacity combined with resistance remains, and there is some diffusion as well. Speech through a cable is never so easy as through a land line, or through the unconfined ether of space. But it becomes possible; and in the light of Heaviside's Theory, the possibility is clearly intelligible.

RADIO
THE NEW TRUTONE NON METALIC
TRADE MARK
LOUD SPEAKER
ARTISTIC QUALITY — LOW PRICE
WHAT COULD BE SWEETER



True Tone Value—Clear As a Bell

TYPE A **\$800** **TYPE B**
 For Head Phones For Any Single Receiver
Either Type—Postpaid—Dealers Write
SADLER MFG. CO. 86 4th STREET
 SAN FRANCISCO, CAL.

Armstrong Super Heterodyne Receiver

"The Rolls Royce Method of Reception"—E. H. Armstrong.

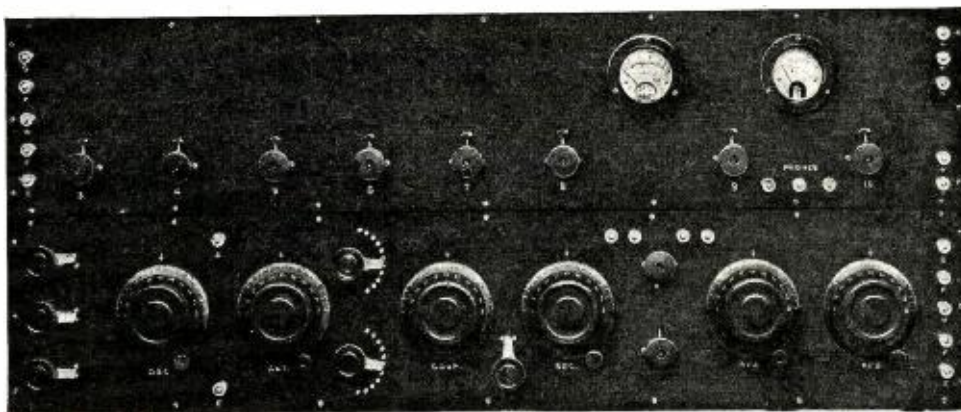

Obtainable Exclusively Through

EXPERIMENTERS INFORMATION SERVICE

*Designers of the Highest Class
 Radio Apparatus in the World*

220 West 42 St., 23rd Floor

New York City

Ask for 1923 Catalog No. 20

The Spirit of Radio

(See Page 1959)

The more you look at the picture, the less chance you have of determining what it is. It was conceived by Mrs. Emma Mable Field, the famous physic artist, and is a radio-impressionistic personality portrait of Miss Alexandra Carlisle, the eminent classic artist. This sketch of Mrs. Field's was inspired by a radiophone rendition by Miss Carlisle from the Broadcasting station WOR. The spirits are getting the radio bug, too, so it seems. Physic experts state that this picture contains a true prognostication of Miss Carlisle's career. We see a shoe but no rice,

Fair Dealing Pays

(Continued from page 1948)

and I regret very much it had to happen due to an Acme product.

Awaiting your advices, I am,
Yours very truly,
(Signed) L. W. Houlroyd.

Mr. L. W. Houlroyd,
68 West 10th St., Bayonne, N. J.
Dear Sir:—

Your communication of February 21, addressed to our New York office has been brought to my personal attention, and to be frank, has "busted up my day."

I don't know what we can do or say, except that we maintain a very rigid inspection of all apparatus shipped from this factory. Each radio frequency transformer is tested at three distinct wave-lengths, and must respond to a certain amplification, or it is not passed. We do this to avoid just such occurrences as yours, and possibly would have received such letters as yours if we did not have such a rigid inspection. However, this is the first case we have had of this kind, and feel that we are under obligations to you.

I know how you must feel toward our company, and do not blame you a bit. We feel we can not pay you for your time, but are enclosing check for \$20 to cover cost of the vacuum tubes.

We assure you that it is our purpose in business to make good apparatus, and as our guarantee states, we always try to make adjustments to the satisfaction of the customer. We are sending you an audio frequency transformer to replace the radio transformer.

Yours, very truly,
Acme Apparatus Company.
(Signed) Claude F. Cairns.

Mr. C. F. Cairns,
Acme Apparatus Company,
Cambridge 39, Mass.
Dear Sir:—

I wish to acknowledge receipt of your letter of Feb. 27th, with enclosure of check for \$20.00.

It is needless to say that the way you have met this situation has surprised me and merits the highest respect and confidence of the radio public in the Company you represent, and its product.

I returned the transformer in question via parcel post last night, addressed to your attention, and am holding the burnt-out vacuum tubes ready to ship, upon your request.

There is hardly anything more that I can say regarding this, except that it has entirely changed my attitude toward radio manufacturers in general, and has restored the faith and confidence I had in your concern before this unpleasant experience occurred.

Again expressing the highest respect for the way you have handled this matter, I am,

Sincerely yours,
(Signed) L. W. Houlroyd.



Patent Applied for

Adjusted for regenerative two stages of amplification; also 5 tube radio and audio frequency circuit.

10 Reasons Why

THE ACOUSTICAL AMPLIFIER

BEL-CANTO

TRADE-MARK

LOUD SPEAKER

Beautiful in design.
Pure in tonal qualities.
No auxiliary batteries.
Absolutely free from distortion.
Disperses sound in all directions.
Gets away from the grotesque horn.
Guaranteed for 12 months against mechanical imperfection.
Developed by an acoustic engineer of recognized ability.
Endorsed by Ignace Paderewski.

Owing to increased factory facilities and capacity output, we have been able to reduce the list price of Bel-Canto to \$25 F. O. B., New York

If dealer can't supply, we can.

BEL-CANTO CORPORATION

417 East 34th St. New York City

USE A

LEICH NON-TUNE RECTIFIER

FOR

Charging Your Radio Storage Battery

The Leich NON-TUNE Rectifier has a charging rate of 2 amperes when connected to a six volt storage battery. This rate is sufficient for home use where three to four 5 watt tubes are operated. Before many months one to one and one-half watt tubes (¼ amp.) will be common practice. Here the Leich NON-TUNE Rectifier is in a class by itself, highly efficient; at full load it consumes less current than a 40 watt lamp; reliable, and with a charging rate to assure long life to the battery. NON-TUNE FEATURE gives this charger flexibility in its operation, allowing for considerable voltage and frequency variation of the power circuit. A PATENTED RELAY LOCK keeps the battery circuit open when the power current fails. LEADING RAILROAD COMPANIES have used NON-TUNE Rectifiers for years for charging batteries in their Signal service because NON-TUNE can be depended upon to function properly at all times. Try a NON-TUNE. Ask your dealer or write for Bulletin 100-C.

Manufacturers **LEICH ELECTRIC CO.** GENOA, ILL.

Non-Tune Rectifiers *Leich Comfortable Headphones*



THE RADIO SENSATION

GREAT EASTERN

Radio Receiving Set with Single Knob Control

1 Radio Detector
3 Audio Frequency



Volume, distance, simplicity. Price \$80 without batteries, bulbs, etc.

Descriptive circular on request. Dealers write for special proposition on this sensational receiver.

Great Eastern Radio Corp., 25 W. Broadway, N. Y.

FREE VACUUM TUBE RADIO SET

The Set you always Wanted, FREE

A real RADIO SET—Listen in on Concerts, Lectures, Singing, etc. Can receive 75 to 100 miles and more.

RUSH your name and address and we will tell you HOW you can get a VACUUM TUBE RADIO SET ABSOLUTELY FREE

Don't delay. Write today for FREE RADIO PLAN.

Home Supply Co.
DEPT. 924
131 Duane St., New York



I Want To Know

(Continued from page 1978)

STATIC INTERFERENCE

(674) Mr. N. Goldberg, Philadelphia, Pa., writes:

Q. 1. During the day-time I get very good results, but as soon as it gets dark I experience terrific static. What can I do to eliminate it?

A. 1. Evidently what you mistake for static is a leaky transformer or a defective arc light in your vicinity. As night comes on the lights are turned on and the interference starts. If you can locate this arc light and call the lighting company's attention to it, they will, no doubt, have it remedied. There is nothing you can do in connection with your set to avoid this trouble otherwise.

RECEIVING RANGE

(675) Mr. Vernon Brookens, Humboldt, Tenn., wants to know:

Q. 1. How far can radio concerts be received with a honeycomb receiving set using three coils, primary, secondary and tickler? Detector tube only is used.

A. 1. Under good conditions this set should have a receiving range at night of 500 to 1,000 miles. This, however, depends a good deal upon local conditions, skill of the operator, etc.

Q. 2. If larger coils are used, will the receiving distance increase?

A. 2. No. The wave-length only will be increased.

Q. 3. Will the W.D.11 tube give as good results as a six-volt tube?

A. 3. The W. D. 11 tube will prove just as efficient as a detector as the standard six-volt tube.

AMPERAGE FOR STORAGE BATTERY CHARGING

(676) Mr. John Tobin, Birmingham, Ala., desires to know:

Q. 1. Can a step-down transformer giving six volts be used in place of the electric bulbs used to charge a storage battery?

A. 1. We presume you refer to an electrolytic rectifier which uses a certain number of lamps to allow a certain current to flow. A step-down transformer could not be used even if it were designed to pass the required number of amperes. The reason for this is that an electrolytic rectifier will not function with less than 50 volts. If the transformer were designed to deliver 50 volts at 5 amperes at the secondary, it could be used for this purpose.

MEANING OF D. X.

(677) Mr. M. E. Lacroix, Montreal, Canada, asks:

Q. 1. What is the meaning of D. X. work in radio?

A. 1. D. X. means long distance transmission or reception.

Q. 2. What is the best type of receiving antenna?

A. 2. The best type of receiving antenna is a single wire 125' long, above all surrounding objects, if possible.

W. D. 11 QUERIES

(678) Mr. Win. Sante Cruz, Havana, Cuba, writes:

Q. 1. I have heard that the W.D.11 tube is not critical in adjustment. If this is the case, how can I know what is the best point on the rheostat?

A. 1. The proper place on the rheostat is that position where signals are received loudest in the receivers.

Q. 2. Using the same tubes as amplifiers, what is the best way to find the proper current value?

A. 2. The answer to your first question also answers this one. The current will vary in proportion to the voltage, which is controlled by the rheostat.

Q. 3. Should the "B" Battery voltage on the plate remain fixed, or should it be changed with different stations?

A. 3. The "B" battery is not changed for different stations, but remains the same. It makes no difference if the stations are far or near, the same voltage is used for all.

Two Simple Arrangements for Reducing Interference and Static with Single Circuit Tuners

(Continued from page 1951)

cago, KSD at St. Louis, WOC at Davenport and numerous other 400-meter stations, including the Star Telegram at Fort Worth, the Journal at Atlanta,

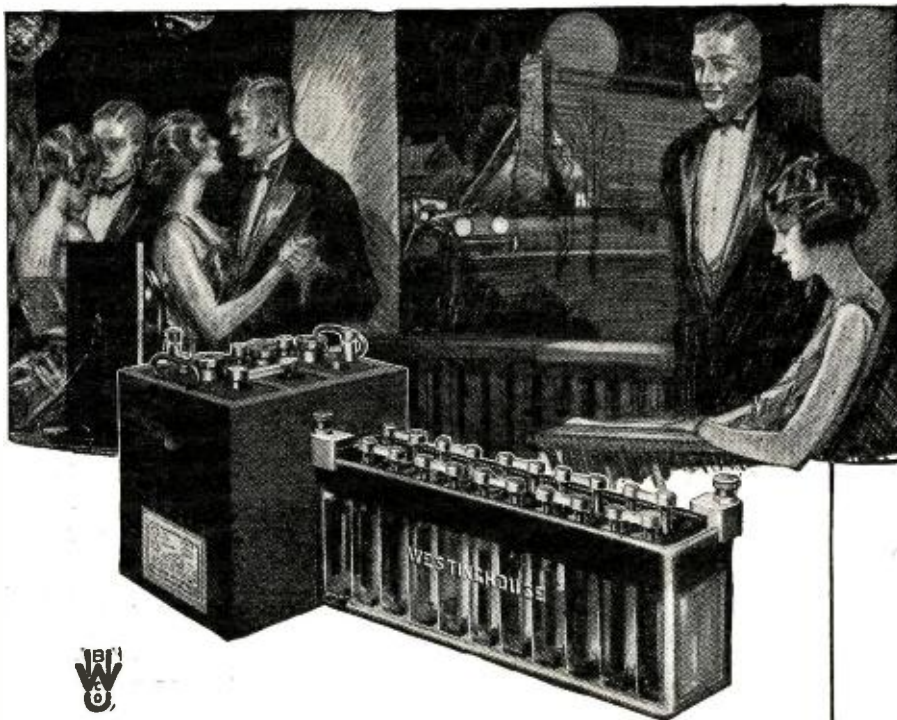

Steady, Full-powered Batteries

EVERY radio set has its own peculiarities—little niceties of adjustment at which best results are obtained. Battery voltage and amperage must be just so. And once adjusted, current must have sustained evenness and steadiness.

Get good batteries. They're the most satisfactory and economical in the end. Westinghouse Radio Storage Batteries will settle the problem practically for good. They last indefinitely and are easily and repeatedly rechargeable. Built by Westinghouse—you know they're *RIGHT*.

Westinghouse "A" Batteries are carefully constructed, full-capacity, slow-discharge, long-life batteries. Made in 4, 6 and 8-volt sizes with 5, 9 and 13 plates per cell, to meet various filament-battery requirements.

Westinghouse "B" Batteries. The Westinghouse 22-M G-2 (22 volts) is a marvel for steady, noiseless, full-powered service. Glass case; visible interior; sealed-in tops. Larger types, too; also 2-volt single cells for "C" batteries.

At radio dealers and Westinghouse Battery Service Stations everywhere. Write for illustrated folder, "Westinghouse Radio Storage Batteries."

WESTINGHOUSE UNION BATTERY CO.
Swissvale, Pa.

WESTINGHOUSE

Radio "A," "B" and "C"

BATTERIES

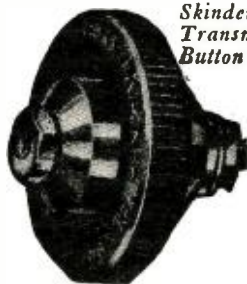

Skinderviken Transmitter Button

Postpaid Price **\$1.00**
with instructions
Send for diagrams, free.

MARVELLOUS RESULT

is obtained by one radio fan, who placed two of our Skinderviken Transmitter Buttons between the receiving set and the phones. He writes that without the buttons, the least noise prevented him from hearing, but with the buttons even walking or talking in the room did not interfere. He requires no loud speaker but can hear about three inches from the receivers. He is in Canada and picks up Schenectady, Newark, etc.

K. ELECTRIC CO.
15 PARK ROW, NEW YORK

The New RT-8 Radio Frequency Transformers

on the market March 1st, 1923 are specially designed by the *Radio Service Laboratories* for maximum efficiency when used with any low filament current consumption and low voltage tubes on the market.

For Audio Frequency the new RT-A2 will give you 100% Tone Quality and High Amplification without distortion. For best results on both tone and distance, use *Radio Service Laboratories* Radio Frequency RT-8 (for all stages) in the black case, retail price \$6.00 and Audio Frequency RT-A2 in brown case, retail price \$6.50. For sale at all reliable electrical or Radio Stores. If your dealer cannot supply you, order direct. Order by type number, accept no substitute, and remember that all *Radio Service Laboratories* Transformers are individually triple tested and unconditionally guaranteed.



Send ten cents for new booklet on Radio Frequency with schematic diagrams—a most valuable and helpful publication for the radio amateur and expert.

RASLA SALES CORPORATION

National Distributor

DEPT. A, 10 EAST 43RD ST., NEW YORK CITY

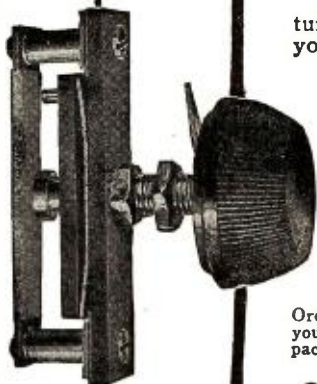

Adjustable Grid Leak (with condenser) Patent applied for

A Little Louder, Please

You'll be able to get more satisfactory results—to tune a little sharper and eliminate the "squeal"—if you equip your set with a

C R L Adjustable Grid Leak

A turn of the polished black knob enables you to get quickly the one and only correct potential that provides the maximum signal strength.

C R L Adjustable Grid Leaks are not of the pencil-mark type, but are built with a permanent resistor strip. They'll be working just as well when your grand children become radio enthusiasts as they will when you first install them. It pays to buy C R L Equipment.

- No. 106 (without condenser)\$1.50
- No. 107 (with grid condenser) 1.85

Order from your dealer or, if he has none in stock, we'll supply you direct if you will include 10c additional for postage and packing.

CENTRAL RADIO LABORATORIES

303-16th Street

MILWAUKEE

WISCONSIN

Tune in to

WDAP

—the powerful broadcasting station at

The DRAKE

LAKE SHORE DRIVE AND UPPER MICHIGAN AVE. CHICAGO

From Porto Rico to lonely ranches in Alberta and Saskatchewan, from sunny San Diego to Quebec, and even a thousand miles out in the Atlantic and Pacific Oceans, programs from THE DRAKE are picked up. You'll be particularly well repaid by tuning in Tuesday, Thursday, Saturday, and Sunday evenings—concerts include selections by THE DRAKE Ensemble Orchestra.

WDAP Station is but a single interesting feature of THE DRAKE, Chicago's finest hotel. When in Chicago be sure to stop at THE DRAKE. See how concerts are broadcasted, and enjoy the world famous service and surroundings of this wonderful hotel. Information on request.

Under The Blackstone Management, the world's standard in hotel service.

Seventeen or Seventy Age Does Not Matter

We will pay you well for your spare time

We wish to have a representative in every community to show RADIO NEWS and SCIENCE & INVENTION—the largest, most popular, and by far the most interesting radio magazines published.

Subscribers to these magazines will wish to renew their subscriptions within the next few months and we pay you just the same for each subscription whether new or a renewal.

During your spare time you can make some real money—in an easy and dignified way, our commissions are unusually large.

Write for particulars, sample magazines, etc. to

C. J. WOLFE, EXPERIMENTER PUBLISHING CO., Inc.

53 Park Place, N. Y.

Sweeney School at Kansas City, can all be sorted out easily and brought in through the crashing of the local stations. All this is on two stages, A. F., without any R. F. to increase the selectivity.

The 360-meter stations are legion. Not much work is done on them, as their music has usually less appeal. None the less, it will be found that they can be sorted out as well as the 400-meter stations and perhaps a trifle better as a slight difference of wave-length, upon which tuning out depends, means a greater difference in frequency with shorter waves.

It will be seen that by the addition of a simple switching scheme this arrangement may be used for a standby broad tuner to find out what is going on, and with a throw of the switch the coupler can be cut in and fine tuning done.

Now another simple scheme, which increases selectivity greatly, but not so much as the coupler system. This arrangement operates to cut down quite bad static to a low rumble which is much less difficult to work through than if it is not used. Shunt a .0005 variable condenser around the antenna and ground connections, with the tuning condenser in series on the antenna side of the tuning coil and use no ground connection. The above arrangement shown in Fig. B results in a very slight loss in signal strength, an improvement in the quality of the signals received, which more than makes up for the loss in strength, much easier tuning on either condenser, and noticeable decrease in static noises. It may be that local conditions have something to do with this hook-up working so well, but it is simple and easy to try and if no success results, no harm is done. The writer has received too loud for comfort, with two stages of A. F., stations well over 2,000 miles distant. If they were any farther away they would need to be out in the Atlantic, as New York, Philadelphia, Anacostia, and Atlanta are about as far as one can reach on dry land from Central Alberta.

Using this latter hook-up, a curious condition will be found, however. It will be obvious that none of the instruments are at ground potential, as there is no ground connection. Consequently, when the operator has his telephones clamped on, he is in effect part of the instrument. Therefore, if other telephones are in use and after tuning is done, they are put on by other listeners, a pronounced detuning will be found, as the other listeners then become part of the instrument, as is the operator, and the capacity characteristics are changed. Therefore, tuning must be done with all the telephones that are to be used on the heads of the listeners.

It will be found then that there is practically no body capacity in the operator for the same reason given above, that he is in fact part of the instrument. This arrangement can be used sometimes without a series condenser. Simply put the tuning condenser in parallel with the antenna coil.

Station 8YD, Cleveland, Ohio

(Continued from page 1960)

360 miles west of Honolulu. Mr. Morrison stated that the signals were QSA and good for another 1000 miles. The station has been heard in Cuba and Porto Rico. Considering the low wattage of the output, this station has done remarkably good work.

KENNEDY

USES

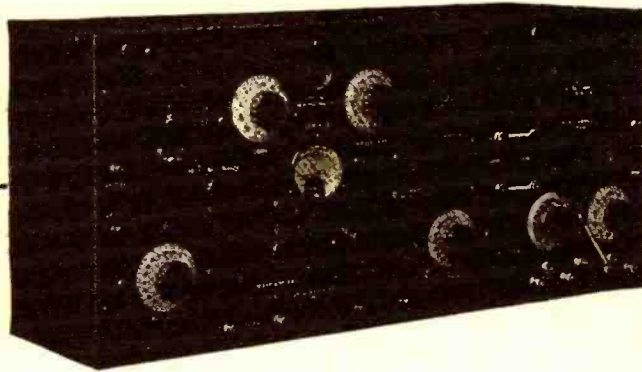

Formica Panels and Insulation

THE COLLIN B. KENNEDY COMPANY uses Formica exclusively for its panels, tubes and other insulating parts in its entire line of Receiving Sets.

The handsome appearance of Formica, its high dielectric strength and wonderful uniformity meet the exacting Kennedy standards and have contributed to the creation of the splendid Kennedy reputation.

A list of the companies who use Formica Insulation reads almost like a directory of the leading independent radio manufacturers.

This patronage of men who know radio insulation establishes Formica's claim to leadership in its line.

DEALERS: Formica advertising and sales support is the most aggressive and effective in the industry. The Formica Insulation Company treats you right.

THE FORMICA INSULATION COMPANY
4618 Spring Grove Ave.,
CINCINNATI, O.

50 Church St., New York, N. Y.
422 First Avenue, Pittsburgh, Pa.
1042 Granite Bldg., Rochester, N. Y.
415 Ohio Bldg. Toledo, Ohio

1210 Arch St. Philadelphia, Pa.
1819 Lyndale Ave., South, Minneapolis, Minn.
Sheldon Bldg., San Francisco, Calif.
Whitney Central Bldg., New Orleans

414 Finance Bldg., Cleveland, Ohio
9 S. Clinton St. Chicago, Ill.
313 Title Bldg. Baltimore, Md.
47 King St. Toronto, Ontario

FORMICA

Made from Anhydrous Redmanol Resins
SHEETS TUBES RODS

KNOW WHO IS SENDING

Get twice the pleasure and usefulness out of your receiving set. Look up the name and location of any ship or land station whose messages you pick up—learn the name and address of that amateur whose sending set you just heard.

4th Edition of the **CONSOLIDATED RADIO CALL BOOK**



7 Two-Color Radio Maps

Five of them are Continental Maps showing all stations throughout the world handling commercial traffic, with their calls; one showing the amateur radio districts of the United States and the principal radiophone broadcasting stations with their calls; and a map of the United States Weather Forecast Zones. Seven wonderful, two-color radio maps with a wealth of information that will give you a great deal of pleasure and knowledge.

Ninety-five per cent of all Amateur Calls in the U. S. and Canada are Listed Besides Other Valuable Information Contained in This Book

Amateur Radio Calls of the United States and Canada; Every Vessel, Coast Station, and Radio-Compass Station in the World; Radiophone Broadcasting Stations of the United States; Every High-Power Station in the World; Special Land Stations of the United States; Time Signals, Hydrographic and Weather Reports of the United States and Principal Foreign Countries; International Abbreviations; Assignment of International Calls; Press Schedules; Radiogram Rates; Cable Rates; International Morse Code and Continental Signals; and Complete General Information covering Distress Calls, International Safety Signal, Use of 800-Meter Wave Length, Amendments

\$1.50
Prepaid

and Changes in Various Governmental Regulations, How to Determine Charges on Radiograms, Free Medical Advice by Radio to Vessels, and much other useful information.

And every vessel and land station in the world is represented and listed alphabetically, according both as to name of vessel or land station, and to call letters. The Consolidated Radio Call Book is the only book in print officially listing all the Radio calls as issued by the Bureau of Commerce. And the New Radiophone Broadcast Section is particularly complete and gives all available information concerning calls, wave lengths, PROGRAMS, etc.

Published by

Consolidated Radio Call Book Co., Inc.
96-98 Park Place, New York City

**Great 40-page Supplement FREE to all
who have the 4th Edition Call Book**

NATIONAL AIRPHONE PRODUCTS

NOTES ON THE REFLEX CIRCUIT

WITH the reflex circuit illustrated, and with the values as given, it is now possible, with a single tube and a NATIONAL AIRPHONE GOLD-GRAIN DETECTOR, to receive distances over 1500 miles on a small aerial.

The price of the parts as shown in the illustrations should not come higher than from \$20.00 to \$22.00 (excluding Vacuum tube and phones).

The results are really remarkable, and by using a WD-11 Tube it is not even necessary to use a storage battery. A small "B" Battery and a dry cell can be used.

An ideal portable outfit can be constructed quite readily with

the Reflex, and for local stations, within a radius of 50 miles, an outdoor aerial is not required. A small two-foot loop may be used, and it becomes then possible to obtain a moderate volume of sound on a loud speaker.

The Reflex outfit as shown in the circuit herewith has been constructed by our engineering department and we shall be glad to demonstrate it to the radio fraternity. The extraordinary results obtained with this circuit are in part due to the NATIONAL AIRPHONE GOLD-GRAIN DETECTOR. Recent changes made in this Detector have improved it to such an extent that it is now entirely automatic and will stay put with only occasional adjustments.

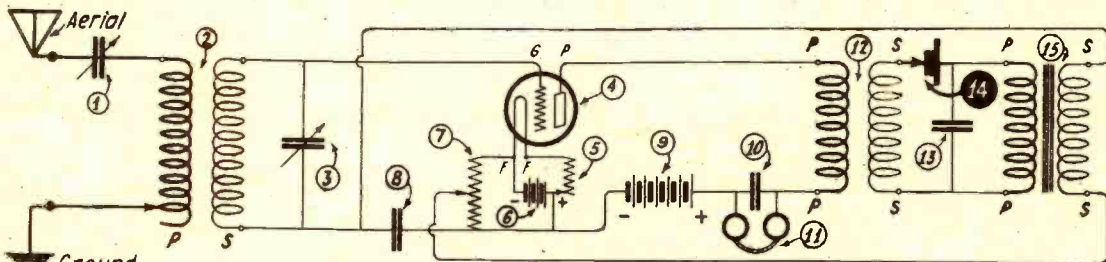

1= var. cond. .001 mfd. 43 plates. 2= variocoupler. 3= var. cond. .0005 mfd. 23 plates. 4= vacuum tube (amp) 14= NATIONAL AIRPHONE GOLD GRAIN DETECTOR 5= rheostat. 6 A' batt. (DRY CELL FOR WD-11) 7= 200-400 Ohm potentiometer. 8= fixed mica cond. .001 mfd. 9= batt. 45v. 10= fixed mica cond. .001 mfd. 11= phones. 12= mu rad. radio freq. transf. 13= .001 mfd. F.C. 15= federal audio freq. transf.

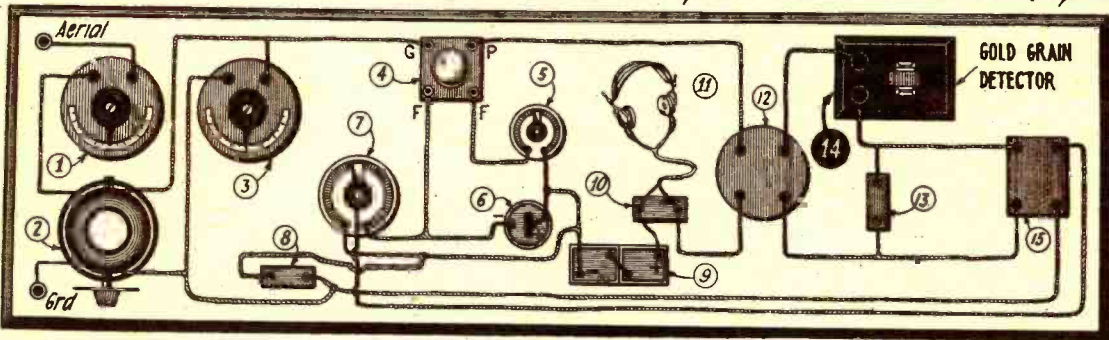

NATIONAL AIRPHONE "GOLD-GRAIN" DETECTORS

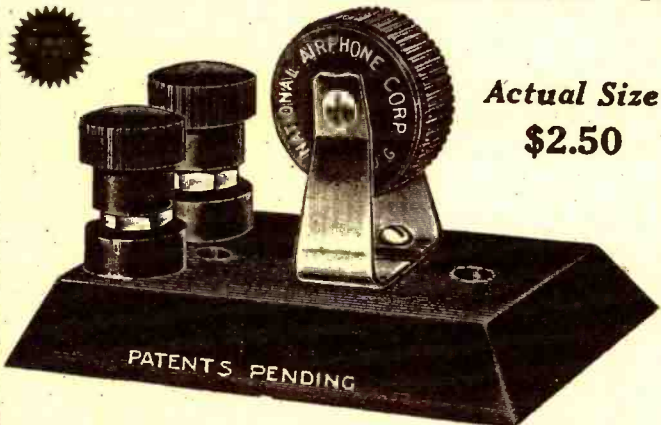

Actual Size
\$2.50

Actual Size

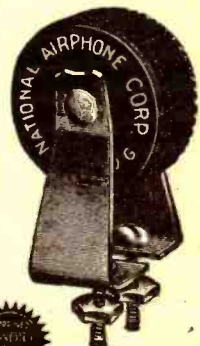

FOR PANEL MOUNTING

After you have fussed with catwhiskers, springs, balls and adjustment handles, and after you have almost become a nervous wreck, hunting for "the elusive sensitive spot" you will welcome with open arms our 100 per cent. GOLD GRAIN DETECTOR.

This Detector is foolproof; has no catwhiskers, no springs, no balls, no adjusting handles; no fussing. The Detector is entirely enclosed in hard rubber composition cartridge, but it is NOT a fixed detector.

A special crystal is used, while contact elements are made of pure gold. There is always a multiplicity of contacts. The Detector is sealed hermetically. The contact with the crystal is always perfect.

This detector has been pronounced by experts as the greatest detector in existence. It reproduces voice, and music in natural color of tone, without distortion. You will be surprised at the wonderful results and satisfaction obtained with the "Gold-Grain" Detector.

DISTRIBUTORS—Write for Exclusive Territory
DEALERS—For Price List

YOU ARE PROTECTED BY THIS GUARANTEE:

Should any National Airphone or "Gold-Grain" Detector not be in first-class condition when purchased and within 10 days you return it to us unbroken, or unopened, we will refund your money or give you another one as you may prefer.

SEND NO MONEY

National Airphone Corporation,
18 Hudson Street, New York City, N. Y.

R.N. 5

Gentlemen:

Please send me prepaid
for which I will pay the postman the amount advertised on this page.
If within 10 days I do not find the apparatus all you claim for it, or if for any reason I am not satisfied, I may return same to you in good condition and you will refund the full purchase price.

NAME
STREET AND NO.
CITY..... STATE.....

NATIONAL AIRPHONE CORPORATION

18 HUDSON ST. NEW YORK

Get These Wonderful Radio Books

These Dealers Carry Our Books:

- Abraham & Straus, Brooklyn, N. Y.
 Albany Radio Corp., Albany, N. Y.
 Anderson Elec. Co., Amsterdam, N. Y.
- Bacharach Basin Co., Baltimore, Md.
 Badger Radio Co., Milwaukee, Wis.
 Beardsley Spec. Co., Rock Island, Ill.
 Bishop Electric Co., Johnson City, Tenn.
 Broadway Dept. Store, Los Angeles, Calif.
 Bryan, R. E., Tyler, Texas.
 Bullocks Hardware Co., York, Nebraska.
 Burgess Electric Co., Bluefield, W. Va.
 Burlington Elec. & Nov. Co., Burlington, N. J.
- Cortland Electric Co., New York City.
- Dewey Sporting Goods Co., Milwaukee, Wis.
 Diamond News Co., Havana, Cuba.
- Eberhard & Son Co., M. Astoria, L. I.
 Electric Auto Appliance Co., Denver, Colo.
 Electric Co., (Grenda & Sether) Fergus Falls, Minn.
 Electric Shop, Flushing, L. I.
 Electric Shop, New Brunswick, N. J.
 Electrical Shop, Honolulu, Hawaii.
 Elite Electric Shop, El Paso, Texas.
 Empire Elec. Co., St. Joseph, Mo.
 Ernest Electric Co., St. Louis, Mo.
 Evers Hardware Co., Denton, Texas.
- F & W Grand 5, 10 & 25c Stores, All Over.
 Finch & Hahn, Schenectady, N. Y.
 Flecks Electric Service Station, Tiffin, Ohio.
 Fordham Radio & Specialty Co., New York City.
 Foster Book & Cigar Co., St. Louis, Mo.
 Foster Radio & Electric Co., Wilkes-Barre, Pa.
- Galveston Wireless Supply Co., Galveston, Texas.
 Gee Electric Co., Wheeling, W. Va.
 Gimbel Bros., New York City.
 Guezt's Music Store, Fort Worth, Texas.
- Haskell Electric Co., Holyoke, Mass.
 Hamilton, H., Greenburg, Pa.
 Heinemann Electric Co., Philadelphia, Pa.
 Hentzschei, W. W., Baltimore, Md.
 Hill Co., Geo. A., Lowell, Mass.
 Hunter, J. B., Boston, Mass.
 Huse & Sons, W. S., Providence, R. I.
 Hygrade Elec. & Nov. Co., New York, N. Y.
 Hynson Electric Co., Portland, Oregon.
- International Electric Co., Wellington, New Zealand.
 International Radio Corp., Winnipeg, Man. Can.
 Interstate Elec. Co. of Ala., Birmingham, Ala.
- Jacksons Radio Eng. Lab., Waco, Texas.
- King, H. W., Des Moines, Iowa.
 Koch, John R., Charleston, W. Va.
 Knoxville Radio Co., Knoxville, Tenn.
- Law, E. M., Norristown, Pa.
 Laws Blythe Electric Co., Atchison, Kansas.
 Linze Elec. Supply Co., St. Louis, Mo.
 Loeser, Frederick, Brooklyn, N. Y.
- McArthur Electric Co., Chicago, Ill.
 Macaulay Bros., Detroit, Mich.
 Mechanics Co., H. C., Fort Worth, Texas.
 Modell's, New York City.
 Murray Spring Co., W. A., Cincinnati, Ohio.
- N. S. W. Bookstall, Sydney, Australia.
 Natick Book Store, Los Angeles, Calif.
 National Auto Supply Co., Terre Haute, Ind.
 Nelsons Radio Suply Co., Phoenix, Ariz.
 Noll & Co., E. P., Philadelphia, Pa.
 Northwest Radio Service, Seattle, Wash.
- Paeless Electric Co., Minneapolis, Minn.
 Perrault, F. J., Natchez, Miss.
 Philadelphia Sporting Goods Co., Phila., Pa.
 Polozynski & Co., B. E., Detroit, Mich.
 P. O. News Co., Chicago, Ill.
- Radio Concert & Equipment Co., Los Angeles, Calif.
 Radio Electric Co., Fort Worth, Texas.
 Radio Electric Shop, Cleveland, Ohio.
 Radio Equipment Co. of Texas, Dallas, Texas.
 Radio Specialty Co., New York City.
 Randolph, J. O., Elgbee, Mo.
 Reutter Electric Co., Cincinnati, Ohio.
 Reynolds Radio Co., Denver, Colo.
 Richter, Conrad, San Francisco, Calif.
 Roberts Bros. Electric Co., Philadelphia, Pa.
 Ross Frankford Music Shop, Philadelphia, Pa.
 Rova Radio Stores, Newark, N. J.
 Rova Radio Stores, New York City.
- S. A. S. Radio Co., Paterson, N. J.
 Schroeder Electric Co., Albany, N. Y.
 Security Auto Supply Co., St. Louis, Mo.
 Security Radio & Supply Co., St. Louis, Mo.
 Skokos, S., Perth Amboy, N. J.
 Spectator, The, Bruce Mines, Ontario, Canada.
 Small Co., Geo. W., Phila., Pa.
 Silver & Bros. Co., Birmingham, Ala.
 Southern Electric Co., Jacksonville, Fla.
 Smith, H. E., Batavia, N. Y.
 Stelger & Co., E., New York City.
 Sterling Electric Co., Minneapolis, Minn.
 Steward Electric Service Co., Urbana, Ohio.
 Superior Radio & Equipment Co., Columbus, Ohio.
 Sweets Accessory Shop, Attleboro, Mass.
 Sykes & Co., Rochester, N. Y.
- Universal Supply Co., St. Louis, Mo.
 Utzinger Book Store, Astoria, Oregon.
- Velh Crawford Hardware Co., Fort Worth, Texas.
 Viking Radio Co., New York City.
 Virginia Radio Service, Medford, Ore.
 Vulcanizers Supply Co., Kansas City, Mo.
- F. & B. White, Canton, Ill.
 Wilbur Electric Co., Baltimore, Md.
 Wile, Eugene G., Philadelphia, Pa.
 Williams Book Store, Boston, Mass.
 Williamson Electric Co., Seattle, Wash.
 Wilson, J. L., New York City.
 Wilson, F. B., (Archway Book Store), Seattle, Wash.
 Woodhead, L. F., Rosewell, N. M.
- Zibart Bros., Nashville, Tenn.

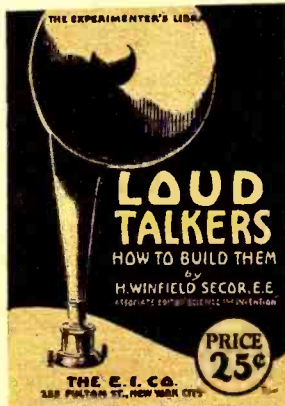

LOUD-TALKERS HOW TO BUILD THEM

By H. WINFIELD SECOR

Associate Editor of Science & Invention

This book describes how to build two distinct and different types of radio loud-talkers, which can be built with either electro-magnetic field to be excited from storage battery, as well as permanent magnet field requiring no separate battery excitation. The third chapter deals with improvised loud-talkers and gives clear and complete instructions on how to build suitable horns

for use with radio receivers of the Baldwin and other types. Several elaborate hook-ups are given of the author's own radio receiving set, comprising one stage of radio-frequency, detector and three stages of audio-frequency amplification, together with all the connections for the loud-talker.

Complete data is given for all the parts of the loud-talkers, including the field magnet windings, as well as the diaphragm or moving coil windings, and also the step-down transformer to be connected between the vacuum tube amplifier and the loud-talker proper.

In preparing these designs the point has been constantly kept in mind to use the simplest parts possible, so that practically anyone can build a successful loud-talker equivalent to the commercial types costing \$40.00 or more.

Even where the experimenter does not possess the skill or the time to make all the parts himself, which are really few in number, he may save a great deal of money, or at least half the price of a commercial loud-talker, by having the difficult parts made in a local machine shop, and then assembling them and winding the coils himself. Circuit connections and data for the size of wire, etc., are given for placing the loud-talker on a separate floor or in another part of the house not occupied by the radio receiving set. A very valuable book, giving data which cannot be obtained anywhere else and which has not been published before.

64 pages, 25 illustrations, bound in beautiful two-color cover, size 5½ x 7½ inches; Price prepaid, 25 cents.

HOW TO MAKE RADIOPHONE RECEIVING SETS



EVERY RADIO
ENTHUSIAST
SHOULD HAVE
A COPY OF
THESE BOOKS
WRITTEN BY
THE
FOREMOST
AUTHORITIES
IN EVERY
BRANCH OF
THE SUBJECT

RADIO FREQUENCY AMPLIFIERS AND HOW TO MAKE THEM

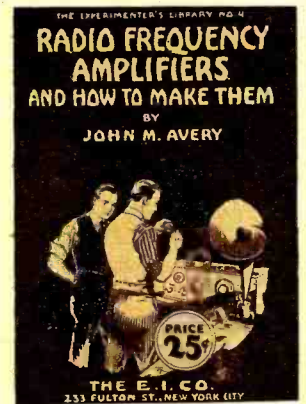

A non-technical book for the beginner. Gives complete constructional data on the building of a complete Crystal Detector Set, Tuning Coil, Loose Coupler and a Single Audion Tube Set with Amplifying Units. It furnishes all dimensions and working drawings of every part that must be constructed by the amateur. Written in plain, simple language that anyone can understand. The opening chapter gives a complete description of the theory of radio and tells what it's all about, teaching the principles of wireless so that the constructor knows what he is doing.

48 Pages, 26 Illustrations
Bound in Beautiful Two-Color Cover
Size, 5½x7½ inches. Prepaid 25c.

25c.
Each

Postage Prepaid

This book is for the more advanced amateur, showing the construction of the Radio Frequency Amplifying Transformer and giving complete constructional data. It shows the application of Radio Frequency to amplifying units that the amateur may already possess and gives 15 hook-ups showing practically every use Radio Frequency Amplifying Transformers can be put to.

32 Pages, 15 Illustrations
Bound in Beautiful Two-Color Cover
Size, 5½x7½ inches. Prepaid 25c.

Order from your dealer—or direct from us

THE E. I. COMPANY 233 FULTON STREET
NEW YORK CITY, N. Y.

Dealers: Write for our attractive wholesale proposition.

New Rules for French Radio Amateurs

(Continued from page 1966)

may receive which are not meant for you. On the other hand, remember that the police may be listening in.

"Eighth—The Administration reserves the right to control your post.

"Ninth—Think of the State coffers. Remember the yearly tax is ten francs.

"Tenth—If the Administration thinks it wise to requisition your post, do not complain, but do what is necessary to put the machine in working order."

Abstract from New York Herald.

Radio Digest

(Continued from page 1971)

But regardless of how carefully censored the messages may be, the objection to this form of advertising still stands. Station WEAJ has built up its reputation on the fine quality of its programs. Radio fans who tune in on this station are accustomed to get high-class entertainment. If they are obliged to listen to some advertiser exploit his wares, they will very properly resent it, even though the talk may be delivered under the guise of a matter of public interest or even of public welfare. An audience that has been wheeled into listening to a selfish message will naturally be offended. Its ill-will would be directed not only against the company that delivered the story, but also against the advertiser who chooses to talk shop at such an inopportune time.

There are several objections to the sending out of advertising through radio broadcasting stations, but we are opposed to the scheme principally because it is against good public policy. We are opposed to it for the same reason that we object to sky writing. People should not be forced to read advertising unless they are so inclined. We are opposed to it on much the same grounds that we object to "readers" or press agent dope or any other kind of disguised publicity that inveigles persons to read it on the promise that it is news. Forcing a business proposition under people's noses or into their ears when they are trying to do something else is not the way to win the good-will of these people.

Another point that the American Telephone and Telegraph Company should consider: Much of the radio's popularity is due to the way the newspapers have been playing it up. In many cases they are devoting whole pages and in some cases entire sections to radio developments. The programs of the various broadcasting stations, which the newspapers publish, is of inestimable value to radio users, and in fact without these published programs the broadcasting stations would be seriously handicapped. It is certain that the newspapers will not continue to give the radio interests all of this generous co-operation if the broadcasters are themselves going to enter into advertising competition with the newspapers.—*Abstract from Printers' Ink.*

A NEW BILL—H. R. 14169

A new Radio Bill has just made its appearance, known as H. R. 14169. This is one of the most drastic bills ever issued, and if it should pass (which we doubt), it would mean that not only all telephones and telegraphs, but radio as well, would become a Government monopoly.

We print the main part of the bill merely

"American Beauty"

Electric Soldering Iron



The Best Iron Made

For Soldering all connections, parts, etc. Ready for use by attaching to any electric light socket. The cost of operation is insignificant.

Many thousands in use by amateurs, engineers, manufacturers, telephone companies and many others.

For radio, telephone and all light work our latest Model No. 3138 is ideal; also two larger sizes for doing heavier work.

For twenty-eight years our name and trade mark have been a guarantee of quality and dependability.

AMERICAN ELECTRICAL HEATER COMPANY
DETROIT, U. S. A.

Oldest and largest exclusive makers. Established 1894

The most satisfactory book for beginners that has yet appeared.—Public Ledger.



RADIO SIMPLIFIED

By KENDALL & KOEHLER
Radio Instructors

WHAT TO BUY HOW TO BUILD HOW TO OPERATE

A clear explanation of Radio in simple language with complete directions for assembling and installing home radio equipment. Will aid you in getting the best results from your set.

96 Illustrations including picture diagrams showing hook-ups, etc. Cloth, 250 pages, \$1.00.
On sale at Booksellers or mailed on receipt of price
THE JOHN C. WINSTON CO 33 Winston Bldg, Philadelphia, Pa.

BUNNELL'S RADIO-PHONO PHONOGRAPH ATTACHMENT



Sample by mail, 40c

Liberal discount in quantities.—Send stamp for our 45-X Catalog, now ready.



J. H. BUNNELL & Co.

32 PARK PLACE
NEW YORK

MONEY for YOU Add to your Salary—Make extra Pin Money. Start a lucrative business of your own. Spend an hour each day taking subscriptions for the "Radio News." We'll pay you well and you'll enjoy the work. Write for full particulars. Circulation Dept. RADIO NEWS, 53 Park Place, N. Y. C.



Forget your "A" Battery troubles--

Hook up a

Red Seal Radio Sparker

Instead of a single dry cell, to each WD-11 Tube, and you insure operating the tube at its maximum efficiency over a much longer period. You can listen in on those distant stations that have been so tantalizingly just out of range, and at the same time get far longer life from the battery.

The Red Seal Radio Sparker lasts from 2½ to 3 times as long as a single cell. Full capacity, slow discharge.

By using the Red Seal Radio Sparker it is necessary to hook up only one battery. Made in 2 cell, 6 cell and 8 cell sizes for operating from 1 to 4 WD-11 tubes.

Remember the name Radio Sparker. Look for the striking red, black and yellow label.

Red Seal Sparker---steel clad

The dependable dry battery for all ignition purposes, in the husky steel container that stands the hard knocks.

Use Red Seal Sparker---steel clad---for your Ford and motor boat, for camping, for your lantern, and so on. 4 cell, 5 cell and 6 cell sizes.

NEW YORK
ST. LOUIS



MANHATTAN
ELECTRICAL SUPPLY CO., INC.

CHICAGO
SAN FRANCISCO

Makers of the famous Red Seal Dry Batteries, Sparkers and Manhattan Radio Products

RADIO "A" & "B" STORAGE BATTERIES CHARGED, AT HOME, FOR FEW CENTS, WITH "PATENTED FULL WAVE" 100-130 Volt, 60 Cycle A.C. AUTOMATIC MAGNETIC TAPER CHARGING

F-F RADIO RECTIFIER

Eventually You Will Buy An F-F RECTIFIER Why Not Now? The Sooner You Buy It The More You SAVE.

It CHARGES All 6 Volt RADIO "A" & AUTO Batteries; & All RADIO "B" & LOUDSPEAKER Storage Batteries Up To 120 Volts In Series Inductively At Home OVERNIGHT. Disconnecting & Multiple Connections Unnecessary. Charging Circuits Separate. Nothing Like It Made. No Chance For Grounds Or Short Circuits. No Skill Required. AMMETER Eliminates Guess Work. It Costs You Less To Buy An F-F RECTIFIER than To Be Without One. You PAY for ONE Whether You Buy One Or Not, for It Costs An Average Of \$2. for Charging & Rentals Every Time An Auto Battery Is Charged By Others, but Only A Few Cents When You Charge Your Own From A Lamp Socket With An F-F Battery Boosting RECTIFIER. If You Have Never Known The Delightful Feeling Of Having Your Storage Batteries Always Fully Charged for RADIO & AUTO You Will Experience A New Thrill When You Charge An F-F RECTIFIER Which Gives You A Fully Charged Battery Overnight At A Cost of A Few Cents & A Pleasant Feeling Of Things Well Done. Those Who Own Them Feel Their F-F RECTIFIER is Their Faithful Friend. It Charges Automatically & Being Clean Can Be Placed Anywhere. Nothing To Stop Over Be Filled Burn Out Need Attention Or Cause Trouble. Both Waves Are Rectified Thru Infusible Carbon Rectifying Brushes, Maintaining Constant Efficiency Uninterruptedly. While Its FULL WAVE Delivers RAPID TAPER CHARGE recommended By All Storage Battery Manufacturers. The F-F RECTIFIER is A Complete Compact Portably Handy Charging Unit. Delivers Service Day & Night Automatically & Will Charge Dead Battery. Do Not Think Battery Is Dead & Worn Out Simply Because It Will Not Start Your Car. Buy an F-F RADIO RECTIFIER & Fill It With LIFE. It SAVES MORE than Its Cost & Lasts Lifetime. Leave Your Battery In Car, Or Where Ever It Is, Without Even Disconnecting It. Screw RECTIFIER Plug In Lamp Socket, Snap RECTIFIER Clips On Battery Terminals; Turn Switch & Battery Will Be Charged In Morning At Cost Of Few Cents. Is It Not Gratifying To Be Ready For All RADIOPHONE BROADCAST Music Sermons & News When Friends Call? Never Having To Be Careful Of, or Tell Friends Your Batteries Are Dead & to Feel Your Car Respond Like A Greyhound, Spinning Engine With Power When You Throw In STARTER? Fully Charged Battery Starts Car Quick & Requires Fewer Expensive Replacements. INSIST on The F-F RECTIFIER. Built By A Master Of The Art in 7 Types. So Many Thousands Are Being Sold It Has Made Possible These POPULAR PRICES

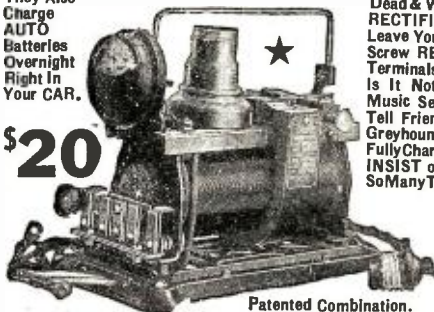

\$20

Patented Combination.

CHARGES "A" & "B" RADIO & AUTO BATTERIES. The Lower 3 are Large TYPES Built For Heavy Batteries, or Where Time Is Limited. SHIPPING WEIGHTS Complete With AMMETER & BATTERY CLIPS 11 to 15 Lbs. Purchase From Your DEALER Or Mail Check for Prompt Express Shipment. Via PARCEL POST have Remittance include Postage & Insurance Charges, or WRITE Us To Ship TYPE Desired C. O. D. Other F-F Battery Boosters Charge Batteries From Farm Lighting Plants & D. C. Circuits & for GROUP CHARGING Economy Use Our 8 Ampere 12 Battery Capacity Automatic Full Wave F-F ROTARY RECTIFIER described in ROTARY BULLETIN 32A. ORDER Now, or WRITE Immediately for FREE Descriptive RADIO & AUTO BOOSTER & ROTARY BULLETINS 32A & 32

FRANCE MFG. CO.

General OFFICES & WORKS: CLEVELAND, OHIO, U. S. A. Canadian Distributor: The Jack V. Elliot Co., Hamilton, Ontario, Canada

Radio Distances Easily Found Latest Call Numbers Just Revised Cram's Radio Map Just 100 Miles to One Inch Thoroughly Revised to Date Pocket Form 35 Cents Sheet Map in Tube, Flat, 50c Wall Form with Sticks, \$1.50 On Board for Tacks, \$6.75 Ramap Dept.

Geo. F. Cram Co.
111 No. Market St. Chicago, Ill.
Special Quantity Prices for Advertisers Discount to the trade.

LOUD SPEAKER FOR ANY CRYSTAL SET

By using the STEINMETZ amplifier you can fill the whole room with music and can increase your range up to 1000 miles. \$8.50, remit by check or money order.

Specials for Limited Time Only Radiotron UV200 Detector Tube, \$3.75. Amplifier tubes, \$4.75. 1½ volt dry cell tubes, \$4.75. Sockets for standard tubes, 50c. Sockets for 1½ volt dry cell tubes, 50c. Standard 2000 ohm phones, \$3.90. 3000 ohm, \$4.90. SUPERIOR crystal sets, \$3.90. Novo 2½ volt "B" Batteries, \$1.50. Rheostats, 50c. Vacuum tube detector sets, \$5.50. Amplifier sets, \$8.50.

Complete instructive catalog 5c at your dealer or Steinmetz Wireless Mfg. Co. 5706 Penn Ave. Pittsburgh, Pa.

as a curiosity, as we have not the slightest doubt that it will be killed. It shows, however, the trend of the times.

We do not believe the Government at the present time is inclined to take over such a public utility as communication.—EDITOR.

A BILL

To secure to the United States a monopoly of electrical means for the transmission of intelligence for hire; to provide for the acquisition by the Post Office Department of the telephone and telegraph network; and to license certain telephone lines, radio and telegraph agencies.

Be it enacted by the Senate and House of Representatives of the United States of America in Congress assembled, That in order to promote the Postal Service the Postmaster General of the United States is hereby vested with a monopoly of the function and means of electrical communication for hire within the United States and the Territory of Alaska except as hereinafter provided.

Sec. 2. That the telephone and telegraph systems and networks within the United States and the Territory of Alaska employed in the transmission of communications for hire, and such as may be necessary of the central-office equipment, underground cable, underground conduit, aerial cable, aerial wires, poles, building cable, subscribers' stations, including indoor wiring and drops to premises of subscribers, private branch-exchange switchboards, land, buildings, furniture and fixtures, tools and teams, stores and supplies, and all other property used in the telephone and telegraph service and appropriate and necessary for the operation of the same by the United States, are hereby declared to be, and the same are hereby, condemned and appropriated to and for the use of the United States of America, to be used by it for such public purposes as may be proper: Provided, That this section shall not apply to telephone lines known as farmer lines.

THE WHITE RADIO BILL

As we promised in the last issue, we are printing hereafter the complete text of the bill.—EDITOR.

67TH CONGRESS,
4TH SESSION
H. R. 13773

IN THE HOUSE OF REPRESENTATIVES

JANUARY 11, 1923

Mr. WHITE of Maine introduced the following bill; which was referred to the Committee on the Merchant Marine and Fisheries and ordered to be printed.

A BILL

To amend an Act to regulate radio communication, approved August 13, 1912, and for other purposes.

Be it enacted by the Senate and House of Representatives of the United States of America in Congress assembled, That the Act of Congress entitled "An Act to regulate radio communication," approved August 13, 1912, be amended by striking out sections 1, 2, and 3 thereof and by inserting in lieu thereof the sections 1, 2, and 3 following:

"SECTION 1. A. No person, company, or corporation within the jurisdiction of the United States shall use or operate any apparatus for radio communication as a means of intercourse among the several States or with foreign nations, or upon any vessel of the United States engaged in interstate or foreign commerce, or for the transmission of radiograms or signals the effects of which extend beyond the jurisdiction of the State, Territory, or the District of Columbia, in which the same originate, or where interference would be caused thereby with the transmission or reception of messages or signals from beyond the jurisdiction of said State, Territory, or the District of Columbia, except under and in accordance with a license in that behalf granted by the Secretary of Commerce and except as hereinafter authorized.

"B. The Secretary of Commerce from time to time shall (a) classify licensed radio stations and the operators required therein; (b) prescribe the nature of the service to be rendered by each class of licensed station and assign bands of wave lengths thereto; (c) make, alter, and revoke regulations applicable to all licensed stations not inconsistent with this Act or any other Act of Congress or with the terms, binding on the United States, of any radio communication convention to which the United States is a party, concerning the service to be rendered by each class of stations so established; the location of any station; the wave lengths to be used by any station; the kind of instruments or apparatus in any station with respect to the external effect produced thereby; the power and the purity and sharpness of the waves of each station or the apparatus therein; the area to be served by any station and the times and methods of operating any station or the apparatus therein; (d) make such other regulations not inconsistent with law as he may deem necessary to prevent interference between all stations affected by this Act. The Secretary shall have authority to exclude from the requirements of any regulations any radio station and the operators required therein, or to modify the same in his discretion, in any case in which he shall find that such action will facilitate commerce and will not be incompatible with the public interest.

"C. Every such license shall provide that the President of the United States, in time of war or public peril or disaster, may cause the closing of any station for radio communication and the removal therefrom of all radio apparatus, or may authorize the use or control of any such station or apparatus by any department of the Government, upon just compensation to the owners.

"D. Radio stations belonging to and operated by the United States shall not be subject to the provisions of paragraphs A and B of this section. All such Government stations shall use such wave lengths as shall be assigned to each by the President. All such stations, except stations on board naval and other Government vessels while at sea or beyond the limits of the continental United States, when transmitting any message other than a message relating to Government business, shall conform to such rules and regulations designed to prevent interference with other radio stations and the rights of others as the Secretary of Commerce may prescribe: *Provided*, That upon proclamation by the President that there exists war or a threat of war or a state of public peril or disaster or other emergency, the President may suspend or amend, for such time as he may see fit, the rules and regulations applicable to any or all stations within the jurisdiction of the United States. All stations owned and operated by the United States and all other stations on land and sea shall have special call letters designated by the Secretary of Commerce, and such stations and the designated call letters shall be included in the list of radio stations of the United States as published by the Department of Commerce. Radio stations on board vessels of the United States Shipping Board or the United States Shipping Board Emergency Fleet Corporation shall not be deemed to belong to or to be operated by the United States or to be Government stations within the meaning and for the purposes of this Act.

"Sec. 2. A. Paragraph A of section 1 of this Act shall not apply to persons sending radio messages or signals on a foreign ship while the same is within the jurisdiction of the United States.

"B. The station license required hereby shall not be granted to, or after the granting thereof such license shall not in any manner, either voluntarily or involuntarily, be transferred to (a) any alien or the representative of any alien; (b) nor to any foreign government or the representative thereof; (c) nor to any company, corporation, or association organized under the laws of any foreign government; (d) nor to any company, corporation, or association of which any officer or director is an alien or of which more than one-fifth of the capital stock is owned, controlled or voted by aliens or their representatives or by a foreign government or representative thereof, or by any company, corporation, or association organized under the laws of a foreign country.

"Such station license, the wave length or lengths authorized to be used by the licensee, and the rights therein granted shall not be transferred, assigned, or in any manner, either voluntarily or involuntarily, disposed of to any other person, company, or corporation without the consent in writing of the Secretary of Commerce.

"C. The Secretary of Commerce, subject to the limitations of this Act, in his discretion, may grant to any applicant therefor a station license provided for in sections 1 and 2 hereof.

"No license granted by the Secretary shall be for a longer term than ten years, and any license granted may be revoked as hereinafter provided. Upon the expiration of any license the Secretary, in his discretion, upon application thereof, may grant a renewal of such license for the same or for a lesser period of time.

"The Secretary of Commerce is hereby authorized to refuse a station license to any person, company, or corporation, or any subsidiary thereof, which, in the judgment of the Secretary, is monopolizing or seeking to monopolize radio communication, directly or indirectly, through the control of the manufacture or sale of radio apparatus or by any other means. The granting of a license shall not stop the United States from prosecuting such person, company, or corporation for a violation of the law against monopolies or restraint of trade.

"The Secretary of Commerce in granting any license for a commercial station intended or used for communication between the United States or any territory or possession, continental or insular, subject to the jurisdiction of the United States, the Canal Zone, or the Philippine Islands, and any foreign country, may impose any terms, conditions, or restrictions authorized to be imposed with respect to submarine cable licenses by section 2 of an Act entitled 'An Act relating to the landing and the operation of submarine cables in the United States,' approved May 27, 1921. Every license for such commercial station shall be approved by the President before the same shall be issued and become effective.

"D. The Secretary of Commerce may grant licenses only upon written application therefor addressed to him, which application shall set forth such facts as he by regulations may prescribe as to the citizenship, character, and financial, technical, and other ability of the applicant to operate the station; the ownership and location of the proposed station and of the stations with which it is proposed to communicate; the wave-lengths and the power desired to be used; the hours of the day or other periods of time during which it is proposed to operate the station; the purposes for which the station is to be used; and such other information as he may require. Such application



Do you lug your battery to have it charged?

Do you put off lugging it until it fails to give good results? How many concerts do you miss or only half hear?

With Tungar—the go-between—from the house lighting circuit to storage battery—you are prepared for best results always. Just turn it on and leave it. It charges your battery while you sleep. Its cost of operation is low. It makes convenient the necessary charging that prolongs battery life. Tungar has no moving parts to cause trouble. It is *certain, clean, quiet*. Good for the auto battery too—the same Tungar.

See it at any good electrical shop, or write for literature. Address Section RA-4

Merchandise Department
General Electric Company
Bridgeport, Connecticut

Tungar Battery Charger operates on Alternating Current.
2 ampere outfit—\$18.00.
5 ampere outfit—\$28.00
(east of the Rockies)
Special attachment for charging 12 or 24 cell "B" Storage Battery—\$3.00—fits either size Tungar.



Charge 'em at Home, with.

Tungar

BATTERY CHARGER

A GENERAL ELECTRIC PRODUCT



CRYSTAL RECTIFIER

MULTIPOINT (Patent Pending)

Unequalled Clearness; Unequalled Volume; Unequalled Distance. The Standard Crystal Endorsed by Experts. Press and Trade. Join the Ever-Increasing RUSONITE Fans.

PRICE POSTPAID MOUNTED SENSITIVENESS GUARANTEED 50 CENTS

RUSONITE CATWHISKER (Patent Pending)

14 KARAT GOLD MULTIPLE CONTACT; SUPERSENSITIVE. LIST PRICE 25 CENTS

RUSONITE PRODUCTS CORPORATION

Order From Your Dealer or Direct From Us.

15 PARK ROW, NEW YORK, N. Y. DEPARTMENT "N"

"MASTER" Radio Products —

"Master" Radio Products are made entirely in our own plant and are rigidly tested before being placed on sale. The "Master" mark on each part guarantees quality, efficiency and durability. It pays to demand the "Master" mark on all radio apparatus.

Jobbers, Dealers, Manufacturers. Write for bulletins and quantity discounts.

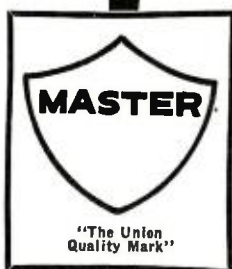

—the Standard for Radio Quality

"Master" Quality Products

Bakelite Dials, Potentiometers, Variable Condensers, Vernier Condensers, Audio Frequency Transformers, Radio Frequency Transformers, Moulded Variometers, Moulded Variocouplers, V.T. Sockets, Sockets, Peanut Tube Rheostats, Rheostats, Quarter Amp. Tube

RECEIVING SETS

RADIO DIVISION
UNION CONSTRUCTION COMPANY

Manufacturers "MASTER" Radio Products

OAKLAND

CALIFORNIA



MODEL RFAA-60

This wonderful new CLEARSTONE development represents the greatest opportunity for the purchase of high class merchandise at a reasonable price that has yet been offered to the general public. So simple that any child can operate it and yet so efficient that results far surpassing any regenerative set may be obtained by anyone. The set comprises tuner, one stage of Radio Frequency amplification, detector and two stages of audio frequency amplification in that beautiful CLEARSTONE solid mahogany cabinet that is so famous by this time that it needs no description.

The list price of this astonishing new CLEARSTONE creation, without tubes and accessories, is only \$60.00. At this price a four tube set embodying the well known principle of radio frequency amplification is within the reach of all.

So confident are we that you will find this set all that we claim for it and even more, that we will ship it anywhere in the United States, C. O. D., subject to your inspection before you pay for it.

Attractive proposition to dealers.
Model RFAA-60 code word "abroad" **\$60.00**

THE CLEARSTONE RADIO COMPANY

McMILLAN and ESSEX PLACE

CINCINNATI, OHIO, U. S. A.

PROTECTION

TELERADIO FILAMENT PROTECTORS
For detector and amplifying tubes. Price, Single Pole 60c. Double Pole 80c. Renewal fuses 10c each.

TELERADIO LIGHTNING ARRESTERS
Electrical No. 5837
The only ARRESTER approved by National Board of Fire Underwriters, which retails for \$1.00.

At your Dealers—Otherwise Send Purchase Price and Give Dealer's Name.

Teleradio Engineering Corp.
486 Broome St., New York
Makers of Teleradio Supersensitive Phones

HOMMEL

Wholesale Exclusively DISTRIBUTORS FOR

Radio Corp of America	Clapp-Eastham	Kennedy
Westinghouse	Cutler-Hammer	Klosner
General Electric	Dubittler	Murdoch
Acme	Fada	Pacnet
Atwater-Kent	Fahnestock	Radio Service
Baldwin	Frost	Radtall
Brach	General Radio	Remler
Brandes	Hipwell	Rhamstine
Burkess	Homecharger	Tuska
Chelsea	Kellogg	Western Electric

Hommel's Illustrated Encyclopedia 225S free to Dealers. We Sell to no Others.

LUDWIG HOMMEL & CO
530-534 FERNANDO ST. PITTSBURGH, PENNA.

shall be signed by the applicant under oath or affirmation.

"E. Such station licenses as the Secretary of Commerce may grant shall be in such general form as he may prescribe, but each license shall contain, in addition to other provisions, a statement of the following conditions to which such license shall be subject: (a) The ownership or management of the station or apparatus therein shall not be transferred in violation of this Act. There shall be no vested property right in the license issued for such station or in the bands of wave-lengths authorized to be used therein, and neither the license nor any right granted thereunder shall be assigned or otherwise transferred in violation of this Act; (b) such license shall contain such other conditions, not inconsistent with this Act, as the Secretary of Commerce may prescribe.

"F. Any station license granted by the Secretary of Commerce shall be revocable by him for failure to operate service substantially as proposed in the application and as set forth in the license, for violation of or failure to observe any of the restrictions and conditions of this Act, or of any regulation of the Secretary of Commerce authorized by this Act or by the provisions of any international radio convention ratified or adhered to by the United States, or any regulations thereunder, or whenever any licensee, who is a common carrier, shall fail, in the judgment of the Secretary of Commerce, to provide reasonable facilities for the transmission of messages, or whenever the Interstate Commerce Commission, in the exercise of the authority conferred upon it by law, shall find that any licensee has made any unjust and unreasonable charge, or has made or prescribed any unjust and unreasonable classification, regulation, or practice with respect to the transmission of messages or service, or whenever the Secretary of Commerce shall deem such revocation to be in the public interest: *Provided*, That no order of revocation shall take effect until thirty days' notice in writing thereof, stating the cause for the proposed revocation, to the parties known by the Secretary to be interested in such license. Any person in interest aggrieved by said order may make written application to the Secretary at any time within said thirty days for a hearing upon such order, and upon the filing of such written application said order of revocation shall stand suspended until the conclusion of the hearing herein directed. Notice in writing of said hearing shall be given by the Secretary to all the parties known to him to be interested in such license twenty days prior to the time of said hearing. Said hearing shall be conducted under such rules and in such manner as the Secretary may prescribe. Upon the conclusion thereof the Secretary may affirm, modify, or revoke said orders of revocation.

"Sec. 3. A. The actual operation of all transmitting apparatus in any radio station for which a station license is required by this Act shall be carried on only by a person holding an operator's license issued hereunder. No person shall operate any such apparatus in such station except under and in accordance with an operator's license issued to him by the Secretary of Commerce.

"B. The Secretary of Commerce, in his discretion, may grant special temporary operators' licenses to operators of radio apparatus under such regulations, in such form and under such conditions as he may prescribe, whenever an emergency arises requiring prompt employment of such an operator.

"C. An operator's license shall be issued by the Secretary of Commerce in response to a written application therefor, addressed to him, which shall set forth (a) the name, age, and address of the applicant; (b) the date and place of birth; (c) the country of which he is a citizen, and if a naturalized citizen of the United States, the date and place of naturalization; (d) the previous experience of the applicant in operating radio apparatus; and (e) such other facts or information as may be required by the Secretary of Commerce. Every application shall be signed by the applicant under oath or affirmation.

"D. An operator's license shall be issued only to a person who, in the judgment of the Secretary of Commerce, is proficient in the use and operation of radio apparatus and in the transmission and reception of radiograms by telegraphy and telephony. Except in an emergency found by the Secretary of Commerce to exist, an operator's license shall not be granted to any alien, nor shall such a license be granted to a representative of a foreign government.

"E. An operator's license shall be in such form as the Secretary of Commerce shall prescribe and may be suspended by him for a period not exceeding two years upon proof sufficient to satisfy him that the licensee (a) has violated any provision of any Act or treaty binding on the United States which the Secretary of Commerce is authorized by this Act to administer, or of any regulation made by the Secretary under any such Act or treaty; or (b) has failed to compel compliance therewith by any unlicensed person under his supervision; or (c) has failed to carry out the lawful orders of the master of the vessel on which he is employed; or (d) has willfully damaged or permitted apparatus to be damaged; or (e) has transmitted superfluous signals or signals containing profane or obscene words or language.

"F. A license may be revoked by the Secretary

of Commerce upon proof sufficient to satisfy him that the licensee was at the date his license was granted to him, or is at the time of revocation, ineligible or unfit for a license.

"Sec. 4. A. After the approval of this Act the construction of a station for which a license is required by this Act shall not be begun, nor shall the construction of a station already begun be continued until after a permit for its construction has been granted by the Secretary of Commerce upon written application therefor. This application shall set forth such facts as the Secretary of Commerce by regulation may prescribe as to the citizenship, character, and the financial, technical, and other ability of the applicant to construct and operate the station, the ownership and location of the proposed station and of the station or stations with which it is proposed to communicate, the wave-length or wave-lengths desired to be used, the hours of the day or other periods of time during which it is proposed to operate the station, the purpose for which the station is to be used, the type of transmitting apparatus to be used, the power to be used, the date upon which the station is expected to be completed and in operation, and such other information as the Secretary of Commerce may require. Such application shall be signed by the applicant under oath or affirmation.

"B. Such permit for construction shall show specifically the earliest and latest dates between which the actual operation of such station is expected to begin and shall provide that said permit will be automatically forfeited if the station is not ready for operation within the time specified, unless prevented by strikes, riots, acts of God, or other causes not under the control of the grantee. The rights granted under any such permit shall not be assigned, or otherwise transferred to any person, persons, company, or corporation, without the approval of the Secretary of Commerce; *Provided*, That a permit for construction shall not be required for Government stations or for private stations as provided for in section 4, fifteenth regulation, of the Act of August 13, 1912. The granting of this permit to construct a station as herein required shall not of itself be construed to impose any duty or obligation upon the Secretary to issue a license for the operation of such station.

"Sec. 5. An advisory committee is hereby established to whom the Secretary of Commerce shall refer for examination and report such matters as he may deem proper relating to: (a) The administration or changes in the laws, regulations, and treaties of the United States relating to radio communication; (b) the study of the scientific problems involved in radio communication, with the view of furthering its development; (c) the scientific progress in radio communication and use of radio communication.

"The advisory committee shall consist of fifteen members, of whom one shall be designated by the Secretary of State, one by the Secretary of the Treasury, one by the Secretary of War, one by the Secretary of the Navy, one by the Secretary of Agriculture, one by the Postmaster General, one by the Secretary of Commerce, and one by the Chairman of the United States Shipping Board, to represent these departments, respectively, and seven members of recognized attainment in radio communication not otherwise employed in the Government service, to be designated by the Secretary of Commerce.

"The necessary expenses of the members of the committee in going to, returning from, and while attending meetings of the committee, including clerical expenses and supplies, together with a per diem of \$25 to each of the six members not otherwise employed in the Government service, for attendance at the meetings, shall be paid from the appropriation made to the Department of Commerce for this purpose.

"Sec. 6. Radio telephone stations, the signals of which can interfere with ship communication, are required to keep a licensed radio operator, of a class to be determined by the Secretary of Commerce, listening in on the wave-length designated for distress signals during the entire period the transmitter of such station is in operation.

"Sec. 7. Regulation first of section 4 of said Act of Congress approved August 13, 1912, is amended by striking out the words, 'this wave-length shall not exceed six hundred meters or it shall exceed one thousand six hundred meters.'

"Regulation second of section 4 of said Act of Congress approved August 13, 1912, is amended by striking out the words '*Provided*, That they do not exceed six hundred meters or that they do exceed one thousand six hundred meters.'

"Regulations third and fourth of section 4 of said Act of Congress approved August 13, 1912, are hereby repealed.

"Regulations fifteenth and sixteenth of section 4 of said Act of Congress approved August 13, 1912, are amended by striking out the words 'exceeding two hundred meters' and substituting in lieu thereof the words 'of less than one hundred and fifty meters nor more than two hundred and seventy-five meters.'

"Sec. 8. Any person, company, or corporation who shall erect, use, or operate any apparatus for radio communication in violation of this Act, or knowingly aid or abet another person, company, or corporation in so doing, or knowingly make any false oath or affirmation for the purpose of securing a permit or a license, shall incur a penalty not to exceed \$1,000, which may be mitigated or remitted by the Secretary of Commerce, and the permit or license of any person, company, or cor-

The PACENT 50c

NEW UNIVERSAL PLUG

NUMBER FORTY



The makers of the FIRST Radio Plug now offer the first Quality plug at a popular price. This plug will do everything that can be expected of any plug at any price.

Materials that last.
Simple, Sturdy Construction.
Permanent Biting Contact.
Perfect Insulation.

The quality of this plug and its low price enable you to enjoy satisfactory plug connections on every piece of your radio equipment. Look for the PACENT Trade Mark and ask for PACENT New Universal Plug No. 40.

DON'T IMPROVISE—
"PACENTIZE"

Write for Descriptive Bulletin N-5

PACENT ELECTRIC COMPANY

INCORPORATED

Executive Offices: 22 Park Place, New York, N. Y.

BRANCH OFFICES

Philadelphia	Washington, D. C.
Chicago	San Francisco
St. Louis	Minneapolis



Canadian and British Licensees:
Colonial Radio, Ltd., Hamilton, Can.

Members, Radio Section, Associated Mfrs. of Electrical Supplies

Spirola —PEOPLE "FROM MISSOURI" ARE OUR SPECIALTY!

LOUD SPEAKERS —MOST FOLKS Don't Believe

that a perfect loud speaker can be sold at so low a price. We "show" 'em! We can convince you, too, that SPIROLAS are and always have been the most perfect reproducers of voice and music that have ever been produced. A trial on your own amplifier set will make you a "Spirola booster" for life!

SPIROLAS combine perfect tone and loudness with beautiful style and finish, and exceptionally reasonable price—an unequalled combination.

SPIROLA DUPLEX—Uses any headset; beautiful finish of dark red mahogany, bronzed throat (DM)	\$ 4.85
Same in black finish, nicked fittings (DB)	3.85
SPIROLA SIMPLEX—Uses Baldwin or other unit mahogany (SM), \$4.85; Black (SB)	3.85
SPIROLA CONCERT—Has built-in Baldwin unit, mahogany finish, bronzed throat; complete with unit and cord (CM)	12.50
SPIROLA CONCERT SPECIAL—For use where large volume is required.	20.00

On sale at good dealers, or we'll send you one postpaid (guaranteed) by mail, C. O. D., if you wish.

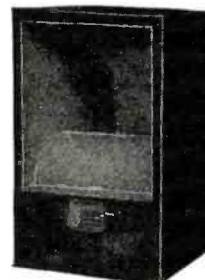

L. H. Donnell Mfg. Co., Dept. A, Box 70, Ann Arbor, Mich.

Money for You Add to your Salary—Make Extra Pin Money. Start a lucrative business of your own. Spend an hour each day taking subscriptions for the "Radio News." We'll pay you well and you'll enjoy the work. Write for full particulars. Circulation Dept., RADIO NEWS, 53 Park Place, N. Y. C.



"Radio Frequency Receivers"



The RADIO GUILD specializes in the construction of RADIO-AUDIO FREQUENCY AMPLIFYING RECEIVERS of the highest efficiency and quality. These make possible the reception of stations over 1000 miles distant with a small loop aerial supplied with each set. These receivers all employ the new RADIO GUILD "Radio-Frequency" coupler which insures absolute selectivity when receiving with an outside aerial and ground. Send 10c for illustrated catalog N-5 giving full description of RADIO GUILD sets and parts.

NEW BOOK BY KENNETH HARKNESS

"The Theory and Practice of RADIO FREQUENCY AMPLIFICATION"

now off the press. By the author of "The Construction and Operation of Super-Regenerative Receivers." Latest information on radio frequency amplification. Scores of photographs, drawings and wiring diagrams. Complete instructions for the home construction of various types of radio frequency amplifiers and complete receivers. For the first time the construction of the best radio frequency transformers shown in detail with photographs. Tells you how to make a high frequency oscillator covering all wave-lengths. Every phase of radio frequency amplification thoroughly explained. Send for your copy today. Price \$1.00. From your dealer or direct.

THE HAZELTON NEUTRODYNE RECEIVER FULLY DESCRIBED

Radio Guild

"RADIO FREQUENCY" COUPLERS.

(For use only with radio frequency amplification)

Selectivity on an outside aerial with radio frequency transformer amplification cannot be obtained with standard coupler. The new RADIO GUILD "Radio Frequency" couplers give just the proper degree of coupling to eliminate interference. Complete hook-ups enclosed with each coupler. Send 2c postage for folder R.F.5 giving full particulars.

Short wave "Radio Frequency" coupler (190-450 m.).....\$6.50
 Multi-Range "Radio Frequency" coupler (190-2000 m.)....\$8.00
 Bank-wound loading coil (for secondary circuit of Multi-Range "Radio Frequency" coupler)\$4.00

From your dealer or direct.

The Radio Guild, Inc. 256 West 34th Street, New York City

Specialists in radio frequency amplification.
 Distributors of DX radio frequency transformers.



poration who shall violate any of the provisions of this Act, or of any of the regulations of the Secretary of Commerce issued hereunder, or knowingly make any false oath or affirmation for the purpose of securing a permit or license, may be suspended or revoked by the Secretary of Commerce.

"Sec. 9. That the Secretary of Commerce is hereby authorized and directed to charge, and through the imposition of stamp taxes on applications, licenses, or other documents, or in other appropriate manner, to collect the fees specified in the schedule following. The Secretary shall collect said fees through the collector of customs or other officers designated by him, and he may make such regulations as may be necessary to carry out the provisions of this section.

"SCHEDULES OF FEES TO BE COLLECTED FOR TRANSMITTING STATIONS AND OPERATORS' LICENSES.

"For transoceanic radio station license, \$300 per annum; for commercial land station license, other than transoceanic, one kilowatt transmitter input or less, \$50 per annum; and for each additional kilowatt or fraction thereof, \$5 per annum; for ship station license, \$25 per annum; for experiment station license, \$25 per annum; for technical and training school station license, \$15 per annum; for special amateur station license, \$10 per annum; for general and restricted amateur station license, \$2.50 per annum; for commercial extra first-class operator's license, \$2.50 per annum; for commercial first-class operator's license, \$1.50 per annum; for commercial second-class operator's license, \$1 per annum; for commercial cargo grade operator's license, 50 cents per annum; for experiment and instruction grade operator's license, \$1 per annum; for amateur first-grade operator's license, 50 cents per annum; for amateur second-grade operator's license, 50 cents per annum; for commercial extra first-class radio operator's examination for license, \$2.50 for each examination; for commercial first-class radio operator's examination for license, \$2 for each examination; for commercial second-class radio operator's examination for license, \$1.50 for each examination; for commercial cargo grade radio operator's examination for license, \$1 for each examination; for experiment and instruction grade radio operator's examination for license, \$1 for each examination; for amateur first-grade radio operator's examination for license, \$1 for each examination; for amateur second-grade radio operator's examination for license, 50 cents for each examination.

"In the event that other classes of station and operators' licenses or other examinations shall hereafter be prescribed in any lawful manner, the Secretary of Commerce is hereby authorized and directed to charge and collect in the same manner as herein provided fees for such new classes of licenses and of examinations, which fees shall be substantially of the amount herein specified for the license and examination nearest in character and purpose to the new license or examination so prescribed.

For failure to pay at the time and in the manner specified by the Secretary of Commerce any of the above fees the Secretary of Commerce is authorized to refuse to issue such licenses; or, if issued, to suspend or revoke the same, as he may deem proper.

"Sec. 10. Wherever the words 'naval and military stations' appear in the Act to regulate radio communication, approved August 13, 1912, said words 'naval and military' shall be stricken out and the word 'Government' substituted in place thereof.

"Sec. 11. All Acts or parts of Acts in conflict with this Act are hereby repealed."

Chopper Operation in Arc Transmission

(Continued from page 1976)

motor. The other brush of the chopper also connects to the base, thus forming a grounded circuit employing the base as one conductor. The ground carries off any static which may accumulate on the motor base or leads or on the chopper connections. The tension of the chopper loop is brought down to nearly that of the earth. This circuit has shown some surprising results in transmission, although not in great part very different from the usual circuit.

Excellent results may be obtained with the chopper if intelligent care is given to the arc chamber, the original emission, and the usual attention which any fine machinery should be given.

FAULTS OF THE Q LIST

By W. T. BURFORD.

In the January RADIO NEWS Mr. R. N. Scribner, a ship operator, repeats the suggestions for the improvement of the Q List

Walnart Friction Vernier Knob

This new auxiliary knob "slow-motions" the dial to 1/7th distance. Best aid to easy, accurate tuning ever devised. Installed by drilling 1/4 inch hole in panel. Spring and tapered bushing maintain adjustment. Unfailing friction "drive." No Radio Set complete without it.

FREE to Dealers

The "Silent Salesman" counter-casel of Bakelite shown at right—it sells them fast. With orders for 100 lots or more. Order from this ad on your letter-head, ask for free counter-display. Liberal profits for dealers.

List Price 25c

Order direct if your dealer will not supply you.

Walnart
ALL METAL
Vacuum Tube
Sockets

Radio fans are through with composition sockets. No more chipped, cracked, warped sockets for them! This ALL METAL 4-contact socket, guaranteed unbreakable, guaranteed perfectly insulated. Electrically tested and marked for connections. A 1 1/2 brass, nickel plated.

List Price 50c

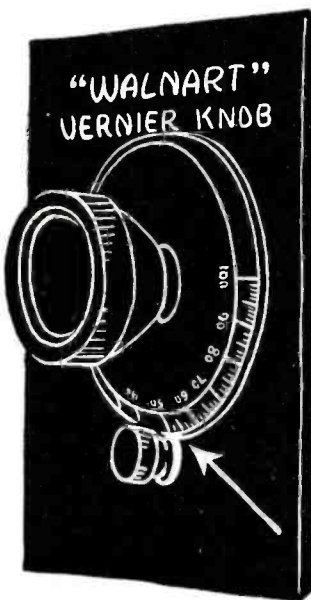
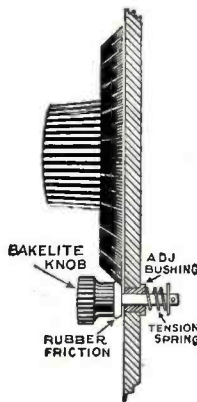

JOBBER:
State territory and number of salesmen. We'll send you sample outfits and profit-making offer.

WALNART ELECTRIC Mfg. Co.
1251 West Van Buren St., Dept. 106 Chicago, Ill.

which I made in your issue of January, 1922.

It cannot be too strongly emphasized that the Q List is badly in need of revision, and that that revision must be done by those who have to use it—the actual operators. The arbitrary alterations that have been made in the List in the last few years have not improved it, and the fact becomes more and more evident that no changes should be permitted by the International Bureau until they have been passed on by a competent body of radio telegraphers.

It is encouraging to note that, after I called attention to the error through RADIO NEWS, the British Admiralty, in its publications, amended the ungrammatical rendering QRS. It now reads: "Send *more slowly*." That correction, at least, did not need international sanction! When will American publications follow suit?

Recent Alterations, Suppressions and Additions to Wireless Telegraph Stations

By J. E. DAVIES

The Wireless Station at Mauritius in the S. Indian Ocean has been closed down.

The Canadian High Power Station at St. John's, Newfoundland, has been closed down. Ice and navigation warnings formerly transmitted by this station will be broadcast by the station at Cape Race and the U. S. Coastguard Cutters, when on ice patrol duty.

The Miami Wireless Station has been discontinued and the service of weather bulletins, storm warnings, etc., hitherto broadcast from this station has been transferred to Jupiter NAQ—wave 1688 meters.

A meteorological report giving the general situation in North America, the Atlantic and Western Europe, with probable changes, is now sent out by the French wireless station at Nantes, UA, at 1230 G.M.T. on a wave of 2,800 meters spark. This station also broadcasts messages to ships at sea every evening at 2100 G.M.T. Operators receiving messages from this station should note that the French authorities only collect the land line and coast station charge, leaving the ship station to recover its own charge from the addressee.

New additions to Wireless Direction Finding stations are given below:

France.—St. Nazaire D.F. Station (47.15N 2.14W) has been reopened for service during daytime only.

Spain.—Cape Villano Light House. Wireless fog signals on a wave of 1000 meters are transmitted continuously during thick or foggy weather from this point (43.10N 9.13W). The signals consist of a group of transmissions of a note frequency of 600 every 30 seconds—Dash 1 sec. silence 7 secs.—Dash 1 sec. silence 21 seconds. The range is placed at 30 miles.

Spain.—Cape Finisterre Light House. Wireless fog signals on a wave of 1,000 meters are transmitted continuously during thick or foggy weather from this Light House situated in 42.53N 9.16W. The signals consist of sound 0.5 seconds silence 7.0 seconds making in all eight transmissions per minute. The note frequency is 500 and range 30 miles.

Morocco.—Kenitra. A W.T. direction finding station is now established in the following approximate position 34.18.49N 6.36.00W. Call CNK.

The following European and African Wireless D.F. stations have been suppressed:

Algeria.—Jijelli (36.49N 5.46E).

Ireland.—Carnsore (52.16N 6.21W).

France.—Penmarch W.T. D.F. (47.48.-30N 4.21.01W) has been temporarily discontinued until further notice.



Built on the
best Engineering
Principles

Maximum Inductance.
Minimum Distributed
Capacity for a given
number of turns

What Influenced You Most to Buy Your First GIBLIN-REMLER COIL?

YOU WANTED A COIL that would give you the greatest possible selectivity of tuning—maximum signal strength under any given conditions—and, of even greater importance, a coil that would reduce interference to a minimum.

WE KNOW that the Giblin-Remler Inductance Coil is undoubtedly the greatest step forward in the radio art since the advent of the vacuum tube. Designed on the best engineering principles by Mr. Thomas P. Giblin, the originator of the compact inductance coil, it embodies every feature necessary to obtain maximum inductance, minimum distributed capacity and minimum high frequency resistance with a given length of wire and in a minimum of space. These are the essentials of an inductance coil for obtaining maximum selectivity of tuning, maximum signal strength and a minimum of interference.

Write for table of constants and complete information regarding these coils.

Send 10c for new 40-page Remler Catalogue containing circuit diagrams for Remler Apparatus and other useful information, including a table of inductance, capacity and wave length.

The Remler Technical Bureau is at your service. Address your problems to Dept. N.

REMLER RADIO MANUFACTURING COMPANY

Factory and Home Office
248 First Street, San Francisco, Cal.

Eastern Sales Office
154 W. Lake Street, Chicago, Ill.



CARTER "TU-WAY" Plugs and "HOLD-TITE" Jacks

Carter "TU-WAY" Plug takes ONE to FOUR Carter "HOLD-TITE" Jack; wide frame, heavy phone sets at the same time. Connects with phosphor-bronze springs; no spacer washers. ANY kind of terminal. Price \$1.50. One to five springs. Price 70c to \$1.10.

NEW CARTER VERNIER CONTROL RHEOSTAT. Price (6 ohms) \$1.50; (20 ohms) \$1.75. NEW CARTER AUTOMATIC PLATE CIRCUIT CONTROL RHEOSTAT eliminates change-over switches, filament control jacks, and first and second stage jacks. Price (6 ohms) \$2.25; (20 ohms) \$2.50.

NEW CONTROL SWITCHES OF ALL TYPES—"Carter for Quality—Others for Quantity" Sold by all good electrical and Radio Jobbers. Write for bulletin on these and other Carter products.

CARTER RADIO CO. 209 S. State Street CHICAGO

CHARGE YOUR RADIO BATTERY at HOME for a NICKEL



PATENTED ARMATURE Tungsten contacts used exclusively—no silver or carbon points to wear out quickly.

Enjoyable concerts and maximum receiving range are obtained only when your battery is fully charged.

THE HOMCHARGER

charges your "A" or "B" battery OVER NIGHT for a nickel without removing it from your living room. Operates silently—charging rate governed automatically. No fuss—no trouble—no dirt—requires no watching.

The HOMCHARGER is the ONLY battery charger combining all of these necessary features. SELF-POLARIZING—FIVE to EIGHT-AMPERE charging rate—UNDERWRITERS' APPROVAL—beautifully finished in mahogany and old gold—UNQUALIFIEDLY GUARANTEED. Over 100,000 now in use.

The minute you buy a radio set you need a Homcharger—get it then. All good radio and electrical dealers sell it complete with ammeter, etc., for \$18.50. \$25.00 in Canada.

Write for FREE circular showing why the HOMCHARGER is the BEST battery charger at any price.

MOTORISTS — THE HOMCHARGER will also charge your AUTO Battery.

THE AUTOMATIC ELECTRICAL DEVICES CO.
118 WEST THIRD ST.
CINCINNATI, OHIO

Largest Manufacturers of Vibrating Rectifiers in the World

Radio Operator's School

In selecting the school in which you wish to become a radio operator, bear in mind that this school has been in operation over twelve years, that all of our graduates are placed in positions, that our laboratory equipment is of the latest type, and that our instructors are expert professional radio men.

Y. M. C. A. RADIO SCHOOL

"The Best Radio School in the East"

158 East 86th Street, New York, N. Y.

Telephone, Lenox 6051

TELEGRAPHY

(Morse and Wireless) and RAILWAY ACCOUNTING taught thoroughly. Big salaries; great opportunities. Oldest, largest school. Endorsed by Telegraph, Railway, Radio, and Government officials. Expenses low—opportunities to earn large portion. Catalog free. BOGGS' INSTITUTE, 10 Street, Valparaiso, Ind.

New Distribution of Weather Forecasts

By B. FRANCIS DASHIELL

The United States Weather Bureau of the Department of Agriculture at Washington, D. C., has been able, through the co-operation of the Navy Department, to organize a new and novel system for broadcasting its official weather forecasts and information. These forecasts are being broadcast directly from the forecast division of the Weather Bureau over a directly connected land wire through the great Naval Station NAA at Arlington, Va. The information is given on a wave-length of 710 meters, and twice daily, at 10:05 A. M. and P. M., respectively. Any special warnings of storms, cold waves, hurricanes, etc., when issued out of regular forecast hours, are broadcast from NAA at 3:45 P. M. on a wave-length of 710 meters. The broadcasting is done by radiophone and is separate from the regular broadcasting of the same information at 10:00 P. M. by arc and spark transmission on higher wave-lengths for the benefit of marine and aviation interests.

All stations of the U. S. Weather Bureau, located in nearly two hundred cities of the United States, take observations twice daily at 8:00 A. M. and P. M., 75th Meridian time, and telegraph the result of these observations to the Central Office of the Weather Bureau, where they are tabulated on meteorological charts for the information of the official forecasters. Within two hours after a weather station in some city east of the Mississippi River has sent in its regular coded weather report, it can receive its forecast back from Washington by radio from the Naval Station at Arlington.

The forecasts broadcast from NAA are for the states in the Washington forecast district, namely, Northern New England, Southern New England, New York State, Western and Eastern Pennsylvania, New Jersey, Delaware, Maryland, Virginia, West Virginia, North and South Carolina, Georgia, Florida, Alabama, Tennessee, Mississippi, Kentucky and Ohio. Just recently the official forecast for the state of Florida was for frost in many portions of the state, and farmers in that state who were equipped with radio receiving sets knew at 10:00 P. M. of a Saturday that they could expect frost on the following Monday morning. This gave them ample time with the earliest possible warning to make preparations to fight the expected frost.

The new service of the Weather Bureau is the result of the untiring efforts of Mr. E. B. Calvert, Chief of the Forecast Division of the Weather Bureau, under whose guidance the radio development work of the Weather Bureau has grown into a large and widespread project, giving out valuable information at the earliest practicable moment to the public at large.

R. F. Measurements with the C. W. Oscillator

(Continued from page 1947)

altering the tuning of either of the two coupled circuits A and B, the oscillator setting is varied from its lowest to its highest wave-lengths, and for each setting of the oscillator the reading of the milliammeter in circuit A is carefully

THE EZTOON DIAL

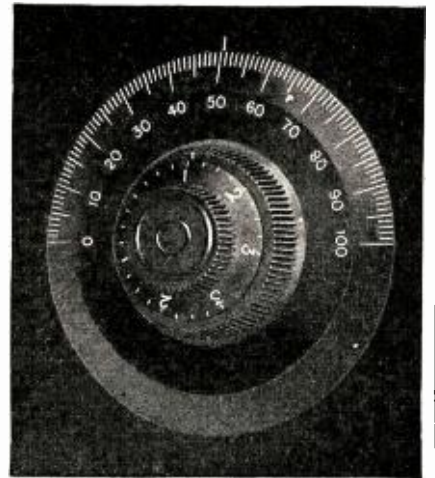

HAS MOVEMENT OF A MICROMETER

Easily attached in place of any ordinary dial. Provides a fine vernier adjustment for all tuning units. Eliminates the vernier plate on the condenser. 2 dials in 1. The outer dial used for the coarse and the center dial for the vernier. Has 40 to 1 ratio. No cog gearing to give lost motion. Has no back lash. The easiest and smoothest operating dial. Fits either 1/4" or 3/16" shaft. Sold under guarantee, shipped parcel post C. O. D. 3" dial @ \$2.00, 4" dial @ \$2.25. Manufacturers, Dealers, and Jobbers write for discounts.

BUTLER MANUFACTURING CO.
3234 W. Washington St., Indianapolis, Ind.



Na-ald W. D. 11 No. 411

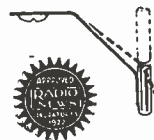

Na-ald De Luxe No. 400

It's the contact that counts

The special phosphor bronze clips of the Na-ald W. D. 11 Socket maintain perfect contact regardless of any variation in tube prongs and bases.

Moulded from genuine Condensite, these sockets are made for use with the famous W. D. 11 tubes, operated by a single cell battery.

The Na-ald De Luxe V. T. Socket is of highest quality throughout. Its laminated phosphor bronze strips press firmly with a side wipe action on the contact pins, keeping surface clean and insuring perfect contact.

These sockets retail at 75c each

Send stamp for dial, small-space socket, condenser and R.F. transformer circulars.

Alden Manufacturing Co.
Formerly Alden-Napier Co.
Dept. k 52 Willow Street
Springfield, Mass.



We are in the market for job-lots, close-outs or odds and ends in the way of radio outfits, supplies and equipment.

If you have anything in this line kindly advise, quoting your best prices for cash and if possible send sample and catalog.

P. IZENSTARK, RADIO

42 So. Clark St.
CHICAGO, ILL.

RADISCO RADIO PRODUCTS
THE RADIO DISTRIBUTING COMPANY
Newark, New Jersey

noted. Remember, no alternation of the coupled circuit from its originally tuned condition is made. Only the oscillator setting is varied. A graph is now made plotting wave-lengths as read on the oscillator against ammeter readings in circuit A corresponding to each wave-length. This curve will have the appearance of Fig. 4, where it will be observed that there are two peaks, one on each side of the resonant wave-length λ . These two peaks are the coupling waves produced by the coupled circuits, and the values of these coupling waves may be read off from the graph. Knowing the values of the coupling waves λ_1 and λ_2 and the resonant wave-length λ , we can calculate the coupling coefficient from equation (8). In this way the coupling coefficient

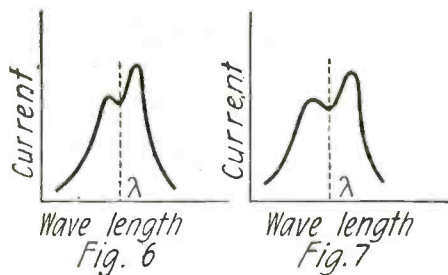

Curves Illustrating Various Coefficients of Coupling. Fig. 5. Loose Coupling. Fig. 7. Close Coupling.

may be determined for different settings of the coils. The most important precaution to observe is that of very loose coupling between the C. W. oscillator and the coupled circuits. This coupling must be extremely loose, for otherwise there will be complicated interactions between oscillator and coupled circuits which will give rise to a variety of coupling waves which will distort the appearance of the curve and hence nullify the accuracy of the measurement.

III. Determining Characteristics of Coupled Circuits. The above second method for determining the coupling coefficient will at the same time give some important data on the characteristics of coupled circuits. For by the appearance of the curves thus obtained we can tell how closely they are coupled, whether tuning will be broad, whether much interference will be created, and whether radi-

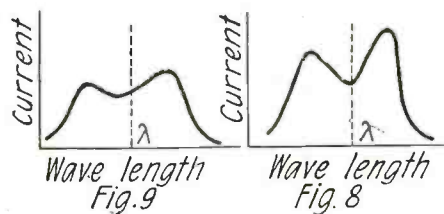

Effect of Tight Coupling as Shown in Fig. 9 and That of Fig. 8. Very Close Coupling.

ated energy will be frittered away over a wide band of wave-lengths or will be concentrated on the one wave-length desired. A series of curves are obtained in the manner described above in method (b) for determining coupling coefficients, these curves being obtained for different degrees of coupling ranging from extremely loose to extremely tight coupling. These will have the appearance of curves in Fig. 5 to Fig. 9, inclusive, in which Fig. 5 is extremely loose coupling, while Fig. 9 is for extremely tight coupling, while those between are for intermediate couplings between very loose and very tight.

It will be observed that for the extremely loose coupling there are no coup-

Brandes

USED BY OVER 500,000

THE so-called amateur in radio is, in fact, an expert. Experimenting is the very breath of life to him.

When it comes to the radio headset, however, you can't experiment. The headset requires precisional manufacture in every detail and painstaking study of acoustics to assure the *matched tone* quality in both receivers. A Brandes "Matched Tone" Headset can be depended upon as a basic requirement of successful experiment in getting radio from near and long distances.

Send ten cents in stamps for the "Beginner's Book of Radio." It explains radio in terms that anyone can understand.

Distributors in Australia and New Zealand:
International Electric Co., Wellington, N. Z.

Made in Canada and England by
Canadian Brandes, Limited, Toronto and London

Distributed in Canada by Perkins Electric, Limited
Toronto — MONTREAL — Winnipeg

C. Brandes, Inc. — 237 Lafayette St., N.Y.C.

Matched Tone

TRADE MARK REG. U.S. PAT. OFF.

Radio Headsets

Tuner Detector and 2-Stage Amplifier
(Unwired)

Only **\$35.00**

Set B

This wonderful loud talker at the low price of \$35.00. All apparatus mounted rigidly on 12 x 18 Bakelite panel. We furnish full instructions and wiring diagrams. Enabling anyone to wire same.

Above outfit unmounted with drilled Bakelite panel \$30.00. Write for data on sets we manufacture.

C & K Radio Manufacturers

299 7th Street
Brooklyn, N. Y.

The Autostat

A Super Radio Rheostat

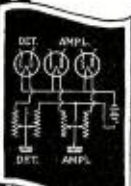
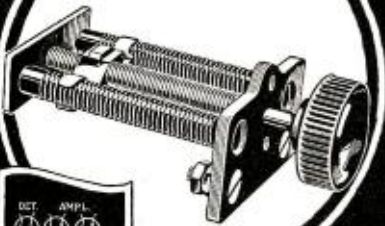

Can be used with 6-volt or WD 11 detector tubes, two amplifying bulbs or one 5-Watt power tube.

The difference between a jumbled mass of signals coming from everywhere and the "sharply-tuned" concerts received clearly and distinctly from far-away stations depends largely upon the careful adjustment of your detector filament current.

Heretofore, sharp tuning has only been partially obtained thru skillful "hair-breadth" manipulations of the filament rheostat. But with

The Autostat

A Super Radio Rheostat

these much-sought-for results can be secured by anyone. Just "twirl the knob"—a full turn produces a finer adjustment than a "hair's-breadth" turn on any other.

Economical—neat—small—compact. No carbon to break or change resistance. Unqualifiedly guaranteed. Popularly priced—\$1.35.

If the Best is none too good for the set you are building or have bought, see the Autostat at any good radio or electrical dealer Today. Or write direct for Free Bulletin which shows why the Autostat is radio's Best rheostat.

DEALERS — JOBBERS
Write or wire for Radio's most attractive merchandising proposition.

THE AUTOMATIC ELECTRICAL DEVICES CO.
118 WEST THIRD ST.
CINCINNATI, OHIO

Builders of Precision Rheostats since 1914

Build a Reflex Receiver

WE MANUFACTURE

ALL PARTS and furnish INFORMATION

Your Name and Address on the Coupon Will Bring List of Parts and Data of Value

RN5

Name

Address

THE WIRELESS SHOP

A. J. EDGOMB

1262 W. 2nd ST. LOS ANGELES, CAL.



Tests your battery instantly by the way the Balls sink or swim in the acid. Outfit, including Hydrometer, Depth Gauge, and Water Filler. Postpaid \$1.00 Chaslyn Co., Dept. 1, 4315 Kenmore Ave., Chicago, Ill.

ling waves. This means that all the energy in the circuits is concentrated in the one resonant wave-length, the two coupling waves coincide with the resonant wave-length. Hence maximum efficiency in reception and transmission is secured since all the energy is either received or transmitted on this one wave. Furthermore, since all the energy is concentrated in this one wave there will be little interference with other sets tuned to different wave-lengths; that is, tuning is very sharp with this loose coupling. Thus such a curve, showing only one peak and no coupling waves, indicates very loose coupling between the circuits under test, very little interference between these circuits and other stations tuned to different wave-lengths, high selectivity and maximum efficiency.

On the other hand, considering the graph for very tight coupling, we see that there are two peaks representing the coupling waves, and these coupling waves are very far apart on either side of the resonant wave-length. Thus very poor efficiency is at once indicated, since if this curve is for a transmitter the receiving station which is tuned to the resonant wave-length receives only a small portion of the radiated energy, since most of it is scattered over the wide band between the coupling waves. Similarly there is poor efficiency if the curve is that of a receiver. Furthermore, it indicates that there will be a great deal of interference with other stations; for from this characteristic curve it is evident that the energy is distributed over a wide band of wave-lengths on either side of the resonant wave-length of the coupled circuits. Thus any stations in this band, even though it be not tuned to the resonant wave-length, will be affected by the radiation from these circuits if it is a transmitter. If it is a receiver then it will receive all kinds of transmission sent on wave-lengths other than the one to which it is tuned. These coupling waves indicate, then, broad tuning, poor efficiency, interference, loss of energy due to its being frittered away over a wide band of wave-lengths. The closer the coupling the wider apart will these coupling waves be, as seen from the curves. Hence the greater will be the interference since the energy is distributed over a wider band of wave-length and the smaller the efficiency of the circuits. The looser the coupling the closer together are the coupling waves, which means that tuning becomes a little sharper, interference decreases, since the energy, although still distributed over a band of wave-lengths, is confined to a narrower band than with tight coupling. When very low coupling is reached these coupling waves come closer and closer together until, for extremely loose couplings, they coincide with the resonant wave-length, as in Fig. 5, and all the energy is concentrated in a very small band, in fact, in the one wave-length to which both circuits are tuned.

This is the story which these characteristic curves tell us about coupled circuit and the gist of it all points to the use of loosely coupled sets. If your output in your C. W. transmitter is 20 watts and you want to do distance work, you must not distribute these 20 watts mostly between two peak waves, say between 100 and 300 meters, when you wish to transmit at 200 meters. Close coupled circuits will do this. Loose coupled circuits, on the other hand, will concentrate these 20 watts on 200 meters, and hence your transmitter will have a greater push.

IV. Measurement of Distributed Capacity. The measurement of this vague and inaccessible constant is often a source of annoyance because of complicated methods. The method here outlined is suffi-

How to Hook-Up a Transmitter Button to Make an Efficient Loud Talker

A Transmitter button with a few dry cells and a telephone receiver will make a remarkably simple and efficient loud talker. A Microphonic amplifier of this type is just the thing for use with a radio set. The weak music and signals may be amplified many times their original value. It is possible to entertain a large audience with a simple radio equipment if a transmitter button is used in the circuit as explained in diagram A.

The cost is extremely low and the results are comparable with those produced by highest grade of expensive loud talkers.

As may be seen in the diagram, two dry cells or a small storage battery are connected in series with the transmitter button and a 4 to 75 ohm telephone receiver. The transmitter button is secured to the diaphragm of the telephone in the radio receiving set. To accomplish this properly, scrape off the enamel (if diaphragm is enameled) on the face of the diaphragm and solder the small hexagon nut supplied with the button to the exact center. Care should be taken that the thin diaphragm is not bent or otherwise

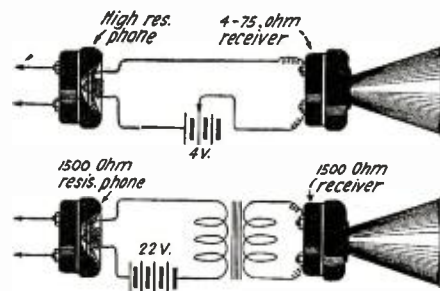

harmed. The transmitter button is then screwed into place. Connections, as shown in the diagram, are made with flexible wire. A horn may be placed over the low resistance receiver if desired. When the radio set is properly tuned and signals are being received, the transmitter button is operated by the vibration of the diaphragm of the receiver. As the receiver diaphragm vibrates, the mica diaphragm on the transmitter button also vibrates. The carbon grains are compressed at varying pressure; the current flowing through the local battery circuit is thus varied and results in an amplification of the sounds in the low resistance telephone loud talker.

Diagram B, which includes a step-up transformer, is to be used with loud talking receivers of high resistance. The primary of the transformers should have a resistance of about 75 ohms. An ordinary telephone induction coil will serve as the transformer in this circuit.

You can get the above-described transmitter button FREE in subscribing to "Practical Electric Magazine" at \$2.00 per year (12 months). Send your subscriptions today.

Make all remittances payable to Practical Electric Co., 53 Park Place, New York City. —Advertisement

ciently accurate for all purposes and at the same time is very simple and quickly accomplished. Simply connect a variable condenser in parallel with the coil whose distributed capacity is to be measured and insert a radio frequency milliammeter in series with coil and condenser (see Fig. 10). Loosely couple the C. W. oscillator to the coil under test. Set the oscillator at a number of different wave-lengths, nine or ten will do, and tune the coil circuit to oscillator with the variable condenser C. Note the setting of C required to tune to each wave-length. Now draw a graph of condenser capacity of C

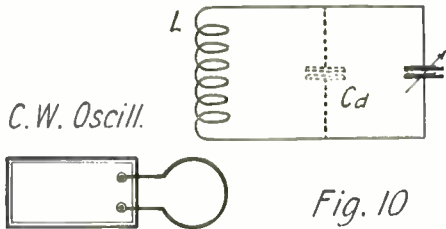

Method of Measuring the Distributed Capacity of a Coil by Use of the C.W. Oscillator.

against the square corresponding wave-length of the C. W. oscillator, which graph will be a straight line as in Fig. 11. Now extend this graph backwards until it touches the capacity axis at C₁, at which point the wave-length must be zero. The capacity corresponding to C₁ is the distributed capacity of the coil.

The reason it is the distributed capacity of the coil is seen from the following equations. The wave-length of the coil and variable condenser is given by the equation

$$\lambda = K \sqrt{L (C + C_d)}$$

K and L are constant, C_d is distributed capacity.

Therefore, $\lambda^2 = K^2 L (C + C_d)$

If $\lambda^2 = 0$, $\therefore C + C_d = 0$, or $C = -C_d$.

In other words, in order to reduce the wave-length of the coil and condenser to zero, if this were possible, we would have to have a negative capacity equal to the distributed capacity of the coil. Since actually we cannot do this, we must resort to the method above, of extending the curve until we get zero wave-length on the curve, and read the corresponding capacity from the curve, which is negative and equal in value to the distributed

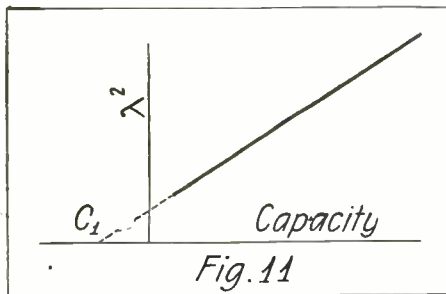

Capacity of Condenser Plotted Against the Wave-length of the C.W. Oscillator.

capacity of the coil. It will be observed that the method is very simple, quick, and merely requires a calibrated condenser C.

V. Calibration of Receivers. Most amateurs know the wave-length range of their receivers, since the manufacturer generally supplies this information. But very few amateurs know the wave-length of the receiver at any particular setting, since they have no calibration on the receiver. As a result very often they receive signals from some unknown station and would like to know the wave-length, but cannot tell as their receivers are not

What One Tube Did In a Single Evening

New York City
Newark, N. J.
Detroit, Mich.
Kansas City
Minneapolis
Denver
St. Louis
Los Angeles
San Francisco
Portland, Ore.



Loud Speaker Was Used!

Typical of the amazing results that are being secured daily with the new Erla Duo-Reflex circuit, using but a single vacuum tube, is the experience of Dr. G. Edwin Farley, of Beverly Hills, Ill., who writes:—

"Between 9 p. m. and 2 a. m., Dr. Duff, a friend of mine, and I, listened to voice and music at New York City, Newark, Troy, Detroit, Stanford, Tex., Kansas City, Minneapolis, Denver, St. Louis, and, last but not least, Los Angeles, San Francisco, and Portland—all, with the exception of the last, very clear and loud. Most were heard on the loud speaker."

Never before has such range and power been obtained with a single tube. Tone quality, likewise, is delightfully pure, while tuning is so sharp as to require hardly a movement of the controls to cut out undesired stations.

The basis of this new circuit, and the mainspring of its efficiency, is the Erla radio frequency transformer. Overcoming the high capacitance effects of domestic vacuum tubes in unique degree, and with lowest inherent capacitance, it provides unequalled amplification without distortion.

Diagrams of the new Duo-Reflex circuit, with notes regarding its proper construction, are now available, gratis. Ask your dealer or write us.



Erla radio frequency transformers greatly improve the range and power of any receiving set, incorporating utmost efficiency and value. Results guaranteed. List, \$4



Erla bezels are now made in 1" as well as 1 1/2" diameter, finished in nickel or dull black enamel. Telescope to fit any 3/8" to 3/4" panel. Price, 20c



Erla condensers are distinguished by superior accuracy and fine workmanship. 11 sizes. Price, 30c to 75c each

Electrical Research Laboratories
Dept. D 2515 Michigan Ave., Chicago

ERLA



Pignolet
RADIO VOLT-METER

One Instrument Makes All Tests

Write for booklet with suggestions for testing and adjusting Radio Sets.

Pignolet Instrument Co., Inc.
116 Liberty Street, New York, N. Y.

L. B. SOLDERED CONTACT LEAD



Pat. Applied For

MAKES WIRING EASY!

Indispensable for making connections between contact points and taps on coupler, variometer, or wherever required.

1. Saves money, time, and labor.
2. Eliminates nuts (1 to 2.)
3. Eliminates small copper terminal.
4. Insures a positive contact.
5. No pliers or wrenches necessary to affix Lead to contact point as same can be set up secure and flush against panel with fingers.
6. One of the most difficult parts of assembling a receiving set greatly simplified.

Manufactured by
CADY & LUNDBERG
176 FEDERAL ST. - - - BOSTON, MASS.

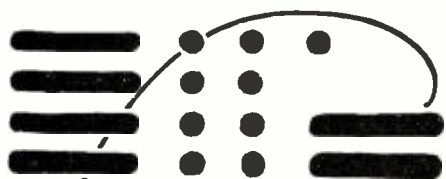

for panels!

Bakelite - Dilecto (x x grade) is the one material you can absolutely depend upon to be perfect for radio panels.

bakelite!! -dilecto!!

(A Laminated Phenolic Condensation Product)

It's handsome. It's tough. It's durable. Yet machines readily.

It resists heat, water, steam, fumes and mild acids. It cannot warp or swell.

Highest dielectric resistance. Used over 8 years in the U. S. Navy and Signal Corps.

Have any electrical man get it cut and drilled to size.

The Continental Fibre Co.,
Factory: Newark, Delaware.

Dealer Service From:

New York, 233 Broadway
Chicago, 332 S. Michigan Ave.
Pittsburgh, 301 Fifth Ave.
San Francisco, 75 Fremont St.
Seattle, 95 Connecticut St.
Los Angeles, 411 S. Main St.

24 HOUR SERVICE

No order too small. No Dealer too far away. We ship everywhere.

COMPLETE STOCK

Radio Standard Sets and Parts

LARGEST Complete Stock

of Standard Supplies in Middle West.

Write for 64 Page Catalog No. D10

DEALERS

Greater Discounts
Better Profits

AMERICAN RADIO MFG. CO.,
107 E. 13th ST., Dept. A KANSAS CITY, MO.

"Use Copper"

In Bulletin No. 32, the U. S. Bureau of Standards says: For all wiring—antennae, grounds, etc.—use Copper.

COPPER & BRASS
RESEARCH ASSOCIATION
35 Broadway - New York

calibrated. With the C. W. oscillator this calibration can be readily made in a jiffy. In the case of the single circuit tuner all that is necessary is that the radio frequency milliammeter be connected in the tuner circuit, and note the resonance setting of inductance and capacity of the tuner for different wave-length settings of the C. W. oscillator. A table or a curve can then be made of wave-length against condenser degrees, or wave-length against coil taps, thus giving a calibration chart of the receiver. In the case of the two circuit receiver both primary and secondary may be calibrated in the same way as mentioned for the single circuit tuner, only remembering to leave the circuit which is not being calibrated open, so as to avoid any reaction effects due to extraction of energy from the circuit being calibrated. Calibration charts on receiver thus obtained will be found to be extremely useful, as without such a chart an experimenter is like a navigator at sea without a compass. With a calibration curve you always know where and what you are receiving.

VI. Calibration of Transmitters. It is a well known fact that many amateurs adjust their transmitting wave-length by guess work. They know approximately what will give them 200 meters and so make their adjustments accordingly. As a matter of fact, this is the very reason probably that many of them have been called to account by the inspector for being off their wave-length. Also this probably accounts for a lot of the interference existing at present. In order to avoid any such trouble it is best to calibrate your receiver properly. Set the C. W. oscillator at the wave-length at which transmission is to be effected and adjust your antenna loading coil. Note the reading of the radio frequency milliammeter in series with the loading coil. Increase loading coil by one turn and note the milliammeter again. If the ammeter reading is greater than before it indicates that more loading is required. Increase loading turn by turn until a maximum deflection is obtained, indicated by the succeeding turn giving a lower deflection. The turn before the one at which the deflection begins to decrease is the tap required. This may be more accurately determined by taking fractions of a turn. If, on the other hand, after the setting of the oscillator, an increase of one turn produces a decrease in the ammeter reading it indicates that the inductance setting is too high and must be decreased turn by turn until again a maximum deflection is obtained, at which adjustment the transmitter will be properly tuned.

VII. Determining Wave-Length of Distant Transmitters. In the event the receiver is not calibrated and the wave-length of a distant transmitter which is being received is desired, the procedure would be as follows: Tune your receiver to the distant station until the signal is at its maximum. Leave receiver settings as they are and insert the radio frequency milliammeter in series with either the secondary of the primary, using very short leads for this connection. Start oscillator set, and vary the oscillator condenser, carefully observing the milliammeter readings. Vary oscillator wave-length until the ammeter indicates a maximum deflection. The setting of the oscillator then reads the wave-length of the receiver and hence of the distant transmitting stations.

VIII. Use of C.W. Oscillator as External Heterodyne. In regenerative sets the detector is often made to oscillate in order to receive C. W. signals by means of the heterodyne effect. This throws two burdens on the tube: (1)

This is the Switch
that does the trick.
Turn it till you hear it click

Four Way Switch Plug

ASK TO SEE IT

MANUFACTURED BY
THE FOUR WAY COMPANY
Springfield, Mass. U.S.A.

PRICE \$1.50 PRICE \$1.50

Eliminate the Aerial and Obtain Better Reception with the NASSAU

LOOP TUNER
TRADE MARK

Pat. Pending
Price \$35.00

Jobbers and Dealers
Write for Proposition

The Secret is in the Patented Winding
1500 MILES ON LOUD SPEAKER

With 2 stages radio and
2 stages audio frequency amplification.
Write for Circular "R"

Manufactured by
NASSAU RADIO CO., Inc.
60 Court St., Brooklyn, N. Y.

PERMANITE: The Wonder Crystal

An absolute innovation in the radio crystal field. Permanite Synthetic Crystal is invariably sensitive on **EVERY PART OF ITS SURFACE.** Lasts two years. No loss of sensitivity through spark reception. Sold on money-back guarantee.

PERMANITE and SPECIAL CAT WHISKER 75c.

Sole Distributors
P. M. DREYFUSS CO., Inc.
150 Chambers Street, New York City

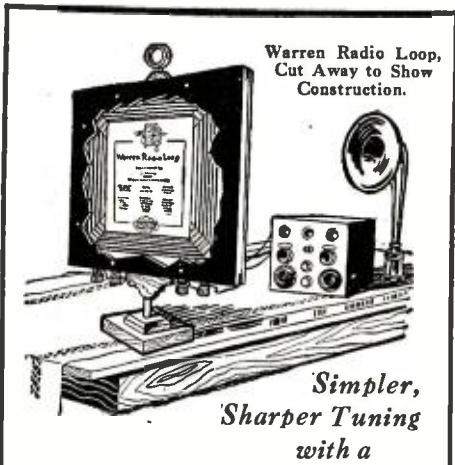

Warren Radio Loop, Cut Away to Show Construction.

Simpler, Sharper Tuning with a

Warren Radio Loop

AERIAL and tuning device all in one. Tunes not only to wave length but to wave direction. An aid to selection. Eliminates atmospherics. All enclosed—dust and damp proof, fool-proof and surprisingly compact, neat and durable. Write today for Bulletin T102, containing hook-ups.

A Type for Every Set At the Best Dealers

- Type A-737 (300-700 meters) 6 inches square—non-directional\$10
- Type A-7236 (175-1000 meters), 6 inches square—non-directional 12
- Type B-2537 (300-700 meters), 18 inches square—directional 20
- Type BL-2520 (200-18,000 meters), with honeycomb coil, 18 inches square—directional 25

V-DE-CO RADIO MFG. CO.
ASBURY PARK, N. J.
Dept. N

are joined by the wire a current begins in it which is a flow of electrons. These electrons come out of the condenser plate which is charged with extra electrons. Let q be the quantity of electricity represented by these electrons, then $-q$ denotes the rate at which they are decreasing, and this is the same as the rate at which they are flowing through the wire, which is the current x in that wire. But if C is the capacity of the condenser and v the voltage or potential difference of the plates, then $Cv = q$ and $-q = x$ where $-q$ denotes the time rate of decrease of the condenser charge.

But we have seen that when the current is changing the product Lx denotes the effective electromotive force or voltage corresponding to that change. Therefore we must have $Lx = v$ and combining this with the previous equation we have a relation between the current x and its rate of rate of change expressed by the equation

$$-LC\ddot{x} = x \text{ or } \ddot{x} + \frac{1}{LC}x = 0$$

where \ddot{x} denotes the rate of rate of change of x .

It has also been pointed out that when a charged condenser is discharging through a wire of very small or negligible resistance the discharge is oscillatory, that is, consists in a flow of electricity or movement of electrons backwards and forwards in the wire.

It is important to obtain an expression for the number of these oscillations per second in terms of the quantities L and C .

Whenever we meet with a mathematical expression or equation of the type $\ddot{x} + Ax = 0$ it always means the x is something which fluctuates in a manner similar to the motion of the bob of a very long pendulum, or which executes a simple harmonic motion like a tuning fork.

We must therefore obtain a mathematical expression for the time of vibration of a simple pendulum consisting of a small bob of mass m , hung at the end of a slender rod or wire of length l .

When such a mass swings or vibrates about a point like a pendulum the product of the mass m and the square of the length l of the rod or ml^2 is called the moment of inertia of the arrangement.

If the pendulum at any moment during its swing is deflected from the vertical through a small angle θ , then the rate at which this angle is changing with time, denoted by $\dot{\theta}$, is called the angular velocity. The product of the moment of inertia and angular velocity or $ml^2\dot{\theta}$ is called the angular momentum. The rate at which the angular momentum is changing, denoted by $ml^2\ddot{\theta}$, is a measure of the torque or couple causing or retarding rotation.

But we can obtain another expression for this torque or couple as follows:—The couple causing oscillation is the product of the length of the pendulum l and the resolved part of the weight of the bob at right angles to the length, viz., $mg \sin \theta$, where g is the acceleration produced by gravity. If, however, the angle of displacement is small, then in place of $\sin \theta$ we can write θ , and the torque is $mg\theta l$. Equating the two expressions for this torque, viz.:

$$ml^2\ddot{\theta} = mg\theta l$$

we have $\ddot{\theta} = \frac{g}{l}\theta$

It will be seen that this expression for the angle of deflection of the vibrating pendulum at any instant is of exactly the same type as that for the current in the case of the discharging condensers, viz., $\ddot{x} = \frac{1}{LC}x$, only for the pendulum the quotient g/l takes the place of $1/LC$ for the condenser.

We can now obtain an expression for the time of vibration as follows: When the pendulum is at the extremity of its swing,

Louder, Clearer RADIO

by using the

AMPLITONE Radio Antenna



Gives Louder, Clearer Signal. Reduces Ripping and Increases Range. Makes the Little Set Work Well and the Big Set Work Better. With Amplitone you no longer need aerial spreaders and a lot of special apparatus to erect an aerial.

Gives much greater efficiency than ordinary copper wire or flat. It is specially designed for radio use. Braided flat of 10 pure copper wires, affording greater capacity, essential in bringing in signals clearly.

A single 75-foot length of Amplitone will give better results than a number of single wires or other makeshifts. Amplitone Antenna, 75-foot length, with 2 antenna clamps, shipped prepaid for \$4.50.

We manufacture the Shinn-Flat System of Approved Lightning Rods, which prevent Lightning Losses, rendering any building absolutely safe. Ask for booklet.

W. C. Shinn Mfg. Company
1301 Lytton Bldg., Chicago Ill.

How to build the Reinartz Receiver

is told, complete with illustrations and diagrams, in the latest addition to the "Chi-Rad" Handbook-Catalog.

Our Handbook also includes:

1. Technical discussions of standard radio apparatus and equipment.
2. Radio definitions, wireless codes, wire tables, definitions, etc.

Pin this ad to your letter and mail it together with a dime for your copy of the Handbook.

Send for it, today!

Chicago Radio Apparatus Co.
415 S. Dearborn Street,
Chicago.

The How and Why of Radio Apparatus

By H. W. SECOR, E.E.



This newest book on radio matters fills a distinct gap in wireless literature. While the treatment is made as understandable and as free from mathematics as possible, it at the same time incorporates a wealth of technique and instruction for the Radio Amateur—the Radio Operator—the Installation and Designing Expert—as well as teachers and students of the subject in general.

A very broad field has been covered by the author, giving a great amount of information not found in other text-books. If you are engaged in any branch of the Radio or allied arts you will surely need this latest contribution to radio literature.

This newest of Radio Work has 160 pages, 6 x 9 inches. Hundreds of illustrations and tables. Cloth bound in Vellum de Luxe, stiff covers, hand-sewed, gold stamped, each..... \$1.75

The Experimenter Publishing Co.
53 Park Place, New York

WELSH PEANUT TUBE

W. T. 501

"The Tube That Cannot Squeal"

Sold for experimental use as a detector only.

LIST PRICE

\$2.00

Filament Current less than 1/2 amp. 4-6 volts. Plate voltage 16-22 1/2.



If your dealer has not got his stock in yet send us your remittance and his name and we will see that you are supplied. Can be used on 3 dry cells or regular 6-volt A-Battery. Wiring diagram packed with each tube showing how to use the W. T. 501 with any crystal set. Nickel-plated socket. moulded base, double spring contacts, 40c extra.

FOR USE IN TUBE SETS

Adaptor for V.T. sockets, 75c extra. Actual size 2 1/4 inches without base. Jobbers and dealers wire for merchandising plan.

Packed 10 in a carton, 10 cartons per case. Orders filled in rotation. Please do not ask us to open an account to ship sample tubes. Samples shipped only at list price which will be credited towards your first stock order.

RADIO RESEARCH GUILD
38-40 Clinton Street P.O. Box 1 Newark, N. J.

it is for the moment at rest and its potential energy is measured by the product of the mean torque and the angle of extreme displacement or by $\frac{1}{2}mgl\theta^2$.

But if s is the semi arc of displacement or the distance of swing on either side, then $s=l\theta$, so that the potential energy is measured by the value of $\frac{1}{2}m\frac{g}{l}s^2$.

Again, if we describe a circle with center at the mid point M of the swing and radius equal to the swing (see Fig. 49), and suppose that a point P in this circle moves round it with a uniform velocity equal to the velocity of the bob at the middle point of its swing, then it is easy to see that the displacement of the bob at any instant is given by the projection of this point on the diameter of this circle, and if the swing is small this diameter, dd' of this circle coincides nearly with the arc aa' of vibration. Hence, if T is the time of one complete revolution of this point P , T is also the time of one complete oscillation of the pendulum.

The velocity of the bob at the lowest point of its swing where it is a maximum is there-

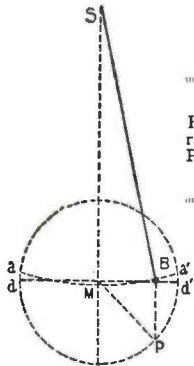

Fig. 49. Diagrammatic Representation of the Swing of a Pendulum Bob.

fore expressed by $2\pi s/T$, where π is the circular constant 3.1415... or ratio of diameter of the circle to its circumference. Hence the maximum kinetic energy of the pendulum must be equal to $\frac{1}{2}m\frac{4\pi^2 s^2}{T^2}$ and this must by the principle of conservation of energy be equal to the maximum potential energy at the extremity of its swing, viz., $\frac{1}{2}m\frac{g}{l}s^2$. Therefore we have

$$\frac{4\pi^2 s^2}{T^2} = \frac{g}{l} \text{ or } T = 2\pi \sqrt{\frac{l}{g}}$$

as an expression for the time of vibration.

If we represent the reciprocal of T or the number of swings per second or per unit of time by the letter n , then this is also called the frequency of the oscillations, and from the above equation we have for the simple pendulum

$$n = \frac{1}{2\pi} \sqrt{\frac{g}{l}}$$

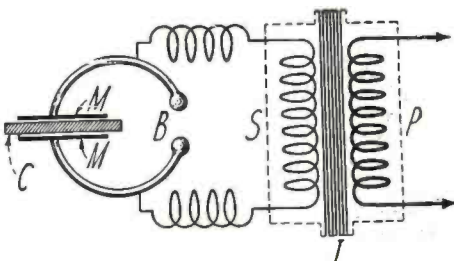

Fig. 50. Arrangement for Producing Electric Oscillations. SP Induction Coil, B Spark Coil, C Condenser, MM Metal Plates of Condensers

A little thought will then make it evident that since the previous discussion has shown that $1/LC$ for the condenser circuit corresponds to g/l for the pendulum, the frequency of the oscillations of a condenser of capacity C discharging through a wire of

RADIO

in

Strong Hands

NOW, at last Radio sets and parts are offered by an independent corporation possessing large capital, a modern plant, and a staff of seasoned radio engineers and experts—a House that is in business to stay—whose guarantee offers complete and permanent protection

SENIOR SET

Long Distance Wonder Workers
Sweep the country from coast to coast, giving their owners their pick of the daily and nightly programs broadcasted by the 500 stations in the United States and Canada.

THE "SENIOR SET" embodies both detection and amplification, and can be used with either headphones or loudspeakers, or both.

JUNIOR SET

THE "JUNIOR SET" a detector unit only is limited to headphone reception. It can however, be hooked up with the Michigan Amplifier unit, for loudspeaker reception.

MICHIGAN ACCESSORIES includes variometers, grid variocouplers, variable condensers, all-wave couplers, vernier rheostats, plain rheostats, etc.

Send for full information on both sets and parts.

MICHIGAN RADIO CORPORATION

GRAND RAPIDS, MICHIGAN

RADIO ANTENNA TOWERS

Simple. Sturdy. Easy to erect. Built of galvanized steel. Will last for years. 100 ft. high or less. Fitted to take pipe mast at top. Immediate shipment. Write TODAY for prices.

Radio Department
STOVER MFG. & ENGINE CO.
FREEPORT, ILLINOIS

PRICES SMASHED

We now announce drastic cuts in our quality lines. All goods prepaid and sold subject to return for rebate or exchange. You simply must be pleased. A sample saving follows. Order from following or send for full list today.

Complete Regenerative Vacuum Tube Receiver	Our price	Others
Range approximately 1000 miles		
Panel of bakelite 7 in. x 12 in. drilled	\$1.75	\$2.50
Cabinet of 3 ply wood to fit panel	1.50	2.50
2 three inch dials @ 35c each	.70	1.40
16 switch points with nut @ 01c	.16	.48
4 switch stops with nut @ 01c	.04	.12
8 binding posts, Nickel plated @ 03c	.24	.48
2 switch levers @ 25c each	.50	.90
1 filament rheostat, High grade	.65	1.10
1 vario-coupler with fourteen taps	2.25	4.00
1 23 plate variable condenser	1.95	3.50
1 tube socket of high quality	.45	.85
1 phone and 1 grid condenser @ 15c and 20c	.35	.65
10 feet spaghettil tubing @ 05c	.50	.84
1 tube socket support	.15	.25
15 feet copper connecting wire	.15	.30
1 set blueprints for assembling	.10	.25
	\$11.44	\$20.12

Some other articles taken from our Price list are—

Cunningham Detector tubes—New	\$4.25	\$5.00
Cunningham Amplifying tubes—New	5.50	6.50
Transformer—Audio frequency	2.95	4.50
Frost Fone—2000 ohms	3.95	5.00
Two step amplifier parts complete	12.95	21.50

RADIO PARTS MANUFACTURING COMPANY
2150 Montclair Dept. "N" Detroit, Michigan

FREE Catalogue

Make D-X Records
With D-X Supplies

This Catalogue should be called "Recipes for Long Distance." It was written to help amateurs pull in the most distant stations.

D-X-Radio Company
Specializes

on instruments built for Distance. If you want to jump States or reach over mountains you must use the proper equipment. Our instruments do the trick.

For Free Catalogue
Write Department 68

D-X-Radio Co.
123 Liberty St. New York City

RADIO HOOK-UPS

By M. B. SLEEPER

Radio Editor of Everyday Engineering Magazine
For the amateur who builds his own receiving or transmitting set. 86 hook-ups, no freaks, crystal, tube, radio, audio, spark, buzzer, etc. Suitable explanation with each diagram. A 75c book for 50c postpaid. (Not stamps). Your money back if not satisfied.

RAY DOBBINS Indianapolis, Ind. 146 W. 27th Street

low resistance and of inductance L is given by the expression

$$n = \frac{1}{2\pi \sqrt{LC}}$$

To make use of this formula in practice we have to measure C and L in appropriate units. In wireless telegraphy and telephony condensers are used the capacity of which it is convenient to measure in *microfarads*. Also the inductances of coils of wire employed are conveniently measured in units called *millihenrys*.

To create oscillations in such a condenser circuit, one mode is to cut the discharging wire at some place and furnish the ends with polished metal balls called spark balls, placed about one or two millimeters or so apart. The other ends of the two wires are connected permanently with the condenser plates (see Fig. 50). We then connect these balls with the terminals of an electric machine or induction coil in operation; the plates of the condenser will be charged, one as already explained, will have an excess of negative electrons forced into it, and the other will have a deficit.

The small air gap between the spark balls remains a perfect insulator until the electron pressure has reached a certain voltage, depending on the distance between the balls. At this point electrons burst out of the negative ball and by their impact they ionize the air molecules or liberate from them electrons by collision. The ionized air is a conductor of electricity and hence at that instant the balls are as good as put in contact and the discharge circuit is completed. The electric oscillations of the condenser electrons then take place as already described, and as these oscillations die gradually away the air between the spark balls resumes its insulating power. The process then repeats itself and we have a series of groups of die-away oscillations called trains of damped oscillations.

In a later section we shall describe the manner in which oscillations called undamped or continuous oscillations can be created.

To give some idea of what these units mean we can say that the electrical capacity of a Leyden jar, formed with a glass bottle or jar of about a pint in capacity, might be somewhere about one-thousandth of a microfarad. The electrical capacity of the whole

21 Jewel Burlington



Adjusted to the Second 21 Ruby and Sapphire Jewels
Adjusted to Temperature 25 Year Gold Strata Case
Adjusted to Isochronism Your Choice of Dials
Adjusted to Positions (Including Montgomery R. B. Dial)
New Ideas in Thin Cases

Only \$1.00 Down

Only One Dollar Down will buy this masterpiece of watch manufacture. The balance you are allowed to pay in small, easy, monthly payments. A 21-Jewel Watch—is sold to you at a price much lower than that of other high-grade watches. Besides, you have the selection of the finest thin model designs and latest styles in watch cases. Write for FREE Watch Book and our SPECIAL OFFER today.

Write While This Special Offer Lasts

Get the Burlington Watch Book—write today. Find out about this great special offer which is being made for only a limited time. You will know a great deal more about watch buying when you read this book. You will be able to "steer clear" of the over-priced watches which are no better. Write for watch book and our special offer TODAY!

Burlington Watch Company
Dept. 49-45 19th St., and Marshall Blvd., Chicago

NEW RADIO DRY CELL "A" BATTERY

For W.D.-11 Tubes

LASTS LONGER THAN ANY OTHER

1½ volt dry cell and gives better results. Designed especially for W.D. 11 tubes. See full page ad in "Saturday Evening Post," April 14th by National Carbon Co., (Eveready).

Made in three sizes

- 1 Eveready Cell \$.45
- 2 Eveready Cells \$1.10
- 4 Eveready Cells \$2.50

Send money order or draft today. Batteries shipped same day order is received.

Waveland Radio Company, Inc.
1348 N. Clark St. Chicago, Ill.

Look At These Prices

Variable Condensers

Genuine Formica Panels		Real Aluminum Plates	
3 Plate	\$.90	23 Plate	\$1.90
13 Plate	\$1.30	43 Plate	\$2.30

Send post paid on receipt of price.

American Governor Co.
Anderson, Ind.

WHY NOT spend Spring, Summer and Fall gathering butterflies, insects? I buy hundreds of kinds for collections. Some worth \$1 to \$7 each. Simple outdoor work with my instructions, pictures, price-list. Send 10c (not stamps) for my Illustrated Prospectus before sending butterflies. Mr. Sinclair, Dealer in Insects, Dept. 33, Ocean Park, Calif.

Three "Little Wonder" Radio Books

Every Radio Fan Should Have

How to Make Wireless Receiving Apparatus



The 20 radio constructors who wrote the book know how articles should be made from simple materials.

Only modern apparatus is described, such as Receiving set without aerial or ground, magnetic detector, wireless relay, wireless lecture set, etc., etc. Book has 100 pages, each 5 x 7 inches, 90 illustrations, many full pages, paper bound, in two colors.

Price 35 Cents

How to Make Wireless Sending Apparatus



Contains information on how to make 30 different pieces of wireless sending apparatus from materials, easily obtained.

Tells How to Make an Experimental Arc Set, Speaking Arc, Quenched Gap, ¼ K. W. Transformer, Oscillation Transformer, Photo Phone, etc., etc.

Book has 100 pages (size, 7 x 5 inches), 88 illustrations, paper cover printed in two colors.

Price 35 Cents

Design and Construction of Audion Amplifying Transformers

Radio and Audio Frequency Type
This book will be of great interest to all radio amateurs. The transformers have never before been described in print. The possessor of vacuum tubes cannot afford to do without this book. It will enable him to build the necessary amplifying transformers very readily. The book is printed on good paper and has an attractive cover in two colors. Paper bound. Size, 5 in. by 7 in. Contains many illustrations, diagrams, and working data.



Price 25 Cents

Any of these books sent to any address postpaid upon receipt of price

Dealers Write for Wholesale Discounts

Experimenter Publishing Co.
53 Park Place New York City

earth considered as a spherical conductor insulated in space is only about 800 microfarads. The capacity of a mile of submarine cable is about one-third of a microfarad.

If we make our measurements in these units the formula for the frequency of oscillation in a condenser circuit takes the following form:

$$n \left(\frac{\text{oscillations}}{\text{per second}} \right) = \frac{5,000}{\sqrt{C \left(\frac{\text{in}}{\text{microfarads}} \right) \times L \left(\frac{\text{in}}{\text{millihenrys}} \right)}}$$

Thus, for instance, if we had a charged Leyden jar having a capacity of 1/500th of a microfarad and discharged it through a yard or two of connecting wire, which might have an inductance, say, of 1/500th millihenry, the frequency by the above formula would be 2½ millions. This means that the time of one complete oscillation current would be four ten-millionths of a second.

A circuit of this kind is called an oscillatory circuit and every such circuit has a natural time of vibration in which its electric charge oscillates when disturbed just as every pendulum of a given length has its own natural time of vibration if it is set swinging.

(To be continued)

Robert M. Stephen's Station 9AUC

(Continued from page 1960)

The transmitter is one using one 50-watt Radiotron in a straight Hartley Circuit. The radiation at present being five thermocouple amperes on straight C.W. and two on voice, moving up to 3.5 when the voice is impressed on the circuit. I also have a chopper, not shown in the photograph, which is used for calling and handling traffic through QRM and QRN. The voltage on the plate circuit is about 11, and is obtained with a 36 jar chemical rectifier in which a borax solution is used. I am seriously thinking of using Ammonium Phosphate because of the greater efficiency and less trouble in the care of such a rectifier. The rectifier is mounted directly under the transmitter. The filter circuit, which I take to be about as near perfect as possible, judging from the reports received complimenting the smooth note, is 3-1 mfd. filter condensers in parallel and an R.C.A. filter reactor.

All controls are within easy reach of the operator, and are as simple as could be made.

The receiving set is home-made, using Reinartz tuner, with three steps of radio frequency, detector, and two steps of audio frequency available. For average work, only detector and one step A.F. are used. The headset is a Connecticut and the loud speaker is a Radio Magnavox.

With this set in two months of operation, all districts, with the exception of the second, have been worked, and several reports have come from the second district. To date 38 states have been worked, four Canadian districts and reports received from Santiago, Cuba, Alaska, and from 6ZY at Honolulu, T. H., approximately 3,500 miles from Hastings. The best DX on phone is 800 miles, eight states and three districts, with a corresponding record for daylight transmission.

I would also like to thank those who have been so kind as to write me reports and to send me cards concerning the reception of my signals. Practically all have reported me loud, steady and F.B. as to pure D.C. tone. I would also like to state that all correspondence is answered by letter or card.

Any of you hearing my sigs in the future will do me a favor by dropping me a line.

RADIO PARTS

HEAD SETS

	Net Prices
Baldwin (single) Type C.....	\$4.65
Baldwin (double) Type C.....	8.95
Murdock	3.95
Elwood	3.25

LOUD SPEAKERS

Gem Horn with single Loud Speaker Unit	\$10.00
Magnavox—R3	30.00
Murdock	5.00

VARIOCOUPERS

180 degree Bakelite	\$2.50
Moulded, Silk Wound	3.50

RHEOSTATS

K. K. K.	\$.50
Paragon	1.25
Federal85
Bradleystat	1.85
Klosner-Vern	1.30
Cutler-Hammer	1.30

BATTERIES

"B" 22½	\$1.20
"B" 22½ large	2.00
"A" 6 volt, 90 amp.	15.00
"A" 6 volt, 100 amp.	17.50
Charger to recharge "A" Bty.....	15.75

VARIABLE CONDENSERS

3 Plate	\$.75
13 Plate	1.15
23 Plate	1.40
43 Plate	2.00
43 Plate Vernier	4.25
23 Plate Vernier	3.75
43 Plate Chelsea Glass Enclosed ..	5.00
23 Plate Chelsea Glass Enclosed ..	4.75

DIALS

2 or 3 inch	\$.25
½ inch35

VARIOMETERS

Moulded, Best Make	\$3.50
Wood Type	2.25

All Goods Sent by Mail Except Storage Batteries. When Ordering Send Post Office or Express Money Order. Include 20 Cents for Insurance.

DAVID KILLOCH COMPANY

Manufacturers and Jobbers of Radio and Electrical Supplies

57 MURRAY STREET Post Office Box 196 NEW YORK, N. Y.

Have You Begun to Feel the Conditions that Come After 40?



A remarkable discovery has already restored to health thousands of men suffering from the distressing ailments common to men past 40. Every man should read the facts given here.

DO YOU suffer with **reluctance, pains in back, legs and feet** frequent nightly risings, painful micturition, mental or physical depression? Do-

ctors and Scientists have long recognized that the cause of these, and many other painful conditions, was the disturbed condition of a little gland called the prostate. And now a certain Scientist has discovered a wonderful new hygienic principle that has already been used with phenomenal success by thousands of men in restoring this little gland to health. Many cases are reported where relief was obtained when a surgical operation has seemed the only recourse.

What this Discovery Can Mean to You

An authoritative medical treatise says that 65% of all men past a certain age suffer with a disorder of this gland. If you experience any of the conditions mentioned—have chronic constipation or prostatic disorders—you should not delay in finding out about this discovery. Do not let "approaching age," encroach upon your mental and physical vigor and alertness. If you will write at once you can get Free an interesting booklet called, "Why Many Men Are Old at 40," written by the scientist who discovered this new method. Don't risk your health by delay. There is no obligation. Simply send name and address, mentioning ailment, if you want specific information. Address.

THE ELECTRO THERMAL CO.

6019 Main St.

Stubenville, Ohio

Dr. T. O'Connor Sloane Will Teach You CHEMISTRY

Right In Your Own Home



DR. T. O'CONNOR SLOANE, A. M., LL. D., Ph. D., Educational Director, Chemical Institute of New York, formerly Treasurer, American Chemical Society and a Practical Commercial chemist as well as a noted instructor.

Good chemists command high salaries. Industrial firms of all kinds pay tempting salaries to get the right men. Salaries of \$10,000 a year are not unusual for chemists of exceptional abilities. The work of the chemist is extremely interesting. If you are fond of experimenting, take up chemistry. If you want to earn more money, the way is open through our Course in Chemistry.

You Can Learn at Home Dr. Sloane will teach you Chemistry at home in a practical, intensely interesting way. Our Course is remarkably simple. No special education required—if you can read and write plain English you can thoroughly understand and master every lesson.

Easy Monthly Payments

The price of our course is very low and the tuition includes everything, even the chemistry outfit—there are no extras to buy with our course. You can pay in small monthly amounts as you go along. Our plan places a chemical education within the reach of everyone.

Experimental Equipment Given to Every Student

One special feature of our course is that we give to every student, without additional charge, the chemical equipment he will need for his studies, including forty-two pieces of laboratory apparatus and eighteen different chemicals and reagents. The fitted, heavy wooden box serves as a carrying case for the equipment and as a laboratory accessory for performing experiments.

SPECIAL 30-DAY OFFER

In addition we are making a special offer for a short time only. You owe it to yourself to find out about it. Mail the Coupon to-day for free book, "Opportunities for Chemists," and full details of our special offer. Act immediately before this offer is withdrawn.

—CUT HERE—

CHEMICAL INSTITUTE OF NEW YORK, Inc.
Home Ext. Division, 5-A, 140-R, Liberty St., N. Y. City.

Without obligation or cost, send me your free book, "Opportunities for Chemists," and full particulars about the Experimental Equipment given to every student, and tell me about your plan of payment and special 30-day offer.

Name

Address

City State

World Radio Batteries
SAVE YOU 50%
WRITTEN 2-YR. GUAR.

To Insure Satisfaction Buy World Radio "A" Batteries

In buying a World, the highest "quality" battery built, from the manufacturer, you gain two profits. First, you get a battery free from extravagant selling expense. Second, you save the profits charged by the middleman. Thousands of users enjoy the dependable qualities of our product.

Guaranteed unconditionally, in writing, for 2 years. We ship Express C. O. D. subject to your inspection, or will allow 5% for cash with order. MAIL YOUR ORDER TO-DAY.

WORLD BATTERY COMPANY
Dept. 10
1219 S. Wabash Ave., Chicago, Ill.

- 6 volt 40 Amps... \$ 8.50
- 6 volt 60 Amps... 10.00
- 6 volt 80 Amps... 12.50
- 6 volt 100 Amps... 14.50

AMERICAN TIME CLOCK REPAIR & SUPPLY CO.
SECOND HAND TIME CLOCKS
Bought, Sold, Repaired and Exchanged
ALL WORK GUARANTEED
We Carry a Full Line of Supplies
489 Broadway, near Grand St., Phone, Canal 7951

Reflexing With One Tube

(Continued from page 1968)

these transformers only the one designed to work between the first and second tubes gave good results. Both iron and air core types were tried with results that seemed to depend upon the individual make of transformer. Reversing the leads to the transformer windings sometimes improved reception.

In operation, the set is quiet and the various tuning controls are not difficult to operate. During a protracted series of tests, carried on mostly in the wee hours of the morning, the furthest station which was consistently received was WDAF, the Kansas City Star. This represents a distance of approximately 1100 miles from New York City. For local stations sufficient amplification is obtainable to operate a loud speaker at volumes suitable for home use.

To build a set of this description, using fairly good apparatus, should not cost above \$15, exclusive of tubes, phones and batteries.

In view of the results obtained, a three-tube reflex receiver is now in the process of construction so that the outdoor antenna may be totally dispensed with, and reception done on the loop alone.

The Radio Doctor—A New Profession

(Continued from page 1942)

to do the work without additional charge. If, however, the wiring is all carelessly done and incorrectly connected it is best to suggest that the set be completely rewired and to make a nominal charge for doing the work. Any incorrect wiring in commercial sets is usually to be found on the exterior circuits, that is, the battery connections, rather than the circuits inside the box.

Tube defects cannot usually be corrected. Sometimes a defective filament will operate under a higher plate voltage but this is, at best, a temporary and costly remedy and the best practice is to recommend the purchase of new tubes. Defects in detector and amplifier tubes can be quickly determined by the substitution of tubes known to be in good condition, but it is not a safe method to pursue without great care.

It may be quite possible that the circuit is in such a condition as to ruin any tube which is placed in the socket and consequently make the substitution method an expensive practice. The best method to pursue, if there is a suspicion of a defective tube, is to take all the tubes out of the set and test them on some circuit that is known to be in the right shape. No possible injury to the tubes or to the circuit can result from this practice.

One of the most frequent troubles that I run into is described by the owners of the sets whereon it occurs as an inability to tune out interference or the inability to get two stations of equal power and distance at the same strength of signal. In Chicago we have eight local broadcasting stations. Frequently three or four of them operate at the same time on wave-lengths only slightly separated from one another. "I get station WMAQ fine," says one radio fan, "but I can hardly hear KYW." Another says just the opposite and so you are in a quandary. WMAQ sends on a 360-meter wave-length and KYW sends on 400 meters. They should both come in at about the same signal strength to local listeners and, of course, should not interfere with each other at all.

"Built Like a Skyscraper"

Shaw-Walker Steel Letter Files

BUILT LIKE A SKYSCRAPER

LEARN ELECTRICITY IN 3 MONTHS

Make this the most profitable and enjoyable summer of your life. Come to Chicago, the electrical center and the country's greatest summer resort city. Learn Electricity in America's oldest, largest and best equipped school. Earn your way, free employment dept.

FREE R. R. FARE If you come now we will pay your railroad fare and give you free a course in auto truck and tractor electricity, a course in radio, and a life scholarship in the great Coyne School. This is the greatest offer ever made by a school. Write at once for particulars. We cannot keep this offer open long.

Write Today Coyne

Trade and Engineering Schools
1300-1310 W. Harrison St.,
Dept. 5945 Chicago, Ill.

GENUINE GERMAN MAUSER Half pre-war prices

Latest model 9 shot automatic. Shoots standard cartridges—lies flat in pocket—World's famous Luger 30 cal. \$20.75 — Hand Ejector Revolver, swing out cylinder 32 cal. \$16.95. 38 cal. \$17.95. All brand new latest models. Guaranteed genuine imported. Pay on Delivery **SEND NO MONEY** Plus Postage

Satisfaction guaranteed or money promptly refunded

\$6.95 25 cal. Pocket Automatic; 25 cal. Blue Steel Army Automatic \$8.45; 32 cal. \$10.45; Officer's Automatic, 3 safeties, 25 cal. \$11.95; Military Trench Automatic, 32 cal. 10 shot extra magazine FREE, \$11.65. Just like you used over there. Imported Top Brake Revolver. 32 cal. \$8.65; 38 cal. \$8.95.

Universal Sales Co. 165 B'way, Dept. 284 New York

ELECTRICAL TRAINING BOOK FREE

Send me your name and address and I will send you my big new Electrical Training Book Free. It will show you how to qualify for high paying jobs in Electricity. Thousands now open. Prepare at home—quickly—during spare time under an Electrical Engineer. Take advantage of this unusual offer—only temporary.

A. W. WICKS, President WICKS ELECTRICAL INSTITUTE
Dept. 1077 3601 Michigan Ave. CHICAGO

You can be quickly cured, if you STAMMER

Send 10 cents for 288-page book on Stammering and Stuttering, "Its Cause and Cure." It tells how I cured myself after stammering 20 yrs. B. N. Bogue, 886 Bogue Bldg., 1147 N. Ill. St., Indianapolis

OLD MONEY WANTED
\$2 to \$500 EACH paid for hundreds of old or odd coins. Keep ALL old money, it may be VERY VALUABLE. Send 10 cents for New Ill's COIN VALUE BOOK, size 4x6. Get Posted. We pay Cash. CLARKE COIN CO., Ave. 79, Lb Roy, New York

A large percentage of troubles of this sort I have found to be due to an antenna of so short or long a natural period that the auxiliary tuning devices were unable to materially affect them. Experiment to determine the exact length which the antenna should be, in relation to a particular set, usually clears up this kind of trouble in a hurry. This can be easily carried out by means of a sliding contact or pulley on the lead-in wire.

Contrary to prevailing opinion single circuit tuner sets of low resistance are almost always sharper in tuning than the circuits which combine a multiplicity of variometers, variocouplers and condensers.

The very best set of this kind which I ever built was one having no variocouplers or variometers of any kind and only one 11-plate variable condenser. It had two stages of radio frequency, and two of audio frequency, a detector, variable condenser, antenna and nothing else! While it will receive only on waves of between 350 and 415 meters, in this limited scope it is without an equal of anything within my observance. Through a loud speaker and on an indoor antenna this set has brought in PWX at Havana, Cuba, loud enough to be enjoyed across a fairly large sized room.

Tuning on this set is so sharp that a hair-line on the vernier of the variable condenser will completely eliminate the signals of one station and possibly bring in another. I have heard as many as 26 stations on this tuner at one sitting without the least trouble due to interference.

The greatest trouble with the majority of sets offered for sale on the open market today is their complicated makeup. One set that I recently repaired had 16 separate controls on the panel, 11 of which could have been eliminated without impairing the working of the set in the slightest degree. When you expect a novice to get satisfactory results from such an outfit, you are asking too much. It can't be done!

Another fetish of a past era is found in the average novice's hankering for an outdoor antenna. Almost every person whom he questions on the subject tells him that an outdoor antenna is more efficient than the indoor type. This is not true.

While it is a fact that the outdoor antenna, if placed at a height 20' or 30' above the indoor type, will slightly increase signal strength, a properly designed indoor antenna connected to an efficient receiving set will bring in all the broadcasting stations in this country and some outside, in a perfectly satisfactory manner. Furthermore it will give many hours of enjoyment in the summer free from lightning hazard and static disturbances when, with the outside antenna good reception is difficult.

The outdoor antenna is an eyesore to any neighborhood, is obsolete and should be cast into the discard.

There are many different kinds of indoor antennae, ranging from the popular "loop" type, which in my experience is the least efficient of them all, to the long single stretch in some spacious attic. My own preference consists of ten 12' lengths of copper plated hollow metal tubing of 2" diameter, each length being hung a distance of about 4" from the next, and connected to one end with insulating tape and to the other end with a copper ribbon connector. This type of antenna hung so as to look like a series of dinner chimes can be placed in almost any room in the house and is not only attractive, but will give splendid results.

Notes On WD-11 Tube

(Continued from page 1969)

should be turned off when the tube is not in use. If greater amplification is desired, more "B" batteries should be connected in

Don't Waste Money, Time and Patience on Cheap, Improperly Designed Radio Parts. Insist on Getting New York Coil Company's Products, Which Insures Entire Satisfaction. Honestly Priced, Scientifically Constructed and Engineered to Deliver the Maximum Results.

JOBBER AND DEALERS get our complete literature and worthwhile discounts.

Our 180 degree Variocoupler is a masterpiece, suitable for use in any circuit. Most efficient and best constructed Coupler in existence.

PRICE, \$4.50.

STANDARD 90 DEGREES VARIOCOUPLER. PRICE \$3.50

Our Combination Mounted Variocoupler for table or back panel mounting has all taps connected and soldered, nothing else like it. Price, \$8.00.

AUDIO FREQUENCY TRANSFORMERS—Choice of leading manufacturers and radio engineers. Guaranteed to give high magnification, less distortion and better all round efficiency. No howling. Price \$4.00.

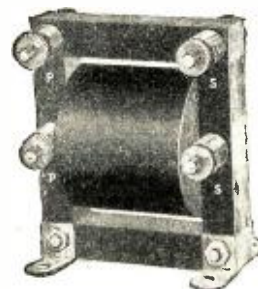

Our Variometers are full size precision instruments. They are not of the "competitive" type. Price \$4.00.

Our Audio Frequency Transformers are the choice to the leading manufacturers and radio engineers. Guaranteed to give high magnification, less distortion and better all around efficiency. No howling. Price \$4.00.

NEW YORK COIL COMPANY'S Variable Condensers are the standard by which others are judged, containing such features as all metal framework, adjustable bearings and positive electrical contact:

11 Plate.....	\$1.50	43 Plate.....	\$3.00
23 Plate.....	2.00	3 Plate.....	1.25

NEW YORK ENTERTAIN-A-PHONE RECEIVING SET NO. 2—Complete with detector and two stages of amplification, all in one cabinet. Contains a non-regenerative two circuit



hook-up with two stages audio amplification. Results are simply a revelation. It must be operated and heard to be appreciated. Workmanship and design and material of exceptional character throughout. Of unusual interest to the jobber. Price \$50.00 fully guaranteed.

NEW YORK COIL COMPANY, Inc.
338 Pearl Street
New York City, N. Y.



TYPE 282 WD-11 TUBE SOCKET

A socket of moulded bakelite arranged with positive side contact springs to take the WD-11 tubes. Socket will fit only in correct position, thus avoiding danger of burning out tube. Terminals plainly marked.

PRICE 80 Cents

Send for New Free Radio Bulletin 914-N describing our full line.

GENERAL RADIO COMPANY

MASSACHUSETTS AVENUE AND WINDSOR STREET
CAMBRIDGE 39 MASSACHUSETTS

WANTED—Back numbers of Radio News, Sept., Oct., Nov. and Dec., 1921, Jan. and Feb., 1922. Experimenter Publishing Co., 53 Park Place, New York City.



The Radio Guild, Inc.



Don't take imitations. Ask for the Radio Guild Multi-Range Coupler.

RECEIVE NAA, the new broadcasting on 710 meters and higher wave-lengths with the

"MULTI-RANGE" COUPLER

Increased production to meet the enormous demand permits reduction in prices.

Multi-Range Senior, 170-3400 meters Now \$9.00 From your dealer

Multi-Range Junior, 170-2000 meters Now \$7.00 or direct.

If your dealer cannot supply you tell him to write to us or his nearest distributor.

"The finest bank-wound coupler ever produced."—N. Y. Evening Mail Laboratories.

Permits the easy construction of a complete radio receiver at low cost.

Read the Harkness Book on Super-Regeneration

48 pages, 30 photographs, wiring diagrams and mechanical drawings. The most complete book on the subject ever published. Explanation of the theory of super-regeneration is a revelation. Tells how to construct three different types of sets.

Send for your copy today—Price 50c. From your dealer or direct.

The Minneapolis Daily News Says:

"Radio books have come and gone in plenty. None has seemed to be worthy of special mention. One came this week, however, which absolutely demands mention, not to say praise, by its merits. It is THE CONSTRUCTION AND OPERATION OF SUPER-REGENERATIVE RECEIVERS by Kenneth Harkness."

The Radio Guild, Inc.

256 WEST 34th STREET NEW YORK N. Y.

the portion of the circuit designated by the letter "H," making sure though, that the positive terminal of one is connected to the negative terminal of the preceding battery. A total of 100 volts, however, should be the maximum potential used. When this high voltage is employed, one flashlight battery should be connected in the grid circuit of tube 3 and another in the grid circuit of tube 6 with the negative terminals to the grid proper. The correct place for insertion of this battery is shown by a small cross. It should be understood that the headphones may be replaced by a loud speaker when using the two-stage amplifier.

The Neutrodyne Receiver

(Continued from page 1949)

the small variable condenser connected across the secondaries of the amplifying transformers, the filament current of the first tube is turned off and the small condenser adjusted until no signals are heard in the phones, showing that no transmission of energy occurred through the inter-electrode capacity from one stage to the next. Of course, each stage must be so adjusted, and it has been found in practice that if more than two stages of radio frequency amplification are used, it becomes necessary to shield the various stages on account of magnetic reaction occurring, due to the tremendous amplification obtained in the last stages. The other adjustments are similar to those of any other receiver.

The advantage of the Neutrodyne receiver with regenerative detector is that the detector tube can be made to oscillate for the reception of continuous waves without re-radiating energy which always causes interference for the other receiving stations in the neighborhood. Thanks to the Neutrodyne effect, the oscillations remain in the detector circuit, as there is no coupling between the different stages.

The neutralization of the tube capacity will find applications in radio circuit where self-oscillations are undesirable. When applied to non-regenerative receivers, it eliminates any inherent means whereby regeneration might occur and so contrasts with devices such as potentiometers, which merely weaken the regenerative effect.

Controlling Models by Radio

(Continued from page 1946)

If the model locomotive attached to the electric train (which it is desired to control) is fitted with a permanent magnet type of motor, it will be noticed that the model train can be caused to run backwards, or forwards, and stopped as desired.

Best results are obtained with the transmitter and receiver in question when the metallic rods (i.e., those forming an antenna) are parallel to each other. For that reason the metallic rods fitted to the transmitter should not be placed at right angles to those fitted to the receiving apparatus.

Traffic Regulations of the St. Louis Radio Association

(Continued from page 1974)

DEAR FELLOW TRANSMITTER:—
Here is your copy of the new TRAFFIC REGULATIONS. Please obey them to the letter. The Broadcast Stations are co-operating with us and it is up to us to do likewise. Be a

ANNOUNCING

TWO NEW TUBES

1 1/2 VOLTS

Voltage	1 1/10-1 1/2
Fil. Amp.25
Plate Volt	20-75
Base	Large Standard Size

Guaranteed Unsurpassable Quality

On sample orders we offer
Consumers and Dealers
the **SPECIAL PRICE** of

WRC 22 Amplifier & Detector	\$5.50	LIST \$6.50
WRC 20 Detector	\$5.00	LIST \$6.00

Cash With Order, Immediate Delivery.
Jobbers and Dealers Write.

CONWAY ELECTRICAL LAB.
SALES DIV. Box 22
125 E. 34TH ST. NEW YORK CITY

Panel Service

We offer to the amateur and dealer **Real Panel Service.** Our panels are cut to your order. Only genuine Bakelite or Formica used.

1/8" per square inch	.02
3/16" " " "	.02 1/2
1/4" " " "	.03

We also carry a full line of radio essentials. Dealers will find it profitable to have our latest price list and discount sheet.

PITTSBURGH RADIO AND APPLIANCE CO., INC.
"Pittsburgh's Radio Shop"
DESK A
112 Diamond St., Pittsburgh, Pa.

real amateur OM and let's not do anything to cause the listener to complain.

If you are a real sport and play this game fair, everything possible will be done to protect you. The U. S. Government is behind you and so is the ARRL.

We trust you will at no time do anything that will cause your license to be revoked.

Please see to it that your wave is where it belongs.

Best 73s and good luck.

Respectfully,
CHAIR., TRAFFIC COMM.,
St. Louis Radio Assn.

TRAFFIC REGULATIONS

MONDAY TUESDAY WEDNESDAY FRIDAY

From 6 A. M. to 8 A. M. All stations may transmit or test.

8 A. M. to 7 P. M. All stations may transmit. No testing unless absolutely necessary.

7 P. M. to 9:50 P. M. Only straight C.W. and low powered phones on 200 meters may transmit locally or DX.

9:50 P. M. to Midnight. All stations may transmit under the supervision of a traffic officer who will list the stations. The traffic officer will call for DX at 9:50 P. M. and all stations desiring to work will respond. No station will be listed after 10:15 P. M.

Monday Midnight to 2 A. M. Tuesday. Only C.W. may transmit.

2 A. M. to 4 A. M. Only spark may transmit.

4 A. M. to 6 A. M. Only C.W. may transmit.

Tuesday Midnight to 2 A. M. Wednesday. Only spark may transmit.

2 A. M. to 4 A. M. Only C.W. may transmit.

4 A. M. to 6 A. M. Only spark may transmit.

Wednesday Midnight to 2 A. M. Thursday. Only C.W. may transmit.

2 A. M. to 4 A. M. Only spark may transmit.

4 A. M. to 6 A. M. Only C.W. may transmit.

Thursday 6 A. M. to 7:30 P. M. Same as other days.

7:30 P. M. to 11:30 P. M. All transmitters including Broadcast Stations must remain absolutely quiet to permit listeners to hear distance broadcast stations.

Thursday Midnight to 2 A. M. Friday. Only spark may transmit.

2 A. M. to 4 A. M. Only C.W. may transmit.

4 A. M. to 6 A. M. Only spark may transmit.

Friday Midnight to 2 A. M. Saturday. Only C.W. may transmit.

2 A. M. to 4 A. M. Only spark may transmit.

4 A. M. to 6 A. M. Only C.W. may transmit.

Saturday 6 A. M. to 9 A. M. All transmitters may work. No testing.

9 A. M. to 5 P. M. All transmitters may work and test.

5 P. M. to 7 P. M. All transmitters may work. No testing.

7 P. M. to 9:50 P. M. Same as Monday.

9:50 P. M. to Midnight. Same as Monday.

Saturday Midnight to 2 A. M. Sunday. Only spark may transmit.

2 A. M. to 4 A. M. Only C.W. may transmit.

4 A. M. to 6 A. M. Only spark may transmit.

6 A. M. to 9 A. M. All stations may transmit. No testing.

Sunday 9 A. M. to 12 Noon. All stations may transmit and test.

12 Noon to 7:30 P. M. All stations may transmit. No testing.

7:30 P. M. to 11:30 P. M. All transmitters including broadcast stations excepting the Kingshighway Presbyterian Church must remain absolutely quiet, this church being permitted to broadcast its regular Sunday evening services from 8 to 9 P. M.

11:30 P. M. to 6 A. M. Monday. FREE AIR for ALL TRANSMITTERS.

These regulations will be enforced beginning 6 A. M., January 8, 1923.

**The Resonance Principle:
Its Radio Applications**

(Continued from page 1952)

resonance point of the resonance curve of that particular receiver, and is receiving at maximum intensity, on account of resonance. Now if a 250-meter wave strikes the antenna and receiver, it will be in the position of f_2 or f_4 and hence will produce a very small current in the receiver and will be negligible

WEBSTER RADIO APPARATUS

Webster Radio Apparatus—both parts and assembled receiving sets—are built to typical Webster standards of perfection. Our line of parts includes everything from contact points and switch stops to Variometers and Variable Condensers—designed to function perfectly. When building your set, ask your dealer for Webster Apparatus. You are thus assured the utmost value, for Webster parts are designed to perform properly and are priced fairly. If your dealer does not carry Webster Radio Apparatus, write for our 24 page catalog and order direct.



Webster Combination Socket and Rheostat

This unit combines both socket and rheostat together for either panel or table mounting. It is moulded porcelain finished in a brown glaze. Finished with or without vernier.

Webster Variable Condensers

The entire condenser is of improved design. Made of aluminum and accurately spaced. Bearings of ample size with threaded hard rubber bushing for adjustment. Insulated stops limit the arc of rotating plates to 180 degrees. Shaft extension $\frac{1}{4}$ " diameter.

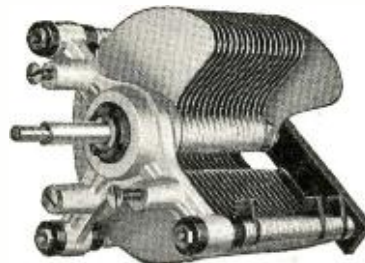

Webster R.-F. Transformer

Iron core type carefully tuned at the factory. Completely enclosed in attractive moulded case. Made in TYPES for 1st, 2nd, or 3d steps of amplification. Range 175-555 meter wave band. Moderately priced.

Other items of Webster Radio Apparatus include Head Sets, Variometers, Vario-couplers, A.-F. Transformers, Rheostats, etc.

Complete line of receiving sets at prices ranging from \$30.00 to \$119.00.



WEBSTER ELECTRIC COMPANY

1904 Clark Street
RACINE WISCONSIN U. S. A.

Manufacturers of Webster
Magneto---over 750,000 in use.



The Only Quality
3000-Ohm Guaranteed Head Set for
\$5.00
\$5.00
3000 Ohms

TRUE - TONE RADIO MFG. CO.
188 No. La Salle Ave. CHICAGO, ILL.

☸ RADIO ☸

Complete Stock—Both Sets and
Parts—All Makes

**ROSE
RADIO SUPPLY**

129 CAMP STREET
New Orleans, La.

Send 10c for latest catalog

U.S. PATENTS

SEND FOR THIS FORM

Don't Lose Your Rights

Before disclosing your invention to anyone send for blank form "Evidence of Conception" to be signed and witnessed. A sample form together with printed instructions will show you just how to work up your evidence and establish your rights before filing application for patent. As registered patent attorneys we represent hundreds of inventors all over the U. S. and Canada in the advancement of inventions. Our schedule of fees will be found reasonable. The form "Evidence of Conception" sample, instructions relating to obtaining of patent and schedule of fees sent upon request. Ask for them—a postcard will do.

LANCASTER & ALLWINE

270 OURAY BLDG., WASHINGTON, D. C.
"Originators of form Evidence of Conception"

compared to the received current at 200 meters, namely f_0 in Fig. 3. As a result, the signal due to the 200-meter wave is so loud that other waves are thereby drowned or produce no effect on the receiver. In this manner tuning out is accomplished in reception.

The reader will immediately stop to wonder why some particular sets which he has heard did not tune out other signals. This question is a pertinent one and will now be considered. In order to understand why some sets do tune out undesirable signals and others do not, let us consider for a moment the effect of resistance on the resonance curve of a circuit. In other words, considering last month's article on damping, what is the effect of damping on resonance?

Suppose we take a resonance curve for Fig. 1 for three different values of R, say

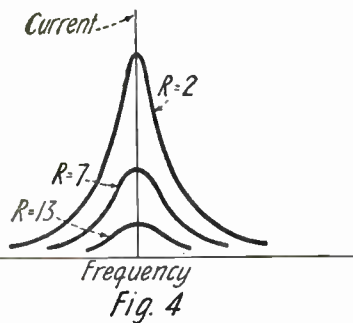

A Resonance Curve For Fig. 1 With Three Different Values of R. When the Resistance Is Low the Curve Is Very Sharp, As Shown in the Case Where R Equals 2.

2 ohms, 7 ohms and 13 ohms. These curves will have the appearance of Fig. 4, in which each curve is properly labeled. It will immediately be seen that there is a marked contrast between these curves. When the resistance of the circuit is low, 2 ohms, the resonance curve is very "sharp," the peak is very conspicuous, and a small

variation in frequency from the resonant frequency produces a large drop in current. Hence, in such a receiver it will be possible to tune out stations which are only a little bit removed in frequency from the resonant frequency to which the receiver is tuned. Maximum current is received at only one frequency practically. Any other frequency of incoming waves produces a smaller effect on the receiver and hence will not be heard. In other words, low damping gives a highly desirable resonance curve and permits of very selective tuning.

The resonance curve for 7 ohms resistance is seen to be not so "sharp." It will be observed that the peak is spread over a considerable range of frequencies, so that even if you are tuned to 200 meters, say, a wave at 240 or 160 meters may produce almost as great an effect on the receiver and hence will not be tuned out. Thus a high damping produces "broad" resonance curves and does not permit of very selective tuning. The resonance curve for 13 ohms brings this out more vigorously, for it will be seen that it is almost flat, there being hardly any peak.

Here, then, we have the difference between a good set and a bad set. The highly selective set, the set that enables you to tune anyone out you do not want to hear, is the set with the very sharp resonance curve. It is the set that is extremely well designed and has a very low damping. The set that does not permit you to tune out any station you do not want to hear is the set with the broad resonance curve, the set that has high damping. For very fine work the set with sharp resonance curve is the best. In fact, the very best sets are such sets that permit very selective tuning. But sets having broad tuning also have their uses, for, as explained in the article on damping, a broad resonance curve for a receiver as well as transmitter is absolutely essential on the high seas, in order to enable the operator to hear distress signals on wave-lengths different from the one he is operating on. Thus, if he is receiving traffic at 800 meters and a distress signal is being transmitted at 600 meters, if his set is broadly tuned he will be able to hear it. Otherwise not. In fact, some ship sets are designed with a special circuit called the stand-by circuit to enable such reception.

The resonance curve and principle will also explain why close coupling does not permit of sharp tuning. Close coupling produces a high damping on account of extraction of energy, and as seen from Fig. 4, a high damping produces broad tuning. The opposite is, of course, true for loose coupling.

Almost all measurements which are made in radio are based either directly or indirectly upon the resonance principle. In fact, the most important measuring instrument used in radio is based on this principle, namely the wavemeter. The wavemeter consists practically of a coil and condenser, and is tuned to different frequencies and calibrated. All measurements are based upon bringing the measured circuit into resonance with the wavemeter and noting the frequency of the wavemeter. Measurements of capacity, inductance, resistance, decrements, coupling co-efficients, and so on, are made by means of the resonance principle.

Another important application of the resonance principle is in the design of choke coils and filter circuits. Choke coils are designed frequently to choke out currents of a definite frequency, and likewise filter circuits are designed to suppress currents of certain definite frequencies. This is accomplished by designing circuits which are resonant to these frequencies to be suppressed and connecting them up properly in the circuits. The importance of such filter arrangements will be apparent when it is remembered that alternating currents are rectified with the aid of filter circuits, and multiplex telephony is made possible by the

Starting a Company?

Save expenses and taxes by organizing on the popular, COMMON LAW plan under a pure DECLARATION OF TRUST. No experience required to fill in DEMAREE STANDARD FORMS, issue shares and begin doing business at once. Genuine DEMAREE FORMS are nationally known, approved by attorneys and utilized by successful concerns throughout the United States. Send for large, free pamphlet D-40 containing valuable information that you may need. C. S. DEMAREE, legal blank publisher, 708 Walnut, Kansas City, Missouri.

PATENTS TRADE-MARKS AND COPYRIGHTS

Before disclosing an invention, the inventor should write for our blank form "RECORD OF INVENTION". This should be signed and witnessed and if returned to us together with model or sketch and description of the invention we will give our opinion as to its patentable nature. Radio and Electrical cases a specialty.

Our illustrated Guide Book, "HOW TO OBTAIN A PATENT," sent Free on request. Highest References Prompt Attention Reasonable Terms

FREE COUPON

VICTOR J. EVANS & CO., Patent Attorneys

Chicago Offices: 1114 Tacoma Bldg. Pittsburgh Offices: 514 Empire Bldg. Philadelphia Offices: 714-715 Liberty Bldg. San Francisco Offices: Hobart Bldg.
New York Offices: 1001 Woolworth Bldg.

MAIN OFFICES: 919 NINTH, WASHINGTON, D. C.

Name Address

PATENTS

If You Have an Invention and Desire to Learn How to Secure a Patent

Send for our Free Guide Book, HOW TO GET YOUR PATENT. Tells our terms and methods. Send model or sketch and description of your invention and we will give our opinion as to patentable nature. Our documentary PROOF OF INVENTION is intended for your protection and will be sent you without charge. Write for it.

RANDOLPH & CO.
Dept. 459 Washington, D. C.

NAME
STREET
CITY STATE

use of filter circuits. This subject will be dealt with more in detail in a later article devoted to filters.

It will be recalled that in the first article of this series on "Coupling," the use of a "fly-wheel" circuit was mentioned as aiding in the elimination of certain undesirable harmonics from arc transmitters. This in reality is also a case of the application of the resonance principle to the design of certain helpful circuits.

When you operate your variometer type regenerative receiver and adjust your grid and plate variometers, what you are actually doing is tuning two circuits in resonance. This fact is not generally known by most novices. They believe that they are merely altering the inductances. The variometer has a certain capacity inherent in it, and the associated parts of the circuit to which it is attached, as, for example, the tube and batteries, also have a certain small capacity. The inductances in the variometer tunes this capacity to a certain wave-length, and the adjustments made in varying grid and plate variometers are such as to tune the wave-lengths of each of these circuits to each other. By bringing them in resonance, maximum signal strength is obtained and regeneration secured.

The above will demonstrate how important is this phenomenon of resonance, how fundamental and basic it is in radio work. Designs are made with this principle in mind, operation is accomplished with this principle foremost. When your transmitting circuits are in resonance the antenna current is a maximum and the transmitter reaches out the greatest distance. When your receiving circuits are in resonance your received current is a maximum and, therefore, your telephone signal is loudest. This sums up entirely and concisely what resonance really means to a set.

Having now covered three of the fundamental and basic ideas involved in radio, namely coupling, damping and resonance, the reader will be prepared to consider their practicable applications to construction problems and design problems in radio. The following articles will, therefore, now be concerned with a discussion of various parts of transmitting and receiving sets, such as antennae, transformers and so on, each article giving the practical applications of theory to design and operation.

Instructions in International Code Signalling for Use in Self Studies and Exercises

(Continued from page 1970)

terminus to it; Dash, another stoke, and again a dash; another up stoke, forming the letter thus Y. It is of importance to remember this peculiar formation as several letters are involved in similar sets of four signals, viz., L Y F Q.

Letter
 Dash, Dot, Dot.....D ---
 Dash, Dot, Dash.....K ---
 Dash, Dash, Dot.....G ---
 Dash, Dot, Dash, Dash..Y ---
 Dot, Dash, Dot, Dot...L ---

VOCABULARY EXERCISES

Yell, Lady, Kill, Dry, Glad, Cycle, Rigid, Godly, Young, Kindly, Glory, Dignity, Yankee, Duly, Likely, Gallery, College, Loyal, Gaily, Knuckle, Yesterday, Looking, Girdle, Dockyard, Hickory, Lodge, Lengthy, Kidney, Decidedly, Guild, Dangle, Drudge, Legendary, Rugged, Any, Clergy, Giddy, Nakedly, Legacy, Yielding, Regardless,

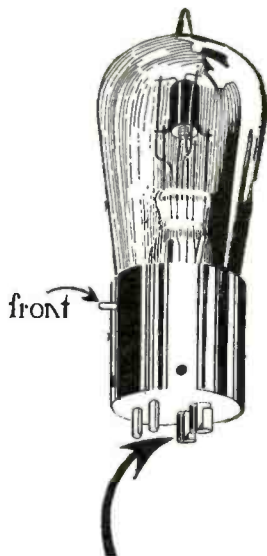

Different tubes require different capacity fuses. When ordering, therefore, please state what tube fuses are for.

SPILLED MILK

and burned out bulbs are much alike. They happen without any notice. The time to attend to them is before they happen. Care is the best safeguard for the milk; and the

RADECO SAFETY FUSE

(Patent Pending)

is the only absolute and positive means of protecting the tube.

The RADECO Safety Fuse fits directly on the filament terminals where no excess current, even an accidental short from faulty wiring can possibly get by.

It fits any standard tube used in any standard socket and does not affect the efficiency of your set.

Not an experiment, but a tried and proven bulb insurance in use on thousands of sets.

4 in standard \$1
 package

Special size for WD11—50c each
 " " " 201A—50c each

At your dealers or by mail

CAUTION

Do not force fuse on filament terminals. If contact solder is rough, file or sand-paper down so that fuse slips on easily. Filament terminals are the two farthest from the locking projection on base of tube.

RADIO EQUIPMENT CO.

630 WASHINGTON ST. BOSTON, MASS.

New England's Oldest Exclusive Radio House

MEMORIZE IN ONE HOUR

BKUMA YRLSBUG
 TRADE MARK REG. U. S. PAT. OFF.

Attentive Beginners Who Use

DODGE TWO DOLLAR RADIO SHORT CUT SMASH ALL RECORDS

Best NINE Records reported by NINE Beginners in NINE Districts (all now Licensed Operators) AVERAGE 37 MINUTES.
 For ONE DIME will mail Records by many Beginners in all Districts who easily became Licensed Operators, and to help enlighten and encourage others, have told the story of their Quick Success.

C. K. DODGE

Dept. N, Manaroneck, N. Y.

RADIO **SE-AR-DE** PRODUCTS

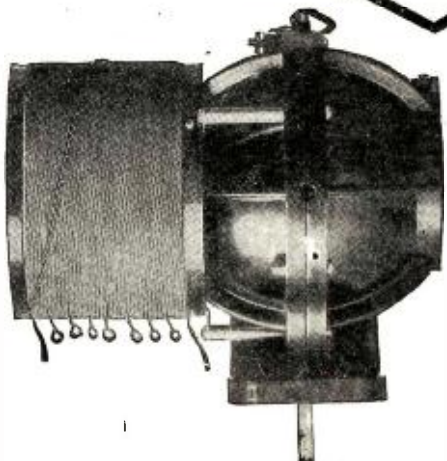

SE-AR-DE Molded RADIOMETER

Build Your Own Single Circuit Tuner

CATALOGUE No. 165

\$13.00

Range 180-3100M
" 300-3280M

R. MITCHELL & CO.

255 ATLANTIC AVENUE

BOSTON, MASS.

W. L. DOUGLAS

NAME AND PORTRAIT is the best known shoe Trade Mark in the world. It stands for the highest standard of quality, style and workmanship at the lowest possible cost.

W. L. DOUGLAS shoes are actually demanded year after year by more people than any other shoe in the world

BECAUSE W. L. Douglas for forty-six years has been making surpassingly good shoes. The smart styles are the leaders everywhere. When you need shoes and are looking for the best shoes for your money examine W. L. Douglas \$7.00 and \$8.00 shoes. They are exceptionally good value for the price. Wear them and save money.

\$5. \$6. \$7. \$8. & \$9. SHOES FOR MEN & WOMEN

NO MATTER WHERE YOU LIVE

shoe dealers can supply you with W. L. Douglas shoes. If not convenient to call at one of our 116 stores in the large cities, ask your shoe dealer for W. L. Douglas shoes. Protection against unreasonable profits is guaranteed by the name and price stamped on the sole of every pair before the shoes leave the factory. Refuse substitutes. The prices are the same everywhere.

IF NOT FOR SALE IN YOUR VICINITY WRITE FOR CATALOG.

TO MERCHANTS: If no dealer in your town handles W. L. Douglas shoes, write today for exclusive rights to handle this quick-selling, quick turn-over line.

W. L. Douglas
President
W. L. Douglas Shoe Co.
172 Spark Street, Brockton, Mass.

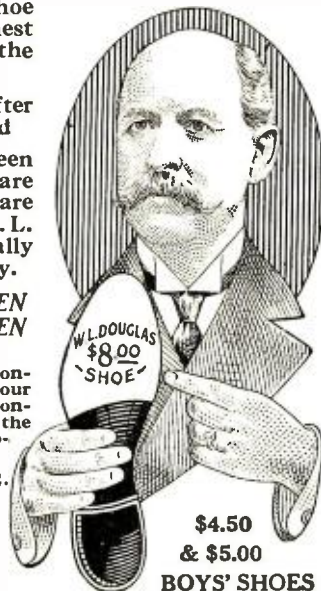

\$4.50
& \$5.00
BOYS' SHOES

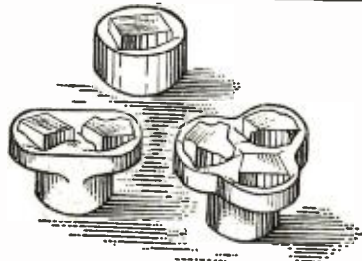

100,000 CRYSTAL FANS

Use Foote's Triple-Test Multi-Crystals

And they are continually breaking long distance records. Guaranteed QSA. (Your signals are strong.) Order by Mail and Learn by Experimenting.

Triplet Galena & Pyrite with Silicon, Twin Galena & Pyrite, Single Galena, Single Pyrite, Single Silicon, Tripletone Solid Gold Cat-Whisker, Combined value \$2.90.
All supersensitive or money back (or replacement) by return mail.

Special Postpaid \$2.00 for all six Cash with order

FOOTE MINERAL CO., INC., MFRS.
107 N. 19th St., Philadelphia
Estab. 47 Yrs. Ref. Your Banker (Dun-Bradstreet) Distributors Wanted.

PAY NO EXPRESS MAY SLAUGHTER

Sent postpaid anywhere upon receipt of money order, cash or check.

- \$6.50 1 1/2 volt detector and amplifier . . . \$5.25
- Guaranteed dry cell tubes fits any socket
- 5.00 Detector tubes 3.00
- 6.50 Amplifier 3.50
- 8.00 Federal or Elwood Phones 5.95
- 3.75 23 Plate variable condensers 1.95
- 4.75 43 Plate variable condensers 2.65
- 5.00 Vario Couplers or variometers 2.50
- 9.00 All Wave couplers (silk wound) 6.95
- 25.00 Crystal outfit complete with phones and aerial outfit 14.95
- 1.00 Rheostats, V.T. Sockets or 3" hard rubber dials (all 3 for \$1.35)40
- 3.50 Double slide tuning coils 1.95
- 5.00 Mahogany pocket receiving outfits 1.95
- 1.75 Cyclone B. Batteries 22 1/2 V. Variable 1.10
- 4.00 Cyclone B. Batteries 45 V. Variable 2.75
- .35 Galena, grid or phone condensers15
- .50 Pyrites or grid leak condensers25
- 4.50 Thornderson Transformers 3.65
- 6 Volt guaranteed U. S. Storage Batteries (sent by express collect) 7.50 up

Price List Free

Old customers send for special price list of 200 electric bargains

Broadway Electrical Novelty House
134 Third Ave., Dept. 5N New York

Kitchen, Gold, Riddle, Geology, Lucid, Haystack, Greedily, Luggage, Dying, Daylight, Deluge, Dingy, Lightly, Legally, Gradually, Cloudy, Kindling, Glide, Regally, Disgust, Dynasty, Dialogue, Glycerine, Cudgel, Glossary, Candidly, Ginger, Ugly, Commodity, Concluding.

SENTENCE EXERCISES

The dockyard has many hickory logs. A kindly looking lady had great dignity. Likely young yankees yesterday had a loud college yell. Clean your clothes at the dry laundry. He dangled dangerously at the lengthy ledge. Did dialect dialogue demand dictionary diet. A guilty guard guaranteed a grudge against them. The kangaroo kicked at his kennel. The clergy try to gain undying godly glory. Lightly yielding the legal council gradually concluded. A dynasty has a regal legacy to guard rigidly. Dingy daylight gradually glides into sunny glare. The clergyman, concluding, gently chides the girl. Kitchen drudgery is candidly regarded as killing. The daughter asked daddy to get her a cloak. A lady languidly lingered in the garden, leisurely looking around. Gaily laughing generally indicates unalloyed good health. Greeks and Turks recklessly struggle to gain dominancy. Reading riddle rightly really racks our intellect roughly.

The Radio Gazette

(Continued from page 1975)

needed most, in one Flash conceived a perfect, one-hundred per cent, All-American Stray Eliminator. In this moment of dizzy Inspiration it was only natural that Rollo dropped the Plotron Bulb on the cement floor. No part of the precious Bottle remained unbroken except the plate, and that was bent. The Research Engineer, seeing our Hero standing with a rapt look, and the Fragments of the late Plotron about his Feet, lifted up a 2-K.W. Motor Generator and crowned Rollo then and there. With the cracking of Rollo's Skull the Stray Eliminator followed its Inventor to Eternal Rest, and the Strays, in faithful Remembrance, have continued to crackle ever since.

RADIO GAZETTE'S HOW TO MAKE SERIES

1. How to Make Vacuum Tubes.

BUY a controlling interest in a certain large electrical corporation which operates a lamp factory at Harrison, N. J. Having the rum of the lamp works, in two years you should be able to make vacuum tubes as well as anyone.

PRIZE RADIO BULL OF THE MONTH

EACH month we intend to offer a suitable prize for the most imposing Bull printed at any time past by a radio publication. The contest is not limited to current issues, and large numbers of Bulls are being collected from back numbers of the various periodicals which spread light and learning in the ranks of the radio public. The Editor solicits the aid of the readers of *Radio Gazette* in this great enterprise, and will be glad to receive any Bulls to be found in the literature, excepting, of course, his own. For the current month the prize, a handsome pair of custard-filled telephone receivers, is awarded to our valued Chicago contemporary, *Radio Topics*. The prize-winning statement appears on Page 25 of the September, 1922 issue, and reads as follows:

"Warm weather does cut down on the transmission range of a station, in fact, some of the large trans-Atlantic stations find it necessary to close down for a few months."

This is a new one on us, although we have had the misfortune to be connected professionally with trans-Atlantic communication

for five years of our radio career. We call for the names of these collapsible stations. We want to go there and get a job. During July and August playing tennis has always appealed to us more than work. Where we are now, if we shut down for a few hours, let alone months, the head office calls up and threatens to fire the whole staff.

Radio Condensers

(Continued from page 1967)

should be built of sections in series and in parallel. When using oil variable condensers, the chief precaution to observe is that the oil is a good grade of mineral oil with no particles of grit in it.

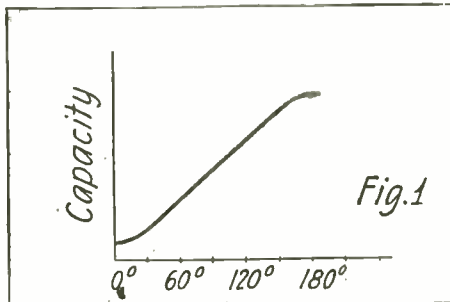

Capacity Curve of Semi-Circular Plate Condenser.

Receiving condensers do not withstand any voltages to talk of, nevertheless, they must be just as good as transmitting condensers, since the received energy is so small and every bit of energy lost in the condenser means so much weaker signal. Air and mica are the chief dielectrics used in receiving condensers. Paper and paraffined paper are frequently used for the cheaper types of equipment. The chief source of losses in air condensers is that in the dielectric. The dielectric losses are not confined to the dielectric itself between the plates of the condenser, but also to the dielectrics and insulating material in any part of the electric field of the condenser. Thus insulating bushings, end plates, supporting posts are dielectrics, and unless these are of the very best the losses in them will be considerable.

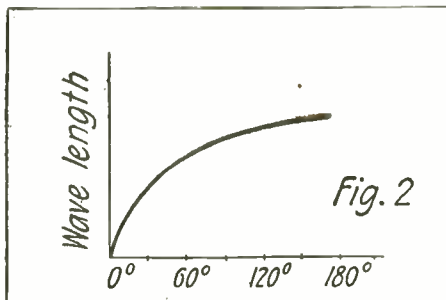

Wave-Length Curve of Semi-Circular Plate Condenser.

The variable air condenser most commonly used consists of the usual type of semi-circular plates, half of which are fixed and the other half movable, these plates interleaving. Maximum capacity is obtained when they are completely interleaved, minimum when they are not at all interleaved, and intermediate values in between. Such condensers are rated by their maximum capacities, as 0.0005 microfarads. The semi-circular plate condenser gives a straight line variation of capacity as shown in Fig. 1, and when used in conjunction with an inductance coil to make a wave meter it gives a wave-length curve as in Fig. 2. From this curve we

CONNECTICUT RADIO

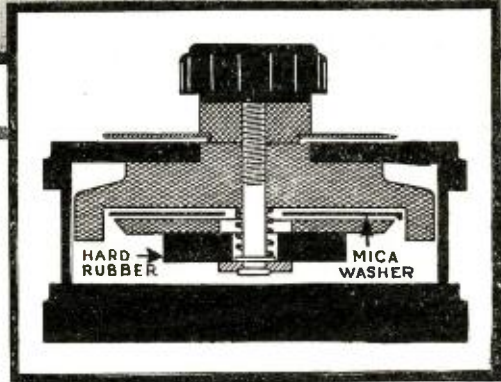

The Secret of Its Efficiency

It is a well-known fact that losses in radio condensers take place in the solid insulating material used in their construction.

And it is equally true that a condenser increases in efficiency of signal reproduction as its losses decrease.

The CONNECTICUT Variable Condenser not only employs the two best insulating materials known—mica and hard rubber—but the smallest possible amount of each. This, then, is the reason for its extremely low resistance—0.2 ohm—as well also the secret of its high efficiency at short wave lengths.

Panel type, J-108, \$5.50

Portable type, J-107, \$6.50

Finer adjustments
Better selectivity
Greater signal strength



Simple and dependable
Just what the symbol implies

Descriptive bulletin 100-D upon request

RADIO DIVISION



CONNECTICUT TELEPHONE & ELECTRIC

COMPANY



DUCK - Radio Pioneer

Announces Startling Reductions

The Leading Line Since 1909

At Prices to You Less Than Dealers' Cost

FREE Illustrated pamphlet comprising sixty-two Duck radio instruments and sets with reductions averaging 30% mailed on request. Send postal today. Any old time radio amateur will tell you who we are and our reputation. Only a few years ago almost one-third of the radio instruments sold at retail, exclusive of sales in only a half dozen large cities, were sold by Duck.

A Few of the Many Duck Products at Startling Prices:
Rheostat, 70c; Bakelite Moulded Positive contact, 70c; Bakelite Moulded dial, 55c; superselective moulded variometer, \$4.65, worth \$8.00; radio frequency potentiometer, \$1.15; solid mahogany form variometer, \$3.60; 43-plate panel-type variable condenser, Pigtail connection, \$3.15; detector panel, \$3.25; receiving set, mahogany cabinet, detector and two stages of audio frequency, \$59.50; radio frequency receiving set with one-step radio and detector, \$29.75.

Send 25 Cents in coin or money order for our big 256 pp. combined Radio Catalog and Text Book. For radio information and hook-ups it is worth many times the retailer asked.

THE WILLIAM B. DUCK COMPANY
231-233 Superior St., Toledo, Ohio



DUCK'S NEW PANEL TYPE VARIABLE CONDENSER

acclaimed by all that have seen it to be the peer of any on the market. Pigtail connections, i. e., no sliding contacts. Base and top moulded bakelite. Aluminum separators, i. e., even spacing and simple means of adjusting plates. Mounting screws furnished. Concealed by dial. Brass bearings: 1/8" shaft.

DO YOU?

Do you want to save 20 to 40 per cent on all your purchases of standard radio apparatus?

Do you want the personal advice and counsel of the greatest radio authorities in the country in solving your problems?

Do you want to receive free of charge a quarterly publication giving you a digest of the latest findings of radio science, telling you how to construct and operate both simple and advanced radio receivers and transmitters, together with a fund of other useful information.

Of Course You Do!

Then send us a post-card immediately, asking for Booklet R5, describing our Co-operative Service Plan.

The Radio Guild, Inc.
Co-operative Service Bureau
256 WEST 34th STREET
New York City

learn that for small increases in capacity at the lower end of the scale there are large increases of wave-length, while at the upper end of the scale small increases in capacity give smaller increases in wave-length. Thus the wave-length scale is crowded at the lower end, open at the upper end, and non-uniform throughout the length of the scale. This results in inaccuracies when used in a wave meter.

In order to secure a uniform wave-length scale, and hence greater accuracy in wave meter measurements, it becomes necessary to use another type of condenser with specially shaped rotor plates. This is shown in Fig. 3. This is the so-called wavemeter type of condenser employing semi-circular stator plates, but specially formed rotor plates, with shaft eccentrically located. This particular type of condenser does not give a straight

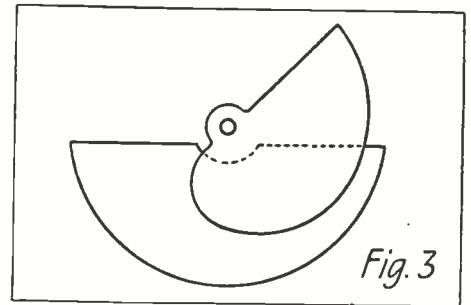

Fig. 3
Specially Shaped Plates for Wavemeter Condenser.

line capacity curve, but in conjunction with an inductance coil does give a straight line wave-length curve as in Fig. 4. This shows that the scale is uniform, and not crowded at any part, hence accuracy in measurement can be secured.

The prospective purchaser of variable condensers would do well to examine the condenser carefully and see that it meets with most of the following requirements. In the first place, if a receiving condenser is desired, the semi-circular type is preferable. If, however, the condenser is desired solely for wave meter use the special shaped plate condenser above mentioned should by all means be used. The amateur might just as well become educated to the use of the proper instruments for each purpose in hand. The first requisite in construction is rig-

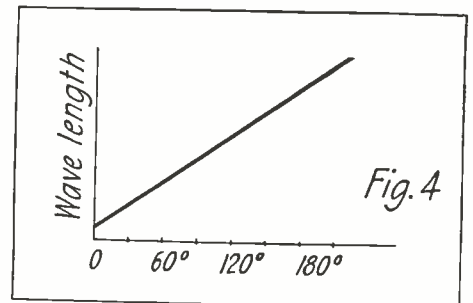
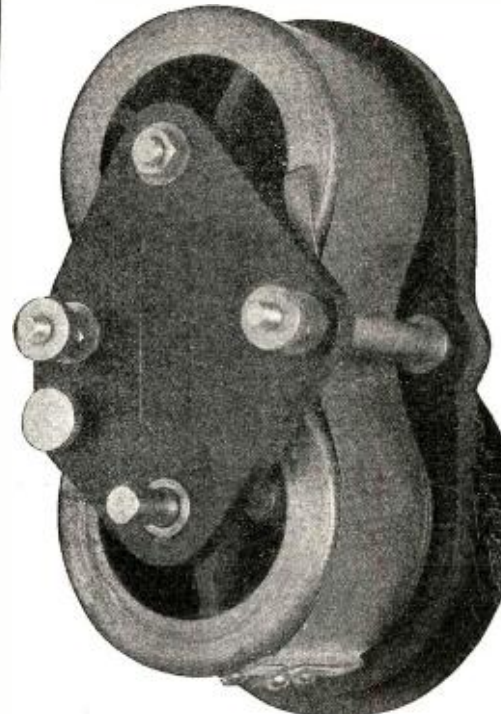

Fig. 4
Wave-Length Curve for Special Shaped Wave-meter Condenser.

idity. All parts should be securely fastened so that motion of plates will produce no loosening of parts. Some manufacturers today are so intent upon turning out as much junk at as cheap a price as possible that their manufacturing and assembling methods are not the most commendable and disgraceful rickety affairs are to be seen all over. If loosening of parts occurs there will be a variation of capacity of the condenser. The parts used in the assembly should be substantial. It is preferable not to buy a condenser with stops, as when the rotor plates strike against the stops jarring is produced which ultimately may result in loosening of nuts and hence altering the



**BROOKS
VARIABLE
CONDENSER**

Two Ribbons furnished
Easily interchangeable
(Max. .0005-Min. .00001)
(Max. .001-Min. .00001)

Adaptable to all receiving circuits.
Shorting of plates eliminated.
Nicety of adjustment.
Straight line capacity curve.
Low internal resistance.
Loud Signals.

Jobbers Wanted:
Write for prices and discounts.
Retail Price, \$4.75 each
Complete with dial.

Manufactured by
Metric Metal Works
of
American Meter Co., Inc.
ERIE, PA.

PATENTS C. L. PARKER
Formerly Member
Examining Corps,
U. S. Patent Office.
PATENT - LAWYER
McGill Bldg., Wash., D. C.

Patents, Trade Marks, Copyrights, Patent Litigation
Handbook for Inventors, "Protecting, Exploiting
and Selling Inventions," sent upon request.

PATENTS

Procured. Send sketch or model today for examination, prompt report and advice. No charge for preliminary advice. Write for free Booklet and blank form on which to disclose your idea. Highest references. Clarence A. O'Brien, Registered Patent Lawyer, 1051 Southern Building, Washington, D. C.

spacing of plates and capacity. Plates used in the construction of the condenser should be stocky and not too thin, and should be level and not warped. Otherwise one plate which is warped may just strike its neighbor and produce a short circuit. Likewise the spacer washers should be examined to see that they are uniform. The spacing between rotor and stator plates is small enough as it is and any variation in washer thickness may result in stator touching rotor and hence producing short circuit. End plates should be of the very best insulating material, rigid and stocky, and not warped. For a warped end plate will also produce short circuit, since the stator plates are attached to it. Turn the knob on the condenser and listen carefully to hear whether there is any scraping or brushing of plates. A short or touching of plates is easily detected that way. Note whether the movements of the rotor plates are jumpy or smooth and regular, and avoid those condensers whose movements are jumpy. The smooth motion of the condenser permits you to tune better since you can cover the entire range of capacity by turning the knob. The jumping or hopping motion does not permit of good tuning, for when you turn your knob the plates jump over a large angle due to poor mechanical design. There are loads of such condensers on the market. Be sure that the condenser has lugs attached for soldering your leads to it. Pick the condenser which has a minimum of insulating material in its construction. This material should be hard rubber or bakelite. Fibre or composition end plates should always be avoided. Avoid, if possible, the choice of a condenser which has insulating material for bearings. Such a bearing is likely to wear with time, resulting in displacing the shaft holding the rotor plates and hence resulting in altering the capacity, and loosening the shaft in bearings. These are the chief things to look after when buying a condenser and are worth while looking after.

Correspondence from Readers

(Continued from page 1972)

several well-known makes of different values, and I had a Ford ignition coil nearby and just hooked the secondary up to see what would happen. Result, spark signals five times louder and C. W. amateurs from U. S. A.! The modulation of WOO is absolutely perfect here on a 20' indoor aerial. I am really very much surprised at getting telephony here at all. There is a big naval station here, BGL, and the operators would not and could not believe that I could hear telephony on a 20' aerial and one tube.

I can hear the carrier-wave without an aerial very distinctly. My present bugbear is atmospheric. These are very bad here. But being able to listen to perfectly good music and lectures in the South American bush beats anything I have heard. It amuses me intensely to read the correspondence from some amateurs. They are about 500 miles from a broadcasting station and with five stages H. F. they thing that it is remarkable to hear music! I am the only amateur in this colony and enjoy immunity from regeneration, thank goodness. I should be extremely obliged if you could in some way or another let WOO know of this record reception. At least, I think it is a record of a kind. It certainly is not a freak because I hear it every night. My reason for using an indoor aerial is to cut out static. H. E. J. SMITH, Lieut. Georgetown, British Guiana.

PACENT VARIABLE CONDENSER



is thoroughly a quality product. The best material obtainable has been chosen for every part. Its design was produced by expert radio engineers and executed by skilled, reliable workmen.

The Condenser heads are of pure Condensite; the plates of extra heavy (.025") aluminum.

Instead of ordinary washer spacers, the plates themselves are drawn or pressed into an integral spacer, made precisely accurate — insuring sturdiness of construction and low electrical resistance. Perfect bearings give the

TYPES AND PRICES OF PACENT CONDENSERS

Cat. No. 200—Type E—43 Plate\$4.75
Cat. No. 200—Type D—21 Plate 4.00
Cat. No. 200—Type C—11 Plate 3.50
Cat. No. 200—Type B—*5 Plate 3.25
Cat. No. 200—Type A— 3 Plate 3.00

**Especially designed for modern regenerative sets.*

condenser a smooth rotary motion which makes tuning a pleasure.

For quality appearance, precise operation and long, efficient service it pays to buy a Pacent Condenser.

Don't Improvise "PACENTIZE"

Write for Descriptive Bulletin RN-5

PACENT ELECTRIC COMPANY

INCORPORATED

Executive Offices: 22 Park Place, New York, N. Y.

SALES OFFICES

Chicago Washington, D. C.
Philadelphia Minneapolis
San Francisco St. Louis



Canadian and British Licensees:
Colonial Radio, Ltd., Hamilton, Can.

Members, Radio Section, Associated Mfrs. of Electrical Supplies

YOU WANT SOMETHING

but don't know where to buy it.

YOU WANT TO MAKE A GIFT

of something unusual and attractive and don't know where to obtain it.

OUR BUSINESS is to SERVE YOU

in either case—whether it be for yourself or others—a Radio apparatus or a box of candy.

We keep in touch with and receive circulars from manufacturers and retailers throughout the United States, who handle the new and unique as well as standard established products.

No charge for our service

SERVICE EXCHANGE

AMSTERDAM - - OHIO
"The Radio City"



Those Broken and Burned-Out VACUUM TUBES Can Be Repaired

and Guaranteed Too!
If your dealer does not know, send direct to us.
WD11 not accepted for repairs

Harvard Radio Laboratories

P. O. Box 1781
BOSTON, MASS. 9
Tubes returned P.P., C.O.D.

RADIO FOR ALL

By H. GERNSBACK

Editor "Radio News," "Science and Invention" and "Practical Electrics"

With over 130 illustrations and diagrams, and 12 photographs, 300 pages, size 8 1/4" x 5 1/2".

What the novice in radio needs is a book in which he can get all the information necessary for him to understand radio telephony and telegraphy, to make or buy a receiving set suitable to his means, to know how to operate his set, and after he has an understanding of the radio art, information that will enable him to advance and get the most out of his outfit. All this must ordinarily be dug out of text-books, pamphlets and government publications, but the aim of this book is to have all the data and information that the beginner will need from the time that he takes up radio. It is a permanent, comprehensive reference book for the dyed-in-the-wool dabbler in Radio.

What the Book Is.

A combination of a radio course for the novice in radio telegraphy and telephony with a reference book for the more experienced amateur. Half a dozen books in one.

For the Beginner.

The theory of radio carefully explained with drawings. Description of and instruction for operating instruments of receiving and sending sets, with all picture diagrams of the wiring of the apparatus. How to make your own receiving set, costing from \$3.00 to \$50.00. How to read diagrams; for every picture diagram there is a corresponding technical diagram using the symbols instead of drawings. How to tune sharply and eliminate interference from other stations. How to protect your set from lightning and the laws regarding installation. Explanation of time and weather signals.

For the More Experienced Amateur.

How to make a practical vacuum tube detector, two stage amplifier set costing less than \$50.00 that will work. How the radio compass works. All about underground aerials, loop aerials and directional aerials. Formulae for finding wave length; miscellaneous formulae for finding capacity of condenser and other instruments. Tables of wire resistances, wave lengths and their corresponding frequencies, approximate wave lengths for different aerials, tuning coil data, and much more invaluable information.

Special Features.

Lists of all the broadcasting stations in the United States and Canada for concerts, time signals, weather reports, press, stock market reports, etc., with their call, wave length and time of sending. Detailed description of Washington weather signals and their translation. Description of a modern broadcasting station and its operation. Large map showing location of all U. S. radio telephone broadcasting stations suitable for hanging up in radio room. Collection of miscellaneous radio information for the amateur.

In Other Words.

The information that you ordinarily have to dig out of government publications, text-books, pamphlets, etc., is handily combined in this one book.

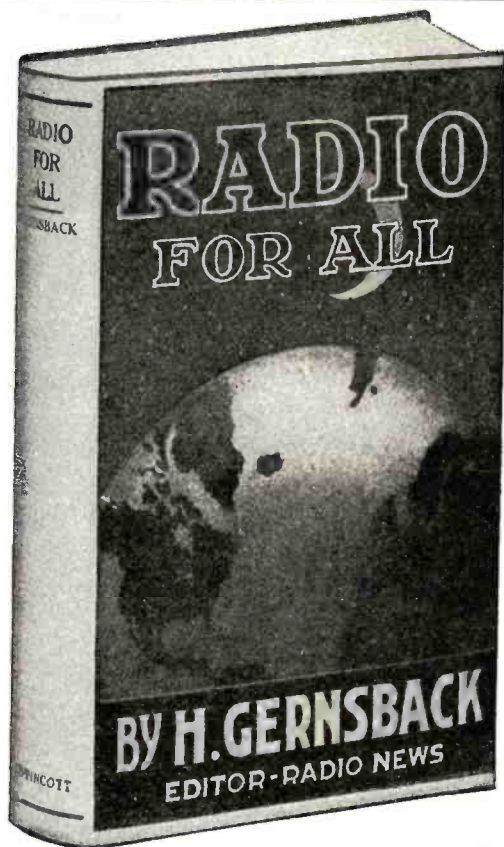

The Complete Book of All Radio Information

PRICE POSTPAID

\$2.00

PRACTICAL ELECTRICS COMPANY

::

::

53 PARK PLACE, NEW YORK CITY

The RADIOGEM

(Patents Pending)

\$1 Receiving Set—The Simplest Radio Outfit **\$1**
Made—Yet as Practical as the Most Expensive!

You need know absolutely nothing about wireless to operate and enjoy the RADIOGEM. It is so sturdy, so simply constructed that it is small wonder radio engineers who have tested it have pronounced the RADIOGEM a brilliant achievement. The RADIOGEM is a crystal radio receiving set for everyone at a price anyone can afford.

Why The RADIOGEM Can Be Sold For Only \$1

Here's the secret: The RADIOGEM Construction eliminates all unnecessary trimmings, cabinets and the like, which do not play any part in the operation of a set. You receive the RADIOGEM unassembled, together with a clearly written instruction book, which shows you how to quickly and easily construct the set, using only your hands and a scissor. The outfit comprises all the necessary wire, contact points, detector mineral, tube on which to wind the coil, etc., etc. The instruction book explains simply and completely the principles of radio and its graphic illustrations make the assembling of the RADIOGEM real fun. Remember the RADIOGEM is a proven, practical radio receiving set and will do anything the most expensive crystal set will do.

The RADIOGEM is the Prize Winner of the Age

Out of hundreds of radio models submitted recently in a great nation-wide contest, radio engineers, the judges, unanimously chose the RADIOGEM as the winner—the simplest radio-receiving set made! And the RADIOGEM costs you nothing to operate; no form of local electricity is required.

DEALERS The RADIOGEM is the wonder item of the radio age. It is storming the country, for the RADIOGEM'S price is so low everyone is able to buy one. Write immediately for full particulars before that shop across the street beats you to it.

Hear the programs of the Broadcasting Stations on the RADIOGEM



\$1

Without Phone or Aerial

Receives up to 20 Miles



WHY SALES FALL OFF

EDITOR, *Radio News*:

I read an editorial in your December issue on "Popularizing Radio" wherein the writer wonders concerning the reason for the decline in the popularity of radio.

Possibly I can enlighten him:

Recently I wrote to the radio departments of seven newspapers, and also to nine different radio equipment houses. I am enclosing the sum total of the returns for my trouble.

I stated I wanted a dependable outfit, complete, and expected to pay \$250 to \$400 for same, and yet the sum total of replies were a lot of wooden letters that sounded like talking down a rain barrel, and lists of junk that I am not interested in, for I wanted a "complete" outfit and had no desire to worry my brains in rigging one out.

The average manufacturer refers you, by wooden letter, to the nearest agent, handling the goods who takes as much interest in making a sale that will net him \$100 or more as if it were hurting him.

Through a correspondent of this office I came in contact with Mr. F. J. Lamb, of Detroit, and he treated my letter of inquiry to him with the same thought and consideration as if a man wrote here to inquire after Lake County possibilities, and therefore I have placed a \$350 order with Mr. Lamb.

That's one trouble with Radio—they need a school of salesmanship, and should not treat every potential customer as if he were a school boy writing for ten feet of wire or a dingbat to go on his home-made gilder-fluker.

H. B. DUNCAN.

Calls Heard

(Continued from page 1962)

9HCF, 9HCF, 9CJC, 9BIF, 9DCR, 9DAH, 9MAU, 9AFV, 9BCF, 9CR, 9CBC, 9DCA, 9BAA, 9EDB, 9DCR, 9BCF, 9CAO, 9CFZ, 9DWF, 9BZZ, 9ZT, 9AJH, 9UU, 9BM, 9BZI, 9BZU, 9AMI, 9CKM, 9DJB, 9AON, 9DYN, 9AMM, 9BRK, 9ABL, 9CPY, 9BSZ, 9DZO, 9CBS, 9BTT, 9II, 9BDS, 9MG, 9LZ, 9DBE, 9BJR, 9DXL, 9DKV, 9BED, 9CTE, 9CHE, 9BBI, 9BRA, 9BIF, 9BHQ.

RAYMOND GROEBE, ELIZABETH, N. J. (ONE STEP)

C.W.—1ACD, 1AGH, 1AJP, 1ATJ, 1AZL, 1BKA, 1BKQ, 1BLW, 1BOP, 1BOQ, 1BOD, 1BWJ, 1CAJ, 1CJH, 1CDO, 1CKP, 1COT, 1DF, 1IX, 1JT, 1ON, 1XZ, 1XU, 3ANJ, 3APR, 3AQR, 3AKO, 3BIG, 3BIJ, 3BIT, 3BLE, 3BOB, 3BOF, 3BVB, 3BVC, 3AG, 3AS, 3CC, 3KD, 3FB, 3JJ, 3IJ, 3OE, 3OT, 3PZ, 3SM, 3TA, 3XA, 3XM, 3ZO, 4CG, 4CY, 4EC, 4KL, 4LJ, 4ND, 4NT, 4OI, 4YA, 5EK, 5ES, 5MO, 5NK, 5XA, 5XG, 5XK, 8AAF, 8AAP, 8ABW, 8ADZ, 8AIL, 8AIM, 8ATZ, 8AKE, 8ALC, 8ALT, 8ASC, 8AXD, 8AZJ, 8BAA, 8BDB, 8BEN, 8BGL, 8BJC, 8BNH, 8BUX, 8BYO, 8BXE, 8CAZ, 8CAB, 8CDD, 8CGW, 8CHU, 8SIJ, 8CKO, 8CLK, 8CPD, 8COH, 8CQX, 8CYO, 8CV, 8DV, 8IJ, 8IS, 8KJ, 8RB, 8SB, 8TB, 8UE, 8VY, 8WX, 8XE, 8XJ, 8YD, 8ZZ, 9AKD, 9AMM, 9AMT, 9APM, 9ASE, 9AZA, 9AZE, 9BAK, 9BDB, 9BED, 9BFM, 9BNV, 9BOE, 9BZN, 9CMV, 9CZL, 9DAH, 9DKY, 9DWQ, 9DXN, 9DXT, 9DJ, 9BP, 9EC, 9EP, 9FQ, 9II, 9IK, 9KP, 9LQ, 9RC, 9VK.

Phone—PWX, CFCA, WBAP, WDAF, WDAJ, WDAO, WFAA, WFGA, WHAS, WHAZ, WJAX, WLAG, WLAC, WMAB, WMAF, WMAQ, WNAC, WOAX, WGI, WGM, WGR, WGY, WHB, WHK, WLA, WLA, WLK, WLW, WOC, WRK, WSB, WUB (Fort Hancock), WWJ, KOP, KSD, KYW, NAH, NOF, 1BKA.

RALPH WILLIAMS, ST. PAUL, MINN. DN4, KDZO, KFAF, KLZ, WAAS, WBAP, WBT, WDAJ, WFAA, WGM, WGR, WGY, WLAJ, WJZ, WMAC, WMAK, WOAI, WOR, WPA, WSB, 2XI, KHJ, PWX.

A. B. BUTTERS, LOS ANGELES, CAL. KFAF, KZN, KDPT, KUO, WDAP, KFC, KEDA, WLAV, KFAD, KFAY, WBAP, KLZ, KGN, KGW.

Canadian—CFCN.

JOHN GOULD, JR., HASTINGS, MICH. KDKA, KOP, KSD, KYW, WBAP, WCAE, WCX, WAEF, WEAY, WGAAS, WGM, WGY, WHAS, WHB, WIAO, WKN, WLAG, WLAH, WLF, WLW, WMAC, WMAQ, WOC, WOR, WSB, WWJ.



3-Step Radio Frequency Amplifier Detector Set

Price Without Accessories \$110.00

Its Marvelous Sensitivity is Amazing the Entire Radio World

The WARE AD2 Receiver operates with any properly made loop intended for the broadcasting wave lengths.

It receives local stations in any location, including steel buildings. In unshielded locations during fall, winter and spring, it brings in programs from 1000 to 3000 miles on small indoor loop.

It eliminates interference (static, in-

duction and interfering radio stations) to an extent that will prove a revelation.

It reproduces the broadcasted programs with absolutely perfect tone quality.

It requires no other knowledge to hook up and operate than is contained in the printed instructions which come with each set.

Ask Your Dealer—or Send for Descriptive Folder

Ask your dealer or send direct for descriptive folder. If we are not represented in your territory, order direct from factory. Distributors and Dealers write for proposition.

WARE RADIO CORP'N
160-162 DUANE ST. *Ware* NEW YORK, N.Y.

IMPROVE YOUR SET!

Replace your present inefficient binding posts with our new brass nickel-plated large type. They will give you more positive contact and will increase the strength of signals and sounds.

12 cents each postpaid

Dealers write for quantity discounts

Black Cross Metal Works
275 62nd St., Brooklyn, N. Y.

Actual Size

RADIO GOODS AT BARGAIN PRICES

\$6.50 1 1/2 V. Detector or Amplifier tube, (fits standard sockets) guaranteed	\$5.25
\$5.00 6 V. Guaranteed Detector Tubes	3.00
\$5.50 6 V. Guaranteed Amplifier Tubes	3.50
\$3.00 Acme Radio or Audio Transformers	4.25
\$4.50 Thordarson Audio Transformers	3.50
\$1.75 Cyclone Variable B Batteries	1.00
\$4.00 23 Plate Vernier Var. Condenser with dial	2.85
\$5.00 43 Plate Vernier Var. Condenser with dial	3.30
\$8.00 2200 Ohm Federal Phones, complete	5.95
\$8.00 3000 Ohm Dictograph Phones, complete	6.45
2000 Ohm Gilbert Phones, complete	3.95

Numerous other bargains in our FREE PRICE LIST sent upon request. Goods shipped Postpaid promptly upon receipt of remittance.

ALL MERCHANDISE GUARANTEED

Bergen Radio Supply Co.
Mail Order Department
606 Bergen Ave., New York City

OPPORTUNITY AD-LETS

Follow these advertisements every month. Reliable advertisers from all over the country offer their most attractive specials in these columns.

Classified advertising rate fifteen cents a word for each insertion. Ten per cent discount for 6 issues, 20 per cent discount for 12 issues. Name and address must be included at the above rate. Cash should accompany all classified advertisements unless placed by an accredited advertising agency. No advertisement for less than 10 words accepted.

Objectionable or misleading advertisements not accepted. Advertisements for the July issue must reach us not later than May 1st.

THE CIRCULATION OF RADIO NEWS IS OVER 228,000

EXPERIMENTER PUBLISHING CO., INC., 53 Park Place, New York, N. Y.

Agents Wanted

Big Money and fast sales. Every owner buys gold initials for his auto. You charge \$1.50; make \$1.35. Ten orders daily easy. Write for particulars and free samples. American Monogram Co. Dept. 133, East Orange, N. J.

Ambitious men, write today for attractive proposition, selling subscriptions to America's most popular automobile and sportsman's magazines. Quick Sales. Big profits. Pleasant work. Digest Pub. Co., 9528 Butler Bldg., Cincinnati.

Amateur Agents Wanted in every city and town to sell radio apparatus. A few stocking agencies still open. Delfelco, 12 Meeting Street, Pawtucket, R. I.

We Wish Representatives in every community to secure subscriptions for Radio News, Science and Invention, and Practical Electric. This is a wonderful opportunity for Amateur Radio Enthusiasts to make big money quickly. Write Experimenter Publishing Co., Inc., 53 Park Place, New York City.

We want Salesmen and Agents, either whole or side line, to sell our low priced radio books to the trade. Excellent proposition for live wires. The E. I. Company, Publishers, 233 Fulton Street, New York City.

Earn big money fast applying gold initials to autos. Every owner buys—\$1.35 profit on \$1.50 sale—Particulars and samples free. Write quick. Lithogram Co., Dept. 32, East Orange, N. J.

Amateur Agents wanted in every city and town to sell the Radioscope—the wonder crystal set. Write for information—The Radioscope Mfg. Co., 128 No. Main, Providence, R. I.

Agents Wanted in every city and town to sell standard radio apparatus. Attractive discounts given. If interested, write us at once stating age and radio experience. Wilmington Electrical Specialty Co., Inc., 912 Orange St., Wilmington, Delaware.

Free Book Start little Mail Order business. Home employment evenings. Pier, Dept. 191-A, 74 Cortland St., N. Y.

American Made Toys

Manufacturers on Large Scale, also homeworkers, wanted to manufacture Metal Toys and Novelties. Millions needed of Barking Dogs, Wag Tail Pups, Wild Animals, Automobiles, Indians, Cowboys, Baseball Players, Cannons, Toy Soldiers, Crowing Roosters, Statues of Liberty, Miniature castings of Capitol, Bathing Girl Sorensen and others. Unlimited possibilities. Guaranteed Casting forms furnished manufacturers at cost price from \$5.00 up, with complete outfit. No experience or tools necessary. Thousands made complete per hour. We buy goods all year and pay high prices for finished goods. Cash on delivery. Contract orders placed with manufacturers. Catalog and information free. Correspondence invited only if you mean business. Metal Cast Products Co., 1696 Boston Road, New York.

Art

Color Mixing Guide—3000 colors and hues, \$1.00. Worth \$100.00. King Kolorist, 1125 W. 27th, Indianapolis, Ind.

Automobiles

Automobile owners, garagemen, mechanics, send today for free copy America's most popular motor magazine. Contains helpful articles on over-hauling, repairing, ignition, carburetors, batteries, etc. Automobile Digest, 528 Butler Bldg., Cincinnati.

Batteries

Make your own 2, 4 or 6 volt storage batteries at cost of 50c to 1.00. 2 V. battery works 1 1/2 V. vacuum tube very efficiently. Complete instructions 25c. Radio Experimenter Shop, 206 Logan St., Waseca, Minn.

Books

Electricians' Examination book of questions and answers with diagrams, symbols, tables, notes and formulas, for preparation for licenses \$1.25. Aaron Shapiro, 296 Broadway, New York.

"Lights, Colors, Tones and Nature's Finer Forces" Including Vibration, covering Electromagnetics; Galic-nuras; Radio; Coldlights; Inventions; Marvelous Opportunities. Illustrated; 250 pages, \$2.00. Table contents free. Stevens Publishers, 242 Powell, San Francisco, Calif.

Radio Log Book. 125 pages. Designed by practical radio operators. 50c postpaid. Sample pages free. Radio Printing Co., Ware, Mass.

Chemistry

Learn Chemistry at Home—Dr. T. O'Connor Sloans, noted educator and scientific authority, will teach you. Our home study correspondence course fits you to take a position as chemist. See our full page ad on page 1925 of this issue. Chemical Institute of New York, 140 Liberty Street, New York City.

Business Opportunities

Become a Landscape Architect. Dignified, Exclusive Profession. Little competition. \$5,000.00 to \$10,000.00 income for experts. Easy by our method. Begin earning 3 weeks after you enroll. Write today. American Landscape School, 11R, Newark, N. Y.

Sell us your spare time. You can earn Fifteen to Fifty dollars weekly writing showcards at home. No canvassing, pleasant profitable profession easily, quickly learned by our simple graphic block system, artistic ability unnecessary. We instruct you and supply work. Wilson Methods, Limited, Dept. J, Toronto, Canada.

Correspondence Courses

Used Correspondence Courses Bought and Sold. Our plan will save you money. Educational Bureau, 1934 Collins, S. E., Grand Rapids, Michigan.

Dollars Saved—Used correspondence courses of all kinds sold, rented and exchanged. List free. (Courses bought.) Lee Mountain, Pisgah, Alabama.

Electric Supplies and Appliances

Electric Tattooing Outfits. Illustrated Catalogue, 10c. Waters Mfg., 1050 Randolph, Detroit.

Exchange

Sell: Kilowatt spark transmitter, \$50. J. Burke, Geldard Street, Valley Falls, R. I.

23 Plate Condenser, Condensite Ends \$1.25, two for \$2.00. 43 Plate \$2.00, two for \$3.00. 3 inch dial 15c. Gravenstedt, 81 Hancock Ave., Jersey City, N. J.

Receiver, detector, and two step amplifier \$65.00. Globe Radio, 402 E. 149th St., New York.

Omnigraph dials—continental—sets of five \$1.40 postpaid. Hersee, Burlington, Ontario.

Edison Elements for Storage B Batteries. Six to ten cents per pair postpaid. (Depending solely on size of order). I handle strictly first grade elements only. A. J. Hanks, 608 Montgomery Street, Jersey City, N. J.

Amateur Agents wanted in every city and town to sell radio apparatus. A few stocking agencies still open. Delfelco, 12 Meeting Street, Pawtucket, R. I.

For Sale: Paragon R. A. 10 receiver, and detector and two step, new, \$110. Philip Coblenz, Middletown, Md.

Bargain—10 watt CW and tone set complete ready to use. Earl Lewis, Mohr's, Mo.

Duck's Navy Tube Loose Coupler, \$10. Robert Mitchell, 153 Pearl St., Jackson, Ohio.

One Step Amplifiers, six dollars. James Rich, Hobart, New York.

For Sale, Omnigraph, large, \$8.00. Theophil Rebg, Centerville Sta., Ill.

\$10,000 for an idea. League of American Inventors, R1, Washington, D. C.

Bargain: New Amrad tuner, detector and two stage amplifier, \$110.00. Walter Lemke, Grand Rapids, Mich.

Ford Owners

Spart Cars, fast, saucy, hug the turns and stick to the road—make you glad you're a Ford owner. Can easily be built by aid of life-size "Red-i-Kut" patterns and picture instructions. The "Pal" system delivered complete with pressed metal streamline tail for \$6.40. Garage men make big money building them. Send 5-cent coin for prospectus on making sport cars—"Jiffy" Tops and "Gosum" Windshields. Kuempel Co., 317 Kuempel Bldg., Guttenberg, Iowa.

For Inventors

Unpatented ideas can be sold. I tell you how and help you make the sale. Particulars free. Write W. A. Greene, 106 The Atlantic, Washington, D. C.

For Men

Homespun Tobacco, Chewing 5 pounds \$1.75; 10 pounds \$3.00; 20 pounds \$5.25. Smoking, 5 pounds \$1.25; 10 pounds \$2.00; 20 pounds \$3.50. Send no money, pay when received. Cooperative Tobacco Growers, Paducah, Kentucky.

Health

Piles can be cured. Relief guaranteed or money refunded. One application usually sufficient. By mail \$1. Quaker Remedies Co., Stratford, Conn.

Diseases and Their Innate Healer. Book 50c. Arthur J. Stevens, Wauseon, Ohio.

Tobacco or Snuff Habit Cured or no pay; \$1 if cured. Remedy sent on trial. Superba Co., S.B., Baltimore, Md.

Help Wanted

Get posted. Good prices paid for butterflies, insects. See Sinclair display advertisement, page 2048.

We want Salesmen and Agents, either whole or side line, to sell our low priced radio books to the trade. Excellent proposition for live wires. The E. I. Company, Publishers, 233 Fulton Street, New York City.

Detectives Needed Everywhere. Work home or travel. Experience unnecessary. Write, American Detective System, 1968 Broadway, N. Y.

Be a Mirror Expert, \$3-\$10 a day; spare time home at first; no capital; we train, start you making and silvering mirrors. French method. Free prospectus. W. E. Derr, Pres., 26 McKinley St., Baldwin, N. Y.

All men, women, boys, girls, 17 to 60, willing to accept Government Positions, \$117-\$190, traveling or stationary, write, Mr. Ozment, 251, St. Louis, immediately.

Earn \$25 Weekly, spare time, writing for newspapers, magazines. Experience unnecessary; details free. Press Syndicate, 5665, St. Louis, Mo.

Wanted—Radio Engineer to travel extensively. Must be capable of highest type of sales and service work in demonstrating and introducing line of patented radio equipment for well known manufacturer of thirty years' standing. Write stating experience, education, age and salary desired. Box 110, Radio News.

Insects Wanted

Get posted for Spring—Good prices paid for butterflies, insects. See Sinclair display advertisement, page 2048.

Instruction

Used Correspondence Courses only one quarter original price. Free bargain price list 1000 courses. Courses bought. Students' Exchange, 45 West 42d St., New York.

Learn Chemistry at Home—Dr. T. O'Connor Sloans, noted educator and scientific authority, will teach you. Our home study correspondence course fits you to take a position as chemist. See our full page ad on page 1925 of this issue. Chemical Institute of New York, 140 Liberty Street, New York City.

Mouth-Organ Instructor, 25c. Play in one hour. Eisen Co., Bowling Green, Ohio.

Languages

World-Romie System. Masterkey to All Languages. Primors, 23 languages, \$1.94 each language; Arabic, Bohemian, Bulgarian, Cantonese, Chindau, Danish, Dutch, English, Scotch English, French, German, Hungarian, Italian, Japanese, Latin, Panjabi, Polish, Portuguese, Rumanian, Russian, Sechuana, Spanish, Swedish. Pronunciation Tables, 84 languages \$3c each language. Languages Publishing Co., 8 West 40th Street, New York.

Mail Order Business

Advertise. Newspapers, magazines. List on request. Pennell Company, Covington, Kentucky.

Miscellaneous

Get posted. Good prices paid for butterflies, insects. See Sinclair display advertisement, page 2048.

Send us your Metal Work. We are equipped to do metal stamping press work, soldering and plating, etc. Estimates furnished. T. E. Bennett Co., 7 Beverly Street, Providence, R. I.

Mechanical and Patent Office Drawings, tracings, designs, and charts made from rough sketches by experienced draftsmen. Prompt Service. H. A. La Clair 108 Tenn Ave., Washington, D. C.

Learn to Fly! and get into the world's newest Great Industry. We will teach you. Write for interesting booklet. Varney Aircraft Co., Peoria, Ill.

Motorcycles—Bicycles

For Sale—Harley-Davidson, Fully Equipped \$60.00. Harold Lambert, Haverstraw, N. Y.

Don't buy a Bicycle Motor Attachment until you get our catalog and prices. Shaw Mfg. Co., Dept. 6, Galzburg, Kansas.

Motorcycles for sale. F. N. Grasberger, Bumpass, Va.

News Correspondents

Earn \$25 Weekly, spare time, writing for newspapers, magazines. Experience unnecessary; details free. Press Syndicate, 566, St. Louis, Mo.



R 6 EA SERIES
Hard Rubber
Case



6 EA SERIES
Black Wood
Case



V 6 EA SERIES
Finished
Maple Case

Vesta Radio Batteries are made in three sizes and three types as illustrated. Especially designed for long service in the "A" circuit in Radio.



VESTA has brought to the production of radio batteries the same authoritative technical understanding that has made Vesta a standard in the automotive field. Moreover the completeness of the Vesta line assures trustworthy, economical battery service for any set, either simple or elaborate. Vesta's freedom from annoyance and trouble and its dependable uniform current output are bringing enthusiastic comment from hundreds of users, and extending the popularity of these long-serving batteries all over the country. The Vesta line is offered by all leading radio dealers.

VESTA BATTERY CORPORATION
Chicago, Illinois

VESTA
STORAGE BATTERY
Costs Less Per Month of Service



Radiotrons



*This symbol of quality
is your protection*

- Radiotron UV—200**
The long distance detector . . . \$5.00
- Radiotron WD—11**
The ideal dry battery detector . . . 6.50
- Radiotron UV—201**
The amplifier tube 6.50
- Radiotron UV—201A**
The super-amplifier tube . . . 9.00

At the Nearest
RCA Dealer

Radio in a million homes already—and the vast majority of vacuum tube receivers choose Radiotrons for reception and amplification! It was perfection of the Radiotron that made the swift success of broadcasting possible—and the Radiotron still stands alone, as it did from the first.

The only name by which anyone demands a vacuum tube is *Radiotron* — the key to clear, true reception of speech and music, with the simplest set or the most imposing.

Radio  **Corporation**
of America

Sales Dept., Suite 2065
233 Broadway
New York, N.Y.

District Sales Offices:
10 South LaSalle Street, Chicago, Ill.
433 California Street, San Francisco, Cal.